

AT MICROFICHE
REFERENCE
LIBRARY

A project of Volunteers in Asia

The Propagation of Tropical Fruit Trees

by R.J. Garner, Saeed Ahmed Chaudhri, et. al.

Published by:

Commonwealth Agricultural Bureau
Farnham Royal
Slough SL2 3BN
ENGLAND

Available from:

same as above, or UNIPUB

Reproduced by permission.

Reproduction of this microfiche document in any form is subject to the same restrictions as those of the original document.

THE PROPAGATION OF TROPICAL FRUIT TREES

by

R. J. GARNER, SAEED AHMED CHAUDHRI
AND THE STAFF OF THE
COMMONWEALTH BUREAU OF
HORTICULTURE AND PLANTATION
CROPS

Horticultural Review No. 4
Commonwealth Bureau of Horticulture and
Plantation Crops
East Malling, Maidstone, Kent



Published by arrangement with the

FOOD AND AGRICULTURE ORGANIZATION
OF THE UNITED NATIONS

by the

COMMONWEALTH AGRICULTURAL BUREAUX

THE PROPAGATION OF TROPICAL FRUIT TREES

This and other publications of the
Commonwealth Agricultural Bureaux
can be obtained through any major bookseller
or direct from:
Commonwealth Agricultural Bureaux,
Central Sales,
Farnham Royal,
Slough, SL2 3BN,
England.

THE PROPAGATION OF TROPICAL FRUIT TREES

by

R. J. GARNER, SAEED AHMED CHAUDHRI
AND THE STAFF OF THE
COMMONWEALTH BUREAU OF
HORTICULTURE AND PLANTATION
CROPS

Horticultural Review No. 4
Commonwealth Bureau of Horticulture and
Plantation Crops
East Malling, Maidstone, Kent



FOOD AND AGRICULTURE ORGANIZATION
OF THE UNITED NATIONS

COMMONWEALTH AGRICULTURAL BUREAUX

*First published in 1976 by the
Commonwealth Agricultural Bureaux
Farnham Royal, Slough, SI 2 3BN, England
Reprinted 1985.*

© Commonwealth Agricultural Bureaux. 1976

ISBN – 0 85198 351 0

All rights reserved. No part of this publication may be reproduced, in any form or by any means, electronically, mechanically, by photocopying, recording or otherwise, without the prior permission of the copyright owner.

CONTENTS

Page

PART 1. MATERIALS AND METHODS

by

R. J. Garner

Introduction	1
The nursery	4
Pots and other containers	9
Potting composts	15
Propagation by seed	20
Vegetative propagation	30
Division	32
Cuttings - one	49
Cuttings - two - source of cuttings	51
Cuttings - three - treatment of the cuttings	60
Cuttings - four - planting environment	69
Polyembryony	82
Grafting - one - process and materials	83
Grafting - two - approach grafting	101
Grafting - three - detached scion grafting	109
Grafting - four - bench grafting	142
Grafting - five - grafting established trees	148
Planting out	167
Bibliography	172

PART 2. THE TREE SPECIES

<i>Anacardium occidentale</i> by G. K. Argles	184
<i>Annona</i> spp. by D. O'D. Bourke	223
<i>Artocarpus altilis</i> by Patricia Rowe-Dutton	248
<i>Artocarpus heterophyllus</i> by Patricia Rowe-Dutton	269
<i>Averrhoa</i> spp. by G. E. Tidbury	291
<i>Carica papaya</i> by F. E. Theakston	304
<i>Chrysophyllum cainito</i> by Martha H. Ingram	314
<i>Durio zibethinus</i> by G. E. Tidbury	321
<i>Eugenia</i> spp. by G. K. Argles	334
<i>Garcinia mangostana</i> by Jill E. K. Cox	361
<i>Lansium domesticum</i> by Margaret H. Blackler	376
<i>Malpighia glabra</i> by G. K. Argles	386
<i>Mangifera indica</i> by Saeed Ahmed Chaudhri	403
<i>Manilkara achras</i> by Patricia Rowe-Dutton	475
<i>Myrciaria cauliflora</i> by G. K. Argles	513
<i>Nephelium lappaceum</i> by T. E. Walter	518
<i>Psidium guajava</i> by D. O'D. Bourke	530
<i>Ziziphus mauritiana</i> by D. O'D. Bourke	554
Bibliography of general books and articles	564

PART ONE
MATERIALS AND METHODS

by

R. J. GARNER

Formerly of
East Malling Research Station, Maidstone, Kent.

CONTENTS

INTRODUCTION

CHAPTER		Page
I	THE NURSERY	4
	Site	4
	Soil	4
	Water supply	5
	Physical requirements	5
	General protective measures	6
	Overhead shade	7
	Plastic fabric	7
II	POTS AND OTHER CONTAINERS	9
	Durable containers	9
	Clay pots	9
	Metal cans	10
	Rigid plastic pots	11
	Non-durable containers	11
	Baskets	11
	Bamboo joints	12
	Banana sheaths	12
	Coated paper containers	12
	Mulch-paper and compressed peat pots	13
	Polyethylene bags and sleeves	13
III	POTTING COMPOSTS	15
	Basic structure and composition of composts	15
	Food supply	16

CHAPTER	Page
IV	20
PROPAGATION BY SEED	
Collection of seed	20
Storage of seed	21
Pre-treatments	22
Viability tests	23
Sowing or planting the seed	24
Sowing at stake	25
Sowing in seed-beds	26
Time to sow the seed	27
Depth and pose of seed	28
Sowing in containers	29
V	30
VEGETATIVE PROPAGATION	
Systems of vegetative propagation	30
VI	32
DIVISION	
Stooling	32
Essentials	32
Stool establishment	34
Annual treatment	34
Constriction of shoots	35
Layering	36
The etiolation method	36
The blanching method	39
Simple layering	39
Ground layering of branches	40
Serpentine layering	40
Mulching of ground layers	41
Air layering (syns. Marcotting, Gootee)	42
Essentials	42
Age of shoots	43

CHAPTER	Page
Coating cuttings	65
Controlled temperature storage	66
X CUTTINGS - FOUR	69
PLANTING ENVIRONMENT	69
Basic requirements	69
Field planting of cuttings	69
Protective measures for cuttings	73
Propagating pits	73
Half-span sheds	73
Glass covered frames and cases	74
Polybag rooting of cuttings	75
Basket rooting of cuttings	76
Tents and tunnels	77
Mist sprays	77
Continuous versus intermittent mist	78
Temperature of the rooting medium	78
Spray nozzles and water supply	79
Pipework and fixtures	80
Shade and protection	80
Composition of bed	80
Hardening rooted cuttings and transference	81
XI POLYEMBRYONY	82
XII GRAFTING - ONE	83
PROCESS AND MATERIALS	83
Compatibility	83
Life	84
Wounding to expose the cambia	85
Anchorage of the parts	87
Tools and accessories	87
Knives, chisels and cleavers	87
Shears and secateurs	88
Saws	89

CHAPTER	Page
Graft-seals and wound dressings	89
Clay and admixtures	90
Hand mastics	90
Cold brush seals	91
Hot waxes	92
Paints and dips	93
Tying materials	94
Natural fibres	94
Rubber strips and patches	94
Plastic strips	96
Waxed cloth and string	97
Caps and covers	98
Scion collection and treatment	98
XIII	
GRAFTING - TWO	101
APPROACH GRAFTING	101
True approach grafting	101
Spliced approach graft	102
Tongued approach graft	103
Bottle grafting	104
Inarching	104
Cleft inarching	104
Rind inarching	106
Separation of successful grafts	108
XIV	
GRAFTING - THREE	109
DETACHED SCION GRAFTING	109
Bud grafting	109
Shield budding (T-budding)	109
Patch budding	112
Flute budding	114
Ring budding (annular budding)	116

CHAPTER	Page
Forkert budding (brown budding)	116
Green strip budding	118
Chip budding (plate budding)	121
Chip budding in the cotyledon stage	121
Inlay chip budding	123
Aftercare of bud graft :	125
Apical grafting	126
Splice graft (whip graft)	126
Whip and tongue graft	127
Double tongue graft (big tongue graft)	129
Strap and saddle grafts	131
Wedge or cleft graft	134
Oblique wedge graft	134
Side grafting	136
Side cleft graft	136
Spliced side graft (vener side graft)	136
Slotted side graft	138
Double working and interstems	140
 XV	
GRAFTING - FOUR	142
BENCH GRAFTING	142
Bench grafting on roots	142
Bench grafting in the cotyledon stage	144
Nurse grafting	145
 XVI	
GRAFTING - FIVE	148
GRAFTING ESTABLISHED TREES	148
Topworking	148
Cleft graft (split graft)	149
Oblique cleft graft	151
Whip and tongue graft	151
Veneer crown graft	151

CHAPTER		
	Strap graft	155
	Approach graft	157
	Aftercare of topworked trees	157
	Frameworking	158
	Stub graft	158
	Side graft	160
	Inverted L rind graft	161
	Slit graft	162
	Aftercare of frameworked trees	162
	Repair grafting	164
	Bridge grafting	164
	Tree invigoration by approach grafting	165
	Bracing	165
XVII	PLANTING OUT	167
	Early management of the plantation	169
	Protective paints	170
	Deblossoming	170
	Fencing and windbreaks	170
	Maps and records	171
	BIBLIOGRAPHY	172

FIGURES

	Page
1. The stooling method	33
2. The etiolation method of layering	36
3. Air layering (Marcotting)	42
4. Stem capacity to root	55
5. Suckling	62
6. East Malting cutting bins under overhead protection	67
7. Multiple foot-operated dibber	71
8. Small propagation case for use in the tropics	75
9. Examples of cambial contact	86
10. Tying bud grafts	95
11. Spliced approach graft	102
12. Tongued approach graft	103
13. Bottle grafting	105
14. Cleft inarching	106
15. Rind inarching with an L incision	107
16. Rind inarching	108
17. Shield budding	111
18. Removing the wood from the bud shield	111
19. Patch budding	113
20. Flute budding	115
21. Forkert budding	117
22. Green strip budding	119
23. Chip budding	122
24. Inlay chip budding	124
25. Splice graft (whip graft)	127
26. Whip and tongue graft	128
27. Double-tongue graft (big-tongue graft)	130
28. Strap or side-saddle graft	132
29. Saddle graft	133

	<i>Page</i>
30. Wedge or cleft graft	135
31. Oblique wedge graft	137
32. Side cleft graft	137
33. Spliced side graft (veneer side graft)	139
34. Slotted side graft	140
35. Wedge grafting in the cotyledon stage	146
36. Use of self-sealing crepe rubber	147
37. Tool and mallet slung together	150
38. Cleft graft (split graft)	150
39. Methods of cleaving obliquely	152
40. Oblique cleft graft	153
41. Veneer crown graft	154
42. Strap graft	156
43. Stub graft	159
44. Side graft	160
45. Inverted L rind graft	161
46. Slit graft	163
47. Inlay approach graft	166
48. Tree staking	168

INTRODUCTION

An attribute of anything living is its propensity to be different. This provides the basis for selection and survival. Whenever attention is focussed on a particular plant, whether it be cashew or jackfruit, mango or jujube, great variation is found in certain external and internal features, resulting in wide differences in individual plant behaviour in no way reducible by cultural management. This natural seedling variation may be increased by the plant breeder to provide a wider choice for selection and a valuable gene-bank for further work in the improvement of plants (G19*).

Having obtained a range of variability, the plant raiser then isolates his chosen few. The improvement of tree crops and other long-lived woody subjects presents many problems not encountered with annual plants. A major impediment is the longer life-cycle and the time taken to pass through the juvenile and labile phases of development during which the adult characters are being established. A hurried assessment of plants before they have become fully adult may prove disappointing. The early growth features, even the first fruits, may give but a passing indication of ultimate behaviour. This is also true of the plant's regenerative capacity. Cuttings taken from plants in the early seedling or juvenile phase root very readily. This propensity to root commonly falls off as the source plant approaches the flowering or adult phase (40). With easily rooted subjects which root well in the adult phase this deterioration may pass unnoticed, but in those very difficult to root such as the clove (*Eugenia caryophyllus*) it is extremely noticeable (79).

Hitherto, most fruit cultivars have been selected from chance seedlings which have already survived many hazards and are in the adult fruiting phase. Indeed, their choice is largely based upon their fruiting character, the juvenile phase being no longer a problem. This is true of the majority of tree fruit cultivars throughout the world, thus it has come about that the chance seedling has monopolized the garden and

* References to the bibliography prefixed with the letter 'G' relate to the Bibliography of General Books and Articles to be found at the end of this book.

orchard. From now onwards, however, it can be expected that the work of geneticists and plant breeders will itself contribute an increasing supply of superior cultivars.

The first step in improvement is to pick out high-yielding individuals possessing other merits such as good form (122). Selection will also be made for ease of harvesting, such as position of the fruit in relation to the leaves, and even ripening, particularly where the entire crop is to be harvested at one picking. Further improvement is dependent on a breeding programme designed to combine desired qualities to produce planting material of even greater value.

The two methods of propagating, sexual or asexual, should not be regarded as alternatives, for one does not replace the other, but each attains quite different ends. In the scientifically advanced pome fruit industry of the temperate zone, every tree, almost without exception, has been raised vegetatively, both scion and rootstock. Moreover, the differing influence of the clonal rootstocks now available enables growers to select composite trees of standard performance to suit their particular soil, climate and chosen method of culture (51). These advances have led to increased production and to major improvements in market quality. Such advances have largely stemmed from organized research and extension work during the last fifty years. There is good reason to expect a similar result in the tropical field.

It is important to appreciate the quite different consequences of the two main methods of multiplication, the seed involving variation, the vegetative clone eliminating variation, except for the chance mutation. It is equally important to realize that there is a third method which is a mixture of both. This method involves grafting and can have three quite different effects. When a given scion is grafted upon a collection of seedlings, each tree may be expected to develop somewhat differently. When grafted upon a vegetatively-propagated clonal rootstock it will give a comparable performance, though the composite plant is no longer truly clonal because the proportions of the two components may differ, or the specific effects of rootstock and scion may be partly or wholly nullified by suckering from the roots or by rooting from the scion. The third grafting system, in which pieces of root and shoot are taken from a single individual own-rooted plant and joined to form

new plants, as is done when the subject is difficult to propagate from root and shoot cuttings, is the only truly clonal method involving grafting.

The three propagation systems, sexual, asexual (vegetative), and mixed (involving grafting), will be described, but the early sections of this Part are intended to provide some general recommendations on the establishment and equipment of a plant nursery.

THE NURSERY

Site

The concentration of tree raising in nurseries, involving as it does a high labour cost and the use of much special equipment, demands the best possible choice of site. There should be ready access to an ample water supply but freedom from any risk of flooding. The land should be flat if possible, otherwise it must be carefully contoured, and in a sheltered position. Soils should be avoided that are highly calcareous, heavy or very sandy or which contain many stones which make it difficult to lift plants without damage.

Soil

The land should be cleared of tree roots and weeds and thoroughly and deeply cultivated to a depth sufficient to achieve this and to break any hard pan which may be present.

Where well-drained land is selected, cultivation to a depth of 20 to 30 cm (8 to 12 in) is fully adequate. Both top and subsoil should be tested for pH reaction. Tropical fruits in general do well in slightly acid soils, a pH of about 6.5 being optimal.

In the preliminary clearing of land for a nursery, care should be taken to avoid leaving the disturbed soil long exposed to the sun. As Webster and Wilson (122) emphasized, a clean fallow suffers from the disadvantage that the bare soil is exposed to sun, wind and rain, with consequent risk of erosion by wind and water. They suggest the provision of protective covering by such means as stubble-mulching, killing weeds chemically leaving them lying on the surface, or even by growing a temporary vegetative cover selected for its low demand on water. In Tanzania it has been shown (95) that in the semi-arid tropics a sowing of 20 lb (9 kg) viable seed per acre of teff grass (*Eragrostis abyssinica*) could suppress volunteer weeds and lead to the storage of subsoil moisture for the future crop. The aim in all cases should be to minimize bare-soil disturbance and to shorten as much as possible the time of exposure of soil to the elements.

Water supply

Water must be constantly available in adequate quantity to meet the continuing needs of the nursery. Water of drinkable quality is not necessary for plants, but it must not have a high salt content. Continuous use of hard water raises the soil pH substantially and such water should be used only with great care. Rain water, being soft and clean, is an ideal alternative.

Water that is dirty with particles of vegetative or other organic matter will provide conditions for the development of slimes, leading to blocked pipes and nozzles. Where this is the only water available it should be passed through a gradation of coarse to fine filters to lessen the risk of pipe blockage. This is particularly necessary when using mist propagation units. Bore-hole and well water, when not too highly charged with minerals, being free of organic contamination, is excellent.

Where a pumped water supply is conveyed some distance through pipes there is always a marked reduction in pressure at the outlet points. This can be minimized by the use of large diameter pipes leading from the source right up close to the outlets. An abundant water supply is essential to provide a sufficient flow to permit of heavy watering at any given time. Where supplies have to be economized or rationed there is a tendency to give too little water at shorter intervals, resulting in rapid salt accumulation in the surface soil around the plants due to evaporation. Where water is restricted, occasional heavy waterings should be given to wash out accumulated salts.

Physical requirements

When planning a nursery it is essential to consider the basic requirements for efficient plant multiplication, both by seed and vegetatively. The aim is to provide an environment to meet the needs of the material and to condition it for success in its permanent site.

Plants primarily respond to physical or climatic factors and become conditioned to their particular environments. Seeds carry forward 'built-in' characteristics from their parents. The same is true of cuttings, though this is not so commonly appreciated. Once a seed or cutting is

removed from the parent, any treatment given will be confined to the separated material and there will be no continuing modifying influence or support by the parent. There is then a need for nursing, less critical for seeds, which are complete entities, than for cuttings which are discrete parts and must be nursed to wholeness.

Successful nursery procedures depend upon a proper appreciation of local climatic factors, mainly of temperature, rainfall and atmospheric humidity, light intensity and duration (118), and their interaction. These main factors may be locally modified by the presence or absence of extensive water surfaces, altitude and aspect, and surrounding vegetation, all of which have a major influence on local winds.

The plant raiser's problem is to provide conditions in the immediate vicinity of his nurslings which will guard them from adverse effects of violent temperature fluctuations, intense sun heat and light, high evaporation and damaging winds, yet provide sufficient warmth, light and moisture to ensure root and shoot development and adequate photosynthetic activity of the leaves.

General protective measures

Having chosen a nursery site with regard to soil working conditions, drainage, water supply, ready access to labour and transport, the main consideration is to provide shelter from strong winds. This may already be adequately provided by forest or mature plantation trees; otherwise, well supported eight to ten-foot (2.5 to 3.0-m) fences of reed or split bamboo held in line by horizontal pieces of rough timber, should be erected whilst some quick-growing hedging is being established. It must be remembered, however, that such fences afford protection for a distance of only about 2½ times their own height.

Many different kinds of intimate protection are used in nurseries. Glass structures, so widely used in temperate zones, quickly overheat in hot sun and are generally unsuitable for use in the tropics. Structures which have proved more useful have been a combination of partial shading overhead with moisture-retaining covers below to provide the desired ecoclimate in the immediate vicinity of the plant. For effective heat protection the top shade should be placed some distance above the lower moisture-retaining polyethylene

or other material to permit free circulation of air between the two layers. As short a distance as one foot (30 cm) is said to be effective, but the majority of workers prefer much higher top shade.

Overhead shade

For a high-shade 'walk-in' nursery the horizontal shading is placed about eight feet (2.5 m) above ground to provide ready access. The shading material must be supported on strong posts spaced eight to ten feet (2.5 to 3.0 m) apart in lines that may be twenty to twenty-five feet (6.0 to 7.5 m) apart, although the exact distance will be governed by the length of supporting cross-pieces available. Two-inch (5-cm) steel pipes, set in concrete, are sometimes used instead of wooden posts and cross members may be replaced by tightly-drawn stout wires to support the shading material. If the ends of the wires are fixed to 'dead men' the whole structure is strengthened.

Various materials serve for shading, including laths, bamboo, banana leaves and palm branches. A favourite used in Malawi (107) is composed of grass woven into two-inch (5-cm) chicken wire. This lasts up to two years, requiring little attention once installed and it withstands storms and strong winds.

Lath houses are commonly used to provide 'walk-in' and other shade structures. They are somewhat expensive compared with those made from grass, leaves or bamboo. The laths may be pre-fabricated as rollable mats or blinds to ease the work of installation. The individual laths, commonly some two inches (5 cm) wide, are spaced to provide the degree of shading required. A 50 per cent cover is often used (121); this may not, however, result in 50 per cent of available light reaching the plants.

Plastic fabric

Overhead shade is also provided by woven plastic material commonly referred to in the United States as saran. This is available in different densities, is light-weight and readily attached to wires (see above). Rather stronger polypropylene fabric serves the same purpose of providing shade and weather protection. The life of some of these plastic materials is apt to be rather short, especially in hot sunny regions.

It is better to have many small spaces in the overhead shading rather than large spaces accompanying large opaque areas. The light from many small apertures quickly alternating with shade gives more even conditions for plant growth. Moreover there is less danger of channelling heavy rainfall to particular spots. Uneven rain distribution is also engendered by drooping top shade, which precipitates water to the lower levels through which it cascades causing damage and erosion.

POTS AND OTHER CONTAINERS

Plants in containers are more under the control of the nurseryman than those planted out in the field and are therefore dependent on the skill, care and management of the operator. Containers are widely used for all propagating methods, frequently for seedlings as well as vegetatively raised material. They are particularly valuable for cuttings and grafted plants, not only because these demand careful nursing but also because of their greater value due to high labour input.

All containers, unless made alongside where they are to be filled, should be shaped so that they nest together compactly, otherwise they will take up considerable storage space. Collapsible containers, such as those made from polyethylene lay-flat tubing or folded waxed paper, present no problem. Rigid containers such as clay pots and rigid plastic imitations, whether round or square, tapered toward their base, not only economize storage space but also greatly ease the removal of the plant and soil intact at planting time. Non-tapered metal containers, commonly salvaged from canneries, hotels and restaurants, are quite often used for plants but these must be cut down each side with powerful shears or tin-snips to permit removal of the plant, often incurring, while doing so, some root damage and the risk of cut fingers.

There are two main classes of container - the durable, used repeatedly, and the non-durable which goes with the plant into the planting pit where it disintegrates without impeding root development. Locally woven baskets and factory-made peat-fibre pots are examples of the latter. The features of containers found especially suitable are mentioned here, but it is appreciated that there are many locally available containers and materials which may be found adequate for plant raising, such as bamboo joints and folded leaves.

Durable containers

Clay pots. Earthenware porous clay pots are in general use throughout the world in sizes from thimbles to bushels,

usually circular and tapered to facilitate emptying. They may be used repeatedly until accidentally broken. With continued re-use salts tend to accumulate in the earthenware, from which they may be removed by soaking in water in a tank or stream. It has been found possible to achieve both a reduction of salinity and disinfection of the pots in one operation (6) by heating the water in which they are soaked to 140° to 180°F (60° to 82°C) for 24 hours. This destroys algae and mosses, as well as disease organisms. The pots may then be rinsed in clean water if desired. Provision for drainage is essential. Where very coarse potting mixtures are used, particularly in small pots, special internal drainage may be unnecessary, but in larger pots it should be placed over the holes. Small pots need only one hole in the middle of the bottom but pots above six inches (15 cm) in diameter should have three or four holes and these should be covered with pot shards (corks). Pots of ten inches (25 cm) and more should have additional holes low down in their walls, close to the bottom and these should also be covered with shards when filling. When filled, these large pots should be stood on free-draining gravel, broken brick or coarse clean ashes, otherwise the drainage holes may become blocked.

With respect to small pots (3 to 5 inches or 8 to 13 cm) they are best not crocked, particularly where they are to be stood on a level layer of fine sand as a means of sub-irrigation. If the sand is placed on a sheet of polyethylene and kept moist the smaller non-crocked pots will obtain much if not all of their water requirement by capillarity.

Irrespective of type of plant container about a sixth of the pot depth should be left unfilled so as to receive water which will be sufficient to percolate and completely moisten the pot contents at a single watering.

The porous nature of unglazed earthenware permits some movement of air and water through the sides of the pot and some consider this to be preferable to the conditions imposed by impervious materials such as metal or plastic.

Metal cans. Provided tapered steel cans are galvanised or well painted to prevent rusting they may be re-used many times. Being thin they nest well for transport or storage and, compared with clay pots of similar size, are relatively light in weight. They are manufactured in sizes from one gallon (4.5 l) upwards and provided with numerous holes for drainage.

In some countries meat and other processors pack their products in tapered cans or buckets coated with tin and lacquer. With holes punched in their bottoms (from inside the can outwards) they make excellent plant containers. Soil in metal containers exposed to the sun, either in the nursery or at the planting site, may, however, become overheated, causing root damage (123), and some protective shade may be necessary.

Rigid plastic pots. There are many shapes and sizes now available and, provided they cover the points already enumerated, they are quite acceptable. They are non-porous and must therefore have fully adequate drainage holes; holes in the base should be associated with miniature runnels to the side of the pot for good drainage. Some types are fragile and cannot be lifted by their rims and so need careful handling. Having chosen the particular size and shape required it is helpful to keep that size separate from other batches of similar size, otherwise, when nested together they get wedged one with another and it becomes difficult to part them again without cracking. Damage may also occur when extracting the plant by inverting and tapping the rim of the pot.

Non-durable containers

Baskets. Probably one of the earliest non-durable plant containers was the basket loosely woven from coarse grasses or split bamboo reeds grown in the locality. On transplanting to the permanent site, the basket with the plant is placed in the ground and any root disturbance is thereby avoided. Baskets are comparatively cheap to make; the clear instructions which follow were supplied by E. E. Cheeseman (see 28). In the West Indies the baskets were made of 'tirite' (*Ischnosiphon arouma*), a marantaceous plant growing abundantly in the local forests. Its stems are about 1 cm (0.4 in) in diameter. They are split lengthwise, scraped to remove the pith, and dried. The dry material is dampened in working to make it easier to handle. The first step is to lay six strong pieces of tirite about two feet (0.6 m) long in the form of a star, crossing at their centres. These are fixed in this position by interweaving a circular tie to form the bottom of the pot. The twelve ribs are bent upwards and weaving is continued to form the sides of the basket. The last inch (2.5 cm) or so of the rib is bent over and tucked into the weave to finish off the top of the basket. Larger

baskets may be made by using coarser materials and rather more crossing pieces for the uprights, but a basket diameter of from five to eight inches (13 to 20 cm) with a height of between eight and twelve inches (20 and 30 cm) will cover the practical handling range. When roots appear through the sides of the pot it is time to transfer the plants into pits in the field.

Bamboo joints. Bamboo joints have frequently been used as pots, and as they are very resistant to decay they could also be classed as durable. Large bamboo stems cut transversely just below each node form useful pots of somewhat limited size; a hole should be made through the node for drainage. If the potted seedlings are left in bamboo until they are pot-bound it may be necessary to split the pots to release them. This difficult operation may be avoided by splitting the unfilled pot into two halves and binding these together again with one round turn of wire before use. If to be re-used the two halves should be kept together.

Banana sheaths. The dried sheaths of bananas may be used for plant pots (G19). The basal portions of two petioles placed opposite each other round a log as a temporary support while tying them together with fibres, form quite practical, open ended pots or cylinders to hold well-structured media. Lengths of dried banana sheath, three or four inches (7.5 or 10 cm) wide, are also readily formed into pots as follows (91). A short post, fixed upright in the ground, or a cut-down tree trunk, makes a suitable mould on which to form the pot. Strips of fibre are laid crosswise on the top of the mould and folded down the sides to enclose it completely. The strips are then tied down to form the depth of pot desired and bent back towards the top of the mould where they are again tied. The surplus ends of the sheaths are then cut off and the completed pot lifted off. This method of construction may be adapted to form containers from various kinds of leaves, fibres and other materials, including pieces of waxed or tarred paper; the natural fibre ties may be replaced by non-rotting plastic string.

In many localities baskets made from natural materials have now been largely replaced by plastic sleeves or bags (see below).

Coated-paper containers. Paper, cardboard and compressed fibre, if impregnated with paraffin wax, bitumen or other

water-repellant materials of a non-poisonous nature, make excellent temporary containers that are generally more rigid than polybags (polyethylene bags). Although they are non-durable it is desirable to remove them, at least in part, at the field planting stage, normally by tearing. None except the smaller sizes, and those made of the tougher materials, can safely be lifted by the rim. They must be handled individually using both hands.

Paraffined paper drinking cups, if punched with drainage holes, are useful for raising seedlings for early lining-out in nursery rows. They must be removed at transplanting and may give further service if carefully handled. They are cheap, light in weight and occupy little storage space.

Bitumen-coated paper pots are available in various sizes and are comparatively inexpensive, of light weight and readily nested for transport and storage. For maximum life the paper should be completely impregnated with water-proofing material, but treating the inside surface only may suffice for short-term use. In general, it is unnecessary to remove the sides of the pot when planting out, but it may be advisable to pull away the base, particularly where this is formed of a number of layers.

Mulch-paper and compressed peat pots. Mulch-paper and also compressed peat pots, widely used in small sizes in temperate zones, have a comparatively short life, particularly in alkaline soils. Roots readily penetrate the walls of these pots under moist conditions and this reduces the risk of a planting check at transference. If the pots are plunged in a nursery bed care should be taken to leave about one inch (2.5 cm) of the rim above the medium to postpone collapse of the pot. Peat fibre pots are obtainable in small sizes up to four inches (10 cm) in diameter. Units of six or twelve, fixed together as a tray, may save labour in handling but they have a very short life.

Polyethylene bags and sleeves. The invention of polyethylene has had a profound effect upon plant-raising practices. Its use in film form for plant containers is now widespread, replacing many of the traditional materials already described. It is waterproof, tough and flexible, light in weight, readily stored until required, transparent or opaque, relatively inexpensive and readily obtainable. Bags of all

sizes, often called polybags, are obtainable in various thicknesses. Where sleeves, i.e. open-ended cylinders rather than bags, are required, extra drainage may not be necessary but the bags should have numerous holes in their base and, particularly in larger sizes, additional holes in their sides up to half their height.

When required in quantity polybags can be made available in a particular shape, size and thickness. For unimpeded tap-root development very deep bags are sometimes used, requiring firm mutual support in the nursery. Black polybags are more commonly used than clear; the main difference is that the clear polybags permit the growth of algae and seedlings on the inside of the containers where exposed to light on the outside of the nursery bed, but this is of little consequence. Soil in black containers with their sides exposed to the sun may overheat and this may seriously affect root development in the container. Examination of the effects of high soil-temperature (47) has shown that soil in non-porous black containers exposed to the sun may rise to 115° F (46° C), whereas containers covered with aluminium foil or shaded by a wooden board have temperatures similar to that of the air. This overheating adversely affects root development and causes a one-sided root development and poorer establishment in the field. The influence of root temperature on plant growth, namely dry weight gain, plant height, root extent and form, flowering and fruiting, has recently been extensively reviewed by Cooper (20).

When filled the polybags are stood close together on the ground in blocks up to some six feet (1.8 m) wide to permit inspection and watering from alleyways. Support may be given to the outer rows by sleepers, baulks of timber or low walls, but adjustment of the ground level when first standing-out should make this extra support unnecessary provided there is adequate wind protection.

Plants in polybags are already largely protected from water loss during transport and are at less risk than those in porous containers. When comparing polybags with clay pots or other tapered containers it should be remembered that polybags, size for size (diameter and depth), hold about twice as much compost and provide additional root-run.

POTTING COMPOSTS

Plant raisers have used many different potting or container composts. Most of these are quite satisfactory, but some have proved unreliable, causing loss of valuable plants and consequent delay in fulfilling planting projects. Such losses have occurred in all parts of the world, eventually leading to methodical investigations into the basic requirements for the successful production of container composts. The investigations at the John Innes Institute in England (68) and those at the California Agricultural Experiment Station in America (6) cover the subject well and provide a sound basis for their recommendations.

Lawrence and Newell (68) found that there were three essential characteristics of a good container compost:

- (1) It should possess a crumbly structure that permits the entry of air and be able to hold moisture while permitting excess to drain away.
- (2) It should provide an adequate and balanced food supply at every stage of plant growth.
- (3) It should be free from all harmful organisms and other substances.

Basic structure and composition of composts

Lawrence and Newell (68) urge that the same ingredient could be used for each mix to obtain uniform results. This will not always be possible, but the principles will always hold good. The Californian workers, who evolved the University of California (U.C.) system, based their mixes on fine sand with peat or sawdust, adding nutrients and lime according to the many different purposes in view.

Generally speaking, loam, peat and sand are the basic ingredients of container composts. A loam contains sand, silt and clay in approximately equal proportions. It may also contain a little humus, but this is of negligible importance as it is added separately. The best loam has just enough clay in it to leave a 'greasy' smear when rubbed

by the finger (68). Humus, or organic matter, can be supplied in the form of leaf-mould (e.g. from forest floors), swamp peat, coconut fibre refuse, pulverized bark, etc. Leaf mould rots quickly and does not maintain a well-draining structure when it is kept in containers for a long time. More rot-resistant materials are generally preferable. Sand is added to obtain correct physical condition and good drainage. It should be clean, free of fine particles and grade up to 1/8 inch (0.3 cm). The proportions of these main ingredients may be varied according to the quality of each. If the loam is inclined to be sandy, rather less sand should be used; if the organic matter is finely decomposed, more sand should be used or some coarser unrotted material such as coconut fibre should be added; if the local sand is too fine, a more suitable one should be sought. The test of a well-structured mix is that it will not surface-pack when watered but will drain within a few minutes and will not shrink from the sides of the container when dry.

The traditional recipes for potting composts, resulting from long experience, invariably contain a large proportion of well-structured organic matter such as leaf-mould and animal manure, peat or other fibrous material, together with sand or fine grit. Loam or silt soils are often added to provide trace elements and improve water-holding power and to encourage the development of roots adapted to meet the soil conditions of the open field. Mixes fulfilling these requirements are detailed by many authors. Singh, in his monograph on the mango (111), advocates equal parts of soil, compost and leaf-mould; the soil should not contain too much clay but should be modified by the inclusion of, or total substitution by, canal or river silt. Others in India (G24) set their rooted cuttings in a mixture of leaf-mould, soil and sand in the ratio 3:2:1.

For both young seedlings and cuttings a more open structure is required such as sand, loam, peat (or peat substitute) in the ratio 2:1:1, whereas for plants 'growing on' in containers the ratio could well be 1:2:1 (48).

Food supply

The basic ingredients must be supplemented with plant food materials. For germination and early healthy development of seedlings phosphate is particularly important. For further growth and development a steady supply of nitrates,

in addition to phosphate and potash, must be assured. All composts should include some calcium in the form of ground limestone or chalk or, where magnesium is apt to be in short supply, in the form of dolomitic limestone. The initial dose of nitrogen may be supplemented by periodic liquid feeds, but the inclusion in the compost of slow-release materials such as ground hoof and horn, or one of the patent slow-release fertilizers now available, ensures a more steady source of plant nutrient. These two ways of feeding are often used in conjunction.

The John Innes composite fertilizer additives, thoroughly incorporated in the mix, all per cubic yard (0.76 m³) of soil mix, are as follows:

Seed compost

Superphosphate	2 lb (0.9 kg) (16% phosphoric acid)
Chalk	1 lb (0.45 kg) (55% calcium oxide)

Potting compost

Hoof and horn	2 lb (13% nitrogen)
Superphosphate	2 lb (16% phosphoric acid)
Sulphate of potash	1 lb (50% potash)

The U.C. type soil mixes are based on the two ingredients fine sand and peat moss. Other materials such as sawdust or shavings, pulverized bark, coconut fibre, rice hulls or chaff, may be substituted for all or part of the peat. The sand particle range recommended is 0.05 to 0.5 mm (0.002 to 0.02 in); the peat preferred is sphagnum peat. By varying the proportion of these it is possible to meet most requirements. The mixing operation is made easier by moistening the peat a day or two in advance. Baker (6) lists some 30 rates of additives appropriate to different sand/peat bases. The following are examples:

Sand/peat (75/25%)

For fast-growing rooted cuttings or transplants also for potting-on, all per cubic yard of soil mix.

Hoof and horn or blood meal	2½ lb (1.1 kg)
Potassium nitrate	6 oz (0.17 kg)
Potassium sulphate	4 oz (0.1 kg)
Superphosphate	2½ lb (1.1 kg)
Dolomite lime	4½ lb (2.0 kg)
Chalk	1½ lb (0.6 kg)
Gypsum	1½ lb (0.6 kg)

Peat/sand (75/25%)

For seed germination and transplanting, supplementary nitrogen soon required:

Potassium nitrate	4 oz (0.1 kg)
Potassium sulphate	4 oz (0.1 kg)
Superphosphate	2 lb (0.9 kg)
Dolomite lime	5 lb (2.3 kg)
Chalk	4 lb (1.8 kg)

When mixing these additives with the basic ingredients it is as well to mix all together with a small portion of the sand and to spread this over the heap of peat and sand for the main mixing.

Supplementary feeding should be started when the plant roots first reach the sides and bottom of the container, long before a pot-bound condition or starvation symptoms appear. It is conveniently given in dilute liquid form. Recommended dilutions vary greatly. To supply nitrogen alone, 15 oz (0.4 kg) of sulphate of ammonia per 100 gallons (455 l) of water at ten-day intervals would probably suffice. To supply nitrogen, phosphate and potassium to fully rooted plants Lawrence (68) suggests liquid feeds containing three to six lb (1.4 to 2.7 kg) per 100 gallons (455 l), preferably of rain water to avoid precipitation of salts; the feed to be made and used the same day and applied at weekly or ten-day intervals according to need.

Baker (6) lists a range of liquid feeds for use with U.C. peat/sand bases, two of which are most commonly used. For nitrogen only one lb (0.45 kg) of ammonium nitrate is dissolved in 100 gallons (455 l) of water. To supply the three main fertilizers to plants already well established in containers, dissolve half a pound (0.23 kg) each of ammonium nitrate, mono-ammonium phosphate and potassium chloride in 100 gallons (455 l) of water and apply in place of a regular irrigation as considered necessary.

In U.K. nurseries liquid feeds for container plants are currently based largely on equal proportions of ammonium nitrate and potassium nitrate at concentrations of from 200 to 400 p.p.m. depending on the plant species. Phosphate may be added occasionally but may be adequately supplied in the basic mix.

Foliar feeds are of undoubted value, especially high-nitrogen feeds for semi-shade plants exposed to full sun. They should be sprayed on the plants during growth flushes at seven to ten-day intervals. It is generally true that the nitrogen requirement rises as the plants are increasingly exposed to sunlight, and particularly when shaded plants are being hardened to light as they leave the nursery and enter the open plantation.

PROPAGATION BY SEED

Propagation by seed is the primary method of plant multiplication and remains the principal way of raising the majority of tropical fruits. It has advantages and disadvantages. Being merely an extension of the natural way it is easy. The seed endows the young plant with power to overcome initial adverse features of the environment by means of stored food accompanied by a high root/shoot ratio. Furthermore seeds normally possess power to respond appropriately to the environment by means of inhibitors and 'timing' devices related to physical features such as moisture, temperature and light. With few exceptions the seedling starts free of virus infection.

Collection of seed

Collecting seed from suitable sources can do much to minimize seedling variation. Collection from groves of high reputation from which inferior plants have been eliminated is recommended. Such seed sources may well be established in isolated areas or villages, either by planting only selected seedlings there or, where practicable, planting vegetatively-propagated clones in seed gardens. Seedlings arising from such a source tend to reproduce characteristics observed in the parents (48).

Seed from a single plant established in a mixed collection, as found in an arboretum for example, would be a poor source from the variation point of view. On the other hand seed from a pure stand of a clonal cultivar lacking cross-pollination may not prove so satisfactory as that from a stand of two or more clones with regard to health and vigour. When a seed source has acquired a reputation by progeny testing it may sometimes, if properly exploited, prove of far greater value to the grower for propagation purposes than for fruit production.

The best time to harvest most seeds is when the fruits are fully ripe. Occasionally it may be advantageous to collect somewhat immature fruits for seed in order to reduce losses from depredation by birds and other predators, and because sometimes this results in more rapid germination, but most tropical fruit seed responds best when taken from mature

fruits for immediate sowing. In some cases fleshy or oily seeds have a very short storage life precluding wide dispersal owing to the time taken in transit. Once harvested, seeds need very close attention to ensure that viability is retained until they are sown.

The phenomenon of polyembryony (the formation of more than one embryo in an embryo sac) occurs in a number of plants, notably mango and citrus. Adventive embryos arise from the cells of the nucellus and are highly uniform, being of vegetative origin. If, after germination, the generative seedlings can be distinguished from the vegetative seedlings and eliminated, a non-variable line of descendants should result. This is discussed in more detail later under vegetative propagation (p. 82).

Storage of seed

Seed viability can be maintained for a considerable time under appropriate storage conditions. It has been shown (9) that, although all kinds deteriorate very rapidly in the tropics, it is possible, by humidity and temperature control, to extend the viability of many valuable seeds, thus permitting direct seeding in a planned planting programme. In the main, moisture content and storage temperature determine the keeping quality of seeds in storage.

Moist seed, freshly harvested, rapidly deteriorates in the high ambient temperatures of the tropics; but over-drying is equally dangerous. Seed cleaned of any adhering fruit pulp by washing should be surface-dried under shade and kept cool thereafter. Very few data are available on the storage of tropical tree-fruit seeds but it may be appropriate to quote some values available for rubber (*Hevea brasiliensis*), soya bean (*Glycine max*) and oil palm (*Elaeis guineensis*), all of which possess high oil contents.

Rubber seed can be stored at ambient temperatures for up to two months (105). Good results have been obtained by mixing the seed with an equal volume of sawdust (10 per cent initial moisture content) and spreading this mixture in shallow layers inside perforated polyethylene lay-flat tubes to avoid heat build-up. Under these conditions viability was unimpaired for at least two months and was still about 50 per cent even after four months; moreover no germination occurred in the bags.

Soya seed loses viability rapidly at high ambient temperatures in Trinidad, particularly when poorly ventilated and with initial moisture contents above 14 per cent (115). Under conditions in Trinidad, with maximum and minimum temperatures of about 85° and 68° F (29° and 20° C), and with humidity at saturation point almost every night, a 90 per cent loss of viability occurred over a 10-month period, whereas similar seed cool stored at 55° to 60° F (13° to 16° C) retained full germinating power.

The treatment of oil palm seed is described in the following section.

As experience is gained it will become clear that varietal characteristics are among the factors determining the life-span of seeds and the skilled propagator will use this knowledge, where appropriate, in his choice of particular seed sources.

Pre-treatments

Although it is true that sound, fresh seed of most tropical plantation crops soon germinates after planting, exceptions occur. Oil palm may serve as an example, giving slow and erratic germination in the absence of special treatment. The technique recommended (103) is to place moist clean seed in a container covered by a sheet of polyethylene (gauge 0.002 in: 0.005 cm) and to mist-spray the seed three times a week. Optimum temperature was found to be about 39° C (102° F), with a duration of treatment of 70 - 80 days. Higher temperatures for brief periods were only slightly harmful, but any marked heat reduction was accompanied by a large drop in germination rate. Following the ten weeks treatment an ambient seed-bed temperature of 25° - 28° C (77° to 84° F) has given over 80 per cent germination in 12 to 15 days. Additional treatments to prevent or reduce losses from diseases caused by organisms associated with the seed, or present in the seed-bed, may be helpful. Chemical treatments are the most common method (45). Organic fungicides are used more than inorganic and they are conveniently applied as dusts. In general, it is found that proprietary dusts are efficient and economical. The makers' explicit directions should be carefully followed. All dusts present hazards to workers and special precautions are necessary. When treating large quantities of seed, clean filter masks should be worn and the treatment applied in the open or in a well ventilated

hed. Ideally, the treatment room should be provided with exhaust fans to collect the floating dust. The operators should wash away any personal contamination with soap and water, this being particularly important prior to eating or drinking.

Both dusts and fluid disinfectants or protectants must come into close contact with each seed. For small lots of seed this is conveniently achieved by placing seed and material in a tumbling barrel or old-fashioned butter churn. Larger quantities may be well mixed on a concrete floor by turning three or four times with a shovel. In general, the seeds of tropical fruits exhibit little or no dormancy.

Among tropical plants, however, the seed of wattle (*Acacia mearnsii*) germinates well following treatment with boiling water. The seeds are dropped into a vessel of boiling water which is then removed from the heat source and left overnight to cool. The seed may then be sown, or washed, dried and stored.

Viability tests

In seed testing, the sample on which the test is made must be representative. A bulk should be well mixed prior to sampling. This is safely accomplished with dormant seed, but if germination has begun considerable damage may be done. In this case the sample should be hand selected from different positions in the heap or layer. Seeds should be taken from not less than ten different positions in the bulk, whether this is in sacks or rigid containers or in a single heap. When the individual samples are found to be more than sufficient they should be put together, well mixed and then halved by a single movement. If necessary, one of these halves may be re-mixed and halved again, to obtain a manageable sample for testing.

Seed may be tested for a variety of characteristics such as purity or lack of contamination by other seeds, seed size, internal condition, cleanliness, freedom from progressive rots and, above all, germination percentage and vigour.

Each sample to be tested should be soaked or otherwise moistened and placed in a suitable temperature. Small seeds may be lined-out on moist filter or blotting paper and covered with glass covers within a controlled cabinet or incubator. Large seeds, such as avocado, are better partially

buried in a layer of sand or clean fibrous material. This permits the seed to be kept in appropriate orientation. Records should be taken at regular intervals, daily if necessary, of numbers germinated in relation to time and grading, incidence of rotting and vigour of germination.

Various quick viability tests have been devised to provide data for a rapid report on germination capacity. In the 'cutting' test the seeds are simply cut open and empty or damaged ones counted (9). A variation of this, known as the 'half-seed' method, is to soak the seed and cut off one end, without injuring the embryo, placing the remainder of the seed in reduced light in a germinator where greening of the cotyledons indicates viability. Non-viable embryos rot quickly without turning green.

Early appraisal of dormant, or seemingly dormant, seed may be made by use of the tetrazolium test. This TZ test is especially useful in evaluating dormant seeds just harvested (18) and also when seeking the cause of non-germination of firm seeds that remain dormant at the end of growth tests.

For the TZ test the seeds should be soaked in water for a day or more to facilitate even absorption of the chemical and subsequent clean cutting, where this is necessary. It is generally recommended that small seeds (grains, etc.) be cut through before they are placed in the solution, but larger seeds should be treated without cutting. A suitable solution is 0.25% 2,3,5-triphenyl tetrazolium chloride in water, i.e. 1 g in 400 ml. Seed immersed in this solution for one to two days in complete darkness at temperatures of 75° to 90° F (23° to 32° C), should be adequately stained. The solution is discarded and the seed kept wet and cool by immersion in water in a refrigerator at 40° to 50° F (4.4° to 10° C) till testing. In the test the seed coat is removed to reveal the degree of staining of the tissues. Strong, healthy, viable tissues are stained red. Weaker tissues, of old seed or seed badly harvested or improperly stored, will be mottled or only palely coloured, whilst dead tissues are white. Confirmation of the individual staining reaction may be obtained by inspection of sliced seed.

Sowing or planting the seed

There are three main ways of sowing seeds. They may be sown *in situ*, commonly termed 'sowing at stake', in

prepared seed-beds or in containers such as pots, bags or baskets.

Sowing at stake. Sowing seed *in situ*, where the plants are to remain throughout their lives, has some advantages over transplanting from nurseries, including the avoidance of transport of bulky containerized plants from a distance, but there are a number of hazards, only partly overcome by good management and horticultural care. The wide spacing of the seed sites, involving considerable areas, lessens opportunity for frequent and regular inspection and permits extensive damage to occur before adequate control measures can be implemented. Depredation by rodents and birds is only partially mitigated by sowing a number of seeds at each site and mulching these with branches, straw, woodwool, etc. A general drawback to sowing *in situ* is the early occupation of the land, which might otherwise have been cropped or undergoing preparatory treatment, for example to eradicate weeds, prior to the planting of nursery-raised trees, in some cases already grafted. Moreover, it is found that establishment failures and supplying with new seed or transplanted material, both demanding widely scattered supervision, leads to variable development and productivity of the plantation. Points in favour of sowing at stake include the avoidance of damage to the tap-root and really firm anchorage from the beginning, initial vigour and a considerable saving in the use of skilled labour in the nursery.

It is recommended that the land be cleared and deeply cultivated well before planting time. After marking out, the pits should be dug well in advance of planting the seed. A period of one month is recommended to permit weathering. About two weeks before planting the seeds, the pits are filled with a mixture of top soil, compost or rotted manure, wood ash and sometimes, in accordance with local recommendations for particular situations, some phosphatic fertilizer may be added. This should be well forked into the soil to avoid direct contact with the roots. These operations should take place in time to plant the seed soon after the onset of rains in order to lessen the need for watering. From three to five seeds should be planted in each hole to allow for germination failures and losses caused by pests. If the seeds are set five or six inches (13 to 15 cm) apart it will facilitate thinning to the single selected plant later. When removing the others care should be taken not to disturb the roots of

the selected plant. This may be achieved by placing a foot firmly beside the selected plant, pulling the discarded ones upwards, and refirming the disturbed soil by treading.

As soon as the seed has been planted, protection from pests should be provided. Crows, doves and other birds, jackals, rodents and monkeys, may be attracted to the seed and young seedlings. They may be deterred by placing a close thorny enclosure around each site, over and through the mulch mentioned earlier, and this should be maintained until the first growth flush is well developed. The surface soil of the pit and its immediate surrounds should be kept free from weeds. In dry spells the sites should be well watered and in periods of intensive insolation shade may be provided by leavy branches, fern and palm fronds, inserted around the young plant to incline over it.

Sowing in seed-beds. Bulky organic weed-free materials may be incorporated during the preliminary cultivations, care being taken to obtain an even distribution to avoid uneven development of the seedlings. It is important to select a row spacing and plant density which will provide room for good sturdy growth combined with economy and convenience in working, but the best layout naturally varies with the crop and material to be raised. In very favourable situations where the land is flat, extremely well drained and otherwise excellent, it is possible to leave the soil level, providing only access paths, the seed being sown in long rows some 15 to 30 cm (6 to 12 in) apart with 60 cm (24 in) paths every 1.5 m (60 in). Most sites, however, are best made into raised nursery beds with sunken paths between. Beds of 120 cm (47 in) width may be hand-weeded by reaching in from the paths, thus granting freedom in choice of spacing of the seed and avoidance of surface compaction by treading. Although it is possible to work from 40 cm (16 in) paths, a width of about 60 cm (24 in) is often preferred. Following marking out, the top soil from the paths is thrown onto the beds. In this operation the lowering of the path by 10 cm (4 in) will provide soil to raise the bed some 5 cm (2 in) and result in a differential of 15 cm (6 in) which will provide ample surface drainage in soils of good structure. On a large scale this work can be done by improvised ploughs and scrapers. Following preparation, and before sowing, inorganic fertilizers may be incorporated into the upper two or three inches (5 to 8 cm) of the bed before its final consolidation.

Granular fertilizers can be spread by hand or by a mechanical distributor. A simple hand-drawn drill-like distributor may be improvised. The fertilizer should be incorporated in the upper three to five inches (8 to 13 cm) of soil by forking or raking. On a large scale light tractor-propelled rotovators will greatly speed the work. Although it may be easier merely to spread and roll-in fertilizer, this is a practice which can somewhat reduce germination, owing to the close proximity of the material to the seeds (1). The loss from this practice has been lessened by mixing the material in the open drill using a narrow rake or hand hoe before planting the seed.

Rates of fertilizer application should be related to the nursery conditions and the crop to be raised, and full advantage taken of local advice and analytical facilities. Of the main nutrients, nitrogen, phosphorus and potassium, it is generally recommended that phosphatic and potassic fertilizers be applied before sowing and that nitrogen be provided by light top-dressings at intervals until the seedlings leave the nursery. There is no advantage in applying highly soluble nitrogen fertilizers before sowing because they will be washed through to the subsoil and below before the young plants can make use of them.

The degree of consolidation necessary depends on the nature and condition of the soil, and whether it is dry or wet, but some degree of firmness is essential in order that soil moisture may reach the upper layers containing the seeds, by capillary action, and so prevent the soil surface from drying out. This is especially important for small seeds, but with large seeds, set comparatively deeply, it is rather less so. Soil of really good structure, containing plenty of organic matter, can hardly be firmed too much, but a poorly structured soil, particularly when wet, may be much damaged by treading or rolling.

Once the seed-beds are prepared there may be a considerable development of weed seedlings and small root pieces. These may be destroyed by the application of contact non-residual herbicides such as paraquat prior to sowing.

Time to sow the seed. In the tropics the time of planting seeds is intimately associated with the availability of moisture; many crops are therefore sown at the beginning of the rains (27). For some crops with low water requirement it

may be possible to sow during the dry season, provided there is sufficient soil moisture for germination to take place. An important factor in the production of seedlings is to have them fit for transplanting when field conditions are favourable. This may entail sowing the seed in the dry season under adequate irrigation. Seeds with a very short life are best sown immediately and if this coincides with a dry period the only solution is to have the nursery irrigated and independent of rainfall.

Sound management will ensure that the seeds have undergone their preliminary treatments including cleaning and storage, as already detailed and, where considered advisable, a period of soaking in water immediately prior to sowing. Widely differing pre-sowing soaking periods have been suggested as helpful, from a few hours to as much as a week or more. With fresh seed, kept moist and cool after collection and extraction, a final water-soak may be of little benefit, but where the seed is aging there would appear to be some advantage in it (102).

Depth and pose of seed. Almost every different kind of seed has its own optimum sowing depth in relation to local conditions, but, in general, large seeds are best planted more deeply than small and all more deeply in open sandy soils than in stiff clays. Thus from early times gardeners have advocated a depth approximating to two or three times the diameter of the seed, remembering that plants which lift their cotyledons above the soil should not be planted too deeply. However, the exposure of fleshy cotyledons, e.g. of cashew, which are much sought after by predators, is a serious disadvantage. Work by Rao et al. (101) to ascertain the effect of various planting depths and positions or attitudes of cashew seeds has made it clear that planting at a depth of two to three inches (5 to 8 cm), with the stalk end upwards and inclined at about 45° to the soil surface is best, as it combines a high germination rate with low percentage cotyledon emergence. It has also been shown that the germination percentage falls rapidly as planting depth increases beyond three inches (8 cm).

When seeds are first sown in trays or other containers it is customary to plant them less deeply than in the open nursery rows, even with the points of the seeds above the surface of the medium or only slightly covered as recommended for avocado (78). Other authors (618) boldly recommend appropriate seed depths for various fruits, whether in containers or open nursery, thus covering mango seed one to one-and-a-half

inches (2.5 to 4 cm), giving half that depth for cherimoya and pawpaw, and for guava only one quarter of an inch (0.6 cm). There is indeed a wide variation in recommended depths, but it should be remembered that the response of the seed will largely be governed by its immediate environment. In continuously moist conditions, as under electronically controlled mist, the seeds may germinate rapidly when fully exposed on the surface, but subsequently they will be displaced by the thrusting of the issuing radicle or plumule and form inferior twisted plants for transference. On the other hand, over-deep planting may compel the plant to exhaust its reserves in growing to the surface, and make it more difficult to lift without damage and also to replant. The chief aim of the sower should be to place the seed for stability, access to moisture and warmth, and posed and spaced for straight and sturdy growth.

Sowing in containers. Raising seedlings in individual containers for later transference to the field, with minimal disturbance of the roots, confers a number of advantages but involves considerably more investment of labour and money than either sowing *in situ* or in nursery beds. Plants raised in containers can be established in their permanent position in the field without suffering a severe check so commonly experienced following bare-root planting. Container-raised plants can be more readily protected from predators than those grown directly from field-sown seed. These features of container-raised plants favour a full establishment at a single planting and obviate the expensive operation of replacing missing plants, which may go on for more than a season and result in an uneven plantation with a delay in the attainment of full production.

Included among the adverse features of container usage is the fact that the plants must be transferred to their permanent site before the roots have become spirally congested or twisted around. Plants with spiralled roots may never recover. Any roots already entering this state upon arrival at the planting pit should be teased loose and spread outwards on the floor of the pit. Another point to be considered is the difficulty of transporting containerized plants over long distances or over awkward terrain, not only because they are heavy but also because they require considerable space during transport to accommodate them in an upright position, their maximum height having to govern the shelf spacing in the vehicle. Plants raised close to the plantation will not have these transport problems to the same degree.

VEGETATIVE PROPAGATION

As explained earlier, the two modes of plant propagation, by seed and vegetatively, while both resulting in plant increase, have quite different effects. One of the attributes of seedlings is variation of individuals which may provide for improvement or deterioration. On the other hand, vegetative propagation multiplies the individual. It is the real basis of horticulture, enabling the plant raisers not only to aim at perfection by selection but to perpetuate at will any advance achieved.

Systems of vegetative propagation

Plants are vegetatively propagated in two main ways, by division or by cuttings. Under the term 'division' come all those processes by means of which a part of the plant, usually the stem, is induced to grow roots and shoots before separation from the parent. This is simply preparation for division and covers stooling, layering, and all types of marcottage or gootee.

Propagation by cuttings consists in the taking of comparatively small pieces of a plant and setting them in situations where they are able to develop to wholeness. Cuttings can be taken from any part of a plant, root, shoot or leaf, and each can be treated in many different ways. They readily lend themselves to 'factory' methods, for they are compact and convenient to handle even in large numbers and plant production is therefore flexible, unlike that in a layer bed which once installed yields a similar number of rooted progeny each year regardless of fluctuating needs.

In addition to the two modes of vegetative multiplication - division and cuttings - there is another major system involving the joining of one plant to another by grafting. Whether grafting has any place in truly clonal propagation depends on circumstances. The placing of scions of clonal origin on rootstocks of other kinds, seedlings or vegetatively raised, does not multiply the total number of plants but merely increases one kind at the expense of others. If only one of the components is truly clonal the result is a mixed population. Even if two true but different clones are joined together it does not follow that the results will be truly clonal, for

the proportion of each may differ, rootstock suckers arise or scion roots enter the soil. For truly clonal propagation by grafting one must join parts of the same clone as when an established plant is dismembered and pieces of root and pieces of shoot are grafted together to form complete plants which, in turn, may be treated similarly.

Still another mode of vegetative propagation is based on polyembryony which takes place within some seeds. This will be discussed under this main heading of vegetative propagation, following description of the systems division, layers and cuttings.

DIVISION

Many plants both woody and herbaceous naturally multiply themselves by developing offshoots or side-plants. In some cases specialized organs enable the plant to establish vegetative progeny at some distance from the parent either by runners (stolons) or by arching their shoots or boughs so that the tips of such branches reach the ground, where they root. Offshoots arising at the base of a plant are often seen in monocotyledonous plants such as the date palm, pineapple and others. Some plants spread very efficiently by forming adventitious buds upon their roots and thus develop new plants; numerous examples are seen among woody plants where they are often termed suckers. Such suckers, whether close to or distant from the parent may be readily removed, complete with roots, and established elsewhere. Where plants form clusters of shoots at ground level the whole plant may be lifted, divided and replanted. Thus a limited form of division may be carried out at the early seedling stage by splitting seedlings directly stem and root are clearly discernible (73). This is known as twinning and is only of limited application.

Any plants naturally adapted for propagating themselves by division, including those which readily form adventitious roots from their shoots or branches, will respond well to various comparatively simple propagation techniques, all of which can be described as layering or, as stated earlier, preparation for division. The term layering covers all processes in which a part of the plant, usually the stem is induced to grow roots and/or shoots before separation from the parent. Thus the term covers stooling, layering, and all types of marcottage or gootee. It is convenient to deal with these subdivisions individually.

Stooling

Essentials. The basic requirement for successful stooling is the plants' power to produce numerous root-bearing shoots in response to severe pruning, in a position where it is

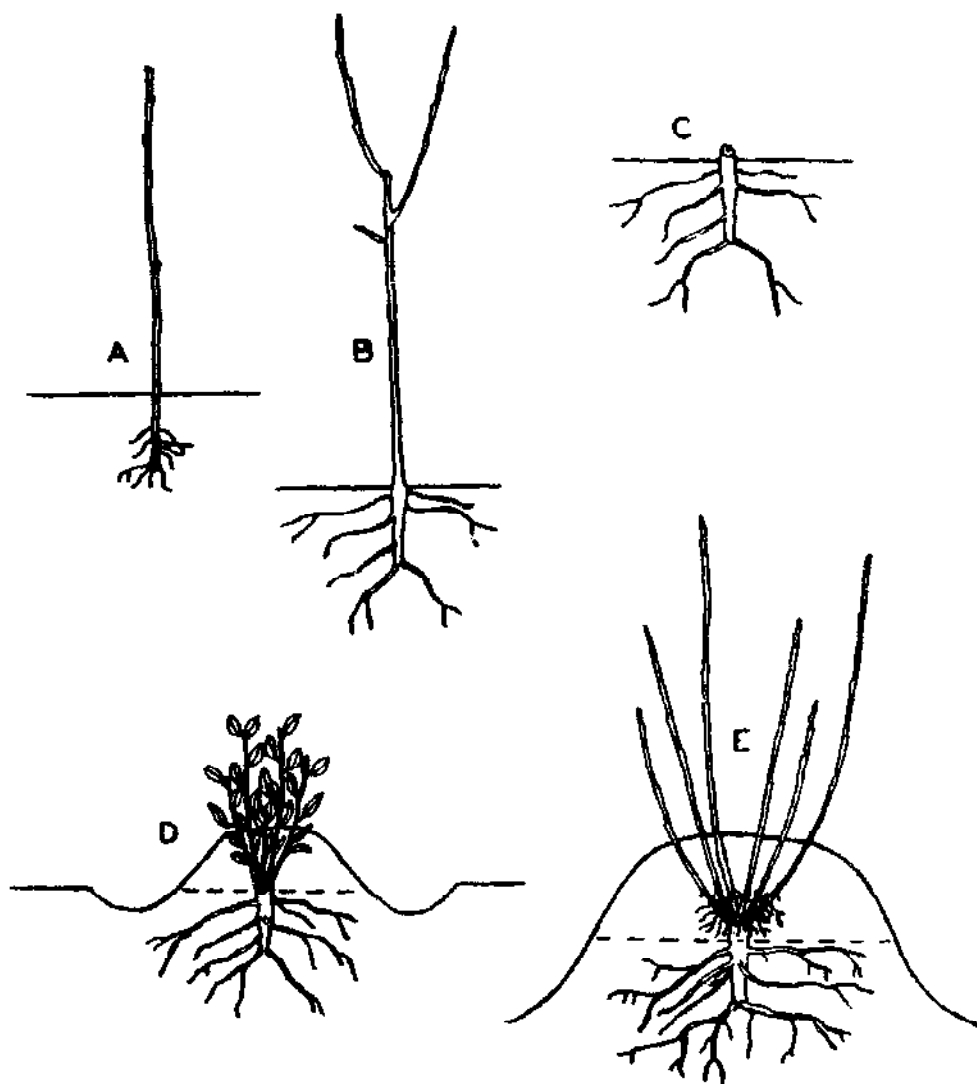

FIGURE 1

The stooling method

A = Newly-planted parent. B = Established parent. C = Cut down one year after planting. D = New shoots earthed a first time. E = Rooted shoots on the stool ready for collection.

convenient to cover the bases of the shoots with soil or compost. Success comes from the maintenance of vigorous growth, early covering of the shoot bases so as to provide time for root initiation and development in one growing season, and the avoidance of excessively deep earthing or covering which buries active leaves and thus progressively weakens the stool and shortens its productive life (32).

Stool establishment. On a small scale it may be possible to stool isolated plants already established in the locality, but for practical convenience parent plants should be placed in rows. Row spacing must be wide enough to permit ready access and to provide sufficient area of soil for subsequent mounding of well-developed stools. Spacing at two to three feet (60 to 90 cm) in rows some five feet (1.5 m) apart has proved sufficient.

After one growing season, and when well established, the plants are cut down to within one or two inches (2.5 or 5 cm) of the ground. This cutting should be done with a sharp knife or clean-cutting shears and the cut surface sealed with a suitable wound dressing, care being taken to avoid covering the stem from which shoots will grow.

In free rooting species the stool is not normally earthed-up until shoots have developed, but with shy-rooting subjects a light covering of about one inch (2.5 cm) is sometimes given. This not only provides a better rooting environment for the base of the shoots but also prevents overheating of the bare stool.

Annual treatment. When the new shoots from the stools are five or six inches (13 or 15 cm) high, soil is drawn up to and amongst them to half their height. When the shoots have made further growth more soil is added. Still later yet more soil may be added to ensure that a depth of soil of up to six to eight inches (15 to 20 cm) is stabilized round the shoot bases. In areas of heavy rain it may be difficult to maintain a mound of soil. This problem may be solved by the use of fibrous composts, pulverized bark, sawdust or coconut fibre refuse as mounding material. The addition of a modicum of loam soil to this open fibrous material encourages the formation of roots better adapted for successful transplanting.

When necessary, mounding material may be kept in position by boards or strips of material, such as bituminous roofing felt, fixed at the sides of the mound.

At the end of the second season, when the new shoots have rooted, the mounding material is removed and all the shoots are cut off close to the parent stool which is then left exposed until a further crop of shoots arise. The new shoots are then mounded as in the previous year. Some protection of the bare stool may be given by a light covering of twigs or fern. Stools may last many years but the productive life of a stool depends on the kind of plant and horticultural care, including correct timing of cutting down, mounding and removal of rooted shoots. Should some of the shoots not be rooted or be poorly rooted, they may be successfully established if treated like hardwood cuttings. These are described in a later section.

Constriction of shoots. Many workers have found that constricting the base of new shoots by wiring increases rooting (32). When the stool shoots are half grown or semi-lignified, with a period of further growth and secondary thickening to follow, they are wired close to the base. Thin copper wire is used in three or four turns round the shoot taking care not to cut the bark too severely. Narrow, easily tied strips of polyvinyl chloride may serve instead of wire. It is recommended that not more than two-thirds of the shoots should be wired (56) so that the parent plant may have the benefit of those left. The wired shoots are covered, or recovered if previously earthed, as described above. Further thickening of the wired shoots brings about constriction and rooting takes place just above the wire. An analytical study (116) showed that carbohydrate accumulation above a girdled shoot base is a major factor in the promotion of rooting above the girdle, but root promoting substances or their precursors and increased development of disorganized tissue also play their part.

Wiring of stooled plants and also of branch layers has proved successful in the clonal propagation of guavas in South Africa (96). Only weak rooting occurred during the first season and it was found best to leave the wired shoots a further year. It appeared possible to obtain an annual supply of well rooted layers by wiring part of the available shoots each year and, when removing those well rooted, to wire a further batch.

The operation of wiring individual shoots, especially when preceded by earthing, unearthing and re-earthing is somewhat labour-consuming. A simplification of the process (55) is afforded by the placing of a galvanized steel strip of screen (3/16 in or 5 mm square mesh) 18 in (4.5 cm) wide, over the cut-back stumps before covering them with soil. As the new shoots develop they grow up through the screen and are girdled as they thicken. This girdling promotes rooting close above the screen and facilitates the later separation of the shoot. For fast-growing plants, quickly producing thick shoots, a somewhat larger mesh may be needed. Rigid plastic mesh has also been used with some success.

Layering

The etiolation method.

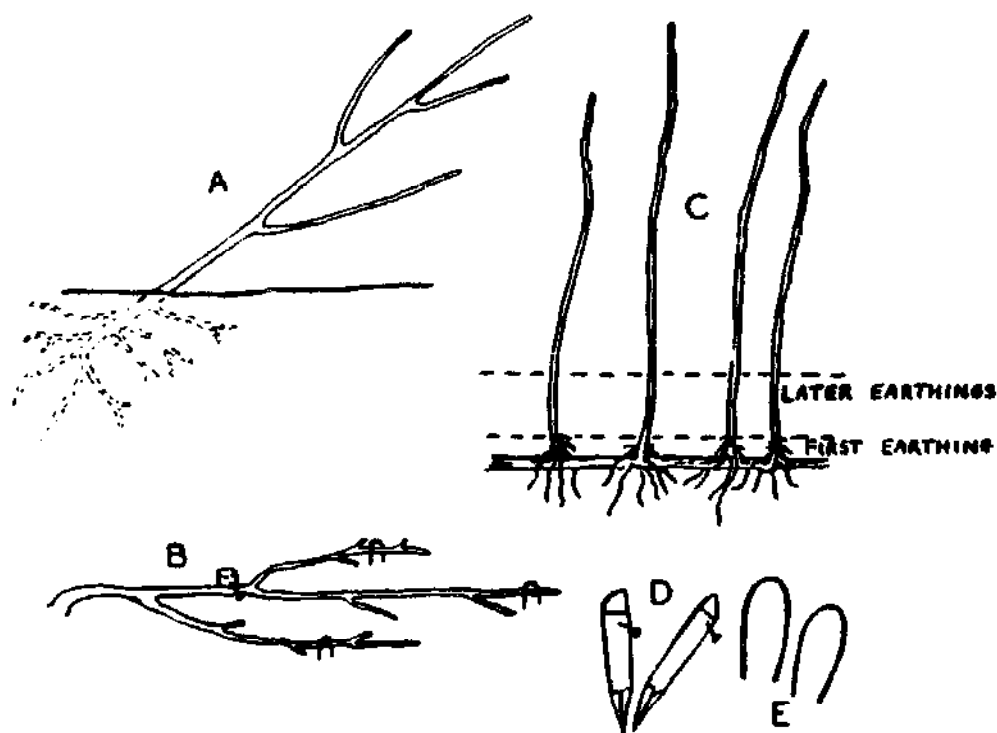

FIGURE 2

The etiolation method of layering

A = Newly-planted parent. B = Established and pegged down one year after planting. C = Rooted shoots on the parent layer one year later. D = Home-made wooden pegs with 2-inch wire nail near upper end. E = Wire (gauge 10) doubled for pegging down slender shoots.

Shoots developed in complete darkness differ from those exposed to light in three main ways. They are white, or pale yellow, and have no leaves within the region etiolated; when growing through a covering of soil or compost their tips are bent over as occurs with the plumule of a deep-planted seed and their internal stem structure is modified, having less fibrous tissue than exposed shoots. In practical terms the etiolated shoot is somewhat more like a root than a stem, with an increasing propensity to form adventitious roots. Etiolation is quite different from blanching. In blanching, a shoot already fully exposed to light and already having normal leaves is earthed or otherwise covered so that it only gradually loses its green colour in an intimate environment where root initiation and development is encouraged. Ready rooting plants respond well to blanching but shy-rooting plants only to methods of layering which involve etiolation (28; 32; 65).

To form a layer bed, young plants of the variety or rootstock to be propagated are planted at an angle of 45° , in single rows, all inclined in the same direction to form a continuous line of shoots when laid down. Such rows are spaced some six feet (1.8 m) apart. When the plants are well established, normally after one growing season, they are pegged down flat in shallow trenches along the rows. In some areas it has been found inadvisable to use freshly cut, non-treated wooden stakes in pegging down the layers as fungi may thus be introduced. The use of metal pegs, or stout wire bent in the form of a U, obviates the danger. The pegging down is made easier by first removing a spade-full of soil from close under the parent stem, this, moreover, reduces the risk of stem breakage. With deciduous trees this is done in the dormant season but with the evergreen trees of the tropics, which are seldom completely dormant, certain modifications may be necessary. Thus, when leafy shoots are pegged down flat, as many leaves as possible should be bent upwards and a friable compost placed beneath the leaves so that the leaf-blades remain in the light. A compost depth of two inches (5 cm) is adequate. It may be found that the re-arrangement of leaf angle, coupled with the sun heat reflected from the soil, may result in severe leaf scorch and necessitate the provision of some light overhead shade by trees or by lath structures.

As the new shoots push up through the layer of soil or compost, a further inch (2.5 cm) or so of soil is placed upon them. No soil is added where shoots have not yet appeared.

This process is repeated two or three times during the first few weeks of the growing season. It has the effect of ensuring the etiolation of the first inch (2.5 cm) or so of the young shoot and it is from this area that roots will eventually arise. Without this etiolation there is little or no rooting.

After the initial earthings, and when the shoots have grown three or four inches (8 or 10 cm) above the soil, earth is again added to half the height of the shoot. Further additions are made at intervals of a few weeks until the bases of the shoots are buried six or eight inches (15 or 20 cm), but at no time should the shoots be buried to more than half their total length.

At the end of the growing season the soil is drawn away from the bases of the shoots and the rooted shoots are removed at their juncture with the parent layer. Unrooted shoots are left to be pegged down as described above. If all the shoots are rooted, some of the most vigorous ones must be left for pegging down, one strong shoot per foot (30 cm) of row sufficing. At each layering the laid shoots must lie alongside those they overlap, they must not cross each other, and they must be kept as flat as possible. If allowed to bend upwards from their point of origin only a limited number of very vigorous shoots will arise near the top of the bend in a position difficult to cover with soil. When pegging down strong shoots inclined to break at their juncture with the parent layer the bending strain may be distributed by first bending the shoot at right angles to the direction of the layer, half-way towards the ground, and then completing the flattening by forcing it alongside the other laid shoots.

Working with a ten-year-old layer bed (113) it was found that a reduction in length of the laid, or parent, shoots markedly increased rooting as did removing the buds from the top sides of the laid shoots; both reduction of shoot length and removal of buds increased the output of rooted layers. Thus, shoots arising from the underside of the layer rooted best. They were etiolated over a greater length and also had a bend at their base.

Although the etiolation method has been used mainly for the propagation of clonal rootstocks it can, of course, equally well be applied to trees which it is desired to establish on their own roots.

The blanching method. The layer bed is established exactly as in the etiolation method described above, and the plants are pegged down similarly, but the laid shoots are not covered until they have grown to ten inches (25 cm) when they are earthed to a third or half their height. This initial exposure of the laid shoots ensures a maximum number of new shoots, unlike the darkening, or etiolation, process which tends to suppress development of some of the buds. The method works well with ready rooting subjects and is more productive than stooling, particularly in the first few years. A well-established layer bed, particularly if firmly pegged down, may be converted to a continuous stool by closely cutting down all the shoots and thereafter treating the row as though it were a collection of stools. As the method does not involve immediate earthing, any leaves on the shoots remain exposed and fully active while the new shoots are developing.

Simple layering. The first requirement for maximum production by simple layering is to have an ample and continuous supply of shoots from the parent, and sufficient space for placing them in the surrounding soil. A spacing of ten feet (3 m) may prove sufficient and, after a season for establishment, the parent plant should be severely pruned, or stooled, to encourage the production of numerous fast-growing shoots capable of being bent to the ground. This bending will tend to force further shoots for the next season's layering. Such shoots may come from the crown of the plant or from the lower parts of the bent shoots.

Before layering, the soil about the parent plant should be cleared of weeds, well cultivated and generously manured with compost.

The layering consists in bending down each shoot and burying a part of it in a shallow hole in the ground, so that the tip is in the air. The part in the hole may be held firmly in position by a stone or peg before refilling the hole. The buried portion is sometimes wounded by cutting in various ways or by twisting. The simplest method of cutting is by a single stroke upwards on the underside of the shoot to be buried. This cut may extend more than half-way through the shoot. The upward bending in the burying process opens the cut and the entry of soil prevents the cut surfaces from growing together. With the cut underneath, the upward bending sometimes extends

the cut by breakage and hence some operators cut the upper side and give a sideways twist when bending the shoot upwards. This modification prevents breakage and completely separates the cut surfaces.

When all available shoots have been layered they should be well watered. This watering should be repeated during dry spells. When the rooted layers have been removed, the basal parts of the parent shoots are pruned back to encourage replacement shoots for further production. When successive crops of layers have been taken, the surrounding soil should be replenished with fresh soil and compost.

Ground layering of branches. Selected branches of mature plantation trees are sometimes subjected to simple layering, but the process is cumbersome and interferes with cultivations. The rooting response is often slower than from vigorously growing well established parents and the resulting plants may be slow to establish after severance. The system is essentially the same as in simple layering but the bending-down process must be more individually applied.

In his book on the mango, L. B. Singh (111) advocates the selection of low-growing branches which may be bent to touch the ground without breaking; here they are attached to pegs firmly fixed in the ground. Singh describes the wounding of the part to be buried, much as detailed above for simple layering, and recommends that the layer should be kept moist by frequent watering. After two or three months, inspection may reveal sufficient rooting for severance and eventual establishment in the nursery, otherwise the soil is replaced for a further period. It is advisable to sever the layer gradually by nicking the branch close below the rooting point and to complete the cutting through a few weeks later. Even then it is advisable to leave the severed plant in position, continuing to water it for a further two to three weeks before potting it into a large container of nutritive compost to encourage vigorous growth under partial shade, with close attention to watering.

Serpentine layering. Long shoots are bent in an undulating way, alternately covered and exposed, thus a number of rooted layers may be obtained from one shoot. The method works well in the propagation of climbers but is rarely used in that of

non-climbing woody plants. The technique is similar to that of simple layering, except that the branch is alternately covered and exposed along its length, one or more buds being left to develop shoots between each buried part to bear shoots and leaves which will serve to nourish the new roots of their section. When well rooted the layered branch is lifted and cut into sections each comprised of a rooted portion and its distal piece of shoot.

Mulching ground layers. Whereas in temperate climates, with a well distributed rainfall, bare-soil temperatures rarely rise to a point where they inhibit root growth, this is not true in the tropics where bare soil exposed to the sun may overheat at midday and fall substantially in temperature at midnight. Such fluctuations may seriously check root development and should be reduced by any practical means available.

The mounding or ridging of soil in stooling, and continuous row layering, normally tend to increase soil temperature fluctuation. There are two main ways of moderating this. One is to place the parent plant in a shallow pit or trench to reduce the need for a high mound. Such deep planting unfortunately increases the labour of un-earthing, removing the crop of rooted shoots and re-laying. The other way is to maintain close round the layer a mulch of material such as banana leaves, sugar cane trash, or guinea grass (*Panicum maximum*). Such mulches reduce the daily fluctuation in soil temperature by decreasing the gain of heat by day and the loss of heat by night (20). The effect of a mulch decreases as it decays and it should be replenished from time to time until the crop itself provides sufficient shade.

In simple layering, ground layering of branches, or serpentine layering there is no need to mound the soil, indeed, it is better to place the layers in shallow depressions where they will gain and retain the maximum water from rain or irrigation. Even so, a mulch placed around the laid shoots will have a beneficial effect by conserving soil moisture and maintaining an even temperature close round them.

Air layering (Marcotting, Gootee)

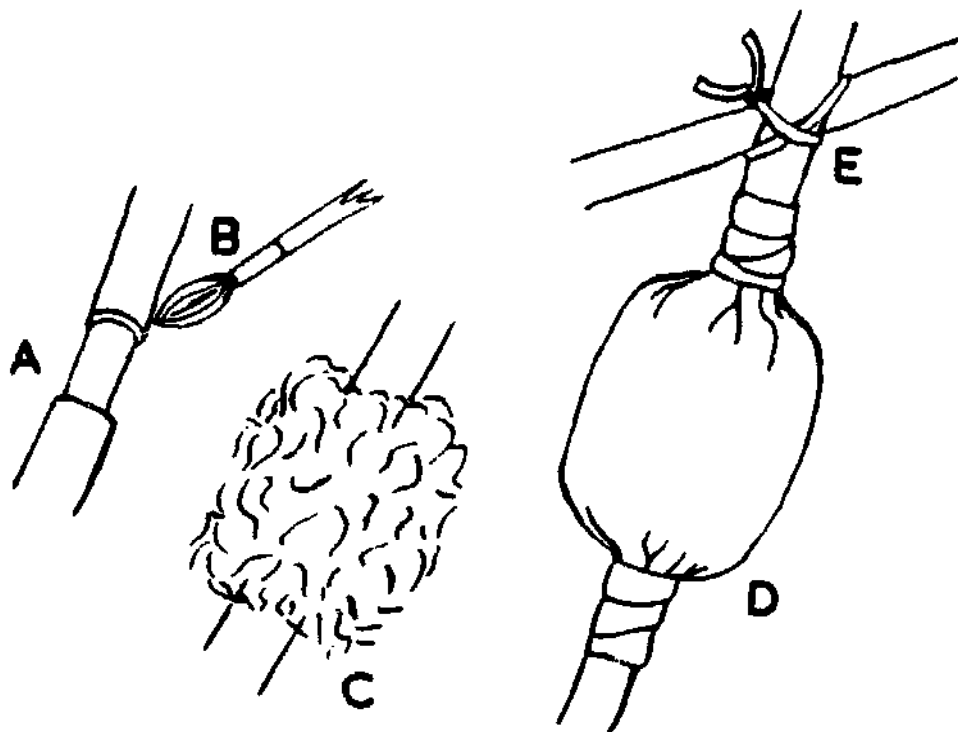

FIGURE 3

Air layering (Marcotting)

A = Shoot ringed. B = Painted for one inch above the ring with growth substance. C = Rooting medium. D = Film enclosure. E = Support by a neighbouring branch.

Essentials. Essentially the treatment (also called marcotting or gootee) is to girdle a shoot and surround the wound with moist material until roots emerge, when the rooted shoot is severed from the parent and established as a new individual. This is an ancient method well described by many writers as a reliable though somewhat tedious way of propagating very many woody plants, including avocado (94), cashew (see Part 2) and mango (111).

Age of shoots. Judging by the many results of trials with a wide range of species it would seem that young shoots, with a fast growing potential in a position on the parent tree where there is adequate light, respond best to marcotting. Firm shoots sufficiently lignified to withstand the necessary manipulation, yet young enough to respond to treatment, should be selected. Generally it will be found that one-year-old shoots with a good supply of leaves and leaf-buds are ideal for rapid root initiation and development, which largely depend on the downward flow of essential substances from developing leaves and shoots growing above the marcot. Thus it is that the phasic development of the actual shoot and not that of the parent tree as a whole is vital. The shoots should always be young, and can be obtained on old trees by heading them back. In mango, shoots of less than two years of age have been shown to give a higher percentage of rooting than older ones (110). However, with cashew (99) it was found that one-year-old wood was better than current season's growth.

Girdling and wounding. It has sometimes been suggested that slicing, notching or half-cutting-through, are alternatives to complete girdling or cincturing, but these partial interruptions of the downward movement of materials are less effective than complete girdling. Where success has followed mere wounding it may have been brought about by extensive tissue damage, and consequently girdling effect, or by excessive use of a highly concentrated growth substance.

As to the best season for the operation, work in various countries has shown that there is no major advantage in choosing a particular month. The condition of the shoot is the important factor; it should be young and active but not too soft, and one or two-year-old shoots have generally proved the most suitable. A practical consideration of some importance is to time the operation so that the rooted shoot is due for removal for transplanting early in the rainy season so as to facilitate establishment.

The position of the cincture, whether above or below a bud or midway along an internode, is relatively unimportant but it should be placed where it can be conveniently wrapped and be supported either by being tied to a neighbouring branch or to a stick or cane. Another practical consideration is the eventual size of the rooted layer. The rooting of very large branches leads to establishment difficulties. Size

reduction by pruning, at the moment of transference, may aid survival but may result in a mis-shapen plant based on lateral development. Suitable shoot sizes about the cinctured position have varied from 9 to 24 inches (23 to 61 cm) in length and from pencil thickness up to half an inch (1.25 cm) in diameter. A cincture a little above the base of the shoot will be ideally placed with regard to root formation and support.

The cincture itself is made by removing a complete ring of bark. Widths advocated have varied from one-eighth to three inches (0.3 to 7.6 cm). The essential aim is to stop the downward movement of carbohydrates and growth substances so that they accumulate above the cincture and are available for the initiation and development of roots. This interruption of flow should be as complete as possible without interfering with the upward passage of water and other materials to the shoot above. An eighth-inch (0.3 cm) girdle will heal and form a bridge too quickly, whilst a three-inch (7.6 cm) gap is excessive. An inch (2.5 cm)-wide girdling will generally serve and this can be made by two encircling cuts and the removal of the intermediate rind. The operation can be done with a sharp knife or with a double bladed tool. These cuts should not enter the wood (xylem) of the shoot for this not only checks the upward sap flow but, by weakening the shoot structure, increases the risk of loss by breakage. The vital necessity of preventing the downward flow of materials cannot be overstressed. Some workers have treated the bared wood-surface with disinfectants or other chemicals in an attempt to prevent the formation of a new rind, but with no clear benefit. A somewhat more efficacious treatment is to rub a pad of steel wool, or other abrasive, around the cincture to remove all traces of meristematic tissue. Another method is to pull twine or strong plastic thread very firmly into the wound to prevent bridging by callus:

Synthetic growth substances. It has become customary to apply synthetic growth substances to the upper part of the cincture and to about the first inch (2.5 cm) of the bark immediately above it. This is not essential for readily rooting subjects but has generally proved helpful in speeding root formation and in increasing the number and length of roots. Many substances have been used with success, the most popular being indole acetic acid, indole butyric acid and naphthalene acetic acid, or mixtures thereof. They may be applied diluted in alcohol, in inert dusts or in grease bases such as lanolin.

From a survey of the literature it would seem that the most effective single substance for assisting root formation is indole butyric acid (IBA). To prepare an alcoholic solution of IBA (or other crystalline growth substance) dissolve 1 g in 50 ml of ethyl alcohol, methyl alcohol or methylated spirit and then dilute this with an equal volume of water to make 100 ml of solution containing 10,000 p.p.m. IBA. To dilute the 10,000 p.p.m. to 5,000 p.p.m. add a further 100 ml of 50/50 alcohol/water mixture. Stored in well-stoppered opaque bottles in a refrigerator, the solutions retain their activity indefinitely, and should be strong enough for shy-rooting subjects.

Dusts containing synthetic growth substances ready for use may be purchased or can be made as follows. To make a dust containing 10,000 p.p.m. of growth substance dissolve 1 g of the substance in 40 ml of methylated spirit or 95 per cent alcohol, and stir this into 100 g of pharmaceutical talc to form a smooth paste. This should be done in a darkened room away from strong light (117). Stir the paste while it is drying until it becomes a fine dry powder. This prepared dust remains active for six months or more if stored in a closed opaque container in a refrigerator.

Lanolin pastes, which are particularly convenient for use in marcotting but are now regarded as an obsolete treatment for cuttings (5), are made by stirring the growth substance into the molten lanolin and then allowing it to cool (93). To make a paste containing 5,000 p.p.m. of growth substance melt 200 g of lanolin and thoroughly stir into this molten lanolin 1 g of IBA, or other growth substance required. This prepared paste will keep indefinitely if stored in a well-stoppered opaque glass vessel within a refrigerator.

The alcoholic solution is conveniently applied by means of an artist's camel-hair brush, the liquid being contained in a small glass bottle held close to the cinctured shoot. The bottle should be stoppered between each individual application. The liquid should wet the lower inch (2.5 cm) or so of the bark close above the cincture as well as the adjacent cut edge. An inadvertent wetting of the exposed wood (xylem) is of little consequence. The solution should be allowed to dry before applying the medium.

Dusts can be generously applied by means of a half-inch (1 cm) brush. If insufficient dust adheres, the bark above the cincture should first be wetted with water or a mixture of 50/50 methylated spirit and water.

Lanolin pastes are applied by means of a small pliable serrated spatula, a brush of stiff bristle or by the finger protected by a rubber finger-stall.

Rooting media. The choice of the rooting medium to place around the cincture has been widely studied and the present view is that a wide range of media are satisfactory (see page 15). A good medium should be open in structure to permit air and moisture movement and be able to retain its structure throughout the rooting process. It should therefore not ferment or otherwise breakdown, hence live sphagnum moss has been widely accepted as a basis, but coir fibre and coir dust, wood shaving and sawdust have all proved excellent as basic ingredients. Work with cashew in Tanzania (89) showed that vermiculite alone was superior to fibre, moss, coir, sawdust or a 50/50 mixture of vermiculite and sand. It is an advantage if the selected material is light in weight and holds together whilst being placed in position during the wrapping procedure. Whilst an open, light-weight medium provides an excellent rooting environment, it should be remembered that the main hazard in marcot propagation occurs during transference and establishment. From general experience it has been learned that transference to soil or mixtures thereof, whether in containers or the open nursery, is more readily accomplished if the marcotting medium contains a modicum of loam or clay soil. A medium of equal parts clay soil and sieved leaf mould has proved superior to moss alone in regard to rooting and survival of mango air layers in India (120) but it should be remembered that heavy additions of soil increase the need for extra support for the marcot.

Wrapping the air layer. The medium should be well moistened. Fibrous material should be thoroughly wetted and squeezed free from excess water at the moment of application. It may be convenient to pack the material round the cinctured part before placing the wrapping over it. Often a better way is to place the medium on the wrapping and so lift it into position. Polyethylene sheet is an ideal wrapping material, being both water-tight and transparent, obviating the need to water the marcot and enabling the new roots to be seen when they come through the rooting medium. As with many other kinds of enveloping material polyethylene may be punctured and torn by birds. Where this occurs the only remedy appears to be an outer cover of really tough, resilient material such as a piece of inner tube from a car tyre. The polyethylene film

must be thin enough to be wrapped and folded round the shoot to form an air-tight enclosure. Thicknesses of from 100 to 400 gauge (0.001 to 0.004 in or 0.025 to 0.1 mm) are suitable. Thicker films are difficult to fold sufficiently tightly to prevent drying of the enclosed medium. Occasionally it is possible to manoeuvre a length of polyethylene lay-flat tube, three or four inches (8 or 10 cm) wide, over the top of a shoot bearing only small leaves and to fix this below the cincture and then to fill it with rooting medium before closing it tightly above. Mostly a square of sheeting must be used, the size varying with the situation. Pieces measuring about 7 x 10 inches (18 x 25 cm) are normally large enough to contain a ball of medium some three inches (8 cm) long and 2½ inches (6.5 cm) in diameter, leaving two inches (5 cm) for a double-fold lengthwise and two inches (5 cm) at either end for closely wrapping round the shoot.

Having made the cincture and applied the growth substance, a handful or so of moist medium is placed in the middle of the wrapping and immediately lifted into position round the shoot, the two edges of the wrapping are matched together and folded over twice to hold the medium quite firmly. The lower open end is closed by a twisting motion very firmly round the shoot and there tied or taped with plastic strip or strong adhesive tape. The medium is firmed below the open top, using the fingers, before tightly taping. The wrapping and tying must be done in such a way that no opening is left for evaporation from the medium. The tie at the top end should always begin on the bare shoot and be spiralled down on to the wrapping to prevent excessive rain seeping down into the marcot. Sometimes, in spite of all wrapping precautions, marcots become waterlogged. This appears to be due to overheating of plastic-wrapped marcots by direct sunshine followed by heavy rain which, flowing down the shoot, rapidly cools the marcot, setting up a strong suction pressure which draws water into the marcot through even the smallest opening. An outer loose covering such as that suggested as a protection against birds, or a white paper covering, will reduce excessive water intake.

In the absence of plastic materials or rubber sheeting a great variety of wrapping materials have been used such as gunny (hessian sacking), cloth, various fibres, barks or leaves, or even old boots, but the distinct advantage in efficiency of using transparent, foldable plastic sheet, not least the

absence of the need to water a plastic-covered marcot, ensures its present and future popularity.

Transference of the rooted air layer. When the marcot has rooted sufficiently to ensure successful transplantation (the period may vary from as little as 30 to more than 100 days) the procedure of separation should begin. Ideally this is done in stages, the branch is half nicked close below the wrapping and completely severed one or two weeks later. At this moment of separation the rooted marcot is vulnerable to adverse weather conditions and it is advisable to place it in a container and to take it through the full nursery procedure as described for young seedlings or newly-rooted cuttings, including adequate nutritional treatment to build a fully self-contained plant for transference to the plantation.

CUTTINGS — ONE

Definitions and basic factors

Cuttings are parts of plants which are separated from the parent and treated in various ways to encourage the production of a complete plant. The cutting may be a piece of root, stem, leaf, a single bud or eye, or merely a tiny piece of meristem. If a root cutting, then this must grow a shoot from an adventitious bud, and continue to extend in order to establish a balance between shoot and root. If a stem cutting, it must produce adventitious roots to balance stem growth. A leaf cutting, without a bud, must initiate and develop both a root and a shoot, but a leaf-bud cutting needs only to initiate roots to form a separate plant. In propagation by meristem culture the separated part must initiate root, shoot and complementary tissue.

As mentioned earlier, plant variation provides opportunities of selection for individual characters for specific purposes including regenerative attributes. Not only do species behave differently, but cultivars of a single species often respond very differently to particular treatments. Thus it is that the propagator's choice of a particular cutting in regard to phasic and nutritional status so vitally contributes to the achievement of high efficiency in plant multiplication. But he must appreciate that cuttings are also influenced, after collection, by handling treatments and subsequent environment, between all of which there is powerful interplay. The selected cutting must be nursed so that it develops into a whole plant.

The behaviour of cuttings depends upon many factors and these have been investigated by numerous specialists throughout the world. The propagator can profit from a study of the results obtained, provided he adapts them to the problems encountered in his own field. Fortunately there are general rules, or guide lines, applicable to all plants and conditions. The source quality of the cutting is profoundly influenced (32) by the contributory factors of the genotype, phasic development and nutrition of the parent plant,

itself influenced by local environment, heat, light and rainfall. The cardinal rule is that a cutting must be alive when collected and thereafter be kept alive while it is becoming a complete entity capable of fending for itself.

Some workers have laid down guide-lines for propagation by cuttings. Bayley Balfour (10) states that the cutting method consists in:

- (1) Maintaining adequate water supply in the cutting until it is able to absorb for itself.
- (2) Applying stimuli to encourage the development of the new water-absorbing organs, and to promote the development of the shoot.
- (3) Securing adequate temperature and aeration at the rooting end of the cutting.

Although these directions may well be accepted as principles it is clear that very many practical factors are involved and that they vary in their effect in relation to each other (38), e.g. a soft herbaceous cutting requires less hormonal stimulation than a woody cutting, and a leafless cutting may need less shade than a leafy one. The practical factors may be grouped for consideration under three heads:

- (1) Source or internal condition of the cutting when collected.
- (2) Treatment of the cutting between collection and planting.
- (3) Environment prior to planting.

CUTTINGS — TWO

SOURCE OF CUTTINGS

Clonal influence

Much has been said in the introduction concerning plant variation and opportunities for selecting plants with desired attributes, including that of ready vegetative propagation, and a warning was given against relying on full persistence of this capacity beyond the juvenile phase. A striking example of a change in rooting behaviour is seen in rubber (*Hevea brasiliensis*) where cuttings root readily when juvenile but only very slowly, or not at all, when the source plant has reached the fruiting or adult phase. Nevertheless, the capacity to root generally remains with most plants in sufficient degree to achieve effective propagation.

The response of the cutting is materially governed by its origin or source; it has been said that its future is largely patterned by its history.

Culture of source plant

Having selected the plant required to be multiplied it should be cultured to provide adequate quantities of material for cuttings of high regenerative capacity. As a cutting-source plant approaches the flowering or mature phase its rooting capacity is reduced. On the other hand, cuttings of parts of plants in active vegetative growth have high regenerative capacity, whether such active or fast growth is associated with the juvenile phase, adventitious origin or invigoration by a vigorous rootstock, hard pruning or environmental control. Any treatment giving rise to increased vegetative vigour, with postponed flowering, will enhance the propensity to regenerate vegetatively (40). A simple practical way to produce good supplies of regenerative shoot cuttings is to hard-prune established plants (83). It is often found convenient to prune isolated established plants for cuttings severely, but for ease of management and of collecting cuttings, and also to reduce the risk of admixtures during collection, it is best to

establish separate hedges or rows of selected plants solely for shoot-cutting production. The basic rules also hold for root cuttings, only in reverse. The best root cuttings are obtained from young newly-established plants up to two or three years of age. Well rooted young plants should be root-pruned and set in a stone-free soil conducive to the rapid production of straight roots. The stems of the plants should not be reduced beyond the level necessary to ensure survival of the plant in order to obtain a high shoot/root ratio, which engenders rapid root production. The considerable labour needed for collecting roots has led to the practice of taking a few roots from each nursery-raised plant at lifting-time. This is a sound procedure with healthy non-grafted plants, or with grafted plants free of virus or other systemic disease, though there is always a danger that any varietal admixture of roots will increase in complexity with each generation in the absence of careful management.

Cutting-source plants, whether isolated or in hedges, should be given every possible attention in the way of weeding and pest and disease control, and should receive annual dressings of complete fertilizer. Mulching and any necessary irrigations should be given according to local conditions. Foliar sprays of one per cent urea may be found useful in maintaining healthy leaf and shoot growth.

Choice of material from parent plant selected

The age, shape and size of the cutting will decide the initial form of plant produced and directly affect its early growth pattern and value for field planting. Some plants exhibit two distinct types of shoot, known as fans (horizontal, plagiotropic) and chupons (vertical, orthotropic). Cuttings of fan shoots normally continue to produce only fan shoots, whilst chupons give rise to erect plants. Vertical shoot development can often be obtained in established fan-form plants by hard cutting back, but it is simpler to select erect cuttings at the start. Moreover it is generally found that erect vigorous shoots root more readily than fans. The periodical hard pruning of cutting-source plants, advocated above, will greatly increase the production of straight vertical shoots for efficient propagation.

Laterals or terminals

The rooting behaviour of cuttings varies from tree to tree and between different parts of the same tree. In general, an uncrowded non-pruned tree develops roughly a pyramidal form, at least in its early years, with one or more leading shoots and with lateral branches diminishing in length as the height from the ground increases. In the lower and older lateral branches the growth rate decreases and they become redundant. Consequently growth activity moves higher up the plant and the best cuttings are found at higher and higher levels. The terminal shoots of leading branches often exhibit comparatively long internodes with a low leaf/shoot ratio and are generally too coarse for use as cuttings. So, the best position from which to collect cuttings is where the shoots are active, yet not too coarse, close jointed and with a high leaf/shoot ratio.

Shoots from plants pruned regularly, particularly from flat-topped isolated plants or hedges, will tend to be of one class, redundant laterals and coarse leaders having been eliminated.

Firmness of shoots for cuttings

Vigour is opposed to ripeness; a vigorous shoot retains its leaves longer and flowers less profusely than a less vigorous one. In a sense it is both less adult and less mature, and it roots better. However, it may be more tender and sensitive to other influences and as a cutting it demands more nursing. This is well seen as the new shoot develops through the flush or growing season. At first it is tender, and as a carefully nursed softwood cutting it is quick to root, but also quick to die. A little later it becomes semi-lignified and in this state it roots more slowly and needs less nursing. When fully developed the shoot becomes less sensitive, slower to root and more tolerant of its surroundings. High rooting potential goes with vigour and immaturity but such material needs careful nursing. A well ripened cutting, being relatively insensitive, survives well, but a soft immature cutting may die before it can root. Hence a compromise must be made. With suitable controlled environments, such as propagation cases with bottom heat or mist installations, the soft cutting should be used. Otherwise

the firm cutting is to be preferred.

Structure and rooting relationship

A comparison of the anatomical structure of stems with their capacity to form adventitious roots has shown that a relationship exists between anatomy and rooting capacity in a wide range of species (11). Many workers have found a close connexion between the presence of a sclerenchymatous sheath of fibres and sclereids outside the phloem and ends of the medullary rays, and rooting behaviour. Where this sheath is substantial and complete, propagation is found to be extremely difficult (Figure 4). But where it is incomplete, dispersed into groups or absent, rooting is often readily accomplished. It has not always been possible definitely to forecast rooting potential by the presence or absence of a fibrous sheath, but the negative correlation has been so close that, for general propagation purposes, it has proved a reliable means of forecasting the speed and degree of rooting likely to be achieved. Detailed summaries of many research reports (4; 48; 98) suggest ways in which the structural development of shoots may be modified to increase rooting potential. Beakbane (11) suggested various courses open to propagators in order to obtain more readily-rooting cuttings from otherwise shy-rooting clones. Shoots from parts of plants in the juvenile phase, such as are obtainable from plants still in a juvenile condition, or from adventitious shoots, or shoots arising directly from roots, also fast-growing shoots of recent origin, possess fewer primary phloem fibres than normal shoots. It is such material that the propagator must seek for ready rooting.

Juvenile and adult phases

Once a source plant has become fully adult it is doubtful if it can ever re-enter the completely juvenile phase except by seed regeneration. Nevertheless, the plant can, as it were, take some steps back towards a juvenile condition in which state its internal structure will be modified, notably by a reduction in phloem fibre, resulting in more ready rooting. Treatments to effect this include severe pruning (40) as in stooling and hedging, complete disbudding to encourage sphaeroblast development (7; 22; 37) and grafting upon vigorous compatible rootstocks to obtain very fast growth (39), or by

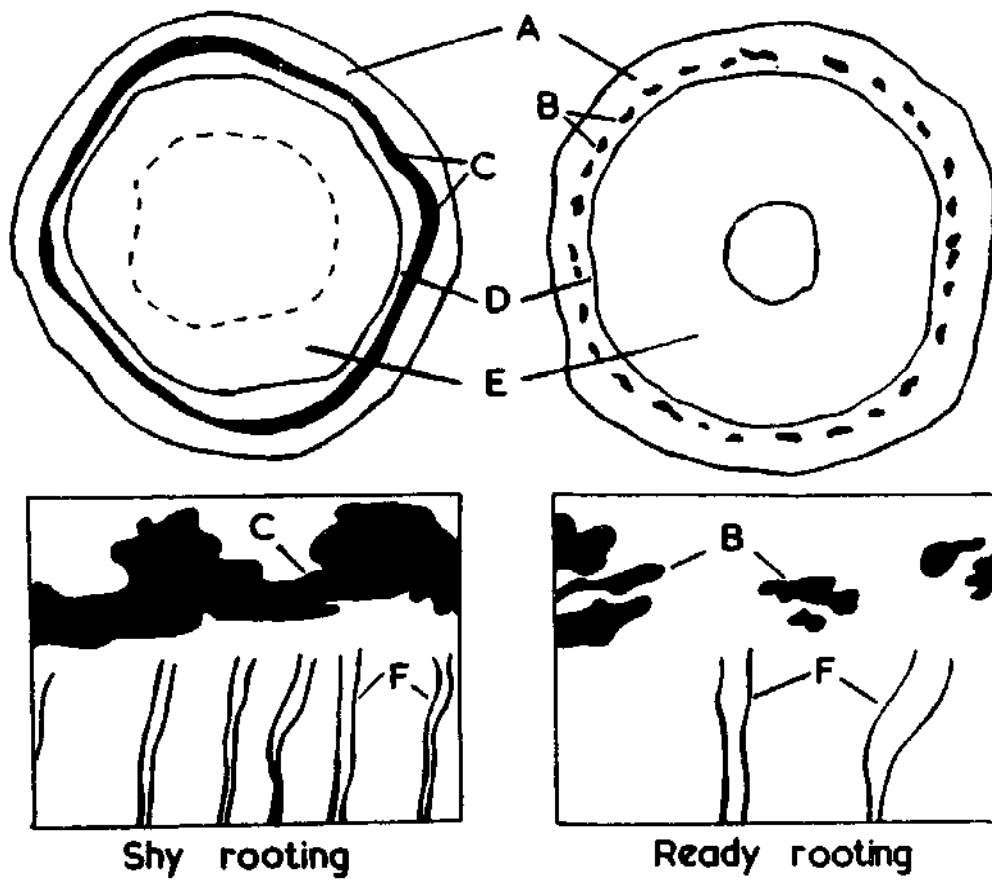

FIGURE 4

Stem capacity to root

Transections (diagrammatic) after Beakbane (1969). A = Cortex.
 B = Fibre groups. C = Fibre sheath. D = Secondary phloem.
 E = Xylem. F = Rays.

grafting repeatedly upon successive young juvenile seedlings at short intervals (84). Adventitious shoots from roots have a number of characters distinctly reminiscent of the juvenile form, including a lessening of phloem fibres. To obtain a supply of vigorous adventitious shoots from roots, scions of pieces of root of subjects able to form buds on their roots may be grafted on the tops of established seedlings (see p.126). The rooting capacity of shoots of adventitious origin falls off in succeeding vegetative generations (40). Decline of regenerative power with age in the clonal root system closely resembles that observed in seedling root systems (42). In seedlings this is an expression of juvenility and the parallel in the mature clone suggests that adventitious formation of roots in mature stem tissue may largely restore regenerative capacity, which then again falls off with age.

Etiolation and ringing

Shoots of a wide range of woody plants develop incipient root initials internally, more frequently towards the base of the shoot (71) but also at or close to each node (15). These initials may be encouraged to develop in darkness or reduced light, particularly in a moist environment, such as is involved in layering as described above. Thus it is possible to increase the rooting propensity of shoots whilst on the source-plant before they are taken for cuttings, by blanching the basal inch (2.5 cm) or so of the young shoots directly they appear. There are various ways of doing this. One is to place black tubes of waxed paper or plastic (31) over the new shoots before the leaves expand, so that they develop in darkness for two or three inches (5 or 7.5 cm) before emerging into the light. Tubes of a quarter inch (0.6 cm) diameter some four inches (10 cm) long are suitable, depending on the nature of the plant. If the lower end of the tube is lightly bound with copper wire or strong plastic thread, constriction will occur and lead to an increase in the rooting potential. Complete etiolation (see p. 37) is practically impossible to apply except by a layering process, not applicable to the above-ground parts of a shrub or hedge plant. Early blanching, however, can be applied in a number of ways to young shoots by binding with black, or otherwise opaque, adhesive tapes. Such binding also serves to constrict

the base of the shoot and this may contribute to increased rooting of the shoot as a cutting. Black paints, such as bitumen water emulsions, may be substituted for the light-excluding tape but have no constricting effect.

Attempts have been made to improve the quality of material for cuttings by wiring and ringing shoots while they are still attached to the parent plant. The best results are generally obtained by ringing leafy shoots some two or three weeks before collection (17; 112). Basal and middle parts of shoots root better than tips. A further increase in rooting has sometimes been obtained by the application of growth substances at the ring, but it appears that the ringing alone contributes most to success. The cutting should be taken with its base immediately below the girdle and then treated as a normal cutting.

Heeled and non-heeled cuttings

A "heel" is a portion of older tissue at the base of a young shoot torn or cut from the parent. Heeled cuttings are widely recommended as giving better results than straight or heel-less cuttings. This recommendation needs qualification. In softwood cuttings the presence of a heel is usually a disadvantage, increasing the time taken to form roots and reducing the number of cuttings rooted (53). In general, it is best to take cuttings exactly at the base of the shoot. It is considered (36) that the value of a heel on a cutting is principally to ensure that the base of the shoot is included in the cutting, for it is in this basal region that the anatomy of the shoot lends itself to ready root emergence and it is here that natural growth substances tend to collect and synthetic stimulants are best applied.

Species that root readily throughout the length of their shoots may be cut into a number of pieces for cuttings. In most of these the position of the basal cut in relation to nodes is of little consequence but it is well to form the apical end of each cutting close above a bud to avoid having a dead snag in this position which will give rise to sideways growth. If the cuttings are grouped into basal, middle and apical cuttings it will be possible to provide special treatments to each class and encourage an even development in the cutting-bed.

Size of cuttings

The choice of cuttings of a particular size is largely

governed by their regenerative behaviour and partly by the use to be made of the resulting plant (32). Small, quickly rooting cuttings may be economically rooted in somewhat costly structures such as closed cases and mist-spray units since they occupy minimal space and are soon succeeded by further batches. Large leafy cuttings, because more space is needed, may only be acceptable if they root rapidly and then pass quickly through the nursery hardening processes.

Some woody plants, notably citrus, are best bud-grafted into young quick-growing stems and long cuttings are then undesirable because the stem is already becoming hard. Short cuttings are used to produce a young shoot to receive the scion bud. Long cuttings planted deeply, particularly where rooting occurs chiefly at the base of the cutting, are more difficult to lift from the nursery than short cuttings. Nevertheless, if long cuttings succeed in the open ground, or under other low-cost conditions, and are accepted by the planter, they have much to recommend them. Large cuttings produced on well established open-grown plants receiving minimal attention gain their size in the cheapest possible way. They need only to acquire roots to achieve wholeness for planting. Once initiated, roots from large cuttings will make rapid headway.

Very large cuttings are sometimes recommended. Examples are seen in kapok (*Ceiba pentandra*), where orthotropic branches two to three inches (5 to 8 cm) in diameter and four to six feet (1 - 2 m) long are readily established (G19) and large fencing posts of young seedling rubber (*Hevea brasiliensis*) will form trees.

Single-node cuttings with a single leaf are among the smallest cuttings, and are commonly used in tea (*Camellia sinensis*). The size of the cutting is governed by the size of the leaf which, being set horizontally without overlapping, decides the spacing required. Leaf-bud cuttings with very large leaves take up less space if the leaf is inclined at 45° but may need some support such as a sliver of bamboo stuck through the leaf blade.

Root cuttings of widely different size have been used with success. When roots are removed from the soil they dry very quickly and must be kept moist under shade till planted. Small thin roots will dry extremely quickly and this often precludes their successful regeneration. On the other hand, very large pieces of root will result in ungainly planting

material. Sizes up to the length of a man's foot and as thick as his first finger have proved suitable, but shorter cuttings, where successful, provide a neater plant for transference to the field.

CUTTINGS — THREE

TREATMENT OF CUTTINGS

Protection from drying

In accordance with the precept that an adequate water supply in the cutting must be maintained, great care should be taken to reduce water loss in the cutting material from the moment it is taken from the source plant. To ensure that the cutting contains a good supply of water at the time of collection it is widely recommended that cuttings should be collected in the early morning when they are fully turgid. Herbaceous leafy cuttings lose water very quickly. Root cuttings, having no surface protection against water loss, and not exhibiting water loss by wilting leaves, are in considerable danger of drying and must be kept moist at all times. Leafless stem cuttings dry comparatively slowly but even these may be seriously damaged by drying. Indeed, the greatest hazard to cuttings is desiccation which, if carried too far, means certain death (35).

Moist-lined containers should be used to hold the cuttings as they are collected. Such containers should exclude direct sun heat and air movement. Polyethylene bags are excellent provided they are not exposed to the sun. Cardboard or wood containers lined with polyethylene and containing some moist material such as wet cloth or newspaper are excellent. Closed containers should not be tightly filled or the cuttings may be killed by suffocation and heating. Polyethylene bags when containing living material should remain adequately ventilated.

When skilled workers are available to collect shoots for cuttings, the point of severance may be also the base of the cutting. This ensures early collection of downward moving substances at the base of the cutting and the earliest possible start to wound healing processes. This procedure is not possible when branch systems are collected for later division into cuttings.

Some operators, in their concern to maintain moisture in cuttings between collection and planting, stand them in water.

With very few exceptions this has the deleterious effect of soaking away substances from the base of the cutting. It is better to prevent water loss from the cutting rather than attempt to add more.

The reduction of water loss from leafy cuttings is often brought about in practice by removal of part of the leaf area (14), but in removing leaves it must be remembered that any reduction in leaf area may reduce rooting, other things being satisfactory. Cuttings with very large leaves, or compound leaves on long petioles, may individually occupy an excessive area in the cutting bed. Such cuttings may require less room if their leaves are lightly bunched together by thread or plastic strip.

Wounding cuttings

Additional wounds at the base of cuttings have sometimes been associated with increased rooting, particularly when followed by hormone treatment, probably due to a greater intake of the material. Various kinds of wound have been used including the removal of a shallow slice from one side, extending an inch (2.5 cm) or so from the base of the cutting. Longitudinal slitting of the bark and splitting the basal end crosswise for an inch (2.5 cm) or so has sometimes proved beneficial, chiefly with hardwood cuttings.

Nurse grafting

Cuttings of valuable cultivars that are difficult to propagate by customary methods may be induced to root by temporarily grafting them to roots or cuttings of subjects which root more readily. A simple way is to graft a piece of root, or a whole root of a related seedling, onto the base of the cutting and to bind wire or metal strip close above the graft junction before planting deeply in the cutting-bed (see p.145). The cutting-scion will root above this constriction and may be transplanted separately later. It is suggested that the nurse-root supplies moisture and soil nutrients to the cutting until it fends for itself. A similar but larger effect is obtained by approach-grafting a seedling, or other readily obtainable plant, to a rootless cutting (30). A reverse type of nursing, in which a cutting is supplied with extra stems and leaves by grafting a piece of young related seedling on its apex, has sometimes stimulated rooting of a cutting found difficult to root. This has been carried further by the suckling technique (34) in which hardwood cuttings are planted alongside well established compatible plants into which

they are inarched by grafting (Figure 5) and there left until they develop their own roots and shoots before being separated and transplanted.

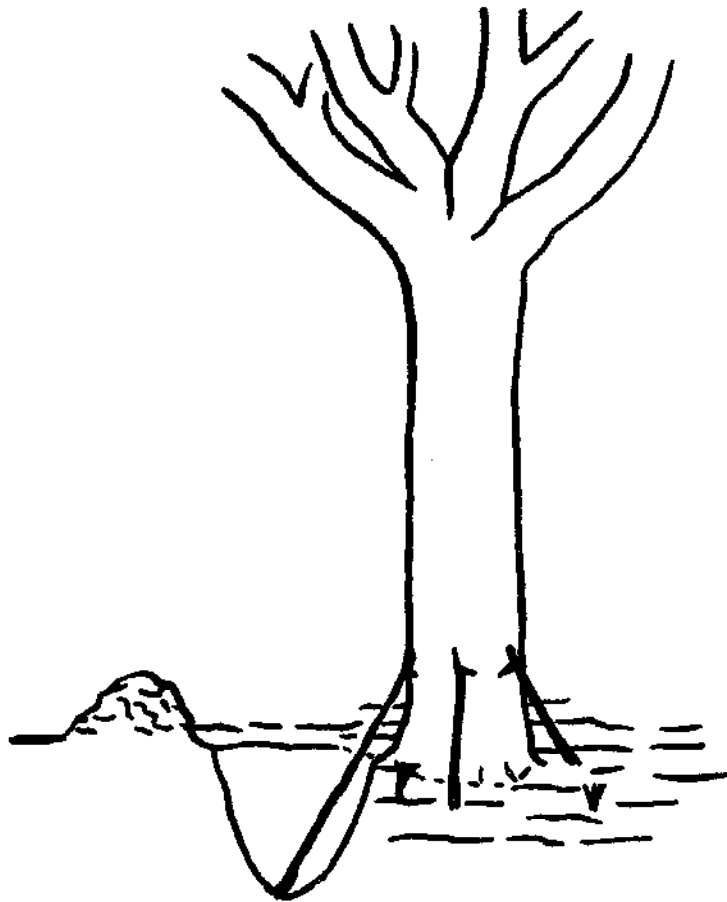

FIGURE 5

Suckling

Hardwood cuttings nourished by an established plant until they root.

Use of synthetic growth substances

Of the various ways in which growth substances are applied, those proving the most practicable are the dust

method and the solution method, employing various carriers and solvents (93). Injection, soaking, the insertion of impregnated wicks or splinters, wrapping with prepared bandages, spraying or painting with solutions, smearing with lanolin in which substances are dissolved, are among many other methods which have been tried with varying success.

The preparation of solutions and dusts is as described on page 44 for use when air layering. Ready prepared dusts and solutions are obtainable commercially and many propagators rely on such sources for their material. If it is desired to have materials made up to a particular formula this can be done by a local pharmaceutical chemist.

The dust method. The usual method of application is to dip the bases of the cuttings, a number at a time, into the dust so that the lower inch (2.5 cm) or less is covered. Where it is found that the dust does not adhere, the bases of the cuttings may be dipped into water to moisten them before dipping into the dust. Even better adherence, and penetration of the growth substance, may be obtained by momentarily pre-dipping the cutting base in 50 per cent ethanol or methylated spirit.

To avoid exposing the bulk supply of dust to contamination by moisture and foreign material it is as well to place a quantity of it in a shallow dish sufficient only for the task in hand. Once used, the surplus material should not be returned to the bulk supply. After dipping the cuttings into the dust they should be lightly tapped on the side of the vessel so that any excess falls back into the container. The treated cuttings are planted immediately. They should not be pushed into the medium, as this removes most of the dust, but should be placed in a small trench or dibbled hole.

Solution methods. There are two main ways of solution application, the dilute solution method and the concentrated solution (or instantaneous dip) method. The dilute solution method depends upon the slow uptake of comparatively dilute water solutions over periods varying from 8 to 24 hours. Concentrations used vary from as low as 5 to 25 p.p.m. for very soft herbaceous cuttings up to 100 p.p.m. or more for cuttings very difficult to root. In practice it is convenient to place prepared cuttings in the solution at the end of one day's work and to plant them next morning, some 16 hours later. The

cuttings are stood in the solution with their bases immersed about one inch (2.5 cm). Any basal leaves, which would otherwise be covered by the solution, are first removed, as it is found that soaked leaves tend to rot. The temperature and humidity of the surrounding air affects the amount of solution entering the cutting and it is advisable to shade the cuttings and protect them from air currents during the absorption period. One should make sure that all the cuttings remain in the solution throughout the treatment, after which they should be rinsed in plain water and planted normally.

The concentrated dip method. The customary procedure is to dip the bases of stem cuttings momentarily half an inch to two inches (1.25 to 5 cm), according to size, in an alcoholic solution of synthetic growth substance and to plant immediately (49). Recent work has indicated that dipping depth and duration may be critical (60; 85; 86).

Although the final result of treatment largely depends on the cultivar reaction and the growth substance concentration, the highest proportion of cuttings rooted is generally obtained by merely wetting the basal cut surface of the cutting. The detrimental effect of deep dipping increases with concentration and this is due to the application of growth substance to the epidermis. Nahlawi and Howard (85) have shown that epidermal application of concentrated IBA dips is only beneficial when insufficient stimulation is obtained by basal application alone. To facilitate shallow dipping, cuttings should be prepared with smooth transverse basal cuts. The solution is best placed in shallow dishes or small trays and the work should be done in a cool draught-proof building, to avoid evaporation and concentration of the solution. The aim should be to wet only the cut surface and avoid splashing the sides of the cutting. Rather higher concentrations of growth substance should be used for shallow dipping than for deep dipping. For shallow dipping, or basal wetting, concentrations in the range of 2,500 to 5,000 p.p.m. IBA, or equivalent, are suitable. Nahlawi and Howard (86) found that the rooting response of plum rootstock hardwood cuttings to 50, 500 and 5,000 p.p.m. IBA was influenced by the duration of treatment in the solution; 18 minutes, 30 seconds and 5 seconds being needed to achieve similar levels of rooting at the respective concentrations. It is suggested that dipping for a relatively short time (say 5 seconds) in a suitably high concentration is probably the most convenient

practical way of treating large numbers of cuttings. The need to ensure adequate entry of growth substance into the cutting at the place of highest rooting response may explain why, in general practice, very high concentrations have had to be used when carried in powders such as talc, from which immediate uptake would be minimal, and also why dipping durations of up to 24 hours are recommended for aqueous solutions.

Coating cuttings

Protecting newly planted nursery stock from drying by plastering with mud, wrapping with straw, reeds or bark, and painting with lime and clay washes, has been practised since ancient times to augment the natural waxy protection already possessed by plants in varying degree. More recently a number of water-proofing coatings have been used to check loss of moisture from plant material, particularly when transplanting, in transport or when on display in exhibitions (80). The surface sealing of cuttings has been examined to a limited extent, sufficient to indicate the likely value of such treatments and also the possible consequence of their misuse (32).

Water loss from the above-ground parts of cuttings, with or without leaves, may be reduced by dipping their upper parts in commercially produced anti-transpirants such as S.600, Wiltpruf, etc., taking care to follow the maker's recommendations. Home manufacture of anti-transpirants involving the use of emulsifying equipment has been described in some detail (80).

Nahlawi and Howard (86) mention the use of a polyvinyl-chloride resin seal at the basal end of hardwood cuttings to prevent subsequent entry of solutions through the epidermis (see above). If the basal cut is covered with sealing material, a fresh cut must be made to remove the sealing compound to allow for entry of the solution and normal uptake of water during the propagation period.

In connexion with basal sealing of cuttings and the free entry of water it is of interest to find that wilting has been attributed to the presence of lanolin on the basal cut surface following the use of lanolin as a vehicle for growth substance treatment (26).

Controlled temperature storage

Subjecting cuttings after collection to periods of warmth before planting has often led to increased rooting. Such success has only been achieved by close attention to other factors, notably moisture relations both external and internal, the timing and degree of growth substance application and, above all, the closest control of temperature levels and duration of treatment.

Practical propagators have long based their cutting procedures on the adage "warm bottoms and cool tops". This is exemplified by mist propagation, where water sprays cool the leaves by evaporation and by the greater success in rooting tea and other plants in comparatively cool highland areas. In temperate zones, where bud dormancy lasts for a considerable period, it has been found that warmth at the base of a stem cutting encourages root initiation and development in advance of shoot growth and leads to improved establishment. With hardwood leafless cuttings placed in controlled storage through the dormant season the advantages are four-fold (50), viz. (i) providing a cutting "bank", obviating the necessity to plant cuttings immediately after collection, (ii) to provide an ideal rooting environment during the early life of the cutting, (iii) as an insurance against deficient soil temperature, and (iv) to supply any special temperature requirement beyond the scope of the natural surroundings.

In warm climates where plants experience no prolonged clear-cut dormant period it is possible that the rooting and establishment of stem cuttings may be hastened by the application of extra warmth to the base of the cutting. Work on warm storage in America (15) and in England (59) has led to the development of warm storage bins for large scale use (57).

In the absence of detailed information on the use of controlled storage of cuttings in the tropics it is only possible to suggest procedures based on successful work in the temperate zone. Howard and his associates working at East Malling, England, with deciduous fruit-tree rootstocks and various ornamental trees have indicated the lines to be followed. Rooting rate increases with rising temperature to an optimum level, but, if this level is maintained longer than about four weeks, rotting occurs. Heat must be applied to the base of the cutting only, by electrical soil-warming wires controlled by a rod thermostat placed level with the base of the cuttings (Figure 6).

A loading of up to 15 W/ft² is adequate. Howard states (23), "This equipment is installed in insulated bins, preferably sited in a cool insulated building such as a stone barn, to ensure minimum bud development and maximum freedom from draughts which cause cuttings to become dry and the rooting medium to dry out and need frequent and harmful rewetting. Careful siting of the thermostat is needed to ensure maximum contact between the sensitive rod and the rooting compost at one to one-and-a-half inches (2.5 to 4 cm) above the heating wires and on the same level as the base of the cuttings. A thermometer plunged to the same depth will accurately record the temperature in the rooting zone. The rooting compost is a 1:1 mixture of coarse sphagnum peat and coarse grit (up to 3/16 inch (0.5 cm) diameter) about ten inches (25 cm) deep. Rewetting of the compost should not be neglected, but conservation of existing moisture is essential since rotting

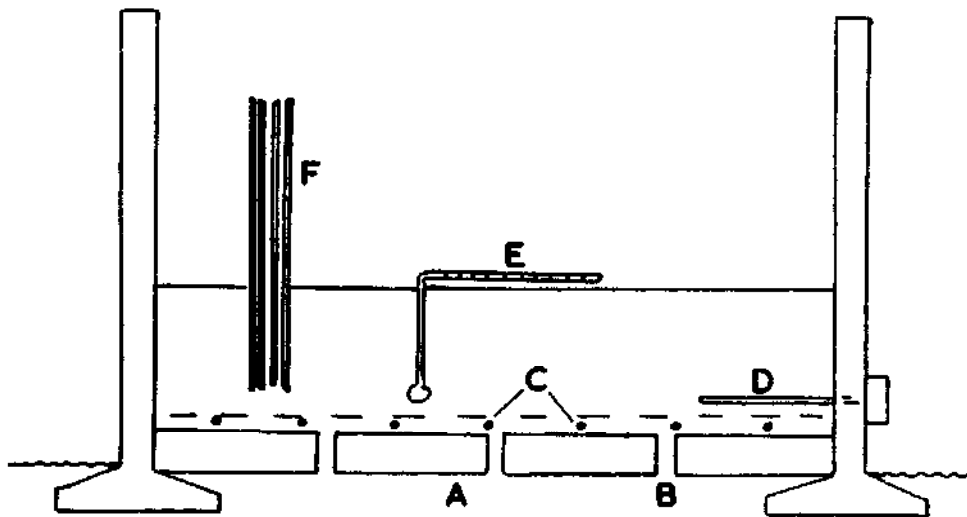

FIGURE 6

East Malling cutting bins under overhead protection

Vertical section (diagrammatic) after Misc. Pub. 85, E. Malling Res. Stat. A = Coarse drainage. B = Drainage between floor blocks. C = Warming wires attached to underside of 'weldmesh' screen. D = Rod thermostat. E = Earth thermometer. F = Cuttings

occurs if the compost is saturated. Good drainage is essential and the moisture status should be assessed at the base of the cuttings. Compost re-used over a period of years will result in increased loss from rotting. Annual replacement of the rooting medium is recommended and this is most easily and thoroughly done if the warming wires are attached to the underside of the protection grid so that they can be lifted clear to allow the bin floor to be swept and disinfected".

For those who decide to try warm storage under tropical conditions it is suggested that, for bin treatment, cuttings be collected at, or soon after, the completion of a flush. They should be partially defoliated, to reduce loss of water and to allow for close spacing, treated with growth substance and placed in the bin where they may be lightly moistened overhead from time to time, using a syringe or very fine spray. Whereas a basal temperature of 70°F (21°C) is optimal in temperate regions a somewhat higher temperature is required to obtain sufficient differential in the tropics. A basal temperature in the region of 85° to 90°F (30° to 32°C) with a top temperature some 20°F (11°C) lower may prove helpful.

CUTTINGS — FOUR

PLANTING ENVIRONMENT

Basic requirements

The planting environment of cuttings has probably received more attention and discussion than any other aspect of vegetative propagation, but this must not limit due attention being given to the important factors involved in the source and treatment of the cutting. Cutting behaviour is patterned by its history, its treatment between collection and planting and its nursing environment thereafter. Results depend on the interplay of all the factors involved.

The cutting environment must provide conditions in which the cutting remains alive and able to initiate and develop new structures and, at the same time retain the power to grow into a new plant. The basic nursery requirement is to prevent desiccation whilst providing adequate aeration, moisture, light and warmth. Such requirements may be met by exotic treatments but the practical propagator will envisage the problem of transplanting the rooted cutting to a normal soil environment. Hence it is wise to provide rooting media related, in some degree, to subsequent environments. Where very open media are employed, such as clean coarse sands, plain moss or fibre, the incorporation of a small amount of loam will greatly aid transplanting and will also mitigate the effect of a temporary inadequate water supply during the rooting period.

Field planting of cuttings

Where it is found that plants will root readily from comparatively large cuttings, say six inches (15 cm) long and at least one-fifth inch (0.5 cm) thick, they may be economically propagated in the open if given minimal attention as regards shading and watering. An area of well drained flat land should be selected and this should be fenced against marauders. Subject to a good supply of irrigation water being available an established plantation providing a moderate shade canopy, or a forest fringe, often proves suitable.

The planting distances of cuttings should be governed by

the form of cultivation practised. In large beds cultivated mechanically the rows must be wider than when entirely hand cultivated. The spacing within the rows should be sufficient to allow for development of the plant prior to transference. Spacings of two to eight inches (5 to 20 cm) are generally suitable.

The cuttings may be planted by dibber provided the holes can be made sufficiently deep, and each cutting can be set in close contact with the bottom of the hole and the soil be pressed firmly against the sides of the cutting. It is possible to speed the dibbing work by the use of a trident or multiple, foot-operated, dibber (Figure 7). Such implements should have blunt points to avoid leaving an air space below the cutting base.

Grip planting, in which a spade or similar bladed implement is pushed into the soil and moved backwards and forwards to leave a slit-like opening into which the cuttings are pushed, is an acceptable method provided the soil is sufficiently crumbly to close around the cutting when firmed with the foot or by a heavy wheel. In stiff soils such a procedure does not allow the cutting to reach the bottom of the slit, nor does the soil close round the cutting. Trench planting is preferable to grip planting in such soils.

Trench planting has many advantages. Using a spade or plough, a trench with one vertical side is opened to the required depth and the cuttings are stood close against this side either upright or slanting. Some sand or grit may be placed in the bottom of the trench to a depth of one to two inches (2.5 to 5 cm) to provide good well-aerated conditions round the cutting base. Some operators find it convenient to put this material into the trench before inserting the cuttings, so that the cuttings are held in position while the trench is being filled. Soil sufficient to half-fill the trench is now placed in it and trodden firmly against the base of the cuttings. This firming at the cutting base is very important and is best done with the heel. One's leg is kept rigid throughout its length and the whole weight of the body is transferred towards the cutting base by suddenly lifting

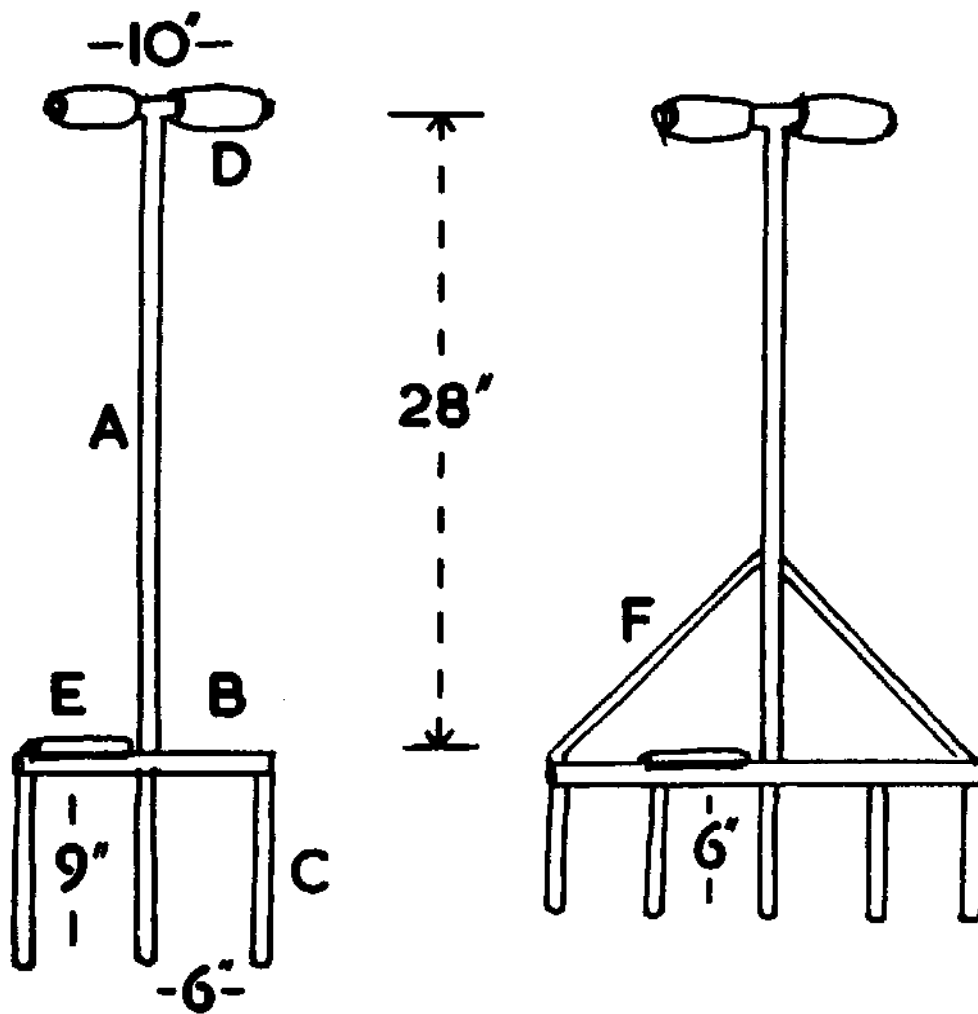

FIGURE 7

Multiple foot-operated dibber

- A = $\frac{1}{2}$ -inch water pipe welded to $\frac{1}{2}$ x 1-inch bar B.
 C = $\frac{9}{16}$ -inch rods welded to the bar. D = Hand grips.
 E = Foot rest. F = Support for large dibber.

the disengaged leg. Merely pressing the soil down, with the knee flexed, does not have the same beneficial effect. If treading is well done, in one movement, the planting is completed by levelling-off the soil, otherwise another treading is given after adding more soil before finally levelling-off with crumbly surface soil. On completion of planting, the soil between the rows may be lightly cultivated and a mulch applied.

After planting it is often helpful to give a heavy watering sufficient to moisten the soil down to and beyond the base of the cuttings. Under continued dry conditions the cuttings should be watered from time to time. To make the most of limited water supplies some operators fill the trenches with water after giving the basal treading, before replacing and levelling-off the top soil.

It is generally advisable to insert cuttings to at least two thirds of their length to protect them from drying. Most propagators habitually remove the leaves from the parts which will be below ground so that the rotting leaves shall not infect the body of the cutting. However, it is not certain that this is really necessary; some investigators suggest that attached lower leaves help to increase water absorption by the cuttings (44) and may, for a limited period, return some food substances to the stem of the cutting before they decay, even though the leaves are in complete darkness (90).

Under ideal soil conditions, where it is possible to form a deep tilth, cuttings may be pushed straight into the soil. Stiff shoot-cuttings lend themselves to this treatment. They should be pushed down deeply, provided that at least the apical bud remains above or only very slightly below ground level. Any upper adhering leaves should remain above ground. In the pushing-down operation it is advisable to wear either a stout thumb stall or a handiron or palm. To avoid damage to the apical bud the stem of the cutting should be left a little above the apical bud by cutting through the internode. Pushed-in cuttings may also be set slantwise. Long cuttings too can be 'pushed in', leaving the tops exposed, but this is inadvisable except under moist conditions.

Root cuttings, provided they are sufficiently stiff, are eminently suitable for push-in planting, the apical ends being at or close to the soil surface and these covered with a light open mulch.

Protective measures for cuttings

This section should be read in conjunction with 'The nursery' starting on page 4.

Propagating pits. One of the simplest ways of protecting leafy cuttings from desiccation and providing them with a steady supply of moisture and an equable temperature is to put them in pits. This is an ancient method which has often proved successful but it involves considerable labour. The pits should be sited where they will not be filled with surface water by heavy rains; a small bank of soil around the edge of the pit will help to prevent this. They are normally located under high shade. A pit depth of three feet (0.9 m) is common (G11). A well-aerated open mixture of coarse grit and friable soil should be placed in the bottom of the pit to a depth of four to six inches (10 to 15 cm) to receive the cuttings. After watering the cuttings the pit is covered against the direct sun with a temporary shade of leaves or fern, preferably in the form of a thatched hurdle, but thin enough to admit ample light to the cuttings. Leaf-covered pits should be sprayed over at frequent intervals and the shade thinned as the cuttings become established. Another way is to shade with 'Netlon' or close netting stretched flat across the pit so that watering can be given through the net. White polyethylene may also be used as a cover but this should be arched over the pit to shed rain which otherwise pushes the cover into the pit. If the arched polyethylene is left open at its ends, like a tunnel, watering can be done without moving the covering.

Half-span sheds. A slanting thatched roof, eight to nine feet (2.4 to 2.7 m) wide, beginning at ground level or on a low ridge, wall, or thatched fence, and reaching a height of five feet (1.5 m) or so on the side open to the morning sun may prove quite satisfactory for many ready-rooting subjects. A three-foot (0.9 m)-wide cutting bed, which can be reached from the front without treading on the bed permits close spacing of the cuttings. Sand and compost should be worked into this bed before planting and the cuttings should be well watered at planting. A cover of thin polyethylene (100 or 200 gauge) held down at the edges with a little soil, or by a batten, will almost completely protect the cuttings from drying until they root, when it should be gradually removed and the cuttings sprayed and watered as necessary. Further hardening-off is accomplished by gradually thinning the overhead shade.

Glass covered frames and cases. These are normally used in conjunction with more or less permanent structures. In hot climates soundly constructed overhead shade is essential. This should be built so that no pieces fall onto the glass below. The glass-covered frames or cases may be at ground level or waist high for ease of operation. In the former the lights may be supported on a board edging and the latter on brick or concrete walls. Ground level frames should contain a drainage layer of gravel or broken brick on which is placed a sheet of a quarter-inch (6 mm) plastic net to receive the rooting medium and prevent it from being washed down and blocking the drainage. The netting also simplifies the task of replacing the rooting medium. Waist-high frames need strong support, normally afforded by brick or breeze-block walling. If metal piping or angle-iron is used for support, the open space beneath the frame is available for other purposes.

For the rooting of leafy cuttings in frames it is usually necessary to reduce the overhead available light to 50 per cent and to maintain high humidity round the cuttings with minimal addition of shade. Although high humidity is easily maintained by heavy shading this causes leaf-shedding and non-rooting. The aim is to admit as much light as possible to the cuttings whilst maintaining a moist atmosphere around them. This is largely achieved by frequent or continuous wetting of the cuttings and interior walls of the frame. However, frequent watering leaches essential materials from the cuttings and causes waterlogging of the medium. The need for frequent watering may be reduced by cooling the sloping frame covers by the evaporation of water from a layer of muslin or other coarsely woven material kept wet by a trickle of water from a trough or reservoir placed at the higher side of the frame. The water level in the reservoir may be controlled by a ball valve.

Another way to keep the temperature uniform was developed in Dutch Guiana by Floor for the propagation of tropical evergreens (32). A box having holes in the bottom for drainage is half filled with washed sand or similar medium (Figure 8) and lidded with a tray composed of a sheet of glass and a raised metal edge to hold about half an inch (1.25 cm) of water. The box is placed under high shade but fully exposed to morning light and 50 per cent light thereafter. The whole apparatus is covered with a blanket at night to maintain warmth.

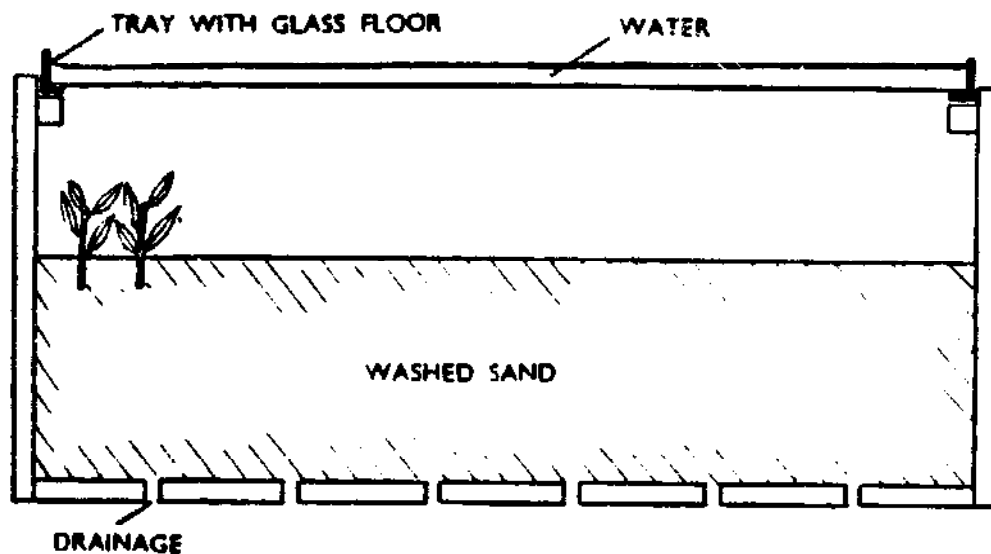

FIGURE 8

Small propagation case for use in the tropics

Polybag rooting of cuttings (see also p. 13). Small, thin (150 gauge) polyethylene bags have been variously employed, both for the individual establishment of seedlings and for the rooting, establishment and conveyance of cuttings to the field (88). The base of a semi-hardwood cutting bearing a few trimmed leaves is placed in wet leached sawdust laid in coconut fibre. This is folded round and held by a rubber band resulting in a ball about half the size of a clenched fist. The balled cutting is placed in a 150-gauge plastic bag, one third of a pint (190 ml) of water is added, the neck of the bag tied with string and the whole suspended by the string under a cloth shade permitting the passage of up to one-tenth of incident light. When the cutting is well rooted the bag is taken to the nursery or field where the fibre-balled cutting is extracted and planted. The surplus water in the bag is poured over the plant and the bag inverted

over the plant with the mouth resting on the soil. Two banana leaves are pushed slantwise into the surrounding soil on either side to shade the cutting. The bag is removed a week or so later and used again. The withering banana leaves serve to harden the plant by a gradual reduction of shade.

Hurov and his associates (62) report that the bag method is economical because it obviates potting-on and facilitates transport and establishment in the field. It can be readily adapted to meet particular needs. Hurov recommends the use of polybags six or eight inches (15 or 20 cm) wide and fifteen to twenty inches (38 to 50 cm) deep. An open light-weight potting mixture is well moistened and placed in the bag to a depth of about five inches (13 cm) and there firmed, without bursting the bag. The basal two inches (5 cm) or so of the cutting is inserted in the medium and again firmed, the bag is pulled up over the cutting and closed by twisting or folding and clipped or pinned. No water is given until the roots can be seen at the base, when the bag should be gradually opened and some holes made in the bottom of the bag. Water should now be given and the overhead shade reduced a little to harden the cuttings before planting out.

Basket rooting of cuttings. A very economical method developed in West Africa for cacao cuttings (76) may be adapted for a wide range of woody trees and shrubs. Short cuttings of two or three nodes, bearing viable leaves, are given normal growth substance treatment and inserted in 6 x 7 inch (15 x 18 cm) baskets (see p. 11). In West Africa the baskets are filled with potting soil round a central core of rooting medium (50:50 sand and composted palm fibre) into which the cuttings are inserted. A group of a hundred or so baskets is placed on the ground under slatted or other 'walk under' shade and well watered. A sheet of polyethylene, 300 gauge or thicker, is laid over the cuttings and held down at the edges with battens. Inspection and watering are made easier if one edge is held down firmly by soil and the opposite edge by a batten attached to it. The recommendation for cacao cuttings (76) is to raise the sheet early in the morning every third day and to spray the cuttings lightly, using only about one pint (570 ml) of water for every 50 cuttings to avoid the risk of water-logging. When rooted the cuttings are hardened by uncovering for two or three hours in the early morning and, after one week, this period is gradually extended until in about four weeks the sheet is no longer required and the overhead shade remains the sole protection until planting time.

Tents and tunnels. Plastic tents and tunnels of various size have proved excellent for the rooting and establishment of cuttings throughout the world. In the tropics it is usual to provide overhead shade to reduce incident light some 75 per cent and to use 300- to 500-gauge clear plastic for the tents. A light dome-shaped framework, some three to four feet (0.9 to 1.2 m) wide, is used to support the sheet. Small gauge, 6 x 6 inch (15 x 15 cm) 'Weldmesh", as used for reinforcing concrete paths, provides a suitable support. Any sharp corners or protrusions should be wrapped with plastic film or tape.

When the cuttings have been inserted and well watered, the wire support is bent over and the edges buried to form a rigid support for the plastic. The plastic is then laid over and the edges are held down by soil. This is done by forming a straight-edged trench some four inches (10 cm) deep, with a flat bottom into which the sheet is put and held by returned soil lightly trodden to stretch the sheet. With quick-rooting material under favourable conditions the initial watering may suffice until the hardening phase, when the plastic is gradually removed and water is given. If the cuttings take a long time to root the plastic should be lifted every three to four weeks for watering. The author is greatly indebted to I. P. Scarborough, horticulturist to the Tea Research Foundation, Mulanje, Malawi, for information on the use and management of plastic tunnels for cuttings.

Large walk-in plastic tunnels and single-span greenhouses are widely used in temperate and sub-tropical regions for the rooting of a wide range of cuttings. However, even in temperate zones it is advisable to use 500-gauge white plastic to reduce incident light. The success of such structures in the tropics must depend upon the reduction of light and heat by high shade and provision for internal water sprays. Full descriptions of such and detailed instructions for their erection have been published by the Agricultural Development and Advisory Service of the Ministry of Agriculture, Fisheries and Food, London (1973).

Mist sprays

Modern mist spray propagation is merely mechanization of the frequent hand syringing long practised by gardeners (10). A review and digest of mist propagation of cuttings (104) outlines the history of its aims, development and practical use

In propagation and nursery projects. Its effect upon cuttings has been well described by Hess (52) and Snyder (114). The object is to maintain a film of water on the leaves at all times which results, by evaporation, in a reduction of leaf temperature and leads to reduced transpiration and respiration, thus making possible propagation under high light intensity with accompanying high rates of photosynthesis.

Mist is a superlative nurse for leafy cuttings and therein lies a danger. In the mist environment the cutting becomes acclimatized and then, when mist is no longer required, the cutting needs to be carefully hardened prior to planting out. To assist this procedure the amount and frequency of the sprays should be kept to the essential minimum and be further reduced as soon as the rooted cuttings can stand alone. Reliability is the basis for success and in a mist unit this chiefly depends upon the provision of a supply of clean water at a more or less constant pressure (see p. 5) coupled with a well-maintained control system electronically or otherwise automatically operated. Hence it is not surprising that mist propagation has so often failed to function in tropical areas where local conditions are inadequate (108). In such circumstances the sealed plastic tent will prove superior, being less exacting and yet yielding satisfactory results (109). Although fully-automatic mist may not be possible, manually controlled mist and coarse sprays are invaluable in the nursery, being quite economic when the size of the enterprise justifies the full-time attention of a trained operator.

Continuous versus intermittent mist. Although a continuous mist spray system is easier to install and maintain than an intermittent one it often applies an excessive amount of water which produces leaching in the cuttings and a waterlogged bed, unless full provision is made for drainage; moreover it lowers the temperature of the rooting medium. Intermittent mist is generally preferred, controlled by an interval-timer or by 'weather conscious' devices. A time-clock may be used to turn the system on in the morning and off at night.

Temperature of rooting medium. In cool climates artificial heating is regarded as essential. This is accomplished by electric soil-warming cables laid beneath the rooting medium. Suitably earthed mains voltage cable, plastic or lead covered, is now used in coils about six inches (15 cm) apart to give a loading of 15 W/ft². A rod-type thermostat controls the

temperature. This should be placed at right angles to the coils and an inch (2.5 cm) or so above them, level with the bases of the inserted cuttings. In temperate regions it has been found that the optimum base temperature lies between 70° and 80° F (21° and 26.5° C) for most species. In the lowland tropics the ambient temperature will normally be adequate and obviate the need for artificial heating. In extensive work with rubber cuttings in Malaya, Tinley (119) obtained no benefit from the use of additional heat. It is considered that the continual rapid evaporation of water deposited on the leaf surface will maintain the leaf at 10° F (5-6° C) below normal and help to provide an adequate inverse temperature gradient. In general, heating will be unnecessary but it may have to be provided in regions of high altitude where soil temperatures may fall substantially below 70° F (21° C) at night.

Spray nozzles and water supply. Deflection type nozzles are by far the best, provided water pressures are reasonably good. They were designed especially for mist propagation. A stream of water is directed onto a flat surface where it is broken into a fine spray. The MacPenny nozzle, which is readily adjusted and incorporates a filter, is very good, giving a reasonable coverage even under reduced pressure. At nozzle pressures above 30 p.s.i. nozzles may be set at intervals of four feet (1.2 m). Individual nozzles may be closed over vacant parts of the bed or whilst working.

Adequate supplies of clean water must be available, the ideal being filtered rain-water although this is rarely possible. The presence of large quantities of mineral substances will not only block nozzles but will also interfere with leaf activity. Screens and filters should be provided at various stages in the supply to reduce the risk of blockage at the nozzles. Water consumption by intermittent mist may be as high as 2½ gallons (11 l) per hour at each nozzle. So, in one line of ten nozzles (bed 5 x 40 ft or 1.5 x 12 m), 25 gallons (114 l) may be needed each hour and 250 gallons (1137 l) in one 10-hour day. Continuous fine mist may require twice this amount.

Where mains pressure is low or variable a booster pump will be necessary to raise the water pressure. A one hp electrical centrifugal pump will raise the mains pressure from 15 to 50 lb/in² when operating a flow of 400 gallons (1818 l) per hour. Absolute reliability of a well-atomized spray is

essential and there should be a static water supply available at all times, in case the mains fail. In addition there should be a completely independent pressure supply by means of a petrol-driven pump to cover all eventualities.

Pipework and fixtures. The water must be brought to the unit in large-bore pipes to avoid pressure impedance; two inch (5 cm) should be regarded as minimal for other than the smallest installation. Such a pipe serving a number of beds at right angles to it should have a screw-plug or valve at its two extremities for flushing out sediment. There should be flexible connexions between this two-inch (5 cm) pipe and the spray lines so that individual lines may be readily moved. These and the pipe leading to the nozzle connexions should have $\frac{1}{2}$ inch (1.9 cm) bore and the extremity should again have a plug or valve for washing through. The $\frac{1}{2}$ -inch (1.9 cm) line and $\frac{1}{4}$ -inch (1.25 cm) nozzle connexions should be of plastic or aluminium alloy to obviate scaling and corrosion, the common cause of blockage.

The overhead system is recommended as this allows ready adjustment of spray-lines and their use elsewhere as desired. The drip from such lines is of little consequence under tropical conditions. The overhead spray-line is supported some three feet (0.9 m) above the bed either on posts or cross-bars fixed to the overhead shade structure. It is important to start with the tops of the nozzles all level, later adjustment being extremely difficult. Uneven nozzles cause excessive drip and uneven spraying, as well as excessive water loss by dribbling.

Shade and protection. Air movement can upset the most carefully designed mist system, and although it is not necessary or advisable in the tropics to have complete enclosure, some overhead and side shading is necessary and also all-round protection from wind.

Composition of bed. Perfect drainage is essential. This, provided there is no drainage impedance in the soil beneath, may be achieved by building the bed directly on the ground, within low retaining walls or boards. First a layer of broken brick, then a layer of granite, or other clean rock chippings, followed by a six-inch (15 cm) layer of 1:1 coarse clean sand and peat or partly rotted sawdust. Pure sand may be used but root formation is then likely to be less amenable to transplanting.

With some subjects it may be possible to root the cuttings in a four-inch (10-cm) layer of sand/sawdust (or pure sand) placed directly on the soil surface and to leave the cutting to extend its roots downwards until lifting time. In such a situation the spray-line may be removed and used elsewhere, provided the necessary irrigation is given to the rooted plants in some other way.

Hardening rooted cuttings and transference. Once rooting has occurred, normally after a month or so according to the species, the spray should be gradually reduced until it is only applied occasionally during the hottest part of the day, and then not at all. The shade may also be gradually removed. As the spray is reduced it will be necessary to irrigate the rooting medium by hose or watering can or by manually controlled spray lines. It will then be convenient to add nutrients to the rooting medium either through irrigation or by solid dressings. Another way is to provide a nutrient spray for the final spray application each day throughout the period the cutting is in the bed so that it is available for absorption during the night. On a small scale this can be applied by watering can; on a large scale it is worth while arranging a separate tanked supply to which one can switch for the final evening application. Tinley, in Malaya (119), gave his cuttings continuous mist through the day and changed to nutrient mist for the last spray, using a solution containing a mixture of urea, potassium nitrate and diammonium phosphate. Magnesium and minor elements might advantageously be added in this way.

Mist spray reduction can be achieved by use of a 'weaner' (an electronic device) which reduces misting frequency by set amounts, e.g. 1/3 or 1/6 the normal rate. Alternatively the sensitive element may be placed close to a mist nozzle so that it dries more slowly, or an interval timer may be used. If the rooted cuttings are to be established in pots, baskets or perforated polyethylene bags they may be lifted from the rooting bed, potted and then either returned to the same mist or placed under an intermittent spray beneath other shade.

Working with the difficult subject rubber, Tinley (119) found it convenient to place rooted cuttings in perforated polyethylene bags holding 12 lb (5 kg) of soil (similar to John Innes No. 2) in an open, well-drained compost with adequate nutrients. He placed these under clock-controlled mist, reducing to no spray at all and full light after four weeks.

POLYEMBRYONY

Certain plants, notably cultivars of mango and citrus, produce polyembryonic seeds, that is, seeds which contain several embryos, only one or possibly none of which is the result of fertilization, the others arising from cells outside the embryo sac and being thus essentially vegetative in origin. If, after germination, the sexual seedlings can be distinguished from the vegetative plants and eliminated, a pure line of vegetatively-produced descendants should result (G4).

In some fruits the sexual seedling, resulting from hybridization, may be suppressed at germination and only the vegetative ones develop into plants. This behaviour may occur more frequently with certain cultivars of one species than with others, resulting in clonal populations in a given locality as with the mango.

Since 'seedling' propagation is normally less costly than vegetative it would seem worth testing the degree of polyembryony in valuable cultivars before resorting to vegetative propagation. In some cases it may be possible to stimulate very young embryonic shoots to proliferate in the very early cotyledon stage for use as cuttings which possess a high rooting potential because they are truly adventitious in origin (see juvenile and adult phases, p. 54).

GRAFTING — ONE PROCESS AND MATERIALS

Grafting has many uses (34) chief among which are three:

- (1) To propagate, or assist in propagating, plant varieties not otherwise conveniently propagated.
- (2) To substitute one part of a plant for another.
- (3) To join plants each selected for special properties, e.g. disease resistance or adaptability to special conditions of soil or climate.

In addition, grafting may be used to repair damage, to overcome stock/scion incompatibility, to invigorate weakly plants and to elucidate research problems. Whereas a plant composed of two parts taken from two plants is not truly vegetatively propagated (see p. 30), yet it is a way of multiplying a selected plant, albeit at the expense of another. Indeed, grafting often proves the only efficient way to multiply selected cultivars and therefore merits close attention both to the basic requirements for its success and the exploitation of known techniques and their further development. The basic requirements are four:

- (1) Compatibility between stock and scion.
- (2) Life of the parts joined together.
- (3) Wounding to expose cambia or other meristematic tissue.
- (4) Anchorage of the parts.

Compatibility. Much attention has been given to problems of stock/scion incompatibility and some excellent reviews are available (3;82). Mutual relationships of the parts joined is essential for a long-lived union; plants of different families form no permanent union. Generic differences do not always involve failure to join but, in general, it has proved safer to keep within a genus. But even within a species, graft failure may occur. In fact, the botanist's classification serves only as a rough guide for it is founded upon the reproductive characters, and experience has

taught that this is not a reliable guide to graft compatibility. Something more than kinship is required for a good union (16).

Symptoms of incompatibility may be delayed, sometimes long enough to permit a satisfactory or even improved cropping performance. This is sometimes seen when one of the components is a tolerant carrier of a slow-spreading virus to which the other is susceptible. Again, where union breakage is the sole cause of union failure, the compound tree may long survive if supported by an efficient stake. In such cases there is no suggestion of interference with the passage of essential plant foods across the union. Thus, such incompatibility is not comparable to a constricting girdle. In fully compatible unions, where the fibres are firmly interlocked, there is no free passage for all materials or intermixing of tissues. Each component retains its own characteristics right up to the junction, as can be clearly seen when plants with coloured cell sap are grafted upon those with colourless cell sap, the colour ceasing abruptly at the union.

Components of widely differing maturity, such as an unripened scion and a mature stock, form satisfactory unions provided they can be joined without crushing the tissues. Differing growth rate due to differential response to seasonal conditions is no impediment to full compatibility. Nor do the parts have to be matched size for size, provided that at least some parts of the wounds are made to coincide.

Life. The fact that both stock and scion must be alive and biologically active, not only when first positioned but throughout the grafting process, is ignored at the grafter's peril. On the contrary, a full appreciation of the need to use only healthy material and to protect this by horticultural care against the hazards of desiccation will help to ensure success. Herbaceous leafy material requires a moist environment, warmth and light for growth processes to continue more or less normally. Suitable conditions may be provided by mist sprays, polyethylene tents or other protection. Defoliated material may be intimately protected by anti-desiccants including smears, paints and dips, provided they are non-poisonous. The aim is to prevent both drying and waterlogging.

When the scions, or the rootstocks, are stored or

transported long distances the utmost care is necessary to protect them from both overheating and drying. Moist storage, above freezing point, such as that provided by jacketed stores is ideal. During the grafting work the scions, and the rootstocks also when bench grafting, should be kept cool in moist wraps or containers away from sun heat till the moment of the operation. Thereafter protection is given by seals and other covers.

Wounding to expose the cambia

Provided the parts placed together are living and mutually compatible, the only remaining essential is that the cambia or other meristematic tissues are at least in some degree in contact, or so close together, that they achieve contact by further growth. Grafting comes about by the healing in common of wounds (34). Wound healing is not governed by innate dormancy but proceeds at any season subject only to suitable growth conditions, mainly warmth and moisture. Clearly, wound healing is imperative and has first call on plant resources, so it is wise to avoid making wounds in excess of grafting needs. In nature, healing tissue develops to meet across the wound and, in grafting, slight misplacement of the components is acceptable, provided the parts live until organically united.

Although it is a comparatively simple matter to place the cambia in contact where the stems are of similar size, it requires rather more care to achieve cambial contact between stems of different size and age. In one-year-old stems the rind is thin and the cambium is close to the outside of the shoot, but in older stems the rind is much thicker and the cambium much further from the surface. Thus the matching of the outer edges of the rind will not bring about cambial contact and it is always necessary to place the inner edges of the rind together (see Figure 9). The rind of roots is considerably thicker than that of stems of the same size and in stem/root grafting it is vitally necessary to place the inner edges of the two rinds in contact. Any grafting process which involves lifting the rind from the wood when the cambium is in active growth will reveal the position of the cambium, for it is in this region that the separation occurs. Some cambial tissue adheres to the lifted rind, whilst some remains attached to the wood, and

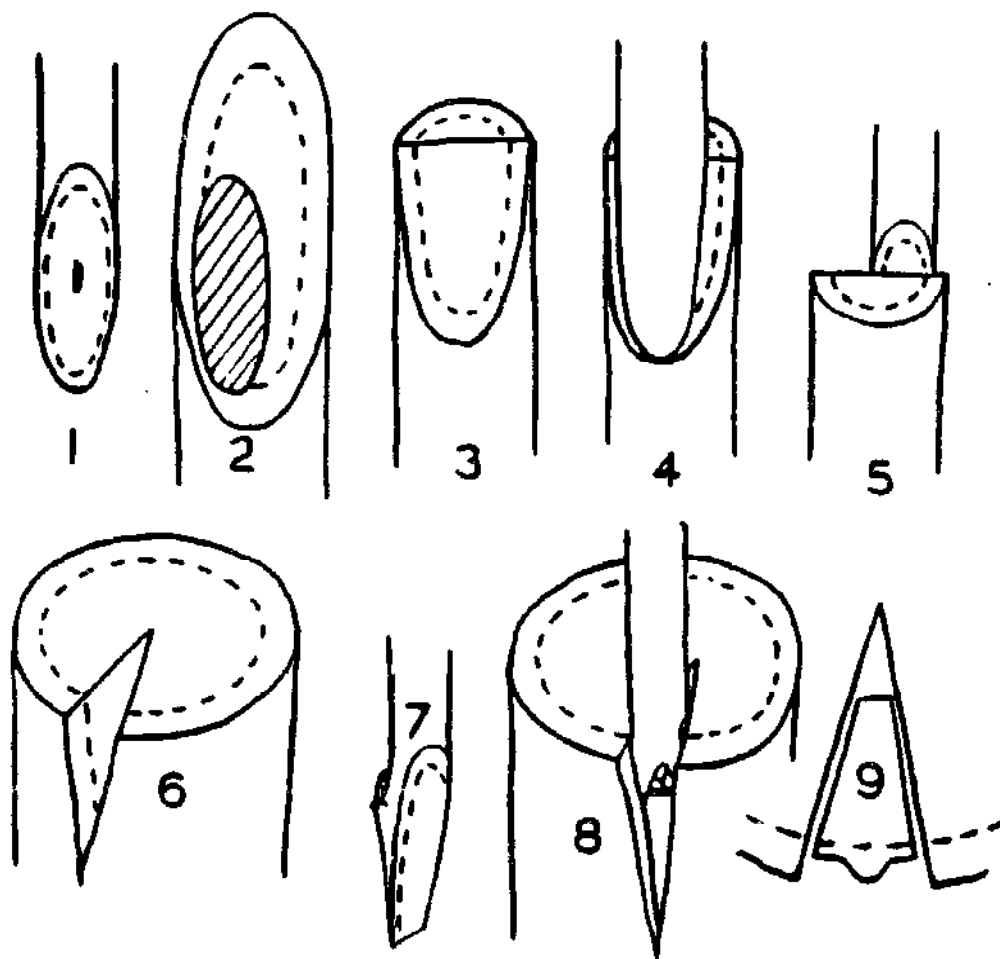

FIGURE 9

Examples of cambial contact

1 = Scion with thin rind. Cambium (dotted line) close to the outside of the rind. 2 = Stock with thick rind. Shading indicates cut surface of scion and limits of cambial contact. 3 = Stock prepared to achieve good apical and basal contact with scion cambium. 4 = Scion applied to stock. Note good contact at base and matching of inner rind (cambium) rather than outer rind (bark). 5 = Good cambial contact at top of stock. 6 = Large stock with thick rind prepared for thin scion. 7 = Scion with thin rind. 8 = Stock and scion fitted. Note parts of stock rind outside the scion. 9 = Cross-section. Note alignment of cambia and unmatched barks.

much of it is moist and slippery to the touch. This cambium, whether remaining on the wood along with other meristematic elements, or on the rind, is able to continue growth, laying down new rind on the outside and new wood on the inside, provided it is protected from the air and does not become infected with destructive organisms.

Anchorage of the parts

The graft components may be firmly held together in many ways. Self-holding grafts such as some wedge and cleft grafts are perfectly anchored; when well done they exert high pressure at the junction and also avoid the risk of constriction by the tie, or its premature loosening. Many tying materials are used. In the past the chief ligatures were bast and other fibres, raffia, jute, wool, cotton, various twines and waxed tapes. These have been largely replaced by rubber strips and patches, plastics of various kinds, nails, pins and clips. In some cases quick setting mastics may obviate the use of ties.

Firm anchorage is essential, the degree of firmness only limited by the resistance of the tissues to crushing. Ready release of the tie or other fixative, once the union is effective, is also an important consideration. Feeble tying permits the callus to force apart the components and thus preclude or delay the build-up of adequate pressure for union formation.

In grafting large woody stocks, as when re-working established trees, it is possible to anchor the parts with nails. This obviates constriction by the tie and eliminates the need for release. The nail remains buried in the woody tissues without detriment to growth. Tapered nails tend to split the material and should not be used. Gimp pins, or other parallel-sided nails, with a thin shaft and flat head, are ideal.

Tools and accessories

Knives, chisels and cleavers. Tool care is indicative of good workmanship. Edge tools, particularly, should be carefully maintained by the operator and protected from misuse. Other knives should always be at hand for general pruning and trimming work and for cutting string and releasing ligatures. A good lasting cutting edge must not

only be smooth and sharp but also strong and lasting. Knives with folding blades are more convenient to carry and the cutting edges are protected against damage when not in use, but fixed blades are stronger and are particularly valuable for heavy cutting and trimming and for preparing large hardwooded stocks for grafting. Small and delicate knives such as scalpels, lancets and razors, are commonly made with fixed handles and are best kept in their special cases between operations. The joints of all folding knives should be oiled to lessen wear, which is otherwise the main cause of their deterioration.

Domestic knives and carpenters' chisels are often quite adequate for grafting work and may be adapted in various ways. A kitchen knife is commonly used in budding large material. Large tools are readily controlled by the operator and give flatter cuts than thinner flexible tools. Moreover, being in common use they are relatively inexpensive. Orthodox grafting knives should be of good quality and have a straight-edged blade strongly set in a handle large enough to afford a comfortable grip. Curved blades are difficult to sharpen but a straight blade can be perfectly sharpened on a flat sharpening stone. The stone should remain fixed throughout the sharpening operation and not be held in the hand. The whole width of the stone should be used so that its surface remains flat. The knife is held to the stone at an angle of between 20° and 25° and moved forward along the stone against the cutting edge. The edge is thus 'pushed on' to the knife and not 'drawn away' by the stone. When beginning to sharpen, the direction of the movements may be changed every half-dozen strokes but the operation should be finished off by single strokes in alternate directions. A correctly sharpened knife will retain a good edge for many hours' work and during it only require stropping on a leather to retain a perfect edge.

Some toolmakers provide knives bevelled on one side only, like a chisel. Such are preferred by some workers but beginners should take note that such one-sided sharpening makes the knife 'cut in' one way and 'skid off' in the other. However, knives so sharpened form excellent flat non-digging cuts which are particularly necessary when side grafting by splicing and kindred methods.

Shears and secateurs. Nothing has proved equal to a well

sharpened knife for making clean cuts in a chosen position. Nevertheless, a pair of shears or secateurs is almost indispensable for the rapid preparation of rootstocks and trees for grafting. Parrot-billed shears are generally found unsuitable for nursery work because they do not cut close enough when removing lateral shoots, though the large parrot-bills with long handles, sometimes known as 'mighty cutters', are useful for harvesting ground layers and stool shoots.

The anvil type shears tend to crush one side and, like the parrot-bills do not cut close. It is generally found that shears with one curved blade which passes a strongly made narrow anvil, scissor fashion, are able to cut laterals cleanly from a main stem and also serves to cut close to buds, simulating a knife cut.

Saws. Saws will be required for preparing large trees for grafting. The saw blade should be narrow and self supporting so that it can pass between closely spaced branches. The rough or ridged surface left by the saw may be shaved off with a knife. There is little evidence that this shaving treatment is an advantage, but where ends of limbs are left unsealed, the rough surface certainly holds more moisture and may assist the establishment of certain diseases which enter through wounds. When removing lateral branches the saw cut should be made flush with the surface of the supporting branch or trunk; similarly, when lowering the main stem the cut should be made close to a lateral branch and no snag or stub left which would die back, and so prevent rapid healing. Small limbs should be supported as the cut nears its end to prevent tearing the rind below the cut. Large limbs should be removed by first undercutting them some distance from their base followed by an upper cut an inch (2.5 cm) or so nearer the base. The stub is then removed by a third cut, without risk of tearing.

Graft seals and wound dressings

The cut surfaces exposed at grafting time are covered to prevent the entry of water and limit the passage of air. They should adhere well and remain stable while at the same time allowing for changes due to growth. Above all, seals and wound dressings must not injure the stock or scion. Good sealing may help to prevent the entry of disease organisms and damage by predators, particularly when the material contains a non-injurious disinfectant or insecticide.

Very many materials will meet these requirements and it is not surprising that a host of substances have been used for sealing. From early times various clay and clay/dung mixtures have been used but in modern times many other materials have become available many of which are preferred to clays and other bulky packs. A few examples from each class may indicate their special attributes and lead to further adaptation of suitable materials.

Clay and admixtures. These bulky materials are only suitable for large grafts as used when topworking established trees or inarching or approach grafting stout stems able to support the weight of the pug. A suitable grafting pug may be made by kneading two parts clay with one of fresh cowdung. The incorporation of some cowhair or other fine fibre prevents the material from falling away when dried. Alternatively the pugged graft may be wrapped with cloth or plant-fibres of various kinds to hold it in place. When the graft has taken, the growth itself may slough off the dried pug but obstinate pieces may be dispersed by striking them simultaneously on either side with wooden billets.

Plain clay, or pug, is useful for smearing into large cracks formed when cleft-grafting large stocks. This prevents the entry of soft sealing materials which otherwise might prevent the joining of the plant tissues. Plasticine, as used for modelling, serves the same purpose as clay but is more expensive.

Hand mastics. Hand mastics and waxes are quite satisfactory for use on a small scale but are generally found to be too time-consuming for large scale use. They must be readily pliable yet not so soft as to flow away from the graft under the influence of the noonday sun. The best hand waxes contain a fair proportion of beeswax, which is expensive. A common practice is to melt varying amounts of resin, beeswax and tallow together, stir and then pour this mixture into a bucket of cold water to permit thorough kneading and pulling. The hands should be well greased with some spare tallow to prevent sticking. Recipes vary in accordance with local weather conditions, the proportions ranging from 10 to 12 per cent tallow, 30 to 70 per cent resin, and 20 to 60 per cent beeswax. A small increase in the amount of tallow will soften the mastic; increasing the resin will harden it; and increasing the beeswax will improve

malleable quality whilst maintaining stability. Mastics for hand application should remain firm when not in use and be softened for application by frequent kneading. Where the grafter works alone there is some danger of his hands carrying the seal on to the cut surfaces. With two workers this may be avoided.

Cold brush seals. Seals that depend on the rapid evaporation of a solvent may prove unsuitable in hot climates largely because they must be stored in air-tight containers and only be exposed in small quantities at one time.

Here is a typical formula (34):

Resin	2 lb (0.9 kg)
Beeswax	1 lb (0.45 kg)
Talc	¼ lb (0.11 kg)
Methylated spirit	¼ pint (0.28l)

Melt the resin, then add the beeswax. When melted and stirred, remove from the heat and add the talc, previously warmed, stirring all the time. When thoroughly mixed, remove the vessel to the open air away from any fire or naked light, and while warm but not hot, add the spirit gradually, stirring all the time. Store the mixture in air-tight containers in a cool place. The seal is applied with a small, fairly stiff brush.

A simpler, brush-applied, cold mastic may be made by dissolving shellac in methylated spirit as commonly done by carpenters for covering knots prior to painting. It is thinner than the above resin and beeswax mixture, being more like a paint (which see).

Bitumen/water emulsions have largely replaced the old mastics and are recommended for general use. They are available specially prepared for dressing tree wounds and for sealing grafts. Being water emulsions they may be further thinned by the addition of a small quantity of clean water. They are particularly useful for dressing wounds, as they exhibit excellent covering power and are harmless to trees. Where the method of grafting entails

leaving gaps and crevices, as in some cleft methods, these paint-like materials are not entirely successful in covering the gaps and it is advisable to pre-fill them with pug or other non-flowing material before applying the emulsion. Bitumen emulsions set in the presence of air and it is necessary to avoid exposing them in bulk. Brushes must be washed with water at intervals during work; it helps to keep the brushes immersed in water whenever they are not actually in use. If heavy rain occurs within an hour of sealing it may be necessary to repaint the grafts.

Unless definitely known to be harmless to trees, bitumastic paints and waterproofing materials should not be used as graft seals. Amongst well tried proprietary bitumen emulsions are Arbrex, Flintkote and Tree Heal.

Hot waxes. Waxes, melted and applied by brush, or by dipping in the case of bench grafts, are probably the most popular graft seals. Each formula may be varied to suit particular conditions. In hot climates the amount of inert solid should be increased to prevent running, though for the hottest climates the bitumen emulsions may prove more suitable.

Dark-coloured or black waxes may become very hot in strong sunlight and are not so suitable as those of lighter colour (21). Some bright red waxes have been more attacked by birds than waxes of nondescript colour. Pitch waxes, which melt only at a high temperature and become unworkable below about 120°C (248°F), must be continually reheated and are therefore more wasteful of time than waxes which are workable at a more moderate temperature and therefore cool relatively slowly. Waxes based on resin fall into this latter category.

Resin based hot wax:

resin	10 lb (4.5 kg)
beeswax	2 lb (0.9 kg)
siliceous earth (Fuller's earth)	1 lb (0.45 kg)

Melt together the resin and beeswax and stir in the siliceous earth. To reduce any tendency to flow in hot weather the amount of inert solid may be increased.

Paraffin based hot wax:

paraffin wax	5 lb (2.3 kg)
siliceous earth	3 lb (1.4 kg)
zinc oxide	1 lb (0.45 kg)

Melt the wax and stir in the siliceous earth and zinc oxide. Stir in also a little turpentine to soften the mixture, as may be found necessary for the local conditions.

Melted paraffin wax alone can be used as a graft seal. It is obtainable in varying degrees of hardness (melting point) and one should be selected to suit the local climate. Unlike the wax mixtures mentioned above, selected paraffins exhibit a narrow melting range from the solid to liquid state and there is some risk of applying the wax at too high a temperature merely to achieve a thin, clear seal.

Paints and dips. Once the scion material is cut it is vitally important to protect it from drying (see p. 85). Paints and dips of many kinds have proved helpful. Partial protection of budwood in transit is given by momentarily dipping the cut ends in molten paraffin wax or similar material, followed by wrapping with plastic film or insertion in polyethylene lay-flat tubing, within an opaque cover. Complete dipping of scion wood is sometimes advised when it has to be packed for transport. Low-melting paraffin wax is suitable for this and also some proprietary anti-desiccants. It is essential that the material used should either set or dry to a non-sticky condition and be in no danger of being smeared onto the cut surfaces made when grafting.

Wax and other dips have been used to obviate the subsequent sealing of the completed graft. The scion wood is first cut into grafting lengths, then tied in bundles and completely dipped in the anti-desiccant and hung up to dry. At grafting, the work is completed by merely tying with tape or other close-fitting strip, without additional sealing. The author has used household water-emulsion paint for this pre-sealing, leaving the dipped scion-bundles to dry overnight.

Tying materials

Provided a material is readily obtainable, is non-poisonous to the stock and scion, is not injurious to the operator, is pliable yet sufficiently strong to maintain adequate pressure whilst the graft-union forms, there is no reason why it should not prove suitable as a graft tie. Materials, already widely used, fall into four main categories.

Natural fibres. Raffia, hitherto the most commonly used tying material, is obtained from the raffia palm (*Raphia ruffia*). It is soft and strong and is best used slightly damp. This condition may be achieved by wrapping a small hank at a time in wet cloth and so carrying to the work. Many other fibres have been used, including bast from the inner bark of a number of trees and also leaf fibres of palms and banana. Natural fibres do not stretch and care must be taken to release them before they cut into the growing plant; neither do they seal the graft, as do many synthetic materials. But with some methods of grafting sealing is not essential, indeed, airtight sealing may, in some cases, be harmful.

Rubber strips and patches. The main advantages of rubber are its stretching power and sealing properties. There are many sizes and qualities. Natural rubber is quickly destroyed by direct sunlight and by contact with petroleum solvents. Synthetic rubber is not so susceptible to failure in sunlight. Prepared rubber budding-strips four to six inches (10 to 15 cm) long, stretchable to some 18 inches (45 cm) with consequent thinning, normally leave considerable space uncovered between the turns. Where a complete cover is required much wider strips must be used. Both wide and narrow strips are fixed by lapping the first turn over the beginning of the strip and tucking the end under the last turn.

Rubber patches (29) up to 1½ inches (4 cm) square, fixed on the opposite side of the stock by means of a wire staple, have proved a rapid means of tying inserted buds where no very high pressure is required (Figure 10).

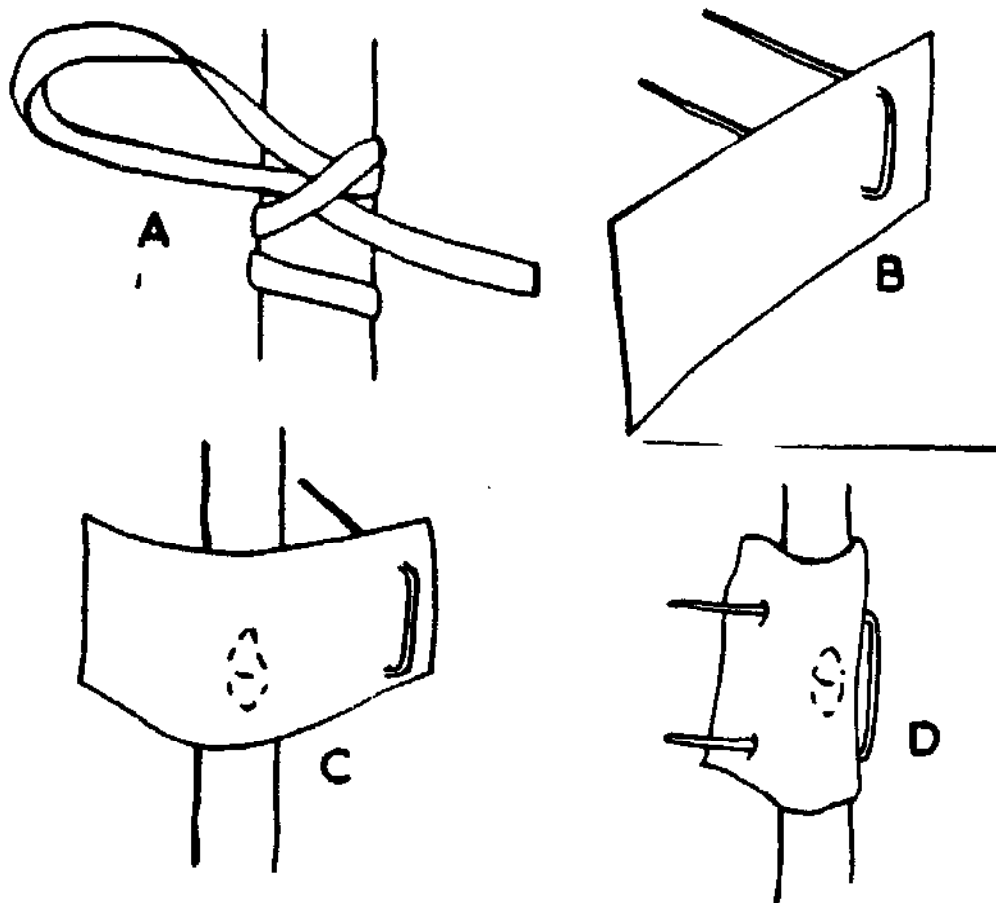

FIGURE 10

Tying bud grafts

A = Plastic (P.V.C.) strip looped to facilitate removal.
 B = Fleischhauz (1957) rubber-sheet and steel-wire staple.
 C = Sheet placed over the bud and pulled firmly round behind the stock. D = Staple pushed through and held by tensed sheet.

When grafting thin and delicate herbaceous stocks it is difficult to tie with the usual ligatures. In these cases a sheet form of self-sealing pure crêpe rubber has proved useful (46). A piece of rubber sheet is folded round the graft and pressed together so that it grips and seals the graft. This is then covered with a sheet of tin-foil to prevent deterioration of the rubber in sunlight (Figure 36).

Plastic strips. Various proprietary strips are produced specially for tying and sealing buds and grafts. Most of them are made either of polyethylene or polyvinyl chloride (PVC), the latter being rather stronger and particularly suitable for very firm tying. Both materials must be released to avoid constriction and, being impervious to moisture, should be removed by cutting or unwinding as soon as the graft has united, otherwise some rotting may occur beneath the bandage due to the enclosure of moisture. Polyethylene of up to 300 grade (see p.13) will stretch under tension to provide some latitude in the time of removal and make possible the complete enclosure of the eye of the bud without undue crushing or flattening, except where the bud is exceptionally prominent.

Strip width and thickness can be varied to suit the grafting method. Narrow strip, up to $\frac{1}{4}$ inch (0.6 cm), may be fixed by tucking under, as with rubber strip (q.v.). Wider strips and bandages cannot readily be tucked-in and, when non-adhesive, must be pinned, clipped or otherwise held by a separate tie or a morsel of wax.

Plastic strips generally are chemically inert and may be re-used repeatedly. To facilitate salvage the strip is hitched with a loop (Figure 10) for easy removal. The strips are washed in hot water and domestic detergent to free them from grease and dirt.

Waxed cloth and string. Wax-impregnated cloth or tape forms both a self-fixing tie and a very efficient seal. Low quality cotton sheeting or tape, easily torn, is prepared by dipping in molten wax. Mixtures recommended vary from equal parts of beeswax and resin to rather more complex mixtures as under:

(a)	(b)
4 parts beeswax	1 part beeswax
2 " resin	4 " resin
1 " tallow	1 " tallow
	1 " raw linseed oil*

* This must be non-treated raw linseed oil, not 'boiled' or treated oil used in paints, for this contains poisonous substances which may kill or otherwise damage plant tissues.

Cloth may be impregnated in various ways. The cloth may be rolled on a stick before dipping in molten wax or it may be unrolled from one spool on to another, via the molten wax and a scraper to remove surplus wax. To locate the edge or end of the waxed cloth this should be tied with a readily identifiable piece of string. Where a large number of graftings require the same length of tape, it may be cut into lengths, rolled on small spools of a hundred or so lengths, and then dipped in very hot melted wax. For ease of unrolling the strips from the spool, the end of one strip may be lapped one inch (2.5 cm) over the beginning of the next, so that removing a strip raises the end of another.

Waxed twine or cotton (crochet or knitting cotton) is commonly used. The spools are dipped, after locating the beginning of the twine, into melted wax for up to half an hour and allowed to drain. If the wax is melted over a fire the spools should be suspended in the vessel, otherwise they may char where resting on the bottom of the container. When grafting, the spools may be kept soft by immersion in warm water. It is unnecessary to knot the tie, it is merely broken off and remains in position.

Caps and covers. Protecting newly grafted plants against wind, rain storms and hot sun may be necessary. Where nursery structures (p. 6) give shade and a moist atmosphere no additional protection is required, but where plants are grafted in situ in the open, or bench grafts are set out at an early stage some temporary protection may be helpful in raising the percentage success and may also speed development of the plant. Thatch protection has already been mentioned (p. 73). Very simple individual protectors may be made from waxed paper, or from bitumen-lined paper such as 'Sisal Kraft', folded into either an open-ended cylinder or a cone fixed by a pin or staple. Cylinders provide adequate ventilation, avoiding heat build-up, but cones should remain open at the apex. A little soil heaped around the base of the protector prevents it blowing against the graft. If the grafted plant is staked the protector can be passed over the stake and plant. Polyethylene sleeves and bags may be used but they must be well ventilated, preferably by having a number of holes in their sides. Merely leaving the top open will not serve, because the soft material may fold over and adhere to itself. Waxed paper drinking cups inverted over new grafts and supported clear of the scion buds by one or two small stakes, or a piece of bamboo or reed buckled to grip the cup from inside, may serve.

Scion selection and treatment

Parent trees from which scions are to be taken should be labelled and their position recorded and mapped. If given an individual number this can be repeated when labelling the scions and so provide further information on the quality of the parent as a scion source. When scion-wood is to be stored for a considerable time, or packaged and transported, the labels should be strongly affixed and indelibly marked. Large woody scions may be directly numbered or otherwise coded on the bark or on a sliced patch at their base. Labels should be attached so that they cannot slip off the ends of the shoots. Straight, smooth shoots may have to be threaded through and the ties knotted. Even the best labels should be supplemented by notes in the nursery book (p. 171).

There is considerable evidence of the transfer of certain diseases from the scion-wood trees to the nursery in the form of latent spores, invisible to the naked eye until they cause lesions in the nursery material. Treatment with fungicide has given a high degree of control of disease

transfer (12; 67); commercially available fungicides based on captan (Orthocide), didecyldimethyl ammonium bromide, DDAB (Deciquam), dodine (Cyprex), Melprex and ferbam (Fermate) have been used at conventional concentrations. Bud-wood should be treated, preferably by dipping in an aqueous dispersion of the fungicide and allowed to become completely dry before grafting operations begin. Working with rubber (*Hevea brasiliensis*) it was found advantageous to treat also the area on the rootstock destined to receive the bud patch. This was conveniently done by wiping with a cloth dipped in the fungicide dispersion. Although the above treatments provide a high degree of protection it is only by completely freeing the scion source plants from infection that the highest possible standard of control is attained.

Within an individual tree there is considerable variation in scion quality. Shaded and attenuated shoots from the lower parts of large trees are inferior to those well exposed to light in the outer and higher parts. Moreover, the inner, shaded shoots are more prone to carry the spores of diseases such as mildew and canker, not only because they are unripe but also because they have not been efficiently sprayed. The few coarse shoots found at the apex of the tree are most unsuitable as scions.

Leafy shoots lose water very quickly and it is customary to remove all leaves at the time of collection by cutting through the petiole. The petiole base adhering to bud-wood may serve as a convenient 'handle' when budding, but has no other useful purpose and, if enclosed by the tie, may be crushed, causing rotting of neighbouring tissue. If petioles are severed a week or so before collecting the bud sticks the petiole bases will abscise, leaving a healed scar. When de-leafed the shoots must be protected from drying by placing them in a moist and shaded container. When it is necessary to collect bud-wood well in advance, either for long distance transport, or because it is in a suitable condition for use before the stocks are ready, appropriate cool storage conditions should be provided.

Within an individual shoot there is considerable variation in form and growth potential of the buds. Shoots on severely pruned trees will tend to have a high proportion of desirable vegetative buds. Such buds are of particular value in those species in which single buds are mainly flower buds, incapable

of producing a vegetative shoot. Species which commonly bear mixed buds, or have axillary buds in reserve are acceptable, but scions possessing only vegetative buds are better. The expansion of flowers on a newly grafted scion may dry it out before it has united. They should be nipped out at grafting time.

GRAFTING — TWO

APPROACH GRAFTING

Provided the four basic requirements are met (p. 83) almost any carpentry will serve, as is demonstrated by the very many different techniques employed, some complex and difficult, others simple and easily accomplished (34). It is the latter which are of immediate concern and from which examples are now selected to cover the most practical and productive range. They fall under two main heads: (1) grafting by approach, in which scion and stock are not, or are only in part, severed from the parent plant until a union is effected, and (2) grafting with detached scions.

True approach grafting

Approach grafting is somewhat cumbersome compared with detached scion grafting, largely because of the space occupied by the completed graft and by the high degree of horticultural care demanded in watering and gradual separation over a period. Nevertheless approach grafting may be regarded as an almost foolproof method provided the necessary time and patience are given; time and patience are indeed absolutely essential. The principal need is to provide a constant supply of moisture to the ingrafted plant, accompanied by firm anchorage. In-grafted plants must be firmly supported. This is difficult on an elevated platform subject to movement of either component by high winds. The danger is reduced by tying the components together below the graft so that they move in concert. Even so, attendance to high platforms is difficult and costly; it is much better to graft close to the ground, best of all to have the ingrafted plant plunged or actually planted in the ground close to the scion-wood tree where it can be conveniently watered or mechanically irrigated. Some subjects in favourable areas may be planted close to the plant which provides the scion and allowed to establish there well before grafting time. After grafting, good anchorage is achieved by attachment to stakes in the ground.

Although approach grafts may be successful at any time it may be advantageous to graft either at the beginning of the

rainy season in regions of light rain or at the end of a heavy rainy period, the object being to avoid both drought and rain-storms, and yet to coincide with a favourable period for growth (111).

Spliced approach graft (Figure 11). The stock and scion, preferably of equal size, are sliced deeply with flat cuts to match; these cuts may be up to three or four inches (8 or 10 cm) in length. These cut surfaces are placed together and very firmly tied, taking care that the upper and lower ends of the cuts coincide and that tying presses particularly hard at these points. Sealing completes the work.

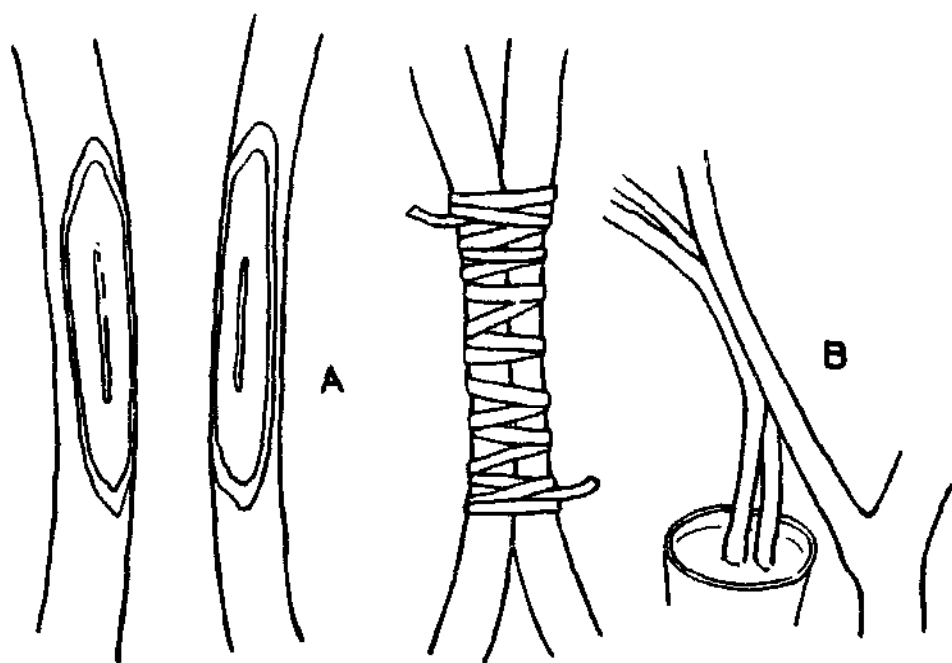

FIGURE 11

Spliced approach graft

A = The components sliced to expose the cambium in equal pattern. B = Two small stocks set against one scion.

Tongued approach graft (Figure 12). Long deep slices are removed from both stock and scion so that the cambia are equally exposed. A tongue is made, starting about one third way along the stock slice and proceeding downwards until it is two-thirds of the way down the slice. A similar tongue is formed in the scion, but in the reverse direction. Both tongues must be square across so that the sliced surfaces lie flat against each other when interlocked. Very firm tying is essential as in spliced approach grafts (q.v.). The graft should be sealed.

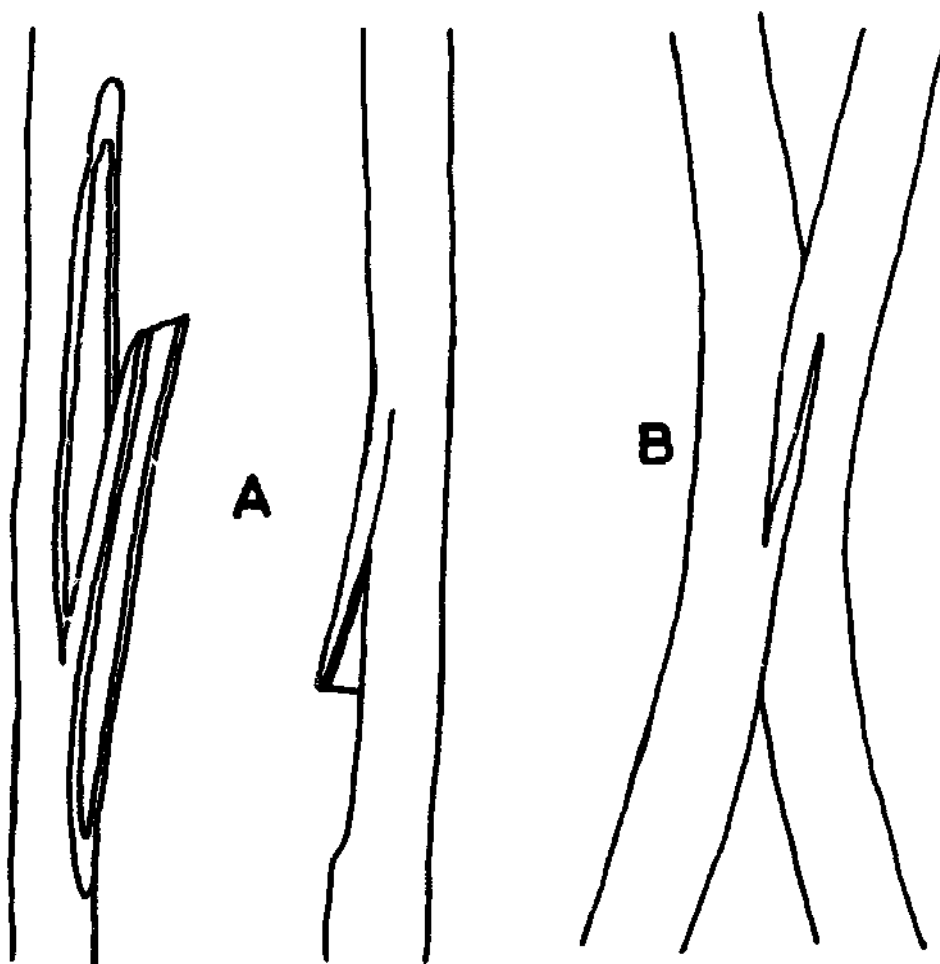

FIGURE 12

Tongued approach graft

- A = The components sliced and tongued.**
- B = Fitted together and ready for tying.**

Bottle grafting (Figure 13). Both leafy and leafless shoots may be approach grafted provided they can be prevented from wilting. The rootless shoot or small branch stands in a bottle of water until a union is formed. Some overhead shade and protection is helpful such as that given by a small sheaf of reeds or grass tied around the completed graft. A few lumps of charcoal placed in the water help to keep it sweet and clean. At no time must the water fall below the level of the cut end of the scion. A leafy scion is best collected from the parent by severing under water, slipping the filled bottle under its lower end and so conveying it to the grafting site. The bottle can best be held firmly to the stock branch if first wrapped in cloth.

Inarching

Under this heading come all those methods in which one of the partners is decapitated and inserted into the other so that there are two parts below the graft and one above. This technique is employed for joining rootstocks to selected scion varieties which are otherwise difficult to root or to graft as detached scions. The rootstocks, already in pots or polybags, or established in the soil close to the scion-source tree as for approach grafting (*q.v.*), are placed so as to meet the young branches without undue bending and where they can be held to a stake or other anchor to prevent straining at the graft. Inarching is also commonly used to invigorate weakly trees by augmenting their root systems, for bridging trunk and branch wounds and for furnishing bare limbs with lateral growths.

Cleft inarching (Figure 14). This is a very simple method to use when the components are not more than an inch or so (2.5 cm) in diameter. An upward cleft is made in the stem equal in size to a wedge cut at the top of the shoot to be inserted. A short, deep cleft is needed where it is desired to transfer the shoot to the inserted stock as rapidly as possible, as for propagation, but a shallow cut suffices where the inarching is designed to add to the vigour of a tree without checking its already feeble growth by a deep incision. The graft should be well bound and sealed. Waxed cloth or tape is ideal for this purpose.

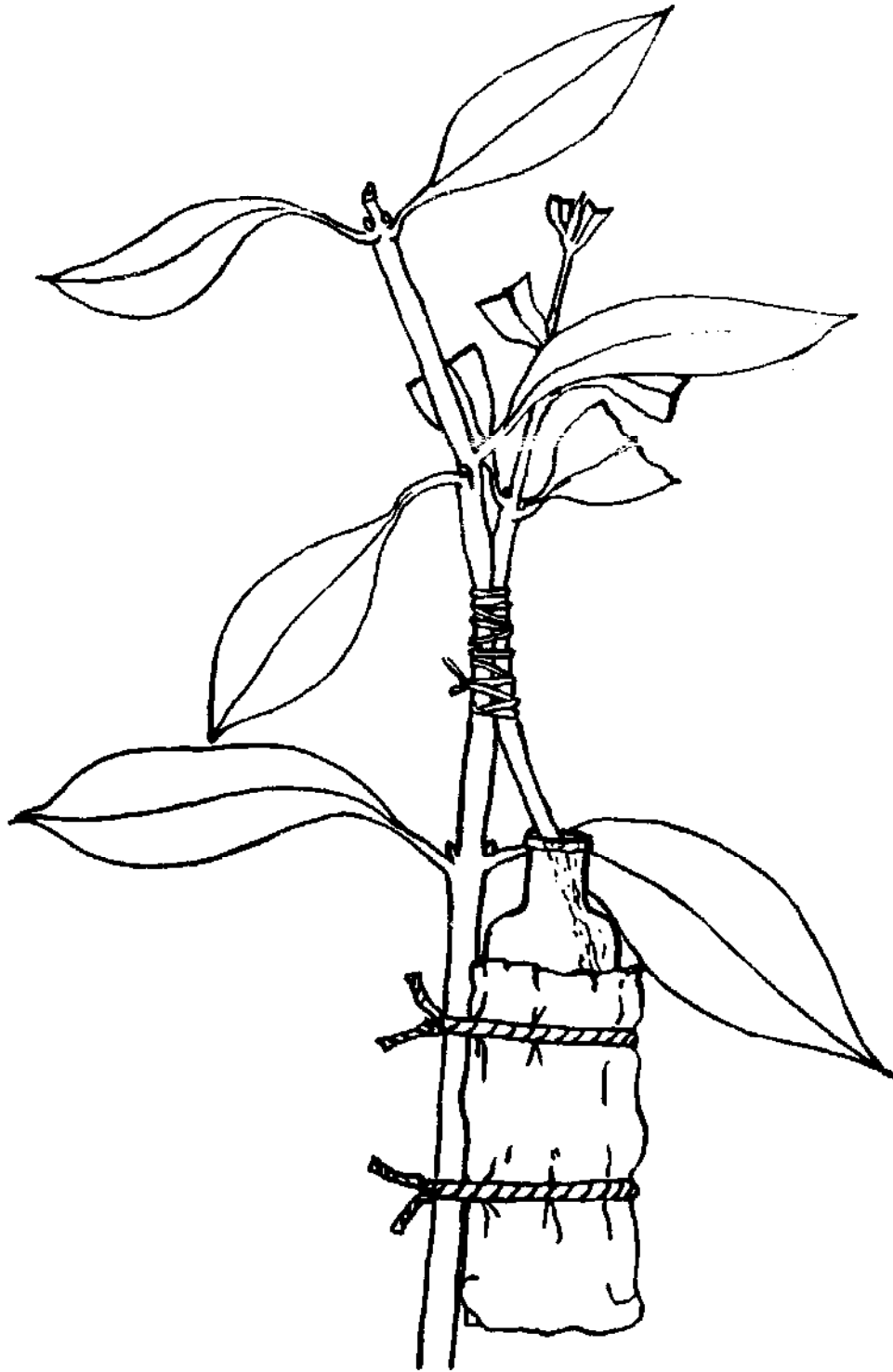

FIGURE 13

Bottle grafting

The leafy scion is approach-grafted to the established stock. The base of the scion is kept in water until a union has been formed when this base is cut off close to the stock. The head of the stock is also removed, preferably by stages.

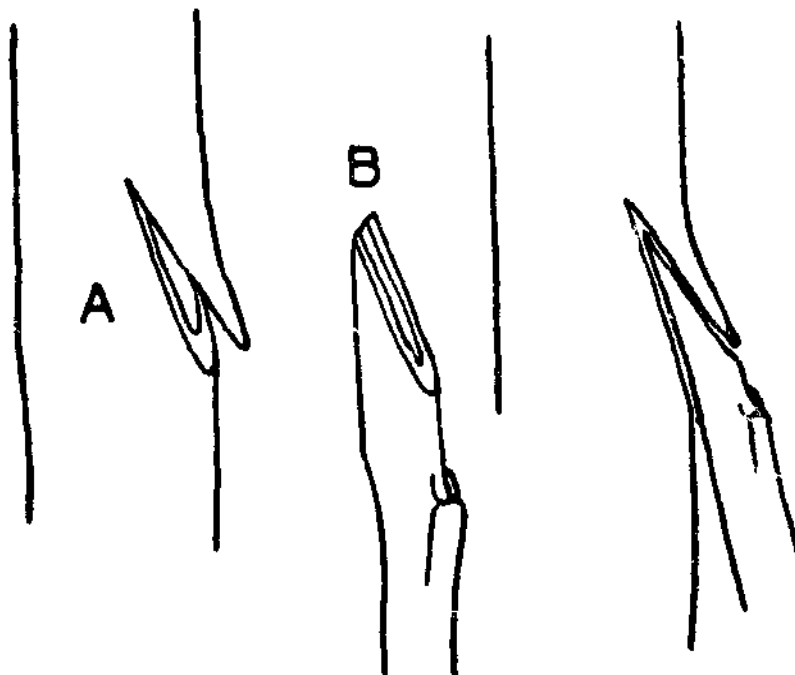

FIGURE 14

Cleft Inarching

A = An upward cut forms a cleft. B = A wedge is made to fit into the cleft. This graft must be firmly tied.

Rind inarching. Where it is necessary to inarch a thick component with a small one a rind method is more practical than a cleft, provided the rind lifts readily. Probably the simplest method of all is to make an L-shaped incision in the thicker component. The thinner part to be inserted is prepared (Figure 15) by making one principal cut (A) and a second cut (B) on the opposite side to expose the cambium. A thin shaving may be taken from the edge of the cut (A). One vertical radial cut (C) is made in the rind of the larger partner and an upward inclined incision connects this in the form of an open L. The prepared end is inserted under this rind and fixed by a thin nail or gimpe pin. The work should be well sealed.

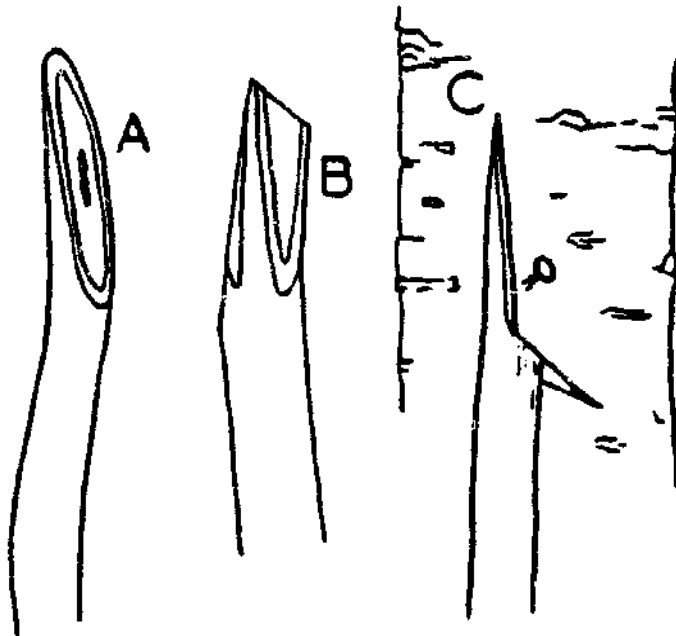

FIGURE 15

Rind inarching with an L incision

A rather more complex method, making a very neat job (Figure 16) requires the thinner component to have one principal cut (A), two very shallow cuts (B), and the removal of the tip (C) to strengthen the end and expose the cambium. Two parallel incisions (D) are made in the rind of the larger component and the lower ends of these are joined by a third cut (E) inclined upwards through the rind. The rind is now raised a little and the thinner component inserted. The rind is pushed outwards and some of it is cut off. Two nails serve to hold the parts firmly and sealing completes the operation.

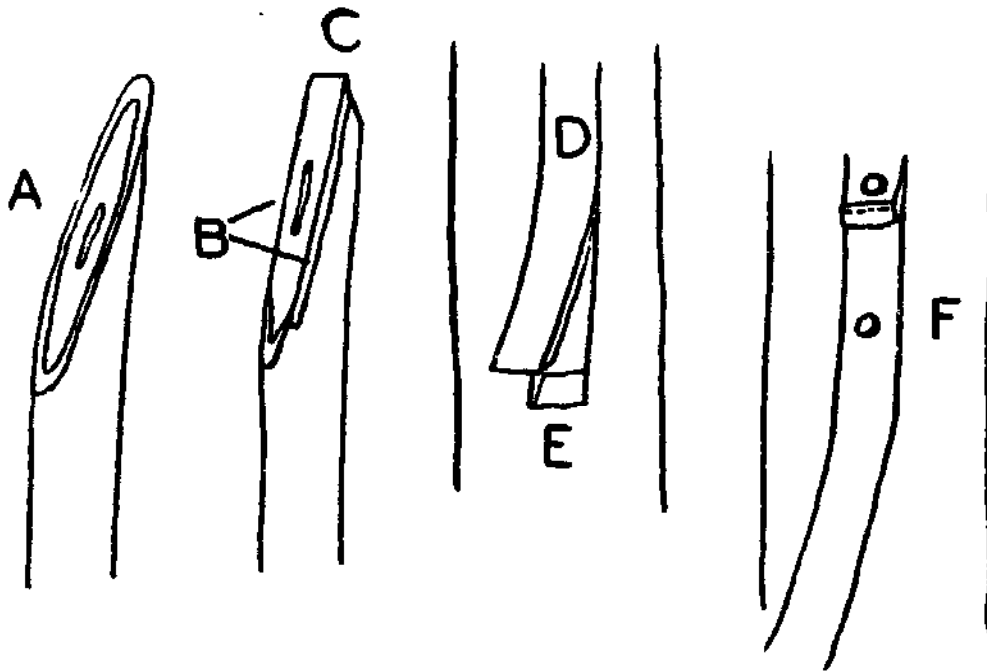

FIGURE 16

Rind inarching

Separation of successful grafts

As in the air layering process (p. 48), separation and transfer, via the nursery to the open field, should be done in stages. Approach grafts and inarches may take about two months to form a sufficiently sound union for safe separation, which should be a gradual process. Adequate support must be maintained throughout. First the scion is nicked an inch or so (2.5 cm) below the union. After one week this nick should be deepened, and one week later completely cut through and the 'tail' trimmed back close below the union. It is advisable to seal all cuts as they are made. At the same time the top of the stock should either be reduced by about half, or completely removed close above the union. The newly separated plants should be taken through the nursery as advised for young seedlings and newly rooted cuttings (q.v.).

GRAFTING — THREE

DETACHED SCION GRAFTING

Grafting with detached scions requires extra care in maintaining life in both scion and rootstock throughout the grafting process and until the composite plant is well established (see p. 84). Though it is thus more hazardous than approach grafting it demands less labour per graft and, by its relative simplicity lends itself to standardization essential in the exploitation of mass production techniques. The aim must be simplicity with efficiency. The methods now to be described are the basic methods used in the propagation of woody plants by grafting and adaptable for particular plant material and local conditions. Descriptions of those highly ingenious methods advocated to meet peculiar circumstances have been given elsewhere (8; 34).

Bud grafting

Grafting with a scion possessing only one bud, or a single cluster or eye of buds, and a small piece of the supporting tissue, not extending across the whole of the stem cross-section, is often termed budding, though it is really bud grafting. Most of the methods now to be described are rind grafts. Cleft bud grafting, not dependent on separating the rind from the wood, is exemplified by the chip method. In all these the scion is comparatively small and is best left attached to the scion-shoot and so carried to the stock for final manipulation.

Shield budding (T-budding). This method is sometimes known as T-budding, indicating the form of incision in the stock or, more rarely, 'inoculation' because the shield is inserted under the rind, or 'oculation' with reference to the implanting of an eye of buds.

Shield budding is most easily employed where the stock rind is pliant and not too thick to fold round the inserted bud. It is best done when the rind of the stock is readily separated from the wood. The scion bud-wood (bud-sticks) are usually taken from shoots of the current season's growth,

but where buds remain viable on older stems and branches these may also be used, provided they are not too large for insertion. Leafy shoots must be defoliated immediately after collection to reduce moisture loss. This is commonly done by removing the unripe tip of the shoot and cutting through the petioles of the lower leaves close to the shoot (see p. 99).

In the operation of shield budding (Figure 17) the stick of buds is held by the upper end and the first good bud nearest this is removed by a shallow slicing cut which begins half to one inch (1 to 2.5 cm) below the bud, passes under the bud and comes out well above it (A). The bud shield should contain a sliver of wood but should be quite thin and flexible so that it will bend to fit closely the curved surface of the wood of the stock and be neatly enfolded by the stock rind. If the knife blade is arrested before it quite attains the surface at the finish of the cut, and the removal of the bud patch is completed by tearing, the patch, or shield, will terminate in a long strip of rind which may be used as a convenient handle. This handle is cut off after bud insertion (H). The stock (B) is prepared by making a T incision (D) through the rind down to the wood. The rind is raised (E) and the bud inserted (F). The tail of the handle (H) is cut off exactly at the horizontal incision and the bud is firmly tied (see p. 94). The bud must remain firmly tied for two or three weeks and thereafter the stock must not be constricted.

Almost every separate movement in the act of budding has been modified to suit the operator's particular convenience or, less commonly, because such variations in techniques have proved more efficient. Some modifications have improved the take of buds in some areas and with particular species.

Removing the wood from the bud shield: Some operators remove the sliver of wood from the shield before insertion. In the method described above the shield is cut thin, but where the wood is to be removed a thicker shield is preferred. To remove the wood, bend the tail or handle of rind (Figure 17) to and fro so that the layer of wood separates from the thin rind in the tail.

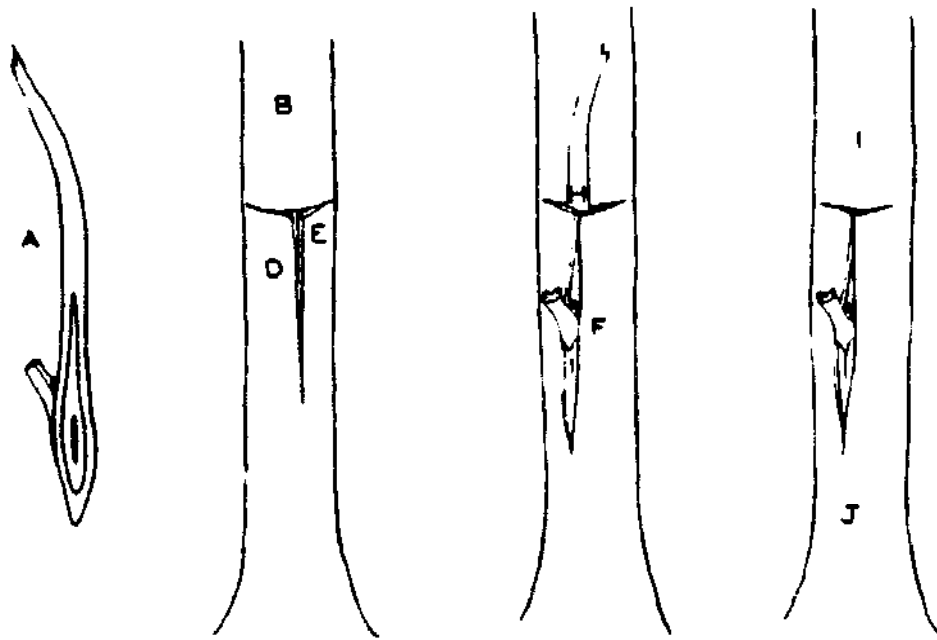

FIGURE 17

Shield budding

The bud (eye) prepared and inserted in the stock ready for tying. Refer to text for full description.

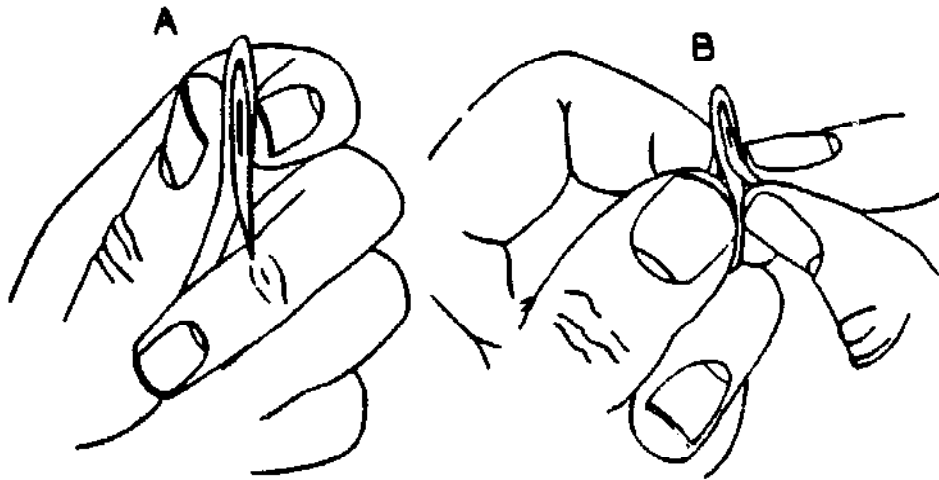

FIGURE 18

Removing the wood from the bud shield

Place the petiole or bud protuberance between the finger and thumb, with the cut surface uppermost, so that the tail lies along and in line with the thumb (Figure 18). The second finger grips the tail against the base of the thumb, and the sliver of wood is flicked upward and backwards, increasing the bending motion slightly (B) as it is about to leave the inner eye of the bud. The little knob (bud trace) should remain attached to the shield. It is not always vital that this should stay but it is generally considered that a hollow shield should not be used.

Inverted T incision: This has long been advocated for use in wet conditions to avoid the entry of water which may rot the bud, but efficient use of plastic or other modern waterproof wraps should overcome this tendency. The inverted T is traditional in the budding of citrus (63). Recent work (19) indicates that the horizontal cut used in the T incision impedes the access of descending growth substances to the bud whereas the inverted \perp does not and therefore helps to improve bud performance under certain conditions.

Inversion entails a different preparation of the bud shield which must now be held with the base towards the operator and the knife proceeds from above the bud downwards. The bud shield is drawn upwards beneath the rind; otherwise the technique is the same as for normal shield budding. With non-petioled bud wood it may prove more difficult to slide the bud under the rind. The tip of the knife may be used to draw the shield into its final position, but great care must be taken to avoid injuring the bud itself.

Patch budding. This is a simple veneering process in which a patch of rind, including a bud, is lifted from the scion and used to replace a patch of rind removed from the stock. There are many practical modifications, including the Forkert, flute and ring methods (see below). In all these success largely depends upon ready separation of the rind from the wood and good vegetative growth potential as seen in well-pruned scion-source material and in young actively growing rootstocks. Thus it is that the timing of the operation is so important, budding at the beginning of a major growth period being best. For ease of manipulation the stock and

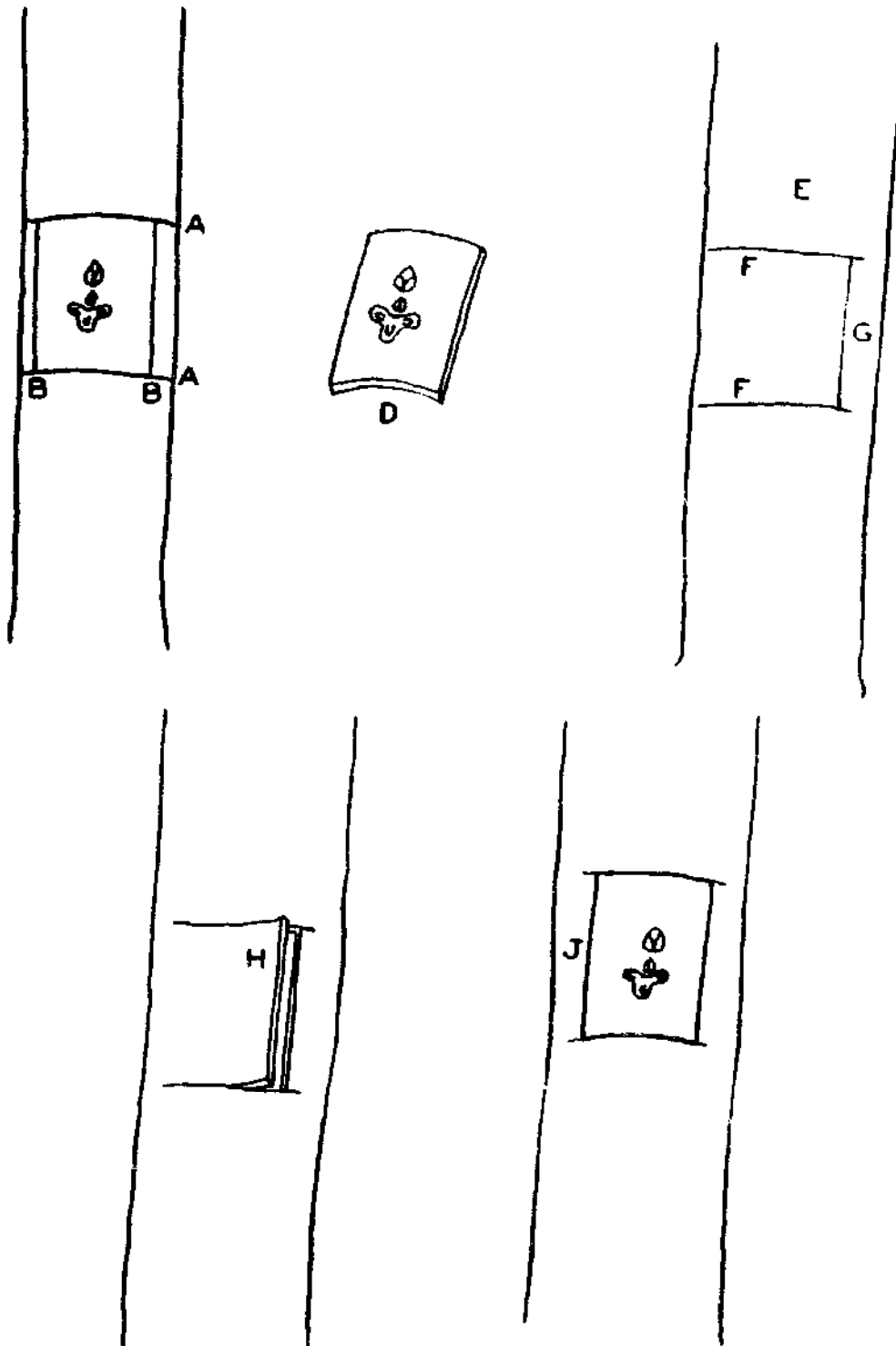

FIGURE 19
Patch budding

scion should be of approximately the same age and diameter and in such condition that the rind parts readily from the wood. When the rind of the stock is considerably thicker than the rind of the scion, the stock rind should be pared down so that, when in position, the scion is either level with or above the stock rind. This facilitates firm tying of the patch. By the use of a knife with two parallel blades (Figure 19), cuts are made horizontally round the budwood, through the rind above and below the selected bud. Two vertical cuts (B) made with a single blade connect the horizontal cuts, and the piece (D) containing the bud is removed. The stock (E) receives similar horizontal cuts (F) slightly longer than the width of the patch. A single vertical cut (G) enables the rind to be raised and peeled back (H) so that the bud may be placed in position. The stock rind is peeled back a distance equal to the width of the bud. A vertical cut (J) removes the surplus stock rind, and all exposed edges of stock rind and scion patch are in contact. Tying completes the operation. In some cases it appears to be advantageous to seal the exposed cut surfaces and to shade the bud by tying a young leaf to the stock above the graft so that the bud is covered and water running down the stock stem is diverted from the bud.

Flute budding. This is an extended patch used when it is required to interrupt almost completely connection between the upper and lower parts of the stock at the graft or to provide a sound embracing attachment early in the life of the graft. The scion is prepared (Figure 20) by making two parallel horizontal cuts (A) encircling the bud wood (B), through the rind down to the wood. One vertical cut (D) connects the two horizontal cuts and enables the bud on its ring of rind to be removed. If the horizontal length of this bud ring is more than sufficient to encircle some seven-eighths of the stock, it should be shortened by a vertical cut removing the required amount of surplus rind. This will avoid completely girdling the stock when fitting the bud patch and, if the bud patch dies, the head of the stock will be saved. Similar horizontal cuts (E) are made almost completely round the stock and a vertical cut (F) enables the rind to be raised from the wood. The vertical edge (K) of the rind patch carrying the bud is placed against the

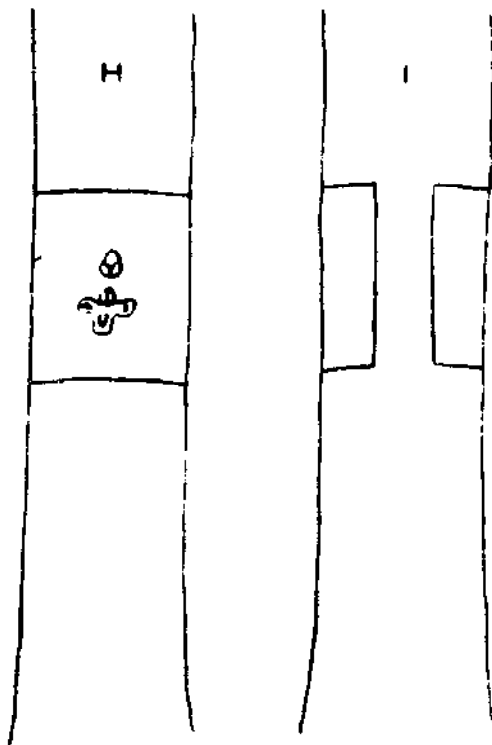
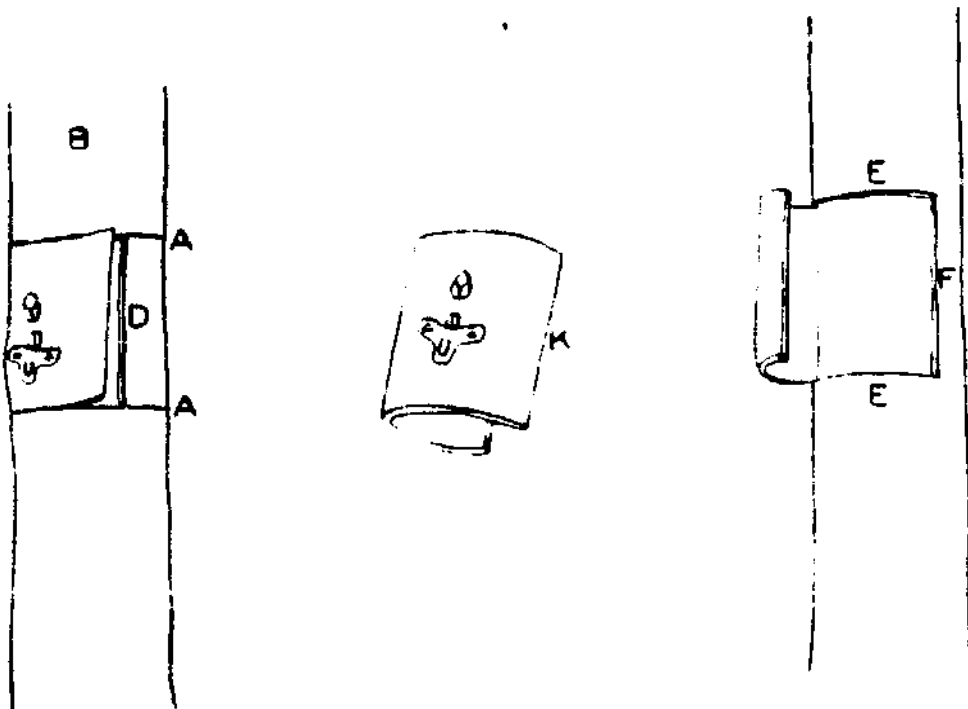

FIGURE 20
Flute budding

corresponding cut edge (F) of the stock. The rind of the stock between the horizontal cuts is then peeled back until the bud patch fits the stock. The raised rind of the stock is removed by a vertical cut to coincide with the edge of the bud patch. Opposite sides of a budded stock are shown at (H) and (I). Tying, sealing and shading complete the operation.

Ring budding (annular budding). This method is an extension of the flute method so that the stock is completely girdled by the scion and beyond this needs no further description. Should a ring bud fail to unite with the stock the parts of the stock above the ring eventually die.

Forkert budding (brown budding). Since its development in Indonesia, primarily for rubber (*Hevea brasiliensis*), this method has proved excellent for many widely differing species. Where, as in rubber, the subject exudes latex or resin when cut or bent, the method provides means of reducing the risk of exudates contaminating the grafting surfaces. This is achieved (see below) by keeping the rind of the bud shield unbent whilst removing the sliver of wood. The procedure is fully described in Planters' Bulletin No. 20 (1955), issued by the Rubber Research Institute of Malaya.

Well-developed budwood, brown in colour and leafless, is best collected on the day of budding. It is kept cool and protected from bruising by placing it in a container or soft wrapping. On reaching the nursery the budslips (patches) are sliced from the budwood by means of a sharp kitchen knife cloth-wrapped at its tip for use with both hands. Only a few slips should be cut at one time, to minimize drying time.

Stocks, preferably one or more inches (2.5 cm or more) thick at the budding position, and in active growth, should be wiped clean with a coarse cloth dipped in a fungicide dispersion (see p. 99) and allowed to dry.

When bud grafting rubber it is recommended that three cuts should be made through the stock rind, one horizontal of $\frac{1}{4}$ inch (2 cm) and from the ends of this two vertical ones three or four inches (8 or 10 cm) long, preferably on the shady side. A dozen or so stocks should be cut in advance of budding to give time for coagulation of the latex. Remove

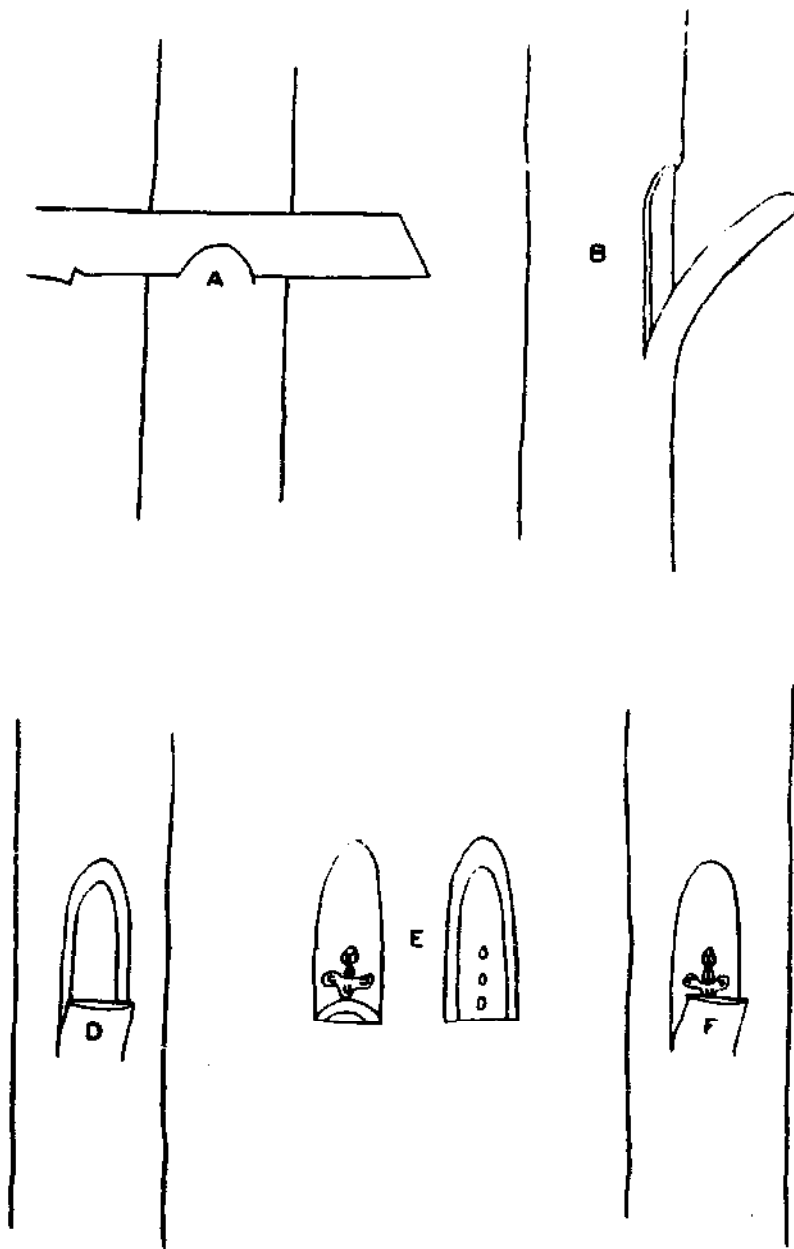

FIGURE 21

Forkert budding

the sliver of wood from the bud slip taking care not to bend the rind. This can be done by holding the slip tautly by each end and then grasping the sliver of wood with the teeth and bending it away, taking care not to touch or soil the cambial surface of the bud patch. If the bud-trace comes away with the wood the patch is best discarded. The de-wooded patch is placed on a clean board or work-box, cambium uppermost, and the edges trimmed to fit within the incised patch on the stock leaving a gap or frame of about 1/8 inch (0.3 cm). The stock flap is now lifted with the spatula end of the budding knife and the bud inserted without rubbing or sliding the cambial surfaces together. The flap is then closed over the bud and tied with either a bandage or palm frond slip and twine. To shade the bud from sunlight, a few leaves are tied above the binding so that they hang over the bud (24).

The details given here relate to an upward-pointing flap but the technique is equally successful using a downward flap.

After about three weeks the ties should be removed and the flaps cut away at the ridge formed near the attached end. In exposed situations the leaf shade should be renewed. Two or three weeks later the bud may be forced into growth by gradually reducing the top of the stock or by complete removal and sealing of the wound.

Working with plants other than rubber (Figure 21) some workers make only the horizontal cut (A) and then peel the rind (B) to expose the cambium. The rind may peel in one or several strips. Two thirds of the length of the flaps thus formed are removed (D). The bud (E) is cut to fit the stripped area and, after de-wooding, is placed partly beneath the remaining portion of the flap (F), taped and shaded.

Green strip budding. Following the wide success of the Forkert method, H. R. Huron in North Borneo developed a practical way of bud grafting rubber when in the young green-wood stage, using buds from a new flush on rootstocks 2 1/2 to 5 months old. It is essential that the buds should strip cleanly from the scion wood. Although this technique was specially developed for the somewhat difficult-to-bud latex producer *Hevea brasiliensis*, there is no reason why it should not prove

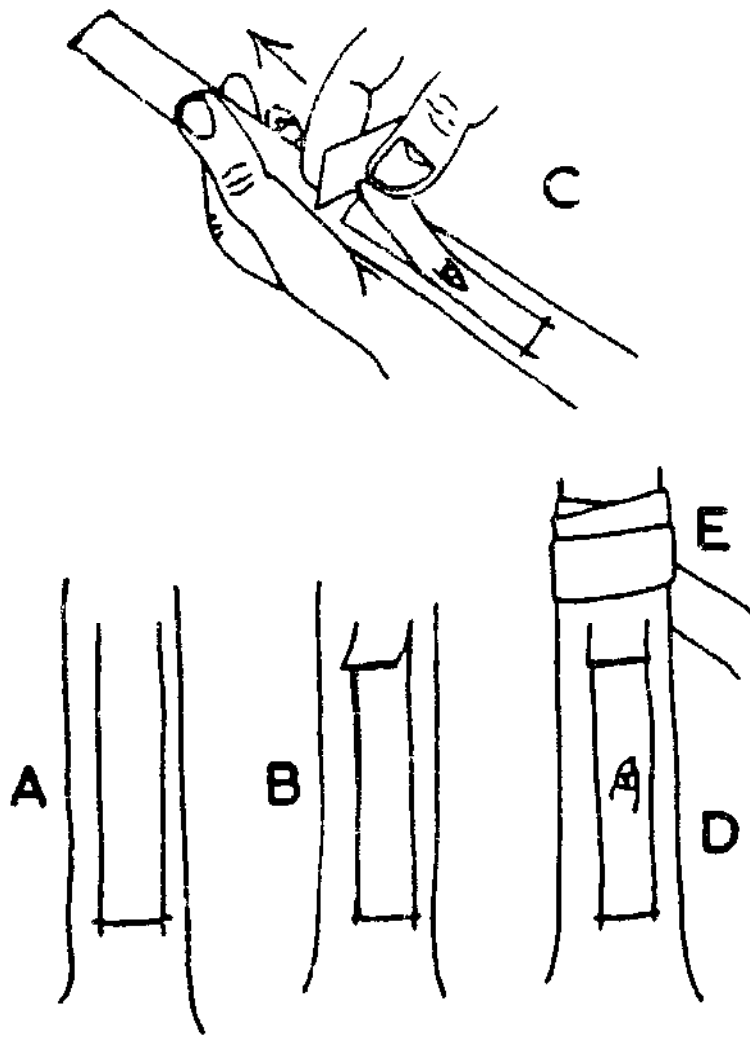

FIGURE 22

Green strip budding

A = Two vertical 3-inch incisions and one rolling horizontal incision in the stock. B = The strip pulled back and cut off, leaving a 1/4-inch flap. C = Corresponding cuts outlining the bud patch. The patch gripped between knife and thumb at its lower extremity and pulled (in direction of arrow) without bending and so placed in the stock panel. D = The bud-patch held by the flap and in edge-to-edge contact at its lower end. E = The plastic tie, held by two or three turns well above the patch, is spiraled downwards and half-hitched below the patch (see text).

successful with a wide range of tropical trees. Working with rubber, Hurov and Chong (62) issued a detailed description of the technique which was found successful and might well be adapted for other subjects and to particular local conditions.

Budwood sources are best established specially to provide successive flushes of green terminal shoots with semi-hardened but flexible stems, though vigorous growth flushes on mature trees are also suitable. Such shoots may be collected by grasping them by their leafy tips and pulling them off, so avoiding bruising the lower parts from which leafless bud patches are later to be stripped. If the rootstocks are established near the source of scions losses from bruising whilst in transit will be minimized. The leafy tops are cut off immediately after this shoot plucking. With rubber it is necessary to dip the cut ends about $\frac{1}{4}$ inch (0.6 cm) in molten wax to prevent contamination of the surface of the wood with latex. The defoliated budsticks should be placed in small ventilated bags of thin polyethylene inside containers, or other protective wrapping, and kept shaded and cool until used.

Suitable rootstocks for budding should be vigorous, have ripened (brown) basal bark and be from pencil size up to one inch (2.5 cm) thick. Two three-inch (8-cm) vertical incisions are made about $\frac{1}{3}$ inch (0.8 cm) apart a few inches above ground level and are connected at their lower ends by a horizontal rolling incision. The released strip is pulled gently upwards and cut off leaving a $\frac{1}{2}$ -inch (1-cm) flap and a two to three-inch (5 to 8-cm) long exposed panel. With latex exuders the budwood should have been collected at least 4 hours previously. Incisions two to three inches (5 to 8 cm) long are made on either side of the bud about $\frac{1}{3}$ inch (0.8 cm) apart and cut above by rolling the stick against the knife. A similar cut is made two to three inches (5 to 8 cm) below this, the patch gripped between knife and thumb and gently pulled off without bending it. Bruised or otherwise damaged patches should be discarded. The healthy patch, held as indicated (Figure 22), is inserted, gripped by the flap remnant and in close edge-to-edge contact with the lower cut on the stock. Binding should begin a little above the patch and flap and proceed spirally downwards with adequate overlap, taking care by finger pressure that the patch does not slip sideways whilst binding. Bud grafted plants should be cut to about three inches (8 cm) above the bud some two weeks after budding.

Chip budding (plate budding). There are many variations but it would seem that none of the more complex techniques is superior to the very simple chip method which so perfectly provides good cambial contact and is so easily anchored by simple tying or taping. Since the simple method now to be described is a cleft graft it may be used over a longer season than a rind graft (72) and, provided the scion-chip is properly sealed against drying, it may succeed at almost any time. It is an ancient method but only recently (61) has it been proved superior in performance to commoner techniques including shield budding with or without T incisions, and is now being used for a wide range of species of fruit, ornamental and forest trees. Those who are not yet acquainted with the method would do well to try it.

The stock is wiped clean, as with other methods. Standing over the stock (D), with the budwood in hand, a cut is made downwards in the side of the stock with the knife held horizontally so that the bottom of the cut, though curved where it begins, is horizontal at its base (58). A second cut, one or two inches (2.5 or 5 cm) long, judged to fit the bud shield, is made downwards to meet the first and the piece of stock so released is discarded. The budwood is then held with its base towards the operator and is given a horizontal cut (A) about $\frac{1}{4}$ inch (1 cm) below the bud, and a second cut (B) starting an inch or so (2.5 cm) above the bud to join the first, thus releasing a bud-chip (C) to fit the prepared stock (D). The chip is held by the stock flap (E). The stock rind is usually found to be somewhat thicker than the chip rind and a margin or layer of the outer rind of the stock should be left visible to ensure that the cambia or inner edge of the rind of both stock and chip coincide. This is not necessary when a thin stock is used as in (F). Some operators prefer to cut the scion bud first and then to cut the stock to fit the scion. Very firm tying is particularly important for this cleft method, along with perfect sealing with plastic or waxed tape. Twine or thread ties should be lightly sealed with a coating of wax. It may prove inadvisable to tie over the actual bud, particularly when it is very prominent, otherwise complete covering with thin plastic strip such as one inch- (2.5- cm) wide 200 gauge polyethylene may improve bud take. Shading, as described for the Forkert method, is advisable in exposed situations.

Chip budding in the cotyledon stage. Because the simple chip budding technique described above is readily accomplished

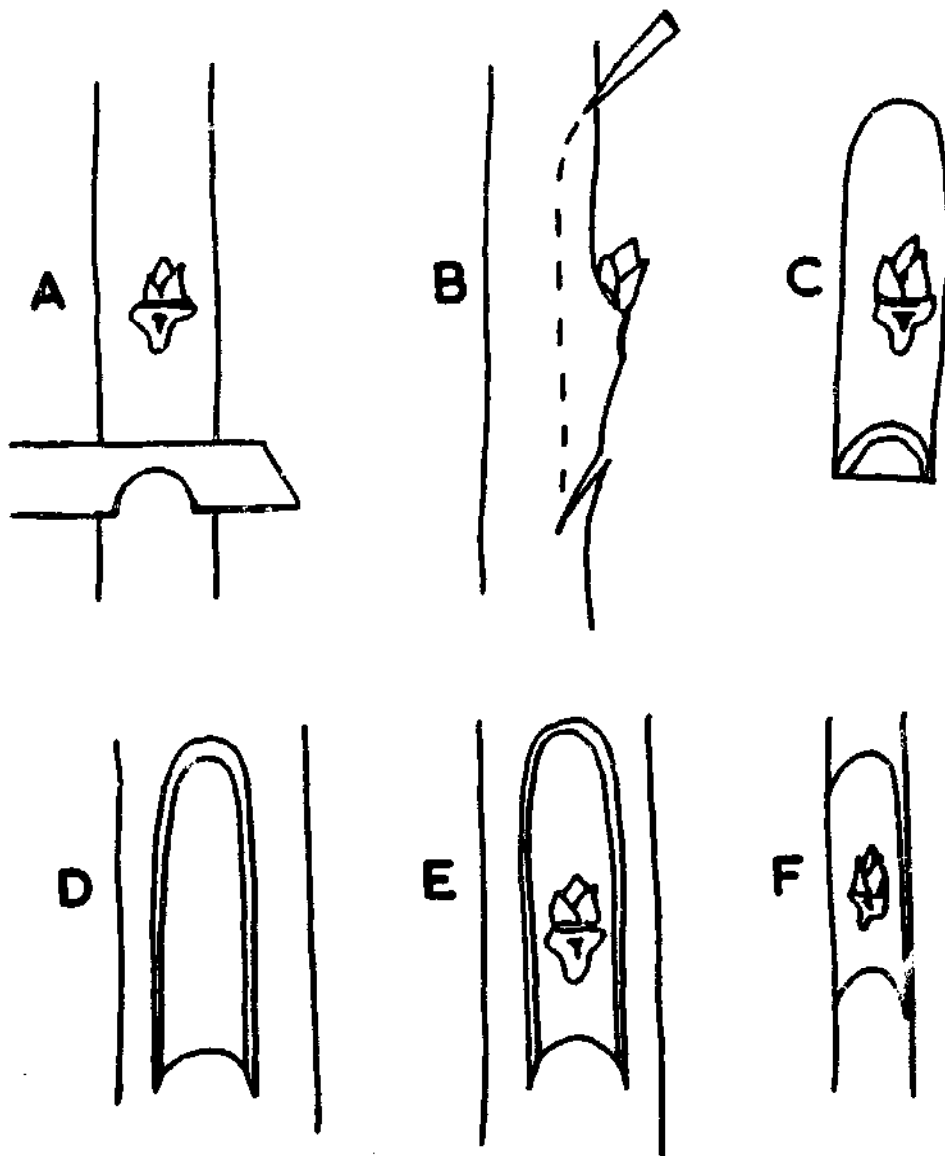

FIGURE 23

Chip budding

by smooth flat cuts with a razor or thin sharp knife, it is excellent for grafting soft active tissues. Provided the tissue has developed beyond the 'watery' stage, so that it maintains its structure when cut and placed together, the earlier it is grafted the sooner will union take place, given reasonably adequate horticultural attention, notably shading and irrigation. Indeed, whenever it is found that tissues of woody plants are slow to unite, or when united the bud is slow to develop an adequate shoot in a reasonable time, it is worth trying bud grafting at a much earlier stage in the life of both the stock and the scion shoot which is to provide the bud. Examples of this are the 'pink stage' budding of mango (74) and the green chip budding of guava (64). Costs of production of bud grafted mango trees were markedly lowered by grafting three-week-old seedlings still in the succulent red stage with buds of selected cultivars taken from terminal shoots in the last stages of pink stem, the shoots being no thicker than 3/8 inch (2 cm). Thicker material gives too large a chip for use on young stocks.

Some two weeks prior to grafting, the leaves are closely cut from the bud-wood shoots, leaving only two leaves at their tips. This remaining piece of petiole will abscise and the bud will swell. Each shoot should yield from five to eight usable buds. The normal chip budding technique (Figure 23) is used, taking particular care not to bruise the tissues. Workers in Florida (74) recommend wrapping the graft completely with one and a half turns of two inch (5 cm) - wide very thin polyethylene and binding over this with rubber strip. Two weeks later the binding and covering is removed, and one week later still the stock is cut down to three leaves above the graft. When the bud has grown three or four inches (8 or 10 cm) the head of the stock is removed close to the bud and the wound is sealed. The season for budding at this early stage depends on the availability of germinating seed.

Inlay chip budding. Also described as veneering with green shoots, this method has been used for budding tea (25) and may be of use with some tropical fruits (Figure 24). The scion is simply sliced from the shoot, with its leaf attached, and squared at both ends (A). The leaf-blade should be considerably reduced to check drying. Two parallel cuts, just as wide as

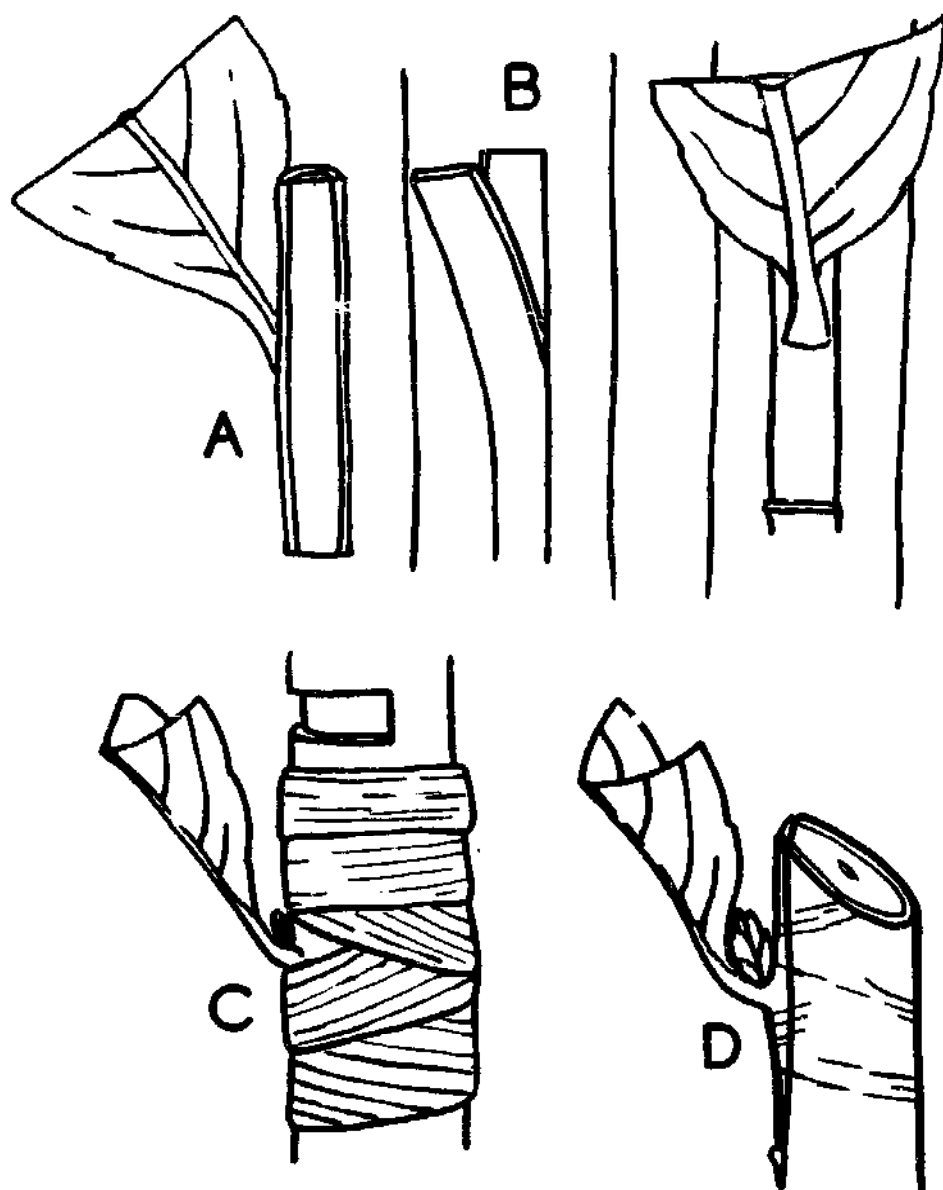

FIGURE 24

Inlay chip budding

the scion and connected at the top, enable the rind to be lifted and peeled downwards. The scion is placed in this cavity and the peeled rind cut off level with the base of the scion bud. Waxed cloth, or polyethylene strip, is used for binding and all exposed cut surfaces are sealed. After ten days a healthy half-leaf denotes success. A strip of rind (C) is now taken off the stock above the graft. After another ten days, when the bud begins to swell, the head of the stock and the bandage are removed.

Aftercare of bud grafts. Bud grafting normally entails the positioning of the scion relatively low down on a rootstock in active growth, particularly from the stock's extremities. Most tree species exhibit a powerful apical dominance so that growth from the newly placed scion-bud is suppressed. Only by removing or checking the upper dominating growth can the scion be forced into activity and so become the trunk and branches of the new tree. But first the new bud must be given every opportunity of uniting with the stock. Good horticultural care should be continued in the form of cultivation, disease control, wind protection, shading and irrigation. After a few weeks, inspection may reveal that the bud has united with the stock and that the ties are tending to constrict. The ties should be released and either removed entirely or lightly replaced for a further period until the union is fully secure. Any sucker growths may be removed at this time. The growth of the stock above the bud should not be reduced by pruning until the time comes to force scion growth. If in doubt as to the stage at which the bud should be forced, some propagators merely bend the stock over and tie it down to a neighbouring plant or peg so that the bud is positioned at the top of the bend, thus acquiring apical dominance. Then, when the bud has developed into a shoot, they gradually prune back the stock close to it. This technique ensures a continuing food supply to the roots during scion bud development. Another means of bud forcing is to brut (half-break or snap-over) the shoots to remove their dominance but retain their growth contribution, cutting them right away later. New buddings may also be forced by removing a ring of rind from round the stock immediately above the inserted bud. Half-rings on the budded side often attain the same end without destroying the upper part of the stock.

Throughout the period when the scion bud is first extending and the top of the stock has just been removed the budlings are particularly vulnerable to damage. Temporary supports for the new tender growths also serve as guards. The simplest form of support is provided by cutting through the stock some four or five inches (10 or 13 cm) above the bud leaving a snag to which the new growth is carefully looped, allowing space for rapid expansion of the young growth. If the stock is cut through close above the bud the new growth may be left unsupported but a protective stake is often found worthwhile. Bamboo shields obtained by cleaving four inch (10 cm) - diameter bamboo to form half-rounds and pointing them for driving in to half-surround the young shoot have proved excellent both for protection and the encouragement of erect growth. When the stock is cut-over it is advisable to dress the cut with a protective paint to prevent desiccation of the tissues close to the bud and the entry of disease organisms. Where a snag is left to support the new growth this is removed either after the first flush or when it is considered that the new growth has hardened sufficiently.

Apical grafting

Apical or end-to-end grafting takes many forms. As in all grafting the basic essentials must be met, including that of anchorage of the parts, and in these end-to-end methods the simplest way to achieve this is to provide a good overlap of each on the other, as in splicing or whipping. Although it may be possible to obtain cambial contact by abutting stocks and scions of equal diameter, anchorage is then only obtainable by means of artificial splints, entailing extra labour and expense. It is far better to use overlapping, self-holding methods such as the splice, whip-and-tongue, strap and wedge.

Splice graft (whip graft). A long slanting cut (A) is made at the basal end of the scion (Figure 25). A corresponding cut (B) is made at the apical end of the stock. The cut surfaces are placed together (D) so that the cambial regions (C) are in contact. Stock and scion are bound together and the cut surfaces are sealed.

A plain splice, such as this, must be held together whilst tying; hence it is not a convenient method for use at ground level but only for bench or pot work, or high working, where the same person does both cutting and tying. The following whip and tongue method has not these limitations.

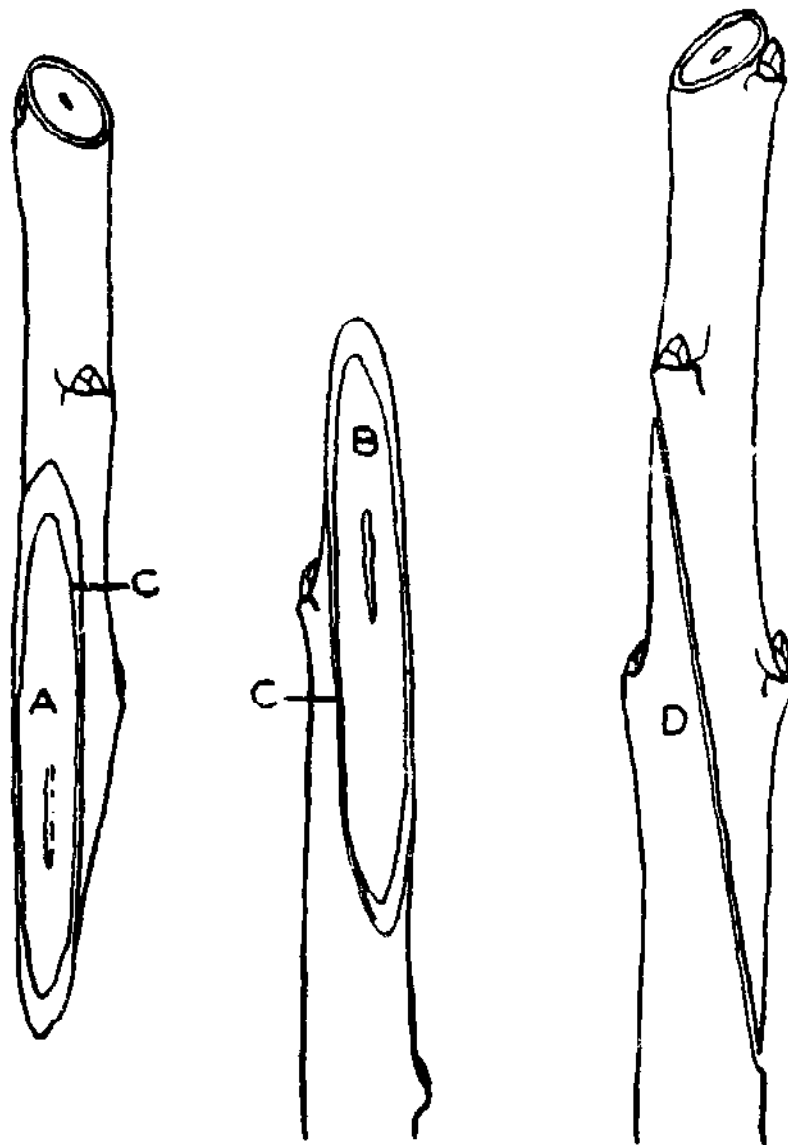

FIGURE 25

Splice graft (whip graft)

Whip and tongue graft. This method is most suitable when the scion and stock are comparatively small, not more than one inch (2.5 cm) in diameter. It is similar to the splice graft except for the tongue which serves to hold stock and scion together, so that the operator has both hands free for tying, or so that the fitted graft can be left for an assistant to bind and seal.

Whip and tongue grafting (Figure 26) is used to best advantage when stock and scion are of equal diameter. A flat slanting cut, the length of which is about six times the thickness of the scion, is made at the basal end of the scion. A downward-pointing tongue (A) is made in the apical half of this slanting surface. A slanting cut, corresponding in length to that of the scion, is made upwards through the stock. An upward pointing tongue (B) is made in the apical half of this slanting surface. The cut surfaces of the scion and stock are placed together so that the tongues interlock (D) and the cambial regions (C) are in contact over as great a length as possible. If the stock is considerably larger than the scion it is advisable to take only a comparatively shallow slice off the stock (E) so that the cambium of the large stock coincides with that of the smaller scion (F) and the cambia at the top end (G) are well matched to promote a complete, non-splitting union by subsequent formation of callus.

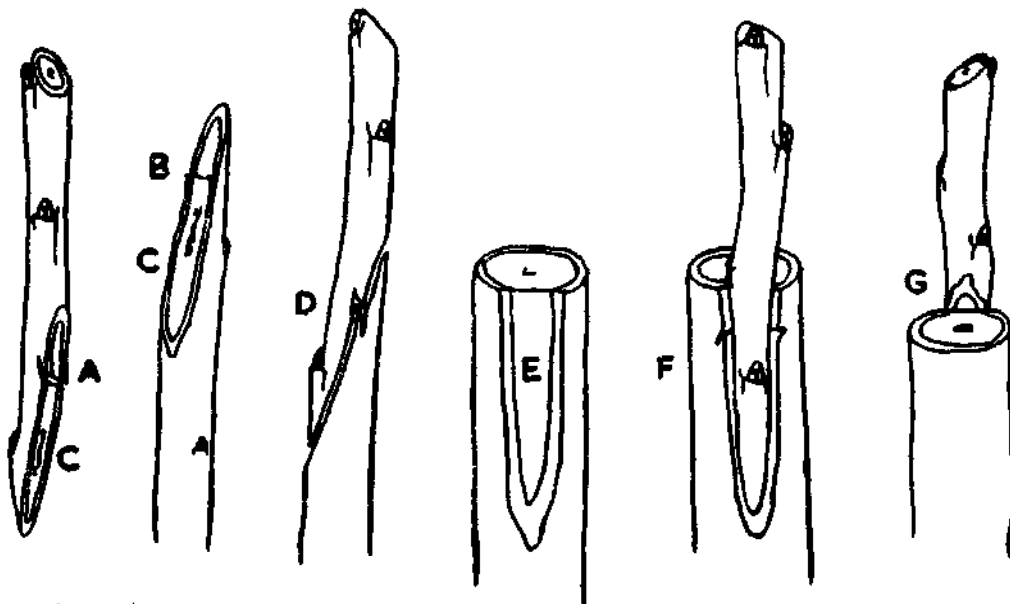

FIGURE 26

Whip and tongue graft

When beheading a thick stock to receive the scion the transverse cut is normally made horizontally (as depicted) so that the tie of twine or similar material may extend to the top of the stock without slipping, so holding the scion firmly against the edge of the transverse cut. But if wide tapes of polyethylene or waxed cloth are used, the top cut should be sloped about 45° to facilitate neat wrapping and sealing of the top of the stock.

Double tongue graft (big tongue graft). With subjects which have a large pith this method often succeeds where others fail. Well-ripened, solid scion-wood, found at the base of the past season's growth, preferably already de-leafed naturally or following petiole severance, makes the best scions (Figure 27). It may be well to collect the scion-wood along with a short length of older wood attached, so that the true base of the shoot may be freshly cut to form the base of the scion.

The scion (A) is prepared with a strap (B) made by cutting upwards, from below a bud, slightly into the wood, but not as far as the pith. A long slanting cut right through the scion-wood is made (C) from a little above the level of the upper end of the strap to just below the lower end of the strap. The knife is now inserted backwards in the cleft (D) and brought downwards to straighten the 'big tongue' (E). The slender tip of the strap, containing no cambium, is cut away by a slanting downward cut.

The stock is cut transversely, preferably in the region of the hypocotyl or root, where the cross-sectional area of the pith is minimal. A slice is then taken off the side, so that the cambium is exposed to fit the inner surface of the scion strap. A deep cleft (G) is now made, beginning one-eighth of an inch (0.3 cm) from the top of the slice and ending level with its base. The scion is now fitted and a small piece of stock rind is raised to cover the exposed cambium at the base of the scion strap (H). The graft is tied firmly with stout twine and all cut surfaces are carefully sealed.

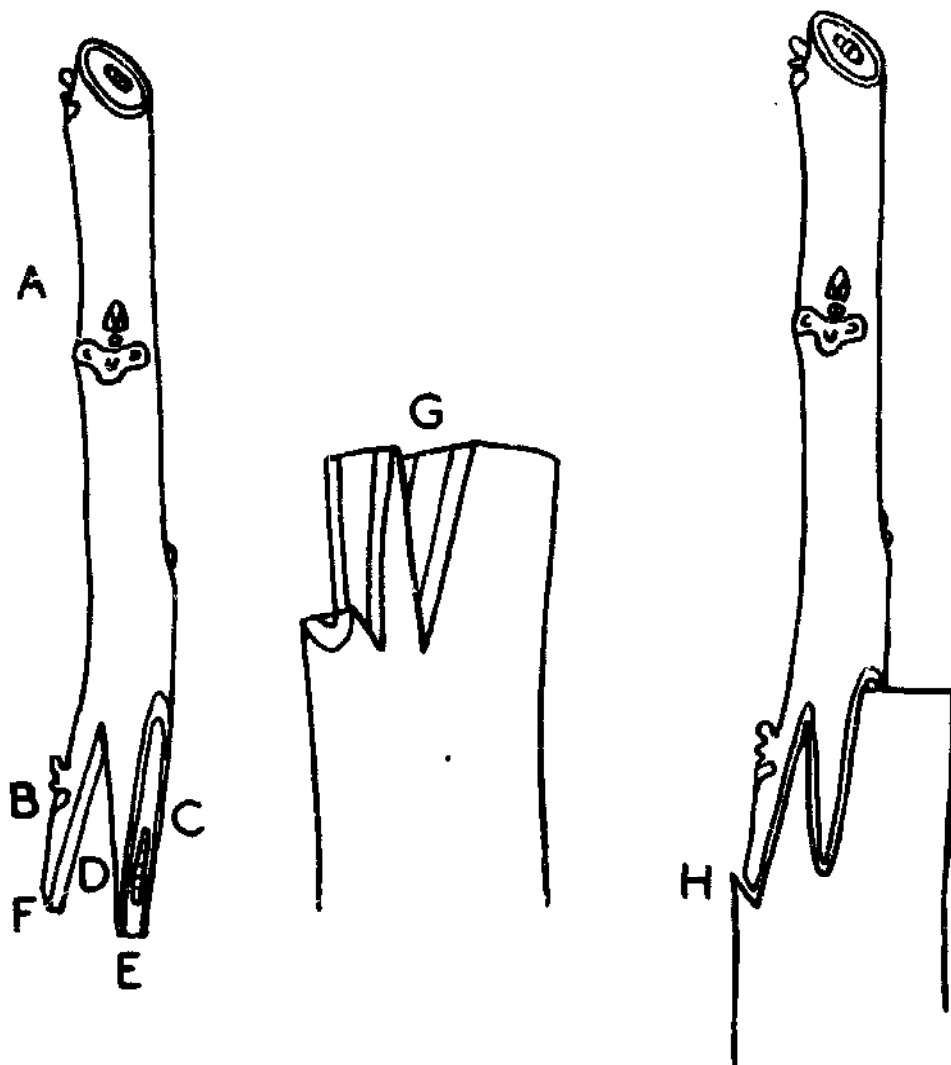

FIGURE 27

Double-tongue graft (big-tongue graft)

Strap or saddle grafts. These grafts form extra strong junctions due to the scion grasping both sides of the stock and they also rapidly form a well healed union. They have long been advocated for bushy evergreens subject to storm stress. Many techniques have been devised but all are modifications of straps or saddles.

The strap method is virtually a saddle with unequal sides devised for grafting a small scion to a somewhat large stock. The scion is prepared (Figure 28) by first raising a strip of bark (A) with a small amount of wood upon the scion-wood opposite a bud (B). The knife is reversed and a slanting cut as long as or longer than the strap is made through the scion wood to a point an inch or so (2.5 cm) below the bud. A tongue (C) is raised midway along this second cut surface.

The head of the stock is removed by a long slanting cut (D), and a second but shallower cut (E) is made on the opposite side to form an upward-pointing unequally sided wedge. A tongue is raised up on the surface of the first cut on the stock to correspond with the scion tongue. Stock and scion are fitted together (F) and firmly tied, and the cut surfaces are sealed. Where the stock is much greater in diameter than the scion, as in topworking established trees (q.v.), the strap is made correspondingly longer and the tongue is usually omitted.

For saddle grafting, the stock and scion should be about the same size. The scion is prepared by cutting upwards through the rind and into the wood on opposite sides of the scion piece. The knife should penetrate more deeply into the wood as the cuts are lengthened and, before the knife is withdrawn, turned as sharply as possible towards the middle of the scion, so that the middle portion may be removed and the scion (A) have the required saddle formation (Figure 29). The stock (B) is cut transversely and receives two upward cuts (D) on either side, sufficiently deep to expose the cambia so positioned as to match those in the saddle of the scion. The apex (E) of the stock is shaped to fit the saddle. Stock and scion are fitted together, firmly tied and sealed.

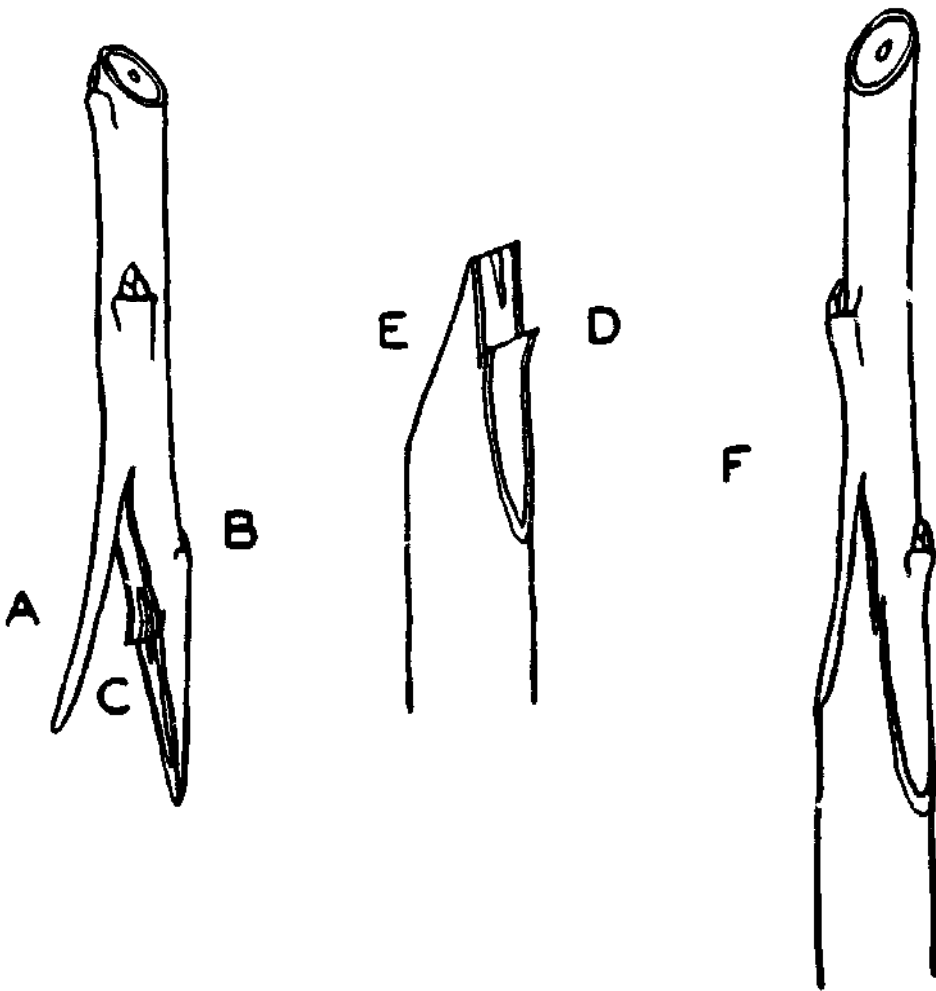

FIGURE 28

Strap or side-saddle graft

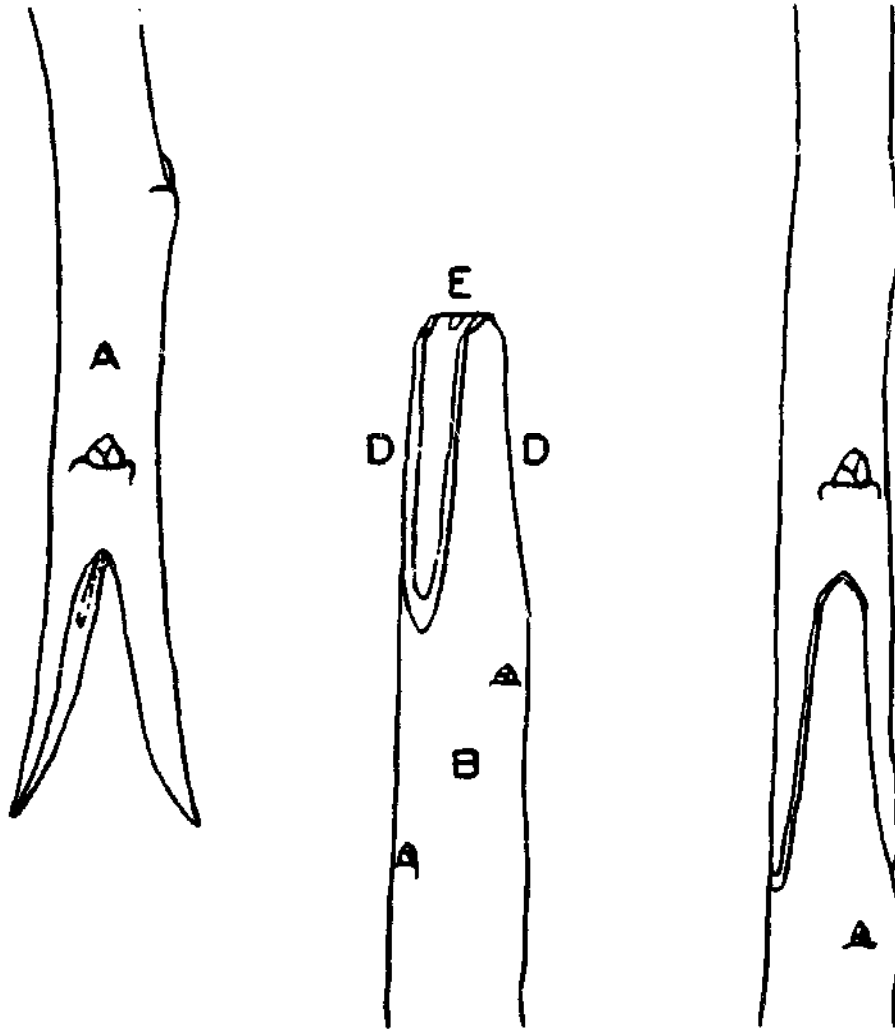

FIGURE 29

Saddle graft

Wedge or cleft graft. In its simplest form this graft is an easy way to join scions to whole, or pieces of, root and is commonly used to multiply rootstocks vegetatively which are difficult to root from cuttings (see p. 54). It is also eminently suitable for grafting tender herbaceous material whilst in the cotyledon or terminal growing point stage (34). Wedge grafts, of many kinds, are also employed in the grafting of woody subjects as met with in topworking mature trees (q.v.). The scion may be of the same or less diameter than the stock. As with all cleft methods it is vitally necessary for the operator to ensure that the cambia of stock and scion are placed in intimate contact and clamped together firmly, either by the stock itself or by a peg, clip, adhesive tape or strong tie.

The scion (A) is prepared with its basal end in the form of a wedge (Figure 30). The stock is split at its apical end (B) and the scion inserted so that the apical portions (C) of the cut surfaces of the scion are just visible and at least one side of the cambia of stock and scion is in contact. The graft requires tying and sealing, except where it is possible to obtain a union by placing it in moist material.

Oblique wedge graft. This graft can take the place of the popular whip and tongue graft in favourable circumstances. The scion is prepared (Figure 31) with its base in the form of an unequally sided wedge (A). The scion should be as short as practicable and it is usually necessary to prepare the base of the scion before separating it from the scion-wood in order to grip the scion whilst cutting. The apical bud (B) and longer basal cut should be on the same side of the scion. The stock is cleft in the side (C), no deeper than the middle, and is pressed aside to open the cleft (D). The scion is inserted with its longer cut towards the stock and its apical bud uppermost. The stock is then released and cut off close above the inserted scion (E). The graft should be well sealed with a hard setting wax. This graft needs no tying.

BIBLIOGRAPHY

1. ALDHOUS, J.R.(1972). Nursery practice. *Bull. For. Commiss., London*, 43.
2. ANON. (1955). *Plant. Bull. Rubber Res. Inst. Malaya*, 20: 83-8.
3. ARGLES, G.K. (1937). A review of the literature on stock-scion incompatibility in fruit trees, with particular reference to pome and stone fruits. *Tech. Commun. imp. Bur. Hort.* 9.
4. ARGLES, G.K. (1969). Root formation by stem cuttings. I. Successive stages. *Nurserym. Gdn Cent.*, 148: 651-8.
5. AUDUS, L.J. (1959). *Plant growth substances*. Leonard Hill, London, 2nd Ed.
6. BAKER, K. F. (1957). The U.C system for producing healthy container-grown plants. *Manual Calif. agric. Exp. Stat.* 23.
7. BALDINI, E. and MOSSE, B, (1956). Observations on the origin and development of spnaeroblasts in the apple. *J. hort. Sci.*, 31: 156-62.
8. BALTET, C. (1910). *The art of budding and grafting*. Crosby Lockwood, London.
9. BARTON L.V. (1961). *Seed preservation and longevity*. Leonard Hill, London.
10. BAYLEY BALFOUR, I. (1913). Problems of propagation. *J. roy. hort. Soc.*, 38: 447-60.
11. BEAKBANE, A.B.(1969). Relationships between structure and adventitious rooting. *Proc. int. Plant Prop. Soc.*, 19: 192-201.
12. BENNETT, M.(1972). Epidemiology - infection in the nursery. *Rep. E. Malling Res. Stat. for 1971*, p. 118.

Windbreaks, by checking wind speed, have a number of good effects. They lessen wind battering of the leaves and fruits, they increase pollination by encouraging insect visitors, they reduce evaporation from the soil and transpiration of the plants and, to a small degree, increase air humidity. Living windbreaks should be composed of well anchored tall trees, preferably leguminous, augmented with shrubs on the windward side, so spaced as to allow part of the wind to pass through at reduced velocity to produce a cushioning effect to leeward and an increase in the distance that is effectively sheltered, which may amount to some 20 times the height of the windbreak and to have some effect up to double that distance.

Maps and records

A precise scale map of each plantation is useful though not essential, but without adequate records of the material planted, including its name, age and origin, future planning for further development may be gravely handicapped. A readily available master plan should be kept in a safe place and a notebook or file, containing details of the many items and occurrences connected with the project, should be maintained. A separate strongly bound pocket book available to the man in the field should contain, in headed column form, all necessary data for row and tree identification. Individual tree labels, or indelibly coloured or code-shaped tags, are helpful to both field workers and visitors but they are of less importance than maps and written records.

The manuring of young trees is simply accomplished by scattering fertilizer round each tree over an area roughly corresponding to the spread of the root system. Thus, at first, application over a circular area of about one foot (30 cm) radius is normally adequate, this area being increased as the trees develop.

Protective paints

If the newly planted tree has a bare stem exposed to the sun some damage may result from excessively high temperatures. Plants are particularly vulnerable because of a reduced sap flow combined with the increased exposure on leaving the shady and moist nursery environment. The day temperature of exposed stems may be lowered considerably by a coating of whitewash or of a white water-emulsion paint such as is commonly used for interior decoration.

Deblossoming

Some young trees flower soon after transplanting. This early flowering, occasionally followed by fruiting, is mainly at the expense of vegetative growth which is so essential for the development of a strong basal framework to the tree. The inflorescence should be nipped or cut off immediately it emerges, the process being continued until the new growth is well established (111).

Fencing and windbreaks

A strong woven-wire fence, with barbed wire at the top, may be effective against both animals and trespassers but its initial cost is very high. If wood posts are used they should be thoroughly treated against termites and rotting. Hedges are less expensive initially but need much maintenance if they are to remain effective. Strong thorny hedges are often advocated, but all hedges tend to develop holes in their lower parts as they mature. A combination of a simple barbed-wire fence with an inside thorn hedge is probably ideal. Merely to exclude animals, strands of barbed wire fixed to trees at the edge of the clearing may suffice.

Early management of the plantation

A newly established plantation will have large areas of its soil exposed, and this soil will need to be shielded from direct sunlight which raises soil temperatures and increases the rate of decomposition of organic matter (122). Exposure to the direct impact of rainfall breaks down the soil structure, seals the surface, reduces penetration and increases run-off and erosion. Even on flat land a sealed surface increases water loss by evaporation. Until the tree crop has developed to form a more or less closed canopy, some intimate soil protection should be provided. The nature of this protection will depend on the local rainfall and irrigation facilities and by the feasibility of growing cash or green-manure cover crops. In areas of sufficient rainfall it may be possible in the early years to grow cash crops between the trees or some ground cover creeper. Such plants should not be grown close to the trees and so compete with them and they should have their own manurial programme.

Ground cover plants not only protect the soil against erosion but also provide leaf litter and dead roots to improve the physical condition of the soil, raising the base exchange capacity, releasing minor elements and plant nutrients which subsequently become available to the tree crop.

Where rainfall is sufficient a natural regeneration of weeds, controlled by frequent slashing, may accomplish the necessary soil conservation, but where rainfall is inadequate periodic cutting of weeds cannot be recommended owing to competition for water (95). The best procedure in the drier areas is mulching with grass, brushwood or vegetable trash.

Mulching aids the infiltration of water and improves and conserves soil structure. Mulches are best applied immediately after planting, at the beginning of the rainy season. An ideal mulch is one that is readily penetrated by rain, retains its form through the season and can eventually be cultivated into the surface soil; later to be replaced with a further mulch. The mulch can safely be sprayed with herbicides to check the regeneration of weeds.

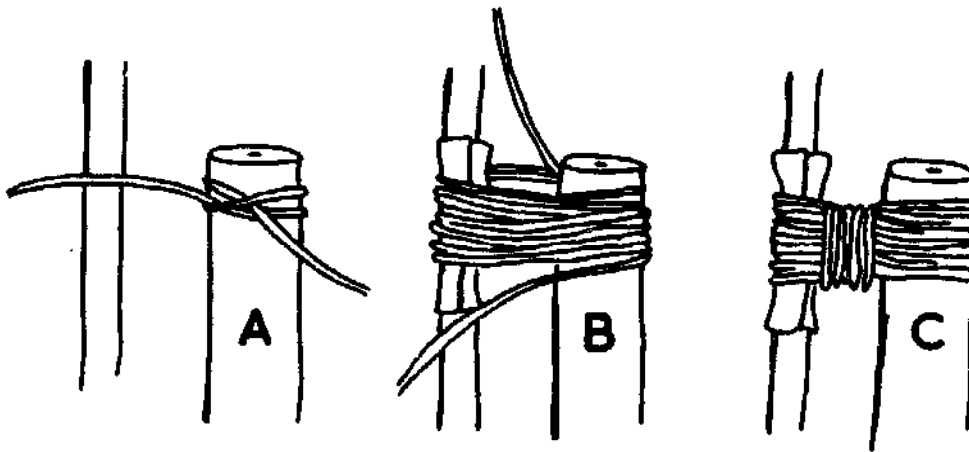

FIGURE 48

Tree staking

A = A clove-hitch near the top of the stake. B = Cord loosely encircling stake and tree protector. C = Cord wound tightly round encircling tie to keep stake and tree apart.

Many kinds of tying material may be used. An efficient and economical method is to place a small sheaf of palm, or a few strips of sacking, round the plant stem between plant and stake, and then a length of coir string or thin rope somewhat loosely round both tree and stake, then over and over between stake and tree to form a separating pad. As the tree grows the tie tightens and then, if support is to continue, it must be adjusted or replaced.

A mulch of straw, fern fronds or leafy branches should be laid round each plant, taking care to leave uncovered a few inches round the stem of the tree to prevent the base becoming excessively wet and prone to attack by disease organisms and to discourage small rodents from chewing the bark. If hot sunny weather is prevalent some small leafy boughs, palm or banana leaves should be stuck around each plant to provide partial shade and protection from drying winds.

PLANTING OUT

One of the most important factors making for high productivity in modern plantings is efficient transplanting and early care of the young trees (122) in order to obtain a full stand of plants that grow vigorously and reach the productive stage as quickly as possible.

The beginning of the rainy season, or immediately before, is generally considered the best time to plant. The site having been prepared and marked out, the tree holes or pits should be dug. In reasonably good soil there is no advantage in making the holes larger than will accommodate the plant roots. When transplanting from seed-beds or lines, the plants, whether previously undercut or not, should be well watered a few hours before lifting to aid the retention of soil around the roots. If possible, each plant should be lifted with a ball or cube of soil and placed on a square of polyethylene or sacking which is then wrapped round to hold the soil in place and reduce drying whilst in transit to the plantation. Containerized plants should likewise receive a thorough irrigation prior to moving. During transit both balled and containerized plants should be closely shaded with cloths or a canvas tilt.

Planting depth should approximate to the soil level in the nursery. Firm planting should be the rule by treading when the planting hole is about half filled and again when full, finishing off with an inch or so (2.5 cm) of friable soil. The plants should be well watered, preferably before topping-off with the friable soil. If stakes are required these may be either driven into the base of the planting pit before placing the plant, or driven in after planting. When tying the plant to the stake care must be taken to prevent the plant stem rubbing on the stake by placing the upper tie close to the top of the stake (Figure 48).

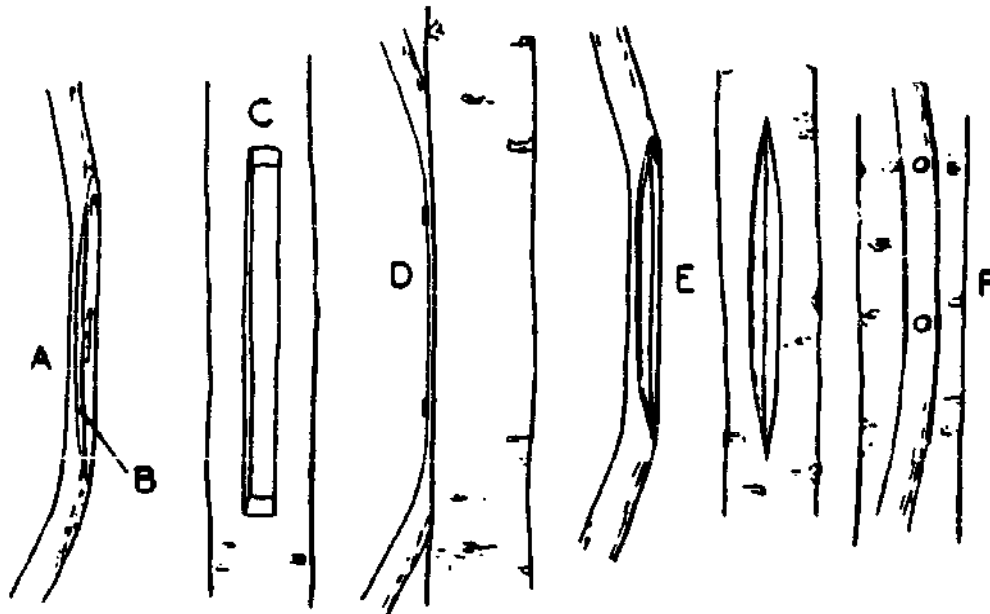

FIGURE 47

Inlay approach graft

A = The smaller component prepared by one main slicing cut and two very small straightening cuts (B). C = The rind of the larger component removed from between two parallel incisions. D = Fitted and held by two small nails. E = Method used when rind does not separate readily from the wood. F = Laid in and nailed.

branch, preferably already inclined somewhat towards the branch to be grafted to it, is pulled down and across to pass alongside and beyond the recipient branch so that, as nearly as possible, it forms a triangle with the two limbs. Two parallel incisions are made in the limb, extending slightly round it, just as wide as the lateral is thick, and the rind between is peeled away. A slice is removed from the lateral, corresponding in length to the strip of rind removed. The sliced lateral is placed in this rindless channel and there fixed with three or four thin nails. The lateral should be slightly bent round the limb but for not more than one fifth of the limb's circumference, otherwise the lateral may snap. This slight bend forms a much stronger graft than a straight junction. The graft should be sealed and the part of the lateral extending beyond the junction should be left until a sound union has been established.

Tree invigoration by approach grafting. Where the use of unsuitable rootstocks or damage to the roots has resulted in stunted trees, it is often possible to improve growth by inarching into them more vigorous plants which eventually take over the duties of the original roots. Two plants placed on opposite sides of the tree may prove sufficient, but large trees may respond more quickly if a larger number are used. The grafts should be placed as low as convenient. A fairly large hole should be dug close to the tree, between the existing main roots. The new rootstock plant, preferably previously containerized, may be grafted before the hole is re-filled. This facilitates manipulation. The hole should be filled with top soil in which has been incorporated some rotted dung. The rootstock should be planted firmly, taking care not to wrench the graft, and should be well watered. Grafting by approach is preferable to inarching, the inlay approach technique being particularly suitable when one of the partners is very large. Mature trees often have extremely thick rind, consequently manipulation by rind methods is difficult. Such thick rind should be thinned to make it pliable, by slicing off the outer layers at the place of inarching (54). This should be done before incising the rind. The small component is prepared (Figure 47) by a long slicing cut (A) followed by very shallow straightening cuts at the sides (B).

The large component receives two parallel cuts (C) through the rind, spaced the width of the smaller partner. The rind is removed from between these two incisions and the parts fitted together and fixed with two thin nails (D). Sealing completes the operation.

If the rind does not lift readily, the smaller component may be prepared by two cuts (E) forming a long wedge, and the larger grooved by two deep incisions, so that when fitted the cambia of the two partners are lightly pressed together. Nails are used to fix the graft. Sealing completes the work.

Bracing. Branches forming a narrow angled crotch have a tendency to split apart, generally as the tree comes into cropping. Such branches may be prevented from splitting apart by joining one to the other with a well placed natural brace. A lateral branch from one limb is approach grafted to the other. This lateral

Repair grafting

Generally it is better to repair a damaged tree than to replace it with a young one. Certain of the methods already described, notably approach grafting, inarching and bridging, are useful for the rehabilitation of damaged trees. Although repair grafting will not assist trees already affected with some systemic disease it may well restore trees suffering localized damage.

Bridge grafting. Trees girdled by animals, or by localized cankers, will die unless branches and roots are reconnected. Death may not occur until one or two years after girdling since nutrients pass up in the undamaged wood and enable the leaves to function, but eventually the roots die because no metabolites return to them via the rind. Reconnection of the girdled rind saves the tree. If the rind has been eaten away down to ground level, the soil should be removed to expose some undamaged rind and replaced after grafting. The edges of the bark should be trimmed and any discoloured tissue, due to canker or other disease must be pared away before grafting. Defoliated scions of sufficient length for ease of manipulation are required. Small trees an inch or so (2.5 cm) in diameter can be saved by one side-cleft grafted bridge. Larger trees should have one bridge for every inch (2.5 cm) of their diameter. Thus a trunk 6 in (15 cm) thick would have five or six bridges spaced some three inches (8 cm) apart. The inverted L rind graft (Figure 45) already described for frameworking (p.161) is one of the simplest bridging methods.

Insert the lower end first, a few inches below the girdle, and nail firmly in position; then prepare and insert the apical end a few inches above the girdle in a reversed incision. It is easier to obtain a good fit if the bridge is bowed outwards. Girdled branches are prone to sucker from below the girdle. When sufficiently long these suckers form excellent bridges requiring only a single graft, preferably an approach graft so that the upper part forms a reserve branch whilst also contributing to a sound union.

All cut surfaces should be sealed. The girdled area should be painted with an anti-desiccant and, if exposed to direct sunlight, the whole area, including the bridges, whitewashed or otherwise shaded. Young growth from the bridges should be rubbed out as it appears.

operation. The whole tree should be sprayed or painted with whitewash. Mature trees are generally too large for the provision of overhead shade but some protection is obtained from bunches of fern or palm tied to the ends and sides of the limbs. Such protective material must be tied firmly so that it cannot damage the scions in stormy weather.

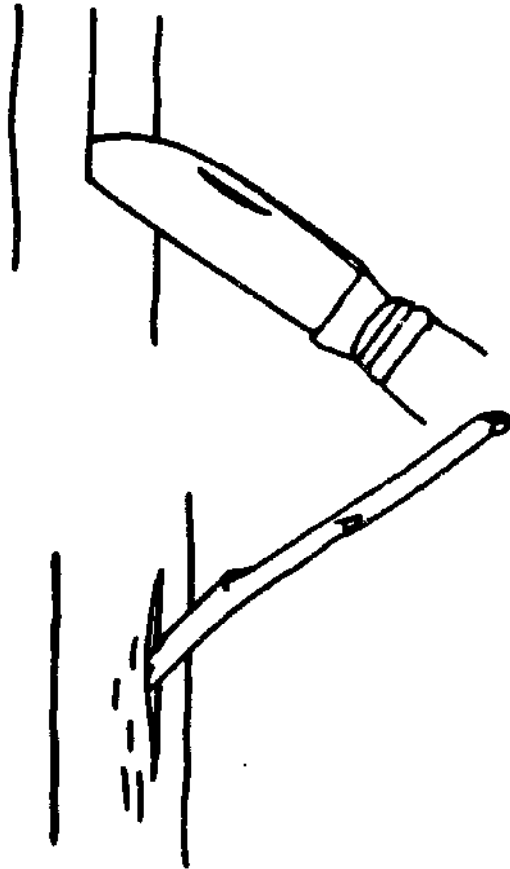

FIGURE 46

Slit graft

Sucker shoots arising from the old variety should be rubbed out as they appear, except where a new scion is clearly dead, when a sucker should be allowed to develop for later grafting. If sufficient scions have been used very few suckers will arise in later years, and these may be removed at pruning time.

by first making one sloping cut of about one and a half inches (4 cm) in length at the basal end, followed by a very shallow cut at one side, just sufficient to expose the cambium (A). The scion is then reversed and a shallower cut than the first is made a little to the side of the scion, away from the small second cut (B). The limb to be grafted now receives a cut (C) as depicted in Figure 45. The term inverted L does not accurately describe this cut. In the diagram it will be noted that the longer, or lower, cut is not made in line with the limb, as this would cause the scion to lie along the limb at an unnatural angle, but is so made that the scion stands away from the surface of the limb. The top cut in the rind is not made at right angles to the lower one but more nearly approaches 150° . It is also cut obliquely into the rind, thus enabling the scion to enter beneath the rind more easily and to fit snugly into position.

The scion is inserted (D) and is held firmly in position by a flat-headed nail or gimp pin, which is driven right home through the rind and scion into the wood. When the rind is abnormally thick, $\frac{1}{4}$ -inch (2-cm) nails of fine gauge are used. Stout nails tend to split the scion. In sealing this type of graft it is especially important to ensure that water cannot enter between the scion and the limb.

Slit graft. This very simple method is particularly successful where the rind separates readily from the wood. Branches less than an inch (2.5 cm) thick are not suitable for slit grafting and should be stub or side grafted. The tree is cleared of laterals. The base of the scion is cut to form a wedge an inch (2.5 cm) or so long. A two-inch (5-cm) oblique slit is made along the limb so that the tip of the knife meets the wood of the limb at a tangent (Figure 46).

The scion is pushed into the slit and finds its way between wood and rind. The scion may be set at any desired angle by raising or lowering the apex. All cut surfaces are sealed; no tying or nailing is required.

Aftercare of frameworked trees. As with freshly topworked trees precautions must be taken to prevent insect and other damage. The considerable number of scion buds, developing throughout the tree, will themselves soon provide some shade and cooling effect, but the tree's limbs and trunk remain largely exposed for some weeks after the grafting

ends in the form of an unequally sided and comparatively long wedge (A, B and C). In preparing the scions, advantage should be taken of the slightly zigzag nature of the shoots, in order that the scion, when inserted, may stand away from the framework branch as much as possible, so that the angle is approximately that of a lateral shoot. A cut is made into the side of the branch at an angle of about 20° and never deeper than one-quarter of the diameter of the branch. The cut is opened by slight bending of the branch and the scion is inserted so that its cambium is in contact with that of the framework. The thin lip of bark raised from the branch prior to inserting the graft is cut off after the scion has been pushed home (D). In order to complete the graft it only remains to seal the exposed cut surfaces.

Inverted L rind graft. All lateral shoots are removed before grafting begins. The scion is prepared (Figure 45)

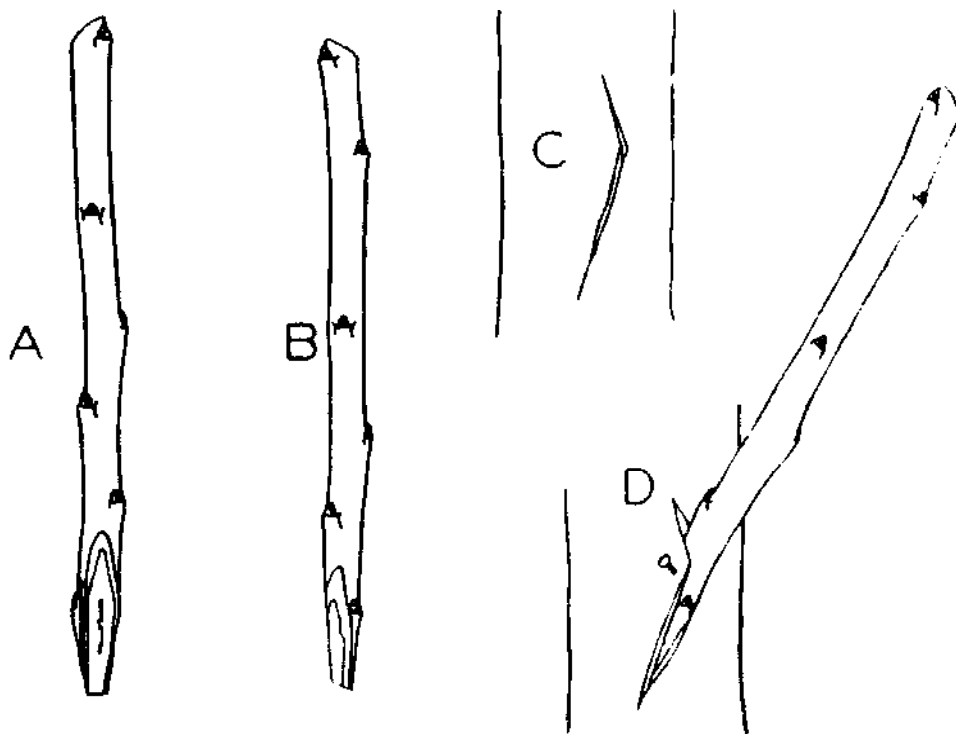

FIGURE 45

Inverted L rind graft

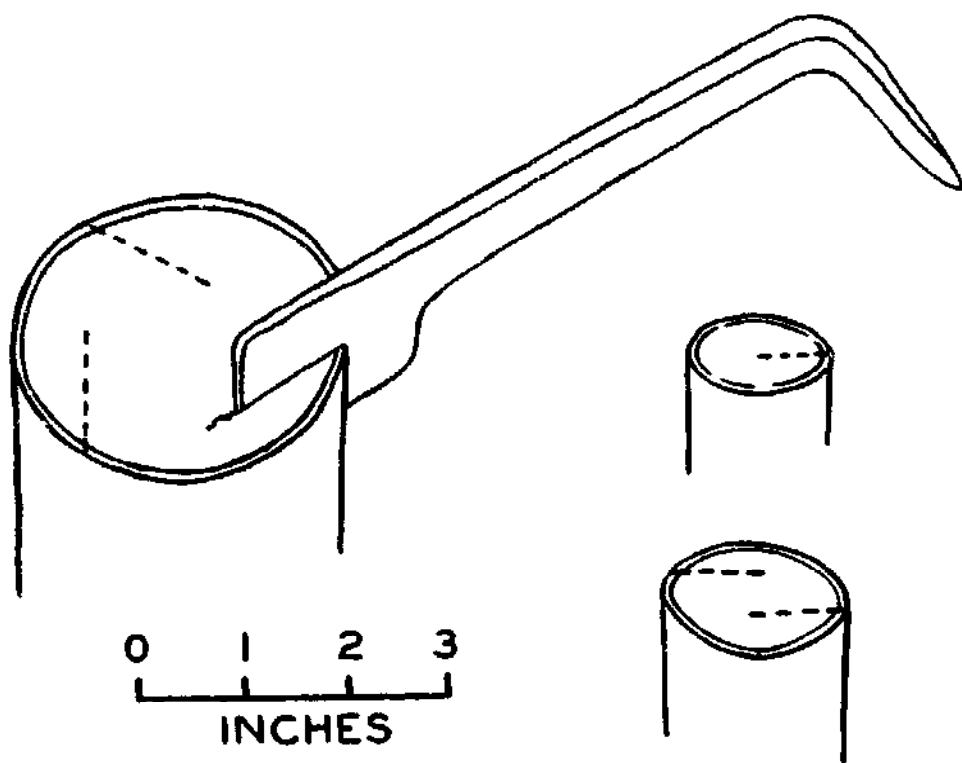

FIGURE 39

Methods of cleaving obliquely

Note treatment of large, medium and small limbs.

thick rind of the stock and the thin rind of the scion. The wedge or tool is removed and the scions are held fast by the pressure of the limb (C). For rapid work it is an advantage to sling the tool and mallet together (Figure 37) with a thong or cord, so that when the tool is used as a wedge the mallet may be left to dangle and the operator is free to use both hands for the preparation and insertion of the scions. Hand pressure on the free end of the tool serves to open the cleft for the insertion of the scions and firm gripping of the scions upon release.

When sealing large clefts some moist clay should be placed in the clefts and vertical splits to prevent liquid seals from running too far into them or between any ill-fitting scion and stock. When all exposed cut surfaces have been carefully sealed, including the end of the limb and the side splits, the scions and the limb should be whitewashed. Additional protection against sun-scald is given by fern or palm branches tied to the limbs so that they provide shade above the grafts.

Oblique cleft graft. This method avoids splitting the heartwood of the limb and permits each limb to be furnished with one or more scions. The clefts, none of which should extend right across the branch (Figure 39) are opened by means of the grafting tool and the scions are inserted, particular care being taken to see that the cambia are in contact (Figure 40).

Removing the tool causes the scion to be held firmly and no other fixing is necessary. Careful sealing and protection are essential as in the cleft method (above).

Whip and tongue graft. This method (see p.127) is used in topworking for grafting small lateral branches. Such laterals are produced when trees are severely cut back. As the laterals appear, those not required are pinched back to provide intimate shade. At grafting time the selected shoots are cut to within a few inches of the limbs and there whip-and-tongue grafted. When the scions are well grown, the unwanted stock growths, not required for supplementary grafting or for shade, are gradually removed.

Veneer crown graft. This is one of the best methods to use when the rind of the stock limb can be readily lifted, as at the beginning of the rainy season. The tree is beheaded as described for other topworking methods. The scion is prepared with one major cut (Figure 41)

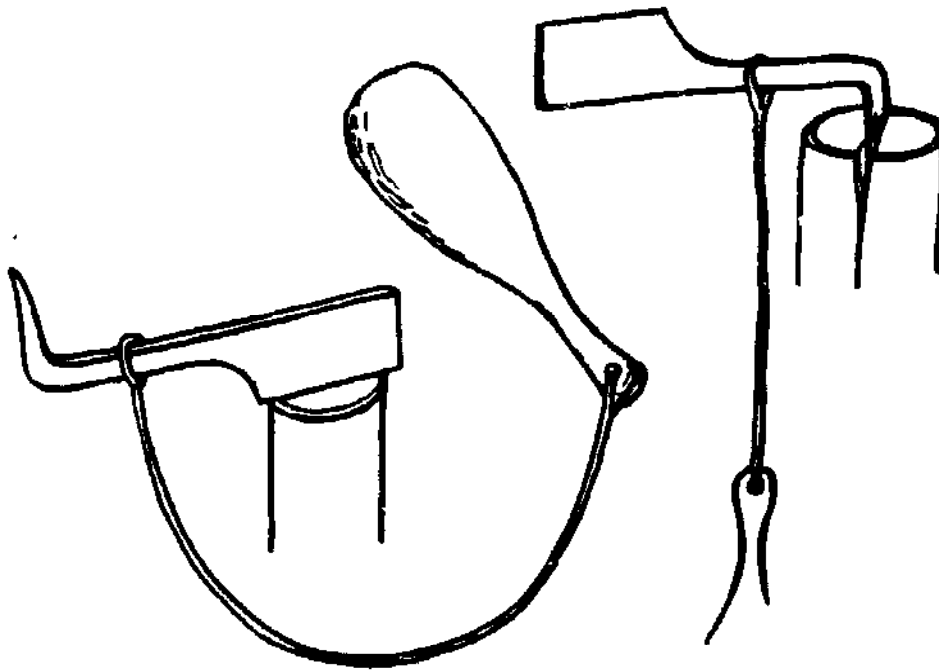

FIGURE 37

Tool and mallet slung together

The cord should be long enough to permit free movement. When the wedge is driven into the cleft, the mallet is dropped and the operator uses both hands to prepare and insert the scion.

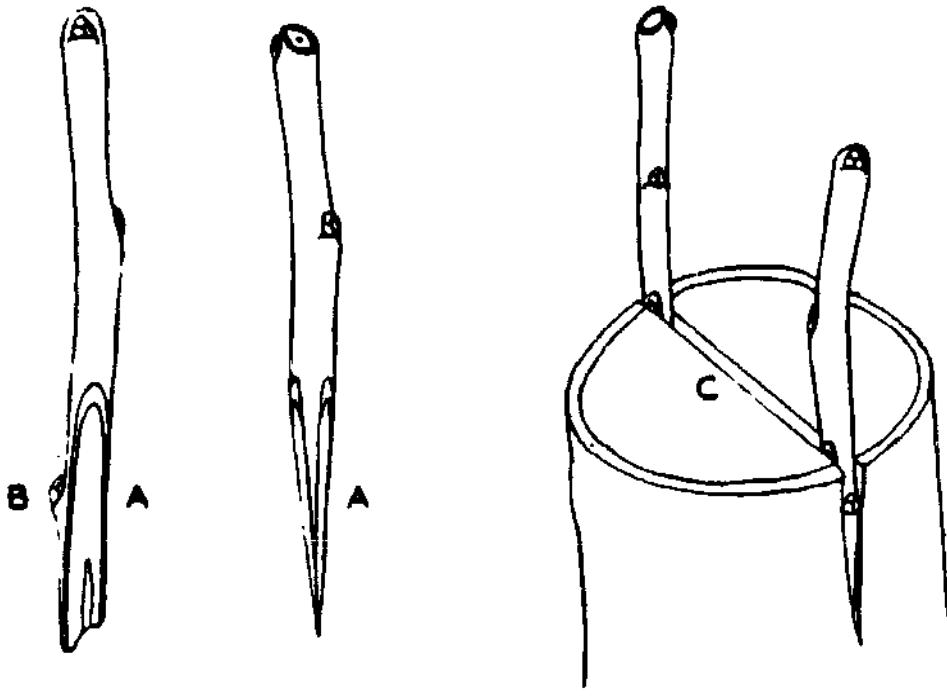

FIGURE 38

Cleft graft (split graft)

the temperature of the sapwood of fully exposed branches was found to be some 15°F higher than that of similar branches that had been whitewashed. This difference is likely to be greater in the tropics where the surface temperature of branches directly exposed to the noonday sun may far exceed normal lethal temperatures. All small branches below the general level of grafting should be left intact for at least a year to feed the roots and retain growth activity. Such branches are commonly known as sap drawers or lungs. The presence of such branches in no way diminishes scion growth but actually increases it, encourages healing and reduces the risk of loss due to diseases which enter through wounds.

In preparing trees for topworking it should be remembered that large wounds take a long time to heal, and it is better to insert scions into two small limbs above a fork rather than in one large limb lower down. Branches of five inches (13 cm) or more in diameter should be sawn off higher up, where their diameter is not more than three or four inches (8 or 10 cm). Eventually it is best if only one scion remains at the end of each limb of the old variety, as this makes for strength at the new union. Two or three scions inserted at the end of each limb serve to retain life at the edges of the cut surface but all except one should be removed by stages as the wound heals.

The methods of grafting are very numerous. Those of special value are certain of the simple cleft and rind methods used in apical grafting. Approach grafting (q.v.) has also been used with success in tropical regions (100; 111).

Cleft graft (split graft) The cut end of the limb is cleft diametrically. This cleft is opened by inserting either a long handled wedge or the spiked end of the grafting tool midway along the cleft (Figure 37). The scions, preferably of one-year-old wood, bearing three or four buds, are prepared (Figure 38)

by two slanting cuts at their base in the form of a long tapering wedge (A). The presence of a bud (B) between the two cut surfaces and about half-way between the point at which the cuts begin and the base of the scion is an advantage. The scions are inserted so that their cambial regions are in contact, due allowance being made for the

GRAFTING — FIVE

GRAFTING ESTABLISHED TREES

As the years go by, new cultivars become available superior in quality and yield, possibly also in disease resistance, ease of harvesting and market acceptance. So it becomes necessary to change from the old to the new. This can be achieved in either of two ways. The existing trees may be grubbed and replaced with those of greater value, or they may be re-grafted. Much work is entailed in grubbing established trees, new trees cost money and when planted in ground recently occupied by mature trees, they not infrequently fail to make satisfactory growth. By re-grafting, the trunk and branches and the whole root system are retained and the new scions soon form fruiting branches.

Trees may be re-worked in two main ways, by topworking or frameworking. In topworking, the branches to be grafted are removed almost entirely and the cut ends set with scions of the desired cultivar. In frameworking the main framework branches are retained and furnished with new scions. The beginning of the rainy season is considered best for the work.

Topworking

The removal of a large proportion of the main branches disturbs the root/shoot ratio or growth balance of the tree and this may cause the death of much of the root system. Root growth is maintained by leaving some leaf-bearing branches unpruned until the new scions have become well grown during two or three seasons. Such branches may then be removed, or grafted in their turn.

The removal of large branches exposes previously shaded parts and this may be followed by bark-scald, death of tissues and graft failure. This may be prevented by leaving sufficient branches, as above, to provide shade. The exposed cut branches should be painted or sprayed with whitening to check overheating. In California (16)

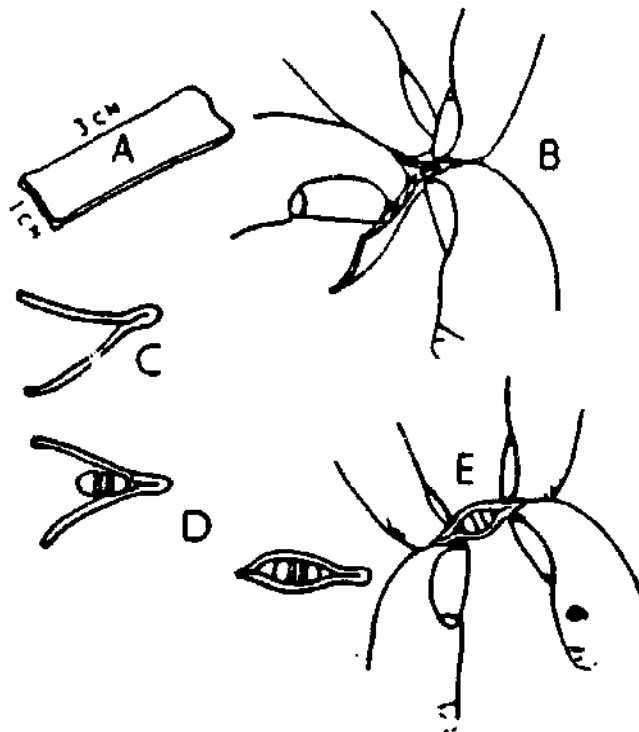

FIGURE 36

Use of self-sealing crepe rubber

A = Strip of self-sealing crepe rubber. B = Folded and nipped along folded edge between thumb and forefinger. C = Folded strip ready for use. D = Strip placed around the graft and free ends in contact. E = Strip tightened by nipping both sides equally between thumbs and forefingers.

level so that the scion forms its own roots above the union. This scion-rooting will be hastened if the scion is constricted close above the union by extending the graft tie, and hitching it, a little above the union. Alternatively, a pliable metal strip may be folded and locked around the scion immediately above the union. Constriction by a few turns of wire is less efficient because, being narrow, it is readily overgrown and permanently bridged.

Short cuttings of shy-rooting cultivars can be nursed by splice approach grafting them (see p.102) with a quick-rooting cutting. The suggestion is (30) that the early-rooting component supplies moisture to the whole, so maintaining the shy rooter until it has time to root. When the shy rooter has formed its own roots the nurse is removed by breaking or cutting away.

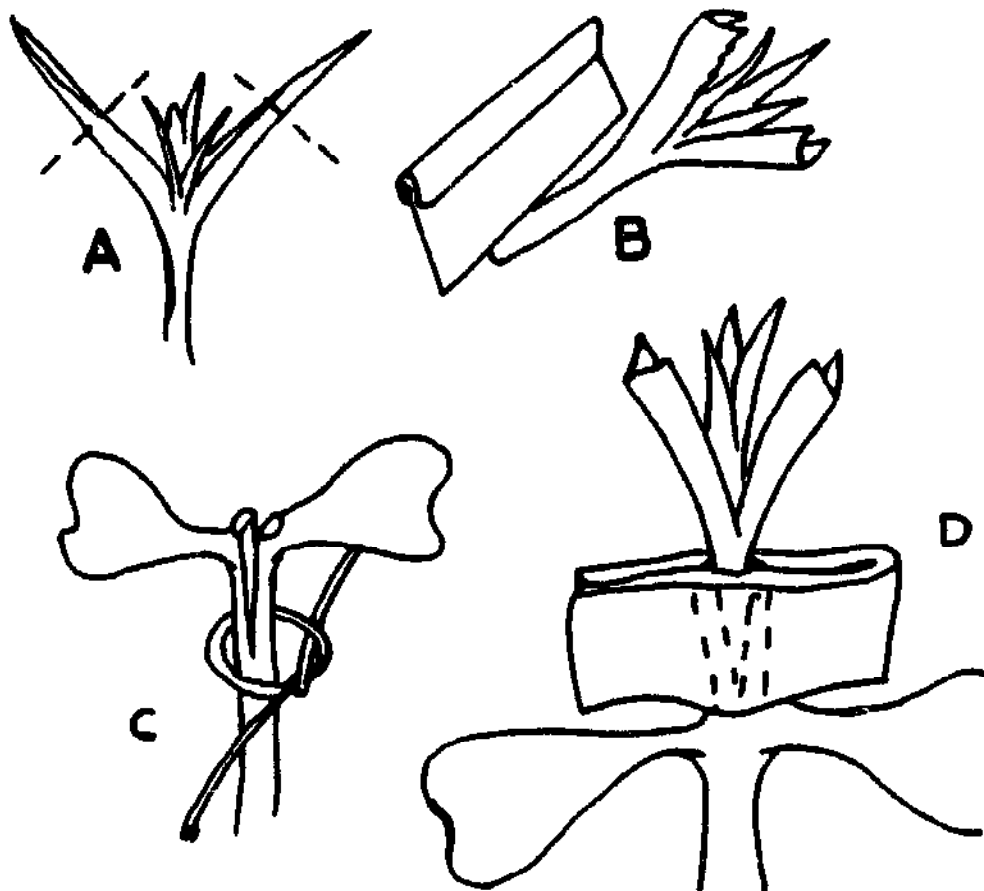

FIGURE 35

Wedge grafting in the cotyledon stage

A = Scion trimmed to reduce transpiration. B = Cut down on to a clean surface to form wedge. C = Stock prepared and thread in position for easy adjustment after scion inserted. D = Graft secured with self-sealing rubber (see Fig. 36).

for graft establishment. In this environment union and sprouting occur in some two weeks, when the plants are gradually hardened-off for later transference, in containers, to the open field.

Macadamia has also responded well to seed grafting (70). The technique is much as described above but it is recommended that the scion wood, preferably from non-flowering shoots, be cinctured at least four weeks before collection. The scion should have two whorls of buds and should be defoliated at the time of collection. Grafting is done when the radicle has extended about two inches (5 cm), by which time the shell is sufficiently opened to accept the scion. The wedge-based scion is inserted by forcing it into the cotyledons as far as possible without splitting the nut into two pieces. The insertion must be made at an angle of 90° with the cotyledon faces, not into the division. The top of the scion should be sealed and the plant set in a well drained medium to avoid rotting. Winter or spring grafting is recommended, the seed stocks having been forwarded as required.

Seedlings in which the cotyledons come above ground (epigeal) are readily wedge grafted in the cotyledon stage (33) with soft tips of scion varieties. Young seedlings showing their first true leaves are cut transversely immediately above the cotyledons (D) and cleft between them (Figure 35).

A tip scion, not more than an inch or so (2.5 cm) in length, is formed into a wedge, any unfolding leaves are trimmed to reduce transpiration. Cutting the scion lengthwise downwards onto a card is sometimes easier than in the hand (A, B). The scion is inserted and gently but firmly tied. Self-sealing crêpe rubber (Stericrepe) makes an excellent tie and seal (Figure 36).

Nurse grafting

Many tree fruits grow and crop well upon their own roots, so avoiding the nuisance of suckers from inferior rootstocks and the risk of incompatibility. Such cultivars, selected for their fruiting rather than their rooting characters, are commonly found to be difficult to root from cuttings or layers and must be helped to do so by a nurse plant.

One of the simplest nursing methods is to graft a seedling root onto the base of a shoot of the selected cultivar and to plant it with the union well below soil

If the grafting and subsequent planting are completed in a period of rain, sealing may not be necessary, provided the grafts are covered with soil. Generally, however, sealing will greatly reduce losses from both drying and rotting.

Bench grafting in the cotyledon stage.

In moist situations excellent results are obtained by grafting in the cotyledon stage. Success appears to depend on the maintenance of good growing conditions, particularly of moisture, light and warmth. Workers in India (77) suggest that full use should be made of periods of prolonged rain, when work is only possible under cover. Mango stones were sown in July and the seedlings were used as rootstocks for selected cultivars when one week old. The tips of terminal shoots, defoliated ten days before grafting were used as scions. Of a number of methods tried the plain splice was most successful. The seedlings were sliced through by a one inch cut starting close to the seed. The base of a two to three inches (5 to 8 cm) terminal scion received a similar cut and stock and scion were fitted together, bound very firmly with polyethylene strip and planted in pots under protection.

The use of a germinating seed to aid regeneration of plant parts is an ancient idea (32). Recently (81) large seeds have been used with good success to nurse shy-rooting cuttings of related species. Seeds which retain their cotyledons below ground (hypogeal) are germinated and, when the radicle is some two inches (5 cm) long, both radicle and plumule are sliced off to reveal the cotyledon connective. This connective, or petiole stub, is split with the point of the knife and the wedge-shaped base of the scion is inserted so that the cambium of the scion is in firm contact with the cut surfaces of the petiole stub (75). The seed grafts are set two or three inches (5 or 8 cm) deep in an open medium, under protection, as are non-grafted leafy cuttings.

The 'stone grafting' of mango is said to have a number of advantages over other methods (13). The method is essentially as described above. Both wedge and splice techniques are successful and the whole operation is performed under a lath house, or other improvised shelter, with the help of a nursery frame

are separated and each piece receives a scion, then the method is termed piece-root grafting. Young seedlings, or rooted layers and cuttings are commonly used as rootstocks. Many subjects do not form shoots below their cotyledons and, if grafted at or below the hypocotyl, do not form stock suckers. Stocks raised by layering or from shoot cuttings may sucker from below the graft but this propensity varies greatly. Some species do not develop buds in darkness so that deep planting prevents suckering. These matters should be considered when choosing the grafting position.

The stocks are lifted, trimmed and graded. Tap roots are normally shortened to about eight inches (20 cm). The portion of stem to be grafted is wiped with a cloth to remove grit which would otherwise blunt the grafter's knife. Wiping the part concerned is preferable to soaking or washing the stock or scion because washing a root or stem system increases the rate of water loss once the surface has dried. The scion wood, like the stocks, should be size-graded and cut to the required length.

Where the graft is cut and tied by one operator, the plain splice (see p. 126) and wedge (see p. 134) are suitable. Where one person cuts and fits the graft, leaving another to tie, the whip and tongue (see p. 127) or other holding method must be used. Whichever method is used, it is important to make a good join by matching the cambia, taking particular care that the cut surfaces of the scion lap onto the cambium of the stock and not onto the outer rind surface. Bad fitting often results in callus knots at the union. Firm tying is important. The use of tying material which later stretches or disintegrates, obviates the work of releasing the tie. If lasting ties are used such as rubber strip, plastic or waxed twine, the tie should be arranged for easy release. After tying, all cut surfaces should normally be sealed. A convenient way of doing this is to dip the scion and grafted portion into a suitable wax, such as a paraffin based hot wax (see p. 92) or pure paraffin (see p. 93). The wax should be kept fluid in a water-jacketed heater to prevent it getting too hot. A quick dip into the molten wax should be closely followed by a dip of the waxed portion into cold water.

GRAFTING — FOUR

BENCH GRAFTING

This term is applied to any grafting process performed where both stock and scion are unplanted, regardless of the technique involved. The work is usually done sitting or standing at a bench, hence the name. The bench system permits the use of a number of mechanical aids and easy management to speed the work. The workers and plant material should be placed under shade and storm protection, with ready access to a supply of water. All materials should be arranged in order of use so that smooth progress is continuous. Materials should be placed at readily accessible levels where they are within easy reach from a sitting position. It is well to have requisites on raised inclines at right angles to the work bench and to have moist containers at a lower level to receive the completed grafts, thus eliminating as far as possible the lifting and lowering of materials and the need for grafters to bend or stretch. Above all, plant materials, containers, soil mixes or other media should be kept adequately moist at all times (see Life, p. 84).

Bench grafting is used not only to unite selected cultivars with rootstocks at an early stage but also for multiplying trees upon their own roots, as in the propagation of clonal rootstocks or the interposing of an interstem between a readily available root and a desired cultivar, a process often termed double working, used to overcome stock/scion incompatibility or to influence growth vigour.

Bench grafted material, except stocks well established in substantial containers, requires a period of nursing to fit it for safe transference to the field. Overhead slat shade alone may be sufficient but most material requires the additional protection of tents or closed cases for gradual hardening.

Bench grafting on roots

If one rootstock is used for each scion it is known as whole-root grafting, but if the stock roots

grafting. The upper scion is whip grafted to the upper end of the intermediate. The basal end of this composite scion is now grafted to the rootstock and both grafts are sealed. Where the rootstock is already planted in the nursery the composite scion must be sealed and kept moist until it reaches the stock for the second grafting. The period between the first and second operation may be delayed, provided the composite scion is meanwhile kept moist and cool. Added protection may be provided by dipping the composite scion in an anti-desiccant as advocated for cuttings (p. 65) and for scionwood (p.93).

Where it is considered best to do all the work in the open nursery on rootstocks already established, the intermediate may be grafted in various ways, including bud grafting or inarching, and these grown for a season before the upper scion is applied. This preliminary establishment of the intermediate, especially where the rootstocks are vary variable, may contribute to uniformity and provide a better stem for the grafting operation. Where the object is stem building the lower union must be established well in advance of the upper union. In some cases the upper graft is not made until the single grafted tree reaches the orchard.

Double working provides a way of obtaining, in one tree, an economical root system, a disease resistant stem and a productive head. For example, rootstocks selected for their health and vigour, and ready availability, may be grafted at ground level with a disease-resistant clone and then, at head height or a short distance along the main limbs, be topworked with a cultivar selected for its fruit-bearing capacity.

In temperate climates (48) much use has been made of double working in the production of dwarf apple trees. Seedling or other vigorous rootstocks are double grafted, normally in one operation, with a short piece of a selected dwarfing rootstock. Such trees crop very early in their lives and remain highly productive in relation to their size, thus the output of fruit from a given area is substantially increased.

Where it is desired to reduce the ultimate size of trees, to facilitate cultivation and harvesting, stem building with a selection known to check vigorous growth, may prove worthwhile. The vigour-monitoring effect of an interstem appears to increase with its length, being greatest when it forms both trunk and lower parts of the fruit-bearing branches.

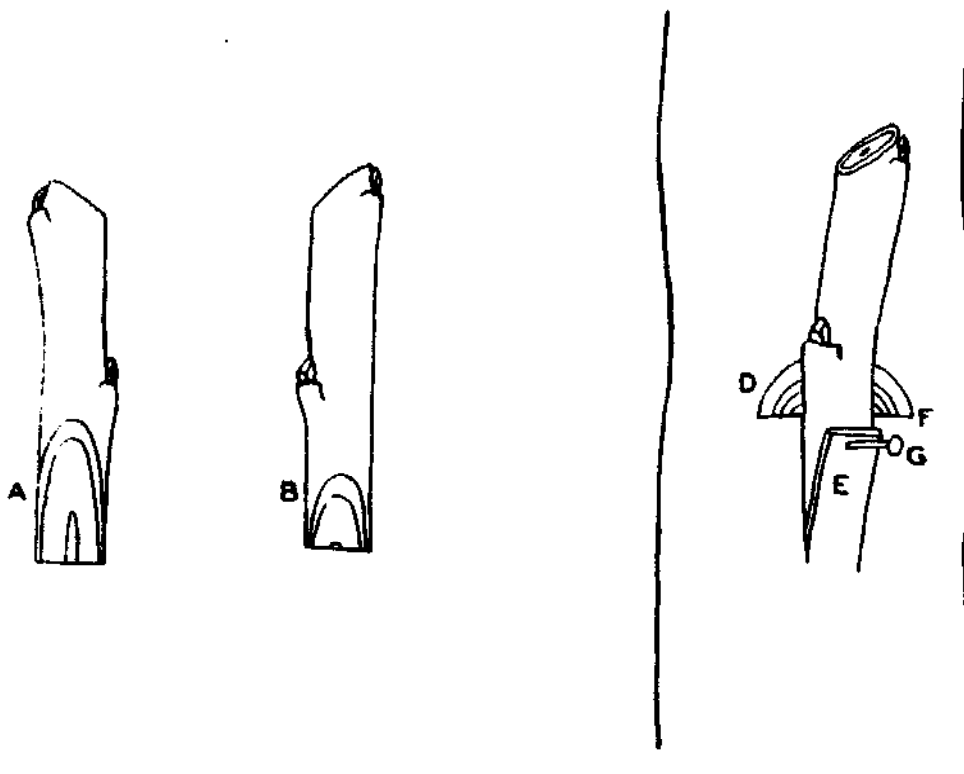

FIGURE 34

Slotted side graft

Double working and interstems

When a plant is grafted twice, so that it has two unions one above the other, it is said to be double worked and the intermediate piece is commonly termed an interstem. Double working has various purposes (34,48). Its widest use is in changing trees of inferior varieties to more desirable kinds, or to obtain a more uniform performance in the orchard (111). But primarily, double working is employed to (1) overcome incompatibility between scion and rootstock (82), (2) build trees with strong straight stems (stem building), (3) increase resistance to disease by providing resistant stems, (4) curtail vigour and increase fruiting. To overcome incompatibility the work must be done early in the life of the plant, either by bench grafting, or double grafting in the nursery in a single operation. The scion-wood of the intermediate variety, selected for its compatibility with both rootstock and upper scion, is cut into lengths of six inches (15 cm) or less, only large enough to be comfortably held whilst

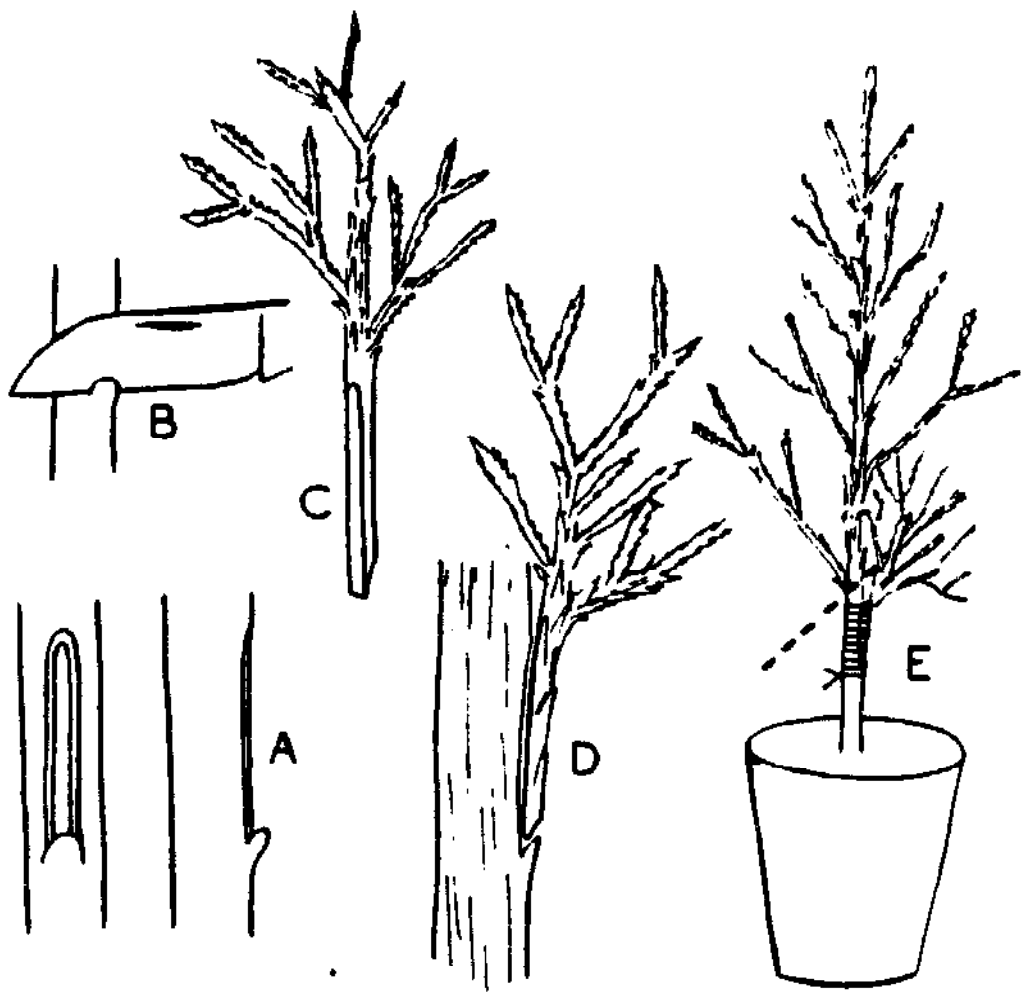

FIGURE 33

Spliced side graft (vener side graft)

vegetative bud have proved successful on nursery-grown seedlings and on plants established in containers under slat or other overhead protection. The scions are completely or partially defoliated at the time of collection and inserted low down where they are conveniently protected by covering with soil, compost, moss or fibre.

Grafting normally takes place at or immediately before a main growth period. A flat smooth shallow cut (A), about two inches (5 cm) long, is made downwards near the base of the stock (Figure 33). A second cut (B), at 45° to the first, serves to remove a thin strip of rind and wood. The scion (C) is prepared with a long and short cut to correspond with the prepared stock to which it is fitted (D) and is firmly tied, and then sealed and protected. When united the head of the stock is reduced by stages down to the union (dotted line E) and the wound sealed. In his book on the mango L. B. Singh (111) advocates notching at two inches (5 cm) above the graft when the scion begins to shoot so as to speed the growth, deepening the notch gradually until the head of the stock is completely removed, meanwhile maintaining irrigation.

Slotted side graft. This method is useful when the stock is considerably thicker than the scion and the rind of the stock is thick, inflexible and difficult to fit closely round the scion using other rind methods. The scion is prepared (Figure 34) with its basal end in the form of an unequally sided wedge (A and B). The stock receives a downward cut penetrating to the wood. A transverse cut at the base of the downward cut produces a step (D) in the side of the stock. Two parallel cuts, very slightly closer together than the width of the scion to ensure a tight fit, are made downwards from the transverse cut. These two cuts should equal the length of the longest slanting cut of the scion. The rind (E) between the parallel cuts is raised slightly, and the scion, with its longer cut surface towards the branch, is pushed down under the raised rind until the whole of the tapered base of the scion is below the level of the transverse cut (F) in the stock. A gimppin (G) (see p. 162) is driven through the upper part of the raised rind, through the scion and into the wood of the stock. Exposed cut surfaces are sealed. When the scion is established the stock is sawn through close above the graft and the cut sealed. The method is eminently suitable for refurnishing bare limbs or trunks with lateral branches.

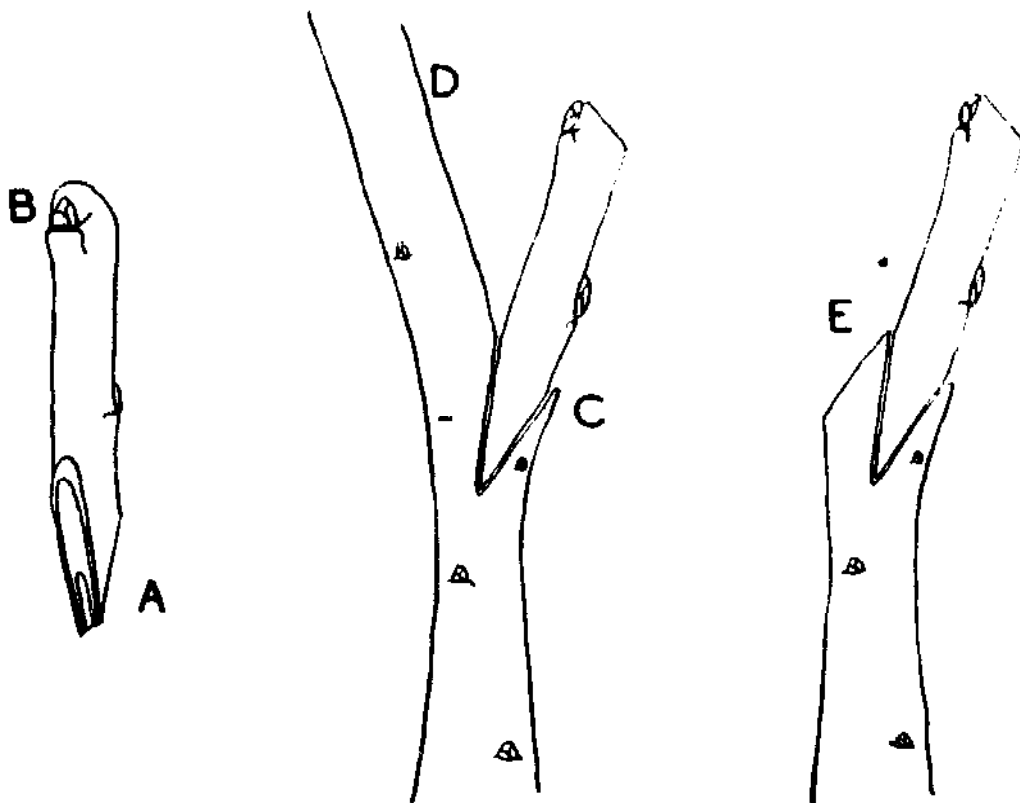

FIGURE 31

Oblique wedge graft

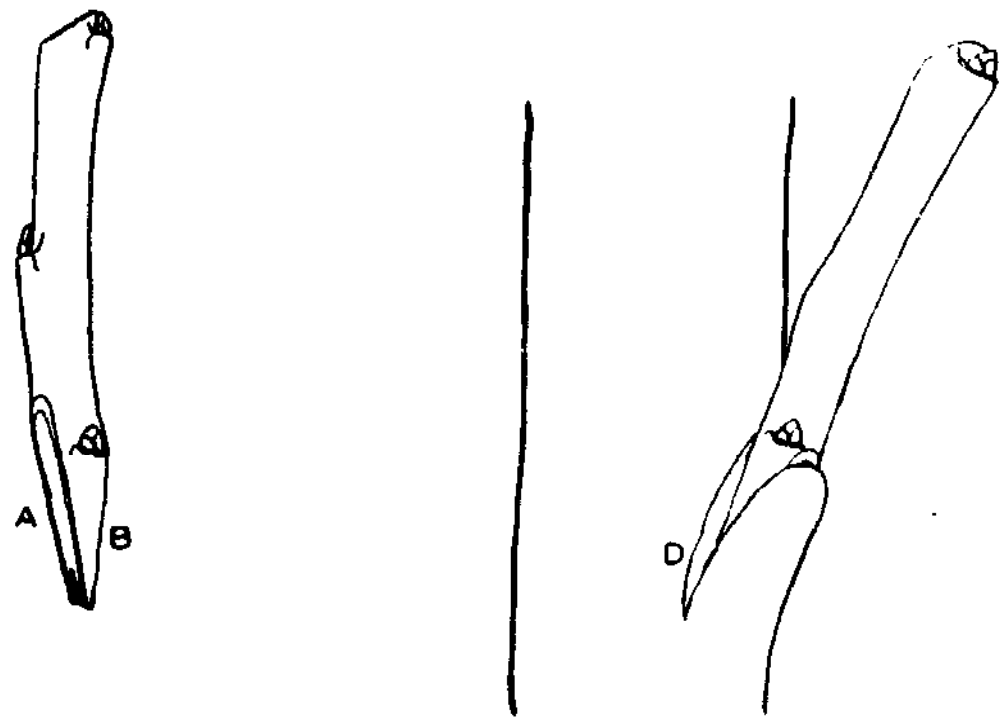

FIGURE 32

Side cleft graft

Side grafting

Although all except apical grafts might be considered to be side grafts, even bud grafts and inlays, those selected for description here under "side grafting" are generally so regarded. They all permit the top of the stock to continue to function, more or less as it did before grafting, until union is complete, at which time the head of the stock is removed just above the junction. Where, as in frameworking described later, one stock is side grafted with a number of scions the body-frame of the stock is a permanent feature.

Side cleft graft. This resembles the oblique wedge graft (q.v.), an apical self-holding graft using a short scion, but the scion for this side graft may be quite long, provided it is tied and the upper part of the stock is retained. Two slanting cuts, one (A) slightly longer than the other (B), are made at the basal end of the scion, at opposite sides, to form a gradually tapering wedge (Figure 32). An incision (D) is made in the side of the stock at an angle of about 20° and of sufficient depth to permit the insertion of the wedge. The longer side of the wedge is placed against the stock stem in such a position that the cambial regions of stock and scion are in contact. By bending the stock so that the incision (D) is opened, the scion may be pushed home more readily. The graft is best tied with strong twine and sealed; alternatively it may be bound with strong waxed cloth to resist movement at the graft junction due to swaying of the top of the stock during union formation. When union is complete the head of the stock may be cut back close to the graft and sealed, but if in doubt this should be done in two or three stages.

Spliced side graft (veneer side graft). This differs little from the side cleft graft except that the stock receives only a shallow cut, raising a thin slice of even thickness resembling a veneer. It is widely used throughout the world for the propagation of shy-rooting ornamental trees, particularly evergreens and conifers which may justify extra protection for a period following grafting. It is commonly used when bench grafting (q.v.), either on rootstocks established in small containers or on bare-root seedlings which are then plunged in pits or frames. The method is also successful in the open, using defoliated scions, treated with anti-desiccants (see paints and dips, p. 93), or temporary covers of thin plastic or waxed paper (see caps and covers, p. 98). Very short, one-inch (2.5-cm), terminal scions with an apical

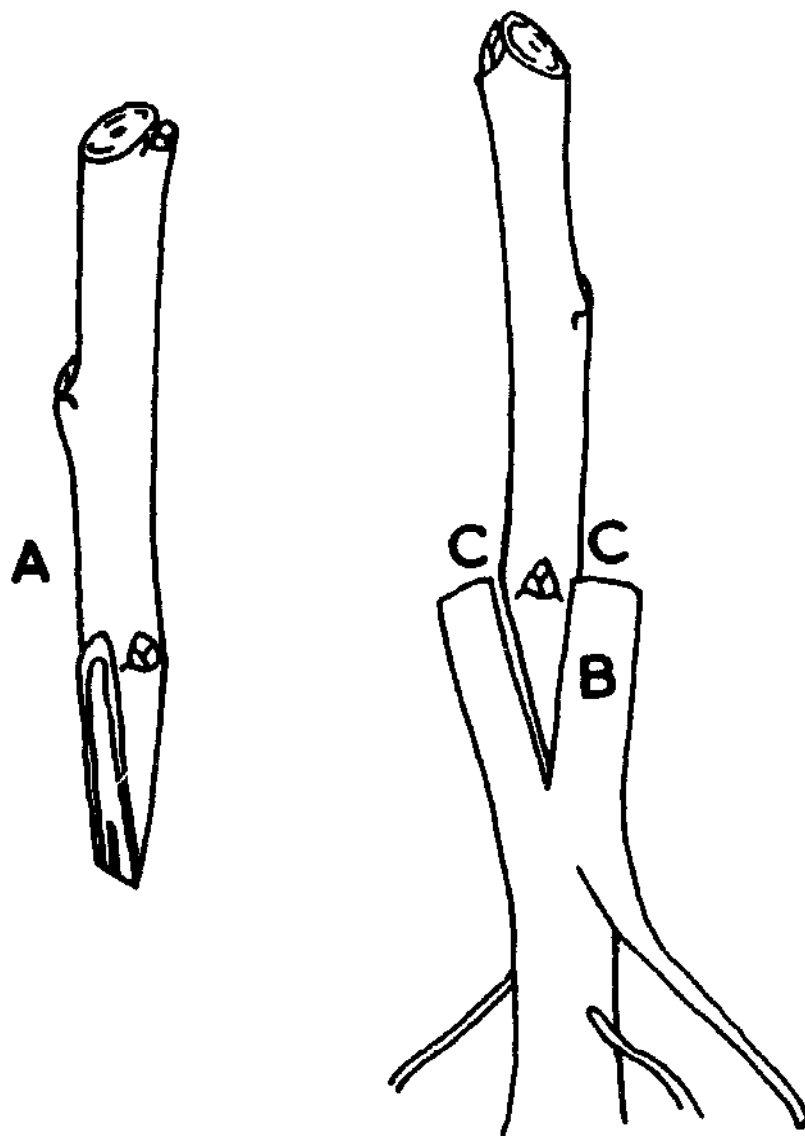

FIGURE 30
Wedge or cleft graft

13. BHAN, K. C., SAMADDAR, H. N. and YADAU, P. S. (1969). Chip budding and stone-grafting of mangoes in India. *Trop. Agric., Trin.*, 46: 247-53.
14. BIALE, J. B. (1939). Transpiration of lemon cuttings in reference to leaf-root relationship. *Proc. Amer. Soc. hort. Sci.*, 36: 250-4.
15. CHADWICK, L. C. (1931). Factors influencing the rooting of deciduous hardwood cuttings. *Proc. Amer. Soc. hort. Sci.*, 28: 455-9.
16. CHANDLER, W. H. (1925). *Fruit growing*. Constable, London.
17. CHAUDHRY, M. S., ULLAH, M. H. and AHMED, S. (1962). Some studies on effects of ringing and etiolation treatments on the rooting of sweet lime cuttings. *Punjab Fruit J.*, 26/27: 321-6.
18. COLBRY, V. L., SWOFFORD, T. F. and MOORE, R. P. (1961). Tests for germination in the laboratory. In *Yearbook of agriculture*. Washington, D.C., pp. 433-43.
19. COLES, J. S. and CAMPBELL, A. I. (1969). Better results with inverted 'T' budding. *Grower*, 72: 167-8.
20. COOPER, A. J. (1973). Root temperature and plant growth. *Res. Rev. Commonw. Bur. Hort. Plant. Crops* 4.
21. CURTIS, O. F. and BLAKE, J. H. (1936). The temperature of grafts as influenced by the type of wax and shading. In *Proc. 27th annu. Mtg north. Nut Growers' Assn*, N.Y., pp. 41-4.
22. DERMEN, H. (1948). Chimera apple sports and their propagation through adventitious buds. *J. Hered.*, 39: 235-42.
23. EAST MALLING RESEARCH STATION (1973). Propagation of clonal rootstocks by hardwood cuttings. *Misc. Publ. E. Malling Res. Stat.* 85.
24. EDGAR, A. T. (1958). *Manual of rubber planting (Malaya)*. Incorporated Soc. Planters, Kuala Lumpur.

25. EMDEN, J. H. VAN (1940). Een nieuwe entmethode voor thee. *Arch. Theecult. Ned. - Ind.*, 24: 16-25.
26. EVENARI, M. and KONIS, E. (1938). The effect of hetero-auxin on root formation by cuttings and on grafting. *Palestine J. Bot.*, 1: 13-26, 113-18.
27. FAO (1961). Agriculture and horticultural seeds. *FAO agric. Studies* 55.
26. FEILDEN, G. St. C. and GARNER, R. J. (1940). Vegetative propagation of tropical and sub-tropical plantation crops. *Tech. Commun. imp. Bur. Hort. Plant. Crops* 13.
29. FLEISCHHAUER, O. (1957). Ein neuartiger Okulationsschnellverschluss. *Deutsche Baumschule*, 9: 23-5.
30. FLOOR, J. (1952). Proeven met vermeerdering door entstekken. *Meded. Inst. Vered. Tuinbouwgew.* 40.
31. GARDNER, F. E. (1937). Etiolation as a method of rooting apple variety stem cuttings. *Proc. Amer. Soc. hort. Sci.*, 34: 323-9.
32. GARNER, R. J. (1944). Propagation by cuttings and layers. Recent work and its application, with special reference to pome and stone fruits. *Tech. Commun. imp. Bur. Hort. Plant. Crops* 14.
33. GARNER, R. J. (1951). The grafting of very young apple seedlings. *Rep. E. Malling Res. Stat. for 1950*, pp. 71-5.
34. GARNER, R. J. (1967). *The grafter's handbook*. Faber, London, 3rd Ed.
35. GARNER, R. J. (1969). Forget not the essentials. *Proc. int. Plant Prop. Soc.*, 19: 202-3.
36. GARNER, R. J. and HATCHER, E. S. J. (1948). The selection of hardwood stem cuttings of an apple rootstock. *Rep. E. Malling Res. Stat. for 1947*, pp. 71-5.

37. GARNER, R.J. and HATCHER, E.S.J. (1955). The production of sphaeroblast shoots of apple for cuttings. *Rep. E. Malling Res. Stat. for 1954*, pp. 73-5.
38. GARNER, R.J. and HATCHER, E.S.J. (1957a). The interplay of factors influencing rooting behaviour of shoot cuttings. In *Rep. 14th int. hort. Congr., Netherlands, 1955*, pp. 204-14.
39. GARNER, R.J. and HATCHER, E.S.J. (1957b). Rootstock effect on the regeneration of apple cuttings. *Rep. E. Malling Res. Stat. for 1956*, pp. 60-2.
40. GARNER, R.J. and HATCHER, E.S.J. (1962). Regeneration in relation to vegetative vigour and flowering. In *Rep. 16th int. hort. Congr., Brussels, 1962*, pp. 105-11.
41. GARNER, R.J. and WALKER, W.F. (1938). The frameworking of fruit trees. *Occas. Pap. imp. Bur. Hort. Plant. Crops* 5.
42. GISEVIUS, R. (1950). Beitrag zur Wurzlingsvermehrung bei Apfelgehölzen. *Züchter*, 20: 296-302.
43. GLOYNE, R.W. (1964). Some characteristics of the natural wind and their modification by natural and artificial obstructions. *Sci. Hort.*, 17: 7-19.
44. GRAHAM, R.J.D. (1943). Presidential address. *Trans. bot. Soc. Edinb.*, 33: 347-56.
45. HANSON, E.W., HANSING, E.D. and SCHROEDER, W.T. (1961). Seed treatments for control of disease. In *Yearbook of agriculture*. Washington, D.C., pp. 272-80.
46. HARRIS, R.V. and HILDEBRAND, A.A. (1937). An investigation of strawberry virus disease in Ontario. *Canad. J. Res.*, 15: 252-80.
47. HARRIS, R.W. (1968). Factors influencing root development of containergrown trees. *Proc. int. Shade Tree Conf., 1967*, pp. 304-12.

48. HARTMANN, H.T. and KESTER, D.E. (1968). *Plant propagation: principles and practices*. Prentice-Hall, N.J., U.S.A., 2nd Ed.
49. HATCHER, E.S.J. and GARNER, R.J. (1951). Aspects of rootstock propagation. II. The development of the concentrated dip method of treating hardwood cuttings with growth substances. *Rep. E. Malling Res. Stat. for 1950*, pp. 116-21.
50. HATCHER, E.S.J. and GARNER, R.J. (1957). Aspects of rootstock propagation. IV. The winter storage of hardwood cuttings. *Rep. E. Malling Res. Stat. for 1956*, pp. 101-6.
51. HATTON, R.G. (1927). *Fruit growing in the Empire - Standardization of horticultural material with special reference to rootstocks*. Empire Marketing Board, London.
52. HESS, C.E. and SNYDER, W.E. (1957). A physiological comparison of the use of mist with other propagation procedures used in rooting cuttings. In *Rep. 14th int. hort. Congr., Netherlands, 1955*, pp. 1133-9.
53. HITCHCOCK, A.E. and ZIMMERMAN, P. W. (1932). Relation of rooting response to age of tissue at the base of greenwood cuttings. *Contr. Boyce Thompson Inst.*, 4: 85-98.
54. HODGSON, R.W. (1923). Saving the gophered citrus tree. *Circ. Calif. agric. Exp. Stat.* 273.
55. HOGUE, E.J. and GRANGER, R.L. (1969). A new method of stool bed layering. *HortScience*, 4: 29-30.
56. HÖSTERMANN, G. (1930). Versuche zur vegetativen Vermehrung von Gehölzen nach dem Dahlemer Drahtungsverfahren. *Ber. dtsh. bot. Ges.*, 48: 66-70.
57. HOWARD, B.H. (1971). Propagation techniques. *Sci. Hort.*, 23: 116-26.

58. HOWARD, B.H. (1974). Chip budding. *Rep. E. Malling Res. Stat. for 1973*. pp. 195-7.
59. HOWARD, B.H. and GARNER, R.J. (1955). High temperature storage of hardwood cuttings as an aid to improved establishment in the nursery. *Rep. E. Malling Res. Stat. for 1964*, pp. 83-7.
60. HOWARD, B.H. and NAHLAWI, N. (1970). Dipping depth as a factor in the treatment of hardwood cuttings with indolylbutyric acid. *Rep. E. Malling Res. Stat. for 1969*, pp. 91-4.
61. HOWARD, B.H., SKENE, D.S. and COLES, J.S. (1974). The effects of different grafting methods upon the development of one-year-old nursery apple trees. *J. hort. Sci.*, 49: 287-95.
62. HUROV, H.R. and CHONG, Y.F. (1960). Illustrated description of the green bud strip budding of 2-8 month old rubber seedlings. *Pamphl. N. Borneo Dep. Agric.* 9.
63. IMPERIAL BUREAU OF FRUIT PRODUCTION. (1932). Investigations on the standardization of citrus trees by propagation methods. *Tech. Commun. imp. Bur. Fruit Prod.* 3.
64. JAFFE, A. (1970). Chip grafting guava cultivars. *Plant Propagator*, 16(2): 6.
65. KNIGHT, R.C., HATTON, R.G., AMOS, J. and WITT, A.W. (1928). The vegetative propagation of fruit-tree rootstocks. *Rep. E. Malling Res. Stat. for 1927, Suppl. A.10*, pp. 11-30.
66. KURUP, C.G.R. (EDITOR) (1967). *The mango: a handbook*. I.C.A.R., New Delhi.
67. LANGFORD, M.H., CARPENTER, J.B., MANIS, W.E., GORENZ, A.M. and IMLE, E.P. (1954). Hevea diseases of the western hemisphere. *Plant Dis. Repr. Suppl.* 225: 37-41.

68. LAWRENCE, W. J. C. and NEWELL, J. (1941). *Seed and potting composts*. Allen and Unwin, London, 2nd Ed.
69. LEE VALLEY EXPERIMENTAL HORTICULTURE STATION (1973). Film plastic single span greenhouses. Prototypes designed and erected at the Lee Valley Experimental Horticulture Station. *Leafl. Lee Valley exp. Hort. Stat.* 17.
70. LEIGH, D. S., TROCHOULIAS, T. and AUSTEN, V. C. (1971). Propagation of macadamia. *Agric. Gaz. N.S.W.*, 82: 333-6.
71. LEK, H. A. A. van der (1930). Anatomical structures of woody plants in relation to vegetative propagation. In *Proc. IXth int. hort. Congr., London*, pp. 66-76.
72. LESLIE, W. R. (1938). *Results of experiments 1931-37*. Dominion Exp. Stat., Morden, Manitoba, 63 pp.
73. LOOMIS, H. F. (1942). Methods of splitting *Hevea* seedlings. *J. agric. Res.*, 65: 97-124.
74. LYNCH, S. J. and NELSON, R. (1950). Mango budding. *Proc. Fla St. hort. Soc. for 1949*, 62: 207-9.
75. MCKAY, J. W. and JAYNES, R. A. (1969). Chestnuts. In *Handbook North American nut trees*, Ed. R. A. Jaynes. Northern Nut Growers Ass., U.S.A., pp. 264-86.
76. MCKELVIE, A. D. (1957). The polythene sheet method of rooting cacao cuttings. *Trop. Agric., Trin.*, 34: 260-5.
77. MAJUMDAR, P. K. and RATHORE, D. S. (1970). Bench grafting in mango. *Indian Hort.*, 14: 11-12.
78. MALAN, E. F. and MEULEN, A. van der (1954). Propagation of avocados. *Fmg S. Afr.*, 29: 499-502.
79. MAY, W. B. (1951). Private communication.
80. MILLER, E. J. et al. (1950). Studies on the development, preparation, properties and applications of wax emulsions for coating nursery stock and other materials. *Tech. Bull. Mich. agric. Exp. Stat.* 218.

81. MOORE, J. C. (1963). Propagation of chestnuts and camellia by nurse seed grafts. *Comb. Proc. int. Plant Prop. Soc.*, 13: 141-3.
82. MOSSE, B. (1962). Graft-incompatibility in fruit trees. *Tech. Commun. Commonw. Bur. Hort. Plant. Crops* 28.
83. NUKHERJEE, S. K., MAJUMDER, P. K., BID, N. N. and GOSWAMI, A. M. (1967). Standardization of rootstocks of mango (*Mangifera indica* L.). II. Studies on the effects of source, invigoration and etiolation on the rooting of mango cuttings. *J. hort. Sci.*, 42: 83-7.
84. MUZIK, T. J. and CRUZADO, H. J. (1958). Transmission of juvenile rooting ability from seedlings to adults of *Hevea brasiliensis*. *Nature*, 181: 1288.
85. NAHLAWI, N. and HOWARD, B. H. (1971). Effect of position of IBA application on the rooting of plum hardwood cuttings. *J. hort. Sci.*, 46: 535-43.
86. NAHLAWI, N. and HOWARD, B. H. (1972). Rooting response of plum hardwood cuttings to IBA in relation to treatment duration and cutting moisture content. *J. hort. Sci.*, 47: 301-7.
87. NAIK, K. C. (1941). Studies on propagation of the mango, *Mangifera indica* L. *Indian J. agric. Sci.*, 11: 736-68.
88. NICHOLS, R. (1958). Propagation of cacao in plastic bags. *Nature*, 181: 580.
89. NORTHWOOD, P. J. (1964). Vegetative propagation of cashew (*Anacardium occidentale* L.) by the air-layering method. *E. Afr. agric. For. J.*, 30: 35-7.
90. OVERBEEK, J. van, GORDON, S. A. and GREGORY, L. E. (1946). An analysis of the function of the leaf in the process of root formation in cuttings. *Amer. J. Bot.*, 33: 100-7.
91. PARRY, M. S. (1956). Tree planting practices in tropical Africa. *FAO For. Dev. Pap.* 8.

92. PATIL, J. S. (1972). Papaya can surely be more paying. *Indian Hort.*, 17(2): 9-10.
93. PEARSE, H. L. (1948). Growth substances and their practical importance in horticulture. *Tech. Commun. Commonw. Bur. Hort. Plant. Crops* 20.
94. PEDRO, A. san (1935). Preliminary studies in the marcottage of the avocado. *Philipp. Agric.*, 23: 681-7.
95. PEREIRA, H. C., WOOD, R. A., BRZOSTOWSKI, H. W. and HOSEGOOD, P. H. (1958). Water conservation by fallowing in semi-arid tropical East Africa. *Empire J. exp. Agric.*, 26: 213-28.
96. PREEZ, W. P. du (1954). Propagation of guavas. *Fmg S. Afr.*, 29: 297-9.
97. PRESTON, A. P. (1964). The wind factor in orchard tree spacing. *Sci. Hort.*, 17: 67-73.
98. PRIESTLEY, J. H. and SWINGLE, C. F. (1929). Vegetative propagation from the standpoint of plant anatomy. *Tech. Bull. U.S. Dep. Agric.* 151.
99. RAO, V. N. M. (1958). Studies on the vegetative propagation of cashew (*Anacardium occidentale L.*). I. Air-layering by cincturing and etiolation of shoots. *Indian J. agric. Sci.*, 28: 181-97.
100. RAO, V. N. M. (1967). Propagation practices. In *The mango: a handbook*, Ed. C. G. R. Kurup. I.C.A.R., New Delhi, pp. 32-69.
101. RAO, V. N. M., RAO, I. K. S. and HASSAN, M. V. (1957a). Studies on certain aspects of germination of seeds in cashew (*Anacardium occidentale Linn*). *Indian J. agric. Sci.*, 27: 25-34.
102. RAO, V. N. M., RAO, I. K. S. and HASSAN, M. V. (1957b). Studies on seed viability in cashew. *Indian J. agric. Sci.*, 27: 289-94.
103. REES, A. R. (1959). Germination of oil palm seed: large scale germination. *J. W. Afr. Inst. Oil Palm Res.*, 3: 83-94.

104. ROWE-DUTTON, P. (1959). Mist propagation of cuttings. *Digest Commonw. Bur. Hort. Plant. Crops* 2.
105. RUBBER RESEARCH INSTITUTE OF MALAYA (1967). Propagation and planting methods. *A. R. Rubber Res. Inst. Malaya for 1966*, pp. 25-7.
106. RUBBER RESEARCH SCHEME, CEYLON (1943). Notes on rubber seedling nurseries. *Adv. Circ. Rubber Res. Scheme Ceylon* 3.
107. SCARBOROUGH, I. P. (1971). Private communication.
108. SCARBOROUGH, I. P. (1973a). Private communication.
109. SCARBOROUGH, I. P. (1973b). Private communication.
110. SINGH, L. B. (1954). Propagation of mango by air-layering for rootstocks. *Proc. Amer. Soc. hort. Sci.*, 63: 128-30.
111. SINGH, L. B. (1960). *The mango*. Leonard Hill, London.
112. SINGH, S. M. and KUMAR, H. (1967). Influence of ringing of source shoots and concentrations of indole-3-butyric acid on the performance of phalsa (*Grewia asiatica* L.) stem cuttings. *Indian J. agric. Sci.*, 37: 151-4.
113. SINHA, A. C. (1942). Studies on the vegetative propagation of plum rootstocks by layering. *J. Pomol.*, 20: 1-11.
114. SNYDER, W. E. and HESS, C. E. (1957). An evaluation of the mist technique for the rooting of cuttings as used experimentally and commercially in America. In *Rep. 14th int. hort. Congr., Netherlands, 1955*, pp. 1125-32.
115. SPENCER, G. E. L. (1931). Seed storage and germination. The use of cool storage in retaining the germinating power of some oily seeds. *Trop. Agric., Trin.*, 8: 333.
116. STOLTZ, L. P. and HESS, C. E. (1966). The effect of girdling upon root initiation: carbohydrates and amino acids. *Proc. Amer. Soc. hort. Sci.*, 89: 734-43.

117. STOUTEMYER, V. T. (1939). Talc as a carrier of substances inducing root formation in soft-wood cuttings. *Proc. Amer. Soc. hort. Sci.*, 36: 817-22.
118. TEMPANY, H. and CRIST, D. H. (1958). *An introduction to tropical agriculture*. Longman, London.
119. TINLEY, G. H. (1960). Vegetative propagation of clones of *Hevea brasiliensis* by cuttings. In *Proc. nat. Rubber Res. Conf., Kuala Lumpur*, pp. 409-18.
120. TRIPATHI, H. N., MAITI, R. G. and SINGH, S. M. (1961). Effect of media and concentrations of plant regulators on air layering in mango (*Mangifera indica* L.). *Balwant Vidyapeeth J. agric. sci. Res.*, 3: 16-19.
121. URQUHART, D. H. (1961). *Cocoa*. Longman, London, 2nd Ed.
122. WEBSTER, C. C. and WILSON, P. N. (1966). *Agriculture in the tropics*. Longman, London.
123. WONG, T. L., HARRIS, R. W. and FISSELL, R. E. (1971). Influence of high soil temperatures on five woody-plant species. *J. Amer. Soc. hort. Sci.*, 96: 80-3.

PART TWO

THE TREE SPECIES

by

VARIOUS AUTHORS

ANACARDIUM OCCIDENTALE — CASHEW

by

G. K. ARGLES

Formerly of the Commonwealth Bureau of Horticulture
and Plantation Crops

ECOLOGY AND BOTANY IN RELATION TO PROPAGATION

Distribution and ecology

The cashew is a native of tropical Central and South America and the West Indies but has become naturalized in many other tropical countries. Although it may be found growing at elevations up to 4000 feet (1200 m) it is best suited to the lower elevations, and self-sown seedling trees are particularly abundant in coastal regions.

Some of the regions in which cashews have become naturalized have an average annual rainfall of only about 20 inches (500 mm), which may be very unevenly distributed. There is no doubt that the cashew's reputation for drought resistance is well-founded although it is sufficiently adaptable to be grown successfully in some areas with rainfalls up to 150 inches (3800 mm). In parts of southern Tanzania where cashews are grown on a substantial commercial scale the average annual rainfall is commonly 30 - 40 inches (760-1016 mm).

One factor of particular importance in the resistance of cashew trees to drought is the extent to which they suffer competition for water and nutrients from neighbouring cashew trees or weeds. It has been found that widely spaced, clean-weeded trees can flourish by exploiting the water reserves in the soil under conditions where the annual rainfall is some 35-36 inches (900 mm) while evaporation from an open surface is nearly 80 inches (2000 mm). Such trees continue to transpire freely and to grow throughout the dry season, whereas closely spaced trees providing a closed canopy may suffer severe water stress.

Little appears to be known about the reactions of cashews to temperature apart from the fact that they are sensitive to

frost and to excessively hot dry weather such as occurs in parts of northern India. Nor has any information been encountered on their response to variations in daylength.

Cashews are often grown on soils that are considered to be too poor or stony for most other crops, but they prefer loams or sandy loams to very sandy soils. Whatever the nature of the top-soil, free drainage and the absence of brackish conditions are considered to be essential. On heavier soils or on soils with impeded drainage near the surface the trees are apt to be poorly anchored and may sometimes be uprooted by strong winds despite a reputation for wind resistance. Given soils with suitable textures, the trees appear to tolerate a fairly wide range of pH values.

From the standpoint of propagation the implications of these observations would seem to be as follows:

(1) As the cashew is able to adapt itself to a variety of climatic and soil conditions, anyone wishing to propagate it is presented with a relatively wide choice of environments in which to raise seedlings or to grow selected mother trees for the production of either seeds or shoot material for vegetative propagation.

(2) The fact that self-sown seedling trees so often establish themselves in areas that are subject to severe droughts suggests that no major problems should be encountered in raising cashews from seed, and that it should also be possible to overcome difficulties experienced in transplanting young trees and thus encourage the use of selected clones in place of seedlings.

(3) Under conditions where periods of drought occur it seems clear that mother trees selected to provide graftwood, layers or cuttings should be grown at wide spacings and be kept free from weed competition to prevent them suffering from water stress that is likely to reduce their propagation ability. *(G15; G19; G23; G24; 18; 37; 75)

* References to the bibliography prefixed with the letter 'G' relate to the Bibliography of General Books and Articles to be found at the end of this book.

Shoot growth

The cashew is a spreading evergreen tree that occasionally reaches 40 feet (12 m) in height. The lower branches may sometimes trail on the ground and under favourable conditions may occasionally strike root. The leaves, arranged alternately, are leathery and glabrous.

Where climatic conditions are suitable and soil moisture is adequate, as in parts of Tanzania, some shoot growth may occur in every month of the year, but even where this happens two or three peak periods of growth are usually evident. In bearing trees one of these main growth periods, sometimes called the flower flush, is essentially generative, in that most, though not all, of the shoots formed give rise to terminal inflorescences soon after they have ceased to extend. The other growth flushes are essentially vegetative, in that they give rise to few, if any, inflorescences. Under some conditions the trees may become "dormant" after the completion of a vegetative flush, with little or no further shoot growth occurring for periods of up to two or three months.

In some regions the largest amount of new extension growth is made by the flower flush which develops over a period of several months during relatively dry weather, and under such conditions a growth peak occurring during the rainy season may be relatively small. In other regions the flower flush may be less pronounced and the largest amount of new extension growth may arise from a vegetative flush that coincides with the rainy season. In either case, however, and also in areas where only two peak periods of growth are recognized it would seem that a distinct vegetative flush, consisting of lateral shoots, always develops soon after the main crop of fruits has matured.

The pattern of growth presented by bearing trees may thus perhaps best be defined as one of indeterminate flushing, with individual shoots emerging at different times over comparatively long periods. This suggests that pronounced physiological differences may exist between individual branches of a tree throughout the periods when growth is occurring. The nature of these physiological differences is unknown, although in the flower flush they seem to be reflected in differences in the sturdiness and total leaf area of bearing and non-bearing shoots.

Whether similar patterns of growth occur in young trees

in the juvenile, non-fruiting stage does not seem to have been recorded. Nor does it seem that any studies have yet been made on the anatomy of cashew shoots from different growth flushes.

In terms of vegetative propagation the cashew would appear capable of providing, during many months of the year, an unusually wide and interesting range of shoot material, which is likely to show substantial differences in rooting, and perhaps grafting, ability. The choice extends from purely vegetative shoots produced on juvenile trees or at seasons when adult trees are not flowering and fruiting, to both vegetative and generative shoots produced during the flower flush. Moreover, with any given growth flush it will normally be possible to select shoots differing in their stage of maturity.

This breadth of choice emphasizes the need in investigations on methods of propagation for adequate descriptions of the shoot material used. Such descriptions are likely to be of far greater value than details of the dates on which shoots happen to have been taken. (G19; 13; 20; 41; 51)

Root growth

The existence of a dominant tap-root in young cashew seedlings is sometimes blamed for difficulties experienced in transplanting them successfully. In older trees the tap-roots are said to penetrate deep into the soil, thus playing an important part in the resistance of the trees to drought. Recent excavations of trees in Tanzania, however, suggest that emphasis placed on the original tap-root may have been somewhat exaggerated. Even in very young trees, only 1½ to 2½ years old, very extensive lateral root systems were found extending to almost twice the diameter of the canopy. These roots were supplemented by vertical "sinker" roots, some emerging from the original tap-root and others from various points along the main lateral roots. These observations suggest that severing the tap-root shortly before or during the transplanting of a young tree should not in itself jeopardize the survival of the tree, provided that the soil into which it is planted is in a condition which encourages the rapid development of both lateral and vertical roots.

So far as is known no information is available on the periodicity of root growth. In as much as some top growth

may occur throughout the year it is probably safe to assume that some root growth is also taking place during the greater part of the year. It would be of interest to discover if, as in certain other tropical evergreens, peak periods of top growth are followed closely by peak periods of root growth, because this might provide an indication as to the times when the rooting ability of cuttings or layers would be relatively high (41; 70).

Flowering and fruiting

Cashew trees usually start bearing appreciable crops in their third to fifth year, although some fruits may be borne on trees that are younger and sometimes little more than one year old. The juvenile, non-bearing stage, which many propagators favour as a source of free-rooting cuttings, is therefore much shorter than in many other tree crops.

The cashew inflorescence is a lax, terminal, many-flowered panicle, in which male flowers outnumber hermaphrodite flowers, usually by about six to one, but occasionally by much higher proportions.

Inflorescences are normally borne on only one of the main growth flushes, although occasionally some flowers and fruits are borne on one of the other growth flushes. The period during which inflorescences appear on the flower flush may, however, extend from two to five months, during which flowering may reach one or more distinct peaks. Under favourable conditions the majority, but not all, of the shoots formed in this growth flush produce flowers.

In India wind is thought to be the main pollinating agent, but elsewhere various insects appear to play an important role. Bagged inflorescences do not set fruit, but fruits can be produced by artificial self-pollination as well as by open cross-pollination. Following pollination there may be a substantial fall of fruitlets, which is generally attributed to physiological causes, but may also be accentuated by insect attack.

A period of two to three months elapses between fruit set and fruit maturity. The true fruit or nut reaches its maximum size during the first half of this period, whereas the fleshy cashew apple, consisting of an enlarged pedicel, receptacle and disc, makes most of its growth during the second half of the period. The harvesting period lasts from

one-and-a-half to three or four months, depending on the region.

Although light showers of rain during flowering may not be harmful and may even sometimes be beneficial, heavy rain during flowering or fruit development may result in the crop being lost.

With many woody plants the presence of flowers and particularly of fruits is regarded as detrimental to the formation of roots by cuttings or layers made during the fruiting period. Although with the cashew there is some evidence that air-layers made on non-bearing shoots will root more readily than layers made on bearing shoots, the prolonged period over which inflorescences develop may conceivably mean that the impact of flowering and fruiting on rooting ability is less pronounced than in species which have a short flowering and fruit-setting season.

Where circumstances necessitate taking shoots for vegetative propagation during the flowering and fruiting season, it might be worth investigating methods of preventing fruit set, as for example by the use of chemicals or, where facilities exist, perhaps by applying sprinkler irrigation to simulate heavy rain. (G15; G18; G19; G24; 4; 13; 19; 39; 41; 51)

Diseases and pests

Cashews appear to be relatively free from diseases which may damage or destroy young trees in the nursery or are likely to affect adversely shoots used for vegetative propagation. On the other hand, they are subject to attack in many areas by various species of thrips and by capsid bugs (*Helopeltis* spp.), and it would be reasonable to assume that severe attacks by these leaf-sucking insects might have a particularly adverse effect on root regeneration by cuttings and layers and on the formation of graft unions. (G18; G19; 13; 41)

PROPAGATION BY SEED *

Introduction

The vast majority of the cashew nuts that figure in an

*In this and subsequent sections substantial use has been made of an unpublished draft review on cashew propagation and planting prepared in 1965 by Mr. G. E. Tidbury, now Director of the Commonwealth Bureau of Horticulture and Plantation Crops.

expanding world trade are harvested from wild self-sown seedlings or from plantations in which the trees have been raised in situ from seeds planted at stake. The preference for planting seeds at stake instead of raising them in nurseries arises from difficulties experienced in transplanting young seedlings successfully. These difficulties are usually attributed, though without any really solid evidence, to the dominant role played by the tap-root. Damage to the tap-root during transplanting is held responsible for reduced growth and cropping associated particularly with loss of ability to withstand drought (29).

Seedling variation and selection

As might be expected with a heterogeneous seedling population yields of nuts vary widely from tree to tree as do the shape and size of the nuts. The cashew apples also vary markedly in shape, size and colour. The results of one study in India suggest that high yielding trees are more likely to bear nuts of medium weight (51-75 per pound = 0.45 kg) than lighter or heavier nuts, but in Tanzania trees bearing large numbers of nuts tend to produce nuts that are too small to be suitable for the cashew trade. Because of this, less than 1 per cent of the trees in a population were considered worthy of selection on a basis of high yield and satisfactory nut size and quality.

Although it has sometimes been assumed that cashew seedlings come reasonably true to type, the studies in Tanzania have revealed marked variations among the progeny of individual parent trees. These presumably arose mainly, if not entirely, from cross-pollination, and only in two out of the eight lines examined was any uniformity evident in fruit characteristics. Whether greater uniformity would be found among progeny resulting from artificial self-pollination remains to be determined, as does the effect of raising seedlings from orchards composed entirely of clones selected for their superior performance.

Thus, as things stand at present, the only positive step that can usually be taken is to collect seeds from individual trees known to produce consistently high yields of good-quality nuts. (6; 24; 27; 29; 39; 41; 66; 68)

Seed quality and selection

Cashew seeds vary markedly in size and weight, but only

the latter character is closely correlated with the kernel content, because the larger nuts commonly contain air pockets between the kernel and shell or between the cotyledons, and their kernels are sometimes defective.

In an experiment in India, using nuts harvested from a single tree, better germination was obtained with seeds of medium weight (60 nuts per pound = 0.45 kg) than with heavier (50 nuts) or lighter (80 nuts) seeds. Somewhat similar results were obtained when the nuts were divided into three groups based on size.

A more useful criterion of seed quality, however, is its specific gravity. A simple way of eliminating seeds with a low specific gravity is to place them in water and discard those that float. In trials nuts that floated showed lower viability and also took much longer to germinate than nuts that sank.

Greater precision in sorting out seeds on a basis of their specific gravity can be obtained by using a sugar solution in place of water. In trials in Tanzania four sugar solutions were used to separate cashew nuts into five categories with specific gravities ranging from below 1.0 to above 1.075. Both the speed of germination and the percentage germination rose progressively with each rise in the specific gravity of the seeds. This has led to the general advice that only seeds which sink in a solution composed of 1½ lb (0.68 kg) of sugar to 1 gallon (4.5 l) of water should be used for planting.

The advantages of separating seeds on a basis of their specific gravity are not limited to better germination. The trials in Tanzania were extended to record the performance of the seedlings raised from the five seed-density groups mentioned above, and these records showed that the seedlings from the higher-density groups grew better and gave a substantially heavier yield of nuts in the first three harvest years than seedlings from the lower-density groups. However, by the time of the fourth harvest, when the trees were nearly six years old, the difference between the high and low-density groups, both with respect to yield and tree girth, had almost disappeared. This is thought to have been largely due to a check to the growth of the high-density trees caused by the larger crops they bore in the earlier years, and it is not considered in any way to nullify the advantages of selecting seeds with a high specific gravity.

All the work on seed selection referred to above has related to nuts collected at one time when they were fully matured. Studies in India suggest that neither the time when mature nuts are collected nor their stage of maturity is likely to affect germination appreciably. The lack of variation in response to time of collection, which covered a two-month period, need perhaps evoke little surprise, but the finding that seeds harvested so early that the apples had barely started to develop and were still shorter than the nuts, germinated as readily as more mature seeds suggests interesting possibilities. In this latter trial all batches of seeds showed 95-100 per cent germination whether the seeds were planted after two days' drying in the sun or after storage for 11 weeks, and their seedlings showed no differences in growth during the first four months. This result does not lend support to a popular belief that nuts used for seed purposes should be collected before they are fully mature, but it does suggest that it might be worth re-examining other criteria of viability, and in particular specific gravity, in relation to the stage of nut maturity.

Studies in Florence have shown that the provenance of cashew seeds can affect the behaviour of the seedlings, notably their response to salinity. Seeds from Mozambique produced plants that were considerably affected by one per cent soil salinity, whereas plants from Kenyan seed tolerated a 1.5 - 2 per cent salinity level. (12; 24; 33; 35; 40; 41; 50; 56; 57; 68; 71)

Seed treatment and storage

In the Indian trial mentioned in the last section reference was made to planting freshly harvested seeds after the nuts had been dried for two days in the sun. Sun-drying is in fact often recommended, sometimes for as long as 12 to 14 days, on the grounds that fresh seeds sown without drying produce seedlings that are weak and liable to insect attack. So far as is known, there is no experimental evidence to support this view, and the results of the Indian trial suggest that there is no dormancy problem in cashew seeds, whether mature or immature, which might require special treatment. On the other hand it was shown in an American trial that chilling (exposure to 4°C for 15 minutes) did accelerate the germination of cashew seeds.

Various other seed treatments have been tested in isolated trials. In India, for instance, treatment with

gibberellic acid improved seed germination. In Italy soaking the seeds in weak solutions of NaOH or NaHCO₃ sometimes increased germination but such treatments were not considered worth while. Daily illumination of the nuts for 12 hours delayed but did not depress germination.

As most seeds are planted at stake and are therefore dependent on rainfall for germination, planting is normally deferred until the start of a rainy season. This means in practice that seed nuts have to be stored for some time before they can be planted.

The effects on seed viability of prolonged periods of storage were studied in India by the same team of workers. They found that when nuts were stored in tins with lids that were not air-tight they retained their viability virtually unimpaired for seven months. Thereafter viability declined and the time taken by the seeds to start germinating rose from two weeks to about three weeks, until by the 14th month no seeds germinated.

In a further trial, involving comparisons between different storage containers, seeds retained their viability for up to 12 months in tins with lids that were not air-tight (95 per cent germination) and comparable results were obtained when the tins had sealed lids, and when the seeds were wrapped in 100-gauge polyethylene film before insertion in the tins. On the other hand, viability declined much more rapidly when nuts were kept in the traditional local manner in single or double gunny bags or in rice straw.

In an attempt to improve the germination of seeds that had been stored for long periods and might be expected to show declining viability, nuts that had been stored for 8 to 14 months were soaked in water for 24 or 48 hours before being planted. Both soaking treatments improved germination percentages slightly and hastened germination by one to four days, but the effects on nuts stored for 11 months or longer were too slight to be of value. On the other hand, the soaking overnight of all cashew seeds, whether fresh or stored, is general recommended practice in Mysore.

In an Italian trial it was found that the viability of the nuts altered very little for 2 years after picking provided they were kept dry. (23; 51; 56; 60; 64; 66)

Seed planting and germination

Where seeds are planted at stake the usual practice is to prepare planting pits a month or more before the date of planting. These pits are commonly about 1½ x 1½ x 1½ feet (46 x 46 x 46 cm) in size and are left open until about 2 weeks before planting, after which they are filled with top-soil, to which farmyard manure or compost may be added. Burnt earth and ashes may also be incorporated. Artificial fertilizers are not normally applied, although the application of rock phosphate is sometimes advocated where similar pits are used for transplanted seedlings. Whether or not this procedure is necessary or even desirable does not appear to have been tested experimentally. It would seem that given suitable conditions a simpler procedure may be satisfactory, because in Madras cashew seeds are sometimes merely planted in plough furrows.

This is not the place to discuss spacing and planting arrangements in detail. Recommendations vary widely, but in general close spacing of about 20 x 20 feet (6 x 6 m) is recommended for infertile soils and wider spacing of about 40 x 40 feet (12 x 12 m) for rich soils. For windy sites as much as 50 x 50 (15 x 15 m) has been suggested. Some authorities also advocate interplanting with filler trees, removing the latter when the orchard has been established for seven to ten years. In view of the results of recent studies in Tanzania on spacing, which were mentioned earlier in the section on Ecology, it would seem that rainfall rather than soil fertility should be the factor given greatest attention when deciding on the spacing to adopt. In regions with long dry seasons wider spacings should be adopted than in regions with more abundant and better distributed rains.

The planting of seeds at stake should obviously be done as early as possible during a rainy season, to give the seedlings an opportunity of becoming established before dry weather supervenes. Even during the rainy season there may, however, be spells of dry weather, during which it may be advisable to provide water and shade.

The fleshy cotyledons of seeds planted at stake are attractive to numerous pests, such as crows, jackals, monkeys and various rodents. As a partial insurance against depredations by these pests, as well as the failure of some seeds to germinate, it is common practice to plant two or three seeds at each site, the individual seeds being about nine

inches (23 cm) apart. In addition, a thorny enclosure is often erected around each site, and this is maintained until the foliage leaves are well developed. Where two or more seedlings succeed in growing, the weaker ones are subsequently removed. Recommendations on the best time to do this range from one to five months after planting.

It must be admitted that from a horticultural standpoint planting at stake is a crude method of establishing an orchard. It is also wasteful of seed, which may be important where only limited quantities of seeds from selected mother trees are available. It is therefore of interest that a recent advisory note from Mysore should advocate raising cashew seedlings in bamboo basket pots or plastic bags. These containers, about 8 x 4 inches (20 x 10 cm) in size, should be filled with a loamy soil supplemented with a little compost, and one seed only should be sown in each container. A major advantage of this system is that the seeds can be sown two or three months before the start of the rainy season, when the well developed seedlings can be planted out with their balls of earth intact.

The advisory note from Mysore also advocates that the seeds should be planted one inch (2.5 cm) deep and with the stalk-end uppermost. This recommendation arises from earlier work in India in which seeds of uniform size from a single tree were planted in six different positions. The highest percentage germination resulted when seeds were planted with their stalk-end uppermost, and this was followed by a treatment in which the stalk-ends were uppermost but the seeds inclined at an angle of 45° and by another in which the seeds were planted flat. Inferior germination resulted when the seeds were planted with their sutures either upwards or downwards, and very poor germination when the stalk-ends were placed downwards. The only disadvantage of planting the seeds with their stalk-ends uppermost was that the fleshy cotyledons were exposed above the soil surface in about 40 per cent of the seedlings and would thus attract the attention of predators in the field. It was therefore concluded that where seeds are to be planted at stake, it might be preferable to use the second-best method, namely stalk-end upwards but seed inclined at an angle, because in this case only about five per cent of the cotyledons were exposed. The need for this precaution should not of course apply to seeds planted in pots; hence the recommendation to plant seeds vertically with their stalk-ends upwards.

In the same series of trials seeds of uniform size from a selected tree were planted at six different depths ranging from one to six inches (2.5 to 15 cm). There was no significant difference in germination between seeds planted one, two or three inches (2.5, 5 or 8 cm) deep, but the percentage germination dropped sharply at four inches (10 cm) and was negligible at six inches (15 cm). Germination was most rapid (average of 17 days) at one inch (2.5 cm), took slightly longer at 2 inches (5 cm) (20 days) and considerably longer at three to five inches (8 to 13 cm) (27-28 days), while at six inches (15 cm) the few seedlings that emerged took 44 days. Examination of the deeper batches of seeds showed that many had started to germinate, but their plumules had failed to reach the surface. On the other hand, with the seeds planted at only one inch (2.5 cm) the cotyledons appeared above the surface on more than half the seedlings that germinated. This contrasted with only five per cent of the seedlings from seeds planted at two inches (5 cm) deep and with no cotyledons emerging in the other treatments. Thus for seeds planted at stake a depth of two or three inches (5 or 8 cm) is considered preferable to one of one inch (2.5 cm).

It is perhaps worth mentioning that in both the trials outlined above the general level of germination was rather low, the best treatments resulting in 52 and 60 per cent germination, respectively. No reason for this is advanced, although in other trials the same workers had obtained germination percentages of between 90 and 100 per cent for all the treatments they had compared. In the absence of any explanation, all that can be said is that it lends support to a fairly widely held view that the cashew seeds are apt to germinate rather erratically.

One factor that may perhaps sometimes account for indifferent germination may be temperature. In a recent study at Florence in Italy samples of cashew nuts that had been grown in Dahomey, Mozambique and Tanzania were germinated at seven different temperatures ranging from 10° to 40°C (50° to 104°F). The three batches of nuts varied considerably in viability, but in each case the highest percentage germination occurred at 35°C (95°F). The percentage germination declined appreciably at 30° and 25°C (86° and 77°F) and sharply at 20° and 40°C (68° and 104°F); at 15°C (59°F) only a few seeds in the batch with the highest viability germinated, while at 10°C (50°F) no seeds germinated. The speed of germination was also very rapid at 35°C (95°F), averaging

just over eight days for the three batches of seeds. It was still rapid at 30° and 25°C (86° and 77°F) (about 11-12 days) and at 40°C (104°F) (about 10 days), but it became much slower at 20°C (68°F) (about 18 days) and at 15°C (59°F) (28 days). These results would appear to be of considerable interest, because if they prove to be generally applicable, they could well account for some of the low germination percentages and relatively slow rates of germination obtained in trials in many regions where temperatures may fluctuate quite sharply. (G15; G24; 3; 7; 14; 16; 32; 33; 35; 42; 43; 45; 46; 47; 56; 59; 60; 63; 65; 66; 69; 71; 72; 73)

PROPAGATION BY GRAFTING

Rootstocks

For all types of graft cashew seedlings have been used as rootstocks. No information has been encountered of variations in the growth of grafted trees which might be attributable to specific rootstock effects or to stock/scion incompatibility. Indeed in the few comparisons that have been made, grafted trees have grown better and fruited earlier than seedling trees of similar age.

Approach grafting

In India approach grafting (often called inarching) and air layering are generally regarded as the most satisfactory means of propagating selected trees vegetatively.

The method used does not appear to differ in any way from that used for other tropical fruits, such as the mango. A seedling rootstock growing in a pot, basket or plastic bag is supported on staging constructed in the tree's canopy, and an appropriate scion shoot and the stem of the rootstock are grafted together by removing matching slices of stem, two to three inches (5 to 8 cm) long, and binding these tightly together. After a union has been formed the scion is severed below, and the rootstock above, the graft.

A series of trials was started at the Central Cashewnut Research Station, Mangalore, in 1954. As seedlings raised in pots had previously proved too spindly and weak for grafting, the rootstocks used in these trials were raised in beds and transplanted into 10 x 4-in (25 x 10-cm) hill-grass pots, containing equal parts of red earth, leaf mould and well rotted farmyard manure, when they were 11 months old and 20-24 inches (50-60 cm) tall, with girths of about 1½ inches (4.5 cm). At the time of potting up, the seedlings were headed back to a half or one-third of their height. They were then grown in shade for about a month, towards the end of which new shoots emerged, and they were then used for grafting.

The grafts were made in the usual way, but were covered with waxed cloth as well as being tied tightly with twine. The potted rootstocks were watered once or twice daily if there was no rain. When union had been completed some three to three-and-a-half months later, severance was carried out in stages. Cuts were first made part of the way through the scion one inch (2.5 cm) below the graft and also part of the way through the rootstock above the graft. The cuts were deepened seven to eight days later and the final severance made after a further four days.

The first trial described was designed to determine the best time of the year in which to carry out approach grafting on bearing trees. Ten grafts were made in each month of the year except for December, January and February, which were considered to be so dry as to make watering costs prohibitive. In six out of the nine months the take ranged from 60 to 100 per cent. These included the pre-monsoon months March and April and also June when the monsoon started. The May batch of grafts showed only 30 per cent take, which was attributed largely to a severe gale, which also damaged some of the April grafts (60 per cent take). Only 30 per cent of the grafts made during the rainy season in August and September formed unions. The number of days from grafting to severance ranged from 86 to 108.

In the following season a similar trial was carried out, but with the grass pots holding the rootstock replaced by 100-gauge polyethylene film wraps, 20 x 12 inches (about 50 x 30 cm) in size, or by sacking covered by the polyethylene. The aim was to reduce costs by obviating the need to water the rootstocks during dry weather. The free ends of the film were tied tightly above and below the grafts. Grafts were made

every month of the year. Results were rather variable, but in each of the six months preceding the monsoon the percentage take reached 50 or more, except for April when it only reached 40. For the remaining six months, July to December, the take ranged from 10 to 40 per cent. In general, the results obtained with polyethylene wraps alone were slightly better than those obtained with the double wraps of sacking and polyethylene. In this trial the time elapsing between grafting and severance ranged from 88 to 133 days.

The results of these trials suggest that approach grafting is likely to be most successful if done during periods when the trees are in an active state of growth, flowering and fruiting, and least successful if done when the trees are dormant or just starting a growth flush. On the other hand, at Kottarakkara in Kerala State, where the monsoon also occurs during June to August, 100 per cent success was obtained with approach grafts made in September and October. Grafted trees raised at Kottarakkara outgrew and outyielded layered and seedling trees of the same age during the first three years.

Some of the trees raised by grafting at Mangalore were also planted out and compared with seedlings of comparable age. One year later the grafted trees were nearly twice the size of the seedlings. Despite this encouraging result, the cost of raising trees by approach grafting remains an obstacle to its wider use. Even with the aid of polyethylene film the grafts were three to four times more expensive than trees raised by air-layering.

Slightly lower costs have been reported from trials in which two- to three-month-old seedling rootstocks were used in place of 12-month-old seedlings. The stocks were again established in grass and polyethylene containers. In two successive years an average of 65 and 70 per cent of the grafts made united satisfactorily. No further details of this modified method appear to have been published. It has, however, been given a new name, air-grafting, and it is possible that one of its aims may be the elimination or reduction of the staging used to support the older and heavier conventional rootstocks.

Yet another modification of approach grafting that has proved fairly successful is the so-called "nurse-grafted Y-cutting method", which was originally evolved for certain citrus species that proved difficult to propagate from cuttings or air-layers. In this method an approach graft is made in the usual way, and then at a point below the next lateral shoot on the same scion branch an air layer is made. If both succeed, two independent plants are produced, the graft from one arm of the Y and the air layer from the other arm plus the stem of the Y.

In trials at Mangalore it was found possible to modify the original procedure in several respects. For one thing polyethylene was available for wrapping both the root ball of the rootstock and the air layer, and for another it was found possible to carry out grafting and air layering at the same time instead of making the graft some four weeks ahead of the layer. When the layer was seen to have rooted it was removed and potted up with the graft still attached. Subsequently when new shoots appeared, the grafted portion was separated. When 10 Y-shoots were treated in this way in each of the months of the year, an average of six grafts and four layers was obtained, that is 50 per cent of the total possible. The best results were obtained with grafts and layers made during the relatively dry period from December to May when the trees were in an active state of growth. The total period taken to produce separate plants ranged from 100 to 143 days, although it was noted that the air layers rooted rather faster than conventional layers made without the aid of nurse grafts. (G15; G24; 24; 30; 32; 35; 36; 53; 54; 68)

Side grafting

Side grafting as a possible method of propagating cashews only appears to have been tested at Mangalore in India, where the procedure adopted was based on the so-called Nakamura method.

In the first of two trials grafts were made in each of 12 months, the scions taken from selected trees consisting of terminal shoots, four inches (10 cm) long and of pencil thickness, and the rootstocks of 1-year-old seedlings. Presumably the leaf blades of the scions were cut off before the grafts were inserted. The result was an almost total failure, nearly all the scions shrivelling within 10 to 15 days of their insertion.

It was therefore decided to repeat the trial, taking steps to prevent the grafts from drying out. This was done by applying damp moss two to three inches (5-8 cm) above and below each graft and enclosing the moss and the graft inside 100-gauge polyethylene film. In addition muslin was suspended above the grafts to shade them from direct sunlight. As soon as the grafts started to grow the muslin and film were removed in stages.

The best takes, ranging from 35 to 70 per cent, were obtained during February to May, which, as noted in the previous section, was the period of active growth when the best results were also obtained at Mangalore with approach grafting. Results were much poorer during and immediately after the monsoon period from June to August. (24; 57)

Veneer grafting

In the Ahmednagar district of India veneer grafting has been studied as a method of raising clonal material *in situ*. It was best used on seedling rootstocks not older than five months and not more than 50 cm (20 in) high with a girth of four to five cm (1½-2 in). The method was most successful if carried out early in the rainy season (June - July) (44).

Tip grafting

Tip grafting of cashews appears to have been tested first in Mozambique about ten years ago where it was used to graft trees in the field. The best time was found to be from November to February. It was recommended that the stocks should be five to twelve months old, 0.6-1 m (2-3 ft) high and with a basal diameter of 1.0-1.5 cm (0.4-0.6 in). Scions should be taken from the current season's shoots one month after the start of flowering. Tips of shoots were whip-grafted, the union was wrapped in plastic tape and the terminal bud was covered in a separate piece of plastic. In a later trial in Mozambique tip grafting proved 59 per cent successful and 96 per cent of the grafts that took survived transplanting. Ten-month-old rootstocks gave better results than ones three months old. A further modification of this method, reported in 1973, was called mini-grafting. This technique made use of splice and cleft grafting with stocks and scions 3-5 mm (0.1-0.2 in) in diameter. Leaves were left on the stock, and the scion had a terminal bud that was on the point of opening. The grafts were wrapped in PVC until union was complete. It is claimed that this method was 100 per cent successful.

Inspired by the good results obtained in Mozambique and the simplicity of the method, tip grafting was also tried out in the Malagasy Republic. Here seedling stocks were raised in pots and grafted when three to four months old, the stem having a minimum diameter of 5 mm (0.2 in) at the point of grafting, 15-25 cm (6-10 in) from soil level. A terminal scion 8-10 cm (3-4 in) long with a swelling terminal bud was used. The scion was prepared four to eight days in advance by removing the leaves. The graft could be planted out about six weeks after working, when the terminal shoot had four to five leaves. The results were excellent, over 90 per cent take being obtained, with 78 per cent survival after transplanting even under adverse weather conditions. (5; 6; 10; 29; 31)

Wedge grafting

This method was recently used in one small-scale test in India. Seed was sown in polyethylene bags and after 21 days the seedlings were grafted with terminal current season's shoots. These scion shoots were either thick (0.4 cm (0.15 in) diameter) or thin (0.3 cm (0.12 in)). Some of the scion shoots had been defoliated seven days before grafting. Two months after grafting the success rate for thin scions was 62 per cent both with and without defoliation, and for thick scions it was only 14 and 20 per cent without and with defoliation, respectively. As wedge grafting is a relatively easy method of propagation, its use with thin scions might be worth further study. (See also tip grafting above.) (12a)

Budding

In view of the fact that shield budding, if successful, is generally regarded as the most efficient and economical method of grafting and that it was reported as being successfully used with cashews in Malaya and the Philippines over 30 years ago, it is surprising that no serious attempt appears to have been made to develop a technique that might be used on a commercial scale. In fact, almost the only information available consists of an early recommendation from the Philippines to the effect that non-petioled mature budwood turning greyish in colour should be used, and that the bud should be inserted at a point where the bark of the stock is in a similar condition.

A technique called chip budding, which appears to be similar to, and may well be the same as, shield budding, gave very promising results in a single trial in India. The rootstocks used were about one year old and the buds inserted were three to four cm (about 1½ in) long with underlying wood. The grafts were bound with polyethylene tape which was removed in three to four weeks, when the stock was cut back at about four to five cm (1½-2 in) above the union. The 88 per cent take was good, and 79 per cent of these grafts survived transplanting.

Patch budding is said to have been used successfully in India and Malaya, but little information is available on this work. In Mozambique patch budding has been used to bud trees in the field, using rootstocks five to twelve months old and scions of the current season's shoots one month after the start of flowering. It is recommended that the ends of the scion shoots be topped one to two weeks before use; buds should then be cut from the fully hardened part. After budding the stock was wrapped with plastic tape and immediately cut off 20 cm (8 in) above the union. This method may not have continued to give good results because 6 years later, in 1973, it is reported from Mozambique that budding had been unsatisfactory. (G4; G6; G15; G24; 5; 9; 10; 30; 32; 33; 34; 43; 44; 62; 68)

PROPAGATION BY LAYERING

Ground layering

Layering, referred to here as ground layering to distinguish it from air layering which has been widely used for cashews, is a method used commercially to propagate many trees and shrubs which have a spreading growth habit and produce branches close to the ground. The cashew has such a growth habit, and indeed when its branches rest on damp ground they sometimes produce adventitious roots.

The rooting of low branches can be encouraged by removing rings of bark or cutting tongues at appropriate places, pegging the branches down and covering them with soil; higher branches can be similarly encouraged to root into pots placed on staging. As trials in Madras have shown, however, these methods are not always successful.

It is rather surprising that the method of layering known as stooling or mound layering does not appear to have been tried with cashews. The cashew produces water shoots from the base of the tree, which are normally removed in pruning. In other plants water shoots of this type commonly possess higher root-forming ability than normal branches, and for stooling their production is often encouraged by regular coppicing. This is followed by earthing up as the shoots develop to etiolate their bases and to provide a moist medium in which roots can develop. (Gl9; 11; 24)

Air layering

Air layering, otherwise known as marcotting or gootee layering, has been widely used to propagate selected clones of cashew, the method adopted being essentially the same as that used for mangoes and many other tropical trees. As with approach grafting the advent of waterproof plastic films has made it much easier to keep the layers moist until roots have formed.

Studies in India, notably at the Central Cashewnut Research Station, Mangalore, and in Tanzania have shed a good deal of light on the following factors that affect the rooting of cashew air layers:

Age of the parent tree

Variation between cashew trees

Age and condition of shoots at the point of air layering

Time of air layering and the stage of growth of the parent tree

Rooting media

Growth substance treatment

Films for wrapping air layers.

Age of the parent tree: Rao and Hassan (52) describe a trial at Mangalore in which air layers were made on trees in five age groups, namely six- to twelve-month-old seedlings, one-year-old seedlings and seedling trees two to five years old and over 20 years old. In all five groups layering was carried out on shoots of the current season, which were between six and nine months old, green, rounded and about the thickness of a pencil, and also in the three older groups of trees on one-year-old shoots. Each layer was prepared by removing a

ring of bark $\frac{1}{4}$ to $\frac{1}{2}$ inch (30 to 60 mm) wide, tying a piece of twine over the cut to prevent callus from the cut surfaces uniting, applying damp moss and enclosing it in a 6 x 5-inch (15 x 13-cm) sheet of 100-gauge polyethylene film. The trial was started in December and repeated in March, June and September. Each treatment consisted of ten layers.

An average of 74 per cent of all the layers formed roots and there were no clear differences in percentage strike attributable to the age of the parent trees. On the other hand, the layers rooted more quickly on the two youngest groups of trees (30 days) than on the older trees (40 days). Conceivably this may be an indication, if only a faint one, that cashew trees in the juvenile stage may possess a potentially higher rooting ability than adult trees.

Variation between cashew trees: It is only to be expected that a seedling population, which shows as wide variations in growth and fruiting characteristics as the cashew, will show differences in the root-forming ability of its shoots. This indeed is the only interpretation that can be placed on the results of a trial carried out by Northwood (38) in Tanzania. In this trial one air layer was made on each of ten different trees in each month of the year. The number of layers successfully rooted and separated ranged from three to ten per tree. While in any given month it might be possible to attribute differences in the rooting of layers to variations in such factors as moisture conditions in the sites on which the trees were growing, differences maintained consistently throughout the year would appear to reflect inherent variations in root-forming ability.

As Northwood points out, poor root-forming ability may not be of much importance when it is only desired to raise a few trees vegetatively, but the elimination of poor rooting individuals would be necessary if ever clonal cashews were to be developed on a commercial scale.

Age and condition of shoots at the point of air layering: In the trial by Rao and Hassan referred to above, both shoots of the current season and one-year-old shoots were layered on the three groups of older trees. A somewhat higher average rooting percentage resulted from layering one-year-old shoots (79 per cent) than from layering six- to nine-month-old shoots (67 per cent), but all the batches of layers, except one, took the same time to root.

In further trials by Rao (49) in which one-year-old shoots were layered in every month of the year and current season's shoots in eight months, the former again showed a higher average strike (76 compared with 60 per cent). The average time taken for roots to appear was slightly longer than in the earlier trial and the young shoots took longer to reach this stage than the older shoots (55 compared with 45 days), but as subsequent root development was somewhat faster in the young shoots, both types of layer reached the stage when they could be separated from the parent tree after the same time (an average of 82-83 days). There was some indication that the older layers formed more roots than the young layers.

The investigations by Rao and Hassan (52) were extended to compare the rooting of current season's shoots and one-year-old wood when rings were cut above a node, at a node and below a node. This trial, which was repeated in four different months, again showed a slightly higher average rooting percentage from the older shoots, but there were no appreciable differences attributable to the position of the ring. On the other hand, in all four months the layers ringed at a node rooted faster (average 38 days) than layers ringed either above or below a node (both 47 days).

In trials in Tanzania it would seem that only current season's shoots have been layered, although in an early report a passing reference is made to the fact that no difference in percentage rooting was obtained when both "green" and "hard" shoots were compared.

The time of air layering and the stage of growth of the parent tree: As mentioned above, the studies at Mangalore included making batches of layers in every month of the year. Rao (49) recorded the stage of growth of the trees in each month. Satisfactory results were obtained at all times of the year except June and July when the monsoon had set in and the trees were described as being dormant. In general, high percentages of rooting were obtained between August and April, the best results being obtained when growth was most active during the flower flush, which in south-west India extends from October to April. It will be recalled that this also proved the best period in which to graft cashews.

A recent advisory note by Aiyadurai (4) confirms that in Kerala as well as in Mysore October to April has proved the best period to make air-layers. He also confirms that one-year-old shoots give better results than current season's shoots, but he makes an interesting distinction between flowered and non-flowered shoots, pointing out that at two research stations non-flowered shoots showed significantly higher rooting percentages than flowered shoots.

Following the publication of Rao and Hassan's results in India similar trials were carried out by Northwood (38) in southern Tanzania, batches of layers being prepared in each month of one year and in three of the most promising months during the next year. The method of air layering resembled that used in the Indian trials though with minor variations including the use of vermiculite in place of moss. The layers were all made on current season's shoots.

A superficial examination of the results of Northwood's trials suggest that they resemble those of Rao and Hassan, in that the best percentages of rooting (60-100 per cent) and also the quickest rooting (66-86 days to separation) were obtained between October and April and the worst results in June and July (10-40 per cent rooting and 168-179 days to separation). However, in terms of rainfall and the flower flush they differ dramatically from those obtained in India. In southern Tanzania November to April is the rainy season, which, according to Bigger (13), is the period when the trees make the greater part of their vegetative growth but do not flower. Flowering occurs in conjunction with a much smaller amount of shoot growth from June to October.

Thus, whereas in India the best rooting of air layers is obtained during relatively dry weather and the flower flush and the worst rooting during the height of the wet season, in Tanzania the best rooting is obtained during relatively wet weather when the trees are not flowering and the worst rooting during dry weather when the trees are starting to flower. There is, however, one important respect in which the results coincide. In both cases the best rooting occurred when the trees were making their major flush of vegetative growth, and this suggests that it is this factor and not rainfall or the presence or absence of flowers and fruits which determines the success of air layering.

Rooting media: In the main Indian trials moss was used as the rooting medium, whereas vermiculite was used in the Tanzanian trials. In other trials in India (30; 36) good results have been claimed for various other substances, including coir fibre, sand, wood shavings and mixtures of sand and sawdust.

Rao and Hassan (52) carried out a trial at Mangalore with eight different rooting media. They obtained good results (70-90 per cent rooting) with the moss from the Nilgiri hills used in most of their trials and with sand, wood shavings, coir husk dust and coir fibre, and poor results (15-30 per cent rooting) with a local moss, sawdust and a mixture of leaf mould and red earth.

In a similar trial in Tanzania Northwood (38) obtained 75 to 81 per cent rooting with vermiculite, sphagnum moss, milled coir fibre and fibre from the palm *Phoenix reclinata*. Moderately good results (62-69 per cent rooting) were obtained with sawdust and a 50:50 mixture of vermiculite and sand. Poor rooting (31 per cent) was obtained with milled groundnut shells.

In the absence of information on such characteristics as the air/water relations of these different media it is impossible to draw any general conclusions, other than that it should not be difficult to provide a suitable rooting medium from among the various materials likely to be available locally in regions where casnews are grown.

Growth substance treatment: Rao and Hassan (52) carried out a trial, repeated in 4 different months, in which indolebutyric acid (IBA) was applied either in the liquid form of Seradix A at 1 or 2 ml/l to the moss rooting medium or in the powder form of Seradix B3 direct to the rings cut in layered shoots.

The effects of IBA on the percentage of cuttings that rooted was generally small, although Seradix A, though not Seradix B3, appeared to improve rooting during the difficult June period. Seradix A at both concentrations did, however, markedly increase the number of primary roots formed by layers made in all 4 months. By contrast, Seradix B3, if anything, reduced the number of roots formed.

In a trial at Bihar Agricultural College, Chhonkar and Singh (15) obtained a slight improvement in the rooting of air layers by treating the upper sides of the rings cut on

one-year-old shoots with 75 p.p.m. of IBA in lanolin paste (88 per cent rooting compared with 71 per cent in the controls). Treatment with indoleacetic acid (IAA) did not improve the rooting percentage. Both growth substances, however, improved the average number of roots produced and their length, IBA having more effect in this respect as the concentration applied rose from 50 to 100 p.p.m., but IAA being most effective at 75 p.p.m.

In a more recent trial in India, Acharyya and Dash (2) treated the upper end of the air layer ring with IBA or NAA at 100, 200 or 300 p.p.m. in white petroleum jelly. IBA at 300 p.p.m. was most effective, resulting in 84.6 per cent successful marcotting compared with 46.2 per cent in the controls; it also gave the longest roots, the greatest number of roots and the shortest period of root emergence. Results with 200 p.p.m. IBA were statistically as good, but NAA was considerably less effective.

In Tanzania vermiculite and sawdust rooting media were soaked in another formulation of IBA, Hortomone A, but a brief report from the Department of Agriculture (68) mentions that it did not give better results than soaking the media in plain water.

Films for wrapping air layers

Polyethylene film in the form of 100-gauge Alkathene was used in most of the air layering trials at Mangalore, while in Tanzania it was used in the form of 150-gauge Alkathene tubing. In one trial at Mangalore, however, Rao and Hassan (52) compared five thicknesses of Alkathene film ranging from 100-gauge to 300-gauge in four different months. While results with the heavier gauges were generally satisfactory, none gave as high a percentage of rooting as the standard 100-gauge film.

Discussion: Among the various methods by which cashews can be propagated vegetatively air layering seems to be generally regarded as the most satisfactory. Trees can be propagated successfully during six or seven months of the year when the parent trees are in an active state of growth, and within this long period it is generally possible to choose times for layering which will result in having plants ready for planting out at the beginning of the rainy season.

In the few cases in which trees raised by air layering have been compared with seedlings they have generally made better growth and come into bearing earlier.

The question remains as to whether air layering can be regarded as an economic method for the large-scale propagation of selected clones. Northwood (38) clearly doubts this, because he describes it as a time-consuming and expensive operation that cannot be regarded as a satisfactory means of producing improved planting material on a large scale for African farmers.

In India, on the other hand, Rao (49) worked out the cost of an air layered plant at only 2 annas 8 pies (about 1p) in 1956. This figure he thought could be cut to about 2 annas by using improved techniques. As mentioned earlier these costs are much below those calculated for trees produced by approach grafting. (G15; G24; 1; s; 4; 13; 15; 24; 30; 36; 38; 49; 52; 54; 68)

PROPAGATION BY CUTTINGS

As is to be expected with any plant that can be raised by layers, it is possible to propagate cashews by cuttings, but attempts so far made to develop a satisfactory technique can only be described as half-hearted, despite the fact that cuttings, if successful, would almost certainly prove a more economical method of vegetative propagation than air layering or approach grafting.

Bailey's *Standard Cyclopedia of Horticulture* (G1) mentions that under temperate conditions cuttings consisting of mature wood with their leaves retained have been rooted under glass.

A short note in a report from Jamaica (26) mentions that an attempt was made to root "hard and semi-hardwood" cuttings, but without success. Although it is not specifically stated, these cuttings appear to have been leafless, because they started leafing out after about two weeks. It is common experience that cuttings of evergreen plants which are taken without leaves or which shed their leaves rarely form roots.

Attempts to strike cuttings in various parts of India and in Tanzania appear generally to have failed, but in the absence of any details as to the methods adopted no reasons for the failures can be suggested. One trial in Mysore did, however, achieve some success. In a brief note on this trial (24) it is stated that when shoots were etiolated for 30 days before cuttings were taken in seven different months, an average of 25 per cent rooted. The best result was obtained in November, when 40 per cent rooted.

So far as can be discovered no one has attempted to root softwood cashew cuttings under mist or in frames enclosed in water-retaining plastic films, although both these aids to propagation have now been available for more than 15 years. Nor would it seem that wounding treatments or root-promoting growth substances have been tested. There is clearly considerable scope for further investigations on this method of propagation. (G1; G15; 24; 26; 30; 33; 34; 68; 69)

HANDLING AND TRANSPLANTING YOUNG CASHEW TREES

As mentioned earlier in the section on Propagation by Seed, the widespread practice of planting seeds at stake has arisen very largely from difficulties experienced in transplanting young cashew seedlings, which have usually been attributed to the inability of the tap-root to recover from injury or disturbance. Planting seeds directly in basket pots or other containers which can be planted intact without disturbing the root ball has also been recommended by some authorities. It is generally agreed that seedlings transplanted with bare roots into the field will rarely, if ever, survive. Difficulties have also been sometimes experienced in establishing approach-grafted or layered plants after they have been separated from the parent trees.

In view of these difficulties, which must be regarded as a major obstacle to the establishment of cashews as an efficient orchard crop, it is surprising that only two investigations have been reported on transplanting techniques. In both of these seedlings were raised in beds and subsequently transplanted into basket pots.

The first trial was carried out by Tai and Popper (67) in Jamaica. They had found that cashews could only be transplanted easily during the first week or two after germination, when the cotyledons were still the only fully

developed part of the plant above ground. In an attempt to overcome the difficulty experienced in transplanting older plants, they subjected plants that were three to five feet (0.9 to 1.5 m) tall, growing in nursery beds to various treatments, including severing the tap-root nine inches (23 cm) below the ground ten weeks in advance of transplanting, heading back the plants lightly and severely, and halving the leaves either at the time of transplanting or two weeks earlier.

The results indicated that little was to be gained from severing the tap-root well in advance of transplanting or in halving the leaves. In fact, only 20 per cent of the seedlings with their tap-roots severed but tops left intact survived, compared with 40 per cent of the seedlings that received no treatment at all. Between 70 and 90 per cent of the plants that had been severely headed back to leave only one-third of the tops survived, compared with an average of 55 per cent for all treatments and of 30 per cent for plants that were not headed back.

Subsequently a similar trial was carried out at Mangalore in India by Hassan and Rao (22). In this case they compared severing the tap-root six weeks or four weeks before transplanting with heading back to leave only half or one-third of the tops. The experiment was repeated over twelve months on seedlings of different ages ranging from six to twelve months.

Here again cutting the tap-root some weeks before transplanting was, if anything, detrimental, only 43 to 50 per cent of all the plants treated in this way survived, compared with 69 per cent of the untreated control seedlings, but both heading-back treatments were beneficial, in that 94 and 81 per cent of all the seedlings cut back to one-third and a half respectively, survived. The heading-back treatments were subsequently repeated on twelve-month-old seedlings in four successive months, the average survival on this occasion being 83 and 93 per cent compared with 60 per cent for the control trees.

In one further trial Hassan and Rao examined the effect of the age of seedlings on their transplanting ability. Batches of seedlings from one to twelve months old were transplanted without any root or top cutting treatments. As found by Tai and Topper very young seedlings transplanted well, an average of 95 per cent of those that were only one month

old surviving. Thereafter the percentage survival declined steadily as the seedlings grew older until it reached only 10-14 per cent when they were six and seven months old. With eight-month-old seedlings, however, it rose again to 60 per cent, and with seedlings that were nine to twelve months old it ranged from 80 to 100 per cent. It is tempting to interpret the results of these trials in terms of fluctuations in the top:root ratio, or to be more precise the transpiring top:absorbing root ratio. One would expect to find a lower top:root ratio in very young seedlings than in somewhat older seedlings that are making rapid shoot growth. Again, as root excavations made by Tsakiris and Northwood (70) in Tanzania have shown, cashew trees that are only one-and-a-half years old may possess such extensive lateral root systems as to suggest that such development must have started at some time during the latter part of the first year's growth of the trees. In other words, the dominant role attributed to the tap-root appears to be relatively short-lived. If extensive lateral root development does occur during the first year, it could conceivably coincide with a rise in the proportions of mature wood to soft flush growth in the tops and lead to a drop in the top:root ratio. Some such pattern of development, if it occurs, might explain the variations found by Hassan and Rao in the survival of transplanted seedlings of different ages, and would also help to explain why heading back, but not tap-root severance, resulted in improved survival.

It must be emphasized that these observations are pure speculation. Whether right or wrong, however, they may serve a useful purpose if they persuade persons working on cashew propagation problems to make a systematic study of root growth in young cashew trees, both seedlings and vegetatively propagated. In particular, such a study should take account of fluctuations in the periodicity of root growth in relation to flushes of top growth, because it is possible that the top:root ratio is at its lowest point, and the trees in the best condition to survive transplanting, when the terminal buds are just starting to swell preparatory to making a new flush of growth.*

*The writer found that young mango trees could be transplanted most readily when the terminal bud showed signs of renewed growth, but not at other times, even though the last terminal flush appeared to have hardened off completely. Similar observations have been reported for certain woody ornamentals in temperate countries.

Finally, it might be worth exploring modern ways of reducing transpiration losses in newly transplanted trees that could perhaps prove more effective than the traditional methods of providing shade and watering the trees periodically. These include the use of anti-transpirant sprays and holding newly potted trees for a period in polyethylene-covered frames in which the relative humidity can be maintained at a higher level than in the open. Mist spraying units adapted for "weaning" newly rooted cuttings could also be used for this purpose. (G15; G24; 7; 14; 22; 26; 30; 33; 35; 42; 43; 45; 47; 48; 61; 65; 67; 69; 70; 72)

CONCLUSIONS AND SUGGESTIONS

Superior trees have been selected in various countries, but it seems probable that the progeny of such trees, when derived from open-pollination, will continue to show considerable variations in yield and quality. It remains to be determined whether the progeny of artificially self-pollinated superior trees, or of collections of superior trees assembled in isolated orchards, will yield sufficiently large crops of nuts of the desired quality.

Cashews have been propagated, though with varying degrees of success, by approach grafting, side grafting, veneer grafting, tip grafting, wedge grafting, shield, chip and patch budding, ground-layering, air layering and cuttings. Of these methods only approach grafting, tip grafting and air layering appear to have been at all widely used or subjected to any detailed study. Approach grafting has been most successful, and plants raised in this way have compared favourably with seedlings in both growth and cropping during the first two or three years. The method is, however, much more cumbersome and expensive than air layering and may not find general commercial application.

Shield budding, generally regarded as the most economical method of grafting, both in terms of labour and the amount of graftwood needed, does not appear to have been studied in any detail as a means of raising cashews, although it was shown to be feasible more than 40 years ago. Further systematic investigation of this method might prove worth while.

Natural layering may occasionally occur when low branches of cashew trees are in contact with moist soil, and this process has occasionally been aided artificially. No attempt appears to have been made, however, to discover whether cashews can be propagated by mound layering or stooling, which, when combined with coppicing, might exploit the potentially higher root forming ability of juvenile shoots or water suckers arising from the bole of the tree.

Air layering appears currently to be the method most widely used to propagate cashews vegetatively. Growth substances can improve results considerably. Compared with approach grafting air layering is relatively inexpensive, but it may still prove too costly for raising trees for commercial purposes.

It has been demonstrated that cashews can be raised from leafy cuttings, but no serious attempts have been made to evolve a satisfactory technique, despite the fact that, wherever cuttings have been found to root readily, they are usually regarded as providing the most satisfactory and economical means of raising clonal material in all cases where a particular rootstock effect is not desired. There is a clear need for systematic studies on raising cashews from cuttings, in which modern techniques, such as the use of mist and of moisture-retaining plastics, are fully exploited.

The use of anti-transpirant chemicals, moisture-retaining plastic covers and mist sprays as means of reducing transpiration losses in newly transplanted trees might repay investigation. A better understanding of the factors affecting survival in transplanting and also perhaps of the factors affecting root development by layers and cuttings, may only become possible when studies have been carried out on the nature and periodicity of root growth in young trees, both seedlings and vegetatively propagated. Anatomical examination of shoots might also be useful as a possible indication of differences in root forming ability that may exist between different clones and also between shoots of a single clone that differ from one another in age or in other respects.

BIBLIOGRAPHY

1. ABRAHAM, P. Air layering is a success with cashew. *Indian Fmg*, 1956, 5 (10):26-7.
2. ACHARYYA, N. and DASH, P. C. Effect of two plant growth substances on cashew air-layers. *Current Sci.*, 1972, 41: 534-5.
3. AHMED, S. Cashew nut, a dollar earning crop. *Punjab Fruit J.*, 1959, 22 (79): 17-18.
4. AIYADURAI, S. G. Cashew propagation: a sure method to raise true progenies of high yielding parent trees. *Indian Cashew J.*, 1968, 5(1): 2-5.
5. de ALBERGARIA, M. S. Enxertia do cajueiro. *Rev. Agric., Moçambique*, 1967, 9(84):14-16.
6. de ALBERGARIA, M. S. O problema da produção do caju. *Rev. Agric., Moçambique*, 1971, No. 139, pp. 23-5.
7. ALBUQUERQUE, S. D. S., HASSAN, M. V. and SHETTY, K. R. How best to raise the cashew. *Indian Fmg*, 1958, 7 (10): 13-14.
8. ANON. Malayan fruits. *Malay.agric. J.*, 1935, 23: 110-33.
9. ANON. Enxertia do cajueiro. *Gaz. Agric. Moçambique*, 1966, 18: 126-7.
10. ASCENSO, J. C. and MILHEIRO, A. V. Nota preliminar sobre e minienxertia do cajueiro. *Agron. Moçamb.*, 1973, 7: 69-72.
11. ATMODIPOERWO, S. Verslag over cultuur en handel van djamboe monjet in de ommelanden van Batavia. *Landbouw*, 1933-34, 9: 603-5.
12. AUCKLAND, A. K. The influence of seed quality on the early growth of cashew. *Trop. Agric., Trin.*, 1964, 38: 57-67.
- 12a. BHANDARY, K. R., SHETTY, K. P. V. and SHET, M. Propagation of cashew by wedge grafting. *J. Plant. Crops*, 1974, 2 (1): 37.
13. BIGGER, M. *Selenothrips rubrocinctus* (Giard) and the floral biology of cashew in Tanganyika. *E. Afr. agric. J.*, 1960, 25: 229-34.

14. BIGI, F. Nota sulle colture dell'anacardio e del avegado in Kenya e sui tentativi e le aspettative d'introduzione delle stesse in Somalia. *Riv. agric. subtrop.*, 1962, 56: 3-20.
15. CHHONKAR, V. S. and SINGH, R. Effects of plant regulators on air-layering in cashewnut (*Anacardium occidentale* L.). *Indian J. Hort.*, 1967, 24: 26-9.
16. CLAY, D. W. T. (Editor). Notes on nursery practices. *Tech. Rep. Minist. Agric. N. Nigeria* 13, 1960, pp.17.
17. CORDOBA, V., J. A. El marañon. Su cultivo y posibilidades de industrialización en Colombia. *Agric. trop.*, Bogotá, 1967, 23: 390-403.
18. DAGG, M. and TAPLEY, R. G. Cashew nut production in southern Tanzania. V - Water balance of cashew trees in relation to spacing. *E. Afr. agric. For. J.*, 1967, 33: 88-94.
19. EKREMENT, E. A. Cashew as an important cash crop. *Ghana Farmer*, 1965, 9: 54-7.
20. GALANG, F. G. and LAZO, F. D. Fruiting as related to vegetative growth in cashew, *Anacardium occidentale* L. *Philipp. J. Agric.*, 1936, 7: 21-33.
21. GLASGOW, S. K. Potential fruit crops in Jamaica. *Proc. Carib. Reg. Amer. Soc. hort. Sci.* 1965, 1966, 9: 83-115.
22. HASSAN, M. V. and RAO, V. N. M. Studies on the transplantation of seedlings of cashew (*Anacardium occidentale* Linn.). *Indian J. agric. Sci.*, 1957, 27: 177-84.
23. IBANEZ, M. L. The effect of cold on tropical seeds. *Turrialba*, 1968, 18: 73-5.
24. INDIAN COUNCIL OF AGRICULTURAL RESEARCH.
Indian Council agric. Res. A.R. 1955-56, 1959, pp. 58-9.
Idem 1956-57, 1959, pp. 45-6.
Idem 1957-58, 1960, pp. 36-8.
Idem 1958-59, 1961, p. 39.
25. INSTITUT FRANÇAIS DE RECHERCHES FRUITIÈRES OUTRE-MER (I.F.A.C.). Section en République Malgache. *Anacardiens*. *Rapp. annu.* 1965, pp. 125-7.
26. JAMAICA.A.R. *Dep. Agric.* 1947, 1949, p.13.

27. JAMAICA.
Investigations 1949-1950, being Bull.(N.S.) Dep. Agric., Jamaica, 47, 1951, pp. 98-100.
28. JENKINS, W.J. The cashew nut industry in western India.
Bull. imp. Inst., Lond., 1938, 36: 44-52.
29. LEFEBRE, A. Multiplication végétative de l'anacardier. Le greffage de bourgeon terminal (tip-grafting).
Fruits, 1971, 26: 859-63.
30. MADRAS. *Admin. Rep. agric. Dep. 1954-55, 1956, p. 70.*
Idem 1955-56, 1957, pp. 101-2.
31. MILHEIRO, A.V. A propagação vegetativa do cajueiro por enxertia de gomo terminal. *Agron. moçamb., 1969, 3: 179-86.*
32. MORADA, E.K. Cashew culture. *Philipp. J. Agric., 1941, 12: 89-103.*
33. MORTON, J.F. New outlook for the cashew (*Anacardium occidentale*) in tropical America.
Proc. Carib. Reg. Amer. Soc. hort. Sci., 1960, 4: 51-7.
34. MORTON, J.F. The cashew's brighter future.
Econ. Bot., 1961, 15: 57-78.
35. MUTTER, N.E.S. and BIGGER, M. Cashew.
Bull. Tanganyika Minist. Agric. 11, 1961, pp. 5.
36. NAYAR, T.G. and JOHN, J. P. Cashew grafts and layers excel seedlings. *Indian J. agric. Sci., 1958, 28: 129-32.*
37. NORTHWOOD, P.J. Cashew production in the southern province of Tanganyika. *E. Afr. agric. For.J., 1962, 28: 35-9.*
38. NORTHWOOD, P.J. Vegetative propagation of cashew (*Anacardium occidentale* L.) by the air-layering method. *E. Afr. agric. For.J., 1964, 30: 35-7.*

39. NORTHWOOD, P.J. Some observations on flowering and fruit-setting in the cashew, *Anacardium occidentale* L. *Trop. Agric., Trin.*, 1966, 43: 35-42.
40. NORTHWOOD, P.J. The effect of specific gravity of seed on the growth and yield of cashew (*Anacardium occidentale* L.). *E. Afr. agric. For. J.*, 1967, 33: 159-62.
41. OHLER, J.G. Cashew growing. *Trop. Abstr.*, 1967, 22: 1-9.
42. PAUL, W.R.C. The cashew nut industry of South India. *Trop. Agriculturist*, 1936, 87: 166-73.
43. PAUL, W.R.C. and CANAGARATNAM, C. The production of cashew nuts in Mannar. *Trop. Agriculturist*, 1937, 88: 6-11.
44. PHADNIS, N.A. and others. Studies in the raising of cashew (*Anacardium occidentale* L.) clonal material *in situ*. *Indian Cashew J.*, 1971, 8(2): 7-13.
45. PORTAS, C.A.M. Acerca do cajueiro no distrito do Congo (Angola). *Agros*, 1961, 44: 145-58.
46. RAO, U.N. and RAO, V.N.M. Cashewnut - a dollar earning crop of India. *Indian Fmg*, 1953, 3(4): 16-17, 32.
47. RAO, U.N. and RAO, V.N.M. Care for cashewnut ? *Indian Fmg*, 1958, 8(2): 7-11.
48. RAO, V.N.M. Multiply the better-yielding cashewnut. *Indian Fmg*, 1956, 6(3): 15-17.
49. RAO, V.N.M. Studies on the vegetative propagation of cashew (*Anacardium occidentale* L.). 1. Air-layering by cincturing and etiolation of shoots. *Indian J. agric. Sci.*, 1958, 28: 181-97.
50. RAO, V.N.M. and HASSAN, M.V. Variations in the seed characters of cashew (*Anacardium occidentale* L.). *Indian J. agric. Sci.*, 1956, 26: 211-16.

51. RAO, V.N.M. and HASSAN, M.V. Preliminary studies on the floral biology of cashew (*Anacardium occidentale* Linn.). *Indian J. agric. Sci.*, 1957, 27: 277-88.
52. RAO, V.N.M. and HASSAN, M.V. Studies on the vegetative propagation of cashew (*Anacardium occidentale* Linn.). Further studies on air-layering. *Indian J. agric. Sci.*, 1957, 27: 453-65.
53. RAO, V.N.M. and RAO, I.K.S. Studies on the vegetative propagation of cashew (*Anacardium occidentale* Linn.). Approach grafting (inarching) with and without the aid of plastic film wrappers. *Indian J. agric. Sci.*, 1957, 27: 267-75.
54. RAO, V.N.M. and RAO, I.K.S. Studies on the vegetative propagation of cashew (*Anacardium occidentale* Linn.). IV.- The nurse-grafted Y-cutting method. *Indian J. agric. Sci.*, 1958, 28: 575-82.
55. RAO, V.N.M., RAO, I.K.S. and HASSAN, M. V. Studies on certain aspects of germination of seeds in cashew (*Anacardium occidentale* Linn.). *Indian J. agric. Sci.*, 1957, 27: 25-34.
56. RAO, V.N.M., RAO, I.K.S. and HASSAN, M.V. Studies on seed viability in cashew. *Indian J. agric. Sci.*, 1957, 27: 289-94.
57. RAO, V.N.M., RAO, I.K.S. and RAO, P.S. A note on side-grafting of cashew (*Anacardium occidentale* Linn.). *Indian J. agric. Sci.*, 1957, 27: 451-2.
58. ROCCHETTI, G. Comportamento alla salsedine dell'anacardio nei primi stadi di sviluppo. *Riv. Agric. subtrop.*, 1970, 64: 237-52.
59. ROCCHETTI G. and PANERAI, L. L'effeto delle temperature sulla germinazione delle castagne di anacardio. *Riv. Agric. subtrop.*, 1968, 62: 228-35.

60. ROCCHETTI, G. and PANERAI, L. Ulteriori indagini sulla germinazione delle castagne di anacardio. *Riv. Agric. subtrop.*, 1970, 64: 151-60.
61. S-, I.C. Cashew nuts *Bull. imp. Inst., Lond.*, 1964, 44: 99-102.
62. SAMADDAR, H.N. and YADAV, P.S. A note on the vegetative propagation of cashewnut, avocado, jack-fruit and custard apple. *S. Indian Hort.*, 1970, 18: 47-9.
63. SAVILE, A.H. and BENNISON, R.H. Notes on Kenya agriculture. V. Plantation crops: cashew-nut. *E. Afr. agric. J.*, 1959, 24: 156.
64. SHANMUGAVELU, K.G. Effect of gibberellic acid on seed germination and development of seedlings of some tree plant species. *Madras agric. J.*, 1970, 57: 311-14.
65. SHETTY, K.R. Development of cashewnut cultivation and industry in Mysore State with special reference to South Kanara district: its possibilities and potentialities. *Mysore agric. J.*, 1957, 32: 47-53.
66. SHETTY, K.T. and BHATKAL, R. Cashew. Note on raising seedlings and planting. *Lal-Baugh*. 1965, 10(3): 34-5.
67. TAI, E.A. and TOPPER, B.F. Transplanting cashew seedlings. *J. Jamaica agric. Soc.*, 1947, 51: 116-18
68. TANGANYIKA. A. R. Dep. Agric. 1956, Part II, 1958, p. 79. *Idem* 1958, Part II (Research), 1959, pp. 16-17. *Idem* 1960, Part II (Research), 1961, p. 13. *Idem* 1961, Part II, 1963, pp. 12-13.
69. TKATCHENKO, B. L'anacardier. *Fruits d'Outre Mer*, 1949, 4: 199-205, 241-8, 281-7.
70. TSAKIRIS, A. and NORTHWOOD, P.J. Cashew nut production in Southern Tanzania. IV - The root system of the cashew nut tree. *E. Afr. agric. For. J.*, 1967, 33: 83-7.

71. TURNER, D.J. Some observations on the germination and grading of cashew nuts. *E. Afr. agric. J.*, 1956, 22: 35-9.
72. VISWANATHAN, P.R. Cashew nuts. *Planter, Kuala Lumpur*, 1961, 37: 543-4.
73. ZWANKJUIZEN, M.T. Improvements in processing and utilization of copra, cassava (gari), rice and cashew nuts suitable for adoption in rural industries. Rep. FAO 1529, 1962, pp. 63.

ANNONA SPP.

by

D. O'D. BOURKE

Commonwealth Bureau of Horticulture and Plantation Crops

INTRODUCTION

Annona (possibly from the Latin *annona*, yearly produce, or else a latinized form of the Spanish *anón*, from Taino*) is the genus which gives its name to the Annonaceae, a fairly primitive dicotyledonous family (14). It contains more than 40 genera, of which only two besides *Annona* produce edible fruit; they include biriba (*Rollinia deliciosa*), which has been used as a rootstock for cultivated annonas, and *Asimina triloba*. The genus *Annona* includes some 120 species from warm countries, mainly from the American tropics and sub-tropics. Many yield edible fruit and have been long domesticated. The four most important species for fruit production are the cherimoya (*A. cherimola*), the bullock's heart (*A. reticulata*), the soursop (*A. muricata*) and the sweetsop (*A. squamosa*). The group has the common name of 'custard apple', a name which is also applied to two different species and a hybrid, and which can therefore lead to confusion. Some of the current common names are as follows:

A. cherimola - cherimoya

A. cherimola x *A. squamosa* - atemoya,
custard apple (in Queensland
and New South Wales)

A. diversifolia - ilama,
cherimoya-of-the-lowlands

A. montana - mountain soursop

A. muricata - soursop

A. purpurea - soncoya

* Or the Latin suggested by the Haitian name *anon* for one of the species. Although commonly spelled *anona* Linnaeus used the double *n*. (Gl)

- A. reticulata* - bullock's heart,
custard apple (in the West Indies),
and often considered the "true"
custard apple.
- A. squamosa* - sweetsop,
sugar apple,
custard apple (in the East)

The annonas have traditionally been associated with gardens and compounds and not commercial orchards, but they have always played an important role in the life of people of tropical America. Terra-cotta vases modelled on annona fruits have been found in prehistoric graves in Peru (35). Annonas are small trees easily grown from seed on a wide variety of soils. The ripe fruits are soft, easily fermented and difficult to transport in the fresh state. They are therefore usually eaten fresh or used to make refreshing drinks, and also to flavour ices, sherbets or puddings. In India they are also valued for their medicinal properties (44). There is at present no reduction in these forms of use but their commercial use is increasing in many countries and this may be expected to lead to increased commercial planting.

The published literature on *Annona* species shows some evidence of confusion of nomenclature; some is also general in its approach to the whole group of cultivated annonas. In this chapter, the following paragraphs refer to annonas in general, the literature on individual species being later reviewed in greater detail, as follows:

	Page
<i>Annona</i> spp. in general	225
<i>A. cherimola</i>	228
<i>A. muricata</i>	233
<i>A. squamosa</i>	236
<i>A. reticulata</i>	239
<i>A. cherimola</i> x <i>A. squamosa</i>	241
<i>A. diversivolia</i>	242
<i>A. glabra</i>	242
Other annonas	242

ANNONA SPECIES IN GENERAL

ECOLOGY AND GROWTH IN RELATION TO PROPAGATION

Distribution and ecology

Annonas were widely distributed after the discovery of the New World and are now to be found in all tropical and subtropical regions. They have been established for so long in India that they have been given names which link them to local legends (44).

They are generally shallow-rooted and do not require deep soils (20). They adapt themselves to acid, neutral or slightly alkaline soils but the majority prefer slightly acid to acid soils (ph 5.5 to 6.5). With the exception of the pond apple (*A. glabra*), sometimes recommended as a rootstock, they do not tolerate waterlogging. Their climatic ranges vary according to their origins. The soursop (the most tropical in its requirements), bullock's heart, sweetsop and ilama are all associated with tropical lowlands. The cherimoya, on the other hand, prefers climates similar to those of its original home, the Andes of Peru and Ecuador.

Growth habit and flower biology

Cultivated annonas are small trees, about 7 m (23 ft) tall, with simple, entire alternate leaves. They may be evergreen or deciduous. The flowers are yellowish and hermaphrodite. They are protogynous and insect-pollinated. They begin fruiting in three to five years (Gl9). The fruit is a syncarp formed by the aggregation of carpels. Fruits are usually roundish, with a muricate, scaled or nearly smooth or netted skin. The edible pulp is soft, pale and sufficiently custard-like to have given the group its common name. The hard seeds are embedded in the pulp. Fruit setting is often unsatisfactory and may usually be improved by hand-pollination. Carpels with unfertilized ovules sometimes cease growing, leading to deformed fruits at maturity.

Varieties

There are recognized named cultivars of all the widely-grown species.

Diseases and pests

In Venezuela the damage caused by *Colletotrichum*

gloeosporioides limits the production of soursop (26). The disease is also serious in other places such as Puerto Rico (35). It may be controlled by sprays of bordeaux mixture, Dithane or Cupravit. There are, in addition, several insect pests which cause much damage. The most important include *Thecia ortygnus*, *Bephrata maculicollis*, *Cerconota annonella* and *Talponia backeri*.

Outside the Americas the damage reported has usually been less intense and in Hawaii, for instance, soursops were found to be relatively free of pests and diseases although they suffered from an unknown, pathological dieback (34).

PROPAGATION BY SEED

Many annonas are traditionally propagated in this way, but the plants then vary widely.

Seeds have been found to store well for 3-4 years and can probably be stored for longer periods. In Egypt fresh seeds showed 45 per cent germination, but after being chilled by being left out at night for a week the germination improved to 90 per cent. Seeds kept for a year germinated well without further treatment (1). Depending on the climate and other factors seed may be sown in a seed-bed or frame and later transplanted to a nursery, sown directly in a nursery, or sown directly in the field. There is usually little difficulty in transplanting annonas.

PROPAGATION BY BUDDING AND GRAFTING

Rootstocks

Annonas are frequently grafted on their own species and on each other. Suitable combinations are noted under the species concerned. At the Sub-Tropical Experiment Station, Florida, cherimoya, atemoya, ilama, soursop and sweetsop have been successfully veneer grafted on one-year-old stock of several *Annona* spp. including sweetsop and *A. glabra* (35).

Budding methods

Shield budding is used for several species. It has been described as best carried out in spring. The rootstocks, about

18 months - two years old, should be $\frac{1}{4}$ - $\frac{1}{2}$ inch (1.0 - 1.25 cm) in diameter. The best budwood is that from which the leaves have dropped, about one year old. It is recommended that buds should be large, about $\frac{1}{4}$ inches (4 cm) in length. If they are too small they may have difficulty in starting and be choked out by the thick bark and rapid callusing characteristic of annonas. The incision may be a T or an inverted T. The bark should be raised carefully and the bud inserted with as little pressure as possible. Waxed tape is recommended for tying. The buds should be unwrapped three or four weeks after insertion. If union has taken place they should be wrapped again loosely and the stock should be cut off some five or six inches (13 or 15 cm) above the bud. The tie should not be removed until the bud has grown several inches (G1).

In Egypt shield budding has also been used successfully in March or April, before the onset of hot dry conditions. Late budding in August and September is possible but usually not so successful. Plants on which budding has failed in April are usually re-worked in August (1).

Grafting methods

Two-year-old seedlings have been recommended for grafting. The operation may be a simple cleft graft, using a scion of well-matured wood from which the leaves have dropped (G1). Veneer grafting has been preferred in Florida (9). In Egypt an ordinary whip graft was found successful. Scions may be prepared from suitable one-year-old branches at the end of the dormant stage (1).

PROPAGATION BY CUTTINGS

Annona cuttings have been rooted by an experimental method. The basal 2 cm ($\frac{1}{2}$ in) of cuttings are inserted through the holes of inverted 7-8 cm ($2\frac{1}{4}$ - 3 in) flower pots and held in place by moss packing. The pots are sunk 2 cm ($\frac{1}{2}$ in) deep in moistened moss litter in a tray under which is installed a thermostatically-controlled low temperature heater. Temperatures of 28-30°C (82-86°F) successfully promoted rooting, which could be speeded up with IBA or IAA (36).

In Florida cuttings five to six inches (13-15 cm) long and $\frac{1}{4}$ - $\frac{1}{2}$ inch (1.0-1.25 cm) in diameter were taken from healthy branches of mature wood during dormancy. They were

set in sand to a depth of four-fifths of their length, with at least one bud exposed. With bottom heat a large percentage were found to root in 28 days (35). Cuttings of well-ripened wood may also be rooted under glass with bottom heat (G1). Propagation by cuttings, however, is not always widely practised.

ANNONA CHERIMOLA — CHERIMOYA

ECOLOGY AND GROWTH IN RELATION TO PROPAGATION

The cherimoya, from the Peruvian *chirimuya*, meaning "cold seeds" (16), is of tropical origin but grows naturally in the Colombian and Peruvian Andes, at altitudes of 1200 and 2000 m (4000 - 6500 ft), where the climate is relatively cool and dry. It has been introduced into several tropical regions but it appears to succeed really well only where the climate is comparable to its native Andean region (33). In New South Wales it is said to do best near the coast where rainfall and humidity are high and winters are warm (11). Its fruit is considered to be not only the best of the group but to be an outstanding fruit in its own right. "Its taste, indeed, surpasses that of every other fruit, and Haenke was quite right when he called it the masterpiece of Nature" (G18).

It is a small tree, rarely growing to more than 25 feet (7.5 m) in height, either erect or somewhat spreading in habit. On poor soils it may not be more than 15 feet (4.5 m) high; it is semi-deciduous (20). The brown velvety tomentum on the lower side of the leaves distinguishes it from other cultivated annonas. It has been planted commercially in California, Florida, Spain, Italy, Australia (NSW), New Zealand and South America. Several cultivars are recognized in these countries.

PROPAGATION BY SEED

There are many areas, including those where the tree is indigenous, where propagation by seed is the normal method. Seeds will retain their viability for several years if kept dry (G18). They should germinate in about four weeks. They are generally sown outside, in a seed-bed or nursery, but sometimes under glass. The details vary according to the region.

They may be covered by $\frac{1}{4}$ inch (2 cm) of soil and transferred to three-inch (7.5 cm) pots when three to four inches (7.5 - 10 cm) high. When eight inches (20 cm) high they should be transferred to larger pots or open ground (G18). In Tucumán, Argentina, where grafting has not been very successful, sowing should be as soon as possible after picking the fruits. The seeds should be covered with not more than 3 cm (1 in) of sifted soil. They should be shaded and watered as required. The plants should be 15-20 cm (6-8 in) high in two to three months (45). In New South Wales the seedlings are transplanted at about 1 year old, 18 inches (45 cm) apart, in nursery rows three feet (1 m) apart (12; 17). In Peru seeds may be kept in water for three to four days prior to sowing, and then sown in a nursery under glass or, if the soil is warm enough, directly into a furrow. They should be covered by 2-3 cm (1 in) of a mixture of organic matter and sand. Germination takes place in four to five weeks depending on the soil temperature. When seedlings are 10-15 cm (4-6 in) high, in two and a half to three months, they are transferred to small pots or to the nursery if the soil is warm (22). In New Zealand seeds should be planted in early spring and seedlings should be nine to twelve inches (23-30 cm) high by the following winter. It is preferable to raise seedlings in the glasshouse and transfer them to outside nursery rows after the first winter (18).

PROPAGATION BY BUDDING AND GRAFTING

Rootstocks

Seedling trees in New Zealand have been reported as producing good quality fruit (18) but it is generally accepted, in New Zealand and elsewhere, that trees should be grafted to obtain the best product. Many rootstocks have been used. In the Philippines, in 1916, *A. reticulata*, *A. glabra* and *A. squamosa* were recommended as congenial stocks (47). In South Africa cherimoya is usually considered to be best budded on cherimoya. However, in hot frostless areas *A. reticulata* provides a vigorous rootstock whereas *A. squamosa* produces a dwarf tree (24; G4; G18). The indigenous *A. senegalensis* has been used as a rootstock in Egypt (24; 1). For wet areas *A. glabra* is particularly recommended as a rootstock (20), but it has been reported to outgrow the scion in Florida (G18). As in South Africa, seedling cherimoyas as stock plants have given the best results in California. In India (Madras) cherimoya grafted on *A. reticulata* fruited six years after planting, when seedling cherimoyas about 11 years old had not

yet fruited. A 93.3 per cent take has been obtained on *A. reticulata* (41). Cherimoya has also been successfully grafted on *A. montana* (13). In Argentina *Rollinia emarginata* has proved more drought-resistant as a rootstock than the free stock normally used. Seed sown immediately after extraction can be grafted when the seedlings are 1 year old immediately after transplanting from the seed-bed to nursery beds (4). In New South Wales it is recommended that seeds for *A. cherimola* rootstocks should be selected from fruits of the most vigorous trees to guard against the disparity in growth as a result of working a robust grower on a weaker one (17).

Budding methods

The methods recommended include shield budding, with or without a T cut, and patch budding (5). The budding operation is not considered difficult (G3), and the age of the stock at the point of insertion of the bud is considered unimportant (G28).

In the Almunecar Valley, Granada, Spain, seedlings with a diameter of $\frac{1}{2}$ inch (2 cm) or more are shield budded in May-June. This is before the trees commence active growth, towards the end of the semi-dormant period which occurs in spring. If they are budded during the period of active growth the abundance of sap may "drown" the bud. Seedlings of large size are preferred. Buds are cut $\frac{1}{4}$ inches (4 cm) long with about $\frac{1}{4}$ to $\frac{1}{2}$ inch (0.6 - 1.3 cm) of leaf stalk remaining and inserted in upright-T incisions about three feet (90 cm) from the ground. Esparto grass is used for tying. Seedlings are usually cut off two inches (5 cm) above the bud immediately after budding, but a better union is obtained if the rootstock is not cut until 15-20 days afterwards, when union has taken place (40).

In Italy budding with an active bud has been recommended. On adult trees pruning beforehand will promote the growth of vegetative branches before budding with either a single bud about to burst or with a pair of buds, one on each side (15). In New Zealand budding is recommended shortly after the beginning of spring growth or in the autumn (18). Budwood should be obtained from the most productive branches of a tree with suitable fruit.

Shield budding has been found very satisfactory in the USA (G18) and elsewhere. It should be done at the beginning of the growing season, when the sap is flowing freely. Stock

plants should be $\frac{1}{4}$ - $\frac{1}{2}$ inch (1-1.25 cm) in diameter (G18; 15) or 1-1.5 cm (0.4 - 0.6 in) (22). Well matured budwood from which the leaves have dropped is preferable and it should be grey, not green, in colour (G28). Buds should be cut $\frac{1}{4}$ inches (4 cm) in length, and tied after the operation with waxed tape, raffia or soft cotton string. The wrapping should be loosened three to four weeks after bud insertion (when the bud has grown several inches) and the stock cut 5-6 inches (13-15 cm) above the bud. It may be advisable to retie after loosening, leaving the bud exposed, otherwise the flaps of the bark may curl back and die, sometimes destroying the buds (17).

In South Africa cherimoya stock plants are budded at 18 months (24), and in Peru at 12-18 months (22).

In a trial in Peru shield budding of cherimoya cultivar ACh-62 on its own rootstock gave a take of 70 per cent and subsequent growth which was better than that from splice, whip-and-tongue, crown and cleft grafts. From all points of view, however, whip and tongue grafting was considered the best method (32).

Grafting methods

Various methods have been used, including splice grafts or whip and tongue grafts on the same rootstocks as those used for budding, viz. *A. cherimola*, *A. squamosa*, *A. reticulata*, *A. glabra* (20) and *A. montana* (13). For grafting, however, it is usually recommended that rootstocks should be two years old, older than those used for budding (20; G18). In the USA cleft grafting has been a common practice. The scion should be well-matured wood from which the leaves have dropped. It may be advisable to paint both scion and the top of the stock around the cleft with melted wax to prevent evaporation. Old seedling trees may be easily topworked, and cleft grafting is again usually employed (G18; 16). Successful grafts on two-year-old stocks of *A. montana* and *A. reticulata* have been obtained by side-veneering in Florida, and within 60 days of grafting leader scion shoots over 2 feet (60 cm) in length had developed (13).

Crown grafting adult trees with two, three or more scions has proved successful in Italy (14). In South Africa whip, splice and cleft-grafting are the common methods and may be easily done before new growth starts (24).

In New South Wales whip and tongue grafting is generally

used but side tongue grafts are also considered suitable. Scions, from the most desirable trees, should be chosen from one-year-old wood which has not yet burst into bud, of a size to match well-grown year-old stocks. Older trees can be topworked by cleft or bark grafting. Side grafting may be used when it is desired to retain the head of the tree until the grafts have grown (17).

In New Zealand it is recommended that seedlings should be grafted shortly after the beginning of spring growth, using one-year-old wood on which the buds are dormant (18).

In Peru recommended methods include cleft grafting or whip and tongue grafting. The grafts are tied and waxed in the normal manner after the operation and the grafted plants are transplanted when 0.90-1.20 m (3-4 ft) in height. In a grafting trial with cherimoya cultivar ACh-62 used both as scion (from five-year-old plants) and rootstock (from one-year-old seedlings either 0.8-1 cm (0.3-0.4 in) or 1.2-1.5 cm (0.5-0.6 in) in diameter) whip and tongue grafting on thicker rootstocks was the most satisfactory method as regards ease of execution, percentage take, subsequent growth and low cost. The growth of all grafts was generally better on thicker rootstocks. Crown grafts, however, grew more quickly than other grafts, all of which gave a take of at least 70 per cent (32).

PROPAGATION BY CUTTINGS

Cherimoya cuttings do not root easily and this method of propagation is not normally used. In a summer trial, leaf cuttings (four to six leaves) of cherimoya under mist with the 6th or 10th node (of the first 16 nodes on a branch) at the base rooted successfully if treated with an IBA dip (7).

AFTER-CARE AND SURVIVAL

Cherimoyas have often proved very easy to transplant, even as six to eight-year-old trees with trunks of four inches (10 cm) or more in diameter (40). They should be transplanted in the spring, while still dormant, at depths no deeper than those of the nursery (11). Fertilizers should not be applied at planting or shortly before as the roots are very sensitive (8). Watering and mulching should be carried out as necessary.

Planting distance general recommendations include 8 x 10 m (9 x 11 yd) for seedlings or self-grafted plants and 6 x 7 m (6.5 x 8 yd) for grafts on *A. squamosa* or *A. reticulata* (20); 8 x 8 m (9 x 9 yd) for grafted plants and 9 x 10 x 10 m (10 x 11 x 11 yd) for plants on their own roots in Peru (22); 20-24 feet (6 - 7 m) apart for budded plants in California (16); 28-30 feet (8.5-9 m) on the square in New South Wales (11); and 25-35 feet (7.5-10.5 m) in orchards in South Africa (24), with 20 feet (6 m) in home gardens.

Young trees may be left unpruned in order to obtain a good crown (20). Little pruning is required to train them to a convenient form (G3).

ANNONA MURICATA — SOURSOP

ECOLOGY AND GROWTH IN RELATION TO PROPAGATION

The soursop is the most tropical of the annonas and from its original home in Central and South America has been transported to lowland tropics throughout the world. It was described by Hernandez de Oviedo, in his *Natural History of the Indies*, as early as 1526 (35). It is a small evergreen tree 25-30 feet (7.5-9 m) high, with the largest fruit of the annonas, some four to twelve inches (10-30 cm) long and weighing as much as 10-15 lb (4.5-7 kg). The fruit is spiny and the flesh is rather acid, aromatic and juicy. Many large black seeds are embedded in the flesh. Fruits are frequently distorted owing to some ovules not being fertilized. They are used to make drinks or to flavour ice cream or puddings. They lend themselves to preserving and processing. Commercial plantations exist in Puerto Rico and Venezuela for the canning of concentrate and juice (33). Although the trees appear tolerant of compact shallow soil (G3) they prefer fairly rich loams and grow best on deep, well-drained soils where an extended root system can develop (20). There is a wide range of forms which may be divided on the basis of sweetness/acidity, fruit shape and juiciness. In the Caribbean, cultivars are generally classified according to their sweetness. A fibreless cultivar has been propagated in Cuba (33). Efforts to cross the soursop with other species have not always been successful (G3), but it has been crossed with the sweetsop (31).

PROPAGATION BY SEED

Soursop is usually propagated by seed, chosen from healthy well-developed trees, but the seedlings obtained may differ markedly in size of tree, size of fruit, number of fruits/tree and other characters. In Venezuela seeds are planted in seed boxes containing a mixture of sand and peat or equal parts of sand and decomposed FYM. The seeds germinate in 15-20 days. The seedlings are transferred to plastic bags containing disinfected soil when they are 15 cm (6 in) in height. They are ready for grafting in five to six months (26). Seeds may also be sown in flats or gallon cans. Kept moist and shaded they will germinate in 30 days or less (33). Germination may, nevertheless, take as long as 60 days (20). Soursop grows quickly and may grow to 2 m (7 ft) in one year, fruiting in the second year (43) or it may bear in three to five years (33). In Hawaii seedling trees showed a potential yield capacity exceeding 8000 lb (3500 kg) acre from the 4th year with increasing yields to 16 000 lb (7000 kg) acre in the 6th year (34).

PROPAGATION BY BUDDING AND GRAFTING

Rootstocks and their effects

Many rootstocks have been tested for soursop. Successful grafting has been carried out on *A. reticulata*, *A. montana* and *A. glabra* although the last-named has sometimes produced a dwarfing effect. In the USA grafts on *A. squamosa* and *A. cherimola* have been short-lived despite the fact that soursop is itself a satisfactory rootstock for *A. squamosa* in Ceylon and India. Soursop seedlings are generally considered to be the best rootstocks for good soursop cultivars (33). In Venezuela, where *A. montana*, *A. squamosa* and *A. glabra* have also been used as rootstocks, the most vigorous plants have been on *A. montana*, but some plants of this combination have been slow in coming into production (26) and the value of the combination has yet to be assessed (27). In Cuba grafting a fibreless cultivar on a normal one gave poor

results. It was difficult to get a soursop scion to take on *A. glabra* rootstock. Although five successful grafts were made they all died subsequently. On *A. montana*, on the other hand, soursop grafts took well and grew well. The grafts were more vigorous than those of soursop on seedling soursop (25).

Budding and grafting methods

In spite of the wide dissemination of soursop in the tropics there is comparatively little published information on its budding and grafting. Budding may be carried out with a dormant bud taken on one-year-old well-matured wood (20). Shield budding appears to be a satisfactory method. It has also been successfully inarched (33). Veneer grafting is used in Venezuela. Material for grafting is obtained from tender, semi-woody shoots. The graft should be uncovered once it has taken in order to avoid rots (26).

PROPAGATION BY CUTTINGS

Soursop is easily propagated by cuttings (33).

AFTER-CARE AND SURVIVAL

Seedlings one foot (30 cm) or more in height may be planted out at the beginning of the rainy season and spaced at about 12 x 15 feet (3.6 x 4.5 m). A spacing of 25 x 25 feet (7.5 x 7.5 m) has also been suggested. For small gardens in Puerto Rico the spacing may be reduced to 8 x 8 feet (2.5 x 2.5m) (33). As a general recommendation trees may be planted out at 4 months at a spacing of 5 to 7 m (16 to 23 ft) (20).

ANNONA SQUAMOSA — SWEETSOP

ECOLOGY AND GROWTH IN RELATION TO PROPAGATION

The sweetsop, or sugar apple, is probably the most widely distributed of the annonas. It is a woody semi-deciduous shrub or small tree reaching 15-20 feet (4.5 - 6m) in height. The fruits are sweet and slightly acid. In 1672 it was described as having "pulp very white, tender, delicate and so delicious that it unites to agreeable sweetness a most delightful fragrance like rose water" (G18). It is a native of Central and South America but now occurs at low and medium elevation throughout the tropics. It is the favourite annona in India (33). It cannot stand frost or long cold periods (20), but withstands drought better than many fruit trees (G18). The fruit is used mainly as a dessert fruit and contains 16-18 per cent of sugars. In addition a highly purgative tea is made from the roots and a mildly laxative and tonic tea from the leaves. The crushed leaves and seeds are considered to have insecticidal properties (35). Sweetsop has been crossed with soursop. The fruits obtained revealed predominantly the qualities of the female parent (31).

PROPAGATION BY SEED

The sweetsop is usually propagated by seed and the seeds retain their viability for several years. There are 4,850 seeds in a kilo (2.2 lb) (1). Fresh seeds are nevertheless usually recommended for sowing. They germinate in 50-70 days. Scarification and soaking for three days assist germination. Seedlings may grow about one foot (30 cm) in a year (47). They may need a year or more before reaching a size adequate for grafting (25). They may take three to four years to come into bearing but they can sometimes do so much earlier (G18). In a trial in India unworked seedlings of *A. squamosa* came into bearing later (22 months) and gave lower yields than grafted plants (19).

Rootstocks and their effects

Of the many rootstocks tried for *A. squamosa*, both *A. reticulata* and *A. muricata* have proved satisfactory and are often recommended (G28). In Florida both *A. reticulata* and *A. glabra* have proved successful rootstocks but *A. squamosa* may itself be the best (36) and is frequently recommended (20). In India successful combinations include *A. squamosa* on *A. squamosa* and *A. squamosa* on atemoya (*A. squamosa* x *A. cherimola*). Atemoya was considered to be the best rootstock in Andhra Pradesh. Other rootstocks such as *A. glabra* and *A. muricata* were not found suitable owing to delayed incompatibility (47). In other trials *A. squamosa* on *A. squamosa* and *A. squamosa* on *A. reticulata* have both given 100 per cent success and fruited at 8 months. The second combination, however, showed better stock and scion girth, scion height and better yield. Grafts of *A. squamosa* on *A. muricata* and *A. palustris* gave 100 and 75 per cent take, respectively, but both died within eight months before reaching bearing age (19); (31). In the warm, humid climate of the Nilgiri foothills *A. reticulata* rootstocks have been found the most satisfactory (42). In Uttar Pradesh good results have been obtained on *A. reticulata* with sweetsop cultivars, Saharanpur Local and Mammoth (both 100 per cent), and Balanagar (93.3 per cent) (41). As a rootstock *A. reticulata* is vigorous, hardy and frost resistant. Its superiority has also been confirmed in Madras (30).

In Cuba trials showed that sweetsop was easily grafted on *A. reticulata* and that subsequent growth was as good as that on *A. squamosa*. Buds of sweetsop took well and grew well for a few months on *A. salzmanni* but eventually died. Take was difficult on *A. purpurea* rootstock and the buds died soon afterwards. Some *A. squamosa* scions took when grafted on *Rollinia mucosa* but they grew slowly and their foliage was chlorotic (25).

A. squamosa has itself been used as a rootstock for other annonas. In Florida it is not so vigorous as *A. reticulata* (9).

Budding methods

Various methods are recommended, including budding with a dormant bud obtained on one-year-old mature wood (20). Shield budding has given good results in Hyderabad. January, March and June were the most favourable months and 75 per cent success was obtained in June. The results were best if the stock was cut back a fortnight after bud insertion. Budding in November and December, July and August gave poor results because of dormancy in November/December and a tendency for buds to decay owing to high humidity in July/August (48). Shield-budding *A squamosa* on its own rootstock and on *atemoya* has given 60-80 per cent success. The bud is taken and used immediately and protected (by Alkathene or banana fibre) for a fortnight, the time needed for union. The rootstock is then cut back by three to six inches (8-15 cm) and the wrapping removed, then replaced, leaving the bud exposed to facilitate sprouting. Shield budding has also been used in Florida and Ceylon. The modified Forkert method of budding is used in Java (47).

In a chip budding trial a bud about 3-4 cm (1-1.5 in) long with its underlying wood about 4 mm (0.15 in) thick was inserted on *A reticulata* rootstock and tied with tape. The tape was removed after 3-4 weeks, exposing the bud, and the rootstock cut back 4-5 cm above the union. Some 53 per cent of buds took but only 43 per cent grew subsequently (39). In Mozambique shield budding with a T-cut and patch budding are both recommended (5).

Grafting methods

In Hyderabad, India, side grafting (limited to the months of December to May) gave 58.4 per cent success. It was more satisfactory than inarching, which has, however, been successful elsewhere (47). In Uttar Pradesh three cultivars, Saharanpur Local, Mammoth and Balanagar, were successfully inarched on *A. reticulata* rootstocks, August being the best month for the operation. The rootstocks, about one year old, were selected for a stem diameter of 8-10 mm (0.3-0.4 in) and transplanted into pots at least one month before the operation. The cut exposing the cambium was about 6 cm (2.4 in) long at a height of 20 cm (8 in). Both stock and scion plants

were similarly cut and tied together with raffia fibre. Union took place in about six to seven weeks. The scion was then detached and the stock half-topped for a week and then fully topped. The take was 100 per cent with Saharanpur Local and Mammoth, and 93.3 per cent with Balanagar (41). Elsewhere, inarching success may vary from 50-87.5 per cent according to the season (39). Cleft grafting has also been used (25).

PROPAGATION BY LAYERING

Limited success (up to 8.33 per cent) with layering has been obtained in Hyderabad. It was most successful during the rainy months of August and September. Marcotting was even less successful (48).

PROPAGATION BY CUTTINGS

In a trial in India neither the kind of shoot nor its position had any effect on the strike of cuttings, which never exceeded 2 per cent (48). In another trial root cuttings gave 2-5 per cent success. Branch cuttings from the basal portions of branches chosen from the middle of trees gave up to 5 per cent rooting. The use of a flat bed was best (47).

AFTER CARE AND SURVIVAL

Seedlings can be transplanted at one year old. A spacing of 4 x 6 m (13 x 20 ft) is recommended (20).

ANNONA RETICULATA — BULLOCK'S HEART

ECOLOGY AND GROWTH IN RELATION TO PROPAGATION

The bullock's heart is grown in most tropical countries, usually as a garden plant. Its fruit is generally considered inferior to that of the cherimoya or sweetsop. It produces a fruit which is more solid than that of the sweetsop, and which

varies more in quality than those of the other annonas. It is a small tree, 20-25ft (6-7.5 m) high, semi-deciduous and tropical in origin, but mature trees are said nevertheless to be able to withstand several degrees of frost. Its requirements are similar to those of *A. squamosa* but it is not so partial to a dry climate (G18).

PROPAGATION BY SEED

It is normally raised from seed. In India these may be sown in May-June, in pots containing one part of sand, one of leaf mould and one of garden soil. Two or three seeds are sown per pot and the pots are kept in semi-shade and watered regularly. The seedlings are easy to transplant. Alternatively seeds may be sown directly in the field, in pits 2 x 2 x 2 feet (0.6 x 0.6 x 0.6 m) dug in May and filled with a mixture of rich garden soil, FYM or compost, and sand. Pits are spaced at a distance of 22-25 ft (6.6 - 7.5 m). Some two to three seeds are sown in each pit and only the best seedling is retained when the seedlings are 6-9 inches (15-23 cm) (12). Spacings of 4 x 7 m (13 x 23 ft) have also been recommended (20).

Rootstocks and their effects

The bullock's heart may be budded in the same way as cherimoya. Congenial stocks for it include *A. muricata*, *A. squamosa*, *A. glabra* or its own species. It produces a more vigorous tree on *A. muricata* than on its own species (20). In Egypt it has been grafted on *A. senegalensis*, a vigorous stock which seems to transmit its vigour to the scion (1). It is also widely used as a rootstock for other annonas, including sweetsop, atemoya and ilama. As a rootstock it is vigorous and usually overgrows atemoya scions, but the grafts are strong and show no other apparent incompatibility (9). As a rootstock for *A. squamosa* it is reputed to increase markedly early growth and fruiting (G3).

Budding and grafting methods

Shield budding with a T-cut and patch budding

have both been recommended, as for other annonas (5).
Cleft grafting has also been used (12).

ANNONA CHERIMOLA X A. SQUAMOSA — ATEMOYA

This is believed to be the "custard apple" grown commercially in Queensland and parts of New South Wales. It is a large spreading tree about 15 feet (4.5 m) high, semi-deciduous, shedding most of its leaves in the winter months. Several cultivars are recognized (37). Some cultivars (e.g. Page) set fruit without hand-pollination but others (e.g. Bradley) do not. A South African cultivar, African Pride, introduced into Florida, required hand-pollinating for heavy crops. The splitting of fruit at maturity may be a problem (9).

PROPAGATION BY SEED

Seed is sown in spring about $\frac{1}{4}$ inch (2 cm) deep in a seed-bed. The seedlings are transplanted into nursery rows when about eight inches (20 cm) high.

Rootstocks and their effects

Atemoya has been successfully grafted on other *Annona* spp. (23) including *A. reticulata*, a vigorous rootstock (9), *A. squamosa* and *A. glabra* (35). It has itself been used as a rootstock for other annonas but it is not as vigorous as *A. reticulata* (9).

Grafting methods

Seedling stock may be grafted in late winter or early spring. A side cleft graft is satisfactory. Scion wood may be cut in autumn, when leaves have fallen (37).

AFTER CARE AND SURVIVAL

Planting in the orchard is from mid August to end September, just before the beginning of spring growth. At planting the young trees should be topped at not more than 30 inches (76 cm) from the ground. Spacing is 30-40 feet (9-12 m), a wider spacing being better on

more fertile soils. Two leaders should be allowed to grow in the first season. They are shortened to about nine inches (23 cm) in the following winter. Similar treatment, the duplication of branches to form short "arms", is applied the following year (37).

ANNONA DIVERSIFOLIA — ILAMA

Although it has been considered the finest annona fruit which can be grown in the tropical lowlands the ilama is not as well known as other annonas in the tropical world. It is a slender tree up to 25 feet (7.5 m) in height. Its climatic requirements are similar to those of *A. squamosa* and *A. reticulata*.

It is traditionally propagated by seed in Mexico and Central America and comes into bearing at three to four years old (G18).

ANNONA GLABRA — POND APPLE

Of no value as a fruit, it has been used as a stock for other annonas. It is tolerant of flooding and recommended for damp conditions (35 ; G18), but it is not as vigorous as *A. reticulata* (9).

OTHER ANNONAS

The mountain soursop (*A. montana*), a small forest tree, has been described as having fruit of remarkably good quality (G18).

The soncoya (*A. purpurea*) is a dooryard tree in Mexico and Central America. It may be considered of interest for breeding (G18).

CONCLUSIONS AND SUGGESTIONS

It is only comparatively recently that some of the annonas have become commercially important so that the improvement of their culture affords a wide field of investigation. Some, like the ilama, deserve to become better known. Among the established annonas easily propagated clonal rootstocks are required for specific purposes within the species. Although seed propagation is easy, methods are needed for the rapid rooting of cuttings, with or without growth regulators. Some species appear to root more easily than others. Although diseases and pests are not generally limiting to production, resistant cultivars could be used advantageously where they are. At the same time the traditional role of the annonas should not be neglected. Better quality fruit will always be appreciated by domestic consumers provided that the trees retain their desirable characteristics of being easy to grow with a minimum of attention.

BIBLIOGRAPHY

1. AHMED, M.S. The annonas in Egypt. *Bookl. Minist. Agric. Egypt. hort. Sect.* 14, 1936, pp. 35.
2. ALLEN, B.M. *Malayan fruits*. 1967. Donald Moore Press Ltd., Singapore.
3. ANON. *Malayan fruits. Malay. agric. J.*, 1935, 23: 110-33.
4. ARMAND, L.M. *Cultivo del chirimoyo. Alm. Minist. Agric., B. Aires*, 1939, 14: 377-9.
5. ASCENSO, J.C. and MILHEIRO, A.V. *Técnicas de enxertia I. Borbulha. Agron. moçamb.*, 1973, 7: 185-94.
6. ASSAF, R. *Bouturage sous brouillard. Critique des différentes techniques, résultats et applications d'un nouveau système. J. agric. trop. Bot. appl.*, 1965, 12: 23-43, 168-93, 292-318.
7. ASSAF, R. *Aptitude à l'enracinement des noeuds et mérithalles successifs des rameaux de quelques espèces fruitières. J. agric. trop. Bot. appl.*, 1966, 13: 289-335.
8. BARNES H. *Custard apple. Qd agric. J.*, 1943, 57: 147-9.
9. CAMPBELL, C.W. *Minor tropical fruit cultivars in Florida. Proc. 83rd annu. Mtg Fla St. hort. Soc. Miami*, 1970, 83, 353-6.
10. CAMPBELL, C.W. and POPENOE, J. *Effect of gibberellic acid on seed dormancy of Annona diversifolia Saff. Proc. trop. Reg. Amer. Soc. hort. Sci.* 1967, 1968, 11: 33-6.

11. CANN, H.J. The custard apple (*Annona cherimola*). *Agric. Gaz. N.S.W.*, 1967, 78:85-90.
12. CHOUDHRY, B.L. Ramphal (*Annona reticulata*) is a good fruit. *Indian Fmg.* 1954, 4(9): 15, 21.
13. COBIN, M. and RUEHLE, G.D., Sub-tropical crops of minor economic importance. *A.R. Fla agric. Exp. Stat.* 1948/1949. pp. 245-7.
14. COBLEY, L.S. An introduction to the botany of tropical crops. Longmans, Green & Co., London, 1956.
15. COSTANTINO, F. Una coltura subtropicale di grande interesse per il Mezzogiorno, l'*Annona cherimola*. *Frutticoltura*, 1963, 25: 243-7.
16. DICKINSON, T.A. Cherimoyas : high demand rewards tedious care. *West. Fruit Gr.*, 1963, 17(7): 20-1.
17. EASTWOOD, H.W. The custard apple. *Agric. Gaz. N.S.W.* 1942, 53: 475-6, 521-4; 54:36-8.
18. EVERETT, P. The cherimoya: a delicious dessert fruit. *N.Z. J. Agric.*, 1952, 84: 168.
19. FAZLULLAH KHAN, K. and SAMBASIVA RAO, I.K. A note on the vegetative propagation and clonal performance in custard apple (*Annona squamosa*). *Indian J. Hort.*, 1953, 10: 140-4.
20. FOUQUÉ, A. Espèces fruitières d'Amérique tropicale. Famille des Annonacées. *Fruits*, 1972, 27:62-72.
21. FREGONI, M. Aspetti della frutticoltura di un paese dell'America Latina: l'Ecuador. *Ann. Fac. Agrar. S. Cuore, Milano*, 1968, 8: 299-379.
22. GARCIA PITTMANN, E. La chirimoya, *Annona cherimola*. *Circ. Estac. exp. agric. La Molina* 71, 1956, pp.26.
23. GONZALEZ, B.M. Outstanding results of agronomic and horticultural research. *Philipp. Agric.*, 1934, 23: 380-99.
24. HARRINGTON, F.B. Cherimoya. *Fmrs' Wkly. S. Afr.*, 13 July, 1955, pp. 58-9, 61.

25. LAZO RODRÍGUEZ, F. La multiplicación de diversas especies de frutas tropicales. *Proc. Carib. Reg. Amer. Soc. hort. Sci.* 1957, 1958, 5:6-11.
26. LEAL, F.J. Notas sobre la guanabana (*Annona muricata*) en Venezuela. *Proc. trop. Reg. Amer. Soc. hort. Sci.*, 1970, 14: 118-21.
27. LEAL, F.J. La fruticultura en Venezuela durante el periodo 1961-1970. *Rev. Fac. Agron.*, 1972, 6(4): 37-56.
28. MADRAS. *Rep. agric. Stats. Madras Pres.* 1943-44, 1945.
29. MADRAS. *Rep. agric. Stats. Dep. Agric., Madras* 1944-45.
30. MADRAS. *Admin. Rep. agric. Dep.* 1954-55, 1956.
31. MADRAS. *Admin. Rep. agric. Dep. Fasli* 1367 (1st July 1957 to 30th June 1958), Parts I and II, 1959.
32. MORAN R., M.J., BAUTISTA C., V., BERMUDEZ R., J., CALZADA B., J. and CHAVEZ F., W.B. Comparativo de dos diametros de patron y cinco tipos de injerto en la propagacion del chirimoyo (*Annona cherimola* Mill.). *An. cient. La Molina*, 1972, 10(3/4):158-76.
33. MORTON, J.F. The soursop, or guanábana (*Annona muricata* Linn.). *Proc. Fla St. hort. Soc.* 1966, 1967, 79: 355-66.
34. NAKASONE, H.Y. Production feasibility for soursop. *Hawaii Fm Sci.*, 1972, 21(1): 10-11.
35. NOONAN, J.C. Review of investigations on the *Annona* species. *Proc. Fla St. hort. Soc.* 1953, pp. 205-10.
36. OPLT, J. A simple method of rooting greenhouse plants (Czech) *Sborn. čsl. Akad. zeměd. Věd., Rostl. Výroba*, 1959, 32:599-602.

37. PREST, R.L. and ROSS, A.A. The custard apple
Qd agric. J., 1955, 8: 17-21.
38. QUEENSLAND. A.R. Dep. Agric. *Stk* 1959-60, 1960.
39. SAMADDAR, H.N. and YADAV, P.S. A note on the
vegetative propagation of cashewnut, avccado,
jackfruit and custard apple (*Annona squamosa*).
S. Indian Hort., 1970, 18(1/2): 47-9.
40. SARASOLA L. Cherimoya culture in Spain. *Yearb.*
Calif. Avoc. Soc., 1960, 44: 47-51.
41. SINGH, S.N. Propagation of custard apple in
Uttar Pradesh. *Sci. and Cult.*, 1959, 25: 78-9.
42. SRIRAM, T.A. and SUNDARARAJ, J.S. An optimum
rootstock for custard apple (*Annona squamosa*).
S. Indian Hort., 1956, 4: 134.
43. STAPLEY, J.H. Insect pests of coconuts in the
Pacific region. *Outlook on Agric.*, 1973, 7(5):
211.
44. THAKUR, D.R. and SINGH, R.N. Pomological
description and classification of some annonas.
Indian J. Hort., 1967, 24: 11-19.
45. TOLL JUBES, J. El cultivo de la chirimoya en
Tucumán y sus posibilidades. *Circ. Estac. exp.*
agric. Tucumán 173, 1964, pp. 13.
46. U.P. DEPARTMENT OF AGRICULTURE, BUREAU OF
AGRICULTURAL INFORMATION. Propagation of fruit
plants. *Agric. Anim. Husb. U.P.*, 1950,
1(3): 19-27.
47. VENKATARATANAM, L. Sitaphal (*Annona squamosa*)
and other *Annona* fruits in India. *Fm Bull.*
Indian Coun. agric. Res. N.S. 29, 1965, pp. 44.
48. VENKATARATANAM, L and SATYANARANASWAMY, G.
Vegetative propagation of sitaphal (*Annona squamosa*).
Indian J. Hort., 1956, 13: 90-100.
49. WILLIAMS, G. Custard apple (*Annona cherimola*).
Qd agric. J., Feb. 1927, pp. 123-6.

ARTOCARPUS ALTILIS — BREADFRUIT

by

PATRICIA ROWE-DUTTON

Formerly of the Commonwealth Bureau of Horticulture and
Plantation Crops

ECOLOGY AND GROWTH IN RELATION TO PROPAGATION

Distribution and ecology

The breadfruit (*A. altilis*, syn. *A. communis*, *A. incisa*) is a large tree restricted to humid tropical regions. Its origin is uncertain but it is probably a native of Polynesia and has certainly long been an important staple food there, being a rich source of carbohydrates. Thence it spread to the other Pacific islands, Malaysia, Sri Lanka and southern India. Plants of the superior seedless form, which can of course only be propagated by vegetative means, were brought to the West Indies from Tahiti in 1792 by the British Captain Bligh, following the epic mutiny on the "Bounty" during his ill-fated first expedition. The inferior seeded form had been introduced to the West Indies some ten years previously by the French. It is grown on a very limited scale in Central and South America, and cannot be cultivated with success anywhere in the United States. Although the breadfruit is now grown in many tropical countries, it has never become an important crop except in the Pacific islands.

A warm, humid, lowland climate is required, with temperatures of 60-100°F (16-38°C) and a well distributed annual rainfall of 80-100 inches (200-250 cm). The tree's need for moisture is generally held to be associated with its very large leaves and shallow root system. It is intolerant of cold and of extreme conditions, such as those found at high altitudes. The mature trees require full exposure, but the young plants appreciate

shade. The best growth is made in deep, moist soils with a high humus content and high fertility; good drainage is essential. (G19; G24; 23; 30)

These facts suggest that vegetative propagation is likely to be most successful if carried out under uniformly warm, humid conditions, with partial shade, and in a well drained rooting medium that is kept constantly moist.

Growth habit

The breadfruit makes a tall, straight, spreading tree, 12-18 m (40-60 ft) high, requiring wide spacing. All parts of the tree contain a viscid, milky latex. Branching usually starts fairly low on the trunk, and the branches are brittle. The leaves, which are concentrated at the ends of the branches, are very large, deeply lobed, leathery and slightly hairy on the lower surface. Their size, 23-60 cm (9-24 in) long and 20-50 cm (8-20 in) wide, could be a problem in propagation by leafy cuttings. In the uniformly wet tropics the tree is evergreen, but in regions with pronounced dry seasons it may be deciduous. (G1; G3; G19; 1; 10)

The root growth of the seedless, vegetatively-propagated forms is shallow and wide spreading, a network of feeding roots developing just below the soil surface. Sections of these roots may even protrude above the surface. Where these protruding or superficial roots are injured, suckers sometimes arise, so that, as Stephens (27) points out, one tree may easily develop into a grove if the suckers are not suppressed. This natural suckering habit is made good use of in propagation, the roots often being cut or bruised intentionally to induce suckering (G15; G18; 27; 30). This ready capacity of roots to regenerate has also led to a more reliable and economic method of propagation, now commonly used, namely by root cuttings (G27). There is no information available on whether the root system of seedling trees differs from that of vegetatively-propagated ones.

Seedling trees come into bearing when they are

eight to ten years old, but vegetatively-propagated trees start to crop within five to six years. Male and female inflorescences, borne separately on the same tree, appear in the leaf axils near the ends of growing shoots. In Tahiti there are generally three main flowering periods a year, while in South India male flowers are present throughout the year and female flowers during February-March and July-August, fruits being ready for harvesting within 60-90 days from the emergence of the inflorescences (G3; G24; 3). This means that there are only relatively short periods, if any, during the year when adult trees are in neither a flowering nor a fruiting condition.

The fruit, formed from the whole inflorescence, varies in size from 10-25 cm (4-10 in) in diameter. In the seedless forms the central core is surrounded by the edible pulp, but in the seeded forms there is little pulp and each fruit contains 50-100 seeds about 2.5 cm (1 in) long, which are sometimes eaten boiled or roasted. The seeds contain no endosperm. (G19; 3; 10)

Varieties

The trees of the two main types of breadfruit, the seeded and the seedless, are fairly similar morphologically, but León (10) notes that the seeded forms, sometimes called the breadnut, are taller and more vigorous. The latter are of little economic importance as they have little or no edible pulp. The origin of the seedless forms is obscure, but they are generally believed to have arisen as bud mutants of seeded forms. Chandler (G3), however, puts forward another suggestion: "Possibly all may have arisen in this way, but I have found no evidence that some of them if not most of them may not have originated as seedling trees with abortive ovules or embryos, that a certain percentage of seedlings may not be seedless as in some *Musa* species."

A regional survey of breadfruit varieties conducted in the Pacific islands, with a view to the selection of early and late types to extend the fruiting season, has shown the immense variation that exists

in this respect (4). Wilder (30) describes 31 clonal varieties, one with seeds, that were grown in Tahiti, and records that these vary greatly in flavour and shape. León (10) also refers to the differences in fruit shape, skin colour, pulp colour, amount of fibre and culinary quality between varieties, and notes that variations in fruit characters are associated with differences in leaf shape. He records that some varieties, such as Mijiwan grown on the Marshall Islands, are intermediate between the seeded and seedless forms, containing only 10-15 seeds per fruit. Varieties grown in the West Indies are said to be starchy, with little distinctive flavour, a fact that is probably responsible for the breadfruit's rather limited popularity there (G3).

With so much variation between individual seedless and semi-seedless varieties, there is clearly scope for the selection of clones that are superior with respect to yield, quality and flavour, and that have an extensive range in season of fruiting. It may also be found that varieties differ in the ease with which they can be multiplied vegetatively, and this possibility would be worth taking into account in any programme of selection.

Diseases and pests

The breadfruit appears to be relatively free from major diseases and pests, apart from a fruit rot which does not affect propagation practices. Virus diseases, which would necessitate special techniques to prevent their perpetuation and spread by vegetative propagation, have not so far been reported in breadfruit.

PROPAGATION BY SEED

The seeded form of breadfruit, which is of little commercial importance, is most commonly propagated by seed. Fresh seeds germinate readily. They lose their viability, however, within a few weeks and should therefore be sown immediately after their extraction from ripe fruit without being allowed to dry out

(G18; G19; G24). Wilder (30), however, mentions that the seeded variety found in Tahiti is not often propagated by seed because the growth of the seedlings is very slow.

In a brief report on the response of some tropical seeds to cold storage, Ibañez (7) observed that breadfruit seeds were not injured by cold treatment at 4°C (40°F) for 15 minutes. Although this indicates that cold storage might not be injurious, the work does not appear to have been followed up and no trials have been carried out to determine whether any cold storage treatment would prolong the viability of the seeds. No other experimental work has come to hand on seed propagation, but as the more valuable seedless forms must anyway be propagated by vegetative methods, the subject is of no great commercial importance, except perhaps for rootstock production.

PROPAGATION BY BUDDING AND GRAFTING

Budding methods

In a trial in Java (G12) breadfruit was budded by the modified Forkert method onto 12-month-old rootstocks of *Artocarpus rigida* with 50 per cent success. Ripe one-year-old budwood, from which the leaves had already fallen, was used and the operation was carried out in both the wet and dry seasons. On rootstocks of *A. integra* (= *A. heterophyllus*, jackfruit) and *A. champeden* practically no success was achieved. In the case of the *A. rigida* rootstocks special care was needed in raising the seedlings; the seed had first to be sown in seed-beds and the seedlings planted out four weeks later into nursery beds at a spacing of 40 x 40 cm (16 x 16 in).

Three reports from the Lamac Experiment Station in the Philippines refer briefly to trials on the budding of breadfruit. Wester (29) mentions that repeated attempts to shield bud breadfruit onto seedlings of the same species all failed. Galang and Elayda (6) record, without details, that breadfruit was successfully shield budded on *camansi* (*Artocarpus* sp.). Padolina (22) notes that breadfruit could be shield budded on *A. elastica* when

budwood, 2½-3 cm (1-1¼ in) long and brownish in colour, from which the leaves had fallen, was inserted in the stock at a position where the bark was greenish to light brown.

In an article in a popular Indian journal, Thomas (28) states that breadfruit can be propagated by budding active buds onto the same rootstock, but he does not describe the method.

Grafting methods

Thomas (28) notes that young shoots of breadfruit can be grafted onto wild jackfruit seedlings, but gives no further details.

In approach grafting trials in the Philippines Galang and Elayda (6) succeeded in grafting breadfruit onto jackfruit (*A. heterophyllum*), *A. elastica* and *camansi* (*Artocarpus* sp.). Padolina (22) also approach grafted breadfruit onto *camansi* (which he identifies as *A. communis*).

In a small trial at the Burliar Fruit Station in Madras State, in which breadfruit suckers were approach grafted onto breadfruit seedlings in December and February, the grafts were ready to be severed within four months (15).

These few reports do not suggest that anyone has been greatly impressed by the value of grafting for the propagation of breadfruit, and the method has not been developed on a commercial scale. This situation might well be changed if a satisfactory dwarfing rootstock were to be discovered.

PROPAGATION BY ROOT SUCKERS

The roots of breadfruit have a tendency to produce adventitious shoots. In soft, moist soil a mass of feeding roots develops only just below the soil surface, and some may even protrude above it. Where these are bruised or cut, a sucker may arise which will develop an independent root system and form a new tree (Gl8; 27). The amount of suckering can be increased by cutting the smaller roots and raising the proximal cut ends above the soil

surface; if the soil around them is kept moist, adventitious buds will be formed and forced into growth. The new shoots can then be separated and transplanted during the rainy season (27; 28). Chevalier (3) has observed that in some areas, Guinea for example, breadfruit trees do not produce root suckers; he considers that this may be a varietal characteristic.

In early times the use of root suckers was the traditional method of propagating the seedless breadfruit in the Pacific islands and South India (G15; G18; 30). The suckers are lifted, together with a section of root, when they are 30-35 cm (12-14 in) tall (20) or, according to Julien (8) as soon as they are mature, which means when the stem becomes woody and produces lobed leaves, the early leaves on suckers being entire. The young shoots grow slowly and are very subject to injury (G18); moreover, they do not transplant readily, so that losses are high, and those that survive take a long time to recover from the shock of transplanting (8). In Tahiti it was the custom to wrap the shoots of the transplanted suckers in banana leaves to reduce water loss (30). In its traditional form this method of propagation is therefore slow, laborious and unreliable, and cannot be considered a commercial proposition.

The only experimental work on propagation by root suckers seems to be a small-scale trial carried out at the Burliar Fruit Station in Madras (13), in which 30 suckers were separated from the parent tree in July 1946 and planted out; of these, only six (20%) rooted satisfactorily within three months. No details are given, but it is concluded that the method cannot compare with propagation by root cuttings, with which up to 90 per cent success has been achieved.

It seems likely that this major problem of transplanting losses is associated with the inadequacy of an independent root system at the time of transplanting. No information is available on this point, but it seems reasonable to suppose that, even if good roots had developed on the attached suckers, it would be difficult to avoid injuring them during the process of lifting

under field conditions. It would be interesting to investigate the effect of lifting the suckers at an early stage, potting them up, and growing them on under carefully watered and shaded conditions in the nursery until a satisfactory root system has been developed. In practice this would be a propagation procedure intermediate between the traditional use of root suckers and the use of root cuttings.

PROPAGATION BY ROOT CUTTINGS

Introduction

Observation of the development of adventitious buds on injured roots of breadfruit led Wester (G27; 29) at the Lamao Experiment Station in the Philippines to carry out a series of experiments with root cuttings in 1913. His technique proved to be a breakthrough in the problem of propagating the seedless breadfruit. The method was much more reliable and more rapid than the traditional use of root suckers, it avoided the heavy transplanting losses, and moreover it could be conducted under controlled conditions and was less wasteful of roots. The whole process, from taking the cuttings, through the nursery stage to field planting, took about 14 months.

Of the many trials with root cuttings that have been carried out since then in various parts of the world, most have confirmed Wester's original work, and some have led to modifications in the technique. The use of a "solar propagator" in Rodrigues island in the Indian Ocean, for instance, has reduced the propagating time to 5 months (8). Root cuttings are now used on a commercial scale for propagating breadfruit in India (G24).

Parent trees and time of taking the cuttings

Differences between the various clones and selections in the regenerative capacity of their roots have not been studied, but the observation by Chevalier (3) that breadfruit trees in some areas do not produce root suckers, and his suggestion that this might be a

under field conditions. It would be interesting to investigate the effect of lifting the suckers at an early stage, potting them up, and growing them on under carefully watered and shaded conditions in the nursery until a satisfactory root system has been developed. In practice this would be a propagation procedure intermediate between the traditional use of root suckers and the use of root cuttings.

PROPAGATION BY ROOT CUTTINGS

Introduction

Observation of the development of adventitious buds on injured roots of breadfruit led Wester (G27; 29) at the Lamao Experiment Station in the Philippines to carry out a series of experiments with root cuttings in 1913. His technique proved to be a breakthrough in the problem of propagating the seedless breadfruit. The method was much more reliable and more rapid than the traditional use of root suckers, it avoided the heavy transplanting losses, and moreover it could be conducted under controlled conditions and was less wasteful of roots. The whole process, from taking the cuttings, through the nursery stage to field planting, took about 14 months.

Of the many trials with root cuttings that have been carried out since then in various parts of the world, most have confirmed Wester's original work, and some have led to modifications in the technique. The use of a "solar propagator" in Rodrigues island in the Indian Ocean, for instance, has reduced the propagating time to 5 months (8). Root cuttings are now used on a commercial scale for propagating breadfruit in India (G24).

Parent trees and time of taking the cuttings

Differences between the various clones and selections in the regenerative capacity of their roots have not been studied, but the observation by Chevalier (3) that breadfruit trees in some areas do not produce root suckers, and his suggestion that this might be a

varietal characteristic, indicates that such differences may exist.

The only reference seen to the condition of the tree from which root cuttings are taken is a recommendation by Julien (8) that cuttings should be selected from healthy, mature plants, as indicated by an abundant exudation of latex. Parsons (23) mentions that roots taken from just below the surface of the soil are best.

The time of taking the cuttings has attracted much more attention. Wester (29) stressed that the cuttings must be taken at the end of the dry season and start of the rainy season, this being from the end of May to July in the Philippines. He observed that up to 80 per cent of the cuttings taken at this time will make healthy plants, whereas at other times of the year very few cuttings will grow. The explanation given for this is that growth ceases during the dry season, and much of the sap is withdrawn from the aerial parts and stored in the roots; the roots will therefore have a high vitality at the end of the dry season, and contact with moist soil in the propagating bed will stimulate the development of adventitious buds. This observation was subsequently confirmed in a trial by Ocanes and Ruiz (21), also working in the Philippines. Very poor results were obtained on cuttings taken during the hot, dry weather of January and March, as compared with cuttings taken in June; during the hot weather many of the former, especially the smaller ones which stored less food, wilted and dried up.

At the Burliar Fruit Station in India (15; 16), where root cuttings were inserted at monthly intervals throughout the year, the highest percentage success was obtained with March planting, again at the end of the dry season; no regeneration occurred during July to November, that is during the monsoon season. Parsons (23) recommends that the operation should coincide with the arrival of the monsoon.

With a solar propagator, which uses the sun's rays for heating, root cuttings regenerate best during

the warm months of the year. In Rodrigues, where such equipment was used, these months are October to May. Reporting on this method, Julien (8) noted that for mass production the first cuttings can be taken in August and the last must be inserted by the end of November. This period coincides fairly well with the driest season, September-November.

Size and age of cuttings

Wester (G27, 29) recommended that the roots, at the point of severance from the tree, should not be more than 6 cm (2½ in) in diameter. This is to avoid excessive damage to the parent tree and also for convenience in handling. Roots less than 1 cm (½ in) in diameter should be discarded because they produce weak plants. Cuttings 25 cm (10 in) long were very successful, but he considered that 20 cm (8 in) is probably sufficient and is more economic.

Otanes and Ruiz (21) made an interesting comparison on the performance of root cuttings of different ages (thicknesses) under different weather conditions. They cut roots into pieces 15 cm (6 in) long and grouped them into hardwood (4.75-2.5 cm diameter), semi-hardwood (2.45-1.75 cm) and softwood (1.70-0.75 cm) categories. At all seasons the hardwood and semi-hardwood cuttings gave better results than softwood cuttings; this was particularly noticeable during the hottest months, when all the softwood cuttings died owing to rapid exhaustion of their food supply. With June planting, the most successful time, hardwood cuttings showed 52 per cent success, semi-hardwood 36 per cent and softwood 16 per cent.

Slightly smaller cuttings have given fair results in the Seychelles (26) and India (G15), but it is now general practice to use roots about 2½ cm (1 in) in diameter and 23 cm (9 in) long (G19; G24).

Root discs, about 2½ cm (1 in) long, were tested as planting material at Burliar in India (16). Monthly plantings were made from June to November, but all the discs dried up.

Rooting media and method of planting

According to Wester (G27; 29) the propagating bed or frame should be filled to a depth of 20 cm (8 in) with clean, sharp, medium-coarse river sand; beach sand is usable provided the salt has been washed out, and sandy loam is a possible alternative. Otones and Ruiz (21) used raised beds of 10-15 cm (4-6 in) of pure river sand over thoroughly dug soil. In the Seychelles coral sand was used satisfactorily (26). Sand is now generally recommended as a rooting medium (G3; 8, 10, 23).

The angle of planting has a striking effect on the results. Wester (G27; 29) stated that the cuttings must be planted diagonally in trenches, so that the thickest end protrudes 3-6 cm (1½-2½ in) above the surface. The spacing should be at least 12 x 25 cm (5 x 10 in) to avoid injury at the time of lifting. Diagonal planting was also used by Otones and Ruiz (21) and is recommended by most authorities (G3; 10; 23), except in India, where horizontal planting is the general, though not always very successful, practice (12;15;16). Several trials in India have shown, however, that roots planted horizontally give much better results than roots planted vertically (G15; G24; 9, 12).

At the Taliparamba Research Station in Madras (15) root cuttings were planted (i) completely under the soil, (ii) with one end protruding, or (iii) with both ends under the soil and the centre portion exposed. No sprouts emerged from the completely covered roots, whereas 50 per cent sprouting was obtained from roots with an exposed end and 25 per cent from roots with the centre exposed; all the sprouts originated from the exposed portions. This result confirms that diagonal planting to leave the larger end exposed is sound practice.

In the solar propagator a special technique of planting was used (8). The roots were placed horizontally on a sand bed about ½ cm (¼ in) apart and covered with 1½ cm (½ in) of sand. After 45 days the roots were

examined for gall-like protuberances (meristematic tissue from which adventitious shoots will develop). All cuttings showing such tissue were laid flat in another bed with the protuberances facing upwards and covered with sand again, while the remainder were replaced. One week later suckers appeared.

Treatment of cuttings

Trimming the root cuttings with a sharp knife and painting the thickest end with coal tar or white lead was recommended by Wester (29); he stressed that great care must be taken not to injure the roots when digging up and planting the cuttings. Otones and Ruiz (21) also painted the cut ends to prevent drying and the entry of fungi, and the practice was recommended by Parsons (23) when a cutting was more than 1½ inches (4 cm) thick.

Julien (8) advised that the cuttings should be dipped in a 2 per cent solution of potassium permanganate before insertion to coagulate the latex. In India a 0.2 per cent solution of potassium permanganate is sometimes used (G15).

The effect of dehydrating the roots by keeping the cuttings at a relative humidity of 50 per cent for a week before planting was tested at Burliar Fruit Station (18). After seven months only one out of 25 cuttings had sprouted compared with three in the controls. That the practice proved detrimental only confirms the advice of other workers that the roots should not be allowed to dry out.

Environmental conditions

Most workers agree that the propagating beds should be kept shaded and the rooting medium well watered (8; 21; 23), but Wester (29) warned that if the sand is watered every day it will become sour and the developing young roots will rot, so it should only be watered when it is dry; the cuttings should, however, be lightly sprayed two or three times a day during hot, dry weather.

The solar propagator used so successfully in Rodrigues island (8; 19) comprised a heating compartment consisting of a shallow tank filled with water and covered with glass to trap the sun's rays and warm the water, over part of which was constructed a propagating frame. The good and fast rooting obtained suggests that the provision of bottom heat in an ordinary frame might be beneficial.

Transplanting and potting up

Wester (G27, 29) noted that the root cuttings were ready for transplanting to the nursery when they were well rooted and had made 20-25 cm (8-10 in) of shoot growth. He found that sprouting was very irregular, but that generally the cuttings were large enough to transplant to the nursery or to bamboo tubes or baskets when they were seven to eight months old; they usually required a further six to seven months before transplanting to the field. In India, too, sprouting has been very irregular; in one trial at Burliar the first sprout appeared in four months and the rooted plants were ready for potting in five or six months (16).

When cuttings were raised in a solar propagator they were considered ready for potting as soon as they bore one leaf (8). On lifting, the end of the root nearest the shoot was again dipped in potassium permanganate at 0.5 per cent and then coated with paraffin wax to prevent rotting. They were planted diagonally in special pots with the paraffined end uppermost. The pots had removable sides to avoid root injury at the final transplanting, and were filled with a mixture of one part by volume leaf mould, one part sand and two parts light soil. The young plants were placed in a shed thatched with coconut leaves and covered with gunny bags for light shade; after about two months the plants were hardened-off by gradually removing the bags. The whole process of propagation took about five months, and over 80 per cent of the root cuttings produced plants.

PROPAGATION BY LAYERING

Apart from a passing mention by León (10) that breadfruit can be propagated by layers, presumably ground

layers, no other reference has been seen to the ground layering of this crop. In view of the fact that stem cuttings of two-to three-year-old wood have been observed to root better than tip cuttings (24) (see below under Propagation by Stem Cuttings), it seems probable that ground-layers could be induced to form roots, but the upright growth habit of breadfruit trees suggests that it would be difficult to find many branches suitable for layering. Mound layering (stooling) of young plants, derived perhaps from root suckers and therefore probably juvenile, does not appear to have been tested, but the successful Kaup method of air layering described below would need only slight modification to become a form of stooling.

The earliest report seen on the successful air layering of breadfruit comes from the Lamao Experiment Station in the Philippines, where Galang and Elayda (6) used vigorous, symmetrical branches with a diameter of 2-6 cm (1-2½ in); they recommended that the operation should be carried out during the rainy season and that the marcots should be kept watered during the dry season. Later, at the same Station, Padolina (22) found that overgrown seedlings in the nursery could be marcotted within 32-44 days, whereas branches of an old tree required three months from the date of covering to the date of separation of the rooted marcot. No details are given of the technique.

Various factors influencing the rooting of marcots were investigated further by Fabello (5), also in the Philippines. He compared young and old branches, both primary and lateral, ringing and partial cutting methods, cutting below and between nodes, covering the marcots immediately and after callusing, and treatment with potassium permanganate (presumably to coagulate the latex). Unfortunately only an abstract of his paper is available to the present writer, and from this it is not always clear which results refer to which treatments. What does emerge, however, is that rooting occurred in 96-108 days on ringed branches without $KMnO_4$ treatment and in 92-97 days with $KMnO_4$. With the partial cutting method roots formed in 112-123 days without, and in 108-111 days with $KMnO_4$. After ringing, young branches

callused more rapidly than old branches, but there was no correlation between earliness of callusing and rooting. Branches cut or ringed immediately below a node gave a higher percentage success than those cut between nodes.

In the Bahamas attempts to propagate breadfruit on a large scale by air layering, using a covering of Air-Wrap, did not prove very successful (24). A small percentage of the marcots rooted quite readily, but the remainder only callused. It was also found that the ringed wood was very brittle and liable to snap in a wind; this problem was overcome by attaching small bamboo splints outside the wrapped marcots.

It has been reported from India that the practice of air-layering root suckers has been used quite successfully on a commercial scale (G24). In a series of trials at the Burliar Fruit Station (15; 16; 17; 18) a high percentage of success was obtained, and the marcots were ready for separation in four to five months. A modification of the technique, called the Kaup method, was developed, in which the suckers are air layered at the height of about six inches (15 cm) from the ground; separation of the rooted marcot stimulates the production of lateral shoots from the stump of the sucker that remains. These lateral shoots can in turn be air layered, thus maintaining a constant supply of material for propagation. Two or three months after separation of the marcots on the main sucker, three to four lateral sprouts develop, the topmost one being ready for air layering in 30-45 days and the lower ones becoming ready at intervals of a fortnight.

In the same series of trials at Burliar (16) air-layering shoots on mature trees gave a lower percentage success (eight out of twelve rooted) than air layering root suckers (seven out of eight rooted). Although it would be unwise to draw any conclusions from such a small trial, the differences are in line with those of Padolina (22) mentioned above, and may have been associated with the more juvenile condition of the root suckers.

None of the reports stated whether growth substances had been used on the marcots.

PROPAGATION BY STEM CUTTINGS

In Bailey's *Standard Cyclopaedia of Horticulture* (61) it is stated that *Artocarpus* species in general can be propagated slowly by cuttings of young lateral growth; no other method of raising the plants is mentioned. León (10) in his authoritative book on tropical crops, notes that, in addition to the common methods of propagation by root suckers and root cuttings, breadfruit may also be propagated by stem cuttings, but he gives no details of the technique. In practice, however, the method appears to be rarely used, and Parsons (23) notes that the breadfruit does not normally root from cuttings.

In trials at the Burliar Fruit Station in India no rooting was obtained from stem cuttings, and these are considered unsuitable material for propagation (615; 9; 12). Cincturing the shoots on the tree before taking cuttings did not improve results (14).

The possibility that growth substances may be necessary for the successful rooting of breadfruit cuttings was investigated in Liberia by Muzik (20). The cuttings used were about 30-37 cm (12-15 in) long and 1 cm ($\frac{1}{4}$ in) in diameter with three to four nodes. They were planted in sand beds under a thatched roof to provide shade, and banana leaves were laid over the beds for three days after planting to prevent excessive drying. Cuttings dipped in 1% IBA gave 80 per cent rooting, whereas untreated cuttings completely failed to root; immersing the base of the cutting in 0.0002% IBA solution for 24 hours was also beneficial, resulting in 60 per cent rooting. These results suggest that the use of growth substances may be an all-important factor in success.

The laborious method of dipping stem cuttings in liquid paraffin wax of low melting point (omitting the portion to be inserted in the soil) before planting, in conjunction with the use of growth substance powder (compound unspecified), has been used successfully in Trinidad (25). It is not stated whether the cuttings

were leafy or not. The author notes that the paraffin wax can be applied conveniently in a wide boiling tube or, in the case of stout cuttings, by applying the molten wax with a camel-hair brush. The technique sounds rather too time-consuming for commercial use. When the same method was tested at the Burliar Fruit Station in India (16) it was a complete failure. All the cuttings treated with paraffin wax, with or without the growth substance Seradix B2 (IBA), as well as the untreated controls, dried up without rooting. It is possible that the failure may have been due to the fact that the cuttings were taken in March-May, i.e. during the hot season.

Mist propagation, using a Fog-Box unit, has been tested in the Bahamas (24). It is recorded that the method did not prove very successful, especially with new wood consisting of growing tips from terminal and lateral branches, but that two to three-year-old wood showed more promise of success. It is possible that the failure of the tip cuttings may have been due to the eventual rotting of the soft tissue under mist, while the older leafless wood could survive long enough to root; if so, the use of growth substances to accelerate rooting might have improved the results with tip cuttings. On the basis of such scanty information, however, one can only speculate on the causes of failure.

A point which does not appear to have been mentioned in any of the reports on propagation by cuttings is the exceptionally large size of breadfruit leaves, which may be as much as 60 cm (24 in) long. Even if the leaves were shortened, the cuttings would take up an inconvenient amount of space in a propagator, and this in itself might make the method uneconomic. Neither has the influence of latex flow been investigated. It is possible that the variable results obtained in the trials reported may be connected with differences in latex flow, as the breadfruit contains a viscid, milky latex in all its parts. In the case of root cuttings, Julien(8) recommends dipping the root pieces in potassium permanganate to coagulate the latex. It might perhaps be worth investigating whether coagulation of the latex in stem cuttings would improve rooting.

No comparative trials have been carried out on the source of cutting material. The potentially higher rooting capacity of root suckers (discussed above under air-layering) might make them more promising material for propagation by cuttings than shoots from mature trees.

CONCLUSIONS AND SUGGESTIONS

The breadfruit has a high food value and culture of the crop might usefully be extended, provided that seedless varieties of superior quality are selected. Among characters that should be considered in selection is ease of vegetative propagation. Only the inferior seeded form can be propagated by seed. No difficulties have been recorded, apart from the short viability of the seed and the slow growth of the seedlings.

The much more valuable seedless varieties must necessarily be propagated by vegetative means. Breadfruit has been budded and grafted onto various rootstocks, but the information available is scanty and the interest it has aroused is small. This situation would doubtless be altered if a satisfactory dwarfing rootstock were discovered.

The traditional method of propagation has been the use of root suckers. This method is unreliable and slow, and heavy losses are incurred during transplanting. Potting up the young suckers at an early stage and growing them on under nursery conditions might help to reduce losses.

The use of root cuttings has generally proved a much more reliable method. With this method plants ready for field planting can be obtained in 14 months, but the use of a solar propagator may reduce this time to five months. The success of the solar propagator suggests that more usual forms of bottom heat might hasten root and shoot development.

Ground layering does not appear to be practised to any great extent. Stooling of juvenile root suckers might possibly prove a simple and cheap method of propagation. Air layering has given satisfactory results, especially in India where the air layering of root suckers is practised commercially. A modification of this method, which allows the development of new laterals on the sucker below the original marcot, thus providing a continuous supply of propagating material, is particularly promising. The process, which has much in common with stooling, takes four to five months.

The results of the few trials that have been recorded on the use of stem cuttings suggest that very poor rooting can be expected unless growth substances, notably IBA, are applied. There is some indication that cuttings from older, leafless wood may root more readily than young leafy cuttings. If this is confirmed it could be advantageous, because the leaves of breadfruit are so large as to make the handling of leafy cuttings cumbersome.

BIBLIOGRAPHY

1. ALLEN, B.M. *Malayan fruits: an introduction to the cultivated species*. Donald Moore Press, Singapore, 1967.
2. ANON. Malayan fruits. *Malay. agric. J.*, 1935, 23: 110-33.
3. CHEVALIER, A. L'arbre à pain et ses congénères. *Rev. Bot. appl.*, 1940, 20: 25-38.
4. COENAN, J. and BARRAU, J. The breadfruit tree in Micronesia. *S. Pacif. Bull.*, Oct. 1961, pp. 37-9.
5. FABELLO, S.F. Propagation of certain species of *Artocarpus* by marcottage. *Thesis Coll. Agric. Philipp. N. 386* (from abstract in *Philipp. Agric.*, 1934, 23: 162-3).
6. GALANG, F.G. and ELAYDA, A.R. Experiments on vegetative propagation of tropical fruits at the Linao Experiment Station, Linao, Bataan. *Philipp. agric. Rev.*, 1924, 17: 203-5.
7. IBÁÑEZ, M.L. The effect of cold on tropical seeds. *Turrialba*, 1968, 18: 73-4.
8. JULIEN, J.B. Propagation of breadfruit (*Artocarpus incisa*) by the "solar propagator". *Rev. agric. Maurice*, 1945, 24: 31-3.
9. KHAN, K.F. Propagation of seedless breadfruit. *Indian J. Hort.*, 1945, 3 (1): 44.
10. LEÓN J. *Fundamentos botánicos de los cultivos tropicales*. Instituto Interamericano de Ciencias Agrícolas de la OEA, San José, Costa Rica, 1968.
11. MADRAS. *Rep. agric. Stats Madras Pres. 1943-44*, 1945.

12. MADRAS. *Idem* 1945-46, 1948.
13. MADRAS. *Idem* 1946-47, 1949.
14. MADRAS. *Idem* 1947-48, 1950.
15. MADRAS. *Idem* 1948-49, 1951.
16. MADRAS. *Idem* 1949-50, 1952.
17. MADRAS. *Rep. agric. Stats Madras St.* 1950-51, 1953.
18. MADRAS. *Idem* 1951-52, 1955.
19. MAURITIUS. *A. R. Dep. Agric. Mauritius* 1938 - 1950.
20. MUZIK, T. J. Effect of hormone on root formation in *Artocarpus communis*. *Science*, 1948, 107: 275.
21. OTANES, R. T. and RUIZ, T. P. Propagation of rimas (breadfruit) by root cuttings. *Araneta J. Agric.*, 1956, 3(2): 56-66.
22. PADOLINA, F. Vegetative propagation experiments and seed germination. *Philipp. J. Agric.*, 1931, 2: 347-55.
23. PARSONS, T. H. Food crops in the tropics. *Trop. Agriculturist*, 1933, 80: 285-9.
24. RUSSELL, O. S. A progress report on research in tropical and sub-tropical fruit at the Government Experiment Station, Nassau, Bahamas. *Proc. Fla St. hort. Soc.* 1953, 66: 167-8.
25. S., G.C. Note on a simple method of plant propagation by cuttings. *Trop. Agric., Trin.*, 1949, 26: 4.
26. SEYCHELLES. *A.R. Dep. Agric.* 1964.
27. STEPHENS, S. E. Some tropical fruits. 4. The bread fruit. *Qd agric. J.*, 1935, 44: 778-80.
28. THOMAS, C. A. You can grow breadfruit in your garden. *Indian Hort.*, 1969, 13 (4): 27.
29. WESTER, P. J. The breadfruit. *Philipp. agric. Rev.*, 1920, 13: 223-9.
30. WILDER, G. P. The breadfruit of Tahiti. *Bernice P. Bishop Museum Bull., Honolulu*, 1928, 50: 83.

ARTOCARPUS HETEROPHYLLUS JACKFRUIT

by

PATRICIA ROWE-DUPTON

Formerly of the Commonwealth Bureau of Horticulture
and Plantation Crops

ECOLOGY AND GROWTH IN RELATION TO PROPAGATION

Distribution and ecology.

The jackfruit (*A. heterophyllus*, syn. *A. integrifolia*), often called the jack or jak, is believed to be indigenous to the rain forests of the Western Ghats in India. It is now widely grown throughout India, particularly on the west coast, in Assam, Uttar Pradesh, South India and the warmer parts of the country at altitudes up to 5,000 feet (1,600 m), although the fruit is of better quality at lower altitudes. It is common in the wet zones of Sri Lanka, and is one of the most important foods of the rural population there, the fruit being rich in carbohydrates. In many areas, particularly Sri Lanka, the timber is considered as valuable as the fruit. The tree spread early to Malaysia and East Africa, and is now grown throughout much of the tropics. It is most popular, however, in parts of Southern Asia. (G15; 9; 20; 22; 23)

Although the jackfruit thrives in a moist, tropical climate, it is less exacting in its requirements than the breadfruit and is adapted to a wider range of conditions. It is tolerant of lower temperatures, but, although mature trees are reported to have survived a temperature of 27°F (-3°C) in Florida, young trees are killed and older ones injured by frost. The young plants also need protection against sunscald. Plenty of moisture in the soil is an essential requirement, but the tree is very intolerant of poor drainage and stagnant water around the roots. The best growth is made on deep alluvial soils of open texture, but the jackfruit will grow on a wide range of soils, provided there is sufficient depth and good drainage. Except in areas where rainfall is plentiful, irrigation is needed. (G3; G15; 20; 23; 37)

It follows that, during propagation, the jackfruit is likely to do best in a well drained rooting medium that is kept constantly moist.

Growth habit

The tree is fairly tall, ranging from 30 to 75 feet (9-23 m) in height, with a straight stem, branching near the base and forming a dense, irregular crown. Unlike breadfruit, the jackfruit is invariably evergreen and its glossy leaves are considerably smaller, usually less than eight inches (20 cm) long. On young plants the leaves are lobed, but on mature trees they are entire. The young plants grow very fast and may reach 25 feet (7.5 m) by their third year. (G16; G19; 9)

The seedlings have a long, delicate taproot which makes them difficult to transplant (20). No information is available on the root system of mature trees. The root suckering habit, which is such a feature of breadfruit trees and has led to the techniques of propagation by root suckers and root cuttings, is not evident in the jackfruit.

In the warmer parts of South India fruit bearing usually starts from the 4th to the 8th year on both seedlings and vegetatively-propagated trees, but in the northern parts of the country seedlings are much slower to bear and may take up to 14 years. In these cooler conditions vegetative propagation has been found to hasten bearing considerably, and can thus help to overcome a serious economic problem. (23; 30)

On young trees the fruits are borne on short stalks on the main branches, but as the trees mature the fruits are produced from the trunk as well. It has been reported that on very old trees fruits may even be formed on the roots below the soil. In most parts of India the tree crops during the summer, with occasional light off-season crops in September-December, but in more tropical regions, such as the East Indies, flowering occurs almost throughout the year, so that fruits of different ages are borne on the tree at the same time. A tendency to biennial bearing has been observed in jackfruit (38); this gives rise to the possibility of a difference in rooting capacity between shoots taken in an "on" and an "off" year. The fruits, which are of immense size, contain between 100 and 500 large oily seeds each. (G16; G19; 20; 23; 37)

Varieties

As the jackfruit has been traditionally propagated from seed, there is a wide variation in productivity and in fruit size, shape and quality, as well as in season of fruiting. Two main types are distinguished, the one soft-fleshed and the other crisp-fleshed. There is also a small-fruited form known as Rudrakshi, which is widely grown in India but is generally considered to be somewhat inferior to the best forms of common jackfruit. This variety appears to maintain its characteristics even when propagated by seed. (G24)

A type known as the Singapore jack was introduced into Madras State in 1947, where it aroused considerable interest. Under favourable conditions, such as the lowland wet zones of Sri Lanka, it is said to come into bearing very early, within about 18 months from sowing, but at higher elevations and in many trials in India it did not prove to be quite so precocious. One of its advantages is that the fruits ripen later than those of the ordinary jackfruit in India, so it can be used to extend the harvest season. The fruits are of medium size and contain only about 80 seeds, and the flesh is crisp and firm; the variety, however, does not always come true from seed, so there is considerable variation in quality. (G15; 23; 24)

Another very precocious variety, called Muttom Varikka, has recently been selected from a seedling population in Kerala and propagated as a clonal variety by air-layering and approach-grafting (36).

The selection of superior seedlings of jackfruit and their perpetuation as clones by vegetative propagation has been part of an improvement programme at Kodur, Burliar and Kallar Fruit Stations in India for many years. This programme has been combined with extensive investigations to find reliable methods of vegetative propagation (G15).

Pests and diseases

The jackfruit is relatively free from serious pests and diseases. A pest that might cause trouble in nurseries is the shoot borer caterpillar, *Margarona caesalis*, which bores into tender shoots and buds. Recommended control measures include the removal of affected shoots, hand picking of the caterpillars, fumigating the bored holes with petrol or calcium cyanide paste and spraying new growth flushes with DDT to prevent egg laying (G23; 2; 23).

The brown weevil (*Ochyromera artocarp*) also bores into tender buds and fruits. Grubs and adults should be destroyed, fallen fruits and buds collected and the trees sprayed with DDT (2; 23).

Mealy bugs and scale insects can sometimes be troublesome. These can be controlled by a contact insecticide such as sulphur dust or lime-sulphur sprays (G24).

The most common disease attacking jackfruit leaves, and therefore likely to be of importance in the nursery, is brown leaf spot (*Phomopsis artocarpina*). This can cause premature leaf shedding. Copper sprays are said to give effective control (2; 23).

No virus diseases appear so far to have been recognized in jackfruit.

PROPAGATION BY SEED

Introduction

The most common and simplest method of raising jackfruit trees is from seed. For the production of fruiting trees the method has obvious disadvantages. The trees do not generally come true from seed, so the practice has led to immense variation in yields, fruit characters and quality. If an outstandingly good seedling is produced it cannot, therefore be perpetuated by seed propagation but must be propagated vegetatively. Seedling trees generally come into bearing within four to eight years in South India, but in cooler regions they may take up to 14 years to fruit (30). Jackfruit seedlings have a long tap-root, and this makes them notoriously difficult to transplant, especially in a bare-root condition. (G19; G24; 2; 20)

Even when selected clones are propagated vegetatively by grafting, usually approach-grafting, the rootstocks have been raised from seed. Seedling rootstocks grow slowly and take about a year to attain a stem thickness suitable for approach-grafting (30). With rootstock production, too, transplanting remains a problem.

The fruits of jackfruit are well supplied with seeds. Culinary varieties may contain up to 500 seeds per fruit, whereas table varieties usually have about 100 (23). Sonwalkar (34) found that there was no apparent relationship between fruit

weight and seed number. He also recorded a wide range in seed weight, from less than 1 g to 7 g per seed.

Polyembryony

Polyembryony is an uncommon occurrence in jackfruit, but Sonwalkar (34) reports that it occurred in two seeds used in his trials in India; one of the seeds gave rise to four plants, the other to two. As the phenomenon appears to be of such sporadic and rare occurrence, the possibility of exploiting it under normal conditions to produce plants true to type seems remote. An observation reported recently by Shanmugavelu (27; 28), however, suggests that polyembryony may be more common than is generally supposed, but that it does not manifest itself except under stimulation. He observed that 20 per cent of the seeds that had been treated with 500 p.p.m. GA produced twin seedlings, and attributes this effect to an increase in the concentration of auxins in the embryo.

Seed storage and germination

Jackfruit seeds lose their viability quickly, and it is commonly recommended to plant them immediately or very soon after extraction (G18; G19; 9; 24). It is reported that the percentage germination falls very rapidly after a month of storage at room temperature, but that the seeds may be stored for some time (time unspecified) in coir dust or sand provided the cotyledons do not dry up (23; 24). Sonwalkar (34) provides some experimental evidence on this point. He stored seeds in paper bags under ordinary conditions and planted them at intervals of two days during one month after extraction. Seeds planted during the first week gave 100 per cent germination and all emerged within 32 days, whereas those planted in the fourth week gave only 88 per cent germination and took 45 days. Thus, although there is some reduction in percentage and speed of germination as a result of storage, it is quite feasible to keep jackfruit seeds for at least a month after extraction. He also found that the heavier seeds remained viable longer than lighter seeds.

Even with freshly sown seeds, Sonwalkar (34) found that large seeds (5-6 g) germinated better and faster than small seeds (2-3 g) and produced more vigorous seedlings. Large, heavy seeds should therefore be selected for propagation. Rao (23) confirms that seeds weighing less than 3 g are undesirable.

The time required for germination normally ranges from

three to eight weeks (20; 23; 34). Even seeds of the same weight showed variation in the time of germination (34). In a report from the Philippines (21) an even wider time range is recorded, but here the difference is associated with the type of jackfruit: the type known as Nangca required only 19 days to germinate, whereas Aluyaa required 60 days.

Seed treatment

It is claimed that soaking jackfruit seeds in water for 24 hours will improve and hasten germination (20; 23). This has been confirmed experimentally by Sonwalkar (34) in a trial in which seeds of three weight categories were soaked in water for 24, 48 and 96 hours. Light seeds (3-4 g) gave the highest percentage germination when soaked for 96 hours, but even a 24-hour soak was beneficial. Heavier seeds gave the highest germination with a 24-hour soak. Soaking also increased the speed of germination.

Growth-substance treatment has also shown promising results in two trials in India. Seeds soaked for 24 hours in NAA at 25 and 50 p.p.m. gave 77 per cent and 60 per cent germination, respectively, compared with 50 per cent in the controls; higher concentrations were less satisfactory. Seedling growth was also by far the best with the 25 p.p.m. treatment. (33). In the second trial soaking seeds for 48 hours in GA at all concentrations from 100 to 500 p.p.m. resulted in 100 per cent germination compared with 80 per cent for untreated seeds. Inconsistent and less satisfactory results were obtained following treatments with IAA, IBA and NAA at 100 to 500 p.p.m. Seed treatment with CPA caused the cotyledons to split and completely prevented germination. Shoot growth of the seedlings was greatly increased by seed treatment with GA, and slightly improved by IAA, IBA and NAA, whereas root growth was somewhat reduced by GA but greatly increased by the other three growth substances. (27; 28)

Seed planting and seedling management

When 4 planting positions were compared by Sonwalkar (34) in India, he found that it was best to plant the seeds either flat or with the embryo pointing downwards. When the embryo was pointed upwards, the seeds took much longer to germinate, and when the narrow end was pointed upwards the percentage germination was slightly lower.

Sonwalkar also showed that planting the seeds in their jackets, that is, without removing the fleshy perianth lobes, was very detrimental, resulting in only 20 per cent germination.

For rootstock production in Java jackfruit seeds were planted in propagating beds at a spacing of 40 x 40 cm (16 x 16 in) under light shade, where they were left until ready for budding (G12). In India seeds for rootstocks are either planted in seed-beds and transferred to pots within six months, or planted directly in pots (G24). Lifting seedlings from the beds, however, is a problem, because the long, delicate tap-root is easily injured and bare-root seedlings do not transplant well. It is generally recommended to raise the seedlings in containers or, in the case of trees on their own roots, to plant the seed in situ. (G19; 2; 20)

If the seed is planted in seed-beds, the seedlings should be potted up before the food reserves in the cotyledons are exhausted (23; 24). Potting up as late as the six-leaf stage has led to 20 per cent mortality (34). It is said that seeds can be germinated satisfactorily in pieces of coconut husk containing enough soil to cover them; they are then planted out in the field with the husk (23; 24). Other containers commonly used are clay pots, bamboo baskets or small bamboo pots, but seedlings in such containers do not remain healthy for more than a month or two (23; 24). Plants in bamboo baskets can be planted with the basket intact, thus avoiding any root disturbance (34).

The growth rate of the seedlings can be increased either by treating the seeds with growth substances (see preceding section) or by treating the seedlings themselves. In India Shanmugavelu (28) found that by treating one-month-old seedlings with GA at 25-100 p.p.m., either as a spray or as a lanolin application to the growing point, shoot growth was much more vigorous and there was a consistent increase in the fresh and dry weights of both shoots and roots. Similar treatment with IBA or NAA mainly enhanced root growth. Such treatment might prove useful in seedling rootstock production, as the rootstocks normally take about a year to reach a size suitable for approach grafting.

Two distinctly curious propagation practices that have been used in India are mentioned by Morton (20). In one of these a young seedling, raised in a three- to four-foot (90-120 cm) bamboo tube, is bent over so as to coil the pliant stem

beneath the soil with only the tip showing; in about five years such a plant is said to produce large and fine fruits on the spiral stem underground. In the other, the whole fruit is buried and the many seedlings that arise are bound together with straw, so that they gradually fuse into a single tree which bears fruit in six to seven years.

PROPAGATION BY BUDDING AND GRAFTING

Rootstocks and their effects

In Java jackfruit has been budded on seedling rootstocks of *A. heterophyllus* (jackfruit), *A. champeden* and *A. rigida* (G12; G16). In India seedlings of the common jackfruit, the small-fruited Rudrakshi jackfruit, *A. hirsuta* (a tall, wild species) and *A. altilis* (breadfruit) have been used as rootstocks in approach grafting trials (G15; 19). The common jackfruit is the most widely used stock. No work seems to have been done on the use of clonal rootstocks.

As regards raising the rootstock seedlings, Magielse (G12) advised that the very large seeds of jackfruit and *A. champeden* should be planted in propagating beds at 40 x 40 cm (16 x 16 in) and provided with light shade. The seeds of *A. rigida* require more care and must first be planted in seed-beds; four weeks later the seedlings can be planted out in nursery beds at 40 x 40 cm (16 x 16 in). Ochse (G16) also stated that the rootstocks require light shade. He noted that *A. champeden* roots deeply and is therefore difficult to dig up. This difficulty of transplanting seedlings is also a serious problem with jackfruit itself, and has been discussed more fully above (see under Propagation by Seed). For rootstock production in India seedlings are either raised in pots or are sown in seed-beds and transferred to pots within six months; they are then grafted six to twelve months later. Experience has shown that lifting seedlings from beds and transplanting grafts from pots to the field are operations that need great care to prevent root injury; they are best carried out on a cool, cloudy evening. (G24)

The age at which the rootstocks are grafted depends partly on the type of grafting that is used. For modified Forkert budding, using *A. heterophyllus*, *A. champeden* and *A. rigida*, Ochse (G16) found that the best results were obtained with stocks 8-11 months old. Magielse (G12), however,

recommended budding at 10-12 months for *A. champeden* and at 12 months for *A. rigida*. He noted that seedlings of *A. heterophyllus* were ready for budding when only six months old, but at that age the growth of the stock was so vigorous that the binding material, which had to remain in place for three weeks, tended to constrict the young stem; he therefore recommended delaying budding until the seedlings are 10-12 months old, when they are not increasing in girth so rapidly. Shield budding trials in Madras State, which all resulted in failure, were generally done on jackfruit seedling stocks about 2½ years old (11; 12). For approach grafting, Singh (30) comments that seedling rootstocks take about a year to attain a suitable thickness, and Rao (23) says they can be used when they are the size of a pencil (6-12 months old). In trials in Madras State, however, approach grafting was usually carried out when the stocks were about 30 months old (7). The only comparative trial on stock age was at Taliparamba (16), where six-month-old jackfruit seedlings, approach grafted with scions of the same age, gave a 76 per cent take and were ready for separation within 3½ months, compared with a maximum take of 25 per cent and slower union with two-year-old seedlings of pencil thickness; this use of younger stocks, resulting in faster propagation, had the additional advantage of reducing the cost of watering.

Some interesting observations have been made on rootstock effects. The very variable results obtained with budding on jackfruit seedlings in Java (G12), success ranging from 50 to 95 per cent, are unexplained, but it is suggested that the variability might possibly have been associated with the abundant flow of latex. This is also suggested as a cause of the low success rate in chip budding trials on jackfruit seedlings in India (25).

Uncongeniality has been found between the jackfruit scion and the breadfruit rootstock in approach grafting trials at Burliar (19); four out of five grafts were separated successfully and the union appeared to be good at the time of separation, but the stock had made more vigorous growth than the scion and all the shoots died within two weeks of separation. Uncongeniality has also been reported for jackfruit approach grafted on *A. hirsuta* at the Taliparamba Research Station in India (16). Although the percentage take on this rootstock has often been fairly high, trials on its orchard performance showed that it was greatly inferior to jackfruit seedling rootstocks in mean

growth and annual growth increment during the first three years after planting. Overgrowth of the scion was marked, and 15 out of 24 grafts died within two years of planting, while the remainder showed a pronounced distortion at the union. In the nursery, too, the growth of *A. hirsuta* seedlings was slow in comparison with that of seedlings of common jackfruit and Rudrakshi jackfruit, and the percentage mortality was higher after lifting and potting (16). Rudrakshi had given very promising results at Kallar; the percentage take has generally been high and yields have been earlier and heavier than on common jackfruit or *A. hirsuta* seedlings (G16; 7; 23).

Although preliminary trials have also been conducted at Kallar (17; 18) on the comparative performance of various rootstocks and ungrafted seedling trees, no definite conclusions have been reached. The main advantage of grafted plants over seedlings is that they are true to type (G24). One interesting comment made by Rao (23) and Richards (24) is that budded trees are of no value for timber because of their low branching habit. In view of the fact that in many areas jackfruit is grown for its timber as much as for its fruit, this is a point worth noting.

Budding methods

The budding of jackfruit has given extremely variable results in different parts of the world. Ochse (G16), describing methods used in Indonesia, recorded that the jackfruit can be budded by the modified Forkert method using budwood from which the leaves had already fallen. The best rootstock was found to be *A. champeden*, although *A. heterophyllus* (jackfruit) and *A. rigida* could also be used. He recommended that the stocks be slightly shaded and be budded when they are eight to eleven months old, using dry fibres of manila hemp as grafting tape. The budding could be done throughout the year.

Magielse (G12) also reported moderate success with modified Forkert budding in Java. He used ripe, one-year-old budwood, from which the leaves had fallen, in both the wet and dry seasons. He recommended that rootstocks of *A. rigida* should be budded when twelve months old and *A. champeden* when ten to twelve months; in each case about 50 per cent success could be expected. Although rootstocks of *A. heterophyllus* could be used when only six months old, it was considered advisable to delay budding until they were ten to twelve months old (see above, under Rootstocks); on this stock 50-95 per cent success was obtained.

Experience in Malaysia has shown that budding on one-year-old seedling rootstocks produces strong trees of uniform growth (G6; 1). Modified Forkert budding has been practised in Sri Lanka, using budwood of the previous season's growth (23; 24).

In trials at the Kodur, Kallar and Burliar Fruit Stations in South India various types of budding have proved completely unsatisfactory (G15; 7). At Burliar flute budding and patch budding on jackfruit seedling rootstocks both failed, while shield budding on the same stock gave a 10 per cent take in May and June but only when the stocks were notched below the bud after insertion; in other months there was no take (10; 11; 12; 13; 17). In Krishnagar in India chip budding on one-year-old jackfruit seedlings gave only 41 per cent success (25); it is suggested that exudation of latex was the cause of this low take.

The only budding method that has given encouraging results in India is patch budding (39). In monthly trials on this method at the Fruit Research Station, Basti, U.P., 100 per cent success was obtained with budding in June and nearly as good results in May and July; in the remaining months the results were less satisfactory. During the successful months rainfall was average and both the stock and scion were in active growth. In these trials a polyethylene band was used as tying material, covering the whole bud at first but loosened to release the bud point after a fortnight. It was evident that great care is needed in the early stages to prevent the sprouting buds from drying up in the hot summer winds. It was also noted that the branching angle is generally narrow in jackfruit, so that bud growth was not very vigorous at first; later, however, shoot growth became stronger than that of seedlings, and after one year the height and girth of budded plants were more than double those of seedling plants.

Grafting methods

In trials at the Burliar Fruit Station in Madras State side grafting, whip grafting and whip and tongue grafting of jackfruit on jackfruit seedling stocks all resulted in failure (G15; 7; 10; 15).

Approach grafting is the only method that has given fairly satisfactory results. An extensive series of trials on this method was carried out at the various Madras State fruit stations (12 - 19). In these, the most satisfactory

rootstocks proved to be common jackfruit and Rudrakshi jackfruit seedlings. They were usually grafted when they were about 30 months old, but younger seedlings (6-12 months) were found to give better results and are now recommended (23). The percentage take varied greatly with the season at which the operation was carried out. In a five-year trial at Taliparamba, Madras (19) the dry season, November-April, proved completely unsuitable for approach grafting; the best period was during the S.W. monsoon in June-August. Although very inconsistent results have been obtained in other time-of-grafting trials, approach grafting during the cool, rainy season is now generally recommended (G24; 23). Union occurs within 30-45 days, and the grafts are ready for separation, in two or three stages, in three to four months; they can be planted out about one month after separation (G24; 23). Though giving a fair percentage of success (60-70 per cent take appears to be common), approach grafting is a slow procedure and transplanting the grafts presents some difficulty.

PROPAGATION BY ROOT SUCKERS AND ROOT CUTTINGS

Unlike the breadfruit, the jackfruit does not commonly produce root suckers. León (9) mentions that the tree may be propagated by root suckers, but this does not appear to be borne out by other writers. In fact, Popenoe (G18) reported that propagation by root suckers or root cuttings is said not to be successful with this species.

PROPAGATION BY LAYERING

Ground layering

The so-called etiolation method of layering, which in essence is a form of stooling, involves laying down young plants, covering them with soil and gradually earthing up the shoots which arise from them, as opposed to layering individual shoots on a mature tree. This method proved very successful on jackfruit in Malaysia (8). The etiolated shoots were said to root easily, both with and without wire ringing, and when planted out they made rapid growth. In this way a continuous supply of rooted plants could be obtained.

Rather surprisingly, in view of this encouraging experience in Malaysia over 40 years ago, the etiolation method has not been tried in India (G24). The few trials on ordinary ground-

layering that have been carried out at the Madras State fruit stations have all resulted in failure (G15; 7; 14; 16; 18; 19). These included the tongue and ring layering methods tested in February, and the layering of cinctured and etiolated shoots at monthly intervals throughout the year. These latter were presumably shoots from mature trees, although the reports are not explicit on this point. Callus formed on almost all the batches of cinctured and etiolated shoots, but root primordia failed to develop even after 15 months (19).

Air layering

With the striking improvements in the technique of air layering in recent years, this method has now become popular with growers and nurserymen raising jackfruit in northern India (30). At first the results were not uniformly good, but the use of appropriate growth substances has markedly improved rooting, and the better root systems produced have increased the rate of survival; in many cases 100 per cent rooting has been achieved (G23; 5; 26; 31). The use of plastic wraps has made it easier to keep the layers moist, and has thus made the process much less laborious. Air layers ready for transplanting can now be produced in about three months (29; 36); this compares very favourably with the other popular method of vegetative propagation, approach grafting, and also avoids the problem of transplanting associated with the use of seedling rootstocks. At the Horticultural Research Institute in Saharanpur, Singh (30) found that trees produced from air layers made considerably greater growth, both in height and girth, during the first six years than seedling trees. Even more important, especially in northern India, the layered trees came into bearing in 4½ years, while seedling trees had not borne fruit in 8½ years; he estimated that trees from air layers would start to fruit at least five to six years earlier than seedlings in northern India, and that the technique could thus help to overcome a serious economic problem in jackfruit production. This precocity was confirmed by Srinivasan (36) at the Research Institute of Kerala in South India; fruits were harvested in three years from the time of layering on a tree that had been produced from an air layer on a juvenile seedling.

The conditions that are necessary for the success of air layering are discussed below.

Time of air layering: The results of three trials in which this factor has been studied all point to the rainy season as

layering that have been carried out at the Madras State fruit stations have all resulted in failure (G15; 7; 14; 16; 18; 19). These included the tongue and ring layering methods tested in February, and the layering of cinctured and etiolated shoots at monthly intervals throughout the year. These latter were presumably shoots from mature trees, although the reports are not explicit on this point. Callus formed on almost all the batches of cinctured and etiolated shoots, but root primordia failed to develop even after 15 months (19).

Air layering

With the striking improvements in the technique of air layering in recent years, this method has now become popular with growers and nurserymen raising jackfruit in northern India (30). At first the results were not uniformly good, but the use of appropriate growth substances has markedly improved rooting, and the better root systems produced have increased the rate of survival; in many cases 100 per cent rooting has been achieved (G23; 5; 26; 31). The use of plastic wraps has made it easier to keep the layers moist, and has thus made the process much less laborious. Air layers ready for transplanting can now be produced in about three months (29; 36); this compares very favourably with the other popular method of vegetative propagation, approach grafting, and also avoids the problem of transplanting associated with the use of seedling rootstocks. At the Horticultural Research Institute in Saharanpur, Singh (30) found that trees produced from air layers made considerably greater growth, both in height and girth, during the first six years than seedling trees. Even more important, especially in northern India, the layered trees came into bearing in 4½ years, while seedling trees had not borne fruit in 8½ years; he estimated that trees from air layers would start to fruit at least five to six years earlier than seedlings in northern India, and that the technique could thus help to overcome a serious economic problem in jackfruit production. This precocity was confirmed by Srinivasan (36) at the Research Institute of Kerala in South India; fruits were harvested in three years from the time of layering on a tree that had been produced from an air layer on a juvenile seedling.

The conditions that are necessary for the success of air layering are discussed below.

Time of air layering: The results of three trials in which this factor has been studied all point to the rainy season as

being the best time to carry out the operation. In West Bengal, Sen and Bose (26) compared the air layering of jackfruit in mid-May, the hot, fairly dry season, and mid-June, the hot, rainy season. Without growth substances, layering in June resulted in a higher percentage rooting and significantly more roots per shoot than layering in May. When IBA was used, 100 per cent rooting was obtained in both months, but IAA and NAA only promoted rooting significantly in the more favourable rainy season.

At Kanpur, U.P., Singh et al. (32) had no success with air layering jackfruit in February, and only 30 per cent success in the second week of August. At the beginning of the rainy season (end of August and early September), however, up to 60 per cent rooting was possible. They note that after this period the results may be less successful because the flow of sap is less active and it is more difficult to remove the bark from the ring.

Also in Kanpur, Jauhari and Mehra (5) had very meagre success with air layering in the spring, February to April, even with growth substances, but they achieved up to 100 per cent rooting during the rainy season of late August to late October.

Age and condition of parent plant and shoot: Air layering of jackfruit has generally been done on mature trees (5; 26). Srinivasan (35; 36), however, found that juvenility was a factor contributing to success, and he used this principle to propagate young seedlings of a selected precocious tree. These air-layers fruited within three years. As seedlings are not reliably true to type, however, the commercial application of this practice seems limited.

Most authors agree that the shoots for air layering should be two to three years old and brownish in colour (5; 29; 30; 31; 32). Singh et al. (32) attributed the failure of younger shoots to the fact that they were growing too actively and were therefore not accumulating enough carbohydrates. In one trial (31) he found that shoots less than 1 cm (0.4 in) in diameter produced fewer and shorter roots and responded less well to growth substances than thicker shoots. On the other hand, Sen and Bose (26) achieved good results with vigorous, terminal, forked shoots with a basal diameter of 1 cm (0.4 in). In the Philippines, Fabello (3) found that young green branches,

3-4 cm (1.2-1.6 in) in diameter, callused earlier than older brownish branches, 4-6 cm (1.6-2.4 in) in diameter; there was no correlation, however, between earliness of callusing and rooting. It is reported from Thailand that semi-hard branches will root rapidly when air layered (4).

Type and size of cut: From an early trial in the Philippines (3) it was concluded that partial cutting of the shoot to be air layered was generally more satisfactory than complete ringing, and that branches cut or ringed below a node rooted better than those cut or ringed between nodes. Complete ringing, however, appears to be general practice, the width of the ring ranging from 4 to 7 cm (about 1½ to 2¾ in). Singh et al. (32) found that a ring 5-7 cm (2-2¾ in) wide was desirable, because a narrower cut tended to callus over completely and thus prevent rooting.

Rooting media and wrapping: A variety of materials can be used as rooting media around the air layers, but very little work appears to have been done on the properties required. Rao (23), for instance, mentions that sand, sphagnum moss, coir husk, coir dust and fine wood shavings are possible media. Singh et al. (32) compared a soil mixture (composed of two parts sand, one part loam and one part canal clay) with pure sieved sand; as the roots emerged, layers of leaf mould were added in stages round the sand. Sand gave much better results than the soil mixture, possibly owing to the better drainage. No other comparative trials have come to light, but reasonably satisfactory results have been obtained with sphagnum moss (5), a sand and clay mixture (29) and a mud poultice (prepared from eight parts tank silt, two parts rotted castor cake and some well minced gunny cloth) covered with a layer of moss (26).

A report from Thailand states that jackfruit marcots can be rooted in 15 days if a cut made in semi-hard branches is covered with a strip of banana leaf for ten days, after which this is replaced by soil wrapped with coconut fibre (4). Gunny bag cloth has also been used for wrapping (32). Since the advent of plastic materials, however, polyethylene film has been used to wrap air layers, as this retains moisture in the rooting medium for a long time and eliminates the need for watering (5; 23; 26).

Growth substance and other chemical treatment: Treating the cut surface of the ringed shoots with a suitable growth substance,

notably IBA, has generally led to a striking improvement in the rooting performance of jackfruit air layers (G23; 26; 29; 30; 31). All trials on growth-substance treatment have been carried out in northern India. At Saharanpur, Singh (29; 30) obtained 72 per cent rooting (compared with 48 per cent in the control) with Seradix A (IBA) or NAA at 0.025%. Rooting was very profuse on the layers treated with IBA and relatively weak on the control shoots, and this was considered to account for the much higher percentage survival of the former after transplanting.

In a comparison of IBA, NAA, IAA and various combinations of these at Lucknow (31), IBA at 1% proved the most effective. With this treatment the air layers rooted most rapidly (in 22 days), gave 100 per cent rooting and produced the greatest average number and length of roots; the roots were produced uniformly all round the shoot, whereas in the control layers rooting was usually confined to one side. At lower and higher concentrations IBA was also beneficial, but to a lesser degree. The other growth substances did not increase the percentage rooting, but some treatments increased the number and length of roots produced. Shoots of 2-2½ years old were more responsive to growth substance treatment than younger shoots.

In a similar trial in West Bengal (26) IBA again showed a significant root-promoting effect, 5,000 p.p.m. being the best concentration; this resulted in 100 per cent rooting (compared with 60 per cent in the control) and also increased the number of roots by 100 per cent. IAA and NAA were only really effective at 10,000 p.p.m., and then only in the more favourable rainy season. MH inhibited rooting.

Jauhari and Mehra (5), working at Kanpur, suggested that mixtures of growth substances were more effective than the use of a single compound. In the rainy season they obtained 100 per cent rooting with mixtures of IBA + NAA at 5,000 and 7,500 p.p.m. each and with a mixture of IBA + IAA at 7,500 p.p.m. each, whereas only 50 per cent rooting was given by the untreated control. The IBA + NAA mixture also resulted in the fastest rooting (21 days), the most and longest roots and the best survival rate. The mixture that did not contain IBA (i.e. IAA + NAA) resulted in fewer roots per marcot than the control and a poorer survival rate in the nursery. In the drier spring season, less favourable for air layering, rooting was meagre with any treatment.

These results indicate that under favourable conditions suitable growth-substance treatment can greatly increase the rooting and survival of air layers.

The only other chemical treatment that has been tested on jackfruit air layers is a 5 per cent solution of potassium permanganate, used in a trial in the Philippines (3). This very slightly increased the speed of rooting from 98-111 days to 92-98 days.

Separation and care of rooted air layers: The only observations on this subject come from a trial carried out at Kanpur by Singh et al. (32). About 2½ months after air layering, when roots were emerging from the outer layer of the leaf-mould rooting medium, the shoot was notched to half its thickness; one week later the shoot was cut through and separated. No other writer mentions this practice of separating the layer in stages. The same authors record that some of the rooted layers were planted in pots and others in a shaded nursery bed. All the plants remained dormant during the winter. With the advent of hot weather the nursery plants produced new buds and grew away well, whereas those in pots shed their leaves, the stems dried out and the plants died; this failure to survive is considered to be due to the roots becoming pot-bound. The observation suggests that care is still needed in growing-on the rooted air layers.

PROPAGATION BY STEM CUTTINGS

In his *Standard Cyclopedia of Horticulture* Bailey (G1) notes that *Artocarpus* species can be propagated slowly by cuttings of young lateral growth. Chandler (G3) mentions that jackfruit cuttings "are said to root sometimes", and a report from Florida (G14) records that propagation is by seed or cuttings. Morton (20) also mentions that in Florida cuttings of young wood have been rooted under mist, but no further details or references are given.

These few rather bald statements give a misleading impression, as the method of propagation by cuttings does not seem to be used anywhere in commercial practice and most of the trials reported have been a complete failure. Only in one trial was a low percentage rooting obtained.

At the Madras State fruit stations hardwood cuttings of all types failed to root (G15; 7). At Burliar no rooting was obtained on heeled, slit or ordinary shoot cuttings made in November and February (14) or on cuttings of the current season's wood, the previous season's wood or old wood taken at intervals throughout the year (15).

Even the use of growth substances produced no improvement in rooting in a trial at the National Botanic Garden, Lucknow (31). In this trial apical, semi-hardwood and hardwood cuttings were treated with IPA (indolepropionic acid) at 0.01%, NAA at 0.05% and 0.10% and the combinations NAA 0.05% + IAA 0.05% and NAA 0.1% + IAA 0.1%. No rooting was obtained with any of the treatments.

The only method which has led to any success is the double-stimulant polyethylene bag method used by Hurov (G8; G9) in Sabah. Using semi-hardwood cuttings, he stood the bases of the cuttings for 12-24 hours in 0.01-0.03% concentrations of various stimulatory chemicals (including two fungicides, two dyes, vinegar and oxalic acid) before giving them a quick-dip treatment in 0.2% IBA. The cuttings were then rooted in closed polyethylene bags. This double chemical treatment led to 20-30% rooting, compared with no rooting by cuttings treated with IBA alone. Hurov obtained good results on a number of tropical crops using this method and, in explanation, suggests that "the first chemical probably sets into action the mechanisms stimulating rooting, while the second chemical probably stimulates these mechanisms".

The very disappointing results obtained so far indicate that the conditions needed to induce rooting in jackfruit stem cuttings are not yet understood. The fact that the stems are capable of forming roots under certain conditions is shown by the success of some forms of layering.

CONCLUSIONS AND SUGGESTIONS

The tree is commonly propagated from seed, and this has resulted in immense variation in the seedling population. Work is already being done in India on the selection of desirable seedlings and their propagation by vegetative means. An extension of this work could lead to a marked improvement in yields and quality and a reduction in the time required for the trees to come into bearing.

The results of one recent trial suggest that polyembryony may be stimulated by seed treatment with 500 p.p.m. GA. It remains to be seen whether this can be exploited to produce plants that are true to type.

Jackfruit may be propagated on rootstocks, the best available at present being seedlings of common jackfruit and Rudrakshi jackfruit. No work has yet been done on the selection of clonal rootstocks, and there is a need for further studies of rootstocks.

Budding has given very variable results; the most promising method appears to be patch budding. This method, apparently so far tested only in north India, still needs to be tried out under other conditions. Of the other types of grafting tested, only approach grafting has been successful.

Encouraging results obtained in Malaysia with the form of stooling or mound layering known as the etiolation method suggest that this technique would be worth testing elsewhere too. Shoots on mature trees do not respond readily to ground-layering.

Air layering appears to be one of the most satisfactory methods of propagation yet tested on jackfruit. Experience suggests that there is a wide range of possible rooting media, but the properties required in such a medium do not appear to have been studied. Treating the ring with a suitable growth substance can greatly increase the percentage rooting, the number and length of roots produced and the survival rate after transplanting; IBA and mixtures containing IBA are the most promising, and there is scope here for further study.

Since several methods of vegetative propagation, namely etiolation layering, air layering, patch budding and approach grafting, have proved practicable with jackfruit, comparative trials on the performance of trees propagated by these various methods might yield useful information.

BIBLIOGRAPHY

1. ANON. Malayan fruits. *Malay. agric. J.*, 1935, 23: 110-33.
2. DUTTA, S. Cultivation of jack fruit in Assam. *Indian J. Hort.*, 1956, 13: 189-97.
3. FABELLO, S. F. Propagation of certain species of *Artocarpus* by marcottage. Thesis Coll. Agric. Philipp. N. 386 (from abstract in *Philipp. Agric.*, 1934, 23: 162-3).
4. FOOD AND AGRICULTURE ORGANIZATION OF THE UNITED NATIONS. *Report of the FAO Conference on Tropical Fruit Propagation in the Far East, New Delhi, 1967*, 1968, pp.19.
5. JAUHARI, O. S. and MEHRA, R. C. Air-layering in *Artocarpus heterophyllus* Lam. and *Psidium guajava* Linn. by treatment with growth regulators. *Allahabad Fmr*, 1960, 34: 137-47.
6. KANNAN, K. and NAIR, T. N. A note on the growth of jack on two rootstocks. *S. Indian Hort.*, 1960, 8 (3/4): 26-7.
7. KHAN, K. F. Clones of jackfruit (*Artocarpus integrifolia*). *Indian J. Hort.*, 1946, 4 (1/2): 46-7.
8. LAMBOURNE, J. Progress report on etiolated shoot method of propagation up to Sept. 1935. *Communication from Director Agric. F.M.S. and S.S.*, 1935.
9. LEÓN, J. *Fundamentos botánicos de los cultivos tropicales*. Instituto Interamericano de Ciencias Agrícolas de la OEA, San José, Costa Rica, 1968.
10. MADRAS. *Rep. agric. Stats Madras Pres. 1942-43*, 1944.
11. MADRAS. *Idem 1943-44*, 1945.
12. MADRAS. *Idem 1944-45*, 1946.
13. MADRAS. *Idem 1945-46*, 1948.
14. MADRAS. *Idem 1946-47*, 1949.
15. MADRAS. *Idem 1947-48*, 1950.
16. MADRAS. *Idem 1948-49*, 1951.
17. MADRAS. *Idem 1949-50*, 1952.

18. MADRAS. Rep. agric. Stats Madras St. 1950-51, 1951.
19. MADRAS. Idem 1951-52, 1955.
20. MORTON, J. F. The jackfruit (*Artocarpus heterophyllus* Lam.): its culture, varieties and utilization. Proc. Fla. St. hort. Soc. 1965, 1966, 78: 336-44.
21. PADOLINA, F. Vegetative propagation experiments and seed germination. Philipp. J. Agric., 1931, 2: 347-55.
22. PARSONS, T. B. Food crops in the tropics. Trop. Agriculturist, 1933, 80: 285-9.
23. RAO, V. N. M. The jackfruit in India. Fm Bull. I.C.A.R., New Delhi, N.S.14, 1965, pp. 18.
24. RICHARDS, A. V. A note on the cultivation of Singapore jak. Trop. Agriculturist, 1950, 106: 12-13.
25. SAMADDAR, B. N. and YADAV, P. S. A note on the vegetative propagation of cashewnut, avocado, jackfruit and custard apple. S. Indian Hort., 1970, 18 (1/2): 47-9.
26. SEN, P. K. and BOSE, T. Effect of growth substances on rooting of jackfruit (*Artocarpus integrifolia* Linn. F.) layerings. Indian Agriculturist, 1959, 3: 43-7.
27. SHANMUGAVELU, K. G. Effect of gibberellic acid on seed germination and development of seedlings of some tree plant species. Madras agric J., 1970, 57: 311-14.
28. SHANMUGAVELU, K. G. Effect of plant growth regulators on jack (*Artocarpus heterophyllus* Lamk.). Madras agric. J., 1971, 58: 97-103.
29. SINGH, L. B. Propagating jackfruit, *Artocarpus integrifolia*, by air-layering with hormones. Curr. Sci., 1951, 20: 102-3.

30. SINGH, L.B. A new technique for inducing early bearing in jackfruit (*Artocarpus heterophyllus* Lam.). *A.R. hort. Res. Inst., Saharanpur, 1960, 1961, pp. 40-6.*
31. SINGH, S.N. Studies on the rootage of fruit plants in relation to hormones. IV. *Artocarpus heterophyllus* Lam. *Sci. and Cult.*, 1955, 20: 393-5
32. SINGH, S.N., FOZDAR, B.S. and SINGH, M. Vegetative reproduction of jack fruit. *Allahabad Fmr*, 1949, 23 (3): 93-7.
33. SINHA, M.M. and SINHA, S.N. Effect of naphthalene-alpha-acetic acid on the germination of jackfruit seeds. *Sci. and Cult.*, 1968, 34: 372-3.
34. SONWALKAR, M.S. A study of jackfruit seeds. *Indian J. Hort.*, 1951, 8 (2): 27-30.
35. SRINIVASAN, K. Juvenility as a factor affecting air-layering in jack. *Agric. Res. J. Kerala*, 1963, 1: 1-3.
36. SRINIVASAN, K. 'Muttom Varikka' - a promising jackfruit variety. *Agric. Res. J. Kerala*, 1970, 3: 51-2.
37. STEPHENS, S.E. Some tropical fruits. 5. The jack fruit. *Qd agric.J.*, 1936, 45: 67-8.
38. TEAOTIA, S.S. and CHAUHAN, R.S. Studies on bearing habits, sex behaviour, floral biology and fruit development in jackfruit (*Artocarpus heterophyllus* Lam.). *Hort. Sci.*, 1969, 1: 29-37.
39. TEAOTIA, S.S., DAYAL, K. and ASTHANA, M.P. Propagation of jackfruit by budding. *Sci. and Cult.*, 1963, 29: 46-7.

AVERRHOA SPP. — CARAMBOLA AND BILIMBI

by

G. E. TIDBURY

Commonwealth Bureau of Horticulture and Plantation Crops

INTRODUCTION

The two species of *Averrhoa* common throughout the tropics are *A. carambola*, the carambola, and *A. bilimbi*, the bilimbi. The former is the more generally regarded as a fruit tree and is now being cultivated on a small orchard scale in tropical and subtropical America. But both are grown as garden trees in all tropical countries.

Averrhoa is a genus of the Oxalidaceae and the acid nature of the pulp is due to the presence of oxalic acid. The genus was named after an Arabian physician called Averrhoes, and to both species are attributed a wide variety of medicinal uses. The original home of the genus has been suggested as the Moluccas by Chandler (G3) and as India and Malaya by Ochse et al. (G17). Purseglove (G19) states that the bilimbi is native to the monsoon regions of Malaysia and that the carambola occurs wild in Indonesia. Burkill (G2) suggests a Malaysian origin for both species: Macmillan (G11) opts for the Moluccas. Thus all authorities suggest an eastern origin except Willis (G30) who chooses the coastal forests of Brazil! At all events both species are now ubiquitous in the tropics. The carambola is recorded (14) as having been introduced into Queensland at the end of the 19th century, and into Florida (1) at about the same time (1890).

Both species form small trees. The carambola fruit is about five inches (13 cm) in length, attractive in appearance, golden in colour, waxy in skin texture and deeply ribbed. The bilimbi fruit resembles a gherkin. Some carambola fruit is sweet enough to be

eaten raw but is usually stewed or used to make jams and preserves or as a refreshing beverage. The bilimbi is much more acid in taste but can be used for making pickles and in curries. Both are used, more so the bilimbi, for cleaning brassware. The carambola contains vitamins A, B and C together with valuable minerals (8) and certain strains have a notably high vitamin C content (G3).

To their undoubted culinary virtues Burkill (G2) accords a long list of medicinal uses attributed to the bilimbi by earlier authors: these include the induction of perspiration when mixed with pepper, which is hardly surprising, the dispelling of languidness by application externally to the body as a paste (again not surprising), a cure for the itch when applied hot, as an eye tonic, for use after childbirth, for coughs, mumps, rheumatism, pimples, rectal inflammation, thrush, beri-beri, biliousness and syphilis! The present writer can only testify to its unquestioned usefulness in cleaning brass.

The carambola, probably because it is so much less acid to the taste, has alas no such medicinal virtues, but it is an exceedingly pleasant fruit to eat and is by far the more useful species.

The specific names are both used as common names in English. Bilimbi derives from the Malayan "belimbing". Carambola is said (G2) to be a corruption of "balimba" attributed to Garcia da Orta who believed this to be the Malay name. The carambola is sometimes also known as the star-fruit, and the bilimbi as the fruit of the cucumber tree.

ECOLOGY AND GROWTH IN RELATION TO PROPAGATION

Distribution and ecology

The carambola is a tree of the tropical lowlands and coasts but will thrive in sheltered situations in the hills up to about 4000 feet (1200m) (11,G15), for example in the Nilgiris. Mature trees will stand mild frosts and young trees, which are sensitive to cold, can be grown to a latitude of 28°N provided they are in warm protected situations (G17). In Florida (1) young trees are likely to be killed by temperatures below 32°F (0°C) but much depends on the duration of the cold weather. Mature dormant trees can tolerate 30-32°F (-1° to 0°C) and show only slight damage at 27-29°F (-3° - 1°C). The warmer areas of Florida are essential for commercial production. Provided the wind is not cold the tree is relatively wind resistant (1).

The carambola is also fairly tolerant as regards soil type provided the drainage is adequate (G17). However, deficiencies of minor elements have been noted (2; G17). Flooding can be most damaging and the tree is relatively suited to dry weather. Nevertheless, a fairly well distributed rainfall typical of its tropical origin (Malaysia, Indonesia) is necessary for normal growth and cropping. In Florida (1) irrigation has been necessary in long dry winter periods. In Indonesia, however, the carambola is reported (G2) to enjoy a climate with a dry season and in Java is associated with teak.

Growth habit and floral biology

The carambola is an attractive small tree and has been fully described by Ochse et al. (G17). It is slender, about 12-15 m (40-50 ft) in height, bearing numerous branches. The bark is grey and smooth and the crown open; the twigs are covered with short yellow hairs when young, but become leafy. The leaves are composed of three to five pairs of ovate leaflets, about

2-9 x 1-4 cm (1-3.5 x 0.5 - 1.5 in) in size, pale green and shiny.

The carambola tree comes into bearing in the fourth or fifth year after planting-out. The flowers are borne on the young or old naked or leafy twigs as short panicles arising from the leaf axils or scars. Panicles also occur at the apical ends of shoots in "sweet" varieties (9). Panicles contain averages of about 16.5 flowers in "sour" and 37.6 in "sweet" varieties. The flowers open in 14 and 21 days, respectively (8). The flowers are about 8-10 mm (0.4 in) in length, rose or red in colour, shortly pedicular and contain five sepals and five petals, both red and white. The ovary is superior. There is some variation amongst the flowers and short-styled and long-styled flowers occur, with a degree of incompatibility as in other members of the Oxalidaceae. In general the short x long style crosses are compatible, but not short x short or long x long. This incompatibility can break down and the best known cultivar, Golden Star, is an example of this. Moreover, Golden Star fruits well when planted in isolation (6).

Anthesis starts at 7.30 - 8.30 a.m. and peaks between 8.00 and 10.00 a.m. (8). The anthers burst as the flowers open. The flowers are cross-pollinated and bees, flies and other insects are the chief pollinating agents. Self-pollination and parthenocarpy do not occur and hand-pollination is less successful than open cross-pollination (9).

Fruit set is relatively high (52.7 per cent in sour and 66.9 per cent in sweet strains) but fruit drop can reach 84 per cent, much of the drop occurring late in the growth period of the fruit (9). The fruit develop up to 12 cm (4.5 in) in length and 6 cm (2.2 in) in diameter and are mature 14-15 weeks after fruit set. From anthesis to maturity takes about 101-108 days (9). The fruit has four or five sharp ribs and the whole is shiny, waxy and golden in colour. The flesh is juicy, faintly acid or sweet and there are one or two seeds in each cell. The seeds are partly enclosed in an aril, ovoid, compressed, about 1 cm (0.4 in) long with a thin, brown, shiny seed coat. The fruit has a pleasant astringent

smell.

The bilimbi is about the same size tree as the carambola which it much resembles. It has a denser, greener appearance, the leaf comprising 10-20 pairs of leaflets. The flowers are dark red and larger than those of the carambola. They arise more from the trunk and older wood, rather as cacao flowers do. Flowers on the trunk tend to be hermaphrodite. There are five locules in each ovary (13). The mature fruits resemble gherkins or small cucumbers, fat and green, and less or hardly ribbed. They are about 7 cm (2.75 in) in length and contain small seeds about 8 mm (0.3 in) long embedded in the pulp (G19). The flesh is very acid and has none of the attractive dessert qualities of the carambola.

In both carambola and bilimbi the flowers are normally produced throughout the year so that fruit in all stages of development are present on the tree at the same time. In Florida, however, the largest crops mature in late summer and autumn (1).

Varieties

Differences between types of carambola have long been recognized but not between types of bilimbi.

In India (8-11) two main carambola types are distinguished, namely sour and sweet. The sour varieties may contain 0.8 per cent of acid. A sweet variety has been observed in West Bengal but it seldom contains more than 5 per cent of sugar (11). Chinese strains are considered to be very sweet, and a high vitamin C content has been attributed to a Brazilian strain (11). In Malaya (G6) considerable variation has been observed amongst carambolas.

In 1957 several seedling strains were planted at Palmira in Colombia and the fruit produced recorded (10). One seedling was outstanding, named Icambola. This produced a taller, more vigorous tree, bearing four times the weight of fruits per tree. The fruit was more uniform and firmer in texture than in other strains;

it had a better texture, a higher pH and soluble solids content and a more acceptable flavour. It was also an early bearer. The following table compares Icabola with the common local type.

	<i>Icabola</i>	<i>Común</i>
length, cm	7.31	7.64
breadth, cm	4.09	4.14
weight, g	58.1	49.9
% soluble solids	8.9	7.9
SS/acids	1.85	3.99
pH	4.2	4.0
% pectic acid	0.70	0.72

Some interesting trials (2) have been undertaken in Florida, where cultivars introduced from Taiwan named Tean Ma, Mih Tao and Dah Pon bore larger and sweeter fruits than local Florida seedlings. Other introductions were made from Hawaii in 1935, and of these one cultivar named Golden Star was outstanding. The fruit of this cultivar is ovoid, ellipsoid in shape, 4-5 inches (10-13 cm) in length, with 4-6 prominent ribs and weighs 4-8 oz (0.11 - 0.22 kg). The cuticle is bright yellow, thick and waxy. The flesh is described as crisp, free from fibre, with an agreeable, mildly sub-acid to sweet flavour. It is said to be a good source of carbohydrates and vitamins A and C. The yields are rather variable, 100 lb (45 kg)/tree being common and, with fertilization, over 300 lb (136 kg)/tree has been obtained.

PROPAGATION BY SEED

Most carambola and bilimbi trees in the world are seedlings and in most eastern countries the production of seedlings is fairly haphazard. Seed selection is advisable; work in Queensland (14) has shown that only a small percentage of seed is fertile. Well-developed sound seed should therefore be used.

The seeds of both species are small and, after cleaning and drying, should be sown in pots or boxes under light shade and kept regularly watered.

After germination the seedlings should be transplanted to nurseries and gradually hardened-off. They are then transplanted in suitable weather to the field and spaced at about 20 x 20 feet (6 x 6m).

It should be remembered, however, that since the seed is produced from cross-pollination, seedlings are most unlikely to be uniform and considerable variation will exist. Moreover, whereas vegetatively-propagated plants may be expected to produce fruit in as brief a period as ten months from planting out, seedling material will not fruit for four or five years and will then bear crops of variable and uncertain quality.

PROPAGATION BY BUDDING AND GRAFTING

Rootstocks

Seedling rootstocks are normally used for carambolas and these should be about one year old and one-quarter to one-half inch (0.6 - 1.3 cm) in diameter.

In Java (G4) the rootstocks are raised from seed planted in beds or boxes. When the seedlings are six weeks old they should be transplanted to lightly shaded nursery beds and spaced out at 1 x 1 feet (30 x 30 cm). The shade should be removed after two to three months, but watering and weeding should be continued. Budding is carried out at 12 months of age and should give 100 per cent success. The bark is thin and lifts easily.

So far, success has only been reported when the rootstock used is of the same species. Bilimbi seedlings were found to be unsuitable as rootstocks for carambola (G4).

The fairly mature, quarter to half-inch (0.6-1.3cm) rootstock seems suitable for budding, inarching, side veneer grafting and cleft grafting. Older stocks have also been used with success.

In Singapore seedling rootstocks are raised in polyethylene bags of 0.06 mm gauge, 25 x 30 cm (10 x 12 in) lay-flat in size, filled with a modified John Innes compost containing 7 parts (by volume) of medium loam, 3 parts of coconut peat and 2 parts of coarse sand. After sowing, the bags are given partial shade and watered daily until the seedlings are three months old. They are then gradually hardened-off to full sunlight before being grafted. The young plants are fertilized monthly with 10 g (1/3 oz) per plant of a 12:17:2 NPK mixture or 50 g (2 oz) of dried chicken manure. When six to eight months old the seedlings are ready for approach grafting or may be budded when about one year old (2a).

Budding

Scion material should be taken from selected trees of which the growth habit, health, productivity and the quality of the fruits are known to be superior.

In the Philippines shield budding has been advised (G4). The budwood should be fairly mature but not old or hard; it should have a smooth, purplish appearance. Petioled buds less than an inch (2.5 cm) in diameter are used. Also in the Philippines (14,15) shield budding using similar budpatches 1 1/2 x 1 inches (4 x 2.5 cm) in size has been successful. In Java (G4) budding by the Forkert method has been successful. This has been described in Part One. The budpatches are cut from non-petioled, ripe one-year-old wood and it is advised that the work should be done in the rainy season.

Grafting

In Florida (2) grafting is considered to be the

best method of raising large numbers of plants. Here the veneer graft is preferred (see Part One). The scion wood is selected from well-matured shoots on which the leaves are still present. The rootstock seedlings should be about one-quarter to one-half inch (0.6 - 1.3cm) in diameter. Also in Florida (3) the cleft graft has been successfully used with carambolas. Grafting has been used with success for the selected variety Golden Star in Florida (1).

Approach grafting or inarching has also been successful. Here the still-attached rootstock and scion are placed near each other and a junction made between them in various ways. These are described in Part One. Once the graft has healed the lower part of the scion shoot and the upper part of the rootstock are cut away, thus separating the newly grafted plant. This method is not without problems as the rootstock must be supported close to the scion tree during the process. Usually some sort of scaffolding must be employed unless the rootstock seedlings are established in light containers which can be attached to the scion tree. Inarching has been reported as being successful in India (3;5;11) and in Florida. In the Nilgiris inarching one-year-old material in June or January showed 80 per cent and 100 per cent success, respectively.

In Singapore approach grafting is preferred to budding as the latter is done on one-year-old seedling rootstocks whereas the former may be undertaken using six to eight-month-old seedling stocks (2a). The rootstocks are placed, in the polyethylene bags in which they were raised, on low benches near the selected tree which is to provide the scions. The technique is described in Part One, and polyethylene film is used to wrap the graft. The rootstocks should be watered once or twice daily and fertilized monthly. After four to six weeks the plastic film can be removed and the graft severed from the scion parent tree. The young grafts are ready to plant-out within a year of sowing the rootstock seeds. Using vigorous material a 100 per cent take may be obtained with ease.

Occasionally, older trees can be topworked. This entails reducing the tree to a manageable size by pruning to leave a number of selected branches. Each of these is grafted with improved scion material. With the carambola this method has been reported as being successful in Florida (1) and in the Philippines (G4), where sour forms were topworked with scion material from sweet trees.

No work has been reported on the grafting of bilimbi but it is probable that similar methods to those used with carambolas would be successful. It should be mentioned, however, that the main value of grafting and budding is to ensure the production of large numbers of uniform plants all showing the improved characteristics of the selected scion. Whereas with carambola superior types have long been recognized and, recently, named superior cultivars have been made available, no such selection work has been reported with bilimbi. The only real virtue of vegetatively propagating the bilimbi is therefore to obtain planting material which will come earlier into bearing than seedlings: this is hardly likely to prove economic with the bilimbi.

PROPAGATION BY LAYERING OR MARCOTTING

The carambola can be propagated by layering. By this method part of a shoot is covered with soil, usually after treatment to restrict the phloem flow, and roots later emerge from the treated part. The shoot can then be severed from the tree below the roots and established in a pot or bed.

Early experiments in Malaysia (G4) were partially successful but shoots constricted by wiring were less easily rooted than those left unwired and only etiolated.

When this method is carried out on a higher shoot and the soil is enclosed in a tube or plastic container fixed around the shoot the method is known as air layering or marcotting. Usually the wiring is replaced by the removal of a narrow ring of bark and the roots arise after the damaged section has callused. In Florida (1; 2) air layering was successful but was found to be slow and inconsistent. The method was considered unreliable and grafting was preferred.

In India (11), however, 100 per cent success was achieved in the Nilgiris when layering was done in January and the method seems more popular. It is true though that marcotting is a method of vegetative propagation long employed in the tropics and often chosen in preference to other methods.

Singh (12) describes a marcotting box which comprises a divided tin box and in which several species were successfully air layered. Carambola, however, was disappointing, callus developing only on the upper part of the ring. R. J. Garner (personal note) considers that the use of a rooting hormone might have improved matters and, possibly, if conditions had been such that the leaves on the shoot above the ring had been more active, roots might have been successfully initiated.

PROPAGATION BY CUTTINGS

Experiments in Florida (2) on propagating carambola from cuttings were not successful.

CONCLUSIONS AND SUGGESTIONS

It will be appreciated that the carambola, and still less the bilimbi, is not an important fruit species. It is a useful garden tree and, until recently, not a crop plant of any real economic significance. For this reason experiments on its vegetative propagation have been few and possibly rather half-hearted. Beyond establishing that budding and marcotting are both feasible little more has been done.

This situation is now changing with the appearance of named cultivars, particularly in Florida, and the probability that carambolas will become, if not popular, at least an interesting addition to the numerous tropical fruit species now becoming known in western markets. Selected superior cultivars will also doubtless make the fruit more popular in the tropics. For this reason one would expect more experimental work to be done in the near future on propagating carambolas.

It would seem that bud grafting is probably the method most likely to be successful. Even with the use of root-promoting growth substances, air layering must always be a cumbersome and expensive method. However, if bud grafting is developed the problem of producing superior rootstocks will arise. This raises the question of layer-beds or the use of cuttings. The latter has not so far been feasible but experiments with rooting hormones, misting, and other modern developments in propagating techniques would be very interesting and possibly of practical value.

The carambola is potentially an important fruit crop. Improved cultivars, commercially produced with good agronomic practices, should provide a very attractive product that would travel well and might prove a great success. The species certainly deserves much more extensive investigation and study, including its vegetative propagation.

BIBLIOGRAPHY

1. CAMPBELL, C.W. The Golden Star carambola. *Circ. Fla agric. Exp.Stats* S-173, 1965, 6pp.
2. CAMPBELL, C.W. Minor tropical fruit cultivars in Florida. *Proc. Fla St.hort.Soc.* 1970, 1971, 83: 353-6, and *Proc.trop.Reg.Amer.Soc.hort.Sci.*, 1970, 14: 66-73.
- 2a. CHUA, S.E. and TEOH, T.S. Propagation by approach grafting and woody cutting of some tropical fruit and ornamental trees. *Singapore J. prim. Ind.*, 1973, 1: 87-95.
3. COBIN M. and RUELE, G.A. Sub-tropical crops of minor economic importance. *A.R. Fla agric.Exp. Stats* 1949, pp. 245-7.
4. GASKINS, M.H. and WINTERS, H.F. Herbicide trials with young tropical and subtropical fruit and nut trees. *Proc. Fla St.hort.Soc.* 1962, 1963, 75: 418-20.

5. I-,B.A. Propagation of fruit plants. *Agric.Anim. Husb.U.P.*, 1950, 1 (3): 19-27.
6. KNIGHT, R.J.,Jr. Heterostyly and pollination in carambola. *Proc.Fla St.hort.Soc.* 1965, 1966, 78: 375-81.
7. NAND, D. Floral morphology and abnormalities in *Averrhoa carambola* L. *Sci. and Cult.*, 1966, 32 (7): 369-70.
8. NAND, D. Flowering and bearing behaviour of carambola (*Averrhoa carambola* Linn.). *Indian J.Hort.*, 1970, 27: 145-52.
9. NAND, D. Pollination, fruit set and fruit development in carambola (*Averrhoa carambola* Linn.). *Indian J. Hort.*, 1971, 28: 278-84.
10. RIÓS-CASTAÑO, D. and SERNA VÁSQUEZ, J. 'Icambola' un nuevo cultivar de carambola, *Averrhoa carambola* Linn., en Colombia. *Proc. trop.Reg.Amer.Soc.hort. Sci.*, 1972, 16 : 125-34.
11. SINGH, D. Kamrakh - sweet and vitamin rich. *Indian Hort.*, 1963, 7 (2) : 8.
12. SINGH, M.P. An improved marcot box for the aerial propagation on fruits. *Indian J. Hort.*, 1954, 11 (3) : 89-93.
13. SOERODIKOESOEMO, W. Development of the embryosac in some cauliflorous plants. *Ann.bogor.*, 1970, 5 (2) : 93-8.
14. STEPHENS, S.E. Some tropical fruits. No.7. The five corner. *Qd agric.J.*, 1936, 45 : 270-1.
15. STEPHENS, S.E. Some tropical fruits. No.8. The cucumber tree. *Qd agric.J.*, 1936, 45 : 397.

CARICA PAPAYA — PAPAWE

by

F. E. THEAKSTON

Commonwealth Bureau of Horticulture and Plantation Crops

INTRODUCTION

Oviedo, who was Director of Mines in Hispaniola between 1513 and 1525, describes in *La historia natural y general de las Indias* (19) a small tree known to the natives as "olocoton", the seeds of which had been brought from beyond Panama. This was the first description of *Carica papaya*, now known in English as papaw, pawpaw or papaya.

The Caricaceae is a small family related to the Passifloraceae, having four genera of which three, including *Carica*, are indigenous to tropical America (G19; G30). The exact origin of *C. papaya* is unknown since it has never been discovered growing wild; however, it is closely related to *C. peltata* which occurs in southern Mexico and Costa Rica, and may have arisen by hybridization (G2; G19).

The name "papaya" was coined by the Spanish in Hispaniola, probably as a corruption of the Carib word *ababay* (G1; G2; 5). From the New World the papaw was taken to Manila and thence to India and East Africa, acquiring a multitude of names en route. Among these are tree-melon and its German equivalent Baummelone, *kēpaya*, *kētela* and *bētek* in Malay, *papai* (fruit) and *mpapayi* (tree) in Swahili, *mamão* (fruit) and *mamoeiro* (tree) in Portuguese, *papaye(r)* in French, *pappali* in Tamil and *ma-la-ko* in Thai. In addition there exists a number of local names such as *fruta bomba* in Cuba, *lechosa* in Puerto Rico and

melón zapote in parts of Mexico (G1: G17; 3; 8).
Ochse (G16) lists almost 100 local names from the Dutch
East Indies.

The papaw is grown throughout the tropics, mainly for its edible fruit but in some areas for the proteolytic enzyme papain which is prepared from the latex of young fruits. By far the largest part of the crop is consumed locally owing to the difficulty of transporting the fruit over long distances, the main exception being the export of fresh papaws from Hawaii to the mainland of the U.S.A. The fruits may be eaten fresh, preserved in vinegar, made into jam, crystallized or boiled as a vegetable when young. A related species, *C. candamarcensis*, the mountain papaw of central America, produces small fruits which are stewed or made into preserves.

ECOLOGY AND GROWTH IN RELATION TO PROPAGATION

Distribution and ecology

The papaw is widely distributed throughout the tropics and sub-tropics, and will grow wherever a frost-free climate is available. However it needs sun, and cool conditions for any length of time will result in slow ripening and poor fruit quality. Most high quality commercial crops in the tropics proper are grown below 1000 m (G17), but on the equator good crops can be grown up to 1500 m (G19). Windbreaks should be provided where necessary.

Papaws will tolerate almost any soil provided it is well drained, but irrigation is necessary during long periods of drought. Very acid soils are unsuitable, and ideally should have a pH of 6.0-6.5 (G17; G19; 1; 26).

Growth habit and flower biology

The papaw is a fast-growing, fairly short-lived, arborescent herb, 2-10 m (6-33 ft) in height with normally a single, smooth, greyish-brown, hollow trunk, 10-30 cm (4-12 in) in diameter, composed of soft, spongy-fibrous tissue. The leaves, which are borne bunched at the top of the trunk, survive only one year. The petiole, 25-100 cm

(10-40 in) long, bears a deeply-lobed, palmate lamina, 25-75 cm (10-30 in) across, each of the 7-11 lobes being itself lobed and coarsely toothed, and with a robust midrib and conspicuous venation. The whole plant is markedly palm-like in appearance (G1; G17; G19; 1; 8).

Papaws first come into bearing when 9-14 months old and may produce as many as 150 fruits per year, although yields decline with age (G19). The tree is normally dioecious, but may be monoecious or hermaphrodite. It has always been thought impossible to determine the sex of a papaw plant before it flowers, but recent studies by Singh and Jindal (24) have shown that male and female seedlings may be distinguished in the nursery by quantitative differences in their phenolic contents.

The flowers are fragrant, the staminate in pendant axillary panicles 25-75 cm (10-30 in) long, the pistillate solitary or in few-flowered cymes. Several other types of flower have been described, including the hermaphrodite *pentandria* and *elongata* forms. Good accounts of the flower biology are given by Ochse et al. (G17), Greenway (8) and Purseglove (G19).

The method of natural pollination is not known with certainty, but whatever the means it is certainly very effective. Very few male trees need be planted to ensure adequate pollination, and isolated female trees have been known to set fruit when 800 yards from the nearest male (G19).

Varieties

There are no clonal cultivars of papaw, but many more-or-less distinct types exist which have developed either naturally or by controlled pollination. Owing to the sensitivity of the crop to environmental conditions locally selected material often produces a better crop than introduced types. One of the best varieties is the hermaphrodite Solo, now grown extensively in Hawaii, which produces fairly small fruits about one pound (0.45 kg) in weight.

Diseases and pests

The greatest danger to young papaw plants, whether seedlings or cuttings, is caused by various rots and wilts, all of which are associated with poor drainage. They may take the form of damping-off or stem or root rots, and can normally be prevented by correct management. Occasionally nematodes and moles may cause root damage (26).

PROPAGATION BY SEED

The inability of vegetative propagation techniques to provide adequate quantities of planting material, together with the readiness with which papaw seed germinates in the tropics, has led to the vast majority of commercial plantings being raised from seed. The seed may be sown "at stake" or in beds or boxes from which the seedlings may be transplanted direct to the field or pricked out for transplanting at a later date. Whatever the method used, the soil must be freely drained but adequately watered. Seed is usually sown about 1 cm ($\frac{1}{4}$ in) deep.

In Tanzania (26) the seed may be sown at stake or in beds raised above ground level. When sown direct about six seedlings are raised at each position, so as to allow for excess males or damage by pests and diseases. When the trees are old enough for their sex to be determined they are thinned to leave one male to every 20-50 females. At least 2 m (7 ft) is allowed between trees in the row.

In India (11) a slightly different technique is employed. Four to five seeds are sown per hill, and these are covered with a 1-cm ($\frac{1}{4}$ in) layer of fine sieved manure and paddy husk. For a higher percentage germination it is recommended that the seed be soaked in a dilute solution of cowdung for 24 hours before sowing. The resulting seedlings are thinned to two per hill and the males subsequently rogued to leave one for every 100 female trees.

Despite its apparent simplicity sowing direct is

not popular owing to the labour involved and therefore transplanting is commonly carried out. Seed-beds, seed-boxes and various other containers may be used. Sowing is normally carried out some three months before the expected time of transplanting, in soil kept moist but not excessively wet. If the seeds are soaked before sowing the seedlings may emerge within ten days, otherwise they may take some three weeks. The seedlings are kept shaded and watered, and just before transplanting the seed-bed is well soaked and the foliage may be reduced. Seedlings with the root-ball attached are quickly moved to their field positions, and only so many as can be transplanted are lifted at any one time.

In southern Queensland (1) seedlings raised in seed-boxes may be first pricked out into seed-beds before transplanting. However, since it is important to avoid root damage during transplanting the trend is towards sowing in containers from which the root-ball can be planted out with as little interference with the root system as possible. Recently perforated polybags have been employed for raising seedlings which are then transplanted by carefully cutting and removing the bag and placing the root-ball in a prepared hole (11). Another technique currently employed in India involves sowing in bamboo baskets; the basket is transplanted together with the seedlings and eventually rots (20).

In experiments in Hawaii (13) pricking-out into containers before transplanting (a) was compared with sowing in containers (b) and with sowing direct in the field (c). After six weeks seedlings raised by method (b) were two and four times the size of those produced by methods (c) and (a), respectively. At five months sowing direct had resulted in trees nearly twice as large as those produced by "double transplanting", and they flowered two months earlier. Seedlings sown direct had fewer twisted roots than transplanted ones, and produced more vigorous and heavier yielding trees.

It is normal practice to use fresh seed for sowing since viability declines rapidly with age. Drying

and refrigeration may delay loss of viability to some extent (1; 7). Removing the sarcotesta improves both germination rate and percentage (6; 15; 18; 23); soaking the seeds in an extract of the sarcotesta, in seed leachates or even in juice from the fresh fruit inhibits germination. Washing the seed has a beneficial effect on germination.

The germination of papaw seed is temperature-dependent with an optimum near 35°C (95°F) (14). Temperatures above 44°C (111°F) and below 23°C (73°F) are detrimental. Night temperature is more critical for seedling growth than day temperature or daylength (14; 17).

Different authors claim different effects of gibberellins on germination. In one experiment (21) treating seeds with up to 8 oz (0.22 kg) of 0.88% K gibberellate/100 lb (45 kg) had no significant effect on either the rate or percentage of germination, whereas in others the germination rate was greatly improved by treating the seeds with up to 1000 p.p.m. gibberellic acid; the percentage germination was, however, not significantly improved (6; 12; 23). NAA and IAA depress germination. The presence of the sarcotesta reduces both the stimulating effect of gibberellin and the inhibiting effects of IAA and NAA on germination (15; 23).

PROPAGATION BY GRAFTING

Papaws may be propagated vegetatively by cuttings or grafting, but neither method has proved commercially viable for the establishment of large scale plantings.

Scions for grafting are normally taken from side shoots produced after a tree has been cut back, the best being those with a small hard knob at the base (8). The scions, a few inches long and the diameter of a pencil, are cleft-grafted on stocks which have normally reached a diameter of 1½-2½ inches (4-6 cm), at which stage they have flowered and the sex can be determined. In Queensland (9) up to 100 per cent success has been obtained with reasonable care and attention to detail.

One purpose for which grafting has been used is the working over of surplus male trees in the plantation. Scions are taken from trees having the desired characteristics and the leaves removed leaving a short stub of petiole. The scions are then rinsed in a strong solution of potassium permanganate and kept wrapped in a cloth wrung out in the same solution. This appears to hasten callusing and stops the flow of sap.

The stock is prepared by making a horizontal cut nearly three-quarters through the stem about ten inches (25 cm) from the ground where the stem is solid. Then starting about ten inches (25 cm) above this cut a deep slice is made down to the horizontal cut. In the step so formed the cleft is made as close to the standing part as possible, and the wedge-shaped base of the scion inserted. The graft union is then bound with raffia and covered with moist soil by earthing up. When the graft has taken the standing part of the stock is removed.

Various other species of *Carica* have been tried as rootstocks for *C. papaya* (10; 22). *C. candamarcensis* was used with 100 per cent success in southern India (4), but although the grafted trees bore outside fruits they were of poor quality.

In experiments in California (16) grafting normal scions of the cv. Solo onto dwarf Solo stocks resulted in trees with less vigour. Flowering and fruit production occurred lower on the stem, and the total quantity of fruit was smaller than on normal Solo trees. Reciprocal grafts resulted in vigorous trees producing flowers and fruit higher on the stem; there was more fruit with less crowding than in the dwarf plants.

PROPAGATION BY CUTTINGS

Rooted papaw cuttings are not difficult to obtain but, as with grafting, have had little commercial significance owing to the ease of seed propagation.

In early experiments in the U.S.A (25) several types of cutting (whole shoots and proximal, distal and median portions of the shoot) of different sizes were compared. The cuttings were placed in a frame or greenhouse and were heavily shaded. Entire shoots rooted best, followed by proximal (basal) cuttings with the solid basal swelling attached. Bottom heat was essential for rooting and IAA application was also beneficial.

In South Africa (2) excellent results were obtained with whole shoots rooted under intermittent mist and with bottom heat of about 85°F (30°C). IBA treatment gave variable results depending on the time of year; in midsummer IBA increased the number of rooted cuttings three times, but at other times of the year the response was less satisfactory. In neither of these studies was any difference noted in the rooting responses of cuttings of different sexes.

As they rooted, the cuttings were transplanted into perforated plastic bags, and when well rooted and hardened-off were transferred to their field positions. Transplanting during the summer was preferable to other times of the year, because the plants continued to grow after transplanting. Stem rot occurred when weather conditions were not suitable, but this was controlled well by watering with a fungicide solution immediately after transplanting (2). The plants raised from cuttings fruited earlier (some after only 4 months) and produced higher yields than those raised from seed.

BIBLIOGRAPHY

1. AGNEW, G.W.J. The papaw. *Qd agric. J.*, 1954, 79: 77-90.
2. ALLAN, P. Papaws grown from cuttings. 1964, *Fmg S. Afr.*, 39 (11): 35-40.
3. ALLEN, B.M. *Malayan fruits*. Donald Moore Press Ltd., Singapore, 1967.
4. ANON Hill papaya, *Carica candamarcensis* Hook. *S. Indian Hort.*, 1954, 2: 17.
5. CHATEAU, R. Notes sur le genre *Carica* L. *Bull. agric. Congo belge*, 1955, 46: 261-70.
6. CHACKO, E.K. and SINGH, R.N. The effect of gibberellic acid on the germination of papaya seeds and subsequent seedling growth. *Trop. Agric., Trin.*, 1966, 43: 341-6.
7. CHACKO, E.K. and SINGH, R.N. Studies on the longevity of papaya, phalsa, guava and mango seeds. *Proc. int. Seed Test. Ass.*, 1971, 36: 147-58.
8. GREENWAY, P.J. The papaw or papaya. *E. Afr. agric. J.*, 1948, 13: 228-33.
9. HANCOCK, W.G. Grafting male papaw trees. *Qd agric. J.*, 1940, 54: 377-9.
10. JIMÉNEZ, H. Injertos entre especies de *Carica*. *Agron. trop., Maracay*, 1957, 7: 33-7.
11. KASHYAP, R. and MAURYA, K.N. You can harvest papaya fruits earlier. *Indian Fmg*, 1969, 19 (7): 21, 23.
12. LANGE, A.H. Gibberellins - new plant growth regulators. *Hawaii Fm Sci.*, 1957, 6 (1): 10.

13. LANGE, A. H. Transplanting papaya versus seeding in place. *Trop. Agric., Trin.*, 1961, 38: 235-43.
14. LANGE, A. H. The effect of temperature and photoperiod on the growth of *Carica papaya*. *Ecology*, 1961, 42: 481-6.
15. LANGE, A. H. Effect of sarcotesta on germination of *Carica papaya*. *Bot. Gaz.*, 1961, 122: 305-11.
16. LANGE, A. H. Reciprocal grafting of normal and dwarf Solo papaya on growth and yield. *HortScience*, 1969, 4: 304-6.
17. LASSOUDIÈRE, A. Le papayer (troisième partie). *Fruits d'Outre Mer*, 1969, 24: 105-13.
18. MOSQUEDA VAZQUEZ, R. Efecto de diversos tratamientos aplicados a la semilla de papaya, sobre su poder germinativo. *Agric. téc. Méx.*, 1969, 2: 487-91.
19. OVIEDO, G. H. *La historia natural y general de las Indias*, 1535.
20. PATIL, J. S. Papaya can surely be more paying. *Indian Hort.*, 1972, 17 (2): 9-10.
21. RAMÍREZ, O. D. Effects of gibberellic acid on germination of papaya (*Carica papaya* L.) seed. *J. Agric. Univ. P.R.*, 1961, 45: 188-90.
22. RICCELLI, M. Injertos entre especies de Caricaceae. *Agron. trop., Maracay*, 1963, 13: 157-61.
23. SAITO, Y. and YAMAMOTO, S. Some studies on the cultivation of tropical horticultural crops in the warm region of Japan. *Bull. Fac. Agric. Miyazaki*, 1965, 11 (1/2): 206-19.
24. SINGH, R. N. and JINDAL, K. K. Studies on sex determination in papaya seedlings at nursery stage. /Abstract/. In *Proc. XIXth int. hort. Congr., Warsaw*, 1974, p.478.
25. TRAUB, H. P. and MARSHALL, L. C. Rooting of papaya cuttings. *Proc. Amer. Soc. hort. Sci.*, 1937, 34: 291-4.
26. WALLACE, G. B. The establishment and running of a papaw plantation. *E. Afr. agric. J.*, 1948, 13: 234-9.

CHRYSOPHYLLUM CAINITO — STAR APPLE

by

MARTHA H. INGRAM

Commonwealth Bureau of Horticulture and Plantation Crops

INTRODUCTION

The genus *Chrysophyllum* contains about 60 species of evergreen trees, most of which are natives of tropical America. *Chrysophyllum cainito*, the star apple or cainito, is indigenous to the West Indies and Central America. It is cultivated in these areas and in South America, Mexico, Florida, and to a limited extent in Hawaii (G18). It also thrives in Sri Lanka, where it was introduced in 1802 (G11; G18), in Singapore, where it was introduced by seed from Jamaica in 1879 (G2), in South India, tropical Africa, Queensland and in the Philippines, where most of the research on its propagation has been carried out.

The fruit is smooth skinned and apple shaped, from 5 to 10 cm (2-4 in) in diameter, and when it is cut transversely the star-shaped section of the central core demonstrates the origin of the common English name. It contains a white, sweet, edible pulp in which are embedded up to 10 glossy dark seeds loosely placed in cavities. The flavour is agreeable (although too bland for some tastes, as the acid content is negligible) provided that the fruit has been thoroughly ripened on the tree, the unripe fruit containing an unpleasant-tasting, viscous latex.

ECOLOGY AND GROWTH IN RELATION TO PROPAGATION

The star apple is tropical in its requirements and thrives in humid atmospheres with relatively high temperatures throughout the year. In South India it is grown in both arid and humid tracts, and does well up to an altitude of 3500 feet (1000 m) in the Nilgiri Hills. It is sufficiently hardy to survive in southern Florida, where old trees are to be found, but requires protection from cold winds for the first two or three years; this early tenderness is one of the reasons why the star apple is not more widespread in Florida (G25).

The trees grow very successfully in the rich, deep soils of Cuba and the West Indies; however, they adapt well to light, sandy soils if well nourished (G25; G18). Fertilizer containing a considerable proportion of potash is recommended for fruiting specimens (G1).

The star apple is a strikingly handsome, ornamental evergreen tree which reaches a height of 50 feet (15 m) given favourable conditions. Growth is graceful, and no pruning appears to be necessary. The leaves are oval, shiny dark green above and silky, coppery gold beneath. The young shoots are of similar appearance to the underside of the leaves and all the silky parts are heavily pubescent. The small, purplish-white flowers are borne in axillary umbellate clusters scattered along mature twigs and partly concealed by the foliage. Trees planted from seed come into bearing after five to nine years. In Florida and the West Indies the fruit is carried on the trees during the winter months and matures in April and May; in India the fruit is obtained in February and March and yields of about 150 lb (70 kg) per tree are reported at the Kallar and Burliar Fruit Stations (G15). However, in Queensland the ripening season occurs in summer, during January and February (8).

Varieties

There are two races or types of star apple, distinguished by the colour of the ripe fruit, which has either a purple or a pale green skin. The purple fruit is thought to have slightly more flavour, and the green is sweeter (G25). Many forms exist, some said to be of exceptional quality, but the only named variety mentioned in the literature here reviewed is Publico, in the Philippines (9).

Diseases and pests

There are no reports of diseases and pests afflicting this crop.

PROPAGATION BY SEED

Most star apple trees are raised from seed, and the usual wide variations in yield, fruit size and quality are found. The seeds germinate readily if planted fresh, and unlike the seeds of many other tropical fruits they retain their viability for several months (8; G18). They should be sown in light, sandy loam, and germination takes about six

weeks (G14; G24). However, Torres (9) in the Philippines reports that well-washed, fresh seed newly extracted from ripe fruit germinated in 15 to 25 days, and seedlings with three to five leaves could be transferred to nursery beds after six to eight weeks. Self-sown seedlings found under bearing trees during May, June and early July can also be transferred to nursery beds for future use as rootstocks.

PROPAGATION BY BUDDING AND GRAFTING

Rootstocks

Seedling rootstocks of the same species are used. *Chrysophyllum cainito* has also been successfully grafted onto rootstocks of the satin-leaf tree, *Chrysophyllum oliviforme* (G25; G4) which is a smaller species but similar in appearance and much more resistant to cold. However, growth was very slow and the plants remained stunted. The age and size at which the stocks are worked depends on the budding or grafting technique chosen. Inarching can begin when seedling stems are as slender as 3 mm (one-eighth inch) in diameter, a size which can be attained with proper care three to five months after sowing (5), but such stocks are too young for other techniques, for which they should have reached at least pencil thickness.

Considerable research on the vegetative propagation of the star apple has been carried out in the Philippines. Tongue inarching was found to be the most practical method for commercial purposes because it could be carried out with very young rootstocks. Patch budding and cleft grafting have been extensively used in local research stations and provincial nurseries. The three techniques are described in detail by Torres (9) from whose report most of the following information is taken.

Inarching

The inarching of star apple on rose apple (*Eugenia jambos*) and vice versa or on their own seedlings has been found easy at Kallar and Burliar (G15), and in the Philippines (5) inarching on one-year-old seedlings was found to be a simple and reliable technique which was 85 to 100 per cent successful. In the tongue-inarching method recommended for commercial propagation potted seedling rootstocks aged six to twelve months are used. The scions are selected from new, actively

growing twigs or branches not more than about a foot (30 cm) in length and with firm but immature stems. The selection of low-growing scion branches can reduce the need for posts or platform supports for the stocks. It takes about 45 to 60 days for the graft union to be completed but with older stock or scion material this period may be doubled. The height of the union should be not more than five inches (13 cm) above the base of the rootstock. Young tops of scions may be removed at the time of inarching to induce the growth of multiple branches for further inarching at a later stage. Cambial union begins after two weeks and inarched plants are separated from the mother plant after 45 to 60 days. Soon after this the tops of the stocks are cut back to leave stubs two to six inches (5-15 cm) above the union. The plants are kept in shade for about a week and then grown-on in sunshine. Stubs are removed when the scions have made some growth. When the plants have reached a height of 1 m (39 in) or more they may be transplanted into the field.

Patch budding

A modified form of patch budding has proved reasonably successful in the Philippines; a success rate of 50 to 80 per cent during the dry season of December to February is reported (G4; 4; 9). In July to September the success rate is reduced to 20 to 60 per cent. In this method, fairly mature, brownish-grey, non-petioled budwood is used, selected from the previous year's growth. The buds are cut an inch (2.5 cm) long and inserted at a point on the stock where it is approximately of the same appearance as the scion. Experience has proved that the removal of the wood sliver beneath the bark of the scion facilitates the union. The cut on the rootstock takes the form of the letter H. Flaps of bark above and below the crossbar of the H are carefully peeled back, and the upper flap may be shortened by cutting off a strip of bark 5 to 7 mm (0.25 in) wide. The prepared scion is carefully inserted into the bared area, the flaps are pressed down on the scion and wrapped and covered completely with budding tape. From 12 to 15 days later the tape may be loosened or partially removed to expose the bud. The rootstocks used in this technique should be 1 or 2 cm (0.4-0.8 in) in diameter at the point of bud insertion (this stage is reached 24 to 30 months from sowing) and they should be grown in the open as patch budding does not succeed with stocks grown under partial shade.

Cleft grafting

This is more exacting than either inarching or patch budding. Once again, the best time for propagation in the Philippines is from December to February, when the rainfall is less frequent. The rootstocks, used at the pencil-thickness stage, are grown in partial shade so that they require less watering and so that pieces of banana petiole may be economically used to cover the grafts. The scions are chosen in the same manner as for patch budding, and the budwood is cut into lengths of four to six inches (10-15 cm), each bearing at least three buds. They are inserted into the stocks at a height of five to seven inches (13-18 cm) from the ground. The grafts are wrapped with budding tape, which is more convenient and successful in the climate of the Philippines than the grafting wax generally used in temperate climates. The banana petiole covers are removed three weeks or more after grafting. The soil should be kept moist. After seven months or so the grafted plants may be balled and subsequently transplanted.

Shield budding

Shield budding with budwood of different ages has proved unsuccessful (G4; 3; 4; 5).

Modified Forkert budding

This was not sufficiently successful for the method to be recommended (4).

PROPAGATION BY LAYERING

Air layering is a simple and moderately successful method of propagating the star apple. In an experiment in the Philippines (5) with branches of about 2, 4 and 6 cm (0.8, 1.6, 2.4 in) in diameter the success rates were 46.7, 25 and 10 per cent, respectively. Torres (9) regards the method as wasteful, since it requires larger branches than the inarching technique. It also limits the production of material for large-scale planting as only a few selected trees can be recommended for commercial propagation.

PROPAGATION BY CUTTINGS

It is generally agreed that cuttings can be successfully grown if they are made from well-ripened, small shoots and placed in strong, moist heat (G1; G4; G18; G20; G21).

CONCLUSIONS

Star apple trees are widely grown for ornament, shade and fruit in tropical America and elsewhere, but although the fruit is to be found in local markets in several countries no information has been encountered on its culture as a commercial crop at plantation level.

With the exception of the work reported from the Philippines, the available information is fragmentary. However, if interest should be aroused in this neglected and minor crop the tongue-inarching method used in the Philippines would provide selected planting material on a commercial scale.

BIBLIOGRAPHY

1. ALLEN, B. M. *Malayan fruits: an introduction to the cultivated species.* Singapore, 1967.
2. FREGONI, M. Aspetti della frutticoltura di un paese dell'America latina : l'Ecuador. *Ann. Fac. Agrar. S. Cuore, Milano*, 1968, 8: 299-379.
3. GONZALEZ, B. M. Outstanding results of agronomic and horticultural research. *Philipp. Agric.*, 1934, 23: 380-99.
4. GONZALEZ, L. G. and GLORIA, P. E. A study on budding the star apple with special reference to the modified Forkert method. *Philipp. Agric.*, 1941, 29: 861-76.
5. GONZALEZ, L. G. and SONGMANI, A. A study of some asexual methods of propagation of the star apple, *Chrysophyllum cainito* Linn. *Philipp. Agric.*, 1940, 28: 836-45.
6. LEONARD, L. Y. and SYLVAIN, P. G. *Traité de culture fruitière*, Haiti, 1931.
7. MAHESHWARI, P. and SINGH, U. *Dictionary of economic plants in India.* ICAR, New Delhi, 1965.
8. STEPHENS, S. E. Some tropical fruits. 14. The star apple. *Qd agric. J.*, 1937, 47: 202-4.
9. TORRES, J. P. Commercial propagation of caimito. *Philipp. J. Agric.*, 1953, 18: 31-43.

DURIO ZIBETHINUS — DURIAN

by

G. E. TIDBURY

Commonwealth Bureau of Horticulture and Plantation Crops

INTRODUCTION

Although rarely if ever cultivated on a plantation scale the durian is widespread throughout the tropics, particularly in Asia, and in some ways is possibly the most famous - or infamous - tropical fruit tree. Certainly, once the fruit is smelt it is never forgotten, and no-one could honestly consider himself fully familiar with the horticulture of the humid tropics who has not tasted it. A very early traveller, Linschott, wrote in 1599 that the fruit "is of such an excellent taste that it surpasses in flavour all other fruits of the world, according to those who have tasted it" - an interesting qualification. The most rapturous description of the flavour is possibly that of A. Russel Wallace who, in *The Malay Archipelago* of 1869, said "its consistency and flavour are indescribable" and then proceeds to describe them as "a rich butter-like custard highly flavoured with almonds ... but intermingled with it come wafts of flavour that call to mind cream-cheese, onion sauce, brown sherry ... it is perfect as it is. It produces no nausea or other bad effect, and the more you eat of it the less you feel inclined to stop. In fact, to eat durians is a new sensation worth a voyage to the East to experience". Others have been far less complimentary: the present writer finds the flavour a nauseating mixture of condensed milk and bad fish. Nevertheless, it is credited, although without written evidence, with aphrodisiac properties and is undoubtedly very highly esteemed by Eastern people.

The main edible part of the fruit is the aril which surrounds the seeds. The latter are also eaten, usually cooked. The unripe fruit can also be cooked as a vegetable.

Durio is a genus of the Bombacaceae and related to kapok. It has some 27 species according to Willis (G30). Burkill (G2) lists seven species in the Malay Peninsula: of these

six are mainly used for timber, *D. oxleyanus* also having some local medicinal properties. Several bear fruit near the bases of their trunks and these are eaten by animals. The only species of any real economic importance is *D. zibethinus* Murr. The specific name *zibethinus* is suggested by Bailey (G1) as being derived from the practice of using the decomposed fruit as a bait for the civet cat or zibet - indeed, the fruit is sometimes known as civet-cat fruit. This may be so, but it could be suspected that the connexion with the civet is more likely to be the similarity between the smell of the fruit and that of the nauseating secretions of the civet cat, also well known to residents in the tropics.

The common name, durian, comes from the Malayan name; similar sounding names - duren, derian, turian - are found in parts of Indonesia and Thailand.

ECOLOGY AND GROWTH IN RELATION TO PROPAGATION

Distribution and ecology

The original home of the durian is not known; Burkill (G2) considers it is probably a native of Borneo, whereas Macmillan (G11) states that it is indigenous to Malaya. Certainly it is widespread in Malaysia generally, and has been introduced into the humid tropics in many parts of the world. It flourishes in India, Sri Lanka and the Philippines and has been successfully introduced into East Africa and the New World tropics.

Burkill (G2) recounts, however, that early attempts to introduce durian growing in Burma must have been unsuccessful as Burmese kings were kept supplied with the delectable fruits by a special service of runners who brought them from beyond Moulmein.

The tree has the reputation of being somewhat selective in its environment (G3), but beyond the general reservation that it is a plant of the humid tropics, it will apparently thrive at quite high elevations and successful growth has been reported at 2000 feet (600 m) in Ceylon (G11) and in the Nilgiri hills of Madras at 2500 feet (760 m) (2; 4). The Burliar trees in the Nilgiris were introduced from Ceylon (5). Nevertheless, the tree grows best nearer sea level. It needs a high relative humidity throughout the year and, since it becomes a very large tree indeed when fully grown, the soil

needs to be deep and fertile. Loams and alluvial soils, well drained but moisture retaining, are desirable. A tree of the forests, the durian grows better for shade and shelter when young.

Growth habit and floral biology

The durian is a noble evergreen tree which can reach a height of 40 m (130 ft) or more. It is well described by Ochse et al. (G17). The upright trunk, unbuttressed, has a brownish-grey bark, rough and flaky, with deep longitudinal splits. It has a diameter of 120 cm (47 in) or more, with fairly low branches and a full, round crown. The young branches are densely covered with coppery scales and bear oblong, acuminate leaves which are petioled and about 25 cm (10 in) long when fully expanded. They are dark green and glabrous on the upper surface, the lower surface bearing a dense covering of golden hairs: the midrib is prominent. The whole crown has a brownish golden appearance combined with the dark foliar mass.

The durian comes into bearing at about twelve years of age. It is cauliflorous, the flowers being born on the main branches in clusters of up to 30 flowers, pendulous, branched in large cymes or fascicles. The pedicels are about 5-7 cm (2-3 in) long and the individual flower is large, about 5-7.5 cm (2-3 in) in diameter. There is an epicalyx and the calyx itself is saccate, four to six lobed, and there are five creamy-yellow petals. The flower has an unpleasant odour, it normally opens in the late afternoon and falls in the morning. The stamens are grouped in 5 lobes bearing up to 12 reniform anthers. The ovary is superior, with a single style with a large yellow or orange stigma.

The biology of the flower has been studied in detail (16). The epicalyx which encloses the flower, splits, the flower then taking two to three days to open fully. This occurs late in the afternoon and the stigma is receptive until 6.00 a.m. next morning.

The anthers start to dehisce at about 9.00 p.m., pollen being shed into the night hours. The anther lobes then fall, followed by the petals and then the sepals. By morning, indeed by 11.00 p.m., only the pistil remains.

Although the pistil is receptive before the flower opens,

the durian is usually self-incompatible. Valmayor, Coronel and Ramirez (16) report that of 150 flowers self-pollinated in one year and 148 in the next year not a single fruit was set. On the other hand, cross-pollination from another tree was largely successful. It is possible to cross-pollinate the flowers in the daytime prior to anthesis and this has also given better fruit set than cross-pollination after anthesis. Nevertheless, it should not be concluded that all durians are self-incompatible and certain trees may be both self- and cross-compatible.

Observations in Malaya (11) have also indicated marked clonal differences in the times of anthesis and anther dehiscence. Some flowers were seen to open as early as 2.30 p.m.

The agents of pollination, which takes place between dusk and dawn, are mainly small bats (8; 16), and at least 10 species of insect were observed to visit the flowers (11). The durian flowers are attractive to bats because of their time of opening, and their odour and size. Experiments with pollen trapping suggest (16) that no wind pollination occurs.

The fruits take about 16 weeks to develop and, like the tree, are splendid in appearance. A tree bears about 50 and as many as 80 or more fruits a year have been recorded (1; 9), and a large fruit can weigh as much as 3 kg (6.6 lb). As can be readily imagined, a large fruit falling from near the top of a tall tree is an object of some hazard. The fruit is stalked, globose, up to 30 cm (12 in) long and 15 cm (6 in) in diameter, pale green in colour and covered with hard, sharp, coarse spines. Inside the fruit are about five locules and the large brown seeds are surrounded by an aril composed of yellowish-white, highly aromatic pulp. It is this pulp which is eaten and so greatly relished.

Varieties

There are no true cultivars of the durian, although distinct types are known everywhere it grows. There is a considerable variety in type and quality, particularly the odour, of the fruit, and some production and comparison of clones has taken place in Malaya (9) and elsewhere. As early as 1866 a number of races were named (G2) in Malaysia, but Ochse suggests that the number of different types is endless.

Diseases and pests

The durian is mercifully free from many pests and diseases. However, a number of common tropical fungal pathogens have been reported from time to time, notably from Malaya (7; 9) where an anthracnose (*Colletotrichum* sp.) and a rim blight (*Phyllosticta* sp.) affected the leaves of seedlings and budded plants in the nursery. Infection can also arise in the snag of the stock which can spread to the budded tissues below.

Perhaps the most serious disease of the tree is patch canker, caused by *Phytophthora palmivora*, which has caused serious losses of budded trees in Malaya (14). The main symptom is an area near the collar which exudes a brownish red gum. This spreads and eventually girdles the plant over the ensuing months, causing leaf-fall, unthriftiness and die-back. Damp conditions are necessary for infection and spread. In the nursery over-shading and heavy mulching are conducive to the disease. It is easily introduced into young plants by pruning wounds and through cracks between low branches and the main stem.

Preventive measures are wide spacing in the nursery, the avoidance of humid conditions, training young plants to have branch-free stems for about six feet (1.8 m) above the ground, and using protective paint when pruning. Fresh infections can be cut out and painted with fungicidal paint.

PROPAGATION BY SEED

The durian is readily raised from seed. In nature the mature fruits abscise from the parent tree and they then dehisce to scatter the seeds. The seeds are described by Singh and Rao (15) who studied germination in detail and conducted experiments on the effect of seed orientation on germination.

The seed is ovoid, 3.5-5 cm (1.4-2 in) in length and 2.5-3.5 cm (1-1.4 in) in diameter. It has a reddish-brown testa and is covered by the aril. The largest seeds are the single occupants of a fruit locule.

The most important fact about the seed is its relatively short period of viability. They should be washed free from the aril, dried and planted as soon as possible. If the seeds are

kept longer than a week poor germination results (4).

In an experiment the seeds were planted a half to one inch (1.25-2.5 cm) below the soil surface, and a comparison was made of planting the seed micropyle downwards or upwards or with the seed placed on its side. The first method produced an "epigeal-like" type of germination whereas the others showed hypogeal germination.

With hypogeal, which is in nature the commonest type of germination, the time taken for the formation of the crozier and the elongation of the hypocotyl was 30-35 days. The plumule then expanded. Some variations in morphological characteristics were shown to be caused by seed orientation in the same study and these are described (15).

The seeds should therefore be planted on beds in airy nurseries, spaced at least twelve inches (30 cm) apart and not over-watered. In Malaysia sand beds are used in the nursery. The seeds germinate in about three days and a very high percentage germination can be expected. If planted not more than three days old this may be close on 100 per cent. At the four-leaf stage some three to four weeks after sowing the seedlings can be transplanted to wider spacing.

An earlier procedure was to transplant still within the nursery, harden-off gradually and plant out as one-year-old stumps. There was always a high percentage of casualties as root disturbance is inimical. This loss could be lessened (G4) by cutting around the seedlings two months before transplanting so as to encourage the growth of many fibrous roots.

Nowadays the seedlings are transplanted as early as 3-4 weeks from sowing or as stumps into black perforated polyethylene bags. These polybags measure some 12 x 10 inches (30 x 25 cm) and are filled with a modified J.I.P. compost comprising seven parts by volume of jungle loam, three parts of peat and three parts of river sand to which is added 2 lb (0.9 kg) of Malameal (an organic fertiliser of animal origin) and 2-3 lb (0.9-1.4 kg) of ground limestone per cubic yard (0.9 x 0.9 x 0.9 m) of compost. (3; 6)

Planting out hardened-off seedlings should be done in the rainy season at a spacing of about 50 x 50 feet (15 x 15 m).

PROPAGATION BY BUDDING AND GRAFTING

Rootstocks

The raising of seedlings which may be used as rootstocks in Malaysia was described (6) in the previous section. Unselected seeds from market fruit are used for this purpose, and little or no work appears to have been done on the selection of rootstock clones or to study their effects. Work in Malaya (13), however, has included clonal trials of scions on known clonal rootstocks.

The most suitable age recommended for working the rootstocks seems to vary from place to place, from as young as three to four months after transplanting (four to five months from sowing), six to nine months (G4) and even one year (G17). But they need to have attained at least pencil thickness five inches (13 cm) above soil level, and some workers would prefer a thicker rootstock and to work higher up the stem.

No work has been reported of budding onto species other than the durian although, *vide infra*, inarching on alien species has been attempted.

Budwood and budding

Needless to say, budwood, which provides the scion of the united tree, should be taken only from selected trees whose growth habit, health, productivity and the quality of the fruits are known to be superior.

The most suitable budwood is taken from terminal twigs near the ends of the shoots and which are about the same girth as the rootstocks. Mature twigs should be selected, but in older shoots the buds have either shot or been shed. The budpatch should be without a petiole and a rectangular portion measuring 0.2 x 1-1½ inches (0.5 x 2.5-4 cm) is removed. The sliver of wood is removed and the patch placed on the stock so that a similar-shaped portion of bark can be lifted and the lifted flap, either upwards or downwards, is cut in half (6). This is a form of the Forkert method of budding, described in detail in Part One. The budwood must not come into contact with water nor stood in water as this prevents a successful union (G4). The petioles may be removed sometime before the bud is required so that the scar may heal over (17).

The best time for budding is the wet season when the bark lifts easily and the take may be over twice as successful as in the dry (17). The young buds, with the flap, are then tied in, leaving the actual bud exposed, with clear plastic strip half-an-inch (1.25 cm) wide and of 0.08 mm gauge (6). In hot, dry weather individual buds may need shading and they are very susceptible to drought.

An interesting experiment in Malaya (7) compared buds taken from branches previously ringbarked below the bud with those taken from non-ringbarked budwood. The former buds had a superior performance. On the other hand, ringbarking the stocks 1-5 days before budding just above the ring did not increase the percentage of takes.

About 18 days after budding the binding should be removed and the bud-patch scratched to see if it is still green. If so, the rootstock is headed back to about one foot (30 cm) above the bud. The bud will then grow out and, when four to five leaves have developed, the rootstock should be further cut back to four inches (10 cm). At the ten to twelve-leaf stage the rootstock is cut smoothly about half an inch (1.25 cm) above the bud. While this procedure has been going on, the plants have been gradually hardened-off by the reduction of shade and watering, and when weather permits may be transplanted to the field (6).

In some places, as mentioned above, the roots may be cut by a sharp spade some weeks before transplanting so as to encourage fibrous root growth and so ensure more successful transplanting.

Approach grafting or inarching

The process of approach grafting has been described in Part One. It comprises selecting a superior tree to provide the scions and placing seedlings of the rootstock near enough for a branch of the scion to be grafted onto the rootstock stem. Thereafter the scion branch is severed below the union, and the rootstock above the union is cut away leaving the rootstock root and lower stem bearing the shoot of the scion variety.

This procedure is relatively easy when the species is low-growing and the rootstock seedlings can be supported from the ground near to the scion branches. But with the

tall durian tree this is plainly difficult unless low branching scions can be trained. Therefore benches or scaffolding must be built around the scion tree, and then tending the grafts becomes an expensive and time-consuming procedure.

However, the method is practised in India (2; 4; G15) and Malaysia (3) and is relatively successful. The seedling rootstocks are raised in the usual way and transplanted into pots, tins or stout polybags. These are placed in position alongside the scion tree and the grafts made. The technique is described in Part One, and polyethylene film is used to wrap the grafts.

The grafts must be tended by watering the seedling stocks once or twice daily and they are examined after one and a half to two months to see if union has taken place. If the graft is successful, the plastic film can be removed after four to six weeks and the scion branch is severed below and the rootstock seedling above the union. The new plant can thereafter be hardened-off and eventually planted out in the field. In India (4) separation is done in three stages and takes about six months.

Time of year seems important: in India (4) 100 per cent success was achieved with inarching in October. In November the success rate fell to 80 per cent; other months showed up to 20 per cent success but in February all the grafts failed.

An interesting experiment at Burliar in South India is reported (2; 5; 6a) in which seedling stocks of a wild relative of the durian, *Cullenia excelsa*, were used for approach grafting. I am indebted to Dr. V. N. Madhava Rao of Tamil Nadu Agricultural University, Coimbatore, for subsequent results of this experiment.

The trial was established in 1957 when three durian scions grafted onto durian seedling rootstocks and three on *Cullenia excelsa* rootstocks were planted. Observations continued until 1971 with the following results:

	Durian on durian			Durian on <i>C. excelsa</i>		
	Tree No.1	Tree No.2	Tree No.3	Tree No.4	Tree No.5	Tree No.6
Stock girth (cm)						
Jan. 1957	1.25	1.75	1.50	1.25	1.25	1.25
June 1970	17.0	34.0	35.0	57.0	25.0	46.5
Growth	15.75	32.25	33.50	55.75	23.75	45.25
Scion girth (cm)						
Jan. 1957	1.25	1.75	1.50	1.25	1.50	1.25
June 1970	13.0	32.0	29.0	49.5	22.5	42.0
Growth	11.75	30.25	27.50	48.25	21.00	40.75
Height (cm)						
Jan. 1957	27.5	32.0	32.5	32.5	35.0	22.5
June 1970	206.0	514.0	629.0	859.0	500.5	704.0
Growth	178.5	482.0	596.5	826.5	465.5	681.5
Spread NS/EW (cm)						
Jan. 1957	20/27.5	30/15.0	27.5/ 17.5	17.5/ 27.5	17.5/ 20.0	12.5/ 15.0
June 1970	217/233	540/533	494/502	580/665	390/404	550/532

It is clear that *Cullenia excelsa* imparts more vigour than seedling durian as a rootstock. Furthermore, Tree No.4, on *C. excelsa*, flowered in 1969 and produced a fruit weighing 1.5 kg (3.3 lb) in 1971; it would seem therefore that the *C. excelsa* rootstock may also cause some precocity in the scion.

PROPAGATION BY LAYERING OR MARCOTTAGE

In West Malaysia (6) air layering or marcottage has been achieved but the success rate was very low.

Also in Malaya (G4) shoots of young plants were wired and etiolated, that is a constricting wire was tightened round the shoot to interrupt the flow in the phloem, and the shoot was then pegged down and covered with soil. In this method fresh shoots appear and, after some time, rooting occurs and the young plants can be detached. In Singapore the roots appeared as much as eight to twelve weeks after shoot growth had begun. Elsewhere rooting was accompanied by the production of gall-like growths above the wire. Sometimes the removal of a portion of bark hastens rooting, and of course the whole method may be carried out above ground level by the use of supported containers of soil in which the shoots are pegged.

Nevertheless, there appears little indication that layering is likely to become an economic or effective method of reproduction in the durian.

PROPAGATION BY CUTTINGS

Cuttings have been successfully struck in Malaysia (6), and even in temperate climates under heated conditions cuttings set in sand under glass with bottom heat will grow (G20). But this method has so far been little used.

CONCLUSIONS AND SUGGESTIONS

In some crops, such as the avocado, grafting can be successfully carried out on the very young shoot, or indeed the plumule. In Malaysia (6) experiments are in progress to bud onto the false stem of the durian at various ages, some as early as three weeks from germination. At this station work is also in progress on the orientation of the rootstock seed when planting so as to ensure straight stocks for budding.

Looking at the problem of vegetative propagation of the durian as a whole it is clear that only bud grafting has become a regularly successful and economic method. It

has room for experiment and improvement. Nevertheless, the method which seems to have been almost wholly neglected and yet, if successful would be the most economic, even for the production of rootstocks if clonal rootstocks of a superior type are developed, is the use of cuttings, either stem or root cuttings. It is in this field that future experimentation must lie.

The availability of rooting hormones, the use of mist under tropical conditions and other advances in our knowledge of propagating cuttings all suggest that further study may turn a few tentative successes with durian cuttings into an economic and successful method. Success with other tropical tree crops, including rubber, should encourage work in this direction.

REFERENCES

1. ANON. *The wealth of India, Vol. 3*, CSIR, New Delhi, 1952, pp. 118-19.
2. ANON. *S. Indian Hort.*, 1953, 1, (3): 109.
3. CHUA, S. E. and TEH, T. S. Propagation by approach grafting and woody cutting of some tropical fruit and ornamental trees. *Singapore J. prim. Ind.*, 1973, 1: 87-95.
4. KHAN, K. F. and RAO, I. K. S. A note on the vegetative reproduction of the durian (*Durio zibethinus* L.) by inarching. *Indian J. Hort.*, 1952, 9 (3): 50.
5. KRISHNAMURTHI, S. and RAO, V. N. M. Fruits of the world in Madras - introductions over a century and their performance. In *Advances in agricultural sciences and their application*. Madras Agricultural Journal, Coimbatore, 1965.
6. LOH CHARN LUM, personal communication, 1973.
- 6a. MADHAVA RAO, V. N., personal communication, 1973.
7. MALAYA. *A.R.Dep.Agric.* 1938, 1939.
8. MALAYA. *Idem* 1958, 1959.
9. MALAYA. *Idem* 1960, 1963.
10. MALAYA. *Idem* 1962, 1965.
11. MALAYA. *A.R.Div.Agric.* 1963, 1966.
12. MALAYA. *Idem* 1965, 1968.
13. MALAYA. *Idem* 1966, 1969.
14. NARARATHNAM, S. J. Patch canker of the durian tree, *Malays.agric.J.*, 1966, 45: 291-4.
15. SINGH, H. and RAO, A. N. Seed germination and seedling morphology in *Durio zibethinus*. *Malay.For.*, 1963, 16: 98-103.
16. VALMAYOR, R. V., CORONEL, R. E. and RAMIREZ, D. A. Studies on floral biology, fruit set and fruit development in durian (*Durio zibethinus* Murr.). *Philipp.Agric.*, 1964-65, 48: 355-66
17. WEBSTER, P. J. Recent experiments in shield budding tropical fruits at the Lamao experiment station. *Philipp.agric.Rev.*, 1914, 7: 356-9.

EUGENIA SPP.

by

G. K. ARGLES

Formerly of the Commonwealth Bureau of Horticulture and
Plantation Crops

INTRODUCTION

The genus *Eugenia*, which nowadays is generally accepted as including species hitherto referred to *Syzygium*, comprises nearly 1000 species of evergreen trees and shrubs, most of which are strictly tropical in origin. Many of them yield edible fruits, and some of these are also valued as ornamental trees or hedge plants. The dried flower buds of *E. caryophyllus* yield the spice cloves.

Of the fruit-bearing species only a few have so far achieved any notable popularity outside their countries of origin in tropical South America and in the Indo-Malaysian region. This is hardly surprising in view of the fact that the vast majority of trees of all species are of seedling origin and show considerable variations in fruit size and quality. Moreover, although some species produce fruit of dessert quality, most of them produce fruit that is mainly of value for processing into juices, jellies, etc. Fruit for these purposes is often obtained from wild trees, and where trees are cultivated at all, they are usually grown in garden plots rather than in orchards.

In several of the species superior forms have been recognized, but no systematic attempt appears to have been made to select the best individuals from among these forms and to perpetuate them as named cultivars. There has therefore been little stimulus to evolve efficient methods of vegetative propagation, and such investigations as have been carried out appear to have been largely haphazard and short-lived. These are described briefly below for each species in turn, the species being arranged for convenience in alphabetic order and not in order of their importance.

EUGENIA AQUEA — WATERY ROSE-APPLE

Ecology and botany

Eugenia aquea is described from Indonesia by Ochse (G16) as a tree 3-10 m (10-33 ft) tall, branching near the base. The leaves are glabrous on both surfaces, and thus adapted presumably to withstand frequent wetting. Trees often flower twice a year, in July and September, and the fruits develop quickly, ripening in August and November, respectively.

There are two forms of the watery rose-apple, one with red and the other with white fruits, but no serious attempt appears to have been made to select and multiply superior types of either form.

Propagation by seed

No information on raising seedlings has been encountered.

Propagation by grafting

In trials carried out in Indonesia over 30 years ago (G12; G16) *E. aquea* was budded successfully during the rainy season, using the modified Forkert method, onto seedling rootstocks of *E. javanica* and *E. densiflora*. The budwood consisted of one-year-old shoots with petioles intact and the rootstocks were also eleven to twelve months old. Takes of 70 and 85 per cent were obtained on the two species, but how these trees fared after they left the nursery is not known.

The existence of a delayed form of incompatibility between rootstock and scion thus remains a possibility. This is emphasized by experience with *E. aquea* worked onto seedling rootstocks of the jambolan, *E. cuminii* (G16). Here again the bud take appeared to be satisfactory, but a few weeks after the scions had started to grow they all died.

Propagation by layering

According to Ochse (G16) the watery rose-apple is sometimes propagated by air layering in Indonesia, but no details are given.

In Malaysia Lambourne (9) obtained rapid rooting by mound-layering, provided that the developing shoots were ring-wired as well as etiolated by earthing up.

Propagation by cuttings

No information is available.

EUGENIA CUMINII — JAMBOLAN

Nomenclature

Few trees can have been afflicted with more botanical names, and for that matter with more common names, than the jambolan. The name *E. cuminii* is that adopted by Purseglove (G19) in his authoritative book on the botany of tropical crops, and *cumini*, though spelt with one i, is also used by Julia Morton (10) in a review of the literature on this species, although she prefers the generic name *Syzygium* to *Eugenia*. Among numerous other synonyms that are most widely used is *E. jambolana*. Common names, in addition to jambolan, include jaman or jamun in India, duhat in the Philippines, the Java, Malabar, Portugese or black plum in various regions and even, despite its complete inappropriateness, the Indian blackberry.

Ecology and botany

The jambolan is a native of India, Burma and Ceylon and has become naturalized throughout many other regions of the Far East (10). In India very large numbers of trees are found scattered throughout tropical and subtropical regions and even in the moister valleys of the Himalayas up to about 4000 feet (1300 m) (G15; G24; 5). On the Ganges plain groups of trees are often found growing in marshy areas, and trees in Florida have been known to survive prolonged periods of flooding. It is true that the jambolan is also common, though somewhat smaller in size than usual, on the poor lateritic soils of the Mahableshwar Plateau in India, but here again the rainfall is very high, often exceeding 200 inches (5000 mm) per annum.

The jambolan has been successfully introduced into many other tropical countries, notably in the West Indies and in East and West Africa, and also into various subtropical regions, including Florida, California, Algeria and Israel (G18; 4; 10). In southern California it is considered to be slightly less hardy than *E. jambos*, and in India to be rather more sensitive to cold and drought than seedling mangoes (G24).

The tree itself is a tall and handsome evergreen, and in some areas, such as Florida, it is grown mainly for shade and windbreak purposes. In contrast to some other eugenias it grows quickly, reaching under favourable conditions a height of 30 to 40 feet (9 to 12 m) in 10 or 12 years. When they are fully grown, the trees occasionally reach 100 feet (30 m), but final heights of 40 to 60 feet (12 to 18 m) are more usual. There is a general tendency for the trees to branch and form multiple trunks close to the ground. If cut down, they coppice freely (5) and as they also stand regular clipping they can be used to form a strong and dense hedge (10).

One unusual and interesting growth characteristic of the jambolan is revealed in two excellent photographs included in the review article by Julia Morton (10). These show masses of adventitious roots, one of them anchored in the ground, that emerged from the trunk and main branches of a large tree that had been damaged in a storm. This behaviour suggests the possibility that jambolan shoots contain pre-formed or latent root initials and should therefore possess high root-forming ability when propagated as cuttings or layers. It is also of possible significance that one of the photographs reveals several seedlings emerging around the base of the damaged tree. Their presence in this position suggests that seedlings will tolerate shade and that the parent tree does not produce an inhibitor which will prevent the germination of its own seedlings.

The leaves of the jambolan are leathery and glossy on both surfaces, thus suggesting that they are well adapted to withstand frequent wetting. Normally the old leaves are shed as the new ones emerge, although in some very dry areas there may be a short period when the trees are leafless.

There is usually one main flowering period in the spring and occasionally a minor second period later in the year. Dry weather aids fruit set, but thereafter abundant moisture is needed if the fruit is to develop and ripen satisfactorily. In contrast

to the short time taken by the fruits of many other eugenias to mature, several months usually elapse between flowering and the ripening of jambolan fruits.

As to fruit size and quality there seems to be general agreement that there is a high degree of variation between seedlings and that the majority of seedlings bear fruits that are too small, too astringent or too poorly flavoured to be of value for dessert purposes (e.g. G13; G14; G15; G18; G24; 10). Thus in the United States, where nearly all the trees are of seedling origin, little or no use is made of the fruits. There are, however, trees that bear large and relatively sweet fruits that are small-seeded or even seedless, and several authorities urge that the best of such trees should be selected and propagated vegetatively. Unfortunately, little attention has been paid so far to their advice, and the vast majority of jambolan trees continue to be raised from seed.

From this brief survey of the ecology and botany of the jambolan several points emerge that should have relevance to its vegetative propagation. Most of these will be mentioned below in the appropriate sections, but there is one aspect that would seem to deserve a general mention at this stage. All the evidence points to the fact that the jambolan needs an abundant supply of water if it is to make maximum growth. It is probable therefore that success in propagation, whether by seed or vegetatively, will depend to a large extent on the ability of the nurseryman to provide a consistently moist environment both above and below ground.

Propagation by seed

Jambolan seeds sown fresh usually show a high percentage germination within two to three weeks (G14; G24), but if stored they are apt to lose their viability within a month (16).

In North India fresh seeds are commonly sown in June-July in well prepared beds, the seeds being placed in pairs 1½-2 inches (4-5 cm) deep about nine inches (23 cm) apart in rows that are only six inches (15 cm) apart.

In Algeria cold frames are used for the same purpose (4).

Where seedlings are required as rootstocks for use in approach-grafting, the seeds are sometimes sown in pots or seedlings are potted-up from beds at the end of their first year. Indeed Chaturvedi (5) considers that sowing seeds in basket pots is preferable to sowing them in beds. Both shade and a plentiful supply of water are needed in the early stages, although subsequently full sunlight is beneficial.

Seedlings are apt to grow slowly in their first season, and in North India they may be only six to nine inches (15-23 cm) tall by the time growth ceases in the autumn (G24). During the winter covers of thatch may be needed to protect them from frost. Seedlings raised in beds may be planted out in their permanent sites in the following spring or during the monsoon season (August-September). Seedlings growing in basket pots may be kept until the beginning of their third monsoon, which suggests that they may not grow so fast as plants grown in beds, which, in Florida at least, may reach as much as 12 feet (4m) in two years (10).

In view of the rapid growth of jambolan trees after their first year, it is doubtful whether much would be gained by discovering means of hastening early seedling growth. Conventional methods of doing this, such as the use of fertilizers, do not seem to have been tested, but Shanmugavelu (17) obtained an increase in both the fresh and dry weights of shoots and roots when one-month-old jambolan seedlings were sprayed once a week for eight weeks with the potassium salt of gibberellic acid.

Propagation by grafting

The large size of jambolan trees on their own roots is an obvious handicap to anyone wishing to grow them as a commercial orchard crop. Methods of grafting are thus of particular interest, especially if a compatible rootstock can be found which produces

a dwarf tree.

Unfortunately, the search for suitable rootstocks appears to have been half-hearted. Over 30 years ago Magielse and Ochse (G12) in Indonesia budded jambolan on *E. densiflora* and *E. javanica*, but the buds failed to take. Rather more recently Carra (4) mentioned that it has been claimed that jambolan can be veneer-grafted onto two relatively small eugenias, *E. ugni* and *E. jambos*, but he gives no details concerning the results obtained or the source of the claim.

All additional information on the grafting of jambolans relates to the use of seedling jambolan rootstocks, and only in one instance is a rootstock effect mentioned. This is a rather curious case, mentioned by Mendiola (G13) in 1926. A seedless, but small-fruited, type of jambolan found in the Philippines was budded onto a seeded, large-fruited stock. When the scion fruited, the fruits were much larger than those of its parent, and some were seedless while others contained seeds.

When we come to grafting techniques, the ground becomes somewhat firmer. Shield budding, modified Forkert budding and approach grafting all appear to have been successful with jambolan seedlings as root stocks.

As long ago as 1916 Waster (G27) gave a brief description of shield budding in the Philippines. He advocated using barely mature green or reddish budwood with petioles attached and cutting the buds 4-4.5 cm (about 1½ in) long. The age of the stock at the point of insertion proved unimportant. Jambolans are also sometimes propagated by budding, presumably shield budding, in Florida (G14).

In Indonesia (G12: G16) the modified Forkert method of budding proved a satisfactory means of propagating large-fruited white varieties on jambolan seedlings during the rainy season. One-year-old budwood with petioles attached was used.

The modified Forkert method of budding is also occasionally used in India, where it has given better results than shield budding (G24). The best time to bud is July-August, when the stock seedlings are about one year old and $\frac{1}{2}$ - $\frac{3}{4}$ inch (6-12 mm) in diameter. Waxed tape is used for wrapping. The disadvantage of budding in the nursery is that it takes two to three years from the time the rootstock seeds are sown to produce a budded tree large enough to be planted out. By this time a deep root system will have developed which makes transplanting difficult. This difficulty can be avoided by planting out the seedling rootstocks when they are young and easy to transplant, leaving them to grow for two or three years and then inserting buds on three or four individual branches. Budding at stake in this way is best done over two years to avoid the shock of heading back the whole tree at one time.

Approach grafting is also used to some extent in India (G24). This is done in June-July when the seedling rootstocks are nearly 1 year old. The main difficulty experienced lies in finding an appreciable number of suitable branches on the scion trees that are situated reasonably close to the ground.

Propagation by layering

In a small trial at Annamalai University in India, Shanmugavelu (16) obtained 100 per cent rooting of air layers in two months when these had been treated with NAA or IBA but not when no growth substance had been applied. The layers were made on shoots 1-2 cm ($\frac{1}{2}$ - $\frac{3}{4}$ in) thick growing on 20-year-old trees. A ring of bark 1 cm ($\frac{1}{2}$ in) wide was removed, and the growth substances were applied at 0.1 per cent in lanolin to the upper parts of the rings. The girdled portions were covered with damp sphagnum moss and enclosed in 200-gauge polyethylene film. In terms of roots produced per layer the response to NAA (14 roots averaging 4.9 cm (2 in) in length) was somewhat greater than to IBA (three roots averaging 2.6 cm (1 in)).

Apart from a passing reference to propagation of jambolans by air layering in Florida (10) no other information on layering, air or ground, or to stooling have been encountered, but in view of the fact that the jambolan is reported to regenerate readily if coppiced and has been shown in certain circumstances to produce aerial roots, the possibilities of various types of layering and particularly of stooling would seem worth exploring.

Propagation by cuttings

The capacity to produce aerial roots, mentioned in the last section, suggests that it should not be difficult to propagate jambolans from cuttings. Indeed, Carra (4) in Algeria states that cuttings taken from semi-hard shoots in the spring and placed in sand in closed frames should root readily, but he gives no details. Experience elsewhere, however, has been less encouraging.

In Calcutta, Gupta and Chattopadhaya (6) failed to obtain any rooting response when softwood (greenwood) tip cuttings, 18 cm (7 in) long, were taken during the summer (June-July), the rainy season (August-October) or during the winter (November-January), despite the fact that these were treated with IBA or NAA as 24-hour soaks at 5-8 p.p.m. or as 10-second dips at 2-10 mg./ml before being planted in either sand or soil.

Subsequently Shanmugavelu (15) tested the effect of somewhat higher concentrations of growth substances in a trial carried out at Annamalai University between August and November. He used one-year-old leafy hardwood cuttings, nine inches (23 cm) long, and soaked the bottom 1½ inches (4 cm) for 24 hours in IAA, IBA or NAA, each at 25, 50 and 100 p.p.m., before setting the cuttings in raised sand beds. The best results obtained after 70 days in the beds were 45 per cent rooting with 100 p.p.m. IBA and 40 per cent with 100 p.p.m. IAA. Some rooting occurred with the lower concentrations of IAA, but none with the lower concentrations of IBA or with any of the concentrations of NAA (in contrast to the

response obtained with air layers). None of the untreated control cuttings rooted.

These few results, while demonstrating that jambolan cuttings can be rooted, are not impressive. There are, however, various possibilities that would be worth exploring before deciding whether or not this method of propagation could be practicable on a commercial scale. Among these are varietal differences in rooting ability, the clipping or hedging of stock plants to provide juvenile shoots for cuttings and the use of mist or of humid atmospheres in closed cases as has been advocated for some other eugenias.

Planting out

No problems have been reported in transplanting young jambolan trees, provided that they are protected against drought and frost (5), but by the time they are about two years old the root system may have become so deep as to make transplanting more difficult (G24).

EUGENIA CURRANII — LIPOTE

Ecology and botany

According to Sturrock (G25) the lipote develops into an upright tree of medium height in the Philippines but makes more spreading growth not exceeding 20 feet (6 m) in height in southern Florida. Trees are tender when young but become hardier as they mature. They grow well on light sandy soils but will not tolerate waterlogging. Growth, however, tends to be slow and fruiting irregular.

There are marked variations in fruit quality between seedlings, some having an attractive mildly acid flavour while others are astringent. The pectin content of the fruit is very high. Selection of superior types, combined with vegetative propagation, will have to be undertaken before the lipote can be considered suitable for commercial planting.

Propagation by seed

No information is available.

Propagation by grafting

Sturrock (G25) mentions that the lipote can be propagated by grafting but gives no details. Feilden and Garner (G4) quote Wester as advocating budding in the Philippines, using budwood with petioles attached that is turning brown and roughish and the bud shields cut 1½ inches (4 cm) in length. As no particular variety of rootstock is suggested, presumably seedlings of *E. curranii* are used for the purpose; their age at the point of insertion is unimportant.

Propagation by layers and cuttings

No information is available.

EUGENIA DENSIFLORA

Although not itself grown as a fruit tree, *E. densiflora* has been used as a rootstock for several other eugenias in Indonesia (G4; G12; G16). It is said to be easily raised from seed and to show resistance to attacks by termites.

EUGENIA DOMBEYI — GRUMICHAMA

Ecology and botany

In its native habitat in Brazil this attractive glossy-leaved tree often reaches a height of 50 feet (15 m), but in less tropical regions, such as southern Florida and Hawaii, it grows more slowly and may not exceed 20 feet (6 m) in height (G18; G25). In Florida it has proved comparable in hardiness to the pitanga, *E. uniflora*, trees having survived temperatures as low as 26°F (-3°C). It is, however, subject to mineral-deficiency chlorosis on both alkaline and acid sandy soils.

Both Popenoe (G18) and Mowry et al. (G14) consider the fruit of the grumichama, which takes only one month to mature after flowering, to be superior to that of several other eugenias which are much more widely grown. In Brazil three varieties have been recognized that differ in the colour of the fruit flesh, but all are regarded as being comparable in quality. Among the trees found in Florida, all of which are seedlings, there is much variation in fruit quality, but the population is too small at present to justify the selection of superior forms (G25).

Propagation by seed

In Florida grumichamas are raised from seeds, which retain their viability for several weeks and take about one month to germinate (G14). Seedlings have proved rather difficult to grow during their first year, and they take four to five years to come into bearing.

Propagation by vegetative means

No information appears to be available.

EUGENIA JAMBOS — ROSE-APPLE

Ecology and botany

Native to the Indo-Malaysian region, where it has for long been cultivated for its rose-scented fruits, the rose-apple with its thick glossy evergreen leaves makes a handsome tree that commonly reaches a height of 25 to 30 feet or more (7.5- 10 m) and has a spread of similar dimensions (G14;G18;G19;G24;G25).

It appears to succeed equally well in the warm moist tropics and cooler and drier subtropics (G18), although in Algeria, where it only reaches 4-5 m (13-16 ft) in height, it needs a rich deep soil and frequent irrigation during the summer (4). It has proved fairly hardy in southern Florida and southern California. It has grown satisfactorily on various soils so long as they are not subject to waterlogging (G25).

The fruit of the rose-apple, which has a high pectin content, is generally regarded as somewhat insipid. If superior types exist, they have not been identified. The fruits contain one or two seeds, which are often polyembryonic. In two small trials at Taliparamba in South India a few seeds yielded as many as three seedlings and the number of seedlings per seed averaged between 1.33 and 1.36 (G15).

Propagation by seed

Although in theory the existence of polyembryony should make it possible to produce rose-apple seedlings that are true to type, there is no evidence to show what proportion of the seedlings that emerge are of asexual origin and whether in fact they can be distinguished from seedlings of sexual origin.

In Algeria rose-apple plants are raised from seeds sown as soon as the fruits have been harvested (4). Seed also provides the main method of propagation employed in other countries, and there is nothing to suggest that it presents any difficulties.

Propagation by grafting

In a trial in Java (G12) 90 per cent success was achieved when *E. jambos* was budded by the modified Forkert method during the rainy season onto seedling stocks of *E. densiflora* and *E. javanica*. The budwood consisted of one-year-old shoots with petioles attached and the stocks were also eleven to twelve months old. *E. densiflora* was considered to be the better of the two rootstocks.

In the Philippines Wester (G27) found that the rose-apple could be shield budded on rose-apple seedling stocks. He advocated using greenish to brownish, well matured budwood and cutting the bud shields 3 cm (1½ in) long. The age of the stock at the point of insertion was unimportant.

In India (14) budding by the 'T' or chip methods was unsuccessful. Veneer grafting, however, when practised in July on one-year-old seedlings with shoots of the spring flush, resulted in 31 per cent success.

Propagation by layering

Both Naik (G15) and Singh et al. (G24) mention that the rose-apple can be layered, but they give no details.

In a brief postscript to a paper describing a laboratory experiment Bose et al. (2) mention that root development occurred in rose-apple shoots that had been ringed and the rings kept smeared for 48 hours with crude polyporin (a fungus extract with antibiotic properties). Following this treatment it would seem that the polyporin was washed out with the distilled water and the ringed areas covered with moist cotton wool which was rewatered daily. It is not of course suggested that this would be a practical method of raising rose-apple trees, but it does demonstrate that air layering should be feasible. Saha (14) reports from India that 60 per cent of air layers rooted when treated with 500 p.p.m. IBA, provided they were propagated in spring and not in the rainy season; these layers, however, did not survive the summer weather.

Lambourne (9) also mentions that air layering was used in Malaya to produce plants that were subsequently used for mound layering. These plants, established in a bed, were pegged down, and their shoots were etiolated by earthing up and ring-wired. Although the etiolated layers did not root so readily as those of *E. javanica*, a number of rooted plants were detached and successfully grown-on in bamboo-joint pots.

Propagation by cuttings

Sanders in his *Encyclopaedia of Gardening* (G21) includes *E. jambos* among several eugenias grown as

ornamental stove plants in Britain. To propagate these plants he advocates taking cuttings of firm shoots during the summer and inserting them in a sandy soil under a bell-jar with a temperature range of 55° to 75°F (13° to 24°C).

More recently Breviglieri and Costa (3) included *E. jambos* cuttings among numerous species tested at the University of Pisa under intermittent mist in three grades of vermiculite and three of sand. The trials lasted from early July to the end of September. Although full details of the procedure and results are not given for the rose-apple cuttings, it is mentioned that 50-60 per cent of them rooted quickly and that each cutting produced numerous roots.

In a trial in India (14) semi-hardwood cuttings were taken from the spring flush in July. Rooting was promoted by treatment with 1,000 p.p.m. NAA, but even this resulted in only 20 per cent success.

EUGENIA JAVANICA — SAMARANG ROSE-APPLE

Ecology and botany

In its native habitat of Java *E. javanica* makes a tree 5 to 15 m (16-50 ft) tall, which characteristically branches near the base of the trunk (G16). The leaves are glabrous on both surfaces. It needs a fertile soil and is widely cultivated on the plains of Indonesia, where its fruit is considered to be superior to that of the watery rose-apple, *E. aquea*. It is also grown in parts of India, as for example in the south at altitudes up to 4000 feet (1216 m) (G15) and in West Bengal, where, at the risk of confusing it with *E. aquea*, it is sometimes called the water apple (12).

In both Indonesia and India red or pink and white-fruited forms exist. In West Bengal a white-fruited form known as 'Alba' bears seedless fruits, while the fruits of the pink form contain one or two seeds. Seedless fruits are also often found in Java. Apart from these broad distinctions and the perpetuation of seedless forms such as Alba by air-layering or other

methods of vegetative propagation, it would not appear that any serious attempt has been made to select and multiply varieties with superior fruits.

Percy-Lancaster and Bose (12) describe an F_1 hybrid between the Alba form of *E. javanica* and the rose-apple, *E. jambos*. The hybrid possesses the prolific fruiting habit of Alba, but the fruits, which are seeded and larger than those of either parent, have the fragrance and sweetness of the rose-apple. They found that the hybrid could be easily propagated by air layering but give no details of the method employed.

Propagation by seed

The Samarang rose-apple is commonly raised from seeds, wherever these are readily available. In Java seedlings have also been used as rootstocks for seedless forms and for several other eugenias (G12; G16). Seedlings are subject to attack by termites, but no other problems have been mentioned. Presumably, as with other eugenias, the seeds should be sown as soon as possible after the fruits have been harvested.

Propagation by grafting

In trials in Java (G12), in which the modified Forkert method of budding was used, 90 per cent success was obtained when *E. javanica* was worked onto seedlings of *E. densiflora* and *E. javanica* during the wet season. In both cases the rootstocks were raised in seed-beds and transferred when very small to nursery beds where they were spaced 30 x 30 cm (12 x 12 in). They were budded when eleven to twelve months old, and the budwood, with petioles intact, was also twelve months old. Attempts to bud *E. javanica* onto jambolan (*E. cuminii*) and guava (*Psidium guajava*) seedlings were unsuccessful.

Naik (G15) also mentions that it proved easy to graft *E. javanica* onto *E. jambos* stocks at Kallar Research Station in south India, but he does not

describe the method of grafting used nor how the trees fared subsequently.

Propagation by layering

According to Naik (G15) layering, presumably conventional ground layering, proved an easy method of propagating *E. javanica* at Kodur Research Station in South India. Air layering is also sometimes used in Indonesia (G16) and Malaya (9). The methods employed have not been described, which suggests that conventional procedures are satisfactory. The low-branching habit of the Samarang rose-apple should facilitate either form of layering.

In Malaya Lambourne (9) planted rooted air layers of *E. javanica* in beds, where they established themselves readily. When they were subsequently pegged down and the shoots arising from them etiolated by earthing up, large numbers of these shoots rooted, many within a month or two, whether or not they were wire-ringed. Some difficulty was experienced, however, in getting the rooted layers established in bamboo-joint pots, and Lambourne considers that clay pots might have given better results.

Propagation by cuttings

In view of the ease with which *E. javanica* shoots strike root when layered, it is surprising that apparently no one has tried to raise plants from cuttings. Adapted as the tree is to wet tropical conditions and with its glossy, water-repellent leaves, its cuttings may well root satisfactorily under mist or in cases with high relative humidity.

EUGENIA KLOTZSCHIANA — PERO DO CAMPO

Popenoe (G18) describes *E. klotzschiana* as a small slender shrub, 4-5 feet (1.2 - 1.5 m) tall, which is native to the plains of Minas Gerais in central Brazil. Its leaves are hard and brittle and silvery pubescent

underneath, and its pear-shaped, downy and highly aromatic fruits, two to four inches (5-10 cm) long, contain one to four seeds.

No information has been encountered regarding seedling variation in fruit quality or methods of propagation.

EUGENIA LUSCHNATHIANA — PITOMBA

According to Popenoe (G18) *E. luschnathiana* is found growing wild and also in cultivation in the State of Bahia, Brazil, where it makes a handsome tree 25-30 feet (7.5 - 9 m) tall with glossy leaves. In Florida it grows more slowly and is smaller in size, but it appears to be quite hardy and adapted to various soils (G25).

The orange-yellow fruits, about one inch (2.5 cm) long, commonly contain one seed but occasionally as many as four. The uses of the fruit are similar to those of *E. uniflora*, and in Florida some steps have been taken to select superior types with a view to commercial production. Sturrock (G25) mentions that, although hitherto usually raised from seed, it has proved easy to graft, but he does not describe the method employed.

EUGENIA MALACCENSIS — MALAY ROSE-APPLE

Ecology and botany

A native of Malaysia, *E. malaccensis*, known variously as the Malay rose-apple, Malay apple, large-fruited rose-apple and in Hawaii as the ohia, is a handsome tree, ranging from 5 to 20 m (16 to 65 ft) in height, that has been planted throughout the tropics as an ornamental or windbreak and for its fruits (G16; G19). Trees tend to branch near the base, and their leaves are thick and glabrous on both surfaces. Good growth depends on a fertile soil, ample moisture and the absence of frost.

Ochse (G16) regards the fruit of this species as one of the best among the eugenias, but other authorities (18; G19; 7) consider it to be rather insipid and pithy. This disagreement regarding its merits may arise from the wide variations in fruit quality found among seedlings. In Indonesia most trees bear red fruits with dark red longitudinal streaks, but there is also a pear-shaped white-fruited form of inferior quality. In Hong Kong the fruits are often seedless, although normally each fruit contains one large seed. The need to select superior types has been stressed, and it follows from this that efficient means of vegetative propagation are also necessary.

Propagation by seed

In Hong Kong (7) and elsewhere the Malay rose-apple is normally raised from seeds sown soon after the ripe fruits have been harvested. In Indonesia (G12) when seeds are sown in seed-beds over 80 per cent of the seedlings are commonly destroyed by termites before they have become large enough to be transferred to nursery beds. To prevent this happening it is a common practice to sow the seeds in basket pots which are kept under light shade under conditions where they can be protected against termites.

It is perhaps worth mentioning that in India Roy (13) has found that some ovules of *E. malaccensis* contain more than one embryo as well as other abnormalities, including double nucelli each containing an embryo-sac, and the development of an aposporic embryo-sac in an otherwise sterile ovule. As, however, there is no evidence that more than one seedling emerges from a seed, these findings are only likely to prove of practical significance if means can be found of inducing the production of apomictic seedlings that come true to type.

Propagation by grafting

In Java (G12) repeated attempts to bud *E. malaccensis* onto seedling rootstocks of *E. densiflora*, *E. polycephala* and *E. cuminii* and onto interstocks of *E. jambos* all ended in failure. On the other hand, up to 95 per cent

success was obtained during both the wet and dry seasons on 1-year-old seedling rootstocks of *E. malaccensis* growing in basket pots. The budwood used was also one year old with petioles attached. The method of budding was the modified Forkert, and it proved important to ensure that the rootstocks were in the right condition because their bark was thick and brittle and apt to tear.

Propagation by layering

According to Firminger (G5), writing over 100 years ago, *E. malaccensis* can be propagated by layering, but no one seems to have explored this possibility further, despite the low-branching habit of the trees.

Propagation by cuttings

E. malaccensis is among the eugenias mentioned by Sanders (G21) as being grown under glass as stove plants in Britain and which can be propagated by cuttings of firm shoots inserted during the summer in a sandy soil under a bell-jar maintained at temperatures ranging from 55° to 75° F (13° to 24°C).

In North Borneo, Eurov (G8; G9; G10) included cuttings of *E. malaccensis* among those of numerous woody plants set in 14 x 8 inch (36 x 20 cm) 0.02 mm gauge polyethylene bags containing a mixture of eight parts decomposed rice husks and two parts fine river sand. Before insertion the bases of the cuttings were treated with various chemicals, often a soak lasting 12 to 24 hours followed by a quick dip. With *E. malaccensis* cuttings 40 per cent rooting was obtained when they were soaked in NAA at 0.01 to 0.03 per cent (the exact concentration used is not clear) followed by a quick dip in IBA at 0.2 per cent, compared with 10 per cent when the initial soak was in phenoxyacetic acid and nil when the IBA dip was used alone.

It is difficult to draw any firm conclusions from the results of this somewhat exotic method of striking cuttings or from Sanders' generalization. The Malay rose-apple with its glossy leaves is, however, clearly

well adapted to growing under wet tropical conditions, and it would therefore probably be worth trying soft or semi-hardwood cuttings under mist or in humid closed cases.

EUGENIA POLYCEPHALA

The only information traced on this species and its propagation is contained in a paper by Magielse and Ochse (G12) published 45 years ago. In trials with the modified Forkert method of budding they obtained 50 per cent success when buds from one-year-old shoots with petioles intact were inserted during the rainy season into two-year-old seedling rootstocks of the same species. The seedling stocks were raised in basket pots and were found to need heavy shading. Attempts to bud *E. polycephala* onto various other (unspecified) *Eugenia* species were unsuccessful.

EUGENIA TOMENTOSA — CABELLUDA

This species, which is almost unknown outside its native Brazil, is briefly described by Popenoe (G18) as an ornamental tree 15-25 feet (4.5-7.5 m) tall with tomentose leaves. Its fruits, which have downy skins, are juicy and pleasant in flavour but are not considered of much merit. No information is available on its propagation.

EUGENIA UGNI

Ecology and botany

Described by Carra (4) as originating in South America, notably in Chile, *E. ugni* (syn. *Myrtus ugni*) makes a small tree 5-6 m (16-20 ft) tall, that is sufficiently hardy to grow satisfactorily in southwest England. In Algeria trees may require irrigation during the summer.

Propagation by seed

In Algeria (4) *E. ugni* is raised from seeds that are sown as soon as the fruits mature during October. The seedlings are planted out the following spring (February-March) and need to be watered regularly at least during their first year.

Propagation by cutting

In England, Sheat (G22) recommends taking cuttings in November consisting of firm side shoots of the current season's growth, three to five inches (7.5-12.5 cm) long, with a heel, and inserting these in a standard rooting medium (e.g. three parts turfy loam, one part sand, one part peat or peat moss) in a cold frame. A liberal quantity of sand should be placed along the base of the cutting trench. The cuttings can be lifted late in the following spring or in the early autumn and lined out in sheltered nursery beds. Using this technique a high percentage of success can be expected.

EUGENIA UNIFLORA — SURINAM CHERRY, PITANGA CHERRY

Ecology and botany

The Surinam or pitanga cherry (*E. uniflora*, syn. *E. michelii*), considered by some people to be the best of the eugenias, is native to Brazil but has become widely distributed throughout the tropics and subtropics, notably in Florida where it is valued for its fruit and especially as an ornamental shrub and hedge plant (G14; G15; G18; G19; G24; G25; 11).

In Brazil the Surinam cherry occasionally reaches a height of 25 feet (7.5 m), but in the subtropics, where it is normally rather slow growing, it often only reaches 7 to 13 feet (2 to 4 m) (G14; 4; 7). In shape it is broad and compact, with branches emerging close to the ground and branchlets thin and wiry. The leaves are glabrous.

Although young plants may need protection from frost, mature shrubs have survived temperatures of 27°-28°F (-3° to -2°C) without serious injury (G18; 4). In south India it grows successfully at altitudes up to 5500 feet (nearly 1700 m) as well as at lower elevations (G15; G24). In the United States it grows and fruits better in the warm moist climate of southern Florida than in the drier climate of southern California, and abundant moisture is particularly

necessary during fruit development (G18; G25). Irrigation is also needed during the dry winter season in Hong Kong, and if the soil is also well manured seedlings treated in this way should start fruiting in their third or fourth year (7).

The trees produce one main crop a year and sometimes a subsidiary crop. The fruits, which contain one and occasionally two seeds, develop very quickly, maturing three to six weeks after flowering. In Florida two distinct forms of *E. uniflora* are recognized, one with bright cherry-red fruits and the other with deep crimson, almost black fruits (G18). Within these forms there is considerable variation among seedlings as to fruit size and quality, but grafted plants of some superior selections are now available and are being planted on a small commercial scale for juice production (G25).

As the Surinam cherry is becoming of interest as an orchard crop, it is clear that the current widespread practice of raising plants from seed should give way to the vegetative propagation of selected varieties. As to the choice of methods of vegetative propagation the tree possesses several interesting characteristics, none of which, however, appears so far to have been exploited in its propagation. These include:

(1) The low-branching, spreading growth habit which should facilitate ground layering.

(2) Tolerance to hard clipping when grown as a hedge, which suggests that it should be possible to obtain 'juvenile' material for cuttings and also perhaps for stooling.

(3) A marked tendency to produce suckers from buds arising spontaneously on the roots (8, 11), which again suggests possibilities with respect to stooling and of course the use of the suckers themselves either rooted in situ, or as cuttings that are physiologically juvenile.

Propagation by seed

Surinam cherry seeds germinate within three to five weeks, provided that they are sown as soon as the ripe fruits have been harvested (G16; G24; 4; 7; 11). They are apt to lose their viability rapidly if handled incorrectly. Popenoe (G18) states that they can be kept for a month or more if washed immediately after their removal from the fruit and then dried. In Brazil, Aroeira (1) obtained 90 per cent germination in nine weeks when seeds from ripe fruits had been shade-dried

for seven days, and he also found that these seeds remained viable for about two months when kept in open containers under laboratory conditions or at 3°-10°C (37°-50°F). Germination was almost as good after five months' storage in open containers at 3°-10°C. By contrast all seeds kept in closed containers at 3°-10°C died within two months, which he attributes to lack of oxygen having been more detrimental than the considerable loss of moisture suffered by seeds stored in open containers.

Seeds can be sown in beds, seed boxes or pots. Where they are sown in beds Parsons (11) advocates placing them about half an inch (1.25 cm) and not more than one inch (2.5 cm) deep, 2 inches (5 cm) apart in rows nine inches (23 cm) apart. The seedlings should remain in the seed-bed until they are three inches (7.5 cm) tall, after which they can either be potted-up or planted in nursery beds nine inches (23 cm) apart. From the nursery they can be transferred to their permanent sites when eight to nine inches (20-23 cm) tall. If sown in pots a two-inch (5-cm) pot will suffice (G18).

Propagation by grafting

Various authorities (G14; G18; G27; 11) report that *E. uniflora* has been successfully whip and cleft grafted, presumably onto its own seedlings. Most of these reports are second-hand and no details are given. The same applies to a report that this species can be veneer grafted onto *E. jambos* and *E. ugni* (4).

The only first-hand experience of grafting reported in the literature is that described by Wester (G28) as long ago as 1920. He found cleft grafting to be successful during the dry season in the Philippines. The scions consisted of mature brownish twigs two-and-a-half inches (6.5 cm) long, the stocks did not exceed 10 mm (0.4 in) in diameter, and the point of insertion was not more than three inches (7.5 cm) above the ground.

Propagation by layering

There are no reports that any form of layering has been tried as a means of propagating the Surinam cherry. Both ground layering and especially stooling would be worth testing.

Propagation by cuttings

Carra (4) in Algeria states that *E. uniflora* can be successfully raised from cuttings taken in the spring from semi-hard shoots and inserted in a sandy soil under glass with bottom heat.

No other information on cuttings has been encountered, but the Surinam cherry with its glossy leaves and high moisture requirement, might well be a suitable subject for mist propagation. Cuttings taken from stock plants kept clipped like a hedge or from suckers emerging from roots would probably possess higher rooting ability than cuttings taken from bearing trees.

EUGENIA UVALHA — UVALHA

Popenoe (G18) mentions the uvalha as being found wild in southern Brazil, where it is also sometimes cultivated for its juicy and aromatic fruits, but he gives no information on its propagation.

EUGENIA ZEYLANICA

According to Naik (G15) *E. zeylanica* (*Syzygium zeylanicum*) is a small handsome fruit tree found in the western Ghats in south India, but he does not describe its propagation.

CONCLUSIONS AND SUGGESTIONS

Most of the eugenias discussed in this chapter appear generally to be valued as much for their decorative characteristics as for their fruits. Although some of them produce fruits of considerable merit for eating fresh or in various processed forms, few serious attempts have been made to select and multiply superior varieties among seedling populations that often show wide variations in fruit size and quality. Except on a very small scale with such species as *E. uniflora*, commercial orchards are conspicuous by their absence. In these circumstances it is hardly surprising that information on methods of vegetative propagation is distinctly sketchy and that gaps in knowledge are formidable.

Nevertheless, if any worthwhile progress is to be made in future, reliable and economic methods of vegetative

propagation will have to be evolved. In considering possible developments towards this end the following points might be worth bearing in mind.

Some of the better-known *Eugenia* species when grown on their own roots make trees that are too large for modern orchard purposes. Most of these species can be grafted or budded successfully onto seedling rootstocks of their own species and also sometimes onto other species. Among the latter there may be some that have a dwarfing effect on tree size.

Certain eugenias are said to regenerate freely if coppiced or to tolerate frequent clipping when grown as hedges. Such species might lend themselves to propagation by stooling.

Where a species produces root suckers, the suckers themselves may be used as a source of plants or as cuttings which should be physiologically juvenile, or conceivably it might prove possible to raise plants from root cuttings.

Leafy cuttings have only been used as a means of propagation to a limited extent and results have been mixed. Only in one case, that of *E. jambos*, have softwood cuttings been rooted under mist, although nearly all the eugenias, with only minor exceptions appear to possess the glossy leaves and high moisture tolerance which would probably make them suitable subjects for propagation under mist or in very humid closed cases.

BIBLIOGRAPHY

1. AROEIRA, J. S. Dormência e conservação de sementes de algumas plantas frutíferas. *Experientiae*, 1962, 2: 541-609.
2. BOSE, S. R., BOSE, A. B. and DEY, K. L. Effect of crude polyporin on seed germination and root growth: a preliminary study. *Science*, 1948, 107: 63.
3. BREVIGLIERI, N. and COSTA, L. La propagazione per talea con la nebulizzazione. *Ital. agric.*, 1957, 94: 21-39.

4. CARRA, P. Les arbres fruitiers exotiques. *Rev. hort. Algér.*, 1951, 55: 178-81, 205-8, 228-34, 284-7.
5. CHATURVEDI, M. D. Jamun is another of our prized trees. *Indian Fmg*, 1956, 5(12): 17-19.
6. GUPTA, J. C. S. and CHATTOPADHAYA, S. S. K. Hormones and rooting in intact plants and cuttings. *Curr. Sci.*, 1954, 23: 294-5.
7. HERKLOTS, G. A. C. Notes on ten fruit trees. *Food and Flowers, Hong Kong*, 1948, No.1, pp.38-58.
8. HUNZIKER, A. T. Raíces gemíferas en algunas plantas leñosas argentinas. *Rev. argent. Agron.*, 1946, 13: 47-54.
9. LANBOURNE, J. The etiolation shoot method of fruit propagation. *Malay. agric. J.*, 1935, 23: 514-27.
10. MORTON, J. F. The jambolan (*Syzygium cumini* Skeels) - its food, medicinal, ornamental and other uses. *Proc. Fla St. hort. Soc.* 1963, 1964, 76: 328-38.
11. PARSONS, T. B. The cultivation of fruits in Ceylon with cultural details - III. *Trop. Agriculturist*, 1932, 79: 86-90.
12. PERCY-LANCASTER, S. and BOSE, T. K. Studies on hybrids of *Syzygium*. *Indian J. Hort.*, 1965, 22: 87-8.
13. ROY, S. K. Embryology of *Eugenia malaccensis* Lam. *Curr. Sci.*, 1960, 29: 189-90.
14. SAHA, A. K. Some investigations of vegetative propagation of jaman (*Syzygium jambos* L.). *Allahabad Fmr*, 1969, 43: 187-9.
15. SHANMUGAVELU, K. G. Induction of rooting on the stem cuttings of some avenue plants. *Madras agric. J.*, 1966, 53: 470-2.
16. SHANMUGAVELU, K. G. A note on air-layering of eugenia (*Eugenia jambolana* Lam.) and neem (*Azadirachta indica* A. Juss.). *S. India Hort.*, 1967, 15: 70-1
17. SHANMUGAVELU, K. G. A note on the effect of gibberellic acid on the root and shoot weights of some tree species. *Madras agric. J.*, 1967, 54: 44-5.

GARCINIA MANGOSTANA — MANGOSTEEN

by

JILL E. K. COX

Commonwealth Bureau of Horticulture and Plantation Crops

INTRODUCTION

The genus *Garcinia* includes many edible species, by far the best known being *G. mangostana*. It was named by Linnaeus after Laurent Garcin (1683-1751), a French botanist and traveller who was the first to publish a botanical description of the mangosteen (G20).

Over 400 species of *Garcinia* have been identified and 40 edible garcinias are listed by L. Pynaert (quoted in a paper by Bourdeaut and Moreuil) (2). Many edible wild species in Malaya are cultivated locally on a small scale; Burkill (G2) describes 24 that are used for various purposes and Allen (1) mentions six commonly grown for their fruit. The acid fruit can serve as a flavouring substitute for tamarind, as for example those of *Garcinia atroviridis* (Malaya), *G. cambogia* (India) and *G. planchonii* (Indo-China region). The seed oils may be used in food; *G. indica* and *G. morella* yield a non-drying oil used for kokam butter (G2; 6) and *G. cambogia* seeds contain 30 per cent of edible fat which has a commercial value in India (30). The fruit of different species may provide flavourings, fish preservatives, syrups and jams, sources of acid for coagulating rubber latex, tannins and medicinal preparations. Some species, for example *G. indica*, *G. tinctoria* and *G. cambogia*, (G23) may prove useful for the canning industry. The yellow dye, gamboge, is obtained from the bark resin of several garcinias, particularly *G. hanburyi* and *G. cambogia*. A feature of the genus is the yellow or white latex present in most parts of the plant; in mangosteen the exudation of this latex by the fruit pericarp and the branches is regarded as a disorder and known as "gamboge" (G4; 11).

The mangosteen is generally considered to be superlative among tropical fruit in its flavour and aroma. Fairchild (7; 8) enthusiastically refers to it as the "queen of fruits", with a flavour that is "absolutely and indescribably delicious" but "suggestive of the pineapple, the apricot and the orange". He likens the texture to that of "a well-ripened plum, so delicate that it melts in the mouth like ice-cream". Unfortunately, in contrast to some other garcinias, the desirable mangosteen has proved extremely difficult to propagate by vegetative methods and to some extent from seed. Its seed is, in fact, formed with nucellar tissue so that every seedling is similar genetically to its parent (G19; G20). Possibilities for breeding and selection are therefore restricted and most research work so far has centred on the improvement of vegetative propagation methods.

ECOLOGY AND GROWTH IN RELATION TO PROPAGATION

Distribution and ecology

The Guttiferae family, to which *Garcinia* belongs, is naturally distributed in the zone between 10° latitude north and south (11). The majority of garcinias are native to S. E. Asia, but the genus is scattered over tropical Africa, Asia, Polynesia and America. The mangosteen is native to Malaysia and its cultivation outside this area is restricted because of its particular climatic requirements. Temperatures below 5°C (41°F) and above 38°C (100°F) are lethal and those less than 20°C (68°F) retard growth (18); furthermore an annual rainfall above 50 inches (1270 mm) and some shelter are necessary (G15). The ideal would appear to be a temperature range between 25° and 35°C (77° and 95°F) with a relative humidity of over 80% (2).

The mangosteen is grown widely in Malaya, Indonesia, the Philippines, Burma, Ceylon and parts of Thailand. A few trees are grown in Hawaii and the West Indies. Several acres are reported to be in production in Honduras and elsewhere in the Panama Canal Zone; there are limited possibilities for commercial production in the south of Florida (G17; 5; 33) and there are some plantations in Cuba. The mangosteen was introduced into Ceylon about 1800 and is said to thrive at up to 2000 feet (610 m) in the moist region (G11). It was first grown in India during the 18th century; between 1880 and 1890 plantings were made at the Kallar and Burliar Stations in Madras State (18). It is now found mainly on

the lower slopes of the Nilgiris between 1200 and 3500 feet (91 and 1067 m) and near Courtallam. It reached the West Indies before 1855; the source of the present trees was probably seed sent from Kew (27). In Australia, seed was introduced into southern Queensland and New South Wales as early as 1854 but there is no record that these seedlings ever fruited. Some later introductions were made from Java (28). Plantings in the Malagasy Republic were first made in 1901 (24).

Garcinia dulcis and *G. livingstonei* are also cultivated on a fair scale in some countries (16); *G. livingstonei*, native to east Africa, grows quite well and is hardy in Florida but the fruit is thin-fleshed and merits improvement (G3; G14; G25). The heavy-bearing *G. xanthochymus* is under trial in the Malagasy Republic, and has proved hardier and far easier to grow than the mangosteen in Queensland (28). With the notable exception of mangosteen, garcinias generally have vigorous root systems and the economic importance of some species may depend more on their suitability as mangosteen rootstocks than on their fruit quality.

Growth habit and flower biology

The mangosteen, when raised from seed, seldom begins to fruit until it is at least six to eight years old and may not bear until the 15th-20th year if it is growing under sub-optimal conditions (10; 16; 33). The mature tree reaches a final height of between 32-82 feet (10-25 m). Purseglove (G19) describes it as slow-growing, with glossy bright leaves, black bark and a dense pyramidal crown and it has a most attractive appearance even when not fruiting. The greenish-white flowers are borne singly or in pairs, usually at the ends of the branchlets over two years old, and are unisexual-dioecious. Cobley (6) and others state that male as well as hermaphrodite flowers exist, but there is conflicting evidence for this assumption. Only female trees with fertile staminodes are reported from Malaya and Java (G19), Madras State (19) and Puerto Rico (33), and the fruit is usually parthenocarpic. There are seldom more than two seeds per fruit and these are formed asexually from nucellar tissue (13, G19). Winters and Rodriguez-Colon (34) quote M. A. Sprecher in describing the seed as a "hypocotyl tubercule" originating from the inner integument of the ovary. Horn (13), writing in 1940, states that descriptions of fruit from Java, Malaya, Trinidad and elsewhere conform precisely to those

for Puerto Rico fruit. The cultivated mangosteen is apparently a polyploid, cytological studies by Tixier (31) showing that $2n = 96$ whereas in other *Garcinia* spp. $2n = 48$.

The fruit, a dark purple berry, is about 4-7 cm (1.5-2.75 in) in diameter. The calyces and stigmatic lobes persist until it ripens and it has a smooth, hard pericarp with a tendency to exude latex if damaged in any way. When it is cut open, four to eight white, juicy segments are revealed; they are reminiscent of the lobes of a peeled orange and vary slightly in size according to whether or not they contain a seed. Trees flower once or, more usually, twice a year. From records kept at the fruit stations in Madras State the main flowering seasons are April-May and October-November (19) with the fruit being harvested in July-October and January-March (18). On the Ivory Coast flowering in February-March and June-August occurs 125-150 days before fruit harvest and follows two vegetative flushes in December-January and June-July. In lower Burma the fruit is produced in November-late January and also from mid-April to the end of July, with the main production in May and June. In Ceylon fruiting occurs from May to July in the lowland regions and in August-September in higher ones (11). In the Malagasy Republic there are four vegetative flushes and flowering occurs three months before harvest; peak cropping takes place in February-May and October-December although harvesting is often prolonged (2). There is frequently a tendency to alternate bearing, whereas some trees produce heavy crops consistently (20), and there is also seasonal variation in the duration of the period from flowering to fruit maturity (G15).

The root system of the mangosteen is fragile, slow-growing and easily disturbed. Great care is therefore required during the transplanting of seedlings, which form a long taproot with few laterals. Many writers note an apparent absence of root hairs at all stages of growth. A study at the Azagué Station on the Ivory Coast (2) showed that for a tree 3.8 m (12.4 ft) tall and 2.5 m (8.2 ft) in diameter the main mass of roots occurred at a soil depth of 5-30 cm (2-12 in) and the longest root did not extend more than 1 m (39 in) from the trunk. A more easily-grown subject, the imbe (*G. livingstonei*) is said by Sturrock (G25) to thrive in Florida on both acid sandy and alkaline rock soils. The trees are unisexual-dioecious and the flowers, produced

in February (G14), are borne in axillary clusters where the leaves have fallen. The fruits ripen mainly in June and are the size of a small plum. The flesh, although sweet, is too thin for the fruits to be grown as an economic crop. Trees are raised from seed in Florida; they attain 15-20 feet (4.5-6 m) and are usually multiple-stemmed.

Varieties

All cultivated mangosteens appear to have originated from one type and there are no reports of deliberate selection or of interspecific crosses. Earlier workers reported variants with superior flavour in Java and with larger than usual fruit in the Philippines; some trees in Burma were seen to have a later ripening season (G3). Individual trees may also show consistent heavy bearing or a reduced susceptibility to gamboge disorder (20). More recently Oberti (25) has noted that in Nicaragua there appear to be two distinct types in cultivation, those with large leaves and fruit of variable size and others with small leaves and small fruit. In 1884 Burbridge (4) reported seeing a wild mangosteen in British North Borneo (now Sabah) in which the fruit had only four carpels, each of which contained a perfect seed in contrast to the cultivated form with seven or eight carpels and only one or two seeds. Variants of *Garcinia dulcis* are also recorded in the literature. Brown (3) in 1920 described an improved form, var. *pyriformis*, grown in Java below 1500 feet (457 m), and Ochse (G16) recognizes two classes, one with small sour fruit and the other with large, orange, pear-shaped fruit with a sub-acid flavour.

Diseases and pests

The mangosteen is not subject to attack by many pathogens and where these occur they rarely cause severe damage. The physiological gamboge disorder, in which the branches and fruit exude a yellow resin, may induce bitterness in the fruit if the arils are infiltrated. Wind or pest damage usually incite this (2) and it may be advisable to plant shelter belts as a routine measure. Any injury to the root system is potentially serious, especially in seedlings; seeds that are damaged rarely germinate, and although the presence of gamboge-affected seed pulp does not inhibit germination the seedlings tend to grow more slowly than those from unaffected seeds (G15). Gamboge exudate from cut surfaces may adversely affect the union of grafts, as reported with *G. xanthochymus* (G4). Caterpillars of various species may damage young shoots and leaves and

capsids can defoliate trees (2). Popenoe (G18) quoted a report in 1915 that the fungus *Zignoella garcinae* incited a severe and eventually lethal canker in established trees.

PROPAGATION BY SEED

Since in mangosteen the seeds are formed from nucellar tissue all seedlings are virtually identical. Furthermore polyembryony can be common. Some selection is possible: Havard Duclos (11) states that in Indo-China fruit for seed production is chosen from the second, main, crop on the basis of size, and precociously fruiting trees (G3) are selected as parents since tardiness in fruiting may be an inherited characteristic. Seed size also influences germination (14; 34). In Puerto Rican trials (15) seeds weighing 0.2 g or less germinated very poorly; 100 per cent germination was obtained with seeds of 1 g upwards and virtually all seedlings survived where the seed weight exceeded 1.3 g. Seed weight was positively correlated with plant size after one year of growth. Larger seeds possess a greater food reserve and the germinating seeds can thus better withstand adverse conditions during the long process of root development. The seed is covered by a very thin membrane and if this is damaged or removed there is little protection against desiccation (21; 34). Even the intact seed has short viability, and incorrect storage conditions will reduce this still further. Seed stored in a desiccator over calcium chloride for as little as a week failed to germinate (34). Seeds can survive for three to five weeks when left in the fruit and for almost as long if they are placed in sealed tins in slightly moistened charcoal (G3). In Puerto Rico seed stored at 50°F (10°C), either dry or moist, failed to germinate; holding at room temperature in moist charcoal or peat moss resulted in good germination and prolonged viability (seven or eight weeks). Seed left in the fruit until sowing germinated slower than stored seed and the viability of air-dry seed was lost after four weeks (34).

In Madras, India (20), 70 per cent germination was obtained by sowing pulp-free seed within five days of extraction. In the Philippines (9) seed from fresh fruit averaged 84.91 per cent germination, compared with 71.43 per cent for those from fruit that had begun to decay. Delaying sowing for about 15 days reduced the percentage to 21.43. The same workers obtained over 50 per cent germination with seed collected in Bali and wrapped in moist sphagnum moss in tightly sealed tins for three months.

The average duration for germination ranges from 10 to 54 days, depending on seed age and the sowing medium. Workers in Madras found that seeds from the same tree could vary greatly in germination time in different years and seasons and that up to 11 per cent could show polyembryony (20) up to a maximum of three seedlings per seed. Nucellar embryos can be separated after removal of the aril and the thin covering below (G15).

Chandler (G3) described the process of germination in detail, noting that after the emergence of the first roots a new system developed from the base of the shoot and the original roots ceased to function. Tixier (31), who studied germination in a range of *Garcinia* spp., recorded that the speed depended on the rapidity with which seeds regained their turgescence; in most species seed maturation began with a period of dehydration and passed to a stage of inanitation. Growth-substance treatment has been used in attempts to enhance germination; in Madras (20) soaking for 24 hours in 2,4-D at 0.0025-0.05 p.p.m. gave 54 per cent germination, soaking in GA at 100, 500 or 1000 p.p.m. gave 52.7 per cent whereas soaking in water alone gave as much as 64 per cent germination. Only 38 per cent of unsoaked seeds germinated. The addition of a water extract of brewers' yeast and a nutrient solution to seeds sown in moss proved beneficial in Puerto Rican trials (12). According to Ochse (G17) seeds may be planted after being cut in portions, but since any damage or an uneven supply of the food reserve is likely to inhibit germination it may be that these "portions" were in fact separate embryos in polyembryonic seed.

The sowing medium should be moisture-retentive but well drained. In Indo-China (11) seed is sown either in bamboo pots filled with a rich leafmould-based soil or in a seed-bed. Germination occurs one to two months later and seedlings are transplanted when four leaves have developed. In central America (2) transplanting is carried out at the two-leaf stage, thus probably avoiding a check to root development. The IPAC station at Azaguié, Ivory Coast, uses the following method (2): polyethylene pots, 18 x 10 cm (7 x 4 in), are filled with a peat-sand mixture and placed in shade; the seeds are sown singly in any position since it has been shown that germination was unaffected if seeds were placed on their sides or upside down; three or four months after the second pair of leaves develops, the seedlings are transferred to 30 x 19 cm- (12 x 7.5 in-) pots filled with equal parts of

soil, peat and sand; under ideal conditions the plant height after a year could reach 30-35 cm (12-14 in).

Most of the reported work on germination in other garcinias has concerned the raising of possible rootstocks. *G. xanthochymus* appears to be an easy subject (17) and, in contrast to mangosteen, most other garcinias possess sturdy root systems. *G. cambogia*, which may be grown in India for its fruit as well as for gamboge dye, germinates well and a high percentage of seedlings survive. Its fruit contains about six seeds which are usually sown in April (G28). Trees start to bear after seven years and have bisexual, fully fertile flowers. In studies on rootstocks in Vietnam (31) the seed viability could be assessed by the colour (a dirty green or beige seed is dead) and the exudation of resin (which only occurs in live seed). *G. mimifreusis* and *G. polycentha* seed, still in the fruit, did not remain viable after a three-week journey from Africa and *G. loureiri* seed showed little or no germination after only one week. *G. benthami* seed could last for about three weeks in transit so long as the fruit remained turgid. In Madras (22) seedlings of *G. morella* and the closely related *Calophyllum inophyllum* were easy to transplant because of their relatively short tap roots whereas the longer roots of *G. tinctoria* were liable to be damaged.

PROPAGATION BY BUDDING AND GRAFTING

Since mangosteen seedlings take so long to come into bearing much attention has been directed towards rootstock selection and propagation techniques. In trials in Madras in the 1940s (20; 21; 23) no success was obtained with shield budding (with the wood removed) on three-year-old stocks of *G. tinctoria* or mangosteen. Similar failures are reported by Ochse (G16) in the East Indies. Resin exudation is one of the main problems in vegetative propagation. Feilden and Garner (G4) suggest the use of patch budding, such as has been used for walnut where the exudates from cut surfaces have hindered union; with this method the two horizontal cuts are made in the stock 6 days before budding.

Many of the wild garcinias appear compatible with mangosteen and some interest has been shown in the related genera *Rheedia*, *Clusia*, *Pentadesma*, *Calophyllum* and *Platonia*. Wester (32) reported successful grafts on the "bunag" (apparently *G. benthami*) in the 1920s and gave a long and

descriptive list of edible garcinias and possible rootstock species. Earlier work in Puerto Rico (26) resulted in successful inarching with about 20 rootstocks, but only *G. tinctoria* (particularly), *G. morella* and *G. livingstonei* were considered promising. The seedling rootstocks were lifted with the soil ball encased in coir and wet cloth, then inarched on twigs of mangosteen scion plants. After union the scion material was gradually detached from the parent through progressive deepening of a cut below the union. *Calophyllum calaba* and *C. inophyllum* made poor unions as their stems were softer and they grew more rapidly than the mangosteen. *Platonia insignis* made good unions and scion rooting often followed; the plants were more vigorous.

In the Malagasy Republic *G. xanthochymus* appears to be the most promising rootstock at present; Moreuil (24) notes that *G. spicata* is also under investigation. In southern Florida, where mangosteen requires a rich soil and protection from cold, approach grafting on *G. tinctoria* seedlings has been used to rejuvenate sickly trees by providing a second, more vigorous root system. An amateur grower in Florida (29) successfully grafted mangosteen on *G. spicata* and *G. tinctoria* seedlings. Growth on *Rheedia aristata* was very slow, but *Clusia rosea* seemed promising; unfortunately no further reports on this work appear to have been published. In successful side-cleft grafting on young mangosteen plants in the Ivory Coast short (4- to 5-cm = 1.5-2 in) scions were used; *Pentadesma butyracea* also showed promise (2). During the 1950s work by Gonzalez and Ancoos (9) showed that of 13 species tested, *G. kydia*, *G. venulosa* and *G. morella* were compatible with mangosteen. Young, 14- to 2-month old seedlings formed a more rapid union with the scion than two- to three-year-old rootstocks. In trials on a range of rootstocks in Madras (20) virtually all grafts failed, due to delayed incompatibility, although unions formed in between 10 and 66 per cent of cases. Resin exudation may also have contributed to the failure. Whip and whip and tongue grafts were used. Naik (G15) comments that side grafting by the Nakamura method on seedling mangosteen is easy but that the plants make little or no growth after planting out in the orchard. Even side grafting *in situ* gave poor results. An early report from the Ceylon Botanic Gardens, quoted by Feilden and Garner (G4) stated that unions formed when mangosteen was inarched on *G. cornea* but the plants did not grow on.

In contrast to mangosteen, *G. dulcis* responds well to budding and grafting and is possibly a better proposition in the Malagasy Republic (16). Magielse (G12) found, in trials in the East Indies, that about 60 per cent of buds united on 30-month-old seedling rootstocks in both wet and dry seasons. A Forkert or modified Forkert method was used, the bud being cut from ripe green wood with the petioles removed. No union occurred on *G. loureiri* or *Calophyllum inophyllum*. Cleft grafts on *G. binucao* remained alive for six months, but failed to grow. Wester stated, in early publications by the Philippines Department of Agriculture (G28), that buds of *G. dulcis* and *G. venulosa* should be inserted when the wood of the stock resembled that of the scion or at most was streaked with grey. He found shield budding, using large buds, was best for *G. dulcis* (G29).

PROPAGATION BY LAYERING

Work on marcottage, or air layering, has been carried out with mangosteen in India (20), the Philippines (9), Ceylon (G11) and, more recently, the Ivory Coast (2) but usually without success. In most cases a callus formed, but roots rarely developed. In India the layered branches rooted, albeit very slowly; the application of cow urine or urea slightly hastened rooting, but when the layers were separated 16-18 months after treatment they failed to survive. However, Macmillan (G11) states that in the 1930s mangosteen was propagated in Ceylon by layering, and Ochse (G16) reported marcottage was successful with *G. dulcis* in the Dutch East Indies.

PROPAGATION BY CUTTINGS

Recent experience in the Ivory Coast (2) has shown that mangosteen cuttings will root well under mist. Current trials there are centred on the after-care and establishment of rooted material. Earlier work by Madras workers (20) with cuttings was unsuccessful despite the use of a range of media and propagation dates.

GROWTH-SUBSTANCE TREATMENTS

Seed soaking in solutions of 2,4-D or GA (mentioned earlier) appeared less effective for enhancing mangosteen germination than merely soaking in water. Brewers' yeast and

vitamin B have also been applied to germinating seeds. With layers, cow urine and urea, both sources of natural growth promoters, were found to encourage rooting; these seem to be the only reports of growth-promoters being used in vegetative propagation.

AFTER-CARE AND SURVIVAL

It is vital to avoid root disturbance at any stage of growth, particularly with young seedling mangosteens. High relative humidity, a moist but well-drained soil and some protection from wind and direct sun are essentials during the first few years. In the Ivory Coast (2) one- to two-year-old trees are planted out at about 10 x 10 m (11 x 11 yards), well-rotted manure or compost being added at 80-100 kg (180-220 lb) to each planting hole. *Pueraria phaseoloides* is used as a covercrop, whereas in Puerto Rico intercropping with pineapple is reported. Irrigation was found to be necessary in the Ivory Coast. In Puerto Rico (33) young trees are given a 1-in- (2.5 cm-) deep mulch of rotted manure annually towards the end of the rainy season. In South India (18) the trees are planted 3 x 3 x 3 feet (about 1 x 1 x 1 m) in pits spaced 30-35 feet (9-11 m) apart and filled earlier with a mixture of leafmould, manure and topsoil. The plants are shaded with coconut leaves for up to 4 years and are watered regularly and mulched during dry weather. A topdressing of 100-200 lb (45-90 kg) of well-rotted manure and 10-15 lb (4.5-7 kg) of groundnut cake is applied annually to each tree. Mangosteen flowering is reported to be advanced by nitrogenous dressings, particularly of nitrates.

No pruning appears to be necessary, apart from the removal of dead or diseased wood.

CONCLUSIONS

It would seem that most attempts at rapid propagation of the mangosteen have proved unrewarding, despite the fairly widespread research devoted to this highly-prized fruit over the past century. The most significant advance is, perhaps, the use of mist propagation for cuttings: both scion and rootstock material could also be raised in this way. Sustained high humidity during and after rooting is essential for mangosteen and some recent developments in mist units and techniques suitable for the tropics (e.g. 35-39) could lead

to renewed interest in the crop. Since its climatic requirements are so precise there is unlikely to be much further spread geographically in its cultivation. Improved fruiting types apparently exist in some plantations, although little or no deliberate selection seems to have been carried out. There is need for research into means of producing better material both as regards the ecological needs of the tree and the yield and quality of its fruit.

BIBLIOGRAPHY

(a) *Garcinias*

1. ALLEN, B.M. *Malayan fruits: an introduction to the cultivated species*. Donald Moore Press Ltd., Singapore, 1967.
2. BOURDEAUF, J. and MOREUIL, C. *Le mangoustanier, ses possibilités de culture en Côte d'Ivoire et à Madagascar*. *Fruits d'Outre Mer*, 1970, 25: 223-45.
3. BROWN, W.H. *Wild food plants of the Philippines*. *Bull. Bur. For. Philipp. Is*, 21 1920 (Cited by Feilden and Garner, 1936).
4. BURBRIDGE, F.W. *The native country of the mangosteen*. *Gdnrs' Chron.*, 1884, 21 (523): 23.
5. CAMPBELL, C.W. *Growing the mangosteen in southern Florida*. *Proc. Fla St. hort. Soc.* 1966, 1967, 79 : 399-401.
6. CORLEY, L.S. *An introduction to the botany of tropical crops*. Longmans, Green, London, 1956.
7. FAIRCHILD, D.G. *The mangosteen*. *J. Hered.*, 1915, 6 : 338-47.
8. FAIRCHILD, D.G. *The world was my garden*. Charles Scribner's Sons, New York, 1938.

9. GONZALEZ, L.G. and ANOOS, Q.A. The growth behavior of mangosteen and its graft-affinity with some relatives. *Philipp. Agric.*, 1951, 35 : 379-95.
10. GREGSON, W. The mangosteen in Burma. *Agric. Surv. Burma*, 23, 1935.
11. HAVARD DUCLOS, B. Le mangoustancier. *Fruits d'Outre Mer*, 1950, 5 : 161-6.
12. HORN, C.L. Stimulation of growth in juvenile mangosteen plants. *J. agric. Res.*, 1940, 61 . 397-400.
13. HORN, C.L. Existence of only one variety of cultivated mangosteen explained by sexually formed "seed". *Science*, 1940, 92 : 237-8.
14. HUME, E.P. Difficulties in mangosteen culture. *Trop. Agriculture, Trin.*, 1947, 24 (1/3); 32-36.
15. HUME, E.P. and COBIN, M. Relation of seed size to germination and early growth of mangosteen. *Proc. Amer. Soc. hort. Sci.* 1946, 1948, 48 : 298-302.
16. INSTITUT FRANCAIS DE RECHERCHES FRUITIÈRES OUTRE-MER (I.F.A.C.). *Rapport Annuel 1963-1964*, Paris, pp. 213.
17. INSTITUT FRANCAIS DE RECHERCHES FRUITIÈRES OUTRE-MER (I.F.A.C.). *Rapport Annuel 1966-1967*, Paris, pp. 204.
18. KRISHNAMURTHI, S. and RAO, N.V.M. Mangosteen deserves wider attention. *Indian Hort.*, 1962, 7 (1) : 3-4, 8.
19. KRISHNAMURTHI, S., RAO, V.N.M. and RAVOOF, A.A. A note on the flowers and floral biology in mangosteen. (*Garcinia mangostana* L.). *S. Indian Hort.*, 1964, 12 (3/4) : 99-101.
20. KRISHNAMURTHI, S. and RAO, V.N.M. *Advances in agricultural sciences and their applications*. Madras Agricultural Journal, Agricultural College and Research Institute, Coimbatore, 1965.

21. MADRAS. *Rep. agric. Stats Madras Pres.* 1942-3, 1944.
22. MADRAS. *Idem* 1943-4, 1945.
23. MADRAS. *Idem* 1944-5, 1947.
24. MOREUIL, C. Notes brèves sur quelques espèces fruitières de la côte est de Madagascar. *Fruits d'Outre Mer*, 1971, 26: 53-65.
25. OBERTI, B. Le mangoustanier au Nicaragua. *I.F.A.C. Document* 25, R.A. 68, 1968.
26. OLIVER, G. W. The seedling inarch and nurse plant methods of propagation. *Bull. U.S. Dep. Agric. Bur. Pl. Ind.* 201, 1911.
27. POPENOE, W. The mangosteen in America. *J. Hered.*, 1928, 19: 537-45.
28. STEPHENS, S. E. Some tropical fruits. 1. The mangosteen. *Qd agric. J.*, 1935, 44: 346-8.
29. THAYER, E. F. Mangosteen. *Amer. hort. Mag.*, 1961, 40: 299.
30. THOMAS, C. A. Kodapuli, little known but pays much. *Indian Fmg*, 1965, 15(5): 33-5.
31. TIXIER, P. Contribution a l'étude des *Garcinia*. *Fruits d'Outre Mer*, 1955, 10: 209-12.
32. WESTER, P. J. Edible *Garcinias* and possible mangosteen stocks. *J. Dep. Agric., Puerto Rico*, 1926, 10: 283-305.
33. WINTERS, H. F. The mangosteen. *Fruit Var. hort. Dig.*, 1953, 8 (4): 57-58.
34. WINTERS, H. F. and RODRIGUEZ-COLON, F. Storage of mangosteen seed. *Proc. Amer. Soc. hort. Sci.*, 1953, 61: 304-6.

(b) *Mist propagation*

35. ASSAF, R. Bouturage sous brouillard. Critique des différentes techniques, résultats et applications d'un nouveau système. *J. Agric. trop. Bot. appl.*, 1965, 12: 23-43, 168-193, 292-318.

36. HANGER, B.F. The propagation of *Coffea arabica* using intermittent mist. *Kenya Coffee*, 1961, 26 : 337-8, 341-3.
37. HARTLEY, R. The application of mist propagation for the vegetative propagation of tea. *Tea*, 1969, 10 (2) : 13,15,17.
38. RADSPINNER, A.L. A plastic greenhouse for mist propagation. *Proc.trop.Reg.Amer.Soc.hort.Sci.* 1967, 1968, 11 : 56-60.
39. RANDHAWA, G.S., CHACKO, E.K. and MENON, M.A. A cheap and simple mist propagation unit for research institutes and nurserymen. *Indian J. Hort.*, 1972, 29 (1) : 51-3.

LANSIUM DOMESTICUM —

LANGSAT

by

MARGARET H. BLACKLER

Commonwealth Bureau of Horticulture and Plantation Crops.

INTRODUCTION

The langsat is frequently seen in the markets of far-eastern cities, and in general appearance is similar to the loquat, except that it is of a dull straw or brownish-yellow colour and the leathery skin is pubescent (G1). The white translucent flesh which separates into five distinct segments like those of an orange is very juicy and has a sub-acid flavour with none of the sickly sweetness characteristic of many tropical fruits (G16). Sometimes there is a hint of turpentine, particularly if the membrane which surrounds the segments is eaten. However, it has been described as "one of the finest fruits of the Malayan Peninsula" and Popence (writing in G1) describes the flavour as "very pleasant and refreshing, scarcely comparable to that of any temperate fruit". The fruit may be eaten fresh or prepared in various ways.

The genus, which belongs in the family Meliaceae, contains six or seven species found in India and Malaya (G30). The name *Lansium* comes from the Malayan name for the langsat, 'lansa' or 'lanseh'. In various parts of the east it is also known as lanzon, lanzone, lansone, duku and ayer-ayer (G1). *L. domesticum* appears to be the only cultivated species, although *L. dubium* also has edible fruits (G2).

It is commonly grown in gardens and is found along roadsides in Malaysia and the Philippines.

ECOLOGY AND GROWTH IN RELATION TO PROPAGATION

Distribution and ecology

Lansium domesticum is native to Malaysia, the Philippines and Java where it is widely distributed. It is not generally cultivated outside this area, although it has also been grown in southern India since it was introduced at the Buriar Fruit Station on the Nilgiris in the late nineteenth century (6; G15). It was introduced to Sri Lanka in 1869 but it does not fruit well there and is grown as an ornamental tree (G11). Early in the present century the langsat and its variety the duku (see below) were planted in southern Florida and the West Indies (G1). However, according to Popenoe (G18) it is not suitable for cultivation in Florida or California, probably because the climate is too cold. It will not grow where there is a prolonged dry season. Although typically a tree of the tropics the langsat thrives under the subtropical conditions of southern India at up to 2500 feet (760m) above sea level although it is smaller and less vigorous than elsewhere.

The tree is usually planted below 2000 feet (600 m). Exposed sites should be avoided as strong winds can cause much damage, particularly when the trees are laden with flowers and fruit. The langsat is unexacting in its manurial and water requirements (6; G16), although it prefers a good loamy well-drained soil (4; G13). Slight shade also favours growth (G13).

When the langsat is to be planted on forest land (4) the forest trees are cut down and are burned as they dry. The stumps are left to decay. The cleared land is planted without first being ploughed and weed growth should be checked with a cover crop. Shade trees may be retained during the early growth of the langsat, and later thinned. Avocado, breadfruit and other economic species are sometimes planted as permanent shade trees and add to the farm income. Temporary shade trees may be planted in the early life of a plantation until the permanent shade trees have become established.

Growth habit and-flower biology

The tree is well described by Ochse (G17). It is medium sized, about 50 feet (15-20 m) high, of

symmetrical growth, with a straight trunk 12-15 inches (30-40 cm) in diameter. The small, yellow, bisexual flowers are borne in abundance in racemes 10-30 cm (4-12 in) long on the trunk or largest branches. Langsat trees bear both seeded and seedless fruits. Emasculation experiments by Bernardo et al. (1), showed that the fruits are formed parthenocarpically. Red ants, *Oecophylla smaragdina*, are often found in great numbers around the racemes. More fruits were set by flowers emasculated and colonized by these ants than from flowers emasculated only or from unemasculated controls. However, the data are insufficient for it to be stated confidently that the ants stimulate fruit setting. The fruit is a berry with five cells each containing one or two ovules (G1). Bernardo's emasculation experiments also showed that seeds develop apomictically. The seeded fruits contained one to three seeds. Usually only one seed developed fully (to 1 cm (0.4 in) or more in width). Remains of aborted embryos are found in segments without seeds and in seedless fruits. Such embryo abortion, these authors suggest, may be caused by genetic factors.

The skin is leathery and does not adhere to the flesh (G1). The fruits are round or oval, one inch (2.5 cm) in diameter and 1½ inches (4 cm) long, with a thin buff-coloured rind which exudes a white latex when broken (G6). They are borne in clusters of 5-30 fruits.

Varieties

Although no cultivars are distinguished as such many different types and races have been described by various authors. Burkill (G2) recognizes two types in the Malay Peninsula. Langsat is the name applied to the wild tree and some cultivated races, whilst "duku" is a group name for improved races with rounded, thicker-skinned fruit free of latex.

In Java a third group of cultivated races, known as "chëlörèng", is recognized, with a thick pericarp having less latex than langsat but more than duku.

In Western Java langsat is known as "kokosan" and chēloréng as "bijitan".

Most authors (e.g. G1, G6) use duku to refer to a cultivated and improved form bearing smaller clusters of two to five fruits. The individual fruits are sweeter and larger (1½ to 2 inches (4-5 cm) in diameter) than those of the langsat. The rind is thicker, with no latex, and splits into five pieces when ripe. Ochse (G16) describes these forms as two varieties. Var. *typica* (dookoo, duku) has thinly pubescent young branchlets and leaf under-surfaces, oblong-ovoid or ellipsoid fruits, a thin pericarp with scanty milky juice, small seeds and a thick smooth aril. Var. *pubescens* (kokosan, langsep, langsat) has densely pubescent parts, sub-globose fruits, a thick pericarp with much milky juice, large seeds and a thin sour aril.

Mendiola (G13) also distinguishes two groups in the Philippines, round and elongate-fruited, the latter being sweeter. It is not possible to state which if either of these two groups in the Philippines is 'langsat' and which is 'duku'. Apart from this broad distinction, Mendiola, on the basis of a survey, describes six tree types which are distinguished chiefly by fruit shape, size and flavour. It is not known whether these reproduce true to type. Indeed, it is considered that large scale vegetative propagation from desirable tree types, if possible, might produce better planting material than is obtained from the general practice in the Philippines and in Malaya of propagating from seed. Ochse (G16) considers that the great differences found in langsat fruits are probably the result of continued sexual propagation.

Diseases and pests

The few diseases and pests mentioned in the literature have been recorded mainly on established trees. Orgas (4) mentions an unnamed root disease which attacks both young and old trees but the older ones succumb more easily and it would therefore appear to be unimportant in relation to propagation

and nursery management. The disease is characterized in the field on aerial parts by leaf yellowing and wilting, followed by defoliation. Below ground the roots rot, become brownish black in parts or may decay completely. A wet white cottony fungal mycelium is found penetrating the wood and in the tissues of the decaying roots.

PROPAGATION BY SEED

Seed propagation is the usual method of reproduction. The thin bitter-tasting green seeds, which measure about 1 x 1.5 cm (0.4 x 0.6 in) are cleaned by washing with fresh water to remove any adhering flesh which would ferment or mould and attract ants (4). The seeds are air-dried before planting. Popenoe (618) states that they should be planted as soon as possible after removal from the fruit. They germinate best in a light loamy soil. The following account of seed propagation is based on that of Orgas (4). The seeds are planted closely in a seed-bed, covered with soil to 1 cm (0.4 in) deep. The seed-beds are situated under partial shade. Germination takes one to three weeks. When the seedlings are six inches (15 cm) tall and have at least two pairs of leaves they are pricked out in nursery beds 40-50 cm (16-20 in) apart and are grown on for 1½ to 2½ years before planting-out in the field. Growth is slow and seedling trees do not come into bearing until 12 to 20 years from the time of planting.

Raktakanishta (5), studying the soil requirements of young langsat plants, grew six-month-old seedlings in six soil media, viz. clay loam and river sand in various proportions and a compost of well-decayed and sieved soybean vines. The potted seedlings were kept in the nursery for a month and then transferred outside in diffused sunlight in the shade of bamboo. The seedlings grown in compost appeared healthiest. They also grew fastest, but not significantly so.

Besides the disadvantage of slow growth, propagation by seed has led to great variation in fruit and tree characteristics.

Mendiola (G13) suggests that breeding and selection should be practised for such desirable characteristics as sweet fruit, elimination of the milky juice in the rind and the bitter taste of the covering of the seed, and improved yields, and that a search should be undertaken for and selections made of seedless varieties or bud mutations. With regard to the last mentioned, some trees bear mostly seedless fruits (< 77%). "It is not impossible", states Mendiola, "that some branches of these trees are bud sports as to seedlessness". Propagation by vegetative means from such sports could be used to produce a seedless variety whose fruits would have greater appeal to the consumer. However, if seedlessness results from parthenocarpy, propagation from such material might well give trees with seeded fruits. Regarding attempts to breed for seedlessness Bernardo et al. (1) conclude from their experiments on apomixis that "the finding on the development of lanzone seeds without fertilization or stimulation as caused by pollination indicates that the possibility of breeding for seedless varieties is nil".

PROPAGATION BY BUDDING AND GRAFTING

Rootstocks

The most suitable rootstocks would appear to be seedlings of the same species about four years old for budding (G4) and two to three years old (3) for cleft grafting. In Java seedling rootstocks are produced by planting five or six seeds in a basket of richly manured soil which is kept under a palm leaf shelter. In a year those which germinate will be one foot (30 cm) high. They are planted-out in heavily shaded nursery beds which are mulched with straw and in the dry season are watered twice daily.

Ochse (G16) reports that duku budded with duku resulted in slow bud growth at first, but in the second year the growth of these budded trees was faster than that of seedlings, and shoots from buds grafted onto strongly growing rootstocks could reach a height of 40-50 cm (16-20 in) in one year. Budding duku on

Lansium domesticum var. *pubescens* (the kokosan) gave only 16 per cent success, and on *Sandoricum koetjape*, *Aglaia rufa* var. *celebica*, *Carapa guianensis* and *Dysoxylum macrothyrsum* all buds failed (G4).

Mendiola (G13) reports trials on grafting langsung onto *Sandoricum koetjape* seedlings. These seedlings may be grown in abundance very easily, in contrast to the difficult and slow-growing langsung, but again, in two attempts, this stock/scion combination was unsuccessful. although Mendiola regards it as not impossible. The high temperatures in the hot season when the work was done may have contributed to the failure of the scion to take.

Ochse (G17) says that of the two varieties he describes, *L. domesticum* var. *typica* can be budded onto rootstocks of the same variety although they grow slowly until the second year. *L. domesticum* var. *pubescens* can be used as a rootstock for var. *typica* but gives poor results.

Budding methods

In Java Magielse applied non-petioled mature one-year-old budwood during the rainy season, using the modified Forkert method (G4; G12). This gave 60 per cent success. The bark is very thin and tears easily and the buds must be inserted immediately they are cut or they will dry out rapidly.

In the Philippines Gonzalez (3) had little success with shield budding.

Grafting methods

Cleft grafting and side grafting, particularly the former, were successful in the Philippines (28), although Ochse had little success with these methods in Java (G16). The scions should be of matured but not old wood, 2-2½ inches (5-6cm) long and about 1/3 inch (1 cm) in diameter. They should be inserted in the stocks 2½-4 inches (6-10 cm) above the ground and the wounds

covered with grafting wax.

Orgas (1) considers cleft grafting to be the best method of propagation. He recommends terminal well matured non-petioled scions of the same age as the rootstocks. Each scion should contain at least three or four buds. The freshly cut scions are usually kept for about a month in sandy seed-beds until the buds have protruded about 4-6 mm (0.2 in). The scions can then be inserted. Grafting should be done during the wet season. The rootstock should be equal to or slightly larger in diameter than the scion. Grafted plants begin to bear in seven years from planting in the permanent field.

de la Cruz and Gonzalez (2) carried out trials on cleft-grafting one- and two-year-old *Lansium* seedlings using defoliated, leafy and hormone-treated leafy scions inserted about 15 cm (6 in) above ground. Three months after grafting the average take of all scions on one-year-old rootstocks was 18.9 per cent and on two-year-old rootstocks 20.6 per cent. Scions defoliated one month before grafting did no better than leafy scions, whilst treating the scions with 1000 p.p.m. IAA was detrimental. Banana petiole was a more practical material than sawdust or a test tube for covering the grafts.

Top working

Bark grafting (rind grafting) on five- to ten-year-old seedlings in the Philippines gave little success (3).

PROPAGATION BY LAYERING OR MARCOTTING

According to Ochse (G16) marcots produce roots but it is difficult to keep the rooted marcots alive afterwards. However, Chandler (G3) states that trees can be propagated by marcotting, and Orgas (4) gives the details of the operation. Branches of 1½-2 inches (4-5 cm) diameter are ringed and soil is applied, wrapped in "cabo negro" fibre (*Arenga saccharifera*) or

coconut husk tied in place with fine wire. The marcotted branch is watered as necessary and rooting takes place in about two months. Nowadays plastic sheeting would be used to wrap the marcots and so obviate the need for regular watering. The marcots are severed from the parent plant in five to six months when the secondary roots have penetrated the wrappings. Not too many branches must be marcotted on a single tree and therefore the method is of limited commercial value.

The best time for marcotting is at the start of the rainy season. Some marcotted plants come into bearing in the second year.

PROPAGATION BY CUTTINGS

Work carried out in 1925 in the Philippines (3) indicated that the propagation of langsat from stem cuttings was not practical, but Orgas (4) reports that a success rate of 50 per cent and over is possible under ideal conditions although the method can be recommended only to experienced nurserymen.

Beds 25 cm (10 in) deep are prepared under the shade of trees by digging out much of the soil and replacing it with medium coarse sand which is levelled and packed firmly. Fairly well-matured wood should be used for cuttings. The shoots should be trimmed off close to the stem with pruning shears and both ends cut slantingly with a sharp knife, taking care not to bruise the wood. The cuttings are placed in 1000 ml porcelain jars and 200 ml of a 1.5 to 2% potassium permanganate solution is poured in until about 2 cm ($\frac{1}{2}$ in) of the basal ends of the cuttings are immersed. After about 24 hours of immersion the cuttings are set in the beds to about two-thirds of their length in a slanting position. The cuttings may be transplanted to nursery beds when the root system is well established in about a further four months.

PLANTING IN THE FIELD AND AFTER-CARE

The vegetatively propagated plants or two- to three-

year-old seedlings are set in the field at at least 7 x 7 m (23 x 23 ft). They should not be planted deeper in the field than they were in the nursery. Ring weeding and shallow hoeing around the young plants to a radius of at least 1 m (39 in) should be done at least twice a year and the plants should be mulched during the dry season.

BIBLIOGRAPHY

1. BERNARDO, F.A., JESENA, C.C., Jr. and RAMIREZ, D.A. Parthenocarpy and apomixis in *Lansium domesticum* Correa. *Philipp. Agric.*, 1961, 44 : 415-21.
2. CRUZ, S.T. DE LA and GONZALEZ, L.G. Cleft-grafting lanzones, *Lansium domesticum*. *Philipp. Agric.*, 1953, 37 : 295-300.
3. GONZALEZ, L.G. Outstanding results of agronomic and horticultural research. *Philipp. Agric.*, 1934, 23 : 380-99.
4. ORGAS, A.M. The lanzon (*Lansium domesticum*, Jack). *Philipp. J. Agric.*, 1937, 8 : 77-88.
5. RAKTAKANISHTA, X. The influence of different soil media on the rate of growth of certain kinds of fruit plants. *Philipp. Agric.*, 1940, 28 : 681-91.
6. RAO, I.K.S. The langsat - a new fruit for the humid zones in South India. *S. Indian Hort.*, 1958, 6 : 119-20.

MALPIGHIA GLABRA —

BARBADOS CHERRY

by

G. K. ARGLES

Formerly of the Commonwealth Bureau of Horticulture
and Plantation Crops

INTRODUCTION

Malpighia is the only genus in the Malpighiaceae that includes trees or shrubs bearing edible fruits, and of these only the Barbados cherry deserves serious attention. This species was named *M. glabra* by Linnaeus in 1753, but a few years later, in 1762, he applied the name *M. puniceifolia* to a very similar or identical species. Since then both names have been in common use, and indeed the Royal Horticultural Society's *Dictionary of Gardening* (G20) still lists them separately, describing *M. glabra* as a small tree up to 16 feet (5 m) tall, and *M. puniceifolia* (syn. *M. biflora*) as a shrub only eight feet (2.4 m) tall. Most authorities (G14; G19; G25; 8; 13) agree, however, though not without some reservations, that only one species is involved and that the older name, *M. glabra*, should therefore be applied to it, but Moscoso (9) in Puerto Rico gives reasons for preferring the name *M. puniceifolia* and adds that some botanists have suggested that the Barbados cherry as cultivated may in fact be a hybrid between the two species.

The common names in use are also apt to cause confusion. The name Barbados cherry was used as long ago as 1696 (8), but West Indian cherry and its French equivalent "cerise des Antilles" are in equally common use, and in Puerto Rico, where the fruit has been developed commercially it is known as the acerola. The names Jamaican cherry and Puerto Rican cherry are also found occasionally.

Several other malpighias are apt to be mistaken for the Barbados cherry, as is sometimes the unrelated Surinam cherry, *Eugenia uniflora*. Most of these malpighias, though of value as ornamental shrubs, bear small, inedible fruits, but one species, *M. mexicana* (*M. edulis*), bears large, edible fruits and, to add to the confusion, is known in Costa Rica as the acerola (8). It also seems probable that some natural hybridization takes place between *M. glabra* and a wild species *M. suberosa* that is very common in Cuba (G25).

As its common names suggest, *M. glabra* is a native of the West Indies and of Central and northern South America (G19; 9). At various times it was introduced into other regions, such as Florida, India and the Philippines, but interest in it as a fruit remained negligible for many years. Indeed, Popenoe in his encyclopaedic book on tropical and subtropical fruits (G18) does not mention it at all, and the same can be said of some much more recent books on fruits grown in India (G15; G24).

This lack of interest persisted until as recently as 1945, when it was discovered that the edible portion of the fruit had a substantially higher vitamin C content than the edible parts of all other food plants so far investigated. Only the hips of *Rosa rugosa* are listed by Ledin (8) as containing more ascorbic acid. This led to a flurry of interest, notably in Puerto Rico and Florida, in the selection of superior clones, in means of propagating them vegetatively and in the management of trees established in commercial orchards.

ECOLOGY AND GROWTH IN RELATION TO PROPAGATION

Distribution and ecology

The interest aroused by the discovery of its high vitamin C content was soon followed by a spate of general review articles on the Barbados cherry (2;8;9;13;15), but, although these contain much interesting information, they tend to be rather imprecise when dealing with the ecological needs of the species.

It would seem that the Barbados cherry will tolerate a fairly wide range of climatic conditions, so long as it is not subjected to long periods of cool weather. The plants are tender when young but may survive slight frost without injury once their growth has become woody (G25). They are relatively drought-resistant, but require rain or irrigation during periods of fruit development, and heavy mulching is also regarded as beneficial. In Puerto Rico the Barbados cherry succeeds better near to sea level than at higher elevations, notably where there is a well distributed annual rainfall of about 70 inches (1780 mm).

Trees have been grown successfully on various soils ranging from acid sands to heavy clays, provided that these are never subject to waterlogging for more than a few days. They have, however, shown themselves sensitive to deficiencies of various nutrients, including nitrogen, potassium, calcium and several trace elements.

In terms of propagation these findings suggest that it would be worth paying particular attention to the following points:

(1) Ensuring that plants used as sources of cuttings, graftwood, etc. are not allowed to suffer from nutrient deficiencies.

(2) Providing a propagation environment that is consistently warm and moist but never excessively wet.

Growth

In form the Barbados cherry is a low-branching, spreading shrub rather than a tree, which under favourable conditions reaches a height of 10 to 16 feet (3 to 5 m). Clones vary considerably in their habit of growth, some being very dense and compact and others more upright and open. Both types need pruning, either to thin out branches or to eliminate long straggly growths as the case may be.

New leaves and shoots are covered with hairs, which are apt to cause skin irritation, but the leaves become glabrous as they mature. Leaves and branches

are of two types, namely terminal shoots 6-12 inches (15-30 cm) long with long internodes and relatively large leaves, and short lateral twigs with very short internodes and much smaller leaves. The latter develop from the lower axils on the terminal shoots as well as on older wood.

Young plants form well branched root systems, which make them easy to transplant and establish in the field, but subsequently deep penetrating roots are formed which contribute to the trees' drought resistance (9).

Flowers appear throughout the summer in Florida, but the main flowering period is April-May, coinciding with new vegetative growth. Fruits mature in as little as three to five weeks after flowering, and four or five and sometimes more crops may be borne in a year. The fruits have three and occasionally more "stones", each of which contains one seed.

Some of these growth and fruiting characteristics suggest several interesting possibilities with respect to propagation performance, and these will be mentioned below in the appropriate sections.

Varieties

The fruit of seedling Barbados cherries varies considerably in size, colour and flavour, but that of most seedling trees is too sour to be eaten fresh, which explains its lack of popularity up to 1945. After 1945 energetic steps were taken in Puerto Rico and Florida to select varieties with high ascorbic acid contents and other desirable characteristics including acceptable flavour. Two of these varieties, the Puerto Rican clone B-17 and the clone Florida Sweet, which has an agreeable apple-like flavour as well as a high vitamin C content, were described by Ledin in 1958 (8). Subsequently in Puerto Rico several other clones, with B-15 outstanding, were found to surpass B-17 in both yield and ascorbic acid content (13).

Ledin (8) and Stahl et al. (15), among others, mention the characteristics to be looked for in the selection of superior seedlings, and it is interesting to note that among those they list are ease of vegetative propagation, especially from cuttings.

Diseases and pests

The Barbados cherry suffers to some extent from attacks by various pests and diseases, but only one of these, the common root-knot nematode, *Meloidogyne incognita* var. *acrita*, causes serious damage, especially in Florida. Attempts to control this pest have included the use of resistant *Malpighia* species as rootstocks, but, as is discussed in more detail below in the section on grafting, the results so far obtained have not been satisfactory (8; 13; 15).

PROPAGATION BY SEED

Barbados cherries can be easily raised from seed, but the use of unselected seeds may result in seedlings with undesirable characteristics (9). For this reason the Agricultural Experiment Station in Río Piedras, Puerto Rico, undertook to supply seeds from selected trees, especially for people overseas who might experience difficulty in importing plants or propagating material. These seeds, shipped by parcel post or air freight, met with a brisk demand, at least in the earlier stages.

In Puerto Rico Moscoso (9) advocates sowing seeds in a seed-bed or in rows about one foot (30 cm) apart. The seeds should be placed about two inches (5 cm) apart and covered to a depth of one-quarter inch (6 mm). Partial shade is desirable and the seeds should be watered regularly. When the seedlings are three inches (7.5 cm) tall, they may be potted-up in containers or planted one foot (30 cm) apart in nursery rows spaced two feet (60 cm) apart. They should be transplanted without difficulty to their permanent sites when between six and twelve months old. Soto (14) mentions that the seed takes three to six weeks to germinate in Puerto Rico.

In Florida, where a similar procedure is followed, Ledin (8) makes the additional point that there is no need to remove the stone before planting the seed; in fact attempts to remove the stone are apt to result in damage to the seed. All that is necessary is to clean the stones of all flesh and allow them to dry before planting. Dusting with a seed protectant may help to prevent damping-off of young seedlings.

Even under favourable conditions, however, the germination percentage may often be below 50, owing to the fact that many of the seeds contain non-viable embryos. This may well help to explain poor germination reported by Muthuswamy et al. (10) to have been obtained at Coimbatore in India. What is not known, however, is whether the viability of seeds of a particular clone may vary during the year in relation to such factors as intensity of cropping or season.

PROPAGATION BY GRAFTING

Grafting techniques

Various grafting and budding techniques have been used successfully to propagate Barbados cherry clones, but owing to excellent results obtained with cuttings none of them appears to be practised on an extensive commercial scale.

As long ago as 1920 Wester (G28) reported that in the Philippines the Barbados cherry could be shield budded onto seedlings of the same species. The budwood used was light grey to greenish, mature and with petioles intact.

Ledin (8) mentions that both side-veneer grafting and cleft grafting have proved successful in Florida, while Lazo (7) gives a brief account of a modified type of side graft that resulted in takes of 90 per cent or more in Cuba. The graftwood used in this case was mature and the grafts were kept wrapped in plastic until growth started. Additional protection was provided by keeping the plants in a cool, shaded place.

The only trial reported in which different methods of grafting were compared was one carried out in Venezuela by Holmquist (6). The rootstocks consisted of ten- to twelve-month-old seedlings that had been growing in one-gallon cans during the previous seven or eight months. Four different types of graft were made in May, each on 25 rootstocks, and all the grafts were wrapped in vinyl plastic tape. The best results were obtained with side grafting (88 per cent) and veneer grafting (80 per cent), while with shield budding the take was 64 per cent and with chip budding only 8 per cent.

Rootstocks

In the account of grafting techniques outlined above it

would appear that the rootstocks used in each case were seedlings of the Barbados cherry. Various other *Malpighia* species have, however, been tested as rootstocks with the particular aim of providing a root system that is resistant to the root-knot nematode *Meloidogyne incognita* var. *acrita*.

The first such trials were described briefly by Sturrock (16) from Cuba as long ago as 1939. They arose from the discovery that roots emerging from pots containing Barbados cherry seedlings, referred to as *M. pun(i)cifolia*, became infested with nematodes, whereas roots emerging from pots containing a smaller species, described, perhaps incorrectly, as *M. glabra*, remained uninfested. When the former was grafted onto the latter, a perfect union was formed, but growth was slow and the resultant trees were dwarfed. Moreover the "glabra" rootstocks showed an undesirable tendency to produce suckers from runner-like roots.

Subsequently three other *Malpighia* species were tested as rootstocks for the Barbados cherry. The most promising of these was *M. suberosa*, which during the first two years after grafting promoted satisfactory growth and showed no sign of nematode attack in an infested soil. A second species, *M. urens*, also appeared to be compatible with Barbados cherry scions but showed some susceptibility to nematodes. The third species, *M. cubensis*, appeared to be immune to nematode attack but had not been tested as a rootstock when the article describing the trials was written.

Unfortunately the early promise of *M. suberosa* was not maintained. Plants grafted onto seedlings of this species in Florida either died or remained stunted and gave very small crops (8; 15). Interest was therefore switched to the possibility of finding suitable rootstocks among seedlings that appear to be hybrids between the Barbados cherry and *M. suberosa* (G25). The outcome of this search is not known.

PROPAGATION BY LAYERING

Air layering

Air layering has been used to raise selected Barbados cherries, notably in Florida and Puerto Rico, although the method has been largely superseded by cuttings in recent years (8; 9; 14).

According to Ledin (8) air layering is best done in the spring and summer while the bushes are growing. It is accomplished in the usual way by ringing the stem and covering the ringed portion with damp sphagnum moss enclosed in a sheet of vinyl plastic film. Rooting should occur in four to six weeks, after which the layer can be severed and potted-up. Soto (14) from Puerto Rico notes that the layers take two or three months to root.

At Coimbatore in India Muthuswamy et al. (10) carried out a small trial in mid-November with air layers in which treatment with IBA as Seradix B was compared with no hormone treatment. A one-inch (2.5 cm) ring of bark was removed from shoots of pencil thickness, and in the treated layers the rings were then wetted and Seradix B powder was applied thickly to the upper edge of the ring. The layers were covered with damp moss and enclosed in 150-gauge polyethylene film. Out of ten layers made in each case six of those treated with IBA rooted and were ready for separation 65 to 75 days after layering, but none of the untreated layers rooted. The plants raised from these layers flowered after 10 months compared with 20 months taken by seedlings.

In another trial at Coimbatore (4) the use of black polyethylene to wrap the sphagnum moss medium resulted in 80 per cent rooting and 80 per cent survival of the separated layers, compared with 50 per cent and 40 per cent, respectively, for white polyethylene.

Ground layering and stooling

In spite of the low branching habit of many trees, only one trial has come to light on the ground layering of Barbados cherries, and this is also from Coimbatore (3). One-year-old shoots were tongue layered at weekly intervals during August-September before flowering; after three months 60-85 per cent rooting was achieved.

No report has been seen on stooling.

PROPAGATION BY CUTTINGS

As long ago as 1927 Bailey (61) mentioned, though without giving details, that the Barbados cherry could be raised from cuttings, but little or no attempt seems to have been made to explore the possibility of producing plants from

cuttings on an appreciable scale until 1949, when Ochse and Reark (12) included "*Malpighia*" among cuttings of various species tested in Florida under constant mist in the open. The fact that this trial was a total failure in so far as *Malpighia* was concerned clearly did not daunt other workers, because in 1956 Moscoso (9) was able to write that "air layering and grafting as methods of propagation for West Indian cherries are losing in popularity due to the ease and success of cuttings", and two years later Ledin (8) reinforced this by stating categorically that "the most desirable method of propagating the Barbados cherry in large quantities is by cuttings". This is also the method recommended for commercial use in Puerto Rico (14).

Clonal differences in rooting ability

Several authorities (8; 11; 15) emphasize that cuttings from different Barbados cherry seedlings show considerable variation in their rooting ability. While many root readily without hormone treatment, others need such treatment to root satisfactorily.

Ease of rooting by cuttings is one of the characteristics that is looked for in the selection of superior varieties. Presumably therefore the numbered and named clones so far selected are all relatively free-rooting. No information has been encountered, however, to show whether they differ appreciably from one another in this respect.

Stock plants and their management

No evidence has been encountered which suggests that the condition of stock plants or their management is apt to influence the performance of their cuttings, but two points might be worth bearing in mind.

The first relates to the precocious fruiting habit of the Barbados cherry. Muthuswamy et al. (10) mention, for example, that at Coimbatore in India seedling trees started flowering 20 months after they had been planted out, while trees raised from air-layers took only ten months to reach this stage. This means in practice that a substantial supply of shoots suitable for cuttings will only become available after trees have come into bearing. By analogy with other plants, it might be possible to obtain quicker and better rooting if plants could be maintained in a juvenile, non-fruiting condition. This might be feasible as closely planted Barbados cherries can be trimmed occasionally to form a hedge (8).

The second point concerns the well established responsiveness of the Barbados cherry to fertilizer applications and its sensitivity to various nutrient deficiencies. Most studies on nutrients have naturally been concerned primarily with their effects on fruit yields and composition, but there is clear evidence from other plants that deficiencies of various nutrients, such as potassium and calcium, can have an adverse effect on the rooting of cuttings taken from them. Similar effects may be found to occur in the Barbados cherry.

Types of cutting and times to take them

Published information on these points though precise in some respects is imprecise in others.

Ledin (8) advocates selecting leafy hardwood cuttings from healthy branches, the individual cuttings being five to ten inches (12.5-25 cm) long and $\frac{1}{4}$ to $\frac{1}{2}$ inch (6-13 mm) in diameter with only two or three leaves left intact on the upper portion of the stem. Moscoso (9) suggests using cuttings eight to ten inches (20-25 cm) long taken from healthy branches about half an inch (13 mm) in diameter, and he also recommends leaving two or three leaves on the upper portion of the cutting.

In successful rooting trials under intermittent mist Nelson and Goldweber (11) in Florida and Abrams and Jackson (1) in Puerto Rico used terminal hardwood cuttings and left as many leaves as possible intact. The Puerto Rican cuttings were trimmed to 8-inch (20-cm) lengths and the Florida cuttings to lengths of five to eight inches (12.5-20 cm). The latter were also divided into two groups with diameters of $\frac{1}{4}$ to $\frac{1}{2}$ inch (6 to 16 mm) and $\frac{1}{8}$ to $\frac{1}{4}$ inch (3 to 6 mm), respectively. The thicker cuttings gave better results in terms of percentage rooting and average number and length of roots per cutting than the thinner cuttings, and Nelson and Goldweber conclude that cuttings should not be less than $\frac{1}{4}$ inch (6 mm) in diameter.

In other trials under intermittent mist at Coimbatore (5) leafy cuttings of the past season's growth gave much better rooting and survival than leafless ones.

The lack of precision arises from the use of the terms hardwood and terminal. Thus, Ledin (8) presents a photograph of "leafy hardwood cuttings prepared for rooting", which

appear to be the basal parts of slim terminal shoots, because each cutting is carrying side shoots. Some of the latter have been shortened, but their numerous leaves are intact in contrast to the recommendation made in the accompanying text that all but two or three of the upper leaves should be removed. It is also not clear whether these shoots would best be described as terminal or sub-terminal and as hardwood or semi-hardwood, that is whether they represent the previous or the current seasons' growth. Similarly, the "hardwood terminal" cuttings tested by Abrams and Jackson (1) were taken in mid-May, and again it is not clear if they consisted of shoots formed in the current or the preceding season.

As to the most favourable period in which to strike cuttings Stahl et al. (15) state that in Florida the warmer months, March to October, give the best rooting results with cuttings. The probable implication here is that the higher temperatures of summer are more favourable to rooting than the lower temperatures of other seasons, but it could also imply that the shoots available during the summer possess a higher rooting ability than those available at other seasons.

It would be helpful if steps could be taken to clarify these points. It would also be interesting to discover whether softwood cuttings had been tried under mist, and if so how they performed.

Treatment of cuttings

Wounding: Deliberate wounding by removing slices of stem does not appear to have been tried as an aid to promoting rooting. On the other hand, inadvertent wounding, such as the crushing caused by secateurs, is said by Nelson and Goldweber (11) to encourage rooting, and they advocate trimming the basal ends of cuttings with a knife. The cuttings illustrated photographically by Ledin (8) also show bases trimmed with a knife, each cut slanting steeply and being well below a node.

Growth substance treatment: The value of treating Barbados cherry cuttings, especially those of shy-rooting clones, with IBA and IAA was first mentioned by Stahl et al. (15) in 1955. Of various concentrations tested 2500 p.p.m. as a 30-second dip generally proved the best, IBA being more effective than IAA, but they added that they had seen one report which suggested that a concentration of IBA of 10,000 p.p.m. was satisfactory. Treatment with hormone powders also produced a response, IBA again being better than IAA. To

prepare a suitable powder Moscoso (9) suggests mixing 10 mg IBA with 100 g of talc, which gives a concentration of 0.01 per cent.

Subsequently in a trial in Florida, Nelson and Goldweber (11) compared IBA concentrations of 2.5, 5.0 and 10.0 mg per ml of alcoholic solution (i.e. 2500, 5000 and 10,000 p.p.m.) as five-second dips for cuttings of seven clones. Results for individual clones are not given, but data for three clones considered collectively showed that the 2.5-mg concentration (66-88 per cent rooted, depending on the diameter of the cuttings), almost trebled the percentage of cuttings rooted as compared with the untreated controls (24-30 per cent rooted). The 5-mg concentration gave almost as good results (67-84 per cent rooted) as the 2.5-mg concentration in terms of percentage of cuttings rooted and considerably better results in terms of average number and total average length of roots per cutting. The percentage of cuttings rooted following the 10-mg dip was somewhat lower (38-71 per cent), and there were indications that some of the cuttings, particularly those with small diameters, were injured by this concentration. Nelson and Goldweber concluded that concentrations of up to 5 mg/ml can safely be used in quick-dip treatments and will enhance rooting in most clones. The optimum concentration may, however, vary with the clone and in some cases may prove to be as high as 10 mg/ml. The recommendation to use five-second dips of IBA at 5 mg/ml was subsequently repeated in Ledin's review (8). He also follows Nelson and Goldweber in advocating that the bases of the cuttings should be immersed to a depth of two inches (5 cm) (although recent experience with cuttings of some other plants suggests that shallower dipping might be preferable).

Doraipandian et al. (5) in India compared Seradix B1 (IBA dust) with a 30-second dip in IBA 5000 p.p.m. solution for leafy and leafless cuttings under mist. The best percentage rooting (85 per cent), number of roots per cutting and survival were obtained with Seradix B1 on leafy cuttings, but the dip treatment gave much better results than the untreated controls and produced the longest roots.

Abrams and Jackson (1) in Puerto Rico compared IBA and NAA in powder form with no hormone treatment on cuttings of the clone B-15. The concentration of the hormone powders used is not stated. As many leaves as possible were left on the cuttings which were inserted in sand under intermittent

mist. The average percentages of cuttings rooted after six, eight and ten weeks were approximately 36, 62 and 63, and Abrams and Jackson conclude from this that eight weeks was the most suitable period during which to leave cuttings in rooting beds. At this 8-week stage the percentages of cuttings rooted were 68.5 with IBA, 62 with NAA, and 55.8 without hormone, and the mean numbers of roots per cutting were 4.4, 3.3 and 2.5 respectively. Ledin (8) and Moscoso (9) also mention that roots are usually formed in two months.

There thus seems little doubt that Barbados cherry cuttings will generally respond favourably to growth substance treatment and that IBA will probably give somewhat better results than IAA or NAA. They will not, however, ensure success if other factors are unsatisfactory as was found at Coimbatore in India, where cuttings planted in the open and under shade failed to root despite treatment with (unspecified) growth substances (10).

Fungicide treatment: No information has been found on treating the bases of cuttings with fungicides, but in so far as rotting has sometimes occurred (11; 12) they might be worth a trial, especially when the rooting environment is very moist or the cuttings rather soft.

Rooting media

Numerous rooting media appear to have given satisfactory results with Barbados cherry cuttings, but detailed comparative trials have not been made. Ledin (8) in Florida lists the following as suitable:- vermiculite, peat moss and sand or mixtures of these three materials, wood shavings, crushed granite (chicken grit), zeolite (a water-softening by-product) and pearl-lite (?perlite). Moscoso (9) in Puerto Rico also advocates using mixtures of sand or vermiculite with peat moss or a mixture consisting of equal parts of sterilized soil and sand or vermiculite.

Both these authorities emphasize that the medium must be porous to allow good aeration and drainage. In this respect chicken grit is admirable, but its sharpness is apt to injure the roots when cuttings are removed for potting (11).

There may be some doubt too concerning the suitability of zeolite under some conditions. Nelson and Goldweber (11) used it in their successful trial in which intermittent mist was provided. In an earlier trial, however, Ochse and Reark (12) did not succeed in rooting "*Malpighia*" cuttings under

continuous mist in the open in either coconut fibre or zeolite. The coconut fibre may have been too wet and soggy under these conditions, and the zeolite, consisting of sand particles coated with calcium carbonate to form spheres 0.5 to 5 mm in diameter, had a pH of 8.5, which is well above the level at which cuttings of many plants root satisfactorily.

Rooting environment

Given a well aerated free-draining rooting medium there seems little doubt that Barbados cherry cuttings benefit from a high moisture regime such as that provided by continuous or intermittent mist (8; 9). Continuous mist was used in the trials of Ochse and Reark (12), in which the malpighia cuttings failed to root, but there is no evidence that overwatering may have contributed to this except perhaps where coconut fibre was used as the medium. In the trials of Nelson and Goldweber (11) mist was provided for 24 seconds each minute, and in the experiment described by Abrams and Jackson (1) for five seconds each minute during the hours of daylight. In successful Indian trials (5) mist was applied for 1.5 minutes at intervals of 4.5 minutes during the day. What is rather surprising in all these trials is the use of relatively mature "hardwood" cuttings, because a major advantage of mist with many other plants is that it aids the survival of relatively soft shoots that may possess a higher rooting capacity than more mature material.

With regard to temperature requirements no information is available apart from the remark by Stahl et al. (15) that better results are achieved in Florida in the warmer months than at other seasons. Bottom heat does not appear to have been tried. It does seem possible, however, that direct sunlight, and the high temperatures that may be associated with it may sometimes be detrimental. The unsuccessful trial of Ochse and Reark (12) was carried out in full sunlight in the open, whereas in the successful trials of Nelson and Goldweber (11) and of Abrams and Jackson (1) the cuttings received 50 per cent and 80 per cent of full sunlight, respectively. In his recommendations for rooting cuttings in Florida Ledin (8) advocates the use of shade.

TRANSPLANTING YOUNG BARBADOS CHERRY TREES

In both Florida (8) and Puerto Rico (9; 14) plants raised from seed, cuttings or air layers develop good root

systems in containers and are ready for planting out in the field when six to twelve months old. Planting can be done at any time of the year, but the best results are obtained just before the rainy season.

CONCLUSIONS AND SUGGESTIONS

From being a neglected and even despised Cinderella among the minor tropical fruits the Barbados cherry suddenly became a fruit of considerable importance and interest when it was discovered in 1945 to possess an exceptionally high vitamin C content. To exploit this discovery commercially it was essential to select varieties with superior characteristics and to find efficient ways of propagating these clones vegetatively. Fortunately it has proved easy to raise plants by grafting, air layering and especially by cuttings.

Propagation by several methods of grafting and budding has proved feasible. However, this method is only likely to become of importance if present investigations lead to the discovery of a fully compatible rootstock that is resistant to nematodes and does not dwarf the scion varieties, which are already of a conveniently small size. It is conceivable that if satisfactory rootstocks are discovered they too may have to be raised vegetatively.

Air layering has proved a successful method of propagation, but its use is declining in favour of cuttings. Ground layering has proved reasonably satisfactory in a single trial. Stooling does not appear to have been tried but might be worth investigation.

Propagation by cuttings under mist is now the generally recommended procedure, and there is good reason to believe that, as existing gaps in knowledge are filled, this method of raising plants will become progressively easier and more economical.

BIBLIOGRAPHY

1. ABRAMS, R. and JACKSON, G. C. Influence of root-inducing substances and time intervals on the rooting of acerola cuttings. *J. Agric. Univ. P.R.*, 1959, 43: 152-8.
2. AHMED, S. Barbados or West Indian cherry. *Punjab Fruit J.*, 1959, 22 (79): 15-16.
3. ALAGIAMANAVALAN, R. S., SHANMUGAVELU, K. G. and SUNDARARAJ, J. S. A note on the simple layering of West Indian cherry (*Malpighia puniceifolia* L.). *S. Indian Hort.*, 1969, 17: 86-7.
4. DORAIPANDIAN, A. and GOWDER, R. B. A note on the performance and propagation of West Indian cherry (*Malpighia puniceifolia* L.). *S. Indian Hort.*, 1972, 20: 76-7.
5. DORAIPANDIAN, A., VIJAYAKUMAR, M. and MUTHUSWAMY, S. Propagation of West Indian cherry (*Malpighia puniceifolia*) by rooting of stem cutting under mist. *S. Indian Hort.*, 1973, 21: 30-2.
6. HOLMQUIST, J. de D. Ensayo comparativo de injertación del semeruco o acerola (*Malpighia glabra* L.). *Proc. Carib. Reg. Amer. Soc. hort. Sci.*, 1966, 1967, 10: 46-56.
7. LAZO RODRIGUEZ, F. La multiplicación de diversas especies de frutas tropicales. *Proc. 5th annu. Mtg Carib. Reg. Amer. Soc. hort. Sci.* 1957, 1958, pp.6-11.
8. LEDIN, R. B. The Barbados or West Indian cherry. *Bull. Fla agric. Exp. Stats* 594, 1958, pp.28.
9. MOSCOSO, C. G. West Indian cherry - richest known source of vitamin C. *Econ. Bot.*, 1956, 10: 280-94.
10. MUTHUSWAMY, S. and RAMU, N. A note on air-layering in West Indian cherry (*Malpighia puniceifolia* L.). *S. Indian Hort.*, 1964, 12: 68-9.
11. NELSON, R. O. and GOLDWEBER, S. Further rooting trials of Barbados cherry. *Proc. Fla St. hort. Soc.*, 1956, 1957, 69: 285-7.
12. OCHSE, J. J. and REARK, J. B. The propagation of subtropical fruit plants by cuttings, a progress report. *Proc. Fla St. hort. Soc.* 1950, 1951, 63: 248-51.

13. OSTENDORF, F. W. The West Indian cherry. *Trop. Abstr.*, 1963, 18: 145-50.
14. SOTO, T. El cultivo de acerolas en Puerto Rico. *Circ. Serv. Ext. agric. Univ. P.R.* 49, reprinted 1969, pp.13.
15. STAHL, A. L., KAPLOW, M. and NELSON, R. The present status and future possibilities of Barbados cherries. *Proc. Fla St. hort. Soc.* 1955, 1956, 68: 138-43.
16. STURROCK, D. Some root-stock experiments with *Malpighia*. *Proc. Fla St. hort. Soc.*, 1939, 1940, 52: 42-3.

MANGIFERA INDICA — MANGO

by

SAEED AHMED CHAUDHRI

Food and Agriculture Organization of the United Nations

INTRODUCTION

The mango, *Mangifera indica* L., belongs to the family Anacardiaceae. The genus comprises 62 species; more than a dozen of these produce edible fruits (G1; G3; G18; 285). However, *Mangifera indica* is the only species grown extensively and commercially and is very widely distributed. The mango is one of the most important fruit crops of the tropics and subtropics. The specific name indicates its origin: it has been in cultivation in the Indo-Pakistan sub-continent from time immemorial. Alexander the Great had seen some beautiful mango orchards in the Indus valley as early as 327 B.C. (G1; G18; 285). References are not lacking which suggest that it has been in cultivation in India for well over 4000 years (G1; G3; G11; G14; G18; 285). The age-old association of the mango with Hindu mythology and the occurrence of numerous wild and cultivated varieties in India are clear evidence in favour of the Indian sub-continent being the original home of this important fruit. In view of the preponderance of many species of *Mangifera* in the Malayan archipelago, some workers have thought that Malaysia might have been the land where the mango had originated. Most workers seem in agreement, however, that its native home is in eastern India, Burma and possibly further in the Malaysia and Indo-China region (G1; G3; G18; G19; 285). The presence of fossil records of a primitive species, *M. pentandra*, in Assam and of the phylogenetically most primitive species such as *M. duperreana* and *M. langenifera* in Laos, Cambodia and Vietnam, further supports this contention (195). In any case, *Mangifera indica* has received the greatest attention in the Indo-Pakistan sub-continent, where many horticultural varieties of high standard have developed. Arabs, Portuguese and Spaniards are to be given credit for the early spread of this species throughout the tropics and subtropics (G1; G3; G18; 285). At present, besides India, it

is grown extensively in such countries as Pakistan, Sri Lanka, Burma, Bangladesh, Kenya and Tanzania, Thailand, the Philippines, Malaysia, Indonesia, Vietnam, China, Australia, Egypt, South Africa, Nigeria, Israel, Mexico, Cuba, Brazil and the West Indies. In the mainland U.S.A. the southern tip of Florida, which enjoys a subtropical climate, is the only area where the mango is grown. However, it is one of the important fruit crops of Puerto Rico and Hawaii (G1; G3; G16; G18; G19; 2; 138; 255; 285; 343; 344; 345; 349).

ECOLOGY AND GROWTH IN RELATION TO PROPAGATION

Ecology

Temperature: The mango tree thrives under a wide range of climatic conditions but its profitable cultivation is limited by temperature and precipitation. It can endure a minimum temperature as low as 32° F (0° C), and as high as 114° to 118° F (46°-48° C). It is reported that its growth is minimal at 40° to 50° F (4°-10° C), and maximal around 108° to 110° F (42°-43° C). However, for optimum growth and productivity, 75° to 80° F (24°-27° C), is believed to be ideal (G3; G24; 10; 251; 255; 285; 279). In areas with dry hot summers, with temperatures going beyond 114° F (46° C), the fruits get sun-burnt. High temperature accompanied by low humidity and high wind velocity also proves injurious since this enhances the transpiration rate and upsets the normal physiological balance of the tree (255; 278; 285). The adverse effects of such conditions in hot dry regions can be minimized by irrigation (49; 285). As regards propagation, in Pakistan and northern India, during the hot dry summer, the trees do not show much sap flow and the percentage of success is thus greatly reduced (2; 278).

Frost: The susceptibility of the mango tree to frost varies with its age and state of growth. Young plants of four to five years in active growth are killed outright if the temperature falls below 31°-29° F (-1° to -2° C). Older trees with less growth activity usually escape damage at this range provided the duration of low temperature is not prolonged. Even though the main framework of older trees may not be damaged by exposure to low temperature, tender growth on such trees is seriously damaged (10; 255; 278; 285). Some varieties are known to be more prone to frost injury than others (89). In colder regions the plant ceases

growth before the onset of cold weather, hardening causing it to avoid cold damage.

In tropical countries the mango seldom ceases growth and it is possible to propagate it vegetatively the year round. But this is not true for regions where the tree remains dormant during the autumn and winter months. Similarly, in areas with cold winters the mango tree supports one heavy blossoming when the weather warms in the spring. In tropical countries without any distinct change in season most mango varieties bloom more than once; so much so that some fruit may be seen on the trees throughout the year (2; 25; 285).

Precipitation: The mango grows in areas with scanty rainfall and also in very wet regions. The total amount of rain during a year seems to be of less significance than the season in which it falls. Thirty-five to forty inches (890-1016 mm) of well distributed rainfall are considered sufficient for the successful cultivation of the mango (G3; G18; 10; 278; 279). Due to its deep and well developed tap-root system, it is well adapted to withstand periods of prolonged drought. In parts of India and Pakistan it can flourish in regions with less than ten inches (254 mm) of annual rainfall. However, in such areas it is generally cultivated under irrigation (10; 278; 279; 285).

It does equally well in areas with very high annual rainfall, provided the weather during flowering is relatively dry. Rainfall is then highly detrimental as it hampers the bees' activity, dilutes the stigmatic secretion, and dampens or washes away the pollen, thus resulting in low fruit-set. Bad weather at flowering time is to a great extent responsible for alternate bearing in mangoes (G3; 10; 255; 278; 279; 285).

In certain parts of Puerto Rico, Jamaica, India and Brazil, which receive heavy rainfall during most of the year, mango trees are less prolific. In such areas trees show profuse vegetative growth at the expense of fruiting (88; 255; 285). Success in grafting operations during the rainy seasons in areas of excessive rainfall and high humidity is greatly reduced. Moisture enters the graft incisions and hinders the formation of a graft union. Excessive penetration of water can even cause rotting of the tissues. For profitable cropping the dry season should be well ahead of flowering (G3; G18; G24; 10; 132; 255; 278; 285). This helps the trees to accumulate sufficient carbohydrates, which are

conducive to flowering. Once the fruit is set, wet and hot weather assists fruit growth and ripening.

Wind: In regions subject to high wind velocities mango trees suffer in many ways, such as crop shedding or even by trees falling. The establishment of windbreaks or shelters in such areas can minimize the loss to some extent. In Punjab, India (59), the establishment of young mango grafts in marginal climatic conditions was greatly helped by planting banana suckers to provide shelter. Almost 90 per cent of the plants survived, compared with 62 per cent under *Sesbania aegyptiaca* and 54 per cent under *Cajanus indicus*. The percentage of success in inarching operations is also adversely affected by strong winds. The shaking of the limbs and the shoots during the process of inarching hinders the graft union forming (2; 232; 278; 285).

Altitude: Mango trees in the tropics grow from sea level up to an elevation of about 4000 feet (1220 m), but they seldom bear at higher altitudes. Commercial plantations are almost all located below 2000 feet (610 m). Altitude has a pronounced effect on the time of flowering. For every 400 feet (120 m) increase in height from sea level, the time of flowering is retarded by four days. Similarly, for each degree of latitude south or north of the tropics, flower initiation is delayed by four days (99; 285).

Soils: Mango trees flourish on a wide range of soils. However, they prefer a deep rich fertile soil because of the long tap-root. Excessively sandy soils weaken the tree and lower the quality, size and quantity of fruit produced. The soil should be well drained and without a hard pan. A mango tree can withstand occasional flooding, but orchards on poorly drained soils are generally unthrifty and far less productive (255). Soils with very fluctuating water-tables are adverse for root growth. For the development of a strong root system, the water-table should not be higher than 2.5 m (8 ft) from the surface (278). In Florida the mango thrives on a wide variety of soils, trees becoming very large near the coast where the soils are deep sandy loams (255). In India the mango grows on laterite soils in coastal areas and deep alluvial loams in the plains. The soil pH in most of the well known mango-growing regions in India varies from 5.5 to 7.5 (278). In Pakistan luxuriant plantations are found on deep sandy loam and clay loam soils (10; 112).

On deep, fertile and well-drained soils, rootstock seedlings grow faster and become available for grafting operations much sooner. In very sandy soils transplanting mango plants in balls of soil is difficult.

Growth

The mango is evergreen; it is one of the largest fruit trees and, when planted singly, normally has a spreading form. Several slow-growing varieties are almost prostrate in habit, but usually the tree is erect, either with a broad dome-shaped umbrageous crown or with a tall oval, more or less open crown and ascending branches. A height of 70 feet (21 m) is frequently attained. The height and shape of trees, however, vary considerably among varieties and seedlings. In a climate where neither frost nor wind is likely to kill the tree, it can live to a great age. Trees several hundred years old are reported (G1; G3; G18; 255; 278; 285). The growth habit of the tree is of importance and differs from most other fruit trees. It is not seasonally continuous, but occurs in periodic flushes from the terminal buds and from the axils of leaves on younger branches (101). The number of these periodic growth flushes during the growing season, the time of their initiation and the period over which their growth extends vary according to variety, climate, cultural practices, age and crop load on the tree. In the plains of Pakistan, where the climate is sub-tropical, the first spring flush may start in late February or early March and the final flush may end as late as October, as is the case with younger trees growing under good cultural and irrigated conditions. But in many mature bearing trees of the Langra variety the common character is to produce as many as five flushes from April to August. Each growth flush continues for some time after initiation, becomes quiescent and then breaks out again until growth ceases for that season. The length of each flush is different and is also variable from year to year (365). Studies with Langra at Lyallpur, Pakistan, have also revealed that not all the shoots which initiate their growth in the spring produce subsequent flushes during the growing season. Some may produce two, three or more flushes, whereas others may flush once only and then growth ceases with the initiation of flower bud differentiation. This type of growth habit has been related to alternate bearing. The growth flushes which make their appearance and cease early in the season are the ones more likely to be fruitful in the subsequent year. The growth made in early flushes matures and accumulates sufficient

carbohydrates before the initiation of flower bud differentiation (367). On bearing trees shoots of the first flush are apt to arise from terminal buds of shoots of the preceding year that are not flowering. The second flush arises from lateral buds on shoots that have each a terminal inflorescence that is setting little or no fruit. A third flush may grow from lateral buds on shoots that have ripened a crop, and a fourth from lateral buds on shoots that have been greatly weakened by a crop in the current or preceding year (G3). The presence of foliage of different shades on the same tree shows that all the branches do not flush at the same time.

More recent work in India suggests that growth in mango is largely controlled by endogenous promoters and inhibitors. In the Langra variety the inhibitor level was lowest during peak vegetative growth, and sharply rose when growth ceased. It is expected that the isolation of the endogenous regulators and a study of their physiological properties will help to regulate vegetative growth in relation to fruit bearing and eventually provide an answer to irregular or alternate bearing in most commercial mango varieties (47; 48). Nurserymen would be able to use this information advantageously by encouraging and regulating vegetative growth in quantity at a time most suitable for the various propagation operations. Nevertheless, the growth habit and periodicity of the mango is very helpful in regard to its propagation. It ensures the availability of scion wood in active growth over a long period, thus extending propagation operations almost throughout the year in tropical areas. The spreading growth habit also allows inarching and stooling to be undertaken at ground level.

The leaves are of leathery texture and vary in length from six to sixteen inches (15-40 cm) and in breadth from one to five inches (2.5-13 cm) or even more. They are borne upon slender petioles one to four inches (2.5-10 cm) long. They may be oval, lanceolate, oblong, ovate or obovate, with many intermediate variations depending upon the variety. The leaves are simple, alternate and irregularly placed along the branches, sometimes widely separated and sometimes rounded and glabrous on both surfaces. The foliage at emergence shows much variation in colour. Some varieties have light-green leaves, but most others are characterized by having newly emerged foliage in various shades, varying from light copper to a deep carmine colour, turning green with maturity (G3; G18; 70; 255; 285). The tree retains its leaves well over a year. Every growth flush is usually followed by a light leaf

drop, and the spring flush after the cool winter is followed by an excessively heavy leaf fall (364).

A grafted mango plant usually flowers in the third or fourth year after planting in the field. In dry areas some seedlings take six to eight years to come into bearing (G1; G18; 255; 285). Depending upon locality and variety, flowers are generally produced in the spring. In cool regions the trees remain dormant during the winter and show one main flowering at the onset of spring. In tropical areas more than one flowering usually takes place during the year. Like the foliage, inflorescences on emergence, depending upon the variety, differ in colour and shade (G3; 255). The small yellowish or pinkish flowers are borne in large panicles, one foot (30 cm) or more in length, which are generally terminal but sometimes axillary (G1; G3; G18; 70; 95; 285). The inflorescence tends to be large, a panicle containing 300-500 flowers in some varieties and reportedly more than 7000 flowers in others (G3). The mango produces two kinds of flower, viz. perfect ones having both stamens and pistils, and others which are unisexual. The unisexual flowers, which are staminate, commonly outnumber the perfect ones. Usually there is only one stamen bearing fertile pollen in each flower, the remaining five or six being staminodes (13). However, in the Pico variety in the Philippines, three fertile stamens have been reported (124). The perfect flowers are easily distinguished by the presence of the pistil. Sometimes, more than one pistil may be present. The ovary is small, greenish and single-celled, with the style lateral, curved upwards and having a small, simple and terminal stigma (13).

The mango flower has five small green hairy sepals and five small spreading petals, which are red, orange, pink, greenish or yellow in colour. In some varieties more flowers are perfect towards the apex of the inflorescence than towards the base. The presence of a large percentage of perfect flowers on the terminal portion of the inflorescence is the reason why more fruit is borne on the terminal end (255). For fruit set, pollination is necessary, and most varieties are self-fertile, although cross-pollination seems to be necessary to get good crops (13). Pollination in the mango is chiefly entomophilous (G18; 13; 41; 285). Alternate or irregular bearing is a well known phenomenon. This problem is very closely related to the variety, some varieties being more prone to alternate bearing than others. The condition is, however, greatly aggravated by poor husbandry, bad weather and diseases and pests. It has been studied extensively but

remains as baffling as ever (G3; G18; 268; 285).

In view of this, nurserymen should select varieties not only with good fruit characteristics but also with less tendency to alternate bearing when seeking scion material for propagation.

The fruit is a large drupe. The outermost skin is the epicarp, the flesh is the mesocarp and the hard stone to which many fibres are attached is the endocarp. The endocarp encloses the seed. In size and other characteristics the mango fruit is extremely variable. There are varieties which are hardly larger than a plum and there are others whose fruit weighs as much as four to seven pounds (1.8-3.2 kg) (G3; G18; 70; 285). The shape varies from ovate, ovate oblong, round, oval to oblong. Some of the commonest types are reniform to oblong reniform (9; 13; 70). The skin is smooth, somewhat thicker than that of peach, commonly yellow or greenish yellow in colour. Some varieties assume a beautiful scarlet to deep carmine colour. The pigmentation is more intense on the exposed side of the fruit. The intensity of colour further depends on the climate (13; 70; 285). The flesh is yellow or orange yellow in colour, juicy, often fibrous in seedlings but in the best varieties mostly free from fibre. The seed varies according to the variety: it is flattened, tough and woody, the husk or outer covering enclosing a white kernel (G3; G18; 13; 70; 285). The flavour of the flesh is rich, spicy and much esteemed. The time taken by the fruit to mature is greatly influenced by many climatic factors and also differs between varieties. Under the same climatic conditions, fruit in some varieties takes only two months to mature, while in others it takes almost four months after fertilization (70). The leaf area on the tree seems to have a bearing on the size of the fruit, leaf area per fruit being directly related to fruit size (70). Fruit quality is an important consideration in the selection of varieties for multiplication.

The development of the root system depends on variety, soil, subsoil, soil depth, aeration, the water-table and is also influenced by cultural practices,

such as cultivation, irrigation, mulching and fertilization. Trees on deep soils develop deep and extensive root systems (Gl8; 41; 69; 95; 236;285), but information on the root system of the mango tree is rather scanty. However, it is known that the tree possesses a strong tap-root, which penetrates deeply and reaches the water-table. During the elongation phase only a small number of anchoring root branches seem to develop. After this phase the surface roots develop faster and form a dense mass closer to the surface. Information is lacking on the periodicity of growth of mango roots (285). At Lyallpur, Pakistan, the root system of an 18-year-old seedling mango grown under irrigation in a clay loam soil was exposed. The branched tap-root penetrated to 30 feet (9 m). However, the effective root zone was found to be four feet (1.2 m) in depth and six feet (1.8 m) in spread. A large number of feeder roots were concentrated within this zone. Most roots originated from the base of the trunk rather than from a single tap-root; most were straight with but a few coiling (133). In Queensland, Australia, and at Pusa, India, mango roots reaching 18 feet (5.5 m) have been recorded (95; 285; 303; 304). Due to its deep and well developed root system, the mango is well anchored and well adapted to withstand prolonged periods of drought. In South Africa (231) the study of the root system of a tree of the variety Sabre revealed that 80 per cent of the fibrous roots were below the canopy and within one metre (39 in) depth. The strong tap-root causes difficulties when potting seedlings and when transplanting young grafted plants from nursery rows (71).

Mango races and horticultural varieties

Mango types in cultivation are generally placed into three main groups:

Monoembryonic seedling races: Seed of this type gives rise to only a single sexual seedling. The mango is an entomophilous and freely cross-pollinated plant, so the gametic seedling differs from the female parent and the tree does not breed true to type from seed. All Indo-Pakistan mangoes are monoembryonic, except a few varieties on the western coast of India that are polyembryonic. In Pakistan a

search for polyembryonic varieties ended in failure. Occasionally seedlings with multiple shoots have been recorded, but these were due to branching of the zygotic seedling. In all such instances they were supported by a single tap-root. In order to perpetuate the outstanding qualities of a monoembryonic seedling mango it must always be propagated asexually (G1; G3; G18; G28; 16; 28; 29; 76; 95).

Polyembryonic seedling races. These breed true to type from seed and are generally found in the moist tropics. Mangoes grown in Malaysia, Indo-China, the Philippines, Hawaii, Mexico, Brazil and the West Indies are mostly of this type. More than one seedling emerges from the seed; three to eight seedlings from one seed are common: in the Philippines more than thirty have been recorded (G1; G3; G18; G28; 124; 125). These seedlings are called nucellar seedlings since, except one seedling which is zygotic, all develop from the cells of the nucellus and are thus identical with the parent tree. It is generally believed that in most polyembryonic types the sexual embryo degenerates early in development, with the result that in some varieties all the seedlings are nucellar (164; 285; 306). In the Philippines, Pico and Caraboa are the principal commercial varieties. They retain their characters with remarkable consistency even when reproduced from seed (334). The possibility of the survival of the zygotic seedling, however, cannot entirely be ruled out. The presence of numerous local trees showing distinct and different characteristics from the main polyembryonic types supports this contention (G1; G3; G18; 9; 285). In the early stages of growth it is not possible to distinguish between the sexual and nucellar seedlings, but it is generally believed that the sexual seedling is relatively weak and stunted in growth (G2; G18; 285).

Horticultural varieties: In monoembryonic mangoes, seedlings invariably differ from each other and from the female parent. The wide variations among the seedling progenies have been responsible for the evolution of many promising chance seedlings possessing desirable yield and fruit characters, and these have been further multiplied vegetatively. The clonal

progenies of these desirable seedlings belong to this group of horticultural varieties. The preponderance of standard named cultivars in India and Pakistan is attributed to the fact that, with a few exceptions, all the mango varieties in this region are monoembryonic. Furthermore, the mango in this sub-continent has been in cultivation since time immemorial (2; 8; 278; 285). More recently a number of good mango varieties have been selected in Florida, Hawaii and in other mango-growing countries (80; 148; 150; 185; 234; 235; 255; 349). In India and Pakistan, Alphonso, Langra, Dashehari, Samar Bahisht, Bombay Green, Neelum and Ratul are important cultivated varieties. In Florida, Haden remained a foremost mango variety for a long time; more recently Tommy Atkins and Keitt have replaced almost all other cultivars (171; 183). In Brazil, Espada, Rosa, Carlota, Itamaraca, Bourbon, Coração Magoadado and Maçã are the important cultivars (369). In all mango-growing countries an intensive search continues in order to select better cultivars and strains to meet the divergent needs of the fresh fruit market and of the processing industry (275; 353).

Diseases and pests of importance in propagation

Diseases: Some of the important mango diseases are anthracnose, powdery mildew, bacterial blight, black tip, scab, red rust, seedling wilt and some physiological disorders. These diseases are quite widespread in mango-growing regions, but their virulence depends on the climatic conditions of the different areas. A hot and humid climate is generally favourable for the spread of most of them. Some result in reduced yields, lower fruit grade and quality, and fruit deterioration in storage (129; 243).

Anthracnose and scab attack the mango in all stages of growth and are of wide occurrence. Their incidence on the young rootstock and on parent trees furnishing scion wood retards growth and interferes in propagation (285; 324). From Florida it has been reported that when topworking mango trees the control of anthracnose and scab is essential for success (207).

Malformation of the inflorescence is also a serious problem in India, Pakistan and Egypt (121; 129; 134; 135; 203; 262; 285). More recently it has also been reported from Florida and Brazil (64; 172). Malformed inflorescences resemble monstrous structures of flower aggregation on a very much shortened primary axis which branches copiously to bear secondary and tertiary branches, on which in turn the flowers are borne in clusters. On others the primary axis is not reduced, but the secondary axis bears the bunchy structures of flower aggregations. In yet other cases the flower buds seldom open and remain dull green, assuming with time a fire-burnt appearance. Small leaves are sometimes seen intermingled with malformed flowers (129; 134). A whole tree may be affected or the trouble may be limited to part of the tree or to a single branch only. A branch which shows abnormal inflorescence one year, may subsequently bear entirely normal inflorescence the following year (69). Abnormal size and congregation of vegetative buds in young mango budlings have also been reported (7; 129; 209; 239) both from India and Pakistan and the abnormality has been referred to as 'bunchy top'. On the basis of almost identical symptoms, inflorescence malformation and bunchy top have been considered to be the expression of the same disease. However, the relationship of these two symptoms on the vegetative buds and the inflorescence has not yet been fully established (129).

Inflorescence malformation presents a serious problem in those countries where it occurs, since malformed inflorescences do not set fruit, and in certain varieties 70 to 85 per cent of the inflorescence may be malformed (134; 135; 136).

The efforts to find the causal agent and to devise effective control measures so far remain inconclusive (129; 285). More recently it has been reported that the fungus *Fusarium moniliforme* may be the pathogen. But results reported by other workers are not in agreement (239). Similarly the presence of mango bud mite, *Aceria mangiferae*, has been associated with the incidence of malformation

and its spread. However, studies are again incomplete and have given divergent results (239; 285). Some workers have even suggested that a viral cause should not be ruled out (262).

In view of the economic importance of the malady and the fact that the causal agent is not yet definitely known, it is advisable to take every care in grafting operations. Seedlings showing signs of bunchy top and trees showing symptoms of inflorescence malformation should not be used as rootstock seedlings or as scion parent trees.

Damping-off of young seedlings caused by *Rhizoctonia solani* has been reported from Indonesia (197). *Pythium* sp. also infects young seedlings in the nursery and causes great damage (243; 307).

Pests: Hoppers, mealy bugs, termites, shoot-borers, mites and different species of scale are some of the serious pests. Their virulence and distribution, like the diseases, are related to climatic conditions. Insects are sometimes responsible for heavy losses. Termites do extensive damage to the root system; their attack is sometimes so severe that most of the roots are lost, resulting in the death of the tree. Damage to young seedlings in the nursery is usually more noticeable. Shoot-borers kill the shoots, and heavy infestations with sucking insects defoliate the trees. Fruit flies are responsible for lowering the yield and fruit grade and cause much damage. The mango weevil eats the kernel in the seed and very adversely affects the germination percentage. Unless a strict schedule of plant protection measures is followed, success in mango cultivation on any commercial scale is doubtful.

The incidence of insect pests lowers the vitality of the parent tree, kills shoots and destroys the root system, thus greatly interfering in propagation operations and lowering their success (91;92;93;94; 133;146;255;278;285;347;348).

PROPAGATION BY SEED

The mango can be multiplied with ease by seed or by several vegetative methods of propagation. Most mango plantations in the major producing countries, India and Pakistan, are stocked with seedlings. This has largely been due to the erroneous belief that the tree does not lend itself to easy methods of vegetative propagation. Seed propagation of monoembryonic types has, however, contributed a great deal to the mango industry, since all the present day superior mango varieties are chance seedling selections, which have further been multiplied through asexual methods, although the occurrence of such promising types is rather infrequent. Seedlings, moreover, usually grow into very large trees and this offers difficulties in spraying operations and harvesting. In order to perpetuate a desirable monoembryonic variety it must be propagated vegetatively. This is necessary, not only to ensure uniformity but also to achieve early bearing and productivity and to keep the trees low headed (G1; GJ; G18; 53; 255; 285).

The polyembryonic races breed true to the female parent from seed. However, with the exception of a few types in Indo-China and the Philippines, most polyembryonic mangoes are inferior in fruit characters (GJ; G18; 251). The real value of polyembryony in mangoes lies in the production of nucellar seedlings to be used as rootstocks. This helps to eliminate variations in the performance of grafted plants in the orchards caused by genetic differences in the rootstocks.

In most mango-growing countries propagation through seed is now being used chiefly to raise rootstocks in this way, or to establish windbreaks and avenues, and sometimes by plant breeders for seedling selection. Some polyembryonic varieties in the Far East are still being raised through seed, but this essentially amounts to propagating them vegetatively, since, except for one seedling which comes from the fertilized ovule, the remaining embryos are nucellar in origin and are thus genetically identical to the female parent. The sexual

embryo in most polyembryonic varieties is also believed to be suppressed by the nucellar embryos in the early stage of development (G1; G3; G18; 148; 285).

VEGETATIVE PROPAGATION - ROOTSTOCKS

In some important asexual methods of propagation, such as grafting and budding, raising seedlings for rootstocks is the first necessity. Although an easy and simple operation, this needs to be done carefully. Seeds of polyembryonic races due to their uniformity can be used as rootstocks with advantage so as to minimize variability (22; 86; 155; 156; 157; 158; 159; 160; 161; 162; 163; 217; 244; 245; 310). In countries where monoembryonic races predominate, the use of clonal rootstocks for vegetative propagation would likewise be helpful in reducing orchard variation. In the past some difficulty had been experienced in raising clonal progeny of monoembryonic varieties by rooting cuttings or by layering. The use of growth-regulating substances and rooting cuttings under mist, however, have greatly helped to overcome this hurdle. In India a method has been developed where the parent plants to be used as sources of rootstocks are headed-back close to the ground and the new sprouts arising from the stumps are ringed and treated with 5000 p.p.m. IBA followed by mounding-up with earth. The treated shoots develop numerous fibrous roots within three months, when they are separated for use as rootstocks (368). In order to get vigorous, healthy, uniform and well-united compatible grafts, it is necessary to start with desirable rootstock material.

Rootstocks

The selection of a suitable rootstock is as important as the selection of scion varieties. The rootstock has a strong influence on the growth and longevity of the grafted tree, its yield, fruit quality, time of ripening, disease and pest resistance and adaptability to soil and soil moisture conditions (G1; G3; G18; G24; G27; G28; G29; 43; 44; 113; 115; 142; 161; 163; 181; 200; 225; 228; 256; 350). This important

aspect has often been neglected and, except when required for experimental work, no proper selection of the parent tree for raising rootstock seedlings has been made. The indiscriminate use of assorted mango stones for raising rootstock seedlings is to a large extent responsible for the wide variations in the performance of otherwise clonal progenies. More recently some work on the selection of compatible rootstocks has been reported from Florida, India, Pakistan, Sri Lanka, Malaya, Jamaica and Israel (43;44;83; 86; 113; 115; 161; 181; 200; 205; 212; 213; 217; 218; 219; 220; 224; 256; 263; 295; 333; 357).

Majumdar et al. (169), in India, have classed some 31 rootstocks as very vigorous, vigorous and dwarfing. The use of dwarfing rootstocks helps to keep the tree low headed and thus reduces the cost of spraying, harvesting and other operations.

In Israel (217; 218) three mango cultivars, Haden, Pairee and Mulgoba, were tested on three different rootstocks. Contrary to general belief, Sabre rootstock, in spite of its dwarfing character, imparted greater vigour to the scion. Among the scion varieties, Haden and Pairee showed a greater degree of compatibility, whereas Mulgoba as a scion variety was not successful on Sabre or the other rootstocks used.

In southern India, a polyembryonic variety Bappakai gave a higher germination percentage, grew fast and produced vigorous seedlings large enough for grafting within one year of sowing the seed (202; 240). Sen (269) found the Kalapadi variety from the west coast of India a promising dwarfing rootstock. According to him, it is the scion variety which has the dominant effect rather than the rootstock. Langra, a vigorous variety on the dwarfing rootstock Kalapadi, showed some dwarfing when young. After about 20 years, however, Langra scions, irrespective of the rootstock used, were alike, assuming the general size and vigorous characteristics of the variety. The cultivar Kalapadi, on the other hand, as scions remained dwarf without regard to the rootstock used. In Sri Lanka a semi-wild mango known as Pullima has vigorous seedlings, needs less care and becomes

buddable within six to nine months after sowing (86). Jauhari et al. (119) tried Dashehari seedlings, as well as seedlings of four polyembryonic varieties, viz. Ambalavi, Mylepalium, Olour and Vellai Kolamban, as rootstocks for the Dashehari scion, an important commercial variety in India. Dashehari seedlings proved to be vigorous compared to the polyembryonic rootstocks, which all had a dwarfing effect. The yield of fruit, both in number and weight, was higher on Dashehari rootstocks than on polyembryonic rootstocks, which did not appreciably differ in this respect among themselves. Total soluble solids contents were, however, higher in the fruit harvested from trees on Mylepalium and Vellai Kolamban rootstocks. In Kerala, during a period of six years, the scion varieties Bennet Alphonso and Baneshan, when inarched onto the polyembryonic rootstocks Chandra-Karan and Bappakkai, showed greater height and vigour and were more productive than when they were inarched onto the monoembryonic rootstock Pulliyan (74). In Indonesia the scion varieties Madu, Arumanis, Golek and Manalagi made perfect bud unions with seven different rootstocks, viz. Madu, Gurih, Gadung, Kopjor, Budidaja, Nanas and Saigon: there was no apparent incompatibility. However, Madu and Gurih rootstocks delayed fruiting compared with the others. This trend can profitably be exploited in extending the period of availability of the scion varieties (141; 142). In Jamaica, in a rootstock trial in its fifth year, the scion varieties Julie and Bombay manifested more vigour and made a better bud union on Kidney, Turpentine and Beef rootstocks, whereas Cox, Beef and Turpentine were better rootstocks for the Haden variety (115). In South Africa, Sabre has given a better performance as a rootstock as compared to Kidney, which produces a very high percentage of off-type seedlings. Peach as a rootstock presents difficulties since the seedlings do not transplant well from the nursery (181). In Pakistan, Samar Behisht seedlings were found to be vigorous compared to Langra seedlings and three seedling mangoes. However, seeds obtained from seedling types showed a higher germination than those from grafted trees (78). Naik (200), working in southern India, found polyembryonic rootstocks imparted better vigour to the scion as compared to monoembryonic rootstocks.

Swamy et al. (310) described a rootstock trial started as early as 1939 at the Regional Fruit Research Station, Anantharajupet, South India. In these trials two popular commercial varieties, Baneshan and Neelum, were used as scions. For Baneshan six polyembryonic varieties, and for Neelum four polyembryonic and one monoembryonic varieties were used as rootstocks. In the case of Neelum the plants grew larger on polyembryonic stock as compared to monoembryonic. Goa and Olour rootstocks produced the largest Neelum trees, followed by Salen and Pahutan. With Baneshan the tops were bigger on Pahutan and Olour. It is interesting to note that Pahutan, the most vigorous rootstock for Baneshan, was the least vigorous for Neelum. In respect of yield, Neelum on Pahutan roots gave the maximum yield, followed by those on Goa rootstocks. Monoembryonic seedlings, although less vigorous, in the matter of yield proved better than the otherwise moderately vigorous rootstocks Olour and Salen. Not only were the Neelum fruit harvested on Pahutan roots larger but they also possessed higher total soluble solids. In case of Baneshan, Olour rootstock also influenced yield more than the vigorous rootstocks.

These findings are of immense importance and significance. It emerges clearly that a variety normally producing vigorous seedlings may not impart the same vigour to the scions, and the same is true for yield. These findings also suggest that, in view of such unpredictable behaviour of monoembryonic or polyembryonic varieties, detailed studies should be carried out to select the most compatible rootstocks for the leading scion varieties.

Krishnamurthy (366) reported the failure of Neelum scions on the polyembryonic Olour rootstock and stressed the need for cautious use of polyembryonic rootstocks. Such precaution is all the more important in view of the fact that some monoembryonic and polyembryonic varieties behave erratically under different climatic conditions. Some of the monoembryonic Indian varieties produced more than one embryo in Florida, the Philippines and Puerto Rico. Alphonso and Sufaida, monoembryonic varieties of India, showed 13.3 per cent

and 23.07 per cent polyembryony respectively, in an experiment in Puerto Rico. Contrary to this, polyembryonic varieties introduced from moist tropical countries into Pakistan and northern India, seem to lose their capacity of polyembryony (G3; G18; 6; 22; 110; 285). In addition to the unpredictable behaviour of different varieties as regards the extent of polyembryony, still greater efforts are needed to classify monoembryonic and polyembryonic varieties as vigorous or dwarfing rootstocks. It is generally believed that polyembryonic seedlings are more vigorous and grow more quickly. However, this is not true in the case of some of the varieties and in certain areas. Bakhshi (22), working in the Punjab, India, found seedlings of some monoembryonic varieties to be very vigorous, some were only mediocre in this respect while others were slow to grow. Polyembryonic varieties included in the trial showed poor germination and were slow to grow in the nursery. In Bahia, Brazil, seedlings of some polyembryonic varieties seem to make very slow growth in the nursery. These observations further support the necessity of very careful selection of varieties to be used as rootstocks.

In India some workers tried seedlings of *Semecarpus anacardium*, *Spondias mangifera*, *Spondias acuminata* and *Holigarna grahmi* as rootstocks, but reported failure (41). In Martinique cashew seedlings have been reported to be compatible as rootstocks for mango, and the fruit on cashew roots was almost double the normal size, free from fibre with a smaller seed. In St. Lucia a variety called Long is recommended as a rootstock (339). In Java seedlings of *Manga Madoe* (*M. indica*) have proved to be generally compatible as rootstocks. Seedlings of other *Mangifera* species such as *M. odorata* and *M. foetida* did support the scion for two years, but later developed symptoms of incompatibility. Many plants on *M. odorata* died, while on *M. foetida* thickened ridges developed round the bud union and affected the performance of the top (212). In Senegal polyembryonic mango varieties, notably *Amélioree du Cameroun* and *Francis*, are raised from seed to be used as rootstocks (66). In Sri Lanka, in addition to *M. indica*, *M. zeylanica* also proved to be a compatible rootstock for mango scion varieties (224). However, whereas the former is ready for budding when nine to twelve months old the latter needs nearly eighteen months. In Burma, *Saing* and *Thalapt* mango

varieties have been found to be good rootstocks (359).

In Sri Lanka (140; 253) an experiment at Pelwehara with sour mango (Wal amba), fibre mango (Kohu amba), Bombay mango (Betti amba) and wild mango (*M. zeylanica*) revealed that the wild mango of Etamba took two years to be ready for grafting. It was difficult to transplant but it showed no stock:scion incompatibility. All the varieties of *M. indica* are used as rootstocks, but polyembryonic varieties such as fibre mango and Bombay mango are preferred. In Florida monoembryonic types are preferred by most nurserymen, as the seedlings are vigorous when young. Mango No. 11 is no longer being used as rootstock, since the bark of the seedlings is uneven and rough, not a desirable character for grafting. Among polyembryonic forms, seedlings of Turpentine mangoes are generally used as rootstocks. As a general rule the seeds for raising rootstock come from the most easily available type or variety (150; 255).

Propagating seedling rootstocks

Advice given in the following section may be augmented by reference to Part One.

Seeds should be obtained from fully ripe fruit during the main crop harvest. In most nurseries in mango-producing regions the seeds are collected from different local trees. In some Far-Eastern countries the seeds are collected even from wayside places and fruit markets and are heaped together for germination (2; 255; 285). Information on the relative merits of different varieties or species as rootstocks still remains scanty and the nurserymen utilize whatever seed they can get in quantity (54; 63; 255; 285). Such indiscriminate use of seed material results in a good deal of variation in the rootstock seedlings. The genetic differences in the rootstocks affect the performances and efficiency of grafted trees in the orchard. Such variations in the seedlings of monoembryonic varieties cannot be eliminated. Therefore, to reduce the degree of variation in seedling rootstock, fruit for seed extraction should always be collected from healthy, disease-free and high-yielding trees known to give vigorous seedlings.

The size and weight of the seed influence the percentage germination. Only large, fully developed and plump seeds should be used. Light, diseased and malformed seed should be discarded (6; 79; 278; 285).

Naik (198) observed differences in germination and seedling vigour between the progenies of different parent trees sufficiently great to be of commercial importance.

Giri (78; 79), working at Lyallpur, Pakistan, reported a higher germination percentage and more vigorous seedlings when using seed from syrupy mango types. There were indications that seeds from firm fruit remained dormant for some time after planting. Seeds obtained from seedling trees gave a better overall germination performance than seed from grafted trees. Among the grafted varieties themselves, seedlings from Samar Behisht Chausa trees surpassed those of the others tested in height and girth; seedlings from Langra trees made the poorest growth. Germination and seedling vigour were found to be closely related to the weight of the seed stone (79). From similar studies in the Punjab, India, Bakhshi (22) reported considerable differences in seedling vigour and germination capacity within seed parents. Polyembryonic varieties from Madras included in the trial also showed relatively low germination compared to local monoembryonic varieties.

The mango weevil (*Cryptorhynchus mangiferae*) feeds on mango seeds and can be detected by the presence of holes bored through the endocarp. Such seed and any affected by fungus should be rejected (285).

Mango seeds lose their viability in a short time. It is always better to collect them from a nearby source and sow them within one week of extraction. The germination percentage is usually satisfactory within four to five weeks of extraction if the seed is handled properly after extraction (63; 148; 255; 285). The maximum period for which a mango seed will remain viable is said to be 100 days. About 80 per cent of seed germinate when sown within a month of extraction, 48 per cent when

planted after 38 days and only 12 per cent after 71 days (123). However, if the situation so demands, pulp-free seed can be stored in between charcoal layers for about a month (285). In storage, one foot (30 cm) thick charcoal layers alternate with nine inches (23 cm) thick layers of mango seeds. They are stored in the shade as the seeds quickly lose their viability when stored in the sun (285). In another study charcoal powder was found to be a better medium for storing mango seeds as compared to polyethylene bags, desiccators, refrigeration or open jars. Fifty to sixty per cent of the seed retained its viability up to 90 days when stored in charcoal powder (320). In more recent studies in India, to study the effect of the interval between extraction and sowing and of the storage container on seed germination and seedling growth, some seeds were planted soon after their extraction from the fruit and some seeds were stored the same day, using four different types of container, open plate, cloth bag, polyethylene bag and polyethylene bag with moss. The stored seeds were planted after two, four or six weeks. Planting soon after extraction was found to be the best in all respects. Germination was as high as 90 per cent and the development of the young seedlings was quicker. Storage for two weeks resulted in an appreciable decrease in germination, declining to 70, 55, 75 and 55 per cent, respectively, for the different storage methods. After four weeks of storage, the germination percentages were 0, 0, 70 and 62.5 respectively, and after six weeks of storage only a few seeds (2.5 per cent) stored in the polyethylene bag germinated (293). The viability of mango seeds can be tested by putting them in a pail of water. Seeds which sink to the bottom give a higher germination percentage than those which float. The latter are either less viable or totally non-viable (264).

In most nurseries pulp-free seeds are sown without any other treatment. In some studies, however, careful removal of the husk from the seed stones before sowing has resulted in earlier and more uniform germination and the stems and roots of the seedlings were straight. But this method is not recommended on a commercial scale

because of expense involved. In Florida the difference in the germination of husked and unhusked seeds was found to be insignificant and not worth all the trouble, risk and expenditure involved in removing the husk (148; 255; 285).

In Indonesia it was observed that the generative embryo in polyembryonic seeds is situated immediately behind the porus at the stalk end of the seed and can be eliminated before planting by making a transverse cut through the seed at a small distance from the porus and retaining only the remainder of the seed for planting and for getting fully uniform rootstock material (313).

Arora and Singh (17) studied the effect of plant regulators on fruit drop, fruit quality and seed germination. Seed germination was improved by the application of 2,4,5-T in low concentration in one variety but adversely affected the others included in the trial. Seeds can be sown in different types and sizes of pot or in specially prepared nursery beds. If only a small number of seedlings is required seeds are generally sown in earthenware pots or in plastic bags. These containers are filled with soil and compost. The pots are generally one foot (30 cm) deep with drainage holes. Shallow wooden trays six inches (15 cm) deep are also used (181). For the large-scale production of mango seedlings, however, seeds are sown on specially prepared nursery beds. The area intended for raising seedlings is selected in the shade of large fruit trees or under erections specially constructed to provide protection against sun, wind, rain, and in some areas also against frost. The soil should be a deep, rich loam, well drained and free from hard-pan. For light sandy soils, the addition of organic matter improves texture and fertility. The land is thoroughly cultivated and a heavy basal dressing of farmyard manure, compost or leaf-mould is added. Usually an application of 30 tons of well rotted farmyard manure per hectare is sufficient. After thorough incorporation, the area is divided into beds of convenient size, usually 30 feet x 5 feet (9 x 1.5 m) (285). In wet areas raised beds about six inches (15 cm) in height should be made to improve drainage. The beds should be free from weeds, pebbles and stones. In Queensland a special type of seed-bed for raising mango seedlings has been suggested. In this method the soil from nursery beds is thoroughly worked and brought to a fine tilth to a depth of nine inches (23 cm). It is then removed and replaced above a thin iron sheet. This technique prevents the tap root penetrating deeper than nine inches (23 cm) and

helps in the development of fibrous roots, so that the plants can be transplanted more easily (303; 304).

Sowing follows the harvest of the crop. In most parts of India and Pakistan sowing is generally completed in July. Sowing at a proper depth and the position at which the seed is laid in the soil are most important. This not only affects the germination percentage but also the time taken in emergence and subsequent growth. Selected seeds are sown in parallel lines, one foot (30 cm) apart, on the beds. The distance from seed to seed is generally six inches (15 cm). Sowing in lines helps when removing weeds and eventual lifting of the seedlings. The seeds are placed in the soil not more than two inches (5 cm) deep with the convex side up. In Florida shallower placement is recommended (255). In the Punjab four depths of seed sowing were tried. There was no significant difference between the one and two inches (5 cm) depths of sowing, but these depths were significantly better than sowing three and four inches (8-10 cm) deep (23; 232). In Hawaii, after removing the husk, the kernels are sown edge-wise at a depth of three inches (8 cm) on large propagating benches, holding one-foot (30 cm)-deep washed coral sand. After sowing, the seed-beds or pots should be kept moist by sprinkling. Many factors affect the time of germination, but seeds sown at a proper depth and correct angle in a well prepared medium, with optimal moisture, should germinate within two to three weeks (6; 252; 255; 278).

The seedlings should be kept in active growth by frequent watering, weeding and by a spray and fertilizer programme. In humid areas seedlings are often infected by anthracnose, which must be controlled by fungicidal sprays. In some experiments, immersing the seeds for 24-48 hours in gibberellic acid solution at 25, 50 or 100 p.p.m. or spraying the growing seedlings with GA at 50, 100 or 300 p.p.m. dilution hastened their growth considerably (127; 252; 322). The growth of mango seedlings can also be hastened by monthly spray application of one per cent urea (229). Seedlings in nursery beds grow faster than those grown in pots and other containers.

Both in India and Pakistan, where inarching still remains a chief method of mango propagation, the seedlings are allowed to remain and grow in the nursery beds until they are needed for inarching. Weak, diseased, malformed and abnormal seedlings are discarded at the time of transplanting. Nine-months- to one-year-old seedlings are lifted, about one

month ahead of the grafting operation, and potted in earthenware pots twelve inches (30 cm) deep and eight inches (20 cm) wide at the top, with drainage holes. Great care is needed not to disturb the root system in removing the seedlings. Irrigating the nursery beds a few days prior to potting the seedlings helps to soften the soil and facilitates lifting the seedlings with convenient sized earth balls, without injuring the fibrous roots. At the time of potting the tap-root is slightly trimmed. Rao (251) has mentioned instances where the tap-root is cut at least one month ahead of lifting. In Mysore this is achieved by digging a trench some six inches (15 cm) deep between the nursery rows and the spade is pushed in sideways to cut the tap-roots. The trenches are afterwards filled with farmyard manure and the nursery beds are irrigated to encourage the development of fibrous roots. A month later the seedlings are lifted with the earth balls with very little injury to the adventitious roots. In Madras large seedlings are lifted with relatively small earth balls. The seedlings tops are proportionately cut back to minimize transpiration and so compensate for the temporarily reduced uptake of moisture. In some nurseries the size of each leaf is reduced to half rather than defoliating the plant. A mixture of equal parts of soil, compost and leaf mould is used for filling the pots after the seedling with its earth ball has been placed in position. The pots are then watered, removed to the shade and periodically watered. Potting is usually done one month ahead of the actual inarching operations. This allows sufficient time for the seedlings to settle down before grafting (2; 251; 255; 278; 285).

Mango seeds sown in earthenware pots, wooden boxes or similar containers grow more slowly than those in nursery beds. Pot-grown seedlings usually get pot bound, and take much longer to attain the thickness required for different budding or grafting operations (251; 285).

In Florida seedlings are raised either in nursery beds by direct sowing of seed or by germinating them in sawdust or coconut fibre and transplanting the very young seedlings to nursery rows, usually one to two feet (30-60 cm) apart. When the seedlings are about six inches (15 cm) tall they are sometimes transplanted into cans or pots of proper size for the subsequent budding or grafting operations (63; 255). In some newly developed propagation techniques mango seedlings in the embryonic stage can be utilized successfully.

PROPAGATION BY GRAFTING AND BUDDING

Inarching is a time-honoured method of vegetative propagation; for a very long time it was the only method employed to multiply the mango asexually. However, due to the cost, the cumbersome nature of the operation, the low percentage of success and the long time required to produce grafts by this method, it has fallen out of favour, and other easier methods are now commonly in use (14; 18; 24; 30; 33; 34; 35; 59; 77; 85; 98; 104; 120; 122; 139; 155; 165; 173; 176; 194; 198; 207; 241; 242; 247; 250; 259; 272; 274; 278; 280; 287; 288; 297; 302; 303; 304; 311; 312; 318; 323; 327; 330; 336; 337; 338; 343; 345; 346; 349; 358). Inarching is perhaps still the chief method of mango propagation in India and Pakistan, but is fast being replaced by veneer grafting and shield budding (2; 3; 4; 6; 120; 192; 293; 251; 278; 285). In Florida many new methods of mango propagation have been developed. At present side or veneer grafting are the methods mainly in use (61; 148; 150; 155; 255; 316; 319). In the Philippines cleft grafting has given good results and is the method being employed commercially (334).

Throughout mango-growing countries research is in progress to develop easy methods of propagation or to modify the main techniques presently in use so as to be more adaptable and suitable to local conditions. Inarching, side grafting, veneer grafting, cleft grafting, shield budding and chip budding are generally the methods now being used. The choice of method, among many other things, depends on the age of the rootstock seedlings, the type of propagating material available, the condition of shoot growth, the time of the operation and several climatic factors.

The various methods of grafting have been described in detail in Part One. The following notes have special relevance to grafting in mangoes.

Grafting

Inarching (approach grafting): In India and Pakistan most nurseries use nine- to fifteen-months-old seedlings for inarching (2; 3; 285). In parts of India three-month-old seedlings have given even better results (269), but using very young seedlings for inarching is not common. Giri (358), in Pakistan, has reported greater success with seedlings of vigorous growth (1.3-1.6 cm = 0.5-0.6 in girth) compared to those of medium (1.0-1.29 cm = 0.4-0.5 in) and low (0.7-0.99 cm = 0.25-0.4 in) girth. In Puerto Rico seedlings as old

as two years of age are used for inarching (55). In Hawaii six-months-old rootstocks gave better results than seedlings of two months of age (96). In Indonesia rootstocks varying from eight to fifteen months old are used in inarching (G4; G28; G29). Majhail and Singh (165), in India, observed that seedling size did not affect grafting success in spring, but during the monsoon (July-September) the larger seedlings gave a higher percentage success. Jagirdar (112) in Sind, Pakistan, found no difference in the percentage of success when he used seedlings from three to nine months of age. In Trinidad very high (90-100 per cent) success was possible when seedlings six to eight weeks old were used as rootstocks (328).

Growers often prefer large grafted plants, so nurserymen in Kerala, India, leave inarches attached to the scion trees well over six months. However, in Andhra Pradesh the scions of the cv. Neelum on rootstocks which were 10½, 13½ or 16½ months old at the time of inarching did not show any variation in size, vigour and productivity. Similarly, the cv. Bennet Alphonso on rootstocks of different ages showed little difference in establishment and performance (251).

Trees of outstanding quality, true to type and in good health and vigour should be selected as scion trees. Grafts prepared from older trees are sometimes short-lived (39). Trees with a tendency to alternate bearing and showing symptoms of inflorescence malformation should be avoided (129; 262; 278; 285). Success in inarching is also affected by scion variety (311). Success was higher with Langra as the scion variety as compared to Dusehri and Samar Behisht (18).

In regions with cold winters mangoes remain dormant and grafting operations are not possible. In tropical areas where the plants do not cease growth, inarching can be undertaken all the year round (2; 278; 285). As a general rule, very hot and dry months and excessively rainy periods are avoided. In Pakistan and northern India inarching is usually done twice a year, in February-March or July-August. The trees are then in active growth and the free sap-flow encourages graft union (251; 285). In the Punjab, Pakistan, July-August is preferred because after the spring strong winds in early summer have adverse effects. South India is relatively warmer and this permits inarching during January-February. It is best to complete inarching before the onset of the rains in low-rainfall areas and after the rainy season in regions of heavy rains (69; 285).

Seedling inarching: This method was evolved in Florida where three-week-old seedlings in the first flush of growth are used. The rootstock seedlings are lifted with their cotyledons still intact and their roots wrapped in moss. They are inarched with the scion tree in the conventional manner. The union is soon complete and the young grafts are detached within four or five weeks (131; 216; 285). Singh (282) employed this technique successfully in India and reported 80 per cent success in inarching when he used only eight-week-old seedlings. In Pakistan the use of four-week-old seedlings gave equally good results (311). In another study approach-grafting of about one-week-old seedlings with the branches of similar thickness of fresh tender growth gave a high percentage success. At Lyallpur, Pakistan, September was found to be the best time for this operation. Graft union took place within four to five weeks. By adopting this method all possible graftable branches on a scion tree can be utilized for multiplication. The technique has eliminated the use of pots, scaffolds and watering, since the cotyledons of the seedlings are simply covered with a little moist sphagnum moss and wrapped in plastic film or pieces of gunny bag. The cost of production by this method was found to be only one-quarter of that of the conventional method (131). Garg (72) utilized sufficiently old seedlings in the same manner. The success of his efforts depended on gradual pre-conditioning of the root system of lifted seedlings.

Inarching in situ: To avoid losses in transplanting, mango rootstock seedlings may be raised in prepared pits directly in the field and maintained for 2 - 2½ years before they are inarched with potted plants of the scion variety. Since the plants have well developed root systems they grow vigorously. The method is in use in Gujrat State in India (35).

Topworking by inarching: Inarching may also be used to topwork unprofitable trees, for repairing damage and to invigorate weak-growing trees. The method has been fully described in Part One.

Root grafting: Young seedlings, established in pots or other containers so that three or four inches (8-10 cm) of tap-root below the collar remains exposed, are brought to the scion-source tree and there inarched. The method is described by Singh (285) and may be found in Part One.

Other grafting methods: Many other ways of grafting have been used with success. These include many of the methods described in detail in Part One, such as apical and side grafting, bench grafting and frameworking and repair grafting.

Some successes found with these methods when used with mangoes are mentioned in the following paragraphs.

In India *tongue grafting* gave 82.9 per cent success as compared to only 72.4 per cent for ordinary inarching (41). In similar studies in Puerto Rico a very high percentage of success in mango propagation through tongue grafting had been reported.

In Minas Gerais, Brazil, out of the five methods tried for mango propagation, *cleft grafting* gave the highest success of 97.1 per cent (230). In Cuba many nurseries still use this method for mango propagation with marked success (351).

Side grafting or the 'Nakamura' method of grafting has been developed for fruit trees in Japan (363). The method has been successfully used with mangoes in Florida, Puerto Rico, Hawaii, India, Pakistan, French Guinea and elsewhere (2; 41; 105; 128; 152; 153; 157; 196; 200; 221; 222; 232; 233; 251; 255; 271; 285; 314; 323; 339). The best results in southern India have been during mild weather and in the absence of strong winds, intense heat and heavy rains (251). Some workers have reported greater success by using immature scion shoots as graftwood (157; 314). In southern India success in side grafting varied with different cultivars, reaching 100 per cent with some and only 50 per cent with others (335).

In Florida *veneer grafting* is the most commonly used method for propagating mangoes (58; 150; 255). The method has been tried in other countries and has already become well established and popular in parts of India, Pakistan, Israel, Hawaii and Puerto Rico (3; 31; 188; 307; 344; 360). In India the method had been extensively tested by Mukherjee and Majumdar (188; 193) who reported 80 to 90 per cent success in March-July. Scion wood less than three months old was found unsuitable. Bhabota and Rajput (31) tried three different methods of mango grafting at different times of the year. In all cases veneer grafting proved better than side grafting and cleft grafting. In veneer grafting success reached 88 per cent. In Cameroon, among many methods tried, veneer grafting gave good results, on average 61 per cent

success (307). Zill (352) reported the use of rootstocks having stem diameters from $\frac{1}{4}$ to $1\frac{1}{2}$ inches (2-4 cm). However, in Florida most nurserymen use rootstocks with a stem girth of $\frac{1}{4}$ to 1 inch (0.6-2.5 cm) (255). In Sind, Pakistan, the use of very young rootstocks has given equally good success. Jagirdar (360) did not report any significant difference in success when he used seedlings varying in age from three to nine months. The percentage take, however, improved by the use of mature graft-wood compared with immature wood. In another study he reported differential success with different scion varieties when veneer grafted on nine-month-old rootstock seedlings in March-April; Sindhri and Dasherri showed over 90 per cent success (361).

Rind or crown grafting is not employed on any commercial scale for mango propagation, but can be successful. In Florida, Puerto Rico, Hawaii, Cuba and India the method is considered to be a rapid method of propagation provided the operation is performed at the right time using pre-conditioned scion wood and rootstocks in active growth. Up to 90 per cent success has been reported (70; 236; 285).

Splice grafting has successfully been employed for propagating mango in the Philippines, Peru, Bolivia and India (87; 168; 254; 285; 325; 326). Torres (325; 326), in the Philippines, tried this method on rootstock seedlings from three to nine months of age and reported a high percentage of success irrespective of the age of the rootstock seedlings provided they were in active growth. Majumdar (168) tried splice grafting on the epicotyls of germinating mango seedlings and reported a 50 per cent take. In further studies he used ten- to thirty-day-old seedlings and during August-November obtained up to 80 per cent success with splice grafting, but the eventual survival of the grafts was poor. In Brazil the method has given encouraging results in mango propagation (354).

Budding

The procedure of bud grafting has been described in full detail in Part One. The following notes refer to those features and special types of budding which are relevant to mango propagation (G18; G27; 20; 143; 144; 182; 198; 200; 204; 212; 222; 226; 227; 261; 272; 273; 278; 281; 299; 331; 332; 341; 344).

Shield budding or 'T'-budding for mango propagation was tried for the first time in Florida in 1900 (285). At about the same time it was also tested in India and at first gave only five per cent success. Slowly the method became popular and gave high percentages (51; 132; 285; 289; 290; 291; 292). Suitable conditions are met with in August-September in southern India and in February-June in northern India (251). In Uttar Pradesh and Punjab, India, budding gave a higher percentage of success during March-July (116; 317). In Punjab, Pakistan, three- to twelve-month-old seedlings were shield budded in the nursery twice a year. One-hundred per cent success was recorded in spring (March-April).

Budwood is chosen from mature wood of the past season's flush which should be round and not angular, turning grey. About six leaf blades are clipped off immediately below the cut, leaving the petioles intact. After about 10-15 days the dormant buds in the axils of the cut leaves become prominent and the petioles fall off. At this stage, from budwood about six inches (15 cm) long four to six buds are taken for budding (61; 132; 224; 232; 251). In Florida girdling the scion shoot several weeks prior to their removal increased bud-take markedly (65). In order to determine the desirable bud type and to study the anatomical structure of the union, studies were undertaken at Lyallpur (5; 210). Three types of bud were recognized and described. Three commercial varieties, Langra, Dusehri and Samar Behisht Chausa, furnished the scion-wood. Medium sized, plump, rounded buds with large growing points and numerous scales gave the best bud-take with Langra. Aman Dusehri and Samar Behisht Chausa showed relatively less success in that order (5). In Sind sowing rootstock seedlings in the nursery or germinating the seed in a manure pit and then transplanting to nursery rows did not affect budding success. However, out of three varieties, Langra, Sindhri and Baganpali, bud-take was slightly higher in Sindhri than in the others (362). Bajwa and Ram (276) reported markedly different percentages of budding success for different ecological zones in the same season. They achieved 90 per cent in relatively cool areas and only 45 per cent in the dry hot plains of the Punjab in the month of May. Hosein (102), working in Trinidad, successfully used three- to four-month-old seedlings for 'T'-budding.

Temperature, humidity and the storage media have a strong influence on the length of storage of budwood (114; 251;

281; 301; 308; 339). In Jamaica budwood of different varieties gave satisfactory results after ten days' storage in damp moss, except the cultivar St. Julian (114). At Lyallpur in Pakistan the ends of bud-sticks were sealed by dipping them one-quarter inch (0.6 cm) deep in melted wax. They were then stored in a thermos jug with a little cold water. In this way they were kept in excellent condition for 48 hours. Bud-sticks after sealing with wax can also be stored in fresh banana pith and used successfully after 48 hours' storage (281).

In recent years traditional fibre ties have been largely replaced by more efficient synthetic materials, including adhesive tapes and non-constricting ties which may also serve to protect the bud from drying (15; 255; 285; 290; 343).

The union is generally completed within three or four weeks. The stock is examined 15 days after budding, and if the wound is healed by then and the buds show signs of growth the wrapping is removed and stock is ringed four inches (10 cm) above the union to stimulate the buds to sprout. After the buds have shot, the tops of the rootstock seedlings are cut back gradually. Any new growth on the rootstock is stopped and eventually it is headed-back close to the bud union after the second flush of the scion (95; 149; 255). Soule (298) studied the anatomy and formation of the mango bud union in combinations of two scions and three rootstocks budded at five stages of rootstock growth from first flush to one year old. Haden, Saigon and Turpentine stems of equivalent age and growth rate were indistinguishable anatomically. Four stages in formation of the bud union were: (i) pre-callus, where four days after budding only a wound periderm is present; (ii) callus, where eight days after budding proliferation from tissues mainly near the cambium results in firm attachment of the component; (iii) the cambial bridge, where 12 days after budding cambial layers from rootstock and scion form a bridge and vascular tissues are differentiated within 36-48 days; and (iv) the healed union, where after 6-8 months several cylinders of new tissues are present and the lateral shift of the scion to align with the stock has begun. On completion of the season's growth the plants are large enough to be transplanted (251; 255; 285). For further details of the after-care of bud-grafts see p. 125.

In Florida and Hawaii buds are inserted in inverted 'T' cuts, two- to five-year-old rootstocks being used in the

latter place (96; 255).

In order to avoid loss in transplanting, mango seedlings grown in situ in the orchard have been successfully budded in parts of India and Pakistan (21; 132; 143; 290). The method is described on p.109.

In Punjab, Pakistan, a very high percentage success for in situ budding has been reported, March-April giving better results than August-October (331).

Flap budding has been used in the East Indies (200; 201), and window budding, which is very similar to flap budding, has been used in Queensland by some nurserymen. The bud union takes place within about four weeks (303).

The Forkert method is widely used in the East Indies and Sri Lanka. In Indonesia over ninety per cent success has been reported (46; 212). In mangoes the stock and scion should be in active growth at the time of this operation. In India the method has been tried successfully at the Ganeshkhind Fruit Experiment Station, Poona. One-year-old seedlings raised in the nursery gave 60-70 per cent success when budded by the Forkert method. July-August was found to be the best time for this operation (356). Further studies at Kanpur describe the method on a commercial scale with 100 per cent success during July-August (G24; 315). Scions of Langra and Dashehari were budded by the Forkert method on one-year-old seedlings at 15-day intervals from 20 July to 5 September and 100 per cent success was obtained for both varieties with July budding (277). The conventional Forkert method has been slightly modified and improved in South Africa, Sri Lanka and in the Far East. Success with this method is usually high, hence for mangoes it is preferred to inarching and shield budding (194; 215; 348; 356). In Punjab, India, October was found to be a suitable time for budding by the Forkert method (33). 'H'-budding is a further modification of the Forkert method of budding (285).

Chip budding is being used for mango propagation in Florida, Puerto Rico and Hawaii on an extensive scale and is gaining popularity in India and Pakistan (2; 32; 151; 152; 241; 255; 299; 307).

In chip budding the age of the rootstock is important. Seedlings two to three months old when still in the red and succulent stage are used. Lynch and Mustard (153) attribute high bud-take on young seedlings to the tissue being partially

undifferentiated and there being a broader cambial area. The eyes spring within three to four weeks after budding, probably due to the generous supply of food from the cotyledons (2; 151; 152; 255; 307).

Singh (285) recommended a light application of a nitrogenous fertilizer and regular watering during the period of bud union. The season for chip budding must be related to cropping and the availability of seed for raising young rootstock seedlings (151; 152). Rootstocks over four weeks old generally have a green bark and a well defined cambium. At this stage a slightly modified method of chip budding gives better results (153; 285).

Patch budding: It is believed that patch budding mangoes was first tried as early as the beginning of this century (215; 348; 341a). Besides Florida, it is now being used in India, Zaire, Mauritius, Malaysia, Puerto Rico and Hawaii (116; 184; 285; 315; 317). It is described on p.112 (see also 153; 251; 255; 285). In Malaya patch budding has successfully been employed for mangoes provided it is done between December and February (177). In patch budding experiments on the cultivar Langra in India, the best results were obtained in July by activating the scion shoots two weeks prior to budding. Cutting back the tops of budded stock a week after budding was found better than heading back after two weeks. White polyethylene gave better results than black when used as wrapping material (116).

Teaotia (315) compared patch budding and the Forkert method and found the former superior for the cultivars Langra and Dashehari. In another study he found patch budding and 'T'-budding better than modified Forkert in propagation trials on Langra and Dashehari mangoes during March, May and July for two seasons. Budding was significantly more successful on Langra during one of the two seasons. March was the best month for budding and white Alkathene was better than black for wrapping. Removing the leaf blades of the scion shoots two weeks before budding enhanced bud sprouting, and heading-back the rootstock two weeks after budding was preferable to its immediate removal. In Mauritius patch budding has been adopted as a standard practice for mangoes and usually gives better than fifty per cent success. For a long time inarching was the only method being used for the mango, but patch budding has now been found a satisfactory alternative (176; 177; 178; 179).

PROPAGATION BY CUTTINGS

Several efforts had been made in the past to propagate mangoes through stem cuttings but without appreciable success. More recently, however, the use of growth regulators and rooting under mist have improved the prospects of mango propagation by rooting cuttings (G1; G3; G18; G24; 3; 12; 37; 38; 41; 60; 71; 82; 106; 107; 110; 130; 148; 157; 174; 190; 191; 211; 238; 258; 265; 267; 283; 294; 296; 321; 342). Propagation by cuttings has been described in Part One. The following notes are of special interest as regards the use of the method for mangoes.

Mukherjee et al. (189) reported a higher percentage rooting when they took cuttings from shoots in the lower parts of the tree, compared to the cuttings made from shoots from the middle and the upper parts of the tree. In the same studies cuttings from the shoots of a four-year-old tree gave approximately double the rooting and survival percentages of cuttings from ten-year-old trees. Hussain (103) in Pakistan reported a high percentage rooting success in using hardwood cuttings of mango. Some efforts had been made to root semi-hardwood cuttings with little success (29; 156; 294). For mangoes cuttings are usually six inches (15 cm) long and $\frac{1}{4}$ to $\frac{1}{2}$ inch (18-12 mm) in girth, carrying on an average three to five buds on each. Retention of one or two half leaf blades at the apex helps the initiation of root primordia. This is attributed to the presence of root promoting factors in the leaves (90; 285). Bid et al. (37), in India, studied the rooting ability of plants raised by different methods of propagation such as inarching, veneer-grafting, air-layering, rooting cuttings and seed propagation. Rooting was more profuse in stools obtained from seedlings and veneer grafts as compared with other sources. In northern India and Pakistan cuttings are generally taken in early spring. Hussain (103) reported a higher percentage success in March.

Hardwood cuttings set under mist and treated with some common growth regulators have given very encouraging results (12; 56; 57; 60; 106; 108; 109; 118; 130; 144; 190; 265; 267; 270; 283; 321; 329; 355). IBA and NAA in various strengths have been tried by many workers who have reported varying degree of success. In Zaire softwood cuttings did not root, despite hormone treatment; however, hardwood cuttings treated

with IBA did root (29). Singh (296) reported that ringed hardwood cuttings of mango treated with IBA showed enhanced metabolic activity with increases in reducing and non-reducing sugars and a favourable C/N ratio compared with unringed cuttings or ringed cuttings not treated with IBA.

In Puerto Rico ringing mango shoots and applying NAA to the ring a week before taking the cuttings and, after detaching the cuttings from the parent tree, further treating them by dipping their basal ends in IBA solution greatly increased the rooting percentage (110). Sen et al. (265) reported no rooting in non-ringed hardwood mango cuttings under mist; however, ringing resulted in rooting with 60 per cent success. When ringed cuttings were further treated with 5000 p.p.m. IBA the survival rate rose to 70 per cent. Rooting success can be further improved by using growth regulators in combination with etiolation and invigorating the shoots by heading-back (191). Basu et al. (355) studied the effect of ringing on the rooting of cuttings of the cultivar Fazli. Fifty shoots on a mature tree were ringed and an equal number were tagged as controls. At intervals up to 11 months after ringing, ten shoots representing each group were rooted under spray or later under mist. In the last planting, four out of ten ringed shoots rooted under intermittent mist whereas none rooted under spray. They also took juvenile cuttings either from seedlings or from forced shoots on a mature tree. The shoots were variously ringed and treated with hormones, and cuttings were planted under spray to root. In juvenile seedling cuttings which had received ringing + IBA treatment the rooting success was as high as 88 per cent. It was 60 per cent in those which had been ringed only. Strangely enough, no appreciable root development could be induced by various treatments of ringing, etiolation and hormone application in the case of forced juvenile shoot cuttings from mature trees. Contrary to these findings Sen et al. (270) reported success in rooting one-, two- and three-year-old ringed hardwood stem cuttings taken from a 35-year-old tree. Under intermittent mist the percentage of rooting of cuttings varied from 40 to 80 per cent. Older shoots gave a higher percentage success compared to young ones. Pre-treatment with IBA also improved rooting from 70 to 80 per cent in the case of three-year-old wood. Bid and Mukherjee (38) studied the effects of shoot etiolation, invigorating shoots by heading back and of different media on the rooting of mango cuttings. They reported a higher percentage success with forced cuttings as

compared to unforced cuttings. Etiolation was found beneficial in both types of cutting, and out of five media used, peat moss and sand were the best. In studies at Lyallpur (12) mango cuttings treated with one per cent IAA, NAA or IBA before planting rooted better.

In Egypt (130) three experiments were established to study the effects of various treatments on the storage of mango cuttings. In one, comparisons were made between soaking the cuttings in running tap water for 24 hours, dipping them in hot water ($60^{\circ}\text{C} = 140^{\circ}\text{F}$) for five to ten seconds, flaming the basal ends for one to two seconds, and dipping the basal ends in normal hexane for five minutes. In general, the treatment with running tap water increased the life of the cuttings compared with the other treatments. In the second experiment terminal and middle leafy cuttings were soaked in running tap water for 24 hours and then treated with various growth regulators. The combination of 100 p.p.m. IBA + 10 p.p.m. vitamin B1 + 2% ammonium sulphate + 2% sucrose resulted in greater longevity of treated cuttings. In the third experiment terminal cuttings were kept in cold storage, and 20 days' storage did not appreciably lower their rooting capacity.

In North Borneo leafy and semi-hardwood cuttings of many tropical trees including mango have been successfully rooted in plastic bags containing eight parts decomposed rice husk to two parts fine river sand as the rooting medium. The bases of mango cuttings from three varieties were kept immersed for 12 to 24 hours in different concentrations of various chemicals (lindane, pentachlorophenol, a stain and three antibiotics) before being subjected to a quick dip in 0.2% IBA. Ten to 20 per cent of the cuttings rooted, as compared to nil when treated only with IBA. To improve the light conditions in the afternoons the attachment of aluminium reflectors further improved rooting (G8; G9; G10).

In Israel an entirely new method of rooting cuttings has recently been developed. The cuttings, with leaves still on, are placed horizontally in rows of paper tubes containing a lightweight but nutritionally satisfactory soilless mixture of peat, Styrafoam and rotted organic matter. These tubes are supported horizontally by a wire rod. The cuttings are placed in such a way that the leaves are in constant contact with the moist rooting media whilst the upper portions of the cuttings remain exposed to light and air; this ensures constant foliar absorption of moisture by the leaves and the

larger portion of the cuttings. The method has been used for a number of crops including mango. Controlled light and temperature further helped in root initiation and development (174; 175).

As regards rooting media Hitchcock (97) found a mixture of peat moss and sand more suitably acidic and a better rooting medium than peat, sand or sphagnum moss alone. Acidic media of pH 4.5 to 7.0 are said to give better rooting than basic media (126).

PROPAGATION BY LAYERING

Efforts have been made to induce the development of roots on mango shoots or stems while still attached to the parent plant. The method has chiefly been employed to provide uniform clonal rootstocks of monoembryonic mango varieties. The use of growth-regulating substances and of plastic films as wrapping material has very greatly improved the prospects of success in layering operations. Depending upon the availability of shoots on the parent tree, layering is either done at ground level or at higher levels using pots for holding the ringed shoots or using other materials for covering and wrapping the ringed portions where the roots would develop (166; 187; 285). For details of the various methods of layering, including ground layering, pot layering and air layering (gootee) and other techniques, see Part One.

Ground layering

Healthy, vigorous shoots 1½ to 2 years of age are selected near the soil surface for ground layering. The root formation under ideal conditions is completed within four to five months. In order to avoid double shock to the layers they are not lifted immediately after they have been detached from the mother plant. This helps the young plants to sustain the shock better and when they are potted after a fortnight or so, the percentage of transplanting success is higher (166; 187; 288).

Pot layering

The selected shoots in this case are not bent and covered by soil in mounds at ground level. Instead the ringed portions of scion shoots are buried in specially made earthenware pots. In India the monsoon is considered to be the best

time for this operation. A very low level of success (15-20 per cent) has been reported by using this method (285).

Air layering or gootee

Like inarching, air layering or gootee is one of the oldest methods of mango propagation in India. The method has been greatly improved during the last few years and extensive work in many countries is in progress to further improve this technique (27; 36; 51; 73; 84; 106; 117; 186; 189; 237; 246; 247; 248; 249; 252; 267; 300). Shoots of less than two years of age are considered most suitable for air layering (284). In northeast India air layering is done in the monsoon season, and in south India the operation has even been performed in December, but with a relatively low percentage success. The rainy season helps in the conservation of moisture particularly when gunny pieces have been used as wrapping material (251; 252). On the west coast of India air layers made on plants in active growth during June-July were very successful. This season was also found favourable for the separation of layers and their establishment in the field (251).

The influence of the cultivar on air layering success is pronounced. In Andhra Pradesh, India, out of 11 varieties only five, viz. Neelum, Bennet Alphonso, Beneshan, Piari and Kurrukkan, showed some success with this method. The layers were slow to establish and make growth (251). In another study the cultivars Langra, Himsagar, Bombai and Gulab Khas were included. Langra was found to be a shy rooter and Gulab Khas a good rooter. Bombai and Himsagar were only mediocre. In all these varieties IBA application improved rooting and the ultimate survival of rooted layers (27). In south India shoots of two cultivars, Bennet Alphonso and Kalapadi, were air layered in February and May, respectively. Success in Bennet Alphonso was only 24 per cent, whereas with Kalapadi it was 90 per cent (248).

Many growth regulators have been used to induce rooting in air layering mangoes with varying success. At Saharanpur, India, success was appreciably improved with the application of IBA and NAA (257). Srivastava (300) applied NAA, IBA and a mixture of NAA and IBA to mango layers using 2500, 5000 and 10000 p.p.m. An application of NAA at 10000 p.p.m. was most effective in inducing rooting. Not only was this treatment helpful in promoting 100 per cent rooting but it was also effective in their 100 per cent survival after separation and

their establishment in the field. Sen (266) reported a higher percentage of success in air layering the cultivar Kohitoor when he applied IBA at 500 p.p.m. in lanolin paste to the upper rim of the ring in the middle of June. However, the same treatment in later studies did not give any success. Chhonkar et al. (50) found IBA at 5000 p.p.m. markedly more effective than NAA. This gave 83.6 per cent success, compared with 27.0 per cent with NAA and 15.6 per cent in the control. IBA treatment was also helpful in the establishment of layers in the field. Contrary to the findings of many other workers, the application of IBA immediately after ringing was less effective than application one day later. Air layering in June gave a higher rooting success compared to May, a relatively dry month. A higher percentage of rooting in air layering was also obtained when a mixture of IBA, IAA, PA and NAA at 0.25 or 0.5 per cent in a lanolin paste was used to promote rooting. This was attributed to a synergistic effect (252). In a study in India etiolation treatment alone promoted rooting in mango layers. IBA at 10000 p.p.m. and NAA at 5000 p.p.m. induced 100 per cent rooting and the corresponding survival rates after one year were 95 and 90 per cent, respectively. NAA at 10000 p.p.m. was toxic to etiolated shoots but aided root regeneration in non-etiolated shoots (186).

Sen et al. (267) studied the carbohydrate and nitrogen contents at different stages of root development of mango layers variously treated with IBA, NAA and MH. The increase in rooting due to IBA was associated with a greater depletion of sugars in the bark and wood of the rooting zone. The variation in reserve polysaccharides did not show any correlation with rooting activity. The moisture contents were directly proportional to root formation, and the nitrogen content in the bark progressively increased during rooting.

Basu et al. (27) working with the Langra variety determined changes during root regeneration in air layering. The layers were made with and without IBA used at the time of ringing at 3000 p.p.m. in lanolin paste. Biochemical changes were studied at four different stages, viz. ringing, pre-callusing (eight days after ringing), pre-callusing (19 days after ringing) and at root emergence (34 days after ringing). Eighty per cent of IBA-treated layers rooted with an average of 2.8 roots per layer, compared with 40 per cent rooting and 0.6 roots per layer in the

control. There was no appreciable change in the carbohydrate and nitrogen contents in the tissues of unlayered shoots for 34 days. However, the total carbohydrates increased progressively in untreated and treated layered shoots; subsequently the untreated layered shoots showed a relatively higher amount of available carbohydrates compared to treated layered shoots, where the degree of callusing and root development was greater. Easily available soluble carbohydrates seem to play an important role in the metabolism of regenerating tissue. In both untreated and treated layers there was a considerable fall in soluble nitrogen at the time of root formation (27).

Azzouz and Anis (19), working in Egypt, selected the variety Aromans for air layering and treated the shoots with IAA, IBA and a mixture of equal parts of IAA + IBA at concentrations of 0.25, 0.50 and 1.0 per cent in lanolin. Rooting percentage and root length, number and weight were recorded after 45 to 90 days. The results after 60 and 90 days were much better than those obtained after 45 days. IAA was found generally superior to IBA and the best root system was found after 90 days in marcots treated with IAA + IBA at 0.25 per cent. There was 40 per cent rooting in untreated marcots after 90 days and a maximum of 70 per cent with IBA one per cent treatment.

TOPWORKING

Topworking is carried out either to rejuvenate an old unproductive tree or to replace a diseased top having healthy roots. Likewise topworking a large inferior mango tree with a more desirable scion cultivar is possible. The technique of topworking has been fully described in Part One (see also 2; 25; 42; 44; 69; 150; 182; 201; 207; 208; 223; 253; 255; 286; 340) and mostly comprises budding and grafting procedures.

There are two methods generally applied in the topworking of mango trees. The most common

method is to dehorn the branches or main limbs within a foot (30 cm) or so of the trunk of the tree. In northern India and Pakistan heading-back is done before onset of spring. In Florida it is done in autumn or winter months. The shoots which spring from the cut-back branches are shield budded or veneer grafted in the following summer or autumn months. A few of the weaker branches are sometimes not pruned back but left to provide shade until the new top is established. These branches can be headed-back later on in the same way and the newly emerging shoots budded or grafted in the subsequent season. In areas of intense heat and of bright sunshine there is danger of sunburn injury to the naked trunk after heading-back of the main limbs. A coat of whitewash prevents sunscald (2; 150; 255; 286). In southern Florida good results in topworking mangoes in this way were obtained when the trees were cut-back in late October or early November and the sprouts thinned and veneer grafted in the following March or April (42; 182). In Uttar Pradesh, India, topworking eight-year-old mangoes during June gave a higher percentage success than in April. Patch budding the new sprouts was found to be a better method than either shield or Forkert budding (286). The new growth should be supported for several months to avoid its breaking at the union.

In the other method the tree is headed-back to the main trunk or main limbs, which are cleft or veneer grafted. If the stump is larger than three inches (8 cm) in diameter, several scions are placed around it. Older trees, 20 to 30 years old, have successfully been topworked in this manner (150; 255). In Sri Lanka, Richard (44; 253) developed a method of topworking which eliminated the need of initial dehorning. The technique consists in removing or scraping a triangular piece of bark at a convenient height on the trunk to be topworked. Two vertical and parallel cuts running downward from the lower edges of the triangle are made. The bark is slightly lifted and a scion shoot eight to ten inches (20-25 cm) in length, taken from the current season's growth and trimmed in the form of a wedge so as to fit on the stock, is inserted underneath the flap of the bark.

After insertion the scion is tied in place and covered with grafting wax. About 200 eight-year-old Sabre trees growing on four different rootstocks were successfully topworked to the variety Karuthacolomban by this method.

In Senegal, out of an estimated 250,000 mango trees, 95 per cent are seedlings which give low yields of small and poor quality fruit. Exotic mango varieties have been introduced recently which are now furnishing graft-wood for topworking old seedling trees as part of a large scale rehabilitation programme of fruit production. After topworking the trees come into bearing within two years because of the well developed root system (67).

Double working

A method of topworking already grafted or budded trees is known as double working (G15; 160; 162; 163; 199; 200). A double worked plant is made up of three genetically different parts, viz. rootstock, intermediary stem piece (interstock) possibly of an inferior variety, and the top of the more promising variety. This method has been described in Part One.

In Florida the cultivar Haden for a very long time remained a leading variety, but was at best a poor and irregular bearer. Hence grafted Haden trees have been double worked, using the cultivar Tommy Atkins as the new scion variety; Tommy Atkins is more prolific with very good quality fruit (183).

Double working is also used to overcome graft incompatibility between a desired variety and a good rootstock. Again, in some instances the technique has been used to provide disease or cold resistance and a strong framework (90). In India, Langra, a vigorous variety on a monoembryonic seedling rootstock, with Kalpadi (a dwarfing variety) as interstock, developed into relatively small trees (G15; 269). In another study in Andhra Pradesh four scion varieties grafted on monoembryonic seedling rootstocks with interstocks of two heavy yielding varieties, Neelum and Bangalora,

showed dwarfing of the scion trees and also reductions in yield, suggesting that the heavy-yielding cultivar used as interstock had no influence on the fruit bearing capacity of an otherwise shy-bearing variety. In this instance, however, double working resulted in early fruiting (251; 269; 285).

BIBLIOGRAPHY

1. AGUERO S., D. Injerto en mangos. *Suelo Tico*, 1949, 3: 128-34.
2. AHMED, S. Propagation of mangoes. *Punjab Fruit J.*, 1960, 23(82/83): 49-53.
3. AHMED, S. Propagation of mango by veneer grafting. *W. Pakist. J. agric. Res.*, 1964, 2(1/2): 32-44.
4. AHMED, S. and AHMED, R. Mango budding in nursery stages. *Punjab Fruit J.*, 1960, 23 (82/83):77-9.
5. AHMED, S. and CHATHA, G.A. Some morphological and anatomical studies of scion buds and bud union zone in mangoes. *Punjab Fruit J.*, 1960, 23(82/83): 105-11.
6. AHMED, S. and RASHID, A. Importance of seed in fruit industry. *Agric. Pakist.*, 1961, 12: 552-7.
7. AHMED, S. and SCHLOSSER, E. Effect of some cultural practices on the incidence of mango malformation. *Z. PflKrankh.*, 1972, 79(6): 349-51.
8. AHMED, S. et al. Various aspects of mango industry in Pakistan. *Punjab Fruit J.*, 1960, 23(82/83): 1-4.
9. AHMED, S. et al. Races and varieties of mango. *Punjab Fruit J.*, 1960, 23(82/83): 5-11.
10. AHMED, S. et al. Response of mango to difference in climate and soil conditions. *Punjab Fruit J.*, 1960, 23(82/83): 25-6.
11. AHMED, S. 'Spreading decline' a great threat to citrus industry in Florida. *Punjab Fruit J.*, 1964, 26/27(90/99): 393-5.

12. ALI, N and NAZIR, M. Effect of auxins on carbohydrate and nitrogen contents of mango cuttings. *Pakist. J. Sci.*, 1970, 22(1/2): 12-21.
13. ALI, N. and HAMID MAZHAR. The tree, flower and fruit characteristics of mango. *Punjab Fruit J.*, 1960, 23(82/83): 81-6.
14. ALLAN, R.G. Modern mango cultivation. *Bull. U.P. Dep. Agric., Fruit Ser.* 13, 1935.
15. ANDERSSON, F.G. Horticultural work in the union. *Fmg S. Afr.*, 1940, 15: 517.
16. ARNDT, C.H. Notes on polyembryony and multiple shoots from seed of *Mangifera indica*. *Amer.J. Bot.*, 1935, 22: 26.
17. ARORA, K.S. and SINGH, R. Effect of plant regulators on fruit drop, fruit quality and seed germination in mango. *Indian J. agric. Sci.*, 1964, 34(1): 46-55.
18. ASADULLAH, M. and KHAN, MD. Studies of various factors affecting success in grafting by approach (inarching) in mangoes. *Punjab Fruit J.*, 1960, 23(82/83): 59-70.
19. AZZOUZ, S. et al. Effect of hormones on air layering of mango. *Agric. Res. Rev., Cairo*, 1969, 47(4): 59-67.
20. BAILEY, L.H. *Standard cyclopedia of horticulture*. Macmillan, London & New York, 1927.
21. BAJWA, B.S. and RAM, A. Budding in mango seedlings 'in situ'. *Punjab Fruit J.*, 1946, 10: 10-13.
22. BAKHSI, J.C. Propagation studies with monoembryonic and polyembryonic varieties of mango. *Punjab hort. J.*, 1963, 3: 185-93.

23. BAKSHI, J.C. Germination of mango stones in relation to the depth and time of sowing. *Punjab hort. J.*, 1963, 3: 199-204.
24. BALKRISHNAMURTI, D and JOGIRAJU, G. Graft mango gardens - how to start and maintain them. *Bull. Dep. Agric. Madras* 24, 1932.
25. BARBADOS. *A.R. Dep. Sci. Agric.* 1941.
26. BASU, R.N. and GHOSH, B. Rooting in cuttings of *Mangifera indica* L. *Acta Horticulturae*, 1972, No.24, pp. 61-3.
27. BASU, R.N., et al. Biochemical changes during root formation in *Mangifera indica* L. air layers. *Acta Horticulturae*, 1972, No. 24, pp. 64-71.
28. BELLING, J. Report of the assistant in horticulture, mango. *A.R. Fla agric. Exp. Stat.*, 1908, pp. 110-25.
29. BENINCASI, R. Tentativi di applicazione di tecniche di propagazione agamica in piante da frutto tropicali presso la stazione sperimentale di M'vuazi (Basso Congo) (Kinshasha). *Riv. Agric. subtrop.*, 1970, 64: 182-95.
30. BERWICK, E.J.H. Mangoes in Krian. *Malay. agric.J.*, 1940, 28: 517-24.
31. BHAMBOTA, J.R. et al. Veneer grafting - a successful method of mango propagation. *Punjab hort. J.*, 1971, 11: 40-3.
32. BHAN, K.C. et al. Chip budding and stone-grafting of mangoes in India. *Trop. Agric., Trin.*, 1969, 46 247-53.
33. BHANDARI, K.R. and CHINNAPPA, K.S. Mango (*Mangifera indica*, Linn.). *Lal-Baugh*, 1963, 8(1): 4-17.
34. BHARATH, S. Mango propagation - a modified system of approach grafting. *Trop. Agric., Trin.*, 1958, 35: 190-4.

35. BHAT, S.S. Nursery practices of mango grafting. *Indian Fmg*, 1943, 4: 254-6.
36. BID, N.N. and MUKHERJEE, S.K. Varietal response to etiolation and growth-regulator treatment in air-layering of mango (*Mangifera indica* L.). *Indian J. agric. Sci.*, 1969, 39: 1013-19.
37. BID, N.N. et al. Studies on different methods of propagation of *Mangifera indica* L. with respect to success, survival, growth and their clonal multiplication by stooling. *Acta Horticulturae*, 1972, No. 24, pp. 85-8.
38. BID, N.N. and MUKHERJEE, S.K. Studies into the effects of forced shoot etiolation and different media on the rootage of *Mangifera indica* L. cuttings. *Acta Horticulturae*, 1972, No 24, pp. 77-81.
39. BONAVIA, E. The mango - its propagation and improvement. *Trop. Agriculturist*, 1885, 4: 743.
40. BRODRICK, H.T. Mango diseases. *Leafl. Dep. Agric. tech. Serv. S. Afr.* 72, 1971, pp. 4.
41. BURNS W. and PRAYAG, S.H. *The book of the mango*. Dep. Agric., Bombay, 1921.
42. CARMICHAEL, W.W. Rejuvenation of old mango groves by hedging or top-working to new varieties. *Proc. Fla St. hort. Soc.*, 1957/58, 70: 290-1.
43. CEYLON. *Admin. Rep. Ag Dir. Agric., Ceylon*, 1943-1945.
44. CEYLON. *Admin. Rep. Ag Dir. Agric., Ceylon* 1946, Pt. IV, (D), 1948.
45. CEYLON. *Admin. Rep. Dir. Agric., 1950, Pt IV.(C)*. 1951.

46. CEYLON DEPARTMENT OF AGRICULTURE. The propagation of the mango in the dry zone. *Leafl. Dep. Agric. Ceylon* 113, 1937, pp. 4.
47. CHACKO, E.K. et al. Inhibition of flowering in *Mangifera indica* L. by gibberellic acid. *Acta Horticulturae*, 1972, No. 24, pp. 206-9.
48. CHOUDHURI, J.M. et al. Changes in endogenous growth regulating substances in the *Mangifera indica* L. shoot in relation to growth and development. *Acta Horticulturae*, 1972, No. 24, pp. 196-205.
49. CHEEMA, G.S. et al. *Commercial fruits of India*. Macmillan and Co. Ltd., London, 1954.
50. CHHONKAR, V.S. and SINGH, R.K. Propagation of *Mangifera indica* L. by air layering. *Acta Horticulturae*, 1972, No. 24 pp. 89-92.
51. CHOUDHURY, K.R. A short note on substitutes for moss as plastering material in air-layering of mango. *Sci. and Cult.*, 1959, 25 152-3.
52. CLAY, D.W.T. Notes on nursery practices. *Tec. Rep. Minist. Agric. N. Nigeria* 13, 1960.
53. COBIN, M. Mango selection, propagation and culture. *A.R. Fla agric. Exp. Stat.* 1948-49, pp. 262-4.
54. COLE, K.S. and HAWSON, M.G. The mango in Western Australia. *J. Agric. W. Aust.*, 1963, 4: 331-7.
55. COLLINS, G.N. The mango in Puerto Rico. *Bull U.S. Dep. Agric. Bur. Pl. Ind.* 28, 1903.
56. COOPER, W.C. Transport of root-forming hormones in woody cuttings. *Plant Physiol.*, 1936, 11: 779.
57. COOPER, W.C. and STOUTEMYER, V.T. Suggestion for the use of growth substances in the vegetative propagation of tropical plants. *Trop. Agric., Trin.*, 1945, 22: 21.

58. COOPER, W.C. and FURR, J.R. The cinchona veneer-graft method of propagating subtropical fruit trees. *Proc. Fla St. hort. Soc.*, 1945, 58: 176-80.
59. DHILION, R.S. et al. Studies on the establishment of young mango grafts with various green shelters. *Punjab hort. J.*, 1970, 10: 213-21.
60. DIJKMAN, M.J. Rooting of Haden mango (*Mangifera indica* L.) leaf bud cuttings. *Science*, 1950, 111: 663-5.
61. DUBOIS, L. and VAN LAERE, R. Le manguier au Congo Belge et au Ruanda-Urundi. *Publ. Dir. Agric. Elev. Minist. colon.*, Bruxelles, 1948, p.83.
62. FAHMY, I. A study of the relation between carbohydrate content of scions and graft union in certain tropical fruit trees, and the diffusible auxin content of the scions. *Diss. Abstr.*, 1954, 14: 748.
63. FERNANDEZ E SILVA, R. Notas sobre a cultura da mangueira. *Publ. Serv. Inform. agric.*, Rio-de-Janeiro (S.I.A.) 420, 1944, p. 11.
64. FLECHTMANN, C.H.W. et al. Observações preliminares sobre a malformação em inflorescências de mangueira (*Mangifera indica* L.) e fungo, alguns insetos e ácaro nelas encontrados. *An. Esc. Sup. Agric. Queiroz*, 1970, 27: 281-5.
65. FLORIDA A.R. *Fla agric, Exp. Stats* 1950.
66. FURON, V. La multiplication du manguier au Sénégal. *Fruits d'Outre Mer.*, 1966, 21: 189-93.
67. FURON, V. and PLAUD, G. Topworking mango trees in Senegal. *Fruits*, 1972, 27: 293-6.
68. GANDHI, S.R. Effect of buttress grafting on growth and development of orchard trees. *Poona agric. Coll. Mag.*, 1950, 41(1): 23-44.

69. GANDHI, S.R. The mango in India. *Farm. Bull. I.C.A.R.*, New Delhi, 6, 1955.
70. GANGOLLY, S.R. et al. *The mango*. I.C.A.R., New Delhi, 1957.
71. GARDNER, D.E. and PIPER, R.B. Base of propagation of some sub-tropical fruits by cuttings from young seedlings. *Proc. Fla St. hort. Soc.*, 1943, 56: 124-6.
72. GARG, M.L. Mango grafting made easy and cheap. *Indian J. Hort.*, 1954, 11: 145-6.
73. GARG, M.L. Mango propagation by means of marcotting or air-layering. *Indian J. Hort.*, 1954, 11: 147-8.
74. GEORGE, P.V. and NAIR, T.N.K. On the performance of mono and polyembryonic root-stocks in mango grafts. *Agric. Res. J. Kerala*, 1969, 7: 7-9.
75. GHOSH, B. and BASU, R.N. Studies on the effect of ringing of shoot on rooting of cuttings. *Proc. Ind. Sci. Congr. 55th Sess*, 1968.
76. GIRI, A. A survey on polyembryony in mango. *Agric. Pakist.*, 1965, 16: 467-72.
77. GIRI, A. Transplanting success with varying stem girths of mango seedlings. *Agric. Pakist.*, 1966, 17: 195-200.
78. GIRI, A. Germination percentage, average height and girth of seedlings raised from seedstones extracted from syrupy and firm mango fruits. *Pakist. J. Sci.*, 1966, 18: 79-81.
79. GIRI, A. and CHAUDHARY, M.Y. Relation of mango stone weight to its germination and seedling vigour. *Pakist. J. Sci.*, 1966, 18: 148-50.
80. GODFREY-SAM-AGGREY, W. and ABUTIAE, W.S. Description of some mango cultivars in Ghana. *Ghana J. agric. Sci.*, 1973, 6: 33-42.

81. GODFREY-SAM-AGGREY, W. Mango growing in Ghana. *Ghana Fmr*, 1970, 14: 45-7.
82. GOWDA, M.H.M. Some methods of propagation of mango. In *Fruit nursery practices in India*. Directorate of Extension, Ministry of Food and Agriculture, New Delhi, 1962, pp. 54-64.
83. GOWDER, R.B. and IRULAPPAN, I. Performance of Neelum variety of mango (*Mangifera indica* L.) on polyembryonic rootstocks. *Madras agric. J.*, 1970, 57: 29.
84. GROVE, W.R. Wrapping air-layers with rubber plastic. *Proc. Fla St. hort. Soc.*, 1947, 60: 184-7.
85. GUATEMALA. *Mem. an. Inst. agropec. nac., Div. Invest. agropec.* 1963, 1964.
86. GUNARATNAM, S.C. The cultivation of the mango in the dry zone of Ceylon. *Trop. Agriculturist*, 1945, 101: 227-31; 1946, 102: 23-30.
87. GUZMAN, V.L. Algunos experiments en el palto, mango y plantanu. *Agronomia, Peru*, 1951, 16: 53-65.
88. HARRIS, W. The Mango. *Bull. bot. Dep. Jamaica* 8, 1901.
89. HARTLESS, A.C. Factors influencing mango crops. *Trop. Agriculturist*, 1914, 43: 307.
90. HARTMAN, H.T. and KESTER, D.E. *Plant propagation principles and practices*. Prentice Hall Inc., Eagle Wood Cliffs, New Jersey, 1960.
91. HAQ, A. The fruit flies attacking mango and their control. *Punjab Fruit J.*, 1960, 23(82/83): 194-6.
92. HAQ, A. The mango hoppers and their control. *Punjab Fruit J.*, 1960, 23(82/83): 197-8.

93. HAQ, A. Mango mealy bug and its control. *Punjab Fruit J.*, 1960, 23(82/83): 199-202.
94. HAQ, A. The mango borer and its control. *Punjab Fruit J.*, 1960, 23(82/83): 203-4.
95. HAYES, W.B. *Fruit growing in India*. 3rd Ed. Kitabistan, Allahabad, 1957.
96. HIGGINS, J.E. Shield budding the mango. *Bull. Hawaii agric. Exp. Stat.* 20: 1910.
97. HITCHCOCK, A.E. Effect of peat moss and sand on rooting response of cuttings. *Bot. Gaz.*, 1928, 86: 121.
98. HOOLE, E.T. Grafting mango plants in Jaffina. *Mag. School Agric. Colombo*, 1892, 4: 31.
99. HOPKINS, A.D. Bioclimatics - a science of life and climate relations. *Publ. U.S. Dep. Agric.* 280, 1938.
100. HORN, C.L. The frequency of polyembryony in twenty varieties of mango. *Proc. Amer. Soc. hort. Sci.*, 1943, 42: 38.
101. HOLDSWORTH, M. Intermittent growth of the mango tree. *J. W. Afr. Sci. Ass.*, 1963, 7: 163-71.
102. HOSEIN, I. Mango propagation by a 'T' graft method. *Trop. Agric., Trin.*, 1958, 35: 181-9.
103. HUSSAIN, I. Some studies on the effect of hormones on the rooting of cuttings of horticultural plants. *Thesis, Univ. Punjab*, 1953.
104. HYDERABAD DEPARTMENT OF AGRICULTURE. *The mango - a souvenir*. [1954] Dep. Agric., Hyderabad.
105. INDIA. A.R. imp. Counc. agric. Res. 1940-1, 1942.

106. INDIA COUNCIL OF AGRICULTURAL RESEARCH A.R.
Indian Coun. agric. Res. 1957-8, 1960.
107. INDIA COUNCIL OF AGRICULTURAL RESEARCH. *Idem*
1958-9, 1961.
108. INDIAN AGRICULTURAL RESEARCH INSTITUTE.
Ann. sci. Rep. 1963, 1966.
109. INDIAN AGRICULTURAL RESEARCH INSTITUTE.
Idem 1964, 1967.
110. INSTITUTE OF TROPICAL AGRICULTURE, VAN OVERBEEK, J.
et al. Investigations on the fundamentals of
plant propagation by means of cuttings. *Second*
A.R. Dir. Inst. trop., Agric., Mayaguez, P.R.,
1943-44, 1945.
111. IMPERIAL BUREAU OF FRUIT PRODUCTION. Investigations
on the standardization of citrus trees by
propagation methods. *Tec. Commun. imp. Bur*
Fruit Prod. 3, 1932.
112. JAGIRDAR, A.P. and MANIYAR, A.K. Mango culture
in Sind. *Punjab Fruit J.*, 1960, 23(82/83):
221-43.
113. JAGIRDAR, A.P. and ALI, Z. Effect of age and
variety of stock plants on the bud take in mango.
Agric. Pakist., 1965, 16: 461-6.
114. JAMAICA. A.R. Dep. Agric. 1945.
115. JAMAICA. Department of Agriculture. Investigations
1949-50. *Bull. Dep. Agric. Jamaica* 47, 1951.
116. JAUHARI, O.S. and SINGH, R.D. Effect of bud
activation, lopping and wrapping materials on
budding in mango (*Mangifera indica* L.) var. Langra.
Punjab hort. J., 1970, 10: 198-202.
117. JAUHARI, O.S. and NIGAM, V.N. Air layering of
mango. In *Fruit nursery practices in India*.
Directorate of Extension, Ministry of Food and

- Agriculture, New Delhi, 1962, pp. 77-81.
118. JAUHARI, O.S. and NIGAM, V.N. Effect of hormones on rooting in cuttings of mango. *Kanpur agric. Coll. J.*, 1958, 17(1/2): 1-3.
 119. JAUHARI, O.S. et al. Root-stock studies in *Mangifera indica* L. *Acta Horticulturae*, 1972, No. 24, pp. 107-9.
 120. JAWANDA, J.S. Propagation of mango in the Punjab. *Punjab hort. J.*, 1963, 3: 171-4.
 121. JAWANDA, J.S. and SINGH, K.K. Some problems of mango industry of North India. *Punjab hort. J.*, 1971, 11: 131-7.
 122. JOGIRAJU, G. Graft mango gardens - how to start and maintain them. *Bull agric. Dep. Madras* 24, 1932.
 123. JOSHI, W.V. Longevity of mango seeds. *Prona agric. Coll. Mag.*, 1938, 30: 18.
 124. JULIANO, J.B. Embryos of Carabao mango (*Mangifera indica* L.) *Philipp. Agric.*, 1937, 25: 749.
 125. JULIANO J.B. Origin of embryos in the strawberry mango. *Philipp. J. Sci.*, 1934, 54: 553.
 126. KAINS, M.G. and MCQUESTAN, L.M. *Propagation of plants*. Orange Judd, N.Y., 1955.
 127. KANNAN, K. and RAO, V.N.M. Effect of gibberellic acid on seed germination, seedling growth and graft 'take' in the mango. *Pap. 4th annu. Sess. Acad. agric. Sci., Coimbatore*, from abstr. in *Madras agric. J.*, 1964, 51: 77-8.
 128. KASHYAP, R. et al. Techniques of side-grafting in mango. *Acta Horticulturae*, 1972, No. 24, pp. 99-100.
 129. KAUSAR, A.G. et al. Diseases of mango. *Punjab Fruit J.*, 1960, 23 (82/83): 178-93.

130. KHALIFA, A. S. et al. Physiological studies on mango cuttings. *Indian J. Hort.*, 1964, 21: 179-85.
131. KHAN, D. A. A new technique for mango propagation. *Pakist. Times*, 12 October, 1966.
132. KHAN, A. A. Mango budding 'in situ'. A new technique likely to revolutionise mango industry. *Punjab Fruit J.*, 1960, 23(82/83): 55-8.
133. KHAN, M. D. Root system of mango (*Mangifera indica* L.). *Punjab Fruit J.*, 1960, 23(82/83): 113-16.
134. KHAN, M. D. and KHAN, A. H. Studies on malformation of mango inflorescence in West Pakistan. *Punjab Fruit J.*, 1960, 23(82/83): 247-58.
135. KHAN, M. D. and KHAN, A. H. Studies on malformation of mango inflorescence in West Pakistan. *Punjab hort. J.*, 1963, 8: 229-34.
136. KHAN, M. D. and KHAN, A. H. Relation of growth to malformation of inflorescence in mango in West Pakistan. *W. Pakist. J. agric. Res.*, 1962, 1: 51-63.
137. KNIGHT, R. J., Jr. Polyembryonic mangos: their unrealized potential. *Proc. trop. Reg. Amer. Soc. hort. Sci.*, 1970, 14: 145-55.
138. KRISHNAMURTHY, S. Mango: in other countries. In *The mango - a souvenir*. Dep. Agric., Hyderabad, [1964], pp. 45-9.
139. KROCHMAL, A. Inarching as a method of propagating tropical fruit trees. *World Crops*, 23: 218-19.
140. KOTALAWALA, J. Techniques of propagation of mango in Ceylon. *Acta Horticulturae*, 1972, No. 24, pp.82-4.
141. KUSUMO, S. et al. Mango root-stock experiment at Poh-djentrek. *Bull. Hort.*, 1971, No.3.
142. KUSUMO, S. and TJIPTOSUHARDJO, S. Tjabang Lembaga Penelitian Hortikult, Malang, Indonesia. Djenis mangga jang baik untuk buah medja. *Bull. Hort.*, *Tjahort*, 1971, 5: 1-24.
143. LAL SINGH and KHAN, A. A. Mango budding in situ. *Punjab Fruit J.*, 1942, 6: 1195-206.
144. LAMBOURNE, J. Progress report on etiolated shoot method of propagation up to September, 1935. *Commun. Dir. Agric., F.M.S. and S.S.*, 1935.

145. LARUE, C. D. Root-grafting in tropical trees. *Science*, 1952, 115: 296.
146. LAZO RODRIGUEZ, F. La multiplicación de diversas especies de frutas tropicales. *Proc. Carib. Reg. Amer. Soc. hort. Sci.*, 1957/1958, 5: 6-11.
147. LAZO RODRIGUEZ, F. Multiplicación del mango por injerto. *Rev. nac. Agric., Colombia*, 1964, 56 (709): 43.
148. LEDIN, R. B. and RUEHLE, G. D. Mango selection, propagation and culture. *A.R. Fla agric. Exp. Stats*, 1954, pp. 291-2.
149. LUTHRA, J. C. and SHARMA, M. M. L. Some studies on the conductability and histology of grafted mango shoots. *Hort. Bot.*, 1946, 35: 4.
150. LYNCH, S. J. Nursery propagation and topworking of mangoes. *Pr. Bull. Fla agric. Exp. Stat.* 560, 1941, p. 4.
151. LYNCH, S. J. and NELSON, R. O. Mango budding. *Proc. Fla St. hort. Soc.*, 1949, 62: 207-9.
152. LYNCH, S. J. and NELSON, R. O. Current methods of vegetative propagation of avocado, mango, lychee and guava in Florida. *Ceiba*, 1956, 4: 315-37.
153. LYNCH, S. J. and MUSTARD, M. J. Mangoes in Florida. *Bull. Fla Dep. Agric.* 135, 1950.
154. MADAVA RAO, V. N. and RAO, I. K. S. Mango grafting with the aid of plastic film wrapper. *S. Indian Hort.*, 1956, 4(2): 54-5.
155. MADRAS. *Rep. Madras agric. Stat.* 1936-7.
156. MADRAS. *Rep. agric. Stats Madras Pres.* 1937-38, 1939.
157. MADRAS. *Idem* 1939-40, 1941.
158. MADRAS. *Idem* 1941-42, 1943.
159. MADRAS. *Idem* 1942-43, 1944.
160. MADRAS. *Idem* 1943-44, 1945.
161. MADRAS. *Idem* 1944-45.
162. MADRAS. *Idem* 1946-47, 1949.
163. MADRAS. *Admin. Rep. agric. Dep.* 1954-55, 1956.

164. MAHESHWARI, P. R. C. et al. Embryological studies in mango (*Mangifera indica* L.). Proc. Indian Sci. Congr. (Broda), 1955.
165. MAJHAIL, H. S. and SINGH, K. K. Inarching in mango. I. The effect of Alkathene wrapper, time of inarching and size of stock seedling. II. The optimum period of grafting and age of stock seedling. Punjab hort. J., 1962, 2: 33-43, 109-13.
166. MAJUMDAR, P. K. and MUKHERJEE, S. K. A note on the propagation of rootstocks in mango. Indian J. Hort., 1961, 18: 167-8.
167. MAJUMDAR, P. K. and RATHORE, D. S. Bench grafting in mango. Indian Hort., 1970, 14(2): 11-12.
168. MAJUMDAR, P. K. and RATHORE, D. S. Epicotyl grafting in mango (*Mangifera indica* L.). Curr. Sci., 1970, 39: 142.
169. MAJUMDAR, P. K. et al. Selection and classification of mango root-stocks in the nursery stage. Acta Horticulturae, 1972, No. 24, pp. 101-6.
170. MAJUMDAR, P. K. et al. Further researches on propagation techniques in mango. Acta Horticulturae, 1972, No.24, pp. 72-6.
171. MALO, S. E. Mango culture in Florida. Acta Horticulturae, 1972, No. 24, pp. 149-54.
172. MALO, S. E. and McMILLAN, R. T. J. R. A disease of *Mangifera indica* L. in Florida, similar to mango malformation. Proc. Fla St. hort. Soc., 1972, 85: 264-7.
173. MARLOTH, R. H. The mango in South Africa. Bull. Dep. Agric. S. Afr. 282.
174. MAURICE, J. Production of small self-rooted and micro-budded sub-tropical fruit trees by horizontal tube method for air freighting. FAO/PL/PTF/69/7, 1969, p.94.
175. MAURICE, J. Suction-grafting and rooting tropical fruit trees. World Crops, 1969, 21: 265-7.
176. MAURITIUS. A. R. Dep. Agric. 1948, 1949.
177. MAURITIUS. Idem 1949, 1951.
178. MAURITIUS. Idem 1950, 1951.
179. MAURITIUS. Idem 1961, 1962.

180. VAN DER MEULEN, A. The modified Forkert method of budding. *Fmg S. Afr.*, 1952, 27: 289-90.
181. VAN DER MEULEN, A. Why and how mangoes are budded. *Fmg S. Afr.*, 1954, 29: 209-12.
182. MINER, J. T. Top-working mango trees in Florida. *Proc. Carib. Reg. Amer. Soc. hort. Sci.*, 1962, 6: 31-3.
183. MITCHELL, E. F. Mango production and marketing practices - Florida. *Proc. Fla St. hort. Soc.*, 1971, 84: 307-10.
184. MOREUIL, C. Le mangquier au Congo. *Rapp. annu. Inst. Franç. Rech. Fruit Outre-Mer*, 1961-62, reprinted in *Fruits d'Outre Mer*, 1963, 18: 295-301.
185. MUKHERJEE, S. K. The mango - its botany, cultivation, uses and future improvement, especially as observed in India. *Econ. Bot.*, 1953, 7: 130-62.
186. MUKHERJEE, S. K. and BID, N. N. Propagation of mango (*Mangifera indica* L.). II. Effect of etiolation and growth-regulator treatment on the success of air-layering. *Indian J. agric. Sci.*, 1965, 35: 309-14.
187. MUKHERJEE, S. K. and MAJUMDAR, P. K. Standardization of root-stocks of mango. I. Studies on the propagation of clonal root-stocks by stooling and layering. *Indian J. Hort.*, 1963, 20: 204-9.
188. MUKHERJEE, S. K. and MAJUMDAR, P. K. Effect of different factors on the success of veneer grafting. *Indian J. Hort.*, 1964, 21: 46-50.
189. MUKHERJEE, S. K. et al. Effect of position of the shoots on the rooting of mango cuttings. *Sci. and Cult.*, 1966, 32: 377-8.
190. MUKHERJEE, S. K. et al. Clonal propagation of mango (*Mangifera indica* L.) through cuttings. *Curr. Sci.*, 1965, 34: 434-5.
191. MUKHERJEE, S. K. et al. Standardization of root-stocks of mango (*Mangifera indica* L.). II. Studies on the effects of source, invigoration and etiolation on the rooting of mango cuttings. *J. hort. Sci.*, 1967, 42: 83-7.
192. MUKHERJEE, S. K. and MAJUMDAR, P. K. 'Veneer' grafting in mango. In *Fruit nursery practices in India*. Directorate of Extension, Ministry of Food and Agriculture, New Delhi, 1962, pp. 65-6.

193. MUKHERJEE, S. K. and MAJUMDAR, P. K. 'Veneer' grafting in mango has its own advantages. *Indian Hort.*, 1961, 6(1): 3.
194. MUKHERJEE, S. K. Propagation and root-stock problems in *Mangifera indica* L. *Acta Horticulturae*, 1972, No. 24, pp. 55-9.
195. MUKHERJEE, S. K. Origin of mango (*Mangifera indica* L.). *Econ. Bot.*, 1972, 26(3): 260-4.
196. MULAT, B. Greffage du manguier. *Fruits d'Outre Mer*, 1959, 14: 219-23.
197. MULLER, H. R. A. Overzicht van de belangrijkste mangga-zeikten in Nederlandsch indies. *Meded. Alg. Proefst. Landb. Batavia*, 1940, 40: 9.
198. NAIK, K. C. Studies on the propagation of the mango (*Mangifera indica* L.). *Indian J. agric. Sci.*, 1941, 11: 738-68.
199. NAIK, K. C. Mango research in Madras. *Punjab Fruit J.*, 1947, 11: 210-13.
200. NAIK, K. C. Mango propagation methods at Fruit Research Station, Kodur (Madras). *Indian Fmg*, 1947, 8: 22-5.
201. NAIK, K. C. Vegetative propagational methods and their relation to tree performance in the mango, *Mangifera indica* L. *Indian J. agric. Sci.*, 1948, 18: 147-56.
202. NAMBAIR, K. P. P. A note on nursery investigation on mango root-stocks. *S. Indian Hort.*, 1957, 5: 33-4.
203. NARASINHAM, M. J. Malformation of panicles in mango incited by a species of *Eriophyes*. *Curr. Sci.*, 1954, 23: 297-8.
204. NIGERIA, Northern Region. *A.R. Dep. Agric. N. Reg. Nigeria 1955-56*, 1959.
205. NIGERIA, Northern Region. *Trienn. Rep. 1959-62 N. Niger. Minist. Agric.*, 1963.
206. NELSON, R. The use of plastic film in the graftage of tropical and sub-tropical plants. *Proc. Fla Mango Forum*, 1953, pp. 15-16.
207. NELSON, R. et al. Top-working procedures for mangos. *Proc. Fla Mango Forum*, 1954, pp. 19-21.
208. NELSON R. et al. Top-working of mangos. *Fla Gr Rancher*, 1955, No. 1, p. 45.

209. NIRVAN, R. S. Bunchy top of young mango seedlings. *Sci. and Cult.*, 1953, 18: 335.
210. NORMA, S. et al. Anatomy of graft union in mango. *Pakist. J. agric. Sci.*, 1970, 7: 113-18.
211. OCHSE, J. J. and REARK, J. B. The propagation of sub-tropical fruit plants by cuttings, a progress report. *Proc. Fla St. hort. Soc.*, 1950/1951, 63: 248-51.
212. OCHSE, J. J. Budding the mango in Netherland East Indies. [Publ.] imp. Bur. Fruit Prod., 1932
213. OCHSE, J. J. Overzicht van onderstammenproeven bij vruchtboomen. *Afd. Landb. Meded. No. IV, Landsdruk. Weltevreden, Java*, 1929.
214. OCHSE, J. J. et al. *Tropical and sub-tropical agriculture. Vol. 1. Macmillan Co. Ltd., London.*
215. OLIVER, G. W. The propagation of the mango. *Fla Exch.*, 1902, 19: 461.
216. OLIVER, G. W. Seedling inarch and nurse plant method of mango propagation. *Bull. U.S. Dep. Agric. Bur. Pl. Ind.* 202, 1911.
217. OPPENHEIMER, C. A stock-scion trial with the mango in Israel. *Hort. Advance*, 1958, 2: 27-36.
218. OPPENHEIMER, C. The relationship between tree size and yield in mango (*Mangifera indica* L.) and avocado (*Persea americana* Mill). *Hort. Advance*, 1960, 4: 6-15.
219. OPPENHEIMER, C. Selection of clonal root-stocks for mango and avocado. *Proc. 16th int. hort. Congr., Brussels*, 1962, 1: 397.
220. OPPENHEIMER, C. A second stock-scion trial with mango in Israel. *Exp. Agric.*, 1968, 4: 209-18.
221. PARSAI, P. S. Mango - new propagation methods. In *The mango - a souvenir. Dep. Agric. Hyderabad*, [1954], pp. 64-7.
222. PARSAI, P. S. Propagation of mango by side-grafting and shield budding. *Punjab hort. J.*, 1963, 3: 180-4.
223. PARSAI, P. S. Top-working inferior type of mango trees to superior varieties. *Nagpur agric. Coll. Mag.*, 1952, 26: 1-3.

224. PARSONS, T. H. The mango in Ceylon. *Trop. Horticulturist*, 1931, 76: 199-211.
225. PARSONS, T. H. The cultivation of fruits in Ceylon with cultural details. I and II. *Trop. Horticulturist*, 1932, 78: 337-42; 79: 19-24.
226. PAUL, W. R. C. and GUNERATNAM, S. C. The propagation of the mango in Jaffna. I. *Trop. Agriculturist*, 1937, 88: 86-91.
227. PAUL, W. R. C. and GUNERATNAM, S. C. The propagation of the mango in Jaffna. II. *Trop. Agriculturist*, 1937, 88: 331-7.
228. PAUL, W. R. C. and GUNERATNAM, S. C. Mango stocks. *Trop. Agriculturist*, 1938, 90: 34-5.
229. PHADNIS, N. A. and SAWANT, R. Y. Preliminary studies on the growth of shoots and their relation to cropping in the Alphonso mango under Vengurla conditions. *Acta Horticulturae*, 1972, No. 24, pp. 210.
230. PINHEIRO, R. V. R. et al. Comparação de modalidades de enxertia na propagação da mangueira (*Mangifera indica* L.). *Rev. Ceres*, 1970, 17: 264-73.
231. PLESSIS, S. F. Du and SMITH, J. H. E. Irrigation and fertilization of mangoes. *Citrus sub-trop. Fruit J.*, 1973, No. 471, pp. 4-7.
232. POPE, W. T. Mango culture in Hawaii. *Bull. Hawaii agric. Exp. Stat.* 58, 1929.
233. POPE, W. T. and STOREY, W. B. Grafting tropical fruit trees in Hawaii. *Circ. Hawaii agric. Exp. Stat.* 6, 1933.
234. POPENOE, W. The mangoes of Cuba. *Pap. Amer. pomol. Soc. Berkeley*, 1915.
235. POPENOE, W. El mango. *Ceiba*, reprinted in *Suelo Tico*, 1959, 11(43): 23-7.
236. POPENOE, W. Mangoes in tropical America. *Proc. Mango Forum*, 1951, p. 18.
237. PRASAD, A. and SINGH, A. R. Mango propagation studies at Government Horticultural Research Institute, Saharanpur, India. *Acta Horticulturae*, 1972, No.24, pp. 93-8.
238. PRASAD, A. and PATHAK, R. A. Response of plant growth regulators to mango (*Mangifera indica* L.). *Trop. Agriculturist*, 1970, 126: 95-106.

239. PRASAD, A. et al. Mango malformation. A review of work done at Horticultural Research Institute, Saharanpur, India. *Acta Horticulturae*, 1972, No. 24, pp. 227-9.
240. PRASAD, A. and AYODHYA, P. Performance studies on polyembryonic varieties of *Mangifera indica* L. *Acta Horticulturae*, 1972, No. 24, pp. 31-5.
241. RAJPUT, C. B. S. and HARIBABU, R. S. Recent techniques of mango propagation. *World Crops*, 1971, 23: 146-8.
242. RAM, K. B. and SAHAI, S. P. Fruit nursery practices in Bihar. In *Fruit nursery practices in India*. Directorate of Extension, Ministry of Food and Agriculture, New Delhi, 1952, pp. 28-42.
243. RAMAKRISHNAM, T. S. Diseases and pests. In *The mango handbook*. I.C.A.R., 1967, pp. 150-96.
244. RANGACHARLU, V. S. Mango roostock investigations. *Andhra agric. J.*, 1955, No. 7.
245. RANGACHARLU, V. S. Mango roostock investigations at the Fruit Research Station, Kodur (South India). *Andhra agric. J.*, 1955, No. 2, pp. 182-6.
246. RANGACHARLU, V. S. and RAO, M. V. 'Air grafting' of mango. (A new technique in the grafting of mango without the aid of soil or water). *Andhra agric. J.*, 1956, No. 1, pp. 105-9.
247. RAO, V. N. M. and RAO, I. K. S. Mango grafting with the aid of plastic film wrapper. *S. Indian Hort.*, 1956, 4: 54-5.
248. RAO, V. N. M. and RAO, I. K. S. Propagation of mango by air-layering. *S. Indian Hort.*, 1956, 4: 56-7.
249. RAO, V. N. M. et al. Propagation of mango by air-layerings. *Ibid*, 1956, 4(2): 56-7.
250. RAO, V. N. M. et al. Improved nursery techniques in mango. In *Fruit nursery practices in India*. Directorate of Extension, Ministry of Food and Agriculture, New Delhi, 1962, pp. 82-3.
251. RAO, V. N. M. Propagation practices. In *The mango handbook*. I.C.A.R., 1967, pp. 32-69.
252. RAO, S. N. et al. Growth regulators in propagation of mango by air-layering. *Punjab hort. J.*, 1963, 3: 175-9.

253. RICHARDS, A. V. Top-working of mango in the dry zone. *Trop. Agriculturist*, 1950, 106: 148-50.
254. DE LA ROCHA G.,G. El injerto del mango. Resultados de los ensayos de propagación obtenidos en la Estación Experimental Agrícola de la Molina. *Bol. Estac. exp. Agric., La Molina* 49, 1953, p. 20.
255. RUEHLE, G. D. and LEDIN, R. B. Mango growing in Florida. *Bull. Fla agric. Exp. Stats* 574, 1955, p. 90.
256. RUSSELL, O. S. A progress report on research in tropical and sub-tropical fruit at the Government Experiment Station, Nassau, Bahamas. *Proc. Fla St. hort. Soc.*, 1953, pp. 187-8.
257. SAHARANPUR. A.R. Fruit Res. Stat. Saharanpur 1950-53, 1957.
258. SAID, H. and SHOUSHAN, A. A. Root formation of cuttings of plants which normally do not root. *Nature*, 1945, 155: 791.
259. SAMBURTY, K. A note on new method of grafting in mangoes. *Indian J. Hort.*, 1949, 6(3/4): 6-7.
260. SANTIAGO, J. K. Propagation of mango by cleft grafting. *Punjab Fruit J.*, 1960, 23(82/83): 71.
261. SARAWAK. A.R. Dep. Agric. 1962, 1963.
262. SATTAR, A. Diseases of mango in the Punjab. *Punjab Fruit J.*, 1946, 10: 56.
263. SCHMIDT, H. Apomixis bei Obstgehölzen. *Erwerbsobstbau*, 1968, 10: 183-6.
264. SEN, P. K. and MALLIK, P. C. The embryo of the Indian mango (*Mangifera indica* L.). *Indian J. agric. Sci.*, 1940, 10: 750.
265. SEN, P. K. et al. Mist propagation of fruit tree cuttings. *Plant Sci.*, 1969, 1: 216-19.
266. SEN, P. K. et al. Propagation of mango, *Mangifera indica* L., by air-layering with growth substances. *Indian Agriculturist*, 1961, 5: 167-72.
267. SEN, P. K. and BOSE, T. K. Physiological studies on regeneration of roots. VI: Effects of growth substances on root formation in *Justicia*, mulberry and mango stem cuttings and concomitant changes in carbohydrate and nitrogenous substances in the rooting tissues. *Indian Agriculturist*, 1964, 8: 102 -19.

268. SEN, P. K. et al. Flowering and biennial bearing in *Mangifera indica* L. *Acta Horticulturae*, 1972, No. 24, pp. 164-9.
269. SEN, P. K. A.R. *Fruit Res. Stat. Sabour, Bihar, 1939.*
270. SEN, P. K. et al. Rooting of mango cuttings under mist. *Curr. Sci.*, 1968, 37: 144-56.
271. SERPA, D. Propagación del mango. *Publ. divulg. Fac. Agron. Univ. Centr. Venezuela* 2, 1964, p. 24.
272. SETHI, W. R. Mangoes on the East African coast. *E. Afr. agric. J.*, 1949, 15: 98-9.
273. SHERWOOD, H. M. Experiences in the propagation of some sub-tropical fruits. *Proc. Fla St. hort. Soc.*, 1940, 53: 169-72.
274. SHIMOYA, C. et al. Anatomia da soldadura do enxerto de garfagem, no tópo, em abacateiro (*Persea americana* Mill) e mangueira (*Mangifera indica* L.). *Rev. Ceres*, 1970, 17: 119-38.
275. SIDDIQUI, S. H. et al. Evolution of new varieties of mango (*Mangifera indica* L.) through induced somatic mutations by ionizing radiation. *Proc. agric. Symp. Atomic Energy Centre, Dacca, 1966*, pp. 34-7.
276. SINGH, B. and RAM, A. Budding of mango seedlings *in situ*, a brief resumé of work done during the years 1943-5. *Punjab Fruit J.*, 1946, 10: 10.
277. SINGH, J. R. and SRIVASTAVA, R. P. Studies in budding of mango. I. *Indian J. Hort.*, 1962, 19: 130-4.
278. SINGH, K. K. and JAWANDA, J. S. Mango cultivation in the Punjab. *Indian Hort.*, 1962, 6(4): 7-10.
279. SINGH, K. K. Climate and cultivation. In *The mango handbook*. I.C.A.R., 1967.
280. SINGH, K. K. and JAWANDA, J. S. Some promising seedling mango trees of Punjab. *Punjab hort. J.*, 1962, 2: 133-8.
281. SINGH, L. and KHAN, A. A. How to prolong the life of mango bud-wood. *Punjab Fruit J.*, 1943, 7: 1264-5.
282. SINGH, L. B. Mango grafting in eight weeks. *Science*, 1951, 114: 393.
283. SINGH, L. B. Vegetative propagation of mango (*Mangifera indica* L.) by air-layering (gootee). *Science*, 1953, 117: 158-9.

284. SINGH, L. B. Propagation of mango by air-layering for root-stocks. *Proc. Amer. Soc. hort. Sci.*, 1954, 63: 128-30.
285. SINGH, L. B. *The mango*. Leonard Hill (Books) Ltd., London, 1960.
286. SINGH, L. B. and SINGH, R. L. Mango budding in situ in Uttar Pradesh. *A.R. Fruit Res. Stat., Saharanpur, 1950-53, 1957*, pp. 44-6.
287. SINGH, L. B. and SINGH, U. R. Mango (*Mangifera indica* L.), 8 week-old graft versus commonly inarched one. *A.R. Fruit Res. Stat., Saharanpur, 1950-53, 1957*, pp. 56-8.
288. SINGH, L. B. Mango grafting in eight weeks. *Science*, 1951, 114: 393.
289. SINGH, L. and KHAN, A. A. Mango budding in situ. *Indian Fmg*, 1943, 4: 199.
290. SINGH, L. and KHAN, A. A. Mango budding in situ, a new technique likely to revolutionise mango industry. *Punjab Fruit J.*, 1946, 10: 14.
291. SINGH, S. Propagation of the mango in the Punjab. *Punjab Fruit J.*, 1946, 10: 8.
292. SINGH, J. R. and SRIVASTAVA, R. P. Budding as a commercial method of mango propagation. *Gardening*, 1961, 3(9): 19-21.
293. SINGH, S. M. and KAISUWAN, T. Effect of interval between extraction and sowing and container for storage on the germination of seedstones and growth of seedlings of mango (*Mangifera indica* L.). *Allahabad Fmr*, 1971, 45: 287-90.
294. SINGH, S. N. and TEOTIA, S. S. Effect of some hormones on the rootage of mango. *Sci. and Cult.*, 1951, 17: 207-10.
295. SINGH, U. R. and BAJPAI, P. N. Investigation on mango root-stock and stionic trials - a review. *Progr. Hort.*, 1971, 2(4): 31-6.
296. SINHA, R. N. et al. An observation on metabolic effect of indole butyric acid in mango and litchi cuttings. *Indian J. Hort.*, 1960, 17: 225-9.

297. SIZARET, A. Nouvelles techniques de pépinières en sols sableux sous climats arides. (Emploi d'une déplanteuse, méthode de la contre-plantation précoce). *Fruits d'Outre Mer*, 1970, 25: 725-39.
298. SOULE, J. Anatomy of the bud union in mango (*Mangifera indica* L.). *J. Amer. Soc. hort. Sci.*, 1971, 96: 380-3.
299. SOULE, M. J., Jr. Influence of type of graftage, age of plant, and certain environmental factors on the loss of water by young mango buddlings. *Diss. Abstr.*, 1954, 14: 2174.
300. SRIVASTAVA, R. P. Studies in the responses of plant growth regulators in air-layered shoots of mango (*Mangifera indica* L.). *J. sci. Res., Banaras Hindu Univ.*, 1960-61, 11: 1-3.
301. SRIVASTAVA, R. P. Propagation of mango and guava by transported buds. *Sci. and Cult.*, 1963, 29: 145-6.
302. SRIVASTAVA, R. P. Recent advances in the vegetative propagation of mango. *Punjab hort. J.*, 1963, 3: 158-63.
303. STEPHENS, S. E. The mango (in Queensland). *Qd agric. J.*, 1948, 68: 71-81, 146-53, 208-15.
304. STEPHENS, S. E. Mango growing in Queensland. *Qd agric. J.*, 1960, 36: 761-6.
305. STEWART, L. B. Methods of propagation. *J. roy. hort. Soc., London*, 1927, 52: 33.
306. STURROCK, T. T. Nucellar embryos of the mango. *Proc. Fla St. hort. Soc.*, 1967, 1968, 80: 350-4.
307. SUBRA, P. Greffage du manguiier au Cameroun. *Fruits d'Outre Mer*, 1954, 9: 498-501.
308. SUNDARA RAO, Y. R. Preservation of budwood. *S. Indian Hort.*, 1956, 4: 3-12.
309. SUNDARAJA, J. S. et al. Off-season cropping of mango. *Acta Horticulturae*, 1972, No. 24, pp. 189-91.
310. SWAMY, G. S. et al. Polyembryonic root-stocks for mango. *Acta Horticulturae*, 1972, No. 24, pp. 110-13.
311. TALUKDAR, M. R. and AHMED, S. Success of inarching done on three varieties of mango on young stocks at Lyallpur. *Pakist. J. Sci.*, 1965, 17: 72-4.

312. TALUKDAR, M. R. Some studies to standardize the propagational methods in mango. *Thesis, W. Pakist. agric. Univ., Lyalpur, 1962.*
313. TAMMES, P. M. L. Vegetative propagation from poly-embryonic mango seeds. *Chron. Hort., 1965, 5(3): 64.*
314. TANAKA, T. A new method in mango propagation. *Commun. hort. Inst., Taihoku, Japan, 79.* (reprinted in *Philipp. J. Agric., 1939, 10: 1-7, 9* and *Proc. agric. Soc., Trin., 1939, 39: 232-8*).
315. TEAOTIA, S. S. Budding in mango (*Mangifera indica* L.). *Kanpur agric. Coll. J., 1963, 23(1): 49-50.*
316. TEAOTIA, S. S. Newer methods of propagation of mango and their economics. In *Fruit nursery practices in India.* Directorage of Extension, Ministry of Food and Agriculture, New Delhi, 1952, pp. 67-76.
317. TEAOTIA, S. S. Studies on the propagation of mango by budding. *Progr. Hort., 1970, 2(1): 35-44.*
318. TEAOTIA, S. S. Here's a new method of inarching in mangoes. *Indian Hort., 1961, 5(3): 5-6.*
319. TEAOTIA, S. S. Economics of different methods of propagation of mango. *Gardening, 1961, 3(10): 47-50.*
320. TEAOTIA, S. S. and SINGH, R. D. Studies on media for storage and germination of mango seedstone (*Mangifera indica* L.). *Punjab hort. J., 1971, 11: 52-6.*
321. THAKURTA, A. G. and DUTT, B. K. Vegetative propagation of mango from 'gootee' (marcotte) and cuttings by treatment of high concentration auxin. *Curr. Sci., 1941, 10: 297.*
322. THOMAS P. et al. Effect of gibberellic acid on nursery stocks of mango (*Mangifera indica* L.) and citrus spp. *S. Indian Hort., 1963, 11: 18-30.*
323. THROWER, L. B. Commercial horticulture in the Sudan. 2. Mango cultivation. *Bull. Minist. Agric. Sudan 11, 1954, p. 66.*
324. TORO, R. A. Plant disease notes from the central Andes. *Phytopathology, 1929, 19: 969.*
325. TORRES, J. P. Splice grafting of mango. *Philipp. J. Agric., 1949, 14: 247-55.*

326. TORRES, J. P. Splice grafting of mango. *Punjab Fruit J.*, 1960, 23(82/83): 73-6.
327. TRAUB, H. P. and AUCHTER, E. C. Propagation experiments with avocado, mango and papaya. *Proc. Amer. Soc. hort. Sci.* 1933, 1934, 30: 382-6.
328. TRINIDAD AND TOBAGO. *Admin. Rep. Agric. Dep.* 1957, 1959, p. 49.
329. TRIPATHI, H. N. et al. Effect of media and concentration of plant regulator on air-layering in mango (*Mangifera indica* L.). *B.V.J. agric. Sci. Res.*, 1961, 2: 18-20.
330. TRULLINGER, R. W. The Federal Experiment Station in Puerto Rico. *Rep. Chief Office Exp. Stats agric. Res. Administ.* 1947, U.S.D.A. Washington, 1948, pp. 357-61.
331. ULLAH, H. and ALI, S. Review of mango budding in situ in the Punjab. *Pakist. Rev. Agric.*, 1955, 2: 74-6, 96.
332. ULVI, A. M. Mango budding. *Indian Fmg.* 1940, 1: 222-5.
333. UNWIN, A. H. *West African forests and forestry*, 1920.
334. VALMAYOR, R. V. The Philippine mango industry - its problems and progress. *Acta Horticulturae* 1972, No. 24, pp. 19-21.
335. VEERARAGHAVAN, R. Side grafting in mangoes. *Indian J. Hort.*, 1945, 3: 45.
336. VENKATARATNAM, L. Research on mango - a survey. In *The mango - a souvenir*, Dep. Agric., Hyderabad, India, [1954], pp. 14-25.
337. VERMA, S. R. A novel mango graft. *Punjab Fruit J.*, 1941, 5: 957.
338. VERMA, S. R. A novel mango graft. *Punjab Fruit J.*, 1942, 6: 1183.
339. WALTERS, E. A. Plant propagation. *Trop. Agric., Trin.*, 1932, 9: 35-9.
340. WESTER, P. J. Experiments in mango propagation. *Philipp. agric. Rev.*, 1911, 4: 97.
341. WESTER, P. J. The mango. *Circ. Philipp. Bur. Agric.* 15, 1919.
- 341a. WESTER, P. J. A contribution to the history of the mango in Florida. *Proc. Fla Mango Forum*, 1951, p. 9.

343. WESTERN SAMOA. *Suppl. A.R. 1969. Dep. Agric., For. Fish. 1970.*
343. WHEATLEY, S.M. The mangoes of the Kenya Coast. *E. Afr. agric. J.*, 1956, 22: 46-54.
344. WOLFE, H.S. The Florida mango industry. *Punjab Fruit J.*, 1960, 23(82/83): 212-14.
345. WOLFE, H.S. The mango in Florida - 1887 to 1962. *Proc. Fla St. hort. Soc.*, 1962, 1963, 75: 387-91.
346. WOLFE, H.S. et al. El cultivo del mango en el Perú. *Bol. tec. Minist. Agric. Pesq., Peru*, 74, 1969, pp. 39.
347. WOLFENBARGER, D.O. Controlling mango insect pests. *Punjab Fruit J.*, 1960, 23(82/83): 205-8.
348. WOLFENBARGER, D.O. Some notes on mango insects: newer pesticide materials in insect and mite control on mangoes. *Proc. Fla Mango Forum*, 1951, pp. 50, 56.
349. YEE, W. The mango in Hawaii. *Circ. Hawaii agric. Ext. Serv.* 388, 1958, p. 26.
350. YOUNG, T.W. Mango research on sandy soils. *Proc. Fla Mango Forum*, 1957, pp. 26-30.
351. ZAYAS, J.C. El-manga *Bull. I.N.R.A., La Haban, Cuba*, 1966.
352. ZILL, L. Top-working of mango. *Proc. Fla Mango Forum*, 1951, p. 147.

SUPPLEMENTARY BIBLIOGRAPHY

353. AHMED, S. Selection and evaluation of local mango cultivars and strains in Northeast Brazil. 6th unpub. Rep. UNDP/FAO/CEPED Proj. BRA. 71/555, 1974, pp. 1-3.
354. AHMED, S. Raising of mango root-stocks. 7th unpub. Rep. UNDP/FAO/CEPED Proj. BRA. 71/555, 1974, pp. 2-3.
355. BASU, R.N. et al. Rooting of mango cuttings. *Indian Agric.*, 1966, 10: 147-51.
356. GANDHI, S.R. Recent advances in horticultural practices. *Poona agric. Coll. Mag.*, 1942, 34: 86-99.
357. GIRI, A. and YAQUB, M. A comparative study of seed germinating and seedling vigour of grafted and seedling mangoes. *W. Pakist. J. agric. Res.*, 1965, 3: 138-44.
358. GIRI, A. Effect of varying girth of seedling stocks on percentage success in enarching in spring and autumn season in mango. *Pakist. J. Sci.*, 1966, 13: 76-8.
359. GRANT, J.W. and WILLIAM, A.N.P. Burma fruits and their cultivation. *Bull. Dep. Agric. Burma* 30, 1949.
360. JAGIRDAR, S.A.P. et al. Effect of type of scion wood and age of stock on the success of veneer graftage in mango (*Mangifera indica* L.). *W. Pakist. J. agric. Res.*, 1968, 6(1): 88-97.
361. JAGIRDAR, S.A.P. et al. Varietal response of veneer grafting in mango. *W. Pakist. J. agric. Res.*, 1968, 6(3): 86-9.

JAGIRDAR, S.A.P. and ALI, S.K. Effect of scion variety and methods of raising stock on bud-take in mango. *W. Pakist. J. agric. Res.*, 1968, 6(1): 63-7.

JOSHI, A.T. Mango nursery practices. In *The mango - a souvenir*. Dep. Agric., Hyderabad, [1954], pp. 68-71.

KHAN, A.A. Relation of growth to fruit bearing of mango. *Punjab Fruit J.*, 1960, 23(82/83): 117-40.

KHAN, N.D. Fruit bud differentiation in mangoes. *Punjab Fruit J.*, 1960, 23(82/83): 141-8.

KRISHNAMURTHY, S. A note on the uncongeniality of Neelum mango on the polyembryonic Olour root-stock at the Fruit Research Station, Periyakulam, Madras State. *Pap. 4th hort. Res. Workers Conf. Poona*, 1961.

SINGH, L. and KHAN, A.A. Relation of growth to fruit bearing in mangoes. *Indian J. agric. Sci.*, 1939, 9: 835.

SINGH, D. Need for clonal selection and standardization in mango. *Punjab hort. J.*, 1963, 3(2/4): 194-8.

SIMÃO, S. *Manual de fruticultura*, 1971, pp. 339-69.

MANILKARA ACHRAS —

SAPODILLA

by

PATRICIA ROWE-DUTTON

Formerly of the Commonwealth Bureau of Horticulture
and Plantation Crops

ECOLOGY AND GROWTH IN RELATION TO PROPAGATION

Nomenclature

The botanical nomenclature of sapodilla is extensive, having undergone numerous changes over the years. The correct name is now considered to be *Manilkara achras*, although in the past the plant has been referred to variously as *M. zapotilla*, *Achras zapota*, *A. sapota*, *Sapota achras* and *S. zapotilla*. The tree also has a variety of popular names, the most common being sapodilla and sapota (not to be confused with sapote), which are used in many parts of the world, chico or chiku in India, bully-tree in Sri Lanka and naseberry in the West Indies.

Distribution and ecology

The sapodilla is thought to have originated in the tropical regions of southern Mexico and Central America. It has now spread throughout the tropics and is cultivated most widely in parts of India and Africa, the West Indies, the Philippines, Malaysia, tropical America and southern Florida. (G1; G19; G24)

Although it thrives best in a strictly tropical, humid climate, the sapodilla appears to be very adaptable as regards climatic conditions. In India, for instance, ideal conditions are found in the equable coastal regions of Bombay, where the temperature range is 55° - 92° F (13° - 33° C), the humidity is high, and the annual rainfall of about 150 cm (60 in) is distributed over June to September. Recently, however, culture has spread to the drier zones of the Deccan plateau and the

sub-montane tracts of northern India. Although large trees can endure drought, irrigation is generally recommended in arid districts owing to the tree's limited root spread. In coastal areas the trees must be protected from strong salt winds, and in exposed areas from hot winds in summer and cold winds in winter. This is presumably to prevent temperature extremes, because the branches themselves are very pliable and not easily damaged by hurricanes. Young trees are killed by freezing temperatures, but mature trees are said to withstand short periods of slight frost, and in southern China it is recorded that they were uninjured by temperatures of 27-28°F (-3°C) for several days. (G15; G18; G24; 7; 10; 43)

Similarly, the sapodilla appears to tolerate a wide range of soil conditions. Deep, rich, porous soils are said to produce the largest and most vigorous trees, but various alluvial loams, light clays and gravelly lateritic soils have also proved satisfactory (G3; G15; G18; 7). In Florida the sapodilla grows well on almost pure limestone or on shallow sands and clays overlying soft limestone, and it tolerates rocky conditions (G18; 47). In India it is said not to thrive over a subsoil of hard rock and, although it is shallow-rooted, at least 60 cm (2 ft) of soil is required (G24). Response to soil conditions naturally depends partly on whether the tree is grown on its own roots or is grafted, and on the rootstock used (G24). There is a diversity of opinion concerning the tree's response to alkalinity, some authors stating that it is equally tolerant of acid and alkaline soils (G25) and that it does not object to lime (G20), and others that soils with a high lime content are unsuitable and will cause chlorosis (G24; 22). Although well-drained soils are generally advocated, the sapodilla appears to withstand temporary waterlogging fairly well (7; 43; 47).

As regards propagation conditions, all that can be concluded from this brief survey is that the environment should be warm, humid and sheltered and the rooting medium light, well drained and plentifully supplied with water. Until the response of the plant

to alkalinity has been determined more exactly, it would be as well to ensure that the pH of the medium is not too high.

Growth habit

There is immense variation in the size of sapodilla trees. Under favourable conditions seedling trees have been recorded as growing to a height of 17-25 m (55-80 ft) (G14; G18; 45), whereas under other conditions they may only attain the size of a large shrub (G6; G16; 25). This difference in size appears to be due to a number of factors, particularly seedling variation or varietal differences, site and soil conditions, and method of propagation, budded trees generally being smaller than seedlings (G15; 45). The form of the tree shows great variation, too. The branches usually extend horizontally and make a compact, rounded crown, and such trees may have considerable ornamental value. Some seedling types or varieties, however, have either drooping or erect branches with open, irregular or pyramidal crowns (7; 25; 47). Low branching and pliable wood are features that make it relatively easy to find shoots suitable for ground-layering. The wood, however, is exceptionally dense and hard, and there are indications that this fact may be partly responsible for the difficulty encountered in rooting shoots of sapodilla. The growth of young seedlings is very slow, a disadvantage in the production of seedling rootstocks.

The tree is evergreen, with glossy, leathery leaves clustered at the ends of young branchlets. The leaves vary in shape, but are entire and usually 5-13 cm (2-5 in) long and 2.5-6.5 cm (1-2.5 in) wide.

An interesting characteristic of the tree is the milky latex that is found throughout most parts, but especially in the bark. This latex, known commercially as chicle gum, is extracted from the bark by tapping the trunk and is used as the basis for chewing gum. According to Malo (38) sapodilla trees were for many years known mainly as a source of chicle, particularly

in Central America, but today manufacturers prefer synthetic ingredients so the trees are now grown mainly for their fruit and their ornamental value. This abundant flow of latex has caused considerable difficulty in grafting, making it necessary to work fast to prevent the latex coagulating around the wound, and to clean the knife frequently. Some authorities have recommended bleeding the cortex of the rootstock to remove the latex before grafting, but this operation is now considered unnecessary (G3; 38).

It has been reported that sapodilla is shallow-rooted (G24; 12), but no exact information is available on the root system of seedling trees. Singh et al. (G24) note that when trees are raised from air-layers most of the roots are concentrated in the top 30-45 cm (1-1½ ft) of soil, but the roots of trees grafted on *Manilkara hexandra* penetrate deeper, being found mainly at a depth of 60 to 90 cm (2 to 3 ft).

The time of coming into bearing is also greatly affected by the method of propagation. Seedling trees take six to eight years to bear, but layered or grafted plants may start to fruit in half that time (45). Air layers are said to produce fruit within a year or so from planting, or may even be fruiting at the time of planting (G6; 7).

The flowers, which are usually borne in the leaf axils but sometimes terminally, are produced over a long period but most profusely on the new flushes of growth following rain. At Taliparamba in southern India, for instance, trees flush and flower at intervals of about 2 months (G15; 7). Moreover, flowers are produced at different times of year on different trees, so fruit may be available during most of the year; some trees bear nearly all the year round when grown under uniform conditions of rainfall or irrigation (45; 47).

On seedling trees there is tremendous variability

in fruit shape, size, pulp colour, texture (presence or absence of stone cells), quality and number of seeds (25; 47). Fruits normally contain two or three seeds, but there may be as many as twelve and a few varieties are seedless (17; 45).

Many authors have commented on the difficulty of propagating sapodillas by vegetative means, and this, together with the slow initial growth and variability of seedlings, has probably tended to limit the commercial production of the crop.

Varieties

Two types of fruit are common on sapodilla trees, the round and the ovoid. In Malaysia these types are described as distinct botanical varieties, trees bearing round fruits being called var. *sphaerica* and those with ovoid fruits var. *depressa* (G2). Ochse (G16) classified and described some of the many named forms within these two races that occurred in the district around Batavia (now called Djakarta). In India, too, most varieties are classified under the headings of round or oval, but it has been found that fruits of both shapes occur on the same tree at the same time or at different seasons of the year (7; 43). A number of named Indian varieties, many of them local, have been described, but Cheema et al. (7) comment that most of the characteristics mentioned in the descriptions are superficial and highly variable, and that there is still need for a proper study and classification of varieties. It is not clear whether the named varieties are clonal or seedling forms. Burkill (G2) mentions that in Tobago, where the tree is always raised from seed, the offspring is considered to be as good as the parent; this suggests that some seedlings may come reasonably true to type. Most workers, however, have stressed the excessive variability of seedling populations in growth habit, productivity, season of maturity and fruit quality, and have urged the need for the vegetative propagation of outstanding types. In 1946 a collection of sapodilla clonal selections was started at the Florida Sub-Tropical Experiment Station, and Ruehle (47) and Campbell and

Malo (2a) describe some of the varieties and selections under observation there. In Cuba a seedless form has been propagated by grafting (17).

In addition to the obvious fruit and tree characters that have to be considered in selecting desirable varieties, it would be useful also to consider the ease of vegetative propagation. There has not been much information published on this point, but Cheema et al. (7) do record the individual responses to air-layering of certain varieties grown in Bombay State. Programmes for the selection of good varieties have inevitably stimulated interest in reliable methods of vegetative propagation by which they can be perpetuated.

Diseases and pests

It has been generally noted that sapodilla is remarkably free from common pests and diseases (G1; G15; G18; 55). In Florida a leaf miner caterpillar (possibly *Eucosmophora* sp.) and certain scale insects have been observed; these can be controlled by parathion (47). In Java caterpillars of *Tarsolepis remicauda* have been known to defoliate trees (G16). In India a stem borer (*Arbela tetraonis*) is a minor pest; it is recommended to treat the galleries with carbon bisulphide, plug the holes with cotton wool dipped in kerosene and plaster them with wet mud (G24; 7; 43). Mealybugs (*Phenacoccus icervoides*) sometimes attack tender shoots in India, and spraying with kerosene oil emulsion, fish oil soap or a contact poison is advised (7; 43). In the Philippines it was found that giant snails ate the leaves of rootstocks in the nursery and had to be controlled by metaldehyde in sawdust bait (15). To prevent rats and squirrels from eating the seeds, growers in Sri Lanka are recommended to enclose the seed-beds in wire-netting (45).

Two diseases of sapodilla foliage, and thus of potential interest to nurserymen, are reported from Florida (47). These are a rust, tentatively identified as *Uredo sapotae*, and a leaf spot which appeared to

cause defoliation; a species of *Septoria* was isolated from the leaf spots. Considerable differences in susceptibility to infection by the rust were exhibited among sapodilla seedlings growing at the Florida Sub-Tropical Station; there were indications that the disease could be controlled by ferbam. A new leaf spot disease, caused by *Phaeophleospora indica*, has recently been observed on sapodilla trees at the Dharwar Agricultural College in India (8); no control measures are mentioned.

It has been observed in India that galls, from which root tips emerge, are often formed on the stems of sapodilla trees (7; 46). Whether these galls are sphaeroblasts has not been recorded, but they are said to be a hereditary, physiological malformation and to retard the growth of the branches, affecting their cropping capacity. Marcots made from galled trees will also form galls, so it is recommended that propagation material should be taken only from trees that do not show this disorder.

PROPAGATION BY SEED

Until fairly recently sapodilla trees have generally been raised from seed (G1; G3; G14; G23; G25; 25; 47; 53), because vegetative propagation was considered difficult and unreliable. As has already been pointed out, however, seedling trees usually show excessive variation and are relatively slow to come into bearing. As methods of vegetative propagation improved, largely because of the desire to perpetuate particularly good seedlings clonally, the practice of raising trees from seed tended to fall into disfavour. In 1957 Tobias (55) reported that it was no longer usual to propagate the crop by seed in India, and since then Indian writers have confirmed that the method is not recommended commercially (G15; 43). In Florida, according to Sturrock (G25), budded or grafted varieties were just starting to appear in nurseries in 1959. Seed propagation is therefore now used mainly for the production of rootstocks on which to graft selected sapodilla varieties or forms.

The fruits usually contain two or three seeds

each, but there may be as many as twelve, and some forms of sapodilla are seedless (G18; 45). The mature seeds are hard, black, shiny and somewhat flattened, about 2 cm ($\frac{1}{2}$ in) long; they are easily separated from the flesh (G14; G18; 10). For rootstock production, Malo (38) recommended that seeds should be collected from vigorous trees and if possible from large fruits which contain large seeds, but there does not appear to be any experimental evidence on the effect of seed size on seedling performance.

There is a divergence of views concerning the possibility of storing sapodilla seeds. According to Popenoe (G18) and Bailey (G1), the seeds will retain their viability for several years if kept dry. Richards (45) noted that they would remain viable for several months if washed and then kept dry, whereas Malo (38) observed that, although it was possible to keep dry seeds for a few months, fresh seeds would germinate faster and produce more uniform seedlings. An experiment in the Philippines (15) showed that seeds sown immediately after collection gave a considerably higher percentage germination (62.5 - 80) than seeds sown even a few days after they were gathered (40-60 per cent germination), and that seeds from sound fruits germinated better than those from decayed fruits. All took 37-40 days to germinate.

Reports from other sources on the speed of germination show a range from a minimum of two weeks in the Philippines (46) to a maximum of two months in Java (G12). This may be partly due to environmental conditions, as is implied in the comment by Popenoe (G18) that in warm weather seeds will germinate within one month, and partly to varietal differences, since in the Philippines it was found that seeds of the varieties Ponderosa and St Croix germinated in 16-32 days, whereas those of Native took 25-44 days (46).

The possibility of improving germination by growth substance treatment has been demonstrated in a trial in Mysore (13). Soaking the extracted seed kernels for 24 hours in IAA, IBA, NAA or GA at various concentrations hastened germination and most of the

treatments improved the germination percentage.

In traditional commercial practice in Sri Lanka the seeds are sown 1.25 cm ($\frac{1}{2}$ in) deep in pans or prepared beds in a mixture of light sandy soil and compost. It is recommended to enclose the beds in wire-netting to keep out rats and squirrels which eat the seeds. Germination takes place in three to four weeks, and about ten weeks later, after the second pair of leaves has appeared, the seedlings can be potted-up or transplanted to nursery beds for budding (40; 45). For rootstock production in Java seeds have been sown in boxes in a shady place and transplanted to nursery beds at 40 x 40 cm (16 x 16 in) about four months after sowing (G12). In Florida it has been found that seeds will germinate readily in flats in perlite or a mixture of vermiculite and peat moss, preferably in a shade house. When the seedlings have two to three pairs of leaves they can be transplanted to No. 10 metal cans or similar containers holding a mixture of sand and peat moss or sand and a light organic soil. Although the seeds germinate better in a shade house, it is considered preferable to expose the transplanted seedlings to full sun (38).

The very slow growth of sapodilla seedlings is generally considered a limiting factor in their use as rootstocks. The time taken to reach graftable size depends on the type of graft used, on varietal differences and on cultural practices. For instance, in Java sapodilla seedlings took three years to be ready for budding (G12), and in Sri Lanka two to three years (45); in the Philippines the fast-growing varieties Ponderosa and St Croix were ready for approach grafting in 11-15 months from sowing, and for cleft grafting in 20-24 months, whereas Native was not ready for approach grafting until it was 30-36 months old (46). In Florida container-grown seedlings suitable for veneer grafting, with a stem diameter of 0.7-1 cm ($\frac{1}{4}$ - $\frac{1}{2}$ in), were obtained in 8-12 months by keeping them well supplied with water and fertilizer from the time the first pair of leaves appeared (38). Some growth measurements have been recorded which

exemplify this problem of slow development. At Taliparamba, after 14 years in the nursery, sapodilla seedlings had reached a maximum height of 55 cm (22 in) and a maximum girth of 1.5 cm (0.6 in) (32, 39); and in the Philippines, after 453 days in the nursery, the seedlings had an average height of only 12.06 cm (4.8 in) and an average girth of 3.06 mm (0.1 in) at a height of one inch from the ground (15). Although these figures refer to isolated instances, the problem of slow seedling growth has been widely acknowledged and has led to the search for rootstocks among more rapidly growing species.

With regard to transplanting the seedlings, Ruehle (47) notes that bare-rooted trees are difficult to transplant and must be cut back severely, whereas container-grown trees need not be cut back. On this score the advisability of raising rootstocks in containers is apparent.

PROPAGATION BY BUDDING AND GRAFTING

Rootstocks and their effects

Grafting in some form or other is now one of the most widely practised methods of vegetative propagation for sapodillas. Apart from seedlings of sapodilla itself, a number of other species and genera among the Sapotaceae have been tested as rootstocks. Whether they have been adopted commercially has depended not only on graft compatibility but also on their availability locally, their nursery performance, their effect on the scions and their response to local conditions. In Florida, for instance, sapodilla seedlings are used almost exclusively because seeds of related species are not readily available (47). In India and Sri Lanka the stocks mainly used are sapodilla, *Manilkara hexandra*, *Madhuca longifolia* and *Madhuca latifolia* (G24; G26; 7), self-sown seedlings of the last three species sometimes being collected from the forest in the neighbourhood of Bombay (7). In the Philippines a search has been made among other related genera for suitable rootstocks that will make

more rapid seedling growth than sapodilla, but none of those tested appears to have become established in commercial usage (15).

In some west coast districts of India marcotting is preferred to grafting, regardless of rootstock, because it is popularly believed that grafted trees bear fruit that has a granular pulp and is less sweet (G24; 7). Tobias (55), however, affirms that the fruit flavour does not differ on the two types of tree. To generalize, grafted trees are commonly considered to have deeper root systems than trees raised from air layers, and therefore to have a firmer anchorage (55), and to come into bearing considerably earlier than seedlings but possibly a little later than layered trees (G17; 10). Reports have differed widely concerning the growth and cropping of grafted trees compared with trees raised from air layers, and also concerning the performance of trees on different rootstocks (7; 44). These differences appear to have been largely associated with the depth and type of soil. Tobias (55) goes so far as to conclude that air layered trees would be quite satisfactory for general purposes, and that grafts are required only for special soil and climatic conditions. This statement may perhaps be an over-simplification of the position, but it does reflect the influence of growing conditions on the results of rootstock trials.

Work on the individual rootstocks tested will be discussed below. The nomenclature of the species involved, all of which are members of the Sapotaceae and many of them closely related, is apt to be confusing, as different authorities have used different systems of classification; hence the most commonly used synonyms are also given.

Manilkara achras (syn. *Achras sapota*)

Sapodilla seedlings have naturally been tested as rootstocks wherever sapodillas have been propagated by grafting. In fact, in Florida they are apparently the only rootstock used, seeds of other related species not being easily obtainable (47), and in a report from

south China in 1946 (10) it was stated that they were the only suitable rootstock known at that time. In Sri Lanka it is considered to be a good compatible stock, although seed is sometimes scarce (45), and no case of incompatibility has been recorded from any country. Evidence that there may be differences in suitability between different types or races of sapodilla, however, was found in trial^s in Indonesia, in which buds and grafts grew somewhat better on the type known as 'sawo apél' than on 'sawo maneela' (G16).

Information is scanty on the performance of trees on sapodilla seedling stocks as compared with other rootstocks or layers. On the heavier soils in India trees on sapodilla are reported to crop as heavily as plants raised from air layers (43). Compared with trees on *Manilkara hexandra* rootstocks, however, they are said in India to have less extensive root systems, make less vigorous growth and give lower yields (42). The less vigorous growth was evident in a trial on approach grafted trees at Taliparamba (39), and lower yields were obtained from trees on a deep loamy soil in north Gujarat (G24). On the other hand, the value in some circumstances of the shallower root system, or possibly of their greater tolerance to alkalinity, compared with that of *M. hexandra*, was demonstrated in an experiment in the dry district of Bombay-Deccan in a soil overlying a calcareous subsoil; here grafts on sapodilla seedlings grew slowly at first but later bore as heavily as layered plants, whereas trees on *M. hexandra* grew vigorously at first but then developed chlorosis and died (G24).

The most serious objection to the use of the sapodilla seedling as a rootstock is its very slow growth in the nursery. This defect has been noted by workers in many regions, including India, Sri Lanka, the Philippines and Indonesia (G12; 16; 7; 15; 39; 45). Usually the seedlings require two to three years to be ready for budding or approach grafting. A trial in the Philippines, however, has shown that there are marked varietal differences in growth rate (46); the selection

of rootstocks for this character might therefore be worth while. In most countries this problem of slow growth has led workers to investigate the possibility of using other more rapidly growing species as rootstocks. In Florida, however, the problem has been tackled from another angle. At the Sub-Tropical Experiment Station special side grafting and veneer grafting techniques have been developed in which seedlings can be grafted when they are only eight to twelve months old, with a stem diameter of about one quarter inch (6mm) (38; 47). Careful attention to watering and feeding enabled the seedlings to reach a suitable size within this relatively short time.

Manilkara hexandra (syn. *Mimusops hexandra*)

This tree, the "khirni", is a native of India and eastwards, and is cultivated for its fruit and for ornament. It is commonly used as a rootstock for sapodilla in India, and is generally considered the best stock for approach grafting, although its performance is not consistent (22; 44). According to Randhawa and Chadha (42) sapodilla trees on *M. hexandra* have an extensive root system and make notably better growth than trees grafted onto sapodilla seedlings or propagated as layers; and the crop is about 24 per cent more than on layered trees and about 84 per cent more than on trees grafted onto sapodilla rootstocks. Singh et al. (G24) also note that the roots of trees on *M. hexandra* are deeper than those of layered trees, being concentrated between the second and third foot of soil; they therefore need at least 3 feet (90 cm) of soil for successful growth. Giving examples of the effect of soil conditions on the rootstock's performance, they record that on a heavy soil at Gandevi (Bombay) and on a deep loamy soil in north Gujarat grafts on *M. hexandra* cropped more heavily than trees raised from layers, whereas on shallow soil derived from granite, which becomes extremely hard on drying, grafts on *M. hexandra* made poor growth and did not crop well. In an experiment in the dry district of Bombay-Deccan, where there is a calcareous subsoil, trees on *M. hexandra* grew vigorously for the first two years but then developed

chlorosis and died, whereas trees on sapodilla seedlings and layered trees did not succumb. Whether this difference was entirely due to the deeper root system of *M. hexandra*, which penetrated the calcareous subsoil, or whether it was also due to its greater sensitivity to alkalinity, is not clear. The latter was probably a factor because, according to Randhawa and Purohit (44), it is a good rootstock for porous soils of low to neutral pH but is unsuitable for clayey soils or for calcareous soils on which the scions will develop lime-induced iron deficiency. This difference between rootstocks in susceptibility to chlorosis may be responsible for the divergence of opinions regarding the response of sapodilla to soil pH.

Various other Indian reports have confirmed that the growth and cropping of trees on *M. hexandra* are usually equal to, and sometimes better than, those of air layered plants or of trees grafted onto sapodilla or on *Madhuca longifolia* or *M. latifolia* (G23; 16; 36; 37; 39; 43). One exception was an early trial at Kallar in which *M. hexandra* was found to be a less satisfactory rootstock than seedling sapodilla (27).

In Sri Lanka *M. hexandra* has proved a better rootstock than *Madhuca longifolia*; trees on it grew vigorously, flowered during the second year and cropped heavily (3; 4; 5). According to Richards (45) *M. hexandra* grows more slowly than *Madhuca longifolia* but is probably more drought-resistant and longer lived. There was no evidence of delayed incompatibility; in the early years the rootstock did not tend to overgrow the scion in girth, although in older trees there was some evidence of slight stock overgrowth; this was not harmful to the growth of the scions and the trees continued to be productive. Chandler (G3) mentions that *M. hexandra* rootstock seems to dwarf the tree and induce earlier bearing.

For rootstock production fresh seeds are generally sown in nursery beds at the beginning of the monsoon (G24; 22). The seedlings are relatively slow growing; in Sri Lanka they are said to require over 18 months to be ready for budding (45), but in India it is reported that when seeds are sown in July the seedlings can be approach grafted in the following March or April (22). At least they do not take so long to be ready for grafting as sapodilla seedlings, and are preferred for this reason (7). In a trial at Taliparamba, however, unworked rootstocks of *M. hexandra* made poorer growth in the nursery than *Madhuca longifolia* or sapodilla

seedlings, but after they had been grafted the trees on *M. hexandra* made the quickest growth in both height and girth (32; 33; 39).

M. hexandra has been found to root easily from cuttings, which must be taken in the rainy season (G15; 28). This property might prove useful if it were desired to raise more uniform rootstock material. Whether the propagation of rootstocks by cuttings would shorten the nursery period remains to be seen.

With approach grafting on *M. hexandra*, percentage takes of 60 per cent and 80.5 per cent have been recorded at Taliparamba (33; 34). With side grafting the take has been low (28; 29). In Sri Lanka it has been successfully Forkert-budded (G24; 4).

Manilkara kauki (syn. *Mimusops kauki*)

Said to be a native of western Malaysia (1), *Manilkara kauki* is a fair-sized fruit tree sometimes cultivated in eastern countries. As early as 1920 Popenoe (G18) reported that sapodilla had been approach grafted and cleft grafted on *M. kauki* at Saharanpur, and that trees on this rootstock were dwarfed and bore at an earlier age than sapodillas on their own roots; he added that they were also said to be more productive. Burkill (G2) mentions that it has been used for budding in India and has a dwarfing effect, and Cheema et al. (7) mention that it has been used in Hyderabad. Richards (45) in Sri Lanka confirmed that it is a dwarfing rootstock and induces early bearing, but noted the disadvantage that the seedlings take two years to reach a size suitable for budding.

In trials in Indonesia *M. kauki* has been used for budding with fair results; 60 per cent success has been quoted, but again the seedlings had to be two to three years old (G12; G16; G17). This slow growth of the seedlings is also mentioned in a report from Burma (18); attempts were made there to propagate *M. kauki* by cuttings for rootstock production, but the cuttings failed to root.

Madhuca longifolia (syn. *Bassia longifolia*)

This Indian tree, from which illipe butter is produced commercially, has been tested widely in India and Sri Lanka as a rootstock for sapodilla. In approach grafting

trials at Taliparamba the percentage success was 60 per cent in one year and 91.6 per cent in the following year, these results being equal to, or better than, those obtained on stocks of sapodilla and *Manilkara hexandra* (33; 34).

Madhuca longifolia has been cited as a suitable rootstock for Sri Lanka (40), where it has the advantages that seeds are plentiful and the seedlings make vigorous growth. It was found that three-to-four-month-old seedlings could be cleft-grafted more successfully than one-year-old seedlings in the dry zone, and that eight-to-nine-month-old stocks could be Forkert budded, although in the wet zone neither grafting nor budding gave satisfactory results (45). It soon became apparent, however, that symptoms of delayed incompatibility were likely to develop on both budded and grafted trees on this stock. According to Richards (45), the scions grew well for the first four to five years but then the stocks outgrew them in girth and threw up suckers, after which the scions declined suddenly. A few of the *M. longifolia* stocks, however, did not show this overgrowth, and it is suggested that these exceptions might be due to the existence of a variant type among the *M. longifolia* seedlings. The possibility of selecting seedlings that do not develop delayed incompatibility, and of propagating them clonally, is a line of investigation that might lead to valuable results, particularly in view of Richards' opinion that, if it were not for the occurrence of stock overgrowth, the use of *M. longifolia* as a rootstock would make it possible to propagate sapodilla rapidly on a large scale. To overcome this problem, trials were started in Sri Lanka to determine whether it was possible to induce scion-rooting in sapodilla on this stock by low working and planting the trees with the union below ground (45), but the results do not appear to have been published.

Several other reports confirm both the vigorous growth of the seedlings and the tendency of *M. longifolia* to develop stock overgrowth (G3; G15; 3; 4; 5; 32; 35; 36; 37; 39). At Kodur trees on *M. longifolia* did not compare favourably in growth and fruiting with trees on *Manilkara hexandra*, but no details are given (G24).

Madhuca latifolia (syn. *Bassia latifolia*)

This species is very closely related to *M. longifolia*, in fact van Royen has recently classified them as two varieties of the same species (Blumea, 1960, 10(1): 53).

Nevertheless, *M. latifolia* does not appear to have been used as a rootstock in Sri Lanka, and such few references as have been made to it by Indian workers have been unenthusiastic, although there has been no mention of delayed incompatibility. This species, like *M. longifolia*, is, however, sometimes preferred to sapodilla, because its seedlings are ready for grafting sooner (7). It is considered a less promising rootstock than *Manilkara hexandra* (G23; G24). In an approach grafting trial at Kallar about 72 per cent united, but in a side grafting trial at Kodur the percentage take was low (28). In Sarawak budding on stocks of this species was only moderately successful (48).

An interesting piece of work has recently been reported from Annamalai University in India on the effect of seed treatment with gibberellic acid (49). Soaking the seeds of *M. latifolia* for 48 hours in GA at 300 or 400 p.p.m. increased their germination rate from 76 per cent to 100 per cent. Seed treatment with all concentrations of the growth substance, from 100 to 500 p.p.m., also considerably increased the shoot growth of the seedlings, although it reduced root length. Although *M. latifolia* does not seem to be a sufficiently promising rootstock to warrant continued investigations on these lines, it might be interesting to see whether similar good results could be obtained on related species, notably sapodilla itself, thus hastening the growth of seedling rootstocks in the early stages.

Other rootstock species

As might be expected, all the other species tested as rootstocks for sapodilla have been members of the Sapotaceae. *Mimusops elengi* was used in a side grafting trial in Florida, but without success (26). At Taliparamba attempts to approach-graft *M. elengi* also failed and the rootstock was considered incompatible (33; 39). *Sideroxylon dulcificum*, the 'miraculous fruit' of West Africa, has been mentioned as a suitable rootstock in Sri Lanka (40), and it has been tested in India (43) but no details are available. In Indonesia budding was unsuccessful on *Chrysophyllum cainito*, the star apple, and on *Lucuma multiflora*, while on *Palaquium javense* the buds took but the plants died a few months later (G12).

The most extensive trial on intergeneric grafting was carried out in the Philippines in an attempt to find rootstocks with a faster rate of seedling growth than sapodilla (15). Out of the nine species tested by approach grafting with sapodilla,

only four showed any signs of compatibility; these were *Palaquium foxworthyi*, *P. merrillii*, *P. philippense* and *Madhuca betis*, but only when grafted as 24-year-old seedlings. The species that failed to unite were *Chrysophyllum cainito*, *C. monopylum* (*C. oliviforme*), *Lucuma mammosa* (*Calocarpum sapota*), *L. nervosa* and *Sideroxylon duclitan*.

Budding methods

Propagating sapodillas by budding has been fairly common practice in some countries, although it is rare in India, but the method used seems to vary regionally. Shield budding is mostly practised in Florida but was more common before the special techniques of side and cleft grafting were developed. Forkert budding is practised mainly in Sri Lanka and Indonesia, while the use of patch budding has only been reported from Jamaica. A report from Sarawak mentions that budding on sapodilla and *Madhuca latifolia* rootstocks was only moderately successful, but the method is not specified (48).

Forkert and modified Forkert budding: In Java 60 per cent success was obtained with the modified Forkert method during both the wet and dry seasons, using ripe one-year-old budwood from which the leaves had already fallen and three-year-old seedling sapodilla or *Manilkara kauki* rootstocks. It was observed that the bark and bast layers on sapodilla are very thick but can be easily peeled off. Usually 90 per cent of the buds had swollen by three weeks after budding, but the buds grew very slowly and even those that had swollen often failed to grow out and died (G12; G16).

In the dry zone of Sri Lanka the modified Forkert method was successful on eight- to nine-month-old stocks of *Madhuca longifolia*, provided they were budded quickly before latex had collected around the wound; later, however, there was a tendency for the rootstock to overgrow the scion. In the wet zone at Peradeniya budding on this rootstock was unsatisfactory, but on the slow growing *Manilkara hexandra* over 50 per cent take was obtained. Buds on this stock were reported to grow vigorously and flower in their second year. *Manilkara kauki* and sapodilla seedlings have also been budded in Sri Lanka, but both these stocks required two to three years before they were ready for budding (4; 45).

In 1963 Singh et al. (G24) recommended the use of Forkert budding in India as a cheaper, easier and more

efficient method of propagation than the common approach-grafting. They considered that there was every possibility of this method being successfully adopted all over the coastal regions of India where the climate is moist and the rainfall heavy. However, it does not yet seem to have been widely adopted, as in 1969 it was still being referred to merely as a possible alternative to approach-grafting (G23).

In a report from Jamaica in 1946 it was mentioned that modified Forkert budding had not so far proved as successful as patch budding (19). Chandler (G3) noted that Forkert budding had been moderately successful but did not specify where.

Patch budding: It was reported in 1949 that this was the only method of vegetative propagation of sapodillas that had given positive results in Jamaica; two-year-old seedlings were used as rootstocks and the growth of the bud shoot was extremely slow (20).

Shield budding: This is the method that used to be practised fairly widely in Florida. It is said to be moderately successful when done in late spring or early summer, May being the most satisfactory month in south Florida (G3; G14). A good description of the procedure, which is similar to that used on mangoes, is given by Bailey (G1) and Popenoe (G18) as follows: sapodilla seedling rootstocks are planted out in nursery rows 3 x 14 feet (90 x 45 cm) apart. In south Florida they should be budded in May, but in strictly tropical regions they can be budded at any time provided the stock plants are in active growth. Budwood should be chosen from young branches that have begun to lose their greenish colour and are turning brown; the buds should be well developed. The shields are cut slightly more than one inch (2.5 cm) long and the wood is removed if it comes out readily. After making the incision in the rootstock, the bud should be inserted and tied promptly, since latex rapidly collects around the wound and makes insertion difficult. Waxed tape is used for wrapping. After three to four weeks the rootstocks may be headed back and the wraps loosened, leaving the buds exposed. Shield budding has also been tried successfully in Canton, where the importance of using fully mature bud-sticks and buds is also stressed (10) It did not, however, prove successful at the Philippines College of Agriculture (14).

Grafting

Approach grafting: In India this method (usually referred to as inarching) is the commonest way of propagating sapodillas vegetatively. It is widely practised commercially in all districts except the west coast, where air layering is preferred; even there approach grafting is gradually gaining popularity. It appears to have been used on a commercial scale for about 25 years, and it has often been claimed that grafted trees are more deeply rooted, more vigorous and higher-yielding than trees raised from air layers. Such effects, however, depend partly on the rootstock used and partly on the soil and climatic conditions (see preceding section on "Rootstocks and their effects"). The objections raised are generally those that would apply to any method of grafting, such as the possible scarcity of seed for rootstock production, the slow growth of most rootstocks and incompatibility problems. The objection that applies specifically to approach grafting is the need for erecting scaffolds or other supports around the parent tree so that the potted rootstocks may be brought close to the scion branches, and the problem of watering and caring for the grafts while they are on the supports. (G23; G24; 42; 44; 45; 46; 55)

The rootstocks generally used for approach grafting in India are sapodilla seedlings, *Manilkara hexandra* and *Madhuca longifolia*. At Taliparamba grafting in August and September gave better results than in October or November (29), although Katyal (22) reports that if seeds of *M. hexandra* are sown in July the seedlings can be approach grafted the following March or April. The grafts take about three months to unite (55) and the take has usually exceeded 70 per cent.

Approach grafting has been tested in Florida but does not seem to have been used there commercially; Lynch (26) mentioned that prior to 1942 this method and bottle grafting were the only grafting techniques that had given even a small percentage of success. It has been tried successfully in Canton (10), and is reported as being promising in Sarawak (48).

The method has also been practised in the Philippines, where it was used in the intergeneric grafting trials on a wide range of rootstocks (14; 15). It was considered a laborious but simple operation, consistently giving 95-100 per cent success. Union took 35-60 days and was most rapid

when both rootstock and scion were growing rapidly, as at the beginning of the rainy season. It was found advantageous to sever the scion branch in stages and to cut off the top of the rootstock a week or so before finally severing the scion branch (46).

A modified system of approach grafting, in which the seedling rootstock with its roots wrapped in peat in a small polyethylene bag is tied to the scion branch, has been used successfully with sapodilla on the Virgin Islands (23).

Cleft grafting: There have been brief mentions of sapodilla having been successfully cleft grafted in various parts of the world, for instance, in Indonesia on seedling sapodillas (G16), at Saharanpur in India on *Manilkara kauki* (G18; 7), in Canton (10), in the Philippines (14) and on old seedling trees in Florida (47). Rodrigo (46), working in the Philippines, commented that it is a more difficult operation than approach-grafting but can give 80-90 per cent success with expert operators. Chandler (G3) reported that cleft grafting of sapodilla seedlings when they were three or four months old seemed to give better results than budding.

The only detailed account of a trial on the method comes from Sri Lanka (45). In the dry zone at Jaffna three- to four-month-old seedlings of *Madhuca longifolia*, grown under irrigation in nursery beds, were cleft grafted with over 95 per cent success using tender terminal scions. The end of the scion was cut to form a wedge and inserted immediately into the cleft made in the stock, which had been topped at a height of four to five inches (10-13 cm). The union was tied with budding tape and the scion protected from sun scorch and desiccation by mango leaves wrapped loosely round it. Union took place within a month, and the scion produced a new flush of growth with subsequent irrigation. When one-year-old rootstocks were used, only 35 per cent success was obtained. The method was not successful in the wet zone at Peradeniya.

Side grafting: In India preliminary trials at Kodur, Kallar and Taliparamba have shown that side grafting of sapodillas is possible on all the common rootstocks, although the percentage take was generally low (G15; 28; 29). At Taliparamba 20-year-old sapodilla trees were top-worked by the slotted side grafting method with 50 per cent success (G15). Side grafting has also been used in Indonesia on sapodilla seedling rootstocks (G16).

In 1942 a method was tested at the Sub-Tropical Station in Florida that was similar to the side veneer grafting method. It involved the use of defoliated terminal scions 5-6 inches (13-15 cm) long, stocks 18-24 inches (45-60 cm) tall and 4-4 inch (6-12 mm) in diameter, and cut surfaces four to five inches (10-13 cm) long instead of the customary two to three inches (5-8 cm). The method proved moderately successful (57 per cent success) on sapodilla seedlings, although grafts on *Mimusops elengi* failed, and it was considered that the extra length of cut surface probably played a major part in the success (26; 47).

A few years later a further improved method of side grafting was developed at the Station which proved well adapted to nursery practice (47). Seedlings of sapodilla, ten to twelve months old with a stem diameter of about one quarter-inch (6 mm), were used as rootstocks. The scions were conditioned on the tree by girdling suitable branches six weeks to several months before grafting to keep the terminal bud dormant and to encourage the accumulation of carbohydrates. The scion consisted of a defoliated terminal shoot three to four inches (8-10 cm) long with a terminal bud. The rootstock was also prepared by cutting through the bark just above the grafting site to allow the latex to bleed out. A cut, two inches (5 cm) long, was then made downwards, barely slicing into the wood, with a small notch at the base, the scion being cut to fit. The graft was tied with rubber budding strips, and the exposed surfaces were covered with asphalt emulsion or grafting wax. Growth usually started within 30 days, and when the first growth cycle had been completed the top of the stock was lopped or removed. Trees ready for field planting could be obtained in two to three years from the time of sowing the seed. The method could also be used successfully on rootstocks that were several years old. Chandler (G3), describing this method, calls it a special form of veneer grafting.

Using this method of side grafting sapodillas, an experiment was carried out in Florida to determine the effect of pre-girdling the scions on the percentage take (12). It was found that girdling significantly increased the maturity of the shoots and their contents of total sugars, starch and hydrolysable carbohydrates, and had a beneficial effect on the success of grafting at all times of the year. Although both girdled and un-girdled scions gave very satisfactory results in early spring, at other times of year girdling proved essential to success. Furthermore, although the

problem of latex flow was not specifically studied in this trial, it was noted that the latex caused no difficulty, particularly when using stock plants of about 5/16 inch (7 mm) in diameter, but that it was necessary to keep the knife free from latex coagulum throughout the grafting operation. Malo (38) confirms that bleeding-out the latex is an unnecessary and time-consuming operation that does not improve the success of grafting.

Veneer grafting: Continuing the work on grafting techniques at the Sub-Tropical Experiment Station in Florida, Malo (38) recently developed a new method by which he claims that nurserymen can produce a large number of plants quickly and reliably. This he calls veneer grafting, although it appears to be a development of the side grafting technique developed by Ruehle (47). Container-grown sapodilla seedlings, eight to twelve months old, are used as rootstocks. They should have five to eight pairs of leaves and a stem diameter of 1/2-3/4 inch (6-8 mm) and be growing vigorously. The scions are obtained from young terminal shoots with the same diameter as the rootstock but, contrary to those used in Ruehle's method, they are not given any pre-conditioning. A 1 1/2-inch (4 cm) strip of bark is removed on the rootstock and scion, barely cutting into the wood, and the grafted scion is wrapped and completely covered with a plastic strip. The plastic is removed after 30 days and the scion growth is forced by cutting back the stock to two leaves. Subsequently, when the scion has reached six to eight inches (15-20 cm) in height, the remainder of the rootstock is cut back to the union. There are several points of special interest in this method. Seedling growth is hastened by careful watering and fertilizer treatment to enable the rootstocks to be ready for grafting at an age of eight to twelve months. There is a period of about two to three months when the seedlings have the right combination of stem diameter and vigour for the best chance of success. The best time of year for grafting seems to be the summer and autumn months. Grafted plants are usually ready for field planting in 20-24 months from the time of sowing the seed; this is a considerable improvement on the two to three years needed by the side-grafting method.

Other methods of grafting: Brief mention has been made, without details, of the following methods having been used on sapodillas: bark grafting in the Philippines (14); bottle grafting in Florida (26); splice grafting in Indonesia (G16); and tongue grafting in Canton (10).

PROPAGATION BY LAYERING

Ground layering

The branches of sapodilla trees often grow near to the ground, either horizontally or drooping, although some forms have erect growth. Where the branches are low, ground-layering is a possible method of propagation. In India the method is said to be popular because it is relatively easy and cheap (G15; G26). However, it is a slow process, layers taking several months to root and some varieties being reluctant to strike root by layering (G23; 7). At Taliparamba attempts to propagate sapodilla by layering failed (28).

Richards (45) in Sri Lanka reported that ground-layers root more readily than air layers. The method he described is the normal one of making a partial ring or slanting cut on the stem, keeping it open with a stone, pegging down the cut shoot in a shallow trench, covering it with good soil and keeping it moist. The rooted layer is severed in stages. The layers are said to develop into vigorous trees that may bear fruit within two years of planting. Nevertheless, Richards considered the method to be slow and cumbersome, with the disadvantage that the number of plants that can be raised from one parent tree is limited.

In Malaya, where the so-called etiolation method of ground-layering was tested on a wide range of plants in the 1930s, little success was obtained with sapodillas (24). In this method rooted marcots are planted in the etiolation beds and, when well established, they are laid down and covered with soil. When the new shoots arising from the buried stems are several inches high, they are earthed up so that the bases become etiolated. In the case of sapodillas it was found necessary to twist wire round the base of each shoot to induce callus formation and stimulate rooting. Although some of the ringed shoots rooted, many failed, and the rooted plants were difficult to establish in bamboo pots after separation and made slow growth (24a).

Air layering

In many parts of the world air layering used to be the commonest method of propagating sapodillas vegetatively. In the Philippines it was the only method used until the 1930s, when Rodrigo criticized it as slow, extravagant and devitalizing to young trees (14; 46). In Sri Lanka it has also been described as a slow and cumbersome method (45).

Air layering is still very common in Malaysia (G2; G6; 2) and has also been used in New Guinea (53). Most of the information on air layering, however, comes from India, where in the west coast districts it is the most popular method of propagation and is widely practised commercially (G23; G24; 7; 55). The advantages claimed for air layering as compared with approach grafting, the other popular commercial method used in India, are that it is easier and quicker, and the fruits on layered plants are generally believed to have a sweeter and less granular pulp (G24; 7; 44). Tobias (55), however, did not agree that there was any difference in flavour. The main defect of air layered trees is that their root system is shallow, most roots being concentrated in the top 1-1½ feet (30-45 cm) of soil, so that the trees are less well anchored (G24; 44). This characteristic, however, may be an advantage in sheltered areas with shallow soils. The cropping performance of trees raised from air layers as compared with grafted trees seems to depend on the soil and climatic conditions and on the rootstock used, but yields have sometimes compared unfavourably with those of trees grafted on *Manilkara hexandra* (G24; 16; 43).

Air layers may flower in the first flush after planting and they usually bear fruit within one to three years, although they may sometimes take as long as four to five years (G6; G16; G17; 2; 7; 45; 46). They should not be allowed to set fruit for the first two years (2).

The time taken for air layers to root seems to vary considerably, from about three months to over a year (G17; G23; G24; 2; 7; 10; 45; 46; 51; 54). In general, marcots of sapodilla tend to take much longer than those of many other plants to be ready for severing (7), and the species is considered to be very difficult to root on account of the woody nature of its tissues (51; 53; 54). Some of the factors and treatments affecting success are discussed below.

Varietal differences: It is well recognized that some varieties of sapodilla do not root satisfactorily from air layers, or take a very long time to do so (G17; G23; 7). In describing some of the varieties grown in Bombay State, where air-layering is common commercial practice, Cheema et al. (7) record their rooting behaviour: Large Calcutta, for instance, is classified as being difficult to root, Kali as giving nearly 50 per cent success, and Dhola Diwani, Long Jungar and Vanjet as rooting easily or very easily. Elsewhere

Kalipatti has been referred to as a variety difficult to root from marcots (54).

Differences have also been noted in the time required to obtain well rooted marcots between some of the forms grown in Java; Sawo bĕtawi, a good, large-fruited form, requires six to twelve months; Sawo koolon, a large-fruited form of less good quality, will root in four months; and Sawo apĕl bĕnĕr sometimes needs a year (G16).

The existence of these differences indicates that rooting capacity should be one of the characters to be taken into account in the selection of improved varieties.

Time of air layering: Some Indian writers advocate March and April as the best months for air layering sapodillas, when the sap is actively moving; it is said that rooting will begin when the south-west monsoon starts in June or July and the layers will generally be ready to detach by mid-September (G24; 22; 43). Other writers say that marcots are generally prepared in late May or early June to give them the benefit of the following rainy season (G23; 7; 46). When this was done in western India the marcots had to be hand watered (before the advent of polyethylene wraps) from October until the following January, when they were ready for severing. In Madras, where the annual rainfall exceeds 100 inches, a method was evolved to avoid this labour of hand watering and also to allow the marcots to be detached at a more favourable time of year than the dry month of January. After the first rainy season they were left on the tree without any watering until the following rains, when they threw out new roots in August; they could then be severed and transplanted during the second rains (7).

The use of polyethylene wraps, which eliminates much of the labour of hand watering, makes it easier to time the air layers so that the rainy season coincides with the time of transplanting rather than the time during which the layers are still attached to the tree. In one growth substance trial, for instance, the layers were prepared in early October when the heavy rains were over and the plants were in active growth, with a view to the layers being ready for transplanting during the next monsoon season (54). Seasonal differences in rooting capacity, however, have still to be considered. This was apparent in another trial using polyethylene wraps, when July proved to be too late for the successful rooting of air layers without growth substance

treatment (51). There is evidently need for further study of the seasonal changes in the rooting capacity of sapodilla air layers.

Age and size of shoot: In India it is generally recommended that branches for marcotting should be about two years old, 1½-2 feet (45-60 cm) long and half an inch (13 mm) in diameter with plenty of leaves (G24; 22; 25), although in one growth substance trial four-year-old branches were used (54). In Malaya branches about three feet (90 cm) long have been recommended (2), and in the Philippines it was apparently common practice to marcot large branches two to three inches (5-7½ cm) in diameter (10). No experimental work seems to have been done to determine the best age or size of shoot for air layering.

Ringing, rooting media and wrapping: It appears to be general practice in marcotting sapodillas to remove a ring of bark about 2½ cm (1 in) wide (2; 55). The effect of latex flow from the cut tissues on their rooting does not seem to have been studied directly, nor has it even been referred to as a problem, except in one trial on the use of growth substances in which special precautions were taken to remove the congealed latex (54). It might be of interest to investigate whether congealed latex could cause a physical barrier to root emergence.

Rooting media and wrapping materials have included soil wrapped in coconut husk fibre, coconut husk mixed with soil, a mixture of soil, sand and compost wrapped in coir fibre, soil wrapped in gunny cloth, a thin layer of a sand-leafmould mixture or soil covered with a pad of sphagnum moss and wrapped in polyethylene, or finely chopped sphagnum wrapped in polyethylene tubing (G24; 2; 10; 22; 45; 51; 54; 55).

A trial in the Philippines showed that the rooting medium had a marked effect on the speed of rooting (46). In a medium of 50 per cent fine sand plus 50 per cent loam good rooting was obtained in four and a half to five months, whereas in pure loam or pure clay rooting took seven to twelve and a half months.

The use of polyethylene wraps instead of the gunny cloth and other materials formerly used has the great advantage of eliminating the need for frequent watering, and is also said to result in faster rooting. Wraps of 200-, 250- and 300-gauge

polyethylene have proved satisfactory, but shading is necessary to prevent the polyethylene from cracking (G24; 22). In one trial in which plastic tubing was used the marcots were watered at intervals of 20-25 days in winter and 15-20 days in summer except during the rainy season (54), whereas formerly marcots often had to be watered daily or from a drip tube in the dry season. Thus, by conserving moisture, polyethylene wraps allow a greater latitude in the timing of air layering.

A method of air layering in earthen pots, similar to that used on litchis, is sometimes practised on sapodillas in Uttar Pradesh. The pots, with two U- or V-shaped notches opposite each other, are tied to the limbs of the trees close to the shoots to be propagated; the prepared shoots are bent and passed through these notches, the cut section being buried in the soil in the pots (7).

A special marcotting box made of tin sheets was tested on several plant species in Madhya Pradesh (50). Although this box gave good results with some fruit trees, such as citrus, no rooting occurred on sapodilla air layers.

Growth substance treatment: A study on the effect of growth substances on the carbohydrate content of the bark of sapodilla branches just above the marcot girdle was carried out by Chinnappa and Kololgi (9) at the College of Agriculture, Dharwar, in 1961. Girdling without hormone treatment was found to increase the content of sugars, cellulose and lignin in the bark, and to reduce the hemicellulose content; the very great increase in lignin content was due to the formation of callus which becomes highly lignified. The treatment of girdles with a mixture of IBA + NAA increased the content of sugars, hemicellulose and cellulose, compared with that of the untreated air layers, but reduced the lignin content and intensified cell division, all changes that helped in the initiation of the rooting process.

In continuation of this work, Sulladmath and Kololgi (54) studied the effect of different growth substances on the speed and percentage of rooting of sapodilla air layers. They found that IAA, IBA and IBA + NAA in talc all induced earlier and better rooting. The best results were obtained with the mixture of IBA + NAA at 10,000 p.p.m.; this gave the earliest rooting (16-18 weeks), the highest percentage

(90 per cent) and the greatest number of secondary and tertiary roots. With IAA the roots were typically long and had few laterals, while NAA alone showed toxic effects. In this trial the untreated controls gave only 40 per cent rooting and took 38-40 weeks to root. The variety used, Kalipatti, is considered difficult to root, and the authors conclude that it requires high concentrations of growth substances. An interesting point in this trial is the care that was taken to remove the latex that had congealed over the girdle, in order to allow absorption of the growth substances. A ring of bark three cm (1 1/4 in) wide was removed, the upper cut being 1.75 cm (7/10 in) below a node; this was covered with sphagnum moss. The following day a further strip of bark 2.5 mm (1/10 in) wide was peeled off just above the upper cut to remove the congealed latex. The growth substance was then applied to the upper cut and to 1.75 cm (7/10 in) above it. No other reference has been seen to the problem of congealed latex on sapodilla air layers.

Less promising results were obtained in a trial in the Punjab (51). In this case NAA and IBA were used separately and in mixture at 100 to 1,000 p.p.m. in lanolin paste. The untreated controls failed to root, but all the growth-substance treatments induced rooting in a certain number of layers. The highest percentage rooting (72.5 per cent), the greatest speed (107 days) and the greatest number and length of roots were given by the mixture at the highest concentration. NAA was significantly inferior to IBA alone. With all treatments the speed and percentage of rooting and root development increased with concentration. Nevertheless, very few roots developed on each layer, even with the best treatment, and those that emerged were short and thick with very little branching. This resulted in a high rate of mortality, the final survival averaging 5 per cent and reaching only 20 per cent even following treatment with the mixture at the highest concentration of 1,000 p.p.m. In view of the well branched root systems obtained by Sulladmath and Kololgi (54) with the same mixture at 10,000 p.p.m., their conclusion that a high concentration of growth substances may be needed for sapodilla appears to be justified.

Treatment and survival of rooted air layers: When roots appear through the rooting medium the branch below the girdle is cut through gradually, severance being completed in about a fortnight (51; 55). The rooted layers are usually potted-up in a good soil or compost and kept in the shade with

regular watering until they are established (G24; 7; 10; 22; 51; 55). Staking the potted layers to prevent shaking has been recommended (G24; 22). Establishment of potted marcots is notoriously difficult, and mortality may commonly be as much as 50 per cent (G23; 7; 24). This is one of the factors that makes air layering an expensive method of propagation, and also confirms the desirability of detaching and potting up the marcots during the rainy season.

PROPAGATION BY CUTTINGS

Sapodilla appears to be a particularly difficult subject to root from cuttings, possibly because of the woody nature of its tissues. It has been asserted by some authorities that shoots cannot be rooted under ordinary conditions (42; 54). Certainly attempts to root cuttings of various types were unsuccessful in Jamaica (21); and at Taliparamba in India, although cuttings remained alive for 10 months, they failed to root (G15; 29).

The use of special propagators and growth substance treatment has sometimes markedly improved rooting, but even then results have been erratic and it has not always been possible to determine which factors have been responsible for success. In a solar propagator, used in Trinidad, the percentage rooting was very low (7a). An I.C.T.A. propagator, in which temperature and transpiration are reduced by covering the bins with wet cheesecloth, was found to be unsuitable for sapodilla cuttings because the light intensity was too low (52). In an attempt to overcome this problem, Stahel (52) developed a new method in Surinam. This involved using a continuous spray of water over the open bins during the daylight hours, only replacing the glass and screens at night. In this way a permanently saturated atmosphere was maintained, the leaves were kept cool by evaporation and by contact with the water, and the light intensity was about 50 per cent of full sunlight. In effect, this was an early, rather crude example of mist propagation. Stahel commented that branch cuttings of sapodilla root only with great difficulty, if at all, but it is not clear whether he actually tried them in this propagator. Using cuttings from vigorous sucker growth, however, he obtained 40 per cent rooting without growth substances and 90 per cent rooting following treatment with a 2 mg/ml solution of IBA. Thus three factors were operative in this trial; the environment,

the sucker growth which may have been juvenile and have thus possessed a relatively high rooting capacity, and the growth substance treatment.

When a normal mist propagator was used in Sri Lanka, over 50 per cent rooting was obtained with cuttings of mature, current season's wood treated with NAA or IBA; the cuttings were ready for field planting within a year (6). From this brief report it is impossible to distinguish the effect of mist propagation from that of the growth substances.

Propagation in polyethylene bags has also been tested as a means of reducing transpiration (G8; G9). In this case the cuttings were stood for 12-24 hours in a 0.01-0.03% concentration of Silbephylline (a medical compound) before being subjected to a quick dip in 0.2% IBA. This double-stimulant treatment, which had been successful on many crops, resulted in only 10 per cent rooting of sapodillas, and cuttings treated with IBA alone failed.

The most successful results reported were obtained in a trial in Florida (11), in which mature, terminal cuttings, taken in May, were inserted in sand in a frame with bottom heat kept at 85°F (29°C). The cuttings were soaked in a 0.01% solution of IAA for 24 hours. By mid-September 100 per cent of the treated cuttings had rooted, but even in the controls there was 80 per cent success. The unique feature of this trial was the very high bottom heat, and it would be interesting to find out whether this is indeed an important requirement for the rooting of sapodilla cuttings.

There are several examples of sapodilla cuttings being unresponsive to growth substance treatment. At Kodur in India one-year-old shoots, either untreated or treated with Seradix A or B, had all died within 90 days (31); and in the following year treatment with Hortomone A at two concentrations had little or no effect on the rooting of cuttings of various ages either with or without leaves (32). A trial at the Araneta Institute of Agriculture in the Philippines (41) was also a failure. In this trial tip cuttings six inches (15 cm) long were taken in November and May, treated with Rootone No. 10 powder or a 2 p.p.m. NAA solution and inserted in five media out of doors under shade. Although none of the cuttings rooted, those in a 1:1 mixture of sand and loam remained alive the longest. As most of the

cuttings produced new leaves and remained alive for about 100 days, it is concluded that it should be possible to induce rooting by some modification of the conditions or treatment.

The occasional triumphs, as well as the reasonable results that have been achieved with air layering, support this optimistic conclusion, but the experiments carried out so far have not been far-reaching enough even to distinguish the main factors conducive to success. Varietal differences in rooting capacity, which have been apparent in air layering trials but have not been studied in relation to cuttings, may be one of the factors responsible for the variable results obtained with sapodilla cuttings.

CONCLUSIONS AND SUGGESTIONS

Although the sapodilla is fairly adaptable to environmental conditions, the response of trees on their own roots and on various rootstocks to soil alkalinity needs clarification. The growth habit is very variable and the wood is exceptionally hard, a factor which may be partly responsible for its poor rooting capacity. The bark contains a milky latex that has been troublesome in grafting. Whether more attention should be paid to the latex flow in air layering is a point that might be considered.

Seedling sapodillas have been widely used as rootstocks, their main defect being their slow growth; varietal differences in growth rate could be exploited, and seed treatment with GA might possibly hasten seedling growth.

The rootstock most favoured in India is *Manilkara hexandra*, although there are indications that it is susceptible to chlorosis on calcareous soils. Of the other rootstocks tested, *Madhuca longifolia* has been the most promising because of its rapid seedling growth. After a few years, however, the stock tends to outgrow the scion. Selection amongst variant types and their vegetative propagation might make it possible to exploit the potentially good properties of this stock. Another species, *Manilkara kauki*, is said to make a dwarfing rootstock, but information on its performance is scanty.

Air layering is the most common commercial method of vegetative propagation in western India. The trees come into

bearing early, but they have a shallow root system and, under many conditions, do not crop as heavily as trees grafted on *M. hexandra*. The establishment of rooted marcots is notoriously difficult. The modern use of polyethylene wraps should now make it possible to time the operation so that the marcots are ready for transplanting during the rains. Seasonal differences in rooting capacity require further study, as does the effect of congealed latex on root emergence. Very little work has been done on growth substance treatment of air layers, but there are indications that high concentrations of growth substances, particularly a mixture of IBA and NAA, would improve rooting.

Sapodilla is a difficult species to root from cuttings, although unrooted cuttings have been observed to remain alive for a long time. Promising results have been obtained with mist propagation, high bottom heat and some growth substance treatments, but results generally have been very erratic. It is possible that cuttings from sucker growth might root more readily than branch cuttings. Varietal differences in rooting capacity, such as have been observed for air layers, may well apply also to cuttings. Much more work is required to determine the conditions needed for reliable root formation.

BIBLIOGRAPHY

1. ALLEN, B. M. *Malayan fruits: an introduction to the cultivated species*. Donald Moore Press, Singapore, 1967.
2. ANON. *Malayan fruits*. *Malay. agric. J.*, 1935, 23: 110-33.
- 2a. CAMPBELL, C. W. and MALO, S. E. Performance of sapodilla cultivars and seedling selections in Florida. *Proc. trop. Reg. Amer. Soc. hort. Sci.*, 1973, 17: 220-6.
3. CEYLON. *Admin. Rep. Dir. Agric. 1943. Part IV. Educ. Sci. Art (D)*, 1945.
4. CEYLON. *Idem* 1944. 1946.
5. CEYLON. *Idem* 1946. 1948.
6. CEYLON. *Idem* 1958. 1959.
7. CHEEMA, G. S., BHAT, S. S. and NAIK, K. C. *Commercial fruits of India with special reference to Western India*. Macmillan & Co., 1954.
- 7a. CHEESMAN, E. E. Personal communication, 1936.
8. CHINNAPPA, B. A new species of *Phaeophleospora* affecting *Achras sapota* L. *Curr. Sci.*, 1968, 37: 566.
9. CHINNAPPA, K. S. and KOLOLGI, S. D. Effect of plant regulators on the cell wall constituents of the bark of chiku (*Achras sapota* L.) above the gootee girdle. *Lal-Baugh*, 1961, 6(4): 29-32.
10. CHUN, W.-Y. and BENEMERITO, A. N. The cultivation of the chico fruit in South China. *Sunyatsenia*, 1946, 6: 263-70.
11. COOPER, W. C. and KNOWLTON, K. R. The effect of synthetic growth substances on the rooting of subtropical fruit plants. *Proc. Amer. Soc. hort. Sci.* 1939, 1940, 37: 1093-8.
12. FAHMY, I. Grafting studies on macadamia and sapodilla in relation to carbohydrates, using pre-girdled scions. *Proc. Fla St. hort. Soc.* 1952, 65: 190-2.
13. FAROOQUI, A. A., NALAWADI, U. G. and SULLADMATH, U. V. Effect of growth regulators on the germination of sapota (*Achras sapota* L.) seeds. *Mysore J. agric. Sci.*, 1961, 5: 341-3.

14. GONZALEZ, L.G. Outstanding results of agronomic and horticultural research. *Philipp. Agric.*, 1934, 23: 380-99.
15. GONZALEZ, L.G. and FABELLA, E.L. Inter-generic graft affinity of the chico. *Philipp. Agric.*, 1952, 35: 402-7.
16. GOSWAMI, K.N. Performance of sapodilla (chiku Kali-patti) on various rootstocks. *Bansilal Amritlal agric. Coll. Mag.*, 1954, 8(1): 6-7.
17. GUTIÉRREZ TEXIDÓ, G. and PARRADO ALVAREZ, J.L. Zapote o nispero sin semilla. *Rev. Agric., Cuba*, 1954, 37(2) : 81-2.
18. HMAWBI. *Rep. Hmawbi agric. Stat. (Burma)* 1933, 1933.
19. JAMAICA A. R. *Dep. Agric. 1944-45, 1946.*
20. JAMAICA. *Idem 1946-47, 1949.*
21. JAMAICA. *Idem 1947-48, 1950.*
22. KATYAL, S.L. Chiku - an all the year cropper. *Indian Hort.*, 1961, 5(3) : 12-17.
23. KROCHMAL, A. Inarching as a method of propagating tropical fruit trees. *World Crops*, 1971, 23: 218-19.
24. LAMBOURNE, J. The propagation of fruit trees. *Malay. agric. J.*, 1934, 22:58-62.
- 24a. LAMBOURNE, J. Progress report on etiolated shoot method of propagation up to September 1935. Communication from Director Agric., F.M.S. and S.S.
25. LEÓN, J. *Fundamentos botánicos de los cultivos tropicales.* Instituto Interamericano de Ciencias Agrícolas de la OEA, San José, Costa Rica, 1968.

26. LYNCH, S.J. Studies of minor fruits and
ornamentals. *A.R. Fla agric. Exp. Stat.* 1942,
pp. 198-203.
27. MADRAS. *Rep. agric. Stats Madras Pres.* 1935-36,
1936.
28. MADRAS. *Idem* 1944-45, 1946.
29. MADRAS. *Idem* 1945-46, 1948.
30. MADRAS. *Idem* 1946-47, 1949.
31. MADRAS. *Idem* 1947-48, 1950.
32. MADRAS. *Idem* 1948-49, 1951.
33. MADRAS. *Idem* 1949-50, 1952.
34. MADRAS. *Rep. agric. Stats Madras St.* 1950-51,
1953.
35. MADRAS. *Idem* 1951-52, 1955.
36. MADRAS. *Admin. Rep. agric. Dep.* 1954-55,
1956.
37. MADRAS. *Idem* 1955-56, 1957.
38. MALO, S.E. A successful method for propagating
sapodilla trees. *Proc. Fla St. hort. Soc.* 1967,
1968, 80: 373-6.
39. PADMANABHAN NAMBIAR, K.P. Note on the performance
of sapota (*Achras zapota*) on three rootstocks
at the Agricultural Research Station, Taliparamba.
S. Indian Hort., 1954, 2(2):62.
40. PARSONS, T.H. The cultivation of fruits in
Ceylon with cultural details. - I. *Trop.*
Agriculturist, 1932, 78: 337-42.
41. DE PERALTA, F. and DE LA CRUZ, J.E. Preliminary
study on vegetative propagation of chico.
Araneta J. Agric., 1954, 2(1) :24-32.

42. RANDHAWA, G.S. and CHADHA, K.L. Current situation, developments and problems in propagation of tropical and sub-tropical fruits in India. *Proc. F.A.O. Conf. on Propagation of Tropical and Sub-tropical Fruits, London, 1969*, pp. 16.
43. RANDHAWA, G.S. and KOHLI, R.R. Sapota cultivation in India. *Indian Hort.*, 1966, 10(4): 3-6, 26.
44. RANDHAWA, G.S. and PUROHIT, A.G. Propagation techniques used or recommended for various tropical and sub-tropical fruits in India. *Proc. F.A.O. Conf. on Propagation of Tropical and Sub-tropical Fruits, London, 1969*. pp. 14.
45. RICHARDS, A.V. Studies in propagation of sapodilla. *Trop. Agriculturist*, 1943, 99:78-82.
46. RODRIGO, P.A. Notes on the propagation of *Ponderosa chico*. *Philipp. J. Agric.*, 1938, 9: 357-64.
47. RUEHLE, G.D. The sapodilla in Florida. *Circ. Fla agric. Exp. Stats* S-34, 1951, pp. 14.
48. SARAWAK. A. R. Res. Branch Dep. Agric. 1968 .
49. SHANMUGAVELU, K.G. Effect of gibberellic acid on seed germination and development of seedlings of some tree plant species. *Madras agric. J.*, 1970, 57(6): 311-14.
50. SINGH, M.P. An improved marcot box for the aerial propagation of fruits. *Indian J. Hort.*, 1954, 11(3): 89-93.
51. SINGH, S., SINGH, K.K. and CHUGH, D.V. Effect of naphthalene acetic acid and indole butyric acid on air-layering in sapota (*Achras sapota* L.). *Indian J. Hort.*, 1962, 19(1/2): 32-41.
52. STAHEL, G. A new method of rooting cuttings of hevea and other trees. *Trop. Agric., Trin.*, 1947, 24:4-6.

53. STEPHENS, S.E. The sapodilla *Qd agric. J.*, 1937, 48: 340-1.
54. SULLADMATH, U.V. and KOLOLGI, S.D. Synergistic influence of 3-indolebutyric acid and alphanaphthalene acetic acid on the rooting of air layers of chiku (*Achras zapota* L.) var. Kalipatti. *S. Indian Hort.*, 1969, 17(1/2):9-17.
55. TOBIAS, K.I. Sapota as an inter-crop in coconut gardens. *Coconut Bull.*, 1957, 11: 80-5.

MYRCIARIA CAULIFLORA AND RELATED SPECIES — JABOTICABAS

by

G. K. ARGLES

Formerly of the Commonwealth Bureau of Horticulture
and Plantation Crops

ECOLOGY AND BOTANY IN RELATION TO PROPAGATION

Authorities (G1; G17; G18; G19) agree that the true jaboticaba is *Myrciaria cauliflora* (syn. *Eugenia cauliflora*), which is a native of Brazil, where it is widely cultivated, notably in the neighbourhood of Rio de Janeiro, for its small, globular, purple, grape-like fruits which are eaten fresh and used in jellies, wines and cordials. Many of the fruits consumed as jaboticabas in Brazil, however, appear to come from other species, notably *M. jaboticaba* (known locally as jaboticaba de Sao Paulo, jaboticaba de cabinho or jaboticaba do matto), *M. trunciflora* and *M. tenella* (known as jaboticaba macia). A type, with red cherry-like fruits, listed as *M. edulis*, has been introduced into South Africa via California (4). In addition, there are various forms or varieties known in Brazil by such names as 'coroa', 'murta', 'branca' and 'roxa', most of which can probably be referred to *M. cauliflora*. There may also be hybrids between the different *Myrciaria* species.

M. cauliflora is a handsome evergreen tree with glabrous leaves that under favourable conditions reaches a height of 35 to 40 feet (10 - 12 m). Its branches emerge close to the ground and spread to give a dense, round habit. *M. jaboticaba* may be somewhat smaller, reaching 20 to 30 feet (6 - 9 m). To attain their full size jaboticabas appear to need a rich deep soil and a moist equable climate. Even under such conditions the early growth of the trees is slow, six to eight years elapsing before seedlings come into bearing.

The flowers and fruits are borne directly on the trunk and larger branches. Given adequate moisture, trees may produce five or

six crops a year, individual fruits taking only a few weeks to develop and ripen (G14; G25). The fruits, which resemble large muscadine grapes, usually contain one seed but occasionally as many as four. The seeds of *M. cauliflora* are usually polyembryonic (G14) and a single seed may give rise to several seedlings, most of which come true to type (3); it is not known, however, whether this applies to all forms of *M. cauliflora* or to other *Myrciaria* species.

Despite the merits of both the tree and its fruit, the jaboticaba has not yet become widely known outside Brazil. Trees have been established for some years in Florida, where they have survived temperatures as low as 26°F (-3°C) but have grown very slowly and seem unlikely to reach much more than 15 feet (4.5 m) in height. In South Africa seedlings of both the jaboticaba and the "cherry of the Rio Grande" (*M. edulis*) raised by Harrington (3;4) have survived temperatures as low as 24°F (-4°C), but, whereas trees of the latter started cropping when four to six years old, it is not expected that the jaboticaba seedlings will come into bearing until they are 8 to 15 years old.

From the standpoint of propagation the following points would seem to be of particular importance:

(1) There is clearly a need to sort out the species, forms and varieties known collectively as jaboticabas with a view to identifying and naming superior varieties that could be perpetuated vegetatively.

(2) Although it might prove possible to raise selected polyembryonic varieties true to type from seed, the slow growth of seedlings and the long time they take to come into bearing suggests that it would be preferable to develop vegetative methods of propagation.

(3) In raising plants, whether from seed or vegetatively, it would seem desirable to provide an environment that is moist and avoids extremes of heat or cold.

PROPAGATION BY SEED

Most of the jaboticabas grown in Brazil and elsewhere are raised from seeds that are presumably normally sown soon after their extraction from ripe fruits. In Florida they usually take about one month to germinate. Fouqué (2) notes that seeds of *M. cauliflora* take 20-40 days to germinate.

In an experiment carried out at Viçosa in the State of Minas Gerais, Brazil, with seeds of a variety of jaboticaba known as Sabará, Aroeira (1) obtained 71 per cent germination after 12 weeks when seeds were sown fresh and had a moisture content of 40.3 per cent. Seeds that were stored for two months in either sealed or open containers at laboratory temperatures lost their viability completely, as did seeds stored for two months in sealed containers at 3°-10°C (37°-50°F). On the other hand, 40 per cent and 43 per cent germination was obtained from seeds that had been stored for two and four months respectively in open containers at 3°-10°C, and a few seeds remained viable under these conditions for eight to twelve months. In the seeds held at low temperatures in open containers for two months or more their moisture content declined to between 11.1 and 14.6 per cent.

Harrington (4) mentions that seeds of *M. edulis* also tend to lose their viability quickly but germinate readily if sown soon after their removal from the fruit.

Seedling jaboticabas may barely reach 18 inches (46 cm) in height when they are three years old (G14). This doubtless explains why Brazilian nurserymen supply trees that are five or six years old (3). Young trees, however, have long tap roots, and care is needed when planting them out to keep the ball of soil intact.

VEGETATIVE PROPAGATION

Published information on the vegetative propagation of jaboticabas is scanty, and such as there is is nearly all second-hand and devoid of details.

Popenoe (G18) mentions that inarching (approach

grafting) is said to succeed in Brazil, and Fouqué (2) reports that in tropical America approach grafting is used to propagate the best varieties of *M. cauliflora* and *M. jaboticaba*.

Sturrock (G25) mentions that grafted plants of highly productive strains are now available in Florida, and a comment by Harrington (4) suggests that these may have been propagated by side grafting. Harrington himself found it easy to propagate jaboticabas by cleft grafting, and he has also found it possible to graft *M. edulis* (4).

Presumably seedlings of the same species were used as rootstocks in all these cases. Grafted jaboticabas are said to come into bearing earlier than seedlings and to make somewhat smaller trees (3). If these and other desirable characteristics are found to be transmitted by certain rootstocks raised from polyembryonic seeds, it might prove possible to identify the asexual seedlings and thus ensure a high degree of uniformity in grafted trees.

The only reference to the use of air layering is a note (2) that the best varieties of *M. cauliflora*, *M. jaboticaba* and *M. trunciflora* are propagated in this way in tropical America.

Only one report (5) mentions a trial with cuttings. This trial was in Florida, the species involved was *M. jaboticaba*, and out of 78 cuttings taken, a solitary specimen was found to have formed roots after eight weeks. Too much should not, however, be read into this discouraging result, because some other genera included in the same trial failed to root altogether, although some have been found subsequently to root readily under suitable environmental conditions. In this particular trial, in which constant mist was supplied to cuttings in full sunlight in the open, it seems probable that the two rooting media tested were unsatisfactory. One of these was coconut fibre, in which most cuttings rotted, and the other was a by-product of a water-softening process in which green sand particles had become coated with calcium carbonate to form spheres ranging in diameter from 0.5 to 5mm. Although the latter was free-draining, its pH was 8.5, which is well

above the level normally regarded as satisfactory for cuttings. Thus, the only conclusion that can safely be drawn is that cuttings of *M. jaboticaba* are capable of forming roots and if given a suitable environment might do so readily. Just what may constitute a suitable environment remains to be determined, but anyone faced with the problem might be well advised to avoid extremes of moisture, temperature and alkalinity.

BIBLIOGRAPHY

1. AROEIRA, J.S. Dormência e conservação de sementes de algumas plantas frutíferas. *Experientiae*, 1962, 2:541-609.
2. FOUQUÉ, A. Espèces fruitières d'Amérique tropicale.II. *Fruits*, 1972, 27 : 120-39.
3. HARRINGTON, F.B. The jaboticaba. *Fmrs' Wkly*, *S. Afr.*, 1954, Jan. 20, p.59.
4. HARRINGTON, F.B. Cherry of the Rio Grande. *Fmrs' Wkly*, *S. Afr.*, 1955, Jan. 12, p. 57.
5. OCHSE, J.J. and REARK, J.B. The propagation of sub-tropical fruit plants by cuttings, a progress report. *Proc. Fla St.hort.Soc.*, 1950, 1951, 63 248-51.

NEPHELIUM LAPPACEUM —

RAMBUTAN

by

T. E. WALTER

Commonwealth Bureau of Horticulture and Plantation Crops

INTRODUCTION

The rambutan is undoubtedly one of the most delectable fruits of the East and, in the regions where it is grown, one of the best known. Outside those regions, however, it is comparatively little known, as its export potential as canned fruit has not been developed.

Its common name is derived from the Malay word "rambut", meaning hair, and its Latin specific name indicates resemblance to a burr (12). Other forms of the name include ramboetan, rambotang and rambustan (18). Formerly the litchi, which it resembles in some respects, was also referred to by some botanists to the same genus, but this is now classified as *Litchi chinensis*; the French, however, continue to confuse the issue by referring to the rambutan as "litchi chevelu" (hairy litchi). The only other *Nephelium* spp. of any importance are *N. mutabile* (kapulasan, pulasan or bulala) and *N. malaiense* (mata kuching).

The fruits have a highly distinctive appearance, due to the yellowish-red, soft, spiny outgrowths which cover the pericarp (13). The main edible part of the fruit is the aril which is white and juicy, with a subtle sweet to sub-acid flavour not unlike that of the litchi. The aril encloses a nut-like kernel which can also be eaten when cooked. The aril is claimed to have a moderately high vitamin C content and the seed has a high oil content (mostly oleic and eicosanoic acids).

ECOLOGY AND GROWTH IN RELATION TO PROPAGATION

Distribution and ecology

The rambutan is indigenous to the Malay Archipelago and is cultivated throughout that region, especially in West Malaysia and Java. Throughout West Malaysia rambutans are to be found in small mixed stands in virtually every kampong (village), and they are also grown on a plantation scale as a sole crop (18). Indeed, in 1964 the total rambutan acreage amounted to no less than 29,600 acres, and it was the sole crop on over 6,000 acres (9). By comparison with other fruits, it is exceeded in economic importance only by bananas, durians and pineapples. In Java it is cultivated mainly in the villages around Djakarta, but it thrives up to an altitude of about 1,000 feet (300 m) (G16). It has also been successfully introduced into the Philippines (11), Sri Lanka, Central America (G3), and India (G24) where trials at the Kallar Fruit Station indicate that it is worthy of further expansion. Attempts to introduce it into Florida and other subtropical countries, however, have not been successful (G25).

A moist, hot climate with a well distributed rainfall is the main requirement of the rambutan. It is tolerant of many soil types, but a deep, well-drained loam is preferred (17).

Growth habit and floral biology

The rambutan tree is medium-sized, seldom attaining a height of more than about 40 or 50 feet (12-15m), and a spread of about 20 feet (6m) (18). When grown from seed it usually has a straight trunk and a densely branched, compact crown.

The leaves are compound, alternate and petiolate, with five to seven pairs of short-stalked leaflets, each about four inches (10 cm) long. The inflorescences are rusty pubescent, erect, axillary or terminal, with many greenish pubescent white flowers. Separate male and female flowers are usually borne on the same inflorescence,

but trees of seedling origin sometimes bear only male or female flowers, or female and a few hermaphrodite flowers. Some trees may set at least a few parthenocarpic fruits. Trees raised from seed bear fruit after about six years, but marcotted plants may start bearing after only two years.

In West Malaysia there are two flowering periods per year, namely March to May and August to September, and crops are harvested from June to September and from November to February. One of the crops is usually much greater than the other and the main crop in one district may coincide with the second crop in another. In Indonesia (Gl6) and the Philippines (3), however, there is only one flowering period, July to September and March to May respectively, and the fruits ripen four to five months later.

In studies in West Malaysia of the relationship between single or double cropping seasons and the weather, Whitehead (18) collected data suggesting that flower formation may be influenced by the weather conditions prior to and at the time of flower bud differentiation. Thus heavy rainfall about three weeks before flowering appears to promote the formation of vegetative buds, whereas dry weather at this time appears to induce flower bud formation. The nutritional status of the tree is another factor of major importance, this in turn being influenced by the size of the preceding crop, tree vigour, pruning and other cultural treatments.

The fruits, which hang in loose clusters of about a dozen, are oval in shape, $1\frac{1}{2}$ - 2 inches (3-5 cm) long and $1-1\frac{1}{2}$ inches (2.5-3cm) wide (6). A nutlet derived from the two-lobed ovary is usually found as a small tubercle at the base of the fruit (18).

The pericarp is covered with soft spines (tubercles) varying in length, and these turn from green to various shades of yellowish-red and crimson when ripe (6). The thin, leathery outer covering is easily removed to expose the gelatinous, pearly white aril, which is the edible part of the fruit. This, in turn, encloses a seed or nut, which may or may not

adhere to the seed coat.

Varieties

It is generally accepted that the rambutan is cross-pollinated, so that under natural conditions there is inevitably wide genetic variation (18). Nevertheless, Ochse (G16) considered that there are seven distinct forms or varieties, and Popenoe (G18) referred to 15 varieties, differing in colour, size and vigour. The kapulasan is sold in Singapore as a rambutan variety, but this is, in fact, another *Nephelium* species (*N. mutabile*). It is readily distinguishable from the true rambutan, by its thick pericarp covered with short, stout spines, and by the fact that it bears clusters of three to five fruits.

Trials on the selection of high yielding clones have been in progress in West Malaysia since 1932 (18), when 144 selections were on trial. By 1946, however, only 21 of these were still traceable, and 11 further selections had been made. The leaf and fruit characteristics, including the canning quality, of 11 of the more important selections in this trial were summarized by Whitehead (18). In other 10-year trials there were wide inter-clonal differences in cropping and other characteristics, but R7 (Kepala besar) was outstanding as regards yield and fruit quality. The fruit had a pleasant, sweet flavour, and moreover its flesh separated easily from the seed, an important characteristic for assessing canning quality. The selections R4 and R3 also had good flavour and canning quality. At 16 years old the average annual yields in this trial amounted to about 5,000 - 6,000 fruits per tree (9) and 18-year-old trees of R7 yielded 11,000 fruits per tree (10). In the Philippines, too, where the rambutan was introduced from Indonesia in 1912, certain trees have been under observation since 1937 and intensive selection has been in progress since 1950 (17). One of the selections, Zamora, yielded over 11,000 fruits (234 kg) in its ninth year.

Diseases and pests

The rambutan seems to be relatively free from serious and persistent diseases and pests, though various outbreaks have been recorded from time to time. Thus in Java an attack of powdery mildew (*Oidium* sp.) caused serious damage around Djakarta and Bogor in 1949 (4); the disease affected flowers, fruits and the young leaves of watershoots, causing premature drop. Wide differences in susceptibility were observed among commonly grown selections, the least susceptible being Simatjan, Sinjonja, Sitangkoe Atjeh, Kering manis, Atjeh tombong, Atjeh gendut, Atjeh pao-pao, Padang ular and Bindjei. The causative fungus was named *nephelii*.

In Malaysia cankers on the main trunk, lateral branches and leaf stalks were recorded in 1963 (8). The causative fungus was named *Dolabra nepheliae*.

The main pests of the rambutan appear to be flying foxes and fruit bats, and Ochse (G16) remarks: "During harvesting the rambutan should be guarded well because flying foxes, fruit bats and other voracious frugivorous animals go out after sunset, and one is obliged to keep watch throughout the night as long as the trees bear ripe fruits". Presumably similar vigilance should also be exerted against nocturnal visits by voracious frugivorous two-legged marauders.

Serious damage has also been recorded in West Malaysia (7) by the caterpillars of two noctuid moths, *Serodes campana* and *Oxyodes scrobiculata*, feeding on the flowers and young shoots. The infestations were controlled by misting with DDT.

PROPAGATION BY SEED

The rambutan is widely - though not advisedly - raised from seed, since this is the easiest method. It is essential, however, that the seed should be freshly prepared and that not more than two days should elapse from the time that the aril is removed. In seed germination studies in the Philippines, Torres et al. (17) found that with freshly prepared seed 87-95

Rootstocks may be propagated either vegetatively by the etiolation method (q.v.) or from seed. The plants are raised in beds, and when they are well rooted or about six inches tall they are transplanted into shaded stock beds at a spacing of 12-15 inches (30-40 cm) (6). These beds should be well cultivated and manured prior to planting, supplemented by manuring at regular intervals during the growing season. The plants are ready to bud when they have attained a diameter of 0.5 - 0.75 inches (12-18 mm) and producing a new flush of leaves.

In Singapore seedling rootstocks are raised in polyethylene bags of 0.06 mm gauge, 25 x 30 cm (10 x 12 in) lay-flat in size, filled with a modified John Innes compost containing 7 parts (by volume) of medium loam, 3 parts of coconut peat and 2 parts of coarse sand. After sowing, the bags are given partial shade and watered daily until the seedlings are three months old. They are then gradually hardened-off to full sunlight before being grafted. The young plants are fertilized monthly with 10 g (1/3 oz) per plant of a 12:17:2 NPK mixture or 50 g (2 oz) of dried chicken manure. When six to eight months old the seedlings are ready for approach grafting or may be budded when about one year old (2a).

Budwood and budding

The best sources of budwood are trees that are normally good bearers, but which have borne little fruit in the current season (G12). Shoots selected for budwood should be well furnished with dormant buds and should be obtained from the tree three to four months after harvest, since at this time the bark will part easily from the wood (6). The most satisfactory buds are those from one-year-old wood of about middle-finger size, from which the leaves have abscised. But since the rambutan is inclined to retain its leaves rather persistently, it is usually necessary to cut the leaflet blades on the selected branches some time before the buds are required, thus inducing natural petiole abscission.

As soon as budwood is cut it should be put in the shade, with its lower end in water. If it is to be transported some distance the cut ends should be dipped in melted wax and the budwood wrapped in banana leaves, moist sacking or polyethylene sheet, so as to prevent moisture loss through evaporation. Bud grafting succeeds best in dull, cloudy weather, but in countries without a marked dry season it can be done at any time except during or immediately after rain. In two-year studies in the Philippines (1) on the relationship between budding success and time of budding, the maximum "take" in both years was in May-July (the rainy season), when 80-84 per cent success was achieved. During the dry season the "take" was no more than about 25 per cent, and in other months it was intermediate. In Sarawak (15) budding in July, August and November gave 71-95 per cent success, but this declined to 38 per cent during September and October.

An essential requisite for a high percentage of success with budding is a soil medium that will ensure rapid, uninterrupted growth. In studies in the Philippines (14) with budded rambutan seedlings grown in fine river sand, rice straw compost, ordinary garden soil or in equal mixtures of all three media, growth in the sand-compost-soil mixture was much the best.

The standard method of budding the rambutan is the modified Forkert system (2) as described in Part One. This requires more than the usual amount of care, since the rind is thin and breaks easily. Experiments in West Malaysia on methods of improving the "take" showed that wide bud-patches gave better results than narrow ones, but variations in the panel design made little difference. The percentage "take" was depressed, however, by removing the flap after budding.

After the bud-patch has been fitted and tied in position the buds are shaded by tying a few leaves over them (6). About 18 days after budding the tying material is removed and the bud-patch re-shaded. In another seven to ten days the stock may be cut back to within six inches (15 cm) of the bud, to encourage the bud to develop. Plants with vigorous shoots can be transplanted about two to three months after the bud starts to grow; weak shoots usually remain backward, and these plants should be discarded. The total time from budding to the production of a plant large enough for planting out is about four to five months.

When preparing budded stocks for the shock of transplanting it is advisable to prune some of the roots about a month beforehand. This is best done by removing the soil four to five inches (10-13 cm) from the stem, three-quarters of the way round; all the roots that reach outside this area and any secondary tap roots are then cut and the soil replaced. This has the effect of encouraging the growth of fibrous roots near the stem, without any lasting adverse effect on the plant. The best time for lifting is between flushes of new growth, when the terminal bud is comparatively dormant. Plants to be planted within a short distance of the nursery beds should be wrapped in sacking, taking care not to break the ball of earth; for long distance transport the plants should be transplanted into ten-inch (25-cm) diameter earthenware pots or bamboo baskets. In Sarawak (15) polyethylene planting bags (polybags) proved quite satisfactory and although some were damaged by rats most remained sound for four months or more.

In other experiments in Sarawak (16) on the effects of time of lifting and basketing successfully budded plants, with or without root pruning, plants were lifted immediately after bud-break of the scion, or when the scion was 18 inches (45 cm) or 3 feet (90 cm) high. With later lifting and root pruning 94-98 per cent success was achieved, compared with 82 per cent success with early lifting. Without root pruning the results were erratic and varied between only 49 per cent and 93 per cent, with early and later-lifted plants, respectively.

Approach grafting or inarching

This method (as described in Part One) is not widely used for propagating rambutan. It was, however, used experimentally in the Philippines (3) in a comparative study of rambutan and bulala (*Nephelium mutabile*) seedlings, and of their relative suitability as rootstocks for the rambutan. The more vigorous rambutan seedlings could be inarched when about five months old, compared with about four months for the bulala. At this early stage, when the seedlings were about 25 cm (10 in) in height, they required support to enable them to withstand the pull of the scion, and inarching was a little difficult. Nevertheless, about 46 per cent success was achieved, and this rapidly rose to 100 per cent with nine-month-old seedlings. Inarching with three-year-old seedlings was much less successful. The inarched plants were ready for cutting after 40-68 days. Subsequently the plants inarched on rambutan seedlings grew more rapidly in height

than those on buliala, though the latter gave better girth increment.

In Singapore approach grafting is preferred to budding as the latter is done on one-year-old seedling rootstocks whereas the former may be undertaken using six to eight-month-old seedling stocks (2a). The rootstocks are placed, in the polyethylene bags in which they were raised, on low benches near the selected tree which is to provide the scions. The technique is described in Part One, and polyethylene film is used to wrap the graft. The rootstocks should be watered once or twice daily and fertilized monthly. After four to six weeks the plastic film can be removed and the graft severed from the scion parent tree. The young grafts are ready to plant-out within a year of sowing the rootstock seeds. Using vigorous material a 100 per cent take may be obtained with ease.

Marcottage (air layering)

This method has been used in West Malaysia for many years, especially by Chinese fruit growers, and also in India and Sri Lanka (6). The selected branch wood should be about 12-18 months old to give the best rooting and establishment, and in trials when older branches were used most of the marcots failed to establish. Roots appear after about 6-12 weeks and when enough have been produced the marcots are cut from the tree and placed in pots under shade; they must then be carefully watered until well established. For large scale planting this method is not really feasible.

Etiolation layering

Experiments on the effectiveness of this method of propagating rambutans were reported by Lambourne (5) in West Malaysia, using marcots of several selections. The rambutan is a relatively shy rooter, and it was found necessary to twist wire round the base of each shoot when earthing-up, in order to induce callus formation and root development. Even so, rooting was somewhat erratic, and several selections produced large gall-like growths, but few roots; others produced roots normally, but the rooted shoots made poor growth in the field. In one trial, rooting was promoted by removing part of the bark as well as ring-wiring and earthing-up when the shoots were about 12 inches (30 cm) high, and shading was advantageous.

PROPAGATION BY CUTTINGS

No work on this method of propagation appears to have been published.

CONCLUSIONS AND SUGGESTIONS

The most obvious propagation areas in which further research is required are the breeding and selection of high-yielding clonal rootstocks and desirable scion cultivars, and the use of cuttings.

BIBLIOGRAPHY

1. ANGELES, E. R. A survey of patch-budding of rambutan (*Nephelium lappaceum* Linn.) at the provincial nursery in Oriental Mindoro. *Araneta J. Agric.*, 1962, 9: 267-73.
2. ANON. Notes on current investigations (agronomy) July to September, 1955. *Malay. agric. J.*, 1955, 38: 268-72.
- 2a. CHUA, S. E. and TEOH, T. S. Propagation by approach grafting and woody cutting of some tropical fruit and ornamental trees. *Singapore J. prim. Ind.*, 1973, 1: 87-95.
3. GONZALEZ, L. G. and LUARDO, B. R. Introduced rambutan trees [*Nephelium lappaceum*] in the college of agriculture and their propagation by inarching. *Philipp. Agric.*, 1947, 31: 133-40.
4. HADIWIDJAJA, T. Over meeldauw bij de rambutan. [*A powdery mildew on rambutan.*] *Landbouw*, 1950, 22: 245-57.
5. LAMBOURNE, J. The etiolation shoot method of fruit propagation. *Malay. agric. J.*, 1935, 23: 514-27.
6. LAMBOURNE, J. The rambutan and its propagation. *Malay. agric. J.*, 1937, 25: 11-17.

7. MALAYA, A.R. Dep. Agric., 1957.
8. MALAYA, *Idem*, 1963.
9. MALAYA, *Idem*, 1964.
10. MALAYA, *Idem*, 1966.
11. MENDIOLA, N. B. Introduction and trial culture of Java nepheliums in the College of Agriculture. *Philipp. Agric.*, 1941, 30: 168-96.
12. MILSUM, J. N. The rambutan. *World Crops*, 1960, 12: 254-5, 264.
13. PATAMAPONGSE, C. and SHOWLER, A. J. Fatty acid composition of the oil of the rambutan, *Nephelium lappaceum*, and of the flame of the forest, *Delonix regia*. *J. Sci. Fd Agric.*, 1969, 20: 137-8.
14. PESQUIZA, L. D. Influence of different soil media on growth of rambutan seedlings. *Philipp. Agric.*, 1956, 40: 146.
15. SARAWAK. A.R. Dep. Agric. 1959.
16. SARAWAK. *Idem* 1960.
17. TORRES, J.P., DIONIDO, P. B. and ZAMORA, A. Selection and propagation of rambutan in Oriental Mindoro, Philippines. *Araneta J. Agric.*, 1962, 9: 146-60.
18. WHITEHEAD, C. The rambutan, a description of the characteristics and potential of the more important varieties. *Malay. agric. J.*, 1959, 42: 53-75.

PSIDIUM GUAJAVA — GUAVA

by

D. O'D. BOURKE

Commonwealth Bureau of Horticulture and Plantation Crops.

INTRODUCTION

The guava, *Psidium guajava*, apparently derives its generic name from the Greek *psizo*, "to feed on pap". Its specific name comes from the Spanish *guayaba*, "guava tree", itself derived from the Aramakan via the Cariban via the Tupian. *Psidium* is one of the genera of the Myrtea division of the Myrtaceae. There are some 140 species, all from tropical America or the West Indies, and many bear edible fruit. Some of these are cultivated like the guava, but the guava is the only one to have become commercially important. The fruits are used in a variety of ways. Sweet juicy fruits from suitable cultivars may be eaten fresh. They may be cooked before eating. They may be used to make preserves, jam, the well-known guava jelly or a paste known as guava cheese. The most important commercial use of guava is for the making of jelly, and fruit slices, juice and nectar are also canned.

ECOLOGY AND GROWTH IN RELATION TO PROPAGATION

Distribution and ecology

As the guava is easily grown from seed it has been carried from its tropical American home to all parts of the tropics, so that it is now one of the most familiar compound trees of tropical countries. Guava seeds are scattered by birds and grow so well that in some areas the plants establish themselves on pastures and waste places and become serious weeds.

The guava may be grown under a wide range of climatic conditions, from lowland tropics up to about 5000 feet (1500 m), and also in climates with a marked dry season. Commercial plantations are best under 1000 m (3300 ft) (G17). It can also adapt itself to a wide range of soil conditions although it grows best in deep fertile soils. It can withstand temporary waterlogging but is killed by frost.

Trees respond to NPK fertilization (51). In Florida and elsewhere deficiencies of Cu, Zn, Mg and Mn have been recorded. They may be controlled by annual sprays containing the required element.

Growth habit and flower biology

Guavas may be large shrubs or trees up to about 10 m (33 ft) in height. They have a rather spreading habit of growth, producing branches close to the ground and sometimes also producing suckers from roots near the trunk. The bark is noticeably smooth, of a greenish-brown or reddish-brown colour, and peels off in thin flakes. The leaves are opposite. The white flowers, about one inch (2.5 cm) in diameter, are either solitary or in two to three-flowered cymes. They arise in the leaf axils of younger branches. They are visited by bees and other insects so that both self-pollination and cross-pollination occur (G19). Natural cross-pollination is about 35 per cent.

The fruit is a round, ovoid or pear-shaped berry, 5 cm (2 in) or more in diameter and 4-12 cm (1.5-5 in) long, surmounted by calyx lobes. It has a thin greenish-yellow skin (exocarp), and flesh (mesocarp) of varying thickness, which may be white, yellow, pink or red. The outer layer consists of finely granular pulp, containing stone cells, inside which is softer pulp in which the many small seeds are embedded. The fruits vary considerably in size and flavour and are distinguished by a very characteristic and penetrating musky aroma which is also of variable intensity. Guavas are rich in vitamin C, containing two to five times the vitamin C content of fresh orange juice.

Varieties

There are several cultivars distinguished by their shape, colour, taste, juiciness and vitamin C content. To maintain their characters they must be vegetatively propagated as they do not come true from seed (G19).

Other species

Strawberry guava or cherry guava (P. cattleianum): Of Brazilian origin, this is a smaller and more bushy tree than the guava, some 7 m (23 ft) in height. It is also more hardy, withstanding temperatures as low as 22°F (-5°C) (G1). Its leaves are thick and leathery, the bark is smooth and grey-brown and the abundant fruits are smaller than those of the

guava, dark-red and with a good flavour. One variety, *lucidum*, has yellow fruits with a milder flavour than that of the ordinary fruits. The fruits may be eaten raw, made into jam or jelly or used for the production of juice.

Propagation is normally by seed. Germination takes 15-20 days and fruiting begins in the second or third year. The tree may also be propagated by root suckers or by layering. Recommended planting distances are 3 - 4.50 m (10-15 ft) in both directions (25).

There is much variation in fruit quality and this is a species which offers great possibilities for improvement.

Brazilian guava (*P. araca*) is a shrubby tree which is occasionally cultivated. The fruit pulp is only edible at full maturity. It may be eaten raw or made into jam. Propagation is by seed and suckers.

Costa Rican guava (*P. friedrichsthalianum*) is a small tree which grows naturally in forests and high savannas from Honduras to Panama. It is occasionally cultivated. Its rather acid fruits are used to make refreshing drinks, jams, jellies and pies. It is propagated by seeds (which require 20-25 days to germinate) and by root suckers.

Diseases and pests

Glomerella cingulata causes the mummification of green fruit and a soft rot of ripe fruit. It also affects the leaves. It may be controlled by copper and captan sprays (6).

In California the black scale (*Saissetia oleae*) may be controlled by fumigation or spraying.

Wilt disease has been troublesome in parts of India. It is caused by the fungi *Fusarium solani* and *Macrophomina phaseoli*, alone or in combination, and may affect either very young trees or trees over five years old. *Psidium* spp. other than guava appear to be resistant.

PROPAGATION BY SEED

Most guavas are propagated by seed (16). Owing to natural cross-pollination seedling trees vary in quality but good trees may nevertheless be obtained in this way. Seed should always be selected from trees with fruit of all the

desired characteristics. In order to increase uniformity seed may be obtained from flowers which have been selfed by bagging (28).

Guava seeds remain viable for about a year. In India seeds washed and dried in the shade and mixed with fine wood ash are stored in tin boxes in a cool place until required (19). In a trial, seed germination and the production of viable plants were not diminished by exposure for 15 minutes to 4°C (39°F) (31). Nevertheless, it is usually recommended that seeds should be sown as soon as possible after extraction from the fruit and drying. Germination may be improved, however, by soaking in cold or tepid water (28a).

A single fruit should furnish about 50 seeds for sowing, which should provide about 25 young plants suitable for transplanting (21). The seeds may be sown in pots, in flats or directly in the nursery, the actual procedure varying according to the region.

In California it is recommended that seeds should be sown as fresh as possible, using light sandy loam and avoiding over-watering. The seedlings should be potted at the two-leaf stage until they are ready to transplant, since they are rather difficult to transplant from open ground (61).

In Hawaii seeds may be sown in flats of sandy soil and covered to a depth of about one-quarter inch (0.6 cm). The soil should be sterilized or else the seeds should be treated with cuprous oxide or other suitable fungicide to prevent damping-off. Young seedlings should be transplanted into individual containers when about one to one and a half inches (2.5 - 4 cm) high for final transplanting in five to seven months when about twelve inches (30 cm) high (28).

In São Paulo, Brazil, the best time for sowing is from July, or earlier, until the end of August. Seeds sown in shallow furrows in the nursery should be well covered and adequately watered. Seedlings are transplanted into containers when 8-10 cm (3-4 in) high for final transplanting at about 25 cm (10 in). The soil of the nursery should be fertile and easily worked (21).

Seedling trees may begin to bear in the second or third year after transplanting.

PROPAGATION BY BUDDING AND GRAFTING

Rootstocks and their effects

Budded and grafted guavas are usually worked on guava rootstocks grown from seed. If guavas are grown where there is a danger of their being cut back to the ground by frost the roots should be of the same variety as the top (51). In India the stock plants are transplanted into pots when about six inches (15 cm) tall. Side shoots are removed to obtain a vigorous straight plant which can be worked when it is about one year old, and as thick as a pencil (19, 28). In Florida it is suggested that seed of a vigorous variety, such as Red Indian, should be grown in seed-beds or three-inch (8-cm) clay pots and later transferred to cans or felt paper tubes. Nursery plants recover more rapidly when transplanted in the field from containers rather than from a seed-bed, and growing in containers eliminates root pruning and the problem of root suckers arising from the cut rootlets. Seedlings are considered to be of workable size when they are $\frac{1}{4}$ to $\frac{1}{2}$ inches (6-9 cm) in diameter, a size reached in about six to seven months (48).

In a trial at Sharanpur, India, the guava cultivar Safeda was grafted onto an air-layered Seedless rootstock and onto a Safeda seedling and compared to a Safeda seedling. Seven years after grafting the Safeda seedling had made the most growth but Safeda on Seedless had the highest yields and fruits which were bigger than the others, with less seeds and more edible portion (55).

Trials have also been carried out using other *Psidium* spp. as rootstocks. At Basti in Uttar Pradesh, India, scions of guava cultivar Allahabad Safeda were grafted onto strawberry guava (*P. cattleianum*), *P. cujavillis*, *P. pumilum* and guava cultivars Florida Seedling, Seedless and Allahabad Safeda. After three seasons there were no significant differences in girth. Trees on *P. cattleianum* were the tallest and gave the greatest yields of fruit. The *P. pumilum* rootstock had a dwarfing effect but fruits on this rootstock had the most seeds, and the highest TSS and total sugars. Trees on *P. cujavillis* produced the largest fruits with the highest ascorbic acid content, but they were rough-skinned and not uniform. Fruit from trees on Seedless had only a small number of seeds, and fruit from trees on Florida Seedling had the highest acidity. All rootstocks were free

of wilt disease [*Fusarium solani*/*Macrophomina phaseoli*] except Allahabad Safeda which, however, had an infection of only 13.3 per cent (69).

A dwarfing effect has also been noted in India with Chinese guava (an unidentified horticultural variety - see 19), which was also found to be resistant to wilt disease. When the cultivar Safeda was approach-grafted onto this rootstock it produced an average of 15 fruits of excellent quality in the first year after grafting. The size of the trees was markedly smaller than that of trees of Safeda on Safeda rootstocks (24).

Budding methods

In trials in India budsticks from Seedless guava were packed in moist sphagnum moss, wrapped in Alkathene film and stored at room temperature for 2, 7, 14 or 21 days before budding. Some budsticks were also coated with wax at both ends. A take of 100 per cent was obtained with up to 14 days' storage but thereafter the percentage take declined, especially with unwaxed sticks. In every case the subsequent growth of fresh buds used as controls was better than that of buds from stored sticks (65). There seems to be no difficulty, however, in storing sticks with waxed ends for up to seven days (66).

The Forkert method of budding has generally proved the most successful with guava, perhaps because the scion is prevented from drying out (51). The improved or modified Forkert method, in which the flap of bark is retained on the rootstock (instead of being 2/3 removed), pulled up over the scion and bound with the scion has also proved successful (44). Buds should be prepared 15 days before budding by removing all leaves from the budstick (44). The bark should peel readily away from the wood. When it adheres tightly budding is usually unsuccessful (27). There are indications that, for the best results and earliest fruiting, only mature buds should be used (48). One third of the rootstock may be removed immediately after the bud has taken, and the remaining portion after three weeks, leaving 2-3 cm (1 in) above the bud. There are, however, variations in the timing of this operation.

In a trial in eastern Uttar Pradesh, the Forkert method gave 92 per cent take in February-March, using buds from one-year-old shoots with one-year-old seedling rootstocks, compared with 32 per cent by the shield method (64). In the

same place during the monsoon both the Forkert method and the patch method gave a complete take when carried out on 3 July or 3 August. The shield method was the least successful. The Alkathene tape in this case was removed after two weeks, instead of three weeks as in the February trial, to allow for more rapid growth during the monsoon (62).

In further trials over three years using the improved Forkert, patch and shield budding and the cultivars used in the previous trials (Seedless and Safeda Allahabad), the first two methods (in which all operated portions were covered with Alkathene tape after budding) were very successful, with 96 per cent and 88 per cent with Seedless and Safeda Allahabad, respectively, for the Forkert method, and 88 per cent and 80 per cent, respectively, for patch budding. Shield budding (with buds 2 cm (0.8 in) in length) was not encouraging. Budding from 11-30 July was best, but good results were also obtained in August and in February. The results in February could be improved by transplanting budded plants into shade and protecting them from extreme heat (66).

Among other methods of budding, T-budding with cultivar Lucknow-49 in March, April, May and June had the highest take (60 per cent) in April. With the cultivars Chittidar and Safeda, T-budding was most successful in April and March, respectively (34). In another trial with Lucknow-49 ring budding and T-budding were unsuccessful because the bud dried out before union could take place, but Forkert and patch budding were successful (39). In the Punjab, Pakistan, T-budding gave 80 per cent take during the first fortnight of March and between mid-July and early August, using a bud from the subterminal portion of the scion shoot in spring and the terminal portion in summer. Scion shoots were defoliated a week before use (4a).

Several trials on the application of growth substances to scion and/or stock at budding have been carried out in India. IBA has usually been employed and has usually slightly increased the take. Soaking buds in IBA at 10 p.p.m. for ten minutes gave 64 per cent and 56 per cent take of the cultivar Chittidar in April and May, respectively, compared with 56 per cent and 53 per cent for untreated buds. In the cultivar, Seedless, however, IBA had a bad effect on bud take but untreated buds had 68 per cent success: the method of budding was unspecified (32). When the cultivars Chittidar and Safeda were T-budded in April and March, IBA at 1 p.p.m.

enhanced bud take in both cases (34).

Forkert budding has also proved successful elsewhere as, for instance, in Hawaii, where the method has been described in detail (28). Vigorous seedling rootstocks of half to one inch (1.2-2.5 cm) diameter are used. Buds should be obtained from a stick the leaves of which have been stripped 10-15 days before removing it from the tree, thus causing the buds to swell. Buds in this condition give a better union and grow readily after budding. Well-grown plants are ready for transplanting four to five months after budding. Budded plants have been observed to grow faster than grafted plants or plants grown from root cuttings. Suckers seldom arise below the union with low-budded plants. Patch budding is also recommended as a reliable method (27). It has given more than 95 per cent success (29).

In Hawaii patch budding has also been recommended for topworking. It was most successful on stump shoots half to three quarters inches (1.2-1.8 cm) in diameter. A "nurse" branch left on the stump increased the rate of growth of a stump shoot, thus decreasing the time needed to grow a shoot large enough for budding, and also reduced undesirable suckering (22).

In Venezuela patch budding has given a 78 per cent take. Budded plants sometimes fruit in the nursery and a plant may bear as many as 40 fruits some six months after budding (58).

In Israel a new method called chip budding has been described. It is best carried out in spring and early summer with well-grown, active buds, prepared by defoliating the budsticks some days before the buds are required. A first cut is made about one-half inch (1.2 cm) or so below the bud at an angle of 45°. Another cut half an inch (1.2 cm) above the bud is then made downwards until it meets the first cut. A chip of the same size and shape as the scion chip is removed from the rootstock. The scion chip is adjusted so that cambium layers match and the whole is bound with transparent plastic. Buds that have taken are green three weeks after budding whereas buds that have failed are dark. When the green buds begin to swell the plastic is removed. During the growing period the scions reach a length of about 80 cm (30 in) and at this stage the trees are ready for transplanting.

This method may also be used for topworking older trees. The trees are cut back to the main trunk or branches early in spring. New shoots are chip budded when they are 5-6 mm ($\frac{1}{4}$ in) thick (37).

Grafting methods

Various methods have proved successful.

In Florida, for veneer grafting, scions should be selected from terminal growth flushes when the stem is still green and quadrangular. Axillary buds should be well developed. If both opposite buds on a budstick are at the right stage of development the budstick may be split to form two scions. Usually, however, one bud of a pair reaches the right stage of development before the other, so the less-developed one is removed. To obtain a good supply of budwood from older parent trees the trees should be pruned back by about one-third in order to obtain a sufficient number of sprouts with desirable buds. Younger parent plants have growth flushes suitable for scions without this procedure. On the stock the length of cut will naturally vary according to the length of scion. No bark should remain on the cambial area where the scion is to be placed. Scions are usually cut into 1 $\frac{1}{2}$ -2-inch (4-5-cm) lengths as they are removed from the parent plant, and stored in damp sphagnum moss until required. The graft is wrapped in plastic, leaving a small opening at the top through which the bud emerges. After three weeks the stock can be cut back, and after four to six weeks the film is removed. The stub of the stock is pruned back when the scion has made four to six inches (10-15 cm) of growth, and covered with grafting wax. This method may be used on stocks from one quarter to four inches (0.6-10 cm) thick (48).

The same method has also proved successful in Florida for topworking guava trees. The trees were cut back in October and allowed to sucker. In January and February the shoots were thinned out to leave three or four equally spaced shoots. The scions, green-barked and quadrangular, were taken from the latest growth flush. Some were wrapped with porolated vinyl film and the others with normal vinyl film. After twelve weeks the total take was 62.1 per cent. The scions wrapped with porolated vinyl film had 73 per cent take compared with 50 per cent for ordinary film, but subsequent differences attributable to the film used proved negligible. On trees where different methods of grafting were combined, a take of 91.1 per cent was obtained with veneer grafting with

greenwood scions but none of the mature wood scions used survived. Autumn grafting using cleft, veneer and bark grafting methods was unsuccessful. Cleft grafting in January and February, however, gave 85 per cent take after twelve weeks. Generally low cambial proliferation in the autumn combined with heavy rainfall during the trial may have contributed to the failure of autumn grafting. In time-and-motion studies it was found that cleft grafting a stump required three times as long as the greenwood veneer grafting of sprouted stumps, and more physical energy (67). Suckering below the graft union may be troublesome in topworked guavas (51).

In New Delhi, India, it was confirmed that green quadrangular terminal shoots of the current year's growth provided better scions for veneer grafting than brown corky shoots of the previous year's growth, especially when twigs of the current year's growth were defoliated 20-45 days beforehand to encourage the development of axillary buds. Scions from seedless varieties were better than those from seeded varieties and, on this occasion, grafting in April was more successful than in March, May or June (45). In another trial, however, the most successful veneer grafting (85 per cent take) was in July, compared with grafting in March, April, June and August. For maximum success scions had to be one to two months old. Older scions (up to four to six months) were unsatisfactory. The two cultivars used, Allahabad Safeda and Seedless, were equally satisfactory as scion producers and ringing the scions 15 days before grafting had no effect (9). In the Punjab, Pakistan, veneer grafting with terminal shoots defoliated a week before use was 80 per cent successful in mid-July, but only up to 61 per cent successful in March. Cleft grafting with fresh budwood gave up to 69 per cent take in mid-February and early March (4a).

In the East, inarching (or approach grafting) has been described as the usual method of grafting, although it may be costly and slow (4a), and it can give up to 95 per cent success (18). As described in Pakistan, potted seedlings of one to two years of age are used as rootstocks. Cuts of one to one-and-a-half inches (2.5-4 cm) long and half-inch (1.2 cm) deep are made on the rootstock and on the scion shoot selected. The exposed surfaces are brought together, covered with wax or mud plaster, and tied tightly with waxed tape or fibre, either in spring or during the monsoon. Union is completed in three months, when the scions may be detached.

It is important to continue to remove unwanted sprouts on the rootstock once the grafted plants have been transplanted (4).

In a trial in 1959-1961, inarching was 80 per cent successful in two autumn seasons and 60 per cent and 34 per cent successful in two spring seasons. Inarching in March was better than April, and in August better than September. Stock-scion union was complete after 75 days (3). On this occasion side grafting and veneer grafting were unsuccessful, whether carried out in spring or in autumn.

PROPAGATION BY LAYERING

There is usually little difficulty about propagating guavas by layering but success may be enhanced by improved methods.

In South Africa young trees in the stool-bed were severely pruned in October and shoots were allowed to develop until the beginning of January, when some were thinned and the remainder tightly bound with copper wire. After nine months wired shoots showed much improved rooting over unwired shoots.

When rooting branch layers the usual method is to bend a low branch, partly sawn through, to scrape off the bark on the lower side and to bank soil all round it, usually in September-October. The soil is then removed after about a year and the layer is sawn off, pruned and transplanted as a tree. With young trees three to four years old, all low-growing, non-permanent scaffold branches can be layered, and it is possible to grow a large number of trees in this way. An improvement on this method is not to scrape off the bark on the lower side of the branch but instead to wind a flexible wire tightly around the branch before covering it with soil. Many strong roots then develop just above the wire (23).

IBA may be used to increase the root-promotion induced by earthing-up. Plants, themselves obtained by air-layering, grown for three to five years at 2.5 x 2.5 feet (0.75 x 0.75 m) spacing are cut back in spring and allowed to shoot for three months. The shoots are ringed in July, treated with IBA at 5000 p.p.m. in lanolin and earthed-up after about ten days to induce rooting. In September the treated shoots are

separated and planted in pots or nursery beds. After their removal new shoots develop and are again induced to form roots by the same method. This process can be repeated year after year. A plot of 15 x 15 feet (4.5 x 4.5 m) can yield at least 300 rooted shoots each year, and their survival is nearly 100 per cent (41).

Aerial layering (or marcotting) is also widely used. In the USA limbs a half inch (1.2 cm) or more in diameter are girdled by removing a strip of bark one and a half times the width of the limb. The girdled area is bound with a ball of moistened sphagnum several inches in diameter and four to five inches (10-13 cm) long, which is then wrapped in plastic and tied at each end. A piece of paper is also tied loosely over the wrap to prevent bird damage and to prevent the moistened moss from overheating. Roots usually begin to form in three to five weeks. When they grow through the ball of moss, the stem may be severed below the girdled area. The plastic is removed and the new plant is potted in manured soil and kept in the shade until new leaves appear. To guard against possible mineral deficiencies the leaves should be sprayed with a Cu-Zn-Mn solution. When the new growth is six to eight inches (15-20 cm) long the plant is hardened in full sunlight before transplanting in the field. Trees can be propagated in four to five months by this method, and costs may be kept low because watering is eliminated (51).

In the tropics the layers should be shaded from the sun. Roots show against the plastic in one to two months. When the layer is severed the upper part should be cut back to 20-30 cm (8-12 in). It is then put into a pot or basket after removing the plastic but leaving the sphagnum (44). The rainy season may prove more favourable than the spring (2). The use of a box or painted tin to form a closed cylinder around the rooting medium was successful when tested with several other trees but under these conditions guava produced only a few roots (60).

Growth substances have often been used to improve air layering, and IBA has been the most generally successful. At Dharwar, India, air layers were treated with a mixture of IBA and NAA at various concentrations. The best results were obtained with a concentration of 10000 p.p.m., and June was found to be the best month for layering (5). In Poona IBA in lanolin was applied immediately after layering shoots of the cultivar Lucknow-49. A concentration of 3000 p.p.m. was

most successful, giving 86.6 per cent rooting and 76.6 per cent survival (11). IBA at 250 and 500 p.p.m. also gave good results, especially in July. The use of sphagnum moss, vermiculite and a potting mixture gave 75, 80 and 70 per cent rooting, respectively (33).

Difficulties may occur if rooted aerial layers which have been separated and placed in pots fail to grow satisfactorily. In Pakistan this was overcome by potting them in a standard rooting medium of soil, sand and leaf mould (1:1:1) and keeping them in a cold frame covered with a sheet of polyethylene to provide sufficient humidity and to reduce the need for frequent watering. Layers potted in February in this manner were ready for transplanting in the field by the following September (56).

PROPAGATION BY CUTTINGS

The use of root cuttings is probably the quickest method of producing clonal plants on their own roots. Such plants do not need to be reworked if they are cut down by frost (72; 73). If guava roots are severed with a spade two or three feet away from the trunk, sprouts will grow and these may be cut off and transplanted later. The sprouting occurs naturally in humid countries but the soil may have to be kept moist in arid ones (73). Root cuttings five to eight inches (13-20 cm) long cut from roots a quarter to half inch (0.6-1.2 cm) in diameter planted horizontally at a depth of three to four inches (8-10 cm) in nurseries or cutting-beds (containing about half cutting sand and half shredded peat moss) will root fairly successfully if the soil is kept moist (51; 73). Root cuttings have also been grown successfully in a solar propagator in Mauritius (43). The number of root cuttings taken from a tree at any time should be limited, however, to avoid damaging the tree (12).

Stem cuttings are normally difficult to root but they may be rooted successfully with the help of growth regulators. Many trials have been carried out for this purpose, using softwood and hardwood cuttings.

In Trinidad guavas are propagated from stem cuttings (soft, green angular tips of stems about eight inches (20 cm) long with six to eight leaves) with more than 90 per cent

success in the standard closed bin propagators normally used for rooting cacao. The basal ends of the cuttings are dipped in a solution of 6000 p.p.m. each of NAA and IBA. The rooting medium is coconut fibre dust or sand, and rooting occurs within 18 days. Trees are cut back hard to increase the yield of cuttings. The cuttings in the bins are sprayed with water two or three times per day to keep the humidity over 95 per cent. Shading is provided to reduce incident light by 65-70 per cent. The rooted cuttings are potted after 18-21 days. A period of hardening is most important after potting (10). In a trial in Hawaii cuttings were dipped in 0.2% IBA and placed in rooting medium in polyethylene bags. The best results were obtained with cuttings taken from epicormic shoots during dry weather (30).

In the East softwood cuttings taken from plants grown from cuttings in the previous year and treated with IBA showed 38 per cent rooting after 12 weeks. Corresponding percentages for cuttings from seven-year-old trees were: root sucker cuttings, 20 per cent; water-shoot cuttings, 11 per cent; sprouts from twigs cut back seven weeks previously, 7 per cent; and cuttings from ordinary twigs, nil (42). When numerous growth substances were tested NAA and IBA (each at 100 p.p.m.) and Seradix A (24 drops in 284 ml water) were most successful in promoting the rooting of cuttings from mature wood. Bud growth often preceded root formation and only 12.5 per cent of sprouted cuttings produced roots (1).

The rooting percentage of cuttings 1-1.25 cm (0.4-0.5 in) thick and 20 cm (8 in) long from shoots with six to eight unsprouted buds taken from an eight-year-old seedless guava was 65 per cent after dipping the basal ends in NAA at 100 p.p.m. for 12 hours, and 40 per cent after similar treatment with IBA (64). In another trial both NAA and IAA at 50 and 100 p.p.m. enhanced the rooting of semi-hard etiolated cuttings. There was more sprouting of new growth with NAA although the roots were more brittle with this treatment. On this occasion IBA was unsatisfactory, perhaps because the concentration was too low (68). Cuttings from twelve-year-old Allahabad Safeda trees treated with IAA, IBA, NAA and phenylacetic acid at 40, 60 and 80 p.p.m. under normal and reduced pressure for periods of 12 to 60 hours showed poor response to treatment. The maximum rooting was obtained with an 80 p.p.m. IAA dip maintained for 48 hours under reduced pressure with cuttings taken in the second week of May. In general, IBA gave the best results, however, and the best period for taking cuttings

was from the end of January to May, compared to July and September (61). Invigorated greenwood cuttings, obtained from shoots after cutting back, behaved like juvenile cuttings as regards rooting ability. IBA at 5000 p.p.m. applied externally gave 90 per cent rooting in invigorated shoots but only 13.3 per cent rooting in non-juvenile shoots (7). Invigorated shoots were found to contain tyrosine and no lysine, and markedly greater quantities of threonine, aspartic and glutamic acids than older shoots, which contained lysine but no tyrosine (8).

Guava cuttings have been induced to root under mist. In Miami, 18 per cent of cuttings maintained in water mist rooted after twelve weeks. No rooting was obtained under nutrient mist, however. The correlation between water volume and the number of rooted cuttings suggested that very small differences in the average hourly mist volume could make all the difference between relatively high root production and poor take (40). In another trial the apical ends of guava cuttings were kept under water mist while the basal ends projected about four inches (10 cm) into a nutrient mist chamber. Under these conditions five out of fifteen guava cuttings rooted (49). In Hawaii vermiculite was found to be the most suitable rooting medium under mist, and cuttings with leaves rooted better than defoliated ones (46).

The use of mist has also been combined with that of growth regulators and, sometimes, with other treatments. In India guava hardwood cuttings from non-ringed shoots failed to root under mist. Treating these cuttings with IBA at 5000 p.p.m. led to 50 per cent rooting. Cuttings obtained from shoots ringed about 40 cm (16 in) from the tip some 30 days before, had a rooting percentage of 80. This was increased to 90 when cuttings from ringed shoots were treated with IBA (57). In South Africa cuttings of the current year's growth trimmed to two nodes leaving two leaves (each of which was halved) were rooted in sand under intermittent mist. Softwood cuttings given a five-second dip in IBA at 4000 p.p.m. before insertion showed 75-90 per cent rooting but the rooting of semi-hardwood cuttings did not exceed 10 per cent (12). In a similar experiment leaf cuttings consisting of a single leaf with an axillary bud and a two-inch (5-cm) portion of stem cut in half longitudinally showed 80 per cent rooting under mist after the exposed portion of stem had been dipped for five seconds

in IBA at 4000 p.p.m. (13). The advantages of IBA and mist were further demonstrated in Haiti, where 44 per cent rooting was obtained after one month under mist with cuttings treated with 0.8% IBA (38), and in Puerto Rico, where overnight immersion of the basal ends of cuttings under intermittent mist in IBA at 200 p.p.m. markedly accelerated rooting, especially with the addition of 2% sucrose. The cuttings were obtained from side shoots induced by severe pruning. Varying the rooting media had no effect (50).

In Puerto Rico rooted cuttings may be placed in black polyethylene bags or in gallon (5 l) cans filled with light potting soil. They are kept under shade and syringed several times a day during the first two weeks. They are subsequently hardened-off and finally placed in full sunlight prior to transplanting in the field (50). Cuttings rooted in propagators also require hardening. Once potted, they are placed in closed bins the covers of which are kept shut for two days and then opened progressively until they are removed by the 14th day. The potted cuttings are then placed in a covered shed for 21 days before being considered ready for the field (10). The potted stage should not be too prolonged, however, because of the danger of plants becoming root-bound (28).

GROWTH SUBSTANCE TREATMENTS

The use of growth substances such as IBA and NAA has been in connection with grafting, layering and propagation by cuttings, and is therefore noted under these sections. Occasionally other substances have been tested. In one trial, rings were cut from the outer cortex of branches of guava trees and the exposed surfaces were treated with crude polyoxin for 24 and 48 hours. The former developed two roots and the latter six roots after 26 days (14).

AFTER-CARE AND SURVIVAL

Pits (about 2 x 2 feet = 0.6 x 0.6 m) to receive transplanted guavas should be dug some months beforehand. In India, before the rains, they are then filled with the original soil mixed with well-rotted cattle manure, except in very fertile soil. Planting distances are about 15-20 feet (4.5-6 m). Planting is carried out as soon as the rains begin. The shoots may be pruned back prior to planting (19). In Hawaii transplanting is more successful in the autumn and winter months when both humidity and rainfall are relatively

high. Planting distances are from 18 to 24 feet (5.5 - 7.5 m) (28).

The use of nutrient sprays combined with frequent and liberal applications of fertilizer has been recommended to make young guava trees grow very rapidly. If properly fertilized they may be expected to produce fruit in the third year and to yield as much as 100 bushels/acre (9,000 l/ha) (51).

CONCLUSIONS AND SUGGESTIONS

The growing importance of guava as a commercial crop points to the need for new, more specialized cultivars and easy methods of propagating them. The possibility of growing reliable cultivars from seed should not be neglected. Trials with rootstocks, either of guava itself or one of the many other species of *Psidium*, including the strawberry guava, have indicated the possible benefits of selecting rootstocks for particular purposes. These could include rootstocks for vigorous growth for commercial orchards and restricted growth for domestic growers, and rootstocks suited to a particular climate, whether tropical or semi-tropical. Such rootstocks would need to be vegetatively propagated, either by layering or marcotting, both reliable methods, or by more rapid methods. Although many trials have been carried out on the rooting of guava cuttings there is still a need for reliable inexpensive methods suitable for wide areas.

Budding methods (especially Forkert and improved Forkert) have proved consistently successful, together with several grafting methods, but more follow-up studies seem to be required to decide on the best methods to use for special purposes. The influence of bud maturity on the earliness of fruiting also requires investigation.

The many species of *Psidium*, several of which are grown as compound trees, also merit investigation with a view to improvement. The strawberry guava, already widely grown, would seem to merit particular attention.

BIBLIOGRAPHY

1. AHMAD, R. Propagation of guava by cuttage. *W. Pakist. J. agric. Res.*, 1963, 1(3): 51-60.
2. AHMAD, R. Propagation of guava by aerial layering. *W. Pakist. J. agric. Res.*, 1964, 2(3): 62-74.
3. AHMAD, R. Some studies on the vegetative propagation of guava (*Psidium guajava*). *W. Pakist. J. agric. Res.*, 1966, 4: 68-79.
4. AHMAD, S. Cultivation of guavas in West Pakistan. *Agric. Pakist.*, 1961, 12: 745-61.
- 4a. ALI, N. and IRSHAD-ul-HAQ New methods of vegetative propagation of guava (*Psidium guajava*). *J. agric. Res., Pakistan*, 1973, 11(1): 69-77.
- 4b. ANON. Dimorphism in guava. *Hawaii Fm Sci.*, 1974, 21/22(2): 1.
5. ANON. Rooting in guava. *Indian Hort.*, 1961, 5(4): 11.
6. APONTE, C.E. El cultivo de guayaba en Puerto Rico. *Carib. Agric.*, 1963, 1: 199-215.
7. BHANDARY, K.R. and MUKHERJEE, S.K. Relation between invigoration and rooting of guava (*Psidium guajava* L.) stem cuttings. *Curr. Sci.*, 1969, 38: 197-8.
8. BHANDARY, K.R. and MUKHERJEE, S.K. Amino-acids in easy and difficult-to-root stem cuttings of guava (*Psidium guajava* L.). *Curr. Sci.*, 1969, 38: 575-6.
9. BHANDARY, K.R. and MUKHERJEE, S.K. Effect of season, age and source of scion and ringing on veneer-grafting of guava (*Psidium guajava* L.). *Indian J. agric. Sci.*, 1970, 40: 495-501.

10. BHARATH, S. Guava propagation from stem cuttings in Trinidad. *J. agric. Soc. Trin. Tob.*, 1970, 70: 396-9.
11. BHUJBAL, B.G. Effective concentration of IBA in the air layering of guava. *Res. J. Mahatma Phule agric. Univ.*, 1972, 3(1): 53-6.
12. BLOMMAERT, K.L.J. Stem cuttings can be obtained more easily with new method. *Fmg S. Afr.*, 1958, 34(9): 10-11.
13. BLOMMAERT, K.L.J. Propagate guavas by means of leaf-bud cuttings. *Fmg S. Afr.*, 1959, 35(5): 29, 32.
14. BOSE, S.R., BOSE, A.B. and DEY, K.L. Effect of crude polyporin on seed germination and root growth : a preliminary study. *Science*, 1948, 107: 63.
15. CAMPBELL, C.W. and MALO, S.E. A review of guava research in Florida. *Proc. Carib. Reg. Amer. Soc. hort. Sci.* 1965, 1966, 9:9-14.
16. CANN, H.J. and SPROULE, R.S. Some tropical fruits. *Agric. Gaz. N.S.W.*, 1963, 74:638-44.
17. CARRA, P. Les arbres fruitiers exotiques. *Rev. hort. Algér.*, 1951, 55:178-81, 205-8, 228-34, 284-7.
18. CHANDRA, D. Recent advances in clonal propagation of guava. *Allahabad Fmr*, 1965, 39:137-9.
19. CHEEMA, G.S., BHAT, S.S. and NAIK, K.C. *Commercial fruits of India*. Macmillan & Co. Ltd., 1954,
20. CORDOBA V., J.A. Guavas. *Agric. trop.*, Bogotá 1961, 17:459-79.
21. DECKER, J.S. Cultura da goiabeira *Bol. Minist. Agric. Brasil*, 1951, No. 1, reprinted as *Publ. Secr. Agric. São Paulo* 840, 1952, pp.22.

22. DEDOLPH, R.R. and BOWERS, F.A.I. Studies on guava propagation. *Hawaii Fm Sci.*, 1960, 9(2):4-5.
23. DU PREEZ, D. Propagation of guavas. *Fmg S. Afr.*, 1954, 29: 297-9.
24. EDWARD, J.D. and SHANKER, G. Rootstock trial for guava (*Psidium guajava* L.). *Allahabad Fmr*, 1964, 38:249-50.
25. FOUQUÉ, A. Espèces fruitières d'Amérique tropicale. II. Myrtacées. *Fruits*, 1972, 27(2): 120-39.
26. FREYRE, R.H. More guavas in Puerto Rico. *Agric. Amer.*, 1947, 7:113-15.
27. HAMILTON, R.A. and NAKASONE, H.Y. Bud grafting of superior guava cultivars. *Hawaii Fm Sci.*, 1967, 16(2):6-8.
28. HAMILTON, R.A. and SEAGRAVE-SMITH, H. Growing guava for processing. *Ext. Bull. Univ. Hawaii* 63, 1954, pp. 19.
- 28a. HAQ, F., KHAN, M.S. and FARIDULLAH, I. Germination trial on guava seed. *J. agric. Res., Pakistan*, 1973, 11(3):121.
29. HAWAII. *Bien. Rep. Hawaii agric. Exp. Stat.* 1958-60, 1960.
30. HUROV, H.R. The polyethylene bag method of rooting cuttings. *Plant Propagator*, 1967, 13(1):7-9.
31. IBÁÑEZ, M.L. The effect of cold on tropical seeds. *Turrialba*, 1968, 17:73-5.
32. INDIA. *Annu. sci. Rep. Indian agric. Res. Inst.* 1958-59, 1962.
33. INDIA. *Idem* 1960, 1963.

34. INDIA. *Idem* 1960 and 1961, 1963.
35. INDIA. *Idem* 1965, 1969.
36. INDIA. A.R. Indian Counc. agric. Res. 1952-1953, 1954.
37. JAFFE, A. Chip grafting guava cultivars. *Plant Propagator*, 1970, 16(2): 6.
38. JOLICOEUR, J. A. The rooting of guava (*Psidium guajava* L.) cuttings with hormones under mist in Haiti. *Proc. Carib. Reg. Amer. Soc. hort. Sci.* 1962, 1962, 6: 57-9.
39. KRISHNAMURTHY, B. L. Budding in Guava. *Lal-Baugh*, 1965, 10(4): 9.
40. KUPERBERG, J. Rooting guava (*Psidium guajava* L. c. Supreme) stem cuttings in a hydroponic mist-type plant propagator. *Proc. Fla St. hort Soc. for 1953, 1954*, 66: 220-3.
41. MAJUMDAR, P. K. and MUKHERJEE, S. K. Guava: new vegetative propagation method. *Indian Hort.* 1968, 12(2): 11, 35.
42. MANOHAR, M. S. Influence of source on the performance of soft-wood cuttings of guava (*Psidium guajava* Linn.). *Allahabad Hort.* 1966, 40: 191-3.
43. MAURITIUS. A. R. *Dep Agric.* 1949, 1951.
44. MERLE, P. Note sur la multiplication végétative du goyavier. *Fruits d'Outre Mer*, 1952, 7: 72-3.
45. MUKHERJEE, S. K. and SINGH, Y. M. Effect of season and nature of shoots on veneer grafting of guava (*Psidium guajava* L.). *Sci. and Cult.*, 1965, 31: 31-3.
46. NAKASONE, H. Y. and BOWERS, F. A. Mist box propagation of cuttings. *Hawaii Fm Sci.*, 1956, 5(1): 1, 7, 8.

47. NEL, R.I. The fruit industry in the winter rainfall area. *Fmg S. Afr.*, 1951, 26:521-5.
48. NELSON, R.O. Propagation of guavas by graftage. *Proc. Fla St. hort. Soc.* 1954, pp. 228-31.
49. OCHSE, J.J. and IWANIEC, W.J. Study on root development. *Proc. Fla St. hort Soc.* 1954, pp. 217-18.
50. PENNOCK, W. and MALDONADO, G. The propagation of guavas from stem cuttings. *J. Agric. Univ.P.R.*, 1963, 47: 280-9.
51. RUEHLE, G.D. The common guava - a neglected fruit with a promising future. *Econ. Bot.*, 1948, 2:306-25.
52. RUEHLE, G.D. A rapid method of propagating the guava. *Yearb. Calif. Avoc. Soc.* 1948, pp. 108-12.
53. RUEHLE, G.D. El cultivo de la guayaba en la Florida. *Agric. trop.*, Bogotá, 1964, 20: 555-64.
54. SAHARANPUR. *A.R. hort. Res. Inst.* 1960, 1961.
55. SAHARANPUR. *Idem* 1961, 1962.
56. SAID, M. and INAYATULLAH. Establishing the rooted layers of seedless guava propagated by aerial layering. *W. Pakist. J. agric. Res.*, 1966, 4(3): 149-50.
57. SEN, P.K. et al. Mist propagation of fruit tree cuttings. *Plant Sci.*, 1969, 1: 216-19.
58. SERPA, D. Importancia de la propagación de guayabas por injerto. *Agronomía, Caracas*, 1965, 1(1):11-12
59. SINGH, J.R. and SRIVASTAVA, R.P. Propagation of guava by budding. *Trop. Agric., Trin.*, 1963, 40:71-3.

60. SINGH, M.P. An improved marcot box for the aerial propagation on fruits. *Indian J. Hort.*, 1954, 11:89-93.
61. SINHA, R.B., MALLIK, P.C. and CHHONKAR, V.S. Effect of plant regulators on rootage of guava (*Psidium guajava*) cuttings. *Indian J. Hort.*, 1962, 19:120-7.
62. SRIVASTAVA, R.P. Preliminary studies in budding of guava. *Sci. and Cult.*, 1962, 28:28.
63. SRIVASTAVA, R.P. Further studies in budding of guava. *Sci. and Cult.*, 1962, 28: 433-4.
64. SRIVASTAVA, R.P. Effect of growth-regulators on rooting cuttings of guava (*Psidium guajava* L.). *J. sci. Res., Banaras Hindu Univ.*, 1962, 12:238-40.
65. SRIVASTAVA, R.P. Propagation of mango and guava by transported buds. *Sci. and Cult.*, 1963, 29:145-6.
66. SRIVASTAVA, R.P. Propagating guava by budding method. *Indian Hort.*, 1964, 8(4): 6-8.
67. TAMBURO, S.E., LYNCH, S.J. and NELSON, R.O. Methods of guava top-working. *Proc. Fla St. hort. Soc.* 1955, 1956, 68:321-4.
68. TEAOTIA, S.A. and PANDEY, I.C. Effect of growth substances on the rooting of guava stem cuttings. *Sci. and Cult.*, 1961, 27:442-4.
69. TEAOTIA, S.S. and PHOGAT, K.P.S. Effect of rootstocks on growth, yield and quality in guava (*Psidium guajava*). *Progr. Hort.*, 1971, 2(4): 37-45.
70. TINGWA, P.O. and ABBADI, S. The vegetative propagation of tropical guava (*Psidium guajava* L.) in the Sudan. *Sudan agric. J.*, 1968, 3(1): 12-20.

71. INDIA, U.P. DEPARTMENT OF AGRICULTURE. Propagation of fruit plants. *Agric. Anim. Husb. U.P.*, 1950, 1(3):19-27.
72. WEBBER, H.J. Extending guava production to California. *Proc. Amer. Soc. hort. Sci.* 1942, 1942, 41:228-33.
73. WEBBER, H.J. The guava and its propagation. *Yearb. Calif. Avoc. Soc.* 1944, 1945, pp. 40-3.

ZIZIPHUS MAURITIANA — INDIAN JUJUBE OR BER

by

D. O'D. BOURKE

Commonwealth Bureau of Horticulture and Plantation Crops

INTRODUCTION

The name *Ziziphus* (Miller 1764), or *Zizyphus* (Jussieu 1789), one of the major genera of the Rhamnaceae, is derived from the Latin *Ziziphum*, derived in turn from the Greek *Ziziphon*, meaning "jujube", the present name of the tree and its fruit. There are about 100 species distributed in the Old and New Worlds, mostly tropical but also growing in Mediterranean and temperate climates.

Many *Ziziphus* species have edible fruits. In Africa they include the North African *Z. lotus*, believed to be the lotus of the ancients, and Christ's thorn, *Z. spina-Christi*. The fruits of *Ziziphus* spp. were consumed more in the past than they are now, and in 1947 Chevalier (6) wrote: "Le récit d'Homère sur les Lotophages ne nous semble pas un mythe. Les jujubiers furent probablement cultivés sur une très vaste échelle, alors que la culture des céréales n'était pas encore réalisée partout". It is not entirely clear, however, whether these North African trees were always deliberately planted or whether they were merely protected where they grew. The latter situation is by far the most common in West Africa nowadays. Useful *Ziziphus* spp. are protected where they appear spontaneously, or are spared when clearing land of vegetation. They are also planted to a limited extent, however, sometimes for the production of hedges or windbreaks.

The Indian jujube or ber (*Z. mauritiana* = *Z. jujuba* (L.) Lam. non Mill.) is the outstanding tropical species. It is an important fruit crop in India, where it has been cultivated for centuries and its culture is mentioned

in the earliest Sanskrit literature. Most of the published work on this species and its cultivation comes from India. There is another widely-cultivated species, the Chinese jujube (*Z. jujuba* Mill. = *Z. sativa* Gaertn.), with which the Indian jujube has frequently been confused. This species is, however, associated with temperate, Mediterranean or occasionally semi-tropical climates but not with the tropics, although there are regions, as in Assam, where the two species may overlap (8).

DISTRIBUTION AND ECOLOGY

Z. mauritiana is believed to be of African origin. It has an extended range in the drier parts of tropical Africa and Asia, being found up to an altitude of about 900 m (3000 ft) above sea level. It has also been introduced to other parts of the tropics, such as Madagascar and tropical America. It grows well under a variety of conditions, being able to tolerate levels of salinity, waterlogging and drought high enough to make mango or citrus culture impossible. For improved cultivation deep sandy well-drained loams, neutral or slightly alkaline, are preferred. Cultivated trees also benefit from irrigation during the fruiting season.

Growth habit and flower biology

It is a naturally thorny shrub or tree, of variable habit, ranging in height from about 2.50 to 15 m (8-48 ft). It may ramify from the base and develops a deep tap root. The leaves are alternate, distichous, elliptical, entire or slightly toothed, distinctly-veined, green and glabrous on the upper surface but cottony and pubescent on the under surface. They are shed, at least in part, during the dry season.

The flowers, arising in the leaf axils, are small and greenish. The fruit is an ovoid drupe. Its colour may vary from yellowish to red or brown. It is about the size of a small cherry on wild plants but may be the size of a plum on improved varieties.

The edible pulp is thin and sweetish. The stone is very hard and encloses a single kernel. Improved varieties tend to be taller, to have larger leaves and fruits but smaller thorns than wild plants. Their fruit shape is also more variable (6). At least one cultivar has been described as thornless.

The fruits may be eaten fresh, dried or candied. The pulp may be dried and fermented to make a drink or a kind of paste resembling gingerbread, once a standard food for travellers (11). The fruits are also used to make sorbets, jam and jelly or are included in chutneys or pickles. They are rich in vitamin C.

Varieties

There are many named cultivars in India. The Regional Fruit Research Station, Bahadurgah, has a collection of at least 40 cultivars (4). They may vary in fruit size and colour, flavour, yields, earliness and fruit-keeping qualities.

Diseases and Pests

The fruit fly (*Carpomyia vesuviana*) is the major pest. Its larvae develop inside the fruit. Infested fruits generally drop off and the larvae then move to the soil in order to pupate. Cultivating the soil or irrigating will therefore give some control by destroying pupae. Spraying foliage with bait containing sodium fluorosilicate has been found a satisfactory method of controlling the adults. Light traps have also been employed. Cultivars may vary in their susceptibility to fruit fly. In a trial with 13 cultivars the thin-skinned, sweet Pamdi, Hyderabad and Banaras Gola fruits were preferred (16). Fruits of a wild species, *Z. nummularia*, were found to be the most resistant.

PROPAGATION BY SEED

Many trees are propagated by seed and remain on their own roots. The seeds should be chosen from trees with desired qualities as regards fruit size, flavour,

high proportion of pulp to stone, yield and hardness. Seeds may be stratified if they are not required immediately. They must be fully ripe. Some 50-70 per cent of fallen fruit may have non-viable seed (21). The stones may be placed in 17-18 per cent salt solution and those that float discarded. Those that are retained should be carefully cracked to extract the kernel (the true seed) which is then sown. Kernels extracted in this way will germinate in about a week whereas stones may take three to four weeks. Seed germination has been improved by the use of GA (18).

In improved cultivation seeds are sown only to provide rootstocks for budding. They may be sown directly in the field, in order to avoid transplanting, or in nursery plots in rows about two feet (0.6 m) apart with nine inches (23 cm) between plants (7). Seeds have been sown and plants successfully raised in polyethylene bags (4;27). Sowing seed in large pots (11 x 9 inches = 28 x 23 cm) has also proved successful, producing the large girth (12 mm = 0.5 in diameter) required for budding in three to four months(23).

PROPAGATION BY BUDDING AND GRAFTING

The exact sequence followed when budding or grafting depends on the succession of the seasons and on the influence of their variations on the growth made by the rootstocks.

Seeds sown in polyethylene bags (20 x 10 cm = 8 x 4 in) in March-April may be transplanted in July (at 8 x 8 m = 26 x 26 ft) and budded in August- September (4). With earlier sowing in January-February seeds may make sufficiently good growth to be budded in June and July (7). If growth is insufficient at this time budding may have to be delayed for a year. In this case the plants are cut back to a few inches above the ground in the April of the second year. New sprouts will arise and the strongest one will be retained for budding in June-July.

A trial with Alkathene bags (27), previously referred to, showed that planting seeds in bags could lead to greater uniformity than planting out in the

field. In this trial, however, nursery-planted seedlings made better growth than those in plastic bags and were as successfully transplanted bare-root provided that the tap root was cut back slightly and dipped in 250 p.p.m. IBA to promote fibrous root formation.

Rootstocks

No work appears to have been carried out on the effect of different rootstocks. It is usually recommended that healthy wild trees should be used as sources of seed for rootstock production (4). The use of wild species other than *Z. mauritiana*, as for instance, *Z. rotundifolia*, *Z. oenopia* and *Z. rugosa*, has also been advocated (15). Wild trees may also be topworked where they stand (22).

Grafting methods

Ring budding, shield budding and whip grafting have all been used. Budsticks should naturally be selected from healthy, high yielding trees. It is important that they should not be allowed to dry out if they have to be transported for any distance. They may be wrapped in moistened paper and polyethylene and should be stored in a cool place until required (10). Recommendations for bench grafting published some years ago were based on the use of the previous season's wood. The graft, tied with raffia and waxed, was allowed to callus in damp moss at an ambient temperature of 40-50°F (4.5-10°C). Planting-out in the nursery followed some three to four weeks later. In the nursery it was recommended that grafts should be completely covered with soil to prevent drying out. This was done by heaping soil around the graft (5).

Modern practice seems to favour shield budding or patch budding. Shield budding is considered better and easier than ring budding, especially if budsticks have to be brought from a distance (4). A bud is inserted at the top of an inverted T cut made in the rootstock and then pushed down under the bark. It is tied in place and should sprout in two to three weeks, when the top of the rootstock is removed. The same method has also been recommended for topworking wild trees (22). The wild trees are headed back in December-January, leaving about 1 m (39 in) of stem above ground. The strongest shoot is the only one retained and this is budded in April or August. If ring budding is used, trees headed back in March-April may be ring budded in June, as soon as fresh growth starts.

At Ludhiana, India, it has normally been the practice to bud one-year-old shoots, but good results have also been obtained by budding in August or September fresh growth which started in early July (4). The advantages of shield budding in August-September rather than in March-April or June, periods when the bark does not peel off smoothly, were generally confirmed in a trial on the best time of shield budding transplanted seedlings in the field (26). Budding was more successful in August especially if the budwood was obtained from mature (12 years) rather than young (2 years) mother plants. Budding with young mother plants, however, was more successful in April. When budding was carried out in the nursery from March to September the best results were again obtained in August. On the other hand in a trial in Uttar Pradesh wild trees headed back to 4 feet (1.2 m) in April gave 95 per cent take when shield budded in June (22). In one trial ringing just above the point of insertion of the scion was found to be beneficial (2).

Patch budding is an alternative to shield budding. It may be done in the third year of a rootstock sown in the field or after 16 months if the rootstock is sown in a pot. The rootstock may be headed back in February-March and a new shoot selected for budding two months later (10).

PROPAGATION BY LAYERING

Layering is uncommon. In a marcotting trial with growth regulators two-year-old branches, 50-75 cm (20-30 in) in length and 1-2 cm (0.4-0.8 in) in diameter, were selected (13). A 3-cm-wide band of bark was removed just below the node and mixtures of IBA + NAA at 2500, 5000, 7500 or 10000 p.p.m. with or without B smeared on the upper cut. The cuts were then covered with damp sphagnum and wrapped in polyethylene. All mixtures induced rooting, the best being IBA + NAA at 5000 p.p.m. plus B.

PROPAGATION BY CUTTINGS

The use of root cuttings has been reported with *Z. jujuba* Mill. but it is not normal practice with *Z. mauritiana*. When *Z. mauritiana* cuttings from one- or two-year-old branches were treated with IBA at various concentrations ranging from 50 to 400 p.p.m. with or without B at 25 p.p.m. and planted in a mixture of sand and leaf mould, there was no rooting (13).

On the other hand, in an earlier trial, profuse rooting was obtained with the application of a mixture of IBA and NAA, each at 10000 p.p.m. to one to two-year-old shoots, followed by enclosure in moss and plastic wrapping. Unringed cuttings dipped in 400 p.p.m. NAA gave 100 per cent rooting (12).

AFTER-CARE

The time of planting-out, usually, but not always, coinciding with the rainy season, varies according to the locality. In Ludhiana, India, budded plants may be planted out in February-March or from July to September. Planting distances of 8 x 8 m (26 x 26 ft), or slightly less, are recommended. Pits about 1 m (39 in) deep and 1 m (39 in) across are dug one month beforehand. They are filled a fortnight later with a mixture of topsoil, 25 kg (55 lb) FYM, 1 kg (2.2 lb) ammonium sulphate and 1 kg (2.2 lb) superphosphate, or with a similar mixture (4). Where termites are liable to cause damage 30 g Aldrex or BHC 5% dust should be mixed with the soil. The pits should be irrigated immediately after filling to allow the soil to settle.

The difficulties of transplanting budded plants were frequently mentioned in the earlier literature, and to avoid having to transplant it was recommended that seeds for rootstocks should be sown directly in the field. These transplanting difficulties do not appear to be unsurmountable, however, and good results have been obtained by transplanting with a good ball of earth, at least 30 cm (12 in) in depth (4). The leaves may fall off after planting out but they normally soon grow again.

CONCLUSIONS AND SUGGESTIONS

The ease with which *Z. mauritiana* can adapt itself to tropical conditions unsuitable for other fruit trees ensures that the cultivation of improved varieties is likely to continue to expand. To-date no work appears to have been carried out on the selection of seeded or clonal rootstocks. This appears to be the most promising line of investigation. This conventional approach, however, should not prevent concurrent investigations on the possibilities of producing improved varieties by direct seeding, a method which would ensure even wider distribution of this interesting fruit.

REFERENCES

1. AMOLAK RAM. Ber (*Ziziphus jujuba*). *Punjab Fruit J.*, annu. No., 1940, 4: 690-1.
2. ANON. Some aspects of heading-back and topworking fruit trees. *Bull U.P. Dep. Agric. Fruit Ser.* 15, 1943, pp. 5. being Leaflets Punjab Dep. Agric. 41 and 95.
3. AWASTHI, A. N. and MISRA, R. S. Effect of pruning on the subsequent vegetative growth, fruit set, fruit drop and quality of ber (*Zizyphus mauritiana* Lamk.). *Punjab hort. J.*, 1969, 9: 54-60.
4. BAJWA, M. S., SINGH, P. and SINGH, R. Ber cultivation in Punjab. *Indian Hort.*, 1972, 16(4): 7-12, 32.
5. CHEEMA, G. S., BHAT, S. S. and NAIK, K. C. *Commercial fruits of India*. Macmillan & Co. Ltd., 1954.
6. CHEVALIER, A. Les jujubiers ou *Ziziphus* de l'Ancien monde et l'utilisation de leurs fruits. *Rev. int. Bot. appl. Agric. trop.*, 1947, 27: 470-83.
7. CHOPRA, D. P. and SRIVASTAVA, G. Ber varieties for western Rajasthan. *Indian Hort.*, 1973, 17(4): 6, 7, 30.
8. DUTTA, S. Jujubes of Assam. *Indian J. Hort.*, 1954, 11: 53-6.
9. EVREINOFF, V. A. Notes sur le jujubier (*Zizyphus sativa* Gaertner). *J. Agric. trop. Bot. appl.*, 1964, 11: 177-87.
10. HUSAIN, A. Propagation of jujube (*Zizyphus jujuba*) by patch budding. *Bangladesh Hort.*, 1973, 1(1): 48-50.
11. JACQUES-FÉLIX, H. Contribution de René Caillié à l'ethnobotanique africaine au cours de ses voyages en Mauritanie et à Tombouctou 1819-1828. *J. Agric. trop. Bot. appl.*, 1963, 10: 287-334; 449-520; 551-602.
12. JAUHARI, O. S. Some observations on vegetative propagation of *Zizyphus mauritiana* Lam. (Ber) from gootees and cuttings with the aid of growth regulators. *Curr. Sci.*, 1960, 29: 30-1.
13. MISRA, A. K. and JAUHARI, O. S. Root induction in layers and stem cuttings of *Morus alba* and *Zizyphus mauritiana* Lam. with special reference to plant growth regulators. *Indian J. Hort.*, 1970, 27 (3/4): 141-6.

14. MUNIER, P. Le jujubier et sa culture. *Fruits*, 1973, 28 (5): 377-88.
15. NAIK, K. C. *South Indian fruits and their culture*. P. Varadachary & Co., Madras, 1949.
16. SAXENA, D. K. and RAWAT, R. R. A study on the incidence, varietal preference and biology of the ber fruit fly in Madhya Pradesh. *Madras agric. J.*, 1968, 55: 328-33.
17. SHANMUGAVELU, K. G. Studies on the effects of plant growth regulators on the seedlings of some tree plant species. *S. Indian Hort.*, 1966, 14 (1/4): 24-35.
18. SHANMUGAVELU, K. G. Effect of gibberellic acid on seed germination and development of seedlings of some tree plant species. *Madras agric. J.*, 1970, 57: 311-14.
19. SINGH, D., BAKHSHI, J. C. and SINGH, K. Flowering and fruiting behaviour of ber, variety Banarsi Karaka (*Zizyphus mauritiana* Lam.). *Punjab hort. J.*, 1970, 10: 21-8.
20. SINGH, K. The ber. In *Fruit culture in India*. Indian Council of Agricultural Research. New Delhi, 1963, pp. 247-51.
21. SINGH, K. K. The ber in India. *Fm Bull. (New Ser.)*, 1964, 17, I.C.A.R., New Delhi.
22. SINGH, L. B. Preliminary trial on top working of ber (*Zizyphus mauritiana* Lam.) in Uttar Pradesh. *Indian J. Hort.*, 1952, 9 (1): 16-19.
23. SINGH, L. B. Raising of ber (*Zizyphus mauritiana* Lam.) and aonla (*Phyllanthus emblica* L.) seedlings for budding in pots. *A.R. Fruit Res. Stat. Saharanpur 1954-56, /1961/*, pp. 34-6.
24. SINGH, P., BAKHSHI, J. C. and SINGH, R. Identification of ber (*Zizyphus mauritiana* Lam.) cultivars through fruit characters. *Punjab hort. J.*, 1972, 12 (2/3): 120-33.
25. SINGH, R. and KHANNA, R. C. Some North Indian cultivars of ber. *Indian Hort.*, 1968, 12 (2): 23-6, 36.
26. SINGH, R., SINGH, P. and BAJWA, M. S. Effect of time of budding on its success in ber (*Zizyphus mauritiana* Lam.). *Sci. and Cult.*, 1977, 38 (4): 214-15.

27. SINGHROT, R. S., BAKHSI, J. C. and SINGH, K.
Vegetative propagation of ber (*Z. mauritiana* Lamk.).
1. Relative performance of seedlings raised in field
and in alkathene bags. *Punjab hort. J.*, 1970,
10 (3/4): 181-6.
28. ULLAH, H. and KHAN, M.-U.-D. Some aspects of jujube
(*Zizyphus jujuba*) (ber) cultivation in the Punjab.
Punjab Fruit J., 1954, 18 (66/7): 16-20.

BIBLIOGRAPHY OF GENERAL BOOKS AND ARTICLES

- G1. BAILEY, L. H. *The standard cyclopedia of horticulture*. Macmillan, New York, 1927, 3 vols.
- G2. BURKILL, I. H. *A dictionary of the economic products of the Malay Peninsula*. Ministry of Agriculture & Co-operatives, Kuala Lumpur, 1966.
- G3. CHANDLER, W. H. *Evergreen orchards*. Lea and Febiger, Philadelphia, 2nd ed., 1958.
- G4. FEILDEN, G. ST. C. and GARNER, R. J. Vegetative propagation of tropical and sub-tropical fruits. *Tech. Commun. imp. Bur. Fruit Prod.* 7, 1936.
- G5. FIRMINER, T. *Manual of gardening for Bengal and Upper India*. Calcutta, 1869.
- G6. GRIST, D. H. *An outline of Malayan agriculture*. Department of Agriculture, Straits Settlements and Federated Malay States, 1936.
- G7. HEYNE, K. *De nuttige planten van Nederlandsch-Indië*. 1927.
- G8. HUROV, H. R. The polyethylene bag and polyethylene bag reflector methods of rooting semi-hardwood cuttings from tropical arboreals by pre-treatment with two chemical stimulants. *Abstr. from Pamphl. N. Borneo Dep. Agric.* 10, 1960, pp. 5, partly reproduced as HUROV, (H.) R. The polyethylene bag method of rooting cuttings. *Plant Propagator*, 1967, 13(1): 7-9.
- G9. HUROV, H. R., FATT, C. Y., LALI, G. and MULKIAMAN, A. B. Double stimulant polythene bag method of rooting cuttings. II. Illustrated description. *Pamphl. N. Borneo Dep. Agric.* 11, 1960, pp. 22.
- G10. HUROV, H. R. The propagation of semi-hardwood leafy cuttings using polyethylene bags and sheets with aluminium reflectors. *Proc. Plant Prop. Soc.* 1961, 1962, 11: 84-6.
- G11. MACMILLAN, H. F. *Tropical planting and gardening with special reference to Ceylon*. Macmillan, London, 1935.
- G12. MAGIELSE, M. M. and OCHSE, J. J. Resultaten van enten en oculeeren van vruchtboomen in den gouvernements-tuinbouwproeftuin "Ragoenan". *Landbouw.* 1930/31, 6: 944-71.

- G13. MENDIOLA, N. B. *A manual of plant breeding for the tropics*. University of the Philippines, College of Agriculture, Manila, 1926.
- G14. MOWRY, H., TOY, L. R. and WOLFE, H. S. *Miscellaneous tropical and sub-tropical Florida fruits*. *Bull. Fla agric. Ext. Serv.* 109, 1941, pp. 96.
- G15. NAIK, K. C. *South Indian fruits and their culture*. P. Varadachary & Co., Madras, 1963.
- G16. OCHSE, J. J. *Fruits and fruit culture in Dutch East Indies*. G. Kolff & Co., Batavia, English ed., 1931.
- G17. OCHSE, J. J., SOULE, M. J., JR., DIJKMAN, M. J. and WEHLBERG, C. *Tropical and sub-tropical agriculture*. Macmillan, New York, 1961.
- G18. POPENOE, W. *Manual of tropical and sub-tropical fruits*. Macmillan, New York, 1920, pp. 474.
- G19. PURSEGLOVE, J. W. *Tropical crops*. Longmans, Green, London, 1968-1972, 4 Vols.
- G20. ROYAL HORTICULTURAL SOCIETY. *Dictionary of gardening*. Oxford University Press, London, 1951, 4 Vols.
- G21. SANDERS, T. W. (revised by HELLYER, A. G. L.) *Encyclopaedia of gardening*. Collingridge, London, 1952, 22nd ed.
- G22. SHEAT, W. G. *Propagation of trees, shrubs and conifers*. Macmillan, London, 1948.
- G23. SINGH, R. *Fruits*. National Book Trust, India, New Delhi, 1969.
- G24. SINGH, S., KRISHNAMURTHI, S. and KATYAL, S. L. *Fruit culture in India*. Indian Council of Agricultural Research, New Delhi, 1963.
- G25. STURROCK, D. *Fruits for southern Florida*. Southeastern Printing Co., Stuart, Florida, 1959.
- G26. U.P. DEPARTMENT OF AGRICULTURE, BUREAU OF INFORMATION. *Propagation of fruit plants*. *Agric. Anim. Husb. U.P.*, 1950, 1(3): 19-27.
- G27. WESTER, P. J. *Plant propagation in the tropics*. *Bull. Philipp. Dep. public Instruction Bur. Agric.* 32, 1916, pp. 87.

- G28. WESTER, P. J. Plant propagation and fruit culture in the tropics. *Bull. Philipp. Dep. Agric.* 32, 1920. (Cited by Feilden and Garner, 1936).
- G29. WESTER, P. J. Notes on grafting tropical fruits. *Philipp. agric. Rev.*, 1920, 13: 363-5. (Cited by Feilden and Garner, 1936).
- G30. WILLIS, J. C. *A dictionary of the flowering plants and ferns*. Cambridge, 1966, 7th ed.