

Alternate Energy

Table of Contents:

[Overview: On Alternate Energy.](#)

The problems of producing your own.

[Electricity: Make your own](#)

We have built many of our own generators. Here we tell you how to do it - using wind, water, bicycles and other means.

[Bikes: Not just for riding](#)

Bikes are a very much overlooked energy source. They can be used to operate all sorts of machines and they can be used to generate electricity.

[Smokemobile: Woodgas](#)

Detailed plans for running your tractor, truck, car or bus on wood. This is a tried and proven method used in Europe during the Second World War when there was a gasoline shortage. Much improved design since then. [There is also a copy of the old method available in .pdf](#)
(for which you need a pdf reader)

[Biofuel: Grow it on the farm](#)

Biofuels are used as a substitute for diesel. They can be grown and processed on the farm. They do not require a still.

[Stills: Make your own fuel from potatoes, corn, etc.](#)

These are a bit trickier and at the present generally illegal, or at the very minimum you can get into a lot of legal hassle.

[Solar: Using the sun for energy.](#)

While it is impractical to home build solar cells for generating electricity, solar is great for cooking and

other applications like heating water.

Click here to return to the
[Individual Agricultural Recovery
After Nuclear Holocaust](#)

The Problem of Producing Your Own

There are many problems in developing and installing independent power systems. For one thing the government is not helpful. To say the least. It is not just our project that finds these hurdles but many others have been stopped also. In the second previous century our local water courses were used for power but in the last hundred years everything possible has been done to prevent their use, including dynamiting what was the main local power producing dam. The government centralized production for economies of scale and did not want competition. Then during the depression when costs were such that the farmers could not afford the electricity from the monopoly the farmers again started a generator at the dam and this is when the system was taken back over by the government and the dam dynamited.

With all the surplus rotting potatoes in the area we might also make a still and produce fuel for our diesel generators. But, presently, there is a \$100,000 annual fine for doing so. We will simply have to wait for a more propitious time.

Click here to return to the
[Table of Contents](#)

MENU: [HOME](#) » [Reconstruction](#) » [Recovery](#) » [Renewal](#) » [Energy Types](#)

Electricity

Make Your Own

Table of Contents:

[Overview: On Making Your Own Electricity.](#)

An overview of the efficiency of different methods of electrical energy generation and the key to comprehending just how much power you are making.

[Bike: Pedal Power](#)

DON'T plan to hook it up to a car generator. You just can't pedal fast enough. Here are several designs. We have built ten pedal power generators for use in the Ark Two shelter. You will see a picture of me actually pedaling one of them and lighting ten 12v florescent trouble lights. Nice trick. Good for exercise. But worse than the old galley ship oars for effort. And I don't know where you are going to get that many slaves. Still there are some applications for bike generators and key to their success are the low RPM generators that I discuss next.

[Low RPM: How to make low RPM generators!](#)

The difficulty with most generators is that you have to turn them too fast before they start generating power. These generators are neat because they put out power at low rpm and so will work with a bicycle, a low head water source, or lower wind power.

[Lawnmower: Turn your lawnmower into a generator](#)

Yep, turn your old gas lawnmower into a generator. This is also where you can use a car generator / alternator. Now if you can just find some gasoline to run the lawnmower.

[Wind: If you have a good windy location.](#)

We have built eight of these wind powered electrical generators. In fact at this writing we are still making the blades. Can't put them up, however, because the neighbors think the sound of the wind on the blades might be too noisy. Have gone to lots of other sites and looked at ones that others have built.

[Waterpower: You should be so lucky](#)

Same problem with waterpower today. We have designed systems for our two generation sites and would like to put them in the water - but the government won't let us. It is not just us - lots of people presently run into that problem, but anyway you can look at our system and we will discuss some aspects of water power. We are very fortunate to have two good water sources and although we can't use them today - things may be different when the time comes.

Motors: Running it backwards

Surprise! Surprise! Yep motors take electricity to run - BUT if you run them BACKWARDS, they put out electricity. The trick is to find something that will run them backwards. Wind or water can do it- for example.

Diesel: Lets not forget the big guys.

Probably the best we have got - if we can keep them running for parts and such - and can get or make fuel for them.

Batteries: Saving energy for future use.

Usually a key component with alternative energy systems is battery storage. Because the alternative energy systems often do not generate high volume it is usually essential to store energy generated during low usage periods for use during high usage periods.

Overview Making Your Own Electricity The Relative Efficiency of Methods

What Watts?

One measure that you want to have clearly in your mind when you start considering electrical generating systems is that of watts. Just take a few minutes to this through if it is not something with which you are already familiar.

It is easiest to think in terms of light bulbs. A one hundred watt light bulb uses 100 watts of electricity per hour. A thousand watt generator would put out a thousand watts in an hour and would therefore light 10 of these light bulbs. A four thousand (which is to say a 4K) generator would light 40 of them. Keep that in mind as you read through the following descriptions.

Alternative Sources of Electricity

There are numbers of ways of building your own electrical generators.

Let me explain briefly my concepts about power generation, in order of efficiency.

a. The most efficient way to get electric power, is to buy it from the power company. Economies of scale make them by far the lowest cost source. The only reasons to have your own power generation are (1) you are too far from the grid (2) you need a back-up in case the grid is down (3) you are very dedicated to some other purpose such as survival, conservation, or innovation. These latter are definitely going to cost you money.

b. The second most efficient way to get electric power, for most people, will likely be to have a diesel or gasoline generator. A diesel combined with a battery storage unit can be relatively efficient in providing reliable power but it takes considerably more commitment than simply paying a bill to the electric company each month. The cost of putting in a substantial system for full off grid use will run between 20K and 40K. We have two diesel generators at the Ark. One is a 75KW and the other a 25KW. With the cost of diesel fuel and maintenace it costs about ten times as much to generate power with them as to buy it from the power company. Still they are main emergency mainstay. The 75KW will light about 750 (100 watt) light bulbs. Do the math. 75KW means 75,000 watts which divided by 100 watts per bulb gives us 750 bulbs which can be lit. In practice, we of course do lots of other things other than light bulbs. We run water and sewage pumps, big air fans, stoves and microwaves, and charge batteries, whenever we are running it.

c. The third most efficient way is with water power. In fact this might be the preferred way but most people will not have an adequate water source. The operative words are HEAD and FLOW. Head is the height that the water falls from and 100 feet is considered reasonable. The higher the better. Flow, the amount of water, is the other factor. Low head systems have been problematical but some people feel they have found a solution. I am no exception. I think the solution is low RPM (Revolutions Per Minute) generators with nozzles on the driving waterwheel to efficiently direct the water force. Unfortunately, the government won't let me try out my theory - but I have everything together ready to try when circumstances change. A useful system for complete household use is probably going to cost over 40K to install. A system on our big falls might produce 40KW and this would be 24 hours per day - without any additional cost of fuel. So yes, because we have such an excellent water source, it would pay for itself. However, when you add in the cost of trying to battle the government to put it in - then it becomes useless.

d. The fourth most efficient way to generate electricity is with wind. Wind is much less efficient than water because in most places it does not blow that constantly. Our little wind generators will produce about 400+ watts each (think in terms of four 100 watt bulbs) and since I am planning to put up 8 of them I will get in the neighborhood of what we would get from our one little 5KW gasoline generator. Most people would not have room for such a windmill farm such as we do, and fortuitously located on the highest hill around. Still the installation of the eight windmills will be around 15K to 20K. You can buy a good 5KW generator for one tenth the price - so you can see what I mean by putting this down as the

fourth most (actually less) efficient way of generating electricity. But if the power company isn't working and you can't get gasoline then this may be the way to go.

e. The fifth most efficient way is with solar cells. This technology has come a long, long way in the last few years but still remains so inefficient that it would take over 100 years for a system to pay for itself, and in fact it undoubtedly never would if you included what the investment would earn elsewhere in interest and take into consideration that the system will physically depreciate before that length of time. One great draw back to solar cells is that the sun only shines half the day, and because of annual position of the earth and blockage by clouds, in many places your are lucky to get power 20% of the time. Unless you are out in space with sunlight 24/7 or have some very low power need at a remote location - forget it.

f. There are a great many other ways to generate electricity. Waves, thermal heat, animal power (the bicycles), chemical methods, nuclear, hydrogen generators, steam boilers, a great variety of fuels and so on and on. But none of these, and most of the above, are not practical for most individuals. Completely forget the many cons that are going around about getting free electricity from machines being suppressed by the oil companies, the government, and giant corporations. I have looked into these extensively for many years - and there is nothing to them as great as the stories sound. If there were a cheaper way to generate electricity the Japanese or the Russians or the Chinese would do it and no US companies would be able to stop them. Engineers in other countries are not dummies and would greatly love to have the electrical power in order to keep up with American productivity.

Click here to return to the
[Table of Contents](#)

MENU: [HOME](#) » [Reconstruction](#) » [Recovery](#) » [Renewal](#) » [Energy Types](#)

Low RPM Generators

This is the main page on this site regarding the construction of generators. While many of the examples are regarding wind driven generators, the principles regarding the generators themselves apply equally to other motive sources. Anyone contemplating building a low rpm generator should look through all the sources on this page. Those persons specifically building a wind generator should also look at our "WIND" page which has on it many things specific to wind generators such as towers, blades, tails and testing them.

Comparison of Generators and Alternators

Most generators and alternators (like off of a car) need to revolve at around 1800 rpm (that is they have to make 1800 revolutions per minute in order to generate power) and it is often difficult to get a third of that speed with most homemade wind, water or other sources.

[Overview: Comparison of Alternators and Generators](#)

[SEALED: Comparison of Alternators and Generators](#)

This is the SEALED mirrored version of this site that won't be opened until after The Great Catastrophe.

Low RPM Generators and Alternators

Since the difficulty with most generators is that you have to turn them too fast before they start generating power these low RPM ones are neat because they put out power at low rpm and so will work with a bicycle, a low head water source, or lower wind power.

The low RPM generators will start generating power at around 100 rpm and remain efficient up to about 600 rpm. Their "sweet spot" is often around 400 rpm but it will vary from generator to generator.

[SEALED: Wooden Low RPM Alternators](#) (SEALED)

This is a SEALED mirrored site that won't be opened until after The Great Catastrophe. This and the link following give more information about building wooden generators. Much of the information is available through the open links.

[SEALED: Alternator from Scratch](#) (SEALED)

This is a SEALED mirrored site that won't be opened until after The Great Catastrophe. The reason that they are mirrored here is that hopefully this way the information will be available later - even if the open links no longer are. Special plans are being made to protect to protect these pages and to distribute them afterwards.

Brakedrum Generators and Alternators

[Brakedrum: Use the brakedrum off an old pickup truck to make a low RPM generator!](#)

Although the literature says these brakedrum generators are easy to make, we made ten of them and found it a considerable challenge. Nevertheless, they all worked reliably and are very durable.

[SEALED: brakedrum_update](#)

This is the SEALED mirrored version of this site that won't be opened until after The Great Catastrophe.

Front Disk Generators and Alternators

There seems to be a trend away from brakedrums to disks. Talking with Hugh Piggot, he tells me that he is writing a new book on this subject.

[Disk 1: Forcefield Low RPM Disk Alternator](#)

[SEALED: Forcefield Low RPM Disk Alternator](#)

This is the SEALED mirrored version of this site that won't be opened until after The Great Catastrophe.

[Disk 2: Making a Volvo Front Brake Disk into a Generator](#)

More details from the same source - on the same idea.

[SEALED: Making a Volvo Front Brake Disk into a Generator](#)

This is the SEALED mirrored version of this site that won't be opened until after The Great Catastrophe.

Wooden Generators and Alternators

Some wind generator designs can be put together very quickly. You can carve less elegant blade designs in an hour or two. Some motors can be used as generators. People have gone out and stuck their wind

generators up on top of a hydro pole that is not being used. Hopefully the need is only temporary anyhow, until a more permanent source of electricity is re-established.

These may not produce so much electricity as a metal based generator and may be not as durable but they may be more accessible for one of the main components.

[Simplest: Wood Axe](#)

This one is particularly fast to build. Even if you don't build it you should study this one because the pictures and explanation by Force Field are so excellent.

[SEALED: Wood Axe](#) (SEALED)

This is this SEALED mirrored site that won't be opened until after The Great Catastrophe. This and the two sealed links following give more information about building wooden generators. Much of the information is available through other open links.

[SEALED: Homebrew Windgenerator](#) (SEALED)

This is a SEALED mirrored site that won't be opened until after The Great Catastrophe. Much of the information is available through other open links.

[Wooden 2: all the plans and information for another wooden one](#)

BUT these are 9 pages of plans mirrored in .pdf format from Home Power Issue #88 are ones that you can download and print off NOW.

[Wooden 3: A key set of plans to study](#)

These are 49 mirrored pages of plans in .pdf format are ones that you can download and print off NOW. While you may not build this unit - you should definitely study these plans from Hugh Piggot because they give you details on many subjects such as how to build a coiler, the winding of a coil and how to wire the coils together.

[SEALED: Additional Info on Coils](#) (SEALED)

This is a SEALED mirrored site that won't be opened until after The Great Catastrophe. Much of the information is available through other open links.

On-line Info: [Lots of info on build it yourself windmills](#)

This is a link to Hugh Piggot's website. Hugh lives in Scotland. This is probably the world's most authoritative source for build it yourself windmills. For those who look into it ahead of time they can get Hugh's book. We also have a .pdf file from Hugh (available on our low rpm generators page) - that gives LOTS of details.

On-line Info: [North American Source for Hugh's info.](#)

This is a link to Bob Budd's website. Bob has built lots of Hugh Piggot's brakedrum windmills, and he has put out a superb video on how to do it. I have watched the video many, many times with many people and have talked with Bob tens of times, and have gone to visit him and see his windmills in the process of our building ten generators ourselves.

Other Generators and Alternators

Microwave Oven: [Making a Microwave Oven into a Generator](#)

This is a particularly neat idea and there are lots of neat ideas at the Windstuff Now site.

SEALED: [Making a Microwave Oven into a Generator](#)

This is the SEALED mirrored version of this site that won't be opened until after The Great Catastrophe.

Testing

Experiment: [Testing your theories](#)

Here are some experiments done by another individual developing a low rpm generator. It is an example of the kind of approach that you may wish to take.

Sealed: [Testing your theories](#)

Same as above but sealed until after the Holocaust.

MENU: [HOME](#) » [Reconstruction](#) » [Recovery](#) » [Renewal](#) » [Energy Types](#)

Discover How To Easily Build a Portable Low Budget Power Generator

" Using an old Lawn Mower and materials you can pick up locally and cheap"

This is from another webpage which says that it is copyrighted but the links to Gemini didn't work and I will be happy to link them if I can find the source but a search on the Internet didn't turn it up.

Here's an easy and inexpensive way to build your own personal power generator. It's a handy little back up system to protect your family from black outs, storms, Y2K, etc. Or, maybe you simply want to get away from it all for a while. It's always nice to know that you can produce your own power whenever and wherever you are.

The following is a step by step tutorial. It shows you the parts you will need, the cost and the best places to get them. We then assemble the whole unit and wire it up, yes, we even include the wiring diagrams. The nice part about this unit is that the generator is built right into the lawn mower deck. You can even strap 2 or 3 batteries on the deck and steer the whole thing wherever you want to go.

Aside from showing you how to build the "Low Budget Power Generator", we are also going to show you how to easily expand your system by using a couple of extra items that will let you maximize your power producing potential. We kept the explanations as clear as possible so that you can keep your time and labor to a minimum. Quite frankly, we wanted to have some fun putting these systems together and hopefully you will too.



We'll be the first ones to admit, these homemade units do have their limitations and they aren't pretty, but they are practical. If you want pretty, go out and spend a pile of your hard earned money on a generator. If you can find one.

We have come up with 4 different ways to build these homemade

generators depending on your preference of items, or the availability of parts in your area. We will use the complete lawn mower version for this tutorial.

First off let's discuss using the vertical shaft lawn mower engine, complete with the mower deck, handle and the works. It's a great idea to build this generator on its own mower deck because you then have an instant transportation system built in. We'll also show you a neat little device you can use to help your generator operate under heavy loads a lot smoother. Mount this on the handle next to your throttle and you will have full control of your generator right at your finger tips.

The Basic Parts You Will Need

The Motor



To drive our project we are going to use what is probably the most common lawn mower engine around, the Briggs & Stratton vertical shaft four-stroke gas engine, in the 3 to 3.5 horsepower range. You will have to remove the cutting blade and replace it with a drive pulley. It's important that the motor shaft extend at least 1 ¼" out of the bottom of the motor, as you will want your pulley to clear any obstacles like the motor mounting bolts.

Take a good look at the motor shaft, in most cases you have a 9/16" mounting bolt holding the cutting blade to a hub that's attached to the end of the motor shaft. The hub has a 3/16" key built in it to match the slot on the motor shaft, which is normally 7/8" in diameter. Make sure the motor shaft is keyed so that your pulley can be fastened securely. This will be the easiest set up you can find. If you run into a motor with a shaft that has only a threaded end and no key way, then walk away from this type of set up as it's way to much work and aggravation to attach a pulley to this type of shaft.

The Alternator

Automotive alternators are little power producing jewels that will be the heart of our systems. When driven by a lawn mower engine, we can produce a steady supply of quick, cheap and reliable power whenever we want. You can purchase alternators from Auto wreckers rebuilt or as is with a warranty for about \$ 25.

While shopping around for all the different makes of alternators, Ford, Chrysler etc. We found the GM alternator the most favorable for our systems. There are two types of GM alternators, one with a built in voltage regulator and the other with an external voltage regulator. **Use only a GM style alternator with a Built in Voltage Regulator**, as they are easier to wire up and work with. We had three main goals in mind when we built our generators. Build em' cheap, safe and simple.





We built our projects using two different alternators with a 40 and 65 amp output. You may also run into different size casings of GM alternators, we stuck with the most common sized casing which measures slightly over 6 ½ " at the mounting hole openings. Your alternator should come with a two-wire molded connector/harness that plugs into the casing. You need this connector to hook up your alternator properly later on. Make sure you have it when you purchase or salvage your alternator. If not, you can pick one up at an automotive supply shop for a couple of dollars (more on this later).

The Power Inverter



The inverter is an electronic device that converts low voltage DC (direct current) electricity from a power source into a standard 120 volt AC (alternating current) that we use in our homes. The power generated from our alternator is a low voltage DC usually around 14 volts. In order to maximize our power capabilities we are going to add an inverter to the system. Inverters are sized by the amount of wattage they can output.

In the case of an emergency you will no doubt want to power some 120volt AC devices in and around your home. You will need to decide what you think is absolutely necessary to run during a power interruption and then calculate how much wattage (power) each device consumes.

You can do this by finding the manufactures rating plate on the appliance you wish to operate. Take the amperage rating of the device and multiply this by the household voltage. Example: An appliance drawing 5 amps of current multiplied by the household voltage. (5 amps x 120 volts = 600 watts). Inverters start as small as 50 watts, and an average household would use an inverter anywhere between 2500 to 4000 watts for "normal everyday operation". Their price tags start at about \$40 to approximately \$1000 to \$2000 for the average home. So the choice is up to you as to which size inverter is right for you. Just remember, your planning for an emergency. If you use good power management you can keep your power consumption to lower levels.

Batteries

When we plan for emergencies, we normally store food, water and extra supplies.....why not power? With your home built systems you have the better of both worlds. You can use the generator to charge a battery or bank of batteries then switch over to directly powering a DC to AC inverter for 120 volt purposes. Then you can use your batteries to power up a selection of 12 volt lights and gadgets. You did buy some 12 volt back up lights didn't you? Or you can reverse the process and run your power inverter off the batteries, the choice is yours.



In an emergency you have a readily available supply of batteries around the house to store power. They can be found in your automobile, your motor boat, your spouse's car, your neighbor's, even your mother in law's car. All can be charged quickly and cheaply with your generator.

The Lawn Mower Deck



Here are a few tips for selecting a desirable lawn mower that will keep your time and labor to a minimum. The simpler the design of the lawn mower the better. You will need to bolt a set of mounting brackets and an alternator to the back of the deck, so choose one that is as flat as possible. We are also going to cut a slot in the



backside of the deck so make sure this part is as flat up and down as possible too. Now take a look underneath. Some mowers have a shroud circling the cutting blade, try to avoid this on the rear side of the mower deck, as we want to keep our cutting to a minimum. And make sure your deck is made of metal, stay away from the plastic ones.

Motor Pulleys



We have used two different styles of pulley's, aluminum and cast iron. A strange thing happens when you remove the cutting blade and hub off your lawn mower engine..... It will not start! The flywheel on your motor is most likely made of lightweight aluminum and it needs the extra weight and momentum of the cutting blade assembly to rotate it through a complete revolution. A flywheels main purpose is to store energy so it can carry the crankshaft through the 3 non-power strokes of a 4-stroke engine. So, the flywheel must shoulder the burden of the rotation for 75 % of the time. If you take away some of it's mass on the motor shaft, it will not run smoothly, heck, it won't even start. So if you have a lightweight flywheel you're going to need a pulley with some weight on it.

So, how do you tell if you have a cast iron or a lighter aluminum flywheel? Take your blade and hub assembly off your motor shaft and start pulling the cord. If after 4 hour's you haven't started the engine, well.... it's a pretty good bet that your flywheel is aluminum and you will have to use a heavier cast iron pulley. Or you can remove the top motor shroud that reveals the flywheel area, put a magnet near the flywheel fins. If the magnet doesn't stick, it's aluminum, if it does stick then you have a heavy cast iron flywheel and you can get away with using an aluminum pulley.



Our motor shaft was $7/8$ " in diameter. It seems that as soon as you look for a pulley with a bore bigger than $3/4$ ", they are very difficult to find in the normal "Retail" stores. So we went to a bearing and transmission shop to buy our pulleys. We found aluminum pulleys gave good service but they didn't stand up to the long hours and wear and tear, as did the cast iron pulleys. So we opted for a cast iron pulley from a company called TB Woods. It uses a system with two parts, an inner bushing and a main pulley. The inner bushing has a split in it. When you tighten these two items together with the mounting bolts supplied, the split bushing closes onto the shaft with a tremendous grip. The pulley was also keyed, so once it's installed, it stays put. We used $1/2$ " wide pulleys on all our projects, with diameters ranging between 3" and 6". We'll discuss the proper pulley diameters later on.

Belts

We stuck with half-inch wide belts to simplify things. We also found out that not all belts are the same. Our alternator is designed to work best with an automotive type belt and our motor pulleys were designed to work best with utility/industrial belts. So, what's a fellow to do?

An automotive belt has a sharper angle or "pitch" on the side of its surface, so it will ride deeper in the motor pulleys. And if you are using a cheap pulley, it will start wearing a groove in the side of the pulley.

The better choice is the industrial belts, but we have differences here too. The half-inch industrial belt is covered by two different styles, the "L" series and the "A" series. The "L" series belt is designed for fractional horsepower applications....light duty. On the other hand the "A" series belt was designed for full horsepower applications, heavy duty. It has more polyester cords built into it for more strength and durability.

We tried all 3 different types of belts and they all worked fine. For short-term use you can get away with using the "L" series fractional horsepower belts or the automotive belts. For heavy work loads and long term use we found the "A" series industrial belts gave us the best service. We purchased our industrial belts at the same place we got our heavy-duty pulleys, a commercial bearing and transmission shop. The general all-purpose belts can be found in the furnace sections of your hardware and building supply shops. And of course the automotive belts are available at your local garage or auto supply shop.

In Our Next Section We Will Show You How To...

- Find a good used lawn mower the cheap and easy way
- Easily modify your mower deck to install the items
- Assemble the mower and items into a working generator

To Continue[Click Here](#)

MENU: [HOME](#) » [Reconstruction](#) » [Recovery](#) » [Renewal](#) » [Energy Types](#)

How to Modify Your Lawn Mower

You're going to have to modify the deck of the lawn mower somewhat, so you might not want to use the family's mower unless you're in a pinch. And don't use the one you borrowed from your neighbor either. You can pick up good used lawn mowers for a song, try garage sales, your local penny saver and newspaper classifieds. We put an ad in the newspaper stating " Wanted good used Lawn Mower" we then pleaded poverty and we got a dozen phone calls with great results spending only \$25 dollars for a good mower with all the features we needed.

Okay lets get started, but first a word from our friend "Larry the Lawyer". **If you build this generator or something similar, you must build it at Your Own Risk, and assume all risks related to it's construction and subsequent use. This tutorial is intended for educational purposes only. No guarantees are expressed or implied as to the accuracy of the information presented here. If you have any doubts consult with the experts you purchase your parts from, before attempting to carry out any of the procedures mentioned here.**

Okay, lets get started tearing this baby apart. First remove the handles and cables. The removal is pretty straight forward with just a screwdriver. You can re-attach the throttle cable later or you can control the engine speed at the throttle control near the carburetor. You will most likely have a second cable coming off the handle to the flywheel brake, a safety feature introduced onto walk behind mowers in the early 80's.

Remove the cable at the handle and the brake lever next to the flywheel, you can leave the brake lever as is just flopping around (it may create some drag on your motor) or you can easily secure it off to the side. If you're not sure which side the lever should be positioned, just pull the starting cord. If it's difficult to pull, the brake is on, if it's easy, the brake is off, now tie the lever off with a twist tie or wire in this position.

Removing the Blade Assembly

Some of these blade hubs can get seized onto the shaft pretty bad after many years and acres of cutting grass. Spray some kind of rust loosening compound onto the area (WD40, RustBuster) if this doesn't work, you will have to use a pulley puller to remove the hub. We schmoozed our local machine shop proprietor into lending out his puller for free, we just left a deposit so he knew it would come back. Now, while your underneath and have the WD40 handy, spray the 3 or 4 mounting bolts you will find holding the motor to the deck. Spin the bolts out and remove your motor for the next couple of steps.



Cutting the Slot



The rear end of the lawn mower deck is a very convenient spot to mount our alternator with a couple of simple metal brackets. But you have to cut a slot in the back of the mower in order for the belt to reach from the motor pulley to the alternator.

You need to cut the slot 6" wide by 1" to 1 ½" tall on the rear vertical side of the lawn mower deck. You can cut this slot quite easily by using an Oxy/Acetylene cutting torch or you can use a grinder with a cutting wheel. And if you're in a really

energetic mood, you can cut it by using a hacksaw.

We need to know exactly where the belt will come through the back off the mower deck, so we know where to cut our slot. So, let's install our motor pulley briefly so we can line up where our belt is going to come out the back. Place the motor pulley as far up the engine shaft as possible and yet still give it enough room to clear all obstacles such as mounting bolts. Now, look through the grass discharge chute. Place a straight edge on the bottom of the motor pulley and determine where the path of the drive belt will end up coming out of the back plate. Mark this spot. Now make this spot the exact center of your 6" by 1 ½" slot. Remember your belt is only ½ " thick so you will have plenty of clearance in case the spot you marked is not exactly centered.

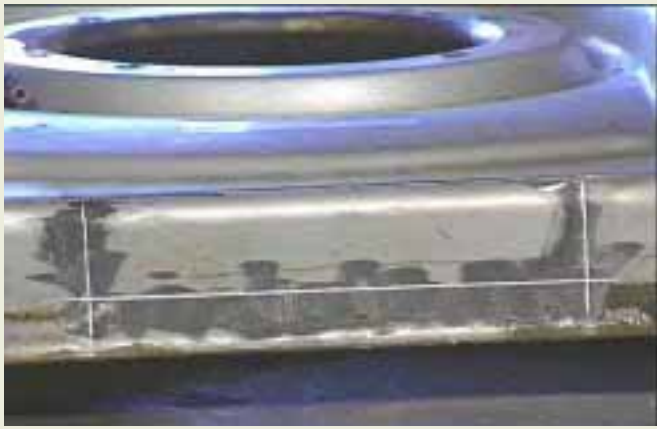

Make sure to remove your motor once again before you



start your cutting. Now cut your slot using the methods described earlier. If you decide to use a hacksaw, you might not be able to cut a "slot." Instead you will have to cut an entire 6" wide piece out from top to bottom. No problem, just bolt a strip of metal or angle iron for a crosspiece along the bottom of the mower deck, to give it some strength again.

Assembling The Project

Mounting the Alternator

In order to mount our alternator we are going to use brackets made from a slotted steel material commonly referred to as angle iron. The dimensions of the angle iron were 1 ½" wide and 1/16" thick. The pre cut slots in this material made it very convenient to make an adjustable bracket for the alternator. The 90 ° angling of the metal gives it a lot of added strength, but it was also very easy to cut by hand using a hacksaw.



On the left hand side is our pivot bracket which we cut to a 7" length. On the right is the adjustable bracket, cut it to a 9" length. The pre-cut slots on this angle iron will allow you to move the bracket front to back so you can have the belt tension adjustment you need. On both brackets we want about 5" contacting the mower deck.

Now drill mounting holes on your mower deck 6 ½ " apart width wise and 2" to 3" inches along the length of the bracket depending on the pattern of the slots on your angled bracket

material. Drill your holes 3/8" thick with the first set of holes 1/2" from the back edge of the mower deck.

We extended the slots in the right hand adjustable bracket by cutting the metal with a hacksaw so we could have a wider range of belt adjustment. Use 5/16" bolts with lock washers, now fasten the ends closest to the motor. Even though we selected a relatively flat mower deck, we still have some uneven contouring to deal with. No problem, we just use spacers on the two mounting bolts closest to the edge. Use whatever you have lying around your house, in our case thick washers and a couple of 1/2" nuts worked perfectly.



Now take your alternator and mount it with the pulley facing down. One side of your alternator has a longer molded mounting hole in its casing, this side will become our pivot side and is mounted with a 3" bolt. The right side of our alternator now becomes the adjustable side. You will need a shorter 1 1/2" bolt to fasten it to the bracket. Use lock washers with your nuts and bolts as well.

Attaching the Pulley and Belt

Position your alternator so that the fan blade clears the mower deck between 1/4" to 1/2". If it's too far away from the deck, you will notice more vibration. Now flip the whole unit over and attach your motor pulley, we used a 5" diameter pulley (more on this later). Next, we need a drive belt, but what length? Here's a tip for getting the right size belt on your first trip to the store. Measure the distance between the two outer edges of the alternator and motor pulleys in their final position. Mark this measurement down. Decide ahead of time if you want the lighter duty "L" series or the heavy duty "A" series. Now head down to your local building supply or commercial bearing store to buy a belt.



When you get there take 2 pulleys off the shelf with the same diameter as your alternator and motor pulleys. Next place a 1/2" belt around them and stretch the belt out. Do this until you find a length of belt that matches the measurement you marked down from your project at home. Don't do what I did. I drove down to the store with my whole project in the trunk of

my car, then ran back and forth into the store exchanging belts until I found one that fit, all the while looking like a complete dork!

Now, place your belt onto the pulleys, grab the right side adjustable bracket with a pair of Vise-grip pliers, pull toward you until you've reached a desired belt tension and then tighten the mounting bolts. Your next step is a simple wiring of the project.

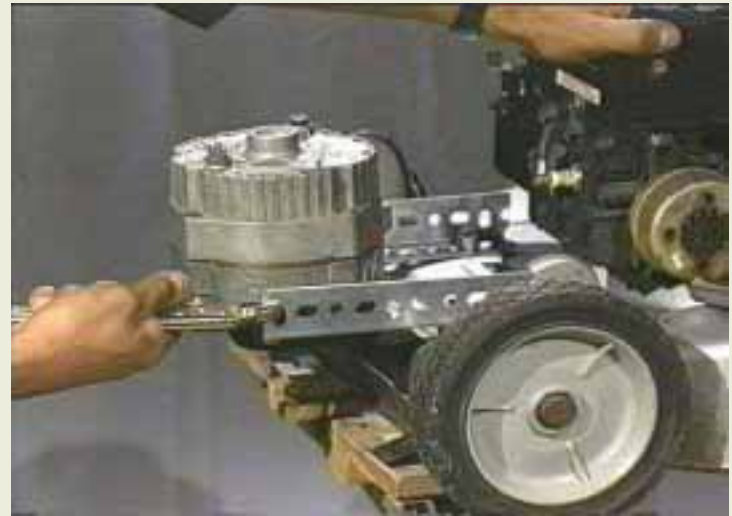

In The Next Section You Will Discover...

- A simple way to wire up your alternator, battery and accessories
- Some neat electrical gadgets you can use in your project
- Some electrical tricks to get the most out of your generator

To Continue...[Click Here](#)

Hooking Up Your Electrical Connections For The Alternator

As was mentioned before, because of safety and ease of hook up, stick with the GM style alternator with a Built in Voltage Regulator. If you are not sure, ask the people you are buying the alternator from, if they can't answer your question consult an automotive parts professional. **"No guarantees are expressed or implied as to the accuracy of the information presented here. If in doubt consult an automotive wiring professional before you attempt any wiring."** If you make a mistake wiring the alternator you run the risk of damaging your batteries, electronic gear and worst of all causing personal injury. We set out to make this project safe and simple, so we are going to concentrate on the easiest hook up.



The electrical connections for your alternator are a simple but important 4-wire hook up. It was mentioned earlier that the GM alternator should come equipped with a 2 wire molded connector/harness. If not, ask for it at the point of sale or you can purchase one at an auto supply store. Ask for a 2-wire harness plug for the GM style alternator with built in regulator. They only cost a couple of bucks.

Attach your harness into the connector slot on the alternator casing. The molded harness only fits one way and ensures you don't get your wires mixed up, so Make Sure You Use It ! You might also want to attach eyelet connectors to the end of the two wires on for your convenience.

Different molded connectors may have different colored wires. We are going to ignore the color of the wires and instead concentrate on the wire identification numbers and letters on the alternator casing. Here are your basic hook ups.

Basic Hook Up

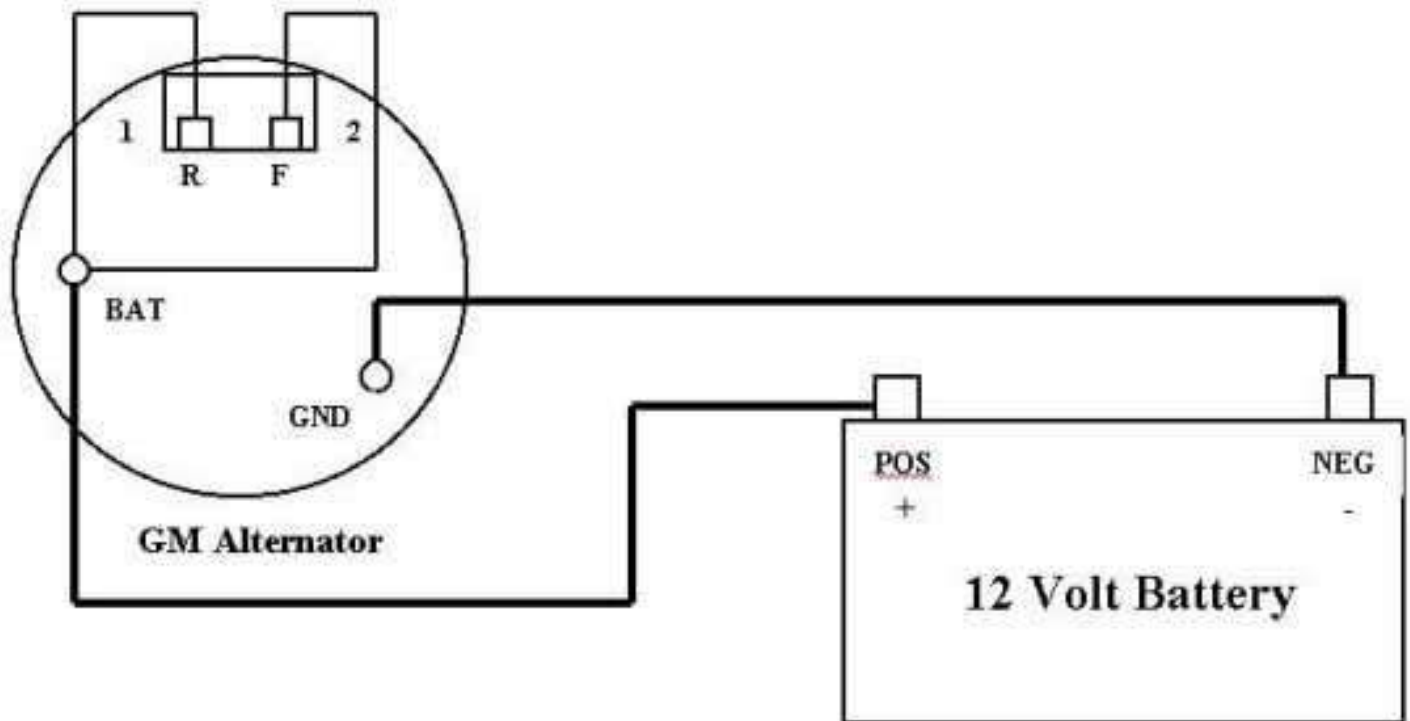

Consult a parts professional for additional wiring information.

1 or R Terminal is the lead that supplies power to the rotor field of the alternator. Connect this to the "BAT" terminal of the alternator or the POSITIVE terminal of your battery. NOTE: when you are not using your system you have to disconnect this lead as it is now drawing power from your battery and will continue until it's completely discharged.

2 or F Terminal is the voltage sensing line for the alternator. Connect this directly to the "BAT" terminal on the alternator or to the POSITIVE terminal of the battery as well.

On/Off Switch

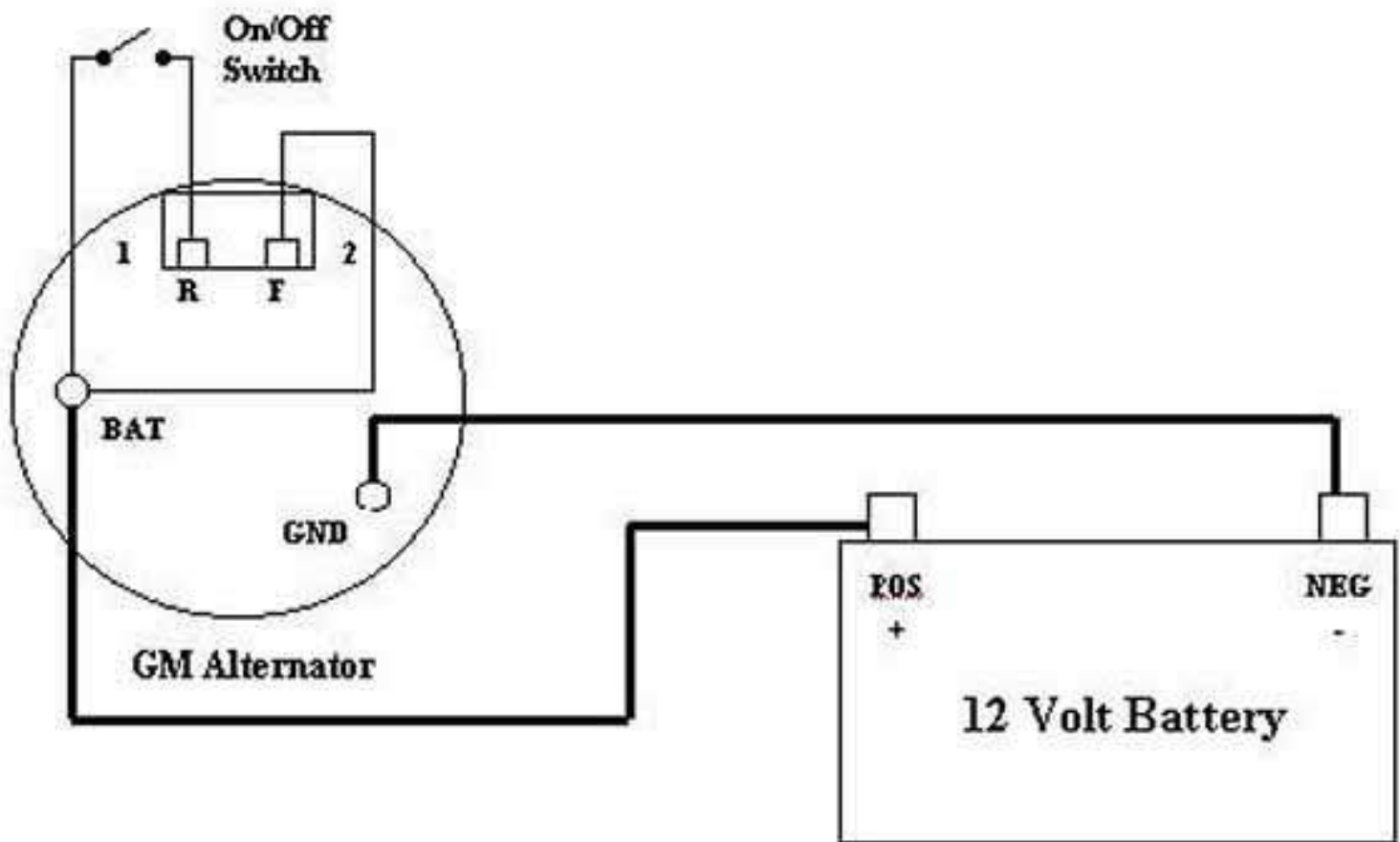

Consult a parts professional for additional wiring information.

1 or R For safety and convenience reasons we have installed a simple on/off switch in the # 1 circuit. When we are not using our generator we can simply turn the switch off and it will preserve the charge in our battery. Another important note is that when this terminal is energized, so is the rotor field inside the alternator.

You will now notice a lot of drag when you try to turn the alternator. Go ahead and try to start the motor, you will pull that cord until your tongue hangs out. You will need to start the motor with the switch "off" then throttle up to your desired speed. You can then turn your switch "on" and introduce the electrical load to the alternator and motor.

This switch also allows us to avoid "sparks" during the unsafe practice of hooking up wires to the battery and alternator while the generator is running. In the presence of vapors coming off the batteries and gas tank, it's a good idea, so PLEASE USE IT !!!

Some Testing Results

What is the ideal size pulley to use?

I hear the subject debated at great lengths. Actually any size pulley between 3" and 8" will work, but there are some differences. An 8" pulley will spin your alternator at a high r.p.m. but will give you very little torque. When it comes time to engage your alternator, it will drag your motor down until it stalls. A 3" pulley on the other hand will give you lots of torque, but a lower r.p.m. at the alternator pulley.

We have discovered that if we try to duplicate what goes on underneath the hood of a car and apply this to our home built generators, we will come up with some favorable results. A quick peek under the hood of a car tells us the motor pulley should be about 5" to 6" in diameter. We found this diameter of pulley gives us an ideal r.p.m for the alternator, with an adequate amount of torque too....But.

Motors With The Same Horsepower Do Not Have The Same Output

We discovered another neat characteristic of the Briggs & Stratton **Vertical** shaft lawn mower engine. We have a **Horizontal** shaft Briggs & Stratton motor of the same horsepower. And we consistently get higher revs from the horizontal shaft motor. We couldn't figure this out at first. Both the motors were in good shape well tuned etc, but? So, I searched through the motor technical manuals for the answer.

According to manufacturer specs, they set the throttle on the vertical shaft mower to approximately 80% of its maximum output. This gives the motor a nice little feature when a schlep like me starts cutting into foot tall **wet** grass. When the motor bogs down, a device on the engine called a "governor" senses the drastic drop in RPM's and immediately allows the engine to throttle up to overcome the extra load, so the motor will not stall. When the patch of wet grass passes by, the engine then throttles back to its normally set speed.

So if you come along and decide to attach a belt and an alternator to this motor (like we just did) fire it up, engage your alternator and dump the load on the motor. Guess what? The motor is gonna think it's in wet grass Heaven. So, if you're using a 5" pulley on your project like we did, you may find that the motor will be dragged down to a stall even with a moderate load applied to it. So, how do we solve this? Well there are a couple different ways. One is to reduce the size of your pulley.

We experimented with a 3" pulley and got some good results. The smaller pulley lets the alternator produce its voltage at significantly lower throttle settings, the trade off of course is a lower amount of current (power) coming out of the alternator.

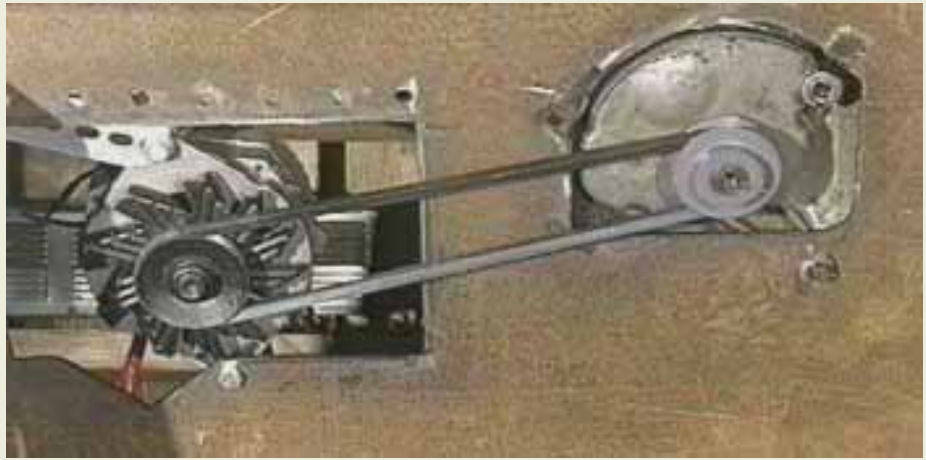

Or,...there is another option. We discovered a handy little gadget that helps us solve the problem of engine stalling when you engage the alternator. It's a GM style headlight/dimmer switch. We installed this into the #1 (R) circuit of the alternator harness. The adjustable dimmer in the switch is actually a variable resistor or otherwise known as a rheostat. It works by using resistance to adjust the flow of current to the alternator's rotor field. The more resistance you have, the less current will flow. This in turn creates a weaker or stronger magnetic field in the alternator, which will then give us more or less power off the alternator. Huh?



Let me explain it in a more practical sense. Let's say you have a generator like we just built operating at normal running speed spinning a 40 Amp alternator. You decide to charge a very low battery. Even if you rev up the motor, when you go to attach your lead from the alternator to the battery, the alternator is going to sense a low battery charge and will try to output a large amount of current. This creates a huge drag on the alternator which in turn bogs down the motor usually until it stalls.

But, this is what happens when you have the dimmer switch in the #1 circuit. You set the switch at its highest resistance level. Now start turning the knob slowly counter-clockwise. As you keep turning the knob to the left, the resistance level in the switch drops allowing more current into the alternator's rotor field, which in turn allows more alternator output. You will notice at this point the alternator is now starting to "load" the motor. The beauty of this method is while you slowly turn the switch and load the motor, you can now offset the load with a higher throttle setting on your motor. You can then adjust the switch some more, then increase the motor revs some more until you get a desired speed, without stalling. This system allows a nice gradual smooth adjustment of the alternator's output. It works really slick, try it. And the switches are cheap too, we picked up ours at an auto wrecker for 5 bucks.

Variable Resistance Dimmer Switch Hook Up

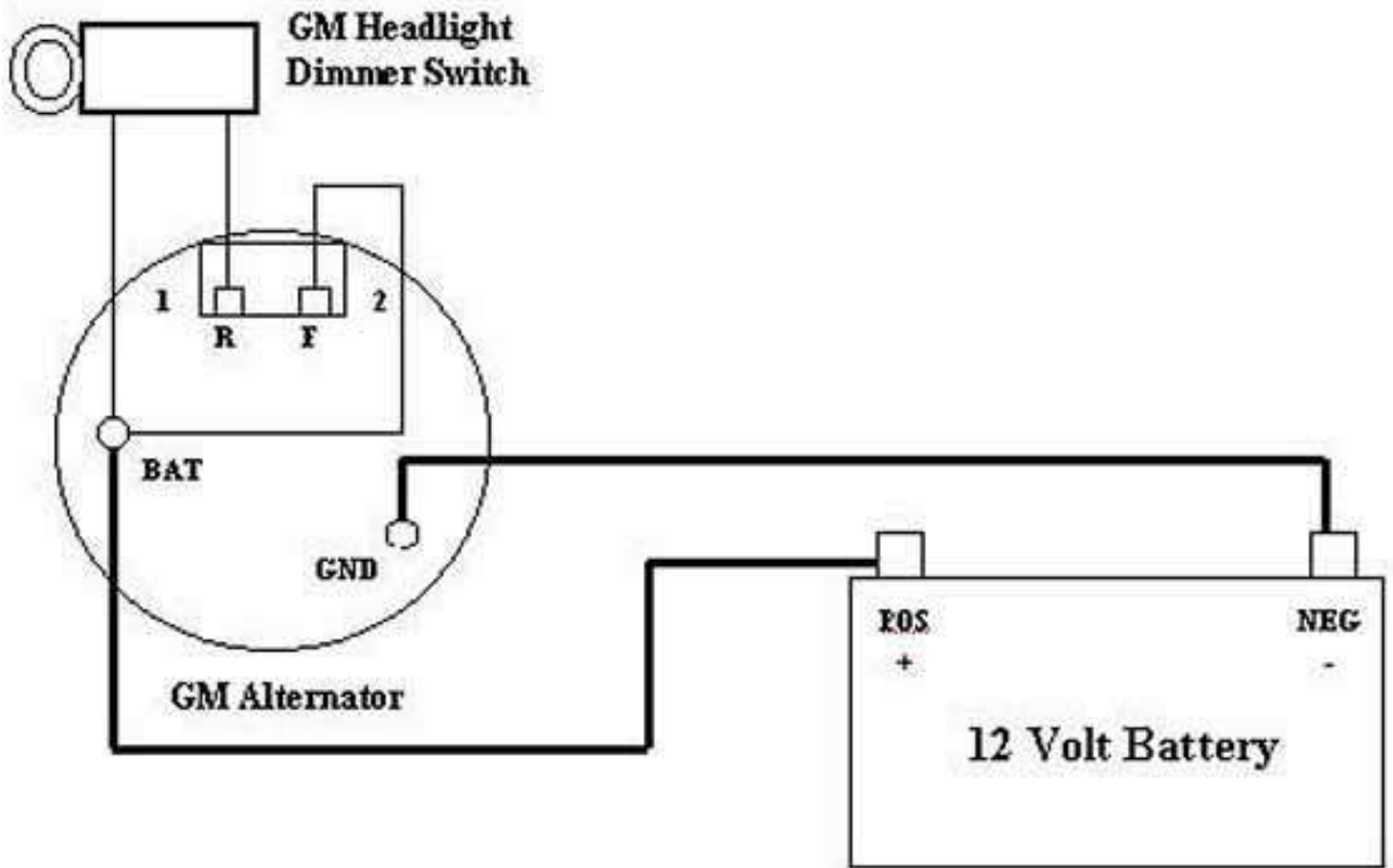

Consult a parts professional for additional wiring information.

Which one of these two methods will work better for you? It's hard to say, depending on the type of motor you will use. How old is it? Is it tuned up? What kind of parts you installed on your project? No two set ups are the same, but at least you have some options. Try what works best for you and stick with it.

Some Final Notes



You can now re-attach your handles. A really handy option is to hook up your throttle cable again and then mount your GM dimmer switch next to your throttle control on the handle. You now have complete control of your generator right at your finger tips.

So, there you have

it. You are now armed with the information to be electrically independent should the need ever arise. Stay healthy and stay powered.

Copyright © 1999 Gemini Media Productions Inc All Rights Reserved

MENU: [HOME](#) » [Reconstruction](#) » [Recovery](#) » [Renewal](#) » [Energy Types](#)

Wind Powered Generators

Many more people will have wind as a resource than will have water as a resource. The principles of building a generator remain very much the same for both but wind has a number of special considerations and anyone considering this as a resource should look at the pages linked below:

Towers: [You have to get them up in the air](#)

Blades: [Or what some people call propellers](#)

Tails: [And mounting the generator](#)

Overview: [Forcefield Overview of Windmill Design.](#)

This is a good overview on Windmill generating systems from Forcefield.

SEALED: [Forcefield Overview of Windmill Design.](#)

This is the SEALED mirrored version of this site from Forcefield that won't be opened until after The Great Catastrophe.

Designs: [Designs for complete wind generating units](#)

Most homemade windmill generator systems need a LOW RPM generator and you will find under our above linked webpage many designs applicable to windmill generators.

Testing: [An important step](#)

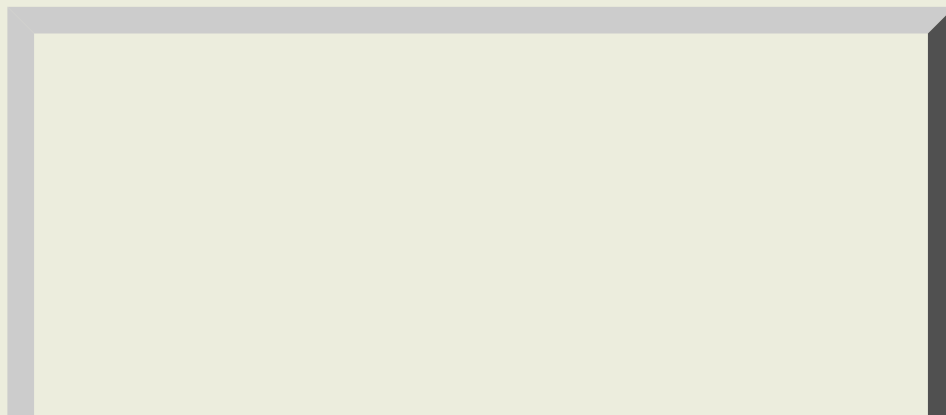

Batteries

Another essential subject to wind generator systems is batteries to store excess power in times of high generation and to make power available when there is no wind. Batteries are discussed on another one of our other web pages.

MENU: [HOME](#) » [Reconstruction](#) » [Recovery](#) » [Renewal](#) » [Energy Types](#)

Towers

Towers

Wind is wonderful. Sometimes. What we are talking about here is more than a gentle breeze. If you live where there is a fairly steady breeze you may have more than you imagine - forty feet up. No matter where you are you want to build a tower at least 40 feet high to get away from ground effect. The wind blows much smoother and steadier (and often times stronger) higher above the ground.

This one is at a nearby friend's home who actually has a half dozen. He is in his eighties and his father built them when he was a boy. Sort of "grandfathered" because it is something we couldn't do today. The point here is that towers can be complicated and dangerous. Can you imagine climbing up and down one with a heavy generator that needs repair.





The towers that I have been admiring (like this one at Bob Budd's) are poles built out of Schedule 40 pipe. (Schedule 80 is too heavy to handle and anything less than Schedule 40 gets pretty weak. Schedule 40/80 measures the wall thickness of the pipe.) Guy wires should be well below the blades so a blade doesn't get chipped.

The bottom of the pipe pole is hinged between a couple of well planted (concreted) H beams and a pipe extends 15 feet out horizontally from the bottom of the tower pole with a diagonal pole to a spot 20 feet up the tower pole to strengthen it. This pipe triangle is then anchored out at the front and released (along with a front guy wire) in order to winch the pole down backwards or back up again. This arrangement makes repairs and periodic maintenance much simpler and one could get the wind generator down and protect it if they had enough warning about a big storm.

[Overview: Forcefield on Tower Design.](#)

Forcefield also gives a good explanation here about tower design.

[SEALED: Forcefield on Tower Design.](#)

This is the SEALED mirrored version of this site from Forcefield that won't be opened until after The Great Catastrophe.

MENU: [HOME](#) » [Reconstruction](#) » [Recovery](#) » [Renewal](#) » [Energy Types](#)

Blades or Propellers

There are volumes of books about blade design. It is one of the most discussed and theoretical aspects of wind generators. However, there seems to also be a body of thought that many simple designs will work relatively well. One can spend many days (as we have for ours) in making a set of blades or there are blades described here that people say that they have put together in a matter of just a few hours.

My thought is that in a nuclear recovery situation the idea may well be to get something up and working as quickly as possible and then once one has the opportunity to do so there is much information here that one can use to experiment and make up their own mind about the trade-off between the efficiency gain from blades that take much longer to build and those that work less well or don't last as long but are quicker to make.

Propellers: [Technical info on how to build blades](#)

This is a 13 page .pdf file from Hugh Pigott and it is chuck full of very technical diagrams and charts.

Propellers: [And still more info on how to build blades](#)

This is a 27 page .pdf file from Hugh Pigott with many more diagrams and pictures that may be even more helpful.

Blade Design: [Some neat diagrams on blade design.](#)

This is the Windstuff Now site.

SEALED: [Some neat diagrams on blade design.](#)

This is the SEALED mirrored version of this site that won't be opened until after The Great Catastrophe.

Blade Design: [A blade in one hour.](#)

This is a Windstuff Now site on how to make a blade in one hour.

SEALED: [A blade in one hour.](#)

This is the SEALED mirrored version of this site that won't be opened until after The Great Catastrophe.



The blades for windmills are designed and work just opposite of those for airplanes.

We are carving ours out of basswood because the wood is "clear" (that is to say the wood has no knots). Other kinds of wood will do, but there is a real art to carving the blades. On my right is a block that we start with and on my left the almost finished propeller blade.

Immediately following are the drawings that Ed drew for our blades.

Ed's Blade Drawings

In this first drawing you see the rough shaped block of wood and how it is marked out into "stations".

Take note that there is a **leading** edge and a **trailing** edge.

The leading edge is wider and blunt. The area behind the trailing edge is what is being cut away.

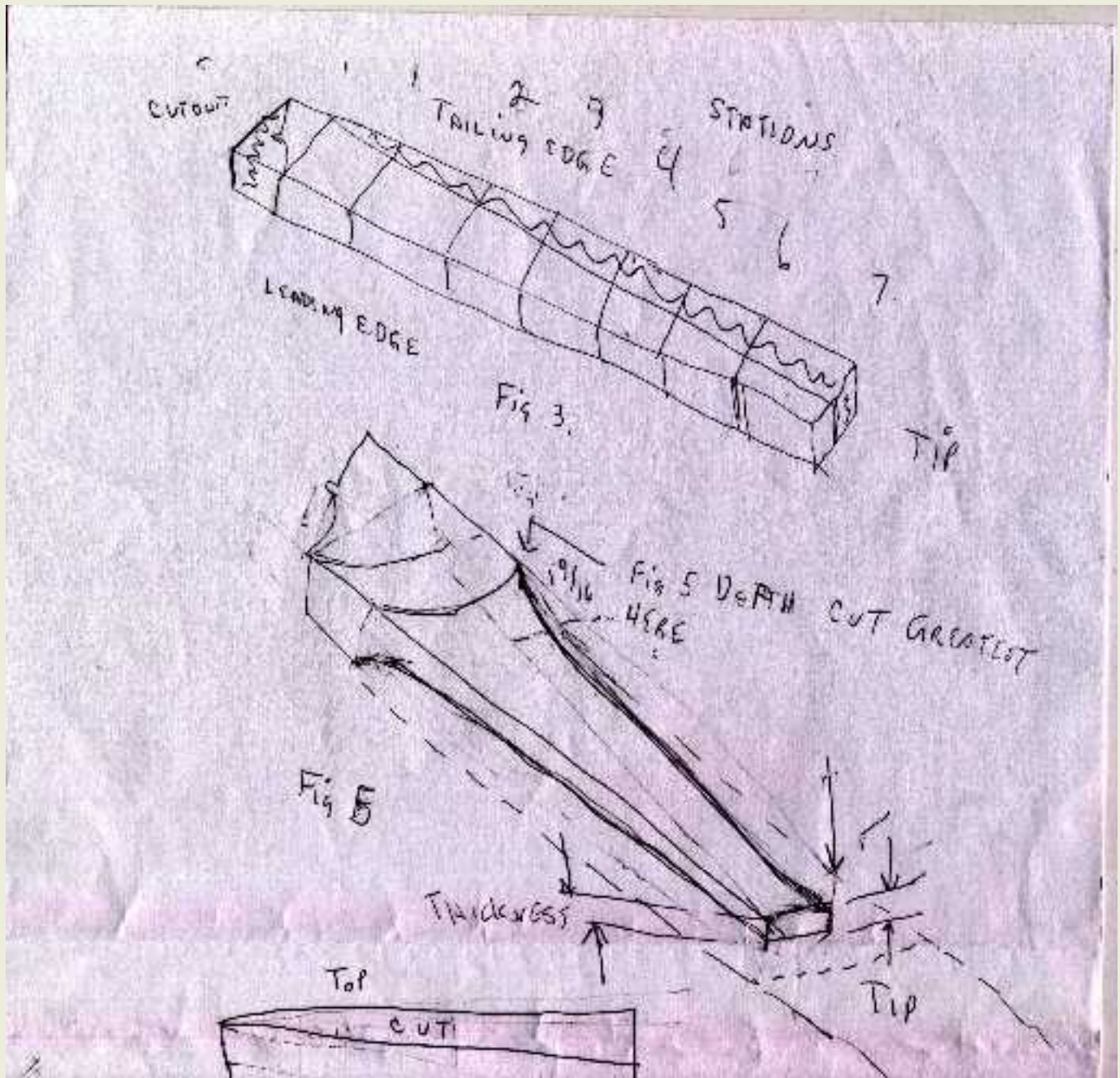

The trailing edge will be cut to a thin knife edge, but in the drawings immediately above and below it is still blunt. This shows a cross view of section 7 which is the very tip of the blade.

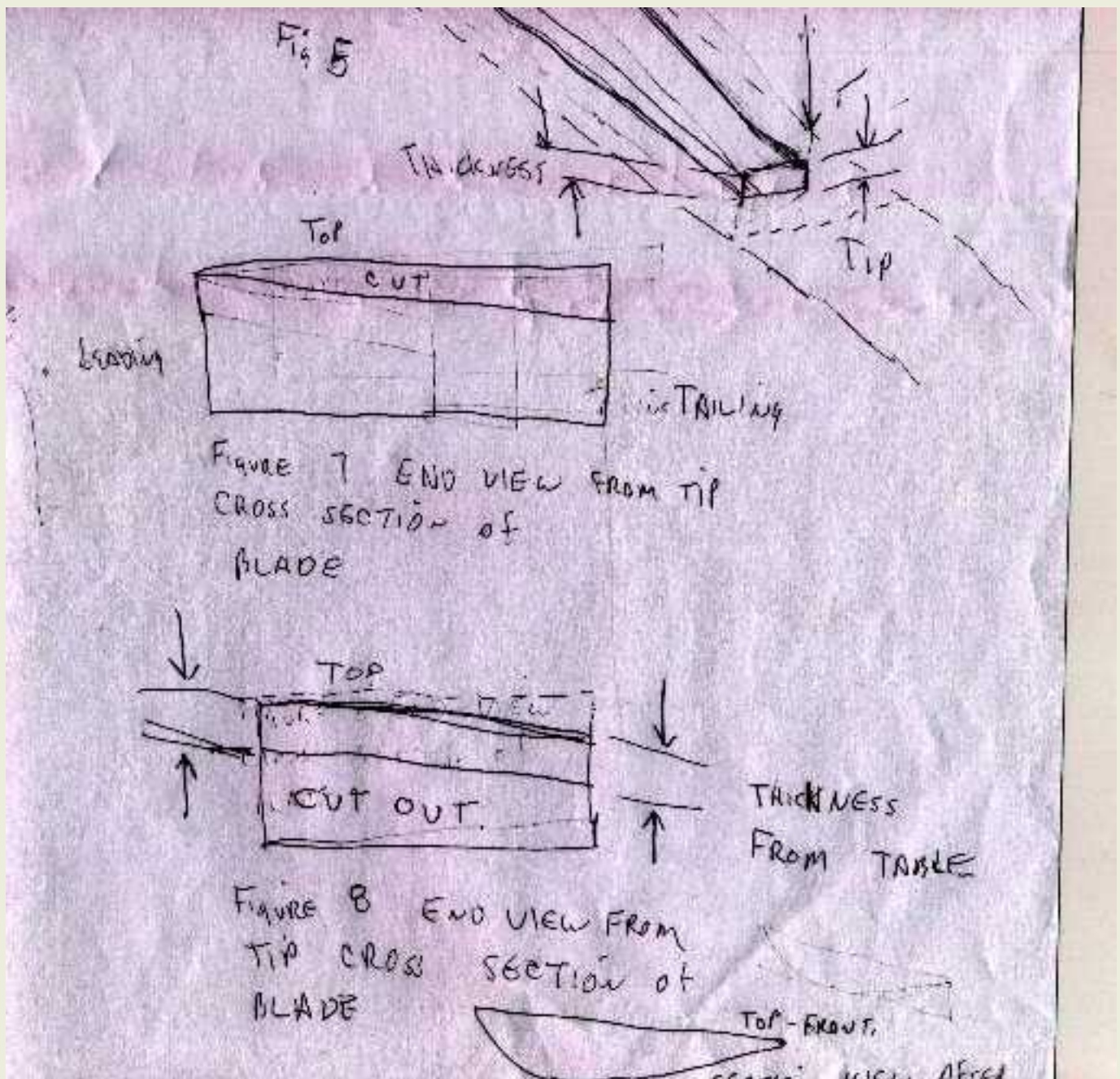

Each of the following drawings, starting at section 2 immediately below and going through each drawing up to section 7, show a cross-section through the wood as to where the finished blade will lay at that point. The depths change at each station because the blade has a twist to it.

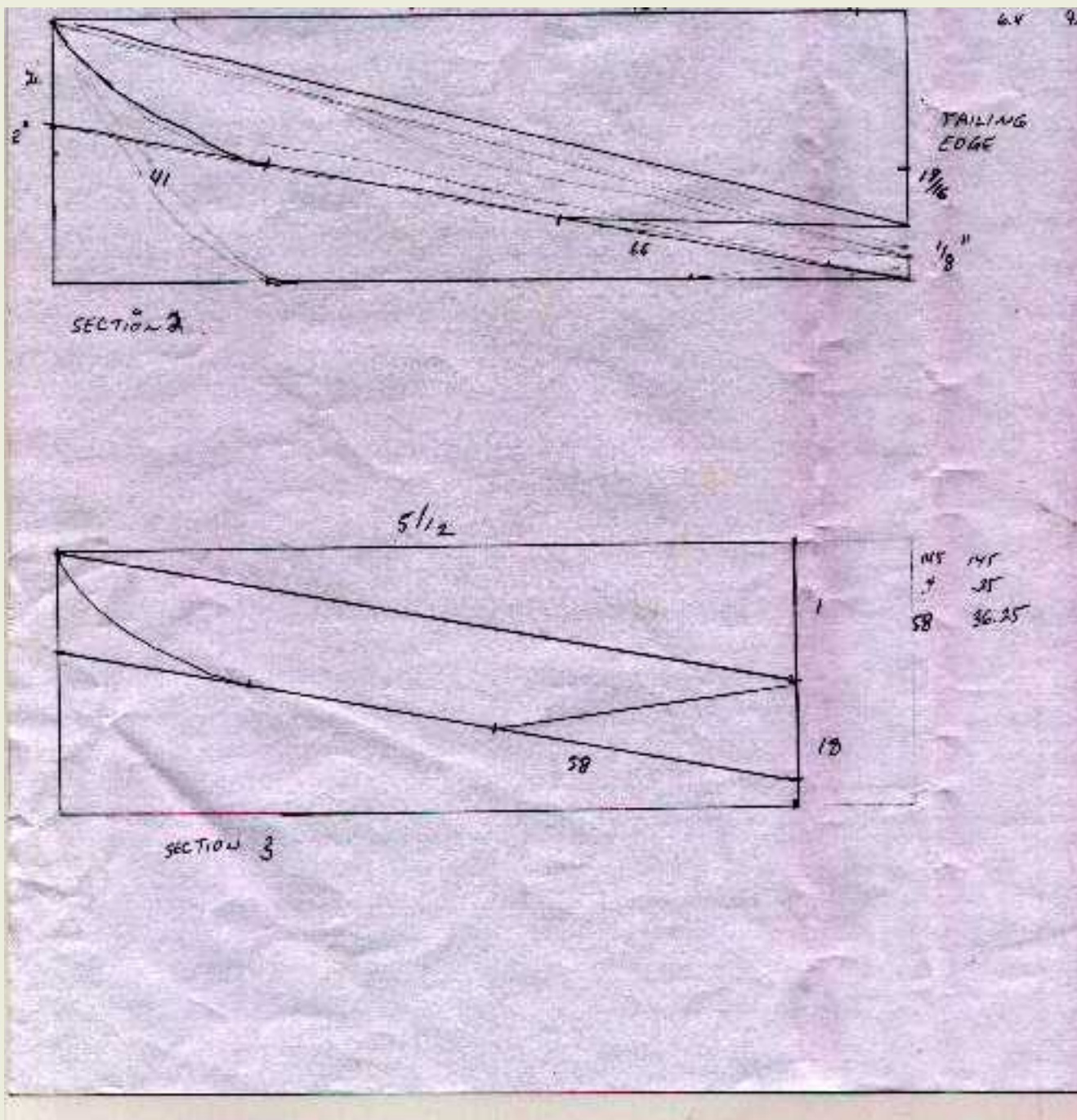

The table on this next drawing shows the thicknesses - at each station.

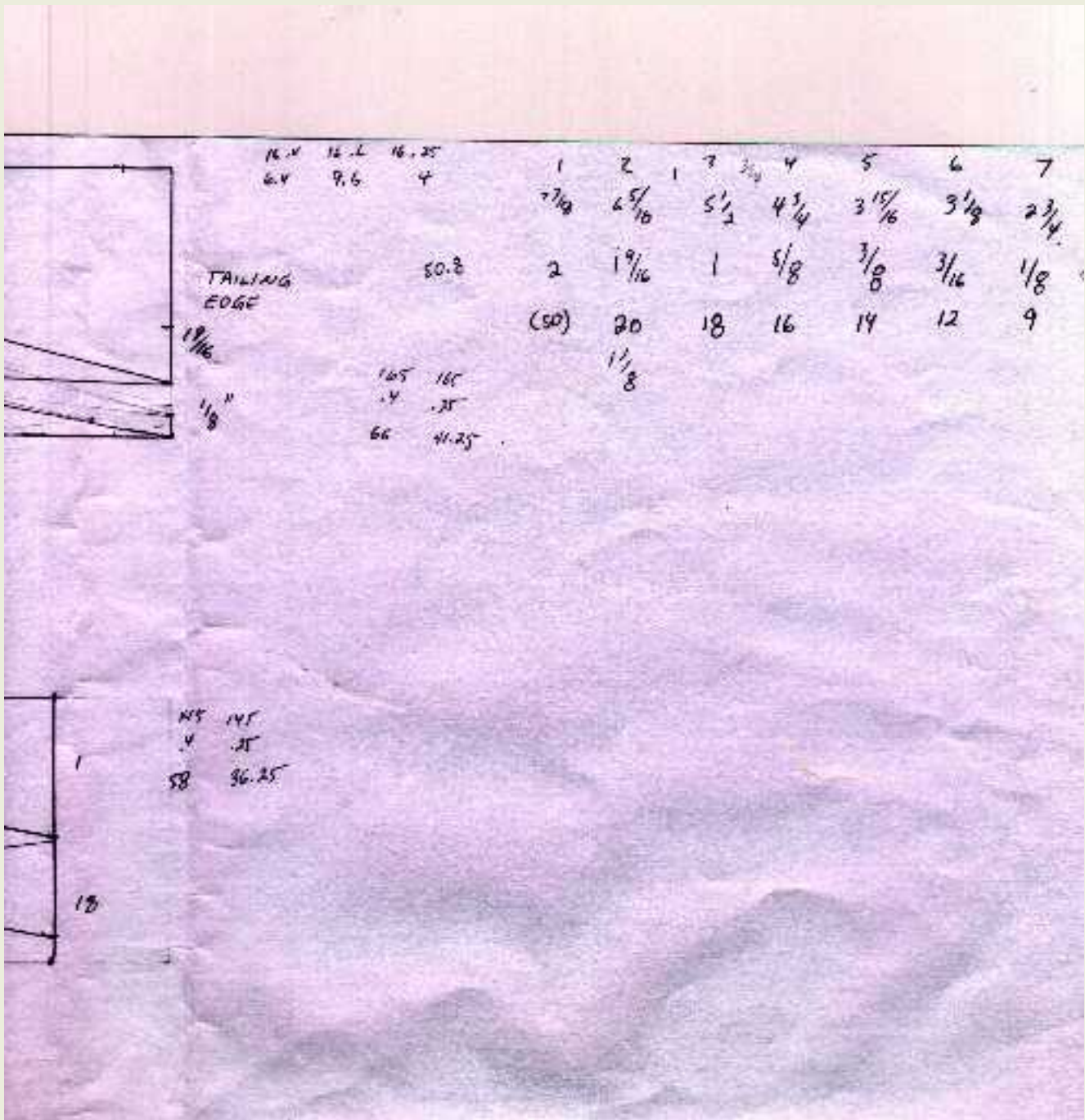

It can be seen from the end view of the block - that about 80% of the wood is cut away in making a blade.

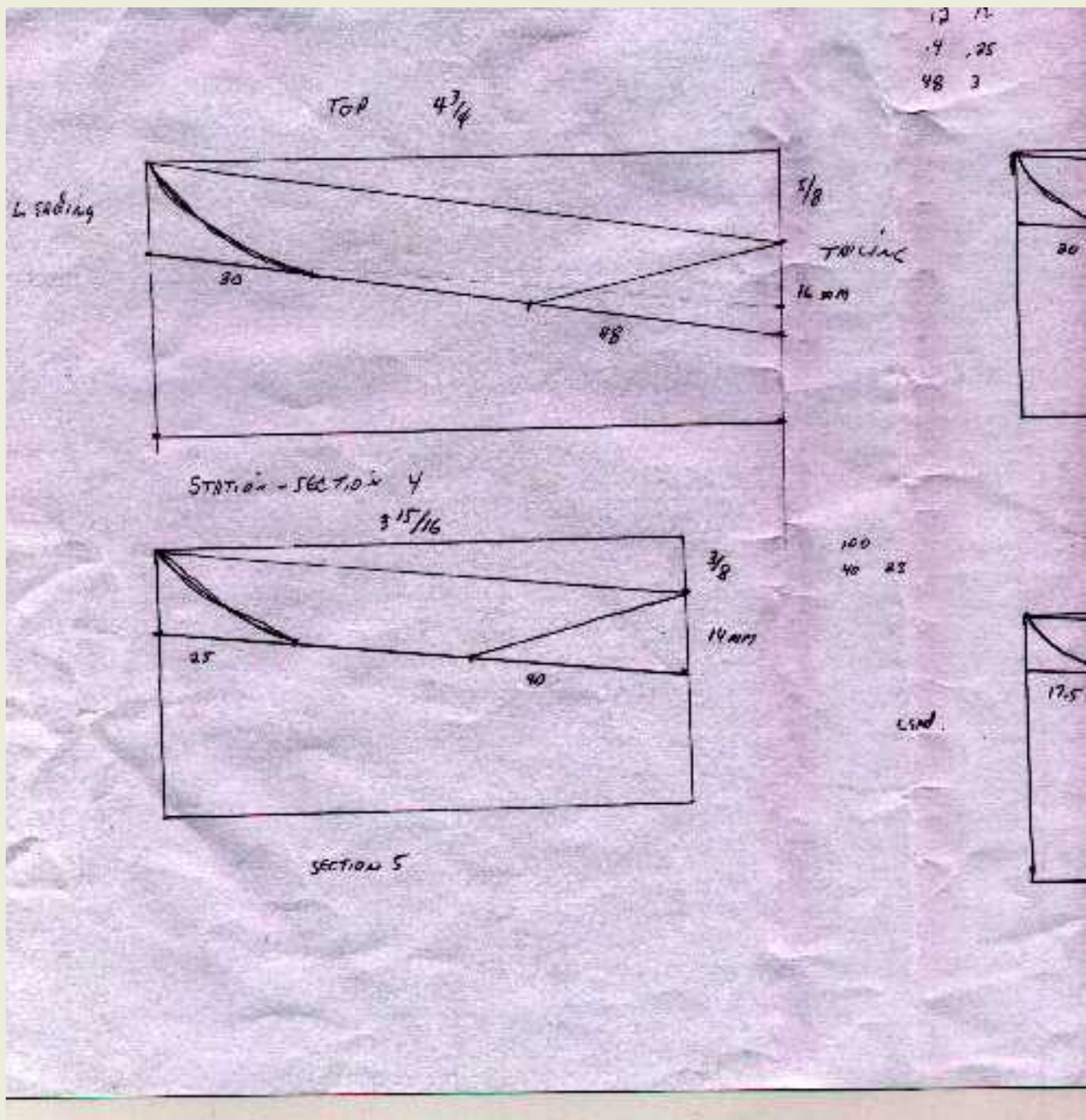

After the blade is sanded and finished it is a good idea to armor the leading edge that bites into the wind - otherwise it will quickly wear down. Armoring can be done with a heavy epoxy or resin - laid on an eighth or more on an inch thick. Periodic maintenance and re-armorng will preserve the blade - and greatly increase its longevity.

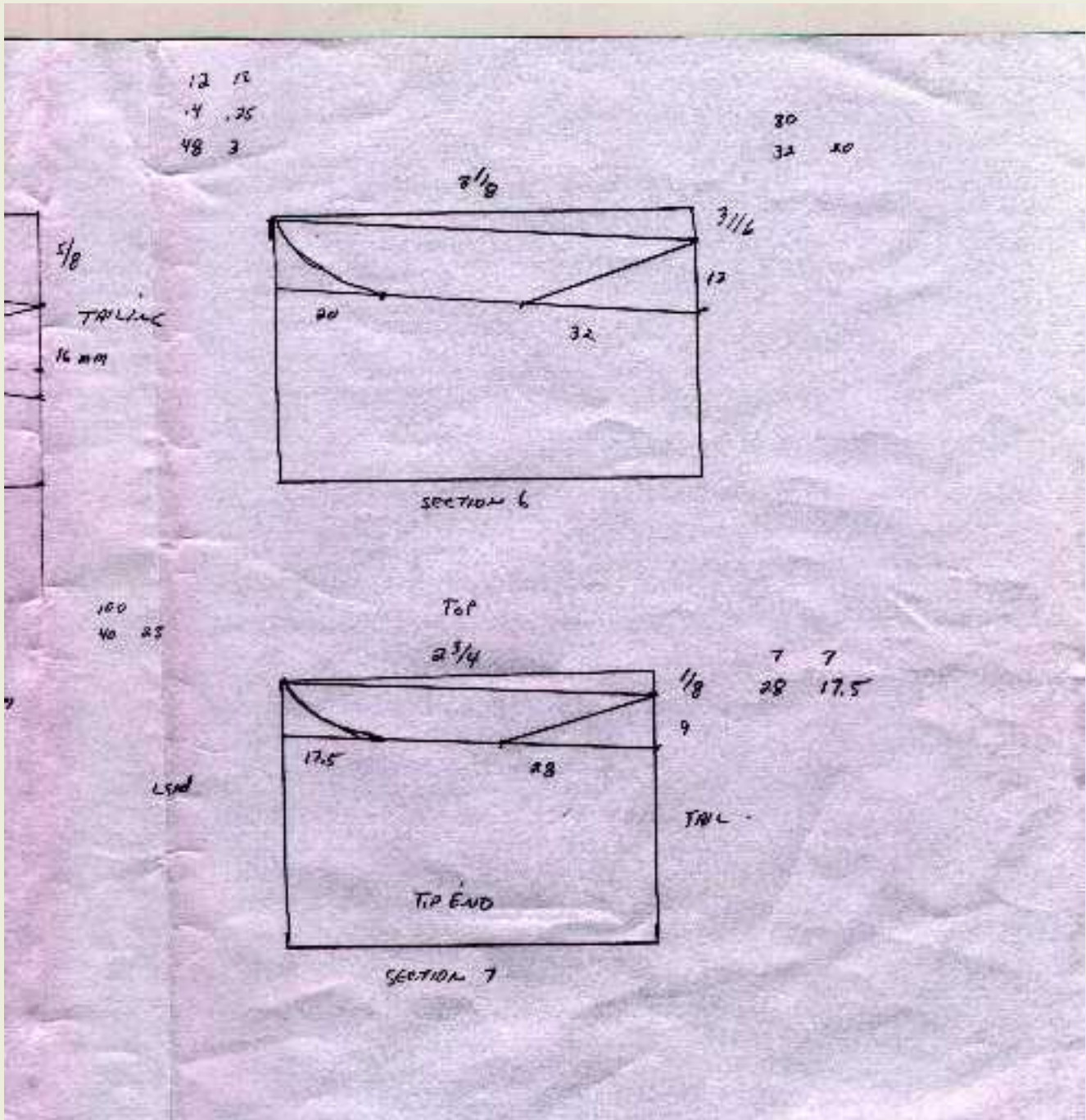

MENU: [HOME](#) » [Reconstruction](#) » [Recovery](#) » [Renewal](#) » [Energy Types](#)

To create a blade design we need to specify the chord width and blade setting angle β at each of a series of stations along the span of the blade

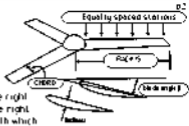

At each station we will create the right shape of the blade to produce the right loading (lift) for the bit of wing with which it will have to deal

The process of calculating the best loading and therefore the best shape is known as 'finite element analysis', and it looks at what each bit of the blade needs to do

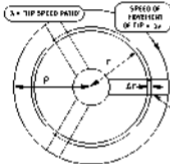

THE BIT OF THE BLADE AT RADIUS r SWEEPS A FRACTION OF THE TOTAL SWEEP AREA AND HAS THE JOB OF SLOWING THE BIT OF WIND DOWN BY THE RIGHT AMOUNT TO SATISFY THE BETZ CRITERION

THE AREA OF WIND IT SWEEPS WILL BE $\Delta r v_t$
ITS HEADWIND WILL BE v_t / λ OR v
WHERE v IS THE TIP SPEED RATIO λ WHICH WE WOULD LIKE IT TO VARY

The apparent wind which a blade 'sees' is altered by its own speed through the air

This headwind adds to the real wind to give the apparent wind, which creates the lift and drag forces

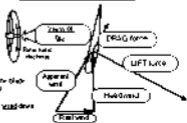

The drag and lift are the direction of the forces as the blade
The drag force opposes the blade's movement
The lift force opposes the blade's movement
Both forces also push the blade downwards and slow the wind down

The mathematics of lift and drag

$$LIFT = C_L \rho v^2 S \sin \alpha$$

$$DRAG = C_D \rho v^2 S \cos \alpha$$

where ρ is the density of air,
 v is the speed of flow,
 S and α is the apparent wind speed

Lift and Drag forces depend on the Coefficients C_L and C_D , which in turn depend on the cross section of blade we are using, and on the angle α at which the wind strikes the blade

The chord line is the longest line in the section, joining the leading and trailing edges



The angle of attack α is the angle the apparent wind direction makes with the chord line

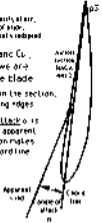

You cannot calculate the lift and drag coefficients

They are measured experimentally in wind tunnels, and recorded in tables

Here is a typical graph of lift vs. angle of attack

As α increases, so does the lift, until a point is reached where the blade stalls



Most flat-ish objects will give a similar sort of LIFT α curve. But cambered, streamlined sections yield better LIFT/drag

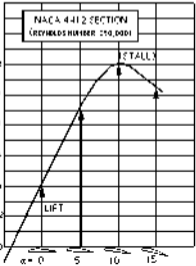

When designing a wind turbine rotor, the angle α will depend on the angle of the apparent wind ϕ , and the blade angle β

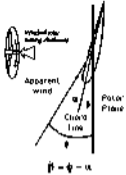

So we have control over α , and thus control over the lift and drag produced by the blade

We shall need to optimise the lift force, to satisfy the Betz criterion, but the blade will not work well unless the drag is minimised

So we have to choose a section and an angle of attack, where the lift/drag ratio is high

Finding the exact best angle α can be an involved process, because the lift and drag coefficients depend on both the section and the Reynolds number (a measure of the size and speed of the blade)

THE REYNOLDS NUMBER IS 68500X (NOM) X APPARENT WIND SPEED (111.5) IF D=2m AND X=5 AND u=5m/s THEN REYNOLDS NO IS ABOUT 120,000

On the left is a pair of graphs which refer to the NACA 4412 section for several different Reynolds numbers

The left hand graph shows lift. The right hand one shows lift/drag

The straight lines through each, represent particular lift/drag ratios. Best lift/drag ratio for a given Reynolds number is 4.5 and the lift to drag line is rotated as far as possible anticlockwise so that it just touches the curve at a tangent. For the NACA 4412, this point of contact is where C_L is about 1 and C_D is about 0.2

Note that low Reynolds number leads to poor lift and low lift/drag ratio, which can be explained for rotors with narrow chord widths in low wind. They are often vertical too (to $\alpha = 90 > 2$) which has better performance than the NACA 4412 at low Reynolds number

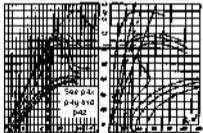

In practice, most sections will produce their best lift/drag at an angle of attack around 5 degrees, so as a general rule where detailed data is not available, we can say that the blade angle β should be set to give this angle of attack, thus

$$\beta = \phi - 5$$

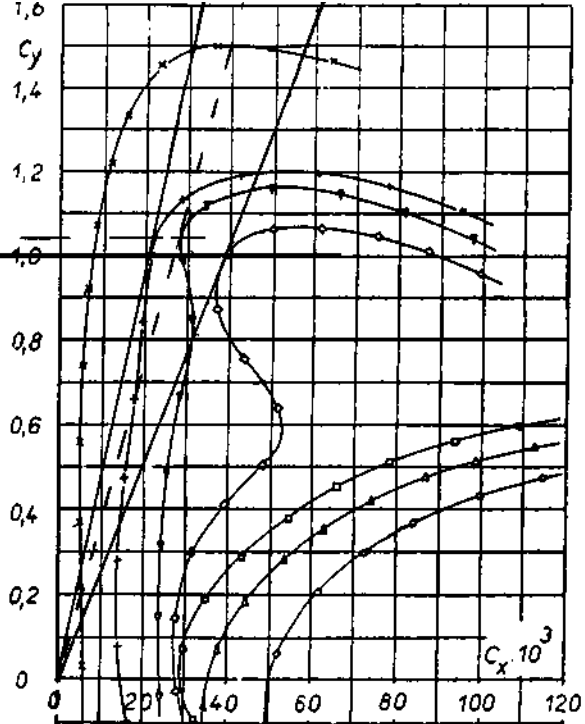
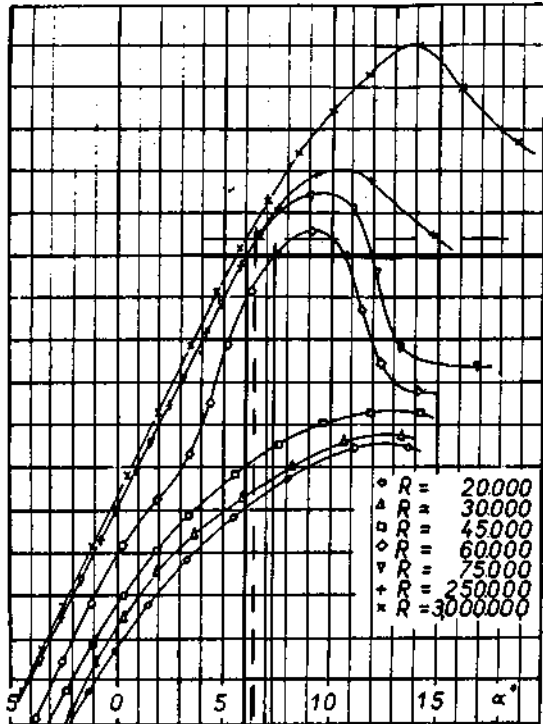

WIND TUNNEL TEST POLARS

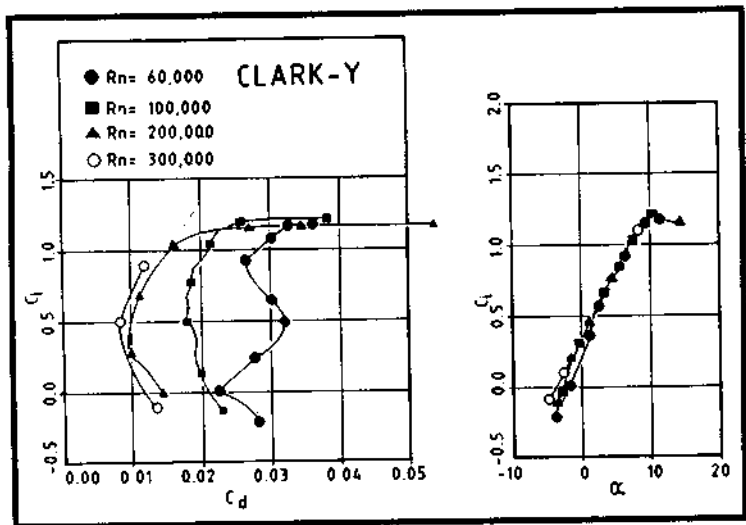

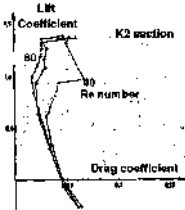

To specify blade angle β we need to know the angle ϕ at which the apparent wind strikes the rotor plane

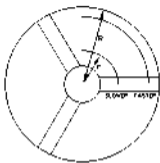

BLADE VIEWED FROM THE TIP

Headwind is greater near the tip (where $r=P$) than it is near the root, so the angle ϕ changes

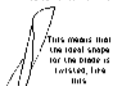

$$W(\phi) \sin(\phi) = Cr/P \sin(\phi)$$

WIND THROUGH THE ROTOR = $(2/3)P$ (FOLLOWING BETZ'S THEOREM)

CALCULATING THE CORRECT BLADE SETTING ANGLE β

$\beta = \phi - \alpha$

WHERE $\tan(\phi) = (Cr/P) / (Cr/P) \sin(\phi)$

SO THE BLADE ANGLE β IS

$\beta = \arctan((Cr/P) / (Cr/P) \sin(\phi)) - \alpha$

WHERE α IS USUALLY AROUND 5 DEGREES

HERE ARE THE MATHS WHICH COME IN USEFUL ON THE NEXT PAGE

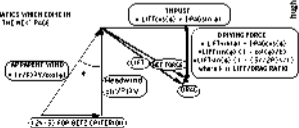

Having worked out β we still need to work out the Chord width. Here is the logic:

Each blade element has a certain band of wind to process.

As radius r grows smaller near the centre, the amount of wind in the band gets smaller too.

The outer parts of the blade therefore do the most work. The inner part is less important but needs a different shape.

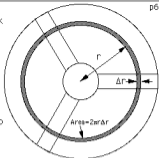

To satisfy Betz, the wind in each part of the swept area of the rotor must be slowed down to 1/3 of its upstream velocity, and this slowing is done by the THRUST force, which is very closely related to the LIFT force.



NEGLECTING DRAG (very small error), THRUST = LIFT $\cos(\phi)$

FOR BETZ, THRUST = $(4/9)\rho A V^2 = (4/9)\rho (2\pi r \Delta r) V^2$

AND WE KNOW THAT LIFT = $CL(\rho/2)BC\Delta r(\text{APPARENT WIND})^2$
 $= CL(\rho/2)BC\Delta r(\lambda V(r/R) / \cos(\phi))^2$

THIS LEADS TO A ROUGH EXPRESSION FOR THE CHORD WIDTH C WHICH WILL PRODUCE THE RIGHT AMOUNT OF THRUST TO MEET THE BETZ CONDITION

$$C = \frac{16\pi R (R/r)}{9\lambda^2 B}$$

where B is the number of blades,
 CL is the lift coefficient,
 C is the chord width, at radius r,
 and V is the free wind speed.
 BCΔr is the area of blade used to produce lift at radius r.

WARNING: FOR SIMPLICITY, WE HAVE ASSUMED THAT CL AND $\cos(\phi)$ ARE BOTH ABOUT = 1. THIS EQUATION WORKS BEST FOR THE OUTER PART OF THE BLADE ONLY.



CONCLUSIONS

C IS INVERSELY PROPORTIONAL TO RADIUS r.
 so the blade shape should be tapered

C IS INVERSELY PROPORTIONAL TO BLADE NUMBER B
 so fewer blades will be wider blades

C IS INVERSELY PROPORTIONAL TO TIP SPEED RATIO SQUARED
 so doubling speed means cutting blade width down to 1/4

Back of envelope blade design:-

1. Choose rotor diameter D to suit your power requirements

Diameter (m)	(Watts) Power
1	50-100
2	250-500
3	500-1000
4	1000-2000
5	2000-3000

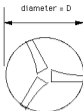

2. Choose a tip speed ratio λ .
You are free to use is trial and error here.
I suggest you opt for a tip speed ratio between 5 and 8.

Tip speed ratio will affect rpm.
shaft speed = $60\lambda V / (\pi D)$ rpm

3. Decide how many blades B to use
(B=3 is the best.
Or try $B=80/\lambda^2$)

4. The width of the blade C in the outer portion, will be :
 $C = 4D / (\lambda^2 B)$

for example if $D=2m$, and tip speed ratio = 7 and $B=2$, then $C = 4 \times 2 / 49 \times 2 = 0.08m$ (or 8cm).

The outer part is the most important, but the inner part should be made wider, to help with starting torque.

5. To find the best blade setting angle β , read it from this graph:-

THIS IS BASED ON THE IDEAL ANGLE FOR A POINT NEAR THE TIP.

STRAIGHT, UNTAPERED, UNTWISTED BLADES
IN PRACTICE MANY WIND TURBINE BLADES ARE BUILT WITH CONSTANT WIDTH AND CONSTANT BLADE ANGLE, LIKE THIS. THERE IS SURPRISINGLY LITTLE LOSS OF EFFICIENCY BY MAKING THIS COMPROMISE.



BUT THERE ARE OTHER GOOD REASONS TO USE A TWIST AND A TAPER:

- BETTER STARTING
- STRONGER BLADE ROOT

IF YOU HAVE A GENERATOR WITH KNOWN POWER OUTPUT AND KNOWN RPM, AND YOU WANT TO BUILD A WINDMILL TO FIT THAT, THEN YOU MAY FIND THIS FORMULA USEFUL:

$$\text{DIAMETER} = (\text{POWER} / (47\pi / \text{RPM})^3)^{0.2}$$

(“0.2” MEANS THE FIFTH ROOT)

FOR EXAMPLE IF POWER = 500 W
AND RPM = 300 RPM
AND CHOSEN TIP SPEED RATIO = 5
THEN BEST DIAMETER WILL BE

$$\text{DIAMETER} = (500 \times (47 \times 5 / 300)^3)^{0.2}$$

$$= (500 \times (0.783)^3)^{0.2}$$

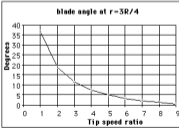
$$= 2.40 \times 0.2 = \underline{3 \text{ metres}}$$

Factors affecting the power coefficient

(where the lost energy goes?)

Loss 1 is the wind which escapes around the side of the rotor. Betz figures out that the best we can do is catch 0.593 of the tower and that to catch even that much we need to slow the wind down to 1/3 of its upstream, free velocity V .

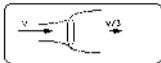

Loss 2 is the lost power in the swirl created by high torque rotors. Glauert figured out that this is worst at low tip speed ratios.



Loss 3 is due to the fact that we are not able to be perpendicular to the wind - there are a finite number of blades, the thrust loading is higher, and some wind prefers to go around the tips. This is known as tip loss.

Tip Loss Force
 $\propto \text{LIFT} \cdot \text{tip} \cdot \text{CL} \cdot \text{CSr} / \text{TR} \cdot \text{D} \cdot \text{R} \cdot \text{I}$
 $\propto \text{LIFT} \cdot \text{tip} \cdot \text{CL} \cdot \text{CSr} \cdot \text{R} \cdot \text{D} \cdot \text{R} \cdot \text{I}$
 SO LIFT:TR RATIO MUST INCREASE WITH INCREASING TIP SPEED RATIO OR ROR, FACTS A HEADWIND TOLL

Loss 5 is drag loss, which depends on LIFT:DRAG ratio. It gets worse for high tip-speed-ratio rotors, where the lift force is rotated furthest from the direction of blade movement.

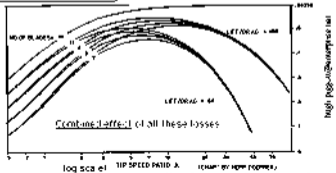

So what is the best design for a wind turbine rotor?

From the graphs it looks as if a tip speed ratio around 5 is ideal with as many blades as possible. The trouble with having lots of blades is that they have to be very narrow or run at very low tip speed ratio for both, to satisfy the Betz condition.

The perfect wind turbine rotor has an infinite number of infinitesimally narrow blades.

The windtunnel type of rotor (right), created by Claus Fugère at windinnovation, follows this logic.

Due to the low Re-numbers the blade profile must be carefully selected and rather thin. To obtain strength and torsional stiffness, this requires a composite structure and skilled workmanship.

Here is a less ambitious planform shape for a blade.

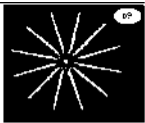

Source: Windinnovation

HERE IS A 12-BLADED WINDTUNNEL ROTOR DESIGN FOR TIP SPEED RATIOS = 5-6. PROBABLY THIS IS THE MOST EFFICIENT SHAPE OF ROTOR.

IN PRACTICE THIS APPROACH IS RARELY USED BECAUSE THE ROTOR IS TOO SLOW. AT HIGHER TIP SPEED RATIOS, 5 BLADES WOULD BE BETTER IN SPITE OF THE LOSSES.

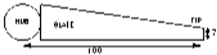

Once you have chosen a blade planform, then the number of blades is dictated by the tip speed ratio -

$$C_T = \frac{16\pi^3 P / r^3}{4Q^2 B}$$

$$\text{THE } B = \frac{16\pi^3 P / r^3}{4Q^2}$$

AT THE TIP, $C = 17/1000$ SO

$$B = \frac{90}{\lambda^2}$$

VALUE OF THE NUMBER OF THE BLADE PERFECT



1 blade, $\lambda = 9$

THE BLADE ANGLES ARE DIFFERENT IN EACH CASE ONLY THE PLANFORM IS THE SAME

2 blades, $\lambda = 6$

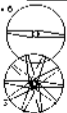

3 blades, $\lambda = 5$

10 blades, $\lambda = 3$

High speed blades
(pros and cons)

The graph to the right shows the speeds and electrical power outputs of windmills with a range of rotor sizes, running at tip speed ratio of 5, in a 12m/s rated windspeed.

For this graph, power is calculated on the basis of rotor $C_p=0.25$ and other losses=40% overall, which is easily possible for small wind turbines. (Other losses are friction, iron, copper and rectifier losses to produce the electricity output.)

Good machines will exceed this performance.

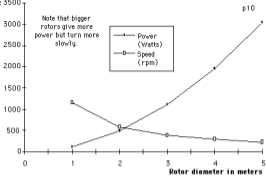

Choice of rotor size (diameter) depends on power required.

Choice of tip speed ratio λ depends on many factors. High tip speed ratio results in higher shaft speed is more efficient for generating electricity, which often outweighs these disadvantages:-

1. Noise from the blades is higher
2. Vibration in case of 2-bladed (or 1-bladed).
3. Blades edges, at high air-speeds suffer erosion.
4. Reduced rotor efficiency, due to drag, and tip loss.
5. Starting difficulties, if the shaft is stiff to turn.

STARTING TORQUE CAN BE ESTIMATED FROM THE FORMULA

$$\text{TORQUE} = \frac{v^2 R^3}{(\text{DESIGN TIP SPEED RATIO})^2}$$

FOR EXAMPLE A 2m DIAMETER WITH TIPS SPEED RATIO $\lambda = 5$ ROTOR IN A 4m/s WINDSPEED WILL HAVE STARTING TORQUE

$$\text{TORQUE} = \frac{4^2 \cdot 1^3}{5^2} = 0.64 \text{ Nm}$$

N.B. THIS IS ONLY AN APPROXIMATION!

BLADE TIPS TRAVELLING AT SPEEDS IN EXCESS OF 80m/s WILL SUFFER FROM EROSION OF THE LEADING EDGES DUE TO IMPACT OF SMALL PARTICLES BORN BY THE WIND. THIS CAN BE COUNTERED TO SOME DEGREE, BY THE USE OF SPECIAL TOUGH COATINGS.

A ROTOR WITH TIP SPEED RATIO 7 IN A 12m/s WIND OR A 5m DIAMETER ROTOR RUNNING AT 350rpm WILL BE AT RISK FROM BLADE EROSION.

THE EFFECT INCREASES DRAMATICALLY WITH INCREASING SPEED

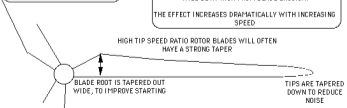

Department for International Development, UK



Wind rotor blade construction

Small Wind Systems for Battery Charging

Contract R 7105

By Teodoro Sanchez Campos ITDG,
Sunith Fernando and
Hugh Piggott

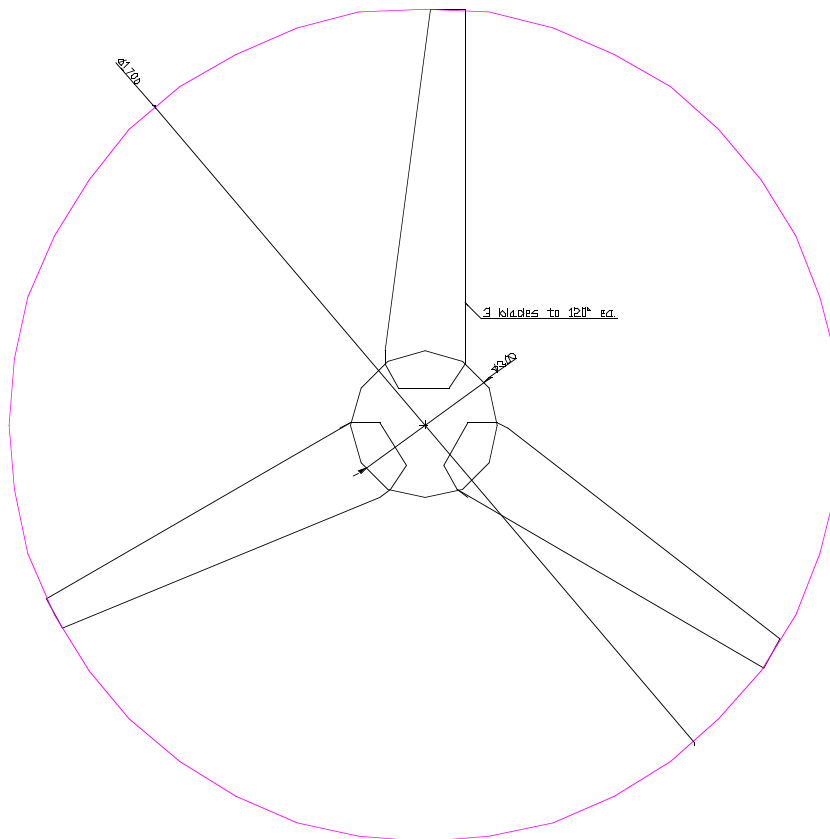

In association with : ITDG-UK; ITDG Peru and ITDG South Asia

This research on small wind energy systems for battery charging is the result of a collaborative effort involving numerous contributors.

The project was managed by Intermediate Technology (known as The Intermediate Technology Development Group or ITDG) under a contract to the UK Department for International Development.

The overall international project was co-ordinated by **Dr Smail Khennas**, Senior Energy Specialist from ITDG with support from Simon Dunnett. The field work in Peru and Sri Lanka were respectively managed by Teodoro Sanchez and Rohan Senerath.

Teodoro Sanchez Campos (ITDG Peru), Sunith Fernando (Sri Lanka) and Hugh Piggott (a UK technical consultant for the project), are the authors of this booklet on the rotor blade manufacture.

The views expressed in this report are those of the authors and do not necessarily represent the views of the sponsoring organisations, the reviewers or the other contributors.

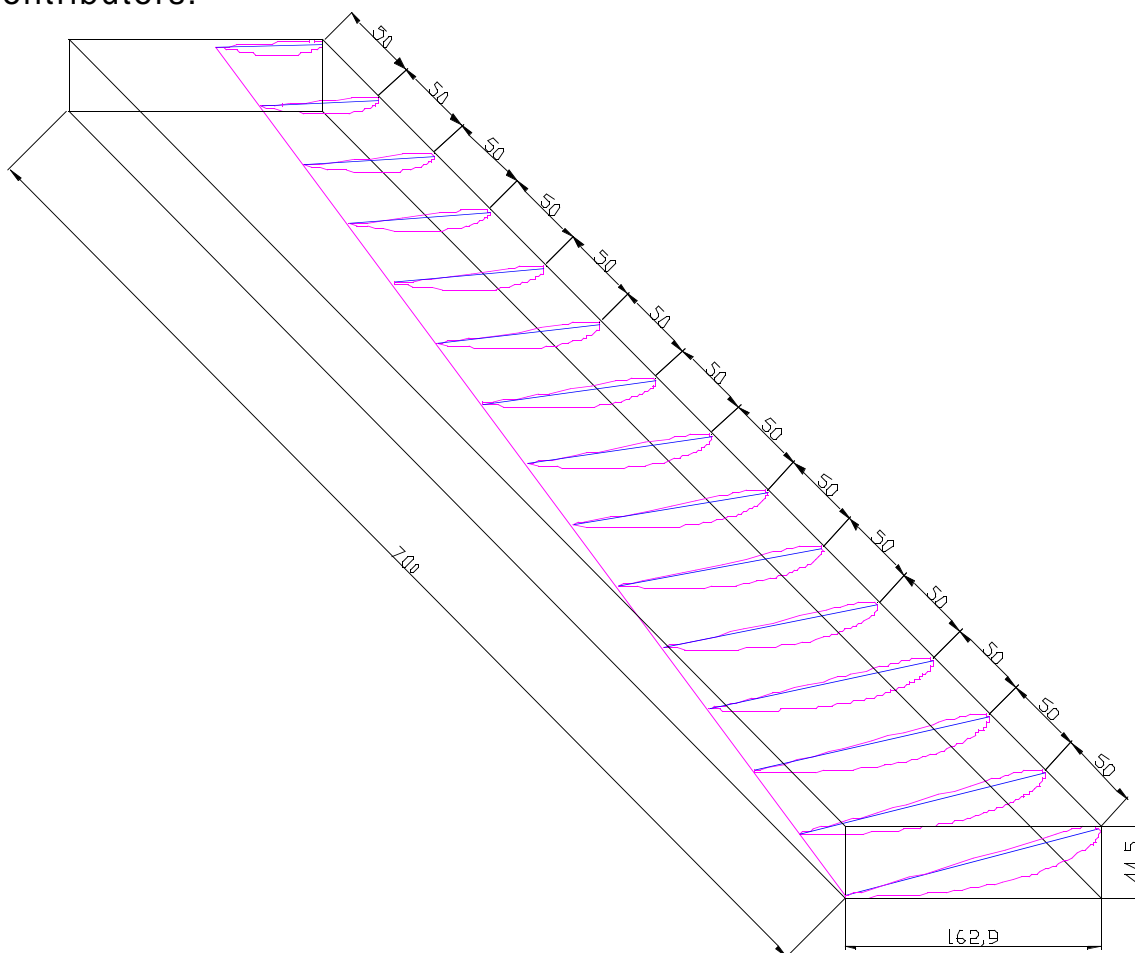

This diagram shows the shape of a blade pattern.

Wind rotor blade construction

Small Wind Systems for Battery Charging

CONTENTS

1. Introduction.....	4
The wind generator	4
Steps in the wind rotor construction procedure	4
The two rotor designs	5
The shapes of the blades	7
2. Templates, Patterns and Moulds	8
Templates	8
Patterns	8
Making two separate patterns	9
Finishing of the surface.	10
An alternative idea : making patterns from metal	10
Making the moulds	11
3. Blade construction.....	13
The procedure in Peru is as follows.	13
4. Testing for strength.....	15
5. Balancing and mounting.....	16
Balancing the rotor	16
Mounting the rotor blades	17
Appendix I :Blade design details	18
Sri Lanka K2 blade design by Sunith Fernando	18
Peru NACA4412 blade designed by Teodoro Sanchez	18

1. Introduction

The wind generator

This booklet is to assist manufacturers in make the blades, or 'wind rotor' for a small wind generator. Another booklet tells how to build the permanent magnet generator (PMG). The wind rotor will be fitted to the PMG. It turns the PMG, and the PMG charges a battery.

The PMG and rotor blades have to be mounted on a 'yaw bearing' at the top of a tower (usually made from steel pipe). The wind generator also needs a tail to make it face the wind. The tail must also automatically turn the wind generator away from strong winds to protect it from damage. The yaw bearing, tail and tower are not described further in this booklet.

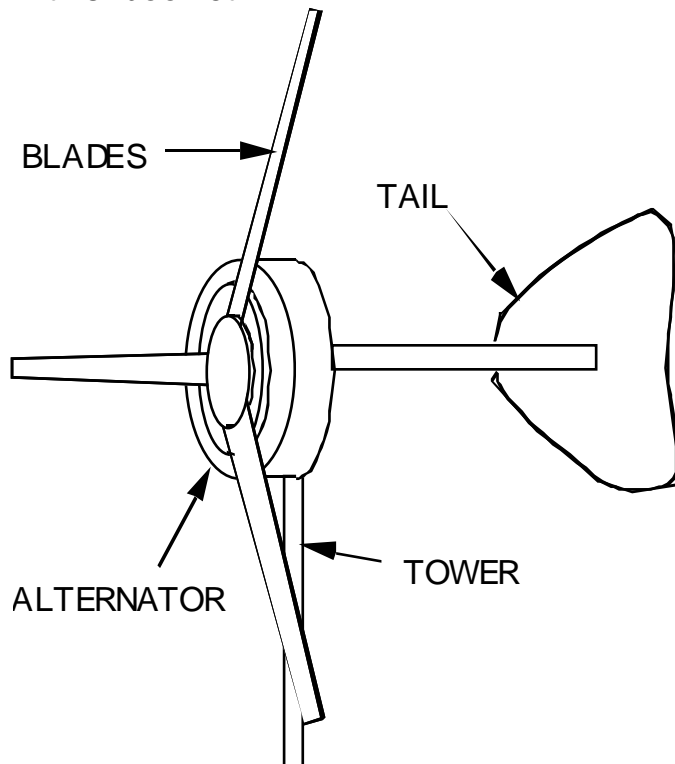

The wind generator is suitable for family needs such as lighting and radio, powered by a 12-volt battery. It is for low and medium windspeeds, common in Peru and Sri Lanka, where the wind turbine is being built.

The blades described in this book are made from fibreglass, (although would also be possible to make them from wood.)

Steps in the wind rotor construction procedure

1. Choose a design for the blades, and make templates from paper or thin aluminium sheet. Copy the drawings

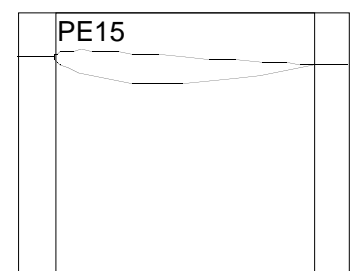

in Appendix II for the templates. The templates will fit the outside of the blades exactly.

2. Use these templates to make a three dimensional pattern in the shape of the actual blade. One can carve a pattern from wood. Or metal sheet or foam could be used instead.
3. Around the pattern, cast fibreglass moulds. We might make enough moulds for a full set of blades for one rotor (three moulds for a three bladed rotor).
4. Use the moulds to make the blades.
5. Make a hub for the blades and assemble the rotor.

If the production team have no experience with fibreglass resin, they may need to ask an expert for help.

We will need to test the strength of the blades, and balance them, so they will be safe and run smoothly.

The two rotor designs

Here are the main features of the two rotor designs described in this booklet:-

Country of origin	Peru	Sri Lanka
Designer	Teodoro Sanchez	Sunith Fernando
Blade section	NACA 4412	K2
Diameter	1.7metres	2.0metres
Tip speed ratio	5	6
Number of blades	3	2

SECTION

The 'blade section' is the shape of the blade in cross-section (cut at 90 degrees). The NACA4412 section is made from two skins with space between. The K2 section can be solid fibreglass resin.

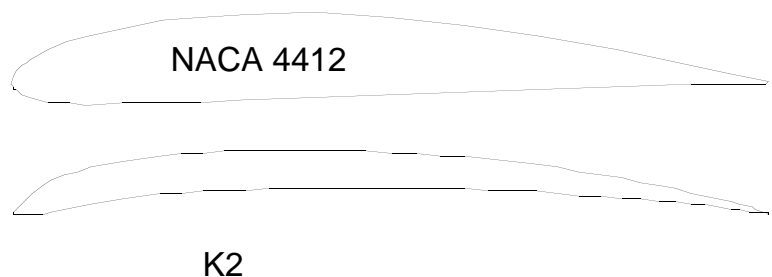

DIAMETER

The larger, 2.0 metre diameter rotor will sweep across more wind, and therefore it can produce more power, in a given windspeed.

TIP SPEED RATIO

The 'tip-speed-ratio' is the speed at which the blade tip should run compared to the windspeed. The shaft speed in revolutions per minute (rpm) depends on the tip speed and the diameter.

$$\text{Rpm} = \text{windspeed} \times \text{tip-speed-ratio} \times 60 / (\text{diameter} \times \Pi)$$

The main reason why the two blade rotor can work at higher tip-speed-ratio is that it only has two blades. The smaller, three bladed rotor will have a slower tip-speed, but will run more smoothly because it has three blades.

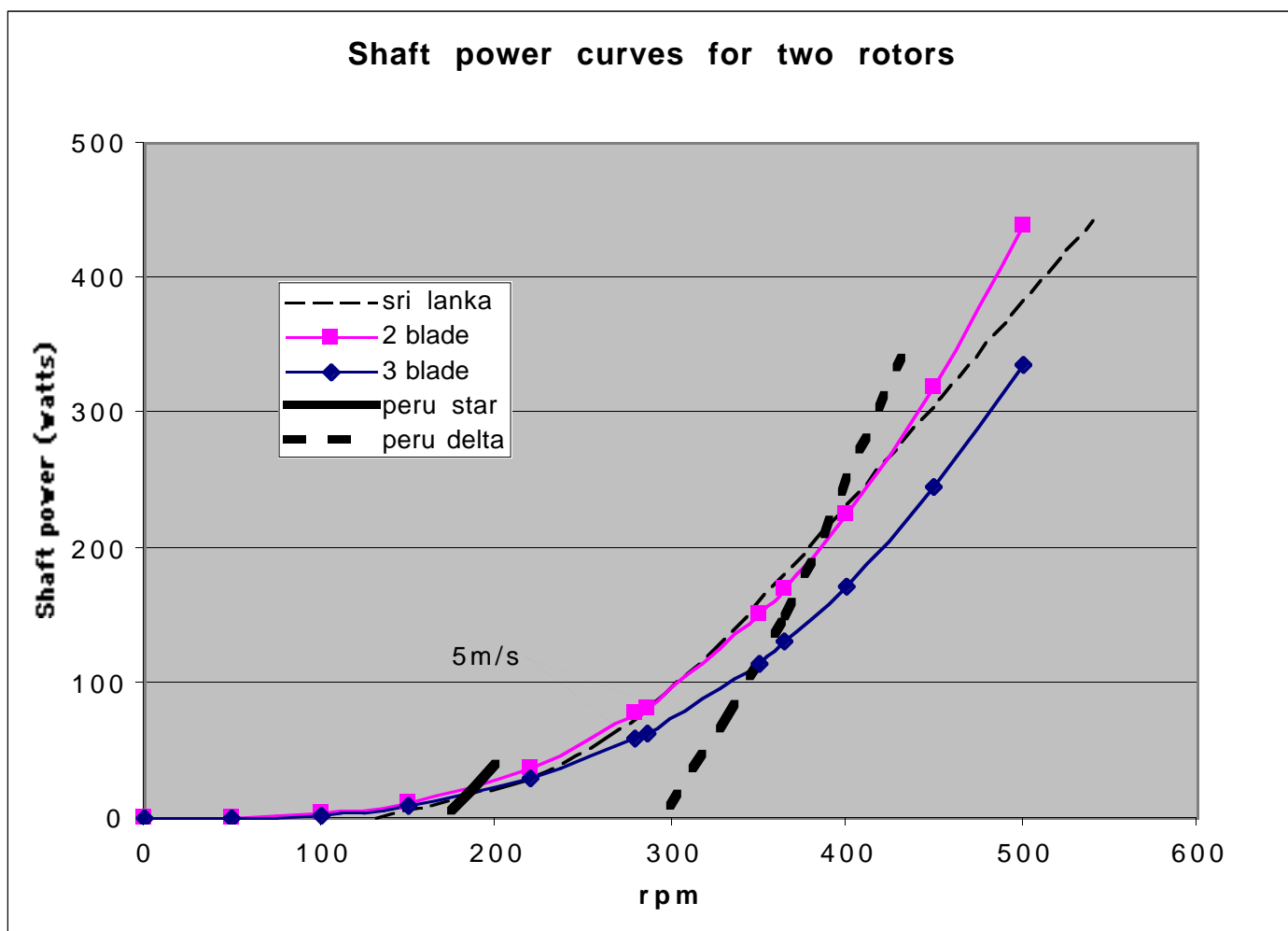

Each rotor is carefully designed to work well with the PMG used in each country. The PMG used in Peru has thicker magnets and a different way to connect the windings. Above is a chart of the power produced by the two rotors over a range of speeds (based on the theory). The chart also shows how much power is needed to drive the alternators in Sri Lanka (dotted) and Peru (two curves for two connections). The 2-bladed rotor (purple) designed in Sri Lanka produces exactly the power required for the alternator used in Sri Lanka. The 3-bladed rotor (blue) from Peru is designed to match the two different cases for the Peru alternator : star connected and delta connected.

At a windspeed 5 metres/second, the two rotors will produce 80 watts and 60 watts of mechanical (shaft) power respectively at 286 and 280 rpm respectively. This point is marked on each curve.

The speed of the wind rotor depends on how it is loaded. If the PMG is disconnected from the battery, the rotor will become unloaded and will run much faster. We try to avoid running the wind rotor unloaded, because it is noisy and stressful.

The shapes of the blades

The dimensions of the blades are listed in Appendix I. The blades are defined at a number of 'stations'. SEE FIGURE 'BLADE DIMENSIONS AT STATIONS' BELOW. Each station has a 'local radius', which is the distance of the station from the centre of the rotor. For each station there is a 'chord width', which is the width of the blade, from one edge to the other.

The 'chord line' is defined as the longest line within the blade section, and it joins the leading edge to the trailing edge. The 'blade angle' (beta) is the angle between the chord line and the plane in which the rotor spins. Given the local radius, chord width and blade angle at each station, we can construct the shape of the whole blade. This is done in Appendix II.

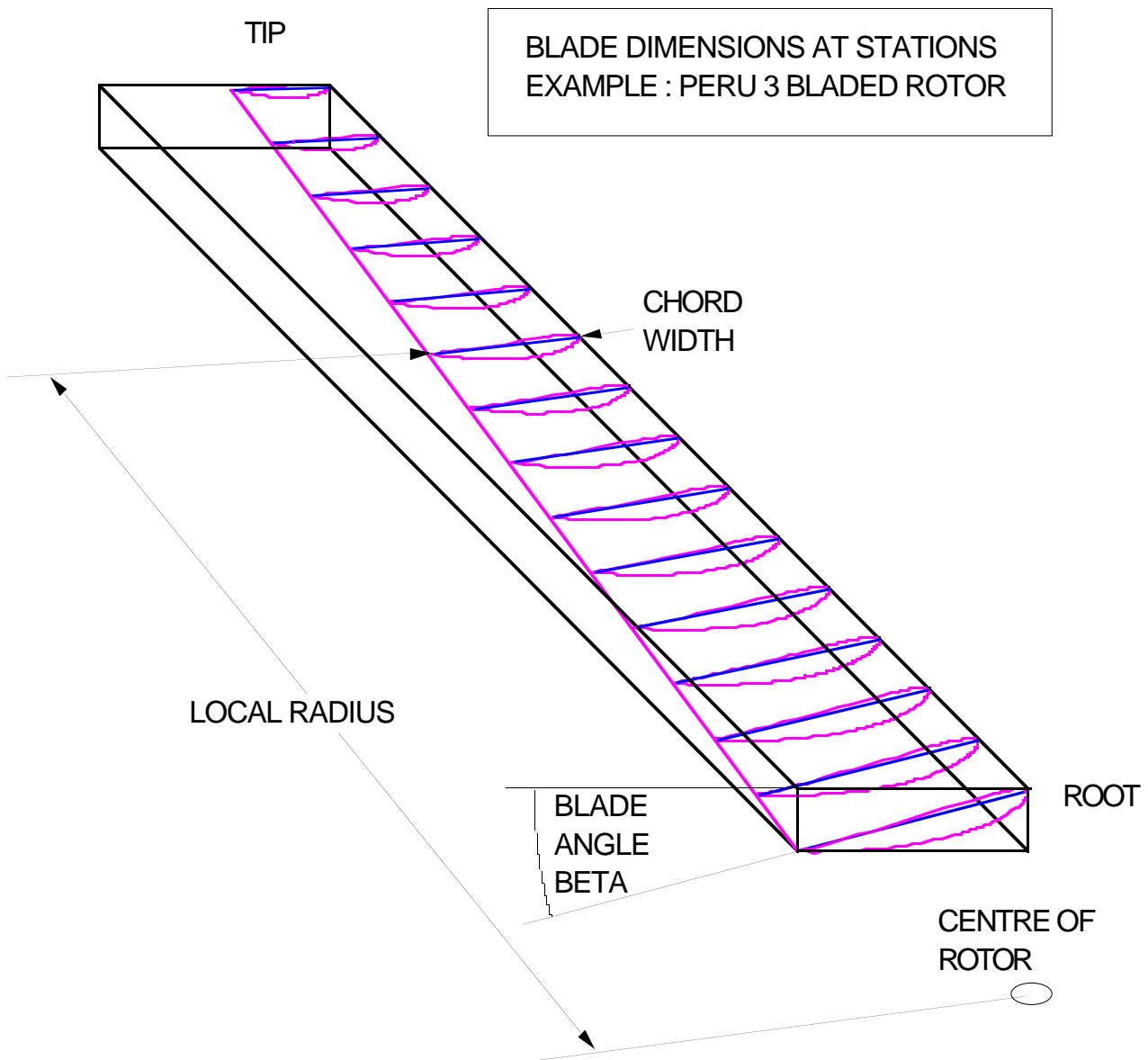

At the root, the shape of the blade changes from an airfoil section into a shape which is suitable for the hub assembly

2. Templates, Patterns and Moulds

Templates

Choose a blade design and make photocopies of the templates in Appendix II. Either cut out these copies and use paper templates to make the pattern, or alternatively use thin aluminium sheet for the templates.

Transfer the shape to the aluminium sheet using carbon paper to trace it, and/or using a punch through the paper to mark the aluminium with the lines.

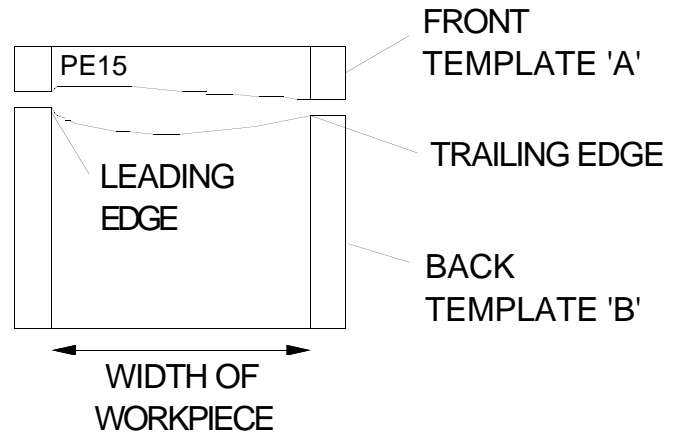

Each template drawing has 3 areas within it:

1. A blade section (remove this)
2. A front template A
3. A back template B (turn it over and use it when carving the back of the pattern)

The vertical lines on the template show the width of the workpiece for the pattern after it has been tapered. The angle of the blade section is the exact blade angle. The top edge of template A is exactly 10mm from the top surface of the blade. The bottom of template 'B' is 60mm below the top surface.

Patterns

The pattern is an object which is exactly the shape of the blade. Use it to make moulds for the blades. There are various ways to make a pattern. It can be made from wood. This is normal. However, wood can warp, and change its shape. It is important to choose a very stable wood. In Peru they have used Coava, which is a hard wood with good stability.

Sunith Fernando in Sri Lanka tried a wooden pattern initially but warping became a problem. "For K2, which is a slender profile, I made the pattern out of two materials. First I got a steel sheet (~ 0.8 mm thick) rolled into K2 outer profile – more or less, and then filled the inside with a paste that we use to fill up dents of automobile bodywork (we call it Cataloy paste). I used the paste to fill up the outer profile also as a thin layer. Then I filed the hardened cataloy paste to the required profile. Thereafter, I got the blade pattern cast in aluminium. It is the aluminium pattern that I gave for fibreglass work."

For the construction of the wooden pattern follow this procedure:

- a). - Buy a rectangular block of wood 45mm x 165mm x 700 mm. The wood should be dry enough before starting the work of carving.

b)- Mark the position of each station. Then draw two lines along the wider faces using the 'workpiece width' on the templates, and cut the wood to the correct width at each station.

c)- Use the templates to mark a leading edge line and a trailing edge line. These are the lines where the two moulds will meet. Here is how to mark these lines: The top of the workpiece should be 60mm above the level of the bench. The right hand side of each template 'B' is the trailing edge. Place it on the bench, against the left hand side of the workpiece as shown, and mark the trailing edge. Do this at each station and then do the same for the leading edge.

d)-Then carve the curved shape of the blade pattern, checking very carefully with the templates at each station.

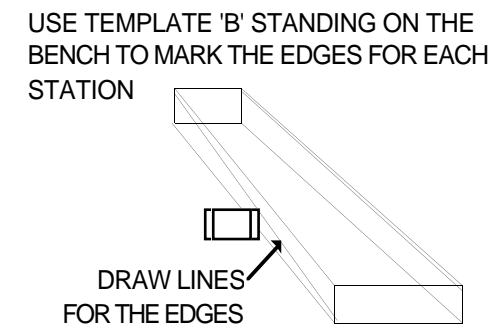
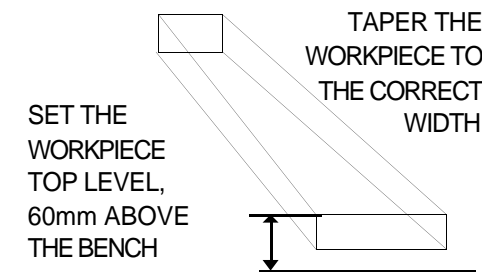
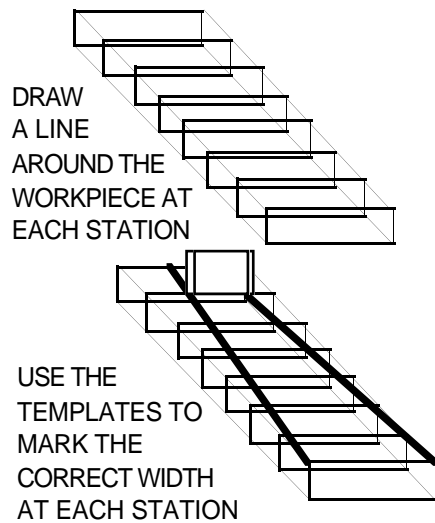

The templates in Appendix II are printed in such a way that one should look at them from the tip of the blade inward. Place the template over the workpiece at its

station. When the pattern is finished, the top edge of the template should be exactly level, and the leading and trailing edge lines should meet the lines drawn earlier on the sides of the workpiece.

Making two separate patterns

The moulds for the blades will be made in two pieces: one for each side of the blade. It is possible therefore to use two patterns instead of one, one for each mould. If there are two patterns, they do not have to be thin, like the blade itself. They can be made from big thick pieces of wood, which will not easily warp.



The photo (last page) shows a pattern being carved from a wooden workpiece which has been built up out of three pieces of wood glued together.

Finishing of the surface.

The finishing of the surface is an important feature because the quality of the surface of the blades will depend on that, therefore it is recommended to use some substance to feel tiny imperfections of wood, and later polish the surface until it looks as regular as possible, paint the pattern and polish again until it is soft enough or good enough to be used as a pattern.

An alternative idea : making patterns from metal

First I must state that this idea has not been tried at the time of writing. It is possible to make patterns for the blades using sheet metal wrapped over metal formers (support pieces). Make two patterns - one for each mould. One is for the back of the blade, and one is for the front.

Cut out the support pieces using the template shapes in Appendix II.

They will be used to support the pattern surface sheet, rather than just to check its shape.

Glue all the support pieces onto a level base at the correct spacings, and then glue a surface sheet down onto them tightly.

There are yet more, other ways to make the patterns. It is possible to make them from foam, cut with a hot wire. This method is popular with model makers.

Probably the simplest method is to carve them from wood, as described above.

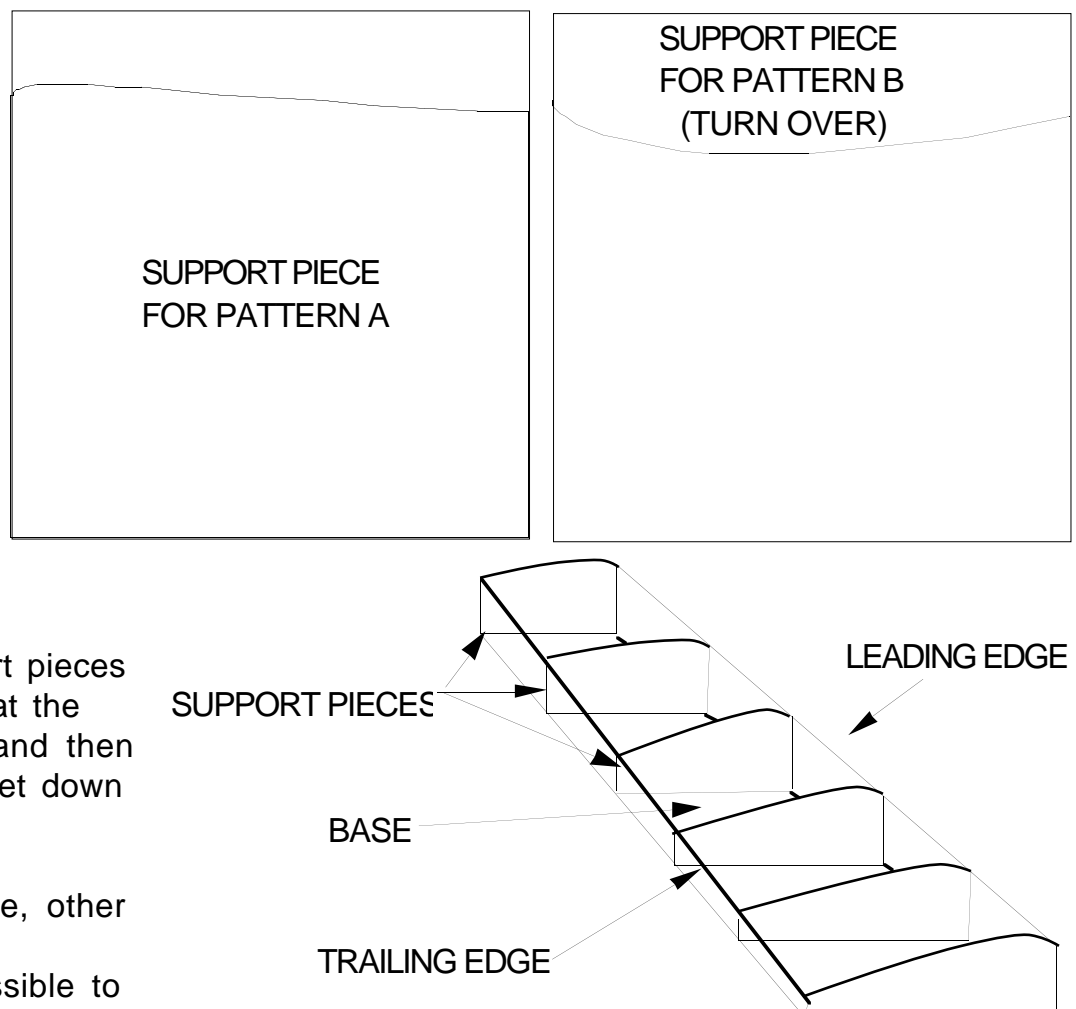

Making the moulds

In Peru, the moulds were manufactured in fibreglass. “The mould is done in two pieces, therefore it is convenient to be careful with splitting the blade into two parts, (or with the splitting line)

“The moulds can be of different materials, resin and fibreglass is always a good option, however it does not have a long life, it is expected that each mould can be useful to produce up to 50 or 60 units of blades.



“Therefore in some cases it would be preferable to use metal ones. Aluminium is a good alternative and it is widely used for fibreglass products.”

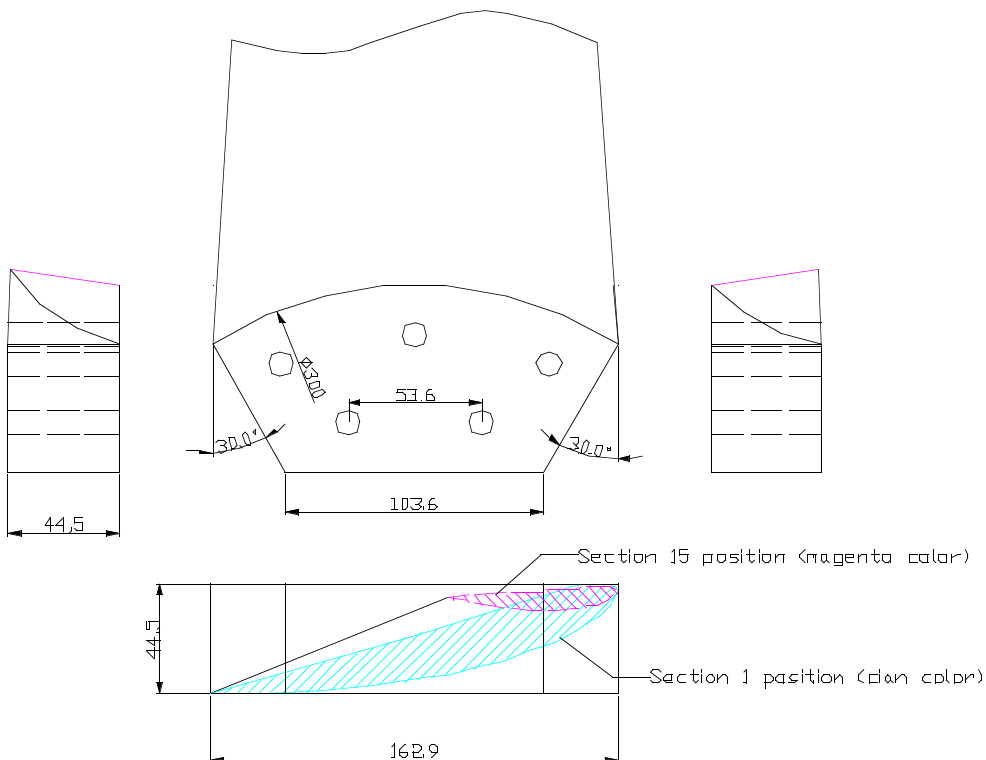

The blade root needs to be shaped to mount easily onto the wind generator. In Peru the root shape is as shown above. All three blade roots are clamped between two steel plates. The transition between the root (mounting portion) and the blade (airfoil

section portion) is to be made smoothly. Avoid using sharp curves which would weaken the fibreglass.

The moulds for the Sri Lankan blades are shown to the right. They were made in fibreglass on an aluminium pattern. One side of the K2 mould is convex, because the upwind side of the blade is to be concave.

The two halves of the mould

When making the first half of the mould, use only one face of the pattern. Make a flat surface around the edges of the pattern which will later become the faces where the two moulds will meet. This can be done with fibreglass resin, wood or plasticene or any material which is easy to work. Take care to follow the edges of the pattern very exactly. When the first half mould has been made one can destroy this flat surface.

It is a good idea to make two holes in the flat surface at the edge of the first half, so that the second half will have two lumps. Later, we will fit the two halves of the blade together inside the moulds. If the lumps are in the holes then the two halves are correctly lined up.

When making the second half of the mould, place the first half against the other side of the pattern. Polish the flat surface around the edges, in the same way as the pattern, so that the fibreglass resin will not stick to it. Make the second half of the mould cover the pattern and also the flat surface, so that the two moulds fit each other perfectly.

If there will be two separate patterns for the two halves of the mould, take great care that the final blade will be the correct shape when the halves are put together. It would be easy to alter the thickness of the blade by inaccurate patterns.



3. Blade construction



The procedure in Peru is as follows.

- a) The mould should very clean before using the resin and fibreglass. Use alcohol or other solvent to clean it.
- b) Use some substance to facilitate the mould separation from the blade when it is ready.
- c) Paint a thin layer of resin in each side of the mould, then a layer of fibreglass (approximately 1mm).
- d) Again a layer of resin on top of the fibreglass, and so on until there is approximately 3 to 4 mm thickness
- e) In the root end of the blade it is possible to use a piece of wood (see diagram below) in on top of one of the sides in order to lower the quantity of fibreglass and resin.
- f) Also in the root of the blade there should be holes in order to assemble the blades to the central hub.

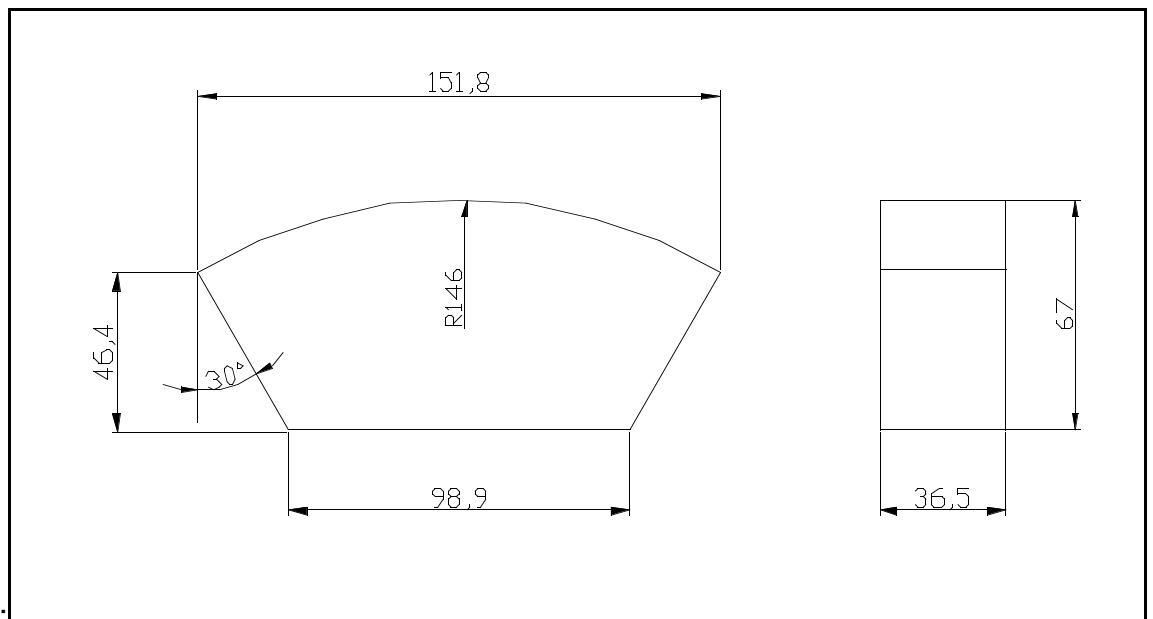

g) Once the 3 to 4 mm of fibreglass have been placed each side of the mould, the next step is to join the halves and tie them together. It is advisable to put some resin in the borders of the moulds in order to fill all the small gaps.



h) Finally, after joining the two pieces of the moulds, it is necessary to use bolts to clamp it. Leave it to set for about 12 to 15 hours.



On the right is a picture of the finished blades.

The outer portion of each blade is hollow. The Sri Lankan rotor has solid blades.

Another option is to use a foam core inside the blade. This can make it stronger if the bending stress causes problems (see section 4).

The outer layer of the blade (gel coat) must be waterproof, with no cracks or fibres on the surface. If water enters the blade, it degrades the strength and changes the balance. If the piece of wood in the blade root becomes wet and then dry, then the blade root will work loose in the hub mounting.

If the blades run for long periods in strong winds, then the leading edges will be eroded. A special adhesive tape is available for protecting the leading edges. Or they can be repaired with cataloy resin, and re-balanced as part of routine maintenance work.

4. Testing for strength

It would be wise to ask an engineer to check the structural design strength of the blades one is building. It is possible to calculate whether the stresses in the fibreglass skin are safe or not. We need to have a safety margin to allow for unexpected events, and for fatigue.

The main stresses on small wind turbine blades arise from centrifugal and gyroscopic forces. The centrifugal force on the blades when they are running at full speed (around 500 rpm) will be approximately 100 times the weight of the blade. If a blade weighs 1.5kg, then the centrifugal force will be around 1.5kN (equivalent to 150kg weight) at this speed. At 1000 rpm the force will be equivalent to 600 kg. This speed could arise if the tail furling system does not work correctly for example.

Wind thrust on each blade is only 50-100N (5-10kg). Thrust force imposes a bending stress on the blade, which adds to the stress from the centrifugal force. Gyroscopic bending moments could also be of that order of size (but rapidly alternating).

For peace of mind and safety it would be wise to test a sample blade by hanging and swinging weights on it until it breaks. This will indicate how large the factor of safety is (if there is one).

If there is a problem with inadequate strength in the blades, then increase the amount of fibreglass, especially in the root area. The resin has no real strength except to bond the glass fibres. If possible, use 'uni-directional' fibreglass mat. It may not be easy to find, but it has double the tensile strength for the same weight. This is a big advantage where the main forces are inertial (centrifugal, and gyroscopic).

Blades will tend to crack at 'stress concentrations' where the skin undergoes sharp changes in shape. Try to keep the blade skin smooth and straight in its transition from the airfoil portion to the root portion.

Blade failures are dangerous and very discouraging. When they occur, it may be necessary to recall and reinforce or replace a large number of blades. It is better by far to ensure that the blades are sufficiently strong at the start of manufacture.

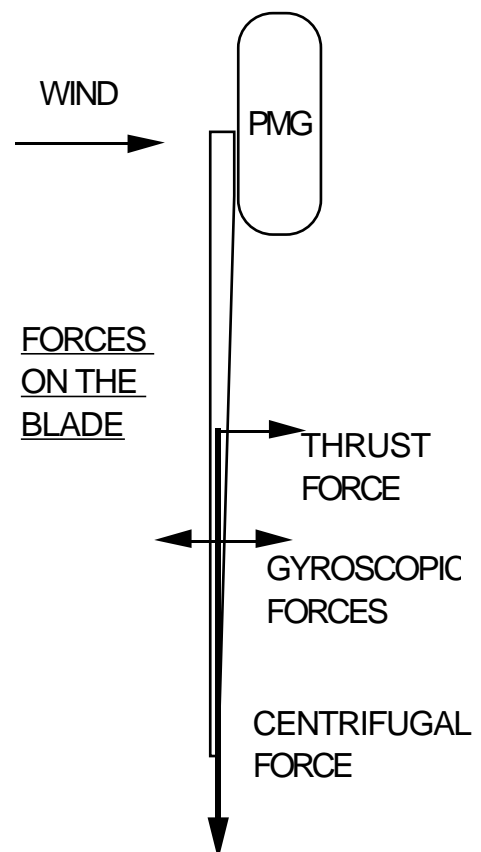

5. Balancing and mounting

Balancing the rotor

If the wind rotor is not balanced then the wind generator will shake as it spins. After hours and days of shaking, parts will begin to drop off. Usually the tail is first to go. It is important to balance the wind rotor carefully. Here are some steps to balance the rotor blades:

1. Support each blade at the root, and weigh the tip. Each blade should have the same tip weight. In order to do this test accurately we support all of the blade roots in exactly the same way. Make a jig which supports the blade root at the centre of the rotor.

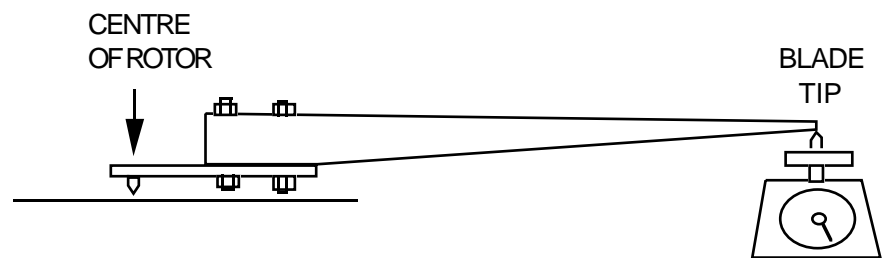

2. Mount the blades on the rotor hub accurately. If there are three blades, then the distance between the blade tips must be the same for each pair. If there are two blades then the line between the tips must pass exactly through the centre of the rotor.

ALL 3 SHOULD
BE EQUAL

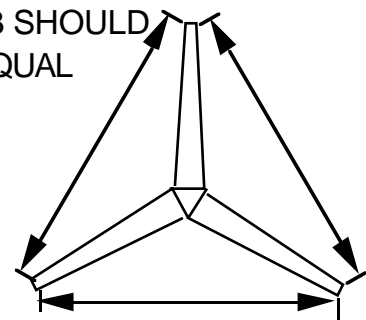

3. When the blades are mounted on the wind generator, check that the tips pass through exactly the same space as they turn. One blade tip should not be in front or behind the others.

LINE PASSES THROUGH CENTRE

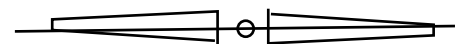

4. Use the balancing techniques described in the PMG manual to check the balance of the whole assembly before using it.

Mounting the rotor blades

The blades must be securely bolted to a central hub which fits on the PMG. Do not bolt the blades directly to the front magnet-rotor, because the gyroscopic forces on the blades will stress the magnet rotor and cause the magnets to hit the stator.

In Peru, the blades are 'sandwiched' between two steel plates. This makes a simple, strong hub. See also the diagram on the cover of this booklet.

In Sri Lanka, the two blades are bolted into a hub which is constructed as a part of the PMG. The rotor hub is an extra plate welded to the front of the PMG bearing-housing tube. Each blade is cradled between two pieces of steel angle which are welded to the plate.

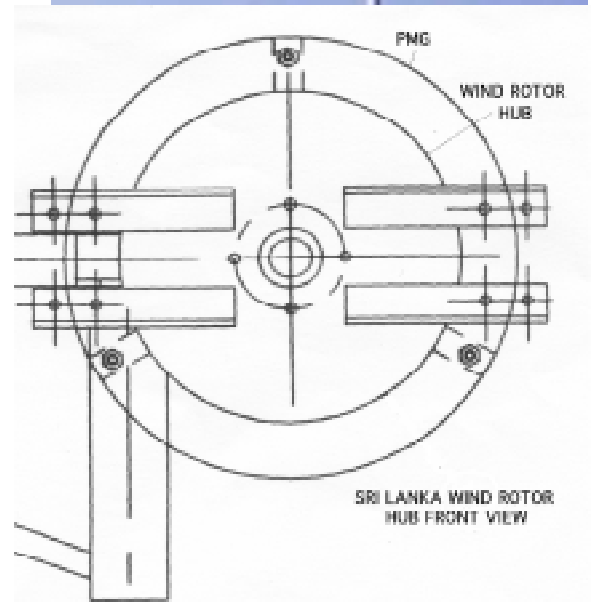
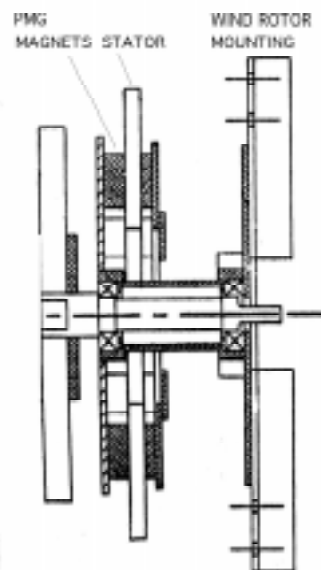

Appendix I :Blade design details

Sri Lanka K2 blade design by Sunith Fernando

Blade station	Local radius	Local speed ratio	Flow angle	Actual chord - m	Re Number	Recalc C_l	Recalc alpha	Recalc Blade angle beta	Actual beta degrees
1	0.2	1.2	29.1	0.180	7.72E+04	1.76	22.9	6.1	11
2	0.3	1.8	20.3	0.170	1.02E+05	1.38	11.0	9.3	10
3	0.4	2.4	15.5	0.160	1.25E+05	1.15	6.6	8.9	9
4	0.5	3.0	12.5	0.150	1.44E+05	1.00	4.7	7.8	8
5	0.6	3.6	10.5	0.140	1.60E+05	0.90	3.7	6.8	7
6	0.7	4.2	9.0	0.130	1.73E+05	0.84	3.2	5.8	6
7	0.8	4.8	7.9	0.120	1.82E+05	0.80	2.9	5.0	5
8	0.9	5.4	7.0	0.110	1.87E+05	0.77	2.7	4.3	4
9	1.0	6.0	6.3	0.100	1.89E+05	0.77	2.7	3.7	3

Peru NACA4412 blade designed by Teodoro Sanchez

Blade station	Local radius metres	Chord width metres	Blade angle beta degrees
1	.15	.1679	14.5
2	.2	.1608	13.6
3	.25	.1537	12.7
4	.3	.1466	11.8
5	.35	.1395	10.9
6	.4	.1324	9.9
7	.45	.1253	9.1
8	.5	.1182	8.2
9	.55	.1111	7.3
10	.6	.104	6.3
11	.65	.0969	5.4
12	.7	.0898	4.5
13	.75	.0827	3.6
14	.8	.0756	2.7
15	.85	.0685	1.8

APPENDIX II : BLADE TEMPLATES ACTUAL SIZE

*THESE TEMPLATES ARE VIEWED FROM THE TIP
LOOKING TOWARD THE CENTRE OF THE ROTOR*

TEMPLATES FOR SRI LANKA 2-BLADE DESIGN USING K2 PROFILE
- 9 STATIONS -

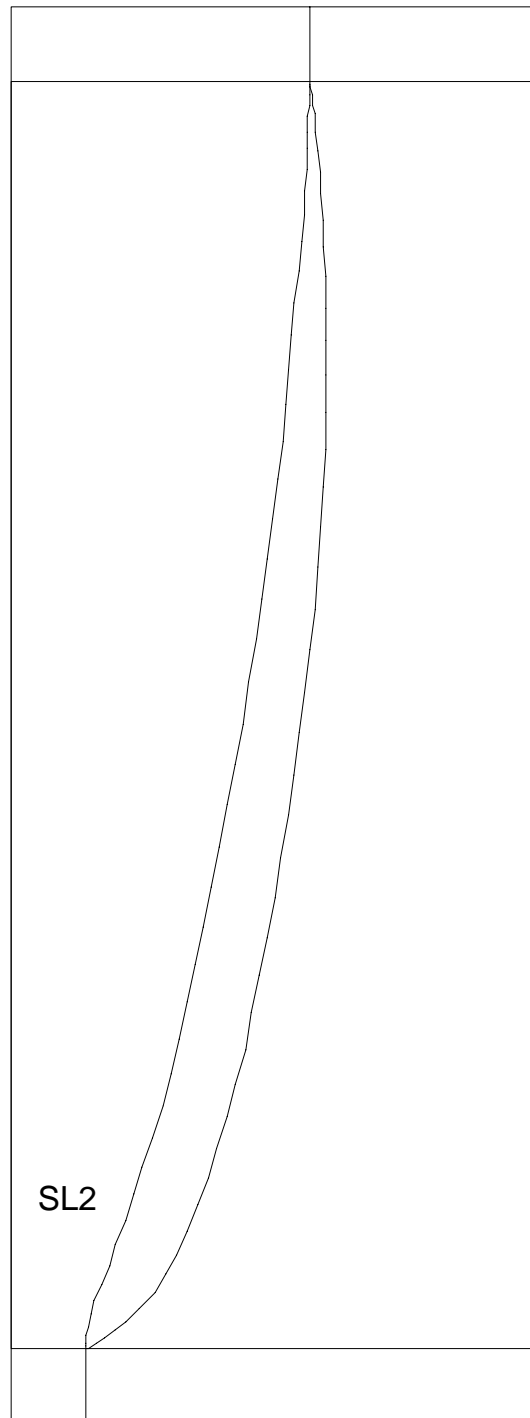
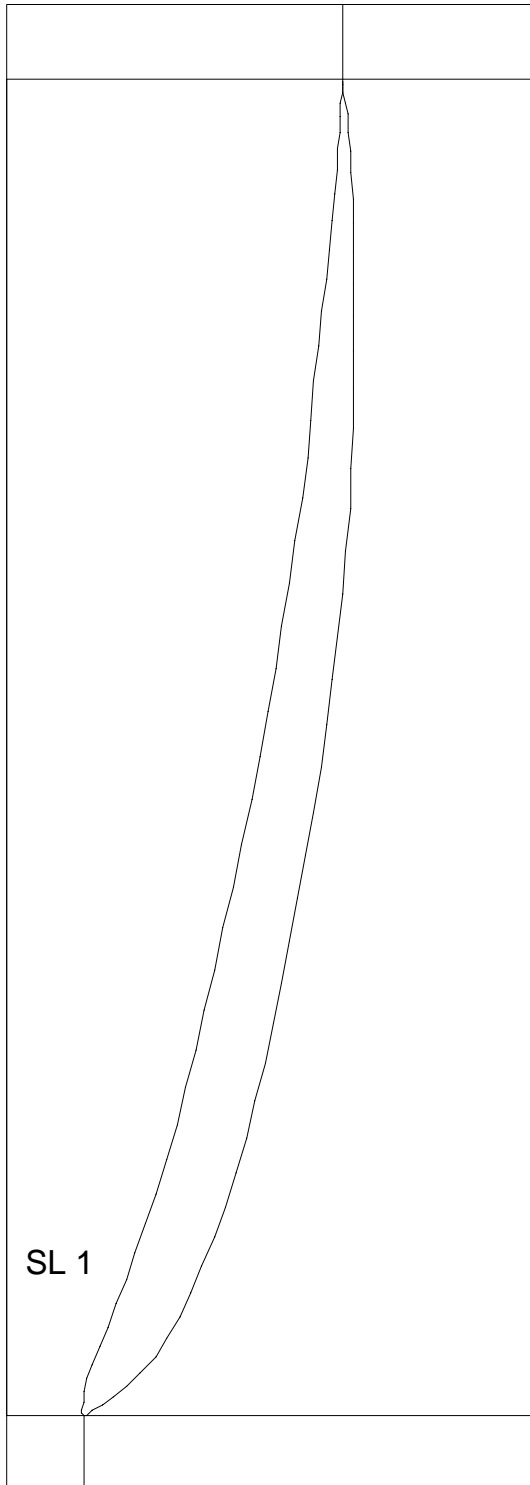

TEMPLATES FOR SRI LANKA 2-BLADE DESIGN USING K2 PROFILE
- 9 STATIONS -

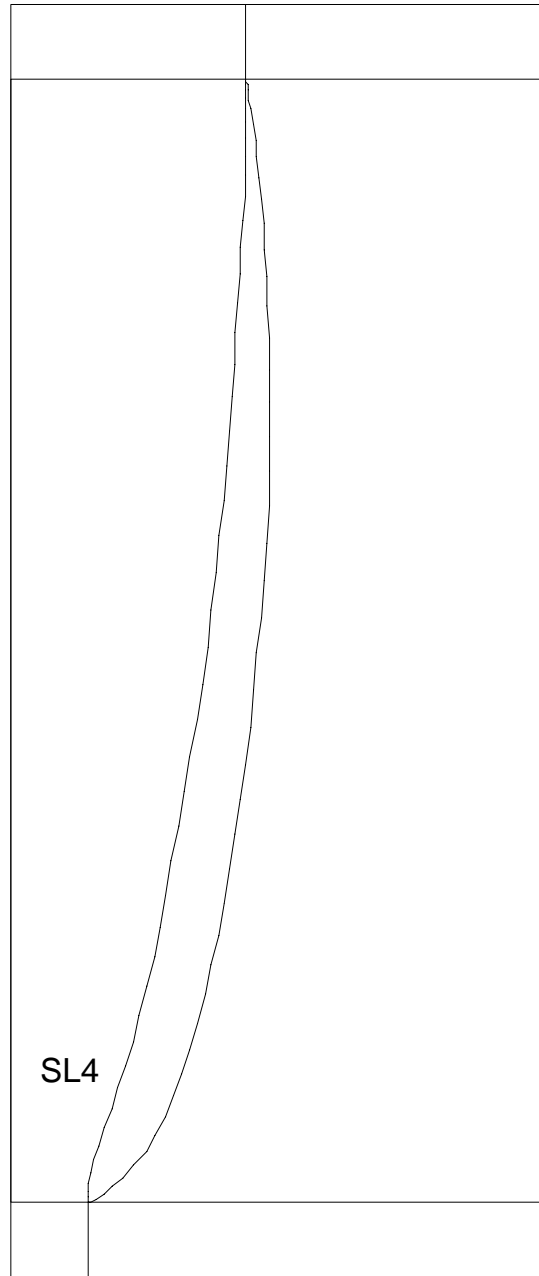
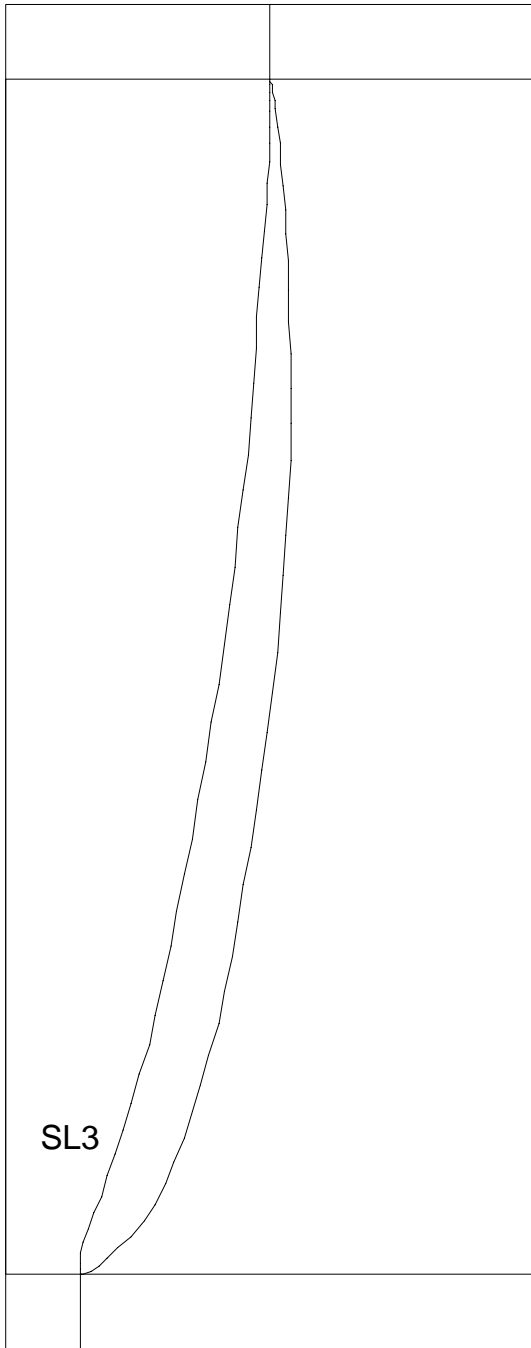

TEMPLATES FOR SRI LANKA 2-BLADE DESIGN USING K2 PROFILE
- 9 STATIONS -

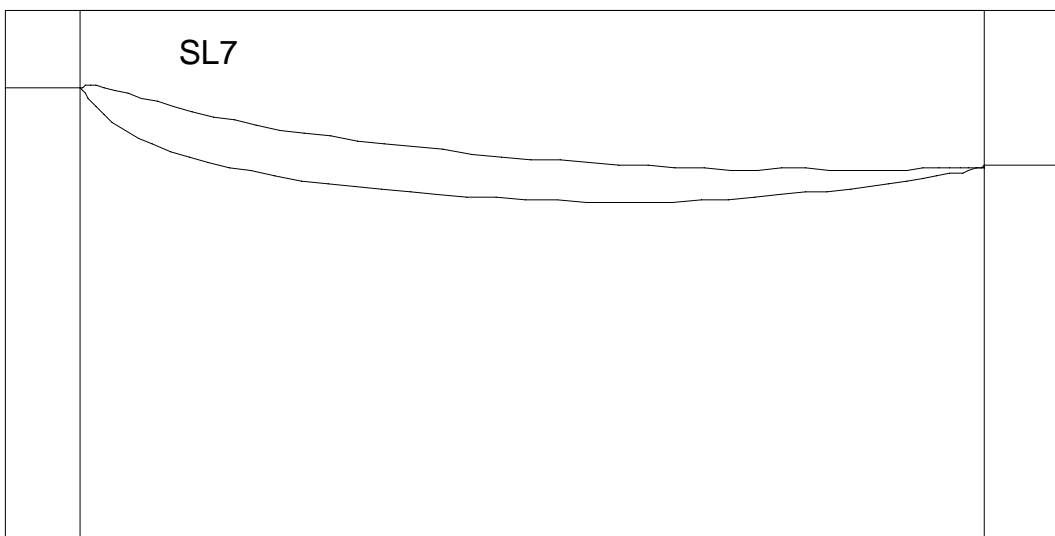
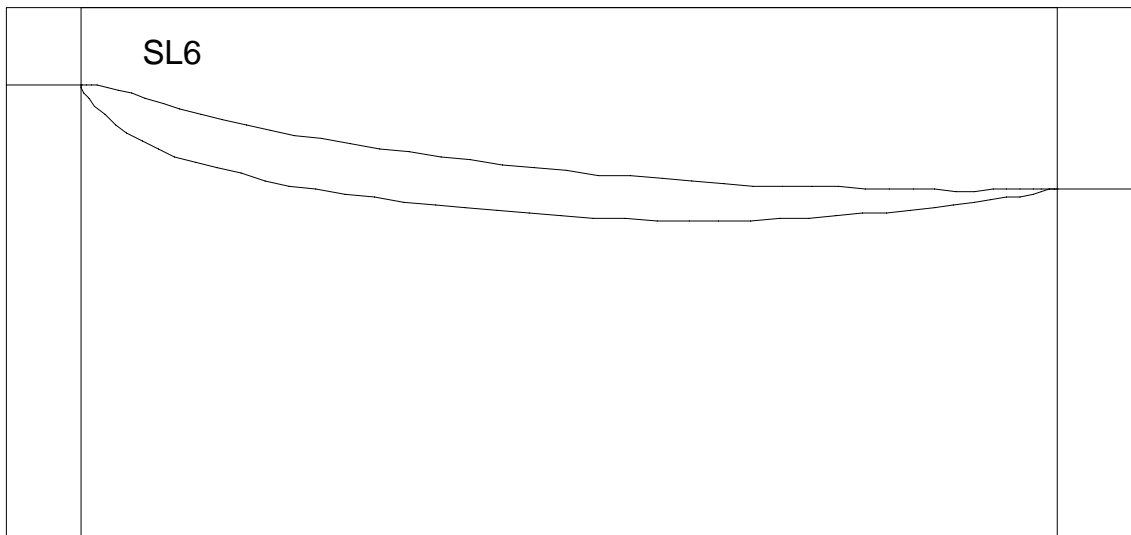
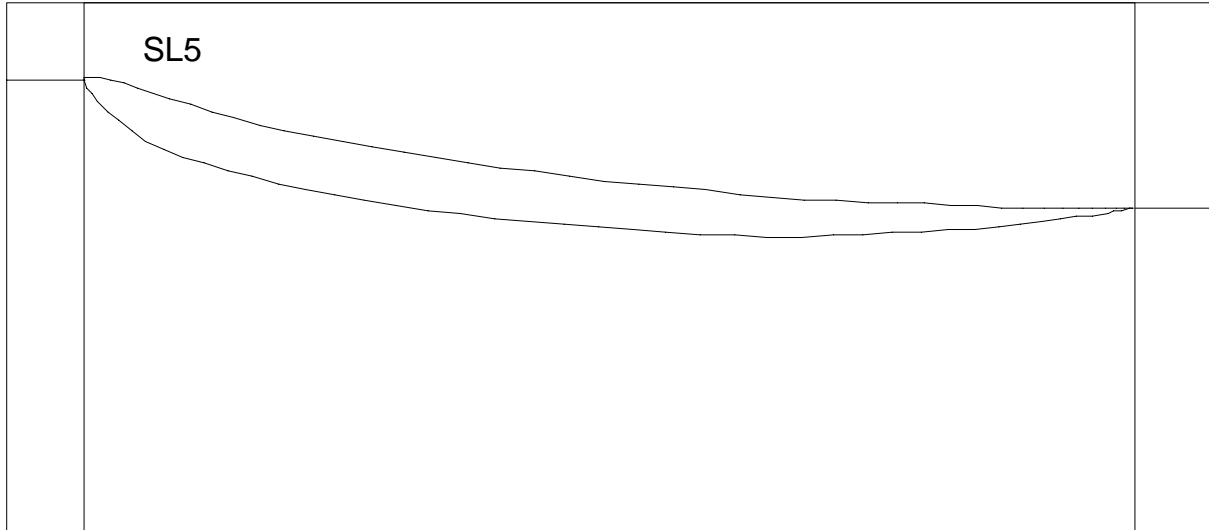

TEMPLATES FOR SRI LANKA 2-BLADE DESIGN USING K2 PROFILE
- 9 STATIONS -

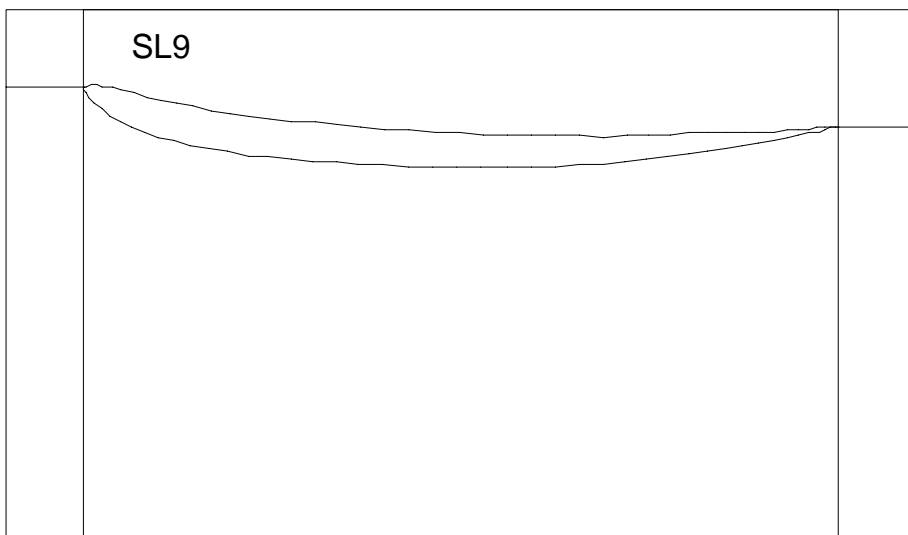
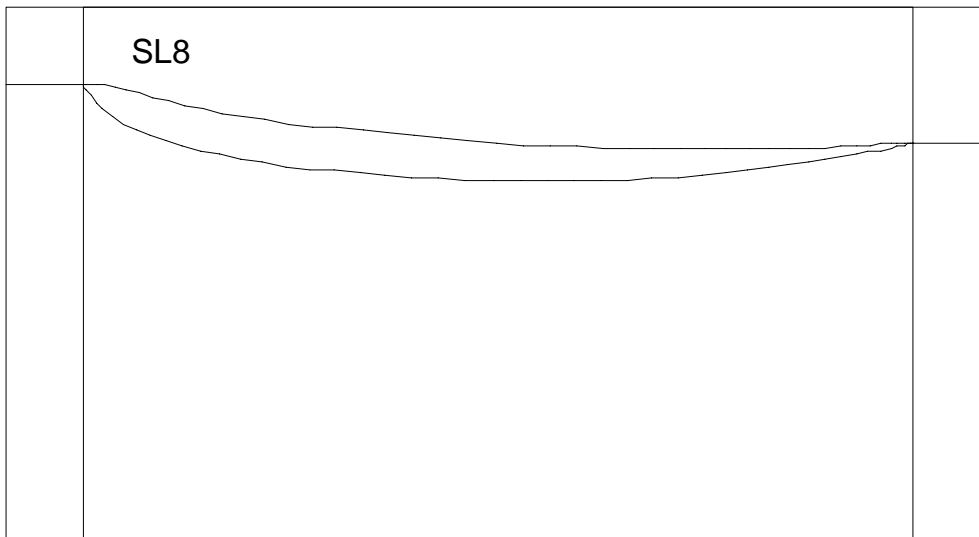

TEMPLATES FOR PERU 3-BLADE DESIGN USING NACA 4415 PROFILE
- 15 STATIONS -

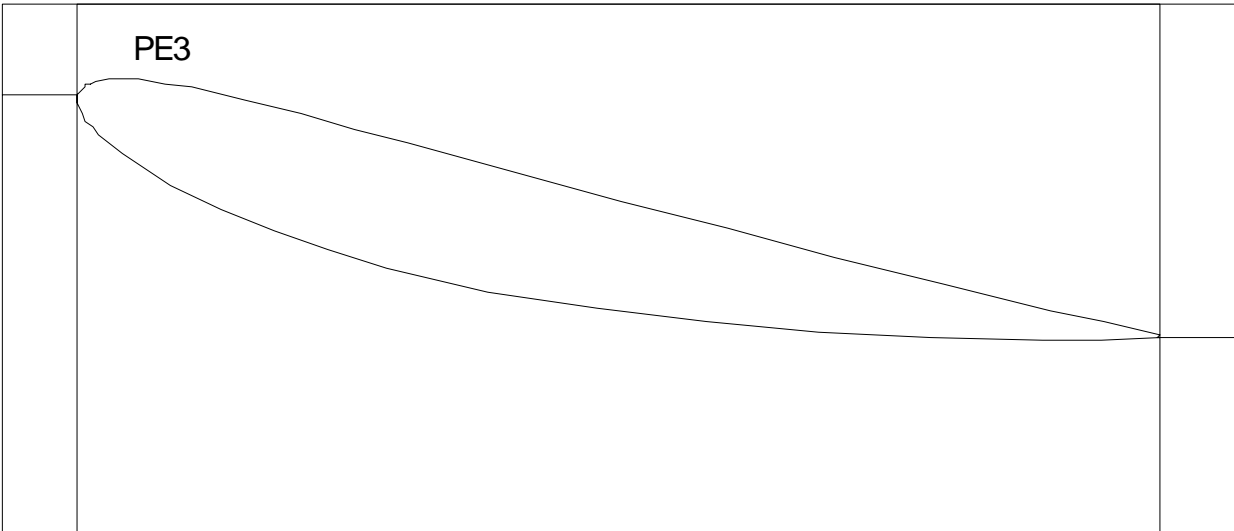
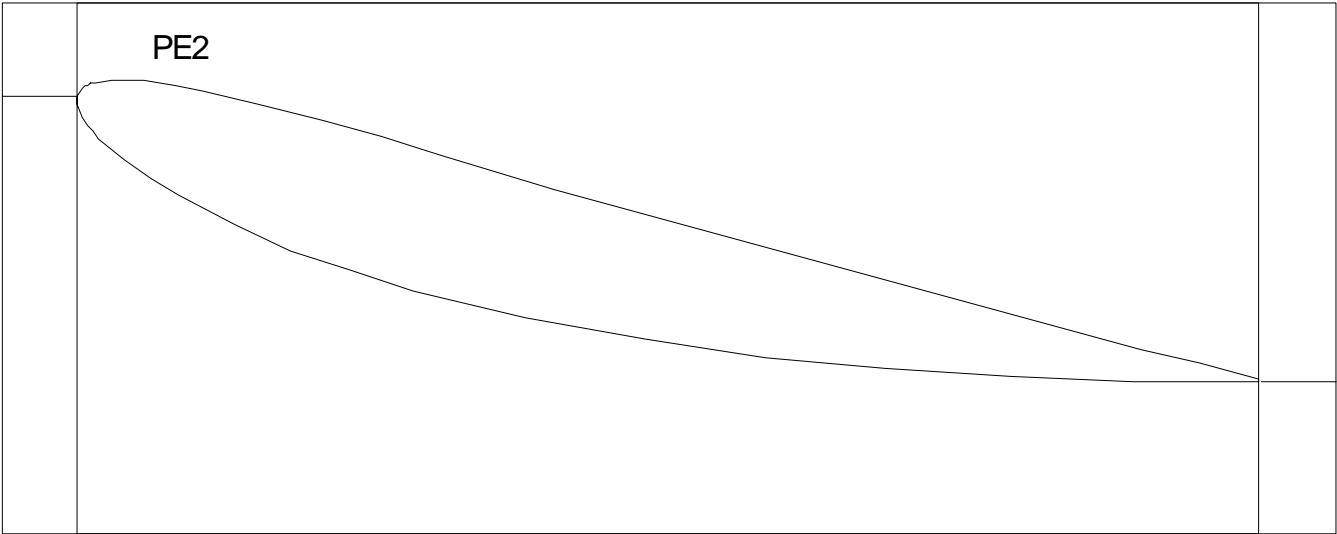
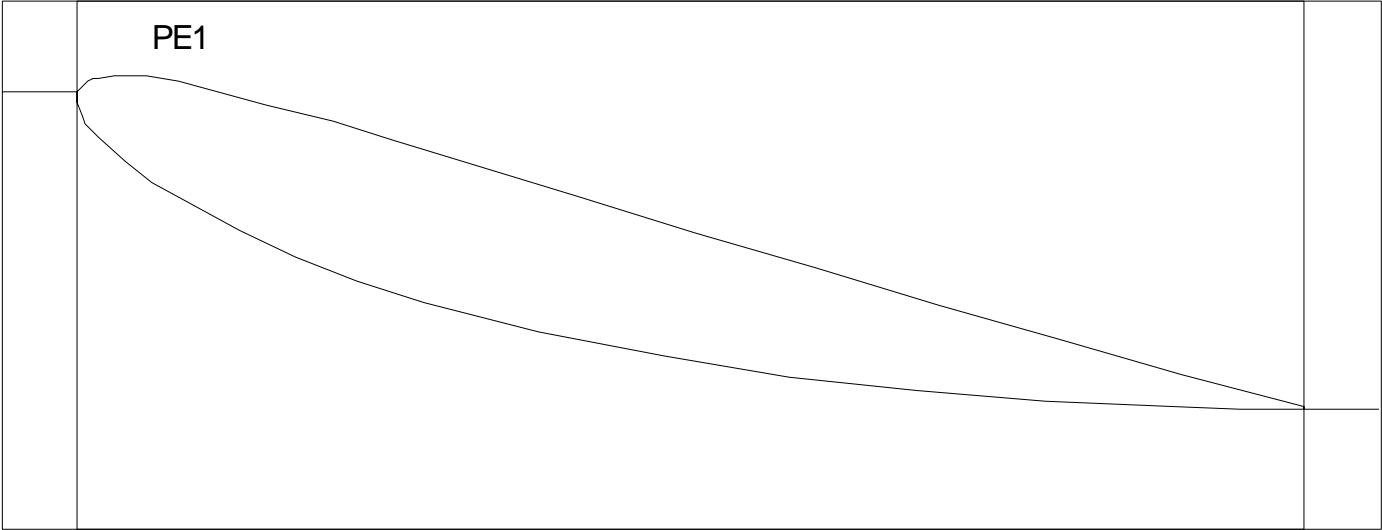

TEMPLATES FOR PERU 3-BLADE DESIGN USING NACA 4415 PROFILE
- 15 STATIONS -

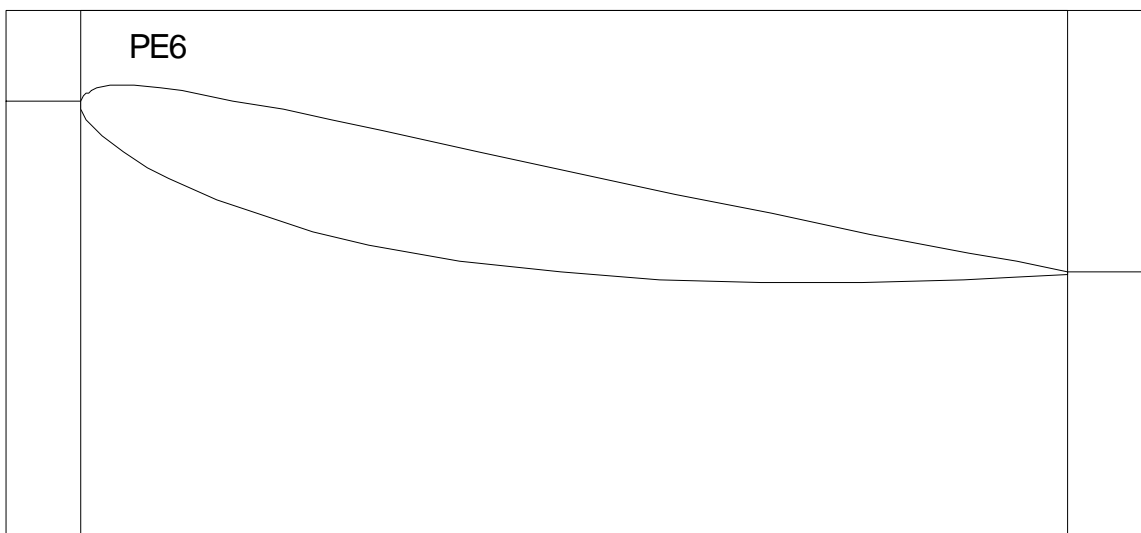
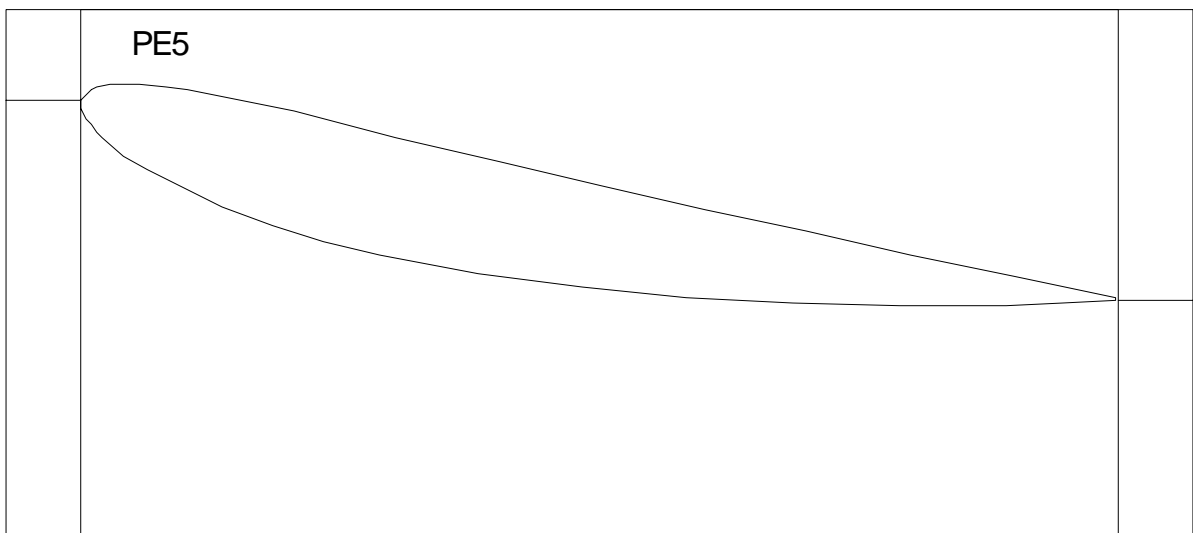
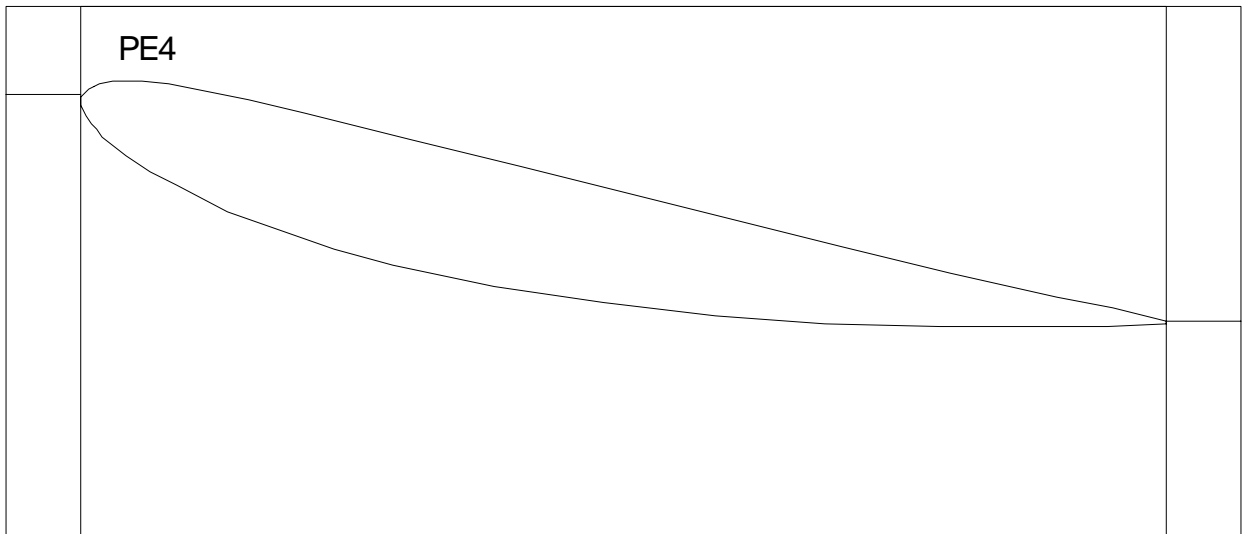

TEMPLATES FOR PERU 3-BLADE DESIGN USING NACA 4415 PROFILE
- 15 STATIONS -

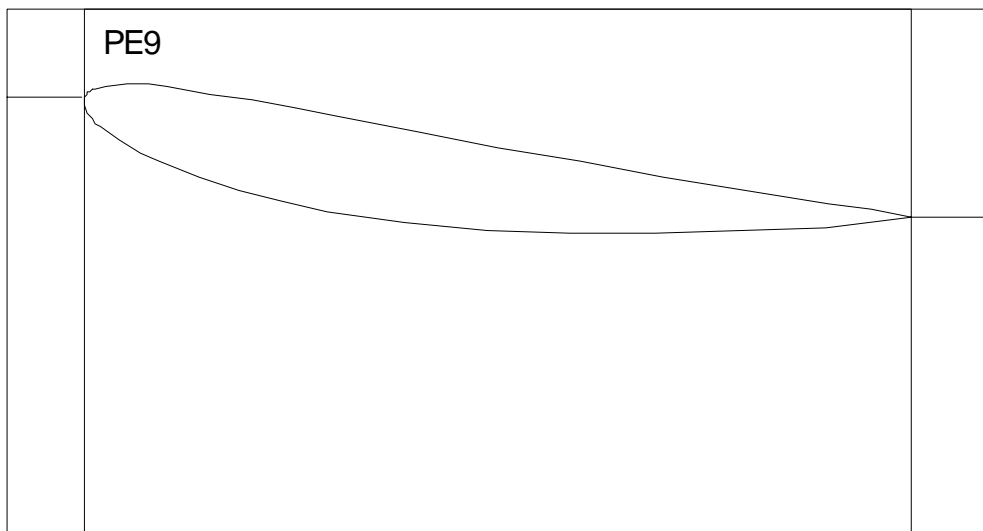
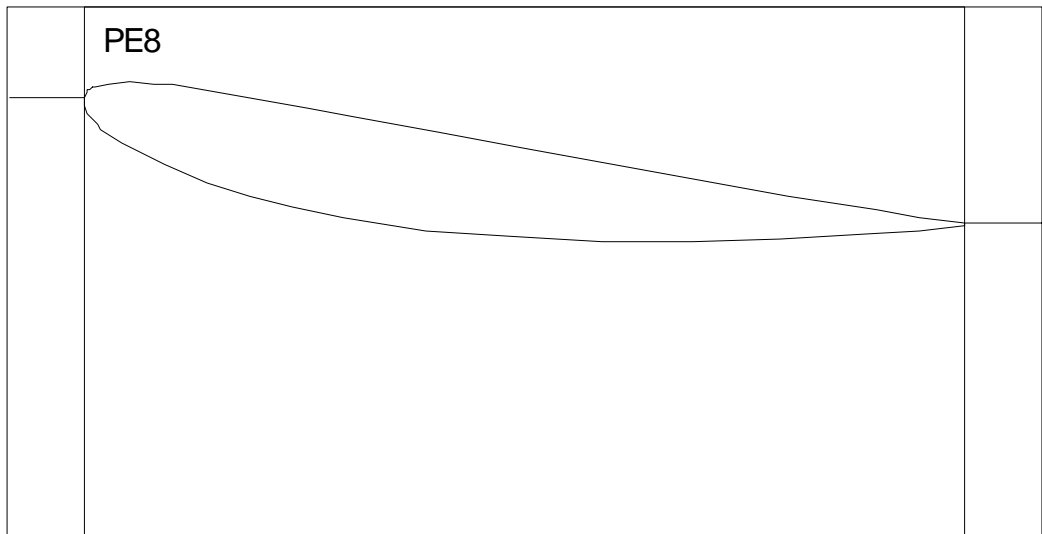
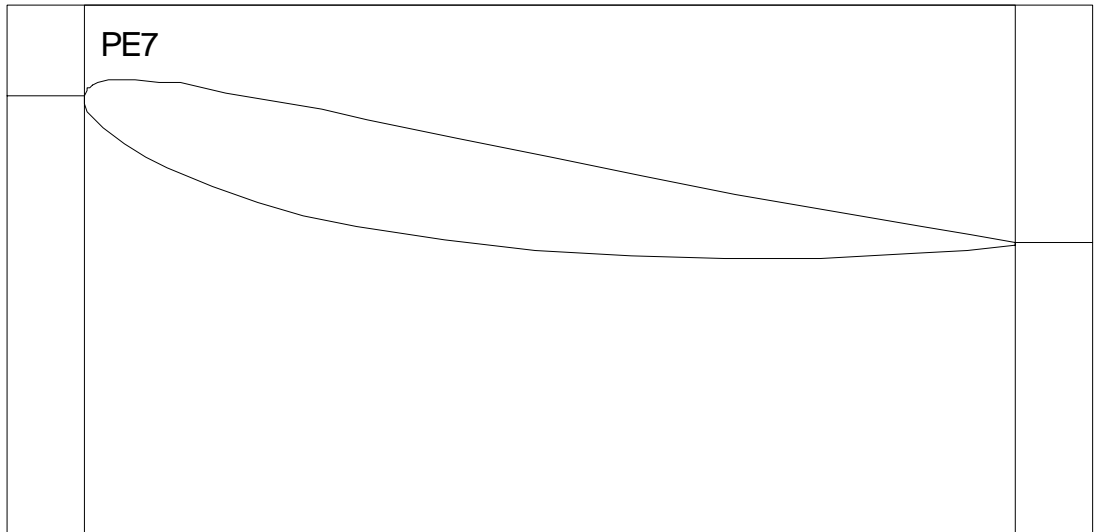

TEMPLATES FOR PERU 3-BLADE DESIGN USING NACA 4415 PROFILE
- 15 STATIONS -

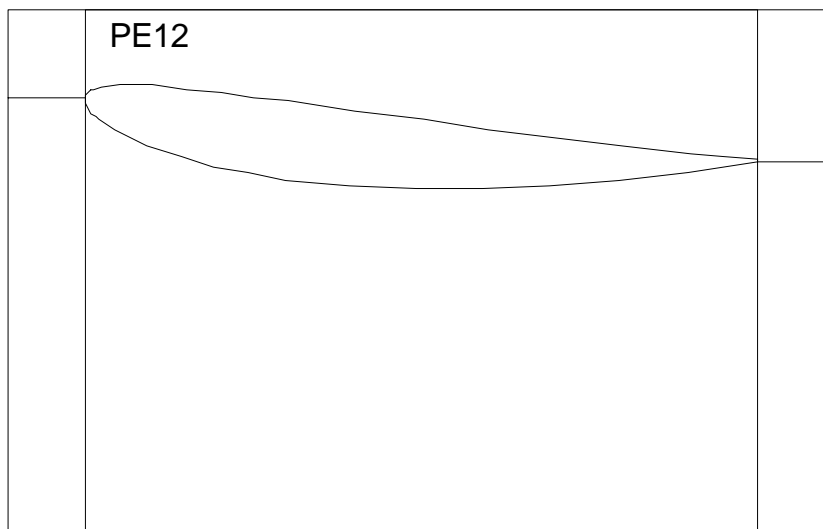
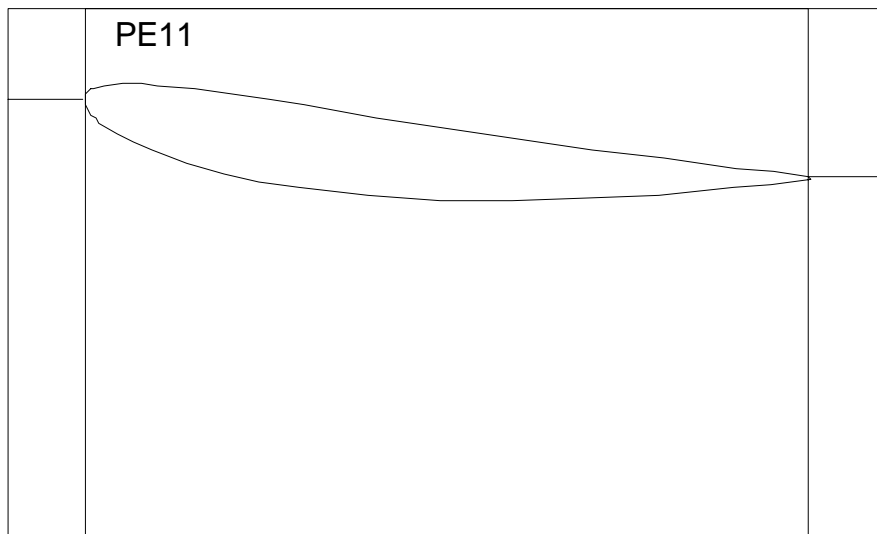
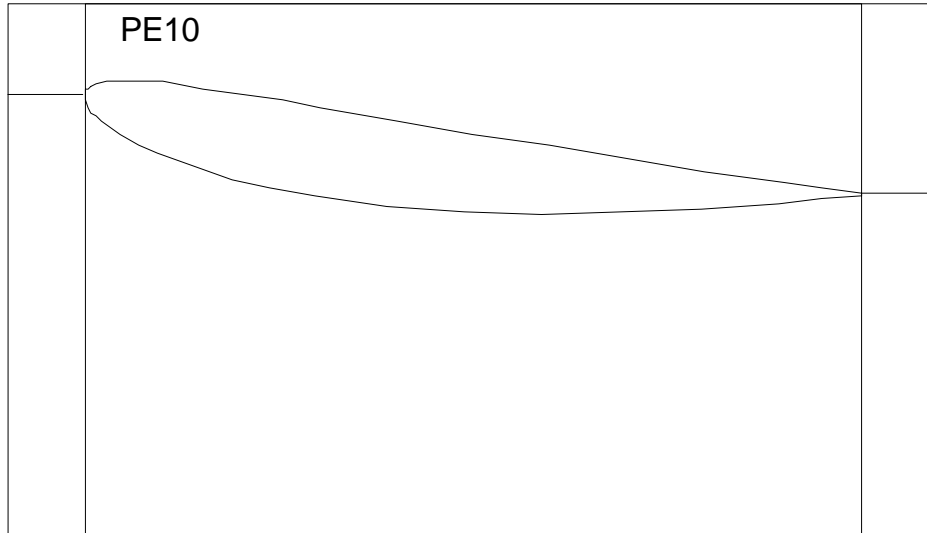

TEMPLATES FOR PERU 3-BLADE DESIGN USING NACA 4415 PROFILE
- 15 STATIONS -

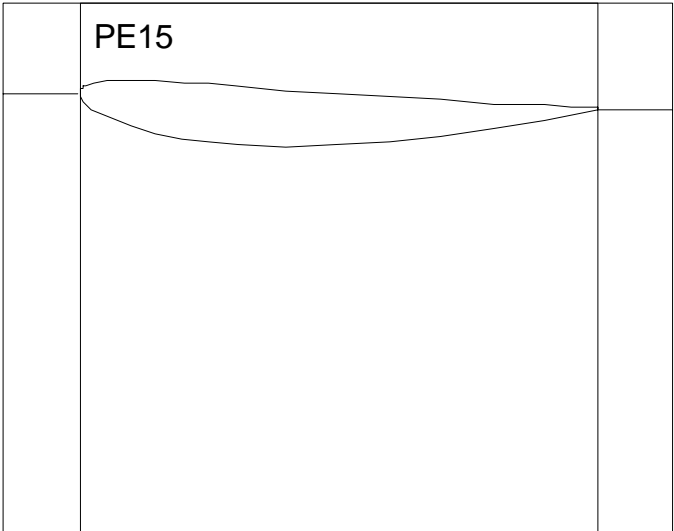
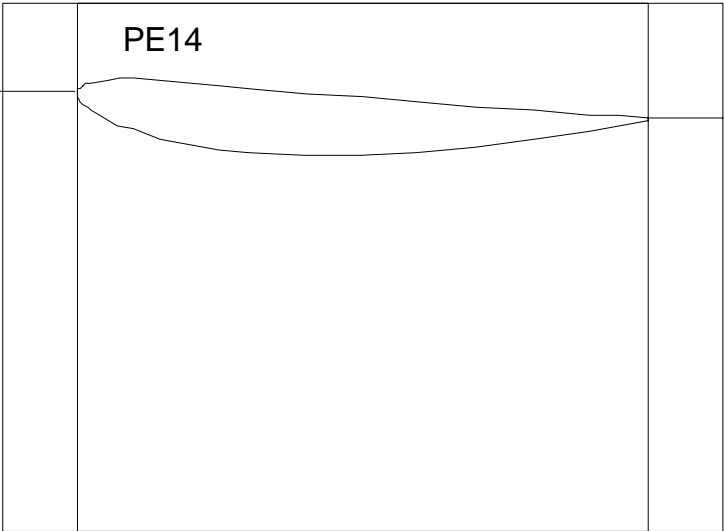

Tails

I hope that I will find time to get more onto this page about tails. They are a very undertreated subject on the web but both Bob Budd and Hugh Piggott give a lot of information in their books.

The purpose of the tail is to keep the propeller facing into the wind in low winds and to turn it from the wind (feather it) when the speed exceeds the windmill's design for either the propeller or the speed of the generator. There are some designers that don't bother but you will have to judge the wisdom of that for yourself.

The mechanism that causes the tail to feather the blades is based upon speed and lift. The greater the speed the more lift and the tail swings to the side. At what speed this should occur depends upon the performance of the individual components of the unit. Units vary in weight, blades vary in performance and every generator has its own sweet spot for performance.

The only way to accurately determine the placement of a tail so that it will do its job is to test it with all the assembled components of its unit. I treat more of that subject on the page dealing with "testing".

[Tail Mounting: Some pictures of a tail mounting.](#)

This is the windstuff now site. It also shows another concept for windgenerators in that it has a chain driven motor as the generator.

[SEALED: Some pictures of a tail mounting.](#)

This is the SEALED mirrored version of this site that won't be opened until after The Great Catastrophe.

[Overview: Forcefield Overview of Windmill Design.](#)

This is a good overview on Windmill generating systems from Forcefield. It does in fact also cover in considerable depth different concepts about "furling" but while I personally have excellent instructions in a video from Bob Budd, I have not been able to find a good source on the Web.

[SEALED: Forcefield Overview of Windmill Design.](#)

This is the SEALED mirrored version of this site from Forcefield that won't be opened until after The Great Catastrophe.

MENU: [HOME](#) » [Reconstruction](#) » [Recovery](#) » [Renewal](#) » [Energy Types](#)

Testing

Propeller Testing

Because every set of handmade propellers is different and because there are probably substantial differences between each homemade generator, both as to performance and weight, the propellers and the completed system need to be tested and the associated tail vane customized so that the unit will feather (turn out of the wind) at its optimal performance speed.

A wind tunnel would be one solution for testing but this is another very clever one from Force Field. In the future I hope to mount ours on a Smokemobile - but that is another story, found elsewhere among our web pages.



[Windspeed: Homemade Easter Egg Anemometer](#)

This is a REALLY neat build it yourself device. Haven't done it ourselves - yet. But we are getting the components together. Pretty important to have one if you are going to be serious about wind generation.

And you shouldn't be surprised that the design is from Force Field. It is presently available at:
<http://www.otherpower.com/otherpowerfront.shtml>

MENU: [HOME](#) » [Reconstruction](#) » [Recovery](#) » [Renewal](#) » [Energy Types](#)

Water Powered Generators

Water is Wonderful. Usually even more wonderful than wind because it is usually more constant. What will be more wonderful still - is if you have a suitable source because very few people are so blessed. We have been double blessed at Ark Two because both of our properties sit upon each of one of the twin headwaters of the Pine River.

Below are links to pictures of the sites and on the web page I present details about the power systems designs and how you could apply the principles to other potential waterpower sites in a nuclear recovery situation. Between the two cases you will find an approach for either of the two opportunities you may find - either a low-head or a high-head situation.

[Waterfall 1: The Large Waterfall at Ark Two](#)

While we cannot implement this system under the present government bureaucratic situation you can still see its potential for use in a recovery situation and under the link below about pumps you can see the studies we have done in preparation and the materials to which we might have access.

[Waterfall 2: The Smaller Waterfall at our Home](#)

Although we are also forbidden to implement this system at this time you can again see the preparations that we have made. More particularly you will find here a presentation of how to build, out of materials salvageable after a nuclear war, a low head waterwheel system for use with a low rpm generator.

[Waterfall 3: Micro Generating with Water.](#)

Here is a micro generating system using water. Its big advantage is that it is constant, so over time one or several could add a significant amount to a battery storage system. It uses a blower out of an old house furnace so that the waterwheel part is very simple to build.

[SEALED: Micro Generating with Water.](#)

This is the SEALED mirrored version of this site from Forcefield that won't be opened until after The Great Catastrophe.

[Pumps: Pumping out power](#)

Surprise! Surprise! Pumps are used to move a liquid (like water) but - if you run the liquid BACKWARDS through them, then they will turn a generator (like that motor described on an earlier page

- maybe even the motor that was used to run them originally). How do you run the liquid backwards - why you use something like a waterfall. This page contains the engineering studies for application to our big waterfall.

MENU: [HOME](#) » [Reconstruction](#) » [Recovery](#) » [Renewal](#) » [Energy Types](#)

Water Power Potential at Ark Two



This is Little Wonder Falls
so named by the Pioneers two centuries prior - because of its wonder and power.
It is at the main Ark site.



At one time there were over fifteen mills in the village. The water would be captured at one dam and then released down to another. There was more water year round in those days because the forests held snow to melt for much longer seasons, and truly there was much more snow in the winters. But this is still the water above our dam.



The way the system would work is that the water would be allowed to build up behind the dam above the falls and then it was let out through the flume in a great rush for a few hours until the water pressure was exhausted. Then the system was shut down and the water was allowed to rise up behind the dam again before the machinery could be started again. In this way the water flowed and stopped in the stream - on again and off again on its way down to the next dam - something that would not be permitted today.

From
the
dam,
under



the
road
and
then
on to
and
over
the
falls
there
is a
flume.

Here you
can see the
flume that



brought the water from the dam on the other side of the road and over the cliff.

Down below the cliff there is still the old water turbine that was used to power the



machinery by driving belts.

The first mill produced what was called Little Wonder Flour. The flour industry, however, was eliminated by the arrival of the railroad which brought hard wheat flour from the western provinces. Hard wheat flour was much preferred over the soft wheat flour produced locally.



Today with much improved electrical generation technology and the significant fall of the property on downstream from the present turbine location the falls could produce a substantial amount of electricity. Certainly enough to power the village. However, under the current bureaucratic situation, at the time of this writing, such an effort would be completely impractical to undertake. Perhaps in the future there will be different circumstances.

The battle with bureaucracy has been immense over the years - and certainly preceding my generation. Two large power generating systems were about three miles further downstream from us. One supplied power to several communities for about 20 miles around. The government, in order to gain economies of scale for larger projects purchased and shut down these and many other smaller producers in the early 1900s. There was a revival in the 1930s during the Great Depression when the farmers could not afford to buy the government power and started a new power house at one of the dams. Once again the government bought it out and then dynamited the dam - so that wouldn't happen again.

At the time of this writing there is much lip service given to environmental concerns and the encouragement of "green" energy. But it is only lip service. The costs of getting through the bureaucratic hoops are so immense that it is totally impractical to try. But, in another time the need for these power sources may come into existence.

We continue to study the systems and gather the materials for that possible future time. On other pages, while explaining about different waterpower electricity generating approaches, I show the figures that engineers have given in our technical studies and some of the equipment we have identified that we could assemble after a nuclear war to make this site operational.

MENU: [HOME](#) » [Reconstruction](#) » [Recovery](#) » [Renewal](#) » [Energy Types](#)

Our Home Water Power Site

In the mystical beauty just outside our back door is our home waterpower site. In the 1800's, because it is located at the main intersection of the village, this was the most prominent (although it was certainly not the largest) watermill site in the village.

At one time there were over fifteen mills on the two headwater streams of the Pine River in the village. The water would be captured at one dam and then released down to another. There was more water year round in those days because the forests held snow to melt for much longer seasons, and truly there was much more snow in the winters.



This is how the village still looks, which is probably about 80 years after this picture taken. Standing at this spot one would see that most of the buildings in the picture are still standing and those are still the only buildings they would see. The only difference I can see is that the street has been paved and the building where the arrow points is where our house is now. The big building behind it was a hotel.





This is our house today at the bottom of the same hill and still looking back up the hill. In the forefront of the picture is the bank of the stream that comes from under the house across the road and runs around behind our house. The big building that was the hotel is barely visible through the big weeping willow in our front yard. There were also two other hotels and a couple of general stores across the street, the buildings for which are still there.

This is where the water starts downward on our property - as it turns away from the road. We have a little over a ten foot drop to the bottom of the dam at the other end of the property which was the first mill on the stream. This stream flows year round and the volume is fairly constant although once or twice I have seen three or four times the volume during times of extended rain.



Standing on the
first bridge behind



our house and looking downstream towards the second.

This is what is left of the old dam at the other end of our property. This doesn't make any difference to our new design using the pipe because all we need is the drop - not the water behind the dam. The dam is now only half as high as it was when we bought the house a quarter century ago and it used to be higher still. In the olden days they would allow the water to fill up behind the dam, a process that I would estimate to take between 45 minutes and a hour and fifteen minutes and then there would be power to mechanically run the saw to cut planks for maybe twenty minutes. As the water went down the saw would get slower and slower and then they would eventually stop and let the water build up again. The dam is now all silted in. I had it cleaned out about twenty five years ago but it silts back in, in about five years.



Here you see myself and my grandson helping my son build a cedar crib to capture the water up near the road.



Here is Capt. Bill in command of the little ark as we sail it into the stream. Bill started as assistant foreman over 20 years ago in the building of Ark Two. Since Percy passed on he has been our foreman.



This was the cedar box down in the stream. We planned to pack dirt along one side and to provide a fish ladder on the other. The box itself strained out sand so that it would not go down the pipe and into our power generating system.



On the back of the cedar box we would have attached this pipe.

And then these new pipes would have been buried in the bottom of the stream so as to not destroy the scenic view. In the face of pressing need for energy after a nuclear war we may not have for a long time the luxury of burying them. Originally the stream was a mosquito marsh but years ago I had it lined with giant boulders and put the bridges from both sides of our property across it. Even this would not be permitted today under current government bureaucracy.



And this is the cedar box back up on the bank after ENFORCEMENT



(that is what the 10 inch high letters say on the front of their truck) made us take it back out.

I have told you this whole story so that you can know the degree that we have worked on this system. We think we have a concept that will work exceptionally well on lowhead water sources. In the following paragraphs I will explain the technological concept of the system so that hopefully others will be able to apply the principles elsewhere.

Every system is unique

Every waterpowered electrical generation system has to be tailor made to:

- the volume of flow
- the height of the head
- the layout of the land
- the climate
- the generation goals
- the materials available
- environmental concerns

There are many sub-subjects consideration such as:

- dam construction
- flume construction
- power house construction

transmission line construction
power distribution
power sharing or restrictions

Varieties of Approaches

There are a variety of technological approaches to meeting each of the requirements but it will be of little benefit to list all that is available today when the real issues will be what is available at the time of nuclear recovery construction when one will have to make do with what they can find then. A concrete dam might be better than an earthen one but you may have to make do with an earthen or even log and stone dam. A higher dam might be better than a lower. But you will have to do what you can safely do with the materials that you have.

Waterwheels

In the olden days the main mechanical power technology used was the water wheel. These fell into two categories of the overshot wheel and the undershot wheel. The advantage of the overshot is that it can be made of "buckets" and the weight of the water as it goes down will greatly add to the wheel's momentum. The larger the wheel the more sustained momentum. The disadvantage of the overshot wheel is that its height takes away from the available head. However, if the head is very high, then this may make little difference. Unfortunately most situations will have the problem of a low head rather than the advantage of a high head.

The undershot wheel only captures the water flowing through and therefore does not gain from the benefit of the weight of the water but is more suitable to lowhead situations. There is actually a third choice, not often seen, and that is the sideshot wheel in which the wheel lies on its side at the lowest level and the water is directed from the side by a nozzle towards the propellers. In this configuration it is possible that the wheel can still be quite large. Indeed this is the design that we have chosen for the house system at the smaller falls.

Turbines

For those who go out and buy waterpower generating systems - the preferred systems are usually turbines. These are finned devices (of a variety of types) some that fit directly into the flume. The design specific to a system needs to meet two factors - the diameter of the pipe and the volume of the water. The volume and diameter will determine the speed of the turbine. For seventy-five thousand dollars, one engineering firm offered to run their computer program for us that would give an optimal design for a turbine on our smaller stream. We declined. But, you can see how technical this could get.

The main designs of small capacity turbines are called the Pelton, Turgo, Francis and Crossflow. Each have their advantages in certain situations and disadvantages in others. However, this is not a proper subject for a

web page dealing with the development of systems in a nuclear recovery situation. Those who have the luxury of building a system ahead of time, when they have the option of obtaining various designs, can research the sources elsewhere on the web.

A Unique Approach for use in Post Nuclear Recovery

Days of touring salvage yards to see what may be applied found that there are often large paddle devices that were industrial air blowers, churning devices, or what were in effect large low volume pumps. By directing the water through nozzels at these paddles or blades we feel that some sustained momentum may be achieved. One of the major considerations is to design the water exit in such a manner that you are not losing the energy in pushing the water out. The idea is not to move the water (although that may have been the original idea behind the device) but instead for our purpose the idea is to get as much energy as possible from the force of the water. For this reason one good approach may be to simply lay the wheel and cabinet on its side (although it was not originally designed to work that way) and cut some holes in the cabinet so that the water will just fall away.

Scientific Principle

There are two considerations or concepts that one must keep in mind with any waterwheel and these are momentum and torque.

Momentum / RPM

Momentum is the speed at which the wheel moves. We measure it in RPM (Revolutions Per Minute). Some people have trouble in thinking in RPM, so I will try to help clarify the concept. The earth has a relatively low rpm. Not even ONE rpm. Not even one revolution per hour. It takes it 24 hours to make one turn. Admittedly - its outer edge is moving at hundreds of miles per hour. And if you think that is big and slow - think of the galaxy. Billions of years to make a revolution although again - its outer edge is moving at thousands of miles per hour. It is just a long way around. Generators (like those on a car) generally need 1800 rpm or more. That is to say they need to make 1800 revolutions per minute. An average speed for our low rpm generators is 400 rpm but to help think this through let us say that it was 300 rpm. At 300 revolutions per minute **it is making 5 revolutions every second**. (60 seconds in a minute times 5 revolutions per second equals 300 rpm (revolutions per minute)). Not terribly fast. Something you can see.

Torque

Torque is a function of BOTH speed and mass. Think of the earth in our example above. While it is moving relatively slowly because of its mass - think of what it would take to stop it. Or the galaxy. The Mass!!

Billions upon billions of stars and planets. Big - slow - although the outer edge is moving at thousands of miles per hour - but the torque!! It may seem that rotation speed is a function of size - because for example the electrons of atoms spin VERY fast - so fast that we speak of their rpm as frequency. But torque is a function of both speed and mass. A very large body with low speed has lots of torque. So does a small body with lots of speed. But it is the total combined that gives the ultimate measure of torque. Closer to the size of things we observe everyday let us take the example of a big truck wheel that is moving very fast. Once it is up to speed even if then just freewheeling it would take a lot of energy to stop it - because it is big and heavy and moving fast.

Conversion of the Mass component of Torque to Momentum

Torque is made up both momentum and mass. The momentum/speed component of torque can be converted to mass/weight and the mass/weight component of torque can be converted to speed/momentum. Let us first look at converting the mass component of torque to momentum. We can do this through the use of gears or pulleys. Chain driven gears may work better around water than belt/pulley driven devices but the principle remains the same. We go from a larger wheel with its torque consisting of a large slow moving mass/weight to a smaller wheel which will then turn faster.

Picture the belt/chain around the large wheel that is turning slowly and then the belt/chain extending down to the smaller wheel which then must turn quickly to keep up with the speed of the belt. The shaft of the smaller wheel can have on it another somewhat larger wheel that will then be turning at the same faster speed of the smaller wheel and a chain/belt from that larger wheel to still another smaller wheel on another shaft will repeat the principle with this second smaller wheel going faster still. The process can be repeated a number of times so that while the first wheel may have been turning only a few revolutions per minute - we can arrive at a wheel turning thousands of revolutions per minute - if that is our goal and PROVIDING that the first wheel has enough torque (combination of weight/mass and energy/momentum) to sustain the drag of the added gears or pulleys.

The reverse principles can be used to make a fast moving small wheel turn more slowly a large wheel, but it is more likely that in our application we are going to need to use the method given in the example. Adding the weight or drag of the belt/chain slows down the big wheel and our problem is that usually we cannot make it go fast enough to overcome the drag that we wish to add to it.

Using a slow waterwheel to run a faster generator

In our above horizontal waterwheel we would have the water hitting the paddles of the the wheel from several sides of the wheel. As an analogy, think of the old playground merry-go-round. Children stand around the outside adding to the speed of the spin. Each one pushing on a bar as it goes by. Eventually they cannot push very much on the merry-go-round because it comes by too fast for them to get a hold on it. Each child is not adding much energy to the wheel as it goes past. Each child's energy potential is being

wasted.

The same thing happens when our waterwheel is coming past the nozzels too fast. The water from the nozzel does not get to hit the blade for very long - so its energy is wasted. The thing to do is to slow down the wheel. We do this by putting more weight on it. Now more energy will go into the wheel at each nozzel. With the merry-go-round there would be more children on the wheel and those standing and pushing would have longer to push the bar in front of them. We use the same principle to capture more of the speed of the water in our nozzels and to change it to torque in the waterwheel. We simply add weight and that slows down the wheel and allows us to capture more energy from the speed and force of the water.

A merry-go-round with few children on it is much easier to stop than another one moving at the same speed with many children on it. That is the effect of mass on torque. A body in motion tends to stay in motion and the heavier the body in motion - the harder it is to stop. This is one of the reasons why we like heavy flywheels in our system.

The Drawback to Flywheels

The DRAWBACK to flywheels is that there is ALWAYS a loss of energy in conversion so ideally we would instead like for our initial wheel to be moving at the end desired speed with the maximum torque it that can master. Because it is difficult, with low head sources, to actually get up to 1800 rpm it is more optimal to use low rpm generators and so consequently our target is more in the area of 400 rpm. The question then becomes one of how much torque (mass/weight - moving at 400 rpm) can we develop from our blade/paddle and nozzel system. We are not wanting to just keep adding weight to the wheel until it slows down to 400 rpm because while it would have good momentum and torque - that is to say it would be difficult to slow down - that weight we added would be just dead weight and the energy (work) that we were using to move it around would be just useless work.

The weight that we want to add as directly as we can to the waterwheel is the weight or energy requirement of turning our generator at 400 rpm. If the waterwheel has the capacity to turn our generator at twice that speed then that is great because we can then let it turn two generators at the same time and we will get twice the electrical output. Conversely, if our waterwheel while initially turning at 400 rpm slows down to half that speed when we add the weight of turning the generator - then perhaps we need a smaller generator or two waterwheels to turn the generator, or a bigger faster waterwheel, or some other combination.

Waterwheel Variables

There are many variables that we can perhaps adjust. The size and weight of the waterwheel, the gear/pulley ratio of the drive to the generator, the number, angle and closeness of the nozzels shooting water onto the paddle/blades and the volume and speed of the water coming through the nozzels. There will undoubtedly be much skill involved in maximizing the adjustments. But no matter - with some reasonable application of the principles involved and some reasonable resources as to waterhead and volume and the components I have described - one should be able to produce some amount of electrical energy. Hopefully

an amount that will make the effort worthwhile.

I would liked to have carried this idea beyond theory, but The Powers That Be would not let me proceed with my experiments. We will have to make do with what we have available but we would particularly have liked to have worked further on the design of the nozzels - an art in itself.



Nozzels

I called around North America and talked with a number of nozzle design engineers and went and visited a couple. Basically what we concluded was that the antique fire hose nozzle of old was the best that we could do. It is long tapered and pointy (at least on the inside). This is somewhat difficult to machine but that is the ideal. One starts with a long bar of steel, (or plastic - if that is what you have and can handle), cut it up into appropriate nozzle lengths and then mill down into the inside.

We have bought all the components for the number (twenty-four) that we think that we will need at our two sites. Connectors, valves, makings for the nozzels, and lots of hose.

In the picture I am holding one of the assembled nozzels. We have also gone ahead and put in place the power house and have acquired the big batteries for the system but we have gone as far as the government will permit us to go.

As I have said - it would have been much better to get our home waterpower system working ahead of time and to prove out the design - but we have gone about as far as the government will permit us to go. We are also considering an altogether different approach for the large waterfall and that is a large pump which we would use as a turbine. But that subject is covered in its own place.

MENU: [HOME](#) » [Reconstruction](#) » [Recovery](#) » [Renewal](#) » [Energy Types](#)

Making Pumps into Electrical Generators

It is unlikely that after a nuclear holocaust you will be able to find a suitable turbine even if you do find a high head water source but here is a solution that has been tried and said to work even in pre-holocaust time.

[How to do it: Using a pump as a turbine](#)

This 38 page .pdf file gives you a lot information about the process. It is however copyrighted and will have to remain locked until after the nuclear war.

Unfortunately, because of government bureaucray we were not able to go ahead and do a demonstration implementation of the solution - still we did do the the engineering studies.

Large pumps are to be found, even now, in ship and oil field salvage yards. They may have been used to pump oil or some chemical so that you would not want to use them to pump drinking water - but that is okay because you are just using them to create power.

Here is a picture of the type of pump that we are talking about:



It is big (stands about 3 and a half feet high), heavy, and dirty - but once it is cleaned up it will probably work just fine. Moreover, you can very possibly use the attached motor, as explained in an earlier webpage, to run backwards and be the generator.

If you don't have a single large enough volume of water - or sufficient pressure in the water to run the pump then

you may be able to use the approach that I suggest on our home waterfall website and that is to cut holes in the casing and aim nozzels in at the blades, so that you are striking them at more than one location.

Don't forget - your goal is not to move the water (which is the original design purpose of the pump) but rather to take the energy out of the flowing water and transfer it to the wheel inside the pump. For this reason - once you have received the energy, the water is really just in the way and you are now having to use energy to get rid of it. Therefore, what you can do is cut other holes in the casing for the water to escape through - because you just want it to leave.

Another point. If you aren't getting enough energy from the wheel to run the motor backward at a sufficient speed to generate electricity you can also substitute a low rpm generator for the motor.

Overall the concepts here should have application for numbers of potential situations. And don't forget the idea of possibly adding a heavy flywheel to add to the torque and smooth out the operation, but also consider the disadvantage of flywheels as discussed under our home falls generating system.

Below is an engineering study on the expected performance of the pump at our large falls location.:

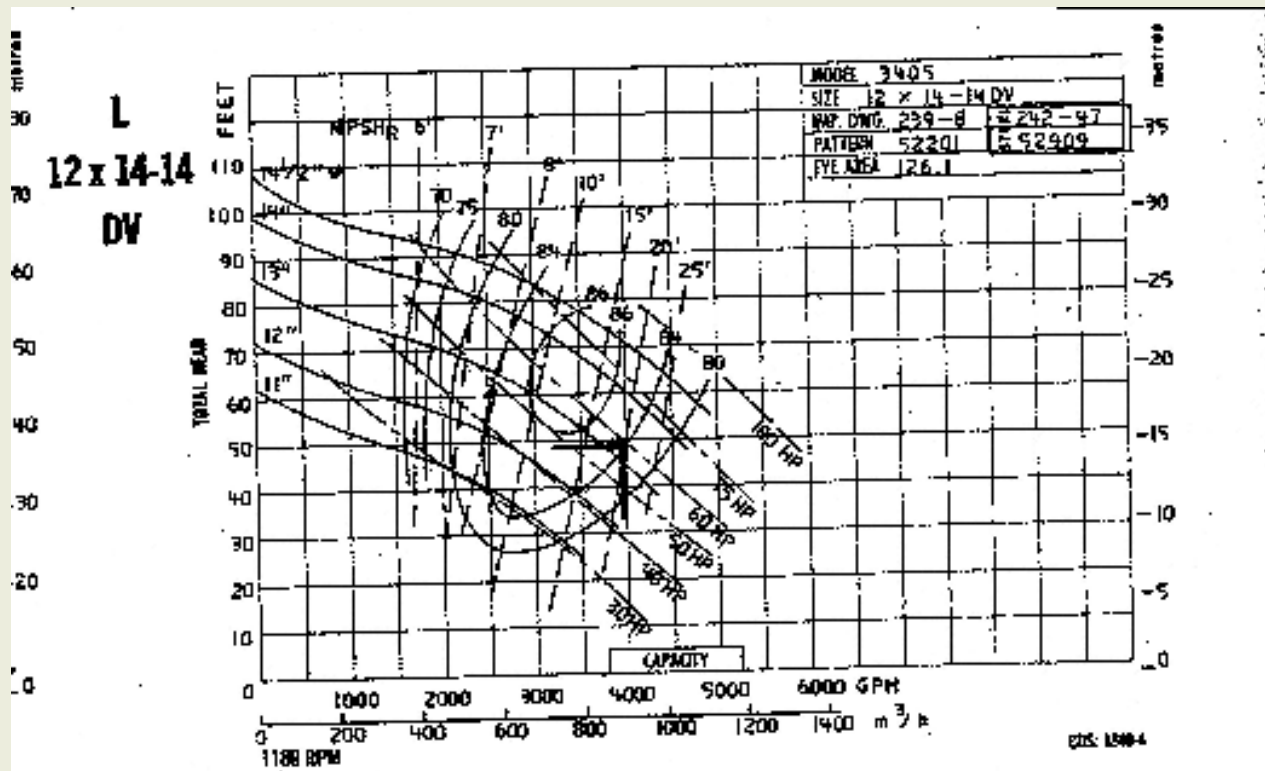

L
 12 x 14-14
 DV
 4000 / 51' @ 1200 RPM \equiv 3933 / 49.3' @ 1180 RPM
 IMPELLER SHOULD BE TRIMMED TO
 APPROXIMATELY 13 1/4" ϕ
 AT THIS SIZE, THIS PUMP WILL FLOW
 4756 GPM @ 60' AND PRODUCE 45.7 KW
 1200 RPM GENERATOR REQ'D

From the above chart, done by US engineers, you can see that it was expected that we would get over 45KW given a flow of 4756 gallons per minute and using a 1200 rpm generator. Twenty four hours per day with no additional energy input it would be the neatest thing we would have going. Then or now.

The following chart, done by Canadian Engineers, shows the site flow expectations in cubed meters per second. I have not yet been able to convert between American gallons per minute and Canadian cubed meters per second to reconcile the two sets of numbers.

Figure No. 1 Flow Duration Curve Horning's Mills

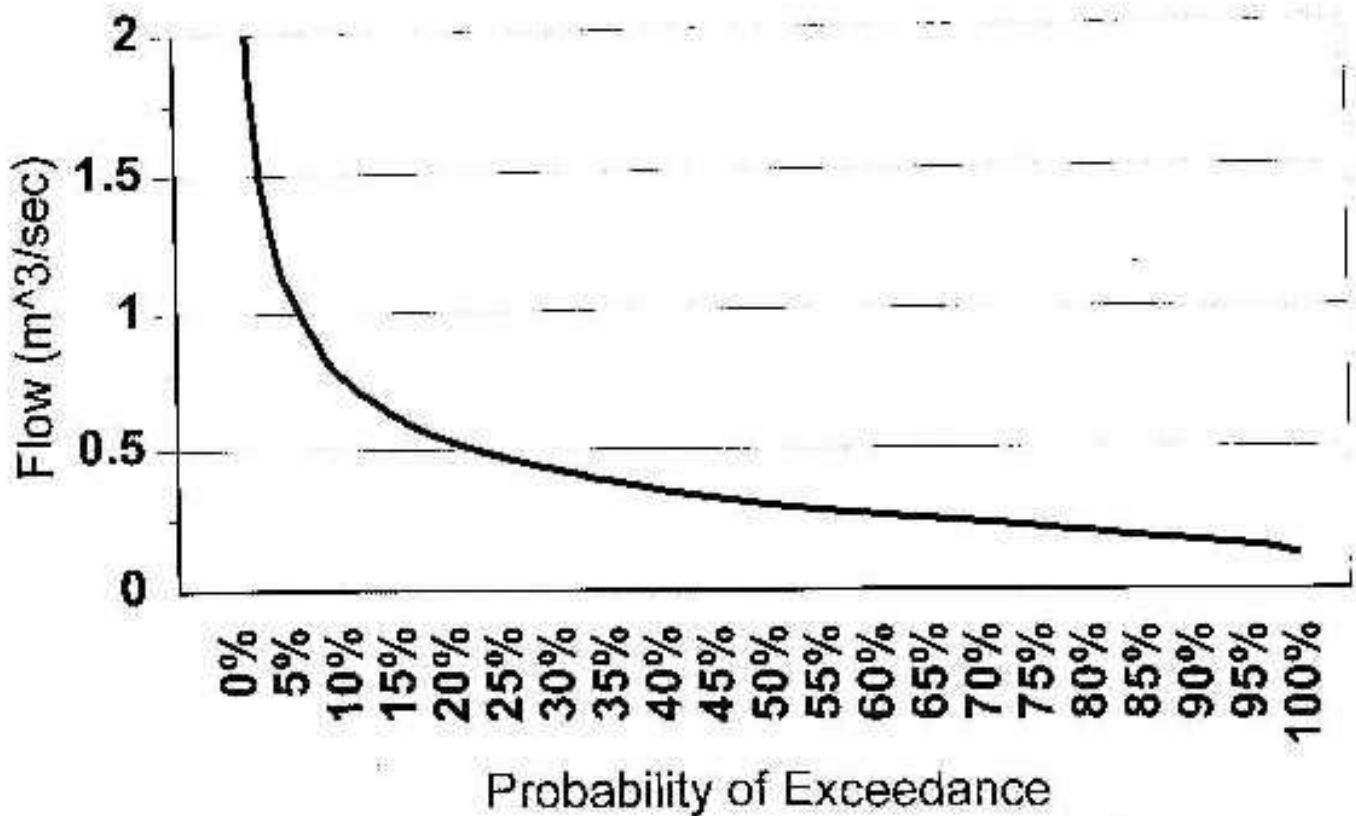

The following chart shows revenue expectations assuming that we could sell the electricity back to the grid under the "green program" which was legislated many years ago and has been talked about endlessly but I know of no one who has personally made it through the bureaucratic hoops. This chart shows a substantial seasonal difference in water flow and while I have seen BIG differences as the result of a storm - I haven't personally noted there to be that kind of seasonal difference. It makes me wonder if the engineers took some seasonal charts rather than considering the actual underground source from which our stream is fed.

Table No. 3
Horning's Mills Fully Developed Site
Revenue Stream - Best Case Scenario

\$0.04 per kWh in off peak periods
 \$0.06 per kWh for winter peak periods
 \$0.07 per kWh for summer peak periods

Month	Net Head (metres)	Usuable Flow (m ³ /sec)	Power kW	kWh	Peak \$	Off Peak \$
Jan	20	0.3	47	35,000	\$933	\$933
Feb	20	0.3	47	35,000	\$933	\$933
March	20	0.3	47	35,000	\$817	\$933
April	20	0.3	47	35,000	\$817	\$933
May	20	0.3	47	35,000	\$817	\$933
June	20	0.3	47	35,000	\$817	\$933
July	20	0.2	24	17,500	\$408	\$467
August	20	0.2	24	17,500	\$408	\$467
September	20	0.2	24	17,500	\$408	\$467
October	20	0.2	24	17,500	\$408	\$467
November	20	0.3	47	35,000	\$817	\$933
December	20	0.3	47	35,000	\$933	\$933
				350,000	\$8,517	\$9,333

Below is the summary engineering study showing, that given the terms of the current "green power" legislation, that the project is financially feasible. Electricity prices have increased since the study was done and as they continue to increase - the case justification of course just gets better and better.

However, the PTB have frustrated all attempts for implementation - not just for us, but also for many others. There has been talk, talk, talk about "green power" and the environment - but it is just talk and impossible hurdles by very antagonistic low level bureaucrats are placed in anyone's way who tries to do anything about it. When my wife and I showed our case to my attorney - he simply replied, "Ah! You are planning to put my children through college!"

Table No. 4
Horning's Mills Fully Developed Site
Revenue Stream - Worst Case Scenario

\$0.028 per kWh in off peak periods
 \$0.06 per kWh for winter peak periods
 \$0.05 per kWh for summer peak periods

Month	Net Head (metres)	Usuable Flow (m ³ /sec)	Power kW	kWh	Peak \$	Off Peak \$
January	20	0.3	47	35,000	\$700	\$653
February	20	0.3	47	35,000	\$700	\$653
March	20	0.3	47	35,000	\$583	\$653
April	20	0.3	47	35,000	\$583	\$653
May	20	0.3	47	35,000	\$583	\$653
June	20	0.3	47	35,000	\$583	\$653
July	20	0.2	24	17,500	\$292	\$327
August	20	0.2	24	17,500	\$292	\$327
September	20	0.2	24	17,500	\$292	\$327
October	20	0.2	24	17,500	\$292	\$327
November	20	0.3	47	35,000	\$583	\$653
December	20	0.3	47	35,000	\$700	\$653
				350,000	\$6,183	\$6,533

After a

nuclear war the practicality - nay the dire necessity of such sources as this will become apparent and so I continue to study and prepare for that eventuality.

MENU: [HOME](#) » [Reconstruction](#) » [Recovery](#) » [Renewal](#) » [Energy Types](#)

Making Motors into Electrical Generators

Here is another interesting idea for generating electricity. Using an electrical motor and running it backwards. There will probably be lots of good motors with their bearings and windings intact, after a nuclear war. It will be just a matter of matching it up to a wind, water, bicycle, small engine or other driving source.

[How to do it: Using motors as generators](#)

This 49 page .pdf file gives you a lot information about the process. It is however copyrighted and will have to remain locked until after the nuclear war.

Below is another method of getting electricity out of motors, but one that requires magnets. Finding the magnets to make the modifications will probably be the greater challenge. Still, there will be magnets out there also. One good source would be old speakers. Another is computer harddrives. The magnets can be taken from them and sawed into the shapes desired. I have sawed some magnets, and that can be a bit tricky too, without a diamond saw or disk. However, there will be all sorts of challenges - and ingenuity can overcome many of them. In sawing magnets you don't want to overheat them or they will splinter and crack. They need to be kept cool by water during the process. Odd shaped magnets can be cut into smaller shapes and then reassembled into the desired shape. They will self-adhere but a glue or adhesive can be used for integrity.

A magnet sawed in half cannot have the two part joined back together - the way they came apart. They will then repel each other. Amazing! And I am not sure that even physicists understand why. I have asked several. There is SO much that I DON'T understand about magnets. I spent many bucks and hours developing a lathe to shape magnets. Unsuccessfully. Had the input and assistance of a number of capable tool makers, and still couldn't get it to work.

Not all our experiments are succesful. Indeed, many (most) are not - or certainly have to be greatly modified from our original design plans. We have had GREAT failures with many things that we have tried - all the way from hydroponics, to ships, submarines and robots. With inputs of enough time, money and engineering many things can be accomplished. The problem is that as individuals we are often very limited in all those inputs. The limitations will probably only increase after a nuclear war. That is why I so greatly appreciate hearing about designs that have been tested and proven.

We have also had some exceptional successes, as evidenced by my marketing of my patents and some other, what I think are, notable accomplishments. What I try try to share in many of these pages is not so much "how to do" as an attitude about "trying to do" because I think it is the latter that is going to be very important during nuclear recovery.

[Motor 2: Supplementing motors with magnets to make generators](#)

This idea from Force Field seems to be relatively simply done - if you can find the magnets.

[SEALED: Supplementing motors with magnets to make generators](#)

This is this SEALED mirrored site that won't be opened until after The Great Catastrophe.

[Motor 3: Tape Drive Motors as Generators](#)

Force Field has lots of experience with low rpm generators. Here is an example from them of a motor being used as a generator without any modification.

[SEALED: Supplementing motors with magnets to make generators](#)

This is this SEALED mirrored site that won't be opened until after The Great Catastrophe.

MENU: [HOME](#) » [Reconstruction](#) » [Recovery](#) » [Renewal](#) » [Energy Types](#)

MENU: [HOME](#) » [Reconstruction](#) » [Recovery](#) » [Renewal](#) » [Energy Types](#)

Diesel and Gasoline Generators

Diesel and gasoline powered generators are an excellent source of electrical power, but of course the problem is finding fuel for them. Every drop of fuel will undoubtedly be scavenged from abandoned vehicles and old storage tanks. Diesels run equally well on furnace heating oil. It is really nothing other than diesel sold under a different taxing system and perhaps with a coloring added to it.

A longer term solution for diesels is the growing and distilling of one's own biofuels. This subject is covered elsewhere in our series of web pages.

It is very beneficial to have storage battery systems associated with diesel and gasoline generating systems. These very often are larger generators that put out way more power than one wishes to consume at the moment that they are running, so it is by far more fuel efficient to store the excess power.

HOWEVER, it is more efficient still to use the power directly without first storing it because about 20% of the energy is lost in the conversion process. For this reason, where it is possible, it is best to bunch up or save up the tasks that require a lot of power until such time as the generator will be running, so that the power can be used directly.

[The Diesels at Ark Two](#)

MENU: [HOME](#) » [Reconstruction](#) » [Recovery](#) » [Renewal](#) » [Energy Types](#)

Batteries and Inverters

Batteries are an important part of alternative electrical systems for two reasons.

First, because the systems often produce so little power, it is important to capture all the power they do produce so that one can have it available at a later time if it is not needed at the moment it is produced.

Secondly, so little power is sometimes produced it is necessary to store it up until one has sufficient to use for the task they wish to undertake.

Banks of large batteries may be difficult to come by but there may be large quantities of automobile batteries about.

[SEALED: The Complete Battery Book](#)

This 98 page .pdf document gives essential information about the care and usage of these batteries and may be very useful information to have. Automobile Batteries will perhaps be the most available.

[Testing: Ammeter.](#)

Forcefield explains how to build and use an ammeter.

[SEALED: Forcefield Ammeter design.](#)

The SEALED version of the Forcefield explanation of how to build and use an ammeter. This file will not be opened until after the nuclear war.

Below is a friend's large battery bank. In actuality he has a half dozen storage sheds with battery banks like this. The batteries require considerable maintenance, the water and acid levels needing to be checked and their charge needing to be replenished, even if they are just kept on standby.

A friend's large battery bank

Inverters

Batteries can be configured for different voltages depending on how they are wired together. It is possible to string out enough to get 110 volts off of them but generally they are used to run 12 volt systems. There are many twelve volt appliances about. They can be found in camping trailers and elsewhere. Also automobiles have a variety of twelve volt motors and devices that can be gotten out of them. The headlights, radios and so forth in automobiles can be used with any sufficiently large twelve volt battery system.

When it is absolutely necessary to convert from 12 to another voltage the device used is called an "inverter". The most common ones convert the power to 110 volts. The problem is that most of the smaller ones, the ones that are most available, and which are relatively inexpensive - costing presently in the one to two hundred dollar range, cannot deliver enough wattage to start pumps or run many household appliances.

Still, if one is fortunate to have an inverter they will probably find many uses that they can put it to. Otherwise, it is best to try to develop things like lighting systems by cannibalizing vehicles for twelve volt sockets and bulbs that one can string together.

MENU: [HOME](#) » [Reconstruction](#) » [Recovery](#) » [Renewal](#) » [Energy Types](#)

Bicycle Power

Bicycles are an important source of transportation that is largely overlooked in North America. I used to oftentime see Mormon Missionaries riding them, and in some areas the Amish. Bicycle paths are becoming more common in many large cities but still it was in China that I realized how under-utilized they are in North America. There in China I traveled through a sea of thousands, more like tens of thousands of them, perhaps even hundreds of thousands while on auto trips. I could see them moving like a mighty river from my high hotel room window.

Bikes were/are used to transport things there that I would have thought unimaginable. I have literally seen a rider with a piano strapped on his back although I do not know if it contained all its guts. Nevertheless, bikes piled high with cabbages, several feet higher than the rider - were a common sight. Bike (or really trike) rick-a-shaws were another common sight. We just don't use the bike anywhere near to that extent in North America. Or we didn't. After the war we may change our attitude about it.

We have used bicycles at Ark Two for many purposes. We use them to mechanically run air blowers, grind wheat, and they can be used for many mechanical purposes such as running a small printing press. Below you see pictures of a bicycle attached to a blower. And we use them for generating electricity.



[Bike 1: Not just for riding \(SEALED\)](#)

This SEALED 144 page .pdf document gives a great amount of valuable information on how to apply bike power to many different kinds of machines. It is a copyrighted document and won't be opened here until after the nuclear war.

Bicycle Power for Generation of Electricity

While I have read lots of articles by people theorizing about using bicycles for electric power generation and I have actually pedaled several ones in the Science Museum and at science demonstrations the three presented here are the best actual bicycle experiments that I am aware of.



Here I am in our garage workshop, pedaling away on our first bike powered generator. Hung around behind me are 8 twelve volt florescent lights which I am lighting by pedaling on the bike.

This generator is hooked to one of several old exercise bikes we have but we also have ten old multispeed bikes waiting down at the shelter. We also have air blowers and wheat grinding mills that we can hook up to them.



We have the system set up so that the florescent lights come on only if the bike is being pedaled. I am lighting all eight lights that you see (plus one more 50 watt Halogen that you can't see) to take the picture. The only light used for the picture was that which I was pedaling. No, I wasn't lighting the heater! That is on a separate circuit.

Ed fixed up a neat system so that any extra power that I pump will go into a battery and not blow up the florescent lights. But the battery doesn't light the lamps.



This is Ed in our garage. Ed has been a major expert on getting all this going.

In the background are the clear basswood boards that I had cut and kilned this summer in preparation for making the blades for windmill propellers. And behind the bike you can see stacked up a number of the brakedrums we were working on.



After we got all ten of the brakedrum generators completed and tested we took one of them to the WLP Picnic to run the sound system amplifiers. The best way to work any of these systems is to pump the power into the batteries so that it will be available whenever you want it - but sometimes we ran the sound system directly off the bike just to show that we could do it.

On the previous low RPM generator web page I link to other pages with more detail about building the brakedrum generators and other low RPM generators and there are lots more detailed pictures of the generators themselves.

[Bike 2: The David Butcher Pedal Powered Generator](#)

The central idea that you want to get from this presentation is the value of a heavy flywheel to smooth out the generation and ease the operation. David also gives a lot of other good information about expected performance.

[SEALED The David Butcher Pedal Powered Generator](#)

This is the SEALED mirrored version of this site that won't be opened until after The Great Catastrophe.

[Bike 3: A Quick and Dirty Bike Generator System](#)

Forcefield has lots of experience with low rpm generators.

[SEALED: A Quick and Dirty Bike Generator System](#)

This is the SEALED mirrored version of this site that won't be opened until after the End of Armageddon.

MENU: [HOME](#) » [Reconstruction](#) » [Recovery](#) » [Renewal](#) » [Energy Types](#)

Construction of a Simplified Wood Gas Generator for Fueling Internal Combustion Engines in a Petroleum emergency



[Introduction](#)

[Contents](#)

Modified by Bruce Beach
from html written by Markus Almroth
<http://www.gengas.nu/byggbes/index.shtml>

From a version developed by:
THE BIOMASS ENERGY FOUNDATION PRESS
1820 Smith Rd., Golden, CO 80401

written by:
H. LaFontaine, Biomass Energy Foundation, Inc. Miami, Florida and F. P. Zimmerman, Oak Ridge National laboratory, Energy Division
FEMA interagency Agreement Number: EMW-84-E-1737 Work Unit: 3521 D

for:
Federal Emergency Management Agency Washington, D.C. 20472 "This report has been reviewed in the Federal Emergency Management Agency and approved for publication. Approval does not signify that the contents necessarily reflect the views and policies of the Federal Emergency Management Agency." Date Published: March 1989 APPROVED FOR PUBLIC RELEASE:

DISTRIBUTION UNLIMITED

Prepared by:

Oak Ridge National laboratory Oak Ridge, Tennessee 37831-6285 for the U.S. Department of Energy

MENU: [HOME](#) » [Reconstruction](#) » [Recovery](#) » [Renewal](#) » [Energy Types](#)

1. WHAT IS A WOOD GAS GENERATOR AND HOW DOES IT WORK?

This report is one in a series of emergency technology assessments sponsored by the Federal Emergency Management Agency (FEMA). The purpose of this report is to develop detailed, illustrated instructions for the fabrication, installation, and operation of a biomass gasifier unit (i.e., a "producer gas" generator, also called a 'wood gas' generator) that is capable of providing emergency fuel for vehicles, such as tractors and trucks, in the event that normal petroleum sources were severely disrupted for an extended period of time. These instructions have been prepared as a manual for use by any mechanic who is reasonably proficient in metal fabrication or engine repair.

1.1 INTRODUCTION

Fuel gas, produced by the reduction of coal and peat, was used for heating, as early as 1840 in Europe, and by 1884 it had been adapted to fuel engines in England. Before 1940, gas generator units were a familiar, but not extensively utilized, technology. However, petroleum shortages during World War II led to widespread gas generator applications in the transportation industries of Western Europe. (Charcoal-burning taxis, a related application, were still common in Korea as late as 1970.) The United States, never faced with such prolonged or severe oil shortages, has lagged far behind Europe and the Orient in familiarity with and application of this technology; however, a catastrophe could so severely disrupt the supply of petroleum in this country that this technology might be critical in meeting the energy needs of some essential economic activities, such as the production and distribution of food.

This report attempts to preserve the knowledge about wood gasification as put into practical use during World War II. Detailed, step-by-step procedures are presented in this report for constructing a simplified version of the World War II, Imbert wood gas generator. This simple, stratified, downdraft gasifier unit can be constructed from materials that would be widely available in the United States in a prolonged petroleum crisis. For example, the body of the unit consists of a galvanized metal garbage can atop a small metal drum; common plumbing fittings throughout; and a large, stainless steel mixing bowl for the grate. A prototype gasifier unit was fabricated from these instructions. This unit was then mounted onto the front of a gasoline-engine farm tractor and successfully field tested, using wood chips as the only fuel; see [Fig. 1-1](#) (all figures and tables are presented at the end of their respective sections).

Photographic documentation of the actual assembly of the unit, as well as its operational field test, is included in this report.

The use of wood gas generators need not be limited to transportation applications. Stationary engines can also be fueled by wood gasifiers to run electric generators, pumps, and industrial equipment. In fact, the use of wood gas as a fuel is not even restricted to gasoline engines; if a small amount of diesel fuel is

used for ignition, a properly adjusted diesel engine can be operated primarily on wood gas introduced through the intake manifold. However, this report is concerned with the operation of four-cylinder gasoline engines rated from 10 to 150 horsepower. If more information is needed about operating gasifiers on other fuels (such as coal, charcoal, peat, sawdust or seaweed), a list of relevant literature is contained in the Bibliography at the end of this report.

The goal of this report is to furnish information for building a homemade wood gas generator made out of ordinary, available hardware, in order to get tractors, trucks, and other vehicles operating without delay, if a severe liquid fuel emergency should arise. Section 1 describes gasification principles and wood gas generators, in general, and gives some historical background about their operation and effectiveness. Section 2 contains detailed step-by-step instructions for constructing your own wood gas generator unit; illustrations and photographs are included to prevent confusion. Section 3 contains information on operating, maintaining, and trouble-shooting your wood gas generator; also included are some very important guidelines on safety when using your gasifier system.

The wood gasifier design presented in this report has as its origin the proven technology used in World War II during actual shortages of gasoline and diesel fuel. It should be acknowledged that there are alternate technologies (such as methane production or use of alcohol fuels) for keeping internal combustion engines in operation during a prolonged petroleum crisis; the wood gasifier unit described in this report represents only one solution to the problem.

1.2 PRINCIPLES OF SOLID FUEL GASIFICATION

All internal combustion engines actually run on vapor, not liquid. The liquid fuels used in gasoline engines are vaporized before they enter the combustion chamber above the pistons. In diesel engines, the fuel is sprayed into the combustion chamber as fine droplets which burn as they vaporize. The purpose of a gasifier, then, is to transform solid fuels into gaseous ones and to keep the gas free of harmful constituents. A gas generator unit is, simultaneously, an energy converter and a filter. In these twin tasks lie its advantages and its difficulties.

The first question many people ask about gasifiers is, 'Where does the combustible gas come from?' Light a wooden match; hold it in a horizontal position; and notice that while the wood becomes charcoal, it is not actually burning but is releasing a gas that begins to burn brightly a short distance away from the matchstick. Notice the gap between the matchstick and the luminous flame; this gap contains the wood gas which starts burning only when properly mixed with air (which contains oxygen). By weight, this gas (wood gas) from the charring wood contains approximately 20% hydrogen (H_2), 20% carbon monoxide (CO), and small amounts of methane, all of which are combustible, plus 50 to 60% nitrogen (N_2). The nitrogen is not combustible; however, it does occupy volume and dilutes the wood gas as it enters and burns in an engine. As the wood gas burns, the products of combustion are carbon dioxide (CO_2) and water vapor (H_2O).

The same chemical laws which govern combustion processes also apply to gasification. The solid, biomass fuels suitable for gasification cover a wide range, from wood and paper to peat, lignite, and coal, including coke derived from coal. All of these solid fuels are composed primarily of carbon with varying amounts of hydrogen, oxygen, and impurities, such as sulfur, ash, and moisture. Thus, the aim of gasification is the almost complete transformation of these constituents into gaseous form so that only the ashes and inert materials remain.

In a sense, gasification is a form of incomplete combustion; heat from the burning solid fuel creates gases which are unable to burn completely, due to insufficient amounts of oxygen from the available supply of air. In the matchstick example above, as the wood was burned and pyrolyzed into charcoal, wood gas was created, but the gas was also consumed by combustion (since there was an enormous supply of air in the room). In creating wood gas for fueling internal combustion engines, it is important that the gas not only be properly produced, but also preserved and not consumed until it is introduced into the engine where it may be appropriately burned.

Gasification is a physiochemical process in which chemical transformations occur along with the conversion of energy. The chemical reactions and thermochemical conversions which occur inside a wood gas generator are too long and too complicated to be covered here. Such knowledge is not necessary for constructing and operating a wood gasifier. Books with such information are listed in the Reference Section (see, for example, Reed 1979, Vol. II; or Reed and Das 1988).

1.3 BACKGROUND INFORMATION

The use of wood to provide heat is as old as mankind; but by burning the wood we only utilize about one-third of its energy. Two-thirds is lost into the environment with the smoke. Gasification is a method of collecting the smoke and its combustible components. Making a combustible gas from coal and wood began around 1790 in Europe. Such manufactured gas was used for street lights and was piped into houses for heating, lighting, and cooking. Factories used it for steam boilers, and farmers operated their machinery on wood gas and coal gas. After the discovery of large petroleum reserves in Pennsylvania in 1859, the entire world changed to oil - a cheaper and more convenient fuel. Thousands of gas works all over the world were eventually dismantled.

Wood gas generators are not technological marvels that can totally eliminate our current dependence on oil, reduce the impacts of an energy crunch, or produce long-term economic relief from high fossil fuel prices, but they are a proven emergency solution when such fuels become unobtainable in case of war, civil upheaval, or natural disaster. In fact, many people can recall a widespread use of wood gas generators during World War II, when petroleum products were not available for the civilian populations in many countries. Naturally, the people most affected by oil and petroleum scarcity made the greatest advancements in wood gas generator technology.

In occupied Denmark during World War II, 95% of all mobile farm machinery, tractors, trucks, stationary engines, fishing and ferry boats were powered by wood gas generators. Even in neutral

Sweden, 40% of all motor traffic operated on gas derived from wood or charcoal (Reed and Jantzen 1979). All over Europe, Asia, and Australia, millions of gas generators were in operation between 1940 and 1946. Because of the wood gasifier's somewhat low efficiency, the inconvenience of operation, and the potential health risks from toxic fumes, most of such units were abandoned when oil again became available in 1945. Except for the technology of producing alternate fuels, such as methane or alcohol, the only solution for operating existing internal combustion engines, when oil and petroleum products are not available, has been these simple, inexpensive gasifier units.

1.3.1 The World War II, Imbert Gasifier

The basic operation of two gasifiers is described in this and the following section. Their operating advantages and disadvantages will also be discussed. This information is included for the technically interested reader only; it is intended to give the reader more insight into the subtleties of the operating principles of the wood gas generator described in this manual. Those readers who are anxious to begin construction of their own wood gas generator may skip the material below and proceed directly to [Sect. 2](#) without any loss of continuity.

The constricted hearth, downdraft gasifier shown in [Fig. 1-2](#) is sometimes called the 'Imbert' gasifier after its inventor, Jacques Imbert; although, it has been commercially manufactured under various names. Such units were mass produced during World War II by many European automotive companies, including General Motors, Ford, and Mercedes-Benz. These units cost about \$1500 (1985 evaluation) each. However, after World War II began in 1939, it took six to eight months before factory-made gasifiers were generally available. Thousands of Europeans were saved from certain starvation by home-built, simple gasifier units made from washing machine tubs, old water heaters, and metal gas or oxygen cylinders. Surprisingly, the operation of these units was nearly as efficient as the factory-made units; however, the homemade units lasted for only about 20000 miles with many repairs, while the factory-made units operated, with few repairs, up to 100,000 miles.

In [Fig. 1-2](#), the upper cylindrical portion of the gasifier unit is simply a storage bin or hopper for wood chips or other biomass fuel. During operation, this chamber is filled every few hours as needed. The spring-loaded, airtight cover must be opened to refill the fuel hopper; it must remain closed and sealed during gasifier operation. The spring permits the cover to function as a safety valve because it will pop open in case of any excessive internal gas pressure.

About one-third of the way up from the bottom of the gasifier unit, there is a set of radically directed air nozzles; these allow air to be injected into the wood as it moves downward to be gasified. In a gas generator for vehicle use, the downstroke of the engine's pistons creates the suction force which moves the air into and through the gasifier unit; during startup of the gasifier, a blower is used to create the proper airflow. The gas is introduced into the engine and consumed a few seconds after it is made. This gasification method is called "producer gas generation," because no storage system is used; only that amount of gas demanded by the engine is produced. When the, engine is shut off, the production of gas stops.

During normal operation, the incoming air burns and pyrolyzes some of the wood, most of the tars and oils, and some of the charcoal that fills the constricted area below the nozzles. Most of the fuel mass is converted to gas within this combustion zone. The Imbert gasifier is, in many ways, self-adjusting. If there is insufficient charcoal at the air nozzles, more wood is burned and pyrolyzed to make more charcoal. If too much charcoal forms, then the charcoal level rises above the nozzles, and the incoming air burns the charcoal. Thus, the combustion zone is maintained very close to the nozzles.

Below this combustion zone, the resulting hot combustion gases - carbon dioxide (CO_2) and water vapor (H_2O) - pass into the hot charcoal where they are chemically reduced to combustible fuel gases: carbon monoxide (CO) and hydrogen (H_2). The hearth constriction causes all gases to pass through the reaction zone, thus giving maximum mixing and minimum heat loss. The highest temperatures are reached in this region.

Fine char and ash dust can eventually clog the charcoal bed and will reduce the gas flow unless the dust is removed. The charcoal is supported by a movable grate which can be shaken at intervals. Ash buildup below the grate can be removed during cleaning operations. Usually, wood contains less than 1% ash (by weight). However, as the charcoal is consumed, it eventually collapses to form a powdery charcoal/ash mixture which may represent 2 to 10% (by weight) of the total fuel mass.

The cooling unit required for the Imbert gasifier consists of a water filled precipitating tank and an automotive radiator type gas cooler. The precipitating tank removes all unacceptable tars and most of the fine ash from the gas flow, while the radiator further cools the gas. A second filter unit, containing a fine mesh filtration material, is used to remove the last traces of any ash or dust that may have survived passage through the cooling unit. Once out of the filter unit, the wood gas is mixed with air in the vehicle's carburetor and is then introduced directly into the engine's intake manifold.

The World War II, Imbert gasifier requires wood with a low moisture content (less than 20% by weight) and a uniform, blocky fuel in order to allow easy gravity feed through the constricted hearth. Twigs, sticks, and bark shreds cannot be used. The constriction at the hearth and the protruding air nozzles present obstructions to the passage of the fuel and may create bridging and channeling followed by poor quality gas output, as unpyrolyzed fuel falls into the reaction zone. The vehicle units of the World War II era had ample vibration to jar the carefully sized wood blocks through the gasifier. In fact, an entire industry emerged for preparing wood for use in vehicles at that time (Reed and Jantzen 1979). However, the constricted hearth design seriously limits the range of wood fuel shapes that can be successfully gasified without expensive cubing or pelletizing pretreatment. It is this limitation that makes the Imbert gasifier less flexible for emergency use.

In summary, the World War II Imbert gasifier design has stood the test of time and has successfully been mass produced. It is relatively inexpensive, uses simple construction materials, is easy to fabricate, and can be operated by motorists with a minimum amount of training.

1.3.2 The Stratified, Downdraft Gasifier

Until the early 1980's, wood gasifiers all over the world (including the World War II designs) operated on the principle that both the fuel hopper and the combustion unit be airtight; the hopper was sealed with a top or lid that had to be opened every time wood was added. Smoke and gas vented into the atmosphere while new wood was being loaded; the operator had to be careful not to breathe the unpleasant smoke and toxic fumes.

Over the last few years, a new gasifier design has been developed through cooperative efforts among researchers at the Solar Energy Research Institute in Colorado, the University of California in Davis, the Open University in London, the Buck Rogers Company in Kansas, and the Biomass Energy Foundation, Inc., in Florida (Reed and Das 1988). This simplified design employs a balanced, negative-pressure concept in which the old type of sealed fuel hopper is no longer necessary. A closure is only used to preserve the fuel when the engine is stopped. This new technology has several popular names, including 'stratified, downdraft gasification' and 'open top gasification.' Two years of laboratory and field testing have indicated that such simple, inexpensive gasifiers can be built from existing hardware and will perform very well as emergency units.

A schematic diagram of the stratified, downdraft gasifier is shown in [Fig. 1-3](#). During operation of this gasifier, air passes uniformly downward through four zones, hence the name 'stratified:'

1. The uppermost zone contains unreacted fuel through which air and oxygen enter. This region serves the same function as the fuel hopper in the Imbert design.
2. In the second zone, the wood fuel reacts with oxygen during pyrolysis. Most of the volatile components of the fuel are burned in this zone and provide heat for continued pyrolysis reactions. At the bottom of this zone, all of the available oxygen from the air has completely reacted. The open top design ensures uniform access of air to the pyrolysis region.
3. The third zone is made up of charcoal from the second zone. Hot combustion gases from the pyrolysis region react with the charcoal to convert the carbon dioxide and water vapor into carbon monoxide and hydrogen.
4. The inert char and ash, which constitute the fourth zone, are normally too cool to cause further reactions; however, since the fourth zone is available to absorb heat or oxygen as conditions change, it serves both as a buffer and as a charcoal storage region. Below this zone is the grate. The presence of char and ash serves to protect the grate from excessive temperatures.

The stratified, downdraft design has a number of advantages over the World War II, Imbert gasifier. The open top permits fuel to be fed more easily and allows easy access. The cylindrical shape is easy to fabricate and permits continuous flow of fuel. No special fuel shape or pretreatment is necessary; any blocky fuel can be used.

The foremost question about the operation of the stratified, downdraft gasifier concerns char and ash removal. As the charcoal reacts with the combustion gases, it eventually reaches a very low density and

breaks up into a dust containing all of the ash as well as a percentage of the original carbon. This dust may be partially carried away by the gas; however, it might eventually begin to plug the gasifier, and so it must be removed by shaking or agitation. Both the Imbert gasifiers and the stratified concept have a provision for shaking the grate; when they are used to power vehicles, they are automatically shaken by the vehicle's motion.

An important issue in the design of the stratified, downdraft gasifier is the prevention of fuel bridging and channeling. High-grade biomass fuels such as wood blocks or chips will flow down through the gasifier under the influence of gravity, and downdraft air flow. However, other fuels (such as shredded wood, sawdust, and bark) can form a bridge that will prevent continuous flow and cause very high temperatures. Obviously, it is desirable to use these widely available biomass residues. Bridging can be prevented by stirring, shaking, or by agitating the grate or by having it agitated by the vehicle's movement. For prolonged idling, a hand-operated shaker has been included in the design.

A prototype design of the stratified, downdraft gasifier design has been developed. The detailed but simple design is described and illustrated in Section 2 (see Table of Contents), however, it has not been widely tested at this time. The reader is urged to use his ingenuity and initiative in constructing his own wood gas generator. As long as the principle of airtightness in the combustion regions, in the connecting piping, and in the filter units is followed, the form, shape, and method of assembly is not important.

[Back to Table of Contents](#)

MENU: [HOME](#) » [Reconstruction](#) » [Recovery](#) » [Renewal](#) » [Energy Types](#)

Table of Contents

[INTRODUCTION](#)

[2nd Edition Introduction](#)

[EXECUTIVE SUMMARY](#)

[S.1. PRINCIPLES OF SOLID FUEL GASIFICATION](#)

[S.2. THE STRATIFIED, DOWNDRAFT GASIFIER](#)

[CONVERSION FACTORS FOR SI UNITS](#)

[LIST OF FIGURES](#)

[LIST OF TABLES](#)

[ABSTRACT](#)

[1. WHAT IS A WOOD GAS GENERATOR AND HOW DOES IT WORK?](#)

[1.1. PRINCIPLES](#)

[1.2. PRINCIPLES OF SOLID FUEL GASIFICATION](#)

[1.3. BACKGROUND INFORMATION](#)

[1.3.1. The World War II, Imbert Gasifier](#)

[1.3.2. The Stratified, Downdraft Gasifier](#)

[2. BUILDING YOUR OWN WOOD GAS GENERATOR](#)

[2.1. BUILDING THE GAS GENERATOR UNIT AND THE FUEL HOPPER](#)

[2.2. BUILDING THE PRIMARY FILTER UNIT.](#)

[2.3. BUILDING THE CARBURETING UNIT WITH THE AIR AND THROTTLE CONTROLS](#)

[3. OPERATING AND MAINTAINING YOUR WOOD GAS GENERATOR](#)

[3.1. USING WOOD AS A FUEL](#)

- 3.2. [SPECIAL CONSIDERATIONS AND ENGINE MODIFICATIONS](#)
- 3.3. [INITIAL START-UP PROCEDURE](#)
- 3.4. [ROUTINE START-UP PROCEDURE](#)
- 3.5. [DRIVING AND NORMAL OPERATION](#)
- 3.6. [SHUTTING DOWN THE GASIFIER UNIT](#)
- 3.7. [ROUTINE MAINTENANCE](#)
 - 3.7.1 [Daily Maintenance](#)
 - 3.7.2 [Weekly Maintenance \(or every 15 hours of operation\)](#)
 - 3.7.3 [Biweekly Maintenance \(or every 30 hours of operation\)](#)
- 3.8. [OPERATING PROBLEMS AND TROUBLE-SHOOTING](#)
- 3.9. [HAZARDS ASSOCIATED WITH GASIFIER OPERATION](#)
 - 3.9.1. [Toxic Hazards](#)
 - 3.9.2. [Technical Aspects of "Generator Gas, Poisoning"](#)
 - 3.9.3. [Fire Hazard](#)

[BIBLIOGRAPHY](#)

MENU: [HOME](#) » [Reconstruction](#) » [Recovery](#) » [Renewal](#) » [Energy Types](#)

INTRODUCTION TO 2nd EDITION

This construction manual was prepared by my friend and colleague, Harry LaFontaine for the Federal Emergency Management Agency, FEMA, assisted by F.P. Zimmerman at the Oak Ridge national Laboratory. The justification for writing this report was that in the event of a war or natural emergency, when liquid fuel supplies were interrupted, individuals could build gasifiers to run engines for transport and power. The manual was originally distributed by FEMA. This edition is the first edition by the Biomass Energy Foundation Press.

Harry was uniquely qualified to write this manual because he built and operated gasifiers during World War II during the daytime as a cover for his Danish Underground activities at night. Harry was also very ingenious in working with the people and materials at hand, so that this is a very practical manual. However, in the intervening years he also came to appreciate the fundamentals of gasification and he also explains these here.

It has been a pleasure to know and work with Harry. He was the founder of the Biomass Energy Foundation in 1983. The BEF is a 501 3C not for profit organization established to promote the use of Biomass.

It grieves me to say that Harry died (while still in the midst of many projects) on April 12, 1994. However, this report lives on as a very useful memorial to his life and experience.

Thomas B. Reed

The Biomass Energy Foundation Press 1810 Smith Rd. Golden, CO.

[Back to Table of Contents](#)

Executive summary

This report is one in a series of emergency technology assessments sponsored by the Federal Emergency Management Agency (FEMA). The purpose of this report is to develop detailed, illustrated instructions for the fabrication, installation, and operation of a biomass gasifier unit (i.e. a "producer gas" generator, also called a "wood gas" generator) which is capable of providing emergency fuel for vehicles, such as tractors and trucks, should normal petroleum sources be severely disrupted for an extended period of time. These instructions have been prepared as a manual for use by any mechanic who is reasonably proficient in metal fabrication or engine repair.

Fuel gas, produced by the reduction of coal and peat, was used for heating as early as 1840 in Europe and by 1884 had been adapted to fuel engines in England. Prior to 1940, gas generator units were a familiar, but not extensively utilized, technology. However, petroleum shortages during World War II led to widespread gas generator applications in the transportation industries of Western Europe. (Charcoal burning taxis, a related application, were still common in Korea as late as 1970.) The United States, never faced with such prolonged or severe oil shortages, has lagged far behind Europe and the Orient in familiarity with and application of this technology. However, a catastrophic event could disrupt the supply of petroleum in this country so severely that this technology might be critical in meeting the energy needs of some essential economic activities, such as the production and distribution of food.

In occupied Denmark during World War II, 95% of all mobile farm machinery, tractors, trucks, stationary engines, and fishing and ferry boats were powered by wood gas generator units. Even in neutral Sweden, 40% of all motor traffic operated on gas derived from wood or charcoal. All over Europe, Asia, and Australia, millions of gas generators were in operation between 1940f and 1946. Because of the wood gasifier's health risks from toxic fumes, most of such units were abandoned when it again became available in 1945. Except for the technology of producing alternate fuels, such as methane or alcohol, the only solution for operating existing internal combustion engines, when oil and petroleum products are not available, has been these simple, inexpensive gasifiers units.

This report attempts to preserve the knowledge about wood gasification that was put into practical use during World War II. In this report, detailed step-by-step procedures are presented for constructing a simplified version of the WWII wood gas generator; this simple, stratified, downdraft gasifier unit (shown schematically in [Fig. S-1](#)) can be constructed from materials which would be widely available in the United States in a prolonged petroleum crisis. For example, the body of the unit consists of a galvanized metal garbage can atop a small metal drum; common plumbing fittings are used throughout; and a large, stainless steel mixing bowl is used for the grate. A prototype gasifier unit was fabricated from these instructions (see [Fig. S-2](#)); this unit was then mounted onto the front of a farm tractor and successfully field tested, using wood chips as the only fuel (see [Fig. S-3](#)). Photographic documentation of the actual assembly of the unit, as well as its operational field test, is included in the body of this report.

The use of wood gas generators need not be limited to transportation applications. Stationary engines can also be fueled by wood gasifiers to run electric generators, pumps, and industrial equipment. In fact, the use of wood gas as a fuel is not even restricted to gasoline engines; if a small amount of diesel fuel is used for ignition, a properly adjusted diesel engine can be operated primarily on wood gas introduced through the intake manifold.

S.1 Principles of solid fuel gasification

All internal combustion engines actually run on vapor, not liquid. The liquid fuels used by gasoline engines are vaporized before they enter the combustion chamber above the pistons. In diesel engines, the fuel is sprayed into the combustion chamber as fine droplets which burn as they vaporize. The purpose of a gasifier, then, is to transform solid fuels into gaseous ones and to keep the gas free of harmful constituents. A gas generator unit is simultaneously an energy converter and a filter. In these twin tasks lie its advantages and its difficulties.

In a sense, gasification is a form of incomplete combustion-heat from the burning solid fuel creates gases which are unable to burn completely because of the insufficient amounts of oxygen from the available supply of air. The same chemical laws which govern combustion processes also apply to gasification. There are many solid biomass fuels suitable for gasification - from wood and paper to peat, lignite, and coal, including coke derived from coal. All of these solid fuels are composed primarily of carbon with varying amounts of hydrogen, oxygen, and impurities, such as sulfur, ash, and moisture. Thus, the aim of gasification is the almost complete transformation of these constituents into gaseous form so that only the ashes and inert materials remain. In creating wood gas for fueling internal combustion engines, it is important that the gas not only be properly produced, but also preserved and not consumed until it is introduced into the engine where it may be appropriately burned.

Gasification is a physiochemical process in which chemical transformations occur along with the conversion of energy. The chemical reactions and thermochemical conversions which occur inside a wood gas generator are too long and too complicated to be covered here; however, such knowledge is not necessary for constructing and operating a wood gasifier. By weight, gas (wood gas) produced in a gasifier unit contains approximately 20% hydrogen (H_2), 20% carbon monoxide (CO), and small amounts of methane, all of which are combustible, plus 50 to 60% nitrogen (N_2). The nitrogen is not combustible; however, it does occupy volume and dilutes the wood gas as it enters and burns in an engine. As the wood gas burns, the products of combustion are carbon dioxide (CO_2) and water vapor (H_2O).

One of the by-products of wood gasification is carbon monoxide, a poisonous gas. The toxic hazards associated with breathing this gas should be avoided during refueling operations or prolonged idling, particularly in inadequately ventilated areas. Except for the obvious fire hazard resulting from the combustion processes inside the unit, carbon monoxide poisoning is the major potential hazard during

normal operation of these simplified gasifier units.

S.2. THE STRATIFIED DOWNDRAFT GASIFIER

Until the early 1980s, wood gasifiers all over the world (including the World War II designs) operated on the principle that both the fuel hopper and the combustion unit be absolutely airtight; the hopper was sealed with a top or lid which had to be opened every time wood was added. Smoke and gas vented into the atmosphere while wood was being loaded; the operator had to be careful not to breathe the unpleasant smoke and toxic fumes.

Over the last few years, a new gasifier design has been developed through cooperative efforts among researchers at the Solar Energy Research Institute in Colorado, the University of California in Davis, the Open University in London, the Buck Rogers Company in Kansas, and the Biomass Energy Foundation, Inc., in Florida. This simplified design employs a balanced, negative-pressure concept in which the old type of sealed fuel hopper is no longer necessary. A closure is only used to preserve the fuel when the engine is stopped. This new technology has several popular names, including "stratified, downdraft gasification" and "open top gasification." Several years of laboratory and field testing have indicated that such simple, inexpensive gasifiers can be built from existing hardware and will perform very well as emergency units.

A schematic diagram of the stratified, downdraft gasifier is shown in [Fig. S-1](#). During operation of this gasifier, air passes uniformly downward through four zones, hence the name stratified:

1. The uppermost zone contains unreacted fuel through which air and oxygen enter. This region serves the same function as the fuel hopper in the older, World War II designs.
2. In the second zone, the wood fuel reacts with oxygen during pyrolysis. Most of the volatile components of the fuel are burned in this zone and provide heat for continued pyrolysis reactions. At the bottom of this zone, all of the available oxygen from the air should be completely reacted. The open top design ensures uniform access of air to the pyrolysis region.
3. The third zone is made up of charcoal from the second zone. Hot combustion gases from the pyrolysis region react with the charcoal to convert the carbon dioxide and water vapor into carbon monoxide and hydrogen.
4. The inert char and ash, which constitute the fourth zone, are normally too cool to cause further reactions; however, because the fourth zone is available to absorb heat or oxygen as conditions change, it serves both as a buffer and as a charcoal storage region. Below this zone is the grate. The presence of char and ash serves to protect the grate from excessive temperatures.

The stratified, downdraft design has a number of advantages over the World War II gasifier designs. The

open top permits fuel to be fed more easily and allows easy access. The cylindrical shape is easy to fabricate and permits continuous flow of fuel. No special fuel shape or pretreatment is necessary; any blocky fuel can be used.

The foremost question about the operation of the stratified, downdraft gasifier concerns char and ash removal. As the charcoal reacts with the combustion gases, it eventually reaches a very low density and breaks up into a dust containing all of the ash as well as a percentage of the original carbon. This dust may be partially carried away by the gas and might eventually begin to plug the gasifier. Hence, it must be removed by shaking or agitation. When the stratified gasifier unit is used to power vehicles, it is automatically shaken by the vehicle's motion.

An important issue in the design of the stratified, downdraft gasifier is the prevention of fuel bridging and channeling. High grade biomass fuels, such as wood blocks or chips, will flow down through the gasifier because of gravity and downdraft air flow. However, other fuels (such as shredded chips, sawdust, and bark) can form a bridge, which will obstruct continuous flow and cause very high temperatures. Bridging can be prevented by stirring, shaking, or by agitating the grate or by having it agitated by the vehicle's movement. For prolonged idling, a hand-operated shaker has been included in the design in this report.

A prototype unit of the stratified, downdraft gasifier design (se Figs. [S-2](#) and [S-3](#)) has been fabricated according to the instructions in this report; however, it has not been widely tested at this time. The reader is urged to use his ingenuity and initiative in the construction of his own wood gas generator. As long as the principle of airtightness in the combustion regions, in the connecting piping, and in the filter units is followed, the form, shape, and method of assembly is not important.

The wood gasifier design presented in this report has as its origin the proven technology used in World War II during actual shortages of gasoline and diesel fuel. It should be acknowledged that there are alternate technologies (such as methane production or use of alcohol fuels) for keeping internal combustion engines in operation during a prolonged petroleum crisis; the wood gasifier unit described in this report represents only one solution to the problem.

[Back to Table of Contents](#)

MENU: [HOME](#) » [Reconstruction](#) » [Recovery](#) » [Renewal](#) » [Energy Types](#)

CONVERSION FACTORS FOR SI UNITS

English units have been retained in the body of this report. The report refers to commercially available materials and sizes which are commonly expressed in English units. The conversion factors for SI (Standard International - metric) units are given below:

To convert from	TO	Multiply by
cubic feet (ft.)	cubic meters (m ³)	0.0283
cubic yards (yd.)	cubic meters (m ³)	0.7646
Fahrenheit degrees (OF)	Kelvin degrees (K)	(see Note 1)
foot (ft)	meter (m)	0.3048
gallon (gal)	cubic meters (m ³)	3.785 * 10 ⁻³
horsepower (hp)	watt (W)	745.7
inch (in.)	meter (m)	0.0254
pound (lb.)	kilogram (kg)	0.4536
quart (qt.)	cubic meters (m ³)	9.464 * 10 ⁻⁴

Note I: To convert temperatures, use the following equation,

$$K = 273 + 0.5556 X (F - 32),$$

where F is the temperature in Fahrenheit degrees, and K is the temperature in Kelvin degrees.

[Back to Table of Contents](#)

LIST OF FIGURES

- [Fig. S-1.](#) Schematic view of the stratified, downdraft gasifier
- [Fig. S-2.](#) The prototype wood gas generator unit mounted onto a tractor
- [Fig. S-3.](#) Wood gas generator unit in operation during field testing
- [Fig. 1-1.](#) Wood gas generator unit in operation during field testing
- [Fig. 1-2.](#) Schematic view of the World War II, Imbert gasifier
- [Fig. 1-3.](#) Schematic view of the stratified, downdraft gasifier
- [Fig. 2-1.](#) The prototype wood gas generator unit mounted onto a tractor
- [Fig. 2-2.](#) Exploded, schematic diagram of the wood gas generator unit and the fuel hopper
- [Fig. 2-3.](#) The fire tube and circular top plate of the gasifier unit
- [Fig. 2-4.](#) Drilling holes into the stainless steel mixing bowl to be used for the grate
- [Fig. 2-5.](#) Chains attached to the lip of the stainless steel mixing bowl
- [Fig. 2-6.](#) Connect the mixing bowl to the top plate with chains
- [Fig. 2-7.](#) Braze, do not weld, the plumbing fittings to the, thin walled drums
- [Fig. 2-8.](#) Exploded, schematic diagram of the grate shaking mechanism
- [Fig. 2-9.](#) Parts for the shaker assembly
- [Fig. 2-10.](#) The support frame can be brazed or bolted to the side of the gasifier unit
- [Fig. 2-11.](#) Containers used in constructing the prototype gasifier unit
- [Fig. 2-12.](#) Cover for the fuel hopper
- [Fig. 2-13.](#) Operating configuration of the fuel hopper and it's cover
- [Fig. 2-14.](#) Lock ring and welded tabs
- [Fig. 2-15.](#) Exploded, schematic diagram of the filter unit
- [Fig. 2-16.](#) Detail of the standoffs for the bottom plate of the filter unit
- [Fig. 2-17.](#) Divider plate (#1) and bottom plate (#3), with standoffs (#4), for the filter unit
- [Fig. 2-18.](#) Circular lid (#1) for the filter unit
- [Fig. 2-19.](#) Blower (#1) with exhaust extension assembly
- [Fig. 2-20.](#) Assembled and installed blower (#1), extension assembly (#4), and conduit connectors for gas inlet (#2) and outlet (#3) on lid of filter unit
- [Fig. 2-21.](#) Filter container (#1) showing latches (#2) for lid and hose (#3) around top
- [Fig. 2-22.](#) Exploded, schematic diagram of the carbureting unit and control valves
- [Fig. 2-23.](#) Schematic diagram of a butterfly control valve
- [Fig. 2-24.](#) Parts required for the butterfly valve
- [Fig. 2-25.](#) Butterfly valve assembly
- [Fig. 2-26.](#) Assembled butterfly valves
- [Fig. 2-27.](#) Assembled carburetion unit

[Fig. 2-28.](#) Carburetion unit attached to engine's existing intake manifold

[Fig. 3-1.](#) Virtually all varieties of wood chips can be used for fuel

[Fig. 3-2.](#) Ignite a single piece of newspaper to start the gasifier unit; push the flaming newspaper through the ignition port and directly into the grate

[Fig. 3-3.](#) Igniting the exhaust gas will demonstrate that the gasifier unit is working properly

[Fig. 3-4.](#) Refill the fuel hopper before it becomes two-thirds empty

[Fig. 3-5.](#) The lid must be used to cover the fuel hopper in wet weather or when shutting the unit down

[Back to Table of Contents](#)

MENU: [HOME](#) » [Reconstruction](#) » [Recovery](#) » [Renewal](#) » [Energy Types](#)

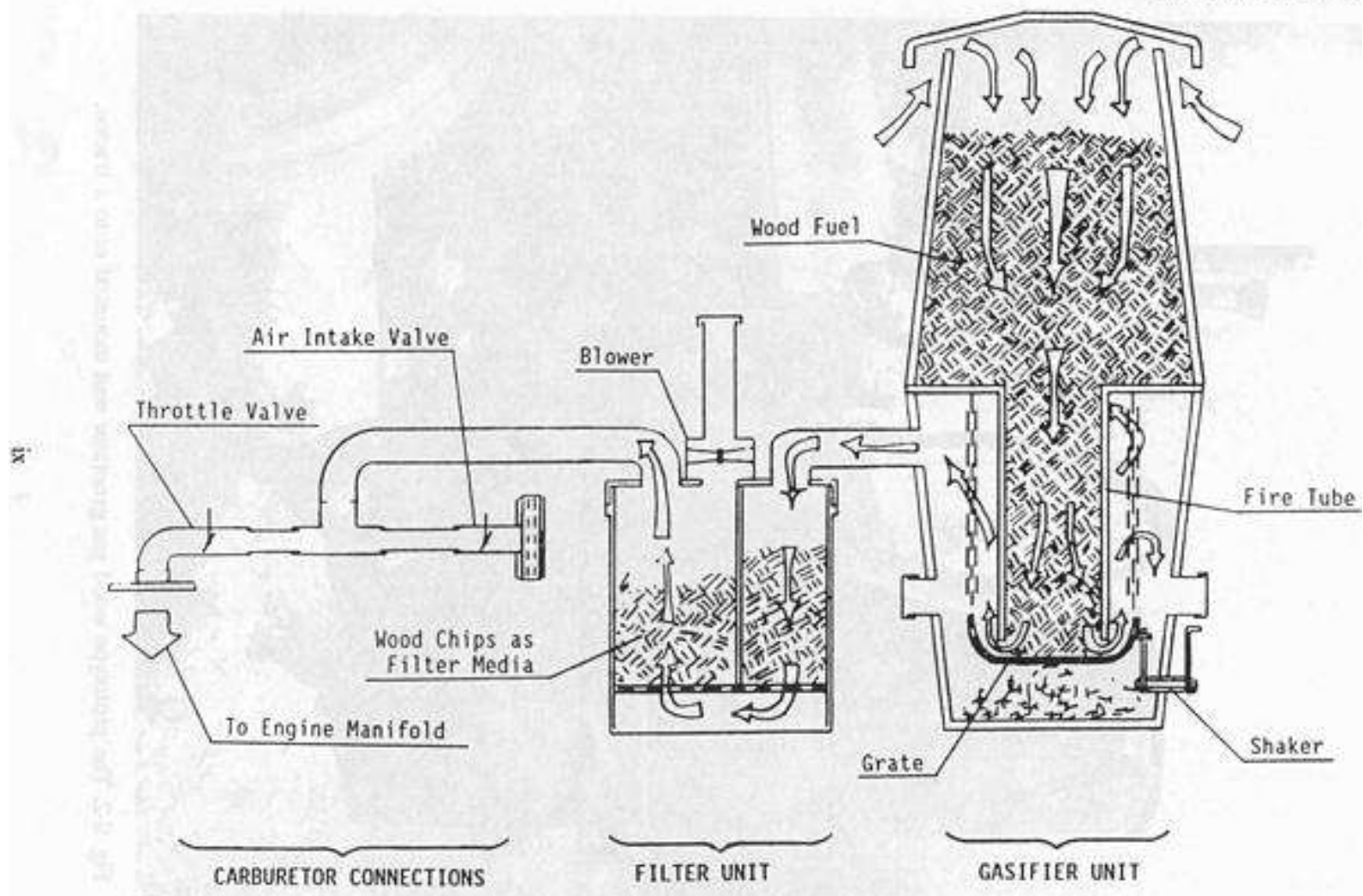

Fig. S-1. Schematic view of the stratified, downdraft gasifier.

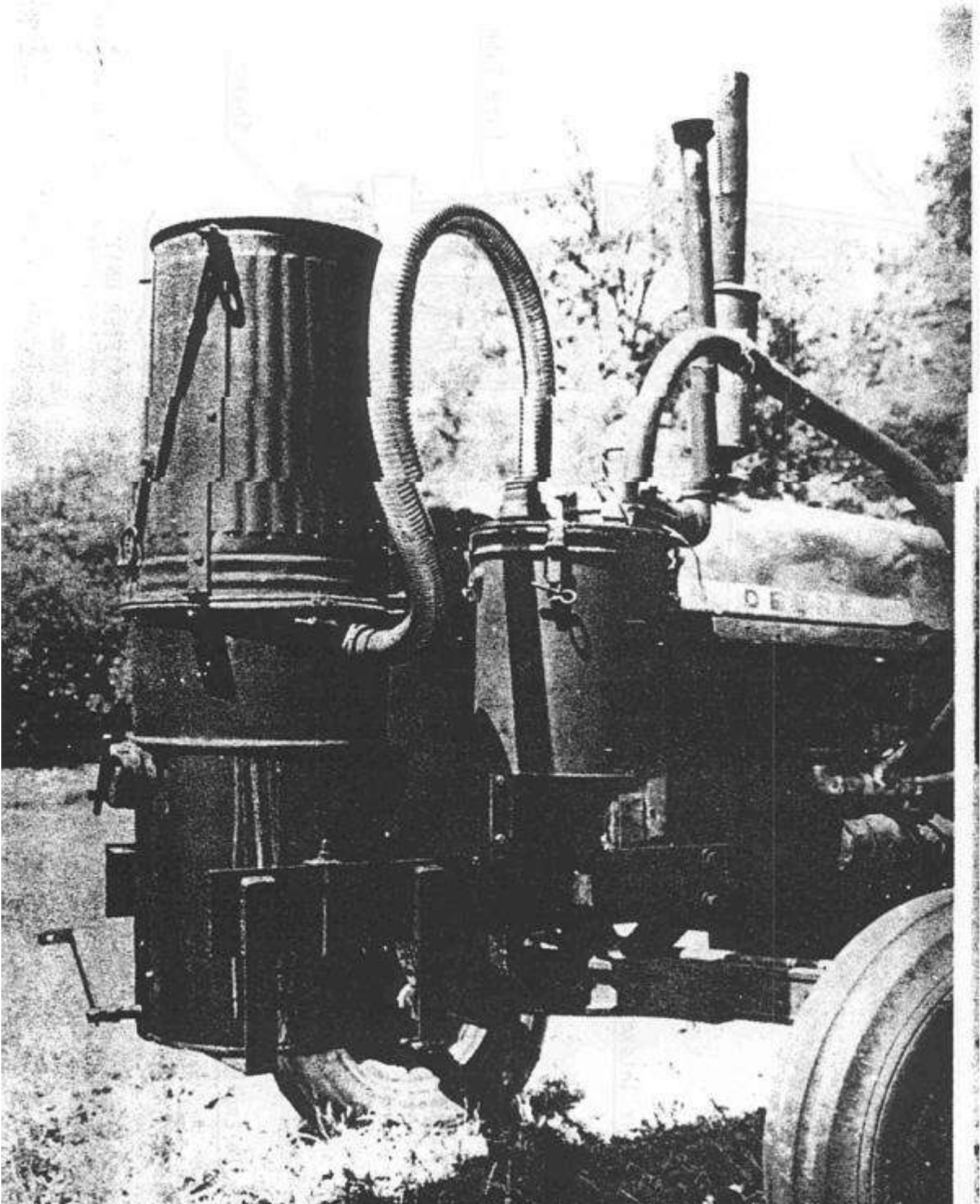



Fig. S-2. The prototype wood gas generator unit mounted onto a tractor.

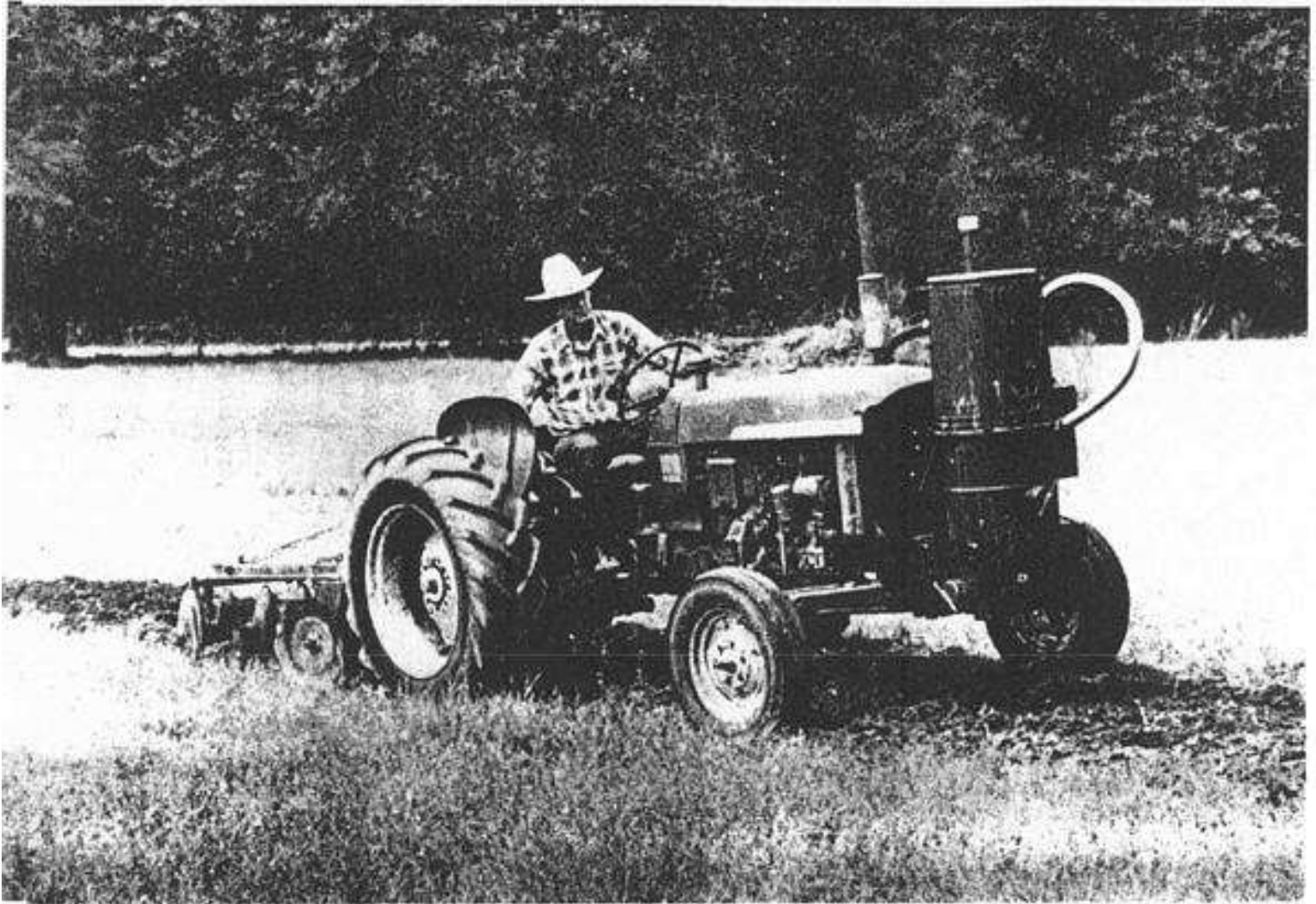

Fig. S-3. Wood gas generator unit in operation during field testing.

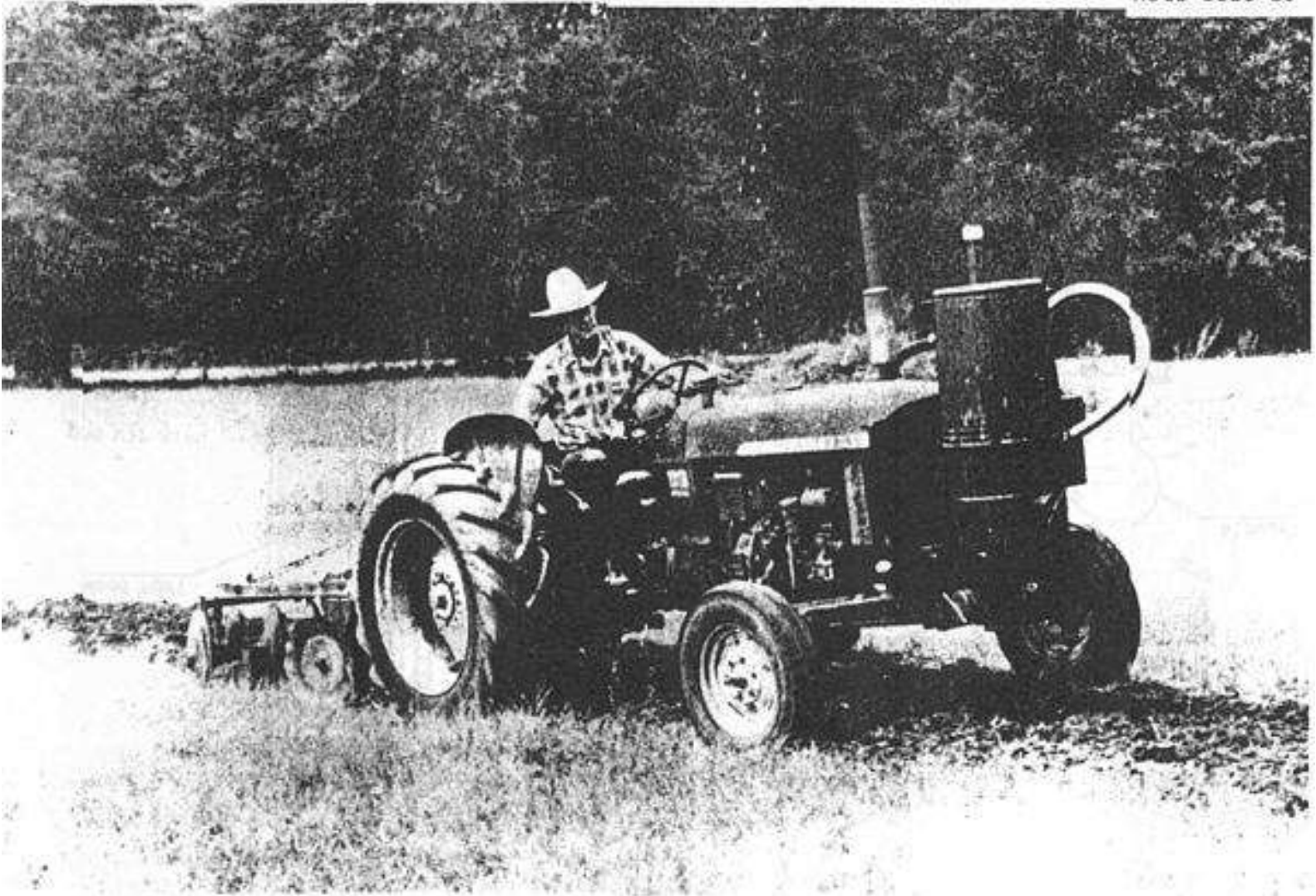

Fig. 1-1. Wood gas generator unit in operation during field testing.

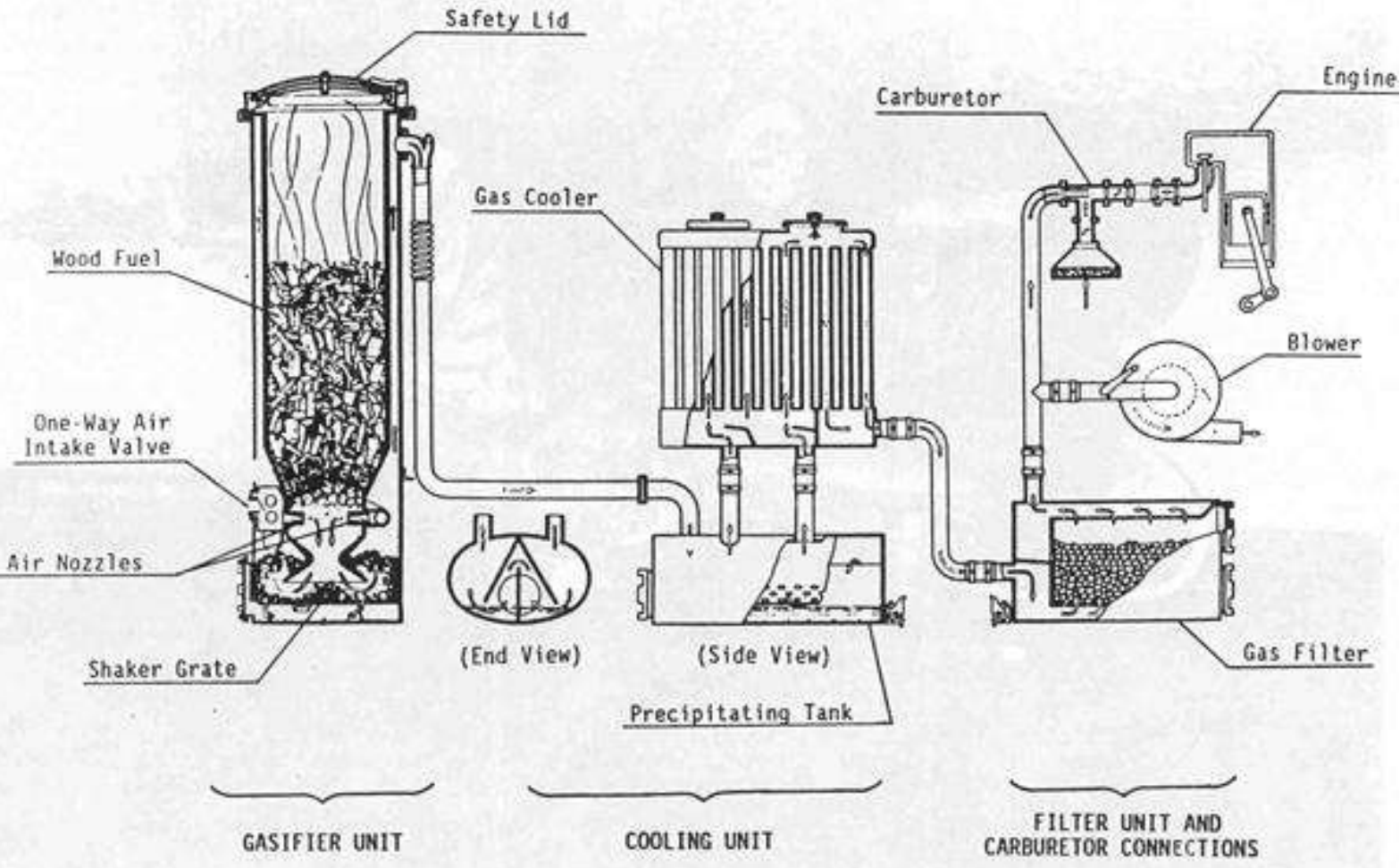

Fig. 1-2. Schematic view of the World War II, Imbert gasifier.

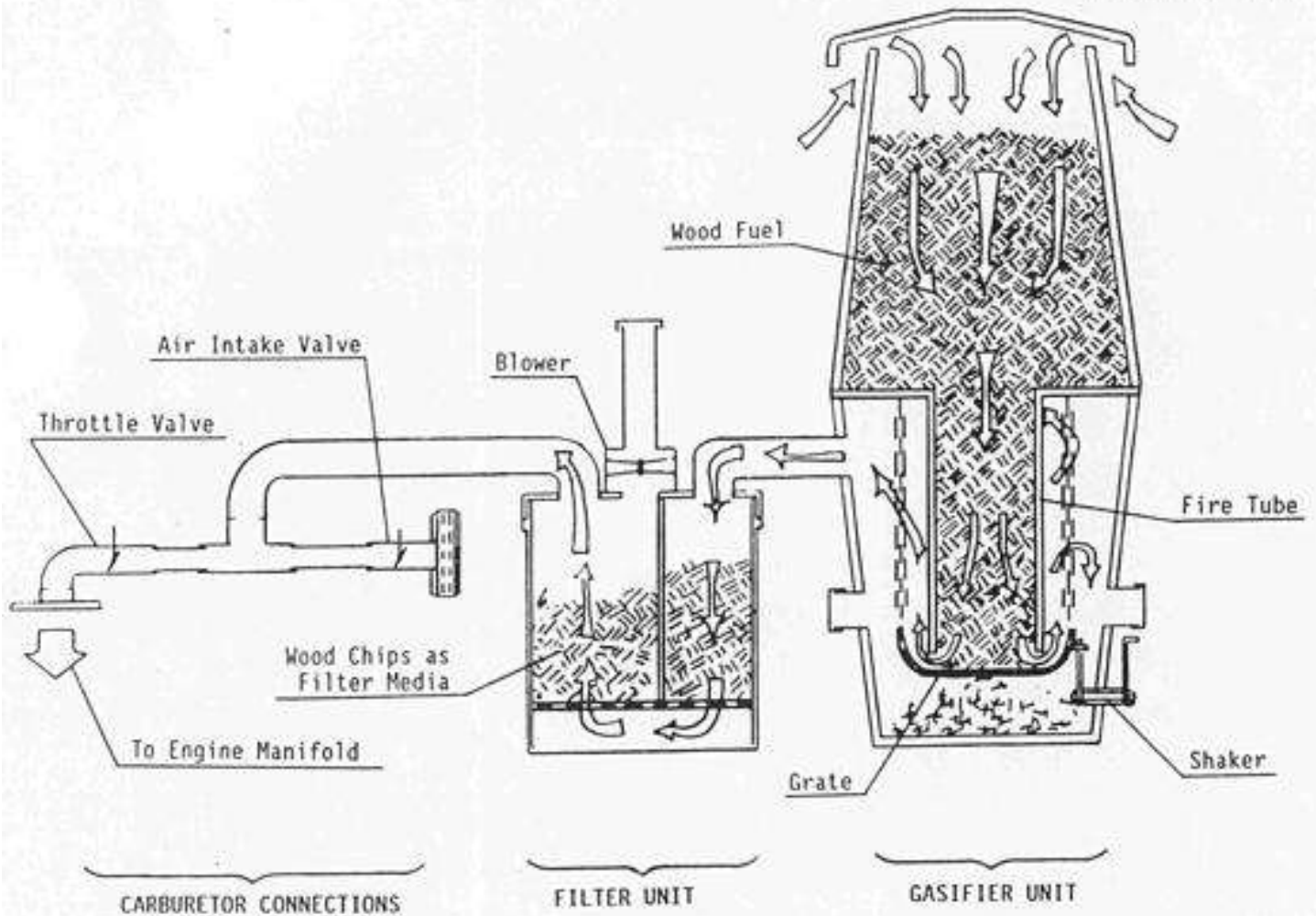

Fig. 1-3. Schematic view of the stratified, downdraft gasifier.

ORNL-Photo 5321-86

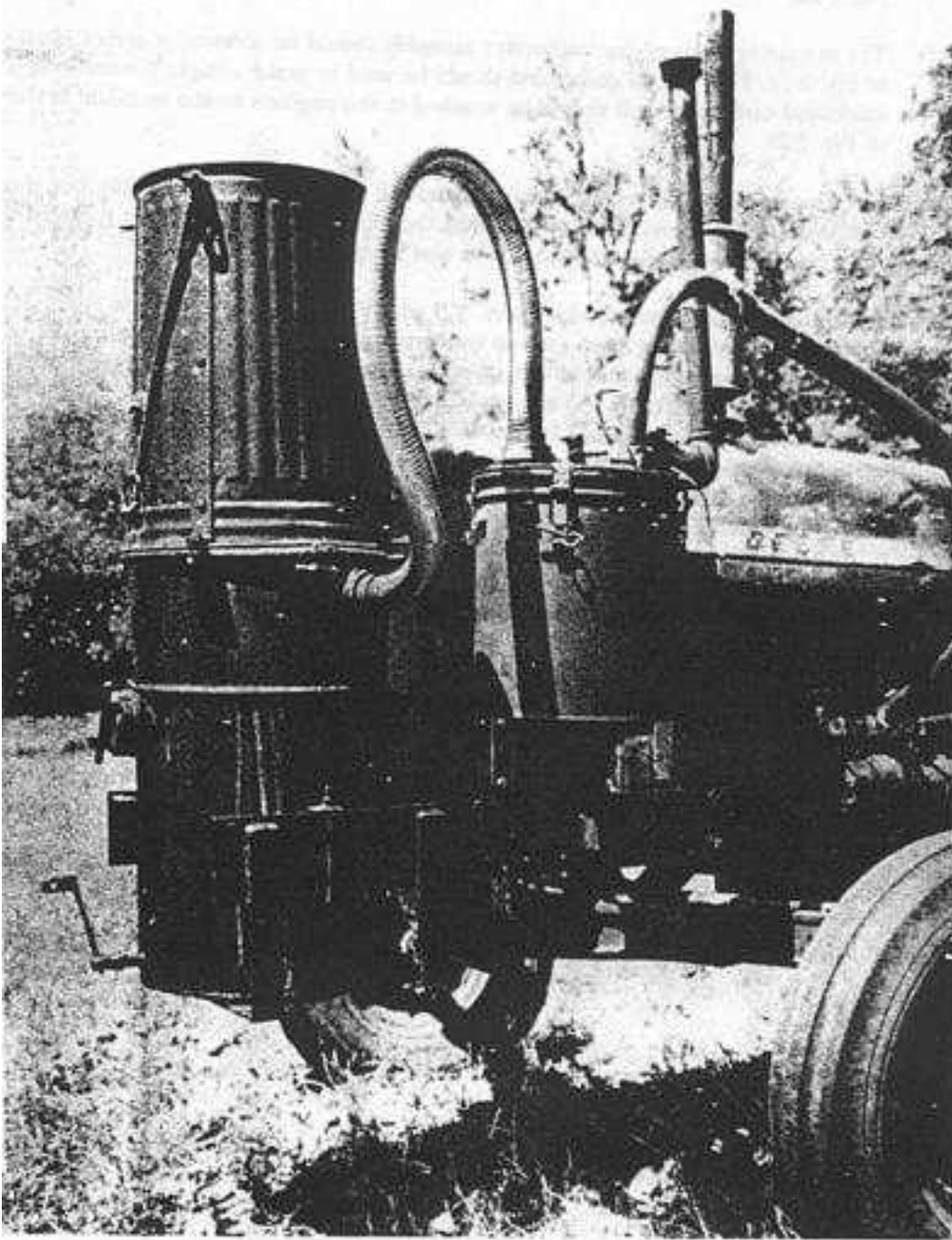

Fig. 2-1. The prototype wood gas generator unit mounted onto a tractor.

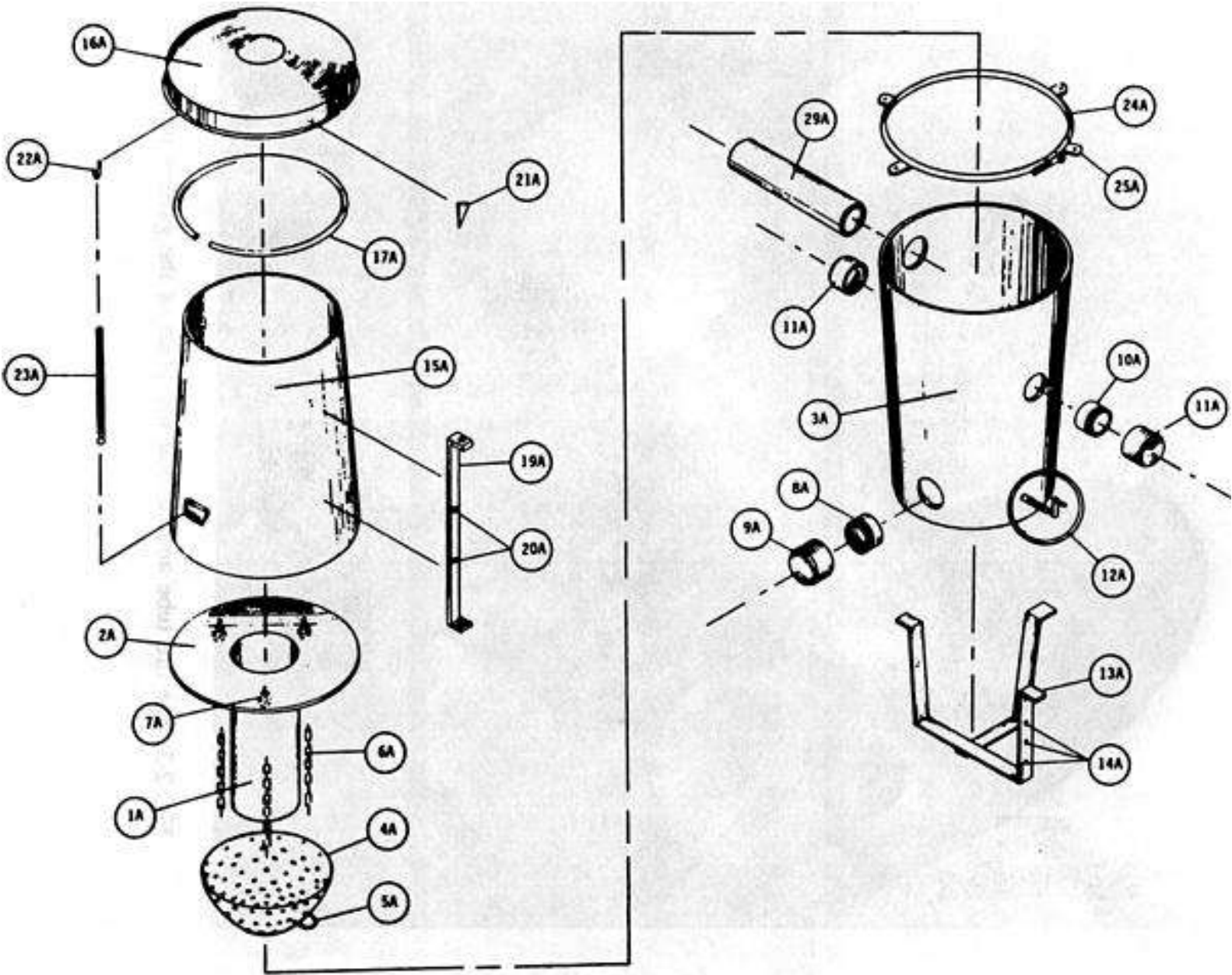

Fig. 2-2. Exploded, schematic diagram of the wood gas generator unit and the fuel hopper.

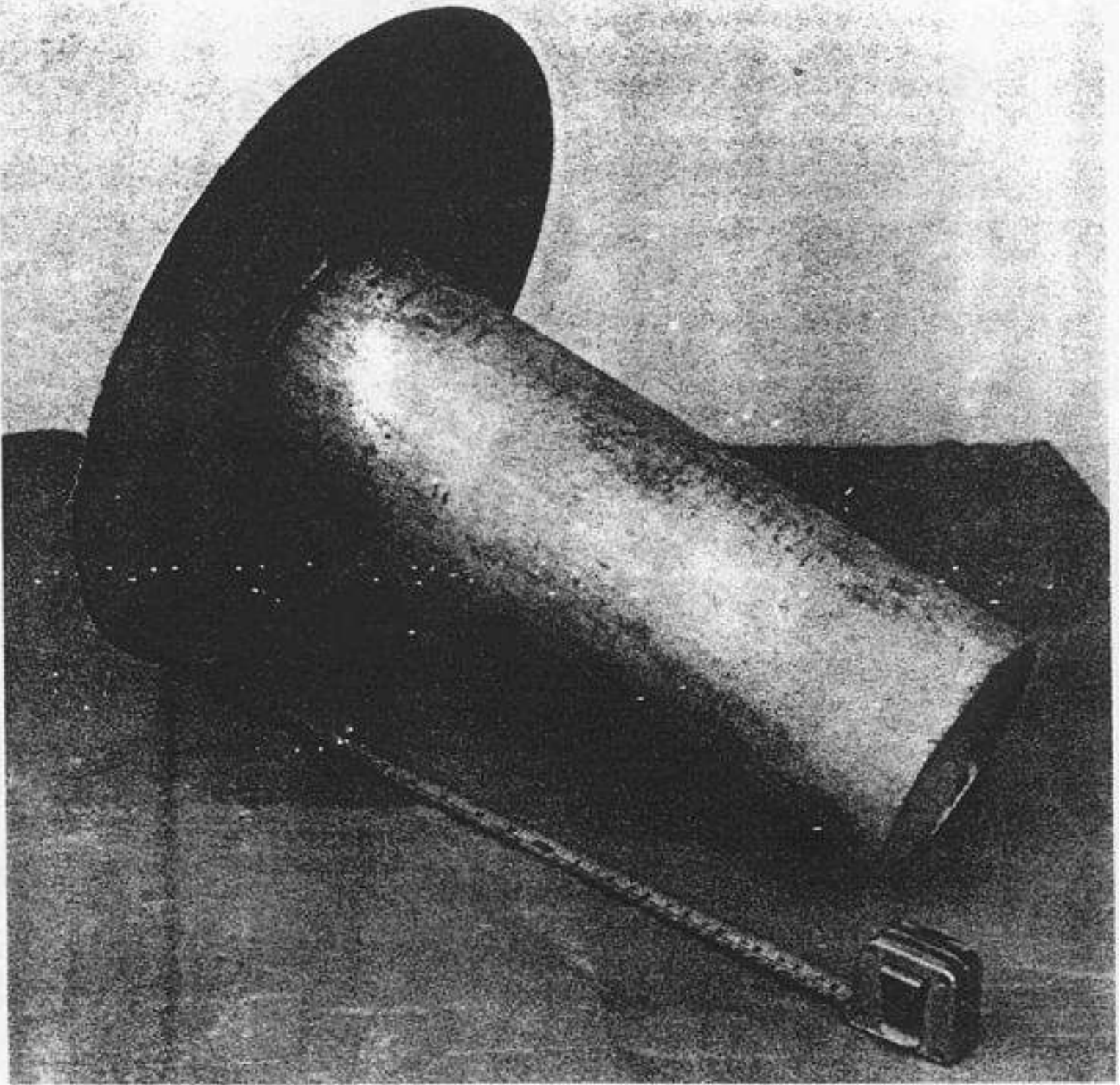

Fig. 2-3. The fire tube and circular top plate of the gasifier unit.

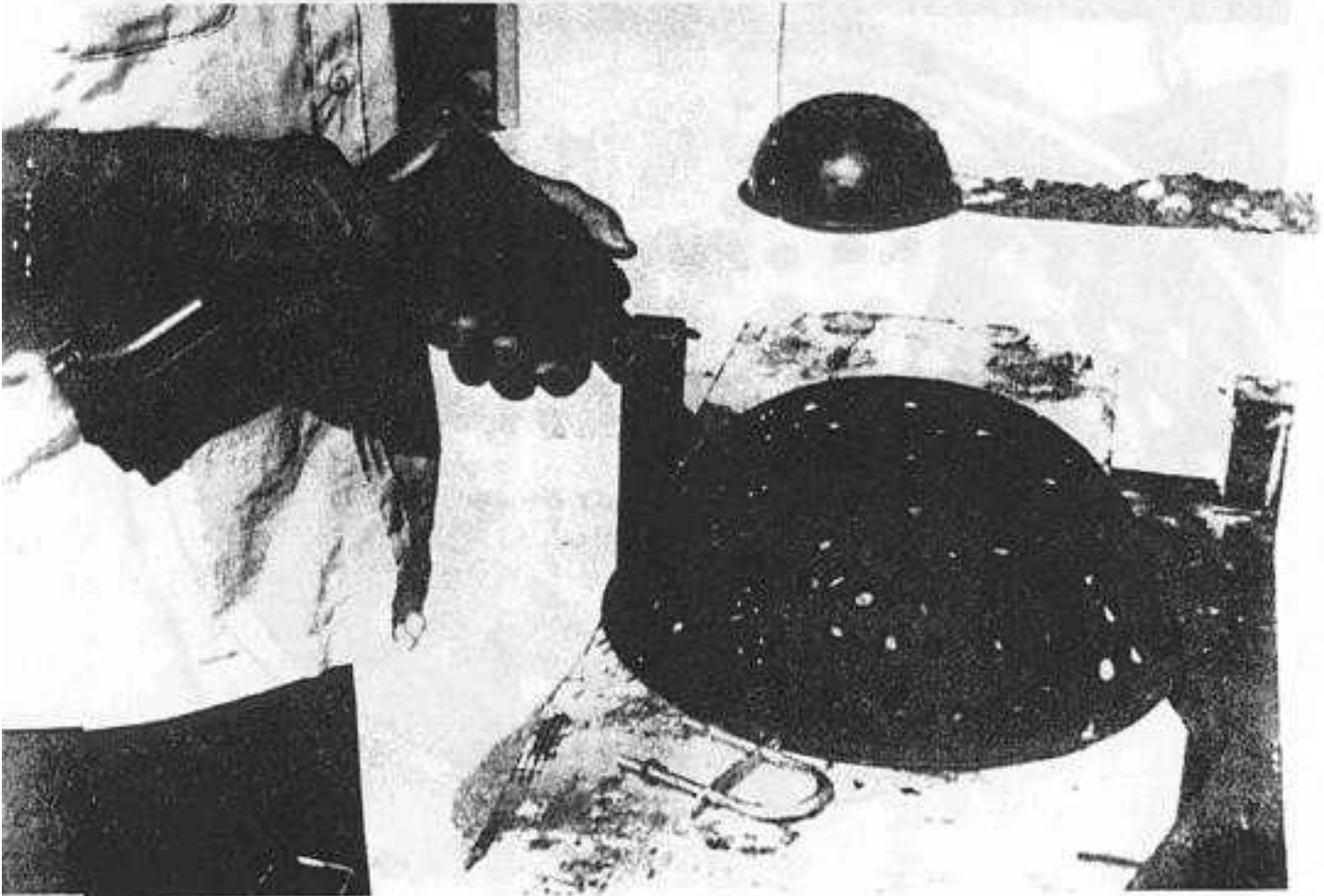

Fig. 2-4. Drilling holes into the stainless steel mixing bowl to be used for the grate. Note the U-bolt in the foreground.

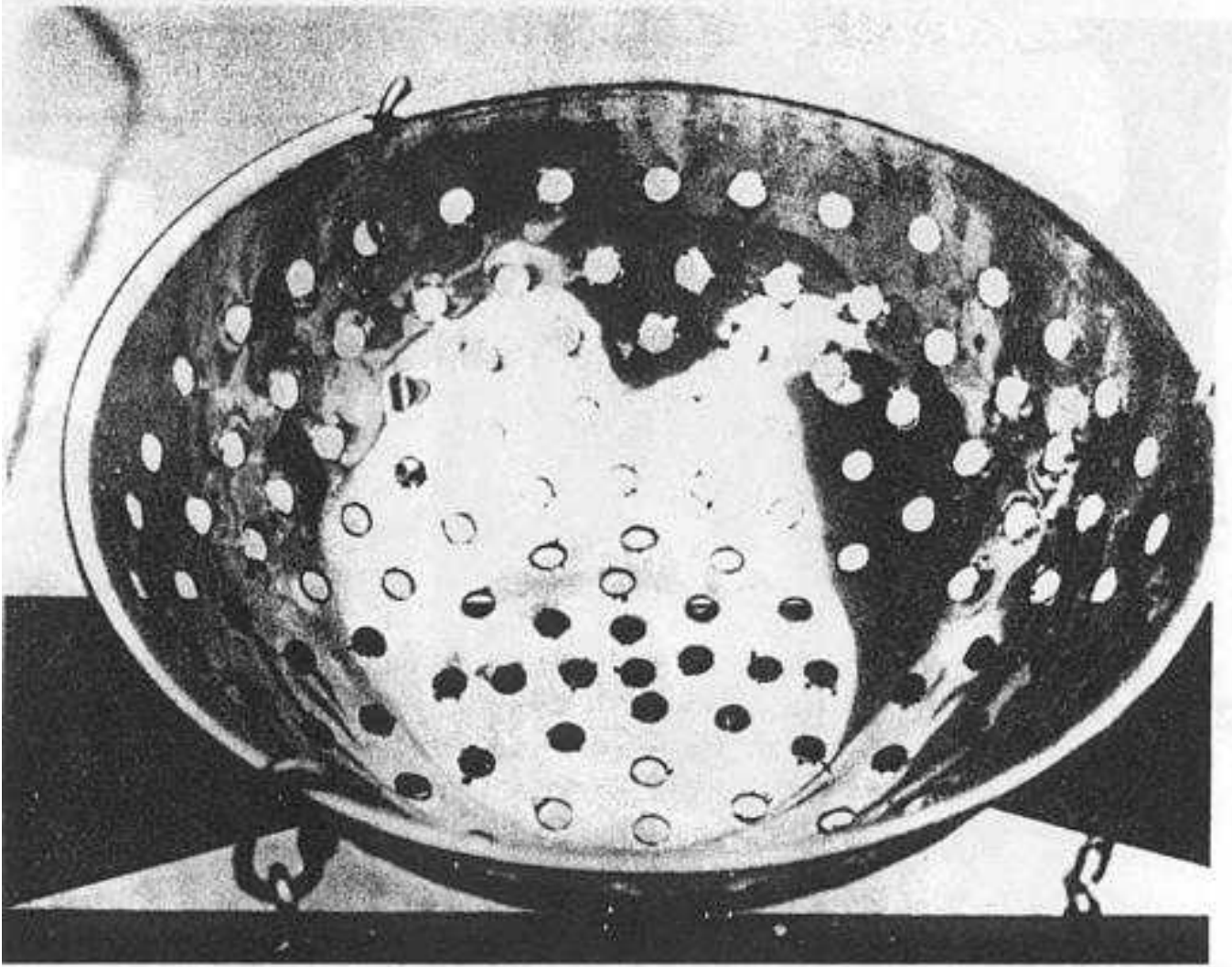

Fig. 2-5. Chains attached to the lip of the stainless steel mixing bowl.

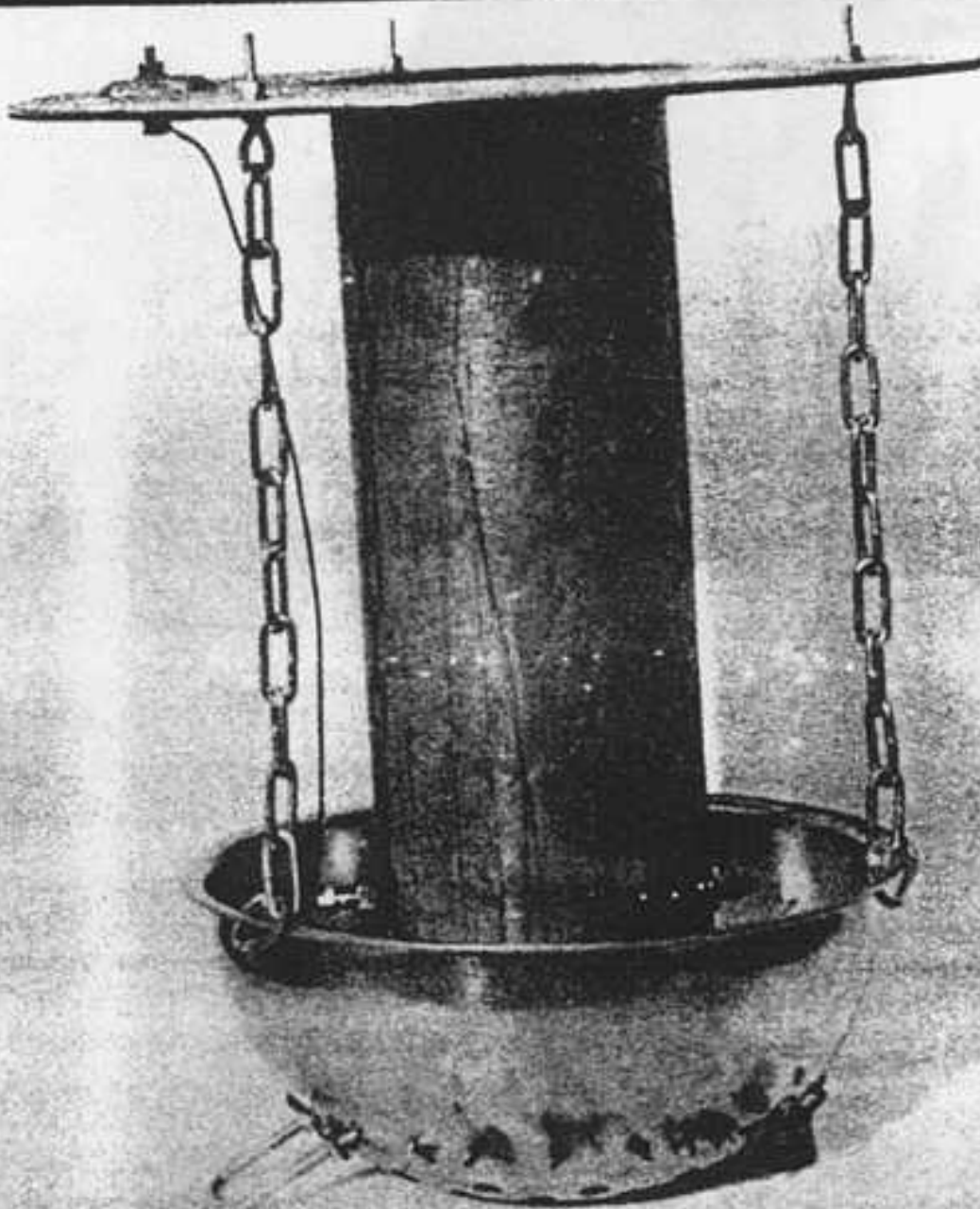

Fig. 2-6. Connect the mixing bowl to the top plate with chains. Note that the diesel ignitor "glow plugs" shown in this photograph were included for experimentation only; they were abandoned in the final prototype design.

ORNL-Photo 4529-87

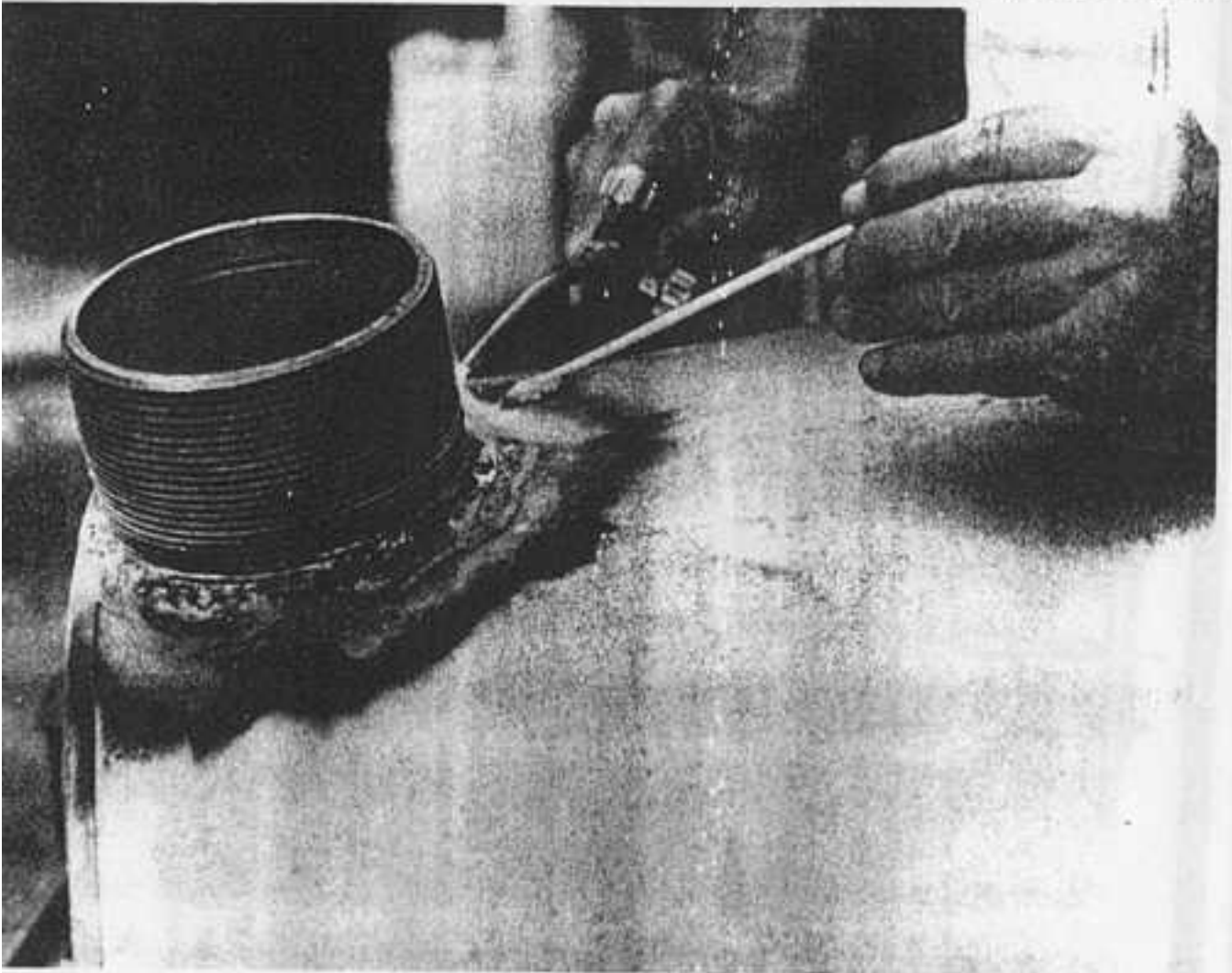
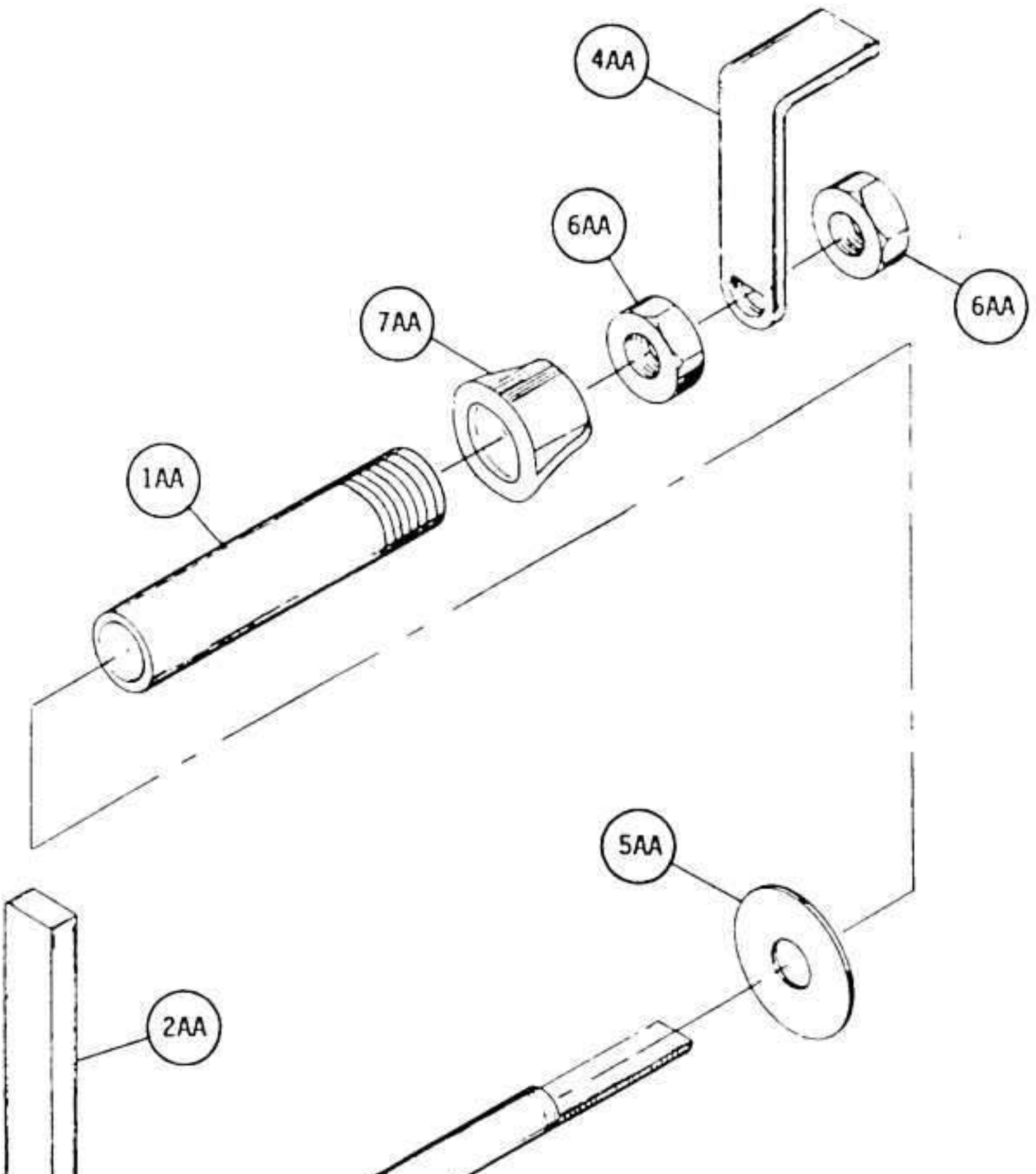

Fig. 2-7. Braze, do not weld, the plumbing fittings to the thin walled drums.



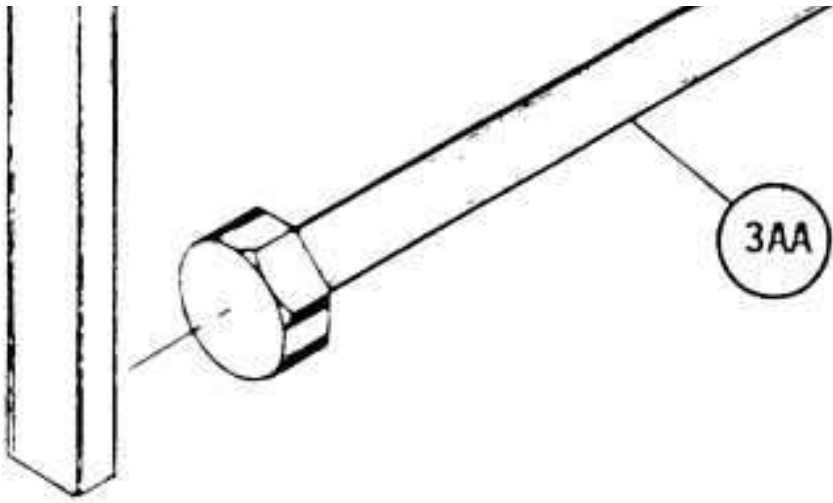

Fig. 2-8. Exploded, schematic diagram of the grate shaking mechanism.

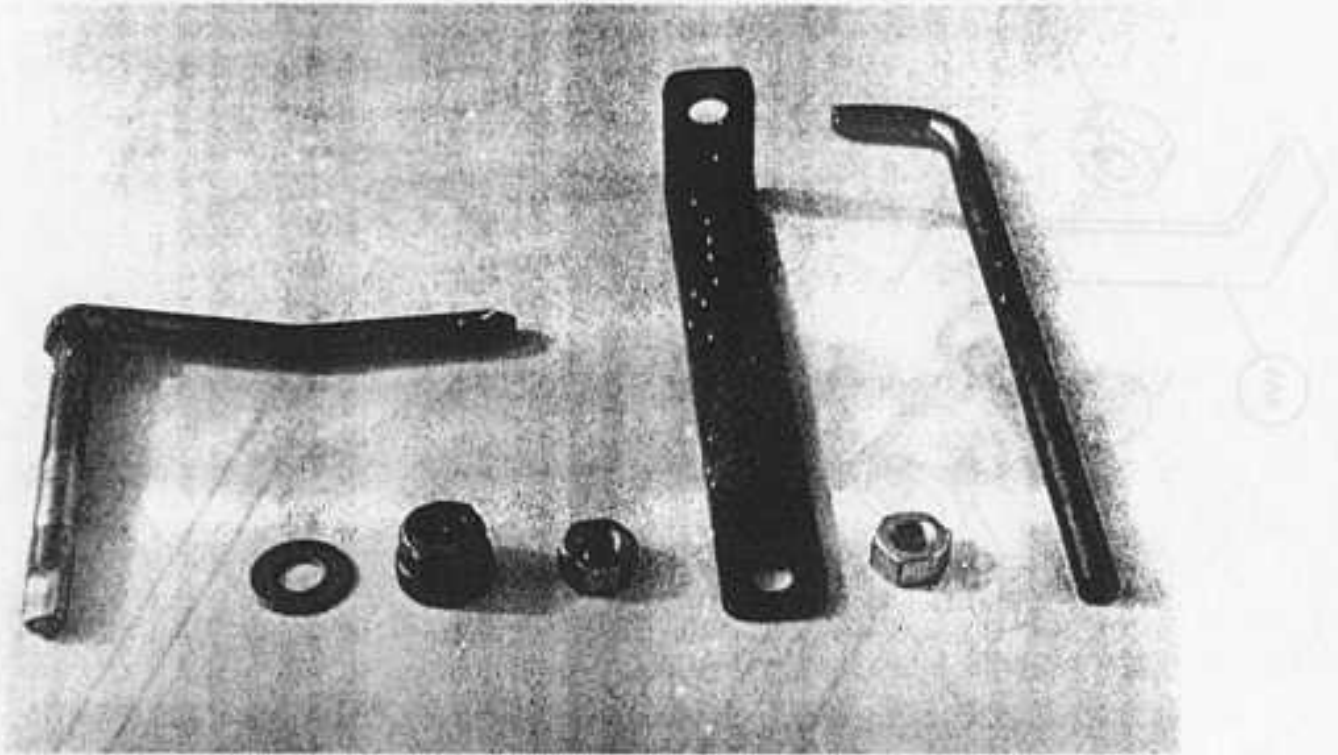

Fig. 2-9. Parts for the shaker assembly. Note the flattened portion of the bolt (at extreme left) which positively locks into the handle (third from right). At the extreme right is a "poker bar" which engages into the hole in the top of the handle to operate the shaker mechanism; the shaker handle will get very hot during normal gasifier operation.

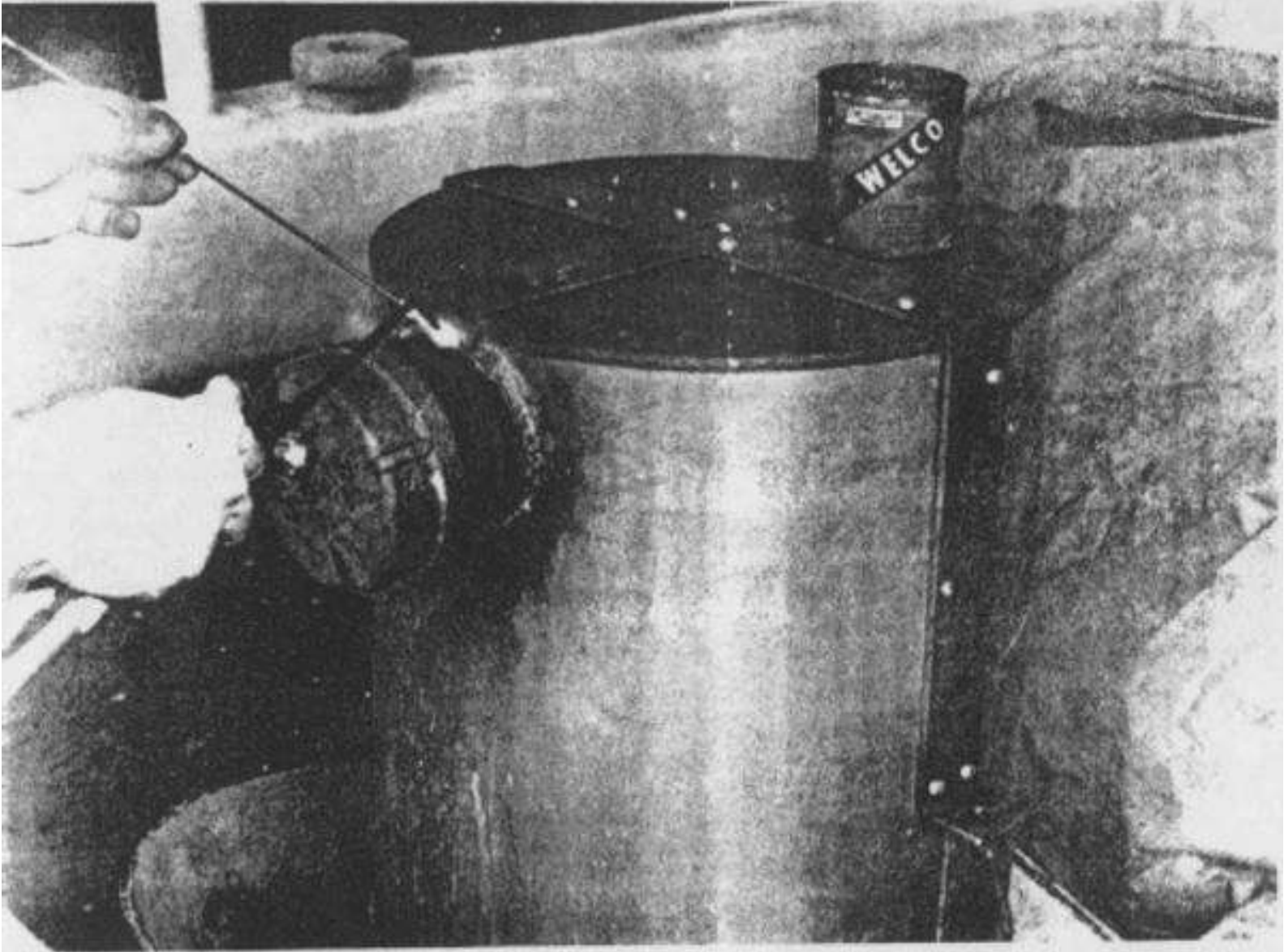

Fig. 2-10. The support frame can be brazed or bolted to the side of the gasifier unit. All bolts should be sealed air tight.

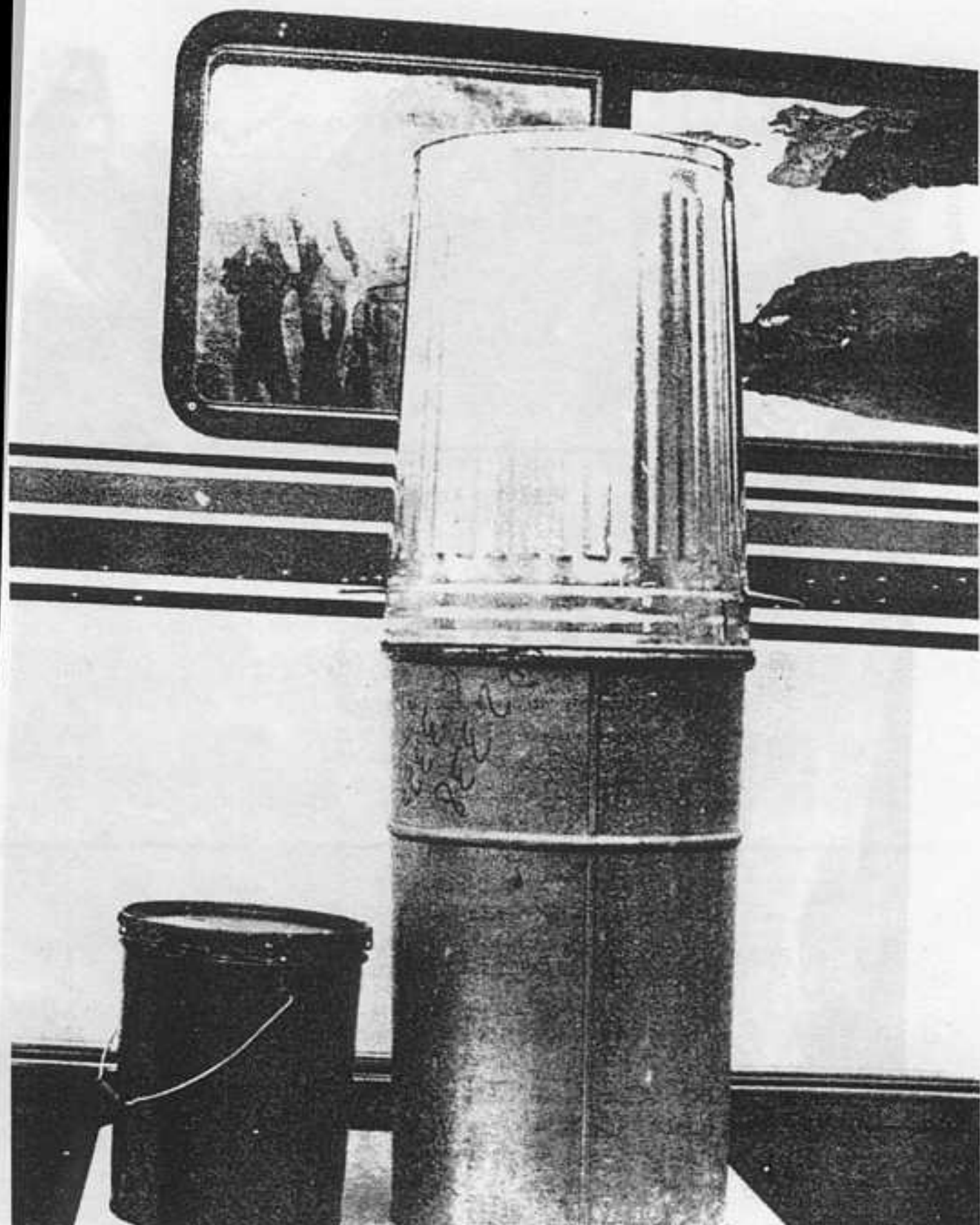



Fig. 2-11. Containers used in constructing the prototype gasifier unit. At right, a 20-gal garbage can (the fuel hopper) is shown on top of a 30-gal metal drum (the gasifier unit housing). The 5-gal paint can, at left, is used as the filter container.

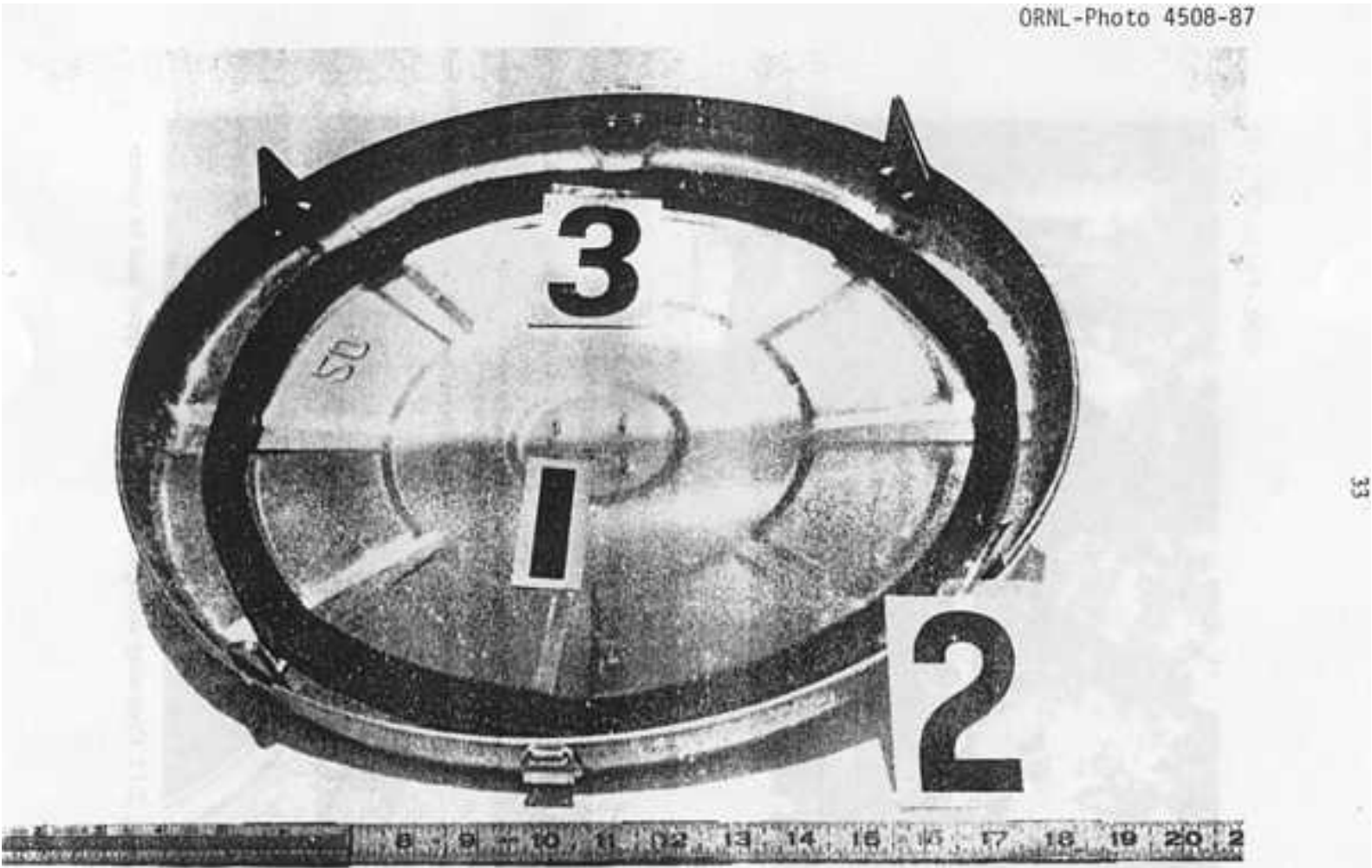
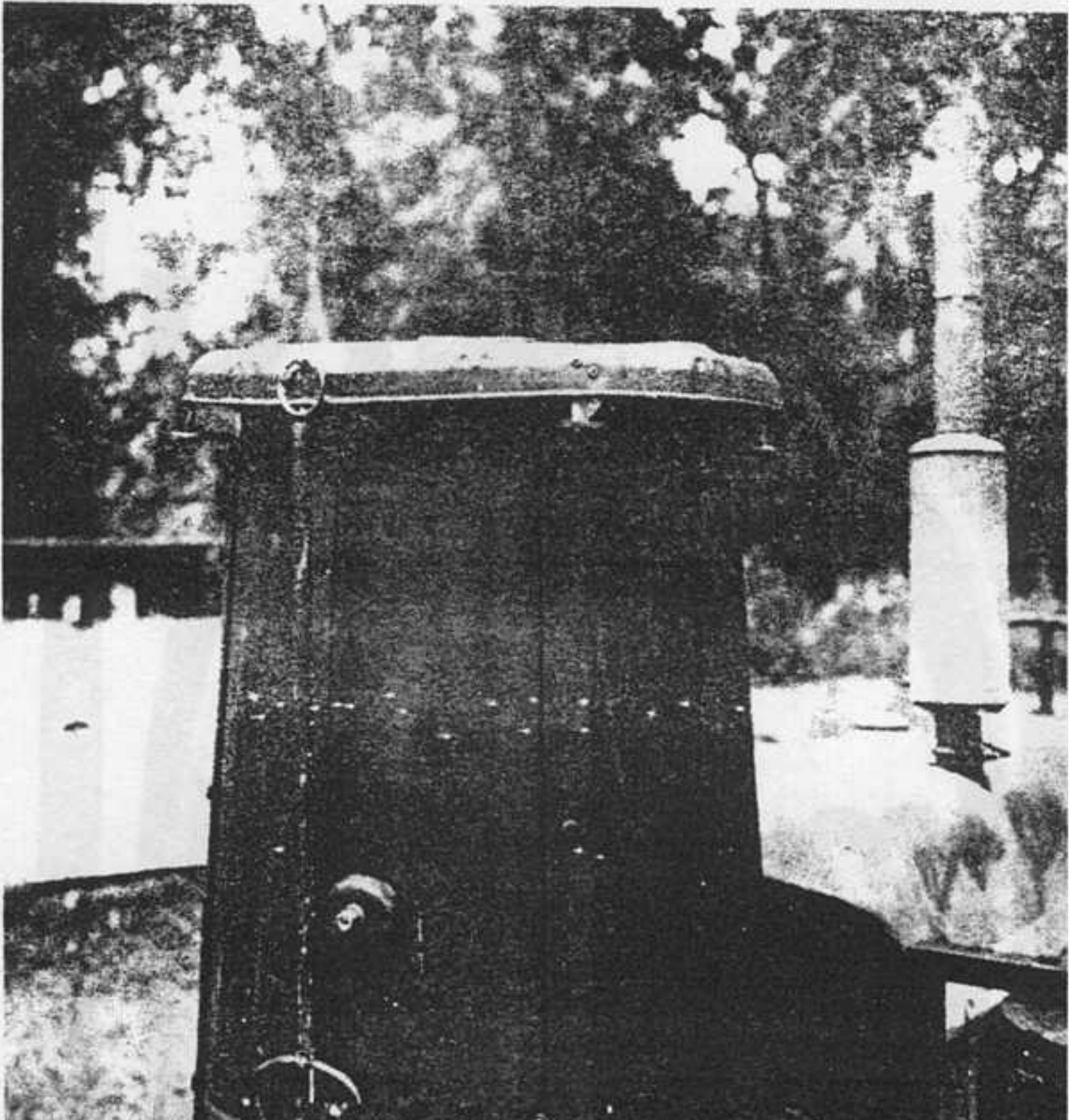

Fig. 2-12. Cover for the fuel hopper. Note the foam weatherstripping (#3) attached to the underside of the lid where it contacts the fuel hopper. Attach four standoffs (#2) to the lid (#1) as shown.

ORNL-Photo 5342-86



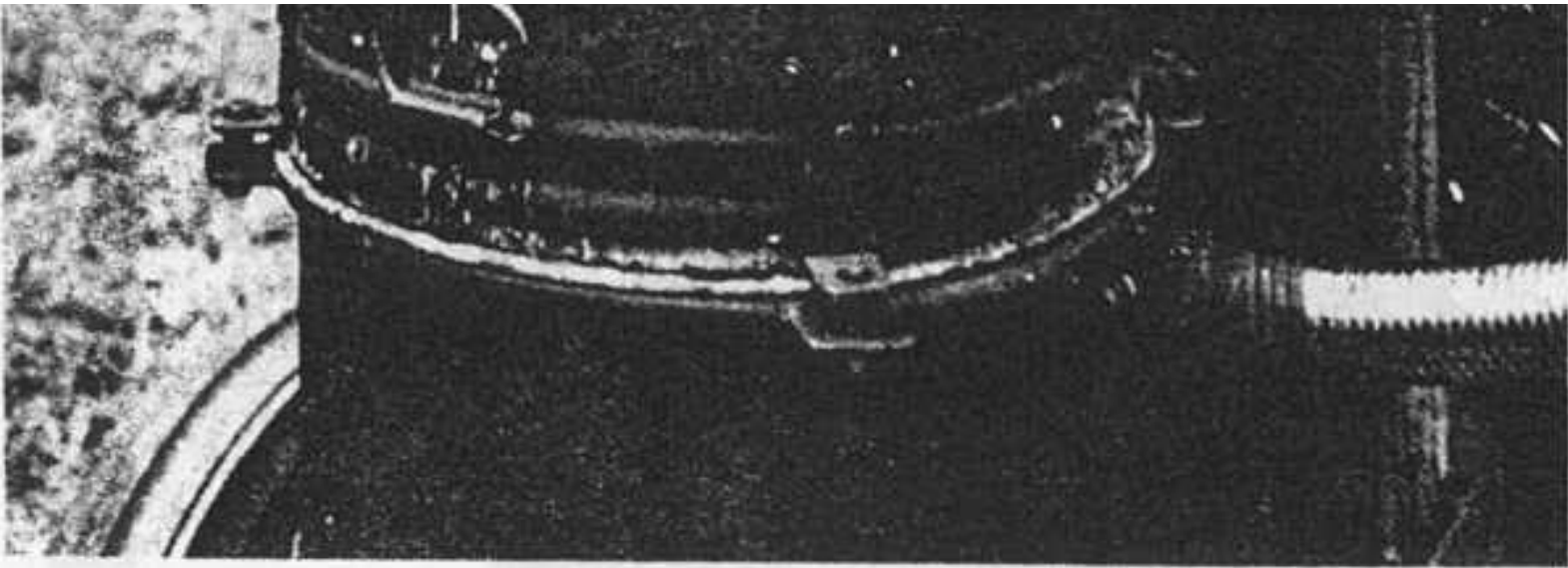

Fig. 2-13. Operating configuration of the fuel hopper and its cover.

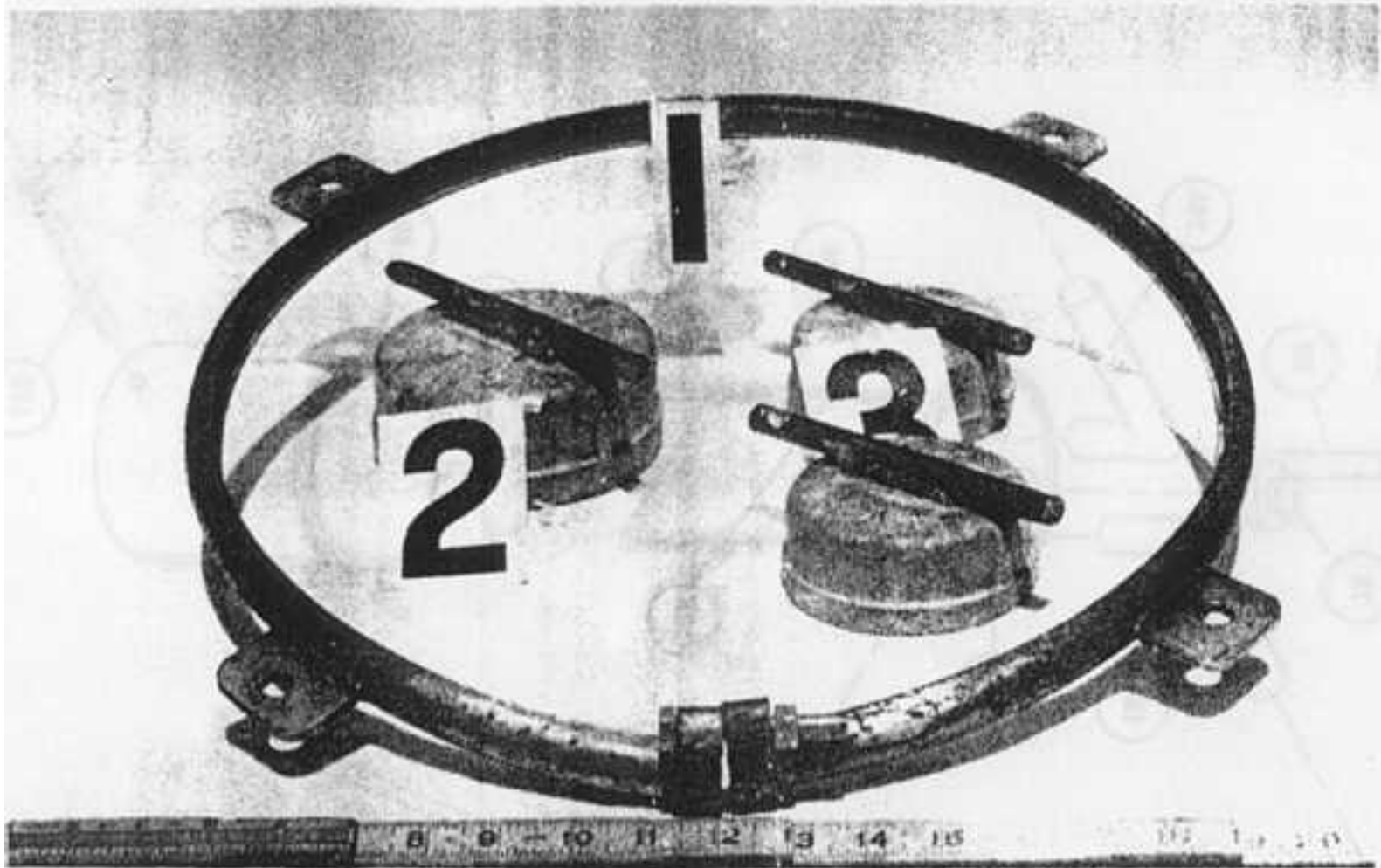
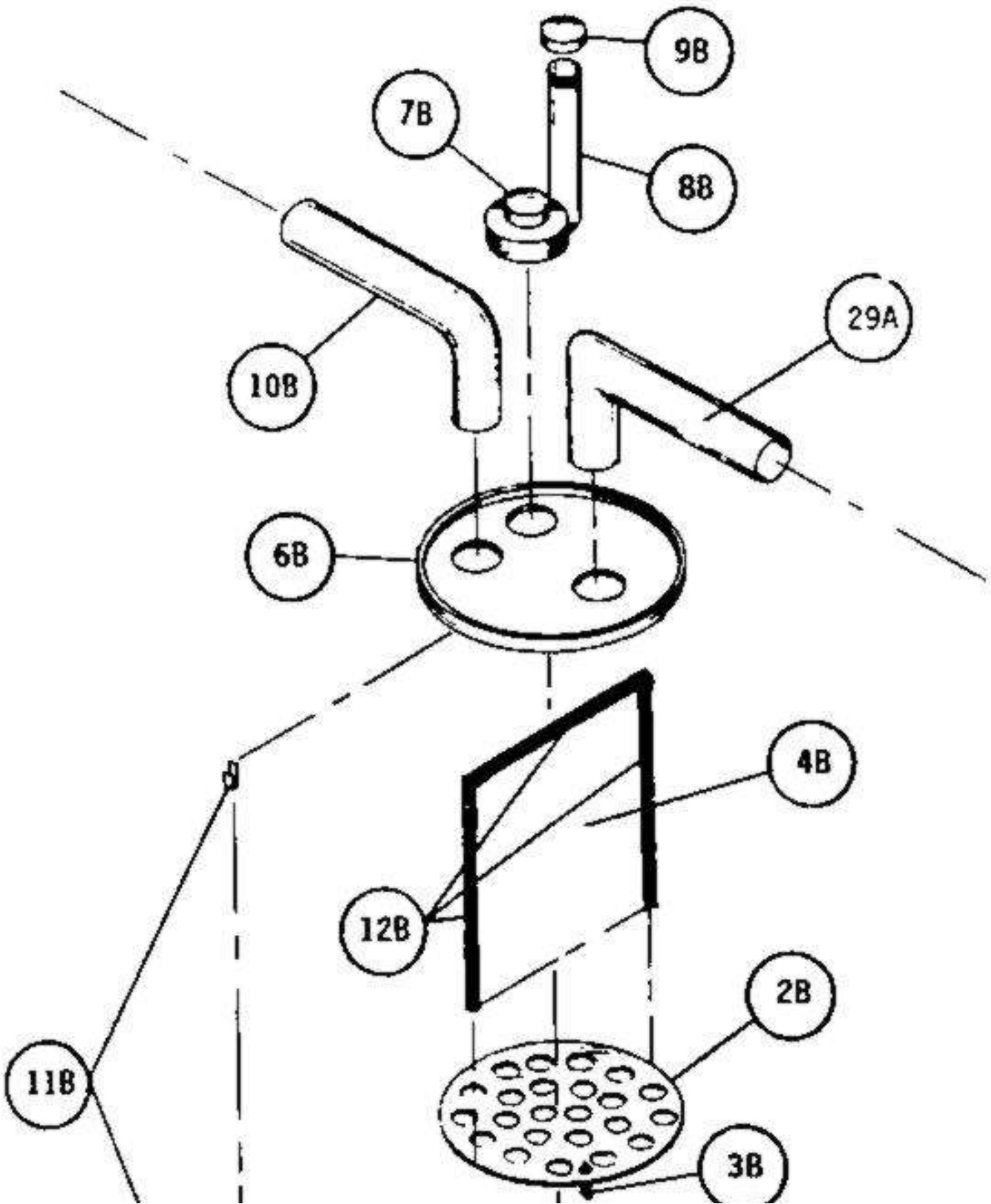

Fig. 2-14. Lock ring and welded tabs. Also pictured inside the lock ring (#1): the ash cleanout cover cap (#2), and the ignition cover cap (#3).



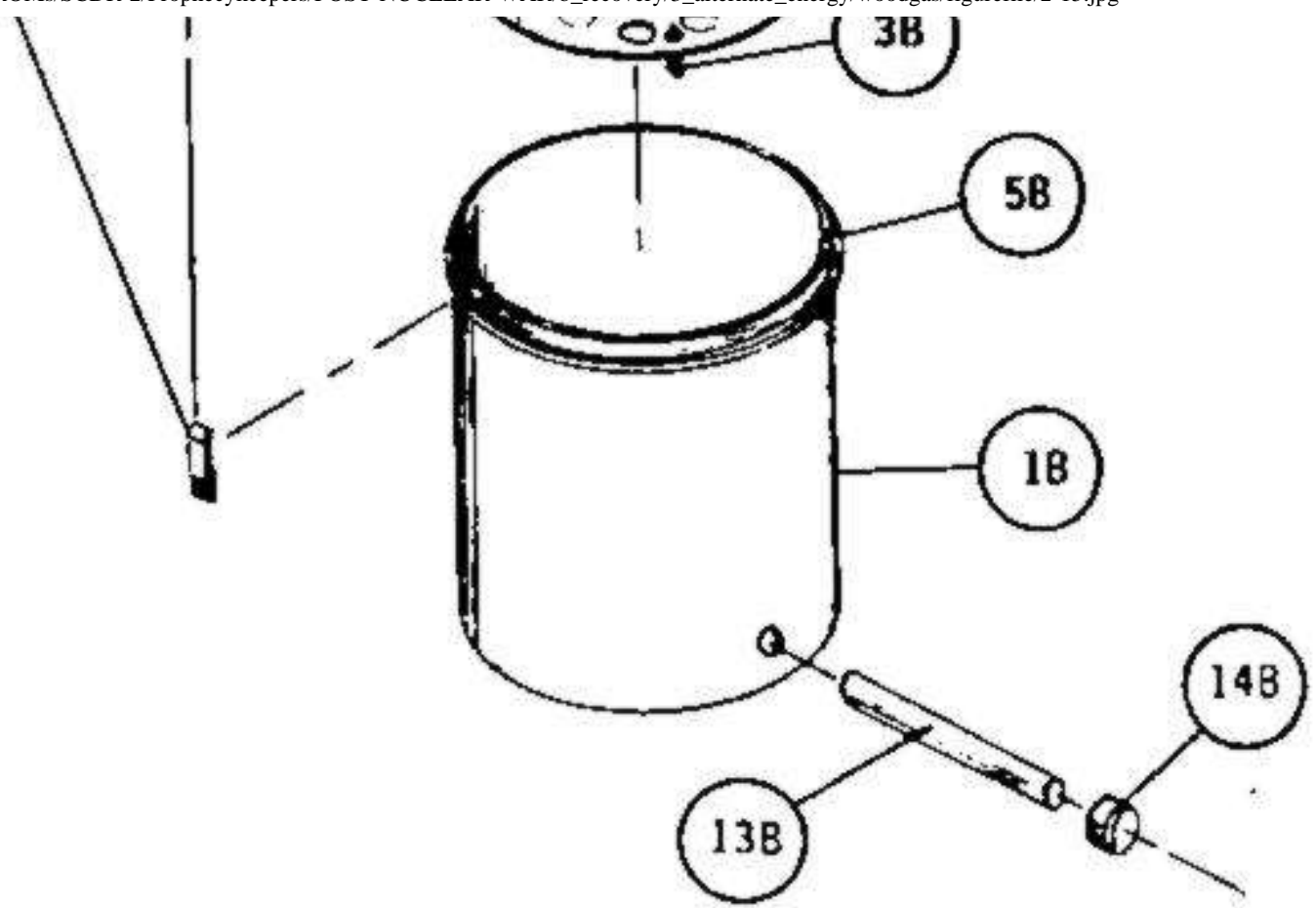

Fig. 2-15. Exploded, schematic diagram of the filter unit.

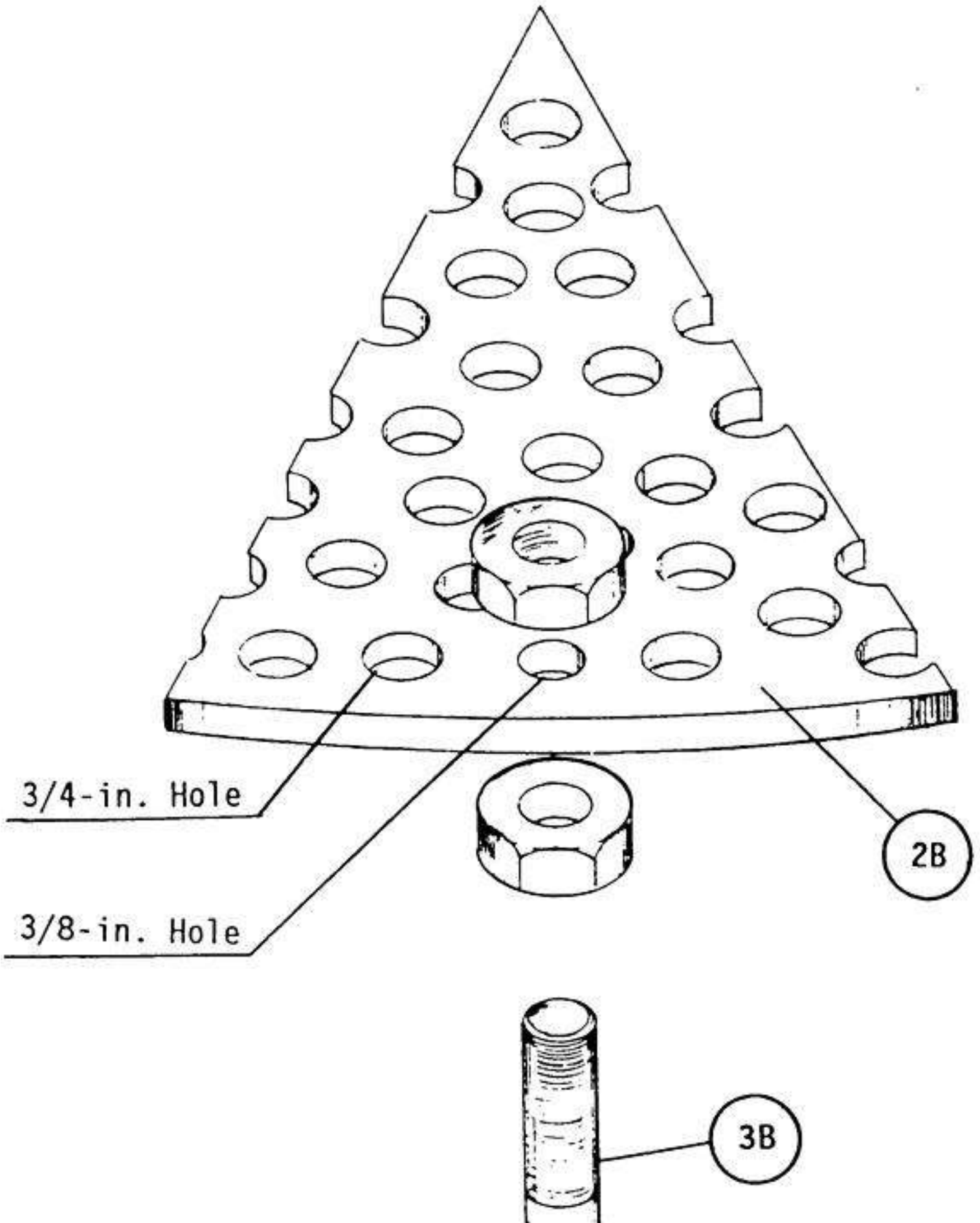



Fig. 2-16. Detail of the standoffs for the bottom plate of the filter unit.

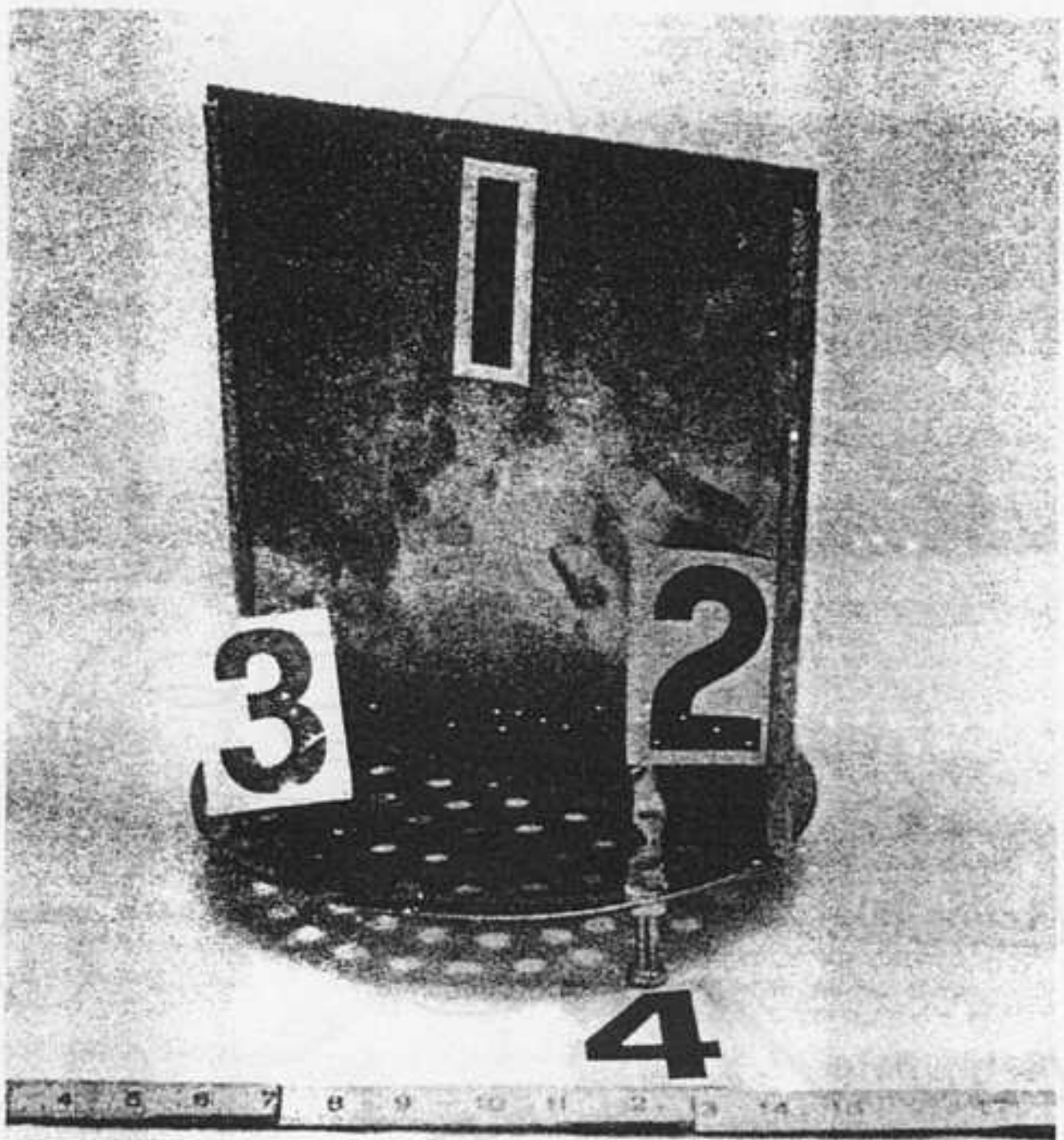

Fig. 2-17. Divider plate (#1) and bottom plate (#3), with standoffs (#4), for the filter unit. Note the high-temperature hose lining the sides of the divider plate.

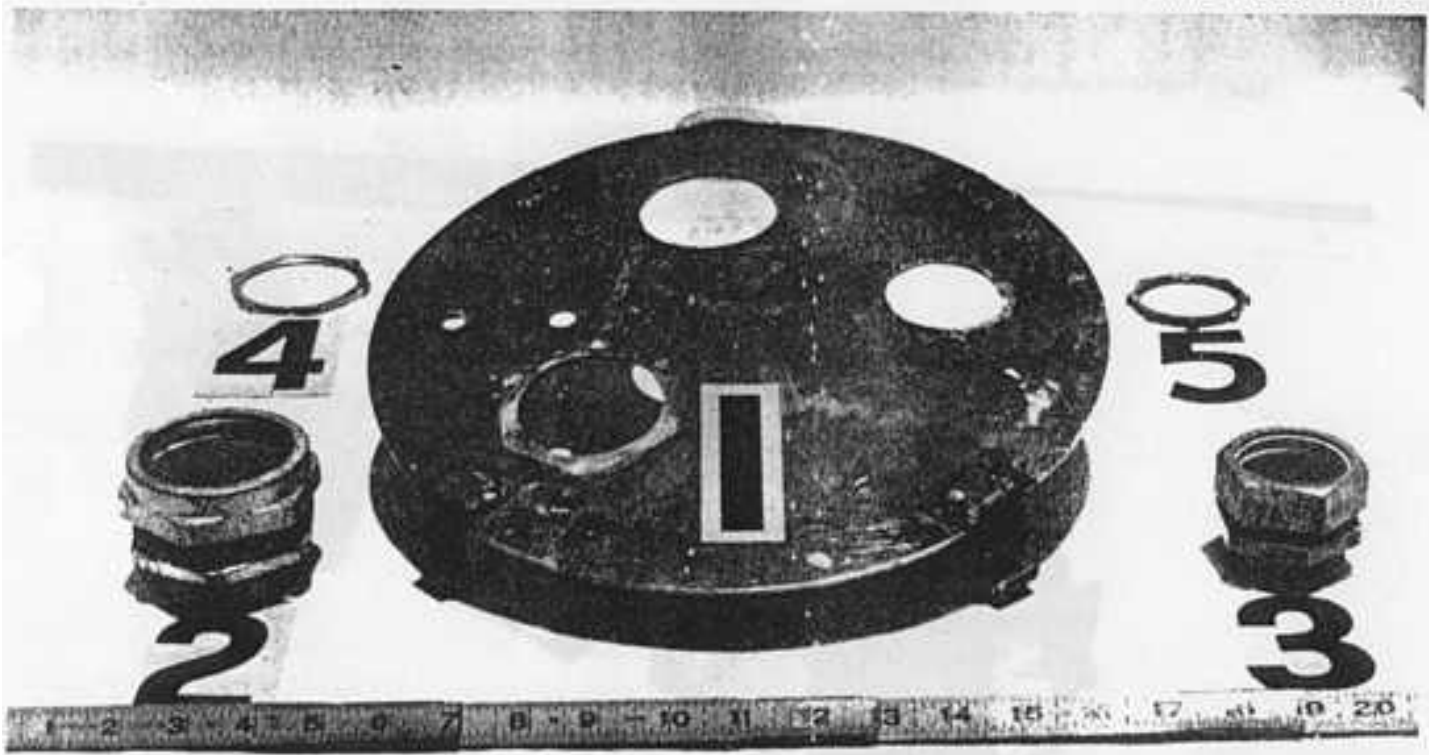

Fig. 2-18. Circular lid (#1) for the filter unit. Note the arrangement of the holes; divider plate would roughly run from 10 o'clock position to 4 o'clock position (assuming 12 o'clock is taken to be at the rear of the photograph). Also shown are the conduit connectors (#2 and #3) and accompanying nuts (#4 and #5) for inside the lid.

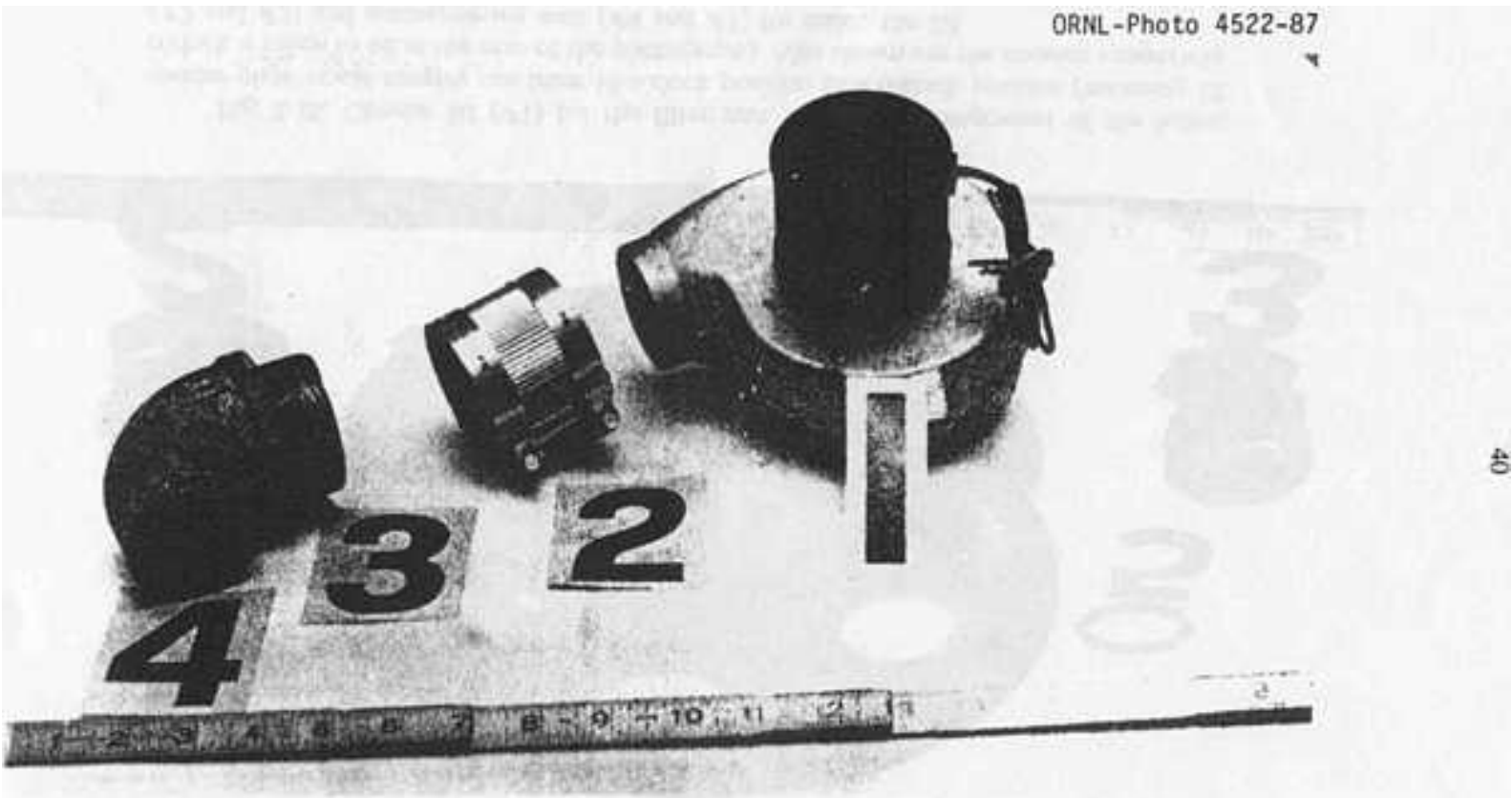

Fig. 2-19. Blower (#1) with exhaust extension assembly. Note adapter coupling (#2), pipe nipple (#3), and elbow (#4) for vertical exhaust pipe.

ORNL-Photo 4512-87



Fig. 2-20. Assembled and installed blower (#1), extension assembly (#4), and conduit connectors for gas inlet (#2) and outlet (#3) on lid of filter unit. Note hook attachments at edge of lid for latches.

ORNL-DWG 87-14558

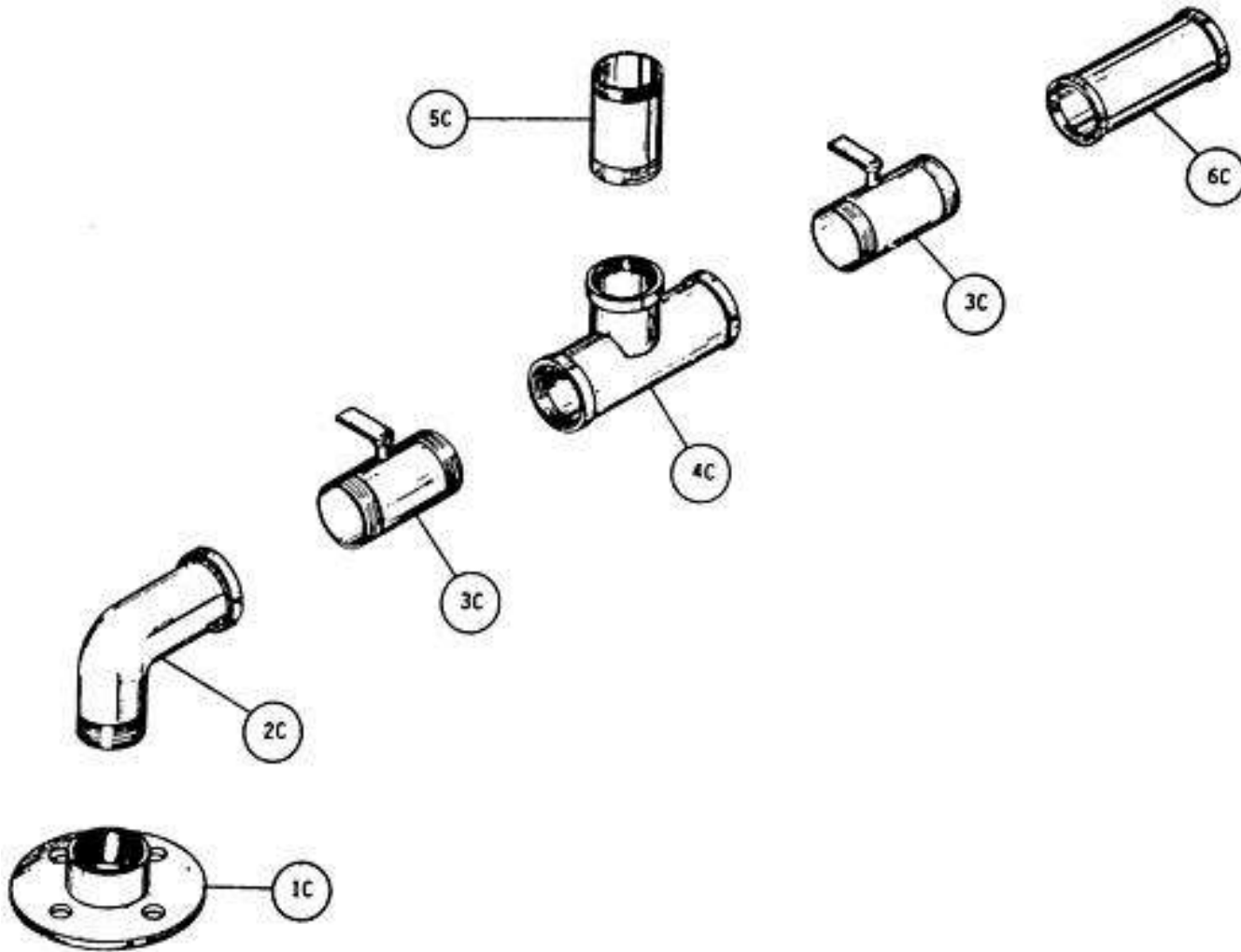

Fig. 2-22. Exploded, schematic diagram of the carbureting unit and control valves.

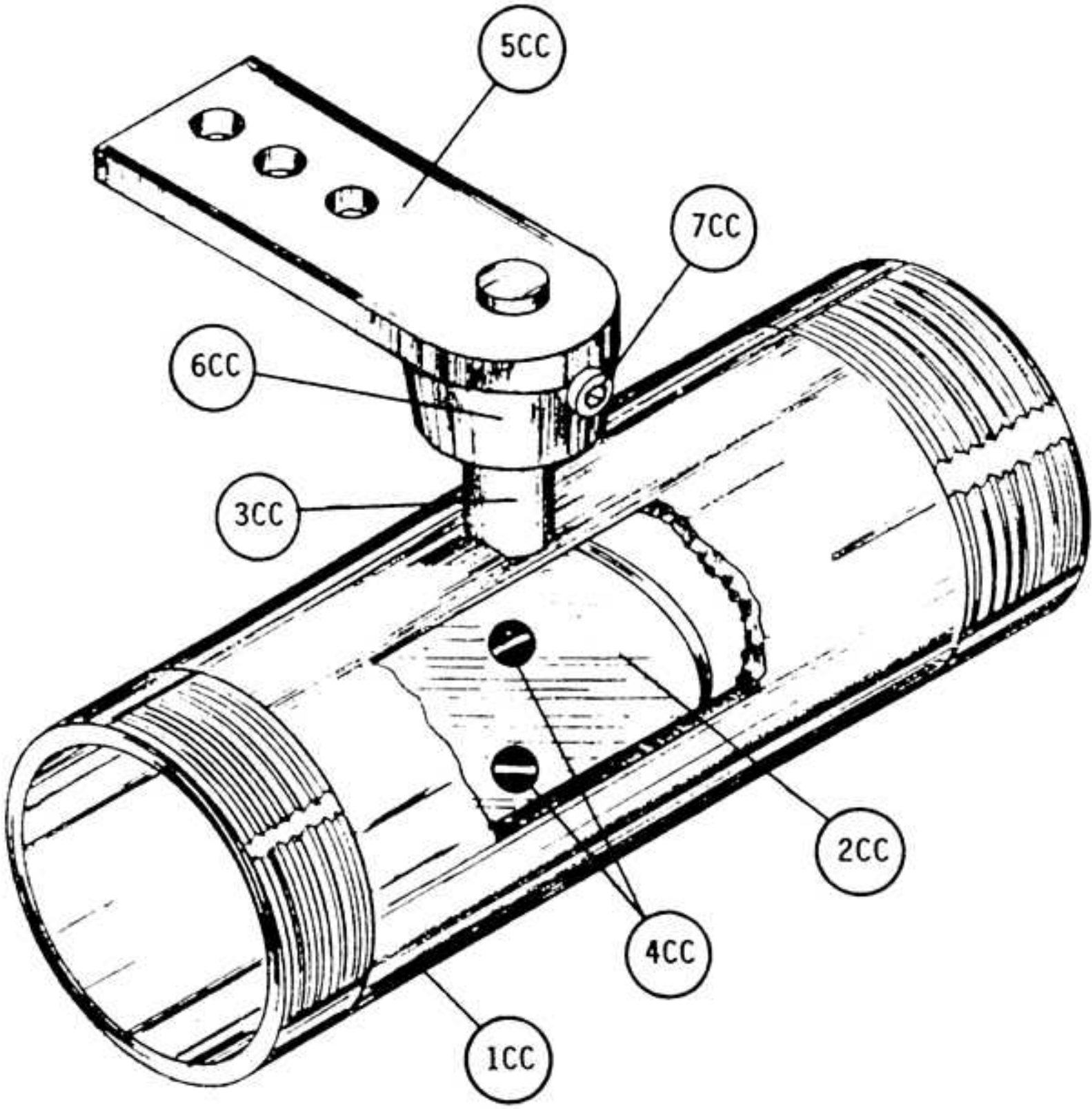

Fig. 2-23. Schematic diagram of a butterfly control valve.

Fig. 2-23. Schematic diagram of a butterfly control valve.

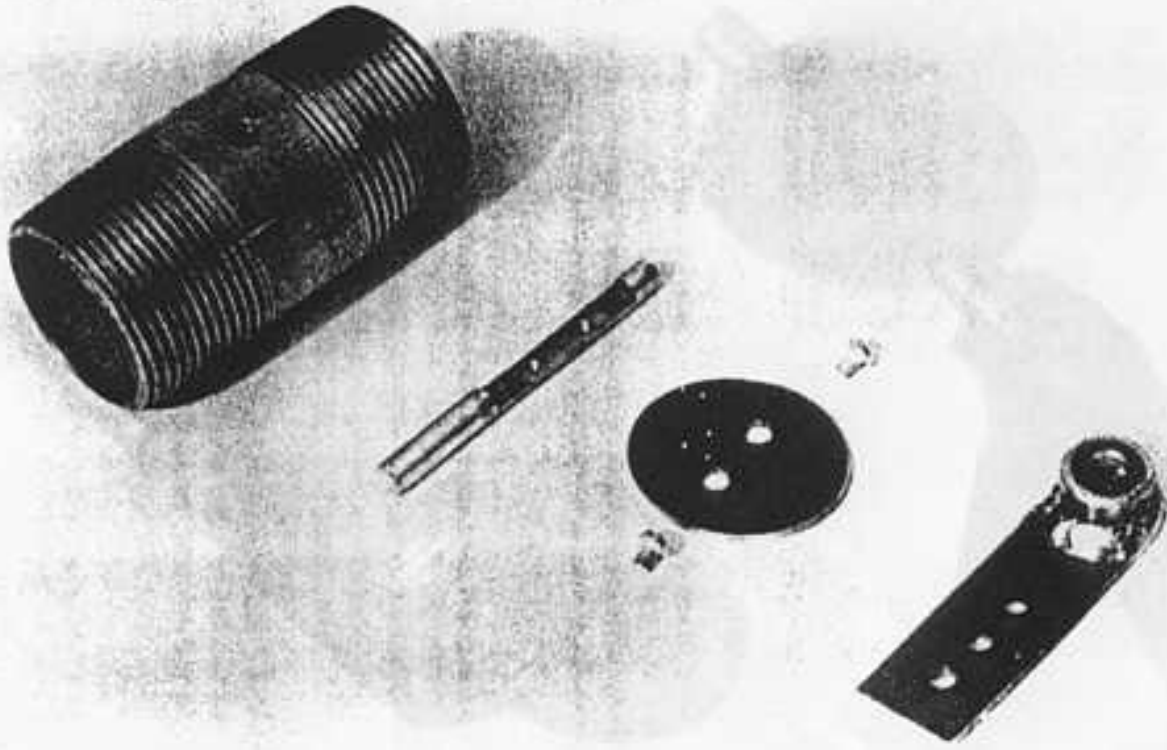

Fig. 2-24. Parts required for the butterfly valve.

45

ORNL-Photo 4485-87



Fig. 2-25. Butterfly valve assembly. Note that the valve has been assembled outside of the valve body for clarity.

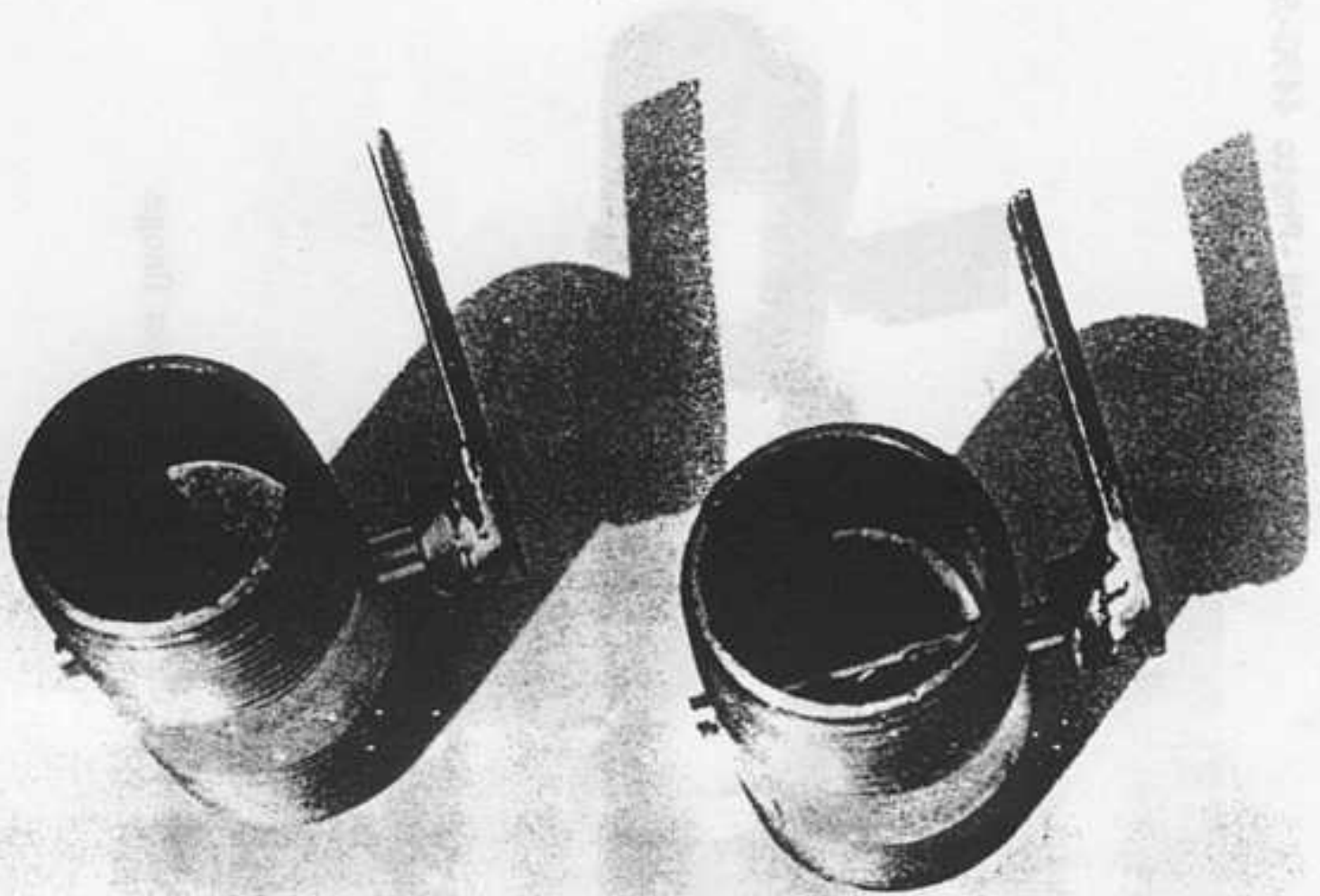

Fig. 2-26. Assembled butterfly valves.

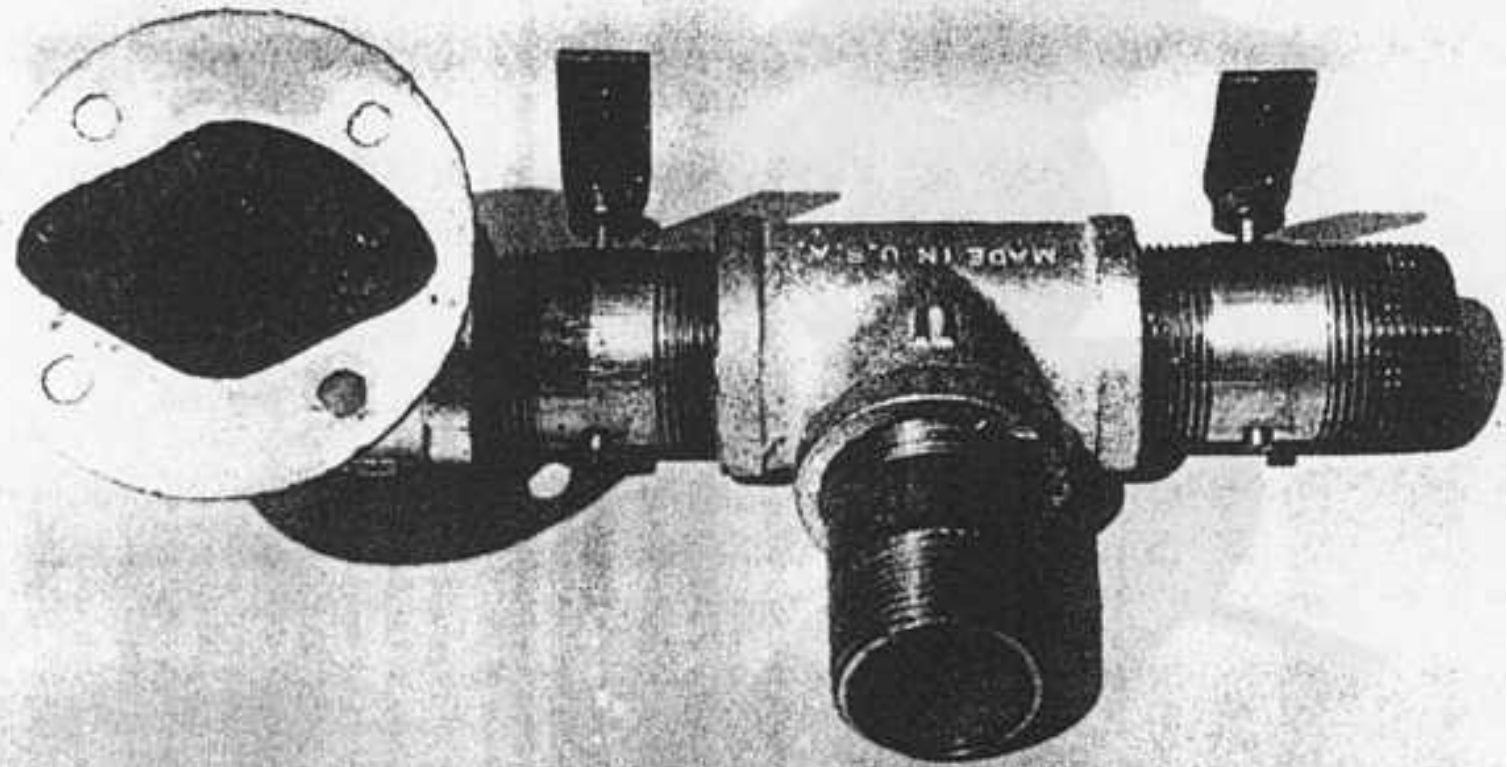

Fig. 2-27. Assembled carburetion unit. Note the gasket on the closet flange.

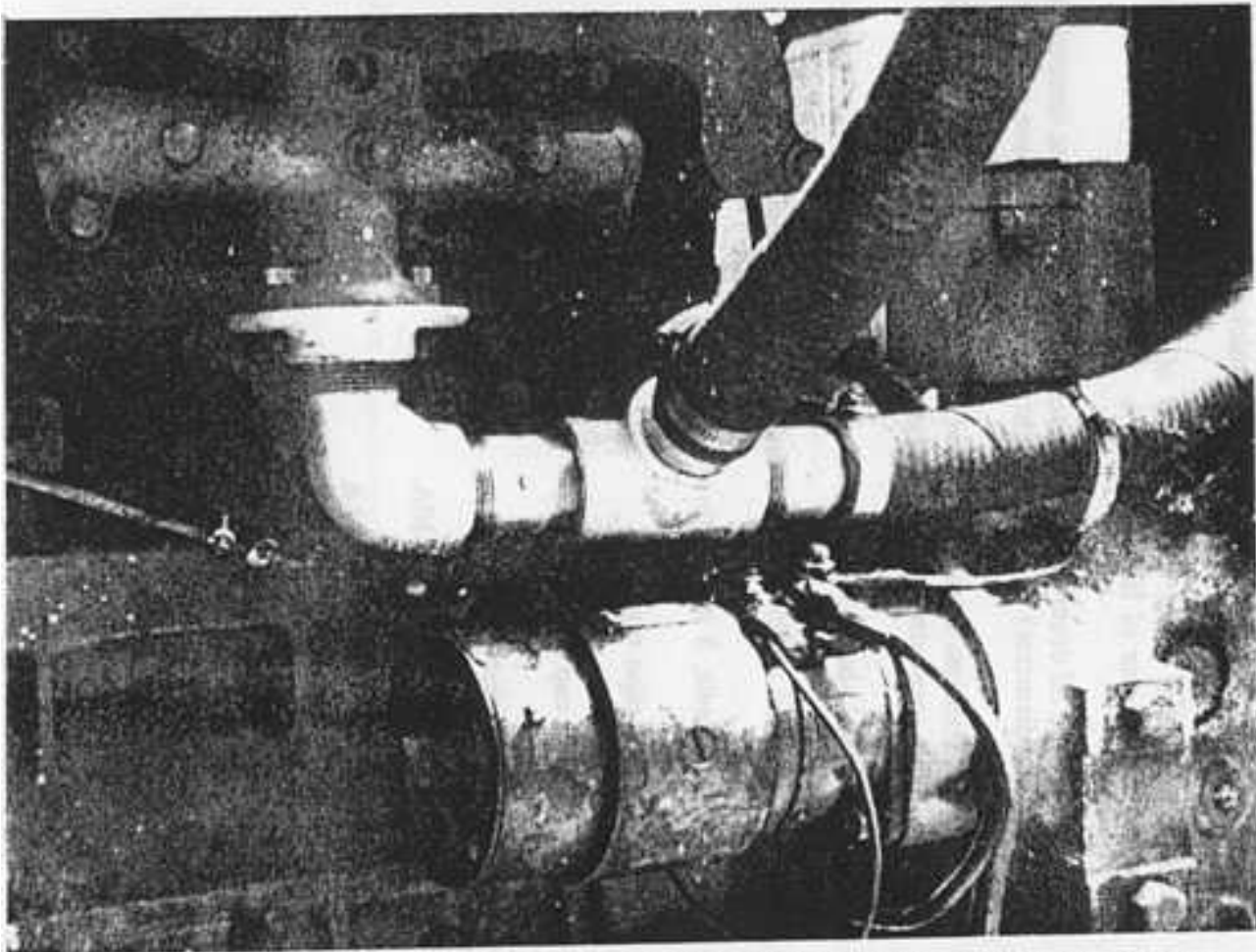

Fig. 2-28. Carburetion unit attached to engine's existing intake manifold. Wood gas enters from the side of the tee; air enters from the right-hand end. The butterfly valve at the right (partially obscured) is connected to the air control (choke) cable; the left valve is connected to the throttle linkage.



Fig. 3-1. Virtually all varieties of wood chips can be used for fuel. (Minimum size for this 6-in. firetube unit: 3/4 by 3/4 by 1/4 in.; maximum size: 2-in. cubes.)

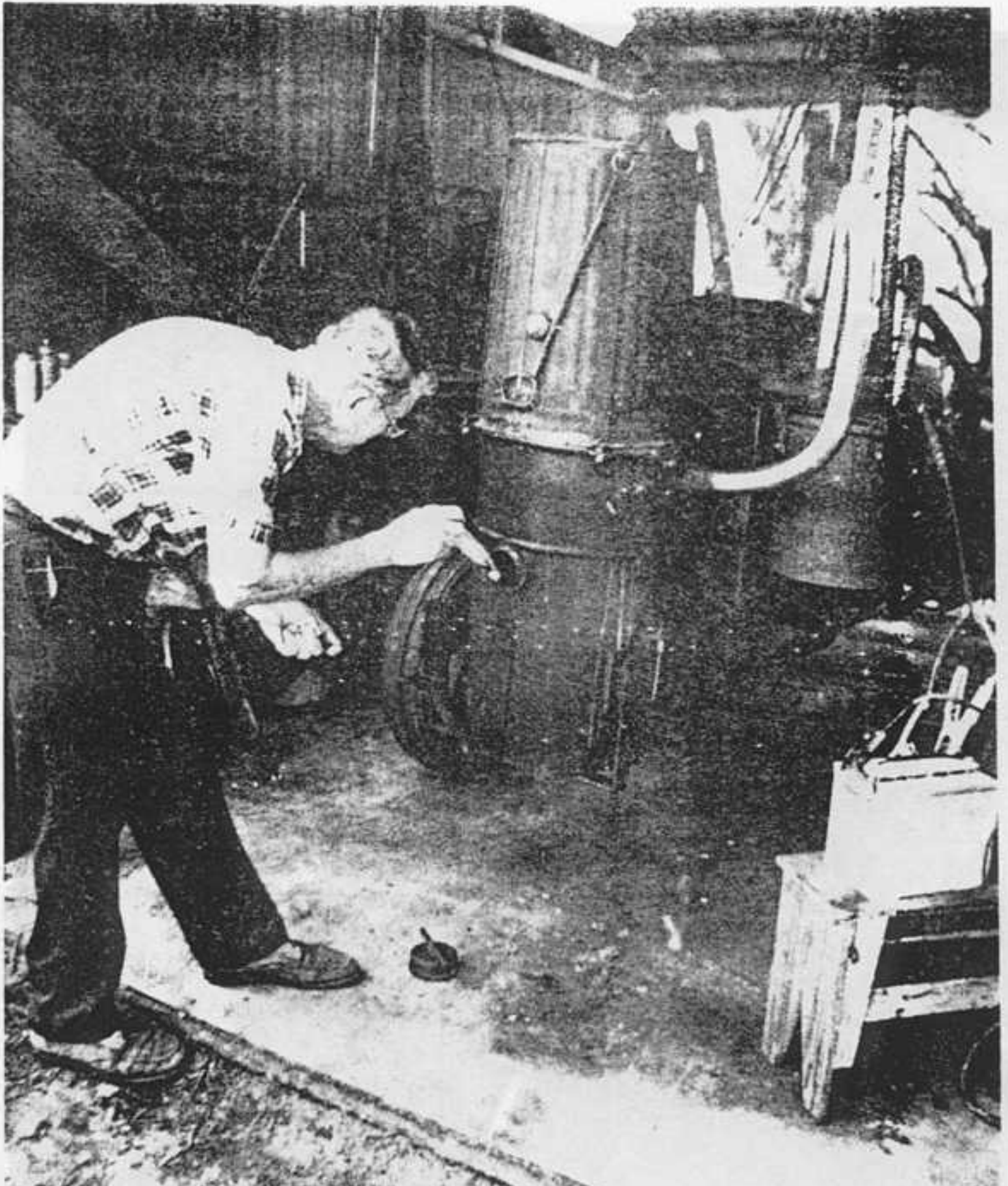



Fig. 3-2. Ignite a single piece of newspaper to start the gasifier unit. Push the flaming newspaper through the ignition port and directly into the grate. (At the right of the photo, note the battery which is operating the blower atop the filter unit.)

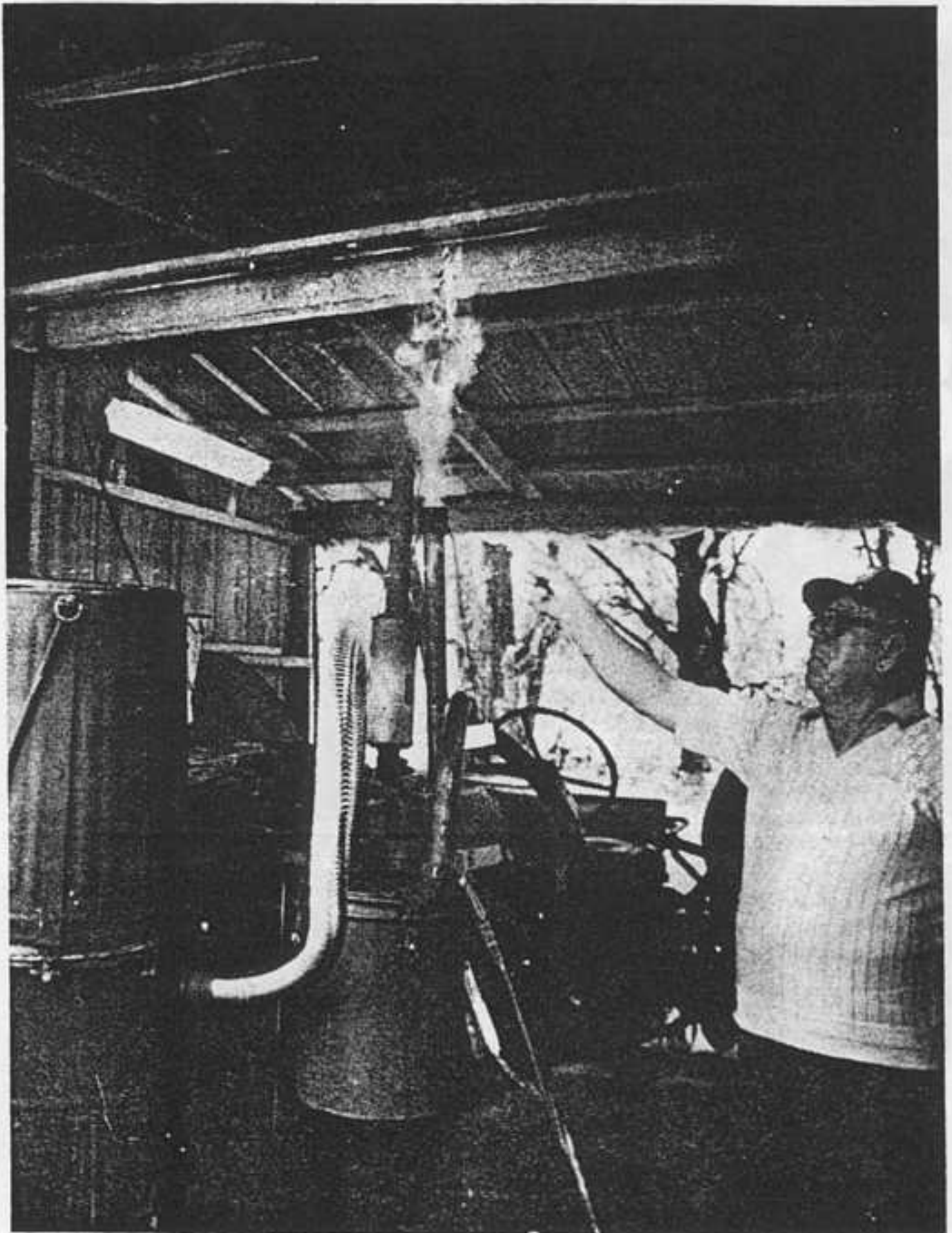

Fig. 3-3. Igniting the exhaust gas will demonstrate that the gasifier unit is working

Fig. 3-3. Igniting the exhaust gas will demonstrate that the gasifier unit is working properly.

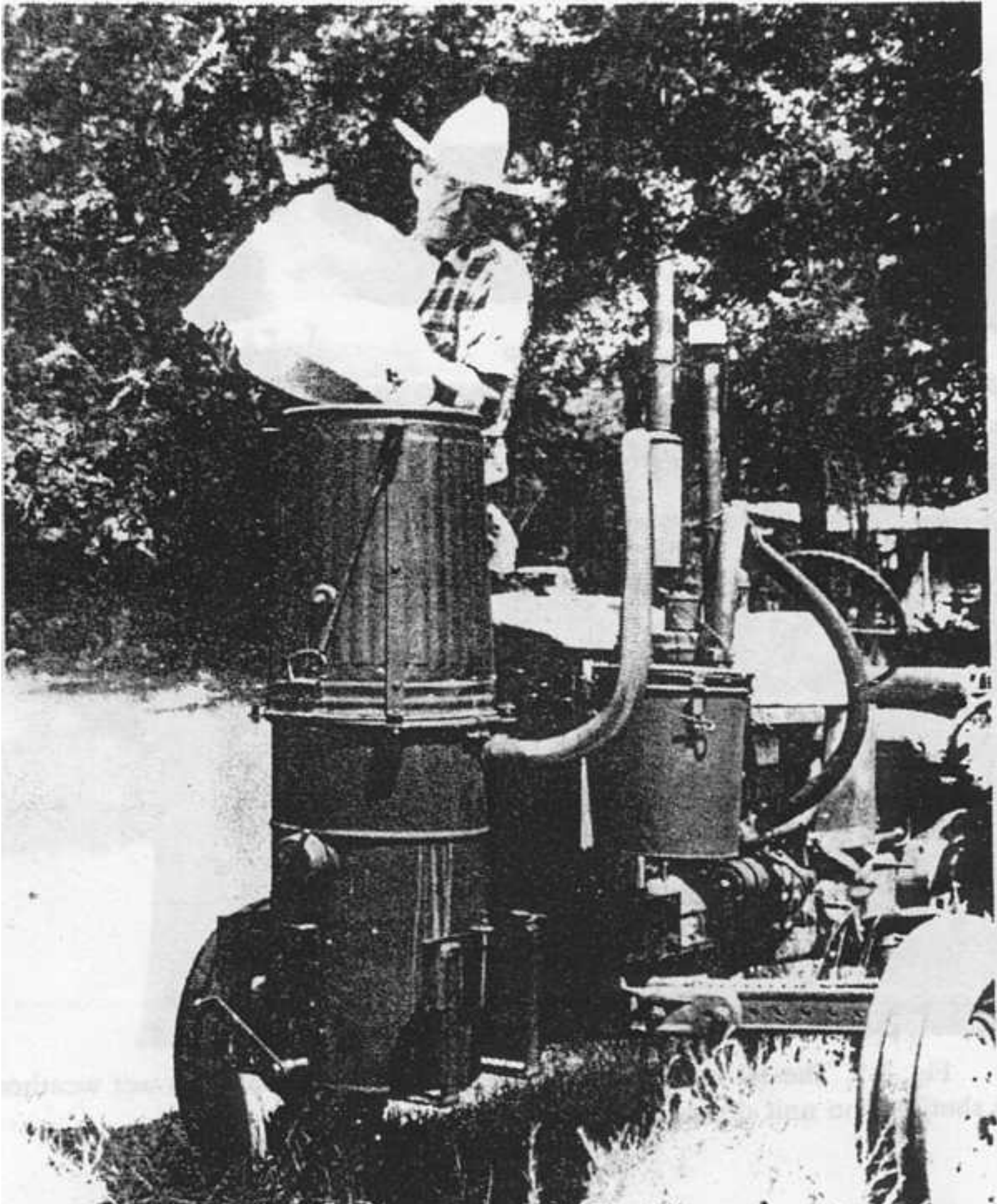



Fig. 3-4. Refill the fuel hopper before it becomes two-thirds empty.

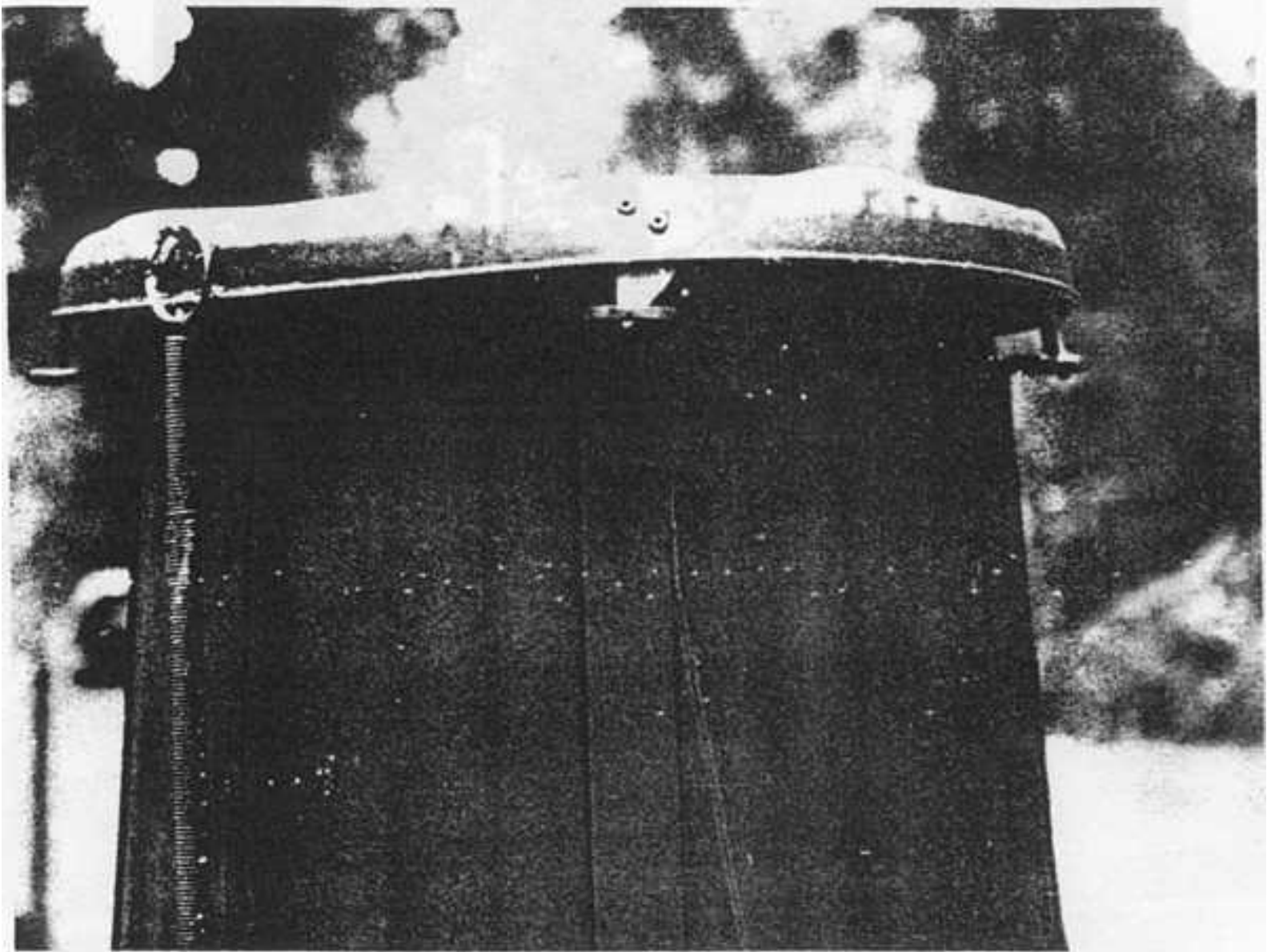

Fig. 3-5. The lid must be used to cover the fuel hopper in wet weather or when shutting the unit down.

MENU: [HOME](#) » [Reconstruction](#) » [Recovery](#) » [Renewal](#) » [Energy Types](#)

LIST OF TABLES

[Table 2-1](#). List of materials for the gasifier unit and the wood fuel hopper

[Table 2-2](#). Fire tube dimensions

[Table 2-3](#). List of materials for the primary filter unit

[Table 2-4](#). List of materials for the carbureting unit

[Table 3-1](#). Trouble-shooting your wood gas generator

[Table 3-2](#). Effects of breathing carbon monoxide

[Back to Table of Contents](#)

MENU: [HOME](#) » [Reconstruction](#) » [Recovery](#) » [Renewal](#) » [Energy Types](#)

Table 2-1. List of materials for the gasifier unit and the wood fuel hopper

Item	Quantity	Description
1A	1	Metal pipe, tube, or other, open-ended metal cylinder; diameter and length from Table 2-2; minimum wall thickness of 1/4 in.
2A	1	Circular metal plate with thickness of 1/8 in.; diameter equal to outside diameter of Item 1A.
3A	1	30-gal metal oil drum or metal container with approximate dimensions of 18 in. (diameter) by 29 in. (height); container must have a bottom.
4A	1	10-quart stainless steel mixing bowl, container, or other stainless steel bowl with approximately 14-in. diameter and 6-in. depth.
5A	1	2-in. metal U-bolt.
6A	1	3/16-in. metal chain with 1-in. links; 7 ft total length.
7A	3	1/4-in. eyebolts, 3 in. length with two nuts for each eyebolt.
8A	1	4-in. metal pipe nipple.
9A	1	Metal pipe, cap for Item 8A.
10A	2	3-in. metal pipe nipple.
11A	2	Metal pipe cap for Item 10A.
12A		Shaker assembly; see Fig. 2-8 .
1AA	1	Metal 1/2-in. pipe; 6 in. length.
2AA	1	Iron bar stock; square or round, 1/2 in.; 6 in. length.
3AA	1	1/2-in. bolt; 8 in. long.
4AA	1	Iron bar stock; rectangular, 1/4 by 1 in.; 10 in. length.
5AA	1	1/2-in. flat washer.
6AA	2	1/2-in. nuts.
7AA	1	Metal pipe cap or bushing for Item 1AA.
13A	1	Iron bar stock; rectangular, 1/4 by 2 in.; 10 ft length.
14A	25	1/4-in. bolts; 314 in. length; with nuts.
15A	1	20-gal metal garbage can or metal container with approximate dimensions of 18 in. (top diameter) by 24 in. (height); bottom is not required.
16A	1	Lid for 20-gal garbage can.
17A	1	Garden hose; 1/2 to 5/8 in. diameter; length equal to circumference of Item 15A.
18A	1	Foam weather stripping with adhesive backing; 1/4 by 1 in.; length equal to circumference of Item 15A.

19A	1	Iron bar stock; rectangular, 1/4 by 2 in.; 10 ft length.
20A	12	1/4-in. bolts; 3/4 in. length; with nuts.
21A	4	Metal triangles; 2 by 2.5 in., 1/8 to 1/4 in. thick.
22A	2	Metal eye hook.
23A	2	Screen door spring, 14 in. length.
24A	1	Lock ring for 30-gal (or larger) oil drum.
25A	4	Metal squares; 2 by 2 in., 1/4 in. thick.
26A	4	3/8-in. bolts; 3 in. length.
27A	1	Tube. of high temperature silicone or liquid high temperature gasket material.
28A	1	60-lb. sack of hydraulic or other waterproof cement [such as SEC-PLUG (tm), which is manufactured by the Atlas Chemical Company, Miami, FL].
29A	1	2-in. pipe, electrical conduit, flexible automobile exhaust pipe, or other metal tubing; 6-ft minimum length. Pipe must be able to withstand temperatures of 400°F.

Table 2-2. Fire tube dimensions

Inside diameter (inches)	Minimum length (inches)	Engine power (hp)	Typical engine displacement (cubic inches)
2-	16	5	10
4-	16	15	30
6	16	30	60
7	18	40	80
8	20	50	100
9	22	65	130
10	24	80	160
11	26	100	200
12	28	120	240
13	30	140	280
14	32	160	320

*A fire tube with an inside diameter of less than. 6 in. would create bridging problems with wood chips and blocks. If the engine is rated at or below 15 horsepower, use a 6-in. minimum fire tube diameter and create a throat restriction in the bottom of the tube corresponding to the diameter entered in the above table.

NOTES: For engines with displacement rated in liters, the conversion factor is 1 liter = 61.02 cubic inches.

The horsepower listed above is the SAE net brake horsepower as measured at the rear of the transmission with standard accessories operating. Since the figures vary when a given engine is installed and used for different purposes, such figures are representative rather than exact. The above horsepower ratings are given at the engine's highest operating speed.

Table 2-3. List of materials for the primary filter unit

Item	Quantity	Description
1B	1	5-gal metal can or other metal container with minimum dimensions of 11.5-in. diameter and 13 in. tall.
2B	1	Circular metal plate; diameter equal to 1/2 in. smaller than inside diameter of Item 1B; thickness of 1/8 in.
3B	3	3/8-in. bolts; 3 in. length with two nuts for each bolt.
4B	1	Rectangular metal plate; width equal to 1/4 in. smaller than inside diameter of Item 1B; height equal to 2.5 in. smaller than internal height of Item 1B; 1/8 in. thick.
5B	1	High-temperature hose, 3/8 to 5/8 in. diameter; length equal to circumference of Item 1B.
6B	1	Circular metal plate; diameter equal to outside diameter of Item 1B; thickness of 1/8 in.
7B	1	12-volt blower (automotive heater type); case and fan must be all metal.
8B	1	Metal extension pipe for blower outlet, including elbows and connections for vertical orientation; 1 ft. minimum length.
9B	1	Cap for Item 8B; plastic is acceptable.
10B	1	1.25-in. metal pipe, electrical conduit, automotive exhaust pipe, or other metal tubing; 2 ft minimum length.
11B	3	Metal latch for securely connecting Items 1B and 6B together. Such devices as suitcase or luggage catches, bail-type latches, window sash catches (with strike), or wing-nut latches are acceptable.
12B	1	High-temperature hose, 3/8 to 5/8 in. diameter; length equal to three times the height of Item 4B.
13B	1	Metal 1/2-in. pipe, threaded on one end; 8 in. length.
14B	1	Metal pipe cap for Item 13B.

Table 2-4.

List of materials for the carbureting unit

Item	Quantity	Description
1C	1	1.25-in. closet flange.
2C	1	1.25-in. male-to-female 45° pipe elbow.
3C		Butterfly valve; see Fig. 2-23 .
1CC	2	1.25-in. pipe nipple or threaded length of pipe, 3-in. length.
2CC	2	Oval metal plate; 1/16 in. thick; short dimension equal to inside diameter of Item 1CC; long dimension equal to 1.02 times the short dimension.
3CC	2	3/8-in. diameter rod; 2.5 in. length.
4CC	4	3/16-in. screws; 3/16 in. length.
3CC	2	Flat bar stock; rectangular 1/2 by 3 in.; 1/8 in. thick.
6CC	1	7/16-in. nut.
7CC	1	1/8-in. set screw.
4C	1	1.25-in. tee with all female threads.
5C	1	1.25-in. pipe nipple or threaded length of pipe, 3 in. length.
6C	1	1.25-in. pipe or hose.
7C	1	Gasket material; sized to cover Item 1C.
8C	1	Tube of pipe compound or Teflon tape for sealing threaded assemblies.

Table 3-1.

Trouble-shooting your wood gas generator

Trouble	Cause	Remedy
Start up takes too long	Dirty system or clogged pipes.	Clean the gasifier unit and all the connecting piping.
	Blower is too weak	Check the blower and the battery's charge.
	Wet or poor quality charcoal	Check charcoal and replace or refill to proper level.
	Wood fuel bridges in the fire tube.	Lightly tamp down the wood fuel in the hopper and fire tube or replace the fuel with smaller-sized chips.
Engine will not start.	Insufficient gas	Use the blower longer during start up.
	Wet wood fuel.	Vent steam and smoke through the fire tube and fuel hopper for several minutes.
	Incorrect fuel-air mixture.	Regulate the carburetor's air control for proper mixing
Engine starts, but soon dies	Not enough gas has been produced.	Use low RPM while starting engine and do not rev engine for several minutes.
	Air channels through fire tube.	Tamp down wood fuel lightly in hopper. <u>Do not</u> crush charcoal above the grate.
Engine loses power under load.	Restricted gas flow in piping.	Reduce air mixture valve setting. Check for partial blockage of unit or piping.
	Leaks in system.	Check all covers and pipes for air tightness

Table 3-2.

Effect of breathing carbon monoxide

Carbon monoxide content of inhaled air (%)	Physiological effects
0.020	Possible mild frontal headache after two to three hours
0.040	Frontal headache and nausea after one to two hours; occipital (rear of head) headache after 2.5 to 3.5 hours.
0.080	Headache, dizziness, and nausea in 45 min; collapse and possible unconsciousness in who hours.
0.160	Headache, dizziness, and nausea inn 45 min; collapse and possible unconsciousness in two hours.
0.320	Headache and dizziness in 5 to 10 min; unconsciousness and danger of death in 30 min.
0.640	Headache and dizziness in 1 to 2 min; unconsciousness and danger of death in 10 to 15 min.
1.280	Immediate physiological effect; unconsciousness and danger of death in 1 to 3 min.

MENU: [HOME](#) » [Reconstruction](#) » [Recovery](#) » [Renewal](#) » [Energy Types](#)

CONSTRUCTION OF A SIMPLIFIED WOOD GAS GENERATOR FOR FUELING INTERNAL COMBUSTION ENGINES IN A PETROLEUM EMERGENCY

H. LaFontaine G. P. Zimmerman

ABSTRACT

This report is one in a series of emergency technology assessments sponsored by the Federal Emergency Management Agency (FEMA). The purpose of this report is to develop detailed, illustrated instructions for the fabrication, installation, and operation of a biomass gasifier unit (i.e., a 'producer gas' generator, also called a "wood gas' generator) that is capable of providing emergency fuel for vehicles, such as tractors and trucks, in the event that normal petroleum sources were severely disrupted for an extended period of time. These instructions have been prepared as a manual for use by any mechanic who is reasonably proficient in metal fabrication or engine repair.

This report attempts to preserve the knowledge about wood gasification that was put into practical use during World War II. Detailed, step-by-step fabrication procedures are presented for a simplified version of the World War II, Imbert wood gas generator. This simple, stratified, downdraft gasifier unit can be constructed from materials that would be widely available in the United States in a prolonged petroleum crisis. For example, the body of the unit consists of a galvanized metal garbage can atop a small metal drum; common plumbing fittings throughout; and a large, stainless steel mixing bowl for the grate. The entire compact unit was mounted onto the front of a farm tractor and successfully field tested, using wood chips as the only fuel. Photographic documentation of the actual assembly of the unit as well as its operation is included.

[Back to Table of Contents](#)

MENU: [HOME](#) » [Reconstruction](#) » [Recovery](#) » [Renewal](#) » [Energy Types](#)

1. WHAT IS A WOOD GAS GENERATOR AND HOW DOES IT WORK?

This report is one in a series of emergency technology assessments sponsored by the Federal Emergency Management Agency (FEMA). The purpose of this report is to develop detailed, illustrated instructions for the fabrication, installation, and operation of a biomass gasifier unit (i.e., a "producer gas" generator, also called a 'wood gas' generator) that is capable of providing emergency fuel for vehicles, such as tractors and trucks, in the event that normal petroleum sources were severely disrupted for an extended period of time. These instructions have been prepared as a manual for use by any mechanic who is reasonably proficient in metal fabrication or engine repair.

1.1 INTRODUCTION

Fuel gas, produced by the reduction of coal and peat, was used for heating, as early as 1840 in Europe, and by 1884 it had been adapted to fuel engines in England. Before 1940, gas generator units were a familiar, but not extensively utilized, technology. However, petroleum shortages during World War II led to widespread gas generator applications in the transportation industries of Western Europe. (Charcoal-burning taxis, a related application, were still common in Korea as late as 1970.) The United States, never faced with such prolonged or severe oil shortages, has lagged far behind Europe and the Orient in familiarity with and application of this technology; however, a catastrophe could so severely disrupt the supply of petroleum in this country that this technology might be critical in meeting the energy needs of some essential economic activities, such as the production and distribution of food.

This report attempts to preserve the knowledge about wood gasification as put into practical use during World War II. Detailed, step-by-step procedures are presented in this report for constructing a simplified version of the World War II, Imbert wood gas generator. This simple, stratified, downdraft gasifier unit can be constructed from materials that would be widely available in the United States in a prolonged petroleum crisis. For example, the body of the unit consists of a galvanized metal garbage can atop a small metal drum; common plumbing fittings throughout; and a large, stainless steel mixing bowl for the grate. A prototype gasifier unit was fabricated from these instructions. This unit was then mounted onto the front of a gasoline-engine farm tractor and successfully field tested, using wood chips as the only fuel; see [Fig. 1-1](#) (all figures and tables are presented at the end of their respective sections).

Photographic documentation of the actual assembly of the unit, as well as its operational field test, is included in this report.

The use of wood gas generators need not be limited to transportation applications. Stationary engines can also be fueled by wood gasifiers to run electric generators, pumps, and industrial equipment. In fact, the use of wood gas as a fuel is not even restricted to gasoline engines; if a small amount of diesel fuel is

used for ignition, a properly adjusted diesel engine can be operated primarily on wood gas introduced through the intake manifold. However, this report is concerned with the operation of four-cylinder gasoline engines rated from 10 to 150 horsepower. If more information is needed about operating gasifiers on other fuels (such as coal, charcoal, peat, sawdust or seaweed), a list of relevant literature is contained in the Bibliography at the end of this report.

The goal of this report is to furnish information for building a homemade wood gas generator made out of ordinary, available hardware, in order to get tractors, trucks, and other vehicles operating without delay, if a severe liquid fuel emergency should arise. Section 1 describes gasification principles and wood gas generators, in general, and gives some historical background about their operation and effectiveness. Section 2 contains detailed step-by-step instructions for constructing your own wood gas generator unit; illustrations and photographs are included to prevent confusion. Section 3 contains information on operating, maintaining, and trouble-shooting your wood gas generator; also included are some very important guidelines on safety when using your gasifier system.

The wood gasifier design presented in this report has as its origin the proven technology used in World War II during actual shortages of gasoline and diesel fuel. It should be acknowledged that there are alternate technologies (such as methane production or use of alcohol fuels) for keeping internal combustion engines in operation during a prolonged petroleum crisis; the wood gasifier unit described in this report represents only one solution to the problem.

1.2 PRINCIPLES OF SOLID FUEL GASIFICATION

All internal combustion engines actually run on vapor, not liquid. The liquid fuels used in gasoline engines are vaporized before they enter the combustion chamber above the pistons. In diesel engines, the fuel is sprayed into the combustion chamber as fine droplets which burn as they vaporize. The purpose of a gasifier, then, is to transform solid fuels into gaseous ones and to keep the gas free of harmful constituents. A gas generator unit is, simultaneously, an energy converter and a filter. In these twin tasks lie its advantages and its difficulties.

The first question many people ask about gasifiers is, 'Where does the combustible gas come from?' Light a wooden match; hold it in a horizontal position; and notice that while the wood becomes charcoal, it is not actually burning but is releasing a gas that begins to burn brightly a short distance away from the matchstick. Notice the gap between the matchstick and the luminous flame; this gap contains the wood gas which starts burning only when properly mixed with air (which contains oxygen). By weight, this gas (wood gas) from the charring wood contains approximately 20% hydrogen (H_2), 20% carbon monoxide (CO), and small amounts of methane, all of which are combustible, plus 50 to 60% nitrogen (N_2). The nitrogen is not combustible; however, it does occupy volume and dilutes the wood gas as it enters and burns in an engine. As the wood gas burns, the products of combustion are carbon dioxide (CO_2) and water vapor (H_2O).

The same chemical laws which govern combustion processes also apply to gasification. The solid, biomass fuels suitable for gasification cover a wide range, from wood and paper to peat, lignite, and coal, including coke derived from coal. All of these solid fuels are composed primarily of carbon with varying amounts of hydrogen, oxygen, and impurities, such as sulfur, ash, and moisture. Thus, the aim of gasification is the almost complete transformation of these constituents into gaseous form so that only the ashes and inert materials remain.

In a sense, gasification is a form of incomplete combustion; heat from the burning solid fuel creates gases which are unable to burn completely, due to insufficient amounts of oxygen from the available supply of air. In the matchstick example above, as the wood was burned and pyrolyzed into charcoal, wood gas was created, but the gas was also consumed by combustion (since there was an enormous supply of air in the room). In creating wood gas for fueling internal combustion engines, it is important that the gas not only be properly produced, but also preserved and not consumed until it is introduced into the engine where it may be appropriately burned.

Gasification is a physiochemical process in which chemical transformations occur along with the conversion of energy. The chemical reactions and thermochemical conversions which occur inside a wood gas generator are too long and too complicated to be covered here. Such knowledge is not necessary for constructing and operating a wood gasifier. Books with such information are listed in the Reference Section (see, for example, Reed 1979, Vol. II; or Reed and Das 1988).

1.3 BACKGROUND INFORMATION

The use of wood to provide heat is as old as mankind; but by burning the wood we only utilize about one-third of its energy. Two-thirds is lost into the environment with the smoke. Gasification is a method of collecting the smoke and its combustible components. Making a combustible gas from coal and wood began around 1790 in Europe. Such manufactured gas was used for street lights and was piped into houses for heating, lighting, and cooking. Factories used it for steam boilers, and farmers operated their machinery on wood gas and coal gas. After the discovery of large petroleum reserves in Pennsylvania in 1859, the entire world changed to oil - a cheaper and more convenient fuel. Thousands of gas works all over the world were eventually dismantled.

Wood gas generators are not technological marvels that can totally eliminate our current dependence on oil, reduce the impacts of an energy crunch, or produce long-term economic relief from high fossil fuel prices, but they are a proven emergency solution when such fuels become unobtainable in case of war, civil upheaval, or natural disaster. In fact, many people can recall a widespread use of wood gas generators during World War II, when petroleum products were not available for the civilian populations in many countries. Naturally, the people most affected by oil and petroleum scarcity made the greatest advancements in wood gas generator technology.

In occupied Denmark during World War II, 95% of all mobile farm machinery, tractors, trucks, stationary engines, fishing and ferry boats were powered by wood gas generators. Even in neutral

Sweden, 40% of all motor traffic operated on gas derived from wood or charcoal (Reed and Jantzen 1979). All over Europe, Asia, and Australia, millions of gas generators were in operation between 1940 and 1946. Because of the wood gasifier's somewhat low efficiency, the inconvenience of operation, and the potential health risks from toxic fumes, most of such units were abandoned when oil again became available in 1945. Except for the technology of producing alternate fuels, such as methane or alcohol, the only solution for operating existing internal combustion engines, when oil and petroleum products are not available, has been these simple, inexpensive gasifier units.

1.3.1 The World War II, Imbert Gasifier

The basic operation of two gasifiers is described in this and the following section. Their operating advantages and disadvantages will also be discussed. This information is included for the technically interested reader only; it is intended to give the reader more insight into the subtleties of the operating principles of the wood gas generator described in this manual. Those readers who are anxious to begin construction of their own wood gas generator may skip the material below and proceed directly to [Sect. 2](#) without any loss of continuity.

The constricted hearth, downdraft gasifier shown in [Fig. 1-2](#) is sometimes called the 'Imbert' gasifier after its inventor, Jacques Imbert; although, it has been commercially manufactured under various names. Such units were mass produced during World War II by many European automotive companies, including General Motors, Ford, and Mercedes-Benz. These units cost about \$1500 (1985 evaluation) each. However, after World War II began in 1939, it took six to eight months before factory-made gasifiers were generally available. Thousands of Europeans were saved from certain starvation by home-built, simple gasifier units made from washing machine tubs, old water heaters, and metal gas or oxygen cylinders. Surprisingly, the operation of these units was nearly as efficient as the factory-made units; however, the homemade units lasted for only about 20000 miles with many repairs, while the factory-made units operated, with few repairs, up to 100,000 miles.

In [Fig. 1-2](#), the upper cylindrical portion of the gasifier unit is simply a storage bin or hopper for wood chips or other biomass fuel. During operation, this chamber is filled every few hours as needed. The spring-loaded, airtight cover must be opened to refill the fuel hopper; it must remain closed and sealed during gasifier operation. The spring permits the cover to function as a safety valve because it will pop open in case of any excessive internal gas pressure.

About one-third of the way up from the bottom of the gasifier unit, there is a set of radially directed air nozzles; these allow air to be injected into the wood as it moves downward to be gasified. In a gas generator for vehicle use, the downstroke of the engine's pistons creates the suction force which moves the air into and through the gasifier unit; during startup of the gasifier, a blower is used to create the proper airflow. The gas is introduced into the engine and consumed a few seconds after it is made. This gasification method is called "producer gas generation," because no storage system is used; only that amount of gas demanded by the engine is produced. When the, engine is shut off, the production of gas stops.

During normal operation, the incoming air burns and pyrolyzes some of the wood, most of the tars and oils, and some of the charcoal that fills the constricted area below the nozzles. Most of the fuel mass is converted to gas within this combustion zone. The Imbert gasifier is, in many ways, self-adjusting. If there is insufficient charcoal at the air nozzles, more wood is burned and pyrolyzed to make more charcoal. If too much charcoal forms, then the charcoal level rises above the nozzles, and the incoming air burns the charcoal. Thus, the combustion zone is maintained very close to the nozzles.

Below this combustion zone, the resulting hot combustion gases - carbon dioxide (CO_2) and water vapor (H_2O) - pass into the hot charcoal where they are chemically reduced to combustible fuel gases: carbon monoxide (CO) and hydrogen (H_2). The hearth constriction causes all gases to pass through the reaction zone, thus giving maximum mixing and minimum heat loss. The highest temperatures are reached in this region.

Fine char and ash dust can eventually clog the charcoal bed and will reduce the gas flow unless the dust is removed. The charcoal is supported by a movable grate which can be shaken at intervals. Ash buildup below the grate can be removed during cleaning operations. Usually, wood contains less than 1% ash (by weight). However, as the charcoal is consumed, it eventually collapses to form a powdery charcoal/ash mixture which may represent 2 to 10% (by weight) of the total fuel mass.

The cooling unit required for the Imbert gasifier consists of a water filled precipitating tank and an automotive radiator type gas cooler. The precipitating tank removes all unacceptable tars and most of the fine ash from the gas flow, while the radiator further cools the gas. A second filter unit, containing a fine mesh filtration material, is used to remove the last traces of any ash or dust that may have survived passage through the cooling unit. Once out of the filter unit, the wood gas is mixed with air in the vehicle's carburetor and is then introduced directly into the engine's intake manifold.

The World War II, Imbert gasifier requires wood with a low moisture content (less than 20% by weight) and a uniform, blocky fuel in order to allow easy gravity feed through the constricted hearth. Twigs, sticks, and bark shreds cannot be used. The constriction at the hearth and the protruding air nozzles present obstructions to the passage of the fuel and may create bridging and channeling followed by poor quality gas output, as unpyrolyzed fuel falls into the reaction zone. The vehicle units of the World War II era had ample vibration to jar the carefully sized wood blocks through the gasifier. In fact, an entire industry emerged for preparing wood for use in vehicles at that time (Reed and Jantzen 1979). However, the constricted hearth design seriously limits the range of wood fuel shapes that can be successfully gasified without expensive cubing or pelletizing pretreatment. It is this limitation that makes the Imbert gasifier less flexible for emergency use.

In summary, the World War II Imbert gasifier design has stood the test of time and has successfully been mass produced. It is relatively inexpensive, uses simple construction materials, is easy to fabricate, and can be operated by motorists with a minimum amount of training.

1.3.2 The Stratified, Downdraft Gasifier

Until the early 1980's, wood gasifiers all over the world (including the World War II designs) operated on the principle that both the fuel hopper and the combustion unit be airtight; the hopper was sealed with a top or lid that had to be opened every time wood was added. Smoke and gas vented into the atmosphere while new wood was being loaded; the operator had to be careful not to breathe the unpleasant smoke and toxic fumes.

Over the last few years, a new gasifier design has been developed through cooperative efforts among researchers at the Solar Energy Research Institute in Colorado, the University of California in Davis, the Open University in London, the Buck Rogers Company in Kansas, and the Biomass Energy Foundation, Inc., in Florida (Reed and Das 1988). This simplified design employs a balanced, negative-pressure concept in which the old type of sealed fuel hopper is no longer necessary. A closure is only used to preserve the fuel when the engine is stopped. This new technology has several popular names, including 'stratified, downdraft gasification' and 'open top gasification.' Two years of laboratory and field testing have indicated that such simple, inexpensive gasifiers can be built from existing hardware and will perform very well as emergency units.

A schematic diagram of the stratified, downdraft gasifier is shown in [Fig. 1-3](#). During operation of this gasifier, air passes uniformly downward through four zones, hence the name 'stratified:'

1. The uppermost zone contains unreacted fuel through which air and oxygen enter. This region serves the same function as the fuel hopper in the Imbert design.
2. In the second zone, the wood fuel reacts with oxygen during pyrolysis. Most of the volatile components of the fuel are burned in this zone and provide heat for continued pyrolysis reactions. At the bottom of this zone, all of the available oxygen from the air has completely reacted. The open top design ensures uniform access of air to the pyrolysis region.
3. The third zone is made up of charcoal from the second zone. Hot combustion gases from the pyrolysis region react with the charcoal to convert the carbon dioxide and water vapor into carbon monoxide and hydrogen.
4. The inert char and ash, which constitute the fourth zone, are normally too cool to cause further reactions; however, since the fourth zone is available to absorb heat or oxygen as conditions change, it serves both as a buffer and as a charcoal storage region. Below this zone is the grate. The presence of char and ash serves to protect the grate from excessive temperatures.

The stratified, downdraft design has a number of advantages over the World War II, Imbert gasifier. The open top permits fuel to be fed more easily and allows easy access. The cylindrical shape is easy to fabricate and permits continuous flow of fuel. No special fuel shape or pretreatment is necessary; any blocky fuel can be used.

The foremost question about the operation of the stratified, downdraft gasifier concerns char and ash removal. As the charcoal reacts with the combustion gases, it eventually reaches a very low density and

breaks up into a dust containing all of the ash as well as a percentage of the original carbon. This dust may be partially carried away by the gas; however, it might eventually begin to plug the gasifier, and so it must be removed by shaking or agitation. Both the Imbert gasifiers and the stratified concept have a provision for shaking the grate; when they are used to power vehicles, they are automatically shaken by the vehicle's motion.

An important issue in the design of the stratified, downdraft gasifier is the prevention of fuel bridging and channeling. High-grade biomass fuels such as wood blocks or chips will flow down through the gasifier under the influence of gravity, and downdraft air flow. However, other fuels (such as shredded wood, sawdust, and bark) can form a bridge that will prevent continuous flow and cause very high temperatures. Obviously, it is desirable to use these widely available biomass residues. Bridging can be prevented by stirring, shaking, or by agitating the grate or by having it agitated by the vehicle's movement. For prolonged idling, a hand-operated shaker has been included in the design.

A prototype design of the stratified, downdraft gasifier design has been developed. The detailed but simple design is described and illustrated in Section 2 (see Table of Contents), however, it has not been widely tested at this time. The reader is urged to use his ingenuity and initiative in constructing his own wood gas generator. As long as the principle of airtightness in the combustion regions, in the connecting piping, and in the filter units is followed, the form, shape, and method of assembly is not important.

[Back to Table of Contents](#)

MENU: [HOME](#) » [Reconstruction](#) » [Recovery](#) » [Renewal](#) » [Energy Types](#)

2. BUILDING YOUR OWN WOOD GAS GENERATOR

The following fabrication instructions, parts lists, and illustrations describe the prototype gasifier unit shown schematically in [Fig. 1-3](#). These instructions are simple and easy to follow. The dimensions in the following plans are given in inches rather than in millimeters to make construction easier for those who might be unfamiliar with the metric system and to allow the builder to take advantage of available, alternate construction materials. It will be obvious to the experienced engineer, mechanic, or builder that most of the dimensions (for example, plate thicknesses and cleanout diameters) are not critical to the acceptable performance of the finished gasifier unit.

The prototype gasifier unit described in the following text was actually constructed and field tested on a gasoline engine farm tractor (a 35-hp, John Deere 1010 Special); see [Fig. 2-1](#). The unit operated very well, and on par with the European, World War II designs, but it has not had the test of time nor the millions of operating hours like the older Imbert design. This new stratified design was developed for the construction of simple, inexpensive emergency wood gas generator units. The prototype design below should be considered to be the absolute minimum in regard to materials, piping and filter arrangement, and carburetor system connections.

The gasifier unit, as described below, is designed to maintain proper cooling, even at moderate vehicle speeds. If this unit is to be used on stationary engines or on slow-moving vehicles, a gas cooler and a secondary filter must be placed in the piping system between the generator unit and the carburetor. The ideal temperature for the wood gas at the inlet to the carburetor manifold would be 70°F, with acceptable peaks of 140 to 160°F. For every 10 degrees above 70°F, an estimated 1% horsepower is lost. Cooler gas has higher density and, therefore, contains more combustible components per unit volume.

The millions of wood gasifiers built during World War II proved that shape, form, and construction material had little or no effect on the performance of the unit. Judicious substitution or the use of scavenged parts is, therefore, quite acceptable. What is important is that:

1. the fire tube dimensions (inside diameter and length) must be correctly selected to match the rated horsepower of particular engine which is to be fueled,
2. airtightness of the gas generator unit and all connecting piping must be maintained at all times, and
3. unnecessary friction should be eliminated in all of the air and gas passages by avoiding sharp bends in the piping and by using piping sizes which are not too small.

2.1. BUILDING THE GAS GENERATOR UNIT AND THE FUEL HOPPER

[Figure 2-2](#) shows an exploded view of the gas generator unit and the fuel hopper; the list of materials is

given in [Table 2-1](#) (all figures and tables mentioned in Sect. 2 are presented at the end of Sect. 2). Only the dimensions of the fire tube (Item 1A) must be reasonably close; all other dimensions and materials can be substituted as long as complete airtightness is maintained. In the following instructions, all item numbers refer both to [Fig. 2-2](#) and to [Table 2-1](#).

The prototype unit described in this report was constructed for use with a 35-hp gasoline engine; the unit has a fire tube diameter of 6 in. (as determined from [Table 2-2](#)). A gas generator unit containing a fire tube up to 9-in. diameter (i.e., a gasifier unit for fueling engines up to about 65 hp) can be constructed from the following instructions. If your engine requires a fire tube diameter of 10 in. or more, use a 55-gal drum for the gas unit and another 55-gal drum for the fuel hopper.

The following fabrication procedure is very general and can be applied to the construction of gas generator units of any size; however, the specific dimensions which are given in the parts list and in the instructions below are for this particular prototype unit. All accompanying photographs were taken during the actual assembly of the prototype unit. The fabrication procedure is as follows:

1. Using the displacement or horsepower rating of the engine to be fueled by the gasifier unit, determine the dimensions (inside diameter and length) of the fire tube (Item 1A) from [Table 2-2](#). Fabricate a cylindrical tube or cut a length of correctly sized pipe to match the dimensions from [Table 2-2](#). (For the prototype gasifier unit illustrated in this report, a 6-in.-diam firetube was used; its length was 19 in.)
2. The circular top plate (Item 2A) should be cut to a diameter equal to the outside diameter of the gasifier housing drum (Item 3A) at its top. A circular hole should then be cut in the center of the top plate; the diameter of this hole must be equal to the outside diameter of the fire tube. The fire tube (Item 1A) should then be welded at a right angle to the top plate (Item 2A) as shown in [Fig. 2-3](#).
3. The grate (Item 4A) should be made from a stainless steel mixing bowl or colander. Approximately 125 holes with diameters of 1/2 in. should be drilled in the bottom and up the sides of the mixing bowl; see [Fig. 2-4](#). A U-bolt (Item 5A) should be welded horizontally to the side of the grate, 2 in. from its bottom. This U-bolt will be interlocked with the shaker mechanism (Item 12A) in a later step.
4. The support chains (Item 6A) are to be attached to the grate in three evenly spaced holes drilled under the lip of the mixing bowl or colander; see [Fig. 2-5](#). These chains are to be connected to the top plate (Item 2A) with eyebolts (Item 7A), as shown in [Fig. 2-6](#). Each eyebolt should have two nuts, one on each side of the top plate, so that the eyebolts can be adjusted to the proper length. When assembled, the bottom of the firetube should be 1.25 in. above the bottom of the mixing bowl.

5. A hole equal to the outside diameter of the ash cleanout port (Item 8A) should be cut into the side of the gasifier housing drum (Item 3A); the bottom edge of this hole should be about 1/2 in. from the bottom of the drum. Because of the thin wall thickness of oil drums and garbage cans, welding is not recommended; brazing such parts to the drums or cans will ensure both strength and airtightness (see [Fig. 2-7](#)).
6. Two holes, equal to the outside diameters of the ignition ports (Item 10A), are to be cut with their centers at a distance from the top of the housing drum (Item 3A) equal to the firetube length less 7 in. (19 in. less 7 in. equals 12 in. for this prototype unit); the holes should be placed opposite each other as shown in [Fig. 2-2](#). The ignition ports should be attached to the wall of the housing drum by brazing.
7. When the ash cleanout port (Item 8A) and the ignition ports (Item 10A) have been attached to the wall of the gasifier housing drum (Item 3A), they should then be closed with pipe caps, Items 9A and 11A respectively. The threads of the pipe caps should be first coated with high temperature silicone (Item 27A) to ensure airtightness. An optional steel crossbar welded to the pipe cap will reduce the effort required to open these caps later.
8. The shaker assembly (Item 12A) is shown in [Fig. 2-8](#). The 1/2-in. pipe (Item 1AA) should be brazed into the side of the housing drum (Item 3A), 1.5 inches from the bottom of the drum; the length of this pipe which protrudes into the drum must be chosen so that the upright bar (Item 2AA) is in line with the U-bolt (Item 5A) on the grate. Likewise, the length of the upright bar must be selected so as to connect into the U-bolt.
9. Weld the upright bar (Item 2AA) to the head of the bolt (Item 3AA). The threaded end of the bolt should be ground down or flattened on one side, as shown in [Fig. 2-9](#), to positively interlock with a slot to be drilled and filed in the handle (Item 4AA). The handle can be formed or bent into any desired or convenient shape.
10. A hole should be drilled in the pipe cap (Item 7AA) so that there is a close fit between this hole and the bolt (Item 3AA). The close fit will help to ensure airtightness.
11. Before assembling the shaker, as shown in [Fig. 2-8](#), coat the bolt (Item 3AA) with a small amount of grease. Before inserting the bolt, fill the pipe (Item 1AA) with high temperature silicone (Item 27A) to ensure airtightness. Tighten the nuts (Item 6AA) so that the position of the handle (Item 4AA) is maintained by friction, yet is capable of being turned and agitated during cleanout or stationary operation.
12. Fabricate the supports (Item 13A) for the gasifier unit housing drum (Item 3A) out of rectangular, iron bar stock. The shape and height of the support flanges must be determined by the frame of the vehicle to which the gasifier is to be mounted. The supports can either be bolted to the bottom and side with the 1/4-in. bolts (Item 14A) or can be brazed directly to the drum; see [Fig. 2-10](#).

Remember to seal all bolt holes for airtightness.

13. Completely cover the bottom of the housing drum (Item 3A) with 1/2 in. of hydraulic cement (Item 28A). The cement should also be applied to the inside of the drum for about 5 in. up the inside walls near the bottom. All edges should be rounded for easy ash removal.
14. The fuel hopper (Item 15A) is to be made from a second container with its bottom up as shown in [Fig. 2-11](#). Remove the bottom, leaving a 1/4-in. lip around the circumference.
15. A garden hose (Item 17A) should be cut to a length equal to the circumference of the fuel hopper (Item 15A) and should then be, slit along its entire length. It should be placed over the edge of the fuel hopper from which the bottom was removed. This will prevent injury to the operator when adding wood fuel to the unit. To insure close fit of the garbage can lid (Item 16A), a piece of weather stripping (Item 18A) should be attached under the lid where it makes contact with the fuel hopper.
16. Cut four support bars (Item 19A) to lengths 2.5 in. longer than the height of the fuel hopper (Item 15A). Drill a 3/8-in. hole in each end of all four support bars; these holes should be centered 3/4 in. from the ends. Bend 2 in. of each end of these support bars over at a right angle; then, mount them evenly spaced around the fuel hopper (Item 15A) with 1/4-in. bolts (Item 20A). One of the bends on each support bar should be as close to the lower edge of the fuel hopper as possible.
17. Cut four metal triangular standoffs (Item 21A) and braze, weld, or rivet them flat against the edge of the garbage can lid (Item 16A) as shown in [Fig. 2-12](#); they must be aligned with the four support bars (Item 19A) attached to the fuel hopper. During operation, the garbage can lid must have a minimum 3/4-in. opening for air passage; the standoffs should provide this clearance, where they are engaged into the holes in the top edges of the support bars (Item 19A); see [Fig. 2-13](#).
18. Two eye hooks (Item 22A) should be attached to opposite sides of the garbage can lid (Item 16A). Two screen door springs (Item 23A) should be attached to the garbage can handle-s and used under tension to keep the top lid (Item 16A) either open or closed.
19. Cut the oil drum lock ring (Item 24A) to the exact circumference of the top plate (Item 2A) so that it will fit snugly around the gasifier unit housing drum (Item 3A).
20. Cut four 2 by 2 by 1/4-in. tabs (Item 25A); then, braze these tabs to the lock ring (Item 24A), evenly spaced and in alignment with the support bars (Item 19A) on the fuel hopper. Drill a 3/8-in. hole in each tab to align with the holes in the fuel hopper support bars (Item 19A). The lock ring is shown in [Fig. 2-14](#).
21. The connecting pipe (Item 29A) between the gasifier unit and the filter unit should be attached to the gasifier housing drum (Item 3A) at a point 6 in. below the top of the drum. This pipe must be a

minimum of 2-in. in diameter and should be at least 6 ft long for cooling purposes. At least one of the ends of this pipe must be removable for cleaning and maintenance. On this prototype unit, an airtight electrical conduit connector was used; this connection is visible in [Fig. 2-1](#). Many similar plumbing devices are available and can be used if they are suitable for operation at 400°F and above. The pipe can also be welded or brazed directly to the housing drum.

22. When assembling the gasifier unit, the upright bar (Item 2AA) on the shaker assembly must be placed inside the U-bolt (Item 5A) on the grate.
23. The lock ring will then clamp the gasifier unit housing drum (Item 3A) and the top plate (Item 2A) together. The fuel hopper support bars (Item 19A) must be attached to the tabs (Item 25A) on the lock ring with bolts (Item 26A). High temperature silicone (Item 27A) should be applied to all edges to make an airtight connection. The lock ring connections are shown in the lower portion of [Fig. 2-13](#).

2.2 BUILDING THE PRIMARY FILTER UNIT

[Figures 2-15](#) and [2-16](#) show exploded views of the primary filter unit; the list of materials is given in [Table 2-3](#) (all figures and tables mentioned in Sect. 2 listed in the figure and table files). In the following instructions, all item numbers refer to either [Fig. 2-15](#) or [2-16](#) and to [Table 2-3](#).

The prototype primary filter unit was made from a 5-gal paint can. That size seems to be sufficient for gasifiers with fire tubes up to 10 in. in diameter. If a fire tube diameter of more than 10 in. is required, then a 20-gal garbage can or a 30-gal oil drum should be used. The Filter unit could be fabricated in any shape or form as long as airtightness and unobstructed flow of gas are provided. If a 5-gal container is used, it must be clean and free of any chemical residue. The top edge must be straight and without any indentations. If an alternate container can be found or fabricated, a larger diameter will permit longer operation between cleanings.

The piping (Item 29A in [Figs. 2-2](#) and [2-15](#)) which connects the gas generator unit to the primary filter should be considered to be a necessary part of the cooling system and should never have an inside diameter less than 2 in. A flexible automotive exhaust pipe was used on the prototype filter unit described below; it was shaped into a semicircular arc so that increased length would achieve a greater cooling effect. The fabrication procedure for the filter unit follows:

1. A hole equal to the outside diameter of the drain tube (Item 13B in [Fig. 2-15](#)) should be cut into the side of the filter container (Item 1B); the bottom edge of this hole should be about 1/2 in. from the inside bottom of the container.
2. The drain tube (Item 13B) should be inserted into the previously cut hole in the filter container and should be positioned so that its nonthreaded end is near the center of the container and is about 1/2

- in. off the bottom. Once this position has been ensured, braze (do not weld) the drain pipe into the side of the filter container. Close the threaded, exterior end of the drain pipe with the pipe cap (Item 14B).
3. Coat the bottom of the filter container (Item 1B) with a 1/2-in. layer of hydraulic cement (Item 28A), taking care not to plug or obstruct the end of the drain tube (Item 13B) with cement (i.e., fill the drain tube with a paper, styrofoam, or other easily removable, but rigid material). The cement should also be applied for about 1.5 in. up the inside walls of the container near its bottom. Round the edges slightly; the cement is to provide a pathway for any liquid condensate to drain out through the drain tube. The cement must be allowed to harden before proceeding with the fabrication steps below. Remove the filler material from the drain tube when the cement has hardened.
 4. A circular bottom plate (Item 2B) should be cut to a diameter 1/2 in. smaller than the inside diameter of the filter container (Item 1B). This will allow for heat expansion and easy removal for cleaning. This bottom plate should be drilled with as many 3/4-in. holes as are practical for the size of the plate. Three evenly spaced 3/8-in. holes should also be drilled around the edge of the bottom plate for the spacer bolts (Item 3B).
 5. [Fig. 2-16](#) shows the detail of using three bolts (Item 3B) as spacers for the bottom plate (Item 2B). The length of the bolts should be adjusted to provide a clearance of about 2-in. between the layer of cement in the bottom of the container (Item 1B) and the bottom plate (Item 2B).
 6. A rectangular divider plate (Item 4B) should be cut to a width 1/4 in. less than the inside diameter of the filter container (Item 1B) and to a height 2.5 in. less than the inside height of the container. This divider plate should then be welded at a right angle to the centerline of the bottom plate (Item 2B) as shown in [Fig. 2-17](#).
 7. Cut a piece of high-temperature hydraulic hose (Item 5B) to a length equal to the circumference of the filter container. It should be slit along its entire length and then placed over the top edge of the filter container (Item 1B) to ensure airtightness.
 8. A circular lid (Item 6B) should be cut equal to the outside diameter of the filter container (Item 1B). Three holes should be cut into this lid for the exhaust pipe (Item 29A) from the gasifier unit, the blower (Item 7B), and the filter exhaust pipe (Item 10B) to the engine manifold. Note the arrangement of these holes: the pipe (Item 29A) from the gasifier unit must enter the lid on one side of the divider plate (Item 4B); the blower (Item 7B) and the filter exhaust pipe (Item 10B) to the engine manifold must be located on the other side of the divider plate. This arrangement can be seen in [Fig. 2-18](#).
 9. The connecting pipe (Item 29A) between the gasifier unit and the filter unit should be attached to the lid (Item 5B) of the filter container. At least one of the ends of the connecting pipe (Item 29A)

must be removable for cleaning and maintenance. On this prototype unit, an airtight electrical conduit connector was used. Many similar plumbing devices are available and can be used if they are suitable for operation at 400°F and above. The pipe can also be welded or brazed directly to the lid.

10. Attach the blower (Item 7B) to the filter container lid (Item 6B). On the prototype gasifier illustrated in this report, a heater blower from a Volkswagen automobile was used. Connections for a vertical extension tube (Item SB) will have to be fabricated as shown in [Fig. 2-19](#). A closing cap (Item 9B) is required for the blower exhaust tube. A plumbing cap of steel or plastic with a close fit can be used or fabricated to fit. The vertical extension and the closing cap are visible in [Fig. 2-1](#).
11. The gas outlet (Item 10B) to the carbureting unit on the engine should be 1.25 in. minimum diameter. In fabricating this connection, all abrupt bends should be avoided to ensure free flow of gas. Using plumbing elbows is one solution. The gas outlet (Item 10B) can either be welded or brazed to the lid (Item 6B) of the filter container or an airtight, electrical conduit connector can be used.
12. Latching devices (Item 11B) should be welded or brazed to the lid (see [Fig. 2-20](#)) and to the sides (see [Fig. 2-21](#)) of the filter container. An air tight connection between the lid and the filter container must be maintained.
13. Cut two lengths of high-temperature hydraulic hose (Item 12B) equal to the height of the divider plate (Item 4B); cut a third length of hose equal to the width of the divider plate. Slit each hose along its entire length. Place the first two hoses on each side of the divider plate, and place the third hose along the top edge of the divider plate as shown in [Fig. 2-17](#).
14. Insert the divider plate (Item 4B) into the filter container (Item 1B), making sure that the hoses (Item 12B) create an airtight seal along all sides. By changing the length of the spacer bolts (Item 3B), adjust the height of the divider plate so that it is exactly flush with the top of the filter container. Make sure that the lid (Item 5B) will seat flatly and tightly against the top edge of the divider plate.
15. Fill the filter container (Item 1B) on-both sides of the divider plate with wood chips, the same kind as would be used for fuel in the gasifier unit. After carefully packing and leveling these wood chips, place the lid (Item 6B) on the filter container, and close the latches tightly.

2.3. BUILDING THE CARBURETING UNIT WITH THE AIR AND THROTTLE CONTROLS

[Figures 2-22](#) and [2-23](#) show exploded views of the carbureting unit; the list of materials is given in [Table 2-4](#) (all figures and tables mentioned in Sect. 2 are presented at the end of Sect. 2). In the following

instruction's, all item numbers refer both to [Figs. 2-22](#) and [2-23](#) and to [Table 2-4](#). The following is a simple and easy way to assemble a carburetor to achieve both air mixture and throttle control. It can be mounted to either updraft or downdraft manifolds by simply turning the unit over. Most of the fabrication procedure below is devoted to the assembly of two butterfly valves: one for the throttle valve and one for the air mixture valve. The remainder of the carburetor unit can be assembled from ordinary, threaded plumbing parts.

The inside diameter of the piping used in the carburetor unit must be related to the size of the engine and should never be smaller than the intake opening on the engine manifold. If in doubt on the inside diameter for the pipe and/or hose sizes, always go with a larger diameter. This will reduce friction losses and will give longer operating hours between cleanings.

When the wood gas leaves the filter unit it should normally be below 180°F. About 2 ft from the filter container, an automotive water hose can be connected to the pipe on the carbureting unit. This rubber hose will keep engine vibration from creating air leaks in the filter unit or in the connecting piping. The hose must be a fairly new item; such hoses have a steel spring inside to keep them from collapsing when negative pressure is applied. The spring will soon rust if it has first been subjected to water and then to the hot wood gas enriched with hydrogen. The fabrication procedure for the assembly of two butterfly valves follows:

1. The manifold adapter (Item 1C in [Fig. 2-22](#)) must be fitted with bolts and/or holes for mounting onto the engine's existing intake manifold. Because gasoline engines are produced with so many different types of intake manifolds, ingenuity and common sense must be used to modify the manifold adapter (Item 1C) for each different engine to be operated on wood gas. A gasket (Item 7C) should be cut to match the shape of the engine intake fitting.
2. The butterfly valve (Item 3C) is shown in [Figs. 2-24](#) and [2-25](#); two such valves are required. A 3/8-in. hole should be drilled through the diameter of each valve body (Item 1CC) at the midpoint of its length.
3. The valve plate (Item 2CC) must be oval in shape with the dimensions given in [Table 2-4](#). An oval valve plate must be used so that, in the closed position, the valve will be about 10° off center. This will ensure that the valve will come to a complete stop in the closed position.
4. The edges of the valve plate (Item 2CC), around the longer diameter of the oval, should be beveled to provide a positive, airtight closure. Two evenly spaced, 1/4-in. holes should be drilled along the shorter diameter of the oval plate.
5. The valve support rod (Item 3CC) should be filed or ground flat on one side as shown in [Fig. 2-24](#); the flat area must begin 1/4 in. from one end and must continue for a distance equal to the inside diameter of the valve body (Item 1CC).

6. Two 3/16-in. holes should be drilled into the flat area of the valve support rod (Item 3CC); these holes must align with the holes in the valve plate (Item 2CC). They must also be tapped (with threads) to accept the valve plate screws (Item 4CC).
7. The butterfly valve (Item 3C) should be assembled by first placing the valve support rod (Item 3CC) through the hole in the valve body (Item 1CC). The valve plate (Item 2CC) should be dropped into one end of the valve body and then inserted into the flat area of the valve support rod. The two screws (Item 4CC) should be used to attach the valve plate to the support rod. Check to see that the assembled valve plate rotates freely and seats completely in the closed position.
8. A nut (Item 6CC) should be welded flat against one side of the throttle arm (Item 5CC) near its end. A 1/8-in. hole should be drilled into the side of the nut and must be threaded to accept the set screw (Item 7CC). At least one hole should be drilled into the throttle arm for attachment of the engine throttle control or air control linkages.
9. Place the nut (Item 6CC) on the throttle arm over the end of the valve support rod (Item 3CC) and use the set screw (Item 7CC) to secure the assembly. The throttle arm can be placed in any convenient orientation. Assembled butterfly valves are shown in [Fig. 2-26](#).
10. The remaining parts of the carburetor assembly should be screwed together as shown in [Fig. 2-27](#). Pipe thread compound should be used to make airtight connections. The assembled carburetor unit should be attached to the engine's intake manifold as shown in [Fig. 2-28](#)
11. This prototype gasifier was designed to operate if gasoline were unavailable; but, if dual operation on wood and gasoline is desired, the elbow (Item 2C) could be replaced with a tee, allowing a gasoline carburetor to also be mounted.
12. The arm on the butterfly valve (Item 3C) which is closest to the elbow (Item 2C) is to be connected to the foot- (or, on tractors, hand-) operated accelerator. The other butterfly valve is to be used as the air mixture control valve and can be operated with a manual choke cable. If the engine has an automatic choking device, then a hand operated choke cable should be installed. Both butterfly valves and their connecting control linkages must operate smoothly with the ability to adjust the valve yet keep it stationary in the selected position during operation. The linkages must close the valves airtight when the engine is off.
13. The air inlet (Item 6C) should be connected by an extension hose or pipe, either iron or plastic, to the existing engine's air filter in order to prevent road dust or agricultural residue from entering the engine.
14. The wood gas inlet (Item 5C) is to be connected to the outlet piping (Item 10B as shown in [Fig. 2-15](#)) from the wood gas filter unit. Part of this connection should be a high-temperature rubber or neoprene hose to absorb engine vibration.

[Back to Table of Contents](#)

MENU: [HOME](#) » [Reconstruction](#) » [Recovery](#) » [Renewal](#) » [Energy Types](#)

ORNL-Photo 4517-87



Fig. 2-21. Filter container (#1) showing latches (#2) for lid and hose (#3) around top.

3. OPERATING AND MAINTAINING YOUR WOOD GAS GENERATOR

3.1 USING WOOD AS A FUEL

Because wood was used extensively as generator fuel during World War II, and since it is plentiful in most parts of the populated United States, it merits particular attention for use as an emergency source of energy. When used in gas generators, about 20 lb. of wood have the energy equivalence of one gallon of gasoline.

Wood consists of carbon, oxygen, hydrogen, and a small amount of nitrogen. As a gas generator fuel, wood has several advantages. The ash content is quite low, only 0.5 to 2% (by weight), depending on the species and upon the presence of bark. Wood is free of sulfur, a contaminant that easily forms sulfuric acid which can cause corrosion damage to both the engine and the gas generator. Wood is easily ignited a definite virtue for the operation of any gas generator unit.

The main disadvantages for wood as a fuel are its bulkiness and its moisture content. As it is a relatively light material, one cubic yard of wood produces only 500 to 600 lb. of gas generator fuel. Moisture content is notoriously high in wood fuels, and it must be brought below 20% (by weight) before it can be used in a gas generator unit. By weight, the moisture in green wood runs from 25 to 60%, in air-dried wood from 12 to 15%, and in kiln-dried wood about 8%. Moisture content can be measured quite easily by carefully weighing a specimen of the wood, placing it in an oven at 220° F for thirty minutes, reweighing the specimen, and reheating it until its weight decreases to a constant value. The original moisture content is equivalent to the weight lost.

The prototype unit in this manual (with an 6-in.-diam firetube) operated well on both wood chips (minimum size: 3/4 by 3/4 by 1/4 in.) and blocks (up to 2-in. cubes); see [Fig. 3-1](#) (all figures and tables mentioned in Sect. 3 are presented at the end of Sect. 3). Larger sizes could be used, if the firetube diameter is increased to prevent bridging of the individual pieces of wood; of course, a throat restriction would then have to be added to the bottom of the firetube so as to satisfy the dimensions in [Table 2-2](#) in Sect. 2.

3.2 SPECIAL CONSIDERATIONS AND ENGINE MODIFICATIONS

To start the fire in the gasifier, the blower must be used to create a suction airflow through the wood in the hopper and downward in the firetube. If an especially high horse power engine is to be fueled by the gasifier unit, then it might be necessary to install two such blowers and run them simultaneously during start-up.

When the wood gas leaves the gasifier unit, all the oxygen pulled down with the air through the firetube has been chemically converted and is contained in carbon monoxide (CO) and water (H₂O). The wood gas is unable to burn without being mixed with the proper amount of additional oxygen. If an air leak develops below the grate area, the hot gas will burn while consuming the available oxygen and will create heat; this will almost certainly destroy the gasifier unit if it is not detected soon. If an air leak develops in the filter unit or in the connecting piping, the gas will become saturated with improper amounts of oxygen and will become too dilute to power the engine. Therefore airtightness from the gasifier unit to the engine is absolutely essential.

Ideally, as the wood gas enters the engine manifold it should be mixed with air in a ratio of 1:1 or 1.1:1 (air to gas) by volume. The carburetion system described in this report will provide this mixture with a minimum of friction losses in the piping. The throttle control valve and the air control valve must be operable from the driver's seat of the vehicle. The engine's spark plug gaps should be adjusted to between 0.012 and 0.015 in.; the ignition timing should be adjusted to 'early.'

3.3 INITIAL START-UP PROCEDURE

Initially, you will need to add charcoal to the grate below the firetube. Subsequent operation will already have the grate full of charcoal which has been left over from the previous operating period.

Fill the firetube with charcoal to a level 4 in. above the grate. Fill the hopper with air-dried wood; then, proceed with the routine start-up directions below.

Charcoal produced for outdoor barbecue grills is not well suited for gas generator use. To produce a better grade of charcoal, place a rag soaked in alcohol on the grate, or place 3 to 5 pages of newspaper on the grate, then fill the fire tube to a height of 10 to 12 in. with well-dried wood. Have all the valves closed and let the Fire tube act as a chimney until the wood is converted to charcoal.

3.4 ROUTINE START-UP PROCEDURE

1. Agitate the grate shaker handle for at least twenty seconds to shake down the Charcoal from the previous operating period.
2. Open the ash cleanout port and remove the ashes from the generator housing drum. Lubricate the threads of the cleanout port with high-temperature silicone, and close the cover of the cleanout port so that it is airtight.

3. Fill the hopper with wood fuel, and tamp the fuel down lightly. Either leave the lid completely off the fuel hopper, or adjust the opening around the lid to a 3/4-in. (or larger) clearance.
4. Close the carburetor's air control valve and remove the cover from the blower exhaust on top of the filter unit. Start the blower, and let it run for thirty seconds to avoid explosion of residual gas in the system. Then, with the blower still operating, proceed with the next step.
5. Open the ignition port, and ignite a 12- by 12-in. piece of newspaper; with a long stick or wire, push the burning sheet of newspaper into the grate; see [Fig. 3-2](#). Close the ignition port. If no smoke appears at the blower's exhaust port, repeat the start-up sequence from Step (5). If repeated attempts fail, new charcoal should be added to the unit as described in Sect. 3.3, above, and the start-up ignition sequence should be repeated.
6. After a few minutes of smoky exhaust, test the gas at the, blower exhaust by safely and carefully attempting to ignite it, see [Fig. 3-3](#). When the gas burns consistently well, stop the blower and replace the cover on the blower exhaust.
7. Open the carburetor's air control valve, adjust the engine's accelerator, and start the engine in a normal manner. Let the engine warm up slowly (two to five minutes). If the engine fails to start or dies repeatedly, restart the blower and repeat the ignition sequence from Step (4).

3.5 DRIVING AND NORMAL OPERATION

Shift gears so as to keep the engine speed (rpm) high at all times. Remember that it is the vacuum created by the pistons that provides the force which moves the gas from the gasifier unit into the engine.

Refill the hopper with wood (as shown in [Fig. 3-4](#)) before it is completely empty, but avoid refilling just before the end of engine operation. Periodically shake down the ashes from the grate. If your system is equipped with a gas cooler, drain water from the cooler from time to time.

Under operation in dry weather, the gasifier can be operated without the lid on the fuel hopper. However, when the gasifier unit is shut down the hopper must be covered to prevent air from continuing to burn the wood in the hopper. Under wet-weather operation, the cover must be placed on the fuel hopper, and then lifted up and rotated about 2 in. until the triangular pieces line up with the holes in the support bars. The tension of the screen door springs will then hold the lid closed. See [Fig. 3-5](#) for clarification.

3.6 SHUTTING DOWN THE GASIFIER UNIT

When shutting down the gasifier unit, turn off the ignition switch and open the carburetor's air control valve for ten seconds to relieve any pressure from within the system. Then, completely close the air control valve, and place the cover tightly on the fuel hopper. When restarting after a short stopover, let the engine warm up briefly. After longer stops (up to one hour), tamp down the wood lightly and try to use the blower for restarting without relighting the wood fuel. After very long stops (over two hours) the charcoal must be ignited again.

3.7 ROUTINE MAINTENANCE

Periodically check all nuts on the gasifier unit, the fuel hopper, the filter unit, and the carburetor for snugness; check all penetrations and fittings for airtightness. In addition, perform the following maintenance activities as scheduled:

3.7.1 Daily Maintenance

Open the ash cleanout port of the gasifier housing drum and remove the ashes after shaking the grate for at least thirty seconds. Replace the cover of the port after coating the threads with high-temperature silicone to ensure airtightness. Open the drain tube, at the bottom of the filter container and allow any liquid condensate to drain out; remember to close the drain tube when finished.

3.7.2 Weekly Maintenance (or every 15 hours of operation)

Clean out the gasifier housing drum, the fuel hopper, and the filter. Rinse out the piping and connections to and from the filter. Replace the wood chips inside the filter, (The used wood chips from the filter can be dumped into the fuel hopper and burned to produce wood gas.) Use high-temperature silicone on all pipe connections and on the filter lid to ensure airtightness.

3.7.3 Biweekly Maintenance (or every 30 hours of operation)

Make sure that all pipe connections are secure and airtight. Check and tighten all mounting connections to the vehicle chassis. Check for rust on the outside of the gas generator housing drum, especially on the lower region. Coat with high-temperature protective paint as necessary.

3.8 OPERATING PROBLEMS AND TROUBLE-SHOOTING

A discussion of problems and their related causes and cures is contained in the trouble-shooting guide of [Table 3-1](#). Many operational problems can be traced to failure to maintain the airtightness of all piping connections and fittings; the piping should be routinely checked to prevent such problems.

3.9 HAZARDS ASSOCIATED WITH GASIFIER OPERATION

Unfortunately, gas generator operation involves certain problems, such as toxic hazards and fire hazards.

These hazards should not be treated lightly; their inclusion here, at the end of this report, does not mean that these hazards are unimportant. The reader should not underestimate the dangerous nature of these hazards.

3.9.1 Toxic Hazards

Many deaths in Europe during World War II were attributed to poisoning from wood gas generators. The danger of 'generator gas poisoning' was one of the reasons that such gasifiers were readily abandoned at the end of World War II. It is important to emphasize that generator gas poisoning' is carbon monoxide (CO) poisoning. Acute 'generator gas poisoning' is identical with the symptoms that may develop if a heating stove damper is closed too early, or if a gasoline vehicle is allowed to idle in a poorly ventilated garage.;[Table 3-2](#) shows how poisoning symptoms develop according to the concentration of carbon monoxide in breathable air. It is important to note that rather brief exposures to very small concentrations of carbon monoxide result in undesirable physiological effects.

In case of carbon monoxide poisoning, first aid should consist of the following procedures:

1. Move the victim quickly out into the open air or to a room with fresh air and good ventilation. All physical exertion on the part of the victim must be avoided.
2. If the victim is unconscious, every second is valuable. Loosen any tight clothing around the neck. If breathing has stopped, remove foreign objects from the mouth (false teeth, chewing gum, etc.) and immediately give artificial respiration.
3. Keep the victim warm.
4. Always call a physician.
5. In case of mild carbon monoxide poisoning without unconsciousness, the victim should be given oxygen if possible.

3.9.2 Technical Aspects of 'Generator Gas Poisoning'

Generator gas poisoning is often caused by technical defects in the functioning of the gas generator unit. When the engine is running, independent of the starting blower, the entire system is under negative pressure created by the engine's pistons; the risk of poisoning through leakage is therefore minimal. However, when the engine is shut off, formation of wood gas continues, causing an increase of pressure inside the generator unit. This pressure increase lasts for approximately 20 minutes after the engine is shut off. For this reason, it is not advisable to stay in the vehicle during this period. Also, the gas generator unit should be allowed to cool for at least 20 minutes before the vehicle is placed in an enclosed garage connected with living quarters. It should be emphasized that the gas formed during the

shutdown period has a carbon monoxide content of 23 to 27% and is thus very toxic.

3.9.3 Fire Hazard

The outside of a gas generator housing drum may reach the same temperature as a catalytic converter on today's automobiles. Care should be taken when operating in areas where dry grass or combustible material can come into contact with the housing drum of the gas generator unit. If a gas generator unit is mounted on a personal car, bus, van or truck, a minimum 6-in. clearance must be maintained around the unit. Disposal of ashes must only be attempted after the unit has cooled down (to below 150°F). Such residue must be placed away from any combustible material and preferably be hosed down with water for absolute safety.

[Back to Table of Contents](#)

MENU: [HOME](#) » [Reconstruction](#) » [Recovery](#) » [Renewal](#) » [Energy Types](#)

BIBLIOGRAPHY

- Anonymous, 'Coast to Coast on Homemade Fuel,' The Mother Earth News (No. 73) pp. 178-179 (January/February 1982).
- Anonymous, 'Wood Gas Update,' in Mother Earth News (No. 71) pp. 164-165 (September/October 1981).
- Anonymous, 'Mother's Woodburning Truck,' The Mother Earth News (No. 69) pp. 126-129 (May/June 1981).
- Chatterjee, A.K., State of the Art Report on Pyrolysis of Wood and Agricultural Biomass, PN-AAK-818, U.S. Department of Agriculture, Newark, NJ, March 1981.
- Cruz, I.E., Producer-Gas Technology for Rural Applications, published by the Food and Agriculture Organization of the United Nations, New York, NY, 1985.
- Donath, E.E., 'Vehicle Gas Producers,' Processing Technology (3) pp. 141-153 (1980).
- Eoff, K.M., and D.M. Post, 'How to Power a Gasoline Engine with Wood,' Technical Reprint No. 1, The Mother Earth News, Hendersonville, NC, 1981.
- Kaupp, A., and J.R. Goss, State of the Art Report for Small Scale (to 50kW) Gas Producer-Engine Systems, USDA Contract No. 53-319R-O-141, University of California, Davis, CA, March 1981.
- Miller, B., State-of-the-Art Survey of Wood Gasification, EPRI-AP-3101, Fred C. Hart Associates, Inc., Washington, DC, May 1983.
- Nygards, N., Wood Gas Generator Vehicles (a translation of the Swedish book), published by Purwaco International, Minneapolis, MN, 1979.
- Oliver, E.D., Technical Evaluation of Wood Gasification, EPRI-AP-2567, Synthetic Fuels Association, Inc., Palo Alto, CA, August 1982.
- Reed, T.B. (ed), A Survey of Biomass Gasification, VoL 1--Synopsis and executive Summary, SERI/TR-33-239 (Vol. I), Solar Energy Research Institute, Golden, CO, July 1979.
- Reed, T.B. (ed), A Survey of Biomass Gasification VoL II -- Principles of Gasification, SERM-33-239

(Vol. II), Solar Energy Research Institute, Golden, CO, July 1979.

Reed, T.B. (ed), A Survey of Biomass Gasification, VoL III -- Current Technology and Research, SERM-33-239 (Vol. III), Solar Energy Research Institute, Golden, CO, April 1980.

Reed, T.B., and A- Das, Handbook of Biomass Downdraft Gasifier Engine Systems, SERI/SP-271-3022, Solar Research Institute, Golden, CO, March 1988.

Reed, T.B., and D. Jantzen, Generator Gas: The Swedish experience from 1939-1945 (a translation of the Swedish book, Gengas), SERI/SP-33-140, Solar Energy Research Institute, Golden, CO, January 1979.

Skov, N., and M.L. Papworth, PEGASUS (Petroleum/Gasoline Substitute Systems), published by the Pegasus Publishing Co., Miami, FL, 1974.

Vietmeyer, N.L., et al., Producer Gas: Another Fuel for Motor Vehicle Transport, published by the National Academy Press, Washington, DC, 1983.

Wise, D.L. (ed.), Fuel Gas from Biomass, published by the CRC Press, Boca Raton, FL, 1981.

Construction Plans for Other Wood Gas Generator Units can be Purchased from the Following Organizations:

PEGASUS Publishing Co.
1995 Keystone Blvd.
Miami, FL 33181

Missouri Gasification Systems, Inc.
Route 3, Box 198
California, MO 65018

Mother's Plans
The Mother Earth News
P.O. Box 70
Hendersonville, NC 28791

Nunnikhoven Industries
P. O. Box 580
Mediapolis, IA 52637

[Back to Table of Contents](#)

MENU: [HOME](#) » [Reconstruction](#) » [Recovery](#) » [Renewal](#) » [Energy Types](#)

Construction of a Simplified Wood Gas Generator for Fueling Internal Combustion Engines in a Petroleum Emergency Final Report



APPROVED FOR PUBLIC RELEASE: DISTRIBUTION UNLIMITED



Construction of a Simplified Wood Gas Generator for Fueling Internal Combustion Engines in a Petroleum Emergency Final Report

by:

H. LaFontaine, Biomass Energy Foundation, Inc.
Miami, Florida

and

F. P. Zimmerman, Oak Ridge National Laboratory, Energy Division

FEMA Interagency Agreement Number: EMW-84-E-1737
Work Unit: 3521D

for:

Federal Emergency Management Agency
Washington, D.C. 20472

"This report has been reviewed in the Federal Emergency Management Agency and approved for publication. Approval does not signify that the contents necessarily reflect the views and policies of the Federal Emergency Management Agency."

Date Published: March 1989

APPROVED FOR PUBLIC RELEASE: DISTRIBUTION UNLIMITED

Prepared by:

Oak Ridge National Laboratory
Oak Ridge, Tennessee 37831-6285
for the U.S. Department of Energy



REPORT DOCUMENTATION PAGE

1a. REPORT SECURITY CLASSIFICATION Unclassified			1b. RESTRICTIVE MARKINGS None			
2a. SECURITY CLASSIFICATION AUTHORITY			3. DISTRIBUTION / AVAILABILITY OF REPORT Unlimited			
2b. DECLASSIFICATION / DOWNGRADING SCHEDULE N/A						
4. PERFORMING ORGANIZATION REPORT NUMBER(S) ORNL-6404			5. MONITORING ORGANIZATION REPORT NUMBER(S) N/A			
6a. NAME OF PERFORMING ORGANIZATION Oak Ridge National Lab.		6b. OFFICE SYMBOL <i>(if applicable)</i>		7a. NAME OF MONITORING ORGANIZATION		
6c. ADDRESS (City, State, and ZIP Code) P. O. Box 2008 Oak Ridge, TN 37831-6190			7b. ADDRESS (City, State, and ZIP Code)			
8a. NAME OF FUNDING / SPONSORING ORGANIZATION Federal Emergency Mgmt. Agency		8b. OFFICE SYMBOL <i>(if applicable)</i>		9. PROCUREMENT INSTRUMENT IDENTIFICATION NUMBER Interagency Agreement No. EMW 84 E 1737		
8c. ADDRESS (City, State, and ZIP Code) 500 C Street, SW Washington, DC 20472			10. SOURCE OF FUNDING NUMBERS			
			PROGRAM ELEMENT NO.	PROJECT NO.	TASK NO.	WORK UNIT ACCESSION NO. 3521D
11. TITLE (Include Security Classification) Construction of a Simplified Wood Gas Generator for Fueling Internal Combustion Engines in a Petroleum Emergency						
12. PERSONAL AUTHOR(S) Harry LaFontaine, Gregory P. Zimmerman						
13a. TYPE OF REPORT Final		13b. TIME COVERED FROM _____ TO _____		14. DATE OF REPORT (Year, Month, Day) March 1979		15. PAGE COUNT 85
16. SUPPLEMENTARY NOTATION						
17. COSATI CODES			18. SUBJECT TERMS (Continue on reverse if necessary and identify by block number) Emergency Technology, Wood Gasification, Wood Gas, Producer Gas, Downdraft Gasifier, Stratified Gasifier, Petroleum Crisis, Alternate Fuels, Internal Combustion Engines			
FIELD	GROUP	SUB-GROUP				
19. ABSTRACT (Continue on reverse if necessary and identify by block number) <p>This report is one in a series of emergency technology assessments sponsored by the Federal Emergency Management Agency (FEMA). The purpose of this report is to develop detailed, illustrated instructions for the fabrication, installation, and operation of a biomass gasifier unit (that is, a "producer gas" generator, also called a "wood gas" generator) which is capable of providing emergency fuel for vehicles, such as tractors and trucks, in the event that normal petroleum sources were severely disrupted for an extended period of time. These instructions are prepared in the format of a manual for use by any mechanic who is reasonably proficient in metal fabrication or engine repair.</p> <p>This report attempts to preserve the knowledge about wood gasification as put into practical use during World War II. Detailed, step-by-step fabrication procedures are presented for a simplified version of the World War II, Imbert wood gas generator. This simple, stratified,</p> <p style="text-align: right;">(contd)</p>						
20. DISTRIBUTION / AVAILABILITY OF ABSTRACT <input type="checkbox"/> UNCLASSIFIED/UNLIMITED <input type="checkbox"/> SAME AS RPT. <input type="checkbox"/> DTIC USERS				21. ABSTRACT SECURITY CLASSIFICATION		
22a. NAME OF RESPONSIBLE INDIVIDUAL			22b. TELEPHONE (Include Area Code)		22c. OFFICE SYMBOL	

19. ABSTRACT (contd)

downdraft gasifier unit can be constructed from materials which would be widely available in the United States in a prolonged petroleum crisis. For example, the body of the unit consists of a galvanized metal garbage can atop a small metal drum; common plumbing fittings are used throughout; and a large, stainless steel mixing bowl is used for the grate. The entire compact unit was mounted onto the front of a farm tractor and successfully field tested, using wood chips as the only fuel. Photographic documentation of the actual assembly of the unit as well as its operation is included.

CONTENTS

	Page
EXECUTIVE SUMMARY	v
S.1. PRINCIPLES OF SOLID FUEL GASIFICATION	vi
S.2. THE STRATIFIED, DOWNDRAFT GASIFIER	vi
CONVERSION FACTORS FOR SI UNITS	xiii
LIST OF FIGURES	xv
LIST OF TABLES	xvii
ABSTRACT	1
1. WHAT IS A WOOD GAS GENERATOR AND HOW DOES IT WORK? ...	3
1.1. INTRODUCTION	3
1.2. PRINCIPLES OF SOLID FUEL GASIFICATION	4
1.3. BACKGROUND INFORMATION	5
1.3.1. The World War II, Imbert Gasifier	6
1.3.2. The Stratified, Downdraft Gasifier	7
2. BUILDING YOUR OWN WOOD GAS GENERATOR	13
2.1. BUILDING THE GAS GENERATOR UNIT AND THE FUEL HOPPER	14
2.2. BUILDING THE PRIMARY FILTER UNIT	17
2.3. BUILDING THE CARBURETING UNIT WITH THE AIR AND THROTTLE CONTROLS	19
3. OPERATING AND MAINTAINING YOUR WOOD GAS GENERATOR ..	55
3.1. USING WOOD AS A FUEL	55
3.2. SPECIAL CONSIDERATIONS AND ENGINE MODIFICATIONS ...	55
3.3. INITIAL START-UP PROCEDURE	56
3.4. ROUTINE START-UP PROCEDURE	56
3.5. DRIVING AND NORMAL OPERATION	57
3.6. SHUTTING-DOWN THE GASIFIER UNIT	57
3.7. ROUTINE MAINTENANCE	57
3.7.1 Daily Maintenance	58
3.7.2 Weekly Maintenance (or every 15 hours of operation)	58
3.7.3 Biweekly Maintenance (or every 30 hours of operation)	58
3.8. OPERATING PROBLEMS AND TROUBLE-SHOOTING	58
3.9. HAZARDS ASSOCIATED WITH GASIFIER OPERATION	58
3.9.1. Toxic Hazards	58
3.9.2. Technical Aspects of "Generator Gas Poisoning"	59
3.9.3. Fire Hazard	59
BIBLIOGRAPHY	67

EXECUTIVE SUMMARY

This report is one in a series of emergency technology assessments sponsored by the Federal Emergency Management Agency (FEMA). The purpose of this report is to develop detailed, illustrated instructions for the fabrication, installation, and operation of a biomass gasifier unit (i.e., a "producer gas" generator, also called a "wood gas" generator) which is capable of providing emergency fuel for vehicles, such as tractors and trucks, should normal petroleum sources be severely disrupted for an extended period of time. These instructions have been prepared as a manual for use by any mechanic who is reasonably proficient in metal fabrication or engine repair.

Fuel gas, produced by the reduction of coal and peat, was used for heating as early as 1840 in Europe and by 1884 had been adapted to fuel engines in England. Prior to 1940, gas generator units were a familiar, but not extensively utilized, technology. However, petroleum shortages during World War II led to widespread gas generator applications in the transportation industries of Western Europe. (Charcoal-burning taxis, a related application, were still common in Korea as late as 1970.) The United States, never faced with such prolonged or severe oil shortages, has lagged far behind Europe and the Orient in familiarity with and application of this technology. However, a catastrophic event could disrupt the supply of petroleum in this country so severely that this technology might be critical in meeting the energy needs of some essential economic activities, such as the production and distribution of food.

In occupied Denmark during World War II, 95% of all mobile farm machinery, tractors, trucks, stationary engines, and fishing and ferry boats were powered by wood gas generator units. Even in neutral Sweden, 40% of all motor traffic operated on gas derived from wood or charcoal. All over Europe, Asia, and Australia, millions of gas generators were in operation between 1940 and 1946. Because of the wood gasifier's somewhat low efficiency, the inconvenience of operation, and the potential health risks from toxic fumes, most of such units were abandoned when oil again became available in 1945. Except for the technology of producing alternate fuels, such as methane or alcohol, the only solution for operating existing internal combustion engines, when oil and petroleum products are not available, has been these simple, inexpensive gasifier units.

This report attempts to preserve the knowledge about wood gasification that was put into practical use during World War II. In this report, detailed step-by-step procedures are presented for constructing a simplified version of the World War II wood gas generator; this simple, stratified, downdraft gasifier unit (shown schematically in Fig. S-1) can be constructed from materials which would be widely available in the United States in a prolonged petroleum crisis. For example, the body of the unit consists of a galvanized metal garbage can atop a small metal drum; common plumbing fittings are used throughout; and a large, stainless steel mixing bowl is used for the grate. A prototype gasifier unit was fabricated from these instructions (see Fig. S-2); this unit was then mounted onto the front of a farm tractor and successfully field tested, using wood chips as the only fuel (see Fig. S-3). Photographic documentation of the actual assembly of the unit, as well as its operational field test, is included in the body of this report.

The use of wood gas generators need not be limited to transportation applications. Stationary engines can also be fueled by wood gasifiers to run electric generators, pumps, and industrial equipment. In fact, the use of wood gas as a fuel is not even restricted to

gasoline engines; if a small amount of diesel fuel is used for ignition, a properly adjusted diesel engine can be operated primarily on wood gas introduced through the intake manifold.

S.1. PRINCIPLES OF SOLID FUEL GASIFICATION

All internal combustion engines actually run on vapor, not liquid. The liquid fuels used by gasoline engines are vaporized before they enter the combustion chamber above the pistons. In diesel engines, the fuel is sprayed into the combustion chamber as fine droplets which burn as they vaporize. The purpose of a gasifier, then, is to transform solid fuels into gaseous ones and to keep the gas free of harmful constituents. A gas generator unit is simultaneously an energy converter and a filter. In these twin tasks lie its advantages and its difficulties.

In a sense, gasification is a form of incomplete combustion—heat from the burning solid fuel creates gases which are unable to burn completely because of the insufficient amounts of oxygen from the available supply of air. The same chemical laws which govern combustion processes also apply to gasification. There are many solid biomass fuels suitable for gasification—from wood and paper to peat, lignite, and coal, including coke derived from coal. All of these solid fuels are composed primarily of carbon with varying amounts of hydrogen, oxygen, and impurities, such as sulphur, ash, and moisture. Thus, the aim of gasification is the almost complete transformation of these constituents into gaseous form so that only the ashes and inert materials remain. In creating wood gas for fueling internal combustion engines, it is important that the gas not only be properly produced, but also preserved and not consumed until it is introduced into the engine where it may be appropriately burned.

Gasification is a physiochemical process in which chemical transformations occur along with the conversion of energy. The chemical reactions and thermochemical conversions which occur inside a wood gas generator are too long and too complicated to be covered here; however, such knowledge is not necessary for constructing and operating a wood gasifier. By weight, gas (wood gas) produced in a gasifier unit contains approximately 20% hydrogen (H_2), 20% carbon monoxide (CO), and small amounts of methane, all of which are combustible, plus 50 to 60% nitrogen (N_2). The nitrogen is not combustible; however, it does occupy volume and dilutes the wood gas as it enters and burns in an engine. As the wood gas burns, the products of combustion are carbon dioxide (CO_2) and water vapor (H_2O).

One of the by-products of wood gasification is carbon monoxide, a poisonous gas. The toxic hazards associated with breathing this gas should be avoided during refueling operations or prolonged idling, particularly in inadequately ventilated areas. Except for the obvious fire hazard resulting from the combustion processes inside the unit, carbon monoxide poisoning is the major potential hazard during normal operation of these simplified gasifier units.

S.2. THE STRATIFIED, DOWNDRAFT GASIFIER

Until the early 1980s, wood gasifiers all over the world (including the World War II designs) operated on the principle that both the fuel hopper and the combustion unit be absolutely airtight; the hopper was sealed with a top or lid which had to be opened every time wood was added. Smoke and gas vented into the atmosphere while wood was being loaded; the operator had to be careful not to breathe the unpleasant smoke and toxic fumes.

Over the last few years, a new gasifier design has been developed through cooperative efforts among researchers at the Solar Energy Research Institute in Colorado, the University of California in Davis, the Open University in London, the Buck Rogers Company in Kansas, and the Biomass Energy Foundation, Inc., in Florida. This simplified design employs a balanced, negative-pressure concept in which the old type of sealed fuel hopper is no longer necessary. A closure is only used to preserve the fuel when the engine is stopped. This new technology has several popular names, including "stratified, downdraft gasification" and "open top gasification." Several years of laboratory and field testing have indicated that such simple, inexpensive gasifiers can be built from existing hardware and will perform very well as emergency units.

A schematic diagram of the stratified, downdraft gasifier is shown in Fig. S-1. During operation of this gasifier, air passes uniformly downward through four zones, hence the name "stratified:"

1. The uppermost zone contains unreacted fuel through which air and oxygen enter. This region serves the same function as the fuel hopper in the older, World War II designs.
2. In the second zone, the wood fuel reacts with oxygen during pyrolysis. Most of the volatile components of the fuel are burned in this zone and provide heat for continued pyrolysis reactions. At the bottom of this zone, all of the available oxygen from the air should be completely reacted. The open top design ensures uniform access of air to the pyrolysis region.
3. The third zone is made up of charcoal from the second zone. Hot combustion gases from the pyrolysis region react with the charcoal to convert the carbon dioxide and water vapor into carbon monoxide and hydrogen.
4. The inert char and ash, which constitute the fourth zone, are normally too cool to cause further reactions; however, because the fourth zone is available to absorb heat or oxygen as conditions change, it serves both as a buffer and as a charcoal storage region. Below this zone is the grate. The presence of char and ash serves to protect the grate from excessive temperatures.

The stratified, downdraft design has a number of advantages over the World War II gasifier designs. The open top permits fuel to be fed more easily and allows easy access. The cylindrical shape is easy to fabricate and permits continuous flow of fuel. No special fuel shape or pretreatment is necessary; any blocky fuel can be used.

The foremost question about the operation of the stratified, downdraft gasifier concerns char and ash removal. As the charcoal reacts with the combustion gases, it eventually reaches a very low density and breaks up into a dust containing all of the ash as well as a percentage of the original carbon. This dust may be partially carried away by the gas and might eventually begin to plug the gasifier. Hence, it must be removed by shaking or agitation. When the stratified gasifier unit is used to power vehicles, it is automatically shaken by the vehicle's motion.

An important issue in the design of the stratified, downdraft gasifier is the prevention of fuel bridging and channeling. High-grade biomass fuels, such as wood blocks or chips, will flow down through the gasifier because of gravity and downdraft air flow. However, other fuels (such as shredded chips, sawdust, and bark) can form a bridge, which will obstruct

continuous flow and cause very high temperatures. Bridging can be prevented by stirring, shaking, or by agitating the grate or by having it agitated by the vehicle's movement. For prolonged idling, a hand-operated shaker has been included in the design in this report.

A prototype unit of the stratified, downdraft gasifier design (see Figs. S-2 and S-3) has been fabricated according to the instructions in this report; however, it has not been widely tested at this time. The reader is urged to use his ingenuity and initiative in constructing his own wood gas generator. As long as the principle of airtightness in the combustion regions, in the connecting piping, and in the filter units is followed, the form, shape, and method of assembly is not important.

The wood gasifier design presented in this report has as its origin the proven technology used in World War II during actual shortages of gasoline and diesel fuel. It should be acknowledged that there are alternate technologies (such as methane production or use of alcohol fuels) for keeping internal combustion engines in operation during a prolonged petroleum crisis; the wood gasifier unit described in this report represents only one solution to the problem.

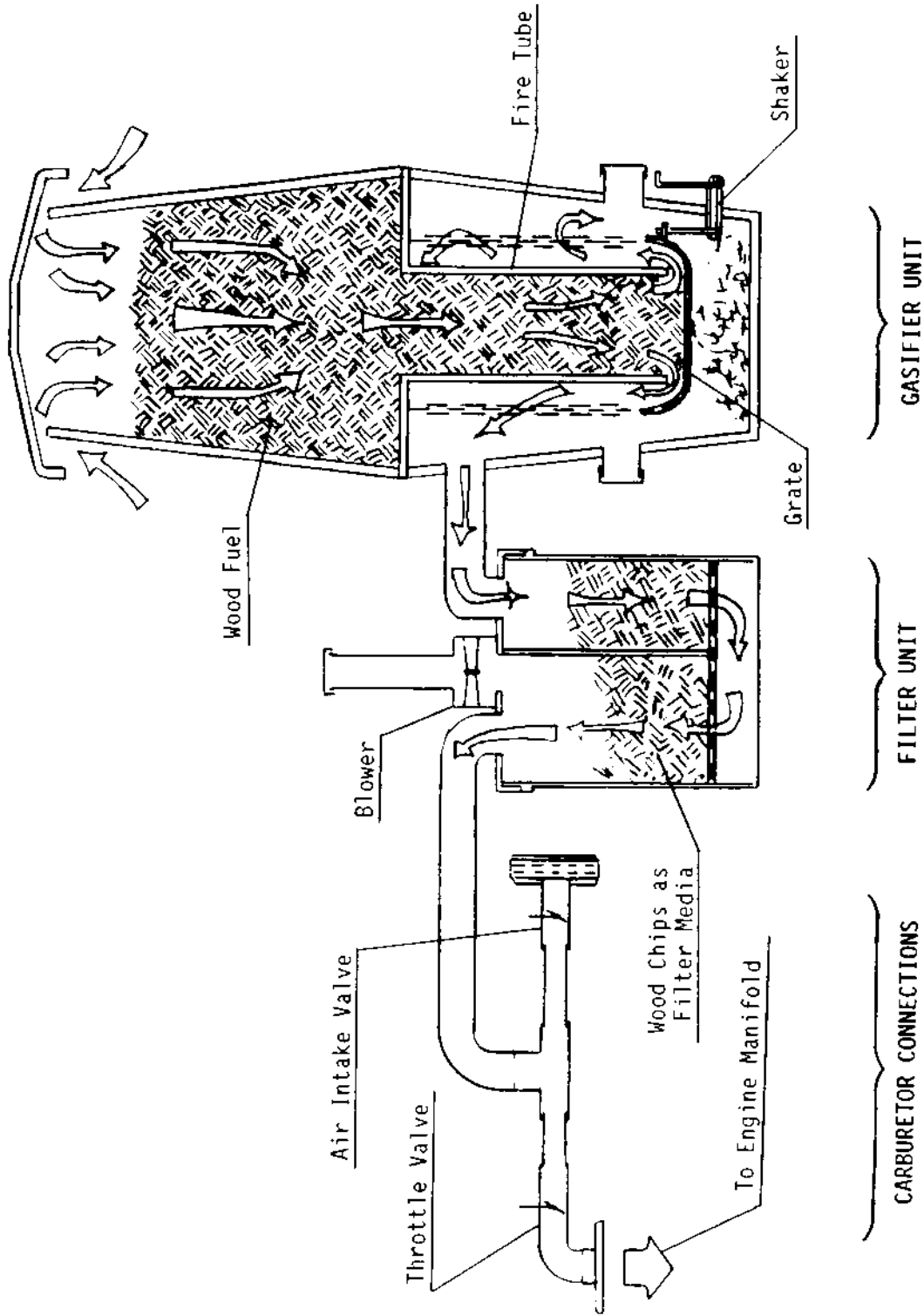

Fig. S-1. Schematic view of the stratified, downdraft gasifier.

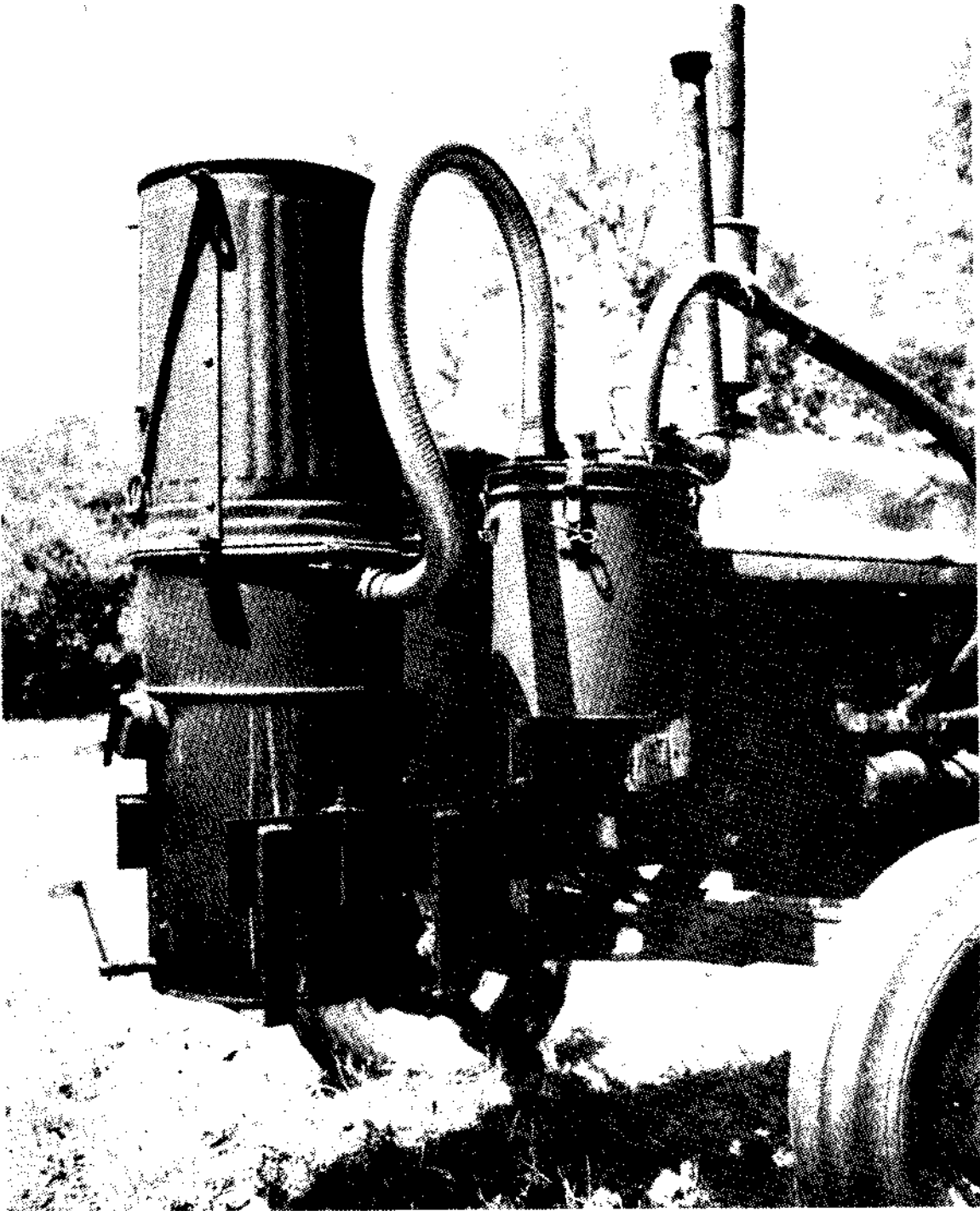

Fig. S-2. The prototype wood gas generator unit mounted onto a tractor.

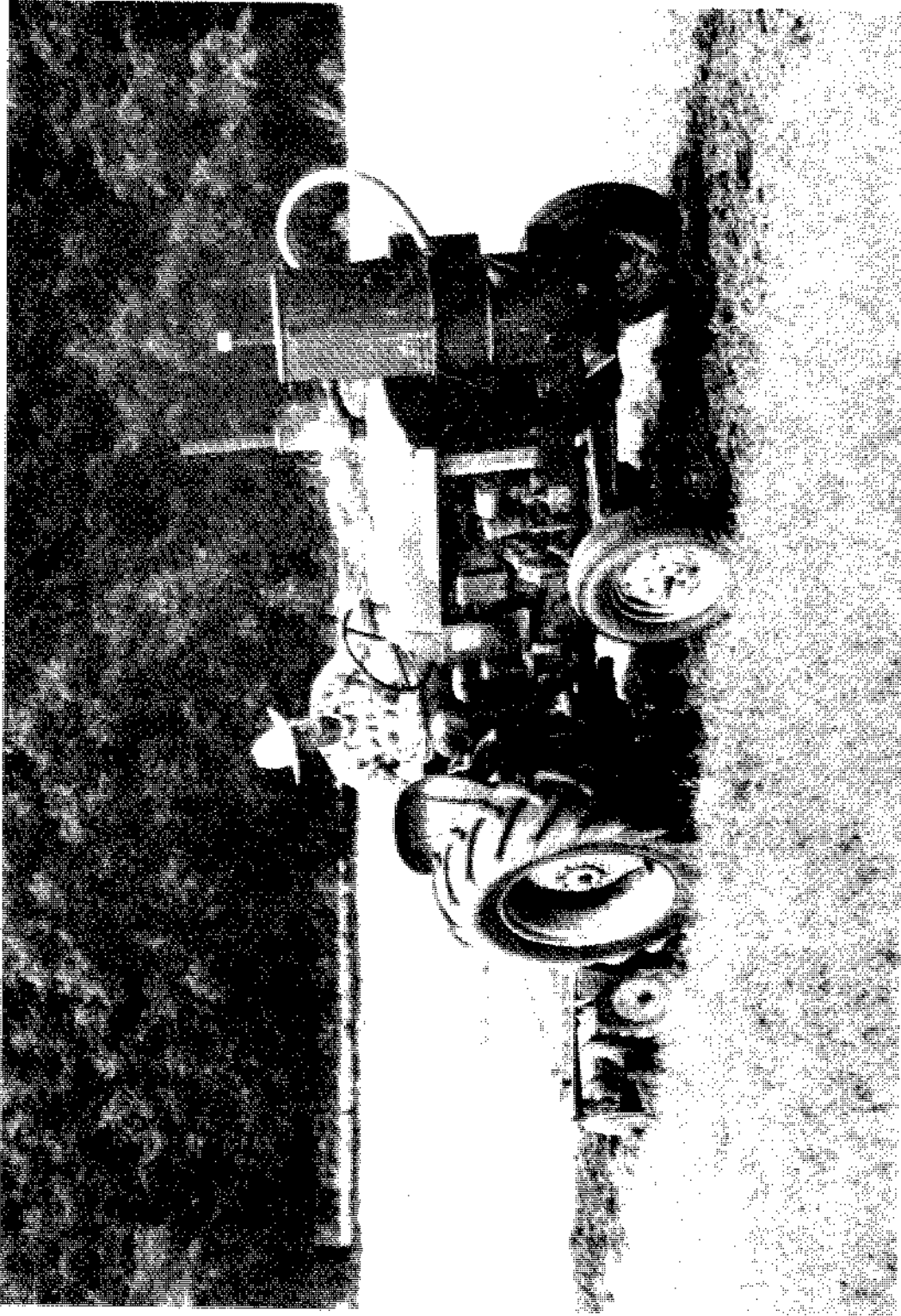

Fig. S-3. Wood gas generator unit in operation during field testing.

CONVERSION FACTORS FOR SI UNITS

English units have been retained in the body of this report. The report refers to commercially available materials and sizes which are commonly expressed in English units. The conversion factors for SI units are given below:

<u>To convert from</u>	<u>To</u>	<u>Multiply by</u>
cubic feet (ft ³)	cubic meters (m ³)	0.0283
cubic yards (yd ³)	cubic meters (m ³)	0.7646
Fahrenheit degrees (°F)	Kelvin degrees (°K)	(see Note 1)
foot (ft)	meter (m)	0.3048
gallon (gal)	cubic meters (m ³)	3.785 X 10 ⁻³
horsepower (hp)	watt (W)	745.7
inch (in.)	meter (m)	0.0254
pound (lb)	kilogram (kg)	0.4536
quart (qt.)	cubic meters (m ³)	9.464 X 10 ⁻⁴

Note 1: To convert temperatures, use the following equation,

$$K = 273 + 0.5556 \times (F - 32) ,$$

where

F is the temperature in Fahrenheit degrees, and

K is the temperature in Kelvin degrees.

LIST OF FIGURES

Fig. S-1.	Schematic view of the stratified, downdraft gasifier	ix
Fig. S-2.	The prototype wood gas generator unit mounted onto a tractor	x
Fig. S-3.	Wood gas generator unit in operation during field testing	xi
Fig. 1-1.	Wood gas generator unit in operation during field testing	9
Fig. 1-2.	Schematic view of the World War II, Imbert gasifier	10
Fig. 1-3.	Schematic view of the stratified, downdraft gasifier	11
Fig. 2-1.	The prototype wood gas generator unit mounted onto a tractor	22
Fig. 2-2.	Exploded, schematic diagram of the wood gas generator unit and the fuel hopper	23
Fig. 2-3.	The fire tube and circular top plate of the gasifier unit	24
Fig. 2-4.	Drilling holes into the stainless steel mixing bowl to be used for the grate	25
Fig. 2-5.	Chains attached to the lip of the stainless steel mixing bowl	26
Fig. 2-6.	Connect the mixing bowl to the top plate with chains	27
Fig. 2-7.	Braze, <u>do not weld</u> , the plumbing fittings to the thin walled drums	28
Fig. 2-8.	Exploded, schematic diagram of the grate shaking mechanism	29
Fig. 2-9.	Parts for the shaker assembly	30
Fig. 2-10.	The support frame can be brazed or bolted to the side of the gasifier unit	31
Fig. 2-11.	Containers used in constructing the prototype gasifier unit	32
Fig. 2-12.	Cover for the fuel hopper.	33
Fig. 2-13.	Operating configuration of the fuel hopper and its cover	34
Fig. 2-14.	Lock ring and welded tabs	35
Fig. 2-15.	Exploded, schematic diagram of the filter unit	36
Fig. 2-16.	Detail of the standoffs for the bottom plate of the filter unit	37
Fig. 2-17.	Divider plate (#1) and bottom plate (#3), with standoffs (#4), for the filter unit	38
Fig. 2-18.	Circular lid (#1) for the filter unit	39
Fig. 2-19.	Blower (#1) with exhaust extension assembly	40
Fig. 2-20.	Assembled and installed blower (#1), extension assembly (#4), and conduit connectors for gas inlet (#2) and outlet (#3) on lid of filter unit	41
Fig. 2-21.	Filter container (#1) showing latches (#2) for lid and hose (#3) around top	42
Fig. 2-22.	Exploded, schematic diagram of the carbureting unit and control valves	43
Fig. 2-23.	Schematic diagram of a butterfly control valve.	44
Fig. 2-24.	Parts required for the butterfly valve	45
Fig. 2-25.	Butterfly valve assembly	46
Fig. 2-26.	Assembled butterfly valves	47
Fig. 2-27.	Assembled carburetion unit	48

LIST OF FIGURES (continued)

Fig. 2-28.	Carburetion unit attached to engine's existing intake manifold	49
Fig. 3-1.	Virtually all varieties of wood chips can be used for fuel	60
Fig. 3-2.	Ignite a single piece of newspaper to start the gasifier unit; push the flaming newspaper through the ignition port and directly into the grate	61
Fig. 3-3.	Igniting the exhaust gas will demonstrate that the gasifier unit is working properly	62
Fig. 3-4.	Refill the fuel hopper before it becomes two-thirds empty	63
Fig. 3-5.	The lid must be used to cover the fuel hopper in wet weather or when shutting the unit down	64

LIST OF TABLES

Table 2-1.	List of materials for the gasifier unit and the wood fuel hopper	50
Table 2-2.	Fire tube dimensions	52
Table 2-3.	List of materials for the primary filter unit	53
Table 2-4.	List of materials for the carbureting unit	54
Table 3-1.	Trouble-shooting your wood gas generator	65
Table 3-2.	Effects of breathing carbon monoxide	66

**CONSTRUCTION OF A SIMPLIFIED WOOD GAS GENERATOR
FOR FUELING INTERNAL COMBUSTION ENGINES
IN A PETROLEUM EMERGENCY**

H. LaFontaine
G. P. Zimmerman

ABSTRACT

This report is one in a series of emergency technology assessments sponsored by the Federal Emergency Management Agency (FEMA). The purpose of this report is to develop detailed, illustrated instructions for the fabrication, installation, and operation of a biomass gasifier unit (i.e., a "producer gas" generator, also called a "wood gas" generator) that is capable of providing emergency fuel for vehicles, such as tractors and trucks, in the event that normal petroleum sources were severely disrupted for an extended period of time. These instructions have been prepared as a manual for use by any mechanic who is reasonably proficient in metal fabrication or engine repair.

This report attempts to preserve the knowledge about wood gasification that was put into practical use during World War II. Detailed, step-by-step fabrication procedures are presented for a simplified version of the World War II, Imbert wood gas generator. This simple, stratified, downdraft gasifier unit can be constructed from materials that would be widely available in the United States in a prolonged petroleum crisis. For example, the body of the unit consists of a galvanized metal garbage can atop a small metal drum; common plumbing fittings throughout; and a large, stainless steel mixing bowl for the grate. The entire compact unit was mounted onto the front of a farm tractor and successfully field tested, using wood chips as the only fuel. Photographic documentation of the actual assembly of the unit as well as its operation is included.

1. WHAT IS A WOOD GAS GENERATOR AND HOW DOES IT WORK?

This report is one in a series of emergency technology assessments sponsored by the Federal Emergency Management Agency (FEMA). The purpose of this report is to develop detailed, illustrated instructions for the fabrication, installation, and operation of a biomass gasifier unit (i.e., a "producer gas" generator, also called a "wood gas" generator) that is capable of providing emergency fuel for vehicles, such as tractors and trucks, in the event that normal petroleum sources were severely disrupted for an extended period of time. These instructions have been prepared as a manual for use by any mechanic who is reasonably proficient in metal fabrication or engine repair.

1.1 INTRODUCTION

Fuel gas, produced by the reduction of coal and peat, was used for heating, as early as 1840 in Europe, and by 1884 it had been adapted to fuel engines in England. Before 1940, gas generator units were a familiar, but not extensively utilized, technology. However, petroleum shortages during World War II led to widespread gas generator applications in the transportation industries of Western Europe. (Charcoal-burning taxis, a related application, were still common in Korea as late as 1970.) The United States, never faced with such prolonged or severe oil shortages, has lagged far behind Europe and the Orient in familiarity with and application of this technology; however, a catastrophe could so severely disrupt the supply of petroleum in this country that this technology might be critical in meeting the energy needs of some essential economic activities, such as the production and distribution of food.

This report attempts to preserve the knowledge about wood gasification as put into practical use during World War II. Detailed, step-by-step procedures are presented in this report for constructing a simplified version of the World War II, Imbert wood gas generator. This simple, stratified, downdraft gasifier unit can be constructed from materials that would be widely available in the United States in a prolonged petroleum crisis. For example, the body of the unit consists of a galvanized metal garbage can atop a small metal drum; common plumbing fittings throughout; and a large, stainless steel mixing bowl for the grate. A prototype gasifier unit was fabricated from these instructions. This unit was then mounted onto the front of a gasoline-engine farm tractor and successfully field tested, using wood chips as the only fuel; see Fig. 1-1 (all figures and tables are presented at the end of their respective sections). Photographic documentation of the actual assembly of the unit, as well as its operational field test, is included in this report.

The use of wood gas generators need not be limited to transportation applications. Stationary engines can also be fueled by wood gasifiers to run electric generators, pumps, and industrial equipment. In fact, the use of wood gas as a fuel is not even restricted to gasoline engines; if a small amount of diesel fuel is used for ignition, a properly adjusted diesel engine can be operated primarily on wood gas introduced through the intake manifold. However, this report is concerned with the operation of four-cycle gasoline engines rated from 10 to 150 horsepower. If more information is needed about operating gasifiers on other

fuels (such as coal, charcoal, peat, sawdust or seaweed), a list of relevant literature is contained in the Bibliography at the end of this report.

The goal of this report is to furnish information for building a homemade wood gas generator made out of ordinary, available hardware, in order to get tractors, trucks, and other vehicles operating without delay, if a severe liquid fuel emergency should arise. Section 1 describes gasification principles and wood gas generators, in general, and gives some historical background about their operation and effectiveness. Section 2 contains detailed step-by-step instructions for constructing your own wood gas generator unit; illustrations and photographs are included to prevent confusion. Section 3 contains information on operating, maintaining, and trouble-shooting your wood gas generator; also included are some very important guidelines on safety when using your gasifier system.

The wood gasifier design presented in this report has as its origin the proven technology used in World War II during actual shortages of gasoline and diesel fuel. It should be acknowledged that there are alternate technologies (such as methane production or use of alcohol fuels) for keeping internal combustion engines in operation during a prolonged petroleum crisis; the wood gasifier unit described in this report represents only one solution to the problem.

1.2 PRINCIPLES OF SOLID FUEL GASIFICATION

All internal combustion engines actually run on vapor, not liquid. The liquid fuels used in gasoline engines are vaporized before they enter the combustion chamber above the pistons. In diesel engines, the fuel is sprayed into the combustion chamber as fine droplets which burn as they vaporize. The purpose of a gasifier, then, is to transform solid fuels into gaseous ones and to keep the gas free of harmful constituents. A gas generator unit is, simultaneously, an energy converter and a filter. In these twin tasks lie its advantages and its difficulties.

The first question many people ask about gasifiers is, "Where does the combustible gas come from?" Light a wooden match; hold it in a horizontal position; and notice that while the wood becomes charcoal, it is not actually burning but is releasing a gas that begins to burn brightly a short distance away from the matchstick. Notice the gap between the matchstick and the luminous flame; this gap contains the wood gas which starts burning only when properly mixed with air (which contains oxygen). By weight, this gas (wood gas) from the charring wood contains approximately 20% hydrogen (H_2), 20% carbon monoxide (CO), and small amounts of methane, all of which are combustible, plus 50 to 60% nitrogen (N_2). The nitrogen is not combustible; however, it does occupy volume and dilutes the wood gas as it enters and burns in an engine. As the wood gas burns, the products of combustion are carbon dioxide (CO_2) and water vapor (H_2O).

The same chemical laws which govern combustion processes also apply to gasification. The solid, biomass fuels suitable for gasification cover a wide range, from wood and paper to peat, lignite, and coal, including coke derived from coal. All of these solid fuels are composed primarily of carbon with varying amounts of hydrogen, oxygen, and impurities, such as sulphur, ash, and moisture. Thus, the aim of gasification is the almost complete transformation of these constituents into gaseous form so that only the ashes and inert materials remain.

In a sense, gasification is a form of incomplete combustion; heat from the burning solid fuel creates gases which are unable to burn completely, due to insufficient amounts of

oxygen from the available supply of air. In the matchstick example above, as the wood was burned and pyrolyzed into charcoal, wood gas was created, but the gas was also consumed by combustion (since there was an enormous supply of air in the room). In creating wood gas for fueling internal combustion engines, it is important that the gas not only be properly produced, but also preserved and not consumed until it is introduced into the engine where it may be appropriately burned.

Gasification is a physiochemical process in which chemical transformations occur along with the conversion of energy. The chemical reactions and thermochemical conversions which occur inside a wood gas generator are too long and too complicated to be covered here. Such knowledge is not necessary for constructing and operating a wood gasifier. Books with such information are listed in the Reference Section (see, for example, Reed 1979, Vol. II; or Reed and Das 1988).

1.3 BACKGROUND INFORMATION

The use of wood to provide heat is as old as mankind; but by burning the wood we only utilize about one-third of its energy. Two-thirds is lost into the environment with the smoke. Gasification is a method of collecting the smoke and its combustible components. Making a combustible gas from coal and wood began around 1790 in Europe. Such manufactured gas was used for street lights and was piped into houses for heating, lighting, and cooking. Factories used it for steam boilers, and farmers operated their machinery on wood gas and coal gas. After the discovery of large petroleum reserves in Pennsylvania in 1859, the entire world changed to oil—a cheaper and more convenient fuel. Thousands of gas works all over the world were eventually dismantled.

Wood gas generators are not technological marvels that can totally eliminate our current dependence on oil, reduce the impacts of an energy crunch, or produce long-term economic relief from high fossil fuel prices, but they are a proven emergency solution when such fuels become unobtainable in case of war, civil upheaval, or natural disaster. In fact, many people can recall a widespread use of wood gas generators during World War II, when petroleum products were not available for the civilian populations in many countries. Naturally, the people most affected by oil and petroleum scarcity made the greatest advancements in wood gas generator technology.

In occupied Denmark during World War II, 95% of all mobile farm machinery, tractors, trucks, stationary engines, fishing and ferry boats were powered by wood gas generators. Even in neutral Sweden, 40% of all motor traffic operated on gas derived from wood or charcoal (Reed and Jantzen 1979). All over Europe, Asia, and Australia, millions of gas generators were in operation between 1940 and 1946. Because of the wood gasifier's somewhat low efficiency, the inconvenience of operation, and the potential health risks from toxic fumes, most of such units were abandoned when oil again became available in 1945. Except for the technology of producing alternate fuels, such as methane or alcohol, the only solution for operating existing internal combustion engines, when oil and petroleum products are not available, has been these simple, inexpensive gasifier units.

1.3.1 The World War II, Imbert Gasifier

The basic operation of two gasifiers is described in this and the following section. Their operating advantages and disadvantages will also be discussed. This information is included for the technically interested reader only; it is intended to give the reader more insight into the subtleties of the operating principles of the wood gas generator described in this manual. Those readers who are anxious to begin construction of their own wood gas generator may skip the material below and proceed directly to Sect. 2 without any loss of continuity.

The constricted hearth, downdraft gasifier shown in Fig. 1-2 is sometimes called the "Imbert" gasifier after its inventor, Jacques Imbert; although, it has been commercially manufactured under various names. Such units were mass produced during World War II by many European automotive companies, including General Motors, Ford, and Mercedes-Benz. These units cost about \$1500 (1985 evaluation) each. However, after World War II began in 1939, it took six to eight months before factory-made gasifiers were generally available. Thousands of Europeans were saved from certain starvation by home-built, simple gasifier units made from washing machine tubs, old water heaters, and metal gas or oxygen cylinders. Surprisingly, the operation of these units was nearly as efficient as the factory-made units; however, the homemade units lasted for only about 20,000 miles with many repairs, while the factory-made units operated, with few repairs, up to 100,000 miles.

In Fig. 1-2, the upper cylindrical portion of the gasifier unit is simply a storage bin or hopper for wood chips or other biomass fuel. During operation, this chamber is filled every few hours as needed. The spring-loaded, airtight cover must be opened to refill the fuel hopper; it must remain closed and sealed during gasifier operation. The spring permits the cover to function as a safety valve because it will pop open in case of any excessive internal gas pressure.

About one-third of the way up from the bottom of the gasifier unit, there is a set of radially directed air nozzles; these allow air to be injected into the wood as it moves downward to be gasified. In a gas generator for vehicle use, the downstroke of the engine's pistons creates the suction force which moves the air into and through the gasifier unit; during startup of the gasifier, a blower is used to create the proper airflow. The gas is introduced into the engine and consumed a few seconds after it is made. This gasification method is called "producer gas generation," because no storage system is used; only that amount of gas demanded by the engine is produced. When the engine is shut off, the production of gas stops.

During normal operation, the incoming air burns and pyrolyzes some of the wood, most of the tars and oils, and some of the charcoal that fills the constricted area below the nozzles. Most of the fuel mass is converted to gas within this combustion zone. The Imbert gasifier is, in many ways, self-adjusting. If there is insufficient charcoal at the air nozzles, more wood is burned and pyrolyzed to make more charcoal. If too much charcoal forms, then the charcoal level rises above the nozzles, and the incoming air burns the charcoal. Thus, the combustion zone is maintained very close to the nozzles.

Below this combustion zone, the resulting hot combustion gases—carbon dioxide (CO_2) and water vapor (H_2O)—pass into the hot charcoal where they are chemically reduced to combustible fuel gases: carbon monoxide (CO) and hydrogen (H_2). The hearth constriction causes all gases to pass through the reaction zone, thus giving maximum mixing and minimum heat loss. The highest temperatures are reached in this region.

Fine char and ash dust can eventually clog the charcoal bed and will reduce the gas flow unless the dust is removed. The charcoal is supported by a movable grate which can be

shaken at intervals. Ash buildup below the grate can be removed during cleaning operations. Usually, wood contains less than 1% ash (by weight). However, as the charcoal is consumed, it eventually collapses to form a powdery charcoal/ash mixture which may represent 2 to 10% (by weight) of the total fuel mass.

The cooling unit required for the Imbert gasifier consists of a water-filled precipitating tank and an automotive radiator-type gas cooler. The precipitating tank removes all unacceptable tars and most of the fine ash from the gas flow, while the radiator further cools the gas. A second filter unit, containing a fine-mesh filtration material, is used to remove the last traces of any ash or dust that may have survived passage through the cooling unit. Once out of the filter unit, the wood gas is mixed with air in the vehicle's carburetor and is then introduced directly into the engine's intake manifold.

The World War II, Imbert gasifier requires wood with a low moisture content (less than 20% by weight) and a uniform, blocky fuel in order to allow easy gravity feed through the constricted hearth. Twigs, sticks, and bark shreds cannot be used. The constriction at the hearth and the protruding air nozzles present obstructions to the passage of the fuel and may create bridging and channeling followed by poor quality gas output, as unpyrolyzed fuel falls into the reaction zone. The vehicle units of the World War II era had ample vibration to jar the carefully sized wood blocks through the gasifier. In fact, an entire industry emerged for preparing wood for use in vehicles at that time (Reed and Jantzen 1979). However, the constricted hearth design seriously limits the range of wood fuel shapes that can be successfully gasified without expensive cubing or pelletizing pretreatment. It is this limitation that makes the Imbert gasifier less flexible for emergency use.

In summary, the World War II Imbert gasifier design has stood the test of time and has successfully been mass produced. It is relatively inexpensive, uses simple construction materials, is easy to fabricate, and can be operated by motorists with a minimum amount of training.

1.3.2 The Stratified, Downdraft Gasifier

Until the early 1980s, wood gasifiers all over the world (including the World War II designs) operated on the principle that both the fuel hopper and the combustion unit be airtight; the hopper was sealed with a top or lid that had to be opened every time wood was added. Smoke and gas vented into the atmosphere while new wood was being loaded; the operator had to be careful not to breathe the unpleasant smoke and toxic fumes.

Over the last few years, a new gasifier design has been developed through cooperative efforts among researchers at the Solar Energy Research Institute in Colorado, the University of California in Davis, the Open University in London, the Buck Rogers Company in Kansas, and the Biomass Energy Foundation, Inc., in Florida (Reed and Das 1988). This simplified design employs a balanced, negative-pressure concept in which the old type of sealed fuel hopper is no longer necessary. A closure is only used to preserve the fuel when the engine is stopped. This new technology has several popular names, including "stratified, downdraft gasification" and "open top gasification." Two years of laboratory and field testing have indicated that such simple, inexpensive gasifiers can be built from existing hardware and will perform very well as emergency units.

A schematic diagram of the stratified, downdraft gasifier is shown in Fig. 1-3. During operation of this gasifier, air passes uniformly downward through four zones, hence the name "stratified:"

1. The uppermost zone contains unreacted fuel through which air and oxygen enter. This region serves the same function as the fuel hopper in the Imbert design.
2. In the second zone, the wood fuel reacts with oxygen during pyrolysis. Most of the volatile components of the fuel are burned in this zone and provide heat for continued pyrolysis reactions. At the bottom of this zone, all of the available oxygen from the air has completely reacted. The open top design ensures uniform access of air to the pyrolysis region.
3. The third zone is made up of charcoal from the second zone. Hot combustion gases from the pyrolysis region react with the charcoal to convert the carbon dioxide and water vapor into carbon monoxide and hydrogen.
4. The inert char and ash, which constitute the fourth zone, are normally too cool to cause further reactions; however, since the fourth zone is available to absorb heat or oxygen as conditions change, it serves both as a buffer and as a charcoal storage region. Below this zone is the grate. The presence of char and ash serves to protect the grate from excessive temperatures.

The stratified, downdraft design has a number of advantages over the World War II, Imbert gasifier. The open top permits fuel to be fed more easily and allows easy access. The cylindrical shape is easy to fabricate and permits continuous flow of fuel. No special fuel shape or pretreatment is necessary; any blocky fuel can be used.

The foremost question about the operation of the stratified, downdraft gasifier concerns char and ash removal. As the charcoal reacts with the combustion gases, it eventually reaches a very low density and breaks up into a dust containing all of the ash as well as a percentage of the original carbon. This dust may be partially carried away by the gas; however, it might eventually begin to plug the gasifier, and so it must be removed by shaking or agitation. Both the Imbert gasifiers and the stratified concept have a provision for shaking the grate; when they are used to power vehicles, they are automatically shaken by the vehicle's motion.

An important issue in the design of the stratified, downdraft gasifier is the prevention of fuel bridging and channeling. High-grade biomass fuels such as wood blocks or chips will flow down through the gasifier under the influence of gravity, and downdraft air flow. However, other fuels (such as shredded wood, sawdust, and bark) can form a bridge that will prevent continuous flow and cause very high temperatures. Obviously, it is desirable to use these widely available biomass residues. Bridging can be prevented by stirring, shaking, or by agitating the grate or by having it agitated by the vehicle's movement. For prolonged idling, a hand-operated shaker has been included in the design.

A prototype design of the stratified, downdraft gasifier design has been developed. The detailed but simple design is described and illustrated in Sect. 2; however, it has not been widely tested at this time. The reader is urged to use his ingenuity and initiative in constructing his own wood gas generator. As long as the principle of airtightness in the combustion regions, in the connecting piping, and in the filter units is followed, the form, shape, and method of assembly is not important.

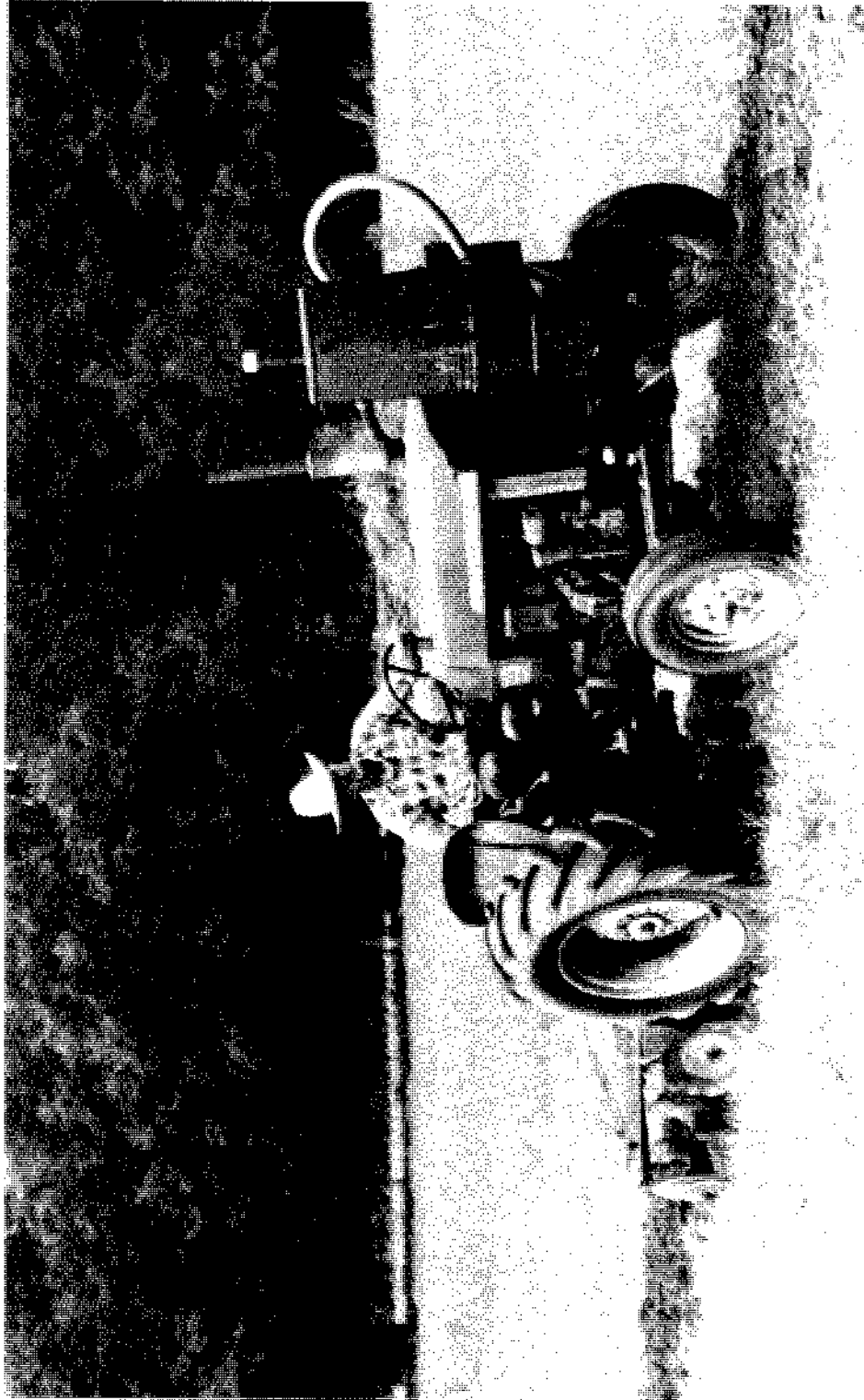

Fig. 1-1. Wood gas generator unit in operation during field testing.

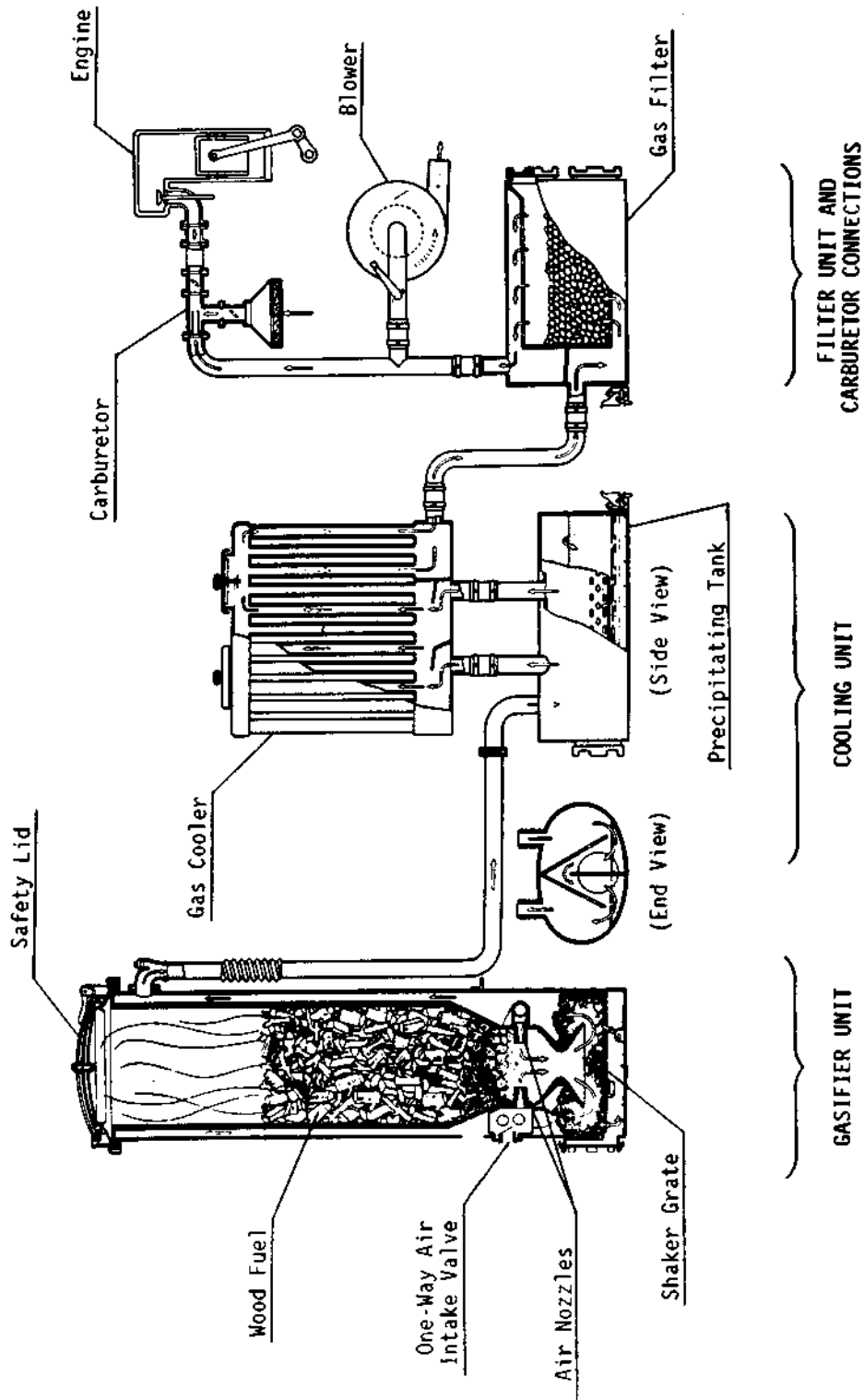

Fig. 1-2. Schematic view of the World War II, Imbert gasifier.

ORNL - DWG 87 - 14553

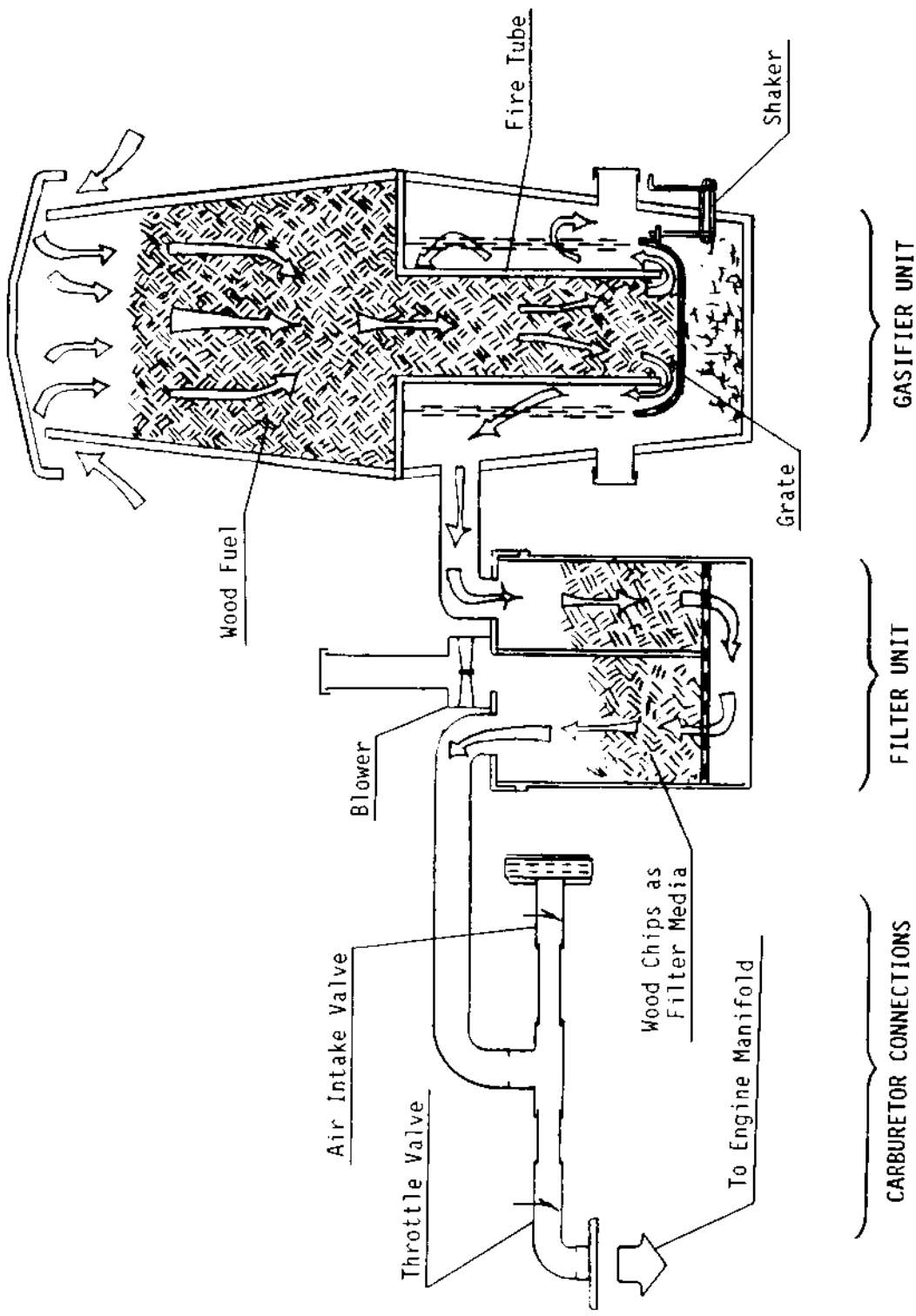

Fig 1-3. Schematic view of the stratified, downdraft gasifier.

2. BUILDING YOUR OWN WOOD GAS GENERATOR

The following fabrication instructions, parts lists, and illustrations describe the prototype gasifier unit shown schematically in Fig. 1-3. These instructions are simple and easy to follow. The dimensions in the following plans are given in inches rather than in millimeters to make construction easier for those who might be unfamiliar with the metric system and to allow the builder to take advantage of available, alternate construction materials. It will be obvious to the experienced engineer, mechanic, or builder that most of the dimensions (for example, plate thicknesses and cleanout diameters) are not critical to the acceptable performance of the finished gasifier unit.

The prototype gasifier unit described in the following text was actually constructed and field tested on a gasoline-engine farm tractor (a 35-hp, John Deere 1010 Special); see Fig. 2-1. The unit operated very well, and on par with the European, World War II designs, but it has not had the test of time nor the millions of operating hours like the older Imbert design. This new stratified design was developed for the construction of simple, inexpensive emergency wood gas generator units. The prototype design below should be considered to be the absolute minimum in regard to materials, piping and filter arrangement, and carburetor system connections.

The gasifier unit, as described below, is designed to maintain proper cooling, even at moderate vehicle speeds. If this unit is to be used on stationary engines or on slow-moving vehicles, a gas cooler and a secondary filter must be placed in the piping system between the generator unit and the carburetor. The ideal temperature for the wood gas at the inlet to the carburetor manifold would be 70°F, with acceptable peaks of 140 to 160°F. For every 10 degrees above 70°F, an estimated 1% horsepower is lost. Cooler gas has higher density and, therefore, contains more combustible components per unit volume.

The millions of wood gasifiers built during World War II proved that shape, form, and construction material had little or no effect on the performance of the unit. Judicious substitution or the use of scavenged parts is, therefore, quite acceptable. What is important is that:

1. the fire tube dimensions (inside diameter and length) must be correctly selected to match the rated horsepower of particular engine which is to be fueled,
2. airtightness of the gas generator unit and all connecting piping must be maintained at all times, and
3. unnecessary friction should be eliminated in all of the air and gas passages by avoiding sharp bends in the piping and by using piping sizes which are not too small.

2.1. BUILDING THE GAS GENERATOR UNIT AND THE FUEL HOPPER

Figure 2-2 shows an exploded view of the gas generator unit and the fuel hopper; the list of materials is given in Table 2-1 (all figures and tables mentioned in Sect. 2 are presented at the end of Sect. 2). Only the dimensions of the fire tube (Item 1A) must be reasonably close; all other dimensions and materials can be substituted as long as complete airtightness is maintained. In the following instructions, all item numbers refer both to Fig. 2-2 and to Table 2-1.

The prototype unit described in this report was constructed for use with a 35-hp gasoline engine; the unit has a fire tube diameter of 6 in. (as determined from Table 2-2). A gas generator unit containing a fire tube up to 9-in. diameter (i.e., a gasifier unit for fueling engines up to about 65 hp) can be constructed from the following instructions. If your engine requires a fire tube diameter of 10 in. or more, use a 55-gal drum for the gas unit and another 55-gal drum for the fuel hopper.

The following fabrication procedure is very general and can be applied to the construction of gas generator units of any size; however, the specific dimensions which are given in the parts list and in the instructions below are for this particular prototype unit. All accompanying photographs were taken during the actual assembly of the prototype unit.

The fabrication procedure is as follows:

1. Using the displacement or horsepower rating of the engine to be fueled by the gasifier unit, determine the dimensions (inside diameter and length) of the fire tube (Item 1A) from Table 2-2. Fabricate a cylindrical tube or cut a length of correctly sized pipe to match the dimensions from Table 2-2. (For the prototype gasifier unit illustrated in this report, a 6-in.-diam firetube was used; its length was 19 in.)
2. The circular top plate (Item 2A) should be cut to a diameter equal to the outside diameter of the gasifier housing drum (Item 3A) at its top. A circular hole should then be cut in the center of the top plate; the diameter of this hole must be equal to the outside diameter of the fire tube. The fire tube (Item 1A) should then be welded at a right angle to the top plate (Item 2A) as shown in Fig. 2-3.
3. The grate (Item 4A) should be made from a stainless steel mixing bowl or colander. Approximately 125 holes with diameters of 1/2 in. should be drilled in the bottom and up the sides of the mixing bowl; see Fig. 2-4. A U-bolt (Item 5A) should be welded horizontally to the side of the grate, 2 in. from its bottom. This U-bolt will be interlocked with the shaker mechanism (Item 12A) in a later step.
4. The support chains (Item 6A) are to be attached to the grate in three evenly spaced holes drilled under the lip of the mixing bowl or colander; see Fig. 2-5. These chains are to be connected to the top plate (Item 2A) with eyebolts (Item 7A), as shown in Fig. 2-6. Each eyebolt should have two nuts, one on each side of the top plate, so that the eyebolts can be adjusted to the proper length. When assembled, the bottom of the firetube should be 1.25 in. above the bottom of the mixing bowl.
5. A hole equal to the outside diameter of the ash cleanout port (Item 8A) should be cut into the side of the gasifier housing drum (Item 3A); the bottom edge of this hole

should be about 1/2 in. from the bottom of the drum. Because of the thin wall thickness of oil drums and garbage cans, welding is not recommended; brazing such parts to the drums or cans will ensure both strength and airtightness (see Fig. 2-7).

6. Two holes, equal to the outside diameters of the ignition ports (Item 10A), are to be cut with their centers at a distance from the top of the housing drum (Item 3A) equal to the firetube length less 7 in. (19 in. less 7 in. equals 12 in. for this prototype unit); the holes should be placed opposite each other as shown in Fig. 2-2. The ignition ports should be attached to the wall of the housing drum by brazing.
7. When the ash cleanout port (Item 8A) and the ignition ports (Item 10A) have been attached to the wall of the gasifier housing drum (Item 3A), they should then be closed with pipe caps, Items 9A and 11A respectively. The threads of the pipe caps should be first coated with high temperature silicone (Item 27A) to ensure airtightness. An optional steel crossbar welded to the pipe cap will reduce the effort required to open these caps later.
8. The shaker assembly (Item 12A) is shown in Fig. 2-8. The 1/2-in. pipe (Item 1AA) should be brazed into the side of the housing drum (Item 3A), 1.5 inches from the bottom of the drum; the length of this pipe which protrudes into the drum must be chosen so that the upright bar (Item 2AA) is in line with the U-bolt (Item 5A) on the grate. Likewise, the length of the upright bar must be selected so as to connect into the U-bolt.
9. Weld the upright bar (Item 2AA) to the head of the bolt (Item 3AA). The threaded end of the bolt should be ground down or flattened on one side, as shown in Fig. 2-9, to positively interlock with a slot to be drilled and filed in the handle (Item 4AA). The handle can be formed or bent into any desired or convenient shape.
10. A hole should be drilled in the pipe cap (Item 7AA) so that there is a close fit between this hole and the bolt (Item 3AA). The close fit will help to ensure airtightness.
11. Before assembling the shaker, as shown in Fig. 2-8, coat the bolt (Item 3AA) with a small amount of grease. Before inserting the bolt, fill the pipe (Item 1AA) with high temperature silicone (Item 27A) to ensure airtightness. Tighten the nuts (Item 6AA) so that the position of the handle (Item 4AA) is maintained by friction, yet is capable of being turned and agitated during cleanout or stationary operation.
12. Fabricate the supports (Item 13A) for the gasifier unit housing drum (Item 3A) out of rectangular, iron bar stock. The shape and height of the support flanges must be determined by the frame of the vehicle to which the gasifier is to be mounted. The supports can either be bolted to the bottom and side with the 1/4-in. bolts (Item 14A) or can be brazed directly to the drum; see Fig. 2-10. Remember to seal all bolt holes for airtightness.
13. Completely cover the bottom of the housing drum (Item 3A) with 1/2 in. of hydraulic cement (Item 28A). The cement should also be applied to the inside of the drum for

about 5 in. up the inside walls near the bottom. All edges should be rounded for easy ash removal.

14. The fuel hopper (Item 15A) is to be made from a second container with its bottom up as shown in Fig. 2-11. Remove the bottom, leaving a 1/4-in. lip around the circumference.
15. A garden hose (Item 17A) should be cut to a length equal to the circumference of the fuel hopper (Item 15A) and should then be slit along its entire length. It should be placed over the edge of the fuel hopper from which the bottom was removed. This will prevent injury to the operator when adding wood fuel to the unit. To insure close fit of the garbage can lid (Item 16A), a piece of weather stripping (Item 18A) should be attached under the lid where it makes contact with the fuel hopper.
16. Cut four support bars (Item 19A) to lengths 2.5 in. longer than the height of the fuel hopper (Item 15A). Drill a 3/8-in. hole in each end of all four support bars; these holes should be centered 3/4 in. from the ends. Bend 2 in. of each end of these support bars over at a right angle; then, mount them evenly spaced around the fuel hopper (Item 15A) with 1/4-in. bolts (Item 20A). One of the bends on each support bar should be as close to the lower edge of the fuel hopper as possible.
17. Cut four metal triangular standoffs (Item 21A) and braze, weld, or rivet them flat against the edge of the garbage can lid (Item 16A) as shown in Fig. 2-12; they must be aligned with the four support bars (Item 19A) attached to the fuel hopper. During operation, the garbage can lid must have a minimum 3/4-in. opening for air passage; the standoffs should provide this clearance when they are engaged into the holes in the top edges of the support bars (Item 19A); see Fig. 2-13.
18. Two eye hooks (Item 22A) should be attached to opposite sides of the garbage can lid (Item 16A). Two screen door springs (Item 23A) should be attached to the garbage can handles and used under tension to keep the top lid (Item 16A) either open or closed.
19. Cut the oil drum lock ring (Item 24A) to the exact circumference of the top plate (Item 2A) so that it will fit snugly around the gasifier unit housing drum (Item 3A).
20. Cut four 2 by 2 by 1/4-in. tabs (Item 25A); then, braze these tabs to the lock ring (Item 24A), evenly spaced and in alignment with the support bars (Item 19A) on the fuel hopper. Drill a 3/8-in. hole in each tab to align with the holes in the fuel hopper support bars (Item 19A). The lock ring is shown in Fig. 2-14.
21. The connecting pipe (Item 29A) between the gasifier unit and the filter unit should be attached to the gasifier housing drum (Item 3A) at a point 6 in. below the top of the drum. This pipe must be a minimum of 2-in. in diameter and should be at least 6 ft long for cooling purposes. At least one of the ends of this pipe must be removable for cleaning and maintenance. On this prototype unit, an airtight electrical conduit connector was used; this connection is visible in Fig. 2-1. Many similar plumbing devices

are available and can be used if they are suitable for operation at 400° F and above. The pipe can also be welded or brazed directly to the housing drum.

22. When assembling the gasifier unit, the upright bar (Item 2AA) on the shaker assembly must be placed inside the U-bolt (Item 5A) on the grate.
23. The lock ring will then clamp the gasifier unit housing drum (Item 3A) and the top plate (Item 2A) together. The fuel hopper support bars (Item 19A) must be attached to the tabs (Item 25A) on the lock ring with bolts (Item 26A). High temperature silicone (Item 27A) should be applied to all edges to make an airtight connection. The lock ring connections are shown in the lower portion of Fig. 2-13.

2.2 BUILDING THE PRIMARY FILTER UNIT

Figures 2-15 and 2-16 show exploded views of the primary filter unit; the list of materials is given in Table 2-3 (all figures and tables mentioned in Sect. 2 are presented at the end of Sect. 2). In the following instructions, all item numbers refer to either Fig. 2-15 or 2-16 and to Table 2-3.

The prototype primary filter unit was made from a 5-gal paint can. That size seems to be sufficient for gasifiers with fire tubes up to 10 in. in diameter. If a fire tube diameter of more than 10 in. is required, then a 20-gal garbage can or a 30-gal oil drum should be used. The filter unit could be fabricated in any shape or form as long as airtightness and unobstructed flow of gas are provided. If a 5-gal container is used, it must be clean and free of any chemical residue. The top edge must be straight and without any indentations. If an alternate container can be found or fabricated, a larger diameter will permit longer operation between cleanings.

The piping (Item 29A in Figs. 2-2 and 2-15) which connects the gas generator unit to the primary filter should be considered to be a necessary part of the cooling system and should never have an inside diameter less than 2 in. A flexible automotive exhaust pipe was used on the prototype filter unit described below; it was shaped into a semicircular arc so that increased length would achieve a greater cooling effect.

The fabrication procedure for the filter unit follows:

1. A hole equal to the outside diameter of the drain tube (Item 13B in Fig. 2-15) should be cut into the side of the filter container (Item 1B); the bottom edge of this hole should be about 1/2 in. from the inside bottom of the container.
2. The drain tube (Item 13B) should be inserted into the previously cut hole in the filter container and should be positioned so that its nonthreaded end is near the center of the container and is about 1/2 in. off the bottom. Once this position has been ensured, braze (do not weld) the drain pipe into the side of the filter container. Close the threaded, exterior end of the drain pipe with the pipe cap (Item 14B).
3. Coat the bottom of the filter container (Item 1B) with a 1/2-in. layer of hydraulic cement (Item 28A), taking care not to plug or obstruct the end of the drain tube (Item 13B) with cement (i.e., fill the drain tube with a paper, styrofoam, or other easily removable, but rigid material). The cement should also be applied for about 1.5 in. up

the inside walls of the container near its bottom. Round the edges slightly; the cement is to provide a pathway for any liquid condensate to drain out through the drain tube. The cement must be allowed to harden before proceeding with the fabrication steps below. Remove the filler material from the drain tube when the cement has hardened.

4. A circular bottom plate (Item 2B) should be cut to a diameter 1/2 in. smaller than the inside diameter of the filter container (Item 1B). This will allow for heat expansion and easy removal for cleaning. This bottom plate should be drilled with as many 3/4-in. holes as are practical for the size of the plate. Three evenly spaced 3/8-in. holes should also be drilled around the edge of the bottom plate for the spacer bolts (Item 3B).
5. Fig. 2-16 shows the detail of using three bolts (Item 3B) as spacers for the bottom plate (Item 2B). The length of the bolts should be adjusted to provide a clearance of about 2-in. between the layer of cement in the bottom of the container (Item 1B) and the bottom plate (Item 2B).
6. A rectangular divider plate (Item 4B) should be cut to a width 1/4 in. less than the inside diameter of the filter container (Item 1B) and to a height 2.5 in. less than the inside height of the container. This divider plate should then be welded at a right angle to the centerline of the bottom plate (Item 2B) as shown in Fig. 2-17.
7. Cut a piece of high-temperature hydraulic hose (Item 5B) to a length equal to the circumference of the filter container. It should be slit along its entire length and then placed over the top edge of the filter container (Item 1B) to ensure airtightness.
8. A circular lid (Item 6B) should be cut equal to the outside diameter of the filter container (Item 1B). Three holes should be cut into this lid for the exhaust pipe (Item 29A) from the gasifier unit, the blower (Item 7B), and the filter exhaust pipe (Item 10B) to the engine manifold. Note the arrangement of these holes: the pipe (Item 29A) from the gasifier unit must enter the lid on one side of the divider plate (Item 4B); the blower (Item 7B) and the filter exhaust pipe (Item 10B) to the engine manifold must be located on the other side of the divider plate. This arrangement can be seen in Fig. 2-18.
9. The connecting pipe (Item 29A) between the gasifier unit and the filter unit should be attached to the lid (Item 6B) of the filter container. At least one of the ends of the connecting pipe (Item 29A) must be removable for cleaning and maintenance. On this prototype unit, an airtight electrical conduit connector was used. Many similar plumbing devices are available and can be used if they are suitable for operation at 400° F and above. The pipe can also be welded or brazed directly to the lid.
10. Attach the blower (Item 7B) to the filter container lid (Item 6B). On the prototype gasifier illustrated in this report, a heater blower from a Volkswagen automobile was used. Connections for a vertical extension tube (Item 8B) will have to be fabricated as shown in Fig. 2-19. A closing cap (Item 9B) is required for the blower exhaust tube. A plumbing cap of steel or plastic with a close fit can be used or fabricated to fit. The vertical extension and the closing cap are visible in Fig. 2-1.

11. The gas outlet (Item 10B) to the carbureting unit on the engine should be 1.25 in. minimum diameter. In fabricating this connection, all abrupt bends should be avoided to ensure free flow of gas. Using plumbing elbows is one solution. The gas outlet (Item 10B) can either be welded or brazed to the lid (Item 6B) of the filter container or an airtight, electrical conduit connector can be used.
12. Latching devices (Item 11B) should be welded or brazed to the lid (see Fig. 2-20) and to the sides (see Fig. 2-21) of the filter container. An air-tight connection between the lid and the filter container must be maintained.
13. Cut two lengths of high-temperature hydraulic hose (Item 12B) equal to the height of the divider plate (Item 4B); cut a third length of hose equal to the width of the divider plate. Slit each hose along its entire length. Place the first two hoses on each side of the divider plate, and place the third hose along the top edge of the divider plate as shown in Fig. 2-17.
14. Insert the divider plate (Item 4B) into the filter container (Item 1B), making sure that the hoses (Item 12B) create an airtight seal along all sides. By changing the length of the spacer bolts (Item 3B), adjust the height of the divider plate so that it is exactly flush with the top of the filter container. Make sure that the lid (Item 5B) will seat flatly and tightly against the top edge of the divider plate.
15. Fill the filter container (Item 1B) on both sides of the divider plate with wood chips, the same kind as would be used for fuel in the gasifier unit. After carefully packing and leveling these wood chips, place the lid (Item 6B) on the filter container, and close the latches tightly.

2.3. BUILDING THE CARBURETING UNIT WITH THE AIR AND THROTTLE CONTROLS

Figures 2-22 and 2-23 show exploded views of the carbureting unit; the list of materials is given in Table 2-4 (all figures and tables mentioned in Sect. 2 are presented at the end of Sect. 2). In the following instructions, all item numbers refer both to Figs. 2-22 and 2-23 and to Table 2-4. The following is a simple and easy way to assemble a carburetor to achieve both air mixture and throttle control. It can be mounted to either updraft or downdraft manifolds by simply turning the unit over. Most of the fabrication procedure below is devoted to the assembly of two butterfly valves: one for the throttle valve and one for the air mixture valve. The remainder of the carburetor unit can be assembled from ordinary, threaded plumbing parts.

The inside diameter of the piping used in the carburetor unit must be related to the size of the engine and should never be smaller than the intake opening on the engine manifold. If in doubt on the inside diameter for the pipe and/or hose sizes, always go with a larger diameter. This will reduce friction losses and will give longer operating hours between cleanings.

When the wood gas leaves the filter unit it should normally be below 180°F. About 2 ft from the filter container, an automotive water hose can be connected to the pipe on the carbureting unit. This rubber hose will keep engine vibration from creating air leaks in the

filter unit or in the connecting piping. The hose must be a fairly new item; such hoses have a steel spring inside to keep them from collapsing when negative pressure is applied. The spring will soon rust if it has first been subjected to water and then to the hot wood gas enriched with hydrogen.

The fabrication procedure for the assembly of two butterfly valves follows:

1. The manifold adapter (Item 1C in Fig. 2-22) must be fitted with bolts and/or holes for mounting onto the engine's existing intake manifold. Because gasoline engines are produced with so many different types of intake manifolds, ingenuity and common sense must be used to modify the manifold adapter (Item 1C) for each different engine to be operated on wood gas. A gasket (Item 7C) should be cut to match the shape of the engine intake fitting.
2. The butterfly valve (Item 3C) is shown in Figs. 2-24 and 2-25; two such valves are required. A 3/8-in. hole should be drilled through the diameter of each valve body (Item 1CC) at the midpoint of its length.
3. The valve plate (Item 2CC) must be oval in shape with the dimensions given in Table 2-4. An oval valve plate must be used so that, in the closed position, the valve will be about 10° off center. This will ensure that the valve will come to a complete stop in the closed position.
4. The edges of the valve plate (Item 2CC), around the longer diameter of the oval, should be beveled to provide a positive, airtight closure. Two evenly spaced, 1/4-in. holes should be drilled along the shorter diameter of the oval plate.
5. The valve support rod (Item 3CC) should be filed or ground flat on one side as shown in Fig. 2-24; the flat area must begin 1/4 in. from one end and must continue for a distance equal to the inside diameter of the valve body (Item 1CC).
6. Two 3/16-in. holes should be drilled into the flat area of the valve support rod (Item 3CC); these holes must align with the holes in the valve plate (Item 2CC). They must also be tapped (with threads) to accept the valve plate screws (Item 4CC).
7. The butterfly valve (Item 3C) should be assembled by first placing the valve support rod (Item 3CC) through the hole in the valve body (Item 1CC). The valve plate (Item 2CC) should be dropped into one end of the valve body and then inserted into the flat area of the valve support rod. The two screws (Item 4CC) should be used to attach the valve plate to the support rod. Check to see that the assembled valve plate rotates freely and seats completely in the closed position.
8. A nut (Item 6CC) should be welded flat against one side of the throttle arm (Item 5CC) near its end. A 1/8-in. hole should be drilled into the side of the nut and must be threaded to accept the set screw (Item 7CC). At least one hole should be drilled into the throttle arm for attachment of the engine throttle control or air control linkages.

9. Place the nut (Item 6CC) on the throttle arm over the end of the valve support rod (Item 3CC) and use the set screw (Item 7CC) to secure the assembly. The throttle arm can be placed in any convenient orientation. Assembled butterfly valves are shown in Fig. 2-26.
10. The remaining parts of the carburetor assembly should be screwed together as shown in Fig. 2-27. Pipe thread compound should be used to make airtight connections. The assembled carburetor unit should be attached to the engine's intake manifold as shown in Fig. 2-28
11. This prototype gasifier was designed to operate if gasoline were unavailable; but, if dual operation on wood and gasoline is desired, the elbow (Item 2C) could be replaced with a tee, allowing a gasoline carburetor to also be mounted.
12. The arm on the butterfly valve (Item 3C) which is closest to the elbow (Item 2C) is to be connected to the foot- (or, on tractors, hand-) operated accelerator. The other butterfly valve is to be used as the air mixture control valve and can be operated with a manual choke cable. If the engine has an automatic choking device, then a hand-operated choke cable should be installed. Both butterfly valves and their connecting control linkages must operate smoothly with the ability to adjust the valve yet keep it stationary in the selected position during operation. The linkages must close the valves airtight when the engine is off.
13. The air inlet (Item 6C) should be connected by an extension hose or pipe, either iron or plastic, to the existing engine's air filter in order to prevent road dust or agricultural residue from entering the engine.
14. The wood gas inlet (Item 5C) is to be connected to the outlet piping (Item 10B as shown in Fig. 2-15) from the wood gas filter unit. Part of this connection should be a high-temperature rubber or neoprene hose to absorb engine vibration.

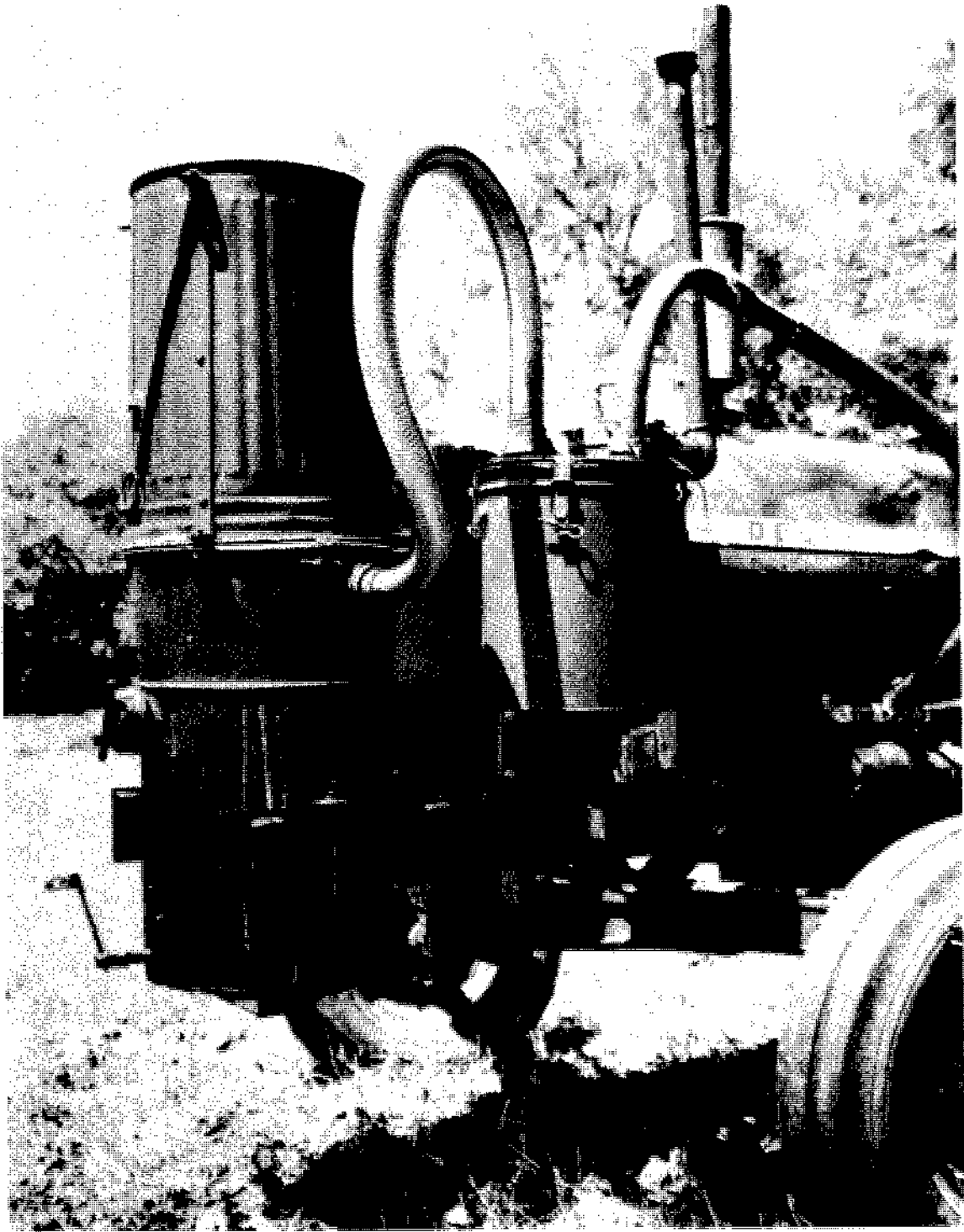

Fig. 2-1. The prototype wood gas generator unit mounted onto a tractor.

ORNL-DWG 87-145

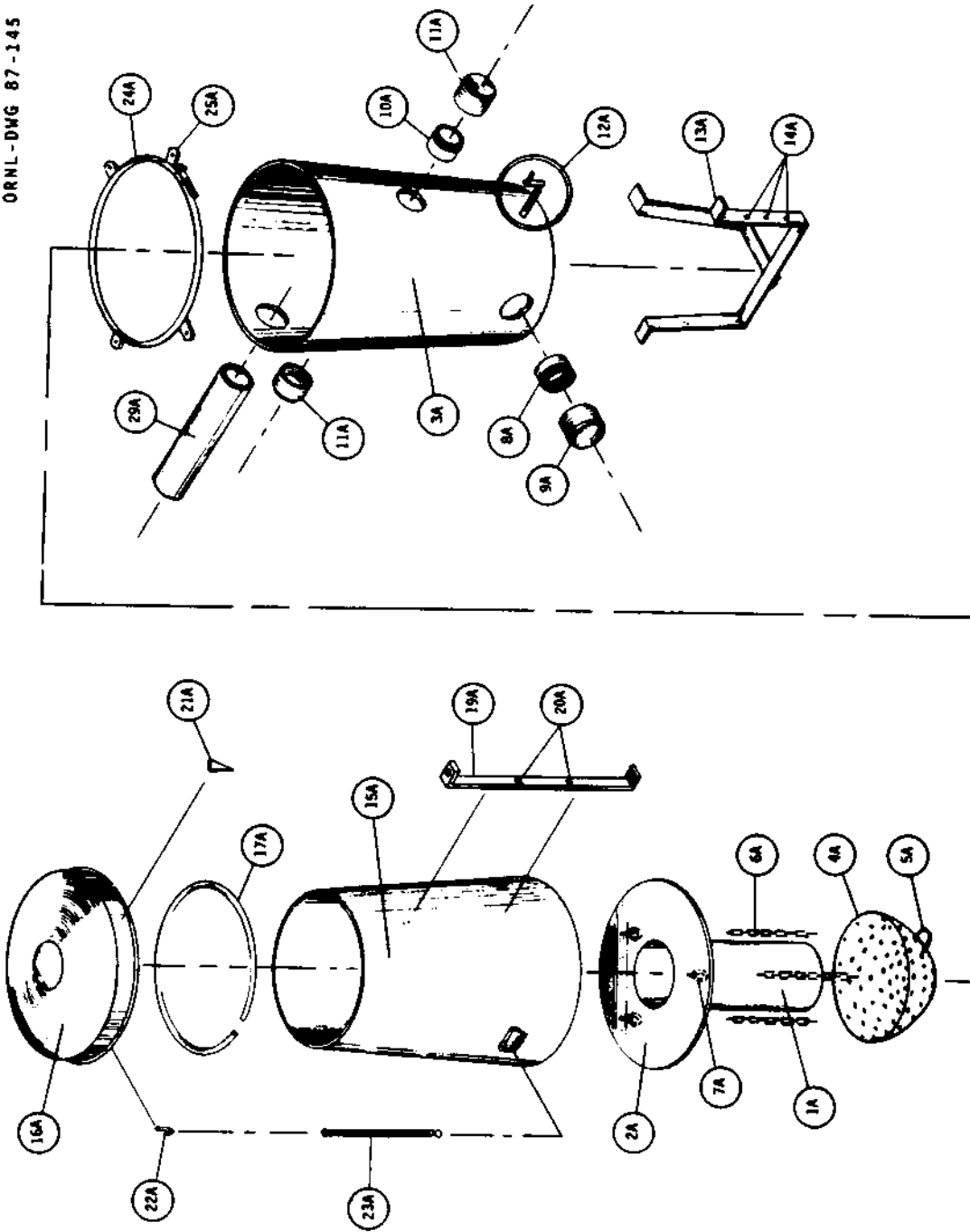

Fig. 2-2. Exploded, schematic diagram of the wood gas generator unit and the fuel hopper.

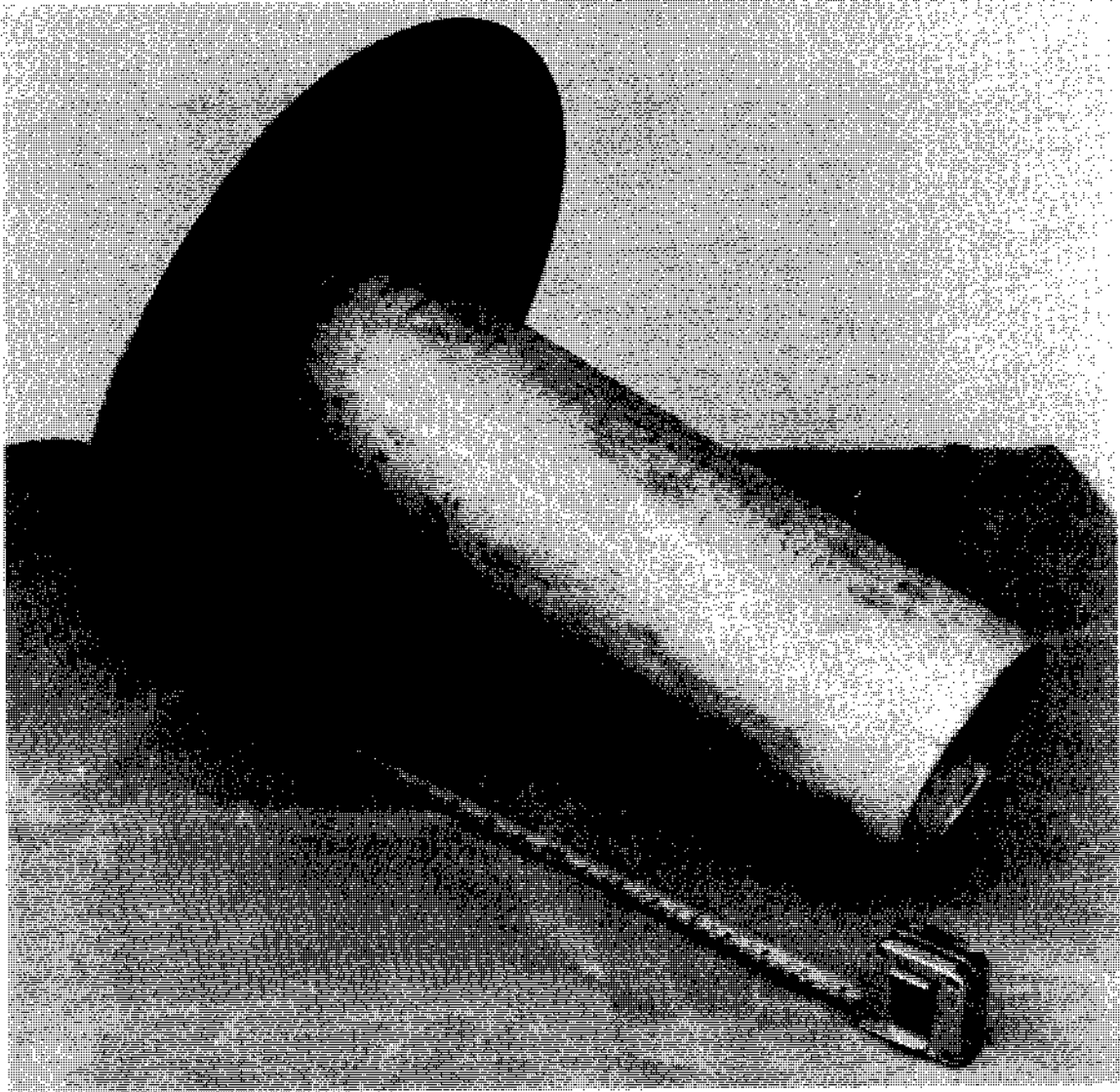

Fig. 2-3. The fire tube and circular top plate of the gasifier unit.



Fig. 2-4. Drilling holes into the stainless steel mixing bowl to be used for the grate. Note the U-bolt in the foreground.

ORNL-Photo 4473-87

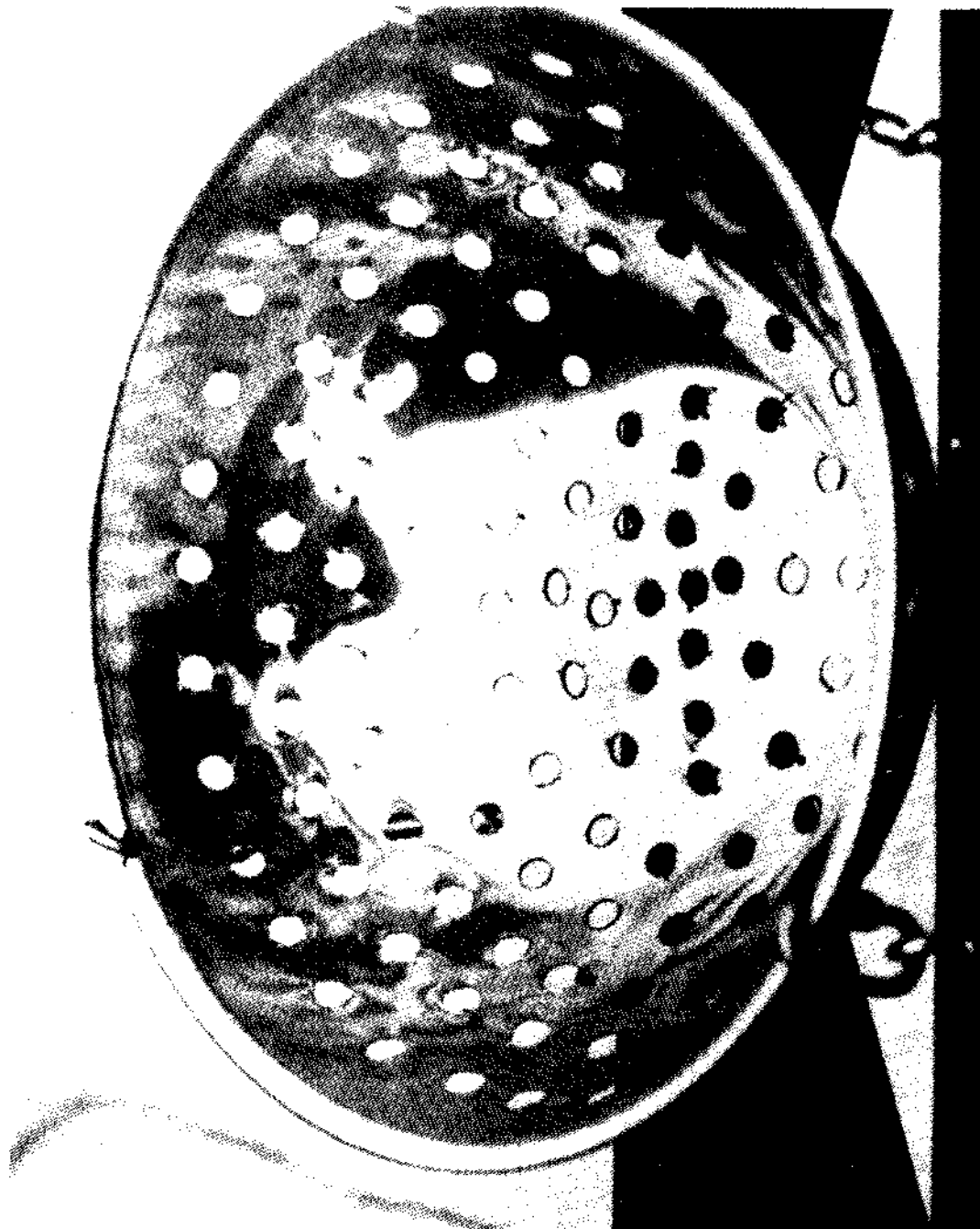

Fig. 2-5. Chains attached to the lip of the stainless steel mixing bowl.

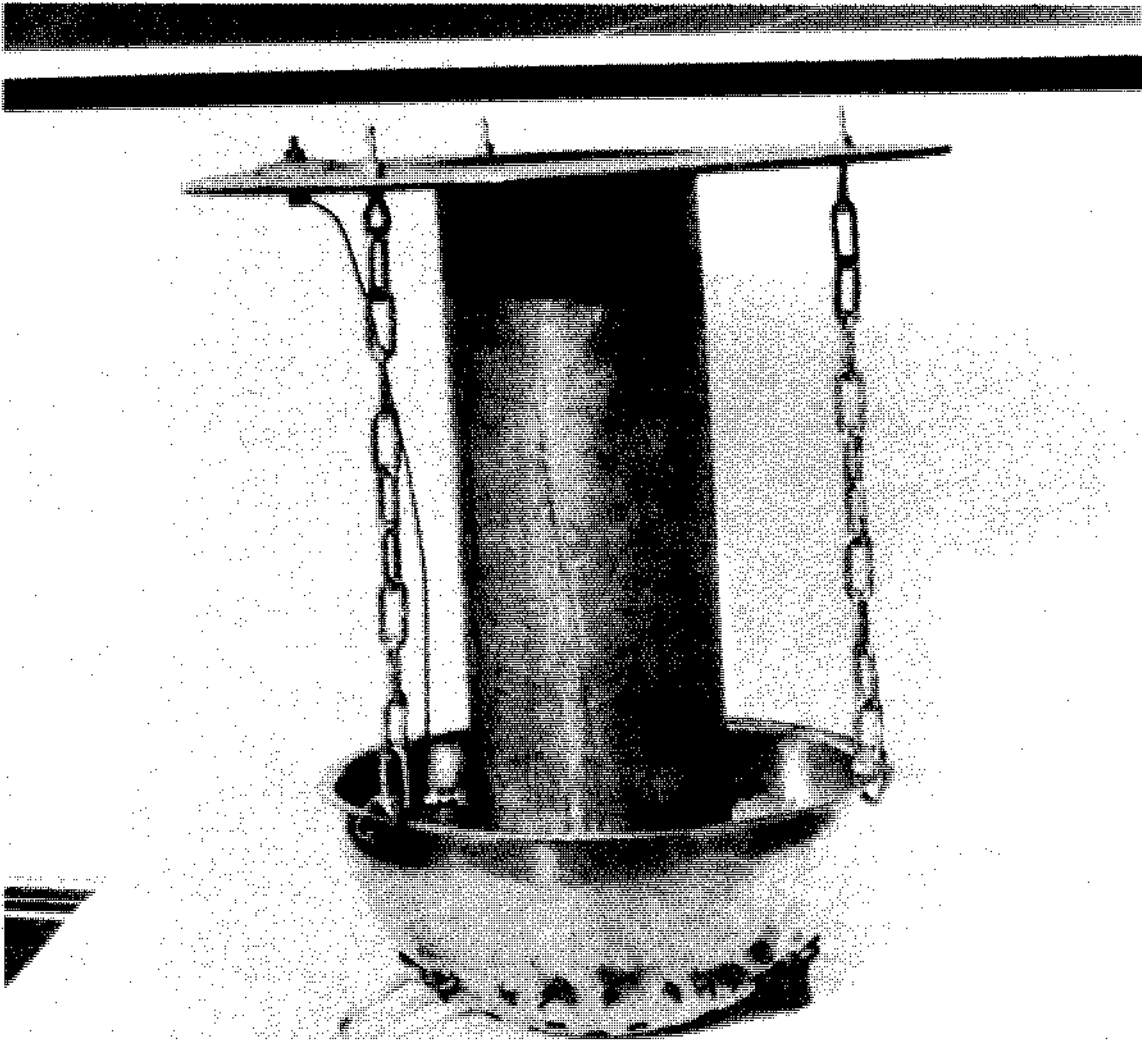

Fig. 2-6. Connect the mixing bowl to the top plate with chains. Note that the diesel ignitor "glow plugs" shown in this photograph were included for experimentation only; they were abandoned in the final prototype design.

ORNL - Photo 4529-87



Fig. 2-7. Braze, do not weld, the plumbing fittings to the thin walled drums.

ORNL-DWG 87-14555

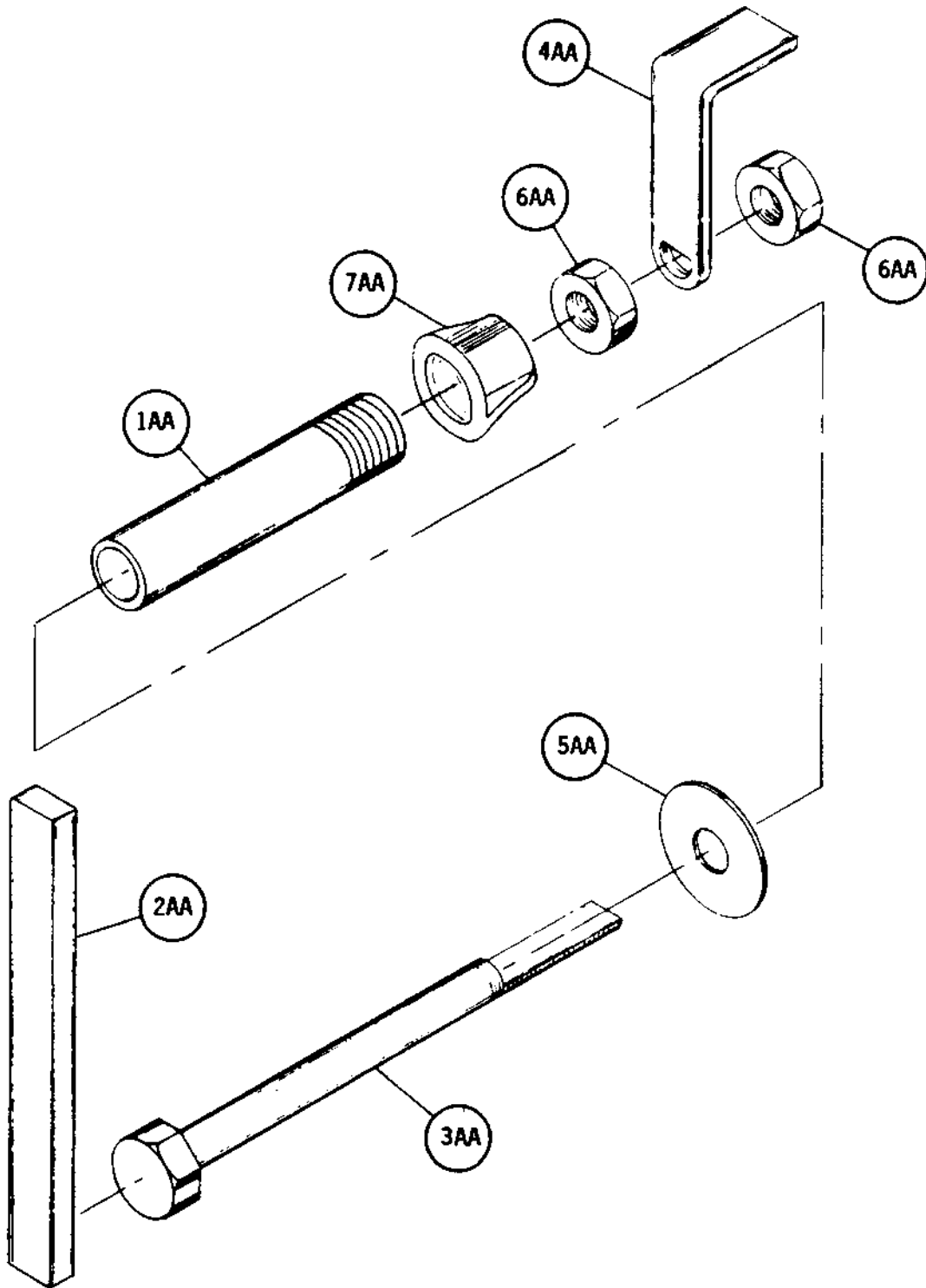

Fig. 2-8. Exploded, schematic diagram of the grate shaking mechanism.

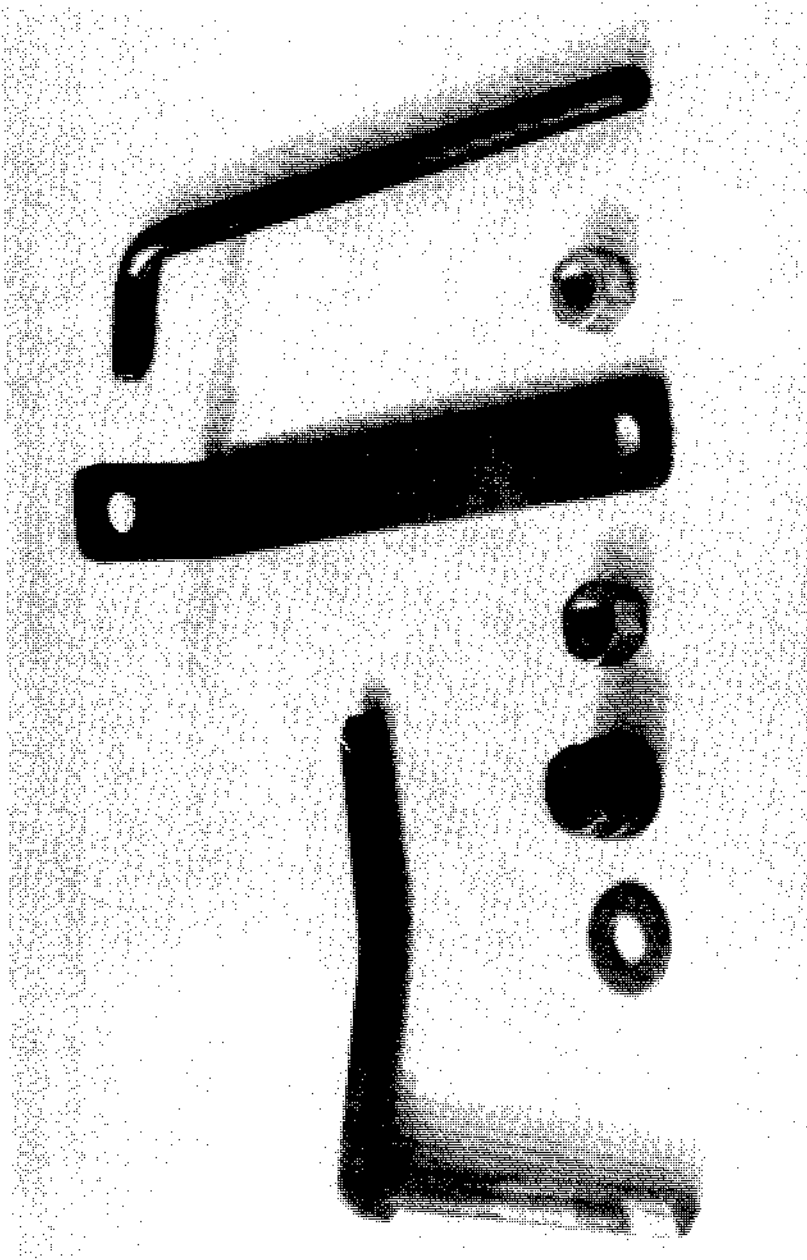

Fig. 2-9. Parts for the shaker assembly. Note the flattened portion of the bolt (at extreme left) which positively locks into the handle (third from right). At the extreme right is a "poker bar" which engages into the hole in the top of the handle to operate the shaker mechanism; the shaker handle will get very hot during normal gasifier operation.

ORNL-Photo 4527-87

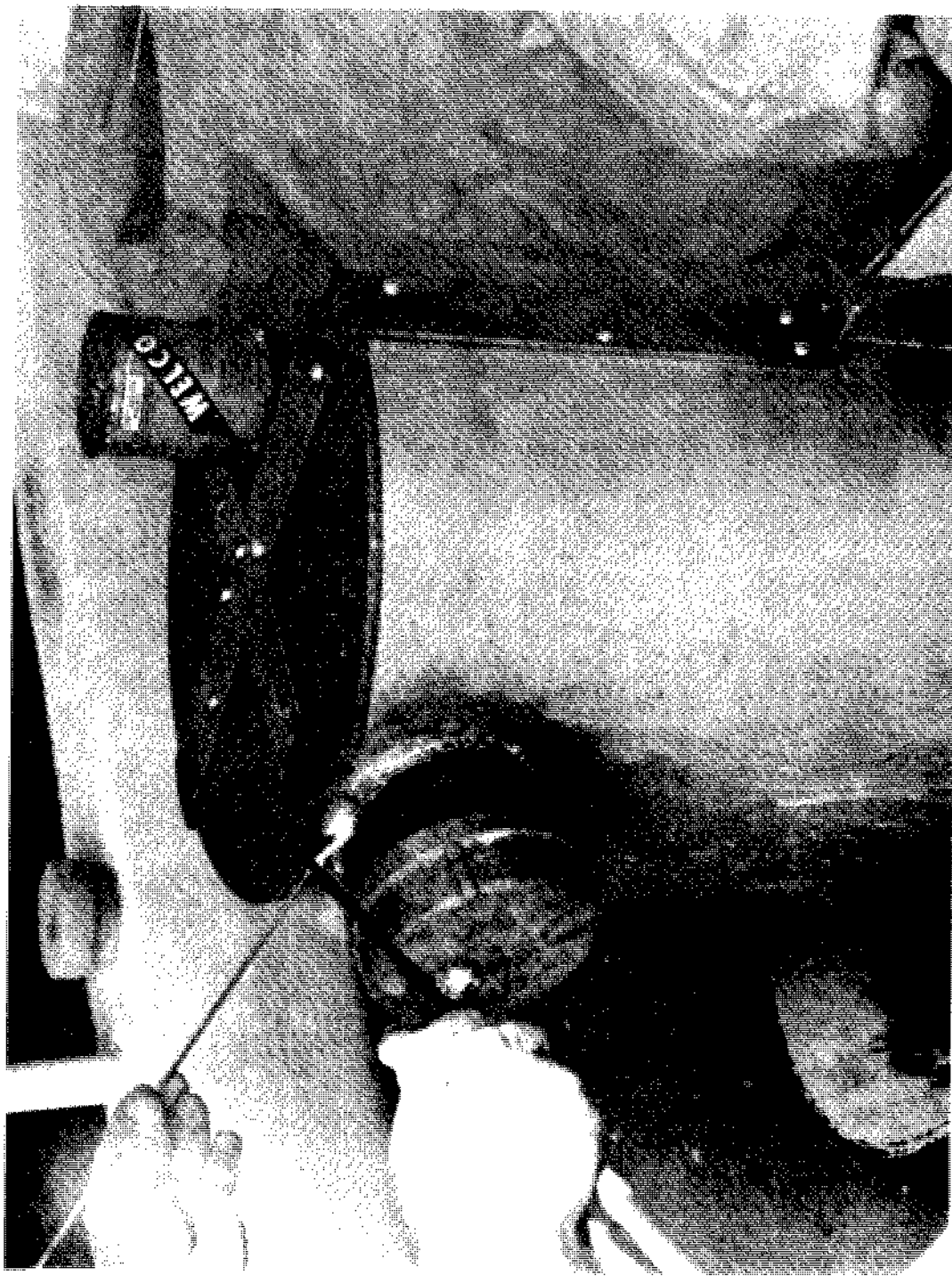

Fig. 2-10. The support frame can be brazed or bolted to the side of the gasifier unit. All bolts should be sealed air tight.

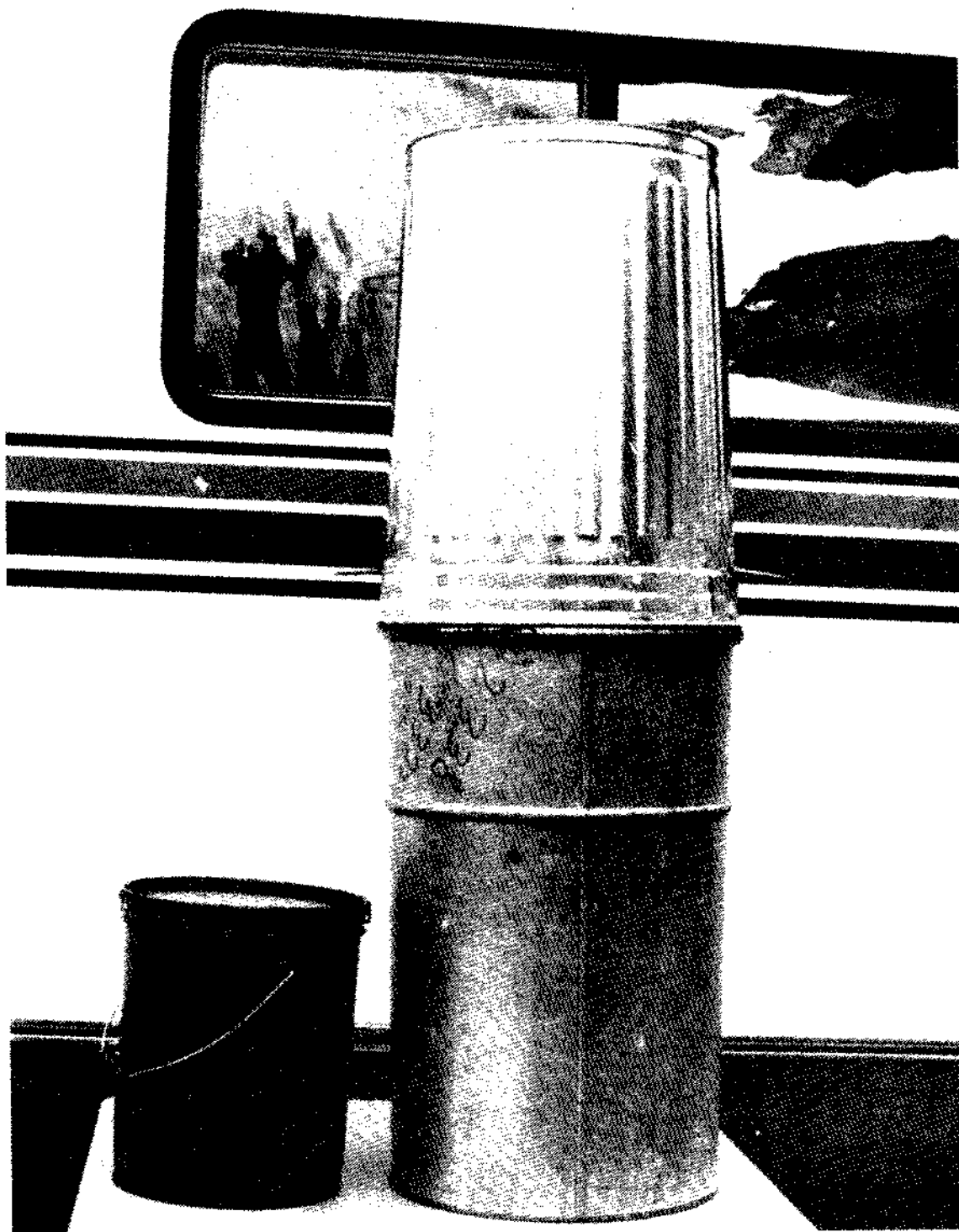

Fig. 2-11. Containers used in constructing the prototype gasifier unit. At right, a 20-gal garbage can (the fuel hopper) is shown on top of a 30-gal metal drum (the gasifier unit housing). The 5-gal paint can, at left, is used as the filter container.

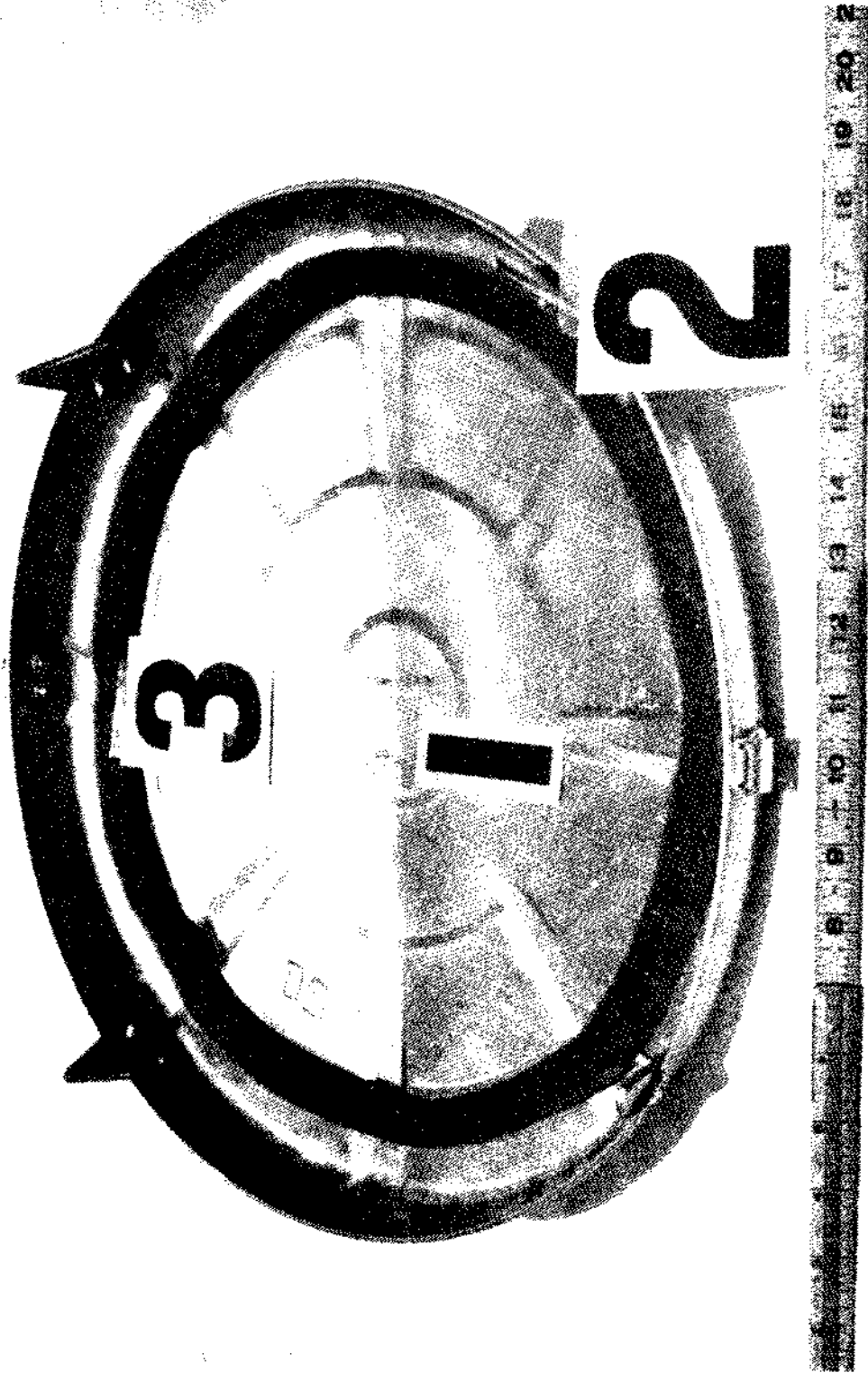

Fig. 2-12. Cover for the fuel hopper. Note the foam weatherstripping (#3) attached to the underside of the lid where it contacts the fuel hopper. Attach four standoffs (#2) to the lid (#1) as shown.

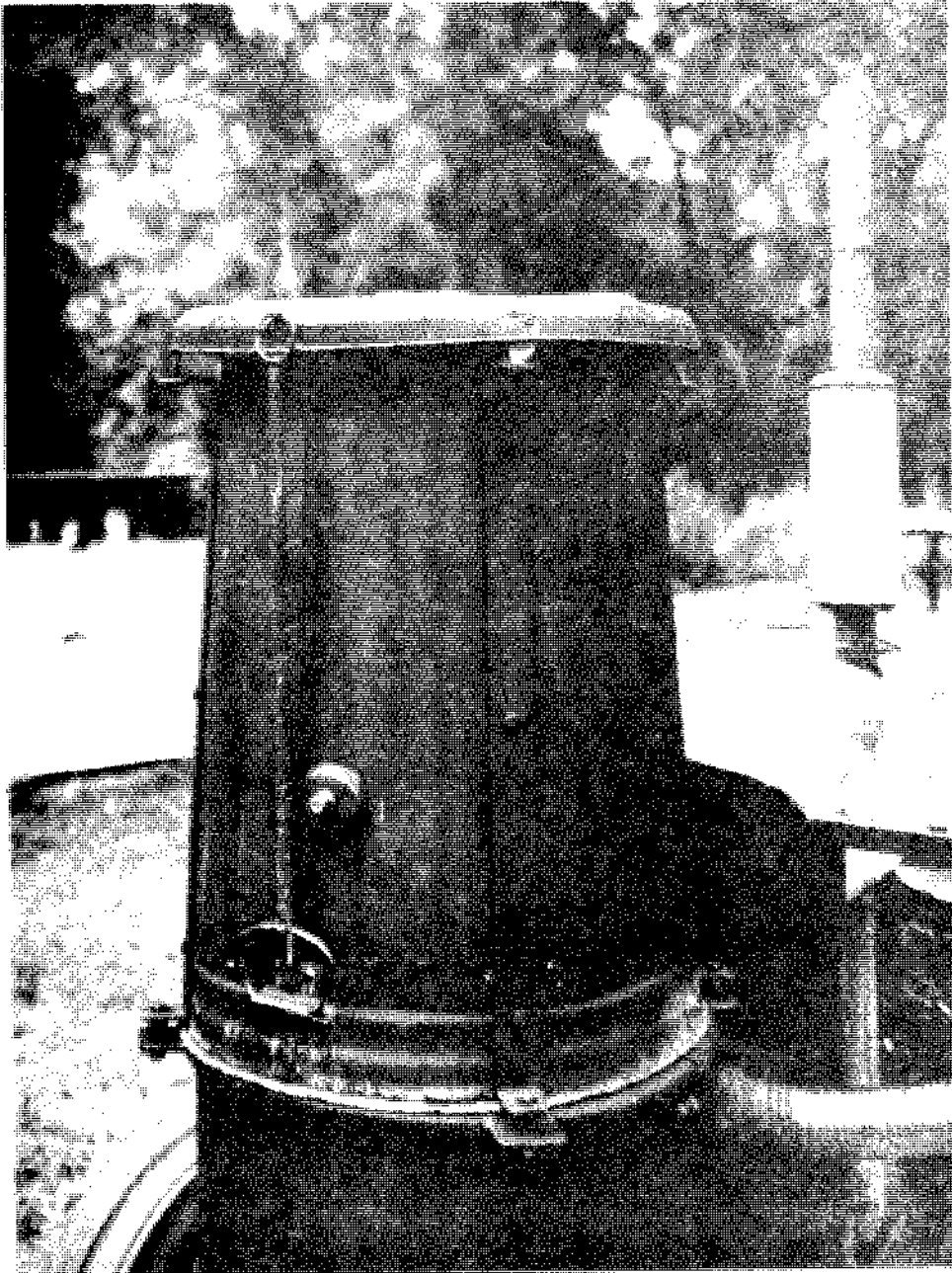

Fig. 2-13. Operating configuration of the fuel hopper and its cover.

ORNL-Photo 4506-87

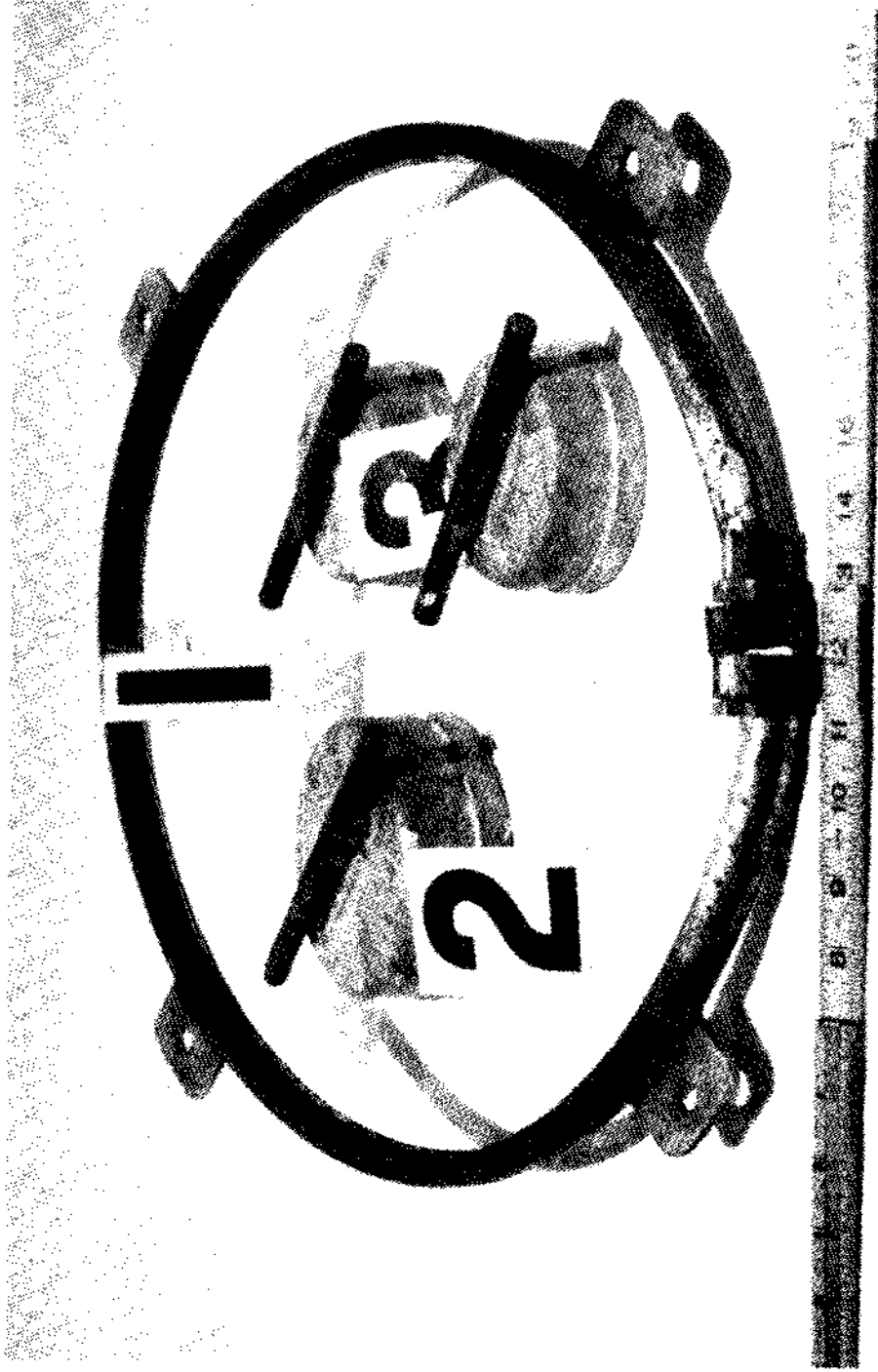

Fig. 2-14. Lock ring and welded tabs. Also pictured inside the lock ring (#1): the ash cleanout cover cap (#2), and the ignition cover cap (#3).

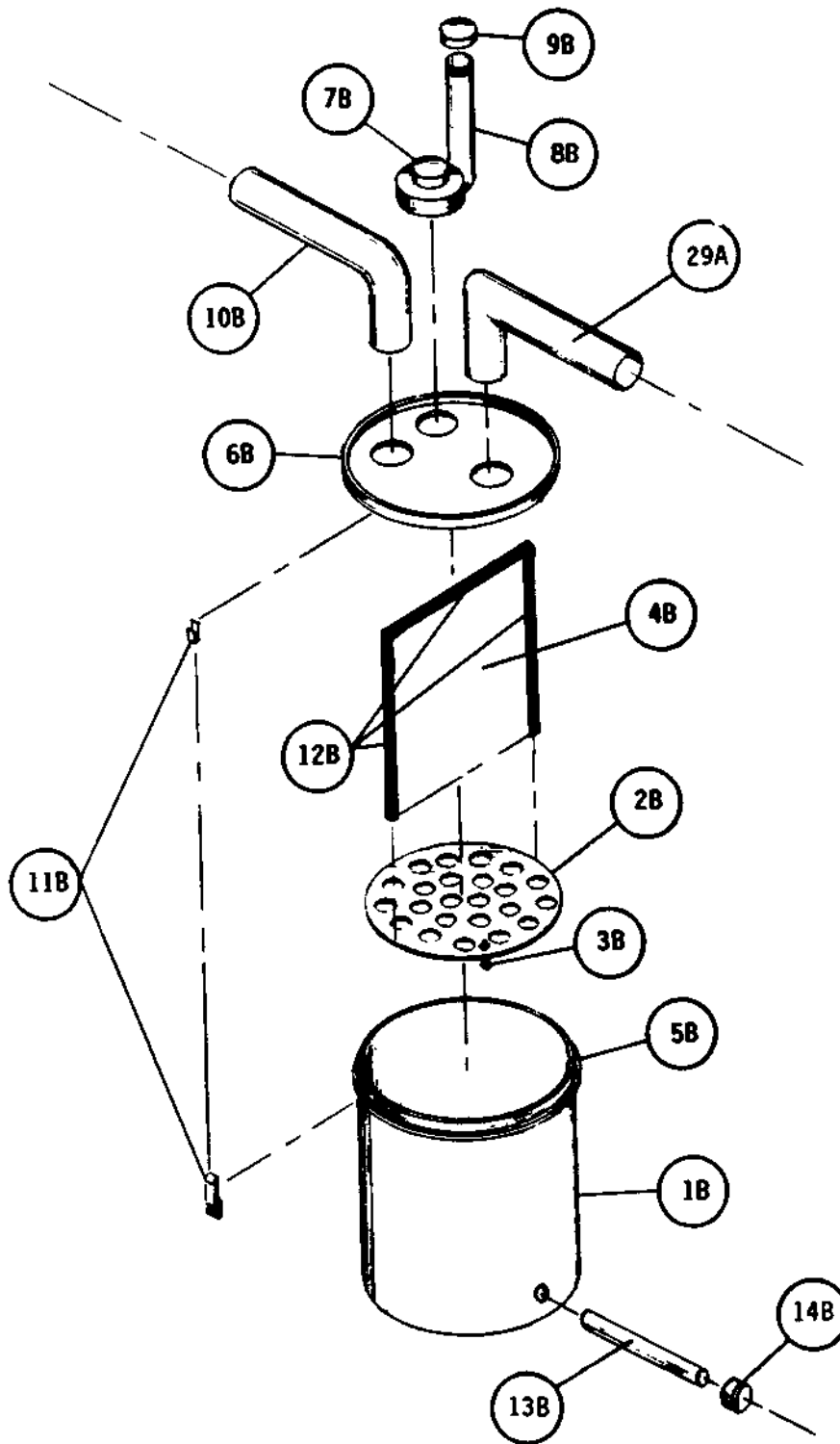

Fig. 2-15. Exploded, schematic diagram of the filter unit.

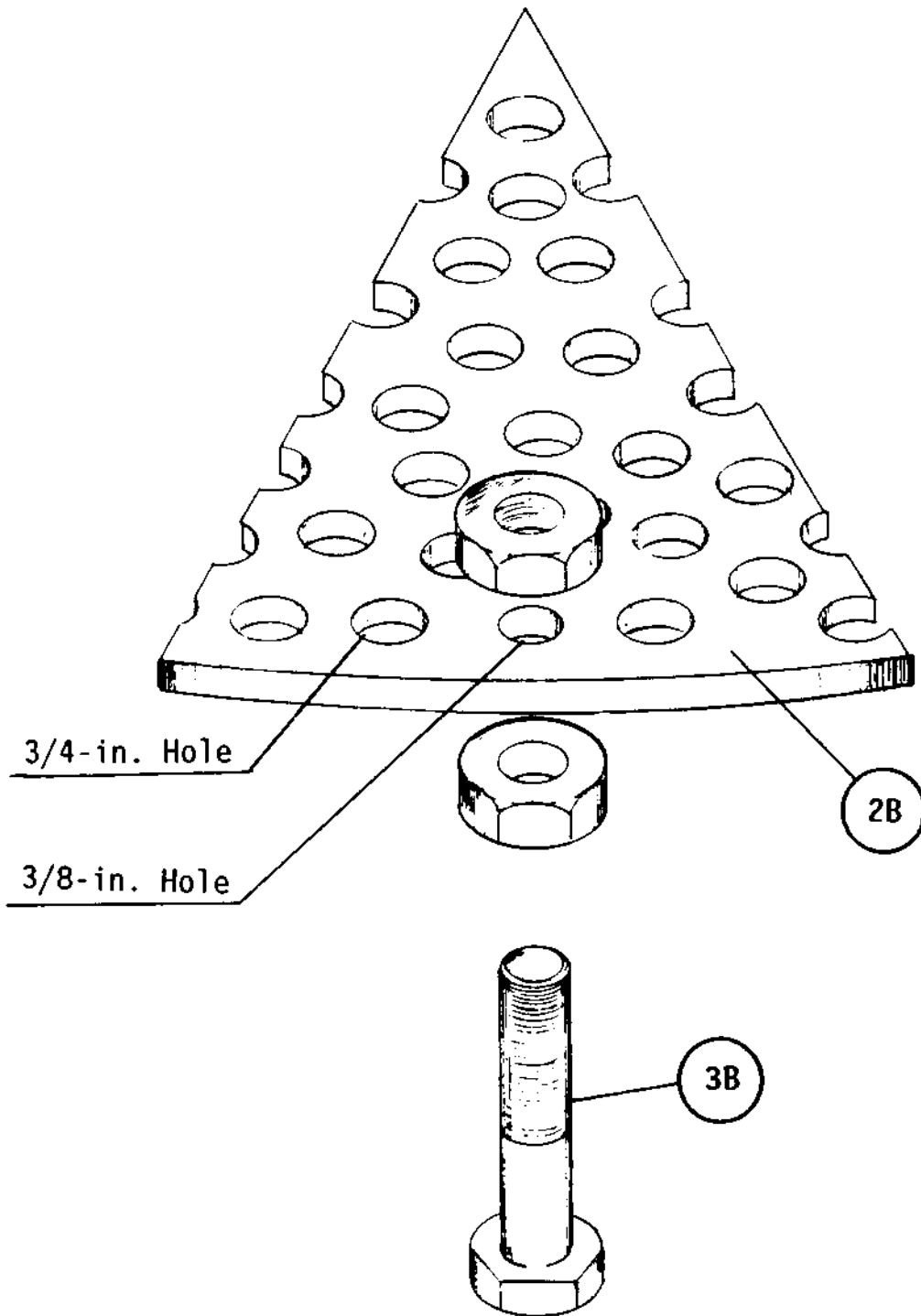

Fig. 2-16. Detail of the standoffs for the bottom plate of the filter unit.

ORNL-Photo 4519-87

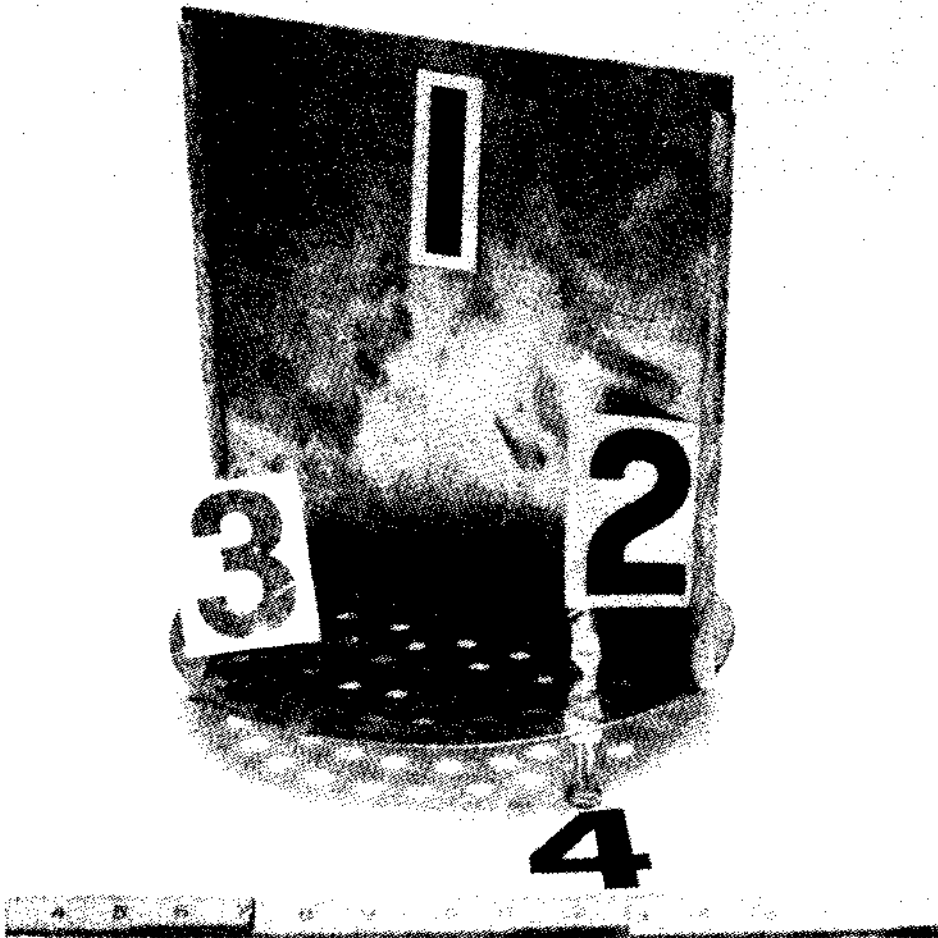

Fig. 2-17. Divider plate (#1) and bottom plate (#3), with standoffs (#4), for the filter unit. Note the high-temperature hose lining the sides of the divider plate.

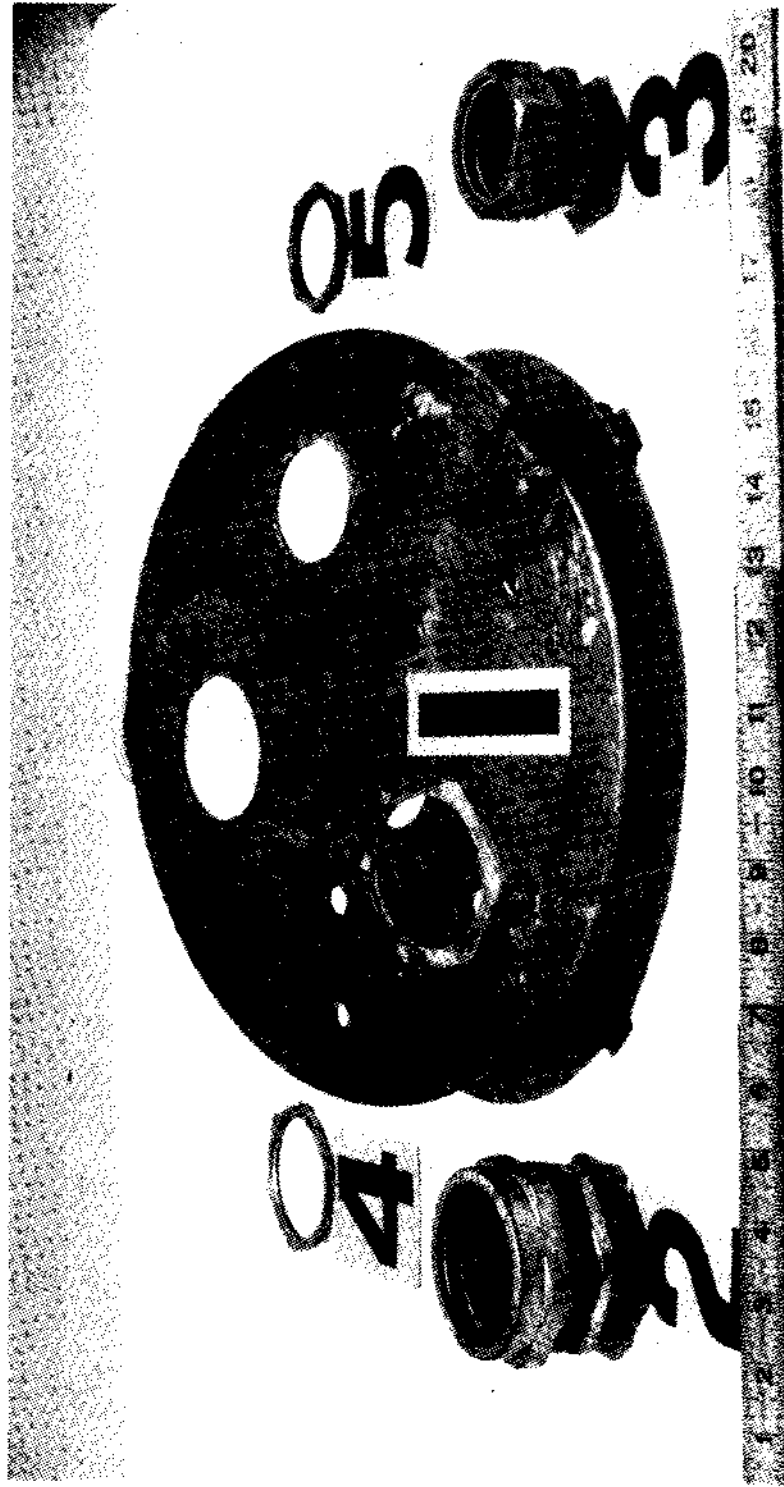

Fig. 2-18. Circular lid (#1) for the filter unit. Note the arrangement of the holes; divider plate would roughly run from 10 o'clock position to 4 o'clock position (assuming 12 o'clock is taken to be at the rear of the photograph). Also shown are the conduit connectors (#2 and #3) and accompanying nuts (#4 and #5) for inside the lid.

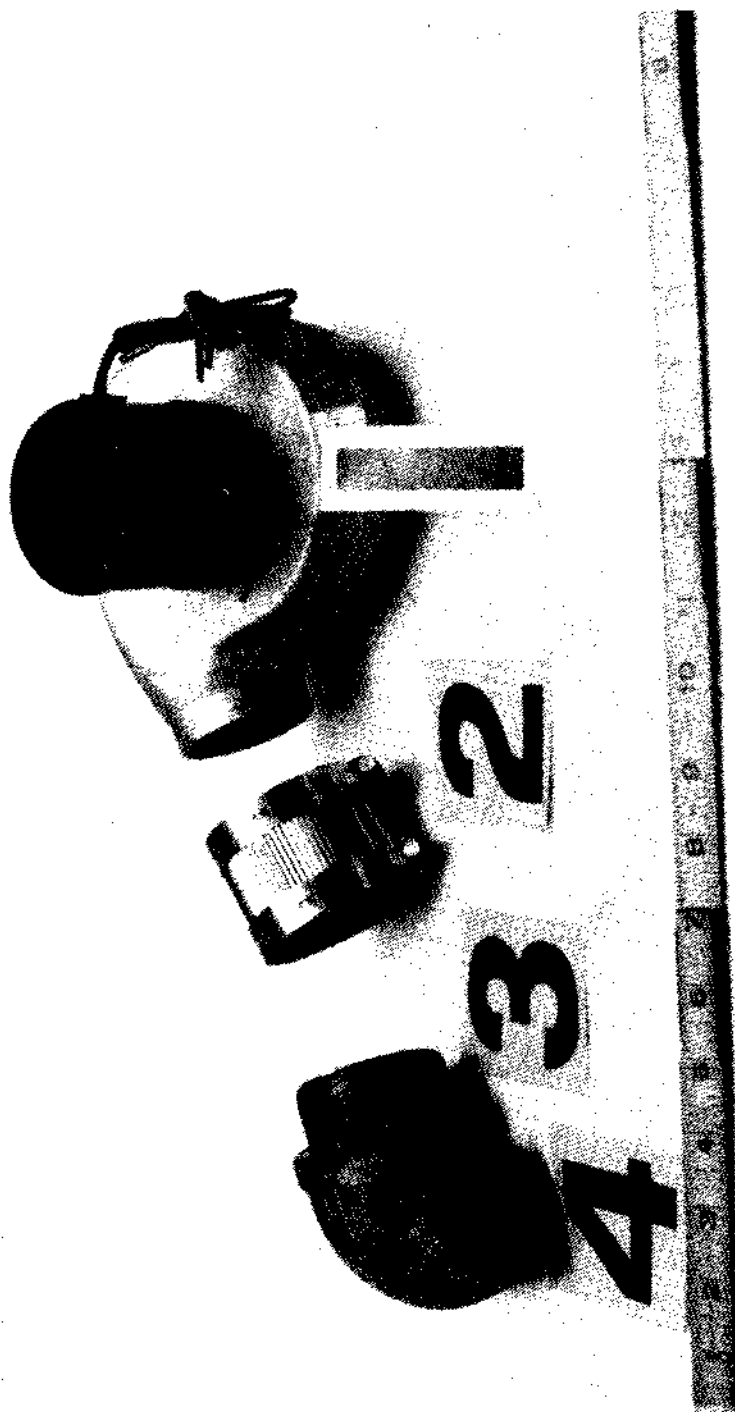

Fig. 2-19. Blower (#1) with exhaust extension assembly. Note adapter coupling (#2), pipe nipple (#3), and elbow (#4) for vertical exhaust pipe.

ORNL-Photo 4512-87

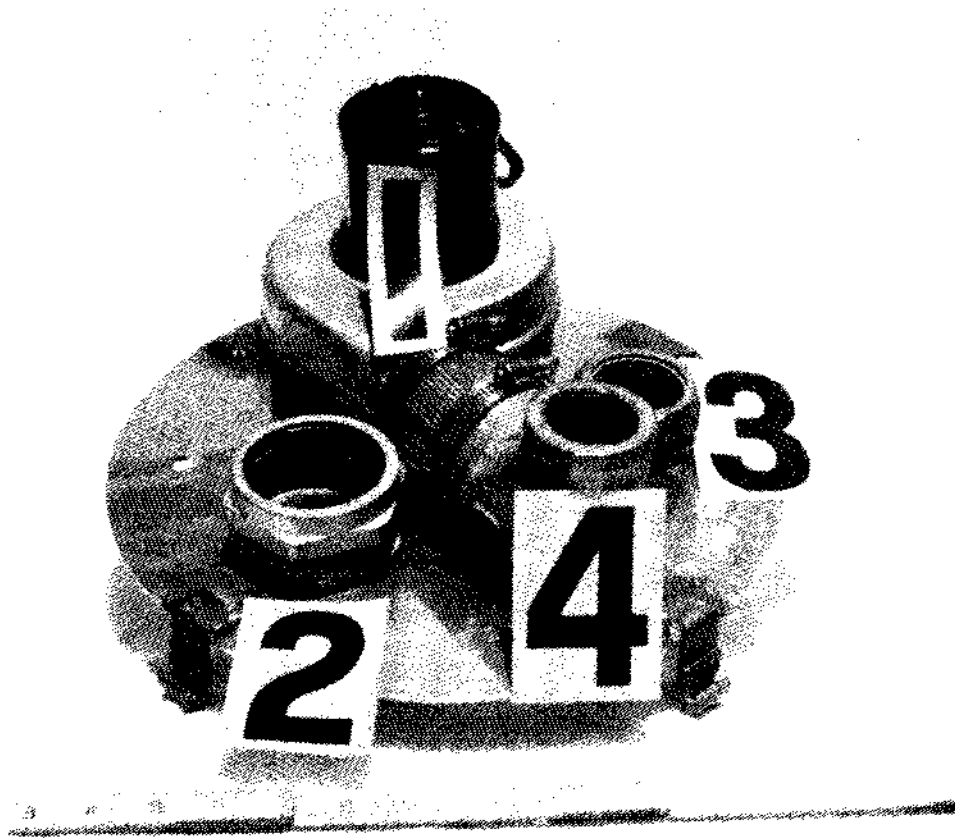

Fig. 2-20. Assembled and installed blower (#1), extension assembly (#4), and conduit connectors for gas inlet (#2) and outlet (#3) on lid of filter unit. Note hook attachments at edge of lid for latches.

ORNL-Photo 4517-87



Fig. 2-21. Filter container (#1) showing latches (#2) for lid and hose (#3) around top.

ORNL-DWG 87-14558

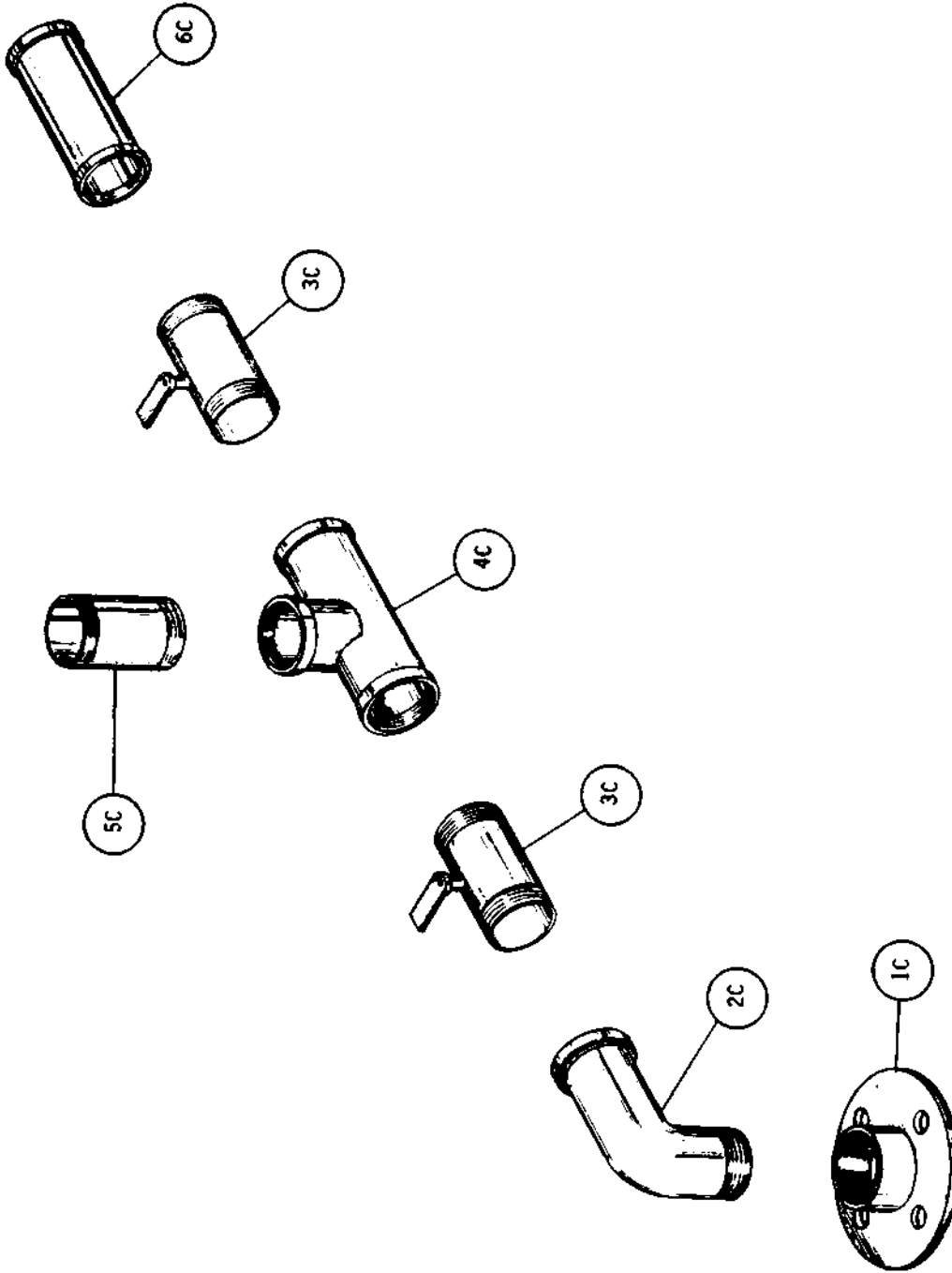

Fig. 2-22. Exploded, schematic diagram of the carburecing unit and control valves.

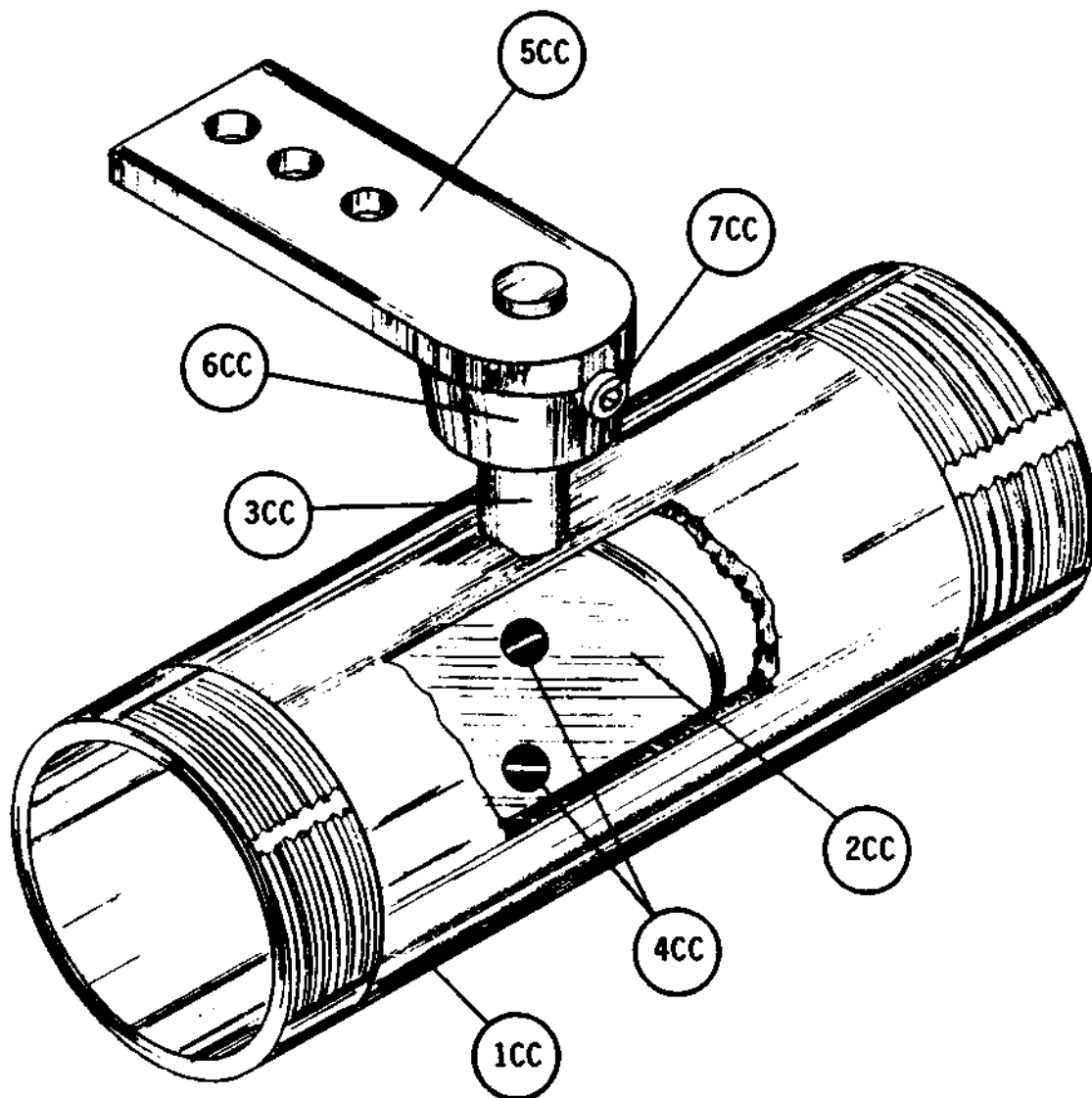

Fig. 2-23. Schematic diagram of a butterfly control valve.

ORNL - Photo 4484 - 87

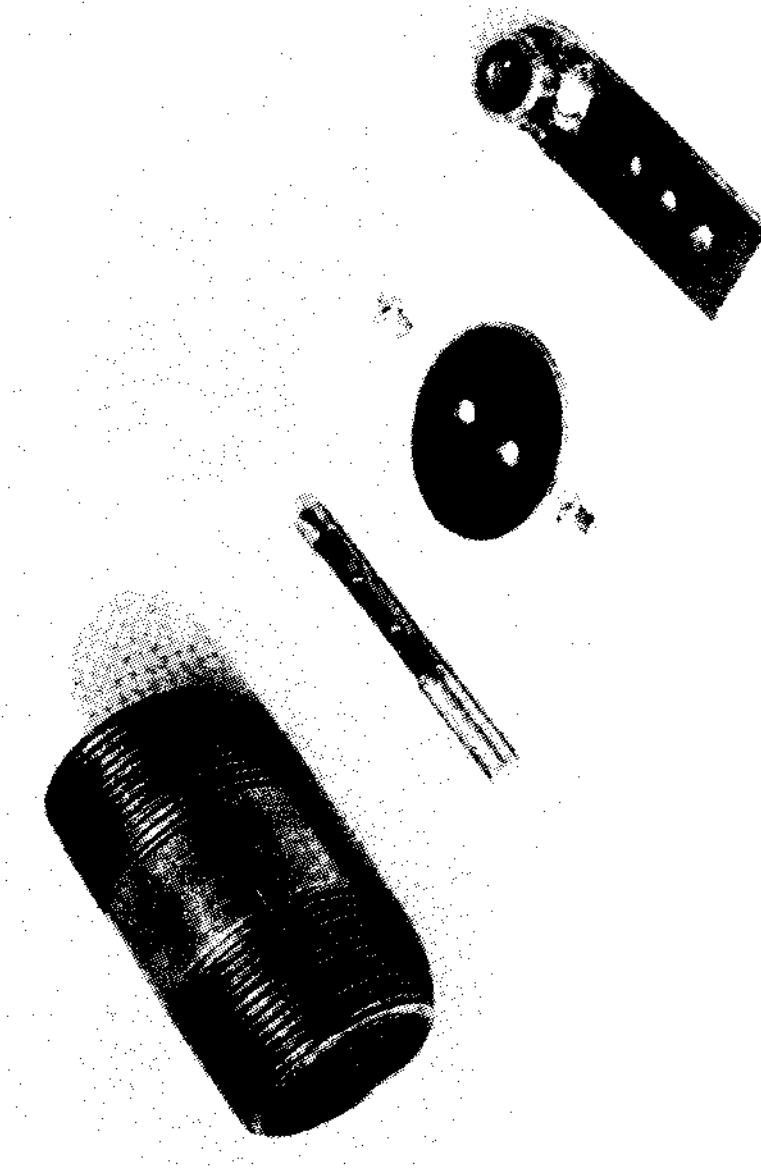

Fig. 2-24. Parts required for the butterfly valve.

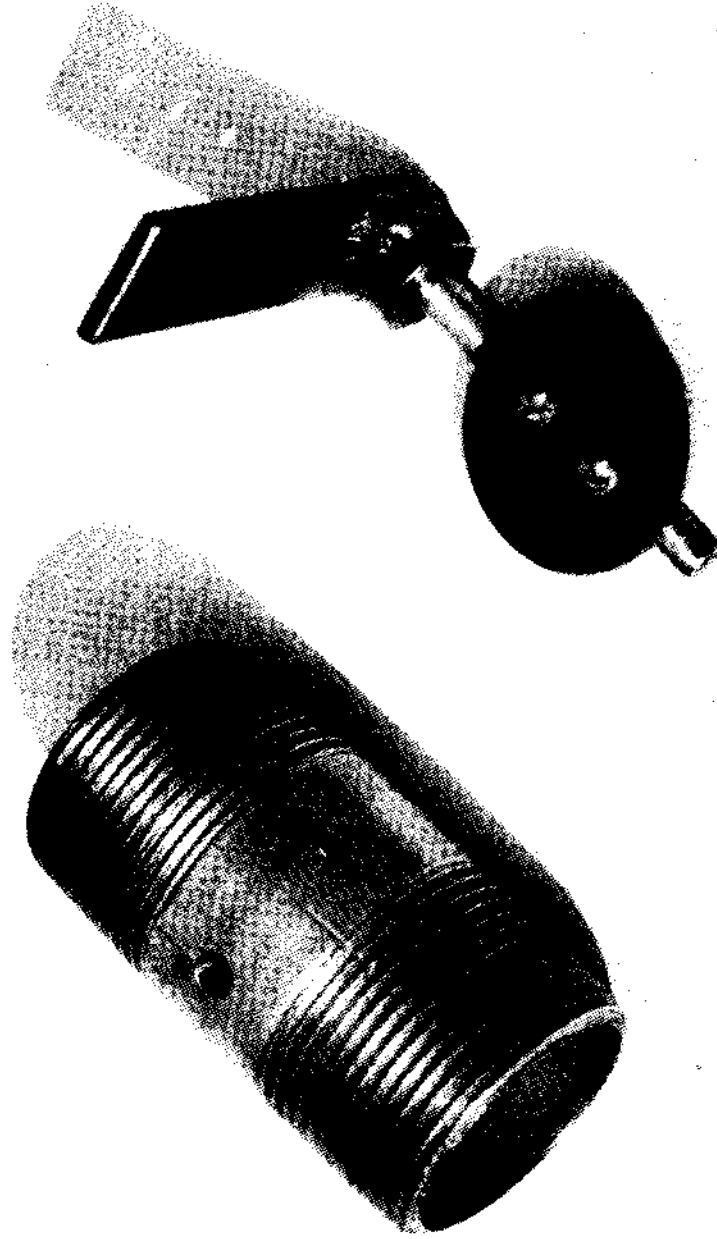

Fig. 2-25. Butterfly valve assembly. Note that the valve has been assembled outside of the valve body for clarity.

ORNL-Photo 4487-87

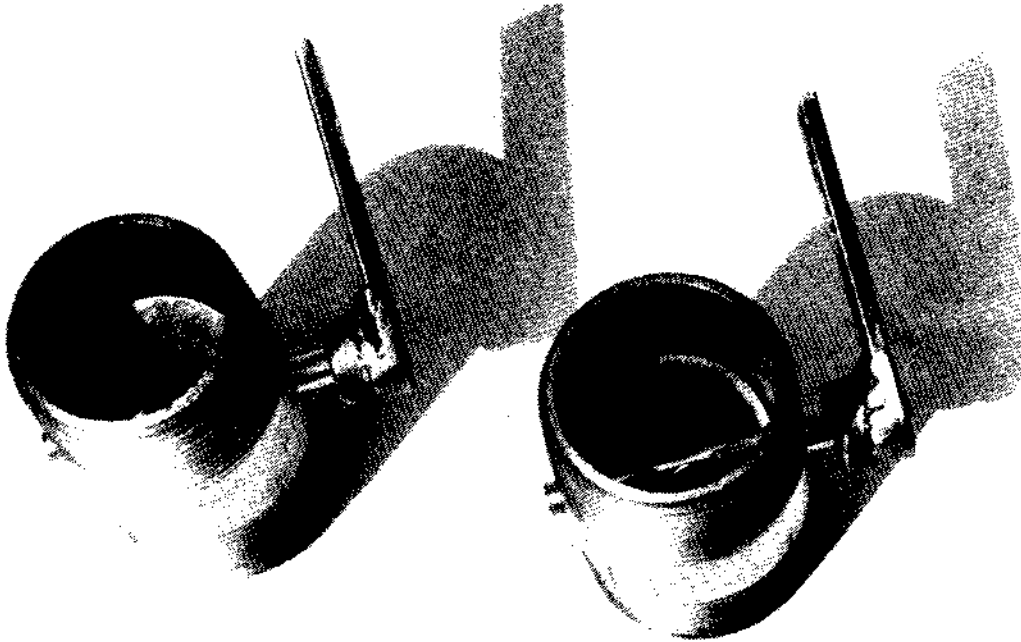

Fig. 2-26. Assembled butterfly valves.

ORNL-Photo 4490-87

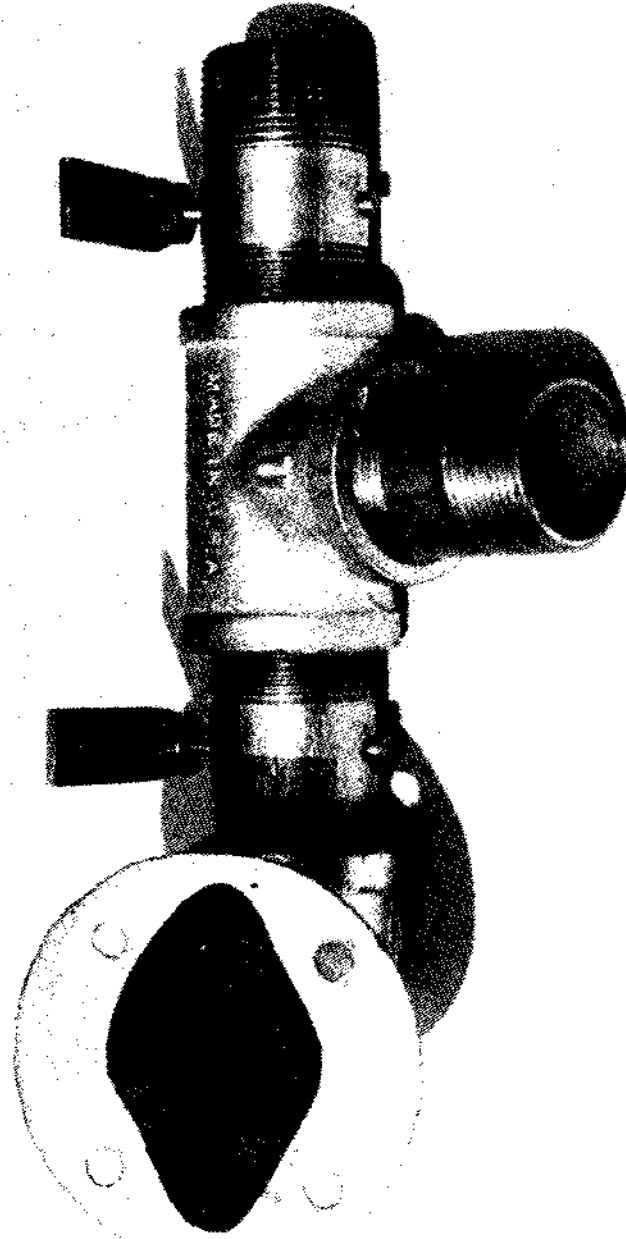

Fig. 2-27. Assembled carburetion unit. Note the gasket on the closet flange.

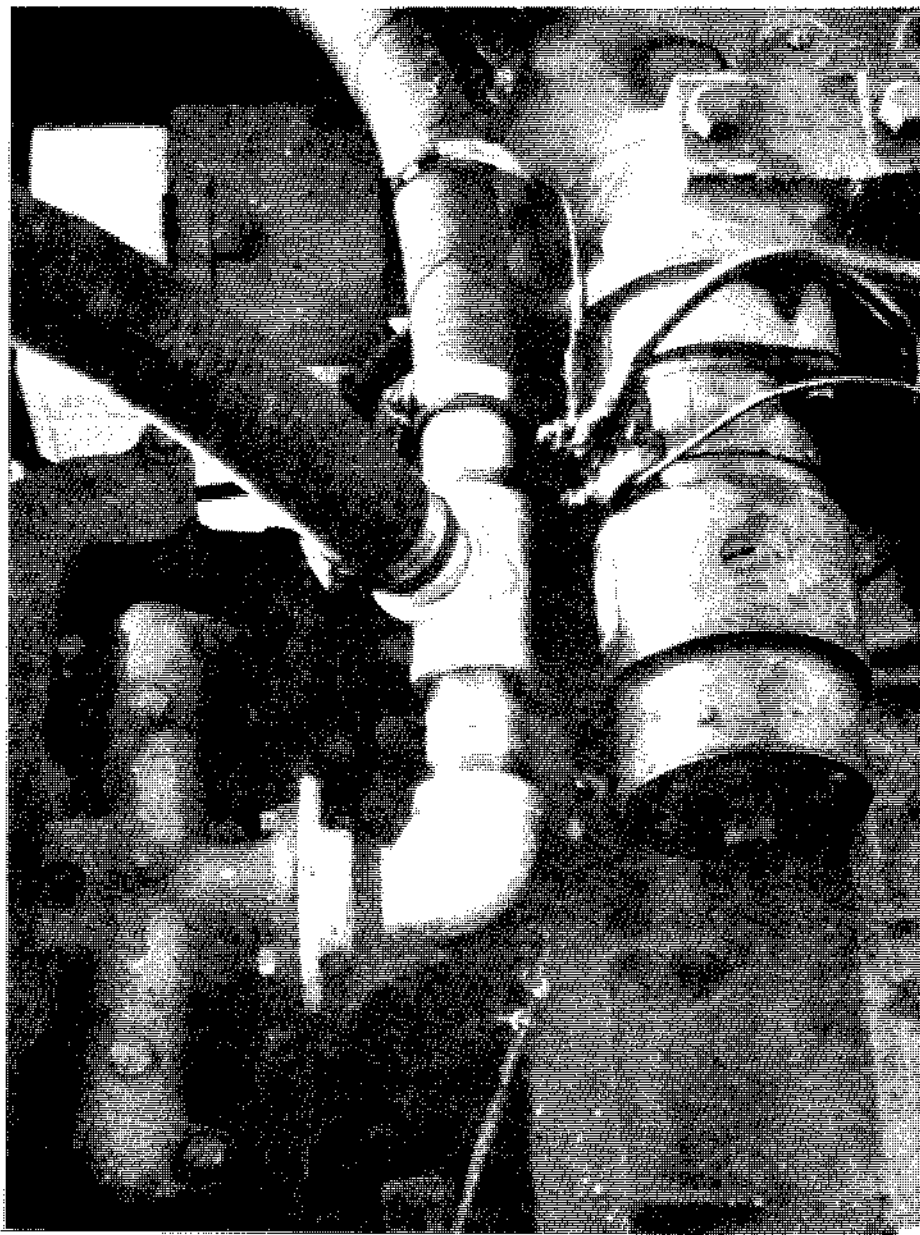

Fig. 2-28. Carburetion unit attached to engine's existing intake manifold. Wood gas enters from the side of the tee; air enters from the right-hand end. The butterfly valve at the right (partially obscured) is connected to the air control (choke) cable; the left valve is connected to the throttle linkage.

Table 2-1. List of materials for the gasifier unit and the wood fuel hopper

Item	Quantity	Description
1A	1	Metal pipe, tube, or other, open-ended metal cylinder; diameter and length from Table 2-2; minimum wall thickness of 1/4 in.
2A	1	Circular metal plate with thickness of 1/8 in.; diameter equal to outside diameter of Item 1A.
3A	1	30-gal metal oil drum or metal container with approximate dimensions of 18 in. (diameter) by 29 in. (height); container must have a bottom.
4A	1	10-quart stainless steel mixing bowl, colander, or other stainless steel bowl with approximately 14-in. diameter and 6-in. depth.
5A	1	2-in. metal U-bolt.
6A	1	3/16-in. metal chain with 1-in. links; 7 ft total length.
7A	3	1/4-in. eyebolts, 3 in. length with two nuts for each eyebolt.
8A	1	4-in. metal pipe nipple.
9A	1	Metal pipe cap for Item 8A.
10A	2	3-in. metal pipe nipple.
11A	2	Metal pipe cap for Item 10A.
12A		Shaker assembly; see Fig. 2-8.
1AA	1	Metal 1/2-in. pipe; 6 in. length.
2AA	1	Iron bar stock; square or round, 1/2 in.; 6 in. length.
3AA	1	1/2-in. bolt; 8 in. long.
4AA	1	Iron bar stock; rectangular, 1/4 by 1 in.; 10 in. length.
5AA	1	1/2-in. flat washer.
6AA	2	1/2-in. nuts.
7AA	1	Metal pipe cap or bushing for Item 1AA.

Table 2-1. (continued)

Item	Quantity	Description
13A	1	Iron bar stock; rectangular, 1/4 by 2 in.; 10 ft length.
14A	25	1/4-in. bolts; 3/4 in. length; with nuts.
15A	1	20-gal metal garbage can or metal container with approximate dimensions of 18 in. (top diameter) by 24 in. (height); bottom is not required.
16A	1	Lid for 20-gal garbage can.
17A	1	Garden hose; 1/2 to 5/8 in. diameter; length equal to circumference of Item 15A.
18A	1	Foam weather stripping with adhesive backing; 1/4 by 1 in.; length equal to circumference of Item 15A.
19A	1	Iron bar stock; rectangular, 1/4 by 2 in.; 10 ft length.
20A	12	1/4-in. bolts; 3/4 in. length; with nuts.
21A	4	Metal triangles; 2 by 2.5 in., 1/8 to 1/4 in. thick.
22A	2	Metal eye hook.
23A	2	Screen door spring, 14 in. length.
24A	1	Lock ring for 30-gal (or larger) oil drum.
25A	4	Metal squares; 2 by 2 in., 1/4 in. thick.
26A	4	3/8-in. bolts; 3 in. length.
27A	1	Tube of high temperature silicone or liquid high temperature gasket material.
28A	1	60-lb. sack of hydraulic or other waterproof cement [such as SEC-PLUG (tm), which is manufactured by the Atlas Chemical Company, Miami, FL].
29A	1	2-in. pipe, electrical conduit, flexible automobile exhaust pipe, or other metal tubing; 6-ft minimum length. Pipe must be able to withstand temperatures of 400°F.

Table 2-2. Fire tube dimensions

Inside diameter (inches)	Minimum length (inches)	Engine power (horsepower)	Typical engine displacement (cubic inches)
2 ^a	16	5	10
4 ^a	16	15	30
6	16	30	60
7	18	40	80
8	20	50	100
9	22	65	130
10	24	80	160
11	26	100	200
12	28	120	240
13	30	140	280
14	32	160	320

^aA fire tube with an inside diameter of less than 6¹/₂ in. would create bridging problems with wood chips and blocks. If the engine is rated at or below 15 horsepower, use a 6-in. minimum fire tube diameter and create a throat restriction in the bottom of the tube corresponding to the diameter entered in the above table.

NOTES:

For engines with displacement rated in liters, the conversion factor is 1 liter = 61.02 cubic inches.

The horsepower listed above is the SAE net brake horsepower as measured at the rear of the transmission with standard accessories operating. Since the figures vary when a given engine is installed and used for different purposes, such figures are representative rather than exact. The above horsepower ratings are given at the engine's highest operating speed.

Table 2-3. List of materials for the primary filter unit

Item	Quantity	Description
1B	1	5-gal metal can or other metal container with minimum dimensions of 11.5-in. diameter and 13 in. tall.
2B	1	Circular metal plate; diameter equal to 1/2 in. smaller than inside diameter of Item 1B; thickness of 1/8 in.
3B	3	3/8-in. bolts; 3 in. length with two nuts for each bolt.
4B	1	Rectangular metal plate; width equal to 1/4 in. smaller than inside diameter of Item 1B; height equal to 2.5 in. smaller than internal height of Item 1B; 1/8 in. thick.
5B	1	High-temperature hose, 3/8 to 5/8 in. diameter; length equal to circumference of Item 1B.
6B	1	Circular metal plate; diameter equal to outside diameter of Item 1B; thickness of 1/8 in.
7B	1	12-volt blower (automotive heater type); case and fan must be all metal.
8B	1	Metal extension pipe for blower outlet, including elbows and connections for vertical orientation; 1 ft. minimum length.
9B	1	Cap for Item 8B; plastic is acceptable.
10B	1	1.25-in. metal pipe, electrical conduit, automotive exhaust pipe, or other metal tubing; 2 ft minimum length.
11B	3	Metal latch for securely connecting Items 1B and 6B together. Such devices as suitcase or luggage catches, bail-type latches, window sash catches (with strike), or wing-nut latches are acceptable.
12B	1	High-temperature hose, 3/8 to 5/8 in. diameter; length equal to three times the height of Item 4B.
13B	1	Metal 1/2-in. pipe, threaded on one end; 8 in. length.
14B	1	Metal pipe cap for Item 13B.

Table 2-4. List of materials for the carbureting unit

Item	Quantity	Description
1C	1	1.25-in. closet flange.
2C	1	1.25-in. male-to-female 45° pipe elbow.
3C		Butterfly valve; see Fig. 2-23.
1CC	2	1.25-in. pipe nipple or threaded length of pipe, 3-in. length.
2CC	2	Oval metal plate; 1/16 in. thick; short dimension equal to inside diameter of Item 1CC; long dimension equal to 1.02 times the short dimension.
3CC	2	3/8-in. diameter rod; 2.5 in. length.
4CC	4	3/16-in. screws; 3/16 in. length.
5CC	2	Flat bar stock; rectangular, 1/2 by 3 in.; 1/8 in. thick.
6CC	1	7/16-in. nut.
7CC	1	1/8-in. set screw.
4C	1	1.25-in. tee with all female threads.
5C	1	1.25-in. pipe nipple or threaded length of pipe, 3 in. length.
6C	1	1.25-in. pipe or hose.
7C	1	Gasket material; sized to cover Item 1C.
8C	1	Tube of pipe compound or Teflon tape for sealing threaded assemblies.

3. OPERATING AND MAINTAINING YOUR WOOD GAS GENERATOR

3.1 USING WOOD AS A FUEL

Because wood was used extensively as generator fuel during World War II, and since it is plentiful in most parts of the populated United States, it merits particular attention for use as an emergency source of energy. When used in gas generators, about 20 lb of wood have the energy equivalence of one gallon of gasoline.

Wood consists of carbon, oxygen, hydrogen, and a small amount of nitrogen. As a gas generator fuel, wood has several advantages. The ash content is quite low, only 0.5 to 2% (by weight), depending on the species and upon the presence of bark. Wood is free of sulphur, a contaminant that easily forms sulfuric acid which can cause corrosion damage to both the engine and the gas generator. Wood is easily ignited—a definite virtue for the operation of any gas generator unit.

The main disadvantages for wood as a fuel are its bulkiness and its moisture content. As it is a relatively light material, one cubic yard of wood produces only 500 to 600 lb of gas generator fuel. Moisture content is notoriously high in wood fuels, and it must be brought below 20% (by weight) before it can be used in a gas generator unit. By weight, the moisture in green wood runs from 25 to 60%, in air-dried wood from 12 to 15%, and in kiln-dried wood about 8%. Moisture content can be measured quite easily by carefully weighing a specimen of the wood, placing it in an oven at 220°F for thirty minutes, reweighing the specimen, and reheating it until its weight decreases to a constant value. The original moisture content is equivalent to the weight lost.

The prototype unit in this manual (with an 6-in.-diam firetube) operated well on both wood chips (minimum size: 3/4 by 3/4 by 1/4 in.) and blocks (up to 2-in. cubes); see Fig. 3-1 (all figures and tables mentioned in Sect. 3 are presented at the end of Sect. 3). Larger sizes could be used, if the firetube diameter is increased to prevent bridging of the individual pieces of wood; of course, a throat restriction would then have to be added to the bottom of the firetube so as to satisfy the dimensions in Table 2-2 in Sect. 2.

3.2 SPECIAL CONSIDERATIONS AND ENGINE MODIFICATIONS

To start the fire in the gasifier, the blower must be used to create a suction airflow through the wood in the hopper and downward in the firetube. If an especially high horsepower engine is to be fueled by the gasifier unit, then it might be necessary to install two such blowers and run them simultaneously during start-up.

When the wood gas leaves the gasifier unit, all the oxygen pulled down with the air through the firetube has been chemically converted and is contained in carbon monoxide (CO) and water (H₂O). The wood gas is unable to burn without being mixed with the proper amount of additional oxygen. If an air leak develops below the grate area, the hot gas will burn while consuming the available oxygen and will create heat; this will almost certainly destroy the gasifier unit if it is not detected soon. If an air leak develops in the filter unit or in the connecting piping, the gas will become saturated with improper amounts of oxygen

and will become too dilute to power the engine. Therefore, airtightness from the gasifier unit to the engine is absolutely essential.

Ideally, as the wood gas enters the engine manifold it should be mixed with air in a ratio of 1:1 or 1.1:1 (air to gas) by volume. The carburetion system described in this report will provide this mixture with a minimum of friction losses in the piping. The throttle control valve and the air control valve must be operable from the driver's seat of the vehicle.

The engine's spark plug gaps should be adjusted to between 0.012 and 0.015 in.; the ignition timing should be adjusted to "early."

3.3 INITIAL START-UP PROCEDURE

Initially, you will need to add charcoal to the grate below the firetube. Subsequent operation will already have the grate full of charcoal which has been left over from the previous operating period.

Fill the firetube with charcoal* to a level 4 in. above the grate. Fill the hopper with air-dried wood; then, proceed with the routine start-up directions below.

3.4 ROUTINE START-UP PROCEDURE

1. Agitate the grate shaker handle for at least twenty seconds to shake down the charcoal from the previous operating period.
2. Open the ash cleanout port and remove the ashes from the generator housing drum. Lubricate the threads of the cleanout port with high-temperature silicone, and close the cover of the cleanout port so that it is airtight.
3. Fill the hopper with wood fuel, and tamp the fuel down lightly. Either leave the lid completely off the fuel hopper, or adjust the opening around the lid to a 3/4-in. (or larger) clearance.
4. Close the carburetor's air control valve and remove the cover from the blower exhaust on top of the filter unit. Start the blower, and let it run for thirty seconds to avoid explosion of residual gas in the system. Then, with the blower still operating, proceed with the next step.
5. Open the ignition port, and ignite a 12- by 12-in. piece of newspaper; with a long stick or wire, push the burning sheet of newspaper into the grate; see Fig. 3-2. Close the ignition port. If no smoke appears at the blower's exhaust port, repeat the start-up

*Charcoal produced for outdoor barbecue grills is not well suited for gas generator use. To produce a better grade of charcoal, place a rag soaked in alcohol on the grate, or place 3 to 5 pages of newspaper on the grate, then fill the fire tube to a height of 10 to 12 in. with well-dried wood. Have all the valves closed and let the fire tube act as a chimney until the wood is converted to charcoal.

sequence from Step (e). If repeated attempts fail, new charcoal should be added to the unit as described in Sect. 3.3, above, and the start-up ignition sequence should be repeated.

6. After a few minutes of smoky exhaust, test the gas at the blower exhaust by safely and carefully attempting to ignite it; see Fig. 3-3. When the gas burns consistently well, stop the blower and replace the cover on the blower exhaust.
7. Open the carburetor's air control valve, adjust the engine's accelerator, and start the engine in a normal manner. Let the engine warm up slowly (two to five minutes). If the engine fails to start or dies repeatedly, restart the blower and repeat the ignition sequence from Step (4).

3.5 DRIVING AND NORMAL OPERATION

Shift gears so as to keep the engine speed (rpm) high at all times. Remember that it is the vacuum created by the pistons that provides the force which moves the gas from the gasifier unit into the engine.

Refill the hopper with wood (as shown in Fig. 3-4) before it is completely empty, but avoid refilling just before the end of engine operation. Periodically shake down the ashes from the grate. If your system is equipped with a gas cooler, drain water from the cooler from time to time.

Under operation in dry weather, the gasifier can be operated without the lid on the fuel hopper. However, when the gasifier unit is shut down the hopper must be covered to prevent air from continuing to burn the wood in the hopper. Under wet-weather operation, the cover must be placed on the fuel hopper, and then lifted up and rotated about 2 in. until the triangular pieces line up with the holes in the support bars. The tension of the screen door springs will then hold the lid closed. See Fig. 3-5 for clarification.

3.6 SHUTTING-DOWN THE GASIFIER UNIT

When shutting down the gasifier unit, turn off the ignition switch and open the carburetor's air control valve for ten seconds to relieve any pressure from within the system. Then, completely close the air control valve, and place the cover tightly on the fuel hopper. When restarting after a short stopover, let the engine warm up briefly. After longer stops (up to one hour), tamp down the wood lightly and try to use the blower for restarting without relighting the wood fuel. After very long stops (over two hours) the charcoal must be ignited again.

3.7 ROUTINE MAINTENANCE

Periodically check all nuts on the gasifier unit, the fuel hopper, the filter unit, and the carburetor for snugness; check all penetrations and fittings for airtightness. In addition, perform the following maintenance activities as scheduled:

3.7.1 Daily Maintenance

Open the ash cleanout port of the gasifier housing drum and remove the ashes after shaking the grate for at least thirty seconds. Replace the cover of the port after coating the threads with high-temperature silicone to ensure airtightness. Open the drain tube at the bottom of the filter container and allow any liquid condensate to drain out; remember to close the drain tube when finished.

3.7.2 Weekly Maintenance (or every 15 hours of operation)

Clean out the gasifier housing drum, the fuel hopper, and the filter. Rinse out the piping and connections to and from the filter. Replace the wood chips inside the filter. (The used wood chips from the filter can be dumped into the fuel hopper and burned to produce wood gas.) Use high-temperature silicone on all pipe connections and on the filter lid to ensure airtightness.

3.7.3 Biweekly Maintenance (or every 30 hours of operation)

Make sure that all pipe connections are secure and airtight. Check and tighten all mounting connections to the vehicle chassis. Check for rust on the outside of the gas generator housing drum, especially on the lower region. Coat with high-temperature protective paint as necessary.

3.8 OPERATING PROBLEMS AND TROUBLE-SHOOTING

A discussion of problems and their related causes and cures is contained in the troubleshooting guide of Table 3-1. Many operational problems can be traced to failure to maintain the airtightness of all piping connections and fittings; the piping should be routinely checked to prevent such problems.

3.9 HAZARDS ASSOCIATED WITH GASIFIER OPERATION

Unfortunately, gas generator operation involves certain problems, such as toxic hazards and fire hazards. These hazards should not be treated lightly; their inclusion here, at the end of this report, does not mean that these hazards are unimportant. The reader should not underestimate the dangerous nature of these hazards.

3.9.1 Toxic Hazards

Many deaths in Europe during World War II were attributed to poisoning from wood gas generators. The danger of "generator gas poisoning" was one of the reasons that such gasifiers were readily abandoned at the end of World War II. It is important to emphasize that "generator gas poisoning" is carbon monoxide (CO) poisoning. Acute "generator gas

poisoning" is identical with the symptoms that may develop if a heating stove damper is closed too early, or if a gasoline vehicle is allowed to idle in a poorly ventilated garage. Table 3-2 shows how poisoning symptoms develop according to the concentration of carbon monoxide in breathable air. It is important to note that rather brief exposures to very small concentrations of carbon monoxide result in undesirable physiological effects.

In case of carbon monoxide poisoning, first aid should consist of the following procedures:

1. Move the victim quickly out into the open air or to a room with fresh air and good ventilation. All physical exertion on the part of the victim must be avoided.
2. If the victim is unconscious, every second is valuable. Loosen any tight clothing around the neck. If breathing has stopped, remove foreign objects from the mouth (false teeth, chewing gum, etc.) and immediately give artificial respiration.
3. Keep the victim warm.
4. Always call a physician.
5. In case of mild carbon monoxide poisoning without unconsciousness, the victim should be given oxygen if possible.

3.9.2 Technical Aspects of "Generator Gas Poisoning"

Generator gas poisoning is often caused by technical defects in the functioning of the gas generator unit. When the engine is running, independent of the starting blower, the entire system is under negative pressure created by the engine's pistons; the risk of poisoning through leakage is therefore minimal. However, when the engine is shut off, formation of wood gas continues, causing an increase of pressure inside the generator unit. This pressure increase lasts for approximately 20 minutes after the engine is shut off. For this reason, it is not advisable to stay in the vehicle during this period. Also, the gas generator unit should be allowed to cool for at least 20 minutes before the vehicle is placed in an enclosed garage connected with living quarters. It should be emphasized that the gas formed during the shut-down period has a carbon monoxide content of 23 to 27% and is thus very toxic.

3.9.3 Fire Hazard

The outside of a gas generator housing drum may reach the same temperature as a catalytic converter on today's automobiles. Care should be taken when operating in areas where dry grass or combustible material can come into contact with the housing drum of the gas generator unit. If a gas generator unit is mounted on a personal car, bus, van or truck, a minimum 6-in. clearance must be maintained around the unit. Disposal of ashes must only be attempted after the unit has cooled down (to below 150°F). Such residue must be placed away from any combustible material and preferably be hosed down with water for absolute safety.

ORNL-Photo 5332-86

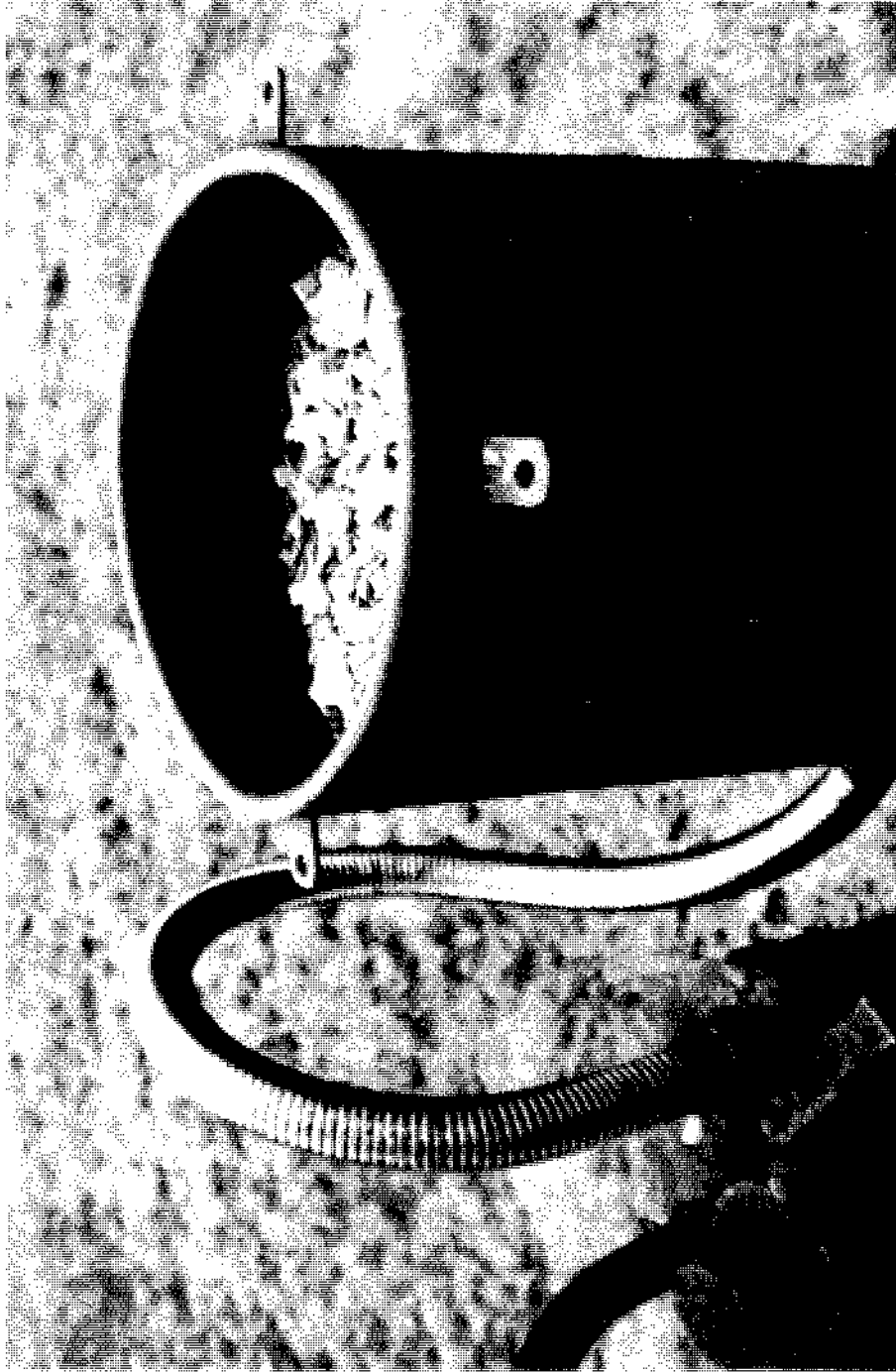

Fig. 3-1. Virtually all varieties of wood chips can be used for fuel. (Minimum size for this 6-in. firetube unit: 3/4 by 3/4 by 1/4 in.; maximum size: 2-in. cubes.)



Fig. 3-2. Ignite a single piece of newspaper to start the gasifier unit. Push the flaming newspaper through the ignition port and directly into the grate. (At the right of the photo, note the battery which is operating the blower atop the filter unit.)



Fig. 3-3. Igniting the exhaust gas will demonstrate that the gasifier unit is working properly.

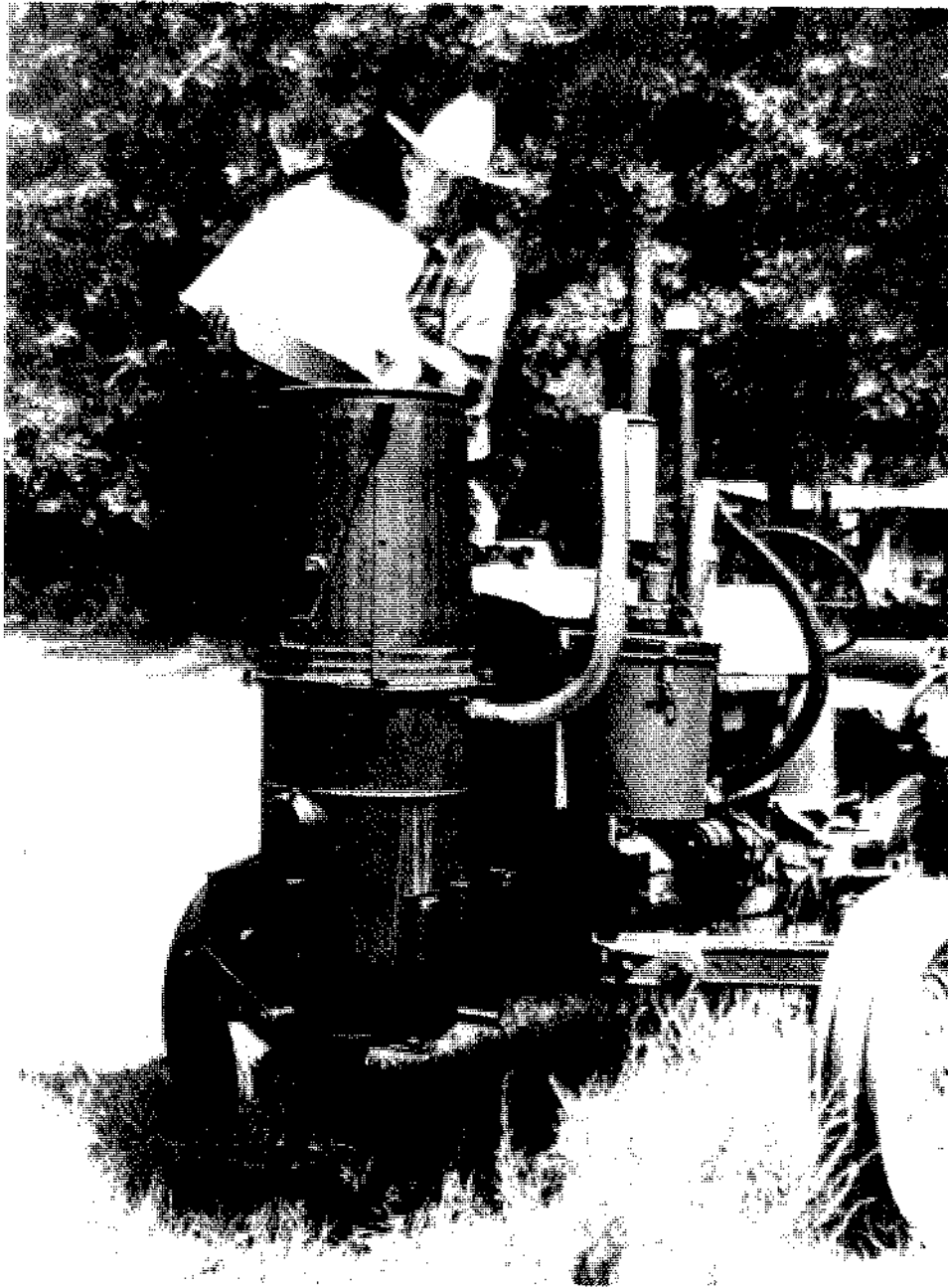

Fig. 3-4. Refill the fuel hopper before it becomes two-thirds empty.

ORNL-Photo 5314-86

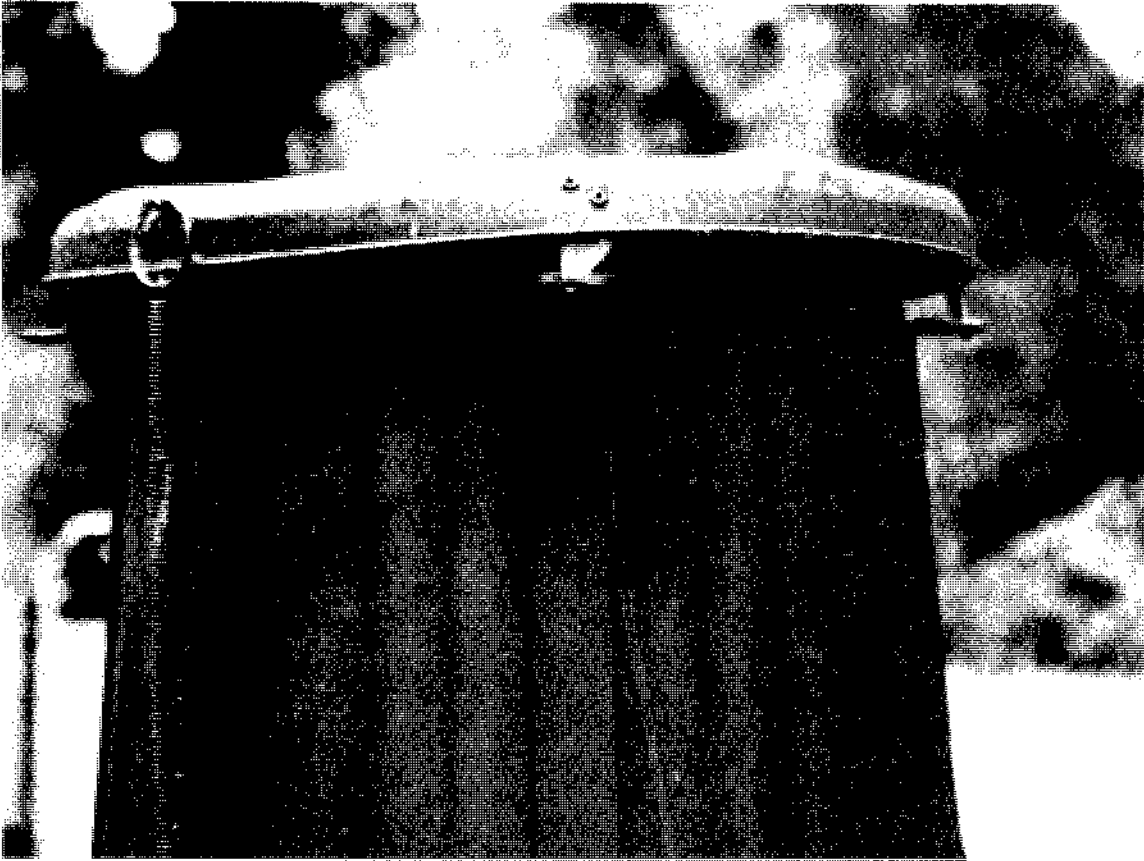

Fig. 3-5. The lid must be used to cover the fuel hopper in wet weather or when shutting the unit down.

Table 3-1. Trouble-shooting your wood gas generator

Trouble	Cause	Remedy
Start up takes too long.	1. Dirty system or clogged pipes.	Clean the gasifier unit and all connecting piping.
	2. Blower is too weak.	Check the blower and test the battery's charge.
	3. Wet or poor quality charcoal.	Check charcoal and replace or refill to proper level.
	4. Wood fuel bridges in the fire tube.	Lightly tamp down the wood fuel in the hopper and fire tube or replace the fuel with smaller-sized chips.
Engine will not start.	1. Insufficient gas.	Use the blower longer during start up.
	2. Wet wood fuel.	Vent steam and smoke through the fire tube and fuel hopper for several minutes.
	3. Incorrect fuel-air mixture.	Regulate the carburetor's air control valve for proper mixing.
Engine starts, but soon dies.	1. Not enough gas has been produced.	Use low RPM while starting engine and do not rev engine for several minutes.
	2. Air channels through fire tube.	Tamp down wood fuel lightly in hopper. <u>Do not</u> crush charcoal above the grate.
Engine loses power under load.	1. Restricted gas flow in piping.	Reduce air mixture valve setting. Check for partial blockage of unit or piping.
	2. Leaks in system.	Check all covers and pipes for air tightness.

Table 3-2. Effects of breathing carbon monoxide

Carbon monoxide content of inhaled air (%)	Physiological effects
0.020	Possible mild frontal headache after two to three hours.
0.040	Frontal headache and nausea after one to two hours; occipital (rear of head) headache after 2.5 to 3.5 hours.
0.080	Headache, dizziness, and nausea in 45 min; collapse and possible unconsciousness in two hours.
0.160	Headache, dizziness, and nausea in 20 min; collapse, unconsciousness and possible death in two hours.
0.320	Headache and dizziness in 5 to 10 min; unconsciousness and danger of death in 30 min.
0.640	Headache and dizziness in 1 to 2 min; unconsciousness and danger of death in 10 to 15 min.
1.280	Immediate physiological effect; unconsciousness and danger of death in 1 to 3 min.

Source: Murakoa, J. S., Shelter Habitability Studies—The Effects of Oxygen Depletion and Fire Gases on Occupants of Shelter, NCEL-TR-144, U.S. Naval Civil Engineering Laboratory, Port Hueneme, CA, July 1961.

BIBLIOGRAPHY

- Anonymous, "Coast to Coast on Homemade Fuel," **The Mother Earth News** (No. 73) pp. 178-179 (January/February 1982).
- Anonymous, "Wood Gas Update," **The Mother Earth News** (No. 71) pp. 164-165 (September/October 1981).
- Anonymous, "Mother's Woodburning Truck," **The Mother Earth News** (No. 69) pp. 126-129 (May/June 1981).
- Chatterjee, A.K., *State of the Art Report on Pyrolysis of Wood and Agricultural Biomass*, PN-AAK-818, U.S. Department of Agriculture, Newark, NJ, March 1981.
- Cruz, I.E., *Producer-Gas Technology for Rural Applications*, published by the Food and Agriculture Organization of the United Nations, New York, NY, 1985.
- Donath, E.E., "Vehicle Gas Producers," **Processing Technology** (3) pp. 141-153 (1980).
- Eoff, K.M., and D.M. Post, "How to Power a Gasoline Engine with Wood," Technical Reprint No. 1, **The Mother Earth News**, Hendersonville, NC, 1981.
- Kaupp, A., and J.R. Goss, *State of the Art Report for Small Scale (to 50kW) Gas Producer-Engine Systems*, USDA Contract No. 53-319R-O-141, University of California, Davis, CA, March 1981.
- Miller, B., *State-of-the-Art Survey of Wood Gasification*, EPRI-AP-3101, Fred C. Hart Associates, Inc., Washington, DC, May 1983.
- Nygards, N., *Wood Gas Generator for Vehicles* (a translation of the Swedish book), published by Purwaco International, Minneapolis, MN, 1979.
- Oliver, E.D., *Technical Evaluation of Wood Gasification*, EPRI-AP-2567, Synthetic Fuels Association, Inc., Palo Alto, CA, August 1982.
- Reed, T.B. (ed), *A Survey of Biomass Gasification, Vol. I--Synopsis and Executive Summary*, SERI/TR-33-239 (Vol. I), Solar Energy Research Institute, Golden, CO, July 1979.
- Reed, T.B. (ed), *A Survey of Biomass Gasification, Vol. II--Principles of Gasification*, SERI/TR-33-239 (Vol. II), Solar Energy Research Institute, Golden, CO, July 1979.
- Reed, T.B. (ed), *A Survey of Biomass Gasification, Vol. III--Current Technology and Research*, SERI/TR-33-239 (Vol. III), Solar Energy Research Institute, Golden, CO, April 1980.
- Reed, T.B., and A. Das, *Handbook of Biomass Downdraft Gasifier Engine Systems*, SERI/SP-271-3022, Solar Research Institute, Golden, CO, March 1988.

Reed, T.B., and D. Jantzen, *Generator Gas: The Swedish Experience from 1939-1945* (a translation of the Swedish book, *Gengas*), SERI/SP-33-140, Solar Energy Research Institute, Golden, CO, January 1979.

Skov, N., and M.L. Papworth, *PEGASUS (Petroleum/Gasoline Substitute Systems)*, published by the Pegasus Publishing Co., Miami, FL, 1974.

Vietmeyer, N.L., et al., *Producer Gas: Another Fuel for Motor Vehicle Transport*, published by the National Academy Press, Washington, DC, 1983.

Wise, D.L. (ed.), *Fuel Gas from Biomass*, published by the CRC Press, Boca Raton, FL, 1981.

Construction Plans for Other Wood Gas Generator Units
can be Purchased from the Following Organizations:

PEGASUS Publishing Co.
1995 Keystone Blvd.
Miami, FL 33181

Missouri Gasification Systems, Inc.
Route 3, Box 198
California, MO 65018

Mother's Plans
The Mother Earth News
P.O. Box 70
Hendersonville, NC 28791

Nunnikhoven Industries
P. O. Box 580
Mediapolis, IA 52637

Biofuels

Table of Contents:

[Overview: Biofuels.](#)

Growing it on the farm.

[Biodiesel: Make Your Own Biodiesel](#)

"Anybody can make biodiesel. It's easy, you can make it in your kitchen -- and it's BETTER than the petro-diesel fuel the big oil companies sell you. Your diesel motor will run better and last longer on your home-made fuel, and it's much cleaner -- better for the environment and better for health. If you make it from used oil it's not only cheap but you'll be recycling a troublesome waste product. Best of all is the GREAT feeling of freedom, independence and empowerment it will give you. Here's how to do it -- everything you need to know. " (Quoted from: Journey to Forever)

[SEALED Make Your Own Biodiesel](#)

This is the SEALED mirrored version of this site that won't be opened until after The Great Catastrophe.

[SEALED Make Your Own Biodiesel -Page 2](#)

This is a second page of the above SEALED mirrored version of the above site that won't be opened until after The Great Catastrophe.

[SEALED Foolproof Way to Make Biodiesel](#)

This particular page appears to be one of **SPECIAL** interest. Here it is still another SEALED mirrored page the original of which is linked from the above open site. This mirrored copy won't be opened until after The Great Catastrophe.

[SEALED Using Straight Vegetable Oil](#)

This page is also one of **SPECIAL** interest. Here it is still another SEALED mirrored page the original of which is linked from the above open site. This mirrored copy won't

be opened until after The Great Catastrophe.

[SEALED Separating Glycerine/FFAs](#)

And a final page from this link of some interest. Here it is still another SEALED mirrored page the original of which is linked from the above open site. This mirrored copy won't be opened until after The Great Catastrophe.

[SEALED From the Fryer to the Fuel Tank](#)

This 1999 SEALED 172 page .pdf file won't be opened until after The Great Catastrophe. It is written by Joshua and Kaia Tickell and is available from Bookmasters P.O. Box 388 Ashland OH 44805 800-266-5564 or 419-281-18902 fax 419-281-6883 email: order@bookmaster.com

[Seed Presses Pressing Oil from Seeds](#)

This 24 page .pdf file lists 56 oil bearing seeds and discusses a variety of methods for extraction and processing. These oils can be used either for food or fuel.

Click here to return to the
[Individual Agricultural Recovery
After Nuclear Holocaust](#)

Making it on the Farm

RAPESEED, LINSEED, FLAXSEED, SUNFLOWERSEED, SESAMESEED, PEANUT, GROUNDNUTS, MUSTARDSEED, POPPY, COTTON SEED etc. are but a few of the seeds that have been suggested for making biofuel. There are also techniques that have used grasses, corn, and all sorts of other vegetable and biomass. Some techniques require stills which we cover elsewhere but perhaps you will find some simpler techniques and guidance in the material presented here.

Click here to return to the
[Table of Contents](#)

MENU: [HOME](#) » [Reconstruction](#) » [Recovery](#) » [Renewal](#) » [Energy Types](#)

Stills

Table of Contents:

[Overview: Stills.](#)

The problems of stills.

[SEALED How Distillation Works](#)

This is a SEALED 8 page .pdf file explains the basic concepts. This site that won't be opened until after The Great Catastrophe.

[SEALED Building a home still](#)

This is a SEALED 78 page .pdf file with lots of pictures. This site that won't be opened until after The Great Catastrophe.

[LINK: Running on Alcohol](#)

This is the present open source for the mirrored copy that we have below.

[SEALED Running on Alcohol](#)

This sealed site has three pages that can be linked from the open site above. This first one describes a small home still that the owner actually uses to provide fuel for a number of automobiles.

[SEALED A Large Farm System](#)

This second sealed site describes a somewhat larger system that was built to produce fuel on a commercial basis.

[SEALED Still Safety](#)

This third sealed site discusses safety aspects regarding stills.

[SEALED Making It On The Farm](#)

This is another SEALED 182 page manual in .pdf that we purchased. This site won't be opened until after The Great Catastrophe.

[LINK: The Manual For the Home and Farm Production of Alcohol](#)

This is the present open source for the mirrored copy that we have below.

[SEALED The Manual For the Home and Farm Production of Alcohol](#)

This is a site SEALED mirror of the above source. This site won't be opened until after The Great Catastrophe. However, below is an overview of the chapters so that you can see its thoroughness AND also at this time you can go to the open site above.

Chapter 1 AN OVERVIEW

- Alcohol Fuel
- Uses of Alcohol Fuel
- Other Alternative Fuels

Chapter 2 BASIC FUEL THEORY

- Chemical Composition
- Combustion Properties
- Volatility
- Octane Ratings
- Water Injection
- Exhaust Composition
- Engine Performance - Straight Alcohol
- Engine Performance - Alcohol Blends

Chapter 3 UTILIZATION OF ALCOHOL FUELS

- Methods of Utilization
- Alcohol Blends
- Pure Alcohol
- Diesel Engines
- Engine Modification
- Alcohol Injection

Chapter 4 ETHANOL PRODUCTION - GENERAL DISCUSSION

- Raw Materials
- Manufacturing Steps
- Process Design

Chapter 5 PROCESSING STEPS COMMON TO ALL MATERIALS

- Dilution
- Ph Control
- Backslopping

Cleanliness

Hydrometers

Chapter 6 PROCESSING STEPS SPECIFIC TO SACCHARINE MATERIALS

General Description

Extraction

Chapter 7 PROCESSING STEPS SPECIFIC TO STARCHY MATERIALS

Preparation of Starchy Materials

Milling

Cooking

Conversion

Malting

Premalting

Preparation of Malt

Enzyme Conversion

Acid Hydrolysis

Mash Cooling

Chapter 8 PROCESSING STEPS SPECIFIC TO CELLULOSE MATERIALS

Cellulose Conversion

Chapter 9 YEAST AND FERMENTATION

Yeast

Yeast Preparation

Fermentation

Fermentation By-products

Note of Caution

Chapter 10 INDIVIDUAL RAW MATERIALS

Sugar/Starch Content vs Alcohol

Saccharine Materials

Fruits

Molasses

Cane Sorghum

Sugar Beets

Sugar Corn Wastes

Starchy Materials

Grains

Jerusalem Artichokes

Potatoes

Sweet Potatoes

Cellulose Materials

Multiple Enzyme Treatment

Chapter 11 DISTILLATION

Distillation Theory

The Reflux Column

Chapter 12 DRYING THE ALCOHOL

- General Description
- Absorption Methods
- Drying With Lime
- Azeotropic Methods

Chapter 13 MASHING AND FERMENTATION EQUIPMENT

- General Discussion
- Batch Cooking and Mashing Equipment
- Fermentation Equipment

Chapter 14 DISTILLATION EQUIPMENT

- Simple Reflux Column
- Condensers
- Boilers
- Reflux Control
- Hydrometer Sump
- Construction of a Reflux Column
- Operation of the Still
- Caution

Chapter 15 SOLAR STILLS

- General Discussion
- Principle of Operation
- Construction of Solar Stills

Chapter 17 PUTTING IT ALL TOGETHER

- Large And Small Systems
- Very Small
- Small
- Medium
- Large
- Considerations

Chapter 18 THE FUTURE

- Present Technology
- New Technology
- Immobilized Enzymes
- Cellulose Conversion
- Alternatives To Distillation
- Biological Research
- Conclusion

The Problem of Stills

I am personally a teetotaler and totally opposed to the use of alcohol as a recreational drink. Still alcohol

does have its medicinal purposes and can also be used as an antiseptic and as a aesthetic. In fact in may be about the only aesthetic available until the production of ether can be established.

Here we are principally talking about the use of stills for making fuel. With all the surplus rotting potatoes in the area we would have liked to make a still and produce fuel for our diesel generators. But, presently, there is a \$100,000 annual fine (license) for doing so. We will simply have to wait for a more propitious time.

The building and operation of a still takes some skill but it is not what we would call a high-tech operation. After all, the skill is most often identified with hillbilly moonshine makers. The designs here will at least demonstrate the principles involved. It may be largely a matter of scale to get up to larger volumes needed for fuel.

Click here to return to the
[Table of Contents](#)

MENU: [HOME](#) » [Reconstruction](#) » [Recovery](#) » [Renewal](#) » [Energy Types](#)

Solar Energy

Table of Contents:

[Overview: Solar Energy.](#)

What works and what doesn't.

[Cooking: An overall survey of solar cookers.](#)

This is an online overall survey of solar cookers that ties into the next two explanations.

[SEALED: Overall survey of Solar Cookers.](#)

The SEALED version of the of the above site. This file will not be opened until after the nuclear war.

[Cooking 2: An overall survey of BOX solar cookers.](#)

Because there are so many different designs of solar cookers the information referenced here has been narrowed to what seemed most applicable to the anticipated immediate needs of nuclear survivors.

[SEALED: An overall survey of BOX solar cookers.](#)

The SEALED version of the of the above site. This file will not be opened until after the nuclear war.

[Cooking 3: A very simple design.](#)

This is a detailed explanation about one exceptionally simple design. With more time and resources one will probably wish to consider one of the other designs in the links above. This design, however, has the additional advantage in that it is very portable.

[SEALED: A very simple design.](#)

The SEALED version of the of the above site. This file will not be opened until after the nuclear war.

[Hotwater 1: Make it with the sun even in cold climates.](#)

This SEALED 9 page .pdf file is about a closed anti-freeze system. This file will not be opened until after the nuclear war.

[Hotwater 2: Build Your Own Solar Water Heater.](#)

This SEALED 118 page .pdf file is much more detailed. This file will not be opened until after the nuclear war.

[Hotwater 3: Solar Hotwater Heating - A DIY Guide.](#)

This SEALED 31 page .pdf file is another system. It is always good to get a variety of ideas and explanations. This file will not be opened until after the nuclear war.

Solar Overview

After a nuclear war, solar power for making electricity is probably not going to be an option unless one happens to find some salvagable solar panels. I obtained books on the subject of making "hobbyist" solar panels and they are so terribly inefficient that it is just not a practical way to go at all. Solar panels operate only during daytime, on days that are not cloudy, and in locations near enough to the equator that you don't get low sun angles and long nights. Consequently commercial solar panels presently have a payout of about a hundred years which means, given interest rates, the value of money, the life expectancy of the panels themselves, and human life expectancy - they just are not a practical way to go in most situations. They have application for some small power requirements in very remote locations but that is about it in many parts of the world. In outerspace with 24 hour sunlight they may be the cat's meow - but nothing that we need to concern ourselves about in a nuclear recovery situation.

Still, sunlight is a great power source for stills, solar cookers and as a means of heating water. Those are the applications that are treated here.

Click here to return to the
[Table of Contents](#)

MENU: [HOME](#) » [Reconstruction](#) » [Recovery](#) » [Renewal](#) » [Energy Types](#)

Individual Agricultural Recovery After Nuclear Holocaust

"The Farmer Comes First in the Reconstruction of Society"
(Techniques for Agriculture Recovery)

bruce@webpal.org

[Bruce M. Beach](#)

Table of Contents:

Prolog: [and about the Author](#)

For over forty years the author has proclaimed the necessity of nuclear survival preparedness. These pages, however, are concerned with the next step - recovery after nuclear holocaust. It is the author's recognition that "*the farmer must come first*" that has led him to develop these pages.

Introduction: [What the Farmer Needs](#)

The societal importance of the farmer
and how society needs to be reconstructed
to reflect that importance.

LETS: [How to operate without money](#)

This will be one of the major problems facing the farmer - and here is the solution. Barter is good - but this is much better. This webpage is actually in another section - but it is so important that it is again listed and linked from here.

Radiation: [Fallout and Radiation *IN FOOD* after a Nuclear War.](#)

There is so much information on this subject that this links to a separate Table of Contents where you will find information on everything including:

Overviews and explanations for the Layman
Fallout on the Farm.

Measuring Radiation in Food
Removing radiation from food and milk
Highly technical documents for health professionals

For much more detailed information about the effect of nuclear weapons, the measurement of radiation, radiation measuring instruments, and so forth, for *other* than in food see: [the Resources Section in the Root Web page](#)

[Agriculture: Farming After a Nuclear War](#)

There is so much here also that a separate Table of Contents is provided. Because many people may be returning to farming after several generations - basic farming skills are covered here but there are also some techniques that modern mechanized farmers may have ignored (such as seed saving and the use of humanure) and that may be of use to the experienced farmer.

There is also a lot about simplified farming in the separate Table of Contents linked from the Pioneering section below:

[Energy: Alternate resources.](#)

There are covered here a variety of alternate energy resources:

- Stills for making an alternate to diesel fuel.
- Generating electricity with home made generators made from:
 - Truck brakedrums using:
 - Windpower
 - Waterpower
 - Bicycle power
 - Small engines, etc.
 - Old electric motors
- Homemade solar power heating systems

[Technology: Simplified Machines and how to make things work.](#)

Explanations of how many machines work and alternate approaches where they can't be fixed.

[Pioneer: The way they did it in the old days.](#)

Many skills that have been practically lost but that may be needed for a time during recovery.

What ????: What else might someone recommend for this series?

What things will farmers need to know that I have not covered here?

Prolog: **About the Author**

The purpose of this web page, as with many others that I written, is to assist mankind in the restoration of society after a nuclear holocaust, which I strongly anticipate to be its destiny.

The sub-title of this essay "*The Farmer Comes First in the Reconstruction of Society*" is self explanatory. Not only is it an obvious truth, it is also a subject dear to the author's roots. While it is true that he is the first generation in his family to be born off the farm, his wife was born on the farm and mostly for the exception of educational years and military service, he has lived in farming communities and among relatives that have remained in that industry.

While the author is particularly suited to deal with the problems of societal reconstruction, having been formally trained as an institutional economist, these subjects that he has written upon for many decades seriously suffer from the defect that there is almost total lack of dialog or critique because they are a subject in which there is practically absolutely no interest on the part of others. If you wish, you may:

click here to see my [bio](#).

and you may click here to learn more about [Ark Two](#)

and click here for more [nuclear recovery info](#).

Click here to return to the
[Table of Contents](#)

Introduction: **What the Farmer Needs**

For the farmer to accomplish his task,
he must have three things.

security

incentive

resources

While confiscation, plundering, theft, exorbitant taxation, forced labor, and other similar forms of social transfer can accomplish short term goals of acquisition, in the long run they are very inefficient. As well as are over-centralization of authority and bureaucratic overburdens.

Free competitive markets, individual initiative, entrepreneurship, private ownership of the means of production, and the other accretions of a free society boundlessly demonstrated their worth in the productivity of the North American farmer when combined with plentiful fertile land, semi-stable markets and revolutionary advances in technology and the biosciences. These permitted, in the last two centuries, an inversion of 90% of the population living on the farm and 10% off to 10% living on the farm and 90% off with there still being great surpluses of production for export.

With all that - the often instability of many of the food product pricing markets, the machinations of the banking and finance industry, along with the vagaries of weather and pestilence combined with the oft-time seeming burden of government regulations to make farm life one of turmoil as society struggled to find a just method of reallocation of resources from an overproductive industry to other fields which were also struggling with problems of oversupply.

The concern for justice, both for the farm community suppliers and the non-farm community consumers, must ever remain the foremost consideration of those who try to regulate the agricultural field at any time. Pure *laissez faire* is not the answer, as evidenced by what happened to the farm community in the Great Depression, and there is no question but that the instability of completely free markets can be equally detrimental to producer and consumer alike.

Scale of production, scale of processing plants, the means of transportation and distribution, costs for machinery, fuel, fertilizer, seed and other resources are all matters that have often been outside the control of the individual farmer or even the farm community as a whole. Any concept that individual farm families can retreat to an isolated unit on their own is totally unrealistic. The great productivity that was achieved in North America was achieved through efficiencies arising out of social organization, specialization and economies of scale.

While there was bounty, there were also many undesirable effects. Styles of life that were not pleasant to those entrapped in them - such as migrant labor, or often what amounted in fact to even slave labor for many producers in the world market. There was the expense of high production at the cost of an often onerous burden to the environment in the destruction of resources that would sometimes take centuries to replace, if they were replaceable at all, and there was reasonable suspicion that some of the methods of production resulted in product that was not as healthy for the end user as it should have been.

To the survivor's of a nuclear holocaust, many of the above points will seem to be but quibbles, and they will simply wish for the "good old days" before the nuclear war. However, we must remember that it was the power of the over centralized bureaucracies and the gigantic soulless corporations that created the problem in the first place. It was their unjust international transfer of resources and products of labor and the lack of universal concern for justice in economic exchange between all nations of the world in both agriculture and other economic spheres that created the social unrest, and eventual holocaust. It is not that institutional greed is more evil than individual greed, it is just that it is less amendable to rectification. Over the last two centuries the resulting terrible cost to the farm community has not been just an economic one but also, for untold tens of thousand families, personal loss of loved ones who were drawn up in the maelstrom of international conflicts, far beyond their personal interest, never to be seen again.

There is no question but that in time, productivity can be restored. However, the real question is - can justice be established - because that is something that has never been achieved. Justice, in this world, has always been, and always will be relative. Because there is always a better way and a worse way, we should try to find the better way. If we decide that we don't like peace, then we can always go back to war. And there is no question, that if we work at it, we can be ready for another nuclear war in twenty years.

Top down design has been the problem. Direction by gigantic entities of power, influence and control. The rule of power politics and special interest groups. The solution is bottom up selection WITHOUT POLITICS. The top will then reflect the aspirations of the bottom. All of this, I explain in the

[LETS](#) system.

Also, under LETS, no matter how misguided or mistaken the policies in the higher echelons may be, there still remains a degree of autonomous local control that permits the amelioration of what could otherwise be intolerable suffering.

Click here to return to the
[Table of Contents](#)

MENU: [HOME](#) » [Reconstruction](#) » [Recovery](#) » [Renewal](#) » [Survival](#)

Fallout and Radiation in Food after a Nuclear War

bruce@webpal.org

[Bruce M. Beach, bio](#)

Click here to return to the
[Social and Economic Recovery
After Nuclear Holocaust](#)

Table of Contents:

[Overview: Layman's overview on Radiation in Food.](#)

A non-technical overview of how radiation gets into food. The effect that it has and what can be done about it.

[Food: Shorter letter on radiation in Food](#)

This was in response to a study that I commissioned. The full report is the next item.

[Radiation in Food: Explanation by a microbiologist](#)

This is the full report by the microbiologist, Aina Shapley. It covers the measurement of radioactivity in food and WATER. [There is also a copy of this available in .pdf](#)
(for which you need a pdf reader)

[Risk: Radiation Risk and Ethics](#)

There was much scare talk about the effects of peace time radiation. This professional paper gives a much different view. It helps to get things into perspective.

[Measurement: Manual of food quality control - radionuclides in food](#)

This .pdf document is the prime authoritative document on the subject. I obtained the information through its author Edmond J. Baratta, International Expert on Radioactivity with the US Food and Drug Administration at the research facility in Winchester, Massachusetts. The document is published both by the FDA and FAO (Food and Agricultural Organization of the UN). 133 pages in length and both very technical and readable in its detailed description of the methodologies and processes involved. However, since it does carry a copyright, and the government charges hundreds of dollars for a copy, this file is presently sealed until after the nuclear war.

[Milk: Removal of Strontium 89 and 90 from milk](#)

How to remove radiation from milk in a processing plant. This is the 61 page masters thesis of David Gene Easterly. I have the author's personal permission to republish it here.

[Potatoes: How to remove radiation from potatoes](#)

(link not yet working)

Now, if I can find this information again.

Click here to return to the
[Social and Economic Recovery](#)
[After Nuclear Holocaust](#)

Table of Contents

Layman's overview on Radiation in Food
(Techniques for Agriculture Recovery -
After Nuclear Holocaust)
by Bruce Beach, Radiological Scientific Officer

[Prolog: Nature of the problem](#)

Why radiation is a problem and how it gets into food.

[Short Term: The Short Term Problem](#)

The short term problem .

[Survival: The Short Term Solutions](#)

The easy solutions for the short term problem.

Long Term: [The Long Term Problem](#)

Why there is a long term problem, and how serious it may be.

Solutions: [The long term solutions.](#)

Fourteen solutions for the long term problem.

Click here to return to the
[Radiation in Food](#)
[Table of Contents](#)

Prolog: [Nature of the Problem](#)

Radiation does not harm food. Radiation in food is very harmful. One needs to make the distinction. Without entering into the debate, about whether microwave ovens harmed food, destroyed vitamins, etc., the irradiation of food in general, and by most researchers, has not been considered as being harmful. In fact it has been found to be very beneficial, for the same reasons that we cook and preserve any food.

However, radiation *in* food is *very* harmful because it is then absorbed by the consumer. Radioactive particles give off energy. This energy weakens, destroys, or otherwise harms cells. One might picture it as little microwave ovens, inside the body, cooking it from the inside. What is cooked are the cells in the body. Just like with any burn, there may be degrees. Sometimes a cell is destroyed completely and if enough are destroyed then we become sick, weaken, or die. Other times, radiation may only damage or deform the cells. The deformed cells may multiply, causing cancer which is one of the main longterm concerns about radiation.

Radioactive particles are isotopes of minerals that the body naturally seeks and absorbs. We call them isotopes because in the nuclear chain reaction process they have obtained one or more extra electrons. In this state they are unstable and will eventually give off the electron as energy and thus return to their stable state. It is that energy which is harmful.

Radioactive isotopes give off their energy in a random fashion but at a predictable rate. That is like saying that everyone in a population will die within 100 years. This we can predict with high probability and build mortality tables to that effect although we don't know when any one individual will die. The

same is true with isotopic atoms. We know that a population of them will give off all their energy in a predictable time, although we do not know when any one atom will give off its energy.

Just as different species of animals have different average lifetimes, for example shorter for fruit flies and dogs than for people, and longer for some species of parrots and turtles than people, so also do the isotopes of different minerals have different average lifetimes. For some isotopes, indeed most, the average lifetime is very short by human lifetime standards. The isotopes last only milliseconds, or less. Gone in far less than the blink of an eye. Their energy makes up what we call the initial radiation of an atomic blast. Most other radioactive particles decay, that is to say lose their energy in a matter of minutes, hours, or days. They linger around to cause the problems that we see in fallout and are the reason that one needs a fallout shelter for a few weeks after a nuclear war. But even with the latter, most of the radiation is gone in a couple of weeks.

The length of time that it takes a quantity of a radioactive isotope to lose half of its energy is what we call its half life. This can vary from milliseconds to a great many years. As mentioned, for most isotopes it is all over in milliseconds, but the ones that we are most concerned about take decades. Let us suppose that the half life of an isotope was 50 years (there are a couple that approximate that) and that we had a sufficient quantity of it that it was giving off 100 rads. Then in 50 years the radioactive source would be giving off 50 rads. In a hundred years it would be giving off 25 rads. In a hundred and fifty years it would be giving off about 12 rads. In two hundred years it would be giving off 6 rads.

For all practical purposes that source would be depleted, that is to say giving off less than 1 rad in three hundred years. As to when it would reach zero that is sort of the old Greek problem of when the bear would get out of the cave. Starting at the back of the cave it has to go half of the distance first to get out. Then at the half-way point it has to go half of the remaining distance to get out. And then at the quarter-way point, half that distance again. And so on. Logically, (this is the problem with logic and math) we can say the bear will never get out of the cave. It is what we call an asymptotic problem.

So there may always be some residual radiation from a nuclear war. Indeed, some people have speculated that there is already residual radiation on the planet from pre-historic nuclear wars. We also get background radiation from the cosmos. So radiation is always with us. Indeed, some radiation may not be harmful. It may even be necessary. Just as arsenic is considered a deadly poison, nevertheless, without any arsenic in your body - you would equally well die. Enough water and you will drown. Not enough and you will die of dehydration. Balance in all things. Probably regarding radiation also. Experiments have shown that people who live at higher altitudes and who therefore receive more natural radiation from the sun and cosmos, have lower incidence of cancer.

But here, we are talking about too much radiation. And most seriously, radiation that has gotten right into our systems through food. As before, a little bit may not hurt, but we are talking about lots. How it happens is this. The food chains filters in the radiation because it is trying to concentrate the minerals and can't tell the difference between a radioactive isotope of a particular mineral, and its non-radioactive isotope variety.

As an example, let us look at iodine. Too much iodine in the body is poisonous. Too little is also very detrimental. The thyroid absorbs iodine for the body. Because we naturally get iodine from the food we eat and because it is generally added to salt, there is little likelihood that today (although in previous centuries it was a problem) that one gets too little. A nuclear explosion creates isotopes of iodine (I-131 and I-132). These have a half life of about 8 days. This means that it will hang around for about a month after a nuclear explosion. That is the reason that we take Potassium Iodide pills, for a month after a nuclear explosion, so that the thyroid will be loaded with iodine and won't accept anymore iodine during that period.

But here is what happened, during the atomic experiments, when people didn't know about this and didn't take the potassium iodide. The radioactive particles were carried up into atmosphere and settled down on the milk shed of southern Utah. There were so few particles that the radiation meters couldn't measure them. However, they washed down into the soil and the bacteria in the soil, seeking minerals, absorbed them in preference to other inert matter. The lichen in the soil, also seeking minerals, then absorbed the bacteria. These were further absorbed by the legumes and higher grasses. Then a cow came along and ate the grass. Each organism concentrated the minerals because that is what it was really seeking.

Indeed, within the body, certain organs filter out certain minerals also. The bone marrow seeks calcium and such, as do the mammary glands which produce milk. As an aside, concentration of radioactive particles in the bone marrow causes leukemia, actually one of the more prevalent forms of cancer caused by radiation. And leukemia destroys the body's immune system which makes it fatal because of all sorts of causes. However, to continue with our journey of a radioactive particle. This particular one, particularly ended up in the milk. When the milk was drunk by a nursing mother, her system too concentrated the mineral iodine, especially in her milk and she thus passed along the radioactive isotopes to her child with their mother's milk. Finally the child's biological system concentrated the iodine in its thyroid and radioactive isotope had by now become so concentrated that if we held a radiation detector up by the child's neck near the thyroid - it buzzed like a rattlesnake.

The radiation had become very detrimental to the children, and there was a high incidence of mental retardation in the St. George area of southern Utah as a result of the atomic experiments in Nevada. Indeed, scientific studies showed that approximately eleven thousand cases of cancer occurred in the general population of the United States, as the result of nuclear testing. Before we get too excited about that, one must remember that about 20 times that number of cases were caused by desired uses of medical and dental x-ray and other sought after uses of radiation.

Yes, radiation causes cancer. So does water cause drownings. And automobiles cause much greater numbers of fatalities than both put together. Before automobiles horse accidents also caused many human deaths. In all these matters, one has to weigh the relative social benefits before they dispense with radiation, water, automobiles or horses. Every activity, whether manufacturing or mining, whether production or sport, has its attendant risk. Pollution from burning coal has caused much more in the way of cancer than industrial radiation ever has, so let us keep things in perspective.

The issues, in this essay, and in the accompanying scientific papers, are how much radiation we will be dealing with for how long a period of time - along with the techniques of dealing with it.

Click here to return to the
[Layman's Overview](#)
[Table of Contents](#)

Short: **The Short Term Problem**

In the short run after a nuclear war the problem is fallout. Fallout that prevents work outside. Fallout that gets onto food. Fallout that contaminates the soil and prevents the immediate planting of new crops. Fallout that kills the animals. Fallout that contaminates the water and streams. Fallout that blows about in the very air itself.

But fortunately all this is a short term problem of just a few weeks and the radiation in the fallout will decay. Following that, one will then have to deal with the problem of long term residual radiation. However, that is a subject for another section. The problem being discussed here is short term radiation and in the next section the short term solutions for dealing with it.

Click here to return to the
[Layman's Overview](#)
[Table of Contents](#)

Survival: **The Short Term Solutions**

The good news is that food that was grown before the nuclear event, does not become radioactive. As long as the radioactive particles that fall on it are removed then it is perfectly okay. Wash off a banana - then peel and eat it. Wash off an egg - crack it open and it is ready to cook. These principles apply to any fruits and vegetables. Scrub the dirt off the potatoes and they will be perfectly fine. Open any can or closed container and the food will be unaffected. A case of tomatoes could have been sitting outside in the fallout and all one would need is to wash off the can and open it.

Some food may take a little more care. Grain stored in a grainery where dust can have gotten in may need to be washed. Animals may have died or gotten sick from the radiation and needed to be slain, but so long as care is taken in handling the exposed part of the animal the meat will still be okay. We are only talking about immediately after the event. Animals that have had an opportunity to forage in fallout

contaminated areas will assimilate the radiation into their bodies and also into products such as eggs and milk.

So, this is the good news. Immediately after a nuclear war, any food that is still around and that would otherwise be edible, will still be edible. If it has spoiled from lack of refrigeration, or some other cause - then that is another matter. However, in rural areas that have storage facilities there should not be any lack of food of some type. In fact there may well be more food than survivors, but eventually they are going to need a new crop - and that is an entirely different matter, covered in a separate section.

Click here to return to the
[Layman's Overview](#)
[Table of Contents](#)

Long: **The Long Term Problem**

The long term problem of radiation after a nuclear war arises from the fact that some isotopes, as explained in a previous section, have half-lives of decades. Those isotopes which have half-lives of centuries are not really a problem because they give off so little energy during a human lifetime that they are irrelevant.

Neither are the isotopes that we are talking about an external bodily threat because they are usually found in very small quantities. However, because they are concentrated by living organisms, and because in food they become internal to the organism, they can be a serious health concern in food. The two most serious problems, long term, are isotopes of cesium and strontium, both of which in themselves are desirable minerals for many living organisms. The organism is unable to distinguish between a beneficial and a harmful isotope and will therefore equally absorb those which are harmful.

Exactly what quantities are of serious concern and how they may be detected and measured are explained in technical papers in this series. The next section will explain, in generalities, how the problem can be dealt with. At present there is no coterie of professionals trained, equipped or experienced to deal with the technical issues. These technicians will have to be developed from individuals with related technical training - after a nuclear holocaust - and it is for that reason that the necessary technical papers are provided here.

Click here to return to the
[Layman's Overview](#)
[Table of Contents](#)

Solutions: The Long Term Solutions

The long term problem of radiation in food is indeed a horrendous one, but not an insurmountable one. We are used to processing food and to preserving it. This is just an additional step like testing for bacteria or other spoilage. Unfortunately, it is not one that is as easily done at home as other food preparation methods have been in the past. Still one can take care to make sure that radiation does not get into their home produced crops - in the first place.

Some of the necessary procedures may at first seem arduous but that is just a matter of custom. Because of radiation, there may be areas of land which one will wish to avoid in growing crops. But really, that is no different than today where some areas are avoided because they are too rocky and others because they are too swampy.

Some plants prefer other minerals rather than cesium and strontium. Those plants and soil with the alternate minerals, or fertilizer containing them, can be used. These again are matters of expertise that need to be developed in each local soil and plant area, so while information assisting those determinations is presented in the accompanying technical papers it is a matter beyond the generalities of this essay.

I have often stated that there are long term strategies for dealing with radiation in food. Many times I have been asked to list examples in one place and so to satisfy that request - I do so now:

1. Selection of land that is not radioactive.
2. Deep plowing land to turn it over and bring non-radioactive soil up to the surface. (This works well only where there is deep topsoil).
3. Selecting plants to match the soil characteristics, i.e.. that they have no desire for the radioactive minerals that are in the soil.
4. Fertilizing the soil with a mineral that will be taken up in preference to the radioactive mineral. (Oftentimes this is calcium as found in marl).
5. Composting and creating soil that does not have radioactivity in it and then using that soil in a green house, or otherwise protecting it from contamination.
6. Using hydroponics gardening or other similar methods that tightly control the mineral uptake of the plants.
7. Using distilled water on the plants. (Unfortunately this deprives them of the minerals that they

need and minerals then need to be added to the water).

8. Removing the radioactivity from the food. See the article on milk processing for example. There are other techniques for other foods.

9. Storing the food until radioactivity decreases. This works well for the radioactive iodine isotope in powdered milk and cheese.

10. Avoiding foods that have high radioactive content. For example, soy milk might be substituted for dairy or mother's milk for children.

11. Eating lower down on the food chain. As explained in an earlier section, radiation is concentrated by living organisms. Each higher level concentrating it more. It is possible to make flour directly out of bacteria. Using non contaminated oil sources from wells or tarsands would then produce pure uncontaminated flour.

12. Avoiding meats and animal products because they are high up the food chain.

13. Classifying foods by radioactive content and using high content foods for feed for animals that will neither produce product nor be eaten - such as dogs. Coincidentally, because of their relatively short life expectancies, in many cases this will not be detrimental to them.

14. Reserving foods with high radioactive content for individuals with short life expectations. Because at some levels it takes twenty years or longer for the radiation to take effect this will not be detrimental to people who are already elderly. Let them have the meat, fresh milk and eggs.

15. This is by no means an exhaustive list and still other strategies will be developed with experience. Food radioactive content can be indicated in packaging, the content can be certified and varieties of foods can be imported from areas that are radioactive free for that particular food. Eat well and prosper.

Click here to return to the
[Layman's Overview](#)
[Table of Contents](#)

MENU: [HOME](#) » [Reconstruction](#) » [Recovery](#) » [Renewal](#) » [Survival](#)

October 13, 1985

Dear Bruce Beach:

I am starting to understand why the information you want is not in literature. The most obvious, the one you are well aware of, is that experts plan to eat stored food. There is enough of it around in North America. I have seen the problem of food discussed in regard to England - their worry is that there just wouldn't be enough food of any kind to feed the surviving population. Therefore, measuring radioactivity in food is not the major problem.

If the attack came at harvest time, in most areas the food wouldn't be harvested because of the external radioactivity. If it came in spring, the plants would be killed or stunted over large areas. There probably would be some areas where there could be some harvest. Here you would have to compare the radioactivity of the washed or the processed product to what you had in stored food. Storage of the fresh food for a few more months might bring the radioactivity down to a safe level. A number of experts have implied that if you survived the first year, you would survive. I don't know a thing about "nuclear winter".

It comes down to measuring radioactivity (fallout contamination) in stored food. It is possible you might get large quantities that have no contamination at all or less than double of normal background. Then you can use a label "no significant radioactive contamination". A Geiger-Mueller counter would be very good for this. If you plan to look after thousands of people, you would need a lot of them.

The problem starts when the food is substantially contaminated. What kind of classification would be meaningful to the general public? There also would be a social problem. You and I might be willing to eat the more contaminated food so that our children and grandchildren could eat less contaminated food. But what about people in thirties and forties who wouldn't have children in the group you were working with or didn't have children at all. Would they take risks for the future benefit of society? At present, I don't find this a very prevalent trait in our society. If things were really scarce, one would also have to protect the individuals whose skills would be essential for the survival of the greatest number of people.

Back to science. You would like to have figures on bars of food telling how much you could eat without getting radiation sickness. For example, a label on a wheat bag saying you can eat 1 lb/day for a year (indefinitely) and not get radiation sickness. To arrive at this figure one would have to take into account the decay rate and the rate at which it is accumulating in the body. Assume that the consumer has no accumulated radioactivity. Despite the oversimplifications to the extent that you might consider it inadequate, I have not come across anything as complicated in the scientific literature. Needless to say I can't do these calculations.

I will be asking this question of a number of health physicists and see if they theoretically could make

some approximations and provide us with a method of doing it, and second, if they would be willing to do it.

Another approach. A Geiger counter would be calibrated against a certain radionuclide (whatever standard you had available), let us say cesium. Now we could have a label on a wheat bag saying "on this date it has the equivalent of X mc of cesium/lb" (meaning, if all the activity measured by the Geiger counter was due to cesium, that is how much it would be; I have invented a new unit). I would have to find somebody who would be willing to estimate how many rads of body burden it would result in if you ate one lb of it. This would have to be modified by (1) what time interval after the measurement was done you started to eat it, (2) the quantity you are eating, (3) how many days you will be eating it, and (4) even the length of time after the explosion has some effect. Next week you get a bag of corn with Y mc/lb of cesium equivalents. The following week it might be back to wheat with a higher level of contamination than before. In effect, each person would have to keep a daily track of their body burden. All of this ignores the external radiation you had received or will be receiving, what internal radiation you had received from inhalation and ingestion (water and other foods) or will be receiving, age of person, weight of person, persons nutritional state and health. Are you starting to understand why this information is not available?

In some ways it might be the best to say by what factor a certain food is above the normal background radiation of the world. There would have to be some chart where one could read off what it would be a certain number of days after testing. This could be related to rough categories for eating indefinitely: completely safe for everybody at 1 lb/day, slight danger to children and pregnant women, danger to children and pregnant women and slight danger to others, danger for everybody. One problem would be that as time went on it would be harder and harder to get a normal background reading. There is no way of getting around that people would be eating different quantities of varying concentration at different times.

My personal reaction is to keep it relative and eat whatever has less ticks with a Geiger counter. If you didn't like the number of ticks, you wouldn't have any choice anyway. Starving to death isn't an easy way to die either. If one looked only for what was relatively better, accurate standardization of a Geiger counter wouldn't be as important. You would need a lot of Geiger counters and a lot of people who understood enough about radioactivity to use a Geiger counter in a meaningful way. I see education of people as one of the biggest problems. How many people do you know in your town at present who know properties of radiation? To how many people would it be meaningful if you quantified the radioactivity?

You were willing to consider going the whole way and getting a spectrometer. That way you would know exactly how much of what you got. Dr. Prudham's question was what good would it do to you if you did have that information? I couldn't answer that question. If you are still considering such a possibility, I would like you to answer the question, in case someone asks it of me again.

Dr. Eaton's comment was that there are so many parameters that it is impossible to work with something

like that. He expressed his sympathy to me when I said that you wanted definite figures.

Since there are more than 10 variables, there are more than 100 possibilities. Judging from the literature, there certainly should be a few people who could take one or two variables and come up with some figures. The only problem is that they would not fit the other 99 cases.

I certainly won't be able to provide you with the information you want, but I am getting close to being able to tell you who are the people who would have the best understanding of the subject. Some of them are acknowledged at the end of the book "Nuclear War Survival Skills".

Hopefully, we come across somebody who is willing to play around for a few days and see if he can come up with a way of quantifying the relative danger of contaminated food.

I have written some 14 letters and I will have more written by the time you get this letter.

You have expressed quite an interest in I-131 in milk and the possibility of decontamination. It is not something that I would recommend. If you will have to stay in your bunker for 6 weeks, the cows would probably be dead. If there are cows and there are people to milk them, the dairy plants are also standing. Convert the milk to canned milk, powdered milk, sterile milk (the kind you can buy in stores now) or cheese and wait until the I-131 decays. Meanwhile, pass a "law" that all canned milk and powdered milk on hand has to be reserved for children under 1 year of age. If the supply is greater than what babies would need for next 3 months (if the cows are alive and there is a prospect of returning to normal), older children could have milk too. If there was plenty of fresh milk, adults might drink it, provided they took KI tablets. (I personally don't see why anybody would want to do it.) A decontamination plant would have to be completely operational before the disaster, otherwise there wouldn't be enough time to get it going before the danger would be over. Besides, there might not be any milk anyway.

The reason why there is so much literature on I-131 is because it is one of the greatest dangers from nuclear power plants. I will find out if the Bruce Nuclear Plant is of the type that could give off large quantities of I-131.

This gives you an idea of what I am doing. You might want to see me. I will be available next week, I will be visiting my relatives in Michigan this Thursday.

Sincerely,
Aina J. Shapley

MENU: [HOME](#) » [Reconstruction](#) » [Recovery](#) » [Renewal](#) » [Survival](#)

Preface: Since Mrs. Shapley completed this study in 1985, there has now been extensive experience of the contamination of the food chain as a result of Chernoybl. In light of this, and other research, Mrs. Shapley, who has remained an active T.E.A.M. Leader in the Ark Two Community, is preparing an addendum to this study. The plan is to post the addendum when it is ready.

Study prepared for Bruce Beach on the

CONTAMINATION OF FOOD PROBLEM AFTER NUCLEAR WAR

December 4, 1985

Aina J. Shapley, B.S., M.S.
(Microbiologist)

TABLE OF CONTENTS

Overview

The most important fission products in food p. 1
p. 10

Methods of measurement p. 20

Lack of standards and MPD p. 24
p. 30

Emergency schemes

Note.

The vast majority of papers referred to have been copied.

A lot of subjects have not been discussed, e.g. units, different instruments, properties of radiation, and dose calculations. They are described in health physics text books. You have *An introduction to radiation protection* by Alan Martin and Samuel A. Harbison and *Radiation Protection* by Jacob Shapiro.

Abbreviations:

OTA = Office of Technology Assessment

DEF = Dose Effectiveness Factors

MT = Megatons

MR = Milliroentgens

R = Roentgens

RAD = Radiation Average Dose

REM = Radiation Equivalent Man

R, REM and RAD are essentially equivalent

Overview

Shapley Page 1

The most thorough and the most authoritative book on *The effects of nuclear weapons* is a book by that title compiled and edited by S. Glasstone and F. J. Dolan, 3rd ed., U.S. Department of Defense and U.S. Department of Energy, 1977. This book is referred to in almost all the articles and books dealing with a nuclear war. It is the source book on the description of the different atomic bombs, their uses and the consequent explosive blast, direct nuclear radiation, direct thermal radiation, EMP, and fallout.

The most thorough study of the probable consequences of nuclear weapons on the United States, as well as on the Soviet Union, was done by the Office of Technology Assessment (OTA), *The effects of nuclear war*, 1979, (for complete ref see [\(Shapley p. 8\)](#) They considered five major cases ranging from 1 atomic weapon to an all out mixed military and population attack of 6500 MT (half of it air bursts and the other half surface bursts).

We are interested in the latent health effects. I have copied 7 of the most interesting pages and given them page numbers in the upper right hand corner. The risk factors for the latent health effects, as well as the sources and the compromises they made to arrive at them are given on [\(Shapley p. 2\)](#) The risk factors they used for latent cancer deaths from internal organ exposures are given on [\(Shapley p. 3\)](#)

Before we go any further, we have to examine some of the categories they use for the way they present their data. Local fallout is what is deposited within 24 hours after the burst. The fraction of nuclear debris in the local fallout varies from 0.8 from surface bursts to 0 from airbursts. Worldwide fallout can be of two kinds, tropospheric and stratospheric. Tropospheric fallout is short (weeks). Stratospheric fallout is in years, e.g. removal half-time for Cs-137 is 5 years. Stratospheric fallout can be from 0 to .99 of the fallout, depending on the altitude and size of the weapon.

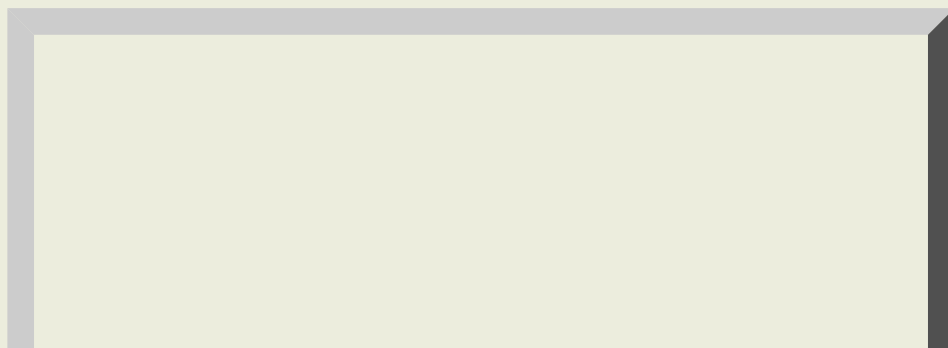

[click here](#) for Shapley Pages 2 and 3
which are a reprint from
OTA (Office of Technology Assessment),
The effects of nuclear war

Shapley Page 4

For the worst scenario (6500 MT) they predict 100 million early fatalities (could be as high as 160 million). On ([Shapley p. 5](#)) they give a comparison of latent health effects from external and internal exposures from local fallout. By far the most of the effects are from external exposure rather than from internal exposure. For cancer deaths only 7% are from internal exposure and for thyroid cancers it is less than 1%. On ([Shapley p. 6](#)) they give worldwide fallout health effects for the U.S. The most interesting thing about this is that they see carbon-14 as the biggest problem in this category. Next table ([also on Shapley p. 6](#)) is total latent health effects and the numbers do look high. The thing to keep in mind is that these figures are for the subsequent 40 years. 6.6 million cancer deaths in 40 years is about 40% of the current U.S. annual rate. It is interesting to note that there are almost as many latent health effects outside of the U.S. (e.g. 4,545,000 cancer deaths). These would be distributed all over the world. If there was a similar attack on the Soviet Union, there would be 167,000 cancer deaths plus all the other latent health effects in the U.S.

([Shapley p. 7](#)) and ([Shapley p. 8](#)) give the summary of their conclusions.

([Shapley p. 9](#)) gives their references.

[click here](#) for Shapley Page 5
which is a reprint of
LOCAL FALLOUT HEALTH EFFECTS
from OTA (Office of Technology Assessment),
The effects of nuclear war

[click here](#) for Shapley Page 6
which is a reprint of three tables
WORLD WIDE FALLOUT HEALTH EFFECTS
TOTAL LATENT HEALTH EFFECTS
and
TOTAL LATENT HEALTH EFFECTS OUTSIDE
OF U.S.
from OTA (Office of Technology Assessment),
The effects of nuclear war

Shapley Page 7.

CONCLUSIONS

The long-term major adverse health effects resulting from hypothesized nuclear scenarios covering a nuclear employment range from a single weapon to a massive attack utilizing thousands of nuclear weapons were calculated. The general findings were as follows:

1. Several million latent cancer deaths could result from a massive nuclear attack directed at urban-industrial, military, and counterforce targets. **note* However, without improved civil defense capabilities, the number of projected latent cancer deaths is small when compared with the total number of early fatalities. Similar magnitudes of thyroid cancers, thyroid nodules, and genetic anomalies are also projected.

**note 5 million worldwide cancer deaths over a period of 40 years represent an increase of about 2 to 3 percent of the current cancer death rate. - They must be using Northern Hemisphere or something. For U.S. this would be closer to 30%.*

2. For limited attacks where the target points are in relatively low population density areas, the resulting number of latent cancer deaths could be large when compared with the total number of early fatalities.

3. For nuclear employments that are dominated by airbursts, the projected number of long-term adverse health effects that would occur in the attacked country is only a small percentage of the projected worldwide total.

4. For airbursts, the resulting number of long-term adverse health effects are larger for low yield weapons (40 KT) than for high yield weapons (1 MT) when compared on a per unit

fission yield basis. The reason is that the nuclear debris of low yield airbursts is confined within the troposphere, whereas most of the nuclear debris from high yield airbursts enters the stratosphere.

5. Increasing the local fallout decontamination effectiveness to residual levels below 0.1 will not materially decrease the total number of long-term latent health effects because the local fallout post-shelter population dose constitutes only a small

Shapley Page 8.

fraction of the total population dose when the fallout levels are reduced by a factor of 0.1 by decontamination.

6. The use of low yield weapons in the surface burst mode rather than high yield weapons as air bursts would increase the long-term latent adverse health effects in the country attacked and decrease the number of the effects in the rest of the world.

7. For massive nuclear attacks (Scenario 5a and 5b), although the number of early fatalities are sensitive to the shelter protection provided the population, the projected total number of latent health effects are relatively insensitive to the shelter protection provided.

Office of Technology Assessment, *The Effects of Nuclear War*, Gale Research Company, Book Tower, Detroit, Michigan 48226, 1984. (This is an extended version of 1979 publication by U.S. Govt. Printing Office.)

Abbreviation used: OTA, *The effects of Nuclear War*.

Shapley Page 9.

REFERENCES

1. The Effects of Nuclear Weapons, Compiled and edited by S. Glasstone and P. J. Dolan, Third Edition, U.S. Department of Defense and U. S. Department of Energy, 1977.
2. Report of the United Nations Scientific Committee on the Effects of Atomic Radiation, General Assembly, Official Records: Seventeenth Session, Supplement No. 16 (A/5216), United Nations, New York, 1962.
3. H. Lee, P. W. Wong, and S. L. Brown, SEER II: A New Damage Assessment Fallout Model, DNA3008F, SRI International, Menlo Park, California, May 1972.
4. (Classified Report)

5. G. R. Crocker and T. Turner, Calculated Activities, Exposure Rates, and Gamma Spectra for Unfractionated Fission Products, USNRDL-TR-1009, U.S. Naval Radiological Defense Laboratory, San Francisco, California, 28 December 1965.
6. N. C. Rasmussen et al., Reactor Safety Study: An Assessment of Accident Risks in U.S. Commercial Nuclear Power Plants, Appendix VI, Calculation of Reactor Accident Consequences, WASH-1400, Nuclear Regulatory Commission, October 1975.
7. H. Lee, W. L. Owen, and C. F. Miller, General Analysis of Radiological Recovery Capabilities, SRI International, Menlo Park, California, June 1968.
8. The Effects on Populations of Exposure to Low Levels of Ionizing Radiation, Advisory Committee on the Biological Effects of Ionizing Radiations, National Academy of Sciences, Washington, D.C., November 1972.
9. R. A. Armistead et al., Analysis of Public Consequences from Postulated Severe Accident Sequences in Underground Nuclear Power Plants, Advanced Research and Applications Corporation, Sunnyvale, California, December 1977.

THE MOST IMPORTANT FISSION PRODUCTS IN FOOD

Shapley Page 10

There are a number of good books on the subject. The most valuable probably is *Radioactivity and Human Diet*, ed. R. Scott Russell, Pergamon Press, 1966. Others: *Radionuclides in Foods*, National Academy of Sciences, 1973. *Radioactive Fallout, Soils, Plants, Foods, Man*, ed. Eric B. Fowler, 1965.

Iodine, strontium, and cesium are the most important radionuclides that enter the food chain and are absorbed by man from the intestinal tract. Barium-140, ruthenium-103, iron-55 can also be absorbed to a small extent. Tritium and carbon-14 are also very important but they are so mobile in the environment, no one can do anything about them. There are many other radionuclides that are important in the first few months after a nuclear explosion if one eats food directly contaminated by the fallout. Although the latter radionuclides are not absorbed by the body, they can do great damage to the intestinal tract while they are

passing through the body.

Iodine. There are some 11 isotopes of iodine that are produced in fission. All except I-129 which has a half-life of 1.6×10^7 years have shorter half lives than I-131.

Isotope	Half-life	Activity relative to 24 hrs after thermal fission of U-235
I-131	8.05 days	1
I-132	2.3 hrs	3
I-133	20.8 hrs	9
I-135	6.7 hrs	5

Although I-132, I-133, and I-135 are more abundant initially, they result in lower doses than I-131 because of their shorter half-lives. I-132 persists in appreciable amounts longer than its half-life would indicate, because it is produced mainly from tellurium-132 which has a half-life of 78 hours. The doses from and I-132 and I-133 can exceed I-131 near the explosion site for the first week. (R. J. Garner and R. Scott Russell, "Isotopes of iodine", in *Radio activity and Human Diet*, 1966.)

Shapley Page 11.

Iodine is readily absorbed through any moist skin or mucosal surface, and essentially all that is ingested is absorbed. The amount of radioiodine taken up by the thyroid is closely dependent on the dietary level of stable iodine. About 20% of the intake ends up in the thyroid. Most of the iodine in man is excreted via the urine, and its biological half-life is 2-4 months. The effective half-life is a little less than its physical half-life, 7.6 days. Iodine is actively concentrated in the thyroid, that means that the concentration in the thyroid is much higher than in plasma.

Since thyroid is relatively small, 20 g, it doesn't take much to damage the gland. The first type of damage is nodules, then cancers and if the dose has been extremely high, destruction of the tissue itself. The result of the last case is hypothyroidism. Radiation induced cancers are almost invariably less malignant than the usual type that aren't induced by radiation. It is, therefore, believed that radiation increases the number of cancers but does not increase mortality as a whole. (Diane G. Crocker, "Nuclear reactor accidents - the use of KI as a blocking agent against radioiodine uptake in the thyroid," *Health Physics*, 46:1265-1279, 1984.)

There is a lot of literature on I-131 as well as on potassium iodide (KI) as a means of preventing the uptake of radioiodine by the thyroid. The reason is that potentially there could be high releases of I-131 from nuclear power plant accidents. Windscale accident in England resulted in the withholding of milk from the market for a while. Initial exposure in such cases is from inhalation, but the subsequent dose from eating contaminated food is 400-700 times higher. The main source of I-131 in human diet is milk,

partly because milk is consumed relatively fresh.

Both KI and potassium iodate (KIO₃) can be used to saturate the iodine uptake system of the thyroid. The advantage of KIO₃ is that it has a much longer shelf life,

Shapley Page 12.

up to 10 years, versus about 2 years for KI. Inside the body I¹³¹ gets quickly converted to I⁻ and acts the same way as if originally it had been KI. About 130 mg of KI completely blocks radioiodine uptake for about 24 hours, 65 mg of KI is probably sufficient for children. It is most effective if given shortly before to 1-2 hours after exposure. The effectiveness of KI decreases rapidly with time after exposure, limited benefit is possible up to 12 hours after a single exposure. KI can be bought at drugstores without prescription in the U.S.

Unfortunately, there are side effects to taking large quantities of KI. It is only when the exposure level is 10 rem that the risk from radiation damage exceeds the risk from KI. In geriatric or coronary patients the hazard from KI might be greater than the radiation hazard under any circumstances. Asthmatics, chronic heart or renal failure patients, patients with hypocomplementemic vasculitis and autoimmune related diseases have reacted very severely to KI treatments. The fetus and the newborn are also susceptible to harmful effects. Unfortunately, this group is also more susceptible to the adverse effects of radioiodine. (Diane G. Crocker, *ibid.*)

The half-life of I-131 is too short for absorption from the soil or from the plant base to be major routes of entry into the food chain. The interval between grain harvesting and consumption is long enough that one doesn't have to worry about iodine. When iodine is deposited on leaves of plants, most of it is not absorbed. A lot of it can be washed off by rain or removed by mechanical processes. All of the above explains why a cow eating grass directly is the main entry route of iodine into the food chain. Levels of contamination in milk have frequently decreased more rapidly than the physical half-life of I-131. This is due to "field-loss" factor. In one case, the activity decreased by a factor of 2 in 2 weeks compared to the loss due to physical decay.

Shapley Page 13.

Fraction of ingested I-131 taken up by the thyroid can vary quite a bit but it is approximately 20% in cow as well as man. I-131 starts appearing in milk in 30 minutes and reaches maximum within 12 hours after a single exposure. The kind of conditions that would be true after a nuclear war, it would be 2-4 days after the start of fallout that it would reach the maximum concentration in milk. Both the cow's udder and the human breast concentrate iodine into milk in relation to the blood iodine level.

I-131 can also be incorporated into egg yolks in chickens on free range. After Windscale accident the activity of I-131 per egg averaged approximately 1/20 of that per litre of milk. (R. J. Garner and R. Scott Russell, *ibid.*)

If iodine were deposited in winter, the iodine hazard would be greatly reduced. The highest levels of contamination occur when the cows are grazing or are fed recently cut herbage. Contamination decreases markedly when stored food is substituted. From this it can be seen that the greatest danger would be right at the haying season. Previous year's stocks would have been exhausted and the next year's stocks wouldn't be in the barn yet.

Summary of the proposed protective measures:

1. Removal of lactating cows from pasturage-feeding system and substitution of stored feed rations. I-131 is reduced to insignificant levels in 3-4 days. The reverse is true if cows are placed on contaminated pasture. If cows were in and kept in when the fallout started, no problem would arise.
 2. Withholding contaminated product to allow radioactive decay.
 3. Supplying milk to areas of high contamination from areas where contamination is low.
 4. Diverting contaminated milk into manufactured products and substituting processed milk, e.g., powdered or canned milk.
 5. Storage of frozen fresh milk.
- Shapley Page 14.
6. Storage of fresh concentrated milk.
 7. Storage of frozen concentrated milk.
 8. Physical removal of iodine-131 from milk with ion- exchange resin.

(Frank A. Todd, "Protecting foods and water against radio- active contamination," pp. 235-256, *Protection of the Public in the Event of Radiation Accidents*, World Health Organization, 1965.)

All of the above, except #1, are completely dependent on the availability of electricity and transportation. Number one is partly dependent on transportation. If there was no electricity, the cows would not be milked. We don't have the personnel who know how to milk cows. So you could learn it in a day, but there is no way you could develop the strength in a short time to milk more than one cow. I called up the local dairy farmer to ask what they would do if there was no electricity. They have 40 cows and they would not be milked unless they obtained a generator. They have had to do that once in the past. Their milk goes down to Guelph, that is more than 100 km away. There are 2 small cheese plants that are a little closer, but she couldn't think of any milk processing plant that would be closer.

Strontium. There are two types of strontium (Sr). Sr-89 is important the first month and Sr-90 is important for a long time. Both emit only B rays.

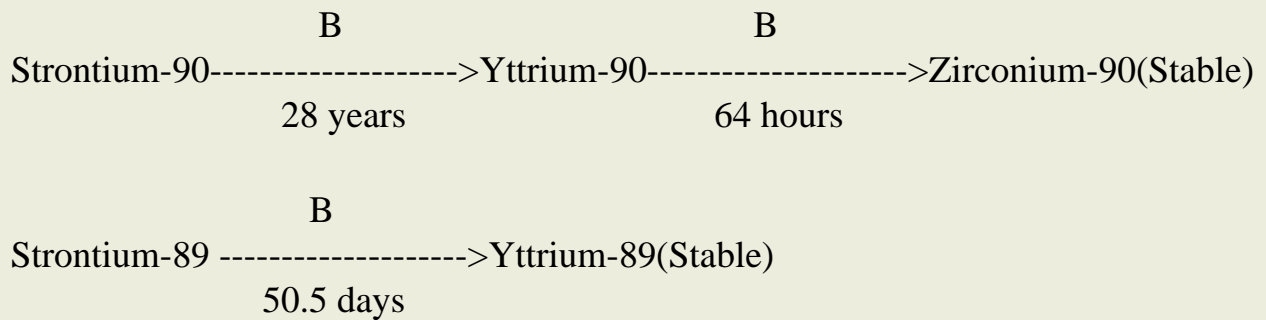

Strontium is metabolized the same way as calcium (Ca). Strontium absorption, however, is discriminated against by body, compared to calcium absorption. Ratios of Sr/Ca in blood is 1/3 to 1/4 of what it is in diet. Mother's milk has half the Sr concentration in blood and the fetus

Shapley Page 15.

also has only half the concentration. The effective half-life in body is 50 days for Sr-89 and 17.5 years for Sr-90. (Cs also has a long half-life but its effective half-life in body is less than 100 days.) Its long effective-half life is what makes Sr-90 such a dangerous radionuclide.

Ratio of Sr to Ca in new bone is in equilibrium with body fluids. In other words, the amount of strontium that gets deposited in bone is dependent on the ratio of Sr/Ca in blood. Therefore, radiostrontium concentration is a lot of times expressed in terms of Ca concentration. The common units are pc of Sr/g of Ca or for milk pc Sr/l.

The main source of strontium in a western diet is dairy products. But that doesn't give the whole picture. As explained above, strontium absorption depends on the level of calcium and dairy products are also the major source of calcium in western diets. It might look like elimination of dairy products would improve the situation but the reverse would be true. More vegetables would be consumed and there the ratio of Sr/Ca is much higher. Third world countries got twice the amount of strontium in their diets compared to that of the western countries.

**The following table of contribution of various foods to Sr-90
in population of N.Y. City
illustrates the differences in calcium levels
and their subsequent effect.**

Food	pc/yr	% total intake	% total intake
		----- ca	----- Sr-90
Dairy products	2080	58	38
Vegetables	1212	9	22
Fruits, fresh and canned	1192	3	22
Cereals and bakery products	588	20	11
Meat, poultry eggs	178	8	3
Fish	5	2	-
Water	200	-	4

Radionuclides in Foods, p. 34, National Academy of Sciences, 1973.

Shapley Page 16.

In vegetables the strontium content can be reduced 19-55% by common home preparation. In canned fruit the reduction can even be higher compared to fresh fruit. The following are given as methods for reducing strontium intake.

1. Protection of packaged and stored foods.
2. Removal of surface contamination by washing and scrubbing of fruits and vegetables.
3. Removal of surface contamination by peeling.
4. Removal of internal contamination of food through processing.
5. Reduction of strontium-90 secretion into milk by supplementing rations of dairy cows with calcium.
6. Removal of radioactivity by use of such processes as ion-exchange, electro dialysis, or calcium phosphate treatment.

Frank A. Todd, *ibid*. One important method Todd doesn't mention is milling of wheat. Whole wheat has twice the Sr/Ca than white flour.

There is a good discussion of remedial measures by C. L. Comar and J. C. Thompson, Jr. with emphasis on "certain aspects of feasible large-scale measures" in *Survival of Food Crops and Livestock in the Event of Nuclear War*, 1970, "Status of remedial measures against environmental radiocontamination".

The plant root makes little distinction between Ca and Sr if they are in the same chemical form. Soluble Ca in the soil acts as a diluent for the Sr - the amount of calcium in soil is important. Generally good agricultural soils result in lower Sr content in food. Strontium deposited on the plants may be trapped and absorbed through those parts of the plant which are above the ground. The amount that is so trapped depends on the form of the plants, it is usually considerable in grasses. Again, a cow comes along and picks it all up, the absorbed and the unabsorbed Sr. Luckily, there is discrimination against strontium relative to calcium by a factor of about 10 which occurs in the transfer of the two elements from the diet of cattle to milk.

Shapley Page 17.

Cesium. Cesium (Cs)-137 is the third most dangerous radio-nuclide that enters very quickly the human food chain after a nuclear fallout. It is an alkali metal like potassium (K) and its behaviour in nature as well as the human body is similar to that of potassium. The relationship between the two, although, is not as close as between Sr and Ca. The decay scheme of Cs-137 is shown below.

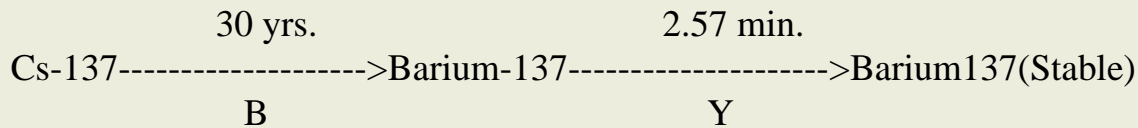

Cesium is around in the environment for a long time, its half-life is 30 years. Quite commonly Cs is referred to as a Y source. Technically this is not correct. Cs decays by a B emission to Ba-137 which has a half-life of only 2.57 min. when it decays by a Y emission to a stable form of Ba. Its "daughter", however, has such a short half-life that Cs is ordinarily identified by Y spectrometry of the Y emission of its daughter. Cs is more common in fallout than Sr by 1.3 to 1.7.

Cesium is freely absorbed from the human intestinal tract and appears to have an average stay of 4 months.. Compared to other radionuclides, it is distributed fairly uniformly over the body. The human body content of Cs-137 is closely related to the level of it in the diet. It is absorbed preferentially to potassium. The ratio of Cs-137/ gK is 3 times higher in body than in food. In animal studies one has to take 9 times the normal level of K to cut Cs-137 level by half. L. Fredriksson, R. J. Garner and R. Scott Russell , "Caesium-137", in *Radioactivity and Human Diet*, 1966.

Sources of Cs in human food:

Cows milk 30% or 25-40%

Grain products 25% or 17-30%

Meat 20% or 12-26%

Fruit 10% or 15%

Vegetables 10% or 15%

Fish important where it forms a large part of diet,

Shapley Page 18.

The two sets of figures just given are from two different sources. They indicate that cesium is distributed relatively evenly among the different food groups.

Because cesium has volatile precursors, a lot of it ends up in stratosphere. Very roughly its mean time in stratosphere is 2 years. As it falls down, it is deposited on any growing vegetation. Most of the Cs that enters the food chain is absorbed by the plants directly and not from soil after it has been washed down. The heaviest fallout occurs in spring because most of the mixing between stratosphere and troposphere occurs during late winter. Areas with higher rainfall can receive twice as much fallout.

Cesium is readily absorbed by clay particles in soil. It is held tightly enough that only a few per cent of Cs-137 in soil is taken up through the roots of plants. Sandy soils and especially soils with a high content of organic matter bind Cs less effectively. Plants grown on these soils have higher Cs-137 content. Most of the Cs contained in the edible parts of vegetables is due to deposition of particulate material on leaves.

Under certain conditions, Cs can undergo considerable concentration in terrestrial and aquatic food chains. Freshwater fish have been shown to contain it in concentrations several thousand times higher than the concentration in their surroundings. Fish feed on lower aquatic organisms which have already concentrated it above the levels present in water. Shellfish do the same thing. Cesium is effectively trapped and retained by the lichen and moss of the tundra, which are major sources of food for caribou and reindeer. Caribou flesh contained up to 100 times the quantities found in meat in mid latitudes.

Once fallout has stopped Cs becomes trapped in the top 2 cm of soil. External radiation from it would continue for many years. Its greatest danger is considered to be genetically.

Shapley Page 19.

Carbon-14. Most of the carbon (C)-14 is released into the stratosphere, from where it equilibrated with the troposphere with a half-time of about 2 years. Tissue C-14 comes into equilibrium with C-14 in the atmosphere with a delay time of about 1.4 years. The retention half-time of dietary carbon in mammals is estimated to be about 40 days. Like tritium, carbon 14 is highly mobile in the environment and no one can do anything about it.

Tritium. Tritium is radioactive hydrogen. Less than 1% of tritium becomes part of the water molecule but it is in this form that it passes through the eco-systems. It behaves identically to ordinary water. It is

highly mobile in the environment and very quickly equilibrates in the different systems.

Iron-55. Two pathways are known for the concentration of iron (Fe)-55. Lichen-caribou pathway is important for Eskimos and Lapps. The second source is marine fish. The marine food chain concentrates Fe-55 even more than the first pathway. The reason for this is the low concentration of stable iron in sea water.

Half-life of Fe-55 in lichens is 1.4 years.

Erythrocyte is considered to be the critical organ.

Ruthenium-106. Ruthenium is known to have accumulated in at least one known food chain. A seaweed in Irish sea that is used by some people in making bread. Critical organ for this case is the lower large intestine. Some people got as much as half the yearly dose limit of rems/yr for lower intestine during the Windscale accident.

METHODS OF MEASUREMENT

Shapley Page 20

There is a lot of literature on the measurement of Sr-89 and -90, I-131 and Cs-137 in the environment and in food. Scientists have been doing it all over the world as the result of the atomic bomb tests in the fifties and the first part of the sixties. The most comprehensive references are: Esther Ferri, Paul J. Magno and Lloyd R. Setter, *Radionuclide analysis of large numbers of food and water samples*, U.S. Dept. Health, Education, and Welfare, 1965. National Center for Radiological Health, *Radioassay Procedures for Environmental Samples*, U.S. Dept. of Health, Education, and Welfare, 1967. *Manual of Standard Procedures*, NYO-4700, Health and Safety Laboratory, U.S. Atomic Energy Commission, New York Operations Office. The above do give details for the procedures but are designed for quantities much smaller than what one would be measuring after a nuclear war. They require highly skilled personnel and very sophisticated equipment.

E. R. Mercer ("Analytical Methods" in *Radioactivity in Human Diet*, ed. R. Scott Russell, 1966.) has a short but clear review of the above methods. He says that in emergencies, when much higher levels of contamination than normal will be acceptable, much simpler analytical methods are adequate. Unfortunately he doesn't describe them. This happens quite a few times, they aren't described because they are obvious to people who work with radioactivity but not so obvious for a person who doesn't have

any experience using different radiation detection instruments or measuring mixtures of different radionuclides. He does make a few relevant comments in passing. If Cs-137 exceeds 300 pc/l in milk, it can be measured directly in a sodium iodide (NaI) crystal scintillation counter. Gamma spectrometric measurement of I-131 can also be done directly on whole milk if the level is high enough. Cesium and iodine can also interfere with each other.

Strontium assays are very complicated, numerous radiochemical separations have to be done. Usually Sr-90 is

Shapley Page 21.

calculated from the amount of its daughter yttrium-90 (Sr-90 decays to Y-90) and Sr-89 is determined by the difference.

Daniel A. Collnick does give a simple method for analyzing, milk (*Experimental radiological health physics*, 1978). Since the ratio, of Cs-137 to each of the Sr isotopes is a fixed constant at the time when fission takes place, the strontium concentrations can be calculated from the cesium concentration.

$$\frac{\text{Cs-137}}{\text{Sr-90}} = 5 \qquad \frac{\text{Cs-137}}{\text{Sr-89}} = 0.03$$

First of all, these formulas are for milk, in the fallout Cs-137 to Sr-90 ratio is about 1.6. Second, Sr-89 has a relatively short half-life compared to Cs-137, so the ratio changes with time, it has to be doubled every 51 days after the fissions have occurred. Cs-137 and Sr-90 have similar enough half-lives that the change with time can be ignored.

The milk is passed through an anion exchange resin. I-131, being the only anion in the group of 4 we are interested in, is retained on the resin and everything else passes through. Resin is transferred to a bottle that is counted in a solid scintillation counter. The result is calculated from a known I-131 sample that has been treated the same way. The strontium isotopes are pure beta emitters, therefore, the effluent can be poured into a beaker that fits into a NaI counter and counted for gamma emissions from cesium. The result is compared to a known amount of Cs-137 under the same conditions. The cesium value is used in the formulas given above to calculate the amounts of the two different strontiums.

Collnick also gives the following very useful table of what would be the dose commitment from milk, given a level of activity in milk when it is at the highest (2-4 days after the event). There must be, however, some mistake in rads for Sr-89. If it is 3 rads in the first year, there is no way with its short half-life it can give 2 more rads in subsequent years.

Shapley Page 22.

Dose Commitment from Milk

Radionuclide	RADS	Max. conc. in milk uc/l,p
Sr-89	3 in 1st yr, 5 total	1.1
Sr-90	3 in 1st yr, 5 total	0.05
I-131	10	0.07
Cs-137	3 in 1st yr, 5 total	0.72

The above is the sort of approach, that I think would be taken, if there were a nuclear holocaust. There are different models for predicting dose commitment from the level of fallout. R. Scott Russel, B. O. Bartlett, and R. S. Bruce, "The significance of long-lived nuclides after a nuclear war," in *Survival of Food Crops and Livestock in the Event of Nuclear War*, 1970. A. Aarkrog, "Prediction models for Strontium-90 and Caesium-137 Levels in the Human Food Chain", *Health Physics*, 20:297-311, 1971. W. F. Lengeman has many papers on prediction models. The measurement would be done from an airplane or for more detail from a car. A. C. Chamberlain, R. J. Garner and D. Williams, "Environmental monitoring after accidental deposition of radioactivity," *React. Sci. Technology*, 14:155-167, 1961.

There are some references that sound good but are not easily available. *Guidance on Offsite Emergency Radiation Measurement Systems, Phase 2: The Milk Pathway*, B. J. Salmonson, L. G. Hoffman, R. J. Honkus, and J. H. Keller, Westinghouse Idaho Nuclear Company, Inc., WINCO-1009, April 1984. Also by the same people, company and title but a different subtitle: *Phase 3: Water and Non-Dairy Food Pathway*, WINCO-1012, October 1984. I wanted to send for these two papers but I couldn't find Westinghouse Idaho Nuclear Co. listed in any of the industrial indexes. The closest I could get is that Westinghouse does have a subsidiary called Bettis Atomic Power Lab, Idaho Falls, Idaho (1-208-526-0111). It could be the same company.

Shapley Page 23.

Daniel A. Gollnick also has a book out *Basic Radiation Protection Technology*, Pacific Radiation Press, 1983. It isn't available in Toronto. It might have the type of information we are interested in because it has been referred to in places where the concern has been nuclear war.

LACK OF STANDARDS AND MPD

Shapley Page 24

Currently there aren't any guide lines for intake of radioactive material under the conditions of a nuclear war. The main reason for this is that radioactivity in food is not regarded as a priority in an event of a nuclear war.

"Eating food produced in the years after a large attack would cause an increase in the cancer rate... this increase would be a small fraction of the number of additional cancer deaths that would result from external radiation." Cresson H. Kearney, *Nuclear War Survival Skills*, p. 65, 1980.

Most vegetables would be fit to eat once they had been thoroughly washed. When it is safe to work outside, can plant new crops - they will be safe to eat. Ivan Tyrell, *The survival Option, A guide to living through nuclear war*, 1982.

"Standing crops in the early stages of growth are damaged by radiation but otherwise are safe to eat if washed clean of dust." p. 105. "Lack of food and water will cause starvation and death of many millions, especially the young and old." p. 115. Diane Diacon, *Residential Housing and Nuclear Attack*, 1984. The latter two books are English and I don't know anything about the credentials of their authors. The quotes that follow are by R. Scott Russell, unquestionably one of the world authorities on strontium and cesium in fallout and their biological pathways.

"In short, the total deaths caused by long-lived nuclides seem broadly comparable to the annual traffic death rate." (Incidentally, the figures for lung cancer from smoking are higher than traffic fatalities.) "Thus, by the standards the community now accepts, remedial action against the risks from long-lived nuclides would not seem justified; The number of casualties would be so small relative to the total loss and the difficulty of avoiding them would be so great that remedial action could not

Shapley Page 25.

reasonably be contemplated." "...efforts to mitigate doses from radiation should be devoted solely to the early period when short-lived nuclides predominate."

R. Scott Russell, B. Bartlett, and R. S. Bruce, "The significance of longlived nuclides after a nuclear war," in *Survival of Food Crops and Livestock in the Event of Nuclear War*, 1970.

The maximum permissible doses (MPD) used now are based on the philosophy that any radiation is bad and the less the better. Dose limiting recommendations by the National Council on Radiation Protection (NCRP) are given in Table 6.1. The levels are very low, for general population, 0.17 rem/year. This is less than the natural background radiation in some places.

There certainly is awareness that maximum permissible doses are not what would be in effect after a nuclear holocaust.

J. C. Thompson, Jr., R. A. Wentworth, and C L. Comar ("Control of fallout contamination in the postattack diet," in *Survival of Food see: (...above1, ...above2, ...above3)* expressed the need for guidelines that respond to tolerance or survival levels of radioactivity rather than the minimum-exposure concept that is in effect now. They would like to have a "system of radiation-exposure priorities" that would become operational after a nuclear attack. They are aware of the irony that the larger the attack, the lower the priority of fallout considerations in food.

"It would be poor operational procedure to initiate efforts to reduce dietary contamination from 10 R to 1 R when general external radiation levels were 100 R and a state of pestilence threatened."

The problem of lack of radiation protection standards designed for nuclear war conditions has been discussed by Lauriston S. Taylor in "Standards for radiation exposure management in accident or nuclear attack," a talk he has given at some recent symposium. (I don't have a complete reference, the paper was sent to me.) The same as J. C. Thompson *et al*, he recognizes that there can really be no fixed standards that can be applied to basically uncontrollable

Shapley Page 26.

328 *Radiation Protection* by Jacob Shapiro

Table 6.1. Dose-limiting recommendations of N C R P (1971).

Occupational exposure limits

Whole body, gonads, lens of eye, red bone marrow

5 rem in any one year

Skin

15 rem in any one year

Hands

75 rem in any one year (25/qtr)

Forearms

30 rem in any one year (10/qtr)

Other organs, tissues and organ systems

15 rem in any one year (5/qtr)

Fertile women (with respect to fetus)

0.5 rem in gestation period (5/qtr)

Dose limits for the public, or occasionally exposed individuals	
Individual or occasional	0.5 rem in any one year
Students	0.1 rem in any one year
Population dose limits	
Genetic	0.17 rem av per year
Somatic	0.17 rem av per year
Emergency dose limits-lifesaving	
Individual (older than 45 yr if possible)	100 rem
Hands and forearms	200 rem, additional (300 rem total)
Emergency dose limits-less urgent	
Individual	25 rem
Hands and forearms	100 rem total
Family of radioactive patients	
Individual (under 45 yr)	0.5 rem in any one year
Individual (over 45 yr)	5 rem in any one year

Source : NCRP, 1971, Table 6.

Shapley Page 27.

radiation situations. The best that we have are what is called "penalty tables". The following is based on

brief, whole body gamma-ray doses:

Dose	Need Medical Care	Able to Work	Die
15-50 R	no	yes	0
50-200 R	no	yes	<5%
200-400 R	yes	no	<50%
450-600 R	yes	no	>50%
>600 R	yes	no	100%

The above is the kind of data that is available but that is not what the situation would be after a nuclear war. There would be a long period of high radiation level followed by even longer period of moderate radiation levels. The following table is a little more useful:

Category	Need Medical Care	Accumulated Exposure in: 1 Week	Accumulated Exposure in: 1 Month	Accumulated Exposure in: 4 Months
A	None	150 R	250 R	300
B	Some (5% die)	250 R	350 R	500
C	Most (50% die)	450 R	600R	--

Lauriston S. Taylor, *ibid.*

There is very little information on *chronic* exposures that scientists could use to develop emergency standards. Needless to say, there is even less information on continuous internal intake of low or large amounts of radioactivity (the only exception is the radium dial painters). Japan did not have any early fallout in 1945. From the Japanese data and past medical uses of radioactivity it is known how many people would get leukemia and other cancers if a certain number of people would be exposed to a certain level of radiation. From this is derived a linear dose-effect relationship without a threshold. Both NCRP and ICRP (International Commission for Radiological Protection) work on assumption that there is no threshold dose of ionizing radiation below which there is no damage. The dose

Shapley Page 28.

effects are assumed to be additive. Taylor does not think it would be true for long range, low or moderate level chronic exposures. Too many theoretically dead persons are still walking around, as he puts it. There are many people who have been working for years within the maximum permissible dose limits for radiation workers. None of them have had any effects of practical importance. He feels the limits could

be 10 times for more higher before there would be any detectable consequences. Taylor blames the lack of war time radiation guidelines on the media and the public. He feels that the news media have so over-exploited radiation matters that the public is truly frightened of *any* radiation exposure.

"This makes the presentation and public acceptance of any kind of emergency planning extremely difficult."

(There is an analogous phenomenon going on right now. 130 people have died so far from AIDS in Canada. At the same time 4000/yr. die in car accidents, plus many more permanently crippled. Half of the latter are caused by alcohol. Yet the public accepts one but is panic stricken of the other.)

Maximum permissible body burdens, plus all the other dose limits have been developed by the International Commission on Radiological Protection (ICRP) and the National Council on Radiation Protection (NCRP). The body burden of a particular radioactive nuclide is the amount of the nuclide in uc which is present in an individuals body. The maximum permissible body burden is the body burden of a particular radioactive nuclide which results in a MPD (Maximum permissible doses that have been developed for external exposure) to the whole body or to one or more organs in the body. It is computed on the basis that it is the only one in the body. The maximum permissible body burden for a radionuclide of a bone seeking element (e.g. strontium, calcium, radium and plutonium) is the number of uc required to deliver to the bone a dose in rems equal to that provided by 0.1 uc of radium-226. Body burdens

Shapley Page 29.

for radionuclides other than bone seekers require the identification of "critical organ" (the organ which is the most sensitive or has the highest concentration). For a nuclide with the whole body as the "critical organ", the maximum permissible body burden for occupational exposure is the activity present continuously in the body which delivers a dose equivalent of 5 rem/year to the whole body. Nuclides which concentrate in abdominal organs are given limiting body burdens which provide 15 rem/year. (Kedar N. Prasad, *CRC Handbook of Radiobiology*, p. 241, 1984.)

Maximum permissible body burdens and maximum permissible concentrations of radionuclides in water for occupational exposures are given in ICRP publications (for references see *Radiation Protection by Jacob Shapiro*, 1981. The following values for the radionuclides that enter the food chain as a result of a nuclear fallout are from *Radiological Health Handbook*, U. S. Dept. Health, Education and Welfare, p. 207, 1970.

Radionuclide	Critical organ	Body Burden uc	MPC water continuous intake uc/cc

Sr-89	Bone	4	10^{-4}
Sr-90	Bone	2	10^{-6}
Cs-137	Total body	30	2×10^{-4}
I-131	Thyroid	0.7	2×10^{-5}

Given equal concentrations, Sr-90 is 100 times more dangerous than Sr-89. The differences can even be higher, radium-226 is 10,000 times more dangerous than tritium.

ICRP Publ. 2 *Report of Committee II Permissible Dose for Internal Radiation*, Pergamon Press, p. 23-27, 1959 talks about permissible concentration of unidentified radionuclides, mixtures of known radionuclides and some of the problems one would run into if one tried to apply the occupational MPC for water to fallout in water and food.

Shapley Page 30.

Assuming Taylor was right that the external doses could be raised 10 times without much danger, the same thing would also apply here. Iodine and strontium -89 could still be increased by much more because of their short half-lives. The figures given were for continuous intake for 40 years. Although one can take in 100 times more Sr-89 than Sr-90, it initially occurs in 180 times the greater concentration than Sr-90. That is why initially it is the more important. Its half life is 51 days and after that Sr-90 becomes the most important contaminant. Unfortunately, strontium is the hardest to measure.

EMERGENCY SCHEMES

Shapley Page 30

The only permissible emergency levels of radioactivity in food and water for civilians were put out by the United States Agricultural Research Service in 1960, *USDA Radiological Training Manual for Inservice Training*. This procedure was still recommended by the U.S. Dept. of Health, Education and Welfare in 1965, *Civil Defense information for food and drug officials*. I haven't come across anything, that would have replaced this procedure.

There is a food and water standard (CDV-787) that is placed in a standard tin. A Geiger-Mueller counter is placed on top of the tin and a reading is taken, should be in 10 to 15 mr/hr area. The tin is filled with food or water when an unknown is tested. Anything below the standard reading is fit for a 10 day consumption. Anything below 2/3 of the standard reading is fit for 30 day consumption period. The values that they represent are 9×10^{-2} uc/g and 3×10^{-2} uc/g for 10 and 30 day consumption periods respectively.

There is a more extensive emergency scheme by J. D. Teresi and C. L. Newcombe, "Calculations of maximum permissible concentrations of radioactive fallout in water and air based upon military exposure criteria," *Health Physics* 4:275-288, 1961. Although this is for water, I think it would also be applicable to directly contaminated food. Permissible levels for food and water are always the same in literature. It would not be applicable to food grown on contaminated soil. Their figures are based on the 14 major contributors in the fallout mixture. This is subdivided in 3 groups: major contributors for the first 7 days, major contributors for 8 - 104 days and major contributors for 105 - 365 days after the explosion.

Shapley Page 31.

On this basis they calculate the allowable $\mu\text{g}/\text{cm}^3$ to give 15 rem in 90 days, eaten in 7 different time spans, from 1 to 90 days and starting at 11 different times after time 0, from 3.5 hrs to 365 days. See their [Table 6](#). They do the same thing for 150 rems in 30 days. See their [Table 7](#). The tables can be used to get values for any other dose e. g., if you want 75 rem dose in 30 days, divide the value by half. They don't say what standard would be used to determine $\mu\text{g}/\text{cm}^3$. I am concerned that the data on which they based their calculations would be outdated. They submitted their paper for publication Nov 1959. The atomic weapons have changed since that time - the fission products would not be in the same proportions now. For example, cesium is not mentioned. There would also be a better idea of the biological effect of some of these radionuclides in 1985.

There are two other methods for emergency monitoring of drinking water. G.W.C. Tait and W. F. Merritt, "Emergency monitoring of drinking; water", *Health Physics* 1:164-168, 1958. See their [Table 5](#).

Dept. of National Health and Welfare (Ottawa), *Control of radioactive fallout in water systems*, 1965, on (p.81) have presented Teresi and Newcombe's 90 day scheme in form of a graph. Whatever the time after explosion, up to a year, one can read off the values for water contamination that would deliver 15 rems in 90 days. They also give a number of handy approximations to know. Curies of beta particle radioactivity = 2 x curies of gamma ray radioactivity for the first 3 months (ibid. p.7). One day following a nuclear detonation: curies of gamma radioactivity per sq. ft. = roentgens/ hr divided by 100.

Shapley Page 32

[click here](#) for Shapley Page 32

which is a reprint of

J. D. Teresi and C. L. Newcombe, 1961

Table 6. Maximum Permissible concentration ($\mu\text{g}/\text{cm}^3$) in water and air of radioactive fallout for seven exposure times (n) at eleven different times after burst to deliver a dose to the critical organ of 15 rems in 90 days (t)

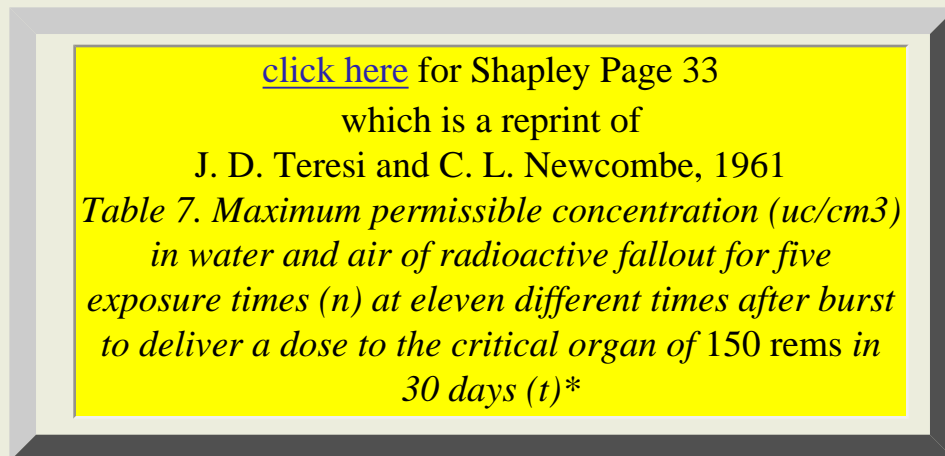

168 EMERGENCY RADIATION MONITORING OF DRINKING WATER

Table 5: *Field measurements mr/hr for maximum permissible water contamination.*

This table applies to any fresh fallout contamination and is for 10 day consumption. Values should be halved for 30 day consumption.

Water body	12hr_1 day_2 days_10 days
Reservoir or lake, measured far from shore.	100_____50_____25_____12

<p>Reservoir pond, etc., measured at arms length from shore, close to surface and over water at least 2ft. deep.</p>	<p>50 _____ 25 _____ 12 _____ 6</p>
<p>Water tank, from 150 to 1000 gal., measured in contact with center of one surface.</p>	<p>50 _____ 25 _____ 12 _____ 6</p>
<p>Water tank, from 2 to 4 gal.</p>	<p>25 _____ 12 _____ 6 _____ 3</p>

G.W.C. Tait and W.F. Merritt

"Emergency monitoring of drinking; water", *Health Physics* 1:164-168.
1958

MENU: [HOME](#) » [Reconstruction](#) » [Recovery](#) » [Renewal](#) » [Survival](#)

From: p. 23/243 of OTA, The effects of nuclear war

Absolute risk is defined as the product of assumed relative risks times the total population at risk. *Relative risk* is defined as the ratio of the risk in those exposed to the risk to those not exposed. The difference between the two risk models leading to major differences in the projected number of cancer deaths lies in the calculated excess of cancers arising from the 0 - 9 years age group at the time of irradiation. Because data on relative risks are sparse and inconclusive, and more data exist supporting the absolute model, the absolute model was used to calculate the latent health effects. Also, because the effectiveness of low exposure rates and/or low radiation exposure doses for producing late health effects remains unresolved, projected cancer deaths were calculated with dose effectiveness factors (DEF) of 1.0 and 0.2 for low exposure rates and doses.* (see below) Also, because there is insufficient data to warrant limiting the risk plateau period to 30 years, a 40 year risk period was used. 9)([see Shapley page 9](#)) Estimates of radiation genetic risks are also uncertain. Reference 8([see Shapley page 9](#)) estimates that the doubling dose for genetic risks to be between 20 and 200 rems although the possibility of it being lower than 20 rems or higher than 200 rems is not dismissed. Since a doubling dose of 100 rems was suggested by Reference 6 ([see Shapley page 9](#)) and it is within the estimated range of Reference 8, ([see Shapley page 9](#)) it was used to project the genetic risks. It follows that if the doubling dose is 20 rems then the projected number of genetic disorders (spontaneous abortions and "other genetic effects") should be multiplied by 5, and if the doubling dose is 200 rems then the projected number of genetic disorders should be halved.

**The (resulting) projected latent health effects
from radiation exposures using a DEF=1
for cancer deaths (are as follows):**

* Multiply by 0.2 for DEF = 0.2

EFFECTS	Number per 10⁶ person rems
Cancer deaths*#####	194.3
Thyroid cancers	134.1

Thyroid nodules	197.4
Spontaneous abortions	42
Other genetic effects	132.4

* A DEF=0.2 implies that the radiation received is only one-fifth as effective per unit of dose for producing latent effects when compared to a high dose received over a short period of time.

Shapley Page 3

From: p. 24/244 of OTA, The effects of nuclear war

**Projected latent cancer deaths
from internal organ exposures (are as follows):**

Organ	Cancer deaths per 10⁶ organ rems
Marrow	45.4
Lung	35.5
Digestive	27.1
Bone	11
Other	75.3

Also, for thyroid exposures from ingested I-131, the effectiveness of the exposure is estimated to be one-tenth that of an external (gamma) exposure. 6)([see Shapley page 9](#))

MENU: [HOME](#) » [Reconstruction](#) » [Recovery](#) » [Renewal](#) » [Survival](#)

*From: OTA, The effects of nuclear war***LOCAL FALLOUT HEALTH EFFECTS**

	PFs=5	PFs=10	PFs=40	Mixed PFs
<u>EXTERNAL EXPOSURE</u>				
Additional Shelter Fatalities	21,712,000	9,441,000	327,200	---
Cancer Deaths (DEF=1)	2,390,000	2,099,000	1,005,000	1,720,000
Cancer Deaths (DEF=0.2)	2,359,000	2,082,000	993,800	1,700,000
Thyroid Cancers	1,650,000	1,449,000	693,500	1,190,000
Thyroid Nodules	2,429,000	2,132,000	1,021,000	1,750,000
Spontaneous Abortions	516,700	453,700	217,200	372,000
Other Genetic Effects	1,629,000	1,430,000	684,700	1,170,000

INTERNAL EXPOSURE

Cancer Deaths (DEF=1)	47,200	80,200	127,800	132,000
Cancer Deaths (DEF=0.2)	9,400	16,000	25,600	26,400
Thyroid Cancers	2,600	4,400	7,000	7,200
Thyroid Nodules	3,800	6,500	10,300	10,600
Spontaneous Abortions	3,100	5,300	8,400	8,700

Other Genetic Effects	9,800	16,600	26,400	27,300
------------------------------	--------------	---------------	---------------	---------------

MENU: [HOME](#) » [Reconstruction](#) » [Recovery](#) » [Renewal](#) » [Survival](#)

OTA, *The effects of nuclear war***WORLDWIDE FALLOUT HEALTH EFFECTS**

	Tropos	Stratos	C-14	Total
Cancer Deaths (DEF=1)	360,100	1,543,000	2,886,000	4,789,000
Cancer Deaths (DEF=0.2)	72,000	308,600	577,200	957,800
Thyroid Cancers	606,800	1,206,000	1,570,000	3,383,800
Thyroid Nodules	893,200	1,776,000	2,311,000	4,980,000
Spontaneous Abortions	49,700	188,200	736,500	974,400
Other Genetic Effects	156,700	590,800	2,324,000	3,072,000

TOTAL LATENT HEALTH EFFECTS

	PFs=5	PFs=10	PFs=40	Mixed PFs
Additional Shelter Fatalities	21,712,000	9,441,000	327,200	---
Cancer Deaths (DEF=1)	7,226,000	6,968,000	5,922,000,000	6,640,000
Cancer Deaths (DEF=0.2)	3,326,000	3,056,000	1,997,000	2,680,000
Thyroid Cancers	5,036,000	4,836,000	4,084,000	4,580,000
Thyroid Nodules	7,413,000	7,119,000	6,011,000	6,730,000

Spontaneous Abortions	1,494,000	1,433,000	1,200,000	1,360,000
Other Genetic Effects	4,711,000	4,515,000	3,783,000	4,270,000

TOTAL LATENT HEALTH EFFECTS OUTSIDE OF THE U.S.		
	DEF=1	DEF=0.2
Cancer deaths	4,545,000	909,000
Thyroid cancers	3,254,000	
Thyroid nodules	4,549,000	
Spontaneous abortions	926,000	
Other genetic effects	2,919,000	

OTA, *The effect of nuclear war*

MENU: [HOME](#) » [Reconstruction](#) » [Recovery](#) » [Renewal](#) » [Survival](#)

J. D. Teresi and C. L. Newcombe, 1961

From:

J. D. Teresi and C. L. Newcombe, "Calculations of maximum permissible concentrations of radioactive fallout in water and air based upon military exposure criteria," *Health Physics* 4:275-288, 1961.**Table 6:** Maximum permissible concentration (uc/cm3) in water and air of radioactive fallout for seven exposure times (n) at eleven different times after burst to deliver a dose to the critical organ of 15 rems in 90 days (t)*

n	Exposure	Time after fission										
		3.5 hr	12 hr	1 day	2 days	4 days	7 days	14 days	28 days	105 days	210 days	365 days
1	Ing. Inh.	2.5 3.7 x 10 ⁻⁴	0.81 1.2 x 10 ⁻⁴	0.48 6.9 x 10 ⁻⁵	0.29 4.0 x 10 ⁻⁵	0.18 2.4 x 10 ⁻⁵	0.13 1.7 x 10 ⁻⁵	6.9 x 10 ⁻⁶ -28.2 x 10 ⁻⁶	7.1 x 10 ⁻⁶ -26.9 x 10 ⁻⁶	0.10 6.4 x 10 ⁻⁶	0.10 6.0 x 10 ⁻⁶	8.0 x 10 ⁻⁶ -25.7 x 10 ⁻⁶
7	Ing. Inh.	0.54 7.7 x 10 ⁻⁵	0.18 2.5 x 10 ⁻⁵	0.10 1.4 x 10 ⁻⁵	5.8 x 10 ⁻⁶ -27.4 x 10 ⁻⁶	3.6 x 10 ⁻⁶ -24.5 x 10 ⁻⁶	2.4 x 10 ⁻⁶ -22.7 x 10 ⁻⁶	1.2 x 10 ⁻⁶ -21.7 x 10 ⁻⁶	1.5 x 10 ⁻⁶ -22.0 x 10 ⁻⁶	1.5 x 10 ⁻⁶ -27.0 x 10 ⁻⁶	1.4 x 10 ⁻⁶ -26.3 x 10 ⁻⁶	1.3 x 10 ⁻⁶ -26.7 x 10 ⁻⁶
14	Ing. Inh.	0.37 5.0 x 10 ⁻⁵	0.12 1.8 x 10 ⁻⁵	6.9 x 10 ⁻⁶ -29.0 x 10 ⁻⁶	3.9 x 10 ⁻⁶ -25.0 x 10 ⁻⁶	2.4 x 10 ⁻⁶ -23.0 x 10 ⁻⁶	1.5 x 10 ⁻⁶ -21.8 x 10 ⁻⁶	7.6 x 10 ⁻⁶ -38.1 x 10 ⁻⁶	7.1 x 10 ⁻⁶ -36.1 x 10 ⁻⁶	8.3 x 10 ⁻⁶ -36.7 x 10 ⁻⁶	7.7 x 10 ⁻⁶ -34.3 x 10 ⁻⁶	6.4 x 10 ⁻⁶ -34.0 x 10 ⁻⁶
21	Ing. Inh.	0.32 4.4 x 10 ⁻⁵	0.11 1.4 x 10 ⁻⁵	5.9 x 10 ⁻⁶ -27.7 x 10 ⁻⁶	3.3 x 10 ⁻⁶ -24.2 x 10 ⁻⁶	2.0 x 10 ⁻⁶ -22.4 x 10 ⁻⁶	1.3 x 10 ⁻⁶ -21.5 x 10 ⁻⁶	5.8 x 10 ⁻⁶ -36.2 x 10 ⁻⁶	5.4 x 10 ⁻⁶ -34.7 x 10 ⁻⁶	5.7 x 10 ⁻⁶ -33.4 x 10 ⁻⁶	5.5 x 10 ⁻⁶ -33.1 x 10 ⁻⁶	4.5 x 10 ⁻⁶ -32.8 x 10 ⁻⁶
30	Ing. Inh.	0.29 3.7 x 10 ⁻⁵	9.7 x 10 ⁻⁶ -21.2 x 10 ⁻⁵	5.4 x 10 ⁻⁶ -26.7 x 10 ⁻⁶	2.6 x 10 ⁻⁶ -23.2 x 10 ⁻⁶	1.8 x 10 ⁻⁶ -22.1 x 10 ⁻⁶	1.1 x 10 ⁻⁶ -21.2 x 10 ⁻⁶	5.3 x 10 ⁻⁶ -34.9 x 10 ⁻⁶	4.5 x 10 ⁻⁶ -33.6 x 10 ⁻⁶	4.4 x 10 ⁻⁶ -32.5 x 10 ⁻⁶	4.1 x 10 ⁻⁶ -32.3 x 10 ⁻⁶	3.3 x 10 ⁻⁶ -32.0 x 10 ⁻⁶
60	Ing. Inh.	0.25 3.2 x 10 ⁻⁵	8.3 x 10 ⁻⁶ -21.0 x 10 ⁻⁵	4.6 x 10 ⁻⁶ -25.4 x 10 ⁻⁶	2.5 x 10 ⁻⁶ -22.9 x 10 ⁻⁶	1.5 x 10 ⁻⁶ -21.5 x 10 ⁻⁶	9.8 x 10 ⁻⁶ -31.1 x 10 ⁻⁶	4.3 x 10 ⁻⁶ -33.7 x 10 ⁻⁶	3.3 x 10 ⁻⁶ -32.6 x 10 ⁻⁶	2.7 x 10 ⁻⁶ -31.7 x 10 ⁻⁶	2.4 x 10 ⁻⁶ -31.5 x 10 ⁻⁶	1.8 x 10 ⁻⁶ -31.4 x 10 ⁻⁶
90	Ing. Inh.	0.24 3.1 x 10 ⁻⁵	8.0 x 10 ⁻⁶ -21.0 x 10 ⁻⁵	4.4 x 10 ⁻⁶ -25.4 x 10 ⁻⁶	2.4 x 10 ⁻⁶ -22.9 x 10 ⁻⁶	1.4 x 10 ⁻⁶ -21.7 x 10 ⁻⁶	9.2 x 10 ⁻⁶ -39.7 x 10 ⁻⁶	3.8 x 10 ⁻⁶ -33.6 x 10 ⁻⁶	2.9 x 10 ⁻⁶ -32.4 x 10 ⁻⁶	2.1 x 10 ⁻⁶ -31.5 x 10 ⁻⁶	1.7 x 10 ⁻⁶ -31.3 x 10 ⁻⁶	1.3 x 10 ⁻⁶ -31.2 x 10 ⁻⁶

* Ing. = ingestion; Inh. = inhalation

From: J. D. Teresi and C. L. Newcombe, "Calculations of maximum permissible concentrations of radioactive fallout in water and air based upon military exposure criteria," *Health Physics* 4:275-288, 1961.

Table 7: Maximum permissible concentration (uc/cm3) in water and air of radioactive fallout for five exposure times (n) at eleven different times after burst to deliver a dose to the critical organ of 150 rems in 30 days (t)*

n	Exposure	Time after fission										
		3.5 hr	12 hr	1 day	2 days	4 days	7 days	14 days	28 days	105 days	210 days	365 days
1	Ing.	27	8.5	5.1	3.0	2.0	1.4	0.78	0.83	1.2	1.3	1.1
	Inh.	4.1×10^{-3}	1.3×10^{-3}	7.7×10^{-1}	4.5×10^{-1}	2.8×10^{-1}	1.9×10^{-1}	1.0×10^{-1}	9.8×10^{-5}	1.2×10^{-1}	1.2×10^{-1}	1.2×10^{-1}
7	Ing.	5.9	1.9	1.1	0.63	0.40	0.26	0.14	0.14	0.18	0.19	0.15
	Inh.	8.6×10^{-1}	2.8×10^{-1}	1.3×10^{-4}	8.0×10^{-5}	5.6×10^{-5}	3.7×10^{-5}	1.8×10^{-5}	1.7×10^{-5}	2.0×10^{-5}	2.0×10^{-5}	1.9×10^{-5}
14	Ing.	4.3	1.4	0.78	0.43	0.27	0.18	$8.8 \times 10^{-21.1 \times 10^{-3}}$	$8.7 \times 10^{-21.0 \times 10^{-5}}$	0.12	0.10	$7.9 \times 10^{-21.0 \times 10^{-5}}$
	Inh.	7.2×10^{-4}	2.3×10^{-4}	1.3×10^{-4}	5.3×10^{-5}	3.8×10^{-5}	2.5×10^{-5}	$8.8 \times 10^{-21.1 \times 10^{-3}}$	$8.7 \times 10^{-21.0 \times 10^{-5}}$	1.1×10^{-5}	1.1×10^{-5}	$7.9 \times 10^{-21.0 \times 10^{-5}}$
21	Ing.	3.7	1.2	0.67	0.38	0.23	0.15	$7.3 \times 10^{-29.8 \times 10^{-6}}$	$6.8 \times 10^{-28.6 \times 10^{-6}}$	$8.1 \times 10^{-28.9 \times 10^{-6}}$	$6.6 \times 10^{-28.6 \times 10^{-6}}$	$5.2 \times 10^{-28.7 \times 10^{-6}}$
	Inh.	5.4×10^{-4}	1.8×10^{-4}	9.7×10^{-5}	5.5×10^{-5}	3.3×10^{-5}	2.0×10^{-5}	$7.3 \times 10^{-29.8 \times 10^{-6}}$	$6.8 \times 10^{-28.6 \times 10^{-6}}$	$8.1 \times 10^{-28.9 \times 10^{-6}}$	$6.6 \times 10^{-28.6 \times 10^{-6}}$	$5.2 \times 10^{-28.7 \times 10^{-6}}$
30	Ing.	3.6	1.1	0.62	0.34	0.21	0.14	$6.8 \times 10^{-29.2 \times 10^{-6}}$	$6.0 \times 10^{-27.9 \times 10^{-6}}$	$6.3 \times 10^{-27.7 \times 10^{-6}}$	$5.1 \times 10^{-27.1 \times 10^{-6}}$	$3.8 \times 10^{-26.4 \times 10^{-6}}$
	Inh.	5.4×10^{-4}	1.7×10^{-4}	8.4×10^{-5}	5.3×10^{-5}	2.8×10^{-5}	2.0×10^{-5}	$6.8 \times 10^{-29.2 \times 10^{-6}}$	$6.0 \times 10^{-27.9 \times 10^{-6}}$	$6.3 \times 10^{-27.7 \times 10^{-6}}$	$5.1 \times 10^{-27.1 \times 10^{-6}}$	$3.8 \times 10^{-26.4 \times 10^{-6}}$

* Ing. = ingestion; Inh. = inhalation

CONTAMINATION OF FOOD PROBLEM AFTER
NUCLEAR WAR

December 4, 1985

Aina J. Shapley

TABLE OF CONTENTS

Overview	p. 1
The most important fission products in food	p. 10
Methods of measurement	p. 20
Lack of standards and MFD	p. 24
Emergency schemes	p. 30

Note.

The vast majority of papers referred to have been copied.

A lot of subjects have not been discussed, e.g. units, different instruments, properties of radiation, and dose calculations. They are described in health physics text books. You have An introduction to radiation protection by Alan Martin and Samuel A. Harbison and Radiation Protection by Jacob Shapiro.

OVERVIEW

The most thorough and the most authoritative book on The effects of nuclear weapons is a book by that title compiled and edited by S. Glasstone and F. J. Dolan, 3rd ed., U. S. Department of Defense and U.S. Department of Energy, 1977. This book is referred to in almost all the articles and books dealing with a nuclear war. It is the source book on the description of the different atomic bombs, their uses and the consequent explosive blast, direct nuclear radiation, direct thermal radiation, EMP, and fallout.

The most thorough study of the probable consequences of nuclear weapons on the United States, as well as on the Soviet Union, was done by the Office of Technology Assessment (OTA), The effects of nuclear war, 1979, (for complete ref see p. 3). They considered five major cases ranging from 1 atomic weapon to an all out mixed military and population attack of 6500 MT (half of it air bursts and the other half surface bursts).

We are interested in the latent health effects. I have copied 7 of the most interesting pages and given them page numbers in the upper right hand corner. The risk factors for the latent health effects, as well as the sources and the compromises they made to arrive at them are given on p. 2. The risk factors they used for latent cancer deaths from internal organ exposures are given on p. 3.

Before we go any further, we have to examine some of the categories they use for the way they present their data. Local fallout is what is deposited within 24 hours after the burst. The fraction of nuclear debris in the local fallout varies from 0.8 from surface bursts to 0 from air-bursts. Worldwide fallout can be of two kinds, tropospheric and stratospheric. Tropospheric fallout is short (weeks). Stratospheric fallout is in years, e.g. removal half-time for Cs-137 is 5 years. Stratospheric fallout can be from 0 to .99 of the fallout, depending on the altitude and

Absolute risk is defined as the product of assumed relative risks times the total population at risk. Relative risk is defined as the ratio of the risk in those exposed to the risk to those not exposed. The difference between the two risk models leading to major differences in the projected number of cancer deaths lies in the calculated excess of cancers arising from the 0 - 9 years age group at the time of irradiation. Because data on relative risks are sparse and inconclusive, and more data exist supporting the absolute model, the absolute model was used to calculate the latent health effects. Also, because the effectiveness of low exposure rates and/or low radiation exposure doses for producing late health effects remains unresolved, projected cancer deaths were calculated with dose effectiveness factors (DEF) of 1.0 and 0.2 for low exposure rates and doses.* Also, because there is insufficient data to warrant limiting the risk plateau period to 30 years, a 40 year risk period was used.⁹⁾ Estimates of radiation genetic risks are also uncertain. Reference 8 estimates that the doubling dose for genetic risks to be between 20 and 200 rems although the possibility of it being lower than 20 rems or higher than 200 rems is not dismissed. Since a doubling dose of 100 rems was suggested by Reference 6 and it is within the estimated range of Reference 8, it was used to project the genetic risks. It follows that if the doubling dose is 20 rems then the projected number of genetic disorders (spontaneous abortions and "other genetic effects") should be multiplied by 5, and if the doubling dose is 200 rems then the projected number of genetic disorders should be halved. The resulting projected latent health effects from radiation exposures using a DEF=1 for cancer deaths are as follows:

<u>Effects</u>	<u>Number per 10⁶ person rems</u>
Cancer deaths *	194.3
Thyroid cancers	134.1
Thyroid nodules	197.4
Spontaneous abortions	42
Other genetic effects	132.4

* Multiply by 0.2 for DEF = 0.2.

* A DEF=0.2 implies that the radiation received is only one-fifth as effective per unit of dose for producing latent effects when compared to a high dose received over a short period of time.

The projected latent cancer deaths from internal organ exposures are as follows:

<u>Organ</u>	<u>Cancer deaths per 10⁶ organ rems</u>
Marrow	45.4
Lung	35.5
Digestive	27.1
Bone	11
Others	75.3

Also, for thyroid exposures from ingested I-131, the effectiveness of the exposure is estimated to be one-tenth that of an external (gamma) exposure.⁶⁾

size of the weapon.

For the worst scenario (6500 MT) they predict 100 million early fatalities (could be as high as 160 million). On p. 5 they give a comparison of latent health effects from external and internal exposures from local fallout. By far the most of the effects are from external exposure rather than from internal exposure. For cancer deaths only 7% are from internal exposure and for thyroid cancers it is less than 1%.

On p. 6 they give worldwide fallout health effects for the U.S. The most interesting thing about this is that they see carbon-14 as the biggest problem in this category. Next table is total latent health effects and the numbers do look high. The thing to keep in mind is that these figures are for the subsequent 40 years. 6.6 million cancer deaths in 40 years is about 40% of the current U.S. annual rate. It is interesting to note that there are almost as many latent health effects outside of the U.S. (e.g. 4,545,000 cancer deaths). These would be distributed all over the world. If there was a similar attack on the Soviet Union, there would be 167,000 cancer deaths plus all the other latent health effects in the U.S.

Pages 7 and 8 give the summary of their conclusions.

Page 9 gives their references.

LOCAL FALLOUT HEALTH EFFECTS

5

	PFs=5	PFs=10	PFs=40	Mixed PFs
<u>External Exposure</u>				
ADDITIONAL SHELTER FATALITIES	21,712,000	9,441,000	327,200	---
CANCER DEATHS (DEF=1)	2,390,000	2,099,000	1,005,000	1,720,000
CANCER DEATHS (DEF=0.2)	2,359,000	2,082,000	993,800	1,700,000
THYROID CANCERS	1,650,000	1,449,000	693,500	1,190,000
THYROID NODULES	2,429,000	2,132,000	1,021,000	1,750,000
SPONTANEOUS ABORTIONS	516,700	453,700	217,200	372,000
OTHER GENETIC EFFECTS	1,629,000	1,430,000	684,700	1,170,000
<u>Internal Exposure</u>				
CANCER DEATHS (DEF=1)	47,200	80,200	127,800	132,000
CANCER DEATHS (DEF=0.2)	9,400	16,000	25,600	26,400
THYROID CANCERS	2,600	4,400	7,000	7,200
THYROID NODULES	3,800	6,500	10,300	10,600
SPONTANEOUS ABORTIONS	3,100	5,300	8,400	8,700
OTHER GENETIC EFFECTS	9,800	16,600	26,400	27,300

WORLDWIDE FALLOUT HEALTH EFFECTS

	TROPOS	STRATOS	C-14	TOTAL
CANCER DEATHS (DEF=1)	360,100	1,543,000	2,886,000	4,789,000
CANCER DEATHS (DEF=0.2)	72,000	308,600	577,200	957,800
THYROID CANCERS	606,800	1,206,000	1,570,000	3,383,000
THYROID NODULES	893,200	1,776,000	2,311,000	4,980,000
SPONTANEOUS ABORTIONS	49,700	188,200	736,500	974,400
OTHER GENETIC EFFECTS	156,700	590.800	2,324,000	3,072,000

TOTAL LATENT HEALTH EFFECTS

	PFs=5	PFs=10	PFs=40	Mixed PFs
ADDITIONAL SHELTER FATALITIES	21,712,000	9,441,000	327,200	----
CANCER DEATHS (DEF=1)	7,226,000	6,968,000	5,922,000	6,640,000
CANCER DEATHS (DEF=0.2)	3,326,000	3,056,000	1,977,000	2,680,000
THYROID CANCERS	5,036,000	4,836,000	4,084,000	4,580,000
THYROID NODULES	7,413,000	7,119,000	6,011,000	6,730,000
SPONTANEOUS ABORTIONS	1,494,000	1,433,000	1,200,000	1,360,000
OTHER GENETIC EFFECTS	4,711,000	4,515,000	3,783,000	4,270,000

TOTAL LATENT HEALTH EFFECTS OUTSIDE OF THE U.S.

	DEF=1	DEF=0.2
CANCER DEATHS	4,545,000	909,000
THYROID CANCERS	3,254,000	
THYROID NODULES	4,549,000	
SPONTANEOUS ABORTIONS	926,000	
OTHER GENETIC EFFECTS	2,919,000	

CONCLUSIONS

The long-term major adverse health effects resulting from hypothesized nuclear scenarios covering a nuclear employment range from a single weapon to a massive attack utilizing thousands of nuclear weapons were calculated. The general findings were as follows:

1. Several million latent cancer deaths could result from a massive nuclear attack directed at urban-industrial, military, and counterforce targets.* However, without improved civil defense capabilities, the number of projected latent cancer deaths is small when compared with the total number of early fatalities. Similar magnitudes of thyroid cancers, thyroid nodules, and genetic anomalies are also projected.
2. For limited attacks where the target points are in relatively low population density areas, the resulting number of latent cancer deaths could be large when compared with the total number of early fatalities.
3. For nuclear employments that are dominated by airbursts, the projected number of long-term adverse health effects that would occur in the attacked country is only a small percentage of the projected worldwide total.
4. For airbursts, the resulting number of long-term adverse health effects are larger for low yield weapons (40 KT) than for high yield weapons (1 MT) when compared on a per unit fission yield basis. The reason is that the nuclear debris of low yield airbursts is confined within the troposphere, whereas most of the nuclear debris from high yield airbursts enters the stratosphere.
5. Increasing the local fallout decontamination effectiveness to residual levels below 0.1 will not materially decrease the total number of long-term latent health effects because the local fallout post-shelter population dose constitutes only a small

* 5 million worldwide cancer deaths over a period of 40 years represent an increase of about 2 to 3 percent of the current cancer death rate. - They must be using Northern Hemisphere or something. For U.S. this would be closer to 30%

fraction of the total population dose when the fallout levels are reduced by a factor of 0.1 by decontamination.

6. The use of low yield weapons in the surface burst mode rather than high yield weapons as air bursts would increase the long-term latent adverse health effects in the country attacked and decrease the number of the effects in the rest of the world.
7. For massive nuclear attacks (Scenario 5a and 5b), although the number of early fatalities are sensitive to the shelter protection provided the population, the projected total number of latent health effects are relatively insensitive to the shelter protection provided.

Office of Technology Assessment, The Effects of Nuclear War, Gale Research Company, Book Tower, Detroit, Michigan 48226, 1984. (This is an extended version of 1979 publication by U.S. Govt. Printing Office.)

Abbreviation used: OTA, The effects of Nuclear War.

REFERENCES

1. The Effects of Nuclear Weapons, Compiled and edited by S. Glasstone and P. J. Dolan, Third Edition, U.S. Department of Defense and U.S. Department of Energy, 1977.
2. Report of the United Nations Scientific Committee on the Effects of Atomic Radiation, General Assembly, Official Records: Seventeenth Session, Supplement No. 16 (A/5216), United Nations, New York, 1962.
3. H. Lee, P. W. Wong, and S. L. Brown, SEER II: A New Damage Assessment Fallout Model, DNA3008F, SRI International, Menlo Park, California, May 1972.
4. (Classified Report)
5. G. R. Crocker and T. Turner, Calculated Activities, Exposure Rates, and Gamma Spectra for Unfractionated Fission Products, USNRDL-TR-1009, U.S. Naval Radiological Defense Laboratory, San Francisco, California, 28 December 1965.
6. N. C. Rasmussen et al., Reactor Safety Study: An Assessment of Accident Risks in U.S. Commercial Nuclear Power Plants, Appendix VI, Calculation of Reactor Accident Consequences, WASH-1400, Nuclear Regulatory Commission, October 1975.
7. H. Lee, W. L. Owen, and C. F. Miller, General Analysis of Radiological Recovery Capabilities, SRI International, Menlo Park, California, June 1968.
8. The Effects on Populations of Exposure to Low Levels of Ionizing Radiation, Advisory Committee on the Biological Effects of Ionizing Radiations, National Academy of Sciences, Washington, D.C., November 1972.
9. R. A. Armistead et al., Analysis of Public Consequences from Postulated Severe Accident Sequences in Underground Nuclear Power Plants, Advanced Research and Applications Corporation, Sunnyvale, California, December 1977.

THE MOST IMPORTANT FISSION PRODUCTS IN FOOD

There are a number of good books on the subject. The most valuable probably is Radioactivity and Human Diet, ed. R. Scott Russell, Pergamon Press, 1966. Others: Radionuclides in Foods, National Academy of Sciences, 1973. Radioactive Fallout, Soils, Plants, Foods, Man, ed. Eric B. Fowler, 1965.

Iodine, strontium, and cesium are the most important radionuclides that enter the food chain and are absorbed by man from the intestinal tract. Barium-140, ruthenium-103, iron-55 can also be absorbed to a small extent. Tritium and carbon-14 are also very important but they are so mobile in the environment, no one can do anything about them. There are many other radionuclides that are important in the first few months after a nuclear explosion if one eats food directly contaminated by the fallout. Although the latter radionuclides are not absorbed by the body, they can do great damage to the intestinal tract while they are passing through the body.

Iodine. There are some 11 isotopes of iodine that are produced in fission. All except I-129 which has a half-life of 1.6×10^7 years have shorter half lives than I-131.

Isotope	Half-life	Activity relative to I-131 24 hrs after thermal fission of U-235
I-131	8.05 days	1
I-132	2.3 hrs	3
I-133	20.8 hrs	9
I-135	6.7 hrs	5

Although I-132, I-133, and I-135 are more abundant initially, they result in lower doses than I-131 because of their shorter half-lives. I-132 persists in appreciable amounts longer than its half-life would indicate, because it is produced mainly from tellurium-132 which has a half-life of 78 hours. The doses from I-132 and I-133 can exceed I-131 near the explosion site for the first week. (R. J. Garner and R. Scott Russell, "Isotopes of iodine", in Radio-

activity and Human Diet, 1966.)

Iodine is readily absorbed through any moist skin or mucosal surface, and essentially all that is ingested is absorbed. The amount of radioiodine taken up by the thyroid is closely dependent on the dietary level of stable iodine, About 20% of the intake ends up in the thyroid. Most of the iodine in man is excreted via the urine, and its biological half-life is 2-4 months. The effective half-life is a little less than its physical half-life, 7.6 days. Iodine is actively concentrated in the thyroid, that means that the concentration in the thyroid is much higher than in plasma.

Since thyroid is relatively small, 20 g, it doesn't take much to damage the gland. The first type of damage is nodules, then cancers and if the dose has been extremely high, destruction of the tissue itself. The result of the last case is hypothyroidism. Radiation induced cancers are almost invariably less malignant than the usual type that aren't induced by radiation. It is, therefore, believed that radiation increases the number of cancers but does not increase mortality as a whole. (Diane G. Crocker, "Nuclear reactor accidents - the use of KI as a blocking agent against radioiodine uptake in the thyroid," Health Physics, 46:1265-1279, 1984.)

There is a lot of literature on I-131 as well as on potassium iodide (KI) as a means of preventing the uptake of radioiodine by the thyroid. The reason is that potentially there could be high releases of I-131 from nuclear power plant accidents. Windscale accident in England resulted in the withholding of milk from the market for a while. Initial exposure in such cases is from inhalation, but the subsequent dose from eating contaminated food is 400-700 times higher. The main source of I-131 in human diet is milk, partly because milk is consumed relatively fresh.

Both KI and potassium iodate (KIO_3) can be used to saturate the iodine uptake system of the thyroid. The advantage of KIO_3 is that it has a much longer shelf life,

up to 10 years, versus about 2 years for KI. Inside the body IO_3^- gets quickly converted to I^- and acts the same way as if originally it had been KI. About 130 mg of KI completely blocks radioiodine uptake for about 24 hours, 65 mg of KI is probably sufficient for children. It is most effective if given shortly before to 1-2 hours after exposure. The effectiveness of KI decreases rapidly with time after exposure, limited benefit is possible up to 12 hours after a single exposure. KI can be bought at drugstores without prescription in the U.S.

Unfortunately, there are side effects to taking large quantities of KI. It is only when the exposure level is 10 rem that the risk from radiation damage exceeds the risk from KI. In geriatric or coronary patients the hazard from KI might be greater than the radiation hazard under any circumstances. Asthmatics, chronic heart or renal failure patients, patients with hypocomplementemic vasculitis and autoimmune related diseases have reacted very severely to KI treatments. The fetus and the newborn are also susceptible to harmful effects. Unfortunately, this group is also more susceptible to the adverse effects of radioiodine. (Diane G. Crocker, ibid.)

The half-life of I-131 is too short for absorption from the soil or from the plant base to be major routes of entry into the food chain. The interval between grain harvesting and consumption is long enough that one doesn't have to worry about iodine. When iodine is deposited on leaves of plants, most of it is not absorbed. A lot of it can be washed off by rain or removed by mechanical processes. All of the above explains why a cow eating grass directly is the main entry route of iodine into the food chain. Levels of contamination in milk have frequently decreased more rapidly than the physical half-life of I-131. This is due to "field-loss" factor. In one case, the activity decreased by a factor of 2 in 2 weeks compared to the loss due to physical decay.

Fraction of ingested I-131 taken ^{up} by the thyroid can vary quite a bit but it is approximately 20% in cow as well as man. I-131 starts appearing in milk in 30 minutes and reaches maximum within 12 hours after a single exposure. The kind of conditions that would be true after a nuclear war, it would be 2-4 days after the start of fallout that it would reach the maximum concentration in milk. Both the cow's udder and the human breast concentrate iodine into milk in relation to the blood iodine level.

I-131 can also be incorporated into egg yolks in chickens on free range. After Windscale accident the activity of I-131 per egg averaged approximately 1/20 of that per litre of milk. (R. J. Garner and R. Scott Russell, ibid.)

If iodine were deposited in winter, the iodine hazard would be greatly reduced. The highest levels of contamination occur when the cows are grazing or are fed recently cut herbage. Contamination decreases markedly when stored food is substituted. From this it can be seen that the greatest danger would be right at the haying season. Previous year's stocks would have been exhausted and the next year's stocks wouldn't be in the barn yet.

Summary of the proposed protective measures:

1. Removal of lactating cows from pasturage-feeding system and substitution of stored feed rations. I-131 is reduced to insignificant levels in 3-4 days. The reverse is true if cows are placed on contaminated pasture. If cows were in and kept in when the fallout started, no problem would arise.
2. Withholding contaminated product to allow radioactive decay.
3. Supplying milk to areas of high contamination from areas where contamination is low.
4. Diverting contaminated milk into manufactured products and substituting processed milk, e.g., powdered or canned milk.
5. Storage of frozen fresh milk.

6. Storage of fresh concentrated milk.
7. Storage of frozen concentrated milk.
8. Physical removal of iodine-131 from milk with ion-exchange resin.

(Frank A. Todd, "Protecting foods and water against radioactive contamination," pp. 235-256, Protection of the Public in the Event of Radiation Accidents, World Health Organization, 1965.

All of the above, except #1, are completely dependent on the availability of electricity and transportation. Number one is partly dependent on transportation. If there was no electricity, the cows would not be milked. We don't have the personnel who know how to milk cows. So you could learn it in a day, but there is no way you could develop the strength in a short time to milk more than one cow. I called up the local dairy farmer to ask what they would do if there was no electricity. They have 40 cows and they would not be milked unless they obtained a generator. They have had to do that once in the past. Their milk goes down to Guelph, that is more than 100 km away. There are 2 small cheese plants that are a little closer, but she couldn't think of any milk processing plant that would be closer.

Strontium. There are two types of strontium (Sr). Sr-89 is important the first month and Sr-90 is important for a long time. Both emit only B rays.

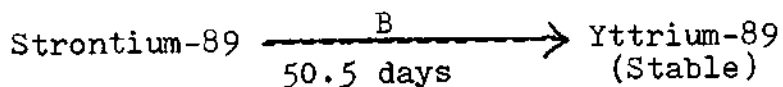
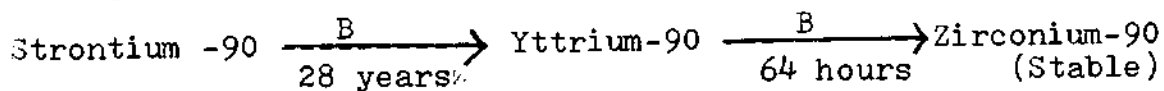

Strontium is metabolized the same way as calcium (Ca). Strontium absorption, however, is discriminated against by body, compared to calcium absorption. Ratio of Sr/Ca in blood is 1/3 to 1/4 of what it is in diet. Mother's milk has half the Sr concentration in blood and the fetus

also has only half the concentration. The effective half-life in body is 50 days for Sr-89 and 17.5 years for Sr-90. (Cs also has a long half-life but its effective half-life in body is less than 100 days.) Its long effective-half life is what makes Sr-90 such a dangerous radionuclide.

Ratio of Sr to Ca in new bone is in equilibrium with body fluids. In other words, the amount of strontium that gets deposited in bone is dependent on the ratio of Sr/Ca in blood. Therefore, radiostrontium concentration is a lot of times expressed in terms of Ca concentration. The common units are pc of Sr/g of Ca or for milk pc Sr/l.

The main source of strontium in a western diet is dairy products. But that doesn't give the whole picture. As explained above, strontium absorption depends on the level of calcium and dairy products are also the major source of calcium in western diets. It might look like elimination of dairy products would improve the situation but the reverse would be true. More vegetables would be consumed and there the ratio of Sr/Ca is much higher. Third world countries get twice the amount of strontium in their diets compared to that of the western countries. The following table of contribution of various foods to Sr-90 in population of N.Y. City illustrates the differences in calcium levels and their subsequent effect.

Food	pc/yr	% total intake	
		Ca	Sr-90
Dairy products	2080	58	38
Vegetables	1212	9	22
Fruits, fresh and canned	1192	3	22
Cereals and bakery products	588	20	11
Meat, poultry, eggs	178	8	3
Fish	5	2	-
Water	200	-	4

Radionuclides in Foods, p. 34, National Academy of Sciences, 1973.

In vegetables the strontium content can be reduced 19-55% by common home preparation. In canned fruit the reduction can even be higher compared to fresh fruit. The following are given as methods for reducing strontium intake.

1. Protection of packaged and stored foods.
2. Removal of surface contamination by washing and scrubbing of fruits and vegetables.
3. Removal of surface contamination by peeling.
4. Removal of internal contamination of food through processing.
5. Reduction of strontium-90 secretion into milk by supplementing rations of dairy cows with calcium.
6. Removal of radioactivity by use of such processes as ion-exchange, electro dialysis, or calcium phosphate treatment.

Frank A. Todd, *ibid.* One important method Todd doesn't mention is milling of wheat. Whole wheat has twice the Sr/Ca than white flour.

There is a good discussion of remedial measures by C. L. Comar and J. C. Thompson, Jr. with emphasis on "certain aspects of feasible large-scale measures" in Survival of Food Crops and Livestock in the Event of Nuclear War, 1970, "Status of remedial measures against environmental radiocontamination".

The plant root makes little distinction between Ca and Sr if they are in the same chemical form. Soluble Ca in the soil acts as a diluent for the Sr - the amount of calcium in soil is important. Generally good agricultural soils result in lower Sr content in food. Strontium deposited on the plants may be trapped and absorbed through those parts of the plant which are above the ground. The amount that is so trapped depends on the form of the plants, it is usually considerable in grasses. Again, a cow comes along and picks it all up, the absorbed and the unabsorbed Sr. Luckily, there is discrimination against strontium relative to calcium by a factor of about 10 which occurs in the transfer of the two elements from the diet of cattle to milk.

Cesium. Cesium (Cs)-137 is the third most dangerous radionuclide that enters very quickly the human food chain after a nuclear fallout. It is an alkali metal like potassium (K) and its behaviour in nature as well as the human body is similar to that of potassium. The relationship between the two, although, is not as close as between Sr and Ca. The decay scheme of Cs-137 is shown below.

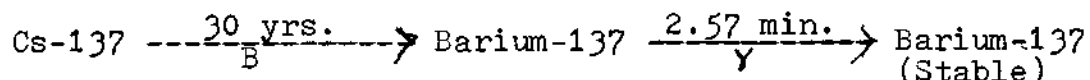

Cesium is around in the environment for a long time, its half-life is 30 years. Quite commonly Cs is referred to as a γ source. Technically this is not correct. Cs decays by a B emission to Ba-137 which has a half-life of only 2.57 min. when it decays by a γ emission to a stable form of Ba. Its "daughter", however, has such a short half-life that Cs is ordinarily identified by γ spectrometry of the γ emission of its daughter. Cs is more common in fallout than Sr by 1.3 to 1.7.

Cesium is freely absorbed from the human intestinal tract and appears to have an average stay of 4 months. Compared to other radionuclides, it is distributed fairly uniformly over the body. The human body content of Cs-137 is closely related to the level of it in the diet. It is absorbed preferentially to potassium. The ratio of Cs-137/gK is 3 times higher in body than in food. In animal studies one has to take 9 times the normal level of K to cut Cs-137 level by half. L. Fredriksson, R. J. Garner and R. Scott Russell, "Caesium-137", in Radioactivity and Human Diet, 1966.

Sources of Cs in human food:

Cows milk 30% or 25-40%

Grain products 25% or 17-30%

Meat 20% or 12-26%

Fruit 10% or 15%

Vegetables 10% or 15%

Fish important where it forms a large part of diet.

The two sets of figures just given are from two different sources. They indicate that cesium is distributed relatively evenly among the different food groups.

Because cesium has volatile precursors, a lot of it ends up in stratosphere. Very roughly its mean time in stratosphere is 2 years. As it falls down, it is deposited on any growing vegetation. Most of the Cs that enters the food chain is absorbed by the plants directly and not from soil after it has been washed down. The heaviest fallout occurs in spring because most of the mixing between stratosphere and troposphere occurs during late winter. Areas with higher rainfall can receive twice as much fallout.

Cesium is readily absorbed by clay particles in soil. It is held tightly enough that only a few per cent of Cs-137 in soil is taken up through the roots of plants. Sandy soils and especially soils with a high content of organic matter bind Cs less effectively. Plants grown on these soils have higher Cs-137 content. Most of the Cs contained in the edible parts of vegetables is due to deposition of particulate material on leaves.

Under certain conditions, Cs can undergo considerable concentration in terrestrial and aquatic food chains. Freshwater fish have been shown to contain it in concentrations several thousand times higher than the concentration in their surroundings. Fish feed on lower aquatic organisms which have already concentrated it above the levels present in water. Shellfish do the same thing. Cesium is effectively trapped and retained by the lichen and moss of the tundra, which are major sources of food for caribou and reindeer. Caribou flesh contained up to 100 times the quantities found in meat in mid latitudes.

Once fallout has stopped Cs becomes trapped in the top 2 cm of soil. External radiation from it would continue for many years. Its greatest danger is considered to be genetically.

Carbon-14. Most of the carbon(C)-14 is released into the stratosphere, from where it equilibrated with the troposphere with a half-time of about 2 years. Tissue C-14 comes into equilibrium with C-14 in the atmosphere with a delay time of about 1.4 years. The retention half-time of dietary carbon in mammals is estimated to be about 40 days. Like tritium, carbon 14 is highly mobile in the environment and no one can do anything about it.

Tritium. Tritium is radioactive hydrogen. Less than 1% of tritium becomes part of the water molecule but it is in this form that it passes through the eco-systems. It behaves identically to ordinary water. It is highly mobile in the environment and very quickly equilibrates in the different systems.

Iron-55. Two pathways are known for the concentration of iron (Fe)-55. Lichen-caribou pathway is important for Eskimos and Lapps. The second source is marine fish. The marine food chain concentrates Fe-55 even more than than the first pathway. The reason for this is the low concentration of stable iron in sea water.

Half-life of Fe-55 in lichens is 1.4 years.

Erythrocyte is considered to be the critical organ.

Ruthenium-106. Ruthenium is known to have accumulated in at least one known food chain. A seaweed in Irish sea that is used by some people in making bread. Critical organ for this case is the lower large intestine. Some people got as much as half the yearly dose limit of rems/yr for lower intestine during the Windscale accident.

METHODS OF MEASUREMENT

There is a lot of literature on the measurement of Sr-89 and -90, I-131 and Cs-137 in the environment and in food. Scientists have been doing it all over the world as the result of the atomic bomb tests in the fifties and the first part of the sixties. The most comprehensive references are: Esther Ferri, Paul J. Magno and Lloyd R. Setter, Radionuclide analysis of large numbers of food and water samples, U.S. Dept. Health, Education, and Welfare, 1965. National Center for Radiological Health, Radioassay Procedures for Environmental Samples, U.S. Dept. of Health, Education, and Welfare, 1967. Manual of Standard Procedures, NYO-4700, Health and Safety Laboratory, U.S. Atomic Energy Commission, New York Operations Office. The above do give details for the procedures but are designed for quantities much smaller than what one would be measuring after a nuclear war. They require highly skilled personnel and very sophisticated equipment.

E. R. Mercer ("Analytical Methods" in Radioactivity in Human Diet, ed. R. Scott Russell, 1966.) has a short but clear review of the above methods. He says that in emergencies, when much higher levels of contamination than normal will be acceptable, much simpler analytical methods are adequate. Unfortunately he doesn't describe them. This happens quite a few times, they aren't described because they are obvious to people who work with radioactivity but not so obvious for a person who doesn't have any experience using different radiation detection instruments or measuring mixtures of different radionuclides. He does make a few relevant comments in passing. If Cs-137 exceeds 300 pc/l in milk, it can be measured directly in a sodium iodide (NaI) crystal scintillation counter. Gamma spectrometric measurement of I-131 can also be done directly on whole milk if the level is high enough. Cesium and iodine can also interfere with each other.

Strontium assays are very complicated, numerous radiochemical separations have to be done. Usually Sr-90 is

calculated from the amount of its daughter yttrium-90 (Sr-90 decays to Y-90) and Sr-89 is determined by the difference.

Daniel A. Gollnick does give a simple method for analyzing milk (Experimental radiological health physics, 1978). Since the ratio of Cs-137 to each of the Sr isotopes is a fixed constant at the time when fission takes place, the strontium concentrations can be calculated from the cesium concentration.

$$\frac{\text{Cs-137}}{\text{Sr-90}} = 5 \qquad \frac{\text{Cs-137}}{\text{Sr-89}} = 0.03$$

First of all, these formulas are for milk, in the fallout Cs-137 to Sr-90 ratio is about 1.6. Second, Sr-89 has a relatively short half-life compared to Cs-137, so the ratio changes with time, it has to be doubled every 51 days after the fissions have occurred. Cs-137 and Sr-90 have similar enough half-lives that the change with time can be ignored.

The milk is passed through an anion exchange resin. I-131, being the only anion in the group of 4 we are interested in, is retained on the resin and everything else passes through. Resin is transferred to a bottle that is counted in a solid scintillation counter. The result is calculated from a known I-131 sample that has been treated the same way. The strontium isotopes are pure beta emitters, therefore, the effluent can be poured into a beaker that fits into a NaI counter and counted for gamma emissions from cesium. The result is compared to a known amount of Cs-137 under the same conditions. The cesium value is used in the formulas given above to calculate the amounts of the two different strontiums.

Gollnick also gives a very useful table of what would be the dose commitment from milk, given a level of activity in milk when it is at the highest (2-4 days after the event). See next page. There must be, however, some mistake in rads for Sr-89. If it is 3 rads in the first year, there is no way with its short half-life it can give 2 more rads

in subsequent years.

Radionuclide	RADS	Max. conc. in milk uc/l
Sr-89	3 in 1st yr, 5 total	1.1
Sr-90	3 in 1st yr, 5 total	0.05
I-131	10	0.07
Cs-137	3 in 1st yr, 5 total	0.72

The above is the sort of approach, that I think would be taken, if there were a nuclear holocaust. There are different models for predicting dose committment from the level of fallout. R. Scott Russel, B. O. Bartlett, and R. S. Bruce, "The significance of long-lived nuclides after a nuclear war," in Survival of Food Crops and Livestock in the Event of Nuclear War, 1970. A. Aarkrog, "Prediction models for Strontium-90 and Caesium-137 Levels in the Human Food Chain", Health Physics, 20:297-311, 1971. W. F. Lengeman has many papers on prediction models. The measurement would be done from an airplane or for more detail from a car. A. C. Chamberlain, R. J. Garner and D. Williams, "Environmental monitoring after accidental deposition of radioactivity," React. Sci. Technology, 14:155-167, 1961.

There are some references that sound good but are not easily available. Guidance on Offsite Emergency Radiation Measurement Systems, Phase 2: The Milk Pathway, B. J. Salmonson, L. G. Hoffman, R. J. Honkus, and J. H. Keller, Westinghouse Idaho Nuclear Company, Inc., WINCO-1009, April 1984. Also by the same people, company and title but a different subtitle: Phase 3: Water and Non-Dairy Food Pathway, WINCO-1012, October 1984. I wanted to send for these two papers but I couldn't find Westinghouse Idaho Nuclear Co. listed in any of the industrial indexes. The closest I could get is that Westinghouse does have a subsidiary called Bettis Atomic Power Lab, Idaho Falls, Idaho (1-208-526-0111). It could be the same company.

Daniel A. Gollnick also has a book out Basic Radiation

Protection Technology, Pacific Radiation Press, 1983.

It isn't available in Toronto. It might have the type of information we are interested in because it has been referred to in places where the concern has been nuclear war.

LACK OF STANDARDS AND MPD

Currently there aren't any guide lines for intake of radioactive material under the conditions of a nuclear war. The main reason for this is that radioactivity in food is not regarded as a priority in an event of a nuclear war.

"Eating food produced in the years after a large attack would cause an increase in the cancer rate... this increase would be a small fraction of the number of additional cancer deaths that would result from external radiation." Cresson H. Kearney, Nuclear War Survival Skills, p. 65, 1980.

Most vegetables would be fit to eat once they had been thoroughly washed. When it is safe to work outside, can plant new crops - they will be safe to eat. Ivan Tyrell, The survival Option, A guide to living through nuclear war, 1982.

"Standing crops in the early stages of growth are damaged by radiation but otherwise are safe to eat if washed clean of dust." p. 105. "Lack of food and water will cause starvation and death of many millions, especially the young and old." p. 115. Diane Diacon, Residential Housing and Nuclear Attack, 1984. The latter two books are English and I don't know anything about the credentials of their authors. The quotes that follow are by R. Scott Russell, unquestionably one of the world authorities on strontium and cesium in fallout and their biological pathways.

"In short, the total deaths caused by long-lived nuclides seem broadly comparable to the annual traffic death rate." (Incidentally, the figures for lung cancer from smoking are higher than traffic fatalities.) "Thus, by the standards the community now accepts, remedial action against the risks from long-lived nuclides would not seem justified; The number of casualties would be so small relative to the total loss and the difficulty of avoiding them would be so great that remedial action could not

reasonably be contemplated." "...efforts to mitigate doses from radiation should be devoted solely to the early period when short-lived nuclides predominate." R. Scott Russell, B. Bartlett, and R. S. Bruce, "The significance of long-lived nuclides after a nuclear war," in Survival of Food Crops and Livestock in the Event of Nuclear War, 1970.

The maximum permissible doses (MPD) used now are based on the philosophy that any radiation is bad and the less the better. Dose limiting recommendations by the National Council on Radiation Protection (NCRP) are given in Table 6.1. The levels are very low, for general population, 0.17 rem/year. This is less than the natural background radiation in some places.

There certainly is awareness that maximum permissible doses are not what would be in effect after a nuclear holocaust. J. C. Thompson, Jr., R. A. Wentworth, and G. L. Comar ("Control of fallout contamination in the post-attack diet," in Survival of Food... see above) expressed the need for guidelines that respond to tolerance or survival levels of radioactivity rather than the minimum-exposure concept that is in effect now. They would like to have a "system of radiation-exposure priorities" that would become operational after a nuclear attack. They are aware of the irony that the larger the attack, the lower the priority of fallout considerations in food. "It would be poor operational procedure to initiate efforts to reduce dietary contamination from 10 R to 1 R when general external radiation levels were 100 R and a state of pestilence threatened."

The problem of lack of radiation protection standards designed for nuclear war conditions has been discussed by Lauriston S. Taylor in "Standards for radiation exposure management in accident or nuclear attack," a talk he has given at some recent symposium. (I don't have a complete reference, the paper was sent to me.) The same as J. C. Thompson et al, he recognizes that there can really be no fixed standards that can be applied to basically uncontrollable

328 Radiation Protection by Jacob Shapiro**Table 6.1.** Dose-limiting recommendations of NCRP (1971).

Occupational exposure limits	
Whole body, gonads, lens of eye, red bone marrow	5 rem in any one year
Skin	15 rem in any one year
Hands	75 rem in any one year (25/qtr)
Forearms	30 rem in any one year (10/qtr)
Other organs, tissues and organ systems	15 rem in any one year (5/qtr)
Fertile women (with respect to fetus)	0.5 rem in gestation period
Dose limits for the public, or occasionally exposed individuals	
Individual or occasional	0.5 rem in any one year
Students	0.1 rem in any one year
Population dose limits	
Genetic	0.17 rem av. per year
Somatic	0.17 rem av. per year
Emergency dose limits—lifesaving	
Individual (older than 45 yr if possible)	100 rem
Hands and forearms	200 rem, additional (300 rem total)
Emergency dose limits—less urgent	
Individual	25 rem
Hands and forearms	100 rem, total
Family of radioactive patients	
Individual (under 45 yr)	0.5 rem in any one year
Individual (over 45 yr)	5 rem in any one year

Source: NCRP, 1971, Table 6.

radiation situations. The best that we have are what is called "penalty tables". The following is based on brief, whole body gamma-ray doses:

Dose	Need Medical Care	Able to Work	Die
15-50 R	no	yes	0
50-200 R	no	yes	<5%
200-400 R	yes	no	<50%
450-600 R	yes	no	>50%
600- R	yes	no	100%

The above is the kind of data that is available but that is not what the situation would be after a nuclear war. There would be a long period of high radiation level followed by even longer period of moderate radiation levels. The following table is a little more useful:

Category	Need Medical Care	Accumulated Exposure in:		
		1 week	1 month	4 months
A	None	150 R	200 R	300 R
B	Some (5% die)	250 R	350 R	500 R
C	Most (50% die)	450 R	600 R	--

Lauriston S. Taylor, *ibid.*

There is very little information on chronic exposures that scientists could use to develop emergency standards. Needless to say, there is even less information on continuous internal intake of low or large amounts of radioactivity (the only exception is the radium dial painters). Japan did not have any early fallout in 1945. From the Japanese data and past medical uses of radioactivity it is known how many people would get leukemia and other cancers if a certain number of people would be exposed to a certain level of radiation. From this is derived a linear dose-effect relationship without a threshold. Both NCRP and ICRP (International Commission for Radiological Protection) work on assumption that there is no threshold dose of ionizing radiation below which there is no damage. The dose

effects are assumed to be additive. Taylor does not think it would be true for long range, low or moderate level chronic exposures. Too many theoretically dead persons are still walking around, as he puts it. There are many people who have been working for years within the maximum permissible dose limits for radiation workers. None of them have had any effects of practical importance. He feels the limits could be 10 times or more higher before there would be any detectable consequences. Taylor blames the lack of war time radiation guidelines on the media and the public. He feels that the news media have so over-exploited radiation matters that the public is truly frightened of any radiation exposure. "This makes the presentation and public acceptance of any kind of emergency planning extremely difficult." (There is an analogous phenomenon going on right now. 130 people have died so far from AIDS in Canada. At the same time 4000/yr. die in car accidents, plus many more permanently crippled. Half of the latter are caused by alcohol. Yet the public accepts one but is panic stricken of the other.)

Maximum permissible body burdens, plus all the other dose limits have been developed by the International Commission on Radiological Protection (ICRP) and the National Council on Radiation Protection (NCRP). The body burden of a particular radioactive nuclide is the amount of the nuclide in uc which is present in an individuals body. The maximum permissible body burden is the body burden of a particular radioactive nuclide which results in a MPD (Maximum permissible doses that have been developed for external exposure) to the whole body or to one or more organs in the body. It is computed on the basis that it is the only one in the body. The maximum permissible body burden for a radionuclide of a bone seeking element (e.g. strontium, calcium, radium and plutonium) is the number of uc required to deliver to the bone a dose in rems equal to that provided by 0.1 uc of radium-226. Body burdens

for radionuclides other than bone seekers require the identification of "critical organ" (the organ which is the most sensitive or has the highest concentration). For a nuclide with the whole body as the "critical organ", the maximum permissible body burden for occupational exposure is the activity present continuously in the body which delivers a dose equivalent of 5 rem/year to the whole body. Nuclides which concentrate in abdominal organs are given limiting body burdens which provide 15 rem/year. (Kedar N. Prasad, CRC Handbook of Radiobiology, p. 241, 1984.)

Maximum permissible body burdens and maximum permissible concentrations of radionuclides in water for occupational exposures are given in ICRP publications (for references see Radiation Protection by Jacob Shapiro, 1981. The following values for the radionuclides that enter the food chain as a result of a nuclear fallout are from Radiological Health Handbook, U. S. Dept. Health, Education and Welfare, p. 207, 1970.

Radionuclide	Critical organ	Body burden uc	MPC water continuous intake uc/cc
Sr-89	Bone	4	10^{-4}
Sr-90	Bone	2	10^{-6}
Cs-137	Total body	30	2×10^{-4}
I-131	Thyroid	0.7	2×10^{-5}

Given equal concentrations, Sr-90 is 100 times more dangerous than Sr-89. The differences can even be higher, radium-226 is 10,000 times more dangerous than tritium.

ICRP Publ. 2 Report of Committee II Permissible Dose for Internal Radiation, Pergamon Press, p. 23-27, 1959 talks about permissible concentration of unidentified radionuclides, mixtures of known radionuclides and some of the problems one would run into if one tried to apply the occupational MPC for water to fallout in water and food.

Assuming Taylor was right that the external doses could be raised 10 times without much danger, the same thing would also apply here. Iodine and strontium -89 could still be increased by much more because of their short half-lives. The figures given were for continuous intake for 40 years. Although one can take in 100 times more Sr-89 than Sr-90, it initially occurs in 180 times the greater concentration than Sr-90. That is why initially it is the more important. Its half life is 51 days and after that Sr-90 becomes the most important contaminant. Unfortunately, strontium is the hardest to measure.

EMERGENCY SCHEMES

The only permissible emergency levels of radioactivity in food and water for civilisns were put out by the United States Agricultural Research Service in 1960, USDA Radiological Training Manual for Inservice Training. This procedure was still recommended by the U. S. Dept. of Health, Education and Welfare in 1965, Civil Defense information for food and drug officials. I haven't come across anything that would have replaced this procedure.

There is a food and water standard (CDV-787) that is placed in a standard tin. A Geiger-Mueller counter is placed on top of the tin and a reading is taken, should be in 10 to 15 mr/hr area. The tin is filled with food or water when an unknown is tested. Anything below the standard reading is fit for a 10 day consumption. Anything below $2/3$ of the standard reading is fit for 30 day consumption period. The values that they represent are $9 \times 10^{-2} \text{uc/g}$ and $3 \times 10^{-2} \text{uc/g}$ for 10 and 30 day consumption periods respectively.

There is a more extensive emergency scheme by J. D. Teresi and C. L. Newcombe, "Calculations of maximum permissible concentrations of radioactive fallout in water and air based upon military exposure criteria," Health Physics 4:275-288, 1961. Although this is for water, I think it would also be applicable to directly contaminated food. Permissible levels for food and water are always the same in literature. It would not be applicable to food grown on contaminated soil. Their figures are based on the 14 major contributors in the fallout mixture. This is subdivided in 3 groups: major contributors for the first 7 days, major contributors for 8-104 days and major contributors for 105-365 days after the explosion.

On this basis they calculate the allowable ug/cm^3

to give 15 rem in 90 days, eaten in 7 different time spans, from 1 to 90 days and starting at 11 different times after time⁰, from 3.5 hrs to 365 days. See their Table 6 on next page. They do the same thing for 150 rems in 30 days. See their Table 7. The tables can be used to get values for any other dose e.g., if you want 75 rem dose in 30 days, divide the value by half. They don't say what standard would be used to determine $\mu\text{g}/\text{cm}^3$. I am concerned that the data on which they based their calculations would be outdated. They submitted their paper for publication Nov 1959. The atomic weapons have changed since that time - the fission products would not be in the same proportions now. For example, cesium is not mentioned. There would also be a better idea of the biological effect of some of these radionuclides in 1985.

There are two other methods for emergency monitoring of drinking water. G.W.C. Tait and W. F. Merritt, "Emergency monitoring of drinking water", Health Physics 1:164-168, 1958. See their Table 5.

Dept. of National Health and Welfare (Ottawa), Control of radioactive fallout in water systems, 1965, have presented Teresi and Newcombe's 90 day scheme in form of a graph. Whatever the time after explosion, up to a year, one can read off the values for water contamination that would deliver 15 rems in 90 days. They also give a number of handy approximations to know. Curies of beta particle radioactivity = 2 x curies of gamma ray radioactivity for the first 3 months (p.7). One day following a nuclear detonation: curies of gamma radioactivity per sq. ft. = roentgens/hr divided by 100 (p.81).

Tevini and Newcombe, 1961

Table 6. Maximum permissible concentration (microcuries) in water and air of radioactive fallout for seven exposure times (n) at seven different times after burst to deliver a dose to the critical organ of 15 rems in 90 days (1)*

n	Exposure	Time after fission												
		3.5 hr	12 hr	1 day	2 days	4 days	7 days	14 days	28 days	105 days	210 days	365 days		
1	Ing.	2.5	0.81	0.48	0.29	0.18	0.13	6.9 × 10 ⁻²	7.1 × 10 ⁻²	0.10	0.10	0.10	8.7 × 10 ⁻²	
	Inh.	3.7 × 10 ⁻⁴	1.2 × 10 ⁻⁴	6.9 × 10 ⁻⁵	4.0 × 10 ⁻⁵	2.4 × 10 ⁻⁵	1.7 × 10 ⁻⁵	8.2 × 10 ⁻⁶	6.9 × 10 ⁻⁶	6.4 × 10 ⁻⁶	6.0 × 10 ⁻⁶	5.7 × 10 ⁻⁶		
7	Ing.	0.54	0.18	0.10	5.8 × 10 ⁻²	3.6 × 10 ⁻²	2.4 × 10 ⁻²	1.2 × 10 ⁻²	1.2 × 10 ⁻²	1.5 × 10 ⁻²	1.1 × 10 ⁻²	1.3 × 10 ⁻²		
	Inh.	7.7 × 10 ⁻⁵	2.5 × 10 ⁻⁵	1.4 × 10 ⁻⁵	7.4 × 10 ⁻⁶	4.5 × 10 ⁻⁶	2.7 × 10 ⁻⁶	1.2 × 10 ⁻⁶	2.0 × 10 ⁻⁷	7.0 × 10 ⁻⁷	6.3 × 10 ⁻⁷	6.5 × 10 ⁻⁷		
14	Ing.	0.37	0.12	6.9 × 10 ⁻²	3.9 × 10 ⁻²	2.4 × 10 ⁻²	1.5 × 10 ⁻²	7.6 × 10 ⁻³	7.1 × 10 ⁻³	8.3 × 10 ⁻³	7.7 × 10 ⁻³	6.4 × 10 ⁻³		
	Inh.	5.0 × 10 ⁻⁵	1.8 × 10 ⁻⁵	9.0 × 10 ⁻⁶	5.0 × 10 ⁻⁶	3.0 × 10 ⁻⁶	1.8 × 10 ⁻⁶	8.1 × 10 ⁻⁷	6.1 × 10 ⁻⁷	4.6 × 10 ⁻⁷	4.3 × 10 ⁻⁷	4.0 × 10 ⁻⁷		
21	Ing.	0.32	0.11	5.9 × 10 ⁻²	3.3 × 10 ⁻²	2.0 × 10 ⁻²	1.3 × 10 ⁻²	5.8 × 10 ⁻³	5.4 × 10 ⁻³	5.7 × 10 ⁻³	5.5 × 10 ⁻³	4.5 × 10 ⁻³		
	Inh.	4.4 × 10 ⁻⁵	1.4 × 10 ⁻⁵	7.7 × 10 ⁻⁶	4.2 × 10 ⁻⁶	2.4 × 10 ⁻⁶	1.5 × 10 ⁻⁶	6.2 × 10 ⁻⁷	4.7 × 10 ⁻⁷	3.4 × 10 ⁻⁷	3.1 × 10 ⁻⁷	2.8 × 10 ⁻⁷		
30	Ing.	0.29	9.7 × 10 ⁻²	5.4 × 10 ⁻²	2.6 × 10 ⁻²	1.8 × 10 ⁻²	1.1 × 10 ⁻²	5.3 × 10 ⁻³	4.5 × 10 ⁻³	4.4 × 10 ⁻³	4.1 × 10 ⁻³	3.3 × 10 ⁻³		
	Inh.	3.7 × 10 ⁻⁵	1.2 × 10 ⁻⁵	6.7 × 10 ⁻⁶	3.2 × 10 ⁻⁶	2.1 × 10 ⁻⁶	1.2 × 10 ⁻⁶	4.9 × 10 ⁻⁷	3.6 × 10 ⁻⁷	2.5 × 10 ⁻⁷	2.3 × 10 ⁻⁷	2.0 × 10 ⁻⁷		
60	Ing.	0.25	8.3 × 10 ⁻²	4.6 × 10 ⁻²	2.5 × 10 ⁻²	1.5 × 10 ⁻²	9.8 × 10 ⁻³	4.3 × 10 ⁻³	3.3 × 10 ⁻³	2.7 × 10 ⁻³	2.4 × 10 ⁻³	1.8 × 10 ⁻³		
	Inh.	3.2 × 10 ⁻⁵	1.0 × 10 ⁻⁵	5.4 × 10 ⁻⁶	2.9 × 10 ⁻⁶	1.5 × 10 ⁻⁶	1.1 × 10 ⁻⁶	3.7 × 10 ⁻⁷	2.6 × 10 ⁻⁷	1.7 × 10 ⁻⁷	1.5 × 10 ⁻⁷	1.4 × 10 ⁻⁷		
90	Ing.	0.24	8.0 × 10 ⁻²	4.4 × 10 ⁻²	2.4 × 10 ⁻²	1.4 × 10 ⁻²	9.2 × 10 ⁻³	3.8 × 10 ⁻³	2.9 × 10 ⁻³	2.1 × 10 ⁻³	1.7 × 10 ⁻³	1.3 × 10 ⁻³		
	Inh.	3.1 × 10 ⁻⁵	1.0 × 10 ⁻⁵	5.4 × 10 ⁻⁶	2.9 × 10 ⁻⁶	1.7 × 10 ⁻⁶	9.7 × 10 ⁻⁷	3.6 × 10 ⁻⁷	2.4 × 10 ⁻⁷	1.5 × 10 ⁻⁷	1.3 × 10 ⁻⁷	1.2 × 10 ⁻⁷		

* Ing. = ingestion; Inh. = inhalation.

Technical Note, 1961

Table 7. Maximum permissible concentration ($\mu\text{e}/\text{cm}^3$) in water and air of radioactive fallout for five exposure times (n) at eleven different times after burst to deliver a dose to the critical organ of 150 rems in 30 days (1).

n	Exposure	Time after fission										
		3.5 hr	12 hr	1 day	2 days	4 days	7 days	14 days	28 days	105 days	210 days	365 days
1	Ing.	27	8.5	5.1	3.0	2.0	1.4	0.78	0.83	1.2	1.3	1.1
	Inh.	4.1×10^{-4}	1.3×10^{-3}	7.7×10^{-4}	4.5×10^{-4}	2.8×10^{-4}	1.9×10^{-4}	1.0×10^{-4}	9.8×10^{-5}	1.2×10^{-4}	1.2×10^{-4}	1.2×10^{-4}
7	Ing.	5.9	1.9	1.1	0.63	0.40	0.26	0.14	0.14	0.18	0.19	0.15
	Inh.	8.6×10^{-4}	2.8×10^{-4}	1.3×10^{-4}	8.0×10^{-5}	5.6×10^{-5}	3.7×10^{-5}	1.8×10^{-5}	1.7×10^{-5}	2.0×10^{-5}	2.0×10^{-5}	1.9×10^{-5}
11	Ing.	4.3	1.4	0.78	0.43	0.27	0.18	8.8	10^{-2}	8.7×10^{-2}	0.10	7.9×10^{-2}
	Inh.	7.2×10^{-4}	2.3×10^{-4}	1.3×10^{-4}	6.3×10^{-5}	3.8×10^{-5}	2.5×10^{-5}	1.1	10^{-5}	1.0×10^{-5}	1.1×10^{-5}	1.1×10^{-5}
21	Ing.	3.7	1.2	0.67	0.38	0.23	0.15	7.3×10^{-2}	6.8×10^{-2}	8.1×10^{-2}	6.6×10^{-2}	5.2×10^{-2}
	Inh.	5.4×10^{-4}	1.8×10^{-4}	9.7×10^{-5}	5.5×10^{-5}	3.3×10^{-5}	2.0×10^{-5}	9.3×10^{-4}	8.6×10^{-4}	8.9×10^{-4}	8.6×10^{-4}	8.7×10^{-4}
30	Ing.	3.6	1.1	0.62	0.34	0.21	0.14	6.8×10^{-2}	6.0×10^{-2}	6.3×10^{-2}	5.1×10^{-2}	3.8×10^{-2}
	Inh.	5.4×10^{-4}	1.7×10^{-4}	8.4×10^{-5}	5.3×10^{-5}	2.8×10^{-5}	2.0×10^{-5}	9.2×10^{-4}	7.9×10^{-4}	7.7×10^{-4}	7.1×10^{-4}	6.4×10^{-4}

* Ing. = ingestion; Inh. = inhalation.

Table 5. γ -field measurements (mr/hr) for maximum permissible water contamination

This table applies to any fresh fallout contamination and is for 10 day consumption. Values should be halved for 30 day consumption.

Water body	Time since bomb burst			
	12 hr	1 day	2 days	10 days
Reservoir or lake, measured far from shore	100	50	25	12
Reservoir, pond, etc., measured at various lengths from shore, close to surface and over water at least 2 ft. deep	50	25	12	6
Water tank, from 150 to 1000 gal measured in contact with center of one surface	50	25	12	6
Water can, from 2 to 4 gal	25	12	6	3

G.W.C. TAIT and W.F. Merritt
1958

Radiation Risk and Ethics

by [Zbigniew Jaworowski*](#)

(This article, while perhaps no longer available there, originally appeared in: [Physics Today](#), 52(9), September 1999, pp. 24-29, [American Institute of Physics](#).)

The established worldwide practice of protecting people from radiation costs hundreds of billions of dollars a year to implement and may well determine the world's future energy system. But is it right?

The psychosomatic disorders observed in the 15 million people in Belarus, Ukraine, and Russia¹ who were affected by the April 1986 Chernobyl accident are probably the accident's most important effect on public health.² These disorders could not be attributed to the ionizing radiation, but were assumed to be linked to the popular belief that any amount of man-made radiation—even minuscule, close to zero doses—can cause harm, an assumption that gained wide currency when it was accepted in the 1950s, arbitrarily, as the basis for regulations on radiation and nuclear safety.

It was under the same assumption that an *ad hoc* Soviet government commission decided to evacuate and relocate more than 270 000 people from many areas of the former Soviet Union where the 1986–95 average radiation doses from the Chernobyl fallout ranged between 6 and 60 millisieverts.

[Note by Bruce: 1 sievert (Sv) = 100 rem. Therefore a millisievert would be about 10 millirem. Remembering that a millirem is one thousandth of a rem and a rem is equivalent to a rad, gray, or roentgen all of what we call 1 R, you can see how low these peace time events were. 1 rem = 0.01 sievert (Sv)]

By comparison, the world's average individual lifetime dose due to natural background radiation is about 150 mSv. In the Chernobyl-contaminated regions of the former Soviet Union, the lifetime dose is 210 mSv—and in many regions of the world it is about 1000 mSv.³ The forced evacuation of so many people from their—presumably—poisoned homes calls for ethical scrutiny. Examining the physical and moral basis of that evacuation action and other radiation policies is the subject of this article.

As they have developed over the last three decades, the principles and concepts of radiation protection seem to have gone astray and to have led to exceedingly prohibitive standards and impractical recommendations. Revision of these principles and concepts is now being proposed by an increasing number of scientists and several organizations. They include Roger Clarke, who chairs the International Commission on Radiological Protection, the Health Physics Society, and the French Academy of Sciences. In addition, in April this year, the United Nations Scientific Committee on the Effects of Atomic Radiation (UNSCEAR) decided to study a possible revision of the basic dosimetric and biological concepts and quantities generally being applied in radiation protection. In the years to come, such reevaluations may trigger what I believe will be welcome changes in the basic worldwide approach to radiological protection.

Natural and man-made radiation

We are all immersed in naturally occurring ionizing radiation. Radiation reaches us from outer space and it comes from radionuclides

present in rocks, buildings, air, and even our own bodies. Each flake of snow, each grain of soil, every drop of rain—and even every person on this planet—emits radiation. And every day, at least a billion particles of natural radiation enter our bodies.

The individual dose rate of natural radiation the average inhabitant of Earth receives is about 2.2 mSv per year. In some regions—for example, parts of India, Iran, and Brazil—the natural dose rate is up to a hundred times higher. And no adverse genetic, carcinogenic, or other malign effects of those higher doses have ever been observed among the people, animals, and plants that have lived in those parts since time immemorial.^{4,5}

In the case of man-made radiation, the global average dose has increased by about 20% since the beginning of the 20th century—mainly as a result of the broader application of x-ray diagnostics in medicine. Other major sources of man-made radiation, such as nuclear power, nuclear weapons tests and the Chernobyl accident, have contributed only a tiny proportion—less than 0.1%—to that increase.

In the regions of the former Soviet Union that were highly contaminated by the fallout from the Chernobyl accident, the increased radiation dose rate for local inhabitants is far less than the dose rate in areas of high natural radiation. In those places, the entire man-made contribution to radiation dose amounts to a mere 0.2% of the natural component.

Three and a half billion years ago, when life on Earth began, the natural level of ionizing radiation at the planet's surface was about three to five times higher than it is now.⁶ Quite possibly, that radiation was needed to initiate life on Earth. And it may be essential to sustain extant life-forms, as suggested by experiments with protozoa and bacteria.⁷

At the early stages of evolution, increasingly complex organisms developed powerful defense mechanisms against such adverse radiation effects as mutation and malignant change. Those effects originate in the cell nucleus, where the DNA is their primary target. That evolution has apparently proceeded for so long is proof, in part, of the effectiveness of living things' defenses against radiation.

Other adverse effects—which lead to acute radiation sickness and premature death in humans—also originate in the cell, but outside its nucleus. For them to take place requires radiation doses thousands of times higher than those from natural sources. A nuclear explosion or cyclotron beam could deliver such a dose; so could a defective medical or industrial radiation source. (The malfunctioning Chernobyl reactor, whose radiation claimed 28 lives, is one example.)

The concern about large doses is obviously justified. However, the fear of small doses, such as those absorbed from the Chernobyl fallout by the inhabitants of central and western Europe, is about as justified as the fear that an atmospheric temperature of 20°C may be hazardous because, at 200°C, one can easily get third-degree burns—or the fear that sipping a glass of claret is harmful because gulping down a gallon of grain alcohol is fatal.

According to recent studies, by far the most DNA damage in humans is spontaneous and is caused by thermodynamic decay processes and by reactive free radicals formed by the oxygen metabolism. Each mammalian cell suffers about 70 million spontaneous DNA-damaging events per year.⁸ Only if armed with a powerful defense system could a living organism survive such a high rate of DNA damage.

An effective defense system consists of mechanisms that repair DNA, and other homeostatic mechanisms that maintain the integrity of organisms, both during the life of the individual and for thousands of

generations. Among those homeostatic mechanisms are enzymatic reactions, apoptosis (that is, suicidal elimination of changed cells), cell cycle regulation, and intercellular interactions.

Ionizing radiation damages DNA also, but at a much lower rate. At the present average individual dose rate of 2.2 mSv per year, natural radiation could be responsible for no more than about 5 DNA-damaging events in one cell per year.

Perhaps we humans lack a specific organ for sensing ionizing radiation simply because we do not need one. Our bodies' defense mechanism provides ample protection over the whole range of natural radiation levels—that is, from below 1 mSv to above 280 mSv per year.^{3,4} That range is much greater than the range of temperatures—about 50K—that humans are normally exposed to. Increasing the water temperature in your bath tub by only 80 K, from a pleasant level of 293 K to boiling point at 373 K (that is, by a factor of only 1.3), or decreasing it below freezing point (that is, by a factor of 1.07), would eventually kill you.

Because such lethal high or low temperatures are often found in the biosphere, the evolutionary development of an organ that can sense heat and cold has been essential for survival. Organs of smell and taste have been even more vital as defenses against dangerously toxic or infected food. But a lethal dose of ionizing radiation delivered in one hour—which for an individual human is 3000 to 5000 mSv—is a factor of 10 million higher than the average natural radiation dose that one would receive over the same time period (0.00027 mSv). Compared with other noxious agents, ionizing radiation is rather feeble. Nature seems to have provided living organisms with an enormous safety margin for natural levels of ionizing radiation—and also, adventitiously, for man-made radiation from controlled, peacetime sources.

In short, conditions in which levels of ionizing radiation could be noxious do not normally occur in the bio-sphere, so no radiation-sensing organ has been needed in humans and none has evolved.

Why radiophobia?

If radiation and radioactivity, though ubiquitous, are so innocuous at normal levels, why do they cause such universal apprehension? What is the cause of radiophobia—the irrational fear that any level of ionizing radiation is dangerous? Why have radiation protection authorities introduced a dose limit for the public of 1 mSv per year, which is less than half the average dose rate from natural radiation and less than 1% of the natural dose rates in many areas of the world? Why do the nations of the world spend hundreds of billions of dollars a year to maintain this standard?⁹

Here I propose some likely reasons:

- The psychological reaction to the devastation and loss of life caused by the atomic bombs dropped on Hiroshima and Nagasaki at the end of World War II.
- Psychological warfare during the cold war that played on the public's fear of nuclear weapons.
- Lobbying by fossil fuel industries.
- The interests of radiation researchers striving for recognition and budget.
- The interests of politicians for whom radiophobia has been a handy weapon in their power games (in the 1970s in the US, and in the 1980s and 1990s in eastern and western Europe and in the former Soviet Union).

- The interests of news media that profit by inducing public fear.
- The assumption of a linear, no-threshold relationship between radiation and biological effects.

Since nuclear weapons are regarded as a deterrent, naturally the countries that possess them wish to make radiation and its effects seem as dreadful as possible. Not surprisingly, national security agencies seldom qualify or correct even the most obviously false statements, such as “Radiation from a nuclear war can annihilate all mankind, or even all life,” or “200 grams of plutonium could kill every human being on Earth.”¹⁰

The facts say otherwise. Between 1945 and 1980, the 541 atmospheric nuclear tests that were performed together yielded an explosive energy equivalent to 440 megatons of TNT (1.8×10^{24} joules). After all those explosions, despite the injection into the global atmosphere of about 3 tons of plutonium (that is, almost 15 000 supposedly deadly 200-gram doses), somehow we are still alive! The average individual dose of radiation from all these nuclear explosions, accumulated between 1945 and 1998, is about 1 mSv, which is less than 1% of the natural dose for that period.

In the heyday of atmospheric testing, 1961 and 1962, there were 176 atmospheric explosions, with a total yield of 84 megatons. The maximum deposition on Earth’s surface of radionuclides from those explosions took place in 1964. The average individual dose accumulated from the fallout between 1961 and 1964 was about 0.35 mSv.

At its cold war peak of 50 000 weapons, the global nuclear arsenal had a combined potential explosive power of about 13 000 megatons,

which was only 30 times larger than the megatonnage already released in the atmosphere by all previous nuclear tests. If that whole global nuclear arsenal had been deployed in the same places as the previous nuclear tests, the average individual would have received a lifetime radiation dose of about 30 mSv from the ensuing worldwide fallout. If we use the years 1961 and 1962 as a yardstick instead, the dose would have risen to about 55 mSv. And even exploding all the nuclear weapons in just a few days rather than over a two-year period would not change that estimate by very much. Clearly, 55 mSv is a far cry from the short-term dose of 3000 mSv that would kill a human.

Of course, the approach taken above, based as it is on averages, fails to account for the immense loss of life and human suffering caused by the mechanical blast, fires, and local fallout that follow nuclear explosions in highly populated areas. However, no matter what the losses to those areas might be, it is certain that human and other life on Earth would survive even an all-out global nuclear war.

A-bomb survivors and linear no-threshold

The survivors of the atomic bombing of Hiroshima and Nagasaki who received instantaneous radiation doses of less than 200 mSv have not suffered significant induction of cancers.^{[11](#)} And so far, after 50 years of study, the progeny of survivors who were exposed to much higher, near-lethal doses have not developed adverse genetic effects.^{[12](#)}

Until recently, such findings from the study of A-bomb survivors had been consistently ignored. In place of the actual findings—and driving the public's radiophobia—has been the theory of linear no-threshold (LNT), which presumes that the detrimental effects of radiation are proportional to the dose, and that there is no dose at which the effects of radiation are not detrimental.

It was LNT theory that the International Commission on Radiological

Protection chose, in 1959, as the basis for its rules of radiation protection. At that time, applying LNT theory was regarded as an administrative decision, based on practical (not to mention political¹³) considerations. Adopting a linear relationship between dose and effect, along with no threshold, enabled doses in individual exposures to be added and enabled population-averaged quantities to be evaluated, and made the administration of radiation protection generally easier. Furthermore, the policy undertone—that even the smallest, near-zero amounts of radiation could cause harm—was politically useful at the time: It played an important part in effecting first a moratorium and then a ban on atmospheric nuclear tests. LNT theory was and still is the pillar of the international theory and practice of radiation protection.

Over the years, however, what started as just a working assumption for the leadership of ICRP came to be regarded—in public opinion and by the mass media, regulatory bodies, and many scientists, and even by some members of the ICRP—as a scientifically documented fact.

The absurdity of the LNT was brought to light after the Chernobyl accident in 1986, when minute doses of Chernobyl radiation were used by Marvin Goldman, Robert Catlin, and Lynn Anspaugh to calculate that 53 400 people would die of Chernobyl-induced cancer over the next 50 years.¹⁴ The frightening death toll was derived simply by multiplying the trifling Chernobyl doses in the US (0.0046 mSv per person) by the vast number of people living in the Northern Hemisphere and by a cancer risk factor based on epidemiological studies of 75 000 atomic bomb survivors in Japan. But the A-bomb survivor data are irrelevant to such estimates, because of the difference in the individual doses and dose rates. A-bomb survivors were flashed within about one second by radiation doses at least 50 000 times higher than those which US inhabitants will ever receive, over a period of 50 years, from the Chernobyl fallout.

We have reliable epidemiological data for a dose rate of, say, 6000

mSv per second in Japanese A-bomb survivors. But there are no such data for human exposure at a dose rate of 0.0046 mSv over 50 years (nor will there ever be any). The dose rate in Japan was larger by 2×10^{15} than the Chernobyl dose rate in the US. Extrapolating over such a vast span is neither scientifically justified nor epistemologically acceptable. Indeed, Lauriston Taylor, the former president of the US National Council on Radiological Protection and Measurements, deemed such extrapolations to be a “deeply immoral use of our scientific heritage.”

Radiation dose and eternity

An offspring of the LNT assumption is the concept of dose commitment, which was introduced in the early 1960s. At that time, the concept reflected the concern that harmful hereditary effects could be induced by fallout from nuclear tests. After almost four decades, the concept of dose commitment is still widely used, although both the concept and the concern ought to have faded into oblivion by now.

UNSCEAR, which first used “dose commitment” in 1962, defined it as “the integral over infinite time of the average dose rate in a given tissue for the world population, as a result of a given practice—for example, a given series of nuclear explosions.” Such integration requires making some daring assumptions and having a superhuman omniscience about population dynamics and environmental changes for all the eons of time to come. Later, in a humbler frame of mind, UNSCEAR introduced the so-called truncated dose commitment, limited arbitrarily to 50, 500, 10 000 or many millions of years. However, the original “infinite” definition is still retained in recent UNSCEAR documents.

To accept the definitions of dose commitment and of collective dose, we must also accept the following premises:

- An LNT relationship between absorbed dose and risk to an individual.
- The additivity of risk (by means of the additivity of dose) during the lifetime of an individual.
- The additivity of risk (dose) across individuals of the same generation.
- The additivity of risk (dose) across the lifetimes of individuals over any number of generations.
- The expectation that late harm due to a dose accumulated over many years or generations (dose commitment) be the same as the harm done by an instantaneous dose of the same magnitude.
- The expectation that late harm due to a given value of collective dose or dose commitment calculated for a large number of people exposed to trifling doses be the same as that calculated for a small number of people exposed to large doses. (This expectation is contrary to the common practice of diluting or dispersing noxious agents below dangerous levels.)

In 1969, UNSCEAR advised making the level of natural radiation a convenient reference for comparing dose commitments from man-made sources. However, during the three decades since the introduction of the dose commitment concept, UNSCEAR has not followed its own advice. The collective dose commitment for the world population from natural sources, truncated to 50 years (650 000 000 man Sv), was published for the first time in UNSCEAR's 1993 report. But why stop at 50 years—when, for man-made radiation, UNSCEAR estimates the dose commitments over infinite time? It is easy to calculate the individual dose commitment from past exposures

to natural radiation for periods comparable to those used for calculating man-made sources of radiation. In making the calculation, one may assume that during the past several million years the natural radiation dose rate has been the same as is now—that is, 2.2 mSv per year.

In the table on this page are presented the values of truncated natural dose commitment for various periods since the putative appearance of some of our ancestors. One may compose a similar table for the collective truncated dose commitments for the global populations integrated over the past generations, information that is also given in the table. One may also calculate the future natural dose commitments of our descendants for tens or thousands of generations.

[Bruce: There was a table here and a couple of other places in the original article but I have not included the tables and figures.]

Each of us is burdened with these values of dose commitment. Do these values represent anything real, or are they just an academic abstraction? What are the medical effects of these enormously high doses?

In an international study, the collective dose for the world population from nuclear dumping operations in the Kara Sea (part of the Arctic Ocean), truncated to the year 3000 AD, has been estimated to be about 10 manSv. Let us explore the implications of that value, which may be equivalent to:

2×10^{-12} Sv per each of 5×10^9 people now living and their descendants from 33 generations in 1000 years (no concern).

Obviously, the use of collective dose obliterates information on the patterns of dose deposition in space and time, which are of major importance for estimating their biological effects, in terms of risk to

humans. Individual doses cannot be additive over generations, simply because humans are mortal, and the dose dies when an individual does. Similarly, individual doses cannot be added for individuals of the same generation because we do not contaminate one another with a dose that we have absorbed. The presence of biological repair processes and the multistage process of cancer induction render the linear addition of small contributions of individual dose to estimate the associated risk of cancer occurrence highly unlikely. Collective dose and dose commitment cannot have any biological meaning. The large values of collective doses and collective dose commitments that have often been published were derived from minuscule individual doses.

For example, UNSCEAR's calculations include the following:

- 100 000 man Sv from nuclear explosions during the past 54 years,
- 205 000 man Sv for the global population in the next 10 000 years from power reactors and reprocessing plants,
- 600 000 man Sv from Chernobyl fallout in the Northern Hemisphere for eternity,
- and 650 000 000 man Sv for the world's population from natural radiation in the past 50 years.

These large values, terrifying as they are to the general public, do not imply that individuals or populations are harmfully burdened by nuclear explosions, nuclear power plants, Chernobyl fallout, or nature. In fact, they provide society with no relevant biological or medical information. Rather, they create a false image of the imminent danger of radiation, with all its actual negative social and psychosomatic consequences. If harm to the individual is trivial, then the total harm to members of his or her society over all past or future time must also be trivial—regardless of how many people are or will have been exposed to natural or man-made radiation. The intellectually invalid concepts of collective dose and dose commitment deserve to be hacked off with

William of Occam's razor .

Enter hormesis

The LNT theory is contradicted by the phenomenon of hormesis—that is, the stimulating and protective effect of small doses of radiation, which is also termed adaptive response. The first report on hormetic effects in algae appeared more than 100 years ago.¹⁶ More recently published hormetic effects include A-bomb survivors' apparent lower-than-normal incidence of leukemia and their greater longevity.¹⁷ Although more than 2000 scientific papers had been published on radiation hormesis, the phenomenon was forgotten after World War II and was ignored by the radiation-protection establishment. It was only in 1994 that UNSCEAR recognized and endorsed the very existence of radiation hormesis. It caused a revolutionary upheaval of radiology's ethical and technical foundations.

Many radiologists have come to realize that their overreaction to theoretical (actually imaginary) health-harming effects of radiation is unethical in that it leads to the consumption of funds that are desperately needed to deal with real health problems. Applying the no-threshold principle for the alleged protection of the public has led to the imposition of restrictive regulations on the nuclear utilities, restrictions that have virtually strangled the development of environmentally benign nuclear energy in the US and in other countries. My own country, Poland, spent billions of dollars on the construction of its first nuclear power reactor—only to abandon the project after what I regard as the politically motivated manipulation of public opinion by means of the LNT theory.

Each human life hypothetically saved in a Western industrial society by implementation of the present radiation protection regulations is estimated to cost about \$2.5 billion. Such costs are absurd and immoral—especially when compared to the relatively low costs of

saving lives by immunization against measles, diphtheria, and pertussis, which in developing countries entails costs of \$50 to \$99 per human life saved.¹⁸ Billions of dollars for the imaginary protection of humans from radiation are actually spent year after year, while much smaller resources for the real saving of lives in poor countries are scandalously lacking.

A practical alternative

There is an emerging awareness that radiation protection should be based on the principle of a practical threshold—one below which induction of detectable radiogenic cancers or genetic effects is not expected. Below such a threshold, radiation doses should not require regulation. Nor is any regulation required for extreme levels, such as those experienced at Hiroshima and Nagasaki, where dose rates were extremely high.

The practical threshold to be proposed could be based on epidemiological data from exposures in medicine, the nuclear industry, and regions with high natural radiation. The current population dose limit of 1 mSv per year could then be changed to 10 mSv per year or more. Individual doses could be evaluated at any level below the practical threshold, but radiation-protection authorities would be required to intervene only if individual doses above the threshold were involved. Adopting a practical threshold would be an important step taken toward dealing with radiation rationally and toward regaining the public's acceptance of radioactivity and radiation as blessings for mankind.

***Zbigniew Jaworowski** *is a professor at the Central Laboratory for Radiological Protection in Warsaw, Poland, and has served on the United Nations Scientific Committee on the Effects of Atomic Radiation. His e-mail address is: jaworo@clor.waw.pl.*

References

1. L. A. Ilyin, *Chernobyl: Myth and Reality*, Megapolis, Moscow (1995).
2. *Chernobyl—Ten Years On, Radiological and Health Impact*, Nuclear Energy Agency, Organization for Economic Co-operation and Development, Paris (1996).
3. *Sources and Effects of Ionizing Radiation*, UNSCEAR, New York (1993).
4. M. Sohrabi, in *High Levels of Natural Radiation*, J. U. A. M. Sohrabi, S. A. Durrani, eds., International Atomic Energy Authority, Vienna, Austria (1990), p. 39.
5. P. C. Kesavan, in *High Levels of Natural Radiation* L. Wei, T. Sugahara, Z. Tao, eds. Elsevier, Amsterdam (1996), p. 111.
6. P. A. Karam, S. A. Leslie, in *Proc. 9th Congress of the International Radiation Protection Association*, International Atomic Energy Authority, Vienna, Austria (1996), p. 12.
7. H. Planel *et al.*, *Health Physics* **52** (5), 571 (1987).
8. D. Billen, *BELLE Newsletter* **3** (1), 8 (1984).
9. J. S. Hezir, statement at the US Environmental Protection Agency's public hearing on the proposed recommendations for federal radiation protection guidance for exposure of the general public, held in Washington, DC, on 22–23 February 1995.
10. H. Koning, *International Herald Tribune*, 27 November 1996, p. 9.
11. B. L. Cohen, *Radiation Research* **149**, 525 (1998).
12. K. Sankaranarayanan, lecture presented at 46th session of the

United Nations Scientific Committee on the Effects of Atomic Radiation, 18 June 1997.

13. L. S. Taylor, *Proc. International Congress of the International Radiation Protection Association*, Israel Health Physics Society, Jerusalem (1980), p. 307.

14. M. Goldman, R. J. Catlin, L. Anspaugh, US Department of Energy research report, DOE/RR-0232 (1987).

15. K.L. Sjöblom, G. Linsley, International Atomic Energy Authority Bulletin **40** (4), 18 (1999).

16. G. F. Atkinson, *Science* **7**, 7 (1898).

17. S. Kondo, *Health Effects of Low-level Radiation*, Kinki U. P., Osaka, Japan (1993).

18. B. L. Cohen, in *Rational Readings on Environmental Concerns*, J. H. Lehr, ed., Van Nostrand Reinhold, New York (1992), p. 461.

MENU: [HOME](#) » [Reconstruction](#) » [Recovery](#) » [Renewal](#) » [Survival](#)

May 26, 1959

To the Graduate Council:

I am submitting herewith a thesis written by David Gene Easterly entitled "Removal of Strontium-89 and Calcium-45 from Milk by Use of Ion Exchange Resins." I recommend that it be accepted for nine quarter hours of credit in partial fulfillment of the requirements for the degree of Master of Science, with a major in Dairying.

Major Professor

We have read this thesis
and recommend its acceptance:

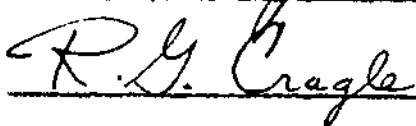
Accepted for the Council:

Dean of the Graduate School

**REMOVAL OF STRONTIUM-89 AND CALCIUM-45 FROM MILK BY
USE OF ION EXCHANGE RESINS**

A THESIS

**Submitted to
The Graduate Council
of
The University of Tennessee
in
Partial Fulfillment of the Requirements
for the degree of
Master of Science**

by

David Gene Easterly

June 1959

ACKNOWLEDGEMENTS

The author wishes to express his sincere appreciation to Dr. B. J. Demott for his assistance in planning and conducting this study, and to Dr. R. G. Cragle for his guidance and assistance in helping to conduct this study. Great appreciation is due the UT-AEC Agricultural Research Laboratory, Oak Ridge, Tennessee, for facilities used in this study and especially to Dr. N. S. Hall, the Director, for encouragement and suggestions. Appreciation is also due R. C. McIlhenny for his advice and suggestions. The author is also exceedingly grateful to one and all of the laboratory staff for the help and advice so freely given.

TABLE OF CONTENTS

	PAGE
INTRODUCTION	1
REVIEW OF LITERATURE	2
Ion exchange	2
Radioactive strontium	7
Radiostrontium movement from atmosphere to milk	9
EXPERIMENTAL PROCEDURE	13
Removal of strontium-89 and calcium-45 from milk of dosed cows	13
Removal of Strontium-89 and calcium-45 from dosed milk	17
Residence and lactation-milk equilibrium studies	17
Removal of calcium-45 and strontium-89 from milk by use of a series of four columns	18
Removal of strontium-89 and calcium-45 from dosed milk by the batch method	19
RESULTS AND DISCUSSION	20
SUMMARY	22
BIBLIOGRAPHY.	50

LIST OF TABLES

TABLE	PAGE
I. Per Cent Removal of Sr ⁹⁰ and Ca ⁴⁵ from Milk of Dosed Cows by Exchange Resin Columns	21
II. Per Cent Removal of Sr ⁹⁰ and Ca ⁴⁵ From Dosed Milk by Exchange Resin Columns	23
III. Analyses of Variances From Eight Trials on Removal of Ca ⁴⁵ and Sr ⁹⁰ From Milk of Dosed Cows and Eight Trials on Removal of Ca ⁴⁵ and Sr ⁹⁰ From Dosed Milk	26
IV. Coagulation Time, Curd Tension, pH and Titratable Acidity of Milk Passed Through an Ion Exchange Column Containing Dowex 50W-X12 Calcium Form.	29
V. Effect of Resin-Milk Contact Time on Per Cent Removal of Sr ⁹⁰ and Ca ⁴⁵ From Dosed Milk	35
VI. Effect of Isotope-Milk Contact Time on Per Cent Removal of Sr ⁹⁰ and Ca ⁴⁵ From Dosed Milk.	37
VII. Per Cent Removal of Sr ⁹⁰ and Ca ⁴⁵ From Milk by Use of a Series of Four Exchange Resin Columns	39
VIII. Radioactivity Retained by Resin After Passage of Milk Containing Ca ⁴⁵ and Sr ⁹⁰	40

LIST OF TABLES (Continued)

TABLE	PAGE
IX. Effect of Milk-Resin Ratio on Per Cent Removal of Sr ⁹⁰ and Ca ⁴⁵ From Milk	41
X. Per Cent of Resin Capacity Exchange by Calcium and Strontium using the Batch and Column System	46

LIST OF FIGURES

FIGURE		PAGE
1.	Modified Ion Exchange Column	14
2.	Effect of Resin-Milk Contact Time on Per Cent Removal of Sr ⁸⁹ and Ca ⁴⁵ From Dosed Milk	36
3.	Effect of Milk-Resin Ratio on Per Cent Removal of Sr ⁸⁹ and Ca ⁴⁵ From Milk	42
4.	Relationship of Milk-Resin Ratio and the Percentage Exchange of Calcium-45 and Strontium-89	44

INTRODUCTION

The increased usage of nuclear power and the testing of atomic weapons have brought the problem of damaging effects of radiation to public attention. In recent months much publicity has been given the passage of strontium from the atmosphere into food and its accumulation in bone.

Due to its long half-life and its biological similarity to calcium, strontium is generally regarded to be one of the principal fission products which are of concern to the health of humans. The strontium level in milk has been steadily rising since 1954, the year adequate routine measures were first made. Since milk is the principal source of calcium of most Western Countries (people in the United States receive 85 per cent of their dietary calcium from milk products (17) it has received attention as a source of strontium.

If the strontium content of milk could be reduced the overall strontium in the diet would be reduced.

The object of this investigation was to determine the feasibility of the use of ion exchange resins to remove strontium from milk.

REVIEW OF THE LITERATURE

Ion Exchange

Although the treatment of water by solid adsorbents such as sand is probably as ancient as civilization itself, the phenomenon of ion exchange was first recognized as such in soil experiments. In 1850, two Agricultural Chemists, Thompson (28) and Way (29) reported on exchange properties of certain soils. Their experiments showed that upon treating certain types of soils with either ammonium sulfate or ammonium carbonate most of the ammonia was adsorbed and lime was released. After further study they decided that such action was due to the complex silicates present in the soils, and concluded that ion exchange was taking place.

The first industrial use of ion exchange was attempted by Harms (13) in 1896. His effort to purify sugar juice by use of base exchange silicates was only partly successful. Gans (9), in 1906 also attempted to utilize ion exchange for industrial purposes. This experimenter employed both natural and synthetic aluminum silicates for the purpose of softening waters and for treating sugar solutions. A significant step in ion exchange history was the observation by Adams and Holmes (1) in 1935, that certain synthetic resins were capable of exchanging ions.

The explanation for the phenomenon of ion exchange may be grouped into three theories; the crystal-lattice exchange theory, the double-layer theory, and the Donnan membrane theory.

The crystal-lattice theory explains ion exchange by assuming that in an ionic solid the constituents of the crystal lattice are present as ions instead of molecules. Complete dissociation of the ionic solid is assumed. Each ion in the crystal is surrounded by a fixed number of ions of opposite charge, and since the coulomb attractive force between these ions is dependent upon the charge on the ions and the distance between them, the ions on the surface are bound less closely than those beneath the crystal surface. When placed in a medium such as water, these surface ions may be easily replaced by ions in solution.

The ease with which the surface ions may be replaced by another ion depends on (a) the nature of the forces binding the ion to the crystal, (b) the concentration of the exchanging ion, (c) the charge of the exchanging ion, (d) size of the two ions, (e) the accessibility of lattice ions, and (f) solubility effects (16).

The double-layer theory, as an explanation of the electrokinetic properties of colloids, has been considered by many to explain ion exchange. The exchange material is believed to be a fixed inner layer of charges surrounded by a diffuse and mobile outer layer of charges which extend into the external liquid media. There is no sharp boundary between the ions in the diffuse outer layer and those in the equilibrium external medium. It may be considered that the concentration of the ions constituting the diffuse layer as varying continuously and depending upon the concentration and pH of the external solution. Therefore, any change in the concentration of the ions in the external solution

upsets the equilibrium and a new equilibrium is obtained. Some of the ions held in the diffuse outer layer will be replaced by some of the new ions.

The Donnan membrane theory pertains to the unequal distribution of ions on two sides of a membrane, when one side contains ions too large to diffuse through the membrane. An unequal distribution will occur because of the undiffusible ions and the necessity of maintaining electroneutrality.

In applying the latter theory to ion exchange, the exchange material is assumed to be the ion too large to diffuse, and although in ion exchange no membrane is used, the interface between the solid and liquid phases is assumed to represent a membrane (16).

Otting (25) discusses the problems involved in the changing of equipment used for water treatment to a design which would be satisfactory from the sanitary viewpoint for ion exchange work in milk. The gravel in the bottom of the water softening device was replaced by a wire screen and a perforated plate to reduce the milkstone. Before a commercially feasible process resulted many changes in design of equipment and revival methods were necessary.

Milk can be modified by treatment with various types of organic ion exchange materials to produce certain desired characteristics. Haller and Morin (12) found that the type and extent of modification can be controlled at will by using the proper exchangers or combination of exchangers and by the proper regeneration of these exchangers. In one treatment these workers produced a soft curd milk of normal pH.

In another, approximately 20 per cent of the citrates, phosphates, and chlorides in addition to calcium and other cations were removed. Still another treatment removed citrates and chlorides and small amounts of calcium and other cations, but no phosphates.

In order to make cow's milk more suitable for the feeding of infants, modifications of the milk is necessary, particularly in the matter of curd tension. In 1930 Lyman (21) revealed that calcium could be removed from cow's milk by placing it in contact with greensand, a highly siliceous sand containing a little magnesia and alumina, and that the resulting milk exhibited soft-curd properties. This application of base-exchange silicates to the commercial treatment of dairy products was probably the first successful use of this principle in connection with a food product.

Murthy and Whitney (23) investigated the effect of mixed cation and anion resins upon the salt content of milk. The batch process was used to treat fresh raw skim milk with cationic and anionic resin mixtures at four different levels each. The pH and the calcium, sodium, and potassium content decreased with increases in cation resin concentration. Citrate, chloride, and sulfate content decreased with increases in anion resin concentration. The nitrogen content was not affected except when coagulation occurred.

Sasaki, et al. (26) studied the effects of treatment with ion exchange resin on heat coagulation of milk. Calcium was adsorbed on a cation exchanger of sulfonic acid structure but no clear relationship was observed between the removal of calcium and the temperature of heat coagulation of milk.

Gehrke and Almy (10) investigated the adsorption affinity to synthetic ion exchange resins of the cations and anions normal to milk. The relative order of adsorption of the cations from the synthetic whey solution was found to be Ca^{++} Mg^{++} K^+ Na^+ .

Baker and Gehrke (4) developed an ion exchange resin contact time method to study the equilibria of calcium in milk and to measure directly the ion-exchangeable calcium. They also reported (5) that heating skim milk to 40°, 60°, and 80° C. for 30 minutes had no noticeable effect on the exchangeability of calcium. However, the exchangeable calcium was significantly decreased as the temperature of heating increased from 100° to 120° C. for holding times of 30 minutes. Similar results were reported by Gehrke and Smith (11) who also observed that as the pH is increased the per cent of instantaneously exchangeable calcium decreases.

Two methods of recovering lactose from cheddar cheese whey were studied by McGlasson and Boyd (22). One method involved passing the original whey through ion exchange resins, removing the whey protein by heat treatment and further purifying the removed lactose solution with ion exchange resins. The second method differed from this only in that the original whey was not treated with ion exchange resins prior to the recovery of the protein fraction. Lactose with a higher degree of purity was recovered by the second method.

Josephson and Reeves (14) found that when mineral ion exchange treated milk was added to evaporated milk it was capable of stabilizing the evaporated product against coagulation during steriliza-

tion at 240° F. for 15 minutes. Mineral ion exchange milk was found to be effective in stabilizing milks exhibiting a wide range of instability to heat.

Nervik, et al. (24), by both a column and a bulk technique, removed nearly 90 per cent of the tracer isotopes of calcium and strontium from milk to which they had added isotopes, using Dowex-50W resin in the sodium form.

Radioactive Strontium

The strontium isotopes (mass numbers 84 through 94 and 97) may be formed as fission products and from the bombardment of other isotopes by nuclear particles. In the fission of Uranium-235 the strontium isotopes have a relatively large yield (about 5.8 per cent strontium-90). No radiation problem is presented by the stable isotopes of strontium 84, 86, 87 and 88. An isomeric form of strontium-87 and the isotopes 91, 92, 93, 94 and 97 have relatively short half-lives (range from ten hours to less than two minutes) and consequently, would decay rapidly compared to an isomeric form of strontium-85 and the isotopes 89 and 90, which have half-lives of 65 days, 55 days, and 25 years, respectively.

Strontium is one of the alkaline earths metals, belonging to Group II of the Periodic Table along with calcium, barium, and radium. Strontium-90 is generally regarded as the principal health hazard among the fission products since it is taken up by the human skeleton where it remains deposited for many years. The metabolism of stron-

tium has been found similar to that of calcium (2, 17, 15). Schulert and Pests (27) found that intravenously administered strontium-85 and calcium-45 in man were somewhat equally divided between bone and soft tissue for the first few days after administration but that after four months, about 99.5 per cent of the isotopes which were retained in the body were found in bone. The retention among the bones was greatest in vertebrae and least in long bone shaft and skull. Initially, the bone exhibited no marked preference for one isotope over the other, however, as strontium-85 was preferentially excreted by the kidney, the relative ratio of calcium-45 to strontium-85 remaining in bone gradually increased. The net retention of the isotopes appeared to level off at about 60 per cent for calcium-45 and 25 per cent for strontium-85. Although strontium retention in the body is less than calcium, the distribution throughout the body seems very similar.

Factors influencing the health hazards of strontium have been estimated by health physicists according to (1) quantities available, (2) initial body retention, (3) fraction going from blood to critical body tissue, (4) radiosensitivity of the tissue, (5) size of the critical organ, (6) biological half-life, (7) radioactive half-life, (8) energy of radiation produced by the radioisotope, and (9) specific ionization and attenuation of energy in tissue.

With the present knowledge, it is hardly possible to do more than broadly indicate the biological damage caused by strontium-90. However, the likely biological damage from ingestion of strontium-90 may be described under four headings: leukemia, bone tumor, life-shortening and genetic damage (6, 18).

According to Lewis (19) leukemia in man can be induced by ionizing radiations and can also occur spontaneously. He estimated that a 5 to 10 per cent increase in the current spontaneous incidence of leukemia would occur if the population were to reach and maintain a body level of strontium-90 amounting to one-tenth of the "maximum permissible concentration". The maximum permissible levels are recommended by the National Committee on Radiation Protection and Measurement and represent concentrations which are currently considered safe over a lifetime and which may occasionally be exceeded for short periods of time.

It has been demonstrated in laboratory animals that acute doses of radiostrontium cause bone tumors. As yet, nothing definite is known regarding the quantitative relationship between the magnitude of the dose and the incidence probability of bone tumors.

Radiostrontium Movement from Atmosphere to Milk

Radioactive fallout is the settling to earth of particles which are radioactive as a result of a nuclear explosion. Radiostrontium comes down mainly in raindrops. Part of the radiostrontium descending will lodge in plants, and part will enter the soil and then enter plants through their roots. The fraction which falls on leaves of growing plants is partially absorbed directly into the plant (7, 20).

Soil, like ion exchange resins, readily absorbs and retains most metal ions, including strontium. Approximately 80 per cent of the strontium-90 deposition is held in the top 2 inches of soil (7, 20).

About 50 per cent of the total is contained in the top one inch layer and the remaining portion in the soil to a depth of about 6 inches. The period for which radiostrontium stays in top-soil without becoming buried relatively deep, due to plowing, dispersion, or transformation into insoluble compounds, is not easily estimated, but probably extends over several years. Many factors, however, such as the nature of the soil, the extent of leaching by rain, the action of worms, and the cracking of the soil in dry weather, will affect the depth of penetration (7).

Very little is known about the actual mechanism of absorption and uptake of metal ions by plants but as strontium is chemically similar to calcium, it is reasonable to assume that calcium and strontium are absorbed in the same manner. The growing plant discriminates against strontium in favor of calcium at the ratio of about 2 to 1 (20). The absorption of strontium-90 by plants in a season is of the order of one per cent of the amount present in soil, the highest values in plants being in leaf tissue (7).

Animals markedly discriminate against strontium relative to calcium in their absorption of these elements from feed. The strontium activity in milk expressed as per gram of calcium present, is much below its value in the animal's ration. The experiments of Comar, et al. (7) and those of Cragle and Demott (8), have shown that the ratio of the strontium concentration in the animal's ration to that in the milk to be about 7-10 to 1. The cow acts as a barrier resisting the flow of strontium along the food-chain from soil to man. This

means that the strontium concentration (per gram of calcium) in milk is only about one-seventh to one-tenth of what it is in the feed the cow eats.

Since strontium and calcium metabolism are very closely associated, concentrations of strontium are generally expressed in terms of calcium. The most common and convenient unit for this purpose is the sunshine unit or sometimes called the Strontium Unit (S.U.), which is equal to the number of micromicrocuries of strontium-90 per gram of calcium. In itself it is not an absolute amount of strontium-90 but applies only to calcium contamination with strontium-90; and it provides a direct measure of this specific contamination. The maximum permissible body burden of strontium-90 for the general public is 0.1 microcurie, corresponding to 100 S. U. (as of April 22, 1959, unofficially 200 S. U.). On the basis of extensive experience of radiologists and technicians in work with X-rays and radium therapy, limited animal experimentations, experience with man and comparison with background concentrations of naturally occurring radioisotopes in our bodies, in the air we breathe and in the water and food we consume, the U. S. National Committee on Radiation Protection has recommended maximum permissible amounts and concentrations of radiation exposure.

The yearly average for the period ending July 1958 for strontium-90 in milk ranged from 4.2 to 10.2 micromicrocuries per liter, as compared to the permissible limit of 80 (unofficially 100 as of

April 22, 1959) micromicrocuries per liter (3). However, the strontium-90 level in milk has been steadily rising since the first adequate measurements were taken in 1954, roughly, in proportion to the rise in the level of strontium-90 deposition in soil. There has been approximately a fourfold increase in the average world strontium-90 content of milk from 1954 to the level of 5-6 S. U. in 1958 (17).

EXPERIMENTAL PROCEDURE

Removal of Strontium-89 and Calcium-45 from Milk of Dosed Cow

Eight daily milk samples from four Jersey cows dosed orally with one dose of calcium-45 and strontium-89 was separated mechanically by use of a DeLaval Junior Model 3300 separator and the skim milk passed through an ion exchange column at room temperature. The columns were 18 mm in diameter and 2½ inches long and contained 50 grams of either Dowex 50-W, 50-100 mesh cross linkage of 4 per cent; Duolite C-20; or Dowex 50-W, 50-100 mesh with a cross linkage of 12 per cent. These resins are strongly acidic, cross-linked polystyrene cation exchangers. Preliminary results indicated that the conventional downflow system could not be used due to packing of the resin, making it impossible to put the desired quantity of effluent through the column. Therefore, the upflow system was used (see Fig. 1) in which solutions were passed in at the bottom and out at the top of the container. Due to the turbulent action caused by the milk entering the bottom this system can not be called a true column action since the "layering" effect associated with column action is not present. Flow rate was adjusted to approximately 7 milliliters per minute to avoid channeling and control contact time.

Both the calcium and sodium form of each of these resins were tested for its effectiveness in the removal of strontium-89 and calcium-45 from skim milk. After initial conditioning of the resin, one liter of milk was passed through each column before the resin was

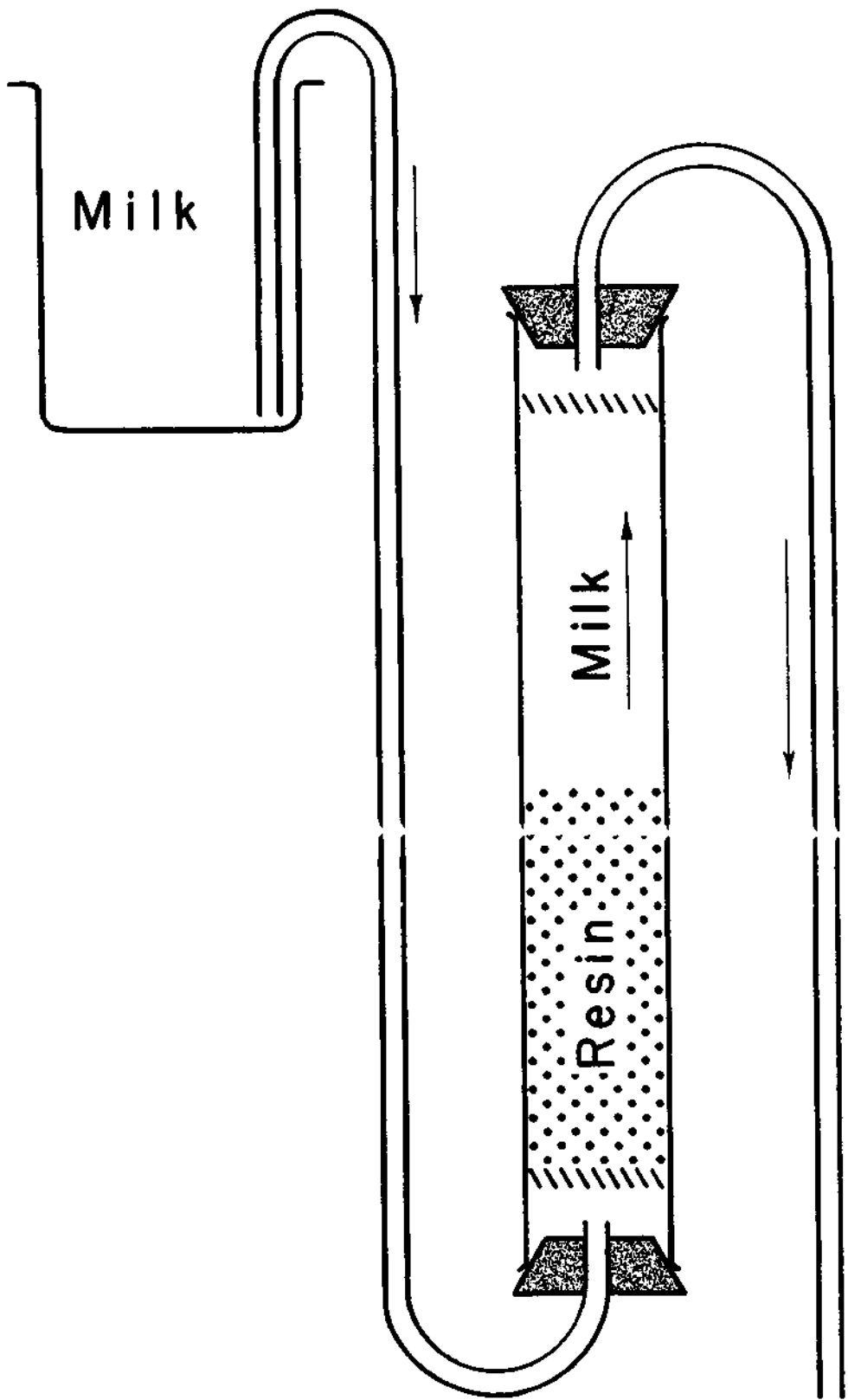

Figure 1. Modified Ion Exchange Column.

again regenerated. After each operation the cations bound by the resin were eluted by treatment with approximately 1500 milliliters of approximately 3 N hydrochloric acid. The columns were then washed with sufficient quantities of calcium chloride or sodium chloride to convert the exchangers into the desired form, followed with 100 to 200 milliliters of distilled water to wash the excess calcium or sodium chloride from the resin. The 2nd, 6th and 10th 100 milliliter portions coming through the column were sampled for analysis. Two twenty-five milliliter samples of milk were taken from each of the 100 milliliter portions. The samples were transferred to porcelain crucibles and dried in an oven at 90-100° C. for a minimum of 16 hours. They were then transferred to a muffle furnace and ashed at 600° C. for approximately 16 hours. Approximately 2 ml of hydrochloric acid was added to the ashed samples to bring the calcium and strontium into solution. The samples were then transferred quantitatively to a 40 milliliter centrifuge tube. One drop of methyl red was added as an indicator. The calcium and strontium were precipitated by adding 3 milliliters of saturated ammonium oxalate, then, by neutralizing the sample with ammonium hydroxide until the solution was faintly alkaline, and by adjusting the solution to a final pH of approximately 5.0 using acetic acid. After the solution was allowed to stand overnight for complete precipitation of the calcium and strontium oxalate, it was centrifuged and the precipitate washed twice with distilled water and transferred quantitatively into a tared cup-and-tube assembly. This assembly consisted of a tapered-end polyethylene cylinder with a

stainless-steel Tracerlab cup forming the bottom. The 4-inch plastic tube was pressed securely into the cup until the assembly was water-tight.

Following centrifugation at 1800 revolutions per minute (920 times gravity) for 10 minutes in a 20 inch diameter International centrifuge, the supernatant was drawn off and the cup removed and dried to a constant weight in an oven at approximately 60° C. The samples were then measured for radioactivity by conventional methods using a thin mica window Geiger-Müller tube connected to a scaler unit.

The activity measurements of calcium-45 are greatly dependent upon the mass of the sample measured primarily because of self-absorption of its relatively low beta energy (0.26 Mev.). The total calcium and the correction for self-absorption were calculated from the mass weight of the oxalate in the dry cup.

All samples were counted with an aluminum absorber of 54.5 or 66.6 mg/cm² and again with no absorber. Both of these absorbers will stop essentially all the calcium-45 beta rays from the sample and will reduce the strontium-89 counts by factors of 1.39 and 1.50 respectively. Therefore, when no absorber was used the activity was due to both isotopes but when the same sample was measured again with an absorber the activity represented a portion of the strontium-89 only. The calcium-45 contribution was calculated by difference. The observed count with the aluminum absorber present, times the appropriate factor represents the corrected strontium-89 count. The total observed count

with no absorber present, minus the corrected strontium-89 count, times the mass correction factor for calcium oxalate self-absorption represents the corrected calcium count.

The same procedure as described above was used for duplicate samples of standards, having no resin contact.

Removal of Strontium-89 and Calcium-45 from Dosed Milk

In this experiment "dosed milk" was used instead of milk from "dosed cows". Here the calcium-45 and strontium-89 were put directly into the milk instead of being administered to the cow. Calcium-45 and strontium-89 were put into fresh raw whole milk at approximately 4 P. M., mixed thoroughly and left undisturbed for 16 hours at 40° F. The following morning the milk was thoroughly mixed again, heated in a water bath to 30° C., and mechanically separated. After bringing the skim milk to room temperature the procedure described previously was followed.

Resin-milk and Isotope-milk Equilibrium Studies

In order to determine how long an ion exchange resin must be in contact with milk containing calcium-45 and strontium-89 to reach equilibrium, a liter of raw skim milk was dosed with calcium-45 and strontium-89, mixed thoroughly and left undisturbed for approximately 16 hours at 40° F. After heating the milk to room temperature, four-100 milliliter samples were put into 250 milliliter beakers and 5 grams of Dowex 50-W, X-12, 50-100 mesh, in the calcium form were added to each beaker. After one minute of mixing, sample one was filtered and two

25 milliliter milk samples ashed, precipitated with ammonium oxalate and counted. The same procedure was followed for samples two, three and four after 10, 60, and 120 minutes of agitation respectively. All samples were mixed by hand for the first minute and by use of a mechanical agitator thereafter. Two 25 milliliter samples of milk having no resin contact were used as standards. The percentage removal of calcium-45 and strontium-89 was calculated for each contact time.

In order to determine how long a sample of milk must be in contact with calcium-45 and strontium-89 for the sample to reach equilibrium, four - 100 milliliter samples of raw skim milk at room temperature were dosed with calcium-45 and strontium-89. After mixing for 1, 10, 30 and 60 minutes the samples were treated by exposure to 5 grams of Dowex 50-W, X-12, 50-100 mesh, in the calcium form for 60 minutes after which the samples were filtered by use of a suction funnel. Two 25 milliliter samples from each exposure time were ashed, precipitated with ammonium oxalate and counted. The percentage removal of calcium-45 and strontium-89 was calculated for each exposure time.

Removal of Calcium-45 and Strontium-89 from Milk by Use of a Series of Four Columns

One liter of milk was passed through a series of four columns, each containing 12.5 grams of Dowex 50-W, X-12, 50-100 mesh in the calcium form. The 2nd, 6th and 10th 100 milliliter portions passing through the last column were sampled for analysis in the same manner as described previously. This experiment was repeated four times. Following the last run the four columns were disconnected and the

resin was washed with 1 liter of 3 N hydrochloric acid. Samples of the eluate from each of the four columns were assayed for radioactivity.

Removal of Strontium-89 and Calcium-45 from Dosed Milk by the Batch Method

Raw skim milk was dosed with calcium-45 and strontium-89, agitated thoroughly by hand and left undisturbed for approximately 16 hours at 40° F. After heating the milk to room temperature six - 200 milliliter samples were put into 400 milliliter beakers and 1, 5, 10, 20, 40, and 100 grams of Dowex 50-W, X-12, 50-100 mesh, in the calcium form, were added. After mechanical agitation for four hours the samples were filtered by use of a suction funnel. Two - 25 milliliter milk samples from each beaker were dried, ashed, precipitated with ammonium oxalate, dried and counted. Two 25 milliliter samples of milk having no resin contact were used as standards. The percentage removal of calcium-45 and strontium-89 was calculated for each quantity of resin.

RESULTS AND DISCUSSION

Values for the percentage of removal of strontium and calcium, from milk of dosed cows, by use of ion exchange resins are summarized in Table I. Significant differences were noted between resins, between ionic form of the resin as well as between portions passed through the column. Results indicate that Dowex 50-W, with a cross linkage of 12 per cent, in the calcium form is the most effective resin tested for removal of strontium-89 and calcium-45 from milk. From these data it is suggested that exchange of like (Ca-Ca) or similar (Ca-Sr) ions is more easily accomplished than the exchange of unlike (Na-Ca or Na-Sr) ions from milk. All three resins in the calcium form showed a slightly higher percentage of removal of strontium than calcium for all samples tested, although the degree varied with resins and the portion of milk passed through the column. A higher removal of strontium and calcium was attained in the first portion of milk passed through the columns as compared to other portions. The percentage removal decreased as the amount of milk passed through the column increased.

The same general conclusions may be drawn from the data presented on removing strontium and calcium from dosed milk (Table II). However, between resins, between ionic form of the resin and between the portion of milk passed through the column, no significant differences for removal of calcium were shown. There was no significant difference between resins for removal of strontium from dosed milk, whereas in the case of milk from dosed cows, between resins, between

TABLE I

PER CENT REMOVAL OF Sr⁹⁰ AND Ca⁴⁵ FROM MILK OF DISED COWS BY EXCHANGE RESIN COLUMNS

Trial	100 ml. Portion of Klutriated Milk Sample	Ca form of resin						Sr form of resin					
		Dowex 50W-4X			Duolite C-20			Dowex 50W-12X			Duolite C-20		
		Sr	Ca		Sr	Ca		Sr	Ca		Sr	Ca	
1	2nd	67	80	73	79	66	62	14	48	44	68	1	47
	6th	55	53	60	59	38	52	5	39	16	52	1	51
	10th	52	40	38	51	44	52	0	31	0	34	0	48
2	2nd	75	80	78	78	64	56	31	48	69	71	12	35
	6th	50	50	68	61	54	45	13	30	42	51	3	28
	10th	55	38	55	48	48	39	0	16	17	30	0	26
3	2nd	60	61	61	52	63	58	29	36	65	70	0	22
	6th	67	58	53	53	48	41	7	19	34	35	0	10
	10th	35	34	44	41	46	39	0	2	18	21	0	10
4	2nd	84	72	82	77	68	59	49	60	79	80	19	50
	6th	59	58	54	56	54	53	9	36	46	56	5	39
	10th	48	46	46	50	50	44	0	22	12	36	9	29
5	2nd	76	74	76	74	65	69	40	57	54	78	0	43
	6th	60	57	60	53	65	54	10	33	38	55	0	34
	10th	36	41	52	48	45	43	0	17	35	31	0	26

TABLE I (continued)

PER CENT REMOVAL OF Sr⁸⁹ AND Ca⁴⁵ FROM MILK OF DISED COWS BY EXCHANGE RESIN COLUMNS

Trial	100 ml. Portion of Klutriated Milk Sample	Ca form of resin						Na form of resin					
		Dowex		Dow x		Duolite		Dowex		Dowex		Duolite	
		50M-4X Sr	Ca	50M-2X Sr	Ca	C-20 Sr	Ca	50M-4X Sr	Ca	50M-12X Sr	Ca	C-20 Sr	Ca
6	2nd	86	74	67	70	70	58	33	42	67	69	4	40
	6th	56	56	60	64	66	44	0	38	40	54	0	28
	10th	58	37	48	45	41	36	3	18	7	39	3	11
7	2nd	81	81	85	89	73	71	37	46	67	64	0	44
	6th	69	53	58	55	65	46	13	26	31	66	4	34
	10th	48	38	50	48	50	35	0	21	2	30	0	19
8	2nd	82	81	86	74	89	77	23	51	64	43	0	30
	6th	59	18	50	46	48	49	7	26	25	40	0	43
	10th	23	39	48	36	43	43	0	20	0	25	0	40
Average	2nd	76	75	76	74	70	64	32	49	64	68	4	39
	6th	59	50	58	56	55	48	8	31	34	51	2	33
	10th	44	39	48	46	46	41	0	18	11	31	2	26

TABLE II

PER CENT REMOVAL OF Sr⁹⁰ AND Ca⁴⁵ FROM DODED MILK BY EXCHANGE RESIN COLUMNS

Trial	100 ml. Portion of Elutriated Milk Sample	Ca form of resin						Sr form of resin					
		Dowex 50W-4X			Dowex 50W-2X			Dowex 50W-4X			Dowex 50W-12X		
		Sr	Ca	Buolite C-20	Sr	Ca	Buolite C-20	Sr	Ca	Buolite C-20	Sr	Ca	Buolite C-20
1	2nd	83	83	89	79	78	71	61	70	87	88	20	38
	6th	71	64	68	70	55	54	33	30	59	66	0	24
	10th	61	53	65	62	43	44	12	36	34	39	0	16
2	2nd	75	79	75	78	68	65	33	50	57	69	6	40
	6th	64	61	62	65	56	62	14	32	40	49	0	20
	10th	54	45	59	59	50	57	0	39	12	36	0	22
3	2nd	76	81	78	80	62	60	31	49	60	74	8	45
	6th	56	57	62	64	49	47	9	40	38	56	0	30
	10th	50	54	58	49	41	55	0	22	9	41	0	18
4	2nd	84	72	80	76	64	56	30	54	68	74	16	34
	6th	73	15	67	62	55	49	21	35	36	55	6	19
	10th	63	41	58	38	35	41	0	22	22	28	0	20
5	2nd	81	77	72	72	72	69	60	61	62	60	28	35
	6th	61	61	61	47	55	47	28	32	48	42	15	28
	10th	55	35	53	34	47	35	6	22	30	33	0	11

TABLE II (continued)

PER CENT REMOVAL OF Sr⁹⁰ AND Ca⁴⁵ FROM DOSED MILK BY EXCHANGE RESIN COLUMNS

Trial	100 ml. Portion of Elutriated Milk Sample	Ca form of resin						Sr form of resin					
		Dowex 50W-4X			Dowex 50W-12X			Dowex 50W-4X			Dowex 50W-12X		
		Sr	Ca	C-20	Sr	Ca	C-20	Sr	Ca	C-20	Sr	Ca	C-20
6	2nd	81	74	81	82	78	88	47	55	69	71	34	50
	6th	64	53	67	61	60	56	28	38	54	56	17	34
	10th	54	44	62	57	54	49	30	26	34	33	11	28
7	2nd	76	59	75	63	63	41	48	38	71	68	18	9
	6th	55	30	66	40	55	29	27	3	50	36	9	0
	10th	52	21	54	26	41	3	7	0	30	0	22	0
8	2nd	73	78	76	82	66	69	38	46	59	70	6	42
	6th	56	57	63	63	53	57	20	36	38	50	0	26
	10th	52	45	52	50	41	41	5	19	20	28	0	17
Average	2nd	79	75	77	76	69	64	44	53	67	72	17	37
	6th	63	50	65	59	55	50	23	31	45	51	6	23
	10th	55	42	58	47	44	41	8	22	24	30	4	17

ionic forms of the resin and between portions of milk passed through the column were all significantly different. Using Dowex 50W-XL2 in the calcium form, the percentage removal of strontium decreased at a faster rate, as measured by the amount of milk passed through the column, when metabolized milk was used, as compared to milk which was dosed 16 hours before the exchange treatment. The average of eight trials showed 76, 59 and 45 per cent removal of the strontium from metabolized milk on samples from the 2nd, 6th and 10th 100 milliliter portions of milk respectively and 79, 63 and 55 for the equivalent samples when dosed milk was used. The removal of strontium from dosed milk is significantly different ($P < .01$) from the removal of strontium from milk of dosed cows while no significantly different removal of Ca^{45} was noted under the same circumstances. This may be due to the incorporation of strontium into the protein molecule in metabolic milk, whereas in dosed milk this would not likely be the case.

Data from eight trials on removal of calcium and strontium from milk of dosed cows and data from a similar experiment using dosed milk were subjected to analyses of variances. The F values for the main effects, and first and second order interactions in these experiments are presented in Table III. Significant differences were noted between resins for the removal of both calcium-45 and strontium-89 milk of dosed cows but not for the removal of either from dosed milk. Significant differences were noted between days following dosing of the cow for the removal of calcium-45 from milk and also

TABLE III

ANALYSES OF VARIANCES FROM EIGHT TRIALS ON REMOVAL OF Ca⁴⁵ AND Sr⁹⁰ FROM MILK OF
 Dosed Cows AND EIGHT TRIALS ON REVAL OF Ca⁴⁵ AND Sr⁹⁰ FROM Dosed MILK

Total	Dosed Cows - Sr ⁹⁰		Dosed Milk - Sr ⁹⁰		Dosed Cows - Ca ⁴⁵		Dosed Milk - Ca ⁴⁵	
	F Value	Tested by	F value	Tested by	F Value	Tested by	F Value	Tested by
Resins	8.12*	RFS	3.02 NS	RF	23.15**	RD	4.35	RF
Days	2.55 NS	DF	2.50 NS	DF	4.88**	RD	29.62**	Error
Form	657.45**	DF	21.76*	RF	77.81*	FS	15.33 NS	RF
Samples	16.85**	RFS	25.37**	RFS	75.10*	FS	40.38**	BS
RD	NS	Error	2.2*	Error	3.28**	Error	1.60 NS	Error
RF	NS	RFS	6.43**	RFS	6.08 NS	RFS	16.54**	Error
BS	NS	RFS	NS	RFS	3.44 NS	RFS	5.33**	Error
DF	2.56*	Error	8.70**	Error	2.21 NS	Error	1.19 NS	Error
DS	2.00 NS	Error	1.05	Error	1.57 NS	Error	0.98 NS	Error
FS	NS	Error	NS	RFS	4.38*	Error	0.43 NS	Error

TABLE III (continued)

ANALYSES OF VARIANCES FROM EIGHT TRIALS ON REMOVAL OF Ca⁴⁵ AND Sr⁹⁰ FROM MILK OF
 Dosed Cows AND EIGHT TRIALS ON RE MOVAL OF Ca⁴⁵ AND Sr⁹⁰ FROM Dosed MILK

Total	Dosed Cows - Sr ⁹⁰		Dosed Milk - Sr ⁹⁰		Dosed Cows - Ca ⁴⁵		Dosed Milk - Ca ⁴⁵	
	F Value	Tested by	F Value	Tested by	F Value	Tested by	F Value	Tested by
RDF	NS	Error	2.05 NS	Error	1.64 NS	Error	0.62 NS	Error
RDS	NS	Error	1.05 NS	Error	1.28 NS	Error	0.68 NS	Error
RFS	14.00**	Error	16.95**	Error	3.46*	Error	1.68 NS	Error
DFS	1.59 NS	Error	0.7 NS	Error	3.75**	Error	0.68 NS	Error
CV	15.7%		10.3%		11.4%		15.3%	

*P < .05

**P < .01

between trials conducted on different days on dosed milk. Strontium-89 removal was not significantly different for either. Significant differences on the removal of calcium-45 and strontium-89 between portions passed through the column (samples) were noted on both dosed milk and milk from dosed cows.

Raw skim milk, without the addition of isotopes, was passed through an exchange column identical to the ones used for milk containing the isotopes. Data on the titratable acidity, curd tension, pH, and rennet coagulation time are shown in Table IV. Before the milk was passed through the exchange column the average pH was approximately 6.71, titratable acidity 0.162 per cent, coagulation time 490.6 seconds, curd tension 61 grams, and the taste was that of normal raw skim milk. The first 100 milliliters of milk passed through the column had a slightly lower pH, a higher titratable acidity, higher curd tension and a lower rennet coagulation time compared to the standard. Under conditions which removed the highest percentage of strontium and calcium from milk, these effects were more pronounced. Therefore, as more milk was passed through the column the closer these properties approached normal milk with the exception of curd tension which continued to increase. The shorter rennet coagulation time is partially indicative of a higher calcium content in treated milk. As calcium concentration increases it tends to form calcium hydrogen phosphate, releasing hydrogen ions from calcium dihydrogen phosphate consequently lowering the pH. Milk so treated (without added radioactivity) was

TABLE IV

COAGULATION TIME, CURD TENSION, pH AND TITRABLE ACIDITY OF MILK PASSED THROUGH AN ION EXCHANGE COLUMN CONTAINING DOWEX 50W-X12 CALCIUM FORM

Trial	Control	100 ml. Portion of Kilterated Milk Sample													
		1	2	3	4	5	6	7	8	9	10	11			
1	Coagulation Time (Sec)	480	40	52	98	85	113	121							
	Curd Tension (grams)	60	110	108	85	140	160	120							
	pH	6.75	6.1	6.07	6.11	6.18	6.21	6.28	6.29	6.31	6.38	6.41	6.41		
	Per Cent Acidity	.164	.18	.20	.195	.19	.195	.195							
2	Coagulation Time (Sec)	485	26	36	43	61	81	108							
	Curd Tension (grams)	60	80	130	115	132	130	127							
	pH	6.7	6.1	6.00	6.1	6.15	6.2	6.22	6.28	6.3	6.35	6.38			
	Per Cent Acidity	.16	.195	.20	.195	.19	.195	.19							

CABLE IV (continued)

COAGULATION TIME, CURD TENSION, pH AND TITRATABLE ACIDITY OF MILK PASSED THROUGH AN ION EXCHANGE COLUMN CONTAINING DOWEX 50W-X12 CALCIUM FORM

Trial	100 ml. Portion of Enriched Milk Sample											
	Control	1	2	3	4	5	6	7	8	9	10	11
3	Coagulation Time (Sec)	525	26		36	54		75		90		110
	Curd Tension (grams)	58	70	120		135		150		190		140
	pH	6.7	5.98	6.1	6.1	6.2	6.21	6.25	6.32	6.38	6.38	6.39
	Per Cent Acidity	.165		.195	.20		.195	.19	.19		.185	
4	Coagulation Time (Sec)	522	26		35	54		82		90		114
	Curd Tension (grams)	60	80	130		135		140		150		135
	pH	6.7	6.2	6.05	6.1	6.18	6.24	6.25	6.32	6.38	6.44	6.45
	Per Cent Acidity	.16		.19	.195		.19	.195	.19		.19	

TABLE IV (continued)

COAGULATION TIME, CURD TENSION, pH AND TITRATABLE ACIDITY OF MILK PASSED THROUGH AN ION EXCHANGE COLUMN CONTAINING DOWEX 50W-XL2 CALCIUM FORM

Trial	Control	100 ml. Portion of Elutriated Milk Sample										
		1	2	3	4	5	6	7	8	9	10	11
5	Coagulation Time (Sec)	455	24	34	34	53	69	89	89	108		
	Curd Tension (grams)	58	76	120	140	140	150	160	160	140		
	pH	6.7	6.2	6.1	6.2	6.23	6.29	6.32	6.33	6.38	6.4	6.45
	Per Cent Acidity	.165	.195	.205	.200	.195	.195	.19	.195	.19		
6	Coagulation Time (Sec)	485	23	34	54	67	91	111				
	Curd Tension (grams)	70	80	140	144	142	152	140				
	pH	6.68	6.12	6.1	6.18	6.19	6.23	6.28	6.3	6.33	6.35	6.4
	Per Cent Acidity	.165	.195	.20	.20	.20	.195	.19	.195	.19		

TABLE IV (continued)

COAGULATION TIME, CURD TENSION, pH AND TITRATABLE ACIDITY OF MILK PASSED THROUGH
AN ION EXCHANGE COLUMN CONTAINING DOWEX 504-X12 CALCIUM FORM

Trial	Control	100 ml. Portion of Elutriated Milk Sample												
		1	2	3	4	5	6	7	8	9	10	11		
7	488	26	43	64	72	93	114							
	Coagulation Time (Sec)													
	60	70	110	128	140	130	125							
	Curd Tension (grams)													
	6.72	6.12	6.18	6.22	6.29	6.38	6.39	6.4	6.48	6.48	6.49			
	pH													
	.16	.195	.195	.195	.195	.195	.195	.195	.185					
	Per Cent Acidity													
8	485	22	36	54	71	92	116							
	Coagulation Time (Sec)													
	63	90	120	138	145	135	119							
	Curd Tension (grams)													
	6.7	6.08	6.1	6.2	6.28	6.3	6.33	6.39	6.4	6.46	6.48			
	pH													
	.16	.195	.20	.195	.19	.19	.19							
	Per Cent Acidity													

TABLE IV (continued)

COAGULATION TIME, CURD TENSION, pH AND TITRATABLE ACIDITY OF MILK PASSED THROUGH AN ION EXCHANGE COLUMN CONTAINING DOWED 50W-X12 CALCIUM FORM

Trial	Control	100 ml. Portion of Elutriated Milk Sample												
		1	2	3	4	5	6	7	8	9	10	11		
Avg. Coagulation Time (Sec)	490.6	26.6	38.2	59.1	71.5	92.3	112.7							
Curd Tension (grams)	61	82	121.9	127.5	142.4	158.7	130.8							
pH	6.71	6.12	6.05	6.17	6.23	6.27	6.29	6.34	6.38	6.41	6.43			
Per Cent Acidity	.162	.192	.199	.196	.192	.189								

tasted and found to have a slightly bitter flavor in those samples which exhibited the largest pH drop.

Data on the removal of strontium and calcium from milk as influenced by the resin-milk contact time are presented in Table V. All contact times were made on a milk-resin ratio basis of 20 to 1 using the batch techniques. Times of 1, 10, 30 and 60 minutes were used. The average of three trials showed 62 per cent strontium-89 and 52 per cent calcium-45 were removed after a contact time of one minute, while 76 per cent strontium-89 and 67 per cent calcium-45 were removed after 120 minutes, the greatest difference being from one to ten minutes ($P < 0.05$). This is illustrated more clearly in Fig. 2 which indicates that the solution had approached equilibrium after 10 minutes but not at the end of one minute.

The data for the removal of strontium and calcium as influenced by the isotope-milk contact time are presented in Table VI. Each sample was intermittently hand agitated for either 1, 10, 30 or 60 minutes, then treated by exposure to Dowex 50W-X12 in the calcium form for 60 minutes under constant agitation. The milk to resin ratio was 20 to 1. Results show approximately 30 per cent removal of strontium-89 and approximately 75 per cent removal of calcium-45 with very little difference between milk agitated for one minute and that agitated for 60 minutes before exchange treatment. The isotopes are fully incorporated into the milk within one minute or the rate of incorporation at this stage is so slow that 60 minutes is not suffi-

TABLE V

EFFECT OF RESIN-MILK CONTACT TIME ON PER CENT REMOVAL OF
 Sr^{90} AND Ca^{45} FROM DOSED MILK

Trial	Resin-milk Contact Time (minutes)	Per Cent Sr^{90} Removal	Per Cent Ca^{45} Removal
1	1	66	56
	10	69	54
	60	77	70
	120	76	69
2	1	57	44
	10	71	64
	60	68	55
	120	78	70
3	1	64	55
	10	75	62
	60	77	72
	120	75	60
Average	1	62	52
	10	72	60
	60	74	66
	120	76	67

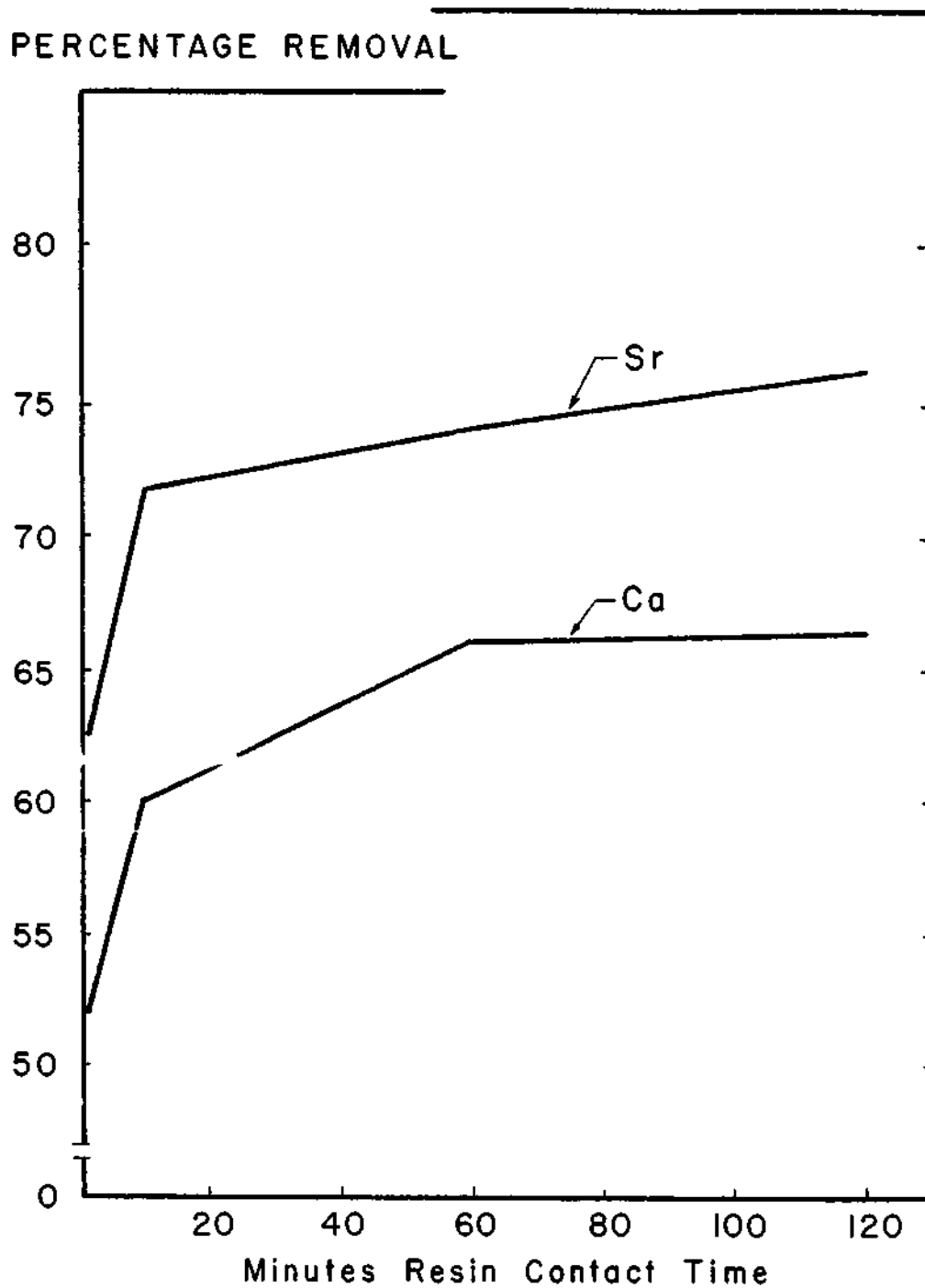

Figure 2. Effect of Resin-Milk Contact Time on Percent Removal of Sr⁸⁹ and Ca⁴⁵ from Dosed Milk.

TABLE VI

EFFECT OF ISOTOPE-MILK CONTACT TIME ON PER CENT REMOVAL OF Sr⁹⁰
AND Ca⁴⁵ FROM DOSED MILK

Trial	Isotope-milk Contact time (minutes)	Per Cent Sr ⁹⁰ Removal	Per Cent Ca ⁴⁵ Removal
1	1	78	71
	10	79	70
	30	76	72
	60	72	61
2	1	83	78
	10	84	77
	30	73	71
	60	80	70
3	1	83	81
	10	73	73
	30	82	87
	60	81	78
4	1	80	73
	10	77	71
	30	83	74
	60	73	61
Average	1	81	76
	10	79	72
	30	79	76
	60	77	68

cient time to show a definite trend, the latter probably being the case since less of the isotopes were removed after contact with the milk 16 hours than 60 minutes.

The data on removal of strontium and calcium from milk by use of a series of four ion exchange columns are shown in Table VII. This experiment was conducted to compare the action of four columns in a series, each containing 12.5 grams of resin, to one column containing 50 grams of resin (Table 2). No differences were noted in the percentage removal of strontium and calcium between the two methods.

Following the last trial each of the four columns of resin was washed with 1 liter of 3 N hydrochloric acid. Forty milliliter samples of the eluate from each of the four columns were assayed and the radioactivity of both calcium and strontium was found to decrease in the resin from the first column to the last (Table VIII).

The data in Table IX and Fig. 3 indicate a direct relationship between the percentage of strontium and calcium removed from milk and the amount of resin used. Because Dowex 50W-X12 in the calcium form had appeared to be more effective in the removal of strontium and calcium from milk than either Dowex 50W-X4 or Duolite C-20 (Tables I and II), it was used in this batch experiment. The percentage removal of strontium-89 ranged from a high of 94, where one part resin was used per two parts of milk, to a low of 21, where one part resin per 200 parts of milk was used. Similarly the percentage calcium-45 removal ranged from a high of 93 to a low of 16

TABLE VII

PER CENT REMOVAL OF Sr^{90} AND Ca^{45} FROM MILK BY USE OF
A SERIES OF FOUR EXCHANGE RESIN COLUMNS

Trial	100 ml. Portion of Elutriated Milk Sample	Per Cent Sr^{90} Removal	Per Cent Ca^{45} Removal
1	2nd	74	75
	6th	67	63
	10th	62	51
	14th	45	38
2	2nd	77	72
	6th	52	59
	10th	57	50
	14th	55	42
3	2nd	71	73
	6th	67	52
	10th	46	30
	14th	40	31
4	2nd	82	74
	6th	73	51
	10th	51	36
	14th	36	31
Average	2nd	76	73
	6th	65	56
	10th	54	42
	14th	44	36

TABLE VIII

RADIOACTIVITY RETAINED BY RESIN AFTER PASSAGE OF
MILK CONTAINING Ca^{45} AND Sr^{90}

Column	Sr^{90} Counts/Min/ 40 ml. Eluate	Ca^{45} Counts/Min/ 40 ml. Eluate	$\text{Sr}^{90}/\text{Ca}^{45}$
1	82	451	0.1818
2	66	427	0.15456
3	39	308	0.12662
4	18	180	0.100

TABLE IX

EFFECT OF MILK-RESIN RATIO ON PER CENT REMOVAL
OF Sr^{89} AND Ca^{45} FROM MILK

Trial	Ratio of Milk to Resin (wt. basis)	Per Cent Sr^{89} Removal	Per Cent Ca^{45} Removal	Increase of Ca Compared to Non- treated milk (%)
1	2	94	93	56.7
	5	89	85	20.2
	10	85	76	21.5
	20	67	56	23.7
	40	50	28	20.4
	200	17	8	6.9
2	2	94	94	54.4
	5	88	83	23.6
	10	83	78	22.5
	20	69	57	20.3
	40	56	42	- 3.8
	200	18	17	0.1
3	2	93	92	60.7
	5	87	83	22.6
	10	82	74	21.8
	20	73	60	22.0
	40	56	34	- 0.5
	200	28	23	- 6.5
Average	2	94	93	57.3
	5	88	84	22.1
	10	83	76	21.9
	20	70	57	22.0
	40	54	34	5.4
	200	21	16	3.3

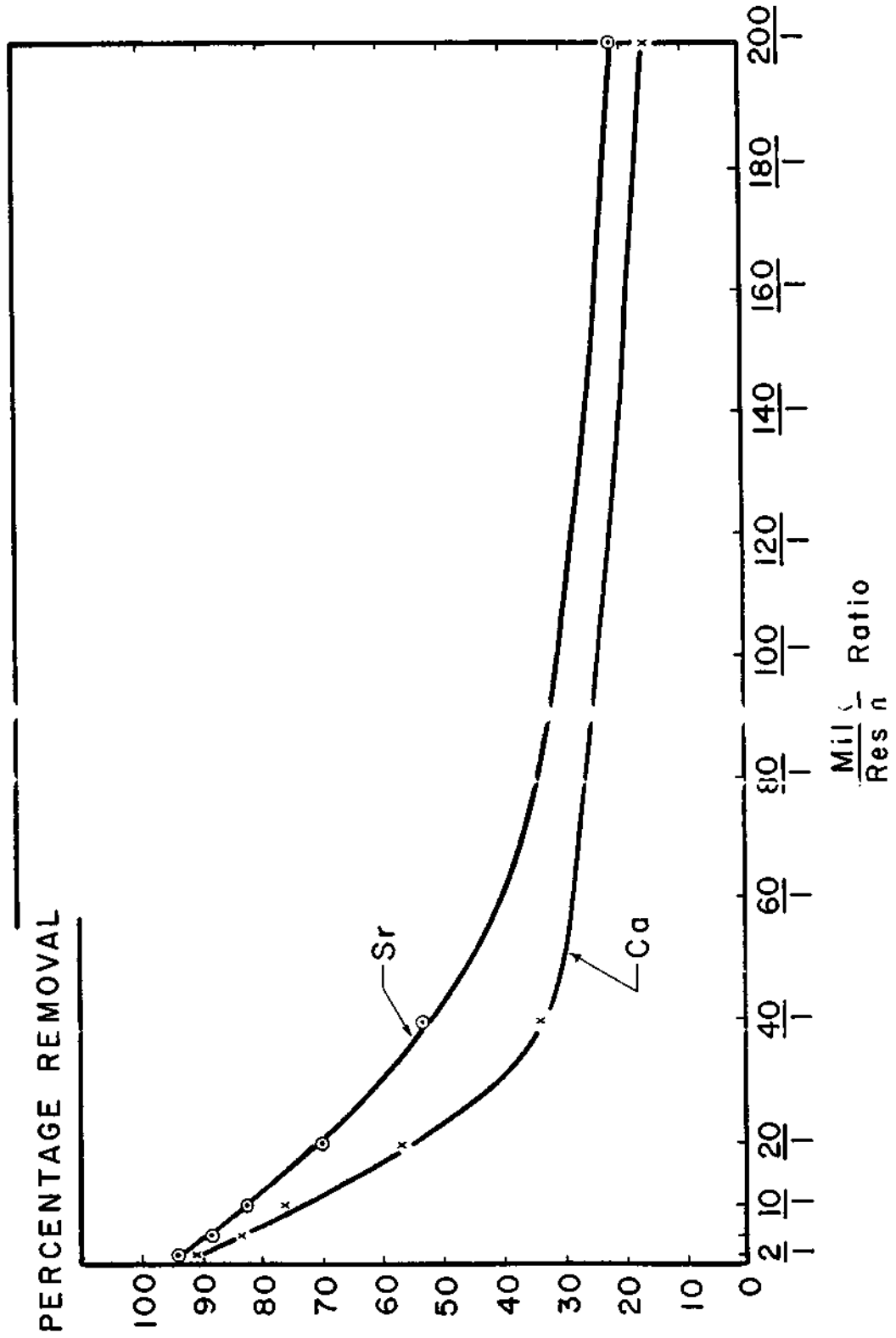

Figure 3. Effect of Milk-Resin Ratio on Percent Removal of Sr⁸⁹ and Ca⁴⁵ from Milk.

per cent. The total resin exchange capacity (Meq./gm.) was approximately twice the amount required for complete removal of the calcium from the milk at a milk-resin ratio of 20 to 1. At the 20 to 1 ratio the average percentage removal of strontium was approximately 70 and calcium 57.

Relationships between resin weight and exchange of calcium-45 and strontium-90 from milk are useful for predictions for different ratios. Since calcium in milk is in a very high concentration (6.23 meq./100 ml.) in relation to strontium (.00093 meq./100 ml.) a linear equation was derived for calcium-45 exchange on the assumption of isotope dilution.¹ This equation is:

$$w = a \frac{1 - f_M^e}{\dots}$$

where: w = weight of moist resin

$$a = \text{slope} \frac{\text{quantity of resin}}{\frac{\% \text{ removed}}{\% \text{ not removed}}}$$

$$f_M^e = \text{Ca}^{45} \text{ percentage found in milk.}$$

This is plotted in Fig. 4 with w on the y axis and $\frac{\text{per cent of isotope removed from milk}}{\text{per cent of isotope not removed from milk}}$ on the x axis.

This equation was tested for strontium also and a non-linear relationship was observed which may have been due to ion selectivity of the resin.

¹Preliminary calculations on these relationships were made by R. C. McIlhenny, Radiochemist, UT-AEC Agricultural Research Laboratory.

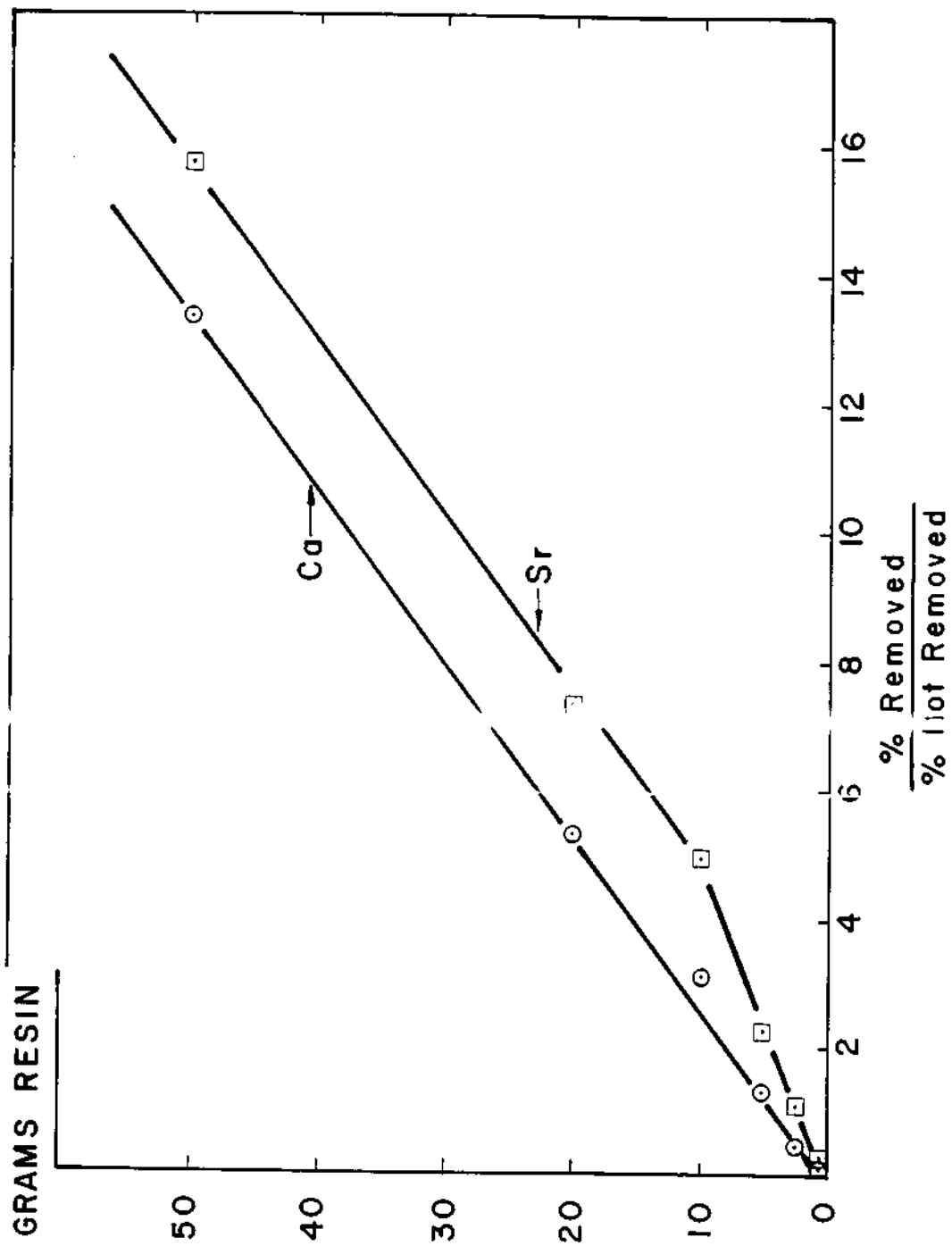

Figure 4. Relationship of Milk-Resin Ratio and the Percentage Exchange of Ca45 and Sr89.

On the basis of calcium oxalate weights, milk treated with the resin contained more calcium than the non-treated milk (Table VIII). This may be due to the excess calcium chloride not being washed from the recharged resin when the batch system was used. Some additional calcium may also come from the exchange of calcium on the resin for strontium and other ions in milk. In general the percentage of calcium removal from milk was less than strontium based on the total calcium and strontium in the untreated milk.

An estimation of the efficiency of the column system versus the batch system was made. The following four equations were derived by the method of least squares from the data presented in Tables 1 and 2.

Ca^{45} dosed milk:

$$y = -33.26 + 1.48736x + \frac{117.8174}{1.063x}$$

Milk from Ca^{45} dosed cows

$$y = -154.0086 + 6.75665x + \frac{238.6207}{1.061x}$$

Sr^{90} dosed milk

$$y = -187.0063 + 5.58810x + \frac{269.86}{1.037x}$$

Milk from Sr^{90} dosed cows

$$y = -98.6204 + 4.20296x + \frac{183.4547}{1.059x}$$

Where $y = \%$ removal and $X = 100$ ml. portions passed through the column.

The integrated forms of these equations for determining the area under the curve were respectively:

$$A = -33.26x + .74368x^2 - \frac{1928.5873}{1.063x} + 1928.5873$$

$$A = -154.0086x + 3.3783x^2 - \frac{4030.0743}{1.061x} + 4030.0743$$

$$A = -187.0063x + 2.7940x^2 - \frac{7430.0660}{1.037x} + 7430.0660$$

$$A = -98.6204x + 2.10x^2 - \frac{3199.895}{1.059x} + 3199.895$$

Since the columns contained 107 milliliters of milk and 50 grams of resin when completely filled, a convenient point of comparison was the per cent of removal for some volume less than 107 ml. and a comparable volume in the batch system. Therefore the area under the curve was determined for 100 milliliters of milk. The comparisons of the systems are presented in Table X. It is estimated that the column was only 86 per cent as efficient as the batch system for removal of Sr^{88} . The corresponding value for Ca^{45} was 88 per cent. The lower efficiency for the column can be attributed to the milk-ion and resin-ion complex not being allowed to come to equilibrium. Milk was found to contain an average of 6.23 meq. of calcium per 100 milliliters and is estimated to contain 0.00096 meq. of strontium per 100 milliliters. The calculations presented in Table X are based on these values.

TABLE X

PER CENT OF RESIN CAPACITY EXCHANGE BY CALCIUM AND STRONTIUM USING THE
BATCH AND COLUMN SYSTEM

System used	Ratio Milk Resin or portion through column	Resin Capacity (meq.)	Isotope Removed	Percentage removed	Meq. Exchanged	Per Cent Resin Capacity Exchanged
Batch	2 - 1	135	Ca ⁴⁵	93	5.79	4.27
Batch	5 - 1	54.3	Ca ⁴⁵	84	5.24	9.6
Batch	10 - 1	27.1	Ca ⁴⁵	76	4.74	17.4
Batch	20 - 1	27.1	Ca ⁴⁵	56	7.10	26.2
Batch	40 - 1	13.5	Ca ⁴⁵	34	4.24	31.3
Batch	200 - 1	2.7	Ca ⁴⁵	16	1.99	73.6
Batch	2 - 1	135	Sr ⁹⁰	94	--	--**
Column	1st 100 ml.	135	Ca ⁴⁵	82	5.10	3.77**
Column	1st 100 ml.	135	Sr ⁹⁰	81	--	--**
*Column	1st 100 ml.	135	Sr ⁹⁰	81	--	--**
*Column	1st 100 ml.	135	Ca ⁴⁵	74	4.62	34.1

*Milk from Dosed cows. All other samples were dosed milk.

**Stable strontium in milk is negligible compared to calcium.

SUMMARY

Much publicity has been given the passage of strontium from the atmosphere into food and its accumulation in bone in recent months. The strontium level in milk has been accumulating at a rate which is causing some alarm due to the damaging effect it may have on the health of humans.

Modified ion exchange resin columns and the batch system have been used to remove strontium-89 as well as calcium-45 from both dosed milk and milk from dosed cows. Dowex 50W-X12, Dowex 50W-X4 and Duolite C-20 were used, the first found to be most effective, by removing 76 per cent of the strontium and 74 per cent of the calcium from milk of dosed cows and 77 and 76 per cent respectively from dosed milk. These data represent only the second 100 milliliter portion of one liter passed through the column.

Using this modified column technique the per cent resin capacity exchanged was only 86 per cent as effective for removal of strontium-89 and 88 per cent for the removal of calcium-45.

Dowex 50W-X12 resin was left in contact with milk for periods of 1, 10, 60 and 120 minutes to study the exchange rate. Differences existed between the 1 and 10 minute periods only.

Using the batch system and dosed milk, the percentage of removal of strontium-89 and calcium-45 decreased as the ratio of milk to resin increased. The percentage of removal ranged from a high of 94 and 93

for strontium and calcium respectively at a milk-resin ratio of 2 to 1 to a low of 21 per cent strontium and 16 per cent calcium at a milk-resin ratio of 200 to 1.

An approximately linear relationship was found between the ratio of calcium-45 removed over that not removed and the quantity of resin used.

BIBLIOGRAPHY

BIBLIOGRAPHY

- (1) Adams, B. A., and Holmes, E. L. Adsorptive Properties of Synthetic Resins. J. Soc. Chem. Ind. 54: 1:6T. 1935.
- (2) Alexander, G. V., Nusbaum, R. E., and MacDonald, N. S. The Relative Retention of Strontium and Calcium in Bone Tissue. J. Biol. Chem. 218: 911. 1956.
- (3) Anonymous. Radioactivity in Milk. Science 128: 762. 1958
- (4) Baker, J. M., and Gehrke, C. W. An Ion Exchange Resin-Contact-Time-Method for the Study of Inorganic Equilibria in Milk. J. Dairy Sci. 37:1409. 1954.
- (5) Baker, J. M., and Gehrke, C. W. The Exchangeable Calcium in Raw and Heated Milk as Determined by the "Resin-Contact-Time-Method". J. Dairy Sci. 39: 1221. 1956.
- (6) Brown, W. M. C. Some Reflections on the Possible Hazards to Man of Low Doses of Radiation. Proceedings of the Nutrition Society 18: 38. 1959.
- (7) Comar, C. L., Russell, R. S. and Wasserman, R. H. Strontium-Calcium Movement from Soil to Man. Science 126: 485. 1957.
- (8) Cragle, R. G. and Demott, B. J. Strontium and Calcium Uptake and Excretion in Lactating Dairy Cows. J. Dairy Sci. 42: In Press.
- (9) Gans, R., Jahrb. preuss. geol. Landesanstalt (Berlin) 26, 179 (1905); 27, 63 (1906); Centr. Mineral Geol. 22, 728 (1913); German Patent 197, 111 (1906); U. S. Patents 914, 405 (March 9, 1909), 943, 535 (December 14, 1909), 1, 131, 503 (March 9, 1915). Quoted by Nachod, F. C. and Schubert, J., editors. Ion Exchange Technology, p3. Academic Press, Inc. New York N. Y. 1956.
- (10) Gehrke, C. W., and Almy, E. F. Action of Mineral Ion Exchange Resins on Milk Constituents. Ind. Eng. Chem. 42: 2344. 1950.
- (11) Gehrke, C. W., and Smith, R. B. The Effect of Heat and pH on the Ion-Exchangeable Calcium and Magnesium in Skim Milk as Determined by the Resin-Contact-Time-Method. J. Dairy Sci. 40: 600. 1957.
- (12) Haller, H. S., and Morin, A. G. Ion Exchange as a Means of Varying the Salt Constituents of Milk. J. Dairy Sci. 33: 305. 1950.

- (13) Harm, F., German Patent 95, 447 (June 2, 1896). Quoted by Nachod, F. C. and Schubert, J., editors. Ion Exchange Technology, p5. Academic Press, Inc. New York, N. Y. 1956.
- (14) Josephson, D. V., and Reeves, C. B. The Utilization of the Mineral-Ion Exchange Principle in Stabilizing Evaporated Milk. J. Dairy Sci. 30: 539. 1947.
- (15) Kulp, J. L., Eckelmann, W. R., and Schulert, A. R. Strontium-90 in Man. Science 125: 219. 1957.
- (16) Kunin, R. Ion Exchange Resins. 2nd Ed. John Wiley and Sons, Inc. New York, N. Y. 1958.
- (17) Larson, B. L., and Ebner, K. E. Significance of Strontium-90 in Milk. A Review. J. Dairy Sci. 41: 1647. 1958.
- (18) Lenihan, J. M. A. Nutritional Hazards Caused by Radioactive Contamination of Foods. Proceedings of the Nutrition Society 18: 34. 1959.
- (19) Lewis, E. B. Leukemia and Ionizing Radiation. Science 125: 965. 1957.
- (20) Libby, W. F. Radioactive Fallout and Radioactive Strontium. Science 123: 657. 1956.
- (21) Lyman, J. F. U. S. Patent 1, 954, 109 (April 10, 1934) as quoted by Otting, H. E. Ind. Eng. Chem. 41:457. 1949.
- (22) McGlasson, E. D. and Boyd, J. C. Improved Methods in the Recovery of Lactose Using Ion Exchange Resins. J. Dairy Sci. 34: 119. 1951.
- (23) Murthy, G. K., and Whitney, R. McL. The Effects of Cationic and Anionic Resins on the Salt Content of Raw Skimmilk. J. Dairy Sci. 36: 559. 1953.
- (24) Nervik, W. E., Kalkstein, M. I., and Libby, W. F. Purification of Milk for Calcium and Strontium with Dowex 50W Resin. UCRL-2674 1954.
- (25) Otting, H. E. Ion Exchange Application in Milk Products. Ind. Eng. Chem. 41: 457. 1949.
- (26) Sasaki, R., Tsugo, T., and Yajima, A. Effects of Treatments with Ion-Exchange Resin on Heat Coagulation of Milk. Chem. Abstr. 52: 9465. 1958.

- (27) Schulert, A. R., Peets, E. A., Laszlo, D., Spencer, H., Charles, M., and Semachson, J. Comparative Metabolism of Strontium and Calcium in Man. J. of Applied Rad. and Isotopes 4: 144. 1959.
- (28) Thompson, H. S. On The Absorbent Power of Soils. J. Roy. Agr. Soc. Engl. 11: 68. 1850.
- (29) Way, J. T. On the Power of Soils to Absorb Manure. J. Roy. Agr. Soc. Engl. 11: 313. 1850.

The *New* Three *R*_s

- every one will have to learn after a Nuclear War -
or other world-wide catastrophe

(but that most people aren't yet ready to even think about)

1. Reconstruction - of society
2. Recovery - of production
3. Renewal - of religion

And a fourth *R* for the present -

4. Resources - for nuclear war survival

by Bruce M. Beach

Radiological Scientific Officer

The Purpose Of These Pages

Our goal is to put essential information for reorganization, recovery and renewal - after a catastrophe such as nuclear war - onto this web site and onto one or two CDs and to make free distribution of these CDs in such a manner that they will be available to survivors of the catastrophe that we feel is now inevitable. While we do not know what form a catastrophe may take, still with the number of nuclear weapons that there are in the world, there is the very great possibility that it may be nuclear. We also realise that in the immensity and intensity of Divine Retribution the very equilibrium of the planet itself may be disturbed.

In the past we have assisted many hundreds of people in obtaining thousands of pieces of radiation detection equipment and we have given away hundreds of pieces to those who could not afford them. We simply no longer have the time to do that but we have stockpiled, tested and labeled hundreds of radiation detection devices (currently worth tens of thousands of dollars) that we will give away to those people that we have to turn away from the door of the shelter.

At that time - the Resources for Survival information on this site will be of considerably less use because we will be past the time to prepare but we have assembled survival guidance material to handout at the

door of the shelter to people for whom we have insufficient room in the shelter to accommodate. In December 2001 we completed a series of 4 twenty-minute videos, on such subjects as building an expedient shelter, which we hope to be able to show to the same group of people.

The plan is to train Radiological Instructors while in the shelter so that they can go out afterwards and train monitoring teams. Equipment has also been stockpiled for these teams.

For over forty years my wife and I have made an intensive effort to alert people to the threat and to urge them to prepare for it. I could never have done alone all that we have done together. For weeks she stood at my side and helped load two printing presses for imprinting of over one-hundred thousand booklets which we gave away absolutely free. Since the advent of the Internet untold thousands more booklets have been downloaded in a printable format for printing and distribution by many other people.

We used many ways of getting the information out to the public. We sent out tens of thousands of pieces of literature through the mails. We set up booths at numerous fairs, I appeared on many dozens of TV and radio programs, many of national and international scope, and there were so many newspaper and magazine articles written about the Ark Two that we long ago lost count. Literally, multiple millions of people heard about our efforts. And we have never charged anyone a penny for any of the information.

Once the Internet became popular, it surpassed all our other efforts of informing people. The interest in our web pages grew to where we get thousands of hits each day. Sometimes, at a period of particular interest it can be tens of thousands. Once, during one three hour period there were over 85,000 hits which completely swamped the system and the server had to pull the plug. Within hours our webmaster had the url rerouted to a new dedicated server directly on the backbone and we were back up. The site was eventually mirrored at over 30 locations. We have no idea how many hits daily there are on all the sites combined.

All this pales, however, compared to our present goal of making recovery information available for the survivors. It is doubtful that the Internet will be working as it is today but if segments of it can be gotten back up then perhaps some of the information can eventually be distributed over more local areas. For this reason we are going to try to get copies of the CDs out to widely distributed ISPs and ask them to retain them for installation on their servers afterwards. Another thought is if people can find a quantity of blank CDs they can take and duplicate the master CDs and distribute them about their geographical area so that those who can get a computer going with local emergency power - will be able to access the information. Any other strategies or suggestions for distribution would be greatly appreciated. We would like for this information to be shared as broadly as possible.

Recovery Information

Some of our key web pages deal with measuring radiation in food and strategies of dealing with radiation in the soil and food chain. There is information available here that I am not aware of being available anywhere else on the web. It spans from the practical "how to" to the highly theoretical necessary for

professionals to set up laboratories. I am a Radiological Scientific Officer and I can assure you that this is the necessary and correct information.

Many of our web pages deal with the technical aspects of small scale farming such as seed saving, fertilizers, crop management and so forth - and many others deal with alternate energy sources and still other subjects necessary to successful small farming, which will have to be a main focus of recovery.

A great many of our resources deal with old Pioneering skills. We cannot just go back to the old ways. We have lost many of the skills. No one had them all then and you would be hard put today to find a wheelwright, a miller, a tanner, a barrel maker. All those trades, like farming, have advanced into modern technology and the present experts seldom have used the old ways. Many of the old implements are no longer around and we certainly don't have the horses. Modern horses are neither bred nor conditioned to pull the plow. Still, in the skills of the past we may find solutions to the problems of the moment.

Beyond recovery there are many web pages, that are a part of this collection, that deal with the subject of the Reconstruction of Society and the Renewal of Religion. These are issues to which men's thought will have to eventually progress but I shall not belabor the point in this overview.

Our Library

Our personal library is very extensive. At one time I counted 13 encyclopedias. These are mostly specialized - like a 14 volume set on gardening and another 16 volume set on do-it-yourself repairs. There are others on health and medicine and a variety of other subjects.

We have also acquired CDs with hundreds of books and one summer put a crew to work microfilming thousands of documents which we have on microfiche. These, plus many many books, are in just our own home but our Ark Two Community librarian is the real gatherer of information - he has many thousands of books, mostly on technology for recovery.

In the future, when people want it, we hope to be able to disseminate all this information widely. There are many blind spots in our library. We have little information on modern technology and almost no information on leading edge technology. Members of our Ark Two community are of far more than average knowledge about nuclear and computers but there are many, many fields such as in modern metallurgy, petroleum refining, hundreds of specialties in chemistry, medicine, and untold numbers of other areas that the expertise to re-establish them will have to survive with the experts - if they are going to be recovered in the immediate decades following.

One major focus of our library has been maps, in order to determine where that expertise may reside. We have thousands of maps. Local road maps. Topographical maps. More and more maps on an expanding scale. We have every map ever published by the National Geographic. We have CDs with map search programs. North American and World Atlases. The list goes on. One map set which we were very desirous of obtaining cost thousands of dollars (far beyond our budget) from the US government. It

comes with a subscription program for real-time updating and the printed book is reprinted annually. A marvelous tool for demographers tracking changing patterns - but one used copy would serve our purposes. Miraculously, on the Internet we found a library discard copy - at a fraction of the cost.

Other associates of ours are providing us with gigabytes of survival information on CDs. Our problem has not been so much one of obtaining information but determining on which to concentrate our limited resources for storing and cataloging. Tons of information is of no use, if you have no way of finding what you want in it. In early years we were given literally tons of new books by libraries and publishers. Expensive new technical volumes that often cost over a hundred dollars each - but we finally had to abandon that effort simply because of lack of storage space and manpower to handle it. Tons had to be destroyed simply because we could not, even with weeks of searching, find a way to transport them to Third World countries who were desirous of having them.

So the problem of the moment has not been getting information but one of determining which information is going to be most useful to survivors. What we offer in these pages, measuring radiation contamination in food, producing food without the modern technology and its skills, finding alternate sources of energy, recovering and repairing remaining machinery, creating the nucleus of an economic system and restoring the basis of functioning society - information on how to do these things - are what we feel will be most needed at the outset. It is our sincerest hope that we will be able to get it to the people who need it and that they will find it useful.

Click here to return to the [Top](#)

1. Reconstruction of Society after Nuclear War

Since most people think that all-out nuclear war is not survivable, either individually or for society, and since somehow most intellectuals feel that to make positive plans for its aftermath would seem to somehow advocate or condone it - there is absolutely no scholarly discussion on this subject. In these pages I give some direction for the

[Reconstruction of Society](#)

along with critiques of ideas on the

[New World Order](#)

and my personal predominant area of effort - which is the development of the

[World Language Process](#)

The "Reconstruction" Site Map

is immediately below

RECONSTRUCTION SITE MAP

Reconstruction of Society After Nuclear War

Immediate Reconstruction of Local Society

Martial Law: Domestic Support Operations

Martial Law: Reconstruction of Social Order

Martial Law: Internment and Resettlement Operations

Camps: Standards for Building Refugee Camps

Health: Field Hygiene and Sanitation

Toilets: Unsewered Toilets

Rescue: Basic Rescue Skills

Death: Mass body disposal

Dead Animal Disposal

Animal Disposal During an Epidemic

How To Make A Fumigating Mask

How To Make An Emergency Gas Mask.pdf

Danger of Dog Packs

Medical: Emergency Medical Facilities

Medical: When There is No Doctor - Locked

Medical: When There is No Dentist - Locked

[LETS: Reconstruction of the Economic System](#)

[Carnegie: Management of Large Scale Enterprise - Table of Content](#)

[The Gospel of Wealth - A Baha'i Perspective](#)

[Introduction by Harvard Editor](#)

[Chronology of Carnegie's Life](#)

[Carnegie's Introduction](#)

[THE PROBLEM OF THE ADMINISTRATION OF WEALTH](#)

[THE BEST FIELDS FOR PHILANTHROPY](#)

[The Advantages of Poverty](#)

[Popular Illusions about Trusts](#)

[An Employer's View of the Labor Question](#)

[Results of the Labor Struggle](#)

[Distant Possessions: The Parting of the Ways](#)

[Americanism versus Imperialism - Part I](#)

[Americanism versus Imperialism - Part II](#)

[Democracy in England](#)

[Home Rule in America](#)

[Does America Hate England?](#)

[Imperial Federation](#)

[The New World Order - An Introduction](#)

[The New World Order - A Philosopher's View](#)

[Quotes by Presidents & Famous People](#)

[Quotes by Other Famous People](#)

[A Proposed New World Order Constitution](#)

[Opposition to the New World Order Constitution](#)

[History of The New World Order](#)

[Hoax regarding The New World Order](#)

[The World Language Process](#)

[Mission of The World Language Process](#)

[History of The World Language Process](#)

[Projects of The World Language Process](#)

[Regularization of English Syntax](#)

[Angel Tongue Tutorial](#)

[Example of Angel Tongue](#)

[Anjel Arabic Representation](#)

[Inactive Webpal Example](#)

[344 Chess Games](#)

[Chancellors of the World Language Process](#)

[The ACCESS System](#)

[Criticisms of The World Language Process](#)

[Frequently Expressed Comments](#)

[Essays on Language](#)

[Lango](#)

[Lango - Introduction and Directory](#)

[The Origins and Spread of English](#)

[English as an Auxiliary Language](#)

[English as a Primary Language](#)

[English and Other Languages](#)

[The Constructed Languages](#)

[The International Auxiliary Language](#)

[The International Language Committee](#)

[Constructed and Organic Languages](#)

[Language in Education and the Media](#)

[Orthography and Orthoepy](#)

[The Language of Empire](#)

[Pidgins and Creoles](#)

[LANGO Grammar](#)

[LANGO Vocabulary](#)

[LANGO Phonology](#)

[LANGO Orthography](#)

[History of English Spelling Revision](#)

[A Suggestion Towards Orthographic Reform](#)

[International Pronunciation and Accent](#)

[Names and Organisation](#)

[Glossary](#)

[WLP proposal to the UHJ](#)

[Essay on Baha'i UAL Teachings](#)

[Short references in the essay](#)

[Bibliography used in the essay](#)

[Raw quotes used in the essay](#)

[Letter to the UHJ on the subject of gender](#)

[UHJ on the subject of gender](#)

[Essential World English](#)

[Prospects for the World Language Process](#)

[Picture Gallery](#)

[China Goals](#)

[China and Volunteer Teachers](#)

[2. Recovery from Nuclear War](#)

This is the page that I am currently trying hardest to interest people in. It has to do with *individual* recovery after a nuclear war and deals primarily with the subject of *agriculture*. For those who have prepared for nuclear survival this is the next level of thought.

The "Recovery" Site Map
is immediately below

RECOVERY SITE MAP

[Individual Agricultural Recovery After Nuclear Holocaust](#)

[Radiation in Food](#)

[Layman's overview on Radiation in Food](#)

[Shorter letter on radiation in Food.](#)

[Explanation by a microbiologist](#)

[Radiation Risk and Ethics](#)

[Manual of food quality control - radionuclides in food](#)

[Removal of Strontium 89 and 90 from milk](#)

[Farming After A Nuclear War](#)

[Gathering Information for Farming After A Nuclear War](#)

[Protection of Food and Agriculture From Nuclear Attack](#)

[Fallout on the Farm](#)

[The Have More Plan](#)

[Basic Seed Saving](#)

[Humanure Handbook](#)

[Humanure Handbook in .pdf format](#)

[The Organic Way to Mulching](#)

[Fence Planner for the Common Sense Fence](#)

[Pressing Oil from Seeds](#)

[Build Your Ark](#)

[The Farmstead Book](#)

[Grow Friuts & Vegetables The Way They Used To Taste](#)

[Advanced Seed Saving](#)

[Alternate Energy](#)

[Make Your Own Electricity](#)

[Overview of Making Your Own Electricity](#)

[Bicycle Power](#)

[David Butcher Pedal Powered Generator](#)

[A Quick and Dirty Pedal Powered Generator](#)

[How to make low RPM generators!](#)

[Comparison of Alternators and Generators](#)

[Wooden Low RPM Alternators](#)

[Alternator from Scratch](#)

[Making a generator/alternator from a brakedrum](#)

[Brakedrum update](#)

[Forcefield Low RPM Disk Alternator](#)

[Making a Volvo Front Brake Disk into a Generator](#)

[Wood Axe - A very simple wind generator](#)

[Homebrew Windgenerator](#)

[All the plans and information for another wooden one](#)

[A key set of plans to study](#)

[Additional Info on Coils](#)

[Making a Microwave Oven into a Generator](#)

[Testing your theories](#)

[How to make a lawnmower into a generator.](#)

[Windpowered Generators](#)

[Towers](#)

[Tower Design](#)

[Blades or Propellers & our own design sketches](#)

[Technical Information on How to Build Blades](#)

[Still More Information on How To Build Blades](#)

[Some Neat Diagrams on Blade Design](#)

[A Blade in One Hour](#)

[Tails](#)

[Some pictures of a tail mounting](#)

[Overall Design Concepts that includes tails](#)

[More Overall Design Concepts that includes tails](#)

[Testing tails](#)

[Building your own anemometer](#)

[Waterpowered Generators](#)

[The Large Waterfall at Ark Two](#)

[The Smaller Waterfall at our Home & Theory of Systems](#)

[Using Pumps as Turbines](#)

[Making Motors into Electrical Generators](#)

[Diesel and Gasoline Electrical Generators](#)

[Batteries](#)

Bicycle Power

Not Just For Riding

Woodgas

Woodgas pdf file

Biofuel

Make Your Own Biodiesel

Make Your Own Biodiesel - Part 2

Foolproof Way to Make Biodiesel

Using Straight Vegetable Oil

Separating Glycerine/FFAs

From the Fryer to the Fuel Tank

Pressing Oil from Seeds

Stills

How Distillation Works

Building a home still

Running on Alcohol

Making it on the Farm

Still Safety

The Manual For the Home and Farm Production of Alcohol

Solar

[Overall Survey of Solar Cookers](#)

[Survey of Box Solar Cookers](#)

[A very simple solar cooker design](#)

[Make hotwater with the sun even in cold climates](#)

[Build Your Own Solar Water Heater](#)

[Solar Hotwater Heating - A DIY Guide](#)

Simple Technology

[The Basic Principles of Machinery](#)

[Descriptions of Simple Machines](#)

[Patterns for Simple Farm Devices](#)

[The Scythe - A tool of the centuries](#)

[Blacksmithing - An essential technology](#)

[How to build your own alternator regulator](#)

[How to build a float switch](#)

[How to do a gas to propane conversion](#)

[How to convert flashlights to use LEDs](#)

Pioneer Methods

[Making the Best of Basics](#)

[Cloudburst - Handbook of Rural Skills and Technology](#)

[Cloudburst Two](#)

[Foxfire One](#)

[Foxfire Two](#)

[Foxfire Three](#)

[Foxfire Four](#)

[Foxfire Five](#)

[Foxfire Six](#)

[3. Renewal of Religion after Nuclear War](#)

Nothing occurs except by the Decisive or Permissive Will of God. Many will ask - if God is Good why did He permit a nuclear war? From the link in the above title I answer that question and present a number of short religious essays intended to help people fulfill God's Divine Purpose coming out of the nuclear war.

The "Renewal" Site Map
is immediately below

[RENEWAL SITE MAP](#)
[Renewal of Religion](#)

[Why God Would Permit Nuclear War](#)

Essays on Religion - Premises

Problems of Prophecy

Mother Shipton

Ouji

Plants One

Plants One Two

Straight Arrow

The Iching

The Seeker

My Declaration

Four Types of Souls - Content

Four Types of Souls - Introduction

The Soul of Self

The Soul of Love

The Soul of Reason

The Soul of Reason

Four Paths to Truth

Authority

The Senses

[Reason](#)

[Intuition](#)

[The Most Clear Proof - Contents](#)

[The Most Clear Proof - Introduction](#)

[The Most Clear Proof - Numbers](#)

[Jesus](#)

[2300 Days](#)

[1844](#)

[Responses](#)

[Where](#)

[When](#)

[Manifestation](#)

[Revelation](#)

[First Step](#)

[Next Steps](#)

[Final Step](#)

[Final Analysis](#)

[The Seven Churches](#)

[Seaching the OCEAN of God's Word](#)

[Meditation and the Path of Prayer](#)

[Prophecies in the Stars](#)

[4. Resources for Survival of Nuclear War](#)

In recent years this subject has been the main entry page to this site. All the pages of survival material are still here and you can go to them by clicking on the above heading.

The "Resources" Site Map
is immediately below

RESOURCES SITE MAP

[Resources for Survival of Nuclear Holocaust](#)

[State by State - Survival Information](#)

[Nuclear Power Plants](#)

[Links to Target Maps \(+ survival info\) of All 50 States](#)

[Target update information](#)

[The Ark Two Community](#)

[Map of the Interior of the Shelter](#)

[Map to the location of Ark Two](#)

[Pictures of the Inside of the Shelter](#)

[Pictures of the outside of the Shelter](#)

[Pictures of the Shelter Construction](#)

[Life in the Ark Two Community](#)

[Ark Two Programs](#)

[The Ark Two Community TEAM leaders](#)

[Radiation and Detectors](#)

[Official Government Detector Instructions](#)

[My explanation - with pictures](#)

[Understanding Radiation](#)

[How to build a KFM](#)

[Free Books for Downloading](#)

[You Will Survive Doomsday - HTML](#)

[You Will Survive Doomsday - .pdf](#)

[11 Steps To Survival - HTML](#)

[11 Steps To Survival - .pdf](#)

[Your Basement Fallout Shelter - .pdf](#)

[Fallout On The Farm - .pdf](#)

[Nuclear Weapons Defense Manual - .pdf](#)

[Nuclear Weapons Defense Manual - Tables - .pdf](#)

[Nuclear Weapons Effects - Radiological Scientific Officers Handbook - .pdf](#)

[Nuclear War Survival Skills - \(replica\)](#)

[Ark Two Programs](#)

[Overall Purpose of the Programs](#)

[Survival Education](#)

[Agricultural Recovery](#)

[Radiological Monitoring Equipment](#)

[Economic recovery](#)

[KI Potassium Iodide](#)

[State by State Recovery](#)

[Family Registry](#)

[Information Broadcast](#)

[Social Reorganization](#)

[Shelter Building \(+ offsite links\)](#)

[A two bus shelter for 24 people](#)

[Easy Printing Plans for a Basement Shelter](#)

[\(offsite links for bug out kits\)](#)

[\(offsite link for KI - Potassium Iodide\)](#)

Filtering Air in a shelter

Kearny Air Pump

Ventilation

Free Consultation on Shelter Building

MENU: [HOME](#) » [Reconstruction](#) » [Recovery](#) » [Renewal](#)

Nuclear Survival Resources & Ark II Fallout Shelter Site

**[Nuclear Targets](#)
and ESSENTIAL survival info
[By STATE](#)**

**[Ark Two Facility](#)
Photos & Info of a 42 Bus
Nuclear Fallout Shelter
Inside, out, and construction**

**[Radiation Detection Equipment](#)
Pictures, Instructions
Variety of types**

**[FREE Survival Books](#)
and
[Ark Two Programs](#)**

**[Shelter Building](#)
alternate Survival and
*KI Information***

**[Free Shelter Consultation](#)
with a
Radiological Scientific Officer**

The author, [Bruce Beach](#), can be reached personally at: survival@webpal.org
Subscribe to his popular mailing list by sending a blank email to:
arktwo-request@deuce.pairowoodies.com
with the subject as [subscribe](#)

MENU: [HOME](#) » [Reconstruction](#) » [Recovery](#) » [Renewal](#)

State Maps and Information for **Nuclear Survival**

(Updated as of October 1st, 2002)

For the last several years, these pages **USED TO** include a list of *hundreds* of (Email VERIFIED) Intentional Communities and Survival Preparedness Groups along with an Ark Two state TEAM Leader in forty-eight of the 50 States.

Because of the changing circumstances that some see as the increasing immediacy of the threat, and because of a perception that there has been a recent change in the social / governmental attitude towards individual rights regarding freedom and property there has been a growing consensus among the individuals that were listed here that it is no longer prudent for them to make their names and locations public. It has become too arduous to maintain the list in response to the growing number of requests for deletion, and the fact that the list was going to become too skimpy to be useful has now led us to have to regrettably abandon it altogether after these many years of effort spent to assemble it.

While for years we have encouraged people to form survival communities and groups and to build shelters and otherwise make preparation - most of those who have done so are of the opinion that there may not any longer be sufficient time to integrate further members into their groups and communities. They are concerned that if the threat situation continues to increase, at the rate that it presently is, they will be overwhelmed by individuals who are not prepared and that those individuals instead of adding to their resources would only be a drag and potential for depletion to what they have prepared.

It is with regret that we have come to this point. Ark Two itself still welcomes any who wish to join its community in Canada AND we are still maintaining the structure of these pages AND THE REGISTRY so that in case of a nuclear war we may be able to implement these structures for providing assistance during the RECOVERY and REORGANIZATION phases. We hope at that time to be able to re-establish contact with, or appoint new, TEAM leaders in all the states and localities and then provide a network for developing assistance and cooperation among them.

**The following States in "red" Generate the MAJOR FALLOUT
According to FEMA**

Click on *your* STATE'S NAME in the DIRECTORY below to see its targets and other IMPORTANT information. Also look at the *TWO* maps at the botom of this page.

<u>Alabama</u>	<u>Alaska</u>	<u>Arizona</u>	<u>Arkansas</u>	<u>California</u>
<u>Colorado</u>	<u>Connecticut</u>	<u>Delaware</u>	<u>Florida</u>	<u>Georgia</u>
<u>Hawaii</u>	<u>Idaho</u>	<u>Illinois</u>	<u>Indiana</u>	<u>Iowa</u>
<u>Kansas</u>	<u>Kentucky</u>	<u>Louisiana</u>	<u>Maine</u>	<u>Maryland</u>
<u>Massachusetts</u>	<u>Michigan</u>	<u>Minnesota</u>	<u>Mississippi</u>	<u>Missouri</u>
<u>Montana</u>	<u>Nebraska</u>	<u>Nevada</u>	<u>New Hampshire</u>	<u>New Jersey</u>
<u>New Mexico</u>	<u>New York</u>	<u>North Carolina</u>	<u>North Dakota</u>	<u>Ohio</u>
<u>Oklahoma</u>	<u>Oregon</u>	<u>Pennsylvania</u>	<u>Rhode Island</u>	<u>South Carolina</u>
<u>South Dakota</u>	<u>Tennessee</u>	<u>Texas</u>	<u>Utah</u>	<u>Vermont</u>
<u>Virgina</u>	<u>Washington</u>	<u>West Virginia</u>	<u>Wisconsin</u>	<u>Wyoming</u>

Because we are so often asked about nuclear reactor sites we have taken the following picture from [Stan and Holly Deyo](#) showing U.S. Nuclear Reactor Sites in relation to earthquake zones.

Map B

Earthquake Zones with Nuclear Reactor Locations

Source: USGS & DOE

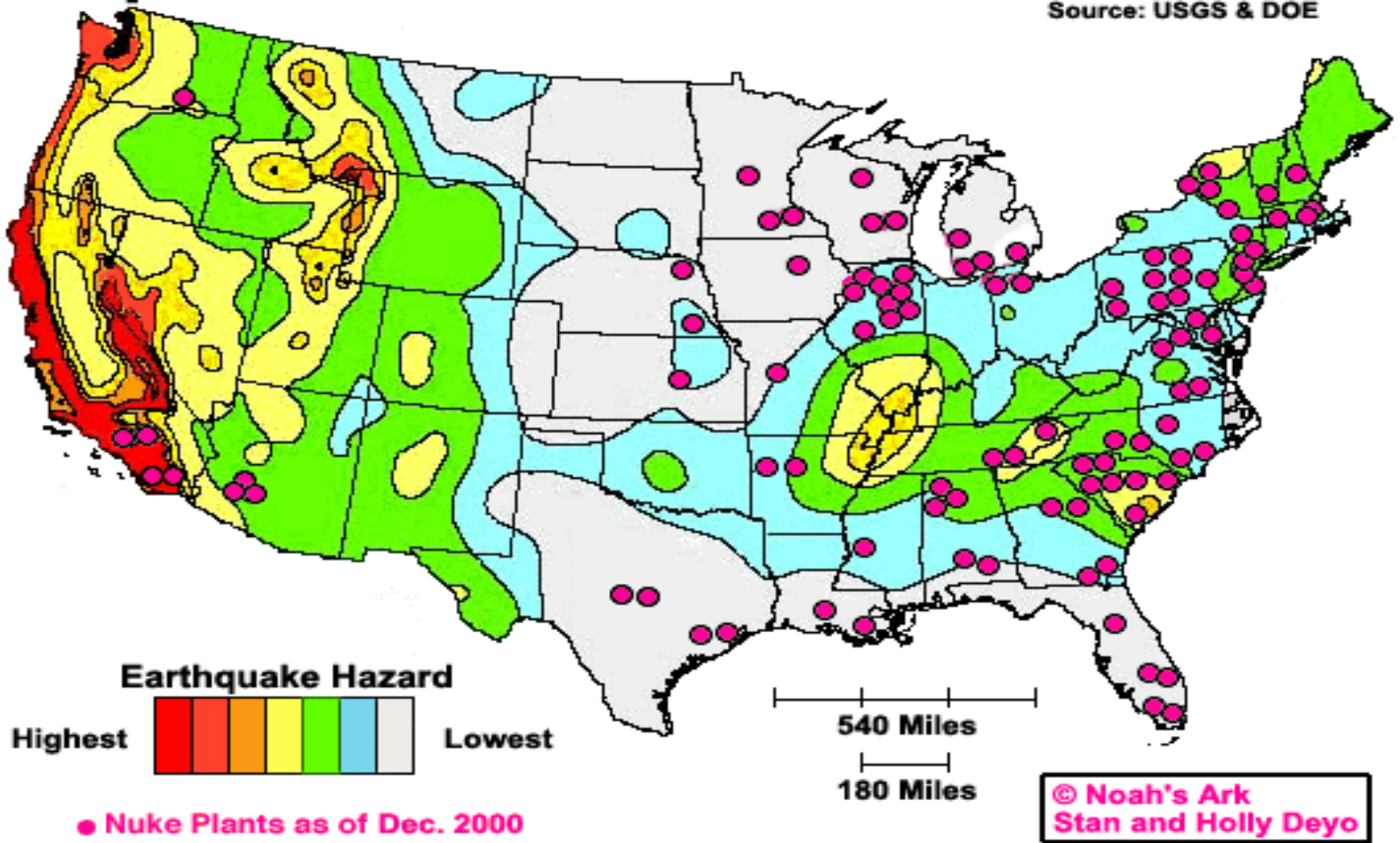

The following is the most commonly used prevailing wind predicted fallout pattern, but remember, fallout can go anywhere or everywhere (and probably will).

Continental US Fallout Pattern for Prevailing Winds (FEMA-196/September 1990)

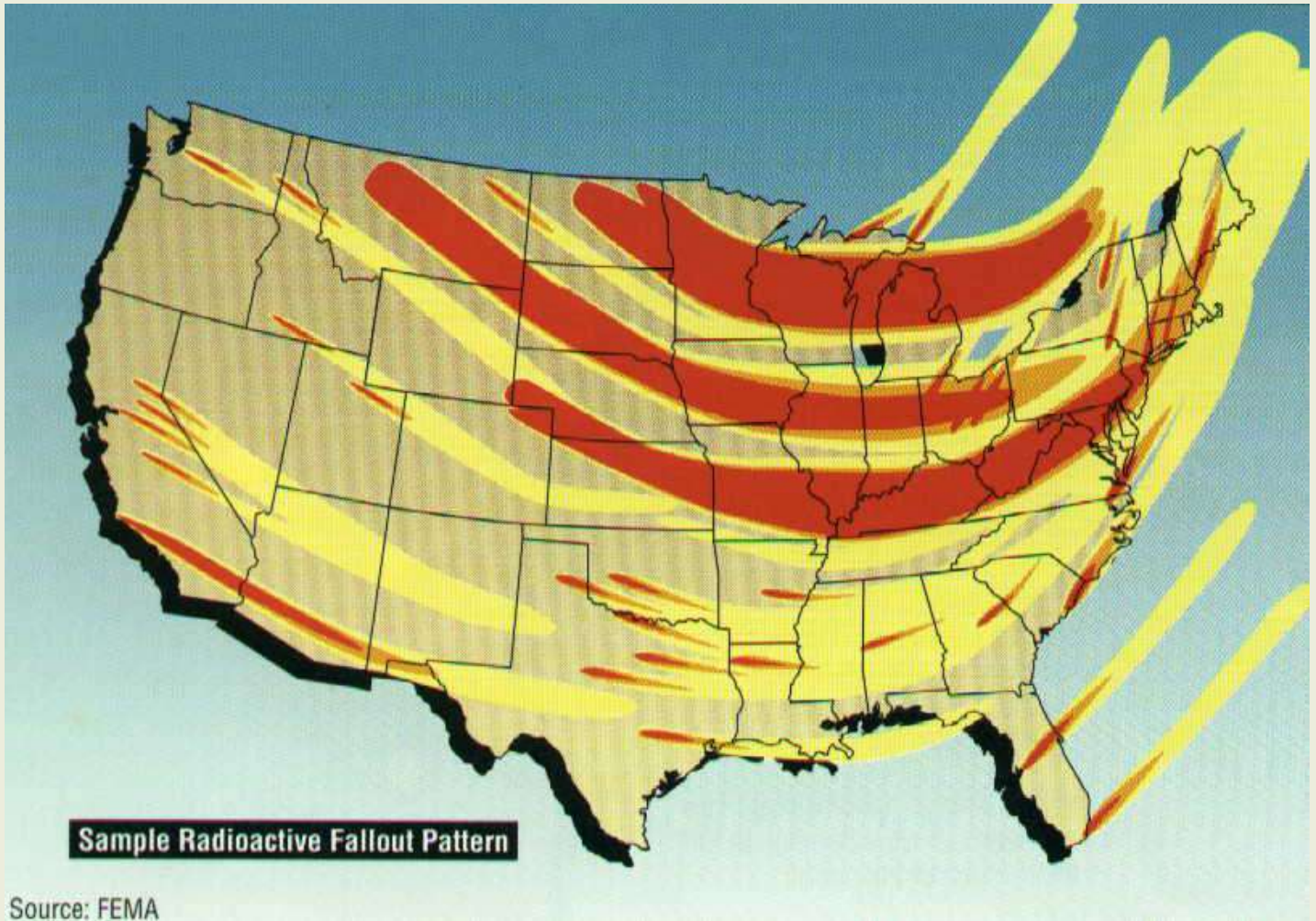

MENU: [HOME](#) » [Reconstruction](#) » [Recovery](#) » [Renewal](#) » [Survival](#)

Nuclear Survival in **Alabama**

This is the nuclear target map for Alabama, but remember, fallout can go anywhere or everywhere (and probably will). After you have looked at this map look at the [Information for Alabama](#) that follows it.

This link will take you back to the [Index of all the States](#)

Nuclear Weapon Target Map for Alabama (FEMA-196/September 1990)

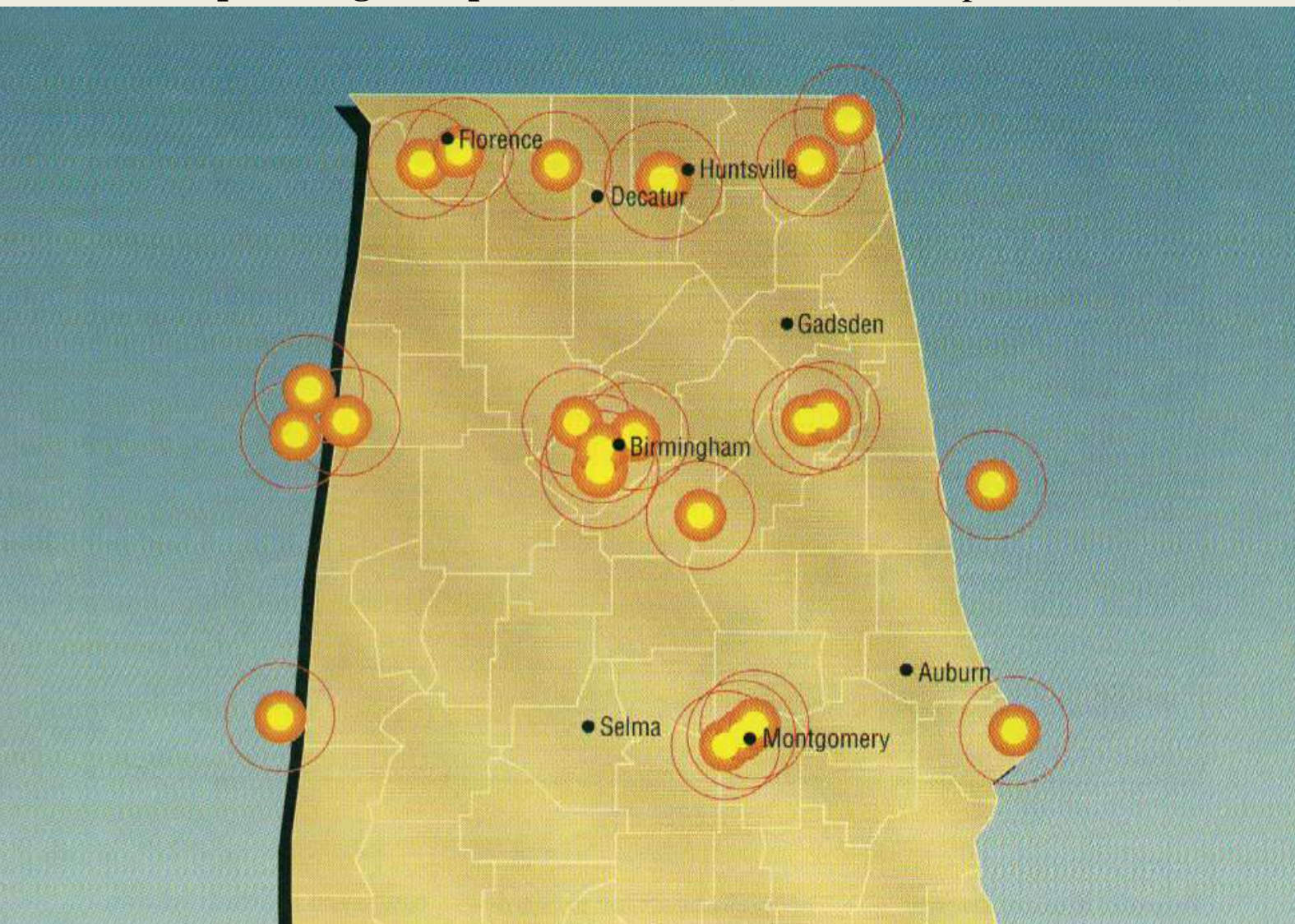

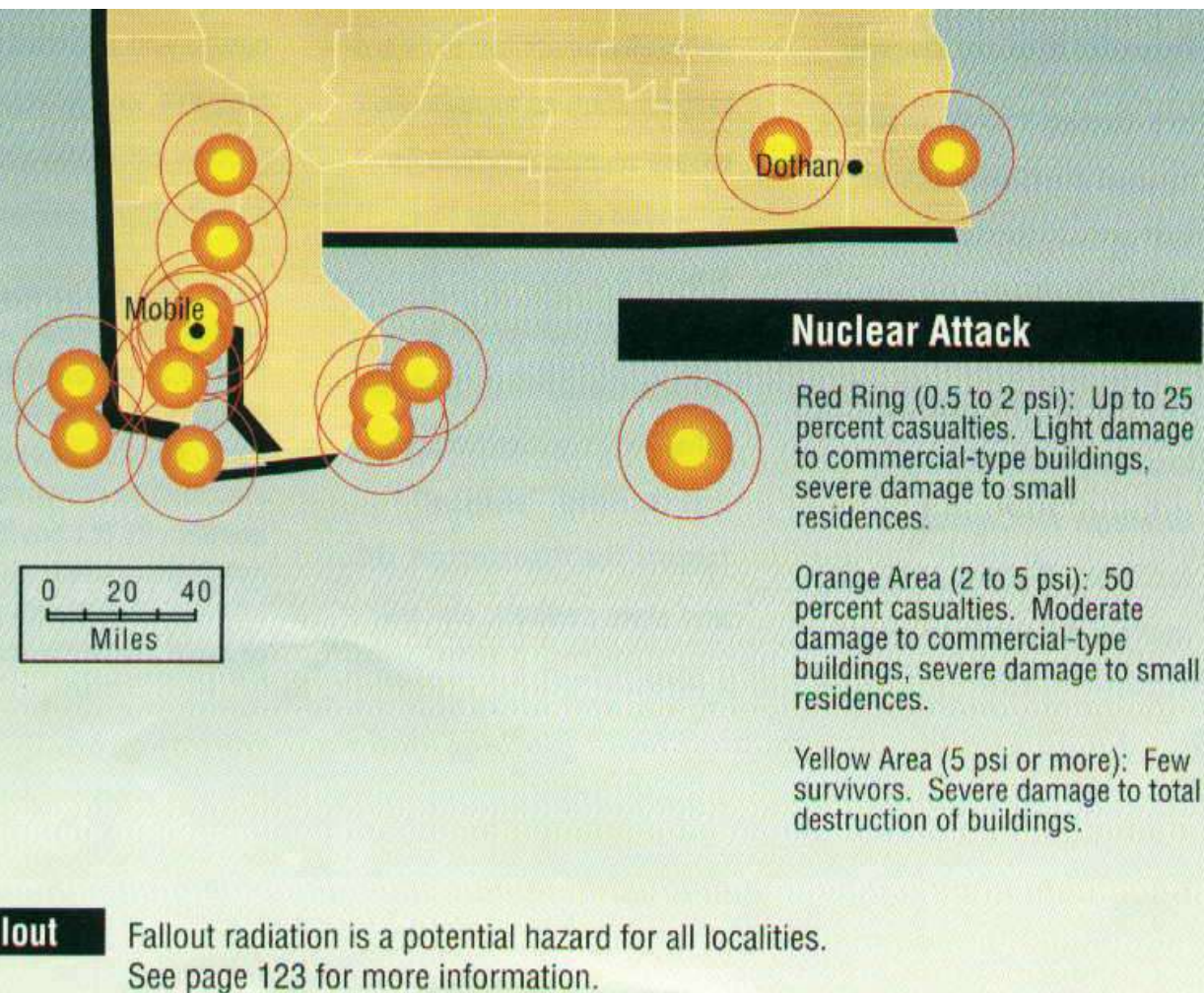

[UPDATE to Target Information!!!](#)

Information for Alabama

This link will take you back to the [Index of all the States](#)

It is recommended that you go through the following 10 steps in studying about the nuclear threat to Alabama.

1. Look at the [State Map](#) above to see the target nuclear areas in Alabama.
2. Look at the [general expected fallout map](#) to see where Alabama (according to the **prevailing wind pattern**) gets fallout from other states.

3. If the state that you live in is anywhere EAST of any of the following 6 states in the **prevailing wind pattern** then look at the states in **RED** on the [INDEX of STATES](#) for

- **Montana**
- **North Dakota**
- **South Dakota**
- **Nebraska**
- **Missouri**
- **Colorado**

These six states contain what is called DENSE PACK which I explain on each of those states pages. **UNDERSTAND** that the wind pattern **COULD** at that time be something other than the "**prevailing**" wind pattern.

4. Bookmark the present URL or make a copy of this present address so that you can come back to it after going to

[Blast Mapper](#).

This mapper is on someone else's web site so that you will need to save this address in order to return here if your back button doesn't work. However, you want to be sure to go the mapper site and calculate the damage to probable targets (cities) around you.

5. Memorize the THREE top rules for survival. They are:

- Number One - **Get out of the cities!**
- Number Two - **Get out of the cities!**
- Number Three - **Get out of the cities!**

6. The follow-on rules are:

- a. Have a shelter

- b. Work with a group (you are going to need the manpower, brainpower, and skillpower).
- c. Stock supplies.

7. My [Main Survival Page](#) contains links to lots of other information such as free books to download about nuclear survival, links to plans for building shelters, and even free consultation about building a shelter.

8. If you are SUPER concerned about nuclear survival you might consider moving within 20 miles of the

[Ark Two Community](#)
(in Canada)

9. And finally if you would like to be on the mailing list of the author of this site - send a blank email to:

arktwo-request@deuce.pairowoodies.com
[with the subject as subscribe](#)

MENU: [HOME](#) » [SURVIVAL](#) » [Index of States](#)

Nuclear Survival in

Alaska

This is the nuclear target map for Alaska, but remember, fallout can go anywhere or everywhere (and probably will). After you have looked at this map look at the [Information for Alaska](#) that follows it.

This link will take you back to the [Index of all the States](#)

Nuclear Weapon Target Map for Alaska (FEMA-196/September 1990)



Nuclear Attack

Red Ring (0.5 to 2 psi): Up to 25 percent casualties. Light damage to commercial-type buildings,

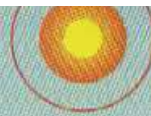
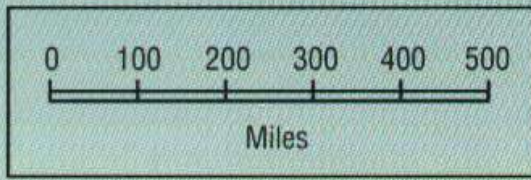

percent casualties. Light damage to commercial-type buildings, severe damage to small residences.

Orange Area (2 to 5 psi): 50 percent casualties. Moderate damage to commercial-type buildings, severe damage to small residences.

Yellow Area (5 psi or more): Few survivors. Severe damage to total destruction of buildings.

Fallout

Fallout radiation is a potential hazard for all localities. See page 123 for more information.

[UPDATE to Target Information!!!](#)

Information for Alaska

This link will take you back to the [Index of all the States](#)

It is recommended that you go through the following 10 steps in studying about the nuclear threat to Alaska.

1. Look at the [State Map](#) above to see the target nuclear areas in Alaska.
2. Look at the [general expected fallout map](#) to see where Alaska (according to the **prevailing wind pattern**) gets fallout from other states.
3. If the state that you live in is anywhere EAST of any of the following 6 states in the **prevailing wind pattern** then look at the states in **RED** on the [INDEX of STATES](#) for

- **Montana**
- **North Dakota**
- **South Dakota**
- **Nebraska**
- **Missouri**

- **Colorado**

These six states contain what is called DENSE PACK which I explain on each of those states pages. **UNDERSTAND** that the wind pattern **COULD** at that time be something other than the "prevailing" wind pattern.

4. Bookmark the present URL or make a copy of this present address so that you can come back to it after going to

[Blast Mapper.](#)

This mapper is on someone else's web site so that you will need to save this address in order to return here if your back button doesn't work. However, you want to be sure to go the mapper site and calculate the damage to probable targets (cities) around you.

5. Memorize the THREE top rules for survival. They are:

- Number One - **Get out of the cities!**
- Number Two - **Get out of the cities!**
- Number Three - **Get out of the cities!**

6. The follow-on rules are:

- a. Have a shelter
- b. Work with a group (you are going to need the manpower, brainpower, and skillpower).
- c. Stock supplies.

7. My [Main Survival Page](#) contains links to lots of other information such as free books to download about nuclear survival, links to plans for building shelters, and even free consultation about building a shelter.

8. If you are SUPER concerned about nuclear survival you might consider moving within 20 miles of the

[Ark Two Community](#)

(in Canada)

9. And finally if you would like to be on the mailing list of the author of this site - send a blank email to:

arktwo-request@deuce.pairowoodies.com

[with the subject as subscribe](#)

MENU: [HOME](#) » [SURVIVAL](#) » [Index of States](#)

Updated October 1st, 2002
UPDATE to Target Information !!!

By Bruce Beach - Radiological Scientific Officer

The FEMA Maps

Target selection continuously changes, for a variety of reasons, most of which are either political or technological. The FEMA target maps are the only official ones that we have and some persons have criticized them because they feel that they are quite old and do not reflect recent military base closings, new facilities and so forth.

Even at their best - the FEMA maps only painted a conceptual picture of a perceived threat. No one could say, then or now, for sure what criteria foreign military target planners would use to select targets, how many missiles they'd commit, how powerful they'd be, how many would actually get through or how accurate they'd be.

One could be CERTAIN, both then and now, that nowhere near the number of targets shown on the maps would actually be struck. Many years ago there was a movie called - "On the Beach", which envisioned total annihilation of human life upon the earth. Nuclear scientists took up the term to measure the strength of the world's nuclear arsenals and concluded that there exists somewhere between 4 and 5 Beaches. That is to say - enough nuclear armaments to eliminate from fallout all human life on earth (four or five times over) if they were all exploded.

Anyone who simply looks at a FEMA map and says - "Ahhh - all those little yellow spots, that is where the bombs are going to fall," or "Ahhh - that yellow spot was a military base near me which no longer exists - so now I am safe", simply does not understand the problem. To begin with, as I explain in my booklet [YOU Will Survive Doomsday](#) a very small percentage of the population will have a bomb fall on them. It is other causes, resulting from the bombing, that will actually kill them. For one thing - fallout can go anywhere and it can be very deadly. As I repeatedly point out - death from fallout radiation is not a pleasant way to go, but death from that cause is avoidable.

The yellow dots on the FEMA maps were 'potential' targets. The criteria in originally selecting them included not only military sites, (which may or may not still exist) but also industrial, transportation, energy producing, and population centers which may have subsequently radically changed. Generally, for the latter, there are simply more.

You should use the FEMA maps only as a general guide to the targeting criteria foreign military planners

would likely use in selecting their targets. A few things have changed dramatically since the maps were drawn. For one thing, the Titan Missile Wings (sites) in western Missouri and eastern Kansas have been deactivated.

HOW MANY NUCLEAR WEAPONS WILL BE USED?

The REAL question then - in evaluating the nuclear threat - is to determine FOR YOURSELF how many nuclear weapons YOU think will be used. The information that I am presenting here, is to help you in making that decision.

Here are some possible conclusions:

- All will be used.
- None will be used.
- Some will be used.

If one thinks that ALL the nuclear weapons will be used - then it is goodbye world. I will accept this as a distinct possibility, or at least the possibility that such a number will be used so as to have the same effect. If you believe *definitively* that is what will occur - then very simply you won't (and don't) have to worry about it. However, I believe (and it is only my personal belief) that because of Divine Intervention, through what will appear to be natural causes, that the event will be extensive - but limited.

On the other hand - there are those who think that because of man's rationality, or God's kindness, that none will be used and we don't have to worry about it. Many of these people feel that I am insane for my concerns. I can only say that I hope they are right.

It is only the third case that I present here. I feel that nuclear WWII is inevitable. Others may feel that it is only probable - or somewhat probable or possible. The degree of your concern will determine the value that you will put on the information that I am about to present, and the action that you will take based upon it.

First - my own conclusions. I feel that a sufficient number of weapons will strike North America to destroy 80% of its population. What that number of weapons will be is what I am trying to estimate. The information presented here is what I base my estimates on.

Presently, in the world, there may be fifty-thousand (50,000) nuclear warheads. Many of these are tactical (for use by field artillery) rather than strategic (for use on ICBMs - Intercontinental Ballistic Missiles). Two years ago, under Clinton, the US had recalled its tactical weapons from the field, and they were no longer under the control of field commanders. HOWEVER, as of this date, under Bush, they have now been again deployed to the field and Bush has cancelled many of the disarmament treaties and has definitively repudiated Clinton's policy of "No FIRST Use" saying that the US may use nuclear weapons -

even pre-emptively.

Of the strategic nuclear warheads, many (most) are now obsolete. They certainly are not mounted on warheads and ready for launch. It is really only the latter than we need to concern ourselves about, and if we wish to take a narrow view of self interest, it is only the potential enemy's that we need to concern ourselves about.

The US owns by far the largest current tested arsenal of nuclear weapons. Russia the second largest, and France may still have the third largest. Israel is thought to have about 400 (up from an estimate of 200 about a year ago). The major change, and it is a big one, is that they have put three nuclear ballistically armed submarines in service. China too, in the last year, has made considerable advance in its nuclear arsenal, particularly as applies to ICBMs of which it now has a number capable of reaching the US.

There are over 20 other countries in the world who are thought to have perhaps joined the nuclear club - but not all, like India and Pakistan, have tested their weapons. These latter, in the last year have made threats to each other - something inconceivable that a nuclear power would openly do even three years ago.

Weapons alone are not enough. One must also have delivery systems. While there is talk of suitcase weapons for terrorist purposes, the delivery system of choice is still the ICBM (Intercontinental Ballistic Missile) or the SLBM (Submarine Launched Ballistic Missile). Complete delivery capability has been defined as the TRIAD. Land, Air and Sea. Of late, one leg of the TRIAD has fallen into disfavor. Russia still has Bisons, and the US both B-52s and B2s, but they are beginning to be recognized as a technology that is becoming rapidly obsolete for nuclear delivery. Improved radar, satellite detection systems, and the much improved accuracy of interception missiles has much decreased their usefulness. They have also become relatively less cost effective. Consequently, the US under the Bush administration has announced that bombers - even the B2 - will no longer be nuclear armed. In the future this will mean that their bases, and bases that would have been used for refueling will no longer have as much priority as a target. This US policy and strategic change is just taking place and will require time to be reflected in the thinking of Soviet target planners.

Theatre nuclear weapons still include aircraft and ship mounted nuclear weapons such as the Cruise Missile, but our major concern here is the ICBM and the SLBM (Submarine Launched Ballistic Missile). So far, we are not aware of, nor are there supposed to be, (but I wouldn't bet on it) any space launched ballistic missiles. In fact, there are only three countries known to have operational SLBMs. The US, Russia, and Israel. Under normal circumstances it is possible to have only about one third of one's fleet on station at a time. For the US and Russia this means a half dozen each, and for Israel one or two because the latter has a total of three subs. If this gives you any particularly comfort it should be pointed out that each of the subs (particularly the US and Russian) carries more destructive power than was used by ALL the world's armies in the Second World War. There may be other terrible weapons (such as HAARP - don't ask) that we know nothing about. Who among us knew about the Atomic Bomb - until it was used.

Until the present US Administration there had been extensive discussion over the last decades about

reducing the world's nuclear armaments. In actuality they had become much more dispersed, efficient, reliable, and capable of being delivered with much greater accuracy. A reduction in their total number is not reflected in a reduction of their destructiveness or effectiveness. Actually, quite the opposite - more destructive power is being developed and deployed in manners that are more efficient. This is true, not only of the US, but also of a number of other countries. Pakistan, India, North Korea, and many others now have capabilities that would have made THEM a premier world power - a half century ago.

The United States currently has 7,295 deployed warheads compared to Russia's 6,094, and while the Bush administration is discussing making cuts down to 1,500 nuclear warheads in the US arsenal, these cuts are not to take place for years. In any case, as I have stated earlier, the ones that we need to be concerned about in making North American target estimates, is the ones held by the potential enemies.

China is thought to have fewer than 300 nuclear warheads capable of reaching the US. Some estimates put the number at even one-tenth of that. Whatever the present number, it is certain that they are in an all out effort to increase the number of their DF-31 and DF-41 rockets that will have that capability. Likewise, Russia, for the last three or four years, has been on a crash program to field as many as possible of their Topol-M, quite arguably the most advanced ICBM in the world. As a result of cancellation of the SALT agreements by Bush, Russia has said they will MIRV (Multiple Independent Re-entry Vehicles) their ICBMs. This is the same as multiplying by some factor the number being deployed. Americans may go on about other countries being backward and stealing their technology but they should remember that the Russians put the first satellite, the first man, and the first space station into space. Likewise the Chinese deployed a satellite and tested a nuclear weapon - decades ago.

But, let us only concern ourselves with what exists at the moment. Conservatively let us say that Russia and China combined currently have 7,500 nuclear warheads supposedly capable of reaching the US. So that we do not just scare ourselves to death, let us suppose that with their deteriorating economies that the maintenance on these have made about half of them operational. Let us say 4,000. And let us say that only half of these would be aimed at North America, the rest being aimed at Europe and other places in the world. This means that only 2,000 would be aimed at North America and let us further assume that US defenses are such that we will stop half of them (although I am not certain how one currently stops an ICBM or particularly a SLBM). But anyway, that leaves us with 1,000 nuclear weapons exploding over North America.

Now, please forgive me, but since I live in Canada, I am going to look at what share we might expect to fall where I live. Canada has ten percent the population that does the US, so I am going to say that Canada is going to get 10 percent of the North American warheads - or one hundred. In Canada we have a rule of thumb that the province in which I live has about 50% of the Canadian population, GNP, industry, and so forth, so I am going to say that we can expect about 50 nuclear weapons in Ontario.

What I am suggesting is that you make the same sort of extrapolation for your state, but I can tell you that when I start adding up the targets around Ontario, I find it hard to find a place to put 50 weapons. But here is an attempt.

- 1 at Niagara Falls - A big power generating source.
- 4 other power generating stations (mostly nuclear)
- 1 on Ottawa (the Capital of Canada)
- 1 at Sault Ste Marie (across the river from a US nuclear forces base)
- 4 other Canadian Military bases (about as threatening as boy scout camps)
- 5 on Toronto and what we call the Golden Horseshoe
- 1 on North Bay (if they don't know it has been deactivated as a NORAD site)
- 17 total

AND I feel that is really stretching it, but I wouldn't really know where to put anymore, without say bombing out some beaver dams or attacking my bus shelter. :) But, anyway, I expect the number is ridiculous, and I really wonder if the province could survive at all if 10% of the 50 weapons - that would be its North American share were used. That would be 5 nuclear weapons, each one more than a hundred times the size of the weapon used on Hiroshima or Nagasaki. Think about it. It is called the unthinkable for a reason. Now, do a similar extrapolation for your state.

On the same ratio of 10% of available weapons, as calculated above, and the 1% or 2% of total weapons existing world wide we would be talking about 100 weapons in North America and 200 world-wide. This would be like the energy release of two thousand SIMULTANEOUS Hiroshimas, along with the accompanying fallout. Lord, (I am not being facetious in addressing the Almighty) how could we possibly survive it? I can only pray that You have a plan.

So, when you look at all those yellow dots on the FEMA map - I think that you can forget that, and start trying to figure it out another way. Here is where I would put something less than 100 weapons in North America, and Lord, I hope it is a LOT less.

TARGET SELECTION

Targets are selected on a:

- Primary
- Secondary
- Tertiary

basis. That is to say - those which have first, second and third priority.

Primary Targets

- a. Three submarine launched high altitude bursts evenly spaced over continental US to create EMP (Electromagnetic Pulse) to knock out communications. The reason they would be submarine launched is because submarines can launch from off both coasts, are the least detectable and can get in the closest - for the least warning.

- b. Satellite to satellite strikes for weaponry, communication, control and surveillance technology that the general public does not know about. Who can guess about something we know nothing about - just as we knew nothing about the atomic bomb before Hiroshima.
- c. Submarine ports on both US coasts and at US controlled ports elsewhere in the world to prevent any submarines that are in port from getting underway. Normally only one third of the fleet is on station at a time. Number of subs that would be eliminated in this way depends on whether the attack comes as a "bolt out of the blue" or that navy is on some "high DEFCON status". The subs are considered the most threatening part of the "Triad".
- d. In the past, NORAD (North American Air Defense) communications centers at Colorado Springs, Colorado and North Bay, Ontario have included been included as Primary Targets. The latter has supposedly been deactivated, but what other 'secret' locations exist and how well the Russians and Chinese know those 'secrets' is problematical.
- e. SAC (Strategic Air Command) bases have been considered a priority for a strike out of the blue. Omaha Nebraska is of course the headquarters. Still, everyone knows that, so other arrangements have been made - such as 'Alice' and 'Looking Glass', which are airborne command centers - and as mentioned previously there is talk about new space and sub-sea elements. Air Bases are a good target for SLBM's (Submarine Launched Ballistic Missiles) especially forward bases in allied countries such as Turkey, Saudi Arabia, Britain, and France (which has its own nuclear force), and Navy Aircraft Carriers wherever they may be (and they would certainly wish they could find the submarines).
- f. Surprisingly, Washington D.C. and the Pentagon have often not made primary target lists. Washington D.C.. because there is one targeting theory that an enemy wishes the leaders to survive so that they have someone to negotiate surrender. The Pentagon, because while we hear of the famous war room and so forth, in actuality the Pentagon then becomes insignificant because we would be beyond the time of planning, policy, and procurement.

Secondary Targets

By this point there would have been used one or two dozen weapons against American Forces.

- g. Beyond first strike, to catch the bombers while on the ground, - air bases and nuclear bombers are no longer considered as prominent a part of the Triad targets as they once were. Previously, it was thought important to get all the ten thousand foot runways in the US to prevent the bombers from returning to refuel and rearm. Not seen as so likely today.
- Major metropolitan areas will of course remain major targets, but these are SECONDARY target issues because they will have little effect upon US retaliatory capability, which are the concern of PRIMARY target issues. Major cities remain major targets simply for the

confusion, affect on morale, and political, social, and economic disruption they will cause the US. Most everyone can identify what the top 20 US city targets will be in this regards. One must remember that there will be similar world targets of US allies, so that recovery assistance will not be available to the US. One must, however, begin to ask - exactly what the geo-political, and overall goals are that target planners wish to achieve. Targets such as these may be used as hostages for negotiation - assuming that the planners have as a part of their model, the ending of the war and achieving some particular goals.

- It used to be thought that US Military training bases, war materials production plants, and such, would be important targets. But that is WWII thinking - not WWIII thinking. Everything, used in the war will already have been made, deployed and trained upon. There will be no time for further preparation or deployment. The only thought will be how to get it stopped.

Tertiary Targets

Tertiary targets no longer have the prominence they once had in target planning, such as they did at the end of WWII when the bomber reigned. Then a bomber, assigned to a primary target, might carry multiple weapons and if it or a companion plane destroyed the primary target then it needed to go on to a secondary target so as not to waste the weapon in re-bombing the same target. This is particularly true of nuclear weapons - where one is sufficient.

A plane would then carry a priority list of additional targets within its range or return path, so that it could dispose of its weapons. With the little likelihood of getting a second chance, it is a matter of use them or lose them.

Between the Primary target sites and the Secondary target sites we have possibly used 50 weapons in North America. So what is left over? The question is - how completely do you want to devastate the land? There has already been enough damage done that the political and social organization has been destroyed. In North America aid flows in to limited disasters, a fire, tornado, earthquake. But now, everywhere would be in disaster. No electrical power, communication, or help available - from anywhere. The following map shows some principle North-South corridors, because I feel that the country would be severed East-West because of river crossings.



It is questionable that society could be restored but just to assure that the devastation is complete and that the country is severed a target planner might select as tertiary targets to destroy the bridges over the Mississippi and Missouri and the key railway passes through the mountains. Key nodes on the electrical, communications, and pipeline grids - and so forth. The following map is comprised of railway and highway nodes linking through Kansas City. You can do the same thing for any other major city.



You can take all those maps - and seek to designate targets. I have done it and I can tell you it is hard to find places to put another fifty bombs.

There are many academic studies that have been made on this subject, by VERY knowledgeable and capable people. If you wish to really study into it more then here is a link that has been highly recommended by both The Bulletin of Atomic Scientists and the Encyclopedia Britannica, both of which are very worthy sources:

<http://www.nukefix.org/>

I have said 100 weapons to devastate America. The nuclear subs alone carry hundreds between them. Launch and move on and wait. That would be the strategy. From satellite and other reports you would eventually be assigned another Tertiary target that hasn't been struck. The process could go on for months with nuclear powered subs. However, I hope that it won't last a week - before we find a way to end it.

How Likely Are the Weapons To Be Used?

By what insanity could mankind possibly pull down upon itself the destruction that I have described above and in [YOU Will Survive Doomsday](#)? My answer is by the same insanity that permits him to build such Abominations of Desolation in the first place. By the same insanity that expresses his selfishness and anger throughout the world almost daily in the killing of what amounts to at least tens of thousands of human beings annually. Men who are intellectual giants and spiritual midgets. Men who have turned from the will of God who loves all His creatures and wants them to all love one another.

One may say, "Yes, but we have gotten this far without using them - so why would it ever change?" But, the change is in the wind. The US says that it is abandoning the policy of MAD (Mutual Assured Destruction). In the past this was the rationale for not having an effective Civil Defense Program and a national civilian shelter program. It was thought that everyone on both sides would be destroyed anyway,

and to implement a shelter program would mean that one did not really believe in MAD - and therefore their shelter preparations would be seen as threatening by the enemy. So, one just wanted to be sure that they had total SECOND STRIKE CAPABILITY accompanied with ASSURED ANNIHILATION of the enemy and no enemy would ever attack them. Thus - the US under the Clinton and previous administrations maintained a "No first strike policy". The Russian's under their previous administrations did likewise, but just recently the Russians have said that they have changed their policy - in favor of first use.

Russia, China and some other countries never agreed that a nuclear war was not survivable and they continuously developed shelter programs. Under the US Reagan Administration it was felt that a defense - popularly called Star Wars - could be built against nuclear weapons. Most thinkers agree that it is an impossible idea, but the very attempt to try it was outlawed under the ABM (Anti Ballistic Missile) treaty. The reason the Russians (who were permitted under the treaty to maintain a few ABMs around Moscow - but which the US felt would be ineffectual) wanted such a treaty, was that they felt the very attempt to develop ABMs would create an arms race they couldn't afford. If any one nation DID come up with a defense - then other nations could be forced to surrender under nuclear blackmail. The US under Bush cancelled the treaty and has gone ahead with ABM development. Continuously, we now hear of some general in Russia or China who says they think that nuclear war is now inevitable.

And then there are all the Third World Countries with their axes to grind. Pakistan, Iran, Iraq, North Korea, Syria, Libya, and others. Yes, their conflicts can bring in the major players. Just the US preoccupation anywhere else can be incentive to China to solve its Taiwan problem. For some countries, such as Israel, nuclear may come to be seen as the only solution. Israel, greatly outnumbered, more than a hundred to one, could easily feel forced to nuke the capitals of its attacking enemies, and in the last few months it has indicated that it would take such "appropriate response" as needed.

For much of the last year, since 9-11-01, there has been expressed increasing concern about the existence of "dirty bombs", suitcase nuclear weapons, nuclear weapons concealed in sea shipping containers, and the delivery of bio/chem weapons, especially dealing with anthrax and smallpox, into North America by various terrorist organizations and the latest "empire of evil" of choice, which happens at this writing to be Iraq.

While the threat of Iraq (and Iran, Syria and Libya) are very great to Israel - these countries have no practical means of large scale attack on the US and for technical reasons widespread attack on the US by bio/chem is improbable. However, the use of WMD (Weapons of Mass Destruction) by ANY power, anywhere in the world, will undoubtedly have a very destabilizing effect. Thus it is that even limited powers can trigger an event that can bring about a world-wide conflagration.

Given the nature of modern weapons and the natural barrier of two great oceans, I do not expect there to be an invasion of any sort into North America. The perils of civil disorder, and responding military rule, rest within. Nevertheless, the threat of world cataclysm has never seemed greater.

No matter how irrational my analysis may seem to many - one fact remains. There are nuclear weapons in

the world. Plenty of them.

MENU: [HOME](#) » [SURVIVAL](#) » [Index of States](#)

This booklet was converted to HTML by our Ark Two Librarian, Fred Walter; a lengthy task which, I for one, wish to express my appreciation.

It contains so many photos that it is probably easiest for you to read it on-line, and some browsers will now print it off but you can capture it and print it off, along with a number of very useful other books from our Ark Two Librarian's easy printing .pdf versions at:

http://groups.yahoo.com/group/Self_Sufficiency/files

You Will Survive Doomsday

By Bruce Beach

Copyright Information

This document is copyrighted. You are welcome to reproduce it, however, for FREE distribution in whatever quantity you desire and by whatever means you desire so long as you reproduce the entire document. Extensive quotes are also welcomed so long as credit is properly given.

Our purpose in publishing this document is to ameliorate the effects of a nuclear holocaust for as many people as we can reach, and to locate as many people as we can who are willing and able to join our nuclear survival group.

Table of Contents

- [Twenty-three myths that are repeatedly heard](#)
- [Useful Figures and Tables](#)
- [Nuclear Survival Groups](#)
- [About the Author](#)
- [Bibliography](#)

MYTHS

Here are twenty-three myths that are repeatedly heard (some much more often than others) that this document tries to dispel.

- [MYTH #01](#): Almost everyone will suddenly be killed on doomsday.
- [MYTH #02](#): Most people would be quickly killed by the bomb blasts, thermal radiation, or radioactivity.
- [MYTH #03](#): You can build an adequate shelter in your basement.
- [MYTH #04](#): You must filter the air coming into a shelter to remove the fallout.
- [MYTH #05](#): Water would become radioactive.
- [MYTH #06](#): There would be no dangerous radioactivity after a couple of weeks.
- [MYTH #07](#): Radiation sickness is not contagious so there is no danger in assisting those affected.
- [MYTH #08](#): Food exposed to radiation becomes radioactive and is therefore not edible.
- [MYTH #09](#): If you have a special *radiation suit* (like you see in the movies and on TV) you will be protected from the radiation.

You Will Survive Doomsday

- [MYTH #10](#): New crops of food grown in future years will not be radioactive.
- [MYTH #11](#): There is no such thing as a fallout pill.
- [MYTH #12](#): There is a fallout pill that will protect you from all radioactivity.
- [MYTH #13](#): There would be dangerous radioactivity for thousands of years.
- [MYTH #14](#): There would be no dangerous radioactivity after a couple of years.
- [MYTH #15](#): You are prepared if you have a two weeks emergency supply of food stored.
- [MYTH #16](#): You should be prepared to be self-sufficient and be able to survive on your own.
- [MYTH #17](#): Any survivors would have to live the rest of their lives underground.
- [MYTH #18](#): Life after doomsday won't be worth living.
- [MYTH #19](#): You need not make any preparation because you are either going to die in the holocaust or be *saved* (religious connotation).
- [MYTH #20](#): The bombs today are so large and there are so many they will destroy the world.
- [MYTH #21](#): You will receive adequate warning from your government.
- [MYTH #22](#): You will receive no warning, and there is no hope if you do.
- [MYTH #23](#): One of the primary targets will be nuclear power plants.

This document is published by a nuclear survival group. The group is not affiliated with any religious group or other organization. We welcome inquiries from all persons interested in joining our survival group. Send email to survival@webpal.org (*Bruce Beach*) for more details.

DOOMSDAY

MYTH #01: Almost everyone will suddenly be killed on doomsday.

You will survive doomsday. And here you thought that if it ever happened the bomb would fall right on you. Probably not. It will more likely go like this.

One day, the inferior Russian computers may make a mistake and decide that the US has already launched a pre-emptory attack against Russia. The US warning system has made that same sort of mistake many times and a number of times we have gotten just minutes away from launching our retaliation before the mistake was discovered. Who is to say the Russians will always be so smart?

Forty minutes after a missile is launched from Russia it will be landing on its target in North America. Before this occurs the US has just minutes within which to respond or it will be caught with its missiles down. The hotline to Russia happens to be not working (this has also happened a number of times before). That is one of the factors that entered into the Russians decision to launch.

So, what's his name in the White House reaches for a jellybean and pushes the button. Interception missiles of course try to stop the Russian missiles before they reach their first two primary targets, NORAD (NORthern Air Defense) headquarters in Colorado Springs, Colorado and its backup at North Bay, Ontario.

These are hardened underground computer and communication sites that may require several bombs to wipe them out. Given the number of missiles that may be intercepted the Russians have sent a handful.

A better way to wipe out the communications of North America is to just explode four thermonuclear devices at a high altitude over the continent. These will generate an EMP (Electro Magnetic Pulse) that will knock out most electric and electronic devices tied into the power grids. It will also knock out any new devices that contain IC's (integrated circuits) and that have an antenna over thirty inches long. That means that your car radio, portable radio, and television will be inoperable, even if the power ever does come back on.

All over the continent the power and lights will suddenly go off. If you happen to be listening to a battery operated old tube type radio (when did you last see one of those?) that is tuned into a "hardened" transmitter sight (I don't know where you will find one) that transmits (fat chance) the EBS (Emergency Broadcast Signal) then you will know that doomsday has begun.

Otherwise you will be standing out there with the rest of us survivors saying, "Nice day, eh? Strange the power would go off on a nice day like this." Silence. The sun will continue to shine, and the birds will sing, and the breezes will blow and you will still not know that they have a bit of a problem up in North Bay. They are no longer there. Silence.

Eventually word may drift in. On the chance that there is something to the rumor you decide to try to call someone. Your spouse, a friend, a relative. Don't bother. Silence. The telephone isn't working either. Even if the EMP hadn't done it in, a mere power outage causes such an overload of demand on the central exchange that you couldn't even get a dial tone.

You are a survivor. Doomsday has occurred and you are a survivor. While you are waiting for the spouse and kids to get home maybe you should do something practical. Like go down to the supermarket and lay in a bit of an extra stock.

You may notice that the little corner store has closed. If he has believed the rumor, he wants to save his stock. And besides, your money may not be worth anything tomorrow. You thought you had seen rapid inflation before but this is like from zero to a million in sixty seconds.

At the supermarket, if you are early enough, you will find pandemonium. If not, you will find practically nothing. Maybe a large bag of dog food (take it) and some cans of floor wax (forget it). The rest of the stuff was all in those carts that you met come flying up the walk as you came running down.

There won't be any girls at the cash registers, (they have done their shopping and gone). Besides, the cash registers aren't working anyhow, with no power. It may have taken the hired manager a little longer to figure out that he should grab what he can and head home to his family, but he has probably gone now. The only cops you will see are the one's grabbing stuff themselves.

If on the way back you spot a shopping basket with something in it - think twice before helping yourself. If there is an altercation there are probably no doctors at the hospital to sew up the lacerations. Everyone else is also too busy to bother calling an ambulance, if they could, and one wouldn't be available if they did.

Of course the trip to the supermarket may have been nothing like that at all. It may have just been a bit more active than usual but if most people haven't caught on yet then we are very lucky. You just keep mumbling under your breath. "Good people, good people - that's the way, that's the way, just stay calm." This way we can just go about doing what we have to do as quickly as we can, while trying to not stir up panic. "Yes. I understand the cash registers aren't working but please let me just help you add this up by hand. No, that's fine, just keep the change."

Then, of course, if everything is really this calm we can take that good old plastic credit card and go out and buy all the good survival stuff that we are going to need and should have gotten beforehand. Don't worry about paying for it, no one is ever going to send you a bill. Getting the stuff home may be a bit of a problem if the car isn't working (the EMP may have wiped out that fancy electronic ignition). "No, that's fine. You don't need to deliver it. I'll just put it here in my little red wagon." But you sure don't want to lug it all the way up to your thirty-second floor apartment, if there is somewhere safe that you can stash it. "Can you really believe that people are staying this calm? How is it that we seem to be so much smarter than the rest?"

More than likely you are now back home and all you have is the fifty-pound bag of dog food. Are you really going to be able to carry it up to your thirty-second floor apartment? You know the elevators aren't working of course. Then maybe you could hide it in the trunk of your car in the garage- if no one sees you.

Ah, back home in the apartment. Home sweet home. The kids are home from school now. Do you have enough guts after that scene at the supermarket to send them out to do some more scavenging? It isn't exactly a party going on out there. Did you see Watts, Detroit, Washington D.C., and Baltimore after some of their similar parties? I did. I think I would keep the kids home. Not much you can do except to wait for the spouse to walk home. Shouldn't be more than a few hours.

The spouse finally makes it home. "What do you mean all you got is fifty pounds of dog food? We don't even have a dog." The electricity isn't on. We can't cook anything anyway. Best to eat everything out of the refrigerator before it spoils. Won't be anymore water as soon as the gravity feed tanks on the roof empty. Hope you saved a few pot's full. If everyone filled up their bathtubs - it is all gone. It has gotten cold. Might as well go to bed. There is no light to see anything by anyway. Certainly not going out in those streets in this dark with all that noise going on down there. Hopefully, everything will look brighter in the morning.

Day Two

Morning comes early with the noise of people throwing pots and pans over the sides of their balconies along with the blankets, pillows and other things that it saves them carrying down. Apparently some of the residents are moving out. Perhaps you should too.

Everything looks better in the light, doesn't it? TV still doesn't come on. Telephone isn't working either. And you know what - the toilet doesn't flush. Can't cook anything. Got to eat what you've got. See, that wasn't so bad. Make it sort of a picnic. Eat it right out of the can. There is not going to be any water to wash dishes.

But see, **we survived doomsday**. Didn't even see an explosion, hear a bomb, or anything. Maybe we should sit down together and try to figure out what we are going to do from here. The bombs may still be coming. Probably are.

If the attacker's plans have gone according to schedule they have probably finished with their primary targets. They have hit the three Titan Wings in Kansas, Missouri and Arkansas (three wings, eighteen missiles each, for a total of fifty-four) or the things have landed in Russia by now, so why bother. They have certainly been knocking the bejammers out of Montana and the Dakotas. Can't hear or see a thing from here of course. [Author's update note: This point is a little dated. The Titan Wings have been decommissioned and both the U.S. and Russia have now put much greater reliance upon the MUCH greater and more reliable destructive power of MIRVed warheads aboard nuclear submarines. The primary targets are now most likely submarine bases, to prevent more subs from leaving port. Further update as of January 1st, 2002. The world keeps changing. Now not only Russia has missiles that can reach the US but China does also. There are now 14 nuclear nations and the number is growing).

Then they will start on the secondary targets. All the SAC (Strategic Air Command) bases both in the US and around the rest of the world. Oh, they have lots to keep them busy for a while. Cities themselves are pretty far down the list. Maybe they won't even go for them. Any airport with over a ten thousand foot runway is pretty important however because the SAC could land and refuel their bomber there. So you know where that puts us. They will probably get around to us in the next day or two.

There are two strategies of warfare. One is called *counterforce* and the other is called *countervalue*. With counterforce you knockout the enemy's forces so he can't harm you. This can be very chivalrous like the fighting codes of the knights of old. You never harm the women and children.

On the other hand, with countervalue, you go after everything the enemy holds dear in order to demoralize him. This was the technique of the Mongolian hordes.

"Take no prisoners." "Eliminate the enemy." "The only good Indian is a dead Indian." "Eliminate the Jews." "Sock it to the Japs."

Women, children, babies, everybody goes.

Now the problem with countervalue warfare is if everybody knows they are either going to win or die, some people can get very tough. So maybe the best thing is to knockout the military forces and hold the cities as hostage. "Now, either surrender or we bomb the cities." Anyway, the cities aren't generally the first targets.

And so here we sit. **Unscratched**, the day after doomsday. But we can see some problems on the horizon. Very possibly the city is going to be bombed in the next day or two. Even if it isn't, how can we stay here? The electricity is off. The heat is off. The water is off. And it isn't coming back on. The elevators aren't working. For older people it is "If we go down (if they can go down), we can't come back up."

There is no more food in the grocery store. And there won't be any more. (Unless you believe your government, which says they will start delivering it in about two weeks - want to bet?). Then there is that horrible stuff called fallout that is going to start showing up in about twenty-four to forty-eight hours, or sooner.

Now, we have all seen or heard about the book and the movie "On The Beach", and Beach himself shows up with the *solution*. A pocket full of cyanide pills. If you want one he will give you one for each of your kids or grandkids. There is only one catch. There are only so many and I don't want them wasted. So you will have to line up each of your children or grandchildren in a row and pop it down their throats right while I am here. How many of you will do it? "Here is your vitamin. Open wide..."

No? Then you really are a survivor. Here you always said you hoped the bomb would fall right on you and then when I offered you an easy out... Oh well, it won't be that bad. A world without electricity, automobiles, radio, television, telephones, and supermarkets. And maybe eventually with only twenty million people in North America. (They won't all be Canadians).

But then, that is the kind of world that was here in 1800. The people then didn't have cars, supermarkets, movies, TV, radio, telephones, modern medicine, airplanes, rockets, and computers. And they survived. They may have even enjoyed life. Maybe even more than many people do today with all their drugs, tranquilizers, and what have you.

People generally are survivors. Put them out on an ice floe in the middle of the arctic with no expectation of rescue, no supplies - nothing - and they will hold on. Some will even survive until they happen to be rescued.

So you are a survivor and you survived doomsday. But you will eventually die. We will all eventually die. That is the nature of this world. The question is not whether or not you will possibly die, but how long you will live, and what life will be like during that time.

So you have survived. And if you and your kids are going to continue to survive you had better get the heck out of the city. Not only is there the possibility that there will be bombs but those little scenes down at the supermarket, or anywhere else a little bit of food happens to show up, are going to become more and more unpleasant as anarchy prevails.

Moreover, without the toilets flushing and with no one removing the dead bodies, health conditions are really going to reach a state you just wouldn't want me to describe. So, off to the country. But, how? And, where?

Before actually departing for the country let us further consider the alternative of staying in the city. Perhaps you are convinced that the Russians would never really get around to bombing your city. Or you feel you have sufficient underground shelter if they do. Nothing, of course, would protect you if there were a direct hit on your shelter, but a good bomb shelter could certainly give you very good protection as little as five miles from ground zero.

The trouble is that subways and underground garages are not designed as blast shelters. They do not have blast vents and doors. Anyone in such a place, at the time of blast, within a couple of miles of ground zero will be subjected to a phenomenon called *popcorning*. Minute particles of greatly accelerated sand will cause blisters to pop out all over exposed parts of the body. This, combined with several other pathological mechanisms, will probably result in a rather painful death within a few days.

Although the blast protection in an underground shelter is much superior to being above ground there are reasons that one is better off staying in their high-rise apartment rather than going to a large public shelter if they feel there is little or no danger of blast.

The public shelters have no supplies and no equipment. The average designated public shelter is supposed to shelter over three thousand people. Can you imagine the anarchy and conditions there? Without food, the first to die will be infants who are not being breast fed. Other early candidates will be persons who require special medications (especially the elderly) and anyone who happens to be injured.

Not only will deaths have negative psychological effects on the survivors, they will create severe sanitation problems. There will be enough sanitation problems anyway if the water and sewage systems are not working. Most of the designated shelter locations do not have sanitary provision for three thousand people in the first place.

One of the greatest hazards in an underground shelter is carbon dioxide poisoning. The designated public shelters, almost without exception, do not have adequate ventilation for large numbers of people over a considerable period of time. And the existing ventilation systems generally depend upon electricity being available.

There are ventilation defense and survival techniques available. However, if you were to try to implement them in a large public shelter situation you would probably be one of the first persons killed by the other survivors. The reason is that most people have misconceptions about either the air becoming radioactive, or containing radioactive particles that they feel would be more dangerous than the carbon dioxide.

Add to these problems the fact that you might not have any light in the shelter, that anarchy may become rampant, and that there will almost certainly be no food, and perhaps, more importantly, no water and you will see why no trained survivalist would want to be caught dead in the place.

Returning to one's own high rise apartment, after the danger of blast is past, gives much more favorable opportunities for continued survival than given by remaining in a public shelter. If you are ten or fifteen stories above the ground the distance will probably adequately protect you from any radiation from the fallout on the ground. If there are ten or more stories above your head then that distance will also protect you from fallout on the roof.

The apartment dweller should try to secure an inner room without any windows. A blast fifteen or more miles away will knock out the windows and it is the glass shards that will kill most people. Pulling drapes and blinds are all helpful defenses. A blast wave will be preceded by a brilliant flash of light. The survivor will have from several seconds to three or four minutes, depending upon the distance from the blast, to duck behind a sofa or to take other shelter.

Training oneself to take similar immediate defensive action can also help give protection from the intense thermal radiation that accompanies a nuclear blast, and that can start fires *fifteen to twenty* miles from ground zero. Fires, in themselves, can be a problem and if you are downwind from a large fire or firestorm you have to watch out for carbon monoxide poisoning.

Fire defense techniques are generally well known so I will not dwell upon them here. One thing you need not do is call the fire department, if you could. There is little they could do, if they were still around, without central water supplies. But the thing you can do is improvise closings to seal off all the apartments above you, and those immediately below you, so that fallout will not blow

You Will Survive Doomsday

in and settle on the floors over your head, or otherwise near you.

Now, it may be possible to organize your activities with other survivors to become a cliff dweller like those of old. A bucket on a rope might be used to haul up water gotten from a nearby stream or pond, and waste could be let down in the same way.

Some ingenuity may be required in providing heat and light, but if you really have sufficient supplies of food for yourself and your fellow survivors to hold out until another crop can be planted and harvested (most survivalists recommend at least two years supply), and you seriously face up to the sanitation problems created by morbidity, and you and your co-survivors are sufficiently organized against anarchy, and there are no more nearer bomb blasts - then you are probably well on your way towards continued survival. At least you are many times better off than being in a public shelter.

There may be all sorts of reasons why you elect to remain in the city rather than head for the country. If the attack comes in the winter and you do not have a planned escape route, adequate clothing and supplies to make the trip, are not physically able to make the trip, and do not have a known destination of refuge, well then...

Those who have most prepared themselves and have made the best plans should pray that their flight does not come in the winter. During a storm, or severely cold weather, it is very likely that many more persons may be killed by exposure than by any other single cause. The roads and highways will most likely be jammed. If there has been an explosion in the vicinity then overpasses and utility lines may have been dropped onto the roadways making them unusable.

Even without a blast having occurred, traffic jams, accidents, or vehicles just running out of gas will probably create bottlenecks that completely clog the roads. Once people find themselves just sitting there, not moving, they will abandon their vehicles. My guess is you can forget using an automobile for escape unless you had a plan and immediately implemented it before the general panic set in.

A motorcycle, scooter, or even a bicycle might offer certain advantages over an automobile. One might carry a smaller form of conveyance on a larger one and then implement the smaller means of conveyance, such as a bicycle, when that became the necessity.

The most dependable means of escape would probably remain walking. If one had to walk all the way out, and they were in any physical shape at all, they could surely do it in two or three days. Once again, proper preparation can make all the difference. Proper walking gear, proper survival clothing, a planned escape route, proper selection of material to be packed, and proper allocation of loads.

And, as before, there are better alternatives. One could have pre-arranged pickup points and times with co-survivors coming from the refuge destination, or in a worsening pre-crisis situation you may have made an early dispersal. But the greater likelihood is that anyone with a practical survival plan who reacts immediately can get out well before the rush sets in.

Just getting out into the country, or to the other side of the mountain, will increase the survivability factors for many people. The threats of blast and thermal radiation will have been greatly reduced. But blast and thermal radiation while very nasty in their effects are not going to kill that many people anyway. Oh, they will kill millions, but as a percentage of the people living the day before doomsday they will, combined, kill only ten to fifteen percent. And most of these will be a considerable distance from the blast and will eventually die as a result of injuries caused by the broken glass shards.

As stated before, depending upon the time of year and the weather, many more may be killed by exposure. But there is still another big killer coming. That is of course the fallout from the weapon explosions that took place many hundreds of miles away. This fallout may require from a few hours to a day or two to arrive. If the weather permits, and the survivors know what they are doing, they may still have time to build an expedient shelter against the fallout.

Techniques for defense against fallout have been developed and tested at great expense by almost every nuclear nation. While information on these techniques has been made readily available, most people have not availed themselves of it.

Two basic techniques are available. One is to leave the contaminated area. But the extent of the contaminated area may be far too wide to escape, or one may not have accurate information as to the delineation of the contaminated area, or they may not have the means of transportation, nor the means of survival should they reach a radiation free area.

The other basic means is to provide shelter within the contaminated area. Weather, ground, and time conditions permitting it is possible to dig a trench and cover it with dirt supported by poles, wooden doors, or a vehicle. Properly designed, such an expedient shelter can make all the difference between avoiding the effects of fallout radiation, and not avoiding those effects.

The details of how to build an expedient shelter are to be found in books listed in the [bibliography](#). One of the most important and often overlooked factors in designing a shelter is the matter of providing an airpump so as to eliminate the problem of carbon dioxide poisoning. The technique for building such an expedient pump from materials readily available in time of crisis is also found there.

The effect of fallout radiation is not always death, although many times it is. Even if it is death it is not immediate death. Intense radiation causes a very painful, and horrible death (what the literature calls a *hard* death) over several days. More likely the effects are drawn out over a period of weeks, months, or even years. As the title of this document points out, all these people will have survived doomsday. It is not a question of survival but the condition of survival with which we must concern ourselves. Everyone will die eventually but it is the quality of life in the interim that is of importance.

MYTH #02 Most people would be quickly killed by the bomb blasts, thermal radiation, or radioactivity.

By the second year after doomsday the combined affects of blast, thermal radiation, and fallout will probably have resulted in some immediate, but mostly delayed, deaths accumulating to 35% of the population that were living on doomsday. Deaths that can be directly attributed to radiation and weapon related injuries will continue until five years after doomsday so that by that time 40% of the population that was living on doomsday may no longer be surviving because of the above named factors.

However, the total population surviving five years after doomsday will probably be only 20% of the number that was living on doomsday) Obviously, nearly half, or perhaps more than half, of the fatalities will be directly contributable to causes other than the bombs.

What then are these equally effective causes of post doomsday mortality? They are exposure, starvation, plagues, and anarchy. While the threat of chemical and biological warfare is not to be ignored the primary causes of these means of mortality can be looked upon as being more *natural*. That is to say they will just result naturally from the breakdown of the social infrastructure that we regularly depend upon for day to day survival.

The four factors that will determine survival are

- Location
- Knowledge
- Preparation
- Luck

On doomsday most people will be living outside of areas that will be struck in initial attacks by blast or thermal radiation. Many others will already be living in areas that will never be damaged by blast or thermal radiation. Both of these groups, if they have the knowledge of what to do, and have made the proper preparations, will very likely find themselves in the group of survivors who are living unharmed five years after doomsday when the surviving population has once again established some semblance of order and is once again multiplying and replenishing the earth.

Selecting and Designing a Shelter

MYTH #03: You can build an adequate shelter in your basement.

For a number of reasons, basement shelters do not offer the amount of protection that is commonly supposed. A proper analogy between them and a survival installation as described later in this document would be to compare a plank with a well-equipped and commanded lifeboat. This is not to say, that if someone finds themselves in the water from a sunken vessel, it is not well to advise them to grab hold of a plank and start paddling in the direction that one hopes there lies shore, if there is no better means of survival, such as a lifeboat, or raft.

Similarly, there is very little protection afforded (starting from the rooftop down) by a layer of shingles, a foot or two of light insulation (composed mainly of air-spaces for the purpose of retaining heat), a quarter to half inch of plaster board, some paint, a carpet on the floor, another layer or two of thin boards, and perhaps some paneling or ceiling tiles if the basement is finished. The distance between the roof and the basement (a two-story house offers more than a bungalow in this way) does allow some additional protection, but this factor, along with the combined density of all the matter described, would not equal more protection than would be afforded by six to eight inches of earth.

When, within such a basement situation, one starts to create an expedient shelter using, as is usually advised, such materials as bookcases and trunks (filled with earth if possible), there are certain design errors that are liable to creep in. Piling dirt or other material on the floor above will help but the greatest dangers will be from the areas outside the basement wall where the foundation extends above the ground. It is best to keep ones shelter at least three feet below the outside ground level, and to have at least three feet of soil above one's head.

The next most overlooked problem is that of proper ventilation, so as to avoid carbon dioxide poisoning. As stated before, most survival experts advise a location other than the basement for such reasons as the threat of carbon monoxide poisoning in case of fire, broken gas mains, and the threat of fire itself that may result from the wide spread firestorms caused by the thermal radiation associated with a nuclear blast.

There are certain advantages to a basement shelter. One may have access to necessities such as food, clothing, and blankets stored in the home. There may still be water available from the hot water tank. And, most importantly, one may feel certain psychological comfort by being in the familiar surroundings of their own home. None of these advantages of course hold a candle to the advantage of being in a properly equipped and manned survival center.

MYTH #04: You must filter the air coming into a shelter to remove the fallout.

One of the general misconceptions regarding fallout and fallout shelters is that the air itself may become radioactive. This is simply not true. Those with a little learning will then say "Ah, yes, but it will contain radioactive particles of fallout". That is true, but a properly designed air intake, even for an expedient shelter, will cause most of the particles to drop out of the air flow before the air enters the shelter.

Should the number of particles still suspended in the air be a problem, an expedient filter, such as a damp sheet hung in the air intake passageway, will do an adequate job of filtering the air.

If the air vents do not have automatic blast valves then the air passage should be quickly shut and remain shut for a few minutes after the brilliant flash of a nearby nuclear explosion (so as to prevent the popcoming effect described earlier). The air passages will have to be shut in every case where there is a large fire nearby that is generating carbon monoxide that would otherwise seep into the shelter.

Most expedient shelters will not have precautions such as those just described. The danger of carbon monoxide poisoning is one of the main reasons that most survival experts recommend that even if one has a basement in their house it is preferable to build an expedient shelter a considerable distance outside and away from existing structures in case of fire.

MYTH #05: Water would become radioactive.

As has been mentioned before, the materials necessary for building an airpump, and an expedient radiation detector, are available in almost every home. Anyone planning on attempting to use the basement survival method should obtain ahead of time the detailed instructions for building these devices, and store these instructions in their home, along with an emergency supply of food and containers for storing approximately 14 gallons of water for each individual that is going to be accommodated.

There is a similar misconception about water becoming radioactive as there is about air becoming radioactive. This may have something to do with misconceptions about the nature of *heavy water*, but we won't go into that here. Radioactive particles do become suspended in water, however, and that is why for the shelter confinement period, you must make sure that you have a sufficient store of potable water available ahead of time.

During the recovery period, after radiation has decreased to the point where it is safe to work outside, there are techniques for letting fallout settle out of water, and for distilling water, in order to make sure that it is safe for drinking and cooking. However, far from keeping air and water out of a shelter, it is absolutely necessary to life that they be available.

While an expedient shelter could mean the difference between life and death, it is probably not something that you would want to continue to use for a very long time.

MYTH #06: There would be no dangerous radioactivity after a couple of weeks.

There is a wide range of misconceptions about what is safe and what is not. The matter is sufficiently complicated that a person should have professional advice. However, if there was no doctor going to be available to set a broken leg I presume you would go ahead and do the best you could. And if one had to build a bridge to get across a river and there was no structural engineer around, again I presume one would have a go at it.

Doctors would like to have their x-ray machines available when setting a leg, and engineers would like to have their surveying equipment, specification guides, and computers or slide rules when they are building a bridge. So you can well imagine a radiological defense officer would like to have radiation detection equipment available when giving advice in a radiation defense situation.

However, if the advice, expertise, or equipment, is not available, one must go on. One rule of thumb is that if there is not enough fallout that you can see it, then there is not enough of it that it will kill you. Fallout is usually small grain dust or grit, often having a light color, but not always. It depends upon its source. The best place to spot it is on a smooth surface, like the hood of a car.

The more dense fallout is, probably the greater the hazard, although there isn't necessarily a direct correlation. It may fall thick enough that quite a little heap of it may be brushed up from a surface that is one foot square. It is possible to build, from common materials found around the home, an expedient radiation detection meter. The details for such a meter are found in books listed in the [bibliography](#).

Even if one has commercially available radiation detection equipment there is still some considerable skill required in its use. For example, almost all survey equipment is designed to be used by an adult of normal stature. This means that if the equipment is held in the hand of a walking adult it will tell how much radiation is being received 3 1/2 feet above the ground, and particularly by the adult's vital organs which are above that level. A child's or an infant's vital organs will be below that level and will be exposed to much more hazardous levels than an adult's. For this reason, if one is passing through an area that is suspected to have any radiation at all, a child should be carried on an adult's shoulders.

There is another rule of thumb that for every seven fold increase in time radioactivity will decrease by ten fold. This is called the seven/ten rule. This is based upon standard decay. It is useful as an example, for training, and in building theoretical models, but in actual practice the decay rate is likely to be something quite different. It is determined by the isotopic composition of the matter under consideration.

There is another commonly held misconception among semi-trained individuals that low levels of radiation cannot be rapidly fatal. Someone, after several days in the confines of a cramped expedient shelter, might conclude that because their meters now indicate a very low level of radioactivity (or perhaps no radioactivity if it is a high-range instrument), that it would now be all right to go outside and sleep on the ground in the cool breezes beneath the bright summer stars.

The fallacy again arises from taking measurements at a level that assumes the vital organs are well above the radiation source. This is not the case when a person is stretched out on the ground for long hours of sleep. These long hours of low level radiation exposure to the vital organs will result in a fatality in just a few days.

Likewise, perfectly healthy adults who take infants out of the cramped, unpleasant, expedient shelter to allow them to play during the day on a blanket spread out on the ground will be quite shocked to see those infants sicken and die in just a few days while they themselves remain healthy. The infant's vital organs again being close to the weak radiation source for a long period while the adults' vital organs are being protected by distance.

MYTH #07: Radiation sickness is not contagious so there is no danger in assisting those affected.

The statement that radiation sickness is not contagious is often found in the literature. That is true. The erroneous conclusion is drawn, however, that being around persons with radiation sickness is not dangerous. The danger arises from the manner in which radiation kills.

Sufficient radiation can cook the vital organs, but more often what happens is that it kills the white corpuscles and the ability of the bone marrow to make more of them. It is the white corpuscles that are the body's defenders against viruses, bacteria, and other disease causing bodies.

Once these defenders are lost the person succumbs to a disease they might have otherwise warded off, and once that disease takes hold in the individual they may become highly contagious.

In this manner there is grave danger of plagues breaking out, and all sorts of illnesses one does not generally see, becoming very threatening. For this reason rigorous quarantine, sanitary measures, and health defense measures must be imposed and enforced.

Becoming aware of such unexpected and unpleasant snares may initially make one feel that the situation is hopeless. The danger really arises from a person's unfamiliarity with the circumstances. There is the story of the explorer who asked the young native if there were crocodiles in a certain stream. He was assured there were not. While then swimming in the stream he once again saw the young lad on the bank and asked for reassurance that there were no crocodiles. "Oh no sir!", replied the shocked young fellow, "They won't come here. They are all afraid of the piranha."

The young fellow would have found himself equally in danger from things with which he was not familiar in our society, like automobiles and electrical appliances. It is not that the hazards are so onerous, but simply that we are not familiar with them.

FOOD - Some Important Considerations

MYTH #08: Food exposed to radiation becomes radioactive and is therefore not edible.

Food is the most serious problem. Most food that is in the house will not be harmed by the radiation, no matter how intense. There are three types of radiation that are found in fallout. Alpha particles, beta particles, and gamma rays. As the first two names indicate, they are particles. They are minute (too small to be seen) pieces of atomic matter that attach themselves to the fallout (bits of dust that may or may not be large enough to be seen).

In any case, these particles may be simply washed off many types of foods that have a natural covering, such as eggs, bananas, potatoes, oranges, etc., or off well sealed foods such as those in vacuum packed cans. Foods such as grains (rice, dry cereals, etc.) that are in partially used packages that have been opened should be viewed with suspicion. Fallout dust may have crept in.

The food in its unopened container or natural covering should be rinsed under flowing water and then placed on a surface that has been similarly cleansed, before opening. Make sure that the hands (and under the nails) have been thoroughly cleansed before handling the food. There is little danger in handling such articles. The radiation given off by these particles is so weak that it will often not even penetrate something as thin as the cellophane wrapper on a package of cigarettes.

You may then ask "Why, then, be concerned?" The reason is that once these minute particles are ingested into the biological system they will get into the organs and the very bone marrow itself where they can do a lot of damage. This is not to say that you need not worry about getting the alpha and beta particles on your skin. You do. Because they can cause skin burns. However, good hygiene practice can eliminate that problem but they are a much more severe hazard internally than externally.

MYTH #09: If you have a special *radiation suit* like you see in the movies and on TV you will be protected from the radiation.

As an aside, this is one of the reasons that those *fallout or radiation suits* that you see in all the pictures and movies and on TV are such a **joke**. Those things are not going to protect the guy from anything, that a couple of good garbage bags wrapped around his feet and made into a hood to go over his head, would not do as well. In fact the garbage bags are in many ways better. They would be considered disposable.

The main purpose of the fallout suits is to prevent the wearer from tracking the fallout into the shelter. The user simply takes the suit off at the door. If the person were to wear it on inside, it would defeat the purpose. There are some clean handling techniques that are beneficial to know and practice, but in a wartime situation there is so much of the stuff around that peacetime standards of exposure and cleanliness lose their meaning.

The gamma rays are another matter. They are very penetrating. No fallout or radiation suit is going to protect you from them. It requires much more dense matter to protect you than you could lift, let alone lug around. This is why one must remain in a shelter when there is intense radiation. With good housekeeping there should not be so much dust inside a shelter as to create a hazard from gamma rays. However, be sure to dispose of the contaminated rinse water that you have used for cleaning the food containers and persons returning from outside. It may contain matter that is giving off gamma rays.

There will probably not be sufficient fallout on the food packages (or you can get rid of it quickly enough) that you need concern yourself about the amount of gamma radiation that you are going to get from that source during the decontamination process. However, the food may have been stored in an area that has received very intense radiation. That can of beans or peaches may have been stored right out there where it was receiving 1000 roentgens of radiation per hour. An amount that would have killed you right away. But it will not be harmed.

That is right. It is perfectly edible. If it were not so I would have told you. It is only living things that radiation hurts. Even then it depends upon the frequency and intensity of the radiation. For example, there are all sorts of radio and TV waves going right through where you are sitting right now and they are not harming you.

The food in the can is already dead and the gamma rays are not going to harm it. They will not make it radioactive. If the radiation is strong enough it may kill any bacteria that happen to still be living in the food and thus preserve it even further. If the food is supposed to contain bacteria (such as yogurt) I am not sure what it would do for that!

Radiation preservation of food is a technique that is already being used in industry and will probably become much more widely used in future years. Many people already have radiation (microwave) ovens in their homes today. One further analogy. Fire will kill living animals but we use it to cook our food. You really shouldn't be overly frightened about radiation, either.

MYTH #10: New crops of food grown in future years will not be radioactive.

Food that is grown in radioactive soil, or that has not yet been harvested when, fallout falls on it is another matter. This food will absorb the particles of radioactive matter into its own structure and thus become dangerous.

The biological food chain acts as a marvelous strainer and concentrator of radioactive isotopes. This was well demonstrated in certain tests that took place at Almagordo. From some intentional surface bursts and because of the unintentional venting of some underground bursts there was some fallout carried onto the milkshed for southern Utah.

The amount of fallout deposited over the surface was so slight that the most selective instruments could not detect it. An atomic or nuclear explosion releases its great amounts of energy by changing some matter into energy. It also changes certain amounts of matter into new and different types of matter. Without going into detail about atomic theory, the nature of the atom with its electron rings, and its nucleus consisting of protons and varying number of neutrons, let us simply say that these new forms of matter are generally unstable isotopes. That means they are going to change into another form of matter.

Once again, the matter, in the process of changing from one state to another, releases certain amounts of energy. It is this energy that we measure as radioactivity. The energy, depending upon the isotope involved, may be rapidly dispelled or it may continue to be released for a very, very long time. Most unstable isotopes release their energy and transform into a stable state within fractions of a second or at least within minutes after a nuclear explosion. Others take hours, and still others days, weeks, or months. Some take centuries.

Each isotope starts out with just so much energy. For all practical purposes we can say it is not going to get any more. Once that isotope has released all its excess energy it will become stable. Since the isotope releases its energy at a specified rate we can say how long it will take to lose half of its energy. After that, it will then take the same length of time again for it to lose (give off) one half of the remaining amount of energy. Question: When will all of the energy be given off by the isotope?

An ancient Greek philosopher posed the same problem. He said, "Suppose there is a bear at the back of a cave. On the first day the bear walks halfway to the entrance. On the next day he walks half of the distance that remained to the entrance after the first day. And on the day following the bear walks half of the distance that remained to the entrance from the previous day. The bear continues to do this same thing on each subsequent day. He walks half of the distance to entrance of what was left from the previous day. The question is: when will the bear get out of the cave?"

The answer is: "Never." This sort of regression is what mathematicians call asymptotic. That is to say the figures continue to approach zero, closer and closer, but they never reach it. So just as the bear never gets out of the cave, all of the energy is never lost. But much (one half) of the energy is lost in the first half-life. And three quarters of the energy is lost by the end of the second half-life. After ten half lives a very large percentage of the energy is gone.

It is because so much of the energy is lost in the early periods (half-lives), as compared to the later periods, that it is important to be in shelter during the early periods after fallout has fallen. We might divide the half-life times of radioactive isotopes into three categories. Very short term, medium term, and very long term.

As mentioned earlier, most of the unstable isotopes generated by an atomic or nuclear explosion are very short term. They give off all their significant amounts of energy in a matter of seconds. Unless you are within very close range of an atomic or nuclear bomb there will be no way for this radiation to reach you. It was this initial radiation that caused the horrible radiation burns and sickness at Hiroshima and Nagasaki.

First the good news. There will not be any persons subjected to long suffering from the initial radiation by the nuclear weapons of today. The bad news is that the reason why is that the weapons blast such a large hole or create such a large area of complete destruction that the initial radiation can't escape. That is to say the totally destructive blast extends beyond the range of the initial radiation.

On the other hand, the survivors of Hiroshima and Nagasaki did not have much problem with fallout. The first major victims of fallout were some fishermen many, many miles downwind from the Bikini Island tests. Fallout is a phenomenon much more associated with nuclear weapons.

Nevertheless, there was fallout in Southern Utah. As stated before, it was so slight it could not be detected by the most sensitive instruments. The specific matter of interest in southern Utah was the isotope 131 of iodine. This was absorbed by minute bacteria in the soil. In the process of filtering the iodine out of the soil the bacteria greatly concentrated it.

The bacteria were absorbed by legumes and other biological forms higher in the food chain. Each in turn further concentrated the iodine isotope.

Finally, after the iodine had found its way into the grass a cow came along and ate it. Now a cow is a very complex organism in itself. There are all sorts of biological activities going on in a cow. Various organs and the bone marrow filter out different minerals for different purposes. One of these complex systems forms milk. This particular cow, and hundreds of others like it, was milked, and the milk was bottled and distributed to children all over the area of southern Utah.

The children were also complex biological organisms. They in turn had numbers of specific organs that specialized in straining out various minerals and compounds from the food that they consumed. The end result was that their thyroids once again concentrated the iodine 131. And this to such an extent that if you held a radiation detector next to their necks it buzzed like a rattlesnake. This was not healthy.

In fact numerous problems developed among the population. There were a great number of mentally retarded children born, and a number of other unpleasant ramifications. This need not have occurred from the iodine 131 if we had known what we know today.

MYTH #11: There is no such thing as a fallout pill.

There is a simple pill that would have prevented the difficulty. It is supplied in every nuclear emergency kit in Russia and available in Denmark and Sweden. Unfortunately it is not sold in North America.

Fortunately, however, the pill is quite simple to make. Ahead of time, obtain a quantity of potassium iodide from your local drug store. Five dollars worth should be lots. When needed, take a regular glass and fill it a fourth or less full of water, and then slowly start pouring in the potassium iodide while thoroughly stirring the water.

Don't worry about how much you pour in. You cannot pour in too much. After a while you will notice that the chemical no longer dissolves in the water. It just lies there on the bottom. This means that the water is saturated. You can now stop pouring in the chemical. More will not help or hurt.

Next take an eyedropper, or a soaked piece of paper if you do not have an eyedropper, and drop four drops onto a little piece of bread for an adult. Or two drops for a child. If you get several times that amount it is not going to harm you (although in much larger amounts it is a poison).

Now take some butter or margarine and make a little ball out of the bread and pop it down. Tastes awful. Ugh. Take once a day for 100 days after the last bomb falls. This is good stuff and you should have it around for reasons other than defense in case of a nuclear war.

If you live anywhere within in a couple of hundred miles of a nuclear generating plant you might suddenly find yourself needing the stuff. The US department of Health rushed a supply of pills to Three Mile Island and they have a standard brochure all printed ready for distribution in case it or some similar site vents.

The department of defense also keeps a supply near the old Titan sites that are deteriorating and breaking down. [Author's update note: Once again those sites have been now decommissioned and no longer present a problem, but much greater concerns now arise from Terrorist Threat, and the U.S. Government is now stockpiling in many cities not only these pills but others for Bacteriological and Chemical Threats]. Canadians have nothing. I'll take that back. They do have lots of nuclear plants and the distinct possibility of bombs exploding over their heads and on their soil.

The reason why the potassium iodide works is that the thyroid will absorb only so much iodine. After that, any iodine taken into the body is passed off by the kidneys. Since the body already has all the good stuff it wants it passes out the bad stuff. This is what we call thyroid blocking.

Do not try to use the tincture of iodine that you put onto cuts. Taken internally it will kill you. And you cannot eat enough iodized salt to do you any good. You would get salt poisoning long before you got sufficient iodine to do the job.

MYTH #12: There is a fallout pill that will protect you from all radiation.

I wish I could tell you about another pill that would solve all your radiation and other problems. But there is none. Unless you mean the cyanide pill mentioned earlier and things really are not that
file:///C:/CDROMs/SCDR-2/Prophecykeepers/POST-NUCLEAR-WAR/d_resources/survival/books/doomsday/index.htm (12 of 26) [9/12/2004 4:03:28 PM]

gloomy. As I hope I have carefully explained, most of the radiation we have to be concerned about from a nuclear bomb will decay in a matter of days or weeks to a level where we can deal with it.

MYTH #13: There would be dangerous radioactivity for thousands of years.

You may say "I've heard that some radiation will be around for thousands and even hundreds of thousands of years". Yes, but those isotopes are our friends. (That may be putting it a bit strongly.) Anyway, they are not near so harmful as many people think. There is the point of view that no radiation is good for you. Some dermatologists maintain that you should not even get a suntan. (Yes, that is radiation that you get from the sun.)

There is even the theory that it is cosmic radiation that causes both overall genetic change, aging, and death. In any case we are all subjected to many sources of radiation every day. The question is not whether or not you are going to receive radiation, but how much and how quickly. Let us compare the radiation we are concerned about with another type of radiation. Heat.

Just as we measure radioactivity in roentgens we measure heat in calories. If I were to tell you that that pipe over there was going to put off a million calories of heat, you might say, "Let me get away from it!". But, if I then said that it was going to be over the next million years, at the rate of one calorie per year, you would realize that you were in greater danger of freezing to death than of burning to death if you were depending upon that pipe for heat.

It is not how much heat is going to be given off (it may be a large amount) but how much over what period of time. A mere two hundred calories suddenly inflicted upon one point of the skin would create a bit of a sting, but hundreds of thousands might be comfortably absorbed from a heating pad over an appropriate period of time.

It is the same with radiation. Most isotopes give off their energy so rapidly that they are like flash bulbs. Flash and they are gone. It just happens right in the vicinity of the bomb. Others are like regular light bulbs that give off their light and heat for some period of time before they burn out. They may travel a long way from the bomb as fallout before they dissipate their energy. For these we need a shelter to protect us if we are in their vicinity. Nothing else will do.

Still others are like those small luminescent lights that some people put in their bathrooms for night-lights. Only weaker still. They just sit there and barely glow for a very long period of time.

Little miniature flashlight bulbs or matches are a good analogy to fallout particles. One or two of them in a room with you will not harm you. But surely you can imagine the situation where if you had thousands and thousands the light would either be blinding or the heat so intense that you would be incinerated.

Fallout is just the same way. A few pieces inside a shelter with you will not harm you, but if you go outside where there are millions of the little beasts lying around then you have had it. The only difference between their radiation and the radiation from a little flashlight bulb or a match is that it is invisible radiation that you cannot see or feel - like that from an x-ray machine.

MYTH #14: There would be no dangerous radioactivity after a couple of years.

After having explained all this, now I must tell you that there are some isotopes that unfortunately do not fall into either the short range of initial radiation (which we do not need to worry about because it does not extend out of the blast area), nor the medium range (that you will be protected from by a fallout shelter), nor the very long range (that decays over so many hundreds of years that their energy is too weak to concern us here).

These remaining isotopes are real meanies. There may be solutions to the problems they present but there are no simple solutions. There will not be enough of them around that they will make walking around dangerous for most people but the problem is that they get into the food chain and that they have relatively short half-lives, between five and 30 years.

That means that during the next couple of hundred years they are going to be giving off most of their energy. Fortunately, some of them are rather rare, and given that they are going to be widely dissipated in worldwide fallout we can largely ignore their effects.

Others may be concentrated in certain areas, certain types of soil and certain foods where we can avoid them also.

So they will not be that serious a problem.

You Will Survive Doomsday

Some others, however, particularly Cesium 137 and Strontium 90, present mayor problems in keeping them out of the food chain. Even here, there are available defense techniques. For example lime, gypsum, fertilizer, or organic matter (in practical amounts) may be applied to low calcium soil, or naturally high calcium soil may be used for growing certain crops which have an uptake preference for calcium over strontium.

There are known refining and purification techniques for some foods and milk, and there are some new techniques which I have discussed with some of the researchers at some of the leading nuclear laboratories, but which the world isn't ready to hear about as yet.

These methods along with others such as land denial, deep plowing, surface scraping, and selective utilization, are harsh realities that are going to have to be faced by the long-range survivors.

MYTH #15: You are prepared if you have a two weeks emergency supply of food stored.

More important to the present theme are questions as to what preparations survivors should be making ahead of time. Since it will take a while to get crops growing again because of social disorganization, ozone depletion in the atmosphere, climatic changes, crop adaptation, early crop failures, soil deprivation, and similar factors, survivors will need a couple of year's supply of food. Wheat and honey are the only two basic foods, of which I am aware, that have an indefinite shelf life. Thousand year old kernels found in the pyramids have still sprouted. Fortunately, these two foods, wheat and honey, meet most adult nutrient requirements. Powdered milk will be necessary if one wishes to reduce the infant mortalities. The infants will not survive otherwise, unless their mothers have adequate natural milk, which is unlikely. Salt is important as a preservative, among other purposes.

In addition to storing the four basic survival foods (wheat, honey, powdered milk and salt), it is highly advisable that one also store a couple of year's supply of a variety of (non-hybrid) seeds. Some seeds will not store very well and need to be continually replaced.

It is equally important to develop certain skills. *Gardening skills.* I particularly recommend the area of hydroponics because this would be one way to grow foods free of contamination. *Preserving skills.* Here I recommend learning to dry foods using hot air. Freeze-drying requires too much elaborate and expensive equipment and freezing itself is not reliable when electricity is not reliable. *Preparation skills.* Bread making, use of lentils, and making of many foods, or their substitutes, that today are commonly gotten in prepared form.

On all of these subjects one could write a book. Indeed many books have been written on them. Even if one does not have time to immediately develop all these skills they might do well to get themselves a survival library and then as a next step acquire the essentials in materials listed in checklists in most well organized manuals.

MYTH #16: You should be prepared to be self-sufficient and be able to survive on your own.

The very best thing that a survival minded person can do, after preparing for themselves an equipped place of refuge, and developing their own survival skills, is to associate themselves with other skilled survivalists. No one person can know everything, and almost everyone can contribute something. Agricultural, medical, mechanical, communicator, you name it, all skills will be needed.

Few people could afford the equipment that an organization can have. One well-equipped laboratory for testing for alpha and beta particles in food costs \$5,000. Along with other radiation detection equipment and many other types of emergency supplies, what individual can afford it? Yet no nuclear survival group should be without one.

Even in building a shelter the mayor expense is the entrance and support mechanisms such as emergency lighting, water source, etc. The incremental cost for space for one additional individual is quite small. Thus, the greater the number of people the overall cost can be spread over, the less the average cost.

Moreover, no individual has the personal resources that a group has. If the head of a single family survival group is injured or lost the chances of survival for that group are much reduced. However, if it is a large group then there are numbers of people available to continue to give support. Just like there are numbers of people available to maintain twenty-four hour watches, or to create a well manned convoy to go after necessary supplies. One more prepared and equipped individual added to such a group is an asset, whereas in a situation like a public shelter, one more unprepared and unequipped individual is just another liability.

A successful survival group will have to be either completely homogeneous or thoroughly committed to thoroughgoing tolerance and appreciation of a wide range of individual preferences regarding society, economics, religion, and future expectations. Still, a shelter is not a democratic society anymore than is a ship or an airliner. The captain's authority is absolute and one should have confidence in his credentials and ability before boarding.

Neither is a shelter a democracy in the sense that there must be much more stringent rules regarding behavior. Everyone must perform assigned duties. There are no wealthy passengers along for a
file:///C:/CDROMs/SCDR-2/Prophecykeepers/POST-NUCLEAR-WAR/d_resources/survival/books/doomsday/index.htm (14 of 26) [9/12/2004 4:03:28 PM]

free ride to be served by others. There are many limitations to personal freedoms such as contraband materials. No drugs or alcohol (except under medical prescription and then as approved by the commander).

All firearms and weapons must be placed in the armory and will not be released except under orders from the commander. All valuables will be receipted and stored in the locker for safekeeping. No private stocks of foods because under survival conditions this can lead to social disorder. No tobacco or smoking inside the shelter, since it would cause discomfort to others.

No loud toys, devices, or other objects that would be environmentally disturbing to others. No large bulky items, or great quantities of any item without the permission of the commander. And no pets or animals unless the survival community has made prior special arrangements for their accommodation.

Tough. Yes, It is tough. But not nearly as tough as the conditions of survival will be for those who are not prepared. There are many items that are not prohibited, and in fact are encouraged. A reasonable supply of one's personal religious literature, the tools and resource manuals of their trade or profession, survival manuals and equipment of every sort, additional supplies of food to be put into the common larder, and extra supplies to be put into the common store.

MYTH #17: Any survivors would have to live the rest of their lives underground.

Many people ask how long they might expect to have to live in a shelter. There are no fixed answers. If your shelter is an expedient hole in the ground you might want to stay in it no longer than was absolutely necessary. Maybe as much as a couple of weeks. If you dug a pretty elaborate hole in the ground you might be able to expand upon it and make it into a place where you could survive through a winter.

If you owned space in a shelter city, like there is in southern Utah or southern California, you might plan to live there the rest of your life. The co-operative shelter that I have been describing in the previous paragraphs is not sufficiently elaborate that anyone would want to make it a permanent home. Some persons would probably be able to find larger and more adequate quarters elsewhere after a few weeks.

Others might improve upon the existing structure and remain there for a year or two until more adequate homes could be built elsewhere. Decontamination procedures would provide work areas, schools, and school grounds outside of the shelter where people would carry on their daily activities after a few weeks. However, it might be beneficial for young children and expectant mothers to sleep in the shelter or a similar structure for several months.

Certain occupations, such as decontamination crews, farmers who work on large un-decontaminated areas, explorers who go into unsurveyed areas, long distance truck drivers, and others who go out of well defined areas for the next several years, will have to be closely monitored to be sure their total exposure does not exceed established limits.

It should be apparent to the reader, from what has been said earlier, that a person may receive substantially larger total doses over a large period of time than over a short period of time, just as with sunlight. A person may easily recover from several small sunburns throughout the years, resulting from staying in the sun overlong for an hour or two each time. If they were to be exposed to the hot desert sun, that many hours all at once, they would succumb.

In the same way one may recover from a number of small radiation burns (although some controversy holds that one never recovers - this seems unlikely), and in just the same way one may receive small amounts of radiation and never feel ill. Just the same, certain biological conditions dictate that certain individuals, (particularly the reproductively active) should receive less radiation exposure and that others may receive much larger amounts.

MYTH #18: Life after doomsday won't be worth living.

Hearing descriptions of this sort some persons wonder if life will be worth living afterwards. For some, most assuredly so. Others do not find life worth living today. How many times have you heard of a person like a famous movie star, who had wealth, fame, beauty, health, the company of famous illustrious persons, opportunities to travel to all sorts of places, and to participate in all sorts of interesting events, the fulfillment of the very aspirations of thousands of young ambitious people and yet that same person committed suicide.

On the other hand there are many individuals who suffer daily from terrible physical afflictions and all sorts of personal misfortunes. Oftentimes in the greatest poverty. And yet, the world over, down through the centuries, they have gone on surviving. Many actually finding happiness, meaning, and perhaps even enlightenment in life. You will survive. The conditions of that survival are up to you.

Undoubtedly, the events that are about to transpire will have a profound effect upon the attitudes of many people and perhaps upon mankind itself. From the cauldron of the holocaust there may spring forth a new race of men who are less concerned with self-interest and who will come to understand man's true nature and his divine destiny.

Some of us may even feel that this event will herald the coming to maturity of the human race. Instead of no future, mankind may have a glorious future. There will be great amounts of resources available, combined with man's great advances in technology, to build a new and glorious world civilization. Providing, of course, that he has learned from this experience and does not just go about preparing for the next war in another twenty to thirty years.

But, I leave each man unto his own vision. While, to myself, looking upon the immensity of the visible universe, and pondering the events that have happened upon this one single planet circling a solitary sun among the uncountable millions in our but one of the innumerable galaxies, I cannot help but wonder if the events that are about to transpire are not less than all that unique in the repetitive cycles of life and nature that we see about us everywhere.

MYTH #19: You need not make any preparation because you are either going to die in the holocaust or be saved (religious connotation).

Men's philosophies today often go to one extreme or the other. Claiming that all is within man's power. Or that nothing is within man's power. There is a middle ground. One can simultaneously feel that nothing can be achieved except by the will of God and think that the results are dependent upon his own efforts. God sets the boundaries and within those boundaries man can have some effect upon the outcome.

MYTH #20: The bombs today are so large and there are so many they will destroy the world.

There are those who feel that the holocaust will destroy everything. And well it might, for there are certainly more than enough nuclear weapons in the world to achieve that end. "Except those days be shortened, none will survive, not even the very elect." But, if it is the Divine Will, those days will be shortened. There are those of us who feel that the Divine Hand is evidenced in the dealings of the world, every moment unto every moment.

The Divine happenings often seem quite natural. If one were to say unto a mountain, "Be thou removed and cast into the sea." and it should occur, another would say an earthquake just happened to happen right then. If the forces of nature should transpire so that in the midst of the holocaust the planet should suddenly tip on its side and place His sign (the Southern Cross) suddenly blazing in the sky above the heads of the people in the northern hemisphere, there are those who would only recognize the natural causes.

Such an event would certainly play heck with the astral, satellite based, and inertial, guidance systems upon which the individual and MIRVed warhead delivery systems depend.

Events would not even have to be as miraculous as I have described in order to limit World War III. There is serious concern on the part of the military that they will not even be able to fight the war because of such factors as the EMP. However, I have faith in the military. I am sure they will do an admirable job of trying to destroy the world.

None of us have an infallible insight into the future or its timetable. Whatever will be, will be. We can but wait upon events to prove our speculations to be right or wrong. While we are working and waiting some of us put our trust in God. Others put it in the Government.

MYTH #21: You will receive adequate warning from your government.

The government at first proposed the individual family shelter plan. Then it abandoned it. Next it proposed the community shelter plan. Then it abandoned it. Then it proposed the relocation plan. Then it abandoned it. Presently it has no plan. Don't you feel abandoned?

The government has millions to spend for destruction but not a penny for defense. The EMO (Emergency Measures Organization) has been completely shut down. The Ontario government was allocated three berths in the Radiological Defense Officers course (for the summer of 1982) given by the Canadian Emergency Measures College at the Emergency Planning Canada Federal Study Center in Amprior, Ontario, but it didn't feel it could afford to send anyone even after our group offered to pay expenses for three people. We appealed all the way up to the Solicitor General's office.

Admittedly, I am authorized to teach the course but during the last course that I taught at one of the community colleges (free gratis) I could not even get any resource personnel to come from

Camp Borden, who are responsible for administering the examinations. I feel abandoned. A radiological detection kit that I used to be able to get for sixty dollars, in the US, now costs in Canada, with import duties (they really want you to have one), federal and provincial taxes, exchange rate, custom's brokerage, and you name it, \$450. Who cares?

The last Radiological Scientific Officers Course taught in Canada was in 1977. No future courses are planned. There are no communities with a nuclear defense plan. I think I can make that an unqualified statement.

Millions for destruction and not a penny for defense. Your family's destruction bill for this year is \$1,300 per member of your family. Do you realize what \$1,000 a year for the last ten years would have bought you in the way of nuclear survival defense? Instead, your government has bought you destruction. Your family's destruction.

Oh, I am well aware of the argument that that pile of bombs has maintained peace in the world for the last ten years, and the belief that it will continue to maintain peace. Believe it if you want to. All the high government officials have their shelters. Why do they need them if you don't? [Author's update note: Curiously, even the government's shelters for civil authorities have now been closed].

If the government knew today that the Russians were going to attack next week, do you think they would tell you? If they did, what would you and the millions like you do? It would only create panic and get in their way. No, I do not think that you would be told. Do you feel abandoned?

MYTH #22: You will receive no warning, and there is no hope if you do.

The fact the government may not warn you, and is not giving you any assistance to defend yourself does not mean that you haven't been warned. There are many people who feel they can see the *signs of the times*. Anyway, if you have read this document, consider yourself warned. You may still have time to prepare. If an attack should occur you probably do not live in a primary target area and will have plenty of time to escape. If you have made preparation.

MYTH #23: One of the primary targets will be nuclear power plants.

Many persons come up with all sorts of rationalizations as to why they should not prepare for survival. One is that there is a sufficient number of weapons in the world, that if they were all used, they could destroy the whole of mankind. This is true.

However, it may be that all the weapons will not be used. Some may be destroyed by the other side. Some may misfire. Others may just fail to get launched. This is why each side has so many extra. Moreover, many persons make the mistake of assuming that it is all in man's hands and determined by man's will. Whatever. It may be that some limited amount of the potential for destruction will be used.

Another rationalization often heard is that the person feels they live in a target area such as in the vicinity of a nuclear generating plant. In actuality the Russians have little need to target the nuclear generating plants and probably can do more damage by not doing so. A bomb on the plant would just blow it to smithereens and the material in the plant might add little to the radioactive fallout. On the other hand, as a result of the EMP, if the plant is left on its own when it loses its computer control it will go into a meltdown and add substantial radioactive material to the atmosphere.

All of this is quite speculative, of course. There are no experts on nuclear war. There is no one living who has been through one. There is general agreement that it will be awfully terrible. It will probably take six or seven months just to bury the bodies. But, there will probably be someone around to it.

Useful Figures and Tables

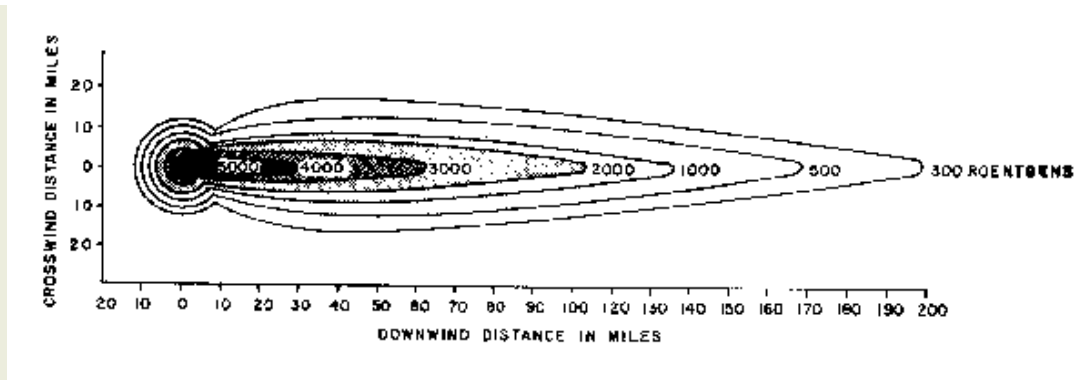

This was the fallout pattern 36 hours after a single 15-megaton thermonuclear device (the Bravo shot of Operation Castle at Bikini Atoll - March 1, 1954) was detonated. The eventual extension of the fallout was more than 20 miles upwind and over 320 miles downwind. The width in cross section was variable, the maximum being over 60 miles. This means there was substantial fallout contamination over an area of more than 7000 square miles.

It is important to note that persons anywhere downwind would not have had to travel more than 40 miles in a direction crosswind to be perfectly safe. Secondly, assuming upperwinds of 150 miles per hour and descent times of 30 minutes, persons 150 to 200 miles away would have over an hour in which to either evacuate the area or to take shelter.

As noted from the chart on [the effects of radiation on humans](#), the 300 roentgens per hour would cause serious illness with some fatalities after an exposure of 1 hour and exposure of 2 hours would certainly cause a hard death occurring in hours to days.

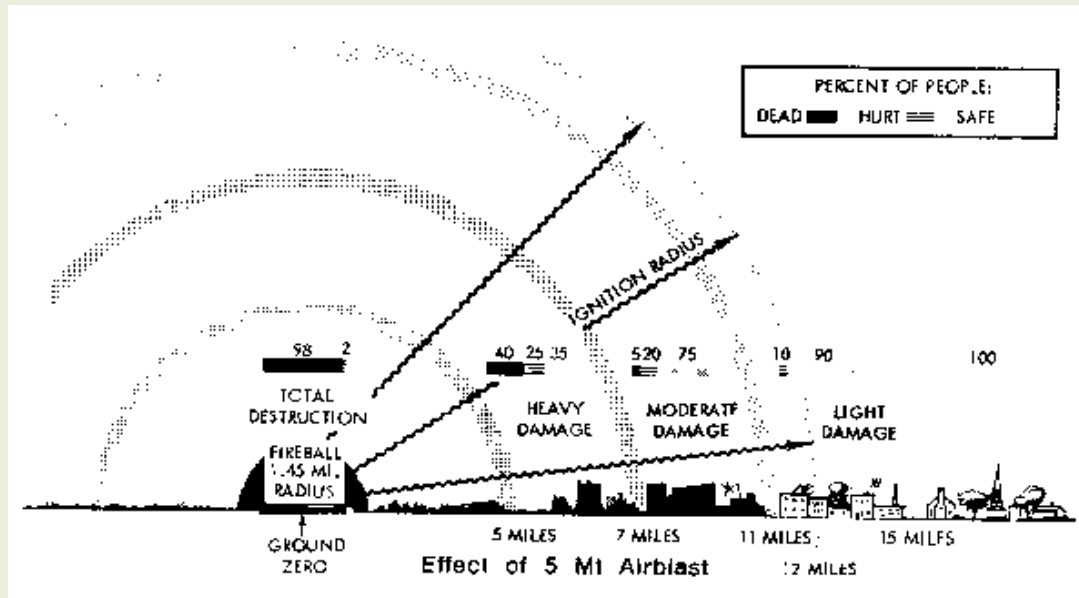

This picture shows the effect of a 5-megaton airblast. While much larger weapons have been developed experimentally their use is unlikely. For one thing they are too hard to deliver and, more importantly, with a 20-megaton weapon we do only about one third the damage that will be caused by 4 five-megaton weapons. 5 to 8 megatons will probably be the average size of the strategic weapons. They will probably be detonated at some altitude around 2000 feet for maximum effect. At 15 to 18 miles on a clear day exposed people will be blistered, and from 18 to 23 miles they will be sunburned.

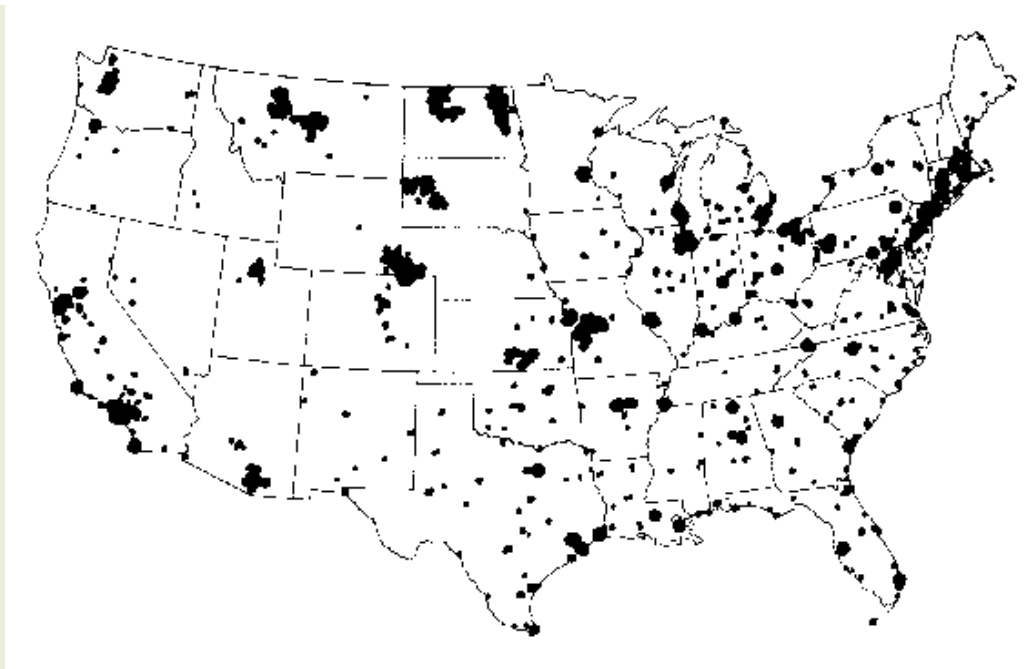

This map shows the principal targets in the US. Major airports, military installations, and railway passes would be targets in Canada. The number two target in North America is North Bay, Ontario.

In an all out nuclear exchange (WW III), with a multiplicity of devices being detonated over a relative short period of time (three days to two weeks is a common estimate), there would most likely be wide spread areas with general radiation levels (in the 5 to 20 roentgen per hour range) over 1000 miles down wind from the blast sites, two to three days after zero hour.

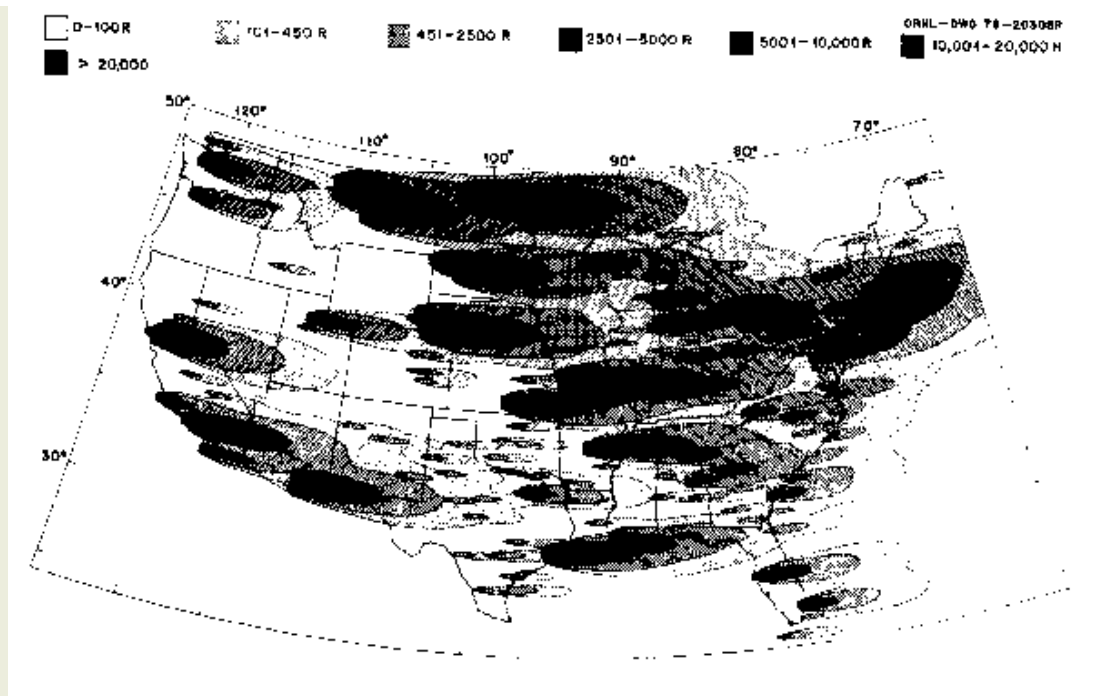

This map indicates the amount of radiation that a person would receive in various areas by remaining in the open for 14 days following the bombing of targets indicated in the map above. It is important to note from the map that even if Canada were not bombed that Ontario would receive 101 to 450 roentgens from the MinuteMan sites in Montana and the Dakotas.

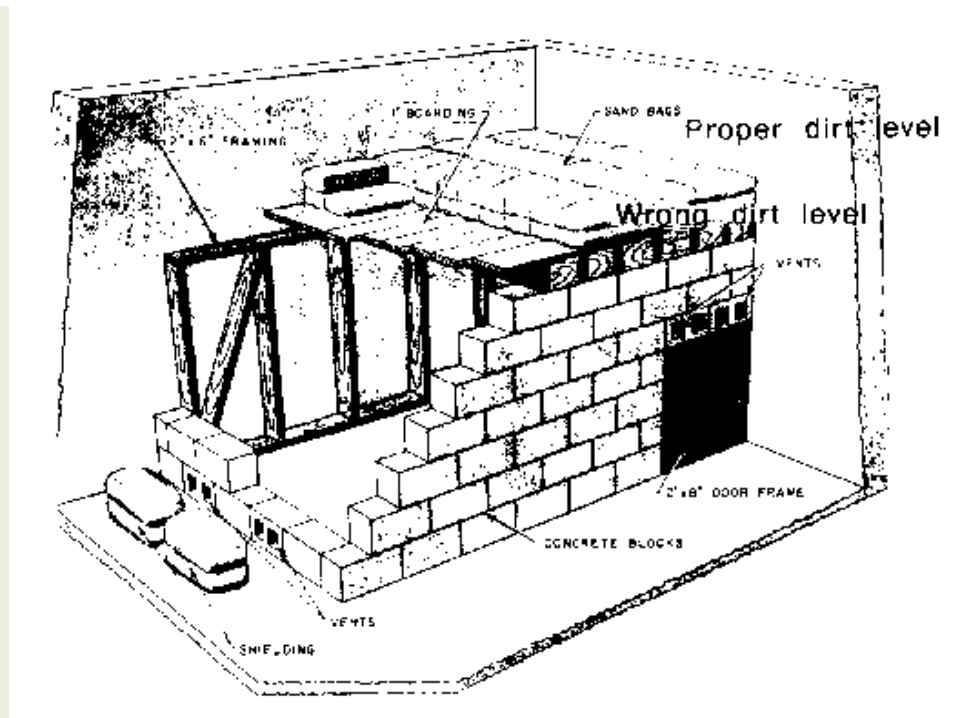

The effect of a mere 10 roentgens per hour (arriving two or three days after a detonation and thus having already lost much of its rapid decay) would cause serious illness after one day's exposure, and (even with continued decay) would cause certain death within a couple of weeks. However, almost any expedient shelter would greatly minimize the effects.

The basement shelter shown here could mean the difference between life and death. As much care as possible should be taken to make sure the shelter roof is below outside ground level. Otherwise, radiation will come in at an angle through the narrow basement wall, as demonstrated.

Seven/Ten Rule

1 hour	-----	1000	roentgens/hour
7 hours	-----	100	roentgens/hour
49 hours (2 days)	-----	10	roentgens/hour
2 weeks	-----	1	roentgens/hour
14 weeks	-----	0.1	roentgens/hour
98 weeks (2 1/2 years)	---	0.01	roentgens/hour

This chart indicates that if one started off with one thousand roentgens of radiation per hour at zero plus 1 hour, that it would take 2 weeks for the radiation to get down to 1 roentgen per hour.

Since death would be almost certain after exposure for even 1/2 hr (see accompanying chart) it is apparent that shelter would be necessary.

The important thing to remember about the seven/ten rule is that it is only theoretical, and that actual decay may follow a different slope. Secondly, in order to use it, one must know the exact time of detonation for the weapon causing the fallout. And thirdly, it is only applicable for calculating the fallout from one weapon, and not for multiple sources.

The SHELTER

Built on the highest point in Ontario.

Available for inspection by seriously interested candidates for its Preparedness Community.

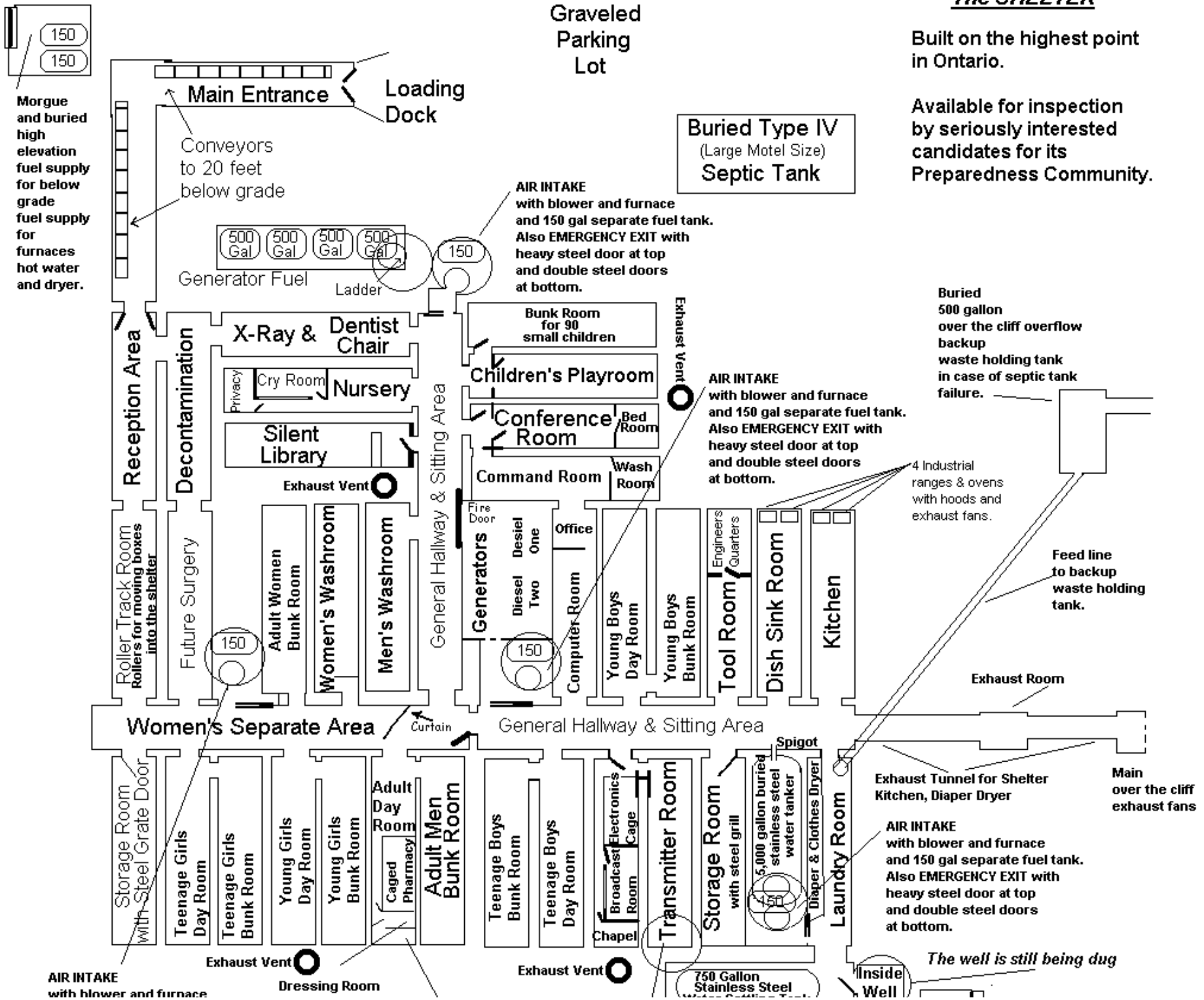

Buried Type IV (Large Motel Size) Septic Tank

Buried 500 gallon over the cliff overflow backup waste holding tank in case of septic tank failure.

Morgue and buried high elevation fuel supply for below grade fuel supply for furnaces hot water and dryer.

AIR INTAKE with blower and furnace and 150 gal separate fuel tank. Also EMERGENCY EXIT with heavy steel door at top and double steel doors at bottom.

AIR INTAKE with blower and furnace and 150 gal separate fuel tank. Also EMERGENCY EXIT with heavy steel door at top and double steel doors at bottom.

4 Industrial ranges & ovens with hoods and exhaust fans.

Feed line to backup waste holding tank.

Exhaust Room

Main over the cliff exhaust fans

Exhaust Tunnel for Shelter Kitchen, Diaper Dryer

AIR INTAKE with blower and furnace and 150 gal separate fuel tank. Also EMERGENCY EXIT with heavy steel door at top and double steel doors at bottom.

The well is still being dug

AIR INTAKE with blower and furnace

Dressing Room

Exhaust Vent

750 Gallon Stainless Steel

Inside Well

and 150 gal separate fuel tank. Also EMERGENCY EXIT with heavy steel door at top and double steel doors at bottom.

and pump room for Immersion Tank

SENSORY DEPRIVATION Immersion Tank
Kept at body temperature and saline level so that person won't sink. Individual placed in tank with classical music will sleep and overcome cabin fever.

Surface Hatch to Below Ground Balloon Launch Room for Antenna Balloon. Access from Transmitter Room to Shelter is through double steel doors.

150 150
Completely external buried bunker gasoline supply.

The secondary exit tunnel is still under construction. New improvements are constantly being made on the shelter.

General Information:

The shelter was designed under the guidance of a number of licensed engineers. It was also inspected by numbers of government agencies, particularly the Federal Government shelter inspection group who said it was the finest shelter they had seen.

There are many, many features to the shelter that cannot be described here because it would too greatly clutter the drawing.

The shelter contains extensive alternative methods of moving air, fighting fire hazards, providing lighting, internal and external communication, and every other conceivably necessary requirement.

For example, it has a great amount of radiological monitoring equipment.

Ramp Exit

Steel door Secondary Exit

Steel door and Grill to be installed at this level

The shelter is built out of extra strength concrete and is heavily reinforced throughout with steel. It far exceeds maximum recommendations both as to radiological and blast protection.

[Author's update note: The above is a map of the underground shelter actually built 90 miles northwest of Toronto. Anyone interested in joining the survival community where it is located should email the author for photos of the existing shelter.]

Examples of the Effects of Radiation on Humans

Roentgens per hour	Duration of exposure	Total dosage of radiation received	Number that will die	Deaths will occur in
5-10	2- 5 hours	10- 50R	none	
50	1- 4 hours	50- 200R	less than 5%	60 or more days
100	2- 4 hours	200- 400R	less than 50%	30 to 60 days
100	4- 6 hours	400- 600R	more than 50%	about one month
100	6-10 hours	600-1000R	all	less than two weeks
200 plus	3 hours plus	600R plus	all	the more intense the radiation the shorter the time before death
1.0	1 week	150R	none	
0.3	1 month	200R	none	
0.1	4 months	300R	none	
1.5	1 week	250R	5%	3 months
0.5	1 month	350R	5%	6 months

You Will Survive Doomsday

0.2	4 months	500R	5%	9-18 months
2.7	1 week	450R	50%	1-3 months
0.8	1 month	600R	50%	2-6 months

Example of the Effect of Shielding

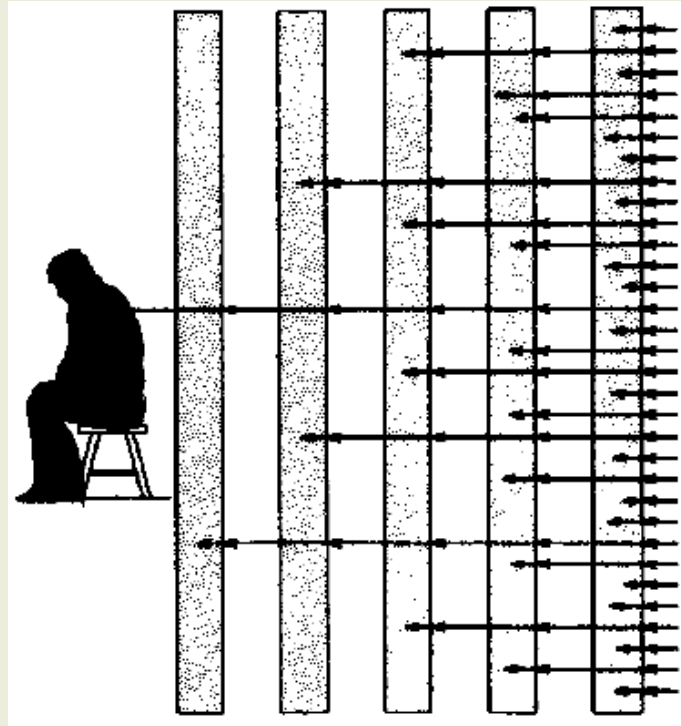

Any material can be used for shielding against radiation. Even feathers. There is nothing magical about lead. It is only the density of the material that matters. A pound of lead and a pound of feathers weigh exactly the same. But it takes a much bigger stack of feathers than it does of lead to make a pound.

Neither feathers nor lead are generally particularly cheap to obtain, so it is usually better to use some other material like dirt or concrete. The more dirt or concrete in the barrier, the greater the protection. Since concrete is more dense (heavier) it only takes about 24 inches of concrete to give the same protection as 36 inches of dirt.

Thirty-six inches (three feet) of dirt will give good protection. Five feet of dirt will give better.

Nuclear Survival Groups

There are probably 12 nuclear survival groups in the city of Toronto. I personally know of four and I have heard of three or four others. (There may be some overlap. I can't be certain.) My guess is that there are another three or four I don't know about. Most such groups are very secretive, for various reasons. Three of the groups are headed up by instructors, like myself, who teach survival courses at the community colleges.

[Author's 1998 update note: The author was maintaining a listing of survival communities in North America].

[Authors October 2002 update note: The list had grown to several hundred intentional communities and survival groups in North America when as a result of consensus of opinion he ceased to

publish it because of government and social attitudes. People on the list were asking to be removed because of fear of repercussions. Waco had occurred his own Ark Two Community had been raided without warrant by 7 police vehicles, including a K-9 unit plus 4 fire vehicles. A total of over 40 personnel as was shown on the National News.]

Most of the groups contain a number of very well trained and experienced people. There are also many other groups scattered around both the US and Canada. They have their own training bases and survival courses. There is a magazine, Survive, where you can learn about some of these groups.

What is a Radiological Defense Officer?

Both in the Canada and the United States the Federal Governments have trained certain individuals to be advisors to mayors and other public officials in time of nuclear disaster. In Canada these individuals are called Radiological Defense Officers.

Certain Radiological Defense Officers have received additional training, so as to become qualified to teach Radiological Defense Officers. These individuals are designated as being Radiological Scientific Officers. The supposed requirement for becoming a Radiological Defense Officer is a Ph.D. in physics, but because of a lack of candidates, individuals with lesser qualifications have been selected.

About the Author

The author of this document built twenty-three fallout shelters in Kansas and Utah in the 1960's. He completed the US Office of Civil Defense course in 1970 after moving to Canada and then the Radiological Defense Officer's course at Arnprior, Ontario in 1976, and the Radiological Scientific Officer's course in 1977.

While in the USAF, he was a control tower operator and graduated as Honor Student from the AACS supply school. Because of this training he was asked to inspect the Titan missile sites after his honorable discharge. He refused because of his understanding of what the missiles could do to mankind. He has been a member of various anti-war groups and his personal motto is "Bell the Cat and Ban the Bomb", but he thinks it is now too late to do either.

His master's degree is in Economics from Texas Christian University, and he holds certificates in both data processing and information technology, the latter from MIT. [He has also written and edited several books in the field of computer science].

Prior to becoming a college teacher of computer science he was a telephony engineer and holds both US and Canadian patents.

He presently devotes a large amount of his time to the nuclear survival group mentioned in this document.

Bibliography

[Author's update note: The two books that I used to most highly recommend were]:

- [Life After Doomsday](#) by *Dr. Bruce D. Clayton*; click on the title of this book to order it from Amazon.com.
- [Nuclear War Survival Skills](#) by *Cresson H. Kearny*; click on the title of this book to order it from Amazon.com.

[Author's 1998 update note: While those two books are still very valuable, and it is a good idea to read more than one author's ideas on the same subject, still there is a new book about which I am quite enthused. This book is the most recent book of which I am aware and it gives some new and updated information. From the source, presentation, and approach of the book it somewhat makes me think that its writing may have been commissioned or supported by the Mormon Church, but (which is not a negative but) whatever its source it is excellent.]

The book is "Nuclear Defense Issues",
by " Paul Seyfried and Sharon Packer of Utah Shelter Systems".

You can order in on the net from:

[Utah Shelter Systems](#)

or by mail (for \$25) from:

Utah Shelter Systems
P.O. Box 638
Heber, Utah 84032-0638
U.S.A.

[Author's update note as of January 1st, 2002: I am now quite enthused about a still newer book.

The book is "No Such Thing as Doomsday",
by "Philip L. Hoag".

You can order it by mail (for \$25) from:

Yellowstone River Publishing
P.O. Box 206
Emigrant, MT 59027
USA
406-333-4707
USA 800-585-5077

MENU: [HOME](#) » [SURVIVAL](#) » [Index of States](#)

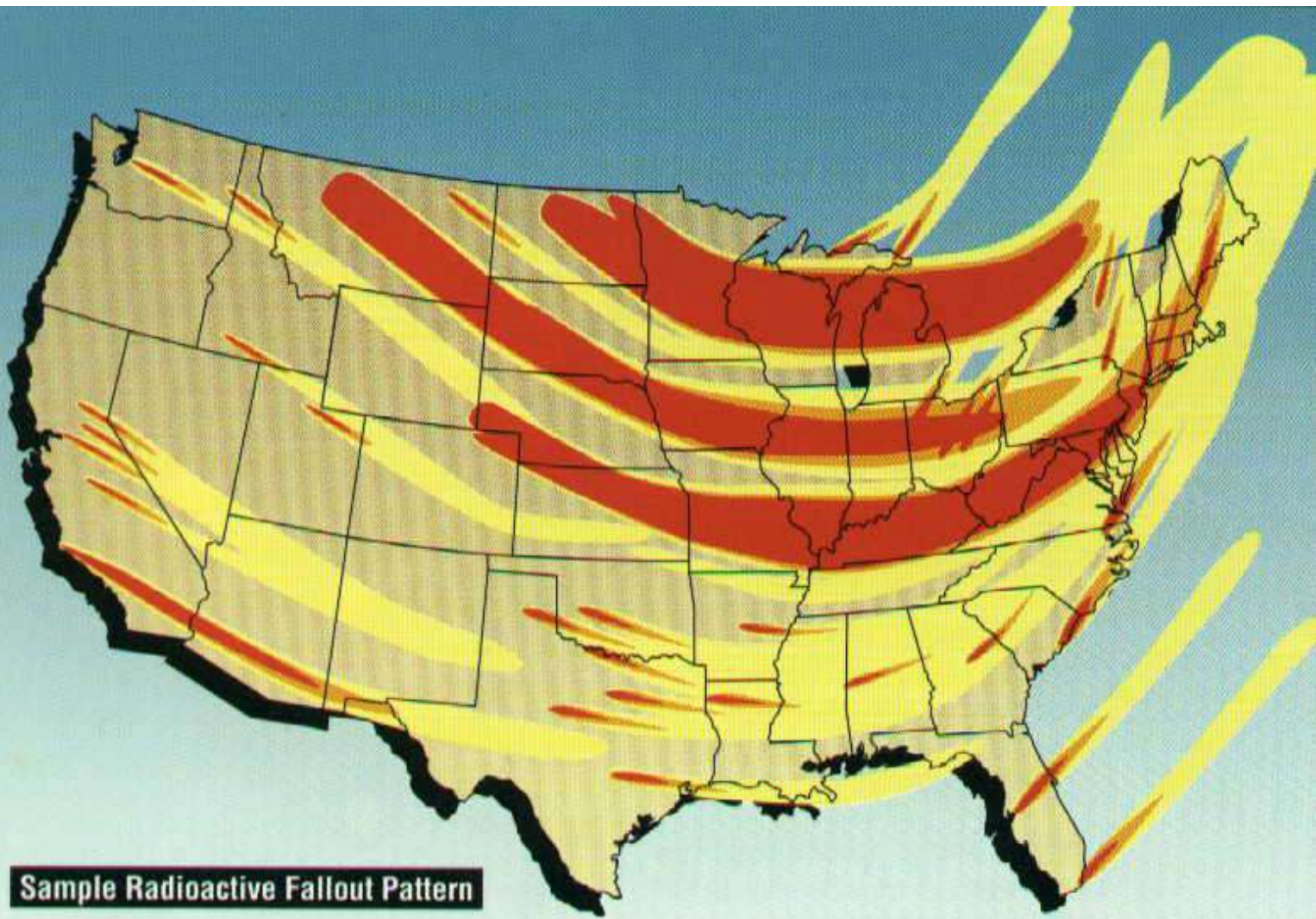

Source: FEMA

MENU: [HOME](#) » [SURVIVAL](#) » [Index of States](#)

The Ark Two Community

The Ark Two Community is the largest pluralistic survival community in North America without any political, religious, or cultural bias. Its purpose is to ameliorate the catastrophe of a nuclear war and to help restore civilization. Inquiries from all are invited. Write an email to:

survival@webpal.org

The Ark Two Refuge Facility

The Ark Two Community in Canada has a 10,000 sq/ft nuclear shelter as part of its refuge facility. This may be the largest Privately Constructed nuclear fallout shelter in the world. 42 buses were used as forms to pour a minimum of 12 inches of high strength concrete that was heavily reinforced with rebar. A minimum of 5 feet to a maximum of 14 feet of earth was pushed back overtop.

Go to:

[PICTURES](#)

for a tour of the complex.

The Ark Two Community is founded and commanded by a government trained and certified Radiological Scientific Officer.

Anyone is welcome to join the Ark Two Survival Community (located in Ontario, Canada) - so long as they do so before the catastrophe occurs. There is no charge for membership nor any restriction other than one be tolerant of the other members. However, it is only practical to be a member if one makes arrangement to live within about 20 miles because it would not otherwise likely be possible to get to the Ark at the time of catastrophe.

The purpose of the Ark Two Survival Community is to ameliorate the effects of a Nuclear War and to help reorganize society afterwards. The community founder believes that a nuclear war is inevitable and therefore in 1980 built the first phase of the Ark Two Refuge and has since expanded it and prepared many ways to assist survivors - as listed on this web site.

The project has not been favorably received by the local and provincial governments. By 1990, when I stopped counting, it had been subject to over 30 court and commission appearances and the

number has greatly increased in the last few years. Legal costs have mounted to hundreds of thousands of dollars. In 1999 there was a raid without warrants involving 7 police vehicles, 4 fire units and over 40 personnel and a K-9 unit, coincidentally caught on video tape by the CBC. Subsequently the facility was hounded with repeated government inspections. Some of the inspectors candidly admitted that it was just harassment, but because of wanting to keep their jobs they of course were not going to put that into writing. It is for this reason that one might refer to the facility as Waco North. A kinder, gentler Canadian version in that The Ark doesn't have any weapons and in that so far no one has been killed by the raiders.

The general public views the project as being operated by an eccentric (in the most favorable terms) or by a nut-case in what is the more usual expressed attitude. For the forty years in which I have built over two dozen shelters and have consulted on many dozens of others, the general ridicule has been extensive, to say the least. "Why do it then?", I have often been asked. Why not get a life, enjoy life and quit worrying about doomsday? The answer is that I don't see the purpose of life, nor happiness in life measured in how many rounds of golf I might play, but rather in service to my fellowman. While I don't have any "visions" or hear any "voices" this appears to me to be the service to which I have been called.

MENU: [HOME](#) » [SURVIVAL](#) » [Index of States](#)

MENU: [HOME](#) » [SURVIVAL](#) » [Index of States](#)

Pictures and Information About
The Ark Two Facility

[MAP of the actual interior of the shelter](#)

[Artist's concept of the interior of the shelter](#)

[MAP to the location of the Refuge Facility](#)

[Interior Photos of the shelter](#)

[Exterior Photos of the Refuge Facility](#)

[Construction Photos of the shelter](#)

[Ark Two Community Life](#)

MENU: [HOME](#) » [SURVIVAL](#) » [Index of States](#)

The SHELTER

Built on the highest point in Ontario.

Available for inspection by seriously interested candidates for its Preparedness Community.

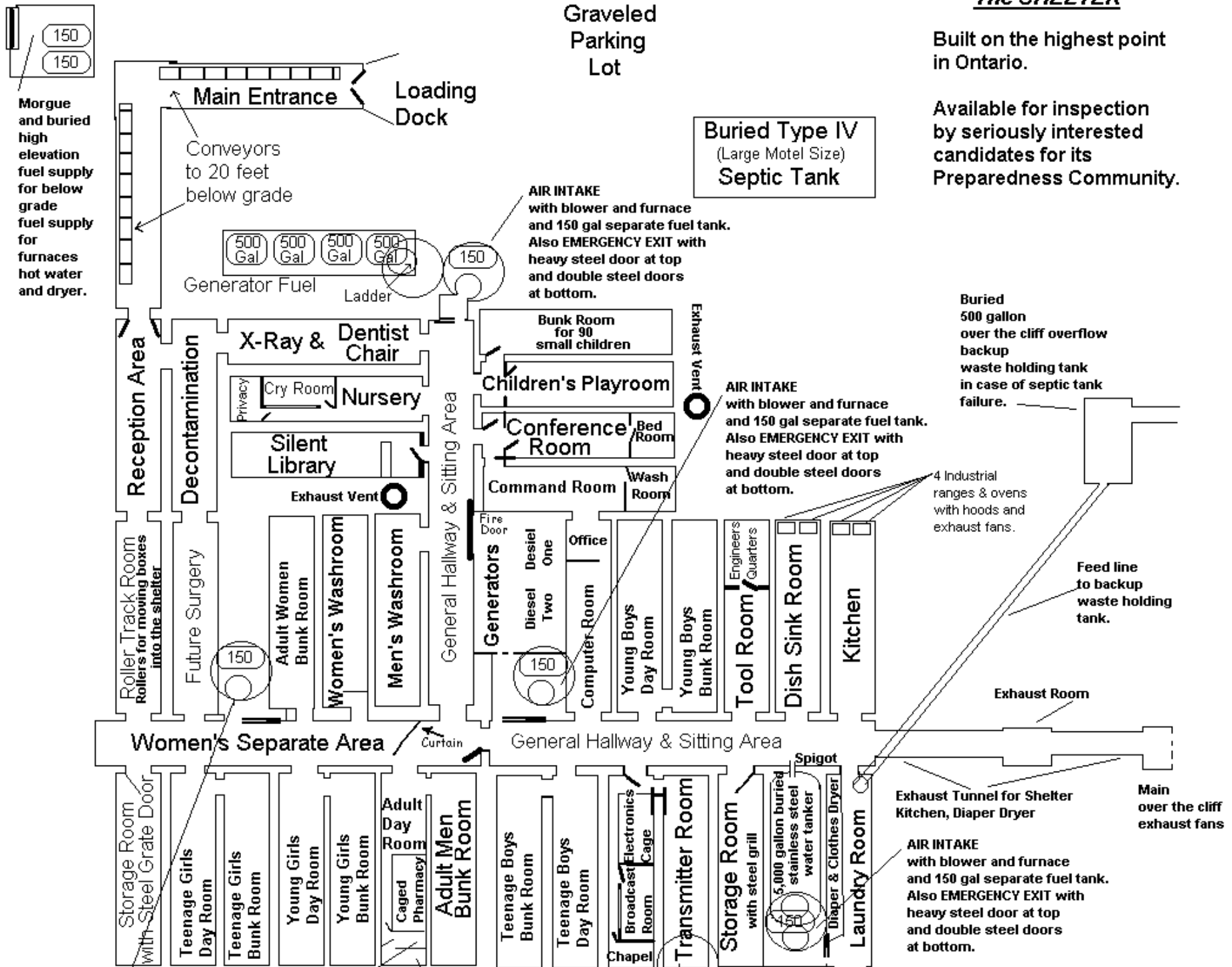

AIR INTAKE
with blower and furnace
and 150 gal separate fuel tank.
Also **EMERGENCY EXIT** with
heavy steel door at top
and double steel doors
at bottom.

Exhaust Vent

Dressing Room
and pump room
for Immersion Tank

Exhaust Vent

SENSORY DEPRIVATION
Immersion Tank
Kept at body temperature
and saline level
so that person won't sink.
Individual placed in tank
with classical music
will sleep and overcome
cabin fever.

Surface Hatch
to Below Ground
Balloon Launch Room
for Antenna Balloon.
Access from
Transmitter Room
to Shelter is through
double steel doors.

750 Gallon
Stainless Steel
Water Settling Tank

Inside
Well

The well is still being dug

150
150

Completely external
buried bunker
gasoline supply.

*The secondary exit tunnel
is still under construction.*

*New improvements are
constantly being made on
the shelter.*

Steel door
and Grill
to be installed
at this level

The shelter is built out of
extra strength concrete and
is heavily reinforced throughout
with steel. It far exceeds
maximum recommendations
both as to radiological and
blast protection.

Ramp
Exit

Steel door
Secondary
Exit

General Information:

The shelter was designed under the guidance of a number of licensed engineers. It was also inspected by numbers of government agencies, particularly the Federal Government shelter inspection group who said it was the finest shelter they had seen.

There are many, many features to the shelter that cannot be described here because it would too greatly clutter the drawing.

The shelter contains extensive alternative methods of moving air, fighting fire hazards, providing lighting, internal and external communication, and every other conceivably necessary requirement.

For example, it has a great amount of radiological monitoring equipment.

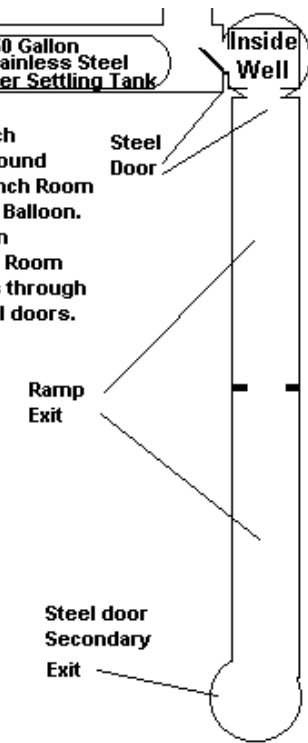

A LOOK AT WHAT'S INSIDE

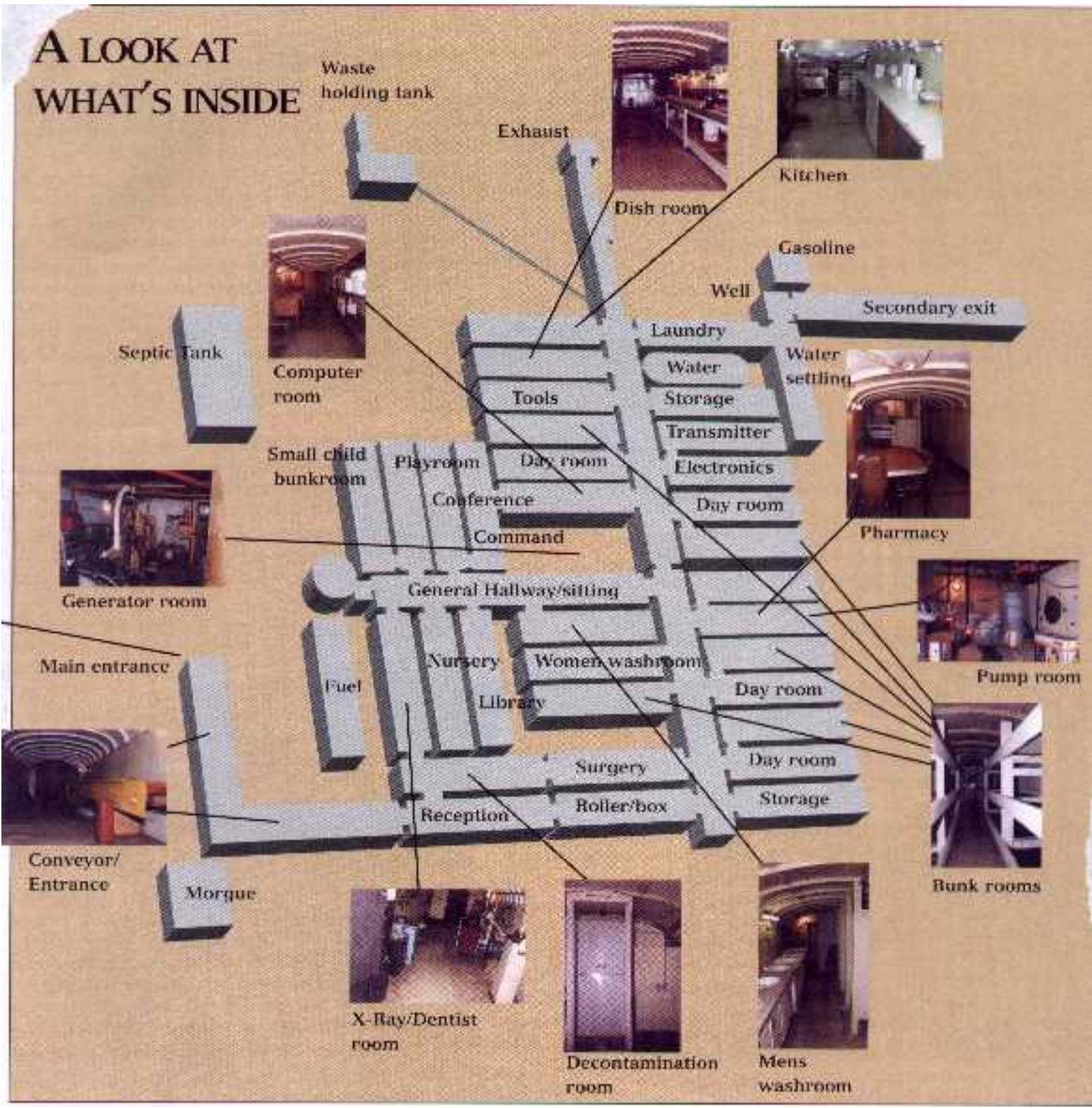

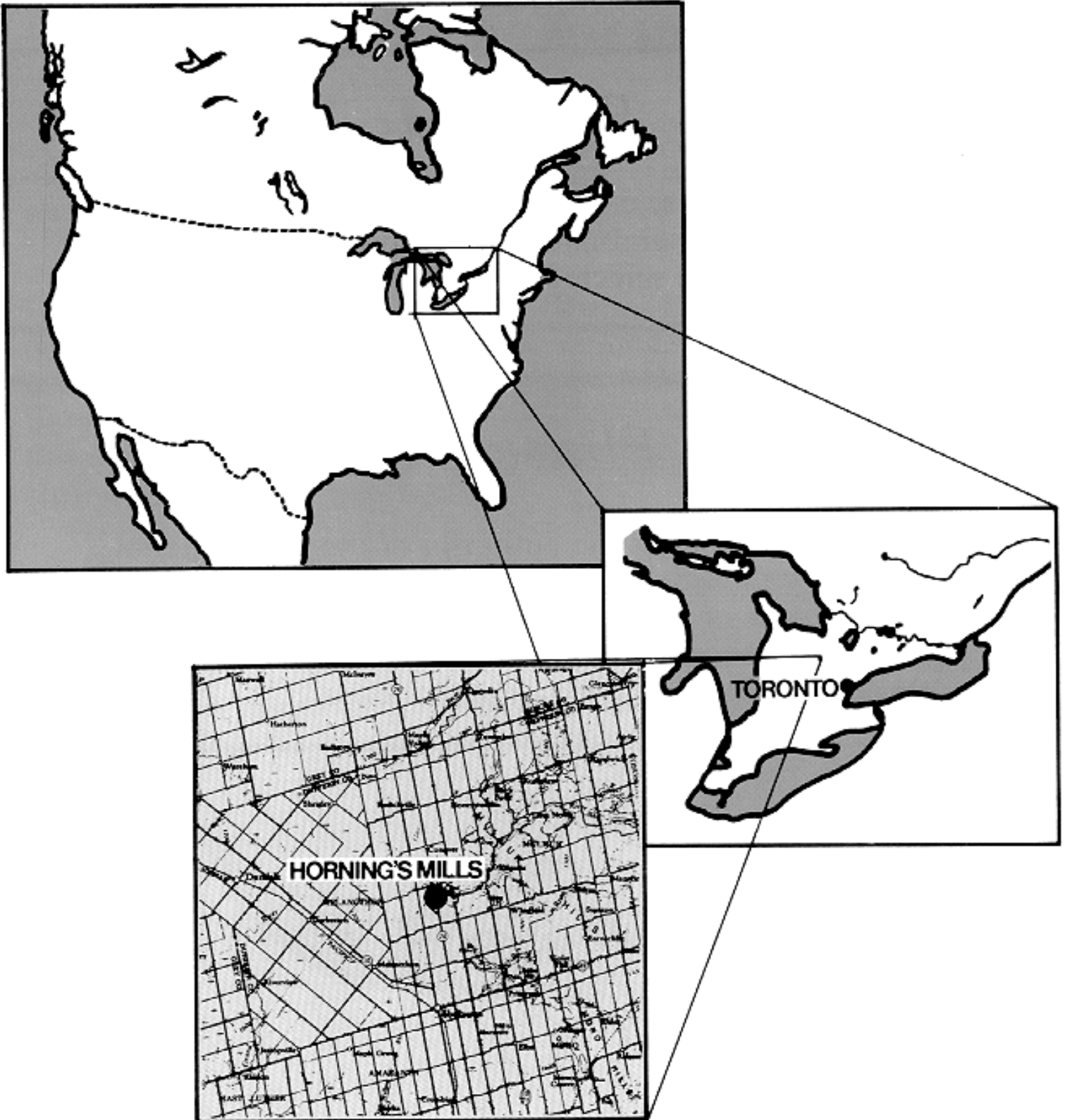

Photos of the Inside of the Ark II Shelter

Pictures of the inside of the shelter can be seen by clicking on the links below. If you have not already looked at photos of the outside, and the *map of the inside*, you may wish to look at them first for orientation.

Many, many times I have been asked - "When will the shelter be finished and ready?" I guess the answer is that, like Disney World, it will never be finished because there is always more that one can do. On the other hand it has been "ready" since 1980. At that time there were only four buses and there was no generator or pump. We brought the water in, in stainless steel milk pails and for lights we used twelve volt car batteries. Toilets were pails with garbage bags, and we would have had to sleep on the floor in sleeping bags. Still we had all the requirements for a survival shelter as listed in the government publications.

Over the years we added water pumps and generators, flush toilets and bunks. Lighting, heating, and dozens of other amenities besides lots of additional space, security and other functionality. I think what people really mean when they look at it and ask the question is, "When are you going to put up the curtains and put around the lace doilies?" Admittedly, twenty thousand dollars of painting and new tile on the floor would make it look a lot better, but then we always think of another purpose of funds that will increase functionality and which would take precedence over cosmetic appearance. Consequently, given the opportunity to spend another twenty thousand on the shelter - there is probably something else we would do, rather than make it look better.

Inside the Main Entrance

Inside the main entrance beyond the loading area there is a heavy steel grate door and electric conveyors that go down two levels.

[The Top Conveyor](#)

There is quite a bit more slope to the floor than is obvious from the photo. The conveyors can operate either direction - to take things into or out of the shelter. They are powered by powerful 220 motors.

[The Bottom Conveyor](#)

At the bottom of the second electric conveyor, which can be seen through the doorway, there is lighter steel grate which can be seen on the left, and another lighter steel entrance door which can be seen on the right.

[The Decontamination Room](#)

The first room inside the shelter is the decontamination room. It contains a shower, a stainless steel double sink and table for decontaminating such things as vegetables, and a full-size bathtub with shower head for decontaminating children and incapacitated individuals.

The Generator Room

[The two big diesel generators inside the facility](#)

There are two large diesel generators that supply the facility. There is on-site a three month fuel storage capacity for the generators. The main generator, in the foreground, was replaced in 1999 with a new 75KW.

Either of the diesel generators will more than completely supply the facility's needs. The yellow Caterpillar back up generator is started by a hand-pull pup engine.

There is also an external 5KW emergency gasoline generator that can actually light the whole shelter or run fire fans for emergency movement of air. Other electrical supply resources are being developed.

Great advances have been made, in the last five years, regarding inverter technology and the power generation system is currently being rennovated to take advantage of these advances.

[Main Generator being installed.](#)

The above picture is of one of the main generators being lifted in during the construction phase gives you some idea of their size.

[Main Power Distribution Panel](#)

Here we see the main power distribution panel. It includes feeds from the outside - which we have presently disconnected, and EMP protection. Below the panel is the tunnel to the main exhaust system.

Air Intake and Distribution

We have, in addition to the powerful exhaust fans, two portable large fire fans with air tubes that can be used to move air rapidly from any one place in the shelter to another. In point of fact, natural air flow seems to be adequate to supply the shelter, but we have made a variety of alternative provisions.

[Air Intake and Blower Bike](#)

This is one of the alternative provisions for moving air. We have stockpiled a number of bikes and blowers, and we have installed throughout the shelter venting systems to which they can be attached. Next to this blower bike there is one of the large air intakes. It can be opened with just the heavy grill, or closed altogether with the steel door.

The Bunk Rooms and Day Rooms

There are seven bunk rooms and six day rooms. (The adults share their day room but the women have a separate section in the facility where they can gather).

The children's bunk room for smaller children has capacity for over 90 children. In addition to this, there is a nursery, and play room.

[Photo of A Bunk Room](#)

Bunk room occupancy is separated by sex and age. People would of course prefer to be housed by families and each person have their own private bed that they could use at any time. However, in order to get the number of people into the shelter that the government standard says that a shelter this size is supposed to shelter, we have to do this in this manner. Each of the seven bunk rooms has 24 bunks. These are shared on three shifts by adults, and 2 shifts by children.

Each day room and bunk room suite is given the name of an animal so that children can remember which is their's, or their siblings.

The suite names are:

- A (Antelope - Adult Women)
- B (Bulls - Adult Men)
- C (Cats - (or Kittens - Young Girls)
- D (Deer - Teenage Girls)

- E (Elk - Teenage Boys)
- F (Frogs - Young Boys)
- G (Gerbels - Very young children)

[Photo of A Day Room](#)

In each of the day rooms there is storage for one's personal belongings. Each person gets a cubicle (a little square space as shown) in which to keep their toothbrush, towel, change of underwear and so forth. The size of the day room as seen in the picture is probably deceptive, and in reality it is twice as large as it appears here.

Wash Rooms

There are of course separate men's and women's washrooms. There is also a laundry room with a large diaper drying facility for babies diapers.

[Photo of Toilet Stalls](#)

There are rods to hold modesty curtains, but the curtains are not in place. Vandals broke the watertanks on the toilets. But that turned out to be a favor. The Health Department wanted us to replace them with low flush toilets - but in retrospect that would still not have been satisfactory. When the generators are off and we are working on low level lighting then the pressure pump will lose its pressure. We will have lots of water, but we will need to carry it in buckets to flush the toilets. By not having water tanks on the toilets this keeps people from emptying the pressure tank and also allows us to better control how often the toilets are flushed so that we don't overflow the waste holding tank before the next power-on pumping time.

[Photo of Men's Washbasins](#)

In the women's washroom there are also children's level wash basins. There were mirrors above the washbasins, but vandals broke them and they have not yet been replaced. Over the years, vandals broke in dozens of times and stole or did about \$15,000 worth of damage. Each time we strengthened the security of where they broke in and it has now been several years since any have gotten in (although there have been signs that many have tried). Curiously the police and local government considered us to be the criminals, because we had made an "attractive nuisance" that attracted the vandals. They have severely punished us for this. The vandals around here, even if caught - are not punished.

[Water Heater](#)

There are a number of hot water tanks located around the facility and there are two alternative ways of heating water, just as there are alternative ways of obtaining water, moving, heating and cooling air,

getting rid of waste disposal and so forth. Details about all the facility's systems are just too voluminous to include them all.

[Alternate Water Heater](#)

This is one of the alternative ways of heating water. It is a circulating tank that is suspended from the ceiling and is attached to a heater plenum. How much actual water heating we will be able to do other than for food and drink, is somewhat questionable. It is highly unlikely that people will be able to take long hot showers.

Water Supply

This is a good spot to discuss the shelter water supply. We are very blessed in having a river and a number of springs on the property. In years past we used a water ram from one of the springs. A water ram is a mechanical way of pumping water uphill by using the force of the water itself. We have presently dismantled the RAM and brought it inside along with a brand new much larger one that we have never installed as yet. The problem was that the ram was outside where it could be tampered with, but as of the summer of 2000 we now have an inside well and do not have to rely upon the rams. Later (afterwards), if there is no electricity, we can re-install the water rams.

[Photo of the Well during construction](#)

On the "construction page" I tell about the miracle of the well. You can read the story there if you like but here I will just explain a bit about the well itself. Water is one of the most essential features of a survival facility. Especially one that might have 500 or a thousand occupants, and we have a sufficient supply to handle that number of people.

[The Three Pumps for the Pressure and Storage System](#)

This picture shows the heart of the water pressure and storage system. The two lower pumps are both one horsepower pumps that together can pump better than 15 gallons per minute. We can refill the top half of our settling tank (the big 500 gallon stainless steel white tank that you can just see the end of on the right), in about 15 minutes, and then turn back off the generators. (We also have a back up hand winch and bucket).

The third pump (on the ceiling and at the very top right in the picture) fills both the big 5,000 gallon stainless steel milk tanker - (told about in a following picture) and pressurizes the vertical tank below it, from the settling tank.

In the year 2,000 when we completed the well we were, for the first time in many years, now able to keep both tanks full. (Years ago we used to fill them with a ram pump, but it was a very slow process). The

well is also what makes it feasible for us to now install a Fire Sprinkler System.

[Steel Steps Into the Well Area](#)

These are the steel steps that go out over the well and into the tunnel leading out the back of the shelter.

[The hand operated bucket winch for the Well](#)

Here we can see down through the steps over the well, the hand winch system which is used to pull water up by the bucket from the well, if all else fails. Every system, water, electric, waste disposal, air movement, and so forth, has several backup systems to it so that if all else fails, then there is a simple hand mechanical system that will permit survival.

[Milk Tanker](#)

Behind the spigots and the wall that I am leaning on, there is a 5,000 gallon stainless steel Milk Tanker, like the ones you see going down the highway. Nope, we don't store milk in it, although milk is admittedly important if infants are going to survive. (For that purpose we do have stored substantial quantities of powdered milk, although we would like to have still more stored). Nope, the Milk Tanker stores water as another backup. Water that we occasionally replace, but intentionally never use. When the water gets half way down in the main settling tank - then we intend to turn on the pumps and refill that tank - so the milk tanker (which is also filled by the same pumps) always stays full and is never touched.

Both of the water tanks are higher than the rest of the shelter and therefore will feed water to anywhere in the shelter by gravity feed. We now have a hose, attached to the spigot that I am pointing at, that will reach anywhere in the shelter. Likewise there is a hose attached to the pressure pump system, in case we have power when we wish to deliver water to some remote location.

[Fire Stations](#)

In addition to the garden hoses, when the shelter is occupied we will maintain throughout shelter manned fire stations which will have buckets of water, sand and fire extinguishers. There is really very little threat of fire, but because fire in a shelter like in an airplane or on a submarine, would be so calamitous (because one would have nowhere to go and could not leave the facility) we take extensive safety precautions.

Kitchens

[Photo of Kitchen](#)

There are actually two kitchens. The ovens shown in both of them have been removed. The ovens shown

were industrial size and had been equipped with new elements. However, it has been decided that they would be an inefficient use of energy, and therefore fuel, and so consequently they have been removed with plans to replace them with a more efficient system.

[Photo of Sink Room](#)

The second kitchen is primarily used as a sink room for doing the dishes.

There are also two locked rooms with grate doors for the storage food, besides other bulk food storage areas. The community has developed and is continuously implementing extensive plans for the storage and production of adequate food supplies.

Other Rooms in the Shelter

There are MANY other rooms in the shelter. While the pictures included here give one a flavor of the shelter environment, you must really study the shelter map to get an idea of its immensity. It is so large that maps are posted throughout the shelter to tell one where they are and how to find their way to another location.

[The caged electronic Repair room](#)

Adjacent to the caged electronic repair room is the transmitter room. We used to have four large transmitters (each about the size of a refrigerator) in the room, but after 15 years they became obsolete and we removed them a couple of years ago and have not yet replaced them.

Behind the repair cage, and down the hallway beside it, there is a glassed-in broadcast room, and behind that a chapel.

[Pharmacy](#)

The pharmacy is another caged area in the shelter.

[Computer Room](#)

Like many of the rooms in the shelter, the computer room currently consists of only desks and chairs. We hope to move-in at the last minute, computers and many other types of equipment (such as microwaves, tools, supplies and so forth). In the past, many types of equipment that we have stored have deteriorated because of the prolonged exposure to underground humidity.

[Dental Room](#)

The dental room has been a prime example of the problem of maintaining systems in the shelter. Vandals broke the X-ray (we have a replacement in storage) and humidity has caused considerable rust on the chair. We have left the chair in place because it is so heavy to move and we feel that we will be able to clean it up once we activate the shelter, .

Some of the many interesting rooms, for which photos have not been included, are:

- The Surgery (as yet still unequipped)
- The Laundry room
- The Silent Library (books are in offsite storage)
- The Conference Room
- The Tool Room
- The Chapel
- The Exercise Areas
- A Privacy Room
- The Nursery and its Cry Room

and numbers of still others as you will see on the map.

MENU: [HOME](#) » [SURVIVAL](#) » [Index of States](#)









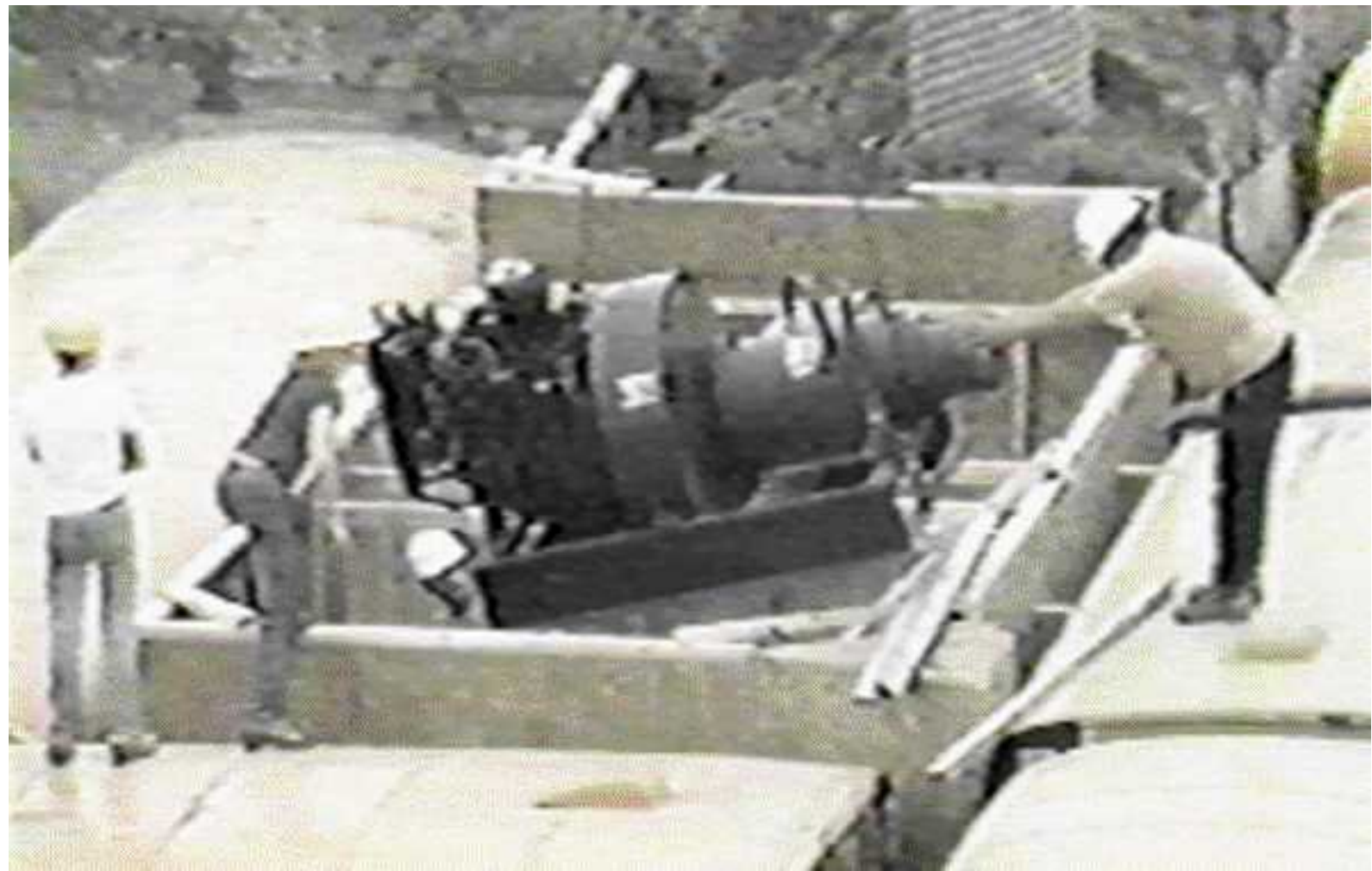











**The Men's Washroom
& Showers**



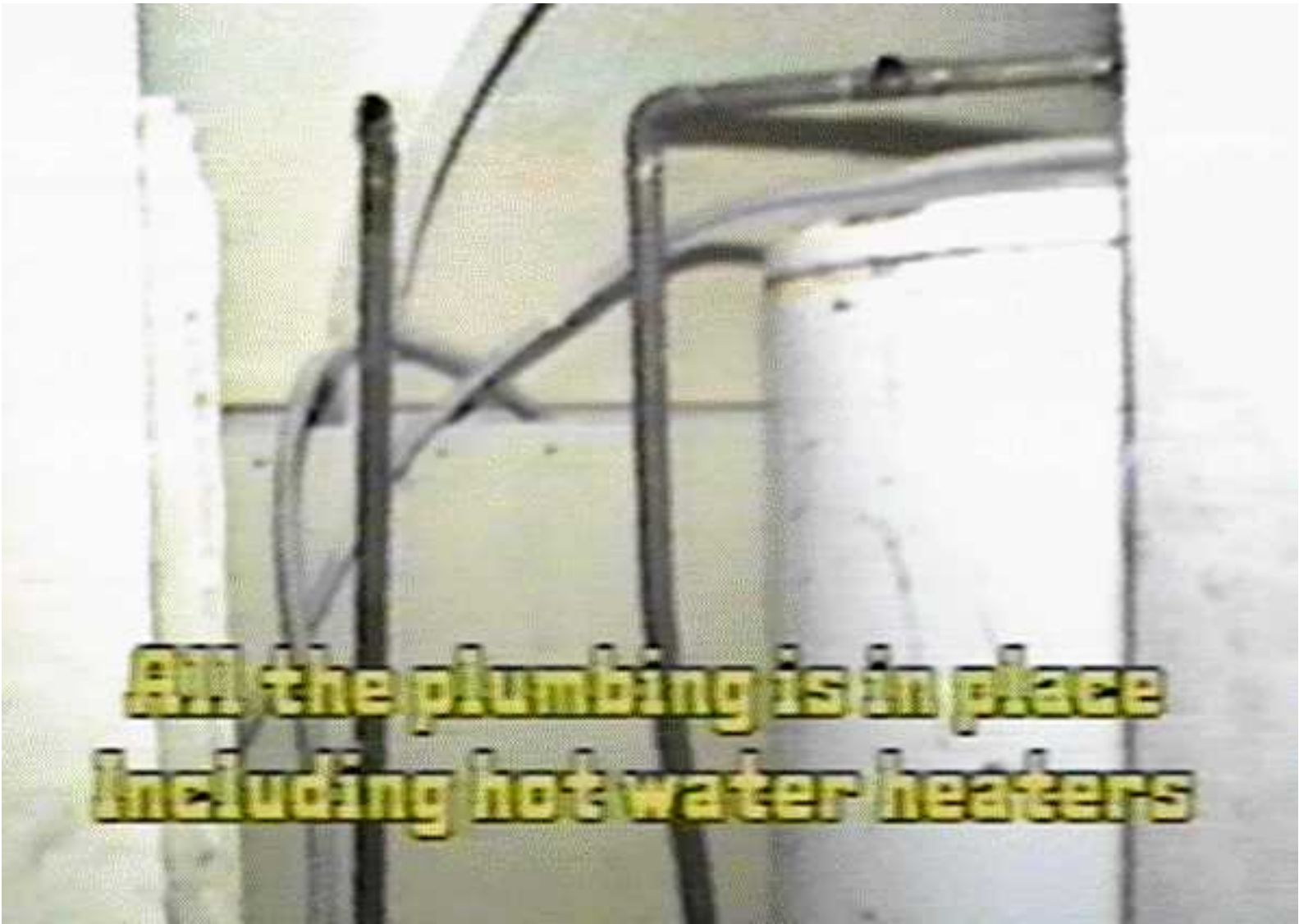

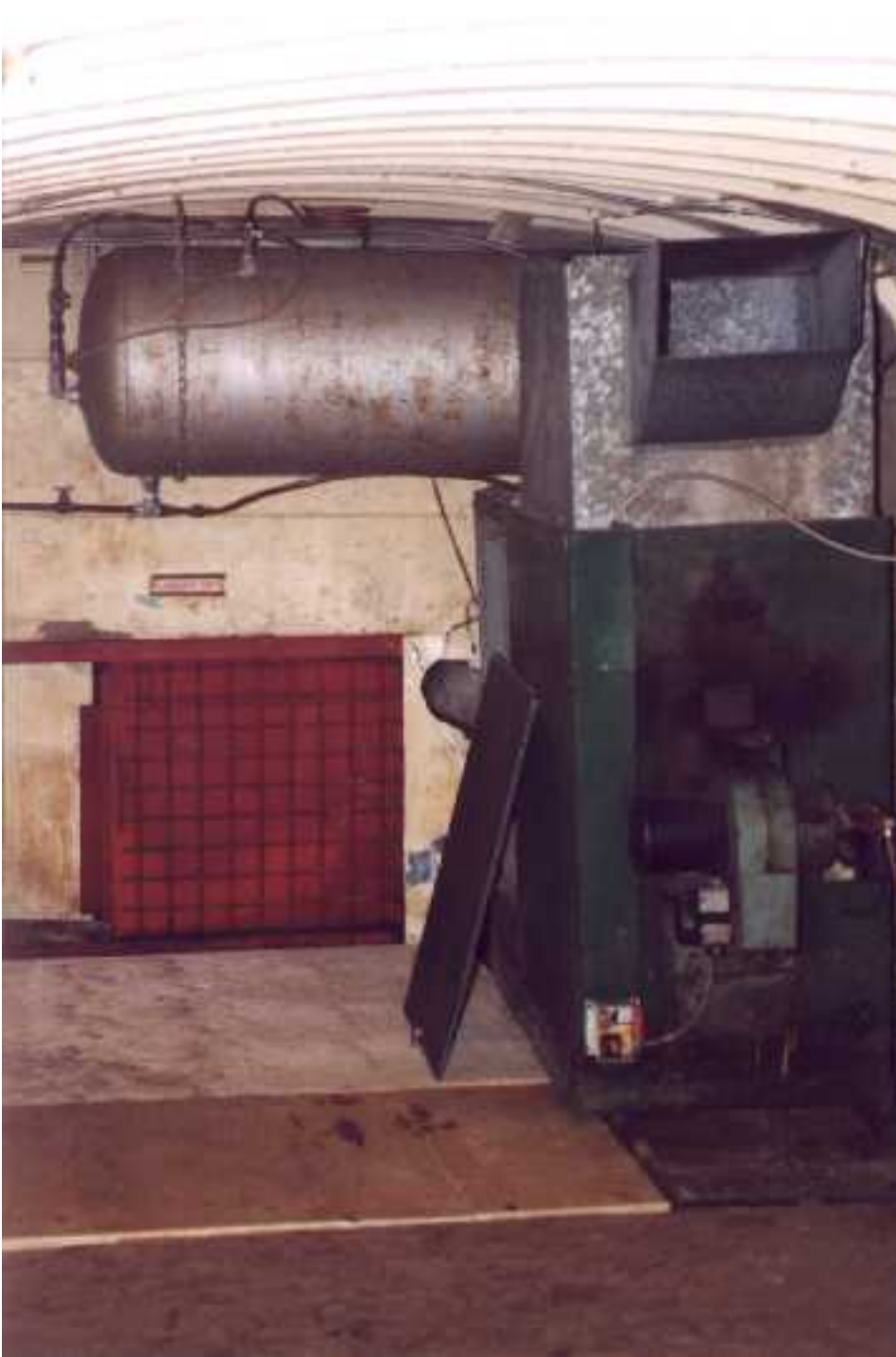

























April 25, 2001

Outside Views of

Ark II



The Front Gate

From the front gate gate of the property one cannot actually see the shelter area, (or even the second tall gate) although a new tall tower and some tall fence posts at one end of the property are now visible over the berm."



Front Gate Lock

This is only the first locked gate that one has to go through, to reach the shelter.



The Road In

This picture of the road in was taken last summer. It becomes impassable during snow storms unless we use snow removal equipment, and then it takes about an hour and a half to clear it and the parking lot.



Outside the Tall Gate

This is the second gate that one passes through in approaching the shelter. The fence is ten feet high, but the gate is much higher in order to allow semi-trucks to pass through.



The Tall Gate from Inside

This is another view of the tall gate from the parking lot inside. In the background you can see the berm that conceals the shelter from the road.



Bike Supply

This is the five-speed bike supply that we maintain in front of the shelter. These can be taken inside later to do such things as drive blowers that we store inside the shelter. They can also be used for other purposes such as running the wheat mill or even to generate low level lighting. There are numbers of other stockpiles around the shelter. Such as fuel bunkers, woodpiles, lumber and steel storage, and so forth. Bikes for transportation are kept in another storage location.



Main Entrance from the Parking Lot

This is the front entrance (which is also actually the loading dock) from the parking lot. In the background you can see a couple of the air-intake towers.



HEAVY STEEL Double Locked Front Door

We have no explosives in the shelter but several persons who have been in the explosive business have likened the shelter to the security of an explosive bunker. Before we put up the high fence, vandals used to damage the lock by putting glue in it although they have not gotten the door open since we put two locks on it several years ago, and now with the lock protector and the high fence about the property, it is even more difficult to get into.

The individual door is actually set inside a pair of wide opening steel doors for bringing in supplies and putting them on the conveyor from the loading dock. Inside these steel doors there is a heavy iron gate, and beyond that before entering the shelter, another steel door. One has to go through two steel doors to gain entrance to the shelter from any entrance or air shaft.

All the external doors open outward, at the insistence of the Fire Marshal, except for the loading dock doors. This latter is so that the occupants cannot be blocked in from the outside, although there are also other escape routes.



The Back Entrance

The back entrance to the shelter is heavily bermed about as protection from a possible but improbable target fifteen or twenty air miles away. The door itself faces away from the target. The shelter is theoretically designed to survive a mile and a half outside the crater of a nuclear weapon. A theory that I hope we don't have to test even at fifteen or twenty miles.



Inside the Back Door

From inside the back door you can see the two separated steel doors at this entrance and the steel steps between them leading down to the tunnel going into the shelter.



The Steel Tunnel from the Backdoor

Once past the two steel doors at the back, there is a steel tunnel (with more slope than the photo appears to indicate) leading down to another set of steel steps that go on down into the shelter. The front entrance was made wheelchair accessible at the Fire Marshal's insistence but the back entrance consists of steel steps and the four emergency exits through the air-intakes have steel ladders.



Hilltop View of the Compound

Looking down from a higher hill on the property one can see the entire compound. The prominent features in addition to the entrances are the surrounding 10ft high fence with its front and back gates, along with the tanks over the airshafts. The whole compound stands above a very high ravine.



Main Powered Exhaust

Although there are many others, the main powered exhaust for the shelter exhausts out over the ravine. Natural air flow might seem to be to pull cool air in from the ravine and to exhaust warmed air out the top, but because we are dealing with fallout we want to pull the air in from as high above ground level as possible, and exhaust it out at the lower level.



Looking down from the exhaust fans

The camera fails once again to give an appreciation of the depth, because the river is actually about 150 feet down from standing on the exhaust fan cabinet, from which this picture was taken.

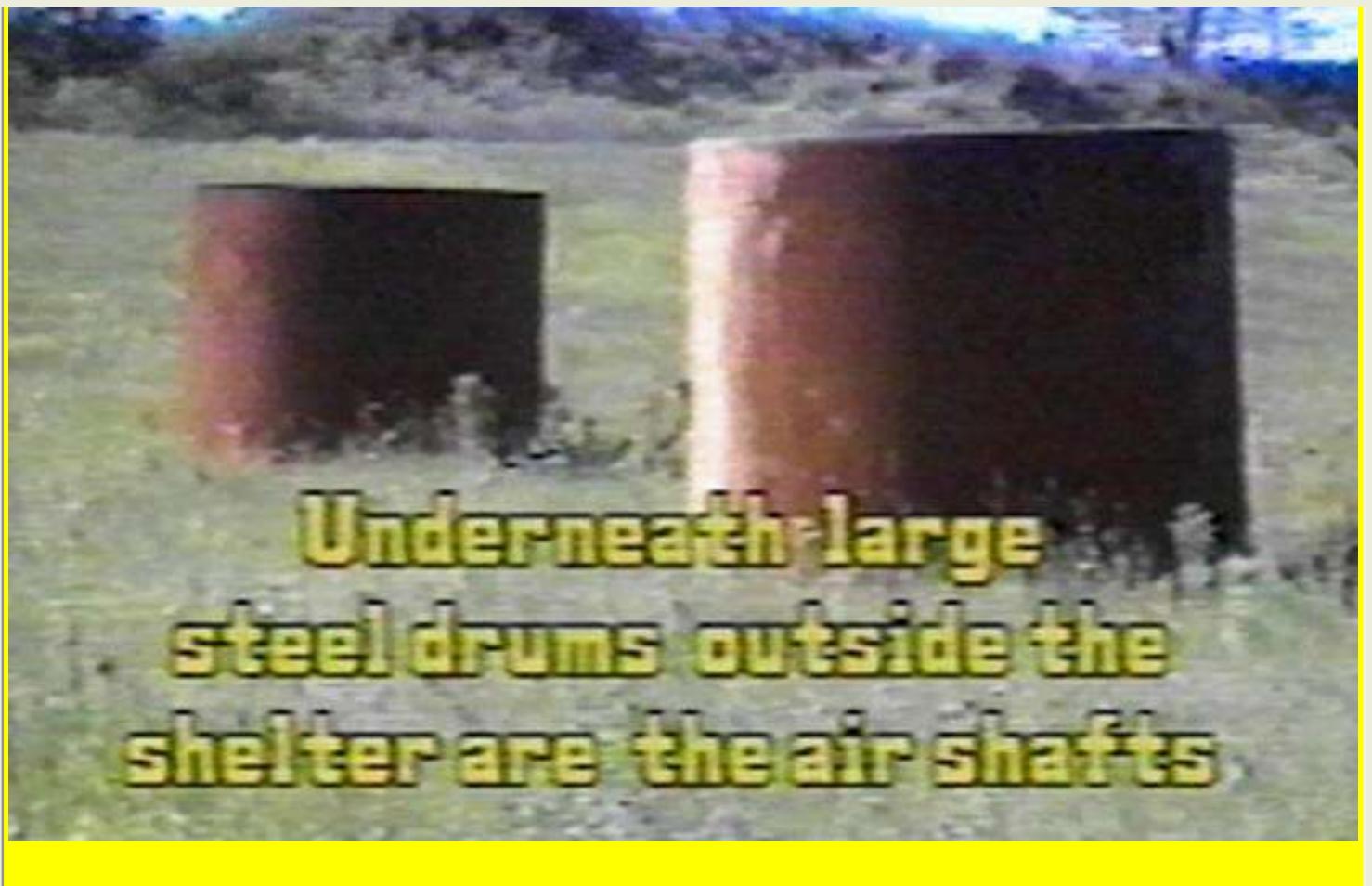

Generator Room Air Shaft Tower

The air shaft housings are taller than a person and 8 feet in diameter. The air actually enters through a heavily screened pipe which faces down on the side. In this way, fallout will not fall into it. An actual air intake pipe is most easily seen on the air shaft tank in the background of the photo of the front entrance.



Air Shaft Tower

Inside each of the airshafts towers there is a vertical shaft that has in it a steel ladder.





Inside the Generator Room Air Shaft Tower

All the air shafts towers are pretty much alike. This is the one for the generator room with its door open.



Inside the Generator Room Air Shaft

Through the open door of the generator room air shaft tower, one can see an additional small (5KW) gasoline powered generator that is maintained OUTSIDE the shelter. The reason for this is that if there should be an emergency involving the main generator room, then we can provide power to air fans. This generator may be moved to any of the air shafts where it may be required.

The large fuel tank seen through the doorway was removed on the Fire Marshal's orders.

Adjacent to this Air Shaft is a highly insulated and muffled exhaust for the main generators down in the shelter. It is so quiet that one can stand right next to it and carry on a conversation in a normal tone of voice.



One of a number of typical exhaust vents.

There are a number of exhaust vents located around the shelter. Each of the vents have a cover and a protective barrier around them (because we have otherwise often damaged them driving over them with a tractor or truck).



Locks on the exhaust vents

All the exhaust vent caps are locked on. Like anything else, with enough time and effort they could be broken into. However, even if one were to hacksaw off the lock, there is no access to the shelter through the air exhausts. At the bottom of the one foot diameter pipe there are usually five inch pipes that run off a distance of five feet to the shelter.



Road Beside Small Fuel Bunker #2

The road has actually been graveled since this shot was taken last summer.



Entrance on Small Fuel Bunker #2

This is the entrance way to a small fuel bunker. There is NO access from the fuel bunker to the shelter.



Door on Small Fuel Bunker #2



Entrance on Small Fuel Bunker #3

This is the entrance way to another small fuel bunker. Again there is NO access from the fuel bunker to the shelter. This fuel bunker actually doubles as a morgue, and the main fuel bunker as a brig.



Observation Tower

At both corners of the compound there is an observation tower that is higher than the fence and which gives a view down both fence lines and to the opposite observation tower and the perimeter access roads. The Fire Marshal has requested that we provide outside storage for certain materials presently in the shelter, and for this reason we have had to build the pictured facility, and are in the process of moving the materials to it. Both this structure, and the fence have actually been built at the Fire Marshal's request but since we were having to build them we have sought to make them useful.



The fence was ordered by the Fire Marshal simply for the purpose of keeping vandals out, with the concern of protecting the vandals. Many improvements about the shelter have been at the Fire Marshal's insistence, such as the large tanks over the air vent escape hatches (to keep them free from snow) and the additional entrance/exit at the back of the shelter. While the total expense has been very large and we had not included them in our original design we are nevertheless pleased with these additional improvements.

It has been an interesting challenge to build the Ark, but as you can see - so far I have survived it.

MENU: [HOME](#) » [SURVIVAL](#) » [Index of States](#)

Photos of Construction

For **free** consultation on how to build your own shelter (and other **free** nuclear survival information) by the only non-governmental RSO (Radiological Scientific Officer) in Canada [CLICK HERE](#).

Construction

Our reason for going into such detail about the construction of our shelter is not just to show how large and strong it is but to let others benefit from our experience.

This was the 24th shelter that the designer has personally built. He has used in other shelters almost every material and method imaginable. Wood structure and sandbags, gunite, corrugated metal, steel construction, steel tanks, concrete forms, and concrete block. The best method found to date has been the use of school buses as forms.

Mind you, one learns from experience, and there are still many things that would be done differently another time around. Mistakes had to be corrected - that now with the experience could be avoided. Still, all in all, the assessment of the Federal Government shelter inspectors who came from Ottawa to view the shelter that, "This is the best shelter that we have ever seen!", seems to be accurate.

[A GREAT DEEP HOLE](#)

To begin the facility, we first dug a DEEP hole. How deep the hole was, you can get an idea by looking at the road the concrete truck has to go up in the above picture. All the shelter lies below the truck and the big pile of dirt behind the truck is a very small part of the fill from the hole that was pushed back over the shelter.

[A MOUNTAIN OF BACKFILL](#)

The mountain of backfill gives you another idea of the depth of the hole, when you see the road used to bring the buses down into it.

[A LINE-UP of BUSES](#)

Here is a picture that shows all the buses being lined up in the hole. The far bus is just being jockeyed into place. On the left of the picture are stacked up forms that are placed around the whole complex. If the buses are accurately placed, each bus acts as a form for the next, and the concrete just fills in between. This is what makes this mode of construction so strong. It is formed like a beehive, with many, many, strong cells. The civil engineer who guided this construction was the engineer who designed the subway system in Toronto and he felt that the concept resulted in an IMMENSELY strong shelter. Especially with the immense amount of reinforcing steel that we put in and the extra strength concrete that we used.

PREPARATION of the BUSES

Here you see how the buses are completely gutted and stripped before being brought to the site, so as to cause no environmental damage. Their engines, transmissions, gas tanks, windows, and so forth, have all been removed at another site. They are brought to the site on their rear wheels only, and then the same tow truck takes those wheels away with it. If you look at the bus in the bottom of this picture you will see how all the windows have been sealed with fibreboard. After the concrete is poured, the fibre board and the buses remain in place. Only the outside forms will be removed.

FORMING and BRACING

Here you can see the outside forms being put in place and how strongly they are braced. This is VERY necessary. The buses are also greatly braced on the inside. Multiple 2 by 4's hammered together to make 4 by 8's and larger, running the length of the top inside and the floor of the bus with the same type of vertical bracing between them every 4 feet. NECESSARY, NECESSARY, NECESSARY. There is also cross bracing, at TWO levels every four feet. All this bracing is of course removed after the concrete is poured, and the AFTER the backfilling is done. The bracing is then used to build bunks and interior walls. There is not too much.

START of the POUR

Here you can see all the buses parked tightly together, and the concrete being poured in between. The framing of doors between the buses must also be securely braced. The importance of STRONG bracing EVERYWHERE can not be over stressed. The concrete is poured over the whole complex bit by bit. Some on every side of all the buses. This is important because otherwise the weight of the concrete would cause the buses to move. Between all the buses is HEAVY wire netting to reinforce the concrete, and because this was private construction we were able to force down in TONS more of scrap steel to further reinforce the concrete.

CLOSE UP OF CONCRETE POURING

Here you can see a close up of the pouring of the concrete. Notice the wire reinforcing rod over the top of the shelter. Every so many feet plastic and tin also had to be laid to create expansion joints. The big

pumper was rented for a week, at \$10K per week, and many concrete trucks were necessary to keep it serviced. One at the pumper, one waiting, one or two on the way back to the mixing yard. One at the mixing yard. One or two on the way to the pumper. From early morning till late at night. Make sure you pick a week of good weather. Talk with the airport meteorologists.

[ONE BIG CONCRETE BLOCK](#)

The one bus being formed up separate from the others is the fuel bus. The rest of the buses end up in one big concrete block, which then must be kept dampened and hosed down for a month to let the concrete set. After the outside forms are removed everything is sprayed with heavy black water proofing (we have never had a leak) and then the bulldozers move the top cover back into place, and after giving everything a week or two to settle we remove the interior bracing. In the following picture there is a corrugated pipe that extends up into the air to the left and in the foreground in front of the workmen. The back fill around this pipe will end up about a foot from the top so you can see how far underground the shelter is after the backfilling.

The Miracle of the Well

[Inside Photo of The Well](#)

[Photo of The Well During Construction](#)

[Photo of The Well During Blasting](#)

These photographs were taken when the inside well was still under construction - but it we completed it in the year 2000. It was a project that had been ongoing for over a decade. The well is wonderful, and I do consider it a true miracle - (just getting it paid for was one alone).

It was a miracle finding the right person to do it. He had been raised in this area and had family here, so answered my ad on the government employment net - just on that whim. He now lives in Northern Ontario and holds 14 mining tickets - including dynamiting. When the Safety Board was called in on us, the inspectors just shook their heads and said we were doing everything right.

We decided on the spot for the well before we ever put in the first bus over 20 years ago. My son Bonnar was the best in our family at water witching - (it is just a word - nothing to do with witchcraft, magic or any such thing - I now understand how it works scientifically) and we had him go out and survey the land.

This is the best spot for the well he said - but it was not where I really wanted to put the shelter. Well, try again I said. Three times we tried and he always picked that spot. Oh well, said I, this will do well for the well.

We lined up the first buses to that spot - and placed the water settling tank facing it. But immediately over the well location, I did not place cement - so that I could dig down through the dirt. And dig I did. Down, down, down. Thinking the water would only be another foot or two.

When the Fire Marshal ordered us to put in a back door, this was the area where it needed to go also, so I thought to just bring it in over the well and have the backhoe dig out the well for me at the same time. We brought in a 7ft in diameter big steel tank for the well casing and I had the backhoe dig down 20 feet to place it.

BUT, we ran into rock, so I had the well casing set on the rock, and later started digging under it. Eventually I put a concrete ring around under the casing to connect it to the rock. (Didn't do as good a job as I thought and we eventually had to scale away quite a bit).

Over the years I tried to dig the hole down further and further. First tried drilling and placing dynamite. But the first dynamiter I got years ago was terrible - and time and again I had to go down and dig out the dead heads. Had to stop that before I became a dead head.

Volunteer crews came and with jack hammers and we pressed on downward. Finally got down to 35 feet several years ago. In sort of an ice-cream cone shape - but no water. Decided that Bonnar was wrong. We know where the water comes out the side of the cliff in a spring, (which was the source we had been using) so we had the surveyor come and survey a tunnel path for us to there. We would dig the vertical shaft down and then tunnel over to the spring.

The water is at fifty-three (53) feet, the surveyor said, but he felt we wouldn't have to tunnel, because he thought we would hit a water table.

In the Summer of '98, the new blaster came and blasted away the thick concrete wall that had created a narrow door between the shelter and the well. We poured a new concrete supporting post, floor and wall and were ready to start.

Then in 2000 he came and widened the well to five feet all the way down from below the 7 ft concrete collar. We rented a tractor, and he brought from up north a marvelous winch to go on it. Also he brought powerful miner's drills, and two great helpers.

He thought they would do eight feet a day, but it averaged out to more like eight inches a day. Finally, weeks later we reached water at 52 feet and 10 inches. Just where the surveyor said we would. It is in a stream about the thickness of a broom stick, that came in through the wall, at the rate of a little over 6 gallons per minute.

We dug down another four feet to create a reservoir, and hollowed out the sides to capture 1500 gallons of water. Then we drilled around the incoming jet of water, to increase the flow. We drilled all around it

everywhere in a six inch circle. to a depth of four more feet back into the rock, but they were all completely dry. And we drilled all around the rest of the well. But this was the only real source of water and it came in only that one stream.

If we had put the well over a few feet in any direction we would have missed it. Thank you Bonnar.

The pumps are now installed. Two one horsepower pumps that together can pump better than 15 gallons per minute. We can fill our settling tank in about 30 minutes, and then turn off the generators. (We also have a back up hand winch and bucket).

A third pump fills the big stainless steel milk tanker - (like you see on the highways) that we have buried underground.

For the first time in many years, we now have both tanks full. (Years ago we used to fill them with a ram pump, but it was a very slow process). The well is also what makes it feasible for us to now install a Fire Sprinkler System.

The well ended up costing over a hundred thousand dollars. But its donation is also part of the miracle.

Current and Future Projects

There are always on-going construction projects to improve the facility. While we consider the facility ready there are always more items that come to mind for equipping it.

MENU: [HOME](#) » [SURVIVAL](#) » [Index of States](#)

Radiological Scientific Officer

On [another page](#) you will find links to all sorts of shelters, if you need additional free help, you can **E-mail me for free consultation.**

While previously, I would have been glad to chat with anyone, about any ideas, the interest has now become so great, and the requests in such number, that I wish to restrict this FREE service to those who meet the following three requirements:

1. They wish to build a shelter IMMEDIATELY and they are not merely "thinking" about it.
2. They already have a place where they can build it.
3. They have some amount of monetary resources they are allocating to the project.

If you meet those three requirements and wish my FREE assistance, please write to me telling me:

- a. your location
- b. describing the nature of the property you have available
- c. any plans you have in mind
- d. what monetary resources you have available
- no matter how limited.

If I can help you in this way:

E-mail me for free consultation at

survival@webpal.org

The old man himself!

.
.
Bruce Beach
January 1998

I am the only non-governmental Radiological Scientific Officer in Canada. I graduated second in the last class that was taught. The pre-requisite for the course was supposedly a Ph.D in physics plus the previous required courses which I had completed with top grades.

While I did not have the required degree I had the good fortune to room next to the top student in the class who permitted me to study with him each evening and sit with him at each meal. We also sat next to each other in class and therefore were always able to team up on in-class projects. It was through his great assistance that I managed to come in second. Prior to that course I had taken three previous government courses. The first in the U.S. and the second and third in Canada. I had also graduated as the Honor Student from a specialized USAF AACS school and based upon this, and work experience with the Western Electric Company as an engineer, was *offered* a high paying job as a civilian doing the acceptance inspection for the USAF nuclear missile sites, *which I declined*.

Over the past many years I have built 24 shelters ranging in capacity from one person to 500. These have been of almost every design conceivable, and I have also consulted on a great many others. I have also written a widely distributed booklet entitled, [You Will Survive Doomsday](#), which is available to you FREE for the downloading.

In fact, I probably became the most *notorious* shelter builder in the world. Several major newspapers, in both the United States and Canada, have done multiple page articles about me. There was an article and picture on the front page of the Canadian national newspaper, and there have been articles about me in the national magazine. As recently as March 2002 I was featured on the front cover of a national construction magazine. Over the years there have been dozens of other newspaper and magazine articles, plus lengthy TV shows, and I have spoken on more radio shows than I can count, often being interviewed by phone from thousands of miles away.

I taught a college course on survival and have been the guest speaker at other college's survival courses and numerous conferences on survival. All told, millions of people have heard me or heard about me, including thousands on a face to face basis in various presentations and shelter tours. I have even been the subject of a post-doctoral dissertation by two Ph.Ds from the University of California who referred to me as the "dean" of American survivalists.

You probably cannot *imagine* the number or variety of survivalist groups that I have met with and heard their ideas. I have also, at one time or another, talked with most of the survivalist leaders in North America and have read many, many volumes of ideas and thoughts on the subject. At this point I am surprised if I hear anything new.

Interest in this subject has come in waves. The Berlin Wall crises, the Falkland Island crises, the Gulf War crises, some particular movie or some other event. Presently, interest is growing again because of activities in the Middle East and as the reality is sinking in that the nuclear threat has never been greater since the time of the Cuban Missile Crisis.

Over the last many years, my wife and I have distributed *free* well over one hundred thousand booklets to try to prepare people for a nuclear holocaust. We have *never* charged a dime for doing this. My position is that I cannot play God, deciding who I will help, so I cannot put up the barrier of money in refusing to help someone, therefore I offer the help freely to everyone.

This has already seemed like a lot of breeze but if you would like to know still something more about me personally, and my other interests, then you can

[link to my personal web page.](#)

MENU: [HOME](#) » [SURVIVAL](#) » [Index of States](#)









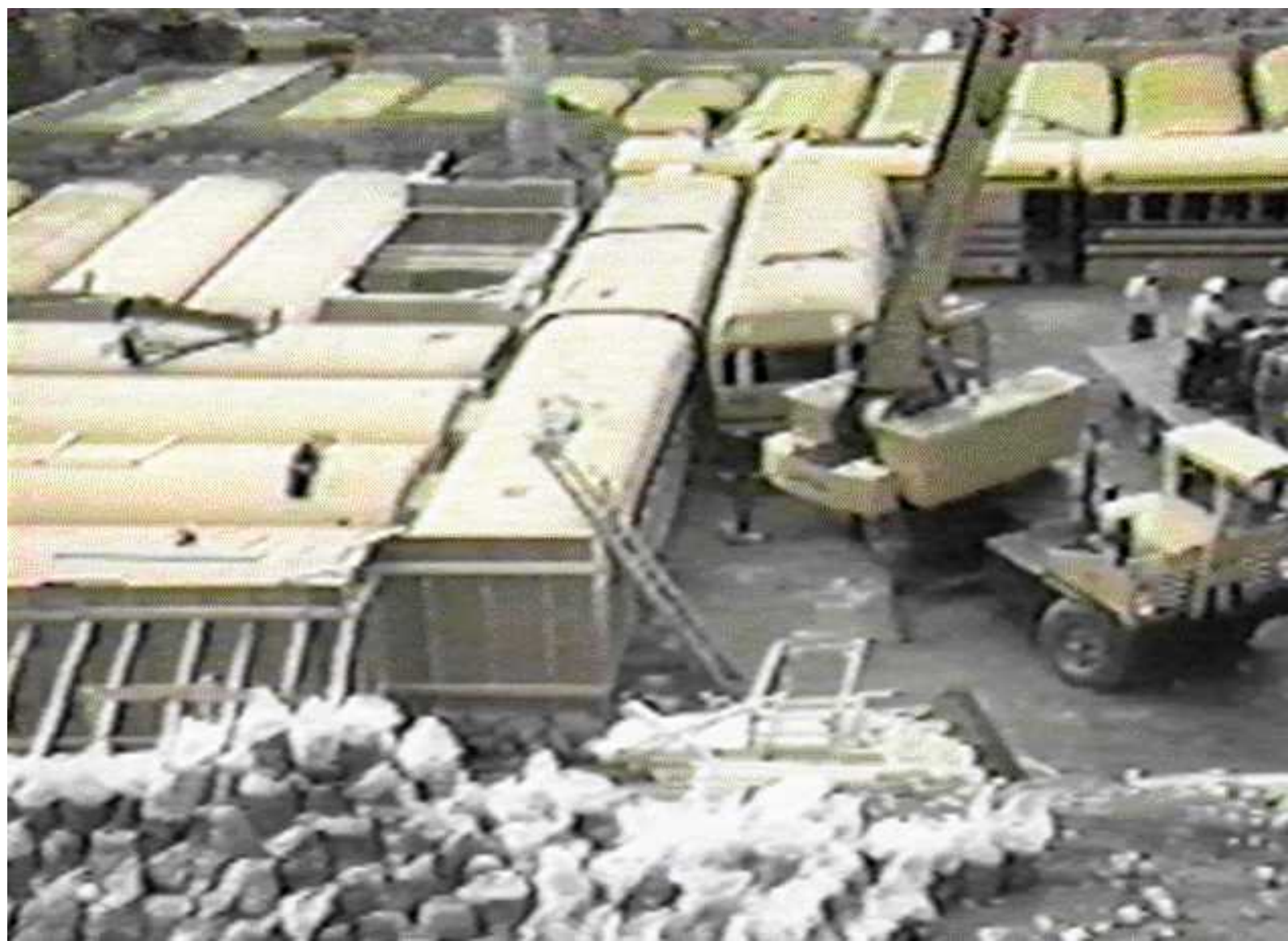













Life in the Ark Two Community

The Ark Two Survival Community is NOT a Commune. Nor is it based upon any particular religious or political concept. It is a pluralistic community that welcomes members from any religious, racial or cultural background.

Except in times of CATASTROPHE the community remains loosely knit. Members of the community can live at a distance, (although this is not recommended) and come to the facility if they feel that a catastrophe is imminent.

For information about the Ark Two Programs

[click here](#)

No one lives in the facility, although several families live nearby. The community tries to develop TEAM leaders with different types of expertise, and the Team leaders generally live within the vicinity.

For information about the Ark Two T.E.A.M.s

[click here](#)

Ideally, new members of the community would purchase or rent their primary home, (or a secondary home such as a resort cottage) within 20 miles of the facility. This, however, is not a requirement. The reasoning behind their having such a home location within the area, however, is that they would be near to the facility, should an emergency occur, and that they would have a base from which to re-establish their lives, during the reconstruction period after an emergency. We are located 90 miles northwest of Toronto, and Canadian Law changed in 1998, so that U.S. residents can purchase property in Canada, without tax penalty, and can reside here, only having to cross back over the border once every six months.

Use of the facility is anticipated in the worse case (an all out nuclear war) to be short term. By this we mean a period of from 3 weeks to six months. The facility would continue to be used as a resource for such functions as community administration, communication, and the ongoing work of agricultural recovery. It would also still be available as a refuge for any other emergencies, such as temporary social disturbances and so forth. Under the nuclear scenario, it is possible that children may need a longer period of sheltering for their sleep periods, than would adults.

Under other scenarios, such as Earth Changes, there would be other uses of the facility. One basic

scenario would be as a refuge from social disturbance and a base for the restoration of agriculture. In this latter regard the facility has fenced off, with a five foot fence a separate protected area for agriculture. The headwaters of the Pine River run through the facility as a water resource, and there are large ponds available.

Key to agricultural recovery is the necessary expertise. Member families of the survival community have farmed on this same land since before the beginning of the last century. It is anticipated that a situation may require labor intensive farming, of the gardening type, that members of the survival community presently maintain. There is sufficient land to provide new members their individual gardening plots, or to let them participate in joint community efforts at food production.

More central to agricultural recovery, is that the whole surrounding area is a well established agricultural community that has been VERY productive over many decades. Nevertheless, in anticipation of EXTREME conditions, preparations have been made for hydroponic seed germination and other such approaches.

For those concerned about Earth Change scenarios, it should be noted that the survival facility is located on the highest level of land in Ontario, far above any possible flood plain. That it is built upon an area of solid pre-cambrian rock, which has suffered no historical earthquake damage, and that the shelter itself, being underground, provides complete protection from any form of radiation, solar or otherwise. Any other personal concerns in this area will be addressed upon request.

During a Catastrophe the shelter operates much like a ship or submarine. There is a shelter commander and crew to maintain its operation. During the state of immediate emergency the shelter is NOT operated as a democracy. In order to protect the maximum number of people, the occupants are separated by age and sex. This admittedly concerns some people, but it must be remembered the facility is a Life Boat, not a Luxury Cruise Liner.

During an emergency, the adults have duties and are only permitted 8 hours per day of bunk time. They will be very busy the rest of the time. Young children and infants, are encouraged to sleep 12 hours a day, so as to reduce activity in the shelter. Nevertheless, in order to accommodate the maximum number of persons, that Canadian Government regulations permit in a shelter this size, it is necessary that all the bunks be assigned for shifts of a fixed number of hours per day, and that on alternate shifts someone else will have to use the bunk. This is the reason the sleeping arrangements have to be assigned by sex and age.

Community organization, aside from the time of emergency, will have to be determined by the community and the circumstances. In a scenario that is not too severe, individuals in the survival community, may simply return to their previous homes and something approximating their previous life style. In a more severe scenario, the members of the survival community may simply merge into the larger surrounding community and whatever response that community makes. In a very severe scenario, the members of the survival community may have to organize themselves into some sort of longer term

continuing entity. All of these responses are hypothetical and there is no need to overly speculate upon them until such time as one sees what the circumstances dictate.

The key to a successful experience in the survival community, is your participation ahead of time. Participation in the TEAM activities, of preparing for contingencies ahead of time. Becoming acquainted with the TEAM leaders and community members, so that you know them, and that they know you. The basis of this community is built upon a Spirit of Service. Those with that spirit will find that they fit right in and that their participation will be greatly appreciated.

If you want to know more particulars about this community, you can contact any of the [TEAM](#) leaders or [The Community Coordinator](#).

If for some reason you feel that this Survival Community is not the one for you, then you should find another more suitable community. To assist you in that we used to have a [list](#) of hundreds of survival groups and communities in North America. However, circumstances have changed and it is now much more difficult to find and make contact with other communities. Whatever you choose to do, we HIGHLY recommend that you join SOME community, if you believe there is an imminent danger, because your chances of survival are greatly enhanced by being in a community rather than being on your own.

MENU: [HOME](#) » [SURVIVAL](#) » [Index of States](#)

The Ark Two Community Nuclear Holocaust Recovery Programs

<p style="text-align: center;">* —</p> <p style="text-align: center;"><u>Introduction to Ark Two & Overall Purpose</u></p>	<p style="text-align: center;"><u>Free Shelter Consultation & Nuclear Survival Info</u></p>
<p style="text-align: center;">** —</p> <p style="text-align: center;"><u>Agricultural Recovery</u></p>	<p style="text-align: center;"><u>Radiological Monitoring Equipment</u></p>
<p style="text-align: center;">*** —</p> <p style="text-align: center;"><u>Economic Recovery</u></p>	<p style="text-align: center;"><u>KI Information and Support</u></p>
<p style="text-align: center;">**** —</p> <p style="text-align: center;"><u>Refuge and Recovery Maps by State</u></p>	<p style="text-align: center;"><u>Family Finding</u></p>
<p style="text-align: center;">***** —</p> <p style="text-align: center;"><u>Information Broadcast</u></p>	<p style="text-align: center;"><u>Social Restoration</u></p>

Purpose: Anyone is welcome to join the Ark Two Survival Community (located in Ontario,

Canada) - so long as they do so before the catastrophe occurs. There is no charge for membership nor any restriction other than one be tolerant of the other members. However, it is only practical to be a member if one makes arrangement to live within about 20 miles because it would not otherwise likely be possible to get to the Ark ([see pictures](#)) at the time of catastrophe.

The purpose of the Ark Two Survival Community is to ameliorate the effects of a Nuclear War and to help reorganize society afterwards. The community founder believes that a nuclear war is inevitable and therefore in 1980 built the first phase of the Ark Two Refuge and has since expanded it and established the following programs.

The project has not been favorably received by the local and provincial governments. By 1990, when I stopped counting, it had been subject to over 30 court and commission appearances and the number has greatly increased in the last few years. Legal costs have mounted to hundreds of thousands of dollars. In 1999 there was a raid without warrants involving 7 police vehicles, 4 fire units and over 40 personnel and a K-9 unit, coincidentally caught on video tape by the CBC. Subsequently the facility was hounded with repeated government inspections. Some of the inspectors candidly admitted that it was just harassment, but because of wanting to keep their jobs they of course were not going to put that into writing. It is for this reason that one might refer to the facility as Waco North. A kinder, gentler Canadian version in that The Ark doesn't have any weapons and in that so far no one has been killed by the raiders.

The general public views the project as being operated by an eccentric (in the most favorable terms) or by a nut-case in what is the more usual expressed attitude. For the forty years in which I have built over two dozen shelters and have consulted on many dozens of others, the general ridicule has been extensive, to say the least. "Why do it then?", I have often been asked. Why not get a life, enjoy life and quit worrying about doomsday? The answer is that I don't see the purpose of life, nor happiness in life measured in how many rounds of golf I might play, but rather in service to my fellowman. While I don't have any "visions" or hear any "voices" this appears to me to be the service to which I have been called.

It is my hope that the programs described below will save tens of thousands of lives and will be useful in restoring society and making people's lives better after the nuclear holocaust.

Click here to return to the
[Table of Contents](#)

Survival Education: For over 40 years the Ark Two Community founder has run a large variety of nuclear survival education programs. This has involved the printing and distribution of over 100,000 printed copies of [FREE books and booklets](#). Now, with the Internet, some of these are available right at this web site to untold numbers of more people for free downloading.

He also provides FREE [consultation](#) on shelter building.

In the process of trying to educate the public he has appeared on dozens of TV programs, dozens of radio shows, and has been written about in a great many magazine and newspaper articles. Many millions of persons have heard about his efforts.

The Ark Two Community has a librarian who has done a magnificent job of compiling on CD ROM, Microfilm, and in other media, thousands of volumes of practical and semi-technical descriptions of technology that we hope will be useful after a nuclear holocaust. We hope to be able to widely disseminate this information after the holocaust.

We have also assembled survival guidance material to handout at the door of the shelter to people for whom we have insufficient room in the shelter to accomodate. In December 2001 we completed a series of 4 videos, on such subjects as building an expedient shelter, which we hope to be able to show to the same group of people.

Click [here](#) to return to the
[Table of Contents](#)

Radiological Monitoring: As a Radiological Scientific Officer I try to provide useful information to people about [Radiation Detection Equipment](#). I have assisted many hundreds of people in obtaining thousands of pieces of equipment and in the past have given away hundreds of pieces. I simply no longer have the time to do that but we have stockpiled, tested and labeled hundreds of radiation detection devices (currently worth tens of thousands of dollars) that we will give away to those people that we have to turn away from the door of the shelter.

The plan is to train Radiological Instructors while in the shelter so that they can go out afterwards and train monitoring teams. Equipment has also been stockpiled for these teams.

Click [here](#) to return to the
[Table of Contents](#)

KI Information and Support: A significant radiological defense is in the use of Potassium Iodide (KI) or one of its derivatives. For this purpose we store in our survival community many tens of thousands of dosages to provide for thousands of people in the month following a nuclear event. These we also plan to provide free to persons that we have to turn away from the shelter.

For those persons interested in making provision for their own families we recommend their contacting [KI4U](#).

Click here to return to the
[Table of Contents](#)

Agricultural Recovery: Key to the survival of society and humanity will be the restoration of Agriculture. This is one of the ***MOST IMPORTANT*** types of information that we provide and I highly recommend that you look at [our webpages on agricultural recovery](#).

Among our shelter supplies we are storing multiple copies of [proven plans](#) for converting tractors to operate on wood combustion. With practically no farm horses or horse drawn implements remaining, and with there probably being low availability of petroleum fuels, knowledge of these and similar techniques could be very valuable. The plan would be to train mechanics locally who would then be dispersed to other agricultural locales to supervise local mechanics in the procedures.

We have also prepared a dozen radiological testing kits, for testing for radiation in food and water. We plan to send these to centralized locations, perhaps in each of the Canadian Provinces. Today it would cost over \$5,000 each to replace these and in the future they may invaluable.

We have also made a point of storing seeds for our own facility, in sufficient quantity to supply a sizable community around us.

Click here to return to the
[Table of Contents](#)

Economic Recovery: One of the most challenging issues will be the re-establishment of a functioning economy with monetary exchange. It is to this subject that we have been able to concentrate our particular skills in so much as I was trained as, and served as professor of Institutional Economics. Extensive study, although not known to the general public, was put into the subject by the US Government. Their summary conclusion was that the best bet was what we call LETS (Local Economy Trading Systems) although they did not go further and develop the concept in detail. That I have done, and have published the methodology for [LETS Entitlement](#) here on the web.

Our plan is after the holocaust to first establish a demonstration system and then train individuals in how

to go to other communities and show them how to replicate it. As the local systems progress we would like to then facilitate exchange between them.

Click here to return to the
[Table of Contents](#)

Refuge and Recovery Maps: For a number of years we maintained for each state of the United States, and for Provinces of Canada, lists of Intentional and Survival Communities, however, it became necessary as of the Oct. 2002 revision to discontinue the list in face of growing governmental and social opposition. For each of the states, we still show [maps with potential targets](#) as listed by FEMA.

It is our hope that after a nuclear holocaust we will be able to replace the current maps with maps showing the actual locations of destruction, information about the extensiveness of the destruction, and the pathways around those areas, as the pathways are developed. We would also hope to include information about surviving resources in the areas and that these maps will then be linked into our Family Finding Registry program.

Click here to return to the
[Table of Contents](#)

Information Broadcast: From the outset it was planned that Ark Two would be a broadcast facility, and for this purpose it was built upon the highest point in Ontario. Originally it was equipped with four transmitters that the radio engineers said had the capability to reach both of the coasts and as far south as Florida. Over the years the transmitters deteriorated and a couple of years ago we scrapped them and they have yet to be replaced.

The idea would be to gather information by short-wave and other means and to then broadcast on a band that could be received by AM receivers in automobiles. Specific broadcast times would be established for times relevant to specific localities.

The content would consist of news, shared recovery experience and expertise, agricultural and medical advice, and survivor lists for various locales at specified times. To what degree we will be able to implement this plan will have to be determined at the time. In the meantime we have upgraded the generator for the transmitter and are making additional steps to continue this program.

Click here to return to the
[Table of Contents](#)

Family Finding: One of the most difficult and yet desirable objectives of individuals will be the finding of missing members of their families. It is for this reason that we hope to establish ***THE REGISTRY*** using the above mentioned [state \(and provincial\) maps](#) with a hierarchial arrangement of T.E.A.M. Leaders to be established in each locality for this purpose. It was found that after the limited atomic blasts in Japan that families that were separated at the time of the blasts often had to go in different directions, and having no central known point to return to, often never found each other again, although there were occasionally happy reunifications decades later.

Using the maps, information gathering systems, and the facilities described under other topics, it is our hope to facilitate family finding. For this purpose our web pages were moved closer to the Internet Backbone (3 hops from the US Backbone whereas we were originally 14 hops) and on a fibre optic network with an ISP that has our own survival philosophy. The Internet was originally designed for nuclear survivability and depending upon how well it fulfills that purpose, or how rapidly it can be restored, then we hope to provide an information network where survivors can register for each of their localities, and seekers will be able to systematically look for family members.

Click here to return to the
[Table of Contents](#)

Social Restoration: The humanitarian motivation behind Ark Two has universal bounds. What the future holds, none of us can know in detail, but the Ark Two founder is one of great optimism. Hopefully mankind will learn from its mistakes and will develop an attitude of universal charity and concern towards all of mankind, regardless of race, religion, culture, or other coincidental distinguishing feature. In this regards there are published here two series of web pages on two subjects that the founder considers to be very germane to establishing peace in the world. One series of pages is on [The New World Order](#) and the other series is on a [Universal Auxiliary Language](#).

Click here to return to the
[Table of Contents](#)

MENU: [HOME](#) » [SURVIVAL](#) » [Index of States](#)

Join the MOST CAPABLE Preparedness Community in North America

Our goal is to have the largest and most CAPABLE
Preparedness Community in North America.

Towards this goal,
we assign our members to T.E.A.M.s.
Together **E**veryone **A**ccomplishes **M**ore
At the moment we have **12** TEAM Leaders.
We would like to start some other Specialist TEAMs
when we can find suitable TEAM leaders.
Perhaps you are a person with those qualifications.

If you would like to explore the possibility of joining our Community
you might like to contact one of the following TEAM leaders
LISTED ALPHABETICALLY
regarding the possibility of their acting as your mentor
in joining our community.
or contact directly

The Community Coordinator

Bruce Beach at:

survival@webpal.org

Ours is a very open and tolerant community. Mainly we look for new members who are tolerant, and have a Spirit of Service, and for TEAM Leaders we look for exceptional skills.

Ours is a very diverse community. Represented in it are three different Major Religions, and several denominations of Christians. There are also different nationalities, and a wide spectrum of educational backgrounds. The thing that we have in common is EARNED mutual trust and confidence. The community, as such, espouses no particular philosophy, political, or otherwise.

The TEAM leaders, in alphabetic order, are as follows:

Microbiotics Team Leader.

Aina (aina@bmts.com) has a Masters Degree in Micro-biology. She has been associated with our Preparedness Community for over 15 years. Aina has done special research in the area of the effect of radiation on plants and food. You may see her letter [Radiation in Food](#) and her paper [Contamination of Food Problem After Nuclear War](#). Aina has gathered together a file drawer of folders filled with research papers on the subject of Radiation in Food, and she is in the process of updating her research in the light of published research resulting from the Chernobyle disaster. Coincidentally, Aina is also an expert on the plants and fauna in our area and will work closely with the Agriculture TEAM leader, in this regards.

Medical Emergency Response TEAM Leader.

Bonnar (bonnarbeach@hotmail.com) has a Bachelor's Degree from Wilfred Laurier, and has completed the Emergency Medical Technician course at Humber College. He has been associated with our Preparedness Community for over twenty years, and has been active in both the building and equipping phase.

Radiological Defense TEAM Leader.

Bruce (survival@webpal.org) has a Masters Degree in Economics and has completed four government courses in Radiological Defense to the highest level of Radiological Scientific Officer and is a certified trainer in Radiological Defense. Bruce is also both a St. John Ambulance and Red Cross First Aid Instructor. A member of Bruce's TEAM is Ron, probably the most experienced designer and manufacturer of nuclear radiation test equipment in Canada, if not in North America. (He has checked, and sometimes designed and manufactured all of our radiation detection equipment.) Bruce has written a well received booklet on the subject of Nuclear Survival that is available **FREE** at: [You Will Survive doomsday](#).

Carpentry Maintenance TEAM Leader.

Dave (eldner@interhop.net) is an experienced Habitat for Humanity builder and is an experienced craftsman, having his own business for many years. He is now associated full-time with an area hospital. Over the years he has worked on many of our shelter projects. He has had on his team, for several years, a licensed plumber.

Administrative TEAM Leader.

Frank (dominion_group2@hotmail.com) Frank has his degree in business

administration from a Toronto college. He is the coordinator of the Canadian Preparedness Network, and the TEAM designation was his original concept for this group. Assisting Frank on his Team are Wilf and Bahia, two other experienced administrators. Frank has not been as active with us for the last couple of years but I got an email for this March 2000 update and he says that he is still there so until I get a phone call or notification otherwise he is still listed.

Agricultural Acquisition TEAM Leader.

Gary (gseaborne@stn.net) has been involved in the wholesale operation of agricultural products for the last fifteen years and has become very familiar with local agricultural resources. During those years he has also given us valuable volunteer assistance in the building of the Ark.

Mechanical Systems TEAM Leader.

John (jsipple@easyfocus.com) is a Wheelwright and has been associated with our Preparedness Community for several years. He works full time, and has many years experience, in large plants as the shift supervisor for mechanical and electrical maintenance. John also ends up with the brunt of moving things for the shelter with his truck and trailer, and we have moved many dozens of loads with his trailer in the last years.

Construction Team Leader.

Percy (percy@heaven.God) in MEMORIAM.

Percy passed on from a heart attack, but we still wish to acknowledge his GREAT contribution to our Preparedness Community. Percy over-saw the construction of our 500 person shelter. We will ever be appreciative of his many years of service. In recent years, many man months of labor have gone into the shelter by Bill, who was Percy's assistant foreman, and who is now assisted by Paul. Down through the years many craftsmen have dedicatedly worked on the shelter including John, who with his able crew, dug our well.

Supply Team Leader.

Peter (P_Corlett@yahoo.com) has been associated with our Preparedness Community for over 10 years. He has been greatly dedicated to identifying a variety of necessary equipment and supplies. He is a full-time professional videographer, and our liason to the barter community. Peter has made a professional video of our survival complex. He will will send you a copy for \$10 copying and handling charges, if you wish.

Medical Team Leader.

Ray (Ray@-----) has been a member of our Preparedness Community for over 15 years. Ray is an M.D. and he will be glad to correspond with

any other physicians who are seriously considering becoming a member of our community. If you are a licensed physician send Bruce your email address and he will pass it on to Ray. We also have two other physicians plus two nurses who are "acquainted" with, and not non-supportive of our activities, that may become active if conditions deteriorate. In the next few weeks we are expecting another doctor to join us from Florida and I have asked him for his permission to add his name here.

Communications Team Leader.

Velda (vhardman@sympatico.ca) Member of the Preparedness Community for over 20 years. Ham Operator (call VE3 LIB) and all that. Probably best to make an appointment by email if you want to talk

Personnel Team Leader.

Warren (wsearch@triad-graphics.com)

works full time as a Graphics Artist and makes the daily commute back and forth to the city. In 2000 he took over as the TEAM Leader for Community Personnel and will be the one making assignments to the various TEAMS.

You - A Team of Your Choice

If you are a person who lives in the Greater Toronto Area or within a couple of hundred kilometers North West of Toronto (our shelter is 90 k.m. N.W. of Toronto City Hall, on the protected side of Caledon Mountain) we would like to invite you to investigate our Preparedness Community.

Although not listed here, we have a number of people who live in the vicinity that have some real talent and skills and that have been quite supportive of our efforts. Should the need arise they will be participating in the shelter and they have been tentatively assigned to the appropriate TEAMS.

If you have a skill that we need, we would like for you to become a TEAM leader. The TEAM leader positions that we are most needing to fill are:

- **Community Health Expert**
- **Telephony and Electronics Repair**
- **Chemist (particularly in regards to pharmaceuticals and plastics)**
- **Petroleum Engineer**
- **Dietician and Food Preparation**
- **Automotive Repair**
- **Security**

- **Agricultural**

Although for the latter we have team members with a combined total of over 100 years of agricultural experience in the area, and potential TEAM members with much more.

If you reside in the U.S. as a U.S. citizen, (and have NO criminal record) you may legally purchase for residence a cottage or farm in the Shelter Vicinity. The only requirement is that you must return to the U.S. for a few hours (minutes?) once every six months.

The members of our Preparedness Community have very diverse views about the future. Some are motivated by millennial concerns, some expect a nuclear holocaust, others anticipate earth changes, and still others social disruptions.

Whatever YOUR particular view or motivation you will most likely find a number of other members of our Preparedness Community with similar viewpoints, and you will find the efforts of ALL the members of our community compatible with your concerns. All persons worthy of trust and confidence, who have a Spirit of Service, will find a Haven in which they can have confidence.

If the above describes you as an individual then please contact RIGHT NOW,

MENU: [HOME](#) » [SURVIVAL](#) » [Index of States](#)

FREE Books on Nuclear Survival

There are many books and pamphlets throughout this web site. Here are a few that deal directly with the subject of survival from nuclear fallout. Elsewhere are others on the subject of recovery and reorganization.

Some of the material is in HTML, other in .pdf, a few in both. Some elsewhere are marked LOCKED because for those we have as yet to obtain copyright permission. The key to open the locked files won't be provided until after a nuclear war but they have been archived so that they will be available..

The material comes from a variety of sources but the bulk of it has been converted to web format, (sometimes HTML and sometimes .pdf and occasionally both), by our Ark Two Librarian. For the last several years it has been an intensive labor of love on his part requiring immense effort and dedication.

Some of the material he maintains in duplicate at another site:

http://groups.yahoo.com/group/Self_Sufficiency/files

The materials, here and elsewhere on this website, that are presently available and unlocked are copyrighted but you are free to:

- link to them
- print them off and distribute them free
 - so long as you do so in their entirety - giving the authors credit
- quote from them - so long as you do so accurately and give credit

Nuclear Weapons and Fallout Defense
in order of importance to read

HTML
[You Will Survive Doomsday](#)

This is an easy to read booklet by a Radiological Scientific Officer that gives an

overall theoretical view of nuclear survival by refuting 23 myths often associated with the subject. It is meant to be read well ahead of time.

.pdf

[You Will Survive Doomsday](#)

This is the 2003 KB .pdf format of the above 24 page booklet.

HTML

[11 Steps To Survival](#)

This is a Canadian Government publication that lays out steps to nuclear survival, and should be the first priority to read in face of an immediate threat.

.pdf

[11 Steps To Survival](#)

This is the 930 KB of 25 pages in .pdf format of the above 47 page booklet.

.pdf

[Your Basement Fallout Shelter](#)

This 1111 KB 31 page booklet explains how to build a basement fallout shelter

.pdf

[Fallout On The Farm](#)

This 790 KB 14 page booklet by the Canadian Government explains basic defenses for use on the farm.

.pdf

[Nuclear Weapons Defense Manual](#)

This 1113 KB 95 page course manual was issued in the Canadian Radiological Defense Officers Course.

.pdf

[Nuclear Weapons Defense Manual - Tables](#)

This 951 KB 34 page manual of tables was issued in the Canadian Radiological

Defense Officers Course.

.pdf

[Nuclear Weapons Effects - Radiological Scientific Officers Handbook](#)

This 2540 KB 124 page handbook was issued in the Canadian Radiological Scientific Officers Course.

[Nuclear War Survival Skills](#)

This is the lengthy and comprehensive classic by Cresson Kearny that explains in detail the techniques needed for nuclear survival. Because of the length of this book, it is stored here in Replica Format. Clicking on the execute file will open it for you. If by chance you do not have Replica on your system it will load it for you and take only a moment to do so if you tell it to go ahead. The pictures do not appear.

Fallout Recovery

in order of importance to read

HTML

[Letter on Radiation in Food](#)

This is an introductory letter by the microbiologist Aina Shapley on the subject of Radiation in Food.

HTML

[Contamination_of_Food_After_Nuclear_War](#)

This is the full report by the microbiologist Aina Shapley who was commissioned by Ark Two to examine the overall problem.

.pdf

[Contamination_of_Food_After_Nuclear_War](#)

This 2687 KB 37 page paper in .pdf format of the above paper by the microbiologist Aina Shapley who was commissioned by Ark Two to examine the overall problem.

.pdf LOCKED

[Manual of food quality control - radionuclides in food](#)

This 13048 KB 133 page paper is the official USDA (United States Department of Agriculture) and UN (United Nations) standard and methodology for measuring radiation in food. This is the prime authoritative document on the subject. I obtained the information through its author Edmond J. Baratta, International Expert on Radioactivity with the US Food and Drug Administration at the research facility in Winchester, Massachusetts. The document is published both by the FDA and FAO (Food and Agricultural Organization of the UN). It is both very technical and readable in its detailed description of the methodologies and processes involved. However, since it does carry a copyright, and the government charges hundreds of dollars for a copy, this file is presently sealed until after the nuclear war.

[Removal Of Strontium-89 and Calcium-45 From Milk](#)

How to remove radiation from milk in a processing plant. This is the 61 page masters thesis of David Gene Easterly. I have the author's personal permission to republish it here.

[Radiation Risk and Ethics](#)

There was much scare talk about the effects of peace time radiation. This professional paper gives a much different view. It helps to get things into perspective.

MENU: [HOME](#) » [SURVIVAL](#) » [Index of States](#)

Embedded Secure Document

The file *file:///C:/CDROMs/SCDR-2/Prophecykeepers/POST-NUCLEAR-WAR/d_resources/survival/books/doomsday/ywsd.pdf* is a secure document that has been embedded in this document. Double click the pushpin to view.



This booklet was converted to HTML by our Ark Two Librarian, Fred Walter; a lengthy task which, I for one, wish to express my appreciation.

It contains so many photos that it is probably easiest for you to read it on-line, and some browsers will now print it off but you can capture it and print it off, along with a number of very useful other books from our Ark Two Librarian's easy printing .pdf versions at:

http://groups.yahoo.com/group/Self_Sufficiency/files

11 Steps to Survival

Canada Emergency Measures Organization

Department of National Defence

Blueprint for Survival No. 4

Make this your handbook for emergencies.

Keep it in a handy place so that you and your family can refer to it quickly should any emergency threaten.

Keep other emergency advice such as first aid and artificial respiration instructions, antidotes for poison, emergency telephone numbers, in the same place.

Introduction

The Canadian Government has joined other peace-minded nations in doing everything possible to reduce world tensions, to assist in the settlement of international disputes by peaceful means and to achieve disarmament with such controls as are necessary to preserve the security of all nations. However, the awesome threat of a major nuclear war involving North America remains a factor in plans for the defence of Canada.

The nature and scale of a possible nuclear attack on North America, and the extent to which Canada would be involved in such an attack, cannot be predicted with accuracy. Our major centres would be at some risk of deliberate attack, random explosions could occur, and there would be the certainty of the danger from widespread, radioactive fallout over most of the Country.

Governments at all levels have made, and are continuing to make, preparations which will reduce the number of casualties, safeguard survivors and contribute to the capacity of this nation to survive and recover from such a tragedy. The purpose of this booklet is to assist individuals and families in making personal survival plans and preparations to guard themselves against the potential dangers of nuclear war.

Many of the precautions which are recommended will serve a double purpose in that they will save lives in peacetime disasters such as flood, tornado, fire, hurricane, blizzard, ice storm or earthquake. Attention has been directed to this important feature throughout the various steps.

All Canadians are urged to read "11 Steps to Survival" with care to act on the advice it contains and to keep it handy for emergencies.

Although protected by Crown Copyright, the contents may be reproduced in whole or in part provided proper acknowledgment of the source is made.

The Queen's Printer
Ottawa, 1969
Cat. No. Id 83-1/4

The Eleven Steps to Survival

Governments and communities at all levels are planning for the survival of our Nation in the event of a nuclear war. But the survival of individuals also will depend upon the preparation that each person makes. Persons ready to take the right action before and following an attack will increase their chances of survival.

This pamphlet describes what YOU can do before and following a nuclear attack. You can greatly increase your family's and your own protection by taking the Eleven Steps to Survival:

- [Step 1](#): Know the effects of nuclear explosions.
- [Step 2](#): Know the facts about radioactive fallout.
- [Step 3](#): Know the warning signal and have a battery-powered radio.
- [Step 4](#): Know how to take shelter.
- [Step 5](#): Have fourteen days emergency supplies.
- [Step 6](#): Know how to prevent and fight fires.
- [Step 7](#): Know first aid and home nursing.
- [Step 8](#): Know emergency cleanliness.
- [Step 9](#): Know how to get rid of radioactive dust.
- [Step 10](#): Know your municipal plans.
- [Step 11](#): Have a plan for your family and yourself.

Step 1: Know the Effects of Nuclear Explosions

A nuclear explosion releases vast amounts of energy in three forms:

1. [Light and heat](#)
2. [Blast](#)
3. [Radiation](#)

The amount of energy released depends upon the size and design of the weapon. A wide range of weapons and delivery systems are available to an aggressor and we have no way of knowing what size of explosions might take place in Canada. For illustration purposes, we describe in this pamphlet the effects of a 5-megaton H-bomb equal to the explosive force of five million tons of TNT. Such a bomb could substantially damage the largest Canadian city.

The effects depend upon whether the weapon is exploded high in the air, or on, or near the ground. An air burst usually produces more fire and blast-damage than a ground burst which results in a big crater and more radioactive fallout. The effects described below are approximate for a 5-megaton explosion and can only be approximate since effects depend upon a number of conditions such as weather, terrain, etc.

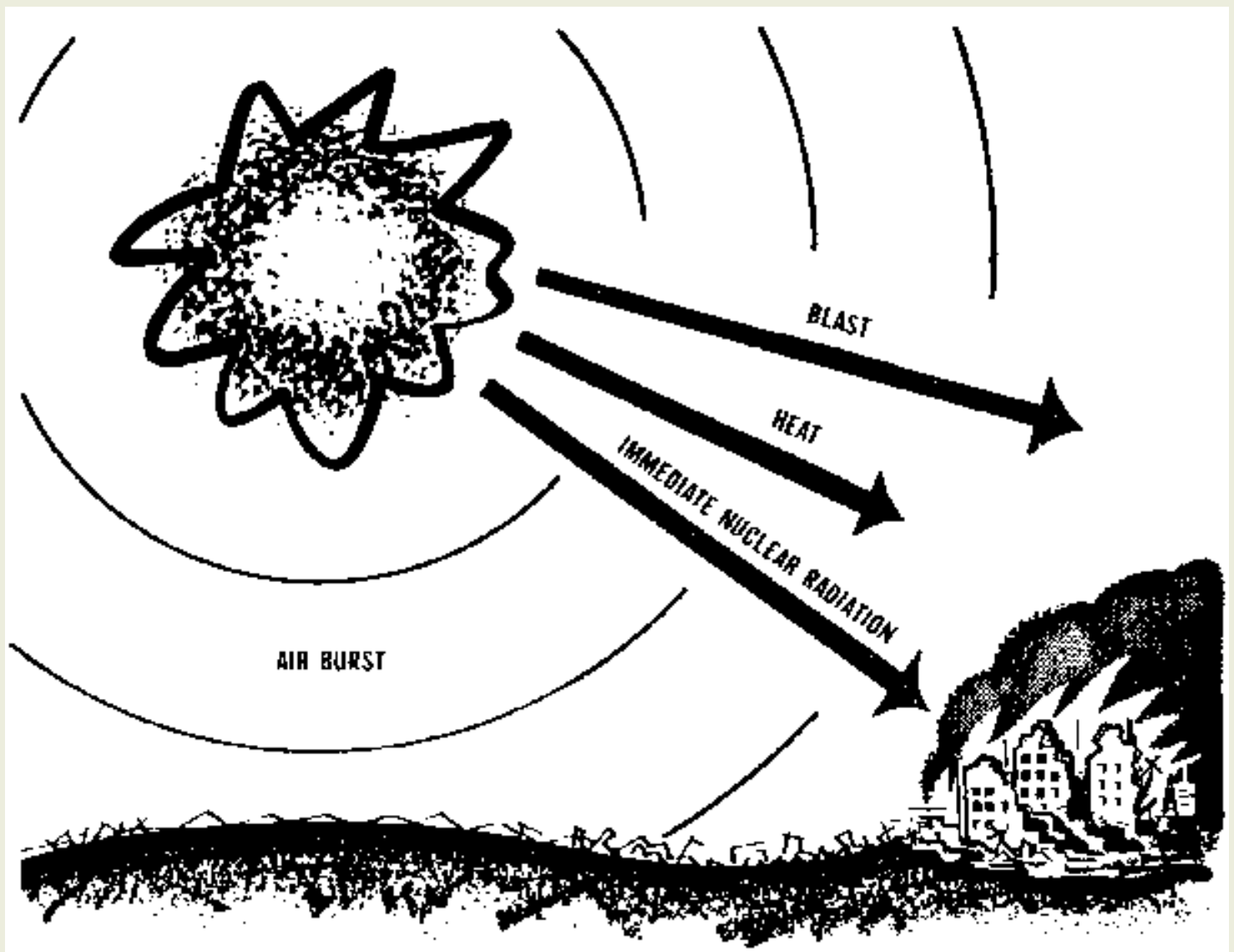

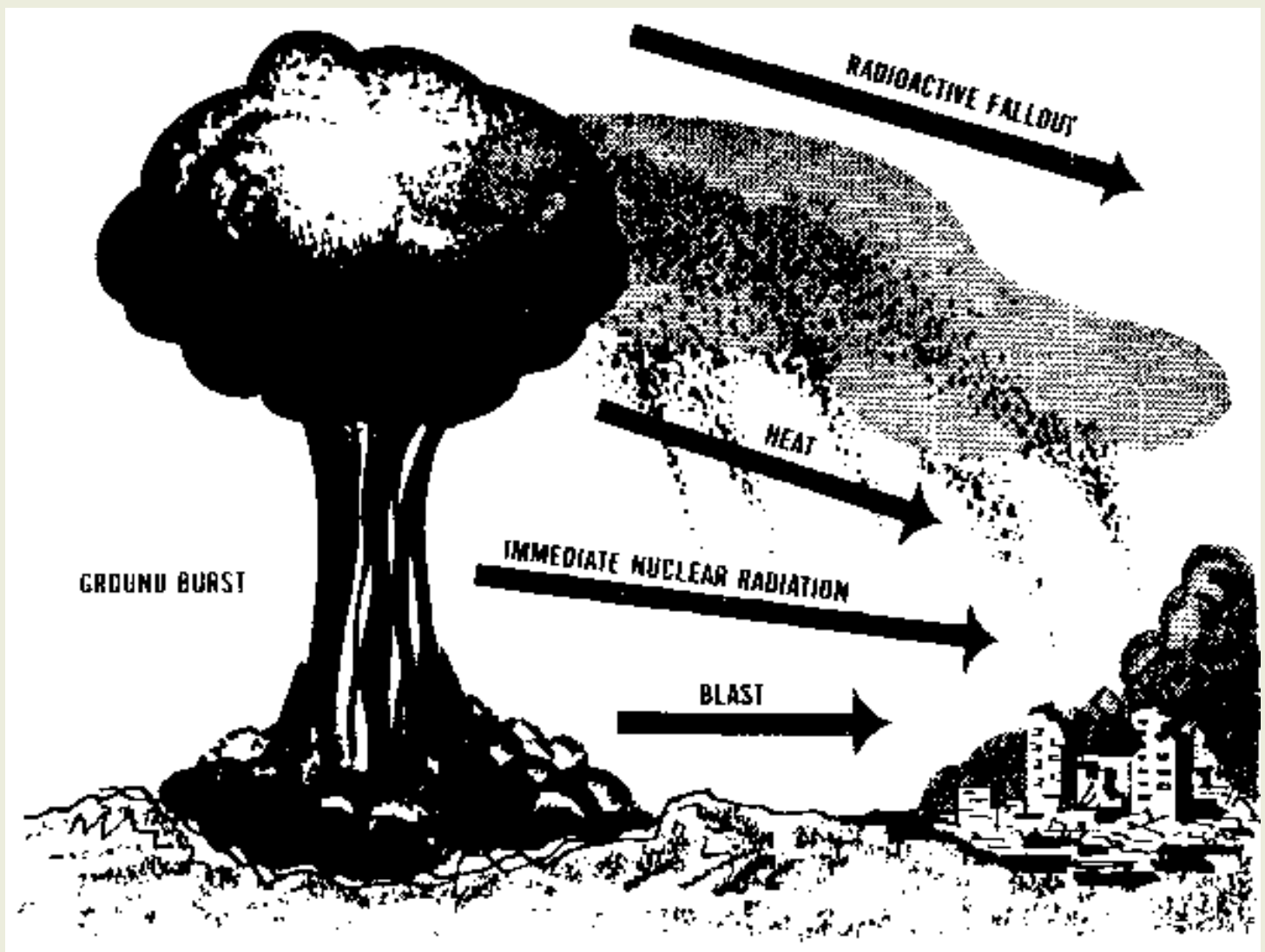

Light and Heat

A blaze of light brighter than the sun is produced by a nuclear explosion. It lasts for about 15 seconds. Temporary blindness and eye injury can result from the glare if eyes are not shielded.

The heat rays from the explosion travel at the speed of light or about 186,000 miles per second. It can start fires up to 20 miles away. Many fires are caused when the heat pulse comes through a window to set fire to curtains, paper, clothing and furniture. The heat flash also can set fire to the outside of wooden buildings.

The following are some examples of the predictable effects on unprotected skin of the heat flash of a 5-megaton weapon exploded on a clear day:

- Skin is badly burned up to 15 miles from the explosion.
- Skin is blistered up to 18 miles from the explosion.
- Sunburn types of burns up to 23 miles from the explosion.

Nuclear explosions in the air rather than on the ground are more likely to produce a greater number of serious burns through the heat flash. Clothing will give some protection. A shield between you and the light will give protection against burns from the heat flash.

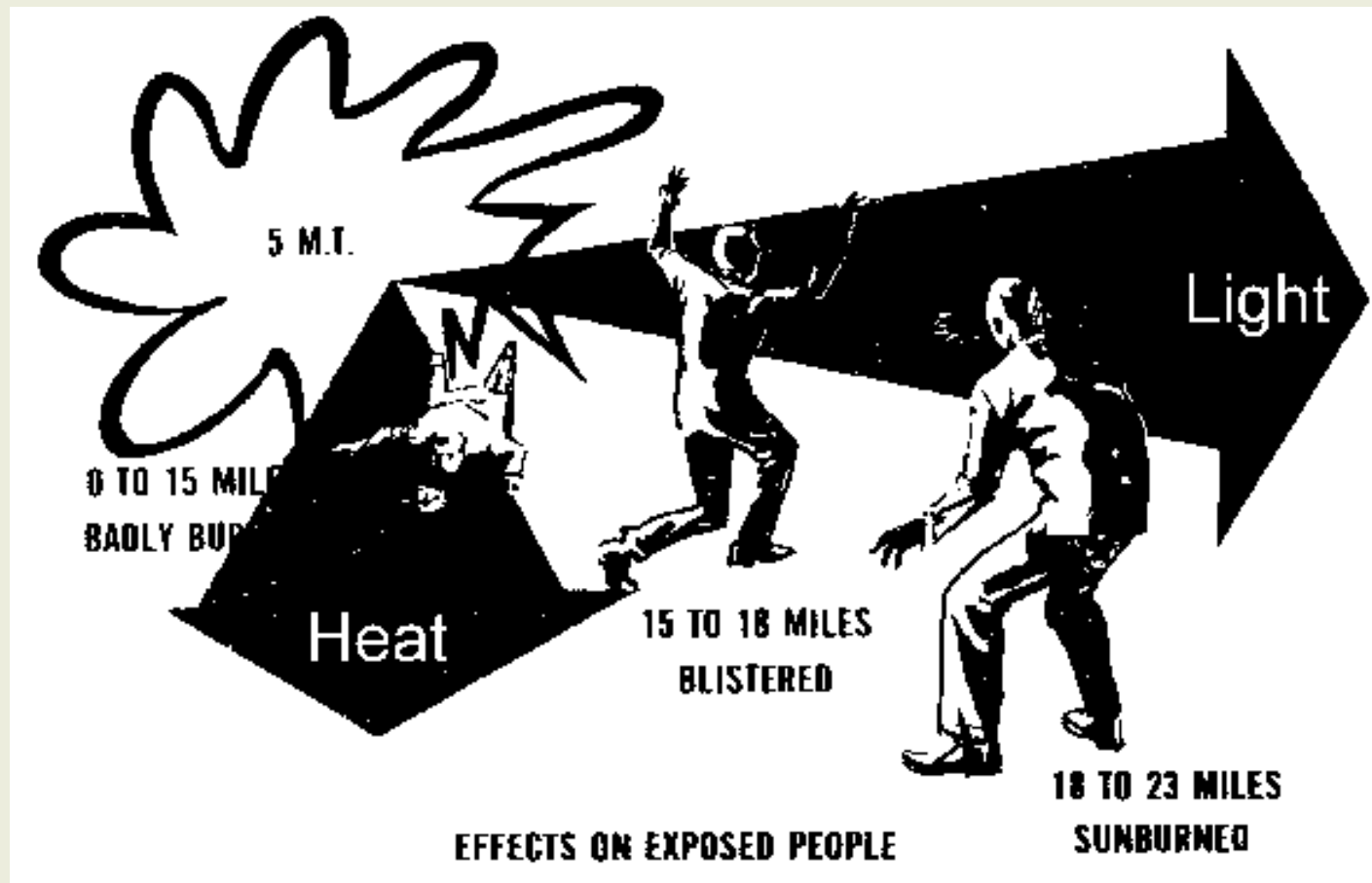
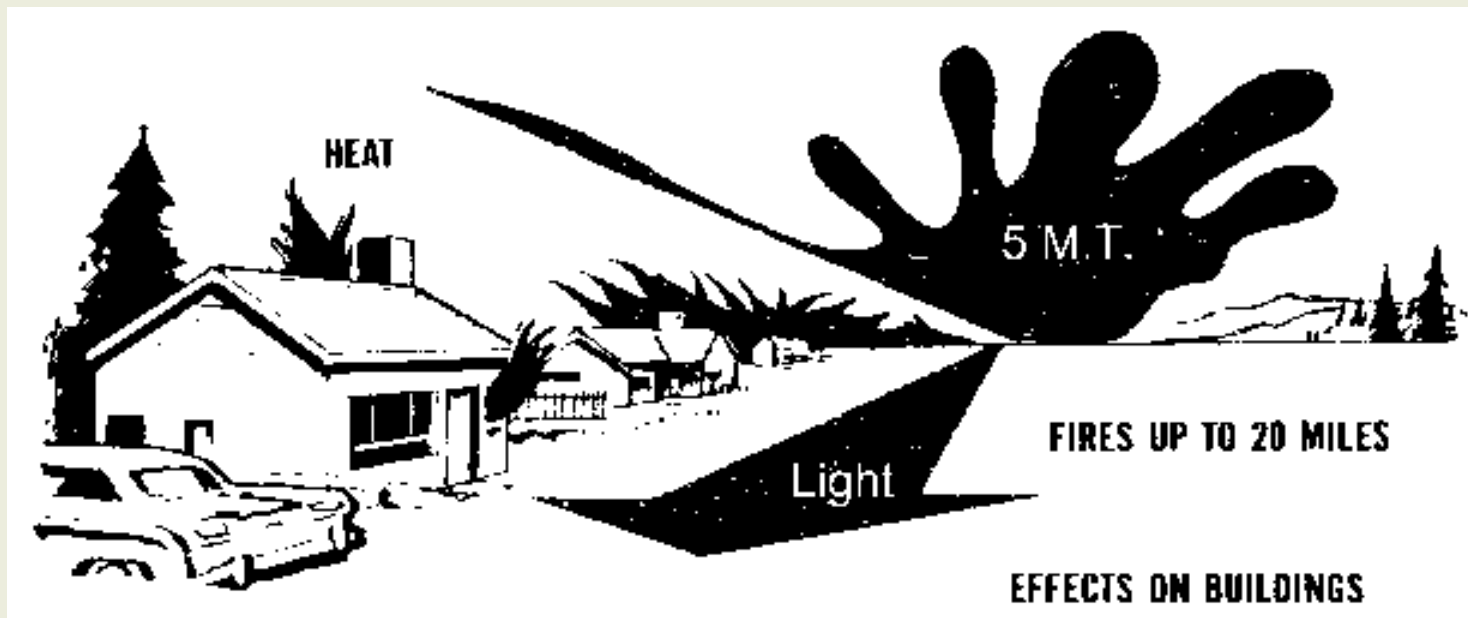

Blast

The blast wave travels more slowly than the heat flash. Several seconds may pass after you have seen the light or felt the heat before the blast wave reaches you, depending on the distance you are from the explosion. It is like the time between seeing the flash of lightning and hearing the sound of thunder. For example, at ten miles from the centre of an explosion, it would take about 35 seconds for the blast wave to reach you. If caught in the open during a nuclear explosion, this time can be used to find some protection from the blast wave.

You might be injured by being thrown about by the blast; therefore, keep low. The greatest danger is from flying glass, bricks and other debris. The blast from a 5-megaton explosion could injure people as far away as 15 miles.

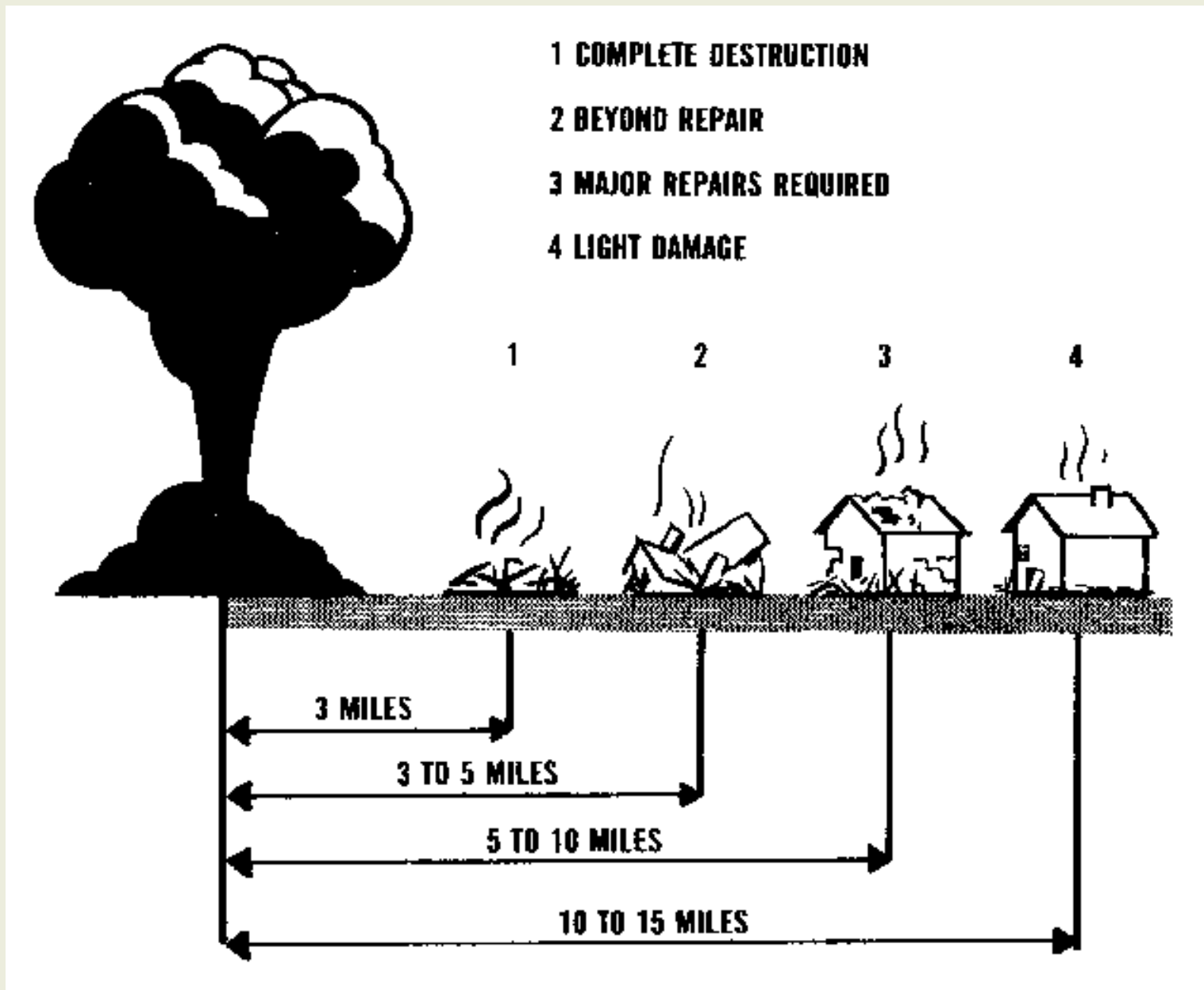

The kinds of damage that the blast can do to buildings are:

- Complete destruction of all buildings three miles from the centre of the explosion.
- Damage beyond repair to buildings three to five miles distant. They would have to be torn down.
- Major repairs required to buildings five to 10 miles distant before they could be occupied.
- Light to moderate damage to buildings 10 to 15 miles distant. They could be occupied during repairs.

A 20-megaton bomb increases the approximate ranges of damage described above to five, eight, sixteen and twenty-four miles.

These are approximate distances as the strength of buildings is not uniform. For example, reinforced concrete buildings are more blast resistant than wood frame structures. In some areas four miles away from the explosion,

concrete buildings might be repairable, while wood frame buildings would be completely destroyed. Windows, of course, are very vulnerable and are apt to be blown in as far away as 25 miles from the explosion.

Radiation

A nuclear explosion causes both immediate radiation and residual radiation.

Immediate radiation is given off at the time of the explosion. It is dangerous only within two or three miles. If you were near the explosion without adequate protection and managed to survive the effects of blast and fire, you could still be seriously affected by immediate radiation.

Residual radiation is given off by the radioactive particles left as "fallout" after the explosion. The danger from fallout would be so great and widespread that it is discussed separately, in [Step 2](#).

Protection against Heat, Blast and Immediate Radiation

The illustrations below show some of the most probable situations in which you might find yourself at the time of a nuclear attack, and what you should do:

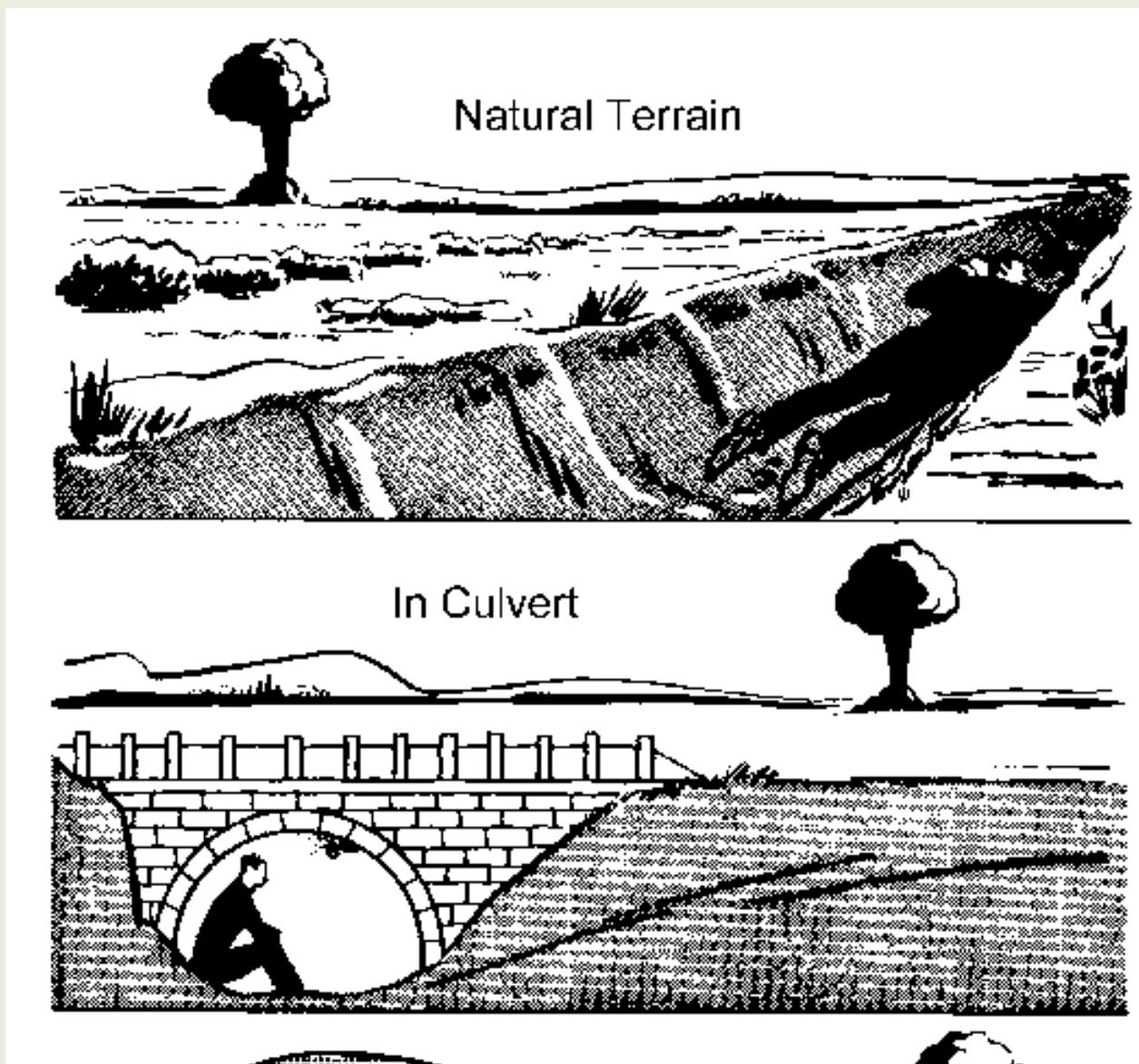

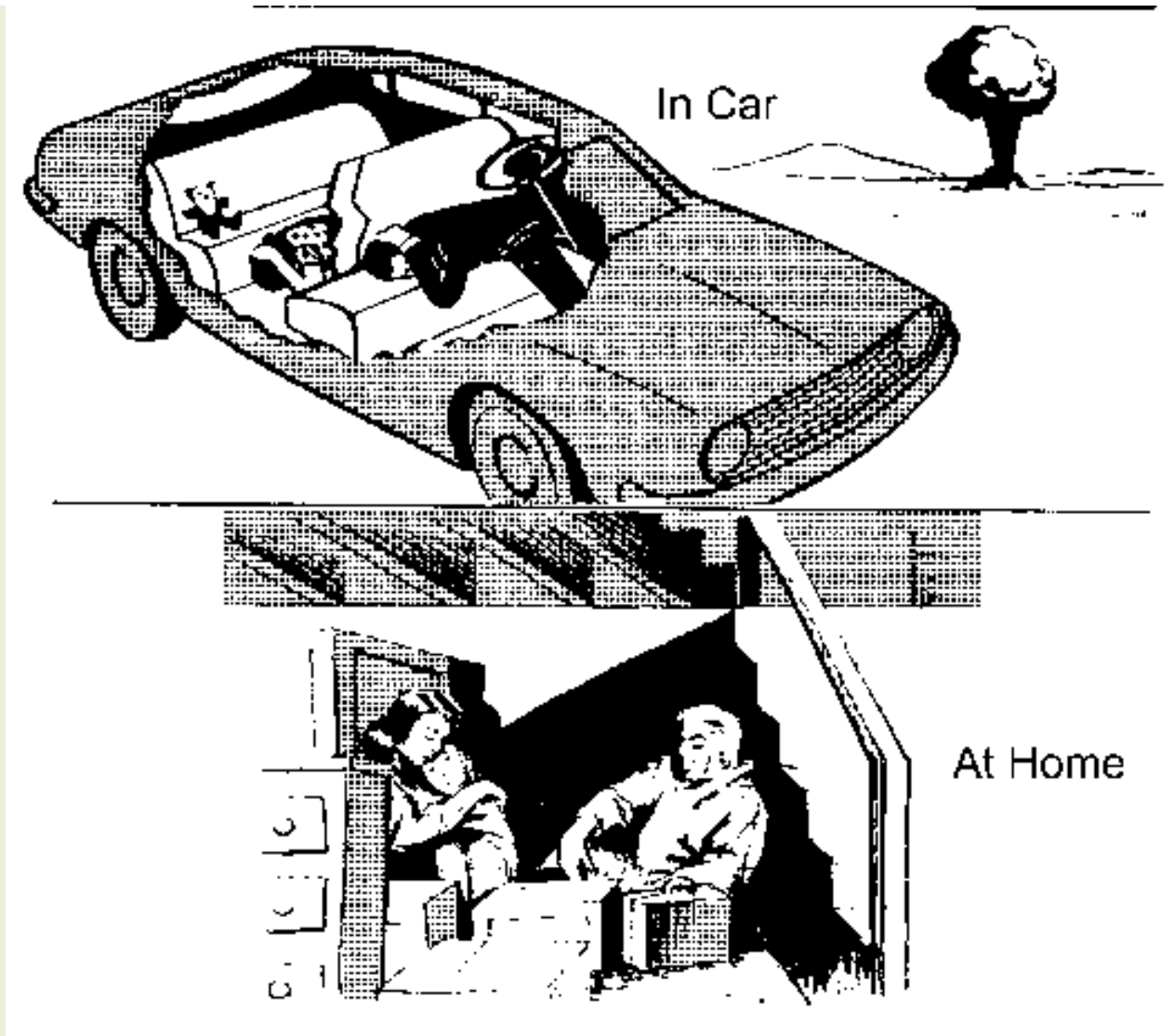

Step 2: Know the Facts About Radioactive Fallout

If a nuclear weapon is exploded on, or near, the ground, danger from radioactive fallout is greatest. The force of the explosion may make a crater up to a mile wide and to a depth of one hundred feet. Millions of tons of pulverized earth, stones, buildings and other materials are drawn up into the fireball and become radioactive. Some of the heavier particles spill out around the point of explosion. The rest are sucked up into the mushroom cloud.

This radioactive material is then carried by winds until it settles to earth. This is called "Fallout". Under some circumstances you may see the fallout; under others you may not.

The radioactivity it gives off cannot be seen. You can't feel it. You can't smell it.

But fallout doesn't come out of the sky like a gas and seep into everything. It can best be described as a fine to coarse sand carried by the winds. Because the wind direction varies at different heights above the ground, it is not possible to judge from the ground where the fallout will settle. It can settle in irregular patterns hundreds of miles from the explosion.

The fallout from a 5-megaton explosion could affect seriously an area of 7,000 square miles. If nothing were done to gain protection during the period of high radioactivity, there would be a grave danger to life in that area.

Because fallout is carried so far and covers such a large area, it could be the greatest danger to the largest number of Canadians in a nuclear war. If Canada was not hit by nuclear bombs, those exploding in the United States close to our border could result in serious fallout in many parts of Canada.

There are four things which determine the amount of radiation reaching your body from fallout:

1. The [time](#) that has passed since the explosion.
2. The length of [time](#) you are exposed to fallout.
3. The [distance](#) you are from the fallout.
4. The [shielding](#) between you and the fallout.

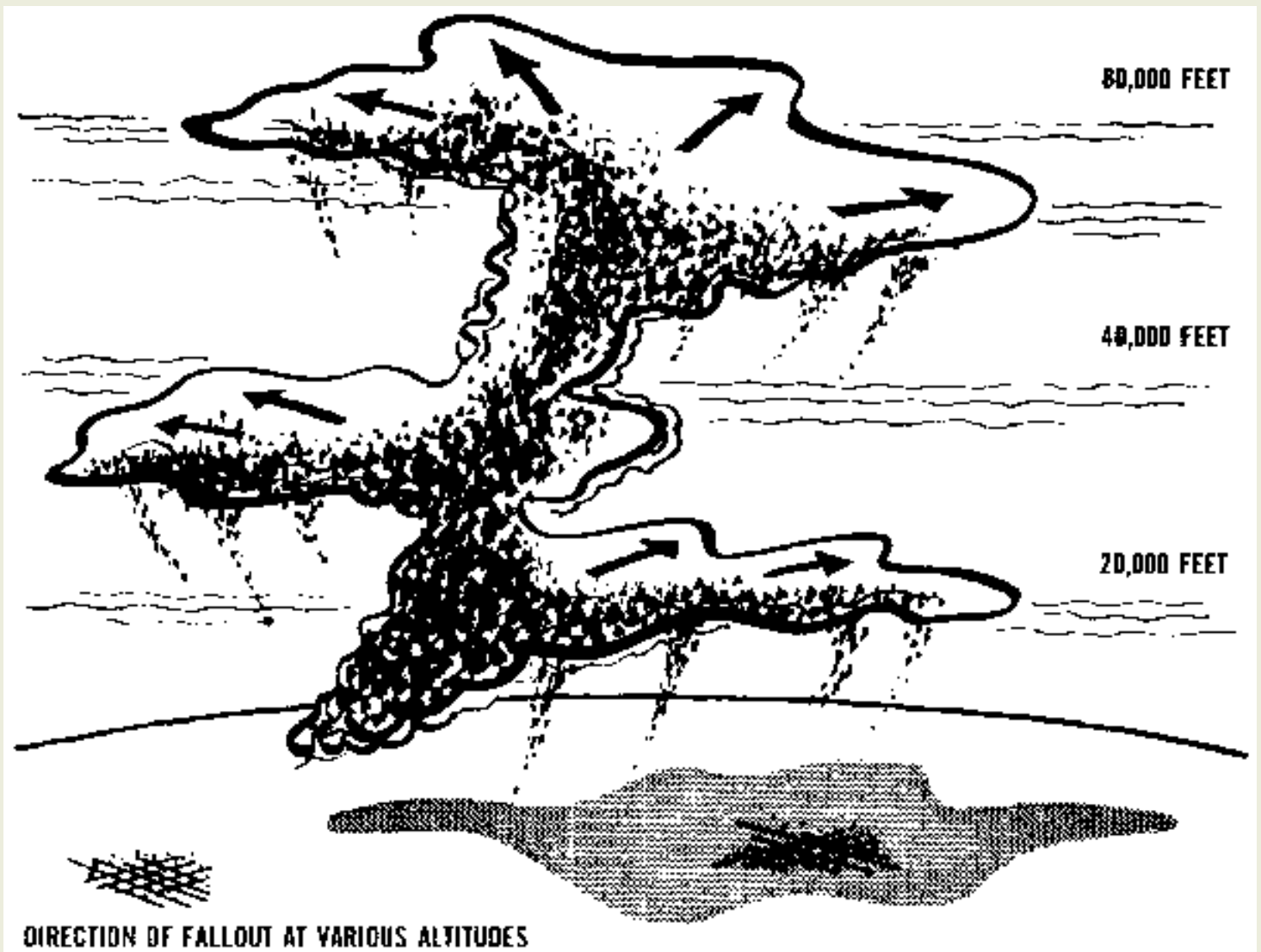

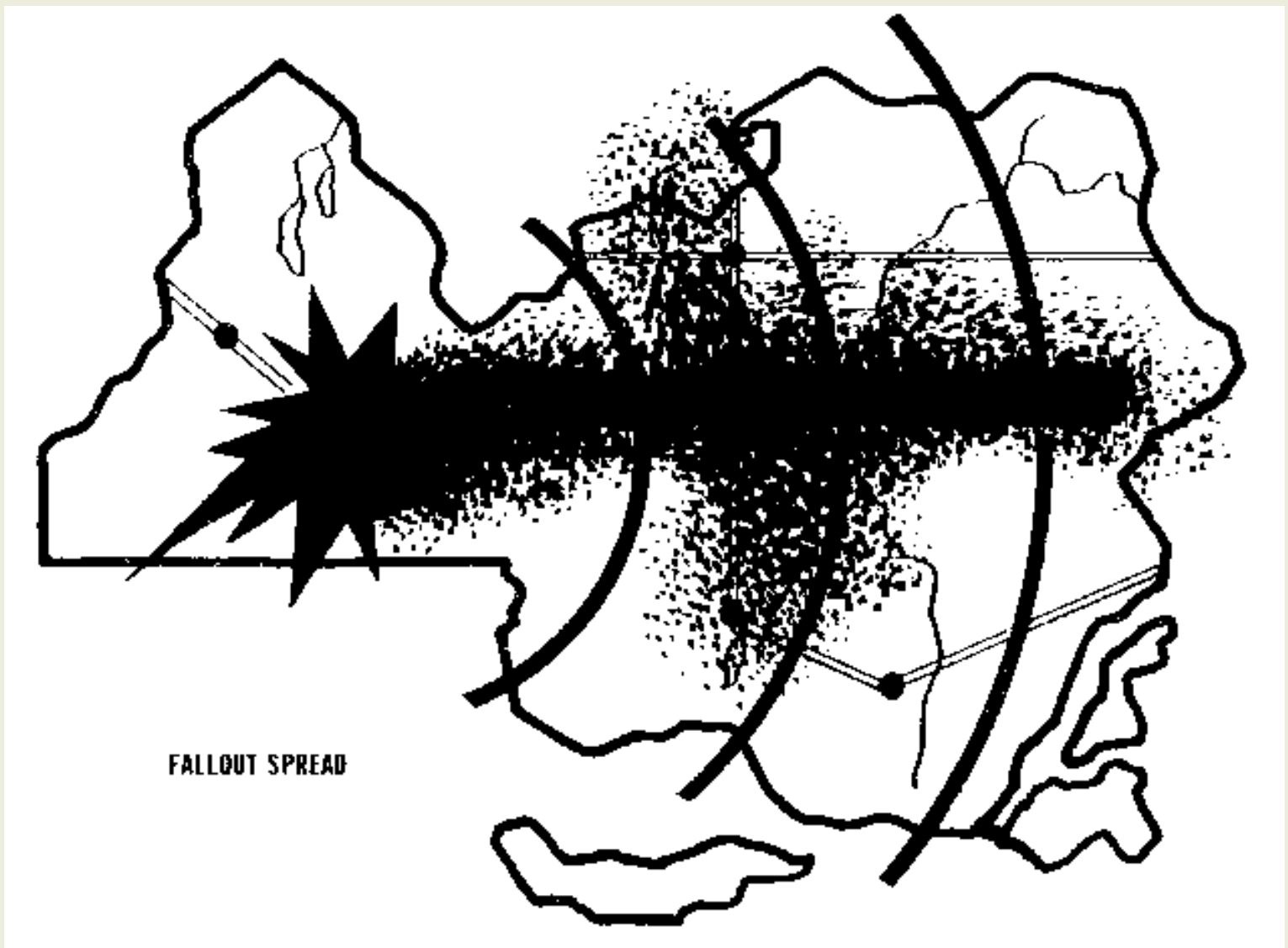

Time

The radioactivity in fallout weakens rapidly in the first hours after an explosion. This weakening is called "decay". After seven hours, fallout has lost about 90% of the strength it had one hour after the explosion. After two days it has lost 99%; in two weeks 99.9% of its strength is gone. Nevertheless, if the radiation at the beginning were high enough, the remaining 0.1% could be dangerous.

Radiation must be measured by special instruments handled by people trained to use them. But, if you stay in a shelter during the first days following an explosion, you escape the strongest radiation. *You should stay in the shelter until radiation has been measured and you have been told over the radio that it is safe to come out.*

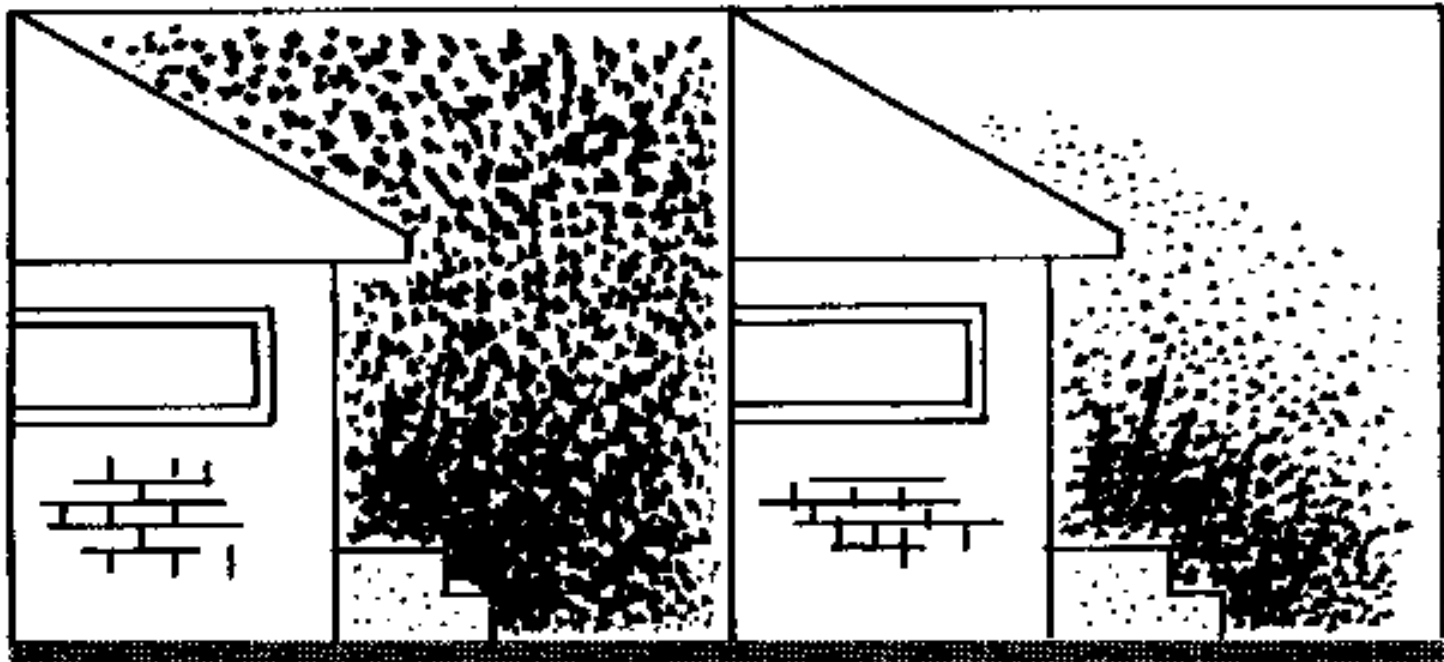

1 HOUR

7 HOURS

RADIATION DECAY TIME

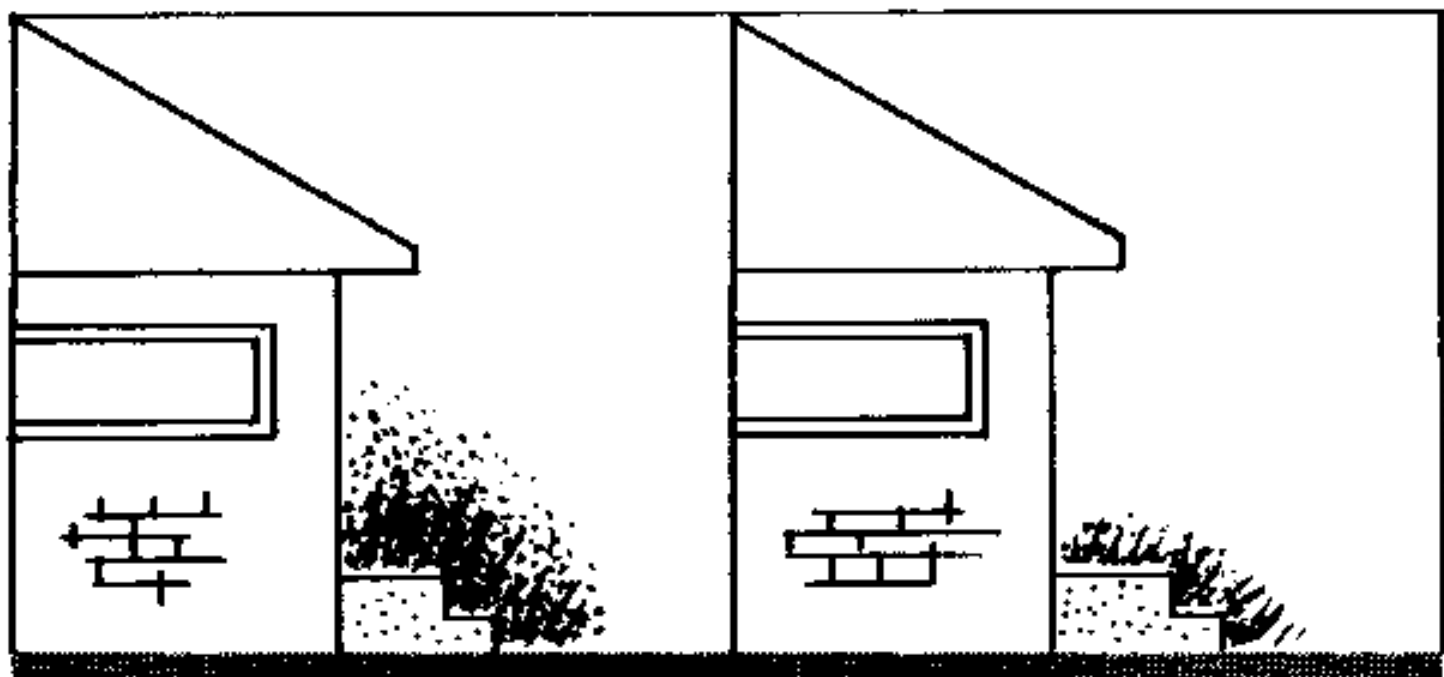

48 HOURS

2 WEEKS

Distance

The strength of radiation reaching your body is reduced the farther you are from the fallout. Here are some illustrations of the safest place to be when you are in various kinds of buildings.

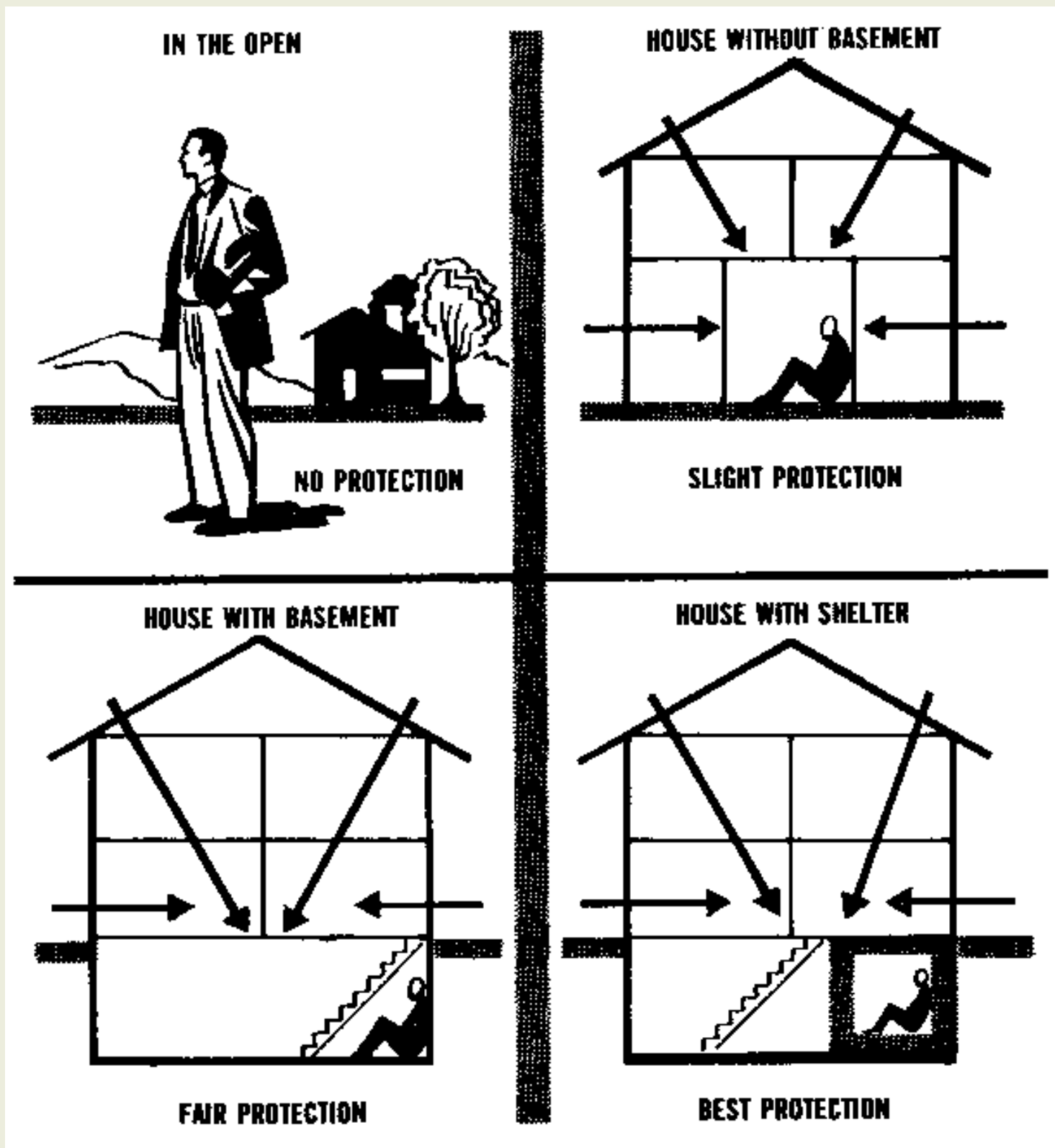

Shielding

The most effective protection is to place some heavy material between yourself and the fallout. The heavier the material the better the protection. Many common materials give excellent protection. The materials and design of the fallout shelter recommended in **Blueprint for Survival No. 1** will stop penetration of 99% of outside radiation.

These thicknesses of material will stop 99% of radiation:

- 16 inches of solid brick
- 16 inches of hollow concrete blocks filled with mortar or sand
- 2 feet of packed earth $\ddot{\text{A}}$ 3 feet if loose
- 5 inches of steel
- 3 inches of lead
- 3 feet of water

A fallout shelter is the best way to protect your family and yourself against radiation because:

- It keeps the radiation at a distance.
- It shields you from radiation.
- The time spent there is the period when radiation is most intense.

By providing your family and yourself with a fallout shelter, you are unlikely to suffer serious effects from radioactive fallout.

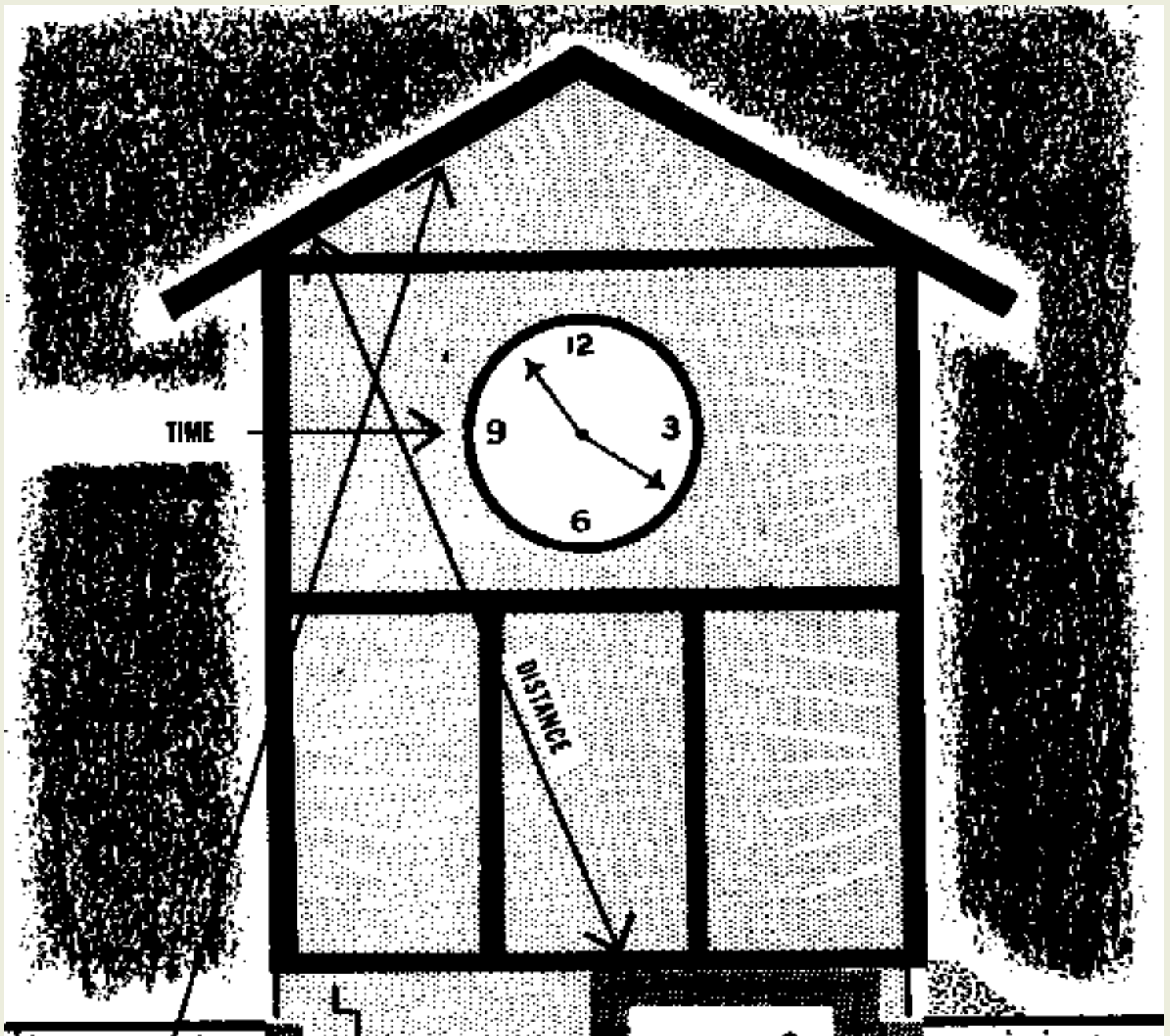

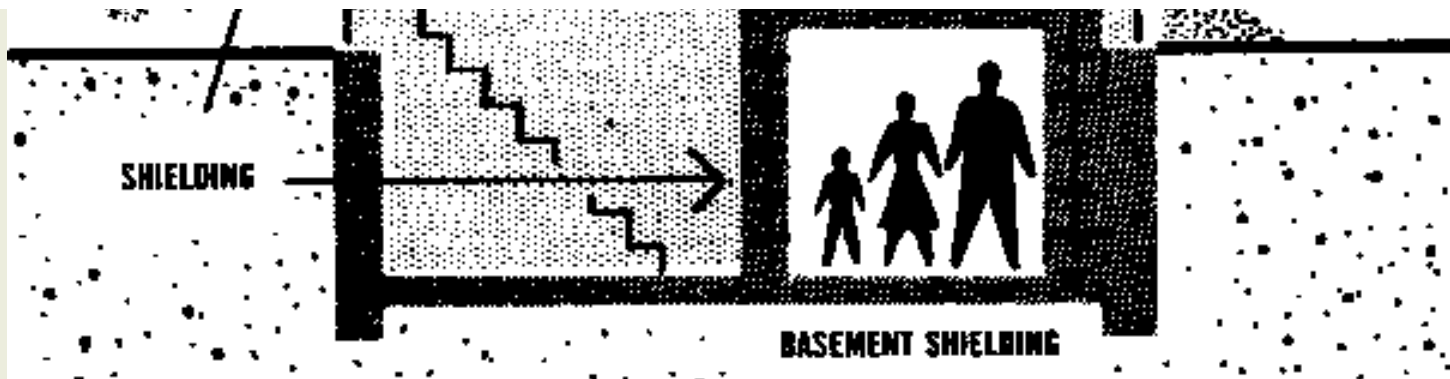

Personal Danger from Fallout

Radioactive particles in contact with your skin for a few hours may produce burns. Follow [Step 9](#) to prevent this danger.

Radioactive particles swallowed in food or water might be harmful. Follow [Step 9](#) to prevent this danger.

Radioactivity from an area of fallout may produce illness in the unprotected individual after a few days. Follow [Step 4](#) to prevent this danger.

Radiation illness develops slowly. It cannot be spread to other people. Except for temporary nausea shortly after exposure, evidence of serious effects from radiation may only appear after an interval of from a few days to three weeks. A combination of loss of hair, loss of appetite, increasing paleness, weakness, diarrhoea, sore throat, bleeding gums and easy bruising indicate that the individual requires medical attention. *Nausea and vomiting may be caused by fright, worry, food poisoning, pregnancy and other common conditions.*

Step 3: Know the Warning Signal and have a Battery-Powered Radio

All Canadian communities where there is a likely need are provided, or will be provided, with sirens. Other areas should have warning arrangements based on local systems such as telephones, horns, bells or factory whistles.

Warning devices are only attention-getters. Dependent on the size of your municipality, the sirens, bells, telephones, etc., will sound the Attack Warning.

There is one type of siren warning signal in Canada:

The ATTACK WARNING Signal

The ATTACK WARNING Signal: A wailing (undulating) tone on the sirens of three to five minutes duration or short blasts on horns or other devices repeated as necessary means:

- An attack on North America has been detected;
- Warning of fallout.

WHEN YOU HEAR THE WARNING SIGNAL, YOU SHOULD TAKE PROTECTIVE ACTION AND LISTEN TO THE RADIO FOR INSTRUCTIONS.

A Radio is Essential

When the Attack Warning sounds, you must take protective action. Take a battery-powered radio with you. Broadcast advice and instruction may help to save your life. If you don't have a portable radio, turn up the volume of your house radio so that it can be heard in your shelter. If away from home you are forced to take emergency shelter and are near a radio-equipped vehicle, turn up the volume and open all the vehicle's doors or windows.

The Canadian Emergency Broadcasting System, a network of all Canadian radio and television stations which will be formed when a nuclear attack on Canada has been detected, will tell you when and how to take emergency protective action against possible attack and shelter against fallout if an attack occurs.

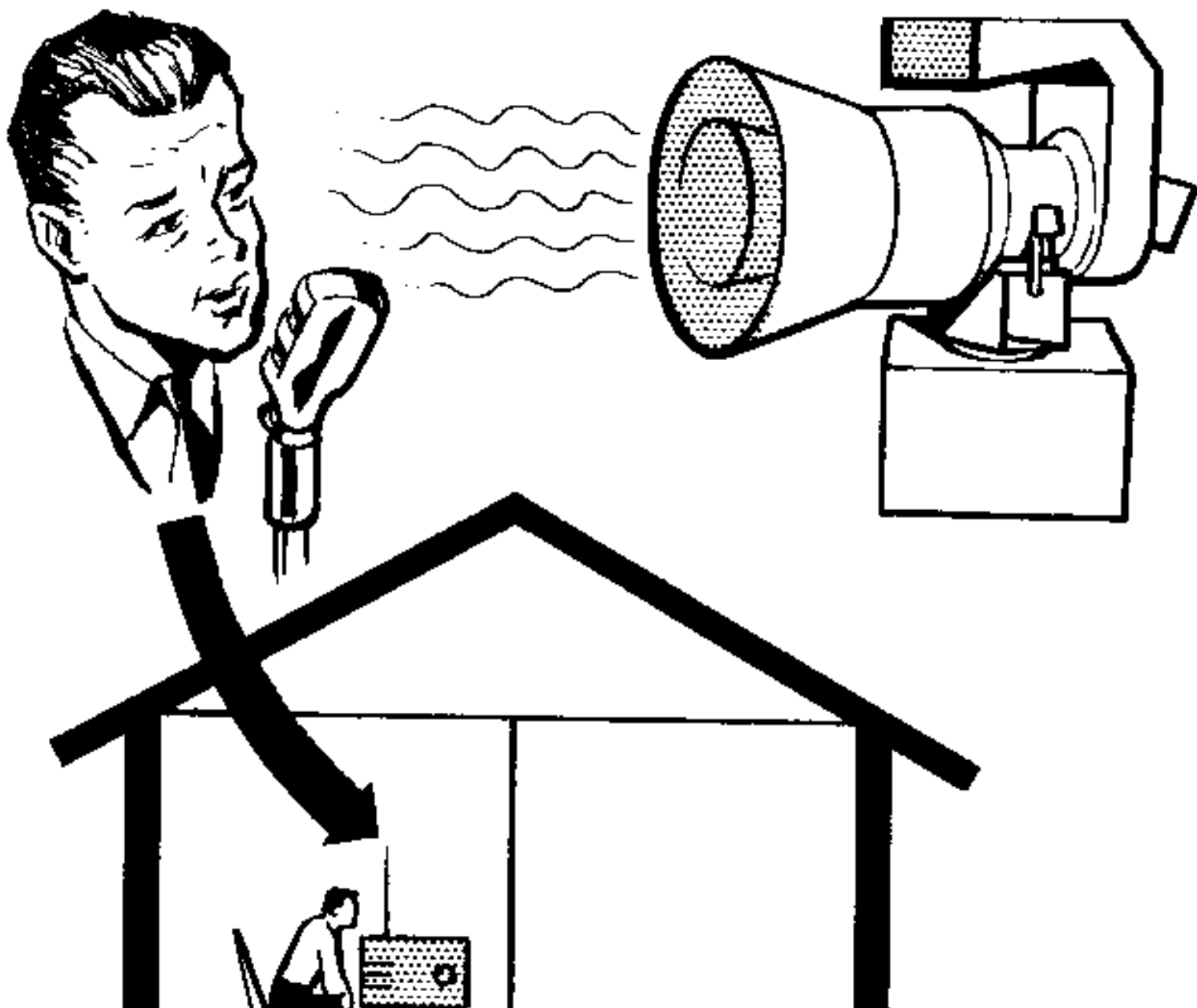

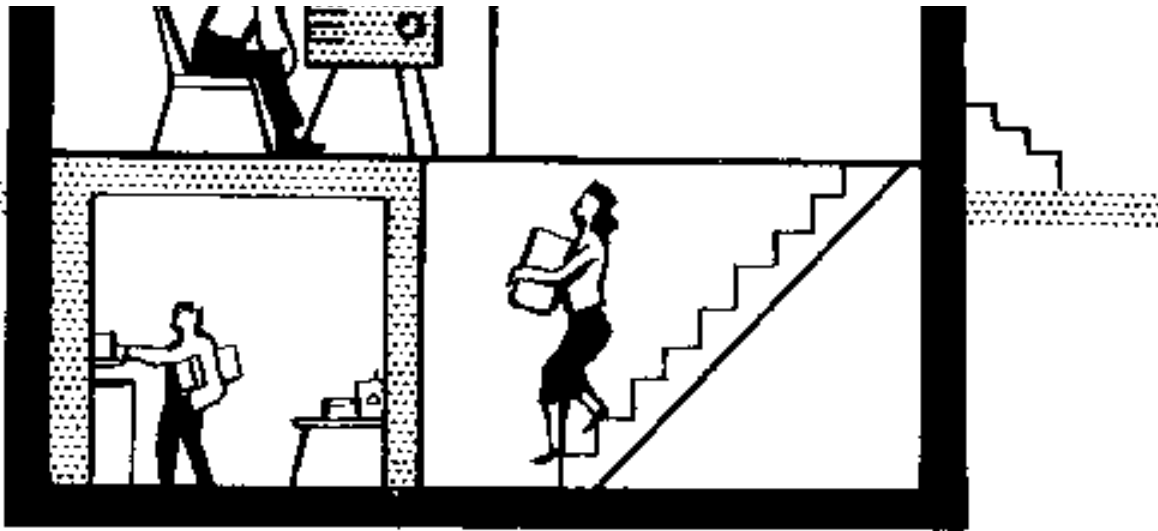

Before Attack

If sirens or warning systems signal impending attack, regardless of where you are or what you are doing, you must take the best available cover against the blast, heat and light effects of nuclear explosions.

Emergency broadcast instructions will include the following advice:

- If you are at home go to the basement or strongest part of your house or building which offers the best protection. If material is handy, improvise blast protection. See Step 4.
- Take your battery radio with you, or turn up the house radio so that you can hear it while under cover.
- Stay away from windows.
- Lie down and protect yourself from flying glass and falling debris.
- Shield your eyes from the flash of an explosion.
- If you are away from home take protective cover immediately.
- If you are travelling, stop and take protective cover immediately, or if you are only a few minutes from a safe destination, proceed and take protective cover immediately.
- Listen to your radio for further instructions.

After Attack

If sirens or warning systems sound following nuclear attacks, the warning may mean another attack or that radioactive fallout is approaching your area. **You will be advised over the radio.** If the advice concerns fallout, you must take cover against the fallout effects. (See [Step 4](#)).

Radio broadcasts will identify areas which will be affected by the fallout and give instructions and advice. These might include:

- Location of nuclear explosions causing local fallout.
- Information about the parts of the country to be affected by fallout.
- Length of time before fallout is likely to reach specific communities or areas.
- Ways to increase fallout protection.
- Supplies to take to your fallout shelter.

- Whether it is safer to stay in your community or area, or to go to other areas.
- Advice as to which areas are free of danger.
- Advice on when to leave shelters and for how long as danger from radioactive contamination diminishes.
- Requests for help in rescue operations, such as rescue, firefighting and medical assistance.
- Advice on conservation of food, water and fuel.
- How to keep warm when power is off and the weather is cold.

Don't Use The Telephone

When the sirens sound don't use the telephone. Listen to a radio or television for information. In the event of an Attack Warning telephone lines will be required for official use.

Step 4: Know How to Take Shelter

It is important to provide your family and yourself with a shelter. But what kind of shelter? This is a decision you must make yourself after studying the problem.

Study your shelter requirements in the same way that you would study accident or fire insurance. Decide upon the degree of protection you want for your family and yourself. Shelter is your insurance against something you hope will not happen, but if it does, will give you protection.

Shelters of the type commonly used in Europe during the Second World War would not provide protection against the blast of a nuclear explosion. They were designed to withstand short shock pressures lasting something like 1/100th of a second. Shelters designed to withstand the pressures created by a nuclear explosion must be able to stand up to pressures lasting as long as 6 seconds. In addition, they must be capable of giving the occupants protection against fires outside the shelter as well as against radiation.

The fallout shelter is designed to give protection against radioactive fallout only. Because most people in Canada probably would not be affected by the blast and heat effects of nuclear explosions, protection against fallout is all that is required by them.

The type of shelter for good protection depends upon the distance it will be from the explosion. Unfortunately, it is not possible to know this in advance. That is why each individual must make his own decision when selecting the type of shelter he wishes to have.

Blueprint for Survival No. 1 gives details of a fallout shelter for the home in which you now live. If you rent the home, the decision to construct a shelter must be taken jointly with your landlord.

Blueprint for Survival No. 2 gives details of a fallout shelter for the new home you may be planning to build.

Blueprint for Survival No. 6 gives details of blast shelters which may be built outside the home.

These pamphlets are available from your local Emergency Measures or Civil Defence Organization.



Improvised Protection Against Blast

One of the simplest ways to improvise some anti-blast protection is to build a lean-to (bed springs or boards) against a work bench or heavy table, preferably in the basement, and pile mattresses on it and at the ends. If the material is readily available it could be built in a matter of minutes after the ATTACK WARNING is sounded and could protect you from loose bricks, flying glass, etc.

If you are in the open and there is a ditch or culvert within easy, quick reach, lie face down in it and cover your face with your arms. Make sure this shelter is not too close to buildings which could collapse into it.

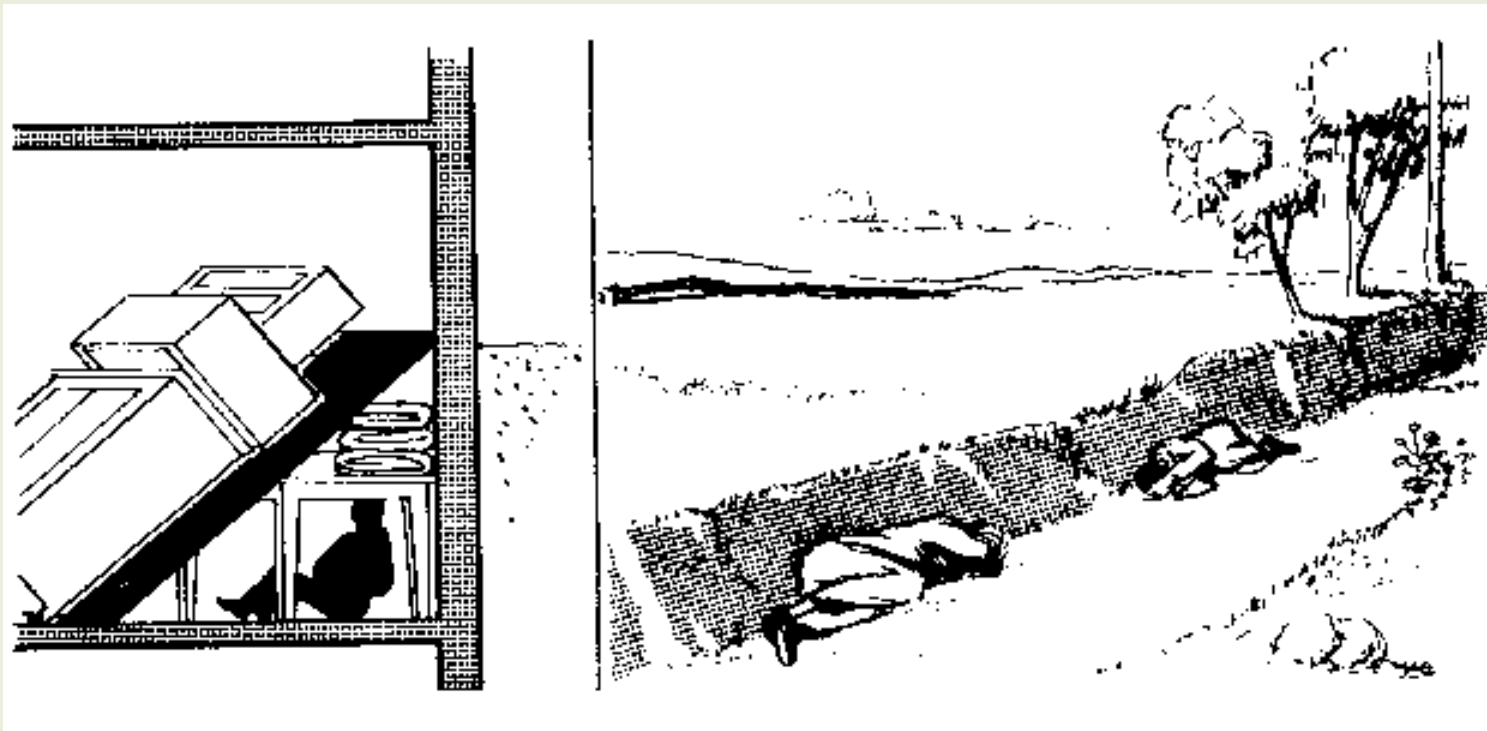

"After" the blast and heat of the explosion, you would have to find other protection against fallout which will come down later. (Don't forget your battery-powered radio).

None of these improvisations is as good as a properly equipped blast shelter, but any single one of them could mean the difference between life and death.

Improvised Protection Against Fallout

You may not have a fallout shelter when warning of approaching fallout is broadcast. Here are some tips on how to increase your protection in a basement. The amount of protection you can build will depend on how much time you have available until fallout arrives.

- You can improvise a small emergency shelter by using furniture, doors, dressers, work-bench and other materials.
- Select a corner of your basement, if possible away from windows, in which to build your shelter. Remove inside house doors from hinges to use as a shelter roof over supports. Supports for the improvised roof can be cabinets, chests of drawers, work-bench, or anything which will bear a heavy load. Use the house doors as a roof surface to provide a base for the heavy material you will have to place on it. Bricks, concrete blocks, sand-filled drawers or boxes, books or other dense items on the roof will help reduce radiation penetration. Around the sides and front of your shelter build walls of dense materials to provide vertical shielding. A small cabinet or dirt-filled box as may be used as a crawl-in entrance which can be closed behind you.
- Remember, the heavier or more dense the material around you, the greater the protection.
- Block basement windows with earth, bricks, concrete blocks, books or even bundles of newspaper. In winter, use packed snow.
- On the floor above the corner of the you select as your shelter area, pile any heavy objects you may have available, such as furniture, trunks filled with clothes, dirt-filled boxes, books, newspapers, or earth from outside.
- Outside, against above ground walls of the basement around your shelter area heap earth, sand, bricks,

concrete blocks or packed snow.



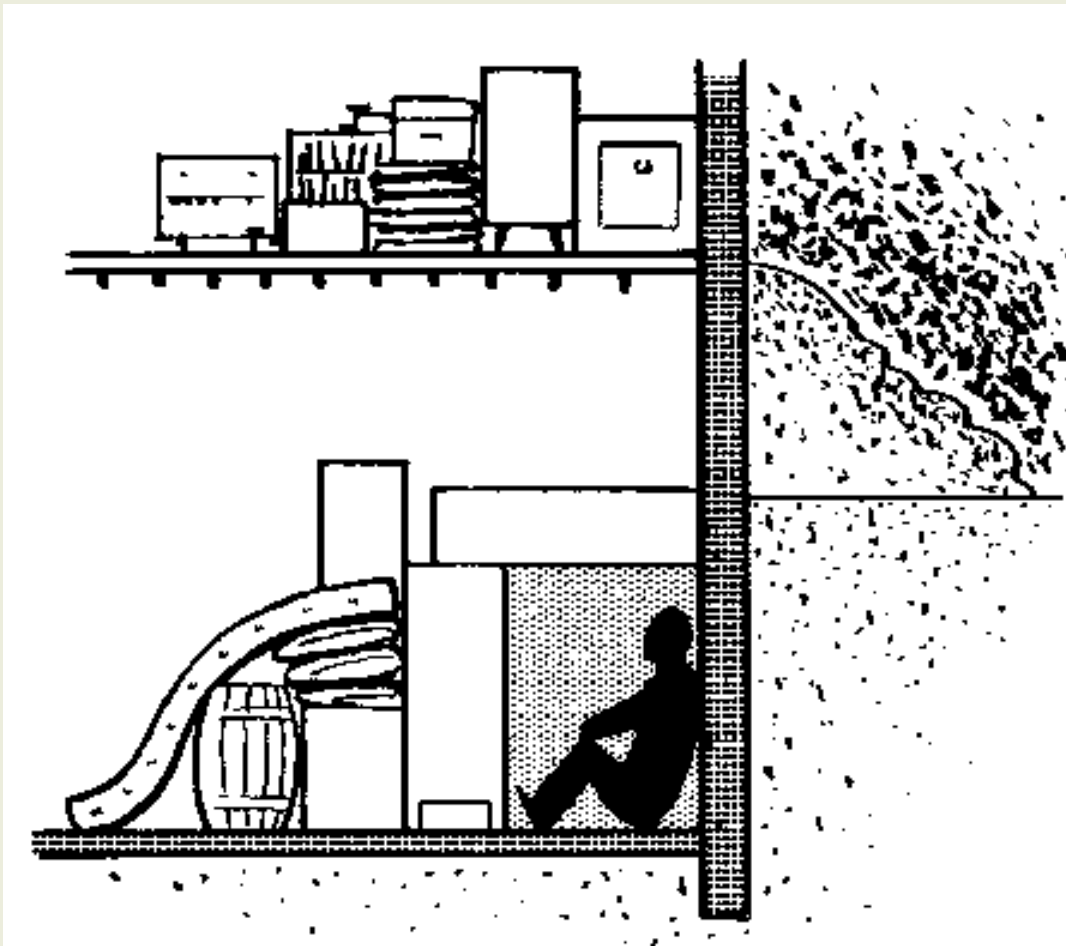

If your home has no basement or crawl space, build your emergency shelter in that part of the house (centre hall or clothes closet) farthest away from outside walls and the roof. Build it as described for houses with basements. On the floor immediately above your shelter area, and against surrounding walls, pile up furniture, trunks, dressers, dirtfilled boxes or other heavy material which will reduce radio-active penetration into your emergency shelter.

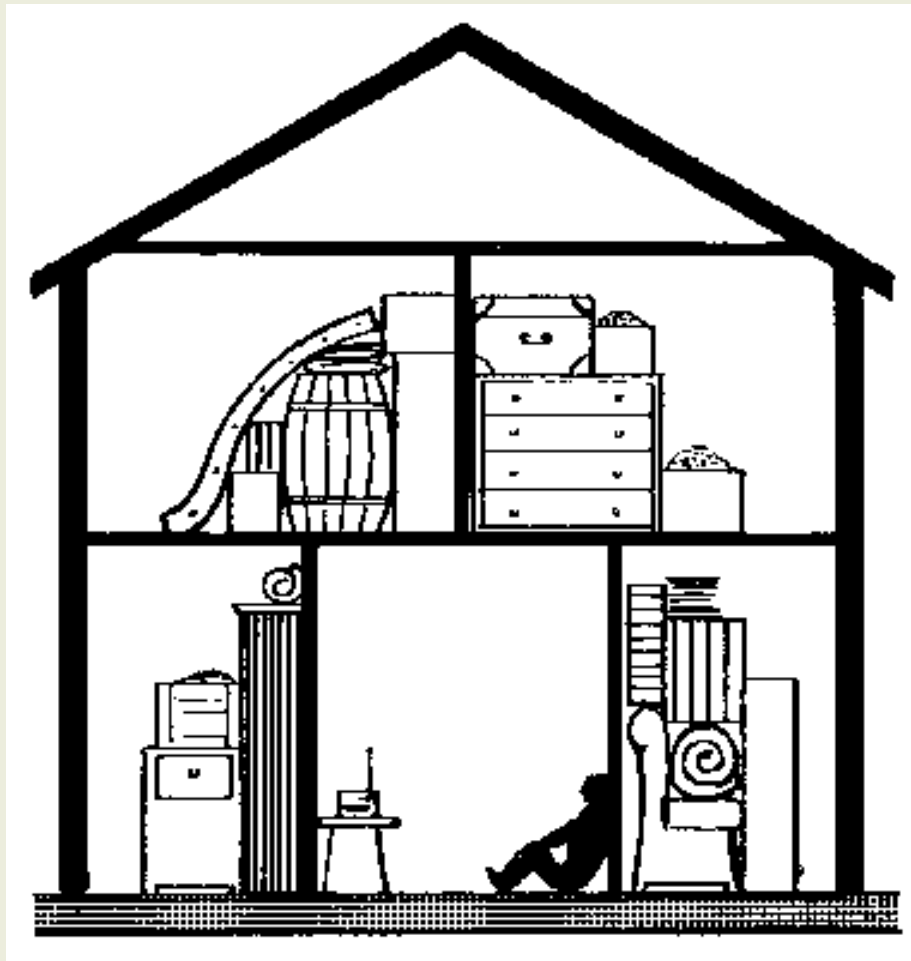

Step 5: Have 14 Days Emergency Supplies

Nuclear attacks on centres of production, and fallout conditions, may curtail the distribution of available food stocks for several days or even weeks following these attacks. Persons who had taken shelter against fallout might be advised to stay in their shelters for as long as 14 days. Those who had chosen to evacuate larger cities would be dependent largely on the resources available in reception towns. Because of these possibilities, it is recommended that every person should have emergency supplies. These supplies should include food, water, battery-powered radio, first aid kit, and where necessary, medical supplies as recommended in [Step 7](#). Heavy clothing would be necessary in winter. Extra changes of clothing should be considered particularly stockings and underclothing.

For those who may choose to evacuate major centres, supplies must be selected carefully because of space limitation in the family car. Supplies should be packaged beforehand so that they can quickly be put into the car. See the pamphlet "Your Emergency Pack" available from your local Emergency Measures or Civil Defence Organization.

Many of the recommended items are already in your home.

Whether you choose to evacuate or take shelter locally, you should have a road map with you. You could then relate the information about areas under fallout, which you would hear about on the radio, to your actual location. Toys, games, books for your children would help to occupy their time if they had to remain in shelter from fallout. Your battery-powered radio will keep you in contact with the outside world.

The following is a suggested list of items from which your two weeks' supplies should be developed to be in your shelter or handy to it.

Equipment

- Beds (bunks or folding)
- Bedding
- Toilet
- Polyethylene bags for toilet
- Table (folding or other)
- Stools (folding)
- Cups and plates (disposable)
- Knives, forks, spoons
- Can opener
- Cooking utensils
- Kerosene cooker (*Do **not** use a pressurized stove in the confines of your shelter.*)
- Kerosene lamp
- Kerosene (sufficient for 14 days)
- Candles
- Safety matches
- Hand basin
- Calendar
- Paper towels
- Garbage can (two if no waste water runoff is possible)
- Garbage bags
- Shovel
- Broom
- Battery radio and spare batteries
- Electric lamp and spare bulbs
- Clock
- Flashlight and spare batteries
- Fire extinguisher
- Hand tools
- Pocket knife
- Axe
- String
- Light rope

Recreational

- Books
- Paper
- Pencils
- Playing cards
- Chess, checkers, other games
- Crosswords, other puzzles
- Knitting, sewing, etc.

- Hobby materials
- Plasticine

Toiletries

- Soap
- Toothpaste
- Toothbrushes
- Detergent
- Nail brush
- Razor, blades and soap
- Women's basic cosmetics
- Tissues (face and toilet)
- Face cloth
- Towels
- Brush and comb

Clothing and Personal Items

Coveralls, rubber boots, rubber gloves for adults. To be used in venturing outside even after instructions have been given that this is safe for short periods.

- Bedding (blankets preferable)
- Warm sweaters and socks
- Change of underclothing and socks
- Personal hygiene items for women
- Baby clothes
- Baby feeding equipment
- Disposable diapers (two-week supply)
- Legal papers
- Plastic sheeting

Medical

(See [Step 7](#))

Food

These are suggested items and amounts for each adult for 14 days in shelter. Check off the items as you stock them in the shelter and mark the purchase date on them. Food stored for emergency use should be used and replaced at least once a year.

- Milk: 14 cans (6-oz) or 6 cans (15-oz) evaporated milk or 1-lb dried skim milk
- Vegetables: 6 cans (15 or 20-oz) - beans, peas, tomatoes, corn
- Fruits: 6 cans (15 or 20-oz) Ä peaches, pears, apple sauce
- Juices: 6 cans (20-oz) Ä apple, grapefruit, lemon, orange and tomato

- Cereals: 14 individual packages (sealed in wax bags inside or outside)
- Biscuits:
 - 2 packages of crackers (1-lb. each)
 - 2 packages of cookies or graham wafers
- Main Dish Items:
 - 2 cans meat (12-oz) - corned beef, luncheon meats
 - 2 cans beef and gravy
 - 2 cans baked beans (15 or 20-oz)
 - 2 jars cheese
 - 2 cans fish (8-oz)
- Canned and Dehydrated Soups: 2 cans (10-oz) - bean, pea, tomato, vegetable

Other Foods:

- 1 large jar or can honey, syrup, jam or marmalade
- 2 lbs. hard candy
- 1 jar or can peanut butter
- 1 package tea bags or instant tea
- 1 jar sugar
- 1 jar instant coffee
- Salt and pepper
- Instant chocolate powder
- Chewing gum

Special Requirements for Children

- For each infant include 14 cans evaporated milk (15 oz) and infant food for 14 days.
- For each child up to 3 years, include 8 extra cans of milk.
- Decrease amounts of other foods according to appetite.
- Food for older children can be the same as for adults; adjust amounts according to appetite.

Water

- Requirements: 7-14 gallons for each adult member of family; more for younger children (some water may be replaced by canned beverages).
- Containers: Store in well-cleaned, covered containers such as large thermos jugs, new fuel cans, large bottles, or plastic containers.
- Change: Change stored water at least once a month.

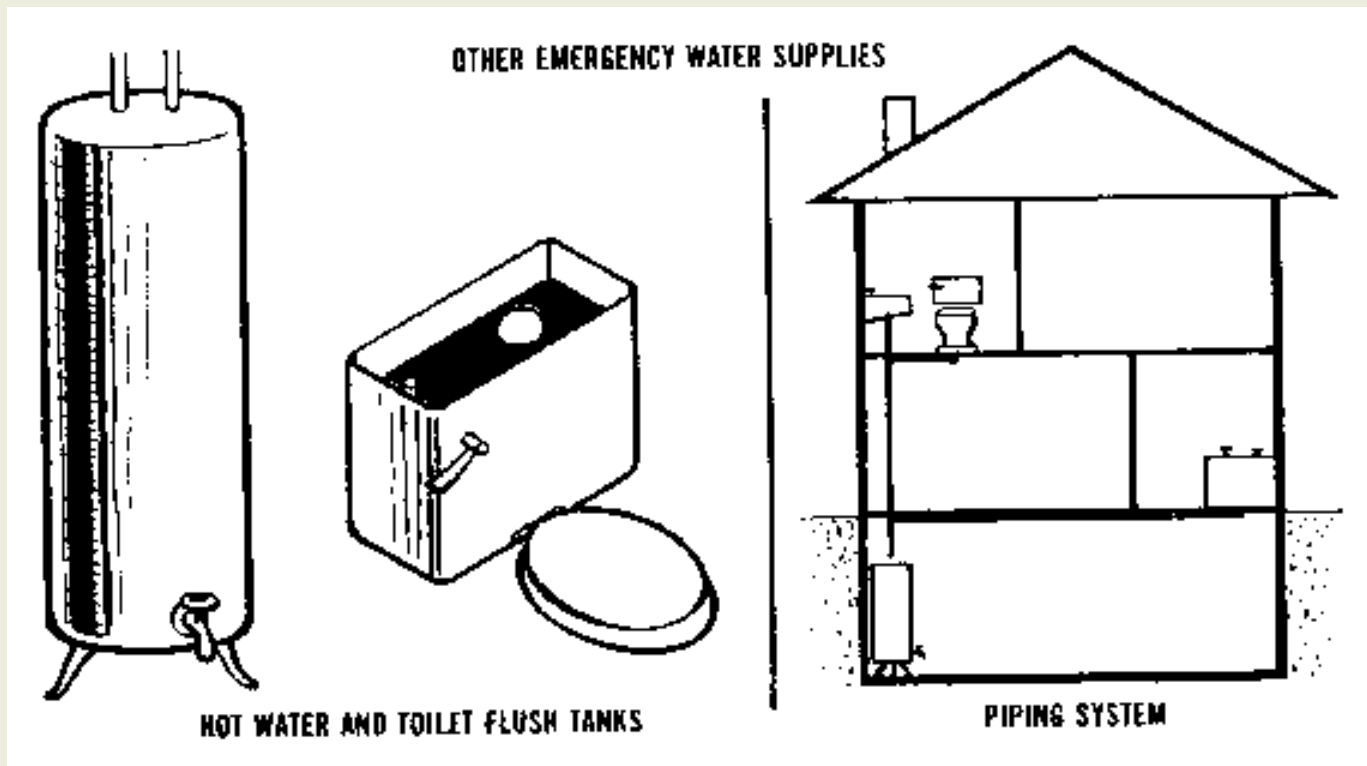

Step 6: Know How To Prevent And Fight Fires

Misinformation about the fire danger from nuclear explosions is widespread and common. For example, some persons believe that the fire-ball would completely incinerate a city. This is not true.

The heat from the fire-ball lasts about 15 seconds and would create fires which are no different from the fires you see in peacetime. They can be put out with water and extinguishers, and if each survivor were able to put out a small fire quickly, mass fires would not take place.

The heat flash from the fire-ball entering through windows and doors could set fire to curtains, clothes, furniture and paper. Other fires could break out in attics, in backyard trash, on wooden shingles and on the outside of houses built of wood particularly if they are unpainted or weathered.

Knowing how to prevent and fight fires at home and at work reduces the number of peacetime fires. The same knowledge will also reduce the number of fires caused by a nuclear explosion.

But how can you fight fires in the presence of fallout? From 5 to 15 miles from the centre of the explosion, there will be many survivors. Fallout will not start coming down for about 30 minutes. During this half hour, survivors should inspect their houses and put out all the small fires they can. They must not rely on the fire department to extinguish these fires.

You should have in your home and place of work, fire extinguishers, or in an emergency, create a water supply for fire fighting in pails, bathtubs, washtubs, etc. Don't rely on being able to use the established water supply system.

Even those who live in areas not attacked may find their fire departments will have to fight major fires elsewhere.

Every householder should learn how to carry out fire prevention and know how to fight small fires. It may prove of value in peacetime!

Your local fire authorities are always anxious to advise you on how to fight fires. Attend any emergency fire fighting classes held in your area.

Here are some tips for an emergency:

- Prepare for emergency by preventing accumulations of trash and rubbish in and around the home. This would include dry leaves and grass, lumber, boxes, cardboard cartons, old unused furniture, bales of newspapers, etc. Keep waste and garbage in covered containers.
- The shaking and twisting of buildings and homes due to blast waves in wartime or earthquakes and explosions in peacetime, may break utility inlets at the point they enter the structure. This may allow gas or fuel oil to flow into basements creating a severe hazard. Do not smoke, strike a match, or a lighter, to light your way into a darkened basement. Gas or oil vapours may be present and a violent explosion and fire may result.
- To lessen the danger of fires and explosions follow local instructions about shutting off utility services when the ATTACK WARNING sounds.
- If you have a coal-burning furnace, or a wood-stove, extinguish it or at least be sure to close all fuel and draft doors.
- Close curtains shutters or venetian blinds on all windows and remove furniture from window areas.



TO FIGHT AN ORDINARY FIRE:

- **Take away its fuel.** Get the burning material out of your home.
- **Take away its air.** Smother it with a blanket, wet if possible, or a rug.
- **Cool it** with water, earth, sand or fire extinguisher.

GAS, OIL, ELECTRICAL FIRES REQUIRE SPECIAL METHODS:

- **Gas fire:** Make sure the gas is shut off and then try to extinguish anything still burning.
- **Oil fires:** Make sure the supply is shut off then smother the fire with earth, sand, rugs or other heavy materials. Don't use water.
- **Electrical fires:** Make sure the electricity is shut off then put out the fire. Don't use water if the power is still on.

PROMPT ACTION TO PUT OUT SMALL FIRES IMMEDIATELY FOLLOWING A NUCLEAR ATTACK WILL SAVE LIVES.

Step 7: Know First Aid And Home Nursing

The acquisition of First Aid and Home Nursing skills prepares individuals to serve effectively in a national emergency. If such an emergency occurs, the care of many thousands of injured or seriously ill persons becomes a tremendous task for the organized health services. Doctors and nurses may not be readily available to assist you. Thus the importance of First Aid and Home Nursing skills takes on a new dimension. The survival of the injured or sick members of your family may become your responsibility.

The main objectives of training individuals in first aid and home nursing are:

1. To preserve life
2. To minimize the effects of injury or illness
3. To relieve suffering or distress
4. To provide continuing care and assist in rehabilitation.

Therefore you must:

- Know and practice life-saving first aid.
- Know and practice simple home nursing measures.

First Aid Supplies

A simple first aid box kept in your shelter or in your evacuation kit should contain:

- 1 bottle mild antiseptic solution (use to clean cuts)

- 5 yards 2-inch gauze bandage
- 2 triangular bandages (use for slings)
- 12 4" x 4" sterile pads (use to cover cuts, wounds and burns)
- 12 assorted individual adhesive dressings (use for minor cuts)
- 2 large dressing pads (shell dressing type) 8" x 8" (Available at minimal cost from St. John Ambulance Association)
- 5 yards 1/2 inch adhesive tape
- 9 assorted safety pins
- 1 small bottle toothache drops (for temporary treatment of toothache)
- 1 tube of petroleum jelly
- 1 small bottle aspirin tablets
- 1 thermometer
- 1 small scissors (blunt ended)
- 1 medicine glass
- 1 pair tweezers
- 4 oz baking soda and 8 oz table salt (make a drinking solution by adding 1 tsp salt and 1/2 tsp baking soda to 1 qt. of water)
- 1 First Aid Manual (St. John Ambulance Association)
- 1 Home Nursing Textbook (St. John Ambulance Association and/or Canadian Red Cross Society)
- 1 packet paper tissues

NOTE: individuals requiring special medication such as insulin should maintain at least 100-days supplies.

First Aid Hints

General Rules:

- Keep calm.
- Keep the injured person lying down in a comfortable position, his head level with his body until you determine whether his injuries are serious.
- Examine for stoppage of breathing, serious bleeding or broken bones. These must be treated immediately before any attempt is made to move the injured person. Do not be hurried into this unless you are in a situation of extreme danger.
- Keep him comfortably warm with blankets or other coverings, under and above the patient.
- Never attempt to give a semi-conscious or unconscious person anything to drink.

Unconsciousness:

An unconscious patient lying on his back may be strangled by his own tongue which will tend to fall back and obstruct the airway. All unconscious persons should be placed lying half over on their faces, (three-quarter-prone position).

If the patient is breathing quietly and easily and his lips are pink and have no froth on them, breathing is not obstructed.

If the patient is breathing noisily and with difficulty, if his lips are blue and frothing, or if his chest is sucked inwards when he breathes in, his airway is obstructed and needs immediate attention.

Keep the airway clear by:

Placing the casualty on his back; supporting his shoulders on a pad of any suitable material available; tilting the head back with one hand on the forehead, the other lifting the neck.

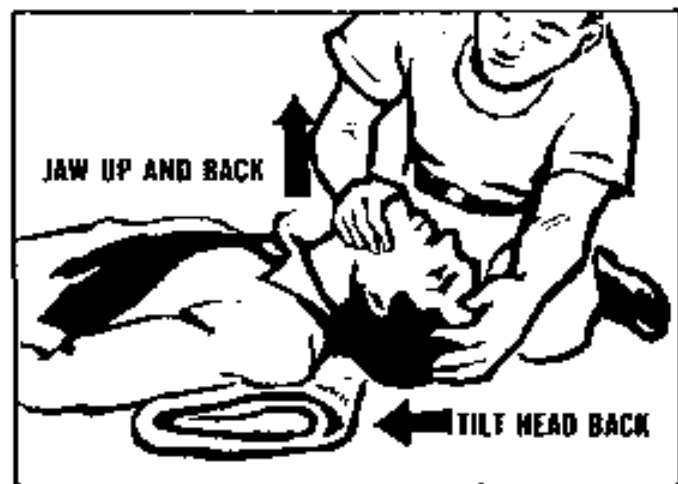
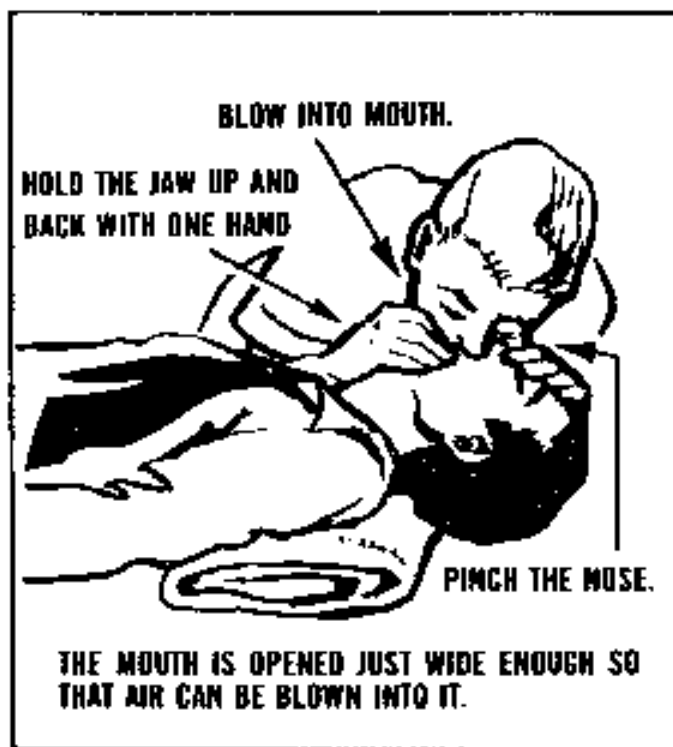

If his breathing stops you can breathe for the patient by blowing air into his lungs. Take a deep breath. Pinch the casualty's nostrils. Place mouth to mouth tightly. Blow into the casualty's lungs strongly enough to cause his chest to rise. The cycle should be repeated every 3 to 5 seconds for an adult and a little more frequently for a child. Blow more gently for a child or a baby, but strongly enough to make the chest rise.

Wounds:

You Must:

- Stop bleeding (haemorrhage)
- Keep out germs (infection)

Cover the wound with a clean dressing to keep out dirt and germs. Bandage it on firmly to stop the bleeding. If a wound is bleeding profusely, hold it firmly with your hand until you can secure an emergency dressing. Any thick pad of clean, soft, compressible material large enough to cover the wound will make a good dressing. Clean handkerchiefs, towels, sanitary pads, tissue handkerchiefs or sheets make good emergency dressings.

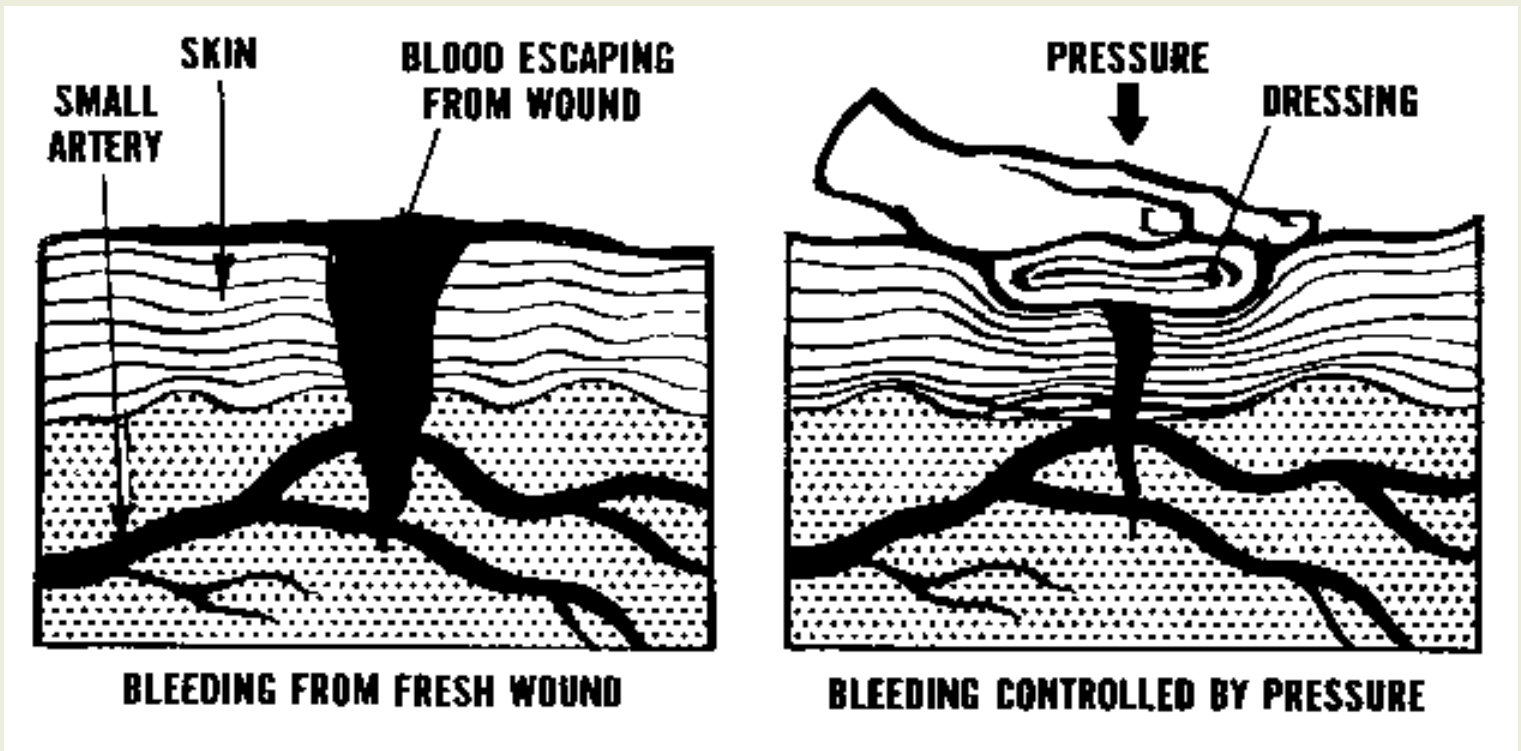

Burns:

Cover the burned area with large, thick, dry dressing and bandage it on firmly.

Encourage the casualty to drink plenty of fluids. A solution of salt and soda is useful to give to casualties with burns and to those who have suffered from serious bleeding.

Broken bones (fractures):

If a limb is very painful and cannot be used, appears to be bent in the wrong place or the casualty says he heard or felt the bone snap, it is likely that a bone is broken.

Sharp ends of a broken bone may damage important structures such as blood vessels and nerves. A broken limb should be steadied and supported to prevent movement of the broken ends before attempting to move the patient.

If a person's back or neck is so severely injured that he is afraid to move because of pain, or cannot move or feel his limbs, you should assume that he has a broken back. He should be moved on a hard, firm stretcher taking great care not to "jack-knife" him by picking up his feet and shoulders. Improvised stretchers can be made from a door, wide board, window shutter, etc. Fill in the natural hollows of the track and neck with padding and support the head on both sides to prevent movement.

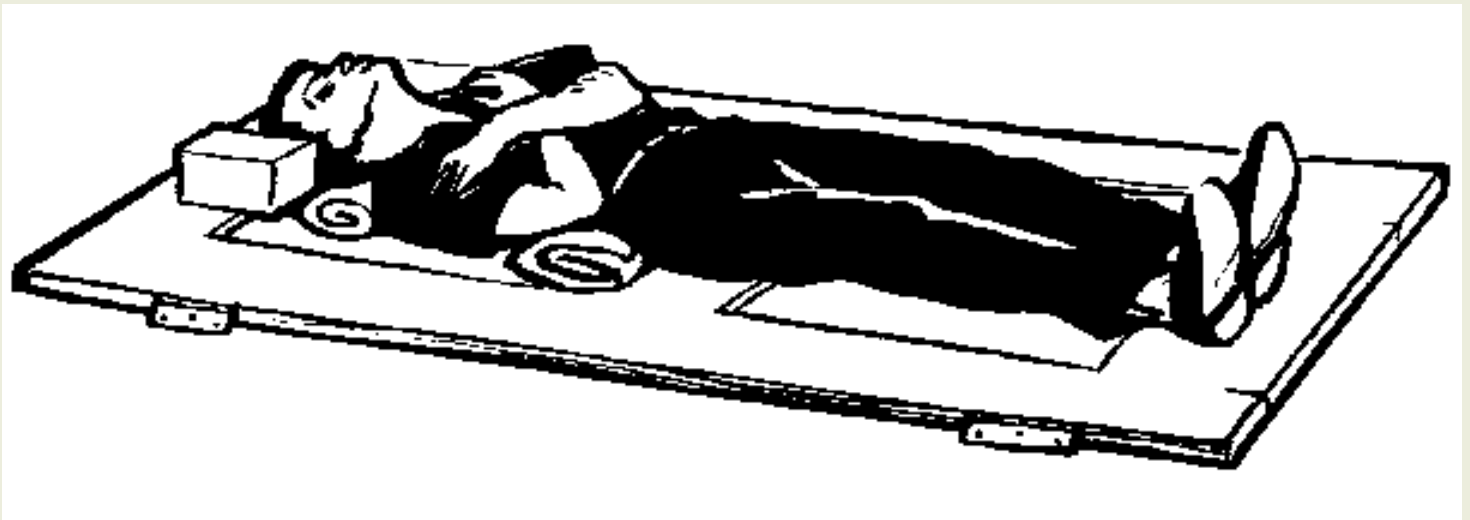

DO NOT:

- Put strong antiseptics into a wound.
- Use a tourniquet.
- Remove clothing which is stuck to a burn.
- Break any blisters or apply creams or grease to a large burn.
- Give anything by mouth to a semi-conscious patient, or to a patient with internal abdominal wounds.

HOME NURSING HINTS

Before medical or nursing help becomes available you may also encounter infant care problems, emotional problems and persons suffering from radiation sickness. What to observe, and what to do for these latter cases, is outlined below.

Infant Care

Breast feeding is preferable but, if not possible, then a formula using powdered or evaporated milk should be prepared under clean conditions.

If vomiting or diarrhoea occurs infants and children become dehydrated very quickly. To avoid this happening give frequent sips of boiled water.

If a rash or fever develops, keep others away from the sick child.

Emotional Problems

Persons who become emotionally disturbed following a disaster should be treated calmly but firmly. They should be kept in small groups, preferably with persons whom they know and encouraged to "talk out" their problem. If they are not otherwise injured they should be given something to do. It may be necessary to enlist the aid of one other calm person to help subdue the overexcited patient. If a stunned or dazed reaction persists over 6 to 8 hours this should be reported to a doctor or nurse immediately one becomes available.

Radiation Sickness

The signs and symptoms of this illness are described in [Step 2](#).

Treatment includes rest, the provision of whatever nutritional food and drink is available and personal encouragement to get well. Swab the mouth gently with mild, warm salt and water if it becomes sore. As these patients are susceptible to infection, keep wounds clean and covered with a sterile dressing. Separate these patients from persons with colds, rash or fever.

Improvised Equipment

The following suggestions may help you care for your patient when proper equipment is not available.

- Bed: A couch, mattress or any well padded, firm surface; if too low raise on bricks, boxes or wooden blocks.
- Bedding Protection: Old crib pads cut into a convenient size and placed over a waterproof sheeting; or several layers of newspaper and heavy brown paper covered with old soft cotton. (Never use thin plastic if patient is a child.)
- Backrest: A straight-backed chair turned upside down at head of bed and securely tied to bed; a triangular bolster or cushions from a chair or chesterfield.
- Bed Cradle: A light wooden box or firm cardboard carton approximately 10 x 12 x 24 inches, with two sides removed; or a hoop sawn in half and the two pieces joined together in the centre.
- Pressure Pads: Soft cushion or foam or sponge rubber pads will protect heels, elbows, back of head or any other body pressure point.
- Bedpan or Urinal: For bedpan use a padded dish or pan; for urinal any wide-necked bottle or jar.
- Hot Water Bottle: A heated brick wrapped in several layers of newspaper.

START TRAINING NOW!

ONE PERSON IN EVERY FAMILY SHOULD BE TRAINED IN FIRST AID AND/OR HOME NURSING.

Courses in these skills are available in most municipalities from your local St. John Ambulance Association or Canadian Red Cross Society.

REGISTER NOW!

Step 8: Know Emergency Cleanliness

Your limited supply of water will have to be rationed and used only for essential purposes. If you have enough warning time before the arrival of fallout, fill your bathtub, all available buckets and pans with water. And remember that there is an emergency supply in your hot water tank. (Don't forget this if in peacetime your water supply has been temporarily disrupted).

The problems of garbage and human waste disposal can be solved even if fallout keeps you in the shelter. Put all your garbage in tightly covered garbage pails. After using your emergency toilet, you should tie human waste in waterproof plastic (polyethylene) bags and place them in the garbage pail. Store a 14-day supply of the plastic bags. After the second day in the shelter, you may risk leaving it for a few minutes for essential tasks. Therefore, when your garbage container is filled, move it out of the shelter.

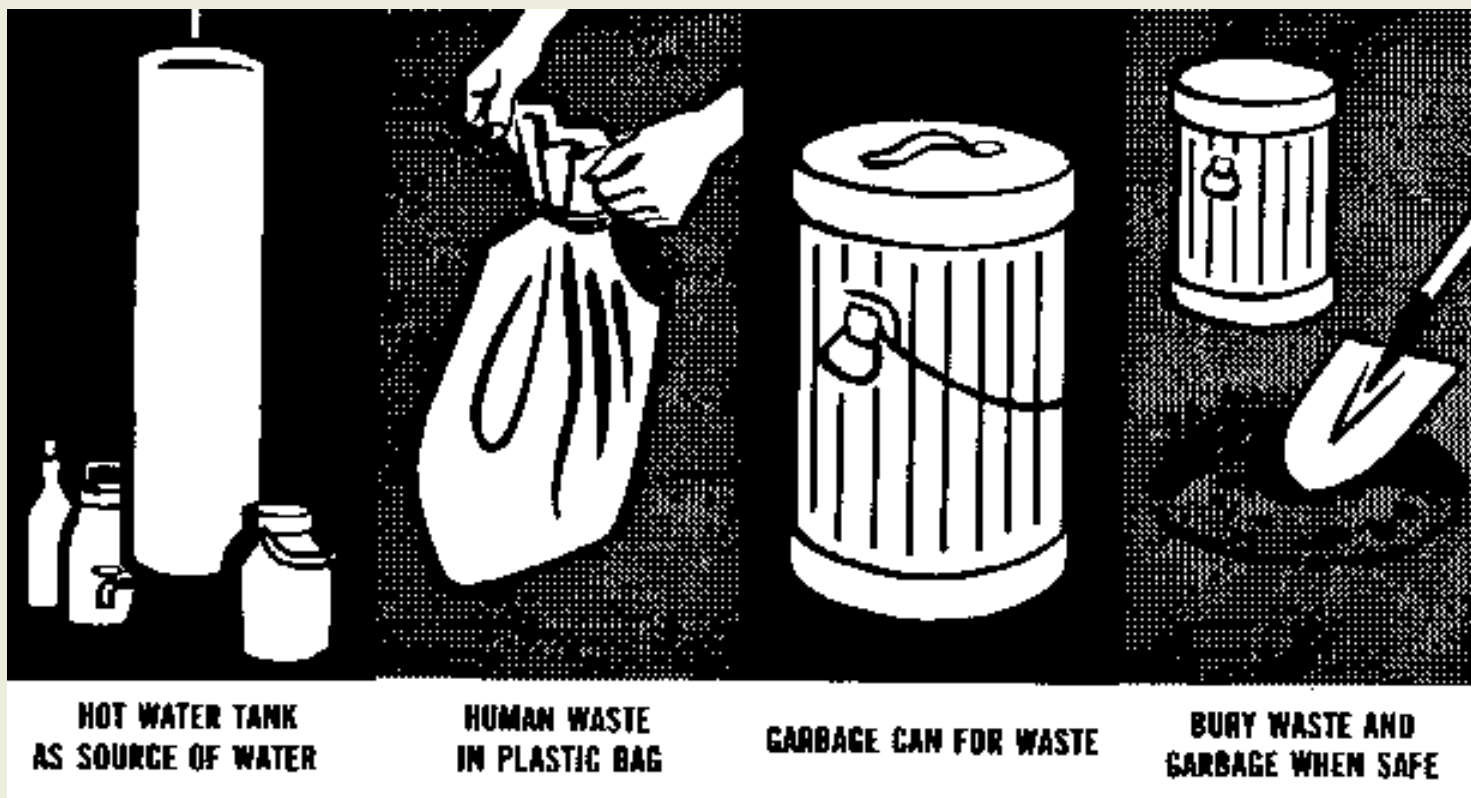

Keep a soft broom in the shelter for tidying it up.

Remember, personal cleanliness in crowded shelter conditions is important to you and your family.

If your area is free of fallout but is without sewage services, bury human waste and garbage in the ground. Dig the pit deep enough so that the waste will be covered by at least two feet of earth.

Step 9: Know How To Get Rid Of Radioactive Dust

In [Step 2](#), fallout was described as "sand". To remove the danger, remove the sand. If you suspect that your clothes have fallout on them, remove your outer clothing before you come inside your home and leave it outside. Don't shake these clothes inside the house or shelter. You would only scatter the fallout grit and create unnecessary danger to others. If you have water, wash thoroughly, particularly exposed skin and hair. But do not scrub your skin as this might rub in the radioactive particles.

Exposure to fallout does not make you radioactive.

Even if you are stricken with radiation sickness, *this sickness cannot be passed on to others.*

Fallout on your clothing or body would expose you and those close to you to radiation. If you suspect you have been exposed to fallout, you will not be a danger to others if you carefully get rid of your outer clothing outside the shelter and wash.



Food and Water

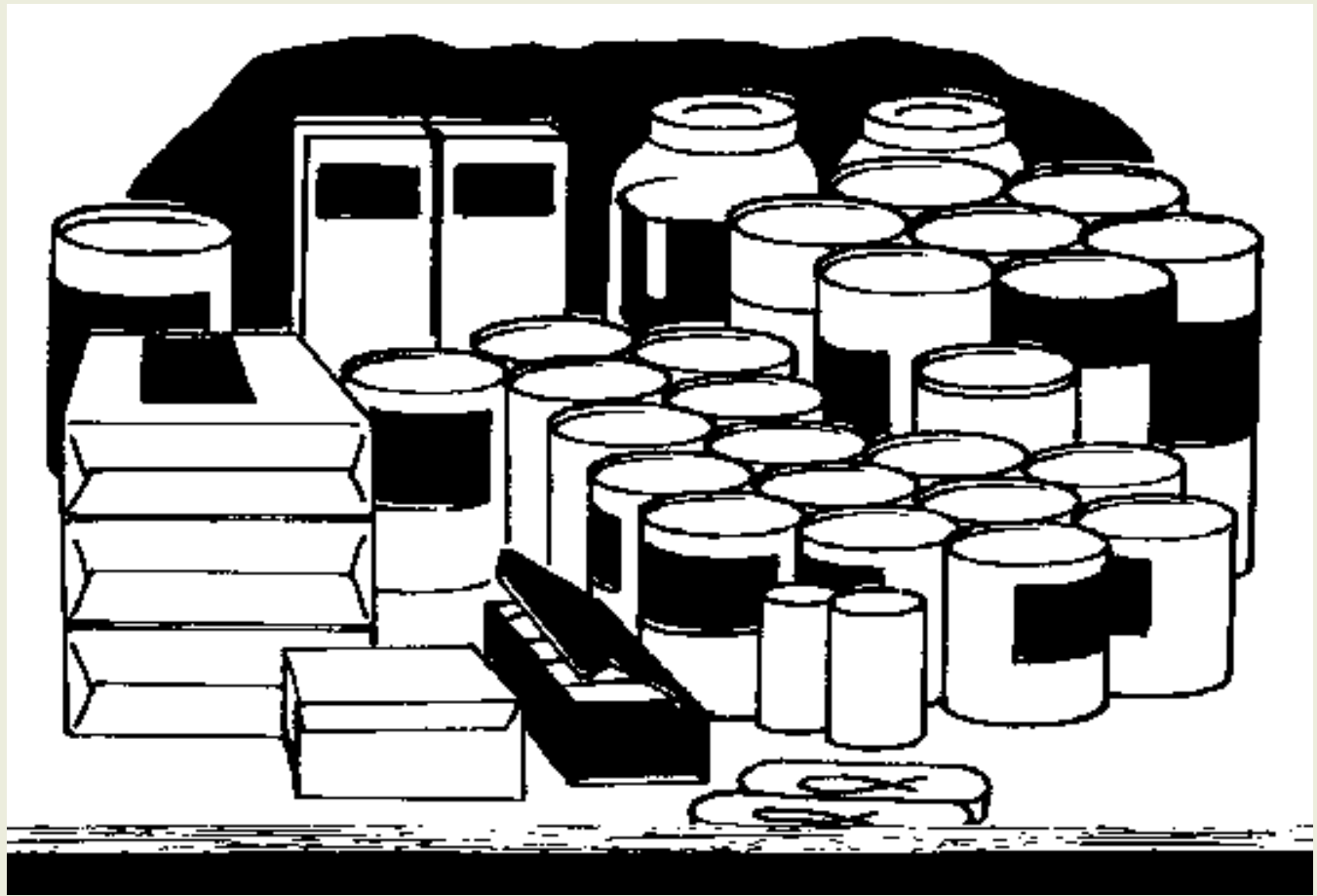

Since most of your food will be in tightly covered containers (cans, bottles, plastic, boxes), it will all be safe to eat or drink if you dust the containers. Food, if it is unspoiled and free of grit or dust, may be eaten during the emergency period.

Be sure to wash fruit and vegetables and peel carefully.

Water will be safe if it is in covered containers, or if it has come from covered wells, or from undamaged water systems.

Step 10: Know Your Municipal Plan

It is important that your local municipality have a plan for a war emergency. And it is just as important that you know that plan.

Over the past several years, provincial and municipal governments, with the assistance of federal authorities, have been steadily developing plans for the protection of the population and the continuity of essential government services in wartime. Most municipalities in Canada have emergency plans to deal with both peacetime disasters and a nuclear attack situation. These include the details of how welfare, health, police, public utilities, fire and other emergency services will operate.

Some larger communities have developed plans to assist in the evacuation of those who would choose to leave before

an attack or who might have to be evacuated as survivors or casualties following an attack. These plans include traffic arrangements to reception centres and medical facilities in nearby communities.

It would be unwise to try and prepare your own family survival plan without first checking to see how it fits in with municipal plans. This would be true whether you plan to go to a safer area before attack or remain at home. It is particularly important that you know and understand the arrangements to instruct the public about staying in shelter and coming out of shelter when it is safe. Fallout is a health hazard which will require countermeasures for personal and family protection including assessment of radiation and advice and instructions to those in shelter.

There must be close understanding and cooperation between the public and municipal authorities responsible for their protection.

Find out about your municipal emergency plans now and keep well informed about them as they are further developed.

Step 11: Have A Plan For Your Family And Yourself

If you know what is contained in the first nine steps, and you know your municipal plan for a war emergency, you should now make your personal and family survival plan. The success of your plan will depend on how many of the suggested recommendations you carry out. Your chances of survival increase as you carry out each recommendation.

Thinking about the problems with which you would be faced should nuclear attack be launched against North America is the first important step. Blast, light, heat and radioactive fallout are the problems. A workable survival plan will include all of the preparations you can make in advance to meet those problems.



In making that plan, there are certain things you must know:

When to take protective action

When the sirens or other warning devices sound and your local broadcast station confirms that an attack on North America has been detected it means that you must take protective action immediately. Would you and your family

- Recognize the Attack Warning signal ?
- Turn on the radio or television and listen for instructions?

Where to take shelter

Deciding where you will take initial protective action and where you and your family will seek shelter from fallout are two basic points which you must consider in making your survival plan. Can you answer the following questions

about seeking immediate protection and shelter:

- Have you decided where you will take shelter if you're not at home when the Attack Warning sounds?
- Will you try to get home?
- Will your family know what to do if you are not at home?
- Is there a shelter plan for your children at school?
- Do you want them to try to get home?
- Does everybody in your family know your survival plan?

In thinking about what you will do or where you would go, you might consider leaving your home to find shelter elsewhere. Before you decide to plan on evacuation, consider the following questions:

- Will protection there be better than in your home?
- Are there sufficient supplies there?
- Can you carry emergency supplies for 14 days?
- Do you know how to get there quickly?

How to take shelter

If you don't have a fallout shelter built in your home, study the guide given in [Step 4](#). It shows how you can improvise emergency home protection. Bearing in mind that density and distance between you and the fallout is necessary, try to estimate if there is enough material and furniture to build an emergency shelter in your basement or the central part of your house.

- Can you move it to where it will be needed quickly?
- Will you have the help you require?

Based on the lists of emergency supplies suggested in Steps [5](#), [6](#), [7](#) and [8](#), try to answer the following questions:

- Do you have them at home?
- Can you collect and move them to the shelter area quickly?
- Does your emergency cooker, lamp, flashlight, radio work?
- Have you containers for water, garbage, hygiene?
- **DO YOU HAVE A BATTERY RADIO AND SPARE BATTERIES?**

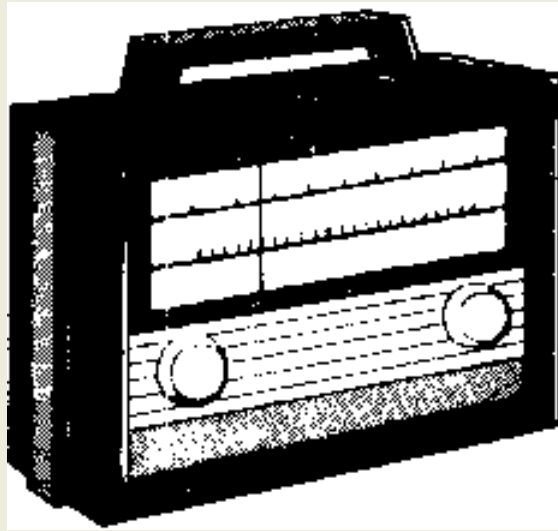

There are many other points which you and your family must resolve for a workable survival plan. This booklet provides most of the essential information on which to base your plans. Read the Steps again, and, as you review each Step, try to answer the questions which apply to your surroundings, your home, your family. Here are a few more which may help:

- Do I know the recommended fire precautions?
- Does anyone in my family know how to fight small fires?
- Can an emergency supply of water be obtained quickly - for fire fighting? for personal use?
- Are first aid supplies and special medicines readily available?
- Does anyone in my family know how to render first aid?
- Can materials for personal hygiene and cleanliness be gathered near the shelter area quickly?
- Do I know what I must do about radioactive dust?
- Do I know the emergency plans of my municipality - for public shelters? for planned evacuation routes? for schools, hospitals, welfare centres? other special instructions?

REMEMBER! YOU MUST PLAN FOR:

- **PROTECTIVE ACTION WHEN WARNED OF ATTACK and**
- **PROVISION OF SHELTER AGAINST THE EFFECTS OF FALLOUT**

On the basis of what you've read and the questions and answers you've thought about, you should now make your survival plan and start making whatever arrangements you can. **BUT MAKE SURE THAT ALL MEMBERS OF YOUR FAMILY KNOW YOUR PLAN AND WHAT TO DO WHEN THE TIME COMES.**

The best way to arrive at a workable plan which will be remembered by your family is to practice it. If you plan on building an emergency shelter, try it now to find out if you have enough material, how much help you'll need, if your proposed area is large enough, and how long it will take to build. Locate and practice moving essential supplies, water, clothing, bedding, etc. Practice the essential things you would have to do.

If you plan to move to what you consider a safer location, make a practice run to make sure you know the quickest and safest route, that protection is available when you get there, and that you can carry all the supplies you think you'll need.

A GOOD SURVIVAL PLAN IS A PLAN WHICH YOU KNOW YOU CAN CARRY OUT.

WRITE DOWN THE IMPORTANT PARTS OF YOUR PLAN.

List for quick reference the important things to be done in the event of warning. As examples, note when and where all members of your family will take shelter at all times; where essential items of food, shelter and other supplies will be obtained; how shelter will be improvised; what windows must be blocked; if you plan on going to what you consider a safer area, details of the route and supplies you will need at your destination.

MENU: [HOME](#) » [SURVIVAL](#) » [Index of States](#)

Embedded Secure Document

The file *file:///C:/CDROMs/SCDR-2/Prophecykeepers/POST-NUCLEAR-WAR/d_resources/survival/books/11steps/11_steps.pdf* is a secure document that has been embedded in this document. Double click the pushpin to view.



Your
**BASEMENT
FALLOUT
SHELTER**

**BLUEPRINT
FOR
SURVIVAL No. 1**

FOREWORD

In announcing the policy of the Government concerning shelters for civil defence purposes, I stated that substantial protection against radioactive fallout could be achieved by family shelters built at home at a modest cost. I said a pamphlet would be issued giving detailed suggestions for those wishing to provide such protection for their families. This is it. Another will be issued shortly with suggestions for shelters that can be built in a backyard.

Although Canada will persist in its efforts to avoid war, and to settle international disputes by peaceful means, there still remains some risk of nuclear war. Should a nuclear war occur, the risk of radioactive fallout will be very widespread, and will endanger many of us in our homes, even though a long way from the bomb explosion. The best and simplest way to safeguard against fallout is by household shelters which will provide protection.

The shelter described in this booklet, although not affording protection against the blast of a nuclear explosion or the fires that may result, will provide good protection against the more widespread radiation danger. These shelters will be a practical and reasonable means of insuring one's family against this risk that would arise should a war occur.

Each householder can and should decide whether or not to have this form of family protection. I recommend it.

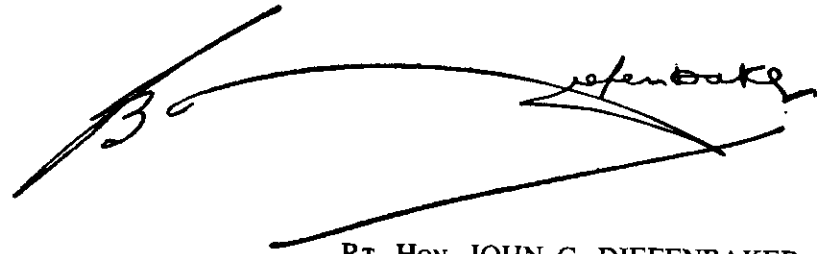
A large, stylized handwritten signature in black ink, which appears to read "Diefenbaker". The signature is written over a horizontal line that spans the width of the signature area.

Rt. Hon. JOHN G. DIEFENBAKER
Prime Minister

TABLE OF CONTENTS

<i>Section</i>	<i>Page</i>
1. WHY A FALLOUT SHELTER	1
2. WHERE AND WHEN FALLOUT SHELTERS . . .	3
3. THE SHELTER AND HOW TO BUILD IT	5
4. LIFE IN THE SHELTER	16
5. HEALTH AND SAFETY	23
6. LEAVING THE SHELTER	25
7. BUILD IT NOW	26
8. ACTION GUIDE	27
9. SHELTER SUPPLIES	29
10. FOOD AND WATER	31
11. ADDITIONAL SERVICES AVAILABLE	32
12. BUILDING MATERIALS	33

NOTE

"The Associate Committee on the National Building Code of the National Research Council considers this design of household fallout shelter to be structurally acceptable for its intended use for installation in the basements of dwellings, for emergency use only.

The Associate Committee makes this statement since the provisions of the National Building Code are intended for use with building for normal conditions of occupancy and not for emergency use."

Produced by the Emergency Measures Organization of the Privy Council Office by Authority of the Prime Minister of Canada, The Right Honourable John G. Diefenbaker.

See enclosed wall chart for working plans

PRINTED BY ALGER PRESS LIMITED
UNDER THE AUTHORITY OF
ROGER DUHAMEL, F.R.S.C., QUEEN'S PRINTER
OTTAWA, CANADA, 1961

1 WHY A FALLOUT SHELTER

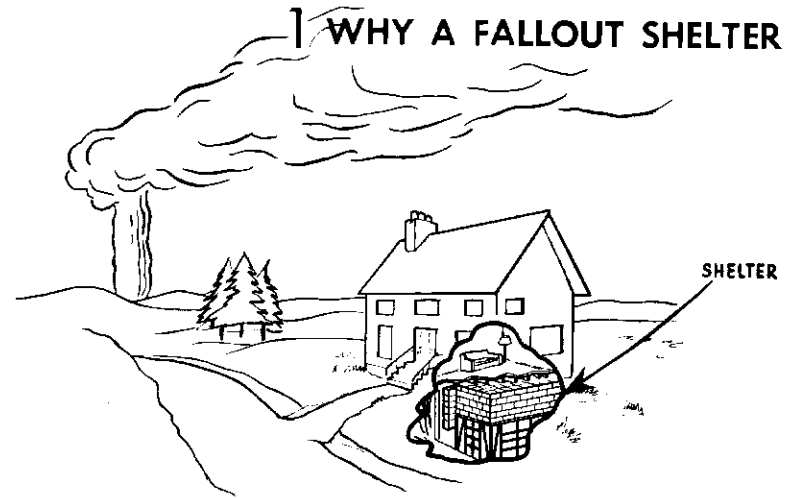

If nuclear war comes, the greatest danger to the greatest number of Canadians is likely to come from radioactive fallout. Fortunately, this danger can be averted or considerably reduced by the use of comparatively simple measures.

To understand how you can protect yourself against fallout, you must know something of its nature.

When a nuclear bomb explodes so that its fireball touches the ground, a considerable amount of earth and other pulverized material is drawn up into the cloud, becoming radioactive in the process. This dust is carried downwind and may be deposited over thousands of square miles of territory. After it has fallen onto the ground, or buildings, it still continues to emit radiation which cannot be detected by the human senses but is harmful to the human body.

For people outside the immediate blast area, one of the greatest dangers may be this radioactive dust. So we should keep such dust away from us.

Study of radiation has shown us how to protect ourselves against it. We know, for example, that the further one is from any source of radiation, the less one is affected by it. Then, while

radiation can pass through walls and other solids, we know that the denser the obstacles it encounters the more its intensity is reduced. That is to say, a solid brick, or stone, or concrete wall will reduce radiation effects more than wooden walls. So, by placing some type of heavy construction between ourselves and the sources of radiation, we can achieve a considerable amount of protection.

Finally, fallout radiation decreases with time; its strength is reduced day by day. So one method of survival open to us is to stay in some form of protected accommodation until the radiation intensity has dropped to the point where it is safe for us to resume a more normal pattern of living.

You would be wise to follow to the letter the procedures recommended here. The fallout shelter has been designed to make maximum use, at minimum cost, of the protective measures already known to be effective. Some choice has been left to the householder—for example: selection of the shelter size and equipment. But unless something is clearly indicated to you as a matter of choice, in your own interest you should consult your local civil defence authority or the Emergency Measures Organization at the address given on Page 32 before you deviate from the pamphlet's recommendations.

The shelter design will allow you to live without fear of radiation or harmful fumes generated within the shelter. In spite of a possible loss of electrical power and normal facilities, there will be enough heat in the shelter, even in our Canadian winters—if you wear warm clothes—to safeguard you from the worst effects of exposure to cold. A prolonged stay in the shelter will almost certainly prove uncomfortable at times, but it should not be unbearable.

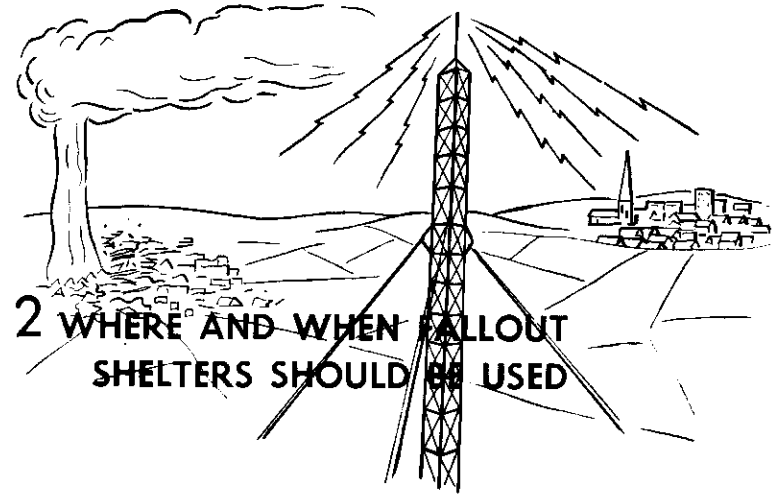

Danger from radioactive fallout may occur in any part of Canada, if a nuclear war occurs, and will be greatest in the southern parts of the country. It would be just as great in rural areas as in towns, and in small communities as well as large. It may come from bombs dropped on defence bases or on large centres or ports selected as targets, from bombs going off in aircraft shot down in battle, or from missiles that miss their targets. Consequently, it is prudent for all Canadians to consider protection against this risk in their own homes.

It's not a blast shelter

You should not take refuge in a fallout shelter as a protection against the blast of an exploding weapon. There is a greater danger in the shelter than elsewhere because it may collapse as well as the house, and it may be more difficult to escape from the shelter if the house catches fire. It is better to seek protection elsewhere against the blast—in the basement lying down near a wall, under a heavy table, close to some exit in case of fire. The fallout shelter is for *after* the explosion, if you're in an area that has not been

devastated by blast and fire but is in the path of the fallout. Warnings of fallout will be broadcast by radio.

Until you build your shelter

If an attack should come before you have time to finish your shelter and your area is subjected to fallout, you should take refuge in a basement, in a corner, if possible under a heavy table, or other support on which should be piled as much heavy material as possible—bricks, books, piles of newspapers, lumber, etc. You should lie there for forty-eight hours, or until notified you can come out. It is much better in such circumstances to suffer from hunger, cold, thirst or other hardships than to run the risk of death or serious injury from radiation poisoning.

Other shelters in target areas

Those living in possible target areas, such as the larger cities, may prefer to build household shelters that will protect them and their family against blast and fire as well as fallout, in case a weapon explodes a few miles away. These are more difficult and expensive to build, costing several times as much as fallout shelters. Detailed suggestions for building such antiblast shelters are being prepared. Those living in or near potential target areas who do not feel prepared to go to the expense of building stronger shelters, can and should protect their families against the fallout danger.

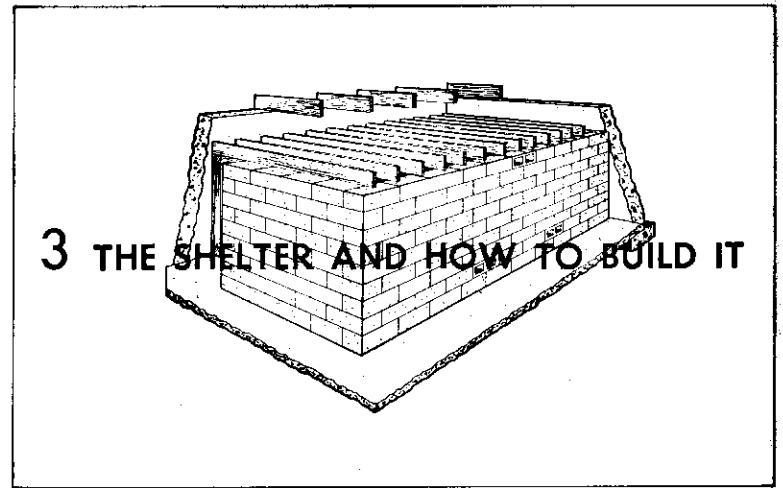

Even an ordinary house provides some protection against radioactive fallout. The safest place inside is a corner of a basement. However, even in this part of the house there will not be, in most cases, sufficient protection to ensure the survival of the householder and his family. It is therefore necessary to add to the protection afforded, and this can best be done by building a basement fallout shelter. The shelter described in this pamphlet will provide the additional protection that is required.

Selection of site

Because the protection already available is highest in a corner of the basement, one of these should be chosen. That corner of the basement with the highest outside ground level will give the best protection and will simplify construction of the shelter. If, however, the ground is level with the basement floor or varies only slightly, then you should place the shelter below a room which contains a considerable amount of heavy equipment, such as a kitchen. In this way you increase overhead protection, and you can improve this further, after a fallout warning has been received, with more furniture, books, magazines, etc.

The corner you select should not have any basement windows inside the shelter. If it does, however, the windows and wood frame must be removed and the opening filled with brick or solid concrete blocks at least eight inches thick. (See Diagram 7(a) on the enclosed chart).

The nature of the shelter

The basement fallout shelter described here has been designed as a "do-it-yourself" project. An able-bodied person should be able to build it by following the instructions in this booklet and the plans on the enclosed chart.

The shelter is a small, protected room built on the concrete basement floor. The walls are made of heavy concrete blocks, except against that part of the cellar wall which is below the level of the ground outside. Here there is no danger from radiation and the wall of the shelter is simply a framework of lumber to hold the concrete blocks above it. The roof of the shelter consists of two layers of loose concrete blocks, laid on planks which are supported by strong wooden joists resting on the two sides of the shelter. The entrance is a short passageway built of concrete blocks to prevent direct radiation coming in the doorway.

Diagram 1 on the enclosed chart shows an outline plan of such a shelter located in the corner of a house basement.

Size

This shelter has been designed to a minimum width of 6 feet 8 inches inside its walls. This width is recommended because it provides for a full-length bed along the end wall furthest from the shelter entrance.

Most houses have a maximum distance of about 10 feet in the clear between the external wall and the beam supporting the floor joists. Thus the shelter will fit into most houses without interfering with the existing structural framework. The height from the underside of floor joists to the basement floor in an average Canadian home is approximately 7 feet 3 inches. This should

still give adequate headroom in the shelter after its roof has been put in place. If the height of your basement is less, the height of the shelter must be reduced by using a method described later in this section.

Diagram 1 on the enclosed chart shows the dimensions of a typical shelter required to accommodate five persons, using a width of 6 feet 8 inches between the inside walls. The size of the shelter should not, if possible, be reduced for families with fewer than five persons because a smaller size shelter is likely to be much less comfortable and may create ventilation problems. Changes in length required to accommodate additional persons are as follows:

<i>No. of People</i>	<i>Clear Inside Width</i>	<i>Clear Inside Length</i>	<i>Overall Length</i>
5	6'8"	9'4"	14'0"
6	6'8"	10'8"	15'4"
7	6'8"	13'4"	18'0"
8	6'8"	14'8"	19'4"

Diagrams 2, 3 and 4 on the chart show various construction details. The materials required to construct the shelter include concrete blocks of several sizes for the walls and roof (solid blocks are suggested but you may use hollow blocks *provided* their hollows are completely filled with sand or mortar as work proceeds); heavy lumber to support the roof and construct the framework against the basement walls; hydrated lime, cement and sand to make mortar; nails, lag screws, bars and washers to be used as described below. The detailed amounts required for the four sizes of shelters noted above are listed on Page 33. Tools required for the project include:

- Mortar Mixing Board
- Shovel and Pail
- Bricklayer's Trowel
- Level and Bricklayer's Line
- Long Straightedge
- Saw
- Hammer
- Drill with masonry bit
- Spanner or Wrench

How to make mortar and lay up masonry

The mortar mix recommended for shelter construction is one part of cementing material to three parts of clean sand. The cementing material may be masonry cement, or Portland cement plus hydrated lime in equal proportions, or Portland cement alone. The usual cement used in construction, called Portland cement, will not give as easy a mix to work with when used alone as will masonry cement. Prehydrated lime, purchased in bags, gives a workable mix when added to Portland cement, but means that an extra ingredient must be purchased.

A ready mortar mix in bags containing both cement and sand, and requiring only mixing with water, is available in some localities.

Mix the cementing materials and sand while dry, then add water and mix again thoroughly. Do your mixing in a shallow box, on a metal or plywood sheet or on a board platform. You may even use the basement floor for mixing, if you do not object

FIGURE 1

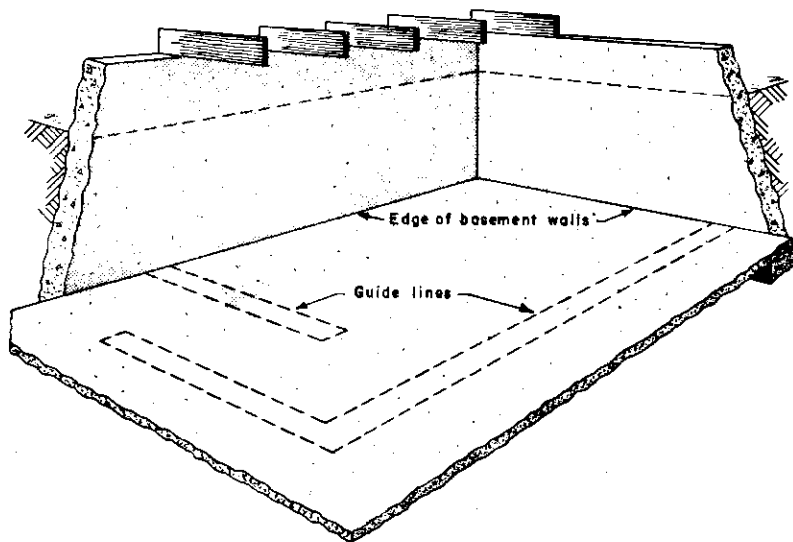

to its discoloration by the cement, but a box or plywood sheet will be more convenient. Mortar sets quickly, so mix only as much material at once as you can use conveniently in fifteen or twenty minutes.

Lay it on the line

Having decided the size of shelter you need for your family, the first step is to mark out "guide lines" on the basement floor as illustrated in Figure 1 on Page 8.

Start on the level

After marking out your "guide lines", check to see if the floor is level. If it is not level, then the procedure illustrated in Diagram 9 on the enclosed chart should be followed. This is to construct a shallow form in which are placed guide blocks to indicate the level to which the concrete is to be finished. The mortar is placed inside this form and finished level with the tops of the guide blocks. After it has set, the form and guide blocks can be removed and the spaces left by them filled in with the aid of an elementary form as shown in Figure 2 below.

FIGURE 2

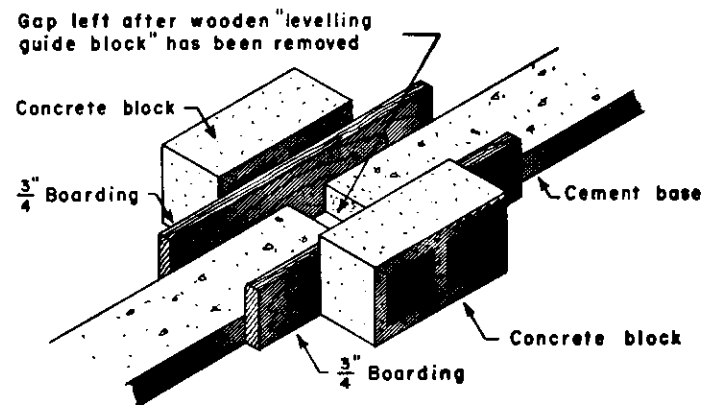

Plan your work

Now that you have a level base, plan so that the walls come out straight and true (See Diagram 11) and to the exact height desired at each stage. Measure carefully the dimensions of the block you have available and remember to add $\frac{1}{4}$ inch to the block height for the thickness of the mortar joint when calculating the heights at any given course.

At corners the blocks must alternate and be fitted together, so you must keep the corresponding mortar joints at the same heights on all walls. Make use of a long, wooden straightedge, a level and a bricklayer's line in checking your work. Do not forget that the cores of hollow blocks *MUST* be filled as work progresses in order to give the desired degree of protection.

Consider carefully how many rows of whole blocks you can get into the height of your wall. The top row of blocks must not be closer than 16 inches to the existing floor joists or you won't have room for your roof. You may not be able to use the nine rows of blocks needed to give you the six feet of clearance within the shelter. (The shelter described in this pamphlet is, of necessity, calculated on the basis that the average Canadian house has 7 feet 3 inches of clearance between floor joists and basement floor).

However, you will want to make use of every inch of headroom your basement offers. If a wall of nine courses, or rows, of blocks is too high and one of eight courses not high enough, the difference can be made up by increasing the height of the level footing you make for the wall and, if necessary, by combining this with a top course of 4-inch blocks on the wall.

The following table will show you how to do this:

<i>If your basement headroom is:</i>	<i>You will need this number of 8-inch courses of blocks</i>	<i>and this increase in height to your level wall footing</i>
7'4" and over	9	Nil
7'3"	8½*	3"
7'2"	8½*	2"
7'1"	8½*	1"
7'0"	8½*	Nil
6'11"	8	3"
6'10"	8	2"
6'9"	8	1"
6'8"	8	Nil

*The half course consists of 4-inch blocks.

If the basement headroom is less than 6 feet 8 inches, which means a shelter headroom of 5 feet 4 inches, you should build the next larger size of shelter in order to ensure having the correct volume of air space inside.

Framing

The blocks which are built against the existing basement walls of the house, above the ground level, rest on 2-inch by 8-inch timber framing, which itself must be supported on a course of cement blocks or concrete at least 3 inches thick (See Diagram 10 on the enclosed chart). The framing reduces the number of concrete blocks required and provides storage space.

Below outside ground level and immediately adjacent to the shelter, the existing concrete wall of the house and the existing ground will provide adequate protection. Therefore, the height of the framing and the number of courses of blocks on top will depend on the level of the ground outside the basement wall. As an example, if it is 4 feet 6 inches from ground level to basement floor, then the top 2-inch by 8-inch board on which blocks are laid must not be more than 4 feet 6 inches from the floor. If the grade outside is lower, so must be the height of the framing. If the ground level is higher than the top side of the shelter roof, then concrete blocks would not be required on these walls. But timber framing must be built on these walls to support the ends of the roof joists. The timber framing must be properly braced

with diagonal pieces and all pieces well "spiked" together, using 4-inch nails (See Diagrams 2 and 3 on the chart).

The framing must be anchored to the existing basement wall as shown in Diagrams 5 and 8 on the chart.

It is important to remember that the height of your framing and blocks on top of it must always correspond to the height of the rows of blocks on the opposite walls so that your shelter will end up at the same height on all sides.

The surfaces of the framing which are to be placed in contact with concrete or masonry should first be treated with some suitable timber preservative such as copper naphthanate. You just paint it on; you'll get the necessary instructions on its use when you buy it.

Walls

Having set the timber framing in position, the corner of the shelter on top of the framing is built about four blocks high (using blocks 16 inches long by 8 inches wide by 8 inches deep), and the remainder of the wall then built to the same height (See Diagram 10). Continue building the wall in this way to the required height.

The blocks which form the 90-degree angles at the corners need to be "toothed" together (as shown in Diagram 11 of the chart) in order to achieve proper bonding and rigidity.

These blocks must support the heavy roof of the shelter. For this reason the wall must be anchored to the existing basement walls. This is done by imbedding a metal bar at every other block between the two top courses of blocks and securing it to the basement wall by means of a lag screw (Diagram 8). Don't forget to drill the holes in the basement wall and secure the bars in place (bent as shown in Diagram 6) before laying the top course.

The first row, or base course, of blocks which form the other walls is set in about $\frac{3}{4}$ of an inch of wet mortar along the guide lines you have drawn on the floor. You then move to the corner

nearest the centre of the basement, build that corner about four blocks high and continue with the remaining walls in the same manner as described above.

Don't forget to insert the vent or air-circulating blocks as shown in position in Figure 3 below and Diagram 1 on the chart. Hollow blocks laid on edge will form suitable openings.

FIGURE 3

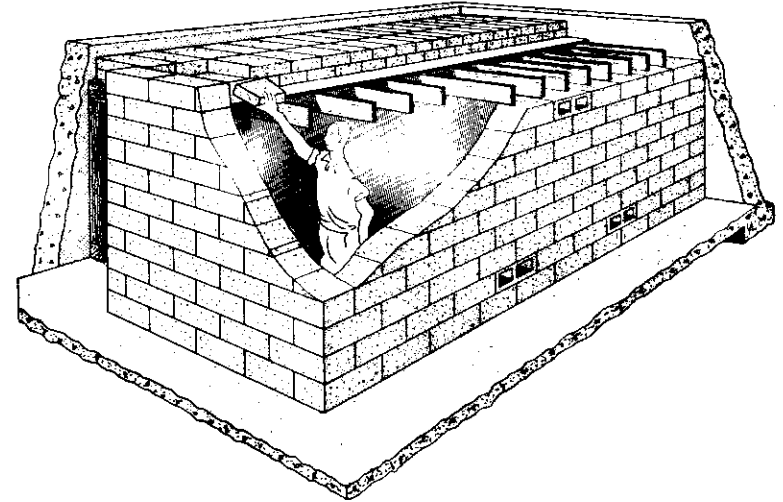

Block designs differ but most blocks will provide about the same area of opening, 40 square inches per block. Four blocks should be arranged for vents, two at the top and two at the bottom of the shelter, providing up to 80 square inches of opening at each level. You may, if you wish, arrange to provide the equivalent area of opening in some other way, such as by leaving out half a block. (If you plan to use solid blocks in your construction programme, it would be an idea also to buy four hollow blocks for the vents).

Before construction of the outer wall has gone too far, all bulky fittings and furniture such as cots, bunks or tables should be placed inside the shelter. Even when these have been put in

place, the walls should not be built all the way to the basement ceiling since a clear space of at least 16 inches is needed overhead to permit construction of the shelter roof.

The baffle wall protecting the shelter entrance from direct radiation must be the same height as the shelter walls.

The roof

When the mortar in the block wall has dried for a period of at least 48 hours, the roof joists may be installed. As the inside width of the shelter is 6 feet 8 inches, then joists, 2-inches by 6-inches by 7 feet 4 inches, should be set 10 inches apart (on 12-inch centres) and placed across the shelter. Each joist should bear on the block walls for a distance of 4 inches at its end. A 6-inch blocking piece is nailed between each pair of joists flush with the inside face of the shelter walls to hold the joists in place.

The space between the joists where they rest on the wall **MUST** be filled with mortar to maintain the required 8 inches of thickness to the top of the roof. This is done by laying one course of 4-inch thick solid blocks which will butt against the end of the joists and which when completed will form a "box" into which the mortar can be poured. (The "box" is formed by the blocking piece between the joists, the sides of two joists and the 4-inch concrete block).

You should note on Diagram 2 of the chart that the joists carrying the roof over the entranceway are supported on two 4-inch by 4-inch posts and a beam placed there for that purpose.

After the spaces between the 4-inch blocks and the joists on the house foundation wall side of the shelter have been filled with mortar, the laying of the 1-inch roof boards may be started at that side of the shelter. The first one or two boards should be placed in position across the roof joists. These boards are nailed to the joists by reaching up through the open space between the joists. Four-inch thick solid concrete blocks are then passed between the joists and placed on the boards. (There is no need to mortar them together). These roof blocks are in two layers which form a total thickness of 8 inches as shown in Figure 3.

Work on the roof continues in a similar manner until the inside of the opposite wall is reached. Again the space between the joists

where they rest on the wall must be filled with mortar. When this has been done, continue with the remaining course of 8-inch blocks to complete the wall. (Note in Diagrams 2 and 3 of the chart that the wall goes up beyond the rafters and the roof does not cover the walls).

Building sequence

In summary, the steps which you should follow in constructing the shelter are:

- (1) Plan your work well. Use the pamphlet in conjunction with the diagrams on the enclosed chart.
- (2) Mark out guide lines on the basement floor.
- (3) Erect timber framing against the outer basement walls and fasten it to them.
- (4) Build the concrete block wall on top of the framing to the required height and anchor it to the basement walls.
- (5) Build the remaining walls to the required height, remembering to move larger objects inside before the walls have been raised too high.
- (6) Place the joists or rafters into position, inserting the necessary blocking pieces between them and filling the spaces between joists and blocks with mortar.
- (7) Construct the overhead protection by nailing on roof boards and placing 4-inch concrete blocks in position, working from the outside wall of the house inwards towards the centre of the basement.

4 LIFE IN THE SHELTER

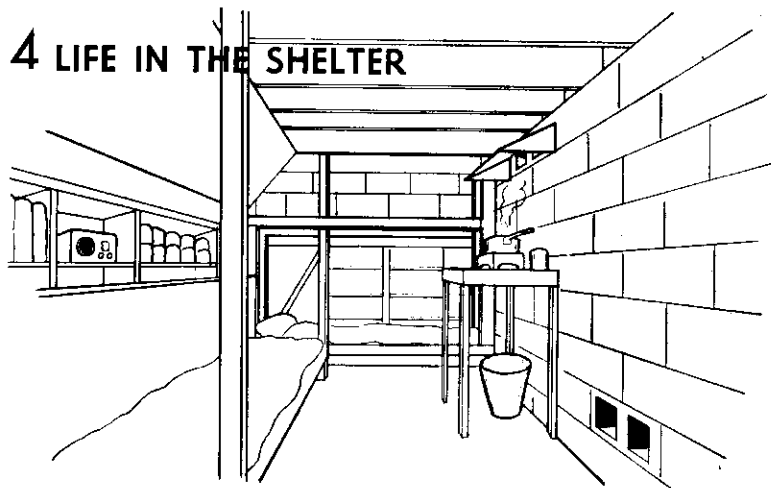

Shelter layout

There isn't much space inside the shelter by normal living standards. And as you may have to live in it for a considerable period, it is wise to arrange the accommodation as compactly and neatly as possible. If, for example, a shelter is to accommodate five people, you could save space by using a 3-tier and a 2-tier bunk. (Three tiers are the most you can fit into the available headroom).

The living space will be improved if bunks can be built so that they can also serve as additional seating or table space. Suggestions on how this might be done are shown in Figure 4. A folding table will leave you more floor area between meal times.

You will undoubtedly adapt the shelter to suit yourself. However, such measures as painting the inside walls of the shelter, painting the concrete floor or placing an old carpet on it, putting up shelves and other minor fittings will all go a long way to improving your comfort.

Proper understanding of the recommended shelter facilities, and good planning in laying out and stocking a shelter can reduce discomfort to a minimum.

FIGURE 4 2 TIER BUNK

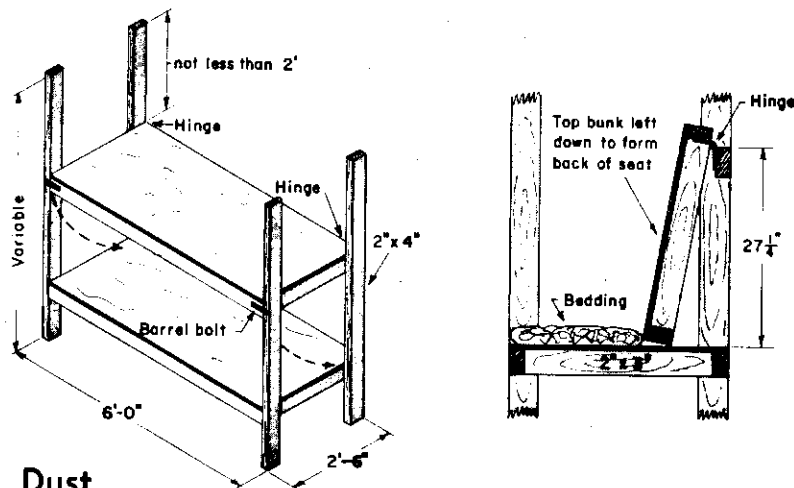

Dust

Ventilation need not be a problem. The shelter does not have to be made airtight or sealed off from the basement. Radiation does not travel with air movement, and provided the house itself is closed up in the normal way (doors and windows closed) radioactive dust will be kept outside.

It is possible that if you live in an area within 25 miles of a potential target, the windows of your house could be blown in without any other serious damage being caused to the house. In this case, it is possible that a small amount of radioactive dust might be deposited inside the house, but this can be kept out of the basement by arranging to have a door or curtain between the basement and the rest of the house. You should also make provision to block up all basement windows. (See Diagram 7(b) on the chart).

Ventilation

The shelter air supply can be regulated by adjusting the curtain in the doorway. (This curtain should be of some heavy material such as canvas). Adjusting the curtain will also, to some extent,

control the heat within the shelter. When the curtain is closed, the air flow will be restricted to the vents in the wall and the temperature and humidity in the shelter will rise. When the curtain is open, air flow will be at a maximum and the temperature will fall.

When the basement is cold, ventilation should be restricted by closing the curtain tightly and perhaps even by blocking half the vent openings top and bottom in order to maintain a comfortable temperature in the shelter. This can be done quite safely so long as no fuel-burning appliance is operating in the shelter. When a fuel-burning appliance is in use and the basement is cold, the curtain may be kept tightly closed but the vent openings should be kept completely clear. At all other times, when the need for heat is not great, both vents and curtain should be used for ventilation while operating an open, unvented fuel-burning appliance.

Heating and cooking

It is possible that damage outside the area where you live may interrupt the supply of electrical power for long periods. This makes it essential to provide for other than electrical methods of cooking and heating which do not involve your making visits to other parts of the house or basement. However, since power may not be interrupted in all areas, or it may be quickly restored, your shelter design may also include facilities to take advantage, up to 1,500 watts, of the normal electrical supply when this is in operation. Wiring should, of course, be installed by a qualified electrician.

In winter, the shelter will almost certainly need to be heated and this will help to increase the air circulation and reduce humidity which might otherwise become oppressive. For shelter heating, high-quality, kerosene-fuelled appliances, available at hardware stores, etc., seem to offer the most satisfactory features. (**WARNING: DO NOT USE** gasoline and other highly volatile liquids because they are far too hazardous for use in a confined space).

The hot gases produced by an unvented fuel-burning appliance will tend to rise. They may be collected and led out of the shelter by placing the appliance directly under a small hood located at one of the top vents. This procedure is recommended for all times when the heat produced is not needed for heating the shelter.

When an open, unvented, fuel-burning appliance is used to warm the shelter, a problem arises. A top vent hood will not only draw off an appliance's gases, but much of the heat produced and existing warm air in the shelter. Further, the warm air in the shelter will rise, leaving the floor cool. So, for the best heating performance under these conditions, the heating appliance should be placed near the floor. Of course, you would be better off with a small closed stove, fitted with a vent pipe. This would heat without subjecting you to unpleasant odours or dangerous gases.

Don't try to convert a small open fuel burner into a closed stove; there can be real danger if the burner and fuel tank are made to operate at too high a temperature. You should use an open hood above the burner.

The quantities of fuel required are not excessive. Even under winter conditions, one gallon of liquid fuel per day should be adequate for all heating, lighting and cooking purposes within the shelter. About $\frac{1}{3}$ pint per hour will provide adequate heating. If this rate of fuel consumption is not exceeded, the ventilation system will be more than adequate to ensure that no hazard to health occurs from depletion of oxygen or production of carbon dioxide. A hood and vent over cooking or heating appliances is recommended. This will both improve ventilation and remove combustion products.

In summer, the shelter may be uncomfortably hot and you should therefore keep cooking to an absolute minimum.

Lighting

Battery-powered lamps, candles or kerosene lanterns or lamps can be used. At least twelve, No. 6 dry cell batteries would be required to provide one watt of electrical output during waking

hours for a two-week period. During hot weather you should use lighting generated from batteries. There are many types of emergency lighting equipment on the market today.

Sanitation

Inside the shelter, the health of your family will depend to a large degree upon the standards of sanitation and personal hygiene that you adopt. Cleanliness is the keynote.

Your major concern will be the disposal of human waste. It is recommended that you install a sanitary toilet provided with polyethylene bags. Your shelter should be pre-equipped with at least a two-weeks supply of large-size bags. After use they should be tied at the neck and deposited in the garbage can or other suitable metal container until they can be disposed of. For the first 48 hours at least, the toilet and garbage can should be placed in the entrance passageway to the shelter. (See Diagram 1). During this period, you and your family should remain within the shelter, unless otherwise officially advised, so blocking this passageway will not matter. After 48 hours, it may be possible to move both items further out into the basement. You will be advised officially. Families with infants should ensure that at least a two-weeks supply of disposable diapers is stored. These too should be placed in polyethylene bags after use and deposited in the waste container.

Washing, especially of hands, is of great importance. Soap, detergents and water do the job best. But, naturally, the waste water from this—and perhaps cooking—has to be disposed of. So it will be important for you to make use somehow of the basement drainage system which normally exists in most houses. One way is to lead a hose from your basement drain to the shelter entranceway, equip the end with a funnel and get rid of the waste water that way. If this is not possible, waste water will have to be treated in the same way as garbage and an additional receptacle for it placed alongside the garbage can.

For reasons of hygiene, and in order to reduce shelter odour, you should provide a number of changes of underclothing for all occupants of your shelter.

Food and water

Radiation conditions may make it necessary for you to live in the shelter for two to fourteen days. Better make sure, then, that you have enough food and water inside the shelter for at least two days; the balance of your supplies—which can be stored outside but close to the shelter—should be enough for at least twelve days. On Page 31 you will find a list of suitable foodstuffs for a 14-day period. These may be bought and stored over a period of time.

As for water, you should have enough to give at least half a gallon daily to each person; a gallon would be even better. Even if you find that the normal water supply to your house has not been cut off after an attack, you should *NOT* use it until you are told definitely that it is safe to do so. The water could be contaminated without your knowing it. In fact, one of the last things you should do before occupying your shelter is turn off the water at the main shut-off valve. (Make sure you know where it is). You should not open it again until you have been advised to do so by local authorities. Once the valve is closed you may use the water stored in your hot water tank as an additional supply.

Communications

Your only contact with the outside world, once you are in the shelter, will be by radio. It is vital, therefore, that you have a battery-powered radio as part of your shelter equipment. It is important that you check the reception in the shelter when you install it; it is possible that you will require an aerial to ensure adequate reception. The radio will *keep you informed* of any changes in the general situation in your area. Broadcasts will let you know when, and for how long, it is possible for you to leave the shelter. Under NO circumstances should you leave the shelter before being told it is safe to do so.

Equipment

The items of equipment with which your shelter should be stocked are listed, for handy reference, on Page 29. After all

essentials which you need, and for which there is adequate room, have been stored, you should give thought to additional items which might make shelter life more pleasant, and which will not take up too much space.

Daily routine

The degree of comfort in shelter living will be governed by two factors—daily routine, and outside conditions. The first of these you can control by the planning that you put into working out a routine for daily life within the shelter. The second you cannot control. Conditions outside the shelter may or may not permit limited excursions to other parts of the house or even out of doors.

In planning a daily routine you should break up the day into various periods for rest, individual and group activity, cooking and feeding, shelter chores, and so on.

5 HEALTH AND SAFETY

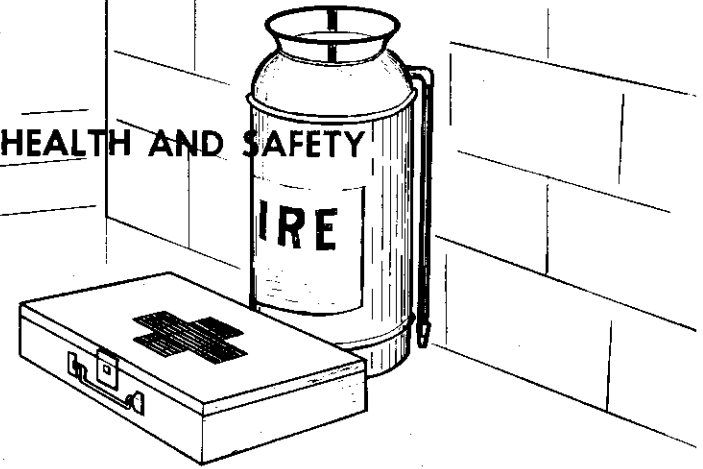

Sanitation and hygiene

Polyethylene bags used for the disposal of human waste, diapers, etc., must be tied at the neck after use and deposited in the garbage can until they can be disposed of by burial or other means.

Water must be rationed according to your supply. Remember, part of the ration will be for washing, especially hands.

Changes of underclothing must be planned according to the supply available.

The main water supply valve must NOT be turned on again until you receive instructions that it is safe to do so.

Ventilation and heating

In winter, the shelter should be heated if at all possible. This will increase air circulation and reduce humidity. Use a kerosene appliance for cooking and heating. Do not burn more than one gallon of fuel per day since this will be adequate for all heating, cooking and lighting purposes. At this rate of consumption there is no problem of fumes.

In summer, the shelter may be too hot and you should aim at reducing the heat generated inside the shelter by keeping cooking to a minimum and using lighting generated by batteries.

Fire precaution

DO NOT use gasoline or other volatile fuels in the shelter. Kerosene is recommended. Consult your local fuel oil company concerning the best grade of kerosene for long-term storage.

DO NOT use dished, reflector-type electric heaters.

Store your fuel in non-leaking containers and make sure that taps, bungs, etc., are out of the reach of children.

See that all sources of ignition such as matches, etc., are in your possession at all times and not accessible to children.

DO NOT locate cooker or heater where a chance fire could block the entrance.

Take great care in refuelling appliances and always use a funnel. It is safer to wait until the appliance has cooled off before refuelling.

Medical supplies

Don't forget to store adequate First Aid supplies, etc., and special medicines if required.

DO NOT leave such supplies within reach of children. A medicine cabinet which can be locked would be a valuable addition to your shelter furnishings.

6 LEAVING THE SHELTER

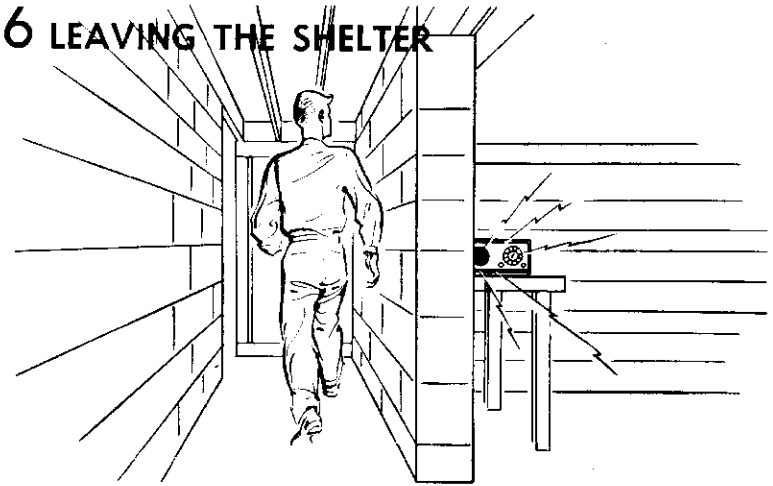

As the radiation intensity outside the house is reduced, it will be possible for you to come out of your shelter for limited periods of time. When you may do so, for how long and where you may go safely will be the subject of instructions issued at the time by local civil defence authorities. Normally, these instructions would be broadcast; under certain circumstances they may be delivered by word of mouth. By whatever means you receive these instructions it will be, of course, extremely important to follow them carefully, otherwise you may endanger the lives of yourself and your family.

Generally, it is anticipated that you will have to remain within your shelter continuously for 48 hours if you happen to be in an area of high radiation. After that, your excursions from the shelter will be in accordance with instructions given you at the time. Even then you should make a point of using the shelter for all non-productive activity, such as sleeping, eating, resting, and listening-in.

In an area subjected to fallout there are safety zones at your home. Safest place is in your shelter; next safest is in the basement below ground; next is upstairs in the house; least safe is outside the house.

7 BUILD IT NOW

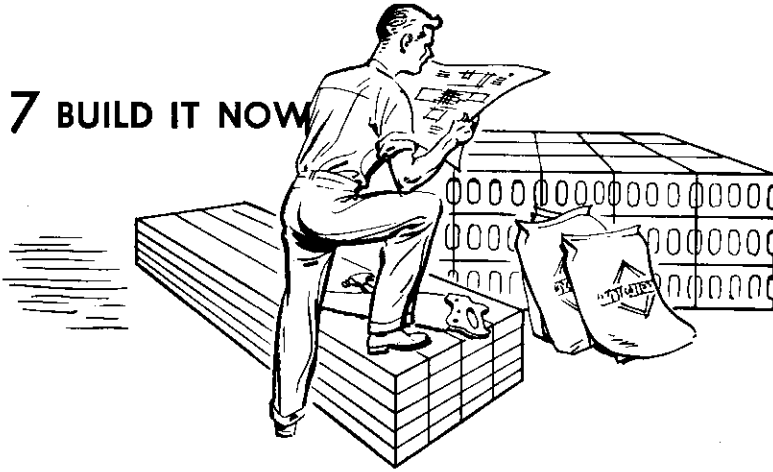

By now you will have realized that there *IS* a great deal you can do to protect yourself and your family from the dangers of radioactive fallout. The shelter described here is based upon the best knowledge available today. However, studies continue and simple means of improving it still further may be found in the future. You should therefore keep in touch with your local civil defence authority.

It is not an expensive shelter, as you will find when you price the list of materials, and if you are prepared to do the work yourself this represents a modest price to pay for your survival. Talk it over with your neighbours and your friends. Perhaps you can all get together and build your shelters as a team—it could be a real community project. You might even consider building the shelter for relatives, friends or neighbours who are not able, for one reason or another, to build their own.

You can accomplish a great deal at little cost, with little effort and a little forethought. What is important, however, is to build the shelter *NOW*. The work cannot be done at the last minute, and it will be too late when the warning is given.

8 ACTION GUIDE

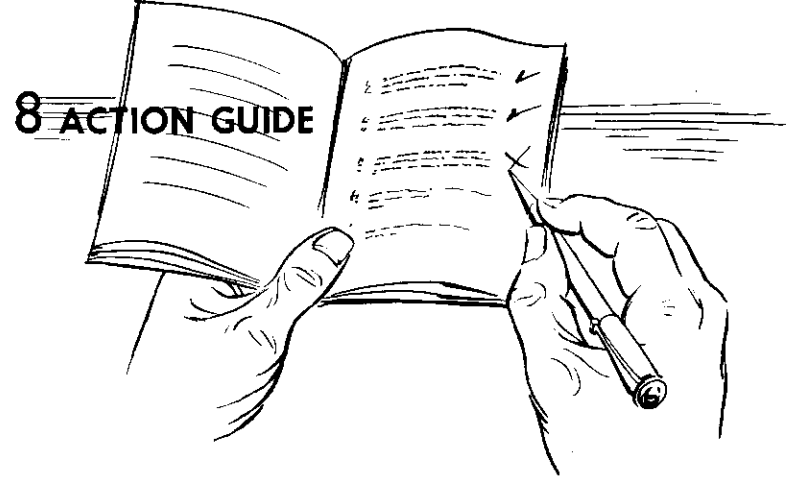

Now You Can:

1. Build your shelter in accordance with the enclosed working drawings.
2. Install the suggested items of equipment. Check them against the list on Page 29. Have you got all the essentials, particularly the shelter radio?
3. Store all the food, water, fuel, batteries, etc., that you will need. Arrange to use and replace at the specified intervals.
4. Plan a family drill for occupying the shelter and practise it. (Remember, *any* adult or adolescent in your home may have to assume command of the situation at the time of an emergency).
5. Plan a daily routine for shelter life.
6. Make preparations so that all basement windows can be quickly and effectively shielded in accordance with instructions.
7. Keep the shelter warm and dry.

If Warning Comes:

1. Turn on your home radio. Wait for instructions. You will be told when to go into your shelter.

2. If there is time—you will be told how much—do as many of the following tasks as you can in this order of priority:

- (a) Shield all basement windows;
- (b) Move clothes and bedding, suitable for the season, into the shelter;
- (c) Move as much furniture, books, magazines, papers, etc., as possible into the room above your shelter;
- (d) Fill up any additional water containers which may be useful later on. These can be left outside the shelter for use when you are told it's safe to venture into the basement;
- (e) Take in any extra reading material, etc., you might need;
- (f) Open an upstairs tap and turn off the water at main shut-off valve.

Go Into The Shelter

1. Last person in places toilet and garbage can in passageway.
2. Turn on the shelter radio. Listen for instructions.
3. Put daily shelter routine into effect.
4. Remain in the shelter until instructed to leave. (In most cases this will come via radio but in some instances civil defence officials may notify you in person).
5. Keep calm. Your family will look to you for leadership.

9 SHELTER SUPPLIES

Equipment

- Beds (Bunks or folding)
- *Table (Folding or other facility)
- *Stools (Fold flat)
- Cooking vessels
- Cups and Plates (disposable)
- Knives, forks, spoons
- Can openers
- Paper towels
- Kerosene cooker
- Kerosene Lamp
- Electric Lamp and Batteries, spare bulbs
- Flashlight
- 10 Gallons Kerosene (2 gals. in shelter; remainder in basement)
- Matches
- Garbage can (2 if no waste water run-off is possible)
- Garbage bags

- Toilet
- Polyethylene bags for toilet (two-week supply)
- Shovel
- Crowbar
- Axe
- Pocket knife
- Whistle
- *Saw
- *Screwdriver
- *Hammer
- *Screws
- *Nails
- Pliers
- Fire Extinguisher (non-carbon tetrachloride)
- * $\frac{1}{4}$ -inch Rope
- String
- Battery Radio
- Clock
- Spare Radio batteries
- Hand basin

Recreational

- *Calendar
- *Books
- Paper
- Pencils
- *Playing cards

- *Chess, checkers, other games
- *Crossword, other puzzles
- *Knitting, sewing, etc.
- *Hobby materials

Toiletries

Soap, toothpaste, tooth-brushes
Detergent
Nail brush
Razor, blades and soap

*Women's basic cosmetics
Tissues (face and toilet)
Face cloth
Towels
Brush and comb

Personal

Bedding (blankets preferable)
Warm sweaters and socks
Change of underclothing and socks
Personal hygiene items for women

Baby clothes
Baby feeding equipment
Disposable diapers (two-week supply)
Plastic sheeting

Medical

First Aid dressings and drugs (commercial First Aid kit)
*Aspirins
*Bicarbonate of soda
*Cough drops
*Nose drops

Specific medicines such as insulin, heart medicines, etc. as required (100-day supply)
Disinfectant
Scissors

Protective clothing

Coveralls, rubber boots, rubber gloves for adults. To be used in venturing outside even after instructions have been given that this is safe for short periods.

*Desirable but not essential.

10 FOOD AND WATER

Food

These are the requirements *per person* for 14 days. Canned foodstuffs should be used and replaced once every six months. Check off the items as you stock them in the shelter.

Milk: 4 cans milk (1 lb. cans, evaporated or dried skim milk)

Vegetables: 6 cans (15 oz. or 20 oz. cans—beans, peas, tomatoes)

Fruits: 6 cans (15 oz. or 20 oz. cans—peaches, pears)

Juices: 6 cans citrus juice (20 oz. cans—apple, grapefruit, lemon, orange, tomato)

Cereals: 14 individual packages (sealed in wax bags inside or outside)

Biscuits: 2 packages crackers (1 lb.)
2 packages cookies

Main Dish Items:

2 cans meat (12 oz.—corned beef, luncheon meats)

2 cans beef and gravy

2 cans beans (15 oz. or 20 oz. cans—baked beans, pork and beans)

2 jars cheese

2 cans fish (8 oz.)

Canned and Dehydrated Soups: 2 cans (10 oz.—bean, pea, tomato, vegetable)

Infant Foods: Meat and vegetable soup, precooked baby cereal, assorted strained fruits.

Other Foods:

1 can honey

2 lbs. hard candy

1 jar or can peanut butter

1 package tea bags

1 jar sugar

1 jar instant coffee

Salt and pepper

Jam, syrup, molasses, jelly

Chocolate powder

Chewing gum

Water

Requirement: 7-14 gallons for each member of the family.

Containers: Store in clean, tightly covered containers such as large thermos jug, new fuel cans, large vinegar bottles, etc.

Change: Change the stored water at least once a month.

11 ADDITIONAL SERVICES AVAILABLE

If you have difficulty in adapting the design to your basement, you may obtain advice on possible modifications by writing to the Emergency Measures Organization, Privy Council Office, East Block, Ottawa, Ontario.

Extra copies of the pamphlet may be obtained from your local or provincial civil defence or emergency measures coordinator.

12 BUILDING MATERIALS

Item	Size	Amount in shelter for:			
		5 people	6 people	7 people	8 people
<i>Concrete Blocks</i> (preferably solid but can be hollow (a))					
Walls	8"×8"×16"	220	240	260	300
	8"×8"×8"	20	20	20	20
Roof	4"×8"×16"	210	250	300	340
Inner Layer Shielding (b)	8"×8"×16" – allow for each course	13	14	16	17
	4"×8"×16" one course only	7	8	10	11

(a) If solid blocks are used, add 4 hollow blocks to the list for ventilation purposes.
(b) Height depends upon height of shelter above ground level.

Item	Size	Amount in shelter for:			
		5 people	6 people	7 people	8 people
<i>Mortar</i>					
Hydrated Lime		200 lbs.	250 lbs.	300 lbs.	350 lbs.
Cement		18 bags	21 bags	27 bags	31 bags
Mortar Sand		3 cu. yd.	3½ cu. yd.	4 cu. yd.	4½ cu. yd.
<i>Lumber (c)</i>					
Posts and Beam	4"×4"×10'0"	2 pcs	2 pcs	2 pcs	2 pcs
Stud wall					
Plates (short)	2"×8"×8'0"	3	3	3	3
Stud wall					
Plates (long)	2"×8"×10'0"	3	—	—	—
	2"×8"×12'0"	—	3	—	—
	2"×8"×14'0"	—	—	3	—
	2"×8"×16'0"	—	—	—	3
Studs	2"×8"× (d)				
Rafters	2"×6"×8'0"	14	16	19	20
Blocking pieces	2"×6"×10'0"	3	4	4	4
Curtain frame	2"×4"×8'0"	2	2	2	2
Roof boards	1"×6"×14'0"	14	—	—	—
	1"×6"×16'0"	—	14	—	—
	1"×6"×18'0"	—	—	14	—
	1"×6"×20'0"	—	—	—	14
Shelving	1"×8"×10'0"	4	5	6	7

(c) Commercial lengths are listed. See diagram dimensions for lengths you cut.
(d) Length depends upon height of shelter above ground level.

Item	Size	Amount in shelter for:			
		5 people	6 people	7 people	8 people
<i>Hardware</i>					
Nails	6 inch	1 lb	1 lb	1 lb	1 lb
	4 inch	6 lbs	7 lbs	8 lbs	9 lbs
	2 inch	3 lbs	3½ lbs	4 lbs	4½ lbs
Copper Naphthanate		As Required			
<i>Framing Anchor</i>					
Lag screws & plugs	3/8"	4	4	4	4
Washers		4	4	4	4
Lumber	2"×4"×8"	2	2	2	2
<i>Wall Anchor</i>					
Lag screws & plugs	1/4"	5	5	6	7
¾" Bar	12" long*	5	5	6	7
Washers		5	5	6	7

*Bent as in Diagram 6 on the wall chart.

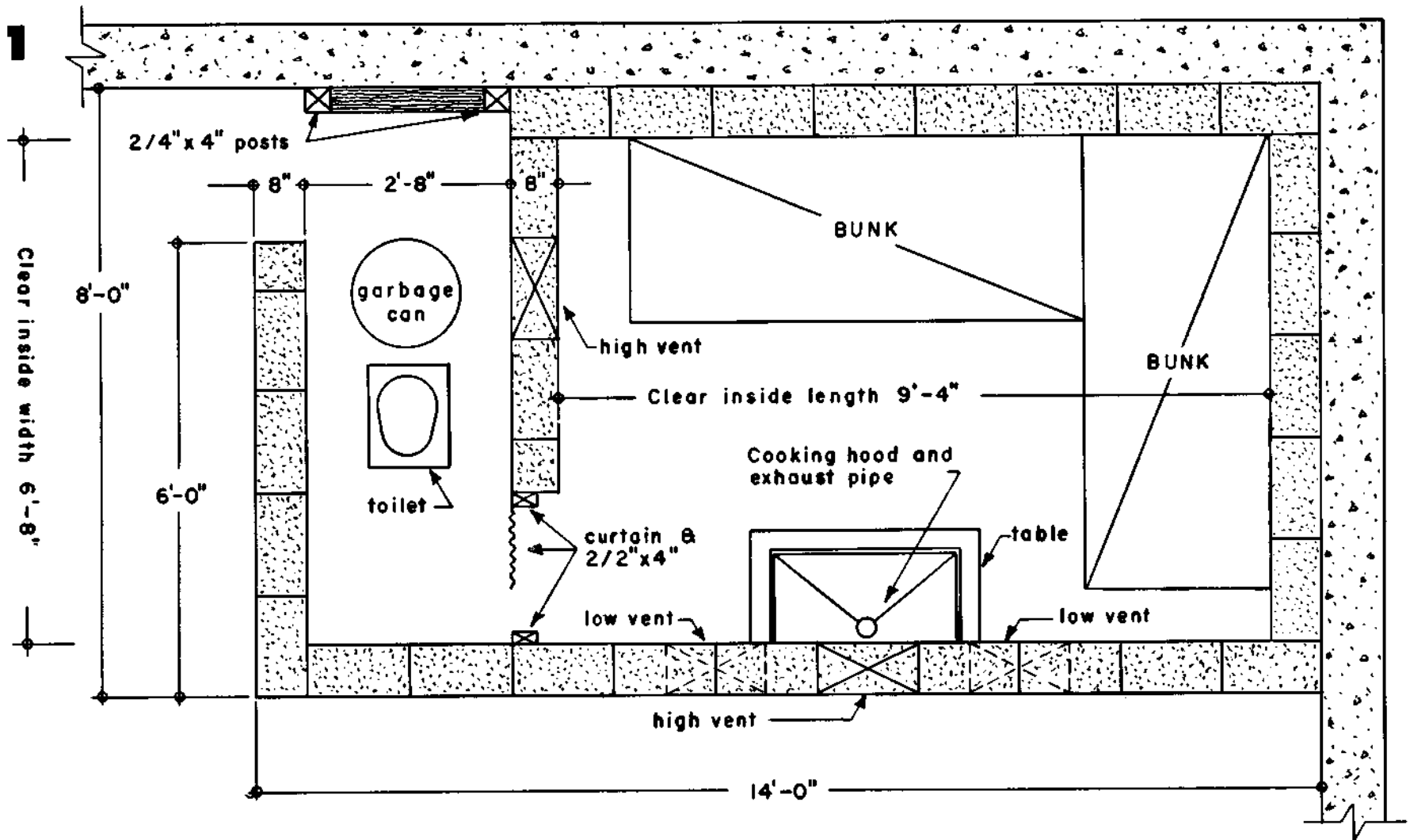

2

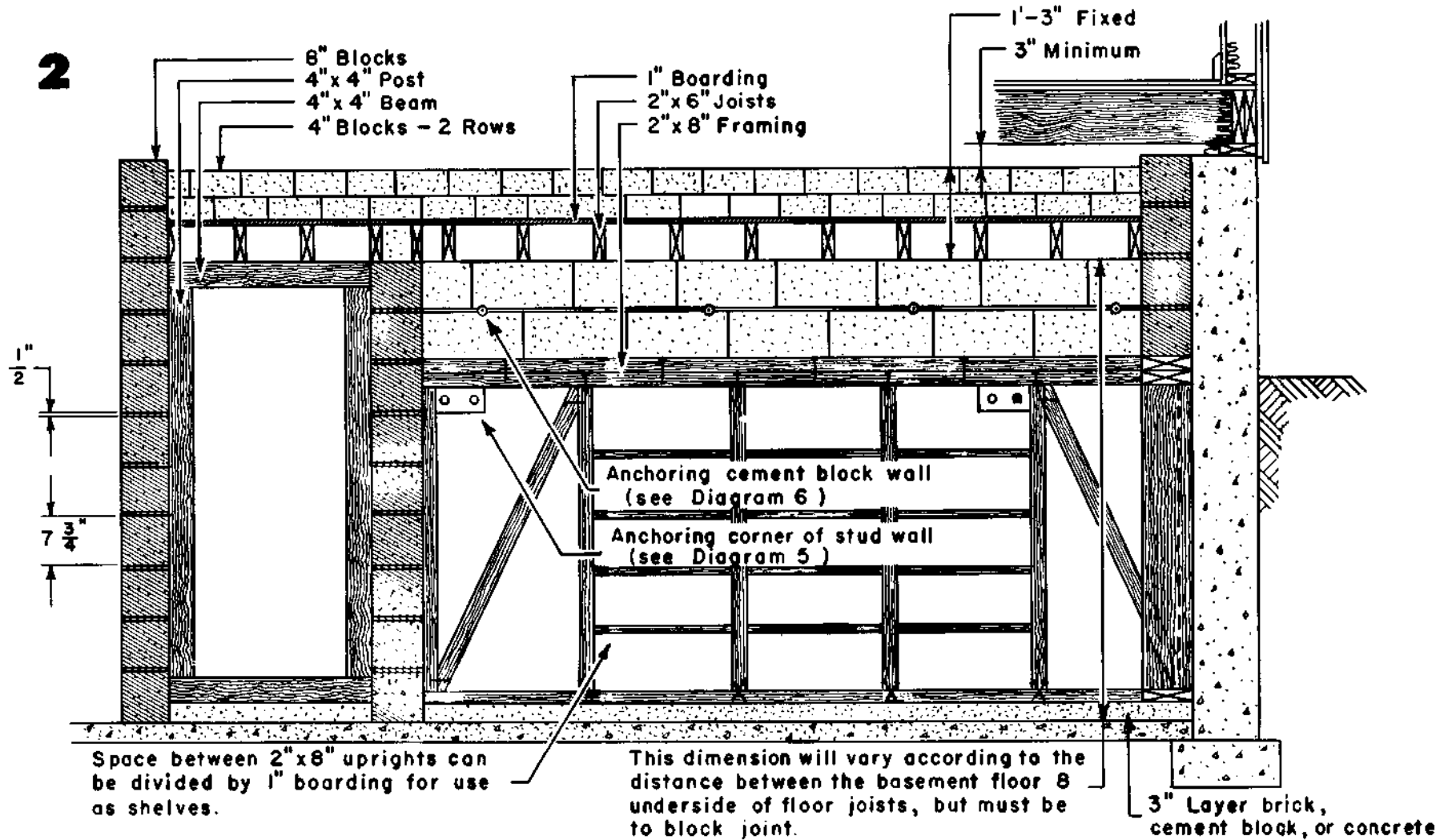

3

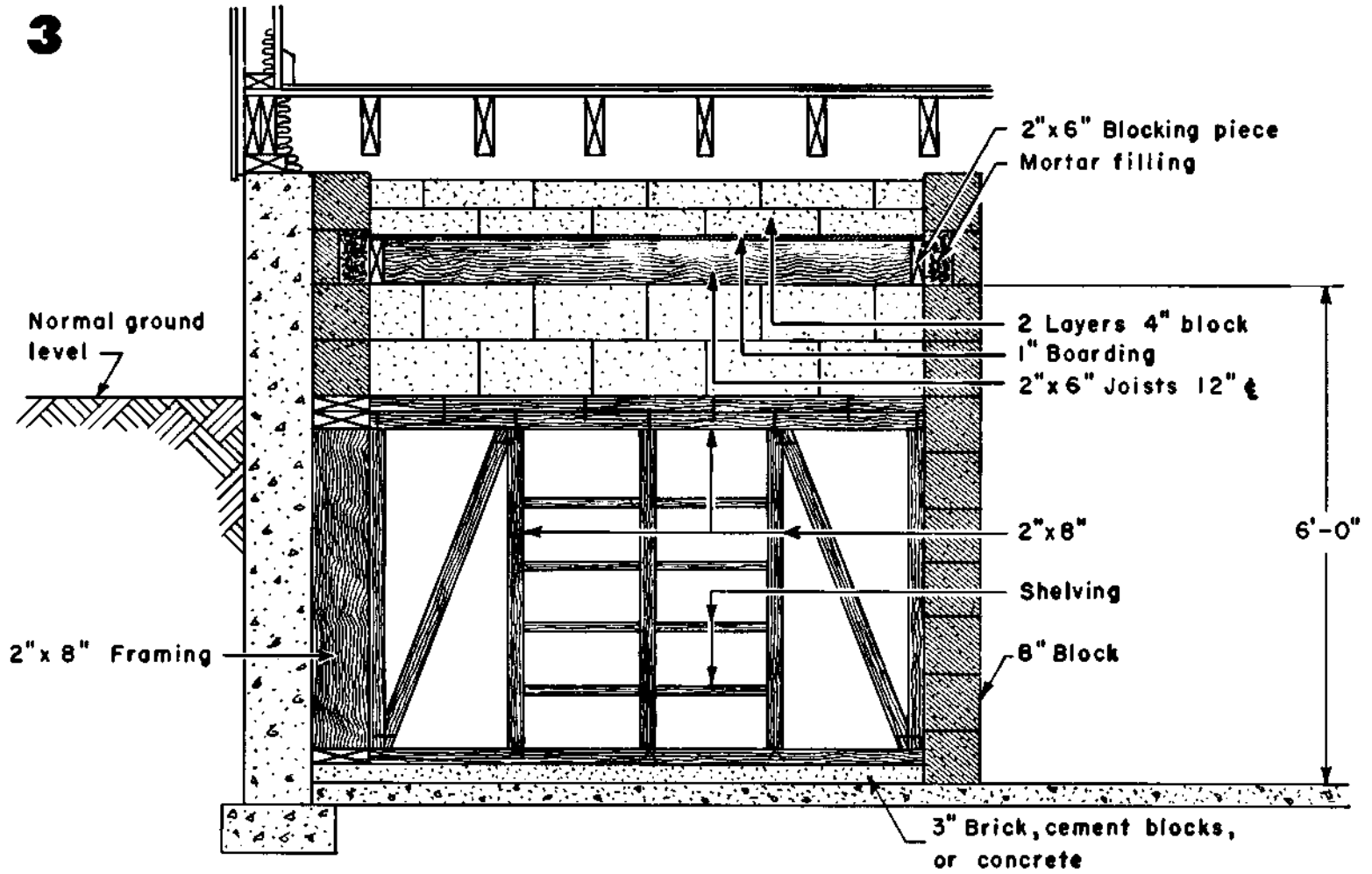

4

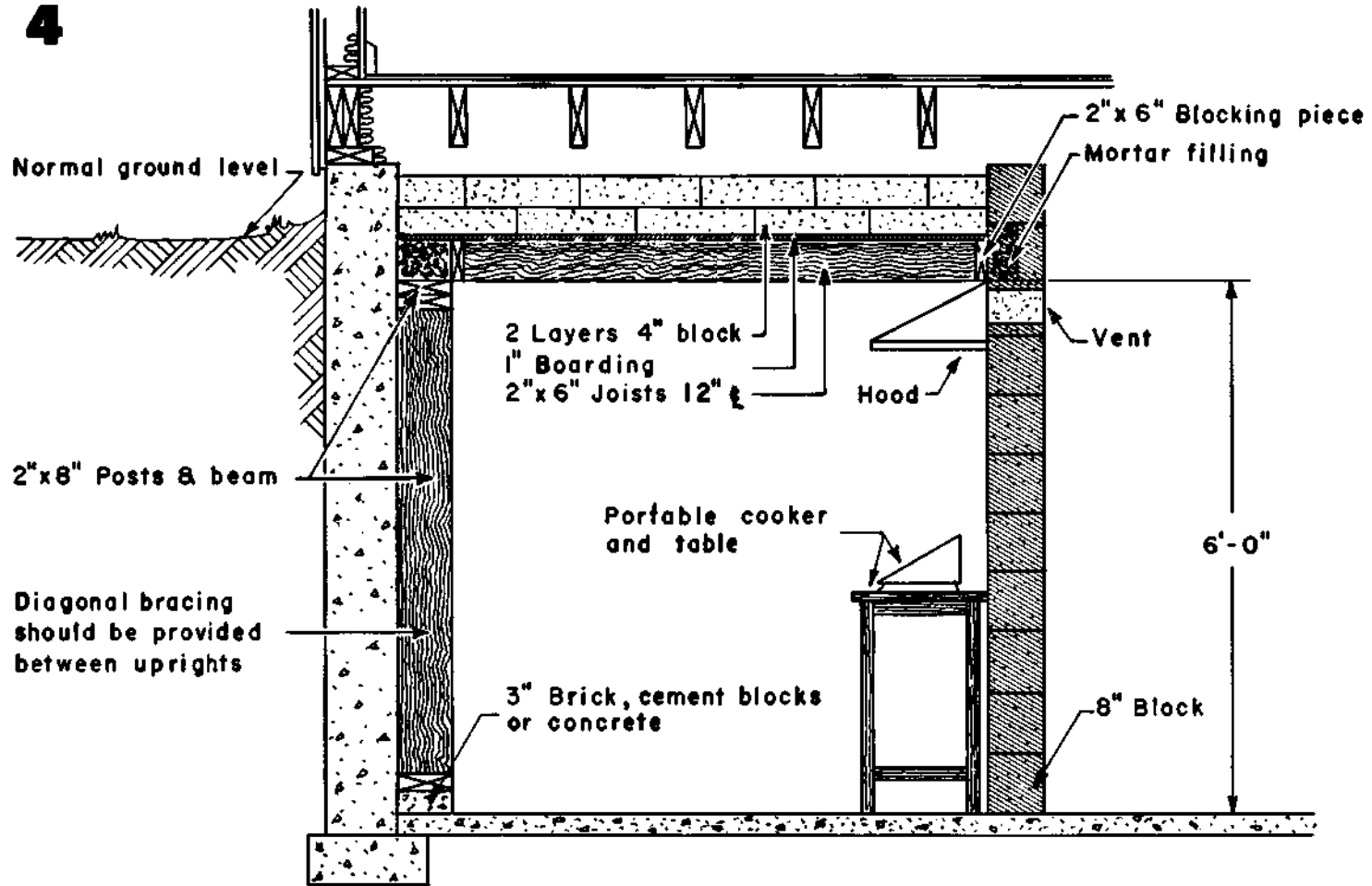

5

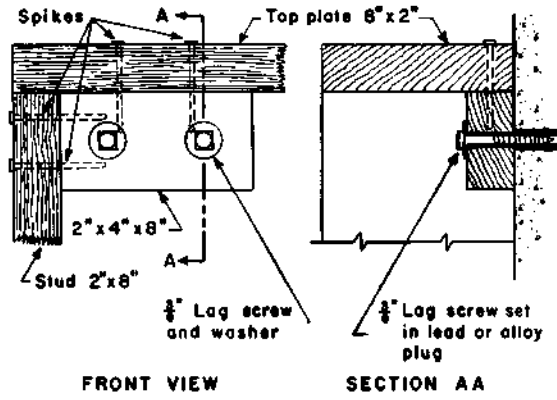

6

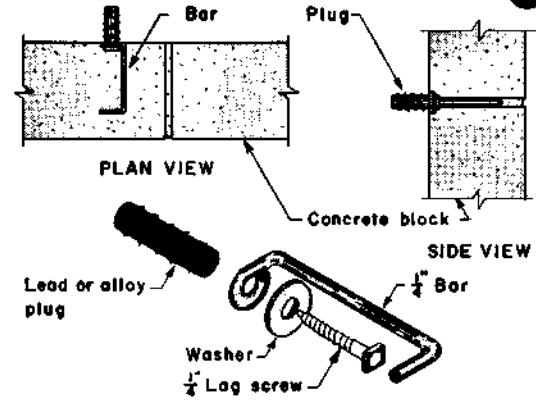

7

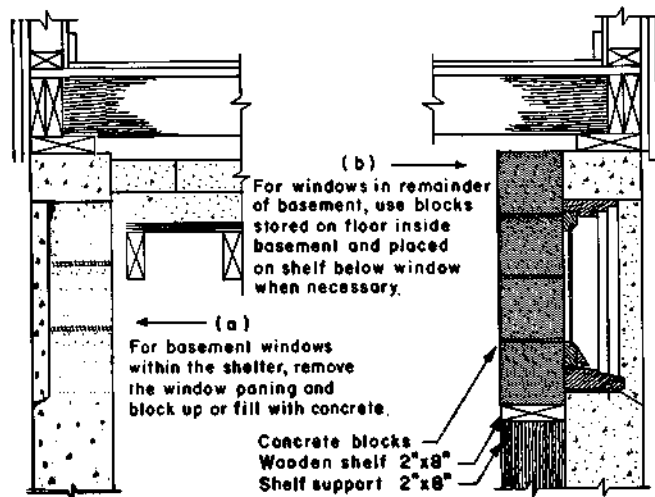

8

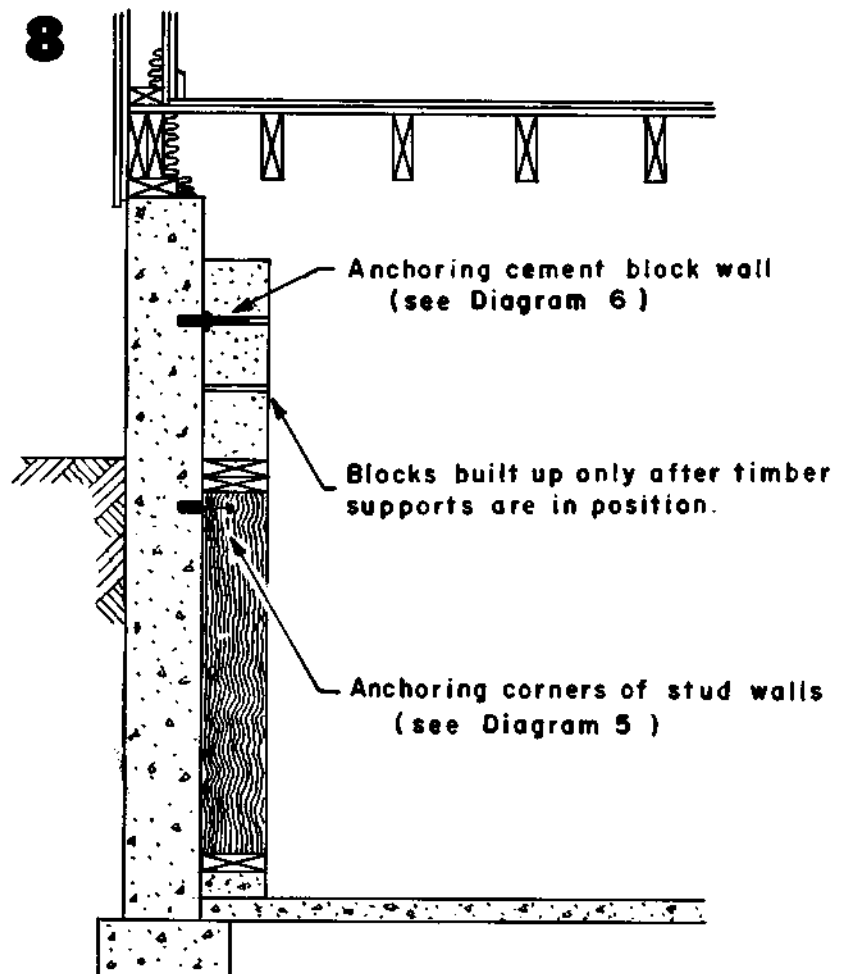

9

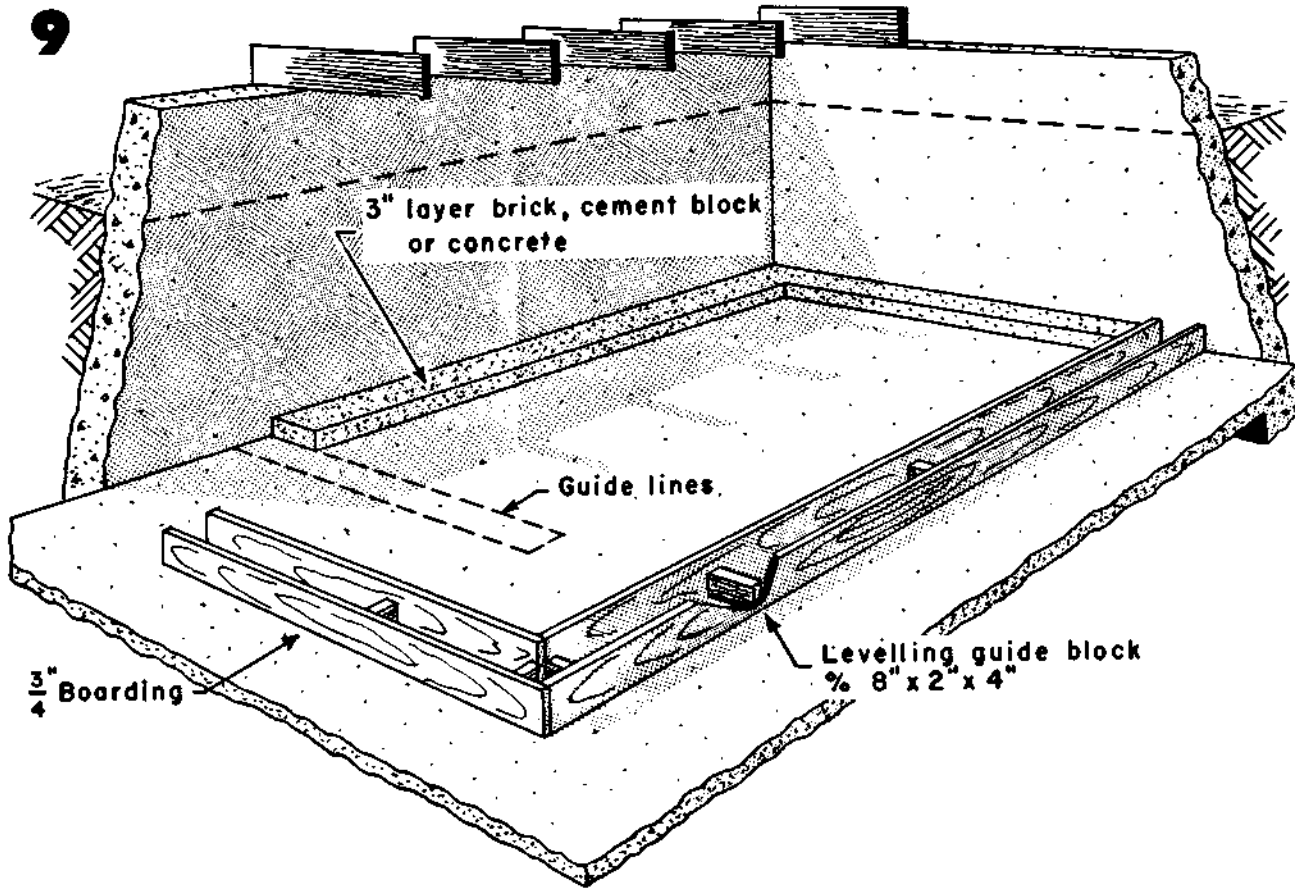

10

← Normal ground level

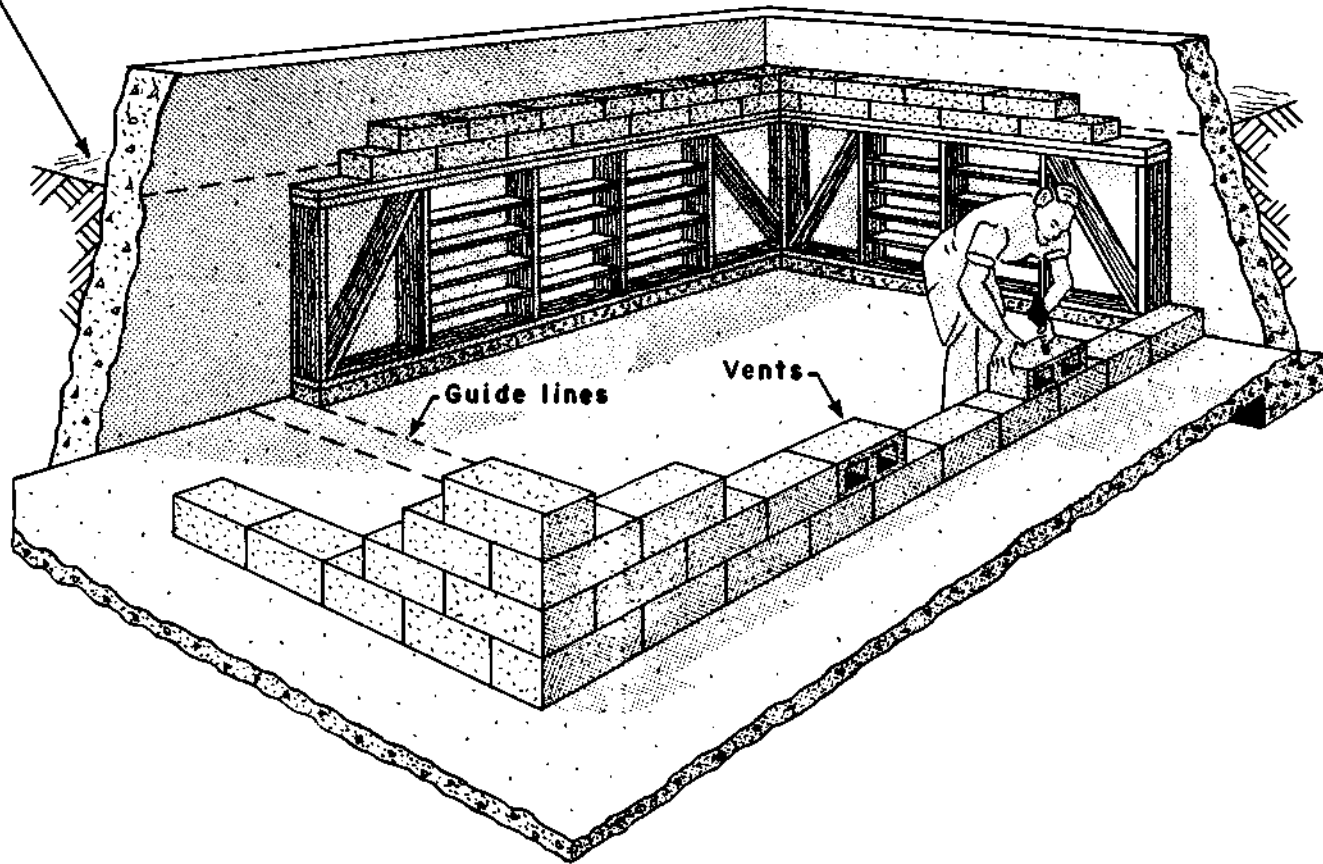

11

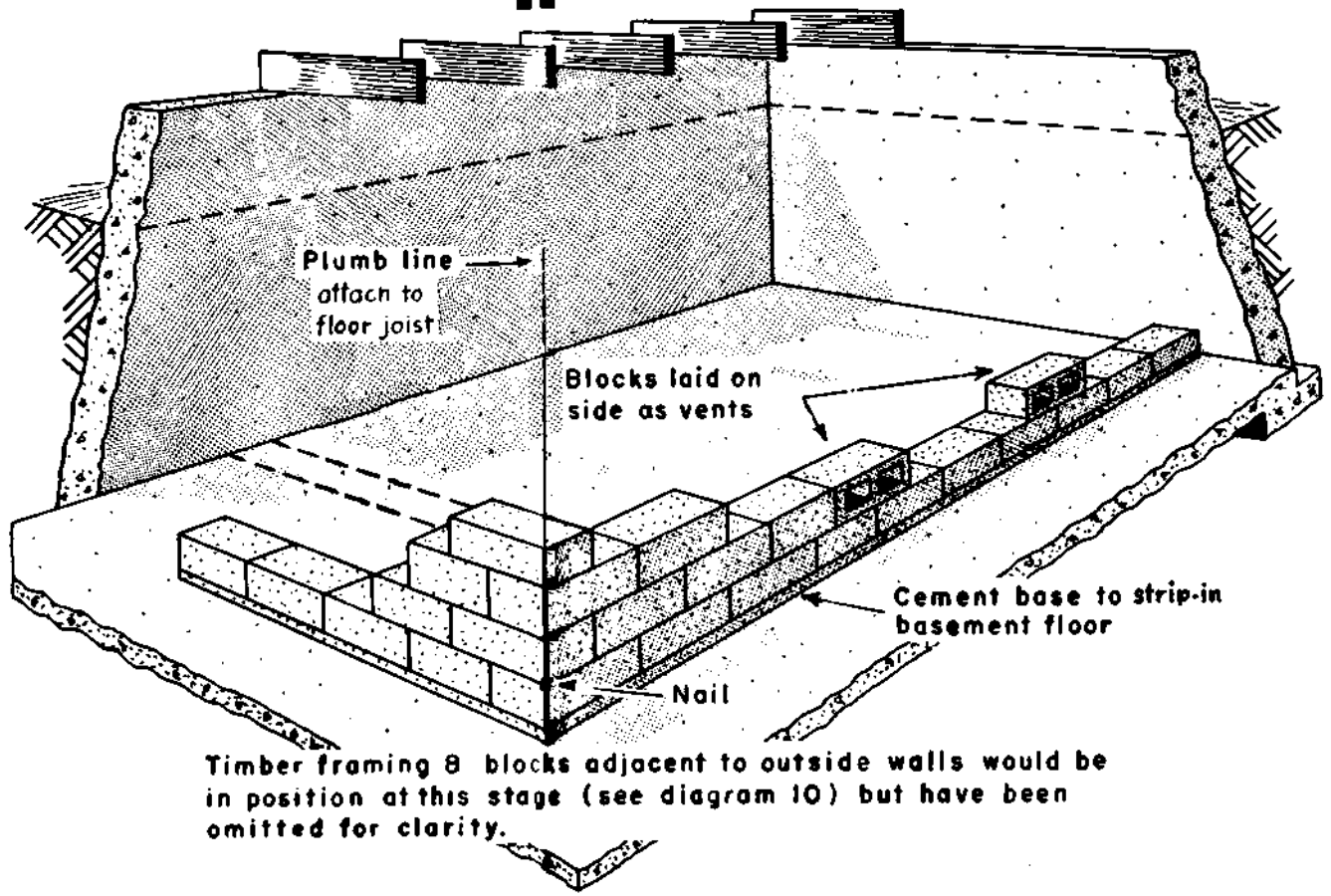

Timber framing & blocks adjacent to outside walls would be in position at this stage (see diagram 10) but have been omitted for clarity.

Nuclear Survival in **Arizona**

This is the nuclear target map for Arizona, but remember, fallout can go anywhere or everywhere (and probably will). After you have looked at this map look at the [Information for Arizona](#) that follows it.

This link will take you back to the [Index of all the States](#)

Nuclear Weapon Target Map for Arizona (FEMA-196/September 1990)

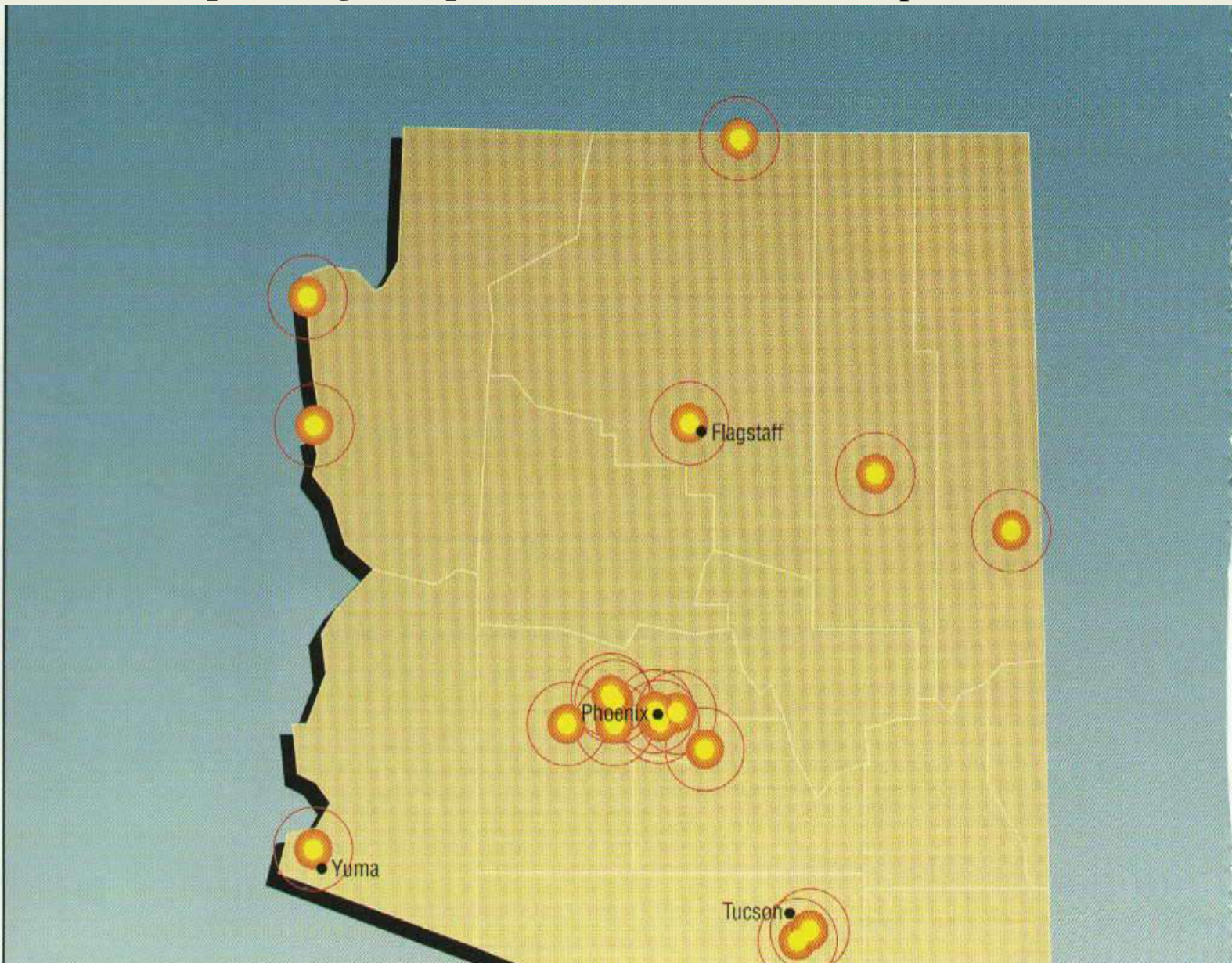

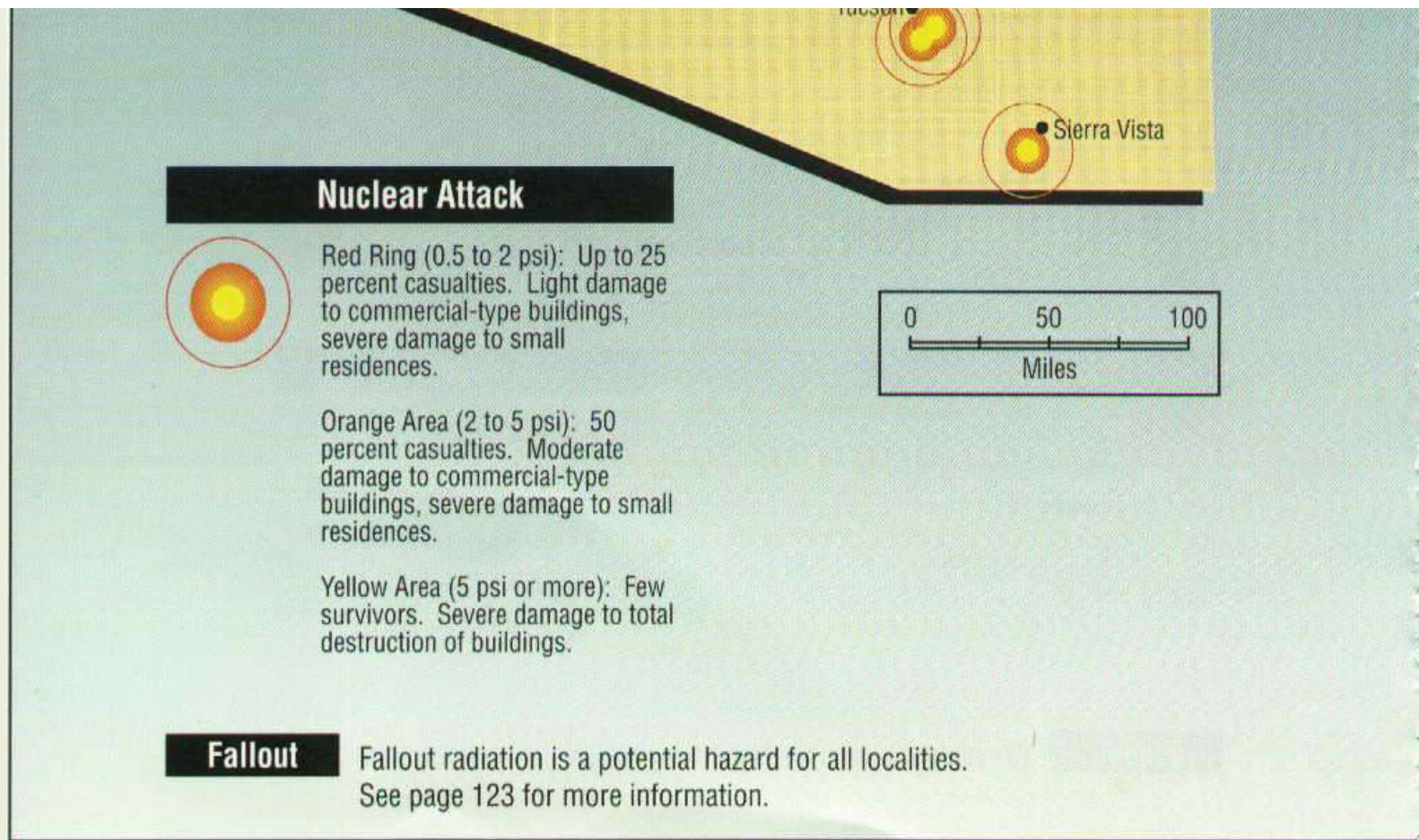

[UPDATE to Target Information!!!](#)

Information for Arizona

This link will take you back to the [Index of all the States](#)

It is recommended that you go through the following 10 steps in studying about the nuclear threat to Arizona.

1. Look at the [State Map](#) above to see the target nuclear areas in Arizona.
2. Look at the [general expected fallout map](#) to see where Arizona (according to the **prevailing wind pattern**) gets fallout from other states.
3. If the state that you live in is anywhere EAST of any of the following 6 states in the **prevailing wind pattern** then look at the states in **RED** on the [INDEX of](#)

STATES for

- Montana
- North Dakota
- South Dakota
- Nebraska
- Missouri
- Colorado

These six states contain what is called DENSE PACK which I explain on each of those states pages. **UNDERSTAND** that the wind pattern **COULD** at that time be something other than the "prevailing" wind pattern.

4. Bookmark the present URL or make a copy of this present address so that you can come back to it after going to

[Blast Mapper](#).

This mapper is on someone else's web site so that you will need to save this address in order to return here if your back button doesn't work. However, you want to be sure to go the mapper site and calculate the damage to probable targets (cities) around you.

5. Memorize the THREE top rules for survival. They are:

- Number One - **Get out of the cities!**
- Number Two - **Get out of the cities!**
- Number Three - **Get out of the cities!**

6. The follow-on rules are:

- a. Have a shelter
- b. Work with a group (you are going to need the manpower, brainpower, and skillpower).

- c. Stock supplies.

7. My [Main Survival Page](#) contains links to lots of other information such as free books to download about nuclear survival, links to plans for building shelters, and even free consultation about building a shelter.

8. If you are SUPER concerned about nuclear survival you might consider moving within 20 miles of the

[Ark Two Community](#)
(in Canada)

9. And finally if you would like to be on the mailing list of the author of this site - send a blank email to:

arktwo-request@deuce.pairowoodies.com
[with the subject as subscribe](#)

MENU: [HOME](#) » [SURVIVAL](#) » [Index of States](#)

Nuclear Survival in **Arkansas**

This is the nuclear target map for Arkansas, but remember, fallout can go anywhere or everywhere (and probably will). After you have looked at this map look at the [Information for Arkansas](#) that follows it.

This link will take you back to the [Index of all the States](#)

Nuclear Weapon Target Map for Arkansas (FEMA-196/September 1990)

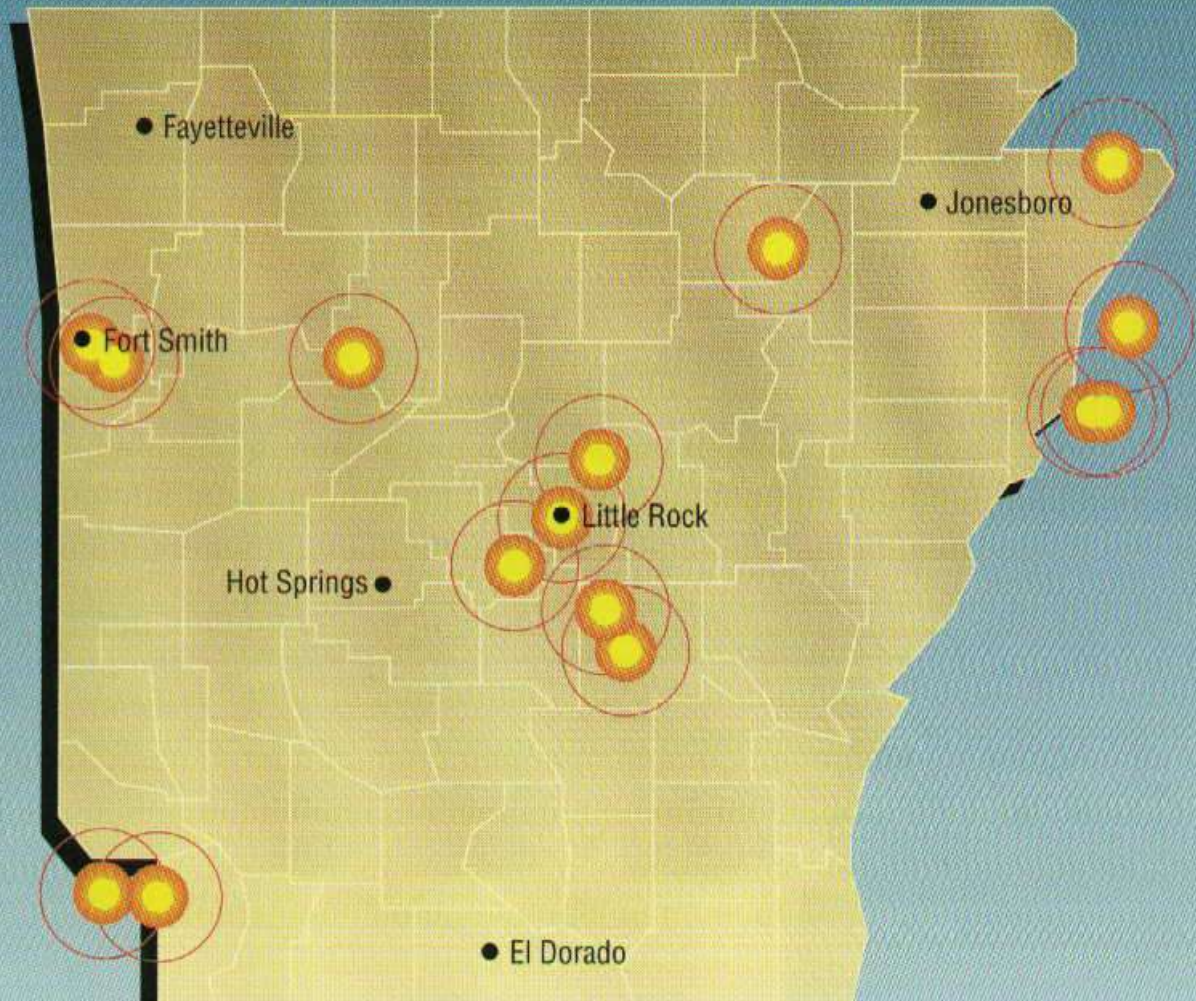

● El Dorado

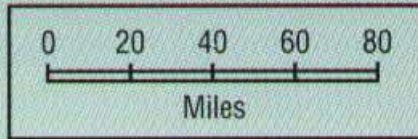

Nuclear Attack



Red Ring (0.5 to 2 psi): Up to 25 percent casualties. Light damage to commercial-type buildings, severe damage to small residences.

Orange Area (2 to 5 psi): 50 percent casualties. Moderate damage to commercial-type buildings, severe damage to small residences.

Yellow Area (5 psi or more): Few survivors. Severe damage to total destruction of buildings.

Fallout

Fallout radiation is a potential hazard for all localities. See page 123 for more information.

[UPDATE to Target Information!!!](#)

Information for Arkansas

This link will take you back to the [Index of all the States](#)

It is recommended that you go through the following 10 steps in studying about the nuclear threat to Arkansas.

1. Look at the [State Map](#) above to see the target nuclear areas in Arkansas.
2. Look at the [general expected fallout map](#) to see where Arkansas (according to the **prevailing wind pattern**) gets fallout from other states.
3. If the state that you live in is anywhere EAST of any of the following 6 states in the **prevailing wind pattern** then look at the states in **RED** on the [INDEX of](#)

STATES for

- Montana
- North Dakota
- South Dakota
- Nebraska
- Missouri
- Colorado

These six states contain what is called DENSE PACK which I explain on each of those states pages. **UNDERSTAND** that the wind pattern **COULD** at that time be something other than the "prevailing" wind pattern.

4. Bookmark the present URL or make a copy of this present address so that you can come back to it after going to

[Blast Mapper](#).

This mapper is on someone else's web site so that you will need to save this address in order to return here if your back button doesn't work. However, you want to be sure to go the mapper site and calculate the damage to probable targets (cities) around you.

5. Memorize the THREE top rules for survival. They are:

- Number One - **Get out of the cities!**
- Number Two - **Get out of the cities!**
- Number Three - **Get out of the cities!**

6. The follow-on rules are:

- a. Have a shelter
- b. Work with a group (you are going to need the manpower, brainpower, and skillpower).

- c. Stock supplies.

7. My [Main Survival Page](#) contains links to lots of other information such as free books to download about nuclear survival, links to plans for building shelters, and even free consultation about building a shelter.

8. If you are SUPER concerned about nuclear survival you might consider moving within 20 miles of the

[Ark Two Community](#)
(in Canada)

9. And finally if you would like to be on the mailing list of the author of this site - send a blank email to:

arktwo-request@deuce.pairowoodies.com
[with the subject as subscribe](#)

MENU: [HOME](#) » [SURVIVAL](#) » [Index of States](#)

Nuclear Survival in **California**

This is the nuclear target map for California, but remember, fallout can go anywhere or everywhere (and probably will). After you have looked at this map look at the [Information for California](#) that follows it.

This link will take you back to the [Index of all the States](#)

Nuclear Weapon Target Map for California (FEMA-196/September 1990)

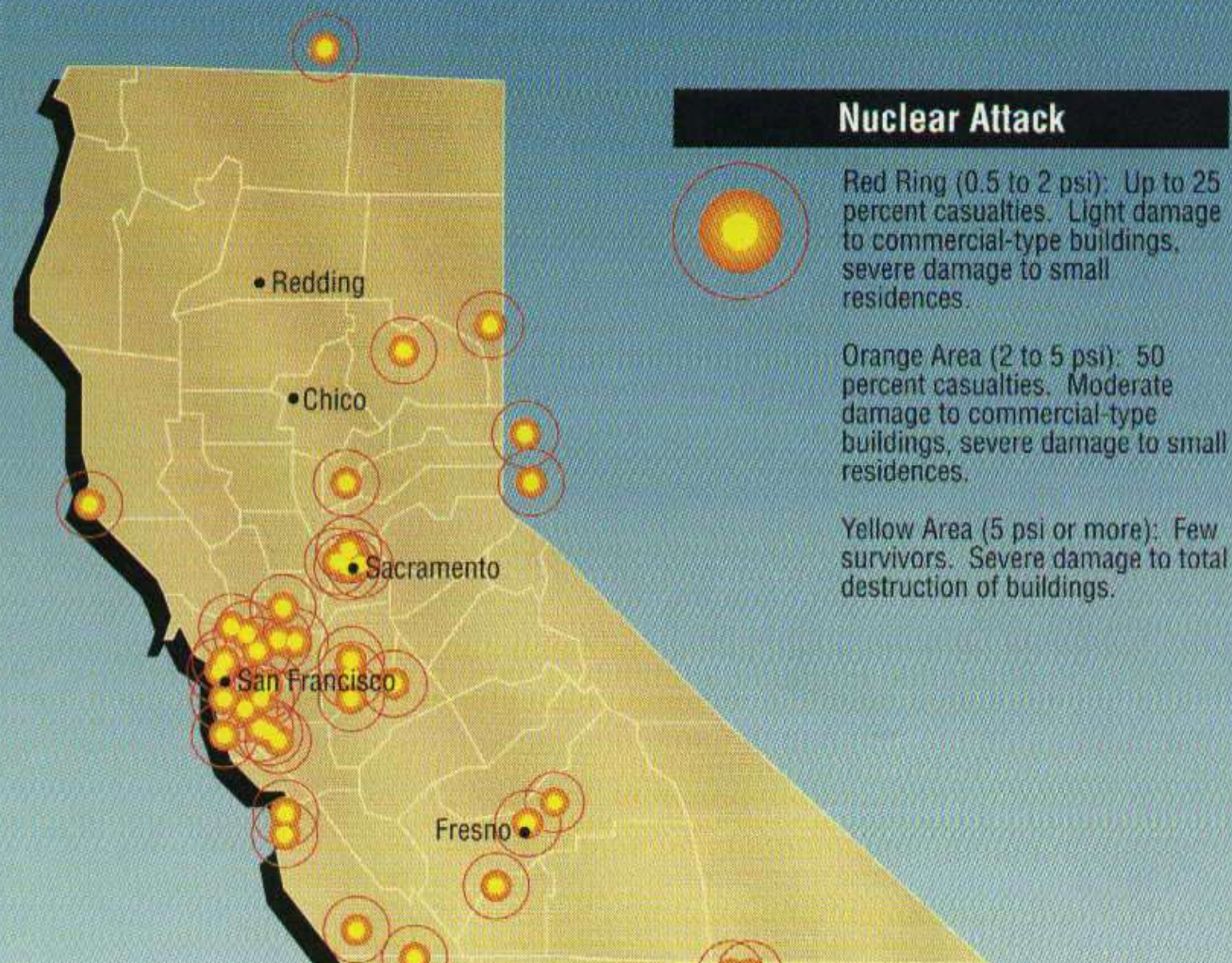

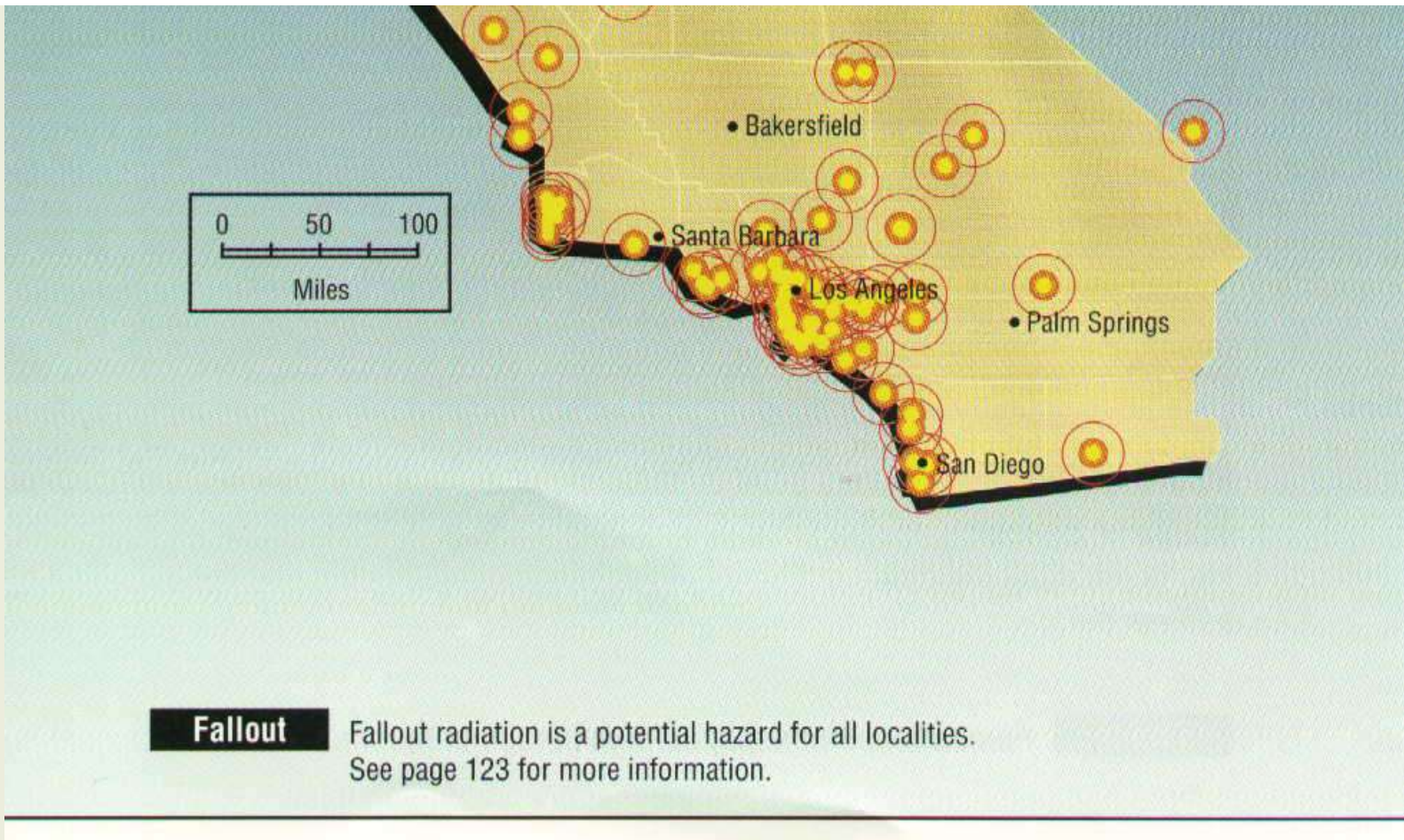

[UPDATE to Target Information!!!](#)

Information for California

This link will take you back to the [Index of all the States](#)

It is recommended that you go through the following 10 steps in studying about the nuclear threat to California.

1. Look at the [State Map](#) above to see the target nuclear areas in California.
2. Look at the [general expected fallout map](#) to see where California (according to the **prevailing wind pattern**) gets fallout from other states.
3. If the state that you live in is anywhere EAST of any of the following 6 states in the **prevailing wind pattern** then look at the states in **RED** on the [INDEX of](#)

STATES for

- Montana
- North Dakota
- South Dakota
- Nebraska
- Missouri
- Colorado

These six states contain what is called DENSE PACK which I explain on each of those states pages. **UNDERSTAND** that the wind pattern **COULD** at that time be something other than the "prevailing" wind pattern.

4. Bookmark the present URL or make a copy of this present address so that you can come back to it after going to

[Blast Mapper](#).

This mapper is on someone else's web site so that you will need to save this address in order to return here if your back button doesn't work. However, you want to be sure to go the mapper site and calculate the damage to probable targets (cities) around you.

5. Memorize the THREE top rules for survival. They are:

- Number One - **Get out of the cities!**
- Number Two - **Get out of the cities!**
- Number Three - **Get out of the cities!**

6. The follow-on rules are:

- a. Have a shelter
- b. Work with a group (you are going to need the manpower, brainpower, and skillpower).

- c. Stock supplies.

7. My [Main Survival Page](#) contains links to lots of other information such as free books to download about nuclear survival, links to plans for building shelters, and even free consultation about building a shelter.

8. If you are SUPER concerned about nuclear survival you might consider moving within 20 miles of the

[Ark Two Community](#)
(in Canada)

9. And finally if you would like to be on the mailing list of the author of this site - send a blank email to:

arktwo-request@deuce.pairowoodies.com
[with the subject as subscribe](#)

MENU: [HOME](#) » [SURVIVAL](#) » [Index of States](#)

Nuclear Survival in **Colorado**

This is the nuclear target map for Colorado, but remember, fallout can go anywhere or everywhere (and probably will). After you have looked at this map look at the [Information for Colorado](#) that follows it.

This link will take you back to the [Index of all the States](#)

***DENSE PACK** - Look at all those target sites. So close Together! It serves a purpose. It is missiles protecting missiles, and this is how it is done. These are "hardened" sites. Meaning it takes a direct ground explosion to dig them out. An air burst will not do it. When you have a ground explosion it throws many tons of dust and sand up into the air. High into the air. This is what will later become fallout carried by the winds hundreds, sometimes thousands, of miles away. But right over that site that has just been hit the sand and grit in the air is very thick for quite a while. Another high speed missile (ICBM) trying to come through it will have its skin torn off just like by sand blasting and it will be destroyed. So the other missile sites nearby are safe. On the other hand, because missiles take off much slower than the speeds they eventually reach, the missiles in the undamaged silos can still be launched and will pass through the dust cloud without be harmed. Neat, eh? See there is a purpose in putting so many in one place. Now the only way that you can dig them out is with what is called a slow walk. Hit a target. Move on further and hit another target where the dust from the first won't hurt you. Come back thirty or forty-five minutes later and hit a second target near where you hit the first, after the cloud has had time to blow away. A slow process. Some silos will already have launched and you will waste the shot. Others can still wait to launch later because you can only get one at a time. This could go on for days. Neat. The military missiles protecting missiles. But they don't protect you, because if you are downwind you will get the fallout. Fatal if you are not in a*

shelter. They call it Defense but it is only Destruction. Nothing here defends or protects you, if they are used.

Nuclear Weapon Target Map for Colorado (FEMA-196/September 1990)

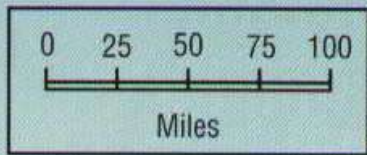
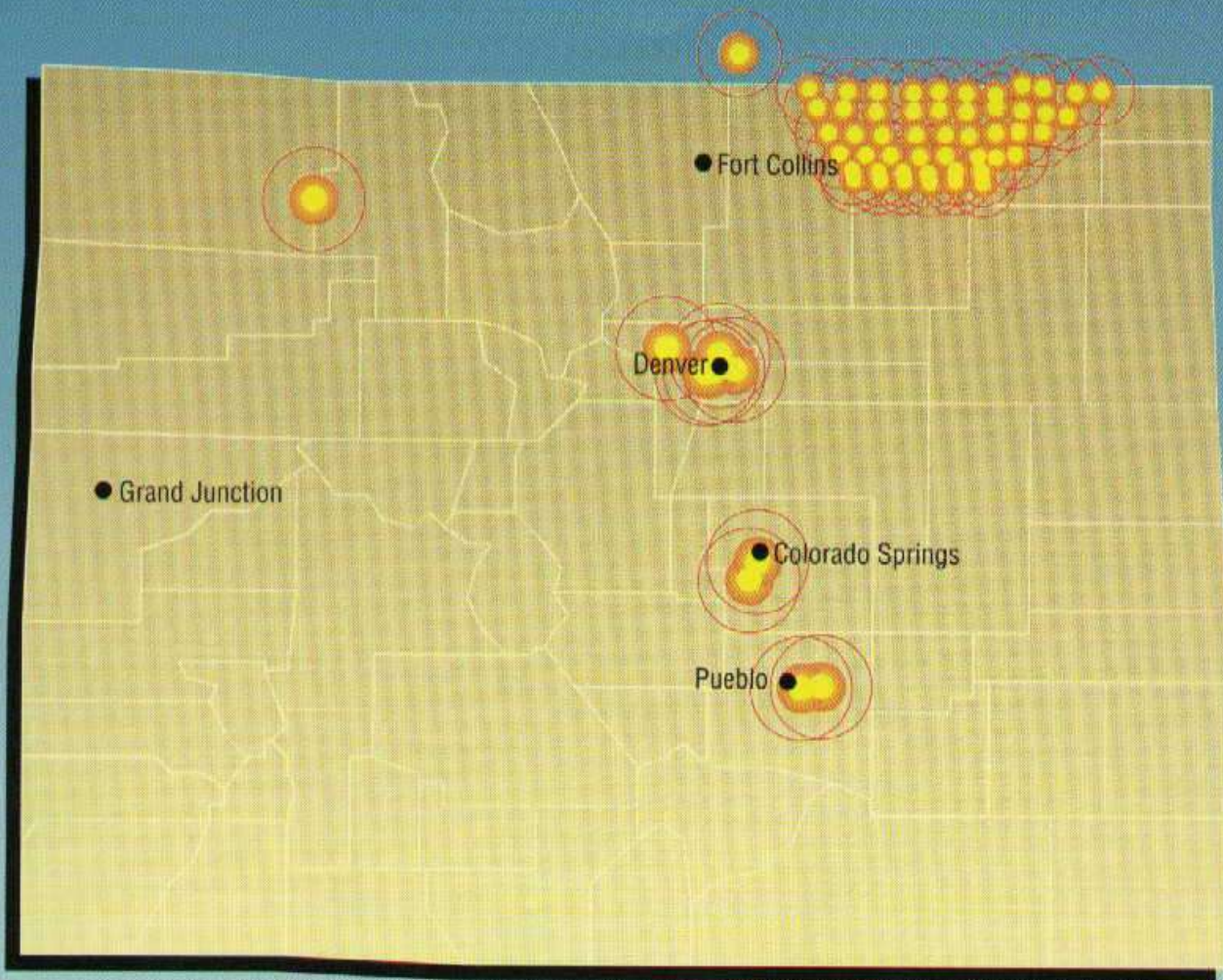

Nuclear Attack



Red Ring (0.5 to 2 psi): Up to 25 percent casualties. Light damage to commercial-type buildings, severe damage to small residences.

Orange Area (2 to 5 psi): 50 percent casualties. Moderate damage to commercial-type buildings, severe damage to small residences.

buildings, severe damage to small residences.

Yellow Area (5 psi or more): Few survivors. Severe damage to total destruction of buildings.

Fallout

Fallout radiation is a potential hazard for all localities. See page 123 for more information.

[UPDATE to Target Information!!!](#)

Information for Colorado

This link will take you back to the [Index of all the States](#)

It is recommended that you go through the following 10 steps in studying about the nuclear threat to Colorado.

1. Look at the [State Map](#) above to see the target nuclear areas in Colorado.
2. Look at the [general expected fallout map](#) to see where Colorado (according to the **prevailing wind pattern**) gets fallout from other states.
3. If the state that you live in is anywhere EAST of any of the following 6 states in the **prevailing wind pattern** then look at the states in **RED** on the [INDEX of STATES](#) for

- **Montana**
- **North Dakota**
- **South Dakota**
- **Nebraska**
- **Missouri**
- **Colorado**

These six states contain what is called DENSE PACK which I explain on each of

those states pages. **UNDERSTAND** that the wind pattern **COULD** at that time be something other than the "prevailing" wind pattern.

4. Bookmark the present URL or make a copy of this present address so that you can come back to it after going to

[Blast Mapper](#).

This mapper is on someone else's web site so that you will need to save this address in order to return here if your back button doesn't work. However, you want to be sure to go the mapper site and calculate the damage to probable targets (cities) around you.

5. Memorize the **THREE** top rules for survival. They are:

- Number One - **Get out of the cities!**
- Number Two - **Get out of the cities!**
- Number Three - **Get out of the cities!**

6. The follow-on rules are:

- a. Have a shelter
- b. Work with a group (you are going to need the manpower, brainpower, and skillpower).
- c. Stock supplies.

7. My [Main Survival Page](#) contains links to lots of other information such as free books to download about nuclear survival, links to plans for building shelters, and even free consultation about building a shelter.

8. If you are **SUPER** concerned about nuclear survival you might consider moving within 20 miles of the

[Ark Two Community](#)

(in Canada)

9. And finally if you would like to be on the mailing list of the author of this site - send a blank email to:

arktwo-request@deuce.pairowoodies.com
[with the subject as subscribe](#)

MENU: [HOME](#) » [SURVIVAL](#) » [Index of States](#)

Nuclear Survival in **Connecticut**

This is the nuclear target map for Connecticut, but remember, fallout can go anywhere or everywhere (and probably will). After you have looked at this map look at the [Information for Connecticut](#) that follows it.

This link will take you back to the [Index of all the States](#)

Nuclear Weapon Target Map for Connecticut (FEMA-196/September 1990)

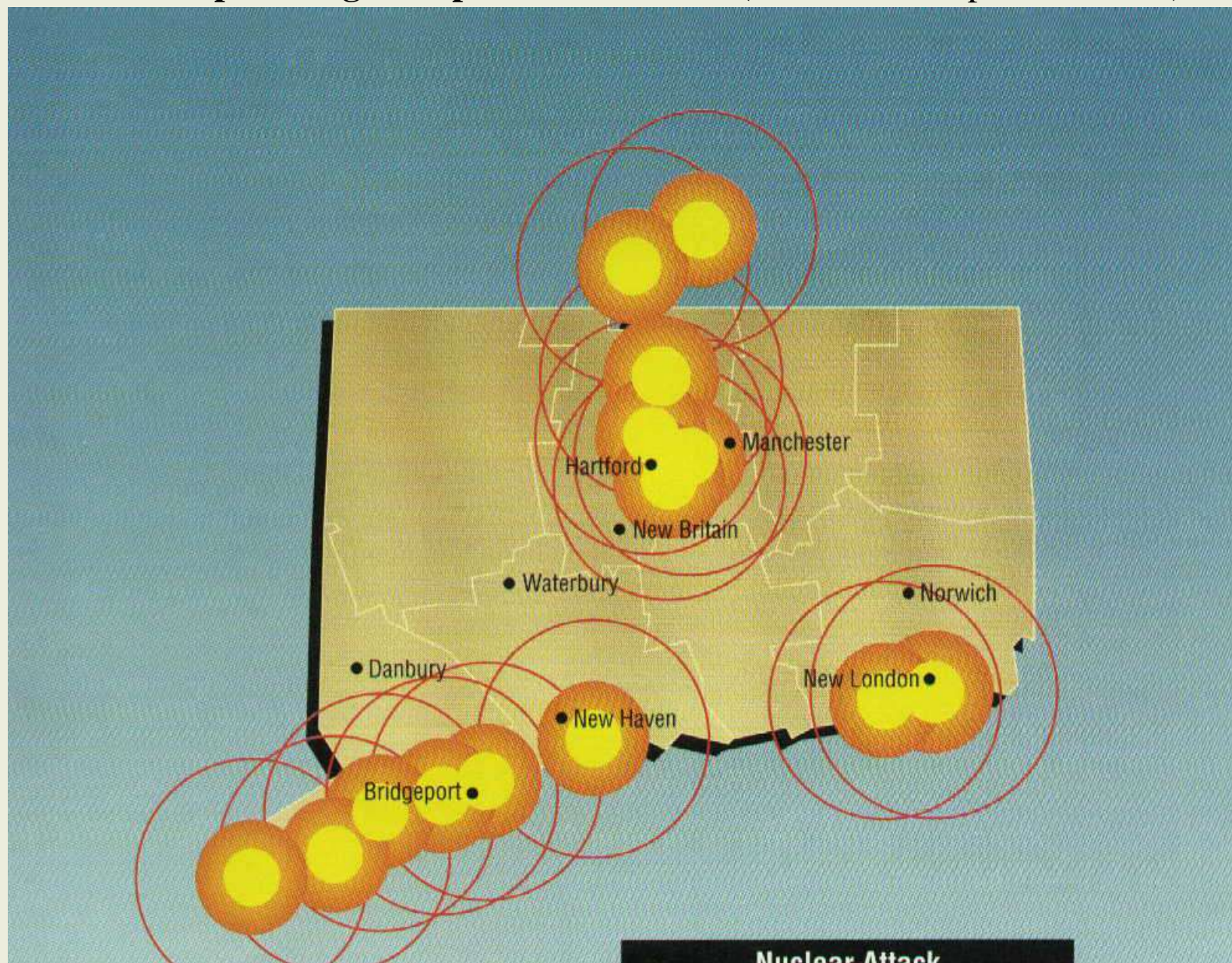

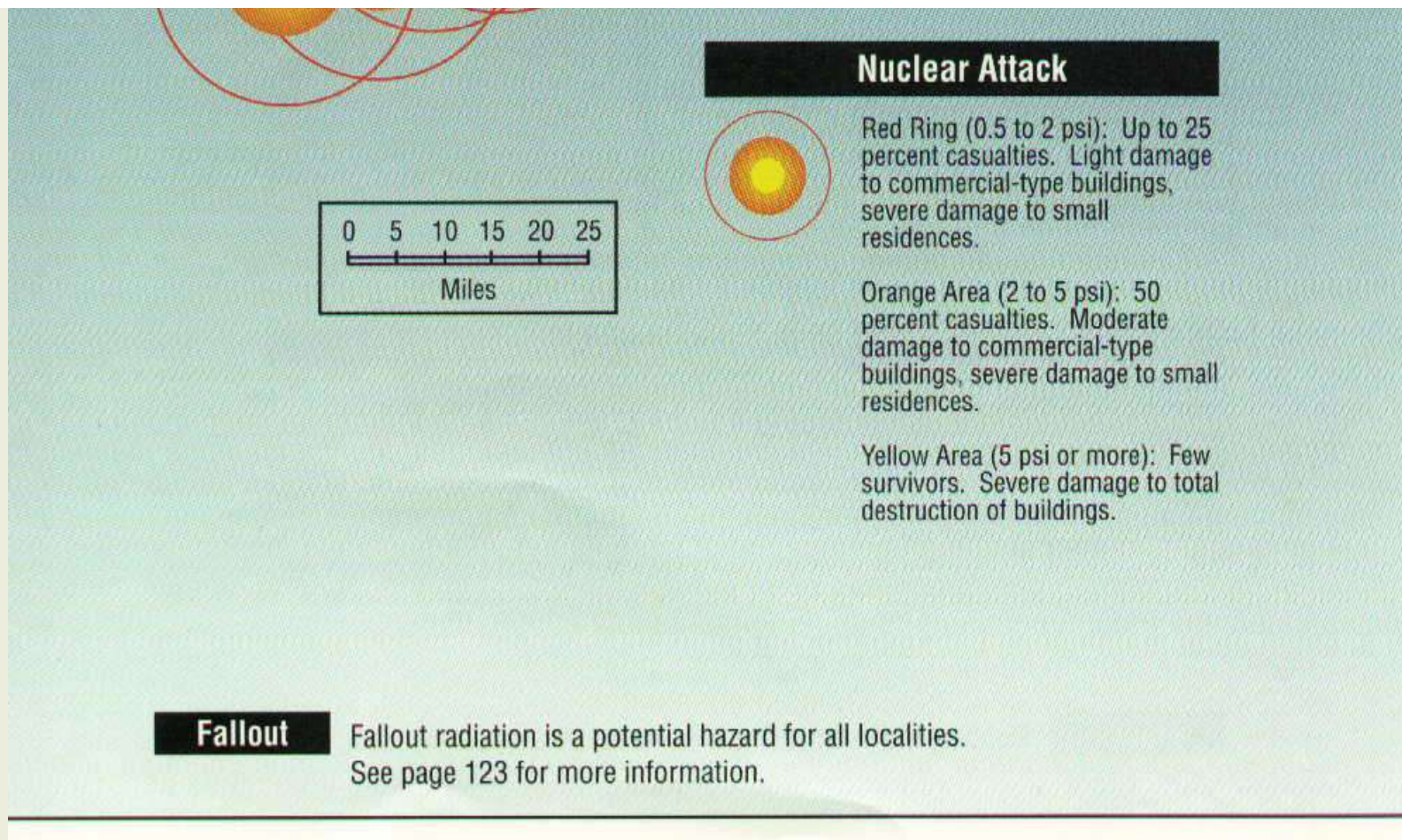

[UPDATE to Target Information!!!](#)

Information for Connecticut

This link will take you back to the [Index of all the States](#)

It is recommended that you go through the following 10 steps in studying about the nuclear threat to Connecticut.

1. Look at the [State Map](#) above to see the target nuclear areas in Connecticut.
2. Look at the [general expected fallout map](#) to see where Connecticut (according to the **prevailing wind pattern**) gets fallout from other states.
3. If the state that you live in is anywhere EAST of any of the following 6 states in the **prevailing wind pattern** then look at the states in **RED** on the [INDEX of](#)

STATES for

- Montana
- North Dakota
- South Dakota
- Nebraska
- Missouri
- Colorado

These six states contain what is called DENSE PACK which I explain on each of those states pages. **UNDERSTAND** that the wind pattern **COULD** at that time be something other than the "prevailing" wind pattern.

4. Bookmark the present URL or make a copy of this present address so that you can come back to it after going to

[Blast Mapper.](#)

This mapper is on someone else's web site so that you will need to save this address in order to return here if your back button doesn't work. However, you want to be sure to go the mapper site and calculate the damage to probable targets (cities) around you.

5. Memorize the THREE top rules for survival. They are:

- Number One - **Get out of the cities!**
- Number Two - **Get out of the cities!**
- Number Three - **Get out of the cities!**

6. The follow-on rules are:

- a. Have a shelter
- b. Work with a group (you are going to need the manpower, brainpower, and skillpower).

- c. Stock supplies.

7. My [Main Survival Page](#) contains links to lots of other information such as free books to download about nuclear survival, links to plans for building shelters, and even free consultation about building a shelter.

8. If you are SUPER concerned about nuclear survival you might consider moving within 20 miles of the

[Ark Two Community](#)
(in Canada)

9. And finally if you would like to be on the mailing list of the author of this site - send a blank email to:

arktwo-request@deuce.pairowoodies.com
[with the subject as subscribe](#)

MENU: [HOME](#) » [SURVIVAL](#) » [Index of States](#)

Nuclear Survival in

Delaware

This is the nuclear target map for Delaware, but remember, fallout can go anywhere or everywhere (and probably will). After you have looked at this map look at the [Information for Delaware](#) that follows it.

This link will take you back to the [Index of all the States](#)

Nuclear Weapon Target Map for Delaware (FEMA-196/September 1990)

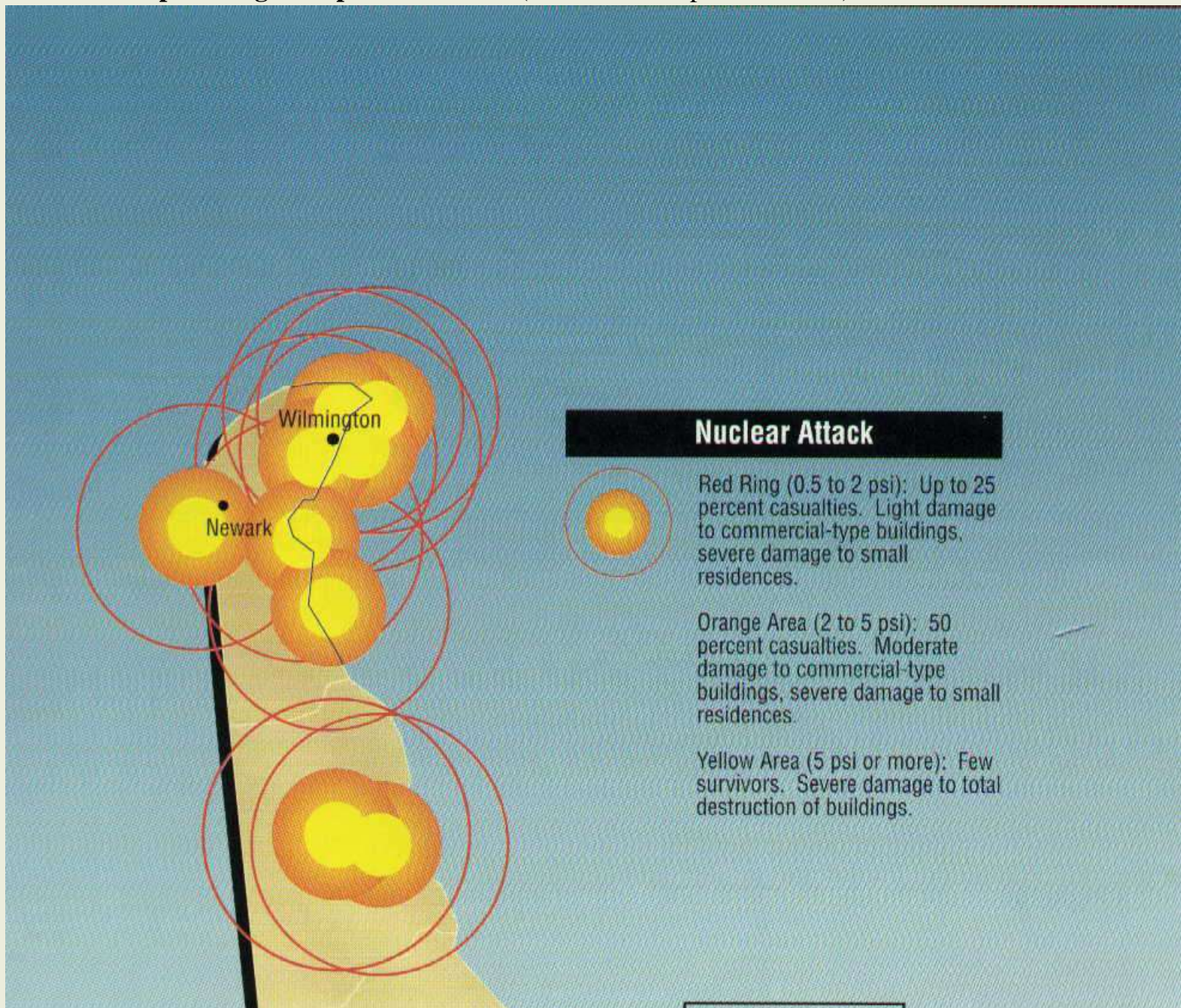

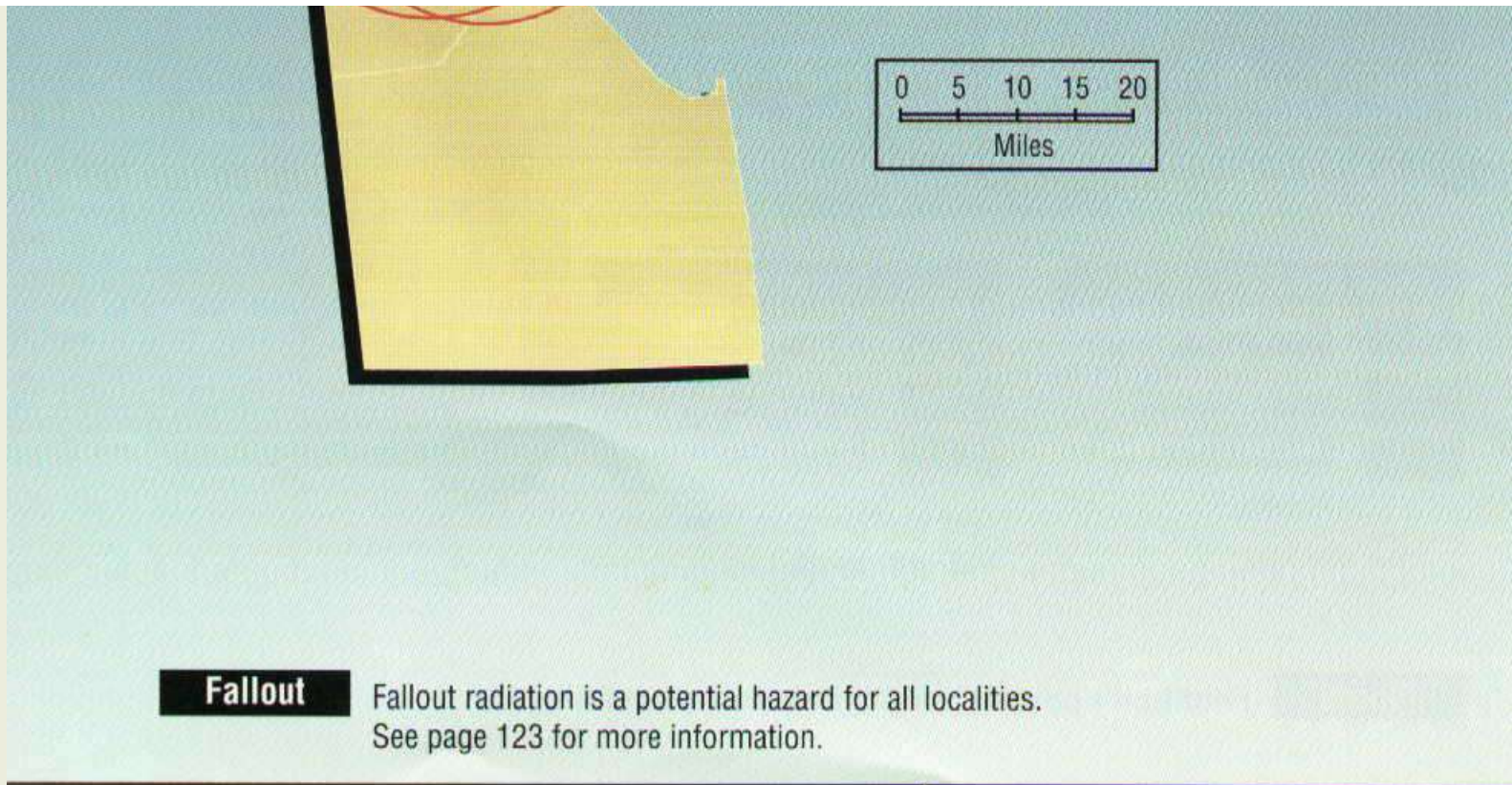

[UPDATE to Target Information!!!](#)

Information for Delaware

This link will take you back to the [Index of all the States](#)

It is recommended that you go through the following 10 steps in studying about the nuclear threat to Delaware.

1. Look at the [State Map](#) above to see the target nuclear areas in Delaware.
2. Look at the [general expected fallout map](#) to see where Delaware (according to the **prevailing wind pattern**) gets fallout from other states.
3. If the state that you live in is anywhere EAST of any of the following 6 states in the **prevailing wind pattern** then look at the states in **RED** on the [INDEX of STATES](#) for
 - **Montana**
 - **North Dakota**
 - **South Dakota**
 - **Nebraska**
 - **Missouri**

- **Colorado**

These six states contain what is called DENSE PACK which I explain on each of those states pages. **UNDERSTAND** that the wind pattern **COULD** at that time be something other than the "prevailing" wind pattern.

4. Bookmark the present URL or make a copy of this present address so that you can come back to it after going to

[Blast Mapper.](#)

This mapper is on someone else's web site so that you will need to save this address in order to return here if your back button doesn't work. However, you want to be sure to go the mapper site and calculate the damage to probable targets (cities) around you.

5. Memorize the THREE top rules for survival. They are:

- Number One - **Get out of the cities!**
- Number Two - **Get out of the cities!**
- Number Three - **Get out of the cities!**

6. The follow-on rules are:

- a. Have a shelter
- b. Work with a group (you are going to need the manpower, brainpower, and skillpower).
- c. Stock supplies.

7. My [Main Survival Page](#) contains links to lots of other information such as free books to download about nuclear survival, links to plans for building shelters, and even free consultation about building a shelter.

8. If you are SUPER concerned about nuclear survival you might consider moving within 20 miles of the

[Ark Two Community](#)

(in Canada)

9. And finally if you would like to be on the mailing list of the author of this site - send a blank email to:

arktwo-request@deuce.pairowoodies.com

[with the subject as subscribe](#)

MENU: [HOME](#) » [SURVIVAL](#) » [Index of States](#)

Nuclear Survival in **Florida**

This is the nuclear target map for Florida, but remember, fallout can go anywhere or everywhere (and probably will). After you have looked at this map look at the [Information for Florida](#) that follows it.

This link will take you back to the [Index of all the States](#)

Nuclear Weapon Target Map for Florida (FEMA-196/September 1990)

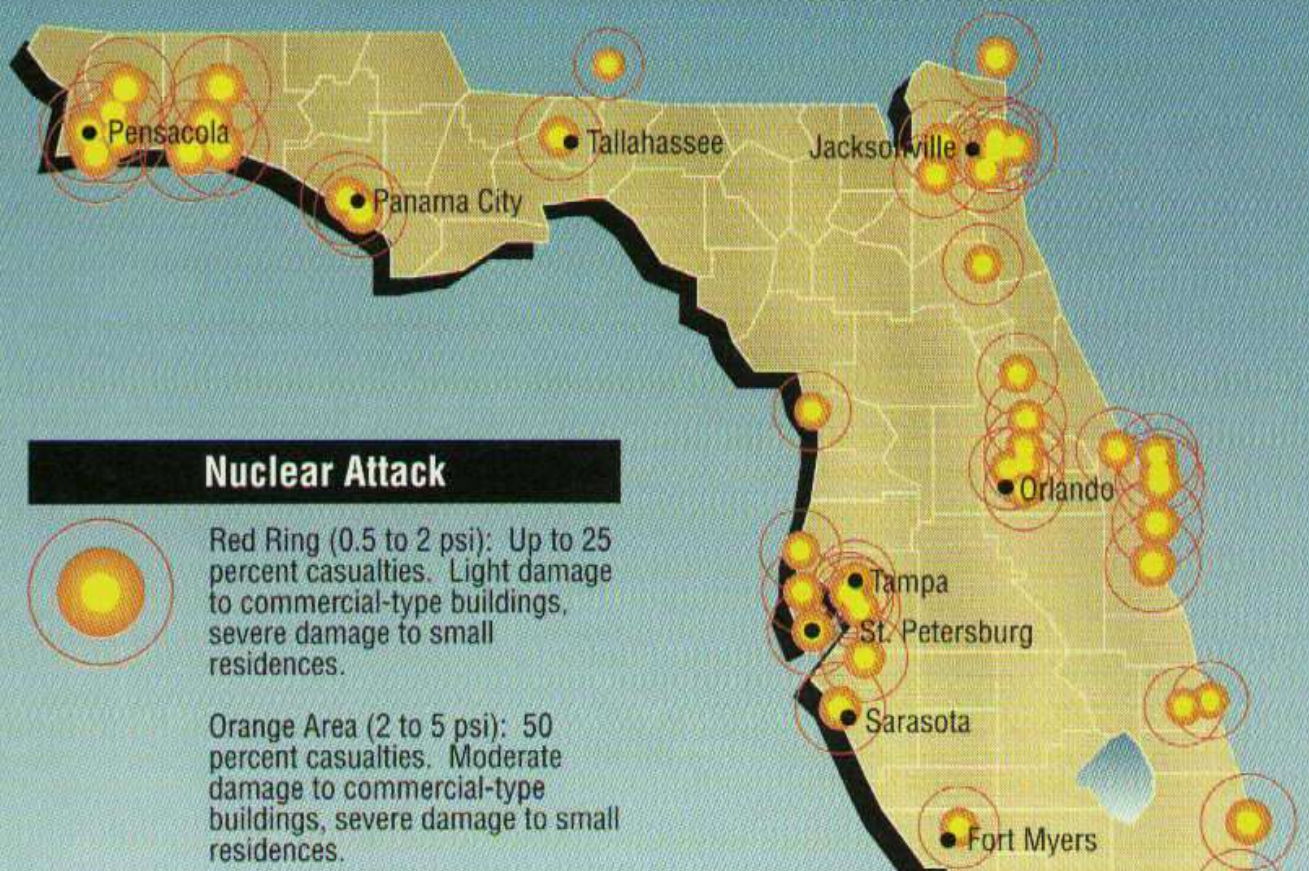

buildings, severe damage to small residences.

Yellow Area (5 psi or more): Few survivors. Severe damage to total destruction of buildings.

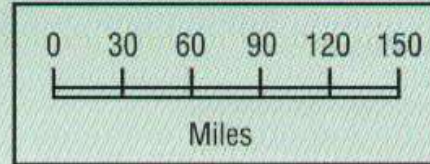

Fallout

Fallout radiation is a potential hazard for all localities. See page 123 for more information.

[UPDATE to Target Information!!!](#)

Information for Florida

This link will take you back to the [Index of all the States](#)

It is recommended that you go through the following 10 steps in studying about the nuclear threat to Florida.

1. Look at the [State Map](#) above to see the target nuclear areas in Florida.
2. Look at the [general expected fallout map](#) to see where Florida (according to the **prevailing wind pattern**) gets fallout from other states.
3. If the state that you live in is anywhere EAST of any of the following 6 states in the **prevailing wind pattern** then look at the states in **RED** on the [INDEX of](#)

STATES for

- Montana
- North Dakota
- South Dakota
- Nebraska
- Missouri
- Colorado

These six states contain what is called DENSE PACK which I explain on each of those states pages. **UNDERSTAND** that the wind pattern **COULD** at that time be something other than the "prevailing" wind pattern.

4. Bookmark the present URL or make a copy of this present address so that you can come back to it after going to

[Blast Mapper](#).

This mapper is on someone else's web site so that you will need to save this address in order to return here if your back button doesn't work. However, you want to be sure to go the mapper site and calculate the damage to probable targets (cities) around you.

5. Memorize the THREE top rules for survival. They are:

- Number One - **Get out of the cities!**
- Number Two - **Get out of the cities!**
- Number Three - **Get out of the cities!**

6. The follow-on rules are:

- a. Have a shelter
- b. Work with a group (you are going to need the manpower, brainpower, and skillpower).

- c. Stock supplies.

7. My [Main Survival Page](#) contains links to lots of other information such as free books to download about nuclear survival, links to plans for building shelters, and even free consultation about building a shelter.

8. If you are SUPER concerned about nuclear survival you might consider moving within 20 miles of the

[Ark Two Community](#)
(in Canada)

9. And finally if you would like to be on the mailing list of the author of this site - send a blank email to:

arktwo-request@deuce.pairowoodies.com
[with the subject as subscribe](#)

MENU: [HOME](#) » [SURVIVAL](#) » [Index of States](#)

Nuclear Survival in **Georgia**

This is the nuclear target map for Georgia, but remember, fallout can go anywhere or everywhere (and probably will). After you have looked at this map look at the [Information for Georgia](#) that follows it.

This link will take you back to the [Index of all the States](#)

Nuclear Weapon Target Map for Georgia (FEMA-196/September 1990)

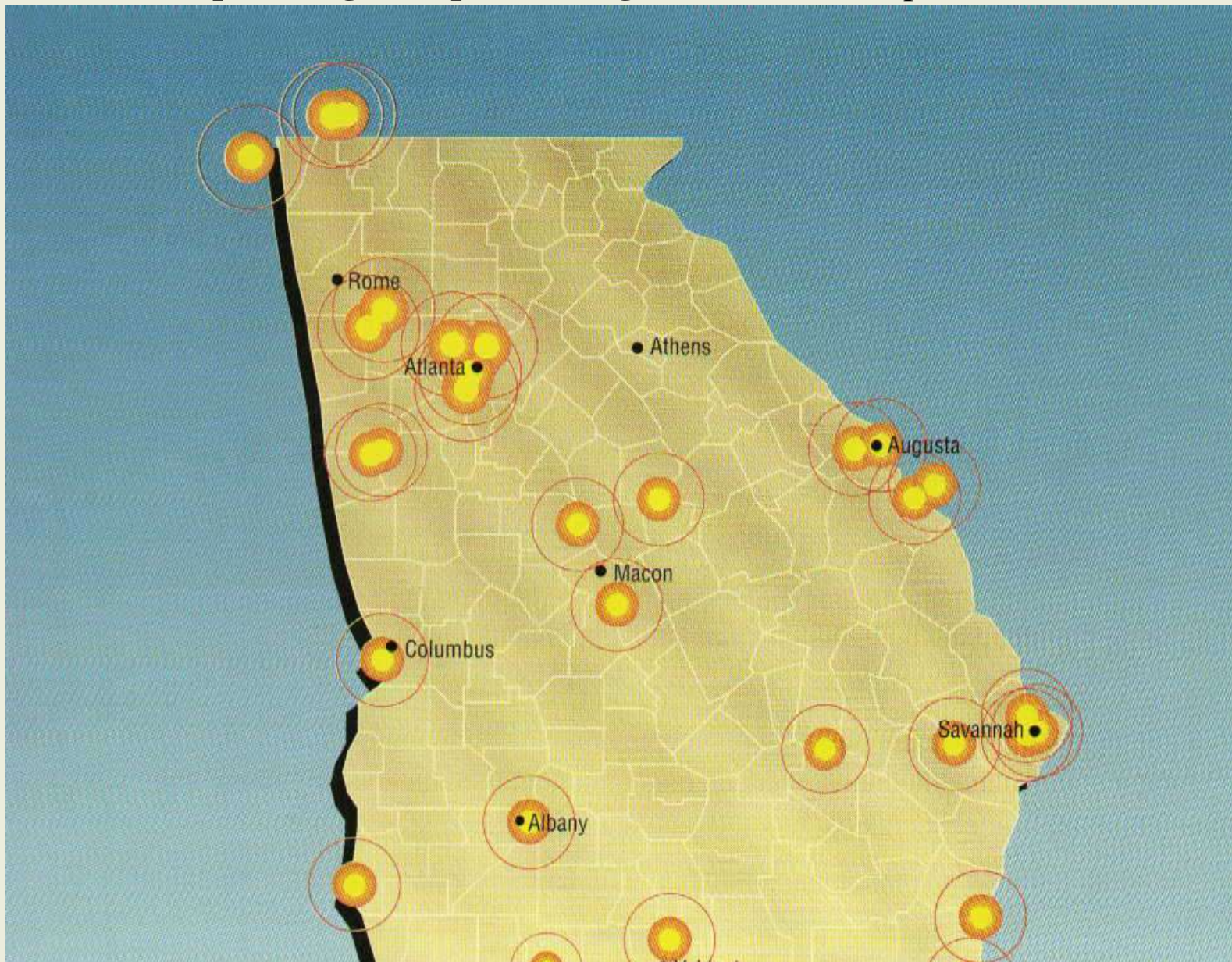

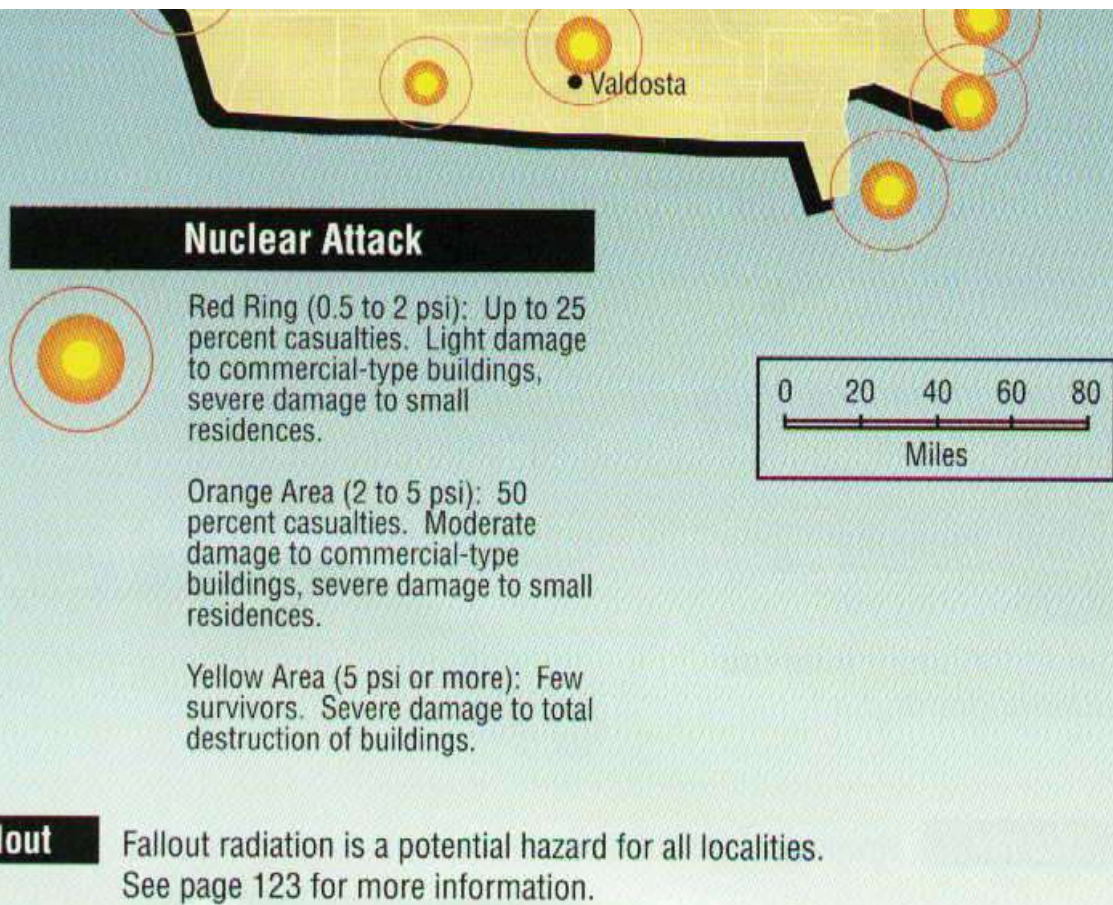

[UPDATE to Target Information!!!](#)

Information for Georgia

This link will take you back to the [Index of all the States](#)

It is recommended that you go through the following 10 steps in studying about the nuclear threat to Georgia.

1. Look at the [State Map](#) above to see the target nuclear areas in Georgia.
2. Look at the [general expected fallout map](#) to see where Georgia (according to the **prevailing wind pattern**) gets fallout from other states.
3. If the state that you live in is anywhere EAST of any of the following 6 states in the **prevailing wind pattern** then look at the states in **RED** on the [INDEX of](#)

STATES for

- Montana
- North Dakota
- South Dakota
- Nebraska
- Missouri
- Colorado

These six states contain what is called DENSE PACK which I explain on each of those states pages. **UNDERSTAND** that the wind pattern **COULD** at that time be something other than the "prevailing" wind pattern.

4. Bookmark the present URL or make a copy of this present address so that you can come back to it after going to

[Blast Mapper](#).

This mapper is on someone else's web site so that you will need to save this address in order to return here if your back button doesn't work. However, you want to be sure to go the mapper site and calculate the damage to probable targets (cities) around you.

5. Memorize the THREE top rules for survival. They are:

- Number One - **Get out of the cities!**
- Number Two - **Get out of the cities!**
- Number Three - **Get out of the cities!**

6. The follow-on rules are:

- a. Have a shelter
- b. Work with a group (you are going to need the manpower, brainpower, and skillpower).

- c. Stock supplies.

7. My [Main Survival Page](#) contains links to lots of other information such as free books to download about nuclear survival, links to plans for building shelters, and even free consultation about building a shelter.

8. If you are SUPER concerned about nuclear survival you might consider moving within 20 miles of the

[Ark Two Community](#)
(in Canada)

9. And finally if you would like to be on the mailing list of the author of this site - send a blank email to:

arktwo-request@deuce.pairowoodies.com
[with the subject as subscribe](#)

MENU: [HOME](#) » [SURVIVAL](#) » [Index of States](#)

Nuclear Survival in **Hawaii**

This is the nuclear target map for Hawaii, but remember, fallout can go anywhere or everywhere (and probably will). After you have looked at this map look at the [Information for Hawaii](#) that follows it.

This link will take you back to the [Index of all the States](#)

Nuclear Weapon Target Map for Hawaii (FEMA-196/September 1990)

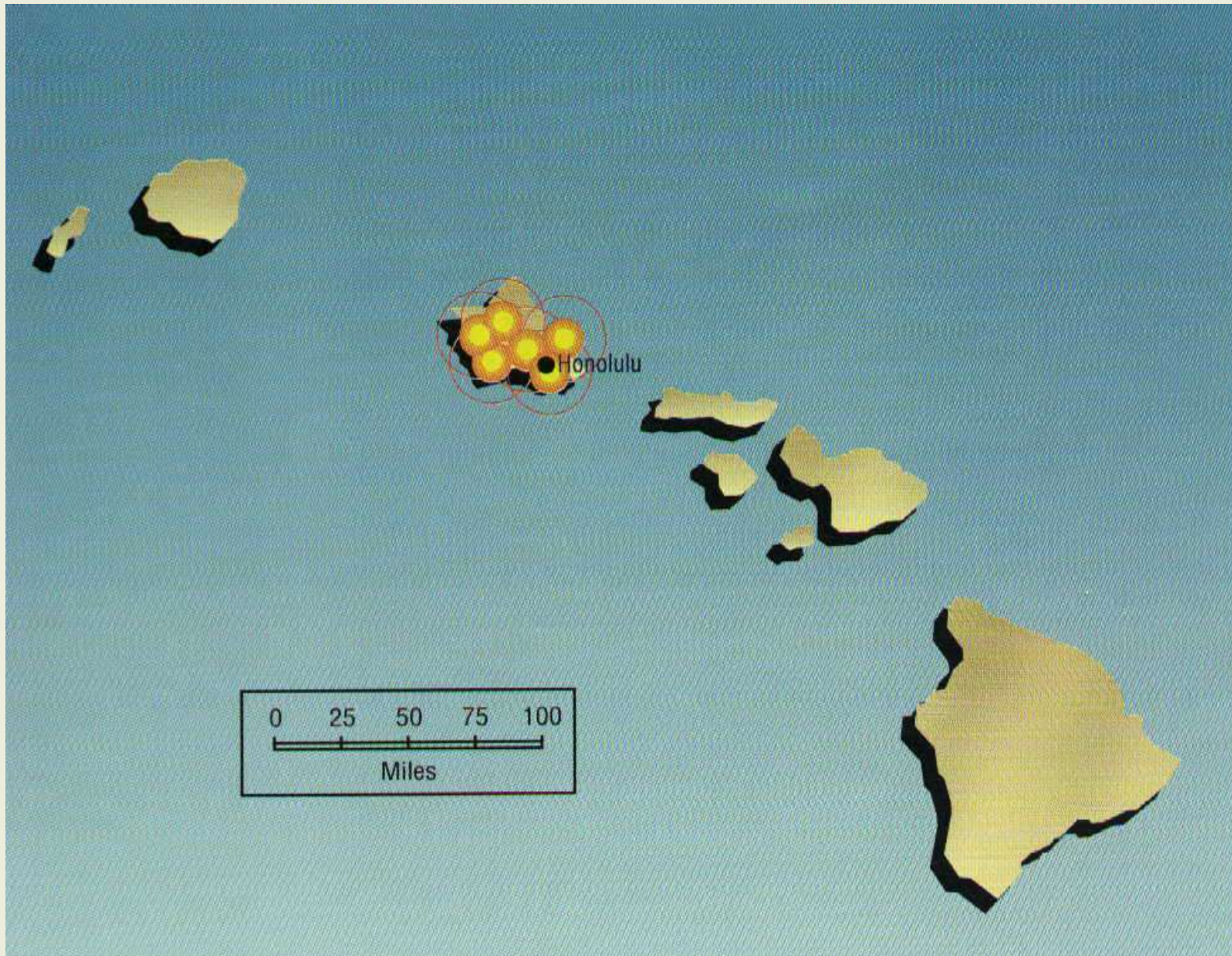

Nuclear Attack



Red Ring (0.5 to 2 psi): Up to 25 percent casualties. Light damage to commercial-type buildings, severe damage to small residences.

Orange Area (2 to 5 psi): 50 percent casualties. Moderate damage to commercial-type buildings, severe damage to small residences.

Yellow Area (5 psi or more): Few survivors. Severe damage to total destruction of buildings.

Fallout

Fallout radiation is a potential hazard for all localities. See page 123 for more information.

[UPDATE to Target Information!!!](#)

Information for Hawaii

This link will take you back to the [Index of all the States](#)

It is recommended that you go through the following 10 steps in studying about the nuclear threat to Hawaii.

1. Look at the [State Map](#) above to see the target nuclear areas in Hawaii.
2. Look at the [general expected fallout map](#) to see where Hawaii (according to the **prevailing wind pattern**) gets fallout from other states.
3. If the state that you live in is anywhere EAST of any of the following 6 states in the **prevailing wind pattern** then look at the states in **RED** on the [INDEX of](#)

STATES for

- Montana
- North Dakota
- South Dakota
- Nebraska
- Missouri
- Colorado

These six states contain what is called DENSE PACK which I explain on each of those states pages. **UNDERSTAND** that the wind pattern **COULD** at that time be something other than the "prevailing" wind pattern.

4. Bookmark the present URL or make a copy of this present address so that you can come back to it after going to

[Blast Mapper](#).

This mapper is on someone else's web site so that you will need to save this address in order to return here if your back button doesn't work. However, you want to be sure to go the mapper site and calculate the damage to probable targets (cities) around you.

5. Memorize the THREE top rules for survival. They are:

- Number One - **Get out of the cities!**
- Number Two - **Get out of the cities!**
- Number Three - **Get out of the cities!**

6. The follow-on rules are:

- a. Have a shelter
- b. Work with a group (you are going to need the manpower, brainpower, and skillpower).

- c. Stock supplies.

7. My [Main Survival Page](#) contains links to lots of other information such as free books to download about nuclear survival, links to plans for building shelters, and even free consultation about building a shelter.

8. If you are SUPER concerned about nuclear survival you might consider moving within 20 miles of the

[Ark Two Community](#)
(in Canada)

9. And finally if you would like to be on the mailing list of the author of this site - send a blank email to:

arktwo-request@deuce.pairowoodies.com
[with the subject as subscribe](#)

MENU: [HOME](#) » [SURVIVAL](#) » [Index of States](#)

Nuclear Survival in

Idaho

This is the nuclear target map for Idaho, but remember, fallout can go anywhere or everywhere (and probably will). After you have looked at this map look at the [Information for Idaho](#) that follows it.

This link will take you back to the [Index of all the States](#)

Nuclear Weapon Target Map for Idaho (FEMA-196/September 1990)

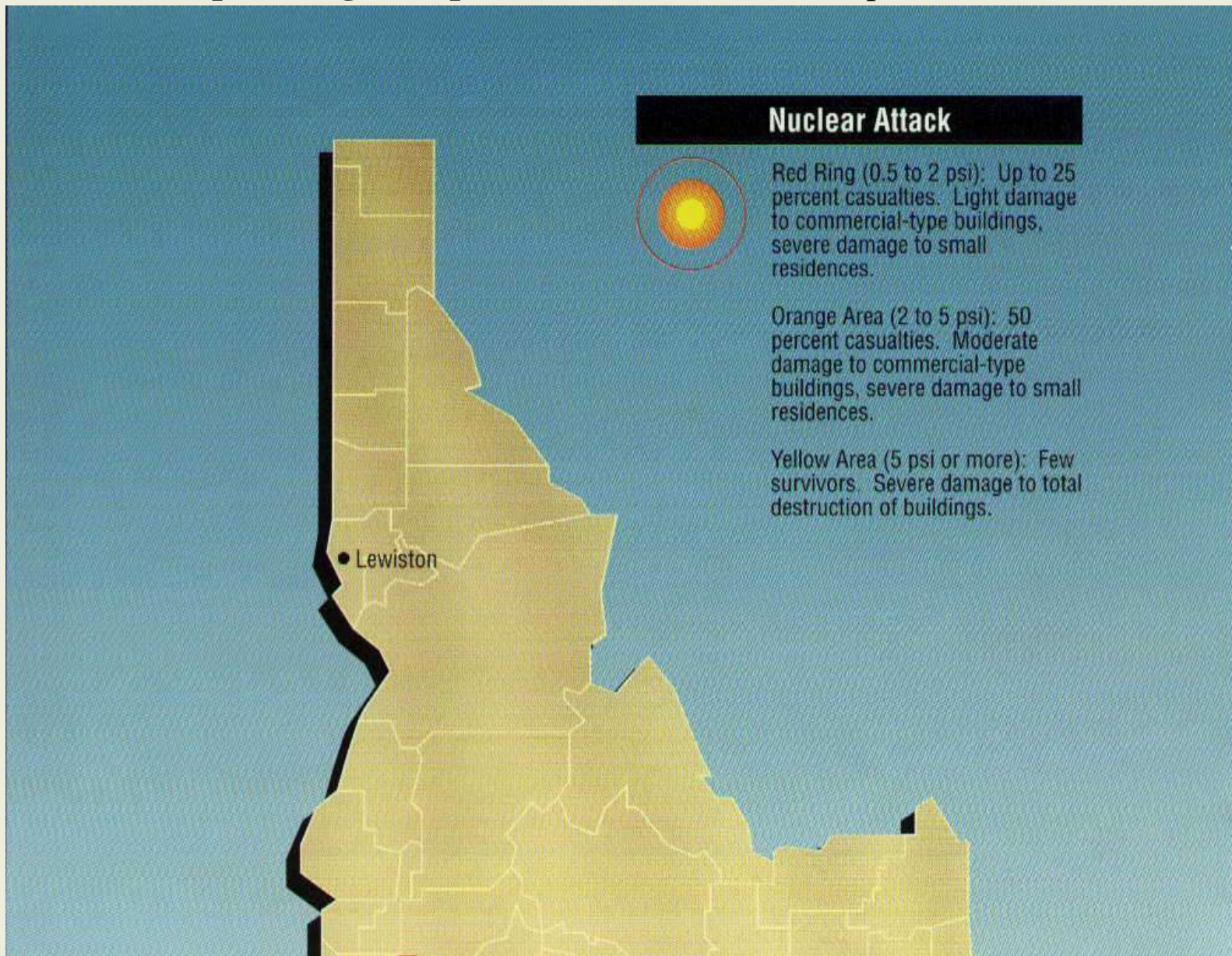

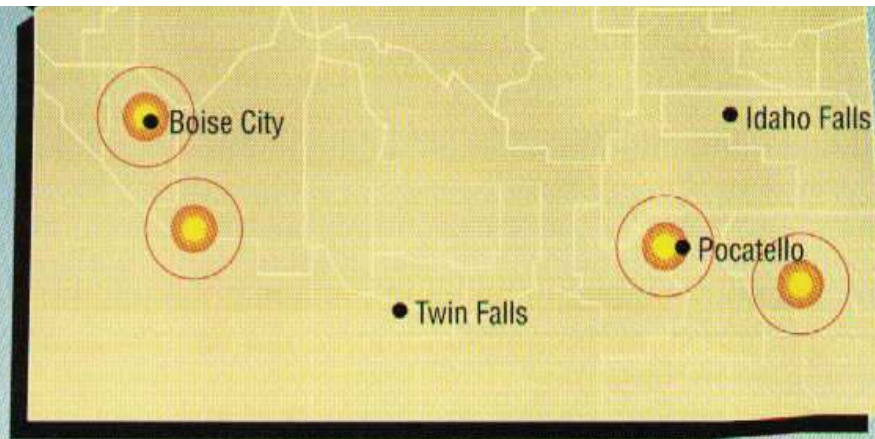

Fallout

Fallout radiation is a potential hazard for all localities.
See page 123 for more information.

[UPDATE to Target Information!!!](#)

Information for Idaho

This link will take you back to the [Index of all the States](#)

It is recommended that you go through the following 10 steps in studying about the nuclear threat to Idaho.

1. Look at the [State Map](#) above to see the target nuclear areas in Idaho.
2. Look at the [general expected fallout map](#) to see where Idaho (according to the **prevailing wind pattern**) gets fallout from other states.
3. If the state that you live in is anywhere EAST of any of the following 6 states in the **prevailing wind pattern** then look at the states in **RED** on the [INDEX of](#)

STATES for

- Montana
- North Dakota
- South Dakota
- Nebraska
- Missouri
- Colorado

These six states contain what is called DENSE PACK which I explain on each of those states pages. **UNDERSTAND** that the wind pattern **COULD** at that time be something other than the "prevailing" wind pattern.

4. Bookmark the present URL or make a copy of this present address so that you can come back to it after going to

[Blast Mapper.](#)

This mapper is on someone else's web site so that you will need to save this address in order to return here if your back button doesn't work. However, you want to be sure to go the mapper site and calculate the damage to probable targets (cities) around you.

5. Memorize the THREE top rules for survival. They are:

- Number One - **Get out of the cities!**
- Number Two - **Get out of the cities!**
- Number Three - **Get out of the cities!**

6. The follow-on rules are:

- a. Have a shelter
- b. Work with a group (you are going to need the manpower, brainpower, and skillpower).

- c. Stock supplies.

7. My [Main Survival Page](#) contains links to lots of other information such as free books to download about nuclear survival, links to plans for building shelters, and even free consultation about building a shelter.

8. If you are SUPER concerned about nuclear survival you might consider moving within 20 miles of the

[Ark Two Community](#)
(in Canada)

9. And finally if you would like to be on the mailing list of the author of this site - send a blank email to:

arktwo-request@deuce.pairowoodies.com
[with the subject as subscribe](#)

MENU: [HOME](#) » [SURVIVAL](#) » [Index of States](#)

Nuclear Survival in **Illinois**

This is the nuclear target map for Illinois, but remember, fallout can go anywhere or everywhere (and probably will). After you have looked at this map look at the [Information for Illinois](#) that follows it.

This link will take you back to the [Index of all the States](#)

Nuclear Weapon Target Map for Illinois (FEMA-196/September 1990)

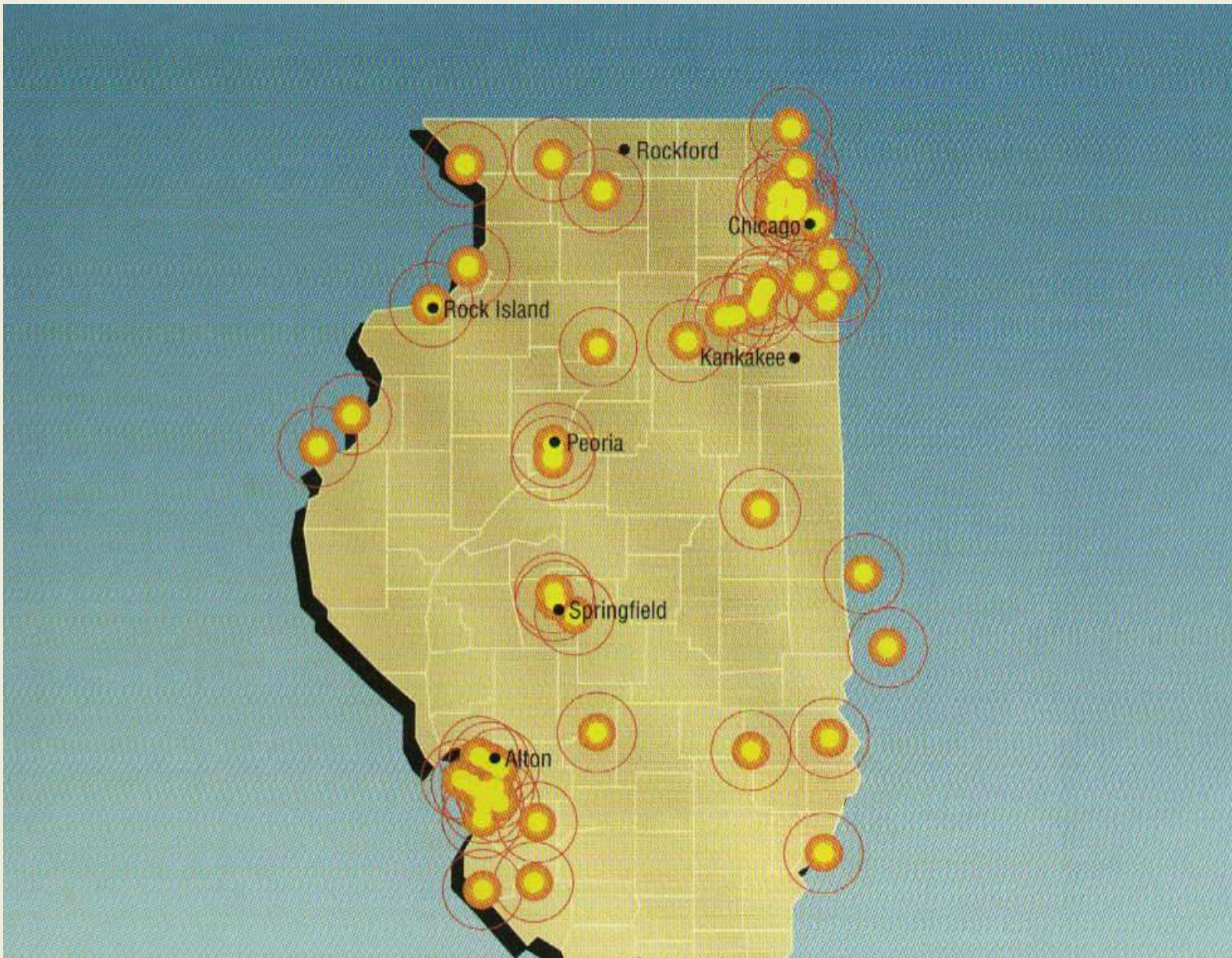

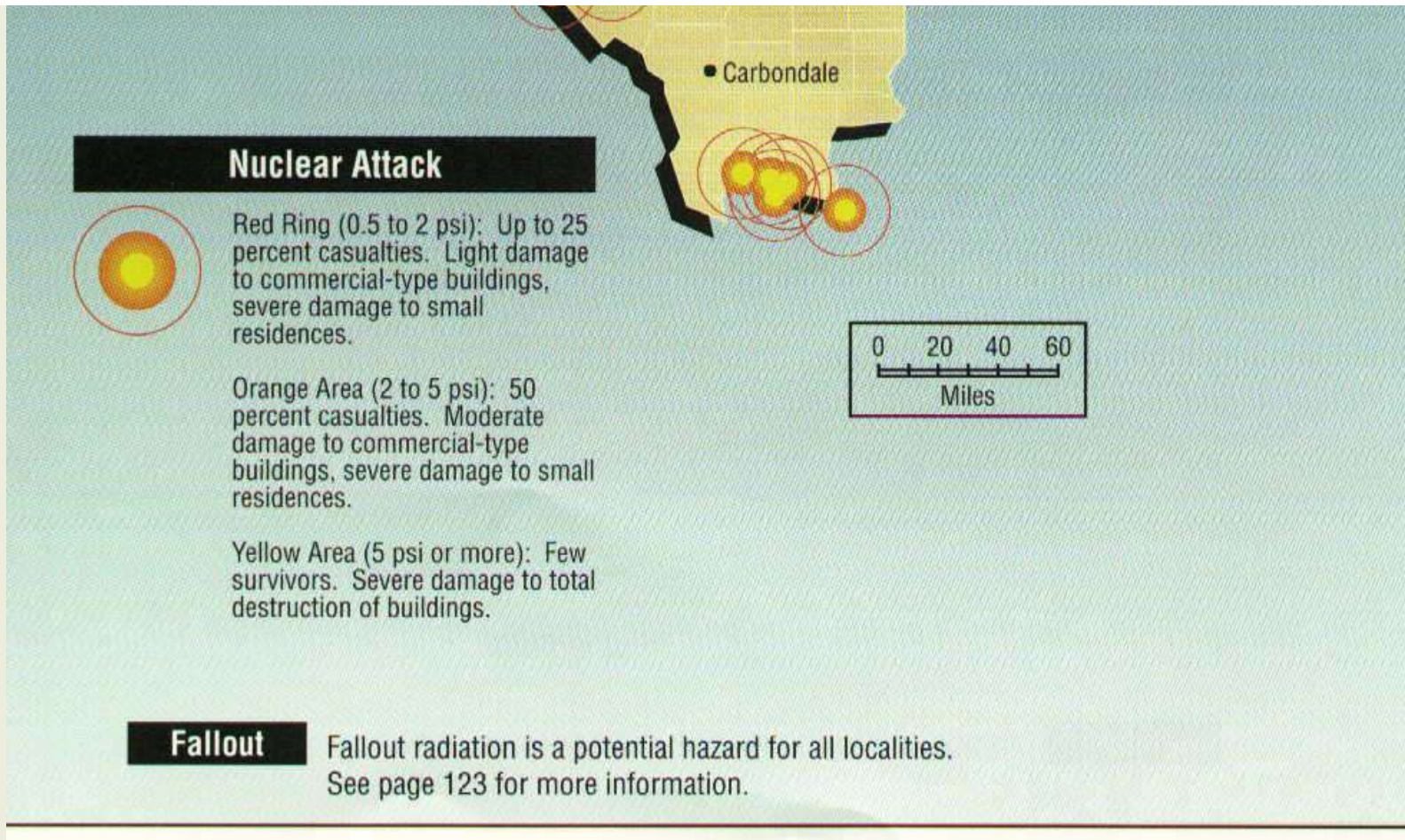

[UPDATE to Target Information!!!](#)

Information for Illinois

This link will take you back to the [Index of all the States](#)

It is recommended that you go through the following 10 steps in studying about the nuclear threat to Illinois.

1. Look at the [State Map](#) above to see the target nuclear areas in Illinois.
2. Look at the [general expected fallout map](#) to see where Illinois (according to the **prevailing wind pattern**) gets fallout from other states.
3. If the state that you live in is anywhere EAST of any of the following 6 states in the **prevailing wind pattern** then look at the states in **RED** on the [INDEX of](#)

STATES for

- Montana
- North Dakota
- South Dakota
- Nebraska
- Missouri
- Colorado

These six states contain what is called DENSE PACK which I explain on each of those states pages. **UNDERSTAND** that the wind pattern **COULD** at that time be something other than the "prevailing" wind pattern.

4. Bookmark the present URL or make a copy of this present address so that you can come back to it after going to

[Blast Mapper.](#)

This mapper is on someone else's web site so that you will need to save this address in order to return here if your back button doesn't work. However, you want to be sure to go the mapper site and calculate the damage to probable targets (cities) around you.

5. Memorize the THREE top rules for survival. They are:

- Number One - **Get out of the cities!**
- Number Two - **Get out of the cities!**
- Number Three - **Get out of the cities!**

6. The follow-on rules are:

- a. Have a shelter
- b. Work with a group (you are going to need the manpower, brainpower, and skillpower).

- c. Stock supplies.

7. My [Main Survival Page](#) contains links to lots of other information such as free books to download about nuclear survival, links to plans for building shelters, and even free consultation about building a shelter.

8. If you are SUPER concerned about nuclear survival you might consider moving within 20 miles of the

[Ark Two Community](#)
(in Canada)

9. And finally if you would like to be on the mailing list of the author of this site - send a blank email to:

arktwo-request@deuce.pairowoodies.com
[with the subject as subscribe](#)

MENU: [HOME](#) » [SURVIVAL](#) » [Index of States](#)

Nuclear Survival in **Indiana**

This is the nuclear target map for Indiana, but remember, fallout can go anywhere or everywhere (and probably will). After you have looked at this map look at the [Information for Indiana](#) that follows it.

This link will take you back to the [Index of all the States](#)

Nuclear Weapon Target Map for Indiana (FEMA-196/September 1990)

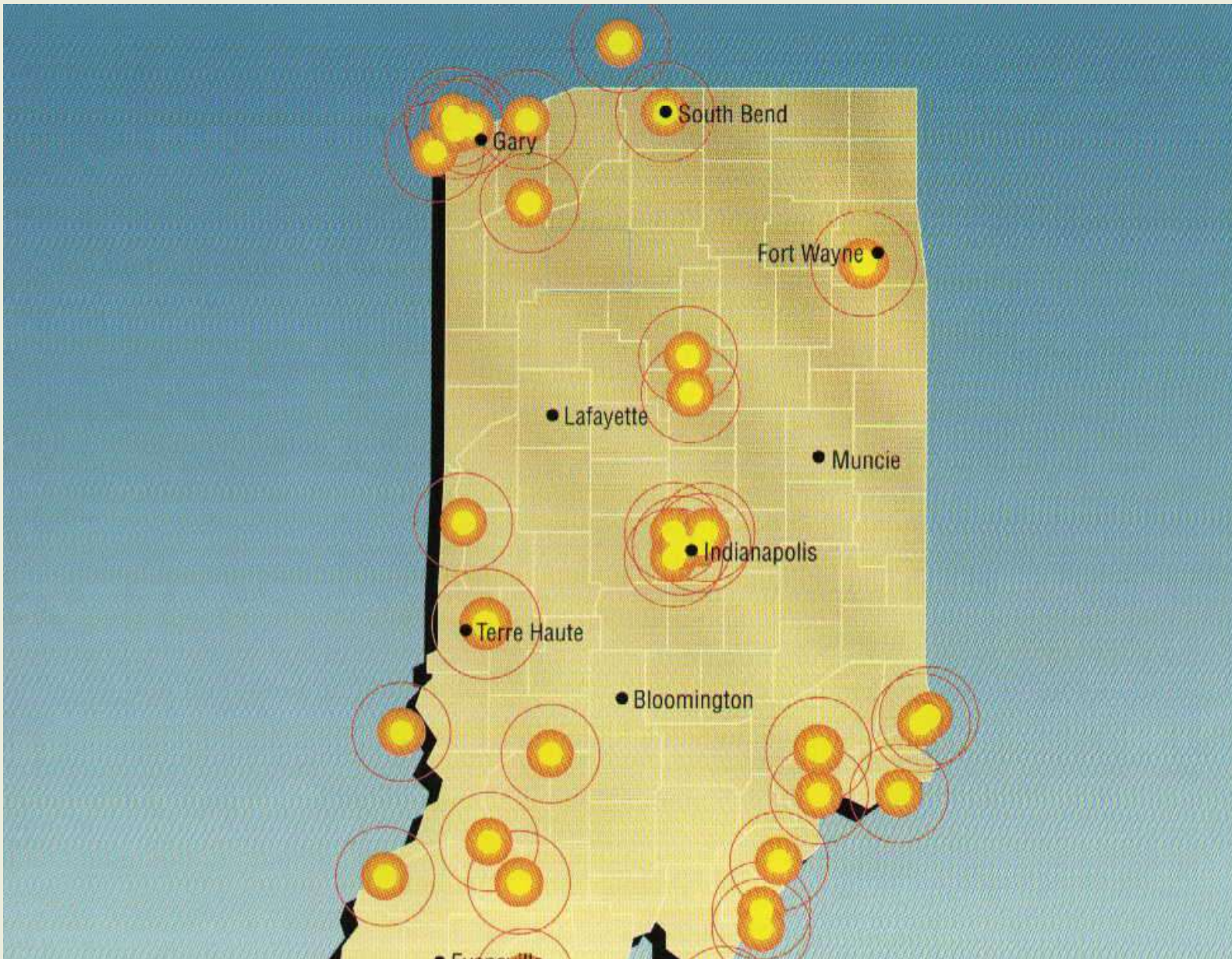

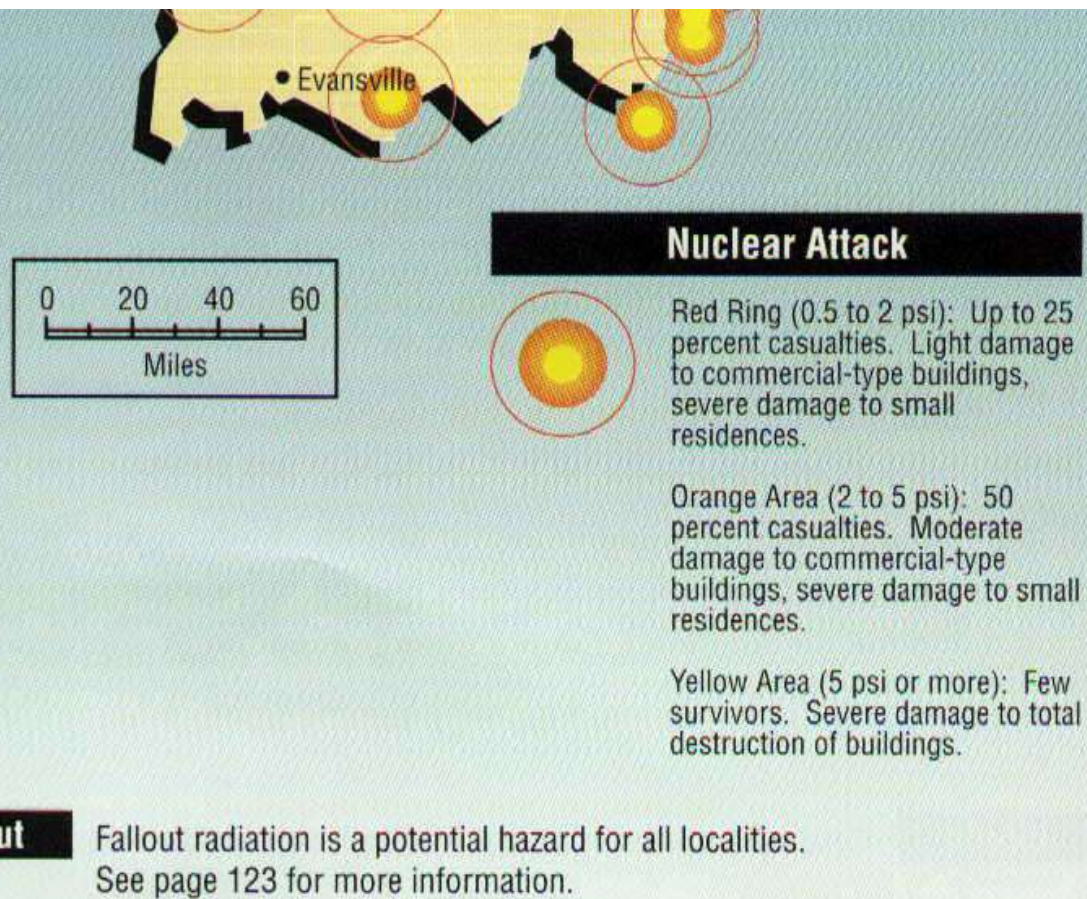

[UPDATE to Target Information!!!](#)

Information for Indiana

This link will take you back to the [Index of all the States](#)

It is recommended that you go through the following 10 steps in studying about the nuclear threat to Indiana.

1. Look at the [State Map](#) above to see the target nuclear areas in Indiana.
2. Look at the [general expected fallout map](#) to see where Indiana (according to the **prevailing wind pattern**) gets fallout from other states.
3. If the state that you live in is anywhere EAST of any of the following 6 states in the **prevailing wind pattern** then look at the states in **RED** on the [INDEX of](#)

STATES for

- Montana
- North Dakota
- South Dakota
- Nebraska
- Missouri
- Colorado

These six states contain what is called DENSE PACK which I explain on each of those states pages. **UNDERSTAND** that the wind pattern **COULD** at that time be something other than the "prevailing" wind pattern.

4. Bookmark the present URL or make a copy of this present address so that you can come back to it after going to

[Blast Mapper](#).

This mapper is on someone else's web site so that you will need to save this address in order to return here if your back button doesn't work. However, you want to be sure to go the mapper site and calculate the damage to probable targets (cities) around you.

5. Memorize the THREE top rules for survival. They are:

- Number One - **Get out of the cities!**
- Number Two - **Get out of the cities!**
- Number Three - **Get out of the cities!**

6. The follow-on rules are:

- a. Have a shelter
- b. Work with a group (you are going to need the manpower, brainpower, and skillpower).

- c. Stock supplies.

7. My [Main Survival Page](#) contains links to lots of other information such as free books to download about nuclear survival, links to plans for building shelters, and even free consultation about building a shelter.

8. If you are SUPER concerned about nuclear survival you might consider moving within 20 miles of the

[Ark Two Community](#)
(in Canada)

9. And finally if you would like to be on the mailing list of the author of this site - send a blank email to:

arktwo-request@deuce.pairowoodies.com
[with the subject as subscribe](#)

MENU: [HOME](#) » [SURVIVAL](#) » [Index of States](#)

Nuclear Survival in

Iowa

This is the nuclear target map for Iowa, but remember, fallout can go anywhere or everywhere (and probably will). After you have looked at this map look at the [Information for Iowa](#) that follows it.

This link will take you back to the [Index of all the States](#)

Nuclear Weapon Target Map for Iowa (FEMA-196/September 1990)

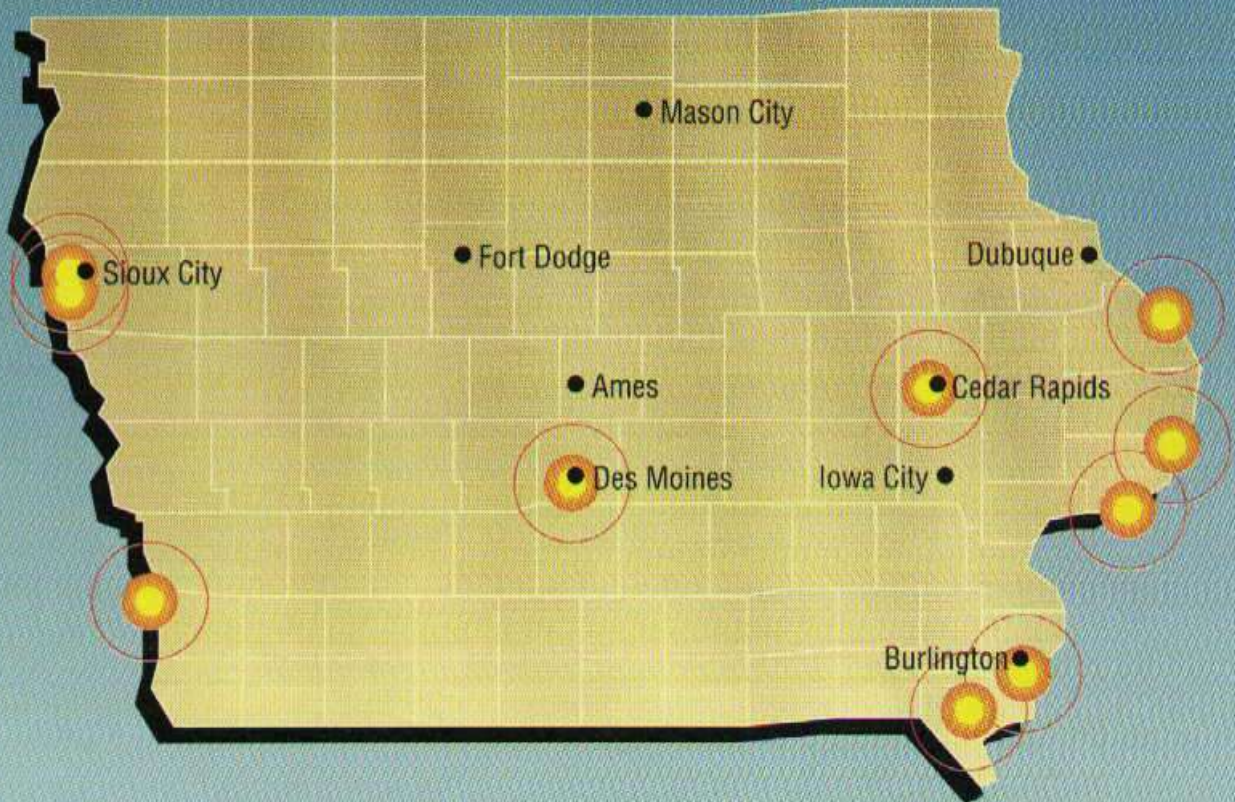

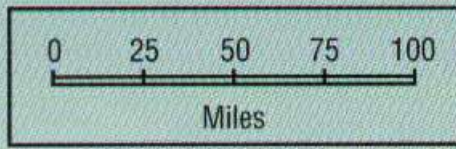

Nuclear Attack

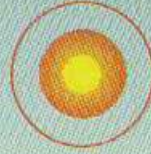

Red Ring (0.5 to 2 psi): Up to 25 percent casualties. Light damage to commercial-type buildings, severe damage to small residences.

Orange Area (2 to 5 psi): 50 percent casualties. Moderate damage to commercial-type buildings, severe damage to small residences.

Yellow Area (5 psi or more): Few survivors. Severe damage to total destruction of buildings.

Fallout

Fallout radiation is a potential hazard for all localities. See page 123 for more information.

[UPDATE to Target Information!!!](#)

Information for Iowa

This link will take you back to the [Index of all the States](#)

It is recommended that you go through the following 10 steps in studying about the nuclear threat to Iowa.

1. Look at the [State Map](#) above to see the target nuclear areas in Iowa.
2. Look at the [general expected fallout map](#) to see where Iowa (according to the **prevailing wind pattern**) gets fallout from other states.
3. If the state that you live in is anywhere EAST of any of the following 6 states in the **prevailing wind pattern** then look at the states in **RED** on the [INDEX of](#)

STATES for

- Montana
- North Dakota
- South Dakota
- Nebraska
- Missouri
- Colorado

These six states contain what is called DENSE PACK which I explain on each of those states pages. **UNDERSTAND** that the wind pattern **COULD** at that time be something other than the "prevailing" wind pattern.

4. Bookmark the present URL or make a copy of this present address so that you can come back to it after going to

[Blast Mapper](#).

This mapper is on someone else's web site so that you will need to save this address in order to return here if your back button doesn't work. However, you want to be sure to go the mapper site and calculate the damage to probable targets (cities) around you.

5. Memorize the THREE top rules for survival. They are:

- Number One - **Get out of the cities!**
- Number Two - **Get out of the cities!**
- Number Three - **Get out of the cities!**

6. The follow-on rules are:

- a. Have a shelter
- b. Work with a group (you are going to need the manpower, brainpower, and skillpower).

- c. Stock supplies.

7. My [Main Survival Page](#) contains links to lots of other information such as free books to download about nuclear survival, links to plans for building shelters, and even free consultation about building a shelter.

8. If you are SUPER concerned about nuclear survival you might consider moving within 20 miles of the

[Ark Two Community](#)
(in Canada)

9. And finally if you would like to be on the mailing list of the author of this site - send a blank email to:

arktwo-request@deuce.pairowoodies.com
[with the subject as subscribe](#)

MENU: [HOME](#) » [SURVIVAL](#) » [Index of States](#)

Nuclear Survival in

Kansas

This is the nuclear target map for Kansas, but remember, fallout can go anywhere or everywhere (and probably will). After you have looked at this map look at the [Information for Kansas](#) that follows it.

This link will take you back to the [Index of all the States](#)

Nuclear Weapon Target Map for Kansas (FEMA-196/September 1990)

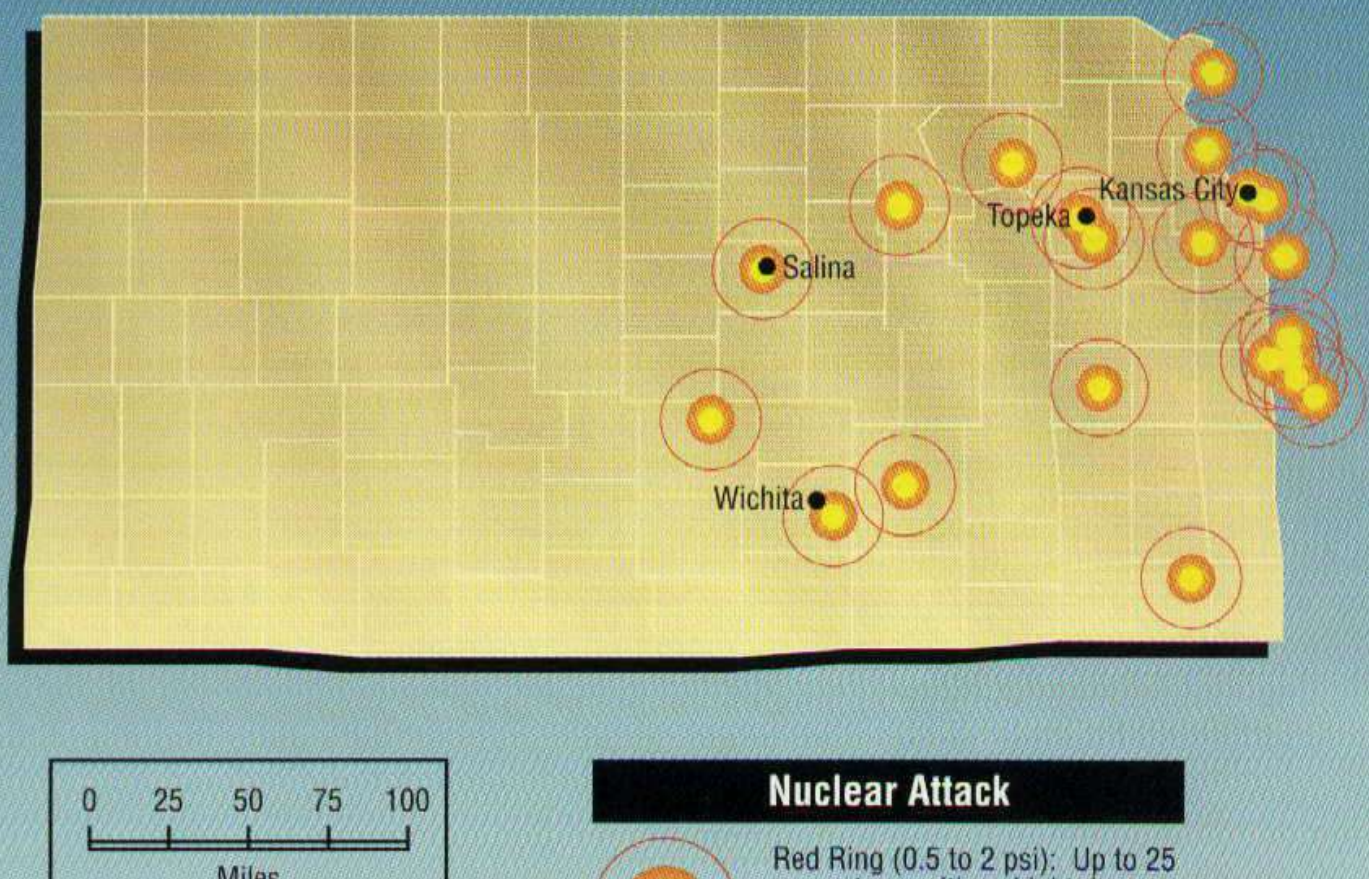

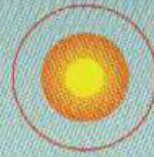
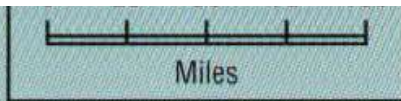

Red Ring (0.5 to 2 psi): Up to 25 percent casualties. Light damage to commercial-type buildings, severe damage to small residences.

Orange Area (2 to 5 psi): 50 percent casualties. Moderate damage to commercial-type buildings, severe damage to small residences.

Yellow Area (5 psi or more): Few survivors. Severe damage to total destruction of buildings.

Fallout

Fallout radiation is a potential hazard for all localities. See page 123 for more information.

[UPDATE to Target Information!!!](#)

Information for Kansas

This link will take you back to the [Index of all the States](#)

It is recommended that you go through the following 10 steps in studying about the nuclear threat to Kansas.

1. Look at the [State Map](#) above to see the target nuclear areas in Kansas.
2. Look at the [general expected fallout map](#) to see where Kansas (according to the **prevailing wind pattern**) gets fallout from other states.
3. If the state that you live in is anywhere EAST of any of the following 6 states in the **prevailing wind pattern** then look at the states in **RED** on the [INDEX of](#)

STATES for

- Montana
- North Dakota
- South Dakota
- Nebraska
- Missouri
- Colorado

These six states contain what is called DENSE PACK which I explain on each of those states pages. **UNDERSTAND** that the wind pattern **COULD** at that time be something other than the "prevailing" wind pattern.

4. Bookmark the present URL or make a copy of this present address so that you can come back to it after going to

[Blast Mapper](#).

This mapper is on someone else's web site so that you will need to save this address in order to return here if your back button doesn't work. However, you want to be sure to go the mapper site and calculate the damage to probable targets (cities) around you.

5. Memorize the THREE top rules for survival. They are:

- Number One - **Get out of the cities!**
- Number Two - **Get out of the cities!**
- Number Three - **Get out of the cities!**

6. The follow-on rules are:

- a. Have a shelter
- b. Work with a group (you are going to need the manpower, brainpower, and skillpower).

- c. Stock supplies.

7. My [Main Survival Page](#) contains links to lots of other information such as free books to download about nuclear survival, links to plans for building shelters, and even free consultation about building a shelter.

8. If you are SUPER concerned about nuclear survival you might consider moving within 20 miles of the

[Ark Two Community](#)
(in Canada)

9. And finally if you would like to be on the mailing list of the author of this site - send a blank email to:

arktwo-request@deuce.pairowoodies.com
[with the subject as subscribe](#)

MENU: [HOME](#) » [SURVIVAL](#) » [Index of States](#)

Nuclear Survival in **Kentucky**

This is the nuclear target map for Kentucky, but remember, fallout can go anywhere or everywhere (and probably will). After you have looked at this map look at the [Information for Kentucky](#) that follows it.

This link will take you back to the [Index of all the States](#)

Nuclear Weapon Target Map for Kentucky (FEMA-196/September 1990)

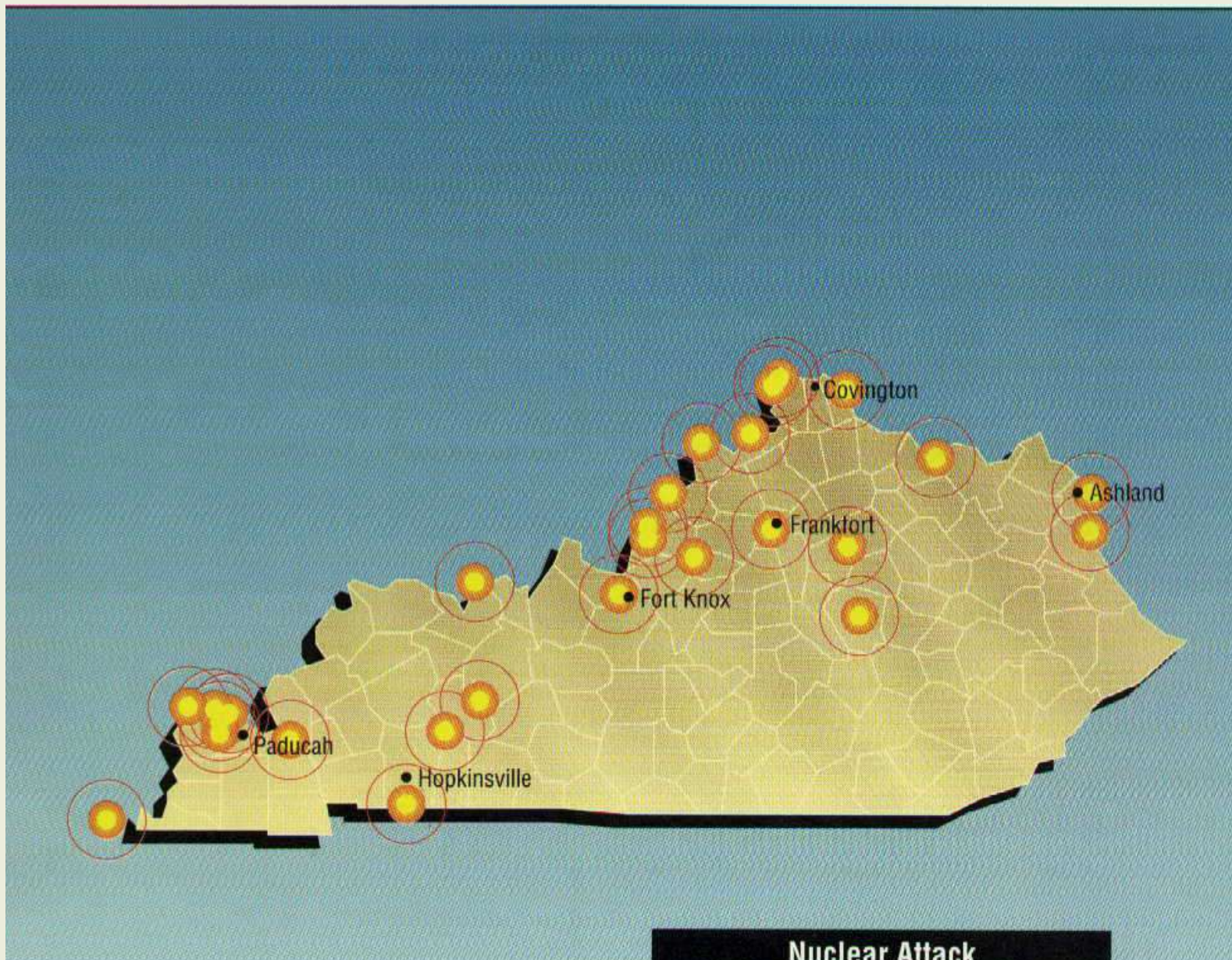

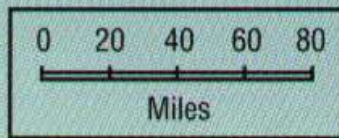

Nuclear Attack



Red Ring (0.5 to 2 psi): Up to 25 percent casualties. Light damage to commercial-type buildings, severe damage to small residences.

Orange Area (2 to 5 psi): 50 percent casualties. Moderate damage to commercial-type buildings, severe damage to small residences.

Yellow Area (5 psi or more): Few survivors. Severe damage to total destruction of buildings.

Fallout

Fallout radiation is a potential hazard for all localities. See page 123 for more information.

[UPDATE to Target Information!!!](#)

Information for Kentucky

This link will take you back to the [Index of all the States](#)

It is recommended that you go through the following 10 steps in studying about the nuclear threat to Kentucky.

1. Look at the [State Map](#) above to see the target nuclear areas in Kentucky.
2. Look at the [general expected fallout map](#) to see where Kentucky (according to the **prevailing wind pattern**) gets fallout from other states.
3. If the state that you live in is anywhere EAST of any of the following 6 states in the **prevailing wind pattern** then look at the states in **RED** on the [INDEX of](#)

STATES for

- Montana
- North Dakota
- South Dakota
- Nebraska
- Missouri
- Colorado

These six states contain what is called DENSE PACK which I explain on each of those states pages. **UNDERSTAND** that the wind pattern **COULD** at that time be something other than the "prevailing" wind pattern.

4. Bookmark the present URL or make a copy of this present address so that you can come back to it after going to

[Blast Mapper.](#)

This mapper is on someone else's web site so that you will need to save this address in order to return here if your back button doesn't work. However, you want to be sure to go the mapper site and calculate the damage to probable targets (cities) around you.

5. Memorize the THREE top rules for survival. They are:

- Number One - **Get out of the cities!**
- Number Two - **Get out of the cities!**
- Number Three - **Get out of the cities!**

6. The follow-on rules are:

- a. Have a shelter
- b. Work with a group (you are going to need the manpower, brainpower, and skillpower).

- c. Stock supplies.

7. My [Main Survival Page](#) contains links to lots of other information such as free books to download about nuclear survival, links to plans for building shelters, and even free consultation about building a shelter.

8. If you are SUPER concerned about nuclear survival you might consider moving within 20 miles of the

[Ark Two Community](#)
(in Canada)

9. And finally if you would like to be on the mailing list of the author of this site - send a blank email to:

arktwo-request@deuce.pairowoodies.com
[with the subject as subscribe](#)

MENU: [HOME](#) » [SURVIVAL](#) » [Index of States](#)

Nuclear Survival in **Louisiana**

This is the nuclear target map for Louisiana, but remember, fallout can go anywhere or everywhere (and probably will). After you have looked at this map look at the [Information for Louisiana](#) that follows it.

This link will take you back to the [Index of all the States](#)

Nuclear Weapon Target Map for Louisiana (FEMA-196/September 1990)

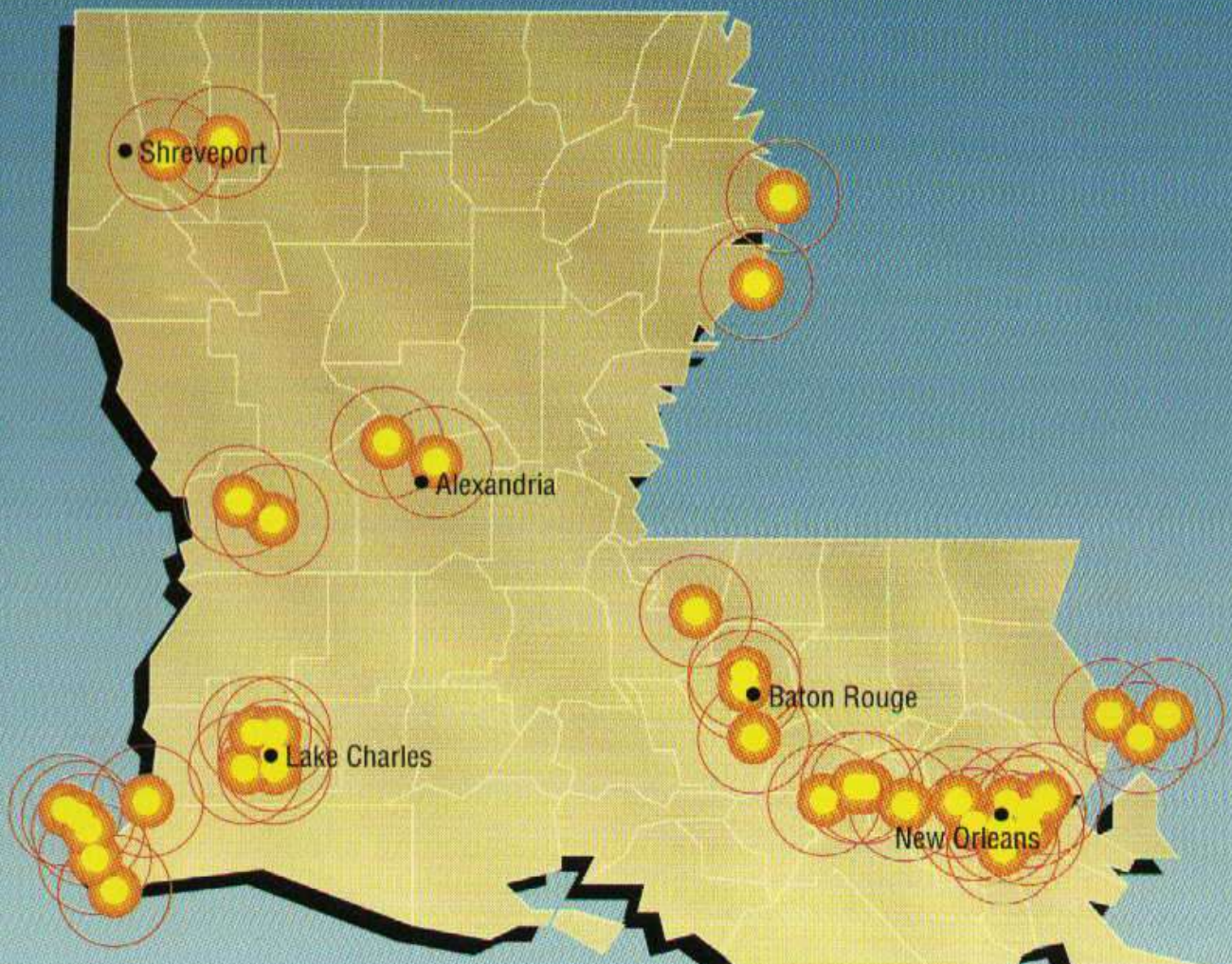

Nuclear Attack

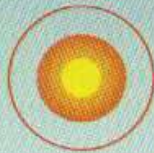

Red Ring (0.5 to 2 psi): Up to 25 percent casualties. Light damage to commercial-type buildings, severe damage to small residences.

Orange Area (2 to 5 psi): 50 percent casualties. Moderate damage to commercial-type buildings, severe damage to small residences.

Yellow Area (5 psi or more): Few survivors. Severe damage to total destruction of buildings.

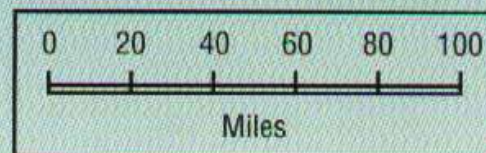

Fallout

Fallout radiation is a potential hazard for all localities. See page 123 for more information.

[UPDATE to Target Information!!!](#)

Information for Louisiana

This link will take you back to the [Index of all the States](#)

It is recommended that you go through the following 10 steps in studying about the nuclear threat to Louisiana.

1. Look at the [State Map](#) above to see the target nuclear areas in Louisiana.
2. Look at the [general expected fallout map](#) to see where Louisiana (according to the **prevailing wind pattern**) gets fallout from other states.
3. If the state that you live in is anywhere EAST of any of the following 6 states in the **prevailing wind pattern** then look at the states in **RED** on the [INDEX of](#)

STATES for

- Montana
- North Dakota
- South Dakota
- Nebraska
- Missouri
- Colorado

These six states contain what is called DENSE PACK which I explain on each of those states pages. **UNDERSTAND** that the wind pattern **COULD** at that time be something other than the "prevailing" wind pattern.

4. Bookmark the present URL or make a copy of this present address so that you can come back to it after going to

[Blast Mapper](#).

This mapper is on someone else's web site so that you will need to save this address in order to return here if your back button doesn't work. However, you want to be sure to go the mapper site and calculate the damage to probable targets (cities) around you.

5. Memorize the THREE top rules for survival. They are:

- Number One - **Get out of the cities!**
- Number Two - **Get out of the cities!**
- Number Three - **Get out of the cities!**

6. The follow-on rules are:

- a. Have a shelter
- b. Work with a group (you are going to need the manpower, brainpower, and skillpower).

- c. Stock supplies.

7. My [Main Survival Page](#) contains links to lots of other information such as free books to download about nuclear survival, links to plans for building shelters, and even free consultation about building a shelter.

8. If you are SUPER concerned about nuclear survival you might consider moving within 20 miles of the

[Ark Two Community](#)
(in Canada)

9. And finally if you would like to be on the mailing list of the author of this site - send a blank email to:

arktwo-request@deuce.pairowoodies.com
[with the subject as subscribe](#)

MENU: [HOME](#) » [SURVIVAL](#) » [Index of States](#)

Nuclear Survival in **Maine**

This is the nuclear target map for Maine, but remember, fallout can go anywhere or everywhere (and probably will). After you have looked at this map look at the [Information for Maine](#) that follows it.

This link will take you back to the [Index of all the States](#)

Nuclear Weapon Target Map for Maine (FEMA-196/September 1990)

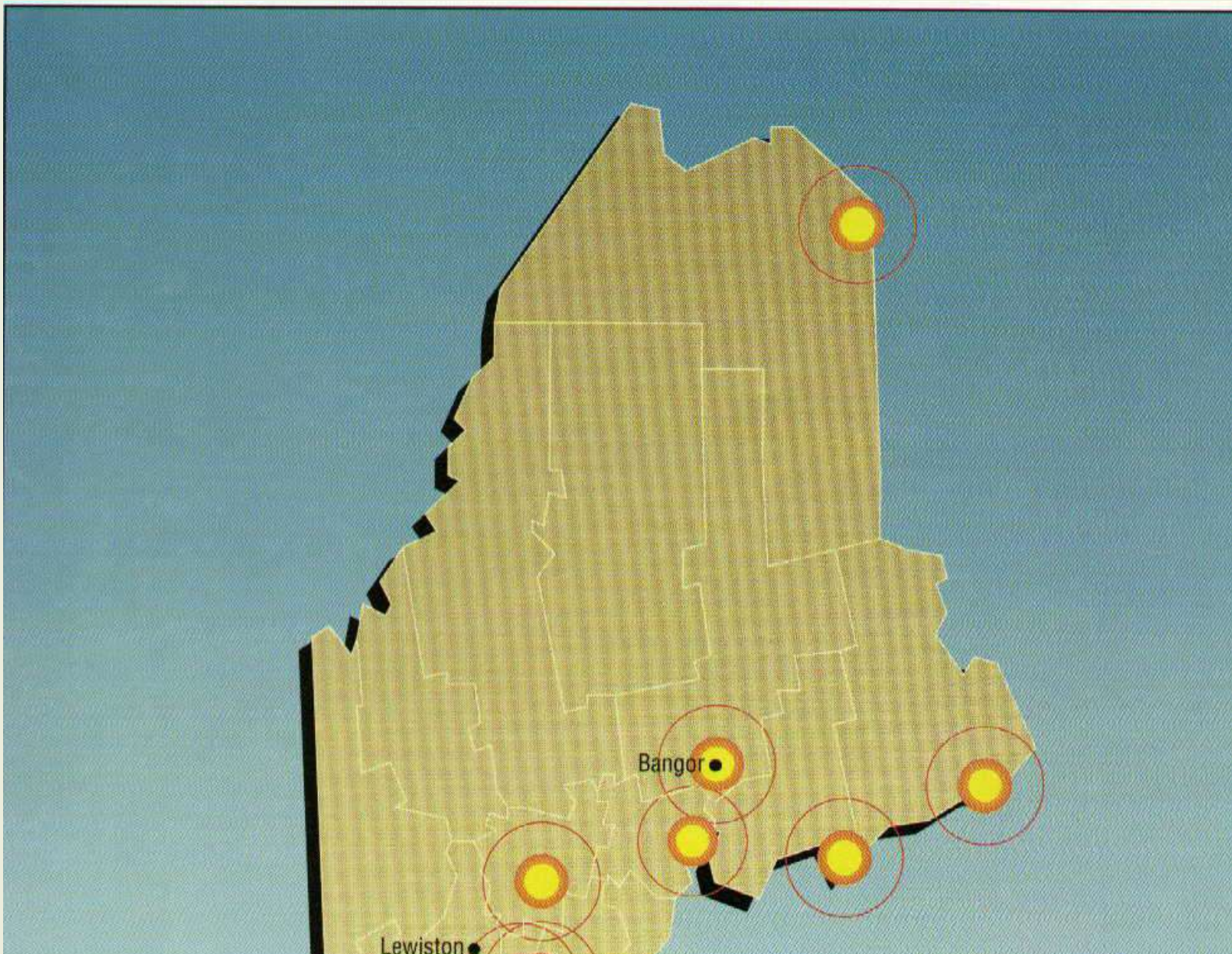

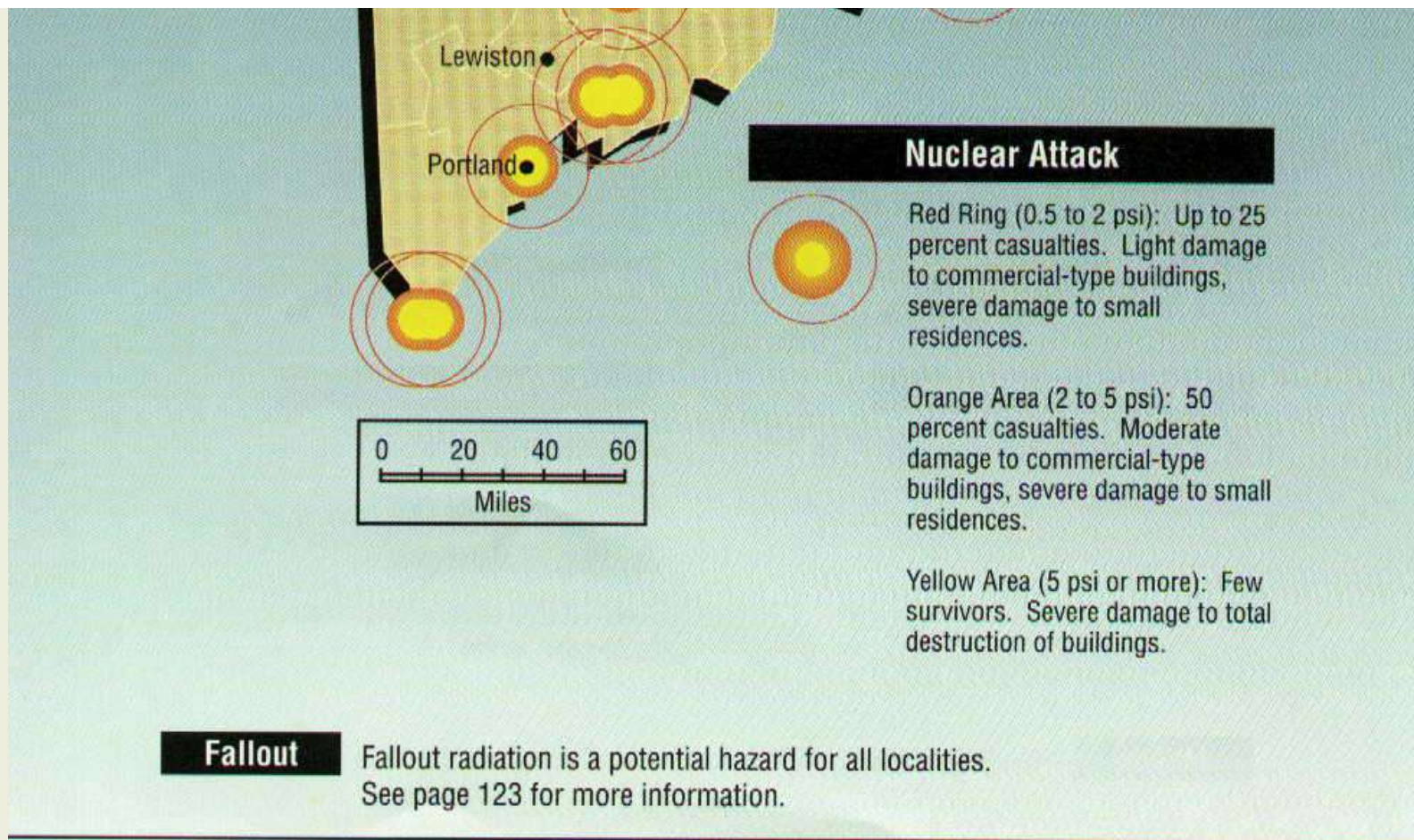

[UPDATE to Target Information!!!](#)

Information for Maine

This link will take you back to the [Index of all the States](#)

It is recommended that you go through the following 10 steps in studying about the nuclear threat to Maine.

1. Look at the [State Map](#) above to see the target nuclear areas in Maine.
2. Look at the [general expected fallout map](#) to see where Maine (according to the **prevailing wind pattern**) gets fallout from other states.
3. If the state that you live in is anywhere EAST of any of the following 6 states in the **prevailing wind pattern** then look at the states in **RED** on the [INDEX of](#)

STATES for

- Montana
- North Dakota
- South Dakota
- Nebraska
- Missouri
- Colorado

These six states contain what is called DENSE PACK which I explain on each of those states pages. **UNDERSTAND** that the wind pattern **COULD** at that time be something other than the "prevailing" wind pattern.

4. Bookmark the present URL or make a copy of this present address so that you can come back to it after going to

[Blast Mapper.](#)

This mapper is on someone else's web site so that you will need to save this address in order to return here if your back button doesn't work. However, you want to be sure to go the mapper site and calculate the damage to probable targets (cities) around you.

5. Memorize the THREE top rules for survival. They are:

- Number One - **Get out of the cities!**
- Number Two - **Get out of the cities!**
- Number Three - **Get out of the cities!**

6. The follow-on rules are:

- a. Have a shelter
- b. Work with a group (you are going to need the manpower, brainpower, and skillpower).

- c. Stock supplies.

7. My [Main Survival Page](#) contains links to lots of other information such as free books to download about nuclear survival, links to plans for building shelters, and even free consultation about building a shelter.

8. If you are SUPER concerned about nuclear survival you might consider moving within 20 miles of the

[Ark Two Community](#)
(in Canada)

9. And finally if you would like to be on the mailing list of the author of this site - send a blank email to:

arktwo-request@deuce.pairowoodies.com
[with the subject as subscribe](#)

MENU: [HOME](#) » [SURVIVAL](#) » [Index of States](#)

Nuclear Survival in **Maryland**

This is the nuclear target map for Maryland, but remember, fallout can go anywhere or everywhere (and probably will). After you have looked at this map look at the [Information for Maryland](#) that follows it.

This link will take you back to the [Index of all the States](#)

Nuclear Weapon Target Map for Maryland (FEMA-196/September 1990)

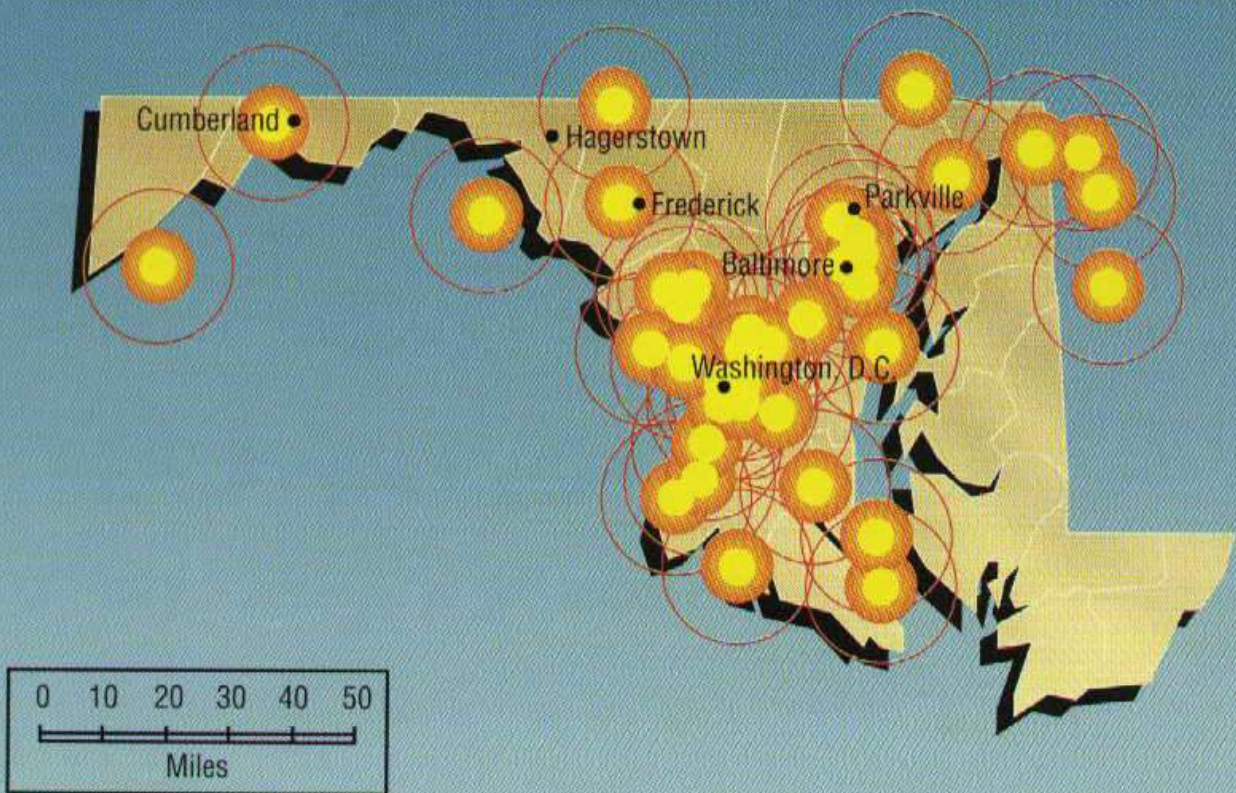

Nuclear Attack

Nuclear Attack

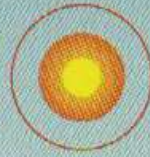

Red Ring (0.5 to 2 psi): Up to 25 percent casualties. Light damage to commercial-type buildings, severe damage to small residences.

Orange Area (2 to 5 psi): 50 percent casualties. Moderate damage to commercial-type buildings, severe damage to small residences.

Yellow Area (5 psi or more): Few survivors. Severe damage to total destruction of buildings.

Fallout

Fallout radiation is a potential hazard for all localities. See page 123 for more information.

[UPDATE to Target Information!!!](#)

Information for Maryland

This link will take you back to the [Index of all the States](#)

It is recommended that you go through the following 10 steps in studying about the nuclear threat to Maryland.

1. Look at the [State Map](#) above to see the target nuclear areas in Maryland.
2. Look at the [general expected fallout map](#) to see where Maryland (according to the **prevailing wind pattern**) gets fallout from other states.
3. If the state that you live in is anywhere EAST of any of the following 6 states in the **prevailing wind pattern** then look at the states in **RED** on the [INDEX of](#)

STATES for

- Montana
- North Dakota
- South Dakota
- Nebraska
- Missouri
- Colorado

These six states contain what is called DENSE PACK which I explain on each of those states pages. **UNDERSTAND** that the wind pattern **COULD** at that time be something other than the "prevailing" wind pattern.

4. Bookmark the present URL or make a copy of this present address so that you can come back to it after going to

[Blast Mapper](#).

This mapper is on someone else's web site so that you will need to save this address in order to return here if your back button doesn't work. However, you want to be sure to go the mapper site and calculate the damage to probable targets (cities) around you.

5. Memorize the THREE top rules for survival. They are:

- Number One - **Get out of the cities!**
- Number Two - **Get out of the cities!**
- Number Three - **Get out of the cities!**

6. The follow-on rules are:

- a. Have a shelter
- b. Work with a group (you are going to need the manpower, brainpower, and skillpower).

- c. Stock supplies.

7. My [Main Survival Page](#) contains links to lots of other information such as free books to download about nuclear survival, links to plans for building shelters, and even free consultation about building a shelter.

8. If you are SUPER concerned about nuclear survival you might consider moving within 20 miles of the

[Ark Two Community](#)
(in Canada)

9. And finally if you would like to be on the mailing list of the author of this site - send a blank email to:

arktwo-request@deuce.pairowoodies.com
[with the subject as subscribe](#)

MENU: [HOME](#) » [SURVIVAL](#) » [Index of States](#)

Nuclear Survival in **Massachusetts**

This is the nuclear target map for Massachusetts, but remember, fallout can go anywhere or everywhere (and probably will). After you have looked at this map look at the [Information for Massachusetts](#) that follows it.

This link will take you back to the [Index of all the States](#)

Nuclear Weapon Target Map for Massachusetts (FEMA-196/September 1990)

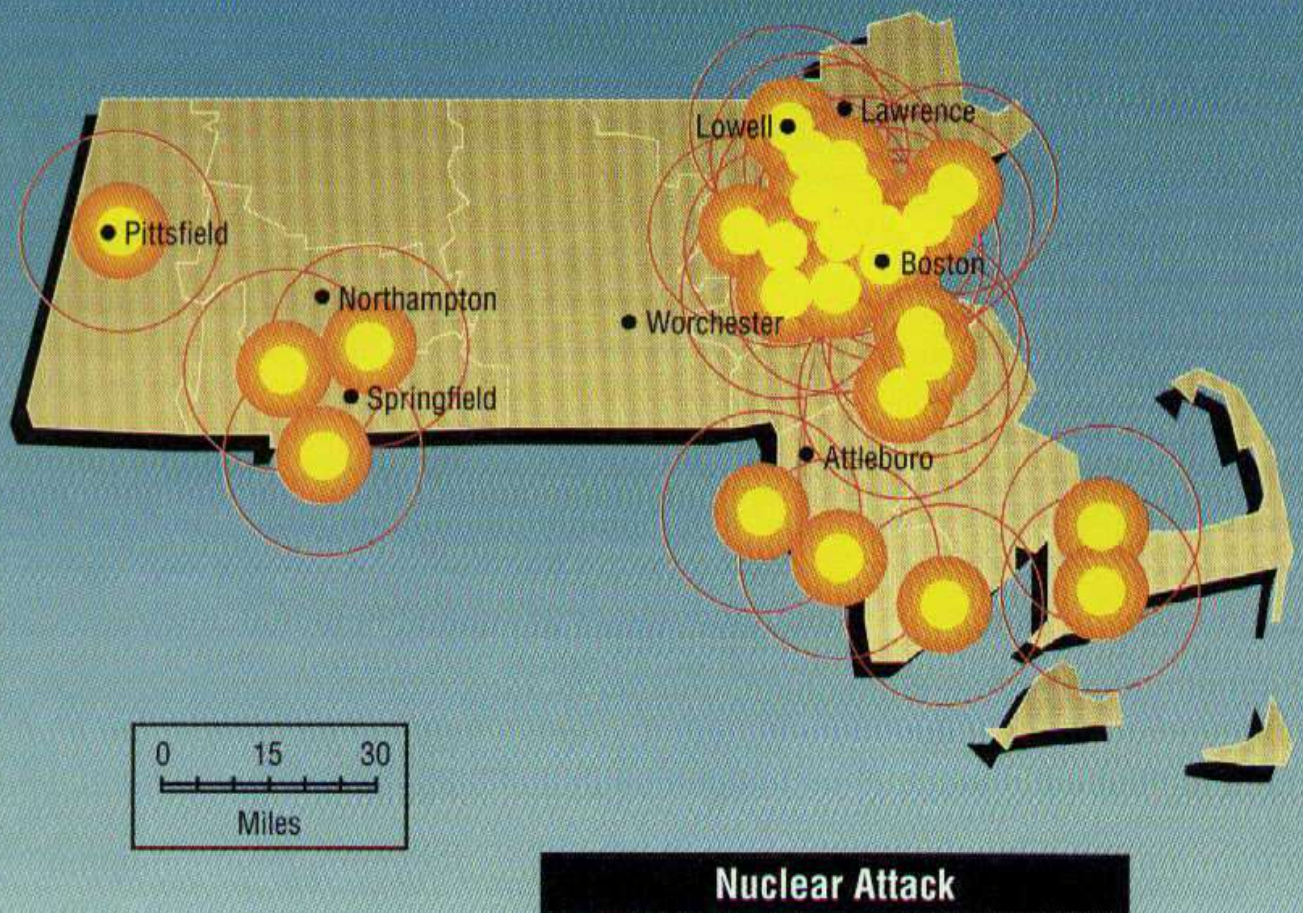

Nuclear Attack

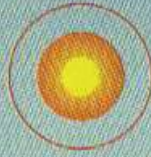

Red Ring (0.5 to 2 psi): Up to 25 percent casualties. Light damage to commercial-type buildings, severe damage to small residences.

Orange Area (2 to 5 psi): 50 percent casualties. Moderate damage to commercial-type buildings, severe damage to small residences.

Yellow Area (5 psi or more): Few survivors. Severe damage to total destruction of buildings.

Fallout

Fallout radiation is a potential hazard for all localities. See page 123 for more information.

[UPDATE to Target Information!!!](#)

Information for Massachusetts

This link will take you back to the [Index of all the States](#)

It is recommended that you go through the following 10 steps in studying about the nuclear threat to Massachusetts.

1. Look at the [State Map](#) above to see the target nuclear areas in Massachusetts.
2. Look at the [general expected fallout map](#) to see where Massachusetts (according to the **prevailing wind pattern**) gets fallout from other states.
3. If the state that you live in is anywhere EAST of any of the following 6 states in the **prevailing wind pattern** then look at the states in **RED** on the [INDEX of](#)

STATES for

- Montana
- North Dakota
- South Dakota
- Nebraska
- Missouri
- Colorado

These six states contain what is called DENSE PACK which I explain on each of those states pages. **UNDERSTAND** that the wind pattern **COULD** at that time be something other than the "prevailing" wind pattern.

4. Bookmark the present URL or make a copy of this present address so that you can come back to it after going to

[Blast Mapper.](#)

This mapper is on someone else's web site so that you will need to save this address in order to return here if your back button doesn't work. However, you want to be sure to go the mapper site and calculate the damage to probable targets (cities) around you.

5. Memorize the THREE top rules for survival. They are:

- Number One - **Get out of the cities!**
- Number Two - **Get out of the cities!**
- Number Three - **Get out of the cities!**

6. The follow-on rules are:

- a. Have a shelter
- b. Work with a group (you are going to need the manpower, brainpower, and skillpower).

- c. Stock supplies.

7. My [Main Survival Page](#) contains links to lots of other information such as free books to download about nuclear survival, links to plans for building shelters, and even free consultation about building a shelter.

8. If you are SUPER concerned about nuclear survival you might consider moving within 20 miles of the

[Ark Two Community](#)
(in Canada)

9. And finally if you would like to be on the mailing list of the author of this site - send a blank email to:

arktwo-request@deuce.pairowoodies.com
[with the subject as subscribe](#)

MENU: [HOME](#) » [SURVIVAL](#) » [Index of States](#)

Nuclear Survival in **Michigan**

This is the nuclear target map for Michigan, but remember, fallout can go anywhere or everywhere (and probably will). After you have looked at this map look at the [Information for Michigan](#) that follows it.

This link will take you back to the [Index of all the States](#)

Nuclear Weapon Target Map for Michigan (FEMA-196/September 1990)

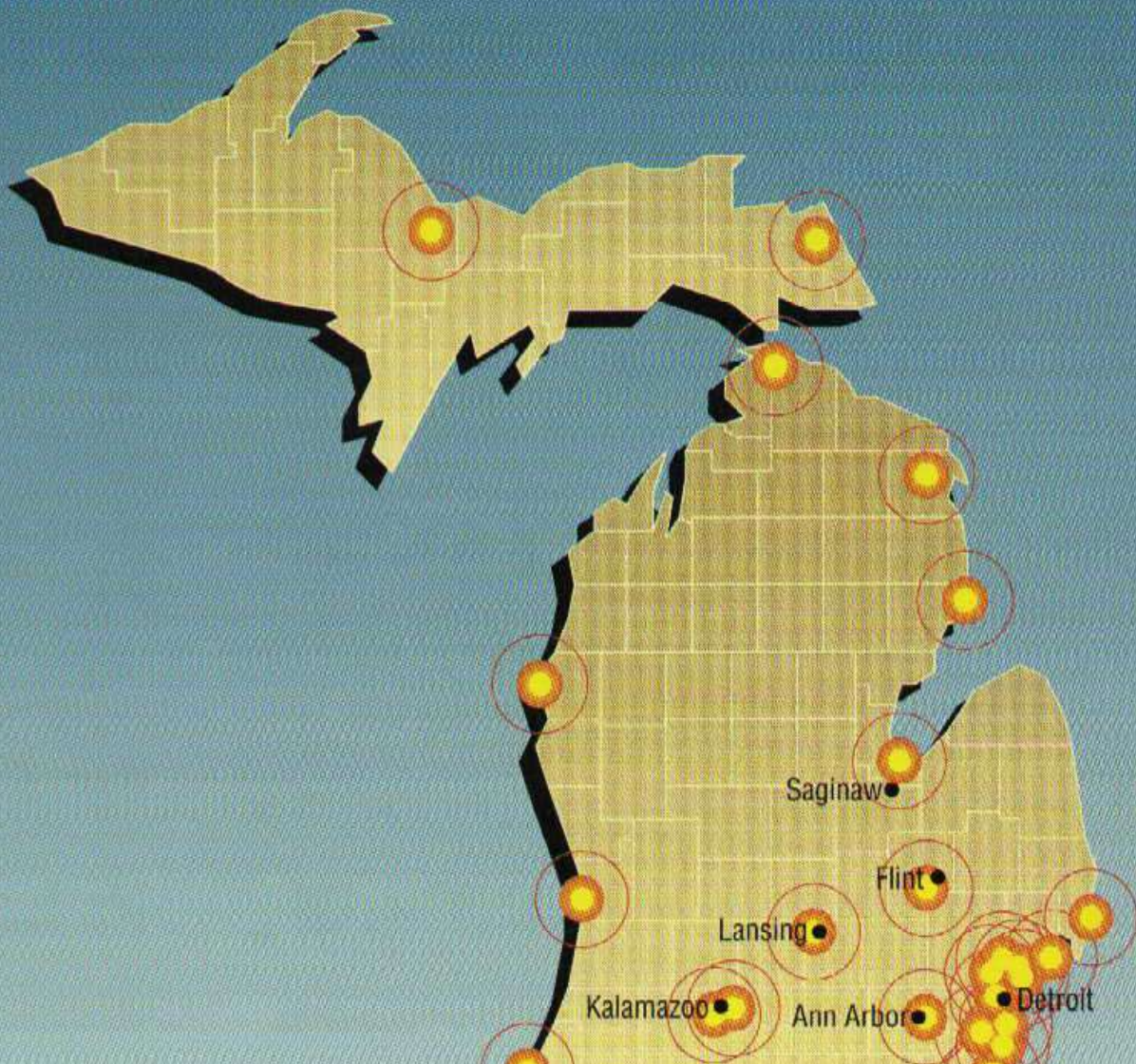

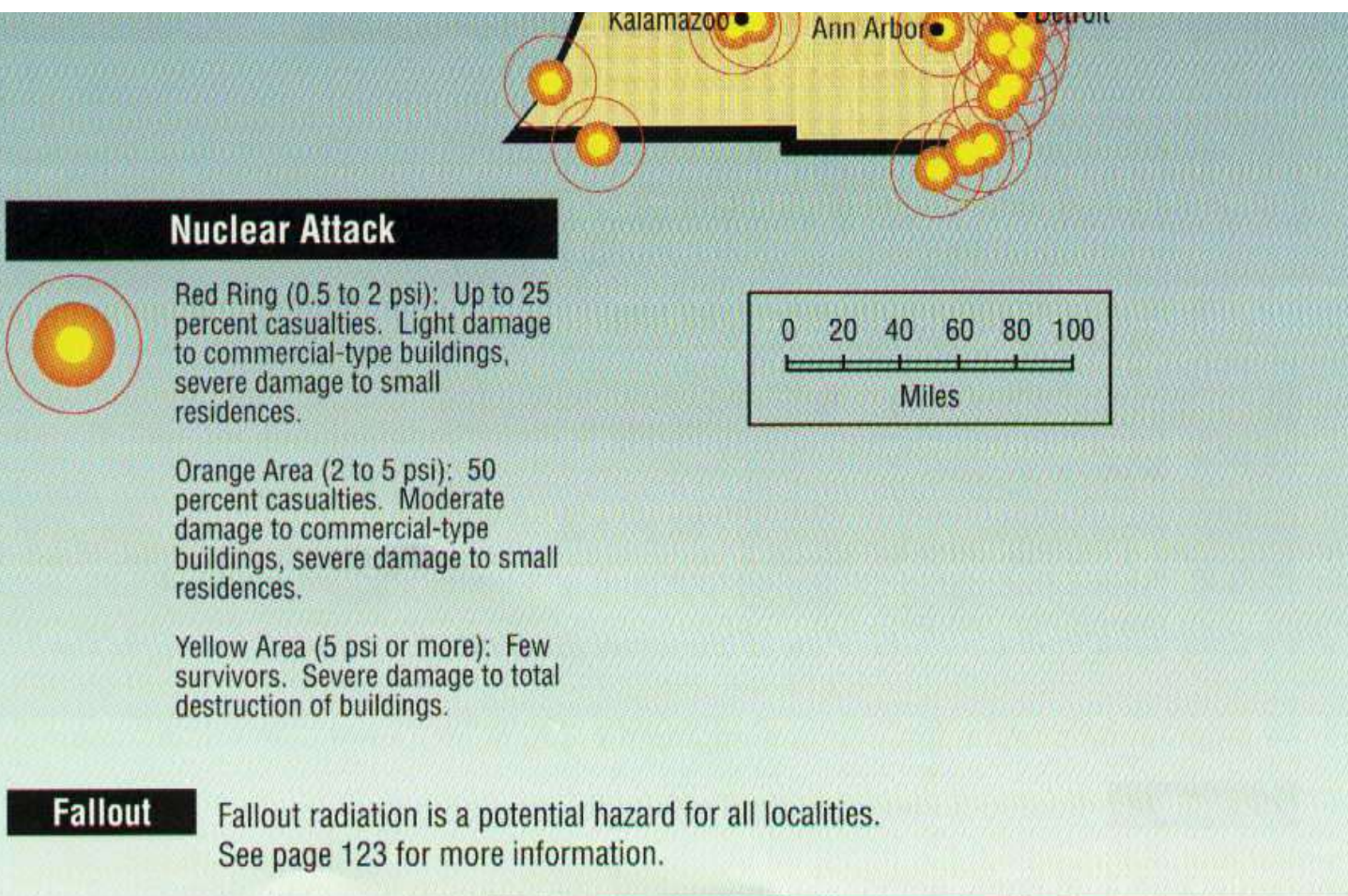

[UPDATE to Target Information!!!](#)

Information for Michigan

This link will take you back to the [Index of all the States](#)

It is recommended that you go through the following 10 steps in studying about the nuclear threat to Michigan.

1. Look at the [State Map](#) above to see the target nuclear areas in Michigan.
2. Look at the [general expected fallout map](#) to see where Michigan (according to the **prevailing wind pattern**) gets fallout from other states.
3. If the state that you live in is anywhere EAST of any of the following 6 states in the **prevailing wind pattern** then look at the states in **RED** on the [INDEX of](#)

STATES for

- Montana
- North Dakota
- South Dakota
- Nebraska
- Missouri
- Colorado

These six states contain what is called DENSE PACK which I explain on each of those states pages. **UNDERSTAND** that the wind pattern **COULD** at that time be something other than the "prevailing" wind pattern.

4. Bookmark the present URL or make a copy of this present address so that you can come back to it after going to

[Blast Mapper](#).

This mapper is on someone else's web site so that you will need to save this address in order to return here if your back button doesn't work. However, you want to be sure to go the mapper site and calculate the damage to probable targets (cities) around you.

5. Memorize the THREE top rules for survival. They are:

- Number One - **Get out of the cities!**
- Number Two - **Get out of the cities!**
- Number Three - **Get out of the cities!**

6. The follow-on rules are:

- a. Have a shelter
- b. Work with a group (you are going to need the manpower, brainpower, and skillpower).

- c. Stock supplies.

7. My [Main Survival Page](#) contains links to lots of other information such as free books to download about nuclear survival, links to plans for building shelters, and even free consultation about building a shelter.

8. If you are SUPER concerned about nuclear survival you might consider moving within 20 miles of the

[Ark Two Community](#)
(in Canada)

9. And finally if you would like to be on the mailing list of the author of this site - send a blank email to:

arktwo-request@deuce.pairowoodies.com
[with the subject as subscribe](#)

MENU: [HOME](#) » [SURVIVAL](#) » [Index of States](#)

Nuclear Survival in **Minnesota**

This is the nuclear target map for Minnesota, but remember, fallout can go anywhere or everywhere (and probably will). After you have looked at this map look at the [Information for Minnesota](#) that follows it.

This link will take you back to the [Index of all the States](#)

Nuclear Weapon Target Map for Minnesota (FEMA-196/September 1990)



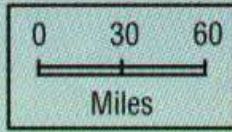

Nuclear Attack



Red Ring (0.5 to 2 psi): Up to 25 percent casualties. Light damage to commercial-type buildings, severe damage to small residences.

Orange Area (2 to 5 psi): 50 percent casualties. Moderate damage to commercial-type buildings, severe damage to small residences.

Yellow Area (5 psi or more): Few survivors. Severe damage to total destruction of buildings.

Fallout

Fallout radiation is a potential hazard for all localities. See page 123 for more information.

[UPDATE to Target Information!!!](#)

Information for Minnesota

This link will take you back to the [Index of all the States](#)

It is recommended that you go through the following 10 steps in studying about the nuclear threat to Minnesota.

1. Look at the [State Map](#) above to see the target nuclear areas in Minnesota.
2. Look at the [general expected fallout map](#) to see where Minnesota (according to the **prevailing wind pattern**) gets fallout from other states.
3. If the state that you live in is anywhere EAST of any of the following 6 states in the **prevailing wind pattern** then look at the states in **RED** on the [INDEX of](#)

STATES for

- Montana
- North Dakota
- South Dakota
- Nebraska
- Missouri
- Colorado

These six states contain what is called DENSE PACK which I explain on each of those states pages. **UNDERSTAND** that the wind pattern **COULD** at that time be something other than the "prevailing" wind pattern.

4. Bookmark the present URL or make a copy of this present address so that you can come back to it after going to

[Blast Mapper.](#)

This mapper is on someone else's web site so that you will need to save this address in order to return here if your back button doesn't work. However, you want to be sure to go the mapper site and calculate the damage to probable targets (cities) around you.

5. Memorize the THREE top rules for survival. They are:

- Number One - **Get out of the cities!**
- Number Two - **Get out of the cities!**
- Number Three - **Get out of the cities!**

6. The follow-on rules are:

- a. Have a shelter
- b. Work with a group (you are going to need the manpower, brainpower, and skillpower).

- c. Stock supplies.

7. My [Main Survival Page](#) contains links to lots of other information such as free books to download about nuclear survival, links to plans for building shelters, and even free consultation about building a shelter.

8. If you are SUPER concerned about nuclear survival you might consider moving within 20 miles of the

[Ark Two Community](#)
(in Canada)

9. And finally if you would like to be on the mailing list of the author of this site - send a blank email to:

arktwo-request@deuce.pairowoodies.com
[with the subject as subscribe](#)

MENU: [HOME](#) » [SURVIVAL](#) » [Index of States](#)

Nuclear Survival in

Mississippi

This is the nuclear target map for Mississippi, but remember, fallout can go anywhere or everywhere (and probably will). After you have looked at this map look at the [Information for Mississippi](#) that follows it.

This link will take you back to the [Index of all the States](#)

Nuclear Weapon Target Map for Mississippi (FEMA-196/September 1990)

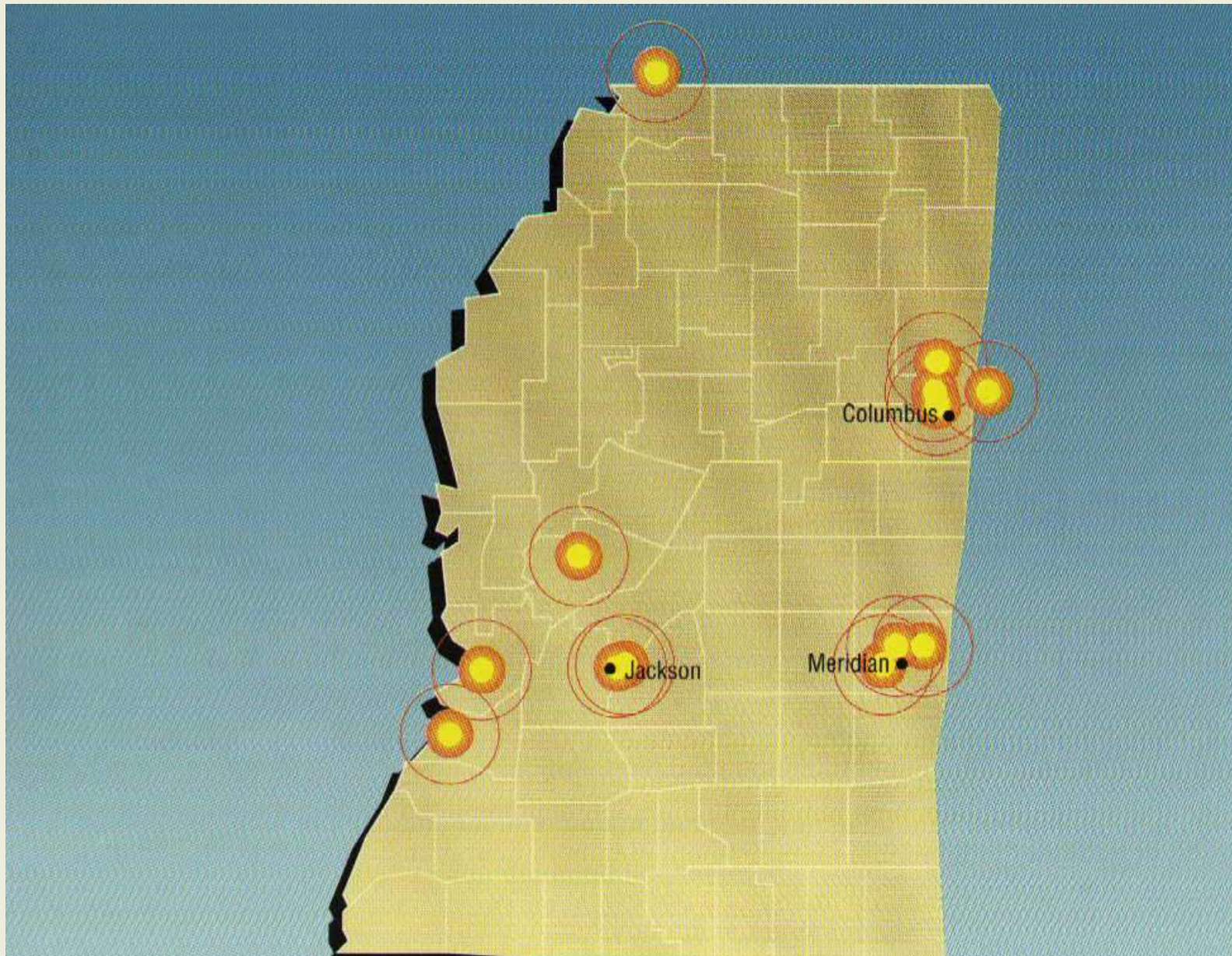

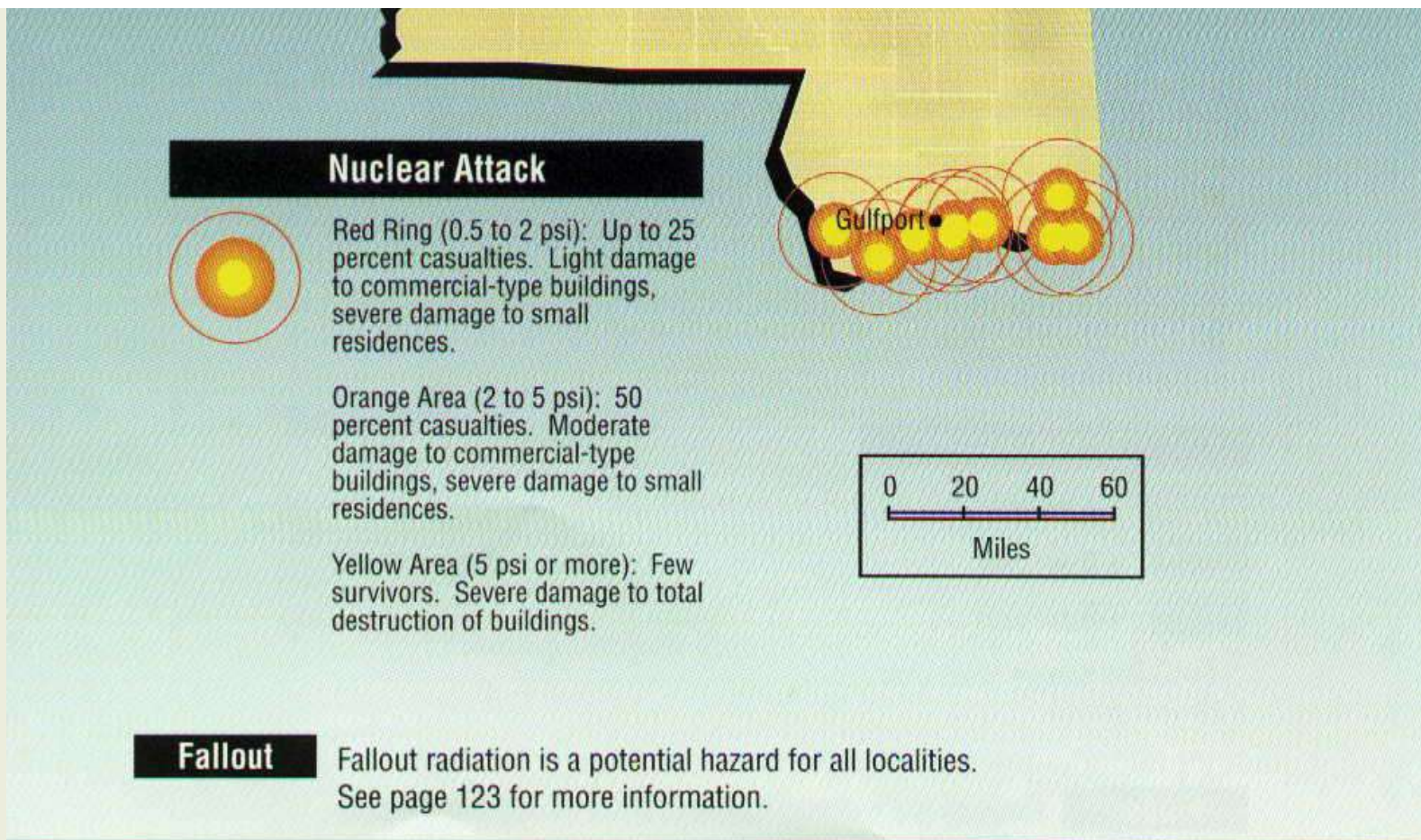

[UPDATE to Target Information!!!](#)

Information for Mississippi

This link will take you back to the [Index of all the States](#)

It is recommended that you go through the following 10 steps in studying about the nuclear threat to Mississippi.

1. Look at the [State Map](#) above to see the target nuclear areas in Mississippi.
2. Look at the [general expected fallout map](#) to see where Mississippi (according to the **prevailing wind pattern**) gets fallout from other states.
3. If the state that you live in is anywhere EAST of any of the following 6 states in the **prevailing wind pattern** then look at the states in **RED** on the [INDEX of](#)

STATES for

- Montana
- North Dakota
- South Dakota
- Nebraska
- Missouri
- Colorado

These six states contain what is called DENSE PACK which I explain on each of those states pages. **UNDERSTAND** that the wind pattern **COULD** at that time be something other than the "prevailing" wind pattern.

4. Bookmark the present URL or make a copy of this present address so that you can come back to it after going to

[Blast Mapper.](#)

This mapper is on someone else's web site so that you will need to save this address in order to return here if your back button doesn't work. However, you want to be sure to go the mapper site and calculate the damage to probable targets (cities) around you.

5. Memorize the THREE top rules for survival. They are:

- Number One - **Get out of the cities!**
- Number Two - **Get out of the cities!**
- Number Three - **Get out of the cities!**

6. The follow-on rules are:

- a. Have a shelter
- b. Work with a group (you are going to need the manpower, brainpower, and skillpower).

- c. Stock supplies.

7. My [Main Survival Page](#) contains links to lots of other information such as free books to download about nuclear survival, links to plans for building shelters, and even free consultation about building a shelter.

8. If you are SUPER concerned about nuclear survival you might consider moving within 20 miles of the

[Ark Two Community](#)
(in Canada)

9. And finally if you would like to be on the mailing list of the author of this site - send a blank email to:

arktwo-request@deuce.pairowoodies.com
[with the subject as subscribe](#)

MENU: [HOME](#) » [SURVIVAL](#) » [Index of States](#)

Nuclear Survival in **Missouri**

This is the nuclear target map for Missouri, but remember, fallout can go anywhere or everywhere (and probably will). After you have looked at this map look at the [Information for Missouri](#) that follows it.

This link will take you back to the [Index of all the States](#)

***DENSE PACK** - Look at all those target sites. So close Together! It serves a purpose. It is missiles protecting missiles, and this is how it is done. These are "hardened" sites. Meaning it takes a direct ground explosion to dig them out. An air burst will not do it. When you have a ground explosion it throws many tons of dust and sand up into the air. High into the air. This is what will later become fallout carried by the winds hundreds, sometimes thousands, of miles away. But right over that site that has just been hit the sand and grit in the air is very thick for quite a while. Another high speed missile (ICBM) trying to come through it will have its skin torn off just like by sand blasting and it will be destroyed. So the other missile sites nearby are safe. On the other hand, because missiles take off much slower than the speeds they eventually reach, the missiles in the undamaged silos can still be launched and will pass through the dust cloud without be harmed. Neat, eh? See there is a purpose in putting so many in one place. Now the only way that you can dig them out is with what is called a slow walk. Hit a target. Move on further and hit another target where the dust from the first won't hurt you. Come back thirty or forty-five minutes later and hit a second target near where you hit the first, after the cloud has had time to blow away. A slow process. Some silos will already have launched and you will waste the shot. Others can still wait to launch later because you can only get one at a time. This could go on for days. Neat. The military missiles protecting missiles. But they don't protect you, because if you are downwind you will get the fallout. Fatal if you are not in a*

shelter. They call it Defense but it is only Destruction. Nothing here defends or protects you, if they are used.

Nuclear Weapon Target Map for Missouri (FEMA-196/September 1990)

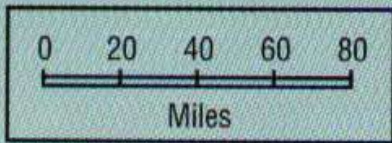
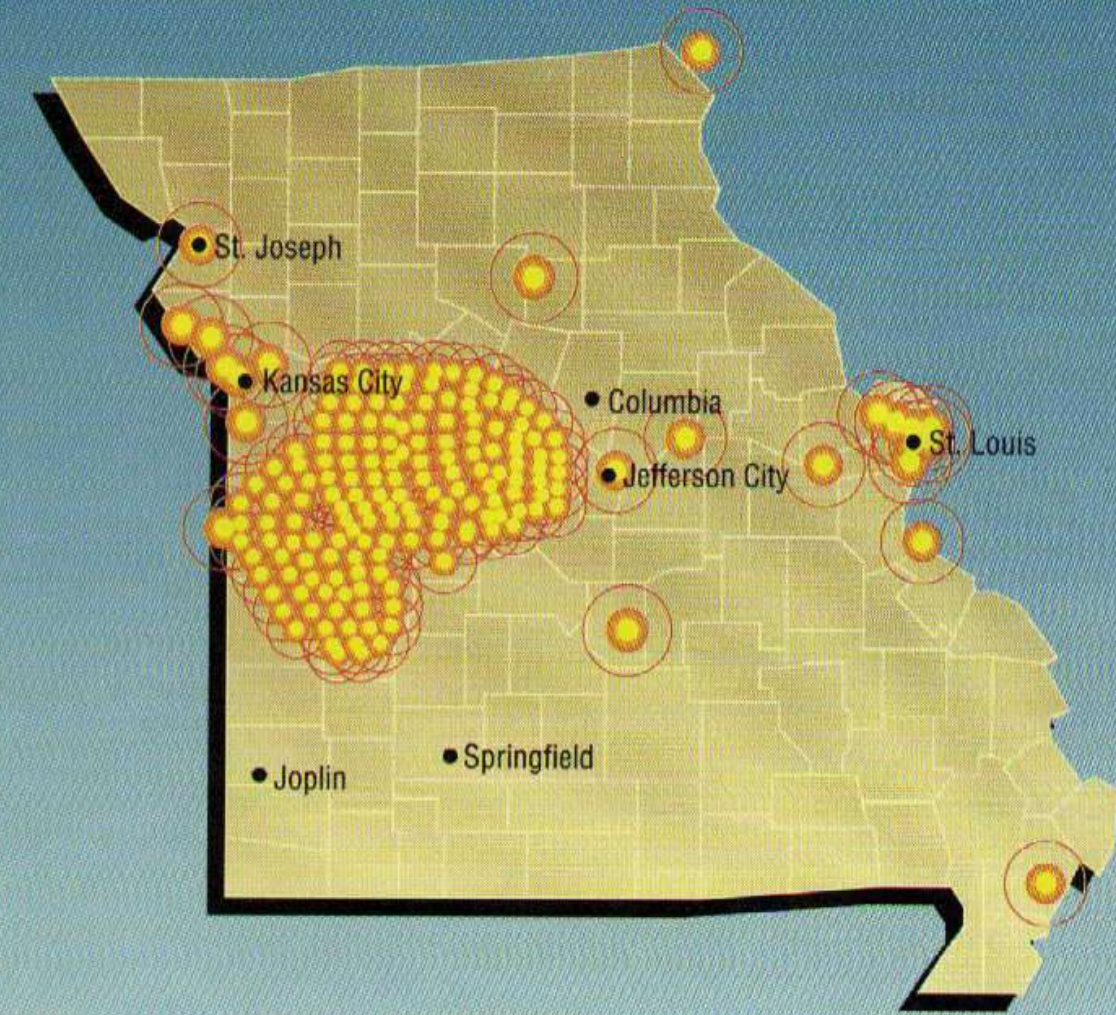

Nuclear Attack



Red Ring (0.5 to 2 psi): Up to 25 percent casualties. Light damage to commercial-type buildings, severe damage to small residences.

Orange Area (2 to 5 psi): 50 percent casualties. Moderate damage to commercial-type buildings, severe damage to small residences.

Yellow Area (5 psi or more): Few survivors. Severe damage to total destruction of buildings.

survivors. Severe damage to total destruction of buildings.

Fallout

Fallout radiation is a potential hazard for all localities.
See page 123 for more information.

[UPDATE to Target Information!!!](#)

Information for Missouri

This link will take you back to the [Index of all the States](#)

It is recommended that you go through the following 10 steps in studying about the nuclear threat to Missouri.

1. Look at the [State Map](#) above to see the target nuclear areas in Missouri.
2. Look at the [general expected fallout map](#) to see where Missouri (according to the **prevailing wind pattern**) gets fallout from other states.
3. If the state that you live in is anywhere EAST of any of the following 6 states in the **prevailing wind pattern** then look at the states in **RED** on the [INDEX of STATES](#) for

- **Montana**
- **North Dakota**
- **South Dakota**
- **Nebraska**
- **Missouri**
- **Colorado**

These six states contain what is called DENSE PACK which I explain on each of

those states pages. **UNDERSTAND** that the wind pattern **COULD** at that time be something other than the "prevailing" wind pattern.

4. Bookmark the present URL or make a copy of this present address so that you can come back to it after going to

[Blast Mapper](#).

This mapper is on someone else's web site so that you will need to save this address in order to return here if your back button doesn't work. However, you want to be sure to go the mapper site and calculate the damage to probable targets (cities) around you.

5. Memorize the **THREE** top rules for survival. They are:

- Number One - **Get out of the cities!**
- Number Two - **Get out of the cities!**
- Number Three - **Get out of the cities!**

6. The follow-on rules are:

- a. Have a shelter
- b. Work with a group (you are going to need the manpower, brainpower, and skillpower).
- c. Stock supplies.

7. My [Main Survival Page](#) contains links to lots of other information such as free books to download about nuclear survival, links to plans for building shelters, and even free consultation about building a shelter.

8. If you are **SUPER** concerned about nuclear survival you might consider moving within 20 miles of the

[Ark Two Community](#)

(in Canada)

9. And finally if you would like to be on the mailing list of the author of this site - send a blank email to:

arktwo-request@deuce.pairowoodies.com
[with the subject as subscribe](#)

MENU: [HOME](#) » [SURVIVAL](#) » [Index of States](#)

Nuclear Survival in

Montana

This is the nuclear target map for Montana, but remember, fallout can go anywhere or everywhere (and probably will). After you have looked at this map look at the [Information for Montana](#) that follows it.

This link will take you back to the [Index of all the States](#)

***DENSE PACK** - Look at all those target sites. So close Together! It serves a purpose. It is missiles protecting missiles, and this is how it is done. These are "hardened" sites. Meaning it takes a direct ground explosion to dig them out. An air burst will not do it. When you have a ground explosion it throws many tons of dust and sand up into the air. High into the air. This is what will later become fallout carried by the winds hundreds, sometimes thousands, of miles away. But right over that site that has just been hit the sand and grit in the air is very thick for quite a while. Another high speed missile (ICBM) trying to come through it will have its skin torn off just like by sand blasting and it will be destroyed. So the other missile sites nearby are safe. On the other hand, because missiles take off much slower than the speeds they eventually reach, the missiles in the undamaged silos can still be launched and will pass through the dust cloud without be harmed. Neat, eh? See there is a purpose in putting so many in one place. Now the only way that you can dig them out is with what is called a slow walk. Hit a target. Move on further and hit another target where the dust from the first won't hurt you. Come back thirty or forty-five minutes later and hit a second target near where you hit the first, after the cloud has had time to blow away. A slow process. Some silos will already have launched and you will waste the shot. Others can still wait to launch later because you can only get one at a time. This could go on for days. Neat. The military missiles protecting missiles. But they don't protect you, because if you are downwind you will get the fallout. Fatal if you are not in a*

shelter. They call it Defense but it is only Destruction. Nothing here defends or protects you, if they are used.

Nuclear Weapon Target Map for Montana (FEMA-196/September 1990)

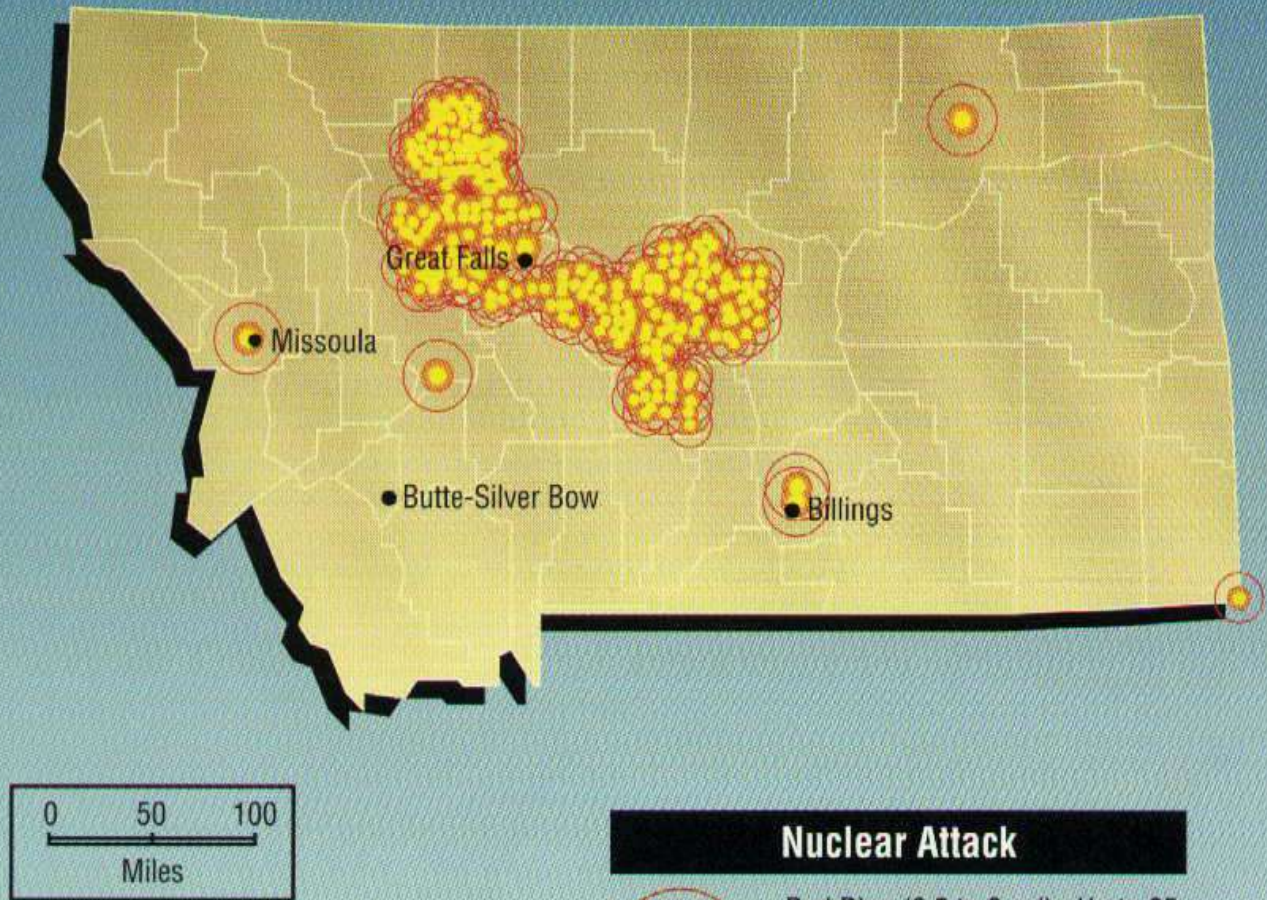

Nuclear Attack



Red Ring (0.5 to 2 psi): Up to 25 percent casualties. Light damage to commercial-type buildings, severe damage to small residences.

Orange Area (2 to 5 psi): 50 percent casualties. Moderate damage to commercial-type buildings, severe damage to small residences.

Yellow Area (5 psi or more): Few survivors. Severe damage to total destruction of buildings.

Fallout

Fallout radiation is a potential hazard for all localities.
See page 123 for more information.

[UPDATE to Target Information!!!](#)

Information for Montana

This link will take you back to the [Index of all the States](#)

It is recommended that you go through the following 10 steps in studying about the nuclear threat to Montana.

1. Look at the [State Map](#) above to see the target nuclear areas in Montana.
2. Look at the [general expected fallout map](#) to see where Montana (according to the **prevailing wind pattern**) gets fallout from other states.
3. If the state that you live in is anywhere EAST of any of the following 6 states in the **prevailing wind pattern** then look at the states in **RED** on the [INDEX of STATES](#) for

- **Montana**
- **North Dakota**
- **South Dakota**
 - **Nebraska**
 - **Missouri**
 - **Colorado**

These six states contain what is called DENSE PACK which I explain on each of

those states pages. **UNDERSTAND** that the wind pattern **COULD** at that time be something other than the "prevailing" wind pattern.

4. Bookmark the present URL or make a copy of this present address so that you can come back to it after going to

[Blast Mapper](#).

This mapper is on someone else's web site so that you will need to save this address in order to return here if your back button doesn't work. However, you want to be sure to go the mapper site and calculate the damage to probable targets (cities) around you.

5. Memorize the **THREE** top rules for survival. They are:

- Number One - **Get out of the cities!**
- Number Two - **Get out of the cities!**
- Number Three - **Get out of the cities!**

6. The follow-on rules are:

- a. Have a shelter
- b. Work with a group (you are going to need the manpower, brainpower, and skillpower).
- c. Stock supplies.

7. My [Main Survival Page](#) contains links to lots of other information such as free books to download about nuclear survival, links to plans for building shelters, and even free consultation about building a shelter.

8. If you are **SUPER** concerned about nuclear survival you might consider moving within 20 miles of the

[Ark Two Community](#)

(in Canada)

9. And finally if you would like to be on the mailing list of the author of this site - send a blank email to:

arktvo-request@deuce.pairowoodies.com
[with the subject as subscribe](#)

MENU: [HOME](#) » [SURVIVAL](#) » [Index of States](#)

Nuclear Survival in **Nebraska**

This is the nuclear target map for Nebraska, but remember, fallout can go anywhere or everywhere (and probably will). After you have looked at this map look at the [Information for Nebraska](#) that follows it.

This link will take you back to the [Index of all the States](#)

***DENSE PACK** - Look at all those target sites. So close Together! It serves a purpose. It is missiles protecting missiles, and this is how it is done. These are "hardened" sites. Meaning it takes a direct ground explosion to dig them out. An air burst will not do it. When you have a ground explosion it throws many tons of dust and sand up into the air. High into the air. This is what will later become fallout carried by the winds hundreds, sometimes thousands, of miles away. But right over that site that has just been hit the sand and grit in the air is very thick for quite a while. Another high speed missile (ICBM) trying to come through it will have its skin torn off just like by sand blasting and it will be destroyed. So the other missile sites nearby are safe. On the other hand, because missiles take off much slower than the speeds they eventually reach, the missiles in the undamaged silos can still be launched and will pass through the dust cloud without be harmed. Neat, eh? See there is a purpose in putting so many in one place. Now the only way that you can dig them out is with what is called a slow walk. Hit a target. Move on further and hit another target where the dust from the first won't hurt you. Come back thirty or forty-five minutes later and hit a second target near where you hit the first, after the cloud has had time to blow away. A slow process. Some silos will already have launched and you will waste the shot. Others can still wait to launch later because you can only get one at a time. This could go on for days. Neat. The military missiles protecting missiles. But they don't protect you, because if you are downwind you will get the fallout. Fatal if you are not in a*

shelter. They call it Defense but it is only Destruction. Nothing here defends or protects you, if they are used.

Nuclear Weapon Target Map for Nebraska (FEMA-196/September 1990)

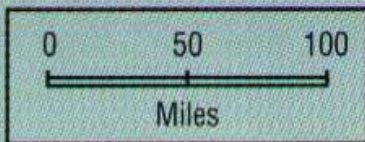
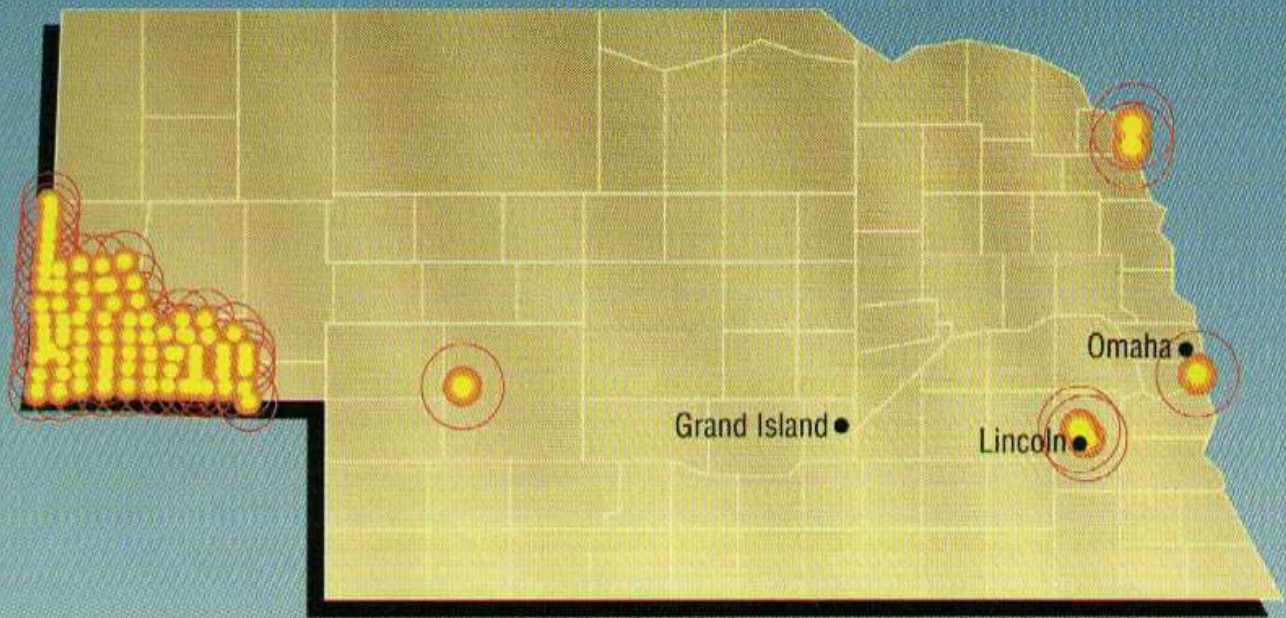

Nuclear Attack

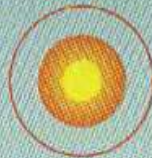

Red Ring (0.5 to 2 psi): Up to 25 percent casualties. Light damage to commercial-type buildings, severe damage to small residences.

Orange Area (2 to 5 psi): 50 percent casualties. Moderate damage to commercial-type buildings, severe damage to small residences.

Yellow Area (5 psi or more): Few survivors. Severe damage to total destruction of buildings.

Fallout

Fallout radiation is a potential hazard for all localities.
See page 123 for more information

[UPDATE to Target Information!!!](#)

Information for Nebraska

This link will take you back to the [Index of all the States](#)

It is recommended that you go through the following 10 steps in studying about the nuclear threat to Nebraska.

1. Look at the [State Map](#) above to see the target nuclear areas in Nebraska.
2. Look at the [general expected fallout map](#) to see where Nebraska (according to the **prevailing wind pattern**) gets fallout from other states.
3. If the state that you live in is anywhere EAST of any of the following 6 states in the **prevailing wind pattern** then look at the states in **RED** on the [INDEX of STATES](#) for

- **Montana**
- **North Dakota**
- **South Dakota**
- **Nebraska**
- **Missouri**
- **Colorado**

These six states contain what is called DENSE PACK which I explain on each of

those states pages. **UNDERSTAND** that the wind pattern **COULD** at that time be something other than the "prevailing" wind pattern.

4. Bookmark the present URL or make a copy of this present address so that you can come back to it after going to

[Blast Mapper](#).

This mapper is on someone else's web site so that you will need to save this address in order to return here if your back button doesn't work. However, you want to be sure to go the mapper site and calculate the damage to probable targets (cities) around you.

5. Memorize the **THREE** top rules for survival. They are:

- Number One - **Get out of the cities!**
- Number Two - **Get out of the cities!**
- Number Three - **Get out of the cities!**

6. The follow-on rules are:

- a. Have a shelter
- b. Work with a group (you are going to need the manpower, brainpower, and skillpower).
- c. Stock supplies.

7. My [Main Survival Page](#) contains links to lots of other information such as free books to download about nuclear survival, links to plans for building shelters, and even free consultation about building a shelter.

8. If you are **SUPER** concerned about nuclear survival you might consider moving within 20 miles of the

[Ark Two Community](#)

(in Canada)

9. And finally if you would like to be on the mailing list of the author of this site - send a blank email to:

arktvo-request@deuce.pairowoodies.com
[with the subject as subscribe](#)

MENU: [HOME](#) » [SURVIVAL](#) » [Index of States](#)

Nuclear Survival in **Nevada**

This is the nuclear target map for Nevada, but remember, fallout can go anywhere or everywhere (and probably will). After you have looked at this map look at the [Information for Nevada](#) that follows it.

This link will take you back to the [Index of all the States](#)

Nuclear Weapon Target Map for Nevada (FEMA-196/September 1990)

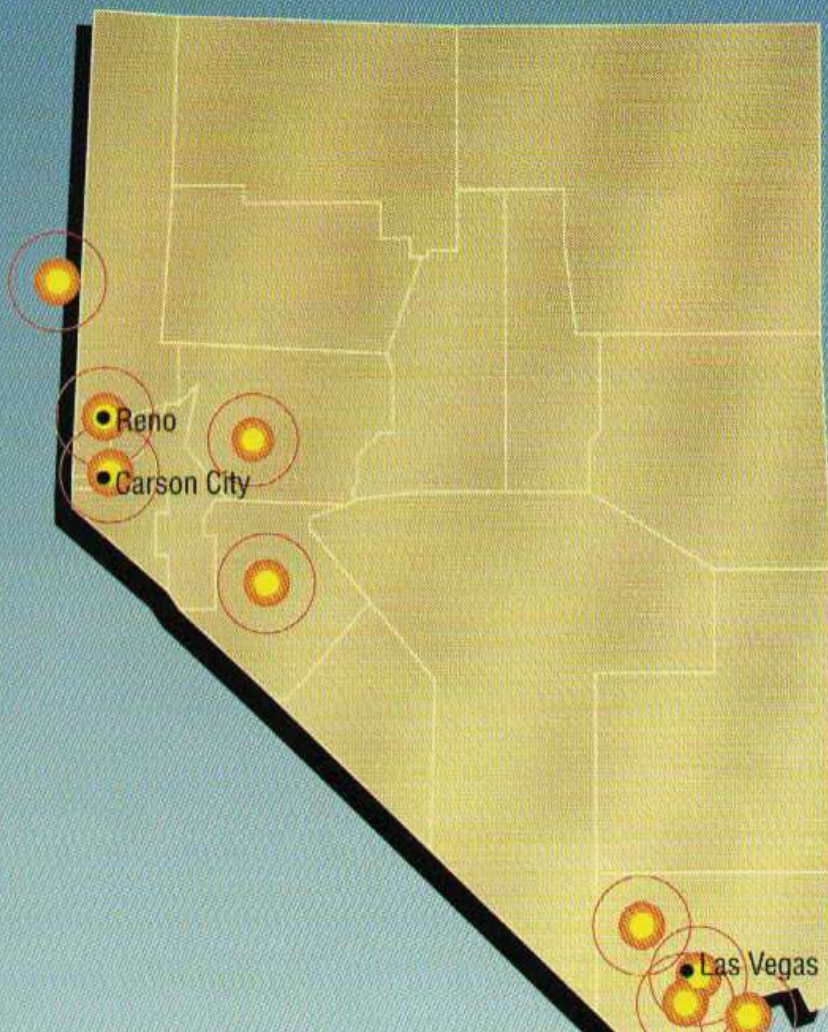

Nuclear Attack



Red Ring (0.5 to 2 psi): Up to 25 percent casualties. Light damage to commercial-type buildings, severe damage to small residences.

Orange Area (2 to 5 psi): 50 percent casualties. Moderate damage to commercial-type buildings, severe damage to small residences.

Yellow Area (5 psi or more): Few survivors. Severe damage to total destruction of buildings.

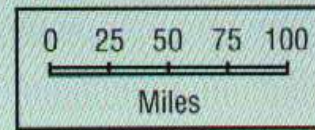

Fallout

Fallout radiation is a potential hazard for all localities. See page 123 for more information.

[UPDATE to Target Information!!!](#)

Information for Nevada

This link will take you back to the [Index of all the States](#)

It is recommended that you go through the following 10 steps in studying about the nuclear threat to Nevada.

1. Look at the [State Map](#) above to see the target nuclear areas in Nevada.
2. Look at the [general expected fallout map](#) to see where Nevada (according to the **prevailing wind pattern**) gets fallout from other states.
3. If the state that you live in is anywhere EAST of any of the following 6 states in the **prevailing wind pattern** then look at the states in **RED** on the [INDEX of](#)

STATES for

- Montana
- North Dakota
- South Dakota
- Nebraska
- Missouri
- Colorado

These six states contain what is called DENSE PACK which I explain on each of those states pages. **UNDERSTAND** that the wind pattern **COULD** at that time be something other than the "prevailing" wind pattern.

4. Bookmark the present URL or make a copy of this present address so that you can come back to it after going to

[Blast Mapper.](#)

This mapper is on someone else's web site so that you will need to save this address in order to return here if your back button doesn't work. However, you want to be sure to go the mapper site and calculate the damage to probable targets (cities) around you.

5. Memorize the THREE top rules for survival. They are:

- Number One - **Get out of the cities!**
- Number Two - **Get out of the cities!**
- Number Three - **Get out of the cities!**

6. The follow-on rules are:

- a. Have a shelter
- b. Work with a group (you are going to need the manpower, brainpower, and skillpower).

- c. Stock supplies.

7. My [Main Survival Page](#) contains links to lots of other information such as free books to download about nuclear survival, links to plans for building shelters, and even free consultation about building a shelter.

8. If you are SUPER concerned about nuclear survival you might consider moving within 20 miles of the

[Ark Two Community](#)
(in Canada)

9. And finally if you would like to be on the mailing list of the author of this site - send a blank email to:

arktwo-request@deuce.pairowoodies.com
[with the subject as subscribe](#)

MENU: [HOME](#) » [SURVIVAL](#) » [Index of States](#)

Nuclear Survival in **New Hampshire**

This is the nuclear target map for New Hampshire, but remember, fallout can go anywhere or everywhere (and probably will). After you have looked at this map look at the [Information for New Hampshire](#) that follows it.

This link will take you back to the [Index of all the States](#)

Nuclear Weapon Target Map for New Hampshire (FEMA-196/September 1990)

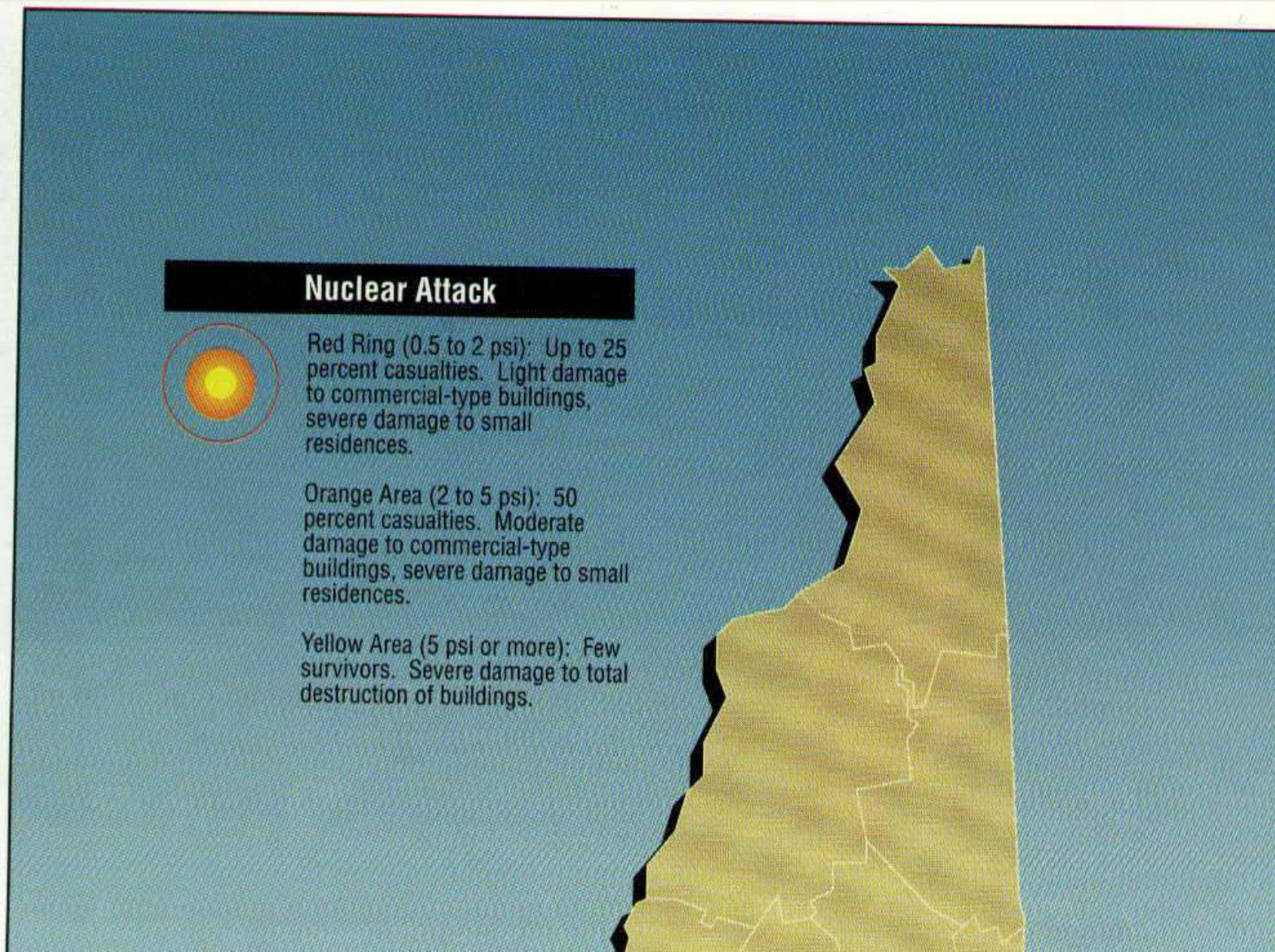

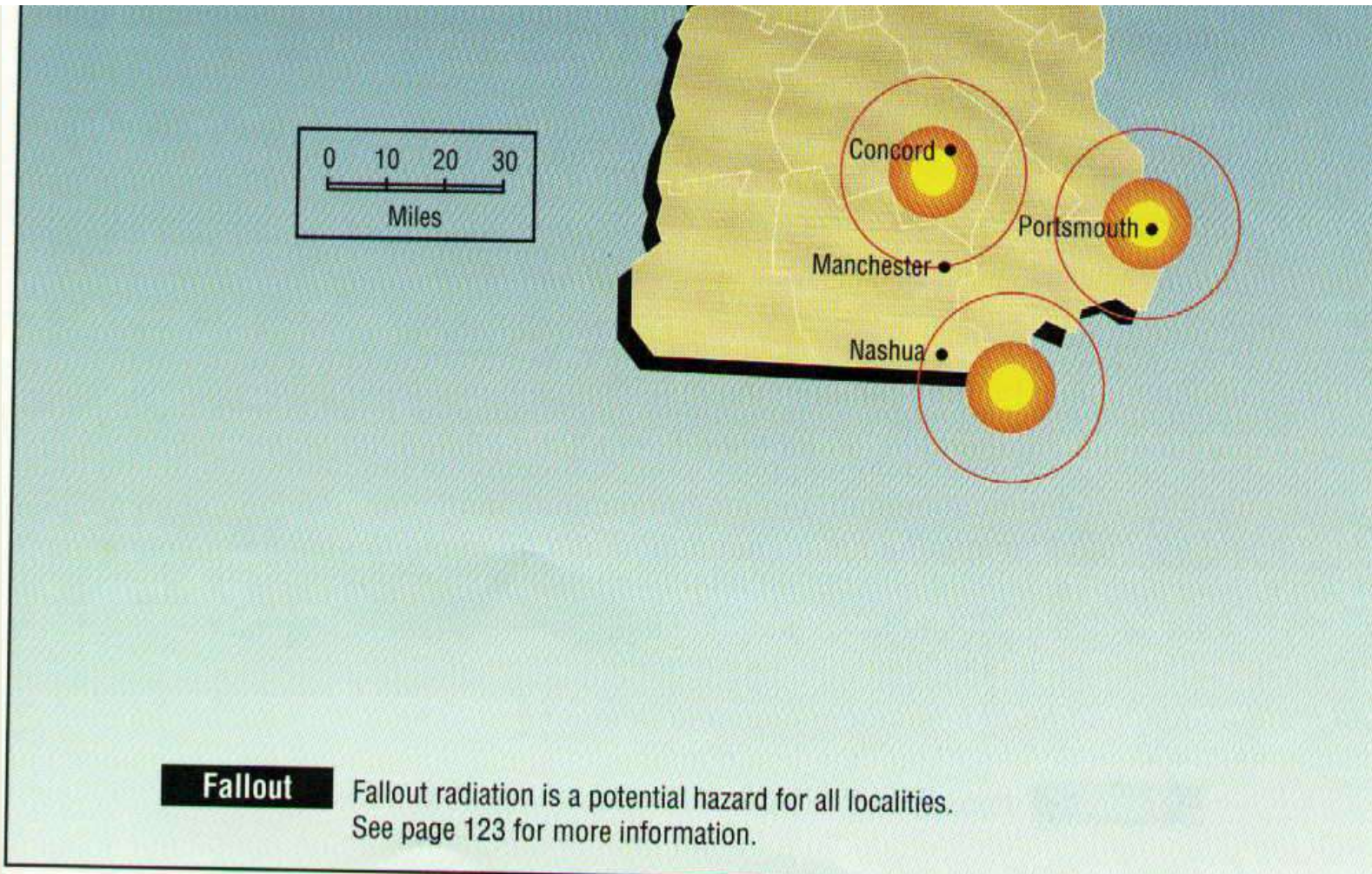

[UPDATE to Target Information!!!](#)

Information for New Hampshire

This link will take you back to the [Index of all the States](#)

It is recommended that you go through the following 10 steps in studying about the nuclear threat to New Hampshire.

1. Look at the [State Map](#) above to see the target nuclear areas in New Hampshire.
2. Look at the [general expected fallout map](#) to see where New Hampshire (according to the **prevailing wind pattern**) gets fallout from other states.
3. If the state that you live in is anywhere EAST of any of the following 6 states in

the **prevailing wind pattern** then look at the states in **RED** on the [INDEX of STATES](#) for

- **Montana**
- **North Dakota**
- **South Dakota**
- **Nebraska**
- **Missouri**
- **Colorado**

These six states contain what is called DENSE PACK which I explain on each of those states pages. **UNDERSTAND** that the wind pattern **COULD** at that time be something other than the "**prevailing**" wind pattern.

4. Bookmark the present URL or make a copy of this present address so that you can come back to it after going to

[Blast Mapper](#).

This mapper is on someone else's web site so that you will need to save this address in order to return here if your back button doesn't work. However, you want to be sure to go the mapper site and calculate the damage to probable targets (cities) around you.

5. Memorize the **THREE** top rules for survival. They are:

- Number One - **Get out of the cities!**
- Number Two - **Get out of the cities!**
- Number Three - **Get out of the cities!**

6. The follow-on rules are:

- a. Have a shelter
- b. Work with a group (you are going to need the manpower, brainpower, and

skillpower).

- c. Stock supplies.

7. My [Main Survival Page](#) contains links to lots of other information such as free books to download about nuclear survival, links to plans for building shelters, and even free consultation about building a shelter.

8. If you are SUPER concerned about nuclear survival you might consider moving within 20 miles of the

[Ark Two Community](#)
(in Canada)

9. And finally if you would like to be on the mailing list of the author of this site - send a blank email to:

arktwo-request@deuce.pairowoodies.com
[with the subject as subscribe](#)

MENU: [HOME](#) » [SURVIVAL](#) » [Index of States](#)

Nuclear Survival in **New Jersey**

This is the nuclear target map for New Jersey, but remember, fallout can go anywhere or everywhere (and probably will). After you have looked at this map look at the [Information for New Jersey](#) that follows it.

This link will take you back to the [Index of all the States](#)

Nuclear Weapon Target Map for New Jersey (FEMA-196/September 1990)

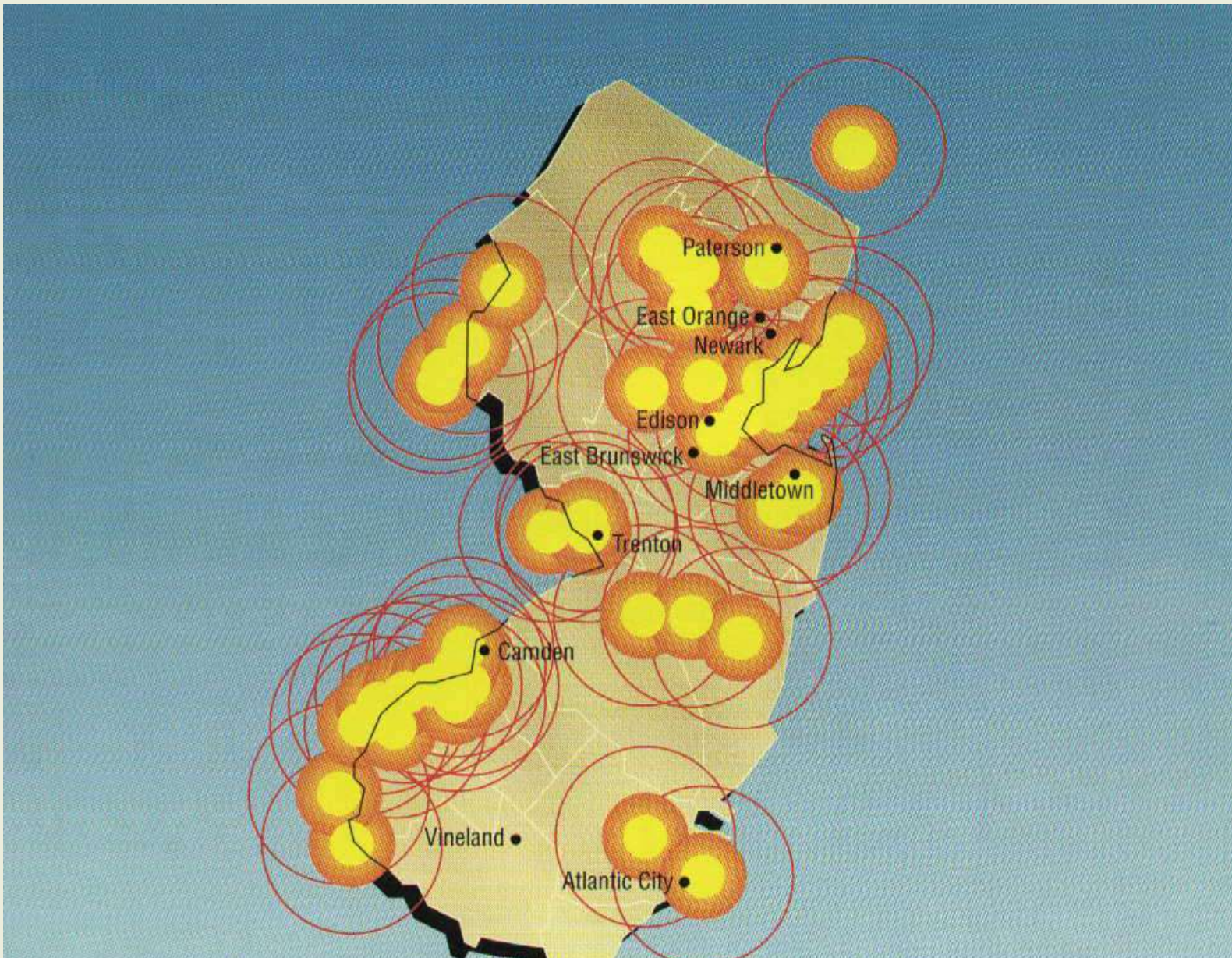

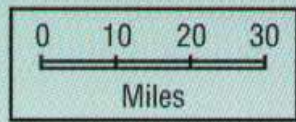

Nuclear Attack

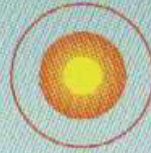

Red Ring (0.5 to 2 psi): Up to 25 percent casualties. Light damage to commercial-type buildings, severe damage to small residences.

Orange Area (2 to 5 psi): 50 percent casualties. Moderate damage to commercial-type buildings, severe damage to small residences.

Yellow Area (5 psi or more): Few survivors. Severe damage to total destruction of buildings.

Fallout

Fallout radiation is a potential hazard for all localities. See page 123 for more information.

[UPDATE to Target Information!!!](#)

Information for New Jersey

This link will take you back to the [Index of all the States](#)

It is recommended that you go through the following 10 steps in studying about the nuclear threat to New Jersey.

1. Look at the [State Map](#) above to see the target nuclear areas in New Jersey.
2. Look at the [general expected fallout map](#) to see where New Jersey (according to the **prevailing wind pattern**) gets fallout from other states.
3. If the state that you live in is anywhere EAST of any of the following 6 states in the **prevailing wind pattern** then look at the states in **RED** on the [INDEX of](#)

STATES for

- Montana
- North Dakota
- South Dakota
- Nebraska
- Missouri
- Colorado

These six states contain what is called DENSE PACK which I explain on each of those states pages. **UNDERSTAND** that the wind pattern **COULD** at that time be something other than the "prevailing" wind pattern.

4. Bookmark the present URL or make a copy of this present address so that you can come back to it after going to

[Blast Mapper](#).

This mapper is on someone else's web site so that you will need to save this address in order to return here if your back button doesn't work. However, you want to be sure to go the mapper site and calculate the damage to probable targets (cities) around you.

5. Memorize the THREE top rules for survival. They are:

- Number One - **Get out of the cities!**
- Number Two - **Get out of the cities!**
- Number Three - **Get out of the cities!**

6. The follow-on rules are:

- a. Have a shelter
- b. Work with a group (you are going to need the manpower, brainpower, and skillpower).

- c. Stock supplies.

7. My [Main Survival Page](#) contains links to lots of other information such as free books to download about nuclear survival, links to plans for building shelters, and even free consultation about building a shelter.

8. If you are SUPER concerned about nuclear survival you might consider moving within 20 miles of the

[Ark Two Community](#)
(in Canada)

9. And finally if you would like to be on the mailing list of the author of this site - send a blank email to:

arktwo-request@deuce.pairowoodies.com
[with the subject as subscribe](#)

MENU: [HOME](#) » [SURVIVAL](#) » [Index of States](#)

Nuclear Survival in **New Mexico**

This is the nuclear target map for New Mexico, but remember, fallout can go anywhere or everywhere (and probably will). After you have looked at this map look at the [Information for New Mexico](#) that follows it.

This link will take you back to the [Index of all the States](#)

Nuclear Weapon Target Map for New Mexico (FEMA-196/September 1990)



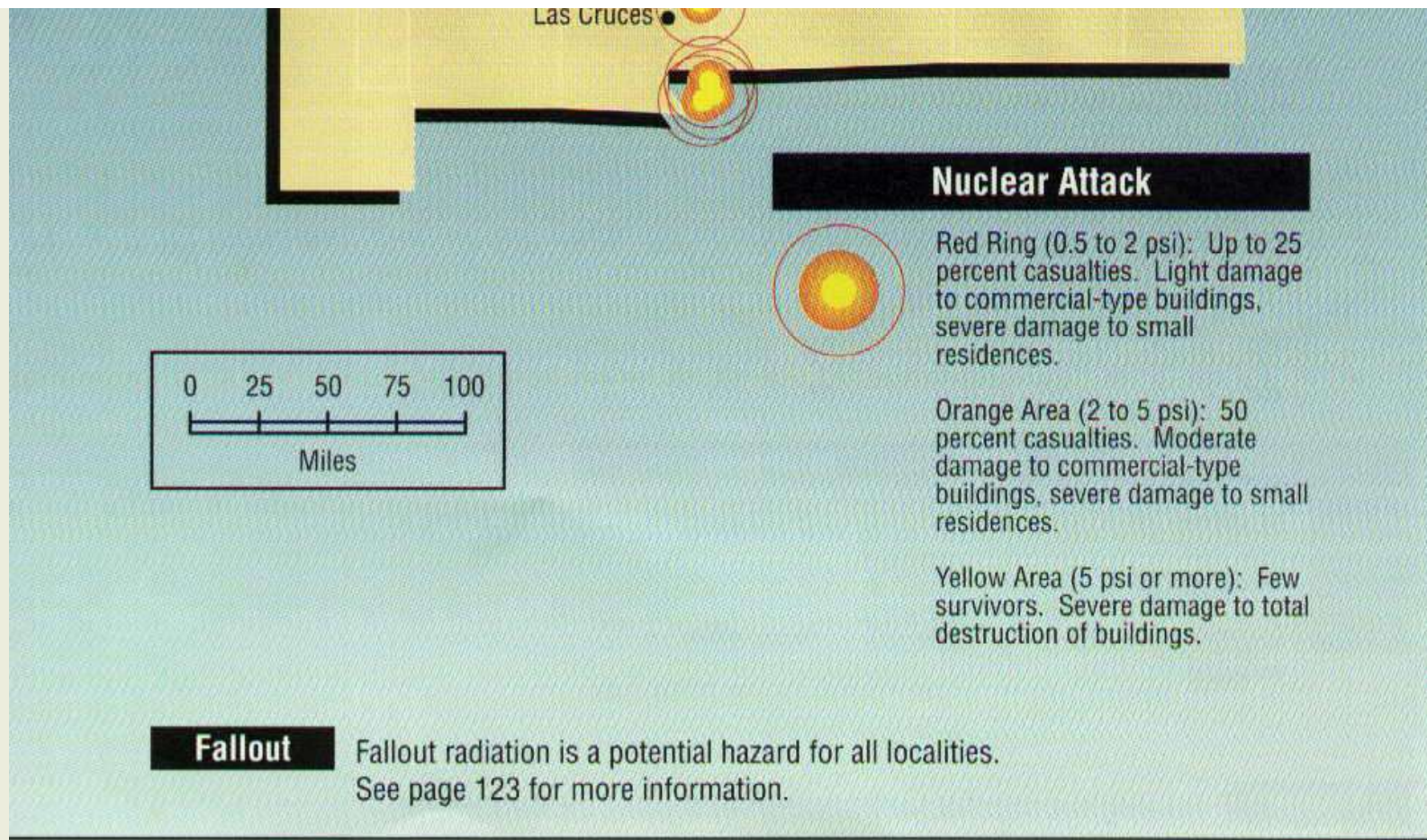

[UPDATE to Target Information!!!](#)

Information for New Mexico

This link will take you back to the [Index of all the States](#)

It is recommended that you go through the following 10 steps in studying about the nuclear threat to New Mexico.

1. Look at the [State Map](#) above to see the target nuclear areas in New Mexico.
2. Look at the [general expected fallout map](#) to see where New Mexico (according to the **prevailing wind pattern**) gets fallout from other states.
3. If the state that you live in is anywhere EAST of any of the following 6 states in the **prevailing wind pattern** then look at the states in **RED** on the [INDEX of](#)

STATES for

- Montana
- North Dakota
- South Dakota
- Nebraska
- Missouri
- Colorado

These six states contain what is called DENSE PACK which I explain on each of those states pages. **UNDERSTAND** that the wind pattern **COULD** at that time be something other than the "prevailing" wind pattern.

4. Bookmark the present URL or make a copy of this present address so that you can come back to it after going to

[Blast Mapper](#).

This mapper is on someone else's web site so that you will need to save this address in order to return here if your back button doesn't work. However, you want to be sure to go the mapper site and calculate the damage to probable targets (cities) around you.

5. Memorize the THREE top rules for survival. They are:

- Number One - **Get out of the cities!**
- Number Two - **Get out of the cities!**
- Number Three - **Get out of the cities!**

6. The follow-on rules are:

- a. Have a shelter
- b. Work with a group (you are going to need the manpower, brainpower, and skillpower).

- c. Stock supplies.

7. My [Main Survival Page](#) contains links to lots of other information such as free books to download about nuclear survival, links to plans for building shelters, and even free consultation about building a shelter.

8. If you are SUPER concerned about nuclear survival you might consider moving within 20 miles of the

[Ark Two Community](#)
(in Canada)

9. And finally if you would like to be on the mailing list of the author of this site - send a blank email to:

arktwo-request@deuce.pairowoodies.com
[with the subject as subscribe](#)

MENU: [HOME](#) » [SURVIVAL](#) » [Index of States](#)

Nuclear Survival in **New York**

This is the nuclear target map for New York, but remember, fallout can go anywhere or everywhere (and probably will). After you have looked at this map look at the [Information for New York](#) that follows it.

This link will take you back to the [Index of all the States](#)

Nuclear Weapon Target Map for New York (FEMA-196/September 1990)

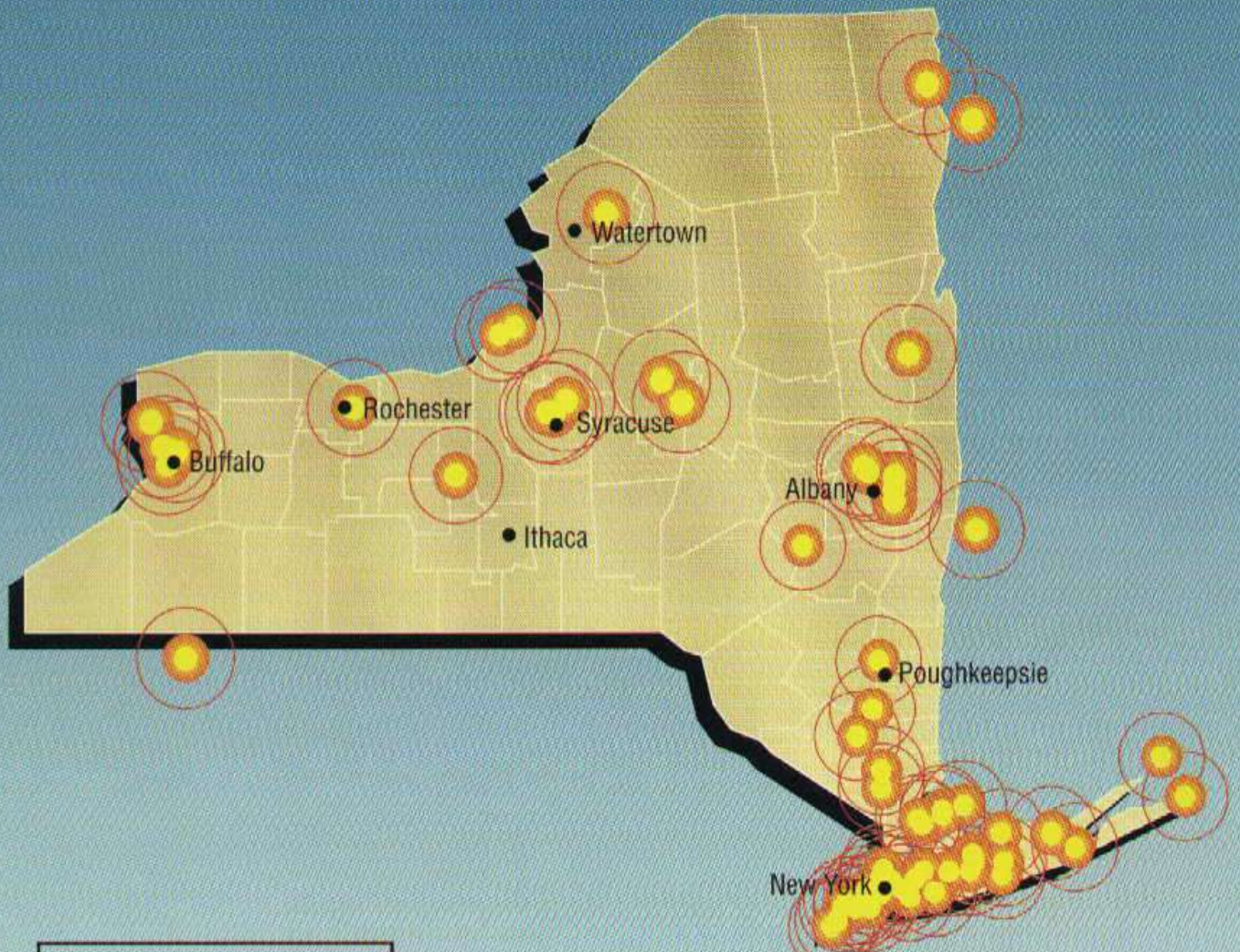

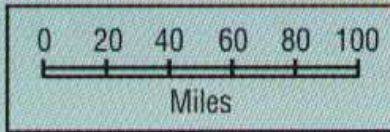

Nuclear Attack

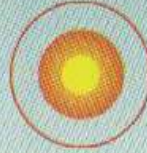

Red Ring (0.5 to 2 psi): Up to 25 percent casualties. Light damage to commercial-type buildings, severe damage to small residences.

Orange Area (2 to 5 psi): 50 percent casualties. Moderate damage to commercial-type buildings, severe damage to small residences.

Yellow Area (5 psi or more): Few survivors. Severe damage to total destruction of buildings.

Fallout

Fallout radiation is a potential hazard for all localities. See page 123 for more information.

[UPDATE to Target Information!!!](#)

Information for New York

This link will take you back to the [Index of all the States](#)

It is recommended that you go through the following 10 steps in studying about the nuclear threat to New York.

1. Look at the [State Map](#) above to see the target nuclear areas in New York.
2. Look at the [general expected fallout map](#) to see where New York (according to the **prevailing wind pattern**) gets fallout from other states.
3. If the state that you live in is anywhere EAST of any of the following 6 states in the **prevailing wind pattern** then look at the states in **RED** on the [INDEX of](#)

STATES for

- Montana
- North Dakota
- South Dakota
- Nebraska
- Missouri
- Colorado

These six states contain what is called DENSE PACK which I explain on each of those states pages. **UNDERSTAND** that the wind pattern **COULD** at that time be something other than the "prevailing" wind pattern.

4. Bookmark the present URL or make a copy of this present address so that you can come back to it after going to

[Blast Mapper.](#)

This mapper is on someone else's web site so that you will need to save this address in order to return here if your back button doesn't work. However, you want to be sure to go the mapper site and calculate the damage to probable targets (cities) around you.

5. Memorize the THREE top rules for survival. They are:

- Number One - **Get out of the cities!**
- Number Two - **Get out of the cities!**
- Number Three - **Get out of the cities!**

6. The follow-on rules are:

- a. Have a shelter
- b. Work with a group (you are going to need the manpower, brainpower, and skillpower).

- c. Stock supplies.

7. My [Main Survival Page](#) contains links to lots of other information such as free books to download about nuclear survival, links to plans for building shelters, and even free consultation about building a shelter.

8. If you are SUPER concerned about nuclear survival you might consider moving within 20 miles of the

[Ark Two Community](#)
(in Canada)

9. And finally if you would like to be on the mailing list of the author of this site - send a blank email to:

arktwo-request@deuce.pairowoodies.com
[with the subject as subscribe](#)

MENU: [HOME](#) » [SURVIVAL](#) » [Index of States](#)

Nuclear Survival in **North Carolina**

This is the nuclear target map for North Carolina, but remember, fallout can go anywhere or everywhere (and probably will). After you have looked at this map look at the [Information for North Carolina](#) that follows it.

This link will take you back to the [Index of all the States](#)

Nuclear Weapon Target Map for North Carolina (FEMA-196/September 1990)

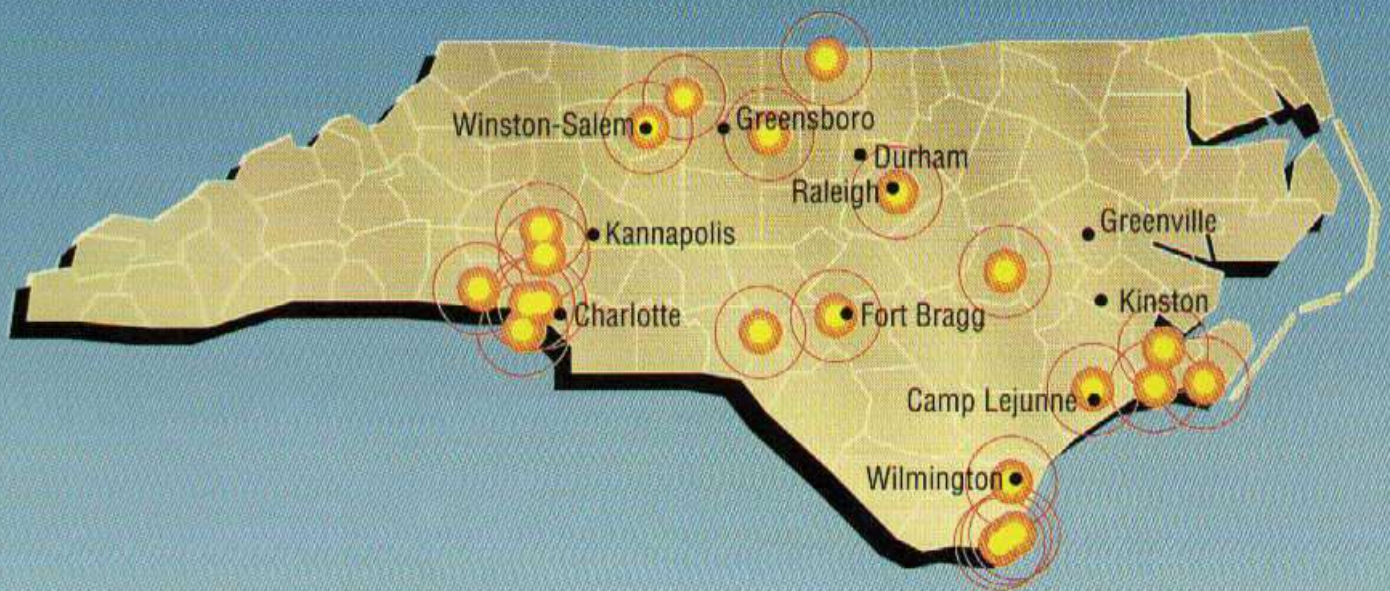

Nuclear Attack

Nuclear Attack



Red Ring (0.5 to 2 psi): Up to 25 percent casualties. Light damage to commercial-type buildings, severe damage to small residences.

Orange Area (2 to 5 psi): 50 percent casualties. Moderate damage to commercial-type buildings, severe damage to small residences.

Yellow Area (5 psi or more): Few survivors. Severe damage to total destruction of buildings.

Fallout

Fallout radiation is a potential hazard for all localities. See page 123 for more information.

[UPDATE to Target Information!!!](#)

Information for North Carolina

This link will take you back to the [Index of all the States](#)

It is recommended that you go through the following 10 steps in studying about the nuclear threat to North Carolina.

1. Look at the [State Map](#) above to see the target nuclear areas in North Carolina.
2. Look at the [general expected fallout map](#) to see where North Carolina (according to the **prevailing wind pattern**) gets fallout from other states.
3. If the state that you live in is anywhere EAST of any of the following 6 states in the **prevailing wind pattern** then look at the states in **RED** on the [INDEX of](#)

STATES for

- Montana
- North Dakota
- South Dakota
- Nebraska
- Missouri
- Colorado

These six states contain what is called DENSE PACK which I explain on each of those states pages. **UNDERSTAND** that the wind pattern **COULD** at that time be something other than the "prevailing" wind pattern.

4. Bookmark the present URL or make a copy of this present address so that you can come back to it after going to

[Blast Mapper.](#)

This mapper is on someone else's web site so that you will need to save this address in order to return here if your back button doesn't work. However, you want to be sure to go the mapper site and calculate the damage to probable targets (cities) around you.

5. Memorize the THREE top rules for survival. They are:

- Number One - **Get out of the cities!**
- Number Two - **Get out of the cities!**
- Number Three - **Get out of the cities!**

6. The follow-on rules are:

- a. Have a shelter
- b. Work with a group (you are going to need the manpower, brainpower, and skillpower).

- c. Stock supplies.

7. My [Main Survival Page](#) contains links to lots of other information such as free books to download about nuclear survival, links to plans for building shelters, and even free consultation about building a shelter.

8. If you are SUPER concerned about nuclear survival you might consider moving within 20 miles of the

[Ark Two Community](#)
(in Canada)

9. And finally if you would like to be on the mailing list of the author of this site - send a blank email to:

arktwo-request@deuce.pairowoodies.com
[with the subject as subscribe](#)

MENU: [HOME](#) » [SURVIVAL](#) » [Index of States](#)

Nuclear Survival in

North Dakota

This is the nuclear target map for North Dakota, but remember, fallout can go anywhere or everywhere (and probably will). After you have looked at this map look at the [Information for North Dakota](#) that follows it.

This link will take you back to the [Index of all the States](#)

***DENSE PACK** - Look at all those target sites. So close Together! It serves a purpose. It is missiles protecting missiles, and this is how it is done. These are "hardened" sites. Meaning it takes a direct ground explosion to dig them out. An air burst will not do it. When you have a ground explosion it throws many tons of dust and sand up into the air. High into the air. This is what will later become fallout carried by the winds hundreds, sometimes thousands, of miles away. But right over that site that has just been hit the sand and grit in the air is very thick for quite a while. Another high speed missile (ICBM) trying to come through it will have its skin torn off just like by sand blasting and it will be destroyed. So the other missile sites nearby are safe. On the other hand, because missiles take off much slower than the speeds they eventually reach, the missiles in the undamaged silos can still be launched and will pass through the dust cloud without be harmed. Neat, eh? See there is a purpose in putting so many in one place. Now the only way that you can dig them out is with what is called a slow walk. Hit a target. Move on further and hit another target where the dust from the first won't hurt you. Come back thirty or forty-five minutes later and hit a second target near where you hit the first, after the cloud has had time to blow away. A slow process. Some silos will already have launched and you will waste the shot. Others can still wait to launch later because you can only get one at a time. This could go on for days. Neat. The military missiles protecting missiles. But they don't protect you, because if you are downwind you will get the fallout. Fatal if you are not in a*

shelter. They call it Defense but it is only Destruction. Nothing here defends or protects you, if they are used.

Nuclear Weapon Target Map for North Dakota (FEMA-196/September 1990)

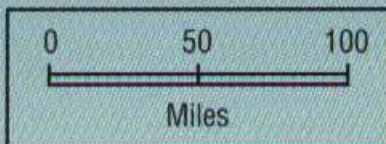
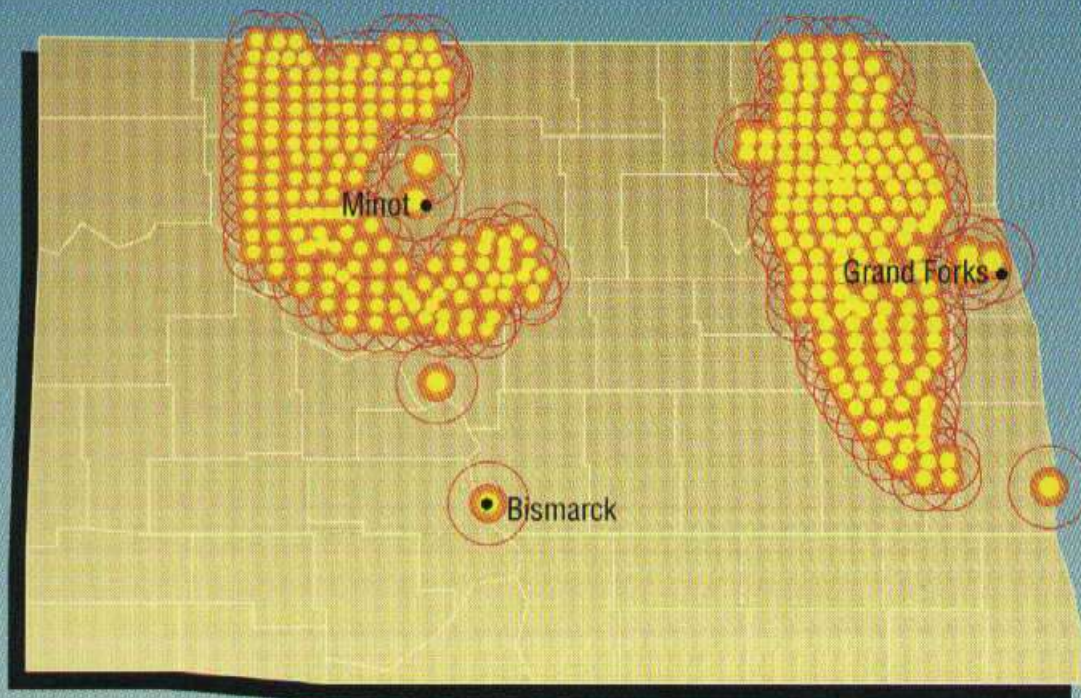

Nuclear Attack



Red Ring (0.5 to 2 psi): Up to 25 percent casualties. Light damage to commercial-type buildings, severe damage to small residences.

Orange Area (2 to 5 psi): 50 percent casualties. Moderate damage to commercial-type buildings, severe damage to small residences.

Yellow Area (5 psi or more): Few survivors. Severe damage to total destruction of buildings.

Fallout

Fallout radiation is a potential hazard for all localities.
See page 123 for more information.

[UPDATE to Target Information!!!](#)

Information for North Dakota

This link will take you back to the [Index of all the States](#)

It is recommended that you go through the following 10 steps in studying about the nuclear threat to North Dakota.

1. Look at the [State Map](#) above to see the target nuclear areas in North Dakota.
2. Look at the [general expected fallout map](#) to see where North Dakota (according to the **prevailing wind pattern**) gets fallout from other states.
3. If the state that you live in is anywhere EAST of any of the following 6 states in the **prevailing wind pattern** then look at the states in **RED** on the [INDEX of STATES](#) for

- **Montana**
- **North Dakota**
- **South Dakota**
 - **Nebraska**
 - **Missouri**
 - **Colorado**

These six states contain what is called DENSE PACK which I explain on each of

those states pages. **UNDERSTAND** that the wind pattern **COULD** at that time be something other than the "prevailing" wind pattern.

4. Bookmark the present URL or make a copy of this present address so that you can come back to it after going to

[Blast Mapper](#).

This mapper is on someone else's web site so that you will need to save this address in order to return here if your back button doesn't work. However, you want to be sure to go the mapper site and calculate the damage to probable targets (cities) around you.

5. Memorize the **THREE** top rules for survival. They are:

- Number One - **Get out of the cities!**
- Number Two - **Get out of the cities!**
- Number Three - **Get out of the cities!**

6. The follow-on rules are:

- a. Have a shelter
- b. Work with a group (you are going to need the manpower, brainpower, and skillpower).
- c. Stock supplies.

7. My [Main Survival Page](#) contains links to lots of other information such as free books to download about nuclear survival, links to plans for building shelters, and even free consultation about building a shelter.

8. If you are **SUPER** concerned about nuclear survival you might consider moving within 20 miles of the

[Ark Two Community](#)

(in Canada)

9. And finally if you would like to be on the mailing list of the author of this site - send a blank email to:

arktvo-request@deuce.pairowoodies.com
[with the subject as subscribe](#)

MENU: [HOME](#) » [SURVIVAL](#) » [Index of States](#)

Nuclear Survival in

Ohio

This is the nuclear target map for Ohio, but remember, fallout can go anywhere or everywhere (and probably will). After you have looked at this map look at the [Information for Ohio](#) that follows it.

This link will take you back to the [Index of all the States](#)

Nuclear Weapon Target Map for Ohio (FEMA-196/September 1990)

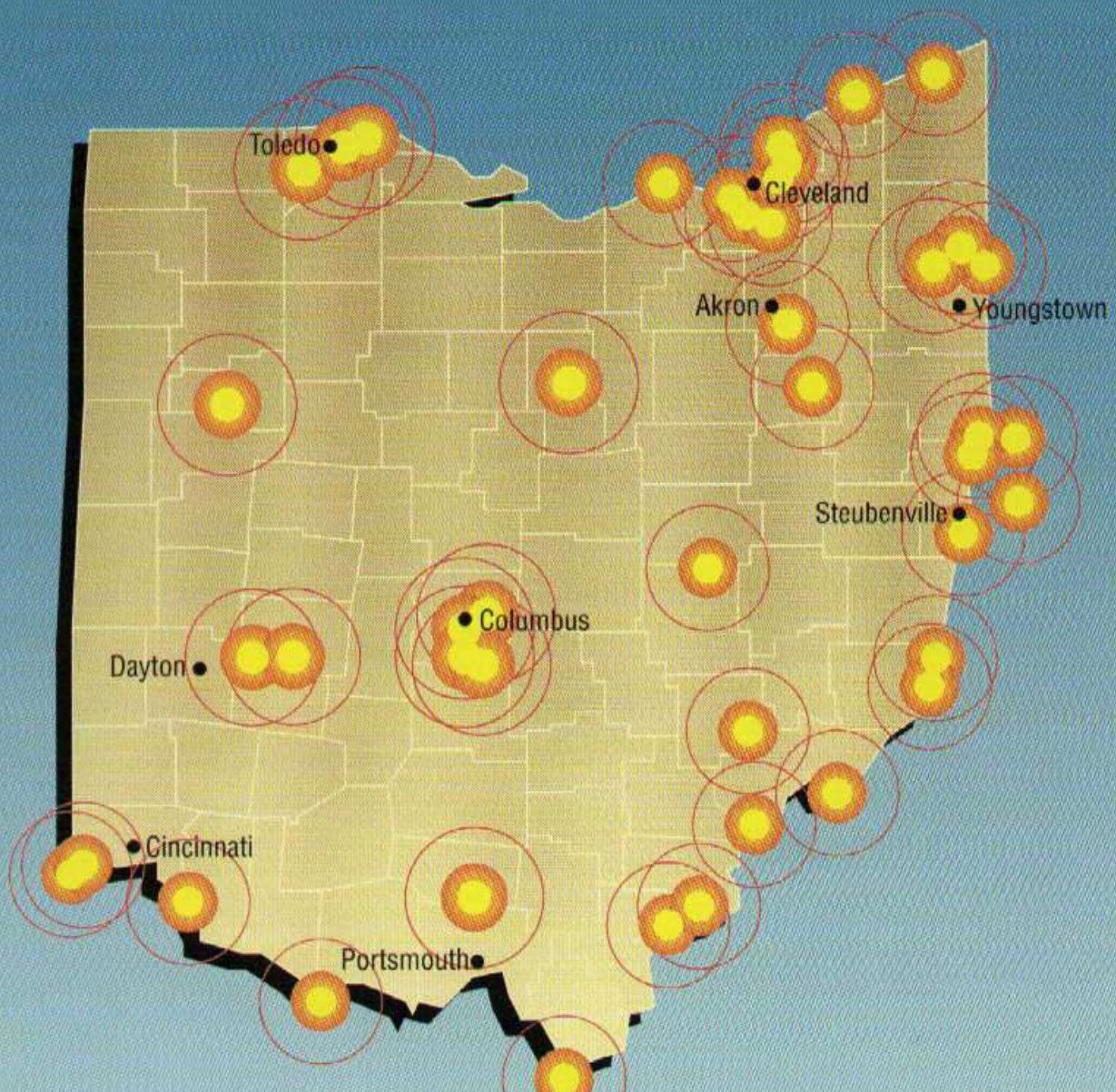

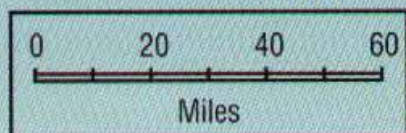

Nuclear Attack

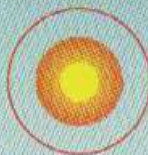

Red Ring (0.5 to 2 psi): Up to 25 percent casualties. Light damage to commercial-type buildings, severe damage to small residences.

Orange Area (2 to 5 psi): 50 percent casualties. Moderate damage to commercial-type buildings, severe damage to small residences.

Yellow Area (5 psi or more): Few survivors. Severe damage to total destruction of buildings.

Fallout

Fallout radiation is a potential hazard for all localities. See page 123 for more information.

[UPDATE to Target Information!!!](#)

Information for Ohio

This link will take you back to the [Index of all the States](#)

It is recommended that you go through the following 10 steps in studying about the nuclear threat to Ohio.

1. Look at the [State Map](#) above to see the target nuclear areas in Ohio.
2. Look at the [general expected fallout map](#) to see where Ohio (according to the **prevailing wind pattern**) gets fallout from other states.
3. If the state that you live in is anywhere EAST of any of the following 6 states in the **prevailing wind pattern** then look at the states in **RED** on the [INDEX of](#)

STATES for

- Montana
- North Dakota
- South Dakota
- Nebraska
- Missouri
- Colorado

These six states contain what is called DENSE PACK which I explain on each of those states pages. **UNDERSTAND** that the wind pattern **COULD** at that time be something other than the "prevailing" wind pattern.

4. Bookmark the present URL or make a copy of this present address so that you can come back to it after going to

[Blast Mapper](#).

This mapper is on someone else's web site so that you will need to save this address in order to return here if your back button doesn't work. However, you want to be sure to go the mapper site and calculate the damage to probable targets (cities) around you.

5. Memorize the THREE top rules for survival. They are:

- Number One - **Get out of the cities!**
- Number Two - **Get out of the cities!**
- Number Three - **Get out of the cities!**

6. The follow-on rules are:

- a. Have a shelter
- b. Work with a group (you are going to need the manpower, brainpower, and skillpower).

- c. Stock supplies.

7. My [Main Survival Page](#) contains links to lots of other information such as free books to download about nuclear survival, links to plans for building shelters, and even free consultation about building a shelter.

8. If you are SUPER concerned about nuclear survival you might consider moving within 20 miles of the

[Ark Two Community](#)
(in Canada)

9. And finally if you would like to be on the mailing list of the author of this site - send a blank email to:

arktwo-request@deuce.pairowoodies.com
[with the subject as subscribe](#)

MENU: [HOME](#) » [SURVIVAL](#) » [Index of States](#)

Nuclear Survival in **Oklahoma**

This is the nuclear target map for Oklahoma, but remember, fallout can go anywhere or everywhere (and probably will). After you have looked at this map look at the [Information for Oklahoma](#) that follows it.

This link will take you back to the [Index of all the States](#)

Nuclear Weapon Target Map for Oklahoma (FEMA-196/September 1990)

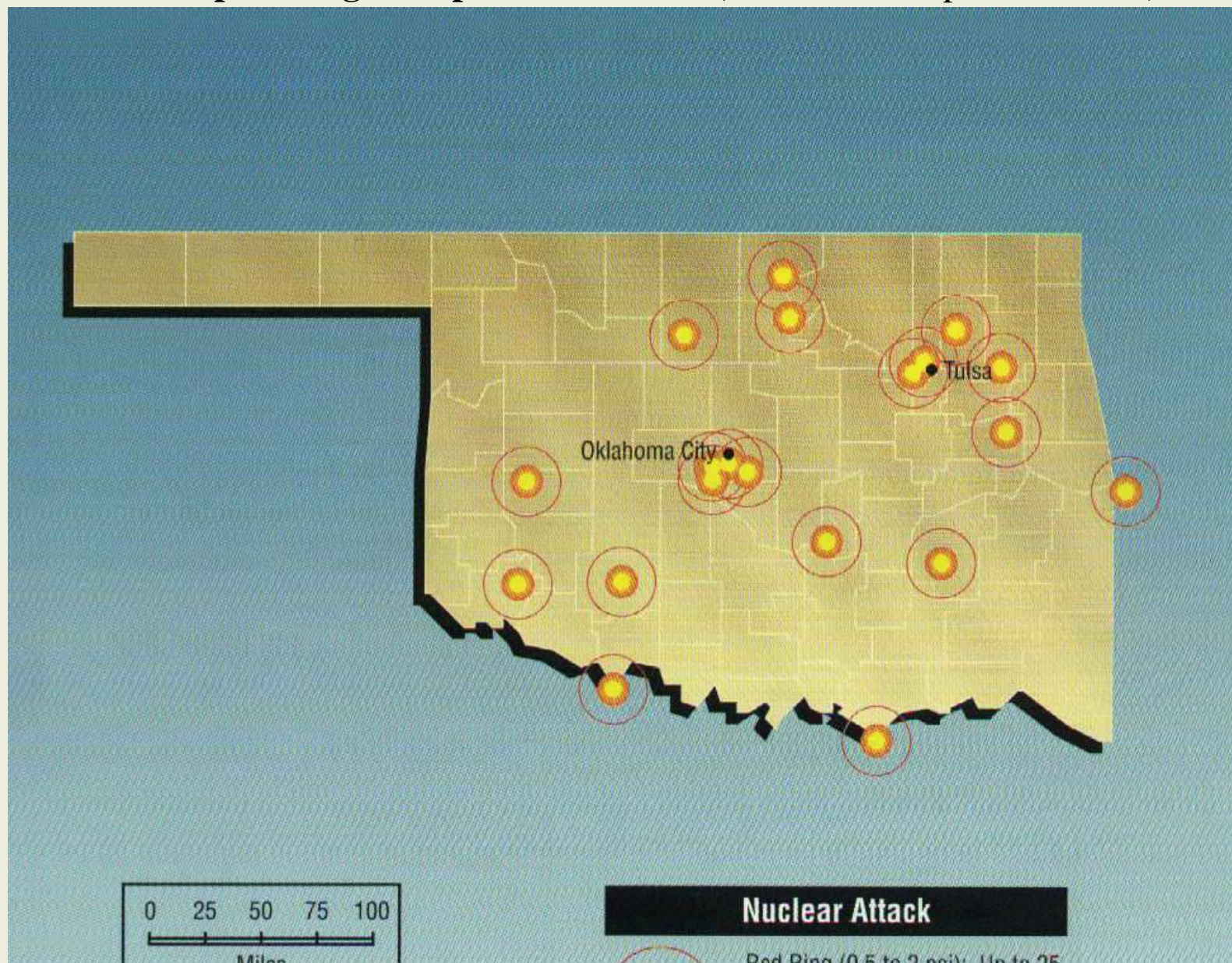

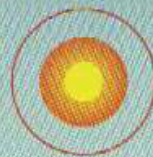
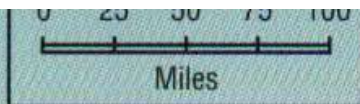

NUCLEAR ATTACK

Red Ring (0.5 to 2 psi): Up to 25 percent casualties. Light damage to commercial-type buildings, severe damage to small residences.

Orange Area (2 to 5 psi): 50 percent casualties. Moderate damage to commercial-type buildings, severe damage to small residences.

Yellow Area (5 psi or more): Few survivors. Severe damage to total destruction of buildings.

Fallout

Fallout radiation is a potential hazard for all localities. See page 123 for more information.

[UPDATE to Target Information!!!](#)

Information for Oklahoma

This link will take you back to the [Index of all the States](#)

It is recommended that you go through the following 10 steps in studying about the nuclear threat to Oklahoma.

1. Look at the [State Map](#) above to see the target nuclear areas in Oklahoma.
2. Look at the [general expected fallout map](#) to see where Oklahoma (according to the **prevailing wind pattern**) gets fallout from other states.
3. If the state that you live in is anywhere EAST of any of the following 6 states in the **prevailing wind pattern** then look at the states in **RED** on the [INDEX of](#)

STATES for

- Montana
- North Dakota
- South Dakota
- Nebraska
- Missouri
- Colorado

These six states contain what is called DENSE PACK which I explain on each of those states pages. **UNDERSTAND** that the wind pattern **COULD** at that time be something other than the "prevailing" wind pattern.

4. Bookmark the present URL or make a copy of this present address so that you can come back to it after going to

[Blast Mapper.](#)

This mapper is on someone else's web site so that you will need to save this address in order to return here if your back button doesn't work. However, you want to be sure to go the mapper site and calculate the damage to probable targets (cities) around you.

5. Memorize the THREE top rules for survival. They are:

- Number One - **Get out of the cities!**
- Number Two - **Get out of the cities!**
- Number Three - **Get out of the cities!**

6. The follow-on rules are:

- a. Have a shelter
- b. Work with a group (you are going to need the manpower, brainpower, and skillpower).

- c. Stock supplies.

7. My [Main Survival Page](#) contains links to lots of other information such as free books to download about nuclear survival, links to plans for building shelters, and even free consultation about building a shelter.

8. If you are SUPER concerned about nuclear survival you might consider moving within 20 miles of the

[Ark Two Community](#)
(in Canada)

9. And finally if you would like to be on the mailing list of the author of this site - send a blank email to:

arktwo-request@deuce.pairowoodies.com
[with the subject as subscribe](#)

MENU: [HOME](#) » [SURVIVAL](#) » [Index of States](#)

Nuclear Survival in **Oregon**

This is the nuclear target map for Oregon, but remember, fallout can go anywhere or everywhere (and probably will). After you have looked at this map look at the [Information for Oregon](#) that follows it.

This link will take you back to the [Index of all the States](#)

Nuclear Weapon Target Map for Oregon (FEMA-196/September 1990)

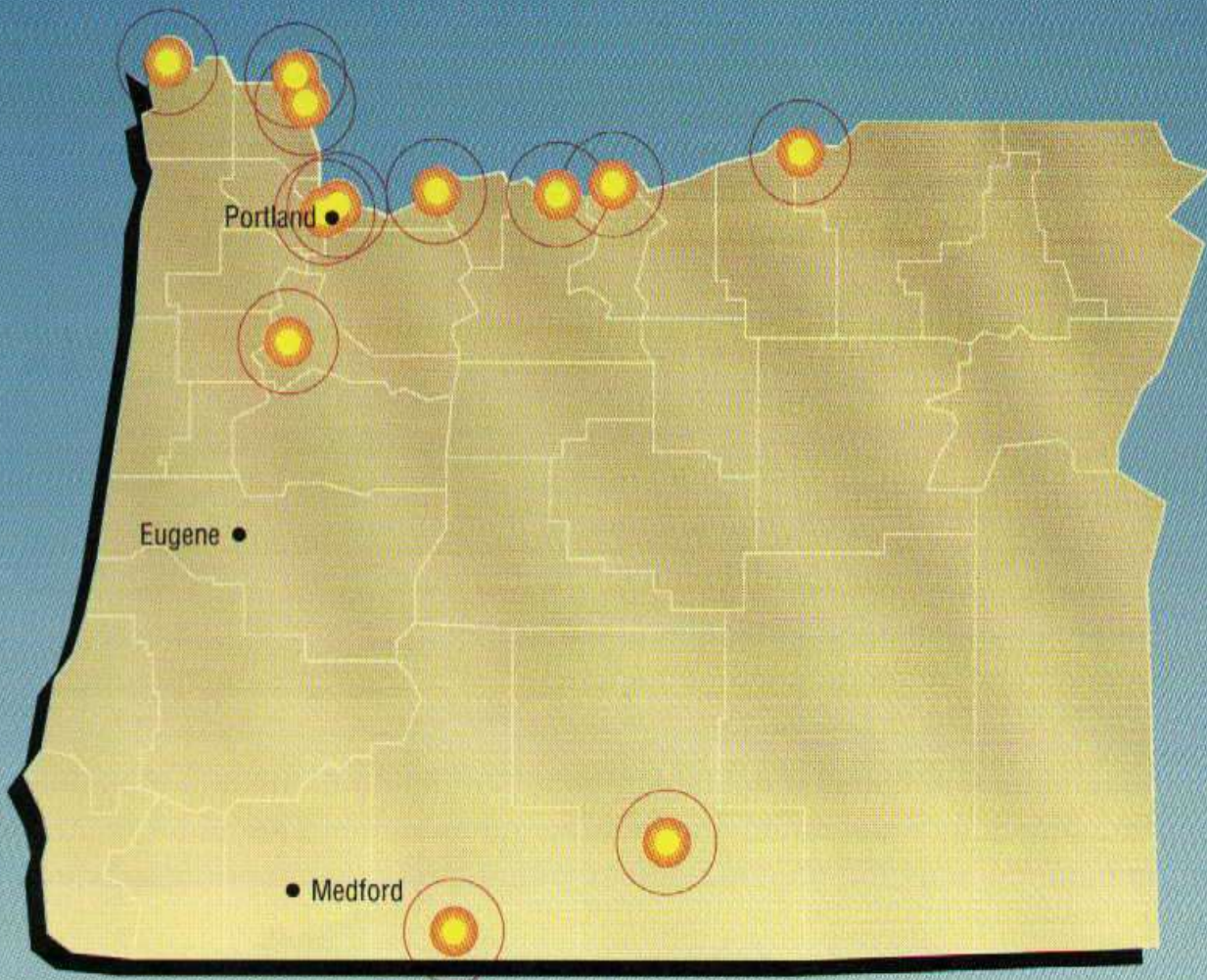

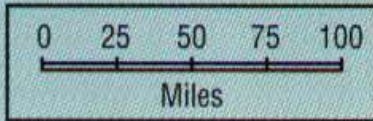

Nuclear Attack



Red Ring (0.5 to 2 psi): Up to 25 percent casualties. Light damage to commercial-type buildings, severe damage to small residences.

Orange Area (2 to 5 psi): 50 percent casualties. Moderate damage to commercial-type buildings, severe damage to small residences.

Yellow Area (5 psi or more): Few survivors. Severe damage to total destruction of buildings.

Fallout

Fallout radiation is a potential hazard for all localities. See page 123 for more information.

[UPDATE to Target Information!!!](#)

Information for Oregon

This link will take you back to the [Index of all the States](#)

It is recommended that you go through the following 10 steps in studying about the nuclear threat to Oregon.

1. Look at the [State Map](#) above to see the target nuclear areas in Oregon.
2. Look at the [general expected fallout map](#) to see where Oregon (according to the **prevailing wind pattern**) gets fallout from other states.
3. If the state that you live in is anywhere EAST of any of the following 6 states in the **prevailing wind pattern** then look at the states in **RED** on the [INDEX of](#)

STATES for

- Montana
- North Dakota
- South Dakota
- Nebraska
- Missouri
- Colorado

These six states contain what is called DENSE PACK which I explain on each of those states pages. **UNDERSTAND** that the wind pattern **COULD** at that time be something other than the "prevailing" wind pattern.

4. Bookmark the present URL or make a copy of this present address so that you can come back to it after going to

[Blast Mapper](#).

This mapper is on someone else's web site so that you will need to save this address in order to return here if your back button doesn't work. However, you want to be sure to go the mapper site and calculate the damage to probable targets (cities) around you.

5. Memorize the THREE top rules for survival. They are:

- Number One - **Get out of the cities!**
- Number Two - **Get out of the cities!**
- Number Three - **Get out of the cities!**

6. The follow-on rules are:

- a. Have a shelter
- b. Work with a group (you are going to need the manpower, brainpower, and skillpower).

- c. Stock supplies.

7. My [Main Survival Page](#) contains links to lots of other information such as free books to download about nuclear survival, links to plans for building shelters, and even free consultation about building a shelter.

8. If you are SUPER concerned about nuclear survival you might consider moving within 20 miles of the

[Ark Two Community](#)
(in Canada)

9. And finally if you would like to be on the mailing list of the author of this site - send a blank email to:

arktwo-request@deuce.pairowoodies.com
[with the subject as subscribe](#)

MENU: [HOME](#) » [SURVIVAL](#) » [Index of States](#)

Nuclear Survival in **Pennsylvania**

This is the nuclear target map for Pennsylvania, but remember, fallout can go anywhere or everywhere (and probably will). After you have looked at this map look at the [Information for Pennsylvania](#) that follows it.

This link will take you back to the [Index of all the States](#)

Nuclear Weapon Target Map for Pennsylvania (FEMA-196/September 1990)

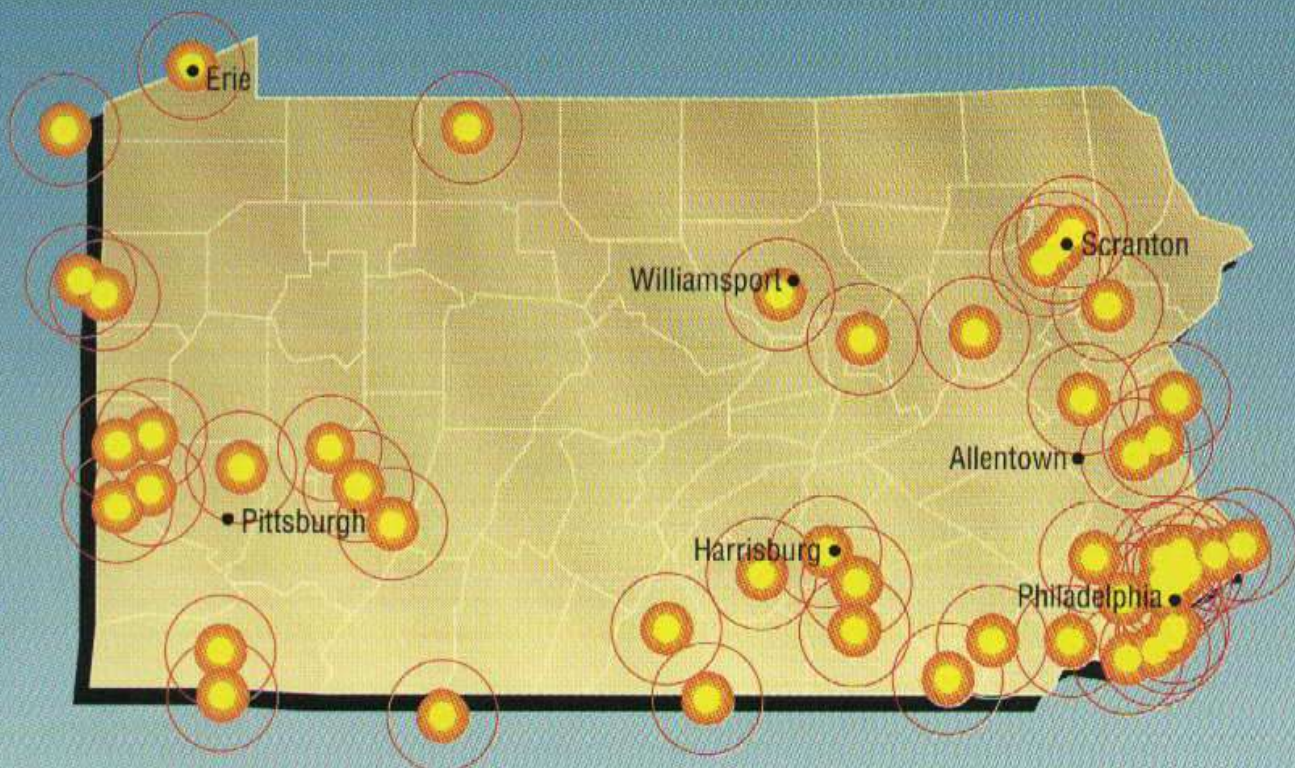

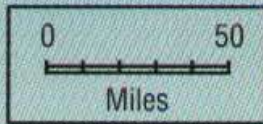

Nuclear Attack



Red Ring (0.5 to 2 psi): Up to 25 percent casualties. Light damage to commercial-type buildings, severe damage to small residences.

Orange Area (2 to 5 psi): 50 percent casualties. Moderate damage to commercial-type buildings, severe damage to small residences.

Yellow Area (5 psi or more): Few survivors. Severe damage to total destruction of buildings.

Fallout

Fallout radiation is a potential hazard for all localities. See page 123 for more information.

[UPDATE to Target Information!!!](#)

Information for Pennsylvania

This link will take you back to the [Index of all the States](#)

It is recommended that you go through the following 10 steps in studying about the nuclear threat to Pennsylvania.

1. Look at the [State Map](#) above to see the target nuclear areas in Pennsylvania.
2. Look at the [general expected fallout map](#) to see where Pennsylvania (according to the **prevailing wind pattern**) gets fallout from other states.
3. If the state that you live in is anywhere EAST of any of the following 6 states in the **prevailing wind pattern** then look at the states in **RED** on the [INDEX of](#)

STATES for

- Montana
- North Dakota
- South Dakota
- Nebraska
- Missouri
- Colorado

These six states contain what is called DENSE PACK which I explain on each of those states pages. **UNDERSTAND** that the wind pattern **COULD** at that time be something other than the "prevailing" wind pattern.

4. Bookmark the present URL or make a copy of this present address so that you can come back to it after going to

[Blast Mapper](#).

This mapper is on someone else's web site so that you will need to save this address in order to return here if your back button doesn't work. However, you want to be sure to go the mapper site and calculate the damage to probable targets (cities) around you.

5. Memorize the THREE top rules for survival. They are:

- Number One - **Get out of the cities!**
- Number Two - **Get out of the cities!**
- Number Three - **Get out of the cities!**

6. The follow-on rules are:

- a. Have a shelter
- b. Work with a group (you are going to need the manpower, brainpower, and skillpower).

- c. Stock supplies.

7. My [Main Survival Page](#) contains links to lots of other information such as free books to download about nuclear survival, links to plans for building shelters, and even free consultation about building a shelter.

8. If you are SUPER concerned about nuclear survival you might consider moving within 20 miles of the

[Ark Two Community](#)
(in Canada)

9. And finally if you would like to be on the mailing list of the author of this site - send a blank email to:

arktwo-request@deuce.pairowoodies.com
[with the subject as subscribe](#)

MENU: [HOME](#) » [SURVIVAL](#) » [Index of States](#)

Nuclear Survival in

Rhode Island

This is the nuclear target map for Rhode Island, but remember, fallout can go anywhere or everywhere (and probably will). After you have looked at this map look at the [Information for Rhode Island](#) that follows it.

This link will take you back to the [Index of all the States](#)

Nuclear Weapon Target Map for Rhode Island (FEMA-196/September 1990)

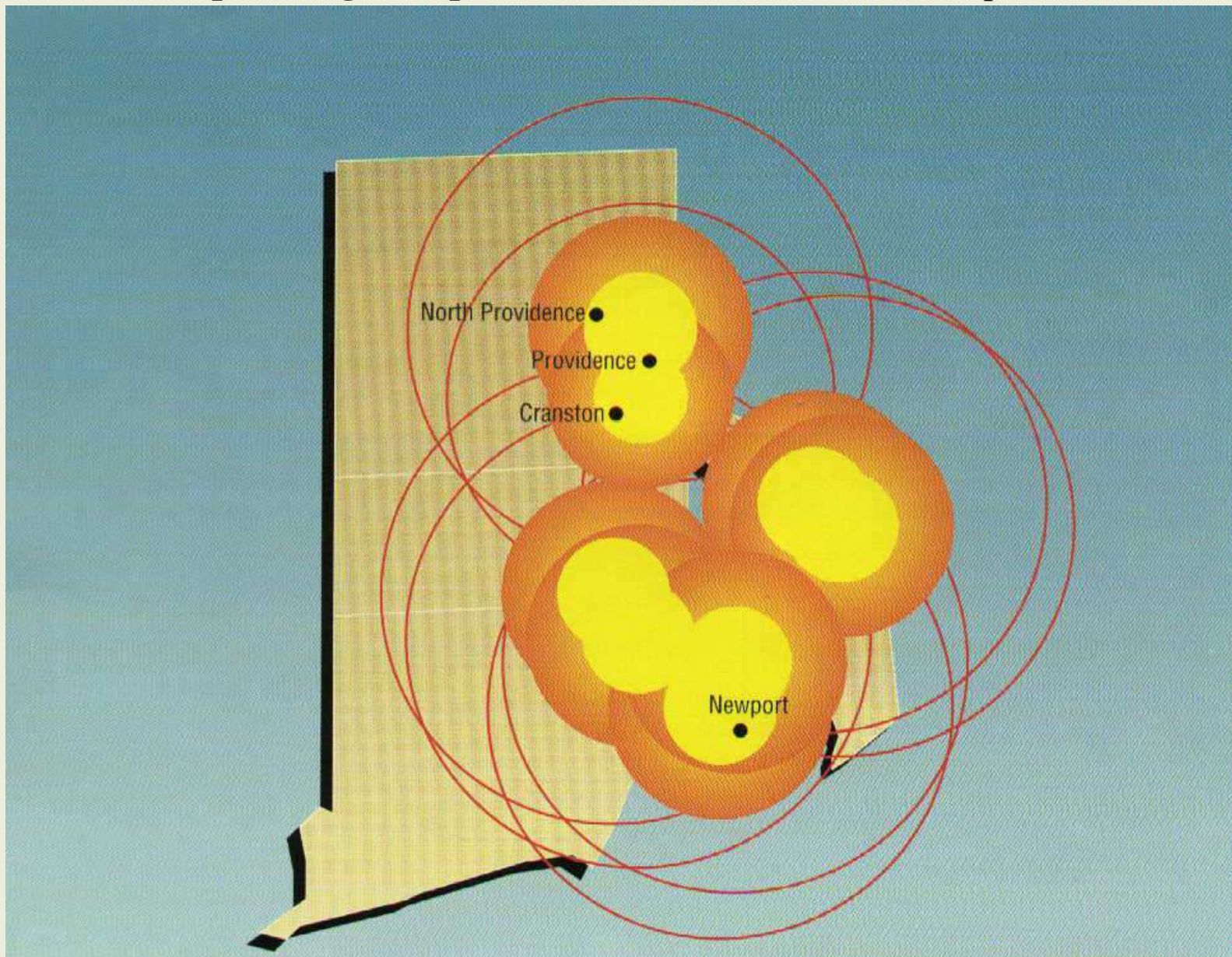

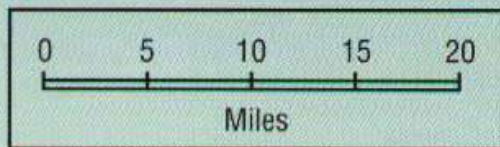

Nuclear Attack



Red Ring (0.5 to 2 psi): Up to 25 percent casualties. Light damage to commercial-type buildings, severe damage to small residences.

Orange Area (2 to 5 psi): 50 percent casualties. Moderate damage to commercial-type buildings, severe damage to small residences.

Yellow Area (5 psi or more): Few survivors. Severe damage to total destruction of buildings.

Fallout

Fallout radiation is a potential hazard for all localities. See page 123 for more information.

[UPDATE to Target Information!!!](#)

Information for Rhode Island

This link will take you back to the [Index of all the States](#)

It is recommended that you go through the following 10 steps in studying about the nuclear threat to Rhode Island.

1. Look at the [State Map](#) above to see the target nuclear areas in Rhode Island.
2. Look at the [general expected fallout map](#) to see where Rhode Island (according to the **prevailing wind pattern**) gets fallout from other states.
3. If the state that you live in is anywhere EAST of any of the following 6 states in the **prevailing wind pattern** then look at the states in **RED** on the [INDEX of](#)

STATES for

- Montana
- North Dakota
- South Dakota
- Nebraska
- Missouri
- Colorado

These six states contain what is called DENSE PACK which I explain on each of those states pages. **UNDERSTAND** that the wind pattern **COULD** at that time be something other than the "prevailing" wind pattern.

4. Bookmark the present URL or make a copy of this present address so that you can come back to it after going to

[Blast Mapper.](#)

This mapper is on someone else's web site so that you will need to save this address in order to return here if your back button doesn't work. However, you want to be sure to go the mapper site and calculate the damage to probable targets (cities) around you.

5. Memorize the THREE top rules for survival. They are:

- Number One - **Get out of the cities!**
- Number Two - **Get out of the cities!**
- Number Three - **Get out of the cities!**

6. The follow-on rules are:

- a. Have a shelter
- b. Work with a group (you are going to need the manpower, brainpower, and skillpower).

- c. Stock supplies.

7. My [Main Survival Page](#) contains links to lots of other information such as free books to download about nuclear survival, links to plans for building shelters, and even free consultation about building a shelter.

8. If you are SUPER concerned about nuclear survival you might consider moving within 20 miles of the

[Ark Two Community](#)
(in Canada)

9. And finally if you would like to be on the mailing list of the author of this site - send a blank email to:

arktwo-request@deuce.pairowoodies.com
[with the subject as subscribe](#)

MENU: [HOME](#) » [SURVIVAL](#) » [Index of States](#)

Nuclear Survival in **South Carolina**

This is the nuclear target map for South Carolina, but remember, fallout can go anywhere or everywhere (and probably will). After you have looked at this map look at the [Information for South Carolina](#) that follows it.

This link will take you back to the [Index of all the States](#)

Nuclear Weapon Target Map for South Carolina (FEMA-196/September 1990)

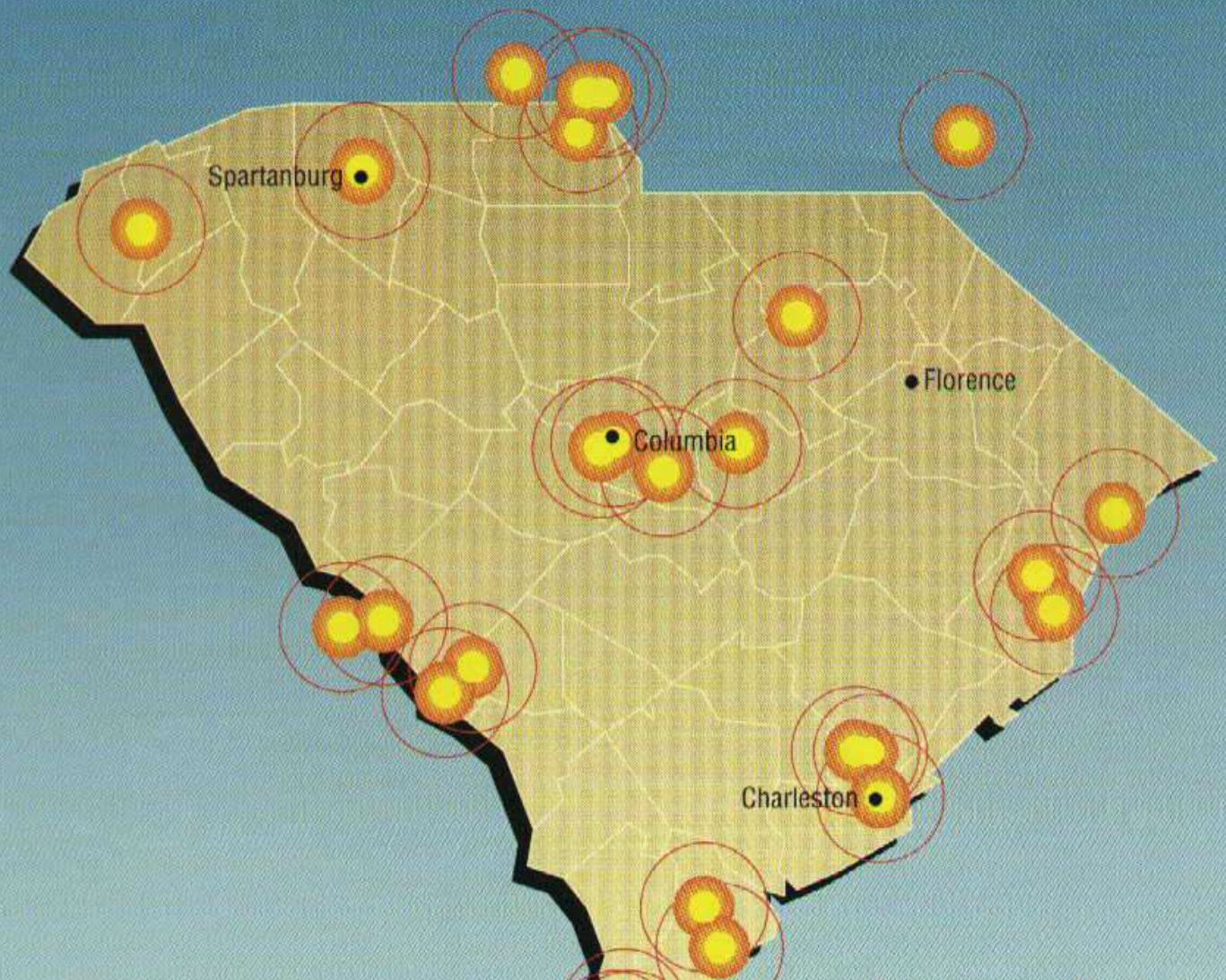

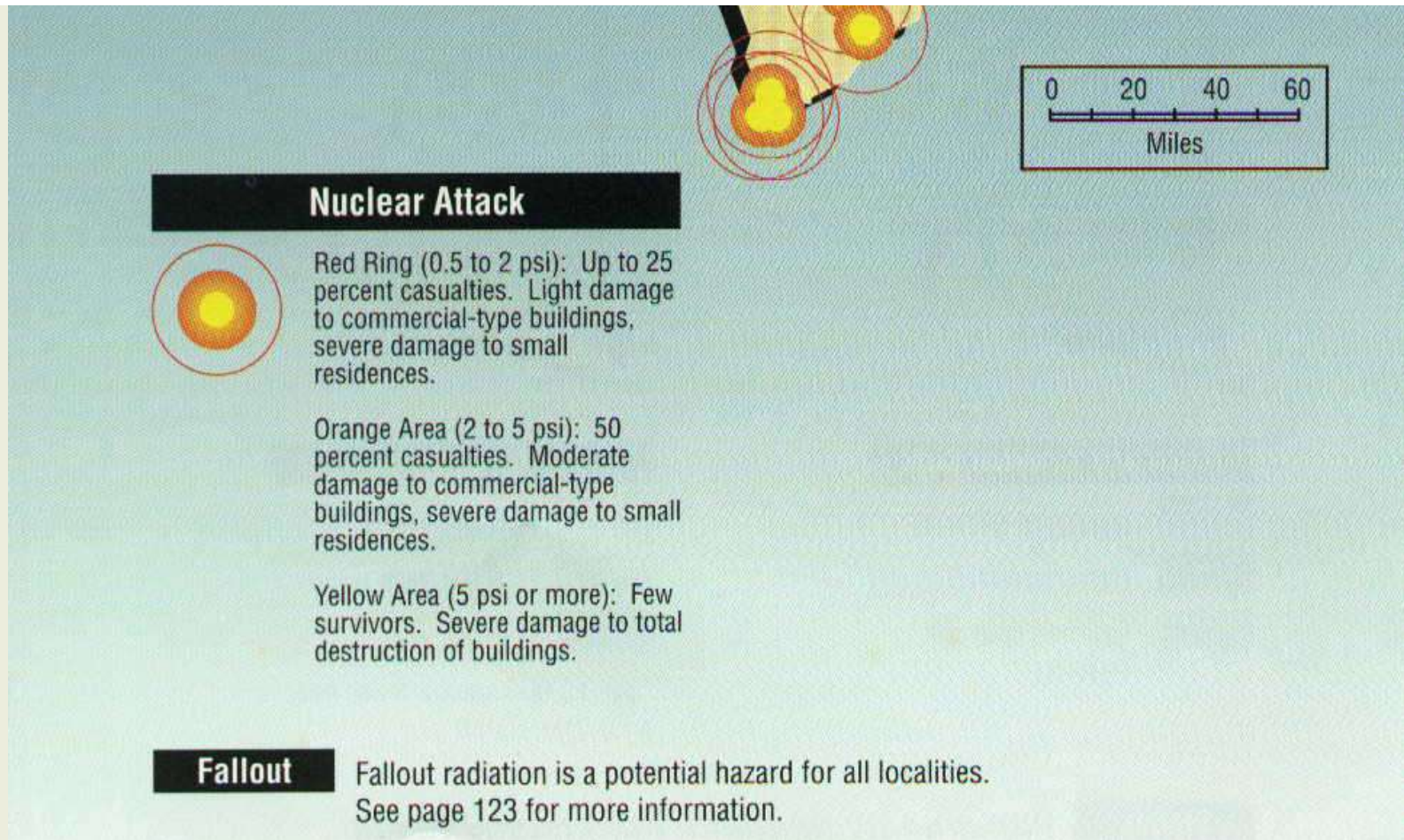

[UPDATE to Target Information!!!](#)

Information for South Carolina

This link will take you back to the [Index of all the States](#)

It is recommended that you go through the following 10 steps in studying about the nuclear threat to South Carolina.

1. Look at the [State Map](#) above to see the target nuclear areas in South Carolina.
2. Look at the [general expected fallout map](#) to see where South Carolina (according to the **prevailing wind pattern**) gets fallout from other states.
3. If the state that you live in is anywhere EAST of any of the following 6 states in the **prevailing wind pattern** then look at the states in **RED** on the [INDEX of](#)

STATES for

- Montana
- North Dakota
- South Dakota
- Nebraska
- Missouri
- Colorado

These six states contain what is called DENSE PACK which I explain on each of those states pages. **UNDERSTAND** that the wind pattern **COULD** at that time be something other than the "prevailing" wind pattern.

4. Bookmark the present URL or make a copy of this present address so that you can come back to it after going to

[Blast Mapper](#).

This mapper is on someone else's web site so that you will need to save this address in order to return here if your back button doesn't work. However, you want to be sure to go the mapper site and calculate the damage to probable targets (cities) around you.

5. Memorize the THREE top rules for survival. They are:

- Number One - **Get out of the cities!**
- Number Two - **Get out of the cities!**
- Number Three - **Get out of the cities!**

6. The follow-on rules are:

- a. Have a shelter
- b. Work with a group (you are going to need the manpower, brainpower, and skillpower).

- c. Stock supplies.

7. My [Main Survival Page](#) contains links to lots of other information such as free books to download about nuclear survival, links to plans for building shelters, and even free consultation about building a shelter.

8. If you are SUPER concerned about nuclear survival you might consider moving within 20 miles of the

[Ark Two Community](#)
(in Canada)

9. And finally if you would like to be on the mailing list of the author of this site - send a blank email to:

arktwo-request@deuce.pairowoodies.com
[with the subject as subscribe](#)

MENU: [HOME](#) » [SURVIVAL](#) » [Index of States](#)

Nuclear Survival in

South Dakota

This is the nuclear target map for South Dakota, but remember, fallout can go anywhere or everywhere (and probably will). After you have looked at this map look at the [Information for South Dakota](#) that follows it.

***DENSE PACK** - Look at all those target sites. So close Together! It serves a purpose. It is missiles protecting missiles, and this is how it is done. These are "hardened" sites. Meaning it takes a direct ground explosion to dig them out. An air burst will not do it. When you have a ground explosion it throws many tons of dust and sand up into the air. High into the air. This is what will later become fallout carried by the winds hundreds, sometimes thousands, of miles away. But right over that site that has just been hit the sand and grit in the air is very thick for quite a while. Another high speed missile (ICBM) trying to come through it will have its skin torn off just like by sand blasting and it will be destroyed. So the other missile sites nearby are safe. On the other hand, because missiles take off much slower than the speeds they eventually reach, the missiles in the undamaged silos can still be launched and will pass through the dust cloud without be harmed. Neat, eh? See there is a purpose in putting so many in one place. Now the only way that you can dig them out is with what is called a slow walk. Hit a target. Move on further and hit another target where the dust from the first won't hurt you. Come back thirty or forty-five minutes later and hit a second target near where you hit the first, after the cloud has had time to blow away. A slow process. Some silos will already have launched and you will waste the shot. Others can still wait to launch later because you can only get one at a time. This could go on for days. Neat. The military missiles protecting missiles. But they don't protect you, because if you are downwind you will get the fallout. Fatal if you are not in a shelter. They call it Defense but it is only Destruction. Nothing here defends or protects you, if they are used.*

This link will take you back to the [Index of all the States](#)

Nuclear Weapon Target Map for South Dakota (FEMA-196/September 1990)

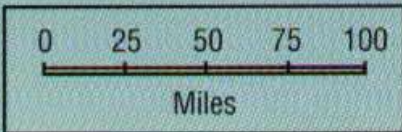
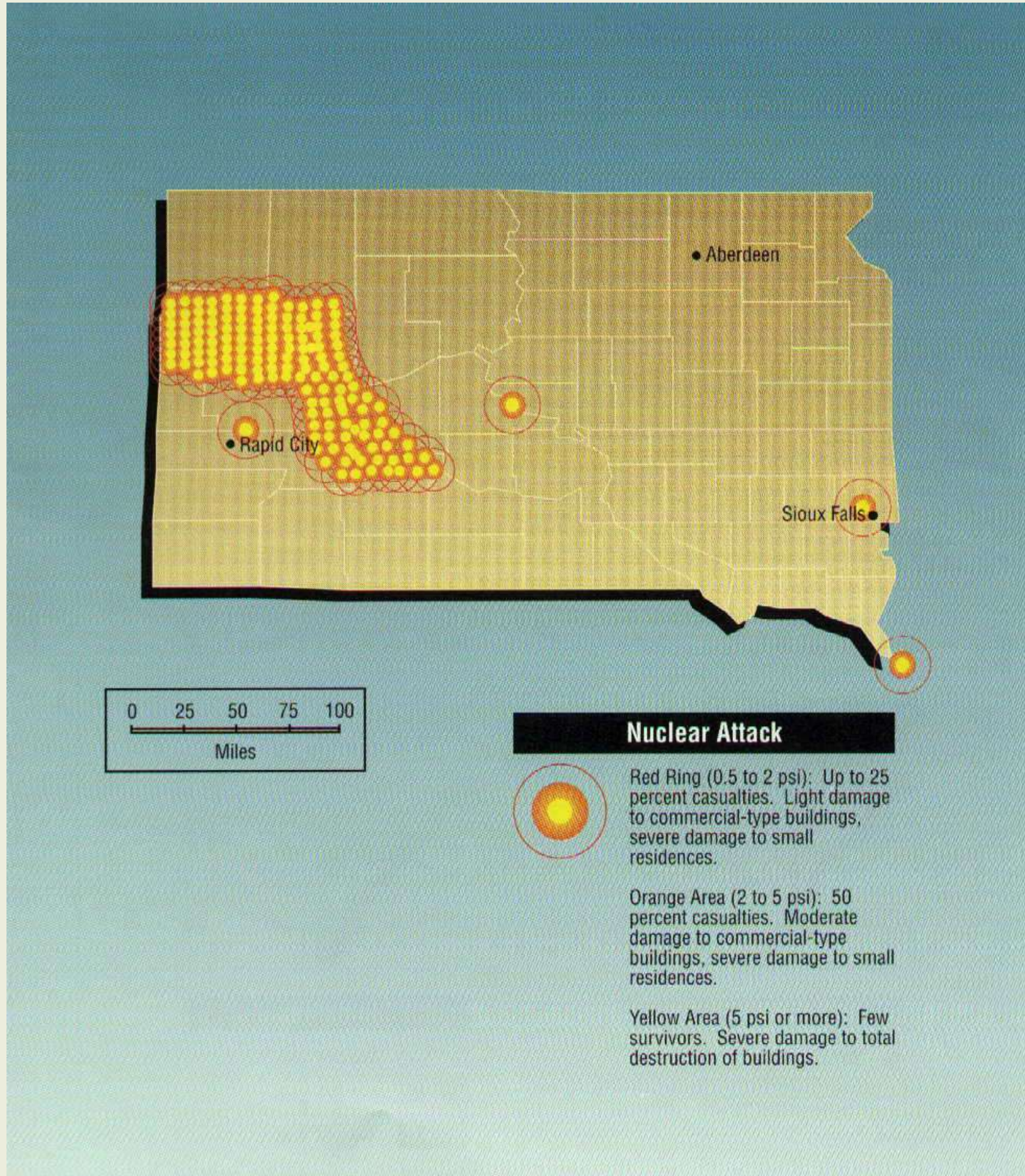

Nuclear Attack



Red Ring (0.5 to 2 psi): Up to 25 percent casualties. Light damage to commercial-type buildings, severe damage to small residences.

Orange Area (2 to 5 psi): 50 percent casualties. Moderate damage to commercial-type buildings, severe damage to small residences.

Yellow Area (5 psi or more): Few survivors. Severe damage to total destruction of buildings.

Fallout

Fallout radiation is a potential hazard for all localities.
See page 123 for more information.

[UPDATE to Target Information!!!](#)

Information for South Dakota

This link will take you back to the [Index of all the States](#)

It is recommended that you go through the following 10 steps in studying about the nuclear threat to South Dakota.

1. Look at the [State Map](#) above to see the target nuclear areas in South Dakota.
2. Look at the [general expected fallout map](#) to see where South Dakota (according to the **prevailing wind pattern**) gets fallout from other states.
3. If the state that you live in is anywhere EAST of any of the following 6 states in the **prevailing wind pattern** then look at the states in **RED** on the [INDEX of STATES](#) for

- **Montana**
- **North Dakota**
- **South Dakota**
- **Nebraska**
- **Missouri**
- **Colorado**

These six states contain what is called DENSE PACK which I explain on each of those states pages. **UNDERSTAND** that the wind pattern **COULD** at that time be

something other than the "prevailing" wind pattern.

4. Bookmark the present URL or make a copy of this present address so that you can come back to it after going to

[Blast Mapper](#).

This mapper is on someone else's web site so that you will need to save this address in order to return here if your back button doesn't work. However, you want to be sure to go the mapper site and calculate the damage to probable targets (cities) around you.

5. Memorize the THREE top rules for survival. They are:

- Number One - **Get out of the cities!**
- Number Two - **Get out of the cities!**
- Number Three - **Get out of the cities!**

6. The follow-on rules are:

- a. Have a shelter
- b. Work with a group (you are going to need the manpower, brainpower, and skillpower).
- c. Stock supplies.

7. My [Main Survival Page](#) contains links to lots of other information such as free books to download about nuclear survival, links to plans for building shelters, and even free consultation about building a shelter.

8. If you are SUPER concerned about nuclear survival you might consider moving within 20 miles of the

[Ark Two Community](#)
(in Canada)

9. And finally if you would like to be on the mailing list of the author of this site - send a blank email to:

arktwo-request@deuce.pairowoodies.com
with the subject as subscribe

MENU: [HOME](#) » [SURVIVAL](#) » [Index of States](#)

Nuclear Survival in **Tennessee**

This is the nuclear target map for Tennessee, but remember, fallout can go anywhere or everywhere (and probably will). After you have looked at this map look at the [Information for Tennessee](#) that follows it.

This link will take you back to the [Index of all the States](#)

Nuclear Weapon Target Map for Tennessee (FEMA-196/September 1990)

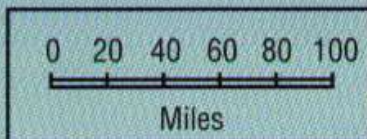
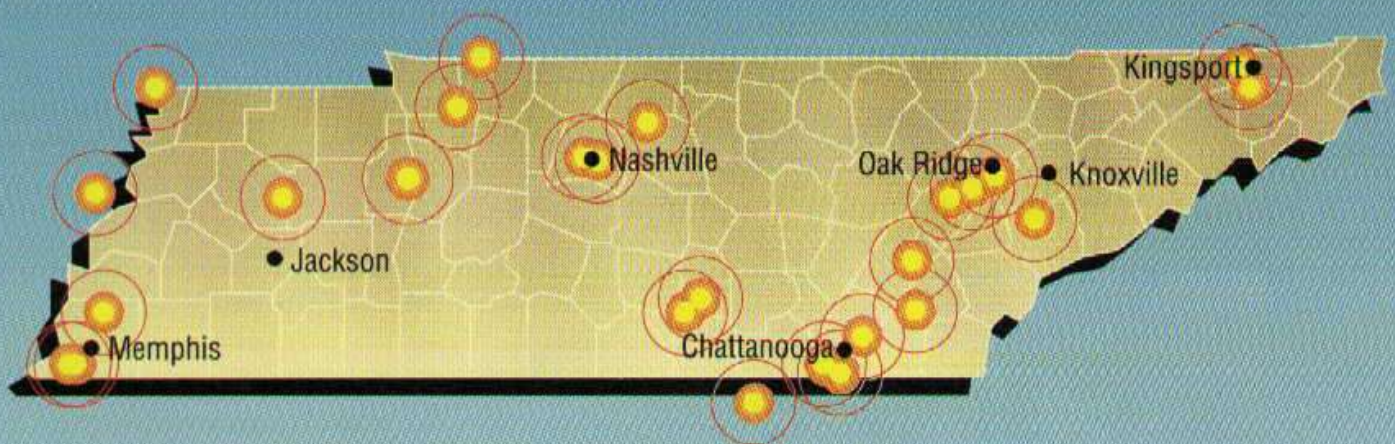

Nuclear Attack

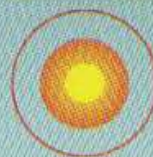

Red Ring (0.5 to 2 psi): Up to 25 percent casualties. Light damage to commercial-type buildings, severe damage to small residences.

to commercial-type buildings,
severe damage to small
residences.

Orange Area (2 to 5 psi): 50
percent casualties. Moderate
damage to commercial-type
buildings, severe damage to small
residences.

Yellow Area (5 psi or more): Few
survivors. Severe damage to total
destruction of buildings.

Fallout

Fallout radiation is a potential hazard for all localities.
See page 123 for more information.

[UPDATE to Target Information!!!](#)

Information for Tennessee

This link will take you back to the [Index of all the States](#)

It is recommended that you go through the following 10 steps in studying about the nuclear threat to Tennessee.

1. Look at the [State Map](#) above to see the target nuclear areas in Tennessee.
2. Look at the [general expected fallout map](#) to see where Tennessee (according to the **prevailing wind pattern**) gets fallout from other states.
3. If the state that you live in is anywhere EAST of any of the following 6 states in the **prevailing wind pattern** then look at the states in **RED** on the [INDEX of](#)

STATES for

- Montana
- North Dakota
- South Dakota
- Nebraska
- Missouri
- Colorado

These six states contain what is called DENSE PACK which I explain on each of those states pages. **UNDERSTAND** that the wind pattern **COULD** at that time be something other than the "prevailing" wind pattern.

4. Bookmark the present URL or make a copy of this present address so that you can come back to it after going to

[Blast Mapper](#).

This mapper is on someone else's web site so that you will need to save this address in order to return here if your back button doesn't work. However, you want to be sure to go the mapper site and calculate the damage to probable targets (cities) around you.

5. Memorize the THREE top rules for survival. They are:

- Number One - **Get out of the cities!**
- Number Two - **Get out of the cities!**
- Number Three - **Get out of the cities!**

6. The follow-on rules are:

- a. Have a shelter
- b. Work with a group (you are going to need the manpower, brainpower, and skillpower).

- c. Stock supplies.

7. My [Main Survival Page](#) contains links to lots of other information such as free books to download about nuclear survival, links to plans for building shelters, and even free consultation about building a shelter.

8. If you are SUPER concerned about nuclear survival you might consider moving within 20 miles of the

[Ark Two Community](#)
(in Canada)

9. And finally if you would like to be on the mailing list of the author of this site - send a blank email to:

arktwo-request@deuce.pairowoodies.com
[with the subject as subscribe](#)

MENU: [HOME](#) » [SURVIVAL](#) » [Index of States](#)

Nuclear Survival in

Texas

This is the nuclear target map for Texas, but remember, fallout can go anywhere or everywhere (and probably will). After you have looked at this map look at the [Information for Texas](#) that follows it.

This link will take you back to the [Index of all the States](#)

Nuclear Weapon Target Map for Texas (FEMA-196/September 1990)

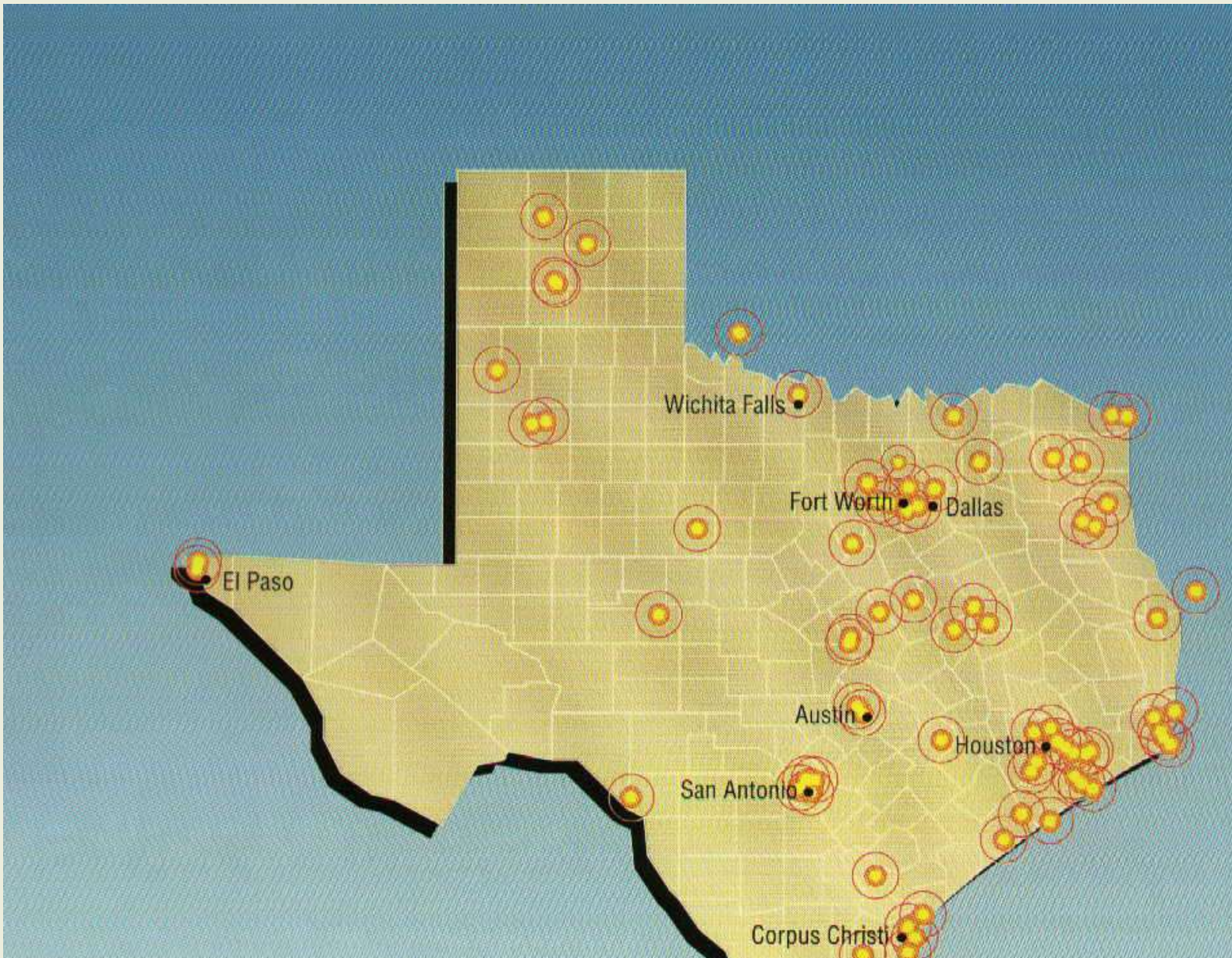

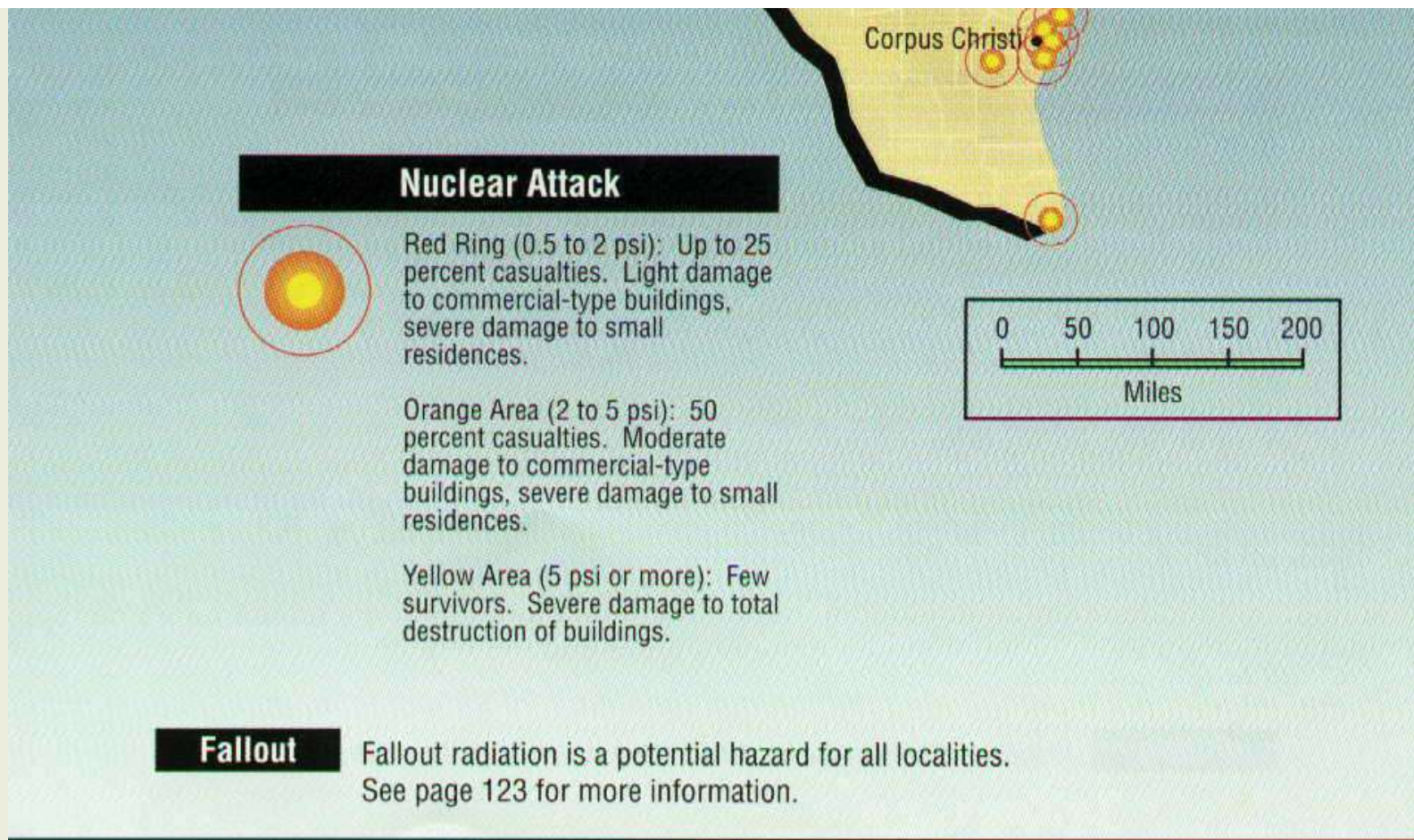

[UPDATE to Target Information!!!](#)

Information for Texas

This link will take you back to the [Index of all the States](#)

It is recommended that you go through the following 10 steps in studying about the nuclear threat to Texas.

1. Look at the [State Map](#) above to see the target nuclear areas in Texas.
2. Look at the [general expected fallout map](#) to see where Texas (according to the **prevailing wind pattern**) gets fallout from other states.
3. If the state that you live in is anywhere EAST of any of the following 6 states in the **prevailing wind pattern** then look at the states in **RED** on the [INDEX of](#)

STATES for

- Montana
- North Dakota
- South Dakota
- Nebraska
- Missouri
- Colorado

These six states contain what is called DENSE PACK which I explain on each of those states pages. **UNDERSTAND** that the wind pattern **COULD** at that time be something other than the "prevailing" wind pattern.

4. Bookmark the present URL or make a copy of this present address so that you can come back to it after going to

[Blast Mapper](#).

This mapper is on someone else's web site so that you will need to save this address in order to return here if your back button doesn't work. However, you want to be sure to go the mapper site and calculate the damage to probable targets (cities) around you.

5. Memorize the THREE top rules for survival. They are:

- Number One - **Get out of the cities!**
- Number Two - **Get out of the cities!**
- Number Three - **Get out of the cities!**

6. The follow-on rules are:

- a. Have a shelter
- b. Work with a group (you are going to need the manpower, brainpower, and skillpower).

- c. Stock supplies.

7. My [Main Survival Page](#) contains links to lots of other information such as free books to download about nuclear survival, links to plans for building shelters, and even free consultation about building a shelter.

8. If you are SUPER concerned about nuclear survival you might consider moving within 20 miles of the

[Ark Two Community](#)
(in Canada)

9. And finally if you would like to be on the mailing list of the author of this site - send a blank email to:

arktwo-request@deuce.pairowoodies.com
[with the subject as subscribe](#)

MENU: [HOME](#) » [SURVIVAL](#) » [Index of States](#)

Nuclear Survival in

Utah

This is the nuclear target map for Utah, but remember, fallout can go anywhere or everywhere (and probably will). After you have looked at this map look at the [Information for Utah](#) that follows it.

This link will take you back to the [Index of all the States](#)

Nuclear Weapon Target Map for Utah (FEMA-196/September 1990)

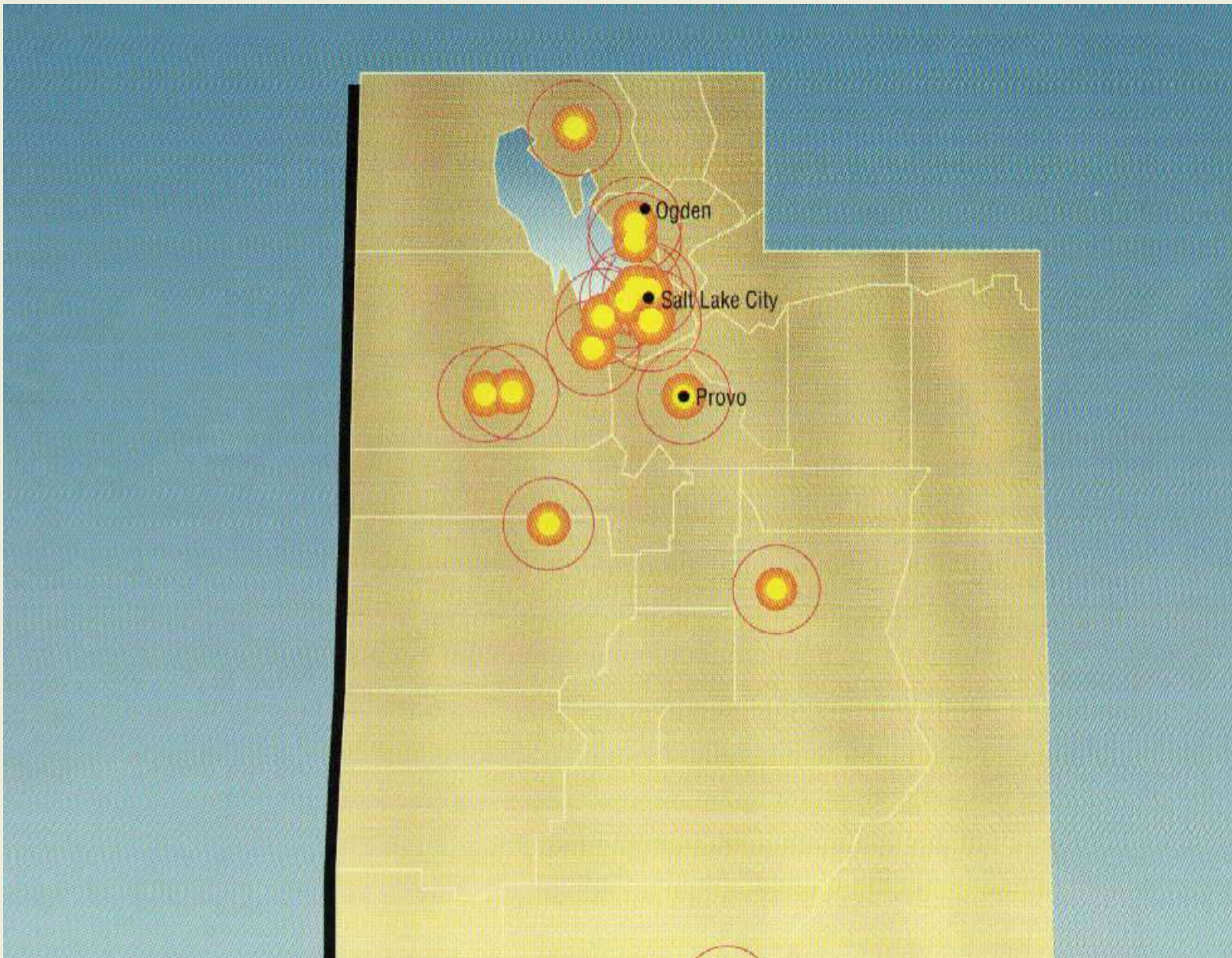

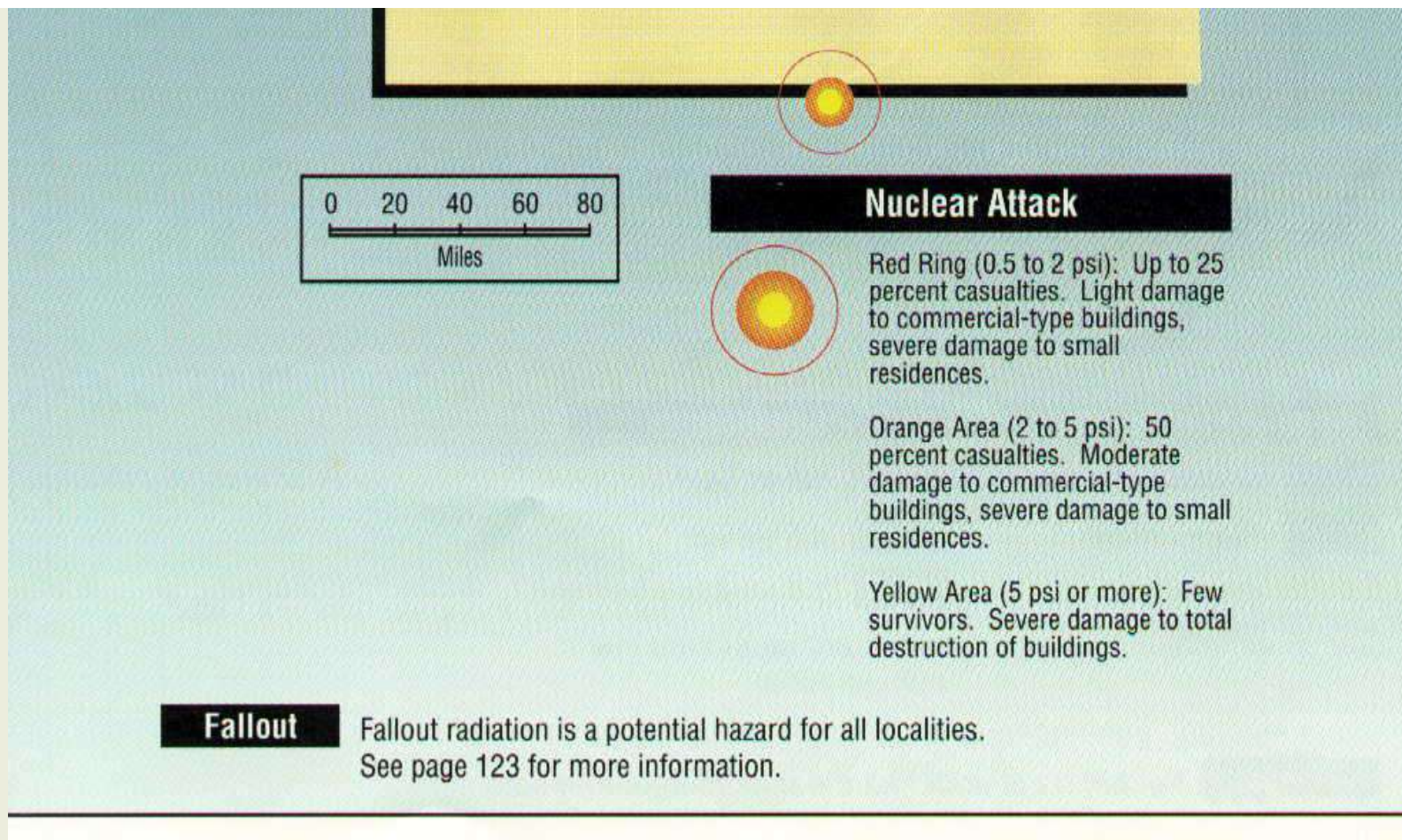

[UPDATE to Target Information!!!](#)

Information for Utah

This link will take you back to the [Index of all the States](#)

It is recommended that you go through the following 10 steps in studying about the nuclear threat to Utah.

1. Look at the [State Map](#) above to see the target nuclear areas in Utah.
2. Look at the [general expected fallout map](#) to see where Utah (according to the **prevailing wind pattern**) gets fallout from other states.
3. If the state that you live in is anywhere EAST of any of the following 6 states in the **prevailing wind pattern** then look at the states in **RED** on the [INDEX of](#)

STATES for

- Montana
- North Dakota
- South Dakota
- Nebraska
- Missouri
- Colorado

These six states contain what is called DENSE PACK which I explain on each of those states pages. **UNDERSTAND** that the wind pattern **COULD** at that time be something other than the "prevailing" wind pattern.

4. Bookmark the present URL or make a copy of this present address so that you can come back to it after going to

[Blast Mapper](#).

This mapper is on someone else's web site so that you will need to save this address in order to return here if your back button doesn't work. However, you want to be sure to go the mapper site and calculate the damage to probable targets (cities) around you.

5. Memorize the THREE top rules for survival. They are:

- Number One - **Get out of the cities!**
- Number Two - **Get out of the cities!**
- Number Three - **Get out of the cities!**

6. The follow-on rules are:

- a. Have a shelter
- b. Work with a group (you are going to need the manpower, brainpower, and skillpower).

- c. Stock supplies.

7. My [Main Survival Page](#) contains links to lots of other information such as free books to download about nuclear survival, links to plans for building shelters, and even free consultation about building a shelter.

8. If you are SUPER concerned about nuclear survival you might consider moving within 20 miles of the

[Ark Two Community](#)
(in Canada)

9. And finally if you would like to be on the mailing list of the author of this site - send a blank email to:

arktwo-request@deuce.pairowoodies.com
[with the subject as subscribe](#)

MENU: [HOME](#) » [SURVIVAL](#) » [Index of States](#)

Nuclear Survival in **Vermont**

This is the nuclear target map for Vermont, but remember, fallout can go anywhere or everywhere (and probably will). After you have looked at this map look at the [Information for Vermont](#) that follows it.

This link will take you back to the [Index of all the States](#)

Nuclear Weapon Target Map for Vermont (FEMA-196/September 1990)

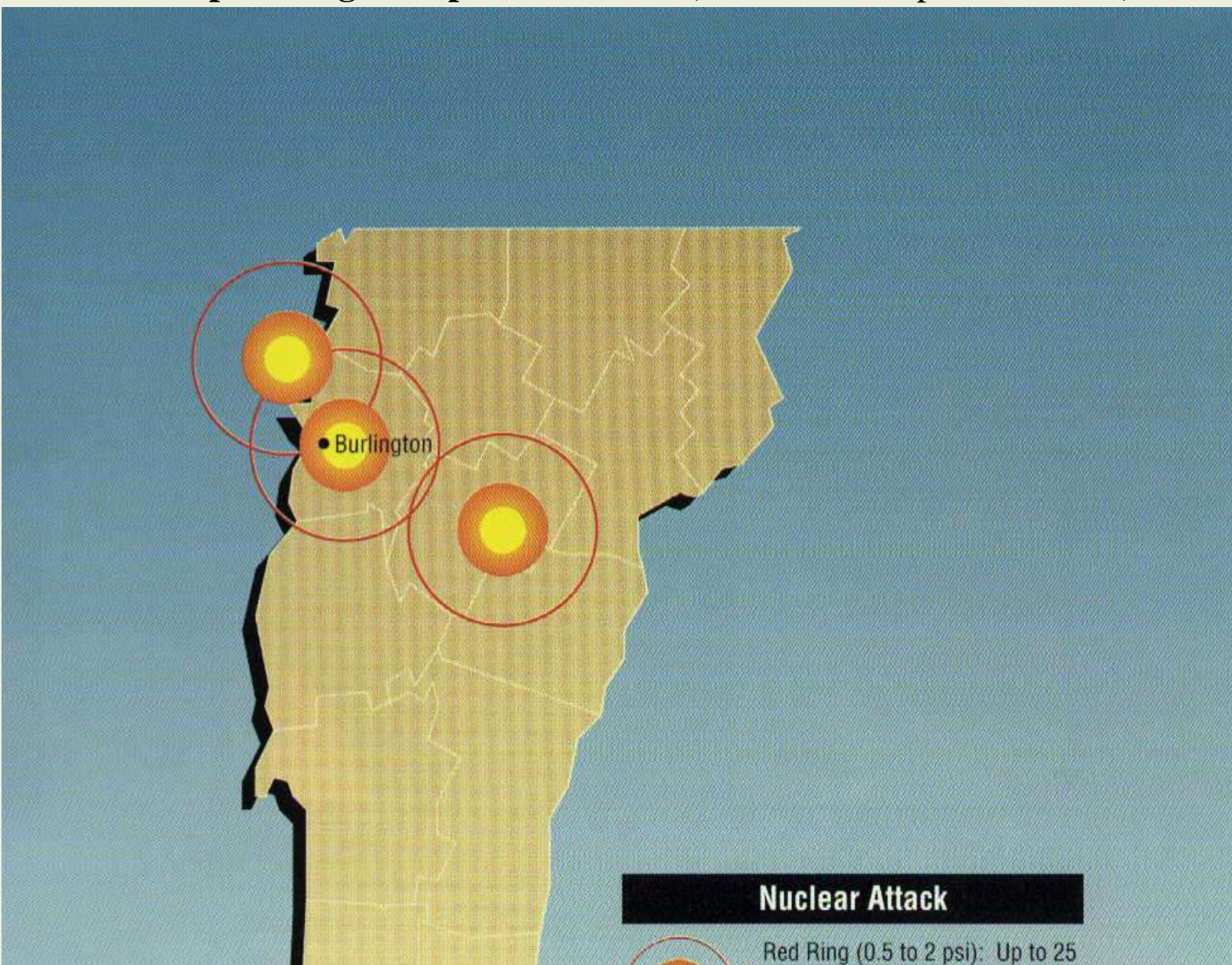

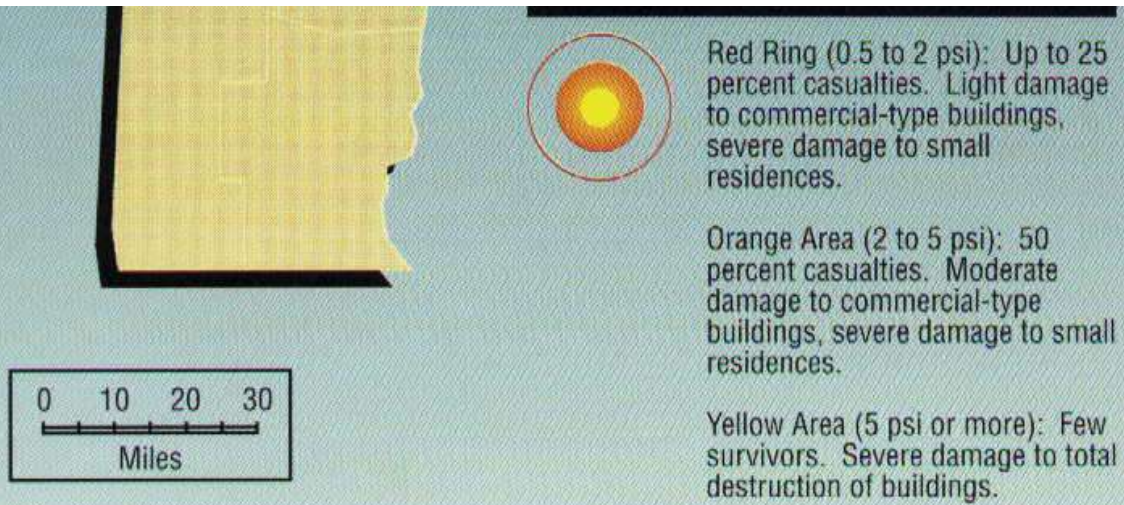

Fallout

Fallout radiation is a potential hazard for all localities. See page 123 for more information.

[UPDATE to Target Information!!!](#)

Information for Vermont

This link will take you back to the [Index of all the States](#)

It is recommended that you go through the following 10 steps in studying about the nuclear threat to Vermont.

1. Look at the [State Map](#) above to see the target nuclear areas in Vermont.
2. Look at the [general expected fallout map](#) to see where Vermont (according to the **prevailing wind pattern**) gets fallout from other states.
3. If the state that you live in is anywhere EAST of any of the following 6 states in the **prevailing wind pattern** then look at the states in **RED** on the [INDEX of](#)

STATES for

- Montana
- North Dakota
- South Dakota
- Nebraska
- Missouri
- Colorado

These six states contain what is called DENSE PACK which I explain on each of those states pages. **UNDERSTAND** that the wind pattern **COULD** at that time be something other than the "prevailing" wind pattern.

4. Bookmark the present URL or make a copy of this present address so that you can come back to it after going to

[Blast Mapper](#).

This mapper is on someone else's web site so that you will need to save this address in order to return here if your back button doesn't work. However, you want to be sure to go the mapper site and calculate the damage to probable targets (cities) around you.

5. Memorize the THREE top rules for survival. They are:

- Number One - **Get out of the cities!**
- Number Two - **Get out of the cities!**
- Number Three - **Get out of the cities!**

6. The follow-on rules are:

- a. Have a shelter
- b. Work with a group (you are going to need the manpower, brainpower, and skillpower).

- c. Stock supplies.

7. My [Main Survival Page](#) contains links to lots of other information such as free books to download about nuclear survival, links to plans for building shelters, and even free consultation about building a shelter.

8. If you are SUPER concerned about nuclear survival you might consider moving within 20 miles of the

[Ark Two Community](#)
(in Canada)

9. And finally if you would like to be on the mailing list of the author of this site - send a blank email to:

arktwo-request@deuce.pairowoodies.com
[with the subject as subscribe](#)

MENU: [HOME](#) » [SURVIVAL](#) » [Index of States](#)

Nuclear Survival in **Virginia**

This is the nuclear target map for Virginia, but remember, fallout can go anywhere or everywhere (and probably will). After you have looked at this map look at the [Information for Virginia](#) that follows it.

This link will take you back to the [Index of all the States](#)

Nuclear Weapon Target Map for Virginia (FEMA-196/September 1990)

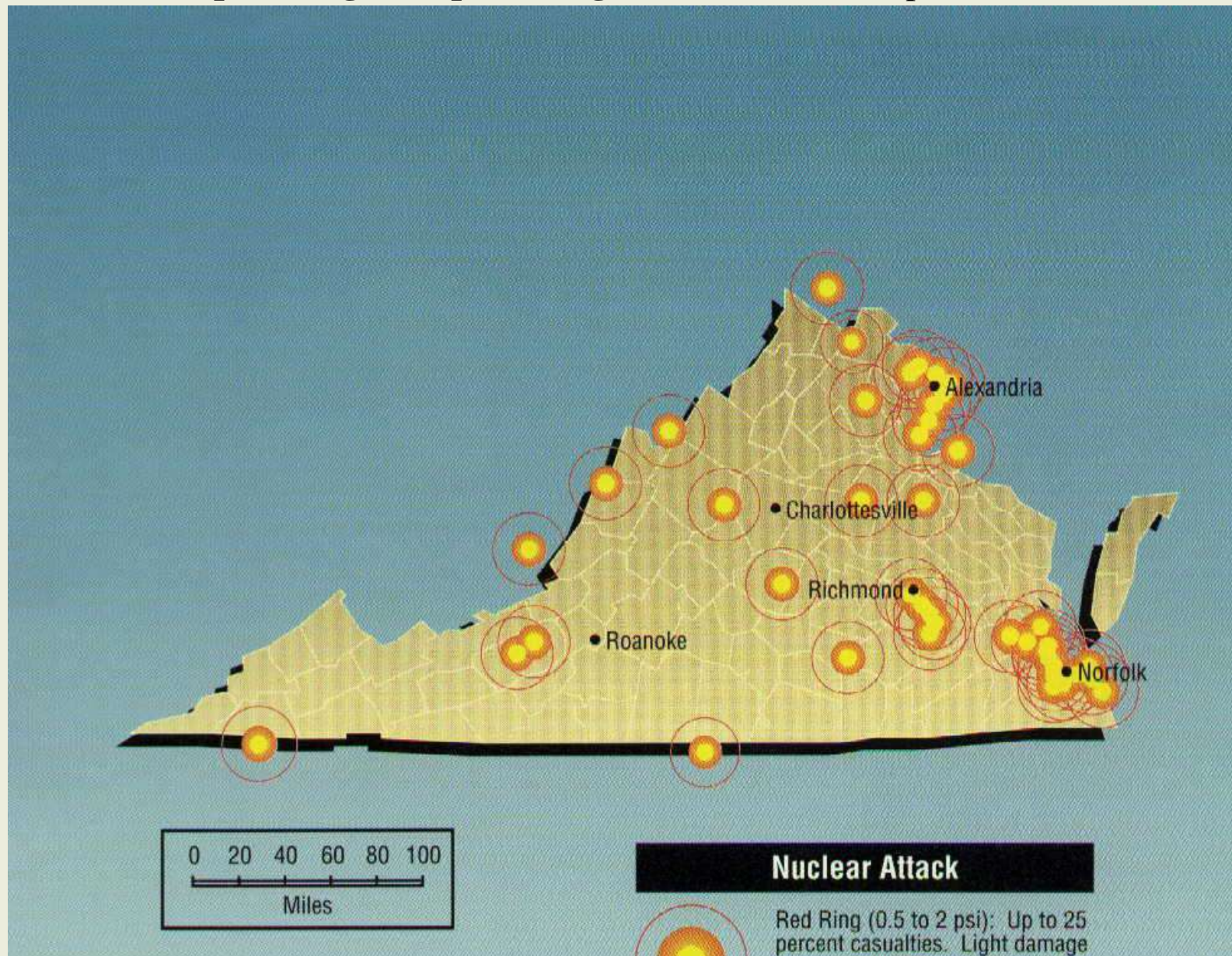



Red Ring (0.5 to 2 psi): Up to 25 percent casualties. Light damage to commercial-type buildings, severe damage to small residences.

Orange Area (2 to 5 psi): 50 percent casualties. Moderate damage to commercial-type buildings, severe damage to small residences.

Yellow Area (5 psi or more): Few survivors. Severe damage to total destruction of buildings.

Fallout

Fallout radiation is a potential hazard for all localities. See page 123 for more information.

[UPDATE to Target Information!!!](#)

Information for Virginia

This link will take you back to the [Index of all the States](#)

It is recommended that you go through the following 10 steps in studying about the nuclear threat to Virginia.

1. Look at the [State Map](#) above to see the target nuclear areas in Virginia.
2. Look at the [general expected fallout map](#) to see where Virginia (according to the **prevailing wind pattern**) gets fallout from other states.
3. If the state that you live in is anywhere EAST of any of the following 6 states in the **prevailing wind pattern** then look at the states in **RED** on the [INDEX of](#)

STATES for

- Montana
- North Dakota
- South Dakota
- Nebraska
- Missouri
- Colorado

These six states contain what is called DENSE PACK which I explain on each of those states pages. **UNDERSTAND** that the wind pattern **COULD** at that time be something other than the "prevailing" wind pattern.

4. Bookmark the present URL or make a copy of this present address so that you can come back to it after going to

[Blast Mapper](#).

This mapper is on someone else's web site so that you will need to save this address in order to return here if your back button doesn't work. However, you want to be sure to go the mapper site and calculate the damage to probable targets (cities) around you.

5. Memorize the THREE top rules for survival. They are:

- Number One - **Get out of the cities!**
- Number Two - **Get out of the cities!**
- Number Three - **Get out of the cities!**

6. The follow-on rules are:

- a. Have a shelter
- b. Work with a group (you are going to need the manpower, brainpower, and skillpower).

- c. Stock supplies.

7. My [Main Survival Page](#) contains links to lots of other information such as free books to download about nuclear survival, links to plans for building shelters, and even free consultation about building a shelter.

8. If you are SUPER concerned about nuclear survival you might consider moving within 20 miles of the

[Ark Two Community](#)
(in Canada)

9. And finally if you would like to be on the mailing list of the author of this site - send a blank email to:

arktwo-request@deuce.pairowoodies.com
[with the subject as subscribe](#)

MENU: [HOME](#) » [SURVIVAL](#) » [Index of States](#)

Nuclear Survival in **Washington**

This is the nuclear target map for Washington, but remember, fallout can go anywhere or everywhere (and probably will). After you have looked at this map look at the [Information for Washington](#) that follows it.

This link will take you back to the [Index of all the States](#)

Nuclear Weapon Target Map for Washington (FEMA-196/September 1990)

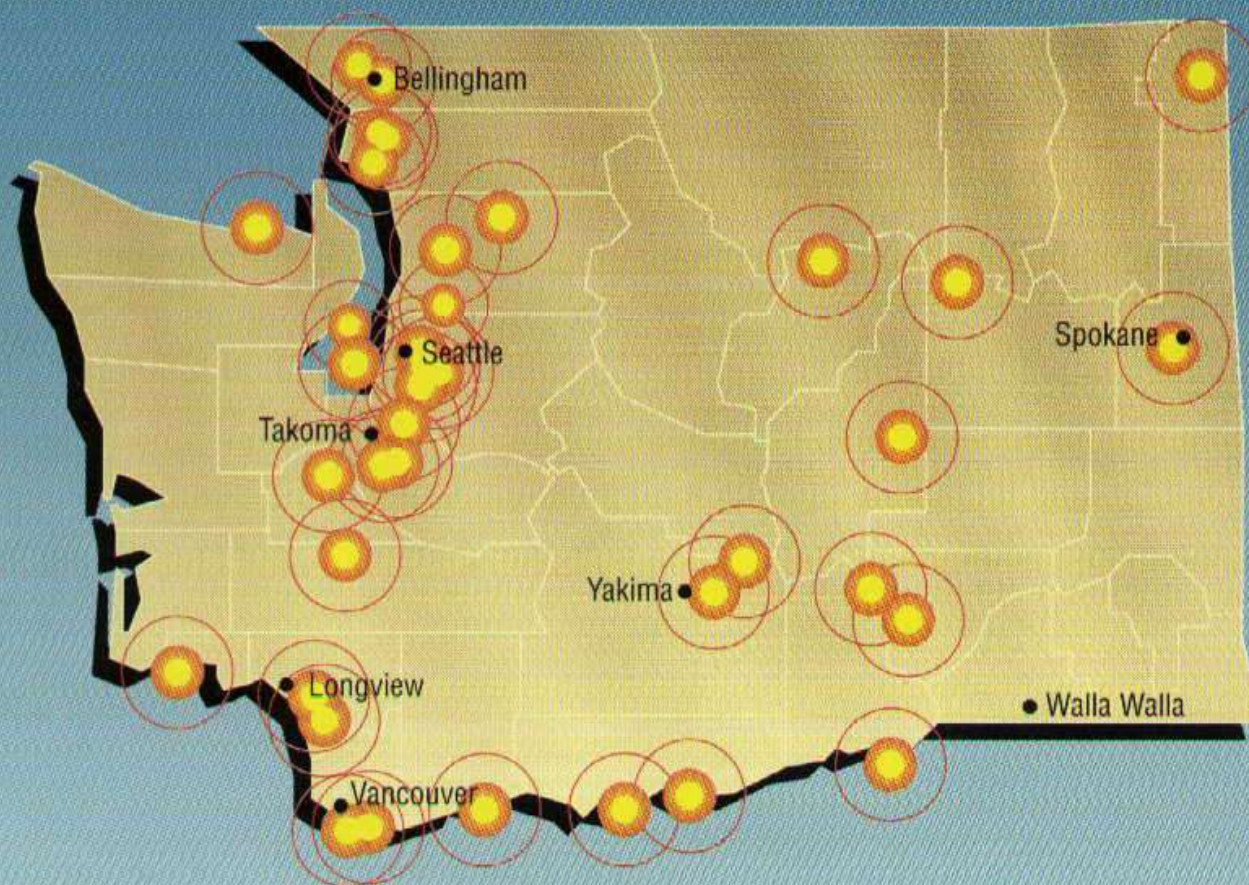

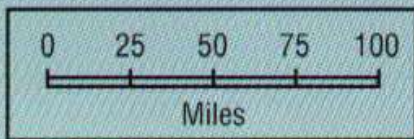

Nuclear Attack

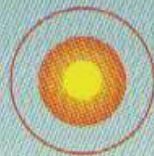

Red Ring (0.5 to 2 psi): Up to 25 percent casualties. Light damage to commercial-type buildings, severe damage to small residences.

Orange Area (2 to 5 psi): 50 percent casualties. Moderate damage to commercial-type buildings, severe damage to small residences.

Yellow Area (5 psi or more): Few survivors. Severe damage to total destruction of buildings.

Fallout

Fallout radiation is a potential hazard for all localities. See page 123 for more information.

[UPDATE to Target Information!!!](#)

Information for Washington

This link will take you back to the [Index of all the States](#)

It is recommended that you go through the following 10 steps in studying about the nuclear threat to Washington.

1. Look at the [State Map](#) above to see the target nuclear areas in Washington.
2. Look at the [general expected fallout map](#) to see where Washington (according to the **prevailing wind pattern**) gets fallout from other states.
3. If the state that you live in is anywhere EAST of any of the following 6 states in the **prevailing wind pattern** then look at the states in **RED** on the [INDEX of](#)

STATES for

- Montana
- North Dakota
- South Dakota
- Nebraska
- Missouri
- Colorado

These six states contain what is called DENSE PACK which I explain on each of those states pages. **UNDERSTAND** that the wind pattern **COULD** at that time be something other than the "prevailing" wind pattern.

4. Bookmark the present URL or make a copy of this present address so that you can come back to it after going to

[Blast Mapper.](#)

This mapper is on someone else's web site so that you will need to save this address in order to return here if your back button doesn't work. However, you want to be sure to go the mapper site and calculate the damage to probable targets (cities) around you.

5. Memorize the THREE top rules for survival. They are:

- Number One - **Get out of the cities!**
- Number Two - **Get out of the cities!**
- Number Three - **Get out of the cities!**

6. The follow-on rules are:

- a. Have a shelter
- b. Work with a group (you are going to need the manpower, brainpower, and skillpower).

- c. Stock supplies.

7. My [Main Survival Page](#) contains links to lots of other information such as free books to download about nuclear survival, links to plans for building shelters, and even free consultation about building a shelter.

8. If you are SUPER concerned about nuclear survival you might consider moving within 20 miles of the

[Ark Two Community](#)
(in Canada)

9. And finally if you would like to be on the mailing list of the author of this site - send a blank email to:

arktwo-request@deuce.pairowoodies.com
[with the subject as subscribe](#)

MENU: [HOME](#) » [SURVIVAL](#) » [Index of States](#)

Nuclear Survival in **West Virginia**

This is the nuclear target map for West Virginia, but remember, fallout can go anywhere or everywhere (and probably will). After you have looked at this map look at the [Information for West Virginia](#) that follows it.

This link will take you back to the [Index of all the States](#)

Nuclear Weapon Target Map for West Virginia (FEMA-196/September 1990)

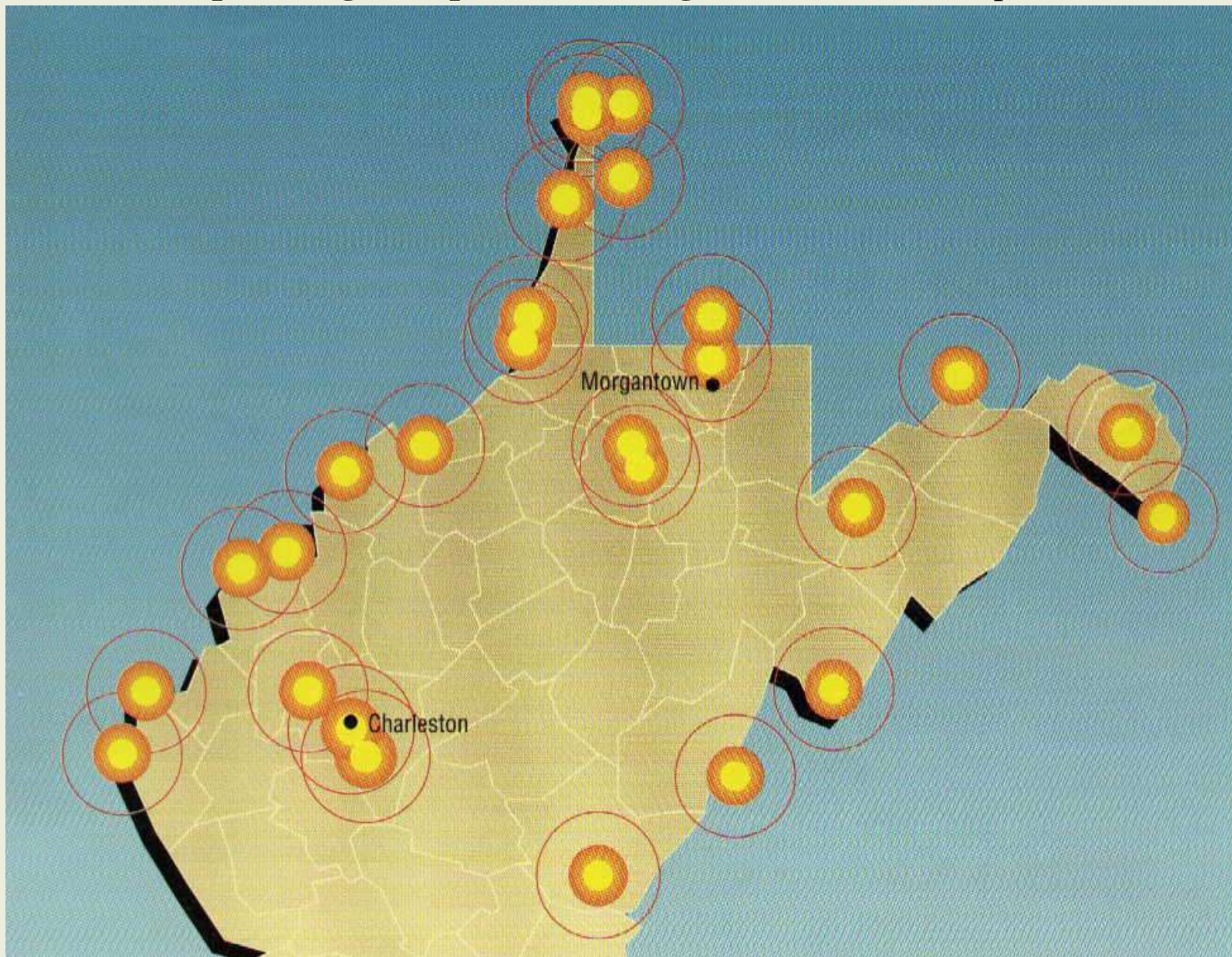

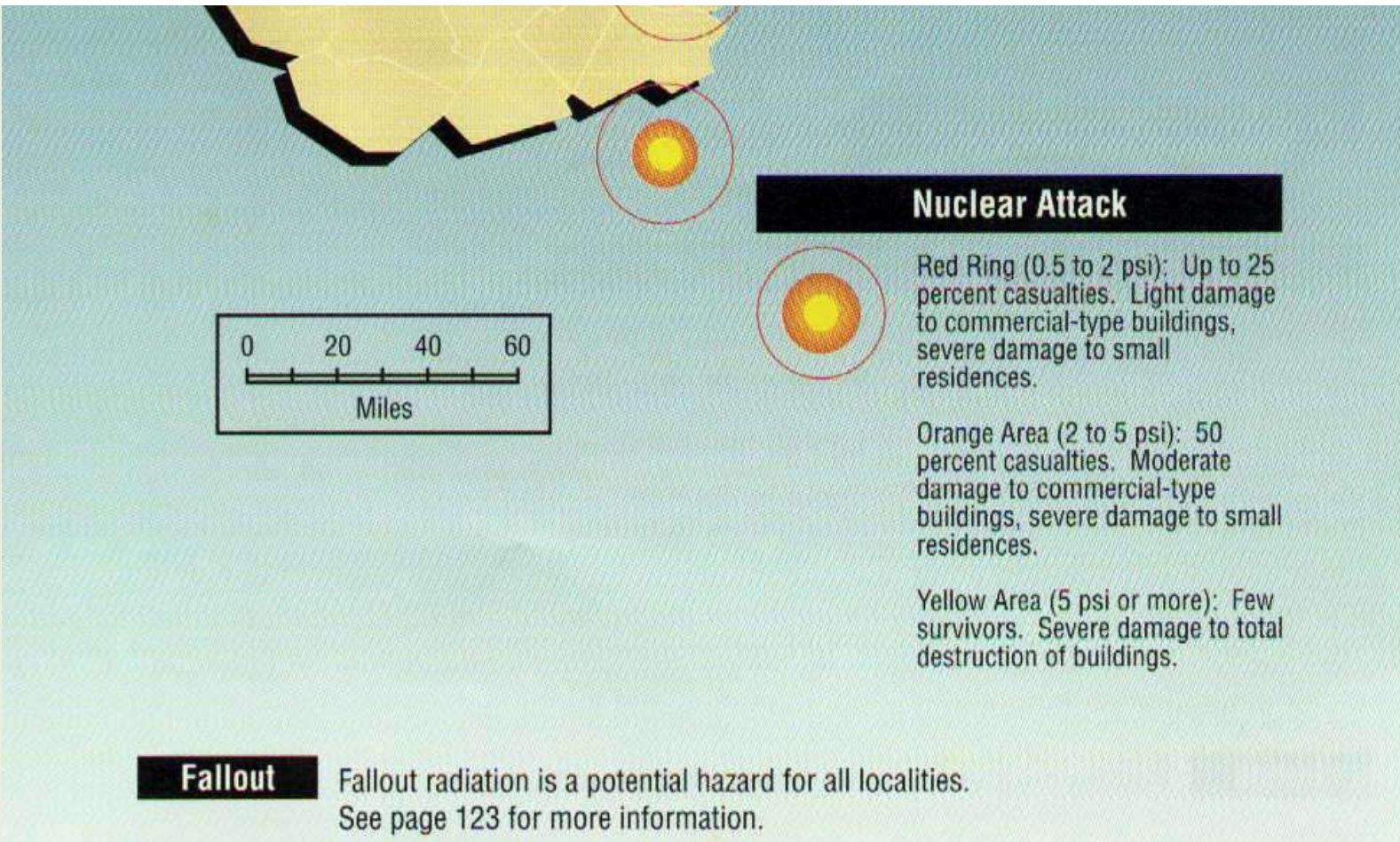

[UPDATE to Target Information!!!](#)

Information for West Virginia

This link will take you back to the [Index of all the States](#)

It is recommended that you go through the following 10 steps in studying about the nuclear threat to West Virginia.

1. Look at the [State Map](#) above to see the target nuclear areas in West Virginia.
2. Look at the [general expected fallout map](#) to see where West Virginia (according to the **prevailing wind pattern**) gets fallout from other states.
3. If the state that you live in is anywhere EAST of any of the following 6 states in the **prevailing wind pattern** then look at the states in **RED** on the [INDEX of](#)

STATES for

- Montana
- North Dakota
- South Dakota
- Nebraska
- Missouri
- Colorado

These six states contain what is called DENSE PACK which I explain on each of those states pages. **UNDERSTAND** that the wind pattern **COULD** at that time be something other than the "prevailing" wind pattern.

4. Bookmark the present URL or make a copy of this present address so that you can come back to it after going to

[Blast Mapper.](#)

This mapper is on someone else's web site so that you will need to save this address in order to return here if your back button doesn't work. However, you want to be sure to go the mapper site and calculate the damage to probable targets (cities) around you.

5. Memorize the THREE top rules for survival. They are:

- Number One - **Get out of the cities!**
- Number Two - **Get out of the cities!**
- Number Three - **Get out of the cities!**

6. The follow-on rules are:

- a. Have a shelter
- b. Work with a group (you are going to need the manpower, brainpower, and skillpower).

- c. Stock supplies.

7. My [Main Survival Page](#) contains links to lots of other information such as free books to download about nuclear survival, links to plans for building shelters, and even free consultation about building a shelter.

8. If you are SUPER concerned about nuclear survival you might consider moving within 20 miles of the

[Ark Two Community](#)
(in Canada)

9. And finally if you would like to be on the mailing list of the author of this site - send a blank email to:

arktwo-request@deuce.pairowoodies.com
[with the subject as subscribe](#)

MENU: [HOME](#) » [SURVIVAL](#) » [Index of States](#)

Nuclear Survival in **Wisconsin**

This is the nuclear target map for Wisconsin, but remember, fallout can go anywhere or everywhere (and probably will). After you have looked at this map look at the [Information for Wisconsin](#) that follows it.

This link will take you back to the [Index of all the States](#)

Nuclear Weapon Target Map for Wisconsin (FEMA-196/September 1990)

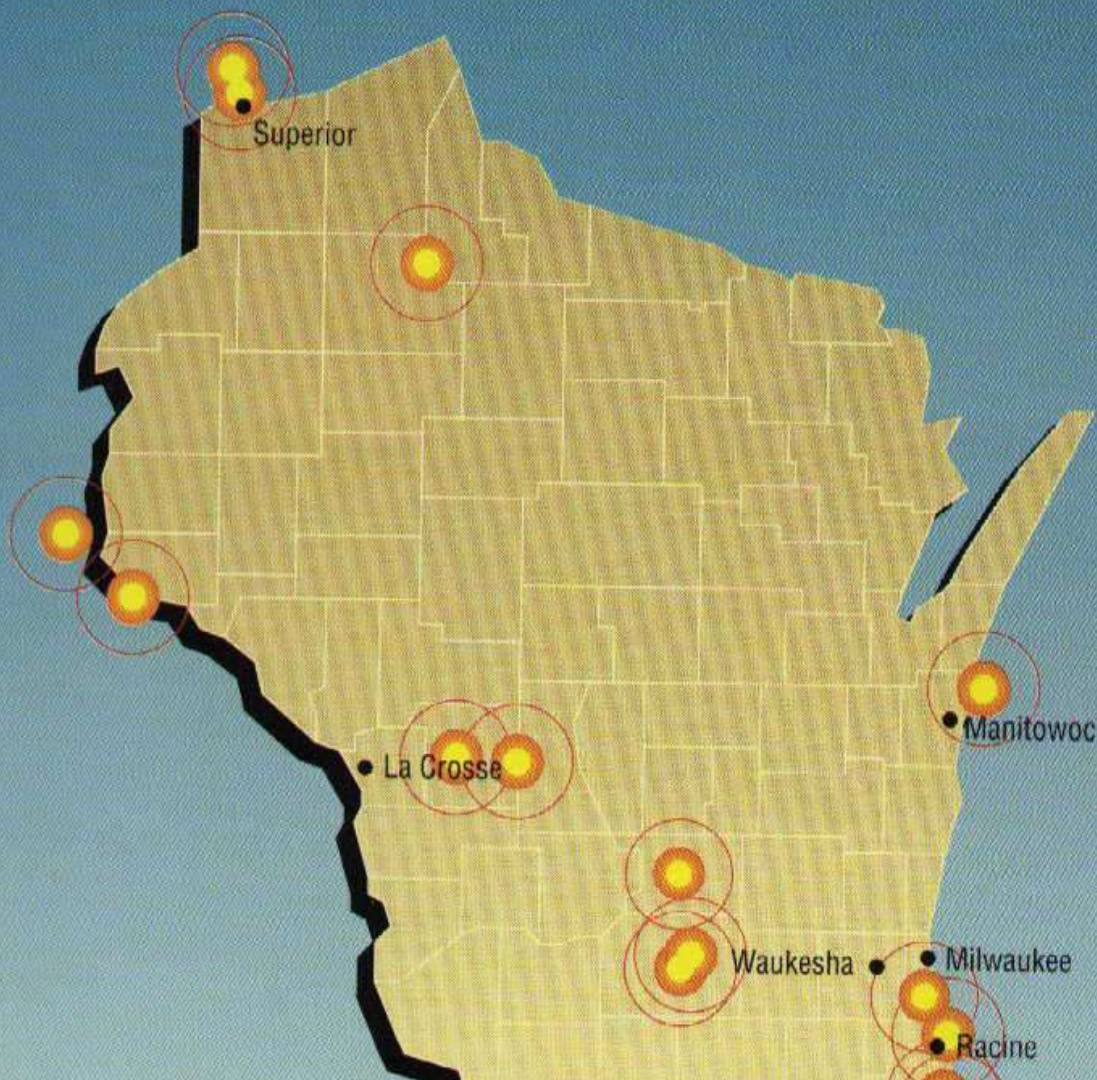

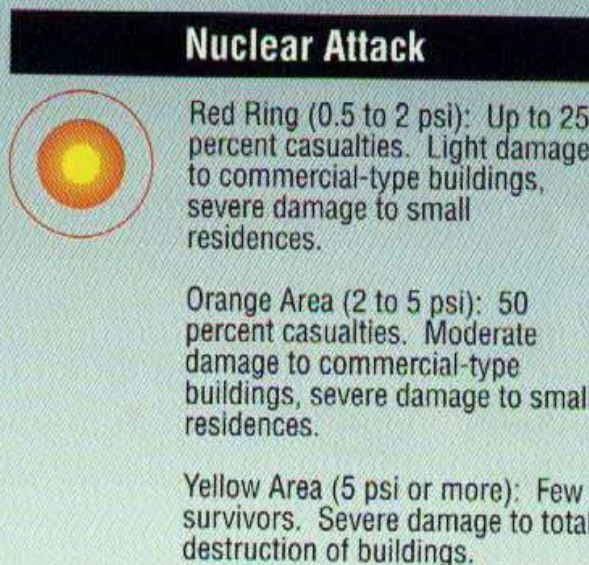
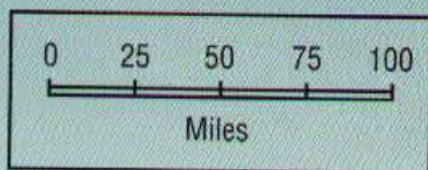

Fallout

Fallout radiation is a potential hazard for all localities. See page 123 for more information.

[UPDATE to Target Information!!!](#)

Information for Wisconsin

This link will take you back to the [Index of all the States](#)

It is recommended that you go through the following 10 steps in studying about the nuclear threat to Wisconsin.

1. Look at the [State Map](#) above to see the target nuclear areas in Wisconsin.
2. Look at the [general expected fallout map](#) to see where Wisconsin (according to the **prevailing wind pattern**) gets fallout from other states.
3. If the state that you live in is anywhere EAST of any of the following 6 states in the **prevailing wind pattern** then look at the states in **RED** on the [INDEX of](#)

STATES for

- Montana
- North Dakota
- South Dakota
- Nebraska
- Missouri
- Colorado

These six states contain what is called DENSE PACK which I explain on each of those states pages. **UNDERSTAND** that the wind pattern **COULD** at that time be something other than the "prevailing" wind pattern.

4. Bookmark the present URL or make a copy of this present address so that you can come back to it after going to

[Blast Mapper](#).

This mapper is on someone else's web site so that you will need to save this address in order to return here if your back button doesn't work. However, you want to be sure to go the mapper site and calculate the damage to probable targets (cities) around you.

5. Memorize the THREE top rules for survival. They are:

- Number One - **Get out of the cities!**
- Number Two - **Get out of the cities!**
- Number Three - **Get out of the cities!**

6. The follow-on rules are:

- a. Have a shelter
- b. Work with a group (you are going to need the manpower, brainpower, and skillpower).

- c. Stock supplies.

7. My [Main Survival Page](#) contains links to lots of other information such as free books to download about nuclear survival, links to plans for building shelters, and even free consultation about building a shelter.

8. If you are SUPER concerned about nuclear survival you might consider moving within 20 miles of the

[Ark Two Community](#)
(in Canada)

9. And finally if you would like to be on the mailing list of the author of this site - send a blank email to:

arktwo-request@deuce.pairowoodies.com
[with the subject as subscribe](#)

MENU: [HOME](#) » [SURVIVAL](#) » [Index of States](#)

Nuclear Survival in **Wyoming**

This is the nuclear target map for Wyoming, but remember, fallout can go anywhere or everywhere (and probably will). After you have looked at this map look at the [Information for Wyoming](#) that follows it.

This link will take you back to the [Index of all the States](#)

Nuclear Weapon Target Map for Wyoming (FEMA-196/September 1990)

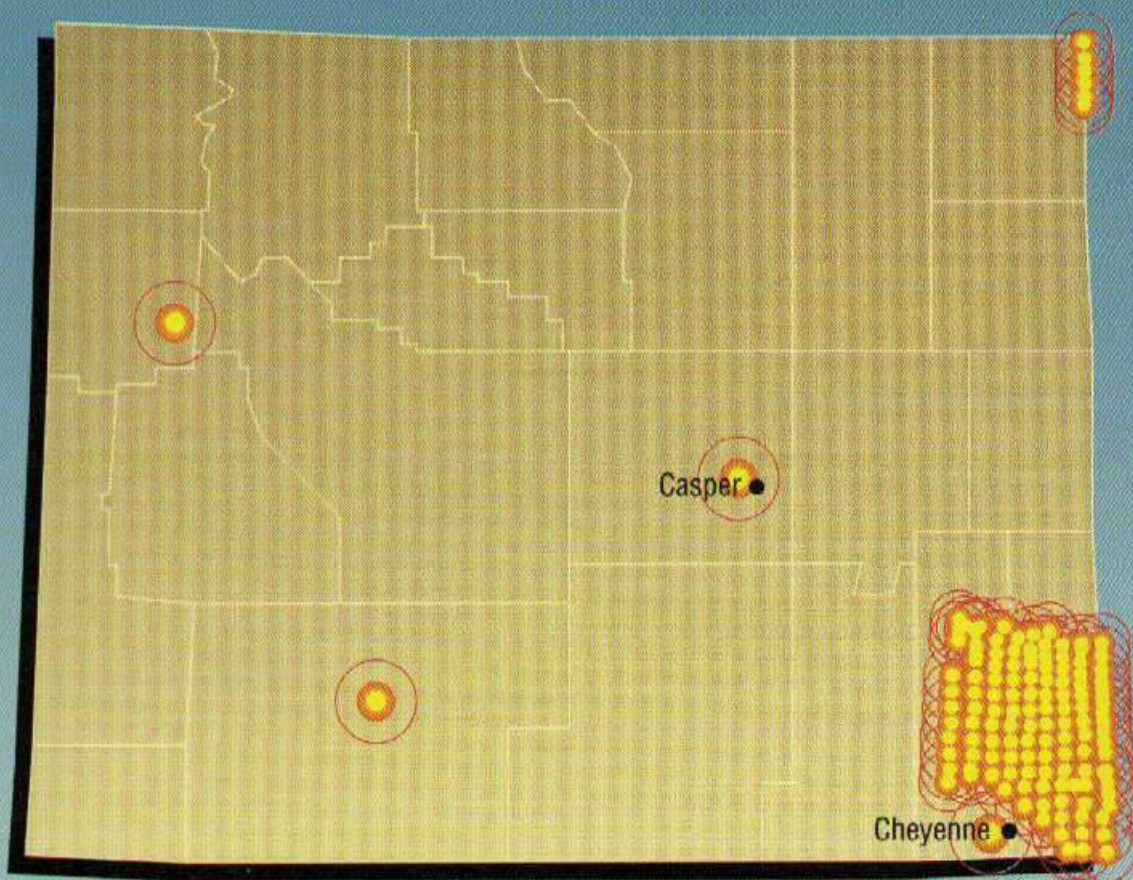

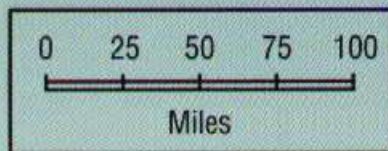

Nuclear Attack



Red Ring (0.5 to 2 psi): Up to 25 percent casualties. Light damage to commercial-type buildings, severe damage to small residences.

Orange Area (2 to 5 psi): 50 percent casualties. Moderate damage to commercial-type buildings, severe damage to small residences.

Yellow Area (5 psi or more): Few survivors. Severe damage to total destruction of buildings.

Fallout

Fallout radiation is a potential hazard for all localities. See page 123 for more information.

[UPDATE to Target Information!!!](#)

Information for Wyoming

This link will take you back to the [Index of all the States](#)

It is recommended that you go through the following 10 steps in studying about the nuclear threat to Wyoming.

1. Look at the [State Map](#) above to see the target nuclear areas in Wyoming.
2. Look at the [general expected fallout map](#) to see where Wyoming (according to the **prevailing wind pattern**) gets fallout from other states.
3. If the state that you live in is anywhere EAST of any of the following 6 states in the **prevailing wind pattern** then look at the states in **RED** on the [INDEX of](#)

STATES for

- Montana
- North Dakota
- South Dakota
- Nebraska
- Missouri
- Colorado

These six states contain what is called DENSE PACK which I explain on each of those states pages. **UNDERSTAND** that the wind pattern **COULD** at that time be something other than the "prevailing" wind pattern.

4. Bookmark the present URL or make a copy of this present address so that you can come back to it after going to

[Blast Mapper.](#)

This mapper is on someone else's web site so that you will need to save this address in order to return here if your back button doesn't work. However, you want to be sure to go the mapper site and calculate the damage to probable targets (cities) around you.

5. Memorize the THREE top rules for survival. They are:

- Number One - **Get out of the cities!**
- Number Two - **Get out of the cities!**
- Number Three - **Get out of the cities!**

6. The follow-on rules are:

- a. Have a shelter
- b. Work with a group (you are going to need the manpower, brainpower, and skillpower).

- c. Stock supplies.

7. My [Main Survival Page](#) contains links to lots of other information such as free books to download about nuclear survival, links to plans for building shelters, and even free consultation about building a shelter.

8. If you are SUPER concerned about nuclear survival you might consider moving within 20 miles of the

[Ark Two Community](#)
(in Canada)

9. And finally if you would like to be on the mailing list of the author of this site - send a blank email to:

arktwo-request@deuce.pairowoodies.com
[with the subject as subscribe](#)

MENU: [HOME](#) » [SURVIVAL](#) » [Index of States](#)

Bruce Beach

Greetings, my name is Bruce Beach and I am adding this page so that anyone desiring to do so may get to know me more personally. I am the coordinator, founder and initial vision holder of the [World Language Process](#). I am a former professor of computer science and have been a student of the world language problem for over thirty years.



I now live in a little village of 200 people, called Horning's Mills, that is about 90 miles northwest of Toronto, Ontario, Canada. My wife was born in this village (and her mother also, in the 19th century). We have many relations that live in the village and I have a son and daughter and grandchildren nearby.



I was born in Winfield, Kansas and raised mostly in Wellington, Kansas where a number of my offspring (children, grandchildren, and great grandchild) still live. I moved to Canada in 1970 to teach in the Northern College System (in Sault Ste. Marie, Kirkland Lake and Kapuskasing) after having previously taught in black colleges in the U.S. (Morgan State and Jarvis Christian College in Hawkins Texas).

Years ago I spent a year in the Arctic as a control tower operator, courtesy of the U.S. Air Force. I have made a couple of trips to China and have travelled somewhat extensively in South America and less so to Europe and elsewhere. I have a total of over 20 children, grandchildren, and a great grandchild, several of which live in Taiwan and the rest in the U.S. and Canada. Below is a picture of myself with some of my grandchildren.



At one time I owned a very large research ship called **Canada's Tomorrow** and one third of the company that built the robotic arm that recovered the space shuttle Challenger. One of the company's robotic arms is in the Smithsonian. I have also written a number of books in the computer sciences, the latest being on the programming language 'C'.



My strongest interests, outside of the [World Language Process](#), lie in the areas

of religion, astronomy and the social sciences. I have no musical or sports talents but was once upon a time an exceptional speed reader, reading as many as five books a day. Now I read only about that many a month. I used to play a little [chess](#) and hold patents on a chess teaching machine that was manufactured some years ago and sold in several countries.

I am somewhat notorious as a survivalist having built two dozen [shelters](#) for myself and others, and I have consulted on many dozens more. I maintain a web page on this subject also, and you can click on the link in the unlikely case that this is something that interests you.

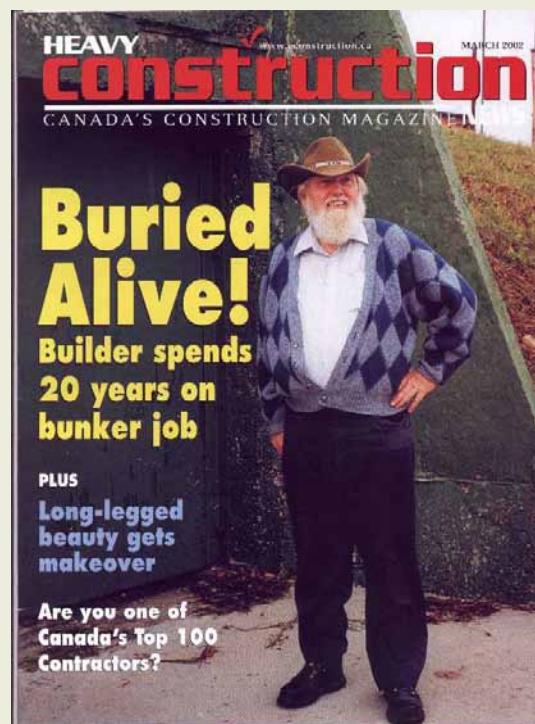

I am an optimist about the long term future of mankind but a pessimist about the immediate future, particularly at this millennialist point. As I have said, I am greatly interested in religion, being a class taught student of Christian Science and a persistent student of the writings of Emannuel Swedenborg for almost forty years. At one time I termed myself a Zen Buddhist and have read many translations of both the Bhagavad Gita and the Koran. I have also thoroughly studied the Mormon religion (I did some practice teaching at BYU) and the Jehovah's Witness religion. I truly appreciate them all and have been a Baha'i for thirty-five years. You can link to my [essays](#) if you are interested to know where

my understanding of the Baha'i Writings has led me. I met my wife at the Baha'i Temple in Wilmette, Illinois which is just outside Chicago. She was guiding at the front door.





My reading interest, in addition to Swedenborg, Computer Magazines, Sky and Telescope and the Bulletin of the Atomic Scientists, is completely eclectic. My favorite books of all time, aside from religious books, have been "Zen and the Art of Motorcycle Maintenance", "The Flatland", "Godel, Escher and Bach", "Varieties of Religious Experience", and many works by J.S. Mills. I have also in the past read gobs in psychology and economics (having a master's degree in the latter). There are times in my life when I have been a science fiction and movie hound but my greatest pleasure now is my children and grandchildren.

This should be about enough to bore you about any one person. I lead a very active life working fourteen to sixteen hours a day. A stroke some years ago blinded me in one eye but I have since reprogrammed myself to type on a Dvorak keyboard. I have loving children who look after me and a wife that everyone,

including myself, says is a saint. I am truly a happy and joyful person, a claim that I wish that more people could make in this technologically illustrious and spiritually dark age.

I can be reached personally at:

language@webpal.org

My hope, of course, is that we can find a mutual interest in furthering the

[World Language Process,](#)

which you can click on and link to if you have come to this page by a different path.

Regards,

Bruce M. Beach



MENU: [HOME](#) » [Reconstruction](#) » [Recovery](#) » [Renewal](#) » [Survival](#)

The Renewal of Religion After Nuclear Holocaust

Table of Contents:

[Prolog: Why God would permit a nuclear war.](#)

Here there is given an answer to a question that will concern many. If God is All Powerful and All Good - then why would He permit a nuclear war?

[Essays: Series of Religious Essays - Premises](#)

This is the introduction to the following series of religious essays. It contains the author's premises of religion but the premises are recommended for reading only by those who wish to discuss the subject of religion with him.

[POP: Problems of Prophecy](#)

Here the author describes his own experiences in seeking true prophetic sources.

[Four Souls: The Four Types of Souls](#)

An examination of the concept that there are four types of souls that helps one to determine their own type.

[Four Paths: The Four Paths to Truth](#)

The Four Paths to Truth are the four paths that every seeker of truth must tread.

[MGP: The Most Clear Proof](#)

"The Most Great Proof", is a step by step examination of the largest, most important and most accurate prophecy ever given.

[Seven Churches: From the Book of Revelation](#)

This is essay discusses the The Seven Churches (mentioned in the Book of Revelation) and

presents what many people find as an astounding explanation.

Ocean: The Revealed Word of God available as NEVER before!

The most marvelous source for searching religious writings starting with the Judaic Tradition. It includes the Old Testament, Gospel, Koran, Baha'i Scripture and many, many others. Over 900 books at the time of this writing. I have spent many hundreds of dollars over the years for the best search programs I could find but none have been nearly as good as this one - and it is FREE.

Meditation: and The Path of Prayer

A discussion of prayer and meditation along with some special Baha'i prayers and a rare translation of a Chant by Abdu'l-baha.

Stars: Prophecies in the Stars

Astrological predictions, as regards individual day to day events, are a superstition. Nevertheless, many people feel that there have been notable signs in the heavens, such as that regarding the Bethlehem Star and the birth of Jesus. Here we examine a more recent and even more astounding phenomena, the fulfillment of an ancient tradition in the Millenium Star.

[Click here to return to the top of this Table of Contents](#)

[Click here to return to the top of the Main Front Page](#)

Why God Would Permit a Nuclear War

In times of great stress some people turn naturally to God. Others question how He could exist and permit the tests, trauma, terror, that they are witnessing or experiencing. The Problem of Pain and evil has always been a challenge to every theological thinker. Some see it as the central question of religion and the human experience.

The questioners ask, "How could an Infinite, All Powerful God, that is Good, permit something like a nuclear holocaust?" "Never mind that Armageddon was predicted in centuries old religious prophecy. That is just another problem", they would say, "because if it was foretold and unavoidable, then what does that do for human free will?"

Man's search for Reality and his relationship to God, is the purpose of human life. These then are not just troubling questions, but central questions, in a sense the ultimate questions with which the seeker must wrestle.

It is unlikely that the present writer will answer, satisfactorily for all, that which centuries of religious volumes have failed to communicate unto the majority of mankind. Namely, that God is Good and that His Purpose is being worked out. Still, I will share with you my own thoughts about why the world wide nuclear war was both inevitable and necessary. Because of its inevitableness, some readers will note that at the time of this writing I speak of it as having been a thing that has already occurred.

First one must wrestle with the nature of God and Man. The Creator and the Creature. The Uncreated and the created. The One Being Infinite the other being finite. The One Being beyond time, space, matter, the other involved in the appearance of time, space, matter. However one views it, maya, illusion, duality, it still seems to be a relationship of opposites.

Because of infinite difference in station between the Creator and the created the only way that the latter can come to know The Former is in the manner and to the degree That Former chooses to reveal Itself to the latter. All the Great Divinely Revealed Religions have said that this has been through a Messenger, Prophet, a Chosen One. It is to Them that every reasonable thinker turns for the answers. No reasonable man would think that he could figure out the great ideas of literature, art, mathematics, or science all on his own - and how much less religion, that is to say the proper practice of his relationship to the Nature and Purpose of God and His Creation.

Thus it is that we turn unto Those Infinite Source of Light. Single in Purpose multiple in appearance, Who have come unto man to reveal God's Divine Purpose. Without exception we are told that God loves man and wishes him well. We are told further that God has bestowed many great bounties upon man, to a degree not shared by any other creature. Particularly the bounty of intellect and abstract thought and the bounty of free will. It is this latter that permits man to choose to recognize and serve God - or not.

The two capacities, intellect and will, the ability to know God and to worship (that is serve) Him, are the two defining characteristics of the human soul. They are what make a man a man. If a person loses the ability to think, reason, imagine, believe, then they are no longer in the human state but have entered a vegetative state. Likewise if they no longer have the capacity to desire, wish, feel, love or hate, then they have no more motivation than a rock. But the two capacities together - that which we think and that which we wish - that which we know and that which we will - are what defines each of us individually. That is who we are. Our very existence. When those capacities depart from the body - the body is dead and then decomposes. The Prophets have all told us that the essence - the ability to know and will - continues on separate from the body and that is why the soul is said to be eternal.

If either of these two faculties, either the ability to think / know / reason, or the ability to will are removed or subverted in man - then he ceases to exist as man. For this reason all men have the freedom and choice to believe in God - or not. If the idea, thought, knowledge of God was simply imprinted upon

them as the recognition of its mother is imprinted upon a baby chick - then man too would be a mere creature of instinct having no more free will to accept or reject God than an automaton or computer programmed with certain facts in its data base and memory.

Likewise, should man not have the freedom to sin, that is to say - to not do the Will of God, then again he would be but an automaton, a robot, a creature completely controlled by instinct and patterning. It is this freedom of being able to recognize and know God combined with the degree of choosing whether or not to be obedient to His Will - that defines and separates the saints, sinners, and satans.

Individually, and collectively, man exhibits and implements these two abilities. We are all individually a product of our genes, culture, and free will. The innate capacities between individuals differs greatly. Those innate capacities are then greatly affected by the education which they receive, which is something that is often largely culturally determined. Nurture versus nature is not a choice because it is nurture, nature AND free will that determines the individual accomplishment. The least of men, have the capacity to recognize God and to be obedient to Him, otherwise they are deprived of that which is truly human. The degree that they do recognize and obey God under adverse circumstances such as genetic or social deprivation may well be indicative of hidden spiritual strengths and qualities. God alone can be the Judge of that.

Nations and cultures to a large degree form individuals - but individuals also change and form cultures. Those who most positively affect the direction of a cultural should be duly honored. Unfortunately, cultures can likewise be affected negatively by other individuals. The collective conscience and consciousness is a mighty force to be dealt with. The overall direction and pattern of development, however, has a Divine Destiny. The Creation remains the purview of the Creator.

To return to the question of why evil and disaster occur. In part it is because there is an interplay between humanity and the rest of creation. Spiritual forces do interact and effect the actions of nature. This is a natural interaction, indeed designed by the Creator, and so to say that some of these natural events are "acts of God" is not far wrong - but the degree to which they are precipitated by human action is hidden from most of mankind.

Other events, such as war, depression, conflict, are more obviously the result of the actions of men. Still, we may ask, as to why God permits them to occur. The answer is that to prevent them would be to violate the principle of the Permissive Will of God which is to allow man to have his own free will. To subvert the free will of man would do more harm than good, because it would mean that man was no longer free and no longer man - but simply again as an automaton or rock.

The human race has long endured, and its destiny has long been seen. To say this does not subvert the free will of man. To give an example, most any elementary school teacher can see in her pupils the overall nature of the child, dullness to brilliance, willingness to rebelliousness, and although the teachers are sometimes surprised or disappointed, in later life, seeing the pupil's development - most often they are not. How many an insightful person can look at the habits and behavior of a teenager and predict for

the disobedient sluggard a life of failure and for the industrious performer a life of accomplishment. These are hardly matters of prophecy. The seeds of the future are evident. So has it been with the human race as a whole. The Prophets of old were able to see the rebellious and warlike nature of man and to see that as he gained more scientific knowledge that his wars would increase in intensity and ferocity. Indeed the Infinite Divine Omniscience would see these things far beyond the ken of man.

To foresee something is not to will something. While God Wills the good of man just as parents will the good of their children whom they can see that they must allow to make their own mistakes. One must be careful in attributing to God some anthropomorphic "motivation" but nevertheless it is the nature that has been created in us that gives us what perception we have of the Divine attributes because we do see these in ourselves and in the creation about us.

Mankind collectively followed such a path of rebellion that a major magazine headlined on its cover years ago that God was dead. Materialism and immorality increased after that date, to such a degree, that it would probably have astounded even those editors. Man's greed and lack of concern for his fellowman grew by immense proportions as evidenced through those years of repeated billion dollar scandals in the business community and the ever increasing proportion of all production and wealth that went into weapons and the means of destruction.

Still, all of this was reflective of the free will of man to choose the Path of God or to choose his own unwisdom and ills. While the chosen path led to destruction, to prevent mankind from choosing it would have been to truly destroy mankind because it would have meant subverting the free will of man and man would therefore no longer have been man. But evil contains its own punishment. The results are as sure as the law of gravity. The headache and hangover follow the drunkenness and while the it is fair to characterize the results as Divine Chastisement and Retribution it still remains of man's own doing.

If it were not for the pain which is the punishment for sin and evil, then man would simply always continue in the path of his own destruction which is the turning away from the Purpose of God. Man's collective ills continued to mount until the Day of Destruction, the Day of Holocaust, the Day of the Great Catastrophe, the Day of Armageddon - all as long predicted and prophesized. If it had not been for That Day then nothing would have turned man back around and once again toward God and His Purpose which is the true happiness of mankind. Consequently, the worse thing that could have occurred was for That Day to not have come - for there to have been no nuclear war.

Some will observe that in addition to the shortcomings of man that I have cataloged, that religion itself has been a major cause of suffering and contention. This is quite true. Dogmatic religions of every stripe have increased man's hatred against man. Also the same can be said of rampant nationalism and racism. Those very things that many men have seen as the highest ideals - their love for their religion, country and culture have in their perverted form been the basis for hate. God loves all mankind and in every part of the world provided for his religious guidance but men perverted that love for man to hatred of those who do not share their religion, country or culture.

The ills of religionism, racism, and nationalism became deeply embedded in mankind as a whole and when these were topped with rampant materialism and immorality mankind was already in hell. The direction that mankind was taking was obvious for many centuries, indeed millennium, and the end results were therefore predictable. The solution was also seen and God has always provided mankind with guidance through His Prophets. The Prophet for this Day and Age has revealed to mankind God's Program for the solution of their ills and the establishment of the Kingdom of Heaven on earth - but it is up to mankind to implement the Plan. For God to do it for man would once again deprive man of his free will and thus destroy him as man.

The message for mankind's darkest hour is that God has created for mankind a Destiny that is very Great, if mankind will choose to accept it. For those who would like to discuss with me further this view of the future and this view of religion I welcome their contacting me. I would ask that you first examine [my premises of religion](#) and let me know of any points in which we differ so that we may have a mutual understanding of what we are discussing.

Peace and love,
Bruce
DawnSayer@webpal.org

Click here to return to the
top of this
[Table of Contents](#)

MENU: [HOME](#) » [Reconstruction](#) » [Recovery](#) » [Renewal](#) » [Survival](#)

Premises of Religion

**I will be most gratified to correspond
about these ideas
with anyone who is interested in doing so.
If you would like to correspond with me you may
do so at:
DawSayer@webpal.org**

**For anyone who would like to discuss religion with me -
there are some points that I would like to first list -
to determine if we agree.**

**If you do NOT agree about one of the following points -
PLEASE let me know,
and also WHAT your position is.
Otherwise, anything that I might say
would be wrongfully based upon the assumption
that it would be understood in a particular way -
and likewise I would be misunderstanding statements
made by yourself.**

**I first list the points
and then give examples
so that you can hopefully
clearly understand what I mean.**

I call these first points "premises".

Premise One.

**There is but One God (Creator) -
(in the Universe, anywhere, anytime -
in any manner of true concept.
Beyond what we call space or time -
or any other qualification that one might make
to say that there is or could be any but**

the One True God.)

Premise Two.

God is separate from His Creation.

(meaning that God the Creator is something different than the Creation and apart from it. The opposite belief, called "pantheism" being that He is in His Creation and that creation itself is god).

Premise Three.

Both God and His Creation are Infinite (and Eternal) -

(meaning without end - beyond definitions of size, or limitations imposed by concepts of space and time).

Premise Four.

God is Infinite Spiritual REALITY and Truth

(but mortal man is subject to illusions, and delusions, about the appearances of reality and truth.)

Premise Five.

God being Infinite and men being finite - men cannot comprehend God on their own.

(This means that God has to make Himself known to man).

Premise Six.

God makes Himself known through His Prophets and Revealed Word.

Premise Seven.

God, and His Creation, being Infinite - means that there always has been -

**and always will be MORE for man
to learn about God and His Creation.**

As examples of the above (by the same number as the premises) -

- 1. Many people in the past have been polytheists,
and many in the world are still so today -
but few avowed Christians, aside from Mormons,
proclaim themselves to believe in more than one god.
A great many people, indeed most people,
actually have difficulty accepting that there is REALLY
only one God and they make in their minds idols
of other powers separate from God.**
- 2. The concept of God and His Creation being one,
which is defined as pantheism,
is more usually found among what we call
New Age Religion.**
- 3. Most people do not really wrestle with
or try to grasp the meaning of the concepts
Infinite and Eternal.**
- 4. Again, the Mormons see God as a physical being,
and that all is matter. Monality versus duality,
like Infinite and Eternal, is another one of those concepts
that many people have not really wrestled with.**
- 5. Man's relationship to God in that man
is completely subservient to God
offends a great number of people today -
who feel that they can figure out anything
through what they call "science"
and that in reality God is unnecessary to them.**
- 6. Recognition of the Prophets
and the Revealed Word -
is almost anathema to many people today.
Their view is, if Jesus existed,
He was "just" a man -
and that Scriptures are simply
a collection of myths, ancient stories,**

and outdated beliefs from early times.

**7. On the other hand -
many people hold an opposite view
regarding Scriptures.
They feel that they have in THEIR scriptures
ALL knowledge and that there is none other.**

**Thus the Jews hold onto only the Old Testament - saying to Jesus -
"What need have we of You. -
We have Abraham and our Fathers (the Prophets).
And the Christians are not about to accept
Mohammad and the Koran,
because they feel the Bible is the FINAL Word of God,
although Jesus said -
that He could not reveal unto them many things
that they were incapable of understanding at that time.
And the Moslems feel that the Koran is the Final Book -
and that Muhammad was the "Seal of the Prophets" -
so that they persecute Those Who follow Him.**

**In discussion with Christians,
a beginning point often is that I say that
Christians hold too small an idea of Jesus.
In response to their question of how that can be -
I respond:**

**1. Many Christians hold Jesus to be God.
"The Father and I are One".
If this is true,
then with God being Infinite
any comprehension about the nature of Jesus
would then need to be Infinite also -
and equally impossible to encompass
as would it be impossible to encompass
the understanding of God.**

**2. While many Christians will repeat phrases
such as -
"Under no other Name under heaven,
shall man be saved,
except through the Name of
the Lord Jesus Christ" -**

**they do not really look at the immensity
that we see today of the Galaxies -
and comprehend what that means.**

**3. Many Christians in talking about Jesus
place Him at one point in time and space -
2,000 years ago on this single planet.
THAT is a very limited idea.**

**The most difficult concept for most person's to comprehend about Baha'i-
is what is meant by the term "Manifestation of God".
This is most often where we need to begin -
but I am willing to discuss instead any other issue
that correspondents wish to discuss.**

I welcome your emails.

**Peace and love,
Bruce
bruce@webpal.org**

MENU: [HOME](#) » [Reconstruction](#) » [Recovery](#) » [Renewal](#) » [Survival](#)

Essays on the Problems and Power of Prophecy

by Bruce Beach

In these essays I describe some of my own experiences in seeking true prophetic sources. These essays and experiences were a series of an email newsletter and if you wish to get right to point that I was driving at - you can just skip to the last one, or even go on to the next series regarding the Four Paths to Truth.

If you have some suggestions or comments you would like to pass on to me about these pages you may do so at:

DawnSayer@webpal.org

If you wish to enter into a discussion with me regarding religion - I highly welcome that. I have some [religious premises](#) that I would like you to review first, and let me know regarding any about which you disagree to help me better understand any points that you are making.

The Essays

POP01 - [Mother Shipton](#)

POP02 - [Ouiji](#)

POP03 - [Plants One](#)

POP04 - [Plants Two](#)

POP05 - [Straight Arrow](#)

POP06 - [The Iching](#)

POP07 - [The Seeker](#)

POP07a - [My Declaration](#)

MENU: [HOME](#) » [Reconstruction](#) » [Recovery](#) » [Renewal](#) » [Survival](#)

POP01 - Mother Shipton

If you have some suggestions or comments you would like to pass on to me about these pages you may do so at: DawnSayer@webpal.org

This POP (Power of Prophecy or Problems of Prophecy) series that I am presenting, shares some of my own experiences in that search.

Those who are not interested in the subject or who feel that they already Know ALL Truth or at least the source for all Truth will find it tedious, and probably will also feel that I am ill-informed. And those who feel that it is impossible to find Prophetic Truths will consider these accounts silly.

I have carefully investigated many claims of prophetic ability, and in the series I will be reporting on some of those investigations. I am beginning this series with my investigation of a famous prophetess by the name of Mother Shipton.

Mother Shipton was born Ursula Sontheil in 1488 in a cave beside the river Nidd in North Yorkshire, England. The location remains today as a popular visitor site, attracting great numbers of visitors annually.

Since 1641 there have been more than 50 different editions of books about her and her prophecies and a great amount of information about her can be found on the Internet.

Many people feel that many of her visions came true within her own lifetime and in subsequent centuries. Mother Shipton is said to have predicted important historical events

**many years ahead of their time -
the Great Fire of London in 1666,
the defeat of the Spanish Armada in 1588 -
as well as the advent of modern technology.**

**She is said to have even forecast her own death in 1561.
She died in 1561.**

Today many find her prophecies are still proving uncannily accurate.

**She wrote her prophecies like poems
and after the following poem**

**I present my own research about her -
prior to the time of the Internet.**

-----A Version of One of Her Poems-----

**And now a word, in uncouth rhyme
Of what shall be in future time
Then upside down the world shall be
And gold found at the root of tree**

**All England's sons that plough the land
Shall oft be seen with Book in hand
The poor shall now great wisdom know**

**Great houses stand in far-flung vale
All covered o'er with snow and hail
A carriage without horse will go
Disaster fill the world with woe.**

**In London, Primrose Hill shall be
In centre hold a Bishop's See**

**Around the world men's thoughts will fly
Quick as the twinkling of an eye.**

**And water shall great wonders do
How strange. And yet it shall come true.**

**Through towering hills proud men shall ride
No horse or ass move by his side.**

**Beneath the water, men shall walk
Shall ride, shall sleep, shall even talk.**

**And in the air men shall be seen
In white and black and even green**

**A great man then, shall come and go
For prophecy declares it so.**

**In water, iron, then shall float
As easy as a wooden boat**

**Gold shall be seen in stream and stone
In land that is yet unknown.**

**And England shall admit a Jew
You think this strange, but it is true
The Jew that once was held in scorn
Shall of a Christian then be born.**

**A house of glass shall come to pass
In England. But Alas, alas
A war will follow with the work
Where dwells the Pagan and the Turk**

**These states will lock in fiercest strife
And seek to take each others life.
When North shall thus divide the south
And Eagle build in Lions mouth**

**Then tax and blood and cruel war
Shall come to every humble door.
Three times shall lovely sunny France
Be led to play a bloody dance**

**Before the people shall be free
Three tyrant rulers shall she see.
Three rulers in succession be
Each springs from different dynasty.**

**Then when the fiercest strife is done
England and France shall be as one.
The British olive shall next then twine
In marriage with a German vine.**

**Men walk beneath and over streams
Fulfilled shall be their wondrous dreams.
For in those wondrous far off days**

**The women shall adopt a craze
To dress like men, and trousers wear
And to cut off their locks of hair
They'll ride astride with brazen brow
As witches do on broomstick now.**

**And roaring monsters with man atop
Does seem to eat the verdant crop
And men shall fly as birds do now
And give away the horse and plough.**

**There'll be a sign for all to see
Be sure that it will certain be.
Then love shall die and marriage cease
And nations wane as babes decrease
And wives shall fondle cats and dogs
And men live much the same as hogs.**

**In nineteen hundred and twenty six
Build houses light of straw and sticks.
For then shall mighty wars be planned
And fire and sword shall sweep the land.**

**Footsteps will be seen in every room,
Left by none other than the man on the moon.
One man's heart shall be given to another,
Blood shall be shared by sister and brother.**

**Voices shall rise in the land of the black,
And the Holy Land shall come under attack.
China will rise as some have foretold,
But the wall that falls will not be so old.**

**When pictures seem alive with movements free
When boats like fishes swim beneath the sea,
When men like birds shall scour the sky
Then half the world, deep drenched in blood shall die.**

**For those who live the century through
In fear and trembling this shall do.
Flee to the mountains and the dens
To bog and forest and wild fens.**

**For storms will rage and oceans roar
When Gabriel stands on sea and shore
And as he blows his wondrous horn
Old worlds die and new be born.**

**A fiery dragon will cross the sky
Six times before this earth shall die
Mankind will tremble and frightened be
for the sixth heralds in this prophecy.**

**For seven days and seven nights
Man will watch this awesome sight.**

**The tides will rise beyond their ken
To bite away the shores and then
The mountains will begin to roar
And earthquakes split the plain to shore.**

**And flooding waters, rushing in
Will flood the lands with such a din
That mankind cowers in muddy fen
And snarls about his fellow men.**

**He bares his teeth and fights and kills
And secrets food in secret hills
And ugly in his fear, he lies
To kill marauders, thieves and spies.**

**Man flees in terror from the floods
And kills, and rapes and lies in blood
And spilling blood by mankind's hands
Will stain and bitter many lands**

**And when the dragon's tail is gone,
Man forgets, and smiles, and carries on
To apply himself - too late, too late
For mankind has earned deserved fate.**

**His masked smile - his false grandeur,
Will serve the Gods their anger stir.
And they will send the Dragon back
To light the sky - his tail will crack**

**Upon the earth and rend the earth
And man shall flee, King, Lord, and serf.
But slowly they are routed out
To seek diminishing water spout**

**And men will die of thirst before
The oceans rise to mount the shore.
And lands will crack and rend anew
You think it strange. It will come true.**

**And in some far off distant land
Some men - oh such a tiny band
Will have to leave their solid mount
And span the earth, those few to count,**

**Who survives this and then
Begin the human race again.
But not on land already there
But on ocean beds, stark, dry and bare**

**Not every soul on Earth will die
As the Dragons tail goes sweeping by.
Not every land on earth will sink
But these will wallow in stench and stink
Of rotting bodies of beast and man
Of vegetation crisped on land.**

**But the land that rises from the sea
Will be dry and clean and soft and free
Of mankind's dirt and therefore be
The source of man's new dynasty.**

**And those that live will ever fear
The dragons tail for many year
But time erases memory**

**You think it strange.
But it will be.
And before the race is built anew
A silver serpent comes to view**

**And spew out men of like unknown
To mingle with the earth now grown
Cold from its heat and these men can
Enlighten the minds of future man.**

**To intermingle and show them how
To live and love and thus endow
The children with the second sight.
A natural thing so that they might
Grow graceful, humble and when they do
The Golden Age will start anew.**

**The dragon's tail is but a sign
For mankind's fall and man's decline.**

**And before this prophecy is done
I shall be burned at the stake, at one
My body singed and my soul set free
You think I utter blasphemy
You're wrong. These things have come to me
This prophecy will come to be.**

**My mother-in-law, who lived to be 90,
during the whole of her adult life,
was a gatherer of newsprint curiosities.
These amounted to many thousands of items
which in her retirement she spent many hours,
days, weeks and months in sorting.**

**I gathered together empty cereal boxes,
covered them in various shades of wall paper,
and lined the walls of a room with shelves
to aid her in her task.
Eventually, I purchased over ten thousand dollars
of microfilming equipment**

**and hired three ladies for a summer
to microfilm all the material she had categorized.
There is sufficient resource in
the material for several books
and I may someday donate it to a library.**

**In reviewing this material on prophecy
I found a number of versions
of the poem by Mother Shipton.
This raised my curiosity
as to which version was correct
and so I made a trip to Chicago and
visited the Central Public Library on Michigan Avenue
where I inspected the listings in the main catalogue.**

**Some references to rare books
led me from one librarian to another
until I reached the chief librarian
who gave me a letter of introduction to the
Rare Books Archives located on the north side of Chicago.**

**Because of the lateness of the hour
I hailed a cab and informed the driver of my hurry,
which in retrospect proved to be an erroneous and incautious act.
I thence braced myself between the seats
and endured with white knuckles and clinched teeth
the most horrifying ride of my life.
This from one who has flown upside down in fighter jets,
ridden with high speed police escorts,
survived several auto crashes, and flown in antiquated aircraft
through the air pockets of arctic storms.**

**Upon arrival the driver turned to me and said,
"I thought you were in a hurry?"
"But not to reach the next Kingdom", I replied.**

**The building before which I was deposited was
an ordinary apartment house of a half dozen stories
and indistinguishable from the dozens of others
that lined the street.
The front entrance was unlocked and the foyer empty
so I passed through them**

**and a second set of doors into a gallery empty
except for a single uniformed policeman who immediately halted me.**

**Upon my presentation of the letter of introduction
he opened an elevator,
pushed a button for another floor and sent me on my way.**

**When the elevator doors opened I found myself in a gallery
similar to the first
and again occupied by a single uniformed policeman.
Once again my credentials were reviewed
and then I was escorted through a set of doors
to a receptionist who still again examined the credentials, interrogated me as to my purposes,
relieved me of my overcoat and briefcase
and finally led me away to a fish bowl sort of room
surrounded on all sides by clear glass paned windows
and in which there was but a single table and a single chair.**

**There shortly appeared another lady
who took in detail my request
and I was then left for another twenty minutes
to examine my fingernails.**

**Upon her return she brought with her a stack
of about a dozen old volumes
and pointed out a button that I was to push
when I was ready to depart.
I was then left alone to examine the treasure.**

**The volumes before me were truly ancient.
I am told that modern printing will not last near so long
because of the sulfur content of the paper.
The ages of the volumes spanned back over several centuries
and the most recent of them leapt frogged back
by many decades the earliest version that, until then,
I had been able to find upon the subject.**

**I first arranged the volumes in the order of their antiquity
and then set about to examine them.
The earliest volumes were of course set in Old English type
with the what appears to us as the f for s symbols,
and the quality of handset type was of course quite different**

**from what we are used to today,
as was also the nature of the prose.
Nevertheless, an hour and a half of study
afforded me numerous insights.**

**To my disappointment I found that in no case
which I could determine were the prophetic references to events
which have occurred
printed prior to the occurring of those events.
In these versions, in the ones that I had examined previously,
and in the many that I have examined subsequently,
there are often references to contemporary events
not found in all the versions.**

**In the version above
the lines starting from:**

**Footsteps will be seen in every room,
to----
But the wall that falls will not be so old.**

are of my own creation.

**About the only reference that I found consistent,
was that regarding snow in the streets and on the housetops,
a symbolic reference that does give one pause to think.**

**I do not wish to be totally disparaging about the poem
for I do not feel that it is entirely without merit
but I do feel that it is an excellent example
of the caution with which one
must approach these matters.**

**There is really little of benefit
that can be communicated by prophetic writings
to anyone who does not have a pure spirit of
scientific inquiry and a mature method of historical analysis.**

**Much of what passes for education today,
even from the universities,
is pseudo scientific.
The true spirit of inquiry**

**into the underlying reality of things is most often missing.
The most advanced scientific thinkers
and the most advanced religious and mystical thinkers are of a kin
but their imitators dogmatically fall
into the morasses of materialism and
superstition, respectively.**

**I hope that I have not overly bored you
with this meandering of a raconteur,
and that you may be curious
about some of the other experiences
that I shall recount in this series.**

**Peace and love,
Bruce Beach
DawnSayer@webpal.org**

MENU: [HOME](#) » [Reconstruction](#) » [Recovery](#) » [Renewal](#) » [Prophecy Directory](#)

POP02 - Ouiji

If you have some suggestions or comments you would like to pass on to me about these pages you may do so at: DawnSayer@webpal.org

This is a continuation of the POP (Power of Prophecy or Problems of Prophecy) series that I am presenting, in which I am sharing some of my own experiences in that field of search.

I had long researched in this area when my wife and I had occasion to stay overnight with friends on our way to Hollywood where I was to see my book agent.

While our hostess was preparing supper I took down one of a large number of 3 ring binder volumes that were on a shelf above the sofa on which we were sitting. There were numerous typed accounts with dates and names of great numbers of sessions with individuals.

Therein I read a dialog with a particular individual, in which it was foretold that he would die in an airplane accident. Hmmm, said I, to myself. Taking the volume I went out to the kitchen and addressed my hostess.

"What are these?", said I.

"Oh, those are Ouiji Board readings", said she.

"But we don't do them anymore", she continued.

(Knowing that I would know that it was dis-recommended by her current religion.)

"Hmmm", said I, "Would you happen to remember whatever happened to this particular individual?"

"Oh, he was killed in an airplane accident", said she.

I continued ---

**"Really? That is what it says here will happen to him!
I have often heard of Ouiji Boards but I have never seen one.
Do you still have one?"**

"Yes", she replied, "But we don't use it anymore".

"Well, I would like to see how it is done."

"Okay, I can show you after supper, but we won't do it ourselves, because like I said, we don't do it anymore."

(More philosophical discussion about its use and accuracy and then after supper my wife and I sit down with the Board between us, and direction from our host and hostess from across the room.)

"Put you hands on the device. Have your wife put her hands on yours. Say a prayer and call on the name of a Spirit Guide".

(I called upon the name of a well known Spiritual Leader, I might say a prophet (with a small p) that had ascended into the next world.)

"Now, start asking questions".

"Where are we going?"

**(To my surprise the device began to spell out a word).
SALEM.**

(Now that was ridiculous. I knew there was a Salem Massachusetts and a Salem in the Carolinas where they had burned the witches, but we were in Utah and headed West. The OPPOSITE direction. So, how in the world was I going to end up in Salem? I asked.)

"How are we going to get there?"

BY THE NORTHERN ROUTE.

(More ridiculous still. So it thought we were going to Massachusetts, but we were heading for Hollywood by the Southern route. I was now ready to reject this non-sense, so I asked a sarcastic question.

"Does this thing really work?"

YES, BUT YOU DON'T NEED IT.

(And so we had a good laugh about it and put the silly thing away).

**Less than two weeks later,
through a very odd set of events,
we ended up without any choice
in Salem, Oregon
that I didn't even previously know to exist.**

**I took the VERY GOOD ADVICE
(knowing the Source)
and never used such a thing again.**

**In previous years,
I had read books about phrenology,
palm reading,
tea leaf reading,
crystal ball gazing
and so forth,
but this was my only personal experience
or experimentation.**

**The problem with these things
(and other things like drugs and channeling)
is that they work -
in the beginning.
But eventually they lead you down a wrong path
of dependence and ineffectuality.**

**I could go into much more detail about these matters,
along with other subjects such as
Brain Washing**

**Deprogramming
and a variety of other phenomena
but that is not the purpose of this presentation.**

**Common sense will tell you,
if you look upon abusers of these phenomena
(any use is abuse)
that their practitioners benefit no more
than alcoholics do from alcohol.**

**Practicing alcoholics BELIEVE they benefit from alcohol,
as fortune tellers believe they benefit from fortune telling,
but you only need to look at the quality of their lives.
If they could really derive such benefits as they claim,
they would pick the winning lottery tickets,
or at least good investments in the stock market,
and would live a much different lifestyle
from than that in which one usually finds them in.**

**I only report this incident to you
that you may know that I have traveled
all these avenues.**

**Today I know many people, personally,
who are dependent on astrology, channeling and such.
I now have a large accumulation of evidence
that it is not beneficial.**

**It is like trying alcohol or drugs.
If you never take the first drink
you will never become addicted.
But like with smoking,
it may be hard to get started,
but it is a lot harder to stop.
So, just don't do it.**

**Peace and love,
Bruce Beach
DawnSayer@webpal.org**

MENU: [HOME](#) » [Reconstruction](#) » [Recovery](#) » [Renewal](#) » [Prophecy Directory](#)

POP03 - Plants One

If you have some suggestions or comments you would like to pass on to me about these pages you may do so at: DawnSayer@webpal.org

This is a continuation of the POP (Power of Prophecy or Problems of Prophecy) series that I am presenting, in which I am sharing some of my own experiences in that field of search.

This time I am going to write about something a little different. A scientific experiment, but at the end I hope you will see the relevance. I actually conducted three series in this area, the last with government funding but at this time I will tell you only about the first two series.

They are with a growth inducer and a growth retardant. I hope that you will carefully read the description of the method and see that it was a carefully controlled experiment. I, and many other hundreds of researchers, have done the same experiment and you are welcome to repeat it yourself.

First came the preparation of the subjects. We bought a dozen brand new aluminum pie pans taking them out of their original plastic wrapping so that we could be sure that none of them had been contaminated.

We then took bags of sterilized soil, purchased from the store, and put the soil in the pans, leveling it off at the top with the blade of a ruler so that we could be sure that every pan had the same amount of soil.

Next we drew a line through the middle of the soil in each pan and took red fingernail polish and painted the edge of the pan one-half way around on one side.

We used the fingernail polish so that it could not be erased or moved, and so that we could always tell which half was which half of the pan.

Next, in each pan, we put from the same seed packages, of non-hybrid seeds, two types of seeds - corn and bean, about two inches apart and two inches from the rim of the pan.

Because the pan was round and we measured the distance between each seed there were two longer rows toward the center with 5 seeds two inches apart then progressing outwards in each direction two other rows with 3 seeds and 2 seeds, for a total of 10 seeds on each side of the pan.

If you have the picture in your mind there were six rows in the pan with a total of 20 seeds and an imaginary line down the middle between the two longest rows. This was done exactly the same with each of the 12 pans.

Now we took a water sprayer and gave each of the pans the same number of squirts of water.

And then we took the fingernail polish and numbered each of the twelve pans. So far as we could tell, everything was now identical.

We then wrote the 12 numbers on separate identical pieces of paper, turned the papers upside down on a table and shuffled them as randomly as we could.

Then we called another person into the room and asked them to randomly select 6 of the pieces of paper, and the numbers of the pans on those pieces of paper we put in the control group.

Next we took two chess pawns, one black and one white, shook them behind and held out two hands, each one containing a pawn and saying which ever one the person selected that is the one that would receive the growth retardant. (They happened to select the dark one and so the red side of the pans with the fingernail polish received the retardant and the other side received the inducer).

The pans were then set on the table in front of the window, and each day they each pan received the same number of squirts of water all from the same water container and each day the pan on one end was removed and taken to the other end and all the pans were moved down one place in the row

so that each would receive approximately the same angle of light throughout the experiment.

The only difference was that twice each day, once in the morning and once in the evening the plants in the experiment received growth inducer on the plain side and growth retardant on the red fingernail polish painted side. The pans in the control group received nothing else than the measured squirts of water.

I hope that you will agree that this was a thoroughly controlled experiment. Now let me tell you the results.

Two weeks later, the 120 plants in the control group (6 pans with 20 plants) were all up one and a half to two inches tall. All healthy green looking - all very nice and even looking like a good farmer's field.

The plants that had received the growth inducer were however very sickly. Only about half had come up at all. Some of these had actually turned down and grown back down into the soil.

The plants that had received the growth retardant were, however, all there. Tall gangly and strange looking. Some over four inches tall - much taller than the control group.

What can we conclude from this experiment? Think about it.

That the growth inducer and the growth retardant had become mixed up?

That each side had received the opposite of what we intended?

This may all seem very off topic, but let me assure you that it isn't.

The reason will be given in my next email.

I just want to give you the time to think about the experiment.

**Remember,
our goal is to find, if we can, a true source of prophecy,
and we have yet, many things to examine.**

**Peace and love,
Bruce Beach
DawnSayer@webpal.org**

MENU: [HOME](#) » [Reconstruction](#) » [Recovery](#) » [Renewal](#) » [Prophecy Directory](#)

POP04 - Plants Two

If you have some suggestions or comments you would like to pass on to me about these pages you may do so at: DawnSayer@webpal.org

This is a continuation of the POP (Power of Prophecy or Problems of Prophecy) series that I am presenting, in which I am sharing some of my own experiences in that field of search.

Now, to explain what the growth inducer and the growth retardent were (in the previous email). They were prayer.

Yes, that is correct - PRAYER.

The plain side had received nothing else except prayer for its growth and the red side nothing else except prayer that it would not grow.

If you find this latter strange, please do remember that Jesus cursed the fig tree and that it withered.

And that such a prayer could be very effective against cancer, plagues of locusts and such.

But no matter, the experiment did go strangely, (the side receiving the prayer for growth - withering, and the side receiving the opposite - growing astoundingly strange). and later I shall explain to you why.

As I have said, these experiments, of the Power of Prayer on Plants, (there is a book by that name) have been conducted at Red Stone University, and elsewhere (I think perhaps Duke) and I know at the University of Wichita, because I later did them there myself.

The experiments have been thoroughly controlled

and there is no statistical possibility that the results are attributable solely to chance.

POP this time stood for the Power of Prayer on plants, but we shall get around to the relationship between prayer and prophecy.

My interest in prayer had been long standing. I am a class taught student of the Massachusetts Metaphysical College which is the training received by Christian Science Practitioners. I had already served as a volunteer War Time Minister, and although I am no longer a Christian Scientist I still have a deep respect for its teachings and can give many testimonies to its effects.

Thus it was, at that time, I approached the Botany Department at the University of Wichita and asked permission to repeat my experiments there. I was granted use of the entire green house, and with the aid of the Department Chairman undertook the experiments on a much grander scale.

We emptied and scrubbed the green house. New flats were obtained along with wheel barrows of sterilized soil. The Chairman insisted that we use hybrid seeds known for their consistent response and even growth. A planting device was devised to assure that all were planted at the exact same depth. A more accurate watering method was stipulated, and so forth.

I won't go into the details, but the end result was that we had rows and rows and rows of the most evenly grown plants that one might imagine.

To my mind the outcome was the result of the exact same cause that had contributed to the reversed results in the first experiment.

What in Christian Science is called mental malpractice.

**I won't go into all the philosophical details,
but there is good reason that Jesus said,
"That whatsoever ye ask for secretly
will be awarded to you openly."**

**Similar results had been reported in the Redstone experiments.
What I think happened in the first case
was that my former wife,
who was quite distraught with me at the time,
was present with the plants on the table all day long,
and she was quite aggravated with me, them, and the experiment,
and consequently the inverted result,
as with much else in my life at that time.**

**In the University green house,
many people made the trip down to the green house,
having heard about the experiment,
to laugh about it.
Their cumulative mental influence
and trust in the power of hybrid seeds
far exceeded mine.
Probably the world's most even crop ever.**

**Miracles are only miracles
to the person for whom they occur.
If by a miracle we mean the repudiation of natural law,
there is no such thing,
but rather there is application of supranatural (not supernatural) law.**

**Jesus said that if you have the faith of a mustard seed
you can move mountains,
but if one claimed this faith to a non-believer
and they asked you to prove it,
and you pointed at a mountain and prayed
and it jumped into the sea
they would simply say,**

"You were just lucky that an earthquake came along right then."

From years of experience

**I know the power of prayer.
I am no longer a Christian Scientist
but it doesn't make any difference who prays.
The sun shines on all,
and God loves all.**

**Many do not know how to pray effectively.
Myself included.
It has been said that God punishes us in two ways.
Either by not answering our prayers,
or by answering them.
I really don't have the wisdom to know what is good.
Jesus plead to be delivered from the cross,
but in the end He said, "Thy will be done".
And that is where I always end up at,
because I never know that what I wish
is necessarily what God wishes.**

**Even my grandchildren pray with more direct desire
than I do.
And I think that is well.
When I have gone to Christian Science practitioners for help
it has been immediately forthcoming for health problems
and all sorts of other problems.**

**On two occasions I was so broke that I had not eaten for 3 days.
Both times I immediately received more affluence than I had previously had in my life.
On the one occasion the next morning.
A very dramatic story, but I won't tell it
and on the other some the next day
but within two weeks I had in my pocket over fifty million dollars.
Literally.
A cashier's check for \$50 million dollars,
plus a one hundred dollar bill that I took and placed with it,
so that I could say that I had over \$50 million dollars
in my pocket at one time.**

**There are MANY other things that I could tell you about,
but once again miracles are only miracles to those to whom they happen.
And I don't like relying upon Christian Science practitioners.
It is sort of like relying upon the Ouiji Board.
It works.
But we don't need it.**

**We are supposed to walk these journey's on our own.
Not that I am saying it is not good to pray with others,
and to ask others for help with prayer when you need it,
because that is a very good thing to do.
But what I am saying is
that I don't have it anywhere nearly all figured out as yet.**

**More to come.
And it all does tie into the subject of prophecy -
eventually.**

**Peace and love,
Bruce Beach
DawnSayer@webpal.org**

MENU: [HOME](#) » [Reconstruction](#) » [Recovery](#) » [Renewal](#) » [Prophecy Directory](#)

POP05 - Straight Arrow

If you have some suggestions or comments you would like to pass on to me about these pages you may do so at: DawnSayer@webpal.org

**This is a continuation
of the POP series
(Power of Prophecy or Problems of Prophecy)
that I am presenting,
in which I am sharing some of my own experiences
in that field of search.**

**For a number of years
after I left Christian Science
(actually, I was excommunicated,
when my former wife informed them
that I had become a nudist -
in my volley ball and sunshine days),
anyway in those years following -
I became a Buddhist.**

**Attended a Buddhist Church for about a year,
and then got into Zen.
(Traveled to temples in China,
and all that sort of thing).
Was much attracted to the teachings in a book called -
"Zen and the Art of Archery".
(Was also very much into Sufi,
and other teachings -
but I have never been that much of a purist -
about anything).**

**For years, after moving beyond Buddhism,
I continued to practice
"Zen and the Art of Archery".
Also taught my children.
Rented a corner lot cat-a-corner across from the house,
on the main corner of our village,**

**and set up an archery range with 4 target butts,
of various distances, so 3 children and I could shoot
at the same time.**

**Each of their special bows,
sized as to weight, left or right hand, and so forth,
still hang on our wall after years of usage.
We sometimes attracted quite a crowd of onlookers,
but I was never much of an archer.
Wrong type muscles to properly pull a bow,
and not really physically adept or coordinated
at anything**

**But the idea of Zen,
is not so much one of physical adeptness,
as that of mental (actually spiritual) mastery.
The question is -
what guides your arrow?**

**The stories are numerous
such as the old Zen Master,
who sent the acolyte out to the garden
to pin the target on a tree,
and then shot the arrow through
the Japanese papered wall of the house
and the acolyte then goes back to the garden
to find it implanted in the bulls eye.**

**Indeed, what is it that guides our arrow?
After years of practice,
I too felt that I was becoming somewhat adept.
The arrows continuously landed in the bullseye.
Finally I summoned wife to come and watch a demonstration.**

**I placed my arrow in the bow.
Raised it to my chin and let it fly.
It did something that it had never done before.
It flipped out of the bow,
tumbled forward and high into the air
above the hill behind the target and to one side
to come down on our dog who was lying peacefully there.
Of all the places to land.**

**The dog was shocked.
So was I.
Fortunately it was a spent arrow
and the dog wasn't hurt,
but what had guided my arrow?
A lack of humility.**

**There are two great tests for each of us in this life.
Self and passion.
Self is the greater test.
Trying to serve God - without self.**

**"Oh, God, if I do this -
how great I will be in Thy sight."**

The Walter Mitty dreams always plague us,

**"How great I will be".
"How people will be astounded with me".
"What great things I will have accomplished".**

**Getting beyond this is very, very difficult.
We must learn to serve God -**

**Neither in hope of heaven
Nor in fear of hell.**

**How willing are we to serve God?
I have a test that I often give people.
Look at the following choices -**

- a. Would you like to be rich and famous for serving God?**
- b. But what if you were given the choice,
that you could provide some great benefit to humanity,
and that while it would make you rich still,
humanity would not recognize you for the benefit.**
- c. Or that you could provide some great benefit for humanity
but that you would always be in great poverty.**

**d. Or that you would provide some great benefit to humanity
but not only would you be in poverty
and not recognized for the benefit
but that people would revile and despise you
because they did not recognize the benefit or that you were the source.**

**e. Or even that you came to understand
that while what you suffered to do
and for which you were reviled
while it was a benefit to humanity
while it was God's wish that you perform it
that you would still go to hell.**

**At which level would you be willing to provide the benefit to humanity?
If you think the latter case strange,
you must remember that the Book says,
"Even in hell will I set my angels to look over them",
so some angels have to serve in hell.
If that is where God wanted you to serve,
is that where you would be willing,
even want to go,
if it were God's will?
You say,**

"You would want to go to hell?"

**Indeed, I look at some of the hells on this earth,
and there I find angels and saints looking after the inhabitants.
Not my bit, I tell myself.**

**"Oh, Lord", I say,
"deliver me from that!"**

**And probably he finds me unworthy (I hope)
(that old self will)
of that.
But we never know.
We will have to do that which we will have to do.**

**But, what does all this have to do with POP
(the Path of Prophecy)?**

**Oh, my brother,
Oh, my sister,
if thou would's't step upon the Path
thou must first purify thy soul,
so that not the least trace of self or passion remains.**

**And thus it is
that I am but an observer -
and not a prophet.**

**Peace and love,
Bruce Beach
DawnSayer@webpal.org**

MENU: [HOME](#) » [Reconstruction](#) » [Recovery](#) » [Renewal](#) » [Prophecy Directory](#)

POP06 - The Iching

If you have some suggestions or comments you would like to pass on to me about these pages you may do so at: DawnSayer@webpal.org

**Through the decades
I have conducted many classes
on the subject of meditation.
At one time traveling a circuit
on weekends week after week
through small communities
where I had placed newspaper ads
in Northern Ontario.
Never have I charged a dime
(nor taken a donation)
for these courses.**

**At another time I had large classes
in what was the then popular
"free college movement"
at a large university.
There came to these classes
week after week
an individual who repeatedly pleaded with me
to allow him to cast the I-Ching for me.
I declined.**

**But, finally I agreed,
on one condition -
that it be cast in the dark.
If you are not familiar with this method,
it is similar to that related in the Book of Daniel
where the king called in his astrologers and soothsayers
and asked them to interpret his dream
without his telling them what the dream was.**

**My fortune teller,
was equally well astounded at my suggestion**

(you must read Daniel to see the king's fortune tellers' response)

but at last he agreed to proceed.

**What we did in this method,
is that I wrote the question on a piece of paper,
folded the paper so the question could not be seen
or changed
and placed it in the middle of the mat
on which we were about to cast the I-Ching.**

**Assuming the traditional positions,
and offering the traditional prayers,
we began the process.**

**If you are not aware of how the I-Ching is cast
I shall briefly explain the process.**

**A die is cast,
and a marker is positioned.
There are something like ten groupings
of five each (as I remember).**

The arrangement would look something like this:

```

10100__11000__00110__01101__11101
11011__01100__01011__00110__10111

```

**The actually arrangment of the ones and zeroes
in the above example
is coincidental.**

I just picked them randomly as an example.

The thing to notice here is that there are two rows

The top row represents

HEAVEN

and the bottom row represents

EARTH.

**Each of the groupings has an interpretative meaning,
and the interpretations are given according to long tradition
as found in Interpretative Books written about the I-Ching.**

**The actual position of the ones and zeroes,
is determined in a ritualistically prescribed order
by casting the die.**

**It takes a while to go through the whole process,
but in the end here was our ACTUAL result.**

11111__11111__11111__11111__11111
00000__00000__00000__00000__00000

**The getting of all the ones in a line
and all the zeroes in another
is the equivalent of flipping a coin
and first getting fifty heads,
and then getting fifty tails all in a row.**

**I was teaching statistics in the college
and I can tell you that the probability of this happening
is much, much less than than of picking all seven numbers
in the lottery.**

**Now the real significance of this comes in regards to the question.
Sort of like that quiz show on TV called Jeopardy
where they give you the answer
and you formulate the question.
This was the answer.
What was the question?**

**First to examine the meaning of the answer.
In this answer
all the ones in heaven
means that heaven is ruling
over all the zeroes on earth.
I won't go into all the mystical significances.**

**But now we opened the paper
so my fortune teller friend could see the question -
It was -**

**"Is the Prophet that I am trying to teach you about
the True Prophet?"**

He never returned.

**Peace and love,
Bruce Beach
DawnSayer@webpal.org**

MENU: [HOME](#) » [Reconstruction](#) » [Recovery](#) » [Renewal](#) » [Prophecy Directory](#)

POP07 - The Seeker

If you have some suggestions or comments you would like to pass on to me about these pages you may do so at: DawnSayer@webpal.org

**This letter in the POP series
is the last one in which I will be talking about
my own experiences.
The next several should be much more interesting
to you,
because they will be talking about YOU.**

**My purpose in talking about my own experiences
has been two fold.
So, that you could know something about me, but,**

**While it is good to know the teacher,
It is better to know thyself.**

**Secondly, I wanted you to know
that I have examined many, many paths to Truth
and while I won't say that there are any false paths
some of them are very, very circuitous.
I am hoping to show to you what I have found to be
The True Path.**

**Many people send me all sorts of information today.
And I am very appreciative to receive it.
Information about all sorts of
dreams
visions
prophets
predictions
and many other interesting things.**

**I have a very Fast Filter
so I can deal with all of these very rapidly.**

**But the problem is
that other people have fast filters also.**

They say to me -

"Beach, do you believe X about _____ ?"

**"And if you don't then you are
wrong, wrong, wrong."**

**You can fill in your own words for the blank,
but just yesterday some them would have been
the Rapture
the NWO
Christ
Resurrection
Reincarnation
and twice about the White Buffalo
and twice about the Environment
and one of the fellows wanted to be removed from the list
because my answer was not the right one about the environment.**

**Many times too,
the blank is about which church
and this can be
Catholic
Mormon (LDS)
or just Christianity itself.
Millions of people out there
have such fast filters
that they would not even be on this list in the first place.**

**The real issue is not
how FAST one's filter is,
but how ACCURATE it is.
Better accurate than fast,
but we get so much information today
that you need to be able to sort out what you are going to examine.**

**Here is a good test.
You have a lot of experience in your life
and have hopefully already sorted out lots of baloney.
As a result you have developed a system of thought,**

perhaps even a philosophy that you trust.

**When someone comes with something new,
then your natural and proper response is,**

**"How does this fit in
with what I already know".**

**If the person has no idea of what you believe,
then they can't explain their belief from your perspective.
It just boils down to:**

"I believe this - you believe that",

about superficial matters with no understanding of why.

**Okay, so they have a great and complicated system,
about physics or whatever,
but they need to be able to put it in terms
that you can understand.**

**It is a long journey to understand a complicated system
but every journey must begin from where you are
and in terms that you understand.
That is the teacher's responsibility
to meet you on the path at the point where you are.
It is then your responsibility
to take the next step on the path
in which the teacher points.**

**If someone shows up at my door in the next few minutes
and says:**

**"Beach, you are full of baloney,
and I can prove it to you."**

I will say,

**"Welcome, welcome in.
I have been waiting for you.
What took you so long to come?"**

**Now, this person, to know that I am wrong,
"full of baloney"
is going to have to know what I believe.
Otherwise, it is as if he says,**

**"Beach I have something WONDERFUL in this box
that you should have."**

and I look in the box and I say -

**"Oh, THAT is wonderful,
but I have something even more WONDERFUL
in my box."**

and he replies,

**"No, no, no, this is the MOST wonderful thing
that there is. There can't be anything more wonderful."**

and I say,

**"Yes, that which you have IS wonderful,
but I have looked in both boxes,
and I know that what is in my box is MORE wonderful."**

still he replies,

**"No, no, no, I have a lot of experience with what is in my box
and there just can't be anything more wonderful."**

At this point, we can't go forward.

If the person is a Christian

I tell them,

**"Yes, Christ is WONDERFUL,
and I would not have you to have Christ any less,
but I want you to have Christ more,
because God is Infinite and there is always more."**

**But, it is often the case that people can only look in their box,
or if they will even glance in another box**

**it is not really to see what is in it
but just so that they can "prove" that what is in their box is better.**

**All this will never do.
One must lay aside their prejudices
no matter what they are
to step forward on the True Path.
People are born into all sorts of prejudices.
You are whatever color skin you are -
because your parents were that color skin.
You speak whatever language you speak -
because your parents spoke that language.
You are probably whatever nationality your parents were,
and a member of whatever religion (Christian, Moslem, Buddhist, Hindu)
that your parents were.
You are in the box that you were born in.**

**Oh, we make small changes,
from one denomination to another.
Learning a "foreign" language,
changing from one political party to another,
but all within the culture of which we are a part.**

**If you were born in America
it is very unlikely that you will end up
as a Buddhist in Japan speaking Japanese
or as a Hindu in India speaking Punjabi.
And why would you want to.
You know that what you have is good.
But it is just that a dramatic change
that I am inviting you to,
because it is to something BETTER.
MUCH BETTER.**

**There is really no need for you to read further
in this particular email.
If you are committed to the journey,
then I have had said enough.
The rest is too much,
because it is again just about my personal experiences.**

Many the tale

**that I would like to share with you -
about a number of mystical experiences in the Arctic,
about my UFO encounters -
(that alone takes over an hour to relate verbally),
but briefly I was a control tower operator
at one of the five experimental Air Force Bases in the U.S.,
and actually sent planes in pursuit.**

**I would like to tell you about my publishing
(for another writer)
lengthy books on Pyramidology
(I was a publisher for some years).**

**I would like to tell you about
many strange astronomical phenomena that I have studied
(I set up a professional observatory at one college)
and you might like to look at my [millenium star](#).**

**I would like to tell you about studies
on the Bible Code
(a way of counting and arranging the letters
in the original Bible Texts
so as to create prophecies).
Or about a study that a friend of mine did
on the Celestine Prophecies,
that really impressed me.**

**I would like to talk further about Bibliomancy,
the various methods of turning randomly
to Scriptures for guidance.
(One method that I am considerably more inclined towards).**

**I could tell you about experiences
in many different Ashrams,
with the Moonies,
and the Hari Krishnas,
with Dianetics and the E-meter
-yep, read the whole book - did the tests.**

**Yes, I took the courses,
received the secrets,
of most every Guru that you can name -**

**from TM (the Beatles favorite)
to the (young at the time) Guru Maharaji
(just checked that he is still around).
All very interesting.**

**Met all sorts of interesting people.
Weekly luncheons with one group
that had several UFO abductees
(so they claimed or believed).
Most of them realized that they were schizophrenic,
having at sometime been hospitalized,
but one may have been one of the few real charlatans
that I have ever met.
He made, and I guess still makes,
a substantial living from his books
which are particularly popular in Japan.
Most of these people are simply self deluded.
Doesn't mean that I don't still like them,
and also that they don't sometimes (mixed in)
have amazing insights -
because they often do.**

**Just like drug and alcohol addicts.
Often amazing insights
about everything except their own problems.
Too often we are quick to call groups cults.
They are just people
who have gotten off the path of reality
more commonly accepted.
Usually the paths have many erroneous elements,
but so then is the path followed
by most "normal" people.
That of knowing all the latest sports scores,
what the popular brand names are for clothing,
knowing who the stars are in the latest movies ,
and all the materialistic hype of modern CULTure,
is another path equally divorced from reality,
as is all the dogmatic conformance to churchianity,
patriotism, or for that matter any other fanaticism
of the current "CULTural revolutions".**

**We should not envy the powerful or rich
(I have been in the same room**

**with a number of U.S. presidents),
nor despise the poor and downtrodden,
for God leads each on their own way.
I have taught volunteer college courses
to lifers in prison,
and have served as a psychiatric social worker,
in several institutions,
and I know that many of these people are
more sincere in their struggle to find reality,
than are masses of people
that freely wander the earth.
I at one time lived a block and a half
from the corner of Haight and Ashbury.
You have to be ooolld
to understand the significance of that.**

**My purpose in reciting all this to you,
is that you may know that
I have examined every avenue,
in the search for Truth.
And as lengthy as is this accounting
it does not begin to exhaust all that I have done.
Strange Rosicrucian experiences.
Serving as Chauffeur and Guard for Ezra Taft Benson,
then Secretary of Agriculture of the United States,
and later Prophet of the Mormon Church
(I put this in for my LDS friends),
and still the list goes on and on.
Who else among you has had your life threatened
in Philadelphia Mississippi
(where three voting workers bodies
were found buried in the dam),
or have lain on the floor with your family
as the gun battles went on in the street
one floor below and a block and a half
from the Black Panther Headquarters.**

**But enough of this.
Too much already,
although I could go on and on.
I receive many emails each day
(all of which I try to answer)
from people with a great variety**

of different belief systems.

**The purpose of the previous emails was to show
the spirit of search
with which one must seek.**

**But, as Jonathan Livingston Seagull once said,
"It is good to be a seeker,
but it is better to be a finder."**

**And in my searching-
I did find.**

**I found not only how to identify the True Prophet,
but I also found the True Prophet.**

The time is now too short to continue with tales.

**The time has come for the Truth to be Told,
and I shall tell you how to find it for yourself.**

**But, you must be willing to make the journey yourself.
No one else can make it for you.**

**Just as every student of mathematics
must work the mathematics out for themselves,
because no one else can do it for them.**

**Oh' we can show the formula,
go through the exercise,
but in the end each one must think it out for their self.**

**Because we live in a Christian Culture,
the proofs that I am going to present are
Christian proofs.**

If we lived in a

Buddhist,

Moslem,

Hindu,

or other culture,

then I would use proofs from those cultures.

It makes no difference

**if you consider yourself a Christian or not,
because you live in a Christian culture,
you will be able to understand the proofs
from a Christian perspective.**

Yes, we will look in the Bible,

**and if you do not currently believe in the Bible,
then afterwards, if you follow the presentation,**

you will come to a new appreciation of its significance.

**So now, our search for the True Prophet,
and the True Prophecies,
has taken this turn.
Bear with me if you will,
or depart in peace.**

**Peace and love,
Bruce Beach
DawnSayer@webpal.org**

MENU: [HOME](#) » [Reconstruction](#) » [Recovery](#) » [Renewal](#) » [Prophecy Directory](#)

MENU: [HOME](#) » [Reconstruction](#) » [Recovery](#) » [Renewal](#) » [Star Directory](#)

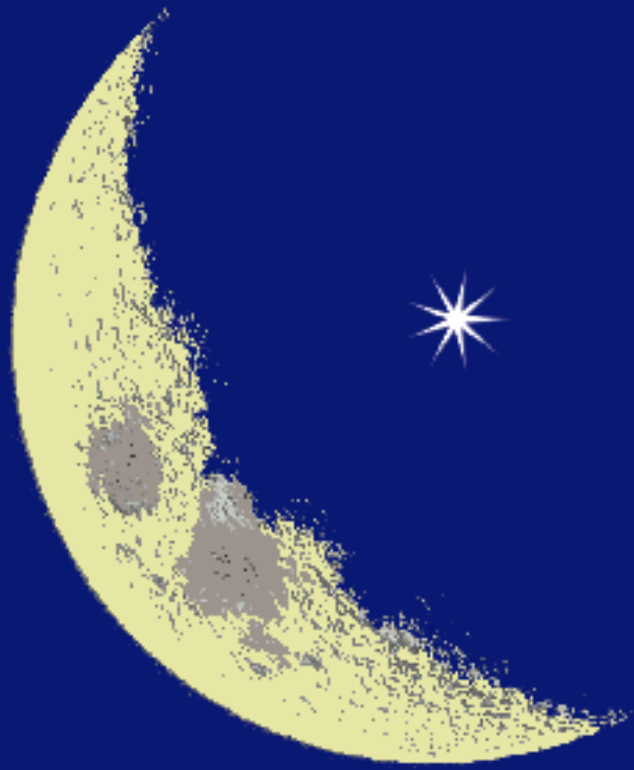

Millennium  *Star*

Millennium Star

Fulfillment of an Ancient Prophecy

This oft-told ancient prophecy,
with roots back in the Sufi and Illuminati teachings,
is reflected in the Tale of the Ancient Mariner,
with its "star dogged moon"
and in the ancient symbolism on the flags of
many modern Moslem countries.

What the prophecy says is that:
at the Time of the End,
a Star will appear between the Crescent Points of the Moon.

Now, all astronomers KNOW that this is impossible.
Stars are generally very large astronomical phenomena like
our sun.

The closest being our sun,
and the others many light years away.
For one, to appear in the orbit,
between us and the Moon,
would be IMPOSSIBLE, they would say,
and WOULD destroy the earth should it occur.

And yet, this phenomena,
this end of the old - beginning of the new,
millennial event - of a Star appearing between the Crescent

Points of the Moon,
WILL OCCUR this very month.

Let me explain:

To the ancients, there were two types of stars,
fixed stars,
and moving stars,
and they both looked alike to them,
since they did not have a telescope.

The only distinction was that the one small group of stars
moved,
and for this reason they called them planets (travelers),
which to them simply meant moving stars.

Now, today we have a different view of planets,
but nevertheless, it is a planet that will appear
between the Crescent Points of the Moon.

But, whoa, hold up you may say, if a planet
is going to change its orbit
and pass between the earth and moon,
that TOO is certainly going to be a catastrophic event.

Well, actually, still some further explanation is needed.
To any primitive people,
that would happen to be occupying the earth at this time,

if they were out tending their flocks on a clear night,
they would notice that new stars,
new traveling stars (planets),
have appeared in the sky.
We call them satellites.

Now, the fact is,
that a Traveler will appear between the
Crescent Points of the Moon.
And I would like to have a photograph of the event.
When and where will it happen?
Well, probably about every month,
from some advantage point on the earth.
To observe and photograph it,
one needs a cloud free night,
(or to be above the clouds)
and for the satellite to be **AT THE CORRECT ANGLE**
between the observer,
and a Crescent Moon.

DawnSayer@webpal.org

MENU: [HOME](#) » [Reconstruction](#) » [Recovery](#) » [Renewal](#) » [Star Directory](#)

POP 07a - My Declaration

If you have some suggestions or comments you would like to pass on to me about these pages you may do so at: DawnSayer@webpal.org

Baha'i's use the term "declaration" regarding their belief in and commitment to Baha'u'llah. Here I will tell you about the event that led to my declaration.

I had been aware of the Baha'i Faith for many years and had visited the Temple in Chicago a number of times.

Then, back in my native Kansas I saw an ad in the Sunday paper with a picture of the Temple and called out of curiosity that there were Baha'i's there.

At the local Baha'i's insistence I visited with the group that morning but told them I had no time to read a book. Their reply was:

"God will give you time."

During next week a major Evangelical Crusade was planned for the City of Wichita. Everywhere one looked one saw banners that proclaimed -

"Hear Haggai"

the evangelist.

**The banners were in store windows,
on car bumpers,
on telephone poles,
and on two big banners
strung across the main street
at both ends.**

"Hear Haggai"

**On the radio,
in the newspapers,
everywhere one looked
or heard - it was:**

"Hear Haggai"

**The newspapers reported
the week long event.
Many thousands in attendance -
the gigantic choir -
the moving sermons.**

**Each evening a Baptist friend
would come and ask me to go
but I was too busy.**

**The final evening he came
and insisted and insisted
telling me that the night before
over a hundred and fifty people
and gone forward to be baptized,
and that this was my last chance to -**

"Hear Haggai"

**In consideration for my friend -
I finally went with him.
The coliseum was packed.**

**The main floor
which was the city basket ball court
was filled with chairs.**

**At one end of the court was a stage
with 150 robed members of the choir
comprised of the joint choirs of
a number of the cities churches.**

**Three of the four balconies surrounding
three sides of the basket ball court
were also filled with only some vacant seats
in the fourth balcony.
Thousands in attendance.**

**It looked something like a political convention
with lettered signs held up on tall poles
showing the seating location
of each of the city's many churches.**

**East Side Baptist,
Rosedale Alliance,
Central Bible Church,
Broadway Church of God,
"Hear Haggai"**

**The church with the largest percentage attendance
was being given new hymnals for the church.
The winning church
had 300% in attendance.
It was a large meeting.**

**The choir and congregation concluded a hymn
and all sat down
and Haggai rose to speak.
Indeed a powerful sermon.**

**I still remember from the sermon
how he pointed out
the number of beneficial institutions of mankind
that have been started
because of the teaching of Christ.**

**There are hospitals,
and schools,
orphanages
and relief organizations of all sorts.
The list goes on into the tens -
as he gave it,
and the numbers of each
in the tens of thousands or more.**

**What man,
he asked,
has ever done more to benefit mankind?
One can look at all sorts
of political organizations
and political philosophies.
Personal organizations,
and personal philosophies
but what has done more
than the teaching of Christ
to benefit mankind?**

**Then he pointed out.
One is either for
or against
this movement that has so benefited mankind.
One cannot say
that they are neutral or indifferent -
because they are either part of the solution
or part of the problem.
Many were the points
that Haggai made of this sort.**

**I concluded that
well it doesn't really do any harm
in supporting Christ -
and better this source of good
than none.**

**When the altar call was given -
no one went up
although over a hundred and fifty
had gone the night before.**

**Even more were expected this night -
but I guess the crowd had thought
to beat the rush.**

**Several times Haggai paused the choir -
and urged sinners to come forward.
One time he gave an exhortation
that those there would be standing
on one side of the Pearly Gates
and that husband, brother, sister, friend
next to them would not be
because they had not turned to them
and offered to go forward with them.**

**My friend stood next to me
like a statue of rock,
but I must have dropped a shoulder
or something
because an usher came up from behind
and asked if I would like to go forward.**

"Well, yes."

**At the front I found myself
and one other fellow who eventually came forward
standing there looking up at the choir.
Haggai finally stopped the music
and looking down at this poor catch said -**

"Well, the Lord is looking for quality - not quantity".

**He assigned to each of us
two deacons (or guards as I called them)
and told them to take us to an upper room
where he would come shortly.**

**And so we marched out -
I and my two guards leading,
and the other fellow and his two guards trailing.**

**Up the broad cement and steel stairways
behind the auditorium**

and into a team dressing room.

**Red brick walls and wooden floors
with windows two feet above one's head.
Fold-down windows with opaque
chicken wire-embedded glass.
Hanging from the 15 ft ceiling
down the middle of the 50 ft room
five single light fixtures on stranded cord
with green shades and 150 watt bulbs.**

**Except for one table -
the otherwise unfurnished room
had lining down the walls on each side
a half dozen 7 ft benches
with patches of white showing through peeling green paint
worn out from a generation of showered athletes
having been sitting upon them.**

**Being first through the door -
my guards and I proceeded forward
several benches and sat down
with one guard on each side.**

**With a couple of benches in between
my companion captive was also similarly seated.
And thus we sat -
in total silence
none of our guards
having every spoken a single word
to either of us.**

**Through the thick walls of the fortress
and away in the distance
we could dimly hear the voices of thousands
raised in praise to the Lord of the Ages.**

**And then -
total silence
as there must have been being offered upon them
a final blessing.**

**And suddenly -
a loud clamor and commotion
as thousands rose from their seats
and moved towards the exit.**

**Bit by bit,
the clamor died away
until again there was total silence.**

Wait.

Wait.

**And then from the distance -
thump, thump, thump
growing louder -
thuMP, tHUMP, THUMP,
and the door burst open
and in marched Haggai with
twenty or more ministers behind him.**

**He stopped in front of the other prisoner,
whose guards IMMEDIATELY
split away from him and departed
as the ministers formed a semi-circle
around behind Haggai, who said -**

"Have you made your decision for Christ?"

*"Well, I was b..b..b.. baptized before -
but it d..d..didn't take."*

"Having you been attending church?"

**At this point one of the ministers said
that the conversant had been attending his
and stepped forward and put his hand on his shoulder
and then with a glance over towards me -
seeing that he did not know me,
led the petitioner from the room.**

**Haggai then turned towards me.
THUMP, THUMP, THUMP,
and the semi-circle formed behind him.
SUDDENLY my guards were GONE!**

"Have you made your decision for Christ?"

*"Well, I have one question that concerns me.
May I ask it?"*

"Yes?"

*"Well, you see I have been attending this
Buddhist Church in Chicago -
and what I want to know is -
'Are my Buddhist friends ALL
really going to go to hell?'"*

**At this point
Haggai glances back over his shoulder
and about a fourth of the ministers**

are standing there shaking there heads up and down -

and about a fourth of the ministers

are standing there shaking there heads side to side-

and about a fourth of the ministers

are standing there sort of shrugging-

and about a fourth of the ministers

are standing there with blank expressions on their faces.

And Haggai says,

"I tell you what I want you to do -"
**and he tells one of ministers to hand him
from the table in the corner
a copy of a pamphlet
of the Gospel of St. John -
(which I have to this day - over forty years afterwards,)
and he says to me -**

"I want you to take this home,

*and each night
and each morning
read a chapter of it
and get down on your knees
and pray to God to show you His Will."*

And then he says,
*"And I want you to call me tomorrow
at my motel
and I will meet with you."*

**So, I did as he said.
And the next morning,
I called at his motel,
and the operator said he had gone for breakfast -
and when I called again -
a little later she said that he had left -
and so I never got to talk to him.**

**But, I did exactly as he said,
and I want to testify to the efficacy of Christian prayer.
Each evening and morning
I read a chapter of the Gospel of St. John
and each morning and evening
I got down on my knees
and I prayed to God to show me His Will.**

**A few nights later -
I was asleep in my room -
when a figure appeared through
the darkened doorway.**

*"Arise -
and dress!"*

*"Wha, wha, what?
Who is that??"*

*"Never mind!
Arise and dress!"*

I fumbled over and turned on the night stand lamp.

**There in the room stood another friend -
from the Christian Science Church.**

*"Uh, what's up doc? -
It is after midnight!"*

"Get up and get dressed."

"Why?"

"Never mind - do it."

"What should I wear?"

*"Those pants, that jersey,
and a warm jacket."*

**Thus it was that I descended the stairs -
in my good suit pants and non-matching garb,
to find his new motorbike parked at the curb.**

"Come on -we'll go for a ride."

*"Neat. But no thanks,
I have been on a motorcycle before
and we had an accident."*

**(Same happened with my father,
and one of my sons was nearly killed on one,
and a friend's son is paralyzed -
I do not care for them.)**

But my friend insisted.

*"Okay, but just around
to the all night restaurant
on the other side of the block."*

"Well, okay."

**We didn't make it.
We were on a one way street.**

**Putt, putt, putt,
slowly up to the stop-light at the corner,
waiting for it to turn green,
which it does
and a car on the four lane road ahead
pulls up on the center lane and stops
to wait at their now red light
and we speed up to go across in front of it and turn -
when a car load of drunks comes through
on the curb lane and hits us.**

I sail completely across the street -

"Take this one first,"

**someone is saying to the ambulance driver.
A phrase which is repeated at the hospital.**

**I ask that a call be placed to my Christian Science Teacher,
(I am what they call a class taught student)
as they take me down to X-ray,
for 14 breaks where the car had hit me -**

*"Wrap it up -
and I will take it home with me."*

**I tell the attendant.
(The other fellow only had a broken shoulder bone.)**

**And so I ended back at my office -
when my father shows up from our home
30 miles south -
having heard about it on the radio.
He arrived at the same time
as one of the Baha'i's I had met.**

**My father and the Baha'i insisted
that I accompany my father home,
where my father summoned a local physician.
Although there were three hospitals in the
town the physician decided
I should be sent back by ambulance to the city,**

**where I was confined to a bed
although I still declined surgery.**

The next day the Baha'i came with a book.

*"See, I told you God would give you
time to read."*

**I had never felt pain
from the moment my CS Teacher was called,
and all the bones set themselves
and healed without surgery,
although I was released a week later
with a leg cast
but the fellow in the next bed was REALLY sick -
and there I was
reading the Baha'i Book
and in exaltation -**

*"I Found It!"
"At Last I Have Found IT!"*

That alone could have killed him.

**My favorite song became,
Jeanette McDonald and Nelson Eddy singing -**

*"Ah, Sweet Mystery of Life -
at last I have found you!"*

I played it over and over and over.

**Each person's experience in their religion
is a mystery.
Each person finds the mystery of life and love
in their own experiences.
For some my experience
may seem more story teller than story -
but we all seek the mystery of life.**

**There are always deeper Truths
and we can always grow deeper to God.**

**Many are the paths
and some may wonder how one can say
that one path is better than another.**

**One never has the FINAL answer
and all that one can do is compare what they have
with what they are given the opportunity to examine.
You have a box --
and I have a box.
You KNOW that what is in your box is beautiful and wonderful.
You just can't imagine
that there can be anything better.**

You say to me -

"Look in my beautiful box."

And I LOOK and say,

*"Yes, that is WONDERFUL! -
but what I have in my box,
is more wonderful."*

**Unless you look in my box -
you will never know.
God is Infinite
and His Creation is Infinite.
If you live 10 million years -
(and you will and many times that more)
you will never begin to exhaust
what you can learn about God and His Creation.**

**But, those who are haughty before God -
and refuse to look in another box,
will never know.
They can progress but only within their box
and as wonderful as that may be
it is still confining
and that is all that they will have
from Eternity unto Eternity -
while there is Infinitely more to God
and His Creation.**

**What we are meant to gain and set in this life
is our attitude of openness to the Holy Spirit -
and not some limited amount of finite knowledge
or dogma.**

**If there is good in all religions,
one may ask -
then what difference does it make
which religion one chooses.
The difference is that one must choose
to do the Will of God -
and they must always be open
to making comparisons and choices
as He leads us on the path.**

**Many a Christian,
many a Mormon,
has borne me their testimony.
Because I lived in Provo, Utah
and would always welcome the practicing Mormon Missionaries
I am sure that I have had more Mormon Testimonies
borne unto me
than any other single individual on earth.**

*"Before I leave -
I want to bear you my testimony."*

*"Oh, no, no -
not that again -
please!"*

"Nope, I am going to do it."

"No, really, you don't have to do it."

"Yes, I do."

*"Well, okay, I suppose so,
if you have to."*

And I am glad that they -

**and the many hundreds of other
truly devout Christians that I have met -
have a Testimony.**

**But I do wish -
that they could also look into my box,
and see then which they think
it is the Will of God that they should choose.**

**Peace and love,
Bruce Beach
DawnSayer@webpal.org**

MENU: [HOME](#) » [Reconstruction](#) » [Recovery](#) » [Renewal](#) » [Prophecy Directory](#)

MENU: [HOME](#) » [Reconstruction](#) » [Recovery](#) » [Renewal](#) » [Survival](#)

Essays on the
Four Types of Souls
by Bruce Beach

This is a continuation of the POP series which were originally an email series of essays.

The intent of the series was to lead the reader through such subjects as the nature of the soul and how it recognizes God through the Four Paths to Truth, and then on to presenting The Most Great Proof.

If you have some suggestions or comments you would like to pass on to me about these pages you may do so at:

DawnSayer@webpal.org

If you wish to enter into a discussion with me regarding religion - I highly welcome that. I have some [religious premises](#) that I would like you to review first, and let me know regarding any about which you disagree to help me better understand any points that you are making.

The Essays

POP08 - [The Four Types of Souls](#)

POP09 - [The Soul of Self](#)

POP10 - [The Soul of Love](#)

POP11 - [The Soul of Reason](#)

POP12 - [The Soul of Spirit](#)

MENU: [HOME](#) » [Reconstruction](#) » [Recovery](#) » [Renewal](#) » [Survival](#)

POP08 - The Four Types of Souls

If you have some suggestions or comments you would like to pass on to me about these pages you may do so at: DawnSayer@webpal.org

Good morning Seekers of the True One,

**Now that you have stepped upon
the Path of Search
for the True Prophet
it is important to know first the Seeker.**

**Who are YOU?
Well I can tell you that
you are a soul,
but as a teacher and traveler
we need to know what kind of soul.**

**There are only four kinds of souls.
I know that this may surprise you.
Some people think that there may be
only one kind of soul.
Others think that every soul is different
and that there are therefore infinite kinds of souls.
But no, there are only four kinds.**

**Recognition of this fact
is to be found in Aristotle, Shakespeare,
and many other classical thinkers
down through the ages.
It was acknowledged in the work of
William James, Americas greatest psychologist
and intimated in that of Pavlov,
which was Russia's. Many thinkers and teachers,
of the East were also aware and today
there is a large body of study on the subject.
But still it is not common knowledge
and most people are not aware that there are only**

four types of souls.

**My source for this information is of course
the True Prophet,
but I have mentioned the above because
Truth is Universal and can be universally found.
2+2=4 in both Russia and the US
or anywhere else one may go
no matter by what name the numbers are called.
So it is with other Truth such as religious truth.**

**Types of things come in limited numbers.
Water can be seen as a**

- **Liquid**
- **Vapor (clouds, fog, steam)**
- **Solid (sleet, hail, ice, snow)**

**and while every snow flake may be unique
it is still one of the three states of water.**

**Each person has blood of some particular type.
You may know yours.
While there are variations within the types,
we still say that there are only so many types.**

**As one last example -
Suppose that we said that there were only
four kinds of animals.**

- **Insects**
- **Birds**
- **Fish**
- **Mammals**

Among the insects there would still be great variety -

**from the tiniest ants to the giant beetles,
and from scorpions to the butterflies.**

And among the birds

**from the humming birds
to the ostriches and the eagle to the parrot.**

In the fish

**from the gold fish
to the Great Blue Marlin,**

and among animals

**from the tiny shrew
to the elephant.**

**With great, great numbers of varieties among all the species,
but still for our convenience we listed them as four categories.**

And no matter how great the variety,

**and the fact that every individual specimen is unique
just as each snow flake is unique**

there remain a limited number of categories.

**And so it is with the soul -
there are but four types.**

**Not to say that there is not great variety in the types,
or that you are not individual and unique,
because both of those things are true.
But it is still true that you have one of the four types
of soul.**

**It is important to know the type of soul.
Otherwise we will end up
putting the canary in the aquarium
and the goldfish in the bird cage.
Yet the world as a whole remains blind to this fact.**

**When you take your child to the kindergarten,
to enroll them in their first day of school
they may ask you a hundred questions
regarding**

- **sex**
- **age**
- **height**
- **weight**
- **even blood type**
- **and IQ**

**but never on the form will you find
the most important of all questions for a teacher -**

what kind of soul will I be teaching?

**In my next four letters
I will be discussing the four types of souls.
It is important to identify and understand
your own type of soul,
but it is also useful to know and understand
the other types.**

It will much help you

- **in teaching your children -**
- **understanding your spouse**
- **getting along with co-workers,**

**and the dozens of other situations
that you meet in life.
It is well to understand others,
even if they do not understand themselves.**

**For a teacher it is essential
to understand the kind of soul
that they are attempting to teach.
And in this I have a problem,
because I cannot know each of you individually.**

**I have taught before through email
on a one to one basis
but I have never tried to do mass teaching
through email
and I know of no other teacher
who has tried to do it either.**

**So perhaps it can't be done.
But perhaps it can.
So it appears that you are a part of an experiment.**

**Somethings can be learned out of a book.
But for other things a teacher appears to be necessary.
Probably no great musician or mathematician
has ever been self taught.**

**In the past I have seen attempts
to teach mathematics by computer.
In fact I was VERY enthused about the idea
and was involved in some very substantial programs
to do so.
Didn't work out.**

**Turns out that you can give printed example
after printed example with a computer
but successful teaching requires interaction
between a pupil and the teacher.**

**The teacher stands at the blackboard and explains
but needs to watch the eyes of the students,
and when they start to glaze over,
the teacher must slow down and wait for them
to catch up.**

**At some point the pupils may just not get it
and the teacher will stand at the blackboard
and tap with the chalk
at some particular point in the formula.
And then the gleam of recognition
will appear in the pupil's eyes
and the teacher can proceed on.**

**Readiness to read,
readiness to learn,
readiness to comprehend,**

**is something comprehended among all primary teachers,
consciously or unconsciously.**

**Many are the stories of the Zen Teaching Masters,
or of the Abbots in the Catholic Monasteries,
who suddenly performed some action
like reaching over and tweaking the pupil's nose,
grasping their ear and not letting go,
or thumping them on the head,
at the moment that they called satorie,
and that the pupil suddenly saw the light.**

**Yes, every student is unique,
and every step along the path is unique,
and every student must make every step for their self.
And therein is the problem,
because I must address a general need,
speaking at one moment to one type of soul
and at another moment to another.
Addressing some with a particular level
of concern or comprehension at one moment,
and those with another at the next.
We shall have to see if this will work.**

**In all communication there are three elements.
There is**

**the SOURCE
the MEDIUM
the RECEIVER.**

**It makes little difference what we are talking about.
It could be light.**

**The source (a bulb, the sun, or a fire)
The medium (light waves - I won't get into the subject of aether.)
The receiver (a mirror or any matter).**

It could be sound.

**The source (a drum or other instrument)
The medium (a gas or liquid such as air or water)
The receiver (an ear or transducer).**

It could be radio.

**The source (a transmitter or star)
The medium (radio waves)
The receiver (a walkman or a radio telescope)**

The principle remains the same.

In this case we have:

**The source (the teacher)
The medium (email)
The receiver (the pupil)**

In each case there is also the MESSAGE.

**The MESSAGE is quite separate from the signal or datum.
The Message should contain Information.
Otherwise, as in writing it is just empty marks, scribbling on paper.
Many people can see the signal
but not get the Message.**

**They can see the notes written on the musical score,
but not hear the Music.**

**They can even hear the sounds of the orchestra
but not hear the Music.**

**The Message and the Music
are something separate from the Signal.**

**The Message and the Music
are something heard in the soul,
not in the ear or in the instrument.**

**For this reason some can pick up the Bible or Koran
or other Book of Revelation
and just have the words sing off the pages to them
while someone else will just see the smudges of words on paper.**

**The problem of lack of communication
rests in either**

**the Transmitter
the Medium
or the Receiver**

**In this case
the MESSAGE
comes from a perfect source.
If you do not GET IT
then the problem rests in**

**the Transmitter (the teacher)
the Medium (email)
or the Receiver (the pupil - YOU).**

**I shall do my best to communicate it to you,
but I assure you
the problem is not in the Message.**

**Peace and love,
Bruce Beach
DawnSayer@webpal.org**

MENU: [HOME](#) » [Reconstruction](#) » [Recovery](#) » [Renewal](#) » [Four Souls Directory](#)

POP09 - The Soul of Self

If you have some suggestions or comments you would like to pass on to me about these pages you may do so at: DawnSayer@webpal.org

**The first of the four types of souls
that I shall discuss
is the type that there are the most of..**

**This is the Soul of Self.
This type of Soul well loves God,
and is well beloved of God.**

**The possessors of this type of soul
are the very backbone and foundation
of society.**

**As with all types of souls
their strengths can become their weaknesses
if they are misused.**

**As with all types of souls
they have their preference as to type of religion,
type of employment,
type of enjoyment and association.**

**These souls delight in order,
and when properly trained and educated
are highly respectful of authority.**

**Every religion whether Christian, Moslem, Jewish,
or any other,
has branches (sects) that provides a haven for these souls,
just as they have branches
that provide havens for other types.**

Some may consider the Catholic church

**to be a monolithic sect
but it is not
and that is why there are many different Orders
within it
so as to provide havens for the different types of souls.**

**The same is true of every religious system
and since things are never black and white
but rather a continuum and spectrum
from the brightness of the noon day sun
to the darkness of night -
a spectrum that includes dawn and dusk,
sunrise and sunset,
there is naught that one can speak on
but that some will eagerly point out the exceptions.**

Birds fly,

but then so does the bat which is a mammal.

Fish swim, and live in the water

but then so does the whale which is a mammal.

**Those who would be argumentative
can always find some evidence to bolster their position.
Nothing is pure in this world.
All is relative.**

**All men contain some feminine characteristics,
and all women some masculine characteristics.
The brightest among us will have some intellectual blind spots,
the dullest will occasionally have a brilliant insight
whether they will recognize it or not.**

**Still we can distinguish noon from midnight,
and the cold of winter
from the heat of summer.
And in like manner
we can make the distinction between the types of souls.**

Although many organizations

attract several types of souls

**Within those organizations that attract a single type
there is often a division of activities
that still further singles out those with some degree
of the qualities found predominately in the other types.**

**By this latter, I mean, that in organizations
that serve those of the Soul of Self,
there will be some individuals who will still fill
administrative or creative functions
although these are not primary qualities of this type of soul,
but those individuals will have those qualities (in a mixed degree)
more than others in the organization.**

**In discussing this first type of soul,
I am also discussing some generalities that apply to all types.
One thing that should be noted
is that soul characteristics do not appear to be inherited,
like blood type or skin color.
Any couple may have offspring
of any soul type.
(Among my half dozen children and dozen grandchildren,
I have had every type that there is).**

**Thus comes the danger
of trying to force children into your own paths.
Though you may be musically inclined
a child may not be at all,
or vice versa - very inclined in that way
where you are not at all.**

**The examples that I could give in this regard
are so numerous, but also so obvious,
that I will not even begin to list them.
Nevertheless, so very, very often,
children are directed into paths that do not really suit them,
and consequently they neither find the joy in life that they might,
nor do they begin to fulfill the potential that they might
in another field.**

**The nature of a child
needs to be recognized at a very young age,**

**because the training to gain full potential
needs to begun very early.
Once the child has been forced into a path
unnatural to its proclivity
it has no choice but to mature in that path
the best that it can
because a full turn around
cannot be accomplished.
But that is the nature of our present world.**

**So much for generalities.
Back to the soul of self.
This soul, in its search for order,
seeks that order in its family,
its government,
its schools and education,
and its employment.**

**These souls can become skilled technicians.
Learning, knowing, applying
in great depth
the rules, regulations, formulas and details
of their disciplines and professions.**

**They also can find fulfillment
as craftsmen, merchants, tradesmen.
Our society, and all societies,
are very dependent upon their contributions.
Their employment is often as electricians,
and plumbers, carpenters, and mechanics.
Farmers and soldiers.
Indeed they are the backbone of the military,
filling the ranks
and the roles of the non-commissioned officers.**

**Unfortunately, souls of other types
can also be found in those positions.
They often do a satisfactory job,
but they themselves are never truly satisfied,
because the positions do not match and fulfill their needs.**

Community service clubs, and veteran's organizations

**have great numbers of members of souls of this type.
They most often have a very similar social and political outlook.
They would prefer to see more order in society,
and are often distressed (and angry) at the disorder that they see,
at the lack of obedience to established rules,
and the lack of conformity to the standards that they admire
and appreciate.**

**As I have stated before,
each soul can turn its capacities for good
in the opposite direction
and thus it is that we also find
the major occupants of our prisons
to be souls of this type.**

**In their misdirected pursuits
they often fill the lower types of bars
involve themselves as participants or observers
in the more violent sports.
Indeed their interests in every activity
from work, to entertainment, to sex, to diet,
can become oriented towards the most base and physical.
They make up the class of petty criminals,
and are the main statistic behind violent crime.**

Every type of soul likes

- **music**
- **food**
- **sex**

and participates in

- **family**
- **work**
- **employment**
- **religion**

and becomes a part of

- **society,**
- **government,**

- **war**

but the distinction can be seen in the varieties and types of responses between the various types of souls.

For each type of soul, there are types of music, food, entertainment, participation in government, religion, work and family, that are beneficial and specific to that type of soul, and there also other types of music, food, entertainment and so forth that are not beneficial.

In future discussion of other types of souls, I shall make some comparative references to the nature of this soul in regards to its search for Truth and also to some of the requirements for the spiritual training of this type of soul.

But, enough for now.

Next time on to the second type of soul.

**Peace and love,
Bruce Beach
DawnSayer@webpal.org**

MENU: [HOME](#) » [Reconstruction](#) » [Recovery](#) » [Renewal](#) » [Four Souls Directory](#)

POP10 - The Soul of Love

If you have some suggestions or comments you would like to pass on to me about these pages you may do so at: DawnSayer@webpal.org

**The second type of the four types of souls
that I shall discuss
is the Soul of Love**

**This type of Soul loves God well,
and God well receives that love.**

**The possessors of this type of soul
breath the very spirit of life into society.**

**As with all types of souls
their strengths can become their weaknesses
if they are misused.**

**As with all types of souls
they have their preference as to type of religion,
type of employment,
type of enjoyment and association.**

**These souls delight in beauty,
and when properly trained and educated
help direct society in the path of compassion,
mercy, and justice.**

**These souls need to be trained
with particular tenderness and sensitivity.
As they mature they must be guided
in experiences that give them appreciation
of the qualities of the other types of souls.**

**These souls can become musicians,
poets and artists.**

**They are also a proper source for healers,
teachers, social workers,
and a wide variety of other occupations.**

**In misdirected pursuits
they create decadent music and art,
associate themselves with others
of weak moral discipline,
and misdirect society as strongly
as they might have morally directed it.**

**In future discussion of other types of souls,
I shall make some comparative references
to the nature of this soul in regards to its search for Truth
and also to some further requirements for the
spiritual training of this type of soul.
But, enough for now.
Next time on to the third type of soul.**

**Peace and love,
Bruce Beach
DawnSayer@webpal.org**

MENU: [HOME](#) » [Reconstruction](#) » [Recovery](#) » [Renewal](#) » [Four Souls Directory](#)

POP11 - The Soul of Reason

If you have some suggestions or comments you would like to pass on to me about these pages you may do so at: DawnSayer@webpal.org

**The third type of the four types of souls
that I shall discuss
is the Soul of Reason.**

**This type of Soul seeks God through Reason,
and God showers great bounties upon it.**

**All men of course possess a rational soul,
as well as a soul with the capacity
for love and obedience.**

**What determines the type of one's soul
is the predominance of one quality.**

**Society as a whole possesses a collective soul.
I don't want to make a major philosophical point of this,
because I don't have a major philosophical point,
but we do appear to have a collective consciousness,
and a collective conscience.**

**Society as a whole goes through stages and cycles.
Maturing or retrograding spiritually.
Most people recognize that we are at the perigee
or low ebb in our present cycle.**

**But the stage of the maturation of
present day society as a whole
is approximately that of adolescence.**

**It is interesting to observe how
ontogeny recapitulates phylogeny
(that is to say how the individuals history
recapitulates that of the human race).**

**Yes, there is evolution,
but it is also true that man is a special and unique creation.
The purpose here
is not to get into the theological battles
that so greatly stir the emotions of some souls
but rather to make some observations.**

**Man (yes man - not some other creature)
began as a single cell in the sea,
and progressed through stages
of multiple cell division.**

**So also does each individual in his ontogeny
that recapitulates that phylogeny.
First as a single cell then as a multiple cell,
in a private sea,
that has the same saline content as the oceans.
And so shall we continue to ever find it
in our blood and our sweat and our tears.**

**Through progressive stages in the womb,
having states similar to that of the tadpole,
salamander, and other creatures,
the embryo travels the path of nature,
to obtain the human form.
At one time having this appendage,
and at another time that,
but growing on to what we are today.**

**In some percentage of births today,
the child is still born with a tail,
but the obstetrician simply separates it from the tailbone,
before sending the infant home.
But, what the physician sends home is a human child,
and such it was from the moment of its conception.
It was never going to grow into a rose or a tiger,
but always into that which it was conceived to be.
Thus it is that the argument between
the Creationists and the Evolutionists is irrelevant,
because while we evolve
we always are, always were, and always will be
what we were created to be.**

**And the race has continued to progress outside of the womb.
Color blindness has decreased
but centuries ago it was quite common
and in the time of the early Greeks almost universal.
We can tell this from their poetry
that under the bluest skies of the Mediterranean
that in their poetry they took no notice
of the azure blue of the skies
in distinction to the green verdure of the fields.**

**We know also that the knights of old were relatively short
to the warriors of the present day.
This is visible in the small suits of armor
still displayed in the castles of Europe.**

**Indeed, induction statistics, from the First World War,
to the Second and later conflicts,
tell us the same, about both these examples.
The race has been, and is, changing (evolving) physically.
But these are not the matters of import to us.
What we are examining here is the spiritual evolution of man.**

**The race as a whole,
and each individual also,
(through the rules of ontogeny recapitulating phylogeny)
follows certain paths of development.**

**And so it that an individual child,
first develops the qualities of the Soul of Self.
Seeks gratification in the physical senses,
and the obedience to authority,
the first word it probably making real use of
being the word "No".**

**The child soon becomes sensitive to emotions,
music and love.
How sensitive a child can be!
And then there begins to develop reason,
the prime facet of this third type of soul.
Psychologists have observed and mapped
the development of the reasoning faculty.
The degrees or relationship and abstractness,**

**that will be apparent in the child
at mental progressive ages of development
and in what order and stages.**

**Such is the development of every soul,
from the point of conception and its coming into existence,
on through to its maturity at around the age of fifteen.
Once mature, the soul continues to spiritually develop, or not,
through Seven Stages - through the choice of its will,
and the guidance of its teachers.**

**These seven stages of spiritual development,
recognized or unrecognized,
take place regardless of the religion to which one belongs
or the church of which one is a member.
But the Seven Stages are another subject,
and one that I shall not cover in this series,
for our purpose here is simply to discover the True Path
and the Source of the True Prophet
so that each one can unravel and discover the Mysteries of Life
for their self.**

**In this particular letter
it has been my purpose to describe
the third type of soul.
The possessors of this type of soul
provide guidance and reason to society.
While they are not so much its conscience
as those of the second type
they nevertheless are the providers of order
for all.**

**But as with all types of souls
their strengths can become their weaknesses
if they are misused.**

**And as with all types of souls
they have their preference as to type of religion,
type of employment,
type of enjoyment and association.**

These souls delight in reason and logic,

**and when properly trained and educated
help direct society in the paths of science,
and discipline.**

**These souls can become engineers,
lawyers, philosophers and theologians.
They are also a proper source for doctors,
teachers, lawyers, scientists of every sort,
both in the social and physical fields.**

**In misdirected pursuits
they lead humanity into materialism,
and greed and inharmony.
They can be the source of great benefit
or great evil, for they bear
the authority of control in society.**

**In the next and final discussion of the four types of souls,
I shall describe the fourth type of soul
and then go on in later letters to some matters about
the nature of the soul itself
and how it finds Truth.**

**Peace and love,
Bruce Beach
DawnSayer@webpal.org**

MENU: [HOME](#) » [Reconstruction](#) » [Recovery](#) » [Renewal](#) » [Four Souls Directory](#)

POP12 - The Soul of Spirit

If you have some suggestions or comments you would like to pass on to me about these pages you may do so at: DawnSayer@webpal.org

The fourth of the four types of souls may be called the Mystical Soul or the Soul of Spirit.

Those of the Mystical Soul, walk the Path of Intuition, and are potentially of the highest and most enlightened type. This type of Soul seeks God through Intuition, and God informs it of its relationship to God.

But the danger of this soul is that it can also most readily fall most deeply into the abyss of vain imaginings.

Substantial numbers of them used to inhabit our mental institutions, until the recent open door policy, and now they often wander the streets.

Among some I have as personal friends, is one who claims to be Jesus, another Sarah the Wife of Abraham. One believes that he is from Venus, (how many Venetians do you count among your friends?), and numerous ones have been UFO abductees and so forth.

The Mystical Soul is a Beautiful Gift, but oftentimes,

**I feel not one to be envied.
Nevertheless, among strange,
and even the irrational ones
they often have insights
that have often astounded me.
For this reason alone,
I count them as dear friends.**

**As a percentage of present day society,
about 60% are souls of self,
20% souls of love,
and 20% souls of reason.
I recognize that adds up to 100%,
and it is the "abouts" that make the difference,
because they leave some small percentage
that are the souls of spirit.**

**I myself am a soul of reason.
It makes no difference.
Each of us are what we are.
In a sense we are all born equal
- just different.
It does no good for one who is a male
to wish that they were female,
or vice versa.
Nor one who is of one race
to wish that they were of another.
We are what we are,
but all loved by God.
None of us will rise
to the full potential and opportunity
that God has provided for us
no matter what state that we are in.**

**The soul of spirit,
must travel the same paths to Truth,
as anyone else.
Those Paths are also Four,
and I shall describe them
in the following four emails.**

**The souls of spirit
have their particular gifts**

**and their particular hazards
like every other type of soul.**

**This is a particularly difficult
and dangerous time for them,
if they are living in the present day
because the darkness of the age
can easily mislead them.**

**They should properly be
the light unto the world,
but when they themselves are dark
then it is darkness upon darkness.**

**In their occupations,
they are often poets,
and some of the more successful,
(although they do not seem to often be successful,
by the world's monetary definitions),
have been in occupations like psychologists.**

**But, for the most part,
in the terms of this world,
they appear to be among the alienated.
Most of the alienated,
come from other types,
particularly the first type,
but nevertheless I have most usually,
found the Mystical Souls among them
as bag ladies, mental patients, hobos and transients,
sometimes living as hermits,
other times in communes, monasteries, and ashrams.**

**Likewise,
Be assured that most of the individuals,
in those situations and locales
are not among the Enlightened,
or even of this type of soul,
but we must be careful not to judge them
by the eyes of the world,
because God says that He leads them on their way,
and sees them with different eyes than we do.**

**There is of course much more that I could say
about these souls, and
there are many other things
that I might discuss with you
about the different types of souls
and about the nature of soul itself.
Many questions that people have
about the purpose of life
and life after death.
Indeed the questions would become endless.**

**However, as I have stated many times,
the purpose of this series is none of that,
but rather its purpose is to show you the Path
to the True Prophet
so that you may discover all those things
for yourself.**

**Until my next letter,
when we shall step forth,
on the first of
the Four Paths to Truth.**

**Peace and love,
Bruce Beach
DawnSayer@webpal.org**

MENU: [HOME](#) » [Reconstruction](#) » [Recovery](#) » [Renewal](#) » [Four Souls Directory](#)

MENU: [HOME](#) » [Reconstruction](#) » [Recovery](#) » [Renewal](#) » [Survival](#)

Essays on the The Four Paths To Truth

by Bruce Beach

These essays are a continuation in the POP series which which were originally sent out in an email newsletter.

The intent of the series was is to lead the reader through such subjects as the nature of the soul and how it recognizes God through the Four Paths to Truth, and then on to presenting The Most Great Proof.

The essays presented here deal with nature of the search for Truth on the The Four Paths to Truth.

If you have some suggestions or comments you would like to pass on to me about these pages you may do so at:

DawnSayer@webpal.org

If you wish to enter into a discussion with me regarding religion - I highly welcome that. I have some [religious premises](#) that I would like you to review first, and let me know regarding any about which you disagree to help me better understand any points that you are making.

POP13 - [Authority](#)

POP14 - [The Senses](#)

POP15 - [Reason](#)

POP16 - [Intuition](#)

MENU: [HOME](#) » [Reconstruction](#) » [Recovery](#) » [Renewal](#) » [Survival](#)

POP13 - Authority

If you have some suggestions or comments you would like to pass on to me about these pages you may do so at: DawnSayer@webpal.org

**In this next four letters,
of the POP Series,
I am discussing
the Four Paths to Truth.**

**There are ONLY four possible paths.
Each and every type of soul,
must travel each and everyone of the paths,
if they are to find the True One.**

**The most used,
the most useful,
Path is
Authority.**

**This path
is the most beloved path,
of the Self Type of Soul,
and yet it must too travel
the other paths also.**

**And all the other types of soul,
must most certainly travel this path.
All souls learn over 90%,
way over 90% of what they learn,
through this path of authority.**

**If we were isolated in a closed room,
or were on an island by ourselves,
and had no teachers,
from the present or the past,
we would unlikely never even learn**

**how to turn the door knob or means
of getting out of the room or off the island.
So we are taught by authorities.**

**First it is our parents,
then our teachers,
and ministers and Sunday School teachers.
We learn from books,
and magazines,
and newspapers,
and the TV, and movies,
and many other places
that we hear people say things.**

**For the most part,
we do not have time to check it all out,
for ourselves,
so we most often separate conflicting opinions,
by asking the source,
and accepting the source we respect.**

**Who said that?
The doctor, the lawyer, the minister,
the teacher, our parents.
Ahh then, that must be right,
because they are our authority.**

**We can do no otherwise.
Even the doctor and pharmacist,
must rely upon the Pharmaceutical Book,
because they do not have time to go check out
the effect of every drug personally.**

**The Engineer must rely upon the Engineering manual,
because he cannot test the strength of everything himself.
EVERY profession relies upon its authorities,
whether medical, scientific, or religious,
because no one has time to check it all out,
for themselves.**

**I could go on at much greater length about
how AUTHORITY is so important as our source of Knowledge,**

**BUT, on the other hand,
AUTHORITY is the main block and obstacle,
to any new advances in knowledge.**

**EVERY new idea,
scientific invention,
discovery of a law of science,
is the repudiation of Authority,
which previously had said,
that it was not THAT way,
or otherwise the new idea is nothing new,
but simply the application of old existing principles.**

**So, there we have the First, and Foremost,
Path to Truth.
Authority.**

**Tomorrow,
the Second Path.**

**Peace and love,
Bruce**

MENU: [HOME](#) » [Reconstruction](#) » [Recovery](#) » [Renewal](#) » [Four Paths Directory](#)

POP14 - The Senses

If you have some suggestions or comments you would like to pass on to me about these pages you may do so at: DawnSayer@webpal.org

**Here now in the POP series
I am presenting
the Second Path to Truth.**

**Each of the Paths are preferred
by one of the Four Types of Soul.
But each type of soul
must travel each of The Four Paths.**

**The four paths develop in the individual,
somewhat in the progressive order
that I have named the four types of souls.**

**The second path is the path of the senses,
and is the one preferred by the Loving Soul.
It is expressed in their art and music,
in their love for nature and life
and yes in the expression of love called sex.**

**The senses are generally listed as five.
Sight, Sound, Taste, Odor and Touch.
If it were not for the senses,
we would be senseless.**

**Some are so convinced of this
that they think that when the body
ceases to sense,
we cease to exist,
or that we then become so nebulous,
as to be practically non-existent.**

But, that is another matter.

**In this world,
we test everything by the senses.
For the physical scientist
if it cannot be seen, or heard,
touched or tasted or smelled,
it does not exist.**

**Sometimes, oftentimes,
the scientist uses instruments
to extend his senses,
and there is no sense possessed
by humans
but that some kind of animal
possesses it 10 fold.**

**But no matter how refined the sense
or instrument
the senses can always deceive.
Examples can be given for each of the senses,
but I shall let one suffice here.
We look at the dawn or sunset,
and the sun appears to move,
but most people today believe
that it is the earth that is moving
and that the sun is standing relatively still.**

**Illusions, mirages, and their like are numerous.
No astronomer can see what is.
The observed pattern in the sky
is made up of light from the stars.
Some from stars at one distance,
and other from stars where the light left there
thousands of times earlier than from the first star,
but all the light arrives to the astronomer at the same time.
Not showing where it is,
relative to the other stars at this moment,
not even showing where it was,
in actual physical relation to the other stars,
of for that matter whether it even still exists,
but rather showing an illusion
of what could never have collectively been.**

This line of thought extends

**into the work of the physicist.
The psychologist knows that all we know
is perception in the mind.
So, while the senses are necessary to that perception,
we know that they are fallible,
and can never be considered
an infallible path to the Truth.**

**The world of sense
is what the Hindu religion calls Maya,
that is to say
the world of illusion.
In western philosophy and metaphysics
such as that of Immanuel Kant
it is recognized not to be the "ding ang sich",
"the thing in itself".**

**Advanced thinkers,
physicists,
philosophers,
all who strive to reach beyond illusion
from matter unto mind,
recognize the limitations of the senses
and the human mind.**

**While we could discuss this subject for hours,
and it is a very popular subject today,
our purpose here has been only to recognize
that the Path of the Senses,
is a fallible path
and that while we must travel it
we must still seek Truth elsewhere.**

**And thus,
tomorrow,
on to the Third Path.**

**Peace and love,
Bruce
DawnSayer@webpal.org**

MENU: [HOME](#) » [Reconstruction](#) » [Recovery](#) » [Renewal](#) » [Four Paths Directory](#)

POP15 - Reason

If you have some suggestions or comments you would like to pass on to me about these pages you may do so at: DawnSayer@webpal.org

**In this POP Series,
I have so far discussed
Authority and the Senses.
What else is there?**

**Reason.
The beloved path of the third type of souls.
The Reasoning Souls.
One can figure out the truth by REASON.
REASON is God's GREATEST gift to man.
It is what most distinguishes man from the animals.
His ability to hold and manipulate abstract thoughts.**

**But, reason is only logic.
Like found in a computer.
Give a particular set of premises,
it can prove anything that follows from those premises.**

**However, human reasoning is not even as good as machine reasoning.
It is often faulty.
Given the few rules of a chessboard,
which is limited to 64 squares,
look at how often humans make mistakes,
in playing chess.**

**Life is MANY, MANY, MANY times
more complicated than a chessboard.
There are a great number MORE parameters,
so when we go to reason about economics,
politics, religion, or any thing else of this world,
we are much more likely to make a mistake.**

**And we make mistakes all the time.
Look at a computer program.
Very few rules as compared to life.
Yet how often is a computer program
of any length written with out bugs?
Just bugs regarding the computer rules,
so that it will not run at all.**

**And then there are very often bugs
regarding the purpose of the program itself.
Reasoning is often very inaccurate.**

**But the real problem is that
even if it is accurate,
it depends upon the premises with which it begins.**

**So, Reason Alone, is not a sure guide to the Truth.
Indeed, while it is God's greatest gift to man,
it is VERY fallible.
Thus we are left with the
Fourth Path.**

**And that tomorrow.
Peace and love,
Bruce
DawnSayer@webpal.org**

MENU: [HOME](#) » [Reconstruction](#) » [Recovery](#) » [Renewal](#) » [Four Paths Directory](#)

POP16 - Intuition

If you have some suggestions or comments you would like to pass on to me about these pages you may do so at: DawnSayer@webpal.org

Now in the POP Series
we come to The Fourth Path to Truth.
It is the chosen path of the
of the Fourth Type of Souls.

We can call it by many names -
Testimony of the Holy Spirit,

- Conscience
- Inspiration
- Intuition
- Enlightenment

or any one of its many other attributes.

It is the BRIGHTEST Path to Truth.

Without this Divine Spark,
no discovery,
religious or
scientific
can be made.

Without it,
the processing of reason
and the human brain
would be as dead
and unimaginative
and uncreative
as a computer or
any other machine.

**Every scientific discovery,
every advance in human thinking,
comes from In-sight,
sight from with-in.
Sight from beyond,
beyond the boundaries,
that existed before.**

**That Divine Spark
rests within each of us,
so long as we breath,
and have life.**

**Every student of mathematics,
draws upon it to initially comprehend
that $2+2=4$, or any higher concept.
For every learner,
each and every concept,
comes as a new insight,
a new manifestation of the intuitive.**

**This power of the mind,
soul,
like all others
is developed through practice.
The power of reasoning,
using the brain,
like any other muscle,
must be developed through exercise.
The storing up of knowledge,
from authority
does not come in a minute.
All the skills of the senses,
being able to sing
like an opera star,
or observe
like a diagnostic physician,
or to listen, or feel,
require a degree of training
that most never master
or even realize exists.
Most particularly is this true
of man's highest mental capacity,**

intuition.

**Concentration,
Contemplation,
Meditation,
are skills still largely undeveloped,
in the majority of mankind.
Yet, these are the disciplines needed
to develop intuition.**

**It seems to come
unheralded and unbidden,
but be assured
never to the unprepared.**

**Intuition is the brightest,
most joyful,
most beautiful path to Truth.**

**And yet,
intuition is the DARKEST,
most misleading,
path of stupid superstition
and vain imaginings.
In this path,
as many are led astray,
with the possible exception of
authority,
as in all the others combined.**

**As great a barrier
as may be the senses,
with its false sense of reality,
and its inducements of idle pleasures,
As faulty as man's reasoning
may ever be,
intuition alone can sweep the soul
into the paths of error
with a degree of confusion
from which only by the
Grace of God
will one ever be recovered.**

**For it is intuition
that whispers into the ear
of every convinced believer,
ONLY my truth is real,
all the others are false.
Only you are safe and saved,
all others have gone astray.
But reason stays its claim,
because how can there be
so many different claims
to be the one and only truth?**

**And so,
we have examined the
Four Paths to Truth,
and have found none
to be infallible.
Some would say there is
a fifth path.
The eclectic path
of combining all four.
But while this is the proper thing to do,
and the SUREST path,
it too still remains fallible.**

**And so,
in the human condition,
we remain BELIEVERS,
NOT KNOWERS
of ABSOLUTE CERTAINTY.**

**And so,
some become discouraged,
and say,
since I can know nothing
of a certainty,
I will believe nothing.
I will be a skeptic
and a scoffer.
Let others be subject
to their idle fancies
and vain imaginations,**

**I will remain steadfast
in my knowledge
that they can know NOTHING.**

**But, my dear friend,
THAT is the path to DEATH,
UNBELIEF,
Dissolution,
and Chaos.
Nothing becoming nothing,
yielding nothing,
attaining nothing.
Nothing.**

**Every Vibrant Soul,
must grasp reality,
as it is presented to us.
It must travel each
of the Four Paths
to the best of its ability,
and remain always open to change,
in recognition of the fact that it
is fallible.**

**For this is the Path of Power
of both Science and Religion.
Building upon the Four Paths,
and discovering reality,
TESTING it,
USING it,
Re-examining it,
Improving upon our comprehension of
IT.**

**For while our feet remain anchored
in the mud and morass of DOUBT,
our spirits soar upon the
Paths of Truth.
Building bridges and skyscrapers,
traveling to stars,
observing the Macrocosm
and the Microcosm,
evidencing the Power of**

Accomplishment.

**And then,
we have it upon the Best of
Authority,
from those Divine Prophets,
that if that soul asks,
it Will receive,
if that soul knocks,
it Will be opened unto it,
and THAT seeker
will be guided from shoals
of insecurity and Unbelief,
to the secure safety of the bay
of Belief in God,
and that which He has Revealed.**

**Thus have I concluded
my explanation of
the Four Types of Souls
and
the Four Paths to Truth.
In my next letter
I shall proceed onto what is called
The Most Clear Proof
in our journey to discover
the Source of Truth
and
The True Prophet.**

**Peace and love,
Bruce
DawnSayer@webpal.org**

MENU: [HOME](#) » [Reconstruction](#) » [Recovery](#) » [Renewal](#) » [Four Paths Directory](#)

Essays on the The Most Clear Proof

by Bruce Beach

"The Most Clear Proof" as presented here in a continuation of the POP Series which was originally a series of email essays whose intent was to lead the reader through such subjects as the nature of the soul and how it recognizes God through the Four Paths to Truth, and then on to presenting The Most Great Proof about who Jesus really was.

In these essays we examine some tests for reality and sanity. And a different paradigm regarding location and time than you were taught in school - plus the definition of "Manifestation", which is key and most difficult concept to comprehend.

The concepts presented here completely changed my world view and the world view of many others who took the time to master them. I hope that you will take the time to carefully study through these 14 essays. Some are just a matter of reading them. Others among them take careful thought and calculation. You need take out pencil and paper and "do the numbers" for yourself.

If you have some suggestions or comments you would like to pass on to me about these pages you may do so at:

DawnSayer@webpal.org

If you wish to enter into a discussion with me regarding religion - I highly welcome that. I have some [religious premises](#) that I would like you to review first, and let me know regarding any about which you disagree to help me better understand any points that you are making.

The Essays

The Proof that Jesus was the Christ

POP17 - [Most Clear Proof - Introduction](#)

POP18 - [Most Clear Proof - Numbers](#)

POP19 - [Jesus](#)

POP20 - [2300 Days](#)

Expectation of the Return of Christ

POP21 - [Year 1844](#)

A New Paradigm

POP22 - [Responses](#)

POP23 - [Where](#)

POP24 - [When](#)

POP25 - [Manifestation](#)

POP26 - [Revelation](#)

The Mathematical Proof

POP27 - [First Step](#)

POP28 - [Next Steps](#)

POP29 - [Final Step](#)

POP30 - [The Final Analysis](#)

MENU: [HOME](#) » [Reconstruction](#) » [Recovery](#) » [Renewal](#) » [Survival](#)

POP17 - Most Clear Proof - Introduction

If you have some suggestions or comments you would like to pass on to me about these pages you may do so at: DawnSayer@webpal.org

Intro to the MCP

**This is an introduction to the Most Clear Proof.
I am going to pause here a moment
and recap where we have been
and to map out where we are going.**

**First I described the Four Types of Souls
and invited you to introspectively determine your type.
This is important so as to understand
how and why you will make the responses that you do
on the journey to Truth.**

**Secondly, we described the Four Paths of Truth,
and saw that while each of them are fallible,
that we must use each of them
on the journey to Truth.**

**What I am going to do now will be a shock
to many of my non-Christian readers.
If you subscribe to a New Age Religion
or No Religion,
please follow, nevertheless, what we are going to do.**

**Almost all my readers were raised in a
"nominally" Christian culture
and therefore you will have no problem
in following the presentation
if you will just make the effort.**

**What I am going to present is a
mathematical proof**

**that Jesus was (is) the Christ
and that the Bible is a reliable source of prophecy.**

**This is not going to hurt you in any way.
Do not be afraid -
I am not trying to turn you into
a flaming Fundamentalist.
Believe me, I get flamed many times a day.**

**As traumatic as you may feel
that such a change in viewpoint
might be for you,
you may rest assured
that the things to follow
will be even more of a challenge
for our Christian Friends.**

**The growth in Truth is
always a challenge
for all of us.
Myself included.**

**After the mathematical proof
about Jesus
we will take a small pause
and look at the
Three Spheres of Reality
used by psychiatrists
to determine whether one is sane or not.**

**From there we will pass on to the
New Paradigm
that will undoubtedly completely change your life
if you comprehend it and accept it.**

**It is on the basis of that paradigm
that I have my own expectations
about the future.
At that point you will understand
why it would have done no good
to explain to you the source of my expectations
without your having understood the paradigm.**

**To begin the journey,
I am going to ask you to read two chapters
in the Bible.
This is not a terribly arduous thing to do.
If you don't have a Bible,
they aren't hard to come by in our society.
It really makes no difference which version you use.
I was raised on the old King James Version -
but whatever you have or get will be fine.**

**The two chapters that I wish you to read are:
Matthew 24
and
Daniel 9**

**We will start into this next time.
Not verse by verse,
but on a mathematical thread.**

**If you follow it through
I can promise you that it will be an experience
that you will remember the whole of your life.**

**How many things can you remember from the past,
that were truly significant to your life
and that you will never forget.
On the other hand,
how many TV shows, Movies, Books,
conversations, events and so forth
have you forgotten.**

**Then take the time,
to do something that will be so significant in your life
that you will never forget it.**

**Till tomorrow,
peace and love,
Bruce
DawnSayer@webpal.org**

MENU: [HOME](#) » [Reconstruction](#) » [Recovery](#) » [Renewal](#) » [Most Clear Proof - Dir](#)

POP18 - Most Clear Proof - Numbers

If you have some suggestions or comments you would like to pass on to me about these pages you may do so at: DawnSayer@webpal.org

In the POP series we are now going to examine the math used in the Bible.

Matthew 24 is possibly the single most read chapter of the Gospels among Christian's today, possibly surpassing the Sermon on the Mount and the Christmas and Resurrection stories.

The reason for this is that it is the chapter in which Jesus prophesizes His return.

In the opening verses the Disciples come to Him and ask Him

"What will be the signs of His Return".

And He answers them, and among those answers is the directive to read and understand The Book of Daniel. (Matthew 24:15)

This was what brought us to the Book of Daniel.

A remarkable Book in itself, and containing many interesting prophecies, particularly about "the Time of the End".

However, our purpose here, is not to examine such prophecies, but rather to show mathematical proof that Jesus was (is) the Christ, and that the Bible is an accurate source of prophecy.

Later we shall use the same mathematical techniques in a much more remarkable way

**and to a much more remarkable degree
to look at other prophecies in the Bible.**

**The reason that we are using the Bible
is because it is the cultural underpinning
of most of you readers
whether you consider yourself Christians,
or even religious, or not.**

**If we were in another culture
such as Hindu, Moslem, or Buddhist,
then we would use the Scriptures of THAT culture,
because the TRUTH that we are examining is universal.
But we are in THIS culture
so we will use THIS cultures Scriptures
to restore an appreciation of the Spiritual Foundation
that underlay this culture but which has become
temporarily weakened.**

**The basis of time translation in interpreting Bible prophecy is
well established. The basis of using a day as a year comes from
Num. 14:34 and Ezek 4:6 and that a week is seven days is of
course based upon the Creation account. The fact that an average
month is thirty days is found in the account of the flood.**

**If you wish to confirm to yourself such a detail you can look at:
Genesis 7:11 and you will find mentioned there
the Second Month and the Seventeenth Day of the month
and later in
Genesis 8:3 there is mentioned 150 days
and immediately after in
Genesis 8:4
the Seventh Month and the seventeenth day of the month.**

**Consequently the above covered a period that was EXACTLY 5 months to the day, (7 months
minus 2 months equals 5 months)
which divided into the 150 days gives us an AVERAGE of 30 days per month.
(5 divided into 150 = 30).**

**The point of all this is NOT to convince you to believe in the story of Noah and the account of The
Flood,
but just to show you the NUMERIC Integrity of the Bible and the system that we are using.**

The math that we will be using is no more difficult than this, but with the following I will conclude today's presentation to allow you to absorb the math up to this point.

It is important that we do this in a step by step fashion.

Leave out a step

and the end result will be questionable.

Comprehend them all and it will be unquestionable.

Okay, our formulas are as follows:

- **a. 1 day = 1 year**
- **b. 1 week = 7 days= 7 years**
- **c. 1 month = 30 days = 30 years**
- **d. 1 year = 12 months = 360 days = 360 years**
- **e. dividing of time - 1/2 time**

a. comes from Numbers 14:34 and Ezekiel 4:6 as mentioned above and is referred to as "prophetic time". Some people refer to references that a 1000 years is as a day for the Lord. This latter does have a scriptural and spiritual meaning but when used in the formulas gives lengths of time so long as to be meaningless to our human experience. Consequently, we use the calculation that a Prophetic Day is a year.

b. comes from the Creation account of the 7 days of creation, and that on the 7th day the Lord rested. Without getting into any arguments about whether that was Saturday or Sunday it is still the source of the week having 7 days in our culture.

c. the calculation to determine that an average month, or a Bible Prophetic Month has 30 days has been given above in the account about Noah and the Flood with the appropriate Scriptural References.

d. The determination of "d" derives from "a" and b and "c" above. That a Prophetic year is 360 Calendar years is simply an extension of the above math. If one Prophetic day = one year and a month is 30 days a Prophetic month is therefore 30 calendar years and the 12 months in a year are therefore 12 times 30 or 360, which is to say that there are 360 Prophetic Days or 360 calendar years in a Prophetic year.

e. this is an equivalency example which we will examine in its proper place.

**To repeat,
the purpose here,**

**has not been to convince anyone of any of the Bible Stories,
but rather to simply show the integrity and consistency of Bible Math.**

**Tomorrow -
an application of these principles
to begin to demonstrate by this math
that Jesus was the Christ.**

**Peace and love,
Bruce
DawnSayer@webpal.org**

MENU: [HOME](#) » [Reconstruction](#) » [Recovery](#) » [Renewal](#) » [Most Clear Proof - Dir](#)

POP19 - Jesus

If you have some suggestions or comments you would like to pass on to me about these pages you may do so at: DawnSayer@webpal.org

One of the most amazing things about Bible Prophecy is the prediction of the re-establishment of Israel. Futurists today have difficulty making predictions 50 years into the future.

Look at these:

"Computers in the future may weigh no more than 1.5 tons."
- Popular Mechanics,
forecasting the relentless march of science,
1949

"I think there is a world market for maybe five computers."
- Thomas Watson, chairman of IBM,
1943

"I have traveled the length and breadth of this country and talked with the best people, and I can assure you that data processing is a fad that won't last out the year."
- Editor in charge of business books for Prentice Hall,
1957

"But what... is it good for?"
- Engineer at the Advanced Computing Systems Division of IBM,
1968, (commenting on the microchip).

"There is no reason anyone would want

a computer in their home."

**- Ken Olson, president, chairman
and founder of Digital Equipment Corp.,
1977**

**"This 'telephone' has too many shortcomings
to be seriously considered
as a means of communication.
The device is inherently of no value to us."
- Western Union internal memo,
1876**

**The prophecies in the Bible,
that many people are concerned about
being fulfilled today,
were made MANY CENTURIES ago.
Is it possible
that there can actually be this kind
of accurate prophecy?**

**And yet, there in the Bible
was the Prophecy and Promise for the Jews
that they would return to Israel and
it came true CENTURIES later.**

**I am going to tell you now about another prophecy
that was made to the Jews
centuries before it came true.**

**Prophecy and the Prophetic Times associated with it
are difficult for many people to see,
and therefore
many people do not recognize its fulfillment
even when it has occurred.**

**Such was the case with Jesus.
He claimed to be the Messiah promised to the Jews.
In fact that was the BASIS of His claim to fame.
If He was not that ONE then,
so far as they were concerned,
it made no difference who he was.**

But, for TWO THOUSAND years the Christians were not able to prove to the Jews who Jesus was while the mathematical PROOF lay RIGHT THERE in the Jews' own Book of Daniel.

This is the reason that we are examining the 4 verses in

The Book of Daniel 9:24-27.

It is surely not too much to take and comprehend

four Bible verses.

(Read them for yourself - as Jesus commanded).

**Verse 24 mentions 70 weeks
comprised of in
Verse 25**

**7 weeks
3 score weeks and
2 weeks and**

Verse 27

**1 week
-----**

**Everyone should know,
from the Abraham Lincoln's Gettysburg Address -
"Four score years ... ago
our fathers brought forth on this continent....."**

**that a score is 20
so 3 score is 60.**

What we have therefore is:

**7 weeks
60 weeks
2 weeks
1 week**

70 weeks total as stated in Verse 24.

**"Seventy weeks to seal up the vision and prophecy
and to anoint the Most Holy"**

70 weeks

x7 days is of course

490 days in Prophetic Terms,

(or as we discussed last time)

490 calendar Years

**To measure a time, one must know from where to begin
and verse 9:25 tells us that this time begins from:**

**"the going forth of the commandment
to restore and build Jerusalem".**

**That historical date you can obtain
from a number of different sources.
Some encyclopedias
(especially Bible encyclopedias)
or the marginal notes of some Bibles,
or other similar references.
(I have looked it up in many places.)**

**The event is referenced is in Ezra 7:13
and most scholars (Christian, Jewish and otherwise)
agree that it occurred in 457 BC.**

**The prophetic date of 70 weeks is broken up into blocks.
Basically, if we look at 69 weeks
plus the one last week
we can see the dates that interest us.**

69 weeks

x7 days is

483 Prophetic days or 483 calendar years.

483 calendar years minus

457 BC takes us to:

26 AD (or 27 AD depending on how you count in the zero year).

**Again a Bible Reference will tell you
that this is when Jesus began His ministry.
(He was born in 4 BC and 26 plus 4 makes Him 30 years old -
when He began it,
which is the age, under Rabbinical Law
that a man could become a Rabbi or Teacher).**

**Again look in a reference and you will find
that Jesus was crucified 7 years later in 33 AD
Seven years is the same as one Prophetic Week
and this means that He fulfilled the Covenant (The Promise)
to the Jews for one week
and just EXACTLY at the TIME
as the Scriptures had prophesized.
(Do read the whole 4 verses in Daniel -
the tell about the Messiah being cut off -
but not for Himself -
because He was a sacrifice for the whole of mankind).**

**But down through the centuries,
the Christians were never able to show this prophecy,
to the Jews,
because as The Book of Daniel says,
it was a SEALED BOOK
and the MEANING was not opened
until the Time of the End.**

**That too is an interesting story -
but for next time.**

**There are many details about this prophecy
that I could talk about for hours.
In fact I used to conduct courses on it that took weeks.
But we are not going into details here.
The following is a chart that I have made up to give you
an overall view.**

Ezra 7:13

457 BC

Dan 9:25 | ___7 weeks___ 408 BC completion of rebuilding

| (49 years)

Dan :25 | ___7 weeks_ & 62 weeks___ = _69_ weeks_ 26 AD John

| (49 years) & (434 years)=_(483 years) the Baptist

Dan 9:27 | _____69 weeks_____ &_1_week=_70_weeks

| (483 years) 7 years=490 years

Dan 9:24 | _____70_weeks_____ 33 AD

| (490 years) Christ

The Prophecy of the Time of Christ

Peace and love,

Bruce

DawnSayer@webpal.org

MENU: [HOME](#) » [Reconstruction](#) » [Recovery](#) » [Renewal](#) » [Most Clear Proof - Dir](#)

POP20 - 2300 years

If you have some suggestions or comments you would like to pass on to me about these pages you may do so at: DawnSayer@webpal.org

**So, there was mathematical proof for the Jews,
all along,
that Jesus was the Christ.
But they never saw it,
and they never accepted Jesus for other reasons.**

**The reasons are listed in the New Testament,
and they are many, many.
Basicly, He did not fulfill their expectations.
They had THEIR tests
and He did not meet them.**

**Of course they said that their tests
were from Scripture
and that since He did not fulfill them
that He was a false prophet.**

**Just as the Jews expected their Messiah
to come and Establish an Earthly Kingdom
so too today
do the Christians expect Him to come and set up a throne
where every knee shall bend and every tongue shall confess,
in some similar earthly fashion.**

**Just as the Jews expected a time of Milk and Honey,
so do many Christians today
expect a Millenium of a Thousand Years of Peace
with Lions literally lying down with Lambs.**

**Some then and now expected phenomena
similar to what is called the Ressurrection,
or Rapture,**

or other Marvelous Miracles.

**They had then,
and Christians have now
quick little tests -
Is the person claiming to be The Return**

living or dead

**- some Christians require
that He comes down from heaven
with nail prints in His hands,
and that He not be buried anywhere.**

**The Jews had believed that Elijah,
(who the Bible said had never died but had been translated),
would come first.**

**"Where is Elijah, (who was to come back down from heaven),
they asked."**

"John the Baptist", said Jesus.

"Can't be - he was born of a woman", they replied.

Where did you come from, they asked Jesus.

Nazareth.

**"The Book says no good will come out of Nazareth',
said they, quoting their Scripture.**

What happened to Jesus, they asked for centuries later.

Crucified.

**"Only those accursed of God are crucified", said they,
again quoting their Scripture.**

**And for century after century,
the Rabbis pointed out,
that the promise of the Messiah, their saviour,
was that:**

**He would gather the Jews together,
"as a mother hen gathers her chicks"**

as promised in Isaiah.

**But the very opposite happened.
At the time Jesus came,
the Jews WERE together in Israel
although under Roman prosecution
and then they were banned from the country
and never allowed to return again
until the Edict of Toleration was given
in 1844.**

**So what other proof would a young Jew need
from his rabbi,
that Jesus was not his Messiah,
not the saviour of the Jews.
But the rabbi could and did present him
with much more proof and evidence.**

**And now this story takes a strange, strange twist.
Because in the last century their grew up
among the Christians and Moslems
what was called
The GREAT Expectation
about the Return of Christ.**

**These numbers that I am telling you about
became WIDELY known.
There is evidence that they were first developed by one
whom many even today recognize as the greatest scientist
the world has ever known. - Isaac Newton.
His literary assistant, Edmund Halley,
discoverer of the periodicity of comets
and after whom Halley's Comet was named
contributed much to the authenticating of calendars.**

**As a result of these numbers,
many, many people began to expect the return of Christ,
in a particular year.
That year was 1844.
They arrived at that number because if one takes the verse -**

Daniel 8:14

**And he said unto me,
Until two thousand and three hundred days;
then shall the sanctuary be cleansed.**

**[We are not dealing here with how these verses
have been interpreted
or might be interpreted
but as before are only interested in
the mathematics and the dates.]**

**This date, and using the same starting point as we used before,
yields -**

**2300 Dan 8:14
-457 B.C.

1843 A.D.**

**1844, rather than 1843,
is taken as the year of the GREAT EXPECTATION
and the Great Disappointment
for the return of Christ.
There are several reasons for this.
One is that there is no year zero.
The other reasons are the differences between lunar
and solar calendars so that 1843 actually ends in 1844.
And still other explanations are given
as to which month in the year actually begins the year.**

**[It used to be that New Year's Day was in March.
A quick proof can be given.
The fifth and sixth months
were changed to the names July and August
after the Roman Emperors Julius and Augustus Caesar.
Sept means seven and hence September.
Octo means eight and hence October.
Like in octave, octogon or octopus,
an eight legged sea creature.
Novem means nine and hence November.
Deca means ten and hence December.
Like in decade, decalog and even decimal.
January was the eleventh month**

**but was renamed in honor of the Roman God Janus.
February was the last month and this is why
we always put any extra days of a year,
like in a leap year, or leap century,
at the end of February.
So the new year begins in March.
Actually on March 21st, at the Spring Equinox.]**

**Prior to 1844 there were many millennialist groups.
With the possible exception of the year 1000
there had never been such intense expectation
in Christendom at one single time.
But the really phenomenal matter is
that similar expectations were
equally intense at that time in some Moslem sects.
Today, the Seventh Day Adventists,
the Latter Day Saints
(hence these two groups' names)
and some fundamentalist groups
still maintain that interest.
The interest was not by any means confined
to either Protestant Christianity
or the United States.
Both the Christian Templars from Germany
and the Carmelite nuns went to Israel
prior to 1844
in expectation that Christ would appear there in 1844.**

**The single largest and most active group
in the United States,
with the possible exception of the Latter Day Saints,
was the Millerites,
the predecessor of the Russelites, Bible Students,
Millennial Dawn, and Watchtower,
all synonyms for the Jehovah's Witnesses
which took the latter name in 1931.
Their disappointment
in the original 1844 expectations
led them to formulate a new date of 1914,
about which their literature still
concedes "wrongful expectations".**

**The thesis here is that
Christiandom's original interpretation (expectations)
of the dates were absolutely correct,
just as were the Jewish interpretations (expectations)
for the first quarter A.D..
What was wrong was the nature of their expectations.
1844 was again a repeat of what happened
in the first century of the Christian Era.**

**But enough for one letter.
Perhaps too much.
God willing, we shall continue again tomorrow.**

**Peace and love,
Bruce
DawnSayer@webpal.org**

MENU: [HOME](#) » [Reconstruction](#) » [Recovery](#) » [Renewal](#) » [Most Clear Proof - Dir](#)

POP21 - Year 1844

If you have some suggestions or comments you would like to pass on to me about these pages you may do so at: DawnSayer@webpal.org

Yesterday's presentation was so paradigm shaking that many undoubtedly could not believe what was said.

That the 1844 GREAT EXPECTATION of the Christians was fulfilled and that Christ returned.

However, the Christians failed to recognize The Return just in the same way and practically for the same reasons as the Jews failed to recognize Jesus at the beginning of the first century.

Many Christians would say, "Well, if it didn't make any more difference than that - if my expectations about rapture, the graves opening, and the Kingdom of Heaven on Earth, were not any more fulfilled than that it doesn't make any difference to me."

Just as many Jews said, "Well if that is the way it turned out for God's Chosen people and we ended up being booted out of Israel and going through the Holocaust at the hands of a nation that called itself Christian - then who needed Him?"

To answer some quick questions:

"Where did Christ return?"

In Persia.

"When?"

1844

"What was His Name?"

The Bab, Meaning the Gate

or Forerunner,

declared Himself on May 22, 1844.

"Where is he now?"

He and His Successor,

Baha'u'llah are buried near each other

at Mt. Carmel in Haifa, Israel.

"How many people know this?"

**There are now over 10 million Baha'i's
world wide.**

**There is much more
that can be said about Them.
Particularly regarding Their prophecies
for the present and future.**

**But I realize that this paradigm
is so shaking
I shall pause here for my next 3 POP emails
while many go screaming for the exits
quoting the same kinds of quotes
as were quoted about
Jesus' appearance at the first century.**

**So a pause or intermission to allow a mass departure,
and during which we will examine
the Three Tests of Reality
used by psychiatrists to determine if a person is sane.**

**Because I am sure that many will wonder how
a sane person can believe that Christ has returned.
But you must remember that this proof started out
for those who did not particularly believe
in Christ and the Bible
in the first place
although they had been raised in a Christian culture.
Our purpose was to raise their confidence in the Bible**

**as a source of Prophecy
through this mathematical proof that
Jesus was the Christ.**

**After the following 3 letter intermission,
we will return to SIMPLER but even more astounding,
indeed,
MUCH MORE ASTOUNDING mathematical prophecies
from the Bible
that have gone TOTALLY unrecognized by the Christians.**

**Eventually, I will explain and summarize
the paradigm upon which all this has been based.
Those who can comprehend and accept that paradigm
will then be able to comprehend
the nature of the prophecies
that I have mentioned before
but have not been able to present
because people knew nothing of
the paradigm upon which they are based.**

**Peace and love,
Bruce
DawnSayer@webpal.org**

MENU: [HOME](#) » [Reconstruction](#) » [Recovery](#) » [Renewal](#) » [Most Clear Proof - Dir](#)

POP22 - Responses

If you have some suggestions or comments you would like to pass on to me about these pages you may do so at: DawnSayer@webpal.org

A slight detour.

I have decided to share with all of you four responses that I have received and my answer to two of them.

I have selected these as being typical of quite a number.

I also very much appreciate the affirmative responses I have received. They mean a lot to me.

From D.

It has been interesting to know your views over the past 2 years. As you expected, many will leave your list after your last mailing. I choose to be one.

I feel that you have been deceived with one of many false messiahs that the Bible prophesied would be appearing during these last days. I hope and pray that your eyes will be opened to the fact that JESUS will appear again just as he said and will take his church to be with him. I believe it will be very soon. Trust in Him only for the forgiveness of your sins and then I can look to meeting you in heaven.

From K.

To save me from deciphering anymore of you paradigms let me cut straight to the point....do you believe that Jesus was/is the Son of God...and am I to understand that you believe Jesus returned in 1844 and is now dead and buried at Mt. Carmel.

My Answer to K.

**The questions that you ask K,
are impossible to answer to you meaningfully.**

**That is the point of a paradigm.
It is a view of the world.**

**Someone who lived in a very hot country
and who had never heard of or seen ice
would find miraculous
the story of someone walking across a river.
The explanation that it had frozen
would be incomprehensible to them.**

**Likewise would be the explanation
to someone who had never seen or heard of a microscope
that the small little bugs that were harming them
were not really invisible
or some type of evil spirits.**

**Your statements
that you want to understand the answers
but not understand the paradigm
would mean that the answers would seem
impossible
ridiculous
illogical
or otherwise out of touch with reality.**

**Whereas, as in the above examples,
a new paradigm gives one a higher sense of reality
and permits them to understand things
that they have not understood before.**

**A new and higher paradigm
explains all that was believed before
and explains WHY it was believed in that way before.**

**As regards Christ Jesus,
the problem with the Christian view
is that Christians have too small a view of Him.
You may think this a strange statement
when you think that you put Him at the center of everything,**

**Preceding everything, the Purpose of everything.
But the statement remains true - too small a view.
But you cannot know what I mean -
without a paradigm shift.**

**Paradigm shifts are as necessary in Religion as they are in Science.
In Science, the Einstein Theory of Relativity was a Paradigm Shift.
The very idea that two parallel lines could meet,
or that a clock traveling in space at a high rate of speed
would reflect that Time had slowed down,
or that light could bend when passing a large gravitational lens or sink,
such as our sun,
or a variety of other such phenomena (he had five proofs)
was a paradigm shift that many still do not understand.
It has not penetrated the consciousness of the man on the street.
Still, for those scientists who have grasped it,
it has permitted the development of atomic and nuclear energy,
new methods of constructing materials used in electronics and computers,
calculations for space travel and explanations for phenomena of astronomy,
and other control over our physical world
that did not exist before.**

**The Einsteinian Paradigm did not destroy the Newtonian Paradigm.
It merely provided a HIGHER explanation and showed the latter
to be a SPECIAL case.
Many of my readers believe that Science deals with relative knowledge
but that religion deals with absolute knowledge.
However, they are wrong.
God's REALITY is ONE.
Science and Religion are the TWO wings of the One Bird,
seeking to explain the ONE REALITY.
That Reality is Absolute,
but because God is Infinite
our understanding is always relative and can always become greater
through REPEATED Paradigm shifts,
so one may as well get used to it
or they will stop growing through eternity.**

**Do you know what the one unforgivable sin is?
It is blasphemy against the Holy Spirit.
This does not mean taking the Name of the Holy Spirit in vain
like we hear many people use the word God or Jesus,
but they don't use Holy Spirit in that way**

(although some Batman followers would try in saying - Holy Smoke).

**No, this means failure to listen to the Holy Spirit.
That is to say
failure to listen to the small calm voice of Truth.
But rather to remain dogmatic and argumentative.
With that attitude then one cannot ever understand the Truth.
Although one may be in error
so long as they are willing to examine with an open spirit
something new that is presented to them
then they can eventually learn to better know the Truth,
but if they close their mind
and won't listen and examine
then they will never find the Truth
and that is why Jesus said blasphemy against the Holy Spirit
is the one unforgivable sin.**

**It is time for you to examine
and to try to comprehend.
When you understand the paradigm
well enough that you can explain it to someone else
then you can say that you understand it.
Until then you are criticizing that which you do not understand
and you have no basis for comparison.**

**I have looked in both the boxes.
I know that what is in both of them is very good.
But having seen in BOTH of them I can make a comparison.**

You need to be able to do the same.

**These communications from P
who was apparently forwarded the Four Paths
but I am not certain that they were read.**

The First Path

There is Only ONE PATH and that is Jesus Christ, and his One holy and apostolic Church. Outside the Church there is no salvation. Today the Church

is hard to find so one may say the only ark available is Mary His Mother who does know the way to His Church. P.

The Second Path

All of this is outside the teaching of the one holy and apostolic Church. Outside the Church there is no salvation. The easiest way to the Church today is through Mary and the Rosary. None else is needed. P.

The Third Path

Reason is subject to Grace. Grace of God not reason is the greatest gift God has given to men. Without grace, reason is what made Eve and thence Adam take of the forbidden KNOWLEDGE tree. P.

The Fourth Path

All of this ... comes from the tree of knowledge that was forbidden to Adam and Eve. It begets PRIDE THE ULTIMATE SIN.

Reason must be subject to Grace, or faith in Jesus Christ and His Church.. NOTHING ELSE IS NEEDED FOR SALVATION. OTHER THAN TO REMAIN A LOYAL AND FAITHFUL SUBJECT OF JESUS AND HIS CHURCH.

The most foolish or unintelligent man, the most unreasoning and humble being, the man of simple faith, THE CHILD is the most assured of heaven. P.

My Answer to P.

Dear P.

Your responses show that you believe that there is really only ONE PATH to Truth, that which has been identified in these four essays as The Fourth Path which you would call the Path of Grace, or others might call the Path of the Holy Spirit, or they might call it by some of the other many names besides those that were listed in the essay.

**Still, the fact abides,
that you have gotten most of your knowledge,
and that upon which you base your beliefs
comes from AUTHORITY
in this case much from the Bible
and what you call the
One holy and apostolic Church.**

**Your type of thinking is what I refer to as Fundamentalist thinking.
It is often reflected in what I have, in discussion with others,
identified as "black and white" thinking.
Very often it is referred to as Dogmatic Thinking.
Dogma simply means the Teaching of some Authority.
In your case what you call the One holy and apostolic Church.
This type of thinking is not, however, restricted to any one sect,
or even any one religion
(it could equally well be Christian, Moslem, Hindu, Buddhist or other)
and most definitely does not need to even be restricted to religious belief,
as demonstrated in my following response to the following correspondent.**

**The following correspondence is from F.
Who has only heard about our discussions
and has never received copies of the Four Paths.**

*Why am I not at all surprised that another proponent of prophecy
"fulfillment" refuses to defend his positions in an open public forum? You
are all alike. You preach to the choir and hide from having your absurd
claims answered by an informed opposition.*

*I have a point to contribute that you may want to consider now. Neither you
nor anyone else can prove a single, verifiable case of prophecy fulfillment.
If you ever find the courage to put your faith where your mouth is, please
contact me. I have an internet forum where the debate can be published.*

My answer to F.

**Can you not see that you are bitter and angry,
and not open to calm and reasonable discussion.**

When you make prejudiced and judgmental decisions like -

"You are all alike."

**When you have never even examined this paradigm,
and have no idea what it is like.**

Or that I am even alike in that I

"preach to the choir"

**because the audience that is being addressed
has absolutely no knowledge of the paradigm either.
Most of them will be resolutely opposed also
because it does not come from a Fundamentalist background
or other paradigm with which they are familiar.**

"and hide from having your absurd claims"

**You have absolutely no knowledge of the claims of this paradigm
because you know nothing about the paradigm itself
and therefore you have no way of knowing whether there are absurdities or not.**

"answered by an informed opposition."

**How could you possibly be informed -
when you know nothing about the paradigm?**

**And why are you in opposition to something that you know nothing about?
That is an entirely biased, bigoted, and closed minded attitude.
If another synonym came to my mind I would use it.**

"Neither you nor anyone else"

**It is against this type of close mindedness that I am presenting the paradigm -
the very idea that one can judge the unknowable -
because neither I nor anyone else can know in advance -
the capabilities of everyone, or anyone else.
I realize that in that statement that I also have invoked
the "paradox of the absolute skeptic".**

"can prove a single,"

**In our previous correspondence,
I explained the limitations of proof,
and the distinctions between "belief" and "knowledge"
based upon evidence.
Did you miss the point?
If you didn't miss the point,
then your now stating this,
is evidence that you are not open to calm rational inquiry.
If you did miss the point,
then that demonstrates that you are not capable of such inquiry.
In either case, then,
what would be the benefit of trying to pursue such inquiry with you?**

"verifiable case of prophecy fulfillment"

**Once again, I have previously pointed out to you
the nature of evidence and verification.
It is a matter that was examined at some depth in the Four Paths to Truth.
Since you have not availed yourself of that presentation
you do not even know what criteria has been established there
in this POP series which I call the "Power or Problems of Prophecy".
The first P stands for Power or Problem -
one is free to make their own choice between the two.**

I have an internet forum where the debate can be published.

**Debate is useless,
when it is conducted with people who are NOT informed
and who are NOT of good will.**

**The good will that is necessary is that one must be willing
and desiring
of seeking the Truth
in an unbiased way.**

**I plan to go on to the 3 spheres of reality -
tomorrow.**

Peace and love,

Bruce Beach
DawnSayer@webpal.org

MENU: [HOME](#) » [Reconstruction](#) » [Recovery](#) » [Renewal](#) » [Most Clear Proof - Dir](#)

POP23 - Where

If you have some suggestions or comments you would like to pass on to me about these pages you may do so at: DawnSayer@webpal.org

**Psychiatrists have a quick test
which they determine
whether a person is sane or not.
They determine whether a person is oriented
to the three spheres of reality.**

Do they know -

- **Who they are?**
- **When they are?**
- **Where they are?**

**"Who are you?"
The psychiatrist asked.**

**"Jesus Christ,"
was the reply.**

**"Who told you that?"
asked the psychiatrist.**

**"God",
was the reply.**

**"No, I didn't",
came the voice
from the next cell.**

**We all have our reality tests.
We do it in accordance with our paradigms -
that is to say our world views.**

**In these next three emails I am going to present
a new paradigm about**

- **who,**
- **when and**
- **where we are.**

**The idea here is NOT for you to believe the paradigm.
It is for you to understand it.
Proofs will be presented later.**

**First we will begin with
"where" you are in-**

1. A paradigm of the origin of this world.

The people asked Moses,

"when did the world begin?",

**and He wrote the story of Creation,
in the Book of Genesis.**

**What He gave them
was a paradigm
(a view of the world)
that was comprehensible to them.**

**He did NOT tell them that there were
other planets in the solar system,
other galaxies,
about the immensity that the Hubble shows to us.**

**Ever since the development
of the telescope
Astronomers have thought
with just a bit more powerful telescope
(the general plea today is for one 15% more powerful)
they would be able to see to the edge of the universe,
(or the origins of The Great Bang,
as they put it.)**

They have just never mastered the concept of INFINITE.

**What is to make them think,
that just as if one gets beyond this solar system,
that there are other solar systems, in this galaxy,
and if one gets beyond this galaxy,
there are other galaxies,
and that if one got beyond this "island universe"
there wouldn't be "other" island universes?**

INFINITE is something Different from BIG or MORE.

**Even then, the astronomers deal
with only the PHYSICAL (visible) universe.
The SPIRITUAL REALITY,
of which the physical reality is only a shadow,
is INFINITELY (that word again) more immense.**

**And so where are YOU,
in all this IMMENSITY?**

Short answer:

**Planet Earth.
Physical Shadow.**

**Locating one's self
is sort of like the school child problem
of sending a return address to God.**

**Name,
street,
city,
province,
country,
planet,
solar system,
galactic arm,
galaxy,
galactic cluster,
island universe,**

island cluster,

where does it end?

Doesn't.

The problem is that one is dealing with an illusion.

The illusion of space.

The illusion is that it is reality,

but the REALITY is much more IMMENSE than the illusion.

In fact, the concept if Immensity is inadequate,

so long as it denotes size.

Even Einstein and the advanced thinker physicists,

say that no matter how real it seems

we must remember that Time, Space and Matter,

are illusions in our minds.

NOT that there isn't a REALITY.

A MUCH DEEPER REALITY.

But, for the man on the street,

these ideas have been incomprehensible.

Of course they have been discussed by all philosophers,

down through time, way back to the Greeks,

and Plato and Socrates.

They have been dealt with more in Eastern Religions,

and in a few Western Religions, such as

Christian Science, and to some degree by Swedenborg.

But, for the most part, the man in the street,

while he hears about these ideas,

he really has just not caught on.

The idea still abounds,

that the earth is the center of the universe.

The center of creation.

That all of creation revolves around the descendants of Adam.

Physically created in seven days.

That it is going to end,

and everything with it.

That the center of it all

is the advent about 2,000 years ago

of one particular individual (Jesus),

on this one particular rock,

whirling about this one particular star.

**When infants first become aware,
their Universe centers around their momma,
and their bassinet.**

Later to their nursery and members of their family.

Eventually to their community and school.

Gradually to their citizenship in their country.

**Most people, today, have not yet grasped the idea
of their citizenship in The World.**

**Their relationship to a Universe and Cosmos beyond that -
completely eludes them.**

**Children, in their infancy, naturally have infant concepts,
of creation and the world about them.**

This applies to mankind as a whole.

**An infant race, like the human race
(we only have a few thousand years of recorded history)
has infant concepts.**

**Young people and teens,
often think they have all the answers and understand everything.**

**That is the way many people are,
with their pat answers, "The Bible says".**

For a child, everything revolves around them.

For a childish race, everything revolves around it.

In its mind,

God created everything for It.

The purpose of everything is It.

**The question is,
where are YOU in the universe.**

**To answer that
you have also to answer the question of
when
and
who.**

**Next time -
when.**

**Peace and love,
Bruce**

DawnSayer@webpal.org

MENU: [HOME](#) » [Reconstruction](#) » [Recovery](#) » [Renewal](#) » [Most Clear Proof - Dir](#)

POP24 - When

If you have some suggestions or comments you would like to pass on to me about these pages you may do so at: DawnSayer@webpal.org

We are examining a new paradigm of who, when and where we are. We have already looked at where, we are now going to examine *when*.

2. An examination of the History and Purpose of Mankind.

Again, in the Bible we see a History set down. The first five books of the Bible, are attributed to Moses.

Just as He wrote an understanding, suitable to the people of the time of how the world was created. So, did he also write an understanding, suitable to the people of the time, of when the world was created.

Some people reject The Bible, because they feel they have a longer view of history. (Others still insist on taking The Bible literally, - creation a few thousand years ago). Both positions are in error.

The Bible is SPIRITUALLY correct. Any seemingly literal statements are RELATIVE. They MUST of necessity be, because they are attempting to describe the INFINITE. To suppose that we are CAPABLE (or indeed may have today ABSOLUTE answers from say science) is at just as infantile a mental stage,

**as believing that the Bible should be believed literally.
Understanding of the ABSOLUTE,
always has been,
and always will be,
RELATIVE.**

**So, what I am about to present,
is a new RELATIVE paradigm,
suitable to mankind's present stage of growth.
It is simply a HIGHER
more INCLUSIVE understanding.
Don't belabor the literalness of it.**

**If you prefer a different paradigm
about which I have not heard
that is fine.
Share it with me.
I am always on the lookout for enhanced paradigms.**

**Anyway, in this paradigm,
we first posit the existence of cycles.
We see them about us everywhere.
Day and night,
the seasons,
life and death,
generation upon generation.
Astronomers even pose them for sunspots,
and the wheeling of the galaxies.
(The latter being too slow - taking billions of years,
for us to have actually observed one).**

**Over billions of years,
stars too are born and die.
But since man has only observed them
with telescopes for a few hundred years
and in recorded history for a few thousand years,
we have never seen the event,
from beginning to end.
Oh, we have seen supernovas,
and with the Hubble
some think we have seen star nurseries,
but we have been around too short a time
to observe a billions-of-years-long process**

**from beginning to end.
We can only Hypothesize
or have Revealed to us the overall process.**

**We do hypothesize that stars go through cycles.
From white dwarf to red giant.
For that matter, for all that we have seen,
because the cycle would be beyond the duration
of the human race,
they might repeat their cycles, repeatedly.**

**The earth is in relationship to the sun,
in its cycle.
Were the earth 10% further from the sun,
it would be so cold
that all its water would freeze,
at its poles,
like Mars.
And if the earth were 10% closer to the sun,
it would be so hot
that all its water would evaporate
and cover it in thick clouds,
like Venus.**

**If the sun were to shrivel further
towards becoming a white dwarf,
Venus would cool,
and its clouds would fall to the surface,
creating seas.
Earth would then become like Mars.**

**Indeed, this is the destiny of the earth,
(why I believe these things
is the subject of another essay).
But even during the time of its fruition
there come and go upon the planet
numerous races of men.
Much like a tree,
passing through its seasons,
blossoming in the spring,
bearing fruit,
and becoming dormant in the winter,
to eventually after many seasons**

wither and die.

**There have been past races upon this planet.
There shall be future races.
Although it is possible
for a race to destroy the planet.
(Observe the missing planet in our solar system,
in what we call the asteroid belt,
as possible evidence of this).**

**It is the destiny and purpose of every star,
to have planets,
and of every planet,
to have its races of men.
Just as it is the destiny (fulfilled or not)
for every tree to be fruitful.**

**There are multitudes of questions
that one can ask about the appearance of the race.
The old arguments
between the Creationists and the Evolutionists.
Both error in fundamental premises.
One as to their materialist
and mechanistic concepts of cause and effect,
and the other as to their dogmatic
literal interpretation
of the Spiritual Analogy
related in the Bible plus their misconceptions
regarding the realities of Time, Space and Matter.**

**It is a curiosity that man has the same saline ratio
in his blood, sweat and tears,
as does the sea.
And one does well to contemplate
the philosophical concept that
Ontogeny Recapitulates Phlyogeny.**

**That the individual starts off as a single cell,
becoming at conception multiple cell in a saline sea, (the womb)
and proceeds through various stages,
having a tail and other appendages,
that atrophy before being born.**

**Nevertheless, this is not a proof of devolution,
(descent from other creatures),
because man has always been man,
whatever his form,
individually or collectively.**

**But as far as evolution is concerned,
the evolving of the species,
as I have stated before,
there is evidence for any observer to see,
by simply looking at the armor of the knights of old,
or the statistics for military induction,
between WWI and WWII.
Whatever.**

**If the paradigm presented here,
is more meaningful to you
than one of creation a few thousand years ago,
and you can bear the idea,
that when you are is -
within this diminishing cycle
of the star that we call the Sun,
in this particular revolution of the galaxy,
that we call the Milky Way,
in this particular expansion
of what we see as our island universe,
etc.
then you have a very different idea of when you are
than someone who feels that all the purpose of ALL life,
revolves around a SINGULAR event,
that happened upon this one rock,
circling this one star,
approximately 2,000 years ago.**

**Next time -
as to who you are.**

**Peace and love,
Bruce
DawnSayer@webpal.org**

MENU: [HOME](#) » [Reconstruction](#) » [Recovery](#) » [Renewal](#) » [Most Clear Proof - Dir](#)

POP25 - Manifestation

If you have some suggestions or comments you would like to pass on to me about these pages you may do so at: DawnSayer@webpal.org

**And now
to my final explanation of the paradigm.
Next time on to the proofs,
but remember the only goal now
is to comprehend -
not to necessarily believe.**

**I have covered where and when we are,
and now on to who we are.**

This is:

3. An analogy of "Manifestation"

**This deals in part,
with who we are,
as a race.**

**And who we are
ties into when we are.
To clarify the Biblical Paradigm.**

**Adam was the first man.
In actuality, there were a Thousand Adams.
Simply lost to history.
In fact, all the Adams,
were pre-historic.**

**The question is what is an Adam.
Or for that matter what is a man.
To be a first man.
To be distinguished from the animals.**

Man has certain unique characteristics.

Language.

Humor.

Abstract thought.

**These are all facets of man's unique intellect,
that distinguishes him from the animal.**

No animal could have explained to it,

that the sun stands relatively still,

and the earth circles about it,

nor even that 2+2 equals four.

**(Yes, I have seen the trick
of counting horses and dogs.)**

The GREATEST of all abstract thoughts,

is the comprehension of God.

This is what truly distinguishes man

from the animals.

Therefore, the first to Recognize God,

is who we call the First Man.

Because God is Infinite, and Man finite,

it is God that must Reveal Himself to Man.

Man is incapable of discovering his Creator on his own.

The pot can never comprehend the potter.

Thus it is, in the scheme of things,

that God chooses One to reveal Himself through.

This One we call a Manifestation of God.

To give an analogy.

Consider Betelgeuse.

The largest known star.

A red giant.

**If someone were to point into a telescope mirror,
and say:**

"There is Betelgeuse",

someone else of a literal mind might reply.

"That cannot be,

**because Betelgeuse is a red giant,
larger than that glass,
larger than this whole planet,
even many times larger than our sun.
It is NOT possible THAT could be Betelgeuse."**

**And then if the first one were to break the mirror,
and on a subsequent night
pick up a different mirror
and say to the skeptic:**

**"Look again,
there is Betelgeuse."**

The skeptic could reply,

**"Even if I were to concede
that what you showed me before,
had been Betelgeuse,
this could not be it,
because that glass has now been broken.
Moreover
if you are going to give me some abstract argument,
about it having been the rays of light
within the glass,
that too is not possible,
for those rays are no longer here.
They have long passed."**

**Many analogies of this type could be given.
The image that you see on this TV or on another.
The light that appears in this lamp,
or another.
All being the same energy.
All having come from the same source.**

**To say that is Bob Hope on this TV,
and Bob Hope on that TV is understandable.
To say that it is Betelgeuse in this mirror,
and Betelgeuse in that mirror is understandable.
To say that the light in this lamp,
and the light in that lamp,**

are both from the same source is understandable.

And so it is with the Manifestation of God.

There is but one God

(as there is but one Betelgeuse)

and whether He selects one Mirror,

or another,

in which to appear,

He remains the One God.

God is Infinite.

(There is no comparison between God and Betelgeuse).

There is no way that Betelgeuse

could be contained in a mirror,

and no way that God

could be contained in a Mirror.

Yet, all we know of Betelgeuse or other stars,

is what we see in the mirror.

And all that we know of God

is what we see in the Mirror

(the Manifestation).

To look at the mirror and say,

"There is Betelgeuse,

is not illogical.

To look at the Mirror (the Manifestation)

and say,

"There is God",

is not illogical.

But to think that Betelgeuse

can be "contained" in the mirror,

is illogical.

And to think that God can be "contained"

in the Mirror (Manifestation)

is illogical.

But, nevertheless,

this is what those who believe in Incarnation, believe.

**Those who believe that Jesus, was God incarnate.
But, what Jesus, was,
was the MANIFESTATION of God.
Not God incarnate.
If the distinction is not important to you
then not to worry about it.
None of us comprehend the nature of God
nor our relationship to Him,
and certainly not the Manifestation's relationship
to Him.**

**But any way, according to this paradigm,
God MANIFESTS Himself,
(Makes Himself known unto men)
through some individual that He selects.
The distinction here,
between Christian Theology is that God can
Manifest Himself as often as He likes.**

**The Manifestations have told us that
God selects only one individual at a time
(on any given planet)
and usually about once every thousand years.
Since God makes Himself known
to all His Creatures,
given the billions of planets throughout the Universe,
it is possible, even probable,
that many Manifestations,
must be occurring simultaneously.**

**The key to all this is,
that the ONLY thing that we can know about God,
is what He tells us about Himself,
through His Manifestations.**

**But, the key also is,
that we must RECOGNIZE the Manifestation.
Individuals recognize the Manifestation,
and because of His influence on their lives,
whole civilizations
come to pay at least lip service to His Station.**

**Those who do not Truly see the Light,
confuse the Light with the Lamp.
They begin to worship the Messenger,
instead of the Message.**

**If the Light appears in a different Lamp,
the Blind will not see it,
but may continue to do obeisance to the Lamp,
that has now been extinguished.**

**Each of the Manifestations
have bestowed upon Them Innate knowledge.
They know ALL the answers.
But Their hearers are not capable of hearing them.
The teacher of First Grade students,
may know just as much
as the teacher of Sixth Grade students,
but the students are just not ready to understand.**

**Each of the Manifestations,
bring two sets of Teachings.**

- **Eternal Spiritual Teachings and**
- **social teachings**

suitable for the people and the Time.

Thus it is that Adam taught that there was a God.

**The first teaching of the Manifestations.
Why we call Him the first man.**

He also gave social teachings regarding

**the establishment of the family
(The story of Adam and Eve),
the command to labor for one's livelihood
(The story of being cast from the Garden),
the command against murder
(The story of Cain and Abel)
and so forth.**

**Later, there came another Manifestation of God.
He reinforced and ENLARGED upon
the Spiritual Teachings of Adam.
He said, Yes, there is God,
but God must be worshipped as a Spirit,
not as the idols that you make with your own hands.**

**There is an interesting story regarding this in the Koran.
Abraham's father's profession was as an idol maker.
One day when the father returned he found that Abraham
had destroyed all the idols, except the largest one.**

**"Abraham! Why did you do this?",
he said with great anger.**

**"It wasn't I father,
it was the Big One, ask him".**

**"You know that he can't speak
and couldn't have done this".**

**"Then, father,
why do you worship that which is dumb
and has no power?"**

**We call that form of worship
practiced by the followers of Abraham - animism.
Like with the North American Indians,
the Spirit is in the Trees, the Wind,
the Water, and so forth.**

**There are many interesting things
that I could write about Abraham,
but I suspect my essays are too long already.**

**The Bible tells how he had three wives.
And each was promised
to become the mother of nations.
The Bible tells about
the descendants of one wife, Sarah.
But other nations
track their lineage to the other wives.**

**Abraham established a new social order.
He sent his brother in one direction
with His brother's sons and their wives and flocks,
and He Himself went the other with His.
This was the beginning of Nomadic Tribes.
A much advanced social order
over that of the Adamic period,
with one male and many wives.
When an organization of the new social order
with many males,
met an organization of the old social order
with one male.
it was a wipe out for the old social order.**

**Later came Moses.
The people had returned to idol worship.
(The story of the Golden Calf).**

**He taught a new Spiritual Teaching.
Yes, there is a God, as Adam taught.
Yes, God is to be worshipped as a Spirit
as Abraham taught.
But the Jews were to have Only ONE God.
(Not that other people didn't worship
other gods.)
"The Lord God of Israel is One".**

**Moses also taught a larger social order.
Rather than just nomadic family tribes,
the Children of Israel were organized into 12 Tribes.
There were thousands in each Tribe.
When an organization of the new social order
with thousands of males,
met an organization of the old social order
with a few males,
it was a wipe out for the old social order.**

**Moses also gave many other social teachings,
both in the Ten Commandments,
and Books of the Law.
But I will pass over these.**

**In due time,
there came as promised by Moses,
the next Manifestation.**

Jesus.

**For Who was He,
if not the one Promised to the Jews?
And He taught a new Spiritual Teaching,
that God is a God of Love.**

**And he taught a new social teaching,
upon which there were built city states.
(Render unto Caesar that which belongs unto Caesar,
and unto God that which belongs unto God).**

**Leading unto a much stronger social order,
that allowed for the organization of people
who were not even related to each other,
as were the 12 Tribes of Israel.**

**And He, Jesus, promised unto them another,
the Paraclete,
as understood by those who recognized Mohammed.**

**And Mohammed brought a new
and Higher Spiritual Teaching.**

**That yes, as Adam taught,
there is God.**

**And yes, as Abraham taught,
He is Spirit.**

**And yes, as Moses taught,
we are to worship One God.**

**And yes, as Jesus taught,
He is a God of Compassion.**

And yes, something new.

**That there is No God but God
(Allah - The Only - the meaning of Allah).**

**Monotheism.
Philosophically comprehended
by the Christians and Jews of Europe,
as a result of the Crusades,
and then spread to Judaism
and most of Christianity
(The Mormons are still not monotheistic).**

**Mohammed also brought new social teachings.
The establishment of Nations.
Even secular historians recognize Him for this.
The law that we call Blackstone Law,
or the Common Law of Europe
is not to be found in the Bible,
but rather is in the Koran.**

**When organizations of the new social order,
met organizations of the old social order,
it was of course a wipe out
for the old social orders.**

**I could write volumes
on all these matters.
But have probably written too much already.**

- **Each of the Manifestations promises a successor**
- **Each brings new Spiritual Teachings**
- **Each brings new Social Teachings**
- **Each reveals a Book**
- **Each starts a new calendar**
- **Each revitalizes the Religion of God**
- **Each revitalizes Society**

**The latest of the Manifestations to come,
are the Twin Manifestations
(One immediately after the Other)
of the Bab and Baha'u'llah.**

They have brought a new Spiritual Teaching,

**that there is but One Religion,
The Religion of God,
and that all Religions,
(that is to say that All the Manifestations)
have always come to renew THAT religion.**

They have also brought new social teachings.

That there is but One race,

**the human race.
That there is but One nation, the World,
and Mankind is its Citizens.**

**There is so much more that I could write,
about Other Manifestations.
Buddha, Krishna, Zoroaster.
There is so much more that I could write,
about the New Teachings,
and the Destiny of the Human Race.**

**But the time has come for
you to think about this new paradigm.
About who we are.**

**A race of people,
receiving Progressive Revelation from God,
through His Manifestations,
as we now make the transition
from Spiritual Childhood,
through Adolescence,
into Spiritual Maturity.**

**A view quite different from the Christian view.
This is a view in which we are at The Beginning,
rather than at the Ending.**

**A view in which
we are having our relationship to God,
being Progressively taught to us
by the Manifestations of God,
rather than a view
in which all truth has already been revealed.
A view in which we are at the beginning of maturity,
rather than at the end.**

**A view in which,
once again the Manifestation of God,
has come to Mankind,
and it is the responsibility of every individual
to recognize Him and serve Him.
This is the ONLY salvation for us.**

**Individually or collectively.
Because, whether we desire it or not,
who we ALL are is
the servants of God.
(Obedient or disobedient, and that is who we are).**

**This is the paradigm
that I have asked you to comprehend.
The matter of acceptance and belief
comes next.
For that there needs to be proof.
And for that I shall continue next -
with the Most Clear Proof.**

**Peace and Love,
Bruce
DawnSayer@webpal.org**

MENU: [HOME](#) » [Reconstruction](#) » [Recovery](#) » [Renewal](#) » [Most Clear Proof - Dir](#)

POP26 - Revelation

If you have some suggestions or comments you would like to pass on to me about these pages you may do so at: DawnSayer@webpal.org

**There are as many paradigms
as there are people.
We all view the world differently.**

**Some people view the world
as having been created a few thousand years ago -
others think that it may have been
millions or billions of years ago.**

**Whatever one imagines
it is too little
because we are dealing with
the Infinite and Eternal
and that is a different concept.
A different paradigm.
A different way of looking
at the world and Reality.**

**Some people see Creation in a "magical" way.
Others feel that they have a "scientific" appreciation of Creation.
But no matter what our concepts
the best that we can know today is that
they are limited and relative to the Absolute Reality.**

**There are many speculations held by people
about the nature of reality,
the nature of creation,
the source and purpose of our being.**

**I hear a great variety,
about reptilian evolution,**

**seeding from the stars,
special creation from the dust,
and many others that I won't delve into.**

**The two extremes which I challenge are
scientific materialism
that says man has all the answers in his intellect
with no need for revealed religion
and its opposite pole
dogmatic orthodoxy
which says all Truth has been already revealed
and no further Truth can be revealed.**

**It has been to the followers of scientific materialism
that I have made the attempt
to prove mathematically
that Jesus was the Christ
and that the Bible was a reliable source of prophecy.**

**While the mathematical proof that Jesus was the Christ
was a difficult emotional challenge to the atheist and agnostic
the next mathematical proofs from the Bible
will be an equally difficult emotional challenge
to any of a dogmatic orthodox religious inclination
who have managed to hold on to this point.**

**Because whereas before
we used mathematical proofs
to show from the Jewish Old Testament Scriptures
that those Scriptures contained prophecies about the Christian Religion
we are now going to use the Christian Gospel
to show with EVEN GREATER MATHEMATICAL SURETY
that the New Testament contains prophecies about other religions
such as the Moslem and the Baha'i.**

**There are many marvelous prophecies in the Book of Revelation,
but they are mostly concealed from Christians
who give fantastic superstitious interpretations about them.
The Book of Revelation contains prophecies
about things both past and future.
It is through understanding its prophecies about things past
that we can have confidence about its prophecies of things future.**

In my next email

**I shall get into the mathematical proofs
and while I shall not spend a lot of time
dealing with the prophecies themselves
other than showing the mathematical key to them
my dear saintly wife has asked that I at least share with you
a typical interpretation of one of those Scriptures.**

**Many a Christian has opened the Book of Revelation
to find Marvelous Prophecies and Exhortations
directed to several small and insignificant congregations
in the vicinity of Israel.**

The Churches Addressed

**were not those actual specific congregations,
but the church names were used in the Prophecies
as type designators or markers
for whom to the Messages were actually addressed.
Each of these tiny little congregations were but symbols
for the Religions of the World.
Each one being used as a Symbol for one of the
World's Major Religions.**

**This is why they were so Important as to be addressed
in this Summary Book of Christian Revelation.
What was actually being addressed was
each of the World's Major Religions.**

The Seven Religions were:

- 1. Sabaenism:**
Southwest Arabia and later Ethiopia-
Revelator unknown. 4000 - 5000 B.C.
- 2. Hinduism:**
India -
Krishna. 2000 - 3000 B.C.
- 3. Judaism:**
Egypt -
Moses. 1250 B.C.
- 4. Zoroastrianism:**
Persia -
Zoroaster. 900 - 1000 B.C.

5. Buddhism:

India -

Buddha - 500 - 530 B.C.

6. Christianity:

Palestine -

Christ. 26 A.D.

7. Moslem:

Arabia -

Mohammed. 622 A.D.

While a study of each of the ancient religions would be interesting and I might be able to make it interesting to some of you since I have a degree in Comparative Religions it is far beyond the limits of this presentation.

Nevertheless, it was not beyond the view of the Bible. And it was to each of these Religions that the Book of Revelation was addressed.

Rev: 1:4

" John to the seven churches which are in Asia ----"

The messages are not addressed to the Churches (Religions) in the order (above) of their appearance, but one who has studied the religions can determine which Church is which by the nature of the Message delivered unto it.

The references to things like Seven Stars being in the Hand (or Crown) of the Messenger or the Seven Golden Candle Sticks are symbolic and again refer to the Seven Religions being in the Hand and Kingdom of the Lord, and that He walks among them. One might note also that it is the Angel of Each Church that is addressed.

Rev. 2:1 Ephesus

Rev. 2:8 Smyrna

Rev. 2:12 Pergamos

Rev. 2:18 Thyatira
Rev. 3:1 Sardis
Rev. 3:7 Philadelphia
Rev. 3:8 Laodiceans

**Each Church (Religion) is generally praised
for some aspect of its behavior
and chastised for some other aspect.
And thus it is with any open minded student
of comparative religion
that usually we can find some
strong beneficial point in each religion
along with some characteristic weakness in its followers.**

**I am not as much a student of the Book of Revelation
as my dear wife.**

**(She does not like for me to refer to her as saintly,
but I tell her that since everyone else does also,
how can I deny it. But let me tell you also,
it is not always easy living with a saint.)**

**My wife has deeply studied the book,
has taken courses with numbers of churches,
maintains 3 ring binders on the subject,
and a library of reference books.**

**She would have me tell you much more,
than this little bit,
but that is not my intention here,
and it is only in deference to her
that I have told you so much as I have.**

**Next time, now, I can return
to the mathematical proofs.**

**Peace and love,
Bruce Beach
DawnSayer@webpal.org**

MENU: [HOME](#) » [Reconstruction](#) » [Recovery](#) » [Renewal](#) » [Most Clear Proof - Dir](#)

POP27 - First Step

If you have some suggestions or comments you would like to pass on to me about these pages you may do so at: DawnSayer@webpal.org

In the previous emails
I have presented a paradigm
that states that ALL the Revealed Religions
(Major Religions with a culture, etc.)
have come from God.

We now turn to mathematical proof
in the Bible
regarding one of them.
Specifically the Moslem Faith.

First we need to gather the numbers.
So far as I am aware
after many years of study on the subject -
the following are the only locations in the Bible
that have the following numbers.

"Scriptures"

DAN	8:14	1844 A.D. from our previous proof regarding Christ)
	7:25	time, times, and div. of time
	9:27	midst of week
	12:7	time, times, & half
Luke	4:25	three years and six months
REV	11:2	42 months
	:3	1260 days
	:9	3 1/2 days

:11	3 1/2 days
12:6	1260 days
:14	time, times, & half
13:5	42 months

**The First Step is to
bring the numbers
to a common denominator**

- **time, times, & div. of time and**
- **time, times, and a half, and**
- **the midst of the week (one half of seven days)**

are all equal to

3 and 1/2

Let us consider the first of these :

time is

1

times is plural and therefore in this case

2

dividing of time, or dividing of one is

1/2

therefore -----

3 and 1/2 total

likewise:

time = 1

times = 2

a half= 1/2

3 and 1/2 total

"Scriptures"

DAN 8:14 1844 A.D. from our previous proof regarding Christ)

7:25 3 1/2

9:27 3 1/2

12:7 3 1/2

Luke 4:25 three years and six months

REV 11:2 42 months

:3 1260 days

:9 3 1/2 days

:11 3 1/2 days

12:6 1260 days

:14 3 1/2

13:5 42 months

**I will pause here so that you can look at this
and see if you see how the rest come to the
common denominator.**

**The answer -
next email.**

**Peace and love,
Bruce
DawnSayer@webpal.org**

MENU: [HOME](#) » [Reconstruction](#) » [Recovery](#) » [Renewal](#) » [Most Clear Proof - Dir](#)

POP28 - Next Steps

If you have some suggestions or comments you would like to pass on to me about these pages you may do so at: DawnSayer@webpal.org

Continuing with our mathematical proof from the Bible that the Book of Revelation talks about religions other than the Christian.

We had thus far brought the following scriptures to this much of a common denominator.

"Scriptures"

DAN	8:14	1844 A.D. from our previous proof regarding Christ)
	7:25	3 1/2
	9:27	3 1/2
	12:7	3 1/2
Luke	4:25	three years and six months
REV	11:2	42 months
	:3	1260 days
	:9	3 1/2 days
	:11	3 1/2 days
	12:6	1260 days
	:14	3 1/2
	13:5	42 months

Second Step
bringing the numbers
to a common denominator

(3 1/2) prophetic times or years
are equal to 42 months
that is to say:

3 years of 12 months = 36 months
plus a half year of 6 months
brings the total to ----->42 months

Making the substitution in our above table
we get the following:

"Scriptures"

DAN	8:14	1844 A.D. from our previous proof regarding Christ)
	7:25	42 months
	9:27	42 months
	12:7	42 months
Luke	4:25	42 months
REV	11:2	42 months
	:3	1260 days
	:9	42 months
	:11	42 months
	12:6	1260 days
	:14	42 months
	13:5	42 months

Third Step
bringing the numbers
to a common denominator

**42 months is equal to 1260 days (years)
because a biblical month
(as per an earlier proof)
contains 30 days and**

**42 months multiplied by
30 times**

1260 days (years).

**Now making the substitutions
we arrive at:**

"Scriptures"

DAN	8:14	1844 A.D. from our previous proof regarding Christ)
	7:25	1260 days (years)
	9:27	1260 days (years)
	12:7	1260 days (years)
Luke	4:25	1260 days (years)
REV	11:2	1260 days (years)
	:3	1260 days (years)
	:9	1260 days (years)
	:11	1260 days (years)
	12:6	1260 days (years)
	:14	1260 days (years)
	13:5	1260 days (years)

**This in itself, was pretty astounding to me
when I first saw it.**

**To think that all these scriptures
were saying the same thing!**

**That all these reduce to 1844
will be the subject of the next email.**

**Peace and love,
Bruce
DawnSayer@webpal.org**

MENU: [HOME](#) » [Reconstruction](#) » [Recovery](#) » [Renewal](#) » [Most Clear Proof - Dir](#)

POP29 - Final Step

If you have some suggestions or comments you would like to pass on to me about these pages you may do so at: DawnSayer@webpal.org

In the previous email e
we arrived at:

"Scriptures"

DAN	8:14	1844 A.D. from our previous proof regarding Christ)
	7:25	1260 days (years)
	9:27	1260 days (years)
	12:7	1260 days (years)
Luke	4:25	1260 days (years)
REV	11:2	1260 days (years)
	:3	1260 days (years)
	:9	1260 days (years)
	:11	1260 days (years)
	12:6	1260 days (years)
	:14	1260 days (years)
	13:5	1260 days (years)

The explanation of how to convert these all to 1844 is found at the start of Revelation Chapter Eleven which is the start of most of the series.

Rev. 11:1-2

*"And there was given me a reed like unto a rod:
and the angel stood, saying,
Rise and measure the temple of God,
and the altar,
and them that worship therein.*

*But the court which is without the temple
leave out,
and measure it not;
for it is given unto the Gentiles:
and the holy city shall they tread under foot
forty and two months.*

**Now the question is
who were the Gentiles that occupied
the area outside the Temple.**

**Answer:
They were the Moslems.**

**So we are not to use the Christian measure
in measuring this forty and two months
but rather the Moslem measure.**

**We have seen how 42 months
(and ALL the other scriptures)
reduce to 1260.**

**Previously, I have given you the following general rule
for finding a date of commencement any Mohammedan year.
This has a maximum error of a day;**

**multiply 970,224 by the Mohammedan year,
point off six decimal places
and add 621.5774.**

**The whole number will be the year A.D.,
and the decimal multiplied by 365
will give the day of the year.**

**Here is the math.
Be SURE to check it through for yourself.**

**It will then be meaningful to you.
If you are not sufficiently interested
to check the math
then you are not sufficiently interested
in the answer for it to make any difference.**

970224

1260

58213440

1940448

970224

1222.482240

621.5774

1844.059640

!!! 1844 !!!

And what happened in 1844?

Two things of significance.

1. There was the Edict of Toleration.

**The above Scripture pointed out -
the holy city shall they tread under foot
forty and two months.**

**After Jesus came as the Messiah of the Jews,
the Jews were scattered and
not permitted to enter the Holy Land.**

**This bothered the Jews greatly
because their scripture in Isaiah had said
that He would gather them
"as a mother hen gathers her chicks".**

**But He said,
"I would have gathered -
but ye would not gather".**

**So they were dispersed,
and not allowed to return,**

but now in 1844 there was given the Edict of Toleration.

**Here is some historical evidence
that came to me just this week,
from another researcher.**

"During the 1970's I was researching parts of the Baha'i Faith and, out of curiosity, wrote about the Edict of Toleration to the PUBLIC RECORD OFFICE in London. The following is the reply I received.

"A translation of the edict, an acknowledgement from Stratford Canning to the Sublime Porte, and an accompanying letter from Canning, dated 23 March 1844, is in Foreign Office, Turkey, FO78/555/No.49. there are several other letters from Canning in the same volume on the question of the religious intolerance of the Turks. The draft of a letter from the Foreign Office, dated 16 January 1844, which made plain the attitude of the British Government and which provided the direct impetus for the negotiations leading eventually to the issue of the edict, is in FO78/552/No.4."

**-you can obtain copies of the English language
documents that refer to it from the Public Record Office in London.**

H.G.Guinness, in his book, "Light for the Last Days" (probably published around the turn of the century) wrote "the decree [Edict of Toleration] was published in the 1260th year of the [Muslim] calendar. It is dated March 21st 1844. This date is the first of Nisan in the Jewish year, and is exactly 23 centuries [2300 years] from the 1st Nisan, BC457, the day on which Ezra states that he left Babylon in compliance with the decree given in the seventh year of the reign of Artaxerxes."

So there we have it ----->

"Scriptures"

DAN	8:14	1844 A.D. from our previous proof regarding Christ
	7:25	1844 A.D.
	9:27	1844 A.D.

12:7 1844 A.D.

Luke 4:25 1844 A.D.

REV 11:2 1844 A.D.

:3 1844 A.D.

:9 1844 A.D.

:11 1844 A.D.

12:6 1844 A.D.

:14 1844 A.D.

13:5 1844 A.D.

**I shall discuss the significance of all this
in my next email
which will be my final email in the POP series.**

**Peace and love,
Bruce
DawnSayer@webpal.org**

MENU: [HOME](#) » [Reconstruction](#) » [Recovery](#) » [Renewal](#) » [Most Clear Proof - Dir](#)

POP30 - The Final Analysis

If you have some suggestions or comments you would like to pass on to me about these pages you may do so at: DawnSayer@webpal.org

This is a summary discussion of the POP Series.

We set off with the idea to discover whether or not prophecy was truly possible, and we examined a number of prophetic claims.

Next we investigated the nature of proof, saying that there are ONLY Four Paths to Truth, and that each is fallible.

We then applied the Four Paths in a Mathematical Proof of Bible Prophecy showing that Jesus was the Christ.

On the same basis we then began to examine the following 12 Scriptures

"Scriptures"

DAN	8:14	1844 A.D. from our previous proof regarding Christ)
	7:25	time, times, and div. of time
	9:27	midst of week
	12:7	time, times, & half
Luke	4:25	three years and six months
REV	11:2	42 months
	:3	1260 days

:9	3 1/2 days
:11	3 1/2 days
12:6	1260 days
:14	time, times, & half
13:5	42 months

And reduced them all down to the following:

"Scriptures"

DAN	8:14	1844 A.D. from our previous proof regarding Christ
	7:25	1844 A.D.
	9:27	1844 A.D.
	12:7	1844 A.D.
Luke	4:25	1844 A.D.
REV	11:2	1844 A.D.
	:3	1844 A.D.
	:9	1844 A.D.
	:11	1844 A.D.
	12:6	1844 A.D.
	:14	1844 A.D.
	13:5	1844 A.D.

The calendar that we used to make this reduction was the Moslem Calendar and was a part of the evidence for our hypothesis that the Bible contains prophecies about other religions.

We then asked what significant thing happened in 1844

and our answer was - two things:

- 1. The edict of toleration
that in fulfillment of Jewish Prophecy
permitted the return of the Jews to Israel.
and**
- 2. The Return of Christ
as prophesized and expected
in the Great Expectation of 1844.**

**(Others, such as the Mormons, would add to this list
things like the martyrdom of Joseph Smith.)**

**In regard to the return of Christ I explained that
over 10 million people world-wide
(mostly from their Scriptures - other than Christian)
now recognize Baha'u'llah as the Return of Christ,
and have accepted a new paradigm about
themselves and this planet in relationship
to the Universe, Space, Time, and to what is called
a Manifestation of God.**

**The following is a chart that I have made
of Prophecies and dates
from the Bible.**

Chart of Prophetic Dates and Sources

Bible Moslem

**1844 1260
(Quran 40:7)
(Quran 32:4)**

- (1) Dan 8:14**
- (2) 7:25**
- (3) 9:27**
- (4) 12:7**
- (5) Rev 11:2**
- (6) :3**
- (7) :9**
- (8) :11**

(9) 12:6

(10) :14

(11) 13:5

(2) (12) 1863 1290 Dan 12:11

(3) (13) 1963 1335 Dan 12:12

(4) (14) 2063 2520 Dan 4:16 360

-457 B.C. :23 x7

2063 2520

(5) (15) 1914 1844

+70 Dan 9:2

----- Jer 25:11

1914 :12

29:10

Isa 23:15

:17

**While I have listed the key
Scriptures, prophecies and dates
I will not be going on to discuss them.**

**To actually understand the references
(in the Book of Revelation)
to the Moslem dates
one has to be acquainted with the Moslem Religion
and Moslem history.**

**Suffice to say,
the references both
in the Book of Revelation
and SURPRISINGLY found with the SAME DATE
in the Koran
both refer to the Return of Christ.
(It surprises many Christians to learn
that the Moslems are looking for
and expecting the Return of Christ.)
However, just as the Jews failed to recognize Jesus,
and the Christians failed to recognize Mohammed,
so have the Moslems failed to recognize**

the Bab and Baha'u'llah.

**If you had been a Jew 2,000 years ago
and had been shown then
(which the Christians were NOT able to do -
but which can be shown now -
because the Books have been opened)
the mathematical proofs from the Old Testament
about Jesus
then you should have been willing to examine
the Gospel of Jesus
and to find out what Jesus had said.**

**Today, you have been shown from the Bible
the mathematical proofs about Baha'u'llah
and you should now be willing to seek out and study
the Teachings of Baha'u'llah.**

**The claim is that
He is the Manifestation to this Day and Age.
That He has brought the solution
to mankind's problems
and has told us in prophecy the nature of our destiny.**

**But all this
you will only discover by studying His own Writings.
To try to dispute about Him
based upon one's present understanding about the Bible,
would be the same as a Jew
refusing to read the Gospel of Christ
and continuing to dispute about Him
on the basis of the Old Testament.**

**To accept all this
(even to the point of being willing to examine His Writings)
of course requires a MAJOR, MAJOR paradigm shift
on the part of a Fundamentalist Christian.**

**I know that it is hard.
Here is just a partial list of the ideas
that a Fundamentalist will think are FANTASTIC
and completely UNBELIEVABLE.**

**1. That the world -
contrary to the Creationist point of view
wasn't created just a few thousand years ago.**

**I realize that the evidence wasn't there
for almost 1500 years - three quarters of the duration
of the development of Christian Theology.**

**Even as recently as when Columbus discovered America,
the sailors that were with him were concerned
that the world was flat
and believed that the sun went around the earth.
It has only been in the last couple of centuries
(a mere ten percent of the time of Christian Theology)
that we have had telescopes to show us
anything approaching the concepts of galaxies
such as we have formed using telescopes
like those on Palomar and Hubble.**

**Archaeology and the study of paleontology
along with discovery and acceptance
by most people of the existence of dinosaurs
just had not occurred.
That the Universe is NOT
SPACE CENTERED
or TIME CENTERED
about the earth and man
was just totally inconceivable
to a Bible Believing Christian on the Street
during most of the time of Christianity.**

**HOWEVER, THE POINT HAS BEEN
THAT THE BIBLE WAS NOT WRONG
about Creation
but simply that it must be understood
in a GREATER MORE INCLUSIVE SPIRITUAL SENSE
and that the explanations given in it
were those suitable for the people
to whom it was revealed -
at their level of understanding at that time.**

2. As shocking a paradigm shift

**as I have asked the Fundamentalist Christian
to make about the non-centeredness of his world
in Space and Time**

**I have asked him to make a MUCH MORE DIFFICULT
paradigm shift about the non-centeredness
of HIS RELIGION
in relationship to the CREATOR
of this IMMENSE Universe we have described.**

**In regards to just this one planet -
we have examined that there have been
GREAT Numbers of People
and cultures on this one little planet that have had
religious guidance other than the Christian one.
Moreover, we have looked at evidence,
that just as the Bible when not taken Literally
but when taken in a Spiritual Sense
is correct in its Creation Accounts
so also does it contain evidence about OTHER Religions.
That the Old Testament had promised
that ALL the nations of the earth
would be blessed by the seed of Abraham's THREE wives
but the Old Testament only tells
the history of the descendant's of one (Sarah).**

**We saw that the Old Testament
gives with MATHEMATICAL ACCURACY
prophecy of the both the first coming of Jesus
and of His Return in 1844.**

**The Jews of course did not accept Jesus,
although His followers, the Christians,
accepted all the Prophets of the Old Testament
(but not the laws of religious practice -
sacrifice, circumcision, Sabbath day, kosher foods, etc.)
of the Jews.**

**However, neither did the Christians accept Mohammed
although there are in the Bible
TEN TIMES
the number of MATHEMATICAL PROOFS (the 1260 dates)
about HIM
and the return of Christ in 1844**

**based on the Moslem Calendar.
Even though the Moslems accepted all the Old Testament,
and the New Testament
(although again not the religious laws
such as baptism and others such as we mentioned above)
and all the Prophets AND Jesus
as explained in the Koran.**

**And once again, the Moslems had the 1844 prophecies,
(in their dates on their calendar)
in the Koran
and were well expecting the Return of Christ
but they also failed to accept Him
at His Return in 1844,
and they persecuted the Bab and Baha'u'llah.**

**3. As difficult as are the first two paradigm shifts
for a Fundamentalist Christian
the THIRD about the NATURE of the MANIFESTATION -
about the VERY CONCEPT of what is meant by a
MANIFESTATION of God
is often just totally incomprehensible to them.
In their eyes it destroys Jesus.
For them He was the Center of Creation -
a one time event
on this one planet
2,000 years ago
around which the whole Universe revolves.**

**That this could be TRUE,
not in the small literal sense that they say,
but in a MUCH GREATER SPIRITUAL SENSE
is to them - just non-meaningful.
But just as Jesus did not come to destroy the Law,
but to fulfill it,
neither did Baha'u'llah come to destroy Jesus,
but rather to fulfill His prophecies.
To unite the world and the religions.
To bring Peace and the Kingdom of Heaven on Earth.**

**4. A FOURTH paradigm shift
is necessary for the Fundamentalist.
It is central to being able to understand those above.**

**This regards the very nature of Truth itself.
This regards about how to understand the Bible -
not in an absolute literal sense -
but in a higher spiritual sense.**

**I have suggested that the CREATOR has to be
so much more EVEN MORE IMMENSE
(I am avoiding the word Infinite
which is more completely incomprehensible)
and to have existed so much LONGER than this earth
(again I am avoiding the term ETERNAL
for the same reasons)
that He is simply unknowable to us
in an ABSOLUTE sense.
For this reason, as Scientists today understand,
our knowledge of just the Creation
leave alone the Creator
is RELATIVE and limited to us
by what I have described as the
Fallible Four Paths to Truth.**

**It is in this sense -
that as we come to know more about
the Creator's Creation
that we gain an EVER EXPANDING sense
of how IMMENSE it is
(billions of galaxies
in the visible universe of the astronomer
and beyond that through the black holes
to we don't know where and on from that
to Infinity
of which we have no concept of the meaning
and the Spiritual World which is the basis of it all.)**

**It is in this sense -
that as we come to know more about
the Creator's Creation
that we gain an EVER EXPANDING sense
of how old it is
(billions of years long -
again into the black holes
where light, and space and time cease to exist,
and the concepts become unmeaningful**

**as we gaze at the thought of Eternity
about which we can have no concept).**

**It is in this sense -
that as we come to know more about
the Creator's Creation
that we gain an EVER EXPANDING sense
of the purpose of it all
that has been increasingly explained to us
in OUR SHORT HISTORY OF TIME
by the Manifestations of God
as they have raised us to increasing social consciousness
and social organizations of
the family, the extended family, the tribe,
the city state, the nation
and now on towards one unified world
with a world government,
so that there can be an ever progressing
peaceful and advancing civilization
to support individuals in their journey
towards spiritual enlightenment.**

**-----
There is so much more that I long to share -
about the nature of the soul,
the nature of life after death,
the purpose of life on this planet,
the future of mankind on this planet,
and many many other issues
but all those things are to be found
in the Writings by the Prophet to this Day and Age -
Baha'u'llah.**

**My poor and inadequate words
do not have the power
to reach and penetrate the soul
with the Spirit of Truth
as does His.**

**My purpose has simply been to point
towards that source
so that you can discover the Truth
from the Source of Truth
for yourself.**

**Those who cannot make the 4 paradigm shifts
will continue to say
that they believe in**

Rapture

(their ascending up into the clouds)

Resurrection

(the graves opening and the dead coming forth)

Return of Christ

**(from the clouds above
with nail prints in his hands)**

Creation

in the last few thousand years.

Centeredness

of this planet in the Universe.

Vicarious redemption of sins

by the suffering of another

**and dozens of other things
because they have FAITH,
and that since I don't believe what they believe
(in the way they believe it -
because I do believe in the accuracy of the Scriptures)
that I have been deceived by a false prophet
and that I am doomed.**

**The fundamentalist ideas have been around for centuries.
They are deeply ingrained in the culture
and are passed on from generation.**

**One has almost gotten them
along with the air that they breath.
But paradigm shifts do occur,
and the ones that I am describing
are occurring.
How long it will take,
decades or centuries, I don't know,
for them to become universal.
But because they are NEARER the Absolute Truth,
these paradigms, and others more advanced,
will eventually replace the present ones
in the collective consciousness of mankind.**

**If you are willing to examine them
with an open heart
and can look at their Source
and the Spiritual Source of Truth
for this Day and Age -
the Writings of Baha'u'llah -
you will be one of the lights of the age,
helping to lead mankind out of the present
relative morass of vain imaginations and superstition
towards greater enlightenment.**

**I hope that you will be a contributor
to the effort.**

**Peace and love,
Bruce
DawnSayer@webpal.org**

MENU: [HOME](#) » [Reconstruction](#) » [Recovery](#) » [Renewal](#) » [Most Clear Proof - Dir](#)

The Seven Churches

If you have some suggestions or comments you would like to pass on to me about these pages you may do so at: DawnSayer@webpal.org

Prolog:

**For most readers -
this will be a very, very strange explanation -
about some verses from the beginning of the
The Book of Revelation.**

**The idea that Book of Revelation is about
Religions other than Christianity-
will just not be acceptable to many Christians.
Yet - that is the explanation presented here.**

**The Book of Revelation
is addressed to Seven Churches.
The churches named are what we call archtypes.
That is to say -
it is not really to the seven
historically insignificant locations named
but rather those names are stand-ins for the real subjects.**

**Oftentimes, the true significance of Scripture
is far beyond the expectations
of the members of the religion who claim ownership
of that Scripture.**

**Thus it is -
that the Messiah expected and promised
in the Jewish Scripture
was the Messiah and Lord
for what was far beyond
what was then probably less than 2 million persons**

who considered themselves "The Chosen People".

Likewise, the Message and Meaning behind the Book of Revelation is much greater than that attributed to it by Christians in general.

This is an introduction to that expanded concept.

Introduction

The Book of Revelation, in the Bible, was a spiritual message revealed by Jesus Christ through St. John the Divine in about 96 AD, sixty three years after Jesus' ascension. John was on the island of Patmos and is believed to have been nearly 90 years old at the time.

The Book of Revelation is a deeply mystical writing and in order to comprehend the dramatic concepts within it, one must be willing to examine it with spiritual eyes and an openness to inquire if there is a deeper meaning than the literal meaning of the words that one sees on the surface.

The prophetic message in the Book of Revelation is about the destiny of seven churches. These are referred to as seven candlesticks and each one has the name of a town that was in John's teaching circuit and which still exists in what is now west Turkey and is somewhat north of what we now call Palestine and Israel.

Revelation -verses 1:10-17 (Introductory Verses)

1:10 I was in the Spirit on the Lord's day, and heard behind me a great voice, as of a trumpet,

1:11 Saying, I am Alpha and Omega, the first and the last: and, What thou seest, write in a book, and send it unto the seven churches which are in Asia; unto Ephesus, and unto Smyrna, and unto Pergamos, and unto Thyatira, and unto Sardis, and unto Philadelphia, and unto Laodicea.

1:12 And I turned to see the voice that spake with me. And being turned, I saw seven golden candlesticks;

1:13 And in the midst of the seven candlesticks one like unto the Son of man, clothed with a garment down to the foot, and girt about the paps with a golden girdle.

1:14 His head and his hairs were white like wool, as white as snow; and his eyes were as a flame of fire;

1:15 And his feet like unto fine brass, as if they burned in a furnace; and his voice as the sound of many waters.

1:16 And he had in his right hand seven stars: and out of his mouth went a sharp twoedged sword: and his countenance was as the sun shineth in his strength.

1:17 And when I saw him, I fell at his feet as dead. And he laid his right hand upon me, saying unto me, Fear not; I am the first and the last:

The central concept being presented here is that the towns and their names represented spiritual "archetypes" of what the prophecy was really about - which is the churches, or rather, major religions of the world.

The little towns themselves, while historical and geographic realities, have fallen into obscurity, but the Prophetic Message about the state of the Seven Churches, The Seven Golden Candlesticks, that is to say the Seven World Religions, in the "Last Days" has come to have GREAT significance.

The first of the seven churches was the Sabean - here called the Church of Ephesus.

2:1 Unto the angel of the church of Ephesus write; These things saith he that holdeth the seven stars in his right hand, who walketh in the midst of the seven golden candlesticks;

2:2 I know thy works, and thy labour, and thy patience, and how thou canst not bear them which are evil: and thou hast tried them which say they are apostles, and are not, and hast found them liars:

This is the most ancient of the churches. It is religion as found in the remmanents of Ancient Tribes of the Earth. Hence the commendation of its Patience.

This church is so ancient (4000-5000 BC) that we don't really know the name of its Revelator, but symbolicaly we contribute it to Adam. Baha'u'llah says there were a "thousand Adams", but much of what is written here is symbolism and we won't dwell upon it.

2:3 And hast borne, and hast patience, and for my name's sake hast laboured, and hast not fainted.

**Each of the Churches receives a COMMENDATION
and a CONDEMNATION.**

This was the commendation of this church.

2:4 Nevertheless I have somewhat against thee, because thou hast left thy first love.

And here is the condemnation.

2:5 Remember therefore from whence thou art fallen, and repent, and do the first works; or else I will come unto thee quickly, and will remove thy candlestick out of his place, except thou repent.

**Which may be why
we really know so little
about this church.**

2:6 But this thou hast, that thou hatest the deeds of the Nicolaitanes, which I also hate.

**The Nicolaitanes were a group
that had risen against religion.
It is to be noted that God hates the deeds
of the Nicolaitanes -
and NOT the people.**

2:7 He that hath an ear, let him hear what the Spirit saith unto the churches; To him that overcometh will I give to eat of the tree of life, which is in the midst of the paradise of God.

**Each of the churches
will receive such a call to enlightenment.**

**The Tree of Life
in the midst of the Paradise of God -
is called the Divine Lote Tree.**

It is said to be the point beyond which there is no passing.

Symbolically it is the Manifestation of God.

**Meaning that one can go no further in Paradise
or know more of God -**

than what is revealed by the Manifestation.

The blessing here

**is that those who are open and receptive -
to what the Holy Spirit says to ALL the churches
will recognize the next Manifestation of God.**

I realize that I am going a bit far

**in delving into such mystical meanings -
so I will restrain myself on such points from here out.**

**The second of the seven churches
was the Hindu -
here called the Church in Ephesus.
The Revelator of this church was Krishna (2000-3000 B.C.)**

2:8 And unto the angel of the church in Smyrna write; These things saith the first and the last, which was dead, and is alive;

**The First and the Last.
The Alpha and Omega.
He which was and ever shall be.**

**In the concept of Progressive Revelation -
all the Revelators are the one and the same.
Jesus said -
"Before Abraham - I am."
The Jews of course disputed with Him about that.**

Here is a similar quote from Baha'u'llah.

XLVII. O Jews! If ye be intent on crucifying once again Jesus, the Spirit of God, put Me to death, for He hath once more, in My person, been made manifest unto you. Deal with Me as ye wish, for I have vowed to lay down My life in the path of God. I will fear no one, though the powers of earth and heaven be leagued against Me. Followers of the Gospel! If ye cherish the desire to slay Muhammad, the Apostle of God, seize Me and put an end to My life, for I am He, and My Self is His Self. Do unto Me as ye like, for the deepest longing of Mine heart is to attain the presence of My Best-Beloved in His Kingdom of Glory. Such is the Divine decree, if ye know it. Followers of Muhammad! If it be your wish to riddle with your shafts the breast of Him Who hath caused His Book the Bayan to be sent down unto you, lay hands on Me and persecute Me, for I am His Well-Beloved, the revelation of His own Self, though My name be not His name. I have come in the shadows of the clouds of glory, and am invested by God with invincible sovereignty. He, verily, is the Truth, the Knower of things unseen. I, verily, anticipate from you the treatment ye have accorded unto Him that came before Me. To this all things, verily, witness, if ye be of those who hearken. O people of the Bayan! If ye have resolved to shed the blood of Him Whose coming the Bab hath proclaimed, Whose advent Muhammad hath prophesied, and Whose Revelation Jesus Christ Himself hath announced, behold Me standing, ready and defenseless, before you. Deal with Me after your own desires.

(Baha'u'llah, Gleanings from the Writings of Baha'u'llah, p. 101)

**This one quote from the Baha'i Writings
pretty much sums up what this is all about -
that each of the Revelators of the Seven Churches
are all the One and the Same.**

**In reality not only they -
but the Manifestations
wherever they appear
throughout the Universe and All time.
That is the reason that there is none other Name (identity - not vocal sound)
under heaven by which men are saved.
It is by the Manifestation - God made Manifest -
who appears through all eternity and all infinity.
Again - I may almost be going too far.**

*2:9 I know thy works, and tribulation, and poverty, (but thou art rich) and I know the blasphemy of
them which say they are Jews, and are not, but are the synagogue of Satan.*

**One must remember that while this is about the Hindus,
at the time it was written
it was to the Christians
and thus recognizes their dealing with the Jews at the time.**

*2:10 Fear none of those things which thou shalt suffer: behold, the devil shall cast some of you into
prison, that ye may be tried; and ye shall have tribulation ten days: be thou faithful unto death, and I
will give thee a crown of life.*

**I could make commentary on each verse -
but you will probably think already
what I will be writing to be overly long -
so I will restrain myself.**

*2:11 He that hath an ear, let him hear what the Spirit saith unto the churches; He that overcometh
shall not be hurt of the second death.*

The message to each of the Churches ends with a similar promise. I will not mention this again.

**The third of the seven churches
was the Jewish -**

**here called the Church in Pergamos.
Coincidentally, each of these Greek names
has a spiritually significant meaning -
but I will not go into such detail.
The Revelator of this church was Moses (1250 B.C.)**

2:12 And to the angel of the church in Pergamos write; These things saith he which hath the sharp sword with two edges;

2:13 I know thy works, and where thou dwellest, even where Satan's seat is: and thou holdest fast my name, and hast not denied my faith, even in those days wherein Antipas was my faithful martyr, who was slain among you, where Satan dwelleth.

2:14 But I have a few things against thee, because thou hast there them that hold the doctrine of Balaam, who taught Balac to cast a stumblingblock before the children of Israel, to eat things sacrificed unto idols, and to commit fornication.

**You can see here
that this is addressed
directly to the Jews -
"the children of Israel".**

2:15 So hast thou also them that hold the doctrine of the Nicolaitanes, which thing I hate.

**Amazingly, today even in Israel -
the far larger majority of the Jews
say in public opinion polls -
that they are "not religious".**

2:16 Repent; or else I will come unto thee quickly, and will fight against them with the sword of my mouth.

2:17 He that hath an ear, let him hear what the Spirit saith unto the churches; To him that overcometh will I give to eat of the hidden manna, and will give him a white stone, and in the stone a new name written, which no man knoweth saving he that receiveth it.

**The "new name" is of course the name of the New Manifestation -
which of course no one recognizeth
except those who do "receive it".
All these things have spiritual significance -
such as the "hidden manna".
Just too much to go into.**

**The fourth of the seven churches
was the Parsee/Zoroastrian -
here called the Church in Thyatira.**

The Revelator of this church was Zoroaster (900-1000 B.C.)

**This church is not very well known about
among most Christians**

**(who in fact know very little about any of the others
except to usually express their prejudices about them.)**

**This religion does appear in the Bible -
when the Magji came following the star
and looking for the Christ child.**

**Those wise men from the East were Zoroastrians
who as told in the Bible had in their religion the prophecies
about the coming Manifestation (Jesus).**

2:18 And unto the angel of the church in Thyatira write; These things saith the Son of God, who hath his eyes like unto a flame of fire, and his feet are like fine brass;

**The emphasis is on fire here
because they are sometimes considered to be
"fire worshippers".**

2:19 I know thy works, and charity, and service, and faith, and thy patience, and thy works; and the last to be more than the first.

The commendation.

2:20 Notwithstanding I have a few things against thee, because thou sufferest that woman Jezebel, which calleth herself a prophetess, to teach and to seduce my servants to commit fornication, and to eat things sacrificed unto idols.

The condemnation.

2:21 And I gave her space to repent of her fornication; and she repented not.

2:22 Behold, I will cast her into a bed, and them that commit adultery with her into great tribulation, except they repent of their deeds.

2:23 And I will kill her children with death; and all the churches shall know that I am he which

searcheth the reins and hearts: and I will give unto every one of you according to your works.

**One has to get into historical matters
to explain many of the verses.**

2:24 But unto you I say, and unto the rest in Thyatira, as many as have not this doctrine, and which have not known the depths of Satan, as they speak; I will put upon you none other burden.

2:25 But that which ye have already hold fast till I come.

2:26 And he that overcometh, and keepeth my works unto the end, to him will I give power over the nations:

2:27 And he shall rule them with a rod of iron; as the vessels of a potter shall they be broken to shivers: even as I received of my Father.

2:28 And I will give him the morning star.

**The study of stars,
and astrology
had great significance
among the Zoroastrians.**

**The allusion to the Morning Star -
and the reference to the search of the Wise Men in the Gospel -
has a connection.**

2:29 He that hath an ear, let him hear what the Spirit saith unto the churches.

**The fifth of the seven churches
was/is the Buddhist -
here called the Church in Sardis.
The Revelator of this church was Gotama Buddha (500 B.C.)**

3:1 And unto the angel of the church in Sardis write; These things saith he that hath the seven Spirits of God, and the seven stars; I know thy works, that thou hast a name that thou livest, and art dead.

**Saying again -
that He has ALL the Seven Spirits of God -
or all the Seven Churches.
The verses altogether**

are a theme about Progressive Revelation.

One of the amazing things about these Scriptures is that they describe the order in which these religions appeared on the earth - as well as the nature of each one of them.

This is of course astounding to those who have an inclination to see - but to those who are fixed in their dogmas they will simply close their eyes and ears and see nothing of this in it.

3:2 Be watchful, and strengthen the things which remain, that are ready to die: for I have not found thy works perfect before God.

3:3 Remember therefore how thou hast received and heard, and hold fast, and repent. If therefore thou shalt not watch, I will come on thee as a thief, and thou shalt not know what hour I will come upon thee.

3:4 Thou hast a few names even in Sardis which have not defiled their garments; and they shall walk with me in white: for they are worthy.

3:5 He that overcometh, the same shall be clothed in white raiment; and I will not blot out his name out of the book of life, but I will confess his name before my Father, and before his angels.

3:6 He that hath an ear, let him hear what the Spirit saith unto the churches.

The sixth of the seven churches was/is the Christian - here called the Church in Philadelphia.

The Revelator of this church was of course Jesus Christ (26 A.D.) I will make mention of the significance of the Greek name for this one name since it is known to Christians.

It means brotherly - and it is common for Christian to refer to their Christian brothers and sisters. Also the city of Philadelphia in the US has the title the City of Brotherly Love.

3:7 And to the angel of the church in Philadelphia write; These things saith he that is holy, he that is true, he that hath the key of David, he that openeth, and no man shutteth; and shutteth, and no man openeth;

Christians will of course see many references to Christ in this verse.

3:8 I know thy works: behold, I have set before thee an open door, and no man can shut it: for thou hast a little strength, and hast kept my word, and hast not denied my name.

3:9 Behold, I will make them of the synagogue of Satan, which say they are Jews, and are not, but do lie; behold, I will make them to come and worship before thy feet, and to know that I have loved thee.

3:10 Because thou hast kept the word of my patience, I also will keep thee from the hour of temptation, which shall come upon all the world, to try them that dwell upon the earth.

3:11 Behold, I come quickly: hold that fast which thou hast, that no man take thy crown.

3:12 Him that overcometh will I make a pillar in the temple of my God, and he shall go no more out: and I will write upon him the name of my God, and the name of the city of my God, which is new Jerusalem, which cometh down out of heaven from my God: and I will write upon him my new name.

**The new name, as before,
is of course the name of the new religion.**

**There are many promises and symbolisms here -
but our purpose has been only to show the general theme -
that these Scriptures are about Seven Major Religions of the World -
which have all come from God.**

3:13 He that hath an ear, let him hear what the Spirit saith unto the churches.

**To say more -
would be to start preaching. :)**

**The seventh of the seven churches
was/is the Moslem/Islam -
here called the Church of the Ladicieans.
The Revelator of this church was Muhammad (622 A.D.)**

It is amazing to the Christians

**(and of course rejected by them)
that the Bible holds prophecies about Muhammad.
The Moslems see MANY, MANY prophecies in the Bible
about Muhammad.
But this is nothing new.
The Christians see many, many prophecies
in the Old Testament -
about Jesus -
which the Jews of course do not see.**

**And of course -
there are many prophecies
in ALL the Religions and Books of God -
including the Koran -
about the End Times
(The Beginning of the Age of Fulfillment)
and the coming of the Messiah to the whole of the world
which the followers of those religions do not see
except as the Return of their own Prophet.**

3:14 And unto the angel of the church of the Laodiceans write; These things saith the Amen, the faithful and true witness, the beginning of the creation of God;

3:15 I know thy works, that thou art neither cold nor hot: I would thou wert cold or hot.

3:16 So then because thou art lukewarm, and neither cold nor hot, I will spue thee out of my mouth.

3:17 Because thou sayest, I am rich, and increased with goods, and have need of nothing; and knowest not that thou art wretched, and miserable, and poor, and blind, and naked:

3:18 I counsel thee to buy of me gold tried in the fire, that thou mayest be rich; and white raiment, that thou mayest be clothed, and that the shame of thy nakedness do not appear; and anoint thine eyes with eyesalve, that thou mayest see.

3:19 As many as I love, I rebuke and chasten: be zealous therefore, and repent.

3:20 Behold, I stand at the door, and knock: if any man hear my voice, and open the door, I will come in to him, and will sup with him, and he with me.

3:21 To him that overcometh will I grant to sit with me in my throne, even as I also overcame, and am set down with my Father in his throne.

3:22 He that hath an ear, let him hear what the Spirit saith unto the churches.

**I have not gone into the meaning
of many of the verses.
But enough -
indeed probably too much.**

**The theme is the Progressive Revelation of God
and it all points towards
the Manifestation of this Day and Age.**

**They that have eye to see
and an ear to hear -
will be joyed to see the bounty
that God has revealed in the Books of Old -
and will be eager to receive
the Message unto the New Age.**

**But many will not see or hear the Message.
Indeed many people look at the Bible
and see only the carbon black of ink
pressed upon the celulose of paper -
and say that they see NOTHING of the Spirit
in it.**

**How joyful to write to those
who are attuned to the Spirit,
and I delight in their writing to me at:**

**Bruce
DawnSayer@webpal.org**

Progressive Revelation - Nine Divinely Revealed Religions

Number	Date	Religion	Prophet	Book	Rev. Verses Church Name

1	5000 B.C.	Sabean	"Adams"	Oral	Rev. 2:1-7 Sabean
2	3000 B.C.	Hindu	Krishna	Vedas	Rev. 2:8-11 Ephesus
3	1250 B.C.	Jewish	Moses	Torah	Rev. 2:12-17 Pergamos
4	1000 B.C.	Parsee/Zoroastrian	Zoroaster	Ivesta	Rev. 2:18-29 Thyatira
5	500 B.C.	Buddhist	Gotama	Tripitaka	Rev. 3:1-6 Sardis
6	26 A.D.	Christian	Jesus	Gospel	Rev. 3:7-13 Philadelphia
7	622 A.D.	Islam/Moslem	Muhammad	Koran	Rev. 3:14-22 Ladicieans
8	1844 A.D.	Babi	Bab	Bayan	Other Chapters
9	1863 A.D.	Baha'i	Baha'u'llah	Aqdas	Other Chapters

Each Prophet/Manifestation/Revelator

Starts a new Calendar

Brings a new Book

Teaches His followers to love God

Teaches His followers to love his fellow man

Reinforces the former spiritual teachings

Brings new spiritual teachings

Brings social teachings suitable for that Day and Age

Tells His followers to watch for the NEXT Prophet - that is - His Return

MENU: [HOME](#) » [Reconstruction](#) » [Recovery](#) » [Renewal](#)

The Ocean of Scriptures

If you have some suggestions or comments you would like to pass on to me about these pages you may do so at: DawnSayer@webpal.org

Prolog:

**This essay assumes
that you have downloaded -**

[Ocean.](#)

**If not -
then you need to pause here and do so -
because that is what this essay discusses.**

**Ocean is an electronic library
that is completely FREE
and while over the last 15 years
I have used over a half dozen electronic libraries
costing many hundreds of dollars
this one GREATLY surpasses all the others in performance.**

**Every few weeks or every couple of months -
WHILE ON LINE
you want to go to the "Resources" pull down window
on the bar on the top of your Ocean screen
and make sure that you have
(1) the latest program version
and
(2) the updates to the bookshelf.**

**I just (May 2002) did this -
and note that I now have 963 books on the bookshelf.
It is always growing,
but it takes up surprisingly little space**

**on your hard disk
for something so Momentous and POWERFUL.**

**You will undoubtedly have much fun with Ocean in
searching the Bible and other Christian books
as well as the Islam works.
However, I have written this essay
for the purpose
of introducing one to The Baha'i Writings.**

Using the System:

**While one may search the entire library
for a reference
it takes a bit longer
and often gives one way too much to look through.**

**As you start using the system
as you may well already have -
it gives you a tutorial on how to use it.
VERY simple.
Just put search words in - in any order
or put in quotes
exact combinations and phrases that you want.**

**Usually it takes very few words to find what you want -
but sometimes you need to add additional words
to reduce the quantity of quotes it brings up.
This is particularly true as one becomes familiar
with Baha'i quotes -
and wishes to locate the source of a particular quote.**

Authoritative versus Commentary:

**Note particularly -
that the Baha'i Library
is divided into TWO categories -
AUTHORITATIVE Baha'i and
Baha'i Studies (or what I have called "*commentary*").**

**You may find it interesting to delve right into
the *AUTHORITATIVE* Baha'i**

**and I will try to explain what is there -
but, if you are new to Baha'i,
I am going to recommend that you first
gain some information from some sources
located in the Baha'i Studies section of the library.**

**Let me, however, tell you -
as marvelous as all this is,
it is by no means the only source on Baha'i
and in due time I hope you will find other sources -
some of which you may find equally astonishing.**

**There are published almost daily
from a variety of Baha'i National Publishing Trusts
and numerous independent Baha'i Publishers
new books about Baha'i.
Years ago - I used to read every new book that came out -
but now I can't even keep up with the titles.**

**There are also many web pages -
web discussion groups,
sites by various Baha'i Communities
and the Official momentous Baha'i sites.
But, not to worry about any of that for the moment.**

The Authoritative Works:

**First, you need to get a structure
to comprehend what it is that you have downloaded.
To do that we need to briefly outline
the history of the Baha'i Faith.
In doing this you will see that the Books
under AUTHORITATIVE Baha'i
follow that outline.**

**You will quickly become acquainted -
with just who the AUTHORITATIVE Sources are -
but at the moment we will more or less just list them,
and hopefully later you will on your own
fill in the details.**

The Authoritative CENTRAL FIGURES:

The Baha'i Faith began in 1844
with the Declaration of

The Bab

the **First Central Figure of the Baha'i Faith.**

The most authentic and extensive source for that history
is in "**The Dawn Breakers**"
a massive tome
which I do not recommend that you start with.

(A much simplified "readers digest version"
is in Baha'i Studies under the title -
"**Release the Sun**".

Perhaps an early book - but not necessarily
the first book to read.

After the martyrdom of the Bab
the **second CENTRAL Figure of the Baha'i Faith** was

Baha'u'llah.

Baha'u'llah is said to have written over 100 Books.
The Persian word for book is "Kitabi" so we get books like
Kitabi-Aqdas (His "Book of Laws") -
Kitabi-Igan (The "Book of Certitude") -
etc.

Many of His Writings are also called "Tablets" -
for example -

"The Tablet of Ahmad" (actually a prayer in this case).

His last and summary work is called -

"The Epistle to the Son of the Wolf",

and His most mystical Writing

is the **"Seven Valleys"**

and

"The Four Valleys".

I had been a Baha'i about seven years before I read these latter -
and at that time I said -

"I have understood/liked/appreciated everything that I have read
until now -

but I get absolutely nothing out of these."

Years later I would come to say -

"If there was nothing else but these in the Baha'i Faith - it would be enough." ;)

You might enjoy reading the first and second of the Seven Valleys - which are the Valley of Search and the Valley of Love. But not necessarily the first thing that you do.

There are a number of compendiums of Baha'i Writings such as the book called - "Gleanings" - and Baha'u'llah often quotes from Himself - and all the subsequent writers quote from Him - so you will often find the same quote in many, many places.

The Third (and last) Central Figure of the Baha'i Faith is

Abdu'l-baha

the son of Baha'u'llah who was called by Baha'u'llah "The Mystery of God" and named by Baha'u'llah as the Center of His Covenant - The Perfect Exemplar of His Faith, the ONLY Interpreter of His Word. Abdul means "servant" - so Abdu'l-baha means the Servant of Baha'u'llah.

Abdu'l-baha, like the Bab and Baha'u'llah, wrote many Tablets. Early on - one of the most interesting things to do - is to read down through the Table of Contents of "Some Answered Questions" where He deals with many, many different issues.

Abdu'l-baha appointed His grandson-

Shoggi Effendi

to succeed Him - with the title of Guardian of the Faith. Effendi means "sir" - so in effect his title is "Sir Shoggi".

**Shoggi Effendi was educated at Oxford -
and writes, in a very scholarly Oxfordian style,
momentous works explaining about the future of the Faith.**

Additonal AUTHORITATIVE Sources:

**After Shoggi Effendi (an AUTHORATIVE source although not a Central Figure)
there was the Trusteeship of the Custodians -
until the**

Universal House of Justice

**(also Authoritative sources)
was established in 1963.
Writings of some of the Hands
will be found in Baha'i Studies
but these, while highly respected,
are not AUTHORITATIVE Sources.**

**The UHJ (Universal House of Justice), however,
as just stated, is an authoritative source -
and so its publications are under that category of search.
For example - they write an annual "**Ridvan Message**".
Ridvan is a particular time on the Baha'i Calendar -
but not to worry about such details for the moment.**

**I will mention one particular book
under AUTHORITATIVE compilations
(there are many) -
but if you go to the Authoritative list -
look under compilations -
and then look under "**Lights of Guidance**"
and then read the Table of Contents of that Book
you will again find a long list of Information
on many Baha'i subjects.
This is just a note for the future -
because of course -
you cannot do everything at once.**

The Commentary Works:

**Now turning to the Baha'i Studies -
Numbers of the Hands are listed there**

(along with other names)
- some of whom write VERY scholarly works -
but there are three Hands -
whose attention that I will direct you to first.

First there is Ruhiyyih Khanum -
or known as Amatu'l-baha
who was the wife of Shoggi Effendi.
She wrote a wonderful book
about the Guardian called
"The Priceless Pearl" -
and later re-wrote it
and called it **"The Guardian"**.
But this book would be a ways down your reading list.

Hand of the Cause William (Bill) Sears -
was a great favorite among Baha'i's
for his humour and writing style.
His **"Thief in the Night"** -
is an entertaining explanation
of what Abdu'l-baha called "The Most Clear Proof" -
but there are many much more scholarly works
on this subject
that are not on the electronic bookshelf.
Bill Sears also wrote **"Release the Sun"** -
the history of the Babi era that I mentioned before.

And finally -
there is J.E. Esslemont -
who wrote
"The New Era"
and while this is an "old" book about the Faith
it is where I would suggest that you begin -
because it gives such a COMPLETE overview.
It is almost like a college text book
(and indeed has been used as such)
but it is not difficult to read.

Of course, you may just wish to search out
answers to questions
using Ocean.

If you wish to query me about what you are reading -
all you have to do is give me the search words
that you used -
and I can duplicate here
what it is that you are looking at.

It is very easy with Ocean
to mail a quote.
All you have to do
is highlight the text
copy it -
and paste it into your email.

So, now you should have a source
for any question that you may ask.
Please ask for any clarification,
or help that I can give you -
and let me know what you are finding in the Ocean.

It is a joy to me
to respond to you on anything you ask.

Bruce
DawnSayer@webpal.org

The Writings Currently in Ocean

Authoritative Baha'i			
Date	Writer	Station	Sample Books
1844-1850 A.D.	The Bab	Prophet/Manifestation Central Figure	(The Bayan) in Selections from Writings of the Bab
1852-1892 A.D.	Baha'u'llah	Prophet/Manifestation Central Figure	Aqdas Gleanings Igan Epistle to to the Son of the Wolf

1892-1921	Abdu'l-baha	Centre of Covenant Central Figure	Some Answered Questions
1921-1957	Shoggi Effendi	Guardian	God Passes By
1957-1963		Custodians	
1963-forward	Universal House of Justice	UHJ	Messages

Baha'i Studies (Commentary)

Writer	Sample Title	About this work
William Sears	Thief in the Night	An entertaining story that covers "The Most Great Proof" of why Baha'u'llah is the Return of Christ
Dr. J.E. Esslemont	Baha'u'llah and the New Era	A thorough explanation about the Baha'i Faith, historically, it beliefs and customs and so forth.
William Sears	Release the Sun	An entertaining presentation of the early beginnings of the Baha'i Faith
Ruhiyyih Khanum	The Priceless Pearl	The story of her life with the Guardian by the wife of the Guardian.
George Townsend	The Heart of the Gospel	A book about the Baha'i Faith by a Christian Minister
George Townsend	Christ and Baha'u'llah	A book about Baha'u'llah by a Christian Minister
Howard Colby Ives	Portals to Freedom	A book about his Baha'i experience
Lady Blomfield	The Chosen Highway	The experience of an early believer.

The above are just some of the books in the Ocean bookshelf that I would recommend to read first. Some of the other books in the bookshelf are perhaps more scholarly, if not more inspirational. There are also many, many other books that one might find to their particular interest through a Baha'i Publishing House, or at a Baha'i bookstore. For example, I have on my bookshelf a half dozen books dealing with Baha'i economics because that is a particular subject that interests me. Someone else may have many books dealing with a subject like life after death or explanations of scripture.

MENU: [HOME](#) » [Reconstruction](#) » [Recovery](#) » [Renewal](#) » [Survival](#)

Prayer

Table of Contents:

[Prolog: Some Thoughts on Prayer and Meditation](#)

The author's personal experience about prayer.

[Ahmad: A Special Tablet.](#)

Shoggi Effendi said: "...the Tablet of Ahmad, have been invested by Baha'u'llah with a special potency and significance, and should therefore be accepted as such and be recited by the believers with unquestioning faith and confidence, that through them they may enter into a much closer communion with God, and identify themselves more fully with His laws and precepts." (Compilations, Baha'i Prayers, p. 208)

[Perspicuous Verses: of Baha'u'llah](#)

Baha'u'llah says in the verses:

"Blessed art thou,
who hast fixed thy gaze upon Me,
for this Tablet which hath been sent down for thee -
a Tablet which causeth the souls of men to soar.

Commit it to memory,
and recite it.
By My Life!
It is a door to the mercy of thy Lord.
Well is it with him that reciteth it
at even tide and at dawn.

[Chant: of Abdu'l-baha](#)

*I had heard the recording a number of decades ago-
and then again at the Baha'i World Congress in New York City in 1992
where I became acquainted with Harjot Sidu and Vido Ighani*

*who provided me with the translation that I first published here,
my not being aware of any other.*

*I have now received from Bob Haugen a translation that appeared in The Baha'i World, 1936-1938,
Volume 7, page 421. The above now largely follows that translation.*

Click here to return to the
top of this
[Table of Contents](#)

Some Thoughts on Prayer and Meditation

These are simply some random thoughts on the subject of prayer and meditation. There are numbers of Baha'i books on the subject and it is not my intention to recap anything printed there.

There are few Baha'i books on the "method" of meditation and although I have taught the subject for several decades I am not prepared to formally make a presentation at this time. There are numerous methods, and Baha'is are free to choose such as is suitable to them, but they are REQUIRED by Baha'u'llah to meditate.

For many years I have had in abeyance a project to correlate the ancient Aphorisms of Pantanjali (one of the best known guides in Hindu literature on the subject of meditation) to statements on the subject in the Baha'i Teachings. In this regards there is a surprising wealth of material, in the Baha'i Writings, as how to sit, focus one's mind, and other such disciplines. To this end, I have made notes of comparison with several versions of Pantanjali translations, including a literal one, (since I do not read Sanskrit) but with Shoghi Effendi's proscription of teaching meditation in Summer Schools, I have not given a high priority to the project.

There is considerable confusion in the minds of many people about the distinctions between prayer and meditation. Recitation, Intonation and Chanting are important and will undoubtedly play a much more prominent role in Baha'i culture in the future. All of us pray, or should pray, but in the Western world - few of us chant. Chanting is to prayer like singing is to talking. Even someone, such as myself, whom everyone announces to be tone (or at least tune) deaf, can but wonder at the capacity of a trained opera singer to overwhelm the combined efforts of an entire church congregation. I have heard beautiful chanting of Baha'i prayers in English, but it is a rarity. A mere cultural quirk because there is nothing specific about the Persian or Arabic languages that makes chanting only possible in those languages.

Also in the Western world, few people meditate. It is more difficult to describe the relationship of meditation to prayer. It is a capability of the human spirit on up the ladder from concentration and contemplation. It passes beyond the murmuring of sound and symbol although we can be led into the ecstasy of it by revealed meditations. As an analogy, let me say that while we all use math and numbers to some extent we can but vaguely guess at the capacities of theoretical mathematicians. There are many other examples of the distinctions between the accomplishments of the trained versus the untrained in areas such as acrobatics, ice skating, dance, sports and other fields of endeavor. What then would lead one to think that all people can pray or meditate equally well without training when few have even stopped to ponder the distinctions between concentration, contemplation and meditation.

Undeniably, quality of prayer is affected by, among other things, purity of heart. But this is a chicken and egg matter. One leads to the other. No matter how inadequate one feels - they must begin to pray. Indeed, prayer may well (and most surely will) reveal to them even much greater inadequacies than they ever imagined. Still it remains the only path to salvation, no matter the type of one's soul, and whatever paths of Truth they trod (matters which I deal with in the POP series).

Many in the Western World are in non-praying societies and the practice and habit of prayer will be very strange to them. Some new Baha'i's find the requirement of even a daily obligatory prayer requiring a discipline that they are not used to. The further discovery that Baha'i's are supposed to also pray both in the morning and evening and to repeat 95 times the Greatest Name (a step towards meditation) is best left to their progressive spiritual development.

Some like myself, (and I share this with you, only so that you may know the variety of Baha'i life) after decades fall into a pattern of almost perpetual prayer. Indeed, I would say that the goal is to have one's every thought focused on Baha'u'llah. To have one's every motivation to be the motivation of Baha'u'llah. Prayer is the path.

Oftentimes in life, tests and difficulties are the motivation to pray. A prayer often learned early on by new Baha'i's and Baha'i children is the Bab's Remover of Difficulties. That too, some come to a convention or practice of repeating nine, nineteen or ninety-five times, in times of exceptional challenge. A personal choice of mine was to repeat the Tablet of Ahmad nineteen times daily. Indeed, for many years, in addition to the Fast prayers, I would say it nineteen times each day for the nineteen days of the Fast. Each one must find their own discipline and it is well to remember that Baha'u'llah CAUTIONS about being given to long prayers.

It is amazing, in a lifetime, how the prayers will add up. How easy and joyful it becomes. That indeed, the most joyful hours of the day become those spent in prayer and meditation. As one progresses along the path of prayer they come to learn that Baha'u'llah has recommended a number for special situations and occasions. I won't go into those now, but one will eventually come to the Perspicuous Verses, which Baha'u'llah recommends (does not require) that one say every "eventide" and "morn". Add to these Abdu'l-baha's Daily Regional Prayers for teaching, and suggested daily prayers for one's loved ones, and one can have a very full prayer schedule. However, to say daily the short noonday prayer sometime

between noon and sunset, along with the 95 repetitions of The Greatest Name (for this some use a rosary) and to say with absolute sincerity The Greatest Name in the morn and evening, fulfills the requirement of God. God does not need our prayers. We pray to benefit ourselves, not God.

A simple repetition of the Greatest Name ninety-five times a day, will add up in a half century of devotion to the Faith, of one having said it over fifteen million times. In actuality, one who is that devoted will find themselves saying it many more times a day than that, and the lifetime multiple will be much greater. A simple saying of the Tablet of Ahmad, *at least* once a day for the last 30 years of their life will result in their having said it over ten thousand times. Those who recite it that regularly ("withhold not thyself therefrom") will again find that they have actually recited it much more often, and consequently many more times than that.

Yes, over the years, the prayers add up, and as Baha'u'llah says - think not that they do not have effect. We are more blessed by our own, and other's prayers, than we can imagine. Today, we live in a non-praying world, and this presentation will seem very strange to many people, but in the future when Baha'i's gather daily in their communities for prayers and the meaning of meditation becomes better understood, then it will become more meaningful and, indeed, commonplace.

Click here to return to the
top of this
[Table of Contents](#)

MENU: [HOME](#) » [Reconstruction](#) » [Recovery](#) » [Renewal](#) » [Survival](#)

TABLET OF AHMAD

He is the King, the All-Knowing, the Wise!

Lo, the Nightingale of Paradise singeth upon the twigs of the Tree of Eternity, with holy and sweet melodies, proclaiming to the sincere ones the glad tidings of the nearness of God, calling the believers in the Divine Unity to the court of the Presence of the Generous One, informing the severed ones of the message which hath been revealed by God, the King, the Glorious, the Peerless, guiding the lovers to the seat of sanctity and to this resplendent Beauty.

Verily this is that Most Great Beauty, foretold in the Books of the Messengers, through Whom truth shall be distinguished from error and the wisdom of every command shall be tested. Verily He is the Tree of Life that bringeth forth the fruits of God, the Exalted, the Powerful, the Great.

O Ahmad! Bear thou witness that verily He is God and there is no God but Him, the King, the Protector, the Incomparable, the Omnipotent. And that the One Whom He hath sent forth by the name of Ali was the true One from God, to Whose commands we are all conforming.

Say: O people be obedient to the ordinances of God, which have been enjoined in the Bayan by the Glorious, the Wise One. Verily He is the King of the Messengers and His Book is the Mother Book did ye but know.

Thus doth the Nightingale utter His call unto you from this prison. He hath but to deliver this clear message. Whosoever desireth, let him turn aside from this counsel and whosoever desireth let him choose the path to his Lord.

O people, if ye deny these verses, by what proof have ye believed in God? Produce it, O assemblage of false ones.

Nay, by the One in Whose hand is my soul, they are not, and never shall be able to do this, even should they combine to assist one another.

O Ahmad! Forget not My bounties while I am absent. Remember My days during thy days, and My distress and banishment in this remote prison. And be thou so steadfast in My love that thy heart shall not waver, even if the swords of the enemies rain blows upon thee and all the heavens and the earth arise against thee.

Be thou as a flame of fire to My enemies and a river of life eternal to My loved ones, and be not of those who doubt.

And if thou art overtaken by affliction in My path, or degradation for My sake, be not thou troubled thereby.

Rely upon God, thy God and the Lord of thy fathers. For the people are wandering in the paths of delusion, bereft of discernment to see God with their own eyes, or hear His Melody with their own ears. Thus have We found them, as thou also dost witness.

Thus have their superstitions become veils between them and their own hearts and kept them from the path of God, the Exalted, the Great.

Be thou assured in thyself that verily, he who turns away from this Beauty hath also turned away from the Messengers of the past and showeth pride towards God from all eternity to all eternity.

Learn well this Tablet, O Ahmad. Chant it during thy days and withhold not thyself therefrom. For verily, God hath ordained for the one who chants it, the reward of a hundred martyrs and a service in both worlds. These favors have We bestowed upon thee as a bounty on Our part and a mercy from Our presence, that thou mayest be of those who are grateful.

By God! Should one who is in affliction or grief read this Tablet with absolute sincerity, God will dispel his sadness, solve his difficulties and remove his afflictions. Verily, He is the Merciful, the Compassionate.

Praise be to God, the Lord of all the worlds.

- Baha'u'llah

MENU: [HOME](#) » [Reconstruction](#) » [Recovery](#) » [Renewal](#) » [Prayers Directory](#)

The Perspicuous Verses

Among others, these perspicuous verses have,
in answer to certain individuals,
been sent down from the Kingdom of Divine knowledge:

'O thou who hast set thy face towards the splendors of My Countenance!

Vague fancies have encompassed the dwellers of the earth
and debarred them from turning towards the Horizon of Certitude,
and its brightness, and its manifestations, and its lights.

Vain imaginings have withheld them from Him Who is the Self-Subsisting.
They speak as prompted by their own caprices, and understand not.

Among them are those who have said:

"Have the verses been sent down?"

Say:

"Yea, by Him Who is the Lord of the heavens!"

"Hath the Hour come?"

"Nay, more;

it hath passed,

by Him Who is the Revealer of clear tokens!

**Verily, the Inevitable is come,
and He the True One,
hath appeared with proof and testimony.**

**The Plain is disclosed,
and mankind is sore vexed and fearful.**

**Earthquakes have broken loose,
and the tribes have lamented, for fear of God,**

the Lord of Strength, the All-Compelling."

Say:

**"The stunning trumpet-blast hath been loudly raised,
and the Day is God's, the One, the Unconstrained."**

"Hath the Catastrophe come to pass?"

Say:

"Yea by the Lord of Lords!"

"Is the Resurrection come?"

"Nay, more;

**He Who is the Self-Subsisting hath appeared
with the Kingdom of His signs."**

"Seest thou men laid low?"

"Yea by my Lord, the Exalted the Most High!"

"Have the tree stumps been uprooted?"

"Yea, more;

**the mountains have been scattered in dust;
by Him the Lord of attributes!**

They say:

"Where is Paradise, and where is Hell?"

Say:

**"The one is reunion with Me;
the other thine own self,
O thou who dost associate a partner with God and doubttest."**

They say:

"We see not the Balance."

Say:

**"Surely, by my Lord, the God of Mercy!
None can see it except such as are endued with insight."**

"Have the stars fallen?"

Say:

**"Yea, when He Who is the Self-Subsisting
dwelt in the Land of Mystery.
Take heed, ye who are endued with discernment!"**

**All the signs appeared when We drew forth the Hand of Power
from the bosom of majesty and might.
Verily, the Crier hath cried out,
when the promised time came,
and they that have recognized the splendors of Sinai
have swooned away in the wilderness of hesitation,
before the awful majesty of the Lord,
the Lord of creation.**

The trumpet asketh:

"Hath the Bugle been sounded?"

Say:

**"Yea, by the King of Revelation!
when He mounted the throne of His Name,
the All-Merciful."**

**Darkness hath been chased away
by the dawning-light of the mercy of thy Lord,
the Source of all light.**

**The breeze of the All-Merciful hath wafted,
and the souls have been quickened
in the tombs of their bodies.**

**Thus hath the decree been fulfilled by God,
the Mighty, the Beneficent.**

They that have gone astray have said:

"When were the heavens cleft asunder?"

Say:

"While ye lay in the graves of waywardness and error."

**Among the heedless is he who rubbeth his eyes,
and looketh to right and to the left.**

Say:

**"Blinded art thou.
No refuge hast thou to flee to."**

And among them is he who saith:

"Have men been gathered together?"

Say:

**"Yea, by My Lord!
whilst thou didst lie in the cradle of idle fancies."**

And among them is he who saith:

*"Hath the Book been sent down
through the power of the true Faith?"*

Say:

**"The true Faith itself is astounded.
Fear ye, O ye men of understanding heart!"**

And among them is he who saith:

"Have I been assembled with others, blind?"

Say:

"Yea, by Him that rideth upon the clouds!"

**Paradise is decked with mystic roses,
and hell hath been made to blaze with the fire of the impious.**

Say:

**"The light hath shone forth from the horizon of Revelation,
and the whole earth hath been illumined
at the coming of Him Who is the Lord of the Day of the Covenant!"**

**The doubters have perished,
whilst he that turned,
guided by the light of assurance,
unto the Dayspring of Certitude hath prospered.**

**Blessed art thou,
who hast fixed thy gaze upon Me,
for this Tablet which hath been sent down for thee -
a Tablet which causeth the souls of men to soar.**

**Commit it to memory,
and recite it.
By My Life!
It is a door to the mercy of thy Lord.
Well is it with him that reciteth it
at even tide and at dawn.**

**We, verily, hear thy praise of this Cause,
through which the mountain of knowledge was crushed,
and men's feet have slipped.**

**My glory be upon thee
and upon whosoever hath turned unto the Almighty,
the All-Bounteous.**

**The Tablet is ended, but the theme is unexhausted.
Be patient, for thy Lord is Patient.**

- Baha'u'llah

MENU: [HOME](#) » [Reconstruction](#) » [Recovery](#) » [Renewal](#) » [Prayers Directory](#)

Translation of Voice Recording of Chant by 'Abdu'l-Bahá

Praise be to God that we are present in this radiant meeting and turning toward the Kingdom of Abha. That which we behold is due to the Grace and Bounty of the Blessed Perfection.

We are atoms and He is the Sun of Reality.

We are drops and He is The Greatest Ocean.

Though we are poor, yet the Treasury of the Kingdom is full of overflowings.

Though we are weak yet the confirmation of the Supreme Concourse is abundant.

Though we are helpless yet our refuge and shelter is (in) His Holiness Baha'u'llah.

Praise be to God!

His traces are evident!

Praise be to God!

His lights are radiating!

Praise be to God!

His ocean is full of waves!

Praise be to God!

His radiance is intense!

Praise be to God!

His bestowals are abundant!

Praise be to God!

His favours are manifest!

Glad-tidings! glad-tidings!

The Morn of Guidance hath dawned!

Glad-tidings! glad-tidings!

The Sun of Reality hath shone forth!

Glad-tidings! glad-tidings!

The Breeze of Favour hath wafted!

Glad-tidings! glad-tidings!

The rain drops of the Cloud of Bounty have showered!

Glad-tidings! glad-tidings!

The hearts are all in the utmost purity!

Glad-tidings! glad-tidings!

**The Sun of the Supreme Horizon hath radiated to all the world with boundless
effulgence!**

Glad-tidings! glad-tidings!

It is the Splendor of His Highness Baha'u'llah!

Glad-tidings! glad-tidings!

Zion is dancing!

Glad-tidings! glad-tidings!

The Kingdom of God is full of exhilaration and commotion.

Stars

DawnSayer@webpal.org

Table of Contents:

[Prolog: Stars and Prophecy](#)

Astrology is based mostly upon superstition. But is there any role of the stars in regards to prophecy? Some thoughts on that point.

[Millenium Star: A Heavenly Message for Today.](#)

Everyone has heard of the Star of Bethlehem but there is another ancient prophecy reflected in the flag of almost every Moslem country. It represents a sign and symbol fulfilled in this day by science. People everywhere on the earth can look up and see the sign of the New Age.

[Conjunction: Coincidence or destiny!](#)

Astounding phenomenon have appeared in the night skies. Are they coincidence or destiny? Either should give one pause to ponder... And the possibility of still further may await regarding the Southern Cross.

[UFO: Are they real?](#)

The author shares some personal experiences.

[Click here to return to the top of this Table of Contents](#)

Star Thoughts

We all look up at the heavens in astonishment

and wonder what our relationship is to them.

Some feel the stars affect our daily lives -
and indeed the phases of the moon
appear to effect not only the tides
but other affairs of human lives -
such as the number of births
in large city hospitals.

Certainly other heavenly effects
such as sun cycles
and their effect upon weather
and radio transmissions are apparant.

In the aggregate
there does seem to be a correlation
between personalities and sun signs
and the Chinese cycles of birth years
appears to have some substance.

But the speculations of astrologers
are simply superstition
that have no more significance
(and no less)
than that of reading tea leaves,
or entrails,
or consulting a Ouiji Board.

I say no less,
because astrological prediction
is not something that can be left
to the mathematical calculation of computers.
It depends upon "psychic" interpretation
and like all psychic phenomena
has an explanation within human reality
(more often human unreality)
that it is detrimental to deal with.

Click here to return to the
top of this
[Table of Contents](#)

MENU: [HOME](#) » [Reconstruction](#) » [Recovery](#) » [Renewal](#) » [Survival](#)

Prophetic Stars of Heaven

"And I will shew wonders in heaven above"

(King James Bible, Acts 2:19)

If you have some suggestions or comments you would like to pass on to me about these pages you may do so at: DawnSayer@webpal.org

The Sesquicentenary (150th Year Anniversary) of the Revelation of Baha'u'llah

Prolog:

In 1852

(150 years ago this year - 2002)

there sat in Siyah-Chal the Black Dungeon of Tihran

Baha'u'llah

with His feet in stocks

and about his neck an enormous chain

of unbearable weight.

He was imprisoned there from August 1852 to December 1852

before being exiled to the Most Great Prison in Acca.

The Story:

The Black Dungeon was really little more

than an unlit sewer

in which were chained together thieves, robbers and highwaymen,

awaiting their execution.

It was without bathing or toilet facilities

creating a horrible stench

that repulsed those sent to remove anyone from there.

*Remember My days during thy days,
and My distress and banishment in this remote prison.
(Baha'u'llah, Compilations, Baha'i Prayers, p. 210)*

**The Bab too
had been a prisoner.**

*Praise be unto Him
Who at this very moment
perceiveth in this remote prison
the goal of My desire.*

*He is the One Who beareth witness unto Me at all times and beholdeth Me ere the inception of 'after
Hin'. [1]*

**[1 The numerical value of the letters of the word Hin is 68.
The year 1268 A.H. (1851-1852 A.D.)
is the year preceding the birth of the Baha'i Revelation.]
(Above selection from: The Bab, Selections from the Writings of the Bab, p. 18)**

**And so it was
that in the YEAR NINE -
which Moslem Year began in October 1852 A.D.
(1269 A.H. the year 'after Hin')
that Baha'u'llah while in the Black Dungeon
sometime between October and December 1852 A.D.
received:**

The Revelation:

*"I was asleep on My couch:
the breaths of My Lord the Merciful passed over Me
and awakened Me from sleep:
to this bear witness the denizens [of the realms]
of His Power and His Kingdom,
and the dwellers in the cities of His Glory,
and Himself, the True.*

*I am not impatient of calamities in His way,
nor of afflictions for His love
and at His good pleasure.*

*God hath made affliction as a morning shower
to this green pasture,
and as a match for His lamp
whereby earth and heaven are illumined.*

(quoted by Abdu'l-Baha, A Traveller's Narrative, p. 77)

"The Couch" is thought of as a symbolic reference to what Baha'u'llah refers to elsewhere as "the tomb of the body". Far was he from having the comfort and luxury of a sofa. These were terrible times of martyrdom and suffering for the Faith.

The same month that year that saw the imprisonment of Baha'u'llah also saw the martyrdom of Tahirih (Qurratu'l-Ayn) "at the height of her beauty and power" (William Sears, Release the Sun, p. 120)

The Dispensation of the Bab ended when Baha'u'llah experienced the intimation of His mission in the Siyah-Chal, the subterranean dungeon in Tihiran in which He was imprisoned between August and December 1852.

(The Universal House of Justice, Messages 1963 to 1986, p. 739)

The intimation of His Revelation to Baha'u'llah in the Siyah-Chal of Tihiran, in October 1852, marks the birth of His Prophetic Mission and hence the commencement of the one thousand years or more that must elapse before the appearance of the next Manifestation of God.

(The Kitab-i-Aqdas, p. 196)

Signs in the Heavens:

Such momentous happenings were symbolized by happenings in the very heavens above.

*"...I see a strange, a unique conjunction in the stars.
It has never occurred before.*

It proves that a momentous event is about to take place..."
(quoted by Abdu'l-Baha, Memorials of the Faithful, p. 110)

Biela's comet disappeared in 1846. It returned in August, 1852.

**This was the very month and year in which Baha'u'llah was cast into an underground prison in Teheran. It was the beginning of the forty years of his Mission which ended in Israel in 1892 with his death; the forty years foretold by Micah during which God would show to the Messiah 'wonderful things'.
(William Sears, Thief in the Night)**

**The Americana record of this astronomical event states:
"Late in August, 1852, the larger portion again came into view; and three weeks later the smaller one, now much fainter than its former companion was seen about 1,500,000 miles in the lead." Sir James Jeans confirms this: "Six years later [1852], when the comet's orbit again brought it near to the sun, two pieces were observed to be one and a half million miles apart." ...Following this twin-appearance, Sir James Jeans states, "neither of them has been seen in cometary form, but the place where they ought to be is occupied by a swarm of millions of meteors, known as the Andromedid meteors. Occasionally these meet the earth in its orbit, and make a grand meteoric display." The two comets were no longer separate comets, but were mingled in one great shower of light, just as the Faith of the Bab and Baha'u'llah are not separate but one in the light which they shed upon the earth.
(William Sears, Release the Sun, p. 218)**

***'Have the stars fallen?'*
Say: 'Yea, when He Who is the Self-Subsisting
dwelt in the Land of Mystery (Adrianople).
Take heed, ye who are endued with discernment!'
All the signs appeared
when We drew forth the Hand of Power
from the bosom of majesty and might.
(Baha'u'llah, Epistle to the Son of the Wolf, p. 132)**

It is said in Scripture and Tradition that at the time of the birth or announcement of every Messenger of God, a star or a sign appears in the heavens. Nimrod was warned of the star that told of the coming of Abraham. The soothsayers warned Pharaoh of the star in the heavens that foretold the coming of Moses. The Magi informed Herod of the new star that guided them to the throne of the "spiritual king," Jesus. The same legend is told of Buddha, Zoroaster, Muhammad and Krishna. What were the signs in the heavens during the appearance of the Bab and Baha'u'llah? The holy Scriptures of all faiths had spoken of

Twin-Revelations that would appear at the "time of the end." Now that the Bab and Baha'u'llah had appeared, fulfilling these prophecies, what were the signs in the heavens? Signs, not for one, but for two Messengers of God, Who would appear almost simultaneously? Some of us know the story of the great comet of 1843 which foreshadowed the coming of the Bab. Sir James Jeans, late British astronomer and mathematician, stated in his book *Through Space and Time*, "oddly enough, many of the most conspicuous appearances of comets seem to have coincided with, or perhaps just anticipated, important events in history. (William Sears, *Release the Sun*, p. 217)

***With regard to the spiritual influence of stars,
though this influence of stars in the human world may appear strange,
still, if you reflect deeply upon this subject,
you will not be so much surprised at it.***
(Abdu'l-Baha, *Some Answered Questions*, p. 245)

Heavenly Events in 2002:

In this Sesquicentenary Year of the Revelation of Baha'u'llah marvelous events are once again happening in the heavens.

Five planets, Jupiter, Mars, Saturn, Mercury and Venus assembled in a rare alignment during Ridvan this year. Such an astounding display won't be repeated for a century. It was an amazing thing for us to observe as we returned home from the Convention Report on eve of the 5th Day of Ridvan.

The five-planet array is a "standout" of the 21st Century, says Robert C. Victor, an astronomer who volunteers at the Abrams Planetarium of Michigan State University and has specialized in predicting and observing unusual configurations of the planets for nearly four decades.

Victor said there will be only three other chances in the coming 100 years to see five planets so tightly grouped, in September 2040, July 2060, and November 2100.

"BUT the groupings of 2040 and 2100 will have some of the planets barely above the horizon as darkness is falling, so viewers will likely have to resort to using binoculars," Victor said. "None of these three groupings will be as accessible to casual skywatchers as (was) the ... spectacular gathering in late April and early May."

And there shall be signs in the sun,

**and in the moon, and in the stars;
and upon the earth distress of nations,
with perplexity; the sea and the waves roaring;**

**Men's hearts failing them for fear,
and for looking after those things which are coming on the earth:
for the powers of heaven shall be shaken.**

(King James Bible, Luke 21:25-26)

**While momentous events may be heralded in the heavens
let no one confuse this recognition,
of the relationship of all things -
and the appreciation of the mysteries
that exist in the heavens and nature,
with the superstitions of Astrology.**

**"Concerning your question
as to the influence of the stars and planets
on the life of a believer;
such ideas should be entirely dissociated from the Teachings.
(Compilations, Lights of Guidance)**

***O handmaid of God!
The stars in the sky do not exert any spiritual influence on this world of dust;
but all the members and parts of the universe
are very strongly linked together in that limitless space,
and this connection produceth a reciprocity of material effects.
(Abdu'l-Baha, Selections from the Writings of Abdu'l-Baha, p. 160)***

"Astronomy is a science, astrology does not come under the same category, but we should be patient with people who believe in it, and gradually wean them away from reliance on such things."

**(Compilations, Lights of Guidance, p. 516)
(From a letter written on behalf of Shoghi Effendi,
dated December 24, 1941, to an individual believer, Ibid., p. 10)**

"We should attach no importance to astrology or horoscopes. No exact science is involved, though sometimes some truth seems involved, but the percentage is small."

**(Compilations, Lights of Guidance, p. 516)
(From a letter written on behalf of Shoghi Effendi,
dated January 15, 1951 to an individual believer, Ibid., p. 18)**

**"...it is absolutely essential that the teachings should not be confused with the obscure ideas related to numerology and astrology and the like. Individuals interested in them are free to believe in and credit such ideas and to make any inferences and deductions they desire from them, but under no circumstances are they expected to identify them with the principles and teachings of the Cause. We must at this stage preserve the purity and sanctity of the Baha'i teachings.
(Compilations, Lights of Guidance, p. 516)**

and then there is

[The Millennium Star](#)

**And in the Future
the Sign of the Southern Cross
but that is a story for a future time.**

MENU: [HOME](#) » [Reconstruction](#) » [Recovery](#) » [Renewal](#) » [Star Directory](#)

My UFO Experience

by Bruce Beach

If you have some suggestions or comments you would like to pass on to me about these pages you may do so at: DawnSayer@webpal.org

I was a USAF control tower operator in the 1950's at Dobbins Air Force Base near Atlanta Georgia.

This air base was one of five in the US that was an authorized stop for top secret aircraft and as such one had to have special security clearance to work at the base.

Many strange aircraft such as Flying Wings, the Black Bird, and others, visited our base. They were usually parked under special guard - some distance away on the tarmac.

We also had so many UFO sightings that the tower was equipped with a special 3-D camera (something very unusual in those days) to take pictures of them - and there was a special form maintained in the tower that all operators on duty had to fill out - when a sighting took place.

I will tell you about my own sighting experiences at that tower and later at another one,

but first I wish to make mention of four other prior acquaintances that I had with the subject.

I have told these following stories in lectures to a number of astronomical societies (usually with accompanying slides) and have presented them to a number of UFO investigators.

In those days - UFO sightings were a very hot subject, and my native Kansas was a particularly active location, perhaps fittingly, because Wichita is called the Air Capitol of the World, with its many aircraft design and manufacturing plants.

My first experience was when at age fifteen I attended a lecture by a UFO abductee (I have known a great many - and will also tell you about some of them). He attributed the UFOs to five apertures in the earth and reported unusual capabilities of their operators such as the ability to levitate.

About that time a Kansan reported that he had been traveling down one of our empty Kansas highways when he spotted some aliens on one side of the road and a spacecraft on the other.

The aliens scurried back across the road to the spacecraft and he tried to stop

but hit and killed one of them.

He took the body to the University of Kansas where it was autopsied and found to have human-like blood.

The body was about three feet tall

and appeared to be that of wizened old male with pink skin.

It was dressed in a silk like garment.

The autopsy is well documented at the university.

Another report of the same time came from a very reliable source.

This from a retired pharmacist and his wife who were flying overseas

and he shot the pictures out the airliner's window.

There is no way that such a substantial and reliable citizen would have faked the pictures or had the technology to do so.

The film was developed at the Kodak laboratory and it was then that the UFO was seen.

The pharmacist had not noticed it when taking the footage.

The film was shown to have been absolutely untampered with.

Finally, during my air traffic control training

I had to take training in radar.

There the instructors explained about an incidence that had occurred with the same type of equipment in the pacific.

These specialists have as much confidence in their equipment as I do in my own eyes.

UFOs would appear on their screens when there were no aircraft in the area.

These would sometimes stand stationary and at other times move along courses at speeds that were not possible for any known aircraft.

They would also make course changes at an angle - and altitude changes that were impossible for any known aircraft.

A great amount of effort was made investigating the phenomena with numbers of top experts flown in from the states.

None of the above experiences were my own but you can imagine my eagerness and interest about the subject especially with so many items appearing almost daily in the press and given the hushed and excited talk among my fellow operators in the tower when they would come off duty having had to have filled out a sighting form - although they were forbidden to share the sighting details.

I bemoaned my deprivation - and at that early age of eighteen was already quite inclined to be given to speculation about both scientific and mystical matters. I had completed a couple of years of college and was in my third year - my Air Force duties being arranged so that I could attend the University of Georgia full-time.

During one of my many metaphysical discourses in the Base Operations the chief dispatcher spoke up and said -

"Well, if you really want to see a UFO there will be some here Saturday night."

"What? How can you know that? They are totally unpredictable. I don't believe it."

"Oh, yes - they will be here."

"How? Why? How? Why?", I insisted.

Finally, he said,

**"Well, if you must know,
I am a Rosicrucian and I meditated -
and that is the message that I got."**

**Now - I was doubly doubtful,
but I agreed to come.**

**He was going to be on duty that night -
and we were to arrive before sunset.**

**Numbers of others heard about my discussion with him
and about 20 of us gathered on the lawn
between the control tower and the Base Operations Building.
Some came equipped with telescope and binoculars.**

**We also brought watermelon
and much discussion between myself and the Rosicrucian.
(I suspect that you can imagine myself in such discussion -
now over 50 years ago.**

**One person later told me later that he hadn't even known
that it was possible to think thoughts like that.)**

**Dusk came and the mosquitoes came out.
I suggested that we take the discussion inside.
About an hour after total darkness
the squawk box from the tower blared -**

"We have UFO's out here."

"Are there any planes in the area?"

"Yes, two JUGs (fighter trainers)

from the Naval Air Station."

"Well, send them after them!"

**(Established SOP (Standard Operating Procedure)
at this tower.)**

**From the first bleep of the squawk box
the screen door of the operations shack had flown open
and a crush of airmen had poured out onto the lawn.**

"Where?"

"There!"

"I see them."

**Through the open doors and windows
we could hear over the squawk box
the discussions taking place between the tower
and the pursuit planes.**

"Yes, tower, I see them - will pursue".

**There was a battle going on to access the telescope.
A voice from the tower -**

**"Turn on the GCA -
(the Ground Controlled Approach radar).**

"It will take 30 minutes to warm it up".

"Go look at the weather radar".

**I was too low in the pecking order
to have any hope of looking through the telescope
or one of the sets of binoculars -
but from the tower to the Base Operations Office**

there was a wire stretching down (for the squawk box).
This I lined up on the largest of the three UFOs
and could see that it was starting to move.

There were three in view.
One larger and the other two smaller or further away.
They had the appearance of a bright orange light -
about the same as one sees on oil well flares -
if you are familiar with those.
One the diameter of a quarter - the other a nickel and a dime.

Their presence had been there for three or four minutes,
but now they began to fade
and from the pursuit plane we could hear -

"Tower- they have disappeared."

"R-roger. We don't see them any longer, either.
Return to your pattern."

I, and my audience, :)
returned to the operations building
and the dispatcher and I continued our discussion
for another hour or so.
End of this event -
but they get more exciting.

Now, for a daytime sighting.
(These stories are usually accompanied by photos -
and I guess I could scan and put them here -
well, maybe someday -
but I feel guilty about taking so much time
to write this - as it is.)

This next event happened on an exceptionally beautiful Saturday.

Usually, I worked the mid-night shift so that I could attend school - but I was also required to pull weekend day shifts.

The ANG (Air National Guard) pilots had to get in so many flying hours each month in order to maintain their ratings.

The weather being exceptionally beautiful - this is the day they all decided to fly. The field had never been so busy.

Three control tower operators on duty already - and I was a spare - with no position available at the console.

Sort of there on punishment for not pulling regular shifts.

So I had to sit perched on the slanted ladder (that went up to the roof) behind the radio receivers.

Excellent view - but borrrring.

No duty except to watch.

Down on the tarmac every old C-45 in the place was cranking its engines.

(If I hadn't had to work -

I would have flown with one of them.

I have all sorts of stories about flights in different kinds of planes, crashes and other exciting events,

but I can always tell more than people can bear to hear.

That comes from being a raconteur.)

**The old C-45s were OLD.
And their radios didn't work very well.**

**"Tawr ths 4#%euc"
"Say again aircraft."
"#%^ tAWR thiz AF 47.^**"
"Aircraft you are garbled -
wiggle your flaps and we will use the light gun."
"@#\$@%%"**

**While all this was taking place the three controllers
would all move over by the speaker
and sort of bend their ears down to it to try to understand it.
And I would sit on my perch -
sometimes giving an advisory -**

**"Plane at base" (the last turn before final)
"Plane entering on downwind"**

**A couple of miles from the field
and running parallel to it
was a large power line
running through a swath cut in the trees.
About once a week a small plane would fly down the power line
to check it.**

**As I was watching I could see the plane
which was at too great a distance for me to make mention
but then it did something unusual -
it turned back away from the tower
and then back toward the power line
and I thought -**

"Aha! the pilot has spotted something that he is going to double check."

**But then -
instead of turning and following down the power line
the plane continued on towards the field.**

"Small plane entering on the downwind", I said.

**A wave from the A controller, who did not even look up -
from trying to understand the speaker with the other controllers.**

**Somehow, the plane was looking strange to me.
In varying light and at varying angles
one has to somehow to sometimes tilt their head
to identify the aircraft silhouette
and the type of aircraft they are observing.
I couldn't see any wings.**

**I leaned forward
and picked the binoculars off the radio console.
Put them to my eyes -
took them away -
put them to my eyes again -
and stood up on one rung of the ladder
leaning out by holding onto another rung
and pointing with the binoculars said,**

**"Get the camera -
(which was sitting on the window sill
beside the B operator position)
we have a UFO out here."**

Again - a wave from the operators.

"Look - its a UFO!"

At this point the UFO had come up and parked right in front of the tower window.

Traditional form saucer shape - bubble on top that appeared solid also without windows. Possible power ports at both ends.

The operators now turned and looked at me - rather than out the window.

"Where?"

"There!", pointing with the binoculars.

But as they turned - it left - at the speed of light to my right. They never saw it.

I had better luck the next time. It was a midnight shift and the shift chief was S/Sgt. Kelly. There were only ever two people on the night shift - myself and a shift chief.

Usually, I was the only one awake. They all loved to work with me because I would sit at the console doing my studies all night long - and they could sleep.

Kelly slept on the floor with his feet towards me - so that I could tap them if I heard the OD (Officer of the Day)

coming up the stairs.

Then he would just kind of sit up on the floor like he was adjusting the radios in the console that was between us and the stairway.

This night we had only one aircraft in the pattern - a PBY (Patrol Boat Navy - they can land on both land and water) over from the Atlanta Naval Air Station that was getting in a required number of TOL (Take Offs and Landings) (you want them to come out to an even matching number). They say the PBY takes off at 75 mph - flies at 75 mph - and lands at 75 mph. Not too terribly exciting but we did have one pilot that had flown with Doolittle - and we were always coaxing him to do a JATO - (Jet Assisted Take Off) in which the plane would fairly jump into the air.

Our base commander had made a ruling much to the pilots' chagrin that the planes had to fly the full length of our ten thousand foot runway before turning out. It made for a long time consuming flight for a PBY. Another thing about the PBYs was that the tower was supposed to visually check that their gear was down - because some of the Navy pilots would forget that we were a land base. Over on the land runway at the Naval Air Station they had a great big bill board that said - "WHEELS" -

but we didn't.

**The PBY had lumbered into the air
and was flapping down the runway
and I was taking one last look around
before I returned to my studies -
when I noticed a light far off the end of the runway.**

Hmmm. Strange.

**Maybe the red light on the end of the Lockheed plant.
Nope. Over to my right the Lockheed light is still there.
Maybe something on the mountain.**

Binoculars -

and scan down to the skyline.

Nope - it is above the skyline.

Big light - maybe Venus -

though that is not usually red -

**and we are past midnight - way too late for Venus
and wrong direction and not early enough
for when it becomes the Morning Star.**

Hmmm. Better study this.

Aircraft maybe.

Steady watch.

No motion.

No change in size - not approaching or retreating.

Possibly a helicopter standing steady -

but no aircraft advisories and highly unlikely.

Theodolite - but way too distance -

and again holding steady.

Besides no notification from weather that they were launching.

The PBY has now long turned out -

and is on downwind.

**"Uh, Kelly,
we have something strange here -**

I think you had better look at it."

"What is it?"

**"I don't know -
I want you to look at it."**

"Why?"

"Well, I think it may be a UFO."

"Knock it off, Beach"

**"Kelly, take a look at this,"
tapping his shoe with my boot.**

"Grrrf. Knock it off, Beach"

**"Kelly, look at this -"
accompanied with a really solid kick!!**

"Growllf -" and Kelly has sprung up.

"Beach, I am going to -"

**"Look -" I say pointing with one hand -
with the other still holding the binoculars
to my eyes.**

**I have never taken them off the UFO
the whole time that I have been talking to Kelly.**

"What is that?"

"I don't know. A UFO."

"Where is the PBY?"

**"On the downwind.
Let me send it after it."**

**"No.
What is that?"
Kelly now has another set of binoculars
trained on it.**

**"A UFO -
lets send the PBY after it."**

**"We can't do that.
What do you think that is?"**

"A UFO."

At this point the PBY speaks up -

**"Tower, this is PBY on downwind -
gear down and locked,
request permission to land."**

"Negative PBY, check at base."

**A long silence. The pilot is looking around -
wondering what in the world? Finally, he says -
hesitantly -**

"R-roger tower, will check base."

**"Kelly, let me send him after it -
he will be glad to go
and he doesn't have anything else to do.
We are authorized to send pursuit planes."**

"What do you think it is?"

**"It is a UFO Kelly.
C'mon Kelly - lets check it out."**

**All this time both Kelly and I have our binoculars
on the UFO. I only take mine down to speak to the PBY.**

**"Tower, this is PBY at base -
gear down and locked
request permission to land."**

"Come on Kelly -"

**"Tower, this is PBY at base -
gear down and locked
REQUEST permission to land."**

**"Negative, PBY.
Check at final."**

A REALLY long silence.

"Roger tower."

**"Come on Kelly -
when he turns final
he is going to be lined right up with it.**

**He can just go right ahead after it.
Let me send him after it Kelly."**

Silence from Kelly.

**"Tower this is PBY.
Turning on final -
Gear down and locked.
AM I cleared to land?"**

**"TOWER! This IS PBY.
On final - AM I cleared to land?"**

"Roger, PBY, your are cleared to land."

"THANK YOU, tower." (Pure ice in the voice).

Kelly finally speaks.

"Okay, you can ask him if he wants to go check it out".

**"Alright!"
I grab the mike.**

**"But you can't speak to him on final."
(This was SOP)**

"Arrrrgh."

**Wait, wait, wait.
Watch UFO through the glasses.**

(Kelly never takes his off it).

**Glance back at the PBY.
Wait, wait, wait.
Watch UFO through the glasses.
Glance back at the PBY.
This one must have figured out how to fly at 30 mph.**

Finally, the PBY touches down.

**"PBX - continue landing roll for immediate take off.
There is a UFO off the end of the runway -
we would like for you to take a look at it."**

**"Roger Tower - PBX continuing landing roll
for immediate take off."**

**"Tower - this is PBX
we are airborne -
where is the UFO."**

"Directly ahead of you PBX."

Silence.

**"Tower, this is PBX -
we still do not see the UFO."**

"It is directly ahead of you PBX."

Silence.

**And then as Kelly and I watched
the UFO faded away.**

**"Tower, this is PBX -
we still do not see the UFO."**

**"Roger, PBX.
It has disappeared.
Check gear on downwind."**

"Roger, Tower."

You can see why shift chiefs

**don't like to send planes after UFOs -
but it was nice to have SOMEONE seeing
what I was seeing.**

**The next episode also occurred at night -
but this time it was in perpetual 24 hour night
in the Arctic.**

**Again, I was the only operator awake in the tower.
Suddenly, there would be a light flash
out of the corner of my eye.**

**I would jerk my head up from my studies,
or turn around if I was standing up.**

Gone - nothing.

**We had no light beacons in the subdued lighting
of this SAC base.**

Sudden alerts would occur.

**Doors at both ends of the hanger would roll up
the fighter would fire up in the hanger -
and be gone -
straight down the runway -
afterburner blazing as it hurled into the sky.**

But usually nothing.

**Just darkness and subdued lights about the base -
except -**

except --

I know I saw a light.

Ask others -

do they ever see it.

Nope.

Almost a pattern, I decide.

Hours to sit in the darkened tower.

**Trying to stare out into the darkness
with out blinking.**

There it was.

Darkness.

And again.

Now I know the direction to look.

There.

Now.

Again.

And again, and again, again.

But then long periods in between.

Some strange phenomena.

But not the Northern Lights - we are too far north.

Days of study.

Finally, I know.

**It is the water trucks,
turning first one curve and then another
up in the mountains
below the skyline
but their headlights faintly catch
many miles away
the snow cliffs on another mountain.**

**Light is phenomenal -
and there are natural explanations
for much of what we see.**

**The early autopsy at the University of Kansas
had a natural explanation.**

**The creature had human like blood
because it was a Rhesus monkey.**

That is from where we get the term RH factor for blood.

The hoaxer had amputated its tail,

**let it heal, shaved it,
dressed it in silk,
and killed it -
before going to the university with his story.**

**The retired pharmacist
was not a hoaxer.
He actually shot the amateur movies.
They weren't doctored.
It took many hours of flying an identical aircraft -
at different angles to the sun
while shooting an identical camera
from the seat in which he had been sitting -
to get the light reflections from off the tail
to again create a UFO on the film.**

**The military radar men
were straight arrow also.
They saw what they saw.
But what they saw,
it was shown after months of investigation -
was a radio signal set off by a special code
aircraft id-transmitter
sent at a very high frequency
by planes that were over the horizon
and completely out of range of their radar.
The signals somehow bounced off the ionosphere.**

**My Rosicrucian friend may also have been a jokester.
In any case, I learned to duplicate what we saw that night.
And have done it.
An aluminum pie pan like you get with a bakery pie.
Punch 20 one inch slits in the bottom of it with a sharp knife.
Take a dozen or so short birthday cake candles.**

**Light them and stick them about the pan.
Put the open end of a light plastic garment bag
from the dry cleaners
over the pie pan
and scotch tape it to the pan
so the pan sits evenly below the bag
and air can be drawn in through the slots in the bottom of the pan.
The bag will fill with the hot air.
Release into a dark moonless night
(in an area where it will not cause a fire when it descends -
I have had them come down on people's house tops -
THAT adds to the excitement!)**

**Now stand and point at the UFO.
You can't tell if its hundreds of yards away -
or miles away -
as it glows eerily in the night sky.**

**Took me years to understand my daytime observation.
Asked psychiatrists -
(I became a psychiatric social worker
and took graduate courses in psychoanalytic theory) -
if we could review the event through hypnosis,
but that is not possible -
because just as with reviewing past lives under hypnosis -
hypnosis IS suggestion -
one will "see" whatever it is that they are "supposed" to see.**

**Finally, I decided it was a delusion.
Not even an illusion -
because with illusions -
such as mirages or my lights in the Arctic,
there is some physical base to the phenomena.
However, I came to the conclusion**

**that if there had been something there -
with all those hundreds of people at the airstrip that day -
someone else would have seen something.
Sometimes you really cannot believe your own eyes.**

**Most of my space abductee friends
are also deluded.**

Although, I have met two charlatans.

**The fellow giving the lectures when I was about fifteen,
knew that he was lying.**

**Another charlatan of my acquaintance
may have been deluded at one time.**

Met with him weekly at a space group luncheon.

His books sold many multiples of thousands.

Especially in Japan.

**He would announce that he was going off
on another space trip -**

**and we wouldn't see him for a few weeks,
but then he would reappear with another book.**

**My Venusian friend is as honest
as the day is long.**

Very deep insights into many things.

How many of you have Venusian friends?

**You may not believe that he is from Venus -
and I may not -
but he does.**

And he travels there quite regularly on occasion.

Lots of traffic to Venus.

I have a number of friends who have gone there.

**They are completely schizophrenic
but it does not make the trip any less real for them.**

Reality is often hard to determine.

**In TRUTH - Reality is ALWAYS hard to determine.
It is nice to have someone share the experience with you -
as many did with myself and my Rosicrucian friend -
or as Kelly and I did that night in the tower -
(I still have no idea what THAT was about).
But, shared mass delusion is not as uncommon
as one might think.
In fact, I would go so far as to say -
that it is very common in almost all cultures.**

**I believe in flying saucers.
Just not sure that I have ever seen one.
I have seen the Roswell autopsy movie -
(Boy, THAT was good!)
but the evidence to me seems pretty certain
that it was a fake.**

**There are many mysteries that I have seen
in the pyramids and various places
that I have traveled about the earth -
that do seem to me to be significant evidence,
but I feel far too many of my friends
accept UFO ideas,
Chemtrail ideas,
Crop Circle ideas,
NEO asteroid and planet ideas,
and all sorts of CONSPIRACY ideas -
without really sufficient evidence.**

**Some cultural ideas
about resurrection, rapture, return -
are so embedded that you do not dare challenge them
with many individuals.**

**But I can tell you -
that in the fifty years since my UFO experiences
I have discovered
that there are MUCH GREATER MYSTERIES
and phenomena that YOU can come to understand
if you are willing to go beyond the
vague fancies and vain imaginings of most men.**

**Those are the TRUTHS that I seek to lead men into -
and it is for that reason alone -
that I take the time to write these long explanations.**

**Those that have already made up their minds
about these many subjects that I have mentioned -
will often just be angry that I appear to challenge
their beliefs.**

**But, I can always hope
that there will be some
who truly seek the Truth
and that will respond -**

**"Beach, if you can really point out the Path -
then I want to hear about it."**

**It is for they -
that I always wait and listen.**

**Peace and love,
Bruce
DawnSayer@webpal.org**

To see my complete religion series, visit:

<http://www.webpal.org/essays/religion/religion.htm>

MENU: [HOME](#) » [Reconstruction](#) » [Recovery](#) » [Renewal](#) » [Star Directory](#)

Farming after a Nuclear War

At one time, almost every home was a little farm. Everyone had a garden and a few chickens. It is a life-style now unknown to present city dwellers but still present to some degree with our village neighbors. It is a life-style to which many will probably return and the purpose of these pages is to help that transition. This is our own little greenhouse.



Table of Contents:

[Library: Gathering Resources for After a Nuclear War.](#)

This web page deals with the technical aspects of farming such as seed saving, fertilizers, crop management and so forth. Other web pages in the hierarchy above this one deal with measuring radiation

in food, alternate energy sources, and other subjects necessary to successful farming.

Farm1: Protection of Food and Agriculture From Nuclear Attack

(In .pdf format.)

This 42 page booklet was the US Department of Agriculture comprehensive attempt to prepare the farmer for nuclear attack. It contains much important information.

Farm2: Fallout on the Farm

(In .pdf format.)

This 14 page booklet is by the Canadian Government and has useful information about crop alternatives after a nuclear war, the handling of animals exposed to fallout, and many other items of information.

More: The Have More Plan

(In .pdf format.)

The "Have-More" Plan (A Little Land - A Lot of Living) by Ed and Carolyn Robinson is a 1940 classic devoted to the creation of a small farm. It is a bit dated in its view of DDT but generally may be exceptionally useful to those who are inexperienced and are trying to start.

Seeds: Basic Seed Saving

(In .pdf format.)

6 pages in .pdf format from Seeds of Diversity.

Humanure: Humanure Handbook

This 200 page book - winner of *many* awards is placed here through the kind permission the author Joseph Jenkins. It can be obtained in print at Jenkins Publishing, PO Box 607, Grove City, PA 16127. To order, phone: 1-800-639-4099. <http://www.jenkinspublishing.com/> .

Humanure: The Handbook available in .pdf format.

Mulch: Explains organic composting.

(In .pdf format.)

This 30 year old 101 page book gives information about mulching.

Fences: Fence Planner for the Common Sense Fence

(In .pdf format.)

This 12 page booklet gives information about wire fences, barbed, stranded, and electric. There are other kinds.

[Seed Presses](#) [Pressing Oil from Seeds](#)

This 24 page .pdf file lists 56 oil bearing seeds and discusses a variety of methods for extraction and processing. These oils can be used either for food or fuel.

The books below this level are copyrighted and will be available (if there is enough Internet to disseminate them) after the nuclear war - when surely no one will object. The information here will indicate the types of information that you might be interested in gathering into your own library ahead of time.

[Ark: Build Your Ark](#)

(In .pdf format.)

"Build Your Ark" (How to Prepare for Self-Reliance in Uncertain Times) by Geri Welzel Guidetti. Published by: The Ark Institute, P.O. Box 364, Monkton, MD 21111, email arkinst@concentric.net : This 248 page Book One on Food Self-Sufficiency covers basic concepts on gardening and goes into detail on soil improvement and insect control. Details are provided on a wide variety of garden vegetables.

[Farmstead: The Farmstead Book](#)

(In .pdf format.)

"The Farmstead Book 1" edited by Paul Harmond and is Published in the US by: Cloudburst Press of America, Inc. 2116 Wetern Avenue, Seattle, Washington 98121 and in Canada by: Cloudburst Pres Ltd., Mayne Island British Columbia V0N 2J0 - This 262 page Book covers soil and woods management on a more macro level than the book above and also covers the farm machine shop.

[Taste: Like They Used To Taste](#)

(In .pdf format.)

"Grow Friuts & Vegetables The Way They Used To Taste" by John F. Adams published by Wynwood Press - New York, New York. This 104 page book deals somewhat with vegetables and seed saving but is more largely devoted to fruit trees.

[Seeds: Saving Seeds](#)

(In .pdf format.)

"Saving Seeds" (The Gardener's Guide to Growing and Storing Vegetable and Flower Seeds) by Marc Rogers and published by Storey Communications, Inc. Pownal, Vermont 05261. 97 pages.

Click here to return to the
[Individual Agricultural Recovery
After Nuclear Holocaust](#)

Overview

Gathering information Resources for Farming After a Nuclear War

This web page deals with the technical aspects of farming such as seed saving, fertilizers, crop management and so forth.

Other web pages, in the previous table of contents in the hierarchy above this one, deal with measuring radiation in food, alternate energy sources, and other subjects necessary to successful farming.

Still other web pages, in the previous table of contents in the hierarchy above this one, deal with old Pioneering skills. There may be some overlap between those and these immediate pages but it is well to look at both of them for what may be start up farming without access to all the present modern technology.

We cannot just go back to the old ways. We have lost many of the skills. No one had them all then and you would be hard put today to find a wheelwright, a miller, a tanner, a barrel maker. All those trades, like farming have advanced into modern technology and the present experts seldom have used the old ways. Many of the old implements are no longer around and we certainly don't have the horses. Modern horses are neither bred nor conditioned to pull the plow. Still, in the skills of the past we may find solutions to the problems of the moment.

Our personal library is very extensive. At one time I counted 13 encyclopedias. These are mostly specialized - like a 14 volume set on gardening and another 16 volume set on do-it-yourself repairs. There are others on health and medicine and a variety of other subjects.

We have also acquired CDs with hundreds of books and one summer put a crew to work microfilming thousands of documents which we have on microfiche. These, plus many many books, are in just our own home but our Ark Two Community librarian is the real gatherer of information - he has many thousands of books, mostly on technology for recovery.

In the future, when people want it, we hope to be able to disseminate all this information widely. There are many blind spots in our library. We have little information on modern technology and almost no information on leading edge technology. Members of our Ark Two community are of far more than average knowledge about nuclear and computers but there are many, many fields such as in modern metallurgy, petroleum refining, hundreds of specialties in chemistry, medicine, and untold numbers of

other areas that the expertise to re-establish them will have to survive with the experts - if they are going to be recovered in the immediate decades following.

One major focus of our library has been maps, in order to determine where that expertise may reside. We have thousands of maps. Local road maps. Topographical maps. More and more maps on an expanding scale. We have every map ever published by the National Geographic. We have CDs with map search programs. North American and World Atlases. The list goes on. One map set which we were very desirous of obtaining cost thousands of dollars (far beyond our budget) from the US government. It comes with a subscription program for real-time updating and the printed book is reprinted annually. A marvelous tool for demographers tracking changing patterns - but one copy would serve our purposes. Amazingly, we found one on the Internet - at a fraction of the cost.

Other associates of ours are providing us with gigabytes of survival information on CDs. Our problem has not been so much one of obtaining information but determining which areas on which to concentrate our limited resources for storing and cataloging. Tons of information is of no use, if you have no way of finding what you want in it. In early years we were given literally tons of books by libraries and publishers. Expensive volumes that cost over hundreds of dollars each - but we finally had to abandon that effort simply because of lack of storage space and manpower to handle it. We passed on trailer loads of books.

So the problem of the moment has not been getting information but one of determining which information is going to be most useful to survivors. These have been our choices. What we offer in these pages, measuring radiation contamination in food, producing food without the modern technology and its skills, finding alternate sources of energy, recovering and repairing remaining machinery, creating the nucleus of an economic system and restoring the basis of functioning society - information on how to do these things are what we feel will be most needed at the outset. It is our sincerest hope that we will be able to get it to the people who need it and that they will find it useful.

Click here to return to the
[Table of Contents](#)

MENU: [HOME](#) » [Reconstruction](#) » [Recovery](#) » [Renewal](#) » [Survival](#)

Embedded Secure Document

The file *file:///C:/CDROMs/SCDR-2/Prophecykeepers/POST-NUCLEAR-WAR/b_recovery/2_farm_recovery/ftpfiles/protection.pdf* is a secure document that has been embedded in this document. Double click the pushpin to view.



Embedded Secure Document

The file *file:///C:/CDROMs/SCDR-2/Prophecykeepers/POST-NUCLEAR-WAR/b_recovery/2_farm_recovery/ftpfiles/fallout_on_the_farm.pdf* is a secure document that has been embedded in this document. Double click the pushpin to view.



THE "HAVE-MORE" PLAN

"A LITTLE LAND— A LOT OF LIVING"

How to Make a Small Cash Income
Into the Best and Happiest Living
Any Family Could Want

BY

Ed and Carolyn Robinson

- Buying a Place in the Country
- Laying Out a Homestead
- Remodeling or Building a House Designed for Country Living
- Part-time Farm Pays for Itself
- A Good Garden with Less Work
- Building a Small Barn
- Earning Money in the Country
- Dwarf Fruit Trees and Berries
- Fish Pond in Your Backyard
- Starting Right with Poultry, Rabbits, Milk Goats or Cow, Bees, etc., etc.

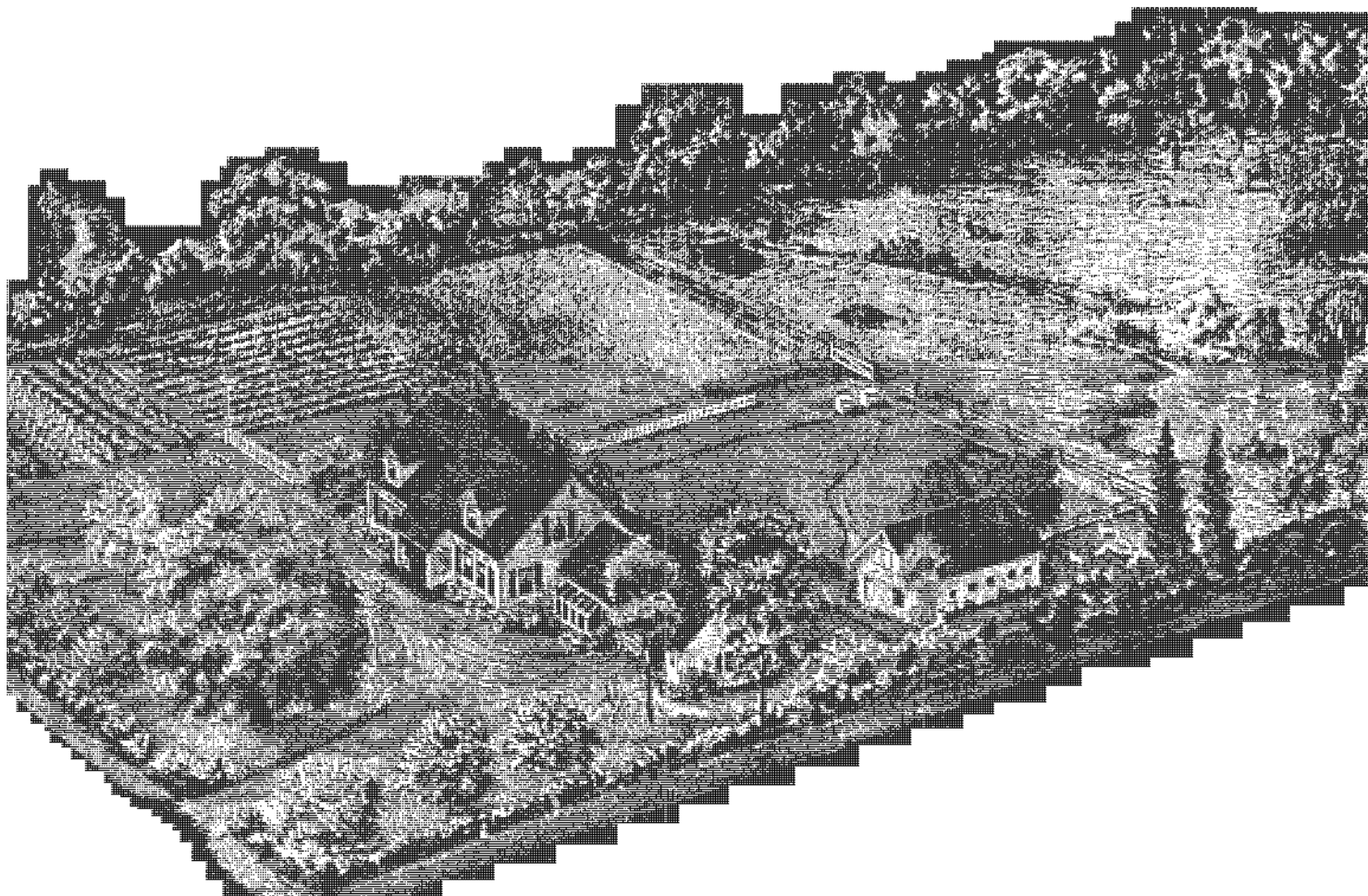

Dear Reader,

Garden Way Publishing Co. is the successor to the Noroton Country Bookstore and we are pleased to make the original "Have-More" Plan by Ed and Carolyn Robinson available again.

This classic book was written in the 1940's by leading experts of the day, to aid the individual in his search for self-sufficiency and independence on a country acre. We have reissued this work unchanged because it is still one of the best references available for the home gardener and homesteader. After all, poultry, goats, lettuce and home canning haven't changed much in a generation. It's no wonder the "Have-More" Plan has been in constant demand since it was first published. It will show you how to do things in ways that work superbly.

There are, however, just a few items mentioned such as the use of pesticides containing DDT, which we trust you will excuse and overlook. Three decades ago our understanding of such hazards was non-existent. We can help you, through our other publications, to learn more about non-toxic materials and techniques.

Many of the bulletins and books that were developed from the "Have-More" Plan are available once again directly from us. Please write to Garden Way Publishing, Charlotte, Vermont 05445 for our free book catalog which lists the "Have-More" Plan bulletins and books, as well as the most current books by all publishers that we feel to be the best on gardening and country living.

Please do feel free to contact me for any help I can be in your quest for "A Little Land—A Lot of Living".

Sincerely,

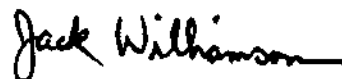
A handwritten signature in cursive script that reads "Jack Williamson".

Jack Williamson
Publisher

Contents

Chapter	Page
1 Why We Moved To The Country	2
2 A Letter To Wives	5
3 What Sort Of A Place In The Country Do You Want?	6
4 Setting Up A Homestead	7
5 Houses Especially Designed For Country Living	9
6 Plan A "Harvest Room" With Your Wife	10
7 Finding A Suitable Place	11
8 A Little House Can Grow	12
9 Score Card Of What To Look For In A "Have-More" Homestead	13
10 Water, Sanitation, Electricity, Roads	14
11 Landscape Your Place—Increase The Value 20%	16
12 Plans For A Small Barn	18
13 The Importance Of Raising Part Of Your Family's Food	20
14 A Good Garden With A Lot Less Work	21
15 Vegetable Planting Chart	24
16 Herbs	25
17 The Kind Of Berries And Grapes Money Can't Buy	26
18 Two Ways To Have Tree Fruits On A Small Place	28
19 Fresh Eggs From Your Own Hens	30
20 New Easy Way To Raise Tender Chicken	32
21 Geese Grow On Grass	34
22 Turkeys Can Be a Profitable Side Line	36
23 Ducks Are Easy To Raise	38
24 Squab	40
25 Rabbit—8 To 14 Cents A Pound	42
26 Ham, Bacon, Pork, Lard	44
27 The Miniature Dairy	46
28 (a) The Modern Dairy Goat	47
29 (b) A Family Cow	50
30 A Few Sheep For The Small Place	52
31 Veal and Beef On The Homestead	53
32 Our Little Sugar Factory	54
33 Have More In Winter Too!	56
34 Winter Gardens—Cold Frames, Hot Beds, Small Greenhouses	60
35 Grow Your Own Fish	61
36 The Woodlot	62
37 Transportation And Power	63
38 Housekeeping On A Homestead	64
39 Homestead Mechanics	66
40 Earning A Living In The Country	69
41 The Country Bookstore	70
42 Let's Rebuild America	72

Why We Moved to the Country and What We Set Out to Accomplish



CAROLYN, our son Jackie, and I haven't any land to sell—we aren't promoting anybody's products. We just want to tell you

some things we learned about how to have more fun, more health and more security than 99% of the people in this world ever had before.

Back in 1942, we Robinsons lived in a big apartment house in New York. Far from having all the conveniences and easy living you are supposed to have in a big city, we discovered we had very little.

In the first place, we always felt restricted. Living in the city wasn't easy, it was difficult. And every time we turned around—it cost us money.

For example, just to let the baby walk or play outdoors cost us money and trouble. First, we had to dress the baby nice (because we were going to the park), then get together blankets, diapers, his toys, etc., carry all this and the baby out to the elevator, wait until the elevator came for us, then outside we would have to walk two blocks and wait for a bus, then ride about 15 blocks and get off the bus, carry everything into the park, and find a spot where we could sit down.

One terribly hot Sunday afternoon we had gone all through this procedure and finally found a spot that wasn't crowded, spread a blanket to sit on, unpacked the baby's toys, diapers, etc. and settled down for a few minutes' peace. Just then a policeman came up to us: "Look—you can't stay here," he said.

"Why not?" I asked.

"How long d'ya think the grass would last if everybody was allowed to set and walk all over it?"

I suddenly remembered as a boy how wonderful it had been to lie in the grass in back of our house in the little New England town in which I was brought up.

We got up to leave. I said to Carolyn, my wife, "Look, let's get out of here!"

"It'll be awful hot back at the apartment," she said, "and Jackie hasn't had any sun for a long time."

"What I mean is let's get out of this dirty, noisy city—let's go live in the country . . ."

That is how we began to think seriously about living in the country. I say think about it—because we thought about it for a long time before we did it. First, we couldn't see how we could afford living in the country. Then we

began to wonder if we couldn't have a garden and maybe some chickens and by raising some of our food have more money so we could afford it.

The trouble was that a couple of our city friends who had farms always said the vegetables they raised cost about three times what they sold for in the store.

In fact, one man we knew about who had a fine modern dairy used to set before his guests two bottles. One was milk, the other champagne. "Take your choice," he'd say. "They cost me the same."

After we thought about this we realized these men were trying to run a commercial farm by remote control. Usually they went to their farms week ends only because it was so far away—and a hired man ran the farm for them. We wanted to keep a city job, for cash income; we wanted to stay near enough to the city to keep its advantages. We wanted to add the security and fullness of living that seemed more likely to come if we owned our home and some land, not much land necessarily, but good land and at least enough of it to raise most of our food.

There was nothing new about this idea. We were aware that Henry Ford and many others had been advocating just this for years. We knew that hundreds of thousands of American families were already doing what we proposed to do.

We faced the fact that we knew absolutely nothing about raising any part of what our family needed to live. In fact, our utter and absolute dependency on my job was appalling. If I should

lose my job—even temporarily—we would have no money to pay our rent—the landlord would put us out.....no money to buy groceries or pay the butcher and we wouldn't eat.

If there were another depression—and I were to lose my job like millions in the last depression—then there wouldn't be a thing to do but stand in line and beg the government for "surplus commodities" . . . rent money . . . relief clothing until things got better again—which might be years!

Living in the city we couldn't save much. Everything we did, almost, cost money. Our biggest item was food. Suppose, we thought, we could raise a big part of our food . . . We knew nothing about farming. But we began to look at things we ate . . . started to study how we could grow them ourselves. For a long time before we actually did move into the country we studied how to raise things. Perhaps in all we read a couple of hundred books and pamphlets on this. We found that most material was out of date and most of the newer books were designed for commercial farming specialists. For example, we found a dozen huge books on commercial dairy cattle, but no simple, up-to-date little book telling us how to produce milk efficiently for our family—and whether it was really economical to do so.

Then again there were lots of people telling you how to choose a farm of say 50-100 or 200 acres, but a dearth of information on telling us how little land we actually needed to raise food for one family.

Yet we gradually accumulated a good

Life in the City



many excellent books and pamphlets—all of which you'll find listed in these pages. When we had a fair idea of what we wanted to do we moved to our small place in Connecticut, about an hour from my job in New York, to try out our ideas.

This plan is the story of our place, of my family and me. It's the true story of how we have built our homestead. I hope you will be able to get some new ideas from it.

We call our plan—the "Have-More" Plan because that is the way it worked for us. Our plan shows how you can have a lovely home of your own on a piece of land that will furnish your family with food, recreation and health. Yes, and extra income too.

**If you'll follow our Plan
Here's how you'll be situated:**

You too can have a good home and an acre or more of land within a few miles of where you work. Your place will pay for itself as you go along—you will eventually own it free and clear. Think what that means—*no more rent to pay!*

You'll have far smaller weekly grocery, meat, and milk bills. With the small scale, modern, labor-saving methods we'll show you, you can raise up to 75% of all your family's food—perhaps do it all in spare time—and find real pleasure in doing it.

You and your family can become truly self-reliant. You will be able to keep your own home in shape, even improve your house and land. You can be healthier and happier. You can be sure that the food you eat is rich in vitamins and minerals. You need never worry very much about losing your job. You can retire years sooner, if you want to, and if you'll put away enough to be assured of just a small regular income.

Best of all, you can do as much or as little of our "Have-More" Plan as you like. You can fit it to your own pocket-book and spare time. If you are in

earnest it makes no difference whether you start with just a few dollars or five thousand.

If You Have a Full-time Job:

You can easily work out the "Have-More" Plan in *spare time*. If you work long hours and don't have a chance to do the whole plan at present, you can do part of it in as little as 15 or 30 minutes a day. Even so you can have all the health, happiness, and security of this kind of living. You can have a fine garden, beautiful flowers, get your fruit trees and berries, asparagus and rhubarb started, and perhaps have a few chickens.

This way of living is especially good for children. You can get your place all paid for and have that wonderful sense of security and independence knowing that you and your family have your place to fall back on—knowing that you could get by with very little cash income if you ever had to.

If You Have a Part-Time Job:

If you work short hours, such as 40 hours a week or less, you can get all the more benefit out of the Plan. Perhaps in your work you have several days a week free or maybe several weeks or months a year free. Perhaps there's an extra member in your household who'd like to help. If you have a place like ours, you can make your spare time worth money by developing a paying hobby right on your own place.

If You Are Planning To Retire:

Or if you have already retired, you can see that this Plan is a most practical way to stretch your retirement income and help keep yourself in better health. If you are going to receive Social Security benefits, or just a small pension, annuity, or small income of any sort, you can look forward to many years of happiness and security.

This Plan in no sense attempts to

turn you into a commercial farmer. There is all the difference in the world between farming for profit and raising only your own family's food. A farmer is a business man whose factory is his land. Probably—if he is really successful—he has become a specialist in producing one crop—milk—or poultry—or fruit. He has spent years learning to become expert enough not only to produce quantity but also to sell wholesale at a high enough price to pay overhead, his labor, machinery costs, etc. You, on the other hand, produce only what your family needs. You save yourself retail prices. You have no labor costs—practically no overhead—no distribution or selling costs. You sell only your surplus—and can easily find a ready retail market among neighbors or friends where you work.

You will be tempted—especially during a food shortage to produce, for example, more chicken than your family can eat—and sell the surplus at a profit. This you can do—but only if you have enough spare time so that you will not have to sacrifice growing some other foods for your family's own use.

The very fact that our "Have-More" Plan calls for raising a variety of vegetables, fruit, poultry, meat and dairy products means a diversification of work, a lot of different things to do, so that none of them becomes tiresome. Planning to have a garden, a cow or milk goats, laying hens and broilers, rabbits, bees—and maybe other livestock—sounds as though you had as much to take care of as many farmers who are notoriously overworked. But you have only sufficient garden, fruit, and livestock to supply your family's food.

A farmer, to have been deferred in the draft, and that meant that he was farming on a full-time basis, had to produce a certain amount, according to government rulings. For example if he himself were responsible for 5 milk cows, 60 hogs, 150 hens, and a 6 acre garden, he would be considered sufficiently productive to be deferred. On the same basis, if you were supplying 75% of your family's food—that is, you had 1/3 of an acre for a garden, 2 milk goats, a dozen hens, 100 broilers, 2 pigs, enough fruit trees and berries, you would have about 1/16 of what a farmer needed to win deferment.

I point this out so you will see that it is entirely possible for you to raise your family's food in your spare time if you go at it efficiently. A garden, hens, broilers, cow or milk goats, bees, etc. sound like an awful lot. Actually, only the variety is impressive—not the quantity.

Another thing, even though you have only enough poultry to supply your family, you use the most up-to-date, easiest way to take care of it. Then again, you will find this plan broken up by projects so that you add one project at a time and get that working perfectly before undertaking another.

Every so often somebody asks

Life at Your "Have-More" Homestead

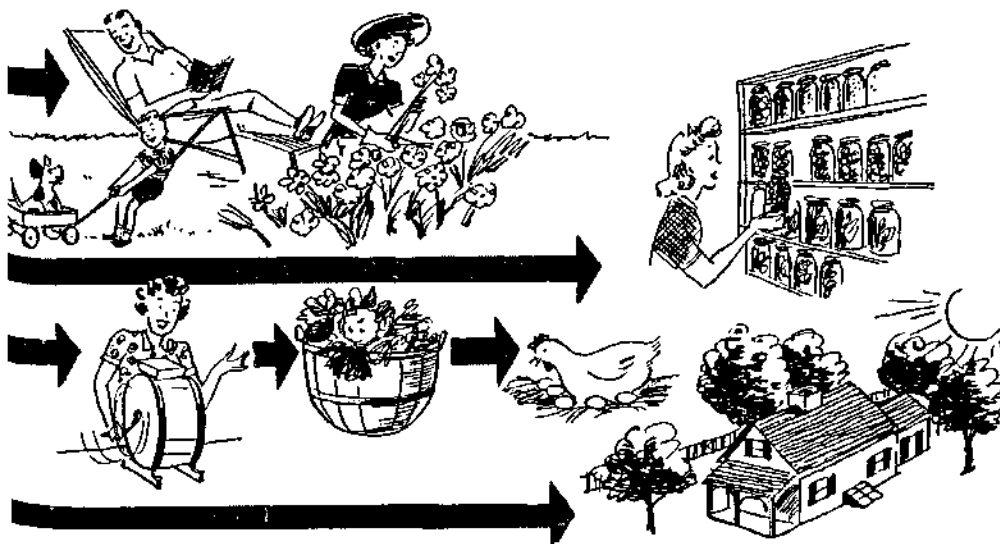

"How much of the Plan should I undertake?"

You yourself will have to decide this. The most difficult job is to get your house, barn, fencing and land ready for efficient operation. But once your place is set to go the actual chore time doesn't take long. A small flock of hens takes about 7 minutes care a day . . . a garden, the biggest and most difficult home food raising project, may take 150 hours a year or so.

Many people moving from the city to the country hesitate to add livestock to their places—because they don't want to be tied down. Livestock, however, can supply 40% of your family's food. Our livestock doesn't tie us down—our neighbors will do chores for us and, of course, we do chores at our neighbors' when they want to go away.

What has amazed us, was how relatively easy and practical it has become in the America of today for the average family with modest income to work out this plan of country living and city job.

No doubt many city families who have considered getting a place "out in the country" where they could live and raise some of their own food, have not done so because they thought it would take too much time and trouble to get back and forth; it would be all hard work and no play; it wouldn't be practical—it would cost more to grow food than to buy it—their chickens would die, the garden wouldn't grow, the bugs and birds would get all the fruit and berries; it would cost too much to get started anyway.

Well, the real reason we have written this Plan is to tell other people that these objections just aren't so. The average family can, today, make the country-living-city-job idea work and they can make it pay.

Some of the reasons why they can make it work today, where they might not have been able to even ten or twenty years ago, are these:

1. *There has been a tremendous amount of highway building in the past*

twenty-five years. Automobiles and busses, plus train service where needed, make it entirely practical for most people to live a considerable distance from their jobs. These same highways and cars have taken the loneliness out of country living, too.

2. *Modern appliances and methods have eliminated much of the really hard work in keeping house and raising food for the family. The pressure cooker and the home freezer, for example, have made preserving far easier than it used to be. The short work week (30-48 hrs.) leaves plenty of spare time for work at home plus plenty of spare time for play. To add work at home on top of a 6 day, 70 hour week was one thing. To do the same work at home on top of a 5 day, 40 hour week is an entirely different thing. What was work actually becomes fun.*

3. *It is easy to learn to raise plants and livestock successfully today. Methods are simpler, more scientific. Seeds and plants are better, surer to grow, more productive. Fertilizers are better. Livestock breeds are better—they produce more per hen, per goat or per pig. Feeds you buy are better, more scientifically prepared. Disease and pest control is far more sure and specific. For example, what the famous sulfa drugs are doing for sick people, they are also doing for sick chickens.*

4. *Low-cost, long-term federal and private financing now bring the possibility of home and land ownership within the means of people who couldn't have even dreamed of it not so many years ago. Mass production of appliances, furnishings, tools, even houses has brought the cost of getting started down to a low figure. Both of these points will be even more true in the post war years. Home freezing equipment, for instance, which before the war was priced in hundreds of dollars will be priced in tens of dollars.*

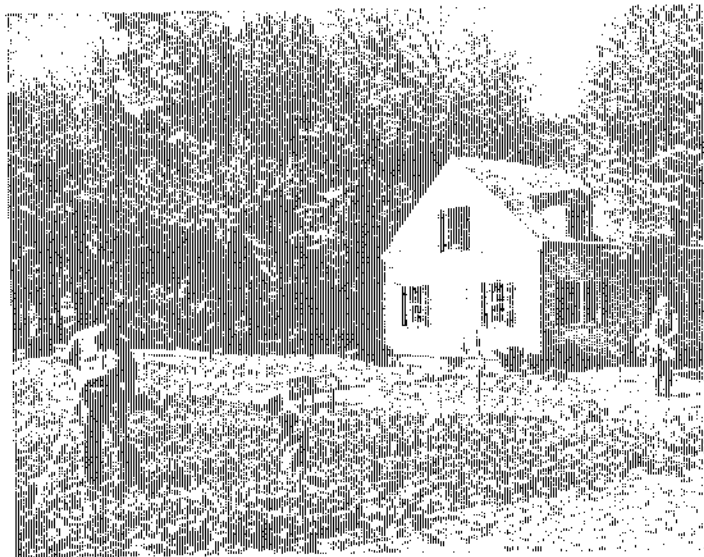

Even at 3½ our son Jackie likes to "help." Actually as yet, he isn't much help, but we try to encourage him. We want him to learn to do things — older children can be a real help on a homestead. And, more important, country living furnishes excellent opportunities for children to develop intelligent and responsible personalities.

Everything we tell you about in our Plan has been tried out by us personally, or by people we trust. We believe we can make it all work just as well as we've said it would. Of course, nobody can guarantee what results other people in other places will get. But I've made a sincere effort to give you honest and frank answers in the plainest language I know how to use.

And I hardly need to remind you that various parts of the country have differing climate and soil conditions. We are telling what we've been doing here in Connecticut (a fine state, by the way) and you will realize what allowances you must make for your own local conditions.

You don't have to spend as much on buildings as we did. We happen to think this a good investment, but are the first to admit that you can get along fine with less expensive buildings.

Building a small barn for your livestock, buying a couple of acres of land instead of simply a lot big enough to set a house on, or shelling out fifteen dollars for a pressure canner is different from the same amount of money spent on a trip to Florida or an expensive dinner and theatre party. Money invested in productive capital will bring you a great deal for a good long time to come.

We believe that many farm families, too, are going to raise more of their own food. They will forego some of their extreme specialization to develop a more rounded self-sufficiency.

If homesteading, as we mean it here, really does become a trend in the post war years, it can itself create vast business and employment opportunities. It can furnish a pattern, an idea, an objective for the city, highway and industrial planning we hear so much about these days. It can contribute greatly to continuing security for all.

A friend once said to me, "Ed, why do you bother with other people? Why don't you settle down and just enjoy your own job and your "Have-More" Homestead? Why try to spread it all over the country?" I may sound silly trying to tell you why. But I feel, somehow, that in the years to come the U. S. is going to need all the help it can get toward happiness and peace and security. We aren't always going to have a boom going on. I've got a boy and I want to see him grow up in a good country, and if ten or twenty million American families can get set as well as we Robinsons are I don't think anything can hurt this nation.

Do you see what I mean? That's why I've worked so hard putting this Plan together. That's why I was so careful to be truthful and sensible in everything we put in it.

Anyway, Carolyn and I think this is a darn good idea and we hope you think it is a good idea—so good you'll want to get some of your friends to buy a copy of this book too.

A Letter to Wives from Mrs. Robinson

Dear Friends:

If your husband reads this plan and then tries to talk you into doing something like it, you might say, "Poor Mrs. Robinson—I'll bet she has to do most of it and I wouldn't be in her shoes for anything." So I thought you might like to know where I stand on all this.

The cue to our success with the "Have-More" Plan is found in one common little word throughout these pages. Our editorial "we" means exactly that—it isn't used just for the sound effect. We have honestly worked together as a team on everything from our first seven hens to writing this Plan. Believe me, the marriage of a man and woman really means something when you start homesteading. Somehow, working close to the earth and with nature seems to make the combination of man and wife more important and, I believe, makes marriage a happier success than is possible in sterile city life.

Do I sound old fashioned? Let me explain that neither Mr. R. nor I came from farms originally. We married and lived in New York City for five years and I suppose we could have been described as city sophisticates. So what we have discovered as an exhilarating way of life comes from actually trying city life and country living and then choosing (intelligently, we think) the better.

Out here on our wee farm my husband really needs me and I, in turn, could not get along without him. When he calls out, "Quick, honey, bring me my bee veil! These bees are in a bad mood," he really does depend on me to help him out.

Mr. R. naturally does the heavy work in the garden and with the animals, while I take care of canning, freezing and household jobs. But!!! We both encroach on the other's job. Mr. R. canned at least 50 quarts of tomatoes and froze a couple of dozen packages of vegetables—all after he got home at night which isn't before 7 o'clock. He's nuts, you think? Maybe, but he says it's a pleasure after sitting at a desk all day. I, in turn, do necessary chores during the day and I usually milk the goats.

Ed always envies me getting in on all the exciting events here—it's I who watched the bees swarm (sad affair, but very interesting), I who greet the fuzzy day old chicks that are so adorable, I who had the great thrill of watching the goslings gradually emerge from their shells, and so on indefinitely. There's always something happening here. That's what made me decide the old idea is really true—if you want to be happy and stay young, keep growing things around you. When you



grow vegetables, flowers, chickens, pigs, geese, goats and a child all at the same time, how can you be bored?

But about the work—that's what's worrying you, I know. Yes, I do work hard, I suppose—at least, other women seem to be impressed. But I don't work any harder than I did when I was employed in an office and at the same time kept house as so many women do. One secret I have found is not trying to keep a spotless house—I have decided it's a waste of time. I guess our other secret is that what seems dull work to many people frequently is fun to us.

Now I don't claim we enjoy doing everything—for instance, picking chickens, washing too many greens at one time for canning, or cleaning out manure. But even these disagreeable jobs are not too bad when done together, and what satisfaction I get when they're done! Being a woman you can imagine my blessed feeling at knowing I have, to name just one item, 25 broilers in my freezer—ready to be cooked for my family or friends whenever I want them. We women probably place security for our families above everything else—so you wouldn't mind being in *my shoes*, would you, if you could say—"I could feed my family well without buying another thing for six months!"

I guess you may think by now that I am a very unsociable person but I like to play as well as anyone else. I get very fed up with it all occasionally. When that happens, I try to park our child and the chores with a neighbor and off I go to the city—the Robinsons don't begrudge Mom her day off, especially when it makes her so glad to get back.

There are certain basic facts about the work though—summer is obviously the busiest season while winter gives you loads of time for parties, dinners or whatnot. Except in the middle of summer we have weekend guests who like to play at farming and in the winter we have supper parties. Incidentally, I find it doesn't cost much to entertain guests since we started our "Have-More" Homestead, because we

always have surplus food on hand. Nature has worked out a swell scheme—by the very fact of winter she forces you to rest. Then when spring comes, you're refreshed and eager to start all over again.

And I think you'll make some new friends you'll like—without exception, the people we have met in connection with our animals have been tops. I don't know whether owning animals makes people nice or whether only swell people care for animals, but whichever it is, both Ed and I have thoroughly enjoyed the new friends we have made.

After you work on some of the "Have-More" projects, you may well find you are so interested you would like to expand one of them on your very own and develop it to "pin-money" size. I, for example, really adore the geese and next year I think I'll raise a fair-sized flock.

There's one more vital point in what the "Have-More" Plan means to me. That's Jack Robinson, our little son. I can't begin to tell you what our new way of life is doing for him. He loves all the animals and already at the age of four wants to help take care of them. And we let him to the best of his tiny ability. He is already an independent little thing, afraid of nothing. And need I say what has been written so many times before—by seeing and helping care for our animals he will naturally grow up knowing many facts of life (and I don't mean just sex, though that is included). Furthermore, he will have a basic understanding of what living is all about and what it means to earn his own bread. I believe it is frequently the country boys who have made good in America—anyhow, I sincerely believe we are giving Jackie the best opportunity in the world to learn everything from hammering a nail to developing an intelligent and responsible personality.

And what's more—he will have all the childhood fun for which country life is famous. From his standpoint alone all this is worthwhile.

As you can see, I can't even keep "we" out of my own letter to you. Your husband can't "Have-More" alone—he needs all your interest and help—but isn't that the way you want it? If you start the "Have-More" Plan I truly believe you'll find many intangible rewards for yourself and your entire family—for you'll all be working together, probably more so than ever before in your lives.

My very best wishes to you with your plan—I hope you'll get as much fun and deep satisfaction out of it as I.

Sincerely,
Carolyn Robinson

What Sort of Place Do You Have — or Want?

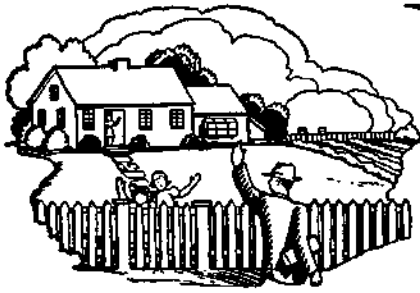

Country home for city worker



Part-time commercial farm



A business at home



A full-time commercial farm



A place to retire

WHEN we first wrote our "Have-More" Plan we thought of it simply as a way a family could raise a good deal of its food on an acre of land.

"A little land—a lot of living" was our idea. Imagine our surprise when we began getting letters such as these:

"Dear Ed and Carolyn,
"Your Plan is just what we've been looking for out here on our 2,200 acre cattle ranch. Why should we drive 40 miles for our groceries? We are putting in a big freezer and raising our meat, fruits, vegetables, etc. . ."

"Dear Carolyn and Ed:
We think your Plan is wonderful. Of course, we aren't interested in raising our own food, but we have bought two-and-a-half acres so that our two children, Emily, 4 and Johnnie, 2½, can have a nice yard to play in. Keep up the good work. We are recommending your Plan to lots of our friends."

From many letters we saw that, in reality, our Plan is basic to five different patterns of country living:

1) **Country Home for City Workers:** In this set-up a family's main income comes from a "full-time" job. The land that this family can use productively is limited to what can be cared for in "spare time". However, with only an acre and an hour's spare time a day it is surprising how much of its food a family can produce, how many improve-

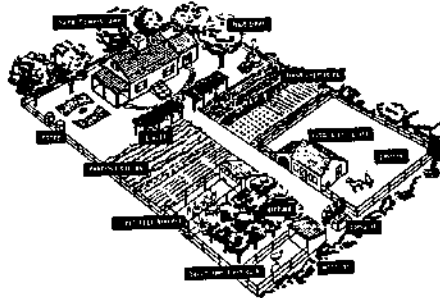

The "Have-More Plan" is basic for all

ments it can make, how much repairing and maintenance it can do. In fact, with proper instruction a willing family can make an acre home in the country productive enough to pay for itself. More important than any economic considerations, however, are the wholesome aspects—a country home gives a family a chance to work together creatively outdoors in the fresh air and sunshine. As the length of the work week shortens and city workers have more time to themselves, home ownership on an acre or so is going to become even more popular.

2) **A Part-Time Commercial Farm:** The distinction between a "Country Home for City Workers" and a "Part-time Commercial Farm" is a difference of degree. But because a Part-time Farm generally requires a good deal more than one to three acres of land, the distinction is important. Inasmuch as the Part-time Farmer will raise some crops for cash, the whole subject of what to raise becomes complicated by the necessity of considering a market. Generally, "part-time" is associated with hobby farming or "subsistence" farming—but thousands of part-time farmers, particularly truck gardeners, nurserymen, and even turkey raisers, farm during the growing season and work in industry during the winter and do well. The most profitable crops for the part-time or small farmer are those produced for home use.

3) **A Business in the Country:** Great opportunity lies in the "rural service field." Recently, the *N. Y. Times* said:

"The tremendous scope of the rural-service field is visualized by few. In the years ahead it is certain to include more frozen-food community locker plants, rural electrification, custom work with power machinery for farmers who prefer to hire instead of own, repair shops for farm machinery, expanded telephone service, scientific soil conservation, modern forestry and refrigeration. There will be opportunities for roadside stand sale of products bought from farmers who live some distance from main roads.

"It seems evident that we are ready for a great expansion toward higher standards of country living. It does not mean more farmers. It does mean many more part-time country homes on the roads radiating from cities and large towns."

Next time you're riding through the country, notice the many signs along the road put up by people operating little businesses of their own. It's just as though a classified telephone directory had come to life. Most of these people, whether business or professional men, own a home with considerable land around it. Very often they have a garden, fruit, berries, chickens, other livestock.

4) **A Full Time Commercial Farm:** Farmers realize farming can be more than a business—it can be a way of life. A farmer who raises only tobacco is no more secure than the man who runs the corner cigar store. But the tobacco farmer, having gone through food rationing, is now apt to be keeping a cow, a couple of pigs, poultry and a large garden. The Department of Agriculture has found that the indigent farmer was the "one-crop" specialist operating on the theory of raising everything to sell and buying all his groceries, meat, milk, and vegetables, just as though he were a city dweller. Today, most farmers know that it is not cheaper to buy their family's food. In the corn belt, points out Rt. Rev. Ligutti, a year's supply of vegetables would cost approximately \$260 for a family of five. In order for the corn belt farmer to earn \$260 cash, he must spend 520 hours working 50 acres of land and produce 2,000 bushels of corn when corn sells at 50 cents a bushel. A vegetable garden only 50 x 100 feet, with \$1.25 spent for seeds plus 50 hours of field work and 25 hours of canning will produce \$312 worth of vegetables. Which is better off—the man who raises corn to buy vegetables—or the man who raises his own vegetables?

5) **A Place to Retire:** Social Security, retirement income insurance, civil service, Army, Navy and the many pension plans of industry mean millions today can look forward to a regular income in later years. The man who will put his spare time in developing a productive country home can retire years sooner. With no rent to pay, with land and the ability to make it produce the family's food, a man can live in grand style on a small pension or other steady income.

The "Have-More" Plan is basic to each of these five ways of country living. Expressed in terms of a "platform," the "Have-More" Plan calls for:

- 1) A source of cash income.
- 2) Home ownership on at least an acre of land.
- 3) A family willingness to use a good part of its spare-time productively and creatively.

Before you dash off to the country and buy a place, consider carefully what sort of country home you want.

Setting Up a Homestead

AN old farmer struck it rich in oil and his family persuaded him to buy a \$4,000 automobile. Never having had anything better than a second-hand Model T, the old boy insisted on only one thing for the new car—the most colossal and expensive set of bumpers he could find!

I wish we'd had some good bumpers when we decided to move to the country. We bumped our noses on land, on the layout of our house, on the location of our barn, fruit trees, and pasture—on nearly everything a family could blunder at. I hope you'll profit by our mistakes!

Setting up a productive country home is probably the biggest and most important job any of us attempt during our lifetime. Despite all of the people who have needed some basic data on setting up a homestead, no one had completely worked the methods out and put them on paper. Every new family has been left to stumble its own way toward the answers.

Not long after our first edition of the "Have-More" Plan went out we began to get letters asking for help in laying out a place. Of course, we couldn't give specific advice without seeing each piece of property; and then, people have different ideas of what they want to do with their place.

Even though no one layout will fit everybody's ideas and site, there are certain basic points that ought not to be violated.

For example, where should you locate your house in relation to the highway? (If you do this right you can probably get the town snow plow to do your snow shovelling for coffee and doughnuts.) Where should your barn be placed with reference to the house? Toward what compass points should house and barn face?

What are the best locations for garden, orchard, pasture, hayfield? In placing fruit trees how much space should be allowed for them to mature without crowding? How can fencing and gates be placed for easy pasture rotation and so livestock can always get water without your having to carry it?

In planning the house itself, how can

you start small and yet make additions through the years so that the finally completed homestead is attractive and efficient for country living?

If you plan your place correctly from the beginning, you will save countless steps in the years to come. You can actually cut your chore time in half. One minute saved twice a day on chores equals 12 hours a year!

Have a Plan

Before you lay out your place you ought to be able to answer all the above points and more too. Even if you're buying a country house that's already built you should have a definite plan for refitting the house and land to your use. Over and over I've seen city people buy a farm, remodel the house but let the land go to rack and ruin. Even if you can't use all the land you've bought, you should learn enough about land management so you can rent your unused land to a neighbor and see that he keeps it in a good state. Idle land deteriorates just as fast as an idle house.

When we moved to the country about the only layout we could find to help us was the diagram below. Even though it shows so little detail as to be of questionable help to the novice, it has two major faults. The combination barn and poultry house should be located where the berry patch is—this will be painfully evident to anyone who has had to carry 100 pound sacks of grain and 150 pound bales of hay from the end of the proposed driveway 90 feet or so to the barn. The second questionable point is that far too many trees are shown in the orchard—a family couldn't possibly eat all the apples, peaches, pears, and cherries which would total about 75 bushels when these trees were mature. Of course,

you might sell the surplus, but it is difficult to make a small part-time orchard pay.

Some Mistakes We Made

At the top of the next page is a sketch of our homestead. The things wrong with it are errors that any novice is apt to make and if we tell you about them you ought to avoid making them. First, although very pretty, there is too much lawn. Our house sits 90 feet back from the road and the front and back lawn take a good hour to mow each week. Second, our small barn is too close to our neighbor's property; there is no room for a poultry run in back of the barn—in front is our backyard play area. Third, our quarter-acre hayfield isn't large enough. Fourth, there are too many trees in our pasture—good pasture grass needs sunlight. Fifth, originally our house sat right in the middle of a woods. We believed this the best way to have trees around the house, believing it would be easy enough to clear land for garden, pasture, and crops while "only God could make a tree". However, we found it is cheaper to build your homestead on clear land and plant a couple of big trees.

Our total acreage is only about 2½. Three to five acres would give us enough pasture for our livestock and enough hay we could then depend on our place to supply us with over 75% of all our food requirements and a high percentage of the roughage and grains needed to feed our livestock.

An "Ideal" Layout

At the bottom of page 8 is a cut of an "ideal" layout for a productive country home. The drawing is available in full-

Shown below is a suggested layout for a 4 acre homestead. To the original 2 acre house plot, 2 additional acres are attached to rear. These 4 acres of good land would not only provide the family vegetables, fruit and berries but more than enough pasture and hay for two or three milk goats or pasture for a cow and a good part of a cow's hay requirements. There is also room for a pig or two plus other livestock.

On the front cover is a suggested layout for a 2 acre homestead, and on page 28 is shown a suggested layout for a half-acre.

We emphasize that these are only suggested layouts. Each family will have its own ideas on just how to manage their own particular place.

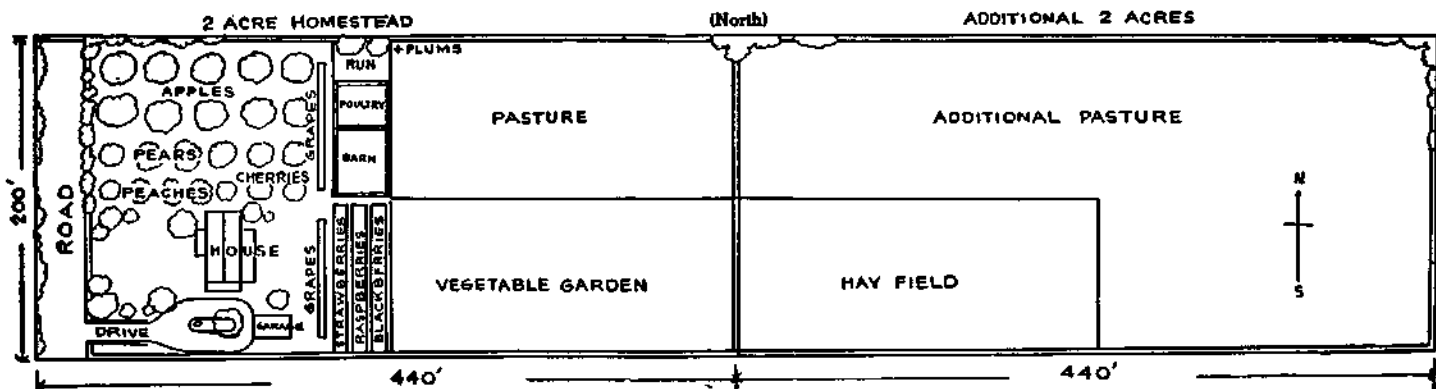

size (about as large as the top of a bridge table). Two experts helped with this "ideal" homestead plan: Milton Wend, author of *How to Live in the Country Without Farming* and John H. Whitney, R.A., an architect who specializes in designing country homes.

About 40 pages of description accompany this excellent plan; all the details can't be given here, but I'd like to point out that this basic plan of the "homestead area" (the country house, garden, barn, orchard, lawn, pastures, etc.) is a good point of departure if you're interested in any of the five productive homes described on page 6.

For example, suppose you want only an acre place in the country where you can have a lovely home, a garden, some dwarf fruit trees, and maybe some chickens. An acre is more than enough room; an acre, remember, is 209 feet by 209 feet. The portion of the ideal layout shown in the lower left-hand corner of this page is just over an acre. You'll notice that this "basic acre" includes a large house, an orchard of standard trees, barn and barnyard, a good-sized garden, flower gardens, lawns, driveways, and even some pasture and hayfield. The pasture and hayfield are not shown complete—the wavy line at the top of the cut indicates that these are only partially shown.

A Larger Place?

If you wanted a larger place, a part-time farm where you could, if necessary, grow 75% of the family's food, then you'd want more pasture space and hayfield. But the basic acre is still an excellent layout.

Then again, if you wanted to carry on a business at home, the office and "shop" to the left of the living room could be built. Naturally, this could be as small or as large as needed for your business.

If you want a commercial farm, then this same homestead acre is a good layout. You'd still want a kitchen garden for home use even if you were growing tobacco, or flowers, or fruit; if you

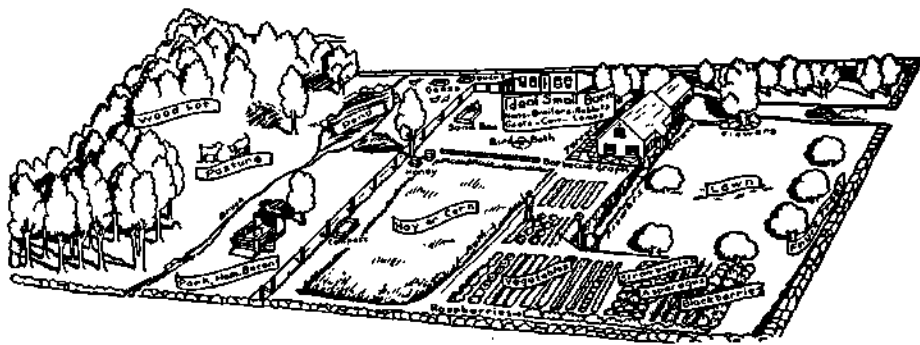

Here's a sketch of our homestead.

were running a commercial dairy or a poultry business then you'd drop your goats or cow out of the small barn, but might well have the rest of the items. Naturally, on a commercial farm you'd add to the basic acre as much land as you needed.

As a place to retire you might want an acre, or enough for a part-time farm.

Basic Acre Most Important

You can see that this basic acre is the key to a productive country home. Even though the house may not suit you, or the exact location of the items may be impossible to achieve, due to the fact that you are remodeling an existing place, or even because you want your place laid out differently, I think you'll find that this "ideal layout" makes a good point of departure. It does indicate basic principles that ought to be kept in mind.

For example:

- 1.) Every bit of land should be used advantageously.
- 2.) Garden rows should be of good length for easy cultivation; and run North and South for equal sunlight.
- 3.) Pasture should be fenced into plots for rotation.
Pasture gates should be wide

enough for entry for haying and plowing equipment.

- 4.) Vegetable garden should be handy to kitchen.
- 5.) Lawn and shrubbery arranged attractively, yet easily cared for.
- 6.) Child's play area screened from street and located so it can be watched from the house.
- 7.) Compost heap should be placed between barn and garden.
- 8.) Trees should be spaced so as not to be crowded at maturity.
- 9.) Shower, bath, dressing room should be accessible from outside.
- 10.) Barn should be to lee of house; close enough to make supervision of livestock easy.
- 11.) Adequate closet and storage space in house.
- 12.) Space for good home workshop.
- 13.) Housing for garden tools, wheelbarrow, lawnmower, small tractor.
- 14.) A cold storage room for vegetables and canned goods.
- 15.) Fencing so arranged that livestock may be turned loose from the barn.
- 17.) Space for home freezer, laundry, fireplace wood.
- 18.) Orchard should not shade garden.

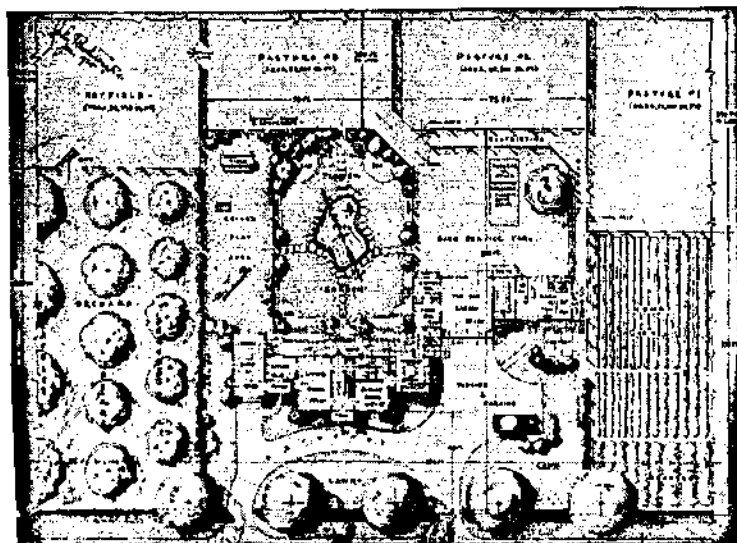

If you're thinking of having a place of your own — or you want to lay your present place out more efficiently — send for "Layout for a Productive Homestead" from which this small reproduction was made.

This will give you an idea of some of the things that you ought to think about when planning a homestead.

Houses Especially Designed For Country Living

TODAY practically all houses are designed for suburban living—not country living. A suburban house is simply an expanded apartment. No provision is made for the more productive kind of life you can live in the country.

For instance, if you have a garden or chickens or fruit trees, and most certainly if you are going to have livestock, you'll find that the small kitchen of the suburban house is totally inadequate. If you're going to have a laundry or you want to start your seedlings indoors or you plan on a quick freezer, you'll find no provision for these in the usual suburban house.

The fundamental differences between the ordinary suburban house and a house that's really satisfactory for productive country living or a small farming operation is illustrated in the three floor plans at the right.

The smaller the house the more difficult it is to provide space for homestead activities. Thus we asked John Whitney, R.A., an architect who specializes in country houses, to take a good small suburban house and show how approximately the same floor area might be laid out in a productive country home.

Note these plans are about minimum—one story, four rooms, with heater space instead of a basement. Ordinarily if 10% of a house is "waste space" (hall area), the plan is considered satisfactory. Hall area in these plans is only 2%!

PLAN A: (705 sq. ft.) Here is an efficient suburban house well planned for that type of living. Note that the kitchen is the small apartment house type. Living room is large.

PLAN B: (705 sq. ft.) This is the same basic plan as "A" achieved by turning "A" up-side-down and reversing it. (Dotted lines show eliminations.) The living-room becomes a "Harvest Kitchen" with heater space, chimney, and bedroom closet off one end thereby eliminating two small closets in larger bedroom and gaining 8 square feet of valuable wall area for dining in the enlarged kitchen. Heat and chimney area of Plan "A" becomes smaller sitting-room. By reversing living-room and kitchen in most suburban house plans you have a better country layout.

PLAN C: (753 sq. ft.) This is an ideal small homestead. By adding 48 square feet, 76 square feet are gained for the "Harvest Kitchen." Here is room for all food preserving activities plus laundry. The living room is 182 square feet compared with 181.5 square feet in Plan "A". Bedrooms are same size in both "A" and "C". By changing the corner closets in Plan "A" there is an additional gain of 8 square feet plus wall space.

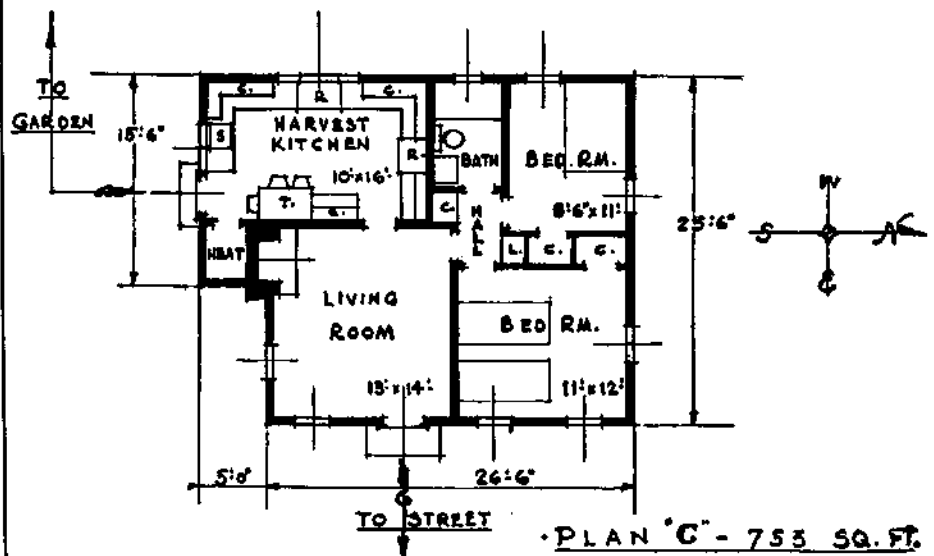
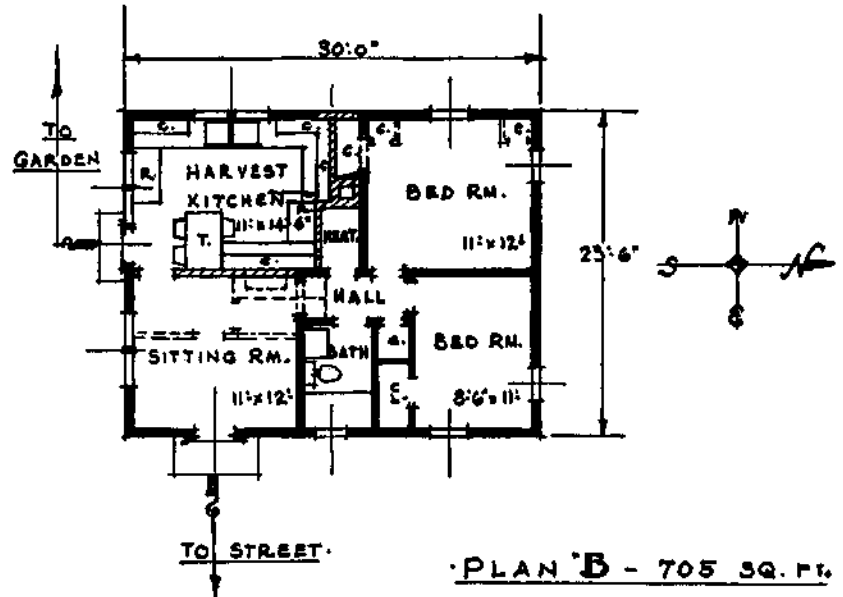
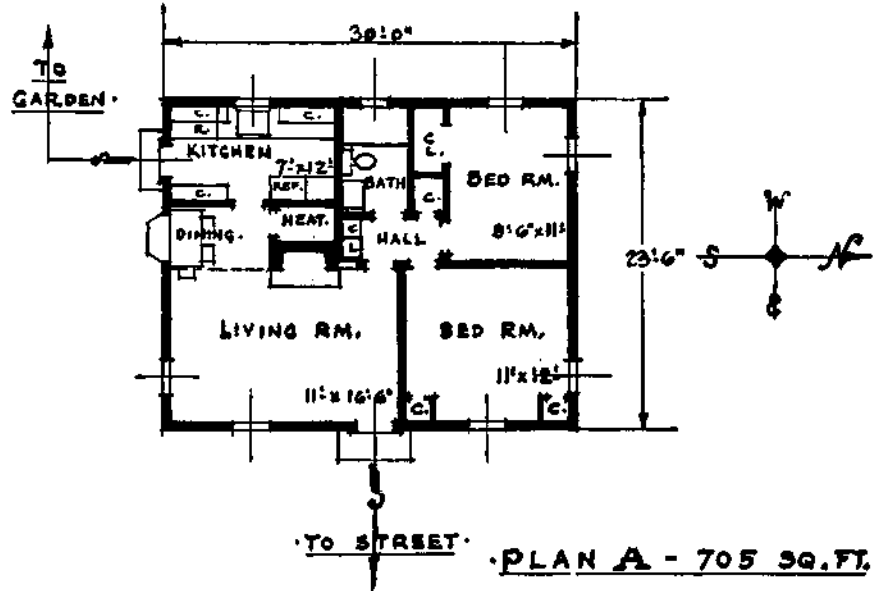

Plan a "Harvest Kitchen" With Your Wife

NOT long after Ed and I moved into our country house I began to realize my department was going to be overcrowded.

One look at our big quick freezer, the cream separator, the honey extractor, the pressure canner—and another look at our small kitchen and we were somehow reminded of trying to get a grand piano into a phone booth!

You see, when you begin to grow a good part of your food you need a "factory" to process it and preserve it. And you just live differently. The ordinary kitchen-dining room combination of the conventional house simply doesn't fit.

What you need is a streamlined, modern little food-conserving set-up, combined with the charm and warmth of Grandmother's kitchen.

We went to John Whitney, an architect who specializes in country houses, with our idea. Together we planned out every detail of food preservation, preparation and serving, added such things as the greenhouse window (for winter herbs, flowers, and spring plant starting), a desk and record-keeping corner and a rocking chair corner for relaxation, darning and sewing and general coziness.

And now we have our "Harvest Kitchen." It has turned out lovelier and more practical than our fondest dreams. Believe me, if you want to make cooking, canning and freezing a joy for your wife build her a "Harvest Kitchen!"

You can add it to any house; you can put it into *new-house* plans; sometimes you can convert your present dining room and kitchen into this needed "Harvest Room" or "Harvest Kitchen" as we call it.

In our "Harvest Kitchen" (see pictures at right) we have such features as a greenhouse window, special milk-handling and cooling equipment, quick-freezer cabinet, hardwood chopping block for meat and poultry dressing, vegetable-cleaning sink, glass-enclosed preserved and canned food compartments, garbage-handling arrangement, dry food storage space, cooking, canning and work space, etc.

Isn't it astounding that such a room has never been designed, not even for a *farmhouse*?

We can't begin to give you all the important details, plans and so forth, but if you're interested in building a country house or remodeling your present one, you can write for our complete portfolio giving full information plus plans drawn up by John Whitney, the architect.



OUR HOUSE: This snapshot shows our house which is the so-called "Cape Cod" style. We found that the ordinary-size kitchen cramped our canning, freezing, and cooking so we planned the addition of an up-to-date version of the old "summer kitchen."



OUR HOMESTEAD: Another snapshot six months later showing how our suburban house has been turned into a homestead by adding a "Harvest-Room." The garage was remodeled—note the greenhouse window. Also, we improved the front entrance and added picket fence at left.



Here is one end of a special room every "Have-More" home needs very, very much. The big, roomy old farm kitchen was its "ancestor"—yet it is completely new in design and conception. We call it the "Harvest Kitchen."



This architect's sketch from PLAN FOR A HARVEST-KITCHEN is one of six showing various ways a "Harvest-Room" may be added to an existing house or planned for if you are building a new house.

Finding a Suitable Place

MAYBE you already have a place of at least $\frac{3}{4}$ of an acre of level, good land. So much the better, but read this section carefully to make sure your land is suitable for intensive cultivation.

I am going to suppose you live in the city—own no land—and know nothing about finding a suitable place in the country.

Here's how you start. Get a good map of your locality. Take a compass and using your place of work as a center point, make a circle the radius of which should be approximately the distance you can travel in one hour.

If you own a car, this radius could well be 25 miles. This 25 mile radius will enclose a territory of 1,962 square miles (an area about equal in size to the whole state of Delaware). If you expect to travel by bus, street car or subway to your job, the radius would be shorter.

Next study the encircled area. Is there any particular part of it in which you would especially like to live? Have you friends in some part? If so—talk to them about finding a place.

The most important single step in the "Have-More" Plan is selecting a suitable place. If there is any question in your mind as to whether you will enjoy owning your own home—raising your own food or living in the country—or any other doubts—rent in the community you select before you buy. Remember, you are choosing a place to make a permanent home—you are not simply leasing an apartment for another year.

The very fact that this first step is so important and difficult is a good thing because if you haven't enough gumption to go out and find yourself a place—then you probably would never

make it amount to anything even if a rich Uncle left you the place in his will.

One reason so many city dwellers continue to go on paying rent and living the restricted life people lead in an apartment seems to be because they don't know how to go about finding and developing a place of their own. Another obstacle is the mistaken belief that they can't afford a country place of their own.

Deal With A Good Real Estate Man

Many people who go to a doctor when they are sick, a dentist when they've got a toothache, balk at going to a real estate man to buy property. Somehow they figure they can find a bargain in real estate themselves if no real estate man enters the picture. Of course, a real estate man is in the business of selling real estate—and he is going to sell everybody he can. But most people who get stuck by a real estate man let him sell them something he wants to sell. They don't tell him exactly what they want—and make him find it for them.

We have prepared a "score-card" which you will find helpful in talking with a real estate man. This "score-card" is a guide to the qualifications a place in the country should ideally have in order for you to utilize it successfully in accordance with the "Have-More" Plan. Of course, you may not find a place that has everything you want, but with your own good judgment and careful consideration you can pick the best suited available place in your chosen locality.

Take this "score-card" with you when you talk to any real estate man.

It will save you time in telling him what you want. It will save you fruitless hours of riding from one piece of property to another only to be disappointed because it is not suitable. But most important, it may save you hundreds of dollars and years of work by protecting you from buying a place that you later find impossible to make productive.

When you are buying property it costs nothing to deal with a real estate man. He gets a commission, usually 5% of the sale price, from the seller. Every real estate man has a number of houses with land listed. This same property may also be listed by other real estate agents. So you can see how competition tends to keep the prices on property in line. Usually, it is the best practice for you to talk to a number of real estate agents. Then, you can do business with the agent you like.

A Word of Caution: If you can, rent a place with an option to buy it at a definite price at the end of a certain time—for example, a year—do this if there is any doubt in your mind about the place and the community.

Land More Important Than House

A good farmer in buying a new farm gives primary consideration to the land—the state it's in . . . whether it's easy to cultivate—neither dry nor wet, nor too sandy, nor too shallow. This you should also do.

We are approaching a wonderful new era of home-building. Shortly houses the like of which we have never seen will become available at low cost. Nobody knows just when these houses will be ready—but authorities agree they are coming. Remember this—and consider seriously buying your land now and getting the land in the condition you want it. Perhaps the house on it—even if it's "just a shack"—can be made livable for the present.

Should you plan to build your own house or buy land with a house on it? This question you can decide for yourself. If you find a suitable piece of land—I mean suitable because of size, condition, levelness, closeness to work—and it has a good substantial house on it that you like then buy it. But if you can't find on one place both a satisfactory house and satisfactory land—take the place where the land is right. You can always build a house—but some land is almost impossible to make fertile.

How Much Money Do You Need?

If you plan to rent a place before you buy—then you can find a house and

Points to check in buying a house (From F. H. A.)

1. Exterior trim.
2. Attic ventilation, attic room.
3. Flashings.
4. Chimney masonry, cap, etc.
5. Roof.
6. Rafters, studding.
7. Roof sheathing.
8. Dormers.
9. Weather-stripping.
10. Lath.
11. Garage—tool space, workshop, etc.
12. Walks and drives.
13. Exterior walls.
14. Sheathing and insulation.
15. Window frames and sash.
16. Blinds, shutters.
17. Porch—beach, transom, door columns, etc.
18. Steps—brick, wood, concrete, tile, etc.
19. Drain tile.
20. Footing.
21. Foundation walls.

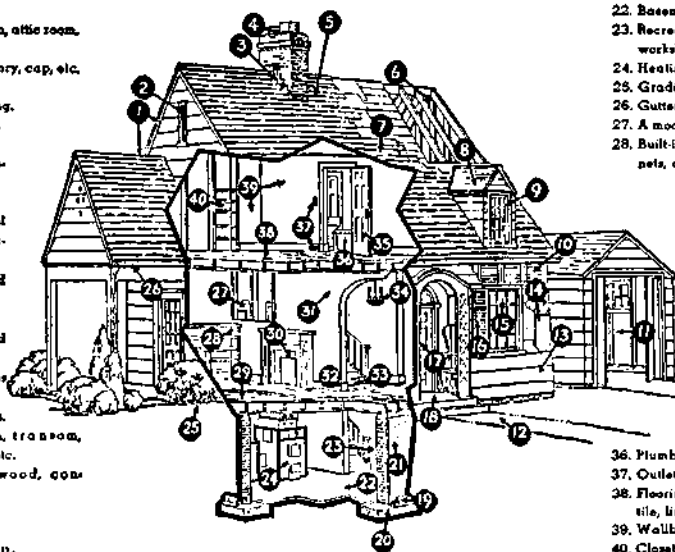

22. Basement floor.
23. Recreation room, laundry, workshop, etc.
24. Heating plant.
25. Grading and landscaping.
26. Gutters, downspouts.
27. A modern kitchen.
28. Built-in bookshelves, cabinets, cupboards, etc.
29. Joists and sub-flooring.
30. Fireplace, mantel, flue.
31. Paint, wall-paper, interior decoration.
32. Interior trim.
33. Stairways—treads, rails, balusters, etc.
34. Electric fixtures.
35. Doors, hardware.
36. Plumbing and fixtures.
37. Outlets and wiring.
38. Flooring—finished lumber, tile, linoleum, etc.
39. Wallboard, plaster, etc.
40. Closet space, shelves, etc.

land for what you are now paying. Specifically, you can rent a satisfactory place for \$15 a month or go as high as \$100, depending on section of country.

If you plan to buy you will find the price of suitable land ranges from \$100 to \$1500 an acre. The larger the piece—the less cost per acre. If you want to buy the land only, this is all right if you are now living close enough to go to it regularly and start getting it in shape.

You can buy land by putting up a cash payment of as little as 30%. Even if your land has no house you perhaps are living close enough to have a garden. The money you don't have to spend on vegetables can then help you pay for the land. Or go get a bank to pay the owner outright and take a mortgage for the balance. If a bank won't give you a mortgage on the land, be careful. There might be something wrong with the land, its location or price.

Perhaps you can buy land with a house on it. You can then put your rent money into paying for the property. Also, a house on the land means you can start immediately making the land pay for itself because if you live there you will be able to put more time into getting your "Have-More" Plan under way.

You may be surprised at this, but 44% of all Americans own their own homes. This the government encourages by sponsoring the Federal Housing Authority (F.H.A.).

F.H.A. makes it possible to buy or build a beautiful modern home and pay for it out of a moderate income.

For example—a small home:

Suppose land and buildings are worth	\$2650.00
Of which the value of land is	150.00
Your down payment would be	150.00
Your F.H.A. loan would be	2500.00
Your monthly payment including principal and financing charges (taxes and fire insurance a couple of dollars extra)	\$ 20.90
At the end of 180 months your F.H.A. loan is completely off . . . you own your home and land.	

For a more expensive home:

Appraised value of property	\$7500.00
Total down payment	900.00
F.H.A. mortgage	6600.00
Average monthly payment over 20-year period (including principal, interest, mortgage insurance)	\$ 43.38

The purchase, or building, of your house will probably be the biggest single financial transaction you will ever undertake. Only if you have a super-abundance of funds can you afford to experiment. Few people have the technical knowledge to tell the difference between a well-built house and a poorly built structure. As the F.H.A. points out:

The very elements which make the proposed loan a 'good risk' to the lender and to F.H.A. are the same elements which assure the borrower of a sound investment, good construction, livability, and comfort in his new home.

A Little House Can Grow Into A Homestead



1. Here's a pay-as-you-go house that starts small and can grow step-by-step. In fact, maybe you can pay for additions out of savings made by raising your family's food.



2. Added to the main section is a nice garage and root cellar . . . garage should be deep enough to provide space for a workbench in rear and garden tools.



3. A dining room, or better yet, a "Harvest Kitchen," has been added. The house now becomes a real homestead.



4. Finally, another bedroom (at right) is built. The so-called Cape Cod style lends itself particularly well to growth.

"Score-Card" of What To Look For In a "Have-More" Homestead

I. LOCATION

Owner's or Broker's Name and Address:

.....

Distance to your job ... Commutation Expense

Time Condition of Roads in winter

In spring Distance to: schools (school bus) to church to town Telephone Available ... Electricity ... Mail Del. ... Express ...

II. WATER SUPPLY

Town water..Artesian well..Shallow well..Spring..

If other than town water have tested by State Health Dept. (free). Be sure you have a minimum of 2-3 gallon flow per minute *even in dry season.*

III. SEWAGE DISPOSAL

Municipal septic tank cess pool

IV. LAND

Total Land Available

Should be at least $\frac{3}{4}$ acre of good, level land. Total of 2 to 5 acres to include orchard, pasture, hay field, and land to grow some stock feed.

Size of GardenDepth of Soil

For family of five should eventually be 100 x 150. Dig holes several places. Top soil should be 7" deep; 12" is better. Important: if top soil only 6" or 7" subsoil should then not be hardpan or deep gravel.

Pasture

$\frac{1}{2}$ to 1 acre for goats; 1 to 2 acres for cow.

Hayfield

Not necessary—but will save you buying hay. 1 to 2 acres for 2 sheep; 2 acres for steer. $\frac{1}{4}$ to $\frac{1}{2}$ acre for goats; 2 acres for cow.

Land for grain crops

Part time farmer probably won't have time for grain. Additional 4-12 acres necessary to grow all livestock grain.

Woodlot

Enough for fireplace—fenceposts, etc.

Lay of land

At least $\frac{3}{4}$ acre level; also hayfield level—pasture, woodland need not be level.

Natural Fertility

Observe present garden, vegetation, etc. Watch out for poor drainage, too sandy or too much clay, too many large stones.

V. OUT BUILDINGS

Garage Tool House Workroom Barn

Poultry House and/or Barn

Barn for dairy, rabbits and poultry ideally should contain a minimum of 500 sq. ft. floor area.

VI. HOUSE (see diagram page 11).

VII. ORCHARD

Apple Peach Cherry

Plum Grape Raspberries

Strawberries Blackberries Blueberries

Currants Asparagus Rhubarb

An established orchard in good condition is worth money. For a family of 5 this should contain: 5 apple, 3 pear, 5 peach, 3 cherry, 2 plum trees, 10 grape vines. . . Small fruits: 50 raspberries, 100 strawberries, etc. (See pages 26-29).

VIII. OTHER

Shade trees

Fencing

(Good fencing is worth considerable)

Length of growing season

(Should be 120 days from frost to frost)

Neighborhood ... Land values going up or down ...

Kind of Neighbors

Possibility of disposal Selling Renting

Extra land available

Desirable place to retire to

Other people in neighborhood raising family food.....

Note tax rate Delinquencies in town

Is title sound Have lawyer search title

Any zoning restrictions against raising livestock, etc....

Asking price

How long property owned by seller

Assessed value

Insured value

What price did owner pay

(Sometimes you can get an idea by inquiring at the town recorder's office)

Why does he want to sell

Is there a mortgage\$.....

Down payment needed\$.....

Estimated cost to repair\$.....

WATER . . . SANITATION . . . ELECTRICITY . . . ROADS

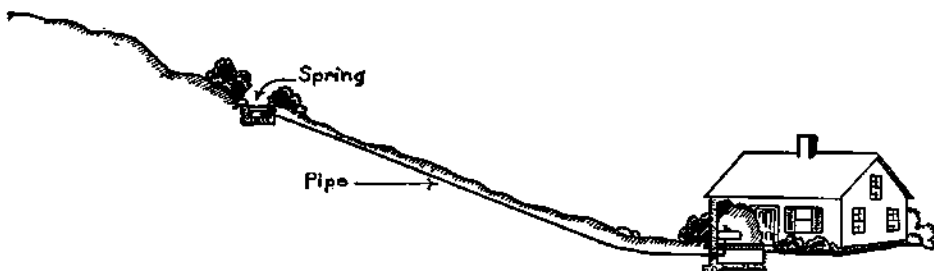

A **SPRING** is simply an opening where water flows out of the ground. It may be located at the bottom of a pond or lake. If you have a good spring near your house you may be saved the expense of digging a well. And if the spring is located on a high enough level you may be able to use a gravity system instead of a pump.

WHEN we bought our house in the country the water, sewage, electricity, and driveway were supposedly all finished. They looked all right to us. But we've had to spend additional money on all four.

Our main expense was the need to rebuild our sewage system—the builder had installed a minimum amount of drainage pipe and no siphon discharge system. We've also piped water to our barn and to our concrete pig pen. It was an easy job to wire our barn with electricity.

We've had to add more fill and build an edging to our driveway. In short, we've found that knowing a little about country water supply, sewage, electricity, and road building is most worthwhile.

If you are used to city water service, you probably think it means an awful lot of expense and trouble to have your own rural water supply. The expense of digging a well is uncertain because you can't be absolutely sure how deep you will have to go. Still there are a lot of people living within 100 feet of a town water main who find it is less expensive to dig their own wells than to buy water from the city. One man I know, who is now building a house in town, has discovered that installing city water will cost him about \$300. On top of this he will have to pay a water bill of about \$25.00 a year. He figured up this bill for a period of ten

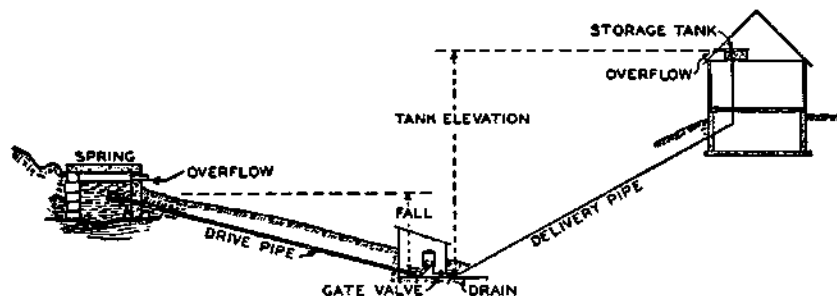

A **RAM** is really a sort of pump but it requires no electricity or gasoline and has no moving parts and is completely automatic. The water virtually pumps itself. There must be at least a 20 inch fall of water between the source and the ram. Under these conditions the ram will pump water to a much higher level, as high as 20 feet.

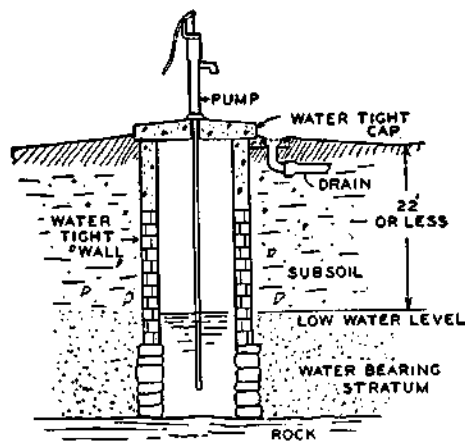

A **DUG WELL** is the kind that is actually dug with hand digging tools. This is the old fashioned type of well you see on many farms today. Wells are not dug by hand so often nowadays as they used to be because it is frequently easier to get a well driven or drilled. Another reason is that the dug well is more easily contaminated by seepage through the walls or from above. On the other hand, this type of well if properly constructed can be kept entirely pure and provide plentiful quantities of water for generations. If you're thinking of digging a well yourself, you'll want to learn more about this kind of well.

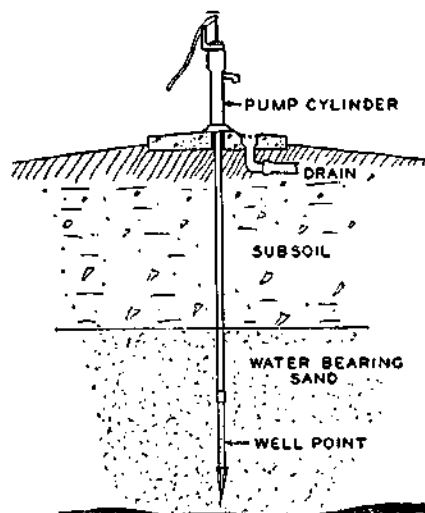

A **DRIVEN WELL** is made by driving into the ground a simple pipe fitted with a well point. It may be either a deep or shallow well, depending on how deep you go to get a satisfactory flow of water. If your soil is suitable for this type of well it is something worth investigating for it usually costs less than drilling a well or digging one. It is not generally considered as reliable as an Artesian well (which produces a steady flow of water), but in some sections it is quite satisfactory. You need a good sized storage tank and you should know what to do if the well points become clogged.

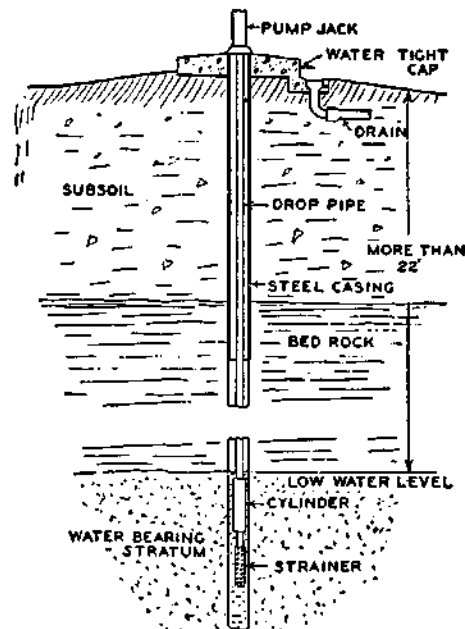

A **DRILLED WELL** is made by drilling a hole into the ground 4 to 8 inches in diameter with special well-drilling equipment. The upper part of this well is lined with a steel casing which protects it from contamination. If you think you will have to go down deep to get water, you should learn more about drilled wells. Also you will need to investigate deep and shallow well pumps. The cost of a shallow well pump is much less and can be used with a good Artesian well when you don't have to pump water up from over 22 feet.

LOCATING THE RURAL WATER SUPPLY

years (\$250) and added it to the \$300 he would pay for installing the city water, getting a total of \$550. When he compared this cost with that of drilling a good Artesian well 100 feet deep and putting in his own electric shallow well pumping system, he found that the city water over a 10 year period would cost him \$50 more . . . And in 20 years this city water would cost \$260 more. In 30 years he could install an entire new pump and tank and still beat the cost of city water for this period by \$400!

Here is a comparison of costs:

YOUR OWN WATER SYSTEM

Low Estimate

Drilling 50 ft. well (@ \$3.50 per foot)	\$175
120 gallon tank	40
Labor	25
Shallow Water Pump	45
Upkeep for 10 years	30
	<hr/>
	\$315

High Estimate

Drilling 300 ft. well	\$1,050
150 gallon tank	50
Labor	50
Deep Water Pump	150
Upkeep for 10 years	50
	<hr/>
	\$1,350

CITY WATER SYSTEM

Installation	\$300
Water bill for 10 yrs.	250
	<hr/>
	\$550

As you can see, your well may cost you anywhere between \$175 and \$1,050. About the only way to predict this cost is to find out how deep your neighbors had to dig their wells. Unless there is something unusual about your situation, you will probably have to go to the same depth. Be sure to have your well water tested for purity. The Health Department will make this test free in most states.

We've discussed a few of the many ways you can obtain water in the country. There's probably one combination just right for your circumstances.

Sewage Disposal

If you don't have city sewage disposal there are three practical solutions to your sewage problem: a cesspool, a septic tank, or a septic tank with a siphon discharge system.

Maybe you can use a cesspool, but on a long term basis you should consider spending a little more money and getting a septic tank.

After we bought our place, we discovered that our septic tank didn't have a siphon discharge system. This caused fouling of the ground near the tank. We had to dig up the whole system and found a siphon discharge tank was needed. The siphon discharge method distributes the sewage more forcefully so it spreads over a much wider ground area. Sometimes you can get by without the siphon discharge feature in a vacation home.

Electricity

If your house has never been sup-

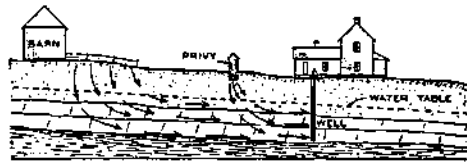

BAD—This well is located too near the barn and sewage disposal system. Sewage seeps into the well or drains directly into ground water the well uses.



GOOD—This well is located where it is not likely to be polluted by the sewage disposal system or livestock in the barn. Cesspool is over 100 feet from the well.

Here is a simple septic system with only one tank and a tile drainage field. Inside the septic tank are anaerobic bacteria which decompose a part of the solids into liquids and gasses. Incidentally these bacteria are killed by pouring strong disinfectants and mouth washes down the drain in your house.

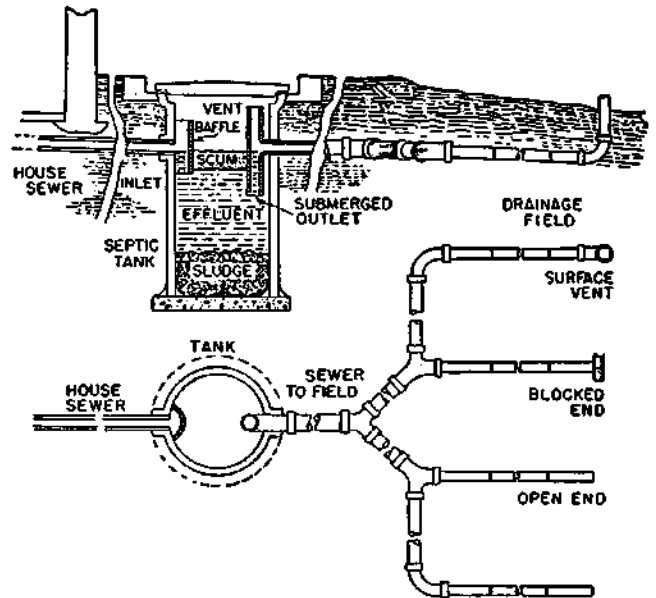

Here is a septic tank with a separate siphon discharge system. Another workable combination is a single septic tank like the one shown above which drains into a cesspool instead of a tile drainage field. The whole problem of proper sewage disposal is so important to health that it will pay you to go into the subject pretty thoroughly before you decide which system to use.

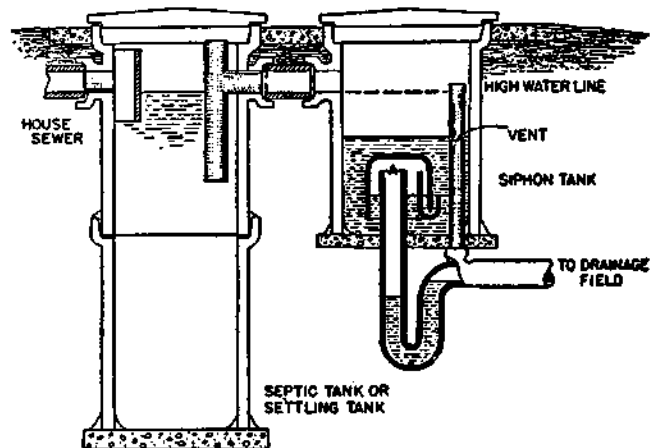

plied with electric power, measure the distance to the nearest power line. In our area the cost of getting this power to the house is about 25¢ a ft. You can reduce this cost by getting neighbors to come in with you. The more people on the line, the less each has to pay. Also, your contract with the power company should entitle you to a rebate when other people come in later. In wiring a house it's important not to underestimate the size of the wire needed. Some day you may want an electric stove, a freezer, electric power tools, or electricity in your barn and hen house so it's safer to use a no. 12 wire rather than a no. 14, the legal minimum.

Roads

Particularly today when land values are high you may save hundreds of dollars by buying land off the road and building your own road to it. Land not touched by a road may be a far more desirable site and usually sells at 30% or 50% less. If you build a road acceptable to your town or county, you can get it declared a public highway and have it kept up by the town.

Landscape Your Place—Increase the Value 20%

Developing a Plan

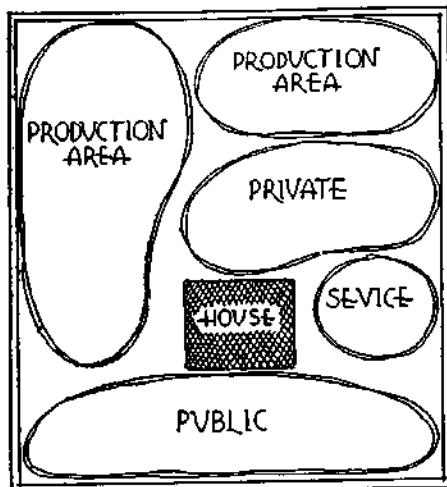

FIRST—Divide your place into four separate areas: public, private, service and production.

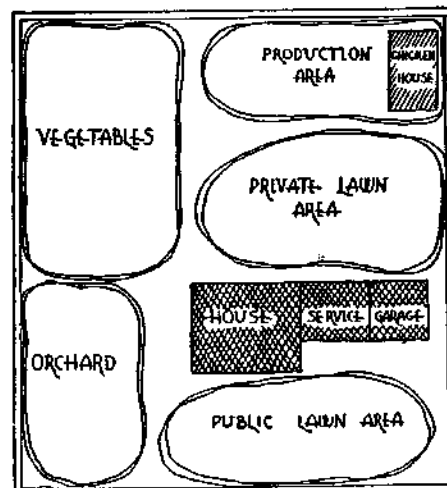

SECOND—In each area lay out the buildings, gardens, lawns as desired.

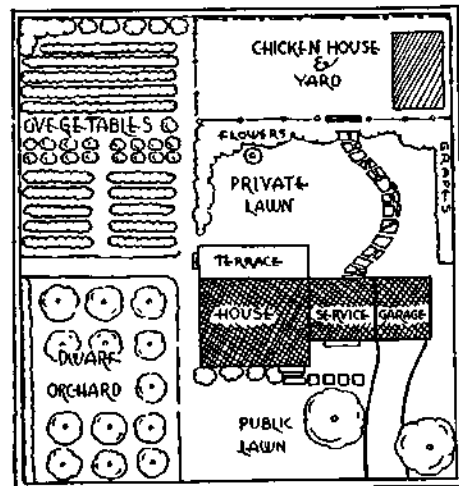

THIRD—Decide how each area should be planted to make boundaries for privacy, beauty and productivity.

ALTHOUGH our homestead is not for sale, in January of this year I was offered more than twice the amount we originally paid for it.

Part of this increase is due to inflation and the housing shortage. But even a few years from now when the housing shortage is over and inflation has levelled off—and maybe real estate prices will take a big drop—even then I feel confident that our homestead will be worth considerably more than we originally paid and will be far more desirable and easier to sell than it was when we bought it.

One big reason for this extra value is the simple combination of a few little things that improve its appearance and its outdoor livability. I don't want to call it landscaping because you may think that means we have a large estate or have spent a lot of money on fancy things whereas what we've actually done is to plant a few inexpensive trees, shrubs and flowers in the most natural places. The amazing fact is with \$25 worth of seeds and plants you can add literally hundreds of dollars to the value of a small place. More important, the place becomes lovelier and more livable. Your aim needn't be to make your yard showy—but just the kind of place people want to be in—a place that feels right outdoors.

If you'll look at the two top pictures of our place on page 10, you can see a couple of smaller changes that made a big difference. See how much better the small evergreens look compared with the tree at the corner. Also note the big improvement in the front entrance. Although it doesn't show too much in the snapshot, the picket fence (at left) gives the house a longer look.

Next time you are driving in the country look at the difference in various houses. Some seem bleak and undesirable. Others seem friendly and inviting. Often you see a new expensive place equipped with many modern improvements that you just wouldn't want to have for yourself. Then you'll notice a less expensive, less modern place, perhaps with a nice orchard and an informal hedge of berry bushes and several nice shade trees. This sort of place, though less modern, is the one that says "home".

Just what is it you do to a country place to make this difference? Here are a few suggestions—a five year plan that can greatly increase the value of a small homestead:

A 5-Year Landscape Plan

1st Year

Become familiar with basic landscaping methods so you can work out a good plan for the entire place. Make a pencil layout of your land showing the

house, road, driveway, nearest neighbors, barn, vegetable garden, etc. On this drawing show where you want to plant shade trees, fruit trees (dwarf), hedges and vines. Then mark desirable spots for flower beds, climbing roses, etc. You may need a screen of privet hedge or hemlock for privacy or to conceal the laundry yard or compost heap or close neighbors. If you want tall trees in a hurry, consider the fast-growing poplars—also privet hedge will grow high in one season. You can plant beds of perennials the first year too, but plant only as many as you can manage. Plant the trees, vines and shrubs first because they will take several years to grow and develop. If you don't like cutting the grass, you needn't have a large lawn. You can make it small by setting a hedge of brambles or berries, for instance, at the desired limits and beyond plant a beautiful field of alfalfa or clover.

2nd Year

Finish planting the flowers and any shrubs still desired. Be sure to have some good perennials (peonies, chrysanthemums, iris, hollyhocks). Study up on outdoor furnishings—maybe a terrace near the house or a trellis for climbing roses or grapes. Decide where you'd like to have a garden seat beneath a good shade tree or possibly an arbor with a love seat, swing or hammock.

3rd Year

Develop your present plantings a little more as needed. By now you may be ready to add the trellis you've been planning and some simple garden furniture. A brick walk set in sand can be very attractive and is easy to do. Consider adding a combination fish pond and garden pool using it partly as a fence with a border of blueberries. Any steep slopes or terraces will make a good place for a rock garden.

4th Year

By now you have finished all the foundation plantings. You are getting fruit from your dwarf fruit trees and berries from your "hedges" of raspberries, blackberries etc. A few finishing touches will probably be needed in the flower bed. Try to have enough flowers so they will bloom continuously from Spring to late Fall. Plant borders along the front walk from the house to the road.

5th Year

The plan should now be about complete, but you will see obvious improvements. For instance, you may want a little more variety now in your flowers and fruits. See if you can't find a few interesting and different varieties in your reference library. Consider ways to blend your animals into the general

scheme—especially ducks and geese in the pond, goats in the more wooded section, sheep on the more distant slopes. By now your experience, plus a little study, will tell you what is needed.

Be sure to take a picture of your homestead before you start this plan and another after it is completed. I'll bet there will be such a difference in the two photographs that you will hardly recognize the old place.

Now finally, to save you needless expense on plants and seedlings and flowers, here are a few practical tips:

- 1.) Always have your holes dug before you get the plants for transplanting.
- 2.) Transplant immediately—don't give the plants time to dry out or they will die.
- 3.) Plan to get "bare root" plants in early Spring or late Fall. At this time it is not usually necessary for plants to be balled and burlapped (as it is in the Summer) so you will save money.
- 4.) Don't buy more plants than you can plant in a day.
- 5.) Most big nurseries have a surplus list of trees and bushes which have grown so large that they must be transplanted. These are often reduced in price "for clearance". They will be perfectly healthy plants if you are dealing with a reliable nursery.
- 6.) If you learn enough about trees and plants and flowers you can master the trick of getting them from the woods and having a "wild garden" on your own grounds. Many varieties cannot be obtained in any other way.

At the right you'll find two aids to landscaping which can be a lot of help. First of all at the top are the two little diagrams showing the "wrong way" and the "right way" to arrange plantings and driveway of a small area. It shows pretty clearly what a mistake it is to just plant anywhere, how you can spoil the looks of your place by bad planning even though you may spend a lot of money for pretty flowers and beautiful trees. Of course you can avoid this by having a landscape architect, but we don't think that is necessary for a small place.

If you will do a little reading on the subject you'll find landscaping is simple and it's easy to learn the don'ts.

Below the "right-wrong" diagram is a landscaping score card which we've adapted from a farmstead score card put out by the Agricultural Extension Service at Ohio State University. You may not agree with all of the things listed here—some points are largely a matter of personal taste and a great deal depends on your locality. But we think you'll find this score card very useful just the same, for checking over your own place and finding ways to improve it.

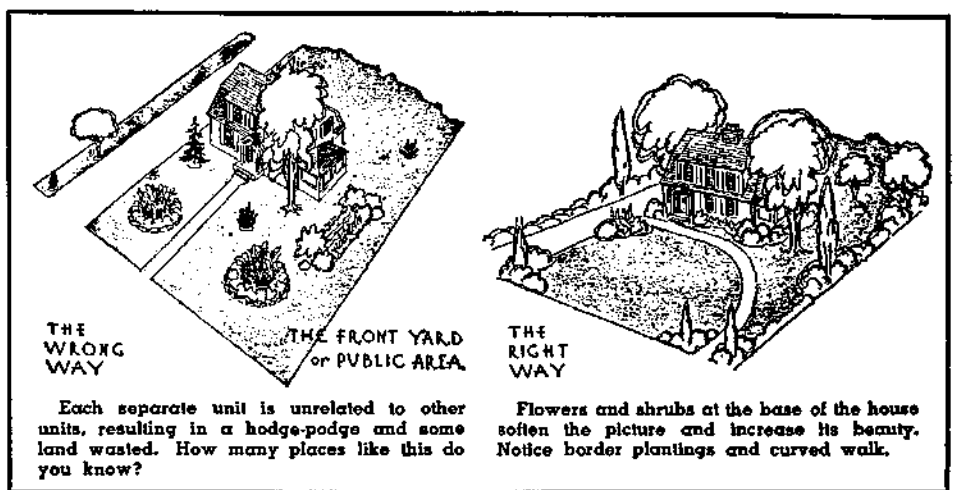

Score Your Own Homestead

	Value points	1st scoring	2nd scoring
I. — CONDITION OF GROUNDS:			
1. Arrangement—well separated areas for lawn, service, storage, stable yards, etc.	8		
2. Livestock and poultry in pens away from house and opposite direction of prevailing winds.	6		
3. Drainage of ground — good natural drainage or by grading and tiling, if necessary.	4		
4. Convenient system of walks and an attractive driveway, hard surfaced.	3		
5. Freedom from rubbish and scattered machinery.	3		
II. — LAWN:			
1. Well graded. Surface should sag rather than bulge. Should slope away from the house in all directions.	5		
2. Should have a smooth dense turf free from weeds.	5		
3. Should have no flower beds, trellis, or benches except around edges. Center should be open.	3		
III. — BUILDINGS:			
1. Dwelling			
a. Good design. Simple, seems to belong to setting.	7		
b. Well painted and in good repair.	4		
c. Appears as the most important building of the homestead as seen from the approach.	3		
2. Outbuildings and barns			
a. Properly placed — not too close to the dwelling.	5		
b. In good repair and painted.	4		
IV. — PLANTING:			
1. Good shade trees in rear of dwelling to form background, and in the front to frame building and to give shade on dwelling where needed.	6		
2. Screen planting of shrubs and trees to hide unsightly objects from dwelling and road.	6		
3. Good taste and restraint in use of vines on walls and fences; and in shrubbery at base of house and along margin of lawn.	5		
4. Some large hardwood trees in barnyard well protected from livestock. Protective frames on all young trees in this area.	3		
5. Some space devoted to the growing of annuals and perennials. Materials well cared for.	5		
V. — SOME PROVISIONS FOR FAMILY RECREATION: (Tennis court, outdoor fireplace, picnic area, etc., well placed.)			
	8		
VI. — ATTENTION TO BEAUTY OF ROADSIDE: (Adjacent to farmstead.) Absence of billboards. Native trees and shrubs preserved. No weeds.			
	7		
TOTALS	100		

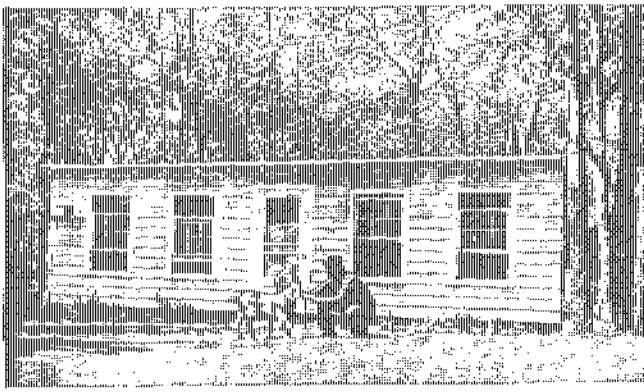

Plans for a Small Barn

THE idea for this "Have-More" Plan came to us at a party—our own "barn warming" party.

When our small "concentrated barn" was finished, we thought it deserved a celebration. And so we invited all the neighbors and our friends to come and see it. We had planned and built our small barn to house not only our milk goats and their kids, but a couple of sheep, 25-30 laying hens, a battery brooder that would produce 30 broilers a month, a six compartment rabbit hutch, a squab loft, plus storage space for grain, straw and bailed hay. Yet the size of the barn was only 16 x 30 feet, as large as a fair-sized living-room.

Of course, Carolyn and I—and Jackie—thought our small barn a thrilling place, but when we discovered how interested our guests were in all the animals and the compact, efficient layouts we had worked out for them, we saw that perhaps many people would be interested in the idea of a family producing a large part of its food in spare time on a small amount of land. Eventually, with the prodding of two friends at the party who are in the publishing business, we got this "Have-More" Plan written.

Now after producing about 75% of our family's food for four years, we realize there are three main fundamentals which set a *productive* country home apart from the ordinary "house in the country." First, the layout of the grounds should be planned for efficient working of the land. Second, a "Harvest Room"—or a large kitchen—carefully planned for the *processing* of food, as well as the preparation, is needed to make the wife's part enjoyable. Third, an efficient small barn is a necessity—a homesteader's livestock can account for 40% to 50% of a family's food.

"Slightly Crazy!"

When we planned our barn we had almost nothing to go by. We wrote to all the barn equipment people, the lumber companies, the state and federal departments of agriculture, asking if they had small barn plans to house goats or a cow, laying chickens, rabbits, sheep, ducks, a pig, pigeons, and geese. Some of the answers indicated that the specialists thought we were slightly crazy. Some wrote of small commercial barns that we might adapt.

Well, we finally ended up with somewhere around \$15 worth of miscellaneous plans. None of them suitable for what we had in mind, however. So we set about designing our own barn. It was quite a job. We got the most efficient layout for poultry from one place, the best arrangement and style of goat stalls came from study and visits to a number of goat keepers and goat dairies. The broiler battery we bought for around \$30 and the rabbit hutch for \$20; both are of wire, sanitary, and efficient.

I was determined that our barn would be easy to operate with the best practices adapted from commercial barns and not cost us a fortune either. We moved to our country house in the fall and didn't start our barn building until the following spring. During the "long winter evenings", which actually flew by as time does at our place, we worked out scale models of goat stalls, brooder, hutch, feed storage, etc.

I was also able to locate not far away, a dilapidated horse barn and bought it "as is" for \$35. It had a lot of good siding and some usable timber in it.

Wrecking Is Fun

Wrecking the old barn was fun. A couple of teen age boys in the neighborhood got interested in my barn project and they turned out to be a big help in tearing down the old barn. In fact, if you can locate an old building to use and get it cheap enough, then I highly recommend rounding up a couple of teen age boys, buying them each a fifty cent wrecking bar, and turning them loose on the barn you want to demolish. Of course, you'd better be around to see that they don't pull the barn down on their heads.

Anyway, a Saturday afternoon and Sunday was enough time for us to get the sizable horse barn down flat. The following half-dozen winter weekends we spent in what is known as "cleaning up the lumber." This is the tedious process of going over every piece of timber and board and pulling out the old nails. Incidentally, this job is what makes it costly to hire a carpenter to take down an old building and re-use the lumber in a new structure. Usually, unless you are given an old building outright, it doesn't pay to have a carpenter pull it down, clean up the lum-

ber, and build with it. A carpenter dislikes old boards because he's apt to run his good saw into a nail and then its an hour's job to resharpen and reset it. Incidentally, an old barn is worth more than an old house—a house doesn't usually supply any more usable lumber and the wrecking job is much greater.

As we cleaned up a pile of lumber, we stowed it in our Crosley, with one of the front seats removed and the top down, and trucked it down the long hill to our place. Naturally, we piled it well so the air could circulate through it until spring.

When the ground thawed, we started building. I believe it was around the first of April when we could actually begin the trenching for the foundation. Before we started, Carolyn and I had a long heated discussion as to exactly where the barn was going to be located. She wanted it six feet closer to the house than I did. Her desire was based on aesthetic reasoning—mine on the practical point that if it were six feet closer, then I would have to dig and chop my way through a tremendous root. Finally, after we delayed the digging a weekend while we argued, we agreed to compromise because the goat we'd bought was due to kid the last week in May and we had to get the barn done so she could freshen in it—a goat is supposed to "take to" a place after she has had her kids there. We compromised by splitting the difference—only I still dug through the root.

In laying out the barn, which was to be 16 x 30 feet, I measured 16 feet one way, then 30 feet along the South side, 16 along the West end, and 30 feet along

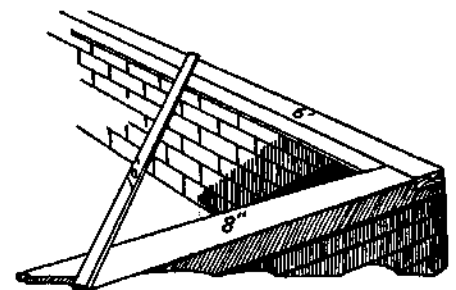

How to make a building square: measure 6 feet on the end sill and 8 feet on the side—if a cross piece then measures 10 feet (from outer edges) the building is square. This is often called "the rule of 5, 8, and 10."

the back. I connected the stakes with string and started to dig. That, it turned out later, was where I made my first mistake. I forgot, or rather didn't know, one important thing. I should have measured diagonally across corners to see if the measurements were the same. By not doing so, I wound up with a parallelogram instead of a rectangle. Not a noticeable one, but I was off about eight inches.

The foot-wide ditch I dug through stone and roots—there was very little soil as I well remember—to a depth of about two feet which is below frost level in our part of the country.

The next step was building the wooden forms into which concrete for the footing and the foundation wall was poured.

Cement—Ready-Mixed!

We ducked the laborious job of mixing gravel and cement and water to make the concrete; we simply ordered the cement ready-mixed just as a professional builder does. Ready-mixed cement delivered to the job costs little more than the materials and this is the best way to buy it when you are using a yard or more—this is the minimum amount usually delivered.

Before the cement stiffened in the forms we sunk about a dozen half-inch, foot-long iron bolts upright to use later to anchor the 4 x 4 sill to the foundation. If you have the bolts on hand it is a simple matter for the man who brings your cement to place these for you.

In two days the cement had hardened so we could take off the forms, but inasmuch as we couldn't do any more cement pouring until the next Saturday, we spent evenings tossing in stones to bring the ground inside the foundation up to within 6 inches of where the top of the floor was to be. Three of the six inches were filled with cinders.

On Saturday we were ready for the floor. The cinders were raked level and the sloping form for the dairy gutter was braced in place. The concrete floor was poured in three sections. The fellow who brought the concrete showed us how to lay two 12 foot 2 x 4's just inside the concrete foundation but three inches down from the top. Concrete was poured and the top of these 2 x 4's used as a guide for another 15 foot 2 x 4 which we sawed back and forth leveling the cement. This is not nearly as complicated as it sounds. We used wooden trowels to smooth off the top surface because we didn't want it as slick as you can make cement with a steel trowel.

The next step, according to the good book on carpentry we were reading, was to "lay the sills." This highly technical sounding procedure simply meant to take a piece of timber, in this case we used 4 x 4's from the old barn, and lay them lengthwise along the top of the concrete foundation. Where necessary, holes were bored in this sill to let the anchor bolts come through; the

washers and nuts were not screwed on for a few more days just to be absolutely certain that the bolts had hardened into the cement. The sills were set all around the foundation except where the doors were to go.

Next, at the four corners, 4 x 4 uprights (7½ feet at front, 4½ feet at back) were set in place, leveled so they would stand absolutely perpendicular by tacking a pair of braces from about half-way up each post down to the sill at either side. Then the corner posts were spiked to the sills. The 7½ foot 2 x 4's were cut and nailed up. The 2 x 4 plate, the piece that goes across the top of the studs, was leveled and nailed. Next the two end rafters were notched and fitted. The end studs cut and fitted under the end rafters . . . then all the rest of the rafters were put in place, we started boarding the sides and roof.

None of this was complicated, but it did take a good deal of time because we had to figure each step out as we went along. In fact, I would like to say right here, that there is nothing complicated about building a chicken house, a barn, or even the traditional country house. And now that the prefabricators are offering complete heating, plumbing, cooking, freezing, and laundry facilities built in one compact unit, building your own house has become about as easy as building a log cabin.

If a person has just a little manual dexterity, say the ability to drive a car, then he will have no difficulty in doing practically all the building that has to be done on a homestead. Carpenters, masons, plumbers, electricians love to make a great mystery of things—and the building codes, the building supply people, the utilities and appliance manufacturers do their best to keep the average householder from doing any building on his own. But the truth of the matter is that most of the skills of

the average mechanic are pretty simple to master. Naturally, their speed and accuracy is based on years of practice. But just as anybody who can read music can play all the notes in a difficult piano piece, anybody can build a barn or a house if he'll get some good manuals on building and good plans for what he wants to build—the difference is that in the case of the amateur at the piano, the piece won't sound right played so slowly, whereas when the building is finished, no one will ever know whether it took a day or a year to build.

Race Against Time

To return to our barn, a couple of rainy weekends, a garden waiting to be planted, plus the inescapable fact that Cassandra, the goat we'd bought but hadn't brought home yet, was due to kid in two weeks, made us call a carpenter to help finish our barn. I am not going to take time to describe in detail just how the interior of our barn was finished—you can get a good idea of that from the sketch shown below. If you want to build a small barn, we've had a draftsman work out complete details with a number of variations.

In the years that we've used our barn, we've found little that we've wanted to change. The only addition we are planning is to extend the barn another 10 feet in length to the West; this will give us more storage space which we will need when we begin harvesting our own hay. Of course, we could change the shed-roof to a gable or gambrel roof and store the hay there, but it is just as cheap to extend the length and eliminate hoisting hay into the loft and climbing up to throw it down.

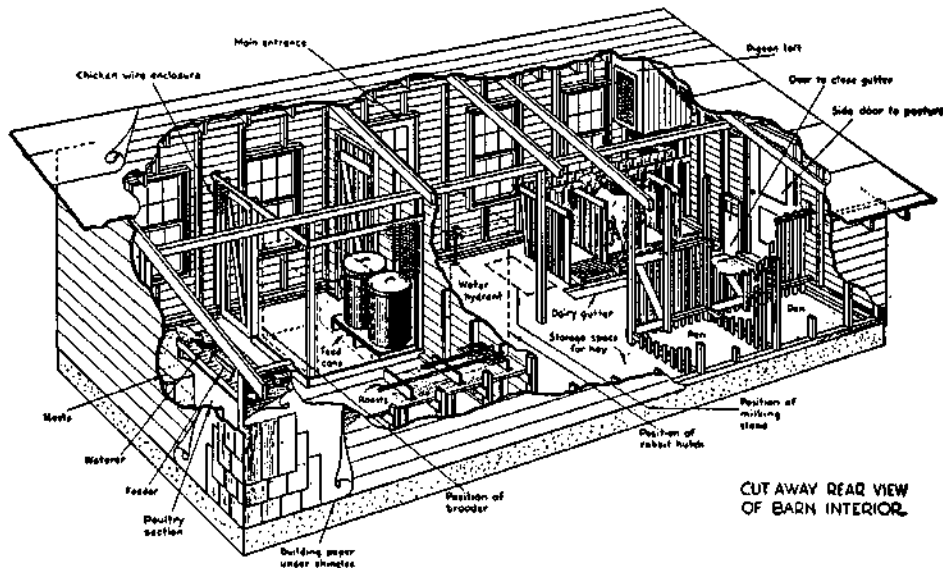

This "breakaway" drawing shows interior of our small barn. We found that this 16 x 30 foot barn efficiently houses 30 hens, 60 broilers, 20 or more rabbits, 4 goats or a cow and calf, 3 or 4 sheep, and a dozen squab. Barn cost \$200 to \$400. Bill of materials, plus complete building plans including 10 large detail drawings of front, ends, interior layout, goat stalls and milking stand, cow stalls, chicken section, squab loft also a turkey sunporch are available.

The Importance of Raising Part of Your Food

WHY do we put so much emphasis on home food production? In the first place, the health of millions of Americans would be far better if every family raised part of the food it eats.

And when we say every family, we really mean every family. No man, no matter who he is, can break the rules of health and escape suffering the consequences. Even the Presidents of the United States, we honestly believe, would be healthier individuals if they tended their own gardens and milked a family cow. Let us explain.

There are two basic reasons for raising part of your own food. First, only by so doing can you be perfectly fed. Secondly, physical contact with the good earth and livestock are the best known antidotes to the mad, hustle and bustle of our present work-a-day world.

There are many lesser reasons for owning your own home and raising part of your own food. There is the basic security of this way of life, an opportunity for the productive use of your spare time, cooperation of the family and the greater enjoyment of family life, the benefits of fresh air, sunshine, outdoor exercise, an opportunity to be creative, the independence and responsibility of land ownership, all in addition to the direct economic benefits.

3 Square Meals and Starve!

A doctor friend who read our Plan said, "Ed, you don't make clear in your Plan how important living-in-the-country and raising-your-food is from the health standpoint."

"Well, we meant to—we sure believe that country living can be healthier. . ."

I replied.

"What I mean," he explained, "is the

belief of so many physicians today that too much time is being spent diagnosing illness and patching up the sick without doing much about the cause. We're finding that basically much disease is caused by the food we didn't eat—and because the food we did eat lacked vital elements."

He spoke of how a millionaire in Manhattan could suffer from hunger as much as a share cropper. This hunger he talked about he called a "hidden hunger"—a lack of minerals and vitamins in food. Of course, he went on, we all know how a lack of iron causes anemia, a lack of calcium causes rickets, goiter is caused by insufficient iodine, night blindness by insufficient Vitamin A, tooth decay by a lack of fluorine, calcium and phosphorus. The thing, he said, doctors now worried about was how many more diseases of civilization were caused by year-in-year-out deficiencies in the food we eat. The unfortunate aspect of all this is the fact that vitamin and mineral deficient spinach looks about the same as spinach right out of a good garden!

Are You Growing Old Too Fast?

My doctor friend stimulated our interest. He opened our eyes to the vast amount of evidence appearing day-by-day on the subject of being healthy by eating properly.

For example, Army doctors found in their young patients symptoms that looked like those of old age. In the early New Guinea campaign young soldiers suffered from dejected appetites, physical and mental fatigue, reduced resistance to infection. Analyses of tinned food showed only slight deficiencies, but when supply ships came with fresh vegetables, fruit and meat,

these minor symptoms of old age disappeared.

And what about the major degenerative diseases of old age? Of middle age, rather—high blood pressure, hardening of the arteries, wearing out the heart, the kidneys, the brain?

Dr. N. Philip Norman, in a Friends of the Land Food Conference in Ohio, pointed out the harm that has been done and is being done to the health of our people by commercial food processing and by our food habits.

He told how all this stuff about vitamin pills had grown as a parasite on the nutrition-for-war-and-defense program—from a little over a million dollars in advertising to two hundred fifty million dollars a year in just four years shows what modern advertising can do with part of the truth. How much good has been done by this? Dr. Norman believes that had we eaten whole-grain cereals in our bread and breakfast food, unprocessed, untouched by the kiln drying, unexploded and not devitalized grain, forage fresh from the vine, tree, and garden—and if we had eaten the meat of animals that had been fed on whole cereals, forage rich with nutrients, especially the internal organs of these animals, and if we had drunk plenty of milk that has been not too badly abused, we would avoid most of these degenerative diseases. There is much evidence to back up Dr. Norman.

3 Ways Food Goes Wrong

Evidence is beginning to appear showing that soil and freshness all effect the mineral and vitamin content of the food we eat. Carrots raised in a mineral-rich soil are more healthful than those raised in poor soil. Hot-house tomatoes, the kind you buy in the store, have but half the Vitamin C content of tomatoes fresh from the garden. Steam-table restaurant fare has a fraction of the value of properly home-cooked foods.

Many of the so-called "fresh" vegetables you buy in the store haven't nearly the value of these same foods out of your garden. Out at Ohio State experiments show that about 43% of the "fresh" vegetables sold in stores have lost the biggest part of their vitamin content. Oranges and grapefruit lose around 30% of their Vitamin C 30 days after picking I've heard.

Now, if you will get yourself a productive home in the country, if you will take a real interest in the fertility of your soil, if you eat plenty of your own home-raised fresh vegetables and fruits, your own fresh eggs, fresh meat, use honey instead of sugar, drink lots of raw whole milk and eat whole grain bread, all the evidence says you and your family will be far healthier and live longer, more active lives as well!

Protective Foods You Should Eat Daily

FOODS	BABY 1 YR.	CHILDREN			ADULTS
		Preschool	Early School	Adolescent	
MILK, whole	1 qt	1 qt	1 qt	½ qt	½-1 qt
VEGETABLES and FRUITS					
Green, leafy, or yellow	¾ Tb	½-¾ c	¾-1 c	1 c	1 c
Tomatoes*	6-7 Tb	¾ c	¾ c	1 c	¾ c
Other vegetables	¾ Tb	½-¾ c	1-1½ c	1½-2 c	1½-2 c
Other fruits	¾ Tb	½-¾ c	¾-1 c	1-1½ c	1-1½ c
MEATS	½ Tb	1 small serving	1 serving	2 servings	1 large serving
EGGS	1	1	1	1	1

*Half as much orange as tomato. Tb = tablespoon; c = cup.

MILK, VEGETABLES (particularly FRESH green leafy ones), MEAT, EGGS and FRUIT are called the "protective" foods because they safeguard the body from a variety of diseases.

These foods are needed at all ages—not only by children and adults, but elderly people.

If you raise them on your homestead, you can eat them generously. Most of us need more calories—potatoes, wholegrain bread and cereals, butter, sorghum, and dried beans are good suppliers of calories. Eat sparingly of sugar and other refined foods!

A Good Garden With a Lot Less Work

EVEN before the victory garden boom there were so many books, articles, pamphlets on gardening that garden writers seemed to be having quite a time of it trying to be original. For example, I have in front of me a cute article in one of the "garden and home" magazines explaining how you can have cucumbers climb a fence, use carrots for borders, and make a tepee for the children by planting pole beans.

Well, maybe garden articles like that appeal to some folks, but what we wanted at our place was somebody to tell us how to raise a lot of vegetables with as little work as possible.

We weren't interested in gardening as a hobby. We wanted to make it pay and believed we could. We knew that out of every dollar's worth of vegetables my wife bought at the store 60 cents went for marketing and handling.

Our first garden was small—about 30 by 40 feet. We simply dug up the ground, mixed in a little all-purpose commercial fertilizer, bought some seeds at "the corner drug store"—and, needless to say, our garden was pretty much of a flop. Some vegetables grew fairly well, but most didn't. And the insects got more out of it than we did.

We were discouraged. Like many city people we thought a garden was "duck soup". But we've found out that

our garden is our most exacting and complex project. Producing eggs, or chickens, or milk, or honey, or pork requires less knowledge than having a good garden. The one especially attractive point about a garden is that even though it is complicated and considerable work, it does not have to be tended every day or twice a day as do livestock. At any rate I wanted to say, don't let your gardening difficulties discourage you from considering livestock projects—it's easier to produce a dozen eggs than a bunch of carrots.

Before we planted our second garden we made up our minds to find out how to do it. I guess maybe we studied a hundred books and pamphlets. Or rather, after reading the first dozen, we skimmed through the rest. We found ourselves reading and rereading the same basic facts.

After our reading, we went ahead with a much larger garden. We planted according to plan and beginning in May had all the fresh vegetables we could eat. In addition, we canned and froze about 275 quarts for winter use. According to Carolyn's figures, our garden saved about \$200—that's \$200 over the \$22.50 we spent for plowing, seeds, fertilizer, and spray.

Looking back over our experience, we have singled out certain fundamentals and ideas we would like to pass along because we believe they will be helpful to anyone interested in having a good garden with less work.

First, we are living in an exciting, revolutionary era—not the least important is the revolution that is taking place in agriculture—particularly in soil conservation. Louis Bromfield summarizes it thus: "The American farmer has largely worked against Nature. Our new agriculture will be based on the principle of working with Nature".

Probably you've read reviews of Edward Faulkner's startling book *Plowman's Folly*. If you haven't read it, do by all means. Briefly, from the Homesteader's standpoint, the implications of Faulkner's theory mean that by more natural care of garden soil—the incorporation of humus and manure into the top soil instead of plowing it ten inches underground—phenomenally more productive crops can be grown. Moreover, these healthy crops need less cultivating, watering (and stand up against attack by disease and insects.) *In short, better gardens with a lot less work!*

Of course, Mr. Faulkner's theories are not entirely proven as yet nor are they entirely new. Many government, state and independent agriculturists have been experimenting along the same lines for a long time. However, his ideas are stimulating and we think you'll profit by reading about them.

Then, too, the new plant hormones

and insecticides are evidently going to make gardening more scientific.

SEVEN FUNDAMENTALS

1. Get Your Soil in Shape

Almost any soil can be made to produce lavishly. But poor soil takes money and time—perhaps hundreds of dollars and years—to put in first-rate shape. For this reason before you buy a place it's a good plan to have

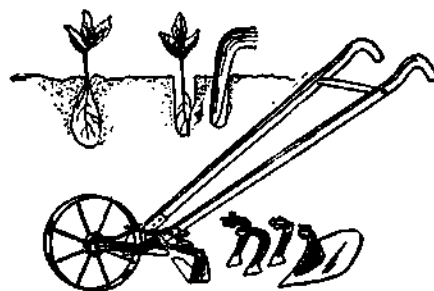

Plant at upper left improperly set out. Soil should have been pressed tightly about roots. Use dibble as shown. WHEEL HOE and attachments make planting and cultivating a lot easier.

soil analyzed; check for hardpan, excessive sand or clay condition.

Even if your soil looks good—have it analyzed. You may buy a soil test kit—they sell for as little as \$2.00. Or you can send it to your State Agricultural Experiment Station for a free analysis. For the address, ask your local paper or seed store.

Organic substance is the primary means of building good soil. The best source for this substance is barnyard manure. Goat manure is excellent. So, too, is cow manure. Poultry manure is extremely rich in nitrogen. Barnyard manure is usually difficult to obtain—but you will have plenty if you carry out the well-rounded livestock operation suggested in this Plan.

Barnyard manure increases the ability of the soil to hold moisture, keeps the soil loose and promotes root development. The best way to handle manure so it won't lose its value is to compost it as shown in the accompanying diagram. Ideally each year a plot 30 x 60 feet should receive a ton of stable manure.

In the summer when the garden is planted, manure can be used mixed with straw or bedding, etc., as a mulch. But take care not to let it come in direct contact with plants. Leaves, straw, hay, garbage—anything that will decompose should be dumped onto the compost heap and after ripening worked into the top soil. Don't bury this humus material by too deep plowing. If you are making a garden in sod land and must plow deep—then plow twice—once in the fall, then in the

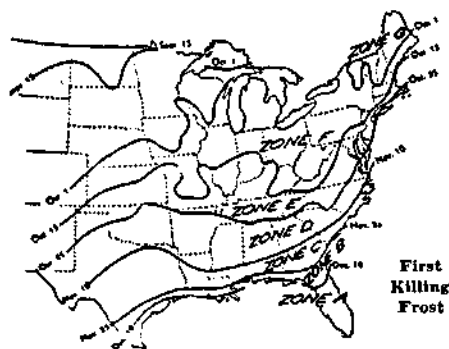
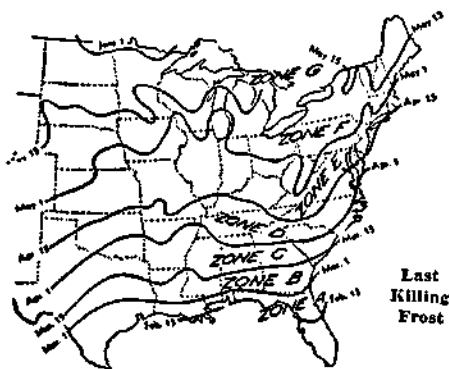

Frost dates for western states vary according to elevation as well as latitude. Accurate dates can be had by writing your State College of Agriculture or Weather Bureau.

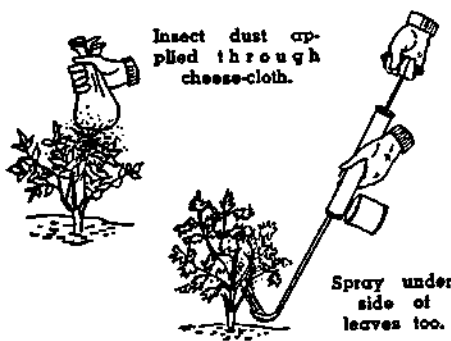

Insect dust applied through cheese-cloth.

Spray under side of leaves too.

spring plow again and bring your valuable top soil back to the surface.

Your soil test will undoubtedly show a deficiency in one of the three basic fertilizers—nitrogen, phosphoric acid, potash. The relationship of these has been worked out for the requirements of various types of vegetables. You can buy various combinations of these three elements—called commercial fertilizers—and work into your ground as you plant. A small application of commercial fertilizer usually brings a greater percentage gain in your harvests than a large application. Remember, commercial fertilizer is only a supplement to barnyard manure. Your soil test will supply you with directions as to the amount of commercial fertilizer you should use. Oftentimes, only super-phosphate is needed when you use barnyard manure. Incidentally, hardwood ashes contain potash; up to 50 pounds per 30 x 60 plot should be mixed into soil annually.

On richly fertilized land plants grow faster and are superior; incredible as it sounds, production of a given amount of vegetables may then take 1/5 as much land—likewise the time required may be cut to 1/5. Insects, too, find it more difficult to ruin healthy plants grown in rich soil.

2. Buy Suitable Varieties of Seeds and Plant According to Specifications

This needs no further explanation. Get seed catalogues in the winter—plan exactly what you want. (See chart on page 24). You can start some seeds, requiring an early start, growing in February or March, either indoors, or in a hot frame. Originally, we found spring so busy with our baby chickens, kids, geese, and young pigs arriving, that we bought tomato, cabbage, peppers, etc., from our local nurseryman as plants. Plants, of course, cost more than seeds. Now we are growing our own plants in our "Harvest Kitchen" greenhouse window.

Most vegetables require warm weather to grow. Don't be in too much of a hurry to plant early; once a seedling is stunted it will never attain normal growth.

Mark rows with a string to get them straight. Make a shallow trench—depth according to seeds—with a hoe. Scatter seeds evenly, cover with fine soil, pat down firmly with back of hoe.

When plants are up to a height of 2 or 3 inches, thin according to seed

man's directions. Even if this seems to leave too few in a row—do it, don't crowd plants. Beets, carrots, greens can be grown large enough so plants pulled in thinning can be eaten.

3. Cultivate, Weed, Mulch

Cultivate between rows with a hoe or wheelhoe often—after every rain—at least once a week during early growing season. Hand-weed along the row as necessary. Be careful not to cultivate so deep you disturb roots. As soon as plants are large enough we find a mulch of bedding from the barn laid between the rows keeps down weeds and holds moisture. This is a real labor-saver.

4. Spray or Dust on Schedule

Garden insects need not cause undue damage if you are ready for them with an insecticide and your garden sprays. Walk through the garden daily to inspect for insects. Read up on insects before they hit you.

One of the most discouraging things to the novice reading about garden insects is their great variety. But classi-



Mexican Bean Beetle



Green Cabbage Worm and Looper



Aphids



Flea Beetle and Injured Leaf

fied according to method of control, the whole question of what to do about garden pests becomes simple.

By far the greatest majority of insects and fungus diseases fall into four classifications according to their method of control:

Type 1. Sucking insects, such as aphids (plant lice), thrip, leaf hopper, and scale. This class of insects feeds by inserting their sharp slender beaks into the leaf stem or blossom, drawing forth the sap which is the vitality of the plant. Contact insecticides applied to this class of insect enter the body by penetrating the skin or pores, causing death by corrosion of the tissues or suffocation. Thorough spraying giving complete coverage on both upper and lower surfaces of the leaves, important.

Type 2. Leaf-eating insects, such as beetles, slugs, worms, caterpillars that eat holes in leaves, are effectively controlled by a stomach poison. Insect eats spray or dust that is on the leaf, the poison becoming effective when mixed with the digestive juices in the stomach.

Type 3. Certain blight and fungus diseases, including leaf-spot, rust, mildew, and anthracnose are satisfactorily controlled by a preventive with copper or sulphur the active ingredient. The tiny disease seeds (spores) ever present in the air are prevented from gaining a foothold on vegetation where a copper or sulphur fungicide has previously been applied. Even after fungus has gained a start, spraying with fungicides will retard and, in some cases, eliminate the disease.

Type 4. Migratory insects (leaf chewers) such as grasshoppers, ants, cutworms, sow bugs, also slugs or snails, don't live on plants but crawl along the ground, generally at night, destroying much vegetation. These crawling types of insects can be controlled by the use of poison baits, poison syrups, or under certain conditions, a sticky substance easily applied which will act like fly paper. (See chart page 24).

5. Irrigation

Probably more harm than good is done by water applied to home gardens. In arid and semi-arid localities watering is, of course, not only necessary, but a whole subject in itself. However, in most sections of the country, except for occasional droughts, a good rain every ten days is all any garden needs. Light sprinkling is bad. If rain does not come, one of the best and easiest ways to water is a rotary sprinkler attached to end of your garden hose and held in one spot for at least an hour. The ground thus soaked needs no more water for ten days to two weeks of dry weather. Cultivate soil after rain but not until surface dries out.

6. Harvest When Tender

Vegetables don't grow evenly from day to day—a warm day following a good rain may push vegetables ahead as much as a number of days not suited to growth. You must inspect the garden every day as vegetables begin to ripen. Pick most on the tender side—they'll taste even better if they're not quite as large as the longer, older, heavy type you are accustomed to buying in the store. Particularly when canning, choose the tender. Never pick ahead of time—wait until just before

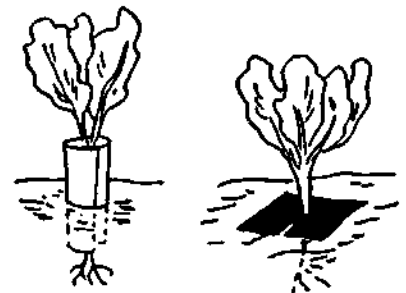

Cardboard or stiff paper wrapped around plants protects them from cutworms. Silt paper (about 4 inches square) protects against maggots.



Succession planting

you're going to use them before bringing fresh vegetables from the garden. Try putting the water on to boil before you pick sweet corn—and cook it only 7-8 minutes for one of nature's most tasty feasts!

7. Keep Your Ground Planted in Green

As soon as your last vegetables are out of the ground in the fall, roughen up the soil and plant rye. This will get a good start before winter and grow again in early spring. When you are ready to plant in spring, incorporate this green manure into the top surface of the soil by disc harrow, or by fork and hoe. This green manure will decay fast when left in top soil and provide natural plant food for your seeds.

Hints for Easier Gardening

New land almost always requires lime to alkalyze the acid content resulting from leaf decay, etc. Your soil test will show whether or not your soil is acid or alkaline and tell you specifically how much lime or possibly its opposite, aluminum sulphate it needs.

An easy way to see that plants get proper amounts of lime is to divide the garden into four sections and lime one section heavily for vegetables in the first group, lime second section moderately, etc.

These require heavy Liming

(3-5 lbs. on 22 foot row every 3-4 yrs.)

Alfalfa	Cabbage	Lettuce
Asparagus	Carrots	Onions
Barley	Cauliflower	Parsley
Beets	Celery	Wheat
Blue Grass	Clover	

These need moderate Liming

(2½-3 lbs. on 22 ft. row every 3-4 yrs.)

Broccoli	Endive	Radish
Chicory	Kale	Raspberries
Corn	Leek	Red Clover
Cucumber	Melons	Rhubarb
Eggplant	Peas	Spinach

These need small amount Lime

(1-2 lbs. on 22 foot row every 3-4 yrs.)

Beans	Pepper	Turnip
Cowpeas	Rye	Rutabaga
Gooseberries	Squash	
Oats	Tomato	

No Lime for these— injury will result from Lime

Blueberries	Grapes	Pumpkin
Cranberries	Plums	
Parsnips	Potatoes	

Natural or Artificial Manure? There is, as probably many of you know, practically a pitched battle going on

amongst two groups of Agricultural Experts as to whether or not fertility is best kept up by use of artificial (chemical) fertilizers or organic substances. The "organic" group ask, "Are Chemical Fertilizers Ruining our Health?" They believe that only properly composted organic matter and barnyard manure should be used to preserve the soil's fertility. On the other hand, certain advocates of chemical fertilizers advocate "soil-less culture"—or growing vegetables solely in chemical solutions. The extreme in either method is costly. Generally, as far as we can judge, soil-less culture certainly seems a passing fad; and more and more attention seems to be given to methods of keeping the soil fertile by putting back manure and humus.

The poor "backyard gardener" is, however, in a tough spot if he is not willing to keep some animals. Right now, he has a hard enough time to gather leaves, garbage, etc., etc., to make his compost and with the new "electric garbage disposal sinks" which chew up garbage and send it down the drain, he's still harder pressed.

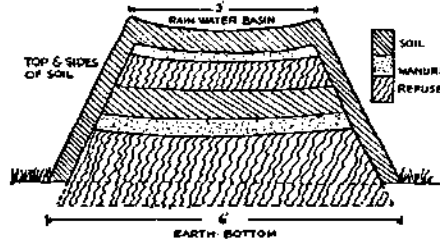

How to make a compost heap

Almost all garden books go into great detail explaining how to build a compost heap—a method of turning waste foods, leaves, inedible garden produce, kitchen parings into humus. Building a compost heap takes a lot of time. First, you choose a shady place for the compost pile. . . build pile in 6 inch layers, keep level, wet it down if necessary every week for 8 to 12 weeks, and then cut through the pile with a sharp spade . . . build it up again, keep watering for 8 to 12 weeks more, then it should be ready to use. . . but it's better after two years. Even then, when you're all done, you have an inferior substitute for barnyard manure. At our place, we don't bother much with a compost heap in the sense that we gather leaves, etc., etc. We feed surplus kitchen parings, vegetable husks, lawn clippings, etc., to the goats, chickens and geese, and in about 24 hours we have excellent manure.

However, to keep manure from losing its value as it will do if exposed to sun and rain, we pile alternate layers of manure and bedding, as shown, and cover with dirt. If this is turned once or twice during a good solid rain it will make excellent humus in six months, winter excepted.

Stake Tomatoes? Peas? In the garden books, you'll find all sorts of flossy ways to stake up tomatoes, Commer-

cial growers rarely bother with staking. And at our place we save a lot of effort by cultivating tomatoes only once, then *mulching* with 3 inches of poultry litter. Tomatoes then grow beautifully, don't require weeding, cultivating or watering. A few will rot on the ground, but simply plant a few extra.

Intercropping? This is the practice of growing 2, 3, even 4 crops on the same area at one time. Quick maturing crops like radishes, lettuce, beans, spinach may be between rows, or in rows of eggplant, tomatoes, melon, okra, or other crops which utilize ground for a complete season. This is all right where your garden is small—but it's lots easier planting, fertilizing, cultivating, spraying, not to do this.

All Purpose Sprays. There are on the market a number of "all purpose" sprays which attack many types of chewing as well as sucking insects. Obviously, these save effort.

Perennials. Asparagus, rhubarb, Jerusalem artichoke and horse-radish may be left in the garden all-year and are practically self-perpetuating.

Leave Ground Rough. Some gardeners are forever worrying their soil: trenching, raking, plowing. Faulkner shows that land apparently produces much better when supplied with plenty of humus which is worked into the top of the soil by disc harrow and left rough. In fact, he points out that the ideal is to make your whole garden a sort of compost heap.

Plant Late. Usually garden writers say take a chance on losing some seed—plant as early as possible. We find it easier to plant a little late. We don't waste effort and seed this way. Anyway, with our well supplied freezer, plus Jerusalem artichoke, parsnip, and asparagus as early vegetables what do we gain by chancing early planting?

Transplanting. Transplant only when you must. Most transplanted plants get a set-back from which they take time to recover and resume growth. And, of course, unnecessary transplanting is wasted effort.

Easy to Grow Vegetables. Beans, beets, broccoli, cabbage, Chinese cabbage, carrots, celtuce, chard, corn, endive, kale, lettuce, okra, onions, parsley, parsnips, peas, potatoes, radishes, rhubarb, spinach, squash, tomato, turnips, Jerusalem artichokes.

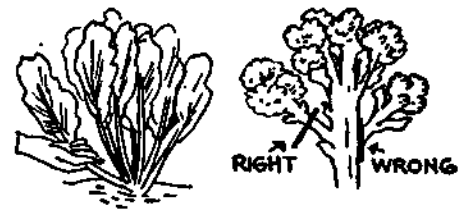

Harvesting swiss chard and broccoli

Vegetable Planting Chart

VEGETABLE	Rows apart feet	Plants apart in row, inches	Planting depth, inches	Seed for 50 feet	Days to germination	Days to yield	Buy plants or seeds	Possible yield per 50 feet of row	For a family of five, Summer and Winter Supplies		Common Insect Pests and Suggested Control
									Row Length	No. of Plantings	
Artichoke, Jerusalem	3	20	3	1/2 peck	8-12	120-140	P	1 1/2 bu.	100	1	Seldom bothered.
Asparagus	2 1/2	20	6	30 plants	8-10	2 yrs.	P	25 bunches of 1 dz. each	100	...	Asparagus beetle. Rotenone.
Parsnip	1 1/2	4	1/2	1 pkt.	15-20	80-100	S P	150 roots	50	1	Seldom bothered.
Rhubarb	4	48	1/4	10 plants	...	2-3 Yrs.	S P	180 stalks	50	...	Seldom bothered.
Beet	1 1/2-2	3-4	1/2	1/2 oz.	7-10	60-75	S S	150 roots	100	3	Seldom bothered.
Chard, Swiss	2	15	1/2	1/2 oz.	7-10	50-75	S S	15 plants	20	1	Blister beetle. Rotenone or hand pick.
Broccoli	2	18	1/2	1 pkt.	6-9	70-80	S P	30 heads	50	1	Same as cabbage.
Brussels Sprouts	2	18	1/2	1 pkt.	6-9	70-80	S P	30 qts.	50	1	(Green Cabbage Worm. Rotenone.
Cabbage, early	2	12	1/2	1 pkt.	6-9	65-75	S P	35 heads	50	1	Aphis. Nicotine dust or spray.
Cabbage, late	2	18	1/2	1 pkt.	6-9	80-100	S P	35 heads	50	1	Same as cabbage.
Chinese Cabbage	2	12	1/2	1 pkt.	6-9	75-85	S S	50 heads	50	2	Same as cabbage.
Carrot	1 1/2	3	1/2	1 pkt.	12-18	60-75	S S	200 roots	100	3	Seldom bothered.
Cauliflower	2	18	1/2	1 pkt.	5-10	55-65	S P	35 heads	50	2	Same as cabbage.
Celery	2	4	1/2	1 pkt.	15-20	90-120	S S	150 bulbs	25	2	Same as celery.
Celery	2-3	5	1/8	1 pkt.	15-20	120-150	S S	120 plants	50	2	Aphis. Nicotine dust or spray. Celery Leaf Flyer-Pyrethrum.
Chicory, Witloof	2	10	1/4	1 pkt.	3-12	for winter	S S S S S S S S	60 roots	50	1	Green Caterpillar. Pyrethrum or hand pick.
Callard	2 1/2	24	1/4	1 pkt.	6-9	90 & on	S S S S S S S S	25 plants	50	2	Same as cabbage.
Endive	1 1/2	9	1/4	1 pkt.	10-14	70-80	S S S S S S S S	60 plants	30	1	Seldom bothered.
Kale	2 1/2	24	1/4	1 pkt.	6-9	70-80	S S S S S S S S	25 plants	25	1	Same as cabbage.
Kohlrabi	2	8	1/4	1 pkt.	6-9	55-65	S S S S S S S S	70 bulbs	50	2	Same as cabbage.
Leek	1 1/2	6	1/2	1 pkt.	7-10	120-150	S S S S S S S S	100 stems	30	1	Onion Thrip. Nicotine sulphate and soap solution or tartar emetic.
Lettuce, leaf	2	12	1/4	1 pkt.	6-8	45-50	S S S S S S S S	50 heads	50	1	Cut Worm. Poison bait on ground.
Lettuce, head	2	12	1/4	1 pkt.	6-8	50-75	S S S S S S S S	50 heads	50	1	Aphis. Nicotine dust or spray.
Mustard	2	9	1/4	1 pkt.	5-8	60-75	S S S S S S S S	50 plants	20	2	Birds. Cover with screen or open-meshed cloth.
Onion	1 1/2	3-4	1/2	1 pkt. or 1 pint sets	7-10	90-110	S or P	150-200 bulbs	50	1	Same as cabbage.
Parsley	1 1/2	4	1/4	1 pkt.	15-20	85-100	S S S S S S S S	150 bunches	30	1	Onion Thrip. Nicotine sulphate and soap solution or tartar emetic.
Peas	2-3	1-2	1	1/2 lb.	7-10	60-80	S S S S S S S S	25-50 quarts	100	3	Seldom bothered.
Potato, white	3	12	4	3 lbs.	8-12	80-120	P S S S S S S S	60-80 lbs.	100	2	Aphis. Rotenone, pyrethrum, or nicotine dust or spray.
Radish	1	1-2	1/2	1 pkt.	3-6	25-60	S S S S S S S S	300-600	25	4	Same as tomato.
Spinach	1 1/2	6	1/2	1 pkt.	7-12	40-50	S S S S S S S S	100 plants	50	2	Cabbage Maggot. Avoid by quick root growth.
Turnip	1 1/2	4-6	1/2	1 pkt.	5-10	50-80	S S S S S S S S	100-150 roots	50	2	Aphis. Nicotine dust or spray.
Turnip, Rutabaga	2	6	1/2	1 pkt.	5-10	80-90	S S S S S S S S	100 roots	50	1	Seldom bothered.
Beans, bush	2-2 1/2	3-4	1 1/2	4 oz.	5-8	50-70	S S S S S S S S	20 qts.	100	4	Mexican Bean Beetle. Rotenone.
Beans, pole	3-4	9, or hills	1 1/2	4 oz.	5-8	65-80	S S S S S S S S	30 qts.	50	4	pyrethrum, or cryolite. Flea beetle, red spiders or corn borer. Apply rotenone dust just before ear forms, then 4 times more 5 days apart.
Corn, early	2 1/2	9	1	1 oz.	5-8	70-80	S S S S S S S S	50 ears	80	1	Corn Ear Worm. Snip off tips of ears after silk dries or apply mineral oil to ear tips.
Corn, main crop	3	12	1	1 oz.	5-8	80-95	S S S S S S S S	50 ears	100	1	Striped Cucumber Beetle. Rotenone.
Cucumber	4	24	3/4	1 pkt.	7-10	60-70	S S S S S S S S	150-200 pickles	50	1	Aphis. Nicotine dust or spray.
Pumpkin	8	60	1	1/4 oz.	7-12	110-130	S S S S S S S S	25-30 fruits	25	1	Squash Bug. Rotenone or hand pick.
Squash, bush	4	36	1	1 pkt.	7-10	55-65	S S S S S S S S	75-100 fruits	50	1	Same as pumpkin.
Squash, vining	6	60	1	1 pkt.	7-10	65-120	S S S S S S S S	40-80 fruits	25	1	Cut Worm. Paper collar around each plant when set out.
Tomato	3-4	36	1/2	1 pkt.	7-12	75-90	P S S S S S S S	175-200 lbs.	75	2	Green Tomato Worm. Dust with rotenone or hand pick. Aphis. Nicotine dust or spray.
Lima beans, bush	2-2 1/2	3-4	1 1/2	4 oz.	5-8	65-75	S S S S S S S S	15 qts.	100	2	See beans above.
Lima beans, pole	3-4	9, or hills	1 1/2	4 oz.	5-8	80-90	S S S S S S S S	20 qts.	50	1	See beans above.
Egg plant	3	30	1/2	1 pkt.	12-15	70-85	P S S S S S S S	50-75 fruits	50	1	Colorado Potato Beetle. Arsenate of lead or Paris green.
Muskmelon	5	48	1	1 pkt.	7-12	80-100	S S S S S S S S	75 fruits	50	1	Flea Beetle. Dust with arsenate of lead.
Okra	3	15	1	1/2 oz.	8-12	50-60	S S S S S S S S	250 pods	50	1	Seldom bothered.
Pepper	2 1/2	24	...	1 pkt.	10-14	65-80	P S S S S S S S	200 fruits	50	1	Cut Worm. Paper collar around each one when set out. Aphis. Nicotine dust or spray.

Very hardy. Not injured by winter freezing.

Hardy. Withstand light frost but not freezing. Plant when ground is easily trowed.

Danger of late frost is over. Don't plant until all tender. Really injured by late frost.

Very tender. Plants injured by un-lined cool weather. Late, may be injured by cool weather.

Herbs



MARJORAM ROSEMARY BALM CHIVES RUE SAGE BURNET BORAGE

ED used to be a little sarcastic about my herbs—referring to my herb garden as “the weed patch.” He claimed he couldn’t tell seedlings from weeds.

But since he’s seen to what good use I put my few herbs and how little trouble they are, he has a new appreciation of them. Herbs really fall into the woman’s department. For although herbs offer a fascinating and learned hobby and can be grown as flowers for beauty, for fragrance, for dyes, vinegars, tea and incense-making, the main use on a homestead is in cooking.

Although I’ve heard a number of women say their husbands didn’t like herbs in cooking, I’m inclined to think that this is one of those preconceived notions that men have about food and ought not to be taken too seriously—especially when they say it after a dinner they’ve relished where herbs have perhaps been used without their knowledge in poultry stuffing, soup, tomato cocktail, iced tea, and fruit cup!

I think the reason more of us don’t use herbs regularly is because there is so much mumbo-jumbo mixed up in most herb literature just as there used to be about serving wines. Once people discover, as they have about wine, that you can use any herb you like in cooking, then a lot more of us will use herbs. Of course, certain herbs seem to be “just right” with certain foods.

Any cookbook worth owning, even conservative Fannie Farmer, has something on herb cooking. Usually for the beginner it’s too much to take in all at once. So, unless you’re an accomplished herb-cook, I suggest you start your herb cooking from the angle of what’s easy to grow in a small herb garden.

Herbs take practically no space, and, because most herbs don’t need any complicated soil preparation, you can grow them without even bothering your husband by asking him to prepare the ground. Because you need only about a dozen plants altogether; you can probably plan your herb garden and dig it up yourself. Herbs shouldn’t be planted in a wet place. A good mix for the soil for herbs is equal parts of compost and loam and double parts of sand—all sifted.

There is little reason for starting herbs indoors. After all, herbs are dried, and when drying is done carefully and the herbs put in screw top jars, they will keep easily from one season to the next. So there’s no special need for an early start.

Herbs are propagated from seed, by cuttings or “layering,” and by root divi-

sion. All annual herbs are best grown from seed . . . many perennials too.

Herbs are best in their own garden. The closer you can locate this to the kitchen the better—when you want a sprig of mint or couple of herbs for a “rainy day stew,” you’ll find you just won’t want to bother getting in the herbs if they’re located too far away.

The wheel garden is made with a heavy wagon wheel. The herbs planted in it should not be too tall growing or the effect of the division by the spokes will be lost. After obtaining a suitable

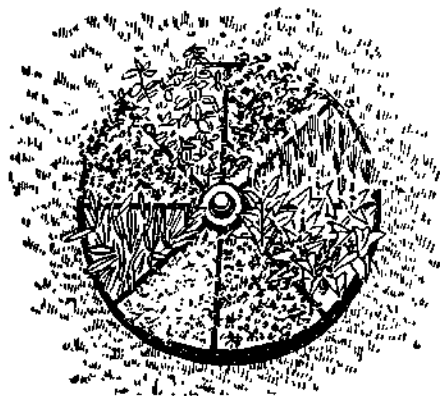

wheel, select a sunny spot on level ground or a gentle slope. Mark around wheel, then dig out the center for hub—the rim should set on the ground. Fill spaces between herbs with sandy loam. If any of the spaces are to be filled with mints, stick plates of metal—old license plates or sheet iron—around the boundary of the mint to prevent it creeping into adjacent beds. Although you can plant most any herbs in this wheel bed, the lower growing varieties make an especially pleasant pattern: parsley, chives, garden thyme, orange or apple mints, lungwort, dietary of crete, thrift, dead nettle—and such annuals as dwarf basil, sweet marjoram, chervil, summer savory, coriander.

Some Easy-to-Grow Herbs

ANISE: 75 days. Annual. 8 inches. Always grow from seed, don’t transplant. Uses: fresh leaves in salad and as a garnish. Good with fish. Seeds: in bread, cake, stew, soups, candy. Medicinal: tea.

BASIL: Sweet: 85 days. Annual 1 to 1½ feet. Germinates easily in 4 or 5 days—if tops are pinched off plants will bush. Spacing: 15 inches for regular—6 inches dwarf varieties. In harvesting, when buds appear use both leaves and buds, cut part way to ground for a second crop. Uses: in soups, meat, some salads. Tie in bunches, dry in sun, store.

BORAGE: 80 days. Annual (self-sowing).

1½ feet. Blue flowers attract bees. Should not be transplanted. Uses: tender leaves are used in salads and to flavor lemonade and other cool drinks, cooked, in pickles. Flower is candied for confection.

CARAWAY: 70 days. 1½ to 2 feet. Biennial seed; planted one year for harvest the next. Plants to stand 8 inches apart. Cultivate first year. When seed clusters ripen second year, snip plants a foot above ground, dry on old cloth a few days, then thresh seeds by slapping with a small stick. Blow off chaff and store in a tight jar. Early ripening seeds may be planted to give a crop the next year. Uses: in breads, cakes, candies—cabbage, soup and salads, in sauerkraut, goulash, baked apple.

CHIVES: Perennial. 6 inches. Seeds germinate slowly. Clumps may be divided in Spring. Uses: leaves give mild, onion-like flavor to soft cheese, vegetable cocktail, soup. Bulbs are chopped and added to sausage to give delicate onion flavor.

CORIANDER: 75 days. Annual 1 to 2 feet. Hardy, slow germination, but easy-culture. Can be grown with caraway. Plants should be thinned to stand 6 to 8 inches. Odor and flavor of growing foliage is unpleasant. As soon as seed tops are ripe, they’re cut off (heavy seeds easily fall to ground if this isn’t done), spread to dry, threshed, and stored in tight glass containers. Uses: in bread, cookies, baked apple, stuffing, sausage.

DILL: 70 days. Annual. 2 to 2½ feet. Easy germination and self-sowing. 10 inches between plants. Don’t transplant. Stake. Uses: for flavoring pickles; also in soups, stews, cream sauce, potato salad.

FENNEL: 60 days. Annual. 1 to 2 feet. Sow in moderately rich soil. Don’t transplant. 8 inches between plants. Uses: Stalks can be eaten like celery. Nutmeg-like seeds used on bread, cakes, sauces, in wine.

MINT: Perennial. 2 feet. Spearmint is ordinary garden variety. Best grown from a few plants. Spreads rapidly in medium rich soil. Uses: in lamb and fish sauces, iced-beverages, fruit cup, in currant and mint jelly, in French dressing for salads. Orange and apple mint not as strong as spearmint.

SAGE: 75 days. Perennial. 1 to 2 feet. 8 inch spacing. Plant seeds; choose “Garden” variety. Uses: as sage tea, in poultry dressing, sausage, soft cheese. Leaves can be smoked as tobacco.

SUMMER SAVORY: 60 days. Annual 1 foot. Seed germinates easily. Spacing 6 inches. Uses: for flavoring gravies, salads, dressings, stews, scrambled eggs and sausage.

SWEET MARJORAM: 70 days. Annual. Slow germination. Spacing 10 inches (requires shade until well started). Many uses either fresh or dried: in sausage, meat pies, roast lamb, cheese and egg dishes, peas, beans, and tomatoes, in vegetable cocktails.

THYME: 85 days. Perennial. 6 to 12 inches. Plant seeds—thin to about 4 inches. Plants may be divided and reset second Spring. When in full bloom, cut, dry, powder by rubbing and store in glass. Uses: green or dried in soups, stews, sausage, gravies, stuffings, with pork, veal, chipped beef, and especially good on lamb or chevon and chicken.



HYSSOP ANISE MINT CHERVIL THYME TARRAGON PEPPERMINT SPEARMINT CHAMOMILE CATNIP LAVENDER COTTON SUMMER SAVORY SAFFLOWER

The Kind of Berries and Grapes Money Can't Buy...



Strawberries

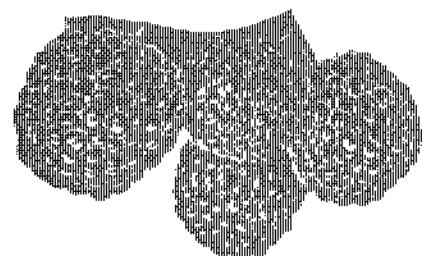

Black Raspberries

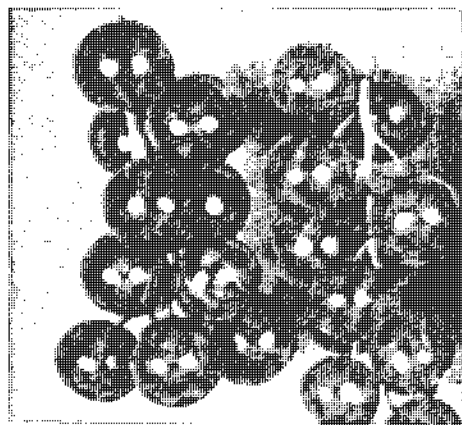

Currants



Gooseberries

BERRIES and grapes are one of the best investments you can make. Here it is early December and this morning for breakfast we had some of our own delicious raspberries and cream. When some friends came to dinner a few days ago we had strawberry shortcake made with our own strawberries. Soon we hope to have currant jelly and our own grapes and lots of delicious fruit juices—perhaps some home-made wine.

Even the smallest place can provide an abundance of mouth-watering small fruits and berries with only a few hours work a year. Home-grown fruits, especially blackberries, gooseberries and currants (all of which are almost too fragile to be handled commercially) offer a family delicacies they'd never otherwise have. Few people, according to government studies, get enough of the so-called "protective" fruits rich in vitamins needed for good health. And most city people never have the chance to indulge in all the fun of growing these fruits on a place of their own.

You can plan your garden so you'll have a succession of fresh fruits ripening from June to October. And all winter you can eat berries you've canned or frozen. Strawberries, raspberries, currants, and grapes are the best known favorites. If you prefer something a little different, you can choose gooseberries, dewberries, or mulberries. (Edible mulberries are delicious fresh, canned or for wine. They grow on a bushy tree.) If space is limited, the bushes make fine hedges and shrubbery. Probably nothing you do will give you more for less cost. By all means choose the better varieties that are too tender and delicate to be found in prime condition in the store. Your local nurseryman can advise you on this and supply plants best adapted to your climate. Before you decide on your planting of grapes and berries, you should learn when each has to be sprayed, pruned and mulched and figure out a schedule for doing this. It's worthwhile to read up on this. Meanwhile, here are some things we learned about growing these fruits that may help you.

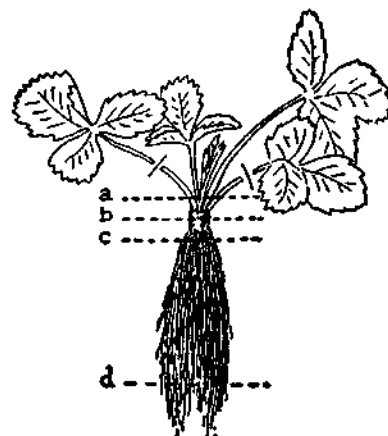

Strawberry plant showing trimming and depths of planting: (a) planted too deep. (b) planted correct depth. (c) not deep enough. (d) pruning of roots.

Strawberries

There's a big difference between strawberries you buy in the stores and those you pick sweet and fully ripe on your own place. Growing them is not difficult. You have a choice of planting them in hills, in matted rows or in spaced-rows. We used the spaced-row system and we think it's easier because it requires less pruning and makes weeding and picking the berries simpler. We planted 100 plants in the Spring and got 55 quarts the next year. Plants usually bear for two or three years, after which they need replacing.

Raspberries

We like raspberries so much we planted 100 bushes—cost \$8.00. This planting should bear for at least 7 years. Perhaps we made a mistake when we chose the *Latham* for our garden because this is really a commercial berry, but it is hardy and we did get wonderful berries. We also planted some *Indian Summer* because this is an everbearing type which means you get berries in the early Summer and another crop in the Fall. The raspberries planted in the Spring gave berries the following year. We learned

Small Fruit Planting Table

	Distance between rows (feet)	Distance between plants (feet)	Estimated Yield per plant	Age of Bearing (in years)
Raspberries	6-8	2-3	1 quart	2
Strawberries	3½	2	¾ pint	2
Blackberries	6-8	2-3	1¼ quart	2
Dewberries	6	6	1 quart	2
Gooseberries	8	3	2¼ quarts	3
Currants	8	3	2 quarts	3
Grapes	8	8	6 pounds	3-4
Blueberries	5'	5'	5-6 pounds	1-2

you shouldn't mulch raspberries with poultry litter in the Spring because it makes the shoots grow too fast. When this happens too many become "Winter killed." Raspberries are pruned early in the Spring, and sprayed 3 or 4 times. Any diseased canes should be removed immediately after crop is over. And that's all we've had to do to get 75 or more quarts of raspberries a year!

Currants

You can't beat currants for jelly. They are hardy, easy to grow. A half-dozen bushes are well worth considering. Some states ban currants and gooseberries because certain varieties supposedly carry white pine blister rust, a disease that destroys white pine trees. Cool moist climates are ideal for currants.

Gooseberries

I hope some of you people who are already living in a "Have-More" home-stead will want to try gooseberries. They make good pies, tarts and jams and the fresh ripe fruit makes a delicious dessert. Even in Canada they can be grown; in cool, moist climates they flourish. (In England they grow so well that the berries are often as large as eggs!) Experts say this fruit has been pretty much neglected in this country—it ought to make an interesting experiment.

Grapes

We planted 10 vines—4 Concord, old-standard, for jelly and jam . . . 2 Caco, a red grape ripening in early September . . . 2 Niagara, white grape which ripens in mid season . . . and 2 Portland, another white grape, which ripens early. Grapes really don't bear heavily until the fourth season, so we haven't actually had any from our vines as yet. All 10 grape vines cost only \$5.00.

Blueberries

Blueberries are rather expensive—\$1.00 per plant, we paid. But four to six are supposed to be enough for an average family. One interesting thing about blueberries—they often fruit the first year and will keep bearing for fifty years. Unhappily, out of our six bushes we lost four last year—the goats ate one and a bulldozer we had ripping

out stumps in our back yard chewed three more.

Blackberries

This fruit makes wonderful jam and jelly. We put in about 15 bushes as a hedge. Blackberries have a reputation for being sour. This is because often times the berries you buy are picked as soon as they turn black—actually they are best when left on the bush until dead ripe. As in the case of other berries, it is important to mulch blackberries. The best time to do this seems to be directly after the berries have been picked. Blackberries don't need commercial fertilizer, but the soil should be kept moist and provided with humus. Thus the mulch.

Dewberries

This is really a blackberry. It is often called "creeping blackberry," the main difference being that it grows on a vine instead of a bramble. The dewberry is sensitive to frost and will not bear good yields unless you plant several varieties to insure cross pollination.

Home Wine-Making

Although the wines we've tried to make have been pretty terrible so far, there's no reason you can't make excellent wines at home. In fact Fortune Magazine says 30 million gallons of wine are made in American homes every year.

Our mistake was in trying to make wine on the basis of "heresy" instead of getting good, clear, authoritative information. If you'd like to make wine from grapes, the main point is to get the *right* grapes. This isn't difficult because every state produces wine grapes. (See Farmers' Bulletin No. 1689). Or you can make delicious "wines" from blackberries, raspberries, elderberries, currants, gooseberries, dandelions, rhubarb, almonds, apples, apricots, barley, cherries, pears, oranges, pea pods, potatoes, tomatoes, rice—recipes for all of these and many more are in "Home-Made Wine Secrets".

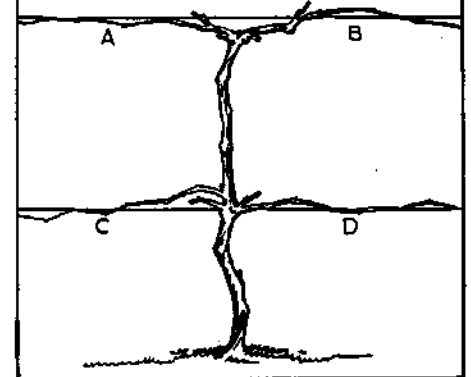
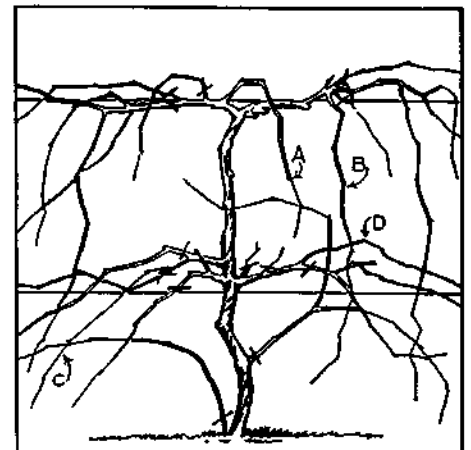

PRUNING—THE SECRET OF SUCCESS: Pruning can become a complicated subject. The main point is that all grapes are borne on branches (called canes) developed from previous year's growth. A little study of grape care and pruning pays high dividends.



(Above) After a raspberry cane has borne fruit it should be cut near the ground. Pruning is simple if you learn what to prune and when.

(Below) If strawberries are mulched as shown less cultivating is needed and you obtain better fruit.

In the Spring red raspberry canes should be cut back to a height of 4 to 5 feet as shown by dotted line. Remove weak canes completely. Leave 3 or 6 canes per plant.

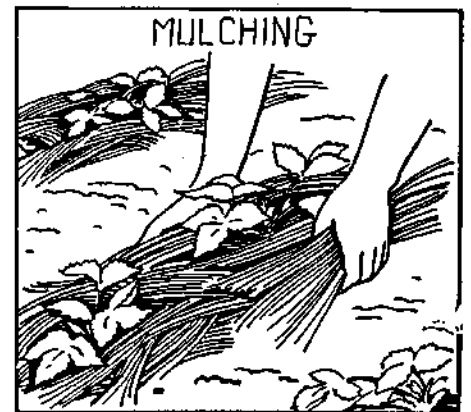
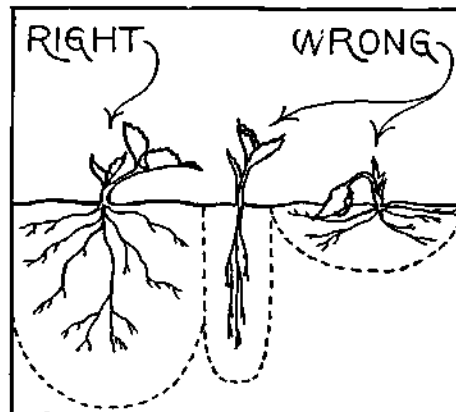

Two Ways to Have Tree Fruits on a Small Place

If the Ed Robinsons of five years ago could have talked with the Ed Robinsons of today about home orchards, the Ed Robinsons of five years ago would have been saved a lot of trouble. Now perhaps we can save you that trouble!

Soon after we first moved to our place we became excited about dwarf fruit trees—pigmy trees that produce delicious, normal size fruit in only 2 or 3 years. But when we went to order some our local nurseryman didn't have the right kind of dwarfs and he advised us to buy standard trees instead.

"But we haven't enough space in our back lot for many big trees," we protested.

"Then why don't you plant your orchard in front of the house?" he suggested.

"Well, we planned to landscape the front with pretty trees."

"Haven't you ever seen an apple tree in blossom?" he asked. Of course we had—so we planted our 18 fruit trees around the house and front lawn. We landscaped with fruit trees instead of shade trees. (Later we discovered that the back of our acre was too swampy for fruit trees anyway. If the roots of young trees stand in water they don't do well.) So we've never regretted our decision to plant fruit trees in front of the house.

We feel that the very first thing people should do when they buy a piece of land—even before the house is built, when possible—is plant a small orchard. The sooner planted, the sooner you will get fruit. The length of time you have to wait before your fruit trees bear seems to discourage a lot of people. But even if you should move before your fruit trees do bear, they'll increase the value of your place many times beyond their cost.

As for the care of fruit trees, our

nurseryman gave us a lecture before he would take our order. He said, "Now remember, you can't simply plant fruit trees and forget about them. You have to spray them—just as you do garden plants—and prune them once a year in addition." It wasn't until after we assured him we would do this, that he would take our order.

More likely than not your own local nurseryman will take a real interest in your fruit growing project. It is a good idea to buy from him rather than a far away nursery selling by mail because not only will you get some good advice from your local nurseryman from time to time, but he knows which varieties do best in your particular locality. Many local nurserymen today buy their young stock from famous nurseries all over the country, so if you want something special he'll get it for you.

We had a lot of fun considering what and how many trees to plant. Before we decided which variety of apples, we visited a commercial apple orchard, bought four or five varieties, tasted them and cooked them.

We learned that commercial growers give the appearance of an apple—or any fruit—undue importance. With them looks seem to rate as high as taste. Probably because appearance sells the apple at the fruit stand. Obviously, the first thing we were interested in was taste . . . next came keeping qualities . . . looks was last on our list.

In selecting the varieties we kept in mind the fact that certain apples ripen in July, others in August, September and October. By planting five apple trees, we would have apples summer and fall—and also a late apple which would keep over the winter.

After considerable reading and a lot of talks with our local nurseryman, the following is a list of the standard fruit

trees we believe sufficient to furnish a large family with enough produce for eating, canning and storage: 3 apple; 4 peach; 3 pear; 2 sour cherry; 1 sweet cherry; 2 plum. In Southern latitudes you can have citrus, apricot, nectarines, fig. Be sure not to plant your young trees too close to the house or to other trees. (See chart.)

The following table will give you an idea about yields and age of bearing:

Kind	Yield, When Full		Age When You May Get Fruit*
	Bushels	per plant	
Apple	6		6-8
Pear	1		5-7
Peach	1		3
Plum	1		4-5
Cherry (sour)	1		4
Cherry (sweet)	1		6-7
Quince	1/2		5-6

*Based on planting 1 or 2 year-old standard trees—older trees usually don't fruit any sooner.

Even though all the fruit catalogues tell you that you can plant in either spring or fall, spring is preferred in most sections. Planting should be done as early as the ground can be worked and before growth has started in the plants. Don't use fertilizer when planting. Use fine earth and tramp earth solidly about the roots with your feet, shovel by shovel. Set trees about an inch deeper than they were in the nursery.

Keep a three foot circle cultivated around the tree trunk. In the fall mulch them with poultry house litter. From the second year on, cultivate regularly and fertilize at end of June by using a barnyard manure mulch. This serves to keep in moisture during hot dry spells in July and August and provides additional food. You will be surprised at how much faster this will bring your trees to bearing.

Some state agriculture departments will send you postcards throughout the year telling you with what and when to spray your fruit trees. Needless to say, this is an invaluable service and you should get your name on your state's list of fruit growers so you can more easily take care of spraying. Ask your County Agricultural Agent about this service.

Dwarf Fruit Trees

Now, after many years of experimental work really good dwarf fruit trees are available. The two exciting things about dwarf fruit trees is that they take very little space and they bear fruit a year or two after you plant them whereas with standard trees you have to wait four to eight years!

Take a look at the comparison chart on the next page. It will help you decide which type of trees to plant.

Dwarf trees have many advantages, and a few disadvantages, when a detailed comparison is made with standard trees. Let's look at the advantages:

Dwarf trees take less space. In the

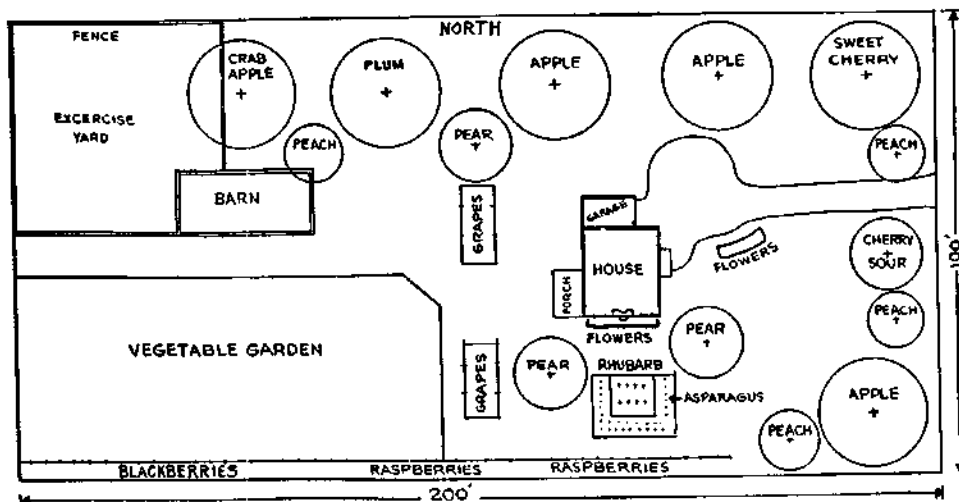

Here is one plan for less than a half-acre homestead showing how you can attractively landscape your grounds with fruit trees. Note that tall trees are generally planted on North boundary. In this plan trees are planted as close as is practical and size (spread) at maturity indicated—scale 1" equals 40'.

space required by 4 standard apple trees, 80 x 80 feet, you can plant as many as 64 dwarf apple trees! Even the ordinary suburban "house and lot" has space for a few dwarfs.

Dwarf trees are easier to spray or dust. All fruit trees must be sprayed or dusted. Dwarf trees, particularly the "little" dwarf or "semi-dwarf" can be sprayed or dusted with an efficient garden sprayer or duster. This is most desirable because the expensive, bulky spraying equipment for standard trees is not needed. Spraying is much easier, and consequently it gets done.

Dwarf trees bear fruit sooner. A "standard" apple tree usually does not produce fruit for 5-10 years after it has been planted. A dwarf tree will often bear fruit in two years!

Dwarf trees are easier to prune. Obviously a tree 5 to 10 feet tall is much easier to prune than a tree 25 to 30 feet tall.

Dwarf trees grow large fruit. Fruit buds, like turnips for instance, need to be thinned if the biggest fruit is to be grown. Dwarf trees, where the tiny fruit can be thinned easily, often produce bigger fruit.

Dwarf trees make possible more variety. Naturally if you can plant 10 to 15 dwarfs in the space required by a single standard tree, you can have 10 or more various kinds or varieties of fruit, instead of one. This has another advantage: you can have early, mid-season and late fruit by selecting varieties that ripen at different times.

Dwarf trees are easier to harvest. Fruit from the smaller dwarfs may be picked from the ground without the bother and danger of climbing a ladder.

Dwarf trees mean less damaged fruit. Fruit dropping from the small dwarfs, particularly when the ground under the trees is mulched with straw, hay or sawdust, is often undamaged.

Dwarf trees produce top-quality fruit. Fruit produced on a dwarf tree not only tastes as good as fruit from a standard tree, but because it is easier to give dwarfs better care, the fruit often surpasses that from large, and particularly old commercial trees.

As for the disadvantages, here are several you should know about:

Dwarf trees are more expensive. Of course prices vary in different localities, but a New York State nurseryman lists

2 year dwarfs at \$3.50 and his standard trees at \$1.75. When the supply catches up with the demand, this difference won't be as great.

Dwarf trees are shorter lived. However, this is not too serious a drawback. A dwarf apple tree will bear for 25 to 30 years compared to say 40 years for a standard tree.

The fruit you get from dwarf trees is full-sized. All standard varieties of fruit are available on dwarf trees; that is you can buy dwarf McIntosh, Baldwin, Northern Spy apples . . . Bartlett, Clapp's Favorite, Duchess, Seckel pears . . . Elberta, Hale-Haven peaches, and so on.

The fact that dwarf trees are easier to care for doesn't mean you can grow them without knowing a few of their peculiarities, however. Certain things about dwarf management are different. They must be planted correctly or they may grow into large trees. Pruning and thinning, though more simplified, is different. You'll find it really fascinating to read up on dwarf trees—also this will insure you against buying the older kind of dwarfs which nurseries used to carry and which weren't always reliable. We recommend you seriously consider planting dwarf apple, pear and possibly sweet cherry trees as these three have been developed the most successfully. Dwarf fruit trees, one of the biggest horticultural advances in years, mean a lot for the small place.

\$50 From a Single Nut Tree!

One day Carolyn and I received this letter:

Dear Ed & Carolyn:

"Here in Georgia a great many pecans are raised commercially and many farmers have a side line grove of the nuts which add considerably to their income. The trees make beautiful ornaments as shade trees besides the crop they bear. One suburban home I know of has two trees that brought in a total of \$84 cash this year. Another single tree I know of bore over \$50 worth of nuts."

Sgt. Herbert P. Keene

This was only one of the letters friends have written us to say that we should include mention of nut trees in our "Have-More" Plan. They pointed out that nut trees are unbelievably



The little girl is four years old—but the dwarf fruit tree has been planted only two years. And just look at the apples!

easy-to-grow, make beautiful shade trees, require less spraying and pruning than fruit trees, and supply the table with a nutritious, easy-to-keep food.

Well, I will say truthfully that about all that I know about nut trees is what I've read about them. We do have on our place one big, old butternut tree that has born huge crops; the nuts have a heavy husk and thick shell, but are mild and good-tasting after you get them cracked.

But Carroll D. Bush, in the *Nut Grower's Handbook* points out that here in America in the past thirty years, more has been accomplished with nut trees than millions of people in the old world accomplished in centuries. Better varieties of both European-Asiatic, and American nuts have been selected and bred for improvement and hardiness.

Today there are nut trees suitable for growing in every state. Of course, nearly everyone is familiar with the great almond and English walnut groves on the Pacific Coast and the pecans in the south. But do you realize the many varieties that have proven successful in the north and eastern states? Here are some of them: Im- great almond and English walnut pecan, hickory, hican (a cross between a hickory and pecan), filbert, almond, Chinese and Japanese chestnuts, heart-nut, and many varieties of hazel nuts.

Although nut growing is by no stretch of the imagination a "get rich quick idea," it does have a definite commercial side. For the homesteader, nut trees do have a good deal to offer.

Fruit Tree Comparison Chart

	Years After Planting To First Fruiting		Orchard Spacing	
	Standard	Dwarf	Standard	Dwarf
Apple	6-8	2-4	40' x 40'	8' x 10'
Pear	5-7	2	20' x 20'	10' x 10'
Sweet Cherry	6-7	4-5	25' x 25'	12' x 12'
Sour Cherry	4	3	20' x 20'	12' x 12'
Plum (Japanese)	4-5	3	20' x 20'	12' x 12'
Plum (European)	4-5	4	20' x 20'	12' x 12'
Quince	5-6	4	15' x 15'	10' x 10'
Neclarine	3	2	20' x 20'	12' x 12'
Apricot	3	3	20' x 20'	12' x 12'
Peach	3	2	20' x 20'	12' x 12'

Fresh Eggs From Your Own Hens

PERHAPS this sounds fantastic but we find that it's not much more work producing our own eggs than it is to make a weekly trip to a poultry farm to be sure we actually do have strictly fresh eggs. Our laying flock of 20 R.O.P. New Hampshires requires about 7 minutes care a day—and gives us on the average 11 eggs daily, year around.

Twenty hens require an 8 x 10 foot house which costs new about \$75. But if your family uses only four eggs a day a house for eight hens can be bought or made for as little as \$30.

Eggs were the first project we attempted when we moved out of the city. We estimated how many eggs we'd like to eat. With three in the family we thought we wouldn't need more than two dozen a week—3½ a day.

In estimating year around egg production, figure a hen will lay an egg every other day—if you can use six eggs a day, then plan on having a dozen hens. So, we bought a ready-made poultry house for \$28., 7 pullets for \$11.00; plus a water pan for 50 cents, a feeder, 69 cents.

If you can drive a nail and cut a straight line with a saw, you can build your own poultry house. If you want to, you can buy a "knock-down" poultry house and assemble it. You'll find them advertised in poultry magazines—be sure to write for catalogues and compare prices—they vary quite widely.

For the first week our 7 pullets (young hens beginning to lay for the first time) didn't lay an egg. One evening when I came from work, I found my wife all excited—our flock had produced an egg! That egg, counting the feed we had on hand cost us \$45.89.

But during the next eight fall and winter months those 7 hens laid 646 eggs—nearly 54 dozen—6½ dozen a month.

During that time we spent \$14.30 on feed—an average of 26 cents per dozen eggs. In our locality eggs sold for 60 cents a dozen. In short, we had saved \$32.40 on eggs and at any time could have sold our hens as fowl for 25 cents a pound or \$11.20.

But with our eggs only costing us 26 cents a dozen instead of 60, we began using more. That's why we have increased our flock. The next spring we raised 25 of the finest R.O.P. (Record of Performance) New Hampshire pullets (cost: 50 cents apiece as day old chicks), culled them down to 20, and began getting more eggs than we could use. With these better laying birds our eggs cost only 16-18 cents a dozen for feed costs. We sell the surplus at 60 or 65 cents a dozen—and right where I work I have more customers than we can supply.

How to Start

When we began studying up on chickens we found that there were many books on how to make a success of poultry commercially, but little information on raising a barnyard flock efficiently. Now, however, there are a number of good books—for example, G. T. Klein's "Starting Right With Poultry."

Many writers tell you any old building is suitable for poultry. But any old building and any old kind of equipment often result in a damp, drafty henhouse—probably ending up with your flock not laying and possibly getting sick.

A separate henhouse, or space in your small all-purpose barn, or a re-

modelled shed which gives 4-5 square feet of floor area per bird is needed. For a dozen hens a house 7' x 8' or thereabouts is satisfactory. The building should face south and permit plenty of sun deep into the building during winter. The house should be well-ventilated, but not drafty. Recent experiments show that it is better to give hens almost no air at all than have them exposed to a draft. Twenty hens give off a gallon of water per day—draft-free ventilation will keep this moisture from being absorbed in litter, doing away with frequent removal of same. With proper draft-free ventilation, you can put litter down in the fall, add more as needed during the winter, fork over weekly, and you should not have to change litter until spring. Then, old litter is used on the garden. But if litter becomes damp, change it right away.

Crushed sugar cane is excellent litter, deep straw or peanut shells are also good—all make good garden mulches. To obtain draft-free ventilation have windows in south only, and have them open in from the top, or hang regular double-window sash that can be regulated top and bottom.

The foundation of the house can be of concrete, which is best, or double-wooden floor with building paper and rat-proof wire between floors.

Interior

As for the interior of the chicken house, at the rear provide a dropping board 3 to 4 feet off the floor perhaps across the width of the house. Six to eight inches above the dropping board on supports, run a one-inch mesh wire. Provide roosts above wire, a foot apart. Allow 10 inches of roost per bird. The wire between roost and dropping board keeps hens clean and saves the eggs laid from the roost.

Nests—while they can be orange crates set a foot or so off the floor at the side of the house—should have a piece of ordinary corrugated carton cut to cover the bottom, then straw or excelsior for nesting material. The corrugated cardboard saves many an egg from breaking, and if an egg should become broken or the nest become messy cleaning is simply a matter of removing the cardboard. Provide a nest for each 5 hens.

Also buy a good waterer—preferably one that has a kerosene or electric heater to keep water from freezing in winter. Get one large enough—our 20 hens drink about two gallons of water a day.

Your State Agricultural College will send you free building plans for a backyard laying house. You can get plans to build a mash and feed hopper from your local lumber man. But it's practically as

See next page

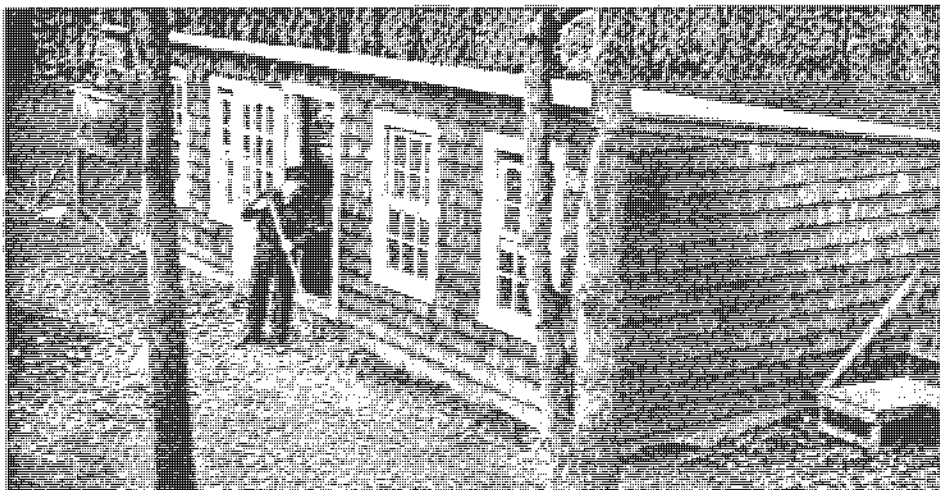

Our small all-purpose barn is 18 x 30 feet. Run at capacity this efficient little building houses up to 30 laying hens and a battery broiler in one section; in the other, 4 milk goats and in two pens up to 6 kids or lambs, plus a six compartment metal rabbit hutch, squab loft, milking stand, also feed and hay.

No-draft ventilation with plenty of sunlight is provided by four windows facing south. A second door at the far end (not visible) opens from the goat dairy section into the fenced pasture. Small hen door on the north side lets hens out into the yard.

Floor is concrete, building is regular frame and sheathing construction with cedar shingles—roof of heavy green mineral surface roofing. Water is piped from the house.

Cost including equipment: materials \$285, labor \$240.

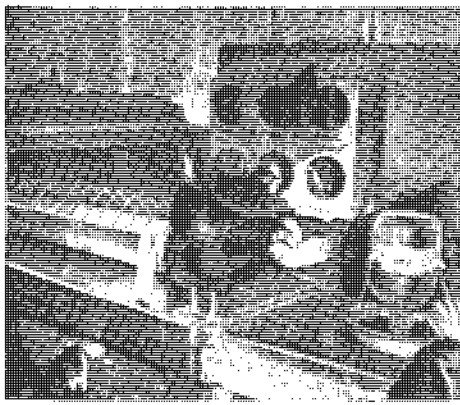

One-third of our barn is a laying pen. Simple and cheap feed and water equipment on a sturdy home-made stand keeps feed and water clean. Also, although it doesn't show up in this snapshot, wire is stretched between roosts and dropping board for sanitation.

cheap to buy a hopper from Sears Roebuck or Montgomery Ward or one of the poultry supply companies. The hopper should be well off the floor with a feeding platform that keeps feed clean and saves waste. Set the hopper and the water in the middle of the floor so that the birds can get the feed easily. (See diagram).

How to Feed

There are more different theories on feeding hens than feeding babies. Here is a simple, satisfactory way. In one large mash hopper (one foot long for each six hens) place a good egg mash in one half—and in the other scratch feed. Keep plenty of mash and scratch before the hens at all times. At first your hens will eat more scratch than mash, then gradually eat half mash, half scratch, which is what they should be eating for best results. (Hang an automatic feeder for oyster shells and grit from a side-wall).

Buy your feed from a hay and feed dealer with a good reputation. Keep a supply of feed on hand—don't let your feed get too low because feed deliveries are unpredictable. You can keep laying hens inside the poultry house all year around—they will lay as well as hens that have a yard. In winter an electric light with an inexpensive automatic switch which turns it on at 4 a.m. will increase your production—not because you're fooling the hens into thinking it's daylight, but because they can see to eat more egg-producing mash.

Mash means eggs—as they say. So keep your birds eating mash. If they drop off, moisten mash (in winter use hot water) and you'll be surprised how your hens will gobble it up.

Culling

"Cull" simply means to eliminate birds that seem sick, weak, or non-layers. Time was when characteristics showing good layers were not widely known, but today almost anyone can

cull their flock by checking these characteristics:

Judging Production

	Laying Hen	Non-Laying Hen
Vent	White, large oblong, moist	Small, round yellow, dry
Comb	Large, red, full, silky	Small, pale, scaly
Pelvic bones	Wide apart, pliable	Close together, rigid
Wattles & Earlobes	Prominent soft	Shrunken rough, dry
Eyes	Prominent sparkling	Listless, sunken, dull

Cull birds after dark. Take out of pen for table use those showing non-laying characteristics. Probably, at first, you won't trust your ability to cull. We were afraid we might "liquidate" a couple of valuable layers—so we kept the "cullers" in a small chicken house for two weeks to see if they were layers. They weren't.

If over 50% appear to be non-layers, probably, the trouble is with you. Exert every effort—feed hot mash, check for lice, mites—for four to six weeks to bring them back into production.

What Breed?

There is no best breed. All fall into three general classifications: egg machines (Leghorns), meat birds (Jersey Giants), all purpose birds (New Hampshire, Plymouth Rocks, R. I. Reds, Wyandottes.) By all means choose one of the all purpose birds—preferably the one your wife likes the looks of best. She'll be collecting the eggs and keeping an eye on the flock while you're away.

You can raise your own laying hens from chicks, particularly if you buy the battery brooder described in the section on broilers. Buy "straight-run" baby chicks using poultrymen's rule of three chicks for every pullet wanted in the fall. When they are six weeks old take out pullets (they'll be smaller, have less comb development) and raise them on range during warm months. (See page 33). Never put young growing chicks with older chickens or hens.



Almost one-half of daily chore time is taken up by watering stock. Running water in barn is easiest single way to save work.

Secondly, if you don't have a brooder, then buy 6 to 14 week pullets from a good breeder. These will begin laying at 20 to 24 weeks. Here you must be careful to buy from a poultry man

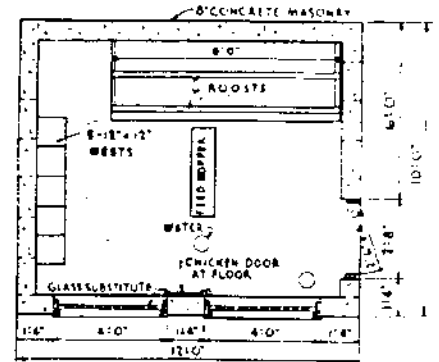

SHED TYPE POULTRY HOUSE
CAPACITY 24 HENS

Diagram of interior of a laying house. Feed and water are placed prominently in the middle of pen to get hens to eat often — "the handier the mash . . . the more eggs."

who is in the business of raising pullets to sell. Be wary of buying from a poultry man who is primarily producing eggs—he usually keeps his best pullets, sells his culls. Only buy 6 week old pullet in the spring or summer when there's plenty of grass range for you to raise them into strong birds.

Thirdly, you can buy 20 week old pullets which are about ready to lay. These will cost \$1.50 to \$2.50 apiece. Buy only pullets—birds less than six month old. And remember, you don't need a rooster to produce eggs.

Prevention of Disease

It has been said that something like 300,000 people go into the poultry business each year to make their fortune—and about 289,000 give up because they couldn't make a go of it commercially. One reason for this bad showing is loss from disease. A backyard poultry raiser should have little trouble on this score if he has disease free birds to begin with and keeps sanitary conditions in the house. We know of any number of people who have been keeping poultry for years without serious loss from disease.

Main points to bear in mind:

1. Keep poultry house clean.
2. Avoid drafts.
3. Don't overcrowd birds.
4. Paint roost once a year or oftener with Carbolinum to get rid of mites. Disinfect water and feed equipment—do this monthly anyway.
5. Isolate any sick bird immediately.
6. If any contagious disease occurs, kill affected birds and bury them immediately.
7. Dust with lice powder if birds are lousy.
8. Feed properly, watch for mouldy feed.

New, Easy Way to Raise Tender Chicken

ONE of the most successful projects we've undertaken is raising chickens to eat—broilers and fryers, in what is called a "broiler battery". This efficient new way of raising eating chickens has become increasingly popular among the large commercial poultrymen during the past few years, but only recently have small broiler batteries been made for family use.

Directly below is a picture of our "home-size" broiler battery. Here is the way it works: In the top deck we place "30 day-old" chicks, dipping their beaks in the water tray (and the mash) as we take them out of the shipping carton. Dipping their beaks once or twice teaches them where to drink and eat. At the rear of the top deck is a heated chamber with a drape at the front. This is the brooder. It's heated automatically by an electric heat-unit. When the brooder drops below a certain temperature, the heat automatically goes on together with a small light. The light attracts the chicks and they duck under the drape into the warm brooder.

As they get hungry they come out to eat and drink from the feed and water trays. Once or twice a day—and it doesn't have to be done at a definite time—we change the water and add feed, a specially prepared battery-broiler mash (be sure to get a vitamin fortified battery feed). The chickens live on wire and are kept sanitary at all times. A few sheets of newspaper spread out in the dropping tray makes

the daily cleaning easy—simply pull out tray and roll up newspaper.

At the end of 4 weeks, the baby chicks are divided into two equal groups—half go into the second deck, half into the lower deck. At the same time, another batch of 30 baby chicks may be added to the top deck.

In another 4 weeks, and each succeeding 4-week period, if you keep your battery running at capacity, you have 30 two-pound broilers.

Feed Cost — 16¢ a Pound

Even with today's expensive feed, our chicken costs us only 16¢ a pound. What's more, our battery takes less than 10 minutes a day to operate and it is truly "so simple a child can run it". Moreover, you can set it up in the basement, garage or shed—provided that, if you run the brooder during the winter, you have enough heat in any of these places to keep room temperature at 50° or above.

If you want to keep for your own use 15 broilers a month, then the other 15 can be sold to friends. By selling them at market prices you ought to earn enough to pay all your feed costs thereby having all the chicken you can eat at no cost.

The brooder is about 4½ feet high, 3 feet wide, and 3½ feet long. This size is made by a number of companies. They range in price from \$23-\$30. Names and addresses of Manufacturers are given at the end of this chapter.

One of the great things about these batteries is that they eliminate practically all chance of your losing your chicks by disease. At this writing I should say we've put over 800 baby chicks through our brooder. The hatchery from which we order our baby chicks—incidentally, we buy all males (cockerels) for they are cheaper and grow faster—sends us 32 chicks but charges for only 30. We have never lost more than these two extra chicks in any batch we've raised. And that isn't because we've been especially lucky, because four different friends of ours have bought broiler batteries—3 of them didn't know enough to tell a hen from a rooster—and all have done well.

Mind These A B C's

If you will remember the following points, I'm sure you will have no trouble in raising chicks in a battery:

- A) Buy good baby chicks—the best cockerels cost only 7 to 13¢ each, depending on the season. You can run the brooder any time of year. Buy chicks of heavy breeds—Hampshires, R. I. Reds, Barred Rocks, White Wyandottes and White Rocks (easiest to dress), or any of these cross bred. Don't buy Leghorns—they are a poor meat bird.
- B) Make sure your feed dealer supplies you with *broiler-battery feed*. This feed is fortified with minerals and vitamins necessary because your chicks won't get sunshine.
- C) Brooder should be started a day before chicks arrive. The room temperature kept at 65°-75°, if possible. Set your brooder so that a thermometer 1" above wire floor inside registers 85°-90°. Fill water troughs with warm water. Let chicks feed upon arrival—unless they're under 36 hours old. Daily feeding period should be 12 to 14 hours. Temperature in brooder is gradually reduced each week until at end of 4 weeks it is down to 70°.
- D) Wash water pans in hot water every other day—see that chicks always have mash, and water and chick grit.
- E) Let chicks have plenty of fresh air—no drafts and don't let temperature in room drop below 50°.

A Few Tips on Dressing Chicken

The first chickens we dressed took about an hour a bird—the other day we did seven in about an hour.

We never particularly liked this phase of our farm activities and have spent a lot of time making it as efficient and simple as possible.

First, instead of using a chopping

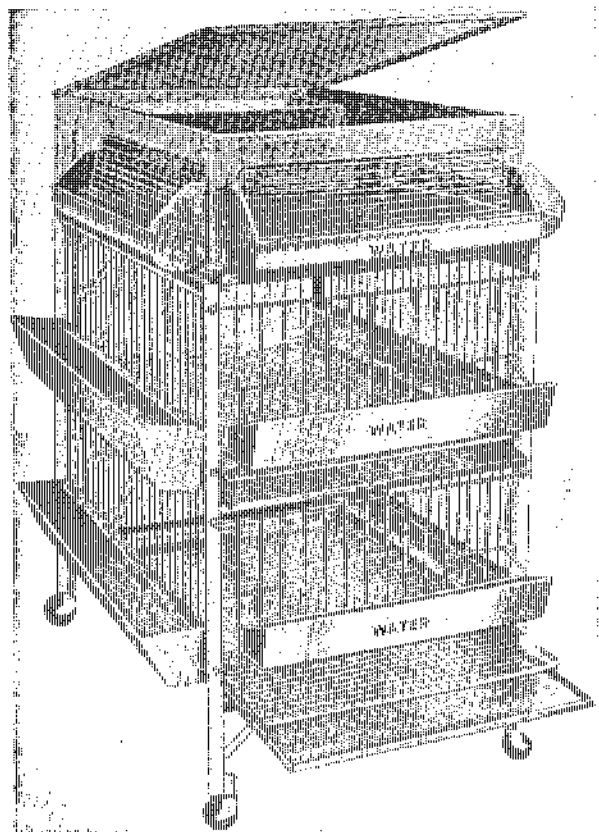

A complete chicken raising plant. With this broiler battery in your basement, garage or shed, and with no other equipment, you can raise baby chicks to 2 or 2½ pound broilers in 8 to 10 weeks. Not more than 10 minutes a day care will give you 30 broilers a month at a feed cost of 16 cents a pound or less, depending on feed prices.

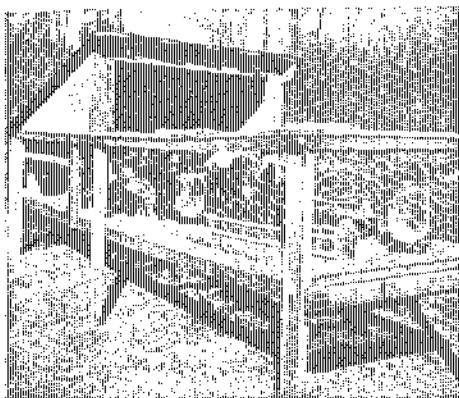

This outside sun porch is a convenient place to transfer 8 to 10 week old broilers and raise them to 3 to 7 pound fryers or roasters. Raising in confinement makes for tenderness and rapid weight gains. Sanitary floor is $\frac{1}{8}$ " wire mesh. Allow one square foot of floor space per bird at 10 weeks — two square feet at 20 weeks.

block and axe or the more expert commercial poultryman's method of sticking through the roof of the mouth, we use a gadget which looks like a miniature guillotine. This extremely humane device makes killing easy, sure and not messy.

Secondly, after dipping the chicken into hot water—not hot enough to burn chicken's skin—for about 30 seconds and plucking the feathers clean, we split the broiler down the back. This makes the intestines easy to remove in a mass. The bird can then be cut completely in half, washed, quartered, and it's done in much less time.

Tenderest Chicken

Battery broilers, fryers, or even roasters—and we've raised and eaten all three—are more tender than chicken grown on range. The reason for this is



One of the simplest most humane ways to kill poultry. A light blow of the hand and blade, held steady in the slot, punctures spinal cord leaving outlet for blood. Blade springs back, chicken is dropped into barrel.

immediately apparent—broilers raised in confinement do not toughen their muscles as do birds grown on range. Battery broilers and fryers, in fact, are usually so tender that the wholesale buyer of live poultry often will not buy them to dress and market, because battery broilers picked up alive at the farm and trucked even 10 to 20 miles, often lose up to 25% of their weight they are so tender. However, this commercial disadvantage is a distinct plus when you are raising chicken for your own use.

Home Made Brooder

If you do not have or buy the battery brooder pictured on the opposite page, you can easily set up a simple brooding outfit as shown. (Or you can buy a simple brooder like this at very small expense.) You can vary size of light bulb, get approximately right temperature under brooder—about 90 degrees one inch from floor, reducing gradually to room temperature in about 4 weeks. Then remove brooder.

Floor space required for each bird is about 7 to 10 square inches under brooder and about $\frac{1}{2}$ square foot outside brooder. Fine meshed wire or tar paper 12" high should be used to confine chicks close to brooder for first week.

Room or building used must be clean, fairly warm (70 degrees desirable—must not be less than 50), well ventilated, preferably with windows facing south for maximum sunlight. Your feed and grain dealer will have litter for floor, inexpensive feeding and watering pamphlets; perhaps free, detailed pamphlets on this phase of poultry raising.

Get your day-old chicks, either from

Summer Range Shelter

Putting pullets "on range" at 6 to 8 weeks old, with simple, shelter-type housing, as illustrated, is probably the best way to get healthy, sturdy birds. You can also raise broilers, fryers and roasters this way, but we think the battery-confinement method described and illustrated elsewhere on these two pages is preferable. You get better eating chicken in shorter time that way.

The shelters can be used in the North from May through October. Allowing the correct amount of floor space per bird—one square foot or more—a shelter 6 feet square would be large enough for 20 to 25 birds. (One of the most important things to remember about keeping any kind of livestock is never overcrowd).

Shelter design can be varied, but is based on these elements: a weather-tight roof; a wire mesh floor eight or more inches off the ground; roosts above this (one-by-two strips nailed flat on top of wire are suitable—allow 10" of roost space per bird); boards or wire all around bottom to keep birds

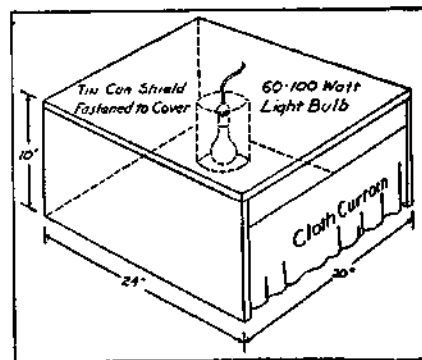

From Washington State College

feed dealer or by mail late in March or April. When six or seven weeks old, along in May (neck and head should be well feathered), birds can be transferred to summer range shelter unless house where started is designed for and has outside yards suitable for their growth to maturity. Cockerels and pullets should be separated at about 8 to 10 weeks of age, depending on the breed—in some breeds they are easier to tell apart than in others.

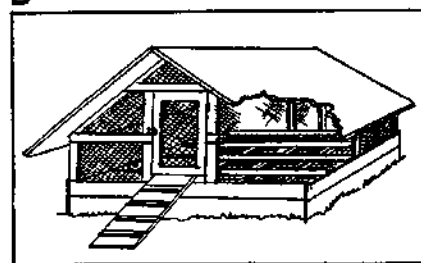

from droppings under floor; wire around sides from floor to roof to allow good ventilation; a door to shut chickens in at night and to keep rodents out.

Range can be any grassy piece of land, clover being particularly good. Allow 100 square feet per bird—the more range and the better the grass, the less boughten feed the birds will need, and the healthier they will be. Fence in to keep chickens away from garden and to keep dogs out. Covered feed trough and water fountain are placed near shelter and should be moved every week or so to assure clean footing for the birds.

Geese Grow on Grass

IN raising poultry, Ed and I believe chickens are fundamental—they furnish both meat and eggs. But after you are producing broilers in your battery and have a flock of laying hens, you ought to consider raising at least one other kind of poultry for variety's sake.

It is up to you to choose geese, ducks, turkeys, squabs—or something fancy like guinea hens or pheasants. You can easily handle one or maybe two of these in addition to your garden, fruits, chickens, goats and bees. You've probably eaten duck and turkey recently, maybe goose and squab. If you haven't eaten these latter two recently, do so—and then plan on raising what ever you like the best.

We Robinsons believe the goose is tops—best-tasting. Yet it seems to be the forgotten fowl in America. The most common objection we hear is that goose is too greasy. But you don't have to eat all the grease any more than you eat all the excess fat on the best cuts of beef. The first Christmas we were married I roasted a goose (at Ed's in-

sistence!) even though I had never tasted it. I used a prune and apple stuffing to offset the richness and pricked the skin to release fat which could then be poured out of the pan. I have been an ardent goose fan ever since. If you like dark meat, which we think more succulent and tasty than white, you should like goose.

Geese are the cheapest and easiest of all poultry to raise. Extremely hardy, they are rarely affected by any disease or insect pests. After they are two weeks old all they need is plenty of water and grass and they will gain a pound a week until they are about 12 weeks old. They may be eaten at this age and are called "green geese". Geese have no use for fancy housing—a simple 3 sided shed where they can keep dry in the severest winter weather is all they want for they prefer to stay in the open even at night. As for fencing, any low wall or fence 36 inches high holds them. At breeding time geese make their own nests, hatch their own eggs.

In Europe and Asia geese have been

highly valued for centuries. As far back as 4000 years ago the Egyptians used goose liver to cure night blindness—and they were right, for scientists now know goose liver is exceptionally rich in Vitamin A because geese eat such large quantities of green grass. Before the war Europeans raised more than 100 million geese a year.

If you live in a closely populated section you will not find geese desirable as their call is a noisy one and they are easily disturbed. In fact, they make good "watch dogs". If you want to keep feed at a minimum, ½ acre of good grass will support 8 to 10 large geese. Of course, you can keep them in smaller areas and supplement their grass with waste greens, vegetables or fruit and a little grain. Oats make a good grain. Geese need sand, grit and oyster shell for egg laying and digestion's sake. But from early spring till winter, it is grass and water than they prefer. If you supply those two things, your geese will virtually raise themselves.

You can start having geese by buying fertile eggs, day-old goslings, "started" goslings, or a matured pair or trio at least two years old. We could find no geese true-to-breed in our section so we bought eggs (35¢ to \$1.00 each) and hatched them under setting hens. It was one of the biggest thrills we have ever had—to see those little goslings hatch out. Here are the rules we would suggest after our experience:

1. Don't pay too much attention to all the free advice you'll get unless it comes from someone who has successfully handled geese for several years or from the Department of Agriculture or State Experiment Station.
2. Order your eggs from a reputable dealer suggested by your county farm agent or one who advertises in a good farm magazine.
3. Get your broody hens promised to you ahead of time by a large poultry keeper if you don't have any of your own. You may buy or borrow them. One hen covers 4 to 5 goose eggs. Move and place the hens on their new nests at night and keep the nest darkened.
4. When you make up the nests, dust them thoroughly with insect powder. Also dust the hens well a day or two before the eggs hatch. (You may use an orange crate on its side for 2 nests if you place a narrow board across the front to keep the eggs from rolling out).
5. Goose eggs, contrary to the usual practice, may be washed before setting. Turn the eggs once a day (when the hen is off her nest) as they are too large for hens to manage.
6. Take good care of your hen and her eggs. It takes from 28 to 35 days for eggs to hatch—a long setting for a hen. Take her off her nest once a day and give her grain and water. Be sure food and water is close so she won't wander off and forget her nest. A hen on goose eggs should not be off nest long enough for eggs to chill.

During the last week sprinkle the eggs with lukewarm water each day. The day before hatching place the eggs in a pan of warm water to cover eggs well and watch your live goslings bob. After a few bobs replace eggs in nest



Carolyn and Jackie get a close-up of a new member of the "family" — a day-old gosling. He came out of the shell yesterday. Today he is able to shift for himself quite well. A setting hen hatched him. Four or five goose eggs can be hatched (in 28-35 days) under a hen while your goose goes on laying more eggs.

and nature does the rest. (You furnish water to duplicate what occurs when a goose returns to her nest with her feathers a little wet.) If the egg should show the first crack of hatching, don't submerge the broken part. It can take a gosling as long as 24 hours to hatch after the first tiny crack in the shell, so don't be worried. Even if a gosling's head has emerged, the European custom is to push the head back into the shell so the gosling can obtain leverage to extricate himself. Take goslings from nest as soon as they hatch; place in a box and keep in a warm place until the hen completes her hatch. It is best to remove goslings because the hen is apt to get ex-cited at the first hatch, leave the rest of the eggs unhatched.

After you have hatched the goslings or if you buy them, keep them in a box with a few cloths in it in the house or some other warm place. A few hours after they are born feed them some chopped green feed—grass, lettuce, etc.—natural food for geese. Stale bread soaked in milk and sprinkled with a little sand, or a warm mash or chick starter may be fed. After the first day or so when they learn to manage their legs, put them out on the grass during the day—provided the weather is warm. But be sure to keep them in a warm dry shelter at night and don't let them out until the dew is off the ground. It is wise to let them have their box or shelter at night until they are well-feathered—at least 3 weeks old.

Care of Mature Geese

Buying matured geese ready for breeding is the most expensive way to start your flock, a good trio costing \$25-\$35. However, if you decide to do this, it's best to mate just a pair, even though it is common to have a trio of 1 gander and 2 geese. Geese prefer to live a monogamous life, in contrast to other birds. After they once mate, they are faithful to each other for years so don't break up their happy union. Buy your geese and pair them in the fall so they will be settled and ready to lay in February (the usual time in mild climates.) Your goose and gander should both be 2 years old to be fully matured and to produce fertile eggs.

The difficult aspects of raising geese are to get fertile eggs and proceed properly with the hatching. Your success or failure begins with the gander. He prefers living with but one female—although sometimes he'll take up with two. But the gander and goose usually must live together some months before they will mate. Although water isn't absolutely necessary, some kind of a little pool (see Chapter on Ducks for making pool) or stream is good because geese breed more easily in water. Once you have fertile eggs, be sure that the hen or goose you set them under is really broody. Start her setting on some hen eggs for a couple of days to make sure she's really serious about hatching

The young geese are 8 weeks old — half-grown and weigh about 9 pounds. The pair of breeders (at left) are two years old. Geese are extremely healthy, eat grass, and practically raise themselves.

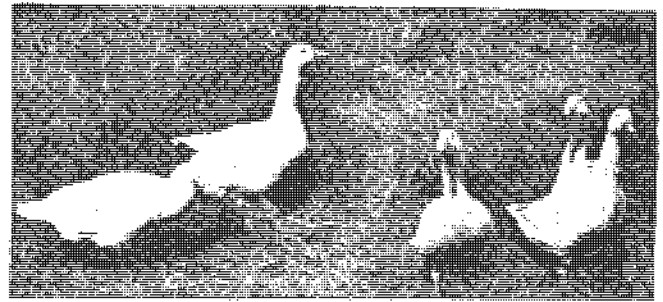

a family before trusting your geese eggs to her.

All the laying goose needs is a barrel or box on its side or some simple shelter and the goose will fashion her nest out of straw, twigs and her own goose down. The average goose of the heavy breeds can lay about 20 eggs, but is able to cover only 12 to 15, so remove the first eggs if you want her to continue laying more than she can set on. After she stops laying and becomes really broody see that she has as many eggs as she can cover well. Then, provided she has water (say, a large pond) so eggs will receive proper moisture, you can relax and let her hatch her own eggs. She'll turn them and do everything necessary.

We find geese are friendly and like to follow us around the yard, except during the mating and hatching season when it's best to stay away from the gander. Geese are fearless and will attack anything—you needn't worry about a rat, cat or dog bothering them.

Choosing a Breed

Every small flock we have seen seemed to be some kind of mixture stemming mostly from the gray and white Toulouse goose. We chose the Embden because my wife wanted all white Toulouse goose. The other two best known breeds in this country are the African and Chinese. Both have distinctive knobs on their heads. The African is brown, apt to be noisy. Chinese geese may be white or fawn, weigh from 10 to 12 lbs., are apt to be noisy. They belong to the exhibition breeds.

Though we don't expect you to go into the business of raising geese we thought you might like to know that the commercial by-products of the

goose are exceptional. When geese are specially fattened they develop large livers which can be made into the famous "pâté de foie gras" which means "patty of fattened goose liver".

You know how goose feathers are valued in pillows and upholstery, but did you know they are widely used in artificial flowers, Christmas tree decorations, fish lures, powder puffs, and many other things? And goose skins are also used in one kind of powder puff besides their more familiar use as cracklings. And that "awful goose fat" we hear about so much is known to many people as "schmaltz"—is exquisite in taste and highly regarded by knowing cooks for pastry shortening, bread spread and other cooking.

Some people like "schmaltz" plain as a bread spread—or if that is too fat, you can make a Swedish bread spread. Cover bottom of skillet with goose fat, add finely chopped onion (1 large) and unpeeled apple (about 3 medium), brown slightly. Add ½ cup goose fat and simmer over very low flame until onion and apple are soft. Then place in container and in refrigerator where it will keep a long time. Use cool.

To make plucking easier dissolve 2 cakes of paraffin (poultry plucking wax obtainable from a poultry supply house is better than ordinary paraffin) in a large kettle of boiling water. Dunk the goose thoroughly in this mixture immediately after it is killed and bled. Then start plucking right away. The paraffin ruins the feathers for future use, but if you really want the down you can dry pick.

Despite the difficulty of picking, we think the goose is a wonderful bird!

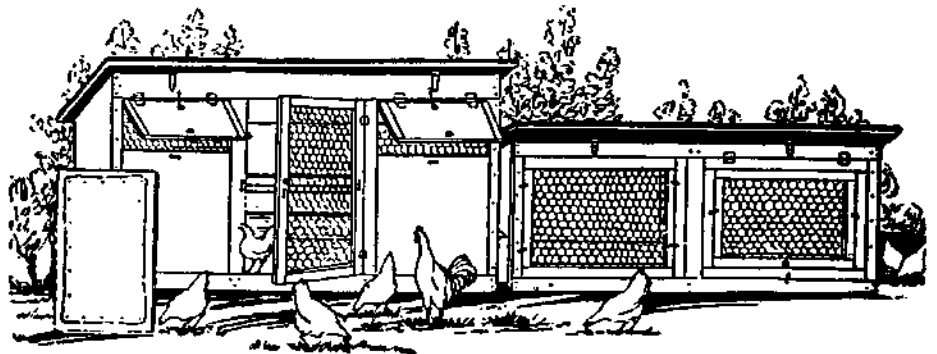

We bought this little poultry house and the scratch shed (at right) for our original backyard flock of 7 laying hens. It cost \$28.00. Since then we've used it as a coop to fatten broilers and as a shelter for our geese.

Turkeys Can Be a Profitable Sideline

WHEN you start producing food for your family, money will begin to lose its importance. You won't be digging into your pockets every time you turn around. First, you yourself will be producing a good part of your food and secondly, you'll be trading your surplus with your neighbors.

For example, we trade geese for turkeys with one of our neighbors, Tyler Long. Ty and his father have always had a hankering to raise turkeys. For a long time they just talked about it, then a couple of years ago they started in doing it.

Unlike a lot of people, including a few farmers I've met, they were frank with themselves in admitting to begin with that they didn't really know much about turkey raising. They determined to find out all about the newest and best ways of going ahead, start on a small scale. So they talked to any number of commercial turkey men, our county agent, and read everything they could get their hands on about turkeys.

Just to give you an idea of how well they've done, in 1942 the national turkey mortality rate from all causes was reported to be 28%. In 1943, when feed conditions were at their worst in 20 years, Ty kept his mortality rate down to 15%.

While it's true that scientific turkey raising requires certain precautions not always necessary in chicken raising, if a few general principles are followed with care, turkeys can be a surprisingly easy, inexpensive and interesting way of increasing your food supply. Turkeys, incidentally, produce more meat per pound of feed than almost any other kind of poultry.

We say this after observing Ty Long's experience raising turkeys. In fact, we have gotten him to give detailed, week by week, instructions, explaining exactly how a family can scientifically raise a dozen or so turkeys.

What Breed?

By no means try to hatch out turkeys from eggs—buy day-old chicks or poults as they are actually called. Place your order early, sometime between December and March. The importance of good breeding in the day-old poults cannot be stressed too much.

Ty recommends buying them from a well-recommended breeder rather than from a hatchery. You can get names from the magazine, *Turkey World*, (Mount Morris, Ill., 15c a copy) or consult your county agent. Don't decide on a breeder farther away than

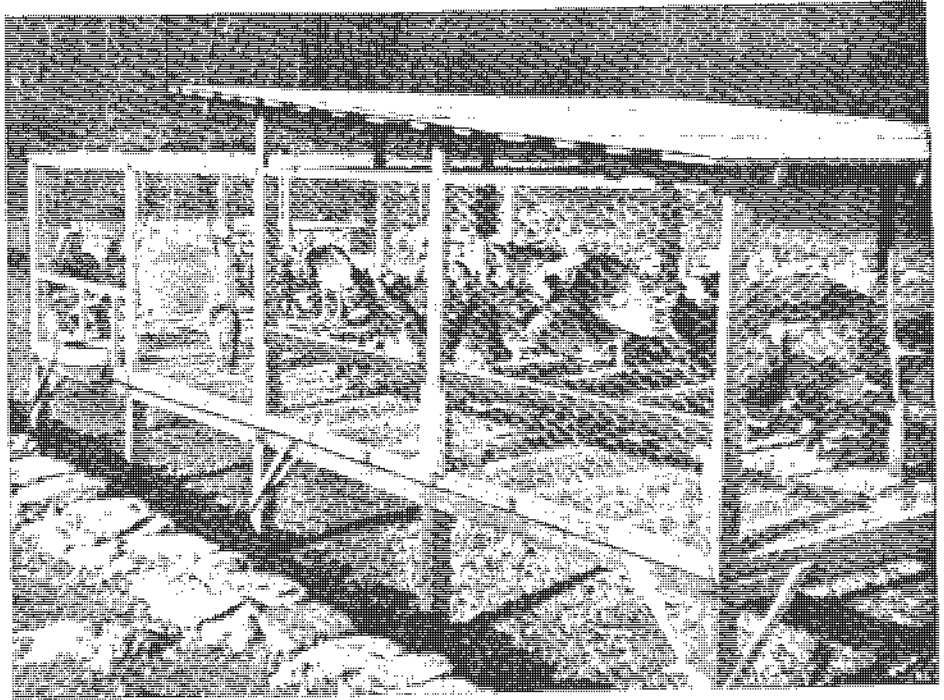

Twelve or thirteen turkeys should have a cage at least 10' by 12' with 12' of feed hoppers running along the outside. Roosts should be built in the sheltered end of the cage, using 2-by-4's with wide side as the roosting surface and allowing 14" space per bird. Top of roosts should be 20" from the wire floor and a space of 24" should separate one roost from another. Allow the birds complete access to the floor under the roosts, otherwise you cut their exercise area to the bone. A slanting roof of very heavy roofing paper and three sides of the same material (removed in above photo) should protect the roosting section.

300 miles, preferably closer. Specify shipment by Railway Express.

Most breeders specialize in Broad Breasted Bronzes—they give more meat per pound of frame. This is a good breed to start with, unless you want one of the smaller breeds. If, for your family use, you'd like to wind up with eight or ten fully grown turkeys, you'd best order 15 poults. Poults sell for from \$.50 to \$.75 apiece. These 15 will probably narrow down to twelve for the cage and eight or ten for your family and friends. You may, of course, do much better than this, in which case you can easily sell your surplus at a nice little profit.

Poor sanitation and dampness, huddling caused by improper heat control, and failure to start eating are the greatest causes of death in young poults. Because a battery brooder provides a maximum of sanitation and dryness, practically eliminates huddling, and its confined quarters are a big help in starting poults eating, we believe a battery is the easiest and safest way to raise your turkeys for the first four weeks. Equally important, a battery brooder reduces labor to a minimum. (See article on broiler battery, page 32).

Here are Tyler Long's week-by-week instructions. Don't let their seemingly lengthy detail discourage you. It's really easier than it sounds, and, besides, Ty is more of a "perfectionist" than most of us are likely to be.

Week-By-Week Instructions

These instructions are not intended to be absolute. We feel that reasonable appli-

cation of them plus common sense circumstances not discussed in this short article will result in your successfully raising your turkeys.

From First Day To Fourth Week

At least 2 days before the poults come, completely scrub battery, inside and out, feeders and waterers with hot soapy water. Rinse with hot water. Spray with a warm 4% solution of any reliable coal-tar disinfectant. Only then will your poults be reasonably safe from germs left by the battery's former inmates. Be sure all surfaces are thoroughly dry before the poults come in contact with them. Cover dropping board with newspaper to facilitate daily removal of droppings.

At least 4 hours before poults' arrival regulate temperature under hover (using brooder thermometer or thermostat) to between 95° and 105°. Reduce to 90° the third day. Thereafter a drop of 5° per week is usually advisable. However, behaviour of birds themselves is best barometer of their comfort. Cold poults usually huddle (their most dangerous habit), peep loudly and protestingly. Overheated poults act drugged and listless. Comfortable poults either sleep quietly or peep in a low, contented voice. Above all guard against huddling. More poults die in the first four weeks from smothering caused by huddling than from any other single cause.

On the other hand, it's just as important to remember that over-heating the birds at any stage of the game tends to produce a delicate, over-sensitive turkey. It is usually best for the first two or three nights to wake up at 1 or 2 a.m. to see that turkeys are comfortable. This is a chore, but a necessary one, since as many as 50% of your poults can be killed in one night by huddling.

Before placing your poults in their new quarters, fill the hoppers almost to overflowing with a turkey starter mash from a reputable feed concern. (If the mash is not Vitamin D fortified, add and mix thoroughly 1% Cod Liver oil until the birds are out in the sun.) Sprinkle about one teaspoonful

of fine hard chick grit to each three poult on top of the mash, so that they will get their "teeth" with their first meal. Continue giving this grit twice weekly until the tenth week. Fill the waterers with water the temperature of your hand. Continue for two weeks, then change to tap water. Keep both feeders and waterers filled to this level until poults can reach down into them.

Some of your poults may refuse to eat when you first get them. Put down a newspaper and scatter on it some chick scratch. Usually they will peck at this. Next day put chick scratch on top of mash in feeders.

Wash the waterer every day in hot soapy water. Keep it filled with fresh, clean water. Wash feeders every ten days. Stir old feed in with new to prevent any becoming stale.

Inspect your poults upon arrival, culling out any malformed, injured, or dying ones. The simplest, most humane method is to snap the neck with a quick, strong twist of the hand. The same treatment should always be accorded any deathly sick or badly injured birds as a protective measure for the rest of your flock. However, like chickens, no disease or injury to which a turkey is susceptible can in any way render the flesh unfit for human consumption. But any birds that are to be eaten should be killed so that they will bleed.

Disease Control

Baby turkeys are subject to a number of diseases, the most prevalent of which are coccidiosis and brooder pneumonia. The former is usually recognizable by bloody droppings and a general washed-out look to the bird. Pneumonia can sometimes be detected by the presence of phlegm in the nasal passage and some shivering. In each case the poult must be segregated from the others, kept warm and dry and fed warm milk, with an eye-dropper, if necessary. Nothing more can be done in the case of brooder pneumonia. The development of coccidiosis is sometimes arrested by administering a 1% solution of Epsom salts. This must be followed in six hours by dried skim milk mixed with the mash or water. Commercial anti-coccidiosis agents are sometimes found helpful. Never return the sick bird to its regular quarters until you are fairly certain a cure has been effected—you must not risk infecting the others. (Lederle's Sulfaguanidine, a new "sulfa" drug, has frequently halted rampages of coccidiosis when other measures failed.)

Keep a weather eye out for the condition known as "pasting-up", when the poult's droppings remain stuck to his backside. This is serious, as a poult (or chick) can die very quickly from the poisons caused

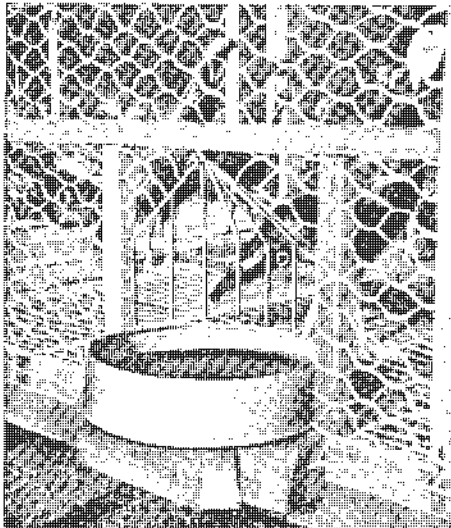

Detail of waterer: pan is protected by a wire guard. Construction prevents birds from contaminating water and enables you to water birds from outside.

by a clogged-up intestinal tract. Treatment we found safest: With a medicine dropper apply several drops of inexpensive mineral oil on and around the drooping, which will soon be worked off. Do not try to remove it; the poult's sensitive skin is easily injured.

From Fifth To Tenth Week

The advantages of raising turkeys in battery brooders will turn into serious disadvantages if the birds are kept in them after the four week period. Many growers leave poults in batteries only 16 days. The fact that the birds are allowed to develop neither immunity to disease-bearing bacteria nor resistance to less favorable climatic conditions in its protecting confines is responsible for this. Therefore, at least at the start of the fifth week the poults should be moved to a clean, dry, thoroughly disinfected floor covered with at least an inch of good quality shredded litter, preferably sugar cane shavings. The average temperature, at the floor, of their new quarters (section of garage, barn, enclosed porch, small brooder house, etc), should be somewhere between a minimum of 65° and a maximum of 75°. If it is not possible to use the top-section of your battery as their hover (in which case you would remove the dropping board, floor grid, removable sides, feeders and waterer, using it only as a source of heat and shelter on top of the litter), build or buy a small auxiliary hover. (See Chapter on Broilers).

Such a hover, which can be quite simply constructed of insulation board with either 2 or 3 25-watt bulbs or a commercial heating element installed in the roof, must be large enough and adjustable in height so as to accommodate all the birds when they are ten weeks old, at which time they should be more than twice the size they were at four. The temperature should be gradually reduced (if necessary, vary the number and size of the bulbs) so that the birds get little artificial heat for the next to the last two weeks and none whatever during the last two weeks. Important considerations in selecting the poults' new quarters are adequate ventilation facilities and a good supply of sunlight, at times directly on the birds, if possible. Be careful about direct drafts on the birds for the first 3 weeks in new quarters. It would be much to your advantage if you could provide the turkeys with direct access to the air and sun in a small, fine gravel-covered yard or wire-covered cage connected with their new quarters. To accustom the poults to outside temperatures and breezes, be sure to leave all ventilation facilities wide open for the last ten days and nights.

Litter should be thoroughly stirred every other day and completely changed weekly. This is necessary both to combat germs and to keep their walking surface dry, a point of great importance. It is also important to keep the waterers on three-inch high wire platforms to prevent contamination.

Mash should now be fed in a regular chick hopper, water in a one or two quart glass or metal chick waterer. Finely chopped tender green-stuff (lettuce, spinach, orange, cabbage, grass, clover, etc.) can now be fed the poults to great advantage. Scatter moderate amounts each day on top of their mash. Otherwise, feed, grit and water conditions remain as before. (8th week—start to mix growing mash with starter. Gradually increase to all growing, 10th week)

From the sixth week on, a careful watch must be kept for the most dread of all turkey illness, "blackhead." (For identification and treatment of this and other turkey diseases get the Dept. of Agriculture's Bulletin 1652 *Diseases and Parasites of Poultry*.) Sanitation and segregation of infected birds is your best weapon in fighting both blackhead and coccidiosis. Lederle's Phenothiazine has arrested many epidemics of blackheads, but cannot be guaranteed as a positive cure. If any signs of lice are detected a very light sprinkling of drops of "Black Leaf 40" wherever the birds bed down, be

it litter or roost, will rid them of the torments and dangers of lice.

From Tenth Week To Maturity

By the tenth week, under normal conditions, your poults should move to their permanent outside quarters. However, if poor feed or other circumstances prevent normal development or if the weather is unfavorable, it would be best to delay the transfer for a short time. These permanent quarters should consist of a solidly built wire-floored four foot high cage, with its base thirty inches off the ground and supported by pine or fir 4 x 4's whose bases have been dipped in creosote.



Ty Long feeding his turkeys. He says feeding time takes only a few minutes when hoppers are conveniently placed outside cage and adequate to hold a week's supply of feed. Good size for hoppers—8" deep, 8" wide, covered by 12" slanting roof.

If possible, open face of roost enclosure should face south. Sides and top of the cage may be constructed with lath or 2" poultry netting. Great caution should be exercised in eliminating all possible surfaces on the floor where droppings can collect. Bevel 2" x 3" (on the top) so that they will just hold staples 18" apart for the 1" by 2" flooring. A door should be placed on any side of the cage not taken up by the feed hoppers. Eliminate all sharp points or surfaces where the turkeys might injure themselves.

By this time a complete change from starting to growing mash should take place. Continue feeding chopped greens whenever possible. The grit, still lightly sprinkled on top of the mash twice weekly, should now be changed to broiler size. Starting with the 12th week broiler scratch, consisting preferably, of cracked corn, oats and wheat, should be fed in approximately one-quarter of the hopper space, boxed off from the rest. By the 20th week this should have been gradually increased to half the hopper space. Also near the 20th week the grit should be changed to full-sized and the scratch, consisting of the same ingredients, to full-size. Gradually increase the percentage of grain to mash until by the 20th week the birds are eating 50% of each. At this time it would make for a better finished turkey if you can make the scratch mixture 70% to 80% corn. It is possible, the last few weeks, to increase the consumption of feed by feeding a moist mash, made by mixing hot water on top of the dry mash in hoppers. However, care should be taken that none of the dry feed becomes sour. Remember the principle of finishing turkeys is to stuff them with as much feed of high caloric value as is possible.

An ailment known as perosis or "slipped tendon" is more prevalent in turkeys from the tenth week on, but it sometimes occurs earlier. Usually hereditary or nutritional in origin, perosis is sometimes introduced through infection. The trouble is easily recognized by the severe lameness and crookedness of one or both of the victim's legs. For treatment see the Farmer's Bulletin of poultry disease, No. 1652.

(Continued on next page)

Turkeys (Continued)

Your turkeys are ready to kill when they have a fine layer of fat covering the entire body (shown by a white or yellowish appearance of the skin, rather than the purple tint of the muscle tissue) and when at least 95% of the pinfeathers have disappeared. This usually takes from 24 to 28 weeks, but any number of circumstances can delay the finishing. If you want your turkeys to be the best you ever tasted, you'll just have to be patient. A well finished Broad Breasted Bronze tom should weigh a minimum of 18 pounds and often as high as 26 and 28. The hen (whose flesh is not of a quality superior to the tom's) should weigh from 12 to 16 or 17 pounds. A smaller breed will weigh proportionately less.

During starving time, 18 hours before killing, provide plenty of fresh water.

Killing and Picking

For a turkey slaughterer or amateur standing, decapitation with a sharp axe or machete is quickest, easiest. Immediately after the head has been severed, the bird should be elevated so blood is allowed to drip for about ten minutes. The plucking should take place immediately after the blood has stopped dripping. Again, the simplest method of plucking for amateurs is the semi-scald dip. Using a large vessel similar to a wash tub and a cooking thermometer to assure a temperature about 175°, the entire body of the turkey should be immersed for about 40-50 seconds. The feathers should come out with great ease; if not, dip again. It may be necessary to use gloves or pliers on certain of the wing and tail feathers. After the bird has been completely plucked, it should be hung by feet in a room with a temperature from 30° to 40°, and preferably, a relatively high humidity. If there is any food in the crop, the entire crop should be removed through a neat 3" incision in the front of the neck. Sew this up to prevent drying out and squeeze the vent to remove any droppings that may be there.

The turkey may be cleaned and roasted at any time after two days of chilling have passed; if the temperature and humidity are correct he may be kept up to 10 days. We recommend that you take your first bird to be cleaned to the butcher in order that you may learn the tricks of the trade directly from him.

Points To Remember

In conclusion, here is a digest of the cardinal principles of scientific turkey raising. 1) Sanitation and dryness are your most efficient weapons against disease. 2) Never overcrowd your birds at any stage of their development. Always provide more space rather than less. 3) Never allow your turkeys to come in contact with chickens or any other poultry. Keep them as far from other fowl as possible. If the turkeys are to live in any shelter formerly used by other poultry always thoroughly disinfect those quarters. If there has been any disease there, always fumigate with formaldehyde and potassium permanganate. 4) Always allow adequate space at the feeders and waterers. This means that every bird should be able to eat at the same time and four birds should be able to drink at the same time. 5) Remember that turkeys are but recently descended from their parental wild stock—avoid all unnecessary loud noises, sudden movements and other disquieting influences, since they are much more timid and easily frightened than other poultry. 6) Always slip on rubbers or different shoes when going into the turkey shelter, so as to reduce the possibilities of infection from your chickens. Do not allow any visitors into area where turkeys walk.

Ducks are Easy to Raise

P EOPLE are always giving us something. We got our trio of Muscovy ducks one day when a lady who lives near our Country Bookstore in Noroton, Connecticut, moved. They were breeders and she didn't want to have them killed. Knowing that we had a small farm, she thought we might like them.

There is a good deal to be said for making ducks your second poultry project, particularly if you have any kind of small stream or pond on your place, although neither is necessary. One of the unusual things about ducks is that they are well adapted to either a small place or to large-scale commercial production.

Don't start a duck project unless your family is fond of duck. If you're anywhere near as successful as we've been, you'll have a lot of duck. The trio that was given to us has produced over 25 ducklings in the first six months. Incidentally, Muscovy ducks are better eating, we think, than the ordinary Pekin variety that you get in the market.

Anyway, ducks do furnish delicious variety for the table. Many people like duck eggs, too, especially for cooking. Ducks require relatively little care and are practically free of disease problems. They are efficient and economical meat producers, gaining weight rapidly even when allowed to forage for much of their food.

You have three choices as to how to plan your duck raising program. You can keep a small flock of breeders the year around. You can buy day-old ducklings and brood them like baby chicks, but with less heat and care. Or you can buy duck eggs and hatch them out under hens.

Keeping A Small Flock Of Breeders

If you just plain like ducks and like having them around; if you would like having some duck eggs for eating or

cooking in addition to having duck meat; if you have some grass forage land; if you have a stream or pond—then keep a small flock of breeders.

You don't have to qualify on all these points to keep a flock of breeders, but if you do, then your flock will practically keep themselves, providing you with plenty of tasty meals from spring until late fall.

If you don't have forage, ducks can be fenced in, but will require more feed. If you don't have the stream or pond, you can provide a sunken trough, half-barrel or pan. You can raise ducks successfully without any water, but they like water to wash themselves in and it is said to be best if the eggs are moistened regularly during the setting. This moistening occurs naturally whenever the ducks return to the nest with wet feathers from bathing.

For housing almost any kind of shelter will do. A small coop with a door like that on page 39 would be ideal, because if you want to gather eggs it is a good idea to keep ducks shut in until 9 or 10 a. m. Supply litter on floor for warmth and dryness.

Your ducks will build their own nests in the shelter or around the place and will each hatch twelve to fifteen or even more ducklings at a sitting, and they will probably do it at least twice a year. They may produce eggs the year around, heavily from early spring through July. The number of ducklings you let them hatch will be determined by how many eggs they lay and how many you take to eat.

One drake for up to five or six ducks is a workable arrangement, but you will probably want to start with a "trio" of one drake and two ducks. A small flock will give you all the ducks that you want.

Ducks of most breeds are ready to eat from the age of about 10 weeks on. The commercial raisers force their flocks to a peak of growth and fatness at about nine weeks and then market the whole flock at one time. After that

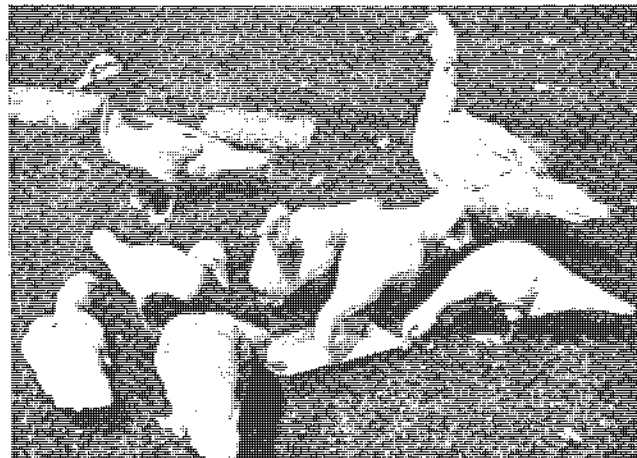

Here are our quackless Muscovy ducks. We chose this breed because they aren't noisy; they have a better flavor, we think; they're very hardy and free from disease. Our trio of drake and two ducks produced 18 young ducks on their first hatchings. These ducklings are about 6 weeks old.

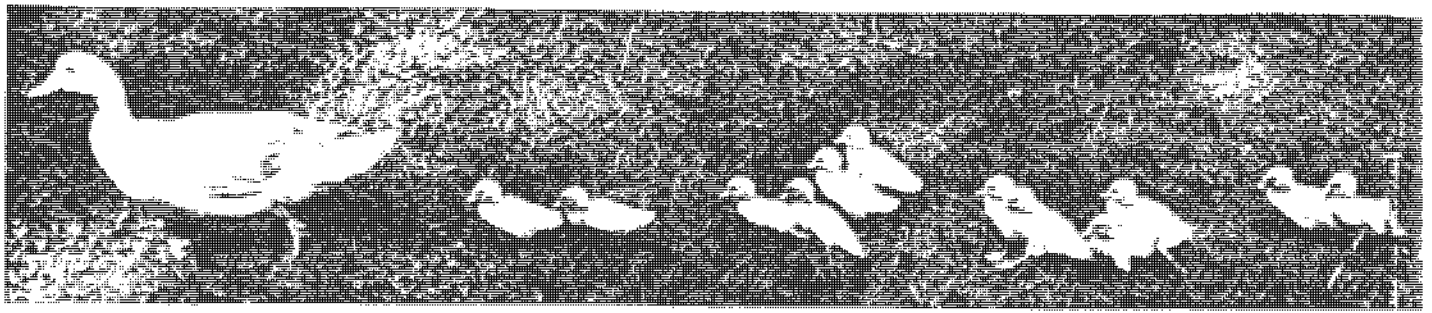

age the ducks will go into a moult and gain weight very slowly no matter how much they are fed. This is no great disadvantage in the small home-size flock which is foraging for much of its food anyway, and the usual practice is simply to start eating the ducks when they are big enough, and to go on eating them as needed until they are all gone, saving only the breeders chosen to be carried over to the next year.

Your original trio of breeders may be kept for two or three years or even longer, but more probably you will select from your whole flock a new drake and new ducks for breeders every year or two. You will probably want to buy or "swap" in new blood occasionally. There are many breeds of ducks, but the three breeds most suitable for the home flock are probably the Pekin, the Muscovy and the Indian Runner. The Muscovy is the largest, the Pekin next. The Runner lays the most eggs. Neither the Pekin nor the Runner is a good "sitter," and you would probably have to hatch their eggs under hens.

The Muscovy is a good big duck, the mature drake weighing 10 pounds and the duck 7 pounds, and they are a very hardy, self-reliant breed. The Indian Runners weigh only 4 to 4½ pounds at maturity. One important advantage of the Muscovy is that it is quackless and won't bother your neighbors. Muscovies are fliers, though, and if your fencing isn't pretty high, you may have to clip the outermost feathers from one wing.

A trio of one or two year old Muscovy ducks, of good healthy stock, will cost you about \$10.00, and you can obtain them by mail from breeders who advertise or perhaps you know some

one who raises them near you. Day-old Muscovies will probably cost from 40¢ to 60¢ apiece.

If you can't get the duck pellets, the simplest thing to do is to feed the same mash and grains you feed your chickens. A wet mash is sometimes fed, but this is an extra "wrinkle." When growing ducks are not able to forage, keep feed before them most of the time as you would for chickens.

If your ducks have a stream, pond or fairly large, clean bathing trough, you don't need to provide other drinking facilities. If they don't, you should

The season when they are easiest to get runs from April through July.

By starting a dozen ducklings two or three times during the season, the first batch early in April, you can have a steady supply of eating ducks coming along from mid-June until late fall. And again, of course, if you have a quick freezer, you can have roast duck any day of the year you choose.

You can brood your ducklings in the same way you brood chicks, except that they require artificial heat for only three weeks—a shorter time than chicks do.

Setting Duck Eggs Under A Broody Hen

There are points to watch carefully in this method. One is that you obtain the broody hen at just the right time. She should be in the first week of her broodiness because duck eggs take about 4 weeks (a week longer than chicken eggs) to hatch, and she may tire of the job unless you get her when she has just gone broody. (Muscovies take 5 weeks to hatch.)

You should also care for the hen faithfully during the period of incubation. Take hen off nest daily, feed and water her. Usually she will stay off only five minutes to eat and drink, then get back on eggs herself. If she doesn't, put her back before eggs cool. Dust her well with insect powder at the beginning. You must also be sure the eggs are moistened (sprinkled with water) the last few days of the period.

A hen can usually hatch only seven to nine duck eggs, because they are so much bigger than chicken eggs. A rat-proof coop with wire run, as illustrated, is advisable for the hatching period of about 4 weeks and also for the brooding period of about 3 weeks.

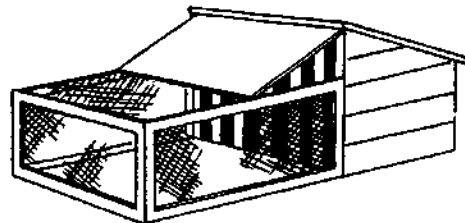

Coop and wire run suitable for hatching and brooding of ducklings with a hen. The bars keep hen confined, but let ducklings get sunlight and fresh air safe from dogs, cats, rats, etc. Top lifts up to allow cleaning, feeding, watering.

provide a reasonably deep (4 inches anyway and at least 12 to 15 inches across) supply of water. This is because of the peculiar nasal construction of ducks. They need to be able to get most of their bill in water when drinking.

Buying Day-Old Ducklings

You can get day-old ducklings through your feed dealer, from a neighbor who raises ducks, or by mail from people who advertise in farm journals.

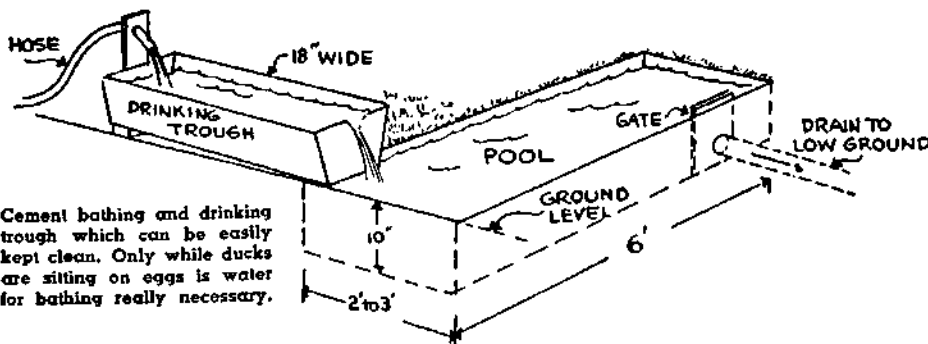

Cement bathing and drinking trough which can be easily kept clean. Only while ducks are sitting on eggs is water for bathing really necessary.

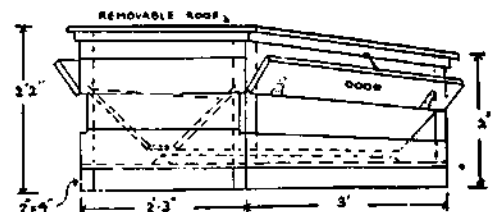

Ducks are messy feeders and will waste less if pellets instead of mash are used. Here is cross section of pellet hopper used by commercial duck raisers. It can be made any size to hold from one to several hundred pounds of pellets, thus saving much labor. "Flaps" can be closed to cut down time pellets are available to the ducks, thus forcing them to forage.

Squabs . . .

AS we've said we chose geese as our secondary poultry project, and we don't go in seriously for squabs. We thought we should include squab raising in the Plan, however, for those people who would want to raise them, particularly folks who live in the more crowded areas where there are city zoning regulations against chickens and other poultry. There are very few cities or towns that have strict ordinances against keeping pigeons.

In preparing this section about squabs we've visited a number of squab raisers and we've done a good deal of studying and reading. What we tell here is what we'd want to know before we started a new project.

Squab is one of those dishes that are usually thought of as being expensive, delicious and reserved for epicures. You can't even buy squab at most meat markets. Many people haven't so much as tasted this mouth-watering treat.

And yet, if you decide to have another poultry project in addition to chickens, you'll find squabs to be both interesting and delicious. Also, pigeons are among the easiest kinds of poultry to raise, among the surest of success.

They are not really cheap, though, even when you raise your own. They will cost you about half as much to raise as to buy, which means they will cost you about 35¢ to 50¢ apiece, depending on the price of feed at the time and other factors. Still, when you consider that one squab is about all one person can eat at a sitting, and that they are such a treat, the cost isn't so high at that.

Another point to remember is that it is just about as easy to raise twice the number of squab you will want for your own family, as it is to raise barely

enough. You can then easily sell the surplus to cover all your costs (first class hotels and restaurants are always in the market for squabs), or you can swap the surplus with neighbors for things they raise and you don't or you can make presents of squabs to friends.

What Size Flock?

First, taking into account the size of your family, decide how many squabs you will probably want in the course of a year. (Squab, incidentally, is defined by the U. S. Dept. of Agriculture as "a young pigeon which is marketed just before it is ready to leave the nest, usually at from 25 to 28 days of age, when it weighs from 12 to 24 ounces.")

One good pair of breeder pigeons should raise 12 to 14 squabs in the course of one year. They may do this at a more or less even production rate throughout the year, but more probably production will be greater in spring and summer than in fall or winter. If you have a quick freezer you can, of course, "even out" production by freezing when there is a surplus.

If you don't have a freezer, then you will probably want to plan to have enough breeders to produce all the squabs you'll need even during the poorer months.

Figuring in this way it will be found that a "loft" of 12 pairs of breeders will probably produce an abundance of squabs for your family.

Housing

Pictured on this page is the type of housing we would suggest. For 12 pairs of breeders the dimensions of the house should be about 6 feet wide and 8 feet deep (48 square feet to allow the 4 square feet of floor space per pair that is needed). It is important that the house should be as rat proof as possible, and, as in the case of chicken housing,

that it be dry, well ventilated and facing south for maximum sunlight. Open or semi-closed front may be used, but, as you would expect, the warmer the house in winter the better. A maximum temperature of 40 degrees F. in winter will tend to increase squab production, but you can get along fine without artificial heat.

There should be a double nest for each pair of breeders. Orange crates, with three inch board nailed across front at bottom and a six inch hinged landing board, piled one on top of another will serve for this purpose. Twelve such crates would be needed for a 12 pair house. If you build your own nests, each one should be about 12 inches square and 15 inches high.

Long leaf pine needles, straw, hay and tobacco stems are all used for nesting material. If nest bowls (which can be purchased from supply houses) are used, nesting material is not so necessary but some material is generally provided. The nesting material may be kept in a crate or rack in one corner of the pen to prevent waste. The pigeons will carry the material to build their own nests.

On the south side of the house there should be a wire-covered yard or "fly" as it is called. It can be approximately the same size and shape as the house. One-inch-mesh wire is good to use as it keeps out sparrows and rats. This wire should extend 12 inches into the ground, making a right angle bend at the bottom and extending 12" to 18" away from the pen to keep rats out.

Three to four inches of sand or gravel makes an ideal floor as this drains freely and is cleaned easily. A cement yard sloped to drain well and with one inch of sand is even better. "Running boards" about 8 inches wide should be placed on sides of pen, as illustrated.

Water, Feed and Health

Bathing in addition to drinking water must be provided for pigeons. An ordinary dishpan will serve for bathing and should be filled with water and left in the yard (except on cold winter days) for not over one hour or two a day. Then empty the pan and turn over so that pigeons cannot soil it.

For drinking water, use a regular chicken fountain. The water should be changed daily and the fountain kept clean. Obviously, running water handy to pen is a desirable convenience.

The young squabs are fed by the parents. The pigeons themselves should be fed a ration of whole grains—no mash or green feed. Minerals are fed in a separate mixture. Ordinary chicken feed will not do.

The simplest procedure is to buy a prepared pigeon ration from your grain dealer—and be willing to pay considerably more per pound for it than for chicken feed. It usually pays to buy the better grades offered, because they contain more of the ingredients the pigeons

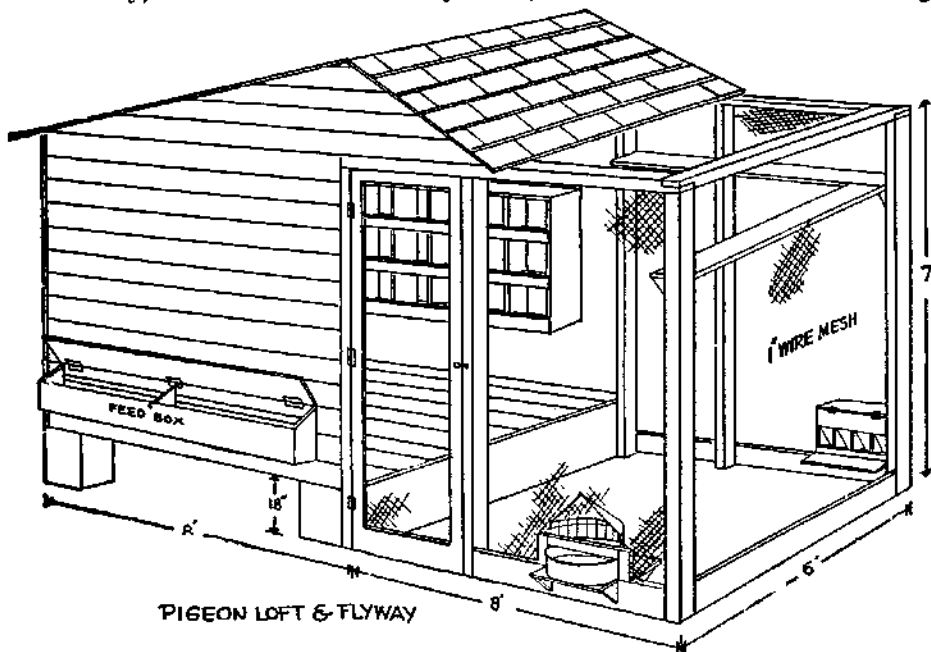

House is shown with open front. Wood or cardboard partition can be used to close two thirds of opening for winter months. Note that feed trough, water fountain and grit hopper can all be "serviced" without entering pen.

like and which are particularly good for them, such as peas.

A good pigeon feed will contain from 13 to 15 percent protein, 60 to 70 percent carbohydrates, 2 to 5 percent fat, and not over 5 percent fiber. You will find an analysis of the feed you buy tagged to the bag. One pair of breeders will probably eat about 90 to 100 pounds of grain per year.

Use a self-feeder hopper of type illustrated—one that holds feed waste to a minimum. Since pigeons will pick out certain favorite grains it is advisable to put only about one day's supply of grain in the hopper at one time.

At your feed dealer's you can also obtain a prepared pigeon grit, mineral mixture. This should be fed in an open pan or hopper, slightly moist, and kept before the pigeons at all times.

Pigeons are subject to many of the diseases which affect other poultry. However, in a small flock founded on healthy stock and with reasonably careful management, you should have little trouble. The floor of the house should have one inch of sand or gravel, droppings should be raked from house and yard once a week.

Nests and nest bowls should be cleaned whenever squabs are "harvested"—and nests containing eggs or squabs should not be disturbed. Twice a year house and pen should be thoroughly cleaned and disinfected.

Getting Started

You can purchase foundation stock from a pigeon breeder in your community, or order by mail from anywhere in the country. The magazine *American Pigeon Journal* (15¢ a copy, \$1.50 a year, address: Warrenton, Mo.) carries ads of breeders, or consult your county agent or grain dealer.

There are many breeds of pigeons, but the following are the best suited to squab production: *King*, *Carneaux*, *Swiss Mondaine*, *Homer*, *Runt* (the largest of all breeds). You can't go wrong by choosing *King* or *Carneaux*, because they are both among the most popular breeds and you will probably find it easier to connect with a good breeder, possibly one near you.

It is as important to get good pigeon stock as it is to get good stock for all your other poultry and animal projects. Get your pigeons from a careful breeder who keeps accurate records of the production and weight of his squabs and who guarantees both age and sex.

You will want mated pairs, at least 6 to 8 months old, and yet not too old—not more than two years old. As a rule, it rarely pays to keep breeders more than 5 years. (You can eat your old pigeons, but they aren't as good as the squabs. An old pigeon is worth about 25¢ and can be eaten in pigeon pie.)

After you get your flock established you can raise your own breeders. During April, May and June you will perhaps have more squabs than you need

for the table. You can raise some of these and when they are 6 to 8 months old they can be mated. One advantage in raising your own breeders is that they produce better at home where hatched.

But to begin with, you can expect to pay about \$3.00 to \$5.00 per pair of good breeders. Your best plan for getting good stock at a fair price is

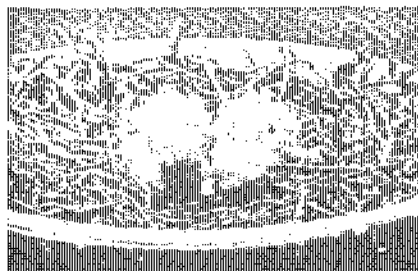

Squabs 24 hours old.



2 weeks old.



3 weeks old.



3½ weeks old—will be ready to eat when fully feathered underwing in another week. (Courtesy U. S. Dept. Agr.)

to deal with the most reliable breeder you can find. The wise procedure is probably to start with two or three or four pairs of breeders, and then to increase your flock as you go along.

Pigeons usually remain with the same mate for life. Together they rear and feed the squabs. The hen pigeon will lay one egg, skip a day, and lay again. If more than two eggs are laid, remove the extra ones, because a pair of breeders can tend no more than two squabs properly at one time. The incubation period of the eggs is 17 days. Both parents build the nest and take turns sitting on the eggs.

The hen often lays another setting of eggs when the squabs are two or three weeks old and leaves the feeding of the first pair of squabs largely to the male. This is the principal reason why double nests are provided for each pair of breeders.

The parent birds feed the squabs on a thick, creamy mixture called pigeon milk, produced in their crops. Care should always be taken not to frighten pigeons, especially while feeding their young, and squabs should not ever be disturbed more than is necessary.

In case a squab dies during the first week or ten days, another single squab may be placed in the nest, provided the two are about the same size. This gives the pigeons without squabs the opportunity to begin producing again sooner than they would otherwise.

If the parent birds become sick or die, the young birds may be fed by hand if they are at least a week old. They should be fed at least 2 and preferably 3 times a day on grain that has been soaked for about 8 hours. Drop into the squab's mouth—feed enough to fill but not stuff crop.

Harvesting

Squabs grow rapidly and are ready to eat about 26 days old or when fully feathered under the wings. Don't delay in eating them when ready because they will soon lose their baby fat and the flesh will begin to get hard.

To kill, hang squabs by the feet on a hook or nail and cut jugular vein in neck. (The professional way is to cut the vein, with a long, slender-bladed knife, inside the mouth just below base of skull). Lock the wings to keep from flapping, twist one behind the other.

Dry - pick the squabs immediately after killing because the feathers are very hard to pull out if the birds get cold. Pick the squabs on a bench or in your lap—do not hang on a wire. Pick clean and remove pin feathers. Skin is very tender, tears and bruises easily.

As soon as picked, cool for an hour or so in ice water, but not more than three hours. Clean as you would a young chicken. Cooking the squabs may sound like a problem but it isn't. All cook books give recipes.

Rabbit—8 to 14 Cents a Pound

ONE of the first projects I wanted when we moved to our place in the country was rabbits. I had read many times that they produced excellent tasting meat at little cost. Carolyn, however, was sort of skeptical of the project because she thought that she she might not be able to eat the rabbits—they looked so cute.

One pay-day when I happened to read an advertisement offering a six compartment, all-metal wire hutch for sale for less than \$20 I couldn't resist this good buy. The hutch eventually came, but Carolyn was still skeptical and, anyway, we were up to our necks getting our barn finished up, learning to milk, running our broiler battery, our bees, goats, and setting the geese. It wasn't hard to put off getting the rabbits for a while.

Then, a friend of mine, Wally Boren noticed I hadn't done anything with my rabbit hutch and he asked if he couldn't use it until I got ready. That was all right with me. He borrowed the hutch, set it up in his garage and began reading up on the subject of rabbits.

Choosing a Breed

Wally picked a variety called the Chinchilla. You can take your pick of several good meat breeds. Wally favored the medium sized breeds—weighing around 8 to 10 pounds grown. You could go in for the Flemish Giants, for instance, that sometimes weigh 20 pounds. They eat a lot more, of course, and their fryers, at 7 to 9 weeks, weigh not too much more than do those of

the medium breeds at the same age. The New Zealand Whites are another popular medium weight breed—their white fur is worth more than the Chinchilla...and there are a number of other good medium weight breeds.

Of course, there are Angoras (with their beautiful, white, long fur) and other "fancy" breeds. But these are not meat rabbits. In ordinary times many of the small rabbit raisers don't bother to save the skins, but they do have some value. Right now, for example, buyers are offering from 30 cents a pound to 90 cents apiece. You can obtain names of buyers from one of the rabbit magazines.

Wally started with a "trio"—a young buck nine months old and two does of the same age. He bred the does shortly after he got them. The following month he had 17 bunnies. Seven is a big enough litter, according to the experts, for one doe to raise. So Wally destroyed four from one litter of 12 and gave the other doe an extra to bring her litter of 6 up to 7. Wally rubbed a little Mentholatum on her nose so she couldn't smell the difference between her own and the young one from the other litter.

At seven weeks all 14 of the young rabbits were alive and frisky. At this age they weighed 44 pounds. The two does were bred again.

8c to 14c A Pound

Wally kept some careful records. Here's what he learned from them. A Chinchilla weighing 3 pounds, live weight will cost you from 25c to 35c or a little more to raise. You'd pay a dollar, at least, in the market for him.

Wally figured out how much time it took him to raise one 3 pound fryer. It took one hour flat. That is, he explained, "I spent 14 hours actual chore time—as a dub beginner—raising 14 meat-meals for the family. I could cut that in half, but I like pattering around them."

Wally had such good luck with the rabbits that, of course, I wanted to see what I could do. Wally, who is a most generous-minded fellow, kept us supplied with rabbit—he kept saying that after all he had to pay "rent" in some form or other for the hutch. Carolyn and I both liked rabbit very much; it tastes something like chicken but has a "firmness" that chicken doesn't have. I guess it was a year before I got my hutch back and got to keeping rabbits myself.

Incidentally, after we did get the rabbits we didn't mind the idea of raising them to eat—I guess after eating some rabbits raised by somebody else it's easier to go into rabbit raising strictly from the standpoint of raising



U. S. Rabbit Exp. Sec.

Here is how to cut up a rabbit. He makes six generous pieces, plus the liver — as good as chicken liver.

them for meat and not let yourself make pets of them. Of course, when you can put rabbits or chicken or anything else in a freezer and leave them there for a few weeks or months you'll find that you think of them as "meat" — not "cute animals."

What To Feed Rabbits

You'll see in the diagram on Page 43 a hayrack indicated for each hutch. This you keep full of hay—the rabbit experts, because the industry is located in California where Alfalfa is easily obtainable, recommend Alfalfa. But a good, leafy clover hay is all right. Timothy isn't as high in protein as clover, but if it's properly cured it's better than a poorly cured clover or Alfalfa. The rabbits can manage the hay better if it is cut up in 3 or 4 inch lengths. (Take a handful, squeeze it into a bundle and saw it off into a box with an ordinary hand saw.) You can also feed vetch, cow peas, and other rich hays. You can give your rabbits dried scraps of bread and crusts; also any kind of vegetable parings and tops they'll eat. You can feed them lawn trimmings and weeds. But don't leave what they fail to eat in the pen. Take it out next day and pretty soon you'll find what they like best and how much to feed. Rabbits relish carrots and other root vegetables. Feed green feeds sparingly at first if your rabbits aren't used to them. Sometimes they over-eat and bloat or get diarrhea.

You also feed them one of the prepared rabbit pellet foods or whole grain—they don't seem to like any grain that's ground up too fine. You can ask the man you buy your rabbits from for directions as to what he's found the best methods of feeding.

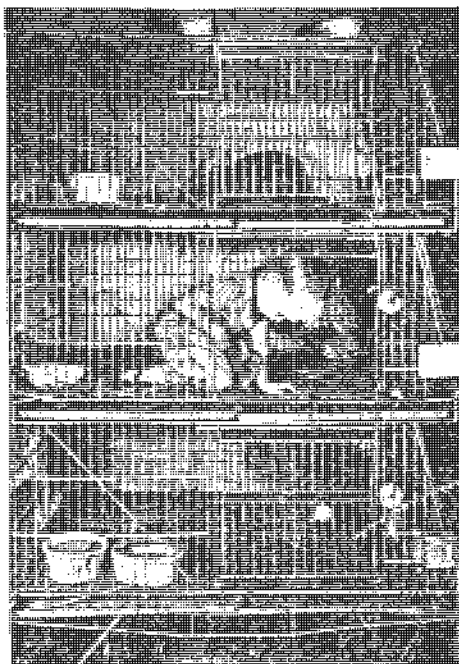

When Jacks, three years old in this picture disappears we look in the rabbit hutch. Country raised, he's independent and fearless.

How Fast Do Rabbits Multiply?

Everybody has a story about how fast rabbits multiply. I remember a friend of mine who had a small family and worried about this when getting his rabbits. In fact, he decided that he'd start with the minimum a single doe and a single buck. He was a salesman and everytime I'd see him I'd ask, "Well, how many rabbits have you now." The first month it was just two. The second month it was two. The third month it was still two. About this time my friend began to worry about his rabbits *not* multiplying. And when, at the end of the fourth month, he still had only two, I began to get a little suspicious. Sure enough, he didn't have a doe and a buck—he had two bucks!

Determining the sex of a rabbit is easy. Get the man you buy your rabbits from to show you.

I find that two does and a buck produce 40 or 50 rabbits a year to eat. At three pounds or more that is all our family needs.

You breed about every 90 days. Gestation only takes 30 to 32 days. The young nurse for five or six weeks, learning to eat as they go along. At six or seven weeks you put the young fryers in another hutch or two and eat them between then and ten or twelve weeks. Or you process the whole tender crop at 8 or 9 weeks and quick-freeze all except the one you want for dinner then.

You can eat them as fryers until they're seven or eight months old—full grown. But by that time they've eaten a great deal of fairly high priced food and therefore aren't so much of a bargain, cost-wise. Better separate the young bucks from the does at 3 months.

You can kill off old rabbits at the end of a couple or even three years and make a stew out of them. The skin from a mature rabbit is worth considerably more than from "fryers."

You can "inbreed" with no harm. Just keep a young doe or two out of a litter and breed her to your same buck when she's about 7 to 9 months' old. You can stagger your breeding times, having one fresh litter coming in every 6 weeks from one doe or the other. But if you adopt this system, you can't exchange the young between the does. Every 3 or 4 years buy or trade for a new buck.

And while we're on the subject of buying, try to get good, healthy and strong animals. You don't care about a "show" rabbit but do get good blood. They may even cost you from \$10 to \$25 a trio; you aren't likely to save money by starting out with \$3 worth of scrubs. However, don't worry about pedigree or perfect markings or blue ribbon winners.

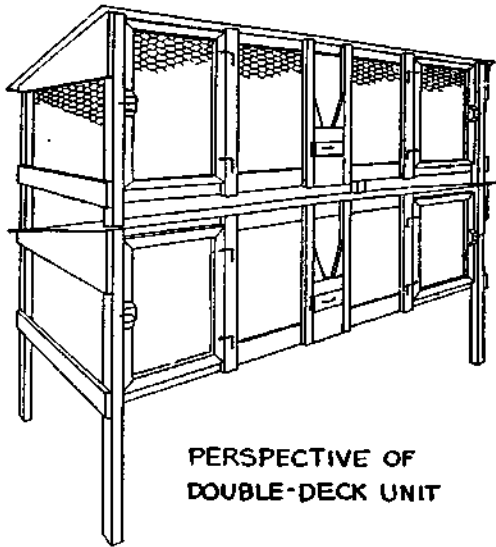

PERSPECTIVE OF
DOUBLE-DECK UNIT

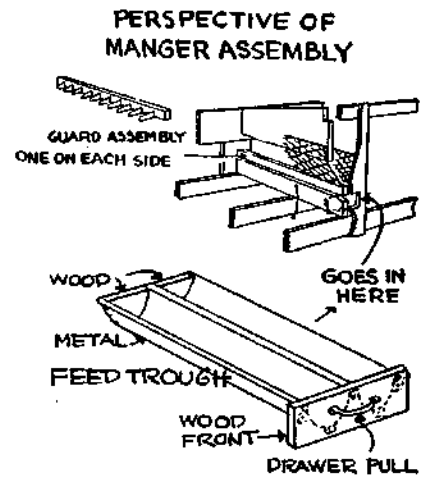

Here is a good wood-and-wire type of hutch.

Building the Hutch

Rabbits are very hardy animals, easy to raise and extremely clean. They can stand a lot of cold weather. They can't stand very much of a *wetting* and *hot weather* gets 'em down. They wear fur coats in *summer* remember. They have to have clean feed trays and clean water. They need a cool, shady summer place with lots of ventilation, *some* sunshine occasionally and a good roof. We keep our metal hutch in the barn. We clean it out once a week, keep plenty of straw on the floor and in the nest box (a nail keg with a strip across it—see illustration) and, in winter we water the rabbits night and morning, taking the water out before it freezes. In summer we keep the water trays always full. They drink a lot.

Hasenpfeffer

Here is a recipe for the famous German way of preparing rabbit. Cut up your rabbit meat and put it into a jar. Cover with vinegar or wine and water, equal parts. Add one sliced onion, salt, peppers, few cloves, bay leaves.

Let this soak in a cool place for two days. Then remove and wipe the meat dry and brown it *thoroughly* in a frying pan, in hot butter, turning it often. Gradually add the sauce or juice you pickled it in, and let simmer about half an hour, until tender. Before serving stir in one cupful of thick sour cream.

There's a lot more you ought to know about raising rabbits before you go ahead. But I've tried to give you an idea of what's involved. There are one or two good books on rabbits that you'll find worth while reading. You ought to have more detailed information about hutch building, about dressing a rabbit, about keeping records, etc. "See Country Bookstore Catalog."

All in all the impression I'd like to leave is that rabbits are one of the first projects any one interested in home food production should investigate.

The space required by my rabbits is only 3 x 10 feet—and rabbits can be started any time of year.

Easterners are behind the times in discovering how delicious rabbit tastes. In California, where rabbit is king, many prefer it to chicken which it resembles.

No other meat is easier, quicker, as inexpensive for the homesteader to produce as rabbit ... and it's easier to dress than chicken.

Two good does and a buck will give a family easily 180 pounds of good-tasting meat per year.

A modern, self-cleaning hutch fitted with the new automatic watering, requires less than 5 minutes attention a day.

Suggested Reading:

Rabbits For Food and Fur, \$3.00.

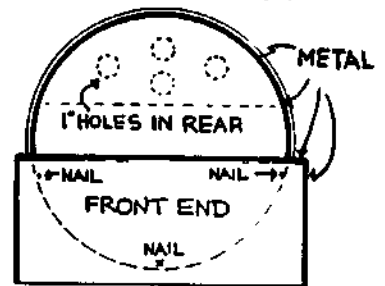

NEST BOX

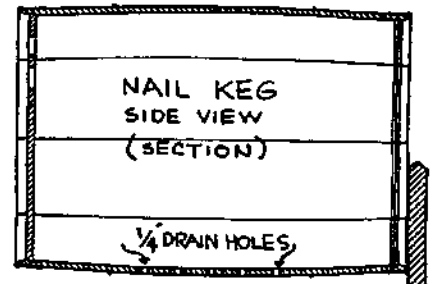

Here's a dandy nest box, made from a nail keg. The doe pulls hair and makes a warm fur-lined nest for the young before their birth. You keep the nest box in the doe's hutch from a couple of days before the young arrive until they are ready to leave the nest.

Ham, Bacon, Pork, Lard

*"You can breed the pigs and buy the corn and get on;
You can raise the corn and buy the pigs and get on;
If you buy the corn and buy the pigs to feed, you haven't got a chance;
But if you breed the pigs and raise the corn you'll make money."*

—Louis Bromfield

EVEN though this pessimistic little poem's about raising pigs commercially, it has a point that the backyard farmer shouldn't forget. The really profitable way to raise your own pork is to raise and fatten your pigs chiefly with surplus garden products, table scraps, home-grown corn.

The first year we started our plan, we raised two pigs. Because we didn't have many surplus vegetables, we bought about \$35 worth of grain per pig. We paid \$12.50 for inoculated 7 week-old pigs in April, had them slaughtered in December when they weighed 285 pounds. The dressed weight (per pig) was 230 pounds. In short, our pork cost 22¢ a pound. Last year it cost around 18¢.

From this experience we learned a few important points: For a family of three or four one pig will give quite a bit of meat. Even a 200 pound pig (live

With only 3 in the family, the amount of table scraps and surplus garden vegetables we had was discouragingly small when fed to two pigs. Incidentally, a pig will do well even if it doesn't get much grain. To keep feed bills down, you should plant a patch of corn or supply extra food scraps or garden or orchard produce. In fact, good pasture, fenced into three lots for rotating will supply 10 to 15 percent of the total food for a couple of pigs.

A single pig, unlike a single goat, doesn't get lonely.

From weaning time (6 to 8 weeks) a pig should put on about a pound a day. If fed grain entirely it will eat nearly ½ ton from April to December. But with pasture and surplus produce—vegetables, corn stalks, fruit, skim milk, acorns, and table scraps, even 200 pounds of grain will produce a good sized pig.

The backyard farmer shouldn't try to keep a sow, breed her, and produce young pigs. This requires a lot of time, trouble, experience and feed.

A young pig (or two) should be bought in the Spring—a March or April born pig is best. Such an animal costs at 6 to 8 weeks of age \$5 to \$12. Buy either a young sow pig or a barrow (castrated male). Be sure the pig is inoculated against cholera. This usually costs 50 cents. The young pig should also be wormed before you buy it.

It has often been pointed out that the day you buy your pig is the day you'll make or lose the most money. In short, buy from a good breeder or farmer with clean, disease-free stock. Be careful you don't get a runt. Choose a young pig that's long—a chunky one will make too much lard. The breed is not important—all breeds have been developed to produce meat.

Easiest Way to Feed

The simplest way to feed a pig is to provide grain, (corn-on-cob, wheat or barley), a protein supplement (alfalfa leaf left from the hay fed goats for example), and a mineral mixture or a complete hog ration in separate compartments of an automatic hog feeder. This feeder plus an automatic waterer cuts chore time to the bone. Automatic feeders, which let animals eat as much and whenever they like, work best of all with pigs. No matter how much food you put before a pig it will eat only until full—never overeat.

Feeders and waterers are sold by Sears and Montgomery Ward.

Feed garbage, surplus garden produce etc. in a trough. This you can easily make, especially if you buy iron trough



Six-week old pigs, already weaned, can be bought by mail. By feeding surplus garden vegetables, table scraps, and some grain they'll grow to 175—200 pounds in 20 weeks.

ends. Save garbage in separate can and keep free from paper, soap, glass, dish-water, etc. Don't feed garbage older than 3 days.

Housing

Housing for a pig or two from April to December can be of the simplest. The standard portable A-type hog house is satisfactory and can be bought knock-down for around \$35. However, the backyard farmer probably hasn't enough land to require a portable house. A simple shed structure, 8 x 6 feet, 5 feet high in front, 3 in the rear, is most satisfactory. The front is open and the sun, which is the best disinfectant of all, can penetrate to the rear of the house. The roof is tar-paper, the rest of the shed is made of wood, including the floor which is set well off

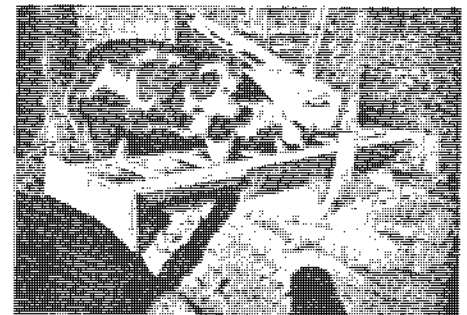

Simple hog feed trough for garbage. Note braces which give each pig a chance to eat. Wide end boards keep pigs from upsetting trough.



Our ¼ ton of pork! When we bought young pigs the chicken-wire netting was necessary to keep pigs in. Incidentally, have you heard the old farmer's definition of a good fence: "Hog tight at the bottom—goat high—and sturdy enough to hold a bull".

weight) will give about 55 pounds of hams and shoulder, 40 pounds of bacon and loin, plus lard, sausage, pigs feet, etc. Two pigs are sufficient for a family of 6 to 8.

With only three in our family we made a mistake keeping our pigs until they weighed 300 pounds. After pigs go over 225 pounds their ratio of weight gained to food consumed drops.

We found that if you buy a 7 to 10 weeks old pig, innoculated, properly weaned, fed and cared for, you shouldn't have any trouble raising it.

Building A Sanitary Pig Pen

the ground to keep the pigs dry. In the fall we keep the floor bedded with straw.

New Method of Raising Pigs

Of special interest to the backyard farmer are the experiments sponsored by the Portland Cement Association, Chicago, Illinois. These experiments have to do with the confinement system of raising pigs on concrete. Like the battery-broiler system, instead of permitting animals to range, all food is brought to the pigs. Less than 15 square feet of pen is allowed per pig, obviously a system which requires so little land is of interest to the backyard farmer.

Inasmuch as pigs spend their whole life on concrete this makes possible maximum sanitation. Concrete floors are swept or flushed with a garden hose daily. A pit provides a sanitary, easy method of holding manure until it can be spread over the garden.

Confinement on cement eliminates "rooting" and racing about. This results in unbelievably fast growth. John Hendricks, who is given credit for developing this method of growing hogs, reports average growth of a hog to be:

Age	Weight
67 days	82 lbs.
132 days	195 lbs.
260 days	325 lbs.

The photos at right are our adaptation of the commercial hog raisers' confinement-on-concrete system which we have scaled down to a size suitable for 1 to 4 pigs. The confinement pen has worked out fine.

Watering is done automatically by attaching a Montgomery Ward double-drinking cup to the bottom of a barrel. This barrel can be filled once or twice weekly with a garden hose.

Slaughtering

There is no need for the novice to do his own slaughtering. Your feed dealer will put you in touch with a man who will dress your pigs, smoke the hams, bacon, make sausage, hog's head cheese, liverwurst.

Or you can have your pigs slaughtered and dressed and do your own curing and smoking.

And boy—wait until you taste your own bacon and ham smoked country style—and that wonderful, honest-to-goodness all pork sausage—and fresh roast pork! If yours is as good as ours turned out you'll say you've never tasted any so delicious ever before.

With a proper set-up, fattening a pig will return more for the time spent than most any other project.

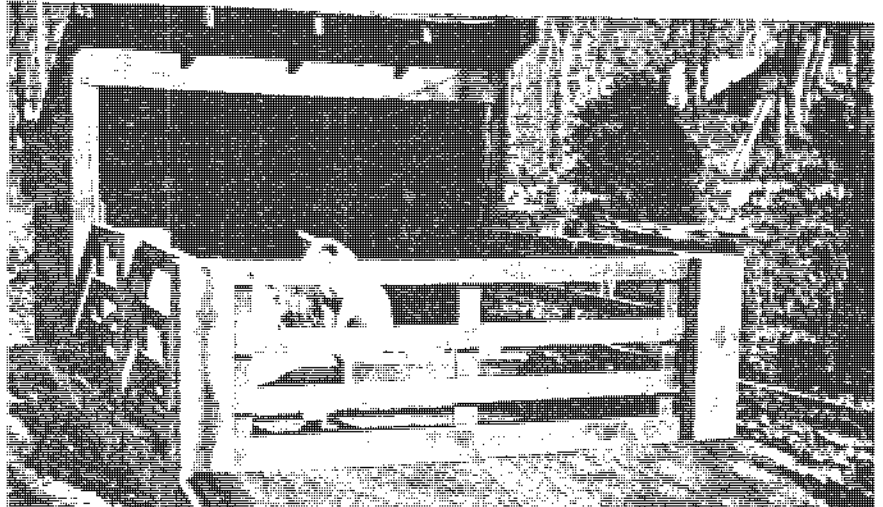
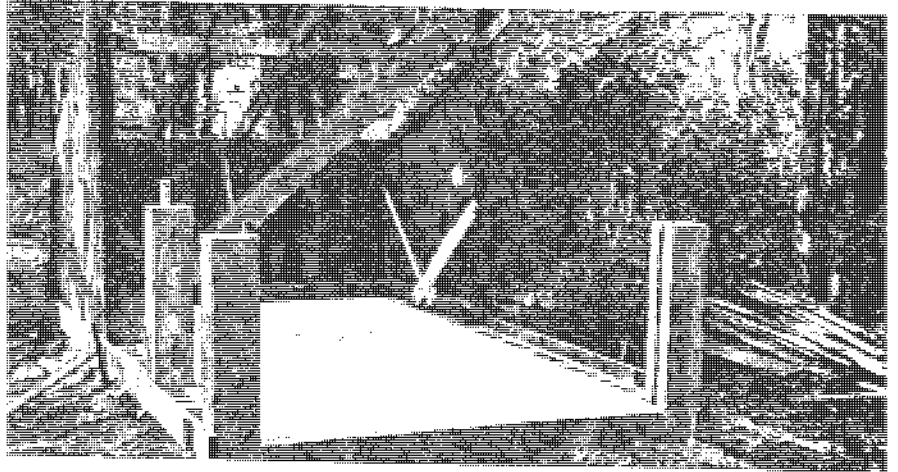
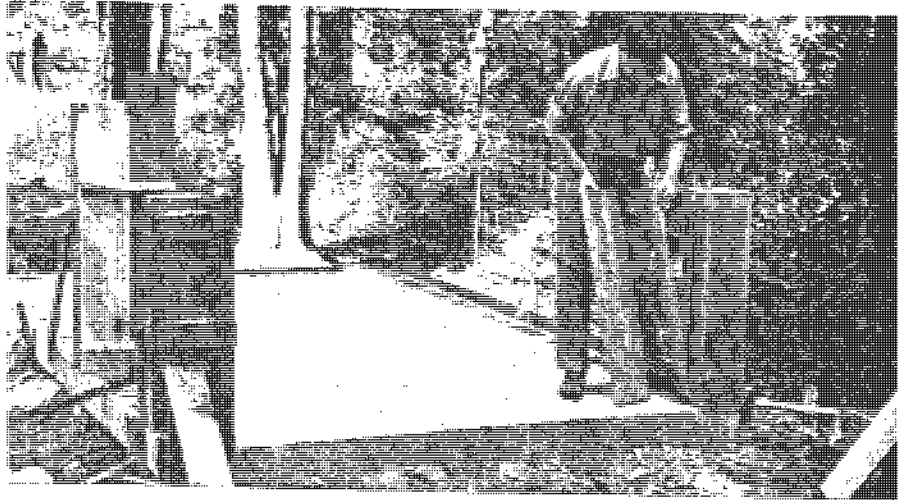
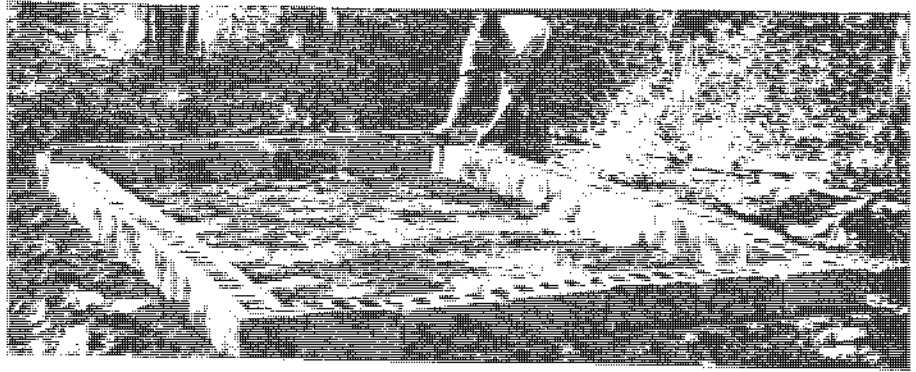

The Miniature Dairy

"A small, well balanced collection of livestock can contribute forty to forty-five per cent of the average family food budget. Contrast this to the fifteen to twenty per cent that the home garden and orchard can supply. . ." *HOW TO LIVE IN THE COUNTRY WITHOUT FARMING.*

SURPRISING as it seems there are in this country about 5 million families keeping a family cow or goats. Yet I don't believe there is \$100 a year spent by anybody promoting the idea of keeping a cow or goats for the family's own milk supply.

Obviously, if over 5 million families in this country are producing their own milk (this figure does not include any commercial dairy with more than three cows) it must be a sound practice.

As a matter of fact producing your own milk is actually so economically sound, so basic in good times or bad, so widespread a practice across the width and breath of our country, and so simple to do that until recently there has been no book available to tell a city man moving to the country the few things he ought to know to supply his family with milk and dairy produce successfully.

There are in the United States a total of over 27 million milking cows and goats—approximately one per family. Your family, if "well-nourished", is already using the complete milk supply of at least one cow. One of the first things a family should decide when it moves to the country is whether it is going to take over the care of a cow or goats or continue to go on paying somebody else to do this.

Cow and goat milk differ in many minor respects but in only this one important aspect: goat milk is naturally homogenized—the cream does not rise. But the cream can be extracted with a separator. A minor difference is in color; goat milk is whiter than cow milk. Butter and cheese can be produced from goat milk just as from cow milk.

Whether you choose to keep a cow or a couple of goats should be decided on the basis of how much milk your family can use, how much time your family can make available for milking, feeding, caring for your dairy—that includes butter, cheese, and ice-cream making if you keep a cow—and how much and what type of land you have available.

The following two chapters on goats and a family cow will, we hope, help you decide whether or not you'd like to produce the dairy products your own family needs.

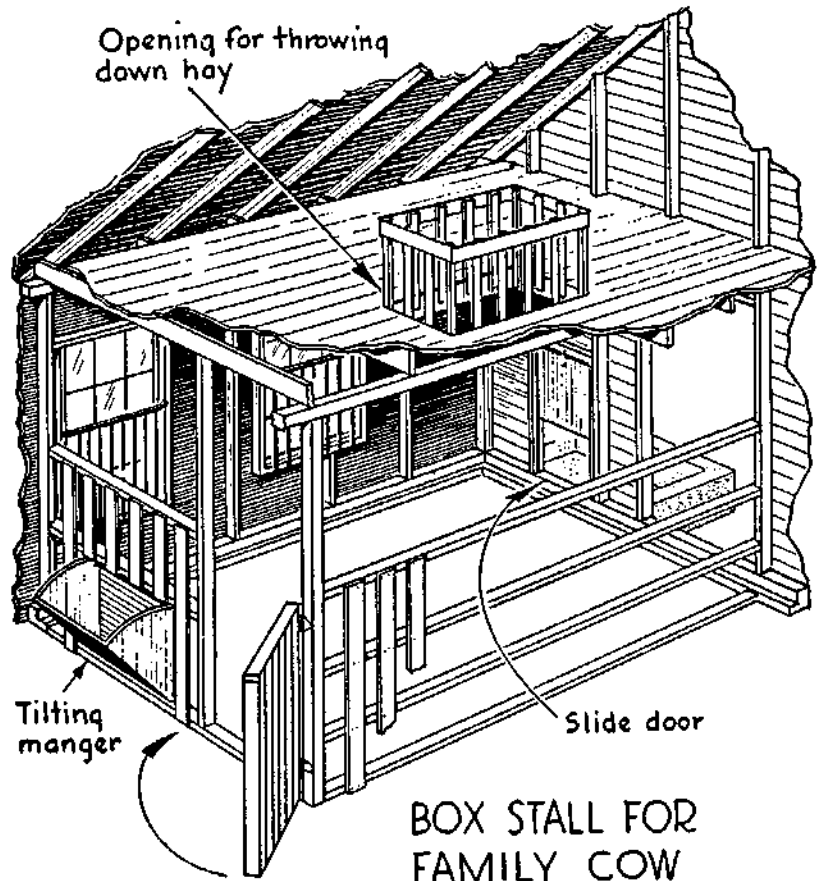

BOX STALL FOR FAMILY COW

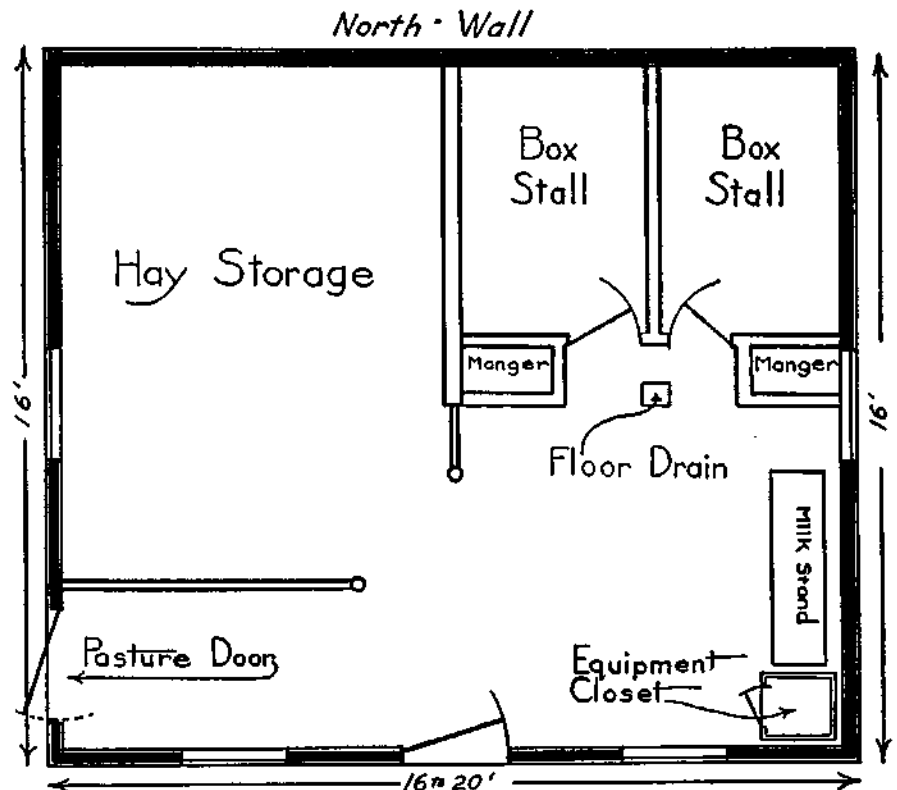

Two-Goat Barn

The Modern Dairy Goat

Of all our farm animals the least appreciated by city friends who visit us are our goats. "Goats! You don't actually keep goats, My goodness, why?"

"Have you ever tasted goat milk?" we ask.

"No—and I don't want to!" is the answer more often than not. But, possibly at lunch time, we serve them two half-filled glasses of milk. "One is goat milk—one is cow milk . . . Just for fun, tell us which is which," we say.

Almost invariably our city guests can't tell them apart. Sometimes, if they've read that goat milk is whiter they can guess. But they always are amazed that our goat milk has no "strong" taste.

In the face of the public's misunderstanding of the dairy goat it takes courage to decide to keep them. Here's how we happened to do so.

One day when we sat down and figured what our milk, butter and cheese cost we found we were spending about 25% of our food budget in the dairy department. This was in line with what nutritional experts recommended. It was obvious then that production of our own milk ranked with raising our own fruits and vegetables from an economic as well as a nutritional standpoint. We figured on a garden and fruit trees plus a cow or goat to supply milk, cream, butter and cheese and we'd have one-half of all our family's food requirements.

Of course, either a cow or a goat can be stall fed and be given only a small exercise yard. But, ideally, a cow requires 1 to 2 acres of good pasture, an hour a day of care, and supplies 10 to 20 quarts of milk a day. Ideally two

goats require less than an acre of pasture (brush, fern and shrubbery are their favorites), 30 minutes a day, and provide 3 to 7 quarts of milk daily, the year round. A goat eats only 1/16 of what a cow needs. Goats are freer from disease so that both animal and milk are safer.

For the small place everything is in favor of the goat except a goat's reputation. Believe it or not, the modern dairy goat is almost the exact opposite of what the American public believes she is. As we have already said, the prejudice against goat milk is unfounded as far as our experience is concerned

What the Goat Gives You

Let's make a list of all the products the dairy goat can furnish you:

1. *Milk*, not just ordinary stuff, but a rich, full-bodied milk. Goat's milk is naturally homogenized, small fat globules make it easier to digest. Frequently, it's used for invalids and children allergic to cow's milk. It's fine in coffee and makes a delicious, smooth ice cream. Also, goats are easier to milk.

2. *Cream*. Goat's milk has lots of cream, but it rises very slowly. Consequently, it is best to have a small cream separator. The cream may be whipped or used in any of your customary ways.

3. *Butter*, unusually smooth in texture, pure white, easily colored just as cow butter is colored.

4. *Cheese*. You have probably already enjoyed goat's cheese as millions of pounds are imported from Europe besides the domestic supply.

5. *Meat*, or chevon, as goat's meat is correctly named. Young buck kids 4 or 5 months old provide 35-45 pounds of dressed meat. Chevon makes many succulent dishes, and in the South particularly is considered a great delicacy.

Most likely you have eaten chevon without knowing it—thousands of pounds are sold each year as lamb. We think it is tastier than lamb, but Mrs. R. found it should be cooked a little longer.

6. *Furs and Skins*. Furs from newborn kids are beautiful and may be made into coats, jackets. A tannery or furrier can prepare the hides for you.

7. *Fertilizer*. Goat manure is one of the richest, most valuable manures—excellent enough to be in demand by greenhouses and fruit growers. You, however, will want to use it liberally yourself, for it will help you "have more" vegetables, fruits and flowers. Of all manures, it's the most inoffensive. You can see why from children's name for it, "nanny goat berries."

Considering all the products, the modern dairy goat is a valuable asset. Because of a goat's size a small barn is satisfactory. Also when it comes time each year to breed a goat you can hoist her into your car easily and get her to a buck. Goats are so easily handled that women frequently run large dairies.

Perhaps we seem unduly enamoured of our goats so we include this letter sent to the "Dairy Goat Journal," a magazine, (October, 1943). We quote: *I purchased a grade doe for \$15 which is giving me 3½ quarts a day of excellent quality milk. Two quarts of cow milk had been costing me \$8 per month. A grade cow would cost me \$75 to \$125 so I am somewhat amazed when people speak of milk being expensive and hard to obtain. I had a laugh when the editor of a farm magazine said that something should be done about it when an old stinky goat beat an honest dairyman out of \$7 or \$8 a month.*

My goat is giving \$13.65 worth of milk a month and her feed costs about 10 cents a day. She doesn't stink either!

This checks with our own experience—except our goats cost more than \$15.

Cost of a Goat

A good goat now costs considerable since their value is being recognized rapidly. Our first goat, a grade Nubian doe, with her two kids cost us \$40. Our second goat (a young doe) was given to us by a friend who has a 20-goat dairy. Our third which was shipped to us 2,000 miles from one of America's best goat breeders cost us \$49, including shipping.

We now have two milking does. When they first freshen they produce

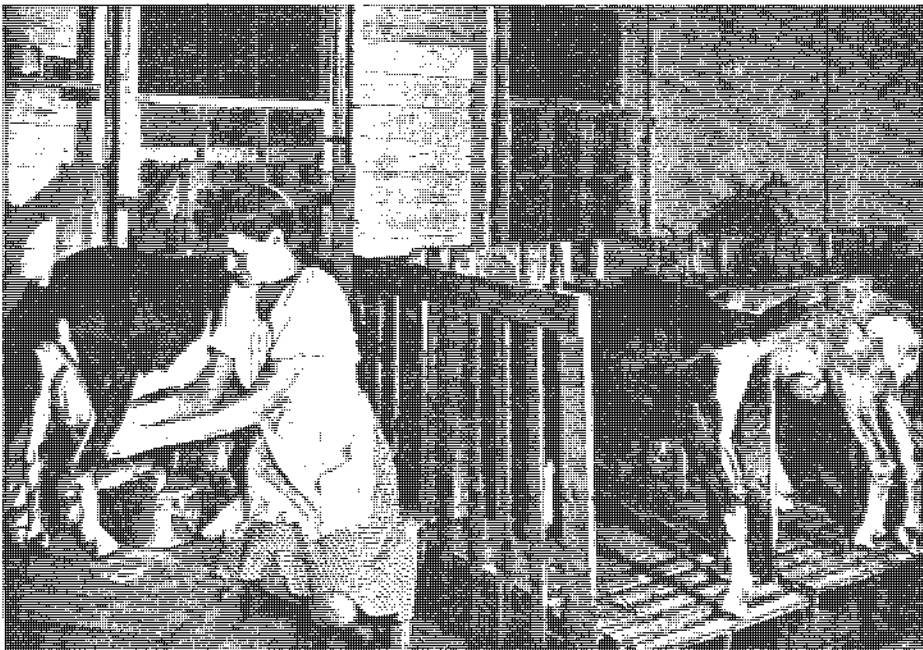

Milking a goat is far easier than milking a cow. Notice 4-quart milk pail partially covered to help keep milk clean.

a total of eight quarts a day. Eight or nine months later, before we dry them up, they are producing 1½ to 2 quarts a day. A goat generally gives more milk on her second and subsequent freshenings than on her first. Five to seven quarts of milk are easily used by a family of three. It takes about 8 or 9 quarts to make a quart of cream or a pound of butter.

Goats are sensitive to changes of ownership and home. It takes them several months to adjust themselves completely. In fact, they become so closely attached to individuals that they give more milk to the person who stands by them at kidding time and handles their new-born young.

We believe the perfect solution to the family milk supply is two milk goats. Two grade goats are better than one purebred for several reasons. You can arrange to have milk all year round by breeding one goat in September, the other in January. Two "three-quart" grade does cost less than one fancy six-quart doe as six-quart does are rare and cost \$100 to \$200. Goats also love companionship and will give better results when they have company instead of being kept in solitary confinement.

There are three ways of starting your miniature goat dairy economically:

1. You may buy four month old kids for about \$15 or \$20 and raise them to breeding age (about 15 to 18 months). They'll cost \$10-\$15 a year to keep.

2. You may buy a purebred goat past her prime, breed her to give you good young stock. Goats reach their peak at about 6 years, but live to be about 12 years old.

3. Or you may buy a good common doe, breed her to a purebred buck and improve your stock while getting milk at the same time.

We are working on the third plan ourselves and think it's the best. Kids from a good doe pay for her upkeep. The only drawback to raising your new kids (the doelings for future milk stock and bucks for slaughter) is their need for part of your milk supply. A kid should have a quart of milk daily for at least 2 months but we find we can substitute skim milk we have left after separating the cream, or substitute cheaper evaporated or powdered cow's milk after kids are a few weeks old.

Goat Breeds

If you decide to buy a dairy goat you will find there are three popular breeds—Nubian, Saanen and Toggenburg. Keep away from the ordinary, short-haired American goat, commonly known as the old "alley goat." Goat breeders as a whole will not recommend one breed above another.

We chose the Nubian because it gives the richest milk rather than large quantity and because of the popularity of the breed in our section (an important consideration when breeding

time comes). It is not profitable for the small goat owner to keep a buck—a registered purebred buck is expensive, must be housed separately from the does as he is responsible for the unpleasant odor. Nubians range from cream to black in color, have long drooping ears and distinctive Roman shaped noses.

The Saanens are white or light cream and are the heaviest milk producers. The two goat dairies we know best have both Saanen and Nubian goats—thus combining the highest in quality with quantity.

Toggenburgs are brown with two white stripes down the face and white hocks. Toggenburgs are a popular breed. French Alpines and Rock Alpines are two other breeds relatively new in the United States.



Wilhelmina at 1 month.



Wilhelmina at 22 months.

Guides to Buying

1. Visit several goat dairies. To locate dairies subscribe to one of the four dairy goat magazines, (\$1 per year) and look at ads. Or contact your County Agricultural Agent.

2. See the goat that interests you milked. Ask for her milk record if the dairy keeps records. Milk is measured in pounds. One pint equals one pound. A good goat gives 3 to 6 pounds a day.

3. Look for a goat with depth of body

and well-sprung ribs—points which indicate good food capacity.

The udder should be large and even, carried well under the body and with good-sized teats for easy milking.

5. Get a hornless doe or one disbudged. Horns are dangerous to other goats, children and the milker.

6. If the goat is registered get her papers at the time you buy—proof of registered stock means the doe's value and her kids will be higher if you wish to sell.

Housing

A home for your dairy goats may be as simple or expensive as you wish as long as it keeps goats, feed and living quarters clean and dry. Whatever housing you do provide, plan the arrangements well. Place your pens, stalls and feed so that you take as few steps as necessary. Each minute saved on twice-a-day chores means 12 hours less work a year.

If you are just starting the "Have-More" Plan and cannot afford to build a miniature barn you may use any small, draft-free building you have or can buy secondhand. A shed 6' x 10' can accommodate two does. At kidding time, divide the pen into two smaller pens by use of a hurdle. A wire floor of ¾" heavy gauge mesh, held off the pen floor by a lumber frame keeps bedding dry and goats clean. A feed rack of wood slats will keep goats from wasting hay. (The grain ration should be fed in heavy, hard to tip-over, individual pans which can be bought for about 50c each.)

If you can build or develop part of your barn especially for the goats, you will find a miniature dairy attractive and easy to keep clean. We built our small barn to house laying chickens and our broiler battery in one part, goats, rabbits, sheep, and pigeons in the other. The floor is of cement which is easy to wash, especially with its small dairy gutter, running behind goat stalls. The 18" wide gutter is on a slight slope toward the wall with its own small opening to the outside. Thus dirt, manure and other trash may be swept into the gutter and outside into an iron wheelbarrow.

Our goat stalls are built of wood, on a wooden platform 8 inches off the floor. Each stall is 24" wide and 35" long and divided from the next by a partition 32" high. In front of all the stalls runs a long feed manger. Stalls are separated from the feed rack by slats or solid walling with keyhole opening for goats' heads—this keeps them from wasting hay. A feature we developed to keep a milking goat clean is a removable individual stall floor, the front solid, the rear slatted. Manure falls through the slats into the gutter and also doesn't get tramped down so it's hard to remove. Each stall's floor can be lifted out, cleaned easily and dried in the sun.

The goat barn should open directly to the pasture enclosed by a sturdy wire fence 4' high—goats are agile jumpers. Goats may be tethered on chains or ropes with swivels at both ends to prevent tangling—but tethering takes too much time.

Feed and Health

It costs about 10¢ a day to feed a producing doe when you buy all the feed. Goats relish stale bread and other kitchen scraps providing these are clean and free from mold. Contrary to popular opinion, we found goats meti-



Two pens for kids or maternity ward. A ¼" wire mesh floor tacked to 1" x 2" wooden frame and laid over cement floor keeps bedding in kid pens fresh longer.

culous in their food habits—they won't touch food dropped on the floor or contaminated in any way. And they dote on variety—my wife says they take after me (or vice versa).

During the winter a milking doe should have about 2 lbs. of alfalfa or clover hay (750 pounds yearly which you can raise on ¼ of an acre), 1½ lbs., when possible, of corn 'silage or roots (turnips, carrots, etc.) and 1 to 2 lbs. of grain ration. When on pasture, we feed less grain, only a little hay, no 'silage. The mixing of grains is too complicated for us—it's best to buy a prepared ration sold by a reputable hay and feed dealer. Clean warm water should be supplied at least in the morning and night and goats encouraged to drink (a few drops of molasses in the water makes it appealing.) Salt bricks should be accessible at all times.

Goats are naturally healthy, hardy animals and if they are well cared for you should have no trouble. They rarely get tuberculosis (as cows do) or Bang's disease, one cause of undulant fever in humans. We are following the rule required of dairies—having a veterinarian test the goats twice a year.

As a final precaution, you can pasteurize your milk by heating it to 142° F and holding it at this temperature or slightly higher for 30 minutes—or raise to 160° F for 15 seconds. In either case milk should be cooled rapidly by putting container in ice water. Also, we suggest you have a vet the first time

your goat kids—just for your peace of mind, as goats seldom have any trouble giving birth. You can expect 2 kids at the second kidding and you may get 3.

How to Milk

"How did you learn to milk?" is one of the most frequent questions our city friends ask. We truthfully answer, "by reading how." So can you. Here's how:

Sit with your right side next to the doe's right side, your shoulder close to her shoulder. Hold the teats, thumbs outside fingers. Close your grasp, beginning at the top (thumb and index finger) and successively close the other fingers, thus forcing the milk down the teat and out. Milk firmly but gently until milk stops flowing. Then strip the teats by running the thumb and first finger from the top of each teat to the bottom until the last drop is out. Gently nudging the bag encourages the milk flow. You will be slow and awkward at first as you will have to think about each step but it won't be long until you'll be doing it so casually you'll be surprised at people asking you where you learned.

We warn you that the first few milkings may seem like desperate events in your life—we laugh and laugh now when we look back at our struggles. Don't try to learn with just one hand. Use both hands from the beginning and keep a firm hold even if the doe tries to move around. She will test you out a time or two but you can keep her right front leg in place with your right shoulder and her right rear foot in place with your left wrist. Once you show her you won't let her go she will be quite patient with your efforts.

You will want a small milk stand which you can easily build yourself. It is simply a small stand about 1½' off the floor—40" long and 22" wide. At the front end you place posts 55" high and slats 4½" apart with one slat movable so that the goat's head can go through before you straighten the slat up to hold her in place. A rail on the side opposite the milker keeps the goat from moving too freely. See picture of our homemade milking stand.

When it comes to handling your milk I think you'd better do what my wife tries to do—follow dairy rules as well as you can. She insists on using a disinfectant (planned for milking equipment) on the milk pail, milk jars (we use canning jars because of their wide mouths) and in water used to wash the udder. The teats and the milker's hands must be dried thoroughly before milking, the first stream of milk from each teat thrown away. We strain the milk through filters, discarded after use, then set the jars of milk in ice water as rapid cooling creates a healthier, better-tasting milk.

Pasteurization with a tested goat is up to you. Raw milk certainly tastes

better and some experts say it has more food value.

When it comes to feeding milk to your kids, by all means pan feed them. If you let them nurse, you lose control of your milk supply. Bottle feeding is a messy affair. After the kids are born place them in a box or basket so they cannot get out to their mother. After you pan feed them a few days they will not try to nurse and can run with the mother. Dip your finger in the milk, let them lick it and get them to follow your finger into the pan. After a time or two your only trouble will be keeping the milk from being spilled as the kids dash for it. Feeding the kids is fun even though commonly called a "chore."

Time Savers

1. Try to have running water in the barn or as close as possible.
2. Store feed close to feed racks to save time and mess.
3. If you build, plan a dairy gutter sloping to an outside opening of its own.
4. In the pens build racks of slats or heavy wire mesh to stand an inch or so off the floor to keep bedding cleaner and drier.
5. In the stalls place removable wooden racks for ease in cleaning.
6. Fence in a pasture if possible—the initial work is easier than continuous tethering.



Even a Crosley is big enough to carry your goat. Mimi is on her way to visit Ptolemy, a prize Nubian buck.

A Family Cow

KEEPING a cow, like marriage, is a confining and responsible relationship not to be entered into lightly. Flirtation, study, an engagement, even trial marriage are advocated, for dairymen, like fond parents, are unduly enamoured of their heifers.

Like marriage, too, keeping a family cow is a great institution. In fact, American agricultural writers often refer to the cow as "The Foster Mother of the Human Race." This is undoubtedly a little over-enthusiastic for in many parts of Europe 80% of the milk is goat milk.

The first time you squat on your brand-new, insignificant three-legged milk stool and your new cow towers above you, a thousand pounds of the Lord-Only-Knows-What combination of unknown evil, wickedness, and danger and you see her big, horned head turn at the fumbling indignities you are attempting under her hind-quarters, you're bound to experience a sinking in the pit of your stomach and an intense feeling that a cow is too gigantic an undertaking for you. Anyway, if this feeling doesn't come over you at the beginning of your first milking, then it will unquestionably at the end when it dawns on you that all that milk, that big pail of milk, is going to be duplicated night and morning every day for the next ten months.

Actually, a cow isn't large or dangerous. In fact, compared with your car she's less than one-third the weight—and when you realize that the auto is responsible for some 30,000 deaths a year, not including some hundreds of thousand injuries, then you'll have to agree that a cow isn't dangerous. A family cow, particularly a Jersey, becomes the gentlest of pets.

As for the superabundance of milk—it's none too much when translated into terms of milk for the family, cream, skim-milk for chickens, pigs, and a calf, and particularly if you want to make ice cream, butter and cheese. If yours is an average, decently fed family, you are already using one cow's entire milk supply. There are in the United States, according to the census, something like 26,000,000 producing cows. That is at least one cow for each American family enjoying a sufficient amount of milk and milk products. In short, the point is: Are you going to keep a cow or go on paying somebody else to do it for you?

I know it's hard to believe that a family accustomed to buying one or a couple of quarts of milk a day can easily use 10 or 12 quarts. It was that way with us when we started getting 6 or 7 quarts of milk from our two milking goats. Honest, though, if you're going to have a productive homestead, you'll find it simple to use the milk effectively without setting up a milk

route. For example, you'll be able to have plenty of real, heavy cream—for coffee, for cereal, for berries, for ice-cream, for cooking, for butter-making. Remember, it takes 10 quarts of milk to produce one quart of cream. And a quart of cream makes only a pound of butter . . . or a quart-and-a-half of ice cream . . . and just ask your wife how much butter and cream she'd like to



Isn't she lovely . . .

use in cooking if she could use all she wanted!

For every quart of cream you produce, you'll have about 9 quarts of skim milk. This is the finest food you can feed pigs, chickens and other poultry. If you still think you'll have too much milk, there's the annual calf that your cow will produce. If you raise the calf to veal size, about 180 pounds, the calf will consume daily a pint of milk for each ten pounds it weighs.

Another thing to bear in mind is that although a cow isn't by any means something you can turn on or shut off like a faucet, you can to a certain extent control the amount of milk she produces; she can be just as efficient producing less milk, strange as this might seem. The efficiency of a cow is simply a comparison between what she costs to keep and how much she produces. During the course of a year a commercial dairy cow will consume about 2 tons of hay, require one to two acres of good pasture, and eat 2,000 pounds of grain or other concentrates. A homesteader interested in self-sufficiency usually has the pasture land and can make the hay, but has to buy the grain. A cow, however, doesn't need grain. Professor Carl Bender, of Rutgers, explained to me how a cow could be kept in perfectly good health on a diet of good hay, good pasture and in winter succulents such as beet pulp or the sugar beets themselves. Obviously, a cow that isn't fed grain won't give as much milk—probably it'll give only 70% of what it would give when fed grain to supplement pasture and hay. But to the homesteader considering what to do with a cow's full production of milk, a cow that will give 7

quarts of milk a day instead of 10 quarts might be preferable, particularly when she can also eliminate a grain bill.

Less than an eighth of an acre will provide the 25 pounds of sugar beets a day necessary to feed your cow during the months when pasture is not good. Beets or mangels can be stored in a root-cellar. They are simply washed and sliced before feeding.

The more the countryman looks into the business of keeping a cow, the more practical it seems. Your first cost, buying the cow and fixing up to keep her, is figuratively speaking your last cost. For if you have some suitable pasture and raise your own hay and succulents, then the only other regular cash outlay should be about \$15 dollars a year breeding and veterinary fees. On the credit side you should get at least 5,000 pounds of milk (about 2,500 quarts), a calf which will give you 90 pounds of veal, and 12 tons of good manure. If you've had to buy manure, then you'll appreciate how valuable 12 tons is.

All this sounds pretty rosy. But there is the other side, too. Although neither an elaborate nor expensive building is required, you'll need a barn of some sort. It should be draft-free, have a decent sized window to let in plenty of sun and fresh air.

Also, you'll need a place to store two tons of hay. Hay can be stacked outside the barn and covered with canvas, but this should be considered only an emergency measure. Of course, if you're going to buy your hay, you can buy it by the bale and then you'll need very little space. Eventually, you'll want to make your own hay, and you'll need storage space of at least 10 x 10 x 10, or the equivalent, to store two tons of loose hay. Incidentally, the rule for finding the number of tons in a mow is: Multiply length x width x height (in feet) and divide by 400 to 500 depending on the length of time the hay has been in—there's also a slight variation depending on the type hay.

Another thing you'll want is between one and two acres of good pasture. The pasture should be fenced into three small pastures to let you rotate the cow. Although many people stake out their cows, this is needless trouble compared to fencing a pasture so the cow can simply be turned loose into the pasture from the barn.

You'll need some equipment: milk pail, water pail, milking stool, square manure shovel, 6 prong manure fork with tines not over 1 3/4" apart—wider tines allow droppings to fall through—cow halter and rope, curry comb and brush, barn thermometer, udder wash cloths, milk scale, milk production record chart, insect spray gun, hay forks—one in loft, one in barn level—and a metal wheelbarrow. Total cost—about \$30.

You should also run water to the barn. And you'll want to work out a manure pit or compost system for easy handling of manure.

Then there are certain items needed to handle the milk efficiently. Milk setting cans . . . milk strainer and filter discs . . . an inexpensive butter churn and, if you can afford it, a small separator.

That'll be most everything—except for the cow.

What Breed To Select?

There is no best breed. Oftentimes a Jersey is the first choice for a family cow because its milk is richer and it is a smaller cow. A few people find a Jersey's milk too rich. (See table.)

One thing to determine before selecting a particular breed is how you're going to get your cow bred each year. Find out from your County Agent about the availability of artificial insemination. If this isn't possible, then you'll be better off by getting a cow of the same breed as the most convenient bull, if you intend to raise any heifers.

Buying a Cow

When you set out to buy a cow the most important thing to do is to be sure that you buy a healthy one. Have her tested for both tuberculosis and Bang's disease, and see that her udder is free of mastitis. Your veterinarian will check up on these.

If the seller hasn't kept accurate milking records, and only about one in ten dairymen do, then be present at two—or better three—successive milkings. Or ask for a written guarantee of the cow's milk production.

Buy from a reliable man. Remember, in spite of all the to-do about judging cattle at the shows by external appearance nobody can honestly tell how good a milker a cow is by looking at her. If that were possible there wouldn't be the thousands of dollars spent on record-keeping by the big milk producers.

A young cow is worth more than an old cow. Although, if you get an especially good buy in an old cow with an outstanding milk record, you might consider buying her and replacing her as soon as possible with her heifer. Naturally, this is something of a gamble. She may have a couple of bull calves before a female—and when she

does have a heifer, it'll be almost 2½ years before the heifer will be milking. A cow reaches its prime at about 7 years of age; if healthy and well-cared for she will produce well to 10 or more years.

How Much Time Does a Cow Take?

For 10 months of the year the family cow must be milked twice a day. Milking should be regular, but can be done at any two periods 12 hours apart. There is absolutely no reason to milk a cow at such an ungodly hour as 5 or 6 A. M.—that is, not a family cow. A cow will do as well milked at noon and again at midnight. Or a cow can be milked on a 10-14 hour schedule—say 8 in the morning and 6 in the evening. But milk her regularly—at least within ½ an hour of her scheduled time.

Feeding will take about 10 minutes and needs to be done morning and night.

Pasturing shouldn't take but a minute or two if you have wired runs from barn down to pastures. (See "Layout for a Productive Homestead.")

Caring for milk—straining, cooling, washing utensils 5 to 10 minutes.

Separating, every other day, about 10-15 minutes to run through 25 quarts or so; about 8-10 minutes to clean separator.

Butter making from cream takes about 30 minutes.

A small cheese takes about 3 hours to make, spread over about 6 weeks time.

In addition, a certain amount of time will be needed to make a couple of tons of hay a year and produce the sugar beets or other ensilage.

This sounds like quite an undertaking when you add it all up. But compare keeping a cow with a family garden. The dairy products consumed will exceed in retail value the total possible saving from the operation of a well-run vegetable garden including canned and stored vegetables.

Milking will take about 20 minutes—morning and night. Cleaning barn and removal of manure about 15 minutes. Grooming cow—about 5 minutes.

Watering should be made automatic. If by hand it will take 5 to 10 minutes.

Raising a calf calls for teaching the calf to drink and then pan feeding three times a day for 4 to 6 weeks.

Specific Costs and Returns

Too often the benefits of productive country living have been interpreted solely in economic terms. How much more valuable is fresh milk with a 5% fat content as compared with the two or three day old store milk of only about 3% butter fat? To some people milk is milk—but to others fresh, rich milk and heavy cream from a Jersey cow is worth twice what ordinary milk costs.

Anyway, here are two sets of returns on keeping a cow. Neither take into account that fresh milk is usually preferable.

The first figures are from a state bulletin and are averages:

"Actual costs, on the average, for first year if pasture, housing, and bedding are available without monetary expenses are shown in the paragraph that follows:

Cow purchase price \$100 to \$200 (average usefulness of young cow five years) . . .	\$150
10 pounds grain (mixed ration) daily multiplied by 200 (days) equals 2000 pounds @ \$30 to \$50 per ton	40
15 to 20 pounds hay (alfalfa, clover, or mixed clover and timothy) multiplied by 200 (days) equals 2 tons @ \$20.540	60
(Amount depends on size of cow and her appetite. Plenty of hay is absolutely essential.)	
Breeding and Veterinary fees	15

\$265

Returns from a good cow per year are: 3,000 to 5,000 quarts of milk @ 10¢ equal to \$300 to \$500."

Now for some specific figures from the book, *The Family Cow*.

"Jeanne is an ordinary crossbred Jersey-Guernsey purchased for \$85. Her record of 1943 may be of interest even if the costs and prices may not apply elsewhere or at other times. She freshened in May and was milked for 318 days. She produced 8337 pounds of milk, ranging from a peak of 42 lbs. to a minimum of 12 lbs. This amounted to 3877 quarts of milk, an average of 12.2 qts. per day. Butterfat ranged up to 5.35% so she probably produced around 420 pounds of fat. This is equivalent to 462 pounds of 90% butter or an average of 1.45 lbs. of butter a day if all the milk had been thus used.

"Dairy products were consumed and sold as follows:

	Consumed	Saved	Sold	Cash Income
Milk	1200 qts. @ 15¢	\$180.00	250 qts.	\$35.46
Cream	80 pts. @ 35	31.50	70 pts.	27.26
Butter	90 lbs. @ 50	45.00	135 lbs.	67.31
Cheese	50 lbs. @ 12	6.25	32 lbs.	4.00
Skim	300 gal. @ 15	45.00	236 gal.	39.42
Buttermilk	70 qts. @ 9	6.30	30 qts.	2.70
		\$314.05		\$176.15

There are several bookkeeping approaches to these figures but they all show one thing clearly—that the family cow is a pretty good investment!

Cows Have Character

	Ayrshire	Brown Swiss	Guernsey	Holstein	Jersey
Average size at maturity (pounds)	1200	1350	1100	1300	1000
Color	Red and White	Dark Brown	Yellow	Black and White	Fawn
Butter test (per cent)	4	4	5	3.45	5.3
Disposition	Nervous	Docile	Active	Docile	Nervous
Maturity (months)	28	34	27	29	25
Adaptability for beef	High	High	Low	High	Low

From "A Practical Guide to Successful Farming."

A Few Sheep For The Small Place



CITY people who take up country living are generally amazed at the bounty of the land and are always giving something to friends. I guess that's why Carolyn's aunt, who'd recently bought a farm in Alabama, sent us one of her home-grown lambs. And that's how we learned a little about sheep.

A single lamb, like a single goat, is a lonesome creature. We tried using him as a "lawn-mower" on the front lawn but he bleated half the time. Finally, although we knew it wasn't the best practice we turned him out to pasture with our goats.

The goats had never before seen a lamb—and I guess the lamb had never seen goats. Goats and lamb eyed each other suspiciously. The ridges of the goats' backs bristled. Then the lonesome lamb, in a friendly fashion, ran toward the goats. Frightened, the goats scampered away and it was a couple of hours before they would let the lamb get near them. Finally, they sniffed him over and philosophically accepted this "ugly duckling". Our lamb was no longer lonesome.

This lamb proved so little trouble that the following year we bought two, fattened them, and had them butchered just as with our first. In many parts of the country I'm told the sheep's skin pays the cost of the butchering, but our butcher didn't seem to want the skin. For \$3.50 we had it made into a rug—they sell for \$7.50 to \$20.00. Buying one or two lambs, fattening them for 30 to 60 days, and then having them slaughtered is *not* the most economical way to produce your own lamb, however.

Often times, a weaned lamb when moved will lose weight for awhile and consequently require more grass and grain before they "make" 90 to 100 pounds, the customary weight at which

they are slaughtered. Then again a young lamb is apt to cost \$7.00 to \$20.00. The one point in favor of buying and fattening a lamb is that this is an easy way to gain experience.

Before we discuss a better way to get started, lets take a look at what is necessary in the way of pasture, grain, equipment, time, and money to economically produce your own lamb.

Good Pasture Essential

The first thing you should be able to supply is good grass. You don't need much grass pasture—it takes about a quarter-acre of grass, 750 pounds of hay, and 100 pounds of grain yearly to support one sheep. Remember, though, you should have at least two sheep.

As for the hay, alfalfa is best. In fact, you can raise and fatten your lambs solely on good grass and good alfalfa. Clover and soybean are good hays also.

Many different grain combinations are suitable for feeding sheep. The easiest plan for the homesteader with goats is to buy "sheep and goat" ration. In *Starting Right With Sheep* a mixture of two parts oats to one part bran is recommended as the best all-around sheep feed. For fattening use five parts wheat, two parts corn, two parts oats, one part linseed-oil meal. Sheep must have plenty of water.

Now the most economical way of getting started with sheep is to buy a couple of bred ewes in the winter. Ewes should be vigorous and in good flesh, but never fat. Also make sure they are free of external and internal parasites (notice droppings) otherwise the new born lambs will become infested. Bred ewes sell from \$10.00 to \$50.00 depending on whether they are scrubs, grades or registered purebreds, the reputation of the seller, age and merit of the animals. Fleece, conforma-

tion, age and udders should receive close inspection.

Housing and Equipment

Housing for sheep can be simple, a three-sided shed with roof and a dry dirt floor is satisfactory. Two sheep need an 8 by 10 foot pen or building. A wood or wire rack is necessary for feeding hay and a trough or manger for grain. Salt and phenothiazine mixed according to directions you get with the phenothiazine, plus water are kept available at all times.

Fencing

While it is true that sheep may be tethered by a chain and swivel, this is not practical. Sheep are not good lawn-mowers—they'll eat the grass too close. Tethered sheep cannot be left out all night, and they are easy prey for dogs. *Dogs are sheep's worst enemy! In fact, the primary purpose of fencing for sheep is to keep a stray sheep-killing dog out rather than the sheep in.*

Choosing A Breed

In general there are two types of sheep—the wool and the meat variety. The homesteader should choose a meat variety. The breeds differ a great deal according to various sections and systems of management, but the part-time farmer should choose from the meat or so-called medium wool class—Southdowns, Shropshires, Hampshires, Ox-fords, Dorsets, Cheviots. Unless you're going to keep a ram, it's a good idea to find out which breed of ram is available in your neighborhood. When your first lambing time comes (about 145 days after breeding) you might have to have a veterinary present. The simplicity of the whole thing will give you confidence to handle subsequent lambings yourself.

All in all, sheep are easier to handle than cows, goats, horses, or poultry.

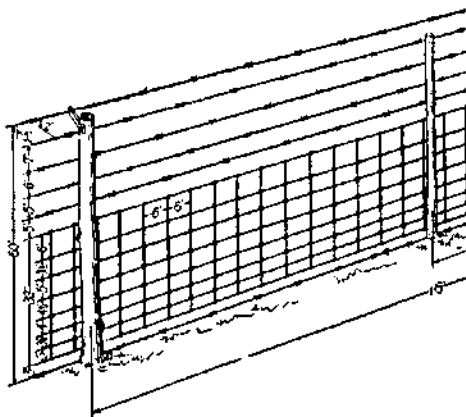

A Good Fence For Keeping Your Sheep Safe From Dogs

Veal and Beef on the Homestead

A FRIEND of mine who likes to eat once chose to spend his vacation at a Western Dude Ranch. He figured that for once he'd get all the tender juicy steaks and roast beef he could eat.

When he came back I asked, "How were the steaks?"

"Oh, good . . . good," he answered—but I detected an odd note in his voice.

He explained. "Funny thing about that ranch—even though they had a couple of hundred steers on the place they got their beef from Chicago. . ."

If a Western Ranch specializing in the production of beef cattle doesn't even raise beef for its own use then what right has a homesteader to think that he can profitably do so?

On one or two acres you probably won't go very deeply into beef production. But even on two acres if you are keeping a cow you'll find yourself raising beef in the shape of veal. Veal, as you know, is calf meat.

Once a year your family cow, like all dairy cows, has a calf. In the ordinary dairy, bull calves and heifer calves from low producing cows generally are slaughtered as veal at an early age. Often, before they are two weeks old because the dairyman does not want to bother feeding them or providing the milk they need. This early butchering is one reason why more people don't like veal. Early butchered veal hasn't anywhere near the quality of eight week veal. The best veal is from milk fed calves about eight weeks old. And this top-quality veal is the kind that the part-time farmer can easily produce because when the family cow freshens and starts producing 12, 14 or 16 quarts of milk a day a few quarts can be fed to the calf and the family still will have enough for drinking, cream, butter—and enough for cheese and chickens too.

Feeding The Calf For Veal

The calf should either stay with the cow for the first three or four days to suckle the first milk, the *colostrum*, or the cow should be milked and the milk given to the calf. If the latter procedure is followed, I think you will find that the calf will learn to drink from a pail more easily. We find it very difficult, for instance, to let a young goat kid nurse and then attempt to teach it to drink from a pan.

The weight of the calf will determine how much he should be fed. If allowed to stay with his dam, he will consume small amounts frequently. This is ideal, but you cannot favor him in this way if he is separated from the cow. On the average, feed eight to ten pounds (4 to 5 qts.) of milk per day, generally one-half in the morning, one-half in the evening. Milk should be at body temperature, and pails kept very clean. Give the calf a dry pen, free from

drafts. If he is not hungry, miss a feed rather try to make him eat. As age increases, gradually increase the amount.

If some skim milk is to be used, decrease the amount of whole milk gradually (one pint or less at a feed) and add equal amounts of skim. Warm the skim milk. Do not boil.

Raising A Steer

During the meat shortage there was a great revival of interest among small farmers, estate owners, and homesteaders in beef for home use.

If your place has enough good pasture (1 acre per steer) and enough good quality hay (2 acres of clover or alfalfa would be ideal), then you might consider raising a steer. Shelter can be simply a three sided shed; if you don't have to carry water, then a steer won't take much time.

A fellow down the road from me who has just about two acres has a steer project underway with a minimum of trouble and investment. He simply went to a dairy with a herd of Holsteins (Brown Swiss and Ayrshires make good beef too; Jersey and Guernsey not so good), bought himself a young male calf, weaned him, and tethered him out in the orchard. He kept the calf on grass all spring, summer, and fall. In October he started feeding some corn he'd grown and at the end of November he had the fatted calf slaughtered. Naturally, if he were going to sell this young steer (he had the vet castrate it) he'd have had to hold the animal for another 9 months or even a year. But for home use this baby steer provided some excellent eating.

What Is "Baby Beef?"

A number of people with small country places have an idea that because their place is small "baby" beef would be just the thing. "Baby" beef are young, well-bred, good quality cattle, often Angus, which are slaughtered at the tender weights of 700 to 1,200 pounds. BUT they are fed grain just as soon as they will take it—the idea being to keep them from losing their baby fat. The part-time farmer who probably doesn't grow much grain, won't find them economical, but of course they do make delicious beef.

How To Put On Fat

Is it practical for the part-time farmer or small farmer to raise an honest-to-goodness beef steer?

From what I've seen in the Northern part of our county I say yes—but he would go at it quite differently than the usual commercial operator.

The whole object in fattening a steer is to make it put on weight. Well-larded beef is the kind that has fine flavor, tenderness, and is good and

juicy. Incidentally, the next time a butcher shows you a steak look to see if it has streaks of white running through the red beef. This is fat—and the steak should be good and tasty.

Ordinarily, beef cattle are shipped off the ranches in the West to the Corn Belt where they are put in feeding lots and fed corn and other grains until they are fat enough to slaughter.

A Mid-west farmer buys beef cattle to fatten for market. You can do the same. Usually, for example, a couple of car-loads of Western steers are brought into our County Seat each spring to be sold to local farmers and estate owners. These "feeder" steers are usually from 6 to 12 months old and ordinarily sell for \$8 to \$12 a hundred pounds. Obviously, they're not a cheap investment and you'd do well to fatten a few pigs or some sheep before you try a steer.

In place of the intensive grain feeding program of the Midwest, there is another method that is probably more suitable for the small or part-time farmer. This is the "pasture method." It can be undertaken in two ways:

- 1.) *High-quality pasture may furnish the sole feed.*
- 2.) *Pasture during the grass season and then hay and grain for 6 or 8 weeks to finish off.*

Pasture doesn't make as finished a steer nor is it as fast as dry-lot grain feeding, but it is much cheaper and oftentimes more profitable even though the final beef doesn't bring so high a price. In addition the steer should have plenty of fresh water and a salt lick.

A new device that has made fattening a steer or two more interesting to the small farmer is the electric fence. A single strand of electric fencing is adequate to hold a steer and it is, of course, easy and inexpensive to put up.

Perhaps, however, the quick-freezer is doing still more to stimulate interest in home production of beef. The home freezer and freezer lockers mean that it is entirely possible for a single family to utilize the 500 pounds of dressed meat obtained from a good-sized steer. Five hundred pounds is not nearly as much as it sounds when you remember that the average annual consumption of beef is 65 pounds per person. If freezer space is limited remember that some cuts can be hung for weeks before cooking. Also you can make some corned beef, smoked beef, dried beef, or use the chuck in delicious canned stews. Another good plan is to divide your beef 50-50 with a neighbor slaughtering his steer one year and yours the next.

Our Little Sugar Factory

WE didn't decide to have bees until we had laying hens, chickens to eat, goats, pigs,, and, of course, our garden all producing.

As I look back I believe it was my father who got us interested in the idea of keeping bees. Actually, he didn't know anything about bee-keeping, but every time he visited us he brought along a jar of honey. He liked

Parts of a Modern Beehive

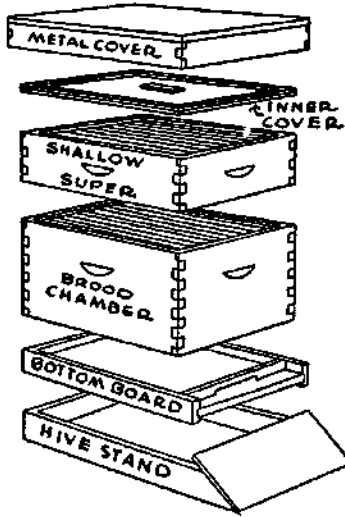

honey so much and believed it so much more healthful than sugar, he got us interested in producing our own.

We've found out that doctors do recognize that honey is the perfect sweet—it's easier to digest, furnishes a quick source of energy, and, unlike sugar, contains minerals.

Also about this time we were reading a book called *The Farm Primer* in which the author says that a hive or two of bees will increase the fruit yield by 30 percent and even make the fruit taste better. Moreover, he pointed out that a hive of bees requires only 8 hours of care per year and gives about 75 pounds of honey. Seventy-five pounds per hive seemed a lot but I've since heard of single hives producing as high as 500 pounds. Of course, it's unlikely a novice will get as much as that.

One lunch hour in New York, I went down to a bee equipment place. All I meant to do was buy a booklet called "Starting Right with Bees" I was going to read first—and get the bees later. I asked them how much the equipment necessary to have one bee hive would cost. They said, "About \$20—including a queen and three pounds of bees—but right now we have only one complete amateur outfit left."

It seems they were having trouble getting zinc to make bee smokers. This is no longer true. Obviously, if I were

going to have bees, then I'd best sign up for them right then and there. So I made out a check for the works.

Incidentally, somewhat later on in talking to Mr. C. C. Whitehead, one of the best amateur bee-keepers in Connecticut, I found it was his opinion that the only way to learn about bees is to get up your courage and order a complete beginner's outfit as I did and then you'll just have to learn or else—

One of the nice things about bees is that if you sign up for a beginner's outfit in January to March, you'll learn a good deal before the bees arrive.

That's because your outfit arrives in two shipments. The first shipment is equipment—later, sometime in April, depending on the weather, the queen and three pounds of bees—about 15,000 of them—arrive.

In the first shipment, you get a smoker, bee feeder, hive tool, bee veil, a booklet of directions, a year's subscription to a bee magazine, wax foundation; plus a hive, a deep super and two shallow supers, knockdown.

We spent about three evenings assembling the bee hive and supers—unassembled, 200 odd pieces look like a jig-saw puzzle. Each piece is so perfectly cut, it's fun putting them together.

The hive is simply a box-like structure. At the bottom is a stand with an alighting platform. Set on top of this is the bottom of the hive—3 or 4 boards cleated together to make a floor. Upon this rests a large oblong box without top or bottom. This is called the hive body or brood chamber. In it are hung ten wooden frames each one holding a patterned sheet of wax. The bees draw these sheets of wax into cells. In the cells the young bees are hatched.

On top of this large box you eventually place a shallow box, maybe two or three. These are called supers and like the hive body each hold ten frames. The honey stored by the bees in the hive body must be left with the bees for winter food. But the honey stored in the supers can be taken away and extracted. A queen excluder is placed between the hive body and the supers to keep the queen from laying eggs in the supers. On top of the super—or supers—for they may be piled one on top of the other—is an inside cover. Then over all is the tin-topped wooden cover which telescopes down over inner cover and top super to make the hive waterproof.

All the above—hive, supers, bottom, inner cover, frames and sheets of wax are sent you in pieces—and you put them together. Very complete directions (printed in about seven languages for a bee hive is standard throughout the world) are provided. We had a little difficulty putting the hive to-

gether because our playful kitten chewed up the directions, but we still made out all right.

By the time you get the hive together and painted, you'll understand a little something about the art of bee-keeping. You'll also have a chance to study up on what to do when the bees arrive.

Let me tell you, you'll get a real thrill when you come home some day and find the second part of your order—a screened box about a foot square crammed full of 15,000 buzzing bees.

I'd read that anyone can handle bees—if they do it properly—and not get stung. But I'll admit I had my doubts the evening Carolyn took me into the garage, pointed to the cage of buzzing bees the expressman had brought and said, "Well, do you want to put the bees in the hive now or after supper—remember, that's your department!"

I confess I postponed putting the bees into the hives until after supper. I also sneaked upstairs for a last reading of the chapter "How to Install Bees in a Hive".

Well, after supper I set up the hive and carried the caged bees out to the uncovered hive. I wore the bee-veil, but no gloves. It wasn't that I was being brave, I just couldn't find a pair of leather ones.

In opening the cage, I spilled the syrup can that goes along with the bees—spilled it all over my hand and about 3,000 bees tumbled out after it. Before I knew it my hand was covered with crawling bees. For about ten seconds I stood perfectly still. Then, suddenly I realized I was not being stung!



Pointing to the top entrance. In late years this second entrance, especially in the north, has demonstrated its advantages. It saves the bees from death in case bottom entrance gets clogged with snow or dead leaves. Also provides better ventilation.



At first Carolyn would have no part of the bees. Later, she learned you can handle bees without getting stung. Note "frame" of honey.

The bees were happily lapping the sugar syrup off my hand—that is, the two or three thousand that could get a lick in. I began to think again and remembered to put the opened cage inside the hive. Then, somehow, I brushed the bees off my hand into the hive, released the queen, put the cover over the hive, and went to the house.

Mrs. R. had been watching me from the kitchen window. I came in, undid my veil and tossed it onto a chair.

"Didn't you get stung?" she asked.

"Of course not—why should I?" I replied, shrugging my shoulders.

Right then and there I *did* get stung. It seems that one lone bee had crawled from my hand, up my arm, and when I shrugged my shoulders, I pinched her—and she let me have it.

I've dwelt at some length on the way I felt handling bees for the first time because so many people are missing the very real benefits they can have keeping bees because they are afraid of being stung.

All the rest of the year I was stung only twice. Both stings were due to my own carelessness. For example, one day I had been working hard in the garden in the hot sun. In fact, it was so hot that I wore only dungarees. Suddenly, I remembered I should feed the bees some sugar water. I carried it over to the hive, not stopping to put my veil on—or even a shirt. I opened the hive, flipped off the cover, bent over to pick up the Boardman bee feeder and had no sooner straightened up when I was stung by three bees. That was my fault for being so brisk and blowing my hot breath on the bees.

One other time I pinched a bee and she stung me. But by then I'd learned to rub, not pull the stinger out. And by getting the stinger out *fast* the sting was hardly more than a mosquito bite. With my veil, and gloves and handling the bees properly, I don't get stung.

For quite some time—from the middle of April when the bees arrived until the first honey flow in June—I fed the bees a mixture of sugar and water. This is fed by the bee feeder which

holds an inverted Mason jar with its zinc top perforated.

After the clover blossoms, the first real honey flow is on and the bees make their own honey. You'd think it might be smart not to get your bees until the honey flow started so you wouldn't need to feed them sugar-water. But the reverse is true. Although 15,000 bees sound like a lot of bees, they're just the nucleus of the hive. A strong hive builds up to three or four times this size. A few days after your bees arrive, the queen should begin producing eggs—at the rate of 2,000-3,000 a day. These eggs are attended by the 15,000 bees and the eggs begin to hatch 16 to 18 days later. So if you get your bees in April your colony should be built up to a fair size when the first honey flow starts in June.

For the first two or three months after our bees arrived the only help we had was from our books. I well remember one line in a book that proved comforting again and again—"The amateur is apt to err by giving the bees too much attention." So whenever I was in doubt about doing this or that I didn't do it.

This system worked fine until one evening when I arrived on the 6:42, Mrs. R. said, "Well, a phenomenon of nature took place today—"

I didn't like the way she said it. "What do you mean?"

"You guess," she replied.

"Jackie has started to talk."

"No."

"One of the geese laid a golden egg."

"No—your bees have swarmed."

Sure enough, in our back yard way at the top of the highest tree was a huge swarm of bees. My wife said she'd heard them come out of the hive around noon—they sounded like a squadron of high-flying airplanes, and after flying around a bit they'd clustered at the top of the tree.

It so happened that very morning a fellow commuter had told me about a neighbor of his, a Mr. Whitehead, who was an expert bee-keeper. All I knew about swarming was that bees don't usually stay around long after they swarm—sometimes only a half-hour. So I telephoned Mr. Whitehead.

Mr. Whitehead calmed me down—told me he'd lend me another hive. Then said that I should take a ladder, climb the tree, cut the branch on which the bees clustered, take it down and hang the bees on a clothes-line overnight. All this I did—incidentally without getting stung. The cluster was a foot in diameter and three feet long.

The next morning I got up at 5:30 A.M., spread a sheet on the ground in front of the newly set up hive, shook the bees off the branch and watched them stream into the new hive. Two hours later the last of them were marching into the hive—and I now had two hives of bees, for there was quite

a colony still left in my original hive.

Right here I'd like to say that Mr. Whitehead has since taught me a lot about bees. Incidentally, one of the real pleasures of bee-keeping is getting acquainted with other folks who keep bees—they are a fine bunch of people.

If you're really interested in starting in with bees, visit a beekeeper in your locality—tell him you're thinking of getting a hive of bees and see if he won't invite you over to his place to watch him open his hives. If you can, spend a few hours with a beekeeper and if you will read *First Lessons in Beekeeping* you should get along fine.

It wasn't until some time after we got our bees that we found out that we could not expect much honey from them the first year particularly because we let them swarm. The reason for this is simply that the bees have all they can do to draw the wax foundation into cells plus raising the young bees and storing enough honey for themselves. Our bees had stored up over 60 pounds of honey their first year which we left them to eat over the winter. We took only four or five pounds for our own use. The second year we had about 60 pounds of honey for our own use.

Bees are one of the most fascinating things you can have. They require only a few feet of space, gather their own food, and need only 8 hours care per hive a year. You can have bees even if you live in the city. I know of a beekeeper who lives in Brooklyn.



A honey "extractor" is used to whirl the honey out of the comb. Jackie and his friend were glad to sample each batch.

Have More In Winter, Too!

NOW we come to a part of the "Have-More" Plan that probably gives Ed and me the most satisfaction of all—preserving food in various ways so that we "live off the fat of the land" all year round.

Food preservation also has very practical compensations. Vegetables cleaned and prepared in the summer or fall save hours of shopping and of preparation in the kitchen during months to come. Furthermore, home preserved food costs less. For example, our home preserved tomatoes cost us about 5¢ per quart.

Folks today are lucky to have two wonderful modern ways of conserving food: quick freezing and pressure canning—besides that dependable old stand-by, the root cellar. One obvious rule applies to them all: use only the best of your fruits and vegetables, those just ripe and free from blemishes. If you take tough old string beans and freeze or can them, you're still going to have tough old beans. At first it hurts to throw away even one bean you've raised. But it isn't long before you realize you have plenty of the best and you can afford to give the few tough ones to the pigs or chickens.

If you want to keep your preserving to a minimum, enjoy your food to the fullest extent while it is at the height of its season instead of trying to have something different every day of the week. We certainly do not get tired of eating sweet corn nearly every day for weeks when it comes fresh from our own garden.

To show you how we have a lot of variety in our home-grown food with the least effort, here is a list of foods we emphasized, each in season. We

don't claim we ate only these items at these times, but we used them primarily—we supplement our home-grown list with things we don't grow, for instance, seafood, beef, etc.)

SUMMER (July-September)

Fresh garden vegetables—tomatoes, peas, string beans, lima beans, beets, corn, cucumbers, lettuce, summer squash, egg-plant, new potatoes, etc. Fresh fruits, raspberries, strawberries, blackberries, etc. Broilers, roasters, rabbit. All kinds of frozen meat (from winter killing). Milk, butter, cottage cheese, eggs.

FALL (October-December)

Root cellar vegetables—cabbage, beets, carrots, turnips, Hubbard and acorn squash, potatoes, Jerusalem artichokes (leave in ground). Greens still in garden: kale, broccoli, chinese cabbage, collards. Stored fruits—apples and pears. Baked beans and stews. Chicken, fricassee or pies (culled hens), broilers and roasters. Other fowl—(geese, turkeys, ducks). Lamb, chevon, rabbit. Milk, eggs, cheese.

WINTER (January-March)

Vegetables and fruits—rest of those stored in the root cellar—some canned and frozen vegetables, fruits. Fresh pork or chevon, smoked hams and shoulders, sausage, bacon. Frozen or fresh chicken. Other fowl (as you cull). Rabbit.

SPRING (April-June)

Vegetables and fruits—canned or

frozen. Spring garden greens, such as dandelions, beet tops, asparagus. Fresh rhubarb. Jerusalem artichokes, and parsnips left in garden over winter. Radishes, lettuce. Hams and bacon (cured in winter). Baked beans. Broilers, frozen or fresh. Other meats from freezer. Milk and eggs.

While we're making lists, here's one you'll find helpful in deciding whether to store, can, freeze or dehydrate the various vegetables from your garden.

Easy Storage: potatoes, carrots, beets, onions, winter squash, turnips.

Best for Freezing: all meats and poultry, snap beans, shell beans, lima beans, asparagus, peas, corn, all greens and berries.

Best to Can: tomatoes, snap beans, shell beans, soy beans, peas, corn and some fruits depending on your own likes.

Most Successfully Dried: soy beans, lima beans, kidney beans, peas, corn, onions, some fruits.

Cold Storage or Root Cellar

It so happens that the old trick of putting away root vegetables and some fruits in a cool, moist place is both easy and cheap and for certain things the best way to store.

The necessary conditions are a cool, moist atmosphere (temperature 35° up to 45°), darkness, and protection from rats and mice.

We are unfortunate in having a very small basement. What we would have liked is a cellar storage section about 10' x 6' and at least 6' high, for standing room and plenty of shelf space. A section of the basement can be walled off with economical concrete blocks or insulating board. Good insulation and a close-fitted insulated door are most important, especially if you have a furnace in the basement. A small window is also necessary in order to control the temperature within the storage unit. An earthen floor is best—it gives your storage the proper humidity. If you have a cement floor you must sprinkle it with water every day or two, or keep a bucket of water in the room. In basement storage it is also best to pack carrots, beets, and other root vegetables (except potatoes) in a barrel or crock with damp leaves or sand.

But don't hurry your harvesting to put the vegetables in storage. It is the early part of the storage period that is most dangerous. It's hard to get the temperature down to 40° or less when the weather is still warm so leave root crops in the soil until the ground is almost ready to freeze. Tomatoes, onions,

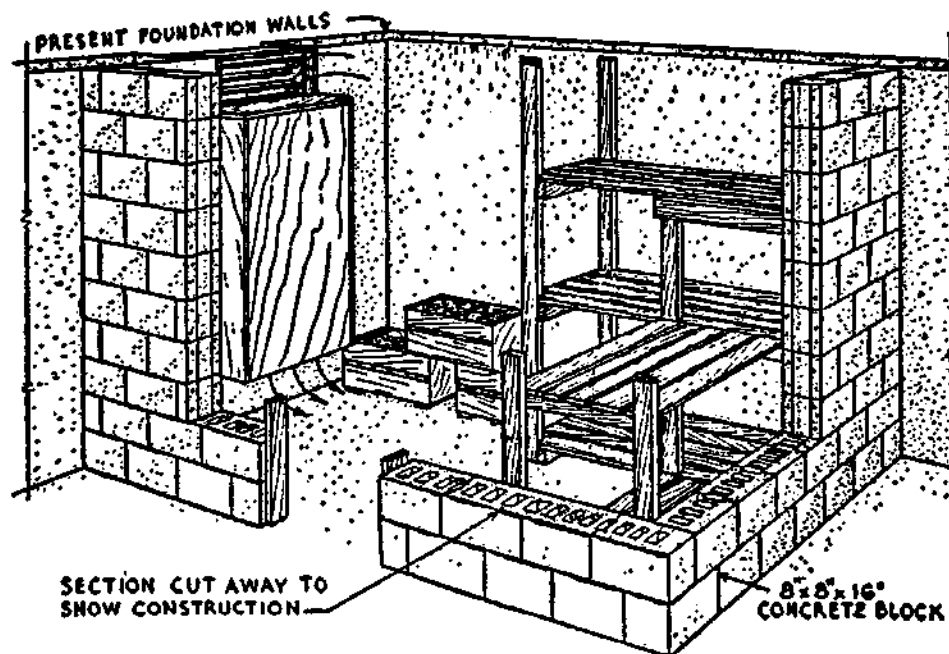

A Good Storage Cellar for Vegetables and Fruit.

squash and pumpkins, of course, have to come in before the first killing frost.

Squash, pumpkins and dry beans keep best in the attic, if you're lucky enough to have one that's warm and dry. Onions should be kept cool and dry.

Lettuce, spinach, broccoli, cauliflower, brussel sprouts, collards, kale and Chinese cabbage are hardy enough to survive light frosts and can even be left in the garden long after frosts if they are given protection with straw. We have been surprised how long you can eat right out of your garden, even in our cold New England climate. At times we have had some of these hardy vegetables in the garden until December. We've found, too, you can save your full-sized green tomatoes — just pull up the whole vine before the first frost and hang, or store the tomatoes in small baskets. They will gradually ripen if kept in a warm (not hot!) place.

But don't make one mistake we did! We didn't weed out the poor specimens at first and we lost a lot of our precious vegetables.

Bank storage space—if you have a hill handy—can be made with concrete or heavy lumber walls and ceiling. It should be at least 6' x 5' x 5' high and covered with 3 feet of dirt. No extra moisture or damp packing is necessary. In fact, getting plenty of drainage is the main problem along with keeping out vermin.

There are other methods of storage: sinking a barrel upright in the ground which is not too satisfactory because it holds so little. Another is the trench method which is simply digging a trench below frost and lining with straw; vegetables are then added, and all is covered. Obviously, it's not easy digging vegetables out and you can't check up on them easily.

For people with small cellars like us or for those of you who are planning new houses with radiant heating (which doesn't require expensive cellar space), it might be possible to have shed-type storage space attached to the garage. Of course, the walls would have to be insulated, as with the other methods, and the thickness would have to be determined by the material you used. We have not tested out this idea but it would seem to be a workable plan.

Obviously, cold storage is such an easy way to conserve food that it is probably the first method you will want to take advantage of.

Hub of The Homestead THE FREEZER

If you could take a peek in our freezer today, or any day, you would see an amazing, wonderful assortment of delicious foods. For on our miniature farm, nearly all activities lead to the freezer. Into it goes almost any-

thing and everything we can raise, plus items we buy. And the food comes out fresh whenever we want it—summer or winter. No other method of preserving food has ever made such a happy situation possible.

From the standpoint of abundance, we have eaten better on our homestead than we ever have before — and that includes the war years of scarcity and rationing. The chicken we take out of our freezer is tender, delicious. Yes, we have corn-on-the-cob and lush raspberries in January, and goodtasting greens as well as lots of other things from our past year's garden . . . and it tastes as good as it did fresh out of the garden.

Ed and I both believe the quick-freezer is one answer to man's long search for a way to harness the bounty



of nature. At any rate, we know it's a way ordinary people like us can have more security and independence than we ever thought possible.

The freezer was one of the first big capital investments we made and after using it, it would still be the first if we were starting over again. Ed loves to say that if you want to get your wife interested in homesteading, just get her a freezer. I must admit it helped intrigue me with country living and now I'm glad it did, for I would never go back to the city.

A freezing cabinet cuts your cost of living and at the same time raises your standard of living. Even if you did not raise any of your own food you could buy fresh vegetables, fruits or meat in quantities at wholesale or seasonal prices and store them away. The cabinet should eventually pay for itself from your savings in such buying. It costs

very little to run a freezer—about the same as an electric refrigerator.

Of course, if you raise your own food the savings are even greater. If you hunt or fish, you can put away some of your favorite wild duck or fresh trout for the time you couldn't otherwise enjoy such delicacies. Or you can even make some good trades with your friends—we have swapped some of our home grown fowl and meat for such tasty things as newly dug clams, fresh fish and that rare treat, venison.

You already know that in comparison with canned foods, many frozen foods taste better, look better and have more food value. We have even found that vegetables and fruits frozen immediately after picking are better than the so-called "fresh" stuff you buy in the market. When you stop to think how many hundreds or thousands of miles an out-of-season tomato or cauliflower travels to meet you you realize that the word "fresh" may mean a variety of things.

As a home-maker I have found there are many, many pleasures connected with our freezer besides its unequalled service in preserving foods. A freezer saves a tremendous amount of shopping time because you have your own little storehouse of vegetables, fruits and meats, ready to use. If you find you need a lot of fresh bread and don't make your own, you simply buy a large quantity and freeze it. What's more, you can freeze stale bread and when it defrosts, it's fresh again. Practically a miracle, isn't it?

A freezer has fascinating possibilities. Every fall we freeze lots of sweet apple cider at a cost of 2¢ a quart for morning fruit juice, or it's elegant for hot, mulled cider on a winter's evening. Also when I make stews, soups or home-baked beans, it's just about as easy to cook double or triple the amount needed and freeze some for future use. You can also freeze cakes and pies—or the dough to be used for pies and cookies. There seems to be no limit as to what a freezer can do.

If you are preserving your own foods, you'll find that freezing is far easier than canning. To show you how simple it is, here are the steps involved in freezing green peas:

1. Pick the peas from your garden.
2. Shell and wash the peas, discarding old or imperfect ones.
3. Blanch peas. That simply means placing peas in a colander or wire basket and immersing them in rapidly boiling water (at least a gallon to a pound of peas) for one minute.
4. Then immediately immerse peas in cold running water.
5. Drain and pour peas in to a moisture-vapor-proof bag or container and seal.
6. Place package in freezer.

Quick freezing fruits is absurdly simple. Take strawberries for instance. Remove stems, wash, cover with sugar-



When guests come in unexpectedly for meals, Mrs. R. can serve a wonderful dinner on short order, complete with half-a-dozen meat choices, corn-on-the-cob, and fresh strawberry shortcake. If you want to interest your wife in home food production, plan to get her a quick freezer.

ers widely distributed will make as phenomenal a change in this country as did low priced cars. With a good freezer and a little piece of land you can be just about as independent and as secure as you wish. The freezer can be the secret of one goal all we Americans constantly work for—freedom from want. Anyhow, that's what our freezer means to us.

Home Canning

There was a time when practically every article written on canning started out with the old saw—"Eat what you can—and can what you can't."

Today, that's so far from reality it isn't even funny. Of course, you eat all you want during July, August, September and October directly from the garden. Then, as we've pointed out, it's easiest to utilize a root cellar. Next is preservation by freezing—if you're lucky enough to be able to use this wonderful new method. Then comes canning.

In all frankness, it is best to preserve certain things in glass jars—tomatoes, sauerkraut, pickles, stewed fruits, preserves and jelly. But canning, even with a pressure cooker, is more difficult than freezing and the results, minus the exceptions noted, are, we think, inferior to freezing.

I will say that the savings in canning your own fruits and vegetables instead of buying them is tremendous. I know that's contrary to what we've been told, but it's true because you do it all on your own place—you don't pay for all the traveling raw vegetables do to get to a factory and back in cans to grocery shelves. Take the popular tomato as an example—here is the cost of our 75 quarts of home canned tomatoes the best we can figure it:

Plants	\$1.00
Spray25
Jar tops75
Jars (amortized on 10 yr. basis)...	.45
Cooking (coal stove) estimated25
Spices05
	<hr/>
	\$3.25

75 quart commercially sell at 22¢ each—\$16.50
Our Savings: 80%.

And we do not blush at saying our tomatoes are superior to what you can buy in taste, color and texture!

Prejudice had been built up against home canning by making it appear to be a back-breaking complicated chore. But we have found it fun by doing only a few jars each day in the summer instead of trying to do it all in a few days. It is pretty simple, especially with the help of the booklets put out by the canning jar companies. We happen to have a Kerr booklet (Kerr Glass Manufacturing Co., Huntington, W. Va.) which cost 10¢ and which led us successfully through all our canning, though neither Ed nor I had ever canned before.

Canning is not complicated but it

syrup, package, freeze. When it comes to meats, it's nothing at all once the meat is cleaned and cut, ready for cooking. Just wrap and freeze.

There is a wide assortment of containers made especially for freezing—that is, vapor and moisture proof. I won't describe these here, for you will have to get a bulletin or book with complete directions if you are going to freeze foods.

We bought our freezer shortly before Pearl Harbor and paid \$440 for it. It is a 13 cubic foot cabinet and holds approximately 700 pounds of food. The price we paid was high, but few freezers had been made at the time we bought ours. Now, many large companies are building them, with mass production the price is lower; \$230 for one similar to ours.

Many people have been using frozen food lockers which have rented for \$6-\$15 a year. If the locker plant is situated conveniently to your home, you may prefer this method of having a frozen food supply. A locker plant usually offers the convenience of packaging and cutting meat for you and also provides a place to hang and cool meat before freezing.

However, I personally prefer a quick-freezer at home where I can tuck away a few boxes of fruits or vegetables or a small quantity of meat as I find time to prepare them. When you are raising large quantities of your own food, it

may become practical to use both a home freezer and a locker, as you would then have the convenience of both arrangements. Or another plan would be to build (or have built) your own freezer room and cool room.

From our own experience we have learned several things about buying and running a freezer. We made a serious mistake in placing our freezing cabinet in our garage where the temperature drops below freezing in the winter. We discovered that such low temperatures prevent the motor from operating properly, so we now have it in our "Harvest Room." After having our freezer break down once and losing some of our hard-earned foods, we know now that there should be some signal to warn you when the temperature rises above the danger point. There should also be instructions fastened on the freezer to tell you when and where to oil the motor. These things we learned from our one bitter lesson and we wanted to pass them along. It pays to buy a good cabinet from a reputable dealer and with so many new designs developed during the war years it will be wise to look over a number of freezers before choosing yours. Whatever your intentions are on using a freezer, we would certainly recommend getting one with a special compartment for quick-freezing your own food.

We certainly believe that food freez-

does require accuracy. To make the work easier, get all your equipment ready to use before you actually prepare the food. And by all means do your preparatory work in a pleasant place. At first we did ours on our back terrace, but now we have our delightful "Harvest Room."

It is usually suggested that you plan 100 quarts of fruit and vegetables for each member of your family, but if you are seriously trying to be self-sufficient and are preserving food only by canning we believe you would want somewhat more. However, the first year aim for the 100 and the next year you'll be able to adjust the amount to your own needs. The 100 quarts should be approximately divided into one-third fruits, one-third vegetables and one-third tomatoes or tomato juice.

That figure sounds rather forbidding doesn't it, from the standpoint of quantity and time to preserve? Let's take up the question of quantity. In the case of apples, one bushel produces about 20 quarts; cherries, 24 quarts; peaches, 25 quarts; plums, 30 quarts; berries, 24 quarts. That is a good deal more of each fruit than any one person will eat during the non-productive season. So

Pressure Canner.

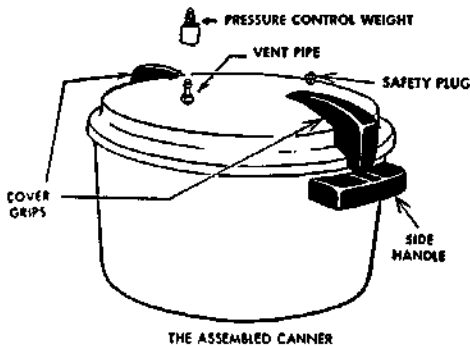

to achieve your goal you would only have to can a few quarts of each fruit as it came in season. The same principle applies to vegetables.

As for canning equipment, by all means try to get a pressure canner. It is recommended by all authorities as the safest way to can your vegetables properly and it saves time, fuel and work.

Still unknown to thousands of families the pressure canner is also a miraculous cooker. It will cook a complete meal in 10 to 15 minutes, including soup, roast and vegetables! Using little water, it saves valuable vitamins and minerals. It tenderizes cheaper cuts of meat. It can preserve surplus meat, poultry or fish, although we believe that the quick-frozen method is best.

As for pressure cooker size you will want an 18 quart canner (holds 5 quart jars) or a 25 quart size (7 jars). With the canner you will receive a booklet giving you a time table for processing and general directions for canning.

Even if you don't go in for all the "Have-More" Plan, we believe in "canning all you can" anyway—and that goes for peace time as well as during a war or a depression. Believe me, it will give you a tremendous feeling of satisfaction and security when you begin to line up the jars on your shelves. Ed is just as proud as I am to point to the canning shelf and say, "I canned those bread and butter pickles." Such bragging is good for the soul—it's one of those intangible satisfactions you get from homesteading.

Salt Some Away

Another easy way to keep certain vegetables is to salt them down. The one big fault with this method is that it destroys a lot of the vitamins and minerals. For this reason we have not done any brining (except to make sauerkraut, ham and salt pork).

Everybody knows about salting cabbage to make sauerkraut. I put mine up in jars as I have found this even easier than the crock method. It is also possible to salt away corn, beans, cauliflower, turnips and peppers.

Alternate layers of washed vegetables and salt are packed into earthen crocks and weighted down. If enough brine to cover vegetables completely is not formed, a concentrated brine made with boiling water may be added. Use $3\frac{1}{4}$ cups of salt (common or coarse salt is better than fine table salt) to 6 quarts of water. Keep in a cool place—the vegetables are ready to use at any time.

To desalt for use, put salted vegetables in a big pan, cover with cold water, heat to luke warm, stir and pour off water. Repeat until vegetables are only slightly salty. Then you can cook in regular manner.

Dehydration

During the early part of the war I read a lot of articles telling how wonderfully easy it was to dry your vegetables and fruits at home. Well—in our attempt to carry out miniature farming in the easiest, most modern way, we borrowed one of the very best home model dehydrators which set back one of our neighbors about \$40.

We soon found that proper dehydration is not so terribly simple after all. It takes as much preparatory work as canning and it is more difficult than freezing foods. We think its worst feature is the long drawn out drying process. It takes 10 hours just to dry the food thoroughly; you can scarcely complete the project in one day.

In our section of the country where there is much moisture in the air, dehydrated food should be packed in tightly sealed jars so it won't absorb water again until you use it. And when you do, dried food takes pre-soaking to return it to its normal state.

We do not believe home dehydra-

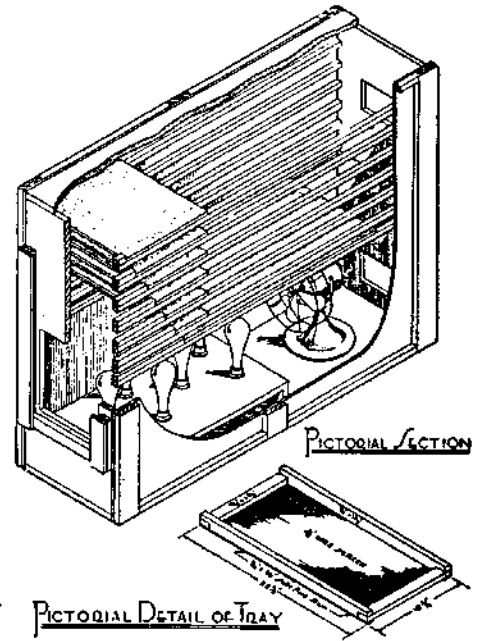

tion will ever be widely used in America except where it is specifically desirable for reasons of taste, geography or space. Frankly, we couldn't stand the taste of the three things we tried—snap beans, spinach and broccoli. But if your family is extremely fond of dried beans and peas then it would be worthwhile to dry them. Also, we all know that certain fruits are splendid dried.

If you are interested in drying foods, we suggest you try it out in your cooking oven first and see if you like the idea. You'll get about the same results you'd get with a special machine. Place oven door open and set the temperature at 165°. You'll have to get the length of time for drying your specific vegetable or fruit from an instruction booklet. Then freshen up the dried samples, cook them and see if you like them. If you do approve, you can either buy or build a dehydrator.

You can build a dehydrator using a small electric fan and a bathroom heater but the thermostat is quite important. It is probably just as well to buy the whole dehydrator or else use your oven. Detailed building plans may be obtained from your County Farm Agent.

We'd suggest you read a little booklet called "Dehydrating Fruits and Vegetables," put out by General Electric Company, Schenectady, N. Y. It costs 10¢ but it is well worth reading before you decide to go in for dehydration.

WINTER GARDEN—Cold Frame, Hot Bed, Small Greenhouse

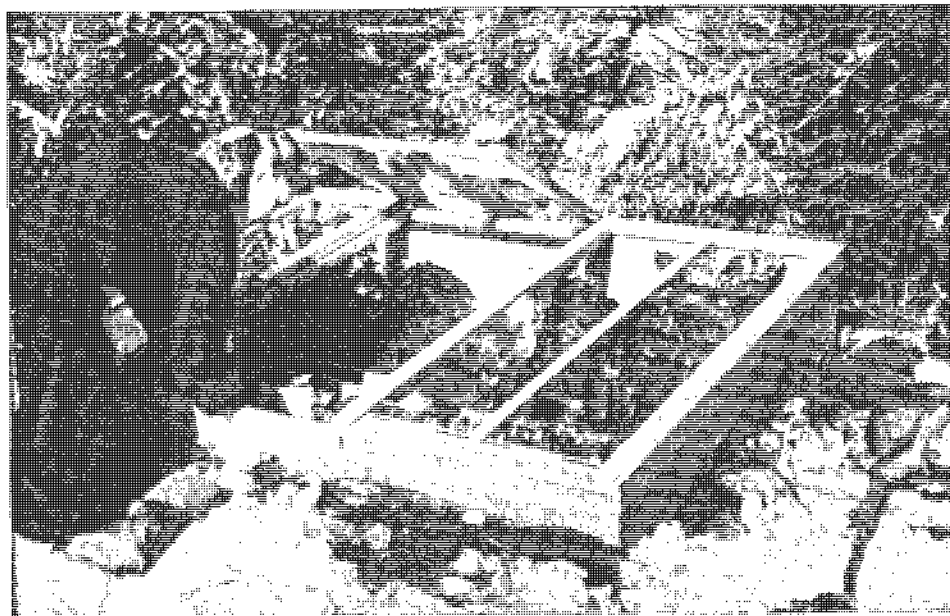

Hot bed made with new-type, small-size, putty-less sash. A hotbed is simply a cold frame heated by a bottom layer of manure or an electric heating unit.

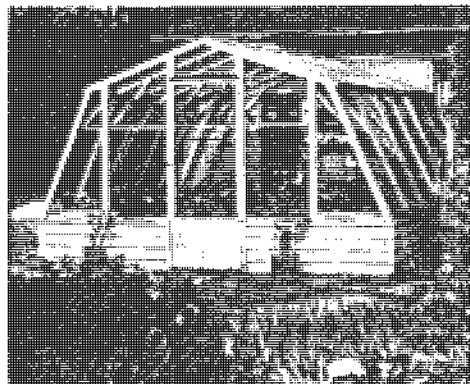

(Left) A small greenhouse may be attached to the house and heated by the house furnace.

(Below) Interior of a small greenhouse that can be bought for \$300. This new Lord & Burnham greenhouse has automatic temperature control and automatic watering.



WHEN we first produced our own vegetables, we looked into starting plants under glass. Because this seemed complicated and because we had only about an hour or so of spare time a day to devote to our food-raising activities, we decided we'd buy our plants from a good local greenhouse.

The main reason for growing plants under glass in all of the U. S. (except for the extreme Northern States with their exceptionally short growing season) is to spread the products of your garden over as long a period as possible. Once you have a freezer, glass gardening isn't nearly as vital.

Probably you've read about the new small greenhouses with automatic watering and temperature control that sell in the neighborhood of \$300. We talked to the manufacturer, the Lord & Burnham people at Irvington-on-Hudson, N. Y., to find out if these were economical and practical. Here's their answer:

"Frankly, from a straight economic point of view we cannot justify a greenhouse in a 'Have-More' project—we would not attempt to, any more than you can justify the purchase of any luxury on straight economic grounds.

"For an ardent amateur gardener, a greenhouse has a different appeal. It permits him to keep his hands in the soil all winter; it permits him to have the satisfaction and pleasure of growing plants and flowers. The best satisfaction comes to those specializing in bringing in unusually fine quality of some particular specie or variety. Then the greenhouse owner can raise plants for setting out in the spring and do it easier and more satisfactorily than in a hotbed or cold frame."

I do think it was pretty fine of these people who sell greenhouses to give us such an honest estimate. They just don't believe a small greenhouse will "pay for itself" on the average homestead. It seems that the value of a greenhouse depends largely on how far north you live. If you live where the grocery stores carry most summer vegetables all winter it probably won't pay you to grow vegetables in a greenhouse.

Commercial growers north of New Haven and especially up past Springfield, Massachusetts into Vermont and New Hampshire can make a greenhouse pay on just one tomato crop. Further north, in Ontario, Canada, it is easier for a commercial grower to make a sure success with winter vegetables.

If you think you'd like to have a greenhouse you might consider attaching it to your house. This lowers the heating cost considerably. I know that Fred Rockwell, editor of *Home Garden*, has a greenhouse hitched to the southeast corner of his house. The greenhouse is heated by the same furnace that heats the house. This is an economical arrangement because on sunny winter days the greenhouse absorbs a lot of heat and contributes this extra heat to the house. Fred says this system works so well his fuel bills are no higher than before he had his greenhouse.

Grow Your Own Fish

HAVING a fish pond in your back yard seems almost too good to be true. But Government experts say you can easily build a pond for as little as \$100, and that a one-acre fertilized pond will normally yield by hook and line "something like 40 or 50 one-pound bass and about 600 to 800 quarter-pound sunfish each year".

We were surprised to learn that you don't need a stream or brook to have a fish pond. In fact, experts say it's better not to build your pond by damming a brook because the pond is too easily destroyed by floods. They recommend excavating a naturally low area using the run-off from the surrounding terrain as the source of water. Or you can use a spring or well. The pond should be 6 to 12 feet deep to protect the fish from freezing and possible drought.

Over 7,000 farmers grow fish in their own ponds. You stock a fertilized pond in Spring or Fall with fingerlings of bluegill sunfish and large-mouth bass and you can fish them out after 4 to 12 months. The fingerlings are obtained free or at a small cost from State Hatcheries or from the U. S. Fish and Wildlife Service. Some states, Ohio for one, will practically build the pond for you.

To keep plenty of fish growing in the pond the experts have worked out a fascinating "food chain". First you distribute about 100 pounds of regular 8-8-4 crop fertilizer in the water. After a few days the water will take on a brown or greenish tinge which means the fertilizer has caused the growth of microscopic plants called algae on which young sunfish thrive. Then (in Spring or Fall) stock a one-acre pond with about 800 fingerlings of sunfish and 100 of bass. The sunfish live on the algae and the bass live on young sunfish. This food chain will continue producing fish year after year so long as you keep the pond sufficiently fertilized and do plenty of fishing! It's impossible to catch too many fish by hook and line. In fact not fishing out enough sunfish may result in too many for the amount of algae and the sunfish won't grow to eating size. The same will happen if there aren't enough bass to eat the young sunfish. For more variety you can also grow bullheads, pickerel, and other fish, but stocking must not be done indiscriminately or it may upset the whole balance in the food chain.

A permanent drainpipe in the dam facilitates draining; if pipe is large enough fish pass through so you can catch them the "easy way." Young trees, shrubs and grass planted around the pond make cover for wild life.

P. S. from Carolyn R.

Personally I don't want to go swimming in any old brown water full of algae, but as a fish pond it sounds wonderful and I hope we can build one!

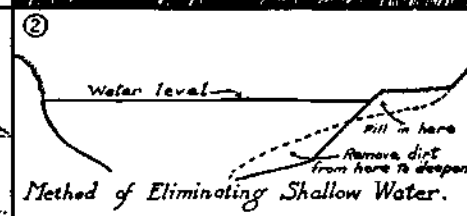
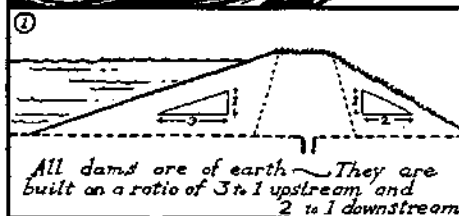

The Woodlot

ORIGINALLY our house was located in the midst of two acres of woods. As we've cleared our land, we've had plenty of firewood.

It's a good idea to have an acre or so of woods. Just the dead and fallen timber will give you about a cord of wood per acre each year for your fireplace—and some fence posts too. Maybe you can harvest some lumber—it's much cheaper to haul it to a local sawmill than it is to buy lumber these days. About 6 months of exposure to sun and air is necessary to dry green lumber.

A woodlot is little trouble. Here is a simple program that will help you keep your woods in good condition and at the same time provide you with firewood and some lumber:

- 1.) Fence out livestock. They eat saplings, injure young roots, cause erosion, and in time can ruin a woodlot.
- 2.) Take all diseased or down trees for firewood.
- 3.) Practice *thinning*. This simply means cutting out the weed trees and "crowders" so the good lumber trees will grow faster. It should be done about every two years. Save what you cut out for fenceposts, bean poles, etc.
- 4.) Prune off excess branches on lumber trees to prevent knots. Save these branches for firewood. Learn to recognize your valuable lumber trees, and mark them with a band of white paint.
- 5.) Harvest every lumber tree before it becomes over-age. You should learn the proper size tree to cut. Government studies show a 9 inch maple will bring only 1/36 of the price paid for a 26 inch maple. The profitable way to sell is to make the cutting yourself and haul the logs to the mill.
- 6.) Plant seedlings in any bare patches you find in your woodlot. Trees will grow in the poorest possible soil where no crops can be grown.
- 7.) If your trees are attacked by blight, disease, or insects, ask advice from your State Forester, or County Agricultural Agent.
- 8.) Protect your woods from fire!

For construction on your place you can hire (or borrow) a portable sawmill to come to your woodlot and saw up lumber trees there. This will be a lot cheaper than buying lumber. Whatever you do, never cut an entire stand of trees. Leave at least 5 large seed-producing trees per acre, and plenty of saplings and younger trees.

Fence Posts

Soft woods such as willow, soft maple, beech, and box elder will last only 3 to 5 years in the ground as fence posts. But you can make them last 20 to 25 years by boiling the lower ends in a steel drum of creosote. Let them cool in a second drum of creosote for best results.

How Much Is A "Cord"?

A standard cord is a stack of 4-foot lengths 4 feet high and 8 feet long. However, firewood is usually cut in shorter lengths so a "cord" of firewood

may not be a standard cord. If you have occasion to compare different prices for a "cord" of firewood, it's a good idea to get the measurements, so there is no misunderstanding.

Clearing

By all means don't try to save money by buying wooded land and clearing it to make your garden or pasture. Clearing is really tough work and it's expensive no matter what method you use. You have a choice of four methods of removing stumps (after you've cut down the trees) and you'll probably have to use *all four* ways on some of the big stumps before getting them out! The most primitive is to dig and grub the stump out with a pickaxe and axe. It's a long tough job. Allow at least 1/2 a day to dig out a 6 inch stump this way. A quicker way is to burn them out, using a portable burner which you may be able to borrow from a neighbor. We burn out small stumps this way in less than 2 hours. The burner has a strong forced draught which produces intense heat. However, it doesn't burn all the roots—you have to chop them out. Blasting is another way. Small stumps can be blasted entirely out of the ground and large stumps can be loosened up this way and then pulled out with a block and tackle or a patented pulling device hitched to a team or tractor. For details and safety precautions on blasting write to the Superintendent of Documents, Washington, D. C. for U.S.D.A. Bul. #191.

All in all, I really believe the best method of clearing is to hire a bulldozer. It's amazing how much damage a bulldozer can do in a short time. In just eight hours the bulldozer we hired (at \$5.00 an hour) cleared about 20 stumps, 2 big boulders, and did all the grading and filling necessary to give us a good level half-acre garden plot.

Erosion Control

If you have waste land where the soil is too poor for crops, you can grow trees there. They'll take many years to grow to maturity but meanwhile they prevent erosion, add beauty to your homestead, and increase its value. (In some localities you will be assessed slightly higher taxes for the acres you plant to forest, but they're worth it.) Your State Forestry Department may provide free seedling trees.

HEATING VALUE TABLE

GOOD	FAIR	POOR
Hickory	Chestnut	White Pine
Beech	Hemlock	Cottonwood
Locust	Catalpa	Aspen
White Oak	Box Elder	White Spruce
Ash	Butternut	White Fir
Birch	Soft Maple	
Sugar Maple		
Elm		
Black Walnut		
Apple		



The spirit is willing...

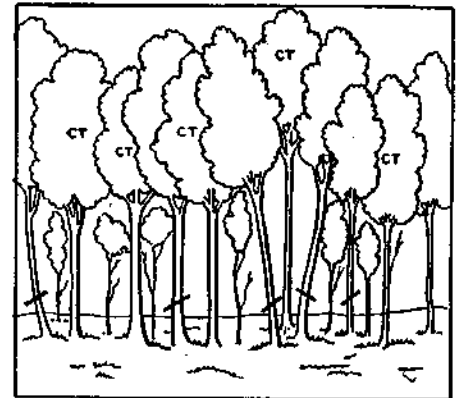
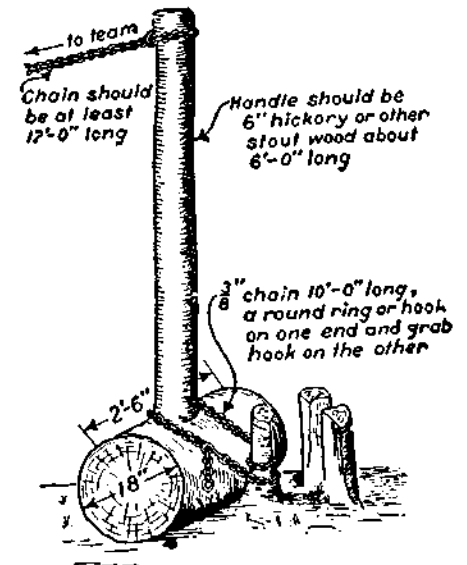

Diagram of a typical group of trees showing which trees to cut and which to save. Trees marked CT are the crop trees you are saving till ready for harvest. Notice you cut some large trees to allow younger trees to grow.



A simple stump puller like this can easily be made. It increases the pulling power of a team, car, or tractor about 6 times.

Transportation and Power

SOME kind of car is almost a necessity in the country. Even so, present day cars are not very satisfactory for productive country living.

Today cars are made primarily for city dwellers. That is they are made to transport people—and only people. In the country on a small farm there's a lot of other things in addition to people that you want to move. To name a few: lumber, hay, grain, livestock, poultry, firewood, gravel, cement, earth, produce. On a large farm a truck is probably a worthwhile investment but on a small place there is not enough work for a truck and there's many a need that a truck won't solve.

There are countless jobs around a small place that you can get done a lot easier with some power equipment. Until recently, the manufacturers more or less turned their backs on the small farmer. Now they realize the terrific potentiality in supplying the small land-owner and a number of power units for the small place are coming on the market.

In trying to decide how best to solve our Transportation and Power needs we made up the table below. Perhaps this will help you solve your problems. All prices are estimated for new equipment; obviously good second-hand equipment may be bought cheaper.

For example, in place of the 9,000 "garden type tractors" manufactured yearly before the war, over 100,000 are expected to be sold post-war. The "garden tractor" people are trying to put out better and more powerful machines. At the same time the manufacturers of large-scale tractors are developing smaller models for use on farms of 40 acres or less. All this can only result in better and cheaper power equipment for the small land-owner.

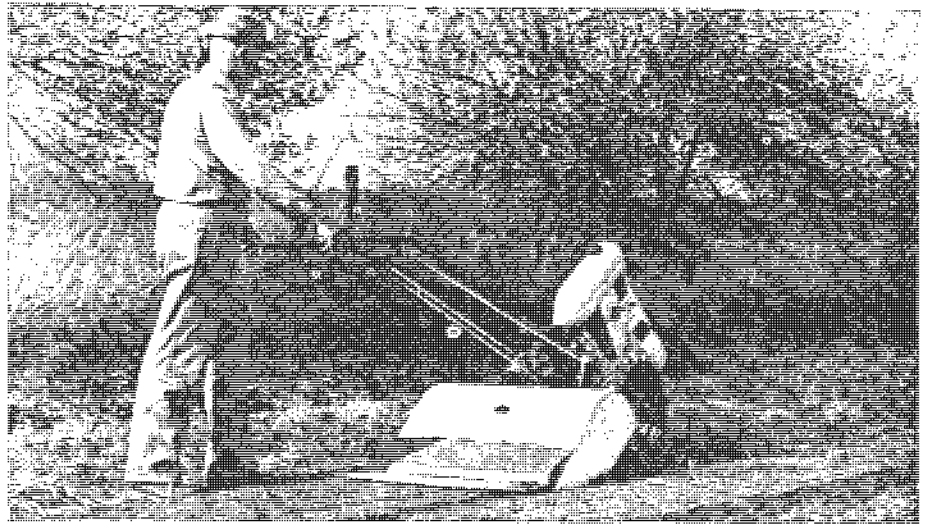

A Walking Tractor that plows, disks, and harrows in one combined operation—a "new" principle of cultivation ideal for some small areas.

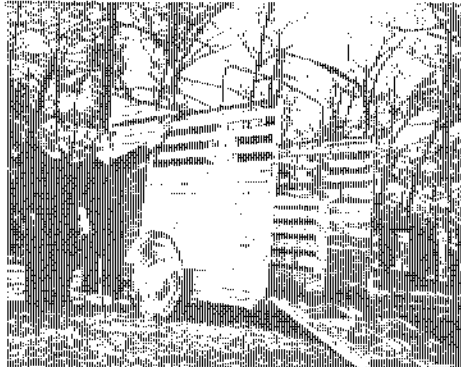

A Utility Trailer plus the family car is worth consideration. This home-made trailer is built low to facilitate loading . . . carries 2 animals . . . has many other uses.

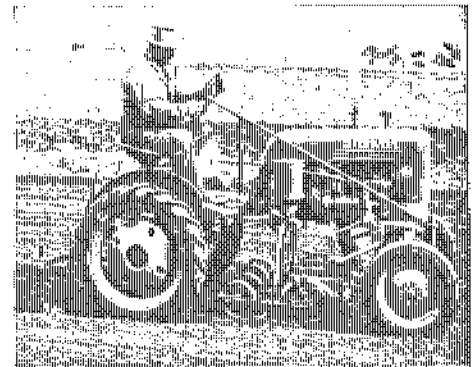

A Baby Tractor with the full complement of attachments offers the small-acreage farmer low cost power for all field and garden operations.

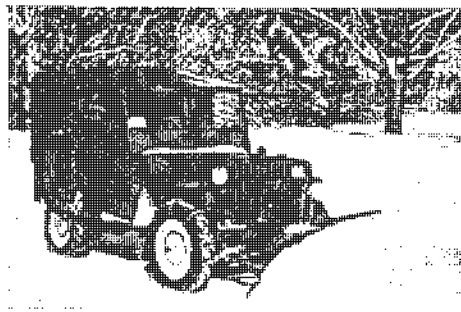

A Civilian Jeep works as tractor, passenger car or small truck and as auxiliary power plant for running all sorts of machinery from saws to your freezer in an emergency.

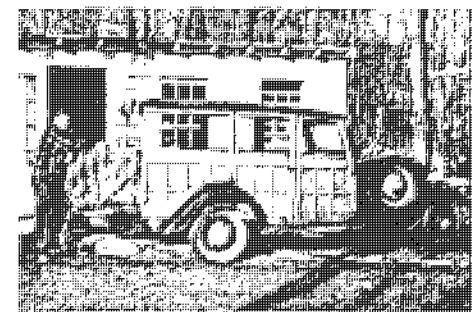

A Station Wagon is an all-purpose car for country homes. Unfortunately its cost is high and the wood construction needs yearly paint or varnish.

The Needs	Possible Solutions			
	Civilian Jeep	Car & Trailer	Station Wagon	Walking Tractor
Getting to work	Yes	Yes	Yes	No
Shopping	Yes	Yes	Yes	No
Social Life	?	Yes	Yes	No
Long Trips	?	Yes	Yes	No
Heavy Loads	Yes	Yes	Yes	(short distances (with trailer))
Moving Livestock	(with trailer)	Yes	(not large animals)	No
Snow Plowing	(with attachment)	(with attachment)	(with attachment)	(with attachment)
Power "take-off" for Sawing Wood, etc.	Yes	No	No	Yes
Cutting Lawn	?	No	No	Yes
Cutting Hay	Yes	No	No	Yes
Cultivating & Plowing	Yes	No	No	Yes
Cost (New)	\$1,500	\$1,150	\$1,350	\$500.

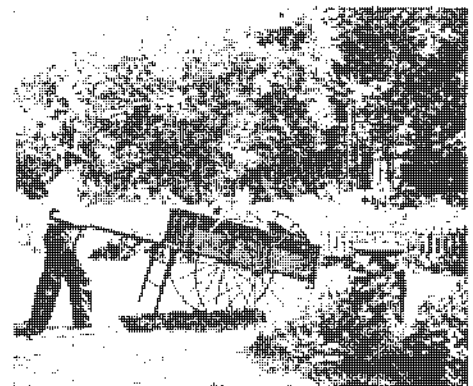

An Army Cart holds about four times the load of an ordinary wheelbarrow and is still easy to manage.

Housekeeping on a Homestead

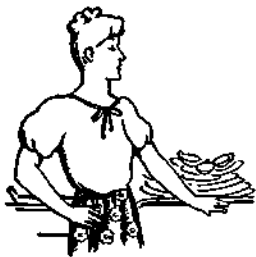

HOUSE-keeping should be a challenging subject to us American women. Instead, many of us consider it with boredom, or

with resentment that we have to do it at all—and if our husbands try to talk over our methods, we are likely to fly off the handle and wind up with the old come-back, “Well, I’d just like to see you take care of the house for a while!” I’m afraid I have to admit to just such arguments with Ed in the past, and to be honest, there is something to be said on both sides.

I do believe that there have been several things outstandingly wrong with modern housekeeping and that homesteading can answer some of our problems. The more important drawbacks I’ve found are:

(1) *Our own attitude toward housekeeping* is probably the key. I’m afraid that many of us look down our noses at it—we consider most any other job but homemaking glamorous. What we forget is that every job, whether it’s a man’s job or a career woman’s job in office or factory, has its own monotonous routines, too.

(2) *Lack of creative work in modern housekeeping.* Women really can’t be blamed for considering “housekeeping” a routine bore—that’s about all that’s left of homemaking in the city or suburbs. I don’t know how you classify your jobs, but, outside of raising children, I consider cooking about the only creative work left in most city and suburban homes today. The current trend seems to be for more and more of the family work, recreation and even child raising to be handled outside the home. All that will be left is vacuuming, washing dishes, and dusting—all negative and unstimulating.

(3) *Lack of economic satisfaction.* Since today’s woman has been brought up to be independent, it’s no wonder she’s not satisfied with the eternal routine left in the home. She’s not increasing her family’s security unless it’s in the negative way of cutting down expenses. Since the urban custom is to buy everything eaten, worn or used, it’s no wonder urban women have begun to feel their best contribution to their families would be jobs outside the home.

(4) *Lack of housekeeping efficiency.* Manufacturers have done much to make housekeeping efficient and easy,

but keeping house still needs a thorough engineering job done on it. The amount of your daily work is determined the minute you choose your house, the type of furnishings you put in it, the way you arrange your storage space and the type of clothes you buy. If we women want to contribute more to our families we will have to make routine work as efficient as possible.

What Does A Homestead Do To Housekeeping?

It makes a big difference in your housekeeping when you have a homestead. When I lived in the city I had no interest whatsoever in housework except for learning to cook elegant meals. I became so bored with apartment housekeeping I found a job in a large New York City department store. And did I add anything to Ed’s and my security? I did not—for it took practically all my salary to provide adequate clothes for my job, lunches, bus fares, a part-time maid and other incidentals. Now that I am a partner on a homestead, housekeeping is just the routine part of a bigger job—not the be-all, end-all of my existence.

Of course you have much more to do on a country place than in the city. But these new jobs are stimulating, creative and varied. Think of the satisfaction of having a freezer stuffed with luscious food you helped raise yourself. Imagine your canning shelves laden with full, glistening jars—your handiwork.

And you can do all sorts of other things: separate milk to get heavy cream, make scrapple, make cheese, extract honey from the combs, (this is a 3-ring circus of fun!) and serve dinners of “home-raised” products that guests really appreciate!

There are also many pleasurable activities outdoors. The pigeons, geese and ducks, and all the new born goats can be your special projects. You’ll help with the garden, have herbs and all the beautiful flowers you want. Someone has said, “He who lives with the land has innumerable professions.” He is, for example veterinarian, farmer, gardener, animal husbandman, chemist, accountant, manager, weatherman, machinist and so on. That is equally true for the wife who shares homesteading activities.

Once you get started doing and making things for yourself you’ll probably want to do even more—do more sewing for your house—make your own Christmas presents (we’re raising popcorn this year for little remembrances)—maybe even make some rugs or do weaving. You can also raise or make

things for sale. Life will become a question of how can you do all that you want to do.

Because a homestead offers a woman an unlimited field of creative activities, it removes the complaints against housekeeping.

First, your own attitude is brighter and more interested.

Second, your work gives you pleasure and satisfaction because it is creative.

Third, you have that fine independent feeling of holding your security in your own hands, and you’ll take great pleasure in knowing your children are being well-fed and growing up in the most wholesome of surroundings.

Fourth, you are more of an executive and have more interest in increasing your efficiency.

In the book “Zero Storage” Mr. Sparkes, the author, describes the Fylers, a family of seven who have been homesteading and he sums up the economic point with this sentence. “For Mr. Fyler, one fact must be crystal-clear: by reason of the land and the freezer, instead of one Fyler, seven are now helping to make the family living.”

When Jackie gets a little older, there will be three Robinsons instead of two “bringing home the bacon.” Before we started homesteading it was just *Father!*

Now For The Housekeeping Itself

It has taken me three years of “homesteading” to realize how ridiculous it is to judge a woman’s housekeeping ability by whether or not her country house is spotless, with dishes and beds attended to by 10 a. m. Instead of ironing or dusting, you will want to pick strawberries that are just ripe, wrap a chilled lamb for the freezer or go



fishing with your children. But your very annoyance with the routine tasks will give you the incentive to cut down the time they take. And when you tackle them with this sort of outlook, they

immediately become more interesting! It seems to me, proficiency in housekeeping falls into three main divisions:

- (1) Layout and furnishing of your house.
- (2) Equipment.
- (3) Management and organization.

The House And What You Put In It

Architects are now beginning to realize that a woman's working areas should be laid out in an orderly, convenient way. I have begun to see more plans recently where washing, ironing, sewing, cooking and children's play areas are correlated instead of being scattered all over the house from attic to basement. Also on a homestead you will want to consider whether the bathroom is handy to the outdoors, whether there is plenty of space for outdoor clothes where you usually enter and whether there is sufficient place for country tools and equipment. The amount of your routine work is somewhat determined the minute you choose a house. If you should build a new house, there will be many new designs and ideas to choose from. For instance, new radiant heating (hot water pipes under the floor) not only provides a healthier heating plan, but it will mean less work for Mama—no dusting and no painting those unsightly dust catchers called radiators. Also floors over the heating pipes may well be tile—warmer in winter, cooler in summer. And if the floors are pretty and warm—why, fewer rugs to pay for or to clean.

If you already have a conventional house there are still plenty of things you can do to make housekeeping easier. On your floor you can use patterned or neutral colored rugs which don't show dirt quickly, or scatter rugs which can be picked up and washed. The floor itself is easier to clean if it's waxed and a vacuum cleaner can often be used on it to more advantage than a dust mop. Or if you have an old unsightly floor, spatter painting might be the answer to simple care. Wooden furniture collects less dust if it's waxed instead of polished with oil.

When it comes to upholstered furniture most of us know how much simpler it is to have slipcovers which can be removed and washed easily. And if you buy or make slipcovers, bedspreads and draperies out of material that doesn't have to be ironed, (say seersucker, monkscloth—rubber or aluminum cloth that can be washed with a hose) then you've saved yourself even more work. These are just a few samples of what you can do if you look at your work with a mental question mark.

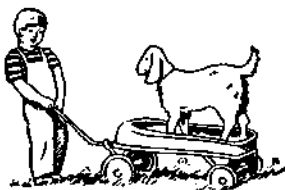

Equipment

I remember a city husband saying, "I don't want my wife to have any more gadgets to make her apartment keeping easier—she'll just spend more money shopping!" I guess it's true in the city that the more spare time you have the more money you spend. There's not much else to do.



On a homestead, however, spare time is time to use productively. Of course you can run into town but you don't want to go when you've got a garden to plant or the bees are getting ready to swarm or a new lamb is expected.

So machinery for housekeeping and homesteading jobs is a good investment, for you use this equipment to create more for your family. One homestead husband told me he would rather have an electric mixer with all its extra parts in his home than an automobile (granting that a car wasn't a vital necessity to his job).

Here are some specific ways to use equipment on a homestead like ours:

a) *Cooking.* The freezer is one of the greatest aids to cooking. While its primary function is to preserve raw food, it is a boon to better cooking management. While you're cooking stews, soups, beans, creamed foods, cakes, cookies or breads, it is easy to make double or triple batches and put part of them in the freezer for another meal. You can assemble a variety of dinners from soup to dessert, place each dinner in one bag or box and freeze it for future quick delivery. Lunches too can be prepared for the week and frozen each complete in a separate lunch box. I should mention that "a grocery store in your home" also saves a surprising amount of shopping time.

The electric mixer with all its parts is another wonderful aid to better and speedier cooking. Besides whipping up cakes, milk shakes, cream and meringues, the mixer can be used to squeeze oranges, grind coffee, peel potatoes and shell peas and beans.

The pressure cooker is a splendid contrivance. Ed discovered ours at the N. Y. World's Fair and considered it the most wonderful thing at the whole fair. The actual cooking time for a stew is just 15 minutes!

b) *Dishwashing.* The electric dish-

washer not only saves labor but also time because you store the dishes in the washer and run the machine once a day. But if you don't have a dishwasher, you can approach this chore somewhat as if you did have the appliance. In other words, washing the dishes after each meal is another one of those silly standards we have set up for ourselves. If you rinse the dishes, stack them, wash them once or twice a day, rinse with boiling water and towel-dry only the silver, you will save yourself almost as much time as the machine can save.

c) *House cleaning.* The vacuum cleaner can often be used to good advantage on the floors themselves and for more of the dusting jobs. However, cleaning can chiefly be simplified by the furnishings you choose and your own good management.

d) *Washing And Ironing Clothes.* Of course, we all know that washing is being reduced to the minimum by certain types of machines which wash, rinse, and even dry for you. As for ironing if you hang flat things like sheets and towels very smooth and straight, there's really no reason for ironing them at all. I have heard any number of men and women say they loved to sleep between sheets fresh from the country-scented breezes. Such clothing as seersucker dresses and cotton knit shirts also need no ironing (or the very slightest touch) if they are hung carefully on the line. Those fabrics which insist on being ironed (and how many we can do without!) should be taken down while damp to save the sprinkling job. Notice how your ironing depends on your washing routine and both depend even more on how you shop. As one clever homesteader wife in Ohio wrote, "I begin my ironing when I do my shopping"



All in all I've found that housekeeping in the country can be run a little more like a business. Each housewife, as an executive (when the Boss is away) will want to do her own planning, adapting the schedule to the weather vane—whether there are raspberries just ready to pick or whether it's high time for a relaxing swim.

The women I've met who are interested in homesteading in the modern way are smart—they know that they will have a big job to do.

But they also know the rewards are tremendous.

Homestead Mechanics



WHEN we lived in a city apartment we didn't even want to know how to fix a dripping faucet or repair a sagging door or paint our storm windows.

It's different when you have a place in the country of your own—you want to learn how to maintain your homestead. You also want to utilize all the labor-saving equipment that is practical. It doesn't seem right not to understand the workings of machines and devices we have to depend on every single day. And what a difference between the resentment you sometimes feel when you have to pay big repair bills and the feeling of real satisfaction you get from making repairs yourself. Even if you've never done more than stand by and watch a carpenter or a painter or a plumber at work there are a few simple repair jobs you can learn to do that will mean a big cash saving and a very pleasant form of recreation. Of course some jobs are frankly annoying, but I do think many are relaxing and fun to do. On days when other things don't go just right you come home from work mentally tired. Then your workshop can be a welcome refuge and little constructive jobs you do will reward you with a sense of accomplishment.

One morning last February the sink in our kitchen refused to drain properly and when I tried to clear it with the rubber plunger the water only backed up more. Finally, I sent for the plumber and after looking over the situation he dug to our septic tank and removed the lid. By this time I felt pretty helpless because I knew so little about plumbing and hadn't properly understood the trouble at first. This sense of helplessness is something that repair people are quick to notice. It is their cue to be mysterious about whatever repairs are needed and to encourage you to feel more helpless and more completely dependent on their superior knowledge. But I asked the plumber a few questions and he finally broke down and told me that the trouble was simply a blockage of the pipe and that I could

have saved about \$25 if I had known enough to prevent it!

Insurance underwriters say the majority of all accidents occur at home—accidents that can often be prevented just by replacing a loose board or repairing an electric fixture, or attending to the furnace properly. For this reason alone it's more than worthwhile to learn a few practical fundamentals of painting, carpentry, masonry, plumbing, electricity and last, but not least, simple auto maintenance.

Painting

The outside of a building is best painted at least once every four years. This is because wood deteriorates rapidly when there is no paint to protect it from moisture. The hardest work in painting usually is scraping off the old

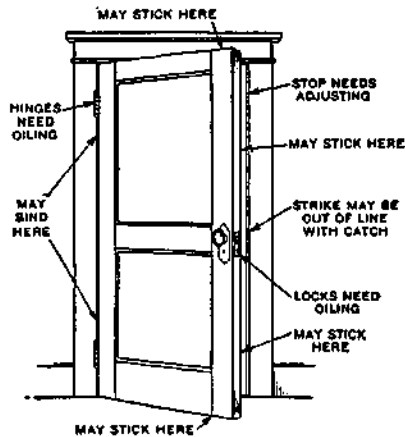

9 ways a door can go wrong

paint. Correct use of paint remover, wire brush, steel wool, or a scraper can often save you hours of needless work. You should learn how to store brushes properly and also the best method of storing paint for safety from fire. The difference between flat paint, enamel, varnish, wall sizing, and water paints is basic knowledge for every homesteader. For your kitchen there is a new 25% DDT water-based paint which can be sprayed or brushed on. It is said to kill flies and insects that walk or alight on it. An application remains effective 2 to 3 months inside and 2 to 3 weeks outside.

Carpentry

If you like making things out of wood the first thing to make is a good workshop for your homestead. So many workshops I've seen are located in attics or cellars or barns where it's nearly always too cold or too hot or too damp or too dark to work. The workshop is worth the same consideration and planning as your kitchen. If it must be in the attic or cellar it should be properly heated, insulated and lighted. Once you have a good workshop you can make it pay for itself many times just

by doing simple repairing or building. I never did any building until we put up our small barn. Since then I've watched a neighbor put up an entire two-story house single-handed. He says the amount of knowledge needed to build a small house is surprisingly little if you have a good set of plans. A carpenter earns about \$15 a day, and by doing your own carpentry you can save that much while you yourself learn to master the fundamentals. Here is a check list of ten fundamentals in carpentry. See how many you know already:

1. How to lay shingles.
2. How to use the steel square.
3. How to file and set saws.
4. How to use the chalk line.
5. How to use a mitre box.
6. How to set girders and sills.
7. How to make joints.
8. How to hang doors.
9. How to lath.
10. How to lay floors.

Masonry

One of the "trickiest" masonry jobs is supposed to be building a fireplace and chimney. But two high school boys I know apparently never heard how tricky it is because they built a fireplace out of fieldstone in a little house on Owasco Lake near Auburn, N. Y. and put up a 20-foot brick chimney. They dug and laid the concrete foundations, installed the damper, the flue, and put in fireproof bricks where required for proper fire protection. I admit they had some help — they had a ten minute conversation with a mason and read about three books! I haven't ever built a fireplace myself—about all the masonry I've done so far is to put in a cement floor in our small barn and pig pen. It's really worthwhile learning how to mix and pour concrete and lay foundations — you'll use it again



32-111111

Why not paint your own house? Anyone can do a good job who is willing to read up on all the little tricks of the trade. Paint prolongs the life, increases value. If you do your own you can save up to 90%.

and again. If your cellar is damp, look into the new damp-proofing paint. It's a white powder you mix with water and scrub into the concrete or brick. The tiny particles penetrate and then expand which is said to work wonders in waterproofing masonry. It was developed by the French for waterproofing the Maginot line and is now being manufactured in this country for general use under the name, *Aquella*.

Plumbing

Once you've learned how to repack a dripping faucet and replace a washer and clean out a trap below the sink or basin you know the three most common plumbing repairs a house needs. From there you can easily go on and learn how to install running water in your barn, or put in a modern hot water system, or an extra shower. Even if you don't want to do any plumbing work yourself I do think it is necessary to understand the operation of plumbing systems just for your own self-protection. Some people actually believe that pouring coffee grounds down the sink drain helps keep it cleaned out! You probably know others who think nothing of pouring hot grease down the sink or piling the drain full of lye indiscriminately. These people would never have a quarter of the plumbing repairs they have now if they had a better understanding of preventive maintenance.

Electricity

Maybe you already know enough about electricity but what about your wife? So many fires are started by wives who don't understand the electrical appliances they use quite well enough for their own safety! Here is a little quiz in electrical safety facts every wife should know:

1. What is the difference between a volt, an ampere, and a watt?
2. What causes a fuse to blow?
3. Is it safe practice to replace a 20 amp. fuse with a 15 amp. fuse?
4. Is it safe practice to replace a 20 amp. fuse with a penny?
5. It doesn't matter if the insulation on a lamp cord is worn bare so long as the lamp is kept turned off?
6. Why is it dangerous to turn on any electrical appliance while you are touching a water pipe or have wet hands?
7. Is it dangerous to replace fuses while the floor beneath the fuse box is wet?
8. About how much current does a washing machine use compared to a toaster?
9. Why is it inadvisable to use a toaster, an electric heater, and a curling iron all at once?
10. Is it possible to get a fatal shock from a 110 volt socket?

Any woman who can answer all the above questions satisfactorily is pretty

A Good Layout for a Home Workshop

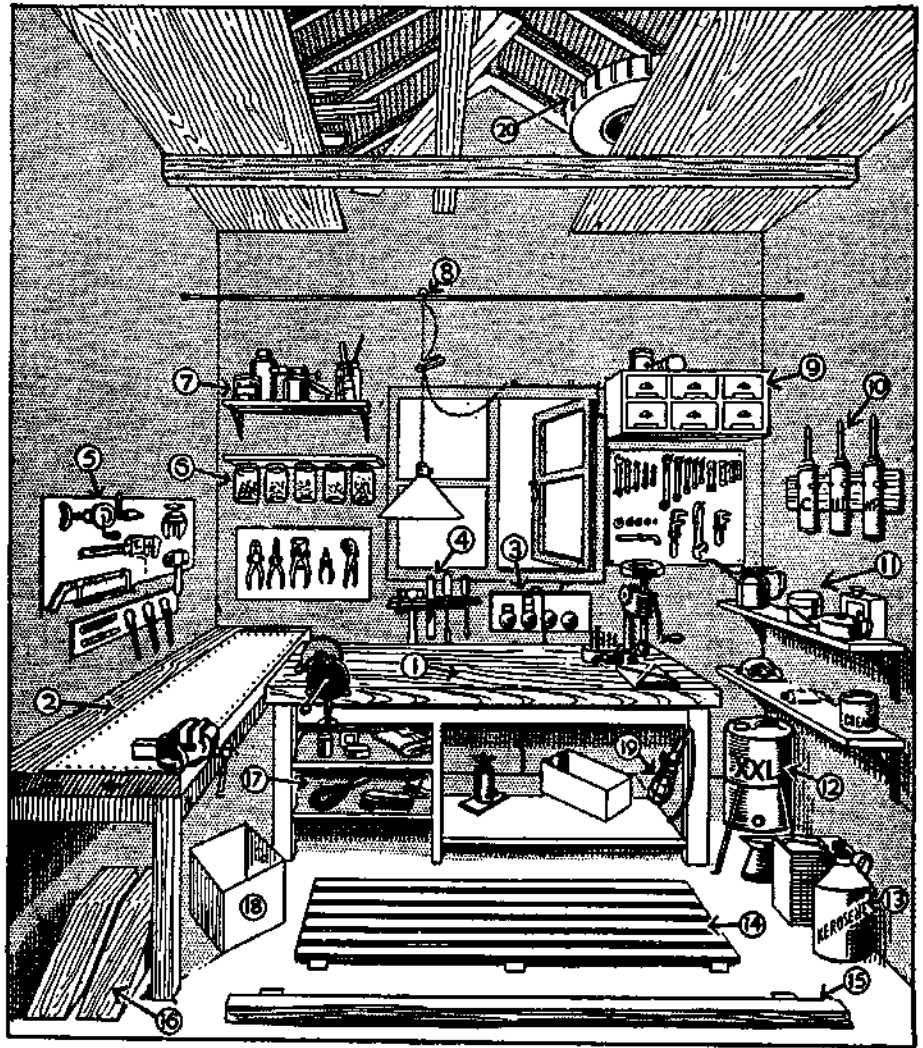

- 1.) Bench for light work.
- 2.) Bench for heavy work—sheet iron protects top.
- 3.) Electric outlets and switches.
- 4.) Small tool rack made from two converging laths, spaced $1\frac{1}{2}$ in. apart at one end and $\frac{1}{2}$ in. at the other.
- 5.) Rack for heavy tools.
- 6.) Screw-topped jars for nuts and bolts.
- 7.) Shell for painting materials.
- 8.) Trolley for light—clothespin adjusts cord length.
- 9.) Drawer for small parts.
- 10.) Three grease pumps; one for Universal joints, one for water pump, one for

- chassis bearings.
- 11.) Lubrication equipment.
- 12.) Five or ten-gallon oil drum on stand.
- 13.) Gasoline and kerosene, kept in different shaped cans to prevent error.
- 14.) Wooden platform protects feet from cold.
- 15.) Stop for front wheels of car.
- 16.) Ramps on which front or rear wheels can be run to facilitate greasing, etc.
- 17.) Shelf for washing and cleaning materials.
- 18.) Rubbish box.
- 19.) Inspection lamps.
- 20.) Storage in rafters for timber, tires, etc.

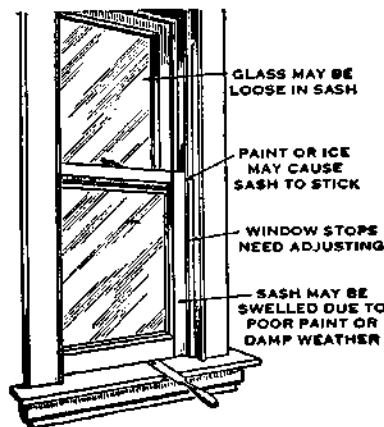

Common window troubles.

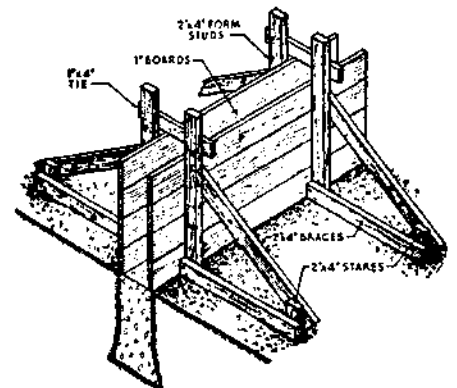

Foundation walls above grade may be formed in this manner where earth walls of the trench stand straight and true, and where a wide footing is not required.

well informed on electricity. After your wife has taken this quiz she ought to have the privilege of giving you one, so here are a few additional questions for men:

1. Explain how to read the electric meter.
2. Show how to make 3 different wire splices and explain the proper use for each.
3. If you make changes in the wiring does your fire insurance policy still cover you?
4. What gauge wire is usually the legal minimum for house wiring?
5. What is the amperage of the ordinary house circuit?

Some people may not agree, but Carolyn and I feel we ought to understand the buildings and machines and devices we have to depend on . . . understand at least enough about them so we can take care of them properly and not be too easily intimidated when something goes wrong. We think this knowledge is insurance on our way of living. This is part of the security we are seeking. It is also part of the fun we are having.

Build Your Own House?

Perhaps the ultimate achievement in the field of "homestead mechanics" is to build your own house.

No doubt this may seem to you to be such a terrific undertaking that it is a laughable idea, but in the immediate neighborhood of our Homestead we know of six people who have built their own houses. They range from a G. I. who is just completing a three room bungalow, to an artist friend who has, over a period of four or five years, built a house worth over \$20,000.

Of course, in pioneer days almost everyone, with some community help, built his own house. At the turn of the century when plumbing, electricity and central heating became common, house building became more complicated and too much of a job for all but the most ambitious. Today, however, with the development of the factory-made utility unit which concentrates on the difficult-to-build bathroom, furnace room and kitchen, building your own house becomes something a handy man with sufficient spare time might consider doing.

This factory-made utility unit includes all the major mechanical components of a house. At one stroke, and for a predetermined price, the utility unit solves most of the costly and complicated installation problems involved in a conventional house. Additional factors which make house building simpler are radiant heating, which means a much simpler foundation, and new "panel type" exterior and interior walls which are simpler to erect.

Of course, a man doesn't have to build all his house—he can build as much as he wants to. But if he were

to build every bit of his house he would be able to save nearly 50% of the cost. Perhaps the most practical reason of all for building your own house is the obvious fact that today it is almost impossible to get anybody to build one for you.

What About Power Tools?

There are so many different power tools available now that it's pretty hard to decide which ones are just fascinating gadgets and which can be useful enough to justify their cost.

Maybe you'd like to have a lathe, a power saw or an electric drill in your work shop but you don't want to spend a lot of money for any one of these things unless it will more or less pay for itself.

















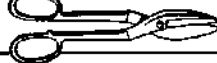

One way to figure this out is by using

a simple rule of thumb that says: "Don't buy any power equipment or machine unless the number of hours you will use it in one year equal at least ¼ the number of dollars you pay for it." This rule is based on the assumption that almost everyone's time is worth \$1.00 an hour and that the time the machine saves you will be used productively. Obviously, if this time were just wasted it couldn't contribute anything to the cost of the machine. We think you can safely apply this rule to any power tool you are thinking of buying and get a fair idea of just how much you really need it.

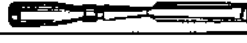
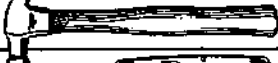
Suggested Reading:

- Plans For Ideal Homestead Workshop* 35¢
Carpentry Craft Problems \$2.50
Plumbing Installation and Repair \$2.00
House Wiring Made Easy \$1.65

Bare Necessities Tool Kit

	PAINT BRUSHES									✓
	TRY SQUARE								✓	✓
	JACK PLANE									✓
	CROSSCUT HAND SAW								✓	✓
	SOLDERING COPPER									✓
	HAND GRINDER									✓
	OILSTONE									✓
	FILE									✓
	SMALL TROWEL								✓	
	TIN SNIPS								✓	✓
	YARD STICK								✓	✓
	PUTTY KNIFE								✓	✓
	HAND DRILL								✓	✓
	SMALL DRILLS 1/16" TO 1/2"								✓	✓
	1" WOOD CHISEL								✓	✓
	16 OZ. CLAW HAMMER								✓	✓
	KNIFE								✓	✓
	SIDE CUTTING PLIERS								✓	✓
	LONG NOSE PLIERS								✓	
	SMALL SIZE SCREWDRIVER								✓	✓
	MEDIUM SIZE SCREWDRIVER								✓	✓
	10" MONKEY WRENCH								✓	
		PLUMBING	ELECTRIC	DOORS	WINDOWS	CEMENT	SHARPENING	GENERAL		

Earning Money In The Country

MAYBE you'd like to move your job to the country? Maybe, as it happened to us and as has happened to many others, you'll find you enjoy living in the country so much you'll come to realize you'd like to *work* in the country as well as *live* there.

Perhaps if you now live or work in a big city you'll say to yourself, "But how can I earn a living in the country—I'm no farmer!"



Don't let that bother you. You may not have realized it, but most of the people who live in the country aren't farmers any more. Look at the figures:

1. According to the latest census, the farm population is 30 million.
2. The non-farm population in towns or small cities under 25,000 is 49 million.
3. In towns as small as 2,500 or less there live over 27 million non-farmers.

What's perhaps even more significant, the Census shows that while the farm population stayed at 30 million between 1930 and 1940, the non-farm population in towns of 25,000 or less increased by 5,329,432—an increase of 12%, a percentage increase nearly double that of the country as a whole!

Never before in our nation's history has there been such wonderful opportunity to earn a good living in the country as there is today. Two momentous events are taking place: cities are spreading out . . . small towns are growing. In this trend to decentralization lies the new American frontier of opportunity.

Take Your City Skill To The Country

The great movement away from the cities has been going on steadily ever since the automobiles became cheap enough for millions to own. This move is easy to see. Look at your own city or town. Aren't the better class new homes being built further away from the center of the city? Even 10 or more miles outside the city proper? Notice what this is doing to business. See the new community shopping centers . . . the so-called "service" industries are following the people.

More people are engaged in the "ser-

vice" industries than in manufacturing or farming. If you now are working in a "service" industry, you'll find—if you'll look into the matter—that there is untold opportunity in the *rural* service field. Remember, one advantage the city man moving to the country has over the country man is his more developed skill at earning a cash income.

If you're in one of the many "service" industries in the city, is there a need for your particular service in the country? Listed below is a group of services already being supplied by people in a town of 13,188 people. These are not *imagined* businesses—they're taken right out of the classified phone book for the town of Emporia, Kansas.

Abstractors
Accountants -
Adding Machines
Advertising
Airports
Ambulance Service
Architects
Attorneys
Auditors
Automobile Agencies
Automobile Repairing
Automobile Equipment
Automobile Graveyards
Awnings
Bakers -
Barbers
Batteries
Beauty Culture Schools
Beauty Shops
Beverages -
Bonds
Books -
Bottlers -
Bowling Alleys
Broadcasting Stations
Brokers, Investment
Building & Loan Assn.
Building Materials
Butane Gas
Butchers -
Cafes
Carpenters
Carpet Cleaning
Cemeteries
Chairs, Renting
Cheese
Chinaware
Chiropractors
City Offices
Cleaners
Clothing
Clubs, Country
Clubs, Night
Clubs, Social
Coal
Concrete Products
Confectioners -
Contractors
Credit Reporting Bureaus
Dairies -
Dairy Products -
Dead Animal Removers
Dentists
Department Stores
Doctors
Draperies
Drayage
Druggists

Dry Goods
Electric Appliances, Household
Electric Appliances, Repairing -
Electricians
Elevators, Grain
Exterminators, Termite
Farm Implements
Feed
Filling Stations -
Film Developing
Films
Fire Insurance
Five & Ten Cent Stores -
Floor Machines, Renting
Florists
Freight Truck Lines
Fruits Retail -
Funeral Directors
Furnaces
Furniture -
Furniture Repairing -
Garages -
General Merchandise
Gift Shops
Glass, Plate
Grain
Greenhouses -
Hardware
Hatcheries, Poultry -
Hats, Cleaning
Heating Contractors
Hemstitching
Hotels
Ice Cream -
Ice Cream Manufacturers -
Implement
Insulation Applicators
Insulation Materials
Insurance
Investments
Jewelers
Junk
Laboratories, Medical
Ladies Ready-to-Wear
Laundries
Linoleum
Live Stock Commission Companies
Loans
Lumber -
Lunch Rooms -
Machine Shops
Machinery Contractors
Mens Furnishings
Millinery
Monuments

Motor Trucks
Motor Repairing
Movers
Newspapers
Oil Marketers
Optometrists
Osteopathic Physicians
Packing Houses
Paint
Pharmaceutical
Photo Finishers
Photographers
Physical Therapy Technicians
Physicians & Surgeons
Pies -
Pipe
Plumbers
Pop Corn -
Poultry -
Printers
Produce -
Publishers
Radio Broadcasting Stations
Radio Service
Radios
Ranges, Gas
Real Estate
Refrigeration Equipment
Refrigerators, Serviced
Rendering Plants
Restaurants
Roofers
Rug Cleaning -
Rugs

Salvage, Automobile
Seeds -
Service Stations
Sewing Machines
Sheet Metal Work
Shoe Repairers
Skating Rinks
Storage -
Tailors
Taxicabs
Tea Rooms
Tents
Termite Control
Theatres, Open Air
Tourist Courts
Towing, Automobile Tractors
Transfer, Baggage
Truck Lines
Trucks, Motor
Undertakers
Upholstering
Venetian Blinds
Veterinarians
Vulcanizing
Wall Paper
Wall Paper Removing
Warehouses, Merchandise
Washing Machines
Washing Machines, Repairing
Watches, Repairing
Welding
Wrecker Service, Automobile

If you want to live in a smaller town and you find that the population is so small that the region can't support a full-time taxi service, for example, maybe you can combine your taxi service with an ambulance service, undertaking service, a car rental service and a delivery service.

Or you might combine a bookstore, newsstand, stationery store, mimeograph service, photostat service, local employment service, house rental service and travel information. Just a country store often supplies everything from shoes to meat—you can add up services until you're making the cash income you need.

Big Business Discovers The Country

You don't necessarily have to have a business of your own to work and live in the country. Big business is on the move—and you'll find new country job opportunities increasing all the time.



The largest aluminum producer in the world, at Alcoa, Tennessee, is in a town of 5,000

—and it isn't a suburb of a city either. The Sylvania Electric Company, one

of the largest manufacturers of lamps has found that the location of its factories in smaller towns has resulted in increased efficiency.

Ford-Ferguson and John Deere, both makers of farm equipment, have found that by locating plants in the midst of farm country instead of the heart of a big city many advantages accrue.

General Motors and General Electric both have planned programs for decentralizing. So too has International Business Machines. In fact, the atomic bomb has given decentralization such impetus that there's no telling what's going to happen.

The war showed that big business could profitably sub-contract to the small manufacturer. For example, Pratt & Whitney are said to have issued over 18,000 separate sub-contracts.

Homer Hoyt, Director of Economic Studies of the New York Regional Plan Ass'n. has pointed out some of the disabilities of the large city industry. He writes in *Civil Engineering* for August 1945:

"It is now a question not of how fast our cities will grow, but of whether they will grow at all . . . The very great advantages of New York's site have led to a higher standard of living than obtained in the Nation as a whole, and the highest cost of municipal services, which have tended to increase overhead costs of doing business and also labor rates. The congestion of a large population has likewise increased costs by the friction of traffic congestion in central areas, by the cost of subways and express highways to transport so great a population from places of work to residences, and by the extra expense of going great distances to secure an adequate water supply. In addition, in a city which has long enjoyed such great natural advantages, it was possible to succeed, even with some relatively inefficient methods on the part of labor and capital. In so rich a market, high charges could be levied for certain services, make-work policies could be adopted, and still the market would bear the burden.

for human beings. Gardens and small farms may give the security and the health which are lacking within the city walls. Fresh air and sunshine come once more within reach. In the future, large cities with high population density will no longer be needed. As production methods advance, it will be increasingly possible for production plants to divide into small units and be dispersed over a wide area, perhaps the entire country. Production would then become not only less expensive but also more efficient, for manufacture in the large city has come to be increasingly uneconomical and wasteful of energy and time."



Summing up these trends, Arthur E. Morgan in the excellent book "A Business Of My Own" says:

"For a long time the railroad and steam power favored centralization. Today the big city with its congestion, inefficiency, insecurity, and high cost, is a less favorable environment, while good highways, electric power, small unit machinery, and other conveniences, have greatly improved the status of the small community. In the eastern part of our country many industrial units are leaving the cities for small town locations, sometimes hundreds of miles distant."

If You Decide to Move Your Job

From the many letters we receive from folks who say, "I want a homestead like yours—and I want to work nearby so I don't have to waste any more time than necessary getting back and forth to work," we know that there is great interest in *working* as well as *living* in the country.

The fact that moving your job and setting up a homestead are both major tasks doesn't in the least effect the validity of either. But unless you're well fixed for an income to tide you over the transition period, it would be smart not to move your job and start a homestead at the same time. I don't believe it makes any difference which you do first. If you keep your present job and get your homestead all set up and running and perhaps paid for, then you'll have learned a good deal about business opportunities in your section. If on the other hand, you don't like your present job and want to find another in the country, then in getting your country job under control, you'll have

learned enough about the country to find a good site for a homestead.

And while you're riding through the country keep your eyes open for all the road signs put up by people operating little businesses of their own.

Of course, you're aware of lots of tourist camps, wayside markets, filling stations, and real estate agents. But also notice the less conspicuous signs,—the country lawyer, country doctor, country sign painter, the country tailor, the country radio repair man, the country beauty shop, the plumber, the upholsterer, the photographer. The small manufacturing plant, the craftsmen—and so on.

Often these people operate right from their own homes—and their places have enough land so they can really live. Enough so they can have a garden, fruits, berries, chickens—maybe a family cow.

There are just millions of folks in the country who've found out how to combine making a cash income with the home production of food.



A reference library can be most useful and important.

We have heard it said that "you can't learn to do this and that out of a book." However, judging from our own experience, we don't think this is strictly true. Here at our place we've got what you might call a reference library, with books and pamphlets on all sorts of subjects, and hardly a week goes by but what we "look up" how to do quite a lot of things.

We believe that every family who has a homestead should have a reference library—just the way all good cooks have cook books. You don't need a whole room full of books. You can get along with relatively few, if you choose them wisely.



"As cities grow older, traditional and customary practices which tend to impair efficiency become embedded in their economic structure."

Another expression of the trend toward decentralization is that of L. Hilberseimer in his book *The New City* (1944):

"Resettlement in the country as the exodus from the city gather momentum has obvious and far-reaching benefits



LET'S REBUILD AMERICA . . .

FROM the day the automobile was invented there has been an ever increasing movement of families to the countryside surrounding the cities. In these post-war years this trend may become almost a stampede.

We Robinsons are only one family out of hundreds of thousands who have discovered how practical it is to hold a job in town and to go daily to it from a home and an acre or so of land.

The only thing different about us is that we wrote the "Have-More" Plan about this way of living which has meant so much to us in security, health and happiness. We wanted to tell other families about our experiences so that they could profit by what we'd learned and thus succeed more quickly at setting up homesteads of their own.

The response we've had to our "Have-More" Plan has made us very happy but it has almost snowed us under at times. Not only have we had thousands of letters from other families telling us of their plans and asking advice—but we've heard from scores of manufacturers, real estate people, insurance companies, magazine and newspaper editors, and so on.

Here are just a few examples:

Soon after the "Have-More" Plan was published, *Better Homes and Gardens Magazine* asked us to write an article for them, with pictures, about our place. *The Reader's Digest* reprinted it. Then many other magazines and newspapers ran stories about the "Have-More" Plan. We were interviewed on the radio a number of times.

Real estate firms from all over the country write to us continually about their plans for dividing land into acreage plots instead of 50 foot lots as they might have done a few years ago.

Architects and builders have told us they are going to offer homes especially designed for country living.

One of the biggest insurance companies has asked our advice in developing a special low-cost, long-term

mortgage financing plan for families who want to have homesteads.

The Macmillan Company of New York has asked us to edit a whole series of books on the subjects people need to know about to succeed at homesteading.

The men in the services showed so much interest in the "Have-More" Plan that the Army bought a special printing of 55,000 copies for libraries.

We have talked to dozens of business men and have read about scores of others, including some of the biggest in the country, who are planning to move their offices and factories out of the cities so that their employees can enjoy the advantages that go with the ownership of a home and a little land.

In other words, it has sometimes looked to us as though just about everybody in the cities of America wants to move out to the countryside to live and to work!

And why not? Why wouldn't that be a good idea? Why shouldn't we set ourselves that goal—to rebuild our country in the next twenty or thirty years so that every family that wants to can own its home and a little land?

It is entirely practical for us to do so. We certainly have the productive capacity to build a whole new highway system, to move many factories away from the crowded cities, to build the millions of new homes, the equipment and furnishings that would go in them!

There was a time when a factory had to be located near water or rail transportation. Nearness to raw materials, nearness to markets, nearness to what was called a "labor supply" were the important considerations. Hardly anybody thought about whether the location chosen would be one where the workers in the factory would enjoy living.

Today, only four out of ten families in this country own their homes. In the big cities only one out of four families owns its home. Move factories away from the big cities, give people access to lower priced land, give them half a chance to own their homes, and the ratio may be reversed. How much sounder—how much better governed—would this country be if six instead of four families out of ten owned their homes—if the sense of responsibility, the interest in public affairs, the pride and independence that go with the ownership of property were theirs?

America needs a goal. It needs something tangible to work toward. Look what this nation has accomplished when it had a clear-cut job to do—like winning a war or opening the West.

For the sake of national security itself, remembering the atom bomb; for the welfare and happiness of every family; for the sake of having a big, worthwhile job to do—so that we can unite in doing it instead of quarrelling with each other—let's rebuild America so every family that wants to can own a home and a little land!

Basic Seed Saving

from Seeds of Diversity Canada

Seed saving is the simple act of helping plants to do what they do naturally: grow seeds and reproduce. When you grow your own seeds, you can grow your favourite varieties every year without buying them. You can maintain your own supply of unusual, or hard-to-find seeds. You can even try your hand at breeding your own new varieties! It's fun and it's easy. **The plants do all the work.**

People have been saving seeds for about 10,000 years. Long before there were any seed companies, long before professional seed-growers existed, ordinary people grew seeds for their own vegetables, grains, fruit, and flowers. There are many people alive today who can remember when most Canadian farmers and gardeners saved their own seeds as an ordinary part of their fall routine. They weren't experts in genetics, or university graduates in biology, but they knew a few simple things about plants. You can learn them here, and grow your own seeds too.

There are four main aspects of good seed saving:

- 1) Choosing varieties to meet your expectations
- 2) Controlling pollination
- 3) Selecting the most desirable seeds at harvest
- 4) Cleaning and storage

Choosing Varieties

Seed catalogues usually distinguish two general types of plants: **hybrid** and **open-pollinated**.

In typical garden vegetables, an **open-pollinated** plant variety is a "true" or "purebred" variety. Both of its parents were the same variety, and all of its offspring will be the same too. Since every generation is identical to the generation before it, you can collect and replant their seeds over and over for many years and still have the same variety.

In some crop species, notably ornamentals and grains such as corn or rye, **open-pollinated** often means that the variety is a mixture of many slightly different plants. For instance, open-pollinated annual flowers can simply be a mixture of colours. Open-pollinated corn varieties such as Golden Bantam frequently have some variation from one plant to the next. Even though the plants are not exactly uniform, they are considered to be all part of the same variety.

A **hybrid** variety is a crossbreed. Its parents were different varieties and it is a combination of the two. A combination of two different open-pollinated varieties is called an **F1 hybrid**. A combination of two hybrids is called an **F2 hybrid**. F1 hybrids are known for being very uniform (each plant is exactly like the others), partly because of the pollination control that is needed to create them. Some hybrids show greater vigour than open-pollinated varieties of the same species. This "hybrid vigour" is especially evident in grasses and cross-pollinating species, but less strong in species such as beans and tomatoes that normally self-pollinate.

There is a problem with saving seeds from hybrid plants. Since their genes are a combination of their parents' genes, their offspring will receive a mixture of an already mixed bag. A seed collected from a hybrid plant might produce a plant similar to the hybrid, or it might resemble one of the hybrid's original parents, or it might be an altogether new combination. To make matters even more unpredictable, two seeds from the same hybrid fruit will not necessarily contain the same combination of genes, so will not necessarily grow up the same.

Controlling Pollination

If two non-identical plants cross-pollinate (one is fertilized by pollen from the other), the seeds will be hybrids. They will consist of some combination of the two parent plants. Sometimes this is alright. For example, if you have a bed of mixed annual flowers and you plan to save some of the seeds to plant another mixed bed next year, it doesn't matter if the flowers cross-pollinate. The colours are already mixed anyway.

There are times when you want to prevent cross-pollination. Say you have two favourite varieties of tomato, one orange and one red. You want to replant the same two every year, so you want to keep each variety pure. Another example might be an heirloom bean variety that you want to keep pure, since you can't buy it from any seed company.

Cross-pollination can be prevented by:

- 1) Separating different varieties by enough distance so that pollen, or insects carrying pollen, can't travel between them.
- 2) Making a physical barrier to prevent insects from carrying pollen from one plant to another.

First you have to look at the anatomy of the flowers. There are three basic types of flowers:

- 1) Complete, self-pollinating
 - e.g. tomato, bean, pea, lettuce, wheat, barley
 - each flower has both male and female parts close together. Petals are tightly closed to keep insects out. These flowers almost always pollinate themselves, automatically preventing cross-pollination. In some cases (about 1 out of 20) a determined insect can crawl inside and cross-pollinate the flower, so a short isolation distance is still recommended.
- 2) Complete, cross-pollinating
 - e.g. petunias, onions, hollyhocks, rye
 - each flower has both male and female parts, but they are far apart and the flower is open, allowing insects in easily. These flowers are generally able to self-pollinate, and sometimes do, but they are cross-pollinated by insects just as often. Large isolation distances or insect barriers are required to prevent cross-pollination.
- 3) Incomplete, cross-pollinating
 - e.g. melons, cucumbers, corn
 - each flower is either male or female. Pollen must be carried from a male flower to a female flower for fruit and seeds to be produced. Large isolation distances or insect barriers are required to ensure that pollen comes from plants of the same variety as the female flowers.

Self-pollinating flowers are tightly closed, so insects and wind-blown pollen can't get in easily. They are also **complete** with both male and female parts in every flower. They (almost) always pollinate themselves, making it easy to keep varieties pure. In fact, it's fairly difficult to make hybrids of self-pollinating species.

In some rare cases, these plants can cross-pollinate over short distances. Pollen can drift for a few feet from any plant, further if the pollen is light and dusty, or an insect can sometimes push its way into a tightly-closed flower. We recommend that different varieties of self-pollinating plants should be separated by at least 10-15 feet in the garden, but the further the better to ensure that they remain pure.

Note that if two identical plants cross-pollinate, it has the same result as self-pollination.

Cross-pollinating flowers are open, allowing wind and insects to transfer pollen to any plant within several hundred feet. Most cross-pollinating garden plants have heavy, sticky pollen so they need insects such as bees to carry it. Since bees can travel up to a quarter of a mile from their hive, it is usually recommended to keep different varieties of these plants separated by a quarter of a mile to prevent them from crossing. Other plants have fine, dusty pollen which is carried by wind. Spinach, beet and grains such as corn and rye are among these. They must be separated by a greater distance of a mile or more.

Incomplete flowers are always the cross-pollinating kind. The name means that each flower is either male or female, but never both. Squash, cucumber, melon, corn, and spinach are examples. Pollen is not only able to move freely, by wind or insects, the plant requires something to move pollen from the males to the females. Without insects, no fruit would set on these flowers and no seeds would be produced. The best way to control pollination of these varieties is to learn the difference between the flowers and to hand-pollinate them.

Insect barriers are easy to make with spun-polyester row cover material, old nylons, paper or fine cloth. Cover a few flowers or entire plants, preventing insects from reaching the flowers. Don't use plastic film to cover plants, since it will trap heat from the sun and fry them! If the flowers are self-pollinating, they will pollinate inside the bag and the seeds will be purebred. If the flowers are incomplete, they will need help to transfer their pollen.

Usually, plants will only cross with other plants of the same species. For instance, different kinds of squash can cross with each other, but they cannot cross with cucumbers. However, some species are related closely enough that they can pollinate each other. For example, broccoli and certain kinds of wild mustard can cross-pollinate, producing an inedible hybrid. Lettuce can cross with its wild cousin, so learn to identify wild lettuce if you want to grow lettuce seed. Radishes can cross with mustard and chinese cabbage. If in doubt, consult a seed-saving book. These relationships are well-known and documented.

Selecting Seeds

Seeds must be allowed to ripen fully on the plant or they will not germinate. It's important to know at what stage the seeds are ripe. Flower seed heads are usually only ripe when they turn brown and dry. Fleshy fruit such as tomatoes and cucumbers should generally be very ripe, or even over-ripe before they are picked for seed-saving.

Although green tomatoes turn red and soft after they are picked, they do not continue to grow and develop. Immature seeds cannot mature unless the fruit is fed from the vine. Shelf-ripened tomatoes don't have true vine-ripened flavour, nutrition and may not have viable seeds.

If you aren't sure what your mature seeds will look like, keep a few seeds back in the spring. Then you can compare them to the ripening seeds. Compare size, colour and especially plumpness.

Collect seeds from the plants that are most like the plants that you want to have in future years. If you are trying to preserve an heirloom variety, choose seeds from many plants to maintain the natural diversity of characteristics. For example, some varieties of beans have natural variations in colour within their population. Some of each colour must be saved to preserve the variety completely.

If you want to try to create your own new variety, collect seeds from the plants that are closest to your ideal. For example, you might collect seed from the first tomato to ripen each year. Theoretically, you should be able to select early-ripening genes this way and eventually all of the resulting tomato plants should bear fruit a little earlier. Another example is to collect seeds from your favourite colours of a mixed planting of annual flowers. Cross-pollination may make this difficult, but every year that you repeat this you should get a higher proportion of that colour in your own special mix.

Choose seeds from plants that are free from disease since some disease organisms can survive on the seed surface and re-infect the whole planting next year. Seeds that are lumpy, mouldy or discoloured should not be kept for seed, unless absolutely necessary.

Cleaning

Seeds that are dry when collected (such as most flower seeds) should be freed from chaff and bits of the flower, which can harbour fungus spores, and should be stored in paper envelopes. Seeds from fleshy fruit such as tomatoes and cucumbers need to be cleaned well. These seeds are surrounded by a jelly-like substance that should be removed before storage. This seed jelly is meant to inhibit germination so that the seed does not sprout in the fall when the fruit drops. In nature, the jelly would rot during the late fall, and by the time the seed had been exposed, it would be too cold for it to sprout until spring.

To remove the seed jelly, simply scrub the seeds with your fingers or a towel. If you are saving a large number of seeds, you can use a method called "fermentation". Seed companies which grow and package many thousands of seeds cannot scrub them all with towels, so they use this simple, though disgusting, method. Place the seed pulp in a closed container and keep it in a warm place for 3 or 4 days. Don't let it dry out, but don't add water unless you have to. Soon, mould will cover the surface of the pulp and the jelly will rot, creating a delightful aroma. Holding your nose with one hand, strain the pulp through a sieve with lots of water and the seeds should come out clean. While the seeds are being rinsed, see if any of them float. Especially with tomato, cucumber and melon seeds, if they sink they're good; if they float, they're duds.

Storage

The best conditions for storing seed are, not surprisingly, the opposite of the conditions required for germination. Seeds germinate best in warm, moist conditions and store best in cold, dry conditions. Most seeds can remain viable for a few years in paper envelopes in dry air at room temperature. You can extend their lifetime considerably by keeping them cold in a refrigerator.

Inside every seed is a tiny plant embryo that lives by "eating" a stored quantity of starch. When the food runs out, the embryo dies and the seed will not germinate. The way to keep a seed alive for a long time is to slow down its metabolism. The lower the temperature and humidity, the slower the seed consumes its food.

A simple rule of thumb is that the sum of the temperature in degrees Fahrenheit and the percent relative humidity should be less than 100.

Temperature (degrees F) + Relative Humidity (%) < 100

More or less, for every 10 degrees that the temperature is reduced, seeds will live for twice as long. Humidity is very bad for seeds. If they absorb moisture, even from the air, they start to prepare for germination, and use up a lot of their stored food. **Never** store seeds in a humid greenhouse, a damp basement or garage, a laundry room, or a growing area where there are plants evaporating water into the air.

Seeds should be well-dried before they are put into storage. Open air drying is easiest. There are a few simple methods for testing seed dryness.

- * The hammer test: hit one of your seeds with a hammer. If it shatters, it's well-dried. If it just mashes, it needs to be dried further. (or rather, the others do)
- * The al dente test: a well-dried bean or pea should feel hard when you bite on it. If you can easily make tooth marks, it needs to be dried further.

If air-drying doesn't work, for instance if the air is too wet in your area, you can dry seeds in a food dehydrator or a slightly-warm oven, but avoid temperatures over 95F, since the seeds can be damaged by too much heat. Seeds do need a little moisture to stay alive, so don't try to make them dryer than they would naturally become in the open air.

Paper envelopes allow moisture to escape, preventing deadly condensation. Seeds can also be stored in jars, but it is a good idea to put a little silica gel in the jar too, to absorb excess moisture. Silica gel can be purchased at most craft

stores (it's used for drying flowers) for about \$10/kg. Most brands contain a few indicator crystals which turn blue when the gel has absorbed a certain amount of moisture. Heating the gel in an oven at about 200F dries it out again

A good system is to store your year-to-year seeds in paper envelopes in a cool, and especially dry place. Keep long-term backups in tightly-sealed glass jars in a consistently cool or cold place (humidity in your basement doesn't matter if the jars are well sealed). Note that plastic allows more moisture through than you might think – use glass jars. If you really want to keep seeds for a long time, you can jar them as above, and store them in a freezer. As long as they are well-dried, they will keep for many years. Frozen seeds should be kept in well-sealed jars, since the freezer can over-dry them, similar to freezer-burn, and fatally dehydrate the seed.

Isolation Distances and Seed Viability

The statistics on the following page are typical of those found in seed-saving books. They are provided as a guideline only, since there can be a lot of variation from garden to garden. Your own experience is the best teacher.

Isolation distance for bee-pollinated plants really means "how far will a bee travel while collecting pollen and nectar?" The actual distance depends a lot on the geography of the area, the types and quantities of flowers available and the distance from the hive. A guideline of 1/4 mile is usually given for these plants, but the actual required distance can be anywhere from 100 feet to 1/2 mile.

Isolation distance for wind-pollinated plants really means "how far do the plants have to be separated so that there is an 'acceptably small' chance of pollen being blown from one to the other?" Again, the actual distance depends on the usual direction of the wind, nearby wind blocks such as trees and fences, the weight of the pollen, humidity, and the amount of pollen being produced in your planting. One or two miles is often recommended, but as little as 1000 feet is sometimes enough, especially for large plantings.

Seed viability, or "shelf life" varies greatly with temperature and humidity. The figures given below are typical for seeds stored in a dry, cool place such as a dry cellar (or a humid cellar with the seeds in dry jars). Seeds stored at room temperature, but still dry, will usually last about half as long. Seeds stored in a humid location can lose their viability within a few months to a year.

A germination test can be helpful if you want to know how good your seeds are. Sprout 10 or 20 seeds in a small pot of potting soil or vermiculite, or wrap them in a paper towel and keep them moist in a warm place (wrapped in plastic on top of the fridge is good). In a week or two, some of the seeds should sprout. If less than ¼ of them do, you should consider regrowing them. If fewer than half of the seeds sprout, the rest of the batch is probably close to dying; time to plant them and collect fresh seeds.

The isolation requirements below are taken from How to Save Your Own Vegetable Seeds, by Seeds of Diversity Canada.

The seed storage statistics are typical for seeds stored in a dry, cool place.

	distance	shelf life(yrs)			distance	shelf life(yrs)	
		avg	max			avg	max
Angelica		1	3	Marjoram		3	7
Asparagus		5	8	Melon, Musk	1/4 mile	5	10+
Basil		8	10+	" , Water	1/4 mile	6	10+
Bean	15-20 ft	6	10+	Mustard	1/4 mile		
" , Kidney	15-20 ft	3	8	Nasturtium		5	8
" , Lima	1 mile			Okra	1 mile	5	10+
" , Runner	1/2 mile			Onion	1/4 mile	2	7
" , Soy	10 ft	2	6	Parsnip	1/4 mile	2	4
Beet	1/4 mile	6	10+	Parsley		3	9
Borage		8	10+	Peas	15-50 ft	3	8
Broccoli	1/4 mile	5	10	Peanut		1	1
Brussels Sprouts				Pepper	500 ft	4	7
	1/4 mile			Pumpkin	1/4 mile		
Cabbage	1/4 mile	5	10	Radish	1/4 mile	5	10+
" , Chinese	1/4 mile			Rhubarb		3	8
Calendula		3	7	Rosemary		4	?
Carrot	1/4 mile	4	10+	Rutabaga	1/4 mile		
Catnip		5	6	Sage		3	7
Cauliflower	1/4 mile			Salad Burnet		3	9
Celeriac	1/4 mile			Salsify	1/4 mile	2	8
Celery	1/4 mile	8	10+	Savory		3	7
Collard	1/4 mile			Sorrel		4	7
Corn	1/4-1 mile	2	4	Spinach,	1 mile+	5	7
Cucumber	1/4 mile	10	?	" , New Zealand		5	8
Cress, Garden		5	9	Squash	1/4 mile		
Dill		3	5	Strawberry		3	6
Eggplant	50 ft	6	10	Sunflower	1/4 mile		
Gourd		6	10+	Sweet Cicely		1	1
Horehound		3	6	Swiss Chard	1/4 mile		
Hyssop		3	5	Tansy		2	4
Kale	1/4 mile			Thyme		3	7
Kohlrabi		5	10	Tomato	15-20 ft	4	9
Lavender		5	6	Turnip	1/4 mile	5	10+
Leek	1/4 mile	3	9				
Lentil	10 ft	4	9				
Lettuce	15-20 ft	5	9				
Lovage		3	4				

MENU: [HOME](#) » [Reconstruction](#) » [Recovery](#) » [Renewal](#) » [Survival](#) » [Humanure Content](#)

The Humanure Handbook

[Front Cover](#) - [Back Cover](#)

Table Of Contents:

[Show Full Contents](#) - [Awards](#)

[Reader Feedback From The First Edition](#)

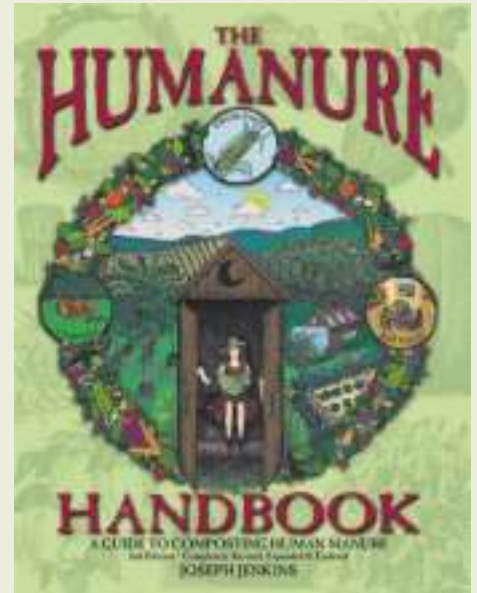

0 - [The Beginning](#)

1 - [Crap Happens](#)

2 - [Waste Not Want Not](#)

3 - [Microhusbandry](#)

4 - [Deep Sh*t](#)

5 - [A Day In The Life Of A Turd](#)

6 - [Composting Toilets And Systems](#)

[Worldwide Sources of Composting Toilets](#)

7 - [Worms And Disease](#)

8 - [The Tao Of Compost](#) (*how to do it!)

9 - [Alternative Grey Water Systems](#)

10 - [The End Is Near](#)

[References](#)

APPENDICES

- Appendix 1: Temperature Conversions
- Appendix 2: Sources of Wetland Plants
- [Appendix 3: US State Regulations](#)

[Glossary](#)

Other Goodies:

[Join a discussion](#) with your fellow humanure composters!

PalmOS file in DOC format: [Chapter 8: Tao of Compost](#)

Copyright 1999, Joseph C. Jenkins

The following information may be reproduced subject to the following three conditions:

- 1) The information must not be changed or altered
- 2) The following information must accompany all copies:

Source: The Humanure Handbook. Jenkins Publishing, PO Box 607, Grove City, PA 16127. To order, phone: 1-800-639-4099.

<http://www.jenkinspublishing.com/>

- 3) The reproduction is not done for profit. Persons wanting to use excerpts or artwork from this book for a profit venture must contact the publisher for permission.

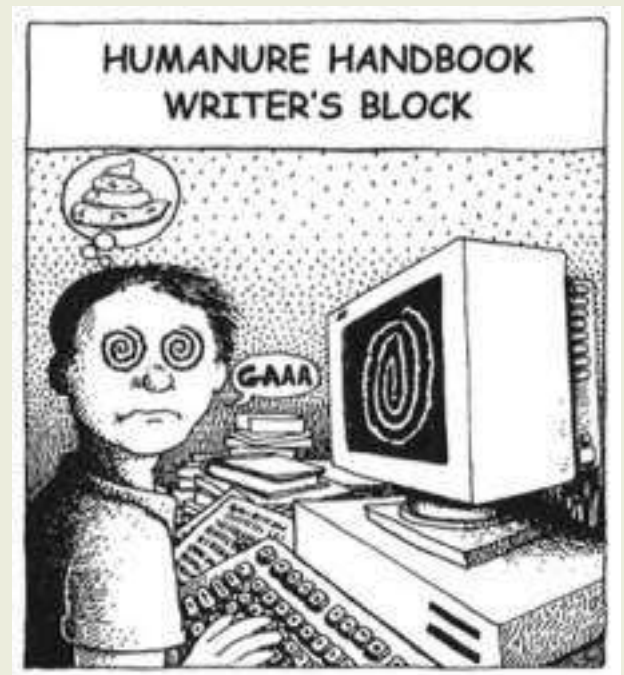

MENU: [HOME](#) » [Reconstruction](#) » [Recovery](#) » [Renewal](#) » [Survival](#) » [Humanure Content](#)

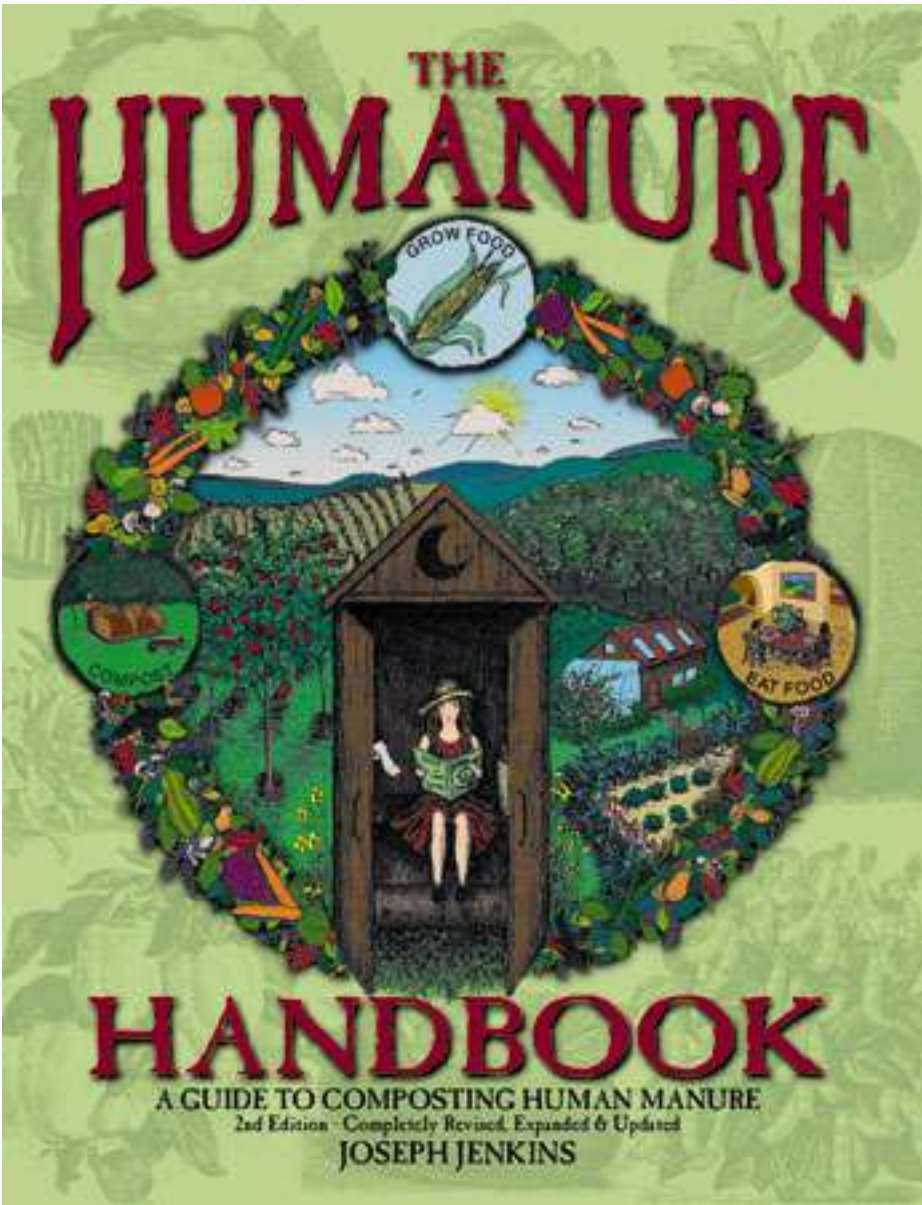

2nd EDITION
COMPLETELY REVISED
EXPANDED AND UPDATED

A book of great environmental importance.
302 Pages, 29 Photographs, Over 100 Tables and Figures,
Index, Glossary, Appendices, and a few bad jokes.

The Humanure Handbook

Now in dozens of countries worldwide • Amazon.com category #1 best seller

COMMENTS FROM READERS AND REVIEWERS:

- "World-shaking."
- "The perfect self-published book."
- "One book that could save the world."
- "Almost certain to become a classic in its field."
- "One of the most important books ever written."
- "Should be required reading for everyone on the planet."
- "You have answered questions I have held open since childhood."
- "After reading this book, you will never flush a toilet with indifference again."
- "Answers every question anyone could have about managing a compost toilet and compost pile."

Humanure: waste or resource? Joseph Jenkins boldly steps where no author has gone before. Considered by many a "moving" book, The Humanure Handbook will surprise you with its timely relevance, delight you with its humor, and impress you with its thorough research. Brilliantly simple, profoundly mundane, this is one book you will never forget. Full of "eye-candy" illustrations, practical information, history, philosophy, and science, it addresses an issue relevant to each and every human being on Planet Earth.



ISBN 0-9644258-9-0



9 780964 425897

\$19.00 US

Distributed by Chelsea Green

The Humanure Handbook

A Guide to Composting Human Manure

[Front Cover](#) - [Back Cover](#)

Table Of Contents:

[Show Chapters Only](#) - [Awards](#)

[Reader Feedback From The First Edition](#)

0 - [The Beginning](#)

1 - [Crap Happens](#)

2 - [Waste Not Want Not](#)

- [Human Nutrient Cycle](#)
- [Soiled Water](#)
- [Waste Vs. Manure](#)
- [Recycling Humanure](#)

3 - [Microhusbandry](#)

- [Vintage Compost](#)
- [Compost Defined](#)
- [Naturalchemy](#)
- [Solar Power in a Bananna Peel](#)
- [Gomer The Pile](#)
- [Four Necessities for Good Compost](#)

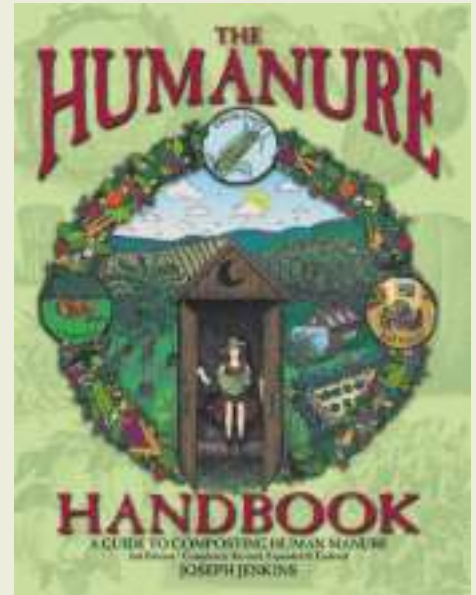

- [The Carbon / Nitrogen Ratio](#)
- [Thermophilic Microorganisms](#)
- [Four Stages of Compost](#)
- [Compost Biodiversity](#)
- [Compost Myths](#)
- [Compost Miracles](#)
- [Vermicomposting](#)
- [Practice Makes Compost](#)

4 - [Deep Sh*t](#)

- [The Ego Vs. The Eco](#)
- [Asian Recycling](#)
- [The Advances of Science](#)
- [When the Crap Hit the Fan](#)
- [Asian Update](#)

5 - [A Day In The Life Of A Turd](#)

6 - [Composting Toilets And Systems](#)

- [Composting Toilets Must Be Managed](#)
- [Fecophobia and the Pathogen Issue](#)
- [Owner Built Composting Toilets](#)
- [Asian Composting](#)
- [Commercial Composting Toilets](#)
- [Worldwide Sources of Composting Toilets](#)

7 - [Worms And Disease](#)

8 - [The Tao Of Compost](#) (*how to do it!)

- [Primal Compost](#)
- [The Sawdust Toilet](#)
- [The Compost Bins](#)
- [Normal Composting Bin Sequence](#)
- [Normal Composting Bin Sequence \(Continued 1\)](#)
- [Normal Composting Bin Sequence \(Continued 2 - Not Available\)](#)

- [Pathogenic Populations and a Two Year Retention Time](#)
- [Analyses](#)
- [Monitoring Compost Temperature](#)
- [Fecofrigginfobia](#)
- [Legalities](#)
- [Environmental Potty Training 101](#)

9 - [Alternative Grey Water Systems](#)

10 - [The End Is Near](#)

[References](#)

APPENDICES

Appendix 1: Temperature Conversions (Not Available)

Appendix 2: Sources of Wetland Plants (Not Available)

[Appendix 3: US State Regulations](#)

[Glossary](#)

Other Goodies:

[Join a discussion](#) with your fellow humanure composters!

PalmOS file in DOC format: [Chapter 8: Tao of Compost](#)

Copyright 1999, Joseph C. Jenkins

The following information may be reproduced subject to the following three conditions:

- 1) The information must not be changed or altered
- 2) The following information must accompany all copies:

Source: The Humanure Handbook. Jenkins Publishing, PO Box 607, Grove City, PA 16127. To order, phone: 1-800-639-4099.

<http://www.jenkinspublishing.com/>

- 3) The reproduction is not done for profit. Persons wanting to use excerpts or artwork from this book for a profit venture must contact the publisher for permission.

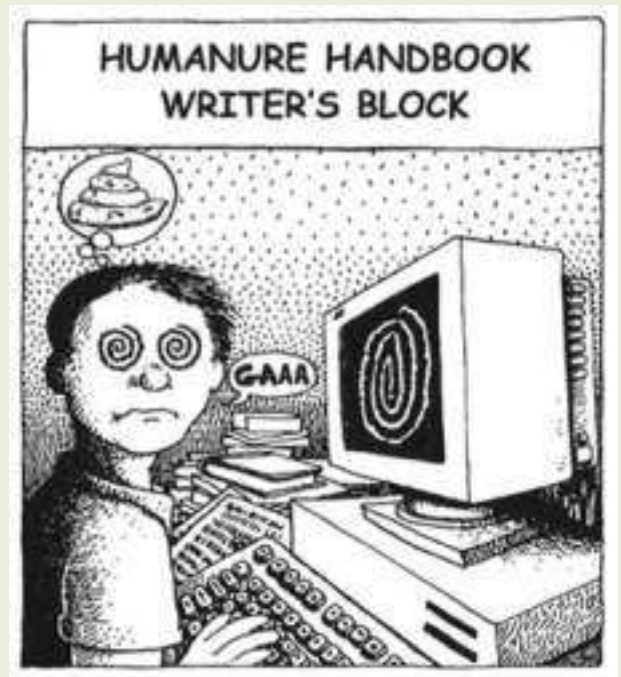

MENU: [HOME](#) » [Reconstruction](#) » [Recovery](#) » [Renewal](#) » [Survival](#) » [Humanure Content](#)

MENU: [HOME](#) » [Reconstruction](#) » [Recovery](#) » [Renewal](#) » [Survival](#) » [Humanure Content](#)

REAPING THE REWARDS OF RECYCLING

'Humanure' an Amazon.com #1 Category Bestseller Two Years Running, ForeWord Magazine Book of the Year finalist; Finalist in the Ben Franklin Awards for Excellence in Publishing



UPDATE! May 22, 2000: The Independent Publisher Book Awards 2000 has selected its winners, which include:

THE TEN OUTSTANDING BOOKS OF THE YEAR:

Most Likely To Save the Planet: *The Humanure Handbook (2nd Edition)*, by Joseph Jenkins; [Jenkins Publishing](#)

These results [have been posted](#) on the [Independent Publisher](#) website in time for the start of BookExpo. Award plaques and certificates were delivered on Friday morning, June 2, at BookExpo, or mailed to those who didn't attend. Specific title judging reports were sent to all publishers. Thanks to all 550 publishers that entered, and congratulations to you all for your excellent work.

Who would have ever thought that a book about composting --especially one proposing how to safely recycle human excrement -- would run to the top of Amazon.com's bestseller lists two years in a row? Or become a finalist in ForeWord Magazine's 1999 Book of the Year competition and in the Ben Franklin Awards for Excellence in Publishing?

Certainly not Joseph Jenkins, author and tradesperson, whose success with *The Humanure Handbook: A Guide to Composting Humanure* has earned him some dubious titles such as "King of Compost" and other unmentionables, and placed him on the receiving end of some pretty off-color jokes, but has also gained him some recognition as both an author and publisher.

"I never expected it [*Humanure*] to go anywhere," Jenkins said. "I didn't know how anybody would react, so I expected the worst. I estimated that maybe one person in a million would be interested."

However, since 1994, when the book was first published, *Humanure* has sold out four printings and is now in its fifth printing and second edition, having over thirteen thousand copies in circulation. In fact, Jenkins quickly sold out his first print run of 660 books, which, he thought, would "last him a lifetime;" he now sells approximately 500 of his books every month.

He has been contacted by hundreds of people all over the United States, and has sold his *Humanure* books in over 31 different countries around the world. The book has been written up by many media, including the *Associated Press*, *Mother Earth News*, *Natural Health* magazine, and *Whole Earth Review* and has been talked about on Canadian Broadcast radio, British Broadcast radio, Radio America, and even the Howard Stern show.

Using a biological, low-technology system of thermophilic composting, Jenkins has successfully recycled his own family's organic material for over twenty years. The end product: hygienic, nutrient-rich humus, is used to amend the soils in his food garden. *Humanure* was the inevitable result of Jenkins' two decades of practical experience with composting and organic gardening paired with extensive research

gleaned from scientific journals and texts.

But this is much more than a book on composting. In it, Jenkins exposes many environmental problems that have resulted from our view of organic materials as "wastes," and reveals what he feels are the underlying reasons why our relationship with the Earth is so dysfunctional. A review in *HortIdeas* (September 1999) touted *Humanure* as "one of the most important environmental exposés of all time," ranking right up there with Rachel Carson's *Silent Spring*.

Most recently, however, *Humanure* has received accolades through Amazon.com, an on-line bookstore that is, without argue, probably the largest on-line bookseller in the world, offering 4.7 million books for sale. For two years running, *Humanure* has achieved Amazon.com #1 bestseller status in the category of Soil Science (1998), and this year, in the Nature and Ecology: Recycling category. Jenkins' other self-published book, *The Slate Roof Bible*, was an Amazon.com #1 bestseller in 1998, in the Roofing category, and ranked #2 in 1999.

Humanure was one of seven finalists in ForeWord Magazine's Book of the Year Award program. More than 1,000 titles were entered in the 1999 competition, and award-winners were selected in twenty-three categories. ForeWord Magazine established this award in 1998 to recognize the vital books published by small, independent and university presses.

The *Handbook* is also one of three finalists in the Gardening/Agriculture category for the 2000 Benjamin Franklin Awards for Excellence in Publishing, a prestigious national award sponsored by the Publisher's Marketing Association, a non-profit trade association of 3,400 publishers. This year, over 1,600 entries were submitted, of which 165 were chosen as finalists. Award winners will be announced in June at the Book Expo America, the largest publishing trade fair in the world, which will be hosted in Chicago at the McCormick Place.

Source: Jenkins Publishing, PO Box 607, Grove City, PA 16127. To order, phone: 1-800-639-4099.
<http://www.jenkinspublishing.com/>

MENU: [HOME](#) » [Reconstruction](#) » [Recovery](#) » [Renewal](#) » [Survival](#) » [Humanure](#)
[Content](#)

Pot Luck Literary Appetizers

Reader Feedback from the First Edition

The first edition of this book was self-published on a meager budget and was expected, by the author, to require a total lifetime print run of about 250 copies. It was assumed that there was little, if any, interest in the topic of composting human manure, but the degree and nature of feedback that resulted from this unlikely book was surprising. The first edition of Humanure eventually amounted to over 10,000 copies in circulation. Excerpts from a sampling of the letters sent to the author are presented below. Some of the writers offer insight about their own composting experiences, which you, the reader, may find useful or interesting. At the very least, the following testimonials are inspiring, and they indicate that more than a few people care about our planet, and how we live on it.

“Thank you so much for your book. I believe that it is one of the most important books ever written. (I also enjoyed your web site very much.) I finished reading your book less than a month ago and have already participated in building two compost bins and am currently in the process of building the toilets to go with them.” S.U. in ME

“The potential of the ideas in Humanure is so great in problems such as hollow food, landfill capacities, population densities . . . that I feel rather evangelical about the book and hope that others will also.” R.S. in OH

“If this short sentence, ‘We are defecating in our drinking water,’ was put in front of our eyes frequently enough, more and more people would realize that this absurd behavior can’t go on much longer.” S.A. at BioLet International “You have done the world a great service, and I thank you from the bottom of my (heart)!!” B.F. in NV

“I’m so glad you wrote this book - one lady told us it should be required reading for everyone on the planet!” D.W. in PA

“My husband and I own a small sawmill with plenty of leftover sawdust needing to be put to use. Also, my 74-year old father thinks human waste should not be used in a garden, and I want to prove him wrong.” A.M. in WA

“Your book is pure gold, just what I needed to give to my County Health Department head who is willing to go along with my desire for alternative systems.” M.T.

“Your discovery of the proper small scale of the operation is world-shaking, together with the exemplary continuous-by-small-increments rate of production.” F.A. in DE

“I enjoyed your book immensely. It clarified several technical and practical points. My mother is appalled that we would put one of ‘those things’ in the new house we’re building, certain it can’t be legal. Now that you’ve put the point in print we’ve been reduced from lawbreakers to just crazy. Pleasing me and irritating my mother, you score big in my two favorite categories.” K.L.

“This wonderful book fits right into my COMPOST=REDEMPTION religious philosophy. You have answered questions I have held open since childhood.” R. in MA

“May I join the chorus, too? The most exciting book I’ve read in a long, long time is yours. What a gem! Fun! A bumper sticker ad for the book should read, ‘The Humanure Handbook Proves It: People Are Smarter than Shit!’ Some people, anyway. ‘Fecophobia’: A new word for me and one that speaks volumes. As E.O. Wilson discovered ‘biophilia,’ so there is such a thing in humans as ‘biophobia,’ and you’ve discovered and named very appropriately one of its roots: fecophobia. It’s a real problem, and its solution, I think, is biophilia, fecophilia. Your discovery of appropriate shit technology, including an appropriate ‘throne,’ makes the billions we spend so we can shit in drinking water appear finally and totally absurd.” V.L. in FL

“I should have written this letter sooner. I would like to say that it is relatively rare to read a book of the calibre of the Humanure Handbook. A book that is enjoyable to read, empowering, hilarious, and has eye-candy pictures throughout. It’s an unbeatable combination.” J.D. in CA

“My budget is limited, so I don’t buy many books. This one, however, I really had to have for my personal library. I borrowed your book via interlibrary loan and have already read it twice, but I wanted one to keep! Please send the Humanure Handbook!” L.M.

“I really celebrate your book and your willingness to step forward and break the crystallizations of fear around composting human manure. I know for a fact I would not be taking the steps toward taking responsibility for managing the feces and urine within our community without this book.” L.F.

“After having finished your book, the Humanure Handbook, I’m more convinced than ever that those in charge of our society have no idea what the hell they’re doing.” J.R. in ME

“I knew nothing about this topic and by chance I purchased your book. Before reading I felt a little reluctance. However, once I started reading, I couldn’t stop. As English is not my mother language, it took a lot of time (all the words I didn’t understand I looked up in

my dictionary). You are doing a great service to humanity by having the courage to publish your book. It is said that example is the best teacher.” B.E. in Belgium

“Your book proved to be not only entertaining but also an invaluable source of information and reference. Thank you! At the hostel, your book has made it to the ‘shelf of recommended literature.’ On this shelf we display books we recommend our guests to read. Your book is placed between Thoreau’s *Walden* and *The Encyclopedia of Organic Gardening*.” J.N. in GA

“I just wanted to thank you for your valuable research you have done on the sawdust toilets. I enjoyed your book very much and have loaned it to many friends who seemed too embarrassed (or cheap) to buy it themselves. There must be quite a few readers of your book out there because I am seeing quite a few sawdust toilet and human manure discussions going on in the various straw bale and homesteaders news groups.” D.K. in IL

“I’m just reading the *Humanure Handbook* and kicking myself for a fool! I’ve been composting for a long time. I’ve been buying everything I can on composting — old and new — especially on composting toilets and have been banging on about it for years, but have never managed (apart from the mouldering *Clivus*) to use one. Now the solution is so simple I shall simply remove our existing W.C. under the stairs and replace it with a sawdust toilet and everything else is in place! At the moment, I’ve been saving all my urine, which I add to the woodchip piles and that steams along merrily enough. Thanks for your book and providing the missing link! Yours steamingly,” N.S. in UK

“My wife and I found a copy of your *Humanure* book last year, and have been living well with a sawdust toilet since then. (A blessing, after having spent gobs of time and money putting together a 150 gallon fly-breeding solar toilet — nothing like feeling little crawlies on your bum!)” P.U. in NM

“One thing you’ll get a perplexing kick out of regarding *Humanure* and Papua New Guinea is a problem. Shit is part of you, goes local tradition. There it is, wasn’t there before, dropped out of you. Therefore, it is you. Now with witchcraft being a major player here, all one has to do is pick up some of your shit and do nasty things with it (incantations or who knows what) and voila! you’re done for. When I asked one very devout Seventh Day Adventist lady how her father died, she said, ‘The traditional way. Someone didn’t like him and made magic against him.’ Joe, I don’t think *Humanure* stands a ghost of a chance here, although I’ve mentioned it several times to the living. Go figure on this one.” D.B. in New Guinea

“I am working as a development advisor to the Minister for Agriculture and Livestock here in Papua New Guinea, and [am] working on ways of encouraging people to shifting agriculture practices to site stable agriculture, which will require the input of more organic

material as Papua New Guineans generally have insufficient finance to purchase chemical inputs. Some time ago I purchased . . . a copy of the Humanure Handbook, and I found it quite fascinating. Thanks for the information you put together in the Humanure Handbook.” P.H. in Papua New Guinea

“I’m wracking my brain, trying to find a compelling way to tell you how great I think your book is. Here are some stabs: By the time I got to page 61, I had a mud bucket and a bag of sawdust set up in my bathroom.” K.W. in WI

“Just finished reading your book, and I’m glad. Seeing Mr. Turdly dancing around the compost pile wasn’t my ideal dream. Overall, I think your simple, low-cost and safe thermophilic system is a fantastic solution I’ve been looking for. I’ve been composting and using my own waste the past 20 years. Most of my friends think it odd. I counter that not even barbarians piss and shit in their drinking water.” E.S. in WA

“Please send me two copies of your beautiful book. I live and work at an International Youth Hostel . . . and we’re using your sawdust toilets.” B.S. in GA

“For 22 years, I have used scarab beetle larvae . . . they eat my shit in 5 minutes flat.” C.M. in SC

“I really appreciate the fact that someone finally did their research and put it together in a pleasant, readable form. I have felt strongly about our absence in the food nutrient cycle for a long time, but lack the talent of articulation that you have shown. We have been recycling our humanure since 1979.” S.C. in WI

“Great book! Thanks so much for writing it! I had to call my dear heart long distance immediately to read her what may be the most hopeful environmental news I’ve heard in my 35 years, that something can transmute horrible toxins. Why aren’t all the environmentalists raving about this and demanding major research on the applications?” C. in VT

“Your recently published book, the Humanure Handbook, is one of the most serious and humorous, well-researched yet humble, and motivating works I have read in a while. My personal research for some time now has focused on how to maintain soil fertility with minimal or no reliance on synthetic fertilizers. While I have focused on soil attributes that provide native fertility, I have known all along that a chunk of the cycle was absent. If you could claim credit for engineering the thermophilic decomposers, you would probably win the Nobel Peace Prize.” T.C. in AZ

“From the squatting position, I request a copy of the Humanure Handbook.” E.P. in RI

“I already knew that composting human waste made sense, and I had been looking for more practical information. Your book was exactly the information I was looking for, and it inspired me to put the ideas into action.” B.C. in NYC, NY

“Thank you for putting the time, energy, [and] money into creating this unique, needed book. Your wit, wisdom, factual references and above all, your personal experience, make it a great and encouraging work.” C.L. in NY

“Thank you for providing the information on dealing with shit in a responsible manner. As you know, the simple logic and responsible actions outlined in your book are rare in our society.” J. in AK

“I recently read and thoroughly enjoyed your Humanure Handbook. I am an engineer who currently designs services, including sewers, for new developments. In recent years, however, I have become convinced that the way we deal with humanure, as you call it, is not far short of ridiculous. So, I have begun to educate myself about alternative ways of treatment and reuse.” D.C. in Canada

“Thank you for your wonderful book about an environmental threat most people are unwilling to discuss, yet contribute to daily.” P.K. in NH

“I have taken three dumps since finishing the Humanure Handbook, and all of them have been in plastic buckets and have been covered with sawdust.” M.W. in WA

“You’re right, it is the shittiest book I’ve ever read — but it’s great! Have been a composter for a long time, but you showed me some new tricks.” R.H. in WY

“I want to thank you all so much for the ‘pioneering’ work you have done with humanure and writing the Humanure Handbook . . . with the information you have provided I can complete the cycle.” R.B. in FL

“I . . . spied an ad for your book, the Humanure Handbook . . . up until that point, it had only been a dream to somehow use my waste for fueling something that is necessary for my way of life. Now I have hope for a better future for myself, my family, and for the generations that will live on in this world after me.” O.M. in CA

“A little over a year ago . . . I was in Guatemala . . . when I came upon a certain Humanure Handbook being carried around. I only had access to the book for less than one day, but . . . I devoured it, became a proselytizing devotee of the composting method and thermophilic bacteria and I am forever grateful to you for your amazingly thorough research and easily readable and digestible book.” R.T. in CT

“Thank you for putting out such an important book . . . it feels good to know that there are fellow humans out there that realize that there is a way, a healthy way, to our actions that is good for all.” D.D. in Canada

“Really enjoyed your book! As a public health person and 25 years as an organic gardener, the content was great.” J.P.

“I am stupefied after reading your turdly book! What a masterpiece of modern literature. A real wake-up call for human types. In the future, I intend to follow all of your sensible suggestions and have a sawdust toilet.” W.K. in AZ

“Your book was extremely well-written and answered all the questions I had been having for several years. I knew that somehow there was some missing info about what to do with all the ‘do-do’.” R.L. in FL

“I just picked up the Humanure Handbook. It is full of humor, pluck, good advice and spirit. Someone I know locally has been championing your system for the past year. I’ll have to try it myself.” M.Z. in CA

“I’m almost done reading your book. Terrific. It definitely goes on a shelf next to How to Keep Your Volkswagon Alive and a few other ‘anybody-can-do-this’ type treasures. You’ve got me convinced. I’m partway through building a new house, and I’ve penciled in where the bucket will go.” D.B. in MN

“For many years, I have wondered why we can use cow and horse and pig manure for our gardens, but not human manure. I showed this article to my father who was raised on a farm and he almost gagged. He couldn’t even finish reading the article. I guess you’d call him a fecophobic. Could you mail the handbook in a wrapper that has no mention of ‘humanure’? I live with my parents.” M.C. in CO (future composter)

“I recently purchased your Humanure Handbook. It is fabulous. I want to give it to EVERYONE. Please send me four more.” L.F. in CA

“I have just finished your book . . . and I’m still wiping the tears off my face from laughing so hard. I never thought a book about human excretion could be so humorous, as well as very informative!” A.R. in OH

“I heard so many good things about the book while in the United States for summer holiday . . . that I combed all the bookstores for a copy of it. I am happy to report I have suffered no buyer’s remorse since the purchase. The book is extremely moving, in all sorts of ways. When I leave the urban desert, I plan to practice what you preach in the book. Even more exciting is the prospect that your book has darn near sold my wife on the idea,

too. When she sees the system you describe in action, I know she'll make the final step onto the bandwagon." D.G. in Abu Dhabi (United Arab Emirates)

"We had been looking for some info about safely composting our do-do for some time. Your book was a blessing and please know that it was an easy, fun read. Got the toilet installed day before yesterday and built a bin yesterday. Thank you for all of your hard work in doing the research and letting us all know that we are not alone in our way of living a more civilized way than the present barbaric generation we find ourselves among. What you have given us is the info we have been seeking, which empowers us to make an almost perfect circle with our resources." R.L. in FL

"Two things you might be interested in: a more natural way to eliminate is in the squatting position (supports the colon and all that shit). Maybe you might show (or offer the thought to future readers) of raising the knees higher — a step (simple block of wood, or big rock might be one solution). Also, more (food?) for thought. Urine is not a waste product. It is from the blood in our body. The excess nutrients and minerals that the body does not need at that moment has been filtered out (how marvelous). Taking urine internally has been going on for some time (1000s of years) and by many is considered a wonderful medicine. (Reading: 'Your Own Perfect Medicine') I take my first urine daily. Also, urine is used today in Murine's Ear Wax Removal, hand creams and other [products]. Now is that full of crap . . . or is it?" W.E. in OH

"Your book saved my butt at a town council meeting yesterday. Thank you for writing it." D.W. in CO

"With raised beds and numerous compost piles, it was only natural to be loaned a copy of the Humanure Handbook (carefully handed to me in a plain brown paper bag at church last spring). Great research, clear writing and terrific humor! I really should return that copy, so please send me one." L.U. in WV

"For over 40 years we have lived a more 'natural' way of life. Now the 'Authorities' are making it known we must conform to more (according to their beliefs) appropriate ways. He is 88 and I'm 77 — we need this help now! Please send us a copy of the Humanure Handbook." E.P. in NH

"As parasites attached to the Earth, it would seem that the only conscious thing we do that isn't killing the host, is manuring in the woods, fields or [in] a composting toilet." D.G. in MN

"In the past month I've made two humanure converts, both single women (living separately), both organic gardeners, both professional cooks. The biggest lure for them was the quality of my garden, and the opportunity to avoid purchasing fertilizer and soil

amendments. Now they're hooked, preaching to their friends. Could be the start of a Big Movement." L.W. in WA

"I have just finished your book, which I found in somebody's house near Plettenberg Bay in South Africa. It took me four hours, cover to cover, and it's 3 a.m." A. M-J. in South Africa

"I just got your Humanure book and want more! We are trying to educate the Commissioners and public regarding doing the right thing and your book is timely!" T.P. in NJ

"Could you send me a copy all the way to Guatemala? Communities are ready to start a composting toilet project . . . send it as soon as you can." T.B. in Guatemala

"I liked your book. Putting back nutrients after taking them away makes sense as well as the image of dropping a turd in a five gallon toilet filled with pure drinking water seems crazy." T.O. in NH

"I work in a number of ways with state agencies that 'regulate' compost and land applications of biosolids. I will read your book with an eye toward putting copies in numerous hands — from bureaucrats to legislators to environmentalists — and more." D.R. in TX

"We are just beginning on the adventure of 'recycling' all of our human waste, including manure. And there is so little written that is available — I'm really glad that you took the time to write about your experience." D.P. in CA

"We're a couple of kids (late 60s-early 70s) pursuing composting. It's the only sensible and logical way to go." C. K-L. in OR

"I found your book entertaining, informative, and a great motivating force compelling us to start recycling our 'humanure' immediately. Having grown up with outhouses . . . I always thought there had to be a better way." B.W. in TX

"I'm the graduate student you just sent a copy of your handbook to. The book and resource list have both been just what I needed. I'm trying to get my parents thinking about composting their 'reusable' body materials (they already compost kitchen scraps, as I do). They are in the country with a very shallow well. They are already short of water and their troughs used to catch rain are dry. Dad is a Parasitologist, so you know he'll want to make sure the stuff heats up right. I would like to buy them one of your books. That'll make a good birthday present for Pops." S.M.

“We have a cabin in the mountains of North Central Washington that is off the grid, off the road and off just about everything. My wife and I spent Thanksgiving there and at this time of the year the outhouse is very uncomfortable. I believe your book will allow us to move it to more comfortable quarters.” L.V. in WA

“I’ve spent my whole life recycling, reducing and reusing everything but my own shit and I [am] ecstatically grateful to have your directions reach my lap.” W.

“Thank you for your work in the Humanure Handbook. Your ideas have been a real encouragement to me to give composting a try in my sustainable home project. I was impressed by your research, the depth and scope of your study.” J.D.

“The reason I’m writing is because I believe worm-egg phobia is overblown. I’ve been a pig farmer for decades, had probably literally tons of pig manure dumped on me over the years, have had pig manure get inside open bleeding wounds, have had it ‘splash’ into my mouth, and I can say that I’ve never gotten ill from it nor have I had any intestinal problems except when I got my divorce (ulcer). But I can say quite accurately that I’ve gotten ill a few times from eating in restaurants. I ask you, which is more dangerous, restaurant food or hog manure?” R.T. in WI

“Our son’s Pa . . . was the one who tracked down your book . . . got our head librarian to order one for the Islands library and then created his own techniques. He feeds his bucket to several worm bins. They keep up with it . . . and it smells just fine. He also lines his bucket with a brown paper bag. It keeps clean-up easier — and is a great use for a bag that’s had several uses but isn’t fire starter yet. He found an antique porcelain receptacle with a toilet seat half buried in a vacant lot next to us and gifted me with it. A four gallon square bucket fits nicely and gives me over two weeks of use. When its full, I strap the plastic bucket onto my custom-made bike cart and off I go to our neighboring 10 acres where we are moving to this spring. I’ve got a bin set up using pallets on four sides — three narrow pieces of plywood overlapping on top with rubber tires to hold them down (all recycled, naturally). We’ve got huge piles of straw, manure, sawdust matter from the fairgrounds, bales of hay, bags of leaves and then I’ll occasionally bring some kitchen scraps over. My serious winter sprouting gives me root mats after harvesting buckwheat lettuce, wheatgrass, and sunflowers. They are a great layering agent in our worm bins. I must say — this is very exciting to us — and I can’t wait to dip my probe down into my pile in say, two years. I had to chuckle last week when I came around the corner on my bike with cart and bucket in tow. There was my neighbor directing this huge septic tank down into an excavated hole right next to his house. Everything about his ‘new’ home says toxic to me!” B.L. in WA

“Ah hah!! There is an intelligent lifeform out there. My husband and I have seen your book advertised in Countryside magazine for a good while. I finally came across it at the

local library, checked it out and will eventually add it to our library. Great reading, common sense information, very well researched. We started your sawdust toilet idea at once. We are old dogs, but not too old to know a logical thing when we read it. Thanks, and bless you and yours.” E. & J.C. in OH

“Thank you so much for your book, humorous and well written. We are enjoying it. We have just received it yesterday. We will be posting you the pictures of our composting toilet on the beach this week. And again many thanks.” G.F. in Indonesia

“Humanure and the potential for large-scale . . . even a city size composting collection (apartment building toilets into a central collection dumpster), along with the crimes of the so-called ‘septic system,’ has become one of my most favored topics of conversation and promotion. Often through direct exposition at our farm. Many thanks for your noble work of art and contribution to this stinky species of ape.” R.T. in CT

“I couldn’t resist writing you to say how much I enjoyed your book. Normally I can’t absorb the written word very easily, but I soaked yours up, which I guess is rather appropriate. I’ve been composting for several years now. Robotically and indifferently at first, but gradually developing to a level which I can only describe as obsessive. I bore everyone silly talking about it — except my fellow composters, that is, and there are several around here. As I got more into it, I found myself thinking about the possibility of composting bodily harvests, until it got so every time I sat on the loo and performed, I was begrudging every turd! Becoming more and more conscious of the waste and stupidity of the whole system with every plop, the idea slowly formed in my mind that perhaps I could do something about it. Reading your book clinched it. I have resolved to pull out of the mainstream sewage system, hence the ordering of the most capacious compost bin I could find. As the rest of my family find the idea abhorrent (ha, ha — in their lifetime it will most likely become law!), I’m forced to go it alone.” J.M. in England

“As a small publisher and writer, I don’t often take the time to write fan letters and testimonials, but this is both. We’ve lived on a small island in the Pacific coastal rainforest for 20 years and have been composting/mouldering our shit since we moved here. We’re glad to have some new arguments to use from your book as, over the years, a few guests weren’t too enthusiastic about our system.” C.H. in Canada

“We’ve read your book from cover to cover and are planning to implement it this summer when we move to our paid-for place in the country. Thanks for the great information. I publish a Christian Homesteading magazine. We will [also] be publishing a special newsletter devoted to Y2K problems . . . deal[ing] with the nitty-gritty, how-to preparedness topics and Humanure compost toilets will fit right in.” J.E.

“We live in Mexico in the high desert of San Miguel de Allende where the water is

precious and the soil is lousy. You've solved two of our biggest problems . . . My husband is so FECOPHOBIC, that he swears he neither shits nor farts. Getting him sold on the idea will be a problem. Any suggestions? I, of course, will be the one to empty the bucket." L. in Mexico

"Recently a friend of mine lent me a copy of your book *The Humanure Handbook*. To say that I enjoyed and found useful the contents and message of the book would be a considerable understatement. And in short i would very much like to purchase a copy of my own. Thank you for all your time and effort in making this information available." Rev. H.G. in CA

"Great book! I really loved it. We are soon to move to a new house. I can't wait to start composting humanure. Thank you for all the information in the book. It will sit on a special shelf in the bathroom — reading material for those occupied in communing with nature!" B.C.

"Twelve years ago, I designed and built a solar powered home, and have been repeatedly told (so I now believe) that I am a very creative person. So, as I was reading your incredibly inspiring, well-written, humorous, and innovative book, I kept asking myself . . . Why didn't I think of this? You are truly a gift from — and to — Mother Earth. Thank you, thank you." O.B. in ID

"I continue to be moved to hilarity by your writing, and the cartoons are pretty good too. Best of all is that your method of killing pathogens and parasite eggs and returning nutrients to the soil is virtually free. We are an environmental education center as well as a land trust community. So far we focus mainly on sustainable building, biointensive gardening, and wildlife management. I have a particular interest in a very simple lifestyle — sort of a radical eco-luddite anarchist type myself. Thanks again for the book!" M.M. in TX

"Your book came up in a search on Amazon.com and here I am, having just finished it, feeling like a man whose universe, at least one little corner of it, has condensed and collapsed, fallen into effortlessness, into rightness like a neutron star, like a compost pile. eureka! refinement! My shit makes sense! at last! Thank you." R.P. (fellow common-senser) in MA

Source: The Humanure Handbook. Jenkins Publishing, PO Box 607, Grove City, PA 16127. To order, phone: 1-800-639-4099.

<http://www.jenkinspublishing.com/>

MENU: [HOME](#) » [Reconstruction](#) » [Recovery](#) » [Renewal](#) » [Survival](#) » [Humanure Content](#)

A word with the Author

"The balance of nature is . . . a complex, precise, and highly integrated system of relationships between living things which cannot be safely ignored any more than the law of gravity can be defied with impunity by a man perched on the edge of a cliff."

Rachel Carson - *Silent Spring*

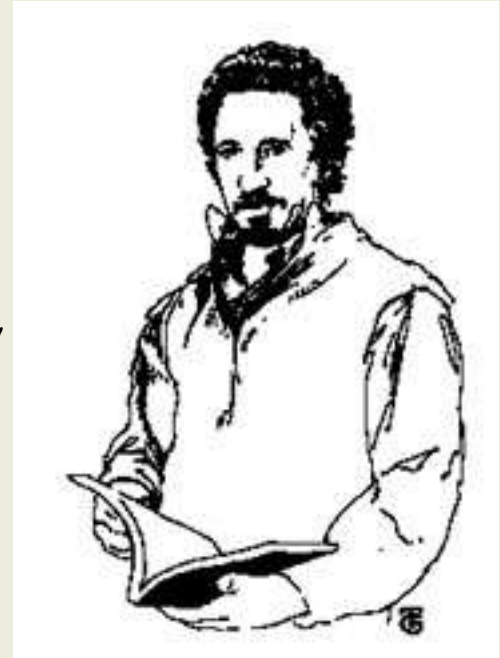

As I was writing this second edition of *Humanure*, I got a phone call from a fellow who was working on a national Community Disaster Preparedness Manual, a project with a federal mandate and federal funding. This project was precipitated by the concerns surrounding the “Y2K” (Year 2000) scenario, which was supposed to be fraught with the wholesale collapse of civilization due to pervasive computer design flaws. Computers would not be able to recognize the beginning of the new century and would just crash. This could result in wide-ranging and possibly prolonged disruptions of electrical, water, food, and fuel supplies, among other things. Or so we were warned.

The authors of this manual had to assume these disruptions could occur for two days, two weeks, or even two months, and the manual had to include instructions for all three of these contingencies.

The people working on this problem seemed to be able to come up with stop-gap solutions for every potential obstacle: food shortages (food can be stored), fuel shortages (wood or kerosene stoves can be used as backup heaters), or no lights (candles would work). There was one problem, however, for which no solution could be found. In fact, the fellow on the phone confided that they were considering abandoning the project altogether, because, in the words of many experts in the field, “it can’t be done.”

What exactly was this impossible problem, you may wonder? In a word — sewage. What do you do when the toilets won’t flush? What happens when the water doesn’t pump and the drains don’t drain? Conveniences like flush toilets are totally dependent upon the electrical grid and completely reliant on a constant water supply. When the electricity is out and water is unavailable, how do you flush a toilet? Answer — you don’t.

When this question was posed to the professionals in the field — wastewater treatment managers, waste management people, and sewage experts, they all drew a blank. One suggested that gravity drains would still work; sewage could be dumped down those drains, eventually reaching a wastewater treatment plant. It could then be heavily chlorinated before being discharged directly into the environment. He admitted this would only work for about two weeks until the chlorine supply ran out, after which the sewage would be released directly into surface waters, totally untreated. He also admitted that wastewater treatment plants only keep about a two week supply of chlorine because it is such a dangerous chemical. After two weeks, in a disaster scenario, raw sewage would be dumped into the environment — a situation that usually precedes the spread of deadly epidemic diseases.

Two things came to mind when I talked to the disaster-manual fellow. First, people need to realize that life as we know it won't continue forever. The environmental repercussions of our consumptive, throw-away lifestyles may catch up to us sooner than we think. Computers crashing may look like a Girl Scout picnic compared to global climate changes, cancer, new epidemics, and other calamities that can now be directly linked to our excesses. People also need to realize how fragile their lifestyles are, hanging by a thinner thread than they can imagine. Some power outages and food/fuel shortages could be a wake-up call for many.

Second, I never cease to be amazed at how thoroughly our society has ignored any constructive alternatives to sewage. We've put all our eggs in the flush toilet basket, and when the toilets won't flush, we're clueless. Ironically, it's this squeamish refusal to look at our own excrement that makes it such a threat to our health and safety. If we can't flush it, since we've developed few alternatives, we just dump it. This is a big mistake, not only because we're discarding valuable organic resource materials, but also because we're polluting our environment in the process, perhaps dangerously so.

So I told the disaster-manual fellow that two five gallon buckets and a large bag of peat moss or sawdust will make an emergency toilet for one person for two weeks. If a compost bin and a steady supply of sawdust or peat is available, that toilet could last indefinitely. With proper oversight and management, that person could be in a Chicago high-rise or in a Boston suburb. But I'm getting ahead of myself.

The point is that we don't know how to deal with human excrement because we don't see it for what it is. It's not a waste material, it's a resource material. When we see it as a resource, we can understand how to recycle it. When we adamantly insist upon seeing it only as a waste material, we're painting ourselves into a corner. By believing we have to *dispose* of that waste, we burden ourselves with an increasingly impossible challenge.

The first edition of *Humanure* went through four printings and around the world to at least 31 countries. It was discussed on British, Canadian, and US airwaves, and on US network TV. It was written up by the Associated Press, and in various national magazines. These are small accomplishments in the publishing world, but significant for a self-published author's first book. Yes, I did say *self-published*. That means I, the author, and I alone, take full responsibility for creating this book, designing it, getting it into print,

marketing it, and making sure it is distributed. I am not a person with deep pockets or an inheritance. I'm a person who writes during the winter months in a small office off my bedroom, at home, in Pennsylvania.

I first published *Humanure* with some degree of hesitancy. After all, composting humanure in America can be as bizarre a concept to some people as the sacrificing of small animals for religious purposes. I wondered how wise it was to publicly admit that I had shat in a bucket for decades. I knew I risked being considered some kind of crank. I imagined Merle at the local hardware store no longer wanting to shake my hand, or making haste to the washroom to scrub his hands immediately thereafter. I wasn't sure I even wanted anyone to *read* the book, and although I knew some people would be fascinated, I just didn't know who or where they were. I estimated that maybe there were 250 people in the US interested in the topic of humanure composting (one in a million), so I printed a small number of books the first time around and assumed they would sit in my garage for the rest of my life until I discovered, one by one, those 250 potential readers.

Was I ever wrong! No sooner had I printed the first batch of books than a friend wanted one. He showed it to his girlfriend, a newspaper reporter, and she showed up at my door — with a camera. In a matter of days, the story of a man composting his family's you-know-what in his backyard was out on the Associated Press, with a huge photo of me poking around in a compost pile with a pitchfork. The TV stations thought this story was newsworthy enough to broadcast, and a friend called to say he saw the book mentioned on the TV morning news. He laughed out loud as he told me of the lady news anchor stuttering when she had to say the word “turd” on TV. Someone should have warned her one of *Humanure's* chapters was titled, “*A Day in the Life of a Turd.*”

Next I got a call from a group of nuns wanting me to do a presentation about humanure at their convent. I never would have expected anything like this, but I obliged them, and they taught me something about spirituality and humility, which is mentioned in Chapter Four. As more time passed, I learned more and more new things from others. In the meantime, I kept selling out of books and doing larger and larger reprints. More speaking engagements popped up. Then the Pennsylvania Department of Environmental Protection told me *Humanure* was nominated for an environmental award. Even the BBC called from London and wanted to do an interview. I seemed to be getting a lot of publicity for a guy who didn't want anyone to read his book.

Then I started to get reader feedback. I suppose people won't write to you if they *don't* like your book, because all of the feedback has been positive. And a lot of it was intriguing enough that I have included “*Reader Feedback*” excerpts throughout this second edition.

Why *did* I write this book, anyway? Probably because I have personally recycled all of my family's humanure since 1979 (twenty continuous years at the time of this writing) using very simple methods. The resulting compost has always been used in our food garden. We have never produced any sewage from our home. Instead, all of our organic residues are carefully recycled by composting and are then returned to the soil, humanure included, thereby maintaining the fertility of our food gardens and

eliminating organic waste altogether.

As I wrote this second edition, I was interviewed by yet another newspaper reporter about my books. The young lady came to my home for the interview and asked, innocently enough, after we were well into the interview, “What do you do with your sewage?”

“We don’t have any sewage,” I replied, matter-of-factly. “I’ve lived here twenty years and we’ve never had any sewage.” The blank look of utter incomprehension on the young lady’s face was worth photographing. She didn’t have a clue, and I don’t blame her. I briefly explained to her that sewage results from the disposal of waste into water, and that when organic materials are instead collected without water and composted, there simply is no sewage. She vowed to cultivate her fledgling understanding of this new concept by actually reading my book. And that, it seems to me, is a good reason for me to have written it.

The more research I did on this topic, the more I realized there was precious little information about humanure recycling in print. It’s no wonder people’s faces go blank when confronted with the concept. Although bits and pieces of information were available, they were scattered about in hard-to-find, obscure references. I knew that where there is ignorance, there is misunderstanding. So I have compiled this information and written this book to try to shed a small ray of light onto what is otherwise a dearth of information. I do not claim, by any means, to have all the answers, but I do hope to be able to provide at least a *starting point* for those who seek information about the topic.

I do not consider myself an “expert.” I make no pretense along those lines. But with 24 years of organic gardening and composting experience, I’ve learned a thing or two which may be of interest to the average reader. I’m sharing those things with you now, and you can digest what you want, and, well, you know what to do with the rest.

By the way, Merle at the hardware store still shakes my hand. And I’m even getting used to his rubber gloves.

JCJ, Winter 1999

Source: The Humanure Handbook. Jenkins Publishing, PO Box 607, Grove City, PA 16127. To order, phone: 1-800-639-4099.

<http://www.jenkinspublishing.com/>

MENU: [HOME](#) » [Reconstruction](#) » [Recovery](#) » [Renewal](#) » [Survival](#) » [Humanure Content](#)

CRAP HAPPENS

Something's About to Hit the Fan

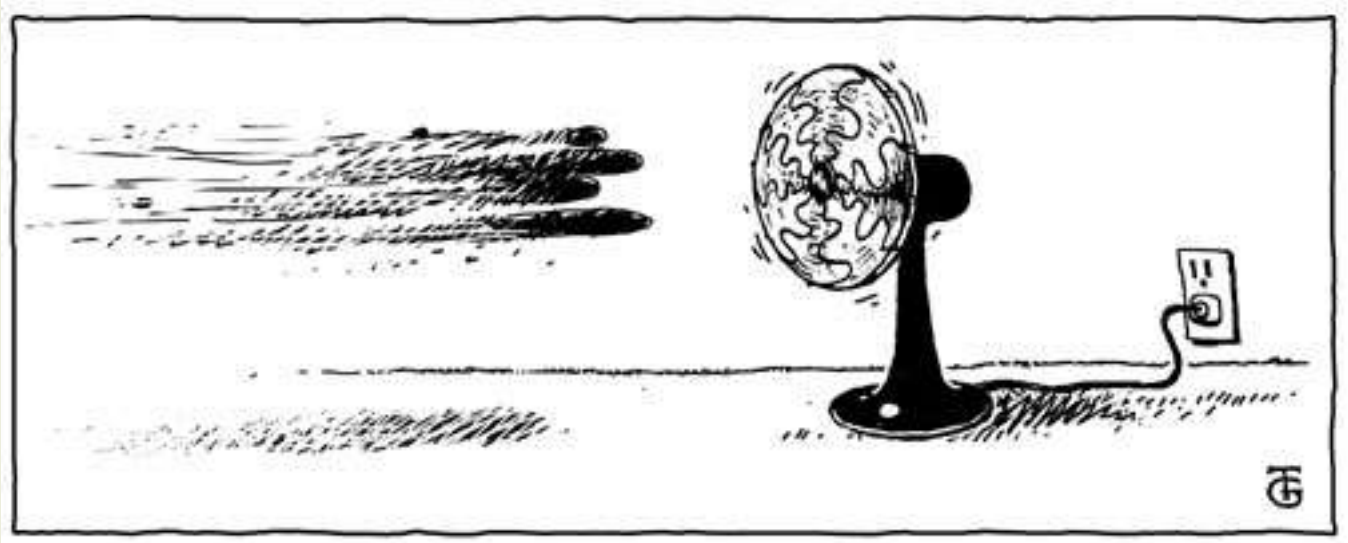

“Human beings and the natural world are on a collision course . . . No more than one or a few decades remain before the chance to avert the threats we now confront will be lost and the prospects for humanity immeasurably diminished.”

1600 Senior Scientists from 71 countries, including half of all Nobel Prize winners, November 18, 1992
World Scientists Warning to Humanity

There is a disturbing theory about the human species that has begun to take on an alarming level of reality. It seems that the behavior of the human race is displaying uncanny parallels to the behavior of pathogenic, or disease-causing, organisms.

When viewed at the next quantum level of perspective, from which the Earth is seen as an organism and humans are seen as microorganisms, the human species looks like a menace to the planet. In fact, the human race is looking a lot like a disease-causing pathogen, which is an organism excessively multiplying, consuming, and producing harmful waste, with no regard for the health and well-being of its host — in this case, planet Earth.

Pathogenic organisms are a nasty quirk of nature, it seems, although they do have their constructive

purposes, namely killing off the weak and infirm and ensuring the survival of only the fittest. They do this by overwhelming their hosts, by essentially sucking the vitality out of them and leaving poisonous wastes in their wake. Pathogens do not give a damn about their host organisms, and they often kill them outright.

This may seem a silly way for a species to maintain its own existence — after all, if you kill the host upon which you feed and upon which your life depends, then you must also die. But pathogens have evolved a special survival tactic that allows them to carry on the existence of their own species even after their host has died. They simply travel to another host, sending out envoys to seek out and infect other organisms even as their main pathogenic population succumbs along with their original host. A man dying of tuberculosis coughs on his deathbed, an act instigated by the infecting pathogen, ensuring that the disease has a chance to spread to others. A child defecates on the dirt outside her home, unwittingly satisfying the needs of the parasites inhabiting her intestines, which require time in the soil as part of their life cycle. A person stricken with cholera defecates in an outhouse which leaches tainted water into the ground, contaminating the village well-water and allowing the disease to spread to other unsuspecting villagers.

In the case of pathogenic organisms that kill their host, the behavior is predictable: multiply without regard for any limits to growth, consume as if there were no tomorrow, and excrete waste products that grievously harm the host. When this is translated into human terms, it rings with a disquieting familiarity, especially as we relentlessly equate human success with growth, consumption, material wealth, and profit.

Suppose we humans are, in fact, exhibiting disease behavior: we're multiplying without regard for limits, consuming natural resources as if there were no tomorrow, and producing waste products that are distressing the planet upon which our very existence depends. Well, there are two factors which we, as a species, are not taking into consideration. First is the survival tactic of pathogens, which requires additional hosts to infect. We do not have the luxury of that option, at least not yet. If we succeed at continuing our dangerous behavior, we also succeed in marching straight toward our own demise. In the process, we can also drag many other species down with us, a dreadful syndrome that is already underway. This is evident by the threat of extinction that hangs, like the sword of Damocles, over an alarming number of the Earth's species.

Second, however, there is one remaining consideration: infected host organisms fight back. As humans become an increasing menace, can the Earth try to defend itself? Absolutely, and in several ways. Number one is climate change, also known as global warming. When a disease organism infects a human

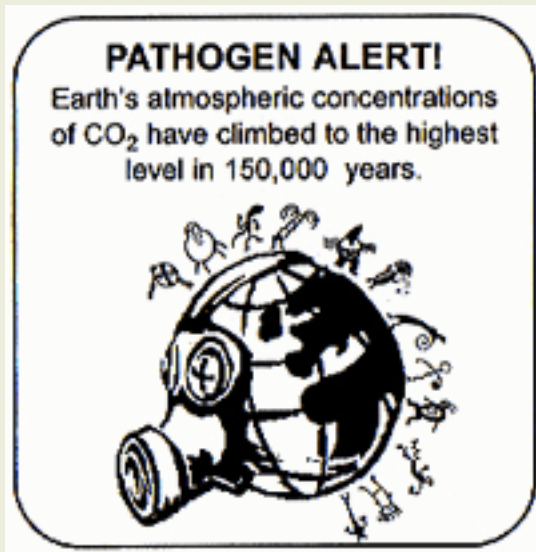

being, for example, one of the defense mechanisms our body deploys is the elevation of its own temperature. This rise in temperature not only inhibits the growth of the infecting pathogen, but also greatly enhances the disease fighting capability within the body. Global warming may be the Earth's way of inducing a fever — as a reaction to human pollution of the atmosphere and human over-consumption of fossil fuels. Sound ludicrous? Don't laugh — read on.

When the internal human body temperature rises, the micro-climate of the body changes, allowing for the sudden and rapid proliferation of antibodies, T-cells, white blood cells, and other defenders against disease. As the *global* climate changes, and as the natural environment chokes with pollution, we humans do

have an idea of what sort of organisms nature can and will suddenly unleash to confront us. They're already beginning to show themselves as insect pest population booms, as well as new strains of deadly bacteria, viruses, and algae particularly toxic to humans.

So Earth's temperature slowly and inexorably rises, and, despite the potentially perilous consequences, humans try to ignore it. Global carbon emissions from fossil fuels are expected to reach nine billion tons per year by 2010,¹ and are expected to raise the Earth's temperature by two to six degrees Fahrenheit in the next century.² The Earth's temperature in 1998 was the highest ever recorded and exhibited the largest annual increase, setting "*a new record by a wide margin,*" according to NASA scientists.³ The 15 warmest years on record have occurred since 1980.⁴ The highest ever sea temperature in the North Atlantic was recorded in 1995, the same year that twice the normal number of tropical storms occurred. Today, ecologists are shocked to see large portions of Antarctica melting, breaking off, and falling into the Southern Sea.⁵ All the while, spokespersons for the fossil fuels industry, the largest economic enterprise in human history, dismiss the frightening evidence as merely environmentalist scare tactics, unsubstantiated by valid scientific proof.

As the planet's temperature rises, it gains a momentum that cannot be stopped, no matter how desperate or repentant we humans may eventually become. The Earth's "fever," like a spinning flywheel, will only subside in *its* own time. With global warming and climate change, we may have created a Frankenstein's monster of astronomical proportions. Unless, of course, we are pathogenic organisms. If so, then we really don't care, do we?

"A great change in our stewardship of the Earth and life on it is required, if vast human misery is to be avoided and our global home on this planet is not to be irretrievably mutilated."

World Scientists Warning to Humanity

Pathogens can often dwell for quite some time within the host organism without causing disease symptoms. Then something happens to spark their growth — they gain a sudden foothold and begin proliferating rapidly. It is at this point that disease effects begin to undeniably show themselves.

Humans began to *strongly* show their pathogenic potential toward the planet during the 1950s, ravenously devouring natural resources and discarding waste into the environment with utter carelessness. Since then, for example, our fish catch has increased by a factor of five, paper consumption by a factor of six, grain consumption tripled, fossil fuel burning quadrupled and atmospheric concentrations of CO₂ have reached the highest level in 150,000 years.⁶

Human consumption can be roughly measured by our output of material goods. Since 1950, the global output of human goods and services grew sixfold. Between 1990 to 1997, human global output grew as much as it did from the beginning of civilization until 1950. In fact, the global economy grew more in 1997 alone than during the entire 17th century.⁷

Now, at the end of the 20th century, our consumptive and wasteful lifestyles have painted a critical global picture. Almost half of the world's forests are gone. Between 1980 and 1995, we lost areas of forestland larger than the area of Mexico, and we are still losing forests at a rate of 16 million hectares a year.⁸ Water tables are falling on every continent from one to three meters per year. Fisheries are collapsing, farmland is eroding, rivers are drying, wetlands are disappearing, and species are becoming extinct.⁹ Furthermore, the human population is now increasing by 80 million people each year (roughly the population of ten Swedens). Such population growth virtually guarantees increased consumption as well as increased waste with each passing year.¹⁰

The damage of human over-consumption shows itself in other ways. Today, half of the coastlines and nearly 60% of the coral reefs on the planet are threatened with overdevelopment, pollution, and overfishing. Although almost no species of ocean fish was overexploited in 1950, now nearly 70% of fish species are either fully exploited or overexploited by humans.¹¹ Oceans and other bodies of water have long been used as dumps by the human species. For example, since 1950, mercury contamination has increased by a factor of five in the Baltic Sea. In the Black Sea, 85% of the marine species have disappeared.¹²

What about extinctions? The natural background rate of extinctions is estimated to be about one to ten species per year. Currently, it's estimated that we're instead losing *1,000 species per year*. More than 10% of all bird species, 25% of all mammals, and 50% of all primates are threatened with extinction. Freshwater fish now face a 37% extinction rate in America, 42% in Europe, and 67% in South Africa.¹³

Plant life is not immune to the forces of destruction that are threatening so many species either. Of 242,000 plant species surveyed by the World Conservation Union in 1997, one out of every eight (33,000

species) was threatened with extinction.¹⁴

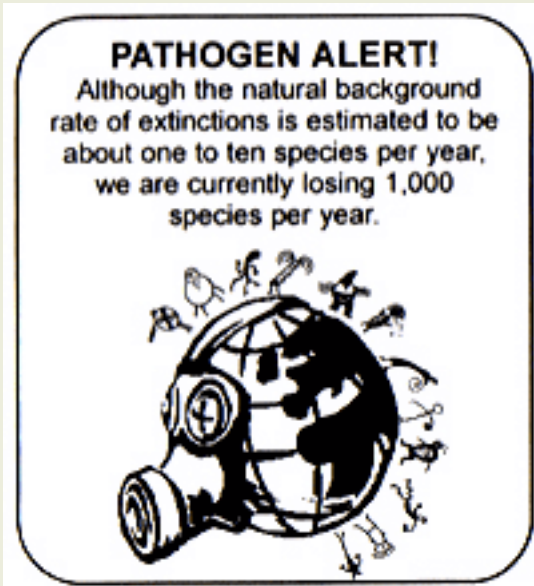

What would drive a species to damage its life support system in this way? Why would we humans disregard our host organism, the Earth, as if we were nothing more than pathogens intent upon its destruction? One answer, as we have seen, is consumption. Somewhere along the line we learned to embrace the idea that more is better, measuring success with the yardstick of material wealth. Some startling statistics bear this out: the 225 richest people in the world (0.000003% of the world's population) have as much acquired wealth as the poorest *half* of the entire human race, while the wealth of the world's three richest people is equivalent to the total output of the poorest 48 countries. We in the United States certainly can raise our hands and be counted when it comes to consumption — our intake of energy, grain, and

materials is the highest on the planet. We Americans can admit to using three tons of materials per month, each of us, and that's not counting food and fuel. Despite the fact that we are only 1/20 of the globe's population, we use 1/3 of the globe's resources. To sustain the entire world at this level of consumption would require no less than three planet Earths.¹⁵

“There is an exceptional degree of agreement within the scientific community that natural systems can no longer absorb the burden of current human practices.”

World Scientists Warning to Humanity

Wanton consumption breeds wanton wastefulness. Since the 1950s, more than 750 million tons of toxic chemical wastes have been dumped into the environment.¹⁶ By the end of the 1980s, production of human-made synthetic organic chemicals linked to cancer had exceeded 200 billion pounds per year, *a hundred-fold increase in only two generations.*¹⁷ By 1992, in the US alone, over 435 billion pounds of carbon-based synthetic chemicals were being produced. In 1994, well over a million tons of toxic chemicals were released into the ¹⁸ environment. Of these, 177 million pounds were known or suspected carcinogens.¹⁹

There are now about 75,000 chemicals in commercial use, and 3,750 to 7,500 are estimated to be carcinogenic (cancer-causing) to humans. That means that one out of every ten commercial chemicals may be cancer-causing — chemicals dispensed into your home via such common household items as aerosols, air fresheners, deodorizers, furniture polish, or the lumber used in the construction of your picnic table.

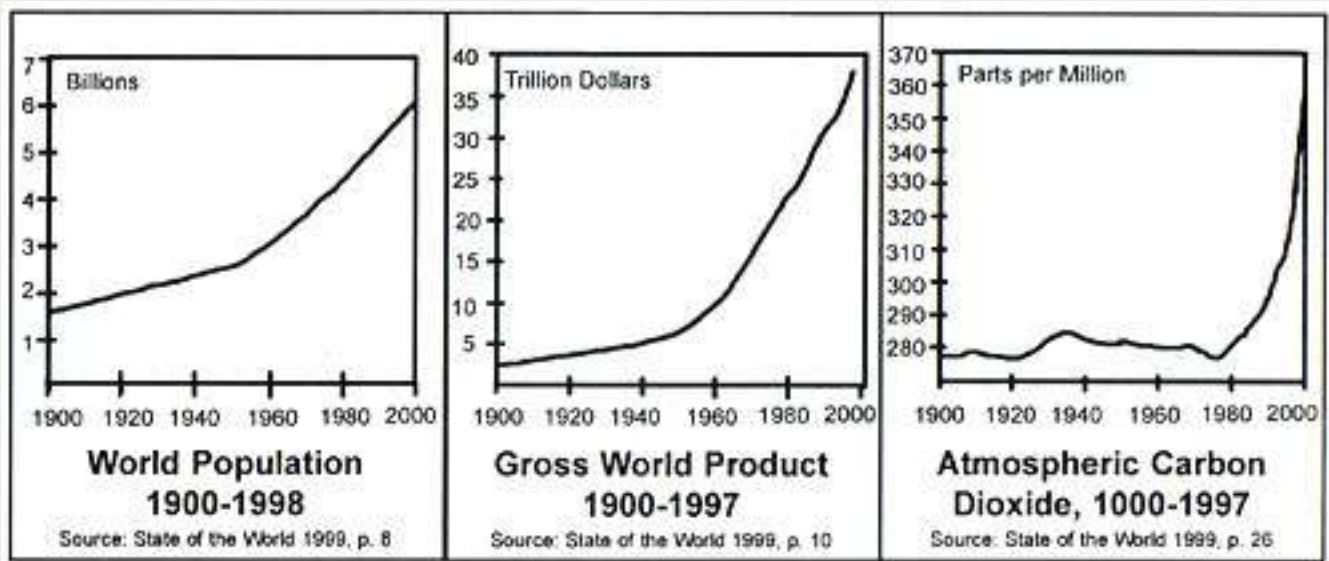

Toxic chemicals have been carelessly dumped into the environment since their creation. Forty thousand of the most notorious dump sites and hazardous waste landfills have been termed Superfund sites. Of these, there are 1,231 “priority” sites, with 40 million people (one in every six Americans) living within four miles of one.²⁰

Today, as a result, 40% of Americans can expect to contract cancer in their lifetimes. I can think of quite a few people, personal friends, who have contracted cancer in the past few years. Marcia, an artist in her mid-forties, got breast cancer a couple years ago and had to have part of one breast removed. Kristin, a school teacher in her mid-forties, and a lifetime organic gardener, also contracted breast cancer last year. Nina (mid-forties) got breast cancer a few years ago and now she has no breasts at all. Kaye (mid-forties), a healthy, Bach Flower Remedy practitioner and natural food advocate, suddenly came down with breast cancer and died. She left several beautiful daughters behind. Sandy, another apparently healthy, slender school teacher in her forties, got cancer of the uterus and had it removed. She never had any children. My mother had lung cancer. Two of my aunts died of cancer. Several of my friend’s fathers have died of cancer, as well as several of my father’s friends. Other friends or their parents have had bouts with cancer, but survived. Some of these were people who lived healthy lifestyles, ate nutritious food, and were active. They still developed cancer. But then, so do animals in the wild, so do fish and sea mammals. Lifestyle seems to have little effect on whether one comes down with the disease. Why? Because there is no escape from the cancer-causing chemicals that now pervade our environment and enter our bodies through the food we eat, the air we breathe, and the water we drink. Even household pets are not immune.

The World Health Organization has concluded that at least 80% of all cancer is attributed to environmental influences. One glaring example of this lies in the fact that industrialized countries have a lot more cancers than countries with little or no industry. Breast cancer rates are thirty times higher in the United States than in parts of Africa, for example. Childhood cancers have risen by one third since 1950, and now one in every four hundred Americans can expect to develop cancer before the age of fifteen. Between 1950 and 1991, incidences of all types of cancer combined have risen 49.3% in the United

States. Cancer is now the second leading cause of death overall, and the leading cause of death among Americans between the ages of 35 to 64. Furthermore, the US EPA projects that tens of thousands of additional fatal skin cancers will result from the ozone depletion that has already occurred over North America.²¹

Cancer is not the only issue associated with the synthetic organic chemicals that we humans have created and have carelessly allowed to pollute the environment. Disturbing new evidence indicates that some of these pollutants mimic natural hormones and can wreak havoc with the endocrine (hormone) systems of many animals, including humans. Male fish are being found with female egg sacs, male alligators with shriveled penises, and *human* male sperm counts are plummeting. Some of these common organic chemical pollutants mimic estrogen, a powerful natural hormone governing the female reproductive system, an excess of which has been linked to cancer. Other chemical pollutants interfere with testosterone, the male sex hormone, or with thyroid metabolism. These chemical pollutants lodge in animal fat cells, traveling up the food chain to concentrate in higher animals — like us. They are becoming increasingly concentrated in human mother's milk, and they cross the placental barrier to enter developing fetuses. It's a well-documented fact that synthetic organic chemical pollutants have traveled far enough to pervade every corner of the world — you may have heard some of their names: dioxin, PCBs, DDT, 2,4-D. *The average person can now expect to find at least 250 of these chemical contaminants in his or her body fat.*²²

Are cancer and endocrine disruption two of Mother Nature's defense mechanisms against organisms that have rudely gone awry? Are they not-so-subtle ways nature tells us that we're doing something wrong? Perhaps, and unfortunately the victims are often the innocent ones who bear no responsibility for the diseased state of the environment.

Our environmental misdeeds may be sowing the seeds of our own destruction in other ways as well. Damaging environmental changes seem to be contributing to the emergence of new toxic organisms, as well as the proliferation of old menaces such as malaria. Fifty new diseases have emerged since 1950, including Ebola, Lyme's Disease, Hantavirus, and HIV.²³ The World Health Organization reports that AIDS (HIV virus) is approaching epidemic proportions in several countries in Africa, and is spreading to India and China.²⁴ Researchers warn of the epidemic potential of the malarial mosquito population should global warming continue.²⁵ Others report epidemic levels of coastal algal blooms, some of which are highly toxic to humans as well as fish, and are directly linked to excessive human pollution.²⁶ Are these disease organisms some of nature's defense mechanisms, emerging in order to attack the human race? Although this is a chilling thought, it's not so chilling as the theory that this is just the beginning of the appearance of new diseases targeting the human race, and that future viruses may be as deadly as the plague and transmitted as easily as is the common cold.

“In effect, we are behaving as if we have no children, as though there will not be a next generation.”

Lester R. Brown

Some would say that it looks like our environment is going to hell in a handbasket. Others would

postulate that the human race is going along with it. Yet there are still those who would scoff at the idea that a tiny organism such as humanity could affect such an ancient and immense being as Mother Earth. This is a ludicrous concept, they argue; the very idea that the human species can be powerful enough to inflict illness on a planetary being is nothing more than egotism. Perhaps. After all, where is there any evidence that a planet can get sick and die? Where could we ever witness a planet that had once possibly teemed with life, where rivers flowed on its surface but long since dried up? Well, how about Mars?

What did happen to Mars, anyway? Our next door neighbor, the Red Planet, apparently was once covered with flowing rivers. What happened to them? Rivers suggest an atmosphere. Where is it? Was Mars once a vital, thriving planet? If so, why does it now appear dead? Could a lifeform on its surface have proliferated so abundantly, so profligately, and so recklessly that it deleteriously altered the planet's atmosphere, thereby knocking it off-kilter, and, in time, killing it? Is that what's happening to our own planet? Is it our legacy in this solar system to leave behind another dead rock to revolve around the sun? Or will we simply destroy ourselves while the Earth, stronger than her Martian brother, overcomes our infection and survives to flourish another billion years?

The answer, if I may wildly speculate, is neither — we will destroy neither the Earth nor ourselves. Instead, we will learn to live in a symbiotic relationship with our planet. To put it simply, the human species has reached a fork in the road of its evolution. We can continue to follow the way of disease-causing pathogens, or we can chart a new course as dependent and respectful inhabitants. The former requires only an egocentric lack of concern for anything but ourselves, living as if there were no tomorrow, as if there will be no future human generations. The latter, on the other hand, requires an awareness of ourselves as a *dependent* part of a Greater Being. This may require a hefty dose of humility, which we can either muster up ourselves, or wait until it's meted out to us, however tragically, by the greater world around us. Either way, we have to collectively make a decision, and the time is running out.

Fortunately, many competent people are already aware of and working on the problems touched upon in this chapter. Each of these problems is a piece to a puzzle, and each of them, when addressed individually, adds up to an overall solution. Like ants, we each work away at our particular areas of concern, doing our tiny bit to be a part of the solution to these problems, whether they be toxic waste, water pollution, global warming, cancer, or species extinctions.

It is ironic, however, that we humans have consistently ignored one problem that is very near to each of us — one waste issue that all of us contribute to each and every day — an environmental problem that has stalked our species from our genesis, and which will accompany us to our extinction. Perhaps one reason we have taken such a head-in-the-sand approach to the recycling of human *excrement* is because we can't even talk about it. If there is one thing that the human consumer culture refuses to deal with constructively, it's body excretions. This is the taboo topic, the unthinkable issue. It's also the one we are about to dive headlong into. For *waste* is not found in nature — it's strictly a human concept, a result of our own ignorance. It's up to us humans to unlock the secret to its elimination. Nature herself provides us with the key, and she has held it out to us for many thousands of years.

Source: The Humanure Handbook. Jenkins Publishing, PO Box 607, Grove City, PA 16127. To order, phone: 1-800-639-4099.

<http://www.jenkinspublishing.com/>

MENU: [HOME](#) » [Reconstruction](#) » [Recovery](#) » [Renewal](#) » [Survival](#) » [Humanure Content](#)

WASTE NOT WANT NOT



“WASTE: . . . Spoil or destruction, done or permitted, to lands, houses, gardens, trees, or other corporeal hereditaments, by the tenant thereof, to the prejudice of the heir, or of him in reversion or remainder . . . Any unlawful act or omission of duty on the part of the tenant which results in permanent injury to the inheritance . . .”

Black’s Law Dictionary

America is not only a land of industry and commerce, it’s also a land of consumption and waste, producing between 12 and 14 *billion* tons of waste annually. Approximately 210 million tons of that total constitutes our annual production of Municipal Solid Waste (MSW), which is the trash each of us personally throws “out” every day.¹

Much of our waste consists of *organic* material including food residues, municipal leaves, yard materials, agricultural residues, and human and livestock manures, all of which should be returned to the soil from which they originated. These organic materials are very valuable agriculturally, a fact well known among organic gardeners and farmers.

What does “organic” mean? The answer is interesting, as there are two opposing sides to this issue. Organic farmers and gardeners contend the word “organic” means that synthetic chemicals are not used

in farming or gardening processes. Chemists chuckle at this interpretation of the word, because in chemistry, “organic” is defined simply as any molecule containing carbon atoms. Many synthetic chemicals are therefore considered “organic” by the chemists of the world, simply because they contain carbon. When a chemist really wants to irk an organic gardener, he simply argues that his synthetic organic compounds (pesticides, for example) are “organic” by definition, and that his chemical garden therefore qualifies as “organic” as well. Technically, both sides are correct, although there is a huge distinction that must be taken into consideration.

Carbon is the basic building block of life. When the plant life of millions of years ago became extinct and settled into the earth, it was transformed into “fossil fuels” such as coal, oil, and gas, leaving plenty of carbon embedded in these fuels. These ancient resources have become the basic stock for the petro-chemical industry, which manufactures many synthetic “organic” (i.e., carbon-bearing) chemicals, including the 2.23 billion pounds of synthetic organic pesticides Americans use each year.² Technically, these chemicals *are* “organic” because they’re derived from what was once plant life.

The ancient chemical stocks are altered and synthesized in laboratories to be *similar* to the physiological chemicals of today, which is why they work so well at killing insects and plants — they can enter their living systems and wreak havoc. Many synthetic organic chemicals make their way into human bodies as well, accumulating in the fat cells and fooling the body into thinking they belong there. They don’t.

Unfortunately, synthetic organic chemicals can mimic natural human hormones, thereby dangerously interfering with the body’s normal functioning. They can also damage human chromosomes, and cause cancer and numerous other diseases. Although technically “organic” because they contain carbon and are derived from ancient life, synthetic organic chemicals have become an environmental disaster due to their persistence (they hang around a long time in the environment), their pervasiveness (they have spread all over the world), and their ability to interfere with the normal functioning of the bodies of many animals (not just humans). For example, human mother’s milk has consistently shown contamination from synthetic organic chemicals since 1951,³ and the incidence of human breast cancer has risen dramatically since then.

In a nutshell, that is why organic gardeners and farmers won’t touch synthetic organic chemicals with a ten foot tomato stake. Instead, they use only organic materials agriculturally that are from the *current* era (i.e., from things that were recently alive, such as trees, lawns, and animals, although peat may be an exception). Therein lies the difference in definitions of the word “organic.” To a chemist, any molecule that contains carbon is organic, no matter how altered it is from its natural state, but to an organic agriculturist, organic material must be benign and beneficial, not toxic and cancer-causing.

WASTE desperdicios مہملات ゴミ袋 垃圾袋 कृड़ा - कम्कट

ELIMINATING WASTE

“It is difficult to overstate the urgency of reversing the trends of environmental deterioration.”

Feces and urine are examples of natural, beneficial, organic materials excreted by the bodies of animals after completing their digestive processes. They are only “waste” when we discard them. When recycled they are resources, and are often referred to as manures, but never as waste, by the people who do the recycling.

We do not recycle waste. It’s a common misuse of semantics to say that waste is, can be, or should be recycled. Resource materials are recycled, but waste is never recycled. That’s why it’s called “waste.” Waste is any material with no inherent value that is discarded and has no further use. We humans have been so wasteful for so long that the concept of waste *elimination* is new to us. Yet, it is an important concept that must become imbued into human consciousness.

When a potato is peeled, the peels aren’t kitchen waste — they’re still potato peels. When they’re collected for recycling as a resource, no waste is produced. Those of you who separate your organic material for recycling are creating no organic waste — a small but highly satisfying achievement.

Many people, especially compost, municipal, and academic professionals, nevertheless adamantly insist upon referring to these recycled materials as “waste.” This is called the “waste mentality.” Many of the people who are developing municipal composting programs came from the waste management field, a field in which refuse has always been waste. Today, however, refuse is increasingly becoming recognized as the resource it always was. Those of us who recycle are eliminating waste, and the term “waste” should not be associated with us. The use of the term “waste” to describe recycled materials is an unpleasant semantic habit that must be abandoned. If we’re eliminating waste, we should talk like it, and be proud of it.

FUN FACTS

Waste Not — Want Not

America is a land of waste. Of the top fifty municipal solid waste producers in the world, America is fifth in line, being outranked only by Australia, New Zealand, France, and Canada. Although the US population increased by 18% between 1970 and 1986, its trash output increased by 25% during that time period, indicating that as time passes, we become more wasteful as a nation. Today, every individual in America produces about four pounds of trash daily, which will add up to 216 million tons per year by the year 2000, almost ten percent more than in 1988. If this sounds like a lot, sit down for a minute: municipal solid waste (the 210 million tons per year just mentioned) makes up only one percent of the total solid waste created annually in the US. The rest

comes from industry, mining, utilities, and other sources.



Source: Hammond, A., et al. (Eds.) (1993). 1993 Information Please Environmental Almanac.

Compiled by World Resources Institute.
Houghton Mifflin Co. New York. (pp.50-51 and 339).

Following the semantics of the waste mentality, one would refer to leaves in the autumn as “tree waste,” because they are no longer needed by the tree and are discarded. Yet, when one walks into the forest, where does one see waste? The answer is “nowhere,” because the organic material is recycled naturally, and no waste is created. Ironically, leaves and grass clippings are referred to as “yard waste” by some compost professionals, another example of the persistent waste mentality plaguing our culture. Many of us humans are trying to mimic nature by eliminating waste *as well* as the mentality that accompanies it, and many of us are succeeding. Hopefully the composting professionals who are stuck in the waste mindset will eventually jump on the “resource recycling” bandwagon. They should, after all, because compost professionals are the front line of an emerging army of people intent upon eliminating waste. Our species has created the concept of waste. It is up to us to avoid it altogether.

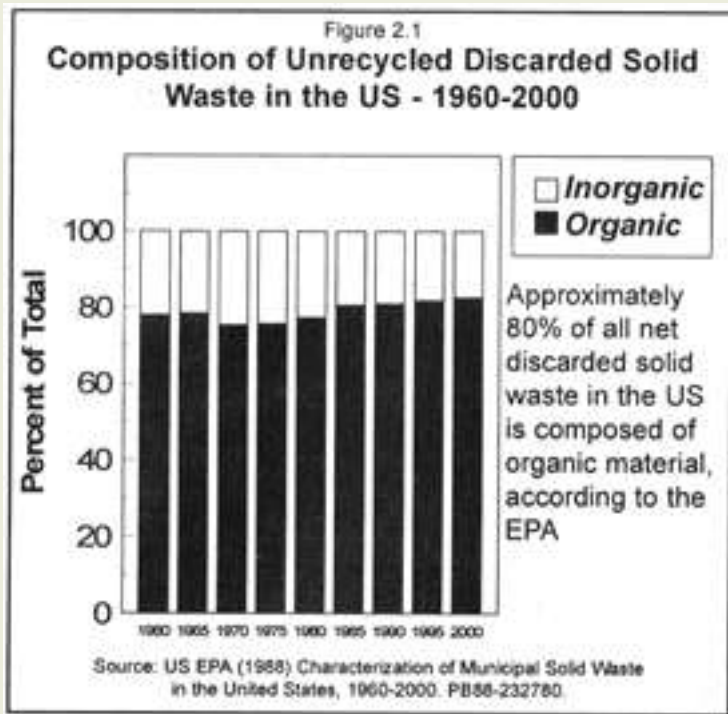

For many years in the United States, when people mowed their lawns, they raked the cut grass, stuffed it into large plastic garbage bags, and set it out on the curbside to be picked up by a garbage truck. The grass was then hauled away and buried in landfills along with the deodorant cans, disposable diapers,

magazines, and the host of other objects of America’s throw-away obsession. Having lived in the country for many years and having had a compost pile since I was first able to dig the earth, I was not aware of this cult-like fanaticism among American suburbanites.

Then one day I visited some friends in the small town near where I live. They were a young couple; he had a Ph.D. and was a professor at the local university and his wife was just finishing her Ph.D.

dissertation. They had just mowed their lawn and had the green bags of grass clippings sitting out along the curb, open, with the contents plainly visible. I looked at the bags, but the sight of *grass clippings* being thrown out as if they were trash was so incongruous to me that, at first, it didn't register, until I did a double-take. "Why are you throwing out these grass clippings?" I asked incredulously.

"We've always done that."

"Why would you do that?"

"That's what you're supposed to do."

"Don't you have a compost pile, for heaven's sake?"

"What's a compost pile? Oh, you mean those big smelly heaps that rats get into? We don't have room for that."

"You can use the grass clippings for mulch," I suggested, as I glanced around their roomy garden, seeing lots of places for compost bins. "Look, see those roses over there? They would love these grass clippings spread around them."

"Nah, we'll just let the municipality take care of our yard waste (emphasis mine)."

At that moment, I realized my poor friends had been working so hard at becoming experts, that they didn't have time to learn about the value of grass clippings. I also suspected that our educational system has been rather remiss in its responsibilities by ignoring fundamental basics of life, such as the need for organic material recycling. After some gentle persuasion, I took the bags and spread the grass around the roses, creating a lovely green carpet, while explaining the benefits of mulch and the powerful soil nutrients resident in grass clippings. My friends watched nervously, but soon relaxed after they realized no one was going to get hurt and no rats were going to jump out at them. I think maybe they learned something valuable that day, but would certainly get no credit for it at their university.

I must give credit where credit is due, however. Many people have realized that the disposal of organic yard and garden material in landfills is unwise, and now, in the US, many states have completely banned the dumping of these materials into landfills. Some of the people who've been responsible for these policies were highly educated, yet they *still* managed to figure it out.

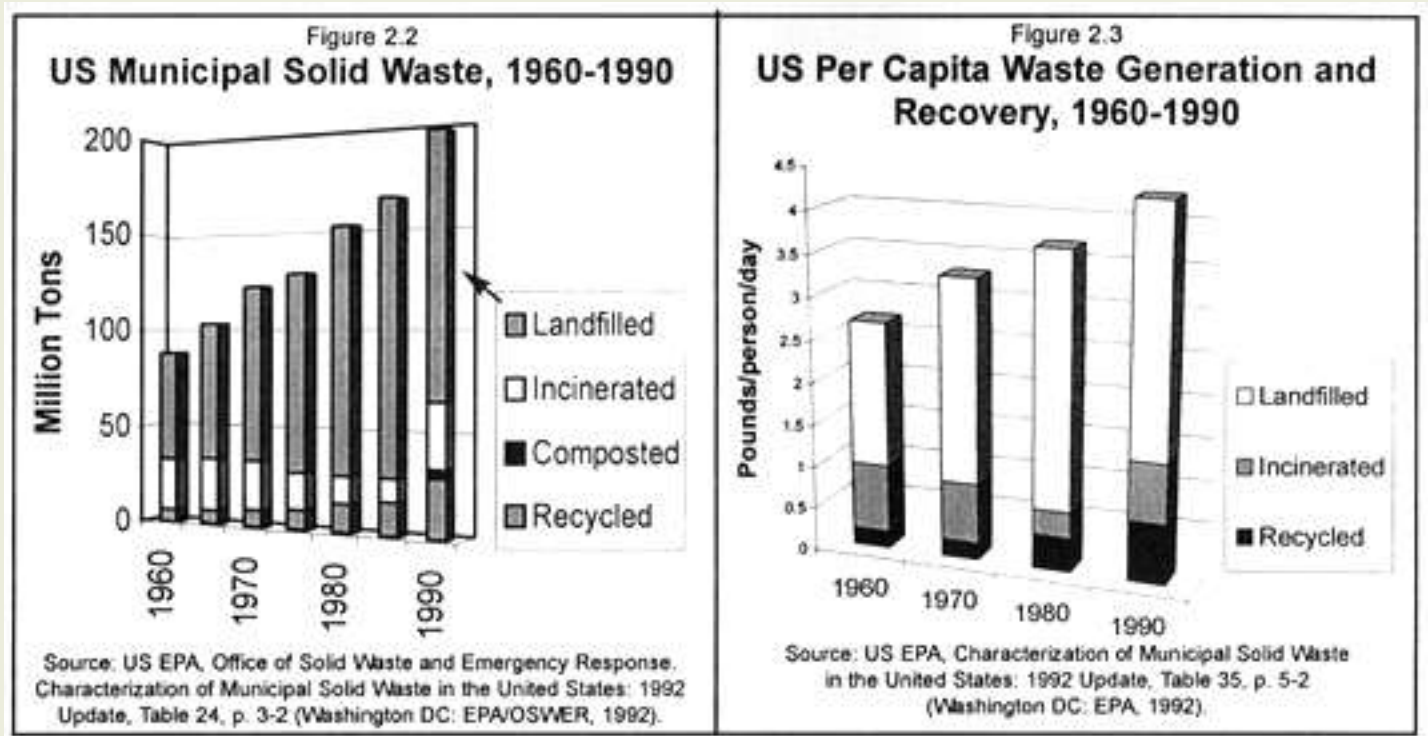

Regardless of the benefits or the hindrances of one's education, we still find no waste in nature. One organism's excrement is another's food — it's that simple. Everything is recycled through natural systems so waste doesn't exist. Humans create waste because we insist on ignoring the natural systems that we are dependent upon. We are so adept at doing so that we take waste for granted and have given the word a prominent place in our vocabulary. We have kitchen "waste," garden "waste," agricultural "waste," human "waste," municipal "waste," "biowaste," and on and on. Yet, our long-term survival as a species requires us to learn to live in harmony with our host planet. This also requires that we understand natural cycles and incorporate them into our day to day lives. In essence, this means that we humans must eliminate waste altogether. As we progressively eliminate waste from our living habits, we can also progressively eliminate the word "waste" from our vocabulary. We can start with the term "human waste."

"Human waste" is a term that has traditionally been used to refer only to human excrements, namely fecal material and urine, which are by-products of the human digestive system. When *discarded*, these materials are colloquially known as human *waste*. When *recycled* for agricultural purposes, however, they're known by various names, including night soil (when applied raw to fields in Asia) and human manure or *humanure*. Humanure is not waste — it is a valuable organic resource material rich in soil nutrients, in contrast to human *waste*, which is a dangerous discarded pollutant. Humanure originated from the soil and can be quite readily returned to the soil, especially if converted to humus through the composting process. Admittedly, humanure is not as benign and easy to work with as grass clippings, but when properly recycled, it makes a wonderful soil additive.

Human *waste* (*discarded* feces and urine), on the other hand, creates significant environmental problems, provides a route of transmission for disease, and deprives humanity of valuable soil fertility. It's also one of the primary ingredients in sewage, and is largely responsible for much of the world's water pollution.

A clear distinction must be drawn between humanure and sewage. Sewage can include waste from many sources (industries, hospitals, and garages, for example) as well as the host of contaminants that seep from these sources (industrial chemicals, heavy metals, oil, and grease, for example). Humanure is strictly human fecal material and urine.

What, in truth, *is* human waste? Human waste is cigarette butts, plastic six-pack rings, styrofoam clamshell burger boxes, deodorant cans, disposable diapers, worn out appliances, unrecycled pop bottles, wasted newspapers, junk car tires, spent batteries, most junk mail, nuclear contamination, food packaging, shrink wrap, toxic chemical dumps, exhaust emissions, the five billion gallons of drinking water we flush down our toilets every day, and the millions of tons of organic material discarded into the environment year after year after year.

Source: The Humanure Handbook. Jenkins Publishing, PO Box 607, Grove City, PA 16127. To order, phone: 1-800-639-4099.

<http://www.jenkinspublishing.com/>

MENU: [HOME](#) » [Reconstruction](#) » [Recovery](#) » [Renewal](#) » [Survival](#) » [Humanure Content](#)

THE HUMAN NUTRIENT CYCLE

“For the living, three things are inevitable: death, taxes, and shit.”

Dan Sabbath and Mandel Hall in End Product

Figure 2.4

THE HUMAN NUTRIENT CYCLE *INTACT* and *BROKEN*

The Human Nutrient Cycle is an endless natural cycle. In order to keep the cycle intact, food for humans must be grown on soil that is enriched by the continuous addition of organic materials recycled by humans, such as humanure, food scraps, and agricultural residues. By respecting this cycle of nature, humans can maintain the fertility of their agricultural soils indefinitely, instead of depleting them of nutrients, as is common today.

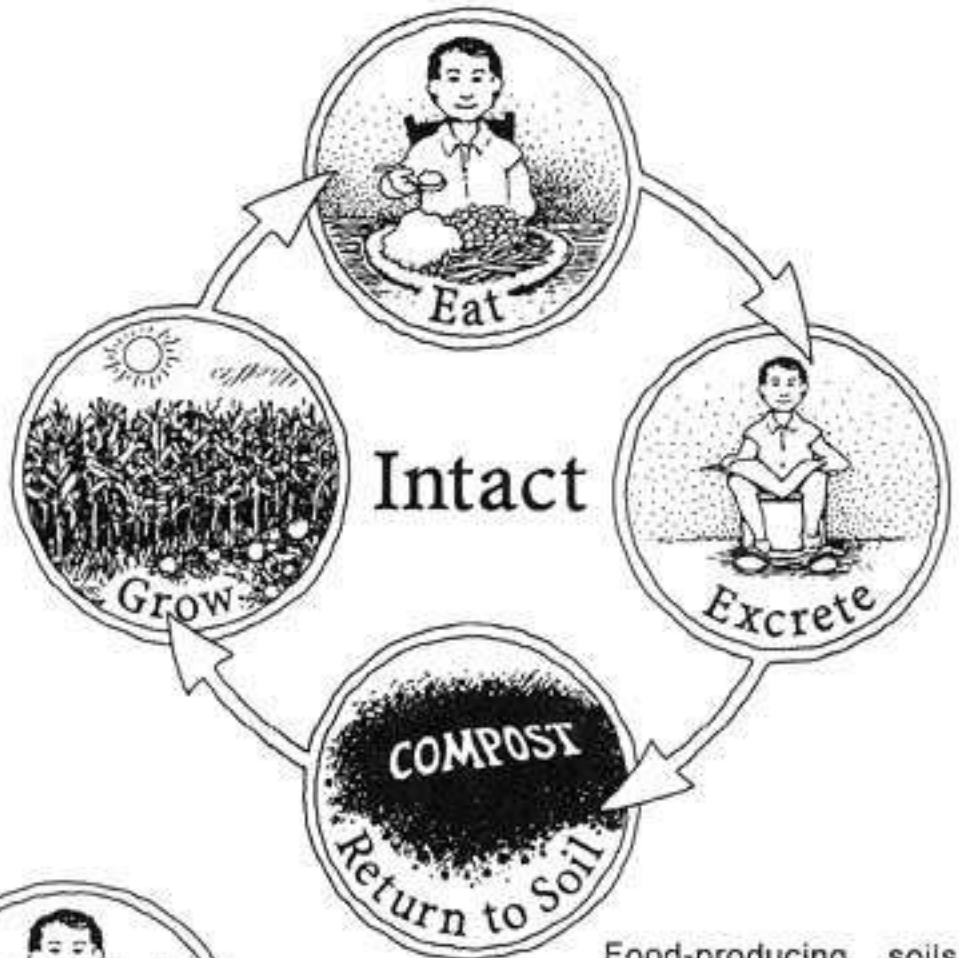

Food-producing soils must be left more fertile after each harvest due to the ever-increasing human population and the need to produce more food with each passing year.

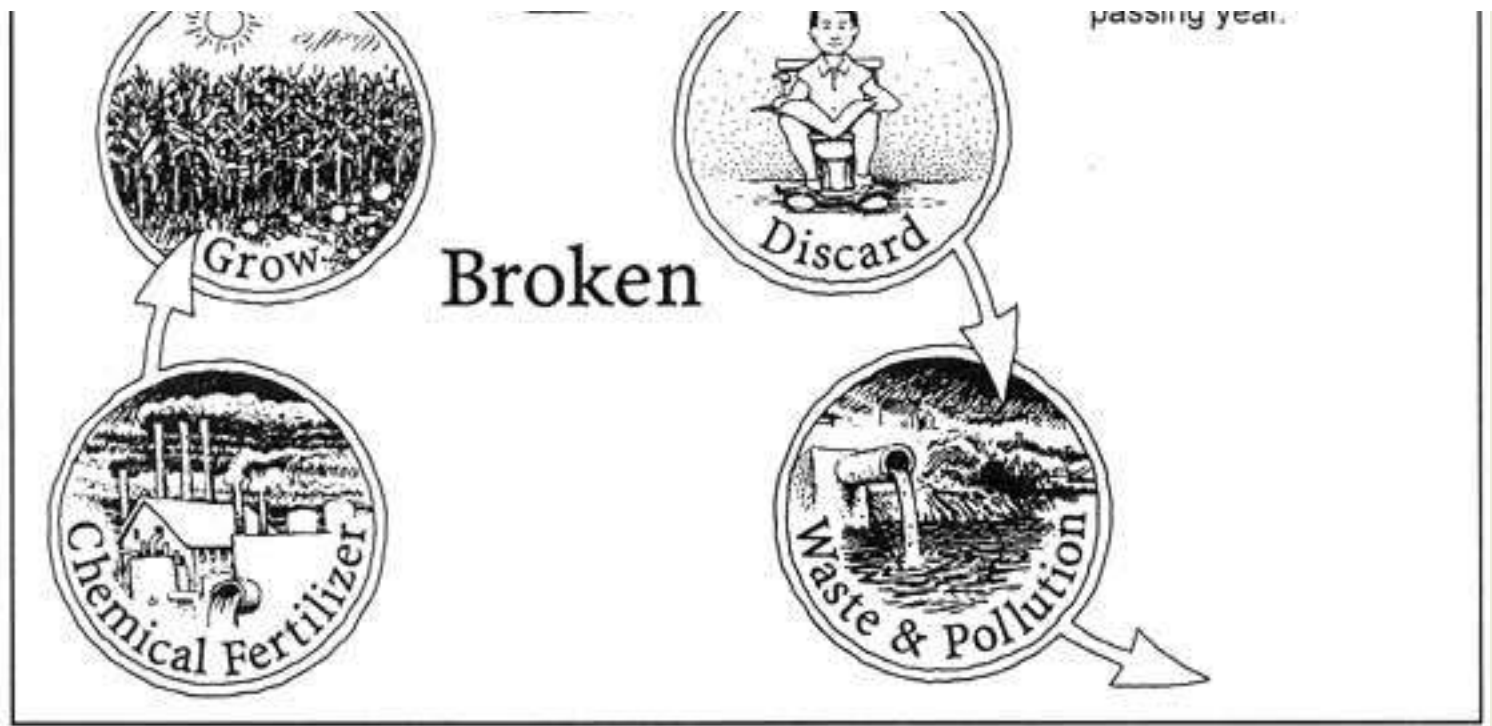

When crops are produced from soil, it is imperative that the organic residues resulting from those crops, including animal excrements, are returned to the soil from which the crops originated. This recycling of all organic residues for agricultural purposes should be axiomatic to sustainable agriculture. Yet, spokespersons for sustainable agriculture movements remain silent about using humanure for agricultural purposes. Why?

Perhaps because there is currently a profound lack of knowledge and understanding about what is referred to as the “human nutrient cycle” and the need to keep the cycle intact. The human nutrient cycle goes like this: a) grow food, b) eat it, c) collect and process the organic residues (feces, urine, food scraps, and agricultural materials), and d) return the processed organic material back to the soil, thereby enriching the soil and enabling more food to be grown. The cycle is repeated, endlessly. This is a sustainable process that mimics the natural cycles of nature and enhances our ability to survive on this planet. When our food refuse is instead discarded as waste, the natural human nutrient cycle is broken, creating problems such as *pollution, loss of soil fertility, and abuse of our water resources.*

We in the United States each waste about a thousand pounds of humanure every year, which is discarded into sewers and septic systems throughout the land. Much of the discarded humanure finds its final resting place in a landfill, along with the other solid waste we Americans discard, which, coincidentally, also amounts to about a thousand pounds per person per year. For a population of 250 million people, that adds up to nearly *250 million tons of solid waste personally discarded by us every year, at least half of which is valuable as an agricultural resource.*

The practice we humans have frequently employed for waste disposal has been quite primitive — we dump our garbage into holes in the ground, then bury it. That’s called a landfill, and for many years they were that simple. Today’s new “sanitary” landfills are lined with waterproof synthetic materials to

prevent the leaching of garbage juice into groundwater supplies. Yet, only about one third of the active dumps in the US have these liners.⁴ Interestingly, the lined landfills bear an uncanny resemblance to gigantic disposable diapers. They are gargantuan plastic lined receptacles where we lay our crap to rest, the layers being carefully folded over and the end products of our wasteful lifestyles buried as if they were in garbage mausoleums intended to preserve our sludge and kitchen trash for posterity. We conveniently flush our toilets and the resultant sewage sludge is transported to these landfills, tucked into these huge disposable diapers, and buried.

This is not to suggest that sewage should instead be used to produce food crops. In my opinion, it should not. Sewage

consists of humanure collected with hazardous materials such as industrial, medical, and chemical wastes, all carried in a common waterborne waste stream. Or in the words of Gary Gardner (State of the World 1998), “*Tens of thousands of toxic substances and chemical compounds used in industrial economies, including PCBs, pesticides, dioxins, heavy metals, asbestos, petroleum products, and industrial solvents, are potentially part of sewage flows.*” Not to mention pathogenic organisms. When raw sewage was used in Berlin in 1949, for example, it was blamed for the spread of worm-related diseases. In the 1980s, it was said to be the cause of typhoid fever in Santiago, and in 1970 and 1991, it was blamed for cholera outbreaks in Jerusalem and South America, respectively.⁵

Humanure, on the other hand, when kept out of the sewers, collected as a resource material, and properly processed (composted), makes a fine agricultural resource suitable for food crops. When we combine our manure with other organic materials such as our food discards, we can achieve a blend that is irresistible to certain very beneficial microorganisms.

The US EPA estimates that nearly 22 million tons of food waste are produced in American cities every year. Throughout the United States, food losses at the retail, consumer, and food services levels are estimated to have been 48 million tons in 1995.⁶ That would make great organic material for composting with humanure. Instead, only 2.4% of our discarded food was being composted in the US in 1994; the remaining 97.6% was apparently incinerated or buried in landfills.⁷

In 1998, industrial countries were only reusing 11% of their organic garbage.⁸ The Organization for Economic Cooperation and Development, a group made up primarily of western industrial countries, estimates that 36% of the waste in their member states is organic food and garden materials. If paper is also considered, the organic share of the waste stream is boosted to nearly an incredible two thirds! In

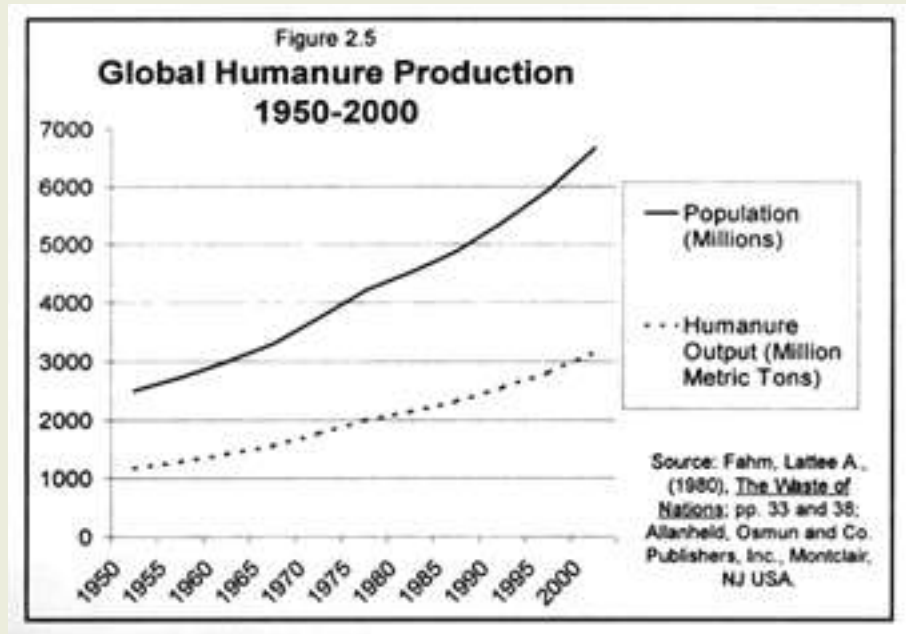

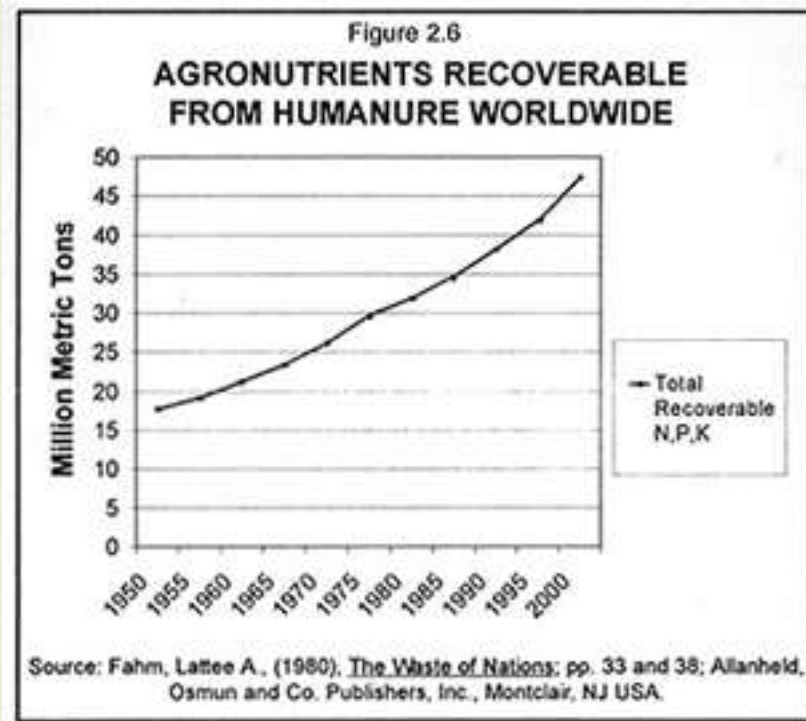

developing countries, organic material typically makes up one-half to two-thirds of the waste stream.⁹ According to the EPA, almost 80% of the net discarded solid waste in the US is composed of organic material (see Figure 2.1).

It is becoming more and more obvious that it is unwise to rely on landfills to dispose of recyclable materials. Landfills fill up, and new ones need to be built to replace them. The estimated cost of building and maintaining an EPA approved landfill is now nearly \$125 million and rising. The 8,000 operating landfills we had in the United States in 1988 had dwindled to 5,812 by the end of 1991. By 1996, only 3,091 remained.¹⁰

In fact, we may be lucky that landfills are closing so rapidly. They are notorious polluters of water, soil, and air. Of the ten thousand landfills that have closed since 1982, 20% are now listed as hazardously contaminated Superfund sites. A 1996 report from the state of Florida revealed that groundwater contamination plumes from older, unlined landfills can be longer than 3.4 miles, and that 523 public water supplies in Florida are located within one mile of these closed landfills, while 2,700 lie within three miles of one.¹¹ No doubt similar situations exist throughout the United States.

Organic material disposed of in landfills also creates large quantities of methane, a major global-warming gas. US landfills are “*among the single greatest contributors of global methane emissions,*” according to the Natural Resources Defense Council. According to the EPA, methane is 20 to 30 times more potent than CO₂ as a greenhouse (global warming) gas on a molecule to molecule basis.¹²

Tipping fees (the fee one pays to dump waste) at landfills in every region of the US have been increasing at more than twice the rate of inflation since 1986. In fact, since then, they have increased 300% and are expected to continue rising at this rate.¹³

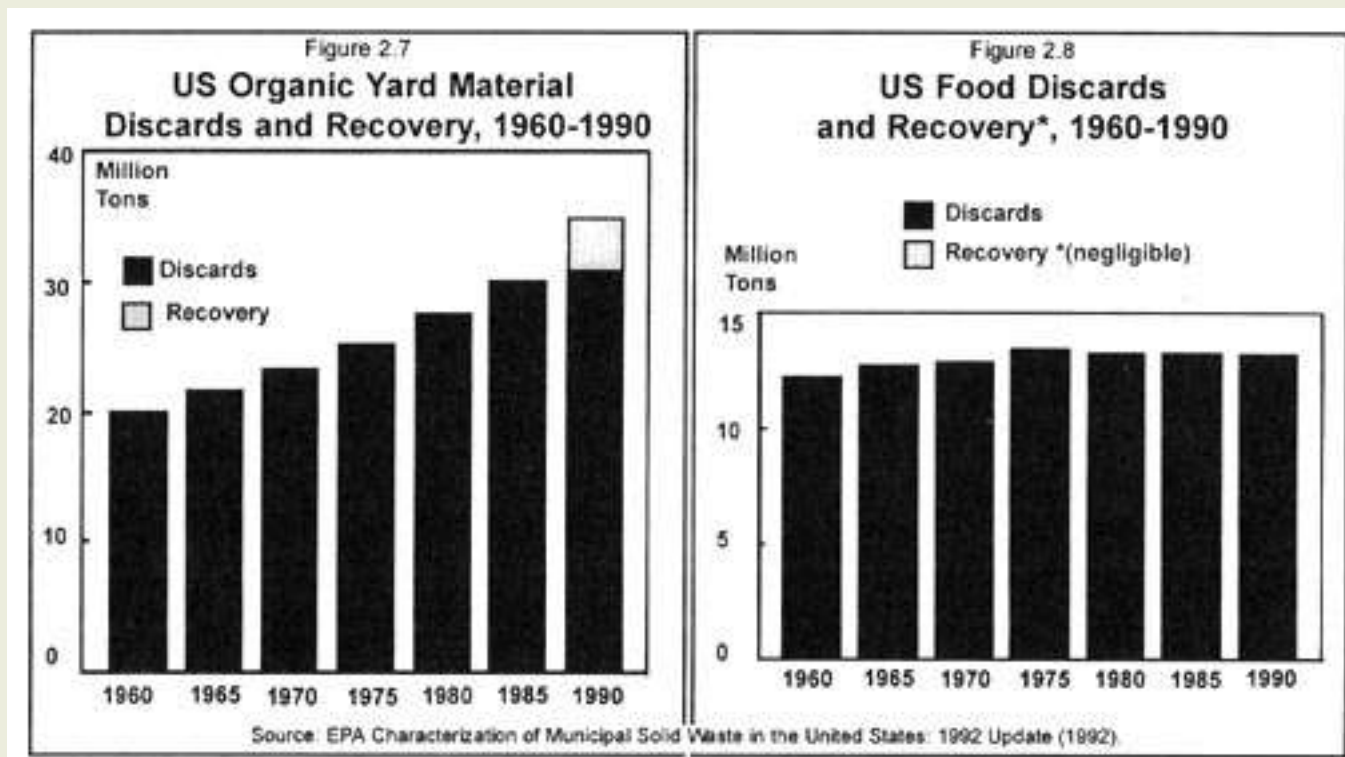

In developing countries, the landfill picture is also bleak. In Brazil, for example, virtually all (99%) of the solid waste is dumped into landfills, and three-fourths of the 90,000 tons per day ends up in open dumps.¹⁴ Slowly we're catching on to the fact that this throw-away trend has to be turned around. We can't continue to throw "away" usable resources in a wasteful fashion by burying them in disappearing, polluting, increasingly expensive, landfills.

As a result, recycling is now becoming more widespread in the US. Between 1989 and 1992, recycling increased from 9 to 14%, and the amount of US municipal solid waste sent to landfills decreased by 8%.¹⁵ The national average for the recycling of all materials in US cities had jumped to 27% by 1998.¹⁶ Composting is also beginning to catch on in a big way in some areas of the world. In the United States, the 700 composting facilities in 1989 grew to more than 3,200 by 1996. Although this is a welcomed trend, it doesn't adequately address a subject still sorely in need of attention: what to do with humanure, which is rarely being recycled anywhere in the western world.

If we had scraped up all the human excrement in the world and piled it on the world's tillable land in 1950, we'd have applied nearly 200 metric tons per square mile at that time (roughly 690 pounds per acre). In the year 2000, we'll be collecting significantly more than *double* that amount because the global population is increasing, but the global land mass isn't. In fact, the global area of agricultural land is steadily *decreasing* as the world loses, for farming and grazing, an area the size of Kansas each year.¹⁷ The world's burgeoning human population is producing a ballooning amount of organic refuse which will eventually have to be dealt with responsibly and constructively. It's not too soon to begin to understand human organic refuse materials as valuable resource materials begging to be recycled.

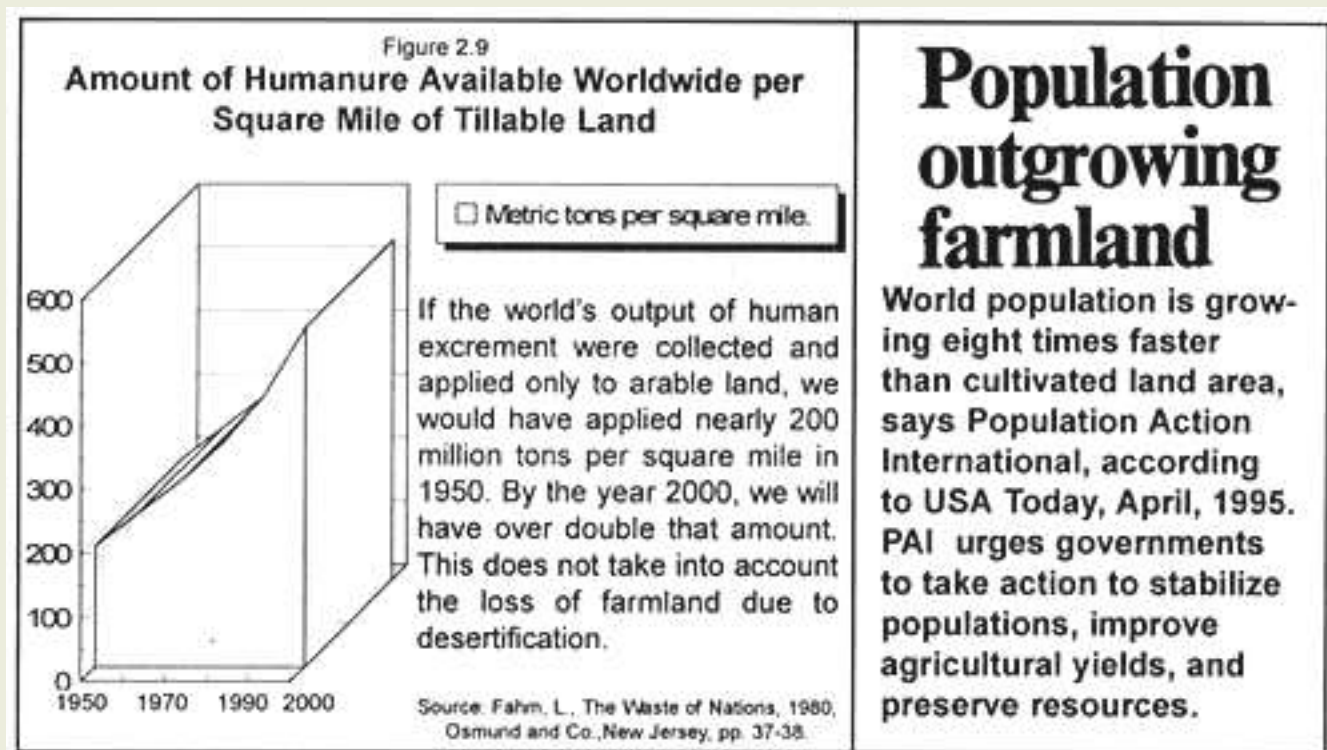

In 1950, the dollar value of the agricultural nutrients in the world's gargantuan pile of humanure was 6.93 billion dollars. In 2000, it will be worth 18.67 billion dollars (calculated in 1975 prices).¹⁸ This is money currently being flushed out somewhere into the environment where it shows up as pollution and landfill material. Every pipeline has an outlet somewhere; everything thrown "away" just moves from one place to another. Humanure and other organic refuse materials are no exception. Not only are we flushing "money" away, we're paying through the nose to do so. The cost is not only economic, it's environmental.

Source: *The Humanure Handbook*. Jenkins Publishing, PO Box 607, Grove City, PA 16127. To order, phone: 1-800-639-4099.

<http://www.jenkinspublishing.com/>

MENU: [HOME](#) » [Reconstruction](#) » [Recovery](#) » [Renewal](#) » [Survival](#) » [Humanure Content](#)

SOILED WATER

“The practice of injecting ‘waste’ products and toxic materials into the arterial waterways of Earth is comparable to the idea of using our own bloodstream as a disposal site for hazardous compounds.”

Keith Helmuth

The world is divided into two categories of people: those who shit in drinking water and those who don’t. We in the western world are in the former class. We defecate in water, usually purified drinking water. After polluting the water with our body’s excrements, we flush the once pure but now polluted water “away,” meaning we probably don’t know where it goes, nor do we care.

Water may cause wars as growth hits cities

The United Nations warned that water shortages created by the world's skyrocketing population and extravagant use could spark wars in the 21st century, according to Reuters News Service in 1996.

This ritual of defecating in water may be useful for maintaining a good standing within western culture. If you don’t deposit your feces into a bowl of drinking water on a regular basis, you may be considered a miscreant of sorts, perhaps uncivilized or dirty or poverty stricken. You may be seen as a non-conformist or a radical.

Yet, the discarding of human organic waste into water supplies obviously affects water quality. By defecating directly into water, we pollute it. Every time we flush a toilet, we launch five or six gallons of polluted water out into the world.¹⁹ That would be like defecating into a five gallon office water jug and then dumping it out before anyone could drink any of it. Then doing the same thing when urinating. Then doing it every day, numerous times. Then multiplying that by about 250 million people in the United States alone.

Even after the contaminated water is treated in wastewater treatment plants, it may still be polluted with excessive levels of nitrates, chlorine, pharmaceutical drugs, industrial chemicals, detergents, and other pollutants. This “treated” water is discharged directly into the environment.

A visit to the local library for a cursory review of sewage pollution incidents in the United States yielded the following:

- In the mid 1980s, the 2,207 publicly owned coastal sewage treatment works were discharging

3.619 *trillion* gallons per year of treated wastewater into the coastal environment.²⁰

- More than 2,000 beaches and bays in twelve states were closed in 1991 because of bacterial levels deemed excessive by health authorities.
- In 1991, the city of Honolulu faced penalties of about \$150 million for some 9,000 alleged sewage discharge violations that were recorded since 1985.²¹
- In 1991, Ohio Environmental Protection Agency fined Cincinnati's Metropolitan Sewer District \$170,000, the largest fine ever levied against an Ohio municipality, for failure to enforce its wastewater treatment program.²²
- In 1991, California was required to spend \$10 million to repair a leaking sewer pipeline that had forced the closure of twenty miles of southern California beaches. The broken pipeline was spilling up to 180 million gallons of sewage per day into the Pacific Ocean less than one mile offshore, resulting in a state of emergency in San Diego County. This situation was compounded by the fact that a recent heavy storm had caused millions of gallons of raw sewage from Mexico to enter the ocean from the Tijuana River.²³
- Environmental advocates sued the city of Portland, Oregon in 1991 for allegedly discharging untreated sewage as often as 3,800 times per year into the Willamette River and the Colombia Slough.²⁴
- In 1992, the US EPA sued the Los Angeles County Sanitation Districts for failing to install secondary sewage treatment at a plant which discharges wastewater into the Pacific Ocean, and for fourteen years of raw sewage spills and other discharges.²⁵
- In April of 1992, national environmental groups announced that billions of gallons of raw waste pour into lakes, rivers, and coastal areas each year from combined sewers. Such sewers carry storm water *and* sewage in the same pipe and tend to overflow during heavy rains, causing many cities to suffer from discharges of completely untreated sewage.²⁶ Combined sewers are found in about 900 US cities.²⁷
- In 1997, pollution caused at least 4,153 beach closings and advisories, 69% of which were caused by elevated bacterial pollution in the water. The elevated bacteria levels were primarily caused by storm-water runoff, raw sewage, and animal wastes entering the oceans. The sources of the pollution included inadequate and overloaded sewage treatment plants, sewage overflows from sanitary sewers and combined sewers, faulty septic systems, boating wastes, and polluted storm water from city streets and agricultural areas.²⁸

It is estimated that by 2010, at least half of the people in the US will live in coastal cities and towns, further exacerbating water pollution problems caused by sewage. The degree of beach pollution becomes a bit more personal when one realizes that current EPA recreational water cleanliness standards still allow 19 illnesses per 1,000 saltwater swimmers, and 8 per 1,000 freshwater swimmers.²⁹ Some of the diseases associated with swimming in wastewater-contaminated recreational waters include typhoid fever, salmonellosis, shigellosis, hepatitis, gastroenteritis, pneumonia, and skin infections.³⁰

If you don't want to get sick from the water you swim in, you can always follow another standard recommendation: don't submerge your head. Otherwise, you may end up like the swimmers in Santa Monica Bay. People who swam in the ocean there within 400 yards (four football fields) of a storm sewer drain had a 66% greater chance of developing a "significant respiratory disease" within the

following 9 to 14 days after swimming.³¹ This should come as no surprise when one takes into consideration the emergence of antibiotic-resistant bacteria. The use of antibiotics is so widespread that many people are now breeding antibiotic resistant bacteria in their intestinal systems. These bacteria are excreted into toilets and make their way to wastewater treatment plants where *the antibiotic resistance can be transferred to other bacteria*. Wastewater plants can then become breeding grounds for resistant bacteria, which are discharged into the environment through effluent drains. Why not just chlorinate the water before discharging it? It usually is chlorinated beforehand, but research has shown that chlorine seems to *increase* bacterial resistance to some antibiotics.³²

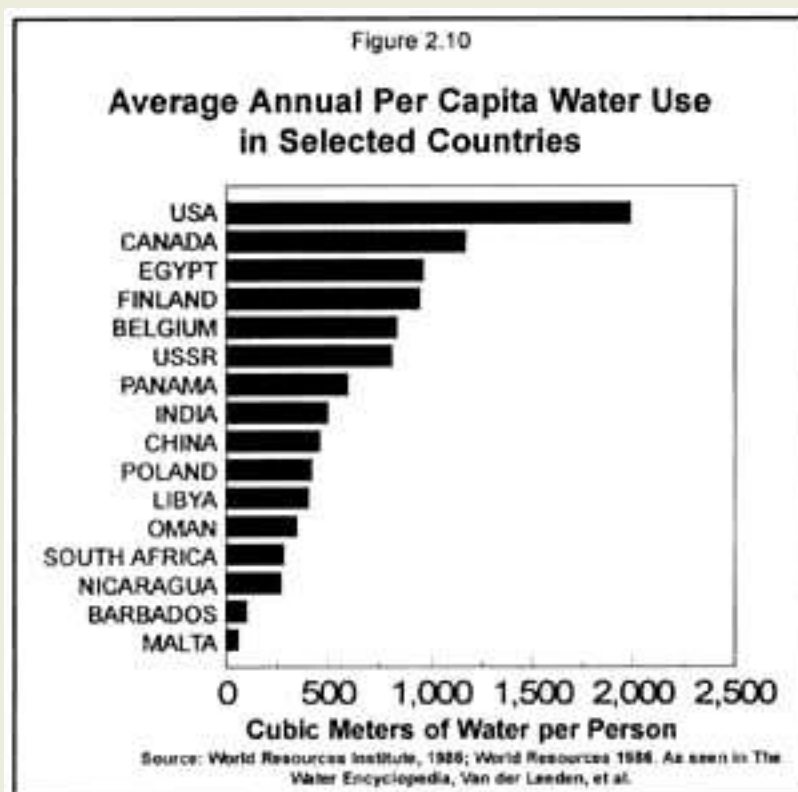

Report: Water bodies remain too polluted

Nearly four out of every ten lakes, rivers, and estuaries remain too polluted to allow fishing, swimming or other aquatic uses at any time of the year, the United States Environmental Protection Agency reported in December of 1995. Sewage, disease-causing bacteria, fertilizer, toxic metals, oil, and grease are among the most frequent pollutants. (Associated Press, 12/15/95)

Not worried about antibiotic resistant bacteria in your swimming area? Here's something else to chew on: 50 to 90% of the pharmaceutical drugs people take can be excreted down the toilet and out into the waterways *in their original or biologically active forms*. Furthermore, drugs that have been partially degraded before excretion can be converted to their original active form by environmental chemical reactions. Pharmaceutical drugs such as chemotherapy drugs, antibiotics, antiseptics, beta-blocker heart drugs, hormones, analgesics, cholesterol-lowering drugs, and drugs for regulating blood lipids have turned up in such places as tap water, groundwater beneath sewage treatment plants, lake water, rivers, and in drinking water aquifers. Think about *that* the next time you fill your glass with water.³³

Long Island Sound receives over a billion gallons of treated sewage every day, the waste of eight million people. So much nitrogen was being discharged into the Sound from the *treated* wastewater that it caused the aquatic oxygen to disappear, rendering the marine environment unsuitable for the fish that normally live there. The twelve treatment plants that were to be completed along the Sound by 1996 were expected to remove 5,000 pounds of nitrogen daily. Nitrogen is normally a soil nutrient and agricultural resource,

but instead, when flushed, it becomes a dangerous pollutant.³⁴

Previous to December 31, 1991, when disposing of US sewage sludge into the ocean was banned, much of the sewage sludge along coastal cities in the United States was simply dumped out at sea. Nevertheless, the city of New York was unable to meet that deadline and was forced to pay \$600 per dry ton to dump its sludge at the Deepwater Municipal Sludge Dump Site, 106 miles off the coast of New Jersey. Illegal dumping of sewage into the sea also continues to be a problem.³⁵ A bigger problem is what to do with sewage sludge now that landfill space is diminishing and sludge can no longer be dumped into the ocean.

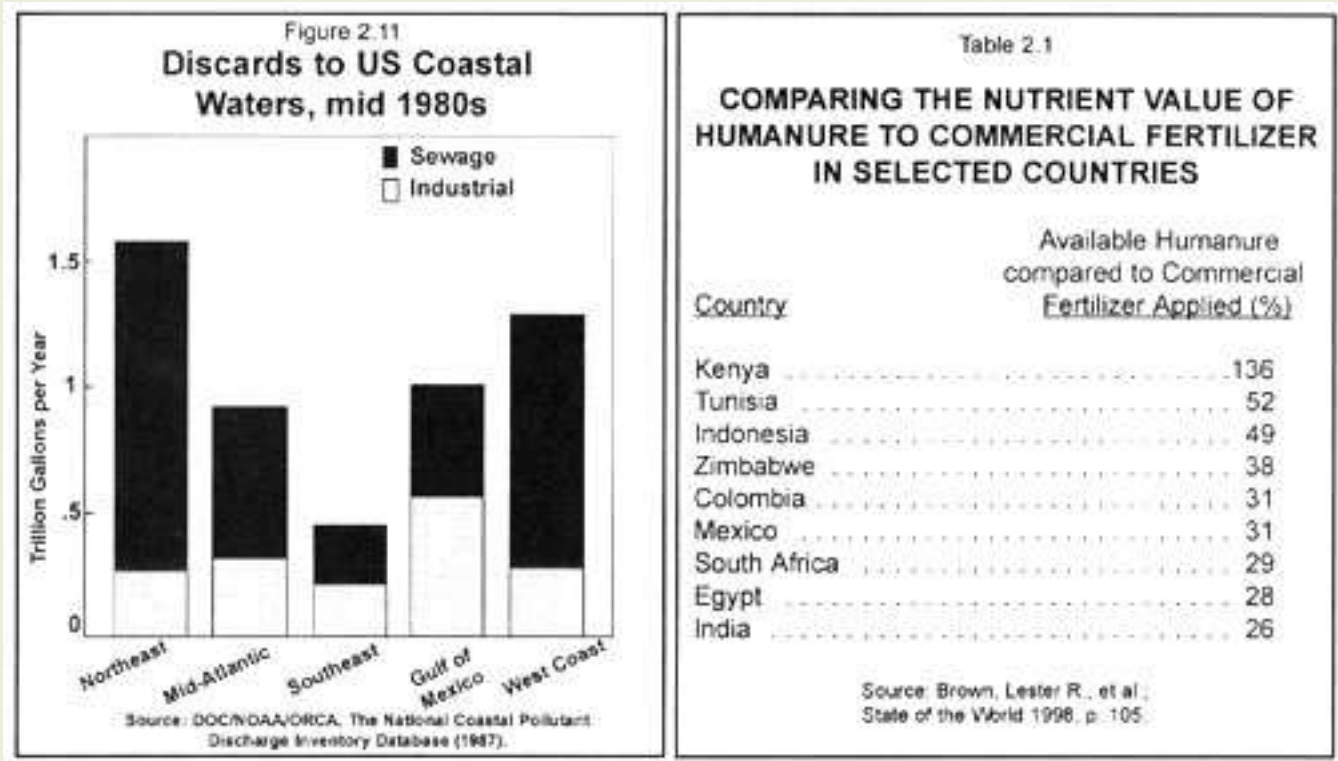

The dumping of sludge, sewage, or wastewater into nature's waterways invariably creates pollution. The impacts of polluted water are far-ranging, causing the deaths of 25 million people each year, three-fifths of them children.³⁶ Half of all people in developing countries suffer from diseases associated with poor water supply and sanitation.³⁷ Diarrhea, a disease associated with polluted water, kills six million children each year in developing countries, and it contributes to the death of up to 18 million people.³⁸ At the beginning of the 21st century, one out of four people in developing countries still lacked clean water, and two out of three lacked adequate sanitation.³⁹

Proper sanitation is defined by the World Health Organization as any excreta disposal facility that interrupts the transmission of fecal contaminants to humans.⁴⁰ This definition should be refined to include excreta *recycling* facilities, as excreta are valuable organic resources which should not be discarded. Compost toilet systems are now becoming internationally recognized as constituting "proper sanitation," and are becoming more and more attractive throughout the world due to their relatively low cost when

compared to waterborne waste systems and centralized sewers. In fact, compost toilet systems yield a dividend — *humus*, which allows such a sanitation system to yield a net profit, rather than being a constant financial drain (no pun intended).

FUN FACTS

about water



- If all the world's drinking water were put in one cubical tank, the tank would measure only 95 miles on each side.
- Number of people currently lacking access to clean drinking water: 1.2 billion.
- Percent of the world's households that must fetch water from outside their homes: 67
- Percent increase in the world's population by the middle of the 21st century: 100
- Percent increase in the world's drinking water supplies by the middle of the 21st century: 0
- Amount of water Americans use every day: 340 billion gallons.
- Number of gallons of water needed to produce a car: 100,000
- Number of cars produced every year: 50 million.
- Amount of water required by a nuclear reactor every year: 1.9 cubic miles.
- Amount of water used by nuclear reactors every year: the equivalent of one and a third Lake Eries.

Sources: Der Spiegel, May 25, 1992; and Annals of Earth, Vol. 8, Number 2, 1990; Ocean Arks International, One Locust Street, Falmouth, MA 02540.

The almost obsessive focus on flush toilets throughout the world is causing the problems of international sanitation to remain unresolved. Many parts of the world cannot afford expensive and water consumptive waste disposal systems. Or, in the words of Gary Gardner (Vital Signs 1998), “*The high costs leave developing countries spending less than a third of what they should in order to provide adequate sanitation, according to WHO. . . Prospects for providing universal access to sanitation are dismal in the near to medium term. . . Despite the attention focused on sanitation, governments have not demonstrated the will to meet this growing challenge.*” [41](#)

Illness related to polluted water afflicted 111,228 Americans from 1971-85. Forty-nine percent of these were caused by untreated or inadequately disinfected groundwater.⁴² Approximately 155 million people in the US obtain their drinking water from surface water sources.⁴³ Several American cities have suffered from

outbreaks of cryptosporidia (protozoa which cause severe diarrhea) since 1984. These protozoa are transmitted when people drink water contaminated by infected human and other animal feces. Outbreaks occurred in Braun Station, Texas, in 1984; in Carrollton, Georgia, in 1987; in Medford and Talent, Oregon, in 1992; and in Milwaukee, Wisconsin, in 1993. The outbreak in Carrollton, Georgia, afflicted 13,000 people, and was caused by contaminated water from a water treatment plant. Hundreds of thousands of people have been afflicted by this bug, for which there is no treatment. The illness runs its course in about fourteen days in healthy people, but can be deadly to people who have weak immune systems.⁴⁴

Modern toilets tax water

291 cities and towns in Japan face water shortages due to the spread of flush toilets, reported the Construction Ministry in April of 1998. Some cities have had to build dams to provide enough water to flush the increasingly popular toilets.

Paris

More than 1 billion people lack access to clean water

The U.N. International Conference on Water and Sustainable Development in 1998 reported that five to ten million people die each year as a result of drinking polluted water, while about 1.2 billion people lack access to clean water. *"Fresh water needed for human needs is rapidly getting scarce"* they reported.

Figure 2.12

US Water Withdrawals 1940-1995

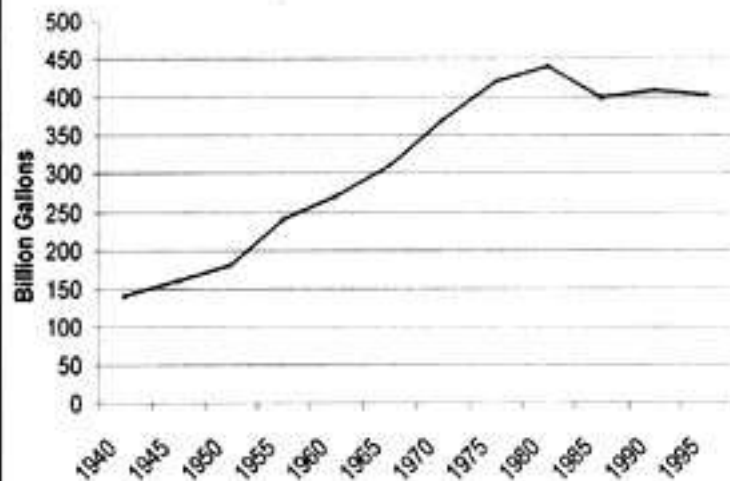

Source: Statistical Abstracts of the United States 1998, p. 240.

In 1995, there were still nearly 10 million people in the US connected to public drinking water supplies from surface sources that were not in compliance with federal standards for the removal of microorganisms. Furthermore, scientists estimate that up to seven million Americans still get sick annually from contaminated drinking water.⁴⁵

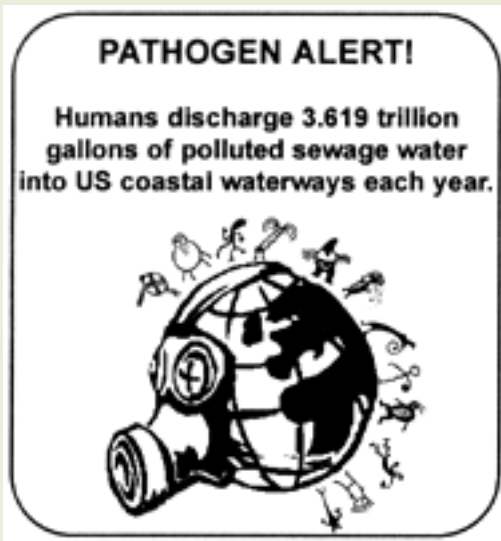

Sanitation problems could be avoided by composting, instead of discarding, humanure. Keeping fecal material out of the environment and out of streams, rivers, wells, and underground water sources eliminates the transmission of various diseases. Composting effectively converts fecal material into a hygienically safe humus, yet composting the humanure of municipal populations is not even being considered as an option in most of the western world.

Not only are we polluting our water, we're using it up, and flushing toilets is one way it's being wasted. Of 143 countries ranked for per capita water usage by the World Resources Institute, America came in at #2 using *188 gallons per person per day* (Bahrain was #1).⁴⁶

Water use in the US increased by a factor of 10 between 1900 and 1990, increasing from 40 billion gallons per day to 409 billion gallons per day.⁴⁷ The amount of water we Americans require overall (used in the finished products each of us consumes, plus washing and drinking water) amounts to a staggering 1,565 gallons per person per day, which is three times the rate in Germany or France.⁴⁸ This amount of water is equivalent to flushing our toilets 313 times every day, about once every minute and a half for eight hours straight. By some estimates, it takes one to two thousand tons of water to flush one ton of human waste.⁴⁹ Or, in the words of Carol Stoner, "*For one person, the typical five gallon flush contaminates each year about 13,000 gallons of fresh water to move a mere 165 gallons of body waste.*"⁵⁰ Not surprisingly, the use of groundwater in the United States exceeds replacement rates by 21 billion gallons a day.⁵¹

Source: *The Humanure Handbook*. Jenkins Publishing, PO Box 607, Grove City, PA 16127. To order, phone: 1-800-639-4099.

<http://www.jenkinspublishing.com/>

MENU: [HOME](#) » [Reconstruction](#) » [Recovery](#) » [Renewal](#) » [Survival](#) » [Humanure Content](#)

WASTE VS. MANURE

“Science now knows that the most fertilizing and effective manure is the human manure . . . Do you know what these piles of ordure are . . . All this is a flowering field, it is green grass, it is the mint and thyme and sage . . . it is the gilded wheat, it is the bread on your table, it is the warm blood in your veins.”

Victor Hugo

By dumping soil nutrients down the toilet, we increase our need for synthetic chemical fertilizers. Today, pollution from agriculture, caused from siltation (erosion) and nutrient runoff due to excessive or incorrect use of fertilizers,⁵² is now the “*largest diffuse source of water pollution*” in our rivers, lakes, and streams.⁵³ Chemical fertilizers provide a quick fix of nitrogen, phosphorous, and potassium for impoverished soils. However, it’s estimated that 25-85% of chemical nitrogen applied to soil and 15-20% of the phosphorous and potassium are lost to leaching, much of which can pollute groundwater.⁵⁴ This pollution shows up in small ponds which become choked with algae as a result of the unnatural influx of nutrients. In 1992, for example, the state of Florida was required to build some 35,000 acres of marshlands to filter farm-related runoff that was polluting the Everglades.⁵⁵ From 1950 to 1990, the global consumption of artificial fertilizers rose by 1000%, from 14 million tons to 140 million tons.⁵⁶ In 1997, US farmers used 20 million tons of synthetic fertilizers,⁵⁷ and half of all manufactured fertilizer ever made has been used just since 1982.⁵⁸ All the while, hundreds of millions of tons of compostable organic materials are generated in the US each year, and either buried in landfills, incinerated, or discharged into the environment as waste.

Nitrate pollution from excessive artificial fertilizer use is now one of the most serious water pollution problems in Europe and North America. Such pollution can cause cancer, and even brain damage or death in infants.⁵⁹ Most cases of infant poisoning occur when infant *formula* is made with nitrate polluted water.⁶⁰ A 1984 US EPA survey indicated that out of 124,000 water wells sampled, 24,000 had elevated levels of nitrates and 8,000 were polluted above health limits (10 mg/liter).⁶¹ In fact, a 1990 EPA survey indicated that 4.5 million Americans were potentially exposed to elevated levels of nitrates from drinking water wells alone.⁶²

The squandering of our water resources, and pollution from sewage and synthetic fertilizers results in part from the belief that humanure and food scraps are waste materials rather than recyclable natural resources. There is, however, an alternative. Humanure and food refuse can be composted and thereby rendered hygienically safe for agricultural or garden use. Much of the eastern world recycles humanure. Those parts of the world have known for millennia that humanure is a valuable resource which should be returned to the land, as any animal manure should.

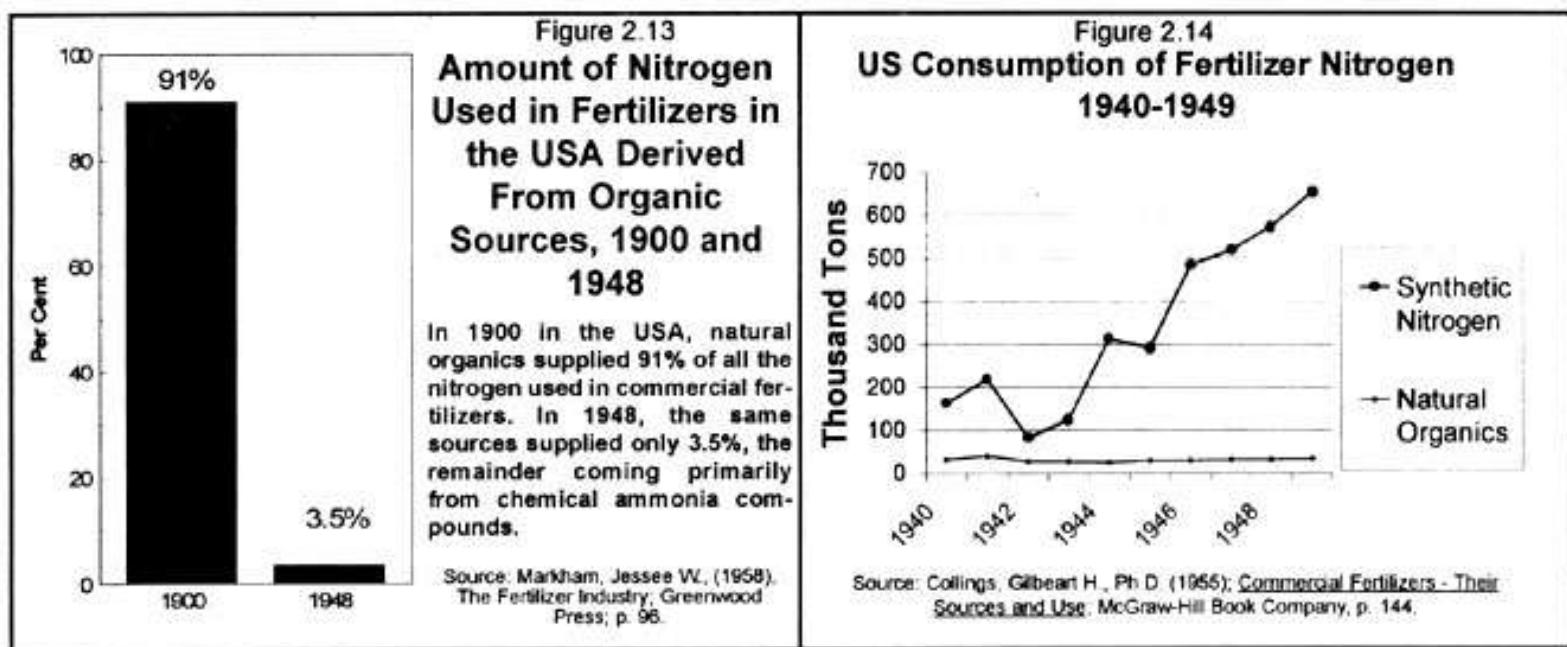

Farmers know that animal manure is valuable. They know that animal manures are digested crops, and that crops are soil, water, air, and sunshine converted into food, and the best way to use that manure is to put it back into the fields from where it originated. So the farmer loads up the manure spreader and flings the manure back onto the fields, thereby cleaning up his barn, saving himself lots of money on fertilizers, and keeping his soil healthy. Sounds reasonable enough. But what about human manure?

Humanure is a little bit different. It shouldn't simply be flung around in a fresh and repulsive state. It should undergo a process of bacterial digestion first, usually known as composting, in order to destroy possible pathogens. This is the missing link in the human nutrient recycling process. The process is similar to any animal's: a human grows food for herself on a field, or in a garden. The food is consumed and passes into the digestive system where the body extracts what it needs, rejects what it doesn't need at the time, or what it can't use, then excretes the rejected material.

At that moment, the digestive system is no longer responsible for the excretion. It's now time for the brain to go to work. The human mind has basically two choices — consider the excretion to be waste and try to get rid of it, or consider the excretion to be a resource which must be recycled. Either way, the body's excretion must be collected. As waste, the material must be dispensed with in a manner that is safe to human health and to the environment; as a resource, the humanure should be naturally recycled.

In some areas of the world, such as Asia, humanure may be applied raw to fields without being composted beforehand. Containers of human excrement are set outside residences in Asia to be picked up during the night and taken to the fields. The content of these containers is called, appropriately enough, "night soil." *That is NOT what this book is about.*

Raw humanure carries with it a significant potential for danger in the form of disease pathogens. These diseases, such as intestinal parasites, hepatitis, cholera, and typhoid are destroyed by composting, either when the retention time is adequate in a low temperature compost pile (usually



Properly composted humanure yields a rich, loamy, pleasant-smelling, hygienically safe soil-building material, here being applied to spring garden beds.

Shanghai, China, a city with an expected population of 14.2 million people in 2000,⁶³ produces an exportable surplus of vegetables in this manner.

considered to be two years) or when the composting process generates internal, biological heat (which can kill pathogens in a matter of minutes). Raw applications of humanure to fields, on the other hand, are not hygienically safe and can assist in the spread of various diseases which may be endemic to areas of Asia. Americans who have traveled to Asia tell of the “horrible stench” of night soil that wafts through the air when it is applied to fields. For these reasons, it is imperative that humanure always be composted before agricultural applications. Proper thermophilic (heat-producing) composting destroys possible pathogens and results in a pleasant-smelling material. Low temperature composting, given adequate time, will yield a compost also suitable for agricultural purposes.

At the very least, raw night soil applications to fields in Asia do return humanure to the land, thereby recovering a valuable resource which is then used to produce food for humans. *Composted* humanure is used in Asia as well. Cities in China, South Korea, and Japan recycle night soil around their perimeters in greenbelts where vegetables are grown.

In some areas of the world, such as Asia, humanure may be applied raw to fields without being composted beforehand. Containers of human excrement are set outside residences in Asia to be picked up during the night and taken to the fields. The content of these containers is called, appropriately enough, “night soil.” *That is NOT what this book is about.*

Humanure can also be used to feed algae which can, in turn, feed fish for aquacultural enterprises. In Calcutta, such an aquaculture system produces 20,000 kilograms of fresh fish daily.⁶⁴ The city of Tainan, Taiwan, is well known for its fish, which are farmed in over 6,000 hectares of fish farms fertilized by humanure. Here, humanure is so valuable that it’s sold on the black market.⁶⁵

*Source: The Humanure Handbook. Jenkins Publishing, PO Box 607, Grove City, PA 16127. To order, phone: 1-800-639-4099.
<http://www.jenkinspublishing.com/>*

MENU: [HOME](#) » [Reconstruction](#) » [Recovery](#) » [Renewal](#) » [Survival](#) » [Humanure Content](#)

RECYCLING HUMANURE

“We stand now where two roads diverge . . .the one ‘less traveled by’ offers our last, our only chance to reach a destination that assures the preservation of our Earth.”

Rachael Carson - *Silent Spring*

Humanure can be naturally recycled by feeding it to the organisms that crave it as food. These voracious creatures have been around for millions, and theoretically *billions* of years, and they’ve patiently waited for us humans to discover them. Mother Nature has seeded our excrements, as well as our garbage, with these “friends in small places,” who will convert our organic discards into a soil-building material right before our eyes. Invisible helpers, these creatures are too small to be seen by the human eye and are therefore called *microorganisms*. The process of feeding organic material to these microorganisms is called *composting*, and proper composting ensures the destruction of potential human pathogens (disease-causing microorganisms) in humanure. Composting also completely converts the humanure into a new, benign, pleasant-smelling, and beneficial substance called *humus*, which is then returned to the soil to enrich it and enhance plant growth.

Incidentally, *all* animal manures benefit from composting, as today’s farmers are now discovering. Compost doesn’t leach like raw manures do. Instead, it helps hold nutrients in soil systems. Composted manures also reduce plant disease and insect damage and allow for better nutrient management on farms. In fact, two tons of compost will yield far more benefits than five tons of manure.⁶⁶

Human manure can be mixed with other organic materials from human activity such as kitchen and food scraps, grass clippings, leaves, garden refuse, paper products, and sawdust. This mix of materials is necessary for proper composting to take place, and it will yield a soil additive suitable for food gardens as well as for agriculture.

One reason we humans have not “fed” our excrement to the appropriate organisms is because we didn’t know they existed. We’ve only learned to see and understand microscopic creatures in our recent past. We also haven’t had such a rapidly growing human population in the past, nor have we been faced with the dire environmental problems that threaten our species today, like buzzards circling an endangered animal.

It all adds up to the fact that the human species must inevitably evolve. Evolution means change, or as Rachel Carson stated almost four decades ago, we must realize that we are now standing at a fork in the

road. Change is often resisted, as old habits die hard, and flush toilets and bulging garbage cans represent well entrenched but non-sustainable habits that must be rethought and reinvented. You will not find profligate, wasteful, and polluting behavior taken for granted on “the road less traveled.”

Consumer cultures of today must evolve toward sustainability. This is a shift that will likely be fought tooth and nail by those powerful, non-sustainable industries that stand to lose profits, and by their paid spokespersons in the newspapers, radio, television, congresses, and senates of the world. Nevertheless, if we humans are half as intelligent as we think we are, we’ll join together cooperatively and eventually get our act together. In the meantime, there are those of you who are doing your share, shifting as you can, incrementally, but surely toward sustainable lifestyle choices. You are also further educating yourselves, as the reading of this book indicates, and perhaps realizing that nature holds many of the keys we need to unlock the door to a sustainable, harmonious existence on this planet. Composting is one of the keys that has been relatively recently discovered by the human race. Its utilization is now beginning to mushroom worldwide.

Source: The Humanure Handbook. Jenkins Publishing, PO Box 607, Grove City, PA 16127. To order, phone: 1-800-639-4099.

<http://www.jenkinspublishing.com/>

MENU: [HOME](#) » [Reconstruction](#) » [Recovery](#) » [Renewal](#) » [Survival](#) » [Humanure Content](#)

MICROHUSBANDRY

Harnessing the Power of Microscopic Organisms

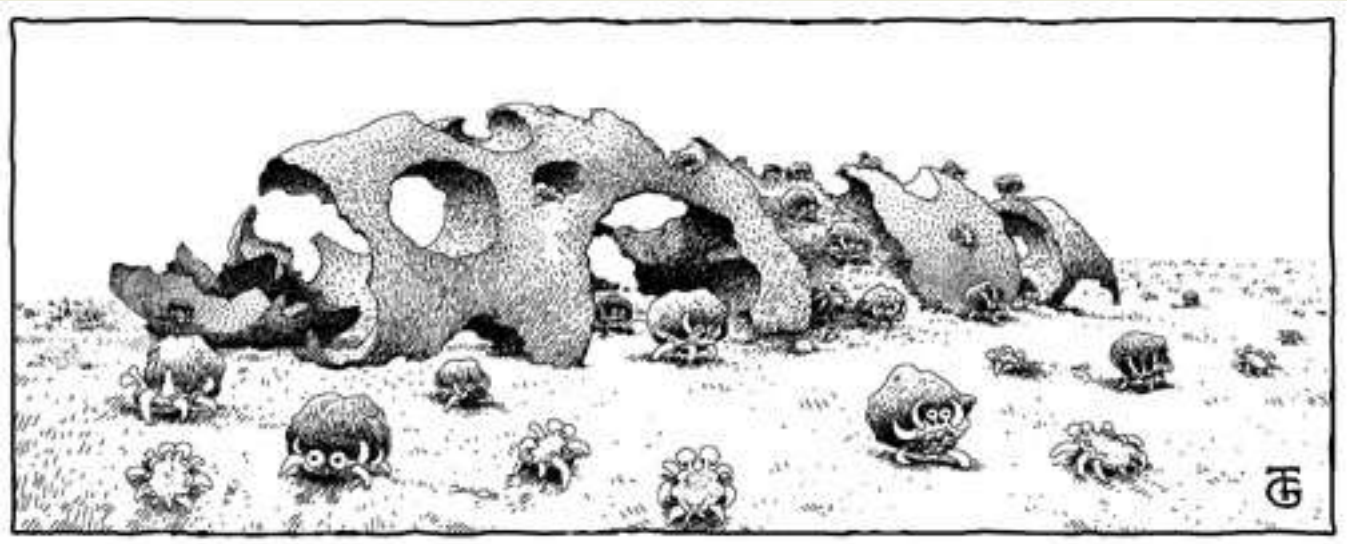

“Anyone starting out from scratch to plan a civilization would hardly have designed such a monster as our collective sewage system. Its existence gives additional point to the sometimes asked question, Is there any evidence of intelligent life on the planet Earth?”

G. R. Stewart

There are four general ways to deal with human excrement. The first is to *dispose of it* as a waste material. People do this by defecating in drinking water supplies, or in outhouses or latrines. Most of this waste ends up dumped, incinerated, buried in the ground, or discharged into waterways.

The second way to deal with human excrement is to *apply it raw to agricultural land*. This is popular in Asia where “night soil,” or raw human excrement, is spread on fields. Although this keeps the soil enriched, it also acts as a vector, or route of transmission, for disease organisms. In the words of Dr. J. W. Scharff, former chief health officer in Singapore, *“Though the vegetables thrive, the practice of putting human [manure] directly on the soil is dangerous to health. The heavy toll of sickness and death from various enteric diseases in China is well-known.”* The World Health Organization adds, *“Night soil is sometimes used as a fertilizer, in which case it presents great hazards by promoting the transmission of food-borne enteric [intestinal] disease, and hookworm.”* ¹ (It is interesting, incidentally, to note Dr. Scharff’s only alternative to the use of raw night soil: *“We have been inclined to regard the installation*

of a water-carried system as one of the final aims of civilization.”)² This book, therefore, is *not* about recycling night soil by raw applications to land, which is a practice that should be discouraged when sanitary alternatives, such as composting, are available.

The third way to deal with human excrement is to *slowly compost it over an extended period of time*. This is the way of most commercial composting toilets. Slow composting generally takes place at temperatures below that of the human body, which is 37°C or 98.6°F. This type of composting eliminates most disease organisms in a matter of months, and should eliminate all human pathogens eventually. Low temperature composting creates a useful soil additive that is at least safe for ornamental gardens, horticultural, or orchard use.

Thermophilic composting is the fourth way to deal with human excrement. This type of composting involves the cultivation of heat-loving (thermophilic) microorganisms in the composting process. Thermophilic microorganisms, such as bacteria and fungi, can create an environment in the compost which destroys disease organisms that can exist in humanure, converting humanure into a friendly, pleasant-smelling, humus safe for food gardens. Thermophilically composted humanure is *entirely different* from night soil. Perhaps it is better stated by the experts in the field: “*From a survey of the literature of night soil treatment, it can be clearly concluded that the only fail-safe night soil method which will assure effective and essentially total pathogen inactivation, including the most resistant helminths [intestinal worms] such as Ascaris [roundworm] eggs and all other bacterial and viral pathogens, is heat treatment to a temperature of 55° to 60°C for several hours.*”³ The experts are specifically referring to the heat of the *compost pile*.

Source: *The Humanure Handbook*. Jenkins Publishing, PO Box 607, Grove City, PA 16127. To order, phone: 1-800-639-4099.

<http://www.jenkinspublishing.com/>

MENU: [HOME](#) » [Reconstruction](#) » [Recovery](#) » [Renewal](#) » [Survival](#) » [Humanure Content](#)

VINTAGE COMPOST

“One of the most fascinating aspects of composting is that it still retains elements of art . . . Producing good compost requires the same level of knowledge, engineering, skill, and art required for producing good wine.”

Roger Haug - The Practical Handbook of Compost Engineering

I first moved out to the country and started living off the land at the age of 22. Being fresh out of college, I knew little of practical value. One word that was a mystery to me was “compost”; another was “mulch.” Although I didn’t know what either of these were, I knew they had something to do with organic gardening, and that’s what I wanted to learn about. Of course, it didn’t take me long to understand mulch. Anyone who can throw a layer of straw on the ground can mulch. But compost took a bit longer.

My compost-learning experiences paralleled my winemaking experiences. Back then, having just graduated from the university, I had been conditioned to believe that the best way to learn was by using books. I had little awareness that instinct or intuition were powerful teachers. Furthermore, simple, natural processes had to be complicated with charts, graphs, measurements, devices, and all the wonderful tools of science, otherwise the processes had no validity. It was with this attitude that I set out to learn how to make wine.

The first thing I did was obtain a scientific book replete with charts, graphs, tables, and detailed step-by-step procedures. The book was titled something like “Foolproof Winemaking,” and the trick, or so the author said, was simply to follow his procedures *to the letter*. This was no simple feat. The most difficult part of the process was acquiring the list of chemicals which the author insisted must be used in the winemaking process. After much searching and travel, I managed to get the required materials. Then I followed his instructions *to the letter*. This lengthy process involved boiling sugar, mixing chemicals, and following laborious procedures. To make a long story short, I succeeded in making two kinds of wine. Both tasted like crap; one was bad and the other worse, and both had to be thrown out. I was very discouraged.

Soon thereafter, a friend of mine, Bob, decided he would try *his* hand at winemaking. Bob asked a vineyard worker to bring him five gallons of grape juice in a five gallon glass winemaking carboy. When the grape juice arrived, Bob took one look at the heavy carboy of juice and said, “*Buddy, would you mind carrying that into the basement for me?*” Which the worker obligingly did.

That was it. That utterance of eleven words constituted Bob’s entire effort at winemaking. Two seconds

of flapping jaws was the only work he did toward making that wine. He added no sugar, no yeast, did no racking, and certainly used no chemicals. He didn't do a damn thing to that five gallons of grape juice except abandon it in his basement with an airlock on top of it. Yet, a year later that carboy yielded the best homemade wine I had ever drank. It tasted good and had a heck of a kick to it.

I admit, there was an element of luck there, but I learned an important lesson about winemaking: the basic process is very simple — start with good quality juice and keep the air out of it. That simple, natural process can be easily ruined by too many complicated procedures, and heck, all those charts and graphs took the *fun* out of it. Making compost, I soon learned, was the same sort of phenomenon.

Source: The Humanure Handbook. Jenkins Publishing, PO Box 607, Grove City, PA 16127. To order, phone: 1-800-639-4099.

<http://www.jenkinspublishing.com/>

MENU: [HOME](#) » [Reconstruction](#) » [Recovery](#) » [Renewal](#) » [Survival](#) » [Humanure Content](#)

COMPOST DEFINED

BENEFITS OF COMPOST

ENRICHES SOIL

- Adds organic material
- Improves fertility and productivity
- Suppresses plant diseases
- Discourages insects
- Increases water retention
- Inoculates soil with beneficial microorganisms
- Reduces or eliminates fertilizer needs
- Moderates soil temperature

PREVENTS POLLUTION

- Reduces methane production in landfills
- Reduces or eliminates organic garbage
- Reduces or eliminates sewage

FIGHTS EXISTING POLLUTION

- Degrades toxic chemicals
- Binds heavy metals
- Cleans contaminated air
- Cleans stormwater runoff

RESTORES LAND

- Aids in reforestation
- Helps restore wildlife habitats
- Helps reclaim mined lands
- Helps restore damaged wetlands
- Helps prevent erosion on flood plains

DESTROYS PATHOGENS

- Can destroy human disease organisms
- Can destroy plant pathogens
- Can destroy livestock pathogens

According to the dictionary, compost is “*a mixture of decomposing vegetable refuse, manure, etc. for fertilizing and conditioning the soil.*” The Practical Handbook of Compost Engineering defines composting with a mouthful: “*The biological decomposition and stabilization of organic substrates, under conditions that allow development of thermophilic temperatures as a result of biologically produced heat, to produce a final product that is stable, free of pathogens and plant seeds, and can be beneficially applied to land.*”

The On-Farm Composting Handbook says that compost is “*a group of organic residues or a mixture of organic residues and soil that have been piled, moistened, and allowed to undergo aerobic biological decomposition.*” The Compost Council adds their two cents worth in defining compost: “*Compost is the stabilized and sanitized product of composting; compost is largely decomposed material and is in the process of humification (curing). Compost has little resemblance in physical form to the original material from which it is made.*” That last sentence should be particularly reassuring to the humanure composter.

J. I. Rodale states it a bit more eloquently: “*Compost is more than a fertilizer or a healing agent for the soil’s wounds. It is a symbol of continuing life . . . The compost heap is to the organic gardener what the typewriter is to the writer, what the shovel is to the laborer, and what the truck is to the truckdriver.*” ⁴

- Can destroy livestock pathogens

SAVES MONEY

- Can be used to produce food
- Can eliminate waste disposal costs
- Reduces the need for water, fertilizers, and pesticides
- Can be sold at a profit
- Extends landfill life by diverting materials
- Is a less costly bioremediation technique

Source: US EPA (October 1997). *Compost-New Applications for an Age-Old Technology*. EPA530-F-97-047. And author's experience.

In general, composting is a process managed by humans involving the cultivation of microorganisms that degrade organic matter in the presence of oxygen. When properly managed, the compost becomes so heavily populated with thermophilic microorganisms that it generates quite a bit of heat. Compost microorganisms can be so efficient at converting organic material into humus that the phenomenon is nothing short of miraculous.

Source: *The Humanure Handbook*. Jenkins Publishing, PO Box 607, Grove City, PA 16127. To order, phone: 1-800-639-4099.

<http://www.jenkinspublishing.com/>

MENU: [HOME](#) » [Reconstruction](#) » [Recovery](#) » [Renewal](#) » [Survival](#) » [Humanure Content](#)

NATURALCHEMY

In the Middle Ages, alchemists sought to change base metals, such as lead, into gold. Old German folklore tells of a tale in which a dwarf named Rumpelstiltskin had the power to spin flax straw into precious metal. Somewhere in the psyche of the western mind was a belief that a substance of little or no worth could be transmuted by a miraculous process into something of priceless value. Our ancestors were right, but they were barking up the wrong tree. The miraculous process of *composting* will transmute humanure into humus. In this way, potentially dangerous waste materials become soil additives vital for human life.

Our ancestors didn't understand that the key to this alchemy was right at their fingertips. Had they better known and understood natural processes they could have provided themselves with a wealth of soil fertility and saved themselves the tremendous suffering caused by diseases originating from fecal contamination of the environment. For some reason, they believed that gold embodied value, and in pursuit of glittering riches they neglected the things of real value: health, vitality, self-sufficiency, and sustainability.

Our ancestors had little understanding of a vast, invisible world which surrounded them, a world of countless creatures so small as to be quite beyond the range of human sight. And yet, some of those microscopic creatures were already doing work for humanity in the production of foods such as beer, wine, cheese, or bread. Although *yeasts* have been used by people for centuries, *bacteria* have only become harnessed by western humanity in recent times. Composting is one means by which the power of microorganisms can be utilized in a big way for the betterment of humankind. Unfortunately, our ancestors didn't understand the role of microorganisms in the decomposition of organic matter, nor the efficacy of microscopic life in converting humanure, food scraps, and plant residues into soil. They didn't understand compost.

The composting of organic materials requires armies of bacteria. This microscopic force works so vigorously that it heats the material to temperatures hotter than are normally found in nature. Other micro and macro organisms such as fungi and insects help in the composting process, too. When the compost cools down, earthworms often move in and eat their fill of delicacies, their excreta becoming a further refinement of the compost.

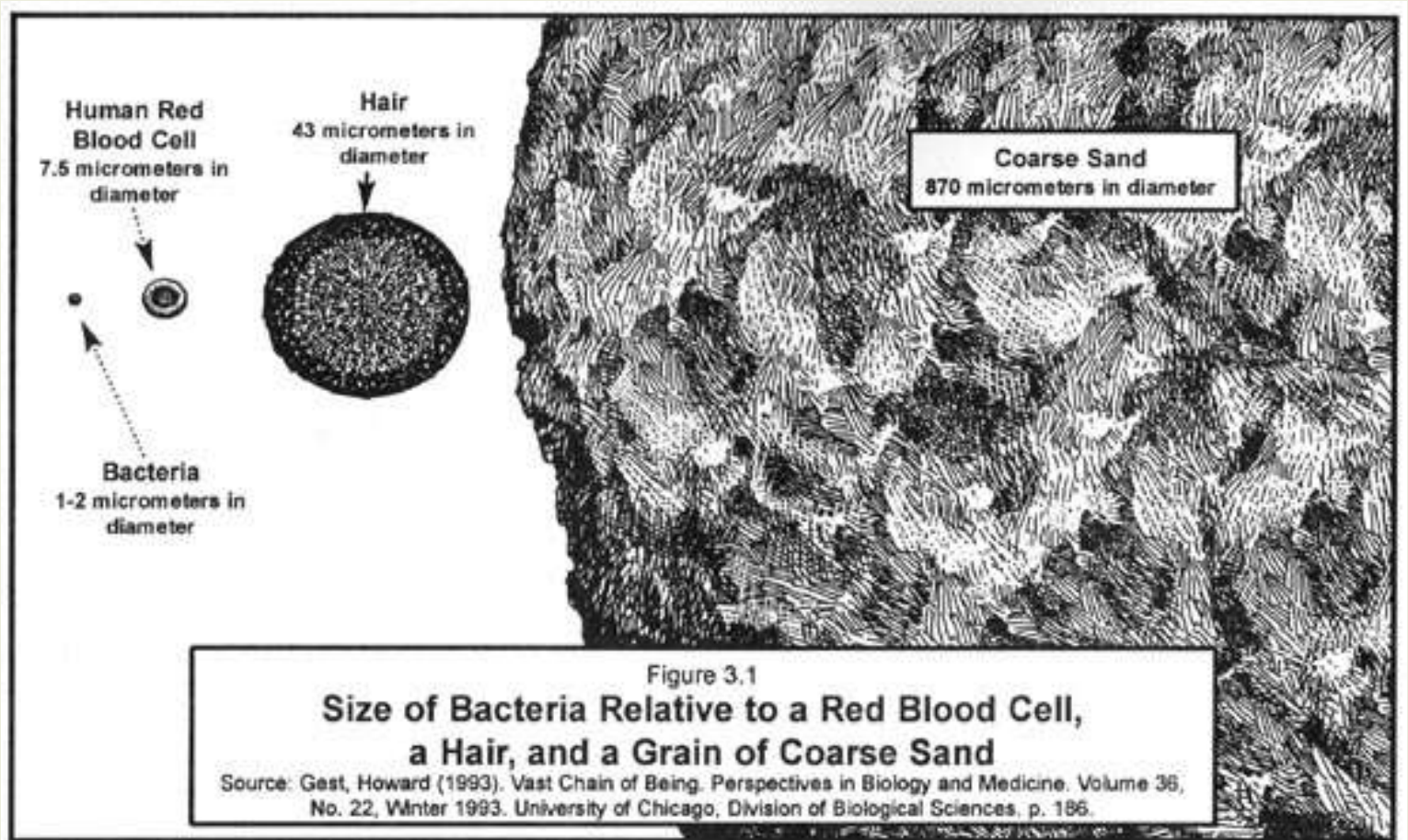

Successful composting requires the maintenance of an environment in which bacteria and fungi can thrive. This is also true for wine, except the microorganisms are yeast, not bacteria. Same for bread (yeast), beer (yeast), yogurt (bacteria), sauerkraut (bacteria), and cheese (bacteria); all of these things require the cultivation of microorganisms which will do the desired work. All of these things involve simple processes which, once you know the basic principles, are easy to carry out successfully. Sometimes bread doesn't rise, sometimes yogurt turns out watery, sometimes compost doesn't seem to turn out right. When this happens, a simple change of procedure will rectify the matter. Once you get the hang of it, you'd think even a chimpanzee could be trained to make compost.

Often, in our household, we have yogurt being made by billions of hard-working bacteria in a few quart mason jars beside the cookstove. At the same time, millions of yeast cells are cheerfully brewing beer in carboys in the back pantry, while millions more yeasts are happily brewing wine beside the beer. Sauerkraut is blithely fermenting in a crock behind the stove; bread is rising on the kitchen counter; and fungi are tirelessly forcing their fruits from oak logs on the sunporch. And then there's the compost pile. At times like these, I feel like a slave driver. But the workers never complain. Those little fellas work day and night, and they do a real nice job.

Source: *The Humanure Handbook*. Jenkins Publishing, PO Box 607, Grove City, PA 16127. To order, phone: 1-800-639-

MENU: [HOME](#) » [Reconstruction](#) » [Recovery](#) » [Renewal](#) » [Survival](#) » [Humanure Content](#)

MENU: [HOME](#) » [Reconstruction](#) » [Recovery](#) » [Renewal](#) » [Survival](#) » [Humanure Content](#)

SOLAR POWER IN A BANANNA PEEL

Organic refuse is stored solar energy. Every apple core or potato peel holds a tiny amount of stored energy, just like a piece of firewood, which is converted into useable plant food by the compost pile. Perhaps S. Sides of the *Mother Earth News* states it more succinctly: “*Plants convert solar energy into food for animals (ourselves included). Then the [refuse] from these animals along with dead plant and animal bodies, ‘lie down in the dung heap,’ are composted, and ‘rise again in the corn.’ This cycle of light is the central reason why composting is such an important link in organic food production. It returns solar energy to the soil. In this context such common compost ingredients as onion skins, hair trimmings, eggshells, vegetable parings, and even burnt toast are no longer seen as garbage, but as sunlight on the move from one form to another.*” ⁵

The organic material used to make compost could be considered anything on the Earth’s surface that had been alive, or from a living thing, such as manure, plants, leaves, sawdust, peat, straw, grass clippings, food scraps, and urine. A rule of thumb is that anything that will rot will compost, including such things as cotton clothing, wool rugs, rags, paper, animal carcasses, junk mail, and cardboard.

To compost means to convert organic material ultimately into soil or, more accurately, *humus*. Humus is a brown or black substance resulting from the decay of organic animal or vegetable refuse. It is a stable material that does not attract insects or nuisance animals. It can be handled and stored if necessary with no problem, and it is beneficial to the growth of plants. Humus holds moisture, and therefore increases the soil’s capacity to absorb and hold water. Compost is said to hold nine times its weight in water (900%), as compared to sand which only holds 2%, and clay 20%.⁶

Compost also adds slow-release nutrients essential for plant growth, creates air spaces in soil, helps balance the soil pH, darkens the soil (thereby helping it absorb heat), and supports microbial populations that add life to the soil. Nutrients such as nitrogen in compost are slowly released throughout the growing season, making them less susceptible to loss by leaching than the more soluble chemical fertilizers.⁷ Organic matter from compost enables the soil to immobilize and degrade pesticides, nitrates, phosphorous, and other things that can become pollutants. Compost binds pollutants in soil systems, reducing their leachability and absorption by plants.⁸

The building of topsoil by Mother Nature is a centuries long process. Adding compost to soil will help to quickly restore fertility that might otherwise take nature hundreds of years to replace. We humans deplete our soils in relatively short periods of time. By composting our organic refuse and returning it to the land, we can restore that fertility also in relatively short periods of time.

Fertile soil yields food that promotes good health. One group of people, the Hunzas of northern India, has been studied to a great extent. One man who studied them extensively, Sir Albert Howard, stated, “*When the health and physique of the various northern Indian races were studied in detail the best were those of the Hunzas, a hardy, agile, and vigorous people, living in one of the high mountain valleys of the Gilgit Agency . . . There is little or no difference between the kinds of food eaten by these hillmen and by the rest of northern India. There is, however, a great difference in the way these foods are grown . . . [T]he very greatest care is taken to return to the soil all human, animal and vegetable [refuse] after being first composted together. Land is limited: upon the way it is looked after, life depends.*” ⁹

Source: *The Humanure Handbook*. Jenkins Publishing, PO Box 607, Grove City, PA 16127. To order, phone: 1-800-639-4099.

<http://www.jenkinspublishing.com/>

MENU: [HOME](#) » [Reconstruction](#) » [Recovery](#) » [Renewal](#) » [Survival](#) » [Humanure Content](#)

MENU: [HOME](#) » [Reconstruction](#) » [Recovery](#) » [Renewal](#) » [Survival](#) » [Humanure Content](#)

GOMER THE PILE

There are several reasons for piling the composting material. A pile keeps the material from drying out or cooling down prematurely. A level of moisture (50-60%) is necessary for the microorganisms to work happily.¹⁰ A vertical stack prevents leaching and waterlogging, and holds heat in the pile. Vertical walls around a pile, especially if they're made of wood, or bales of straw, keep the wind off and will prevent one side of the pile (the windward side) from cooling down prematurely.

A neat, contained pile looks better. It looks like you know what you're doing, instead of looking like a garbage dump. A constructed compost bin also helps to keep out nuisance animals such as dogs.

A pile makes it easier to layer or cover the compost. When a smelly deposit is added to the top, it's a good idea to cover the raw refuse with clean organic material in order to eliminate unpleasant odors and to trap necessary oxygen in the pile. Therefore, if you're going to make compost, don't just fling it out in your yard in a heap. Construct a nice bin and do it right. That bin doesn't have to cost money; it can be made from recycled wood or cement blocks. Wood (not pressure-treated) may be preferable as it will insulate the pile and prevent heat loss and frost penetration. A compost bin doesn't have to be complicated in any way. It doesn't require electricity, technology, gimmicks, or doodads. You don't need shredders, choppers, grinders, or any machines whatsoever.

Compost *pits* are more likely to be used in dry, arid, or cool climates where conservation of moisture and temperature is imperative. The main disadvantage of pits is that they can become waterlogged in the event of an unexpected cloudburst, and excessive water will rob the pile of oxygen, a critical element in the process of decomposition by aerobic microorganisms. Therefore, when pits are used, a roof over them may be an advantage, and air channels may be necessary to allow oxygen to enter the compost.

Source: The Humanure Handbook. Jenkins Publishing, PO Box 607, Grove City, PA 16127. To order, phone: 1-800-639-4099.

<http://www.jenkinspublishing.com/>

MENU: [HOME](#) » [Reconstruction](#) » [Recovery](#) » [Renewal](#) » [Survival](#) » [Humanure Content](#)

FOUR NECESSITIES FOR GOOD COMPOST

MOISTURE

Compost must be kept moist. A dry pile will not work. When people who don't understand compost try to picture a humanure compost pile in someone's backyard, they imagine a giant heap of crap, draining all manner of noxious, smelly liquids out the bottom of the compost bin, and leaching into the groundwater. However, a compost pile is not a pile of garbage or waste. It's a living, breathing mass, a biological sponge which requires quite a bit of moisture. It's not likely to create a leaching problem unless subjected to very heavy rains while uncovered.

Why does compost require moisture? For one thing, composted materials shrink incredibly (40-80%),¹¹ mostly because of water loss. Compost can undergo considerable drying when wet materials are composted.¹² An initial moisture content of 65% can dwindle down to 20 to 30% in only a week, according to some researchers.¹³ It is more likely that one will have to *add* moisture to their compost than have to deal with excess moisture leaching from it.

The amount of moisture a compost pile receives or needs depends on the materials put into the pile and on the location of the pile. In Pennsylvania, there are about 36 inches (about one meter) of rainfall per year, and compost only needs watering during an unusual drought. According to Sir Albert Howard, watering a compost pile in England (where the annual rainfall is 24 inches) is also unnecessary. Nevertheless, the water required for compost-making may be around 200 to 300 gallons for each cubic yard of finished compost.¹⁴ This moisture requirement will be met when human urine is used in humanure compost and the top of the pile is open and receiving adequate rainfall. Additional water comes from moist organic materials such as food scraps. If adequate rainfall is not available and the contents of the pile are not moist, watering will be necessary to produce a moisture content equivalent to a squeezed-out sponge. Graywater from household drains or collected rainwater would suffice for this purpose.

OXYGEN

We want to cultivate *aerobic* bacteria in the compost pile to ensure thermophilic decomposition. This is done by adding bulky materials to the compost pile in order to trap interstitial air spaces. Aerobic bacteria will suffer from a lack of oxygen if drowned in liquid, which is a common problem with commercial and home made composting toilets when improperly managed.

Bacterial decomposition can also take place anaerobically, but this is a slower, cooler process, which can, quite frankly, stink. Anaerobic odors can smell like rotten eggs (caused by hydrogen sulfide), sour milk (caused by butyric acids), vinegar (acetic acids), vomit (valeric acids), and putrefaction (alcohols and phenolic compounds).¹⁵ Obviously, we want to avoid such odors by maintaining an aerobic compost pile.



Figure 3.2: The author probing a humanure compost pile in late winter.

This compost had not yet become thermophilically active.

Of the two thermometers, one has a long probe and the other a short one.

PHOTO BY JEANINE JENKINS

Good, healthy, aerobic compost need not offend one's sense of smell. However, in order for this to be true, a simple rule must be followed: *anything added to the compost that smells bad must be covered with a clean, organic material*. This means you must cover the deposits in your compost toilet and on your compost pile. When you defecate or urinate in your toilet, cover it. Use sawdust, use peat, use clean soil, use leaves, but keep it covered. Then there will be no odor. When you deposit smelly manure on your compost pile, cover it. Use weeds, use straw, use hay, whatever you can get your hands on (especially bulky material which will trap oxygen in the compost), but keep it covered. That's the simple secret to the odor issue.

TEMPERATURE

Dehydration will cause the compost microorganisms to stop working. So will freezing. Compost piles will not work if frozen, which often occurs during the cold winters of the north. However, don't despair, the microorganisms will wait until the temperature rises and then they'll thaw out and, once again, work feverishly. You can continue to add to an outdoor compost pile all winter, even when the pile is frozen solid as a rock. The freezing stage helps to destroy some potential pathogens and, after the thaw, the pile works up a steam as if nothing happened.

BALANCED DIET

A good carbon-nitrogen balance (a good blend of materials) is required for a nice, hot compost pile. Since most of the materials commonly added to a compost pile are very high in carbon, this means that a source of nitrogen must be incorporated into the blend of composting ingredients. This isn't as difficult as it may seem. You can carry bundles of weeds to your compost pile, add hay, straw, leaves, and garbage, but you'll still need one thing: nitrogen. Of course the solution is simple — add manure. Where can you get manure? From an animal. Where can you find an animal? *Look in a mirror.*

Table 3.1
NITROGEN LOSS AND CARBON/NITROGEN RATIO

Initial C/N Ratio	Nitrogen Loss (%)
20.0	38.8
20.5	48.1
22.0	14.8
30.0	0.5
35.0	0.5
76.0	-8.0

Source: Gotaas, *Composting*, 1956, p. 92

Rodale states in *The Complete Book of Composting* that the average gardener may have difficulty in obtaining manure for the compost heap, but with “a little ingenuity and a thorough search,” it can be found. A gardener in the book testifies that when he gets “all steamed up to build myself a good compost pile, there has always been one big question that sits and thumbs its nose at me: *Where am I going to find the manure? I am willing to bet, too, that the lack of manure is one of the reasons why your compost pile is not the thriving humus factory that it might be.*”

Hmmm. WHERE can a large animal like a human being find manure? Gee, that's a tough one. Let's think real hard about that one. Perhaps with a little “ingenuity and a thorough search” we can come up with a source. Where IS that mirror, anyway?

Might be a clue there.

Source: *The Humanure Handbook*. Jenkins Publishing, PO Box 607, Grove City, PA 16127. To order, phone: 1-800-639-4099.

<http://www.jenkinspublishing.com/>

MENU: [HOME](#) » [Reconstruction](#) » [Recovery](#) » [Renewal](#) » [Survival](#) » [Humanure Content](#)

THE CARBON/NITROGEN RATIO

Table 3.2

CARBON / NITROGEN RATIOS

<u>Material</u>	<u>%N</u>	<u>C/N Ratio</u>
Activated Sludge	5-6	6
Amaranth	3.6	11
Apple Pomace	1.1	13
Blood	10-14	3
Bread	2.10	---
Cabbage	3.6	12
Cardboard	0.10	400-563
Coffee Grounds	---	20
Cow Manure	2.4	19
Corn Cobs	0.6	56-123
Corn Stalks	0.6-0.8	60-73
Cottonseed Meal	7.7	7
Cranberry Plant	0.9	61
Farmyard Manure	2.25	14
Fern	1.15	43
Fish Scrap	10.6	3.6
Fruit	1.4	40
Garbage (Raw)	2.15	15-25
Grass Clippings	2.4	12-19
Hardwood Bark	0.241	223
Hardwoods (Avg.)	0.09	560
Hay (General)	2.10	---

One way to understand the blend of ingredients in your compost pile is by using the C/N ratio (carbon/nitrogen ratio). Quite frankly, the chance of the average person measuring and monitoring the carbon and nitrogen quantities of their organic material is almost nil. This is like making wine the “foolproof” way. If composting requires this sort of drudgery, no one would do it.

However, I’ve found that by using all of the organic refuse my family produces, including humanure, urine, food refuse, weeds from our garden, rotting sawdust (which is hauled in), grass clippings, and maybe a little straw or hay now and then, we get the right mix of carbon and nitrogen for successful thermophilic composting. We do not compost newspapers or other burnable materials, we recycle them or burn them in our woodstove.

Nevertheless, no discussion of composting is complete without a review of the subject of the carbon/nitrogen ratio. A good C/N ratio for a compost pile is between 20/1 and 35/1.¹⁶ That’s 20 parts of carbon to one part of nitrogen, up to 35 parts of carbon to one part of nitrogen. Or, for simplicity, you can figure on shooting for an optimum 30/1 ratio.

Hay (legume)	2.5	16
Hen Manure	8	6-15
Horse Manure	1.6	25-30
Humanure	5-7	5-10
Leaves	0.9	54
Lettuce	3.7	---
Meat Scraps	5.1	---
Mussel Residues	3.6	2.2
Mustard	1.5	26
Newsprint	0.06-0.14	398-852
Oat Straw	1.05	48
Olive Husks	1.2-1.5	30-35
Onion	2.65	15
Paper	---	100-800
Pepper	2.6	15
Pig Manure	3.1	14
Potato Tops	1.5	25
Poultry Carcasses	2.4	5
Purslane	4.5	8
Raw Sawdust	0.11	511
Red Clover	1.8	27
Rice Hulls	0.3	121
Rotted Sawdust	0.25	200-500
Seaweed	1.9	19
Sewage Sludge	2-6.9	5-16
Sheep Manure	2.7	16
Shrimp Residues	9.5	3.4
Slaughter Waste	7-10	2-4
Softwood Bark	0.14	496
Softwoods (Average)	0.09	641
Soybean Meal	7.2-7.6	4-6
Straw (General)	0.7	80

For microorganisms, carbon is the basic building block of life and is a source of energy, but nitrogen is also necessary for such things as proteins, genetic material, and cell structure. Microorganisms that digest compost need about 30 parts of carbon for every part of nitrogen they consume. That's a balanced diet for them. If there's too much nitrogen, the microorganisms can't use it all and the excess is lost in the form of smelly ammonia gas. Nitrogen loss due to excess nitrogen in the pile (a low C/N ratio) can be over 60%. At a C/N ratio of 30 or 35 to 1, only one half of one percent of the nitrogen will be lost (see Table 3.1). That's why you don't want too much nitrogen (manure, for example) in your compost: the nitrogen will be lost in the air in the form of ammonia gas, and nitrogen is too valuable for plants to allow it to escape into the atmosphere.¹⁷

That's also why humanure and urine alone *will not* compost. They contain too much nitrogen and not enough carbon, and microorganisms, like humans, gag at the thought of eating it. Since there's nothing worse than several billion gagging microorganisms, a carbon-based material must be added to the humanure in order to make it appealing. Plant cellulose is a carbon-based material, and therefore plant by-products such as hay, straw, weeds, or even paper products if ground to the proper consistency, will provide the needed carbon. Kitchen food scraps are generally C/N balanced, and they can readily be added to humanure compost. Sawdust (preferably *not* kiln-dried) is a good carbon material for balancing the nitrogen of humanure. Sawmill sawdust has a moisture content of 40-65%, which is good for compost.¹⁸ Lumber yard sawdust, on the other hand, is kiln-dried and is biologically inert due to the dehydration. Therefore, it is not as desirable in compost unless rehydrated with water (or urine) before

Straw (Oat)	0.9	60
Straw (Wheat)	0.4	80-127
Telephone Books	0.7	772
Timothy Hay	0.85	58
Tomato	3.3	12
Turkey Litter	2.6	16
Turnip Tops	2.3	19
Urine	15-18	0.8
Vegetable Produce	2.7	19
Water Hyacinth	---	20-30
Wheat Straw	0.3	128-150
Whole Carrot	1.6	27
Whole Turnip	1.0	44



Sources: Gotaas, Harold B. (1956). *Composting - Sanitary Disposal and Reclamation of Organic Wastes* (p.44). World Health Organization, Monograph Series Number 31. Geneva. and Rynk, Robert, ed. (1992). *On-Farm Composting Handbook*. Northeast Regional Agricultural Engineering Service. Ph: (607) 255-7654. pp. 106-113. Some data from Biocycle, *Journal of Composting and Recycling*, July 1998, p.18, 61, 62; and January 1998, p.20.

being added to the compost pile. Also, lumber yard sawdust nowadays can often be contaminated with wood preservatives such as chromated copper arsenate (from “pressure treated lumber”). Both chromium and arsenic are human carcinogens, so it would be wise to avoid such materials.

The C/N ratio of humanure is between five and ten, averaging eight parts of carbon to one part of nitrogen. Therefore, you need to add a fair amount of carbon to humanure to get a 30/1 ratio (see Tables 3.2 and 3.3). I’ve found that the proper balance is obtained by putting all the organic refuse of my household (excluding printed material and burnable paper packaging) in the same compost pile, layered with weeds, straw, hay, leaves, or whatever organic material happens to be within reach. The humanure, when collected in the toilet, is covered with clean, partially rotted, hardwood or softwood sawdust, or another carbon-based material such as peat moss or rice hulls. This carbonaceous “cover material” not only balances the nitrogen, but also prevents odors remarkably well.

It has recently become popular for backyard composters to refer to organic materials as “browns” and “greens.” The browns (such as dried leaves) supply carbon, and the greens (such as fresh grass clippings) supply nitrogen. It’s recommended that two to three volumes of

browns be mixed with one volume of greens in order to produce a mix with the correct C/N ratio for composting.¹⁹ However, since most backyard composters are not humanure composters, many backyard composters have a pile of material sitting in their compost bin showing very little activity. What is usually missing is nitrogen as well as moisture, two critical ingredients to any compost pile. Both of these are provided by humanure when collected with urine and a carbon cover material. The humanure mix can be quite brown, but is also quite high in nitrogen. So the “brown/green” approach doesn’t really work, nor is it necessary, when composting humanure along with other household organic material. Let’s face it, humanure composters are in a class by themselves.

Table 3.3 COMPOSITION OF HUMANURE		Table 3.4 DECOMPOSITION RATES OF SELECTED SAWDUSTS	
Fecal Material: 0.3-0.6 pounds per person per day (135-270 grams), wet weight.		SAWDUST	RELATIVE DECOMPOSITION RATE
Organic Matter (dry weight)	88-97%	Red Cedar	3.9
Moisture Content	66-80%	Douglas Fir	8.4
Nitrogen	5-7%	White Pine	9.5
Phosphorous	3-5.4%	Western White Pine	22.2
Potassium	1-2.5%	Average of all softwoods	12.0
Carbon	40-55%	Chestnut	33.5
Calcium	4-5%	Yellow Poplar	44.3
C/N Ratio	5-10	Black Walnut	44.7
Urine: 1.75-2.25 pints per person per day (1.0-1.3 liters)		White Oak	49.1
Moisture	93-96%	Average of all hardwoods	45.1
Nitrogen	15-19%	Wheat straw	54.6
Phosphorous	2.5-5%	The lower the number, the slower the decomposition rate. According to this data, hardwood sawdust decomposes faster than softwood sawdust.	
Potassium	3-4.5%	Source: Haug, Roger T. (1993). <i>The Practical Handbook of Compost Engineering</i> . CRC Press, Inc., 2000 Corporate Blvd. N.W., Boca Raton, FL 33431 USA, as reported in <i>Biocycle - Journal of Composting and Recycling</i> , December, 1998, p. 19.	
Carbon	11-17%		
Calcium	4.5-6%		
Source: Gotaas, Composting. (1956), p. 35			

Source: *The Humanure Handbook*. Jenkins Publishing, PO Box 607, Grove City, PA 16127. To order, phone: 1-800-639-4099.

<http://www.jenkinspublishing.com/>

MENU: [HOME](#) » [Reconstruction](#) » [Recovery](#) » [Renewal](#) » [Survival](#) » [Humanure Content](#)

THERMOPHILIC MICROORGANISMS

A wide array of microorganisms live in a compost pile. Bacteria are especially abundant and are usually divided into several classes based upon the temperatures at which they grow best. The low temperature bacteria are the *psychrophiles*, which can grow at temperatures down to -10°C , but whose optimum temperature is 15°C (59°F) or lower. The *mesophiles* live at medium temperatures, $20\text{-}45^{\circ}\text{C}$ ($68\text{-}113^{\circ}\text{F}$), and include human pathogens. *Thermophiles* thrive above 45°C (113°F), and some live at or even above the boiling point of water.

Strains of thermophilic bacteria have been identified with optimum temperatures ranging from 55°C to an incredible 105°C (above the boiling point of water), and many temperatures in between.²⁰ The strains that survive at extremely high temperatures are called, appropriately enough, extreme thermophiles, or hyperthermophiles, and have a temperature optimum of 80°C (176°F) or higher. Thermophilic bacteria occur naturally in hot springs, tropical soils, compost heaps, in your excrement, in hot water heaters (both domestic and industrial), and in your garbage, to name a few places.²¹

Thermophilic bacteria were first isolated in 1879 by Miquel, who found bacteria capable of developing at 72°C (162°F). He found these bacteria in soil, dust, *excrement*, sewage, and river mud. It wasn't long afterward that a variety of thermophilic bacteria were discovered in soil — bacteria that readily thrived at high temperatures, but not at room temperature. These bacteria are said to be found in the sands of the Sahara Desert, but not in the soil of cool forests. Composted or manured garden soils may contain 1-10 percent thermophilic types of bacteria, while field soils may have only 0.25% or less. Uncultivated soils may be entirely free of thermophilic bacteria.²²

Table 3.5
COMPARISONS OF DIFFERENT TYPES OF MANURES

<u>Manure</u>	<u>% Moisture</u>	<u>% Nitrogen</u>	<u>% Phosphorous</u>	<u>% Potassium</u>
Human	66-80	5-7	3-5.4	1.0-2.5
Cattle	.80	1.67	1.11	.056
Horse	.75	2.29	1.25	1.38
Sheep	.68	3.75	1.87	1.25
Pig	.82	3.75	1.87	1.25
Hen	.56	6.27	5.92	3.27
Pigeon	.52	5.68	5.74	3.23
Sewage	---	5-10	2.5-4.5	3.0-4.5

Source: Gotaas, Harold B. (1956). *Composting - Sanitary Disposal and Reclamation of Organic Wastes*. pp. 35, 37, 40.
World Health Organization, Monograph Series Number 31, Geneva.

Thermophiles are responsible for the spontaneous heating of hay stacks which can cause them to burst into flame. Compost itself can sometimes spontaneously combust. This occurs in larger piles (usually over 12 feet high) that become too dry (between 25% and 45% moisture) and overheat.²³ Spontaneous fires have started at two American composting plants (Schenectady and Cape May) due to excessively dry compost. According to the EPA, fires can start at surprisingly low temperatures (194°F) in too-dry compost, although this is not a problem for the back yard composter. When growing on bread, thermophiles can raise the temperature of the bread to 74°C (165°F). Heat from bacteria also warms germinating seeds, as seeds in a sterile environment are found to remain cool while germinating.²⁴

Both mesophilic and thermophilic microorganisms are found widely distributed in nature, and are commonly resident on food material, garbage, and manures. This is not so surprising when considering mesophiles, because the temperatures they find to be optimum for their reproduction are commonly found in nature. These temperatures include those of warm-blooded animals, which excrete mesophiles in their stools in huge numbers.

A mystery presents itself, on the other hand, when we consider *thermophilic* microorganisms, since they prefer living at temperatures not commonly found in nature, but in hot springs, water heaters, and compost piles. Their preferences for hot temperatures has given rise to some speculation about their evolution. One theory suggests that the thermophiles were among the first living things on this planet, developing and evolving during the primordial birthing days of Earth, when surface temperatures were quite hot. They have thus been called the “Universal Ancestor.” Estimated at 3.6 billion years old, they are said to be so abundant as to “*comprise as much as half of all living things on the planet.*”²⁵ This is a rather startling concept, as it would mean that thermophilic organisms are perhaps more ancient than anything else alive. Their age would make dinosaurs look like new born babes, still wet behind the ears (however extinct). Of course, we humans, in comparison, have just shown up on the Earth. Thermophiles could, therefore, be the common ancestral organism of all life forms on our planet.

Just as startling is the concept that thermophiles, despite their need for a hot environment, are found everywhere. They’re lingering in your garbage, and in your stool, and have been since we humans first began to crawl on this planet. They have quietly waited since the beginning of time, and we haven’t been aware of them until recently. Researchers insist that thermophiles do not grow at ambient or room temperatures.²⁶ Yet, like a miracle, when we collect our organic refuse in a tidy pile, the thermophiles seem to be sparked out of their dormant slumber to work furiously toward creating the primordial heat they so long for. And they succeed — if we help them by creating compost piles. They reward us for our help by converting our garbage and other organic discards into life-sustaining earth.

The knowledge of living creatures incomprehensibly ancient, so small as to be entirely invisible, thriving at temperatures hotter than those normally found in nature, and yet found alive everywhere, is remarkable enough. The fact that they are so willing to work for our benefit, however, is rather humbling.

By some estimates, humanure contains up to 1,000,000,000,000 (a trillion) bacteria per gram.²⁷ These

are, of course, mixed species, and not by any means all thermophiles. A trillion bacteria is equivalent to the entire human population of the Earth multiplied by 166, and all squeezed into a gram of organic material. These microbiological concepts of size and number are difficult for us humans to grasp. Ten people crammed into an elevator we can understand. A trillion living organisms in a teaspoonful of crap is a bit mind-boggling.

Has anyone identified the species of microorganism that heats up compost? Actually, a large variety of species, a *biodiversity*, is critical to the success of compost. However, the thermophilic stage of the process is dominated by thermophilic bacteria. One examination of compost microorganisms at two compost plants showed that most of the bacteria (87%) were of the genus *Bacillus*, which are bacteria that form spores,²⁸ while another researcher found that above 65°C, the organisms in the compost were almost purely *Bacillus stearothermophilus*.²⁹

Source: *The Humanure Handbook*. Jenkins Publishing, PO Box 607, Grove City, PA 16127. To order, phone: 1-800-639-4099.

<http://www.jenkinspublishing.com/>

MENU: [HOME](#) » [Reconstruction](#) » [Recovery](#) » [Renewal](#) » [Survival](#) » [Humanure Content](#)

FOUR STAGES OF COMPOST

There is a huge difference between a backyard humanure composter and a municipal composter. Municipal composters handle large batches of organic materials all at once, while backyard composters continuously produce a small amount of organic material every day. Municipal composters, therefore, are “batch” composters, while backyard composters tend to be “continuous” composters. When organic material is composted in a batch, four stages of the composting process are apparent. Although the same phases occur during continuous composting, they are not as apparent as they are in a batch, and, in fact, they may be occurring concurrently rather than sequentially.

The four phases include: 1) the mesophilic phase; 2) the thermophilic phase; 3) the cooling phase; and 4) the curing phase.

Compost bacteria combine carbon with oxygen to produce carbon dioxide and energy. Some of the energy is used by the microorganisms for reproduction and growth, the rest is given off as heat. When a pile of organic refuse begins to undergo the composting process, mesophilic bacteria proliferate, raising the temperature of the composting mass up to 44°C (111°F). This is the first stage of the composting process. These mesophilic bacteria can include *E. coli* and other bacteria from the human intestinal tract, but these soon become increasingly inhibited by the temperature, as the thermophilic bacteria take over in the transition range of 44°C-52°C (111°F-125.6°F).

This begins the second stage of the process, when thermophilic microorganisms are very active and produce a lot of heat. This stage can then continue up to about 70°C (158°F),³⁰ although such high temperatures are neither common nor desirable in backyard compost. This heating stage takes place rather quickly and may last only a few days, weeks, or months. It tends to remain localized in the upper portion of a backyard compost bin where the fresh material is being added, whereas in batch compost, the entire composting mass may be thermophilic all at once.

After the thermophilic heating period, the humanure will appear to have been digested, but the coarser organic material will not. This is when the third stage of composting, the cooling phase, takes place. During this phase, the microorganisms that were chased away by the thermophiles migrate back into the compost and get back to work digesting the more resistant organic materials. Fungi and macroorganisms such as earthworms and sowbugs that break the coarser elements down into humus also move back in.

After the thermophilic stage has been completed, only the readily available nutrients in the organic material have been digested. There’s still a lot of food in the pile, and a lot of work to be done by the

creatures in the compost. It takes many months to break down some of the more resistant organic material in compost such as “lignin” which comes from wood materials. Like humans, trees have evolved with a skin that is resistant to bacterial attack, and in a compost pile those lignins resist breakdown by thermophiles. However, other organisms, such as fungi, can break down lignin, given enough time; since they don’t like the heat of thermophilic compost, they simply wait for things to cool down before beginning their job.

The final stage of the composting process is called the curing, aging, or maturing stage, and it is a long and important one. Commercial composting professionals often want to make their compost as quickly as possible, usually sacrificing the compost’s curing time. One municipal compost operator remarked that if he could shorten his compost time to four months, he could make three batches of compost a year instead of only the two he was then making, thereby increasing his output by 50%. Municipal composters see truckloads of compost coming in to their facilities daily, and they want to make sure they don’t get inundated with organic material waiting to be composted. Therefore, they feel a need to move their material through the composting process as quickly as possible to make room for the new stuff coming in. Household composters don’t have that problem, although there seem to be plenty of backyard composters who are obsessed with making compost as quickly as possible. However, the curing, aging, or maturing of the compost is a critically important stage of the compost-making process. And, as in wine-making, an important element to figure into the equation is *patience*.

A long curing period (e.g., a year after the thermophilic stage) adds a safety net for pathogen destruction. Many human pathogens only have a limited period of viability in the soil, and the longer they are subjected to the microbiological competition of the compost pile, the more likely they will die a swift death.

Immature compost can be harmful to plants. Uncured compost can produce phytotoxins (substances toxic to plants), can rob the soil of oxygen and nitrogen, and can contain high levels of organic acids. So relax, sit back, put your feet up, and let your compost reach full maturity *before* you even think about using it.

Source: The Humanure Handbook. Jenkins Publishing, PO Box 607, Grove City, PA 16127. To order, phone: 1-800-639-4099.

<http://www.jenkinspublishing.com/>

MENU: [HOME](#) » [Reconstruction](#) » [Recovery](#) » [Renewal](#) » [Survival](#) » [Humanure Content](#)

COMPOST BIODIVERSITY

Compost is normally populated by three general categories of microorganisms: bacteria, actinomycetes, and fungi (see Figure 3.3 and Table 3.6). It is the bacteria, and specifically the thermophilic bacteria, that create the heat of the compost pile.

Although considered bacteria, actinomycetes are effectively intermediate between bacteria and fungi because they look similar to fungi and have similar nutritional preferences and growth habits. They tend to be more commonly found in the later stages of the compost, and are generally thought to follow the thermophilic bacteria in succession. They, in turn, are followed predominantly by fungi during the last stages of the composting process.

There are at least 100,000 species of fungi known, the overwhelming majority of them being microscopic.³¹ Most fungi cannot grow at 50°C (it's too hot) although some are heat tolerant (thermophilic fungi). Fungi tend to be absent in compost above 60°C, and actinomycetes tend to be absent above 70°C. Above 82°C biological activity effectively stops (extreme thermophiles are not found in compost).³²

To get an idea of the microbial diversity normally found in nature, consider this: a teaspoon of native grassland soil contains 600-800 million bacteria comprising 10,000 species, plus perhaps 5,000 species of fungi, the mycelia of which could be stretched out for several miles. In the same teaspoon, there may be 10,000 individual protozoa of perhaps 1,000 species, plus 20-30 different nematodes from as many as 100 species. Sounds crowded to me. Obviously, good compost will reinoculate depleted, sanitized, chemicalized soils with a wide variety of beneficial microorganisms (see Figures 3.4 and 3.5).³³

COMPOST MICROORGANISMS "SANITIZE" COMPOST

One of the most frequent questions asked of me is, "How do you know that ALL parts of your compost have been subjected to high enough temperatures to kill ALL potential pathogens?" The answer should be obvious: you don't. You never will. Unless, of course, you examine every cubic centimeter of your compost for pathogens in a laboratory. This would probably cost many thousands of dollars, which would make your compost the most expensive in history.

It's not *only* the heat of the compost that causes the destruction of human, animal, and plant pathogens, it's a combination of factors including:

- competition for food from compost microorganisms;
-
- inhibition and antagonism by compost microorganisms;
-
- consumption by compost organisms;
-
- biological heat generated by compost microorganisms; and
-
- antibiotics produced by compost microorganisms.

For example, when bacteria were grown both in an incubator and separately in compost at 50°C, they died in the compost after only seven days, but lived in the incubator for seventeen days. This indicated that it is more than just temperature that determines the fate of pathogenic bacteria. The other factors listed above undoubtedly affect the viability of non-indigenous microorganisms (such as human pathogens) in a compost pile. Those factors require as large and diverse a microbial population as possible, which is best achieved by temperatures below 60°C (140°F). One researcher states that, “*Significant reductions in pathogen numbers have been observed in compost piles which have not exceeded 40°C [104°F].*” ³⁴

There is no doubt that the heat produced by thermophilic bacteria kills pathogenic microorganisms, viruses, bacteria, protozoa, worms and eggs that may inhabit humanure. A temperature of 50°C (122° F), if maintained for twenty-four hours, is sufficient to kill all of the pathogens, according to some sources (see Chapter Seven). A lower temperature will take longer to kill pathogens. A temperature of 46°C (115°F) may take nearly a week to kill pathogens completely, a higher temperature may only take minutes. What we have yet to determine is how low those temperatures can be and still achieve satisfactory pathogen elimination. Some researchers insist that all pathogens will die at ambient temperatures (normal air temperature) given enough time.

When Westerberg and Wiley composted sewage sludge which had been inoculated with polio virus, *Salmonella*, roundworm eggs, and *Candida albicans*, they found that a compost temperature of 47-55°C (116-130°F) maintained for three days killed all of these pathogens.³⁵ This phenomenon has been confirmed by many other researchers, including Gotaas, who indicates that pathogenic organisms are unable to survive compost temperatures of 55-60°C (131-140°F) for more than thirty minutes to one hour.³⁶ The first goal in composting humanure, therefore, should be to create a compost pile that will heat sufficiently to kill all potential human pathogens that may be found in the manure.

Nevertheless, the heat of the compost pile is a highly lauded characteristic of compost that is a bit overblown at times. People think that it’s only the heat of the compost that destroys pathogens, so they want their compost to become as hot as possible. This is a mistake. In fact, compost can become too hot, and when it does, it destroys the biodiversity of the microbial community. As one scientist states, “*Research has indicated that temperature is not the only mechanism involved in pathogen suppression, and that the employment of higher than necessary temperatures may actually constitute a barrier to effective sanitization under certain circumstances.*” ³⁷ Perhaps only one species (e.g., *Bacillus*

stearotherophilus) may dominate the compost pile during periods of excessive heat, thereby driving out or just outright killing the other inhabitants of the compost, which include fungi and actinomycetes, as well as the bigger organisms that you can actually see.

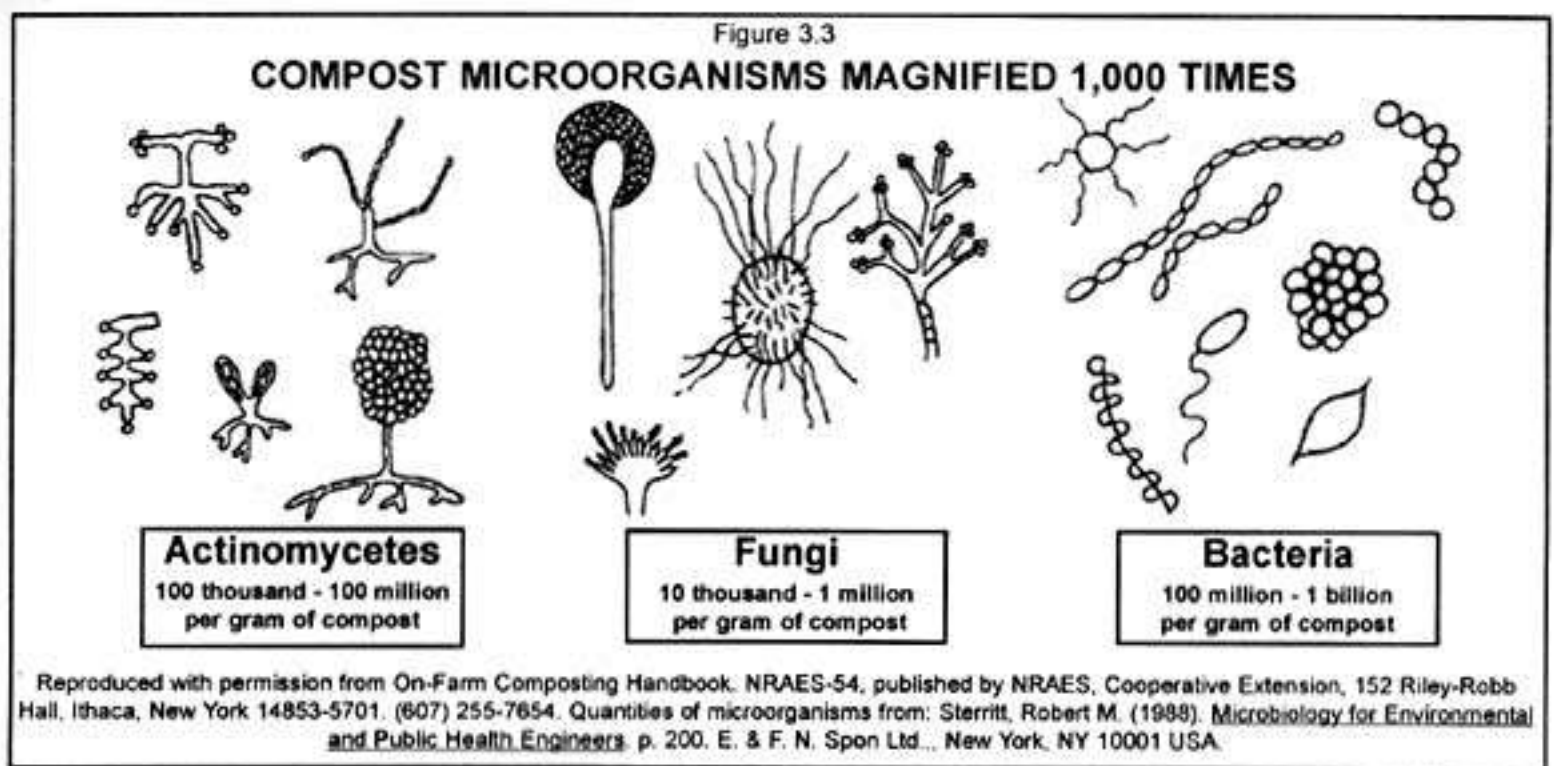

Table 3.6
MICROORGANISMS IN COMPOST

<u>Actinomycetes</u>	<u>Fungi</u>	<u>Bacteria</u>
<i>Actinobifida chromogena</i>	<i>Aspergillus fumigatus</i>	<i>Alcaligenes faecalis</i>
<i>Microbispora bispora</i>	<i>Humicola grisea</i>	<i>Bacillus brevis</i>
<i>Micropolyspora faeni</i>	<i>H. insolens</i>	<i>B. circulans</i> complex
<i>Nocardia</i> sp.	<i>H. lanuginosa</i>	<i>B. coagulans</i> type A
<i>Pseudocardia thermophila</i>	<i>Malbranchea pulchella</i>	<i>B. coagulans</i> type B
<i>Streptomyces rectus</i>	<i>Myriococcum thermophilum</i>	<i>B. licheniformis</i>
<i>S. thermofuscus</i>	<i>Paecilomyces variotti</i>	<i>B. megaterium</i>
<i>S. thermoviolaceus</i>	<i>Papulaspora thermophila</i>	<i>B. pumilus</i>
<i>S. thermovulgaris</i>	<i>Scytalidium thermophilum</i>	<i>B. sphaericus</i>
<i>S. violaceus-ruber</i>	<i>Sporotrichum thermophile</i>	<i>B. stearotherophilus</i>
<i>Thermoactinomyces sacchari</i>		<i>B. subtilis</i>
<i>T. vulgaris</i>		<i>Clostridium thermocellum</i>
<i>Thermomonospora curvata</i>		<i>Escherichia coli</i>
<i>T. viridis</i>		<i>Flavobacterium</i> sp.
		<i>Pseudomonas</i> sp.
		<i>Serratia</i> sp.
		<i>Thermus</i> sp.

Source: Palmisano, Anna C. and Barlaz, Morton A. (Eds.) (1996). *Microbiology of Solid Waste*. Pp. 125-127. CRC Press, Inc., 2000 Corporate Blvd., N.W. Boca Raton, FL 33431 USA.

A compost pile that is too hot can destroy its own biological community and leave a mass of organic material that must be re-populated in order to continue the necessary conversion of organic matter to humus. Such sterilized compost is more likely to be colonized by unwanted microorganisms, such as *Salmonella*. Researchers have shown that the biodiversity of compost acts as a barrier to colonization by such unwanted microorganisms as *Salmonella*. In the absence of a biodiverse “indigenous flora,” such as happens through sterilization, *Salmonella* were able to regrow.³⁸

The microbial biodiversity of compost is also important because it aids in the breakdown of the organic material. For example, in high-temperature compost (80°C), only about 10% of sewage sludge solids could be decomposed in three weeks, whereas at 50-60°C, 40% of the sludge solids were decomposed in only seven days. The lower temperatures apparently allowed for a richer diversity of living things which in turn had a greater effect on the degradation of the organic matter. One researcher indicates that optimal decomposition rates occur in the 55-59°C (131-139°F) temperature range, and optimal thermophilic activity occurs at 55°C (131°F), which are both adequate temperatures for pathogen destruction.³⁹ A study conducted in 1955 at Michigan State University, however, indicated that optimal decomposition occurs at an even lower temperature of 45°C (113°F).⁴⁰ Another researcher asserts that maximum biodegradation occurs at 45-55°C (113-131°F), while maximum microbial diversity requires a temperature range of 35-45°C (95-113°F).⁴¹ Apparently, there is still some degree of flexibility in these estimates, as the science of “compost microhusbandry” is not an utterly precise one at this time. Control of excessive heat is rarely a concern for the backyard composter.

Some thermophilic actinomycetes, as well as mesophilic bacteria, produce antibiotics that display considerable potency toward other bacteria, and yet exhibit low toxicity when tested on mice. Up to one half of thermophilic strains can produce antimicrobial compounds, some of which have been shown to be effective against *E. coli* and *Salmonella*. One thermophilic strain with an optimum growth temperature of 50°C produces a substance that “*significantly aided the healing of infected surface wounds in clinical tests on human subjects. The product(s) also stimulated growth of a variety of cell types, including various animal and plant tissue cultures and unicellular algae.*”⁴² The production of antibiotics by compost microorganisms theoretically assists in the destruction of human pathogens that may have existed in the organic material before composting.

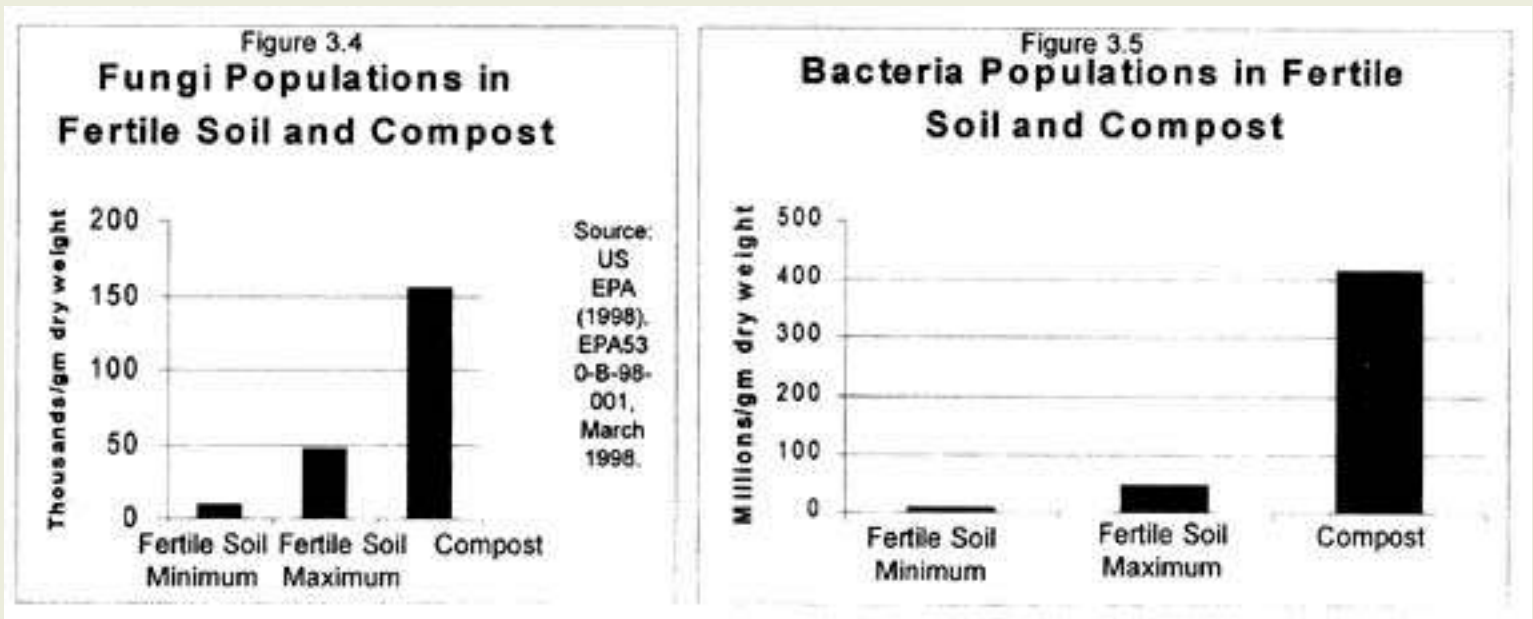

Even if every speck of the composting material is not subjected to the high internal temperatures of the compost pile, the process of thermophilic composting nevertheless contributes immensely toward the creation of a sanitary organic material. Or, in the words of one group of composting professionals, *“The high temperatures achieved during composting, assisted by the competition and antagonism among the microorganisms [i.e., biodiversity], considerably reduce the number of plant and animal pathogens. While some resistant pathogenic organisms may survive and others may persist in cooler sections of the pile, the disease risk is, nevertheless, greatly reduced.”* ⁴³

If a backyard composter has any doubt or concern about the existence of pathogenic organisms in his or her humanure compost, s/he can use the compost for horticultural purposes rather than for food purposes. Humanure compost can grow an amazing batch of berries, flowers, bushes, or trees. Furthermore, lingering pathogens continue to die after the compost has been applied to the soil, which is not surprising as human pathogens prefer the warm and moist environment of the human body. As the World Bank researchers put it, *“even pathogens remaining in compost seem to disappear rapidly in the soil.”* [Night Soil Composting, 1981] Finally, compost can be tested for pathogens by compost testing labs.

Some say that a few pathogens in soil or compost are ok. *“Another point most folks don’t realize is that no compost and no soil are completely pathogen free. You really don’t want it to be completely pathogen free, because you always want the defense mechanism to have something to practice on. So a small number of disease-causing organisms is desirable. But that’s it.”* ⁴⁴ Pathogens are said to have “minimum infective doses,” which vary widely from one type of pathogen to another, meaning that a number of pathogens are necessary in order to initiate an infection. The idea, therefore, that compost must be sterile is incorrect. It must be sanitary, which means it must have a greatly weakened, reduced, or destroyed pathogen population.

In reality, the average backyard composter knows whether his or her family is healthy or not. Healthy families have little to be concerned about, and can feel pretty confident that their thermophilic compost will be safe for their garden, provided the simple instructions in this book are followed regarding

compost temperatures and retention times, as discussed in Chapter Seven. On the other hand, there will always be those people who are fecophobic, and who will never be convinced that humanure compost is safe. These people are not likely to compost their humanure anyway, so who cares?

Source: The Humanure Handbook. Jenkins Publishing, PO Box 607, Grove City, PA 16127. To order, phone: 1-800-639-4099.

<http://www.jenkinspublishing.com/>

MENU: [HOME](#) » [Reconstruction](#) » [Recovery](#) » [Renewal](#) » [Survival](#) » [Humanure Content](#)

COMPOST MYTHS

TO TURN OR NOT TO TURN: THAT IS THE QUESTION

What is one of the first things to come to mind when one thinks of compost? Turning the pile. *Turn, turn, turn*, has become the mantra of composters worldwide. Early researchers who wrote seminal works in the composting field, such as Gotaas, Rodale, and many others, emphasize turning compost piles, almost obsessively so.

Much of compost's current popularity in the West can be attributed to the work of Sir Albert Howard, who wrote *An Agricultural Testament* (1943) and several other works on aspects of what has now become known as *organic* agriculture. Sir Howard's discussions of composting techniques focus on the Indore process of composting, a process developed in Indore, India, between the years of 1924 and 1931. The Indore process was first described in detail in Sir Howard's work (co-authored with Y. D. Wad), *The Waste Products of Agriculture*, in 1931. The two main principles underlying the Indore composting process include: 1) mixing animal and vegetable refuse with a neutralizing base, such as agricultural lime; and 2) managing the compost pile by physically turning it. The Indore process subsequently became adopted and espoused by composting enthusiasts in the West, and today one still commonly sees people turning and liming compost piles. For example, Robert Rodale wrote in the February, 1972 issue of *Organic Gardening* concerning composting humanure, "*We recommend turning the pile at least three times in the first few months, and then once every three months thereafter for a year.*"

A large industry has emerged from this philosophy, one which manufactures expensive compost turning equipment, and a lot of money, energy, and expense goes into making sure compost is turned regularly. To some compost professionals, the suggestion that compost doesn't need to be turned at all is utter blasphemy. Of course you have to turn it — it's a compost pile, for heaven's sake.

Or do you? Well, in fact, NO, you don't, especially if you're a backyard composter, and not even if you're a large scale composter. The perceived need to turn compost is one of the myths of composting.

Turning compost potentially serves four basic purposes. First, turning is supposed to add oxygen to the compost pile, which is supposed to be good for the aerobic microorganisms. We are warned that if we do not turn our compost, it will become anaerobic and smell bad, attract rats and flies, and make us into social pariahs in our neighborhoods. Second, turning the compost ensures that all parts of the pile are subjected to the high internal heat, thereby ensuring total pathogen death, and yielding a hygienically safe, finished compost. Third, the more we turn the compost, the more it becomes chopped and mixed,

and the better it looks when finished, rendering it more marketable. Fourth, frequent turning can speed up the composting process. Since backyard composters don't actually market their compost, usually don't care if it's finely granulated or somewhat coarse, and usually have no good reason to be in a hurry, we can eliminate the last two reasons for turning compost right off the bat. Let's look at the first two.

Aeration is necessary for aerobic compost, which is what we want. There are numerous ways to aerate a compost pile. One is to force air into or through the pile using fans, which is common at large-scale composting operations, where air is sucked from under the compost piles and out through a biofilter. The suction causes air to seep into the organic mass through the top, thereby keeping it aerated. However, this air flow is more often than not a method for trying to reduce the temperature of the compost, because the exhaust air draws quite a bit of heat away from the compost pile. Mechanical aeration is never a need of the backyard composter, and is limited to large scale composting operations where the piles are so big they can smother themselves if not subjected to forced aeration.

Aeration can also be achieved by poking holes in the compost, driving pipes into it, and generally impaling it. This seems to be popular among some backyard composters. A third way is to physically turn the pile. A fourth, largely ignored way, however, is to build the pile so that tiny interstitial air spaces are trapped in the compost. This is done by using coarse materials in the compost, such as hay, straw, weeds, and the like. When a compost pile is properly constructed, no additional aeration will be needed. Even the organic gardening pros admit that, *“good compost can be made without turning by hand if the materials are carefully layered in the heap which is well-ventilated and has the right moisture content.”*

[45](#)

This is especially true for “continuous compost,” which is different from “batch compost.” Batch compost is made from a batch of material that is composted all at once. This is what commercial composters do — they get a dumptruck load of garbage or sewage sludge from the municipality and compost it in one big pile. Backyard composters, especially humanure composters, produce organic residues daily, a little at a time, and rarely, if ever, in big batches. Therefore, continuous composters add material continuously to a compost pile, usually by putting the fresh material on the top. This causes the thermophilic activity to be in the upper part of the pile, while the thermophilically “spent” part of the compost sinks lower and lower to be worked on by fungi, actinomycetes, earthworms, and lots of other things. Turning continuous compost dilutes the thermophilic layer with the spent layers and can quite abruptly stop all thermophilic activity.

Researchers have measured oxygen levels in large-scale windrow composting operations (a windrow is a long, narrow pile of compost). One reported, *“Oxygen concentration measurements taken within the windrows during the most active stage of the composting process, showed that within fifteen minutes after turning the windrow — supposedly aerating it — the oxygen content was already depleted.”* [46](#) Other researchers compared the oxygen levels of large, turned and unturned batch compost piles, and have come to the conclusion that compost piles are largely self-aerated. *“The effect of pile turning was to refresh oxygen content, on average for [only] 1.5 hours (above the 10% level), after which it dropped to less than 5% and in most cases to 2% during the active phase of composting . . . Even with no turning, all piles eventually resolve their oxygen tension as maturity approaches, indicating that self-aeration alone*

can adequately furnish the composting process . . . In other words, turning the piles has a temporal but little sustained influence on oxygen levels.” These trials compared compost that was not turned, bucket turned, turned once every two weeks, and turned twice a week.⁴⁷

Interestingly enough, the same trials indicated that bacterial pathogens were destroyed whether the piles were turned or unturned, stating that there was no evidence that bacterial populations were influenced by turning schemes. There were no surviving *E. coli* or *Salmonella* strains, indicating that there were “no statistically significant effects attributable to turning.” Unturned piles can benefit by the addition of extra coarse materials such as hay or straw, which trap extra air in the organic material and make additional aeration unnecessary. Furthermore, unturned compost piles can be covered with a thick insulating layer of organic material, such as hay, straw, or even finished compost, which will allow the temperatures on the outer edges of the pile to warm enough for pathogen destruction.

Not only can turning compost piles be an unnecessary expenditure of energy, but the above trials also showed that when batch compost piles are turned frequently, some other disadvantageous effects can result (see Figure 3.6). The more frequently compost piles are turned, the more they lose agricultural nutrients. When the finished compost was analyzed for organic matter and nitrogen loss, the unturned compost showed the least loss. The more frequently the compost was turned, the greater was the loss of both nitrogen and organic matter. Also, the more the compost was turned, the more it cost. The unturned compost cost \$3.05 per wet ton, while the compost turned twice a week cost \$41.23 per wet ton, a 1,351% increase. The researchers concluded that

Figure 3.6

Compost Turning Costs

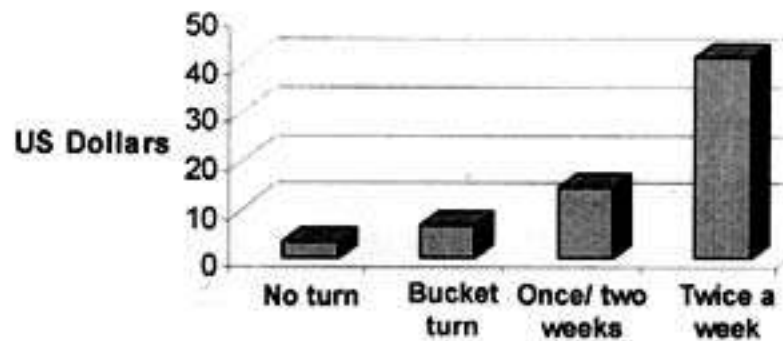

Organic Matter Loss Due to Turning (%)

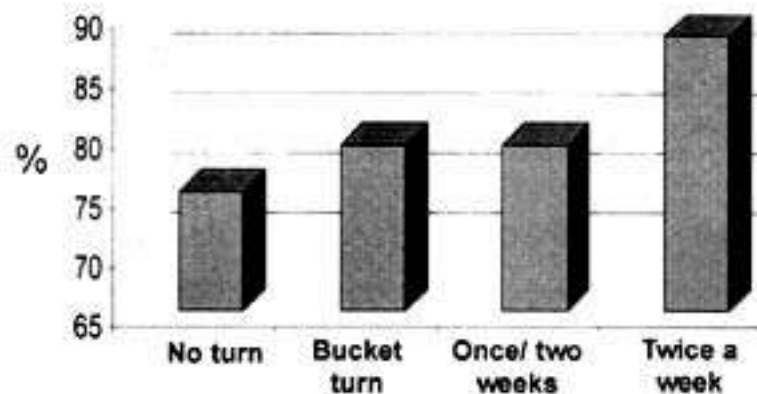

Nitrogen Loss Due To Turning (%)

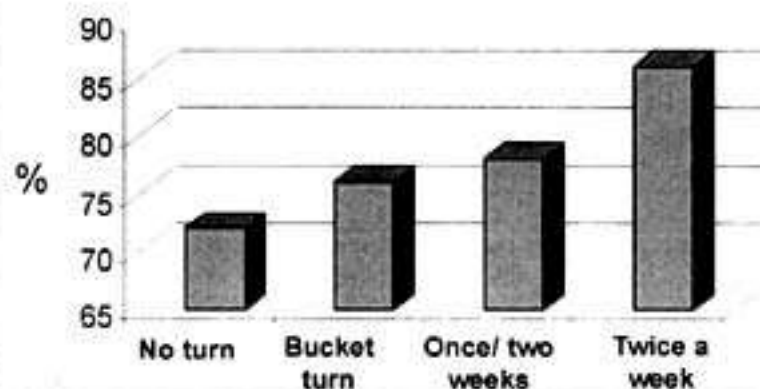

“Composting methods that require intensification [frequent turning] are a curious result of modern popularity and technological development of composting as particularly evidenced in popular trade journals. They do not appear to be scientifically supportable based on these studies . . . By carefully managing composting to achieve proper mixes and limited turning, the ideal of a quality product at low economic burden can be achieved.” ⁴⁸ Backyard composters like the “low economic burden” part of that statement.

no turn	once a turn	once two weeks	twice a week
Source: Brinton, William F. Jr. (date unknown). Sustainability of Modern Composting - Intensification Versus Cost and Quality. Woods End Institute, PO Box 297, Mt. Vernon, Maine 04352 USA.			

When large piles of compost are turned, they give off emissions of such things as *Aspergillus fumigatus* fungi, which can cause health problems in people. Aerosol concentrations from static (unturned) piles are relatively small when compared to mechanically turned compost. Measurements thirty meters downwind from static piles showed that aerosol concentrations of *A. fumigatus* were not significantly above background levels, and were “33 to 1800 times less” than those from piles that were being moved.⁴⁹

Finally, turning compost piles in cold climates can cause them to lose too much heat. It is recommended that cold climate composters turn less frequently, if at all.⁵⁰

DO YOU NEED TO INOCULATE YOUR COMPOST PILE?

No. This is perhaps one of the most astonishing aspects of composting. In October of 1998, I took a trip to Nova Scotia, Canada, to observe the municipal composting operations there. The Province had legislated that as of November 30, 1998, no organic materials could be disposed of in landfills. By the end of October, with the “ban date” approaching, virtually all municipal organic garbage was being collected and transported instead to composting facilities, where it was effectively being recycled and converted into humus. The municipal garbage trucks would simply back into the compost facility building (the composting was done indoors), and then dump the garbage on the floor. The material consisted of the normal household and restaurant food materials such as banana peels, coffee grounds, bones, meat, spoiled milk, and paper products such as cereal boxes. The occasional clueless person would contribute a toaster oven, but these were sorted out. The organic material was then checked for other contaminants such as bottles and cans, run through a grinder, and finally shoved into a concrete compost bin. Within 24-48 hours, the temperature of the material would climb to 70°C (158°F). No inoculants were required. Incredibly, the thermophilic bacteria were already there, waiting in the garbage for this moment to arrive.

Researchers have composted materials with and without inocula and found that, “*although rich in bacteria, none of the inocula accelerated the composting process or improved the final product . . . The failure of the inocula to alter the composting cycle is due to the adequacy of the indigenous microbial population already present and to the nature of the process itself . . . The success of composting operations without the use of special inocula in the Netherlands, New Zealand, South Africa, India, China, the USA, and a great many other places, is convincing evidence that inocula and other additives*

are not essential in the composting of [organic] materials.”⁵¹ Others state, “No data in the literature indicate that the addition of inoculants, microbes, or enzymes accelerate the compost process.”⁵²

LIME

It is not necessary to put lime (ground agricultural limestone) on your compost pile. The belief that compost piles should be limed is a common misconception. Nor are other mineral additives needed on your compost. If your soil needs lime, put the lime on your soil, not your compost. Bacteria don't digest limestone; in fact lime is used to kill microorganisms in sewage sludge (lime-stabilized sludge).

Aged compost is not acidic, even with the use of sawdust. The pH of finished compost should slightly exceed 7 (neutral). What is pH? It's a measure of acidity and alkalinity which ranges from 1-14. Neutral is 7. Below seven is acidic, above seven is basic or alkaline (see Figure 3.7). If the pH is too acidic or too alkaline, bacterial activity will be hindered or stopped completely. Lime and wood ashes raise the pH, but wood ashes should also go straight on the soil. The compost pile doesn't need them. It may seem logical that one should put into one's compost pile whatever one also wants to put into one's garden soil, as the compost will end up in the garden eventually, but that's not the reality of the situation. *What one should put into one's compost is what the microorganisms in the compost want or need, not what the garden soil wants or needs.*

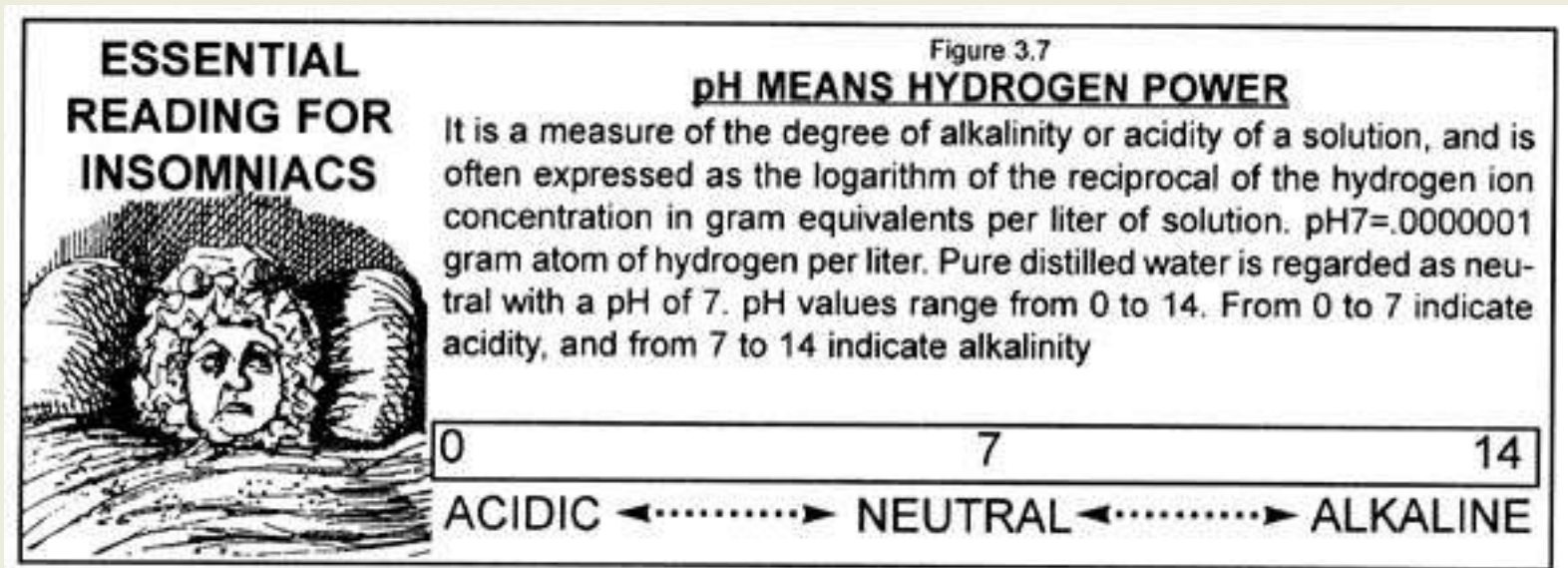

Sir Albert Howard, one of the most well-known proponents of composting, as well as J. I. Rodale, another prominent organic agriculturist, have recommended adding lime to compost piles.⁵³ They seemed to base their reasoning on the belief that the compost will become acidic during the composting process, and therefore the acidity must be neutralized by adding lime to the pile while it's composting. It may well be the case that some compost becomes acidic during the process of decomposition, however, it seems to neutralize itself if left alone, yielding a neutral, or slightly alkaline end product. Therefore, it is recommended that you test your *finished* compost for pH before deciding that you need to neutralize any acids.

I find it perplexing that the author who recommended liming compost piles in one book, states in another, “*The control of pH in composting is seldom a problem requiring attention if the material is kept aerobic. . . the addition of alkaline material is rarely necessary in aerobic decomposition and, in fact, may do more harm than good because the loss of nitrogen by the evolution of ammonia as a gas will be greater at the higher pH.*”⁵⁴ In other words, don’t assume that you should lime your compost. Only do so if your finished compost is consistently acidic, which would be highly unlikely. Get a soil pH test kit and check it out. Researchers have indicated that maximum thermophilic composting occurs at a pH range between 7.5 to 8.5, which is slightly alkaline.⁵⁵ But don’t be surprised if your compost is slightly acidic at the start of the process. It should turn neutral or slightly alkaline and remain so when completely cured.

According to a 1991 report, scientists who were studying various commercial fertilizers found that agricultural plots to which composted sewage sludge had been added made better use of lime than plots without composted sludge. The lime in the composted plots changed the pH deeper in the soil, indicating that organic matter assists calcium movement through the soil “*better than anything else,*” according to Cecil Tester, Ph.D., research chemist at USDA’s Microbial Systems Lab in Beltsville, MD.⁵⁶ The implications are that compost should be added to the soil when lime is added to the soil.

Perhaps Gotaas sums it up best, “*Some compost operators have suggested the addition of lime to improve composting. This should be done only under rare circumstances such as when the raw material to be composted has a high acidity due to acid industrial wastes or contains materials that give rise to highly acid conditions during composting.*”⁵⁷

WHAT NOT TO COMPOST? YOU CAN COMPOST ALMOST ANYTHING

I get a bit perturbed when I see compost educators telling their students that there is a long list of things “NOT to be composted!” This prohibition is always presented in such an authoritative and serious manner that novice composters begin trembling in their boots at the thought of composting any of the banned materials. I can imagine naive composters armed with this misinformation carefully segregating their food scraps so that, god forbid, the wrong materials don’t end up in the compost pile. Those banned materials include meat, fish, dairy products, butter, bones, cheese, lard, mayonnaise, milk, oils, peanut butter, salad dressing, sour cream, weeds with seeds, diseased plants, citrus peels, rhubarb leaves, crab grass, pet manures, and, perhaps worst of all: human manure. Presumably, one must segregate half-eaten peanut butter sandwiches from the compost bucket, or any sandwich with mayonnaise or cheese, or any left-over salad with salad dressing, or spoiled milk, or orange peels, all of which must go to a landfill and be buried under tons of dirt instead of being composted. Luckily, I was never exposed to such instructions, and my family has composted EVERY bit of food scrap it has produced, including meat, bones, butter, oils, fat, lard, citrus peels, mayonnaise, and everything else on the list; we’ve done this in our backyard for almost 25 years with never a problem. Why would it work for me and not for anyone else? The answer, in a word, if I may hazard a guess, is *humanure*, another forbidden compost material.

When compost heats up, much of the organic material is quickly degraded. This holds true for oils and fats, or in the words of scientists, “*Based on evidence on the composting of grease trap wastes, lipids*

[fats] can be utilized rapidly by bacteria, including actinomycetes, under thermophilic conditions.” [58](#)

The problem with the materials on the “banned” list, is that they do require thermophilic composting conditions for best results. Otherwise, they can just sit in the compost pile and only very slowly decompose. In the meantime, they can look very attractive to the wandering dog, cat, raccoon, or rat. Ironically, when the forbidden materials, including humanure, are combined with other compost ingredients, thermophilic conditions will prevail. When humanure and the other controversial organic materials are segregated from compost, thermophilic conditions may not occur at all. This is a situation that is probably quite common in most backyard compost piles. The solution is not to segregate materials from the pile, but to add nitrogen and moisture, as is commonly found in manure.

As such, compost educators would provide a better service to their students if they told them the truth: almost any organic material will compost, rather than give them the false impression that some common food materials will not. Granted, some things do not compost very well. Bones are one of them, but they do no harm in a compost pile.

Nevertheless, toxic chemicals *should* be kept out of the backyard compost pile. Such chemicals are found, for example, in “pressure treated” (i.e. poison-soaked) lumber, which is saturated with cancer-causing chemicals (chromated copper arsenate). What not to compost: sawdust from pressure treated lumber, which is, unfortunately, a toxic material that is more and more available to the average gardener.

Source: The Humanure Handbook. Jenkins Publishing, PO Box 607, Grove City, PA 16127. To order, phone: 1-800-639-4099.

<http://www.jenkinspublishing.com/>

MENU: [HOME](#) » [Reconstruction](#) » [Recovery](#) » [Renewal](#) » [Survival](#) » [Humanure Content](#)

COMPOST MIRACLES

COMPOST CAN DEGRADE TOXIC CHEMICALS

Compost microorganisms not only convert organic material into humus, but they also degrade toxic chemicals into simpler, benign, organic molecules. These chemicals include gasoline, diesel fuel, jet fuel, oil, grease, wood preservatives, PCBs, coal gasification wastes, refinery wastes, insecticides, herbicides, TNT, and other explosives.⁵⁹

In one experiment in which compost piles were laced with insecticides and herbicides, the insecticide (carbofuran) was completely degraded, and the herbicide (triazine) was 98.6% degraded after 50 days of composting. Soil contaminated with diesel fuel and gasoline was composted, and after 70 days in the compost pile, the total petroleum hydrocarbons were reduced approximately 93%.⁶⁰ Soil contaminated with Dicamba herbicide at a level of 3,000 parts per million showed no detectable levels of the toxic contaminant after only 50 days of composting. In the absence of composting, this biodegradation process normally takes years.

Compost also seems to bind lead in soils, making it less likely to be absorbed by living things. One researcher fed lead-contaminated soil to rats, either with compost added, or without. The soil to which compost had been added showed no toxic effects, whereas the soil without compost did exhibit some toxic effects.⁶¹ Compost seems to strongly bind metals and prevent their uptake by both plants and animals, thereby preventing transfer of metals from contaminated soil into the food chain.⁶² Plants grown in lead contaminated soil with ten percent compost showed a reduction in lead uptake of 82.6%, compared to plants grown in soil with no compost.⁶³

Fungi in compost produce a substance that breaks down petroleum, thereby making it available as food for bacteria.⁶⁴ One man who composted a batch of sawdust contaminated with diesel oil said, "*We did tests on the compost, and we couldn't even find the oil!*" The compost had apparently "eaten" it all.⁶⁵ Fungi also produce enzymes that can be used to replace chlorine in the paper-making process. Researchers in Ireland have discovered that fungi gathered from compost heaps can provide a cheap and organic alternative to toxic chemicals.⁶⁶

Compost has been used in recent years to degrade other toxic chemicals as well. For example, chlorophenol contaminated soil was composted with peat, sawdust, and other organic matter, and after 25 months, the chlorophenol was reduced in concentration by 98.73%. Freon contamination was reduced by 94%, PCPs by up to

98%, and TCE by 89-99% in other compost trials.⁶⁷ Some of this degradation is due to the efforts of fungi at lower (mesophilic) temperatures.⁶⁸

Table 3.7
MICROORGANISMS THAT HELP REMOVE METALS FROM WASTEWATER

MICROORGANISM	METAL
<i>Zooglea ramigera</i>	Copper
<i>Saccharomyces cerevisiae</i>	Uranium
<i>Trichoderma viride</i>	Copper
<i>Penicillium spinulosum</i>	Copper, Cadmium, Zinc
<i>Aspergillus Niger</i>	Copper, Cadmium, Zinc
<i>Chlorella vulgaris</i>	Gold, Zn, Cu, Mercury
<i>Rhizopus arrhizus</i>	Uranium

Source: Bitton, Gabriel (1994). *Wastewater Microbiology*, p. 302. Wiley-Liss, Inc. 605 Third Avenue, New York, NY 10518-0012.

Some bacteria even have an appetite for uranium. Derek Lovley, a microbiologist, has been working with a strain of bacteria that normally lives 650 feet under the Earth's surface. These microorganisms will eat, then excrete, uranium. The chemically altered uranium excreta becomes water insoluble as a result of the microbial digestion process, and can consequently be removed from the water it was contaminating (see Table 3.7).⁶⁹

An Austrian farmer claims that the microorganisms he introduces into his fields have prevented his crops from being contaminated by the radiation from Chernobyl, the ill-fated Russian nuclear power plant, which contaminated his neighbor's fields. Sigfried Lubke sprays his green manure crops with compost-type microorganisms just before plowing them under. This practice has produced a soil rich in humus and teeming with microscopic life. After the Chernobyl disaster, crops from fields in Lubke's farming area were banned from sale due to high amounts of radioactive cesium contamination. However, when officials tested Lubke's crops, no trace of cesium could be found. The officials made repeated tests because they couldn't believe that one farm showed no radioactive contamination while the surrounding farms did. Lubke surmises that the humus just "ate up" the cesium.⁷⁰

Compost is also able to decontaminate soil polluted with TNT from munitions plants. The microorganisms in the compost digest the hydrocarbons in TNT and convert them into carbon dioxide, water, and simple organic molecules. The method of choice for eliminating contaminated soil has thus far been incineration. However, composting costs far less, and yields a material that is valuable (compost), as opposed to incineration, which yields an ash that must itself be disposed of as toxic waste. When the Umatilla Army Depot in Hermiston, Oregon, a Superfund site, composted 15,000 tons of contaminated soil instead of incinerating it, it saved approximately \$2.6 million. Although the Umatilla soil was heavily contaminated with TNT and RDX (Royal Demolition Explosives), no explosives could be detected after composting, and the soil was restored to "a better condition than before it was contaminated."⁷¹ Similar results have been obtained at Seymour Johnson Air Force Base in North Carolina, the Louisiana Army Ammunition Plant, the US Naval Submarine Base in Bangor, Washington, Fort Riley in Kansas, and the Hawthorne Army Depot in Nevada.⁷²

The US Army Corps of Engineers estimates that we would save \$200 million if composting, instead of incineration, were used to clean up the remaining US munitions sites. The ability of compost to bioremediate toxic chemicals is particularly meaningful when one considers that in the US there are currently 1.5 million underground storage tanks leaking a wide variety of materials into soil, as well as 25,000 Department of Defense sites in need of remediation. In fact, it is estimated that the remediation costs for America's most polluted sites using standard technology may reach \$750 billion, while in Europe the costs could reach \$300 to \$400 billion.

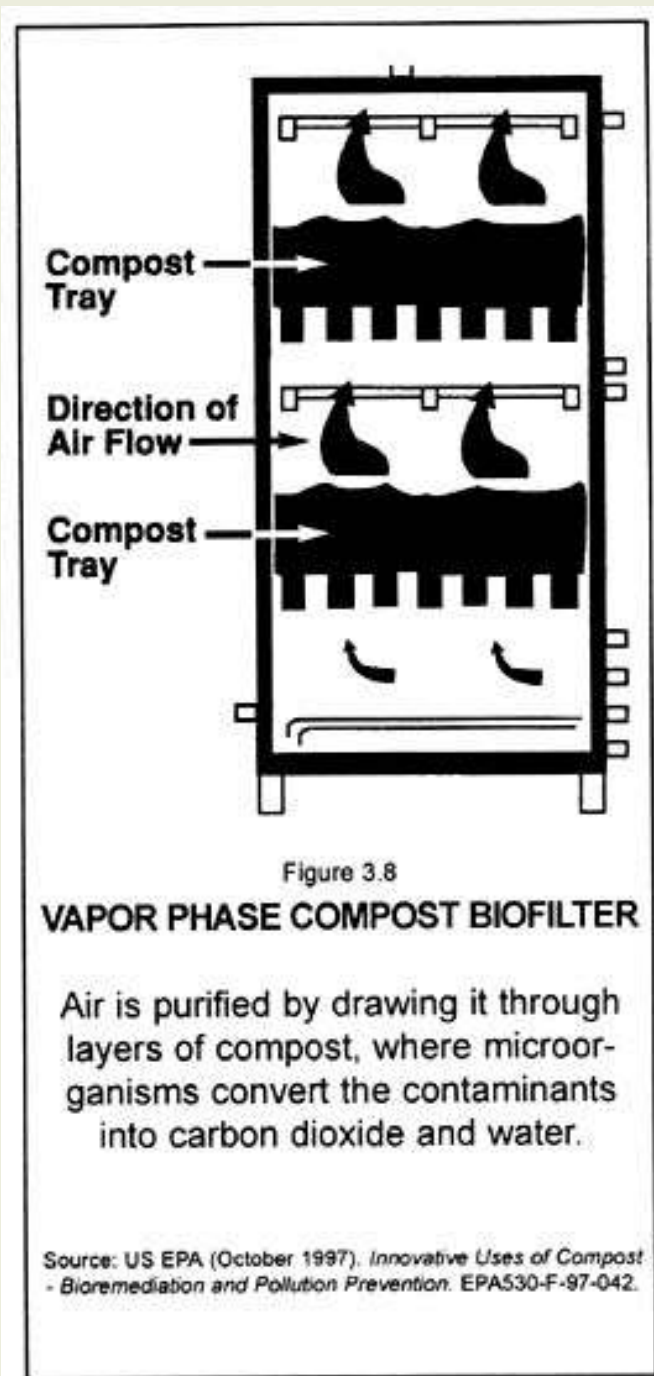

As promising as compost bioremediation appears, however, it cannot heal all wounds. Heavily chlorinated chemicals show considerable resistance to microbiological biodegradability. Apparently, there are even some things a fungus will spit out.⁷³ On the other hand, some success has been shown in the bioremediation of PCBs (polychlorinated biphenyls) in composting trials conducted by Michigan State University researchers in 1996. In the best case, PCB loss was in the 40% range. Despite the chlorinated nature of the PCBs, researchers still managed to get quite a few microorganisms to choke the stuff down.⁷⁴

COMPOST CAN FILTER POLLUTED AIR AND WATER

Compost can control odors. Biological filtration systems, called “biofilters,” are used at large-scale composting facilities where exhaust gases are filtered for odor control. The biofilters are composed of layers of organic material such as wood chips, peat, soil, and compost through which the air is drawn in order to remove any contaminants. The microorganisms in the organic material eat the contaminants and convert them into carbon dioxide and water (see Figures 3.8 and 3.9).

In Rockland County, New York, one such biofiltration system can process 82,000 cubic feet of air a minute, and guarantee no detectable odor at or beyond the site property line. Another facility in Portland, Oregon, uses biofilters to remediate aerosol cans prior to disposal. After such remediation, the cans are no longer considered hazardous, and can be disposed of more readily. In this case, a \$47,000 savings in hazardous waste disposal costs was realized over a period of 18 months. Vapor Phase Biofilters can maintain a consistent Volatile Organic Compound removal efficiency of 99.6%, which isn’t

bad for a bunch of microorganisms.⁷⁵ After a year or two, the biofilter is recharged with new organic material, and the old stuff is simply composted or applied to the land.

Compost is also now used to filter stormwater runoff (see Figure 3.10). Compost Stormwater Filters use compost to filter out heavy metals, oil, grease, pesticides, sediment, and fertilizers from stormwater runoff. Such filters can remove over 90% of all solids, 82% to 98% of heavy metals, and 85% of oil and grease, while filtering up to eight cubic feet per second. These Compost Stormwater Filters prevent stormwater contamination from polluting our natural waterways.⁷⁶

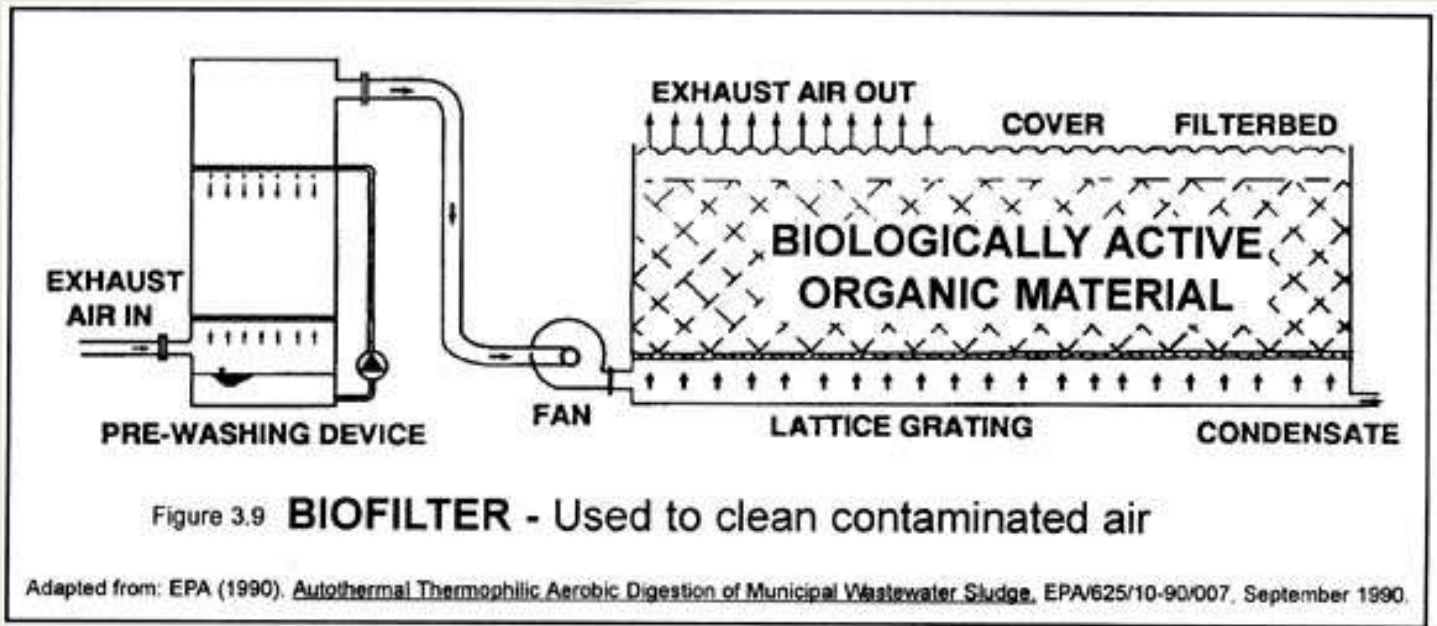

COMPOST DEFENDS PLANTS FROM DISEASES

The composting process can destroy many plant pathogens. Because of this, diseased plant material should be thermophilically composted rather than returned to the land where reinoculation of the disease could occur. The beneficial microorganisms in thermophilic compost directly compete with, inhibit, or kill organisms that cause diseases in plants. Plant pathogens are also eaten by micro-arthropods, such as mites and springtails, which are found in compost.⁷⁷

Compost microorganisms can produce antibiotics which suppress plant diseases. Compost added to soil can also activate disease resistance genes in plants, preparing them for a better defense against plant pathogens. Systemic Acquired Resistance caused by compost in soils allows plants to resist the effects of diseases such as *Anthraxnose* and *Pythium* root rot in cucumbers. Experiments have shown that when only some of the roots of a plant are in compost amended soil, while the other roots are in diseased soil, the entire plant can still acquire resistance to the disease.⁷⁸ Researchers have shown that compost combats chili wilt (*Phytophthora*) in test plots of chili peppers, and suppresses ashy stem blight in beans, *Rhizoctonia* root rot in black-eyed peas,⁷⁹ *Fusarium oxysporum* in potted plants, and gummy stem blight and damping off diseases in squash.⁸⁰ It is now recognized that the control of root rots with composts can be as effective as synthetic fungicides such as methyl bromide. Only a small percentage of compost microorganisms can, however, induce disease resistance in plants, which again emphasizes the importance of biodiversity in compost.

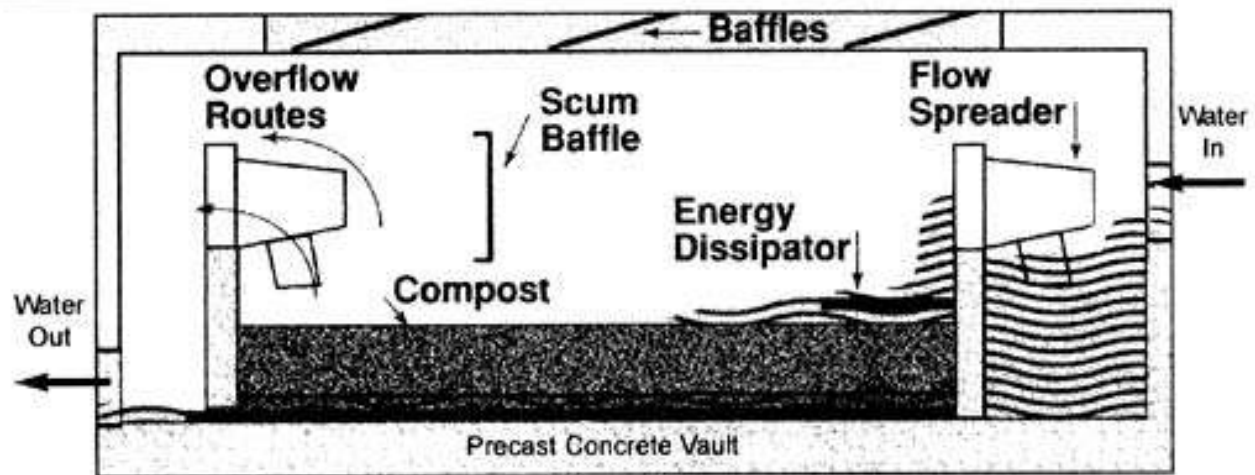

Figure 3.10

COMPOST STORMWATER FILTER

Contaminants are removed from stormwater when filtered through layers of compost.

Source: US EPA (October 1997). *Innovative Uses of Compost - Bioremediation and Pollution Prevention*. EPA530-F-97-042.

Studies in 1968 by researcher Harry Hoitink indicated that compost inhibited the growth of disease-causing microorganisms in greenhouses by adding beneficial microorganisms to the soil. In 1987, he and a team of scientists took out a patent for compost that could reduce or suppress plant diseases caused by three deadly microorganisms: *Phytophthora*, *Pythium*, and *Fusarium*. Growers who used this compost in their planting soil reduced their crop losses from 25-75% to 1% without applying fungicides. The studies suggested that sterile soils could provide optimum breeding conditions for plant disease microorganisms, while a rich diversity of microorganisms in soil, such as that found in compost, would render the soil unfit for the proliferation of disease organisms.⁸¹

In fact, compost tea has also been demonstrated to have disease-reducing properties in plants. Compost tea is made by soaking mature (but not overly-mature) compost in water for three to twelve days. The tea is then filtered and sprayed on plants undiluted, thereby coating the leaves with live bacteria colonies. When sprayed on red pine seedlings, for example, blight was significantly reduced in severity.⁸² Powdery mildew (*Uncinula necator*) on grapes was very successfully suppressed by compost tea made from cattle manure compost.⁸³ "Compost teas can be sprayed on crops to coat leaf surfaces and actually occupy the infection sites that could be colonized by disease pathogens," states one researcher, who adds, "There are a limited number of places on a plant that a disease pathogen can infect, and if those spaces are occupied by beneficial bacteria and fungi, the crop will be resistant to infection."⁸⁴

Besides helping to control soil diseases, compost attracts earthworms, aids plants in producing growth stimulators, and helps control parasitic nematodes.⁸⁵ Compost "biopesticides" are now becoming increasingly effective alternatives to chemical bug killers. These "designer composts" are made by adding certain pest-fighting microorganisms to compost, yielding a compost with a specific pest-killing capacity. Biopesticides must be registered with the US EPA and undergo the same testing as chemical pesticides to determine their effectiveness and degree of public safety.⁸⁶

Finally, composting destroys weed seeds. Researchers observed that after three days in compost at 55°C (131°F),

all of the seeds of the eight weed species studied were dead.⁸⁷

COMPOST CAN RECYCLE THE DEAD

Dead animals of all species and sizes can be recycled by composting. Of the 7.3 billion chickens, ducks, and turkeys raised in the US each year, about 37 million die from disease and other natural causes before they're marketed.⁸⁸ The dead birds can simply be composted. The composting process not only converts the carcasses to humus which can be returned directly to the farmer's fields, but it also destroys the pathogens and parasites that may have killed the birds in the first place. It is preferable to compost diseased animals on the farm where they originated rather than transport them elsewhere and risk spreading the disease. A temperature of 55°C maintained for at least three consecutive days maximizes pathogen control.

Composting is considered a simple, economic, environmentally sound, and effective method of managing animal mortalities. Carcasses are buried in, well, a compost pile. The composting process ranges from several days for small birds to six or more months for mature cattle. Generally, the total time required ranges from two to twelve months depending on the size of the animal and other factors such as ambient air temperature (time of year). The rotting carcasses are never buried in the ground where they may pollute groundwater, as is typical when composting is not used. Animal mortality recycling can be accomplished without odors, flies, or scavenging birds or animals.

Originally developed to recycle dead chickens, the animal carcasses that are now composted include full-grown pigs, cattle, and horses, as well as fish, sheep, calves, and other animals. The biological process of composting dead animals is identical to the process of composting any organic material. The carcasses provide nitrogen and moisture, while materials such as sawdust, straw, corn stalks, and paper provide carbon and bulk for air impregnation. The composting can be done in temporary three-sided bins made of straw or hay bales. A layer of absorbent organic material is used to cover the bottom of the bin, acting as a sponge for excess liquids. Large animals are placed back down in the compost, with their abdominal and thoracic cavities opened, and covered with organic material (sawmill sawdust has been shown to be one of the most effective organic materials with which to compost dead animals). After filling the bin with properly prepared animal mortalities, the top is covered with clean organic material that acts as a biofilter for odor control. Although large bones may remain after the composting process, they are easily broken when applied to the soil.⁸⁹

Backyard composters can also make use of this technique. When a small animal has died and the carcass needs to be recycled, simply dig a hole in the top center of the compost pile, deposit the carcass, bury it over with the compost, and cover it all with a clean layer of organic material such as straw, weeds, or hay. You will never see the carcass again. This is also a good way to deal with fish, meat scraps, milk products, and other organic materials that may otherwise be attractive to nuisance animals. However, one should have thermophilic compost in order to do this, and one can greatly increase the likelihood of his or her backyard compost being thermophilic by adding the nitrogen and moisture that humanure provides.

I keep some ducks and chickens on my homestead, and occasionally one of them dies. A little poking around in the compost pile to create a depression in the top, and a plop of the carcass into the hole, and another creature is on the road to reincarnation. We've also used this technique regularly for recycling other smaller animal carcasses such as mice, baby chicks, and baby rabbits. After I collect earthworms from my compost pile to go fishing at the local pond, I filet the catch and put it in the freezer for winter consumption. The fish remains go straight into the compost, buried in the same manner as any other animal mortality. We have five outdoor cats, and they wouldn't

be caught dead digging around in thermophilic humanure compost looking for a bite to eat. Nor would our dog — and dogs will eat anything, but not when buried in thermophilic compost.

COMPOST RECYCLES PET MANURES

Can you use dog manure in your compost? I can honestly say that I've never tried it, as I do not have a source of dog manure for experimentation (my dog is a free-roaming outdoor dog, and he leaves his scat somewhere out of sight). Numerous people have written to ask me whether pet manures can go into their household compost pile, and I have responded that I don't know from experience. So I've recommended that pet manures be collected in their own separate little compost bins with cover materials such as hay, grass clippings, leaves, weeds, or straw, and perhaps occasionally watered a bit to provide moisture. A double bin system will allow the manures to be collected for quite some time in one bin, then aged for quite some time while the second bin is being filled. What size bin? About the size of a large garbage can, although a larger mass may be necessary in order to spark a thermophilic reaction.

On the other hand, this may be entirely too much bother for most pet owners who are also composters, and you may just want to put pet and human manures into one compost bin. This would certainly be the simpler method. The idea of composting dog manure has been endorsed by J. I. Rodale in the *Encyclopedia of Organic Gardening*. He states, "*Dog manure can be used in the compost heap; in fact it is the richest in phosphorous if the dogs are fed with proper care and given their share of bones.*" He advises the use of cover materials similar to the ones I mentioned above, and recommends that the compost bin be made dog-proof, which can be done with straw bales, chicken wire, boards, or fencing.

ONE WAY TO RECYCLE JUNK MAIL

Composting is a solution for junk mail, too. A pilot composting project was started in 1997 in Dallas-Ft. Worth, Texas, where 800 tons of undeliverable bulk mail are generated annually. The mail was ground in a tub grinder, covered with wood chips so it wouldn't blow away, then mixed with zoo manure, sheep entrails, and discarded fruits and vegetables. The entire works was kept moist and thoroughly mixed. The result — a finished compost "*as good as any other compost commercially available.*" It grew a nice bunch of tomatoes, too.⁹⁰

What about newspapers in backyard compost? Yes, newspaper will compost, but there are some concerns about newsprint. For one, the glossy pages are covered with a clay that retards composting. For another, the inks can be petroleum-based solvents or oils with pigments containing toxic substances such as chromium, lead and cadmium in both black and colored inks. Pigment for newspaper ink still comes from benzene, toluene, naphthalene, and other benzene ring hydrocarbons which may be quite harmful to human health if accumulated in the food chain. Fortunately, quite a few newspapers today are using soy-based inks instead of petroleum-based inks. If you really want to know about the type of ink in your newspaper, call your newspaper office and ask them. Otherwise, keep the glossy paper or colored pages in your compost to a minimum. Remember, ideally, compost is being made to use for producing human food. One should try to keep the contaminants out of it, if possible.⁹¹

Wood's End Laboratory in Maine did some research on composting ground up telephone books and newsprint, which had been used as bedding for dairy cattle. The ink in the paper contained common cancer-causing chemicals, but after composting it with dairy cow manure, the dangerous chemicals were reduced by 98%.⁹² So it appears that if you're using shredded newspaper for bedding under livestock, you *should* compost it, if for no other reason than to eliminate some of the toxic elements from the newsprint. It'll probably make acceptable

compost too, especially if layered with garbage, manure, and other organic materials.

What about things like sanitary napkins and disposable diapers? Sure, they'll compost, but they'll leave strips of plastic throughout your finished compost which are quite unsightly. Of course, that's OK if you don't mind picking the strips of plastic out of your compost. Otherwise, use cloth diapers and washable cloth menstrual pads instead.

Toilet paper composts, too. So do the cardboard tubes in the center of the rolls. Unbleached, recycled toilet paper is ideal. Or you can use the old fashioned toilet paper, otherwise known as corncobs. Popcorn cobs work best, they're softer. Corncobs don't compost very readily though, so you have a good excuse not to use them. There are other things that don't compost well: eggshells, bones, hair, and woody stems, to name a few. We throw our eggshells back to our chickens, or into the woodstove. Bones go into the woodstove, or to the cats or dog. Hair goes out to the birds for nests, if not into the compost pile.

Compost professionals have almost fanatically seized upon the idea that wood chips are good for making compost. Nowadays, when novice composters want to begin making compost, the first thing they want to know is where they can get wood chips. In fact, wood chips do NOT compost very well at all, unless ground into fine particles, as in sawdust. Even compost professionals admit that they have to screen out their wood chips *after* the compost is finished because they didn't decompose. They insist on using them anyway, because they break up the compost consistency and maintain air spaces in their large masses of organic material. However, a home composter should avoid wood chips and use other bulking materials that degrade more quickly, such as hay, straw, sawdust, and weeds.

Finally, never put woody stemmed plants, such as tree saplings, on your compost pile. I hired a young lad to clear some brush for me one summer and he innocently put the small saplings on my compost pile without me knowing it. Later, I found them networked through the pile like iron reinforcing rods. I'll bet the lad's ears were itching that day — I sure had some nasty things to say about him. Fortunately, only Gomer, the compost pile, heard me.

*Source: The Humanure Handbook. Jenkins Publishing, PO Box 607, Grove City, PA 16127. To order, phone: 1-800-639-4099.
<http://www.jenkinspublishing.com/>*

MENU: [HOME](#) » [Reconstruction](#) » [Recovery](#) » [Renewal](#) » [Survival](#) » [Humanure Content](#)

MENU: [HOME](#) » [Reconstruction](#) » [Recovery](#) » [Renewal](#) » [Survival](#) » [Humanure Content](#)

VERMICOMPOSTING

Vermicomposting, or worm composting, involves the use of redworms (*Eisenis fetida* or *Lumbricus rubellus*) to consume organic material either in specially designed worm boxes, or in large-scale, outdoor compost piles. Redworms prefer a dark, cool, well-aerated space, and thrive on moist bedding such as shredded newspaper. Kitchen food scraps are placed in worm boxes and are consumed by the worms. Worm castings are left in their place, which can be used like finished compost to grow plants. Vermicomposting is popular among children who like to watch the worms, and among adults who prefer the convenience of being able to make compost under their kitchen counter or in a household closet.

Although vermicomposting involves microorganisms as well as earthworms, it is not the same as thermophilic composting. The hot stage of thermophilic composting will drive away all earthworms from the hot area of the compost pile. However, they will migrate back in after the compost cools down. Earthworms are reported to actually eat root-feeding nematodes, pathogenic bacteria, and fungi, as well as small weed seeds.⁹³

When thermophilic compost is piled on the bare earth, a large surface area is available for natural earthworms to migrate in and out of the compost pile. Properly prepared thermophilic compost situated on bare earth should require no addition of earthworms, as they will naturally migrate into the compost when it best suits them. My compost is so full of natural earthworms at certain stages in its development that, when dug into, it looks like spaghetti. These worms are occasionally harvested and transformed into fish. This is a process which converts compost directly into protein, but which requires a fishing rod, a hook, and lots of patience.

Source: The Humanure Handbook. Jenkins Publishing, PO Box 607, Grove City, PA 16127. To order, phone: 1-800-639-4099.

<http://www.jenkinspublishing.com/>

MENU: [HOME](#) » [Reconstruction](#) » [Recovery](#) » [Renewal](#) » [Survival](#) » [Humanure Content](#)

PRACTICE MAKES COMPOST

“Composting is easier to do than to describe, and, like lovemaking, magic when you do it well.”

Sim Van der Ryn

After reading this chapter one may become overwhelmed with all that is involved in composting: bacteria, actinomycetes, fungi, thermophiles, mesophiles, C/N ratios, oxygen, moisture, temperatures, bins, pathogens, curing, and biodiversity. How do you translate this into your own personal situation and locate it all in your own backyard? How does one become an accomplished composter, a master composter? That’s easy — just do it. Then keep doing it. Throw the books away (not this one, of course) and get some good, old-fashioned experience. There’s no better way to learn. Book learning will only get you so far, but not far enough. A book such as this one is for inspiring you, for sparking your interest, and for reference. But you have to get out there and *do it* if you really want to learn.

Work with the compost, get the feel of the process, look at your compost, smell the finished product, buy or borrow a compost thermometer and get an idea of how well your compost is heating up, then use your compost for food production. Rely on your compost. Make it a part of your life. Need it and value it. In no time, without the need for charts or graphs, Ph.D.s, or worry, your compost will be as good as the best of them. Perhaps someday we’ll be like the Chinese who give prizes for the best compost in a county, then have intercounty competitions. Now *that’s* getting your shit together.

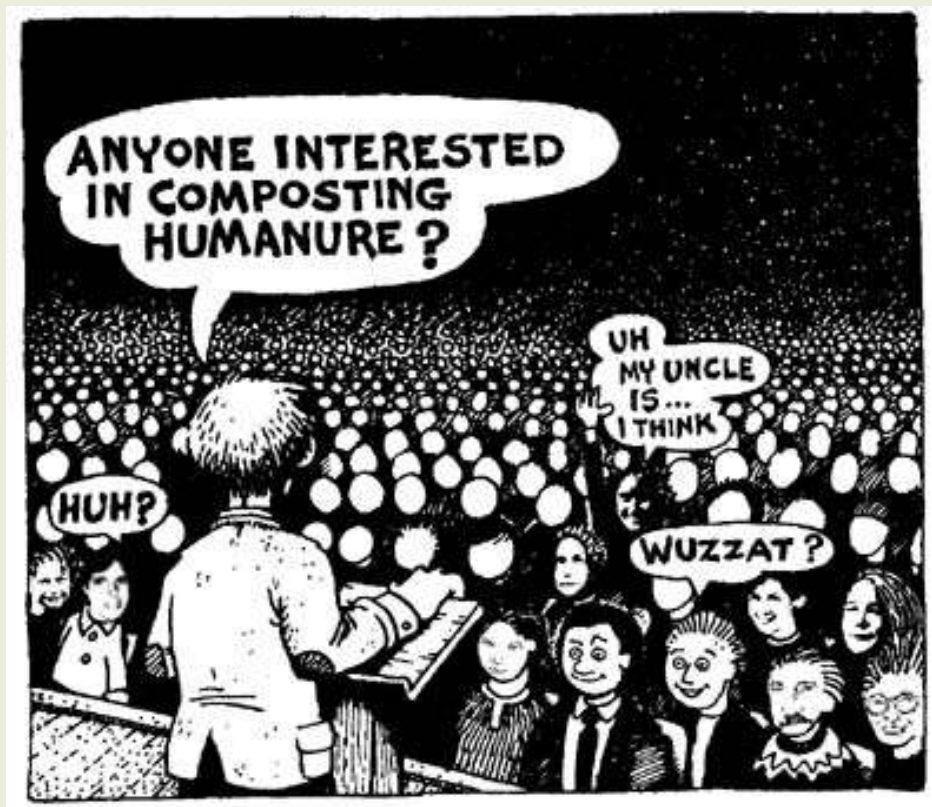



*Source: The Humanure Handbook. Jenkins Publishing, PO Box 607, Grove City, PA 16127. To order, phone: 1-800-639-4099.
<http://www.jenkinspublishing.com/>*

MENU: [HOME](#) » [Reconstruction](#) » [Recovery](#) » [Renewal](#) » [Survival](#) » [Humanure Content](#)

DEEP SH*T

(*Philosophy and Speculation)



“From the Latin word humus for earth, true humility grounds the seeker in truth.”

Edward Hayes - Prayers for a Planetary Pilgrim
(Special thanks to Sister Barbara of Villa Maria, PA)

Composting humanure is an act of humility, and the practice of humility is an exercise that strengthens one’s spirit. The Earth provides us with life; it gives us our children, allows us to pursue our dreams. All of the beauty and joy that makes up our lives ultimately springs from her breasts to nurture and strengthen us. We suckle from her — and then we give back feces and urine — usually in the form of surface and water pollutants.

Shortly after the first edition of this book was published, I was invited to speak to a group of nuns at a convent. It was my first speaking invitation, and I still remember the phone call:

“Mr. Jenkins, we recently bought a copy of your book, *Humanure*, and we would like to have you speak at our convent.”

At this time, I was still doubtful that anyone was even interested in the topic of humanure composting, so I responded, “What about?”

“About the topic of your book.”

“Composting?”

“Yes, but specifically, *humanure* composting.” At this point I was somewhat speechless. I couldn’t understand exactly why a group of nuns would be interested in composting their own shit. Somehow I couldn’t imagine standing in front of a room full of nuns in habits, speaking about turds. But I kept the stammering to a minimum and accepted the invitation.

It was Earth Day, 1995. The presentation went well. After I spoke, the group showed slides of their gardens and compost piles, and then we toured the compost area and poked around in the worm compost boxes. A delightful lunch followed, during which time I asked them why they were interested in humanure, of all things.

“We are the Sisters of Humility,” they responded. *“The words ‘humble’ and ‘humus’ come from the same semantic root, which means ‘earth.’ We also think these words are related to the word ‘human.’ Therefore, as part of our vow of humility, we work with the earth. We make compost, as you’ve seen. And now we want to learn how to make compost from our toilet material. We’re thinking about buying a commercial composting toilet, but we want to learn more about the overall concepts first. That’s why we asked you to come here.”*

A light bulb went off in my head. Of course, composting is an act of humility. The people who care enough about the earth to recycle their personal by-products do so as an exercise in humility, and not because they’re going to get rich and famous for it. That makes them better people. Some people go to church on Sunday, others make compost. Still others do both. Others go to church on Sunday, then throw all their garbage out into the environment. The exercising of the human spirit can take many forms, and the simple act of cleaning up after oneself is one of them. Carelessly dumping waste out into the world is a self-centered act of arrogance.

Humanure composters can stand under the stars at night gazing at the heavens, and know that, when nature calls, their excretions will not foul the planet. Instead, those excretions are humbly collected, fed to microorganisms, and returned to the Earth as healing medicine for the soil. Although today’s religious leaders may scoff at anyone who does not kowtow to the men at the top of their hierarchy, humble composters can ignore the pressures of religious conformity, and instead hold a grain of pure spiritual truth in the palm of their hand.

Source: The Humanure Handbook. Jenkins Publishing, PO Box 607, Grove City, PA 16127. To order, phone: 1-800-639-4099.

<http://www.jenkinspublishing.com/>

MENU: [HOME](#) » [Reconstruction](#) » [Recovery](#) » [Renewal](#) » [Survival](#) » [Humanure Content](#)

THE EGO VS. THE ECO

There are numerous theoretical reasons why we humans have strayed so far from a benign symbiotic relationship with the planet, and have instead taken on the visage, if not the behavior, of planetary pathogens. One of my favorites is “The Ego vs. The Eco” theory, also sometimes called the “Microcosm vs. the Macrocosm,” or, more simply, “Humans vs. Nature,” which I will attempt to explain in brief.

Human beings, like all living things on this planet, are inextricably intertwined with all of the elements of nature. We are threads in the tapestry of life. We constantly breathe the atmosphere that envelopes the planet; we drink the fluids that flow over the planet’s surface; we eat the organisms that grow from the planet’s skin. From the moment an egg and a sperm unite to spark our existence, each of us grows and develops from the elements provided by the Earth and sun. In essence, the soil, air, sun, and water combine within our mother’s womb to mold another living creature. Nine months later, another human being is born. That person is a separate entity, with an awareness of an individual self, an Ego. That person is also totally a part of, and completely dependent upon, the surrounding natural world, the Eco.

When the ego and the eco are balanced, the creature lives in harmony with the planet. In this theory, such a balance is considered to be the true meaning of *spirituality*, because the individual is a conscious part of, attuned to, and in harmony with a greater level of actual Being. When too much emphasis is placed on the self, the ego, an imbalance occurs and problems result, especially when that imbalance is collectively demonstrated by entire cultures. To suggest that these problems are only environmental, and therefore not of great concern, is incorrect. Environmental problems (damage to the eco) ultimately affect all living things, as all living things derive their existence, livelihood, and well-being from the planet. We cannot damage a thread in the web of life without the risk of fraying the entire tapestry.

When the ego gets blown out of proportion, we get thrown off balance in a variety of ways. Our educational institutions teach us to idolize the intellect, often at the expense of our moral, ethical, and spiritual development. Our economic institutions urge us to be consumers, and those who have gained the most material wealth are glorified. Our religious institutions often amount to little more than systems of human-worship, where divinity is only personified in human form, and only human creations (e.g., books and buildings) are considered sacred.

By emphasizing the intellect at the expense of intuition, creativity, and conscience, our educational systems yield spiritually imbalanced individuals. No discussion of a subject should be considered complete without an examination of its moral, philosophical, and ethical considerations, *as well* as a review of the intellectual and scientific data. When we ignore the ethics behind a particular issue, and

instead focus on intellectual achievements, it's great for our egos. We can pat ourselves on the back and tell ourselves how smart we are. It deflates our egos, on the other hand, to realize that we are actually insignificant creatures on a speck of dust in a corner of the universe, and that we are only one of the millions of life forms on this speck, all of whom must live together.

In recent decades, an entire generation of western scientists, a formidable force of intelligence, focused all its efforts on developing new ways to kill huge numbers of human beings all at once. This was the nuclear arms race of the 1950s through the present — a race that left us with environmental disasters yet to be cleaned up, a huge amount of natural materials gone to total waste (5.5 *trillion* dollars worth),¹ a military death toll consisting of hundreds of thousands of innocent non-combatants, and the threat of nuclear annihilation hanging over all of the peace-loving peoples of the world, even today. Surely this is an example of the collective ego being out of balance with the eco.

Religious movements that worship humans are ego-centered. It is ironic that a tiny, insignificant lifeform on a speck of dust at the edge of a galaxy lost somewhere in a corner of the universe would declare that the universe was created by one of their own kind. This would be a laughing matter if it were not taken so seriously by so many members of the human species, who insist on believing that the source of all life is another human, colloquially referred to as “God.”

We humans have evolved enough to know that the idea of a human-like creator-deity is simply myth. We can't begin to comprehend the full nature of our existence, so we *make up* a story that works until we figure out something better. Unfortunately, human-worship breeds an imbalanced collective ego. When we actually *believe* the myth, that humans are the pinnacle of life and the entire universe was created by one of our own kind, we go off the deep end. We stray too far from truth and wander, lost, with no point of reference to take us back to a balanced spiritual perspective we need for our own long-term survival on this planet. We become like a person knee deep in his own excrement, not knowing how to free himself from his unfortunate position, staring blankly at a road map with a look of utter incomprehension.

Today, new perspectives are emerging regarding the nature of human existence. The Earth itself is becoming recognized as a living entity, a level of Being immensely greater than the human level. The galaxy and universe are seen as even higher levels of Being, with multiverses (multiple universes) theorized as existing at a higher level yet. All of these levels of Being are thought to be imbued with the energy of life, as well as with a form of consciousness which we cannot even begin to comprehend. As we humans expand our knowledge of ourselves and recognize our true place in the vast scheme of things, our egos must defer to reality. We must admit our absolute dependence upon the ecosystem we call Earth, and try to balance our egotistical feelings of self-importance with our need to live in harmony with the greater world around us.

Getting back to compost, organic material, and soil nutrients, I must propose some additional philosophical speculation. Theoretically, the Asians evolved over the millennia with spiritual perspectives that maintained, to some extent, a view of the Earth, and of nature, as sacred. These

perspectives did not single out the human race as the pinnacle of creation, but instead recognized the totality of interconnected existence as divine, and advocated human harmony with that totality.

Contrast this to our western religious heritage which taught us that divinity lies only in human form, and that peoples who revere nature are “pagans,” “heathens,” “witches,” and worse. Admittedly, this is a broad and contentious topic, too broad for the scope of this book. Perhaps a few quotes here, however, will help to illustrate the point.

Hinduism, more common to India, but reaching into the Far East, seems to be sensitive to the sanctity of the natural world:

*“When Svetaketu, at his father’s bidding, had brought a ripe fruit from the banyan tree, his father said to him, Split the fruit in two, dear son.
Here you are. I have split it in two.
What do you find there?
Innumerable tiny seeds.
Then take one of the seeds and split it.
I have split the seed.
And what do you find there?
Why, nothing, nothing at all.
Ah, dear son, but this great tree cannot possibly come from nothing. Even if you cannot see with your eyes that subtle something in the seed which produces this mighty form, it is present nonetheless. That is the power, that is the spirit unseen, which pervades everywhere and is all things. Have faith! That is the spirit which lies at the root of all existence, and that also art thou, O Svetaketu.”*

(Chandogya Upanishad)²

Buddhism is a dominant influence in vast sections of Asia:

“May all living things be happy and at their ease! May they be joyous and live in safety! All beings, whether weak or strong — omitting none — in high, middle, or low realms of existence, small or great, visible or invisible, near or far away, born or to be born — may all beings be happy and at their ease! Let none deceive another, or despise any being in any state; let none by anger or ill will wish harm to another! Even as a mother watches over and protects her only child, so with a boundless mind should one cherish all living beings, radiating friendliness over the entire world, above, below and all around without limit; so let him cultivate a boundless good will toward the entire world, uncramped, free from ill will or enmity.”

The Metta Sutra³

Zen is a transliteration of the Sanskrit word “dyhana” meaning meditation, or more fully, “contemplation leading to a higher state of consciousness,” or “union with Reality.” It can be described as a blend of Indian mysticism and Chinese naturalism with a Japanese influence:

“When the mind rests serene in the oneness of things . . . dualism vanishes by itself.”

From the Hsis-hsis-ming by Seng-ts’an⁴

“Zen does not go along with the Judaic-Christian belief in a personal savior or a God — outside the Universe — who has created the cosmos and the human race. To the Zen view, the Universe is one indissoluble substance, one total whole, of which humanity is a part.”

Nancy Wilson Ross⁵

Confucius, like Buddha, was born in the sixth century B.C. and preached a philosophy of common Chinese virtue:

“The path of duty lies in what is near and people seek for it in what is remote. The work of duty lies in what is easy and people seek for it in what is difficult.”

Confucius⁶

The Tao (the way), written by Lao Tsu, a contemporary of Confucius, has provided one of the major underlying influences in Chinese thought and culture for 2,500 years:

“Those who know do not talk. Those who talk do not know. Keep your mouth closed. Guard your senses. Temper your sharpness. Simplify your problems. Mask your brightness. Be at one with the dust of the earth. This is primal union. He who has achieved this state is unconcerned with friends and enemies, with good and harm, with honor and disgrace. This therefore is the highest state of humanity.”

Lao Tsu⁷

Christianity, the primary religious influence of the western world, strongly supports the idea that humans are separate from and dominant over the natural world:

“And God said, Let us make man in our image, after our likeness, and let them have dominion over the fish of the sea, and over the fowl of the air, and over the cattle, and over all the earth, and over every creeping thing that creepeth on the earth. And God blessed them, and God said unto them, Be fruitful and multiply, and replenish the earth, and subdue it: and have dominion over the fish of the sea, and over the fowl of the air, and over every living thing that moveth upon the earth.”

Far Eastern religion has traditionally been imbued with the concepts of oneness, with the belief that the highest state of human evolution is one of harmony and peace with one's inner self and with the natural world. This would certainly seem to contribute to the development of sustainable agricultural methods. When one accepts the sacredness of life, one can easily understand why one should create compost and soil rather than waste and pollution.

For those of you readers who are devout Christians, this analysis of religious history is not intended to be "Christian-bashing," nor is it intended to offend anyone. Christianity must be singled out to some extent because the writer is writing from, and for, a culture that developed from an overwhelmingly Christian heritage. It is interesting to note that direct translations of Christian teachings from the Aramaic language (which Jesus spoke) as preserved in the Dead Sea Scrolls, indicate that Nature was, at that time, considered sacred by practicing Christians (refer to the translations of Edmund Bordeaux Szekeley). Those early teachings became buried under Biblical translations tailored to suit the European cultures of the late Middle Ages, which were hierarchic and male-dominated. Today, Christians can be among the most vocal defenders of the environment.

Historically, Christianity had periods that modern Christians would like to forget about, periods when the human egos involved grew to outrageous and terribly threatening proportions. During these times, male religious leaders claimed divinity and disbelievers were simply terrorized or destroyed. Those dark ages of Christianity adversely affected our understanding of the origins and nature of disease.

Unfortunately, *most* major religions today have drawn their focus toward human-worship, whether it be the Hindu worship of Krishna, the Buddhist worship of Buddha, the Islamic worship of Mohammed, the Christian worship of Jesus, or the bowing to the various human gurus and religious leaders which takes place all over the world. Patriarchal, hierarchic religious institutions still foster bloated egos the farther up the hierarchy one looks. Eventually, the human race will cast aside limiting, static, religious perspectives like a butterfly casts aside a cocoon. In the meantime, a metamorphosis must, and will, take place. That is what we should be focusing on, regardless of the religious institution to which we may currently belong.

Source: The Humanure Handbook. Jenkins Publishing, PO Box 607, Grove City, PA 16127. To order, phone: 1-800-639-4099.

<http://www.jenkinspublishing.com/>

MENU: [HOME](#) » [Reconstruction](#) » [Recovery](#) » [Renewal](#) » [Survival](#) » [Humanure Content](#)

ASIAN RECYCLING

The Asian people have recycled humanure for thousands of years. The Chinese have used humanure agriculturally since the Shang Dynasty 3-4000 years ago. Why haven't we westerners? The Asian cultures, namely Chinese, Korean, Japanese and others, evolved to understand human excrement to be a natural resource rather than a waste material. Where we have human waste, they have night soil. We produce waste and pollution; they historically have produced soil nutrients and food. It's clear to me that Asians have been more advanced than the western world in this regard. And they should be, since they've been working on developing sustainable agriculture for four thousand years on the same land. For *four thousand years* those people have worked the same land with little or no chemical fertilizers and, in many cases, have produced greater crop yields than western farmers, who are quickly destroying the soils of their own countries through depletion and erosion.

A fact largely ignored by people in western agriculture is that *agricultural land must produce a greater output over time. The human population is constantly increasing; available agricultural land is not. Therefore, our farming practices should leave us with land more fertile with each passing year.* However, we are doing just the opposite.

Back in 1938, the US Department of Agriculture came to the alarming conclusion that *a full 61% of the total area under crops in the US at that time had already been completely or partly destroyed, or had lost most of its fertility.*⁹ Nothing to worry about? We have artificial fertilizers, tractors, and oil to keep it all going. True, US agriculture is now heavily dependent upon fossil fuel resources. However, in 1993, we were importing about half our oil from foreign sources, and it's estimated that the US will be out of domestic oil reserves by 2020.¹⁰ A heavy dependence on foreign oil for our food production seems unwise *at best*, and probably just plain foolish, especially when we're producing soil nutrients every day in the form of organic refuse and throwing those nutrients "away" by burying them in landfills or incinerating them.

Why aren't we following the Asian example of agronutrient recycling? It's certainly not for a lack of information. Dr. F. H. King wrote an interesting book, published in 1910 titled Farmers of Forty Centuries.¹¹ Dr. King (D.Sc.) was a former chief of the Division of Soil Management of the US Department of Agriculture who traveled through Japan, Korea, and China in the early 1900s as an agricultural visitor. He was interested in finding out how people could farm the same fields for millennia without destroying their fertility. He states:

"One of the most remarkable agricultural practices adopted by any civilized people is the centuries long

and well nigh universal conservation and utilization of all human waste [sic] in China, Korea and Japan, turning it to marvelous account in the maintenance of soil fertility and in the production of food. To understand this evolution it must be recognized that mineral fertilizers so extensively employed in modern Western agriculture have been a physical impossibility to all people alike until within very recent years. With this fact must be associated the very long unbroken life of these nations and the vast numbers their farmers have been compelled to feed.

When we reflect upon the depleted fertility of our own older farm lands, comparatively few of which have seen a century's service, and upon the enormous quantity of mineral fertilizers which are being applied annually to them in order to secure paying yields, it becomes evident that the time is here when profound consideration should be given to the practices the Mongolian race has maintained through many centuries, which permit it to be said of China that one-sixth of an acre of good land is ample for the maintenance of one person, and which are feeding an average of three people per acre of farm land in the three southernmost islands of Japan.

[Western humanity] is the most extravagant accelerator of waste the world has ever endured. His withering blight has fallen upon every living thing within his reach, himself not excepted; and his besom of destruction in the uncontrolled hands of a generation has swept into the sea soil fertility which only centuries of life could accumulate, and yet this fertility is the substratum of all that is living.” ¹²

According to King's research, the average daily excreta of the adult human weighs in at 40 ounces. Multiplied by 250 million, a rough estimate of the current US population, Americans each year produce 1,448,575,000 pounds of nitrogen, 456,250,000 pounds of potassium, and 193,900,000 pounds of phosphorous. Almost all is discarded into the environment as a waste material or a pollutant, or as Dr. King puts it, “*poured into the seas, lakes or rivers and into the underground waters.*”

According to King, “*The International Concession of the city of Shanghai, in 1908, sold to a Chinese contractor the privilege of entering residences and public places early in the morning of each day and removing the night soil, receiving therefor more than \$31,000 gold, for 78,000 tons of waste [sic]. All of this we not only throw away but expend much larger sums in doing so.*”

In case you didn't catch that, the contractor paid \$31,000 gold for the humanure, referred to as “night soil” and incorrectly as “waste” by Dr. King. People don't pay to buy waste, they pay money for things of value.

Furthermore, using Dr. King's figures, the US population today produces approximately 228,125,000,000 pounds of fecal material annually. That's 228 billion pounds. You could call that the *really* Gross National Product.

Admittedly, the spreading of raw human excrement on fields, as is done in Asia, will never become culturally acceptable in the United States, and rightly so. The agricultural use of raw night soil produces an assault to the sense of smell, and provides a route of transmission for various human disease

organisms. Americans who have traveled abroad and witnessed the use of raw human excrement in agricultural applications have largely been repulsed by the experience. That repulsion has instilled in many Americans an intransigent bias against, and even a fear of the use of humanure for soil enrichment. However, few Americans have witnessed the *composting* of humanure as a preliminary step in its recycling. Proper thermophilic composting converts humanure into a pleasant smelling material devoid of human pathogens.

Although the agricultural use of raw human excrement will never become a common practice in the US, the use of composted human refuse, including humanure, food refuse, and other organic municipal refuse such as leaves, can and should become a widespread and culturally encouraged practice in the United States. The act of composting humanure instead of using it raw will set Americans apart from Asians in regard to the recycling of human excrements, *for we too will have to constructively deal with all of our organic by-products eventually*. We can put it off, but not forever. As it stands now, at least many of the Asians are recycling much of their organic discards. We're not.

Source: The Humanure Handbook. Jenkins Publishing, PO Box 607, Grove City, PA 16127. To order, phone: 1-800-639-4099.

<http://www.jenkinspublishing.com/>

MENU: [HOME](#) » [Reconstruction](#) » [Recovery](#) » [Renewal](#) » [Survival](#) » [Humanure Content](#)

THE ADVANCES OF SCIENCE

How is it that Asian peoples developed an understanding of human nutrient recycling and we didn't? After all, we're the advanced, developed, scientific nation, aren't we? Dr. King makes an interesting observation concerning western scientists. He states: *"It was not until 1888, and then after a prolonged war of more than thirty years, generated by the best scientists of all Europe, that it was finally conceded as demonstrated that leguminous plants acting as hosts for lower organisms living on their roots are largely responsible for the maintenance of soil nitrogen, drawing it directly from the air to which it is returned through the processes of decay. But centuries of practice had taught the Far East farmers that the culture and use of these crops are essential to enduring fertility, and so in each of the three countries the growing of legumes in rotation with other crops very extensively, for the express purpose of fertilizing the soil, is one of their old fixed practices."* ¹³

In western culture, we wait for the experts to figure things out before we claim any real knowledge. This appears to have put us several centuries behind the Asians. It certainly seems odd that people who gain their knowledge in real life through practice and experience are largely ignored or trivialized by the academic world and associated government agencies. Such agencies only credit learning that has taken place within an institutional framework. As such, it's no wonder that Western humanity's crawl toward a sustainable existence on the planet Earth is so pitifully slow.

"Strange as it may seem," says King, *"there are not today and apparently never have been, even in the largest and oldest cities of Japan, China or Korea, anything corresponding to the hydraulic systems of sewage disposal used now by Western nations. When I asked my interpreter if it was not the custom of the city during the winter months to discharge its night soil into the sea, as a quicker and cheaper mode of disposal [than recycling], his reply came quick and sharp, 'No, that would be waste. We throw nothing away. It is worth too much money.'*" ¹⁴ *"The Chinaman,"* says King, *"wastes nothing while the sacred duty of agriculture is uppermost in his mind."* ¹⁵

Perhaps, a few centuries from now, we also will understand.

Source: *The Humanure Handbook*. Jenkins Publishing, PO Box 607, Grove City, PA 16127. To order, phone: 1-800-639-4099.

<http://www.jenkinspublishing.com/>

MENU: [HOME](#) » [Reconstruction](#) » [Recovery](#) » [Renewal](#) » [Survival](#) » [Humanure Content](#)

WHEN THE CRAP HIT THE FAN

While the Asians were practicing sustainable agriculture and recycling their organic resources and doing so over millennia, what were the people of the west doing? What were the Europeans and those of European descent doing? Why weren't our ancestors returning their manures to the soil, too? After all, it does make sense. The Asians who recycled their manures not only recovered a resource and reduced pollution, but by returning their excrement to the soil, they succeeded in reducing threats to their health. There was no putrid sewage collecting and breeding disease germs. Instead, the humanure was, for the most part, undergoing a natural, non-chemical purification process in the soil which required no technology.

Granted, a lot of "night soil" in the Far East today is not composted and is the source of health problems. However, even the returning of humanure raw to the land succeeds in destroying many human pathogens in the manure, and it also returns nutrients to the soil. Let's take a look at what was happening in Europe regarding public hygiene from the 1300s on. Great pestilences swept Europe throughout recorded history. The Black Death killed more than half the population of England in the fourteenth century. In 1552, 67,000 patients died of the Plague in Paris alone. Fleas from infected rats were the carriers of this disease. Did the rats dine on human waste? Other pestilences included the sweating sickness (attributed to uncleanness), cholera (spread by food and water contaminated by the excrement of infected persons), "jail fever" (caused by a lack of sanitation in prisons), typhoid fever (spread by water contaminated with infected feces), and numerous others.

Andrew D. White, cofounder of Cornell University, writes, "*Nearly twenty centuries since the rise of Christianity, and down to a period within living memory, at the appearance of any pestilence the Church authorities, instead of devising sanitary measures, have very generally preached the necessity of immediate atonement for offenses against the Almighty. In the principal towns of Europe, as well as in the country at large, down to a recent period, the most ordinary sanitary precautions were neglected, and pestilences continued to be attributed to the wrath of God or the malice of Satan.*" ¹⁶

It's now known that the main cause of such immense sacrifice of life was a lack of proper hygienic practices. It's argued that certain theological reasoning at that time resisted the evolution of proper hygiene. According to White, "*For century after century the idea prevailed that filthiness was akin to holiness.*" Living in filth was regarded by holy men as evidence of sanctity, according to White, who lists numerous saints who never bathed parts or all of their bodies, such as St. Abraham, who washed neither his hands nor his feet for fifty years, or St. Sylvia, who never washed any part of her body except her fingers.¹⁷

Interestingly, after the Black Death left its grim wake across Europe, “*an immensely increased proportion of the landed and personal property of every European country was in the hands of the church.*”¹⁸ Apparently, the church was reaping some benefit from the deaths of huge numbers of people. Perhaps the church had a vested interest in maintaining public ignorance about the sources of disease. This insinuation is almost too diabolical for serious consideration. Or is it?

Somehow, the idea developed around the 1400s that Jews and witches were causing the pestilences. Jews were suspected because they didn’t succumb to the pestilences as readily as the Christian population did, presumably because they employed a unique sanitation system more conducive to cleanliness, including the eating of kosher foods. Not understanding this, the Christian population arrived at the conclusion that the Jews’ immunity resulted from protection by Satan. As a result, attempts were made in all parts of Europe to stop the plagues by torturing and murdering the Jews. Twelve thousand Jews were reportedly burned to death in Bavaria alone during the time of the plague, and additionally thousands more were likewise killed throughout Europe.¹⁹

In 1484, the “infallible” Pope Innocent VIII issued a proclamation supporting the church’s opinion that witches were causes of disease, storms, and a variety of ills affecting humanity. The feeling of the church was summed up in one sentence: “*Thou shalt not suffer a witch to live.*” From the middle of the sixteenth to the middle of the seventeenth centuries, women and men were sent to torture and death by the thousands, by both Protestant and Catholic authorities. It’s estimated that the number of victims sacrificed during that century in Germany alone was over a hundred thousand.

The following case in Milan, Italy, summarizes the ideas of sanitation in Europe during the seventeenth century:

The city was under the control of Spain, and it had received notice from the Spanish government that witches were suspected to be en route to Milan to “anoint the walls” (smear the walls with disease-causing ointments). The church rang the alarm from the pulpit, putting the population on the alert. One morning, in 1630, an old woman looking out of her window saw a man who was walking along the street wipe his fingers on a wall. He was promptly reported to the authorities. He claimed he was simply wiping ink from his fingers which had rubbed off the ink-horn he carried with him. Not satisfied with this explanation, the authorities threw the man into prison and tortured him until he “confessed.” The torture continued until the man gave the names of his “accomplices,” who were subsequently rounded up and tortured. They in turn named *their* “accomplices” and the process continued until members of the foremost families were included in the charges. Finally, a large number of innocent people were sentenced to their deaths, all reportedly a matter of record.²⁰

One loathsome disease of the 1500s through the 1700s was the “jail fever.” The prisons of that period were filthy. People were confined in dungeons connected to sewers with little ventilation or drainage. Prisoners incubated the disease and spread it to the public, especially to the police, lawyers and judges. In 1750, for example, the disease killed two judges, the lord mayor, various aldermen, and many others in London, not to mention prisoners.²¹

The pestilences at that time in the Protestant colonies in America were also attributed to divine wrath or satanic malice, but when the pestilences afflicted the Native Americans, they were considered acts of divine mercy. *“The pestilence among the Indians, before the arrival of the Plymouth Colony, was attributed in a notable work of that period to the Divine purpose of clearing New England for the heralds of the gospel.”* [22](#)

Perhaps the reason the Asian countries have such large populations in comparison to Western countries is because they escaped some of the pestilences common to Europe, especially pestilences spread by the failure to responsibly recycle human excrement. They presumably plowed their manure back into the land because their spiritual perspectives supported such behavior. Westerners were too busy burning witches and Jews with the church’s wholehearted assistance to bother thinking about recycling humanure.

Our ancestors did, eventually, come to understand that poor hygiene was a causal factor in epidemic diseases. Nevertheless, it was not until the late 1800s in England that improper sanitation and sewage were suspected as causes of epidemics. At that time, large numbers of people were still dying from pestilences, especially cholera, which killed at least 130,000 people in England in 1848-9 alone. In 1849, an English medical practitioner published the theory that cholera was spread by water contaminated with sewage. Ironically, even where sewage was being piped away from the population, the sewers were still leaking into drinking water supplies.

The English government couldn’t be bothered with the fact that hundreds of thousands of mostly poor citizens were perishing like flies year after year. So it rejected a Public Health Bill in 1847. A Public Health Bill finally became an Act in 1848 in the face of the latest outbreak, but wasn’t terribly effective. However, it did bring poor sanitation to the attention of the public, as the following statement from the General Board of Health (1849) implies: *“Householders of all classes should be warned that their first means of safety lies in the removal of dung heaps and solid and liquid filth of every description from beneath or about their houses and premises.”* This may make one wonder if a compost pile would have been considered a “dung heap” in those days, and therefore banned.

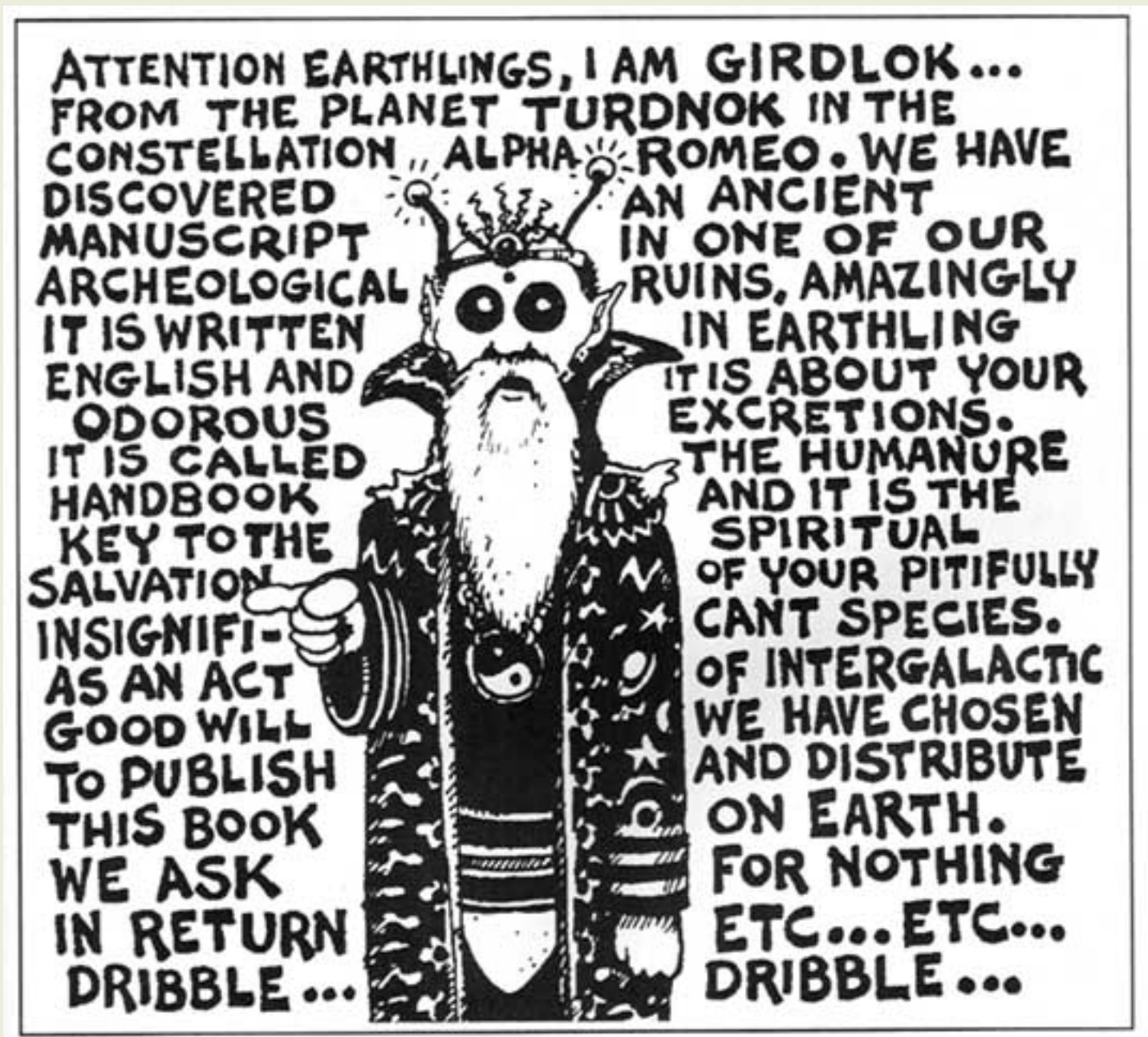

Sanitation in England was so bad in the mid to late eighteenth centuries that, “In 1858, when the Queen and Prince Albert had attempted a short pleasure cruise on the Thames, its malodorous waters drove them back to land within a few minutes. That summer a prolonged wave of heat and drought exposed its banks, rotten with the sewage of an overgrown, undrained city. Because of the stench, Parliament had to rise early.” Another story describes Queen Victoria gazing out over the river and asking aloud what the pieces of paper were that so abundantly floated by. Her companion, not wanting to admit that the Queen was looking at pieces of used toilet paper, replied, “Those, Ma’am, are notices that bathing is forbidden.” ²³

The wealthy folks, including the Tories or “conservatives” of the English government still thought that spending on social services was a waste of money and an unacceptable infringement by the government on the private sector (sound familiar?). A leading newspaper, “The Times,” maintained that the risk of

cholera was preferable to being bullied by the government into providing sewage services. However, a major Act was finally passed in 1866, the Public Health Act, with only grudging support from the Tories. Once again, cholera was raging through the population, and it's probably for that reason that any act was passed at all. Finally, by the end of the 1860s, a framework of public health policy was established in England. Thankfully, the cholera epidemic of 1866 was the last and the least disastrous.²⁴

The powers of the church eventually diminished enough for physicians to have their much delayed say about the origins of disease. Today, the church is no longer an obstacle to the progress of society, and in many cases acts as a force for peace, justice, and environmental awareness in the western world.

Our modern sanitation systems have finally yielded a life safe for most of us, although not without shortcomings. The eventual solution developed by the west was to collect humanure in water and discard it, perhaps chemically treated, incinerated, or dehydrated — into the seas, into the atmosphere, onto the surface of the land, and into landfills.

Source: The Humanure Handbook. Jenkins Publishing, PO Box 607, Grove City, PA 16127. To order, phone: 1-800-639-4099.

<http://www.jenkinspublishing.com/>

MENU: [HOME](#) » [Reconstruction](#) » [Recovery](#) » [Renewal](#) » [Survival](#) » [Humanure Content](#)

ASIAN UPDATE

It would be naive to suggest that the Asian societies are perfect by any stretch of the imagination. Asian history is rife with the problems that have plagued humanity since the first person crawled on this planet. Those problems include such things as oppressive rule by the rich, war, famine, natural catastrophes, oppressive rule by heathens, more war, and now overpopulation.

Today, Asians are abandoning the harmonious agricultural techniques that Dr. King observed nearly a century ago. In Kyoto, Japan, for example, *“night soil is collected hygienically to the satisfaction of users of the system, only to be diluted at a central collection point for discharge to the sewer system and treatment at a conventional sewage treatment plant.”* ²⁵

A Humanure Handbook reader wrote an interesting account of Japanese toilets in a letter to the author, which is paraphrased here:

“I just got through reading your Humanure Handbook. This is the book of the year! Your book really opened my eyes about humanure. I never even thought about using sawdust/leaves/hay as a solution to odors and about thermophilic composting. How brilliant! My only real experience, outside of continuously composting yard refuse/kitchen scraps either in an open pile or directly burying them and then using them on my vegetable garden for over twenty years, comes from living in Japan from 1973-1983. I’ll take this opportunity to tell you all I directly experienced about their humanure recycling. As my experience is dated, things may have changed (probably for the worse as toilets and life were becoming ‘westernized’ even toward the end of my stay in Japan).”

My experience comes from living in small, rural towns as well as in metropolitan areas (provincial capitals) from 1973-1983. Homes/businesses had an ‘indoor outhouse.’ The Vault: Nothing but urine/feces were deposited into the large metal vault under the toilet (squat style, slightly recessed in the floor and made of porcelain). No cover material or carbonaceous stuff was used. It stunk !! Not just the bathroom, but the whole house! There were many flies, even though the windows were screened. Maggots were the main problem. They crawled up the sides of the vault onto the toilet and floor and sometimes even made it outside the bathroom into the hall. People constantly poured some kind of toxic chemical into the vaults to control the smell and maggots. (It didn’t help — in fact, the maggots really poured out of the vault to escape the chemicals.) Occasionally a slipper

(one put on special ‘bathroom slippers’ as opposed to ‘house slippers’ when entering the bathroom) fell into the disgusting liquid/maggot filled vault. You couldn’t even begin to think about getting it out! You couldn’t let little children use the toilet without an adult suspending them over it. They might fall in! Disposal: When the vault was full (about every three months), you called a private vacuum truck which used a large hose placed in an outside opening to suck out the liquid mass. You paid them for their services. I’m not sure exactly what happened to the humanure next but, in the agricultural areas near the fields were large (10 feet in diameter) round, concrete, raised containers, similar in looks to an above ground swimming pool. In the containers, I was told, was the humanure from the ‘vacuum trucks.’ It was a greenish-brown liquid with algae growing on the surface. I was told this was spread onto agricultural fields.” E.A. in IL

In 1952, about 70% of Chinese humanure was recycled. This had increased to 90% by 1956, and constituted a third of all fertilizer used in the country.²⁶ Lately, however, humanure recycling in China seems to be going downhill. The use of synthetic fertilizers has risen over 600% between the mid 1960s to the mid 1980s, and now China’s average annual fertilizer usage per hectare is estimated to be double that of the world’s average. Between 1949 and 1983, agricultural nitrogen and phosphorous inputs increased by a factor of ten, while agricultural yields only tripled.²⁷

Water pollution in China began to increase in the 1950s due to the discarding of sewage into water. Now, about 70% of China’s wastewater is said to be dumped into China’s main rivers. By 1992, 45 billion tonnes of wastewater were flowing into China’s rivers and lakes annually, 70% untreated. In urban areas, 80% of the surface water is polluted with nitrogen and ammonia, and most lakes around cities have become dumping grounds for large quantities of sewage. It is estimated that 450,000 tonnes of humanure are dumped into the Huangpu River alone in a year. Half a million cases of hepatitis A, spread by polluted water, occurred in Shanghai in 1988. Soilborne diseases, practically non-existent in China twenty years ago, are now also causing problems. *“Increasingly, Chinese urban authorities are turning to incineration or landfill as the ways of disposing of their solid wastes rather than recycling and composting, which means that China, like the west, is putting the problem onto the shoulders of future generations.”*²⁸

For a sense of historical perspective, I’ll leave you with a quote from Dr. Arthur Stanley, health officer of the city of Shanghai, China, in his annual report for 1899, when the population of China amounted to about 500 million people, roughly double that of the US today. At that time, no artificial fertilizers were employed for agricultural purposes — only organic, natural materials such as agricultural residues and humanure were being used:

*“Regarding the bearing on the sanitation of Shanghai of the relationship between Eastern and Western hygiene, it may be said, that if prolonged national life is indicative of sound sanitation, the Chinese are a race worthy of study by all who concern themselves with public health. It is evident that in China the birth rate must very considerably exceed the death rate, and have done so in an average way during the three or four thousand years that the Chinese nation has existed. Chinese hygiene, when compared to medieval English, appears to advantage.”*²⁹

Sounds like an understatement to me.

Source: The Humanure Handbook. Jenkins Publishing, PO Box 607, Grove City, PA 16127. To order, phone: 1-800-639-4099.

<http://www.jenkinspublishing.com/>

MENU: [HOME](#) » [Reconstruction](#) » [Recovery](#) » [Renewal](#) » [Survival](#) » [Humanure Content](#)

A DAY IN THE LIFE OF A TURD

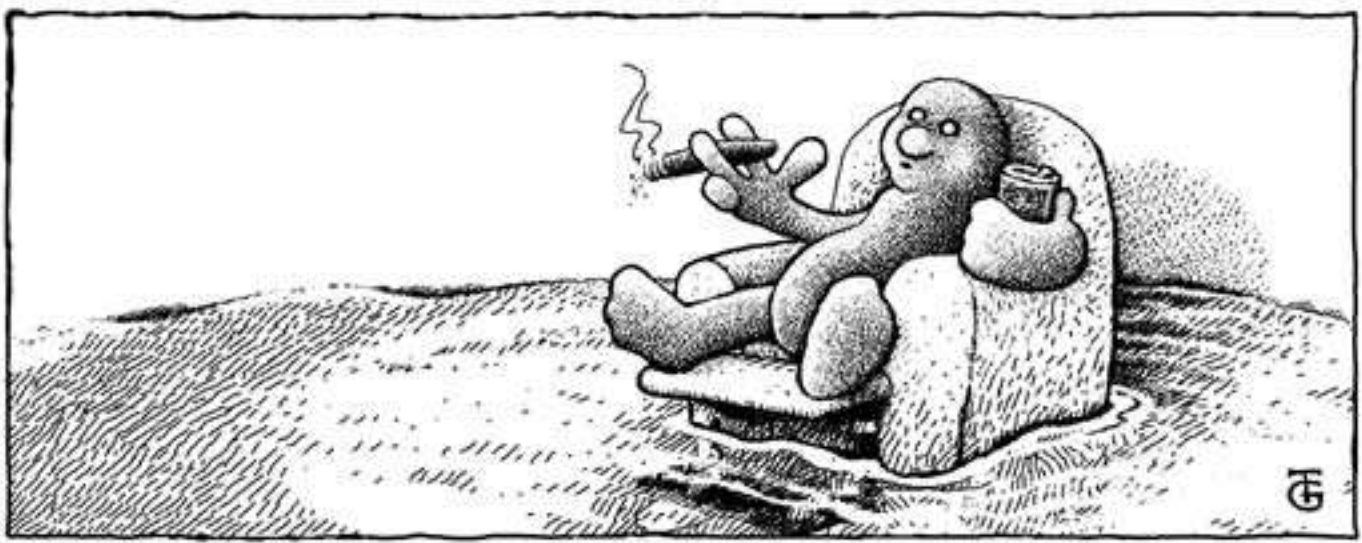

“If I urinated into a pitcher of drinking water and then proceeded to quench my thirst from the pitcher, I would undoubtedly be considered crazy. If I invented an expensive technology to put my urine and feces into my drinking water, and then invented another expensive (and undependable) technology to make the same water fit to drink, I might be thought even crazier. It is not inconceivable that some psychiatrist would ask me knowingly why I wanted to mess up my drinking water in the first place.”

Wendell Berry

When I was a kid, I listened to veterans talking about their stints in the Korean War. Usually after a beer or two, they’d turn their conversation to the “outhouses” used by the Koreans. They were amazed, even mystified about the fact that the Koreans tried to lure passersby to use their outhouses by making the toilets especially attractive. The idea of someone wanting someone else’s crap always brought out a loud guffaw from the vets. Only a groveling, impoverished, backward gink would stoop so low as to beg for a turd. Haw, Haw.

Perhaps this attitude sums up the attitudes of Americans. Humanure is a waste product, plain and simple. We have to get rid of it and that’s all there is to it. Only fools would think otherwise. One of the effects of this sort of attitude is that Americans don’t know and probably don’t care where their humanure goes after it emerges from their backsides, as long as they don’t have to deal with it.

MEXICAN BIOLOGICAL DIGESTER

Well, where it goes depends on the type of “waste disposal system” used. Let’s start with the simplest: the Mexican biological digester, also known as the stray dog. In India, this may be known as the stray pig (see Figure 5.1). I spent a few months in southern Mexico in the late 1970s in Quintana Roo on the Yucatan peninsula. There, toilets were not available; people simply used the sand dunes along the coast. No problem, though. One of the small, unkempt, and ubiquitous Mexican dogs would wait nearby with watering mouth until you’ve done your thing. Burying your excrement in that situation would have been an act of disrespect to the dog. No one wants sand in their food. A good, healthy, steaming turd at the crack of dawn on the Caribbean coast never lasted more than 60 seconds before it became a hot meal for a human’s best friend. Yum.

THE OLD-FASHIONED OUTHOUSE

Next up the ladder of sophistication is the old-fashioned outhouse, also known as the pit latrine (see Figures 5.2-5.5). Simply stated, one digs a hole and defecates in it, and then does so again and again until the hole fills up, after which it’s covered with dirt. It’s nice to have a small building (privy) over the hole to provide some privacy and to keep off the elements. However, the concept is simple: dig a hole and bury your excrement. Interestingly, this level of sophistication has not yet been surpassed in America. We still bury our excrement, in the form of sewage sludge, in landfill holes.

The first farmhouse I lived in during the mid-seventies had an outhouse behind it and no plumbing whatsoever. What I remember most about the outhouse is the smell, which could be described as quite undesirable, to say the least. The flies and wasps weren’t very inviting either, and of course the cold weather made the process of “going to the bathroom” uncomfortable. When the hole filled up, I simply dug another hole twenty feet away from the first and dragged the outhouse from one hole to the other. The dirt from the second hole was used to cover the first. The excrement was left in the ground, probably to contaminate groundwater. Of course, I didn’t know I might be contaminating anything because I had just graduated from college and was quite ignorant about practical matters. Therefore, I plead not guilty to environmental pollution on the grounds of a college education.

Outhouses create very real health, environmental, and aesthetic problems. The hole in the ground is accessible to flies and mosquitoes which can transmit disease over a wide area. The pits leak pollutants into the ground even in dry soil. And the smell — *hold your nose*.

SEPTIC SYSTEMS

Another step up the ladder one finds the septic tank, a common method of human waste disposal in rural and suburban areas of the United States. In this system the turd is deposited into a container of water, usually pure drinking water, and the whole works are flushed away (see Figures 5.6 and 5.7).

After the floating turd travels from the house inside a sewage pipe, it plops into a fairly large

underground storage tank, or septic tank, usually made of concrete and sometimes of fiberglass. In Pennsylvania (US), a 900 gallon tank is the minimum size allowed for a home with three or fewer bedrooms.¹ The heavier solids settle to the bottom of the tank and the liquids drain off into a leach field, which consists of an array of drain pipes situated below the ground surface allowing the liquid to seep out into the soil. The wastewater should be undergoing anaerobic decomposition while in the tank. When septic tanks fill up, they are pumped out and the waste material is supposed to be trucked to a sewage treatment plant (sometimes they're illegally dumped).

SAND MOUNDS

In the event of poorly drained soil, one with a high clay content or else low-lying, a standard leach field will not work very well, especially when the ground is already saturated with rain water or snow melt. One can't drain wastewater into soil that is saturated with water. That's when the *sand mound* sewage disposal system is employed. When the septic tank isn't draining properly, a pump will kick in and pump the effluent into a pile of sand and gravel above ground (although sometimes a pump isn't necessary and gravity does the job). A perforated pipeline in the pile of sand allows the effluent to drain down through the mound. Sand mounds are usually covered with soil and grass. In Pennsylvania, sand mounds must be at least one hundred feet downslope from a well or spring, fifty feet from a stream, and five feet from a property line.² According to local excavating contractors, sand mounds cost \$5,000 to \$12,000 to construct. They must be built to exact government specifications, and aren't usable until they pass an official inspection (see Figure 5.8).

GROUND WATER POLLUTION FROM SEPTIC SYSTEMS

We civilized humans started out by defecating into a hole in the ground (outhouse), then discovered we could float our turds out to the hole using water and never have to leave the house. However, one of the unfortunate problems with septic systems is, like outhouses, they pollute our groundwater.

There are currently 22 million septic system sites in the United States, serving one fourth to one third of the US population. They are leaching contaminants such as bacteria, viruses, nitrates, phosphates, chlorides, and organic compounds such as trichloroethylene into the environment. An EPA study of chemicals in septic tanks found toluene, methylene chloride, benzene, chloroform, and other volatile synthetic organic compounds related to home chemical use, many of them cancer-causing.³ Between 820 and 1,460 *billion* gallons of this contaminated water are discharged per year to our shallowest aquifers.⁴ In the US, septic tanks are reported as a source of ground water contamination more than any other source. Forty-six states cite septic systems as sources of groundwater pollution; nine of these reported them to be the primary source of groundwater contamination in their state (see Figures 5.9 and 5.10).⁵

The word "septic" comes from the Greek "septikos" which means "to make putrid." Today it still means "causing putrefaction," putrefaction being "the decomposition of organic matter resulting in the formation of foul-smelling products" (see Webster). Septic systems are not designed to destroy human pathogens that may be in the human waste that enters the septic tank. Instead, septic systems are

designed to collect human wastewater, settle out the solids, and anaerobically digest them to some extent, leaching the effluent into the ground. Therefore, septic systems can be highly pathogenic, allowing the transmission of disease-causing bacteria, viruses, protozoa, and intestinal parasites through the system.

One of the main concerns associated with septic systems is the problem of human population density. Too many septic systems in any given area will overload the soil's natural purification systems and allow large amounts of wastewater to contaminate the underlying watertable. A density of more than forty household septic systems per square mile will cause an area to become a likely target for subsurface contamination, according to the EPA.⁶

Toxic synthetic organic chemicals are commonly released into the environment from septic systems because people dump toxic chemicals down their drains. The chemicals are found in pesticides, paint and coating products, toilet cleaners, drain cleaners, disinfectants, laundry solvents, antifreeze, rust proofers, septic tank and cesspool cleaners, and many other cleaning solutions. In fact, over 400,000 gallons of septic tank cleaner liquids containing synthetic organic chemicals were used in one year by the residents of Long Island alone. Furthermore, some synthetic organic chemicals can corrode pipes, thereby causing heavy metals to enter septic systems.⁷

In many cases, people who have septic tanks are forced to connect to sewage lines when the lines are made available to them. A US Supreme Court case in 1992 reviewed a situation whereby town members in New Hampshire had been forced to connect to a sewage line that simply discharged untreated, raw sewage into the Connecticut River, and had done so for 57 years. Despite the crude method of sewage disposal, state law required properties within 100 feet of the town sewer system to connect to it from the time it was built in 1932. This barbaric sewage disposal system apparently continued to operate until 1989, when state and federal sewage treatment laws forced a stop to the dumping of raw sewage into the river.⁸

WASTEWATER TREATMENT PLANTS

“Over 90% of all sewage in third world countries is discharged completely untreated; in Latin America the figure is 98%.” Ecological Sanitation, p.2

There's still another step up the ladder of wastewater treatment sophistication: the wastewater treatment plant, or sewage plant. The wastewater treatment plant is like a huge, very sophisticated septic tank because it collects the waterborne excrement of large numbers of humans. Inevitably, when one defecates or urinates into water, one pollutes the water. In order to avoid environmental pollution, that “wastewater” must somehow be rendered fit to return to the environment. The wastewater entering the treatment plant is 99% liquid because all sink water, bath water and everything else that goes down one's drain ends up at the plant too, which is why it's called a *water* treatment plant. In some cases, storm water runoff also enters wastewater treatment plants via *combined sewers*. Industries, hospitals, gas stations, and any place with a drain add to the contaminant blend in the wastewater stream.

Many modern wastewater plants use a process of activated sludge treatment whereby oxygen is vigorously bubbled through the wastewater in order to activate microbial digestion of the solids. This aeration stage is combined with a settling stage that allows the solids to be removed (see Figures 5.11 and 5.12). The removed solids (sludge) are either used to reinoculate the incoming wastewater, or they're dewatered to the consistency of a dry mud and buried in landfills. Sometimes the sludge is applied to agricultural land, and now, sometimes, it's composted. The microbes that digest the sludge consist of bacteria, fungi, protozoa, rotifers, and nematodes.⁹ US sewage treatment plants generated about 7.6 million dry tons of sludge in 1989.¹⁰ New York City alone produces 143,810 dry tons of sludge every year.¹¹ In 1993, the amount of sewage sludge produced annually in the US was 110-150 million wet metric tons. The water left behind is treated (usually with chlorine) and discharged into a stream, river, or other body of water. Sewage treatment water releases to surface water in the United States in 1985 amounted to nearly *31 billion gallons per day*.¹² Incidentally, the amount of toilet paper used (1991) to send all this waste to the sewers was 2.3 million tons.¹³

WASTE STABILIZATION PONDS

Perhaps one of the most ancient wastewater treatment methods known to humans are waste stabilization ponds, also known as oxidation ponds or lagoons (see Figure 5.13). They're often found in small rural areas where land is available and cheap. Such ponds tend to be only a meter to a meter and a half deep, but vary in size and depth, and may be three or more meters deep.¹⁴ They utilize natural processes to "treat" waste materials, relying on algae, bacteria, and zooplankton to reduce the organic content of the wastewater. A "healthy" lagoon will appear green in color because of the dense algae population. These lagoons require about one acre for every 200 people served. Mechanically aerated lagoons only need 1/3 to 1/10 the land that unaerated stabilization ponds require. It's a good idea to have several smaller lagoons in series rather than one big one; normally, a minimum of three "cells" are used. Sludge collects in the bottom of the lagoons, and may have to be removed every five or ten years and disposed of in an approved manner.¹⁵

CHLORINE

Wastewater leaving wastewater treatment plants is often treated with chlorine before being released into the environment. Therefore, besides contaminating water resources with feces, the act of defecating into water often ultimately contributes to the contamination of water resources with *chlorine*.

Used since the early 1900s, chlorine is one of the most widely produced industrial chemicals. About 10 million metric tons are manufactured in the US each year — \$72 billion worth.¹⁶ Annually, approximately 5%, or 1.2 billion pounds of the chlorine manufactured is used for wastewater treatment and drinking water "purification." The lethal liquid or green gas is mixed with the wastewater from sewage treatment plants in order to kill disease-causing microorganisms before the water is discharged into streams, lakes, rivers, and seas. It is also added to household drinking water via household and municipal water treatment systems. Chlorine kills microorganisms by damaging their cell membranes, which leads to a leakage of their proteins, RNA, and DNA.¹⁷

Chlorine (Cl₂) doesn't exist in nature. It's a potent poison which reacts with water to produce a strongly oxidizing solution that can damage the moist tissue lining of the human respiratory tract. Ten to twenty parts per million (ppm) of chlorine gas in air rapidly irritates the respiratory tract; even brief exposure at levels of 1,000 ppm (one part in a thousand) can be fatal.¹⁸ Chlorine also kills fish, and reports of fish kills caused chlorine to come under the scrutiny of scientists in the 1970s.

The fact that harmful compounds are formed as *by-products* of chlorine use also raises concern. In 1976, the US Environmental Protection Agency (EPA) reported that chlorine use not only poisoned fish, but could also cause the formation of cancer-causing compounds such as chloroform. Some known effects of chlorine-based pollutants on animal life include memory problems, stunted growth and cancer in humans; reproductive problems in minks and otters; reproductive problems, hatching problems, and death in lake trout; and embryo abnormalities and death in snapping turtles.¹⁹

In a national study of 6,400 municipal wastewater treatment plants, the EPA estimated that two thirds of them used too much chlorine, exerting lethal effects at all levels of the aquatic food chain. Chlorine damages the gills of fish, inhibiting their ability to absorb oxygen. It also can cause behavioral changes in fish, thereby affecting migration and reproduction. Chlorine in streams can create chemical "dams" which prevent the free movement of some migratory fish. Fortunately, since 1984, there has been a 98% reduction in the use of chlorine by sewage treatment plants, although chlorine use continues to be a widespread problem because a lot of wastewater plants are still discharging it into small receiving waters.²⁰

Another controversy associated with chlorine use involves "dioxin," which is a common term for a large number of chlorinated chemicals that are classified as possible human carcinogens by the EPA. It's known that dioxins cause cancer in laboratory animals, but their effects on humans are still being debated. Dioxins, by-products of the chemical manufacturing industry, are concentrated up through the food chain where they're deposited in human fat tissues. A key ingredient in the formation of dioxin is chlorine, and indications are that an increase in the use of chlorine results in a corresponding increase in the dioxin content of the environment, even in areas where the only dioxin source is the atmosphere.²¹

In the upper atmosphere, chlorine molecules from air pollution gobble up ozone; in the lower atmosphere, they bond with carbon to form organochlorines. Some of the 11,000 commercially used organochlorines include hazardous compounds such as DDT, PCBs, chloroform, and carbon tetrachloride. Organochlorines rarely occur in nature, and living things have little defense against them. They've been linked not only to cancer, but also to neurological damage, immune suppression, and reproductive and developmental effects. When chlorine products are washed down the drain to a septic tank, they're producing organochlorines. Although compost microorganisms can degrade and make harmless many toxic chemicals, highly chlorinated compounds are disturbingly resistant to such biodegradation.²²

"Any use of chlorine results in compounds that cause a wide range of ailments," says Joe Thornton, a Greenpeace researcher, who adds, *"Chlorine is simply not compatible with life. Once you create it, you*

can't control it." ²³

There's no doubt that our nation's sewage treatment systems are polluting our drinking water sources with pathogens. As a result, chlorine is also being used to disinfect *the water we drink* as well as to disinfect discharges from wastewater treatment facilities. It is estimated that 79% of the US population is exposed to chlorine.²⁴ According to a 1992 study, *chlorine is added to 75% of the nation's drinking water* and is linked to cancer. The results of the study suggested that at least 4,200 cases of bladder cancer and 6,500 cases of rectal cancer each year in the US are associated with consumption of chlorinated drinking water.²⁵ This association is strongest in people who have been drinking chlorinated water for more than fifteen years.²⁶

In December, 1992, the US Public Health Service reported that pregnant women who routinely drink or bathe in chlorinated tap water are at a greater risk of bearing premature or small babies, or babies with congenital defects.²⁷

According to a spokesperson for the chlorine industry, 87% of water systems in the US use free chlorines; 11% use chloramines. Chloramines are a combination of chlorine and ammonia. The chloramine treatment is becoming more widespread due to the health concerns over chlorine.²⁸ However, EPA scientists admit that we're pretty ignorant about the potential by-products of the chloramine process, which involves ozonation of the water prior to the addition of chloramine.²⁹

Of course, we don't have to worry. The government will take care of us, and if the government doesn't, then industry will. Won't they? Well, not exactly. According to a US General Accounting Office report in 1992, consumers are poorly informed about potentially serious violations of drinking water standards. In a review of twenty water systems in six states, out of 157 drinking water quality violations, the public received a timely notice in only 17 of the cases.³⁰

ALTERNATIVE WASTEWATER TREATMENT SYSTEMS

New systems are being developed to purify wastewater. One popular experimental system today is the *constructed, or artificial wetlands system*, which runs wastewater through an aquatic environment consisting of aquatic plants such as water hyacinths, bullrushes, duckweed, lilies, and cattails (see Figure 5.14). The plants act as marsh filters, and the microbes which thrive on their roots do most of the work, breaking down nitrogen and phosphorous compounds, as well as toxic chemicals. Although they don't break down heavy metals, the plants absorb them; they can then be harvested and incinerated or landfilled.³¹

According to EPA officials, the emergence of constructed wetlands technology shows great potential as a cost effective alternative to wastewater treatment. The wetlands method is said to be relatively affordable, energy efficient, practical, and effective. Scientists don't yet have the data to determine with assurance the performance expectations of wetlands systems, or contaminant concentrations released by these systems into the environment. However, the treatment efficiency of properly constructed wetlands

is said to compare well with conventional treatment systems.³² Unfortunately, wetlands systems don't recover the agricultural resources available in humanure.

Another system uses solar powered greenhouse-like technology to treat wastewater. This system uses hundreds of species of bacteria, fungi, protozoa, snails, plants and fish, among other things, to produce advanced levels of wastewater treatment. These Solar Aquatics systems are also experimental, but appear hopeful.³³ Again, the agricultural resources of humanure are lost when using any disposal method or wastewater treatment technique instead of a humanure recycling method.

When a household humanure recycling method is used, however, and sewage is not being produced, most households will still be producing graywater. Graywater is the water that is used for washing, bathing, and laundry, and it must be dealt with in a responsible manner before draining into the environment. Most households produce sewage (blackwater). Households that produce *only* graywater are rare, and may even be beyond the comprehension of many government authorities who may insist that every household have a sewage system (e.g., septic system) whether they produce sewage or not. Yet, households which compost their humanure may produce no sewage at all; these households are prime candidates for *alternative* graywater systems. Such alternative systems are discussed in [Chapter 9](#).

AGRICULTURAL USE OF SEWAGE SLUDGE

Now here's where a thoughtful person may ask, "Why not put *sewage sludge* back into the soil for agricultural purposes?"

One reason: government regulation. When I asked the supervisor of my local wastewater treatment plant if the one million gallons of sludge the plant produces each year (for a population of 8,000) was being applied to agricultural land, he said, "*It takes six months and five thousand dollars to get a permit for a land application. Another problem is that due to regulations, the sludge can't lie on the surface after it's applied, so it has to be plowed under shortly after application. When farmers get the right conditions to plow their fields, they plow them. They can't wait around for us, and we can't have sludge ready to go at plowing time.*" It may be just as well.

Problems associated with the agricultural use of sewage sludge include groundwater, soil, and crop contamination with pathogens, heavy metals, nitrate, and toxic and carcinogenic organic compounds.³⁴ Sewage sludge is a lot more than organic human refuse. It can contain DDT, PCBs, mercury, and other heavy metals.³⁵ One scientist alleges that more than 20 million gallons of used motor oil are dumped into sewers every year in the United States.³⁶

America's largest industrial facilities released over 550 million pounds of toxic pollutants into US sewers in 1989 alone, according to the US Public Interest Research Group. Between 1990 and 1994, an additional 450 million pounds of toxic chemicals were dumped into sewage treatment systems, although the actual levels of toxic discharges are said to be much higher than these.³⁷

Of the top ten states responsible for toxic discharges to public sewers in 1991, Michigan took first prize with nearly 80 million pounds, followed in order by New Jersey, Illinois, California, Texas, Virginia, Ohio, Tennessee, Wisconsin and Pennsylvania (around 20 million pounds from PA).³⁸

An interesting study on the agricultural use of sludge was done by a Mr. Purves in Scotland. He began applying sewage sludge at the rate of 60 tons per acre to a plot of land in 1971. After fifteen years of treating the soil with the sludge, he tested the vegetation grown on the plot for heavy metals. On finding that the heavy metals (lead, copper, nickel, zinc and cadmium) had been taken up by the plants, he concluded, “*Contamination of soils with a wide range of potentially toxic metals following application of sewage sludge is therefore virtually irreversible.*”³⁹ In other words, the heavy metals don’t wash out of the soil, they enter the food chain, and may contaminate not only crops, but also grazing animals.⁴⁰

Other studies have shown that heavy metals accumulate in the vegetable tissue of the plant to a much greater extent than in the fruits, roots, or tubers. Therefore, if one must grow food crops on soil fertilized with sewage sludge contaminated with heavy metals, one might be wise to produce carrots or potatoes instead of lettuce.⁴¹ Guinea pigs experimentally fed with swiss chard grown on soil fertilized with sewage sludge showed no observable toxicological effects. However, their adrenals showed elevated levels of antimony, their kidneys had elevated levels of cadmium, there was elevated manganese in the liver and elevated tin in several other tissues.⁴²

Estimated to contain 10 billion microorganisms per gram, sludge may contain many human pathogens.⁴³ “*The fact that sewage sludge contains a large population of fecal coliforms renders it suspect as a potential vector of bacterial pathogens and a possible contaminant of soil, water and air, not to mention crops. Numerous investigations in different parts of the world have confirmed the presence of intestinal pathogenic bacteria and animal parasites in sewage, sludge, and fecal materials.*”⁴⁴

Because of their size and density, parasitic worm eggs settle into and concentrate in sewage sludge at wastewater treatment facilities. One study indicated that roundworm eggs could be recovered from sludge at all stages of the wastewater treatment process, and that two-thirds of the samples examined had viable eggs.⁴⁵ Agricultural use of the sludge can therefore infect soil with 6,000-12,000 viable parasitic worm eggs, per square meter, per year. These eggs can persist in some soils for five years or more.⁴⁶ Furthermore, *Salmonellae* bacteria in sewage sludge can remain viable on grassland for several weeks, thereby making it necessary to restrict grazing on pastureland for several weeks after a sludge application. Beef tapeworm (*Taenia saginata*), which uses cattle as its intermediate host and humans as its final host, can also infect cattle that graze on pastureland fertilized with sludge. The tapeworm eggs can survive on sludged pasture for a full year.⁴⁷

Another interesting study published in 1989 indicated that bacteria surviving in sewage sludge show a high level of resistance to antibiotics, especially penicillin. Because heavy metals are concentrated in sludge during the treatment process, the bacteria that survive in the sludge can obviously resist heavy metal poisoning. These same bacteria also show an inexplicable resistance to antibiotics, suggesting that somehow the resistance of the two environmental factors are related in the bacterial strains that survive.

The implication is that sewage sludge selectively breeds antibiotic-resistant bacteria, which may enter the food chain if the agricultural use of the sludge becomes widespread. The results of the study indicated that more knowledge of antibiotic-resistant bacteria in sewage sludge should be acquired before sludge is disposed of on land.⁴⁸

This poses somewhat of a problem. Collecting human excrement with wastewater and industrial pollutants seems to render the organic refuse incapable of being adequately sanitized. It becomes contaminated enough to be unfit for agricultural purposes. As a consequence, sewage sludge is not highly sought after as a soil additive. For example, the state of Texas sued the US EPA in July of 1992 for failing to study environmental risks before approving the spreading of sewage sludge in west Texas. Sludge was being spread on 128,000 acres there by an Oklahoma firm, but the judge nevertheless refused to issue an injunction to stop the spreading.⁴⁹ Considering that the sludge was from New York City, who can blame the Texans?

Now that ocean dumping of sludge has been stopped, where's it going to go? Researchers at Cornell University have suggested that sewage sludge can be disposed of by surface applications in forests. Their studies suggest that brief and intermittent applications of sludge to forestlands won't adversely affect wildlife, despite the nitrates and heavy metals that are present in the sludge. They point out that the need to find ways to get rid of sludge is compounded by the fact that many landfills are expected to close over the next several years and ocean dumping is now banned. Under the Cornell model, one dry ton of sludge could be applied to an acre of forest each year.⁵⁰ New York state alone produces 370,000 tons of dry sludge per year, which would require 370,000 acres of forest each year for their sludge disposal. Consider the fact that forty-nine other states produce 7.6 million dry tons of sludge. Then there's figuring out how to get the sludge into the forests and how to spread it around. With all this in mind, a guy has to stop and wonder — the woods used to be the only place left to get away from it all.

The problem of treating and dumping sludge isn't the only one. The costs of maintenance and upkeep of wastewater treatment plants is another. According to a report issued by the EPA in 1992, US cities and towns need as much as \$110.6 billion over the next twenty years for enlarging, upgrading, and constructing wastewater treatment facilities.⁵¹

Ironically, when sludge is *composted*, it may help to keep heavy metals *out* of the food chain. According to a 1992 report, composted sludge lowered the uptake of lead in lettuce that had been deliberately planted in lead-contaminated soil. The lettuce grown in the contaminated soil which was amended with composted sludge had a 64% lower uptake of lead than lettuce planted in the same soil but without the compost. The composted soil also lowered lead uptake in spinach, beets, and carrots by more than 50%.⁵²

Some scientists claim that the composting process transforms heavy metals into benign materials. One such scientist who designs facilities that compost sewage sludge states, “*At the final product stage, these [heavy] metals actually become beneficial micro-nutrients and trace minerals that add to the productivity of soil. This principle is now finding acceptance in the scientific community of the USA and is known as biological transmutation, or also known as the Kervran-Effect.*” Composted sewage sludge

that is microbiologically active can also be used to detoxify areas contaminated with nuclear radiation or oil spills, according to the same researcher. Clearly, the composting of sewage sludge is a grossly underutilized alternative to landfill application, and it should be strongly promoted.⁵³

Other scientists have shown that heavy metals in contaminated compost (such as sludge compost) are *not* biologically transmuted, but are actually *concentrated* in the finished compost. This is most likely due to the fact that the compost mass shrinks considerably during the composting process showing reductions of 70%, while the amount of metals remains the same. Some researchers have shown a decrease in the concentrations of *some* heavy metals and an increase in the concentrations of others, for reasons that are unclear. Others show a considerable decrease in the concentrations of heavy metals between the sludge and the finished compost. Results from various researchers “*are giving a confusing idea about the behavior of heavy metals during composting. No common pattern of behavior can be drawn between similar materials and the same metals . . .*”⁵⁴ However, metals concentrations in finished compost seem to be low enough that they are not considered to be a problem, perhaps largely because metal-contaminated sludge is greatly diluted by other clean organic materials when composted.⁵⁵

GLOBAL SEWERS AND PET TURDS

Let’s assume that the whole world adopted the sewage philosophy we have in the United States: defecate into water and then treat the polluted water. What would that scenario be like? Well, for one thing it wouldn’t work. It takes between 1,000 and 2,000 tons of water at various stages in the process to flush one ton of humanure. In a world of just five billion people producing a conservative estimate of one million metric tons of human excrement daily, the amount of water required to flush it all would not be obtainable.⁵⁶ Considering the increasing landfill space that would be needed to dispose of the increasing amounts of sewage sludge, and the tons of toxic chemicals required to “sterilize” the wastewater, one can realize that this system of human waste disposal is far from sustainable and cannot serve the needs of humanity in the long term.

According to Barbara Ward, President of the International Institute for Environment and Development, “*Conventional ‘Western’ methods of waterborne sewerage are simply beyond the reach of most [of the world’s] communities. They are far too expensive. And they often demand a level of water use that local water resources cannot supply. If Western standards were made the norm, some \$200 billion alone [early 1980s] would have to be invested in sewerage to achieve the target of basic sanitation for all. Resources on this scale are simply not in sight.*”

To quote Lattee Fahm, “*In today’s world [1980], some 4.5 billion people produce excretal matters at about 5.5 million metric tons every twenty-four hours, close to two billion metric tons per year. [Humanity] now occupies a time/growth dimension in which the world population doubles in thirty five years or less. In this new universe, there is only one viable and ecologically consistent solution to the body waste problems — the processing and application of [humanure] for its agronutrient content.*”⁵⁷ This sentiment is echoed by World Bank researchers, who state, “[I]t can be estimated that the backlog of over one billion people not now provided with water or sanitation service will grow, not decrease. It

has also been estimated that most developing economies will be unable to finance water carriage waste disposal systems even if loan funds were available.” [58](#)

In other words, we have to understand that humanure is a natural substance, produced by a process vital to life (human digestion), originating from the earth in the form of food, and valuable as an organic refuse material that can be returned to the earth in order to produce more food for humans. That’s where composting comes in.

But hey, wait, let’s not be rash. We forgot about incinerating our excrements. We can dry our turds out, then truck them to big incinerators and burn the hell out of them. That way, instead of having fecal pollution in our drinking water or forests, we can breathe it in our air. Unfortunately, burning sludge with other municipal waste produces emissions of particulate matter, sulfur dioxide, nitrogen oxides, carbon monoxide, lead, volatile hydrocarbons, acid gases, trace organic compounds, and trace metals. The leftover ash has a high concentration of heavy metals, such as cadmium and lead.[59](#) Doesn’t sound so good if you live downwind, does it?

How about microwaving it? Don’t laugh, someone’s already invented the microwave toilet.[60](#) This just might be a good cure for hemorrhoids, too. But heck, let’s get serious and shoot it into outer space. Why not? It probably wouldn’t cost too much per fecal log after we’ve dried the stuff out. This could add a new meaning to the phrase “the Captain’s log.” Beam up another one, Scotty!

Better yet, we can dry our turds out, chlorinate them, get someone in Taiwan to make little plastic sunglasses for them, and we’ll sell them as pet turds! Now that’s an entrepreneurial solution, isn’t it? Any volunteer investors out there?

Source: The Humanure Handbook. Jenkins Publishing, PO Box 607, Grove City, PA 16127. To order, phone: 1-800-639-4099.

<http://www.jenkinspublishing.com/>

MENU: [HOME](#) » [Reconstruction](#) » [Recovery](#) » [Renewal](#) » [Survival](#) » [Humanure Content](#)

COMPOSTING TOILETS AND SYSTEMS

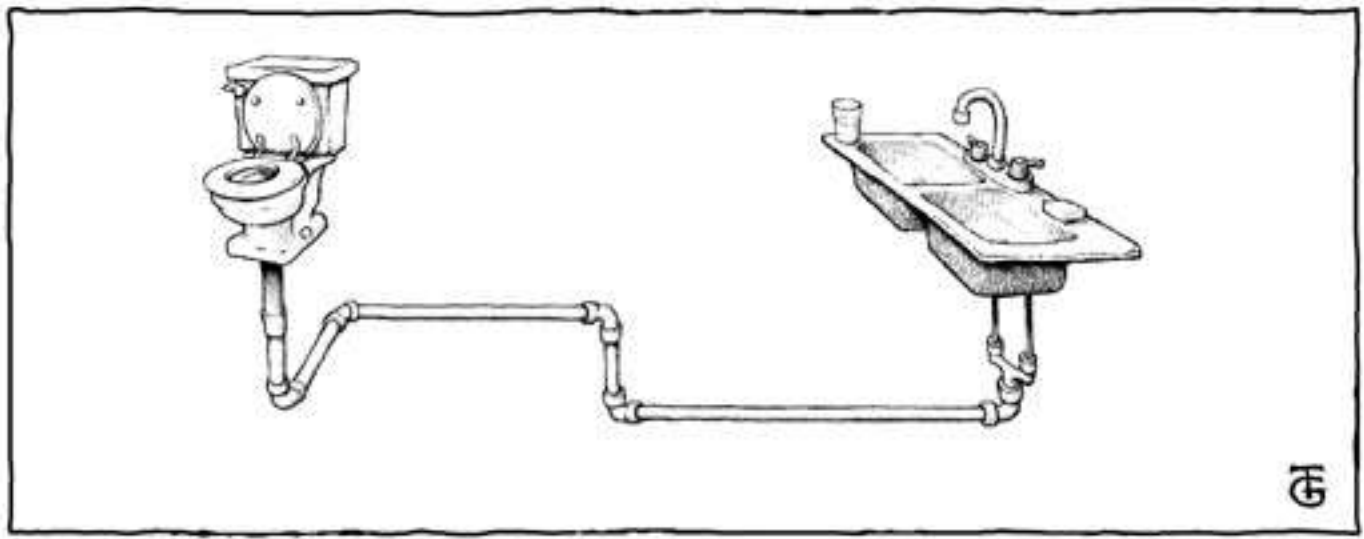

“Simplicity of life, even the barest, is not misery but the very foundation of refinement.”

William Morris

Technically, a “composting toilet” is a toilet in which composting takes place. Usually, the composting chamber is located under the toilet. Other toilets are simply collection devices in which humanure is deposited, then removed to a separate composting location away from the toilet area. These toilets are components of “composting toilet systems,” rather than composting toilets, *per se*.

Humanure composting toilets and systems can generally be divided into two categories based on the composting temperatures they generate. Some toilet systems produce thermophilic (hot) compost; others produce low-temperature compost. Most commercial and homemade composting toilets are low-temperature composting toilets, sometimes called “mouldering toilets.”

The most basic way to compost humanure is simply to collect it in a toilet receptacle and add it to a compost pile. The toilet acts only as a collection device, while the composting takes place at a separate location. Such a toilet requires little, if any, expense, and can be constructed and operated by people of simple means in a wide range of cultures around the world. It is easy to create thermophilic (hot) compost with such a collection toilet. This type of toilet is discussed in detail in [Chapter 8, “The Tao of](#)

Compost.”

The toilets of the future will also be collection devices rather than waste disposal devices. The collected organic material will be hauled away from homes and composted under the responsibility of municipal authorities, perhaps under contract with a private sector composting facility. Currently, other recyclable materials such as bottles and cans are collected from homes by municipalities; in some areas organic food materials are also collected and composted at centralized composting facilities. The day will come when those collected organic materials will include toilet materials.

In the meantime, homeowners who want to make compost rather than sewage must do so independently by either constructing a composting toilet of their own, buying a commercial composting toilet, or using a simple collection toilet with a separate composting bin. The option one chooses depends upon how much money one wants to spend, where one lives, and how much involvement one wants in the compost-making process.

A simple sawdust toilet (a collection toilet) with a separate compost bin is the least expensive, but tends to be limited to homes where an outdoor compost bin can be utilized. Such a toilet is only attractive to people who don't mind the regular job of emptying containers of compost onto a compost pile, and who are willing to responsibly manage the compost to prevent odor and to ensure thermophilic conditions.

Homemade composting toilets, on the other hand, generally include a compost bin underneath the toilet and do not involve carting humanure to a separate compost pile. They tend to be less expensive than commercial composting toilets, and they can be built to whatever size and capacity the household requires, allowing for some creativity in their design. They are usually permanent structures located under the dwelling in a crawl space or basement, but they can also be free-standing outdoor structures. The walls are typically made of a concrete material, and the toilets are most successful when properly managed. Such management includes the regular addition to the toilet contents of sufficient carbon-based bulking material, such as sawdust, peat moss, straw, hay, or weeds. Homemade composting toilets generally do not require water or electricity. Commercial composting toilets come in all shapes, types, sizes, and price ranges. They are usually made of fiberglass or plastic, and consist of a composting chamber underneath the toilet seat. Some of them use water and some of them require electricity. Some require neither. A list of commercial compost toilet manufacturers follows this chapter.

Source: The Humanure Handbook. Jenkins Publishing, PO Box 607, Grove City, PA 16127. To order, phone: 1-800-639-4099.

<http://www.jenkinspublishing.com/>

MENU: [HOME](#) » [Reconstruction](#) » [Recovery](#) » [Renewal](#) » [Survival](#) » [Humanure Content](#)

MENU: [HOME](#) » [Reconstruction](#) » [Recovery](#) » [Renewal](#) » [Survival](#) » [Humanure Content](#)

COMPOSTING TOILETS MUST BE MANAGED

We have used flush toilets for so long that after we defecate we expect to simply pull a handle and walk away. Some think that composting toilets should behave in the same manner. However, flush toilets are *disposal* devices that create pollution and waste soil nutrients. Composting toilets are recycling devices that should create no pollution and should recover the soil nutrients in human manure and urine. When you push a handle on a flush toilet, you're paying someone to dispose of your waste for you. Not only are you paying for the water, for the electricity, and for the wastewater treatment costs, but you are also contributing to the environmental problems inherent in waste disposal. When you use a composting toilet, you are getting paid for the small amount of effort you expend in recycling your organic material. Your payment is in the form of compost. Composting toilets, therefore, require some management. You have to *do* something besides just pushing a handle and walking away.

The degree of your involvement will depend on the type of toilet you are using. In most cases, this involves simply adding some clean organic cover material such as peat moss, sawdust, rice hulls, or leaf mould to the toilet after each use. Instead of flushing, you cover. Nevertheless, someone must take responsibility for the overall management of the toilet. This is usually the homeowner, or someone else who has volunteered for the task. Their job is simply to make sure sufficient cover materials are available and being used in the toilet. They must also add bulking materials to the toilet contents when needed, and make sure the toilet is not being used beyond its capacity, not becoming waterlogged, and not breeding flies. Remember that a composting toilet houses an organic mass with a high level of microscopic biodiversity. The contents are alive, and must be watched over and managed to ensure greatest success.

Source: The Humanure Handbook. Jenkins Publishing, PO Box 607, Grove City, PA 16127. To order, phone: 1-800-639-4099.

<http://www.jenkinspublishing.com/>

MENU: [HOME](#) » [Reconstruction](#) » [Recovery](#) » [Renewal](#) » [Survival](#) » [Humanure Content](#)

MENU: [HOME](#) » [Reconstruction](#) » [Recovery](#) » [Renewal](#) » [Survival](#) » [Humanure Content](#)

FECOPHOBIA AND THE PATHOGEN ISSUE

The belief that humanure is unsafe for agricultural use is called *fecophobia*, a term, I admit, I made up. People who are fecophobic can suffer from severe fecophobia or a relatively mild fecophobia, the mildest form being little more than a healthy concern about personal hygiene. Severe fecophobics do not want to use humanure for food growing, composted or not. They believe that it's dangerous and unwise to use such a material in their garden. Milder fecophobics may, however, compost humanure and use the finished compost in horticultural applications. People who are not fecophobic may compost humanure and utilize it in their food garden. Some may even use it raw, a practice *not* recommended by the author.

It is well known that humanure contains the *potential* to harbor disease-causing microorganisms (pathogens). This potential is directly related to the state of health in the population which is producing the excrement. If a family is composting its own humanure, for example, and it is a healthy family, the danger in the production and use of the compost will be very low. If one is composting the humanure from orphanages in Haiti where intestinal parasites are endemic, then extra precautions must be taken to ensure maximum pathogen death. Compost temperatures must rise significantly above the temperature of the human body (37°C or 98.6°F) in order to begin eliminating disease-causing organisms, as human pathogens thrive at temperatures similar to that of their hosts. On the other hand, most pathogens only have a limited viability outside the human body, and given enough time, will die even in low-temperature compost.

Humanure is best rendered hygienically safe by thermophilic composting. To achieve this, humanure can simply be collected and deposited on an outdoor compost pile like any other compost material. Open-air, outdoor compost piles with good access are easily managed and offer a no-cost, odorless method to achieve the thermophilic composting of humanure. However, such a system does require the regular collection and cartage of the organic material to the compost pile, making it relatively labor intensive when compared to low-temperature, stationary, homemade and commercial composting toilets.

Many people will use a composting toilet only if they do not have to do anything in any way related to the toilet contents. Therefore, most homemade and commercial composting toilets are comprised of large composting chambers under the toilet seat. The organic material is deposited directly into a composting chamber, and the contents are emptied only very occasionally.

Thermophilic conditions do not seem to be common in these toilets, for several reasons. For one, many commercial composting toilets are designed to *dehydrate* the organic material deposited in them. This

dehydration is achieved by electrical fans, which rob the organic mass of moisture and heat. Commercial toilets also often strive to reduce the *quantity* of material collecting in the composting chamber (mostly by dehydration), in order to limit the frequency of emptying for the sake of the convenience of the user. Bulky air-trapping additions to the compost are not encouraged, although these additions will encourage thermophilic composting. Yet, even passive, low-temperature composting will eventually yield a relatively pathogen-free compost after a period of time.

Low-temperature composting toilets include most commercial and many homemade units. According to current scientific evidence, a few months retention time in just about any composting toilet will result in the deaths of nearly all human pathogens ([see Chapter 7](#)). The most persistent pathogen seems to be the roundworm (*Ascaris lumbricoides*) and particularly the egg of the roundworm, which is protected by an outer covering which resists chemicals and adverse environmental conditions. Estimates of the survival time of *Ascaris* eggs in certain soil types under certain conditions are as high as ten years. Although the *Ascaris* eggs are readily destroyed by thermophilic composting, they may survive in conditions generated by a low-temperature toilet. This is why the compost resulting from such toilets is generally not recommended for garden use if it comes in contact with food crops.

People can become rather obsessive about this issue. One man who published a book on this topic wrote to me to say that a two year retention time in a low-temperature composting toilet is generally considered adequate for the destruction of *Ascaris* ova (eggs). He indicated that he would never consider using his own low-temperature compost until it had aged at least two years. I asked him if he was infected with roundworms. He said no. I asked him if anyone else was using his toilet. No. I asked him what he was worried about then. Why would he think there could be roundworm eggs in his compost when he knew he didn't have roundworms in the first place? Sometimes common sense is not so common. The *potential* dangers of humanure can be blown way out of proportion. This is similar to the phobic person who would never go to a movie theater because there may be someone in the theater who has tuberculosis and who may sneeze. Although this is a risk we all take, it's not likely to be a problem.

Source: The Humanure Handbook. Jenkins Publishing, PO Box 607, Grove City, PA 16127. To order, phone: 1-800-639-4099.

<http://www.jenkinspublishing.com/>

MENU: [HOME](#) » [Reconstruction](#) » [Recovery](#) » [Renewal](#) » [Survival](#) » [Humanure Content](#)

OWNER-BUILT COMPOSTING TOILETS

Owner-built composting toilets are in widespread use throughout the world since many people do not have the financial resources required to purchase commercially produced toilets. They tend to be low-temperature composting toilets, although they can conceivably be thermophilic toilet systems if properly managed.

The objectives of any composting toilet should be to achieve safe and sanitary treatment of fecal material, to conserve water, to function with a minimum of maintenance and energy consumption, to operate without unpleasant odors, and to recycle humanure for agricultural use.

The primary advantage of low-temperature toilets is the passive involvement of the user. The toilet collection area need not be entered into very often unless, perhaps, to rake the pile flat. The pile that collects in the chamber must be raked somewhat every few months (which can be done through a floor access door), and the chamber is emptied only after nothing has been deposited in it for at least a year or two, although this time period may vary depending on the individual system used.

In order for this system to work well, each toilet must have two chambers. Fecal material and urine are deposited into the first chamber until it's full, then the second chamber is used while the first ages. By the time the second side is full, the first should be ready to empty. It may take several years to fill a side, depending on its capacity and the number of users. In addition to feces, carbonaceous organic matter such as sawdust, as well as bulky vegetable matter such as straw and weeds, are regularly added to the chamber in use. A clean cover of such material is maintained over the compost at all times for odor prevention (see Figure 6.1).

Some of these composting toilets involve the separation of urine from feces. This is done by urinating into a separate container or into a diversion device which causes the urine to collect separately from the feces. The reason for separating urine from feces is that the urine/feces blend contains too much nitrogen to allow for effective composting and the collected material can get too wet and odorous. Therefore, the urine is collected separately, reducing the nitrogen, the liquid content, and the odor of the collected material (see Figure 6.2).

An alternative method of achieving the same result which does not require the separation of urine from feces does exist. Organic material with too much nitrogen for effective composting (such as a urine/feces mixture) can be balanced by adding more carbon material such as sawdust, rather than by removing the

urine. The added carbon material absorbs the excess liquid and will cover the refuse sufficiently to eliminate odor completely. This also sets the stage for thermophilic composting because of the carbon/nitrogen balancing.

One may also “precharge” the toilet with a “biological sponge,” a thick layer of absorbent cellulose material filling the bottom of the compost chamber to a depth of up to 50% of its capacity. Some suggest that the toilet can be filled to 100% of its capacity before beginning to be used, because if the material is loose (such as loose hay), it will compress under the weight of the added humanure. A bottom sponge may consist of bales of hay or straw buried in sawdust. These materials absorb the excess urine as it is added to the toilet. Fecal material is covered after each use with materials such as sawdust, peat, leaf mould, or rice hulls. A drain into a five gallon bucket (perhaps pre-filled with sawdust) will collect any leachate, which can simply be deposited back on the compost pile. Extra bulking materials such as straw, weeds, hay, and food scraps are regularly added to the compost chamber to help oxygenate and feed the growing organic mass in order to promote thermophilic decomposition. Ventilation can be enhanced by utilizing a vertical pipe installed like a chimney, which will allow air to passively circulate into and out of the compost chamber.

Such systems will need to be custom-managed according to the circumstances of the individuals using them. Someone needs to keep an eye on the toilet chambers to make sure they’re receiving enough bulking material. The deposits need to be flattened regularly so that they remain covered and odorless. Chutes that channel humanure from the toilet seat to the compost chamber must be cleaned regularly in order to prevent odors. When one compost chamber is filled, it must be rested while the other is filled. A close eye on the toilet contents will prevent waterlogging. Any leachate system must be monitored. In short, any composting toilet will require some management. Remember that you are actively recycling organic material, and that means you are *doing* something constructive. When you consider the value of the finished compost, you can also consider this: every time you deposit into a composting toilet, it’s as if you’re putting money in the bank.

Homemade low temperature composting toilets offer a method of composting humanure that is attractive to persons wanting a low-maintenance, low-cost, fairly passive approach to excrement recycling. Any effort which constructively returns organic refuse to the soil without polluting water or the environment certainly demands a high level of commendation.

Source: The Humanure Handbook. Jenkins Publishing, PO Box 607, Grove City, PA 16127. To order, phone: 1-800-639-4099.

<http://www.jenkinspublishing.com/>

MENU: [HOME](#) » [Reconstruction](#) » [Recovery](#) » [Renewal](#) » [Survival](#) » [Humanure Content](#)

ASIAN COMPOSTING

It is well known that Asians have recycled humanure for centuries, possibly millennia. How did *they* do it? Historical information concerning the *composting* of humanure in Asia seems difficult to find. Rybczynski et al. state that composting was only introduced to China in a systematic way in the 1930s and that it wasn't until 1956 that composting toilets were used on a wide scale in Vietnam.¹ On the other hand, Franceys et al. tell us that composting "*has been practiced by farmers and gardeners throughout the world for many centuries.*" They add that, "*In China, the practice of composting [humanure] with crop residues has enabled the soil to support high population densities without loss of fertility for more than 4000 years.*"²

However, a book published in 1978 and translated directly from the original Chinese indicates that composting has not been a cultural practice in China until only recently. An agricultural report from the Province of Hopei, for example, states that the standardized management and hygienic disposal (i.e., composting) of excreta and urine was only initiated there in 1964. The composting techniques being developed at that time included the segregation of feces and urine, which were later "*poured into a mixing tank and mixed well to form a dense fecal liquid*" before piling on a compost heap. The compost was made of 25% human feces and urine, 25% livestock manure, 25% miscellaneous organic refuse, and 25% soil.³

Two *aerobic* methods of composting were reported to be in widespread use in China, according to the 1978 report. The two methods are described as: 1) surface aerobic continuous composting; and 2) pit aerobic continuous composting. The surface method involves constructing a compost pile around an internal framework of bamboo, approximately nine feet by nine feet by three feet high (3m x 3m x 1m). Compost ingredients include fecal material (both human and non-human), organic refuse, and soil. The bamboo is removed from the constructed pile and the resultant holes allow for the penetration of air into this rather large pile of refuse. The pile is then covered with earth or an earth/horse manure mix, and left to decompose for 20 to 30 days, after which the composted material is used in agriculture.

The pit method involves constructing compost pits five feet wide and four feet deep by various lengths, and digging channels in the floor of the pits. The channels (one lengthwise and two widthwise) are covered with coarse organic material such as millet stalks, and a bamboo pole is placed vertically along the walls of the pit at the end of each channel. The pit is then filled with organic refuse and covered with earth, and the bamboo poles are removed to allow for air circulation.⁴

A report from a hygienic committee of the Province of Shantung provides us with additional information on Chinese composting.⁵ The report lists three traditional methods used in that province for the recycling of humanure:

- 1) Drying it — “*Drying has been the most common method of treating human excrement and urine for years.*” It is a method that causes a significant loss of nitrogen;
- 2) Using it raw, a method that is well known for pathogen transmission; and
- 3) “*Connecting the household pit privy to the pigpen . . . a method that has been used for centuries.*” An unsanitary method in which the excrement was simply eaten by a pig.

No mention is made whatsoever of *composting* being a traditional method used by the Chinese for recycling humanure. On the contrary, all indications were that the Chinese government in the 1960s was, *at that time*, attempting to establish composting as preferable to the three traditional recycling methods listed above, mainly because the three methods were hygienically unsafe, while composting, when properly managed, would destroy pathogens in humanure while preserving agriculturally valuable nutrients. This report also indicated that soil was being used as an ingredient in the compost, or, to quote directly, “*Generally, it is adequate to combine 40-50% of excreta and urine with 50-60% of polluted soil and weeds.*”

For further information on Asian composting, I must defer to Rybczynski et al., whose World Bank research on low-cost options for sanitation considered over 20,000 references and reviewed approximately 1200 documents. Their review of Asian composting is brief, but includes the following information, which I have condensed:

There are no reports of composting privys (toilets) being used on a wide scale until the 1950s, when the Democratic Republic of Vietnam initiated a five-year plan of rural hygiene and a large number of *anaerobic* composting toilets were built. These toilets, known as the Vietnamese Double Vault, consisted of two above ground water-tight tanks, or *vaults*, for the collection of humanure (see Figure 6.3). For a family of five to ten people, each vault was required to be 1.2 m wide, 0.7 m high, and 1.7 m long (approximately 4 feet wide by 28 inches high and 5 feet 7 inches long). One tank is used until full and left to decompose while the other tank is used. The use of this sort of composting toilet requires the segregation of urine, which is diverted to a separate receptacle through a groove on the floor of the toilet. Fecal material is collected in the tank and covered with soil, where it anaerobically decomposes. Kitchen ashes are added to the fecal material for the purpose of reducing odor.

Eighty-five percent of intestinal worm eggs, one of the most persistently viable forms of human pathogens, were found to be destroyed after a two month composting period in this system. However, according to Vietnamese health authorities, forty-five days in a sealed vault is adequate for the complete destruction of all bacteria and intestinal parasites (presumably they mean pathogenic bacteria). Compost from such latrines is reported to increase crop yields by 10-25% in comparison to the use of raw

humanure. The success of the Vietnamese Double Vault required “*long and persistent health education programs.*” ⁶

When the Vietnamese Double Vault composting toilet system was exported to Mexico and Central America, the result was “*overwhelming positive,*” according to one source, who adds, “*Properly managed there is no smell and no fly breeding in these toilets. They seem to work particularly well in the dry climate of the Mexican highlands. Where the system has failed (wetness in the processing chamber, odours, fly breeding) it was usually due to non-existent, weak, or bungled information, training and follow-up.*” ⁷ A lack of training and a poor understanding of the composting processes can cause any humanure composting system to become problematic. Conversely, complete information and an educated interest will ensure the success of humanure composting systems.

Another anaerobic double-vault composting toilet used in Vietnam includes using both fecal material *and* urine. In this system, the bottom of the vaults are perforated to allow drainage, and urine is filtered through limestone to neutralize acidity. Other organic refuse is also added to the vaults, and ventilation is provided via a pipe.

In India, the *composting* of organic refuse and humanure is advocated by the government. A study of such compost prepared in pits in the 1950s showed that intestinal worm parasites and pathogenic bacteria were completely eliminated in three months. The destruction of pathogens in the compost was attributed to the maintenance of a temperature of about 40°C (104°F) for a period of 10-15 days. However, it was also concluded that the compost pits had to be properly constructed and managed, and the compost not removed until fully “ripe,” in order to achieve the total destruction of human pathogens. If done properly, it is reported that “*there is very little hygienic risk involved in the use and handling of [humanure] compost for agricultural purposes.*” ⁸

In short, it doesn’t look like the Asians have a lot to offer us with regard to composting toilet designs. Perhaps we should instead look to the Scandinavians, who have developed many commercial composting toilets.

Source: The Humanure Handbook. Jenkins Publishing, PO Box 607, Grove City, PA 16127. To order, phone: 1-800-639-4099.

<http://www.jenkinspublishing.com/>

MENU: [HOME](#) » [Reconstruction](#) » [Recovery](#) » [Renewal](#) » [Survival](#) » [Humanure Content](#)

COMMERCIAL COMPOSTING TOILETS

Commercial composting toilets have been popular in Scandinavia for some time; at least twenty-one different composting toilets were on the market in Norway alone in 1975.⁹ One of the most popular types of commercially available composting toilets in the United States today is the multrum toilet, invented by a Swedish engineer and first put into production in 1964 (see Figure 6.4). Fecal material and urine are deposited together into a single chamber with a double bottom. The decomposition takes place over a period of years, and the finished compost gradually falls down to the very bottom of the toilet chamber where it can be removed. Again, the decomposition temperatures remain cool, not usually climbing above 32°C (90°F). Therefore, it is recommended that the finished compost be buried under one foot of soil or used in an ornamental garden.¹⁰

Because no water is used or required during the operation of this toilet, human excrement is kept out of water supplies, conserving water. According to one report, a single person using a Clivus (pronounced Clee-vus) Multrum (see Figure 6.5) will produce 40 kg (88 lbs) of compost per year while refraining from polluting 25,000 liters (6,604 gallons) of water annually.¹¹ The finished compost can be used as a soil additive where the compost will not come in contact with food crops.

A 1977 report issued by Clivus Multrum USA analyzed the nutrient content in finished compost from seven Clivus Multrum toilets which had been in use for 4 to 14 years. The compost averaged 58% organic matter, with 2.4% nitrogen, 3.6% phosphorous, and 3.9% potassium, reportedly higher than composted sewage sludge, municipal compost, or ordinary garden compost. Suitable concentrations of trace nutrients were also found. Toxic metals were found to exist in concentrations far below recommended safe levels.¹²

If a multrum toilet is managed properly, it should easily be odor and worry-free. As always, a good understanding of the basic concepts of composting helps anyone who wishes to use a composting toilet. Nevertheless, the multrum toilets, when used properly, should provide a suitable alternative to flush toilets for people who want to stop defecating in their drinking water. You can probably grow a heck of a rose garden with the compost, too.

Inexpensive versions of multrum toilets were introduced into the Philippines, Argentina, Botswana, and Tanzania, but were not successful. According to one source, “*Compost units I inspected in Africa were the most unpleasant and foul-smelling household latrines I have experienced. The trouble was that the mixture of excreta and vegetable matter was too wet, and insufficient vegetable matter was added, especially during the dry season.*”¹³ Poor management and a lack of understanding of how composting

works will create problems with any compost toilet. Too much liquid will create anaerobic conditions with consequent odors. The aerobic nature of the organic mass can be improved by the *regular* addition of carbonaceous bulking materials. Compost toilets are not pit latrines. You cannot just defecate in a hole and walk away. If you do, your nose will let you know that you're doing something wrong.

Besides the Scandinavian multrum toilets, a variety of other composting toilets are available on the market today. One manufacturer claims that over 200,000 of their composting toilets have been sold worldwide. The same manufacturer produces a fiberglass and stainless steel toilet which consists of a drum under the toilet seat or under the bathroom floor into which the feces and urine are deposited. The drum is rotated by hand in order to blend the ingredients, which should include food scraps and a carbon material such as peat moss. The toilet can come equipped with an electric heating system and an electrical fan ventilation system. The compost, produced in small quantities which are removed by pulling out a drawer beneath the drum, is said to be suitable for garden purposes. Some of the models require water as well as electricity (although some require no electricity or water).¹⁴

Other composting toilets cost upwards of \$10,000 or more, and can be equipped with insulated tanks, conveyers, motor-driven agitators, pumps, sprayers, and exhaust fans.¹⁵ According to a composting toilet manufacturer, waterless composting toilets can reduce household water consumption by 40,000 gallons (151,423 liters) per year.¹⁶ This is significant when one considers that only 3% of the Earth's water is not salt water, and two-thirds of that freshwater is locked up in ice. That means that less than one percent of the Earth's water is available as drinking water. Why shit in it?

Source: The Humanure Handbook. Jenkins Publishing, PO Box 607, Grove City, PA 16127. To order, phone: 1-800-639-4099.

<http://www.jenkinspublishing.com/>

MENU: [HOME](#) » [Reconstruction](#) » [Recovery](#) » [Renewal](#) » [Survival](#) » [Humanure Content](#)

MENU: [HOME](#) » [Reconstruction](#) » [Recovery](#) » [Renewal](#) » [Survival](#) » [Humanure Content](#)

COMPOSTING TOILETS AND RELATED PRODUCTS: MANUFACTURERS AND SUPPLIERS

(Special Thanks to the World of Composting Toilets Website at:
<http://www.compostingtoilet.org/>)

This list is provided for informational purposes only. Inclusion on this list does not constitute an endorsement by the author.

[AUSTRALIA](#) | [BELGIUM](#) | [CANADA](#) | [CHILE](#) | [DENMARK](#) | [FINLAND](#) | [GERMANY](#) | [IRELAND](#) | [ISRAEL](#) | [KOREA](#) | [LATVIA](#) | [NETHERLANDS](#) | [NEW ZEALAND](#) | [NORWAY](#) | [SOUTH AFRICA](#) | [SPAIN](#) | [SWEDEN](#) | [SWITZERLAND](#) | [UK](#) | [USA](#) | [OWNER BUILT](#) | [COMPOST THERMOMETERS](#) | [BACKYARD COMPOST BINS](#) | [COMPOST TESTING LABS](#) | [AUDIO TAPES](#) | [INTERNET LINKS](#)

AUSTRALIA

CLIVUS MULTRUM AUSTRALIA

115 Railway Avenue, Strathpine, Qld 4500, Australia

Phone: 61 7 3889 6144

Fax: 61 7 3889 6149

Mobile phone: 0419 657851

Website: <http://www.earthlink.com.au/clivus>

Email: www.ats.com.au

Contact: Tony Rapson

Sells the Clivus Multrum range of toilets and graywater systems as well as toilet buildings for use in National Parks and Public areas. Also acts as agent for Separett and EnviroLet composting toilets.

CLIVUS MULTRUM TOILET SYSTEMS (Agent)

9 Holland Street, Fremantle 6160, Western Australia, Australia

Phone: (08) 9430 7777

Fax: 61 8 9430 4305

Email: gaiagnet@cygnus.uwa.edu.au

Agent for Clivus Multrum composting toilets in western Australia.

CLOSET DEPOSIT

3 Redash Place, Cabarita Beach, NSW 2488 Australia;

Contact: Graham Clements;

Supplies own design, inclined base, fibreglass composting chamber. Improved ventilation system for reduced tank size. Also supplies artificial wetlands graywater system in ferro-cement or HDPE plastic with flowform water conditioners.

DOWMUS

Pty Ltd PO Box 400, Mapleton Qld, 4552, Australia

Phone: 61 7 5499 9828

Fax: 61 7 5499 9688

Email: dowmus@ozemail.com.au

Website: <http://www.dowmus.com/>

Supply and install single batch tank system with compost extortion auger. Emphasis on worm and compost fauna treatment. Also incorporating graywater treatment.

GARRY SCOTT COMPOST TOILET SYSTEMS

Mullumbimby NSW, 2482, Australia

Phone: 61 2 6684 3468

FAX: 61 2 6684 4567

Email: maito:enquires@composttoilets.com.au

Website: <http://www.composttoilets.com.au/>

Design, manufacture, supply and service of a wide range of waterless compost toilets. Independent agent for systems manufactured by Clivus Multrum, Natureloo, Envirolet, Separett and selected others. Manufacture of lowcost PBD and Wheelie Batch systems. Ownerbuilder assistance with consultation, components, plans and books. Agent for the Hybrid toilet system, a septic system, with no flush, secondary treatment and excellent performance.

NATURE-LOO

Savannah Environmental Pty Ltd, 74 Brisbane Street, Bulimba, QLD 4171, Australia

Postal Address: P.O. Box 150, Bulimba, Queensland, Australia 4171

Phone: 61 7 3395 6800

Fax: 61 7 3395 5322

Email: info@nature-loo.com.au

Website: <http://www.nature-loo.com.au/>

Contact: Carla Gregg

Patented market-leader in domestic composting toilets: inexpensive, aerated tank, odour-free, batch system. Classic model easily owner-installed in space under floor. Self-contained Compact model can be installed on slab floor, and is suitable for temporary accommodation, holiday cabins, building sites, camp

grounds, etc. Also markets toilet buildings suitable for golf courses, building sites, etc.

ROTA-LOO COMPOSTING TOILET

41A Jarrah Drive or PO Box 988, Braeside, Victoria 3195 Australia

Phone: 61 3 9587 2447

Fax: 61 3 9587 5622

Website: <http://www.rotaloo.com/>

E mail: buzzburrows@rotaloo.com

General info: enquiry@rotaloo.com

Contact: Buzz Burrows (General Manager)

Domestic models, Mini 650, Standard 950 all with removable compost bins. Commercial models, Maxi 1200 (Fiberglass) Maxi 2000, all with removable compost bins. Soltran buildings, remote location Public Toilet Facilities, supplied in kit form in any configuration with combinations of two cubicles either standard or disabled. Graywater systems, plans available for passive systems or electropurification system will clean graywater to potable standard. Other products: Bacterial agents to speed up the decomposition rate. Bacterial agents that terminate odour problems in bad installations. Full range of accessories, fiberglass and ceramic pedestals. Urinals that don't need water for cleaning.

BELGIUM

ECOSAVE SEPRETT (Agent)

Flierenbos 67, 2370 Arendonk, Belgium Ph/Fax: 32 14 67 20 04; Agent for Septum and Separett urine separating composting toilets.

CANADA

CLIVUS MULTRUM CANADA LIAISON OFFICE

1911 Lorraine Place, Ann Arbor, MI 48104-3607

Contact: Laurence Scott

Phone: 734-995-4767

Fax: 734-994-1292

Email: mailto:naylorscott@compuserve.com

CLIVUS MULTRUM CANADA LTD.

1558 Queen Street, East Toronto, Ontario, M4L 1E8 or P.O.Box 783 - Station A, Windsor, Ontario, N9A 6N8

Phone: 800-645-4767

Fax: 416-466-0635 Attn: L H Scott

Email: naylorscott@compuserve.com

CANADA-USA LIAISON

Phone : 734-995-4767

Fax: 734-994-1292

COMPOSTING TOILETS WESTERN (Agent)

1278 Inglewood Avenue, West Vancouver, B.C. B7T 1Y6, Canada

Phone: 1-604-926-3748

Fax: 1-604-926-4854

Contact: Bob Tapp

COMPOSTING TOILETS WESTERN

23646 16th Avenue, Langley B.C.V2Z 1K9, Canada

Phone/Fax: 1-604-533-5207

Contact: J. Rockandel

Supply and install Clivus Multrum composting toilets and Sum-mar composting toilets.

SANCOR

140-30 Milner Ave., Toronto, Ontario M1S 3R3 Canada

USA Toll-Free: 1-800-387-5126

CDA Toll-Free: 1-800-387-5245

International: 1-416-299-4818

Fax: 1-416-299-3124

Email: info@envirolet.com

Website: <http://www.envirolet.com/>

Online Store: <http://www.sancor.net/>

Manufacturer of Envirolet Composting Toilet Systems. The systems include Waterless Self-Contained, Waterless Remote and Low Water Remote models. Available in Non-Electric, 12v Battery, Solar and 110v Electric. Available for purchase online.

SUNERGY SYSTEMS LTD.

Box 70, Cremona, AB T0M 0R0, Canada

Phone: 403-637-3973

Email: sunergy@telusplanet.net

Website: <http://www.compostingtoilet.com/>

Contact: Michael Kerfoot

Also at: SUNERGY'S B.C. OFFICE

2945 Haliday Crescent, Nanaimo, B.C. V9T 1B2 Canada

Phone: 250-751-0053

Fax: 250-751-0063

Sunergy distributes Phoenix composting toilet systems in Canada for residential and public facility applications. Installations from coast to coast include National Parks, Provincial Parks, roadside rest areas, golf courses, responsible housing, etc. Design integrates solar/energy/resource efficiency with a natural whimsy.

SUN-MAR CORPORATION

5035 N Service Rd C9, Burlington Ontario L7L 5V2 Canada

Phone: 1-905-332-1314

Fax: 1-905-332-1315

For a Free Catalogue Call: 1-800-461-2461

Email: compost@sun-mar.com

Website: <http://www.sun-mar.com/>

Long time successful suppliers of bathroom installed composting toilets. Large range of models available for differing situations; both residential and cottage use toilets available.

CHILE

MINIMET

S.A. Av. 11 de Septiembre 1860, Of. 106, Santiago, Chile

Contact: Jaime Arancibia

Phone: 56-2-233-53 69 Fax: 56-2-232-11 95

Email: ggminimet@entelchile.net

Manufactures and sells Clivus Multrum products under license from Clivus Multrum, USA.

DENMARK

A & B BACKLUND APS (Agent)

Ordrupvej 101, DK-2920 Charlottenlund, Denmark

Phone: 45 39 63 33 64

Fax: 45 39 63 64 55

Email: backlund@backlund.dk

We work with ecological environmental engineering and waste to energy subjects. We sell no-mixing composting toilets in plastic, pine wood, metal or china. Our big composting units are made of stainless steel or glassfiber with geotextile sacks. The toilets are either without flushing, with single flushing for urine, double flushing for both urine and feces (but separate), or with vacuum for feces and gravitation for urine. Agent for Separett, Septum, Mullis, WM-Ekologen.

B & O BYGGEINDUSTRI A/S

Pakhus 12, Sdr. Frihavn, Dampfaergevej 8, 2100 Kobenhaun 0, Denmark

Contact: Dany Vandy

Phone : 45 35 43 01 01

Fax: 45 35 43 25 22

Website: <http://www.bobyg.dk>

Email: info@bobyg.dk

Sells and markets Clivus Multrum products as agent for Clivus AB, Sweden.

FINLAND

EKOLET (Biolett)

Estetie 3, FIN-00430 Helsinki, Finland

Phone: +358 40 546 4775, Fax: +358 9 563 5056

Email: ekolet@ekolet.com

Website: <http://www.ekolet.com/>

The Ekolet composting toilet is the manufacturer's own design for domestic and cottage use. Good experience and test results for over 10 years. Requires no water, no additives, low or no el. requirements, cleans the liquid biologically so it can be piped along with graywater. Consists of a toilet seat and a 4 chamber rotating composting tank (polyethene, stainless steel) under the floor. The end-product is ready-to-use odorless fertilizer.

LUONTO-LAITE OY

Kasiniemenraitti 229, Fin-17740 Kasiniemi, Finland

Phone: +358 (0)3 556 8132

Fax +358 (0)3 556 8133

Email: luontola@sci.fi

Marketing: NEXET OY

Ravurinkatu 11 FIN-20380 Turku, Finland

Phone: +358 (0)2 276 0250

Fax: +358 (0)2 276 0251

Email: nexet@nexet.fi

Website: <http://www.saunalahti.fi/luontola>

The Composting Naturum Toilet. Bathroom installed, urine separating, rotary drum, composting toilet. Stylish design toilet in non-PVC plastic.

GERMANY

BIOTECHNIK (Agent)

Sigrid Habel, Lessingstr.6, D-04109 Leipzig Germany

Phone: 49 342 234 8657

Fax: 49 341 980 3391

Agent for Biolett (Ekolet) composting toilets.

PEUSER GMBH (Agent)

Siloweg 1, D-56479 Neunkirchen/Ww Germany

Phone: 49 6436 35 45

Fax: 49 6436 64 99

Agent for Septum toilets and products.

PEUSER GMBH (Agent)

Stollberger Strasse 31 D-09221 Neunkirchen/bei Chemnitz, Germany

Phone: 49 371 281 21 70

Fax: 49 371 281 21 50

Agent for Septum and Separett composting toilets and products.

SANITÄR U. HEIZUNG (Agent)

Uwe Reimer, Hallesche Strasse 9, D-04509 Delitzsch, Germany

Phone: 49 342 025 9281

Fax: 49 177 275 0928

Agent for Biolett (Ekolet) composting toilets.

C. & M. SCHÖNBERGER GBR (Agent)

Blumenstrasse 11; D-61239 Langenhain

Phone: 49 6002-92990

Fax: 49 6002-92980

Agent for Separett Toilets

SOLTEC GMBH (Agent)

Wichmannstrasse 4, Bldg. 10, D-22607 Hamburg, Germany

Phone: +49 40 89 50-25

Fax: +49 40 89 50-28

Email: <mailto:soltec@enbil.de>

Agent for Biolett (Ekolet) composting toilets.

IRELAND

THE OLD RECTORY ROBERT FORRESTER, EASKEY, CO.

Sligo Republic of Ireland

Phone/Fax: 353 96 49 181

Email: adlib@tinet.ie

Agent for Septum and Separett servicing both UK and Ireland.

ISRAEL

ECONET ENVIRONMENTAL TECHNOLOGIES & PROJECTS LTD

Dr. Amram Pruginin, 11 Bialik St, Jerusalem, Israel

Phone/Fax: (972) 2-653 61 71

Email: <mailto:msamram@pluto.mscc.huji.ac.il>

Agent for Clivus Multrum in Israel.

KOREA

CLIVUS KOREA INC.

701 Marco Polo Building, 720-20 Yeoksam-Dong, Kangnam-Ku, Seoul, 135-080 Korea
Phone: 82-2-501-4794/5
Fax: 82-2-568-4631
Contact: J.H. Um
Manufacture and market Clivus Multrum under license from Clivus Multrum USA.

LATVIA

SIA APRITE (Agent)
Gaujas iela 56, Cesis LV-4101, Latvia
Phone/Fax: 371 41 25 033
Agent for Septum toilets and products.

NETHERLANDS (HOLLAND)

CLIVUS MULTRUM ECOSAVE - Mr. Danny Vandy
Noorderbaan 25, 8256 PP Biddinghuizen, Holland
Phone: (31)-321-332-038
Fax: (31)-321-330-975
Agent for Clivus Multrum composting toilets, Septum and Separett.

TECHNISCH BUREAU HAMAR

Heykampsweg 6, 7642 LP Wierden, Netherlands
Phone: 31 546 575697
Email: tbhamar@xs4all.nl
Website: <http://www.xs4all.nl/~tbhamar>

Contact: Hans Baarslag; Makes and sells composting toilets for camping, temporary dwellings and replacement in normal houses. The designs are simple and utilize common materials in their manufacture. They are designed for economic treatment of toilet deposits and some household organic material.

NEW ZEALAND

ECOTECH (Agent)
RD 1 Masters Access Rd., Kaitaia, 0500 New Zealand
Phone/Fax: 64 9 409 4993
Website: <http://www.ecotech.co.nz/>
Email: ecotech/nzed@xtra.co.nz
Contact: J. Douglas Donnell.
Distributors of Sun-Mar composting toilets.

NORWAY

IMPERIAL ENGOS AS

Langgaten 71 A, Postboks 98 N 4301 Sandnes, Norway

Phone: 47 51 66 44 92

Fax: 47 51 62 36 07

Agent for Separett.

VERA VERA MILJO A/S

Postboks 2036, N-3239 Sandefjord Norway

SOUTH AFRICA

DRYLOO

PO Box 75619, Gardenview 2047, South Africa

Phone/Fax: 2711 615 5328

Mobile: 2782 463 0674

Email: theboys@netactive.co.za

Dryloo waterless collapsible low cost composting toilets. Six catchment bags on rotatable piping carousel. No mechanical parts. Suitable for hot conditions. Prov. Pat. 99/1278. Also solar toilet extraction fans. Available from Michael Mayers and Associates. The specialist in African non-flush toilets.

ENVIROLOO ENVIRO OPTIONS (PTY) LTD

P.O. Box 27356, Benrose, 2011, South Africa

Phone: 27 11 6181350

Fax: 27 11 6181838

Established composting toilet maker/installer.

SPAIN

CLIVUS MULTRUM WILLI KNACKSTEDT

Phone /Fax: (34)-95-266 60 25

Mobile: 989 82 22 30

Email: carl@websida.com

SWEDEN

AQUATRON INTERNATIONAL BJORNNASVAGEN

21, S-113 47 Stockholm, Sweden

Phone: 46-8-790 9895

Fax: 46-8-15 7504

Email: info@aquatron.se

Website: <http://www.aquatron.se/>

Contact: Rolf Kornemark or Torgny Sundin.

Systems that use standard flush toilets connected to composting chambers via a centrifugal separator.

The composting chamber is either inclined base, single batch or 4 chamber carousel. Graywater is treated with UV prior to drainage to a Graywater infiltration bed..

CLIVUS MULTRUM AB

Ålberga Boställe, 61050 Jönåker, Sweden

Phone: (46)-155-72310

Fax: (46)-155-72390

Email: torb@clivus-multrum.se

Main office in Europe for Clivus Multrum Composting Toilets

EKOLOGEN AB

Box 11162 - 10061, Stockholm, Sweden

Phone: 46 8 641 4250

Fax: 46 8 798 5650

Urine separating composting toilet systems.

MULLIS - THE BIOLOGICAL TOILET

Luxgatan 1, 119 69 Stockholm, Sweden

Phone: 46 8 656 54 56

Fax (?): +46 8 184 71 8

Email: mullis@hem3.passagen.se

Website: <http://hem3.passagen.se/mullis>

Contact: Uno Finnstrom

Supplies an inclined base composting toilet with 4 air tracks, built in rustfree sheet metal. Can be ordered made in desired length for capacity required.

SERVATOR SEPRETT AB

Skinnebo, S-330 10 Bredaryd, Sweden

Phone: 46 371 712 20

Fax: 46 371 712 60

Email: mailto:servator@mbox200.swipnet.se

Website: <http://www.seprett.com/>

Suppliers of Lectrolav and Separett toilets, and now Septum composting toilets.

SVEN LINDEN AB

Ludvigsborg, 24394 Hoor, Sweden

Phone: 46-415-51335

Fax: 46-415-51115

Mobile: 070 584 76 52

Contact: Sven Linden

Produce a number of capacity tanks based on the single batch system with or without inclined base. Also a wheeled bin system is available.

SWEDISH ECOLOGY AB

Klippan 1A, S-414 51 Goteborg, Sweden

Phone: 46 31 42 29 30

Fax: 46 31 42 49 08

Contact: Harry Lejgren

Agent for the MullToa and Separera systems. These are the equivalent Scandinavian names for the Biolet and UFA toilets supplied by Biolet International.

SWITZERLAND

BIOLET INTERNATIONAL

Weidstrasse 18a, 6300 Zug, Switzerland

Phone : 41 41 710 4728

Fax: 41 41 710 4683

Website: <http://www.biolet.com/>

E-mail: info@biolet.com

Established, world-wide suppliers of 9 models of unit compost toilets for bathroom and under-house installation.

UK

BARTON ACCESSORIES

Morleigh Road, Harbertonford, Totnes, Devon TQ9 7TS, England

Phone/Fax: 44 1803 732878

Supplies the WEB toilet, a waterless electronic/biological toilet unit that fits in bathroom. In-built heat treatment in composting cycle. Is able to supply world-wide. New model: 12/24v DC, small enough for recreational vehicles, boats, motor coaches, domestic; can be run from solar cells, batteries, or wind generator.

EASTWOOD SERVICES

Kitty Mill, Wash Lane, Wenhasston, Halesworth, Suffolk, IP19 9DX, England

Phone/Fax: 44 1502 478165

Contact: Adam East.

UK agent for Sun-Mar composting toilets and low flush systems. Supplier of gray and rain water recycling systems.

EKOLOGEN/NATRUM/SEPTUM EASTWOOD SERVICES

c/o Kitty Mill, Wash Lane Wenhasston Halesworth, Suffolk IP19 9DX England

Phone: 44 1502 478249

Fax: 44 1502 478165

ELEMENTAL SOLUTIONS

Oaklands Park, Newnham-on-Severn Gloucestershire, GL14 1EF, UK

Phone: 01594 516063

Fax: 01594 516821

Email <mailto:mark.es@aecb.net>

Contact: Mark Moodie

Incorporates 'Camphill Water' and 'Nick Grant Ecological Engineering'; responsible for over 100 reed bed sites and compost toilet installations. Ceramic composting toilet pedestals. Own design and site specific composting toilet kits. UK and Ireland agents for 'Aquatron' toilet systems. Co writers of "Sewage Solutions; Answering the Call of Nature" and "Septic Tanks." Low water use fittings. Sewage courses, and rainwater harvesting. Genuine enquiries only please.

KINGSLEY CLIVUS ENVIRONMENTAL PRODUCTS LTD.

Kingsley House, Woodside Road, Boyatt Wood Trading Estate, Eastleigh, Hampshire S050 4ET Great Britain

Phone: 44 01703 615680

Fax: 44 01703 642613

Contact: Viv Murley

Sells and markets Clivus Multrum products as agent for Clivus Multrum USA.

MAURICE MOORE

26 St Mary's Rd, Long Ditton, Surrey KT6, England

Phone: 44 181 398 7951

Agent for Soltrna/ Rota-loo in United Kingdom.

WENDAGE POLLUTION CONTROL LTD (Agent)

Rangeways Farm, Conford, Liphook, Hants UK GU30 7QP

Phone: 44 1428 751296

Fax: 44 1428 751541

Contact: Nigel Mansfield.

Agent for Biolet self-contained electrical compost toilets, in several varieties for home, caravans and portacabins. Also consultants in water, sewage and pollution control.

USA

ADVANCED COMPOSTING SYSTEMS

195 Meadows Road, Whitefish, MT, 59937, USA

Phone: 1 406 862 3855

Fax: 1 406 862 3855

Email: phoenix@compostingtoilet.com

Website: <http://www.compostingtoilet.com/>

Contacts: Glenn Nelson, James Conner

Manufactures the Phoenix Composting Toilet, a continuous throughput system featuring odorless, waterless operation, and built-in liquid respray of the composting pile. Very low energy requirements (five watts). Options include microflush toilets, auxillary evaporators, and photovoltaic systems for off-grid installations. Residential and public facility models available.

ALASCAN CLEARWATER SYSTEM

3498 St. Albans Road, Cleveland Heights, OH 44121 USA

Phone: 1 216 382 4151

Contact: David Kern

Email: Drewid@star21.com

Originally developed, tested and supplied in Alaska. The system uses either one cup per flush, or foam flush toilets, and a basement system comprised of one composting tank, one graywater treatment tank, & optional recycling system. System effluents are topsoil & potable water. They have a 15 minute video about the system, available for \$15 US including S&H.

ALASCAN OF MINNESOTA, INC.

8271 - 90th Lane, Clear Lake, MN 55319 USA

Marketing Manager: Jerry L. Carter

Phone: (320) 743-2909

Fax: (320) 743-3509

Email: <mailto:mail@alascanofmn.com>

Website: <http://www.alascanofmn.com/>

ARCHITERRA ENTERPRISES, INC.

0186 SCR 1400, BRR, Silverthorne, CO 80498 USA

Phone/Fax: 970-262-6727

Email: <mailto:natural@colorado.net>

Website: <http://thenaturalhome.com/>

Catalog: The Natural Home Building Source (24 pages)

We sell and install graywater system packages, and Clivus Multrum and Sun-Mar composting toilet systems.

BIOLET U.S.A.

45 Newbury Street, Boston, MA 02116 USA

Phone: (617) 578-0435

Fax: (617) 578-0465

E-mail: info@biolet.com

Website: <http://www.biolet.com/>

Established manufacturer (since 1972) and worldwide supplier of BioLet composting toilets. Self

contained, remote and non electric units are available.

BIO-RECYCLER CORP.

5308 Emerald Drive, Sykesville, MD 21784 USA

Phone: 1 410 795-2607

Fax: 1 410 549 1445

Contact: Jeremy Criss

Vermiculture based remote processing unit to which toilet deposits are delivered, using minimal water, by vacuum assisted toilet units. The resultant product is high nutrient worm castings used for soil amendment.

BIO-SUN SYSTEMS INC.

RR#2 Box 134A, Route 549, Jobs Corners, Millerton, PA 16936, USA

Toll free: (800) 847-8840

Phone: 1-717 537 2200

Fax: 1 717 537 6200

Email: bio-sun@ix.netcom.com

Contact: Becky Heffner, Al White

Composting toilet system based on the use of in-situ built tank and intermittent compressed air blown through composting pile.

CENTRE FOR ECOLOGICAL POLLUTION PREVENTION

P.O. Box 1330, Concord, MA 01742-1330 USA

Phone 978-369-9440

Email: mailto:cepp@hotmail.com

The CEPP develops, promotes and demonstrates innovative lower-impact technologies and systems, with an emphasis on utilization and zero-discharge approaches. Their most important successes have been the development of low cost net composting systems that are suitable for developing countries and the development of planted treatment systems for graywater utilization.

CLIVUS MULTRUM US

15 Union Street, Lawrence MA, 01840, USA

Phone: 1 978 725 5591;

Toll Free: 1 800 4 CLIVUS

Fax: 1 978 557 9658

Email: forinfo@clivusmultrum.com

Webpage: <http://clivusmultrum.com/>

Contact: Don Mills

Sole manufacturer of the Clivus Multrum, original design of inclined base composting toilet. Residential models as well as commercial systems. Also sell toilet buildings and graywater treatment systems.

CLIVUS NEW ENGLAND

P.O. BOX 127, North Andover, MA 01845 USA
Phone: 978-794-9400
Fax: 978-794-9444

CLIVUS MULTRUM GREAT LAKES, INC.
P.O. Box 1025, Ann Arbor, MI 48106 USA
Phone: 734-995-4767
Fax: 734-994-1292

COTUIT DRY TOILET
Conrad Geysler, PO Box 89, Cotuit, Massachusetts 02635 USA
Phone: 508-428-8442
Email: <mailto:conradg@cape.com>
Website: <http://www.cape.com/cdt>

"CTS" TOILET
Composting Toilet Systems, PO Box 1928, Newport, Washington 99156-1928, USA
Phone: 1 509 447 3708;
Toll Free: 888 786 4538
Fax: 1 509 447 3708
Email: <mailto:cts@povn.com>
Contact: Joel Jacobsen
Inclined base composting toilet system built from fibreglass. 5 models offered with NSF International certification. Also offer pre-engineered toilet buildings and agent for Sun-Mar composting toilets.

ECOLOGY SERVICES
PO Box 76, Delafield, WI 53018 USA
Phone/Fax: 262-646-4664
Contact: Mike Mangan
Sell and install composting toilets, graywater systems, and rainwater collection systems. Sunmar and Phoenix toilets.

ECO-TECH/VERA ECOS, INC.
P.O. Box 1313, Concord, MA 01742-1313 USA
Phone: 978-369-3951
Fax: 978-369-2484
Email: watercon@igc.org
Website: <http://www.ecologicalengineering.com/>

"Tools for low-water living since 1972." Sell a range of products: EcoTech Carousel compost ECO-TECH/VERA (cont.) ing toilet system, as well as composting toilet models from Vera Toga, BioLet, CTS and Sun-Mar; plans for site-built composting toilets; the Septic Protector, vacuum and micro-flush toilets; Washwater Garden graywater system; and related low-water products. Catalog \$2.

JADE MOUNTAIN INC (Agent)

P.O. Box 4616, 717 Poplar, Boulder, CO 80306, USA

Phone: 1 800 442 1972 or 303 449 6601

Fax: 1 303 449 8266

Email: <mailto:info@jademountain.com>

Website: <http://www.jademountain.com/>

You can now download the complete catalog and order online. Supplies a wide range of appropriate technology products (over 6000) and information which includes composting toilets and graywater treatment systems.

LEHMANS HARDWARE AND APPLIANCES (Agent)

One Lehman Circle, P.O. Box 41, Kidron, Ohio 44636, USA

Phone: 330 857 5757

Fax: 330 857 5785

Email: info@lehmans.com

Website: <http://www.lehmans.com/>

Agent for Sunmar, Biolet and Alaskan systems. Store and catalogue mail order sales of products for self-sufficiency. "Serving the Amish and others without electricity with products for simple, self sufficient living since 1955."

MOUNTAIN LION TRADING CO. (Agent)

Sales office: 2404 North Columbus Street Spokane, WA 99207-2126, USA

Phone: 1 509-487-0765 (Voice or Fax)

Email: cj@mtlion.com

Website: <http://www.mtlion.com/sunmar>

Sell a range of products including Sunmar composting toilets.

REAL GOODS TRADING CO. (Agent)

555 Leslie St, Ukiah, CA. 95482, USA

Phone: 1 707 468 9292

Fax: 1 707 468 9394

Email: <mailto:realgoods@realgoods.com>

Website: <http://www.realgoods.com/>

Sun-mar and Biolet composting toilet agents. Stores in Hopland, CA, Eugene, OR and Amherst, WI.

SMARTER WATER COMPANY

Atlanta, GA USA

Email: email@smarterwater.com

Website: <http://www.smarterwater.com/>

Southeastern U.S. distributor of composting toilet systems. Agents for Sunmar composting toilet

systems.

SOILTECH (Agent)

607 East Canal St, Newcomerstown, Ohio, 43832-1207, USA

Phone: 1 614 498 5929

Email: <mailto:soiltech@tusco.net>

Website: <http://web.tusco.net/soiltech>

Contact: Kevin Mills; Distributors of Biolet composting toilets. Also have related products including a mulch starter.

SOLAR COMPOSTING ADVANCED TOILETS (S.C.A.T.)

Larry Warnberg, PO Box 43, Nahcotta, WA 98637, USA

Phone: 360-665-2926

Email: warnberg@pacifier.com

The Solar Composting Advanced Toilet — S.C.A.T. — is a freestanding complete toilet facility designed to recycle human excrement and urine into a relatively dry and deodorized compost which can be safely and easily applied to the immediately surrounding landscape. The S.C.A.T. is suitable for recreational campsites, vacation cabins, construction sites, agricultural and nursery settings.

SUN-MAR CORPORATION

600 Main St., Tonawanda, NY 14150-0888 USA

For a Free Catalogue Call: 1 800 461 2461

Email: compost@sun-mar.com

Website: <http://www.sun-mar.com/>

SUPER TOILETS USA

John Flaherty, 10 Seaside Place, Norwalk, CT 06855 USA

Phone/Fax: 203-831-9810

OWNER BUILT

APPALACHIA SCIENCE IN THE PUBLIC INTEREST

50 Lair St., Mt. Vernon, KY 40456 USA

Phone: 606 256 0077 (main office)

Fax: 606 256 2779

Email: aspi@kih.net

Website: <http://www.kih.net/aspi>

Contact: Jack Kiefer

ASPI has technical bulletins on composting toilets and constructed wetlands including schematics for a compost toilet which ASPI designed, and for a constructed wetland.

BIG BATCH COMPOSTING TOILET EKAT (East Kentucky Appropriate Technologies)

Executive Director, 150 Gravel Lick Branch Road Dreyfus, KY 40385, USA

Phone: 606 986-6146

Contact: Robert J. Fairchild

Another owner-build system that utilizes readily available materials. It is designed around a large rolling polyethylene dump cart with air pipes of PVC placed into it. Two are used, one 'resting' while the other is filled. EKAT is a non-profit organization which provides engineering assistance with appropriate technology projects to families and groups in central Appalachia. The 'Big batch composting toilet' plans are \$7.

ECO-TECH/VERA ECOS, INC.

P.O. Box 1313, Concord, MA 01742-1313 USA

Phone: 978-369-3951

Fax: 978-369-2484

Email: watercon@igc.org

Website: <http://www.ecologicalengineering.com/>

Plans for site-built composting toilets (see previous US listing).

ELEMENTAL SOLUTIONS

Oaklands Park, Newnham-on-Severn Gloucestershire, GL14 1EF, UK

Phone: 01594 516063

Fax: 01594 516821

Email: mark.es@aecb.net

Contact: Mark Moodie

Kits include plans of the chamber recommended for a domestic situation in the UK climate. Includes ceramic pedestal, internal fittings of the tank, water proof 12V or 230V fan (uses ~3W) and power supply where necessary, construction and maintenance manual.

GARRY SCOTT COMPOST TOILET SYSTEMS

Mullumbimby NSW, 2482, Australia

Phone/Fax: 61 2 6684 3468

Email: mailto:compost@mullum.com.au

Ownerbuilder assistance with consultation, components, plans and books.

LONG BRANCH ENVIRONMENTAL EDUCATION CENTER

Big Sandy Mush Creek; POB 369; Leicester, NC 28748 USA

Contact: Paul Gallimore, Director

Phone: 828-683-3662

Fax: 828-683-9211

Email: paulg@buncombe.main.nc.us

Website: <http://main.nc.us/LBEEC>

SOLAR COMPOSTING ADVANCED TOILET (S.C.A.T.)

Larry Warnberg, PO Box 43, Nahcotta, WA 98637, USA

Phone: 360 665 2926

Email: warnberg@pacifier.com

Solar composting toilet plans ([see previous US listing](#))

STAN SLAUGHTER 55 GALLON DRUM COMPOST TOILET - GUIDEBOOK AND PLANS

Stan Slaughter, Tall Oak Productions, Pilar Route, Box 11B, Embudo, NM 87531, USA

Phone: 888 484 4477

Fax: 505 758 0201

Website: <http://www.stanslaughter.com/>

Also has a great audio tape: Rot N' Roll. Offers music/educational programs and a new card game, "Compost Gin."

"SUNNY JOHN" SOLAR MOLDERING TOILET CONSTRUCTION PLANS - \$20/POSTPAID

John Cruickshank, 5569 North County Road 29, Loveland CO 80538

Email: hobbitouse@compuserve.com

Website: <http://ourworld.compuserve.com/homepages/hobbitouse>

COMPOST THERMOMETERS

REOTEMP

11568 Sorrento Valley Road, Suite 10 San Diego, CA 92121 USA

Phone: 619 481 7737

Toll free: 1-800-648-7737

Fax: 619 481 7415

Email: reotemp@reotemp.com

Website: <http://www.reotemp.com/>

BACKYARD COMPOST BINS

COVERED BRIDGE ORGANIC

PO Box 91, Jefferson, OH 44047 USA

Phone: 440 576 5515

GARDNER EQUIPMENT

PO Box 106, Juneau, WI 53039 USA

Toll Free: 800 393 0333

GEDYE COMPOST BINS

555 S. Sunrise Way, Ste. 200, Palm Springs, CA 92262 USA

Phone: 760 325 1035

Fax: 760 778 5383

HARMONIOUS TECHNOLOGIES

PO Box 1716, Sebastopol, CA 95437 USA

Phone: 707 823 1999

Fax: 707 823 2424

Website: <http://www.homecompost.com/>

Bins made from 100% recycled plastic.

PALMOR PRODUCTS

PO Box 38, Thorntown, IN 46071 USA

Phone: 800 872 2822

Fax: 765 436 2490

Website: <http://www.trac-vac.com/>

PLASTOPAN NORTH AMERICA, INC.

812 E 59th St., Los Angeles, CA 90001 USA

Phone: 323 231 2225

Fax: 323 231 2068

Website: <http://www.plastopan.com/>

PRECISION-HUSKY

Equipment Division POD 507, Leeds, AL 35094 USA

Phone: 205 640 5181

Fax: 205 640 1147

Website: <http://www.precisionhusky.com/>

PRESTO PRODUCTS CO.

PO Box 2399, Appleton, WI 54913 USA

Phone: 920 738 0986

Fax: 920 738 1458

RECYCLED PLASTICS MARKETING, INC.

2829 152nd Ave. NE, Redmond, WA 98052 USA

Phone: 800 867 3201

Fax: 425 867 3282

Website: <http://www.rrpm.com/>

C.E. SHEPHERD CO., INC.

PO Box 9445, Houston, TX 77261 USA

Phone: 713 928 3763

Fax: 713 928 2324

Website: <http://www.ceshepherd.com/>

SMITH AND HAWKEN

117 East Strawberry Dr., Mill Valley, CA 94941 USA

Phone: 415 383 4415

Fax: 415 383 8010

Website: <http://www.smithandhawken.com/>

SWING AND SLIDE CORPORATION (SHAPE PRODUCTS)

1212 Barberry Dr., Janesville, WI 53545 USA

Phone: 800 888 1232

Fax: 608 755 4763

THE WILMARC CO.

225 W Grant St., Thorntown, IN 46071 USA

Ph: 765 436 7089

Fax: 765 436 2634

COMPOST TESTING LABS

WOODS END AGRICULTURAL INSTITUTE, INC.

PO Box 297, Mt. Vernon, ME 04352 USA

Phone: 207-293-2457

Toll Free: 800-451-0337

Fax: 207-293-2488

Email: info@woodsend.org

Website: <http://www.woodsend.org/>

Ascaris and coliform testing as well as full nutrient tests. Sells the Solvita(R) Maturity Test Kit which is now approved in CA, CT, IL, MA, ME, NJ, NM, OH, TX, and WA. Has developed a soil-respiration test kit that is approved by the USDA for soil quality investigations.

WOODS END EUROPE AUC

Agrar und Umwelt-Consult GmbH: Augustastrasse 9 D-53173 Bonn, Germany

Phone: 049 0228 343246

Fax: 049 0228 343237

Officially certified for pathogen survival testing. Sells the Solvita(R) Maturity Test Kit which is now approved in CA, CT, IL, MA, ME, NJ, NM, OH, TX, and WA.

CONTROL LAB. INC.

42 Hangar Way, Watsonville, CA 95076 USA

Phone: 831 724 5422

Fax: 831 724 3188

AUDIO TAPES

ROT 'N ROLL

Stan Slaughter, Tall Oak Productions, Pilar Route, Box 11B, Embudo, NM 87531 USA

Phone: 888 484 4477

Fax: 505 758 0201

Website: <http://www.stanslaughter.com/>

SONGS FOR THE COMPOST PILE

Dreams and Bones Performance Company, Jake Weinstein, Rainbow Recycling, 810 State St., New Haven, CT 06511 USA

Phone: 203 865 6507

INTERNET LINKS

EARTHWISE PUBLICATIONS

High Walk House, Kirkby Malzeard, Ripon HG4 3RY England

Phone + 44 01765 658786

Fax on request.

Email: earthwise@earthwise.nwnet.co.uk

World of Composting Toilets: <http://www.compostingtoilet.org/>

International Composting Toilet News: <http://www.nwnet.co.uk/earthwise/journal>

Rot Web: http://net.indra.com/~topsoil/Compost_Menu.html

Compost Resource Page: <http://www.oldgrowth.org/compost/humanure.html>

Humanure Forum: http://www.oldgrowth.org/compost/forum_humanure1

Canadian Composting Toilet Website: <http://www.cityfarmer.org/comptoilet64.html#toilet>

Composting council: <http://www.compostingcouncil.org/>

Others of interest:

http://www.cfe.cornell.edu/compost/Composting_homepage.html

<http://www.composter.com/>

<http://www.history.rochester.edu/class/compost/compost.html>

Vermicomposting:

<http://www.humic.com/>

<http://www.worndigest.org/>

<http://www.wormwoman.com/>

<http://www.vermint.com.au/>

<http://www.wormpage.com/>

<http://www.allthingsorganic.com/>

<http://www.worm-publications.com/>

<http://www.vermitechnology.com/>

Source: The Humanure Handbook. Jenkins Publishing, PO Box 607, Grove City, PA 16127. To order, phone: 1-800-639-4099.

<http://www.jenkinspublishing.com/>

MENU: [HOME](#) » [Reconstruction](#) » [Recovery](#) » [Renewal](#) » [Survival](#) » [Humanure Content](#)

WORMS AND DISEASE

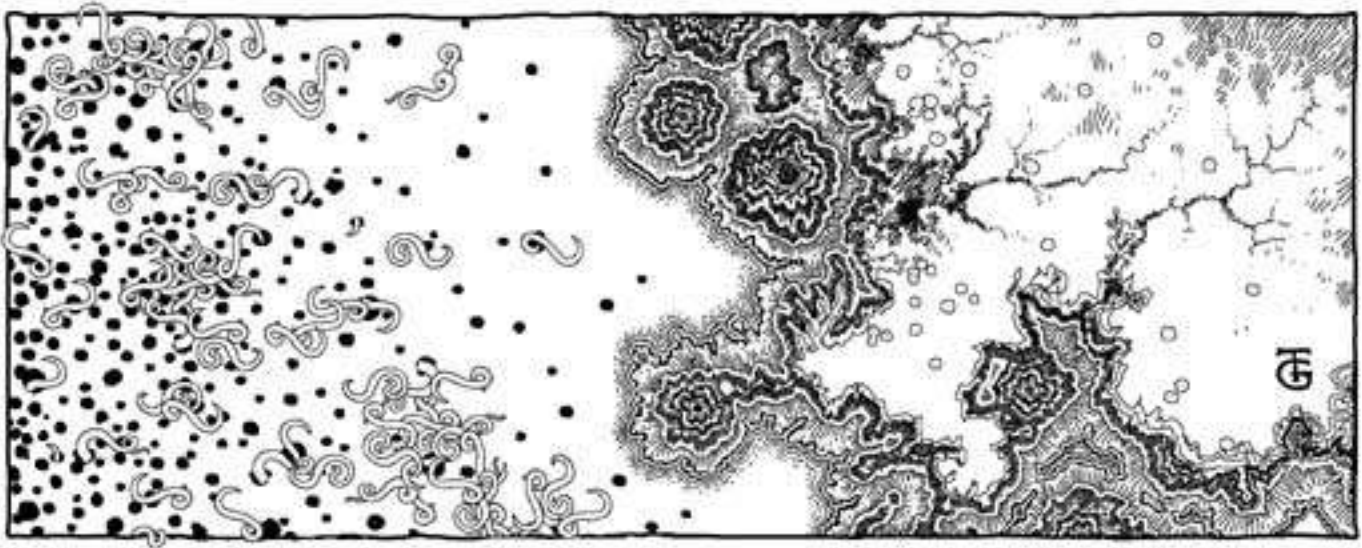

“A well-made compost heap steams like a tea kettle and gets hot enough to destroy all pathogens that may be present when one uses human sewage. An extraordinary device when one thinks about it. Thermophilic bacteria. Bacteria that can live and flourish in temperatures hot enough to cook an egg. How can they survive in such heat? Truly the tricks of nature are extraordinary!”

Robert S. deRopp

I well remember in early 1979 when I first informed a friend that I intended to compost my own manure and grow my own food with it. *“Oh my God, you can’t do that!”* she cried.

“Why not?”

“Worms and disease!”

Of course. What else would a fecophobe think of when one mentions using humanure as a fertilizer?

A young English couple was visiting me one summer after I had been composting humanure for about six years. One evening, as dinner was being prepared, the couple suddenly understood the horrible reality of their situation: the food they were about to eat was *recycled shit*. When this “fact” dawned upon them, it seemed to set off some kind of instinctive alarm in their minds, possibly inherited directly from Queen Victoria. *“We don’t want to eat shit!”* they informed me (that’s an exact quote), as if in preparing dinner I

was simply defecating on plates and setting them on the table. Never mind that the food was delicious. It was the *thought* of it that mattered.

Fecophobia is alive and well and currently afflicting about a billion westerners. One common misconception is that fecal material, when composted, remains fecal material. *It does not.* Humanure comes from the earth, and through the miraculous process of composting, is converted back into earth. When the composting process is finished, the end product is humus, not crap, and it is useful in growing food. My friends didn't understand this; despite my attempts to clarify the matter for their benefit, they chose to cling to their misconceptions. Apparently, some fecophobes will always remain fecophobes.

Allow me to make a radical suggestion: humanure is not dangerous. More specifically, it is not any more dangerous than the body from which it is excreted. The danger lies in what we *do* with humanure, not in the material itself. To use an analogy, a glass jar is not dangerous either. However, if we smash it on the kitchen floor and walk on it with bare feet, we will be harmed. If we use a glass jar improperly and dangerously, we will suffer for it, but that's no reason to condemn glass jars. When we discard humanure as a waste material and pollute our soil and water supplies with it, we are using it improperly, and that is where the danger lies. When we constructively recycle humanure by composting, it enriches our soil, and, like a glass jar, actually makes life easier for us.

Not all cultures think of human excrement in a negative way. For example, swear-words meaning excrement do not seem to exist in the Chinese language. The Tokyo bureau chief for the New York Times explains why: "*I realized why people [in China] did not use words for excrement in a negative way. Traditionally, there was nothing more valuable to a peasant than human waste.*" ¹ Calling someone a "humanure head" just doesn't sound like an insult. "Humanure for brains" doesn't work either. If you told someone they were "full of humanure," they'd probably agree with you. "Shit," on the other hand, is a substance that is widely denounced and has a long history of excoriation in the western world. Our ancestor's historical failure to responsibly recycle the substance caused monumental public health headaches. Consequently, the attitude that humanure *itself* is terribly dangerous has been embraced and promulgated up to the present day.

For example, a recently published book on the topic of recycling "human waste" begins with the following disclaimer: "*Recycling human waste can be extremely dangerous to your health, the health of your community and the health of the soil. Because of the current limits to general public knowledge, [we] strongly discourage the recycling of human waste on an individual or community basis at this time and cannot assume responsibility for the results that occur from practicing any of the methods described in this publication.*" The author adds, "*Before experimenting, obtain permission from your local health authority since the health risks are great.*" The author then elaborates upon a human "waste" composting methodology which includes segregating urine from feces, collecting the manure in 30 gallon plastic containers, and using straw rather than sawdust as a cover material in the toilet.² All three of these procedures are ones I would discourage based on my 20 years of humanure composting experience (no need to go to the bother of segregating urine; a 30 gallon container is way too big and heavy to be able to easily handle; and *sawmill* sawdust does, in fact, work beautifully in a composting toilet. These issues will be thoroughly discussed in the next chapter).

I had to ask myself why an author writing a book on recycling humanure would “*strongly discourage the recycling of human waste,*” which seems counterproductive, to say the least. If I didn’t already know that recycling humanure was easy and simple, I might be totally petrified at the thought of attempting such an “*extremely dangerous*” undertaking after reading that book. And the last thing anyone wants to do is get the local health authorities involved. If there is anyone who knows nothing about composting humanure, it’s probably the local health authority, who receives no such training. I had to read between the lines of the book to find an explanation.

It seems that the author was somehow associated with the “Bio-Dynamic” agricultural movement, founded by Dr. Rudolf Steiner. Dr. Steiner has quite some following around the world, and many of his teachings are followed almost religiously by his disciples. The Austrian scientist and spiritual leader had his own opinions about the recycling of humanure, based as it were on intuition rather than on experience or science. He insisted that humanure must only be used to fertilize soil used to grow plants to feed animals *other* than humans. The manure from those animals can then be used to fertilize soil to grow plants for human consumption. According to Steiner, humans must *never* get any closer to a direct human nutrient cycle than that. Otherwise, they will suffer “brain damage and nervous disorders.” Steiner further warned against using “lavatory fluid,” including human urine, which “should never be used as a fertilizer, no matter how well-processed or aged it is.”³ Steiner, quite frankly, was ill-informed, incorrect, and severely fecophobic, and that fecophobia has, unfortunately, rubbed off on some of his followers. It is unfortunate that sensational, fear-motivated warnings regarding humanure recycling continue to be published.

But, it’s nothing new, and it has historically been based upon ignorance, which is a widespread problem. At one time, for example, doctors insisted that human excrement should be an important and necessary part of one’s personal environment. They argued that, “*Fatal illness may result from not allowing a certain amount of filth to remain in [street] gutters to attract those putrescent particles of disease which are ever present in the air.*” At that time, toilet contents were simply dumped in the street. Doctors believed that the germs in the air would be drawn to the filth in the street and therefore away from people. This line of reasoning so influenced the population that many homeowners built their outhouses attached to their kitchens in order to keep their food germ-free and wholesome.⁴ The results were just the opposite — flies made frequent trips between the toilet contents and the food table.

By the early 1900s, the US government was condemning the use of humanure for agricultural purposes, warning of dire consequences, including death, to those who would dare to do otherwise. A 1928 US Department of Agriculture bulletin made the risks crystal clear: “*Any spittoon, slop pail, sink drain, urinal, privy, cesspool, sewage tank, or sewage distribution field is a potential danger. A bit of spit, urine, or feces the size of a pin head may contain many hundred germs, all invisible to the naked eye and each one capable of producing disease. These discharges should be kept away from the food and drink of [humans] and animals. From specific germs that may be carried in sewage at any time, there may result typhoid fever, tuberculosis, cholera, dysentery, diarrhea, and other dangerous ailments, and it is probable that other maladies may be traced to human waste. From certain animal parasites or their eggs that may be carried in sewage there may result intestinal worms, of which the more common are the*

hookworm, roundworm, whipworm, eelworm, tapeworm, and seat worm.

Disease germs are carried by many agencies and unsuspectingly received by devious routes into the human body. Infection may come from the swirling dust of the railway roadbed, from contact with transitory or chronic carriers of disease, from green truck [vegetables] grown in gardens fertilized with night soil or sewage, from food prepared or touched by unclean hands or visited by flies or vermin, from milk handled by sick or careless dairymen, from milk cans or utensils washed with contaminated water, or from cisterns, wells, springs, reservoirs, irrigation ditches, brooks, or lakes receiving the surface wash or the underground drainage from sewage-polluted soil.”

The bulletin continues, *“In September and October, 1899, 63 cases of typhoid fever, resulting in five deaths, occurred at the Northampton (Mass.) insane hospital. This epidemic was conclusively traced to celery, which was eaten freely in August and was grown and banked in a plot that had been fertilized in the late winter or early spring with the solid residue and scrapings from a sewage filter bed situated on the hospital grounds.”*

And to drive home the point that human waste is highly dangerous, the bulletin adds, *“Probably no epidemic in American history better illustrates the dire results that may follow one thoughtless act than the outbreak of typhoid fever at Plymouth, Pa., in 1885. In January and February of that year the night discharges of one typhoid fever patient were thrown out upon the snow near his home. These, carried by spring thaws into the public water supply, caused an epidemic running from April to September. In a total population of about 8,000, 1,104 persons were attacked by the disease and 114 died.”*

The government bulletin insisted that the use of human excrement as fertilizer was both “dangerous” and “disgusting.” It warned that, *“under no circumstances should such wastes be used on land devoted to celery, lettuce, radishes, cucumbers, cabbages, tomatoes, melons, or other vegetables, berries, or low-growing fruits that are eaten raw. Disease germs or particles of soil containing such germs may adhere to the skins of vegetables or fruits and infect the eater.”* The bulletin summed it up by stating, *“Never use [human] waste to fertilize or irrigate vegetable gardens.”* The fear of human excrement was so severe it was advised that the contents of bucket toilets be burned, boiled, or chemically disinfected, then buried in a trench.⁵

This degree of fecophobia, fostered and spread by authoritative government publications and by spiritual leaders who knew of no constructive alternatives to waste disposal, still maintains a firm grip on the western psyche. It may take a long time to eliminate. A more constructive attitude is displayed by scientists with a broader knowledge of the subject of recycling humanure for agricultural purposes. They realize that the benefits of proper humanure recycling “far outweigh any disadvantages from the health point of view.”⁶

THE HUNZAS

It’s already been mentioned that entire civilizations have recycled humanure for thousands of years. That

should provide a fairly convincing testimony about the usefulness of humanure as an agricultural resource. Many people have heard of the “Healthy Hunzas,” a people in what is now a part of Pakistan who reside among the Himalayan peaks, and routinely live to be 120 years old. The Hunzas gained fame in the United States during the 1960s health food era, at which time several books were written about the fantastic longevity of this ancient people. Their extraordinary health has been attributed to the quality of their overall lifestyle, including the quality of the natural food they eat and the soil it’s grown on. Few people, however, realize that the Hunzas also compost their humanure and use it to grow their food. They’re said to have virtually no disease, no cancer, no heart or intestinal trouble, and they regularly live to be over a hundred years old while “*singing, dancing and making love all the way to the grave.*”

According to Tompkins (1989), “*In their manuring, the Hunzakuts return everything they can to the soil: all vegetable parts and pieces that will not serve as food for humans or beast, including such fallen leaves as the cattle will not eat, mixed with their own seasoned excrement, plus dung and urine from their barns. Like their Chinese neighbors, the Hunzakuts save their own manure in special underground vats, clear of any contaminable streams, there to be seasoned for a good six months. Everything that once had life is given new to life through loving hands.*” ⁷ (emphasis mine)

Sir Albert Howard wrote in 1947, “*The Hunzas are described as far surpassing in health and strength the inhabitants of most other countries; a Hunza can walk across the mountains to Gilgit sixty miles away, transact his business, and return forthwith without feeling unduly fatigued.*” Sir Howard maintains that this is illustrative of the vital connection between a sound agriculture and good health, insisting that the Hunzas have evolved a system of farming which is perfect. He adds, “*To provide the essential humus, every kind of waste [sic], vegetable, animal and human, is mixed and decayed together by the cultivators and incorporated into the soil; the law of return is obeyed, the unseen part of the revolution of the great Wheel is faithfully accomplished.*” ⁸ Sir Howard’s view is that soil fertility is the real basis of public health.

A medical professional associated with the Hunzas claimed, “*During the period of my association with these people I never saw a case of asthenic dyspepsia, of gastric or duodenal ulcer, of appendicitis, of mucous colitis, of cancer . . . Among these people the abdomen over-sensitive to nerve impressions, to fatigue, anxiety, or cold was unknown. Indeed their buoyant abdominal health has, since my return to the West, provided a remarkable contrast with the dyspeptic and colonic lamentations of our highly civilized communities.*”

Sir Howard adds, “*The remarkable health of these people is one of the consequences of their agriculture, in which the law of return is scrupulously obeyed. All their vegetable, animal and human wastes [sic] are carefully returned to the soil of the irrigated terraces which produce the grain, fruit, and vegetables which feed them.*” ⁹

The Hunzas composted their organic material, thereby recycling all of it. This actually enhanced their personal health and the health of their community. The US Department of Agriculture was apparently unaware of the effective natural process of composting in 1928 when they described the recycling of

humanure as “dangerous and disgusting.” No doubt the USDA would have confused the Hunzas, who had for centuries safely and constructively engaged in such recycling.

PATHOGENS

[Much of the following information is adapted from Appropriate Technology for Water Supply and Sanitation, by Feachem et al., World Bank, 1980.¹⁰ This comprehensive work cites 394 references from throughout the world, and was carried out as part of the World Bank’s research project on appropriate technology for water supply and sanitation.]

Clearly, even the primitive composting of humanure for agricultural purposes does not necessarily pose a threat to human health, as evidenced by the Hunzas. Yet, fecal *contamination* of the environment certainly can pose a threat to human health. Feces can harbor a host of disease organisms which can contaminate the environment to infect innocent people when human excrement is discarded as a waste material. In fact, even a healthy person apparently free of disease can pass potentially dangerous pathogens through their fecal material, simply by being a carrier. The World Health Organization estimates that 80% of all diseases are related to inadequate sanitation and polluted water, and that half of the world’s hospital beds are occupied by patients who suffer from water-related diseases.¹¹ As such, the composting of humanure would certainly seem like a worthwhile undertaking worldwide.

The following information is not meant to be alarming. It’s included for the sake of thoroughness, and to illustrate the need to *compost* humanure, rather than to try to use it raw for agricultural purposes. When the composting process is side-stepped and pathogenic waste is issued into the environment, various diseases and worms can infect the population living in the contaminated area. This fact has been widely documented.

For example, consider the following quote from Jervis (1990): “*The use of night soil [raw human fecal material and urine] as fertilizer is not without its health hazards. Hepatitis B is prevalent in Dacaiyuan [China], as it is in the rest of China. Some effort is being made to chemically treat [humanure] or at least to mix it with other ingredients before it is applied to the fields. But chemicals are expensive, and old ways die hard. Night soil is one reason why urban Chinese are so scrupulous about peeling fruit, and why raw vegetables are not part of the diet. Negative features aside, one has only to look at satellite photos of the green belt that surrounds China’s cities to understand the value of night soil.*”¹²

On the other hand, “worms and disease” are not spread by properly prepared compost, nor by healthy people. There is no reason to believe that the manure of a healthy person is dangerous unless left to accumulate, pollute water with intestinal bacteria, or breed flies and/or rats, all of which are the results of negligence or bad customary habits. It should be understood that the breath one exhales can also be the carrier of dangerous pathogens, as can one’s saliva and sputum. The issue is confused by the notion that if something is potentially dangerous, then it is always dangerous, which is not true. Furthermore, it is generally not understood that the carefully managed thermophilic composting of humanure converts it into a sanitized agricultural resource. No other system of fecal material and urine recycling or disposal can achieve this without the use of dangerous chemical poisons or a high level of technology and energy

consumption.

Even urine, usually considered sterile, can contain disease germs (see Table 7.1). Urine, like humanure, is valuable for its soil nutrients. It is estimated that one person's annual urine output contains enough soil nutrients to grow grain to feed that person for a year.¹³ Therefore, it is just as important to recycle urine as it is to recycle humanure, and composting provides an excellent means for doing so.

The pathogens that can exist in human feces can be divided into four general categories: *viruses*, *bacteria*, *protozoa*, and *worms (helminths)*.

VIRUSES

First discovered in the 1890s by a Russian scientist, viruses are among the simplest and smallest of life forms. Many scientists don't even consider them to be organisms. They are much smaller and simpler than bacteria (some viruses are parasitic to bacteria), and the simplest form may consist only of an RNA molecule. By definition, a virus is an entity which contains the information necessary for its own replication, but does not possess the physical elements for such replication — they have the software, but not the hardware. In order to reproduce, therefore, viruses rely on the hardware of the infected host cell, which is re-programmed by the virus in order to reproduce viral nucleic acid. As such, viruses cannot reproduce outside the host cell.¹⁴

There are more than 140 types of viruses worldwide that can be passed through human feces, including polioviruses, coxsackieviruses (causing meningitis and myocarditis), echoviruses (causing meningitis and enteritis), reovirus (causing enteritis), adenovirus (causing respiratory illness), infectious hepatitis (causing jaundice), and others (see Table 7.3). During periods of infection, one hundred million to one trillion viruses can be excreted with each gram of fecal material.¹⁵

BACTERIA

Of the pathogenic bacteria, the genus *Salmonella* is significant because it contains species causing typhoid fever, paratyphoid, and gastrointestinal disturbances. Another genus of bacteria, *Shigella*, causes dysentery. Mycobacteria cause tuberculosis (see Table 7.4). However, according to Gotaas, pathogenic bacteria “are unable to survive temperatures of 55°-60°C for longer than 30 minutes to one hour.”¹⁶

PROTOZOA

The pathogenic protozoa include *Entamoeba histolytica* (causing amoebic dysentery), and members of the Hartmanella-Naegleria group (causing meningo-encephalitis) (see Table 7.5). The cyst stage in the life cycle of protozoa is the primary means of dissemination as the amoeba die quickly once outside the human body. Cysts must be kept moist in order to remain viable for any extended period.¹⁷

PARASITIC WORMS

Finally, a number of parasitic worms pass their eggs in feces, including hookworms, roundworms (*Ascaris*), and whipworms (see Table 7.6). Various researchers have reported 59 to 80 worm eggs in sampled liters of sewage. This suggests that billions of pathogenic worm eggs may reach an average wastewater treatment plant daily. These eggs tend to be resistant to environmental conditions due to a thick outer covering,¹⁸ and they are extremely resistant to the sludge digestion process common in wastewater treatment plants. Three months exposure to anaerobic sludge digestion processes appears to have little effect on the viability of *Ascaris* eggs; after six months, 10% of the eggs may still be viable. Even after a year in sludge, some viable eggs may be found.¹⁹ In 1949, an epidemic of roundworm infestation in Germany was directly traced to the use of raw sewage to fertilize gardens. The sewage contained 540 *Ascaris* eggs per 100 ml, and over 90% of the population became infected.²⁰

If there are about 59 to 80 worm eggs in a liter sample of sewage, then we could reasonably estimate that there are 70 eggs per liter, or 280 eggs per gallon to get a rough average. That means approximately 280 pathogenic worm eggs per gallon of wastewater enter wastewater treatment plants. My local wastewater treatment plant serves a population of eight thousand people and collects about 1.5 million gallons of wastewater daily. That means there could be 420 million worm eggs entering the plant each day and settling into the sludge. In a year's time, over 153 *billion* parasitic eggs can pass through my local small-town wastewater facility. Let's look at the worst-case scenario: all the eggs survive in the sludge because they're resistant to the environmental conditions at the plant. During the year, 30 tractor-trailer loads of sludge are hauled out of the local facility. Each truckload of sludge could theoretically contain over 5 *billion* pathogenic worm eggs, en route to maybe a farmer's field, but probably a landfill.

It is interesting to note that roundworms co-evolved over millennia as parasites of the human species by taking advantage of the long-standing human habit of defecating on soil. Since roundworms live in the human intestines, but require a period in the soil for their development, their species is perpetuated by our bad habits. If we humans never allowed our excrement to come in contact with soil, and if we instead thermophilically composted it, the parasitic species known as *Ascaris lumbricoides*, a parasite that has plagued us for perhaps hundreds of thousands of years, would soon become extinct. The human species is finally evolving to the extent that we are beginning to understand compost and its ability to destroy parasites. We need to take that a step further and entirely prevent our excrement from polluting the environment. Otherwise, we will continue to be outsmarted by the parasitic worms that rely on our ignorance and carelessness for their own survival.

INDICATOR PATHOGENS

Indicator pathogens are pathogens whose detectable occurrence in soil or water serves as evidence that fecal contamination exists.

The astute reader will have noticed that many of the pathogenic worms listed in Table 7.6 are not found in the United States. Of those that are, the *Ascaris lumbricoides* (roundworm) is the most persistent, and can serve as an indicator for the presence of pathogenic helminths in the environment.

A single female roundworm may lay as many as 27 million eggs in her lifetime.²¹ These eggs are protected by an outer covering that is resistant to chemicals and enables the eggs to remain viable in soil for long periods of time. The egg shell is made of five separate layers: an outer and inner membrane, with three tough layers in between. The outer membrane may become partially hardened by hostile environmental influences.²² The reported viability of roundworm eggs (*Ascaris ova*) in soil ranges from a couple of weeks under sunny, sandy conditions,²³ to two and a half years,²⁴ four years,²⁵ five and a half years,²⁶ or even ten years²⁷ in soil, depending on the source of the information. Consequently, the *eggs* of the roundworm seem to be the best indicator for determining if parasitic worm pathogens are present in compost. In China, current standards for the agricultural reuse of humanure require an *Ascaris* mortality of greater than 95%.

Ascaris eggs develop at temperatures between 15.5°C (59.90° F) and 35°C (95° F), but the eggs disintegrate at temperatures above 38°C (100.40° F).²⁸ The temperatures generated during thermophilic composting can easily exceed levels necessary to destroy roundworm eggs.

One way to determine if the compost you're using is contaminated with viable roundworm eggs is to have a stool analysis done at a local hospital. If your compost is contaminated and you're using the compost to grow your own food, then there will be a chance that you've contaminated yourself. A stool analysis will reveal whether that is the case or not. Such an analysis cost about \$41.00 in Pennsylvania (USA) in 1993, and \$33 in 1999. I subjected myself to two stool examinations over a period of two years as part of the research for this book. I had been composting humanure for fifteen years at the time of the testings, and I had used all of the compost in my food gardens. Hundreds of other people had also used my toilet over the years, potentially contaminating it with *Ascaris*. Yet, both stool examinations were completely negative.

Indicator bacteria include fecal coliforms, which reproduce in the intestinal systems of warm blooded animals (see Table 7.7). If one wants to test a water supply for fecal contamination, then one looks for fecal coliforms, usually *Escherichia coli*. *E. coli* is one of the most abundant intestinal bacteria in humans; over 200 specific types exist. Although some of them can cause disease, most are harmless.²⁹ The absence of *E. coli* in water indicates that the water is free from fecal contamination.

Water tests often determine the level of *total coliforms* in the water, reported as the number of coliforms per 100 ml. Such a test measures *all* species of the coliform group and is not limited to species originating in warm-blooded animals. Since some coliform species come from the soil, the results of this test are not always indicative of fecal contamination in a stream analysis. However, this test can be used for ground water supplies, as no coliforms should be present in ground water unless it has been contaminated by a warm-blooded animal.

Fecal coliforms do not multiply outside the intestines of warm-blooded animals, and their presence in water is unlikely unless there is fecal pollution. They survive for a shorter time in natural waters than the coliform group as a whole, therefore their presence indicates relatively recent pollution. In domestic sewage, the fecal coliform count is usually 90% or more of the total coliform count, but in natural

streams, fecal coliforms may contribute 10-30% of the total coliform density. Almost all natural waters have a presence of fecal coliforms, since all warm-blooded animals excrete them. Most states in the U.S. limit the fecal coliform concentration allowable in waters used for water sports to 200 fecal coliforms per 100 ml.

Bacterial analyses of drinking water supplies are routinely provided for a small fee (in 1994 around \$20.00) by agricultural supply firms, water treatment companies, or private labs.

PERSISTENCE OF PATHOGENS IN SOIL, CROPS, MANURE, AND SLUDGE

According to Feachem et al. (1980), the persistence of fecal pathogens in the environment can be summarized as follows:

IN SOIL

Survival times of pathogens in soil are affected by soil moisture, pH, type of soil, temperature, sunlight, and organic matter. Although fecal coliforms can survive for several years under optimum conditions, a 99% reduction is likely within 25 days in warm climates (see Figure 7.1). *Salmonella* bacteria may survive for a year in rich, moist, organic soil, although 50 days would be a more typical survival time. Viruses can survive up to three months in warm weather, and up to six months in cold. Protozoan cysts are unlikely to survive for more than ten days. Roundworm eggs can survive for several years.

The viruses, bacteria, protozoa, and worms that can be passed in human excrement all have limited survival times outside of the human body. Let's take a look at their survival times when deposited raw into soil (refer to Tables 7.8 through 7.12).

SURVIVAL OF PATHOGENS ON CROPS

Bacteria and viruses cannot penetrate undamaged vegetable skins. Furthermore, pathogens are not taken up in the roots of plants and transported to other portions of the plant.³⁰ However, pathogens can survive on the surfaces of vegetables, especially root vegetables. Sunshine and low air humidity will promote the death of pathogens. Viruses can survive up to two months on crops but usually live less than one month. Indicator bacteria may persist several months, but usually only last less than one month. Protozoan cysts usually survive less than two days, and worm eggs usually last less than one month. In studies of the survival of *Ascaris* eggs on lettuce and tomatoes during a hot, dry summer, all eggs degenerated enough after 27 to 35 days to be incapable of infection.³¹

Lettuce and radishes in Ohio sprayed with sewage inoculated with Poliovirus I showed a 99% reduction in pathogens after six days; 100% were eliminated after 36 days. Radishes grown outdoors in soil fertilized with fresh typhoid-contaminated feces four days after planting showed a pathogen survival period of less than 24 days. Tomatoes and lettuce contaminated with a suspension of roundworm eggs showed a 99% reduction in eggs in 19 days and a 100% reduction in four weeks. These tests indicate that

if there is any doubt about pathogen contamination of compost, the compost should be applied to long-season crops at the time of planting so that sufficient time ensues for the pathogens to die before harvest.

PATHOGEN SURVIVAL IN SLUDGE AND FECES/URINE

Viruses can survive up to five months, but usually less than three months in sludge and night soil. Indicator bacteria can survive up to five months, but usually less than four months. Salmonellae survive up to five months, but usually less than one month. Tubercle bacilli survive up to two years, but usually less than five months. Protozoan cysts survive up to one month, but usually less than ten days. Worm eggs vary depending on species, but roundworm eggs may survive for many months.

PATHOGEN TRANSMISSION THROUGH VARIOUS TOILET SYSTEMS

It is evident that human excrement possesses the capability to transmit various diseases. For this reason, it should also be evident that the composting of humanure is a serious undertaking and should not be done in a frivolous, careless, or haphazard manner. The pathogens that may be present in humanure have various survival periods outside the human body and maintain varied capacities for re-infecting people. This is why the *careful management* of a thermophilic compost system is important. Nevertheless, there is no proven, natural, low-tech method for destroying human pathogens in organic refuse that is as successful and accessible to the average human as well-managed thermophilic composting.

But what happens when the compost is not well-managed? How dangerous is the undertaking when those involved do not make an effort to ensure that the compost maintains thermophilic temperatures? In fact, this is normally what happens in most owner-built and commercial composting toilets. Thermophilic composting does not occur in owner-built toilets because the people responsible often make no effort to create the organic blend of ingredients and the environment needed for such a microbial response. In the case of most commercial composting toilets, thermophilic composting is not even intended, as the toilets are designed to be dehydrators rather than thermophilic composters.

On several occasions, I have seen simple collection toilet systems (sawdust toilets) in which the compost was simply dumped in an outdoor pile, not in a bin, lacking urine (and thereby moisture), and not layered with the coarse organic material needed for air entrapment. Although these piles of compost did not give off unpleasant odors (most people have enough sense to instinctively cover odorous organic material in a compost pile), they also did not necessarily become thermophilic (their temperatures were never checked). People who are not very concerned about working with and managing their compost are usually willing to let the compost sit for years before use, if they use it at all. Persons who are casual about their composting tend to be those who are comfortable with their own state of health and therefore do not fear their own excrement. As long as they are combining their humanure with a carbonaceous material and letting it compost, thermophilically or not, for at least a year (an additional year of aging is recommended), they are very unlikely to be creating any health problems, despite the rantings of fecophobes. What happens to these casually constructed compost piles? Incredibly, after a couple of years, they turn into quite lovely humus and, if left entirely alone, will simply become covered with

vegetation and disappear back into the earth. I have seen it with my own eyes.

A different situation occurs when humanure from a highly pathogenic population is being composted. Such a population would be the residents of a hospital in an underdeveloped country, for example, or any residents in a community where certain diseases or parasites are endemic. In that situation, the composter must make every effort necessary to ensure thermophilic composting, adequate aging time, and total pathogen destruction.

The following information illustrates the various waste treatment methods and composting methods commonly used today and shows the transmission of pathogens through the individual systems.

OUTHOUSES AND PIT LATRINES

Outhouses have odor problems, breed flies and possibly mosquitoes, and pollute groundwater. However, if the contents of a pit latrine have been filled over and left for a minimum of one year, there will be no surviving pathogens except for the possibility of roundworm eggs, according to Feachem. This risk is small enough that the contents of pit latrines, after twelve months burial, can be used agriculturally. Franceys et al. state, “*Solids from pit latrines are innocuous if the latrines have not been used for two years or so, as in alternating double pits.*” [32](#)

SEPTIC TANKS

It is safe to assume that septic tank effluents and sludge are highly pathogenic (see Figure 7.2). Viruses, parasitic worm eggs, bacteria, and protozoa can be emitted from septic tank systems in viable condition.

CONVENTIONAL SEWAGE TREATMENT PLANTS

The only sewage digestion process producing a guaranteed pathogen-free sludge is batch thermophilic digestion in which all of the sludge is maintained at 50°C (122°F) for 13 days. Other sewage digestion processes will allow the survival of worm eggs and possibly pathogenic bacteria. Typical sewage treatment plants instead use a continuous process where wastewater is added daily or more frequently, thereby guaranteeing the survival of pathogens (see Figure 7.3).

I took an interest in my local wastewater treatment plant when I discovered that the water in our local creek below the wastewater discharge point had ten times the level of nitrates that unpolluted water has, and three times the level of nitrates acceptable for drinking water.[33](#) In other words, the water being discharged from the water treatment plant was polluted. We knew the pollution included high levels of nitrates, although we didn’t test for pathogens or chlorine levels. Despite the pollution, the nitrate levels were within legal limits for wastewater discharges.

WASTE STABILIZATION PONDS

Waste stabilization ponds, or lagoons, large shallow ponds widely used in North America, Latin America, Africa and Asia, involve the use of both beneficial bacteria and algae in the decomposition of organic waste materials. Although they can breed mosquitoes, they can be designed and managed well enough to yield pathogen-free waste water. However, they typically yield water with low concentrations of both pathogenic viruses and bacteria (see Figure 7.4).

COMPOSTING TOILETS AND MOULDERING TOILETS

Most mouldering and commercial composting toilets are relatively anaerobic and compost at a low temperature. According to Feachem et al., a minimum retention time of three months produces a compost free of all pathogens except possibly some intestinal worm eggs. The compost obtained from these types of toilets can theoretically be composted again in a thermophilic pile and rendered suitable for food gardens (see Figure 7.5 and Table 7.14). Otherwise, the compost can be moved to an outdoor compost bin, layered and covered with straw (or other bulky organic material such as weeds or leaf mould), moistened, and left to age for an additional year or two in order to destroy any possible lingering pathogens. Microbial activity and earthworms will aid in the sanitation of the compost over time.

WELL-MANAGED THERMOPHILIC COMPOSTING SYSTEM

Complete pathogen destruction is guaranteed by arriving at a temperature of 62°C (143.6°F) for one hour, 50°C (122°F) for one day, 46°C (114.8°F) for one week, or 43°C (109.4°F) for one month. It appears that no excreted pathogen can survive a temperature of 65°C (149°F) for more than a few minutes. A compost pile containing entrapped oxygen may rapidly rise to a temperature of 55°C (131°F) or above, or will maintain a temperature hot enough for a long enough period of time to thoroughly destroy human pathogens that may be in the humanure (see Figure 7.6). Furthermore, pathogen destruction is aided by microbial diversity, as discussed in Chapter 3. Table 7.14 indicates survival times of pathogens in a) soil, b) anaerobic decomposition conditions, c) composting toilets, and d) thermophilic compost piles.

MORE ON PARASITIC WORMS

This is a good subject to discuss in greater detail as it is rarely a topic of conversation in social circles, yet it is important to those who are concerned about potential pathogens in compost. Therefore, let's look at the most common of human worm parasites: pinworms, hookworms, whipworms, and roundworms.

PINWORMS

A couple of my kids had pinworms at one time during their childhood. I know exactly who they got them from (another kid), and getting rid of them was a simple matter. However, the rumor was circulated that they got them from our compost. We were also told to worm our cats to prevent pinworms in the kids (these rumors allegedly originated in a doctor's office). Yet, the pinworm life cycle does not include a stage in soil, compost, manure, or cats. These unpleasant parasites are spread from human to human by

direct contact, and by inhaling eggs.

Pinworms (*Enterobius vermicularis*) lay microscopic eggs at the anus of a human being, its only known host. This causes itching at the anus which is the primary symptom of pinworm infestation. The eggs can be picked up almost anywhere; once in the human digestive system they develop into the tiny worms. Some estimate that pinworms infest or have infested 75% of all New York City children in the three to five year age group, and that similar figures exist for other cities.³⁴

These worms have the widest geographic distribution of any of the worm parasites, and are estimated to infect 208.8 million people in the world (18 million in Canada and the U.S.). An Eskimo village was found to have a 66% infection rate; a 60% rate has been found in Brazil, and a 12% to 41% rate was reported in Washington D.C.

Infection is spread by the hand to mouth transmission of eggs resulting from scratching the anus, as well as from breathing airborne eggs. In households with several members infected with pinworms, 92% of dust samples contained the eggs. The dust samples were collected from tables, chairs, baseboards, floors, couches, dressers, shelves, window sills, picture frames, toilet seats, mattresses, bath tubs, wash basins and bed sheets. Pinworm eggs have also been found in the dust from school rooms and school cafeterias. Although dogs and cats do not harbor pinworms, the eggs can get on their fur and find their way back to their human hosts. In about one-third of infected children, eggs may be found under the fingernails.

Pregnant female pinworms contain 11,000 to 15,000 eggs. Fortunately, pinworm eggs don't survive long outside their host. Room temperature with 30% to 54% relative humidity will kill off more than 90% of the eggs within two days. At higher summer temperatures, 90% will die within three hours. Eggs survive longest (two to six days) under cool, humid conditions; in dry air, none will survive for more than 16 hours.

A worm's life span is 37-53 days; an infection would self-terminate in this period, without treatment, in the absence of reinfection. *The amount of time that passes from ingestion of eggs to new eggs being laid at the anus ranges from four to six weeks.*³⁵

In 95% of infected persons, pinworm eggs aren't found in the feces. Transmission of eggs to feces and to soil is not part of the pinworm life cycle, which is one reason why the eggs aren't likely to end up in either feces or compost. Even if they do, they quickly die outside the human host.

One of the worst consequences of pinworm infestation in children is the trauma of the parents, whose feelings of guilt, no matter how clean and conscientious they may be, are understandable. However, if you're composting your manure, you can be sure that you are not thereby breeding or spreading pinworms. Quite the contrary, any pinworms or eggs getting into your compost are being destroyed.³⁶

HOO KWORMS

Hookworm species in humans include *Necator americanus*, *Ancylostoma duodenale*, *A. braziliense*, *A. caninum*, and *A. ceylanicum*.

These small worms are about a centimeter long, and humans are almost the exclusive host of *A. duodenale* and *N. americanus*. A hookworm of cats and dogs, *A. caninum*, is an extremely rare intestinal parasite of humans.

The eggs are passed in the feces and mature into larvae outside the human host in favorable conditions. The larvae attach themselves to the human host usually at the bottom of the foot when they're walked on, and then enter their host through pores, hair follicles, or even unbroken skin. They tend to migrate to the upper small intestine where they suck their host's blood. Within five or six weeks, they'll mature enough to produce up to 20,000 eggs per day.

Hookworms are estimated to infect 500 million people throughout the world, causing a daily blood loss of more than 1 million liters, which is as much blood as can be found in all the people in the city of Erie, PA, or Austin, TX. An infection can last two to fourteen years. Light infections can produce no recognizable symptoms, while a moderate or heavy infection can produce an iron deficiency anemia. Infection can be determined by a stool analysis.

These worms tend to be found in tropical and semi-tropical areas and are spread by defecating on the soil. Both the high temperatures of composting and the freezing temperatures of winter will kill the eggs and larvae (see Table 7.16). Drying is also destructive.³⁷

WHIPWORM

Whipworms (*Trichuris trichiura*) are usually found in humans, but also may be found in monkeys or hogs. They're usually under two inches long and the female can produce 3,000 to 10,000 eggs per day. Larval development occurs outside the host, and in a favorable environment (warm, moist, shaded soil), first stage larvae are produced from eggs in three weeks. The lifespan of the worm is usually considered to be four to six years.

Hundreds of millions of people worldwide, as much as 80% of the population in certain tropical countries, are infected by whipworms. In the US, whipworms are found in the south where heavy rainfall, a subtropical climate, and feces-contaminated soil provide a suitable habitat.

Persons handling soil that has been defecated on by an infected person risk infection by hand-to-mouth transmission. Infection results from ingestion of the eggs. Light infections may not show any symptoms. Heavy infections can result in anemia and death. A stool examination will determine if there is an infection.

Cold winter temperatures of -8°C to -12°C (17.6°F to 10.4°F) are fatal to the eggs, as are the high temperatures of thermophilic composting.³⁸

ROUNDWORMS

Roundworms (*Ascaris lumbricoides*) are fairly large worms (10 inches in length) which parasitize the human host by eating semi-digested food in the small intestine. The females can lay 200,000 eggs per day for a lifetime total of 26 million or so. Larvae develop from the eggs *in soil* under favorable conditions (21°C to 30°C / 69.8°F to 86°F). Above 37°C (98.6°F), they cannot fully develop.

Approximately 900 million people are infected with roundworms worldwide, one million in the US. The eggs are usually transmitted hand to mouth by people, usually children, who have come into contact with the eggs in their environment. Infected persons usually complain of a vague abdominal pain. Diagnosis is by stool analysis.³⁹ An analysis of 400,000 stool samples throughout the US by the Center for Disease Control found *Ascaris* in 2.3% of the samples, with a wide fluctuation in results depending on the geographical location of the person sampled. Puerto Rico had the highest positive sample frequency (9.3%), while samples from Wyoming, Arizona, and Nevada showed no incidence of *Ascaris* at all.⁴⁰ In moist tropical climates, roundworm infection may afflict 50% of the population.⁴¹

Eggs are destroyed by direct sunlight within 15 hours, and are killed by temperatures above 40°C (104°F), dying within an hour at 50°C (122°F). Roundworm eggs are resistant to freezing temperatures, chemical disinfectants, and other strong chemicals, but thermophilic composting will kill them.

Roundworms, like hookworms and whipworms, are spread by fecal contamination of soil. Much of this contamination is caused and spread by children who defecate outdoors within their living area. One sure way to eradicate fecal pathogens is to conscientiously collect and thermophilically compost all fecal material. Therefore, it is very important when composting humanure to be certain that all children use the toilet facility and do not defecate elsewhere. When changing soiled diapers, deposit the fecal material into the humanure receptacle with toilet paper or another biodegradable material. It's up to adults to keep an eye on kids and make sure they understand the importance of *always using a toilet facility*.

Fecal environmental contamination can also be caused by using raw fecal material for agricultural purposes. *Proper thermophilic composting of all fecal material is essential for the eradication of fecal pathogens.*

TEMPERATURE AND TIME

There are two primary factors leading to the death of pathogens in humanure. The first is *temperature*. A compost pile that is properly managed will destroy pathogens with the heat it generates.

The second factor is *time*. The lower the temperature of the compost, the longer the subsequent retention time needed for the destruction of pathogens. Given enough time, the wide biodiversity of microorganisms in the compost will destroy pathogens by the antagonism, competition, consumption, and antibiotic inhibitors provided by the beneficial microorganisms. Feachem et al. state that three

months retention time will kill all of the pathogens in a low-temperature composting toilet except worm eggs, although Table 7.14 (also from Feachem) indicates that some additional pathogen survival may occur.

A thermophilic compost pile will destroy pathogens, including worm eggs, quickly, possibly in a matter of minutes. Lower temperatures require longer periods of time, possibly hours, days, weeks, or months, to effectively destroy pathogens. One need not strive for extremely high temperatures such as 65°C (150°F) in a compost pile to feel confident about the destruction of pathogens. It may be more realistic to maintain lower temperatures in a compost pile for longer periods of time, such as 50°C (122°F) for 24 hours, or 46°C (115°F) for a week. According to one source, “*All fecal microorganisms, including enteric viruses and roundworm eggs, will die if the temperature exceeds 46°C (114.8°F) for one week.*”⁴² Other researchers have drawn similar conclusions, demonstrating pathogen destruction at 50°C (122°F), which produced compost “completely acceptable from the general hygienic point of view.”⁴³

A sound approach to pathogen destruction when composting humanure is to thermophilically compost the organic refuse, then allow the compost to sit, undisturbed, for a lengthy period of time after the thermophilic heating stage has ended. The biodiversity of the compost will aid in the destruction of pathogens as the compost ages. If one wants to be particularly cautious, one may allow the compost to age for two years after the pile has been built, instead of the one year that is normally recommended.

In the words of Feachem et al., “*The effectiveness of excreta treatment methods depends very much on their time-temperature characteristics. The effective processes are those that either make the excreta warm (55°C/131°F), hold it for a long time (one year), or feature some effective combination of time and temperature.*” The time/temperature factor of pathogen destruction is illustrated in Figure 7.7.

In short, the combined factors of temperature and time will do the job of “turning turds into tomatoes.”

CONCLUSIONS

Humanure is a valuable resource suitable for agricultural purposes and has been recycled for such purposes by large segments of the world’s human population for thousands of years.

However, humanure contains the potential for harboring human pathogens, including bacteria, viruses, protozoa, and parasitic worms or their eggs, and thereby can contribute to the spread of disease when improperly managed or when discarded as a waste material. When pathogenic raw humanure is applied to soil, pathogenic bacteria may continue to survive in the soil for over a year, and roundworm eggs may survive for many years, thereby maintaining the possibility of human reinfection for lengthy periods of time.

However, when humanure is *thermophilically* composted, human pathogens are rapidly destroyed, and the humanure is thereby converted into a hygienically safe form, suitable for soil applications for the purpose of human food production.

Thermophilic composting requires no electricity and therefore no coal combustion, no acid rain, no nuclear power plants, no nuclear waste, no petrochemicals, and no consumption of fossil fuels. The composting process produces no waste, no pollutants, and no toxic by-products. Thermophilic composting of humanure can be carried out century after century, millennium after millennium, with no stress on our ecosystems, no unnecessary consumption of resources, and no garbage or sludge for our landfills. And all the while it will produce a valuable resource necessary for our survival while preventing the accumulation of dangerous and pathogenic waste. If that doesn't describe *sustainability*, nothing does.

Source: The Humanure Handbook. Jenkins Publishing, PO Box 607, Grove City, PA 16127. To order, phone: 1-800-639-4099.

<http://www.jenkinspublishing.com/>

MENU: [HOME](#) » [Reconstruction](#) » [Recovery](#) » [Renewal](#) » [Survival](#) » [Humanure Content](#)

MENU: [HOME](#) » [Reconstruction](#) » [Recovery](#) » [Renewal](#) » [Survival](#) » [Humanure Content](#)

THE TAO OF COMPOST

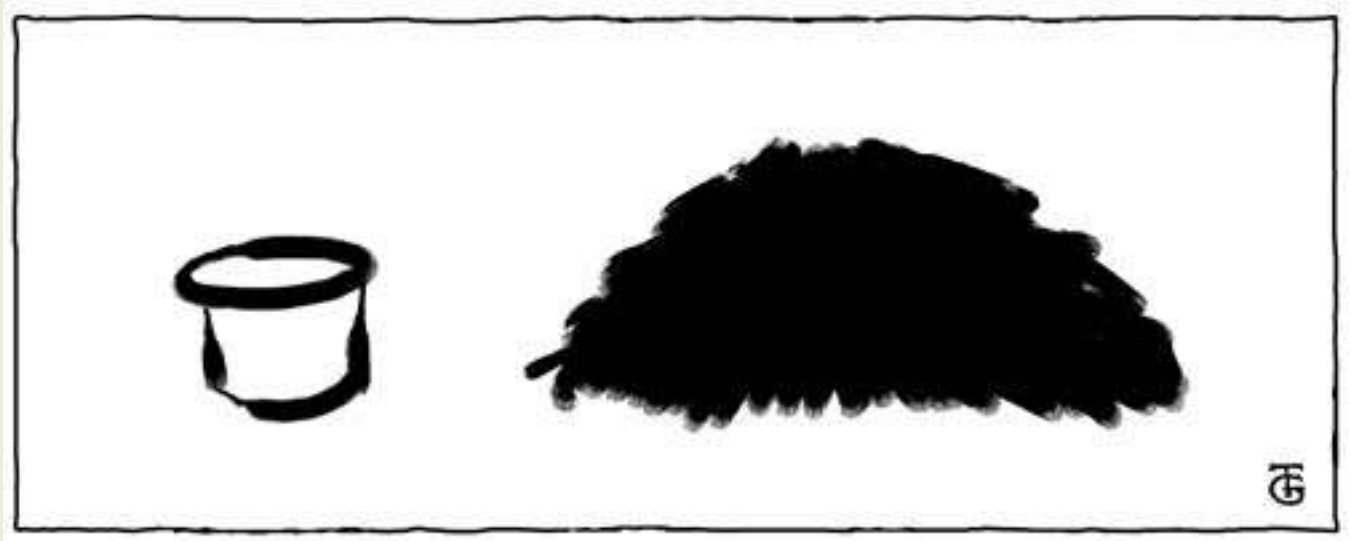

"Aspire to simple living? That means, aspire to fulfill the highest human destiny."

Charles Wagner

Organic material should be recycled by every person on the planet, and recycling should be as normal and integral to daily life as brushing teeth or bathing. Organic materials can be collected by municipalities and composted at central composting facilities. This is now done in many parts of the world where food scraps are composted for urban communities. Toilet materials are not yet being collected and centrally composted in very many places, although such collection will undoubtedly increase as time passes.

However, people can compost their own organic material in their own personal compost bins, in their own backyards. This is already becoming commonplace, and compost bins are now popping up in backyards everywhere like mushrooms after a rain. Composting need not cost money, and it can be practiced by anyone in the world at probably any location where plants can grow. Therefore, it is important that people everywhere learn to understand what compost is and how it can be made.

It is also important that we understand how to compost our toilet materials in a safe and simple manner. A low-cost composting toilet system can be very useful as a back-up toilet in an emergency situation when electrical or water services are disrupted, or when the water supply is diminished as during a

drought, when flushing drinking water down toilets becomes especially ridiculous. It can also be very useful in any area where water or electricity is scarce or non-existent, as well as in developing countries where there may be many people with little or no money to buy commercial composting toilets. Finally, a simple, low-cost composting toilet system is attractive to anyone seeking a low-impact lifestyle, and who is willing to make the minimal effort to compost their organic materials. This chapter details how to compost toilet materials by using a simple, easy, low or no-cost method (a sawdust toilet) which my family and I have used for twenty years at the time of this writing.

The organic materials our bodies excrete can be composted much the same as any apple core or potato peel — by being added to a compost pile. There are essentially two ways to do this. The first is to construct or purchase a toilet which deposits directly into a composting chamber. This is discussed and illustrated in Chapter 6. Such toilets must be properly managed if thermophilic conditions are desired; most commercial composting toilets do not achieve such conditions, and are not meant to.

The second, less expensive, and simpler method is to use one's toilet as a collection device, much the same as any compost bucket, and then compost the contents in a separate compost pile on a regular basis. This simple technique can be done without unpleasant odors, and the toilet can be quite comfortably situated inside one's home. Moving toilet material to a compost bin, however, is an activity that many individuals have no interest in doing, usually not because it is a burdensome task (for a family of four it would involve a twenty minute trip to a compost bin about every three days), but because it's *shit*, for god's sake.

A friend of mine who wanted to use a compost toilet once told me she could never carry “a shit bucket” to a compost bin. She just could not do it, she said, shaking her head. I asked her how often she fed her dog, which was chained about a hundred yards from her house. “Every day,” was her reply.

“How is it that you can carry a container of dog food out to your dog, every day, and not a container of soil nutrients to a compost pile once a week?” (A single person only needs to make a trip to a compost bin once a week.) No reply. “If the ‘shit bucket,’ as you call it, were full of roses, would you be able to carry it to a compost pile once a week?”

“Sure.”

“Then why wouldn't you be able to carry a bucket of other organic material?”

Again, no reply. And none needed. The problem is not practical, it is psychological. I understand perfectly that many people consider the idea of composting their own excrement to be beneath them. In India, such a task was relegated to the “untouchables,” the lowest caste of society. The act of carrying a container of one's own excrement to a recycling bin is an act of humility, and humility is sometimes in short supply. Eventually, toilets in general will be redesigned as collection devices and their contents will be collected and composted as a service by municipal workers. Until then, however, those of us who want to make compost rather than sewage must do it by our own humble selves.

I will never forget the day I introduced a close relative to my composting system. She came to visit me at my newly established homestead one spring day and I gave her a tour of my garden, which was already quite vibrant. A fresh pile of aged compost had been dumped from a wheelbarrow onto one of the raised garden beds and, as we passed, I reached down and scooped up a big handful, thrusting it toward her face. "Smell this," I said. So she put her nose right up to the black earth I held out before me and took a deep breath.

"Boy, that smells good!" she said, inhaling the rich, sweet-smelling aroma of fertile soil, and smiling.

"*This is my alternative to a septic system,*" I proudly informed her, still holding the compost out in front of me as I watched her smile freeze. I will always remember that shocked look on her face, cloaked behind a huge smile. My friend, although very open-minded, had not, prior to that moment, had the experience of so intimately communing with composted humanure. The compost did smell and look wonderful, if I have to say so myself, just like a rich soil from the woods, and I was *proud* of it.

People ask me when I'm going to install a septic system, as if composting is a phase you go through until you become mature and civilized enough to use a flush toilet. Others take one look at my compost toilet and say things like "*I respect the way you're living, but I could never do it.*" Well, I could install a septic system, as I have running water and electricity (when I started using a composting toilet system I lived "off the grid," without electricity, and did so for a period of twelve years). However, a septic system would create environmental pollution and threaten the quality of my ground water, which I drink. It is a *waste disposal* system, collecting and storing waste and allowing the waste to slowly seep into the environment. I'd much rather engage in resource recovery instead of waste disposal, however unfashionable. My compost is my reward — it helps me to grow my food, and that's too valuable for me to be willing to sacrifice.

Source: The Humanure Handbook. Jenkins Publishing, PO Box 607, Grove City, PA 16127. To order, phone: 1-800-639-4099.

<http://www.jenkinspublishing.com/>

MENU: [HOME](#) » [Reconstruction](#) » [Recovery](#) » [Renewal](#) » [Survival](#) » [Humanure Content](#)

PRIMAL COMPOST

Try to imagine yourself in an extremely primitive setting, perhaps sometime around 10,000 B.C. Imagine that you're slightly more enlightened than your brutish companions and it dawns on you one day that your feces should be disposed of in a different manner. Everyone else is defecating in the back of the cave, creating a smelly, fly-infested mess, and you don't like it.

Your first revelation is that smelly refuse should be deposited in one place, not spread around for everyone to step in or smell, and it should be deposited away from one's living area. You watch the wild cats and see that they each go to a special spot to defecate. But the cats are still one step ahead of the humans, as you soon find out, because they cover their excrement.

When you've shat outside the cave on the ground in the same place several times, you see that you've still created a foul-smelling, fly-infested mess. Your second revelation is that the refuse you're depositing on the ground should be covered after each deposit. So you scrape up some leaves every time you defecate and throw them over the feces. Or you pull some tall grass out of the ground and use it for cover.

Soon your companions are also defecating in the same spot and covering their fecal material as well. They were encouraged to follow your example when they noticed that you had conveniently located the defecation spot between two large rocks, and positioned logs across the rocks to provide a convenient perch, allowing for care-free defecation above the material collecting underneath.

A pile of dead leaves is now being kept beside the toilet area in order to make the job of covering it more convenient. As a result, the offensive odors of human feces and urine no longer foul the air. Instead, it's food scraps that are generating odors and attracting flies. This is when you have your third revelation: food scraps should be deposited on the same spot and covered as well. Every stinky bit of refuse you create is now going to the same spot and is being covered with a natural material to eliminate odor. This hasn't been hard to figure out, it makes good sense, and it's easy to do.

You've succeeded in solving three problems at once: no more human waste scattered around your living area, no more garbage, and no more offensive odors assaulting your keen sense of smell and generally ruining your day. You also begin to realize that the illnesses that were prone to spread through the group have subsided, a fact that you don't understand, but you suspect may be due to the group's new found hygienic practices.

Quite by accident, you've succeeded in doing one very revolutionary thing: *you've created a compost pile*. You begin to wonder what's going on when the pile gets so hot it's letting off steam. What you don't know is that you've done exactly what nature intended you to do by piling all your organic refuse together, layered with natural, biodegradable cover materials. In fact, nature has "seeded" your excrement with microscopic animals that proliferate in and digest the pile you've created. In the process, they heat the compost to such an extent that disease-causing pathogens resident in the humanure are destroyed. The microscopic animals would not multiply rapidly in the discarded refuse unless you created the pile, and thereby the conditions, which favor their proliferation.

Finally, you have one more revelation, a big one. You see that the pile, after it gets old, sprouts all kind of vibrant plant growth. You put two and two together and realize that the stinking refuse you carefully disposed of has been transformed into rich earth, and ultimately into food. Thanks to you, humankind has just climbed another step up the ladder of evolution.

There is one basic problem with this scenario: it didn't take place 12,000 years ago. It's taking place now. Compost microorganisms are apparently very patient. Not much has changed since 10,000 B.C. in their eyes. The invisible animals that convert humanure into humus don't care what composting techniques are used today anymore than they cared what techniques may have been used eons ago, so long as their needs are met. And those needs haven't changed in human memory, nor are they likely to change as long as humans roam the earth. Those needs include: 1) *temperature* (compost microorganisms won't work if frozen); 2) *moisture* (they won't work if too dry or too wet); 3) *oxygen* (they won't work without it); and 4) *a balanced diet* (otherwise known as balanced carbon/nitrogen). In this sense, compost microorganisms are a lot like people. With a little imagination, we can see them as a working army of microscopic people who need the right food, water, air and warmth.

The art of composting, then, remains the simple and yet profound art of providing for the needs of invisible workers so that they work as vigorously as possible, season after season. And although those needs may be the same worldwide, the techniques used to arrive at them may differ from eon to eon and from place to place.

Composting differs from place to place because it is a bioregional phenomenon. There are thousands of geographic areas on the Earth each with its own unique human population, climatic conditions, and available organic materials, and there will also be potentially thousands of individual composting methods, techniques, and styles. What works in one place on the planet for one group of people may not work for another group in another geographic location (for example, we have lots of hardwood sawdust in Pennsylvania, but no rice hulls). Compost should be made in order to eliminate local waste and pollution as well as to recover resources, and a compost maker will strive to utilize in a wise and efficient manner whatever local organic resources are available.

Source: The Humanure Handbook. Jenkins Publishing, PO Box 607, Grove City, PA 16127. To order, phone: 1-800-639-4099.

<http://www.jenkinspublishing.com/>

MENU: [HOME](#) » [Reconstruction](#) » [Recovery](#) » [Renewal](#) » [Survival](#) » [Humanure Content](#)

THE SAWDUST TOILET

Simple methods of collecting humanure and composting it are sometimes called cartage systems or bucket systems, as the manure is carried to the compost bin, often in buckets or other waterproof vessels. People who utilize such simple techniques for composting humanure simply take it for granted that humanure recycling is one of the regular and necessary responsibilities for sustainable human life on this planet.

How it works is a model of simplicity. One begins by depositing one's organic refuse (feces and urine) into a plastic bucket, clay urn, or other non-corrodible waterproof receptacle with about a five gallon (20 liter) capacity. Food scraps may be collected in a separate receptacle, but can also be deposited into the toilet receptacle. A five gallon capacity is recommended because a larger size would be too heavy to carry when full. If five gallons is still too heavy for someone to carry, it can be emptied when half-full.

The contents of the toilet are kept covered with a clean, organic *cover material* such as rotted sawdust, peat moss, leaf mould, rice hulls, or grass clippings, in order to prevent odors, absorb urine, and eliminate any fly nuisance. Urine is deposited into the same receptacle, and as the liquid surface rises, more cover material is added so that a clean layer of organic material covers the toilet contents *at all times*.

A lid is kept on the toilet receptacle when not in use. The lid need not be air-tight, and a standard, hinged toilet seat is quite suitable. The lid does not necessarily prevent odor from escaping, and it does not necessarily prevent flies from gaining access to the toilet contents. Instead, the *cover material* does. The cover material acts as an organic lid or a "biofilter"; the physical lid (toilet seat) is used primarily for convenience and aesthetics. Therefore, the choice of organic cover material is very important, and a material that has some moisture content, such as rotted sawdust, works beautifully. This is not kiln-dried sawdust from a carpenter shop. It is sawdust from a sawmill where trees are cut into boards. Such sawdust is both moist and biologically active and makes a very effective biofilter. Kiln-dried sawdust is too light and airy to be a 100% effective biofilter. Furthermore, sawdust from wood-working shops may contain hazardous chemical poisons if "pressure-treated" lumber is being used there. It seems that present-day carpenters are more than willing to expose themselves to the chemical hazards of poison-soaked lumber, which contains cancer-causing chemicals. There is no need for composters and gardeners to duplicate such unwise exposure.

I use rotted sawdust as a toilet cover material because it is a readily available, very inexpensive, local resource which works well. I used to haul a free load home from a local sawmill every so often in the back of my pick-up truck, but now I just have a fellow with a small dump truck deliver me a load every year or two. I have the sawdust dumped in a pile in a corner of my backyard adjacent to my compost bins where it can remain exposed to the elements and thereby slowly decompose on its own, as rotting sawdust makes compost more readily than fresh sawdust. The sawdust itself doesn't cost me anything, but I usually have to pay about five dollars to have it loaded onto the dump truck and another twenty-five to have it hauled. This is an expense I'm

happy to pay every year or two in order to ensure for myself a functional compost toilet system. I would speculate that many other cellulose-based materials or combination of materials would work as a toilet cover material, including perhaps ground newsprint.

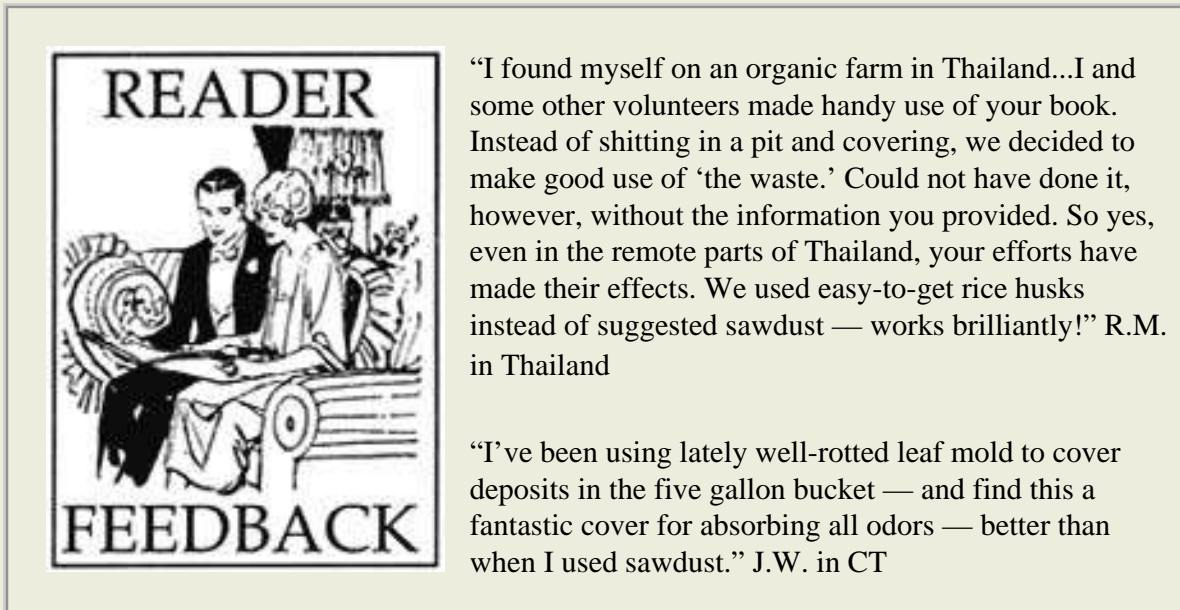

“I found myself on an organic farm in Thailand...I and some other volunteers made handy use of your book. Instead of shitting in a pit and covering, we decided to make good use of ‘the waste.’ Could not have done it, however, without the information you provided. So yes, even in the remote parts of Thailand, your efforts have made their effects. We used easy-to-get rice husks instead of suggested sawdust — works brilliantly!” R.M. in Thailand

“I’ve been using lately well-rotted leaf mold to cover deposits in the five gallon bucket — and find this a fantastic cover for absorbing all odors — better than when I used sawdust.” J.W. in CT

In the winter, an outdoor pile of sawdust will freeze solid. I have to layer some hay over mine and cover it with a tarp in order to be able to access it all winter. Otherwise, feedsacks filled with sawdust stored in a basement will work as an alternative, as will peat moss and other cover materials stored indoors.

The system of using an organic cover material in a small receptacle works well enough in preventing odors to allow the toilet to be indoors, year round. In fact, a full bucket with adequate and appropriate cover material, and no lid, can be set on the kitchen table without emitting unpleasant odors (take my word for it). An indoor sawdust toilet should be designed to be as warm, cozy, pleasant, and comfortable as possible. A well-lit, private room with a window, a standard toilet seat, a container of cover material, and some reading material will suffice.

AMERICAN YARDS AND ENGLISH GARDENS

In the United States, a “yard” is a grassy area surrounding a house; the term is equivalent to the English term “garden.” That grassy area may contain trees, shrubs, or flowers. If it is located in front of the house, it is called the “front yard.” Behind the house, it is the “back yard.” Beside the house, it is the “side yard.” An American “garden” is a plot of vegetables, often located within the yard. An American garden can also be a flower garden or fruit

When the bucket is full, it is carried to the composting area and deposited on the pile. Since the material must be moved from the toilet room to an outdoor compost pile, the toilet room should be handy to an outside door. If you are redesigning a sawdust toilet in a new home, situate the toilet room near a door that allows direct access to the outside.

It is best to dig a slight depression in the top center of the compost pile and deposit the fresh material there, in order to

garden; some American gardens contain flowers, fruits, and vegetables. In the UK, the green area around a house is called the “garden,” whether it contains vegetables, flowers, or nothing but mowed grass. English homes do not have “yards.” So the term “back yard composting,” translated to UK English, would be “back garden composting.”

SAWDUST TOILET VITAL STATISTICS

One hundred pounds of human body weight will fill approximately three gallons (.4 cubic feet, 693 cubic inches, or approximately 11 liters) in a sawdust toilet per week - this volume includes the sawdust cover material. One hundred pounds of human body weight will also require approximately 3 gallons of semi-dry, deciduous, rotting sawdust per week for use as a cover material in a toilet. This amounts to a requirement of approximately 20 cubic feet of sawdust cover material per one hundred pounds of body weight per year for the proper functioning of a sawdust toilet. Human excrement tends to add weight rather than volume to a sawdust toilet as it is primarily liquid and fills the air spaces in the sawdust. Therefore, for every gallon of sawdust-covered excrement collected in a sawdust toilet, nearly a gallon of cover material will need to be used.

keep the incoming humanure in the hotter center of the compost pile. This is easily achieved by raking aside the cover material on top of the pile, depositing the toilet contents in the resulting depression, and then raking the cover material back over the fresh deposit. The area is then immediately covered with additional clean, bulky, organic material such as straw, leaves, or weeds, in order to eliminate odors and to entrap air as the pile is built. The bucket is then thoroughly scrubbed with a small quantity of water, which can be rain water or graywater, and biodegradable soap, if available or desired. A long-handled toilet brush works well for this purpose. Often, a simple but thorough rinsing will be adequate. Rain water or wastewater is ideal for this purpose as its collection requires no electricity or technology. The soiled water is then poured on the compost pile.

It is imperative that the rinse water not be allowed to pollute the environment. The best way to avoid this is to put the rinse water on the compost pile, as stated. However, the rinse water can be poured down a drain into a sewer or septic system, or drained into an artificial wetland. It can also be poured at the base of a tree or shrub that is designated for this purpose. Such a tree or shrub should have a thick layer of organic material (biological sponge) at its base and be staked or fenced to prevent access to children or pets. Under no circumstances should the rinse water be flung aside nonchalantly. This is the weak link in this simple humanure recycling chain, and it provides the

most likely opportunity for environmental contamination. Such contamination is easy to avoid through considerate, responsible management of the system. Finally, never use chlorine to rinse a compost receptacle. Chlorine is a chemical poison that is detrimental to the environment and is totally unnecessary for use in any humanure recycling system. Simple soap and water is adequate.

After rinsing or washing, the bucket is then replaced in the toilet area. The inside of the bucket should then be dusted with sawdust, the bottom of the empty receptacle should be primed with an inch or two of sawdust, and it's once again ready for use. After about ten years, the plastic bucket may begin to develop an odor, even after a thorough washing. Replace odorous buckets with new ones in order to maintain an odor-free system. The old buckets will lose their odor if left to soak in clean, soapy water for a lengthy period (perhaps weeks), rinsed, sun-dried, and perhaps soaked again, after which they can be used for utility purposes (or, if you really have a shortage of buckets, they can be used in the toilet again).

Here's a helpful hint: when first establishing such a toilet system, it's a good idea to acquire at least *four* five gallon buckets, with lids, that are *exactly the same*, and more if you intend to compost for a large number of people. Use one under the toilet seat and two, with lids, set aside in the toilet room, empty and waiting (save

the fourth as a back-up). When the first becomes full, take it out of the toilet, put a lid on it, set it aside, and replace it with one of the empty ones. When the second one fills, take it out, put the other lid on it, set it aside, and replace it with the other empty one. Now you have two full compost buckets, which can be emptied at your leisure, while the third is in place and ready to be used. This way, the time you spend emptying compost is almost cut in half, because it's just as easy to carry two buckets to the compost pile as one. Furthermore, you potentially have a 15 gallon toilet capacity at any one time (20 with the extra bucket), instead of just five gallons. You may find that extra capacity to come in very handy when inundated with visitors.

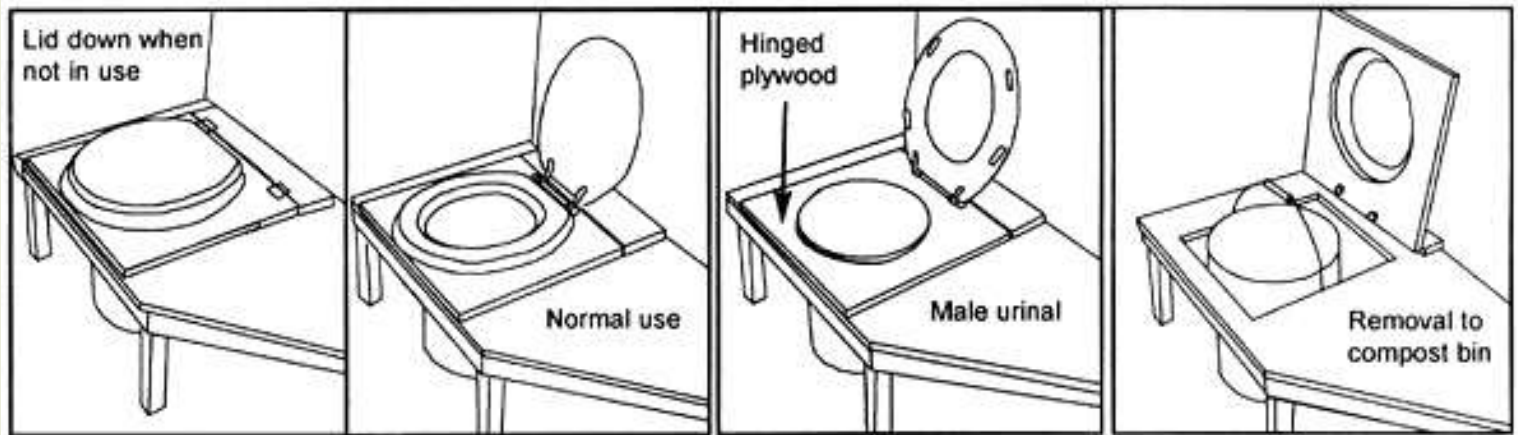

Figure 8.1

SAWDUST TOILET WITH HINGED SEAT

The above diagram shows a simple sawdust toilet permanently built into a toilet room. The compost receptacle (bucket) sits directly on the floor. A standard toilet seat is attached to an 18" square piece of plywood, which lifts up on hinges to allow easy access when removing the compost material. Bucket setback from the front edge of the plywood is 1&1/2". Height of top surface of plywood is 1/2" lower than height of bucket. Bucket protrudes through cabinet to contact bottom of toilet seat ring. Plastic bumpers on bottom of toilet seat ring are swiveled sideways so as to fit around bucket. Actual toilet shown below.



DIRECTIONS FOR SAWDUST TOILET:

1. MAKE YOUR DEPOSIT
2. COVER WITH SAWDUST
3. HAVE A GREAT DAY ~ ENJOY!

Figure 8.2

SAWDUST TOILET WITH LIFT-OFF TOP

Toilet at left came with directions mounted on the wall.

Why should all of the buckets be exactly the same? If you build a permanent toilet cabinet (seat), the top of the bucket should protrude through the cabinet to contact the bottom of a standard toilet seat. This ensures that all organic material goes into the container, not over its edge. Although this is not usually a problem, it can be with young children who may urinate over the top of a bucket receptacle when sitting on a toilet. A good design will enable the bucket to fit tightly through the toilet cabinet as shown in Figures 8.1, 8.2, and 8.4. Since all plastic buckets are slightly different in height and diameter, you will have to build your toilet cabinet to fit one size bucket. You should have extra identical ones when backup capacity is needed to accommodate large numbers of people.

It is much better to set a full toilet receptacle aside, with a lid, and replace it immediately with an empty one, than to have to empty and replace a full one while someone is waiting to use the toilet. There are some things in life we would all like to avoid: you have no money in the bank, your gas tank is empty, you're out of firewood, your pantry is bare, the sun's not shining, the dog has died, and "nature calls," but the shit bucket's full. Put some harmonica music to that last sentence and you'd have *"The Shit Bucket Blues."* One can avoid singing that tune by properly planning and managing a sawdust toilet system.

Theoretically, with enough containers, a sawdust toilet system can be used for any number of people. For example, if you are using a sawdust toilet in your home, and you are suddenly visited by thirty people all at once, you will be very happy to have empty containers ready to replace the ones that fill up. You will also be very happy that you will not have to empty any compost containers until after your company leaves, because you can simply set them out of the way in the toilet room as they fill up, and then empty them the next day.

Experience has shown that 150 people will require four five gallon containers during a serious party. Therefore, always be prepared for the unexpected, and maintain a reserve toilet capacity at all times by having extra toilet receptacles available, as well as extra cover material. Incidentally, for every full container of compost material carried out of a toilet room, a full, same-sized container of cover material will need to be carried in.

Expecting five hundred people for a major gathering out in the woods? Sawdust toilets will work fine, as long as you keep enough buckets handy, as well as adequate cover materials, and some volunteers to manage it all. You will collect a lot of valuable soil nutrients. Which brings to mind a verse created by a friend and sung to the tune of "Old Joe Clark" at one of my own gatherings, here paraphrased:

*"He feeds us lots of party food,
and calls it appetizers.
But we know what he's going to do,
He'll make it fertilizer!"*

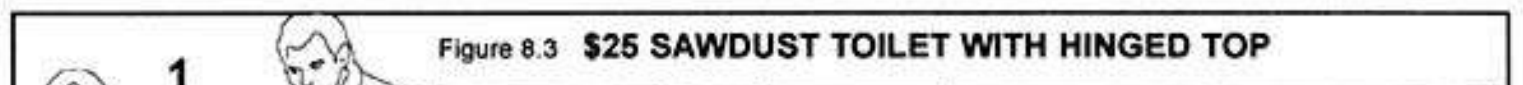
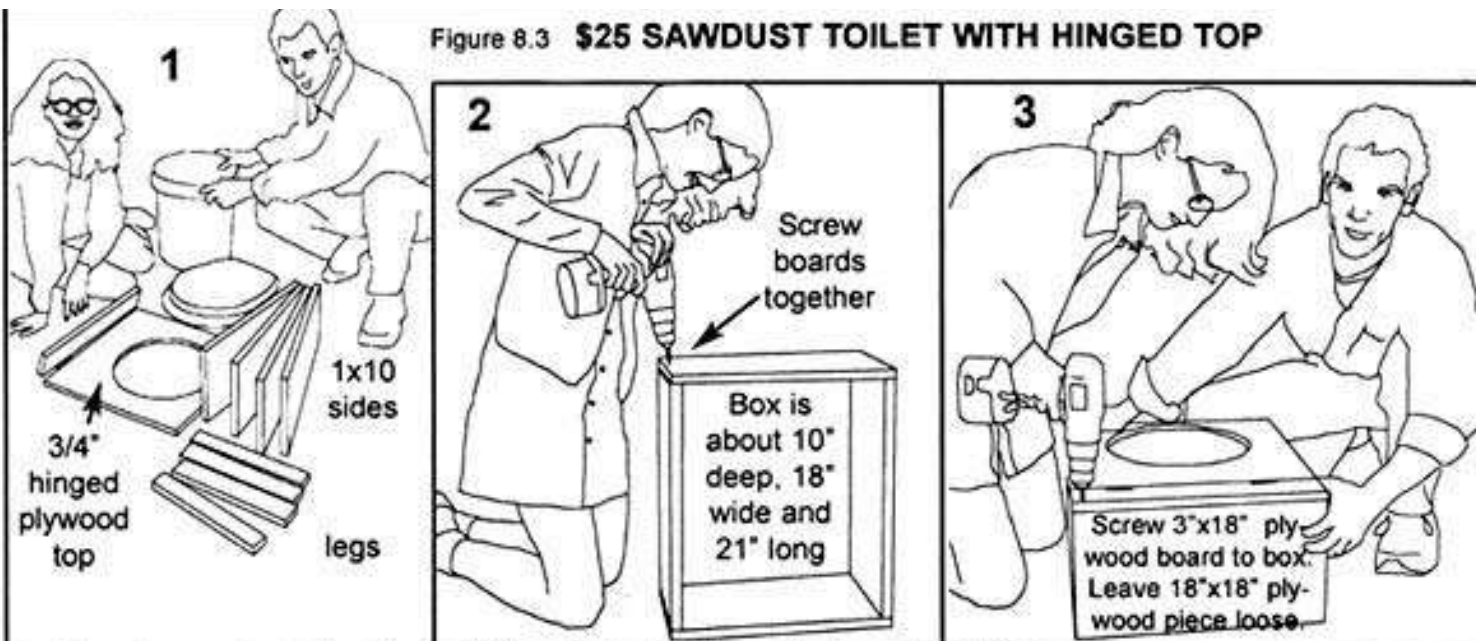
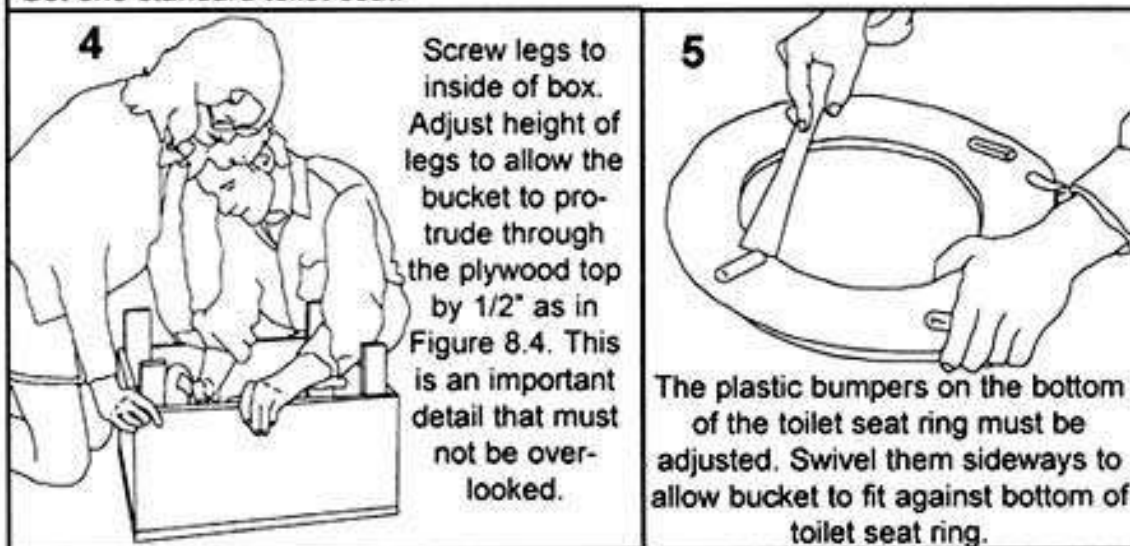

Figure 8.3 \$25 SAWDUST TOILET WITH HINGED TOP



A hinged sawdust toilet box will be 18" wide by 21" long. Get (2) boards 3/4"x10"x18", (2) 3/4"x10"x20.5", (2) hinges, (1) piece of 3/4" plywood 18"x18" and another 18"x3" and hinge them together. Cut a hole in the larger plywood to fit the top of a five-gallon bucket, set back one and one half inches from the front (as in Figure 8.4). Get four five-gallon buckets that are identical. Get (4) 3/4"x3"x12" legs. Get one standard toilet seat.





The advantages of a sawdust toilet system include low financial start-up cost in the creation of the facilities, and low, or no energy consumption in its operation. Also, such a simple system, when the refuse is thermophilically composted, has a low environmental cost, as little or no technology is required for the system's operation, and the finished compost is as nice and benign a material as humanure can ever hope to be. No composting facilities are necessary in or near one's living space, although the toilet can and should be inside one's home and can be quite comfortably designed and totally odor-free. No electricity is needed, and no water is required except a small amount for cleaning purposes. The compost, if properly managed, will heat up sufficiently for sanitation to occur, thereby making it useful for gardening purposes. The composting process is fast, i.e., the humanure is converted quickly (within a few days if not frozen) into an inoffensive substance that will neither attract rodents nor flies. In cold winter months, the compost simply freezes until spring thaw, and then heats up. If the compost is unmanaged and does not become thermophilic, the compost can simply be left to age for a couple of years before horticultural use. In either case, a complete natural cycle is maintained, unbroken.

*Source: The Humanure Handbook. Jenkins Publishing, PO Box 607, Grove City, PA 16127. To order, phone: 1-800-639-4099.
<http://www.jenkinspublishing.com/>*

MENU: [HOME](#) » [Reconstruction](#) » [Recovery](#) » [Renewal](#) » [Survival](#) » [Humanure Content](#)

THE COMPOST BINS

A sawdust toilet requires three components: 1) the toilet receptacle; 2) cover materials; and 3) a compost bin system. The system will NOT work without all three of these components. The toilet is only the collection stage of the process. The composting takes place away from the toilet, and the compost bin system is important.

1) *Use at least a double-chambered, above-ground compost bin.* A three-chambered bin is recommended. Deposit in one chamber for a period of time (e.g., a year), then switch to another for an equal period of time.

2) *Deposit a good mix of organic material into the compost pile, including kitchen scraps.* It is a good idea to put all of your organic material into the same compost bin. Pay no attention to those people who insist that humanure compost should be segregated from other compost. They are people who do not compost humanure and don't know what they're talking about.

3) *Always cover humanure deposits in the toilet with an organic cover material* such as sawdust, leaf mould, peat moss, or rice hulls. *Always cover fresh deposits on the compost pile with coarser cover materials* such as hay, weeds, straw, or leaves. Make sure that enough cover is applied so that there is neither excess liquid build-up in the toilet nor offensive odors escaping either the toilet or the compost pile. The trick to using cover material is quite simple: if it smells bad or looks bad, cover it until it does neither.

4) *Keep good access to the pile* in order to rake the top flat, to apply bulky cover material when needed, to allow air to access the pile, and to monitor the temperature of the pile. The advantage of aerobic composting, as is typical of an above-ground pile, over relatively anaerobic composting typical of enclosed composting toilets, is that the aerobic compost will generate higher temperatures, thereby ensuring a more rapid and complete destruction of potential human pathogens.

The disadvantages of a collection system requiring the regular transporting of humanure to a compost pile are obvious. They include the inconvenience of: 1) carrying the organic refuse to the compost pile; 2) keeping a supply of organic cover material available and handy to the toilet; 3) maintaining and managing the compost pile itself.

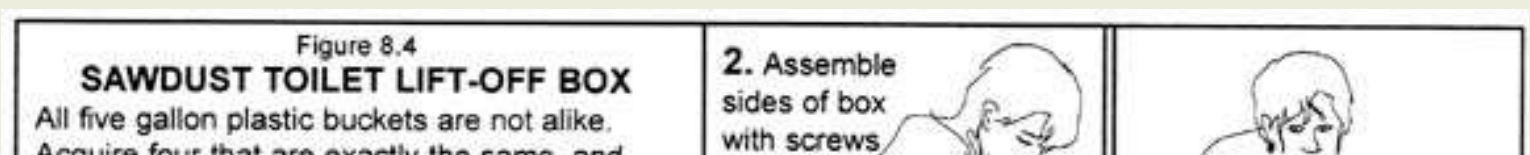

All five gallon plastic buckets are not alike. Acquire four that are exactly the same, and build the box to fit the bucket height and diameter. The bucket should protrude through the top of the box by 1/2" in order to contact the bottom of the toilet seat (as shown in #7).

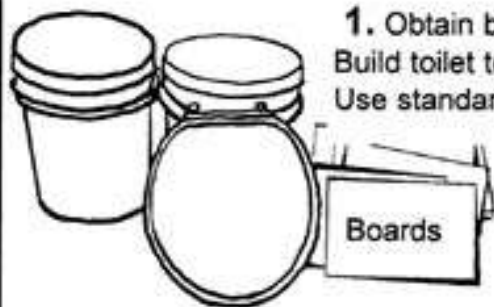

1. Obtain buckets first. Build toilet to fit buckets. Use standard toilet seat.

sides of box with screws and glue (or nails)



3. Attach top boards



4. Set bucket 1 1/2" from the front of the box, and center it. Mark for cut.

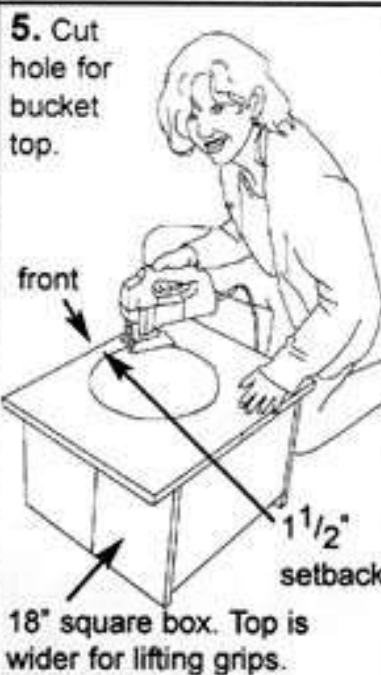

5. Cut hole for bucket top.

6. Compost receptacle will protrude through top of box by 1/2".



7. The overall height of the toilet box is equal to the height of the bucket minus 1/2", allowing the bucket to protrude through the box and contact the bottom of the toilet seat ring.

8. The plastic bumpers on the underside of the toilet seat ring must be turned sideways so as to allow the toilet seat ring to contact the top of the bucket. This ensures that all organic material meant to go into the bucket will get there and not go over the top, as may otherwise happen when little children are seated on the toilet.

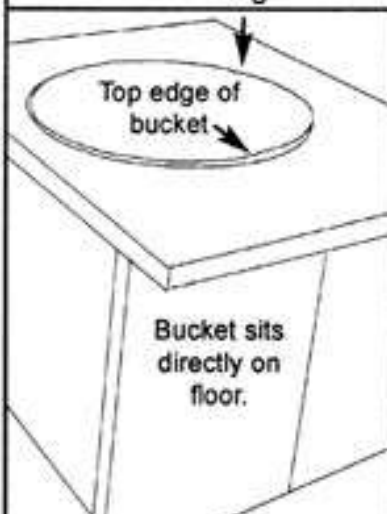

9. Lift box off bucket to empty compost.





Source: The Humanure Handbook. Jenkins Publishing, PO Box 607, Grove City, PA 16127. To order, phone: 1-800-639-4099.

<http://www.jenkinspublishing.com/>

MENU: [HOME](#) » [Reconstruction](#) » [Recovery](#) » [Renewal](#) » [Survival](#) » [Humanure Content](#)

MENU: [HOME](#) » [Reconstruction](#) » [Recovery](#) » [Renewal](#) » [Survival](#) » [Humanure Content](#)

NORMAL COMPOSTING BIN SEQUENCE

It's very important to understand that *two* factors are involved in destroying potential pathogens in humanure. Along with heat, the *time* factor is important. Once the organic material in a compost pile has been heated by thermophilic microorganisms, it should be left to age or "season." This part of the process allows for the final decomposition to take place, decomposition that may be dominated by fungi and macroorganisms such as earthworms. Therefore, a good compost system will utilize at least two composting bins, one to fill and leave to age, and another to fill while the first is aging. A three-binned composting system is recommended, as the third bin provides a place to store cover materials, and separates the active bins so there is no possible accidental transfer of fresh material to an aging bin.

When composting humanure, fill one bin first. Start the compost pile by establishing a thick layer of coarse and absorbent organic material on the bottom of the bin. This is called a "biological sponge"; its purpose is to act as a leachate barrier. The sponge may be an 18 inch layer of hay or straw, grass clippings, leaves, and/or weeds. Place the first container of the humanure/sawdust mix from the toilet directly on the top center of the sponge. Cover immediately with more straw, hay, weeds, or leaves — the cover acts as a natural "biofilter" for odor prevention, and it causes air to become trapped in the developing compost pile, making physical turning of the pile for aeration unnecessary.

Continue in this manner until the bin is full, being sure to add to this bin *all* of the other organic material you produce. There is no need to have any other compost piles — one is enough for everything produced by the humans in your household. If you have small animals such as chickens or rabbits, their manure can go into the same compost pile. Presumably, pet manures can also go into the same compost pile as well (see Chapter 3), although pet manures, like human manures, can contain human pathogens, so thermophilic composting and/or adequate aging of the compost are essential. Small dead animals can also be added to the compost pile.

You need to do nothing special to prepare material for adding to the compost pile. You do not need to chop up vegetables, for example. Just chuck it all in there. Most of the things compost educators tell you cannot be composted *can*, in fact, be composted in your humanure compost pile (such as meat, fats, oils, etc.). Add it all to the same compost pile. Anything smelly that may attract flies should be dug into the top center of the pile. Keep a shovel or pitchfork handy for this purpose and use the tool *only* for the compost. Keep a clean cover material over the compost at all times, and don't let your compost pile become shaped like the Matterhorn — keep it somewhat flattened so nothing rolls off.



SAWDUST TOILET IN NEW RURAL HOME



LIFT-OFF SAWDUST TOILET IN RURAL HOME



PEAT TOILET (PEAT STORED UNDER LID WITH HANDLE)



EMERGENCY SAWDUST TOILET IN BASEMENT OF NEW HOME WITH SEPTIC SYSTEM



HINGED TOP SAWDUST TOILET IN URBAN HOME



SAWDUST TOILET IN "OUTHOUSE"

When you have a sudden large quantity of cover material available, such as an influx of grass clippings when the lawn is mowed, weeds from the garden, or leaves in the fall, place them in the center bin for storage and use them to cover humanure deposits as you need them. It is assumed that you do not use any poisonous chemicals on your lawn. If you do, bag the lawn clippings, take them to a toxic waste dump, and on the way, reflect upon the folly of such toxic behavior. Do not put poisoned grass clippings on your compost pile.

Filling the first bin should take a year — that's how long it takes us, a family, usually of four, with a lot of visitors. We start to fill a compost bin every summer solstice or at some point near that time. Cover the finished compost pile with a thick layer of straw, leaves, grass clippings, or other clean material (without weed seeds) to insulate it and to act as a biofilter, then leave the pile alone. Start filling the second chamber, following the same procedure as the first (start with a biological sponge). When the second chamber is nearly full (a year later), the first one can begin to be emptied onto the garden, berries, orchard, or flower beds. The finished compost does not need to be dug deeply into the soil or buried in a trench on another planet, as the fecophobes insist. It can either be used as mulch, or it can be dug or tilled into the top layer of your garden soil. You can even roll naked in it if you want to (no, I haven't tried this — yet).



The author's triple chambered compost bins, in use for twenty years. The far bin is the active one, the near bin is the aging one, here being broken into for spring planting.

Source: *The Humanure Handbook*. Jenkins Publishing, PO Box 607, Grove City, PA 16127. To order, phone: 1-800-639-4099.

<http://www.jenkinspublishing.com/>

MENU: [HOME](#) » [Reconstruction](#) » [Recovery](#) » [Renewal](#) » [Survival](#) » [Humanure Content](#)

MENU: [HOME](#) » [Reconstruction](#) » [Recovery](#) » [Renewal](#) » [Survival](#) » [Humanure Content](#)

NORMAL COMPOSTING BIN SEQUENCE (CONTINUED)

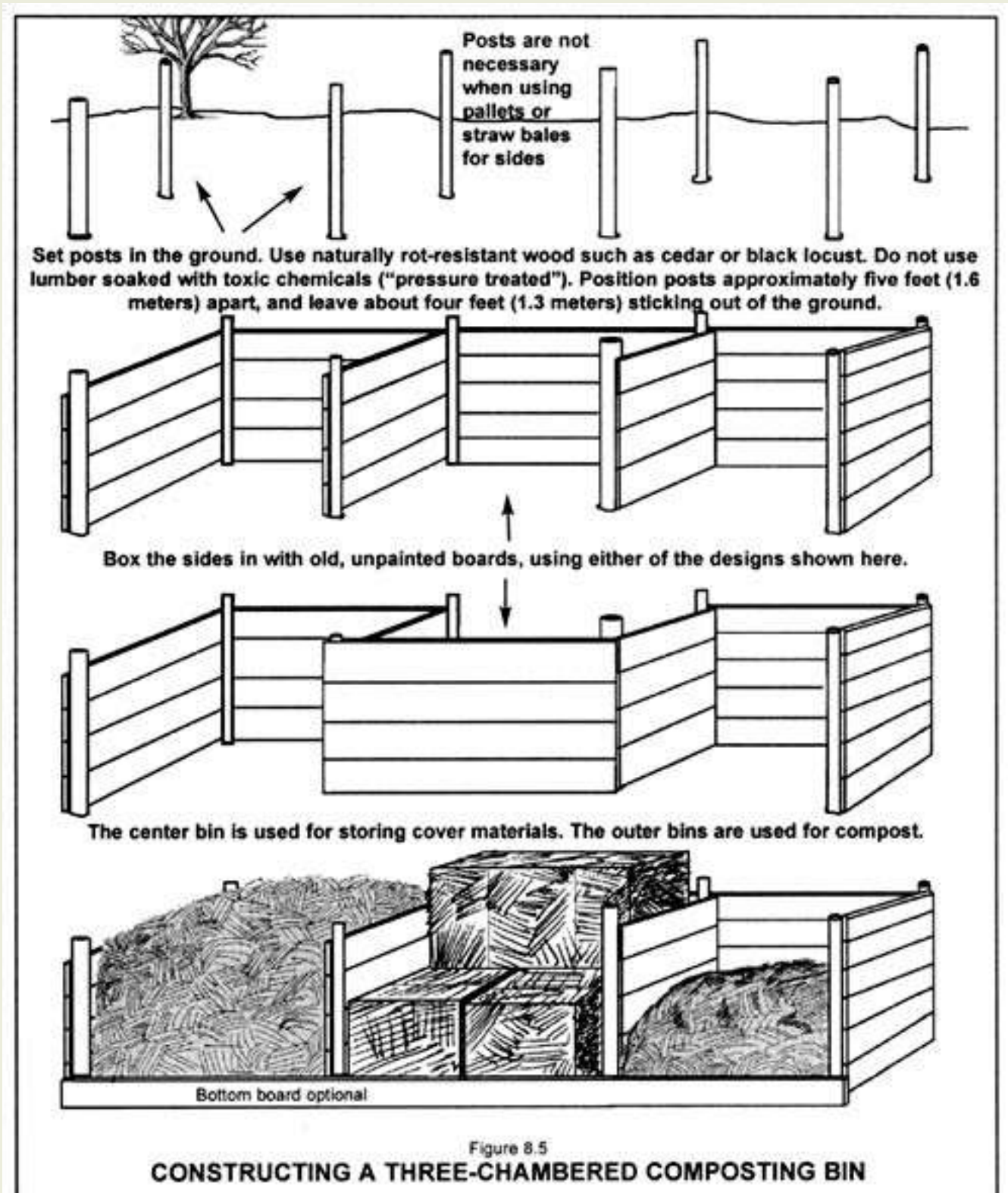

CONSTRUCTING A THREE-CHAMBERED COMPOSTING BIN

The three-chambered bin is ideally suited for humanure composting. The bin can be built of pallets wired, nailed, or screwed together instead of boards. Straw or hay bales (or pallets) can be used to close the open side when filling with compost. Later, the old straw can be used as a cover material. The center bin is used for storing excess cover materials such as garden weeds, lawn grass and leaves, or bales of hay or straw.

A compost pile can accept a huge amount of refuse, and even though the pile may seem to be full, as soon as you turn your back it will shrink down and leave room for more material. So when I say fill the first bin before filling the second, I mean *fill* it. A year is a good period of time for doing so in any area where there is an annual growing season. In the tropics, a shorter period may be necessary; I don't know. You readers who live in the tropics will have to figure that out. In the cold winters of the north, it is quite likely that the compost will freeze solid. You can, however, keep adding to the pile all winter. In the spring when it thaws out, the compost should work up a head of steam as if nothing happened.

Follow a natural timing cycle when making compost, one that is in tune to your agricultural cycle. A yearly cycle works best for me in Pennsylvania, where we have an annual growing cycle (one growing season per year). By late spring, the compost bin has been completely filled and it's time to let it sit until the next spring, when the finished compost will be ready to be removed and added to the garden.

The system outlined above will not yield any compost until two years after the process has started (one year to build the first pile and an additional year for it to age). However, after the initial two year start-up period, an ample amount of compost will be available on an annual basis.



A few people wrote to me wondering what happens to the leachate from the compost pile. Apparently they imagined that noxious fluids were draining into the soil under the pile, and they were concerned that this would constitute a violation of environmental regulations. Ironically, in most rural and many suburban areas, the alternative would be to use a septic system for waste disposal. Septic systems are *designed* to leach waste into the soil. That makes me wonder why people are concerned about possible leaching into the soil from compost while they show no concern for the leaching from septic systems. The answer to the leaching question is two-fold. First, compost *requires* a lot of moisture; evaporated moisture is one of the main reasons why compost shrinks so much. Compost piles are not inclined to *drain* moisture unless during a very heavy rain. Most rainwater is absorbed by the compost, but in heavy rainfall areas a roof or cover can be placed over the compost pile at appropriate times in order to prevent leaching. Second, a thick biological sponge is layered under the compost before the pile is built. This acts as a leachate barrier. If these two factors aren't effective enough, it is a simple matter to place a layer of plastic underneath the compost pile, under the biological sponge, before the pile is built. Fold the plastic so that it collects any leachate and drains into a sunken five gallon bucket. If leachate collects in the bucket, pour it back over the compost pile. The plastic, however, will act as a biological barrier between the soil and the compost, and its use is therefore not recommended by the author. The interface between the compost pile and the soil acts as a corridor for soil organisms to enter the compost pile, and plastic will prevent that natural migration. However, the plastic can provide simple and effective leachate prevention, if needed.

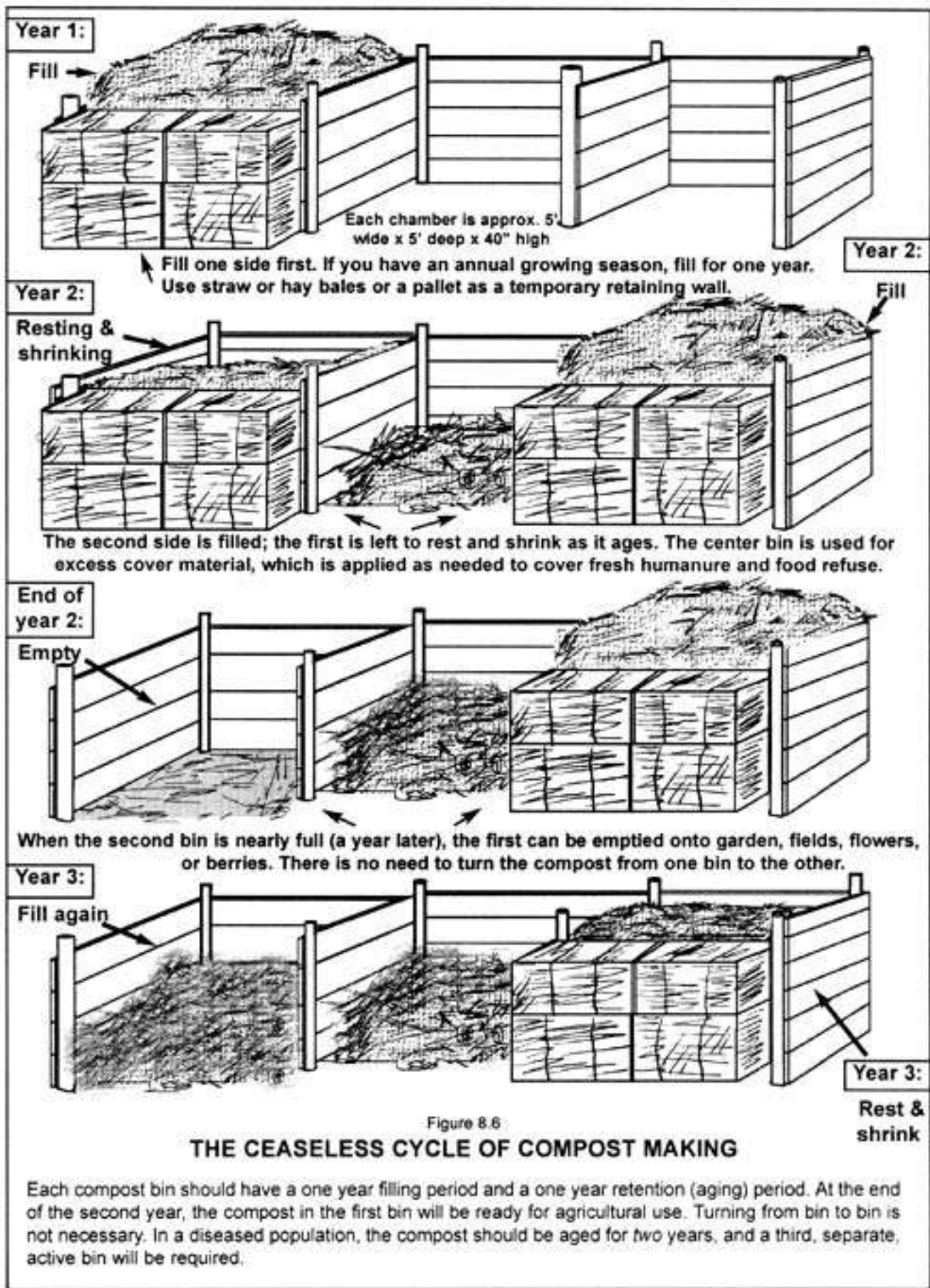

Source: *The Humanure Handbook*. Jenkins Publishing, PO Box 607, Grove City, PA 16127. To order, phone: 1-800-639-

4099.

<http://www.jenkinspublishing.com/>

MENU: [HOME](#) » [Reconstruction](#) » [Recovery](#) » [Renewal](#) » [Survival](#) » [Humanure Content](#)

PATHOGENIC POPULATIONS AND A TWO YEAR RETENTION TIME

DO'S AND DON'TS OF A THERMOPHILIC TOILET COMPOSTING SYSTEM

DO — Collect urine, feces, and toilet paper in the same toilet receptacle. Urine provides essential moisture and nitrogen.

DO — Keep a supply of clean, organic cover material handy to the toilet at all times. Rotting sawdust, peat moss, leaf mould, and other such cover materials prevent odor, absorb excess moisture, and balance the C/N ratio.



DON'T — Segregate urine or toilet paper from feces.

DON'T — Turn the compost pile if it is being continuously added to and a batch is not available. Allow the active thermophilic layer in the upper part of the pile to remain undisturbed.

DON'T — Use lime or wood ashes on the compost pile. Put these things directly on the soil.

DO — Keep another supply of cover material handy to the compost bins for covering the compost pile itself.

Coarser materials such as hay, straw, weeds, leaves, and grass clippings, prevent odor, trap air in the pile, and balance the C/N ratio.

DO — Deposit humanure into a depression in the top center of the compost pile, not around edges.

DO — Add a mix of organic materials to the humanure compost pile, including all food scraps.

DO — Keep the top of the compost pile somewhat flat. This allows the compost to absorb rainwater, and makes it easy to cover fresh material added to the pile.

DO — Use a compost thermometer to check for thermophilic activity. If your compost does not seem to be adequately heating, use the finished compost for berries, fruit trees, flowers, or ornamentals, rather than food crops. Or allow the constructed pile to age for two full years before garden use.

DON'T — Expect thermophilic activity until a sufficient mass has accumulated.

DON'T — Deposit anything smelly into a toilet or onto a compost pile without covering it with a clean cover material.

DON'T — Allow dogs or other animals to disturb your compost pile. If you have problems with animals, install wire mesh or other suitable barriers around your compost, and underneath, if necessary.

DON'T — Segregate food items from your humanure compost pile. Add all organic materials to the same compost bin.

DON'T — Use the compost before it has fully aged. This means one year after the pile has been constructed, or two years if the humanure originated from a diseased population.

DON'T — Worry about your compost. If it does not heat to your satisfaction, let it age for a prolonged period, then use it for horticultural purposes.

Fecophobes, as we have seen throughout this book, believe that all human excrement is extremely dangerous, and will cause the end of the world as we know it if not immediately flushed down a toilet. Some insist that humanure compost piles must be turned frequently — to ensure that all parts of the pile are subjected to the internal high temperatures.

The only problem with that idea is that most people produce organic refuse a little at a time. For example, most people defecate once a day. A large amount of organic material suitable for thermophilic composting is therefore usually not available to the average person. As such, we who make compost a daily and normal part of our lives tend to be “continuous composters.” We add organic material

continuously to a compost pile, and almost never have a large “batch” that can be flipped and turned all at once. In fact, a continuous compost pile will have a thermophilic layer, which will be located usually in the top two feet or so of the pile. If you turn the compost pile under these conditions, that layer will become smothered by the thermophilically “spent” bottom of the pile, and all thermophilic activity will grind to a halt.

In healthy human populations, therefore, turning a continuous compost pile is not recommended. Instead, all humanure deposits should be deposited in the top center of the compost pile in order to feed it to the hot area of the compost, and a thick layer of insulating material (e.g., hay) should be maintained over the composting mass. Persons who have doubts about the hygienic safety of their finished humanure compost are urged to either use the compost for non-food crops or orchards, or have it tested at a lab before using on food crops.

On the other hand, one may have the need to compost humanure from a population with known disease problems. If the organic material is available in *batches*, then it can be turned frequently during the thermophilic stage in order to enhance pathogen death. After the thermophilic stage, the compost can be left to age for at least a year.

If the organic material is available only on a continuous basis, and turning the pile, therefore, is counterproductive, an *additional* year-long curing period is recommended. This will require one more composting bin in addition to the two already in use. After the first is filled (presumably for a year), it is left to rest *for two years*. The second is filled during the second year, then it is left to rest for two years. The third is filled during the third year. By the time the third is filled, the first has aged for two years and should be pathogen-free and ready for agricultural use. This system will create an initial lag-time of three years before compost is available for agricultural purposes (one year to build the first pile, and two more years retention time), but the extra year’s retention time will provide added insurance against lingering pathogens. After the third year, finished compost will be available on a yearly basis. Again, if in doubt, either test the compost for pathogens in a laboratory, or use it agriculturally where it will not come in contact with food crops.

A TIP FROM MR. TURDLEY

Sawdust works best in compost when it comes from logs, not kiln-dried lumber. Although kiln-dried sawdust (from a wood-working shop) will compost, it is a dehydrated material and will not decompose as quickly as sawdust from fresh logs, which are found at sawmills. Kiln-dried sawdust may originate from “pressure-treated” lumber, which usually is contaminated with chromated copper arsenate, a known cancer-causing agent, and a dangerous addition to any backyard compost pile. Sawdust from logs can be an



inexpensive and plentiful local resource in forested areas. It should be stored outside where it will remain damp and continue to decompose. Although some think sawdust will make soil acidic, a comprehensive study between 1949 and 1954 by the Connecticut Experiment Station showed no instance of sawdust doing so.

Source: Rodale, The Complete Book of Composting, 1960, p. 192.

Source: *The Humanure Handbook*. Jenkins Publishing, PO Box 607, Grove City, PA 16127. To order, phone: 1-800-639-4099.

<http://www.jenkinspublishing.com/>

MENU: [HOME](#) » [Reconstruction](#) » [Recovery](#) » [Renewal](#) » [Survival](#) » [Humanure Content](#)

ANALYSES

After nearly 14 years of composting all of my family's and visitors' humanure on the same spot about 50 feet from my garden, and using all of the finished compost to grow the food in our single garden, I analyzed my garden soil, my yard soil (for comparison), and my compost, each for fertility and pH, using LaMotte test kits from the local university.¹ I also sent samples of my feces to a local hospital lab to be analyzed for indicator parasitic ova or worms.

The humanure compost proved to be adequate in nitrogen (N), and rich in phosphorus (P), and potassium (K), and higher than either the garden or the yard soil in these constituents as well as in various beneficial minerals. The pH of the compost was 7.4 (slightly alkaline), and no lime or wood ashes had been added during the composting process. This is one reason why I don't recommend adding lime (which raises the pH) to a compost pile. A finished compost would ideally have a pH around, or slightly above, 7 (neutral).

The garden soil was slightly lower in nutrients (N, P, K) than the compost, and the pH was also slightly lower at 7.2. I had added lime and wood ashes to my garden soil over the years, which may explain why it was slightly alkaline. The garden soil, however, was still significantly higher in nutrients and pH than the yard soil (pH of 6.2), which remained generally poor.

My stool sample was free of pathogenic ova or parasites. I used my own stool for analysis purposes because I had been exposed to the compost system and the garden soil longer than anyone else in my family by a number of years. I had freely handled the compost, with bare hands, year after year, with no reservations (my garden is mostly hand-worked). I repeated the stool analysis a year later (after 15 years of exposure) again with negative results (no ova or parasites observed). Hundreds of people had used my compost toilet over the years, prior to these tests.

These results indicate that humanure compost is a good soil builder, and that no intestinal parasites were transmitted from the compost to the compost handler. This wasn't a laboratory experiment; it was a real life situation conducted over a period of 15 years. The whole process, for me, has been quite successful.



Adequately aged, thermophilically composted humanure is a pleasant-smelling, hygienic material. It can be freely handled and used as mulch in a food garden. The author's asparagus bed is shown here getting its 17th annual spring mulching.

Another five years have passed since I did those analyses, and over the entire 20 year period, all of the humanure compost my family has produced has been used in our food garden (see color photos following this chapter). We have raised a lot of food with that compost, and a crop of lovely and healthy children with that food.

One person commented that the Ova & Parasite lab analyses I had done at the local hospital were pointless. They didn't prove anything, or so the contention went, because there may not have been any contamination by intestinal parasites in the compost to begin with. If, after fifteen years and literally hundreds of users, no contaminants made their way into my compost, then why do people worry about them so much? Perhaps this proves that the fears are grossly overblown. The point is that my compost has not created any health problems for me or my family, and that's a very important point, one that the fecophobes should take note of.

Source: The Humanure Handbook. Jenkins Publishing, PO Box 607, Grove City, PA 16127. To order, phone: 1-800-639-4099.

<http://www.jenkinspublishing.com/>

MENU: [HOME](#) » [Reconstruction](#) » [Recovery](#) » [Renewal](#) » [Survival](#) » [Humanure Content](#)

MENU: [HOME](#) » [Reconstruction](#) » [Recovery](#) » [Renewal](#) » [Survival](#) » [Humanure Content](#)

MONITORING COMPOST TEMPERATURE

ANOTHER TIP FROM MR. TURDLEY



THE SECRET OF COMPOSTING HUMANURE IS TO KEEP IT COVERED

Always thoroughly cover toilet deposits with a clean, organic cover material such as rotting sawdust, peat moss, leaf mould, rice hulls, or other suitable material to prevent odor, absorb urine, and balance the nitrogen. Always cover toilet deposits again, after adding them to the compost pile, with a clean cover material such as hay, straw, weeds, grass clippings, leaves, or other suitable material in order to prevent odors and flies, to create air spaces in the compost pile, and to balance the nitrogen. Such cover materials also add a blend of organic materials to the compost, and the variety supports a healthier microbial population.

Figure 8.7 shows the rise in temperature of humanure compost piles (feces, urine, and food scraps) which had been frozen all winter. The compost consisted primarily of deposits from the sawdust toilet, which contained raw hardwood sawdust (just enough to cover the material in the toilet), humanure including urine, and toilet paper. In addition to this material, kitchen food scraps were added to the pile intermittently throughout the winter, and hay was used to cover the toilet deposits on the pile. Some weeds and leaves were added now and then.

The material was continuously collected over a period of about four months from a family of four, and added to an existing compost pile. Nothing special was done to the pile at any time. No unusual ingredients were added, no compost starters, no water, no animal manures other than human (although a little chicken manure was added to the pile charted on the right, which may explain the higher composting temperatures). No turning was done whatsoever. The compost piles were situated in a three-sided, open-topped wooden bin on bare soil, outdoors. The only imported materials (not from the home) were sawdust, a locally abundant resource, and hay from a neighboring farm (less than two bales were used during the entire winter).

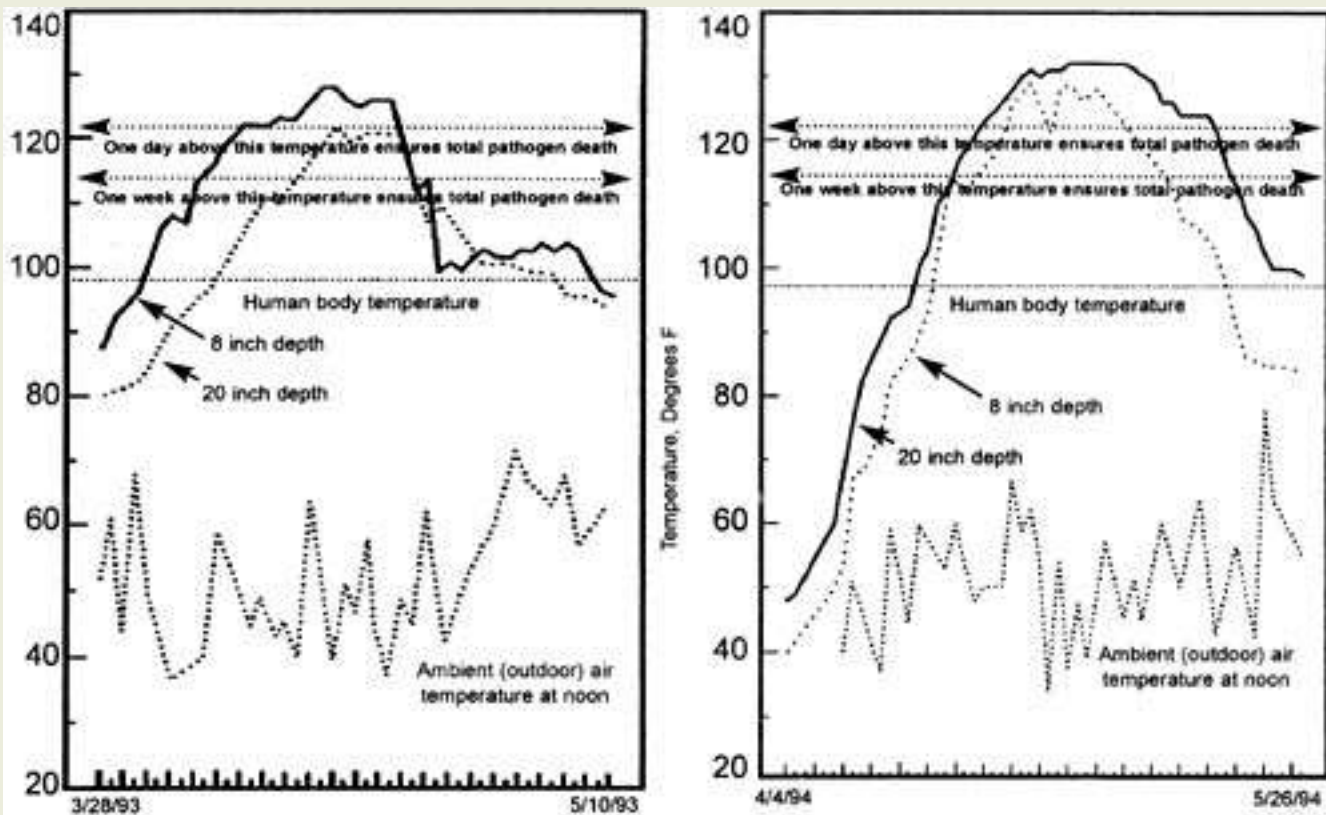

Graph A: Days 3/28/93 to 5/10/93

Figure 8.7

Graph B: Days 4/4/94 to 5/26/94

TEMPERATURE CURVE OF HUMANURE COMPOST PILES AFTER SPRING THAW

The above compost piles were situated outdoors, in wooden bins, on bare soil. The compost was unturned and no compost starters were used. Ingredients included humanure, urine, food scraps, hay, weeds, leaves, and some chicken manure (on right). The compost was frozen solid, but exhibited the above temperature climb after thawing. Fresh material was added to the compost pile regularly while these temperatures were being recorded on unmoved thermometers. The hot area of the compost pile remained in the upper section of the compost as the pile continued to be built during the following summer. In the fall, the compost cooled down, finally freezing and becoming dormant until the following spring. It is imperative that humanure compost rise above the temperature of the human body for an extended period of time. This is the "fever effect," which is necessary to destroy pathogens. A temperature exceeding 120°F for at least one day is preferred, although lower temperatures for longer periods can be effective (see Chapter 7). The heating of the compost should be followed by a lengthy curing period (at least a year).



“Thank you for a wonderful book on a subject where little information is available. We started using our ‘system’ the day after receiving your book. It took about two hours to put together. I wish that more problems that at first seemed complicated and expensive could be solved as simply as this one has with your help.” J.F. in NY

From a Christmas letter to friends and relatives:

“I am sorry to say that the solar toilet...never got off the ground. The plans from the book were sketchy and we weren’t able to get it to work. It’s sitting in the back of the property covered and waiting to be converted into a solar oven. But luckily we read another book [Humanure Handbook] which had an even better method suited for our household. With minimal fuss and expense we set up the system, and it’s working great.” J.S. in CA

Two thermometers were used to monitor the temperature of this compost, one having an 8” probe, the other having a 20” probe. The outside of the pile (8” depth) shown on Graph A was heated by thermophilic activity before the inside (20” depth). The outside thawed first, so it started to heat first. Soon thereafter, the inside thawed and also heated. By April 8th, the outer part of the pile had reached 50°C (122°F) and the temperature remained at that level or above until April 22nd (a two-week period). The inside of the pile reached 122°F on April 16th, over a week later than the outside, and remained there or above until April 23rd. The data suggest that the entire pile was at or above 122°F for a period of eight days before starting to cool. The pile shown in Graph B was above 122°C for 25 days.

According to Dr. T. Gibson, Head of the Department of Agricultural Biology at the Edinburgh and East of Scotland College of Agriculture, “All the evidence shows that a few hours at 120 degrees Fahrenheit would eliminate [pathogenic microorganisms] completely. There should be a wide margin of safety if that temperature were maintained for 24 hours.” [2](#)

The significance of the previous graphs is that they show that the humanure compost required no coaxing to heat up sufficiently to be rendered hygienically safe. It just did it on its own, having been provided the simple requirements a compost pile needs.



“The one alteration I’m going to make to the potty pictured in your book is a hinged door on the front and an attachable wagon handle, and, of course, large wheels on a shallow box the bucket rests in. That’s only because I’m older (55), small and have arthritis. I can’t pick up five gallons of anything wet and heavy. I could empty the bucket on a daily basis, but I don’t know if that’s a good idea or if it would screw up the working of the compost pile [author’s note: it wouldn’t]. Thank you for taking on the work and expense of sharing your experience with those of us who want to leave small or no footprints on our Mother Earth. (P.S. My children will be horrified! No doubt they will choose to stay at a motel and eat at restaurants.)” C.M. in AZ

THE SAWDUST TOILET ON CAMPING TRIPS

Humanure composters have tricks up their sleeves. Ever go on a week-long camping trip or to a camping music festival and hate using those awful portable chemical toilets that stink? If you have a humanure compost bin at home, simply take two five gallon buckets with you on the trip. Fill one with a cover material, such as rotted sawdust, and put a lid on it. Set it inside the empty bucket and pack it along with your other camping gear. Voila! One portable composting toilet! When you set up your camp, string up a tarp for privacy and set the two containers in the private space. Use the empty container as a toilet, and use the cover material to keep it covered. Place a lid on it when not in use. No standing in line, no odors, no chemicals, no pollution. This toilet will last several days for two people. When you leave the camp, take the “soil nutrients” home with you and add them to your compost pile. You will probably be the only campers there who didn’t leave anything behind, a little detail that you can be proud of. And the organic material you collected will add another tomato plant or blueberry bush to your garden. You can improve on this system by taking a toilet seat that clamps on a five gallon bucket, or even taking along a home-made toilet box with seat (as shown in Figures 8.3 and 8.4).

A SIMPLE URINAL

Want to collect urine only? Maybe you want a urinal in a private office, bedroom, or shop. Simply fill a five gallon bucket with rotted sawdust or other suitable material, and put a tight lid on it. A bucket full of sawdust will still have enough air space in it to hold about a week’s worth of urine from one adult. Urinate into the bucket, and replace the lid when not in use. For a fancy urinal, place the sawdust bucket in a toilet cabinet such as illustrated in Figures 8.1, 8.2, 8.3, and 8.4. When the bucket is full, deposit it on your compost pile. The sawdust inhibits odors, and balances the nitrogen in the urine. It sure beats the frequent trips to a central toilet that coffee drinkers are inclined to

make, and no “soil nutrients” are going to waste down a drain.



WHY NOT PLACE THE COMPOST BINS DIRECTLY UNDERNEATH THE TOILET?

The thought of carrying buckets of humanure to a compost bin can deter even the most dedicated recycler. What if you could situate your toilet directly over your compost bins? Here's some reader feedback:

"I finally write back to you after 2 1/2 years of excitingly successful and inspiring use of humanure methods applied to a 'direct shitter' compost. We indeed built a beautiful humanure receptacle 10 feet long, 4 feet high and 5 feet wide, divided into two chambers. One chamber was used (sawdust after every shit, frequent green grass and regular dry hay applications) from May 1996 until June 1997, then

nailed shut. We moved to the second chamber until June 1998 — when with excitement mounting, we unscrewed the boards at the back of the “Temple of Turds” (our local appellation) and sniffed the aroma...of the most gorgeous, chocolate brownie, crumbly compost ever SEEN. Yes, I thrust my hands fully into the heavenly honey pot of sweet soil, which soon thereafter graced the foundations of our new raspberry bed. Needless to say, the resulting berries knew no equal. Humanure and the potential for large-scale . . . even a city size composting collection (apartment building toilets into a central collection dumpster), along with the crimes of the so-called “septic system,” has become one of my most favored topics of conversation and promotion. Often through direct exposition at our farm. Many thanks for your noble work of art and contribution to this stinky species of ape.” R.T. in CT



MORE ON INSTALLING THE COMPOST BINS UNDER YOUR HOUSE

The **Straw Bale House** in Ship Harbor, Nova Scotia, Canada, built in 1993, employed an outhouse until 1998 when a composting toilet was built. The toilet allowed for the direct depositing of humanure into compost chambers underneath the house. Designer/builder Kim Thompson provides feedback:

“Having heard and experienced mixed success with commercial composting toilets, it was exciting to read the Humanure Handbook and

have systems detailed which reinforced ideas that had only existed with me intuitively before. I did a lot of research on the subject, but as far as I could make out, the indoor system I wanted to try hadn't been done before. After several phone conversations with Joe Jenkins, his encouragement, and a sharing of plans, I went ahead with the project. Two concrete chambers, three feet high by five feet square, with four inch thick walls, were built on a six inch gravel base with a French drain, underneath the house. In the bathroom above, a wooden box was fitted with a standard toilet seat as

well as a compartment for sawdust storage. All kitchen scraps, straw, and some garden compost were added regularly to the compost chambers, as well as the sawdust cover material. Red wiggler worms were added as well. Two and a half residents used the toilet, and the first chamber filled in six months.

Because there wasn't a good starter base of organic material, and because there was no drain (one was added later), the compost was, for many months, a sloppy, ineffectual mess. I now recommend layering the following materials in a composting chamber before it is used: one foot of straw, six inches of sawdust, a couple buckets of compost as a starter, one foot of leaf compost, and three inches of sawdust (or something like that depending on availability of local resources). Be sure to include a drainage system from the chambers to prevent a build-up of urine.

Make sure there are screens over the access doors to the chambers which can be easily removed, as easy access to the chambers makes it more likely that they will be maintained and monitored regularly. In a northern climate the chambers need to be constructed in such a way as to insure that they won't heave with the frost. It is important to insulate the chambers during the winter months to optimize conditions for thermophilic activity.

The learning curve on how to maintain and use the system efficiently has been steep. It is like learning how to make bread, easy when you know how. Smell has been the biggest problem so far. We have tried three different ways of venting and find that it still smells on occasion. Venting is currently done through a stove-pipe flue. I intend to install a small photovoltaic fan that will either draw air into the stove-pipe or directly outside through a vent. I injured myself over the winter and found that maintenance of the composting toilet system for a single person with a disability was difficult, especially hauling the bags of frozen sawdust cover material into the storage area. I had thought that establishing thermophilic activity in the second chamber over the winter months would be difficult, but a couple buckets of compost from the first chamber activated the new chamber almost immediately. The draft created by the toilet seat hole while in use, especially in the winter, has been variously described. A simple way of sealing the seat when not in use needs to be developed. We have been using a piece of polystyrene foam with a handle which sits in the box under the seat. It works, but isn't elegant.

I love the fact that I don't have to deal with a septic system and that the compost produced will help feed my family. The composting toilet complements well my work with low impact, natural building systems. Many people who contact Straw Bale Projects about construction are also interested in the compost toilet alternative."

For more information contact Kim Thompson, Straw Bale Projects, 13183 Hwy #7, Ship Harbor, NS
Canada B0J 1Y0; EMail: <mailto:shipharbor@ns.sympatico.ca>

<http://www.jenkinspublishing.com/>

MENU: [HOME](#) » [Reconstruction](#) » [Recovery](#) » [Renewal](#) » [Survival](#) » [Humanure Content](#)

MENU: [HOME](#) » [Reconstruction](#) » [Recovery](#) » [Renewal](#) » [Survival](#) » [Humanure Content](#)

FECOFRIGGINFOBIA

There seems to be an irrational fear among fecophobes that if you don't die instantly from humanure compost, you'll die a slow, miserable, and wretched death, or you'll surely cause an epidemic of something like the plague and everyone within 200 miles of you will die, or you'll become so infested with parasitic worms that you'll no longer be recognized as human (your head will look like spaghetti).

These fears exist perhaps because much of the information in print concerning the recycling of humanure is confusing, erroneous, or incomplete. For example, when researching the literature during the preparation of this book, I found it surprising that almost no mention is ever made of the thermophilic composting of humanure as a viable alternative to other forms of on-site sanitation. When "bucket" systems are mentioned, they are also called "cartage" systems, and are universally decried as being the least desirable sanitation alternative. For example, in *A Guide to the Development of On-Site Sanitation* by Franceys et al., published by the World Health Organization in 1992, "bucket latrines" are described as "*malodorous, creating a fly nuisance, a danger to the health of those who collect or use the nightsoil, and the collection is environmentally and physically undesirable.*" This sentiment is echoed in Rybczynski's (et al.) World Bank funded work on low-cost sanitation options, where it is stated that "*the limitations of the bucket latrine include the frequent collection visits required to empty the small container of [humanure], as well as the difficulty of restricting the passage of flies and odors from the bucket.*"

YET ANOTHER TIP FROM THE INFAMOUS MR. TURDLEY

PRESSURE TREATED LUMBER SHOULD NEVER BE USED TO MAKE COMPOST BINS

Or for anything else, either, when the lumber is soaked with chromated copper arsenate. CCA saturated lumber would be more appropriately called "cancer-soaked" lumber rather than euphemistically referred to as "pressure treated."

Both arsenic and chromium have been classified as human



carcinogens (causing cancer) and are suspected mutagens (causing mutations). The poisons in cancer-soaked lumber are widely documented to leach into the soil and rub off onto skin and clothing.

Such material has no place in organic gardens or compost bins. You can't even safely burn cancer-soaked lumber to get rid of it — it produces highly toxic fumes and ash. Be very careful when getting sawdust from a lumber yard. It may contain highly toxic cancer-soaked sawdust!

I've personally used a sawdust toilet for 20 years and it has never caused odor problems, fly problems, health problems, or environmental problems. Quite the contrary, it has actually *enhanced* my health, the health of my family, and the health of my environment by producing healthy, organic food in my garden, and by keeping human waste out of the water table. Nevertheless, Franceys et al. go on to say that “[humanure] collection should never be considered as an option for sanitation improvement programmes, and all existing bucket latrines should be replaced as soon as possible.” Say what?

Obviously Franceys et al. are referring to the practice of collecting humanure in buckets without a cover material (which would surely stink to high heaven and attract flies) and without any intention of composting the humanure. Such buckets of feces and urine are presumably dumped raw into the environment. Naturally, such a practice should be decried and strongly discouraged, if not outlawed. However, rather than forcing people who use such crude waste disposal methods to switch to other more prohibitively costly waste disposal methods, perhaps it would be better to educate those people about *resource recovery*, about the *human nutrient cycle*, and about *thermophilic composting*. It would be more constructive to help them acquire adequate and appropriate *cover materials* for their toilets, assist them in constructing compost bins, and thereby eliminate waste, pollution, odor, flies, and health hazards altogether. I find it inconceivable that intelligent, educated scientists who observe bucket latrines and the odors and flies associated with them do not see that the simple addition of a clean organic cover material to the system would solve the aforementioned problems, and balance the nitrogen of the humanure with carbon.

Franceys et al. state, however, in their aforementioned book, that “*apart from storage in double pit latrines, the most appropriate treatment for on-site sanitation is composting.*” I would agree that composting, when done properly, is the most appropriate method of on-site sanitation available to humans. I would not agree that double pit storage is more appropriate than thermophilic composting unless it could be proven that all human pathogens could be destroyed using such a double pit system,

and that such a system would produce no unpleasant odor, and would not require the segregation of urine from feces. According to Rybczynski, the double pit latrine shows a reduction of *Ascaris* ova of 85% after two months, a statistic which does not impress me. When my compost is finished, I don't want *any* pathogens in it.

Ironically, the work of Franceys et al. further illustrates a “decision tree for selection of sanitation” that indicates the use of a “compost latrine” as being one of the least desirable sanitation methods, and one which can only be used if the user is willing to collect urine separately. Unfortunately, contemporary professional literature is rife with this sort of inconsistent and incomplete information which would surely lead a reader to believe that composting humanure just isn't worth the trouble.

On the other hand, Hugh Flatt, who, I would guess, is a practitioner and not a scientist, in *Practical Self-Sufficiency* tells of a sawdust toilet system he had used for decades. He lived on a farm for more than 30 years which made use of “bucket lavatories.” The lavatories serviced a number of visitors during the year and often two families in the farmhouse, but they used no chemicals. They used sawdust, which Mr. Flatt described as “absorbent and sweet-smelling.” The deciduous sawdust was added after each use of the toilet, and the toilet was emptied on the compost pile daily. The compost heap was located on a soil base, the deposits were covered each time they were added to the heap, and kitchen refuse was added to the pile (as was straw). The result was “*a fresh-smelling, friable, biologically active compost ready to be spread on the garden.*” ³



From a Public Radio Commentary

“People are saying that the Year 2000 computer problem could foul up a lot of stuff we usually depend on, all at once. I thought I'd give this Y2K Practice Day a try. Turn off the heat, lights, water and phones. Just for 24 hours. The day before Practice Day, I complained to Larry, telling him that I was bitterly disappointed not to try out an emergency toilet. This complaining really paid off. Larry, who's also a writer researching Year 2000 emergency preparedness, phoned a man named Joe Jenkins, author of a book called the Humanure Handbook. Joe reassured my husband of the safe, sanitary, and uncomplicated

method for composting human waste. His solution is based on 20 years of scholarly study. It turns out that the thermophilic bacteria in human waste, when mixed with organic material like peat moss or sawdust, creates temperatures over 120 degrees Fahrenheit, rapidly killing pathogens just as Mother Nature intended.

We grew bold and daring and decided to use our emergency five gallon bucket with the toilet seat, layering everything with peat moss. Larry spent maybe a half hour building a special compost bin. This was right up his alley, since he already composts all the kitchen scraps, yard, and dog wastes.

Surprisingly, I found myself liking that little toilet. It was comfortable, clean, with no odor, just a slightly earthy smell of peat moss. The soul-searching came when I contemplated going back to the flush toilet.

By coincidence, I recently heard a presentation by the director of the local waste treatment facility. He was asked to address the issue of Year 2000 disruptions and explain what preparations were being made. In a matter-of-fact voice, he described what a visitor from another planet would undoubtedly consider a barbaric custom. First, we defecate and urinate in our own clean drinking water. In our town, we have 800 miles of sewers that pipe this effluent to a treatment facility where they remove what are euphemistically called solids. Then they do a bunch more stuff to the water, I forget exactly what. But I do remember that at one point, they dose it with a potent poison — chlorine, of course — and then they do their best to remove the chlorine. When all this is done, the liquid gushes into the Spokane River.

At this meeting was a man named Keith who lives on the shores of Long Lake, down river from us. Keith was quite interested to know what might occur if our sewage treatment process was interrupted. The waste treatment official assured him that all would be well, but I couldn't help reflecting that Keith might end up drinking water that we had been flushing. I like Keith. So I decided to keep on using my camp toilet.

My husband is a passionate organic gardener, at his happiest with a shovel in his hand, and he's already coveting the new compost. He's even wondering if the neighbors might consider making a contribution. I'm just grateful the kids are grown and moved out, because they'd have a thing or two to say."

Judy Laddon in WA (excerpted with permission)

Perhaps the "experts" will one day understand, accept, and advocate simple humanure composting techniques such as the sawdust toilet. However, we may have to wait until Composting 101 is taught at the university, which may occur shortly after hell freezes over.

In the meantime, those of us who use simple humanure composting methods must view the comments of today's so-called experts with a mixture of amusement and chagrin. Consider, for example, the following comments posted on the World Wide Web by an "expert." A reader posted a query on a compost toilet forum website wondering if anyone had any scientific criticism about the above mentioned sawdust toilet system. The expert replied that he was about to publish a new book on composting toilets, and he offered the following excerpt:

"Warning: Though powerfully appealing in its logic and simplicity, I'd expect this system to have an especially large spread between its theoretical and its practical effectiveness. If you don't have a consistent track record of maintaining high temperatures in quick compost piles, I'd counsel against using this system. Even among gardeners, only a small minority assemble compost piles which consistently attain the necessary high temperatures . . . Health issues I'd be concerned about are 1) bugs and small critters fleeing the high-temperature areas of the pile and carrying a coat of pathogen laden feces out of the pile with them; 2) large critters (dog, raccoons, rats . . .) raiding the pile for food and tracking raw waste away; and 3) the inevitable direct exposure from carrying, emptying, and washing buckets.

Some clever and open-minded folk have hit on the inspiration of composting feces . . . by adding them to their compost piles! What a revolutionary concept! . . . Sound too good to

be true? Well, in theory it is true, though in practice I believe that few folks would pass all the little hurdles along the way to realizing these benefits. Not because any part of it is so difficult, just that, well, if you never ate sugar and brushed and flossed after every meal, you won't get cavities either.”⁴

Sound a bit cynical? The above comments are entirely lacking in scientific merit, and expose an “expert” who has no experience whatsoever about the subject on which he is commenting. It is disheartening that such opinions would actually be published, but not surprising. The writer hits upon certain knee-jerk fears of fecophobes. His comment on bugs and critters fleeing the compost pile coated with pathogen-laden feces is a perfect example. It would presumably be a bad idea to inform this fellow that fecal material is a product of his body, and that if it is laden with pathogens, he’s in very bad shape. Furthermore, there is some fecal material probably inside him at any given moment. Imagine that — pathogen-infested fecal material brimming with disease-causing organisms actually sitting in the man’s bowels. How can he survive?

When one lives with a humanure composting system for an extended period of time, one understands that fecal material comes from one’s body, and exists inside oneself at all times. With such an understanding, it would be hard to be fearful of one’s own humanure, and impossible to see it as a substance brimming with disease organisms, unless, of course, one is diseased.

The writer hits upon another irrational fear — large animals, including rats, invading a compost pile and spreading disease all over creation. Compost bins are easily built to be animal-proof. If animals are a problem, the problem can be remedied by lining a compost bin with chicken wire, or surrounding the compost with pallets, straw bales, or similar barriers. In 20 years of humanure composting, we have never had a problem with animals, have never seen a rat in our compost, and our compost bins are not wire-lined. We have had dozens of skunks, possums, and raccoons in our chicken house, but never in our compost pile 50 feet away. It seems that the thermophilic composting process itself makes the organic material undesirable for larger animals, including dogs.

The writer warns that most gardeners do not have thermophilic compost. Most gardeners also leave critical ingredients out of their compost, thanks to the fear-mongering of the ill-informed. Those ingredients are humanure and urine, which are quite likely to make one’s compost thermophilic. Commercial composting toilets almost never become thermophilic. Does the author also condemn those? As we have seen, it is not only the temperature of the compost that destroys pathogens, it is retention time. The sawdust toilet compost pile requires a year’s construction time, and another year’s undisturbed retention time. When a thermophilic phase is added to this process, I would challenge anyone to come up with a more effective, earth-friendly, simpler, low-cost system for pathogen destruction.

Finally, the writer warns of “the inevitable direct exposure from carrying, emptying and washing buckets.” I’m not sure what he’s getting at here, as I have carried, emptied, and washed buckets for 20 years and never had a problem.



“We’ve been joyfully composting for some time already, and adding our humanure since this spring. Your book was immensely informative, helping to dispel some of those culturally imposed myths of fecophobia! Please know that the book is being eagerly passed about and many of our friends have also begun composting humanure, too! Again, thank you for all the years and time you and your family have spent experimenting and actively composting! Your work has been a great asset to our path of a simpler, sustainable and self-reliant lifestyle. We believe we are the keys to changing the dominant paradigm and healing the Earth. Thank you, thank you for the book!” B.C. and J.S. in AK

Other recent experts have thrown in their two cents worth on the sawdust toilet. A book on composting toilets (also about to be published as I write this), mentions the sawdust toilet system.⁵ Although the comments are not at all cynical and are meant to be informative, a bit of misinformation manages to come through. For example, the suggestion to use “rubber gloves and perhaps a transparent face mask so you do not get anything splashed on you” when emptying a compost bucket onto a compost pile, caused groans, a lot of eyes to roll, and a few giggles when read aloud to seasoned humanure composters. Why not just wear an EPA approved moon suit and carry the compost bucket at the end of a ten-foot pole? How is it that what has just emerged from one’s body can be considered so utterly toxic? More exaggeration and misinformation existed in the book regarding temperature levels and compost bin techniques. One warning to “bury finished compost in a shallow hole or trench around the roots of non-edible plants,” was classic fecophobia. Apparently, humanure compost is to be banned from human food production, never mind the human nutrient cycle. The authors recommended that humanure compost be composted again in a non-humanure compost pile, or micro-waved for pasteurization, both bizarre suggestions. They add, “Your health agent and your neighbors may not care for this [sawdust toilet composting] method.”

I have to scratch my head and wonder why the “experts” would say this sort of thing. Apparently, the act of *composting* one’s own humanure is so radical and even revolutionary to the people who have spent their lives trying to *dispose* of the substance, that they can’t quite come to grips with the idea. Ironically, a very simple sawdust toilet used by a physician and his family in Oregon is featured and illustrated in the above book. The physician states, “*There is no offensive odor. We’ve never had a complaint from the neighbors.*” Their sawdust toilet system is also illustrated and posted on the internet, where a brief description sums it up: “*This simple composting toilet system is inexpensive both in construction and to operate and, when properly maintained, aesthetic and hygienic. It is a perfect complement to organic gardening. In many ways, it out-performs complicated systems costing hundreds of times as much.*” Often, knowledge derived from real-life experiences can be diametrically opposed to the speculations of “experts.” Sawdust toilet users find, through *experience*, that such a simple system can work remarkably well.



“My wife and I have just finished reading your handbook and found it an inspiration in our pursuit of alternative living styles. Our system is up and functioning very well for us and already building our future garden bedding. We have discovered a certain level of ‘alienation’ when ‘friends’ have discovered our system. Although not particularly concerned about this ‘friendship purification process,’ we would like to network with other like-minded people to share ideas and experiences. If you have the fortune of knowing anyone using your technique in Eastern Washington-Northern Idaho area, would you please extend to them our invitation of friendship? Thank you for your book and your leadership into the rather solitary world of fecal familiarity.” K.K. and A.K. in WA

“I line the solids bucket with newspapers so that I don’t need to rinse it out.”
A.E. in Australia

What about “health agents”? Health authorities can be misled by misinformation, such as that stated by the above authors. Health authorities, according to my experience, generally know very little, if anything, about thermophilic composting. Many have never even heard of it. The health authorities who have contacted me are very interested in getting more information, and seem very open to the idea of a natural, low-cost, effective, humanure recycling system. They know that human sewage is a dangerous pollutant and a serious environmental problem, and they seem to be surprised and impressed to find out that such sewage can be avoided altogether. Most intelligent people are willing and able to expand their awareness and change their attitudes based upon new information. Therefore, if you are using a sawdust toilet and are having a problem with any authority, please give the authority a copy of this book. I have a standing offer to donate, free of charge, a copy of the *Humanure Handbook* to any permitting agent or health authority, no questions asked, upon anyone’s request — just send a name and address to the publisher at the front of this book.

Well-informed health professionals and environmental authorities are aware that “human waste” presents an environmental dilemma that is not going away.

The problem, on the contrary, is getting worse. Too much water is being polluted by sewage and septic discharges, and there has to be a constructive alternative. Perhaps that is why, when health authorities learn about the thermophilic composting of humanure, they realize that there may very likely be no better solution to the human waste problem. That may be also why I received a letter from the US Department of Health and Human Services praising my book and wanting to know more about humanure composting, or why the US Environmental Protection Agency wrote to me to praise the *Humanure Handbook* and order ten copies (and re-order more later), or why the PA Department of Environmental Protection nominated *Humanure* for a public-awareness environmental award in 1998. Fecophobes think composting humanure is dangerous. I will patiently wait until they come up with a better solution to the problem of “human waste.” I expect there will be a few cold days in hell before that happens.



“Just a note to thank you for sending the gratis copies of Humanure to our local supervisors and health director. A small but significant step forward is shown by the

article on the reverse side and no doubt your book played a part [a newspaper article titled “Law Would Back Waterless Toilets” was copied on the back of the letter]. This victory may not seem like much but, believe me, getting these troglodytes to change their minds on anything is nothing less than a miracle! R.W. in CA

Source: The Humanure Handbook. Jenkins Publishing, PO Box 607, Grove City, PA 16127. To order, phone: 1-800-639-4099.

<http://www.jenkinspublishing.com/>

MENU: [HOME](#) » [Reconstruction](#) » [Recovery](#) » [Renewal](#) » [Survival](#) » [Humanure Content](#)

LEGALITIES

This is an interesting topic. It seems that some people believe that if you do anything differently from the mainstream, it must be illegal. Certainly composting humanure must be illegal. After all, humanure is a dangerous pollutant and must be immediately disposed of in a professional and approved manner. Recycling it is foolish and hazardous to your health and to the health of your community and your environment. At least that's what the fecophobes think. Therefore, recycling humanure can not be an activity that is within the law, can it? Well, yes actually, the backyard composting of humanure is probably quite within the letter of the laws to which you are subjected.

Waste disposal is regulated, and it should be. Waste disposal is potentially very dangerous to the environment. Sewage disposal and recycling are also regulated, and they should be, too. Sewage includes a host of hazardous substances deposited into a waterborne waste stream. People who compost their humanure are neither disposing of waste, nor producing sewage — they are recycling. Furthermore, regarding the regulating of composting itself, both backyard composting and farm composting are exempt from regulations unless the compost is being sold, or unless the farm compost operation is unusually large.

To quote one source, *“The US Department of Environmental Protection (DEP) has established detailed regulations for the production and use of compost created from [organic material]. These regulations exclude compost obtained from backyard composting and normal farming operations. Compost from these activities is exempt from regulation only if it is used on the property where it was composted, as part of the farming operation. Any compost which is sold must meet the requirements of the regulations.”*

[6](#)

Composting toilets are also regulated in some states. However, composting toilets are usually defined as toilets inside which composting takes place. A sawdust toilet, by definition, is *not* a composting toilet because no composting occurs in the toilet itself. The composting occurs in the “backyard” and therefore is not regulated by composting *toilet* laws. Portable toilet laws may apply instead, although the backyard compost exemption will probably allow sawdust toilet users to continue their recycling undisturbed.

A review of composting toilet laws is both interesting and disconcerting. For example, in Maine, it is apparently illegal to put kitchen food scraps down the toilet chute in a commercial composting toilet, even though the food scraps and toilet materials must go to the exact same place in the composting chamber. Such a regulation makes no sense whatsoever. In Massachusetts, finished compost from

composting toilets must be buried under six inches of soil, or hauled away and disposed of by a septage hauler. These laws are apparently written by people who are either lacking in knowledge and understanding, or are fecophobic, or, most likely, all of the above. Such laws can discourage the necessary and important recycling of humanure.

Ideally, laws are made to protect society. Laws requiring septic, waste, and sewage disposal systems are supposedly designed to protect the environment, the health of the citizens, and the water table. This is all to be commended, and conscientiously carried out by those who produce *sewage*, a waste material. If you don't produce sewage, you have no need for a sewage disposal system; laws pertaining to sewage disposal are not your concern. The number of people who produce backyard compost instead of sewage is so minimal, that few, if any, laws have been enacted to regulate the practice. The thermophilic composting of humanure is not a threat to society, it produces no pollution, does not threaten the health of humans, nor contaminate the groundwater or environment. Unfortunately, because this fact is not understood by many people, ignorance remains a problem.

It would be hard to intelligently argue that a person who produces no sewage must have a costly sewage treatment system. What would they do with it? That would be like requiring someone who doesn't own a car to have a garage. And it would be very difficult to prove that composting humanure is threatening to society, especially given the facts as presented in this book. It is much easier to prove that composting humanure is a *benefit* to society. On the other hand, Galileo, the astronomer, was arrested as a heretic and forced to renounce his theory that the Earth revolves around the sun. Yes, that was three hundred years ago, but sometimes it seems like the consciousness of our society as it relates to human manure is still back in the dark ages.

If you're concerned about your local laws, go to the library and see what you can find about regulations concerning backyard compost. Or inquire at your county seat or state agency as statutes, ordinances, and regulations vary from locality to locality. Where I live, septic system permits aren't required for new home construction, but the next county is two properties over and people there are required to have septic system permits before they can build a new dwelling. This is largely due to the fact that the water table tends to be high in my area, and septic systems don't always work, so sand mounds are required by law for sewage disposal. If you don't want to dispose of your manure but want to compost it instead (which will certainly keep it out of the water table, not to mention raise a few eyebrows at the local municipal office), you may have to stand up for your rights.

A reader called from a small state in New England to tell me his story. It seems the man had a sawdust toilet in his house, but the local municipal authorities decided he could only use an "approved" waterless toilet, meaning, in this case, an incinerating toilet. The man did not want an incinerating toilet because the sawdust toilet was working well for him and he liked making and using the compost. So he complained to the authorities, attended township meetings, and put up a fuss. To no avail. After months of "fighting city hall," he gave up and bought a very expensive and "approved" incinerating toilet. When it was delivered to his house, he had the delivery people set it in a back storage room. And that's where it remained, still in the packing box, never opened. The man continued to use his sawdust toilet for years after that. The authorities knew that he had bought the "approved" toilet, and thereafter left him alone.

He never did use it, but the authorities didn't care. He bought the damn thing and had it in his house, and that's what they wanted. Those local authorities obviously weren't rocket scientists.

Another interesting story comes from a fellow in Tennessee. It seems that he bought a house which had a rather crude sewage system — the toilet flushed directly into a creek behind the house. The fellow was smart enough to know this was not good, so he installed a sawdust toilet. However, an unfriendly neighbor assumed he was still using the direct waste dump system, and the neighbor reported him to the authorities. But let him tell it in his own words:

“Greetings from rural Tennessee.

I'm a big fan of your book & our primitive outhouse employs a rotating 5-gallon bucket sawdust shitter that sits inside a 'throne.' Our system is simple & based largely on your book. We transport the poop to a compost pile where we mix the mess with straw & other organic materials. The resident in our cabin before we bought the farm used a flush toilet that sent all sewage directly to a creekbed. An un-informed neighbor complained to the state in 1998, assuming that we used the same system. The state people have visited us several times. We were forced to file a \$100 application for a septic system but the experts agree that our hilly, rocky house site is not suitable for a traditional septic system even if we wanted one. They were concerned about our grey water as well as our composting outhouse. My rudimentary understanding of the law is that the state approves several alternative systems that are very complicated and at least as expensive as a traditional septic. The simple sawdust toilet is not included & the state does not seem to want any civilian to actually transport his own shit from the elimination site to a different decomposition site. The bureaucrats tentatively approved an experimental system where our sewage could feed a person-made aquatic wetlands type thingie & they agreed to help us design & implement that system. Currently, we cannot afford to do that on our own & continue to use our sawdust bucket latrine. The officials seem to want to leave us alone as long as our neighbors don't complain anymore. So, that's a summary of our situation here in Tennessee. I've read most of the state laws on the topic; like most legal texts, they are virtually unreadable. As far as I can tell, our system is not explicitly banned but it is not included in the list of "approved" alternative systems that run the gamut from high-tech, low volume, factory-produced composting gizmos to the old fashioned pit latrine. For a while now, I've wanted to write an article on our experience and your book. Unfortunately, grad school in English has seriously slowed down my freelance writing.”

Cheers, A.S. in Tennessee

Other than the above two situations, I have heard no details from other readers who may have had problems with authorities in relation to their sawdust toilets. Nevertheless, as part of the research for this second edition, I have undertaken a review of US state regulations pertaining to composting toilets, and that information is included in [Appendix 3](#).

In Pennsylvania, the state legislature has enacted legislation “*encouraging the development of resources recovery as a means of managing solid waste, conserving resources, and supplying energy.*” Under such legislation the term “disposal” is defined as “*the incineration, dumping, spilling, leaking, or placing of solid waste into or on the land or water in a manner that the solid waste or a constituent of the solid waste enters the environment, is emitted into the air or is discharged to the waters of the Commonwealth.*” ⁷ Further legislation has been enacted in Pennsylvania stating that “*waste reduction and recycling are preferable to the processing or disposal of municipal waste,*” and further stating “*pollution is the contamination of any air, water, land or other natural resources of this Commonwealth that will create or is likely to create a public nuisance or to render the air, water, land, or other natural resources harmful, detrimental or injurious to public health, safety or welfare. . .*” ⁸ In view of the fact that the thermophilic composting of humanure involves recovering a resource, requires no disposal of waste, and creates no environmental pollution, it is unlikely that anyone who conscientiously engages in such an activity would be unduly bothered by anyone. Don’t be surprised if most people find such an activity commendable, because, in fact, it is.

If there aren’t any regulations concerning backyard compost in your area, then be sure that when you’re making your compost, you’re doing a good job of it. It’s not hard to do it right. The most likely problem you could have is an odor problem, and that would simply be due to not keeping your deposits adequately covered with clean, not-too-airy, organic “biofilter” material. If you keep it covered, it does not give off offensive odors. It’s that simple. Perhaps shit stinks so people will be naturally compelled to cover it with something. That makes sense when you think that thermophilic bacteria are already in the feces waiting for the manure to be layered into a compost pile so they can get to work. Sometimes the simple ways of nature are really profound.

Few people understand that the composting of humanure is a benign method of recycling what would otherwise be a toxic waste material. For that reason, this book is recommended reading for people involved in municipal, county, or township waste treatment or permitting, or resource recovery. So when you’re feeling especially benevolent, buy an extra copy of *Humanure* and give it to your local authority. Anonymously, if necessary.

What about flies — could they create a public nuisance or health hazard? I have never had problems with flies on my compost. Perhaps the compost heats up so fast that flies don’t have a chance to enjoy it. Of course, a clean cover material is kept over the compost pile at all times. Concerning flies, F. H. King, who traveled through China, Korea, and Japan in the early 1900s when organic material, especially humanure, was the only source of soil fertilizer, stated, “*One fact which we do not fully understand is that, wherever we went, house flies were very few. We never spent a summer with so little annoyance from them as this one in China, Korea and Japan. If the scrupulous husbanding of [organic] refuse so universally practiced in these countries reduces the fly nuisance and this menace to health to the extent which our experience suggests, here is one great gain.*” He added, “*We have adverted to the very small number of flies observed anywhere in the course of our travel, but its significance we did not realize until near the end of our stay. Indeed, for some reason, flies were more in evidence during the first two days on the steamship out from Yokohama on our return trip to America, than at any time before on our*

journey.” ⁹

If an entire country the size of the United States, but with twice the population (at that time), could recycle all of its organic refuse without the benefit of electricity or automobiles and not have a fly problem, surely we in the United States can recycle a greater portion of our own organic refuse with similar success today.

Source: The Humanure Handbook. Jenkins Publishing, PO Box 607, Grove City, PA 16127. To order, phone: 1-800-639-4099.

<http://www.jenkinspublishing.com/>

MENU: [HOME](#) » [Reconstruction](#) » [Recovery](#) » [Renewal](#) » [Survival](#) » [Humanure Content](#)

MENU: [HOME](#) » [Reconstruction](#) » [Recovery](#) » [Renewal](#) » [Survival](#) » [Humanure Content](#)

ENVIRONMENTAL POTTY TRAINING 101

Simple, low-tech composting systems not only have a positive impact on the Earth's ecosystems, but are proven to be sustainable. Westerners may think that any system not requiring technology is too primitive to be worthy of respect. However, when western culture is nothing more than a distant and fading memory in the collective mind of humanity thousands (hundreds?) of years from now, the humans who will have learned how to survive on this planet in the long term will be those who have learned how to live in harmony with it. That will require much more than intelligence or technology — it will require a sensitive understanding of our place as humans in the web of life. That self-realization may be beyond the grasp of our egocentric intellects. Perhaps what is required of us in order to gain such an awareness is a sense of humility, and a renewed respect for that which is simple.

Some would argue that a simple system of humanure composting can also be the most advanced system known to humanity. It may be considered the most advanced because it works well while consuming little, if any, non-renewable resources, producing no pollution, and actually creating a resource vital to life.

Others may argue that in order for a system to be considered “advanced,” it must display all the gadgets, doodads and technology normally associated with advancement. The argument is that something is advanced if it's been created by the scientific community, by humans, not by nature. That's like saying the most advanced method of drying one's hair is using a nuclear reaction in a nuclear power plant to produce heat in order to convert water to steam. The steam is then used to turn an electric generator in order to produce electricity. The electricity is used to power a plastic hair-drying gun to blow hot air on one's head. That's *technological* advancement. It reflects humanity's *intellectual* progress . . . (which is debatable).

True advancement, others would argue, instead requires the balanced *development* of humanity's intellect with physical and spiritual development. We must link what we know intellectually with the physical effects of our resultant behavior, and with the understanding of ourselves as small, interdependent, interrelated life forms relative to a greater sphere of existence. Otherwise, we create technology that excessively consumes non-renewable resources and creates toxic waste and pollution in order to do a simple task such as hair drying, which is easily done by hand with a towel. If that's advancement, we're in trouble.

Perhaps we're really advancing ourselves when we can function healthfully, peacefully, and sustainably

without squandering resources and without creating pollution. That's not a matter of mastering the intellect or of mastering the environment with technology, it's a matter of mastering one's self, a much more difficult undertaking, but certainly a worthy goal.

Finally, I don't understand humans. We line up and make a lot of noise about big environmental problems like incinerators, waste dumps, acid rain, global warming, and pollution. But we don't understand that when we add up all the tiny environmental problems each of us creates, we end up with those big environmental dilemmas. Humans are content to blame someone else, like government or corporations, for the messes we create, and yet we each continue doing the same things, day in and day out, that have created the problems. Sure, corporations create pollution. If they do, don't buy their products. If you have to buy their products (gasoline for example), keep it to a minimum. Sure, municipal waste incinerators pollute the air. Stop throwing trash away. Minimize your production of waste. Recycle. Buy food in bulk and avoid packaging waste. Simplify. Turn off your TV. Grow your own food. Make compost. Plant a garden. Be part of the solution, not part of the problem. If you don't, who will?

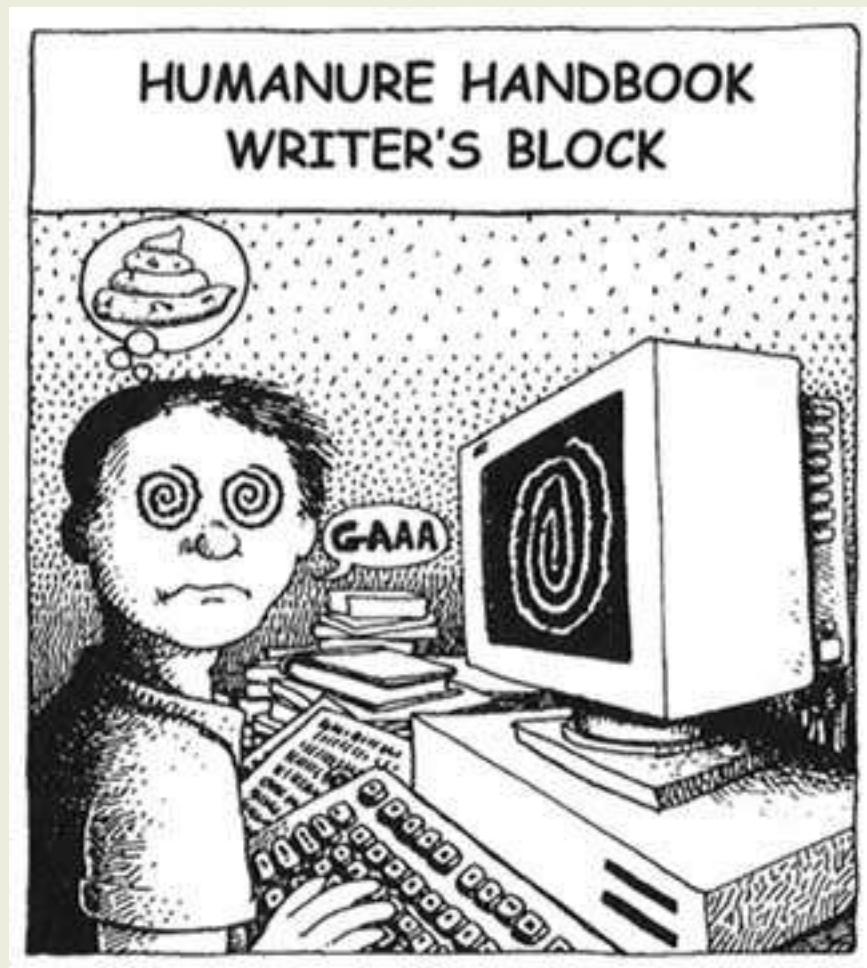

Source: *The Humanure Handbook*. Jenkins Publishing, PO Box 607, Grove City, PA 16127. To order, phone: 1-800-639-4099.

<http://www.jenkinspublishing.com/>

MENU: [HOME](#) » [Reconstruction](#) » [Recovery](#) » [Renewal](#) » [Survival](#) » [Humanure Content](#)

ALTERNATIVE GREY WATER SYSTEMS

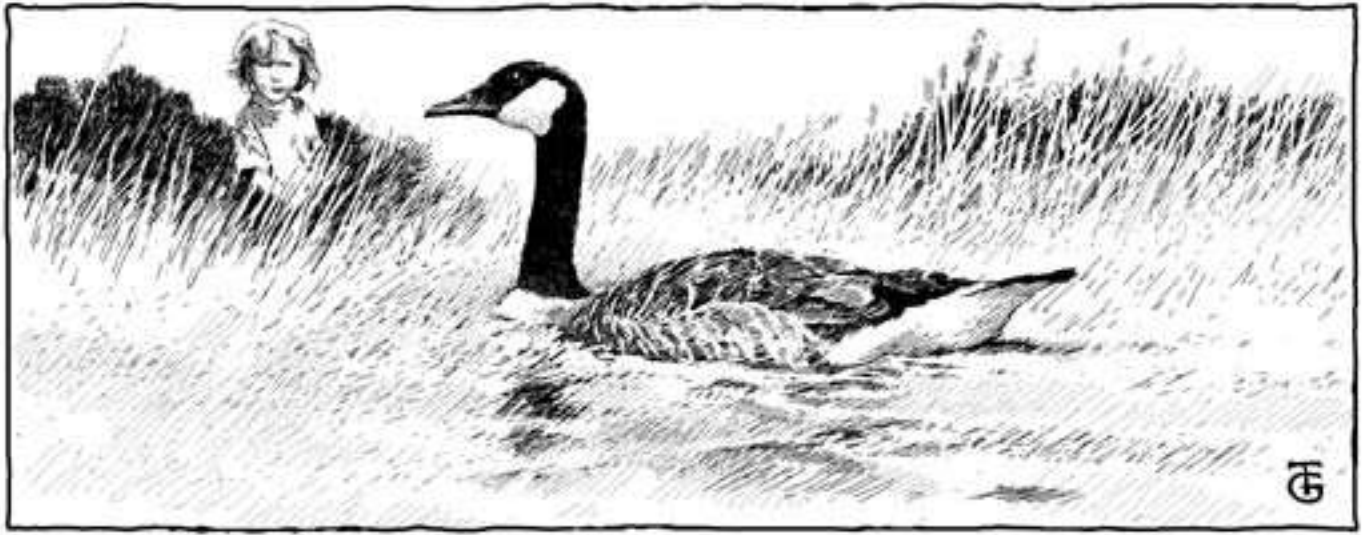

“When dealt with appropriately, graywater is a valuable resource which horticultural and agricultural growers, as well as home gardeners, will increasingly come to appreciate.”

Carl Lindstrom

There are two concepts that sum up this book: 1) one organism’s excretions are another organism’s food, and 2) there is no waste in nature. We humans need to understand what organisms will consume our excretions if we are to live in greater harmony with the natural world. Our excretions include humanure, urine, and *other* organic materials that we discharge into the environment, such as “graywater,” which is the water resulting from washing or bathing. Graywater should be distinguished from “blackwater,” the water that comes from toilets. Graywater contains recyclable organic materials such as nitrogen, phosphorous, and potassium. These materials are pollutants when discarded into the environment. When responsibly recycled, however, they can be beneficial nutrients.

My first exposure to an “alternative” wastewater system occurred on the Yucatan Peninsula of Mexico in 1977. At that time, I was staying in a tent on a primitive, isolated, beach-front property lined with coconut palms and overlooking the turquoise waters and white sands of the Caribbean. My host operated a small restaurant with a rudimentary bathroom containing a toilet, sink, and shower, primarily reserved for tourists who paid to use the room. The wastewater from this room drained from a pipe, through the

wall, and directly into the sandy soil outside, where it ran down an inclined slope out of sight behind the thatched pole building. I first noticed the drain not because of the odor (there wasn't any that I can remember), but because of the thick growth of tomato plants that cascaded down the slope where the drain was located. I asked the owner why he would plant a garden in such an unlikely location, and he replied that he didn't plant it at all — the tomatoes were volunteers; the seeds sprouted from human excretions. He admitted that whenever he needed a tomato, he didn't have to go far to get one. This is not an example of sanitary wastewater recycling, but it is an example of how wastewater can be put to constructive use, even by accident.

From there, I traveled to Guatemala, where I noticed a similar wastewater system, again at a crude restaurant at an isolated location in the Peten jungle. The restaurant's wastewater drain irrigated a small section of the property separate from the camp sites and other human activities, but plainly visible. That section had the most luxurious growth of banana plants I had ever seen. Again, the water proved to be a resource useful in food production, and in this case, the luxurious growth added an aesthetic quality to the property, appearing as a lush tropical garden. The restaurant owner liked to show off his "garden," admitting that it was largely self-planted and self-perpetuating. "That's the value of drain water," he was quick to point out, and its value was immediately apparent to anyone who looked.

All wastewater contains organic materials, such as food remnants and soap. Microorganisms, as well as plants and macroorganisms, consume these organic materials and convert them into beneficial nutrients. In a sustainable system, wastewater is made available to natural organisms for their benefit. Recycling organic materials through living organisms naturally purifies water.

In the US, the situation is quite different. Household wastewater typically contains all the water from toilet flushings (blackwater) as well as water from sink, bathtub, and washing machine drains (graywater). To complicate this, many households have in-sink garbage disposals. These contraptions grind up all of the organic food material that could otherwise be composted, then eject it out into the drain system. Government regulators assume the worst case scenario for household wastewater (lots of toilet flushings, lots of baby diapers in the wash, and lots of garbage in the disposal unit), then they draft regulations to accommodate this scenario. Wastewater is considered a public health hazard which must be quarantined from human contact. Typically, the wastewater is required to go directly into a sewage system, or, in suburban and rural locations, into a septic system.

A septic system generally consists of a concrete box buried underground into which household wastewater is discharged. When the box fills and overflows, the effluent drains into perforated pipes that allow the water to percolate into the soil. The drain field is usually located deep enough in the soil that surface plants cannot access the water supply.

In short, conventional drainage systems isolate wastewater from natural systems, making the organic material in the water unavailable for recycling. At wastewater treatment plants (sewage plants), the organic material in the wastewater is removed using complicated, expensive procedures. Despite the high cost of such separation processes, the organic material removed from the wastewater is often buried in a

landfill.

The alternatives should be obvious. Albert Einstein once remarked that the human race will require an entirely new manner of thinking if it is to survive. I am inclined to agree. Our “waste disposal” systems must be rethought. As an alternative to our current throw-away mentality, we can understand that organic material is a resource, rather than a waste, that can be beneficially recycled using natural processes.

In pursuing this alternative, the first step is to *recycle* as much organic material as possible, keeping it away from waste disposal systems altogether. We can eliminate all blackwater from our drains by composting all human manure and urine. We can also eliminate almost all other organic material from our drains by composting food scraps. As such, one should never use an in-sink garbage disposal. As an indication of how much organic material typically goes down a household drain, consider the words of one composting toilet manufacturer, “*New regulations will soon demand that septic tanks receiving flush toilet and garbage disposal wastes be pumped out and documented by a state certified septage hauler every three years. When toilet and garbage solids and their associated flush water is removed from the septic system, and the septic tank is receiving only graywater, the septic tank needs pumping only every twenty years.*”¹ According to the US EPA, household garbage disposals contribute 850% more organic matter and 777% more suspended solids to wastewater than do toilets.²

The second step is to understand that a drain is not a waste disposal site; it should *never* be used to dump something to “get rid of it.” This has unfortunately become a bad habit for many Americans. As an example, a friend was helping me process some of my home-made wine. The process created five gallons of spent wine as a by-product. When I had my back turned, the fellow dumped the liquid down the sink drain. I found the empty bucket and asked what happened to the liquid that had been in it. “I dumped it down the sink,” he said. I was speechless. Why would anyone dump five gallons of food-derived liquid down a sink drain? But I could see why. My friend considered a drain to be a waste disposal site, as do most Americans. This was compounded by the fact that he had *no idea* what to do with the liquid otherwise. My household effluent drains directly into a constructed wetland which consists of a graywater pond. Because anything that goes down that drain feeds a natural aquatic system, I am quite particular about what enters the system. I keep all organic material out of the system, except for the small amount that inevitably comes from dishwashing and bathing. All food scraps are composted, as are grease, fats, oils, and every other bit of organic food material our household produces (every food item compost educators tell you “not to compost” ends up down a drain or in a landfill otherwise, which is foolish; in our household, it all goes into the compost). This recycling of organic material allows for a relatively clean graywater that can be easily remediated by a constructed wetland, soilbed, or irrigation trench. The thought of dumping something down my drain simply to dispose of it just doesn’t fit into my way of thinking. So I instructed my friend to pour any remaining organic liquids onto the compost pile. Which he did. I might add that this was in the middle of January when things were quite frozen, but the compost pile still absorbed the spent wine. In fact, that winter was the first one in which the active compost pile did not freeze. Apparently, the 30 gallons of liquid we doused it with kept it active enough to generate heat all winter long.

Step three is to eliminate the use of all toxic chemicals and non-biodegradable soaps in one’s household.

Chemicals could find their way down the drains and out into the environment as pollutants. The quantity and variety of toxic chemicals routinely dumped down drains in the US is both incredible and disturbing. We can eliminate a lot of our wastewater problems by simply being careful what we add to our water. Many Americans do not realize that most of the chemicals they use in their daily lives and believe to be necessary are not necessary at all. They can simply be eliminated. This is a fact that will not be promoted on TV or by the government (including schools), because the chemical industry might object. I am quite sure that you, the reader, don't care whether the chemical industry objects or not. Therefore, you willingly make the small effort necessary to find environmentally benign cleaning agents for home use.

Cleaning products that contain boron should not be used with graywater recycling systems because boron is reportedly toxic to most plants. Liquid detergents are better than powdered detergents because they contribute less salts to the system.³ Water softeners may not be good for graywater recycling systems because softened water reportedly contains more sodium than unsoftened water, and the sodium may build up in the soil, to its detriment. Chlorine bleach or detergents containing chlorine should not be used, as chlorine is a potent poison. Drain cleaners, and products that clean porcelain without scrubbing should not be drained into a graywater recycling system.

Step four is to reduce our water consumption altogether, thereby reducing the amount of water issuing from our drains. This can be aided by collecting and using rainwater, and by recycling graywater through beneficial, natural systems.

The "old school" of wastewater treatment, still embraced by most government regulators and many academics, considers water to be a vehicle for the routine transfer of waste from one place to another. It also considers the accompanying organic material to be of little or no value. The "new school," on the other hand, sees water as a dwindling, precious resource that should not be polluted with waste; organic materials are seen as resources that should be constructively recycled. My research for this chapter included reviewing hundreds of research papers on alternative wastewater systems. I was amazed at the incredible amount of time and money that has gone into studying how to clean the water we have polluted with human excrement. In all of the research papers, without exception, the idea that we should simply stop defecating in water is never suggested.

The change from a water polluting, waste-disposal way of life to an environmentally benign, resource-recovery way of life will not occur from the "top down." Many government authorities and scientists take our wasteful, polluting way of life for granted, and even defend it. Those of us who are courageous enough to be different and who insist upon environmentally friendly lifestyles represent the first wave in the emerging lifestyle changes which we must all inevitably embrace. As our numbers increase, our cumulative impact will become more and more significant.

GRAYWATER

"The question of residential water conservation is not one of whether it will occur, but rather a question of how rapidly it will occur."

It is estimated that 42 to 79% of household graywater comes from the bathtub and shower, 5 to 23% from laundry facilities, 10 to 17% from the kitchen sink or dishwasher, and 5 to 6% from the bathroom sink. [By comparison, the flushing of toilets (creating blackwater) constitutes 38 to 45% of all interior water use in the US, and is the single largest use of water indoors. On average, a person flushes a toilet six times a day.^{6]}

Various studies have indicated that the amount of graywater generated per person per day varies from 25 to 45 gallons (96 to 172 liters), or 719 to 1,272 gallons (2,688 to 4,816 liters) per week for a typical family of four.⁴ In California, a family of four may produce 1300 gallons of graywater in a week.⁵ This amounts to nearly a 55 gallon drum filled with sink and bath water by every person every day, which is then drained into a septic or sewage system. This estimate does not include toilet water. Ironically, the graywater we dispose of can still be useful for such purposes as yard, garden, and greenhouse irrigation. Instead, we dump the graywater into the sewers and use drinking water to irrigate our lawns.

Reuse of graywater for landscape irrigation can greatly reduce the amount of drinkable water used during the summer months when landscape water may constitute 50-80% of the water used at a typical home. Even in an arid region, a three person household can generate enough graywater to meet all of their irrigation needs.⁷ In Tucson, Arizona, for example, a typical family of three uses 123,400 gallons of municipal water per year.⁸ It is estimated that 31 gallons of graywater can be collected per person, per day, amounting to almost 34,000 gallons of graywater per year for the same family.⁹ An experimental home in Tucson, known as Casa del Aqua, reduced its municipal water use by 66% by recycling graywater and collecting rainwater. Graywater recycling amounted to 28,200 gallons per year, and rainwater collection amounted to 7,400 gallons per year.¹⁰ In effect, recycled graywater constitutes a “new” water supply by allowing water that was previously wasted to be used beneficially. Water reuse also reduces energy and fossil fuel consumption by requiring less water to be purified and pumped, thereby helping to reduce the production of global warming gases such as carbon dioxide.

Because graywater can be contaminated with fecal bacteria and chemicals, its reuse is prohibited or severely restricted in many states. Since government regulatory agencies do not have complete information about graywater recycling, they assume the worst-case scenario and simply ban its reuse. This is grossly unfair to those who are conscientious about what they put down their drains and who are determined to conserve and recycle water. Graywater experts contend that the health threat from graywater is insignificant. One states, “*I know of no documented instance in which a person in the US became ill from graywater.*”¹¹ Another adds, “*Note that although graywater has been used in California for about 20 years without permits, there has not been one documented case of disease transmission.*”¹² The health risks from graywater reuse can be reduced first by keeping as much organic material and toxic chemicals out of your drains as possible, and second, by filtering the graywater into a constructed wetland, soilbed, or below the surface of the ground so that the graywater does not come into direct human contact, or in contact with the edible portions of fruits and vegetables.

In November of 1994, legislation was passed in California that allowed the use of graywater in single family homes for subsurface landscape irrigation. Many other states do not currently have any legislation regulating graywater ([see Appendix 3](#)). However, many states are now realizing the value of alternative graywater systems and are pursuing research and development of such systems. The US EPA, for example, considers the use of wetlands to be an emerging alternative to conventional treatment processes.

PATHOGENS

Graywater can contain disease organisms which originate from fecal material or urine entering bath, wash, or laundry water. Potential pathogens in fecal material and urine, as well as infective doses, are listed in [Chapter 7](#).

Indicator bacteria such as *E. coli* reveal fecal contamination of the water, as well as the possible presence of other intestinal disease-causing organisms. Fecal coliforms are a pollution indicator. A high count is undesirable and indicates a greater chance of human illness resulting from contact with the graywater. Plant material, soil, and food scraps can contribute to the *total* coliform population, but fecal coliforms indicate that fecal material is also entering the water system. This can come from baby diapers, or just from bathing or showering.

More microorganisms may come from shower and bath graywater than from other graywater sources. Studies have shown that total coliforms and fecal coliforms were approximately ten times greater in bathing water than in laundry water (see Figure 9.1).¹³

One study showed an average of 215 total coliforms per 100 ml and 107 fecal coliforms per 100 ml in laundry water; 1810 total coliforms and 1210 fecal coliforms per 100 ml in bath water; and 18,800,000 colony forming units of total coliforms per 100 ml in graywater containing household garbage (such as when a garbage disposal is used).¹⁴ Obviously, grinding and dumping food waste down a drain greatly increases the bacterial population of the graywater.

Due to the undigested nature of the organic material in graywater, microorganisms can grow and reproduce in the water during storage. The numbers of bacteria can actually increase in graywater within the first 48 hours of storage, then remain stable for about 12 days, after which they slowly decline (see Figure 9.2).¹⁵

For maximum hygienic safety, follow these simple rules when using a graywater recycling system: don't drink graywater; don't come in physical contact with graywater (and wash promptly if you accidentally do come in contact with it); don't allow graywater to come in contact with edible portions of food crops; don't allow graywater to pool on the surface of the ground; and don't allow graywater to run off your property.

PRACTICAL GRAYWATER SYSTEMS

The object of recycling graywater is to make the organic nutrients in the water available to plants and microorganisms, preferably on a continuous basis. The organisms will consume the organic material, thereby recycling it through the natural system.

It is estimated that 30 gallons of graywater per person per day will be produced from a water-conservative home. This graywater can be recycled either indoors or outdoors. Inside buildings, graywater can be filtered through deep soil beds, or shallow gravel beds, in a space where plants can be grown, such as in a greenhouse.

Outdoors, in colder climates, graywater can be drained into leaching trenches that are deep enough to resist freezing, but shallow enough to keep the nutrients within the root zones of surface plants. Freezing can be prevented by applying a mulch over the subsurface leaching trenches. Graywater can also be circulated through evapotranspiration trenches (Figure 9.3), constructed wetlands (Figures 9.4, 9.5, 9.6, and 9.7), mulch basins (Figure 9.10), and soilbeds (Figures 9.11, 9.12, 9.13, and 9.14).

EVAPOTRANSPIRATION

Plants can absorb graywater through their roots and then transpire the moisture into the air. A graywater system that relies on such transpiration is called an Evapotranspiration System. Such a system may consist of a tank to settle out the solids, with the effluent draining or being pumped into a shallow sand or gravel bed covered with vegetation. Canna lilies, iris, elephant ears, cattails, ginger lily, and umbrella tree, among others, have been used with these systems. An average two bedroom house may require an evapotranspiration trench that is three feet wide and 70 feet long. One style of evapotranspiration system consists of a shallow trench lined with clay or other waterproof lining (such as plastic), filled with an inch or two of standard gravel, and six inches of pea gravel. Plants are planted in the gravel, and no soil is used.

Other systems, such as the Watson Wick (Figure 9.3), may be deeper and may utilize topsoil.

CONSTRUCTED WETLANDS

The system of planting aquatic plants such as reeds or bulrushes in a wet (often gravel) substrate medium for graywater recycling is called a “constructed wetland” or “artificial wetland.” The first artificial wetlands were built in the 1970s. By the early 1990s, there were more than 150 constructed wetlands treating municipal and industrial wastewater in the US.

According to the US Environmental Protection Agency, “Constructed wetlands treatment systems can be established almost anywhere, including on lands with limited alternative uses. This can be done relatively simply where wastewater treatment is the only function sought. They can be built in natural settings, or they may entail extensive earthmoving, construction of impermeable barriers, or building of containment such as tanks or trenches. Wetland vegetation has been established and maintained on

substrates ranging from gravel or mine spoils to clay or peat . . . Some systems are set up to recharge at least a portion of the treated wastewater to underlying ground water. Others act as flow-through systems, discharging the final effluent to surface waters. Constructed wetlands have diverse applications and are found across the country and around the world. They can often be an environmentally acceptable, cost-effective treatment option, particularly for small communities.” ¹⁶

A wetland, by definition, must maintain a level of water near the surface of the ground for a long enough time each year to support the growth of aquatic vegetation. Marshes, bogs, and swamps are examples of naturally occurring wetlands. Constructed wetlands are designed especially for pollution control, and exist in locations where natural wetlands do not.

Two types of constructed wetlands are in common use today. One type exposes the water's surface (Surface Flow Wetland, Figure 9.6), and the other maintains the water surface below the level of the gravel (Subsurface Flow Wetland, Figures 9.4, 9.5, and 9.7). Some designs combine elements of both. Subsurface flow wetlands are also referred to as Vegetated Submerged Bed, Root Zone Method, Rock Reed Filter, Microbial Rock Filter, Hydrobotanical Method, Soil Filter Trench, Biological-Macrophytic Marsh Bed, and Reed Bed Treatment.¹⁷

Subsurface flow wetlands are considered to be advantageous compared to open surface wetlands, and are more commonly used for individual households. By keeping the water below the surface of the gravel medium, there is less chance of odors escaping, less human contact, less chance of mosquito breeding, and faster “treatment” of the water (due to more of the water being exposed to the microbially populated gravel surfaces and plant roots). The subsurface water is also less inclined to freeze during cold weather.

Constructed wetlands generally consist of one or more lined beds, or cells. The gravel media in the cells should be as uniform in size as possible and should consist of small to medium size gravel or stone, from one foot to three feet in depth. A layer of sand may be used either at the top or the bottom of a gravel medium, or a layer of mulch and topsoil may be applied over the top of the gravel. In some cases, gravel alone will be used with no sand, mulch, or topsoil. The sides of the wetlands are bermed to prevent rainwater from flowing into them, and the bottom may be slightly sloped to aid in the flow of graywater through the system. A constructed wetland for a household, once established, requires some maintenance, mainly the annual harvesting of the plants (which can be composted).

In any case, the roots of aquatic plants will spread through the gravel as the plants grow. The most common species of plants used in the wetlands are the cattails, bulrushes, sedges, and reeds. Graywater is filtered through the gravel, thereby keeping the growing environment wet, and bits of organic material from the graywater become trapped in the filtering medium. Typical retention times for graywater in a subsurface flow wetland system range from two to six days. During this time, the organic material is broken down and utilized by microorganisms living in the medium and on the roots of the plants. A wide range of organic materials can also be taken up directly by the plants themselves.

Bacteria, both aerobic and anaerobic, are among the most plentiful microorganisms in wetlands and are

thought to provide the majority of the wastewater treatment. Microorganisms and plants seem to work together symbiotically in constructed wetlands, as the population of microorganisms is much higher in the root areas of the plants than in the gravel alone. Dissolved organic materials are taken up by the roots of the plants, while oxygen and food are supplied to the underwater microorganisms through the same root system.¹⁸

Aquatic microorganisms have been reported to metabolize a wide range of organic contaminants in wastewater, including benzene, naphthalene, toluene, chlorinated aromatics, petroleum hydrocarbons, and pesticides. Aquatic plants can take up, and sometimes metabolize, water contaminants such as insecticides and benzene. The water hyacinth, for example, can remove phenols, algae, fecal coliforms, suspended particles, and heavy metals including lead, mercury, silver, nickel, cobalt, and cadmium from contaminated water. In the absence of heavy metals or toxins, water hyacinths can be harvested as a high-protein livestock feed. It can also be harvested as a feedstock for methane production. Reed-based wetlands can remove a wide range of toxic organic pollutants.¹⁹ Duckweeds also remove organic and inorganic contaminants from water, especially nitrogen and phosphorous.²⁰

When the outdoor air temperature drops below a certain point (during the winter months in cold climates), wetland plants will die and microbial activity will drop off. Therefore, constructed wetlands will not provide the same level of water treatment year round. Artificial wetlands systems constitute a relatively new approach to water purification, and the effects of variables such as temperature fluctuations are not completely understood. Nevertheless, wetlands are reported to perform many treatment functions efficiently in winter. One source reports that the removal rates of many contaminants are unaffected by water temperature, adding, “*The first two years of operation of a system in Norway showed a winter performance almost at the same level as the summer performance.*” Some techniques have been developed to insulate wetland systems during the colder months. For example, in Canada, water levels in wetlands were raised during freezing periods, then lowered after a layer of ice had formed. The cattails held the ice in place, creating an air space over the water. Snow collected on top of the ice, further insulating the water underneath.²¹

It is estimated that one cubic foot of artificial wetland is required for every gallon per day of graywater produced. For an average single bedroom house, this amounts to about a 120 square foot system, one foot deep. However, it is better to overbuild a system than to underbuild. Some constructed wetland situations may not have enough drainage water from a residence to keep the system wet enough. In this case, extra water may be added from rain water collection or other sources.

WETLAND PLANTS

Aquatic plants used in constructed wetland systems can be divided into two general groups: microscopic and macroscopic. Most of the microscopic plants are algae, which can be either single cell (such as *Chlorella* or *Euglena*) or filamentous (such as *Spirulina* or *Spyrogyra*).

Macroscopic (larger) plants can grow under water (submergent) or above water (emergent). Some grow

partially submerged and some partially emerged. Some examples of macroscopic aquatic plants are reeds, bulrushes, water hyacinths, and duckweeds (see Figure 9.8 and Table 9.1). Submerged plants can remove nutrients from wastewaters, but are best suited in water where there is plenty of oxygen (water with a high level of organic material tends to be low in oxygen due to extensive microbial activity).

Examples of floating plants are duckweeds and water hyacinths. Duckweeds can absorb large quantities of nutrients. Small ponds that are overloaded with nutrients such as farm fertilizer run-off can often be seen choked with duckweed, appearing as a green carpet on the pond's surface. In a two and a half acre pond, duckweed can absorb the nitrogen, phosphorous, and potassium from the excretions of 207 dairy cows. The duckweed can eventually be harvested, dried, and fed back to the livestock as a protein-rich feed. Livestock can even eat the plants directly from a water trough.²²

Algae work in partnership with bacteria in aquatic systems. Bacteria break down complex nitrogen compounds and thereby make the nitrogen available to algae. Bacteria also produce carbon dioxide which is utilized by the algae.²³

SOILBOXES OR SOILBEDS

A soilbox is a box designed to allow graywater to filter through it while plants grow on top of it (Figure 9.14). Such boxes have been in use since the 1970s. Since the box must be well-drained, it is first layered with rocks, pea gravel, or other drainage material. This is covered with screening, then a layer of coarse sand is added, followed by finer sand; two feet of top soil is added to finish it off. Soilboxes can be located indoors or outdoors, either in a greenhouse, or as part of a raised-bed garden system.²⁴

Soilboxes (soilbeds) located in indoor greenhouses are illustrated in Figures 9.11 and 9.13. An outdoor soilbed is illustrated in Figure 9.12.

PEEPERS

At one point in the development of my homestead, I had to decide what to do with my graywater. My household produced no blackwater or sewage, and we composted all of our organic material. We only had a hand pump at the kitchen sink, and we carried our drinking water from a spring out behind the house. Nevertheless, we still had a sink and bathtub with drains, and the water had to go somewhere.

The choices I had were pretty limited: install an underground septic tank and drain the graywater into it; run the graywater through some sort of biofilter (such as sawdust) and then compost the sawdust on occasion; or try some sort of constructed wetland. I decided to experiment with the last option, mainly because I had an acid-mine-drainage spring running past my house, and I thought the graywater, which tends to be alkaline because of soap, would help neutralize the acid water. I also thought a pond would provide insurance against a drought, when rain water collection for watering a garden isn't reliable.

The acid spring flowed past my house from an abandoned surface coal mine, and when I first started

living beside it, it was choked with long, slimy, green algae. I introduced ducks to the algae-choked water, and quite by accident, I found that the algae disappeared as long as I kept ducks on the water. Whether the ducks were eating the algae or just breaking it up with their feet, I don't know. In any case, the water changed from ugly to beautiful, almost overnight, by the simple addition of another lifeform to the biological system. This indicated to me that profound changes could occur in ecological systems with proper (even accidental) management. Unfortunately, constructed wetland systems are still new and there is not much concrete information about them that is applicable to single family dwellings. Therefore, I was forced, as usual, to engage in experimentation.

I built a naturally clay-lined pond near my house about the size of a large swimming pool, then diverted some of the acid mine water to fill the pond. I directed my graywater into this "modified lagoon" wastewater system via a six inch diameter drain pipe with an outlet discharging the graywater below the surface of the pond water. I installed a large drainpipe to act as a pre-digestion chamber where organic material could collect and be broken down by anaerobic bacteria en route to the lagoon, like a mini septic tank. I add septic tank bacteria to the system annually by dumping it down the household drains. I assumed that the small amount of organic matter that entered the pond from the graywater drain would be consumed by the organisms in the water, thereby helping to biologically remediate an extensively damaged source of water. The organic material settles into the bottom of the pond, which is about five feet at the deepest point, thereby being retained in the constructed system indefinitely. I also lined the bottom of the pond with limestone to help neutralize the incoming acid mine water.

The ducks, of course, loved the new pond. They still spend countless hours poking their heads under the water, searching the pond bottom for things to eat. Our house is located between our garden and the pond, and the water is clearly visible from the kitchen sink, as well as from the dining room on the east side of the house, while the nearby garden is visible from the west windows. Shortly after we built the pond, my family was working in our garden. Soon we heard the loud honking of Canada geese in the sky overhead, and watched as a mating pair swooped down through the trees and landed on our new, tiny pond. This was quite exciting, as we realized that we now had a place for wild waterfowl, a bonus we hadn't really anticipated. We continued working in the garden, and were quite surprised to see the geese leave the pond and walk past our house toward the garden where we were busy digging. We continued to work, and they continued to walk toward us, eventually walking right past us through the yard, and on to the far end of the garden. When they reached the orchard, they turned around and marched right past us again, making their way back to the pond. To us, this was equivalent to an initiation for our new pond, a way that nature was telling us we had contributed something positive to the environment.

Of course, it didn't end with the two Canada Geese. Soon, a Great Blue Heron landed in the pond, wading around its shallow edges on stilt-like legs. It was spotted by one of the children during breakfast, a mere fifty feet from the dining room window. Then, a pair of colorful wood ducks spent an afternoon playing in the water. This was when I noticed that wood ducks can perch on a tree branch like a songbird. Recently, I counted 40 Canada geese on the little pond. They covered its surface like a feathery carpet, only to suddenly fly off in a great rush of wings.

We raise our own domesticated ducks for algae control, for eggs, and occasionally for meat. At one point

we raised some Mallard ducks, only to find that this wild strain will fly away when they reach maturity. One of the female Mallards became injured somehow, and developed a limp. She was certainly a “lame duck,” but the children liked her and took care of her. Then one day she completely disappeared. We thought a predator had killed the defenseless bird, and we never expected to see her again. To the children’s delight, the following spring a pair of wild Mallard ducks landed on our little pond. We watched them swim around for quite some time, until the female came out of the water and walked toward us. Or, I should say, “limped” toward us. Our lame Mallard duck had flown away for the winter only to come back in the spring with a handsome boyfriend! Our new graywater pond was the point of reference for her migration.

My youngest daughter, Phoebe, was given a Canada goose to raise by one of the neighbors. The tiny gosling couldn’t have been more than a day or two old when it was discovered wandering lost along the road. I’m not sure why Phoebe was asked to take care of the goose, other than she loves animals and she had a pond in her backyard, but she enthusiastically accepted the responsibility. She named the goose “Peepers,” and everywhere Phoebe went, Peepers followed. The two of them spent many a day at the graywater pond, Peepers splashing around in the water while Phoebe sat on the shore watching. Soon Peepers was a full grown goose, and everywhere Peepers went, large piles of goose droppings followed. The goose doo situation finally became so intolerable (to Dad, who renamed the goose “Poopers”) that Peepers was furtively exported to the wild. Phoebe was heartbroken.

This spring, as I write this, ten years after our graywater pond was constructed, a pair of honking Canada geese once again flew overhead. Except this time, only the female landed in our little pond. Phoebe went running to the pond when she heard that familiar honking, yelling “Peepers! Peepers!” Peepers had come back to say hello to Phoebe. How did I know it was Peepers? I didn’t. But somehow, Phoebe did. She stood on the pond bank for quite some time talking to the majestic goose, and the goose, also standing on the bank, talked back. They carried on a conversation that is rarely witnessed. Finally, Peepers flew off, and this time, Phoebe was happy.

I have more stories to tell about our graywater pond, and no doubt will have many more in the future. A buried, quarantined, septic tank for graywater, on the other hand, is pretty boring. I believe I made the right decision in deciding to construct a pond for our graywater. The benefits of such a system can go far beyond what one may imagine.

Source: The Humanure Handbook. Jenkins Publishing, PO Box 607, Grove City, PA 16127. To order, phone: 1-800-639-4099.

<http://www.jenkinspublishing.com/>

MENU: [HOME](#) » [Reconstruction](#) » [Recovery](#) » [Renewal](#) » [Survival](#) » [Humanure Content](#)

THE END IS NEAR

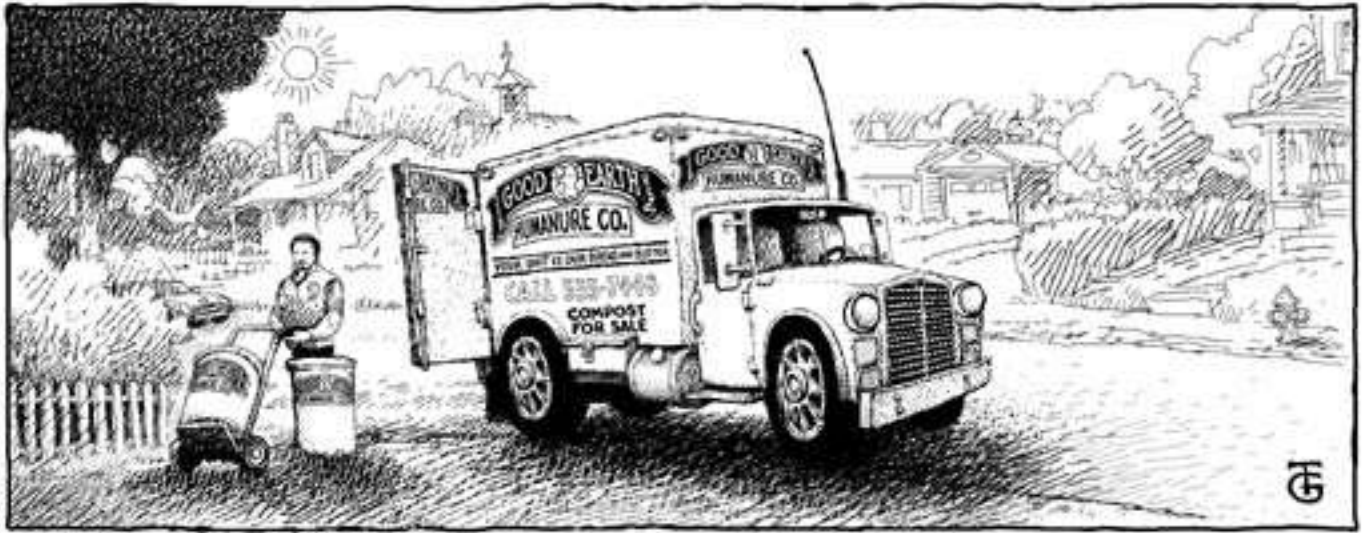

*“If you want to be free, learn to live simply.
Use what you have and be content where you are.”*

J. Heider

Ladies and gentlemen, allow me to introduce you to a new and revolutionary literary device known as the *self-interview*! (Applause heard in background. Someone whoops.) Today I'll be interviewing myself. In fact, here I am now. (Myself walks in.)

***Me:** Good morning, sir. Haven't I seen you somewhere before?*

Myself: Cut the crap. It's too early in the morning for this. You see me every time you look in the mirror, which isn't very often, thank god. What, for crying out loud, would possess you to interview yourself, anyway?

***M:** If I don't, who will?*

MS: You do have a point there. In fact, that may be an issue worthy of contemplation.

M: *Well, let's not get off the track. The topic of discussion today is a substance near and dear to us all. Shall we step right into it?*

MS: What the hell are you talking about?

M: *I'll give you a hint. It often can be seen with corn or peanuts on its back.*

MS: Elephants?

M: *Close, but no cigar. Actually, cigar would have been a better guess. We're going to talk about humanure.*

MS: You dragged me out of bed and forced me to sit here in front of all these people to talk about CRAP?!

M: *You wrote a book on it, didn't you?*

MS: So what? OK, OK. Let's get on with it. I've had enough of your theatrics.

M: *Well, first off, do you expect anyone to take the Humanure Handbook seriously?*

MS: Why wouldn't they?

M: *Because nobody gives a damn about humanure. The last thing anyone wants to think about is a turd, especially their own. Don't you think that by bringing the subject to the fore you're risking something?*

MS: You mean like mass constipation? Not quite. I'm not going to put any toilet bowl manufacturers out of business. I'd estimate that one in a million people have any interest at all in the topic of resource recovery in relation to human excrement. Nobody thinks of human manure as a resource; the concept is just too bizarre.

M: *Then what's the point?*

MS: The point is that long-standing cultural prejudices and phobias need to be challenged once in a while by somebody, anybody, or they'll never change. Fecophobia is a deeply rooted fear in the American, and perhaps Western, psyche. But you can't run from what scares you. It just pops up somewhere else, where you least expect it. We've adopted the policy of defecating in our drinking water and then piping it off somewhere to let someone else deal with it. So now we're finding that our drinking water sources are dwindling and becoming increasingly contaminated. What goes around comes around.

M: *Oh, come on. I drink water every day and it's never contaminated. We Americans probably have the*

most abundant supply of safe drinking water of any country on the planet.

MS: Yes and no. True, your water may not suffer from fecal contamination, meaning intestinal bacteria in water. But how much chlorine do you drink instead? Then there's water pollution from sewage in general, such as beach pollution. But I don't want to get into all this again. I've already discussed human waste pollution in Chapter Two.

M: *Then you'll admit that American drinking water supplies are pretty safe?*

MS: From disease-causing microorganisms, generally yes, they are. Even though we defecate in our water, we go to great lengths and expense to clean the pollutants back out of it. The chemical additives in our water, such as chlorine, on the other hand, are not good to drink. And let's not forget that drinking water supplies are dwindling all over the world, water tables are sinking, and water consumption is on the increase with no end in sight. That seems to be a good reason to not pollute water with our daily bowel movements. Yet, that's only half the equation.

M: *What do you mean?*

MS: Well, we're still throwing away the agricultural resources that humanure should be providing us. We're not maintaining an intact human nutrient cycle. By piping sewage into the sea, we're essentially dumping grain into the sea. By burying sludge, we're burying a source of food. That's a cultural practice that should be challenged. It's a practice that's not going to change overnight, but will change incrementally if we begin acknowledging it now.

M: *So what're you saying? You think everybody should shit in a five-gallon bucket?*

MS: God forbid. Then you would see mass constipation!

M: *Well then, I don't understand. Where do we go from here?*

MS: I'm not suggesting we have a mass cultural change in toilet habits. I'm suggesting that, for starters, we need to change the way we understand our habits. Most people have never heard of such a thing as a nutrient cycle. Many people don't even know about compost. Recycling humanure is just not something people think about. I'm simply suggesting that we begin considering new approaches to the age-old problem of what to do with human excrement. We also need to start thinking a bit more about how we live on this planet, because our survival as a species depends on our relationship with the Earth.

M: *That's a beginning, but that's probably all we'll ever see in our lifetime, don't you think? Some people, like you for example, will think about these things, maybe write about them, maybe even give them some lip service. Most people, on the other hand, would rather have a bag of cheese puffs in one hand, a beer in the other, and a TV in front of them.*

MS: Don't be so sure about that. Things are changing. There are more than a few people who will turn off their TVs, pick the orange crumbs out of their teeth, and get busy making the world a better place. I predict, for example, that composting toilets and toilet systems will continue to be designed and redesigned in our lifetimes. Eventually, entire housing developments or entire communities will utilize composting toilet systems. Some municipalities will eventually install composting toilets in all new homes.

M: You think so? What would that be like?

MS: Well, each home would have a removable container made of recycled plastic that would act as both a toilet receptacle and a garbage disposal.

M: How big a container?

MS: You'd need about five gallons of capacity per person per week. A container the size of a fifty gallon drum would be full in about two weeks for an average family. Every household would deposit all of its organic material except graywater into this receptacle, including maybe some grass clippings and yard leaves. The municipality could provide a cover material for odor prevention, consisting of ground leaves, rotted sawdust, or ground newsprint, neatly packaged for each household and possibly dispensed automatically into the toilet after each use. This would eliminate the production of all organic garbage and all sewage, as it would all be collected without water and composted at a municipal compost yard.

M: Who'd collect it?

MS: Once every couple of weeks or so, your municipality or a business under contract with your municipality would take the compost receptacle from your house. A new compost receptacle would then replace the old. This is already being done in the entire province of Nova Scotia, Canada, and in areas of Europe where organic kitchen materials are collected and composted.

When toilet material is added to the collection system, your manure, urine, and garbage, mixed together with ground leaves and other organic refuse or crop residues, would be collected regularly, just like your garbage is collected now. Except the destination would not be a landfill, it'd be the compost yard where the organic material would be converted, through thermophilic composting, into an agricultural resource and sold to farmers, gardeners, and landscapers who'd use it to grow things. The natural cycle would be complete, immense amounts of landfill space would be saved, a valuable resource would be recovered, pollution would be prevented, and soil fertility would be enhanced. So would our long-term survival as human beings on this planet.

M: I don't know . . . how long before people will be ready for that?

MS: In Japan today, a similar system is in use, except that rather than removing the container and replacing it with a clean one, the truck that comes to pick up the humanure suctions it out of a holding

tank. Sort of like a truck sucking the contents out of a septic tank.

Such a truck system involves a capital outlay about a third of that for sewers. One study which compares the cost between manual humanure removal and waterborne sewage in Taiwan estimates manual collection costs to be less than one-fifth the cost of waterborne sewage treated by oxidation ponds. That takes into account the pasteurization of the humanure, as well as the market value of the resultant agricultural soil additive.¹

M: But that's in the Far East. We don't do stuff like that in America.

MS: One of the most progressive large scale examples I have seen is in Nova Scotia, Canada. On November 30, 1998, Nova Scotia banned all organic material from entering its landfills. The municipality provides free receptacles for every household to deposit their food scraps into. So when a banana peel or burnt pop-tart gets pitched into the trash, it goes into the *green cart* along with egg shells, coffee grounds, and even cereal boxes, waxed paper, and file folders. Then, every two weeks, a truck comes around, just like the standard garbage trucks we're used to seeing, and picks up the organic material. From there, it goes to one of many central composting yards, where the material gets run through a grinder and shoved into a giant composting bin. Within 24 to 48 hours, the thermophilic microorganisms in the garbage have raised the temperature of the organic mass to 60-70°C (140-158°F). And it's a natural process.

The Netherlands was one of the first countries to mandate large scale source separation of organic material for composting, having done so since 1994; in at least five European countries, such separation is common.² Since 1993, in Germany, for example, discarded waste material must contain less than 5% organic matter, otherwise the material has to be recycled, mainly by composting.³ In England and Wales, a target has been set to compost a million tonnes of organic household material by the year 2000.⁴

M: But those are not toilets.

MS: Can't you see? This is only one small step away from collecting toilet materials and composting them, too. Toilets will be redesigned as collection devices, not disposal devices. We've developed the art, science, and technology of composting enough to be able to constructively recycle our own excrement on a large scale.

M: So why don't we?

MS: Because humanure doesn't exist, as far as most compost professionals are concerned. It's not even on the radar screen. Human manure is seen as human waste, something to be disposed of, not recycled. When I was visiting composting operations in Nova Scotia, one compost educator told me there were 275,000 metric tonnes of animal manures produced annually in his county suitable for composting. He did not include human manure in his assessment. As far as he was concerned, humans are not animals and they don't produce manure.

To give you an example of how clueless Americans are about composting humanure, let me tell you about some missionaries in Central America.

M: Missionaries?

MS: That's right. A group of missionaries was visiting an indigenous group in El Salvador and they were appalled by the lack of sanitation. There were no flush toilets anywhere. The available toilet facilities were crude, smelly, pit latrines that bred flies. When the group returned to the United States, they were very concerned about the toilet problem they had seen, and decided they should help. But they didn't know what to do. So they shipped a dozen portable toilets down there, at great expense.

M: Portable toilets?

MS: Yeah, you know, those big, plastic outhouses you see at rest stops along the highways, at construction sites, and festivals. The ones that smell bad, and are filled with a blue liquid choked with floating turds and toilet paper.

M: Oh yeah.

MS: Well, the village in El Salvador got the portable toilets and the people there set them up. They even used them — until they filled up. The following year, the missionaries visited the village again to see how their new toilets were working.

M: And?

MS: And nothing. The toilets had filled up and the villagers stopped using them. They went back to their pit latrines. They had a dozen portable toilets sitting there filled to the brim with urine and crap, stinking to high heaven, and a fly heaven at that. The missionaries hadn't thought about what to do with the toilets when they were full. In the US, they're pumped out and the contents are taken to a sewage plant. In El Salvador, they were simply abandoned.

M: So what's your point?

MS: The point is that we don't have a clue about constructively recycling humanure. Most people in the US have never even had to think about it, let alone do it. If the missionaries had known about composting, they may have been able to help the destitute people in Central America in a meaningful and sustainable way. But they had no idea that human manure is as recyclable as cow manure.

M: Let me get this straight. Now you're saying that humans are the same as cows?

MS: Well, all animals defecate. Many westerners simply won't admit it. But we're starting to. We

Americans have a long way to go. The biggest obstacle is in understanding and accepting humanure and other organic materials as resource materials rather than waste materials. We have to stop thinking of human excrement and organic refuse as waste. When we do, then we'll stop defecating in our drinking water and stop sending our garbage to landfills.

It's critical that we separate water from humanure. As long as we keep defecating in water we'll have a problem that we can't solve. The solution is to stop fouling our water, not to find new ways to clean it up. Don't use water as a vehicle for transporting human excrement or other waste. Humanure must be collected and composted along with other solid (and liquid) organic refuse produced by human beings. We won't be able to do this as long as we insist upon defecating into water. Granted, we can dehydrate the waterborne sewage sludge and compost that. However, this is a complicated, expensive, energy-intensive process. Furthermore, the sludge can be contaminated with all sorts of bad stuff from our sewers which can become concentrated in the compost.⁵

M: Composting sewage sludge is bad?

MS: No. In fact, composting is probably the best thing you can do with sludge. It's certainly a step in the right direction. There are many sludge composting operations around the world, and when the sludge is composted, it makes a useful soil additive. I've visited sludge composting sites in Nova Scotia, Pennsylvania, Ohio, and Montana, and the finished compost at all of the sites is quite impressive.

M: It'll never happen (shaking his head). Face it. Americans, westerners, will never stop shitting in water. They'll never, as a society, compost their manure. It's unrealistic. It's against our cultural upbringing. We're a society of Howdy-Doody, hotdogs, hairspray, and Ho-Hos, not composted humanure, fer chrissake. We don't believe in balancing human nutrient cycles! We just don't give a damn. Compost making is unglamorous and you can't get rich doing it. So why bother?!

MS: You're right on one point — Americans will never stop shitting. But don't be so hasty. In 1988, in the United States alone, there were 49 operating municipal sludge composting facilities.⁶ By 1997, there were over 200.⁷ A solid waste composting plant in Oregon is designed to handle 800 tons of refuse daily.

In Duisberg, Germany, a decades-old plant composts 100 tons of domestic refuse daily. Another plant at Bad Kreuznach handles twice that amount. Many European composting plants compost a mixture of refuse and sewage sludge. There are at least three composting plants in Egypt. In Munich, a scheme was being developed in 1990 to provide 40,000 households with "biobins" for the collection of compostable refuse.⁸

It's only a matter of time before the biobin concept is advanced to collect humanure as well. In fact, some composting toilets already are designed so that the humanure can be wheeled away and composted at a separate site. Eventually, municipalities will assume the responsibility for collecting and composting all organic material from urban and suburban human populations, including toilet materials.

M: Yeah, right.

MS: And you are now revealing the main obstacle toward a sustainable society. Personal attitude. Everything we take for granted today — shoes, clothing, metal tools, electronic equipment, heck, even toilet paper, exists for one reason, and one reason only: because someone in the past cared about the future. You'd be running around naked today chasing rabbits with a stick if people in the past hadn't made things better for us in the present. We all have an obligation to our future generations. That's what evolution is, and that's what survival of the species requires. We have to think ahead. We have to care about our descendants too, and not just about ourselves. That means we have to understand that waste is not good for us, or for future generations. When we dump endless amounts of garbage into the environment with the attitude that someone in the future can deal with it, we are not evolving, we're *devolving*.

M: What's that supposed to mean?

MS: It's simple enough. OK, you have trash. You don't throw the trash "out." There is no "out." It has to go somewhere. So you simply sort the trash into separate receptacles in your home, and that makes it easy to recycle the stuff. When it's recycled, it's not wasted. A chimpanzee could figure that out. It's easy to understand and it's easy to do.

A lot of compost that's been produced by big composting plants has been contaminated with things like batteries, metal shards, bottle caps, paints, and heavy metals. As a result, much of it hasn't been useful for agriculture. Instead, it's been used for filler or for other non-agricultural applications, which, to me, is absurd. The way to keep junk out of compost is to value compostable material enough to collect it separately from other trash. A household biobin would do the trick. The biobin could be collected regularly, emptied, its contents composted, and the compost sold to farmers and gardeners as a financially self-supporting service provided by independent businesses.

The trick to successful large-scale compost production can be summed up in two words: *source separation*. The organic material must be separated at the source. This means that individual families will have to take some responsibility for the organic material they discard. They will no longer be permitted to throw it all in one garbage can with their plastic Ho-Ho wrappers, pop bottles, broken cell phones, and worn out toaster ovens. Organic material is too valuable to be wasted. The people in Nova Scotia have figured that out, as have many others throughout the world. Americans are a little slow.

M: But they're not composting toilet materials, are they?

MS: They're composting sewage sludge, which is a big step in the right direction. Some entrepreneurs are in the sewage composting business in the United States, too. In 1989, the town of Fairfield, Connecticut, contracted to have its yard material and sewage sludge composted. The town is said to have saved at least \$100,000 in waste disposal costs in its first year of composting alone. The Fairfield operation is just a quarter mile from half million dollar homes and is reported to smell no worse than wet

leaves from only a few yards away.⁹

In Missoula, Montana, all of the city's sewage sludge is composted, and the entire composting operation is funded by the tipping fees alone. All of the compost produced is pure profit, and all of it is sold. Composting is a profitable venture when properly managed.

M: But still, there's the fear of humanure and its capability of causing disease and harboring parasites.

MS: That's right. But according to the literature, a biological temperature of 50°C (122°F) for a period of 24 hours is sufficient to kill the human pathogens potentially in humanure. EPA regulations require that a temperature of 55°C (131°F) be maintained for three days when composting sewage sludge in bins. Thermophilic microorganisms are everywhere, waiting to do what they do best — make compost. They're on grass, tree branches, leaves, banana peels, garbage, and humanure. Creating thermophilic compost is not difficult or complicated, and thermophilic composting is what we need to do in order to sanitize human excrement without excessive technology and energy consumption. Thermophilic composting is something humans all over the world can do whether or not they have money or technology.

There will always be people who will not be convinced that composted humanure is pathogen-free unless every tiny scrap of it is first analyzed in a laboratory, with negative results. On the other hand, there will always be people, like me, who conscientiously compost humanure by maintaining a well-managed compost pile, and who feel that their compost has been rendered hygienically safe as a result. A layer of straw covering the finished compost pile, for example, will insulate the pile and help keep the outer surfaces from cooling prematurely. It's common sense, really. The true test comes in living with the composting system for long periods of time. I don't know anyone else who has done so, but after twenty years, I've found that the simple system I use works well for me. And I don't do anything special or go to any great lengths to make compost, other than the simple things I've outlined in this book.

Perhaps Gotaas hits the nail on the head when he says, *“The farm, the garden, or the small village compost operator usually will not be concerned with detailed tests other than those to confirm that the material is safe from a health standpoint, which will be judged from the temperature, and that it is satisfactory for the soil, which will be judged by appearance. The temperature of the compost can be checked by: a) digging into the stack and feeling the temperature of the material; b) feeling the temperature of a rod after insertion into the material; or c) using a thermometer. Digging into the stack will give an approximate idea of the temperature. The material should feel very hot to the hand and be too hot to permit holding the hand in the pile for very long. Steam should emerge from the pile when opened. A metal or wooden rod inserted two feet (0.5 m) into the pile for a period of 5-10 minutes for metal and 10-15 minutes for wood should be quite hot to the touch, in fact, too hot to hold. These temperature testing techniques are satisfactory for the smaller village and farm composting operations.”*

[10](#)

In other words, humanure composting can remain a simple process, achievable by anyone. It does not

need to be a complicated, high-tech, expensive process controlled and regulated by nervous people in white coats bending over a compost pile, shaking their heads and wringing their hands while making nerdy clucking sounds.

I want to make it clear though, that I can't be responsible for what other people do with their compost. If some people who read this book go about composting humanure in an irresponsible manner, they could run into problems. My guess is the worst thing that could happen is they would end up with a mouldered compost pile instead of a thermophilic one (I see this happen a lot). The remedy for that would be to let the mouldered pile age for a couple years before using it agriculturally, or to use it horticulturally instead.

I can't fault someone for being fecophobic, and I believe that fecophobia lies at the root of most of the concerns about composting humanure. What fecophobes may not understand is that those of us who aren't fecophobes understand the human nutrient cycle and the importance of recycling organic materials. We recycle organic refuse because we know it's the right thing to do, and we aren't hampered by irrational fears. We also make compost because we need it for fortifying our food-producing soil, and we consequently exercise a high degree of responsibility when making the compost. It's for our own good.

Then, of course, there's the composter's challenge to fecophobes: *show us a better way to deal with human excrement.*

M: *Sounds to me like you have the final word on the topic of humanure.*

MS: Hardly. The Humanure Handbook is only a tiny beginning in the dialogue about human nutrient recycling.

M: *Well, sir, this is starting to get boring and our time is running out, so we'll have to wrap up this interview. Besides, I've heard enough talk about the world's most notorious "end" product. So let's focus a little on the end itself, which has now arrived.*

MS: And this is it. This is the end?

M: *"This is the end." (Sung like Jim Morrison.) What d'ya say folks? (Wild applause, stamping of feet, frenzied whistling, audience jumping up and down, yanking at their hair, rolls of toilet paper thrown confetti-like through the air, clothes being torn off, cheering and screaming. Someone starts chanting "Source separation, Source separation!" What's this!?! The audience is charging the stage! The interviewee is being carried out over the heads of the crowd! Hot dang and hallelujah!)*

Source: The Humanure Handbook. Jenkins Publishing, PO Box 607, Grove City, PA 16127. To order, phone: 1-800-639-4099.

<http://www.jenkinspublishing.com/>

MENU: [HOME](#) » [Reconstruction](#) » [Recovery](#) » [Renewal](#) » [Survival](#) » [Humanure Content](#)

THE HUMANURE HANDBOOK -- REFERENCE CITATIONS

[CHAPTER ONE](#) | [TWO](#) | [THREE](#) | [FOUR](#) | [FIVE](#) | [SIX](#) | [SEVEN](#) | [EIGHT](#) | [NINE](#) | [TEN](#)

REFERENCES - CHAPTER ONE - CRAP HAPPENS

- 1 - Brown, Lester R., et al. (1998). State of the World 1998. New York: W. W. Norton and Co., p. 115.
- 2 - Brown, Lester R., et al. (1999). State of the World 1999. New York: W. W. Norton and Co., p. 15.
- 3 - Associated Press. (1999 January 12).
- 4 - State of the World 1999, p. 14.
- 5 - State of the World 1999, p. 88.
- 6 - State of the World 1998, p. 3, 10.
- 7 - State of the World 1999, p. 10; State of the World 1998, p. 3.
- 8 - Brown, Lester R., et al. (1998). Vital Signs 1998. New York: W. W. Norton and Co., p. 20.
- 9 - State of the World 1998, p. 4, 5.
- 10 - State of the World 1998, p. 14.
- 11 - State of the World 1999, p. 79, 83.
- 12 - State of the World 1999, p. 87.
- 13 - State of the World 1998, p. 11, 41; State of the World 1999, p. 97.
- 14 - State of the World 1999, p. 13, 97.
- 15 - State of the World 1999, p. 20, 21, 41, 46.

- 16 - Steingraber, Sandra. (1997). Living Downstream. Reading, MA: Perseus Books, p. 70.
- 17 - Living Downstream, p. 90.
- 18 - Colborn, Theo, Dumanoksi, Diane and Myers, John Peterson. (1996). Our Stolen Future. New York: Penguin Books, p.137.
- 19 - Living Downstream, p. 103.
- 20 - State of the World 1999, p. 49; Living Downstream, p. 70.
- 21 - Living Downstream, p. 38, 40, 49, 59, 60.
- 22 - Our Stolen Future, p. 137.
- 23 - Ryan, Frank, M.D. (1997). Virus X. New York: Little, Brown and Co., p. 383-390.
- 24 - State of the World 1999, p. xix.
- 25 - Gelbspan, Ross. (1997). The Heat is On. Reading, MA: Addison-Wesley Publishing Co., Inc., p. 148, 157.
- 26 - Barker, Rodney. (1998). And the Waters Turned to Blood. New York: Touchstone.

REFERENCES - CHAPTER TWO - WASTE NOT WANT NOT

- 1 - Hershkowitz, Allen. (1997). Too Good to Throw Away: Recycling's Proven Record. Washington, D.C.: Natural Resources Defense Council, Chapter 2.
- 2 - Steingraber, Sandra. (1997). Living Downstream. Reading, MA: Perseus Books, p. 95.
- 3 - Living Downstream, p. 238.
- 4 - Too Good to Throw Away, Chapter Two.
- 5 - Brown, Lester R., et al. (1998). State of the World 1998. New York: W. W. Norton and Co., p. 106.
- 6 - Kantor, Linda S., et al. (1997, January - April). "Estimating and Addressing America's Food Losses." Food Review. Washington, D.C.: US Department of Agriculture, Commodity Economics Division, Economic Research Service.
- 7 - US Environmental Protection Agency. (May 1998) Characterization of Municipal Solid Waste in the United States: 1997 Update. Report # EPA530-R-98-007. Washington, D.C.: US Environmental Protection Agency, p. 29, 45.

- 8 - State of the World 1998, p. 102.
- 9 - State of the World 1998, p. 101, 166.
- 10 - State of the World 1998, p. 101.
- 11 - Environment Reporter. (1996 September 27)
- 12 - Too Good to Throw Away, Chapter Two.
- 13 - Too Good to Throw Away, Chapter Two.
- 14 - World Resource Foundation. (1998, April). Warmer Bulletin Information Sheet - Landfill.
- 15 - Hammond, A., et al. (Eds.) (1993). 1993 Information Please Environmental Almanac. New York. Houghton Mifflin Co., p. 60-64.
- 16 - Brown, Lester R., et al. (1999). State of the World 1999. New York: W. W. Norton and Co., p. 141.
- 17 - Daniel, J.E., et al., (Eds.). 1992 Earth Journal. Boulder, CO: Buzzworm Books, p. 94.
- 18 - Fahm, Lattee A. (1980). The Waste of Nations: The Economic Utilization of Human Waste in Agriculture. Montclair, NJ: Allenheld, Osmun & Co., p. 45.
- 19 - Golden, Jack, et al. (1979). The Environmental Impact Data Book. Ann Arbor, MI: Ann Arbor Science Publishers, Inc., p. 495.
- 20 - US Department of Commerce, National Oceanic and Atmospheric Administration, Office of Ocean Resources, Conservation and Assessment. (1987). The National Coastal Pollutant Discharge Inventory Database. Silver Spring, MD: DOC/NOAA/ORCA.
- 21 - Environment Reporter. (1991 November 22) p. 1799.
- 22 - Environment Reporter. (1992 January 3) p. 2103.
- 23 - Environment Reporter. (1992 February 14) p. 2373.
- 24 - Environment Reporter. (1991 December 27) p. 2072.
- 25 - Environment Reporter. (1992 January 17) p. 2144.
- 26 - Environment Reporter. (1992 May 1) p. 13.
- 27 - US Environmental Protection Agency. (September 1997). Beach Program, EPA#820-F-97-002. Washington, D.C.:

US Environmental Protection Agency, p. 5.

28 - Environment Reporter. (1992 July 31). Washington D.C.: Bureau of National Affairs, Inc., p. 1110.

29 - Paul, Elizabeth. (1998). Testing the Waters VIII: Has Your Vacation Beach Cleaned Up Its Act?. Washington, D.C.: Natural Resources Defense Council, Inc.; NRDC Worldview News. (1998). Pollution Persists at US Beaches. Washington, D.C.: Natural Resources Defense Council, Inc.

30 - Bitton, Gabriel. (1994). Wastewater Microbiology. New York: Wiley-Liss, Inc., p. 368-369.

31 - National Resources Defense Council. (1997). Bulletin: Stop Polluted Runoff - 11 Actions to Clean up Our Waters. <http://www.nrdc.org/nrdcpn/fppubl.html>

32 - Wastewater Microbiology, p. 86.

33 - Ralof, Janet. (1998 March 21). "Drugged Waters--Does it Matter that Pharmaceuticals are Turning Up in Water Supplies?" Science News, Vol. 153 (No. 12), p. 187-189.

34 - State of the New England Environment. (1996). Preserving New England Natural Resources. <http://www.epa.gov/region01/soe/coastal.html>

35 - Environment Reporter. (1991 November 8) p. 1745-46; (1992 January 31) p. 2299.

36 - Toward Organic Security: Environmental Restoration or the Arms Race?. Peace and Environment Platform Project, c/o World Citizens Assembly, Suite 506, 312 Sutter St., San Francisco, CA 94018.

37 - Vital Signs 1998, p. 156.

38 - Courier. (1985, January). UNESCO. 7 Place de Fentenoy, 75700 Paris, France.

39 - State of the World 1999, p. 137.

40 - Vital Signs 1998, p. 156.

41 - Vital Signs 1998, p. 156, 157.

42 - Wastewater Microbiology, p. 79-80.

43 - Wastewater Microbiology, p. 261.

44 - Associated Press. (1993 April 10). Observer-Reporter. Washington and Green Counties, PA, p. A2; Carrolton, GA statistics from Wastewater Microbiology, p. 97.

45 - Goldstein, Debra. (1997). "Your drinking water: H₂O+what else?." e-Amicus. Washington, D.C.: National

- Resources Defense Council, <http://www.nrdc.org/eamicus/index.html>; US Environmental Protection Agency. Indicator 2: Population Served by Unfiltered Surface Water Systems at Risk from Microbiological Contamination. Washington, D.C.: US Environmental Protection Agency.
- 46 - Gever, John, et al. (1986). Beyond Oil: The Threat to Food and Fuel in the Coming Decades, A Summary Report. Cambridge, MA: Ballinger Publishing Co.
- 47 - Solley, Wayne B., et al. (1990). "Estimated Water Use in the United States in 1990." US Geological Survey Circular 1081, Table 31. Denver, CO. United State Geological Service, p. 65.
- 48 - National Resources Defense Council. (1996 December 24). Population and Consumption at NRDC: US Population Scorecard. Washington, D.C.: National Resources Defense Council.
- 49 - The Waste of Nations, p. xxiv.
- 50 - Stoner, Carol (Ed.). (1977). Goodbye to the Flush Toilet. Emmaus, PA: Rodale Press, Inc., p. vii.
- 51 - 1993 Information Please Environmental Almanac, p. 340-341.
- 52 - Environment Reporter. (1992 April 24) p. 2877-78.
- 53 - State of the World 1998, p. 100.
- 54 - Sides, S. (1991, August/September). "Compost." Mother Earth News, Issue 127, p. 50.
- 55 - Environment Reporter. (1992 February 28) p. 2439.
- 56 - Brown, Lester R., et al. (1998). Vital Signs 1998. New York: W. W. Norton and Co., p. 44-45.
- 57 - Vital Signs, p. 44.
- 58 - Vital Signs, p. 132.
- 59 - Vital Signs 1998, p. 132.
- 60 - US Environmental Protection Agency. PA IRIS Substance File: Nitrate, CASRN 14797-55-8. Washington, D.C.: US Environmental Protection Agency.
- 61 - 1992 Earth Journal, p. 159.
- 62 - US Environmental Protection Agency. (1990). National Survey of Pesticides in Drinking Water Wells. Washington, D.C.: US Environmental Protection Agency.
- 63 - State of the World 1999, p. 135.

64 - State of the World 1990, p. 184.

65 - Rybczynski, Witold, et al. (1982). Low Cost Technology Options for Sanitation - A State of the Art Review and Annotated Bibliography. Washington, D.C.: World Bank, p. 23.

66 - Cannon, Charles A. (1997 September 3-5). "Life Cycle Analysis and Sustainability Moving Beyond the Three R's -- Reduce, Reuse, and Recycle -- to P2R2 -- Preserve, Purify, Restore and Remediate." In E.I. Stentiford (Ed.), Proceedings of the 1997 Organic Recovery and Biological Treatment International Conference. Harrogate, UK, p. 252-253. Available from Stuart Brown, National Compost Development Association, PO Box 4, Grassington, North Yorkshire, BD23 5UR UK (stuartbrown@compuserve.com)

REFERENCES - CHAPTER THREE - MICROHUSBANDRY

1 - Shuval, Hillel I., et al. (1981). Appropriate Technology for Water Supply and Sanitation - Night Soil Composting. p.2. International Bank for Reconstruction and Development (World Bank), Washington DC, 20433, USA.

2 - Shuval, Hillel I. et al. (1981). Appropriate Technology for Water Supply and Sanitation - Night Soil Composting. p.2. International Bank for Reconstruction and Development (World Bank), Washington DC, 20433, USA.

3 - Shuval, Hillel I. et al. (1981). Appropriate Technology for Water Supply and Sanitation - Night Soil Composting. p.ii. International Bank for Reconstruction and Development (World Bank), Washington DC, 20433, USA.

4 - Rodale, J. I. (1960). The Complete Book of Composting. p. 9. Rodale Books, Inc., Emmaus, PA.

5 - Sides, S. (1991). Compost. *Mother Earth News*. Issue 127, Aug/Sept 1991 (pp.49-53).

6 - Bem, R., (1978). Everyone's Guide to Home Composting. Van Nostrand Reinhold Co., NY (p.4).

7 - Haug, Roger T. (1993). The Practical Handbook of Compost Engineering. p. 2. CRC Press, Inc., 2000 Corporate Blvd. N.W., Boca Raton, FL 33431 USA.

8 - Cannon, Charles A., (1997). *Life Cycle Analysis and Sustainability Moving Beyond the Three R's - Reduce, Reuse, and Recycle - to P2R2 - Preserve, Purify, Restore and Remediate*. As seen in the 1997 Organic Recovery and Biological Treatment Proceedings, Stentiford, E.I. (ed.). International Conference, Harrogate, United Kingdom. 3-5 September, 1997. P. 253. Available from Stuart Brown, National Compost Development Association, PO Box 4, Grassington, North Yorkshire, BD23 5UR UK (stuartbrown@compuserve.com).

9 - Howard, Sir Albert, (1943). An Agricultural Testament. Oxford University Press: New York.

10 - Bhamidimarri, R. (1988). Alternative Waste Treatment Systems. Elsevier Applied Science Publishers LTD., Crown House, Linton Road, Barking, Essex, IG11 8JU, England. (p.129).

11 - Rynk, Robert, ed. (1992). On-Farm Composting Handbook. Northeast Regional Agricultural Engineering Service. Ph:

(607) 255-7654. p. 12.

12 - Haug, Roger T. (1993). The Practical Handbook of Compost Engineering. p. 2. CRC Press, Inc., 2000 Corporate Blvd. N.W., Boca Raton, FL 33431 USA.

13 - Palmisano, Anna C. and Barlaz, Morton A. (Eds.) (1996). Microbiology of Solid Waste. P. 129. CRC Press, Inc., 2000 Corporate Blvd., N.W., Boca Raton, FL 33431 USA.

14 - Howard, Sir Albert, (1943). An Agricultural Testament. (p.48).

15 - Ingham, Elaine (1998). *Anaerobic Bacteria and Compost Tea*. *Biocycle*, June 1998, p 86. The JG Press, Inc., 419 State Avenue, Emmaus, PA 18049.

16 - Stoner, C.H. (Ed.). (1977). Goodbye to the Flush Toilet. Rodale Press: Emmaus, PA, 1977. (p.46).

17 - Rodale, J.I. et al. (Eds.). (1960). The Complete Book of Composting. Rodale Books Inc.: Emmaus, Pa (pp.646-647).

18 - Gotaas, Harold B., (1956). Composting - Sanitary Disposal and Reclamation of Organic Wastes. p.39. World Health Organization, Monograph Series Number 31. Geneva.

19 - *Mixing Browns and Greens For Backyard Success*. *Biocycle*, Journal of Composting and Recycling, January 1998. p. 20 (Regional Roundup). JG Press, Inc., 419 State Ave., Emmaus, PA 18049 USA.

20 - Brock, Thomas D. (1986). Thermophiles - General, Molecular, and Applied Biology. p.4. John Wiley and Sons, Inc.

21 - Madigan, Michael T. et al. (1997). Brock Biology of Microorganisms, Eighth edition. Pp. 150, 167. Information about water heaters, as well as temperature ranges of bacteria.

22 - Waksman, S.A. (1952). Soil Microbiology. John Wiley and Sons, Inc., New York. (p.70).

23 - Rynk, Robert, ed. (1992). On-Farm Composting Handbook. Northeast Regional Agricultural Engineering Service. Ph: (607) 255-7654. p. 55.

24 - Thimann, K.V. (1955). The Life of Bacteria: Their Growth, Metabolism, and Relationships. The Macmillan Co., New York. (p.177).

25 - Wade, Nicholas (1996). *Universal Ancestor*. The New York Times, as seen in the Pittsburgh Post-Gazette, Monday, August 26, 1996, p. A-8.

26 - Brock, Thomas D. (1986). Thermophiles - General, Molecular, and Applied Biology. p.23. John Wiley and Sons, Inc.

27 - Bitton, Gabriel (1994). Wastewater Microbiology. p. 81. Wiley-Liss, Inc. 605 Third Avenue, New York, NY 10518-0012.

28 - Bitton, Gabriel (1994). Wastewater Microbiology. p. 212. Wiley-Liss, Inc. 605 Third Avenue, New York, NY 10518-

0012.

29 - Palmisano, Anna C. and Barlaz, Morton A. (Eds.) (1996). Microbiology of Solid Waste. P. 123. CRC Press, Inc., 2000 Corporate Blvd., N.W., Boca Raton, FL 33431 USA.

30 - Lynch, J.M. and Poole, N.L. (Eds.). (1979). Microbial Ecology: A Conceptual Approach. Blackwell Scientific Publications, London. (p.238).

31 - Sterritt, Robert M. (1988). Microbiology for Environmental and Public Health Engineers. P. 53. E. & F. N. Spon Ltd., New York, NY 10001 USA.

32 - Palmisano, Anna C. and Barlaz, Morton A. (Eds.) (1996). Microbiology of Solid Waste. Pp. 124, 125, 129, 133. CRC Press, Inc., 2000 Corporate Blvd., N.W., Boca Raton, FL 33431 USA.

33 - Ingham, Elaine (1998). Replacing Methyl Bromide with Compost. *Biocycle*, Journal of Composting and Recycling, December 1998. p. 80. JG Press, Inc., 419 State Ave., Emmaus, PA 18049 USA.

34 - Curry, Dr. Robin (1977). Composting of Source Separated Domestic Organic Waste by Mechanically Turned Open Air Windrowing. As seen in the 1997 Organic Recovery and Biological Treatment Proceedings, Stentiford, E.I. (ed.). International Conference, Harrogate, United Kingdom. 3-5 September, 1997. P. 184.

35 - *Applied Microbiology*, December 1969.

36 - Gotaas, Harold B., (1956). Composting - Sanitary Disposal and Reclamation of Organic Wastes (p.20). World Health Organization, Monograph Series Number 31. Geneva.

37 - Curry, Dr. Robin (1977). Composting of Source Separated Domestic Organic Waste by Mechanically Turned Open Air Windrowing. As seen in the 1997 Organic Recovery and Biological Treatment Proceedings, Stentiford, E.I. (ed.). International Conference, Harrogate, United Kingdom. 3-5 September, 1997. P. 183.

38 - Palmisano, Anna C. and Barlaz, Morton A. (Eds.) (1996). Microbiology of Solid Waste. P. 169. CRC Press, Inc., 2000 Corporate Blvd., N.W., Boca Raton, FL 33431 USA.

39 - Palmisano, Anna C. and Barlaz, Morton A. (Eds.) (1996). Microbiology of Solid Waste. Pp. 121, 124, 134. CRC Press, Inc., 2000 Corporate Blvd., N.W., Boca Raton, FL 33431 USA.

40 - Rodale, J. I. (1960). The Complete Book of Composting. p. 702. Rodale Books, Inc., Emmaus, PA.

41 - Curry, Dr. Robin (1977). Composting of Source Separated Domestic Organic Waste by Mechanically Turned Open Air Windrowing. As seen in the 1997 Organic Recovery and Biological Treatment Proceedings, Stentiford, E.I. (ed.). International Conference, Harrogate, United Kingdom. 3-5 September, 1997. P. 183.

42 - Brock, Thomas D. (1986). Thermophiles - General, Molecular, and Applied Biology. p.244. John Wiley and Sons, Inc.

43 - Rynk, Robert, ed. (1992). On-Farm Composting Handbook. Northeast Regional Agricultural Engineering Service. Ph:

(607) 255-7654. p. 13.

44 - *Biocycle*, November 1998, p.18.

45 - Rodale, J. I. (1960). The Complete Book of Composting. p. 932. Rodale Books, Inc., Emmaus, PA.

46 - Smalley, Curtis (1998). *Hard Earned Lessons on Odor Management*. *Biocycle*, Journal of Composting and Recycling, January 1998. p. 59. JG Press, Inc., 419 State Ave., Emmaus, PA 18049 USA.

47 - Brinton, William F. Jr. (date unknown). *Sustainability of Modern Composting - Intensification Versus Cost and Quality*. Woods End Institute, PO Box 297, Mt. Vernon, Maine 04352 USA.

48 - Brinton, William F. Jr. (date unknown). *Sustainability of Modern Composting - Intensification Versus Cost and Quality*. Woods End Institute, PO Box 297, Mt. Vernon, Maine 04352 USA.

49 - Palmisano, Anna C. and Barlaz, Morton A. (Eds.) (1996). Microbiology of Solid Waste. P. 170. CRC Press, Inc., 2000 Corporate Blvd., N.W., Boca Raton, FL 33431 USA.

50 - *Researchers Study Composting in the Cold*. *Biocycle*, Journal of Composting and Recycling, January 1998. p. 24 (Regional Roundup). JG Press, Inc., 419 State Ave., Emmaus, PA 18049 USA.

51 - Gotaas, Harold B., (1956). Composting - Sanitary Disposal and Reclamation of Organic Wastes. p.77. World Health Organization, Monograph Series Number 31. Geneva.

52 - Regan, Raymond W. (1998). *Approaching 50 years of Compost Research*. *Biocycle*, Journal of Composting and Recycling, October 1998. p. 82. JG Press, Inc., 419 State Ave., Emmaus, PA 18049 USA.

53 - Howard, Sir Albert (1943). An Agricultural Testament. Oxford University Press: New York. (p.44). Also see: Rodale, J.I. (1946). *Pay Dirt*. The Devon-Adair Co.: New York.

54 - Rodale, J.I. et al. (Eds.) (1960). The Complete Book of Composting. Rodale Books Inc.: Emmaus, PA (p.658).

55 - Regan, Raymond W. (1998). *Approaching 50 years of Compost Research*. *Biocycle*, Journal of Composting and Recycling, October 1998. p. 82. JG Press, Inc., 419 State Ave., Emmaus, PA 18049 USA.

56 - Poncavage, J. and Jesiolowski, J. (1991). Mix Up a Compost and a Lime. *Organic Gardening*. March 1991, Vol. 38, Issue 3. (p.18).

57 - Gotaas, Harold B., (1956). Composting - Sanitary Disposal and Reclamation of Organic Wastes. p.93. World Health Organization, Monograph Series Number 31. Geneva.

58 - Palmisano, Anna C. and Barlaz, Morton A. (Eds.) (1996). Microbiology of Solid Waste. P. 132. CRC Press, Inc., 2000 Corporate Blvd., N.W., Boca Raton, FL 33431 USA.

59 - US EPA (1998). An Analysis of Composting as an Environmental Remediation Technology. EPA530-B-98-001,

March 1998.

60 - Haug, Roger T. (1993). The Practical Handbook of Compost Engineering. p. 9. CRC Press, Inc., 2000 Corporate Blvd. N.W., Boca Raton, FL 33431 USA.

61 - US EPA (October 1997). *Innovative Uses of Compost - Bioremediation and Pollution Prevention*. EPA530-F-97-042.

62 - US EPA (1998). An Analysis of Composting as an Environmental Remediation Technology. EPA530-B-98-001, March 1998.

63 - Cannon, Charles A., (1997). Life Cycle Analysis and Sustainability Moving Beyond the Three R's - Reduce, Reuse, and Recycle - to P2R2 - Preserve, Purify, Restore and Remediate. As seen in the 1997 Organic Recovery and Biological Treatment Proceedings, Stentiford, E.I. (ed.). International Conference, Harrogate, United Kingdom. 3-5 September, 1997. P. 253. Available from Stuart Brown, National Compost Development Association, PO Box 4, Grassington, North Yorkshire, BD23 5UR UK (stuartbrown@compuserve.com).

64 - US EPA (October 1997). *Innovative Uses of Compost - Bioremediation and Pollution Prevention*. EPA530-F-97-042.

65 - Logan, W.B. (1991). "Rot is Hot." *New York Times Magazine*. 9/8/91, Vol. 140, Issue 4871. (p.46).

66 - *Compost Fungi Used to Recover Wastepaper*. Biocycle, Journal of Composting and Recycling, May 1998. p. 6 (Biocycle World). JG Press, Inc., 419 State Ave., Emmaus, PA 18049 USA.

67 - Young, Lily Y., and Cerniglia, Carl E. (Eds.) (1995). Microbial Transformation and Degradation of Toxic Organic Chemicals. Pp. 408, 461, and Table 12.5. Wiley-Liss, Inc. 605 Third Avenue, New York, NY 10518-0012.

68 - Palmisano, Anna C. and Barlaz, Morton A. (Eds.) (1996). Microbiology of Solid Waste. P. 127. CRC Press, Inc., 2000 Corporate Blvd., N.W., Boca Raton, FL 33431 USA.

69 - Logan, W.B. (1991). "Rot is Hot." *New York Times Magazine*. 9/8/91, Vol. 140, Issue 4871. (p.46).

70 - Lubke, Sigfried. (1989). Interview: All Things Considered in the Wake of the Chernobyl Nuclear Accident. *Aeres U.S.A.* December 1989. (p. 20) [also contact Uta and Sigfried Lubke, A4722 Peuerbach, Untererleinsbach 1, Austria]

71 - US EPA (1998). An Analysis of Composting as an Environmental Remediation Technology. EPA530-B-98-001, March 1998.

72 - Cannon, Charles A., (1997). *Life Cycle Analysis and Sustainability Moving Beyond the Three R's - Reduce, Reuse, and Recycle - to P2R2 - Preserve, Purify, Restore and Remediate*. As seen in the 1997 Organic Recovery and Biological Treatment Proceedings, Stentiford, E.I. (ed.). International Conference, Harrogate, United Kingdom. 3-5 September, 1997. P. 254. Available from Stuart Brown, National Compost Development Association, PO Box 4, Grassington, North Yorkshire, BD23 5UR UK (stuartbrown@compuserve.com).and Schonberner, Doug (1998). *Reclaiming Contaminated Soils*, as well as Block, Dave (1998). *Composting Breaks Down Explosives*. Biocycle, Journal of Composting and Recycling, September 1998, 36-40.

73 - US EPA (1998). An Analysis of Composting as an Environmental Remediation Technology. EPA530-B-98-001,

March 1998.

- 74 - Block, Dave (1998). *Degrading PCB's Through Composting*. Biocycle, Journal of Composting and Recycling, December 1998. p. 45-48. JG Press, Inc., 419 State Ave., Emmaus, PA 18049 USA.
- 75 - US EPA (October 1997). *Innovative Uses of Compost - Bioremediation and Pollution Prevention*. EPA530-F-97-042.
- 76 - US EPA (October 1997). *Innovative Uses of Compost - Bioremediation and Pollution Prevention*. EPA530-F-97-042.
- 77 - Rynk, Robert, ed. (1992). On-Farm Composting Handbook. Northeast Regional Agricultural Engineering Service. Ph: (607) 255-7654. p. 83.
- 78 - Hoitink, Harry A. J. et al., (1997). Suppression of Root and Foliar Diseases Induced by Composts. As seen in the 1997 Organic Recovery and Biological Treatment Proceedings, Stentiford, E.I. (ed.). International Conference, Harrogate, United Kingdom. 3-5 September, 1997. p. 95.
- 79 - US EPA (October 1997). *Innovative Uses of Compost - Disease Control for Plants and Animals*. EPA530-F-97-044.
- 80 - US EPA (1998). An Analysis of Composting as an Environmental Remediation Technology. EPA530-B-98-001, March 1998.
- 81 - Logan, W.B. (1991). "Rot is Hot". *New York Times Magazine*. 9/8/91, Vol. 140, Issue 4871. (p.46).
- 82 - US EPA (1998). An Analysis of Composting as an Environmental Remediation Technology. EPA530-B-98-001, March 1998.
- 83 - Trankner, Andreas, and Brinton, William (date unknown). *Compost Practices for Control of Grape Powdery Mildew (Uncinula necator)*. Woods End Institute, PO Box 297, Mt. Vernon, Maine 04352 USA.
- 84 - Quote from Elaine Ingham as reported in: Grobe, Karin (1998). *Fine-Tuning the Soil Web*. Biocycle, Journal of Composting and Recycling, January 1998. p. 46. JG Press, Inc., 419 State Ave., Emmaus, PA 18049 USA.
- 85 - Sides, S. (1991). Compost. *Mother Earth News*. Issue 127, Aug/Sept 1991 (p.50).
- 86 - US EPA (October 1997). *Innovative Uses of Compost - Disease Control for Plants and Animals*. EPA530-F-97-044.
- 87 - Biocycle, Journal of Composting and Recycling, October 1998. p. 26. JG Press, Inc., 419 State Ave., Emmaus, PA 18049 USA.
- 88 - US EPA (October 1997). *Innovative Uses of Compost - Disease Control for Plants and Animals*. EPA530-F-97-044.
- 89 - Brodie, Herbert L., and Carr, Lewis E. (1997). Composting Animal Mortality. As seen in the 1997 Organic Recovery and Biological Treatment Proceedings, Stentiford, E.I. (ed.). International Conference, Harrogate, United Kingdom. 3-5 September, 1997. Pp. 155-159.

- 90 - McKay, Bart (1998). *Com-Postal-Ing in Texas*. Biocycle, Journal of Composting and Recycling, May 1998. p. 44-46. JG Press, Inc., 419 State Ave., Emmaus, PA 18049 USA.
- 91 - *Garbage: the Practical Journal for the Environment*. May/June 1992, p.66, Old House Journal Corp., 2 Main St., Gloucester, MA 01930.
- 92 - Logan, W.B. (1991). "Rot is Hot." *New York Times Magazine*. 9/8/91, Vol. 140, Issue 4871.
- 93 - Biocycle, Journal of Composting and Recycling, November 1998. p. 18. JG Press, Inc., 419 State Ave., Emmaus, PA 18049 USA.

REFERENCES - CHAPTER FOUR - DEEP SH*T

- 1 - Bulletin of the Atomic Scientists. September/October 1998.
- 2 - Wilson, N.W., (1966). Three Ways of Asian Wisdom. Simon and Shuster: New York. (p.11-12).
- 3 - Ibid. (p.77-78).
- 4 - Ibid. (p.137).
- 5 - Ibid. (p.145).
- 6 - Ibid. (p.140).
- 7 - Lao Tsu. Tao Te Ching. Vintage Books Edition, 1972. Vintage Books (Random House): New York. (#57).
- 8 - Holy Bible. King James Version. The World Publishing Co.: New York. (p.9).
- 9 - Rodale, J. I., (1946). Paydirt, Devon-Adair Co.: NY, (p.vi).
- 10 - *Beyond Oil: The Threat to Food and Fuel in the Coming Decades, A summary Report*. November 1986. Carrying Capacity Inc., 1325 G. Street, NW, Suite 1003, Wash. D.C. 10005.
- 11 - King, F.H., (1911). Farmers of Forty Centuries. Rodale Press: Emmaus, PA 18049.
- 12 - Ibid. (p.193, 196-7).
- 13 - Ibid. (p.10).
- 14 - Ibid. (p.19).
- 15 - Ibid. (p.199).

- 16 - White, A.D. (1955). The Warfare of Science with Theology. George Braziller: New York. (pp.68,70).
- 17 - Ibid. (p.69).
- 18 - Ibid. (p.71).
- 19 - Ibid. (p.73).
- 20 - Ibid. (pp.76-77).
- 21 - Ibid. (p.84).
- 22 - Ibid. (p.85).
- 23 - Reyburn, Wallace (1989). Flushed with Pride - The Story of Thomas Crapper. Pavilion Books Limited, 196 Shaftesbury Avenue, London WC2H 8JL. pp. 24-25.
- 24 - Seaman, L.C.B. (1973). Victorian England. Methuan & Co.: London. (pp. 48-56).
- 25 - Shuval, Hillel I. et al. (1981). Appropriate Technology for Water Supply and Sanitation - Night Soil Composting. Abstract. World Bank, Washington DC 20433, USA.
- 26 - Winblad, Uno, and Kilama, Wen (1985). Sanitation Without Water. Macmillan Education Ltd., London and Basingstoke. p. 12.
- 27 - Edmonds, Richard Louis (1994). Patterns of China's Lost Harmony - A Survey of the Country's Environmental Degradation and Protection. p. 9, 132, 137, 142, 146, 156. Routledge, 11 New Fetter Lane, London EC4P 4EE and 29 West 35th Street, New York, NY 10001.
- 28 - Hoitink, Harry A. J. et al., (1997). *Suppression of Root and Foliar Diseases Induced by Composts*. As seen in the 1997 Organic Recovery and Biological Treatment Proceedings, Stentiford, E.I. (ed.). International Conference, Harrogate, United Kingdom. 3-5 September, 1997. p. 97.
- 29 - Farmers of Forty Centuries. (p.198).

REFERENCES - CHAPTER FIVE - A DAY IN THE LIFE OF A TURD

- 1 - Mancini, K. *Septic Tank - Soil Absorption Systems*. Agricultural Engineering Fact Sheet SW-44. Penn State College of Agriculture Cooperative Extension, University Park, PA 16802.
- 2 - Mancini, K. *Mound Systems for Wastewater Treatment*. SW-43. Same as above.

- 3 - Stewart, John G. (1990). Drinking Water Hazards: How to Know if There Are Toxic Chemicals in Your Water and What to Do If There Are. Envirographics: Hiram, Ohio. (pp.177-178).
- 4 - van der Leeden, F. et al. (1990). The Water Encyclopedia. Lewis Publishers Inc.: Chelsea, Michigan, 48118. (p.526).
- 5 - Ibid. (p.525).
- 6 - Stewart, John G. (as in #3 above, same pages).
- 7 - Ibid.
- 8 - Environment Reporter. 2/28/92. The Bureau of National Affairs, Inc., Washington D.C., (pp. 2441-2).
- 9 - Gray, N.F. (1990). Activated Sludge Theory and Practice. Oxford University Press: New York. (p.125).
- 10 - Journal of Environmental Health. July/August 1989. "EPA Proposes New Rules for Sewage Sludge Disposal". (P.321).
- 11 - Logan, W.B. (1991). "Rot is Hot." New York Times Magazine. 9/8/91 Vol. 140, Issue 4871, p.46.
- 12 - van der Leeden, F. et al. (1990). The Water Encyclopedia Second Edition. Lewis Publishers, 121 South Main Street, Chelsea, Michigan 48118 (p. 541).
- 13 - Garbage. February/March 1993. Old House Journal Corp., 2 Main St., Gloucester, MA 01930. (p.18).
- 14 - Pickford, John (1995). Low-Cost Sanitation - A Survey of Practical Experience. p. 96. IT Publications, 103-105 Southampton Row, London WC1B 4HH, UK.
- 15 - US EPA (1996). Wastewater Treatment: Alternatives to Septic Systems (Guidance Document). EPA/909-K-96-001. US Environmental Protection Agency, Region 9, Drinking Water Program (W-6-3). p. 16-19. and:US EPA (1987). It's Your Choice - A Guidebook for Local Officials on Small Community Wastewater Management Options. EPA 430/9-87-006. United States Environmental Protection Agency, Office of Municipal Pollution Control (WH-595), Municipal Facilities Division, Washington DC 20460. p.55.
- 16 - Manahan, S.E. (1990). Hazardous Waste Chemistry, Toxicology and Treatment. Lewis Publishers, Inc.: Chelsea, Michigan. (p.131).
- 17 - Bitton, Gabriel (1994). Wastewater Microbiology. p. 120. Wiley-Liss, Inc. 605 Third Avenue, New York, NY 10518-0012.
- 18 - Ibid. (pp. 148-49).
- 19 - Baumann, Marty. USA Today. Feb 2, 1994, p. 1A, 4A. USA Today (Gannet Co. Inc.) 1000 Wilson Blvd., Arlington, VA 22229.

- 20 - "The Perils of Chlorine." *Audubon Magazine*, 93:30-2. Nov/Dec 1991.
- 21 - Liptak, B.G. (1991). Municipal Waste Disposal in the 1990's. Chilton Book Co.: Radnor, PA. (pp.196-8).
- 22 - Bitton, Gabriel (1994). Wastewater Microbiology. p. 312. Wiley-Liss, Inc. 605 Third Avenue, New York, NY 10518-0012.
- 23 - Stiak, J. "The Trouble With Chlorine." *Buzzworm*. Nov/Dec 1992. (p.22).
- 24 - Bitton, Gabriel (1994). Wastewater Microbiology. p. 121. Wiley-Liss, Inc. 605 Third Avenue, New York, NY 10518-0012.
- 25 - Environment Reporter. 7/10/92. (p.767).
- 26 - Bitton, Gabriel (1994). Wastewater Microbiology. p. 121. Wiley-Liss, Inc. 605 Third Avenue, New York, NY 10518-0012.
- 27 - *Buzzworm*. March/April 1993. (p.17).
- 28 - *Environment Reporter*. 7/10/92. (p.767).
- 29 - Ibid. 4/24/92. (p.2879).
- 30 - Ibid. 8/7/92. (p.1155).
- 31 - Burke, W.K. "A Prophet of Eden." *Buzzworm*. Vol. IV, Number 2, March/April 1992. (pp.18-19).
- 32 - Environment Reporter. 8/7/92. (P.1152).
- 33 - Ibid. 5/15/92. (p.319).
- 34 - Bitton, Gabriel (1994). Wastewater Microbiology. p. 352. Wiley-Liss, Inc. 605 Third Avenue, New York, NY 10518-0012.
- 35 - Ibid. 3/6/92 (p. 2474) and 1/17/92 (p.2145).
- 36 - Ibid. 1/3/92 (p.2109).
- 37 - Ibid. 11/1/91 (p.1657) and 9/27/96 (p. 1212).
- 38 - Hammond, A. et al. (Eds.) (1993). The 1993 Information Please Environmental Almanac. Compiled by the World Resources Institute. Houghton Mifflin Co.: New York. (p.41).
- 39 - Purves, D. (1990). "Toxic Sludge." *Nature*. Vol. 346, 8/16/1990 (pp. 617-18).

- 40 - Bitton, Gabriel (1994). Wastewater Microbiology. p. 352. Wiley-Liss, Inc. 605 Third Avenue, New York, NY 10518-0012.
- 41 - Rybczynski, W. et al. (1982). Appropriate Technology for Water Supply and Sanitation - Low Cost Technology Options for Sanitation, A State of the Art Review and Annotated Bibliography. World Bank. (p. 124).
- 42 - Ibid. (p. 125).
- 43 - Sterritt, Robert M. (1988). Microbiology for Environmental and Public Health Engineers. P. 160. E. & F. N. Spon Ltd., New York, NY 10001 USA.
- 44 - Fahm, L.A. (1980). The Waste of Nations. Allanheld, Osmun & Co.: Montclair, NJ (p.61).
- 45 - Shuval, Hillel I. et al. (1981). Appropriate Technology for Water Supply and Sanitation - Night Soil Composting. p.5. International Bank for Reconstruction and Development (World Bank), Washington DC, 20433, USA
- 46 - Bitton, Gabriel (1994). Wastewater Microbiology. p. 166, 352. Wiley-Liss, Inc. 605 Third Avenue, New York, NY 10518-0012.
- 47 - Sterritt, Robert M. (1988). Microbiology for Environmental and Public Health Engineers. P. 242, 251-2. E. & F. N. Spon Ltd., New York, NY 10001 USA.
- 48 - Radtke, T.M., and Gist, G.L. (1989). "Wastewater Sludge Disposal: Antibiotic Resistant Bacteria May Pose Health Hazard." *Journal of Environmental Health*. Vol 52, No.2, Sept/Oct 1989. (pp.102-5).
- 49 - *Environment Reporter*. 7/10/92. (p.770).
- 50 - *Environment Reporter*. 11/1/91. (p.1653).
- 51 - Ibid. 1/17/92. (p.2154).
- 52 - Damsker, M. (1992). "Sludge Beats Lead." *Organic Gardening*. Feb, 1992, Vol. 39, Issue 2, p.19.
- 53 - Contact JCH Environmental Engineering, Inc., 2730 Remington Court, Missoula, MT 59801-7121. Phone (406) 721-1164.
- 54 - Miller, T. L. et al., (1992). *Selected Metal and Pesticide Content of Raw and Mature Compost Samples from Eleven Illinois Facilities*. Illinois Department of Energy and Natural Resources. and: Manios, T. and Stentiford, E.I. (1998). Heavy Metals Fractionation Before, During, and After Composting of Urban Organic Residues. As seen in the 1997 Organic Recovery and Biological Treatment Proceedings, Stentiford, E.I. (ed.). International Conference, Harrogate, United Kingdom. 3-5 September, 1997. p. 227-232.
- 55 - US EPA, (1989) - Summary Report: In-Vessel Composting of Municipal Wastewater Sludge. pp. 20, 161. EPA/625/8-89/016. Center for Environmental Research Information, Cincinnati, OH.

56 - Fahm. (1980). The Waste of Nations. (p.xxiv).

57 - Ibid. (p.40).

58 - Shuval, Hillel I. et al. (1981). Appropriate Technology for Water Supply and Sanitation - Night Soil Composting. (summary). International Bank for Reconstruction and Development (World Bank), Washington DC, 20433, USA.

59 - Rivard, C.J. et al. (1989). "Waste to Energy." *Journal of Environmental Health*. Vol 52, No.2, Sept/Oct 1989. (p.100).

60 - See *Garbage*, Oct/Nov 1992, (p.14).

REFERENCES - CHAPTER SIX - COMPOSTING TOILETS & SYSTEMS

1 - Rybczynski, W. et al. (1982). Appropriate Technology for Water Supply and Sanitation - Low Cost Technology Options for Sanitation, A State of the Art Review and Annotated Bibliography. World Bank. Transportation and Water Department, 1818 H Street N.W., Washington D.C. 20433 USA.

2 - Franceys et al. (1992). A Guide to the Development of On-Site Sanitation. World Health Organization, Geneva. (p. 213).

3 - McGarry, Michael G., and Stainforth, Jill (eds.) (1978). Compost, Fertilizer, and Biogas Production from Human and Farm Wastes in the People's Republic of China. International Development Research Center, Box 8500, Ottawa, Canada, K1G 3H9 (pages 9, 10, 29, 32).

4 - Rybczynski, W. et al. (1982). Appropriate Technology for Water Supply and Sanitation - Low Cost Technology Options for Sanitation, A State of the Art Review and Annotated Bibliography. World Bank. Transportation and Water Department, 1818 H Street N.W., Washington D.C. 20433 USA. (p. 114).

5 - McGarry, Michael G., and Stainforth, Jill (eds.) (1978). Compost, Fertilizer, and Biogas Production from Human and Farm Wastes in the People's Republic of China. International Development Research Center, Box 8500, Ottawa, Canada, K1G 3H9.

6 - Winblad, Uno, and Kilama, Wen (1985). Sanitation Without Water. Macmillan Education Ltd., London and Basingstoke. pp. 20-21.

7 - Winblad, Uno (Ed.) (1998). Ecological Sanitation. Swedish International Development Cooperation Agency, Stockholm, Sweden. p. 25.

8 - Rybczynski, W. et al. (1982). Appropriate Technology for Water Supply and Sanitation - Low Cost Technology Options for Sanitation, A State of the Art Review and Annotated Bibliography. World Bank. Transportation and Water Department, 1818 H Street N.W., Washington D.C. 20433 USA.

9 - Ibid.

10 - Clivus Multrum Maintenance Manual, Clivus Multrum, Inc., 21 Canal St., Lawrence, Mass. 01840. (Also contact Hanson Assoc., Lewis Mill, Jefferson, MD 21755).

11 - Ibid.

12 - Ibid.

13 - Source: Pickford, John (1995). Low-Cost Sanitation, Intermediate Technology Publications, 103-105 Southampton Row, London WC1B 4HH, UK. p. 68.

14 - Sun Mar Corp., 900 Hertel Ave., Buffalo, NY 14216 USA; or 5035 North Service Road, Burlington, Ontario, Canada L7L 5V2.

15 - AlasCan, Inc., 3400 International Way, Fairbanks, Alaska 99701, phone/fax (907) 452-5257 [as seen in *Garbage*, Feb/Mar 1993, p.35].

16 - Composting Toilet Systems, PO Box 1928 (or 1211 Bergen Rd.), Newport, WA 99156, phone: (509) 447-3708; Fax: (509) 447-3753.

REFERENCES - CHAPTER SEVEN - WORMS AND DISEASE

1 - Kristof, Nicholas D. (1995). *Japanese is Too Polite for Words*. Pittsburgh Post Gazette, Sunday, September 24, 1995. P. B-8.

2 - Beeby, John (1995). The Tao of Pooh (now titled Future Fertility). Disclaimer, and pp. 64-65. Ecology Action of the Midpeninsula, 5798 Ridgewood Road, Willits, CA 95490-9730.

3 - Beeby, John (1995). The Tao of Pooh (now titled Future Fertility). Pp. 11-12. Ecology Action of the Midpeninsula, 5798 Ridgewood Road, Willits, CA 95490-9730.

4 - Barlow, Ronald S. (1992). The Vanishing American Outhouse. P. 2. Windmill Publishing Co., 2147 Windmill View Road, El Cajon, California 92020 USA.

5 - Warren, George M. (1922 - revised 1928). Sewage and Sewerage of Farm Homes. US Department of Agriculture, Farmer's Bulletin No. 1227. As seen in: Barlow, Ronald S. (1992). The Vanishing American Outhouse. Pp. 107-110. Windmill Publishing Co., 2147 Windmill View Road, El Cajon, California 92020 USA.

6 - Shuval, Hillel I. et al. (1981). Appropriate Technology for Water Supply and Sanitation - Night Soil Composting. p.8. International Bank for Reconstruction and Development (World Bank), Washington DC, 20433, USA.

7 - Tompkins, P., and Boyd, C. (1989). Secrets of the Soil. Harper and Row: New York. (pp.94-5).

8 - Howard, Sir Albert. The Soil and Health: A Study of Organic Agriculture. Schocken: New York. 1947. (pp. 37-38).

- 9 - Ibid. (p.177).
- 10 - Feachem, et al. (1980). Appropriate Technology for Water Supply and Sanitation. The World Bank, Director of Information and Public Affairs, Washington D.C. 20433.
- 11 - Sterritt, Robert M. (1988). Microbiology for Environmental and Public Health Engineers. P. 238. E. & F. N. Spon Ltd., New York, NY 10001 USA.
- 12 - Jervis, N. "Waste Not, Want Not". *Natural History*. May, 1990 (p.73).
- 13 - Winblad, Uno (Ed.) (1998). Ecological Sanitation. Swedish International Development Cooperation Agency, Stockholm, Sweden. p. 75.
- 14 - Sterritt, Robert M. (1988). Microbiology for Environmental and Public Health Engineers. Pp. 59-60. E. & F. N. Spon Ltd., New York, NY 10001 USA.
- 15 - Palmisano, Anna C. and Barlaz, Morton A. (Eds.) (1996). Microbiology of Solid Waste. Pp. 159. CRC Press, Inc., 2000 Corporate Blvd., N.W., Boca Raton, FL 33431 USA.
- 16 - Gotaas, Harold B., (1956). Composting - Sanitary Disposal and Reclamation of Organic Wastes. p.20. World Health Organization, Monograph Series Number 31. Geneva.
- 17 - Sopper, W.E. and Kardos, L.T. (Eds.). (1973). Recycling Treated Municipal Wastewater and Sludge Through Forest and Cropland. The Pennsylvania State University, University Park, PA (pp. 248-51).
- 18 - Ibid. (pp. 251-252).
- 19 - Shuval, Hillel I. et al. (1981). Appropriate Technology for Water Supply and Sanitation - Night Soil Composting. p.4. International Bank for Reconstruction and Development (World Bank), Washington DC, 20433, USA.
- 20 - Sterritt, Robert M. (1988). Microbiology for Environmental and Public Health Engineers. P. 252. E. & F. N. Spon Ltd., New York, NY 10001 USA.
- 21 - Cheng, Thomas C. (1973). General Parasitology. Academic Press, Inc., 111 Fifth Avenue, New York, NY 10003 (p. 645).
- 22 - Shuval, Hillel I. et al. (1981). Appropriate Technology for Water Supply and Sanitation - Night Soil Composting. p.6. International Bank for Reconstruction and Development (World Bank), Washington DC, 20433, USA.
- 23 - Feachem et al. (1980). Appropriate Technology for Water Supply and Sanitation: Health Aspects of Excreta and Sullage Management. Energy, Water and Telecommunications Department of the World Bank, 1818 H Street N.W., Washington D.C. 20433. This comprehensive work cites 394 references from throughout the world, and was carried out as part of the World Bank's research project on appropriate technology for water supply and sanitation.
- 24 - Ibid.

- 25 - Olson, O. W. (1974). Animal Parasites - Their Life Cycles and Ecology. University Park Press, Baltimore, MD (p. 451-452).
- 26 - Crook, James (1985). "Water Reuse in California." *Journal of the American Waterworks Association*. v77, no. 7. as seen in The Water Encyclopedia by van der Leeden et al. (1990), Lewis Publishers, Chelsea, Mich. 48118.
- 27 - Boyd, R. F. and Hoerl, B. G. (1977). Basic Medical Microbiology. Little, Brown and Co., Boston Mass. (p. 494).
- 28 - Cheng, Thomas C. (1973) General Parasitology. Academic Press Inc., 111 Fifth Ave., New York, NY 10003. (p. 645).
- 29 - Sterritt, Robert M. (1988). Microbiology for Environmental and Public Health Engineers. Pp. 244-245. E. & F. N. Spon Ltd., New York, NY 10001 USA.
- 30 - Epstein, Elliot (1998). "Pathogenic Health Aspects of Land Application." *Biocycle*, September 1998, p.64. The JG Press, Inc., 419 State Avenue, Emmaus, PA 18049.
- 31 - Shuval, Hillel I. et al. (1981). Appropriate Technology for Water Supply and Sanitation - Night Soil Composting. p.5. International Bank for Reconstruction and Development (World Bank), Washington DC, 20433, USA.
- 32 - Franceys, R. et al. (1992). A Guide to the Development of On-Site Sanitation. World Health Organization, Geneva. p. 212.
- 33 - Schoenfeld, M., and Bennett, M. (1992). Water Quality Analysis of Wolf Creek. (Unpublished manuscript). Slippery Rock University, Applied Ecology Course, PREE, Fall Semester. (Prof. P. Johnson), Slippery Rock, PA 16057
- 34 - Pomeranz, V.E. and Schultz, D., (1972). The Mother's and Father's Medical Encyclopedia. The New American Library, Inc., 1633 Broadway, New York, NY 10019. (p.627).
- 35- Chandler, A.C. and Read, C.P. (1961). Introduction to Parasitology. John Wiley and Sons, Inc.: New York.
- 36 - Brown, H.W. and Neva, F.A. (1983). Basic Clinical Parasitology. Appleton-Century-Crofts/Norwalk, Connecticut 06855. (pp.128-31). Pinworm destruction by composting mentioned in: Gotaas, Harold B., (1956). Composting - Sanitary Disposal and Reclamation of Organic Wastes . p.20. World Health Organization, Monograph Series Number 31. Geneva.
- 37 - Brown, H.W. and Neva, F.A. (1983). Basic Clinical Parasitology. Appleton-Century-Crofts/Norwalk, Connecticut 06855. (pp.119-126).
- 38 - Ibid.
- 39 - Ibid.
- 40 - Haug, Roger T. (1993). The Practical Handbook of Compost Engineering. p. 141. CRC Press, Inc., 2000 Corporate Blvd. N.W., Boca Raton, FL 33431 USA.
- 41 - Shuval, Hillel I. et al. (1981). Appropriate Technology for Water Supply and Sanitation - Night Soil Composting. p.4.

International Bank for Reconstruction and Development (World Bank), Washington DC, 20433, USA.

42 - Franceys, R. et al. (1992). A Guide to the Development of On-Site Sanitation. World Health Organization, Geneva. p. 214.

43 - Shuval, Hillel I. et al. (1981). Appropriate Technology for Water Supply and Sanitation - Night Soil Composting. p.7. International Bank for Reconstruction and Development (World Bank), Washington DC, 20433, USA.

REFERENCES - CHAPTER EIGHT - THE TAO OF COMPOST

1 - LaMotte Chemical Products Co., Chestertown, MD 21620

2 - Rodale, J. I., (1960). The Complete Book of Composting. P. 650, Rodale Books, Emmaus, PA.

3 - Kitto, Dick. (1988). Composting: The Organic Natural Way. Thorsons Publishers Ltd.: Wellingborough, England. (p. 103).

4 - World of Composting Toilets Forum Update No. 3, Monday, November 2, 1998. Reply to: earthwise@earthwise.nwnet.co.uk.

5 - Del Porto, David, and Steinfeld, Carol (1999). The Composting Toilet System Book - editor's draft. Center for Ecological Pollution Prevention, PO Box 1330, Concord, MA 01742-1330.

6 - Olexa, M. T. and Trudeau, Rebecca L., (1994). *How is the Use of Compost Regulated?* University of Florida, Florida Cooperative Extension Service, Document No. SS-FRE-19, September 1994.

7 - Pennsylvania Solid Waste Management Act, Title 35, Chapter 29A.

8 - Pennsylvania Municipal Waste Planning, Recycling and Waste Reduction Act (1988), Title 53, Chapter 17A.

9 - King, F.H. (1911). Farmers of Forty Centuries. Rodale Press, Inc., Emmaus, PA 18049. (pp.78, 202).

REFERENCES - CHAPTER NINE - ALTERNATIVE GREY WATER SYSTEMS

1 - Waterless Toilets as Repair for Failed Septic Tank Systems. Bio-Sun Systems, Inc., RR #2, Box 134A, Millerton, PA 16936. Ph: 717-537-2200. Email: Bio-sun@ix.netcom.com

2 - US EPA (1992). Wastewater Treatment/Disposal for Small Communities. P. 42. EPA/625/R-92/005. US EPA Office of Research and Development, Office of Water, Washington DC 20460 USA.

3 - Bennett, Dick (1995). *Graywater, An Option for Household Water Reuse*. Home Energy Magazine, July/August, 1995.

- 4 - Gerba, Charles P. et al. (1995). *Water Quality Study of Graywater Treatment Systems*. Water Resources Bulletin, February, 1995, Vol. 31, No. 1, p. 109. American Water Resources Association.
- 5 - Rose, Joan B. et al. (1991). *Microbial Quality and Persistence of Enteric Pathogens in Graywater from Various Household Sources*. Water Resources, Vol. 25, No. 1, pp. 37-42, 1991.
- 6 - Karpiscak, Martin M. et al. (1990). *Residential Water Conservation: Casa del Agua*. Water Resources Bulletin, December 1990, p. 945-946. American Water Resources Association.
- 7 - Gerba, Charles P. et al. (1995). *Water Quality Study of Graywater Treatment Systems*. Water Resources Bulletin, February, 1995, Vol. 31, No. 1, p. 109. American Water Resources Association.
- 8 - Karpiscak, Martin M. et al. (1990). *Residential Water Conservation: Casa del Agua*. Water Resources Bulletin, December 1990, p. 940. American Water Resources Association.
- 9 - Rose, Joan B. et al. (1991). *Microbial Quality and Persistence of Enteric Pathogens in Graywater from Various Household Sources*. Water Resources, Vol. 25, No. 1, p. 40, 1991.
- 10 - Karpiscak, Martin M. et al. (1990). *Residential Water Conservation: Casa del Agua*. Water Resources Bulletin, December 1990, p. 940. American Water Resources Association.
- 11 - Ludwig, Art (1994). Create an Oasis with Greywater. Oasis Design, 5 San Marcos Trout Club, Santa Barbara, CA 93105-9726. Phone: 805-967-9956.
- 12 - Bennett, Dick (1995). *Graywater, An Option for Household Water Reuse*. *Home Energy Magazine*, July/August, 1995.
- 13 - Rose, Joan B. et al. (1991). *Microbial Quality and Persistence of Enteric Pathogens in Graywater from Various Household Sources*. Water Resources, Vol. 25, No. 1, p. 40, 1991.
- 14 - Rose, Joan B. et al. (1991). *Microbial Quality and Persistence of Enteric Pathogens in Graywater from Various Household Sources*. Water Resources, Vol. 25, No. 1, pp. 37-38, 1991.
- 15 - Rose, Joan B. et al. (1991). *Microbial Quality and Persistence of Enteric Pathogens in Graywater from Various Household Sources*. Water Resources, Vol. 25, No. 1, pp. 39, 41, 1991.
- 16 - Bastian, Robert K. (date unknown). Needs and Problems in Sewage Treatment and Effluent Disposal Facing Small Communities; The Role of Wetland Treatment Alternatives. US EPA, Office of Municipal Pollution Control, Washington DC 20460.
- 17 - Hoang, Tawni et al. (1998). Greenhouse Wastewater Treatment with Constructed Wetlands. *Greenhouse Product News*, August 1998, p.33.
- 18 - Golueke, Clarence G. (1977). *Using Plants for Wastewater Treatment*. *Compost Science*, September/October 1977, p. 18.

- 19 - Berghage, R.D. et al. (date unknown). "Green" Water Treatment for the Green Industries: Opportunities for Biofiltration of Greenhouse and Nursery Irrigation Water and Runoff with Constructed Wetlands. and: Gupta, G.C. (1980). *Use of Water Hyacinths in Wastewater Treatment*. Journal of Environmental Health. 43(2):80-82. and: Joseph, J. (1978). *Hyacinths for Wastewater Treatment*. Reeves Journal. 56(2):34-36.
- 20 - Hillman, W.S. and Culley, D.D. Jr. (1978). *The Uses of Duckweed*. American Scientist, 66:442-451
- 21 - Pries, John (date unknown, but 1996 or later). *Constructed Treatment Wetland Systems in Canada*. Gore and Storrie Ltd., Suite 600, 180 King St. S., Waterloo, Ontario, N2J 1P8. Ph: 519-579-3500.
- 22 - Golueke, Clarence G. (1977). *Using Plants for Wastewater Treatment*. Compost Science, September/October 1977, p. 18.
- 23 - Golueke, Clarence G. (1977). *Using Plants for Wastewater Treatment*. Compost Science, September/October 1977, p. 17.
- 24 - For more information, contact Carl Lindstrom at: <http://www.greywater.com/>

REFERENCES - CHAPTER TEN - THE END IS NEAR

- 1 - Rybczynski, W. et. al. (1982). Appropriate Technology for Water Supply and Sanitation - Low Cost Technology Options for Sanitation, A State of the Art Review and Annotated Bibliography. World Bank, Geneva. (p. 20).
- 2 - Kugler, R. et al. (1998). *Technological Quality Guarantees for H.Q. Compost from Bio-Waste*. As seen in the 1997 Organic Recovery and Biological Treatment Proceedings, Stentiford, E.I. (ed.). International Conference, Harrogate, United Kingdom. 3-5 September, 1997. P. 31. Available from Stuart Brown, National Compost Development Association, PO Box 4, Grassington, North Yorkshire, BD23 5UR UK (stuartbrown@compuserve.com).
- 3 - Vorkamp, Katrin et al. (1998). *Multiresidue Analysis of Pesticides and their Metabolites in Biological Waste*. As seen in the 1997 Organic Recovery and Biological Treatment Proceedings, Stentiford, E.I. (ed.). International Conference, Harrogate, United Kingdom. 3-5 September, 1997. p. 221. Available from Stuart Brown, National Compost Development Association, PO Box 4, Grassington, North Yorkshire, BD23 5UR UK (stuartbrown@compuserve.com).
- 4 - Wheeler, Pat (1998). *Results of the Environment Agency Research Programme into Composting of Green and Household Wastes*. As seen in the 1997 Organic Recovery and Biological Treatment Proceedings, Stentiford, E.I. (ed.). International Conference, Harrogate, United Kingdom. 3-5 September, 1997. p. 77. Available from Stuart Brown, National Compost Development Association, PO Box 4, Grassington, North Yorkshire, BD23 5UR UK (stuartbrown@compuserve.com).
- 5 - Johnson, Julie. (1990). "Waste That No One Wants." *New Scientist*. 9/8/90, Vol. 127, Issue 1733. (p.50).
- 6 - Benedict, Arthur H. et. al. (1988). "Composting Municipal Sludge: A Technology Evaluation." Appendix A. Noyes Data Corporation.

7 - Biocycle, January 1998, p. 71.

8 - Johnson, Julie. (1990). *Waste That No One Wants*. (p. 53) see above.

9 - Simon, Ruth. (1990). *The Whole Earth Compost Pile?* Forbes. 5/28/90, Vol. 145, Issue 11. p. 136.

10 - Gotaas, Harold B., (1956). Composting - Sanitary Disposal and Reclamation of Organic Wastes. p.101. World Health Organization, Monograph Series Number 31. Geneva.

Source: *The Humanure Handbook*. Jenkins Publishing, PO Box 607, Grove City, PA 16127. To order, phone: 1-800-639-4099.

<http://www.jenkinspublishing.com/>

MENU: [HOME](#) » [Reconstruction](#) » [Recovery](#) » [Renewal](#) » [Survival](#) » [Humanure Content](#)

APPENDIX 3

State Regulations (US), Compiled in 1999: Composting Toilets, Graywater Systems, and Constructed Wetlands

[AL](#) | [AK](#) | [AZ](#) | [AR](#) | [CA](#) | [CO](#) | [CT](#) | [DE](#) | [FL](#) | [GA](#) | [HI](#) | [ID](#) | [IL](#) | [IN](#) | [IA](#) | [KS](#) | [KY](#) | [LA](#) | [ME](#) | [MA](#) | [MD](#) | [MI](#) | [MN](#) | [MS](#) | [MO](#) | [MT](#) | [NC](#) | [NE](#) | [NV](#) | [NH](#) | [NJ](#) | [NM](#) | [NY](#) | [ND](#) | [OH](#) | [OK](#) | [OR](#) | [PA](#) | [RI](#) | [SC](#) | [SD](#) | [TN](#) | [TX](#) | [UT](#) | [VT](#) | [VA](#) | [WA](#) | [WV](#) | [WI](#) | [WY](#) | [CANADA](#) | [OTHER INFO](#)

Notes: 1. Although many states do not have formal design standards or regulations concerning composting toilets, graywater systems, and/or constructed wetlands as they pertain to on-site sewage management for residences, many of the rules and regulations do contain a section allowing “experimental” and/or “alternative” systems which may be permitted by individual application to the regulating agency. Individuals interested in these systems should check with their state agency for more information.

2. When the phrase “no existing regulations,” is used it is not meant to imply that those systems may be used without prior approval from the local or state permitting agency. In all cases, check with your local or state permitting agency to see what their permitting requirements are.

Alabama: Alabama Department of Public Health, Division of Community Environmental Protection, RSA Tower, Suite 1250, PO Box 303017, Montgomery, AL 36130-3017; Ph. (334) 206-5373; Contact: John Paul O’Driscoll.

REGULATION(S): Chapter 420-3-1: Onsite Sewage Disposal and Subdivision-Onsite Sewage Systems, Water Supplies and Solid Waste Management (23 December 1998). Composting Toilets: As of December 23, 1998, no regulations exist for composting toilets.

Composting toilets are not expressly forbidden, but the homeowner does have to show adequate sewage disposal for graywater. Alabama is working on a set of new regulations, as the current rules have been overcome by time, and are not adequate for many of the situations that the regulated community faces today. The main shortcoming of the current regulations is that they do not adequately address the large systems and alternative technologies that are present today.¹ In the proposed regulations, composting toilets are discussed in Chapter 420-3-1-.59 under Non-Waterborne Systems: Pit Privies, Portable, Composting, and Incinerating Toilets. A composting toilet is defined as a dry closet which combines toilet and urinal waste with optional food waste in an aerobic vented environment. Decomposition of the waste is accomplished by the dehydration and digestion of organic matter, yielding a composted residue which is removed for sanitary disposal.² Conditions which justify the use of non-waterborne systems include when soil and site conditions are unsuitable for on-site sewage treatment and disposal systems (OSTDS) or when water under pressure is not available. Composting toilets must meet the standards of the National Sanitation Foundation (NSF), Canadian Standards Association (CSA), Underwriter’s Laboratory, or Warnock Hershey. Other requirements call for continuous ventilation of the components for the storage or treatment of materials. Disposal of the compost must be in accordance with the guidance of EPA Part 503. Disposal of any liquids from the system must be to a sanitary sewer or to an approved OSTDS.

GRAYWATER: Ch. 420-3-1-.03. Defined, graywater is that portion of sewage generated by a water-using fixture or appliance, excluding the toilet and possibly the garbage disposal.³ References to graywater can be found under 402-3-1-.27 Effluent from Clothes Washing Machine and Residential Spa. Water from these systems can circumvent a septic tank and go into a separate effluent disposal field (EDF). In the current regulations, in the absence of water under pressure, graywater shall be disposed of by an effluent distribution line of 50 linear feet per dwelling. Graywater is also covered under the proposed draft of Ch. 420-3-1-.59. No new recommendations besides the EDF system are proposed.

CONSTRUCTED WETLANDS: A constructed wetland is defined in the proposed rules as a human-made, engineered, marsh-like area which is designed, constructed, and operated to treat wastewater by attempting to optimize physical, chemical, and biological processes of natural ecosystems.⁴ However, there are no existing regulations.

Alaska: Alaska Department of Environmental Conservation, Domestic Wastewater Program, 410 West Willoughby Avenue, Suite 105, Juneau, AK 99801; Ph. (907) 465-5324; Fax (907) 465-5362; <http://www.state.ak.us/dec>.

REGULATION(S): 18 AAC 72 Wastewater Disposal (1 April 1999).

COMPOSTING TOILETS: No existing regulations.

GRAYWATER: 18 AAC 72.990. Graywater means wastewater a) from a laundry, kitchen, sink, shower, bath, or other domestic sources; and wastewater b) that does not contain excrement, urine, or combined stormwater. No existing regulations.

CONSTRUCTED WETLANDS: No existing regulations.

Arizona: Arizona Department of Environmental Quality, 3033 North Central Avenue, Phoenix, AZ 85012-2809; Toll-free Ph. (800) 234-5677; Ph. (602) 207-4335; Fax (602) 207-4872; Contact: Nabil Anouti at (602) 207-4723;

http://www.sosaz.com/public_services/Title_18/18-09.htm

REGULATION(S): Arizona Department of Environmental Quality (ADEQ) Bulletin No. 12, Minimum Requirements for the Design and Installation of Septic Tank Systems and Alternative On-site Disposal Systems (June 1989); Arizona Administrative Code Title 18, Ch. 9, Article 7: Regulations for the Reuse of Wastewater (30 September 1998); Arizona Guidance Manual for Constructed Wetlands for Water Quality Improvement (August 1996).

COMPOSTING TOILETS: No regulations. Bulletin 12 suggests the use of composting toilets where conditions are such as to make it impossible or impractical to construct either a septic tank disposal or an earth-pit privy.⁵ Provided they can be maintained and operated without endangering the public health or creating a nuisance, composting toilets may be permitted.⁶

GRAYWATER: Defined under R18-9-701. Graywater means wastewater that originates from clothes washers, dishwashers, bathtubs, showers and sinks, except kitchen sinks and toilets. Under R18-9-703, section C6, graywater from single and multi-family residences may be used for surface irrigation. The design and construction of the system must be approved by the Department. Irrigation sites must be designed to contain a 10-year, 24-hour (i.e., maximum possible) rainfall event and the graywater must fall under the allowable limits of less than 25 colony forming units per 100 milliliters (CFU/ml) fecal coliform and less than 2.0 mg/l chlorine for surface irrigation. Under section 7, formation of a wetlands marsh is allowable reuse of reclaimed wastewater.⁷

CONSTRUCTED WETLANDS: Bulletin 12 describes onsite alternatives to septic tank and drainfield disposal systems. The first general requirement of Bulletin No. 12 is that alternative onsite disposal systems are intended and will be approved for individual lots only where conventional septic tank systems are not suitable and cannot be approved.⁸ Use of a septic tank with a minimum of two compartments for preliminary solids removal is necessary prior to a constructed wetland. Constructed subsurface flow wetlands are viewed as a beneficial augmenting step in the septic tank system, providing additional treatment between the septic tank and the soil absorption system.⁹ The bulletin points out several benefits of segregating blackwater and graywater: 1) conservation of water resources; 2) potential of recycling valuable nutrients to the soil; 3) reuse potential of recycled graywater; and 4) prolonged life of the septic tank soil absorption system.¹⁰ However, until further field data becomes available and is evaluated, graywater treatment and disposal systems shall be designed similarly for typical residential wastewater septic tank soil absorption systems. Under this scenario, it may be possible to reduce the septic tank system capacities, sometimes by one-third.¹¹

Arkansas: Arkansas Department of Health, Sanitary Division, State Health Building, 4815 West Markham, Little Rock, AR 72201; Ph. (501) 661-2171.

REGULATION(S): Alternate Systems Manual published by Environmental Program Services, Division of Environmental Health Protection (April 1993). According to the Alternate Systems Manual, the Arkansas Department of Health encourages studies and submission of plans for alternative methods of treating and disposing of wastes generated by individual residences.¹² However, if site and soil conditions indicate that a standard septic tank and soil absorption system is feasible, no alternative or experimental system will be considered.¹³

COMPOSTING TOILETS: are allowed as long as they are NSF approved. In fact, composting toilets are currently being used in state park systems.¹⁴ A composting toilet is defined as a device specifically designed to retain and process body waste, and, in some cases, household garbage, by biological degradation. The process may be thermophilic or mesophilic, depending on the design of the toilet.¹⁵ Some manufacturers claim the stabilized compost is safe and may be used as a soil additive in gardens. The actual health risks associated with this composted material have not been adequately assessed. The stabilized compost from a composting toilet must be buried onsite or deposited in an approved sanitary landfill. All composting devices must be evaluated by an ANSI approved laboratory under NSF Standard 41.¹⁶ Approved composting toilets for the state of Arkansas include Clivus Multrum models 08, 08-0A, 08-A, 202 and 205; and Sun-Mar Biological Composting Toilet and Sun-Mar-XL. Each application requesting approval of a composting toilet must also provide for the disposal of the home's graywater.¹⁷

GRAYWATER: Essentially, graywater is treated the same as blackwater. The preferred method of handling graywater is through a conventional septic tank and absorption field. A 35% reduction in the absorption field size will be granted. Other methods of treating and/or disposing of graywater will be reviewed on a case by case basis.¹⁸

CONSTRUCTED WETLANDS (ROCK PLANT FILTERS): Rock plant filters (RPFs) provide secondary treatment to septic tank effluent. RPFs act as artificial marshes that rely on microorganisms and the roots of aquatic plants to achieve treatment. RPF systems may be considered on sites where low soil permeability prohibits use of a conventional septic system. Discharge from an RPF must be retained on site, which requires a lot size of at least three acres. This requirement may be waived on repairs to existing, failed septic systems. All off-site discharges must be undergo chlorination prior to discharge.¹⁹

California: California Department of Water Resources, Water Conservation Office, 1020 9th Street, Sacramento, CA 95814; Ph. (916) 327-1655; Contact: Ed Craddock. For Composting Toilets and Constructed Wetlands Regulations, Contact: California Department of Health Services, 724 P Street, Room 1350, Sacramento, CA 95814; Ph. (916) 654 0584; Fax (916) 657-2996.

REGULATION(S): Appendix G. Graywater Systems. Uniform Plumbing Code, Title 24, Part 5, California Administrative Code (18

March 1997).

COMPOSTING TOILETS: No existing regulations, check with your local or county agency. **GRAYWATER:** G-1. General. (b) The type of system shall be determined on the basis of location, soil type, and ground water level and shall be designed to accept all graywater connected to the system from the building. The system shall discharge into subsurface irrigation fields and may include surge tanks and appurtenances, as required by the Administrative Authority. (d) No permit for any graywater system shall be issued until a plot plan with appropriate data satisfactory to the Administrative Authority has been submitted and approved. When there is insufficient lot area or inappropriate soil conditions for adequate absorption of the graywater, as determined by the Administrative Authority, no graywater system shall be permitted. G2. Graywater is untreated wastewater which has not come into contact with toilet waste. Graywater includes used water from bathtubs, showers, bathroom wash basins, clothes washing machines and laundry tubs or an equivalent discharge as approved by the Administrative Authority. It does not include wastewater from kitchen sinks, photo lab sinks, dishwashers, or laundry water from soiled diapers. Surfacing of graywater means the ponding, running off, or other release of graywater from the land surface. G13 Health and Safety. (a) Graywater may contain fecal matter as a result of bathing and/or washing of diapers and undergarments. Water containing fecal matter, if swallowed, can cause illness in a susceptible person. (b) Graywater shall not include laundry water from soiled diapers. (c) Graywater shall not be applied above the land surface or allowed to surface and shall not be discharged directly into or reach any storm sewer system or any water of the United States. (d) Graywater shall not be contacted by humans, except as required to maintain the graywater treatment and distribution system. (e) Graywater shall not be used for vegetable gardens.²⁰

CONSTRUCTED WETLANDS: No existing regulations.

Colorado: Colorado Department of Public Health and Environment, Water Quality Control Division, 4300 Cherry Creek Drive South, Denver, CO 80246-1530; Ph. (303) 692-3500.

REGULATION(S): Guidelines on Individual Sewage Disposal Systems, Chapter 25, Article 10 (1994).

COMPOSTING TOILETS: Composting toilets, according to the Colorado Department of Health, are defined as unit(s) which consist of a toilet seat and cover over a riser which connects to a compartment or a vault that contains or will receive composting materials sufficient to reduce waste by aerobic decomposition.²¹ Composting toilets receive deposits of feces, urine, and readily decomposable household garbage that are not diluted with water or other fluids.²² These deposits are retained in a compartment in which aerobic composting will occur. The compartment may be located within a dwelling or building, provided that the unit complies with the applicable requirements of these guidelines and provided the installation will not result in conditions considered to be a health hazard as determined by the local health department. The effective volume of the receptacle must be sufficient to accommodate the number of persons served. When the receptacle is filled to 75% capacity, residue from the unit shall be disposed of by acceptable solid waste practices. Composting toilets must be NSF approved.²³

GRAYWATER: Graywater systems collect, treat, and dispose of liquid wastes from sinks, lavatories, tubs, showers, and laundry or other approved plumbing fixtures, excluding toilet fixtures.²⁴ Graywater systems shall meet at least all minimum design and construction standards for septic tank systems based on the amount and character of wastes for the fixtures and the number of persons served.²⁵

CONSTRUCTED WETLANDS: are systems which utilize various wetland plants to provide secondary treatment of wastewater through biological, physical, and chemical processes.²⁶ Constructed wetland systems must be designed by a registered professional engineer. Designs have to be site-specific and must include estimates of effluent quality at the inlet and outlet. Periodic sampling is required at the owner's expense.²⁷

Connecticut: Connecticut Department of Public Health, 410 Capitol Avenue, MS #51 SEW, PO Box 340308, Hartford, CT 06134-0308; Ph. (860) 509-7296; <http://www.dep.state.ct.us/dph>.

REGULATION(S): Connecticut Public Health Code: Regulations and Technical Standards for Subsurface Sewage Disposal Systems, Section 19-13-B100 (Conversions, Changes in Use, Additions) (25 October 1976); Section 19-13-B103 (Discharges 5,000 Gallons Per Day or Less) (16 August 1982); and Technical Standards (Pursuant to Section 19-13-B103) (1 January 1997).

COMPOSTING TOILETS: (b)(1) The local director of health may approve the use of a large capacity composting toilet or a heat-assisted composting toilet for replacing an existing privy or a failing subsurface sewage disposal system, or for any single-family residential building where application is made by the owner and occupant, and the lot on which the building will be located is tested by the local director of health and found suitable for a subsurface sewage disposal system meeting all the requirements of Section 19-13-B103d of these regulations. (2) All wastes removed from composting toilets shall be disposed of by burial or other methods approved by the local director of health.²⁸ 19-13-B103f XI. Non-Discharging Sewage Disposal Systems A. Large capacity composting toilets shall have separate receiving, composting, and storage compartments, arranged so that the contents are moved from one compartment to another without spillage or escape of odors within the dwelling. No large capacity composting toilets shall have an interior volume of less than 64 cubic feet. All toilet waste shall be deposited in the receiving chamber, which shall be furnished with a tight self-closing toilet lid. Food waste or other materials necessary to the composting action shall be deposited in the composting compartment through a separate opening with a tight fitting lid. The final composting material shall be removed from the storage compartment through a cleanout opening fitted with a tight door or lid. The cleanout shall not be located in a food storage or preparation area. The receiving and composting compartments shall be connected to the outside atmosphere by a screened vent. The vent shall be a minimum of six inches in diameter and shall extend at least

20 feet above the openings in the receiving and composting compartments, unless mechanical ventilation is provided. Air inlets shall be connected to the storage compartment only, and shall be screened. B. Heat assigned composting toilets shall have a single compartment furnished with a tight, self-closing toilet lid. The compartment shall be connected to the outside atmosphere by a screened vent. There shall be a mechanical ventilation fan arranged to control the humidity in the compartment and provide positive venting of odors to the outside atmosphere at all times. A heating unit shall be provided to maintain temperature in the optimum range for composting.²⁹

GRAYWATER: (n) Graywater means domestic sewage containing no fecal material or toilet wastes. Sec. 19-13-B103d. Minimum Requirements. (f) Gray Water Systems. Disposal systems for sinks, tubs, showers, laundries, and other graywater from residential buildings, where no water flush toilet fixtures are connected, shall be constructed with a septic tank and leaching system at least one-half the capacity specified for the required residential sewage disposal system.³⁰ Sec. 19-13-B103f. Non-discharging Sewage Disposal Systems (a) All non-discharging sewage disposal systems shall be designed, installed, and operated in accordance with the Technical Standards and the requirements of this section, unless an exception is granted by the Commissioner upon a determination that system shall provide for the proper and complete disposal and treatment of toilet wastes or graywater.³¹

CONSTRUCTED WETLANDS: No existing regulations.

Delaware: Department of Natural Resources and Environmental Control, Division of Water Resources, 89 Kings Highway, Dover, DE 19901; Ph. (302) 739-4761.

REGULATION(S): Regulations Governing the Design, Installation and Operation of On-Site Wastewater Treatment and Disposal Systems (4 January 1984).

COMPOSTING TOILETS, GRAYWATER, CONSTRUCTED WETLANDS: No existing regulations. However, a substantial portion of Delaware's population lives where centralized water supply or wastewater treatment services are limited. The Department's mission is to aid and assist the public in the installation of on-site sewage disposal systems, where possible, by utilizing the best information, techniques, and soil evaluations for the most suitable system that site and soil conditions permit. In the past, inadequately renovated wastewater has contaminated Delaware's groundwater and presented a threat to the public health, safety, and welfare. Corrective measures required the replacement of water supply and wastewater systems at a very high cost which was sometimes borne by the general public. In developing these Regulations, the Department operated under the philosophy that where soil and site conditions permit, the least complex, easy to maintain, and most economical system should be used. The Department's policy is to encourage development of systems, processes, and techniques which may benefit significant numbers of people in Delaware.³²

Florida: Florida Department of Health, Bureau of Water and On-Site Sewage Programs, 2020 Capital Circle SE, BIN #A08, Tallahassee, FL 32399-1713; Ph. (850) 488-4070; FAX (850) 922-6969; <http://www.doh.state.fl.us/>;

<http://www.dep.state.fl.us/ogc/documents/rules/rulelistpa.htm#wastewater>; Contact: David Hammonds; Email:

David_Hammonds@doh.state.fl.us

REGULATION(S): 381.0065 Florida Statutes Regulations: Chapter 64E-6, Florida Administrative Code, Standards for Onsite Sewage Treatment and Disposal Systems (3 March 1998).

COMPOSTING TOILETS: Although they are not widely used, they are allowed, especially in floodprone areas. Florida encourages the use of composting toilets.³³ 64E-6.009 Alternative Systems. Upon approval by the DOH county health department, alternative systems may, at the applicant's discretion, be used in circumstances where standard subsurface systems are not suitable or where alternative systems are more feasible. Under this section, composting toilets may be approved for use if found in compliance with NSF Standard 41. Graywater and any other liquid and solid waste must be properly collected and disposed of in accordance with Chapter 64E.³⁴ 64E-6.010 Disposal of Sewage. No receptacle associated with an onsite sewage treatment and disposal system shall be cleaned or have its contents removed until the service person has obtained an annual written permit (form DH4013) from the DOH county health department in the county in which the service company is located.³⁵

GRAYWATER: as defined under Title XXIX, Public Health Chapter 381.0065 Onsite Sewage treatment and disposal systems, means that part of domestic sewage that is not blackwater, including the waste from the bath, lavatory, laundry, and sink, except kitchen sink waste.³⁶ Graywater systems are described in Rule 64E-6.013(4).³⁷ When a separate system is installed to dispose of graywater, the retention tank for such systems shall meet certain design standards as specified in Rule 64E-6.008(3): The minimum effective capacity of the graywater retention tank shall be 250 gallons, with such system receiving not more than 75 gallons of flow per day. Where separate graywater and blackwater systems are used, the size of the blackwater system can be reduced by not more than 25%. 10D-6.046 Location and Installation. (7) Onsite graywater tank and drainfield systems may, at the homeowner's discretion, be utilized in conjunction with an onsite blackwater system where a sewerage system is not available for blackwater disposal.³⁸ 10D-6.048 System Size Determination (4) A separate laundry waste tank and drainfield system may be utilized for residences and may be required by the county public health unit where building codes allow for separation of discharge pipes of the residence to separate stubouts and where lot sizes and setback allow system construction. (a) The minimum laundry waste trench drainfield absorption area for slightly limited soil shall be 75 square feet for a one or two bedroom residence with an additional 25 square feet for each additional bedroom. 10D-6.055 (k) All graywater tanks distributed by the state shall be approved for use by the department prior to being installed. Such approval shall be obtained only after the manufacturer of a specific model has submitted engineering designs of the tank. (4) Graywater retention tanks - when a separate system is

installed to dispose of graywater, the retention tank for such system shall meet the following minimum design standards: a) the minimum effective capacity shall be as specified in Rule 10D-6.048(3). Liquid depth shall be at least 30 inches; and b) retention tanks shall be baffled and vented as specified in the septic tank construction standards found elsewhere in the section provided that an inlet tee, ell, or baffle shall be provided for graywater tanks.³⁹

CONSTRUCTED WETLANDS: No existing regulations.⁴⁰

Georgia: Department of Human Resources, Division of Public Health, Environmental Health Section, 5th Floor-Annex, 2 Peachtree Street NW, Atlanta, GA 30303-3186; Ph. (404) 657-2700 or 6538; FAX (404) 657-6533; <http://www.ganet.org/dnr/environ/rules>;

Contact: Warren Abrahams, Program Consultant.

REGULATION(S): Rules of Department of Human Resources, Public Health, Chapter 290-5-26: Onsite Sewage Disposal Management Systems (20 February 1998).

COMPOSTING TOILETS: Where the availability of land for installation of conventional septic tank systems is limited so as to allow for only a septic tank and a reduced size absorption system, composting toilets may be considered. Laundry, bath, and kitchen wastes must be disposed of in a conventional septic tank system, although the size of the absorption field may be reduced by 35% from that of a conventional system, provided water conservation devices are utilized. Composted wastes from the treatment unit shall be removed as per the manufacturer's recommendations and the residue shall be buried by covering with at least six inches of soil. Wastes should not be used as fertilizer for root or leaf crops which may be eaten raw. Composting toilets must be certified by the NSF as meeting the current standard or certified by the manufacturer as meeting a nationally recognized standard for such purpose.⁴¹

GRAYWATER: Graywater means wastewater generated by water-using fixtures and appliances, excluding water closets, urinals, bidets, kitchen sinks, and garbage disposals. Chapter 290-5-59, Special Onsite Sewage Management Systems, defines sewage as human excreta, all water-carried wastes, and/or liquid household waste including graywater from residences or similar wastes or by-products from commercial and industrial establishments.⁴² Where a separate graywater system is to be used, the minimum effective capacity of the graywater retention tank shall be 500 gallons. The minimum absorption area for graywater or blackwater absorption systems serving residential properties shall be based on the number of bedrooms and the percolation rate. The blackwater portion of the total daily sewage flow shall be 35%; the graywater portion shall be 65%.⁴³

CONSTRUCTED WETLANDS: No existing regulations. Although no regulations are formally in place, an article in the Georgia Environmentalist gives design information and recommendations for both free water surface (FWS) and subsurface flow (SSF) constructed wetlands.⁴⁴

Hawaii: Department Of Health, Wastewater Branch, Environmental Management Division, 919 Ala Moana Boulevard, Suite 309, Honolulu, HI 96814; Ph. (808) 586-4294.

REGULATION(S): Hawaii Administrative Rules, Chapter 11-62 (30 August 1991).

COMPOSTING TOILETS: 11-62-03 Definitions. "Compost toilet" means a non-flush, waterless toilet that employs an aerobic composting process to treat toilet wastes.⁴⁵ Ch. 11-62-35 states that specific design requirements for composting (and other) toilets shall be reviewed and approved by the director on a case-by-case basis.⁴⁶ Products, if sold in Hawaii, are to be approved by the director, based on appropriate testing procedures and standards as set forth by the National Sanitation Foundation (NSF) Testing Laboratory.⁴⁷ The following toilets are approved the NSF Standard 041: Biolet XL; Clivus Multrum Model M-1, M-2, M-12, M-15, M-18, M-22, M-25, M-28, M-32, M-35, M54ADA; Ecotech Carousel; and Sun Mar Excel.

GRAYWATER: means liquid waste from a dwelling or other establishment produced by bathing, washdown, minor laundry, and minor culinary operations, and specifically excluding toilet waste.⁴⁸ Chapter 11-62-31.1 states that individual wastewater systems may be used as a temporary on-site means of wastewater disposal in lieu of wastewater treatment works in residential developments when there is 10,000 square feet or more of land area for each individual wastewater system.⁴⁹ Section G covers graywater systems and their respective design characteristics.⁵⁰ Graywater conveyance systems include: sand filters, absorption trenches and beds, mounds or seepage pits, or when disinfected in accordance with 11-62-26(b) (which governs total coliform levels), used for irrigation.⁵¹ 11-62-31.1 gives the general requirements for proposed individual wastewater systems. (g) A graywater system shall be designed in accordance with the following criteria: (1) design of graywater systems for dwelling units shall be based on a minimum graywater flow of 150 gallons per day per bedroom; and (2) graywater tanks, when required, shall be sized with no less than a 600 gallon capacity and shall conform to the requirements of section 11-62-33-1(a).⁵²

CONSTRUCTED WETLANDS: No existing regulations.

Idaho: Division of Environmental Quality, 1410 North Hilton, Boise, ID 83706-1255; Ph. (208) 373-0502. Contact: Barry Burnell, Watershed Protection Supervisor.

REGULATION(S): IDAPA 16, Title 01, Chapter 03, Rules for Individual/Subsurface Sewage Disposal Systems (7 May 1993) and the Technical Guidance Manual (TGM) for Individual Subsurface Sewage Disposal Systems. The TGM can be viewed at http://www.state.id.us/phd1/tgm/tgm_toc.htm Section 10 of the Idaho code covers Alternative Systems. If a standard system as described in the rules cannot be installed on a parcel of land, an alternative system may be permitted if that system is in accordance with the

recommendations of the Technical Guidance Committee and is approved by the Director.⁵³

COMPOSTING TOILETS: are defined as toilets within the dwelling that store and treat non-water carried human urine and feces and small amounts of household garbage by bacterial decomposition. The resultant product is compost.⁵⁴ Composting toilets are allowed in residences that also have water under pressure, with the understanding that a public sewer or another acceptable method of on-site disposal is available. Permission must be obtained from the Idaho Health Department, as current plumbing code prohibits the use of composting toilets without their permission.⁵⁵

GRAYWATER: The Technical Guidance Manual contains a draft for graywater system guidelines and design requirements, but current Idaho rules permit graywater systems only as experimental systems.⁵⁶ The draft proposal describes graywater as untreated household wastewater that has not come into contact with toilet waste. Graywater includes used water from bathtubs, showers, bathroom wash basins, and water from clothes washing machines and laundry tubs. It shall not include wastewater from kitchen sinks, dishwashers, or laundry water from soiled diapers. A graywater system consists of a separate plumbing system from the blackwater and kitchen plumbing, a surge tank to temporarily hold large drain flows, a filter to remove particles that could clog the irrigation system, a pump to move the graywater from the surge tank to the irrigation field, and an irrigation system to distribute the graywater. Graywater may not be used to irrigate vegetable gardens. Graywater systems may only be permitted for individual dwellings. The capacity of the septic tank and size of the blackwater drainfield and replacement area shall not be reduced by the existence or proposed installation of a graywater system servicing the dwelling. Graywater shall not be applied on the land surface or be allowed to reach the land surface.⁵⁷

CONSTRUCTED WETLANDS: Constructed wetlands are only permitted under experimental systems. All experimental systems require a variance. Experimental systems also are required to be designed by a Idaho licensed professional engineer.⁵⁸

Illinois: Illinois Department of Public Health, Division of Environmental Health, 525-535 West Jefferson Street, Springfield, IL 62761-0001; Ph. (217) 782-5830; Contact: Elaine Beard or Doug Ebelherr.

REGULATION(S): Title 77: Public Health, Chapter I: Department of Public Health, Subchapter r: Water and Sewage, Part 905: Private Sewage Disposal Code, Section 905.30, Approved Private Sewage Disposal Systems (15 March 1996).

COMPOSTING TOILETS: are approved for private sewage disposal of human wastes.⁵⁹ Compost toilets shall be designed in accordance with the manufacturer's recommendation to serve the anticipated number of persons. The owner of a compost toilet shall maintain the toilet and dispose of the contents in accordance with Section 905.170, which lists several methods of disposal: 1) discharge to a municipal sanitary sewer system; 2) discharge to sludge lagoons or sludge drying beds; 3) discharge to an incinerator device; or 4) discharge to a sanitary landfill.⁶⁰ Compost toilets shall comply with the requirement of the NSF Standard 41 and shall bear the NSF Seal.⁶¹

GRAYWATER, CONSTRUCTED WETLANDS: No existing regulations (governed under experimental systems).

Indiana: Indiana Department of Environmental Management, 100 North Senate Avenue, PO Box 6015, Indianapolis, IN 46206-6015; Ph. (317) 233-7179 or (317) 233-7188; Contact: Alan Dunn or Tim Decker; Email: adunn@ISDH.state.in.us.

REGULATION(S): Regulations, if they existed, would most likely be found under 401 Indiana Administrative Code 6-8.1.

COMPOSTING TOILETS, GRAYWATER: No existing regulations.

CONSTRUCTED WETLANDS: Constructed wetlands are approved only for experimental use in residential situations. Indiana outlines some basic design criteria for subsurface constructed wetlands, as follows: 1) The wetland is usually designed for five to seven days retention time; 2) Each wetland has one cell for residential projects, with each cell having a length to width ratio of no greater than 2:1; 3) The depth of gravel in the wetland is no greater than 24 inches; 4) There are three different gravel sizes in the wetland. The inlet and outlet ends of the wetland have coarse gravel in the range of 1 1/2 to 3 inches in size. The area between the ends has gravel in the range of 1/2 to 1 inch in size. The surface layer of gravel over the entire wetland is usually six inches in depth with a range of 3/8 to 1/2 inch size (pea gravel). All gravels are screened and washed to remove fines; 5) The water level in the wetland is set at a depth of two to three inches below the surface of the gravel by the outlet adjustable sump pipe. The outlet sump pipe is orificed with a 1 1/2 inch hole to regulate the flow from the wetland after a six inch rainfall event to spread the rainfall accumulation over a 24-hour period; 6) The wetlands are lined with at least a 20 mil liner for residential projects; 7) The wetland is tested for leaks over a 24-hour period with at least six inch depth of water above the inlet and outlet distribution and collection pipe; 8) The inlet distribution and outlet collection pipes for each cell of the wetland are placed at the bottom of the wetland gravel; 9) Some commonly used wetland plants are cattails (*Typha* sp.) and bulrushes (*Scirpus* sp.) along with other appropriate species. The shallower rooted plants are located near the inlet because of the higher influent temperatures and high nutrient levels, with deeper rooted plants located toward the end of the wetland; and 10) There is required monitoring at the inlet and outlet ends of the wetland for three to five years. Absorption field criteria: 1) Selection and sizing of the absorption field is always based upon the peak daily wastewater load and the on-site soil survey report that is done by an ARCPAC certified soil scientist, in the area of the absorption field; 2) There is an allowable reduction in the size of the absorption field associated with a subsurface constructed wetland based on the soil loading rate. For soil loading rates equal to or greater than 0.5 gallons per day (GPD) per square foot, but less than or equal to 1.2 GPD per square foot, the allowable reduction in field size is 50%. For soil loading rates of less than 0.5 GPD per square foot but greater than or equal to 0.25 GPD per square foot, the allowable reduction in the field is 33%; 3) There must be a 50 to 100% set aside area for the proposed absorption field associated with the subsurface constructed wetland because this combination is still considered experimental when there is an allowable absorption field size reduction; and 4) The septic

tanks are sized for either a 36 or 48 hour detention time.⁶²

Iowa: Iowa Department of Natural Resources, Wallace State Office Building, 502 East 9th Street, Des Moines, IA 50319-0034; Ph. (515) 281-7814; Contact: Brent Parker.

REGULATION(S): Chapter 69: On-Site Wastewater Treatment and Disposal Systems 567-69.11(455B).

COMPOSTING TOILETS, GRAYWATER: No existing regulations. Constructed wetlands: are governed under 69.1(2). "On-site wastewater treatment and disposal system" means all equipment and devices necessary for proper conduction, collection, storage, treatment, and disposal of wastewater from four or fewer dwelling units or other facilities serving the equivalent of 15 persons (1,500 gpd) or less. This includes domestic waste, whether residential or nonresidential, but does not include industrial waste of any flow rate. Included within the scope of this definition are building sewers, septic tanks, subsurface absorption systems, mound systems, sand filters, constructed wetlands and individual mechanical/aerobic wastewater treatment systems. 567---69.11(455B) Constructed wetlands. 69.11(1) Constructed wetlands shall only be used where soil percolation rates at the site exceed 120 minutes per inch. Because of the higher maintenance requirements of constructed wetland systems, preference should be given to sand filters, where conditions allow. b). The effluent from a constructed wetland shall receive additional treatment through the use of intermittent sand filters of a magnitude of half that prescribed in rule 69.9(455B). c) Effluent sampling of constructed wetlands shall be performed twice a year or as directed by the administrative authority. Tests shall be run on all parameters as required in 69.9(1). d). Specifications given in these rules for constructed wetlands are minimal and may not be sufficient for all applications. Technical specifications are changing with experience and research. Other design information beyond the scope of these rules may be necessary to properly design a constructed wetland system. 69.11(2) a). The wetland shall be of a subsurface flow construction with a rock depth of 18 inches and a liquid depth of 12 inches. b). Substrate shall be washed river gravel with a diameter of 3/4 inch to 2½ inches. If crushed quarried stone is used, it must meet the criteria listed in 69.6(4)"a." c). Detention time shall be a minimum of seven days. (1) This may be accomplished with trenches 16 to 18 inches deep (12 inches of liquid), three feet wide with 100 feet of length per bedroom. This may also be done with beds 16 to 18 inches deep, with at least 300 square feet of surface area per bedroom. The bottom of each trench or bed must be level within ±½ inch. (2) Multiple trenches or beds in series should be used. Beds or trenches in series may be stepped down in elevation to fit a hillside application. If the system is on one elevation, it should still be divided into units by earthen berms at about 50 and 75% of the total length. (3) Each subunit shall be connected to the next with an overflow pipe (rigid sewer pipe) that maintains the water level in the first section. Protection from freezing may be necessary. d). Wetlands shall be lined with a synthetic PVC or PE plastic liner 20 to 30 mils thick. e). Effluent shall enter the wetland by a four inch pipe sealed into the liner. With beds, a header pipe shall be installed along the inlet side to distribute the waste. f). Wetland system sites shall be bermed to prevent surface water from entering the trenches or beds. 69.11(3) Vegetation shall be established on the wetlands at time of construction. Twelve inches of rock is placed in each unit, the plants are set, then the final four to six inches of rock is placed. b). Only indigenous plant species shall be used, preferably collected within a 100-mile radius of the site. Multiple species in each system are recommended. Preferred species include, but are not limited to: (1) *Typha latifolia* - Common cattail; (2) *Typha angustifolia* - Narrow leaf cattail; (3) *Scirpus* spp. - Bullrush; (4) *Phragmites communis* - Reed. Transplantation is the recommended method of vegetation establishment. For transplanting, the propagule should be transplanted, at a minimum, on a two-foot grid. The transplants should be fertilized, preferably with a controlled release fertilizer such as Osmocote 18-5-11 for fall and winter planting, 18-6-12 for spring planting, and 19-6-12 for summer planting. Trenches or beds should be filled with fresh water immediately. d). In the late fall, the vegetation shall be mown and the detritus left on the wetland surface as a temperature mulch. In the early spring, the mulch shall be removed and disposed of to allow for adequate bed aeration.⁶³

Kansas: Department of Health and Environment, Bureau of Water, Nonpoint Source Section, Forbes Field, Building 283, Topeka, KS 66620; Ph. (785) 296-4195 or 1683.

REGULATION(S): No existing regulations. If regulations existed, they should fall under the Kansas Administrative Regulations (KAR) Chapter 25, Article 5, Sewage and Excreta Disposal.

COMPOSTING TOILETS, GRAYWATER, CONSTRUCTED WETLANDS: No existing regulations. Bulletin 4-2, Minimum Standards for Design and Construction of Onsite Wastewater Systems (March 1997) mentions alternative systems when conventional absorption fields or ponds are not suitable.⁶⁴ K.A.R. 28-5-9 gives authority to county health departments, in counties that have local codes, to grant variances for alternative onsite wastewater treatment and disposal systems. The variance request is filed with the county administrative agency.⁶⁵

Kentucky: Department for Public Health, Division of Public Health Protection and Safety, Environmental Management Branch, Community Environment Section, 275 East Main Street, Frankfort, KY 40621; Ph. (502) 564-4856; FAX (502) 564-6533; Contact: Craig Sheehan, R.S., Health Inspection Program Evaluator; Email: Craig.sheehan@mail.state.ky.us REGULATION(S): 902 Kentucky Administrative Regulations 10:085 Kentucky Onsite Sewage Disposal Systems (September 1989).

COMPOSTING TOILETS: are mentioned under 1b, 8. System Sizing Standards. When approved permanent non-water carriage water closet type devices (composting toilets, incinerator toilets, oil carriage toilets, etc.) are installed exclusively in any residence and no other blackwater type wastes are created, the daily design flow unit for that specific residence may be reduced.⁶⁶

GRAYWATER: in Section 2(13) means wastewater generated by water-using fixtures and appliances, excluding the toilet and the garbage disposal.⁶⁷ Graywater standards are mentioned under 13a-c, 8. When improved performance (of a septic system) may be attained by separating laundry graywater waste flows from other residential waste flow for new system installations, or as repair for existing systems, such separation shall be accomplished in the following manner: a) Graywater sewer for the washing machine shall be separated from the main house sewer; b) laundry graywater shall discharge into a lateral bed or trench(es) of a minimum of 100 square feet of bottom surface soil absorption area for a two bedroom residence and an additional 50 square feet for each additional bedroom; c) new system installations where laundry wasteflow separation exists are permitted a 15% reduction in the primary system lateral field requirements shall be allowed only for sites with soils in Soil Groups I-III. On sites with soils in Soil Group IV, such separation may be required, but no system size reduction will be granted.⁶⁸

CONSTRUCTED WETLANDS: or plant-rock filters generally consist of a primary treatment unit, usually a septic tank with two compartments or special filters, with a lined rock bed or cell containing approximately 12 inches of rock and a small overflow lateral field. Aquatic plants are planted in the rock media and treat the effluent to a very high degree. Any excess effluent is disposed of in the lateral field. Wetlands are sized based on 1.3 cubic feet of gravel area for each one gallon of total daily waste flow. A typical size for a three bedroom home would be 468 square feet of interior area. Various length to width ratios are acceptable with generally a relatively narrow width to longer length preferable. The system functions primarily by wastewater entering the treatment unit where some treatment occurs. The partially treated wastewater then enters the lined wetlands cell through solid piping where it is distributed across the cell. The plants within the system act to introduce oxygen into the wastewater through their roots. As the wastewater becomes oxygenated, beneficial microorganisms and fungi can thrive, where they in turn digest organic matter. In addition, fairly large amounts of water may be lost through evapotranspiration. Advantages of installing a constructed wetlands system are that they: 1) are space conservative (approximately 1/3 of conventional rock lateral); 2) can be placed on irregular or segmented lots; and 3) may be placed in areas with shallow water tables, high bedrock or restrictive horizons. Disadvantages include that constructed wetlands systems: 1) require a higher level of maintenance than other conventional systems; 2) may be more costly to install; and 3) have an unknown life span.⁶⁹

Louisiana: Department of Health and Hospitals, Office of Public Health, Sanitation Services, 106 Canal Blvd., Thibodaux, LA 70301; Ph. (504) 449 5007; Contact: Teda Boudreaux.

COMPOSTING TOILETS, GRAYWATER SYSTEMS, CONSTRUCTED WETLANDS: No existing regulations.⁷⁰

Maine: Department of Human Services, Bureau of Health, Division of Health Engineering, Wastewater and Plumbing Control Program, State House Station 10, Augusta, ME 04333-0010; Ph. (207) 287-5689.

REGULATION(S): Maine Subsurface Waste Water Disposal Rules 144A CMR 241(20 January 1998).

COMPOSTING TOILETS: are regulated in Ch. 15, Section 1504.0. A composting toilet is designed to receive, store, and compost human wastes. Stabilized (that is, composted) wastes shall be removed for disposal when the toilet's capacity is reached. The minimum interior volume of a composting toilet shall be large enough to allow complete stabilization of all wastes when the toilet is used continuously at its proposed usage level. Toilet wastes shall be deposited into a receiving area with a self-closing, tightly fitting lid. There shall be a separate access, with a tightly fitting lid, through which food wastes, or other materials needed for the composting process, are routed to the composting compartment. Composted material shall be removed from the storage area through a cleanout opening fitted with a tight door or lid. Non cleanout may be located in a food storage or preparation area. Any liquid overflow shall be discharged to a primitive or conventional disposal field. The contents of an alternative toilet shall be removed and disposed of in a legal and sanitary manner whenever they reach recommended capacity of the alternative toilet.⁷¹

GRAYWATER: 1509.0 Separated Laundry Disposal Systems. The plumbing inspector may approve a separate laundry system for single-family dwelling units. A separated laundry field requires an application for subsurface waste water disposal system completed by a licensed site evaluator and a permit to install the system. Only waste water from a washing machine may be discharged to the separate laundry disposal field designed for that purpose. Separate laundry disposal fields may be designed and used for hot tubs or backwash water. A separated laundry disposal field does not require a septic tank.⁷²

CONSTRUCTED WETLANDS: No existing regulations.

Maryland: Maryland Department of the Environment, Water Management Administration, 2500 Broening Highway, Baltimore, MD 21224; Ph. (410) 631-3778.

REGULATION(S): Regulations may be discussed under Chapter 9, Subtitle 14A. Waterless Toilets (1993).

COMPOSTING TOILETS: Waterless toilets are covered in Chapter 9, Subtitle 14A-01. Waterless Toilets The Maryland Department of the Environment does not prohibit the use of any NSF approved composting toilet for use anywhere in the State. The Department's current regulation is to allow a 36% design flow reduction for residences when utilizing an NSF approved composting/waterless toilet.⁷³

GRAYWATER: Innovative graywater designs are currently allowed on a case-by-case basis under the Innovative and Alternative Program.⁷⁴

CONSTRUCTED WETLANDS: No existing regulations.

Massachusetts: Department of Environmental Protection, Division of Water Pollution Control, One Winter Street, 8th Floor, Boston, MA 02108; Ph. (617) 292-5500; <http://www.magnet.state.ma.us/dep/brp/wwm/wwwhome.htm>; Contact: Doug Roth; Email:

douglas.roth@state.ma.us For graywater, contact: Ruth Alfasso, graywater piloting coordinator; Email: Ruth.Alfasso@state.ma.us

REGULATION(S): 310 CMR 15.000, Title 5: Innovative and Alternative Subsurface Sewage Disposal Technologies Approved for Use in Massachusetts (4 March 1998).

COMPOSTING TOILETS: are certified for general use for new construction and for remedial use. Specific regulations concerning composting toilets follow: 1) compost temperature must be maintained above 131 degrees F (55 degrees C); 2) moisture must be maintained between 40-60% for best results; and 3) the system must be designed to store compostable and composted solids for at least two years, either inside the composting chamber or in a separate compost container. Compost must be disposed by one of two methods: 1) by on-site burial, covered with a minimum of six inches of clean compacted earth; or 2) by a licensed septage hauler. If any liquid by-product exists, it should be discharged through a graywater system that includes a septic tank and leaching system or removed by licensed septic hauler.⁷⁵

GRAYWATER: If the facility generates graywater (i.e., wastewater from sinks, showers, washing machines, etc.) a disposal system is still needed for the graywater. Title 5 has different requirements for remedial use and for new construction. Remedial use is for facilities which have a design flow of less than 10,000 gallons per day, are served by an existing system, and where there is no proposed increase in the design flow. An existing cesspool may be used as a leaching pit, provided that the cesspool is pumped and cleaned and is not located in groundwater, and meets the design criteria of 310 CMR 15.253 with respect to effective depth, separation between units, and inspection access. The cesspool may be replaced by a precast concrete leaching pit meeting those requirements, and the effluent loading requirements of Title 5. A septic tank should also be installed. Pertaining to graywater, a filter system specifically approved by the Department can be used instead of a septic tank.⁷⁶ Non-traditional graywater systems, such as those which use constructed wetlands or evapotranspiration beds, are approved on a piloting, site-specific basis.⁷⁷

CONSTRUCTED WETLANDS: No existing regulations, approved on a piloting basis only.⁷⁸

Michigan: Department of Environmental Quality, Environmental Health Section, Drinking Water and Radiological Protection Division, PO Box 30630, Lansing, MI 48909-8130; Toll-free Ph. (800) 662-9278; Ph. (517) 335-8284.

REGULATION(S): Michigan has one of the oldest existing guidelines for composting toilets and graywater systems. However, as there is no statewide sanitary code, the 46 local health departments define the criteria for onsite sewage disposal and "each county runs its own show."⁷⁹ The Michigan Department of Health publishes Guidelines for Acceptable Innovative or Alternative Waste Treatment Systems and Acceptable Alternative Graywater Systems under authority of Act 421, P.A. 1981 (1986). Under Act 421, an owner of a structure using an acceptable an innovative or alternative waste treatment system (heretofore referred to as "alternative systems") in combination with an acceptable alternative graywater system (heretofore referred to as "graywater systems") shall not be required to connect to an available public sanitary sewer system.⁸⁰ Alternative system means a decentralized or individual waste system which has been approved for use by a local health department and which is properly operated and maintained so as to not cause a health hazard or nuisance. An acceptable alternative system may include, but is not limited to, an organic waste treatment system or composting toilet which operates on the principle of decomposition of heterogenous organic materials by aerobic and facultative anaerobic organisms and utilizes an effectively aerobic composting process which produces a stabilized humus. Alternative systems do not include septic tank-drainfield systems or any other systems which are determined by the department to pose a similar threat to the public health, safety and welfare, and the quality of surface and subsurface waters of this state.⁸¹ A person may install and use in a structure an alternative system or an alternative system in combination with a graywater system. The installation and use of an alternative system or an alternative system in combination with a graywater system in a structure shall be subject to regulations by the local health department in accordance with the ordinances and regulations of the local units of government in which the structure lies. A local health department may inspect each alternative system within its jurisdiction at least once each year to determine if it being properly operated and maintained. 1) A local health department may charge the owner of an alternative system a reasonable fee for such an inspection and for the plan review and installation inspection. 2) The department shall maintain a record of approved alternative systems and their maintenance and adoption. The department, after consultation with the state plumbing board, shall adopt guidelines to assist local health departments in determining what are graywater systems and what are alternative systems. The department shall advise local health departments regarding the appropriate installation and use of alternative systems and alternative systems in combination with graywater systems. 3) A person who installs and uses an alternative system or an alternative system in combination with a graywater system shall not be exempt from any special assessments levied by a local unit of government for the purpose of financing the construction of an available public sanitary sewer system. 4) An owner of a structure using an alternative in combination with a graywater system shall not be required to connect to an available public sanitary sewer system.⁸²

GRAYWATER: system means a system for the treatment and disposal of wastewater which does not receive human body wastes or industrial waste which has been approved for use by a local health department and which is properly operated and maintained so as not to cause a health hazard or nuisance.⁸³ Structures which utilize alternative systems and graywater systems which are self-contained systems that do not have an on-site discharge should not be required to connect to an available public sanitary sewer system.⁸⁴ Alternative systems must meet the requirements of Sections 5 (6) and 21 of the Michigan Construction Code, act 230, Public Acts of 1972 as amended.

Structures using alternative systems must also meet the requirements of the Michigan Plumbing Code.⁸⁵ Alternative systems and graywater systems should be tested by the National Sanitation Foundation (NSF) under Standard 41 testing protocol or by an equivalent independent testing agency and procedure. Lacking this testing procedure, the local health department should require performance data prior to approval. When requested, the Michigan Department of Public Health will assist local health departments in evaluating performance data from the NSF and other sources. Each local health department should require appropriate methods for disposal of stored liquid or solid end products from alternative systems.⁸⁶ To the extent that funds are available, the department will provide training and technical field assistance to local health departments regarding the appropriate installation and use of alternative systems and graywater systems.⁸⁷ A person may petition, in writing, the commission to approve the use of a particular material, product, method of manufacture or method or manner of construction or installation. On receipt of the petition, the commission shall cause to be conducted testing and evaluation it deem desirable. After testing and evaluation, and an open public hearing, the commission may reject the petition in whole or in part, may amend the code in such matter as the commission deems appropriate, or may grant a certificate of acceptability.⁸⁸

CONSTRUCTED WETLANDS: The Department of Environmental Quality provides a document entitled Review of Subsurface Flow Constructed Wetlands Literature and Suggested Design and Construction Practices. Constructed wetlands are run through a primary septic tank and then through a subsurface disposal system.⁸⁹ In fact, this guide recommends that at least two septic tanks should be provided with a total volume of at least two times the design daily flow.⁹⁰

Minnesota: Minnesota Pollution Control Agency, Water Quality Division, Nonpoint Source Compliance Section, 520 Lafayette Road, St. Paul, MN 55155-4194; Ph. (612) 296-7574; <http://www.revisor.leg.state.mn.us/arule/7080>

REGULATION(S): Chapter 7080.9010, Alternative and Experimental Systems [**Repealed as of 02/28/00!**]

COMPOSTING TOILETS: No regulations,⁹¹ except in Subpart 3G which mentions that other toilet waste treatment devices may be used where reasonable assurance of performance is provided.⁹²

GRAYWATER: Use of alternative systems is allowed only in areas where a standard system cannot be installed or is not the most suitable treatment. Subpart 3E of Ch. 7080.9010 states that a toilet waste treatment device must be used in conjunction with a graywater system. Accordingly, toilets wastes shall be discharged only to toilet waste treatment devices. Graywater or garbage shall not be discharged to the device, except as specifically recommended by a manufacturer. Septic systems are required for graywater systems. The drainage system in new dwellings or other establishments shall be based on a pipe diameter of two inches to prevent installation of a water flush toilet. There shall be no openings or connections to the drainage system, including floor drains, larger than two inches in diameter. For repair or replacement of an existing system, the existing drainage system may be used. Toilets or urinals of any kind shall not be connected to the drainage system. Toilet waste or garbage shall not be discharged to the drainage system. Garbage grinders shall not be connected to the drainage system. The building sewer shall meet all requirements for part 7080.0120, except that the building sewer for a graywater system shall be no greater than two inches in diameter. Graywater septic tanks shall meet all requirements of 7080.0130, subpart 1, except that the liquid capacity of a graywater septic tank serving a dwelling shall be based on the number of bedrooms existing and anticipated in the dwelling served and shall be at least as large as the following given capacities: 2 bedrooms, 300 gallon capacity; 3 or 4 rooms, 500 gallons; 5 or 6 rooms, 750 gallons; 7, 8 or 9 rooms, 1000 gallons. 4) Sizing for the system can be 60% of the amount calculated for a standard septic system. For ten or more bedrooms or other establishments, the graywater septic tank shall be sized as for any other establishment, except the minimum liquid capacity shall be at least 300 gallons. Graywater aerobic tanks shall meet all requirements of part 7080.0130. 6) Distribution and dosing of graywater shall meet all requirements of parts 7000.0150 and 7080.0160. 7) A standard graywater system shall meet all requirements of part 7080.0170. Experimental systems are discussed in subpart 3a. They may be used in areas where a standard systems cannot be installed or if a system is considered new technology with limited data on reliability.⁹³

CONSTRUCTED WETLANDS: No existing regulations.

Mississippi: Mississippi State Department of Health, PO Box 1700, Jackson, MS 39215-1700; Ph. (601) 576-7689; Contact: Ralph Turnbo.

REGULATION(S): Mississippi Individual On-Site Wastewater Disposal System Law, Chapter 41-67 (1996).

COMPOSTING TOILETS: 2.3 (28) Non-Waterborne Disposal System - any non-water carried system that treats and/or disposes of human excreta.⁹⁴ Non-Waterborne Wastewater Systems are covered under MSDH 300-Section 02A-XIII-01 (revised February 17, 1997).

1. In remote areas of the State or certain transient or temporary locations, the use of non-waterborne systems such as sanitary pit privies, portable toilets, incinerating toilets, composting toilets and related sewage systems may be approved. Due to their limited capacities, these systems are restricted to receive excreta only. Since such systems require regular service and maintenance to prevent their malfunction and overflow, they shall only be used where the local health department approves such use.⁹⁵

GRAYWATER: No existing regulations.

CONSTRUCTED WETLANDS: Constructed wetlands are discussed in Design Standard VII: Plant Rock Filter System, MSDH 300-Section 021-VII. I. A plant rock filter (constructed wetlands) wastewater treatment system may be utilized as an overland/containment system on sites where soil and site conditions prohibit the installation of a conventional or modified subsurface disposal system. In suitable soils, a plant rock filter may utilize underground absorption to dispose of effluent. It may also be utilized to polish effluent from malfunctioning "seeping" absorption field lines on existing systems. II. The plant rock filter may consist of a single cell, two cells in series

or multiple cells in series. The design will depend on the topography. Differences in individual design, construction materials and construction methods allow each of these types of plant/rock filter to vary widely in their application. Careful consideration should be made during the soil/site evaluation to ensure that the “best choice” is recommended for the particular site. Recommendations developed by the Tennessee Valley Authority’s General Design, Construction, and Operation Guidelines Constructed Wetlands Wastewater Treatment Systems for Small Users Including Individual Residences, Second Edition, have been adopted by reference.⁹⁶

Missouri: Missouri Department of Health, Bureau of Community Environmental Health, PO Box 570, Jefferson City, MO 65102-0570; Ph. (573) 751-6095; FAX (573) 526-6946 or 751-0247.

REGULATION(S): Missouri Laws for On-Site Disposal Systems, Chapter 701, Section 701.025 (28 August 1998).

COMPOSTING TOILETS: No existing regulations. May be covered under “Other Systems.” Where unusual conditions exist, special systems of treatment and disposal, other than those specifically mentioned in this rule, may be employed, provided: 1) reasonable assurance of performance of the system is presented to the administrative authority; 2) the engineering design of the system is first approved by the administrative authority; 3) adequate substantiating data indicate that the effluent will not contaminate any drinking water supply, groundwater used for drinking water or any surface water; 4) treatment and disposal of the waste will not deteriorate the public health and general welfare; and 5) discharge of effluent, if any, shall be within setback distances as described in the rules.⁹⁷

GRAYWATER: Under 701.025,12(b), graywater includes bath, lavatory, laundry, and sink waste, excepting human excreta, toilet waste, residential kitchen waste and other similar waste from household or establishment appurtenances.⁹⁸ Title 19, Division 20, Chapter 3, General Sanitation, defines graywater as liquid waste, specifically excluding toilet, hazardous, culinary and oily wastes, from a dwelling or other establishment which is produced by bathing, laundry, or discharges from floor drains.⁹⁹ There are no design recommendations or regulations governing graywater systems.

CONSTRUCTED WETLANDS: provide secondary levels of treatment, which means that some form of pretreatment (septic tank, aeration tank, lagoon, etc.), must be used prior to the wetland, as wetlands cannot withstand large influxes of suspended solids. The pretreatment used must be capable of removing a large portion of these solids. Effluent from wetlands must be contained on the owner’s property with the same set-back distances as required for lagoons. 1. Free water surface wetlands are shallow beds or channels with a depth less than 24 inches and filled with emergent aquatic plants. This type of wetland shall not be allowed. 2. Submerged flow wetlands are similar to free water surface wetlands except that the channels are filled with shallow depths of rock, gravel or sand. The depth of the porous media is usually less than 18 inches. The porous medium supports the root systems of the emergent aquatic vegetation. The water level is to be maintained below the top of the porous medium so that there is no open water surface. The configuration of a wetland for an individual home can be a one cell or two cells in a series, depending on the soil properties of the site.¹⁰⁰

Montana: Montana Department of Environmental Quality, Lee Metcalf Building, 1520 E. Sixth Avenue, PO Box 200901, Helena, MT 59620-0901; Ph. (406) 444-4633; FAX (406) 444-1374; Contact: Mark M. Peterson, P.E., Environmental Engineering Specialist, Permitting and Compliance Division; Email: mkpeter@mt.gov. REGULATION(S): Circular WQB 5. Minimum Design Standards for On-Site Alternative Sewage Treatment and Disposal Systems (1992).

COMPOSTING TOILETS: Under Chapter 70.1, waste segregation systems consist of dry disposal for human waste such as various chemical and incinerator type systems with separate disposal for graywater. However, regardless of the type of dry disposal system used, the graywater must be disposed of by primary (septic tank) and secondary (subsurface drainfield) treatment.¹⁰¹ Waste segregation systems will only be considered for recreational type dwellings which receive seasonal use or commercial buildings.¹⁰²

GRAYWATER: No existing regulations. Graywater must be disposed of through a septic tank and drainfield system.

CONSTRUCTED WETLANDS: No existing regulations.

Nebraska: Nebraska Department of Environmental Quality, Ground Water Section, PO Box 98922, Lincoln, NE 68509-8922; Ph. (402) 471-2580 or (505) 827-7541;

<http://www.deq.state.ne.us/RuleAndR.nsf/390ed3941b29c12f8625682c006210e9/80857228ae0f5c2786256800005153a8?OpenDocument>;

Contact: Brian Sohall.

REGULATION(S): If they existed, regulations would probably be found in Title 124, Rules and Regulations for Design, Operation and Maintenance of Onsite Wastewater Treatment Systems.

COMPOSTING TOILETS, GRAYWATER, CONSTRUCTED WETLANDS: No existing regulations. Graywater is defined, but no systems are necessarily allowed under Title 124.

Nevada: Department of Human Resources, Health Division, Bureau of Health Protection Services, 1179 Fairview Drive, Suite 101, Carson City, NV 89701-5405; Ph. (702) 687-6615 (general number); Ph. (702) 687-4750 (direct line); Contact: Joe Pollack.

REGULATION(S): R129-98. Sewage disposal is regulated under Nevada Administrative Code 444.750 (February 1998).

COMPOSTING TOILETS: Not approved.

GRAYWATER: systems are governed under Regulation R129-98, Section 78. 1. Graywater may be used for underground irrigation if approved by the administrative authority. A homeowner must obtain a permit to construct, alter or install a system that uses graywater for

underground irrigation from the administrative authority before such a system may be constructed, altered or installed. 2. A system that uses graywater for underground irrigation: a) may be used only for a single family dwelling; b) must not be used in soils which have a percolation rate that is greater than 120 minutes per inch; c) must consist of a three-way diversion valve, a holding tank for the graywater and an irrigation system; d) may be equipped with a pump or siphon, or may rely on gravity to cause the water to flow to the irrigation system; e) must not be connected to a system for potable water; and f) must not result in the surfacing of any graywater. 3. A system that uses graywater for underground irrigation, or any part thereof, must not be located on a lot other than the lot which is the site of the single-family dwelling that discharges the graywater to be used in the system. Section 79. 1. An application to construct, alter or install a system that uses graywater for underground irrigation must include: a) detailed plans of the system to be constructed, altered or installed; b) detailed plans of the existing and proposed sewage disposal system; and c) data from percolation tests conducted in accordance with NAC 444.796 and sections 40 to 43, inclusive, of this regulation. 2. A holding tank for graywater must: a) be watertight and constructed of solid, durable materials that are not subject to excessive corrosion or decay; b) have a minimum capacity of 50 gallons; c) have an overflow and an emergency drain. The overflow and emergency drain must not be equipped with a shutoff valve. 3. A three-way diversion valve, emergency drain and overflow must be permanently connected to the building drain or building sewer and must be located upstream from any septic tanks. The required size of an individual sewage disposal system must not be reduced solely because a system that uses graywater for underground irrigation is being used in conjunction with the individual sewage disposal system. 4. The piping for a system that uses graywater for underground irrigation which discharges into the holding tank or is directly connected to the building sewer must be downstream of any vented trap to protect the building from possible sewer gases. 5. The estimated discharge of a system that uses graywater for underground irrigation must be calculated based on the number of bedrooms in the building, as follows: a) for the first bedroom, the estimated discharge of graywater is 80 gallons per day; and b) for each additional bedroom, the estimated discharge of graywater is 40 gallons per day. 6. The absorption area for an irrigation system that includes a system that uses graywater for underground irrigation must be calculated in accordance with the following parameters: percolation rate of 0-20 minutes per inch, 20 square feet (minimum square feet per 100 gallons discharged per day); 21-40 minutes/inch, 40 gallons/day; 41-60 minutes/inch, 60 gallons/day.¹⁰³

CONSTRUCTED WETLANDS: No existing regulations.

New Hampshire: Department of Environmental Services, Bureau of Wastewater Treatment, 6 Hazen Drive, Concord, NH 03301; Ph. (603) 271-3711 or 3503; <http://www.state.nh.us/gencourt/ols/rules/env-ws.htm>

REGULATION(S): Chapter Env-Ws 1000 Subdivision and Individual Sewage Disposal System Design Rules. Env-Ws 1022 deals with Alternate Systems.

COMPOSTING TOILETS, GRAYWATER, CONSTRUCTED WETLANDS: No existing regulations. New Hampshire, does, however, have extensive regulations pertaining to Alternate Systems, as follows. Part Env-Ws 1024 Innovative/Alternative Technology. The purpose of this part is to provide the methodology and review process for the approval of innovative/alternative individual sewage disposal systems, in compliance with RSA 485-A:29, I. b. This part shall apply to any proposed individual sewage disposal system technology not described elsewhere in Env-Ws 1000. a. "Conventional system" means an individual sewage disposal system regulated under Env-Ws 1000 other than Env-Ws 1024. b. "Innovative/Alternative waste treatment" as defined in RSA 485-A:2, XXI, includes individual sewage disposal systems. c. "ITA" means innovative/alternative technology approval. Env-Ws 1024.03 a. If the system will require ongoing professional maintenance, a service contract for such maintenance shall be executed before operational approval is granted. b. In exchange for obtaining the benefit of an operational approval based on innovative/alternative technology, the owner shall covenant to replace the innovative/alternative system with a conventional system should the innovative/alternative system fail to operate lawfully. The covenant shall be recorded by the owner at the registry of deeds where the property is located. Env-Ws 1024.04 ITA Applications. a. Before an innovative/alternative waste treatment system may be used the technology shall be evaluated and approved in an ITA. b. To obtain an ITA, an owner, designer, or other person shall submit a letter of application that includes the following: 1). A written description of the proposed system; 2) All operational reports, patent information, technical reports, and laboratory reports published on the proposed system, even if the information might in whole or in part reflect negatively on the system; 3) A description of any advantages of the proposed system over conventional systems in the prevention of health hazards, surface and groundwater pollution, and any other environmental benefits; 4). A description of the possible risks to public health, surface or groundwaters, or other aspects of the environment of using the proposed system; 5). The names, addresses, and phone numbers of at least three individuals who have experience in the design operation of the same type of system; 6). The proposed system's effect on the area of land required for operation; 7). A list of any rules under Env-Ws 1000 for which waivers will be required; and 8). A list of site locations where the system has been used, whether successfully or not.¹⁰⁴

New Jersey: Department of Environmental Protection, Bureau of Nonpoint Pollution Control, PO Box 029, Trenton, NJ 08625-0029; Ph. (609) 292-0404 or 4543; <http://www.state.nj.us/dep/dwq/rules.htm>

REGULATION(S): New Jersey Administrative Code 7:9A Standards for Individual Subsurface Sewage Disposal Systems.

COMPOSTING TOILETS: No existing regulations. **GRAYWATER:** 7:9A-2.1 "Graywater" means that portion of the sanitary sewage generated within a residential, commercial or institutional facility which does not include discharges from water closets or urinals.¹⁰⁵ 7:9A-1.8 (c) In cases where the actual volume of sanitary sewage discharged from a facility will be reduced by use of water-saving plumbing

fixtures, recycling of renovated wastewater, incineration or composting of wastes, evaporation of sewage effluent or any other process, the requirement for obtaining a treatment works approval and a NJPDES permit shall be based upon the design volume of sanitary sewage, calculated as prescribed in N.J.A.C. 7:9A-7.4, rather than the actual discharge volume as modified by water conservation or special treatment processes. 7:9A-7.3 (a) The system(s) shall be designed to receive all sanitary sewage from the building served except in the following cases: 1. Separate systems may be designed to receive only graywater, or only blackwater, as allowed in N.J.A.C. 7:9A-7.5. 7:9A-7.5 A graywater system may be approved by the administrative authority provided that all of the requirements of these standards are satisfied and provided that an acceptable means for disposal of the blackwater from the building served is indicated in the system design. When the blackwater from the building served by a graywater system is to be disposed of into a waterless toilet, a variance from the Uniform Construction Code, Plumbing sub-code, N.J.A.C. 5:23-3.5, must be obtained by the applicant prior to approval of the graywater system by the administrative authority and the volume of sanitary sewage to be used in the design of the graywater system shall be determined as prescribed in N.J.A.C. 7:9A-7.4. When the blackwater from the building served by a graywater system is to be disposed of into a separate subsurface sewage disposal system, the blackwater system shall meet all the requirements of this chapter and the volume of sanitary sewage used in the design of both the graywater system and the blackwater system shall be a minimum of 75 % of the volume of sanitary sewage determined as prescribed in N.J.A.C. 7:9A-7.4.¹⁰⁶ 7:9A-7.6 Each system approved by the administrative authority pursuant to this chapter shall consist of a septic tank which discharges effluent through a gravity flow, gravity dosing or pressure dosing network to a disposal field as hereafter described. Seepage pits shall not be approved for new installations except in the case of a graywater system as provided by in N.J.A.C. 7:9A-7.5. Installation of a seepage pit may be approved as an alteration for an existing system subject to the requirements of N.J.A.C. 7:9A-3.3.¹⁰⁷

CONSTRUCTED WETLANDS: No existing regulations.¹⁰⁸ 7:9A-3.11 Experimental systems The Department encourages the development and use of new technologies which may improve the treatment of sanitary sewage prior to discharge or allow environmentally safe disposal of sanitary sewage in areas where standard sewage disposal systems might not function adequately. Where the design, location, construction or installation of the system or any of its components does not conform to this chapter, the administrative authority shall direct the applicant to apply to the Department for a treatment works approval. Depending upon the volume and quality of the wastewater discharged, a NJPDES permit may also be required.¹⁰⁹

New Mexico: State of New Mexico Environment Department, 524 Camino De Los Marquez, Suite 4, Santa Fe, NM 87505; Ph. (505) 827-7545 or 7541 (direct number); FAX (505) 827-7545; Contact: R. Brian Schall, Water Resource Specialist/Community Services.
REGULATION(S): 20 NMAC 7.3, Liquid Waste Disposal Regulations (10 October 1997).

COMPOSTING TOILETS: Composting toilets are allowed, although there is no mention of them in the regulations.¹¹⁰

GRAYWATER: Subpart I, Part 107. AF. "graywater" means water carried waste from kitchen (excluding garbage disposal) and bathroom sinks, wet bar sinks, showers, bathtubs and washing machines. Graywater does not include water carried wastes from kitchen sinks equipped with a garbage disposal, utility sinks, any hazardous materials, or laundry water from the washing of material soiled with human excreta.¹¹¹ Revised regulations will have a separate section allowing graywater systems. However, the system will still have to run through a septic tank. Graywater can then be used for subsurface irrigation.¹¹²

CONSTRUCTED WETLANDS: Constructed wetlands are considered an "alternative system."¹¹³ Subpart II deals with alternative systems. The Department may issue a permit, on an individual basis, for the installation of an alternative on-site liquid waste system, including a system employing new and innovative technology, if the permit applicant demonstrates that the proposed system, by itself or in combination with other on-site liquid waste systems, will neither cause a hazard to public health nor degrade a body of water, and that the proposed system will provide a level of treatment at least as effective as that provided by on-site liquid waste systems, except privies and holding tanks, that meet the requirements of this Part and the New Mexico Design Standards.¹¹⁴

New York: New York State Department of Health, Bureau of Community Sanitation and Food Protection, 2 University Place, Room 404, Albany, NY 12203-3399; Ph. (518) 458-6706; Contact: Ben Pierson.

REGULATION(S): Appendix 75-A, Wastewater Treatment Standards - Individual Household Systems, Statutory Authority: Public Health Law 201(1)(1) (1 December 1990).

COMPOSTING TOILETS: 75-A. 10 Other Systems. (b) Non-Waterborne Systems. (1) In certain areas of the State where running water is not available or is too scarce to economically support flush toilets, or where there is a need or desire to conserve water, the installation of non-waterborne sewage systems may be considered, however, the treatment of wastewater from sinks, showers, and other facilities must be provided when non-flush toilets are installed. The Individual Residential Wastewater Treatment Systems Design Handbook gives more detail regarding composting toilets.¹¹⁵ The State Uniform Fire Prevention and Building Code [9NYCRR Subtitle S Sections 900.1(a) and (b)] requires wet plumbing (i.e., potable water plus sewerage) for all new residences. In accordance with Section 900.2(b), minimal required plumbing fixtures may be omitted for owner occupied single family dwellings if approved by the authority having jurisdiction. Health Department approval for said omission(s) shall be fully protective of public health and be in general harmony with the intent of Section 900.1 (i.e., provide satisfactory sanitary facilities). In some areas of the state where available water becomes insufficient to economically use flush toilets (i.e., even those with only 1.6 gallons per flush) or where a need or desire exists to conserve water, use of non-waterborne systems may be justified.¹¹⁶ **Composters:** These units accept human waste into a chamber where composting of the waste

occurs.¹¹⁷ Composters accept only toilet wastes and kitchen food scraps coupled with supplemental additions of carbon-rich bulking agents such as planar shavings or coarse sawdust. Household cleaning products should not be placed in the unit. Failure to add adequate bulking agents or maintain aerobic moisture can result in the pile becoming hard (and difficult to remove) or anaerobic. The composted humus contains numerous bacteria and may also contain viruses and cysts. Residual wastes (i.e., the composted humus) should be periodically removed by a professional septage hauler. If a homeowner chooses to personally remove the composted humus, it should be disposed of at a sanitary landfill or buried and well mixed into soil distant from food crops, water supply sources and watercourses. The humus comprises an admixture of recent additions and composted older additions and should be disposed of accordingly. Humus disposal sites shall meet Table 2 separation distances for sanitary privy pits.¹¹⁸ These units shall be installed in accordance with the manufacturers instructions. The units shall have a label indicating compliance with the requirements of NSF Standard 41 or equivalent. Only units with a warranty of five years or more shall be installed.¹¹⁹

GRAYWATER: systems shall be designed upon a flow of 75 gpd/bedroom and meet all the criteria previously discussed for treatment of household wastewater.¹²⁰ The treatment of household wastewater is regulated by 75-A.8. Subsurface Treatment. (a) General Information. All effluent from septic tanks or aerobic tanks shall be discharged to a subsurface treatment system. Surface discharge of septic tank or aerobic effluent shall not be approved by the Department of Health or a local health department acting as its agent.¹²¹

CONSTRUCTED WETLANDS: There is no official state policy regarding constructed wetlands. It is doubtful that the state or county health departments would approve them.¹²²

North Carolina: Department of Environmental Health and Natural Resources, Division of Environmental Health, On-Site Wastewater Section, PO Box 27687, Raleigh, NC 27611-7687; Ph. (919) 733-2895 or 7015.

REGULATION(S): Sewage Treatment and Disposal Systems, Section .1900 (April 1993).

COMPOSTING TOILETS: Section.1934. The rules contained in this Section shall govern the treatment and disposal of domestic type sewage from septic tank systems, privies, incinerating toilets, mechanical toilets, composting toilets, recycling toilets, or other such systems serving single or multiple family residences, places of business, or places of public assembly, the effluent from which is designed not to discharge to the land surface or surface waters. Section.1958 (a) Where an approved privy, an approved septic tank system, or a connection to an approved public or community sewage system is impossible or impractical, this Section shall not prohibit the state or local health department from permitting approved non-ground absorption treatment systems utilizing heat or other approved means for reducing the toilet contents to inert or stabilized residue or to an otherwise harmless condition, rendering such contents noninfectious or noncontaminating. Alternative systems shall be designed to comply with the purposes and intent of this Section. (c) Incinerating, composting, vault privies, and mechanical toilets shall be approved by the state agency or local health department only when all of the sewage will receive adequate treatment and disposal.¹²³

GRAYWATER, CONSTRUCTED WETLANDS: No existing regulations.¹²⁴

North Dakota: North Dakota Department of Health, Environmental Health Section, Division of Municipal Facilities, 1200 Missouri Avenue, Bismarck, ND 58504-5264; Ph. (701) 328-5211 or 5150; FAX (701) 328-5200; Contact: Jeff Hauge, P.E, Environmental Engineer.

REGULATION(S): Chapter 62-03-16. Individual Sewage Treatment Systems for Homes and Other Establishments Where Public Sewage Systems are not Available (1996).

COMPOSTING TOILETS: 62-03-16-01. Where water under pressure is not available, all human body wastes shall be disposed of by depositing them in approved privies, chemical toilets or such other installations acceptable to the administrative authority.¹²⁵

GRAYWATER: 62-03-16-01. 6. Water-carried sewage from bathrooms, kitchens, laundry fixtures, and other household plumbing shall pass through a septic or other approved sedimentation tank prior to its discharge into the soil or into an alternative system. Where underground disposal for treatment is not feasible, consideration will be given to special methods of collection and disposal.¹²⁶

CONSTRUCTED WETLANDS: No existing regulations.

Ohio: Bureau of Local Services, Ohio Department of Health, 246 North High Street, Columbus, OH 43266-0588; Ph. (614) 466-5190 or 1390; Contact: Tom Grigsby, Program Specialist; Email: tgrigsby@gw.odh.state.oh.us

REGULATION(S): O.A.C. Chapter 3701-29 Household Sewage Disposal Rules (1977).

COMPOSTING TOILETS, GRAYWATER, CONSTRUCTED WETLANDS: No existing regulations. Chapter 3701-29-20. Variance. (C). Household sewage disposal system components or household sewage disposal systems differing in design or principle of operation from those set forth in rules 3701-29-01 to 3701-29-21, may qualify for approval as a special device or system provided, comprehensive tests and investigations show any such component or system produces results equivalent to those obtained by sewage disposal components or systems complying with such regulations. Such approval shall be obtained in writing from the director of health.¹²⁷

Oklahoma : Department of Environmental Quality, 1000 Northeast 10th Street, Oklahoma City, OK 73177-1212; Ph. (405) 271-7363 or 702-8100 (Division of Water Quality); Contact: Donnie Johnson.

REGULATION(S): Chapter 640. Individual and Small Public Sewage Disposal (1998).

COMPOSTING TOILETS, GRAYWATER, CONSTRUCTED WETLANDS: No existing regulations. Chapter 640-1-12 governs alternative/experimental disposal systems. Where unusual conditions exist, special systems of treatment and disposal, other than individual sewage disposal systems mentioned may be employed, provided that: 1) reasonable assurance is presented to the Department that the system will work properly; 2) the design of the system is approved by the Department prior to installation; 3) there is no discharge to the waters of the state; 4) treatment and disposal of waste are in such a manner as to protect public health and the environment; 5) such systems comply with all local codes and ordinances. (b) Special alternative systems or experimental systems shall be considered on a case-by-case basis, weighing heavily in the approval process. The plans for alternative systems shall be reviewed by the Department and approved or disapproved by the Area or Regional Supervisor. After construction, the installation of the alternative system shall be approved or disapproved by the local DEQ representative. (c) To apply for approval of such systems an applicant shall file two copies of test results based on OAC 252:640-1-9 and two copies of the design plan for the proposed system with the local representative of the Department for the area in which the property is located.¹²⁸

Oregon: Department of Environmental Quality, Water Quality Division, 811 Southwest 6th Avenue, Portland, OR 97204-1390; Ph. (503) 229-6443; <http://www.cbs.state.or.us/> (click on statute/rules and go to oar 918-770 (division 770); <http://landru.leg.state.or.us/ors/447.htm>; <http://arcweb.sos.state.or.us/banners/rules.htm>; Contact: Sherman Olson, Terry Swisher: Ph (503) 373-7488.

REGULATION(S): Oregon Administrative Rules, Chapter 918, Division 790, Composting Toilet Rules (1998); Oregon Revised Statutes 447.115 (1997); OAR Chapter 340, Division 71 (1997).

COMPOSTING TOILETS: As used in ORS 447.118 and 447.124, "compost toilet" means a permanent, sealed, water-impervious toilet receptacle screened from insects, used to receive and store only human wastes, urine and feces, toilet paper and biodegradable garbage, and ventilated to utilize aerobic composting for waste treatment. 447.118 (1) Nothing in ORS 447.010 to 447.160 shall prohibit the installation of a compost toilet for a dwelling by the occupant of the dwelling if the compost toilet complies with the minimum requirements established under this section. (2) Rules adopted under ORS 447.020 shall provide minimum requirements for the design, construction, installation and maintenance of compost toilets. (3) The Director of the Department of Consumer and Business Services with the approval of the State Plumbing Board may require by rule that, in addition to any other requirements provided by law, any manufacturer or distributor of a compost toilet and any person other than the owner of the dwelling in which the compost toilet is to be installed who proposes to install a compost toilet file with the Department of Consumer and Business Services a satisfactory bond, irrevocable letter of credit issued by an insured institution as defined in ORS 706.008 or other security in an amount to be fixed by the department with approval of the board but not to exceed \$5,000, conditioned that such bond, letter of credit or security shall be forfeited in whole or in part to the department for the purpose of carrying out the provisions of ORS 447.124 by failure of such manufacturer, distributor or person to comply with the rules adopted under this section. 447.124 The Department of Consumer and Business Services, with the assistance of the Health Division: (1) May conduct periodic inspections of any compost toilet; (2) Upon making a finding that a compost toilet is in violation of the rules adopted pursuant to ORS 447.118 (2), may issue an order requiring the owner of the dwelling served by the compost toilet to take action necessary to correct the violation; and (3) Upon making a finding that a compost toilet presents or threatens to present a public health hazard creating an emergency requiring immediate action to protect the public health, safety or welfare, may issue an order requiring the owner of the dwelling served by the compost toilet to take any action necessary to remove such hazard or threat thereof. If such owner fails to take the actions required by such order, the department shall take such action, itself or by contract with outside parties, as necessary to remove the hazard or threat thereof.¹²⁹ More specific information regarding composting toilets is given under Chapter 918-718-0010. Composting toilets: 1) must be ventilated (electrical or mechanical); 2) shall have at least one cubic yard capacity for a one or two bedroom dwelling; 3) shall be limited to installation in areas where a graywater disposal system can be installed and used; 4) shall be installed in an insulated area to keep a biological balance of the materials therein; and 5) humus from composting toilets may be used around ornamental shrubs, flowers, trees, or fruit trees and shall be buried under at least 12 inches of soil cover. Deposit of humus from any compost toilet around any edible vegetation or vegetable shall be prohibited.¹³⁰ Composting toilets must be approved by the NSF Standard 41.¹³¹

GRAYWATER: 447.140 (1) All waste water and sewage from plumbing fixtures shall be discharged into a sewer system or alternate sewage disposal system approved by the Environmental Quality Commission or department of Environmental Quality under ORS chapters 468, 468A and 468B. Graywater is technically defined as sewage and still requires a septic tank and drainfield, although the septic system can be reduced in size.¹³² Chapter 340, Divisions 71 and 73: Under the "split-waste method," blackwater sewage and graywater sewage from the same dwelling or building are disposed of by separate systems.¹³³ 340-71-320. Split Waste Method. In a split waste method, wastes may be disposed of as follows: (1) Black wastes may be disposed of by the use of State Building Codes Division approved non-water carried plumbing units such as recirculating oil flush toilets or compost toilets. (2) Graywater may be disposed of by discharge to: a) an existing on-site system which is not failing; or b) a new on-site system with a soil absorption facility 2/3 normal size. A full size initial disposal area and replacement disposal area of equal size are required; or c) a public sewerage system.¹³⁴

CONSTRUCTED WETLANDS: Performance based permits are issued for constructed wetlands. Several systems have been installed in Oregon, but not for single family homes.¹³⁵

Pennsylvania: Department of Environmental Protection, Bureau of Water Quality Protection, Division of Wastewater Management, Rachel Carson State Office Building, 11th Floor, 400 Market Street, Harrisburg, PA 17101-2301; Ph. (717) 787-8184.

REGULATION(S): Title 25. Environmental Protection, Chapter 73. Standards for Sewage Disposal Facilities, Current through 28 Pa.B. 348 (17 January 1998).

COMPOSTING TOILETS: under Chapter 73.1 are defined as devices for holding and processing human and organic kitchen waste employing the process of biological degradation through the action of microorganisms to produce a stable, humus-like material.¹³⁶ Composting toilets are permitted under Ch. 73.65. Toilets must bear the seal of the NSF indicating testing and approval by that agency under Standard No. 41. (b) The device utilized shall meet the installation specifications of the manufacturer and shall be operated and maintained in a manner that will preclude any potential pollution or health hazards. (c) When the installations of a recycling toilet, incinerating toilet or composting toilets is proposed for a new residence or establishment, an onlot sewage system or other approved method of sewage disposal shall be provided for treatment of washwater or excess liquid from the unit. For existing residences, where no alteration of the on lot system is proposed, a permit is not required to install a composting toilet.¹³⁷

GRAYWATER: 73.11. (c) Liquid wastes, including kitchen and laundry wastes and water softener backwash, shall be discharged to a treatment tank.¹³⁸

CONSTRUCTED WETLANDS: No existing regulations. Ch. 73.71 governs Experimental Sewage Systems, which may be implemented upon submittal of a preliminary design plan. Experimental systems may be considered for individual or community systems in any of the following cases: 1) To solve existing pollution or public health problem; 2) To overcome specific site suitability deficiencies, or as a substitute for systems described in this chapter on suitable lots; 3) To overcome specific engineering problems related to the site or proposed uses; and 4) To evaluate new concepts or technologies applicable to onlot disposal.¹³⁹

Rhode Island: Department of Environmental Management, Division of Groundwater and Individual Sewage Disposal Systems, ISDS Section, 291 Promenade Street, Providence, RI 02908-5767; Ph. (401) 277-4700; <http://www.state.ri.us/dem/regs/water/isds9-98.pdf> or [.doc](#)

REGULATION(S): Chapter 12-120-002, Individual Sewage Disposal Systems (September 1998).

COMPOSTING TOILETS: Regulation 12-120-002, amended September 1998, governs composting toilet guidelines. SD 14.00 discusses the acceptability of composting, or humus, toilets, stating that a humus or incinerator type toilet may be approved for any use where a septic tank and leaching system can be installed. The regulation governs two types of composting toilets: 1) large capacity composting toilets; and 2) heat assisted composting toilets. Large capacity toilets must have an interior volume greater than or equal to 64 cubic feet. All waste removed from large capacity composting toilets shall be disposed of by burial or other means approved by the director. Separate subsurface sewage disposal facilities must be provided for disposal of any liquid wastes from sinks, tubs, showers and laundry facilities (SD 14.05).¹⁴⁰

GRAYWATER: The term, "graywater," shall be held to mean any wastewater discharge from a structure excluding the waste discharges from water closets and waste discharges containing human or animal excrement. The term, "sanitary sewage," shall be held to mean any human or animal excremental liquid or substance, any putrescible animal or vegetable matter and/or any garbage and filth, including, but not limited to, any graywater or blackwater discharged from toilets, laundry tubs, washing machines, sinks, and dishwashers as well as the content of septic tanks, cesspools, or privies.¹⁴¹

CONSTRUCTED WETLANDS: No existing regulations. Section SD14.06 governs Innovative or Alternative Technology Approval Procedures (this is an extensive section on the procedures, that are required to install an alternative system).¹⁴²

South Carolina: Onsite Wastewater Management Branch, Division of Environmental Health, Department of Health and Environmental Control, 2600 Bull Street, Columbia, SC 29201; Ph. (803) 935-7945; FAX (803) 935-7825; Contact: Richard Hatfield; Email: HATFIERL@columb72.dhec.state.sc.us

REGULATION(S): Chapter 61-56, Individual Waste Disposal Systems (27 June 1986).

COMPOSTING TOILETS: Composting toilets may be used in conjunction with an approved septic system, for facilities that are provided with water under pressure. If site and soil conditions are not acceptable for an approved septic system, an alternative toilet may be considered, but only if the facility is not connected to water under pressure.

GRAYWATER: No existing regulations. Graywater is included within the Department's definition of sewage and must be managed appropriately. A permit applicant could elect to install separate systems to handle blackwater and graywater, but the same site and soil requirements apply for both systems.

CONSTRUCTED WETLANDS: Constructed wetlands (rock/plant filter) may be installed by an owner, but only in conjunction with an approved pre-treatment system, such as a septic tank, and an approved disposal system, such as a drain field. A limited number of homeowners have elected to use constructed wetlands systems in an effort to mitigate failing conventional systems.¹⁴³ Regulation 61-56, Individual Waste Disposal Systems, grants authority to the Department of Health and Environmental Control to adopt standards for alternative onsite treatment and disposal systems. However, no technical standards have been developed for graywater systems, constructed wetlands or composting toilets.

South Dakota: Department of Environment and Natural Resources, Air and Surface Water Program, Joe Foss Building, 523 East Capitol, Pierre, SD 57501; Ph. (605) 773-3151; <http://www.state.sd.us/state/legis/lrc/rules/7453.htm>

REGULATION(S): Chapter 74:53:01:10 (1 July 1996).

COMPOSTING TOILETS: Unconventional systems are only to be used when water or electrical systems are unavailable. Vault privies, chemical toilets, incinerator toilets, or composting units shall be used when a water or electrical system is not available. With the exception of vault privies, all unconventional systems are considered experimental systems, and plans and specifications shall be submitted to the secretary for approval as an experimental system prior to installation.¹⁴⁴

GRAYWATER: Under Chapter 74:03: 01:38, graywater systems are wastewater systems designed to recycle or treat wastes from sinks, lavatories, tubs, showers, washers, or other devices which do not discharge garbage or urinary or fecal wastes. In areas where they will not create a public nuisance or enter any water of the state, graywater systems are exempt from the requirement that normally states that wastewater is not allowed to surface on, around, or enter state waters. 74-03:01:75. A graywater system shall be designed in accordance with the following criteria: 1) All graywater treatment and recycle systems shall be located in accordance of the distances specified in 74:03.01:56, Table 1; 2) Design of graywater systems shall be based on a minimum graywater flow of 25 gallons per day per person. Three days retention time shall be provided for each graywater tank; 3) Graywater tanks are septic tanks and shall conform to the requirements for septic tanks; and 4) Effluent from graywater systems may be recycled for toilet use, conveyed to absorption fields, mounds or seepage pits, or used for irrigation of lawns and areas not intended for food production. Percolation tests shall be conducted and the minimum size of absorption area shall be determined in accordance with 74:03:01:66 to 74:03:01:69, inclusive.¹⁴⁵

CONSTRUCTED WETLANDS: No existing regulations.

Tennessee: Tennessee Department of Environment and Conservation, Division of Ground Water Protection, L & C Tower, 10th Floor, 401 Church Street, Nashville, TN 37243-1540; Ph. (615) 532-0774; Contact: Stephen Morse, Environmental Manager. Regulation(s): Rules of Department of Environment and Conservation, Division of Ground Water Protection, Chapter 1200-1-6: Regulations to Govern Subsurface Sewage Disposal Systems (1997).

COMPOSTING TOILETS: (2) Composting toilets must be certified by the NSF to be in compliance with NSF Standard 41, and be published in their Listing of Certified Wastewater Recycle/Reuse and Water Conservation Devices before they may be used for disposal of human excreta by non-water carriage methods. (c) A pit privy or composting toilet shall not be permitted for a facility where the facility has running water available unless there is an acceptable means to dispose of wastewater.¹⁴⁶

GRAYWATER, CONSTRUCTED WETLANDS: No existing regulations. However, the Tennessee Valley Authority does publish a set of guidelines for the design and construction of constructed wetlands: Tennessee Valley Authority's General Design, Construction, and Operation Guidelines — Constructed Wetlands Wastewater Treatment Systems for Small Users Including Individual Residences, Second Edition, by Steiner, et al., 1993.

Texas: Texas Natural Resource Conservation Commission, PO Box 13087, Austin, TX 78711-3087; Ph. (512) 239-4775; <http://www.tnrcc.state.tx.us/>

REGULATION(S): Chapter 285: On-Site Sewage Facilities (1999).

COMPOSTING TOILETS: 285.2 (13) Composting toilet - A self-contained treatment and disposal facility constructed to decompose non-waterborne human wastes through bacterial action facilitated by aeration. 285.34 Other Requirements (e) Composting toilets will be approved by the executive director provided the system has been tested and certified under NSF Standard 41 ¹⁴⁷ 285.2 (27)

GRAYWATER: wastewater from clothes washing machines, showers, bathtubs, handwashing lavatories, and sinks not used for the disposal of hazardous or toxic ingredients or waste from food preparations. Subchapter H: 285.80. Treatment and Disposal of Graywater. New construction or modification to an existing graywater conveyance, treatment, storage or disposal system outside of a structure or building must be carried out in accordance with provisions of this chapter and any established requirements of the permitting authority. Any new construction or modification to an existing graywater reuse or reuse conveyance system associated with a structure or building must be carried out in accordance with the requirements of the State Board of Plumbing Examiners.¹⁴⁸ Graywater must be treated through a septic system first.¹⁴⁹

CONSTRUCTED WETLANDS: Permitted under 285.32C. Non-standard systems include, but are not limited to, all forms of the activated sludge process, rotating biological contactors, recirculating sand filters, and submerged rock biological filters (a fancy name for constructed wetlands). Non standard systems submitted for review will be analyzed on basic engineering principles and the criteria established in Chapter 285. These systems will be reviewed as one of a kind, site-specific installations. Whether blackwater or graywater, all domestic water-carried discharges have to go through a septic tank first before going through a wetland system. After passing through the wetland system, it must still go through a drainfield.¹⁵⁰

Utah: Department of Environmental Quality, Division of Water Quality, 288 North 1460 West, PO Box 144870, Salt Lake City, UT 84114-4870; Ph. (801) 538-6146; <http://www.eq.state.ut.us/eqwq/wqrules.htm>

REGULATION(S): If they existed, they may be covered under R317-502-3, Individual Wastewater Disposal Systems (1993).

COMPOSTING TOILETS, GRAYWATER, CONSTRUCTED WETLANDS: No existing regulations. R317-502-3. does speak to

alternative systems. The drainage system of each dwelling, building or premises covered herein shall receive all wastewater (including but not limited to bathroom, kitchen, and laundry wastes) as required by the Uniform Plumbing Code and shall have a connection to a public sewer except when such sewer is not available or practicable for use, in which case connection shall be made as follows: 3.1 To an individual wastewater disposal system found to be adequate and constructed in accordance with requirements stated herein. 3.2 To any other type of wastewater disposal system acceptable under R317-1, R317-3, R317-5, or R317-560. R317-502-20. Experimental and Alternate Disposal Methods. 20.1 Where unusual conditions exist, experimental methods of wastewater disposal may be employed provided they are acceptable to the Division and to the local health department having jurisdiction. 20.2 When considering proposals for experimental individual wastewater disposal systems, the Division shall not be restricted by this rule provided that: A. The experimental system proposed is attempting to resolve an existing pollution or public health hazard, or when the experimental system proposal is for new construction, it has been predetermined that an acceptable back-up disposal system will be installed in event of failure of the experiment; B. The proposal for an experimental individual wastewater disposal system must be in the name of and bear the signature of the person who will own the system; and C. The person proposing to utilize an experimental system has the responsibility to maintain, correct, or replace the system in event of failure of the experiment. 20.3 When sufficient, successful experience is established with experimental individual wastewater disposal systems, the Division may designate them as approved alternate individual wastewater disposal systems. Following this approval of alternate individual wastewater disposal systems, the Division will adopt rules governing their use.¹⁵¹

Vermont: Agency of Natural Resources, Department of Environmental Conservation, Wastewater Management Division, 103 South Main Street, The Sewing Building, Waterbury, VT 05671-0401; Ph. (802) 241-3834; Contact: Bonnie J. Loomer-Hostelter; Email: bonniel@dec.anr.state.vt.us

REGULATION(S): If they existed, they would most likely be found under Environmental Protection Rules, Chapter 1, Small Scale Wastewater Treatment and Disposal Rules (8 August 1996).

COMPOSTING TOILETS, GRAYWATER, CONSTRUCTED WETLANDS: No existing regulations. Innovative systems are regulated under Chapter 1, Small Scale Wastewater Treatment and Disposal Rules. Innovative Systems are governed under subchapter 2, 1-203. Alternative systems are allowed in Vermont only if a back-up, in ground conventional (septic) system is installed.¹⁵² Constructed wetlands as treatment units could be approved if the design was sufficiently reliable given the extended winter season in Vermont. However, for all practical purposes, the discharge from a constructed wetland unit could not be discharged directly into surface waters under these regulations but would have to be discharged to a subsurface leachfield or possibly a sprayfield system.¹⁵³

Virginia: State of Virginia, Office of Environmental Health Services, Main Street Station, Suite 117, PO Box 2448, Richmond, VA 23218-2448; Ph. (804) 225-4030; <http://www.vdh.state.va.us/onsite/regulations/sew-vac4.htm>; Contact: Donald Alexander; Email: dalexander@vdh.state.va.us

REGULATION(S): 12 VAC 5-610-980.

COMPOSTING TOILETS: Article 6. 12 VAC 5-610-970. 3. Composting toilets are devices which incorporate an incline plane, baffles, or other suitable devices onto which human excreta is deposited for the purpose of allowing aerobic decomposition of the excreta. The decomposing material is allowed to accumulate to form a humus type material. These units serve as both toilet and disposal devices. Composting toilets are located interior to a dwelling. All materials removed from a composting privy shall be buried. Compost material shall not be placed in vegetable gardens or on the ground surface. All composting toilets must be certified by the National Sanitation Foundation as meeting the current Standard 41.

GRAYWATER: No existing regulations.

CONSTRUCTED WETLANDS: 12VAC5-640-370. Constructed wetlands are considered experimental and will be considered on a case by case basis by the department. All constructed wetland systems shall be designed to meet or exceed 10 mg/l BOD5 and 10 mg/l suspended solids. Experimental systems are exactly that: experimental. Only the results of testing will determine if they will become an approved method of treating wastewater. Some systems can solve site and soil problems that a conventional septic system cannot handle; however, no system can overcome all of the problems on some difficult sites. The Division is looking to find safe, sanitary and economical solutions for every site but some problems still lack a viable solution. In short, not every site "percs" and many, if not all, alternative technologies are more expensive than a conventional gravel system. The Department urges prospective buyers to get an approval letter or construction permit before buying property you wish to build on.¹⁵⁴

Washington: Department of Health, Community Environmental Health Programs LD-11, Building 2, Airdustrial Center, PO Box 47826, Olympia, WA 47826; Ph. (360) 236-4501 or 3011 (Environmental Health Programs direct line); <http://access.wa.gov/government/awlaws.asp>; Contact: Jen Haywood.

REGULATION(S): WAC 246-272; Technical Review Committee, Guidelines for Composting Toilets (1994); Recommended Standards and Guidance for Water Conserving On-Site Wastewater Treatment Systems (1999).

COMPOSTING TOILETS: I. The Technical Review Committee for On-Site Sewage Disposal, established under WAC 246-272-040, has reviewed the available literature on composting toilets. The committee has determined that composting toilets could be an approved

method of sewage treatment if use is consistent with the guidelines herein. Composting toilets are not designed to handle the total wastewater volume generated in the home. The units are usually designed to accommodate fecal and urinary wastes together with small amounts of organic kitchen wastes. The remaining wastewater originating from bathing facilities, sinks and washing machines (graywater) must therefore be collected, treated and disposed of in an approved manner. Because there generally will be additional wastewater to dispose of, composting toilets are restricted.

II. Composting toilets are any device designed to store and compost by aerobic bacterial digestion human urine and feces which are non-water carried, together with the necessary venting, piping, electrical and/or mechanical components.¹⁵⁵ Section A. Waterless Toilets/WLTs. Composting - Unit designed to store and compost (by microbial digestion) human urine and feces. These units are commonly designed to accommodate fecal and urinary wastes together with small amounts of organic material to assist their function. No water is used for transport of urine or feces within these units. They may be small enough to sit on the floor of a bathroom or large enough to require space below the floor to house the storage/composting chamber.¹⁵⁶ The units may be used to replace private privies or chemical toilets, including such applications as highway weigh stations, warehouses, port facilities, construction sites, residences, etc., may be used in dwellings where water supply is not available or provided (example: mountain cabins), or may be used in dwellings where an on-site sewage system is or can be provided for disposal of graywater. Where non-discharging blackwater treatment systems are used, a 50% reduction in septic tank volume and a 40% reduction in the daily hydraulic loading to be used in sizing the grey water disposal mechanism (drainfield, mound system, etc.) are recommended from standard design requirements. The units may be used in facilities where a public sewage system is provided for disposal of graywater.¹⁵⁷ The devices shall be capable of accommodating full or part-time usage without accumulating excess liquids when operated at the design rated capacity. Continuous forced ventilations (e.g., electric fan or wind-driven turbovent) of the storage or treatment chamber must be provided to the outside.¹⁵⁸ Components in which biological activity is intended to occur shall be insulated, heated, or otherwise protected from low temperature conditions, in order to maintain the stored wastes at temperatures conducive to aerobic biological decomposition: 20 to 50 degrees C (68 to 130 degrees F). The device shall be capable of maintaining wastes within a moisture range of 40 to 75%. The device shall be designed to prevent the deposition of inadequately treated wastes near parts used for the removal of stabilized end products. The solid end product (i.e., waste humus) shall be stabilized to meet NSF criteria when ready for removal at the clean out port.

1. Performance Standards. 1.2.1.2. Toilets of proprietary design must be tested according to the NSF International Standard No. 41 (May 1983).¹⁵⁹ The maintenance of carbon-to-nitrogen ratios of approximately 20:1 are recommended. Consequently, additions of vegetable matter, wood chips, sawdust, etc., can be helpful. Removal of composted and liquid materials shall be done in a manner approved with the local health departments and as a minimum, shall comply with Guidelines for Sludge Disposal, Washington Department of Health, 1954. Persons finding it necessary to handle this material shall take adequate protective sanitation measures, and should wash their hands carefully with soap and hot water. Compost shall not be used directly on root crops or on low-growing vegetables, fruits or berries which are used for human consumption; however, this general restriction does not apply if stabilized compost is applied 12 months prior to planting. Where it can be shown that sludge will not come in direct contact with the food products, such as in orchards or where stabilized sludges are further treated for sterilization or pathogen reduction, less restrictive periods may be applicable. Performance monitoring shall be performed on composting toilets permitted under this guideline. Permits should include a statement indicating the permitter's right of entry and/or right to inspect. The frequency of monitoring shall be: 1) Two years after installation; 2) Four years after installation; and 3) in response to a complaint or problem. Non-water carried sewage treatment units are presently acknowledged to be a method of sewage disposal under the Uniform Plumbing Code, but variances to use the devices might be required by local administrative authorities. Variances must therefore be obtained from these departments together with approval of the local health department before the installation can be allowed. The Revised Code of Washington (RCW) 70.118 gives local boards of health the authority to waive applicable sections of local building/plumbing codes when they might prohibit the use of an alternative method for correcting a failure.¹⁶⁰

GRAYWATER: Section B. Graywater systems are virtually the same as combined-wastewater on-site sewage systems. Gravity flow graywater systems consist of a septic tank and subsurface drainfield. Pressurized graywater systems consist of a septic tank, a pump chamber or vault, and a subsurface drainfield. Other types of alternative systems, pre-treatment methods and drainfield design and materials options may also be incorporated in graywater systems. The primary distinction between a graywater system and a combined wastewater system is the lower volume of wastewater. As a result, the size of the septic tank and subsurface drainfield is smaller compared to a system that treats and disposes all the household wastewater (combined) through a septic tank and drainfield. In addition to the water conserving nature of waterless toilets/graywater systems, the graywater system drainfield can be designed and located to reuse graywater for subsurface irrigation. Drainfield designs (methods and materials) which place the distributed wastewater in close proximity to the root zone of turf grasses, plants, shrubs, and trees may be used to enhance the reuse potential of graywater as it is treated in the soil, assuring public health protection. When graywater systems are designed, installed, operated and maintained to maximize their potential as a graywater reuse irrigation system, various items should be considered. Among these are plant water and nutrient needs and limits, salt tolerances, depths of root zones, etc. The development of a landscape plan is recommended. Graywater treatment and disposal/reuse systems must provide treatment and disposal at least equal to that provided by on-site system. Graywater on-site systems may be used with new residential construction and existing dwellings. Internal household plumbing may be modified (consistent with local plumbing code) to route any portion of the household graywater to the graywater on-site sewage system. Graywater on-site sewage systems may be located anywhere conventional or alternative on-site sewage systems are allowed. Site conditions, vertical separation, pretreatment requirements, setbacks and other location requirements are the same as described in Chapter 246-272 WAC. 2.4 Graywater on-sites sewage systems must provide permanent, year-round treatment and disposal of graywater unless this is already provided by an approved

on-site system or connection to public sewer. Graywater on-site systems must be installed with an approved waterless toilet or other means of sewage treatment for blackwater approved by the local health officer. Graywater systems are intended to treat and dispose “residential strength” graywater. Graywater exceeding residential strength must receive pre-treatment to at least residential strength levels. Design requirements for graywater on-site sewage systems, unless otherwise noted, are the same as requirements for combined wastewater systems presented in Chapter WAC 246-272. Graywater may be used for subsurface irrigation of trees (including fruit trees) shrubs, flowers, lawns and other ground covers but must not be used for watering of food crops of vegetable gardens, any type of surface or spray irrigation, to flush toilets/urinals or to wash wall, sidewalks or driveways. The disposal component of a graywater treatment system may be designed to enhance the potential for subsurface irrigation. The efficiency of graywater reuse via subsurface irrigation depends upon the proximity of the drainfield to the root-zone of plants, shrubs, trees or turf and the method of distribution. This may be enhanced by: Installing narrower-than-normal trenches shallow in the soil profile (state rules do not have a minimum trench width; minimum trench depth is six inches). Gravel and pipe size may limit how narrow a “conventional” trench may be. It is recommended that at least two inches of gravel be provided between the sides of the distribution pipe and trench sidewalls. Small gravel size (no less than 3/4 inch) is recommended for narrow trenches; using pressure distribution to reduce the height of the trench cross section to enable shallow trench placement and to assure even distribution; and using subsurface drip irrigation (SDS) technology for shallow system placement and equal distribution in close proximity to plant, shrub, turf and trees roots. Some agronomic issues that should be considered with graywater reuse are the water needs and salt tolerances of plants to be irrigated. In many cases, the volume of graywater generated may not meet the needs of the landscape plantings. If potable water is used to augment graywater for irrigation within the same distribution network, a method of backflow prevention approved by the local health officer is required. In some geographical and climatic areas, the frost-protection needs of an SDS or a conventional drainfield trench system may be counter-productive to effective graywater reuse via subsurface irrigation (distribution piping may be too deep for plant root systems). In these areas, local health officers may permit seasonal systems where year-round treatment and disposal is provided by an approved sewage system and seasonal subsurface irrigation with graywater is provided by a separate system with a shallow drainfield or SDS. Where seasonal systems are allowed, various administrative and design issues must be addressed. Both drainfields must meet state and local rule requirements, including soil application rates, to assure treatment and disposal at least equal to that provided by conventional gravity or pressure on-site sewage systems according to Chapter 246-272 WAC. 3.4.2 Municipal sewer systems may provide year-round sewage disposal in conjunction with seasonal graywater treatment and disposal systems designed to enhance graywater reuse via subsurface irrigation. Seasonal graywater treatment and disposal/reuse systems must include a three-way diverter valve to easily divert graywater to the year-round disposal field or sewer when needed (when freezing is a problem). Local health officers may permit “laundry wastewater only” graywater disposal or reuse systems for single family residences for either year-round or seasonal use. Graywater systems limited only to laundry wastewater (including laundry sinks) may differ from other graywater systems according to the following: A single compartment retention/pump tank, with a minimum liquid capacity of 40 gallons may be used in lieu of the tank recommendations. The tank must be warranted by the manufacturer for use with wastewater and meet requirements listed in Appendix G of the 1997 edition of the Uniform Plumbing Code (UPC). Minimum design flow for “laundry wastewater only” systems (for the purpose of drainfield sizing) must be based on the number of bedrooms in the residence and must be no less than 30% of the minimum graywater system design flows. A wastewater filter or screen (with a maximum size opening of 1/16 inch) must be provided in an accessible location conducive to routine maintenance. Homeowners are responsible for proper operation and maintenance of their graywater systems. Specific requirements will vary according to the county where the system is located and the specific type of system. See your local health jurisdiction for local system O & M requirements.¹⁶¹

CONSTRUCTED WETLANDS: No existing regulations.

West Virginia: Secretary of State, Administrative Law Division, State Capitol, 1900 Kanawha Boulevard East, Building 1, Suite 157K, Charleston, WV 25305-0770; Ph. (304) 558-6000; FAX (304) 558-0900; <http://www.state.wv.us/sos>; Email: WVSOS@Secretary.State.WV.US; Contact: Leah Powell.

REGULATION(S): Title 64, Interpretive Rules Board of Health, Series 47, Sewage Treatment and Collection System Design Standards (1983).

COMPOSTING TOILETS: Interpretive Rule 16-1, Series VII, 10.1. Composting toilets may be utilized only in conjunction with an approved graywater treatment and disposal system. 10.2 The design and construction of a composting toilet must meet the requirements of NSF Standard 41.

GRAYWATER: 12.1 Those houses served by a graywater disposal system must have a house sewer of not more than two inches in diameter. 12.2. Houses served by graywater disposal systems shall not have garbage disposal units. 12.3 Manufactured graywater disposal systems must be approved by the director. 12.4. Non-commercial graywater disposal systems shall consist of the following: 12.4.1. A soil absorption field designed on the basis of a 30% reduction in water usage, and constructed in accordance with the design requirements for the standard soil absorption fields. 12.4.2. A septic tank sized according to the following room sizes and minimum capacities: 2 rooms, 500 gallons; 3 to 4 rooms, 750 gallons; 5 or more rooms, add 210 gallons for each additional bedroom.¹⁶²

CONSTRUCTED WETLANDS: No existing regulations.

Wisconsin: Department of Commerce, Bureau of Program Management, 715 Post Road, Stevens Point, WI 54481-6456; Ph. (715) 345-

5334; FAX (715) 345-5269; <http://www.commerce.state.wi.us/sb-comm83revisionsandarticles.htm>;
<http://www.legis.state.wi.us/rsb/code/comm/comm083.pdf>; Contact: Jim Klass, Ph. (608) 266-9292 (Water Regulation).

REGULATION(S): If they existed, they may be found in Wisconsin Comm083.

COMPOSTING TOILETS, GRAYWATER SYSTEMS, CONSTRUCTED WETLANDS: No existing regulations.

Wyoming: Department of Environmental Quality, Water Quality Division, Herschler Building, 122 West 25th Street, Cheyenne, WY 82002; Ph. (307) 777-7075; <http://deq.state.wy.us/wqd/w&wwpage.htm>; Contact: Larry Robinson; <mailto:lharmo@missc.state.wy.us>

REGULATION(S): If they existed, regulations would most likely be found in Chapter XI, Part D, Septic Tank and/or Soil Absorption System, Water Quality Rules and Regulations in the Innovative and Alternative section.

COMPOSTING TOILETS, GRAYWATER SYSTEMS, CONSTRUCTED WETLANDS: No existing regulations.

Canada: Systems would be governed by the provincial Ministries of Health (municipal affairs and health, similar to our county government in the US). Check your local agency.

Other information sources: National Small Flows Clearinghouse: West Virginia University, PO Box 6064, Morgantown, WV 26506-6064; Ph. (304) 294-4191; 1-800-624-8301; National Sanitation Foundation: NSF Standard 41: Nonliquid Saturated Treatment Systems: <http://www.nsf.org/>

ENDNOTES (Appendix 3)

1. Memorandum from James M. Coles, Deputy Director. Division of Community Environmental Protection, State of Alabama Department of Public Health. 7 December 1998.
2. Alabama State Board of Health. 7 December 1998. Rules of State Board of Health Bureau of Environmental Services Division of Community Environmental Protection. Chapter 420-3-1, Onsite Sewage Disposal. Draft. p. 126.
3. Alabama State Board of Health, Bureau of Environmental Services, Division of Community Environmental Protection. 23 December 1998. Rules of State Board of Health Bureau of Environmental Services Division of Community Environmental Protection. Chapter 420-3-1, Onsite Sewage Disposal and Subdivision-Onsite Sewage Systems, Water Supplies and Solid Waste Management. p. 6.
4. Alabama State Board of Health. 7 December 1998. Rules of State Board of Health Bureau of Environmental Services Division of Community Environmental Protection. Chapter 420-3-1, Onsite Sewage Disposal. Draft. p. 126.
5. Arizona Department of Environmental Quality (ADEQ). Bulletin No. 12: Minimum Requirements for the Design and Installation of Septic Tank Systems and Alternative On-site Disposal Systems. June 1989. p. 65.
6. Ibid. p. 65-66.
7. Arizona Administrative Code. Department of Environmental Quality, Water Pollution Control. Article 7. Regulations for the Reuse of Wastewater. p. 14, 15, 17.
8. Knight, R. L, Randall, R. and M. Girts. May 1995. Arizona Guidance Manual for Constructed Wetlands for Water Quality Improvement. Arizona Department of Environmental Quality. p. 8-14.
9. Arizona Department of Environmental Quality. June 1989. Engineering Bulletin No. 12: Minimum Requirements for the Design and Installation of Septic Tank Systems and Alternative On-Site Disposal Systems. p.64.
10. Ibid.
11. Ibid. p. 65.
12. Environmental Program Services, Division of Environmental Health Protection. April 1993. Alternate Systems Manual. Arkansas Department of Health. p. 1.
13. Ibid.
14. Ibid. p. 18.

15. Carl J. Graves, R.S., Sanitarian, Arkansas Department of Health. Personal communication. 25 February 1999. 12. Environmental Program Services, Division of Environmental Health Protection. April 1993. Alternate Systems Manual. Arkansas Department of Health. p. 18.
16. Ibid. p. 18.
17. Ibid.
18. Ibid. p. 13-16
19. Ibid. p. 13-16
20. State of California. Building Standards Commission. 28 September 1997. Appendix G. Graywater Systems. Uniform Plumbing Code (UPC). Title 24, Part 5, California Administrative Code. p. 79-85.
21. Colorado Department of Health. 1994. Guidelines on Individual Sewage Disposal Systems. p. 6.
22. Colorado Department of Health. 1994. Guidelines on Individual Sewage Disposal Systems. p. 46.
23. Ibid. p. 47.
24. Ibid. p. 7.
25. Ibid. p. 44.
26. Ibid. p. 6.
27. Ibid. p. 43.
28. Connecticut Public Health Code. Regulations and Technical Standards for Subsurface Sewage Disposal Systems. Section 19-13-B100, Section 19-13-B103, Technical Standards, Section 19-13-B104. January 1997. p. 12.
29. Ibid. p. 42-43.
30. Ibid. p. 7.
31. Ibid. p. 12.
32. State of Delaware, Department of Natural Resources and Environmental Control. 31 January 1995. Regulations Governing the Design, Installation and Operation of On-Site Wastewater Treatment and Disposal Systems. Forward.
33. David Hammonds, Florida Bureau of Water and Onsite Sewage Programs. Personal conversation. 25 February 1999.
34. State of Florida, Department of Health. 3 March 1998. Chapter 64E-6, Florida Administrative Code, Standards for On-Site Sewage Treatment and Disposal Systems. p. 20.
35. Ibid. p. 22.
36. http://www.leg.state.fl.us/citizen/documents/statutes/1998/ch0381/sec0065_.htm 5 April 1999. p. 1.
37. State of Florida, Department of Health. 3 March 1998. Chapter 64E-6, Florida Administrative Code, Standards for On-Site Sewage Treatment and Disposal Systems. p. 31.
38. Florida Administrative Code. 13 February 1997. Standards for On-Site Sewage Treatment and Disposal Systems, Chapter 10D-6.
39. National Small Flows Clearinghouse. 1997. Graywater Systems from the State Regulations. WWBLRG24. p. 19, 20, 23-24.
40. David Hammonds, Florida Bureau of Water and Onsite Sewage Programs. Personal conversation. 25 February 1999.

41. State of Georgia. 20 February 1998. Chapter 290-5-59. Special Onsite Sewage Management Systems. p. D-18.
42. State of Georgia. 20 February 1998 Chapter 290-5-59. Special Onsite Sewage Management Systems. p. 2.
43. Ibid. p. D-19.
44. Corbitt, Bill. 16 July 1997. Aquatic Sewage Treatment Systems in Georgia, Past and Present. Georgia Environmentalist. Georgia Environmental Health Association. p. 8-14.
45. Hawaii Department of Health. 30 August 1991. Amendment and Compilation of Chapter 11-62. p. 62-4.
46. Ibid. p. 62-5.
47. Ibid. p. 62-24.
48. Ibid. p. 62-26.
49. Ibid. p. 62-23.
50. National Small Flows Clearinghouse. 1997. Graywater Systems from the State Regulations. WWBLRG24. p. 25.
51. Hawaii Department of Health. 30 August 1991. Amendment and Compilation of Chapter 11-62. p. 62-23.
52. Ibid. p. 62-26.
53. State of Idaho. 993. IDAPA 16. Title 01, Chapter 03. Rules for Individual/Subsurface Sewage Disposal Systems. p. 16-8.
54. Idaho Division of Environmental Quality. 8 January 1999. Technical Guidance Manual for Individual Subsurface Sewage Disposal Systems. p. 33.
55. Barry Burnell, Idaho Division of Environmental Quality. Personal communication. 8 January 1999.
56. Ibid.
57. Idaho Division of Environmental Quality. 25 October 1996. Technical Guidance Manual for Individual Subsurface Sewage Disposal Systems. p. 1-4.
58. Barry Burnell, Idaho Division of Environmental Quality. Personal communication. 8 January 1999.
59. Illinois Department of Public Health. 1996. Private Sewage Disposal Licensing Act and Code. p. 54.
60. Ibid. p. 63.
61. Ibid. p. 56.
62. Tim Decker, Indiana State Department of Health. Personal communication. 30 April 1999.
63. Iowa Chapter 69: On-Site Wastewater Treatment and Disposal Systems. 567--69.11(455B) Constructed wetlands section.
64. Kansas Administrative Regulations. 1 January 1973. Chapter 25-5-9. Variance. p. 126.
65. State of Kansas Department of Health and Environment. March 1997. Bulletin 4-2: Minimum Standards for Design and Construction of Onsite Wastewater Systems. p. 1.
66. Kentucky Cabinet for Human Resources. September 1989. On-Site Sewage Disposal Systems Regulations. 902 KAR 10:081 and 902 KAR 10:085. p. 25.
67. Ibid. p. 58-59.
68. Ibid. p. 48.

69. Department for Public Health. August 1997. Kentucky Public Health Homeowner's Manual. Onsite Sewage Disposal Systems. p. 29
70. Teda Boudreaux. Louisiana Department of Health. Personal communication 3 May 1999.
71. Department of Human Services. 20 January 1998. Maine Subsurface Waste Water Disposal Rules. 144A CMR 214. p. 15-1, 15-2.
72. Ibid. p. 15-3.
73. Jay Prager, Acting Chief, Division of Residential Sanitation, Maryland Department of the Environment. 26 October 1990. Innovative/Alternative Section. Memorandum: Guidance on Waterless Toilet Systems. p. 1.
74. Ibid. p. 2.
75. Commonwealth of Massachusetts. Executive Office of Environmental Affairs. Department of Environmental Protection. 4 March 1998. 310 CMR 15.000: Title 5: Innovative and Alternative Subsurface Sewage Disposal Technologies Approved for Use in Massachusetts. p.1,9. Commonwealth of Massachusetts. Executive Office of Environmental Affairs. Department of Environmental Protection. 16 April 1998. The Use of Composting Toilets in Massachusetts. p. 1-4.
76. Ibid. p. 4.
77. Ruth Alfasso, Graywater Piloting Coordinator, Massachusetts DEP. Personal communication. 6 January 1999.
78. Ibid.
79. Rick Fallardeau, Michigan Department of Environmental Quality. Personal communication. April 1999.
80. Michigan Department of Public Health. July 1986. Guidelines for Acceptable Innovative or Alternative Waste Treatment Systems and Acceptable Graywater Systems. p. 1.
81. Ibid. Attachment A. Act No. 421. Public Acts of 1980. Approved by Governor. 13 January 1981. p. 1.
82. Ibid. p. 2.
83. Michigan Department of Public Health. July 1986. Guidelines for Acceptable Innovative or Alternative Waste Treatment Systems and Acceptable Graywater Systems. p. 2.
84. Ibid. p. 2.
85. Ibid. p. 3.
86. Ibid. p. 3.
87. Ibid. p. 3.
88. Ibid Attachment C. Act 230, Public Acts of 1972, as amended Michigan Construction Code. p. 1.
89. Rick Fallardeau, Michigan Department of Environmental Quality. Personal communication. April 1999.
90. McGeachy, Ben. date unknown. A Review of Subsurface Flow Constructed Wetlands Literature and Suggested Design and Construction Practices. Michigan Department of Environmental Quality.
91. Roberta Wirth, Minnesota Department of Natural Resources. Personal communication. 14 January 1999.
92. Minnesota Rules. 3 November 1998.. Chapter 7080.0910. Alternative and Experimental Systems.
93. Ibid. Section E1-E7.
94. Mississippi Individual On-Site Wastewater Disposal System Law. 1996. Chapter 41-67. MSDH 300-Section 02A-03.

95. Ibid. MSDH 300-Section 02A-XIII-01.
96. Ibid. MSDH 300-Section 02A-VII-01.
97. Missouri Department of Health. 1995. Missouri Laws Accompanied by Department of Health Rules Governing On-site Sewage Systems. Missouri Laws for On-Site Disposal Systems. p. 1.
98. Missouri Department of Health. 1995 Missouri Laws Accompanied by Department of Health Rules Governing On-site Sewage Systems. Title 19- Department of Health, Division 20-Environmental Health & Epidemiology, Chapter 3- General Sanitation. p. 37.
99. Ibid. p. 9.
100. Ibid. p. 34.
101. Montana Department of Health and Environmental Sciences. Circular WQB 5. Minimum Design Standards for On-Site Alternative Sewage Treatment and Disposal Systems. p. 4.
102. Ibid. p. 5
103. Nevada Adopted Regulation R 129-98. February 1998. p. 59-61.
104. <http://www.state.nh.us/gencourt/ols/rules/env-ws.htm>
105. <http://www.state.nj.us/dep/dwq/rules.htm> p. 11.
106. Ibid. p. 6-7.
107. Ibid. p. 65, 68-69.
108. Ibid. p. 6.
109. Ibid. p. 25.
110. Brian Schall, New Mexico Environment Department. Personal communication. 1999.
111. Ibid.
112. Ibid.
113. New Mexico Environmental Improvement Board. October 1997. Liquid Waste Disposal Regulations. p. 6.
114. New Mexico Environmental Improvement Board. October 1997. Liquid Waste Disposal Regulations. p 38.
115. New York State Department of Health. 1996. Individual Residential Wastewater Treatment Systems Design Handbook.
116. Ibid. p. 56.
117. Ibid.
118. Ibid. p. 56-57.
119. State of New York. 1 December 1990. Appendix 75-A. Wastewater Treatment Standards - Individual Household Systems. Statutory Authority,; Public Health Law, 201(1)(1), New York. p. 31.
120. Ibid.
121. Ibid. p. 14.

122. Ben Pierson, New York State Department of Health. Personal communication. 6 April 1999.
123. National Small Flows Clearinghouse. September 1997. Alternative Toilets from the State Regulations. WWBKRG23. p. 53-54.
124. Joni Cardin, North Carolina Division of Water Quality. Personal communication. 7 January 1999.
125. State of North Dakota. 1996. Chapter 62-03-16. Individual Sewage Treatment Systems for Homes and Other Establishments Where Public Sewage Systems are not Available. p. 249.
126. Ibid.
127. Ohio Department of Health. 1 July 1977. Chapter 3701-29-01 to 3701-29-21. Household Sewage Disposal Rules. p. 21.
128. Oklahoma Chapter 640, Individual and Small Public Sewage Disposal. 1998. p. 12-13.
129. Oregon Chapter 447.115. 1997. <http://landru.leg.state.or.us/ors/447.htm> 21 January 1999.
130. Oregon Chapter 918-790-0010. 1998. http://arcweb.sos.state.or.us/rules/OARS_900/OAR_918/918_770.htm
131. Oregon Chapter 918-770-0050. 1998. Plumbing Product Approval. http://arcweb.sos.state.or.us/rules/OARS_900/OAR_918/918_770.htm
132. Oregon Chapter 447.115. 1997. <http://landru.leg.state.or.us/ors/447.htm> 21 January 1999.
133. National Small Flows Clearinghouse. September 1997. Greywater Systems from the State Regulations. p. 36.
134. Ibid. p. 37.
135. Terry Swisher, Oregon Chief Plumbing Inspector. Personal communication. 14 January 1999.
136. Commonwealth of Pennsylvania. 17 January 1998. Pennsylvania Code. Title 25. Environmental Protection. p. 73-6.
137. Ibid. p. 73-47 - 73-48.
138. Ibid. p. 73-10.
139. Ibid. p. 73-48 to 73-49.
140. Rhode Island. September 1998. Chapter 12-120-002, Individual Sewage Disposal Systems. p. 40-42.
141. Ibid.
142. Ibid. p. 43-46.
143. Richard Hatfield, South Carolina Onsite Wastewater Management Branch. Personal communication. 7 January 1999.
144. <http://landru.leg.state.or.us/ors/447.htm> 7 January 1999.
145. National Small Flows Clearinghouse. September 1997. Greywater Systems from the State Regulations. p. 39-41.
146. Tennessee Rules of Department of Environment and Conservation, Division of Ground Water Protection. 1997. Chapter 1200-1-6: Regulations to Govern Subsurface Sewage Disposal Systems. p. 59.
147. Texas Natural Resource Conservation Commission. 8 January 1999. Chapter 285, On-Site Sewage Facilities. p. 2, 19.
148. Ibid. p. 1, 3.
149. Ken Graber, Texas Natural Resource Conservation Commission. Personal communication. 4 April 1999.

150. Ibid.
151. <http://www.eq.state.ut.us/eqwq/wqrules.htm> 6 January 1999.
152. Bonnie Loomer-Hostetler, Information Services Chief of the Vermont Wastewater Management Division. Personal communication. 7 January 1999.
153. John Akielaszek, Vermont Department of Environmental Conservation. Personal communication. 12 January 1999.
154. <http://www.vdh.state.va.us/onsite/text/appr-sys.htm>
155. Technical Review Committee. June 1994. Guidelines for Composting Toilets. Washington State Department of Health. p. 2.
156. Water Conserving On-Site Wastewater Treatment Systems. 5 April 1999. Washington State Department of Health. p. 3.
157. Technical Review Committee. June 1994. Guidelines for Composting Toilets. Washington State Department of Health. p. 1.
158. Water Conserving On-Site Wastewater Treatment Systems. 5 April 1999. Washington State Department of Health. p. 2.
159. Ibid. p. 4.
160. Technical Review Committee. June 1994. Guidelines for Composting Toilets. Washington State Department of Health. p. 3, 4, 5.
161. Technical Review Committee. June 1994. Guidelines for Composting Toilets. Washington State Department of Health. p. 19, 20, 22, 23.
162. West Virginia Board of Health. 1983. Interpretive Rule 16-1. Series VII. Part V. Sec. 10.0. p. 135.

*Source: The Humanure Handbook. Jenkins Publishing, PO Box 607, Grove City, PA 16127. To order, phone: 1-800-639-4099.
<http://www.jenkinspublishing.com/>*

MENU: [HOME](#) » [Reconstruction](#) » [Recovery](#) » [Renewal](#) » [Survival](#) » [Humanure Content](#)

Humanure Glossary:

actinomycete

Bacteria resembling fungi because they usually produce a characteristic, branched mycelium.

activated sludge

Sewage sludge that is treated by forcing air through it in order to activate the beneficial microbial populations resident in the sludge.

aerobic

Able to live, grow, or take place only where free oxygen is present, such as aerobic bacteria.

algae

Small aquatic plants.

ambient air temperature

The temperature of the surrounding air, such as the outdoor air temperature in the vicinity of a compost pile.

amendment

See “bulking agent.”

anaerobic

Able to live and grow where there is no oxygen.

Ascaris

A genus of roundworm parasitic to humans.

Aspergillus fumigatus

A spore-forming fungus that can cause allergic reactions in some people.

bacteria

One-celled microscopic organisms. Some are capable of causing disease in humans, others are capable of elevating the temperature of a pile of decomposing refuse sufficiently to destroy human pathogens.

biochemical oxygen demand (BOD)

The amount of oxygen used when organic matter undergoes decomposition by microorganisms. Testing for BOD is done to assess the amount of organic matter in water.

blackwater

Wastewater from a toilet.

bulking agent

An ingredient in compost, such as sawdust or straw, used to improve the structure, porosity, liquid absorption, odor, and carbon content. The terms “bulking agent” and “amendment” are often interchangeable.

carbonaceous

Consisting of or containing carbon.

carbon dioxide (CO₂)

An inorganic gas composed of carbon and oxygen produced during composting.

cellulose

The principal component of cell walls of plants, composed of a long chain of tightly bound sugar molecules.

C/N ratio

The ratio of carbon to nitrogen in an organic material.

combined sewers

Sewers that collect both sewage and rain water runoff.

compost

A mixture of decomposing vegetable refuse, manure, etc., for fertilizing and conditioning soil.

continuous composting

A system of composting in which organic refuse material is continuously or daily added to the compost bin or pit.

cryptosporidia

A pathogenic protozoa which causes diarrhea in humans.

curing

Final stage of composting. Also called aging, or maturing.

effluent

Wastewater flowing from a source.

enteric

Intestinal

evapotranspiration

The transfer of water from the soil into the atmosphere both by evaporation and by transpiration of the plants growing on the soil.

fecal coliforms

Generally harmless bacteria that are commonly found in the intestines of warm-blooded animals, used as an indicator of fecal contamination.

fecophobia

Fear of fecal material, especially in regard to the use of human fecal material for agricultural purposes.

fungi

Simple plants, often microscopic, that lack photosynthetic pigment.

graywater

Household drain water from sinks, tubs, and washing (not from toilets).

green manure

Vegetation grown to be used as fertilizer for the soil, either by direct application of the vegetation to the soil, by composting it before soil application, or by the leguminous fixing of nitrogen in the root nodules of the vegetation.

heavy metal

Metals such as lead, mercury, cadmium, etc., having more than five times the weight of water. When concentrated in the environment, can pose a significant health risk to humans.

helminth

A worm or worm-like animal, especially parasitic worms of the human digestive system, such as the roundworm or hookworm.

human nutrient cycle

The endlessly repeating cyclical movement of nutrients from soil to plants and animals, to humans, and back to soil.

humanure

Human feces and urine used for agriculture purposes.

humus

A dark, loamy, organic material resulting from the decay of plant and animal refuse.

hygiene

Sanitary practices, cleanliness.

indicator pathogen

A pathogen whose occurrence serves as evidence that certain environmental conditions, such as pollution, exist.

K

Chemical symbol for potassium.

latrine

A toilet, often for the use of a large number of people.

leachate

Any liquid draining from a source. Pertaining to compost, it is the liquid that drains from organic material, especially when rain water comes in contact with the compost.

lignin

A substance that forms the woody cell walls of plants and the “cement” between them. Lignin is found together with cellulose and is resistant to biological decomposition.

macroorganism

An organism which, unlike a microorganism, can be seen by the naked eye, such as an earthworm.

mesophile

Microorganisms which thrive at medium temperatures (20-37°C or 68-99°F).

metric tonne

A measure of weight equal to 1,000 kilograms or 2,204.62 pounds.

microhusbandry

The cultivation of microscopic organisms for the purpose of benefiting humanity, such as in the production of fermented foods, or in the decomposition of organic refuse materials.

microorganism

An organism that needs to be magnified in order to be seen by the human eye.

moulder (also molder)

To slowly decay, generally at temperatures below that of the human body.

mulch

Organic material, such as leaves or straw, spread on the ground around plants to hold in moisture, smother weeds, and feed the soil.

municipal solid waste (MSW)

Solid waste originating from homes, industries, businesses, demolition, land clearing, and

construction.

mycelium

Fungus filaments or hyphae.

N

Chemical symbol for nitrogen.

naturalchemy

The transformation of seemingly valueless materials into materials of high value using only natural processes, such as the conversion of humanure into humus by means of microbial activity.

night soil

Human excrement used raw as a soil fertilizer.

nitrates

A salt or ester of nitric acid, such as potassium nitrate or sodium nitrate, both used as fertilizers, and which show up in water supplies as pollution.

organic

Referring to a material from an animal or vegetable source, such as refuse in the form of manure or food scraps; also a form of agriculture which employs fertilizers and soil conditioners that are primarily derived from animal or vegetable sources as opposed to mineral or petrochemical sources.

P

Chemical symbol for phosphorous.

pathogen

A disease-causing microorganism.

PCB

Polychlorinated biphenyl, a persistent and pervasive environmental contaminant.

peat moss

Organic matter that is under-decomposed or slightly decomposed originating under conditions of excessive moisture such as in a bog.

pH

A symbol for the degree of acidity or alkalinity in a solution, ranging in value from 1 to 14. Below 7 is acidic, above 7 is alkaline, 7 is neutral.

phytotoxic

Toxic to plants.

pit latrine

A hole or pit into which human excrement is deposited. Known as an outhouse or privy when sheltered by a small building.

protozoa

Tiny, mostly microscopic animals each consisting of a single cell or a group of more or less identical cells, and living primarily in water. Some are human pathogens.

psychrophile

Microorganism which thrives at low temperatures [as low as -10oC (14oF), but optimally above 20oC (68oF)].

schistosome

Any genus of flukes that live as parasites in the blood vessels of mammals, including humans.

septage

The organic material pumped from septic tanks.

septic

Causing or resulting from putrefaction (foul-smelling decomposition).

shigella

Rod-shaped bacteria, certain species of which cause dysentery.

sludge

The heavy sediment in a sewage or septic tank.

source separation

The separation of discarded material by specific material type at the point of generation.

sustainable

Able to be continued indefinitely without a significant negative impact on the environment or its inhabitants.

thermophilic

Characterized by having an affinity for high temperatures (above 40.50C or 1050F), or for being able to generate high temperatures.

tipping fee

The fee charged to dispose of refuse material.

vector

A route of transmission of pathogens from a source to a victim. Vectors can be insects, birds, dogs, rodents, or vermin.

vermicomposting

The conversion of organic material into worm castings by earthworms.

vermin

Objectionable pests, usually of a small size, such as flies, mice, and rats, etc..

virus

Any group of submicroscopic pathogens which multiply only in connection with living cells.

waste

A substance or material with no inherent value or usefulness, or a substance or material discarded despite its inherent value or usefulness.

wastewater

Water discarded as waste, often polluted with human excrements or other human pollutants, and discharged into any of various wastewater treatment systems, if not directly into the environment.

Western

Of or pertaining to the Western hemisphere (which includes North and South America and Europe) or its human inhabitants.

windrow

A long, low, narrow pile, such as of compost.

worm castings

Earthworm excrement. Worm castings appear dark and granular like soil, and are rich in soil nutrients.

yard material

Leaves, grass clippings, garden materials, hedge clippings, and brush.

Source: *The Humanure Handbook*. Jenkins Publishing, PO Box 607, Grove City, PA 16127. To order, phone: 1-800-639-4099.

<http://www.jenkinspublishing.com/>

MENU: [HOME](#) » [Reconstruction](#) » [Recovery](#) » [Renewal](#) » [Survival](#) » [Humanure Content](#)

363.7288 J52h
Jenkins, Joseph C.
The humanure handbook : a
guide to composting human
S
33293006046736

HUMANURE HANDBOOK

A GUIDE TO COMPOSTING HUMAN MANURE

(Emphasizing Minimum Technology and Maximum Hygienic Safety)

Copyright 1994 by Joseph C. Jenkins

All Rights Reserved

Third Printing

The author permits the use of substantial excerpts from this book, providing that the use of such excerpts is not for the purpose of financial profit, and that the source of the information, including title of this book and the publisher's address, is acknowledged on the copied information. This license is granted for the purpose of making information on the subject of composting humanure available to those people who cannot afford to purchase the entire book.

Correspondences and/or book orders may be addressed to:
Jenkins Publishing, PO Box 607, Grove City, PA 16127 USA

ISBN 0-9644258-4-X

Library of Congress Catalog Card Number: 95-94239

The Humanure Handbook

Copyright 1994 by Joseph C. Jenkins
All rights reserved except as outlined on previous page.

Printed in the United States of America. - Published in the United States by:
Jenkins Publishing • PO Box 607 • Grove City, PA 16127 USA.

Acknowledgements

Editorial assistance from the following persons is gratefully acknowledged: Jeanine Jenkins, Joseph J. Jenkins, Michael Crews, Barry Smith, and Stephen Brown.

Thanks also to Tom Benevento for the information on the Guatemalan mouldering toilet and for allowing me to photograph him next to a Clivus Multrum; to Pam Owens for allowing me to photograph her with cedar posts in hand; to Jeanine for gracing the pages of this book with photos of her working with humanure compost; and to all the neighbors and friends who helped in the creation of this book by loaning the author reference materials, by suggesting sources of information, and for allowing the author to photograph their sawdust toilets, which was done in some cases (quite by accident) when they weren't home, allowing for candid photos of sawdust toilets as they look everyday.

A word of appreciation is in order for the Slippery Rock University Master of Science in Sustainable Systems program, Slippery Rock, PA 16057 USA, which played a significant role in encouraging the author to focus his attention on the subject at hand.

A note of appreciation must be added for the international permaculture, organic agriculture, and sustainable gardening communities, whose existence and support has been inspirational.

Finally, a *special* note of recognition must be added in behalf of the author's wife, Jeanine, whose assistance at every stage in the creation of this work was tremendously beneficial.

Photographs, design and graphics are by the author unless otherwise indicated. Some of the graphics include clip art, or modified clip art, and any advertisements or segments of advertisements came from very old magazines found in a barn.

Cartoon artwork on pages 28, 49, 64, 84, 108, 136, 184, 188, and back cover by
Tom Griffin, Otter Creek, Mercer, PA 16137 USA.

Front cover artwork by Joanna and Chris Ithen, Ithen Printing Services, Grove City,
PA 16127 USA.

Third Printing Notes from the Author

When first published, I wondered whether this book would sink or swim, suspecting that not many people would want to read about “*humanure*”. But I should have known - this book neither sinks nor swims. It *floats*. And like a turd that won’t flush, the Humanure Handbook keeps coming back. This is surprising, considering the humor throughout this book is execrable, and there is plenty to be offended or annoyed by if you have a mind for it. Worse, there are two prerequisites to reading this book: you must be able to read, and you must be able to defecate. Apparently there are still *some* people who fit into this category, and for the most part, their comments have been encouraging. Here’s a sampling:

“Your discovery of the proper small scale of the operation is world shaking.”

F. A., Delaware

“I enjoyed the book immensely, but my mother is appalled. Pleasing me and irritating my mother - you score big in my two favorite categories.” K. L., Indiana

“Your book is pure gold, just what I needed to give to my County Health Department.” M. T., Missouri

“Your book was carefully handed to me in a brown paper bag at church last spring. Great research, clear writing and terrific humor.” L. U., West Virginia

“I showed a review of your book to my dad and he almost gagged! Would you mail me one in a plain wrapper? I live with my parents.” M. C., Colorado

“If you could claim credit for engineering the thermophilic decomposers, you would probably win the Nobel Peace Prize.” T. C., Arizona

“We started using our ‘system’ the day after receiving the book. It took about two hours to put together. I wish more problems that at first seemed complicated and expensive could be solved as simply as this.” J. F., New York

“I’ve been composting and using my own waste for the past 20 years. Most of my friends think it odd. I counter that not even barbarians piss and shit in their drinking water!” E. S., Washington

“Fascinating! We are indebted to you for your book Humanure Handbook.”
R. L., New York

“I’m sure you’ve probably heard it all before, but I really appreciate the fact that someone finally did their research and put it together in a pleasant readable form.” S. C., Wisconsin

“For 22 years I have used scarab beetle/larvae . . . they eat my shit in five minutes flat.” C. M., South Carolina

“I live and work in an international youth hostel and we’re using your saw-dust toilets.” B. S., Georgia

"This wonderful book fits right into my compost = redemption religious philosophy. You have answered questions I have held open since childhood." R., Massachusetts

"Just finished reading your book and I'm glad. Seeing Mr. Turdly dancing around the compost pile wasn't my ideal dream." E. S., Washington

"I'm wracking my brain, trying to find a compelling way to tell you how great I think your book is." K. W., Wisconsin

"I've spent my whole life recycling, reducing, reusing everything but my own shit and I'm ecstatically grateful to have your directions reach my lap." W., Maine

"I found your book entertaining, informative, and a great motivating force compelling us to start recycling our "humanure" immediately." B. W., Texas

"It is the shittiest book I've ever read, but it's great!" D. H., Wyoming

"I liked your book. Putting back nutrients after taking them away makes sense as well as the image of dropping a turd in a 5 gallon toilet filled with pure drinking water seems crazy." T. O., New Hampshire

"As parasites attached to the earth, it would seem that the only conscious thing we do that isn't killing the host, is manuring in the woods, fields or a compost toilet." D. G., Minnesota

"Two things you might be interested in: A more natural way to eliminate is in the squatting position. [and] Urine is not a waste product. Taking urine internally has been going on for some time (1000's of years) and by many is considered a wonderful medicine. I take my first urine daily. Also, urine is used today in ear wax removal, hand creams, and other. Now is that full of crap . . . or is it?" W. E., Ohio

"Your book (Humanure) saved my butt at a town council meeting yesterday. Thank you for writing it." D. W., Colorado

"My 74 year old father thinks human waste should not be used in a garden, and I want to prove him wrong." A. M., Washington

"I had to call my dear heart long distance immediately to read her what may be the most hopeful environmental news I've read in my 35 years, that something can transmute horrible toxins. Why aren't all the environmentalists raving about this?" C., Vermont

There have been enough written comments about the Humanure Handbook to fill an entire book. The first two printings have been read in every state in the USA including Puerto Rico, and in at least nine other countries (Canada, Australia, Japan, England, Mexico, Guatemala, Spain, Wales, and Malaysia), by people of all ages (teens to nonagenarians). Perhaps the time has come to make *humanure* a household word. And with enough brown paper bags, perhaps the book will even get passed around a bit!

JCJ - Spring, 1996

TABLE OF CONTENTS

INTRODUCTORY INFORMATION

Page 7

Chapter 1

CRAP HAPPENS

Page 13

Soiled Water; Waste Reduction-Resource Recovery; Waste vs. Manure; Experience Helps.

Chapter 2

MICROHUSBANDRY

Page 29

Naturalchemy; Gomer the Pile; The Carbon/Nitrogen Ratio; Misinformation; Have a Good Blend; Newspaper; Lime.

Chapter 3

DEEP SHIT

Page 51

Waste vs. Manure, Again; The Advances of Science; Holy Sheesh; When the Crap Hit the Fan.

Chapter 4

A DAY IN THE LIFE OF A TURD

Page 65

Mexican Biological Digester; The Old Fashioned Outhouse; Septic Systems; Sand Mounds; Ground Water Pollution from Septic Systems; Wastewater Treatment Plants; Chlorine; Alternative Wastewater Treatment Systems; Agricultural Use of Sewage Sludge; Global Sewers and Pet Turds.

Chapter 5
COMPOSTING TOILETS AND SYSTEMS

Page 85

The Non-Commercial (Homemade) Mouldering Toilet; Commercial Mouldering (or Multrum) Toilets; More Commercial Composting Toilets; Asian Composting; Simple, Low-Tech Humanure Composting.

Chapter 6
WORMS AND DISEASE

Page 109

The Hunzas; Pathogens; Indicator Pathogens; Persistence of Pathogens on Soil, Crops, Manure and Sludge; Eliminating Pathogens From Humanure; More on Parasitic Worms; Summary of Conditions Needed to Kill Pathogens; Conclusions.

Chapter 7
THE TAO OF COMPOST

Page 137

Primal Compost; The Evolution of Compost; Thermophilic Microorganisms; Four Necessities for Good Compost; Doing It; The Sawdust Toilet; Analyses; Low-Impact Composting; Monitoring Compost Temperature; Legalities.

Chapter 8
THE END IS NEAR

Page 175

APPENDICES

Page 185

1) Sources of compost thermometers; 2) Metric conversions; 3) Centigrade/Fahrenheit conversions; 4) Sawdust toilet temperature curve.

GLOSSARY

Page 189

INDEX

Page 193

INTRODUCTORY INFORMATION

Figure A: The human nutrient cycle - intact11
 Figure B: The human nutrient cycle - broken12

CHAPTER ONE

Figure 1.1: Gross solid waste generated in the USA, not including sewage15
 Figure 1.2: Amount of humanure available worldwide per square mile of
 tillable land16
 Figure 1.3: Sewage sludge dumped in U.S. ocean waters, 1973-198618
 Figure 1.4: Average annual per capita water use in selected countries20
 Figure 1.5: Use of fertilizer worldwide since 195019
 Figure 1.6: Amount of nitrogen used in fertilizers in the USA derived from
 organic sources (1900 and 1948)19
 Figure 1.7: Composition of unrecycled discarded solid waste in the
 USA, 1980-200023
 Figure 1.8: Percentage of world population without adequate sanitation21
 Figure 1.9: Composition of municipal waste in USA, 198621
 Figure 1.10: Our increasing impact on planet Earth - world population
 growth, production and fuel consumption since 190022

CHAPTER TWO

Figure 2.1: Size of bacteria relative to a red blood cell, a hair, and a grain
 of sand33
 Figure 2.2: The Marino toilet - 1858 - Copenhagen42
 Table 2.1: Composition of humanure39
 Table 2.2: Carbon/nitrogen ratios for some compostable materials40
 Table 2.3: Nitrogen loss and C/N ratio39

CHAPTER FOUR

Figure 4.1: Biological Digester - South India66
 Figure 4.2: Spread of pollution through dry soil by outhouses66
 Figure 4.3: Pour flush latrines67
 Figure 4.4: The BOTVIP latrine: Botswana's rural ventilated improved
 pit latrines67
 Figure 4.5: Spread of pollution from outhouses (pit latrines) in wet soil68
 Figure 4.6: Cross section of a septic tank68
 Figure 4.7: Septic tank gravity distribution system69
 Figure 4.8: Sand mound waste distribution system69
 Figure 4.9: Sources of ground water contaminants in the United States70
 Figure 4.10: Ground water contaminants in the United States71
 Figure 4.11: Activated sludge wastewater treatment process72
 Figure 4.12: Wetland wastewater treatment system76

CHAPTER FIVE

Figure 5.1: Mouldering toilet (cutaway side view)89
 Figure 5.2: Mouldering toilet (cutaway south view)90
 Figure 5.3: Guatemalan mouldering toilet91
 Figure 5.4: Multrum toilet93
 Figure 5.5: Vietnamese double vault99

CHAPTER SIX

Table 6.1: Pathogens in urine112
 Table 6.2: Viral pathogens in feces113
 Table 6.3: Bacterial pathogens in feces114
 Table 6.4: Protozoan pathogens in feces114
 Table 6.5: Worm pathogens in feces115
 Table 6.6: Survival of enteroviruses in soil119
 Table 6.7: Survival time of some protozoa in soil119
 Table 6.8: Survival time of some bacteria in soil120
 Table 6.9: Survival time of polioviruses in soil120
 Table 6.10: Survival time of some pathogenic worms in soil121
 Table 6.11: Pathogen survival by composting or soil application127
 Table 6.12: Hookworms129
 Table 6.13: Average density of fecal coliforms excreted in 24 hours
 by various animals117
 Table 6.14: Parasitic Worm Egg Death131
 Figure 6A: Transmission of pathogens through septic tank waste

disposal systems	123
Figure 6B: Transmission of pathogens through conventional sewage treatment plants	124
Figure 6C: Transmission of pathogens through waste stabilization ponds	124
Figure 6D: Transmission of pathogens through passive, low temperature composting toilets and mouldering toilets	125
Figure 6E: Transmission of pathogens through a thermophilic composting system	126
Figure 6F: Safety zone for pathogen death	133
Figure 6G: Survival times of fecal coliforms in soil	118
CHAPTER SEVEN	
Figure 7.1: The Tao of the sawdust toilet	154
Figure 7.2: Diagrams of sawdust toilet	155
Figure 7.3: Constructing a simple compost bin	157
Figure 7.4: Two styles of three-chambered compost bins	159
Figure 7.5: Anatomy of a continuous compost bin	160
Figure 7.6: Temperature curve of frozen humanure compost pile after spring thaw	164
Figure 7.7: Camp composter	168
Figure 7.8: Camp composter on a bank	171

SIDEBARS

	PAGE
CHAPTER ONE	
Fun Facts: Waste not want not	14
Fun Facts: About water	18
CHAPTER TWO	
Fun Facts: Carbon/nitrogen ratio	41
Essential Reading for Insomniacs: pH	47
CHAPTER SEVEN	
Essential Reading for Insomniacs: Thermophilic microorganisms	143
A Tip from Mr. Turdley: Sawdust	151
Another Tip from Mr. Turdley: The secret to composting humanure is to keep it covered	153
Yet Another Tip from Mr. Turdley: Pressure treated lumber should never be used for constructing compost bins	156
Do's and Don't's of a Thermophilic Toilet Composting System	166

PHOTOGRAPHS

	PAGE
CHAPTER ONE	
Humanure compost being wheelbarrowed to a garden	17
Humanure compost applied by hand to garden beds	24
CHAPTER TWO	
Humanure compost being removed from a double chambered bin	34
Humanure compost being applied to a raised bed in the spring	45
Probing a compost pile with compost thermometers	46
CHAPTER FIVE	
A Clivus Multrum toilet at Slippery Rock University	94
The contents of a Clivus Multrum toilet being examined through the access door	95
A young lady setting cedar posts for a compost bin	97
A sawdust toilet 100	101
A sawdust toilet showing removability of contents	103
A sawdust shed at a sawmill	103
CHAPTER SEVEN	
Indoor sawdust toilet in new home	152
Sawdust toilet with recessed peat moss container	158
Sawdust toilet in a basement	162
Sawdust toilet made of wooden box	165
Sawdust toilet in mobile home	167
Outdoor sawdust toilet	169
Sawdust toilet "outhouse"	170
CHAPTER EIGHT	
The author at the end of a long day	183

The Humanure Handbook
INTRODUCTORY INFORMATION

"It is more important to tell the simple, blunt truth than it is to say things that sound good."

John Heider



America is a land of waste. Much of what we waste consists of organic material which would prove very valuable if we would recycle it for agricultural purposes. That organic material includes food wastes, municipal leaves and other yard wastes, agricultural residues, and human waste in the form of digestive refuse material, otherwise known as fecal material and urine. The simple blunt truth is that we shit every day and we should be returning that organic material back to the soil.

Each of us is responsible for the byproducts of our digestive systems, namely feces and urine. Feces and urine are not waste. They are natural, organic refuse materials discarded by our bodies after completing the digestive processes. We choose to make these organic materials either waste materials or resource materials depending on what we do with them. When we discard them, we waste them. When we recycle them, we recover a natural resource.

Recycled refuse is not waste. It is a common misuse of semantics to say that waste is, can be, or should be recycled. Resource materials are recycled. Refuse is recycled. But waste is never recycled. That's why it's called "waste". This may seem like a trifling point to some, however it's actually quite important. Those of you who take the responsibility for recycling your refuse materials are not creating waste, and the term "waste" should not be associated with you. If you are composting all of your body's organic refuse and returning it to the soil and someone asks you, "*What do you do with your human waste?*" the correct response would be, "*What waste?*"

So let's define some terms. Feces and urine are byproducts of the human digestive system. They are refuse materials. When discarded, they're known as human waste. When recycled for agricultural purposes they're known by various names, including night soil (in Asia) and human manure or **humanure**. *Humanure is not human waste. Humanure is not waste - it is an agricultural resource.*

Humanure is a valuable organic resource material, in contrast to human waste, which is a dangerous pollutant. Humanure originated from the soil and can be quite readily returned to the soil, especially if properly composted. Human waste (discarded feces and urine), on the other hand, creates significant environmental problems, provides a route of transmission for disease, and deprives humanity of important soil nutrients. It's also one of the primary ingredients in sewage, and is largely responsible for much of the world's water pollution.

When crops of any sort are produced from soil, it is imperative that the organic residues - the refuse materials resulting from those crops, including animal excrements - are returned to the soil from which the crops originated. *This recycling of all organic residues for agricultural purposes should be axiomatic to sustainable agriculture.* Yet, spokespersons for the sustainable agriculture movement in the West remain silent about using humanure for agricultural purposes. Why?

In the 1970's I played around with the idea of composting my own manure for a few years, but I didn't get into it seriously until I settled down on my own homestead in 1979. At that time, I began composting humanure, proceeding through the process instinctively, altering my procedures when necessary, but always maintaining an emphasis on simplicity. Now, fifteen years later, I've decided to write about my experiences for the sake of those who are interested.

In the process of creating this book, I engaged in an extensive review of the literature related to the topic of composting humanure. I have carefully listed all of my references at the end of each chapter, and I encourage the reader to look to those references for verification or for additional information. In that review, I was surprised and even shocked to find that a) there is very little in print on the subject of composting humanure, and b) the information that is available is inconsistent with and sometimes diametrically opposed to the information which I gleaned from my own experiences. For example, current literature still lists humanure as a taboo and dangerous compost ingredient. (I don't. In fact, I would describe it more as an *essential* compost ingredient.) It recommends turning compost piles. (I don't. In fact, turning compost piles can do more harm than good.) It recommends liming compost, using other rock dusts in compost, or covering it with wood ashes (I don't. Rock dusts have no place in a compost pile.) It recommends segregating urine from feces when humanure is composted (I don't, and I can't imagine anything more undesirable than segregating urine from fecal material.) And the list goes on.

Before I continue, I want to make it perfectly clear that I do not consider myself an agricultural or scientific expert in any professional sense of the word. I am simply a layperson with twenty years of gardening experience who has done research

and gained experiences on composting humanure which others may find valuable. Nobody has paid me in any way to write this book, and all expenses incurred have come out of my own pocket.

It has not been my intent or goal, nor will it ever be, to profit financially from this book, although I'd be happy if my production expenses are one day eventually reimbursed. My intent has been to provide helpful information to those who want it, and to stimulate discussion about neglected topics including composting, humanure, the human nutrient cycle, waste, sustainable gardening, sustainable agriculture, etc. I'd roughly estimate that one in a million Americans have an interest in composting humanure. If I manage to find all of them and they read this book, I'll need a total of about 250 copies available in print. If that. On the other hand, there are millions of people throughout the developing world who could benefit from the information in this book. These are people who live simple lives with minimal resources and who are more apt to understand the increasing need to hygienically recycle organic refuse as the human population continues to swell upon an ever-shrinking planet.

I approach this topic (composting humanure) with a certain bias in favor of simplicity; or perhaps *sustainability* would be a more appropriate word. Therefore, most of the practical information that I present in this book reflects a sustainable approach. I don't encourage energy intensive or resource consumptive approaches to humanure composting. The methods I encourage are ones requiring little, if any, technology, and no electricity. They focus on the single family level, and not on the municipal level. The information I present is ideal for people who cannot or do not want to use running water or electricity for organic resource recycling, either by choice, culture, or emergency circumstances, or who have meager material resources at their disposal and can't afford expensive waste disposal systems or the loss of soil nutrients that would result from such systems. It is also ideal for anyone wanting to gain a basic understanding of humanure composting, no matter how complicated a recycling system they want to use for themselves, if any at all.

Composting humanure involves a simple process of microbial digestion. Like anything, the process can be made as difficult or complicated as one wants. It's the *process* itself that's important, not to mention interesting. For example, few people realize that there are reportedly 100 billion bacteria *per gram* of humanure, or that bacteria can digest diesel fuel and TNT, or chemically alter uranium. Some say that microorganisms in a compost pile can even produce enough heat to cook an egg (so far I haven't tried this).

Let's face it- everybody shits. It's one of those basic functions of the human body. We breathe, we eat, we copulate, we defecate, not necessarily in that order. Yet,

few people know anything about what happens to their excrement after it's been flushed down a toilet, or about the value of humanure as agricultural fertilizer, or about how to render it hygienically safe for recycling. Must our topsoil become depleted of nutrients and our agricultural petrochemicals that currently replace those nutrients become scarce, and our water supplies polluted before the art of composting humanure will be taken seriously by the human race?

In a nutshell, the purpose of this book is to explain why we Westerners aren't composting our humanure, why we should be, and how it can be done. Much of the discussion about why we're not doing it is philosophical, with a bit of delving into history and (god forbid) religion. The discussion of why we should be composting humanure focuses on the environmental problems associated with current waste disposal systems, as well as on the loss of agricultural nutrients that is the legacy of such systems. Chapter six focuses on "worms and disease", the often repeated cry of warning from those humans who equate the recycling of humanure with barbaric and unsanitary foolishness. There is no greater barrier to the recycling of humanure than this ignorance of the Western populace. And that ignorance is pervasive, deeply rooted, and tenacious. Granted, the warnings of "worms and disease" certainly bear some merit, however, such warnings tend to be exaggerated, sensational, and rooted in ignorance or fear. It is possibly for this reason more than any other that I have been goaded into writing this book.

The observant reader may notice that there are some apparent inconsistencies in the information presented in this book. In cases where various sources present inconsistent data about specific topics, I have simply reported the data as presented and left the reader to draw his or her own conclusions. Such inconsistencies are infrequent and of little consequence, nevertheless their existence should not be ignored (for example, one source reports that roundworm eggs will die in two hours when subjected to a temperature of 55°C, while another source reports that the eggs will die in ten minutes at the same temperature). Furthermore, don't be surprised if some information is repeated within this book. This is not by accident, as some information is worth repeating, especially as this book may end up on a shelf to be used for later reference by many readers who may tend to refer to only one chapter or another, in which case the repetition of material may be to the reader's long-term advantage.

If you're only interested in composting humanure, and want to skip the philosophy and other extraneous information, go straight to chapter seven. However, I'd encourage the reader to start at the beginning. The story of humanure is an interesting one. It begins with witches, travels to the Far East, and ends up in one's backyard. Not in my backyard you say? Ha! Read on.

J. C. J.

FIGURE A

THE HUMAN NUTRIENT CYCLE - INTACT -

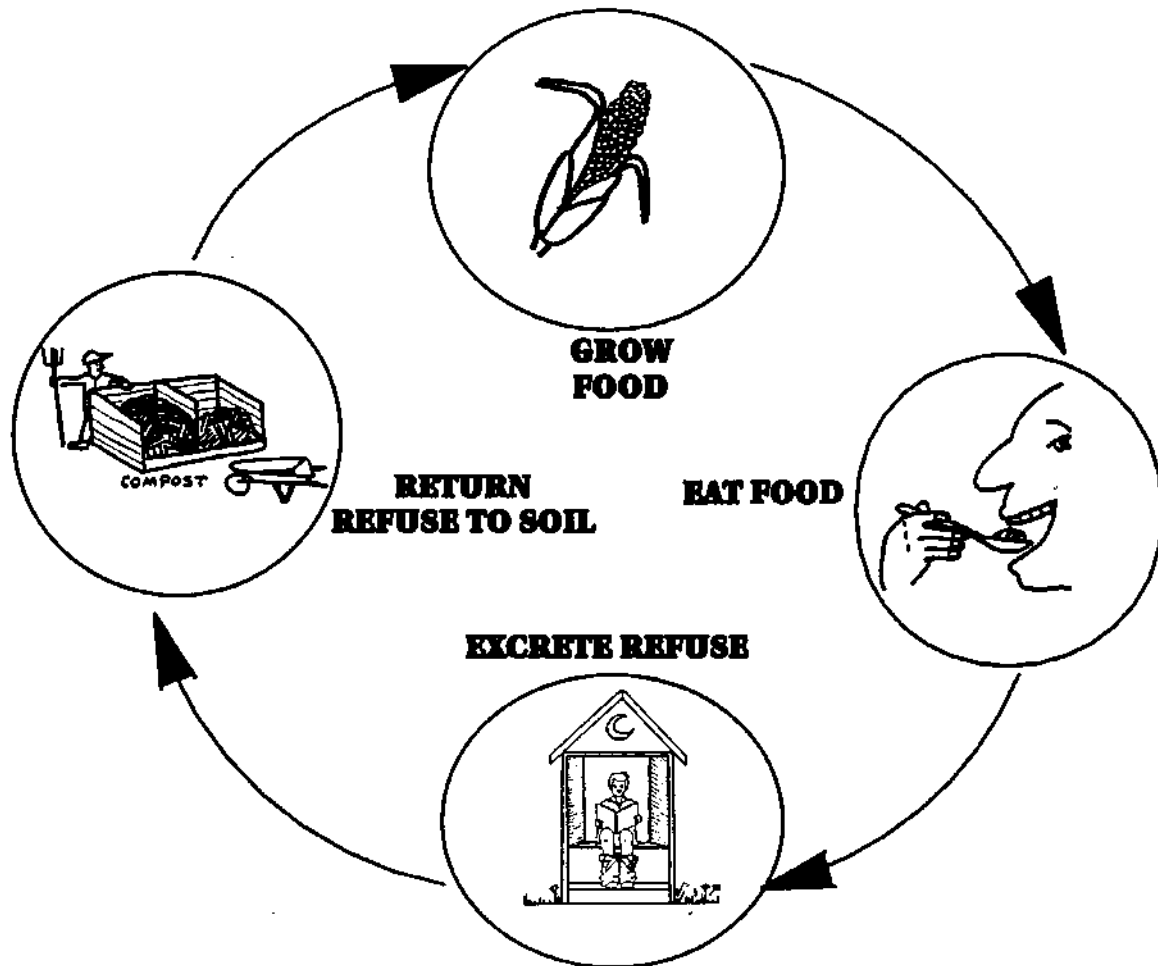

THE HUMAN NUTRIENT CYCLE IS AN ENDLESS NATURAL CYCLE.

IN ORDER TO KEEP THE CYCLE INTACT, FOOD FOR HUMANS MUST BE GROWN ON SOIL THAT IS ENRICHED BY THE CONTINUOUS ADDITION OF ORGANIC REFUSE MATERIALS DISCARDED BY HUMANS, SUCH AS HUMANURE, FOOD SCRAPS, AGRICULTURAL RESIDUES, AND THE LIKE. BY RESPECTING THIS CYCLE OF NATURE, HUMANS CAN MAINTAIN THE FERTILITY OF THEIR AGRICULTURAL SOILS INDEFINITELY, INSTEAD OF DEPLETING THEM OF NUTRIENTS AS IS COMMON TODAY. FOOD-PRODUCING SOILS MUST BE LEFT MORE FERTILE AFTER EACH HARVEST, DUE TO THE EVER-INCREASING HUMAN POPULATION AND THE NEED TO PRODUCE MORE FOOD WITH EACH PASSING YEAR.

FIGURE B

The Human Nutrient Cycle -Broken-

EAT
FOOD



DISCARD
REFUSE



GROW FOOD

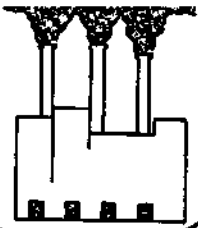

Chemical Fertilizer

Factories: unnecessary consumption of resources and energy with the consequent production of pollutants.

Sewers, water pollution, landfill space used up unnecessarily, agricultural nutrients lost.

CRAP HAPPENS

“Anyone starting out from scratch to plan a civilization would hardly have designed such a monster as our collective sewage system. Its existence gives additional point to the sometimes asked question, Is there any evidence of intelligent life on the planet Earth?”

G. R. Stewart



The world is divided into two categories of people: those who shit in drinking water and those who don't. We in the Western world are in the former class. We defecate in water, usually purified drinking water. After polluting the water with our body's digestive system byproducts, we flush the once pure but now polluted water "away". Away to where? Good question.

This ritual of defecating in water may be useful for maintaining a good standing within Western culture. If you don't deposit your feces into a bowl of drinking water on a regular basis, you may be considered a miscreant of sorts, perhaps uncivilized or dirty or poverty stricken. You may be seen as a non-conformist or a radical. However, these perspectives are based upon ignorance. There is currently a profound lack of knowledge and understanding among Westerners about what is referred to as the "human nutrient cycle" and the need to keep the cycle intact.

The human nutrient cycle goes like this: a) grow food, b) eat it, c) collect and process the food refuse (feces, urine, food scraps and agricultural residues), and d) return the processed refuse to the soil, thereby enriching the soil and enabling more food to be grown. Then the cycle is repeated, endlessly. When our food refuse is instead discarded as waste, the natural human nutrient cycle is broken and all manner of problems can result. Those problems can be summed up in two convenient words: waste and pollution.

Crap happens. However, it's interesting to note that the creation of human waste is a matter of human choice. We *choose* to throw things away rather than recycle them. We *choose* to create waste rather than recycle useful resources, because it's more convenient to discard things than to reuse them. Even though those resources may be refuse materials with little *apparent* value, such as the refuse of our digestive

systems, when recycled, they can prove to be both useful and valuable.

It's common to refer to human fecal material and human urine as "human waste". However, such a term is misleading at best. Human waste actually consists of a huge number of items and substances (cigarette butts for example), and human digestive system refuse is only waste when it's discarded. When it's recycled for agricultural purposes it's called, among other things, human manure or *humanure* for short.

All humans create fecal material and urine. However, some people create human waste, or sewage, while others create humanure, an agricultural resource, depending on whether the material is wasted or recycled. We in the United States each waste about a thousand pounds of humanure every year, which is discarded into sewers and septic systems throughout the land. Much of the discarded humanure finds its final resting place in a landfill along with the other solid waste we Americans discard, which, coincidentally, also amounts to about a thousand pounds per person per year. For a population of 250 million people, that adds up to nearly *250 million tons of solid waste discarded every year, at least half of which is valuable as an agricultural resource.*

This is not to suggest that *sewage* should be used to produce food crops. In my opinion, it should not. Sewage consists of human digestive-system refuse collected along with other hazardous materials such as industrial, medical and chemical wastes, all carried in a common water-borne waste stream. Humanure, on the other hand, when kept out of the sewers, collected as a resource material, and properly

FUN FACTS



WASTE NOT - WANT NOT

America is a land of waste. Of the top fifty municipal solid waste producers in the world, America is fifth in line, being outranked only by Australia, New Zealand, France and Canada. Although the U.S. population increased by 18% between 1970 and 1986, its trash output increased by 25% during that time period, indicating that as time passes, we become more wasteful as a nation. Today, every individual in America produces about four pounds of trash daily, which will add up to 216 million tons per year by the year 2000, almost ten percent more than in 1988. If this sounds like a lot, sit down for a minute: municipal solid waste (the 216 million tons per year just mentioned) make up only one percent of the total solid waste created annually in the United States. The rest comes from industry, mining, utilities and other sources.

processed (composted), makes for a fine agricultural resource material suitable for food crops. Granted, there are certain hygiene considerations involved in the processing of humanure for food purposes, and these will be discussed at length later in this book.

The United States Environmental Protection Agency estimates that 13.2 million tons of food refuse are produced in American cities alone every year. That food refuse would make great organic material for composting, especially if mixed with humanure. If we composted the food refuse, we would be recycling a *resource* instead of creating *waste*. Instead, much of that food waste is buried in landfills, as is most of our discarded feces and urine. Yet, it is becoming more and more obvious that it is unwise to rely on landfills to dispose of recyclable materials. Landfills fill up, and new ones need to be built to replace them. The estimated cost of building and maintaining an EPA approved landfill is now nearly \$125 million. In fact, the 8,000 operating landfills we had in the United States in 1988 had dwindled to 5,812 by the end of 1991. Slowly, we're catching on to the fact that this trend has to be turned around. We can't continue to throw "away" usable resources in a wasteful fashion by burying them in disappearing landfills.

As a result, recycling is slowly becoming more widespread in the U.S.. Between 1989 and 1992 recycling increased from 9 to 14% and the amount of U.S. municipal solid waste sent to landfills decreased by 8%.² This is a welcome trend, however it doesn't adequately address a subject sorely in need of attention: what to do with humanure, which is not being recycled.

If we had scraped up all the human excrement in the world and piled it on the world's tillable land in 1950, we'd have applied nearly 200 metric tons per square mile at that time (roughly 690 pounds per acre). In the year 2000 we'll be collecting significantly more than *double* that amount because the global population is increasing, but the global land mass isn't. In fact, the global area of agricultural land is steadily *decreasing* as the world loses, for farming and grazing, an

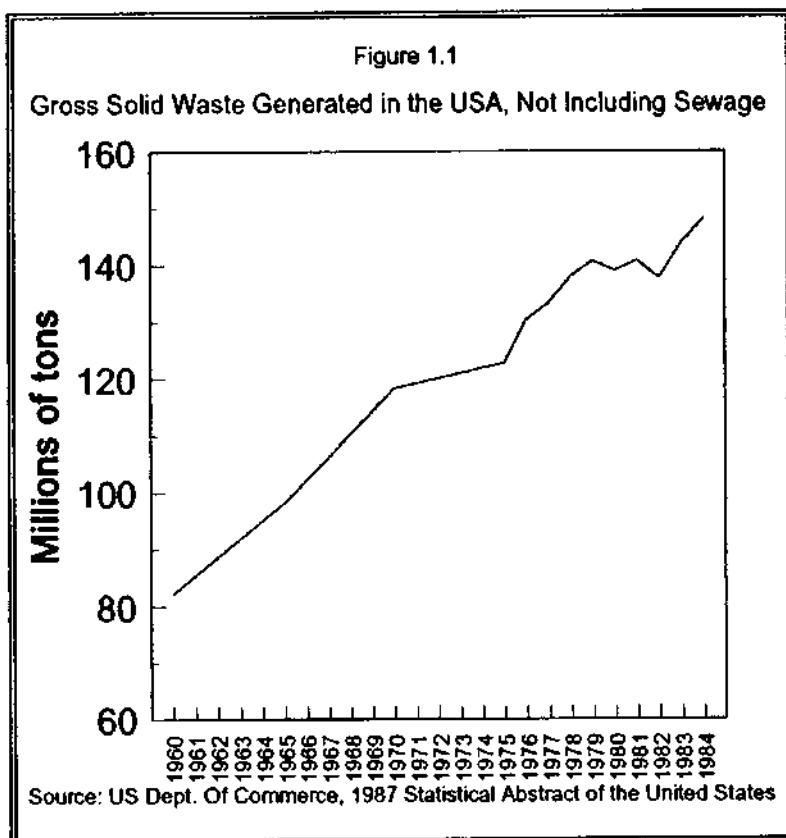
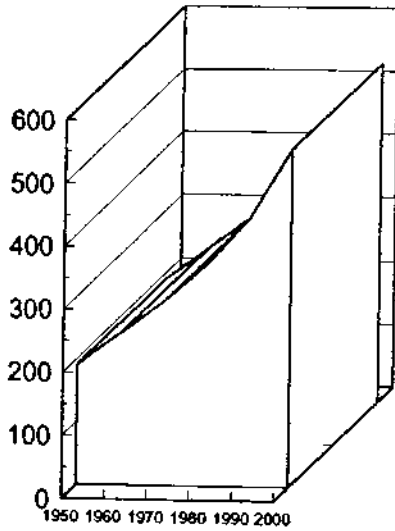

Figure 1.2

Amount of humanure available worldwide per square mile of tillable land.



□ Metric tons per square mile.

If the world's output of human excrement were collected and applied only to arable land, we would have applied nearly 200 million tons per square mile in 1950. By the year 2000, we will have over double that amount. This does not take into account the loss of farmland due to desertification.

(Fahm, L. *The Waste of Nations*, 1980, Osmund and Co., New Jersey, pp. 37-38.)

area the size of Kansas each year.³ The world's burgeoning human population is producing a ballooning amount of organic refuse which will eventually have to be dealt with responsibly and constructively. It's not too soon to begin to understand human organic refuse materials as valuable resource materials begging to be recycled.

In 1950 the dollar value of the agricultural nutrients in the world's gargantuan pile of humanure was 6.93 billion

dollars. In 2000 it will be worth 18.67 billion dollars (calculated in 1975 prices).⁴ This is money currently being flushed down the drain and out somewhere into the environment where it shows up as pollution, and/or landfill material. Every pipe line has an outlet somewhere; everything thrown "away" just moves from one place to another. Humanure and other organic refuse materials are no exception. Not only are we flushing "money" away, we're paying through the nose to do so. And the cost is not only economic, it's environmental.

A cursory review at the local library of sewage pollution incidents in the United States yielded the following: More than 2,000 beaches and bays in twelve states were closed in 1991 because of bacterial levels deemed excessive by health authorities. The elevated bacteria levels were primarily caused by storm-water runoff, raw sewage, and animal wastes entering the oceans. The sources of the pollution included inadequate and overloaded sewage treatment plants, sewage overflows from sanitary sewers and combined sewers, faulty septic systems, boating wastes, and polluted storm water from city streets and agricultural areas.⁵

Also in 1991, the city of Honolulu faced penalties of about \$150 million for some 9000 alleged sewage discharge violations that were recorded since 1985⁶. That same year, Ohio Environmental Protection Agency fined Cincinnati's Metropolitan Sewer District \$170,000, the largest fine ever levied against an Ohio municipality, for failure to enforce its wastewater treatment program.⁷ In 1992, the U.S. EPA sued the Los Angeles County Sanitation Districts for failing to install secondary sewage treatment at a plant which discharges wastewater into the Pacific Ocean, and for fourteen

years of raw sewage spills and other discharges that have violated California Ocean Plan bacteria standards.⁸

That same year California was required to spend \$10 million to repair a leaking sewer pipeline that had forced the closure of twenty miles of southern California beaches. The broken pipeline was spilling up to 180 million gallons of sewage per day into the Pacific Ocean less than one mile offshore, resulting in a state of emergency in San Diego County. This situation was compounded by the fact that a recent heavy storm had caused millions of gallons of raw sewage from Mexico to enter the ocean from the Tijuana River.⁹

Environmental advocates in Portland, Oregon sued the city in 1991 for allegedly discharging untreated sewage up to 3,800 times annually into the Willamette River and the Columbia Slough.¹⁰ In April of 1992, national environmental groups announced that billions of gallons of raw waste pour into lakes, rivers, and coastal areas each year when combined sewers, which carry storm water and wastewater in the same pipe, overflow during heavy rains, also causing many cities to suffer from discharges of completely untreated sewage.¹¹

Much of the sewage sludge along coastal cities in the United States has simply been dumped into the ocean. However, dumping of sewage sludge in the ocean was banned as of December 31, 1991. Nevertheless, the city of New York was unable to meet that deadline and was forced to pay \$600 per dry ton to dump its sludge at the Deepwater Municipal Sludge Dump Site 106 miles off the coast of New Jersey. Illegal dumping of sewage into the sea also continues to be a problem.¹² A bigger problem may be what to do with sewage sludge now that landfill space is



When humanure is composted with other organic refuse, it is converted into a sweet-smelling soil building material. Here it is applied to a garden.

Figure 1.3

Sewage Sludge Dumped in US Ocean Waters 1973-1986

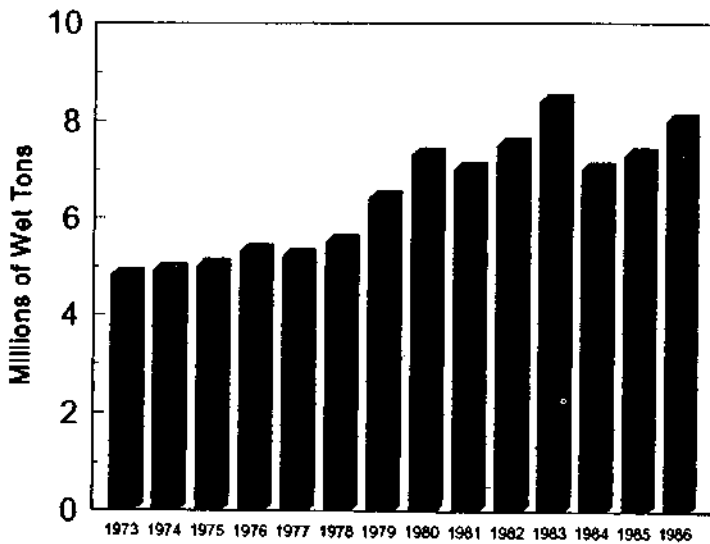

Source: US EPA, 1988, Report to Congress on Administration of the Marine Protection, Research, and Sanctuaries Act of 1972, EPA-503/8-88/002.

diminishing and it can no longer be dumped into the ocean. We'll get into that later.

SOILED WATER

The discarding of human waste adversely affects the quality of our planet's water supplies. First, by defecating directly into water, we pollute the water. Every time we flush a toilet, we launch five or six gallons of polluted water out into the world.¹³ Secondly, even after the polluted water is treated in wastewater treatment plants, it may still

be polluted with excessive levels of nitrates, chlorine, and other pollutants. This treated water is discharged directly into the environment. Also, by discarding organic human refuse materials as waste, we deprive ourselves of valuable soil nutrients. We should be returning the organic material back to the land in order to keep the human nutrient cycle intact.

Instead of using humanure to replenish the soil depleted by agriculture, we manufacture and use chemical fertilizers. From 1950 to 1980 the global consumption

FUN FACTS about water



- ▶ If all the world's drinking water were put into one cubical tank, the tank would measure only 95 miles on each side.
- ▶ Number of people currently lacking access to clean drinking water: 1.2 billion.
- ▶ Percent of the world's households that must fetch water from outside their homes: 67%.
- ▶ Percent increase of the world's population by the middle of the next century: 100%.
- ▶ Percent increase in drinking water supplies by the middle of the next century: 0%.
- ▶ Amount of water Americans use every day: 340 billion gallons.
- ▶ Number of gallons of water needed to produce a car: 100,000.
- ▶ Number of cars produced every year: 50 million.
- ▶ Amount of water required by a nuclear reactor every year: 1.9 cubic miles.
- ▶ Amount of water used by U.S. nuclear reactors every year: the equivalent of one and a third lake Eries.

▶ Sources: Der Spiegel, May 25, 1992; and Annals of Earth, Vol. 8, No. 2, 1990, Ocean Arks International, One Locust St., Falmouth, MA 02540.

of artificial fertilizers rose by 900%¹⁴, and in 1988, U.S. farmers used almost 19 million tons of synthetic fertilizers.¹⁵ All the while, hundreds of millions of tons of organic wastes are generated in the U.S. each year, including humanure, then buried in landfills when they could instead be composted and returned to the soil in place of artificial fertilizers.

Today, pollution from agriculture is said to be a main reason for poor water quality in our rivers, lakes and streams, the pollution being caused by both siltation (erosion) and nutrient runoff due to excessive or incorrect use of fertilizers.¹⁶ For example, in 1992 the state of Florida was required, through litigation, to build some 35,000 acres of marshlands to filter farm-related runoff that was polluting the Everglades with nutrients such as phosphorous.¹⁷ Nitrates from fertilizers are also causing pollution, seeping into ground water, lakes, rivers and streams. A 1984 U.S. EPA survey indicated that out of 124,000 water wells sampled, 24,000 had elevated levels of nitrates and 8,000 were polluted above health limits.¹⁸

Chemical fertilizers provide a quick fix of nitrogen, phosphorous, and potassium for impoverished soils. However, it's estimated that 25-85% of chemical nitrogen applied to soil and 15-20% of the phosphorous and potassium are lost to leaching, much of which can pollute groundwater.¹⁹ Much of this pollution shows up in small ponds which become choked with algae as a result of the unnatural influx of nutrients.

Not only are we polluting our water with agricultural runoff and sewage, we're

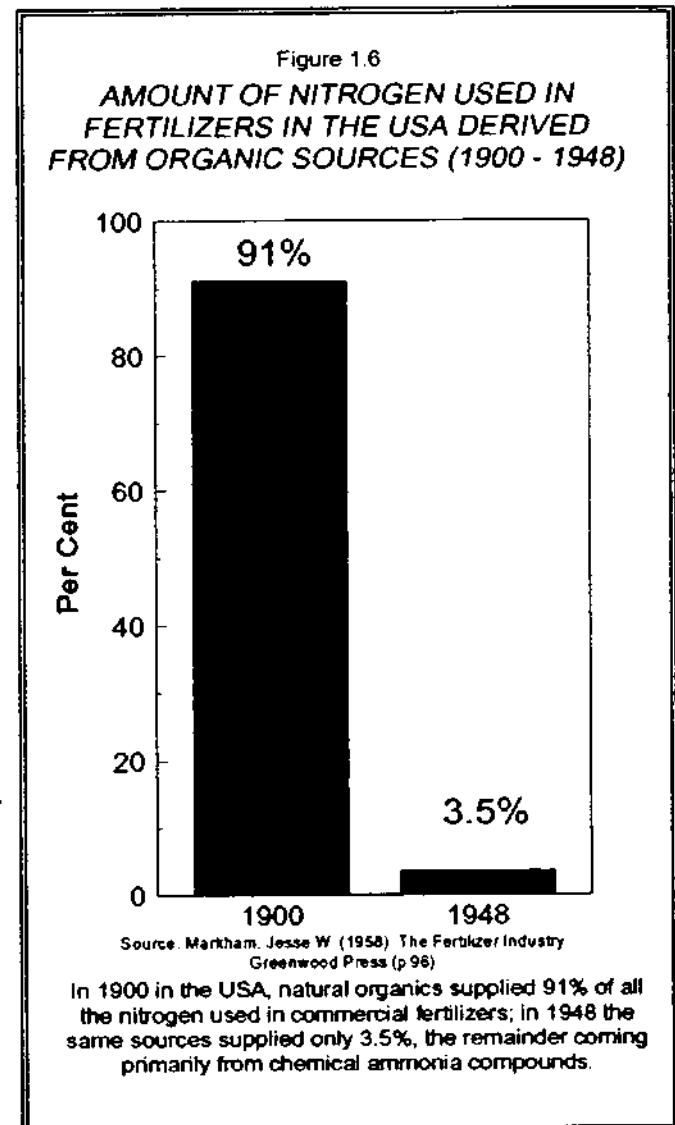
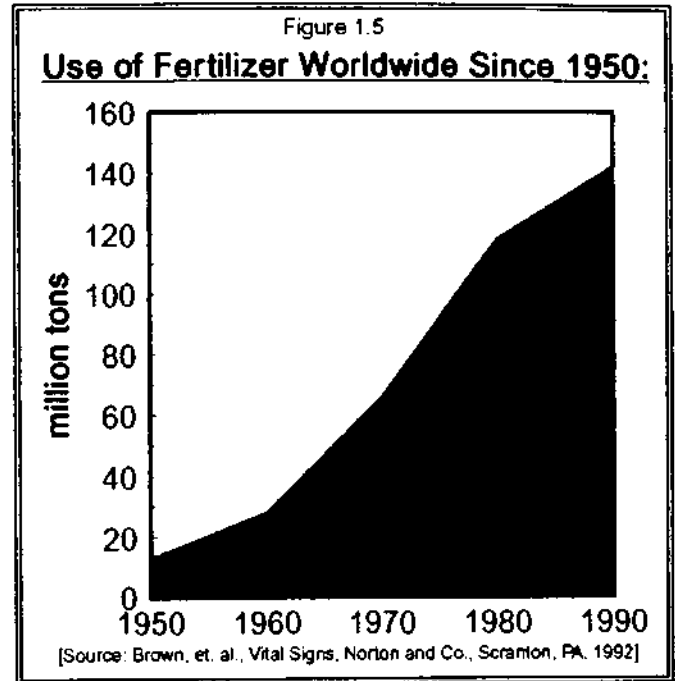
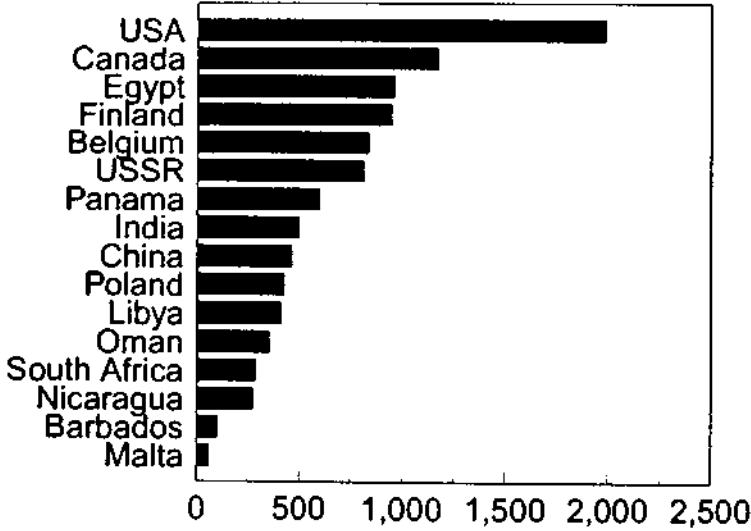

Figure 1.4

Average Annual Per Capita Water Use in Selected Countries



Cubic Meters of Water Per Person
 Source: World Resources Institute, 1986, World Resources 1986.
 As seen in The Water Encyclopedia, van der Leeden et.al.

using it up, and flushing toilets is one way it's being wasted. Of 143 countries ranked for per capita water usage by the World Resources Institute, America came in at #2 using *188 gallons per person per day* (Bahrain was #1).²⁰ The use of groundwater in the United States exceeds replacement rates by 21 billion gallons a day²¹. It takes one to two thousand tons of water to flush one ton of human waste (see chapter 4, reference # 43).

The impacts of polluted water are far ranging, causing the deaths

of 25 million people each year, three fifths of them children.²² Diarrhea, a disease associated with polluted water, kills 6 million children each year in developing countries, and it contributes to the death of up to 18 million people.²³ It's not necessarily the flushing of toilets that's polluting drinking water in developing countries, yet it's still, to a large extent, fecal contamination of water supplies, a problem that could be avoided by composting humanure instead of neglecting to do so. The object is to keep fecal material out of the environment and out of streams, rivers, wells and underground water sources, thereby eliminating the transmission of various diseases. Thermophilic (heat producing) composting will effectively convert fecal material into a hygienically safe humus, yet composting humanure has not become widespread in the West. Instead, human waste continues to pollute the world around us.

But in the United States haven't we solved the problem of water borne diseases? Largely yes, but not entirely. Illness related to polluted water afflicted 85,875 Americans from 1971-82. Forty-nine percent of these were caused by water treatment deficiencies.²⁴ Several American cities have suffered from outbreaks of cryptosporidia since 1984, cryptosporidia being protozoa which cause severe diarrhea. These protozoa enter people when they drink water contaminated by infected feces from humans and animals. Outbreaks occurred in Braun Station, Texas in 1984; in Carrollton, Georgia, in 1987; in Medford and Talent, Oregon in 1992; and in Milwaukee in 1993. Hundreds of thousands of people have been afflicted by the bug, for which there is no treatment. The illness runs its course in about fourteen days in healthy people, but can kill people who have weak immune systems.²⁵

Pollution from sewage and synthetic fertilizers results in part from the belief that humanure and food refuse are waste materials rather than recyclable natural resources. There is, however, an alternative. Humanure and food refuse can be composted and thereby rendered hygienically safe for agricultural or garden use.

Much of the Eastern world recycles humanure. Those parts of the world have known for millennia that humanure is a valuable resource which should be returned to the land, as any animal manure should. The West has yet to arrive at that conclusion.

**WASTE REDUCTION-
RESOURCE RECOVERY**

According to Sandra Postel (1992), *"The protective ozone shield in heavily populated latitudes of the northern hemisphere is thinning twice as fast as scientists thought just a few years ago. A minimum of 140 plant and animal species are condemned to extinction each day. Atmospheric levels of heat-trapping carbon dioxide are now 26 percent higher than the pre-industrial concentration, and continue to climb. The Earth's surface was warmer in 1990 than in any year since record keeping began in*

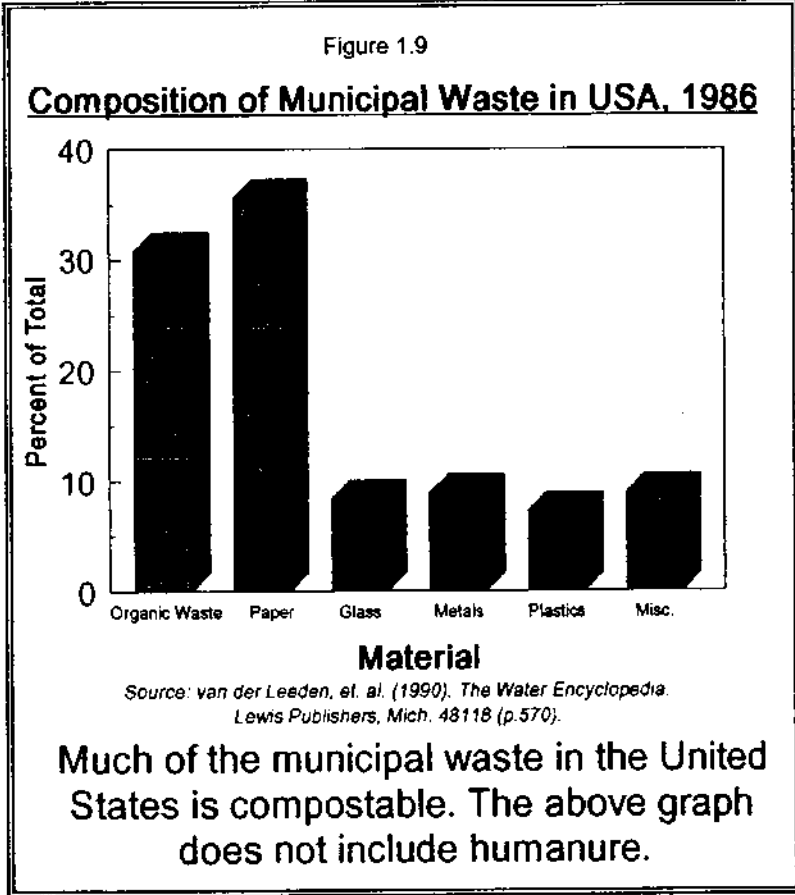
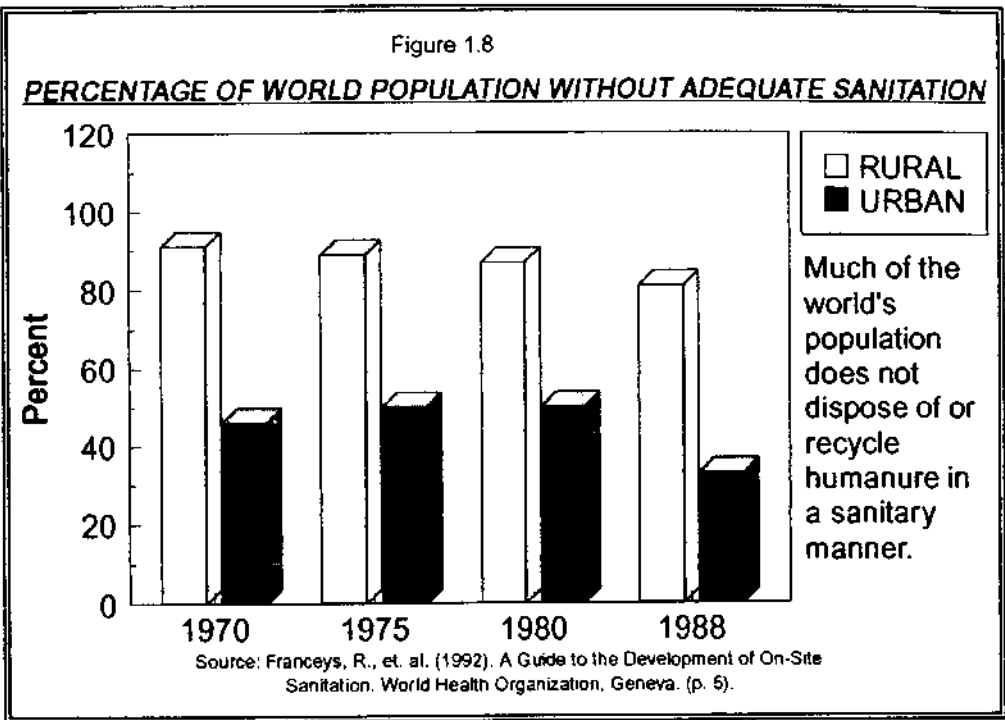

the mid-nineteenth century; six of the seven warmest years on record have occurred since 1980. Forests are vanishing at a rate of some 17 million hectares per year, an area about half the size of Finland. World population is growing by 92 million people annually, roughly equal to adding another Mexico each year; of this total, 88 million people are being added in the developing world."²⁶

Mr. Lester Brown adds that we're losing 24 billion tons of topsoil each year worldwide, and that areas of global farmland, grassland, and forestland are shrinking and being replaced by wasteland.²⁷

It should be added that CO2 levels are on the increase because of air pollution from the burning of fossil fuels such as coal and petroleum, and that CO2 and other gaseous pollutants bring us acid rain, acid fog, acid snow, and smog.

Crap happens. However, we don't inherit the earth, as the saying goes, we borrow it from our children, and we should be stewarding it for our future progeny. That's the sane thing to do. Most humans are sane, and they care about the future, about their children, their own health and their planet's health. The social and environmental problems we're faced with today are caused by poor leadership, lack of political foresight, and fear, greed and corruption caused by power and wealth, or a lack of it. If what Sandra Postel and Lester Brown are saying is true, our resources are dwindling and our ability to support life is slowly but steadily deteriorating. We

Figure 1.10

Our increasing impact on planet Earth:

World population growth, world production, and world fuel consumption since 1950 are increasing at a rapid rate with no end in sight-

Billions

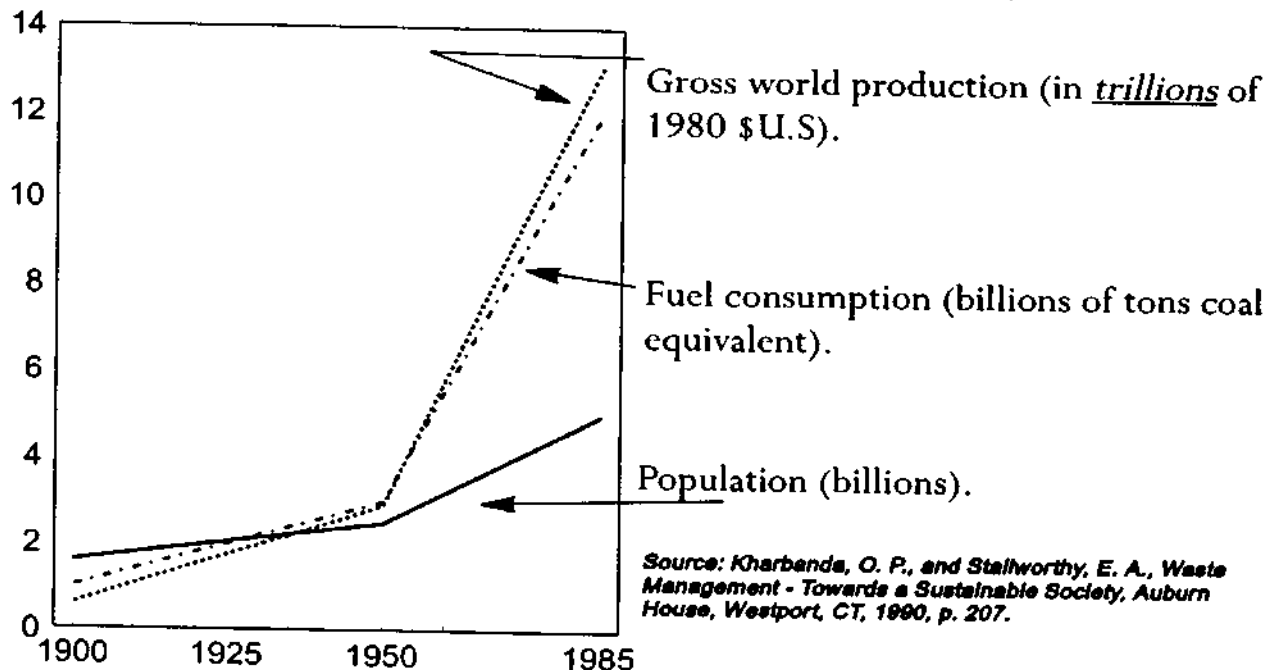

Source: Kharbenda, O. P., and Stallworthy, E. A., *Waste Management - Towards a Sustainable Society*, Auburn House, Westport, CT, 1990, p. 207.

should do something about that, and we can start with ourselves. What can we do? We can change our *minds*.

What we should be discarding is our throw-away *mentality*. Would it be so difficult to replace such a mentality with one which emphasizes *waste reduction and resource recovery*? “Waste reduction - resource recovery” is a worthy motto to lead us toward a sustainable future. A throw-away society eventually strangles itself in its own waste, while squandering valuable natural resources and energy in the process.

Ironically, the majority of the unrecycled solid waste discarded in the United States is organic waste and could be composted and thereby converted into one of the necessities of life: food.

Our refusal, as humans, to take intelligent responsibility for the recycling of our own nutrients, our own manure and food refuse, indicates a very significant blind spot in our understanding of natural processes.

WASTE VS. MANURE

Human digestive-system refuse is only waste if it's not recycled. Otherwise, it's manure, and a valuable resource and soil amendment material at that. Farmers never speak of “cow waste”, they speak of cow manure. Nor does one hear of “horse waste” or “pig waste” or “chicken waste”, instead they are all “manures” and for good reason. They aren't wasted. They're returned to the soil as they should be, thereby completing a natural cycle. These manures are valuable fertilizers for the soil, preventing the soil from becoming depleted of nutrients and inoculating the soil with bacteria and microorganisms which give the soil life and vitality.

Let's take a look at the process. Crops are grown, say oats; the oats are harvested and fed to animals, say cows. Now we stand back and wait. Eventually, the oats, which entered the cow's mouth, go through the cow's digestive system and the

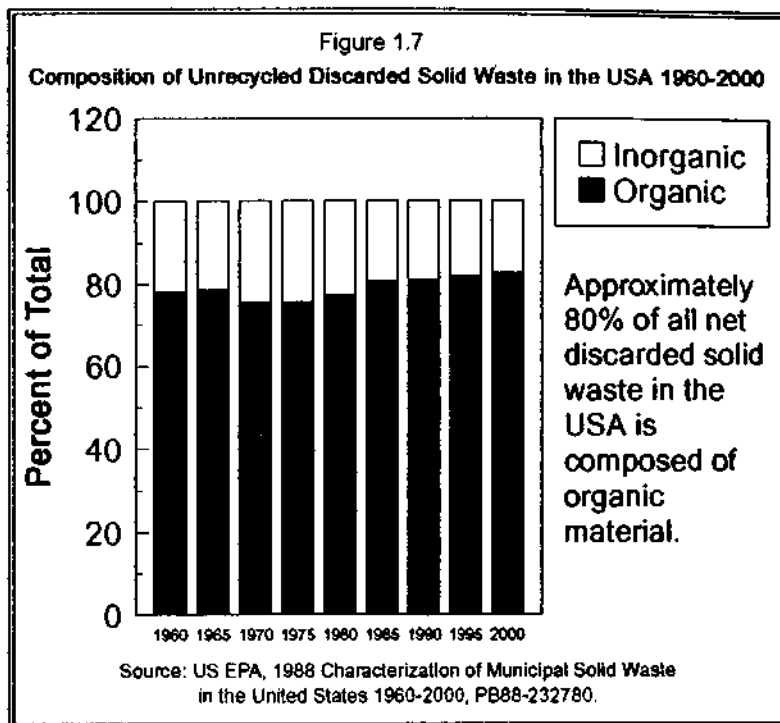



Properly composted humanure yields a rich, loamy, pleasant-smelling soil-building material, here being applied to spring garden beds.

lots of money on fertilizers, and keeping his soil healthy. Sounds reasonable enough. But what about *human* manure?

Humanure is a little bit different. It shouldn't simply be flung around in a fresh and repulsive state. It should undergo a process of bacterial digestion first, usually known as *composting*, in order to destroy possible pathogens. This is the missing link in the human nutrient recycling process. The process is similar to a cow's: A human grows food for itself on a field, or in a garden. The food enters the human's mouth and continues on into the digestive system where the body extracts what it needs, rejecting what it doesn't need at the time, or what it can't use. The body then excretes the rejected material.

At that moment the body is no longer responsible for the excretion. The body did its share of the work, now it's time for the mind to go to work. Thinking must now happen. The human mind now has basically two choices - consider the excretion to be waste and try to get rid of it, or consider the excretion to be a resource which must be recycled. Either way, the body's refuse must be collected. As waste, the human waste must be dispensed with in a manner that is safe to human health and to

cow's body takes what it needs from them. What it doesn't need or can't use goes out the other end and plummets to the barn floor as a "cow patty".

Now farmers know that cow manure is valuable. They also know that those cow patties are digested crops, and that crops are soil, water and sunshine converted into food, and the best way to get rid of those patties is to put them back in the field from where they originated. So the farmer loads up the manure spreader and flings the manure back into the fields, thereby cleaning up his barn, saving himself

the environment; as a resource, the humanure must be conscientiously composted to ensure the destruction of potential pathogens, then returned to the soil.

Much of the humanure (also known as "night soil") recycled in Asia is not composted. It's simply applied raw to the fields. *That is not what this book is about.* Raw humanure carries with it a significant element of danger in the form of disease pathogens. Those diseases, such as intestinal parasites, hepatitis, and others, are destroyed by composting, *when the composting process generates heat.* Raw applications of humanure to fields, on the other hand, are not hygienically safe and can assist in the spread of various diseases which may be endemic to areas of Asia where raw humanure is used. Americans who have traveled to Asia tell of the "horrible stench" of raw humanure that wafts through the air when such a material is applied to fields. For these reasons it is imperative that humanure always be composted before agricultural applications. Proper thermophilic (heat producing) composting destroys possible pathogens and results in a pleasant smelling material.

On the other hand, raw night soil applications to fields in Asia return humanure to the land and thereby do recover a valuable resource which is used to produce human food. *Composted* humanure is used in Asia as well. Cities in China, South Korea and Japan recycle humanure where it's returned to the land around the cities in greenbelts where vegetables are grown. Shanghai (China), a city which had a population of nearly 11 million people in 1970²⁸, produces an exportable surplus of vegetables in this manner.

Humanure can also be used to feed algae which can in turn feed fish for aquacultural enterprises. In Calcutta, such an aquaculture system produces 20,000 kilograms of fresh fish daily.²⁹ The city of Tainan, Taiwan, is well known for its fish, which are farmed in over 6,000 hectares of fish farms fertilized by humanure. Here humanure is so valuable that it's sold on the black market.³⁰

Furthermore, humanure can be mixed with other organic refuse from human activity such as kitchen and food scraps, grass clippings, leaves, garden refuse, and sawdust. When composted, this blend of nutrients can yield a balanced, loamy, rich, pleasant-smelling and hygienically safe soil additive suitable for food gardens as well as for agriculture.

The following chapters discuss the roots of the cultural bias against the recycling of humanure that we Westerners are burdened with. The amazing phenomenon of compost is also discussed, as it is the obvious alternative to organic waste disposal. Various conventional waste disposal systems currently in use, such as sewers and septic systems, are looked at, and a more detailed analysis of their environmental shortcomings is given. Common composting toilets, including home-made as well as store-bought ones, are also looked at, as are simple humanure composting systems

(which focus more on the composting and less on the toilet). The issue of human pathogens associated with humanure is closely scrutinized. Finally, a low-impact, largely technology-free system of humanure composting (the sawdust toilet) is discussed in detail.

EXPERIENCE HELPS

Allow me to interject here that I'm not advocating the composting of humanure based on theory. In fact, I have composted all of my family's humanure since 1979 (fifteen continuous years at the time of this writing) on our rural homestead using a very simple, low-impact, low-technology system (a *sawdust toilet*). The resulting compost has always been used in our food garden.

I've had an unusual opportunity to experiment with the composting of humanure, and this experience has yielded for me an abundance of empirical data. My experiences have made me confident that humanure can be easily and safely composted using only the simplest methods, yielding a valuable soil additive from what would otherwise be putrid and dangerous waste. By no means do I claim to have all the answers. But I do hope to at least be able to provide a *starting point* for those of you who seek information about composting humanure. Perhaps this book will shed a small ray of light onto what is otherwise a vacuum of information.

REFERENCES - CHAPTER 1

- 1 - Hammond, A., et. al. (Eds.). 1993 Information Please Environmental Almanac. Compiled by World Resources Institute. Houghton Mifflin Co. New York. 1993. (pp.50-51 and 339).
- 2 - Ibid. (pp.60-64).
- 3 - Daniel, J.E., et. al, editors. 1992 Earth Journal. Buzzworm Books. Boulder CO. (p.94).
- 4 - Fahm, L.A., (1980). The Waste of Nations. Allenheld, Osmun & Co. Montclair, NJ. (p.45).
- 5 - Environmental Reporter. 7/31/92 (p.1110). Bureau of National Affairs, Inc. Washington D.C.
- 6 - Environmental Reporter. 11/22/91 (p.1799).
- 7 - Environmental Reporter. 1/3/92 (p.2103).
- 8 - Environmental Reporter. 1/17/92 (p.2144).
- 9 - Env. Rep. 2/14/92 (p.2373).
- 10 - Env. Rep. 12/27/91 (p.2072).
- 11 - Env. Rep. 5/1/92 (p.13).
- 12 - Env. Rep. 11/8/91 p.1745-46 and 1/31/92 (p.2299)
- 13 - Golden, Jack. et. al. (1979). The Environmental Impact Data Book. Ann Arbor Science Publishers, Inc., PO Box 1425, Ann Arbor, Michigan 48106. (p. 495).
- 14 - Fahm, L.A., (1980). The Waste of Nations (p.46), see previous listing.
- 15 - 1992 Earth Journal, (p.159).
- 16 - Env. Rep. 4/24/92 (p.2877-78).
- 17 - Env. Rep. 2/28/92 (p.2439).
- 18 - 1992 Earth Journal, (p.159).
- 19 - Sides, S., Compost. The Mother Earth News. Aug/Sept. 1991. Issue 127. (p.50).
- 20 - Beyond Oil: The Threat to Food and Fuel in the Coming Decades. A Summary Report. November, 1986. Carrying Capacity Inc. 1325 G Street NW, Suite 1003, Wash. D.C. 10005.
- 21 - 1993 Information Please Environmental Almanac. (pp.340-341).
- 22 - Toward Organic Security: Environmental Restoration or the Arms Race?. Peace and Environment Platform Project, c/o World Citizens Assembly, Suite 506, 312 Sutter St., San Francisco, CA 94018.
- 23 - Courier. January, 1985. UNESCO. 7 Place de Fentenoy 75700 Paris, France.
- 24 - EPA Journal. Vol. 12 No. 7, September 1986, and Vol. 11 No. 7, September 1985, USEPA Office of Public Affairs, Wash. D.C. 20460.
- 25 - Associated Press, as seen in the Observer-Reporter (Washington and Green Counties, PA), Saturday, April 10, 1993. (p.A2).
- 26 - Brown, L.R. et. al. State of the World 1992. W.W. Norton & Co. New York. (p.3).
- 27 - Brown, L.R. et. al. State of the World 1990. (p.3).
- 28 - Mitchell, B. R. (1982) International Historical Statistics of Africa and Asia. New York University Press, New York, NY, 10003.
- 29 - State of the World 1990 (p.184).
- 30 - Rybczynski, W. et. al. (1982). Low Cost Technology Options for Sanitation - A State of the Art Review and Annotated Bibliography. World Bank. (p.23).

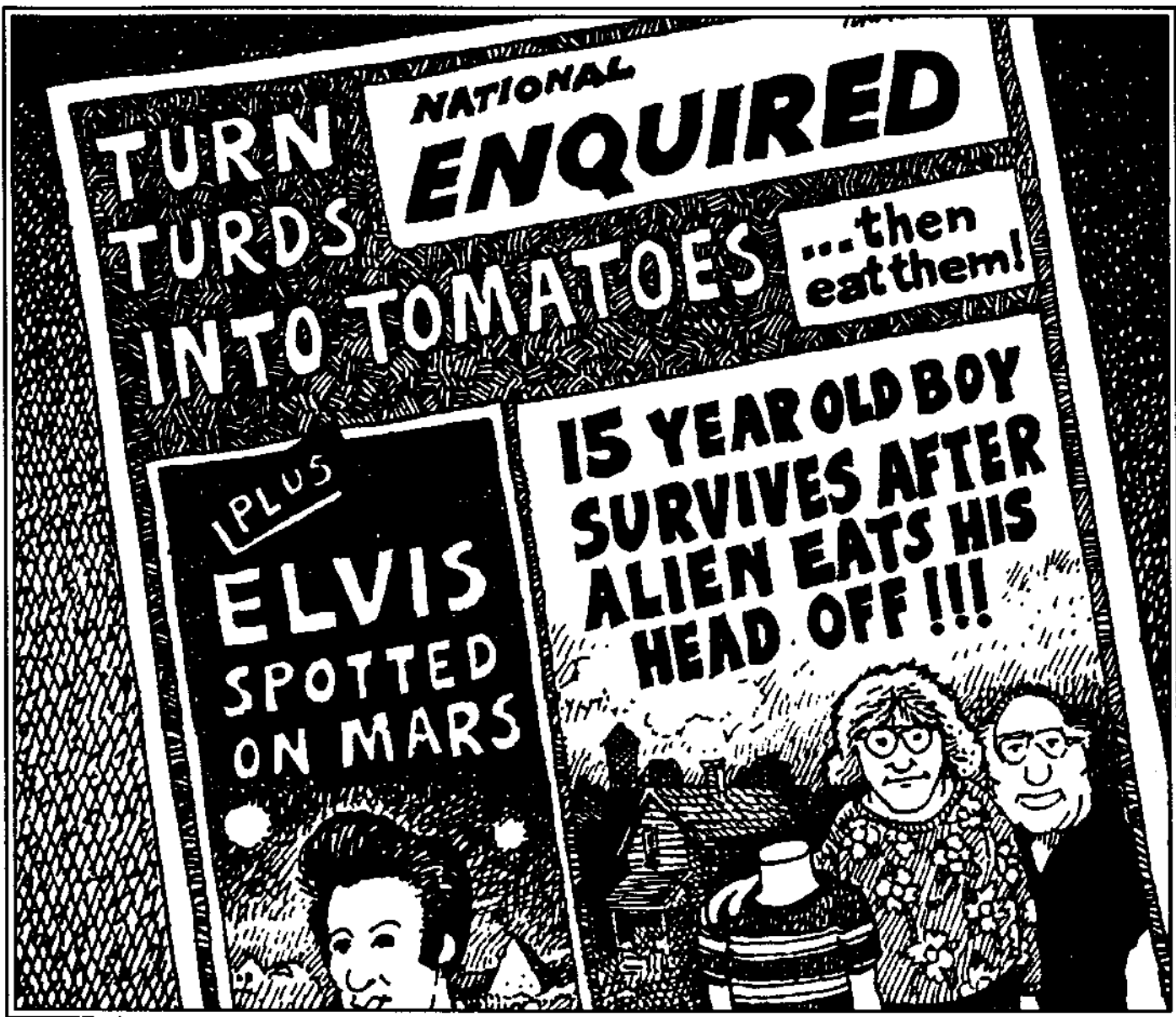

MICROHUSBANDRY

Harnessing the Power of Microscopic Organisms

“Making compost is an art rather than a science. To go about it mechanically, merely following rules, not only will not yield the best results, but the work will not be as enjoyable.”

J. I. Rodale



There are essentially four ways to deal with human excrement. The first is to *dispose of it*. People do this by defecating in water, or in outhouses or latrines. Most of this excrement ends up wasted, buried in the ground, or becomes a source of pollution. The second way to deal with human excrement is to *apply it raw to agricultural land*. This is popular in Asia where “night soil”, or raw human excrement, is spread on fields. Although this keeps the soil enriched, it acts as a vector, or route of transmission, for disease organisms. The third way to deal with human excrement is to *slowly compost it over an extended period of time*. This is the way of most commercial composting toilets and mouldering toilets. Slow composting generally takes place at temperatures below that of the human body (98.6 °F or 37°C). This method of composting eliminates most disease organisms in a matter of months, and should eliminate all human pathogens eventually, although some sources suggest that the total destruction of pathogens may require a period of up to ten years. Slow composting or mouldering, however, creates a useful soil additive that is at least safe for ornamental gardens or orchard use. The fourth way to deal with human excrement is to *thermophilically compost it*.

Thermophilic composting involves the cultivation of thermophilic (heat loving, or heat producing) microorganisms in the initial stage of the composting process. These bacteria and fungi can produce heat sufficient to destroy the disease organisms (human pathogens) that may be present in humanure. Thermophilic composting can render humanure into a friendly, pleasant-smelling, humus safe for food gardens. It's this type of composting which is the primary focus of this book, and this focus is not to be confused with the other three ways of dealing with human excrement. Thermophilically composted humanure is somewhat different from mouldered humanure, and *entirely different from night soil*.

What is compost anyway? I'm glad you asked that question. I remember

when I first moved out to the country and started living off the land at the age of 22. I was fresh out of college, so naturally I knew very little. One word that was a mystery to me was “compost”, another was “mulch”. I didn’t know what either of these things were, I only knew they had something to do with organic gardening, and that’s what I intended to learn about. Of course, it didn’t take me long to understand mulch. Anybody who can throw a layer of straw on the ground can mulch. But compost took a little longer.

Making compost is sort of like making bread, or maybe wine. My compost-learning experiences were a parallel of my wine-making experiences. Back then, having just graduated from the university, I had been conditioned to believe that everything had to be learned by using books. I had little awareness that instinct or intuition were powerful teachers. It seemed I was expected to believe that humans were the only thing in the universe with intelligence, and everything in nature was somehow below us. Furthermore, simple, natural processes had to be complicated with charts, graphs, measurements, devices, and all the wonderful tools of science, otherwise the processes had no validity. It was with this attitude that I set out to learn how to make wine.

Of course, the first thing I did was obtain a very scientific book replete with charts, graphs, tables, and detailed, step by step procedures. The book was titled something like “Foolproof Winemaking” and the trick, or so the author said, was simply to follow his procedures *to the letter*. This was no simple feat. The most difficult part of the process was acquiring the list of chemicals which the author insisted must be used in the winemaking process. After much searching and travel I managed to get the required materials and I then followed his procedures *to the letter*. This lengthy process involved boiling sugar, mixing chemicals etc. To make a long story short, I did succeed in making two kinds of wine in this way. Both tasted like hell though, and had to be thrown out. I was very discouraged.

It wasn’t too long after that when a friend of mine, Bob, decided he would try his hand at winemaking. Bob and I had a friend, Jim, who worked at a Pennsylvania vineyard, and Jim offered to bring Bob five gallons of grape juice for a try at the oenologist’s art. Jim, being the good sport that he is, even brought the juice in a five gallon glass winemaking container (carboy) with an airlock already on top of it (to allow fermentation gasses to escape while preventing air from entering). When he got the grape juice to Bob’s house, Bob took one look at the heavy carboy of juice and said, “*Jim, would you mind carrying that into the basement for me?*” Which Jim obligingly did. That was it. That utterance constituted Bob’s entire effort at winemaking. Two seconds of flapping jaws is the only work Bob did toward making that wine. He added no sugar, no yeast, did no racking, certainly used no chemicals. He didn’t

do a damn thing to that five gallons of grape juice except abandon it in his basement. And yet, that turned out to be the best homemade wine I had ever drunk. It tasted good and had a nice kick to it too. It was superb.

Now, I admit, there was an element of luck there, but I learned an important lesson about winemaking: the basic process is very simple - start with good juice and keep the air out of it. That simple, natural process can easily be ruined by complicating it with scientific procedures, and heck, all those charts and graphs took the *fun* out of it. Making compost is exactly the same sort of phenomenon.

NATURALCHEMY

What exactly *is* compost, you ask again? According to Webster, compost is “a mixture of decomposing vegetable refuse, manure, etc. for fertilizing and conditioning the soil.” To compost means to convert organic refuse into soil or humus. Humus is a brown or black substance resulting from the decay of organic animal or vegetable refuse. Organic refuse could be considered anything on the Earth’s surface that had been recently alive, or from a living thing, such as manure, plants, leaves, sawdust, peat, straw, grass clippings, food scraps, urine etc. A rule of thumb is that anything that will rot will compost. In some cases, even petroleum products are compostable.

In the Middle Ages alchemists sought to change base metals into gold. Old German folklore tells of a tale in which a dwarf named Rumpelstiltskin had the power to spin flax straw into precious metal. Somewhere in the psyche of the Western society was a belief that substances of little or no worth could be transmuted by a miraculous process into materials of priceless value. Our ancestors were right, but they were barking up the wrong tree. The miraculous process of thermophilic *composting* will transmute humanure into humus. In this way, a dangerous waste material becomes a soil additive vital for the processes of human life.

Our ancestors didn’t understand that the key to this alchemy was right at their fingertips. Had they better known and understood natural processes they could have provided themselves with a wealth of soil fertility and saved themselves the tremendous suffering caused by diseases originating from fecal contamination of the environment. For some reason they believed that gold embodied value, and in pursuit of glittering riches they neglected the things of real value in life: health, vitality, self-sufficiency, sustainability.

Their ignorance involved microbiology. Our ancestors had little understanding of a vast, invisible world which surrounded them, a world of billions of creatures

so small as to be quite beyond the range of human sight. And yet, some of those microscopic creatures were already being used to do work for humanity in the form of the fermentation of foods such as beer, wine or bread dough. Although *yeasts* have been used by people for centuries, *bacteria* have only relatively recently become harnessed by Western humanity. Composting is one means by which the power of bacteria can be utilized in a big way for the betterment of humankind. Unfortunately, our ancestors didn't understand the role of microorganisms in the decomposition of organic matter, and the efficacy of microscopic life in converting humanure, food scraps, plant residues and the like into soil. They didn't understand compost.

The decomposition of organic materials requires armies of bacteria which work so hard digesting (decomposing) the refuse they heat the stuff up. Other micro and macro organisms such as fungi and insects help in the composting process, too. When the compost cools down, earthworms often move in and eat their fill of delicacies, their excreta becoming a further refinement of the compost.

And so, successful composting requires the maintenance of an environment in which bacteria and fungi can thrive. Same for wine, except the microorganisms are yeast, not bacteria. Same for bread (yeast), beer (yeast), yogurt (bacteria), sauerkraut (bacteria); all of these things require the cultivation of microorganisms which do the work you want done. All of these things involve simple processes which, once you know the basic principles, are easy to carry out successfully. Sometimes bread doesn't rise, sometimes yogurt turns out watery, sometimes compost doesn't seem to turn out right. When this happens, a simple change of procedure will rectify the matter. Once you get the hang of it, you'd think that even a chimpanzee could be trained to make compost.

Often, in our household, we have yogurt being made by millions of hard-working bacteria in a few quart mason jars beside the cookstove. At the same time, millions of yeast cells are cheerfully brewing beer in carboys in the back pantry, millions more yeasts are happily brewing wine beside the beer, sauerkraut is blithely fermenting in a crock behind the stove, bread is rising on the kitchen counter, and fungi are tirelessly forcing their fruits from oak logs on the sunporch. And then there's the compost pile. At times like these, I feel like a real slave driver. But the workers never complain. Those little fellas work day and night, and they do a real nice job.

Making compost and using it agriculturally has its advantages. The end product of compost making, *humus*, consists of broken down organic matter that is the basis of soil life. Humus holds moisture, and therefore increases the soil's capacity to absorb and hold water. Compost is said to hold nine times its weight in water (900%), as compared to sand which only holds 2%, and clay 20%.¹ Compost also adds slow-release nutrients essential for plant growth, creates air spaces in soil, helps balance

the soil pH, darkens the soil and thereby helps it absorb heat, and supports microbial populations that add life to the soil.

The building of topsoil by Mother Nature is a centuries long process. Adding compost to soil will help to quickly restore fertility that might otherwise take nature hundreds of years to replace. We humans deplete our soils in relatively short periods of time. We can restore that fertility also in relatively short periods of time by composting our organic refuse and returning it to the land.

Another way to look at it is by seeing organic refuse as stored solar energy. Every apple core or potato peel holds a tiny amount of stored energy, converted into useable plant food by the compost pile. Perhaps S. Sides of the *Mother Earth News* states it more succinctly: "*Plants convert solar energy into food for animals (ourselves included). Then the [refuse] from these animals along with dead plant and animal bodies, 'lie down in the dung heap,' are composted, and 'rise again in the corn.' This cycle of light is the central reason why composting is such an important link in organic food production. It returns solar energy to the soil. In this context such common compost ingredients as onion skins, hair trimmings, eggshells, vegetable parings, and even burnt toast are no longer seen as garbage, but as sunlight on the move from one form to another.*"²

Adding compost to soil helps control plant diseases. Studies in 1968 by researcher Harry Hoitink indicated that compost, by adding beneficial microorganisms to the soil, inhibited the growth of disease-causing microorganisms in greenhouses. In 1987, he and a team of scientists took out a patent for compost that could reduce or suppress plant diseases caused by

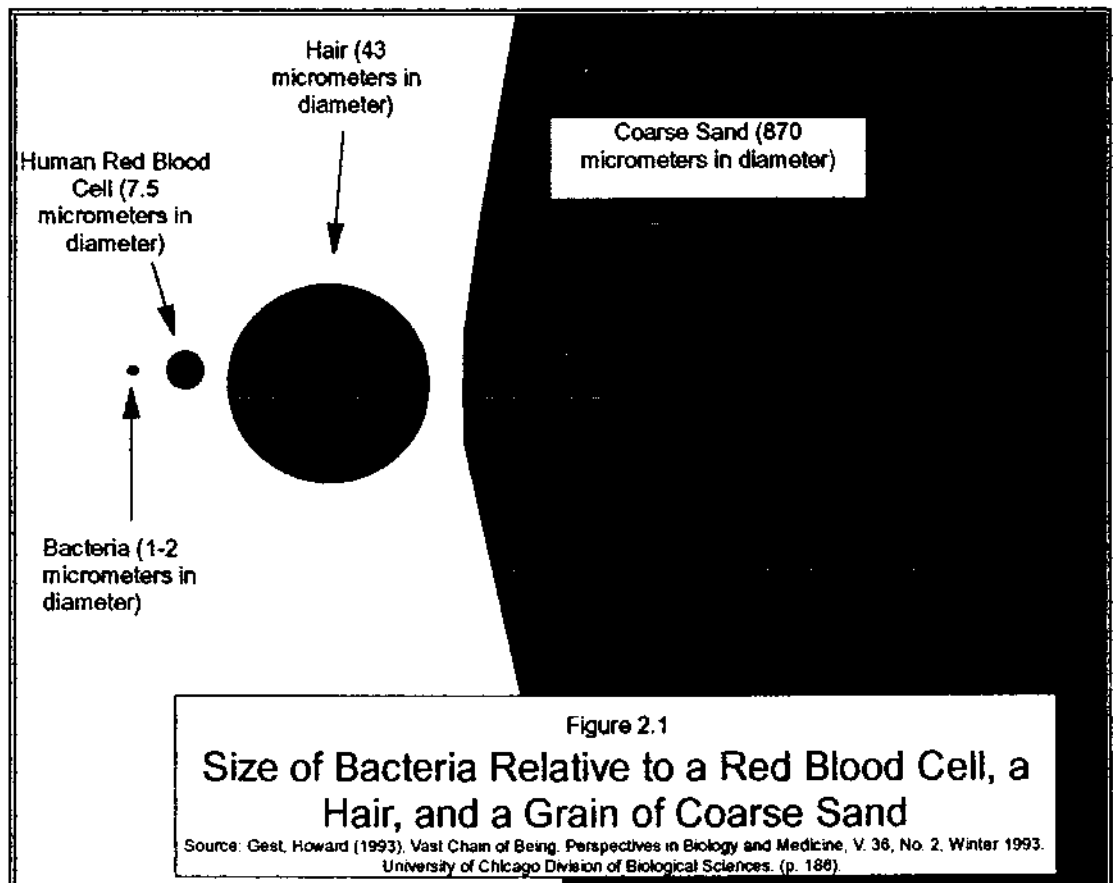

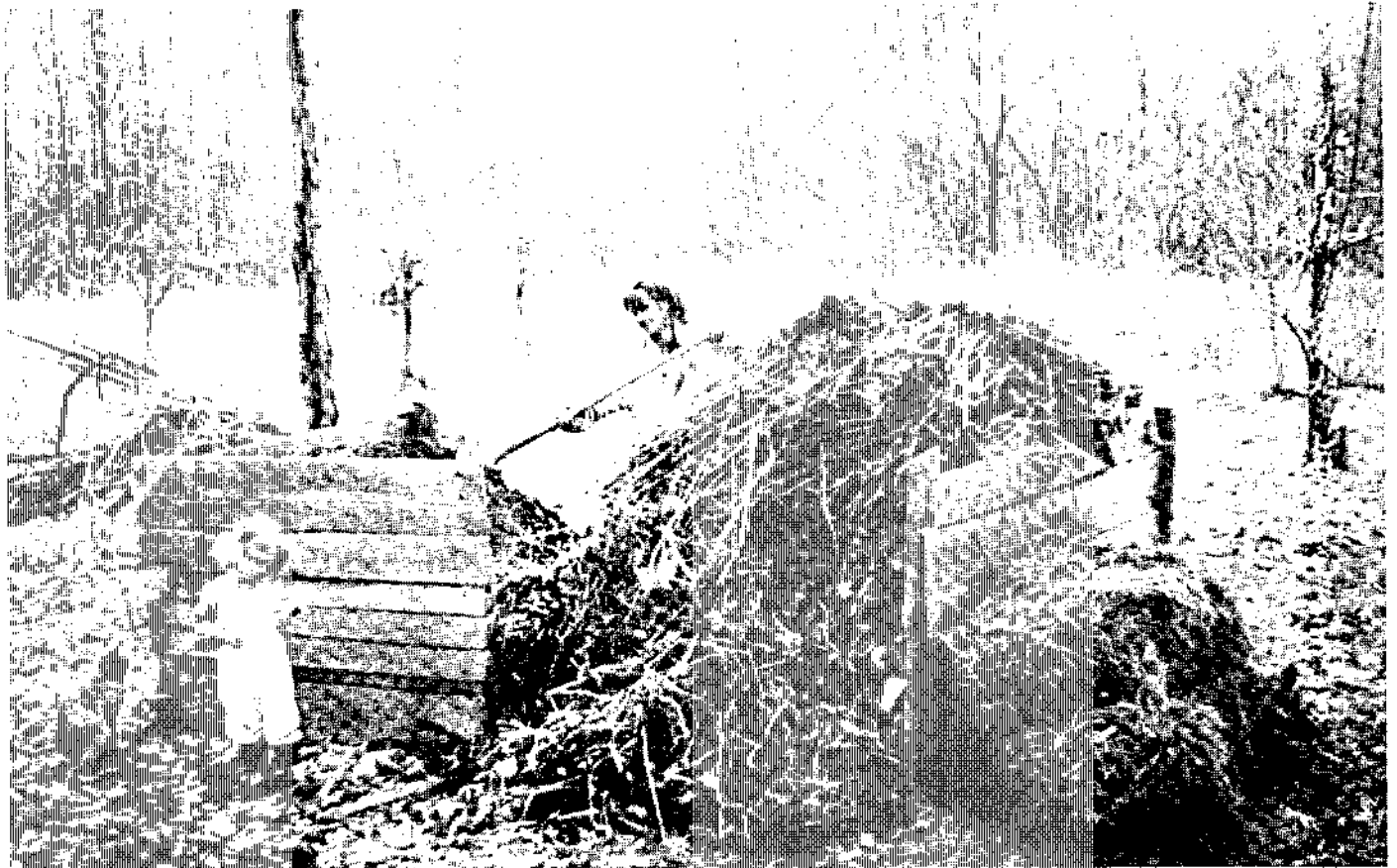

Finished compost is being removed from a double chambered compost bin.

The large pile of refuse in the chamber on the right is undergoing thermophilic decomposition, and represents nearly a year's worth of accumulated material, including humanure. When finished, it will shrink to half its size.

Clean hay is stacked against the right side of the bin to be used as cover material.

three deadly microorganisms: *phytophthora*, *pythium*, and *fusarium*. Growers who used this compost in their planting soil reduced their crop losses from 25-75% to 1% without applying fungicides. The studies suggested that sterile soils could provide optimum breeding conditions for plant disease microorganisms, while a rich diversity of microorganisms in soil, such as that found in compost, would render the soil unfit for the proliferation of disease organisms.³

Besides helping to control soil diseases, compost helps control nematodes, attracts earthworms, and aids plants in producing growth stimulators.⁴ It can also destroy some toxic wastes. One man who composted a batch of sawdust contaminated with diesel oil said, "We did tests on the compost, and we couldn't even find the oil!" The compost had apparently "eaten" it all.

Composting also seems to be able to decontaminate soil polluted with TNT

from munitions plants. The microorganisms in the compost digest the hydrocarbons in TNT and convert them into carbon dioxide, water, and simple organic molecules. Furthermore, some bacteria “eat” uranium. Derek Lovley, a microbiologist, has been working with a strain of bacteria that normally lives 650 feet under the earth’s surface. These microorganisms will eat, then excrete, uranium. The chemically altered uranium excreta becomes water insoluble as a result of the microbial digestion process, and can consequently be removed from the water it was contaminating.⁵

An Austrian farmer claims that the microorganisms he introduces into his fields have prevented them from being contaminated by the radiation from Chernobyl, the ill-fated Russian nuclear power plant, which contaminated his neighbor’s fields. Sigfried Lubke sprays his green manure crops with compost-type microorganisms just before plowing them under. This practice has produced a soil rich in humus and teeming with microscopic life. After the Chernobyl disaster, crops from fields in Lubke’s farming area were banned from sale due to high amounts of radioactive cesium contamination. However, when officials tested Lubke’s crops, no trace of cesium could be found. The officials made repeated tests because they couldn’t believe that one farm showed no radioactive contamination while the surrounding farms did. Lubke thinks that the humus just “ate up” the cesium.⁶

Finally, fertile soil yields food that promotes good health. One group of people, the Hunzas of northern India, has been studied to a great extent. One man who studied them extensively, Sir Albert Howard, stated, *“When the health and physique of the various northern Indian races were studied in detail the best were those of the Hunzas, a hardy, agile, and vigorous people, living in one of the high mountain valleys of the Gilgit Agency. . . There is little or no difference between the kinds of food eaten by these hillmen and by the rest of northern India. There is, however, a great difference in the way these foods are grown. . . [T]he very greatest care is taken to return to the soil all human, animal and vegetable wastes [sic] after being first composted together. Land is limited: upon the way it is looked after, life depends.”* We’ll take another look at the Hunzas in chapter six.

GOMER THE PILE

Back to the compost pile. Notice I said “pile”. Refuse is usually piled up in bins, racks, pits, drums or what have you. There are three basic reasons for piling the composting refuse. First, it keeps the pile from drying out or cooling down prematurely. A level of moisture (50-60%) is necessary for the bacteria to work happily.⁸ A vertical stack prevents leaching, prevents waterlogging, and holds heat in the pile.

Vertical walls around a pile, especially if they're made of wood, keep the wind off and will prevent one side of the pile (the windward side) from cooling down prematurely.

Secondly, a neat, contained pile just plain looks better. It looks like you know what you're doing, instead of looking like a garbage dump.

Thirdly, a pile makes it easier to layer, or cover over the compost. It's a good idea to cover the pile with clean refuse when a smelly deposit is added to the top, in order to eliminate unpleasant odors and to trap necessary oxygen in the pile. Therefore, if you're going to compost your refuse, don't just fling it out in your yard in a heap. Construct a nice little bin and do it right. That bin doesn't have to cost money, it can be made from recycled wood or cement blocks. Wood may be preferable as it'll insulate the pile and prevent heat loss and frost penetration. A compost bin doesn't have to be complicated in any way. It doesn't require electricity, technology, gimmicks or doodads. You don't need shredders or choppers, grinders or any machines whatsoever.

Compost *pits* are more likely to be used in dry, arid or cool climates where conservation of moisture and temperature is imperative. The main disadvantage of pits is that they can become waterlogged in the event of an unexpected cloudburst, and excessive water will rob the pile of oxygen, a critical element in the process of decomposition by aerobic microorganisms. When pits are used, therefore, a roof over them may be an advantage.

What sort of environment does the bacterial community like? As stated, the compost must be moist. A dry pile will not work. When composting humanure, the urine provides quite a bit of the necessary moisture. Other moisture comes from food scraps. In some cases, a compost pile may have to be watered. This would most likely occur in a very dry climate where the pile may also require a roof over it to reduce dehydration. In Pennsylvania, where I live, we have ample rainfall (35 inches per year, nearly one meter) and my compost never dries out, unless during an unusual drought. It is never covered by a roof and leaching has never been a problem. I've rarely had to water my compost. On the other hand, we compost all of our refuse, including our urine. We use rotting hardwood sawdust in our waterless sawdust toilet as an odor-preventing cover material, which also soaks up the urine to create a good moisture balance. Compost should be moist, not wet.

The amount of moisture a compost pile receives or needs depends on the materials put into the pile and on the location of the pile. According to Sir Albert Howard, watering a compost pile in England where the annual rainfall is 24 inches is also unnecessary. Nevertheless, the water required for compost-making may be around 200 to 300 gallons for each cubic yard of finished compost.⁹ This moisture

requirement will be met when human urine is used in the compost and the top of the pile is open and receiving adequate rainfall. If adequate rainfall is not available and the contents of the pile are not moist, watering will be necessary to produce a moisture content equivalent to a squeezed out sponge.

The bacteria we want to cultivate in the compost pile in order to ensure thermophilic decomposition are *aerobic* and they will suffer from a lack of oxygen if drowned in liquid. Bacterial decomposition can also take place anaerobically, but this is a slower, cooler process, which can, quite frankly, stink.

A good, healthy, aerobic compost pile need not offend one's sense of smell. However, in order for this to be true, one simple rule must be followed: anything added to the compost collection that smells bad must be covered with clean organic material. This means in your compost toilet, this means on your compost pile. Shit stinks, I don't care what Adelle Davis* said. When you defecate or urinate in your toilet, cover it. Use sawdust, use peat, use clean soil, use leaves, but keep it covered. Then there will be no odor. When you deposit smelly manure on your compost pile, cover it. Use weeds, use straw, use hay, whatever you can get your hands on (especially bulky material which will trap oxygen), but keep it covered. That's the secret. That's all there is to it (the smell issue, that is).

Dehydration will cause your bacteria to go on strike and stop working. So will freezing. Compost piles will not work if frozen, as during the cold winters of the north. However, don't despair, the bacteria will wait until the temperature rises and then they'll work like hell. I continue to add to my outdoor compost pile all winter, even when the pile is frozen solid as a rock. The freezing stage helps to destroy potential pathogens, and after the thaw, the pile works up a steam as if nothing happened. (See page 164, and appendix 4 on page 187, for charts showing the rise of temperature after a frozen pile thaws.)

Actually, I consider this whole process to be one of the miracles of nature. I take humanure with urine mixed in sawdust from our low-impact toilet, buckets of food scraps from the kitchen, armfulls of weeds from the garden, and anything else on hand, and layer it all onto a pile where it's transformed into a rich loamy garden soil before my eyes. The final product looks and smells like a beautiful soil. This process requires no electricity, no technology, no bells or whistles, no heaters, and no dancing girls. It's a model of simplicity,

The top of a compost pile should be kept somewhat flat. Keep a garden utensil handy to the compost bin for this purpose. I use an old hay fork with a broken handle. The short handle is long enough to rake the top of my pile. The flat top collects water and prevents leaching. It makes it easier to layer things on the pile. Things don't roll

off a flat-topped pile. This is just a simple and standard maintenance procedure. If the pile is frozen and can't be flattened, don't worry about it. When it thaws, flatten the top. Don't overdue it though, as your thermophiles may not like being disturbed!

Don't be confused by layering. Layering occurs naturally. Every time you add something to your pile you're adding another layer. No, you don't have to stir these layers up. Many people believe that you do, but you don't.

Don't be confused about mixing and blending the compost. This happens naturally when you add all of your organic refuse to the same compost pile, including humanure. By adding a variety of materials to the pile, you are creating a mix of ingredients, trapping oxygen into the pile, balancing nutrients, and eliminating the need to turn or stir the pile. If the bacteria like your compost, they'll heat the pile up and won't want to be disturbed by turning or stirring. If they don't like your compost, it's more than likely you're not adding a mix of materials to the pile. One can't just defecate in a 55 gallon drum, throw lime on it and expect it to compost. This is the single most common mistake I've seen made by people trying to compost humanure. They think humanure is dangerous and must be isolated, quarantined from all other compost. This is ironic, as the potential dangers of humanure are most effectively eradicated by thermophilic composting. To get a good, hot pile, you need organic material such as kitchen scraps, garden weeds, and maybe some hay or straw or leaves layered with your manure. These rough materials create interstitial air spaces in the pile that aid the aerobic digestion. They create a good blend of nutrients for the microbes. Think about it, how would *you* like it if you had only crap to eat?

THE CARBON/NITROGEN RATIO

One way to look at the blend of ingredients in your compost pile is by using the C/N ratio, the carbon/nitrogen ratio. Quite frankly, the chance of anyone measuring and monitoring the carbon and nitrogen quantities of their refuse is almost nil. This is like making wine the "foolproof" way. If composting requires this sort of drudgery, no one would do it.

However, I've found that by using all of the organic refuse my family produces, including humanure, urine, food refuse, weeds from our garden, rotting sawdust (which is hauled in), and maybe a little straw or hay now and then, we get the right mix of carbon and nitrogen for successful thermophilic composting.

Nevertheless, no discussion of composting is complete without a review of the subject of the carbon/nitrogen ratio. A good C/N ratio for a compost pile is between 20/1 and 35/1.¹⁰ That's 20 parts of carbon to one part of nitrogen, up to 35

Table 2.1
Composition of Humanure

Fecal Material -

0.3-0.6 pounds per person per day, or 135-270 grams, wet weight.

Organic Matter (dry weight).....	88-97%
Moisture Content	66-80%
Nitrogen.....	5-7%
Phosphorous.....	3-5.4%
Potassium.....	1-2.5%
Carbon.....	40-55%
Calcium.....	4-5%
C/N Ratio.....	5-10

Urine-

1.75-2.25 pints per person per day (1.0-1.3 liters)

Moisture.....	93-96%
Nitrogen.....	15-19%
Carbon.....	11-17%
Calcium.....	4.5-6%
Potassium.....	3.0-4.5%
Phosphorous.....	2.5-5%

Source: Gotaas, *Composting*, (1956), p. 35

parts of carbon to one part of nitrogen. Or, for simplicity you can figure on shooting for an optimum 30/1 ratio.

The reason this ratio is good is because the microorganisms that digest the compost need 30 parts of carbon for every part of nitrogen they consume. If there's too much nitrogen and not enough carbon, the microorganisms can't use the excess nitrogen. Then the excess nitrogen is lost in the form of ammonia gas, which you can

smell. Nitrogen loss due to excess nitrogen in the pile (a low C/N ratio) can be over 60%. At a C/N ratio of 30 or 35 to 1, only one half of one percent of the nitrogen will be lost. That's why you don't want too much nitrogen in your pile: you'll lose a lot of it in the form of ammonia gas, and nitrogen is too valuable for plants to allow it to go to waste (see Table 2.3).¹¹

Table 2.3

NITROGEN LOSS AND C/N RATIO

Initial C/N Ratio	Nitrogen Loss %
20	38.8
20.5	48.1
22	14.8
3005
3505
76	-8

Source: Gotaas, *Composting*, 1956, p. 92

The C/N ratio of humanure is between 5 and 10, or roughly around

Table 2.2 (Source: Gotaas, *Composting*, 1956, p. 44)

Carbon/Nitrogen Ratios for Some Compostable Materials

MATERIAL	% N	C/N RATIO		MATERIAL	% N	C/N RATIO
Urine	15-18	0.8		Grass Clippings	2.4	19
Humanure	5-7	5-10		Amaranth	3.6	11
Activated Sludge	5-6	6		Lettuce	3.7	----
Rotted Sawdust	0.25	208		Cabbage	3.6	12
Raw Sawdust	0.11	511		Tomato	3.3	12
Wheat Straw	0.3	128		Onion	2.65	15
Oat Straw	1.05	48		Pepper	2.6	15
Timothy Hay	0.85	58		Turnip Tops	2.3	19
Poultry Manure	6.3	----		Raw Garbage	2.15	25
Sheep Manure	3.75	----		Bread	2.10	----
Pig Manure	3.75	----		Seaweed	1.9	19
Horse Manure	2.3	----		Red Clover	1.8	27
Farmyard Manure	2.25	14		Whole Carrot	1.6	27
Cow Manure	1.7	----		Mustard	1.5	26
Blood	10-14	3		Potato Tops	1.5	25
Fish Scrap	6.5-10	----		Fern	1.15	43
Meat Scraps	5.1	----		Whole Turnip	1.0	44
Purslane	4.5	8				

The above chart reveals the ratio of carbon to nitrogen in various common organic materials. For example, the C/N ratio of rotted sawdust is 208, indicating that there are 208 parts of carbon to every one part of nitrogen. The optimum C/N ratio for compost is 25 or 30/1, so obviously sawdust should have quite a bit of nitrogen added to it to ensure vigorous microbial decomposition. It should be evident from the above chart that humanure requires a fair amount of carbonaceous material to be mixed with it in order to obtain the optimum C/N ratio of 25 or 30/1. Sawdust happens to work quite well for this purpose, especially if somewhat rotted. When rotted sawdust is used as a cover material in a compost toilet, it also very effectively eliminates odors. Presumably, many common organic materials will work well as compost toilet cover. The idea is to use what's locally available. Note that garbage has nearly an optimum C/N ratio and would feel right at home in a compost pile, and straw and hay are well suited as cover materials for compost piles when manure is to be covered. The carbon in the hay balances the nitrogen in the manure.

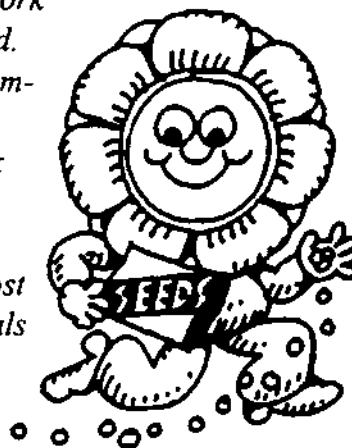

8/1, or eight parts of carbon to one part of nitrogen. Therefore, you need to add a fair amount of carbon to humanure to get a 30/1 ratio and good compost. I've found that the proper balance is obtained by putting all the organic refuse of my household in the same pile, layered with weeds, straw, hay or whatever else happens to be within reach. The humanure is collected in a twenty-liter non-corrodible receptacle where it is constantly kept covered with clean, partially rotted, hardwood sawdust (I live in a hardwood forest). The sawdust adds quite a bit of carbon, although no extra sawdust is ever added to the compost pile other than what's put into the toilet. I'm getting ahead of myself here, as I'll discuss a bio-solids (sawdust) toilet in detail in chapter 7.

MISINFORMATION

There was some literature published on the subject of composting humanure back in the 1970's which insinuated that humanure compost was practically as toxic as nuclear waste. And this information came from a publisher *promoting* the recycling of humanure.¹² Undoubtedly the publisher's intentions were good, and fecophobia (fear of fecal material) is understandable in our culture, but I must question the perpetuation of fecophobia from published information that is incomplete or incorrect. By some stroke of luck I didn't run across this book until recently, although I realize now that many of my acquaintances had been influenced by the publication and therefore feared the use of human excrement in compost. They were rendered fecophobic.

For example, the publisher had strongly recommended that human urine and feces be collected separately as the urine was "good" and the feces "bad". I had seen

FUN FACTS



Proper composting requires a balance of carbon and nitrogen in the organic material being composted. Human excreta is not properly balanced as it is too high in nitrogen, and it requires a carbon material to be added to it for the encouragement of rapid and thorough microbial decomposition. In the mid 1800's, the concept of balancing carbon and nitrogen was not known, and the high nitrogen content of humanure in dry toilets prevented the organic material from efficiently decomposing. The result was a foul, fly-attracting stench. It was thought that this problem could be alleviated by segregating urine from feces (which thereby reduced the nitrogen content of the fecal material) and dry toilets were devised to do just that. Today, the practice of segregating urine from feces is still widespread, even though the simple addition of a carbonaceous material to the feces/urine will balance the nitrogen of the material and render the segregation of urine unnecessary.

Figure 2.2
THE MARINO TOILET
 1858 - Copenhagen

Cutaway view of the chamberpot version:

Source: Rybczynski, et. al. (1982). *Low Cost Technology Options for Sanitation: A State of the Art Review and Annotated Bibliography*. World Bank (p. 10).

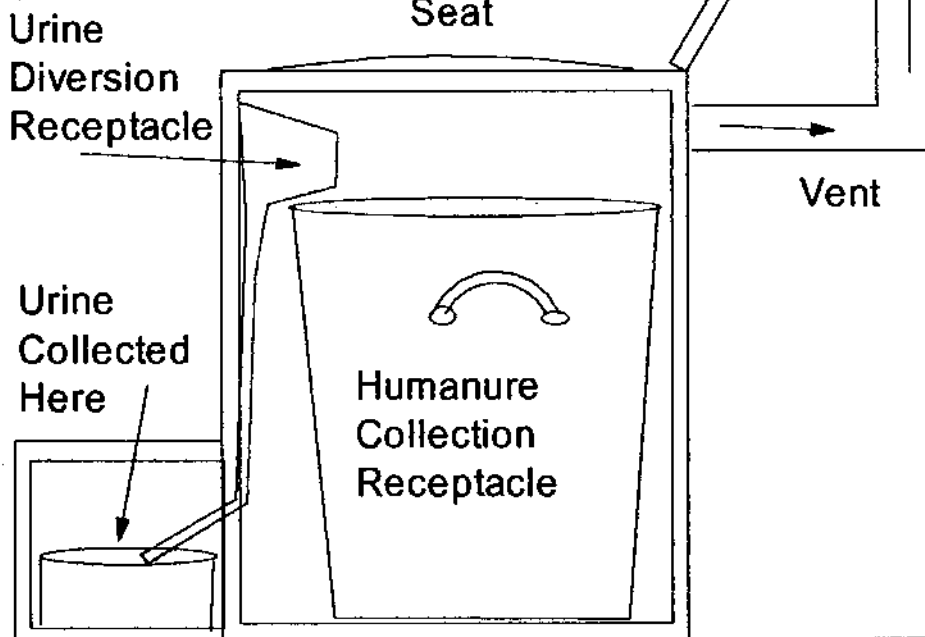

In the mid-1800's, attempts were made to devise humanure collection devices which did not require water. Since the organic material was not being composted, the urine was segregated from the fecal material to minimize odor problems. This technique is still in wide use today, even though the simple use of a semi-dry, organic cover material such as rotting sawdust in the toilet absorbs excess liquids, prevents odors, eliminates flies and makes unnecessary the need to segregate urine. Such a cover material further balances the carbon-nitrogen ratio of the organic material, rendering it suitable for composting.

people doing this, but I could never understand where they came up with this idea until I read that book and also did some additional research into the subject. Urine was to be collected in a bucket and applied to the garden or compost pile, while fecal material was to be collected in a separate receptacle and buried in a trench far away (as in a distant orchard, maybe on another planet) and covered with twelve inches of soil. Now, the idea of defecating in one receptacle and urinating in another seems bizarre enough (I've never tried it and don't intend to),

but if you think fecal material stinks, you should smell a bucket of urine. It's enough to gag a maggot.

A neighbor of mine tried the separation method recommended in the book (defecating in one receptacle and urinating in another). However, the urine stank so bad that he couldn't continue to use this method without modifying the recommended system in some way. He said it was especially repulsive when he had to pour the urine from one container to another when applying it to the garden or compost pile. Now, my neighbor is a resourceful guy and he realized that all he had to do was fill a five-gallon bucket with *sawdust* and urinate in that to eliminate the odors. This worked so well that he wrote to the publisher suggesting this improvement to the

method, but the publisher never responded.

In the Rodale Book of Composting (1992, Rodale Press, Emmaus, PA 18098), human feces is listed under “Materials to Avoid”, where we are informed that *“human feces should not be used unless they have been properly treated and permitted to age sufficiently. Even then, concerns about disease pathogens make the use of such material dubious at best for the home gardener.”*

Ironically, however, the best way to “properly treat” humanure is to thermophilically compost it, which destroys potential pathogens. When humanure is thermophilically composted and then left to age for a while, it makes a fine soil additive for the home gardener. Furthermore, humanure provides a source of nitrogen for compost-making that is available to all people. When that nitrogen source is discarded as waste, we not only lose an essential and critical compost ingredient and an agricultural resource, we also pollute the environment. Rather than perpetuate fecophobia by continuing to relentlessly portray humanure as dangerous and to be avoided, advocates of organic gardening would provide a greater service to society by objectively researching the merits of composted humanure for agricultural purposes.

For example, the World Health Organization Expert Committee on Environmental Sanitation stated at its third session in 1954 that *“the committee recognizes the widespread use, in many parts of the world, of human excreta as fertilizer . . . With the growing world population and the limited extent of world resources, all efforts to utilize sanitary by-products and return them to the soil should be encouraged. The necessity of controlling these activities in such a way as to reduce to an absolute minimum their inherent public health hazards cannot be too strongly emphasized”* (see Rybczynski et. al., 1982).

Granted, humanure can be dangerous. Drink some water polluted with fecal material that came from someone afflicted with typhoid or cholera. You’ll soon find out how dangerous humanure can be when harboring disease organisms and polluting the environment. Cars can also be dangerous. Jump out in front of one on the highway some day and you’ll see what I mean. Matches can be dangerous. Try lighting your bed sheets. No, don’t. But do you get my point? There is potential danger everywhere. Humanure has the potential to be harmful too, but when *thermophilically composted* it is transformed into a friendly and valuable material.

Perhaps Gotaas (Composting, 1956, p.21) best sums it up: *“Van Vuren was unable to demonstrate any health hazards in properly managed [humanure] composting operations in South Africa. His findings are confirmed by Blair [South Africa]; Loots [South Africa]; Hamblin [South Africa]; Acharya [India]; Scharff [Malaya]; and others in Great Britain, Germany, Australia,, the Netherlands, Denmark, and New Zealand.*

HAVE A GOOD BLEND

A sawdust-filled receptacle makes a good urine depository, as my neighbor discovered, but it can also act as a receptacle for human fecal material. Instead of beginning with a full receptacle of sawdust as with the urine receptacle, the sawdust is added after each use so that *there's a clean layer on the top at all times*. Urine is added to the same receptacle. Sawdust is added after urination as well as after defecation, if needed. Then, when the bucket is full, the whole works goes on the compost pile - feces, urine and sawdust (which is saturated with urine). The bucket is then rinsed, and the rinse water also deposited on the compost pile. This, in essence, constitutes the collection process of an absolutely minimum technology hygienic toilet. Waste is completely eliminated using this routine, *but the humanure must be thermophilically composted in a responsible and conscientious manner*. That's the missing link that must be incorporated into the process. How?

At the risk of repeating myself, you must blend the humanure with a healthy mix of other materials if you want good finished compost. What constitutes a healthy mix? If you're a serious gardener, most of your food scraps and some of your garden refuse will do. A clean cover material (such as hay, straw or weeds) ices the cake. It's that simple. I compost everything in the way of organic refuse produced on my small (no livestock,) gardening homestead, in a bin that is approximately five feet by five feet and four feet high. Everything. This provides a nice mix which produces approximately 75 cubic feet of lovely compost each year. If your garden produces large quantities of weeds at times, pile the weeds *beside* the compost bin and use them for cover material *a little at a time* (see three-chambered bin designs on page 159). This subject will be discussed in detail in chapter seven.

Compost shrinks. Unbelievably. That 5x5 bin holds a year's worth of humanure (family of four), and a year's worth of everything else. We just keep piling it on and it just keeps shrinking down and down. We pile, it shrinks. When it's all done, it stops shrinking.

Toilet paper composts too. So do the cardboard tubes in the center of the rolls. Use unscented, undyed paper if you want to keep trace contaminants out of your compost. Unbleached, recycled paper is ideal. Or you can use the old fashioned toilet paper, otherwise known as corncobs. Popcorn cobs work best, they're softer. Corncobs don't compost very readily though, so you have a good excuse not to use them. There are other things that don't compost so well: eggshells, bones, hair, and woody stems, to name a few. We throw our eggshells back to our chickens, or into the woodstove. Bones (rare in our house) go into the woodstove, too, or to the cats or

dog. Hair goes out to the birds for nests, if not into the compost pile.

And never put woody stemmed plants, such as tree saplings, on your compost pile. I hired a young lad to clear some brush for me one summer and he innocently put the small saplings on my compost pile without me knowing it. Later, I found them networked through the pile like iron reinforcing rods. I'll bet the lad's ears were itching that day - I sure had a lot of nasty things to say about him. Fortunately, only Gomer, the compost pile, heard me.



Applying thermophilically composted humanure to a raised bed garden in the springtime.

What about things like sanitary napkins and disposable diapers? Forget it. Sure, they'll compost, but they'll leave strips of plastic throughout your finished compost which is quite unsightly. Of course, that's OK if you don't mind picking the strips of plastic out of your compost. Otherwise, use cloth diapers and washable cloth menstrual pads instead.

Furthermore, it has been reported that food preserved with BHT should stay out of the compost pile, as research has shown that very small amounts of this antioxidant can alter plant growth profoundly.¹³

NEWSPAPER

What about newspapers? Yes, newspaper will compost, but there are some



The author probing a humanure compost pile in late winter. This compost had not yet become thermophilically active. Of the two thermometers, one has a long probe and the other a short one. PHOTO BY JEANINE JENKINS.

concerns about newsprint. For one, the glossy pages are covered with a clay that retards composting. For another, the inks can be petroleum-based solvents or oils with pigments containing toxic substances such as chromium, lead and cadmium in both black and colored inks. Pigment for newspaper ink still comes from benzene, toluene, naphthalene and other benzene ring hydrocarbons which may be quite harmful to human health if accumulated in the food chain. Fortunately, quite a few newspapers today are using soy-based inks instead of petroleum-based inks.** If you really want to know about the type of ink in your newspaper, call your newspaper office and ask them. Otherwise, don't use glossy paper or colored pages in your compost and keep the newspaper to a minimum. Remember, ideally, compost is being made to use for producing human food. One should try to keep the contaminants out of it if possible.¹⁴

On the other hand, Wood's End Laboratory in Maine did some research on composting ground up telephone books and newsprint, which had been used as bedding for dairy cattle. The ink in the paper contained common carcinogenic chemicals,

added made better use of lime than plots without composted sludge. The lime in the composted plots changed the pH deeper in the soil, indicating that organic matter assists calcium movement through the soil *“better than anything else”* according to Cecil Tester, Ph.D., research chemist at USDA’s Microbial Systems Lab in Beltsville, MD.¹⁶ The implications are that compost should be added to the soil when lime is added *to the soil*.

Sir Albert Howard, one of the most well-known proponents of composting, as well as J. I. Rodale, another organic gardening great, have recommended adding lime to compost piles.¹⁷ They seemed to base their reasoning on the belief that the compost will become acidic during the composting process, and therefore the acidity must be neutralized by adding lime to the pile while it’s composting. It may well be the case that compost becomes acidic during the process of decomposition, however, my experience shows me that it seems to neutralize itself if left alone, yielding a neutral end product. Therefore, I’d recommend that you make sure you need to neutralize the pH of your compost before you jump to the conclusion that you do. You can do that by testing your *finished* compost for pH.

I find it ironic that the same author who has recommended liming compost piles in one book (Rodale, as mentioned above), states in another, *“The control of pH in composting is seldom a problem requiring attention if the material is kept aerobic . . . the addition of alkaline material is rarely necessary in aerobic decomposition and, in fact, may do more harm than good because the loss of nitrogen by the evolution of ammonia as a gas will be greater at the higher pH.”*¹⁸ In other words, don’t assume that you should lime your pile. Only do so if your finished compost is consistently acidic. Get a soil pH test kit and check it out.

What is pH? It’s a measure of acidity and alkalinity. pH ranges from 1 - 14. Neutral is 7. Below seven is acidic, above seven is basic (alkaline). If the pH is too acidic or too alkaline bacterial activity will be hindered or stopped completely. Lime and wood ashes raise the pH. This is where things could get complicated, taking us into the domain of the chemist rather than the composter.

How does one become an accomplished composter, a master composter? That’s easy - just do it. Then keep doing it. Throw the books away (not this one, of course) and get some good, old-fashioned experience. There’s no better way to learn. Book learning will only get you so far, but not far enough. There’s nothing worse than someone who’s read a lot of books and thinks s/he knows everything. A book such as the one you’re now reading is for inspiring you, for sparking your interest, and for reference. But you have to get out there and do it if you really want to learn.

One’s best bet is to work with the compost, get the feel of the process, look at your compost, smell the finished product, buy or borrow a compost thermometer and

get an idea of how well your compost is heating up, then use your compost for food production. Rely on your compost. Make it a part of your life. Need it and value it. In no time, without the need for charts or graphs, Ph.D.s, or worry, your compost will be as good as the best of them. Perhaps someday we'll be like the Chinese who give prizes for the best compost in a county, then have inter-county competitions. Now *that's* getting your shit together.

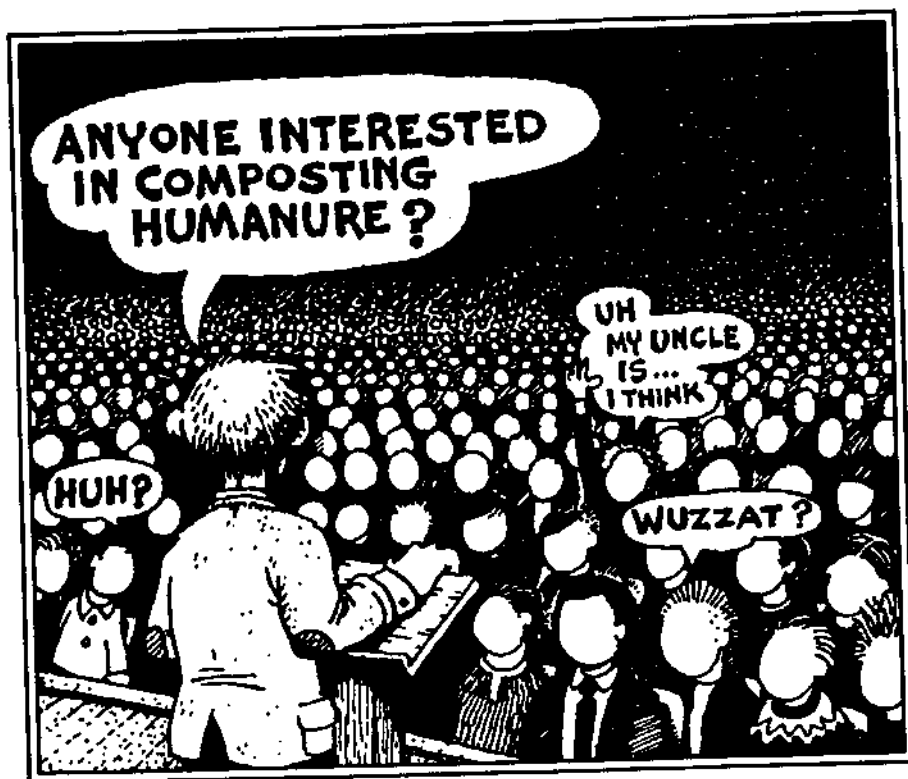

REFERENCES - CHAPTER TWO

- 1 - Bem, R., (1978). Everyone's Guide to Home Composting. Van Nostrand Reinhold Co., NY (p.4).
 - 2 - Sides, S. (1991). Compost. *Mother Earth News*. Issue 127, Aug/Sept 1991 (pp.49-53).
 - 3 - Logan, W.B. (1991). Rot is Hot. *New York Times Magazine*. 9/8/91, Vol. 140, Issue 4871. (p.46).
 - 4 - Sides, S. (1991). Compost. *Mother Earth News*. Issue 127, Aug/Sept 1991 (p.50).
 - 5 - Logan, W.B., (1991). Rot is Hot. (see #3).
 - 6 - Lubke, Sigfried. (1989). Interview: All Things Considered in the Wake of the Chernobyl Nuclear Accident. *Acres U.S.A.* December 1989. (p. 20) [also contact Uta and Sigfried Lubke, A4722 Peuerbach, Untererleinsbach 1, Austria]
 - 7 - Howard, Sir Albert, (1943). An Agricultural Testament. Oxford University Press: New York.
 - 8 - Bhamidimarri, R. (1988). Alternative Waste Treatment Systems. Elsevier Applied Science Publishers LTD., Crown House, Linton Road, Barking, Essex, IG11 8JU, England. (p.129).
 - 9 - Howard, Sir Albert, (1943). An Agricultural Testament. (p.48).
 - 10 - Stoner, C.H. (Ed.). (1977). Goodbye to the Flush Toilet. Rodale Press: Emmaus, PA, 1977. (p.46).
 - 11 - Rodale, J.I. et. al. (Eds.). (1960). The Complete Book of Composting. Rodale Books Inc.: Emmaus, Pa (pp.646-647).
 - 12 - See Stoner, Goodbye to the Flush Toilet (as above).
 - 13 - Sides, S. (as above) (p.51).
 - 14 - *Garbage: the Practical Journal for the Environment*. May/June 1992, p.66, Old House Journal Corp., 2 Main St., Gloucester, MA 01930.
 - 15 - Logan, W.B. (as above).
 - 16 - Poncavage, J. and Jesiolowski, J. (1991). Mix Up a Compost and a Lime. *Organic Gardening*. March 1991, Vol. 38, Issue 3. (p.18).
 - 17 - Howard, Sir Albert (1943). An Agricultural Testament. Oxford University Press: New York. (p.44).
- Also see:
- Rodale, J.I. (1946). Pay Dirt. The Devon-Adair Co.: New York.
- 18 - Rodale, J.I. et. al. (Eds.) (1960). The Complete Book of Composting. Rodale Books Inc.: Emmaus, PA (p.658).

*Adelle Davis was a popular nutritionist in the 1960's and 70's who advocated that people take dietary supplements to replace the lack of nutrition in the typical refined-food American diet. Much of what she wrote about in her list of books was on target. However, she also contended that a healthy person's shit won't stink. Dead wrong on that one, Adelle.

** Contact the National Soy Ink Information Center, c/o Iowa Soybean Association, 1025 Ashworth Road, No. 310, West Des Moines, Iowa 50265-3542.

DEEP SHIT

"I do not think that any civilization can be called complete until it has progressed from sophistication to unsophistication, and made a conscious return to simplicity of thinking and living."

Lin Yutang



The Asian people have recycled humanure for thousands of years. Why haven't we? This is a philosophical question which should be delved into. Now let's think about this for a second. The Asian cultures, namely Chinese, Korean, Japanese and others have evolved to understand human excrement to be a natural resource. Smelly perhaps, but not to be wasted, nor to be conceived of as a waste material. We have human waste, they have humanure (also known as night soil). We produce waste and pollution, they produce soil nutrients and food. It's clear to me that the Asians are more advanced than the Western world in this regard. And they should be, they've been working on developing sustainable lifestyles, especially sustainable agriculture for four thousand years on the same land. For four thousand years those people have worked the same land with little or no chemical fertilizers and, in many cases, have produced greater crop yields than Western farmers, the same farmers who are quickly destroying the soils of their own countries through depletion and erosion.

Here is a fact largely being ignored by people in Western agriculture: *agricultural land must produce a greater output over time because the human population is constantly increasing, but available agricultural land is not. Therefore, our farming practices should leave us with land more fertile with each passing year.* Nevertheless, we are doing just the opposite.

Back in 1938, the U.S. Department of Agriculture came to the alarming conclusion that *a full 61% of the total area under crops in the U.S. at that time had been completely or partly destroyed, or had lost most of its fertility.*¹ Nothing to worry about? We have artificial fertilizers, tractors, and oil to keep it all going? True, U.S. agriculture is heavily dependent upon fossil fuel resources. However, in 1993 we were importing about half our oil from foreign sources, and it's estimated that the U.S. will be out of domestic oil reserves by the year 2020. Some sources also report that the U.S. will be unable to export food beyond the year 2000.² If this is true, then

a heavy dependence on foreign oil for our food production seems unwise at best, and probably just plain foolish, especially when we're producing soil nutrients every day in the form of organic refuse, then throwing those nutrients "away" by burying them in landfills.

Now, it seems to me that if we want to learn something about sustainability, we would look to those people who are doing it. The Chinese have it figured out: *waste not, want not*. But there's a lot more to it than that.

Why don't we follow the Asian example? It's not for a lack of information. Dr. F. H. King wrote an interesting book, published in 1910 and titled Farmers of Forty Centuries³. Dr. King (D.Sc.) was a former chief of the Division of Soil Management of the U.S. Department of Agriculture who traveled through Japan, Korea and China in the early 1900's as an agricultural visitor. He was interested in finding out how people could farm the same fields for 4,000 years without destroying their fertility. He states:

"One of the most remarkable agricultural practices adopted by any civilized people is the centuries long and well nigh universal conservation and utilization of all human waste [sic] in China, Korea and Japan, turning it to marvelous account in the maintenance of soil fertility and in the production of food. To understand this evolution it must be recognized that mineral fertilizers so extensively employed in modern Western agriculture has been a physical impossibility to all people alike until within very recent years. With this fact must be associated the very long unbroken life of these nations and the vast numbers their farmers have been compelled to feed.

When we reflect upon the depleted fertility of our own older farm lands, comparatively few of which have seen a century's service, and upon the enormous quantity of mineral fertilizers which are being applied annually to them in order to secure paying yields, it becomes evident that the time is here when profound consideration should be given to the practices the Mongolian race has maintained through many centuries, which permit it to be said of China that one-sixth of an acre of good land is ample for the maintenance of one person, and which are feeding an average of three people per acre of farm land in the three southernmost islands of Japan.

*[Western humanity] is the most extravagant accelerator of waste the world has ever endured. His withering blight has fallen upon every living thing within his reach, himself not excepted; and his besom of destruction in the uncontrolled hands of a generation has swept into the sea soil fertility which only centuries of life could accumulate, and yet this fertility is the substratum of all that is living."*⁴

According to King's research, the average daily excreta of the adult human weighs in at 40 ounces. Multiplied by 250 million, a rough estimate of the current U.S. population, Americans each year produce 1,448,575,000 pounds of nitrogen,

456,250,000 pounds of potassium, and 193,900,000 pounds of phosphorous, almost all of which is discarded into the environment as a waste material and a pollutant, or as Dr. King puts it, "*poured into the seas, lakes or rivers and into the underground waters.*"

According to King, "*The International Concession of the city of Shanghai, in 1908, sold to a Chinese contractor the privilege of entering residences and public places early in the morning of each day and removing the night soil, receiving therefor more than \$31,000 gold, for 78,000 tons of waste [sic]. All of this we not only throw away but expend much larger sums in doing so.*"

In case you didn't catch that, the contractor *paid* \$31,000 gold for the humanure, referred to as "night soil" and incorrectly as "waste" by Dr. King.

Furthermore, using Dr. King's figures, the U.S. population today produces approximately 228,125,000,000 pounds of fecal material annually. That's 228 billion pounds. You could call that the *Gross National Shit*.

Admittedly, the spreading of raw human excrement on fields, as is done in Asia, will probably never become culturally acceptable in the United States, and rightly so. The use of night soil in this regard produces an assault to the sense of smell, and provides a vector for various human pathogens (disease organisms). Americans who have traveled abroad and witnessed the use of raw human excrement in agricultural applications have largely been repulsed by the experience. That repulsion has instilled among many Americans an intransigent bias against, and even a fear of the use of humanure for soil enrichment. However, few Americans have witnessed the *composting* of humanure as a preliminary step in its recycling. Proper thermophilic composting converts humanure into a pleasant smelling material devoid of human pathogens.

Although the agricultural use of raw human excrement will never become a common practice in the U.S., the use of composted human refuse, including humanure, food refuse, and other organic municipal refuse such as leaves, can and should become a widespread and culturally encouraged practice in the United States. The act of composting humanure instead of using it raw will set Americans apart from Asians in regard to the recycling of human excrements, *for we too will have to constructively deal with all of our refuse materials eventually*. We can put it off, but not forever. As it stands now, at least the Asians are recycling their refuse. We're not.

WASTE VS. MANURE, AGAIN

Human *waste* is human excrement *that is not recycled*. A waste material is

something *with no inherent value*. Waste is something we believe to be useless and we discard it. People who recycle things are not wasting them. People who compost their manure do not produce human waste in the form of body excrements.

Sorry, I know it's a hard concept to grasp, that human waste is *something we create by choice*. In the English language today, human waste is synonymous with human feces and urine. Eventually, this will change. We don't necessarily create human waste naturally. We produce human manure naturally. What we do with it constitutes whether it's waste or not. Now this may seem like a trivial matter to some. You've always known fecal material to be human waste, therefore you'll always call it human waste.

On the other hand, you may be capable of advancing your understanding. As understanding and consciousness change, so does language change. In the same way that the word "man" is no longer appropriate when referring to the human race because we've finally figured out that half of the human race is made up of women, human "waste" is no longer appropriate when referring to humanure, unless that manure is being wasted (which, in the USA, it usually is). There's no reason why we can't clarify our terms, evolve our language a bit, and thereby enhance communication and understanding.

What is human waste? Human waste is cigarette butts, empty beer cans lying along the road, plastic six-pack rings, styrofoam clamshell burger boxes, deodorant cans, disposable diapers, discarded appliances, discarded pop bottles, newspapers, old car tires, spent batteries, junk mail, nuclear garbage, convenience foods, exhaust emissions, the five billion gallons of drinking water we flush down our toilets every day, and the millions of tons of organic refuse discarded into the environment year after year after year.

My household produces one bag of waste, i.e. non-recyclable junk, every two months. Six garbage bags a year that end up in a landfill. I believe that's excessive. It's waste and my family produces it. Let's face it - six bags a year in fifty years means we've "thrown" 300 bags out into the environment. If those all stayed in my own backyard I'd eventually be living by a small mountain of garbage. Our consumption of electricity, use of internal combustion engines, and consumption of consumer goods also add to the waste my family contributes to our ecosystem. Unfortunately, in the United States we take waste for granted. It's a way of life, one promoted by our government and our business leaders and one far removed from the harmonious existence with our planet that a sustainable future requires of us. "Waste reduction - resource recovery" will not be meaningful words to Americans unless they're spoken, written, published, and most importantly, lived.

THE ADVANCES OF SCIENCE

How is it that the Asian peoples developed an excellent understanding of human nutrient recycling which pervades their collective consciousness and is completely accepted and taken for granted, and we haven't? After all, we're the advanced, developed, scientific nation, aren't we? Dr. King makes an interesting observation concerning scientists. He states:

*"It was not until 1888, and then after a prolonged war of more than thirty years, generated by the best scientists of all Europe, that it was finally conceded as demonstrated that leguminous plants acting as hosts for lower organisms living on their roots are largely responsible for the maintenance of soil nitrogen, drawing it directly from the air to which it is returned through the processes of decay. But centuries of practice had taught the Far East farmers that the culture and use of these crops are essential to enduring fertility, and so in each of the three countries the growing of legumes in rotation with other crops very extensively, for the express purpose of fertilizing the soil, is one of their old fixed practices."*⁵ [Emphasis mine.]

In our culture we believe we have to wait for the experts to figure things out before we can claim any real knowledge. This appears to have put us several centuries behind the Asians. It certainly seems odd to me that people who gain their knowledge in real life through practice and experience are shunned, ignored or trivialized by the academic world and associated government agencies. Such agencies will only credit learning that has taken place within their institutional framework. As such, it's no wonder that Western humanity's crawl toward a sustainable existence on the planet Earth is so pitifully slow.

"Strange as it may seem, says King, there are not today and apparently never have been, even in the largest and oldest cities of Japan, China or Korea, anything corresponding to the hydraulic systems of sewage disposal used now by Western nations. When I asked my interpreter if it was not the custom of the city during the winter months to discharge its night soil into the sea, as a quicker and cheaper mode of disposal [than recycling], his reply came quick and sharp, 'No, that would be waste. We throw nothing away. It is worth too much money.'"⁶ The Chinaman, says King, wastes nothing while the sacred duty of agriculture is uppermost in his mind."⁷

Perhaps, a few centuries from now, our scientific community will understand.

HOLY SHEESH

Here I must propose some philosophical speculation. My theory is this: the

Asians evolved over the millennia with a spiritual perspective that maintained, to some extent, a view of the earth, and of nature, as sacred. This was a relatively holistic spiritual perspective which did not single out the human race as being the pinnacle of creation, but instead recognized the totality of interconnected existence as sacred, and advocated human harmony with the Whole.

Now contrast this to our Western religious heritage which taught us that divinity lies only in the human form, and that peoples who revere nature are “pagans”, “heathens”, “witches” and worse. Admittedly, this is a broad and contentious topic, too broad for the scope of this book. Perhaps a few quotes here, however, will help to illustrate my point.

Hinduism, more common to India, but reaching into the Far East, seemed to be sensitive to the sanctity of the natural world:

“He who tries to give an idea of God by mere book learning is like the person who tries to give an idea of the city of Benares by means of a map or a picture.” (Shri Ramakrishna)⁸

“When Svetaketu, at his father’s bidding, had brought a ripe fruit from the banyan tree, his father said to him, Split the fruit in two, dear son.

Here you are. I have split it in two.

What do you find there?

Innumerable tiny seeds.

Then take one of the seeds and split it.

I have split the seed.

And what do you find there?

Why, nothing, nothing at all.

Ah, dear son, but this great tree cannot possibly come from nothing. Even if you cannot see with your eyes that subtle something in the seed which produces this mighty form, it is present nonetheless. That is the power, that is the spirit unseen, which pervades everywhere and is all things. Have faith! That is the spirit which lies at the root of all existence, and that also art thou, O Svetaketu.” (Chandogya Upanishad)⁹

Buddhism is a dominant influence in vast sections of Asia:

“May all living things be happy and at their ease! May they be joyous and live in safety! All beings, whether weak or strong - omitting none - in high, middle, or low realms of existence, small or great, visible or invisible, near or far away, born or

to be born - may all beings be happy and at their ease! Let none deceive another, or despise any being in any state; let none by anger or ill will wish harm to another! Even as a mother watches over and protects her only child, so with a boundless mind should one cherish all living beings, radiating friendliness over the entire world, above, below and all around without limit; so let him cultivate a boundless good will toward the entire world, uncramped, free from ill will or enmity.” (the Metta Sutra)¹⁰

Zen is a transliteration of the Sanskrit word “dyhana” meaning meditation, or more fully “contemplation leading to a higher state of consciousness”, “union with Reality”. It can be described as a blend of Indian mysticism and Chinese naturalism with a Japanese influence:

“When the mind rests serene in the oneness of things . . . dualism vanishes by itself.” (from the Hsis-hsis-ming by Seng-ts’an)¹¹

“Zen does not go along with the Judaic-Christian belief in a personal savior or a God - outside the Universe - who has created the cosmos and the human race. To the Zen view, the Universe is one indissoluble substance, one total whole, of which humanity is a part.” (Nancy Wilson Ross)¹²

Confucius, like Buddha, was born in the sixth century B.C. and preached a philosophy of common Chinese virtue:

“The path of duty lies in what is near and people seek for it in what is remote. The work of duty lies in what is easy and people seek for it in what is difficult.” (Confucius)¹³

The Tao (the way), written by Lao Tsu, a contemporary of Confucius, has provided one of the major underlying influences in Chinese thought and culture for 2,500 years:

“Those who know do not talk. Those who talk do not know. Keep your mouth closed. Guard your senses. Temper your sharpness. Simplify your problems. Mask your brightness. Be at one with the dust of the earth. This is primal union. He who has achieved this state is unconcerned with friends and enemies, with good and harm, with honor and disgrace. This therefore is the highest state of humanity.” (Lao Tsu)¹⁴

Christianity, the primary religious influence of the Western world, strongly supported the idea that humans were separate from and dominant over the natural world:

“And God said, Let us make man in our image, after our likeness, and let them have dominion over the fish of the sea, and over the fowl of the air, and over the cattle, and over all the earth, and over every creeping thing that creepeth on the earth. . . And God blessed them, and God said unto them, Be fruitful and multiply, and replenish the earth, and subdue it: and have dominion over the fish of the sea, and over the fowl of the air, and over every living thing that moveth upon the earth.” (the Bible)¹⁵

Far Eastern culture is imbued with the concepts of oneness, with the belief that the highest state of human evolution is one of harmony and peace with one's inner self and with one's outer reality, i.e. the natural world, one's society, the Universe. This would certainly seem to contribute to the development of sustainable agricultural methods. When one accepts the sacredness of life, one can easily understand why one should create compost and soil rather than waste and pollution.

WHEN THE CRAP HIT THE FAN

While the Asians were practicing sustainable agriculture and recycling their organic resources and doing so over a period of millennia, what were the people of the West doing? What were the Europeans and those of European descent doing? Why weren't our ancestors returning their manures to the soil too? After all, it does make sense. The Asians who recycled their manures not only recovered a resource and reduced pollution, but by returning their excrement to the soil they succeeded in reducing threats to their health. There was no putrid sewage collecting and breeding disease germs. Instead the humanure was, for the most part, undergoing a natural, non-chemical purification process in the soil which required no technology.

Granted, a lot of “night soil” in the Far East today is not completely composted or composted at all, and is the source of health problems in Asia. However, even the returning of humanure raw to the land succeeds in destroying many human pathogens in the manure, and returns nutrients to the soil. We'll get more into this later. Let's take a look at what was happening in Europe from, say, the 1300's on, regarding public hygiene.

Great pestilences swept Europe throughout recorded history. The Black Death killed more than half the population of England in the fourteenth century. In 1552,

67,000 patients died of the Plague in Paris alone. Fleas from infected rats were the carriers of this disease. Did the rats dine on human waste? Other pestilences included the sweating sickness (attributed to uncleanness), cholera (spread by food and water contaminated by the excrement of infected persons), "jail fever" (caused by a lack of sanitation in prisons), typhoid fever (spread by water contaminated with infected feces), and numerous others.

Andrew D. White, cofounder of Cornell University, writes, "*Nearly twenty centuries since the rise of Christianity, and down to a period within living memory, at the appearance of any pestilence the [Christian] Church authorities, instead of devising sanitary measures, have very generally preached the necessity of immediate atonement for offenses against the Almighty. In the principal towns of Europe, as well as in the country at large, down to a recent period, the most ordinary sanitary precautions were neglected, and pestilences continued to be attributed to the wrath of God or the malice of Satan.*"¹⁶

It's now known that the main cause of such immense sacrifice of life was a lack of proper hygienic practices. It's argued that certain theological reasoning at that time resisted the evolution of proper hygiene. According to Mr. White, "*For century after century the idea prevailed that filthiness was akin to holiness.*" Living in filth was regarded by holy men as an evidence of sanctity, according to Mr. White, who lists numerous saints who never bathed parts or all of their bodies, such as St. Abraham, who washed neither his hands nor his feet for fifty years, or St. Sylvia, who never washed any part of her body save her fingers.¹⁷

Interestingly, after the Black Death left its grim wake across Europe, "*an immensely increased proportion of the landed and personal property of every European country was in the hands of the church.*"¹⁸ Apparently, the church was reaping some benefit from the deaths of huge numbers of people. Perhaps the church had a vested interest in maintaining public ignorance about the sources of disease. This insinuation is almost too diabolical for serious consideration. Or is it?

Somehow, the idea developed around the 1400's that Jews and witches were causing the pestilences. Jews were suspected because they didn't succumb to the pestilences as readily as the Christian population did, presumably because they employed a unique sanitation system more conducive to cleanliness, including the eating of kosher foods. Not understanding this, the Christian population arrived at the conclusion that the Jew's immunity resulted from protection by Satan. As a result, attempts were made in all parts of Europe to stop the plagues by torturing and murdering the Jews. Twelve thousand Jews were reportedly burned to death in Bavaria alone during the time of the plague, and additionally thousands more were likewise killed throughout Europe.¹⁹

In 1484, the “infallible” Pope Innocent VIII issued a proclamation supporting the church’s opinion that witches were causes of disease, storms, and a variety of ills affecting humanity. The feeling of the church was summed up in one sentence: “*Thou shalt not suffer a witch to live.*” From the middle of the sixteenth to the middle of the seventeenth centuries, women and men were sent to torture and death by the thousands, by both Protestant and Catholic authorities. It’s estimated that the number of victims sacrificed during that century in Germany alone was over a hundred thousand.

The following case in Milan, Italy summarizes the ideas of sanitation in Europe during the seventeenth century:

The city was under the control of Spain, and had received notice from the Spanish government that witches were suspected of being on the way to Milan to “anoint the walls” (smear the walls with disease-causing ointments). The church rang the alarm from the pulpit, putting the population on the alert. One morning, in 1630, an old woman looking out of her window saw a man who was walking along the street wipe his fingers on a wall. He was promptly reported to the authorities to whom he claimed he was simply wiping ink from his fingers which had rubbed off the ink-horn he carried with him. Not satisfied with this explanation, the authorities threw the man into prison and tortured him until he “confessed”. The torture continued until the man gave the names of his “accomplices”, who were subsequently rounded up and tortured. They in turn named their “accomplices” and the process continued until members of the foremost families were included in the charges. Finally, a large number of innocent people were sentenced to their deaths, which is all reportedly a matter of record.²⁰

One loathsome disease of the 15-1700’s was the jail fever. The prisons of that period were filthy; people were confined in dungeons connected to sewers with little ventilation or drainage. Prisoners incubated the disease and spread it to the public, especially the police, lawyers and judges. In 1750, for example, the disease killed two judges, the lord mayor, various aldermen and many others in London, not to mention prisoners.²¹

The pestilences at that time in the Protestant colonies in *America* were also attributed to divine wrath or satanic malice, but when the pestilences afflicted the Native Americans, they were considered acts of divine mercy. “*The pestilence among the Indians, before the arrival of the Plymouth Colony, was attributed in a notable work of that period to the Divine purpose of clearing New England for the heralds of the gospel.*”²²

Well, let’s not get too far off the track. But perhaps the reason the Asian countries have such large populations in comparison to Western countries is because they

escaped some of the pestilences common to Europe, especially pestilences spread by the failure to responsibly recycle human excrement. They presumably plowed their manure back into the land because their spiritual perspectives supported such behavior. Westerners were too busy burning witches and Jews with the church's wholehearted assistance to bother to think about recycling humanure.

Our ancestors did eventually come to understand that poor hygiene was a causal factor in epidemic diseases. Nevertheless, it was not until the late 1800's in England that improper sanitation and sewage were suspected as causes of epidemics. At that time, large numbers of people were still dying from pestilences, especially cholera, which killed at least 130,000 people in England in 1848-9 alone. In 1849, an English medical practitioner published the theory that cholera was spread by water contaminated with sewage. Ironically, even where sewage was being piped away from the population, the sewers were still leaking into drinking water supplies.

The English government couldn't be bothered with the fact that hundreds of thousands of (mostly poor) citizens were perishing like flies year after year. So it rejected a Public Health Bill in 1847. A Public Health Bill finally became an act in 1848 in the face of the latest outbreak, but wasn't terribly effective. However, it did bring poor sanitation to the attention of the public, as the following statement from the General Board of Health (1849) implies: *"Householders of all classes should be warned that their first means of safety lies in the removal of dung heaps and solid and liquid filth of every description from beneath or about their houses and premises."* This may make one wonder if a compost heap would have been considered a "dung heap" in those days, and therefore banned.

The wealthy folks, including the Tories or "conservatives" of the English government still thought that spending on social services was a waste of money and an unacceptable infringement by the government on the private sector (sound familiar?). A leading newspaper, "The Times", maintained that the risk of cholera was preferable to being bullied by the government. However, a major act was finally passed in 1866, the Public Health Act, with only grudging support from the Tories. Once again, cholera was raging through the population, and it's probably for that reason that any act was passed at all. Finally, by the end of the 1860's, a framework of public health policy was established in England. Thankfully, that cholera epidemic of 1866 was the last and the least disastrous.²³

The powers of the church eventually diminished enough for scientists to have their much delayed say about the origins of disease. Today, the church no longer remains such an insurmountable obstacle to the progress of society, and in many cases acts as a force of hope for peace, justice, and even environmental awareness in the Western world. Our modern sanitation systems have yielded a life safe for most

of us, although not without shortcomings. The eventual solution developed by the West was to collect humanure in water and discard it, perhaps chemically treated and dehydrated, in the seas, on the surface of the land, and in landfills, somewhere away from population centers.

Finally, I'm not naive enough to suggest that the Asian societies are perfect by any stretch of the imagination. Asian history is rife with the problems that have plagued humanity since the first person hatched out of the first egg. You know what I mean: wars, oppressive rule by the rich, more war, famine, natural catastrophes, oppressive rule by heathens, more war, and now overpopulation. There is also ample evidence of diseases and parasites afflicting the Asian peoples even to this day. However, the causes of the health problems that are linked to human excrement most likely stem from the failure to responsibly compost it. Not all Asian families strive to attain impeccably clean surroundings, and they pay for their lax habits with poor health. That is a universal problem.

I'll leave you with a quote from Dr. Arthur Stanley, health officer of the city of Shanghai, China, in his annual report for 1899, when the population of China amounted to about 500 million people, roughly double that of the U.S. today, and no artificial fertilizers were being employed for agricultural purposes - only organic, natural materials such as agricultural residues and humanure were being used:

“Regarding the bearing on the sanitation of Shanghai of the relationship between Eastern and Western hygiene, it may be said, that if prolonged national life is indicative of sound sanitation, the Chinese are a race worthy of study by all who concern themselves with public health. It is evident that in China the birth rate must very considerably exceed the death rate, and have done so in an average way during the three or four thousand years that the Chinese nation has existed. Chinese hygiene, when compared to medieval English, appears to advantage.”²⁴

Sounds like an understatement to me.

REFERENCES - CHAPTER THREE

- 1 - Rodale, J. I., (1946). Paydirt. Devon-Adair Co.: NY, (p.vi).
- 2 - *Beyond Oil: The Threat to Food and Fuel in the Coming Decades, A summary Report*. November 1986. Carrying Capacity Inc., 1325 G. Street, NW, Suite 1003, Wash. D.C. 10005.
- 3 - King, F.H., (1911). Farmers of Forty Centuries. Rodale Press: Emmaus, PA 18049.
- 4 - Ibid. (p.193, 196-7).
- 5 - Ibid. (p.10).
- 6 - Ibid. (p.19).
- 7 - Ibid. (p.199).
- 8 - Wilson, N.W., (1966). Three Ways of Asian Wisdom. Simon and Shuster: New York. (p.11).
- 9 - Ibid. (p.11-12).
- 10 - Ibid. (p.77-78).
- 11 - Ibid. (p.137).
- 12 - Ibid. (p.145).
- 13 - Ibid. (p.140).
- 14 - Lao Tsu. Tao Te Ching. Vintage Books Edition, 1972. Vintage Books (Random House): New York. (#57).
- 15 - Holy Bible. King James Version. The World Publishing Co.: New York. (p.9).
- 16 - White, A.D. (1955). The Warfare of Science with Theology. George Braziller: New York. (pp.68,70).
- 17 - Ibid. (p.69).
- 18 - Ibid. (p.71).
- 19 - Ibid. (p.73).
- 20 - Ibid. (pp.76-77).
- 21 - Ibid. (p.84).
- 22 - Ibid. (p.85).
- 23 - Seaman, L.C.B. (1973). Victorian England. Methuan & Co.: London. (pp. 48-56).
- 24 - Farmers of Forty Centuries. (p.198).

**ATTENTION EARTHLINGS, I AM GIRDLOK...
FROM THE PLANET TURDNOK IN THE
CONSTELLATION ALPHA ROMEO. WE HAVE
DISCOVERED AN ANCIENT
MANUSCRIPT IN ONE OF OUR
ARCHEOLOGICAL RUINS, AMAZINGLY
IT IS WRITTEN IN EARTHLING
ENGLISH AND IT IS ABOUT YOUR
ODOROUS EXCRETIONS.
IT IS CALLED THE HUMANURE
HANDBOOK AND IT IS THE
KEY TO THE SPIRITUAL
SALVATION OF YOUR PITIFULLY
INSIGNIFICANT SPECIES.
AS AN ACT OF INTERGALACTIC
GOOD WILL WE HAVE CHOSEN
TO PUBLISH AND DISTRIBUTE
THIS BOOK ON EARTH.
WE ASK FOR NOTHING
IN RETURN ETC... ETC...
DRIBBLE... DRIBBLE...**



The Humanure Handbook - Chapter Four
A DAY IN THE LIFE OF A TURD

"Civilization is a limitless multiplication of unnecessary necessities."

Mark Twain

"Most of the luxuries, and many of the so-called comforts of life, are not only not indispensable, but positive hindrances to the elevation of [humanity]."

Henry David Thoreau



I remember when I was a kid and veterans would talk about their stints in the Korean war. Usually after a beer or two they'd turn their conversation to the "outhouses" used by the Koreans. They were amazed, even mystified about the fact that the Koreans tried to lure passers-by to use their outhouses by making the toilets especially attractive. The idea of someone wanting someone else's shit always brought out a good guffaw from the vets. Only a groveling, impoverished, backward gink would stoop so low as to beg for a turd. Haw, Haw.

Perhaps this attitude sums up the consciousness of Americans. Humanure is a waste product, plain and simple. We have to get rid of it and that's all there is to it. Only fools and scoundrels would think otherwise. One of the effects of this sort of consciousness is that Americans don't know and probably don't care where their organic refuse goes after it emerges from their backsides, so long as they don't have to deal with it.

MEXICAN BIOLOGICAL DIGESTER

Well, where it goes depends on the type of "waste disposal system" used. Let's start with the simplest: the Mexican biological digester, also known as the stray dog. In India this may be known as the stray pig (see figure 4.1). I spent a few months in southern Mexico in the late 70's in Quintana Roo on the Yucatan peninsula. There, toilets were not available and people simply used the sand dunes on the coast. No problem though, one of the small, unkempt, and ubiquitous Mexican dogs

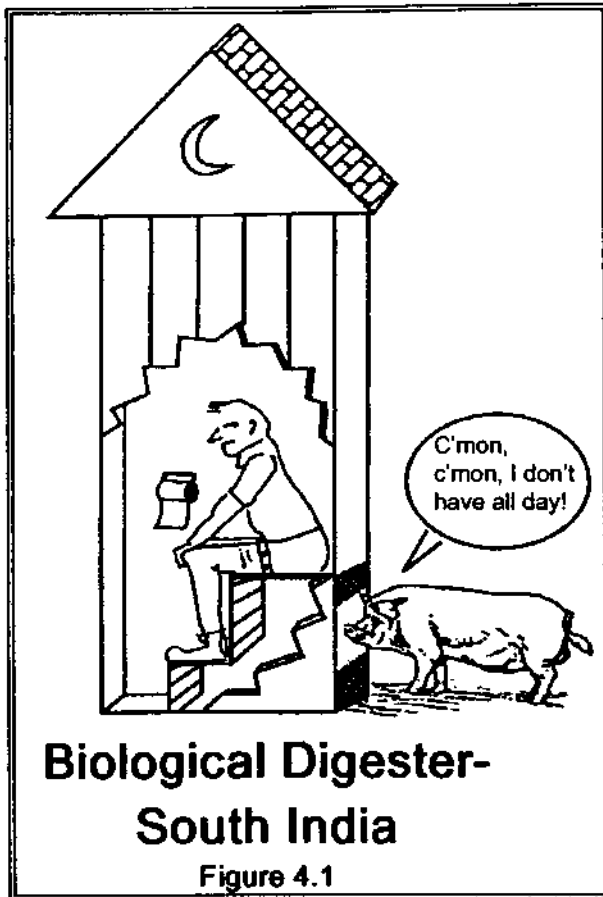

would wait nearby with watering mouth until you've done your thing. Burying your excrement in that situation would have been an act of disrespect to the dog. No one wants sand in their food. A good, healthy, steaming turd at the crack of dawn on the Caribbean coast never lasted more than 60 seconds before it became a hot meal for a human's best friend. Yum.

THE OLD-FASHIONED OUTHOUSE

Next up the ladder of sophistication is the old-fashioned outhouse, which is also known as the pit latrine. Simply stated, one digs a hole and defecates in it, and then does so again and again until the hole fills up. It's nice to have a small building (privy) over the hole to provide some privacy and to keep the elements off. However, the concept is simple: dig a hole

and bury your excrement. Interestingly, this level of sophistication has not yet been surpassed in America. We still bury our excrement, in the form of sewage sludge, in landfill holes. But I'm getting ahead of myself again.

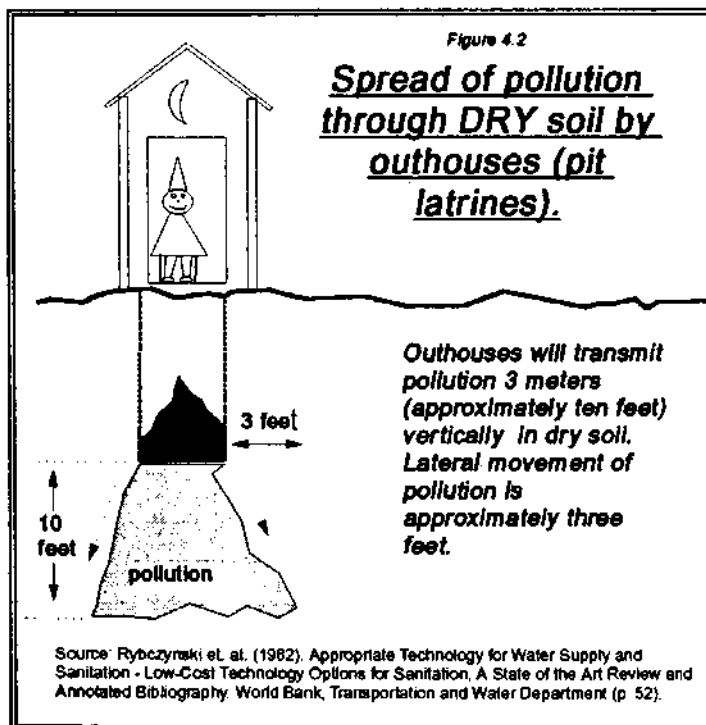

The first farmhouse I lived in during the mid-seventies had an outhouse behind it and no plumbing whatsoever. What I remember most about the outhouse is the smell, which could be described as quite undesirable, to say the least. The flies and wasps weren't very inviting either, and of course the cold weather made the process of "going to the bathroom" uncomfortable. When the hole filled up, I simply dug another hole twenty feet away from the first and dragged the outhouse from one hole to the other. The dirt from the second hole was used to cover the first. The excrement was left in

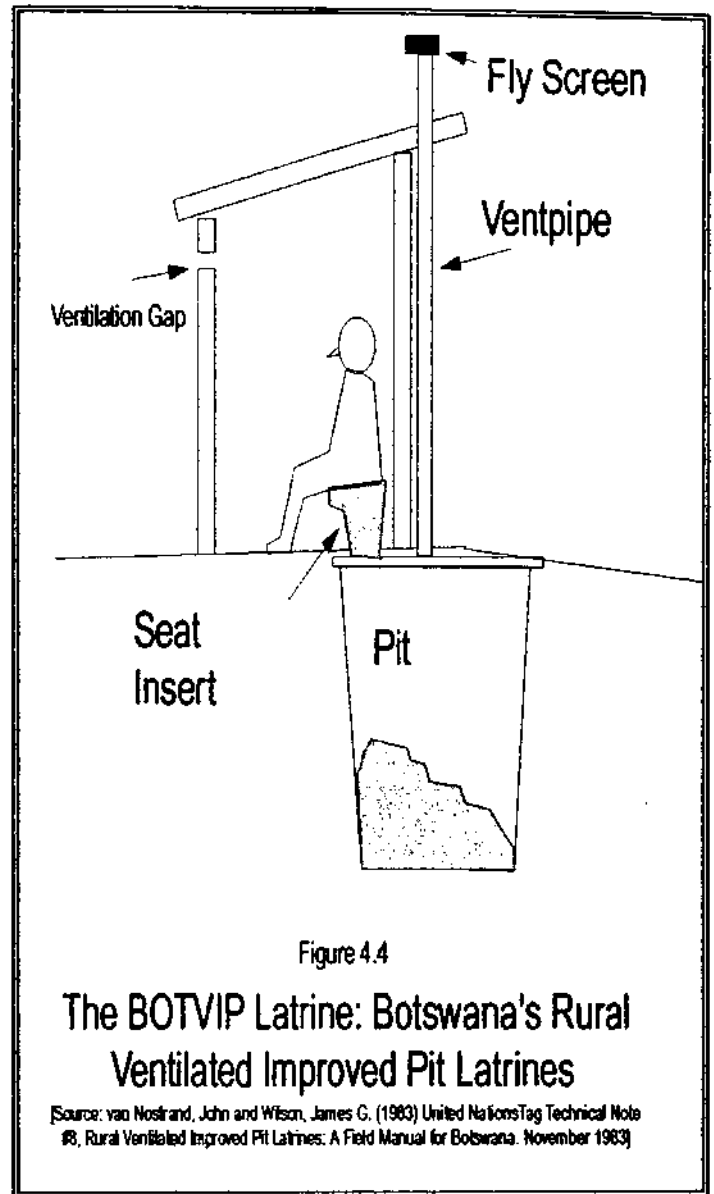
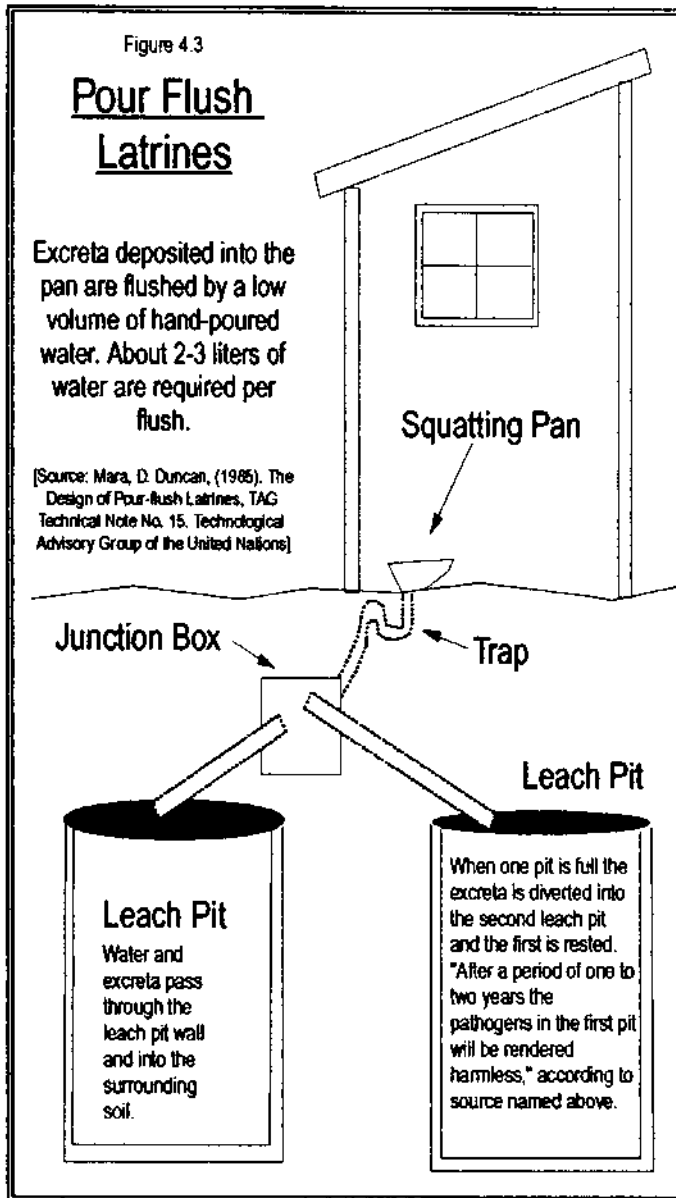

the ground, probably to contaminate groundwater. Of course, I didn't know I might be contaminating anything because, as I've stated earlier, I had just graduated from college and was quite ignorant about practical matters. Therefore, I plead not guilty to environmental pollution on the grounds of a college education.

Outhouses create very real health, environmental and aesthetic problems. The hole in the ground is accessible to flies and mosquitoes which can transmit disease over a wide area. The pits leak pollutants into the ground even in dry soil. And the smell. *Hold your nose.*

SEPTIC SYSTEMS

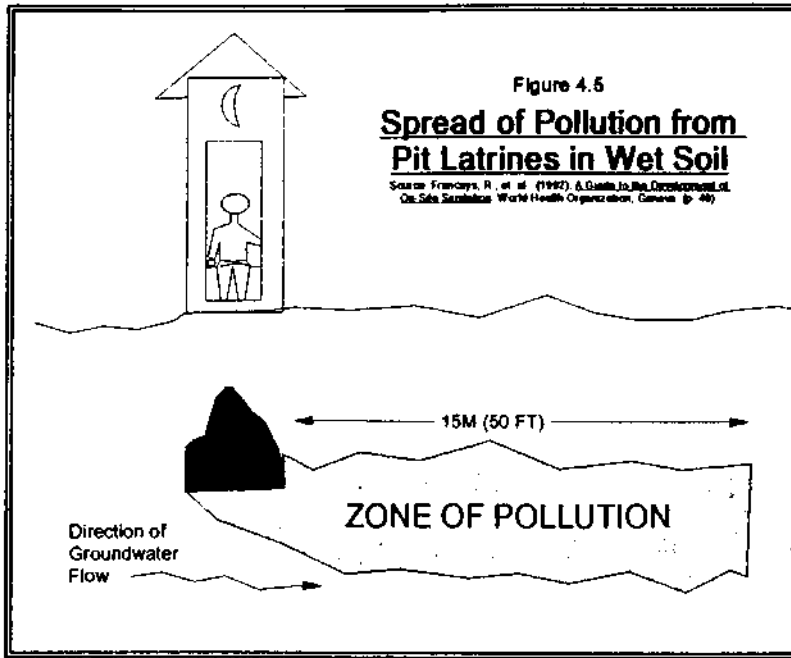

Another step up on the sophistication ladder one finds the septic tank, which is a common method of human waste disposal in rural and suburban areas of the United States. In this technique of organic waste disposal, the turd is deposited into a container of water, usually pure drinking water such as in a toilet, and the water is piped away.

After the turd, now carried by the water, travels away from the house inside a sewage pipe, it

plops into a fairly large underground storage tank, or septic tank, which is usually made of concrete and sometimes of fiberglass. In Pennsylvania (USA), a 900 gallon tank is the minimum size allowed for a home with three or fewer bedrooms.¹ The heavier solids settle to the bottom of the tank and the liquids continue on to drain off into a leach field, which consists of an array of drain pipes situated below the ground surface allowing the liquid to seep out into the soil (see figures 4.6 and 4.7). While in the tank, the wastewater should be undergoing anaerobic decomposition. If septic

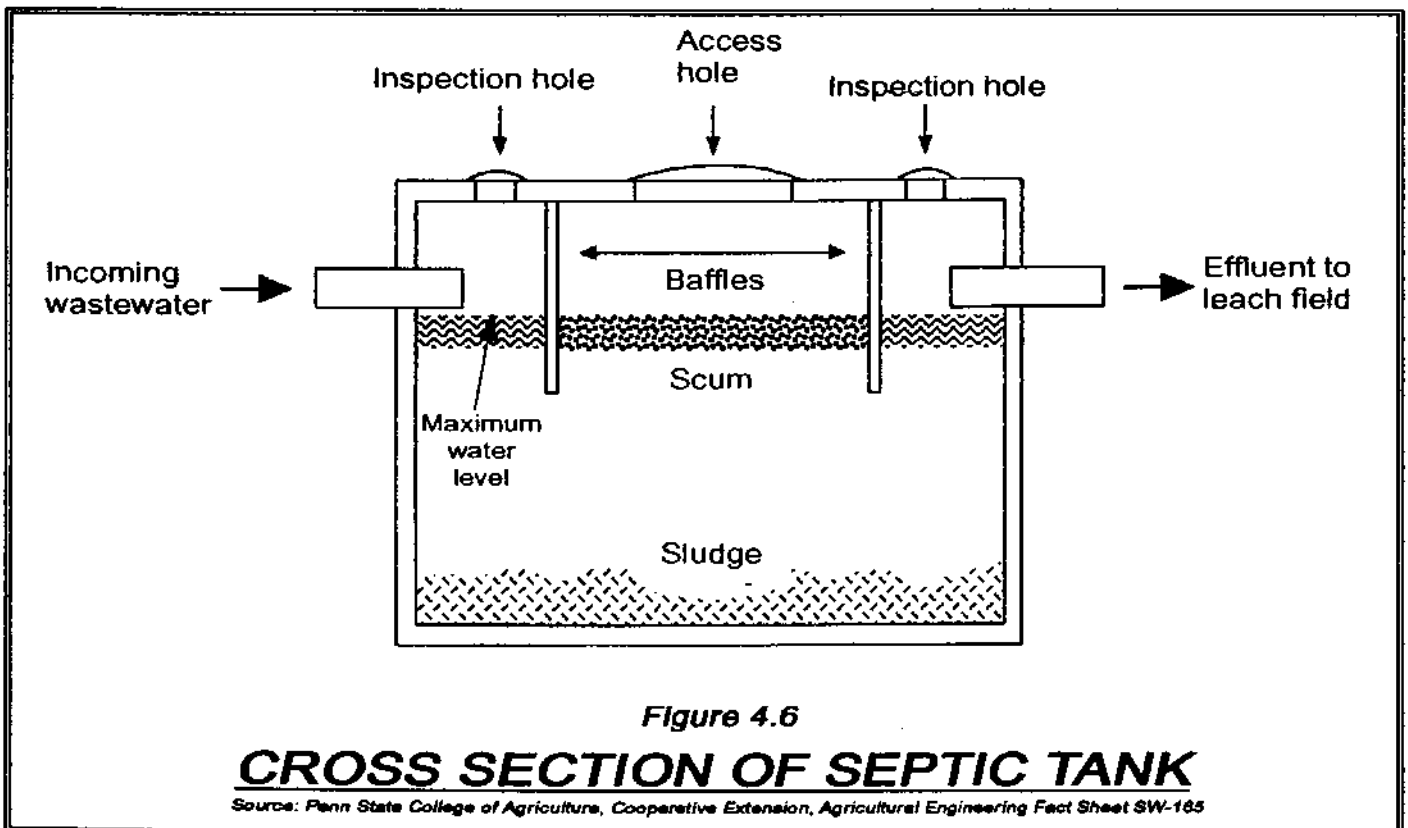

tanks fill up, they are pumped out and the waste material is supposed to be trucked to a sewage treatment plant.

SAND MOUNDS

Some soils drain poorly because they may have a high clay content or may be low-lying or otherwise water impermeable. In the event of poorly drained soil, a standard leach field will not work very well, especially when the ground is saturated with rain water or snow melt. One can't drain wastewater into soil that is already saturated with water. That's when the *sand mound* sewage disposal system is useful. In this method of waste disposal, when the septic tank isn't draining properly, a pump will kick in and pump the effluent into a pile of sand and gravel above ground (although sometimes a pump isn't necessary and gravity does the job). In the pile of sand is a perforated pipeline which allows the effluent to drain down through the mound. Sand mounds are usually covered with soil and grass. In Pennsylvania, sand mounds must be at least one hundred feet downslope from a well or spring, fifty feet from a stream, and five feet from a property line.²

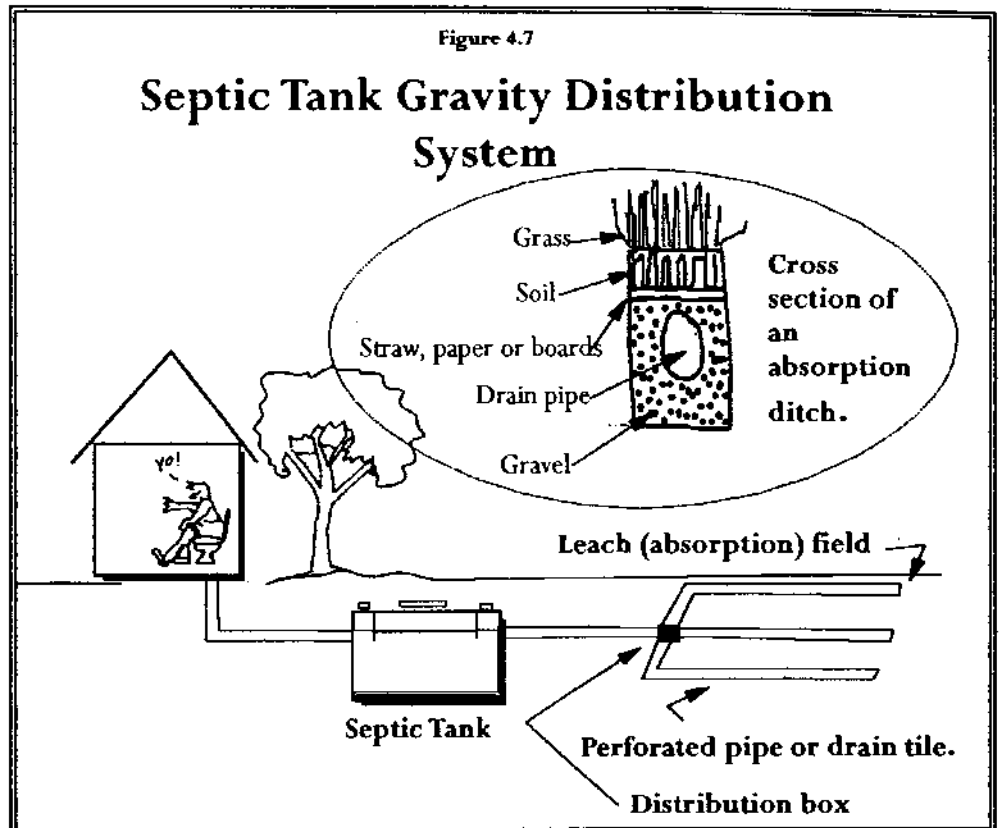

According to local excavating contractors, sand mounds cost \$5,000 to \$12,000 to construct (1993). They must be built to exact government specifications, and aren't usable until they pass an official inspection (see figure 4.8).

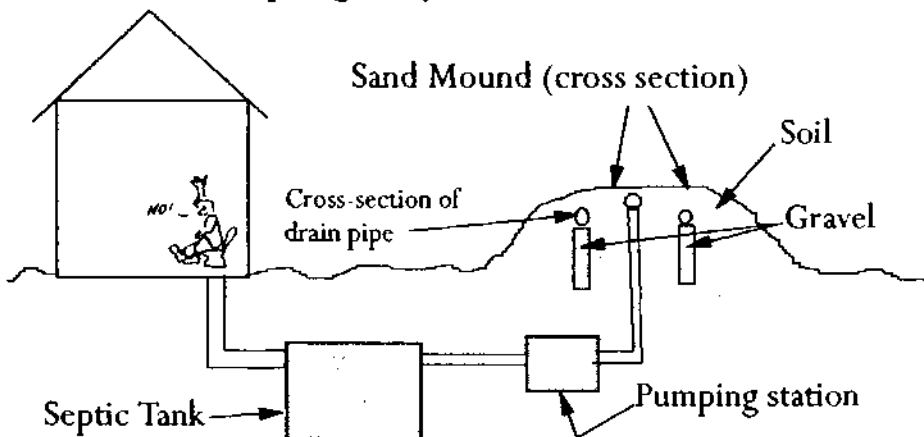

Figure 4.8

Sand Mound (or Trench Mound) Waste Distribution System

GROUND WATER POLLUTION FROM SEPTIC SYSTEMS

We civilized humans started out by defecating into a hole in the ground (outhouse), then discovered we could float our turds out to the hole using water and never have to leave the house. However, one of the unfortunate problems with septic systems is, like outhouses, they pollute our groundwater.



**IF you have a
Septic Tank System...**

There are currently 22 million septic system sites in the United States issuing contaminants such as bacteria, viruses, nitrates, phosphates, chlorides, and organic compounds such as trichloroethylene into the environment. An EPA study of chemicals in septic tanks found toluene, methylene chloride, benzene, chloroform, and other volatile synthetic organic compounds related to home chemical use.³ Between 820 and 1,460 billion gallons of this contaminated water are discharged per year to our shallowest aquifers.⁴ According to the EPA, states reported septic tanks as a source of ground water contamination more than any other source, with 46 states citing septic systems as sources

of groundwater pollution, and nine of these reporting them to be the primary source of groundwater contamination in their state⁵ (see figures 4.9 and 4.10).

The word "septic" comes from the Greek "septikos" which means "to make putrid". Today it still means "causing putrefaction", putrefaction being "the decomposition of organic matter resulting in the formation of foul-smelling products" (see

Figure 4.9

Sources of Ground-Water Contamination in the United States

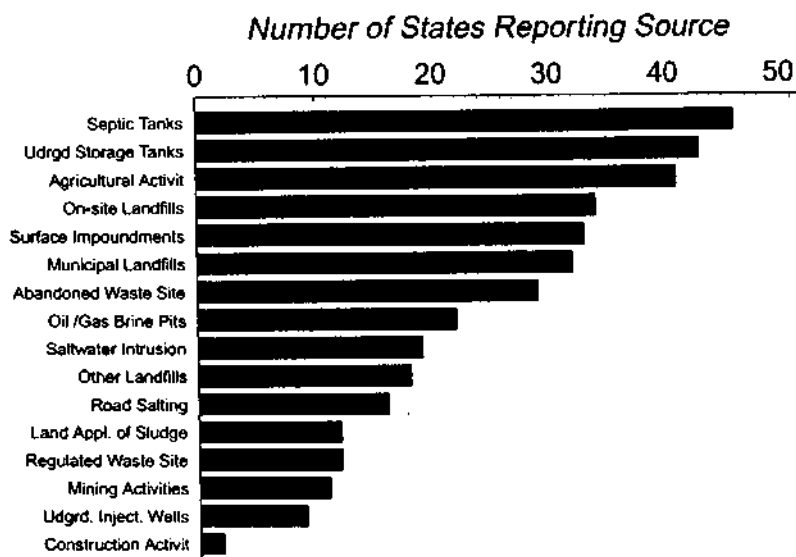

Source: U.S. Environmental Protection Agency, National Water Quality Inventory 1986 Report to Congress, EPA-440/4-87-008

Webster). Septic systems are not designed to destroy human pathogens that may be in the human waste that enters the septic tank. Septic systems are instead designed to collect human wastewater, settle out the solids and anaerobically digest them to some extent, and then leach the effluent into the ground. Therefore, septic systems can be highly pathogenic, allowing the transmission of disease-causing bacteria, viruses, protozoa and intestinal parasites through the system.

One of the main problems associated with septic systems is the problem of human population density. Too many septic systems in any given area will overload the soil's natural purification systems and allow large amounts of wastewater to contaminate the underlying watertable. A density of more than forty household septic systems per square mile will cause an area to become a likely target for subsurface contamination, according to the EPA.⁶

Toxic synthetic organic chemicals are commonly released into the environment from septic systems because people dump toxic chemicals down their drains. The chemicals are found in pesticides, paint and coating products, toilet cleaners, drain cleaners, disinfectants, laundry solvents, many other cleaning solutions, antifreeze, rust proofers, even septic tank and cesspool cleaners. In fact, over 400,000 gallons of septic tank cleaner liquids containing synthetic organic chemicals were used in one year by just the residents of Long Island alone. Furthermore, some synthetic organic chemicals can corrode pipes thereby causing even more heavy metals to enter septic systems.⁷

In many cases, people who have septic tanks are forced to connect to sewage lines when the lines are made available to them. A U.S. Supreme Court case in 1992 reviewed a situation whereby town members in New Hampshire had been forced to connect to a sewage line that simply discharged untreated, raw sewage into the Connecticut River for 57 years. Despite the crude

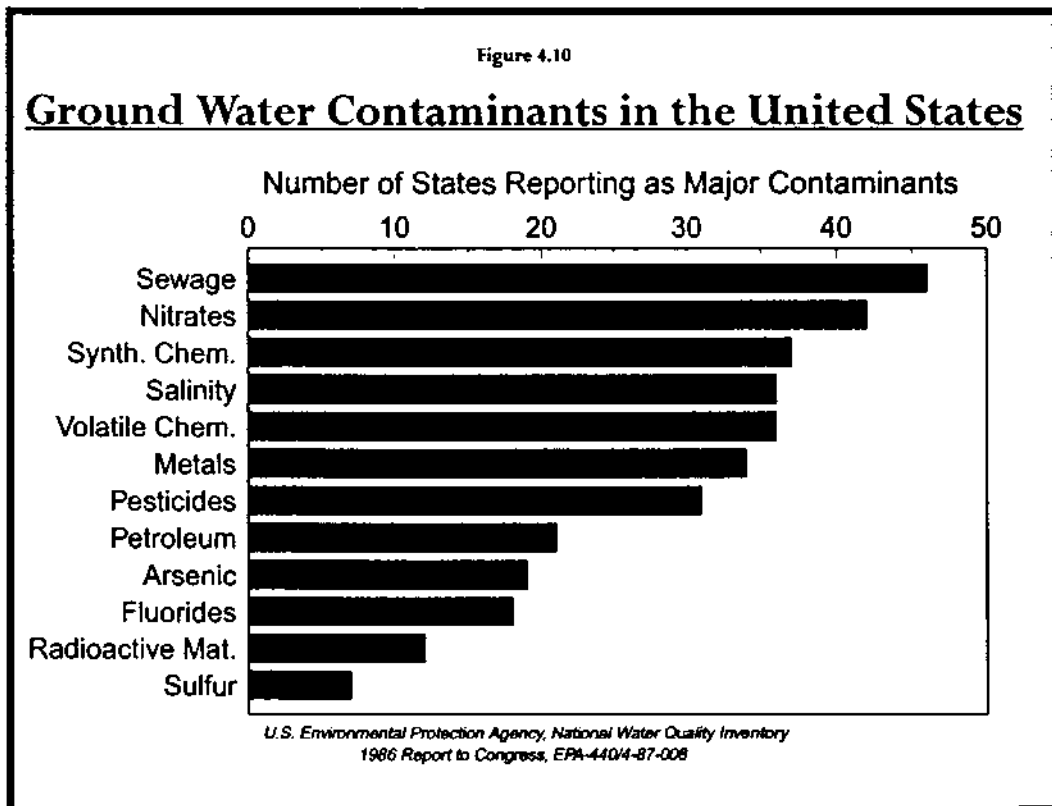

method of sewage disposal, state law required properties within 100 feet of the town sewer system to connect to the system when it was built in 1932. This sewage disposal system apparently continued to operate in this barbaric manner until 1989, when state and federal sewage treatment laws forced a stop to the dumping of raw sewage into the river.⁸

WASTEWATER TREATMENT PLANTS

There's still another step up the ladder of wastewater treatment sophistication: the wastewater treatment plant, or sewage plant. The wastewater treatment plant is like a huge, very sophisticated septic tank, because it collects the water-borne excrement of large numbers of humans. Inevitably, when one defecates or urinates into water, one pollutes the water. Therefore, that "wastewater" must somehow be rendered fit to return to the environment in order to avoid environmental pollution. The liquid entering the wastewater treatment plant is 99% water because all sink water, bath water and everything else that goes down one's drain ends up at the plant too, which is why it's called a *water* treatment plant. In some cases, storm water runoff also enters wastewater treatment plants via *combined sewers*. Also, a lot of contaminants can and do enter this wastewater stream from industries, hospitals, gas stations, and any place with a drain.

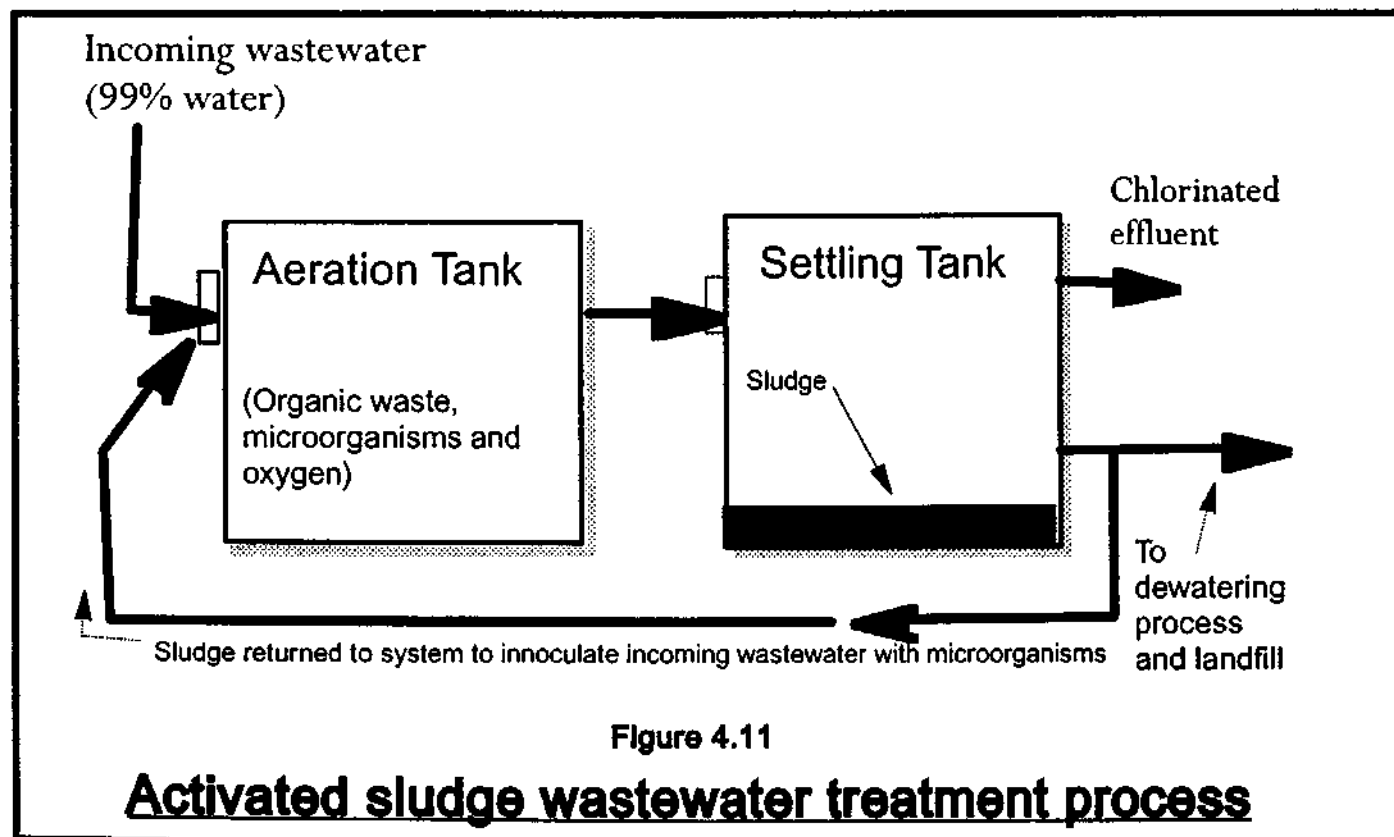

Many modern wastewater plants use a process of activated sludge treatment whereby oxygen is vigorously bubbled through the wastewater in order to activate microbial digestion of the solids. This aeration stage is combined with a settling stage that allows the solids to be removed. The removed solids (sludge) are either used to reinoculate the incoming wastewater, or they're dewatered to the consistency of a dry mud and buried in landfills (see figure 4.11). Sometimes the sludge is applied to agricultural land. The microbes that digest the sludge consist of bacteria, fungi, protozoa, rotifers, and nematodes.⁹ The water left behind is treated (usually with chlorine) and discharged into a stream, river, or other body of water. Sewage treatment water releases to surface water in the United States in 1985 amounted to nearly *31 billion gallons per day*.¹⁰

U.S. sewage treatment plants generated about 7.6 million dry tons of sludge in 1989.¹¹ New York City alone produces 143,810 dry tons of sludge every year.¹² In 1993, the amount of sewage sludge produced annually in the U.S. was 110-150 million wet metric tons. Incidentally, the amount of toilet paper used (1991) to send all this waste to the sewers was 2.3 million tons.¹³

CHLORINE

Wastewater leaving wastewater treatment plants is often treated with chlorine before being released into the environment. For this reason, the act of defecating into water often ultimately contributes to the contamination of water resources with *chlorine* in addition to feces.

Chlorine, used since the early 1900's, is one of the most widely produced industrial chemicals with about 10 million metric tons manufactured in the U.S. each year - \$72 billion worth.¹⁴ Approximately 5% of the chlorine manufactured is used for wastewater treatment and drinking water "purification", amounting to about 1.2 billion pounds annually. The lethal liquid or green gas is mixed with the wastewater from sewage treatment plants, in order to kill disease causing microorganisms, before the water is discharged into streams, lakes, rivers and seas. It is also added to household drinking water via household and municipal water treatment systems.

Chlorine (CL₂) doesn't exist in nature. It's a potent poison which reacts with water to produce a strongly oxidizing solution that can damage the moist tissue lining of the human respiratory tract. Ten to twenty parts per million (ppm) of chlorine gas in air rapidly irritates the respiratory tract, and even brief exposure at levels of 1,000 ppm (one part in a thousand) can be fatal.¹⁵ Chlorine also kills fish, and reports of fish kills caused chlorine to come under the scrutiny of scientists in the 1970's.

The fact that harmful compounds are formed as *by-products* of chlorine use also raises concern. In 1976, the U.S. Environmental Protection Agency (EPA) reported that chlorine use not only poisoned fish, but could also cause the formation of cancer-causing compounds such as chloroform. Some known effects of chlorine-based pollutants on animal life include memory problems, stunted growth and cancer in people; reproductive problems in minks and otters; reproductive problems, hatching problems and death in lake trout; and embryo abnormalities and death in snapping turtles.¹⁶

In a national study of 6,400 municipal wastewater treatment plants, the EPA estimated that two thirds of them used too much chlorine, which exerts lethal effects at all levels of the food chain. Chlorine damages the gills of fish, inhibiting their ability to absorb oxygen. It also can cause behavioral changes in fish, thereby affecting migration and reproduction. Chlorine in streams can create chemical “dams” which prevent the free movement of some migratory fish. Fortunately, since 1984, there has been a 98% reduction in the use of chlorine by sewage treatment plants, although chlorine use continues to be a widespread problem because a lot of wastewater plants are still discharging it into small receiving waters.¹⁷

Another controversy associated with chlorine use involves “dioxin”, which is a common term for a large number of chlorinated chemicals that are classified as possible human carcinogens by the EPA. It’s known that dioxins cause cancer in laboratory animals, but their effects on humans are still being debated. Dioxins, byproducts of the chemical manufacturing industry, are present in the total environment, and are concentrated through the food chain where they’re deposited in human fat tissues. A key ingredient in the formation of dioxin is chlorine, and indications are that an increase in the use of chlorine results in an increase in the dioxin content of the environment, even in areas where the only dioxin source is the atmosphere.¹⁸ Dioxins are unintended byproducts of chlorine use.

In the upper atmosphere, chlorine molecules gobble up ozone, in the lower atmosphere they bond with carbon to form organochlorines. Some of the 11,000 commercially used organochlorines include hazardous compounds such as DDT, PCBs and carbon tetrachloride. Organochlorines rarely occur in nature, and living things have little defense against them. They’ve been linked not only to cancer, but also to neurological damage, immune suppression, and reproductive and developmental effects. When chlorine products are washed down the drain to a septic tank, they’re producing organochlorines.

“Any use of chlorine results in compounds that cause a wide range of ailments,” says Joe Thorton, a Greenpeace researcher, who adds, *“Chlorine is simply not compatible with life. Once you create it you can’t control it.”*¹⁹

There’s no doubt that our nation’s sewage treatment systems are polluting our

drinking water sources with pathogens (see chapter 6). As a result, chlorine is also being used to disinfect *the water we drink* as well as to disinfect discharges from wastewater treatment facilities.



According to a 1992 study, *chlorine is added to 75% of the nation's drinking water* and is linked to cancer. The results of the study suggested that at least 4,200 cases of bladder cancer and 6,500 cases of rectal cancer each year in the U.S. are associated with consumption of chlorinated drinking water.²⁰

In December, 1992, the U.S. Public Health Service reported that pregnant women who routinely drink or bathe in chlorinated tap water are at a greater risk of bearing premature or small babies, or babies with congenital defects.²¹

According to a spokesperson for the chlorine industry, 87% of water systems in the U.S. use free chlorines, and 11% use chloramines. Chloramines are a combination of chlorine and ammonia. The chloramine treatment is becoming more widespread due to the health concerns over chlorine.²² However, EPA scientists admit that we're pretty ignorant about the potential byproducts of the chloramine process, which involves ozonation of the water prior to the addition of chloramine.²³

Of course, we don't have to worry. The government will take care of us, and if the government doesn't, then industry will. Won't they? Well, not exactly. According to a U.S. General Accounting Office report in 1992, consumers are poorly informed about potentially serious violations of drinking water standards. In a review of twenty water systems in six states, out of 157 drinking water quality violations, the public received a timely notice in only 17 of the cases.²⁴

ALTERNATIVE WASTEWATER TREATMENT SYSTEMS

New systems are being developed to purify wastewater. One popular experimental system today is the *constructed, or artificial wetlands system*, which runs wastewater through an aquatic environment consisting of aquatic plants such as water hyacinths, bullrushes, duckweed, lilies, and cattails (see figure 4.12). The plants act

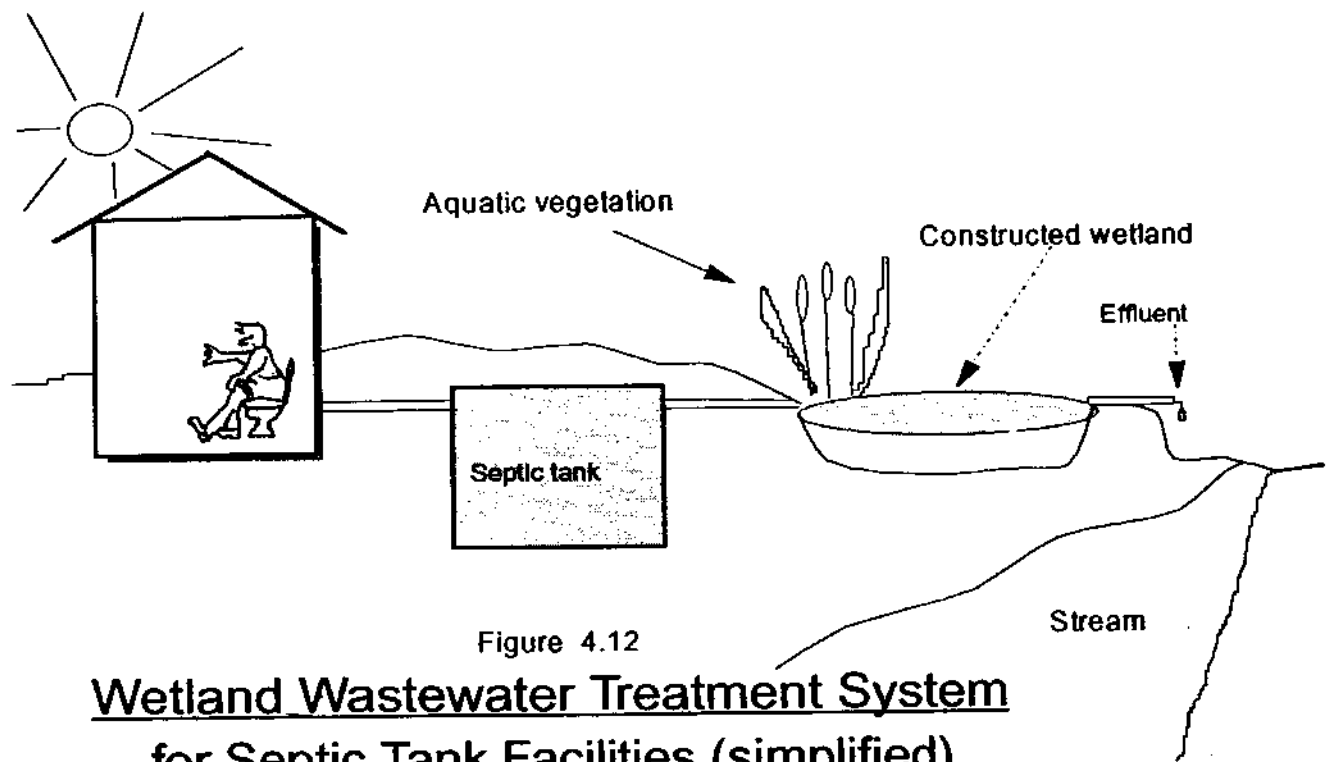

Figure 4.12

Wetland Wastewater Treatment System for Septic Tank Facilities (simplified)

as marsh filters, and the microbes which thrive on their roots do most of the work. They break down nitrogen and phosphorous compounds as well as toxic chemicals. Although they don't break down heavy metals, the plants absorb them, and they can then be harvested and incinerated or landfilled.²⁵

According to EPA officials, the emergence of constructed wetlands technology shows great potential as a cost effective alternative to wastewater treatment. The wetlands method is said to be relatively affordable, energy efficient, practical and effective. However, scientists don't yet have the data to determine with assurance the performance expectations of wetlands systems, or contaminant concentrations released by these systems into the environment. However, the treatment efficiency of properly constructed wetlands is said to compare well with conventional treatment systems.²⁶ Unfortunately, wetlands systems don't recover the agricultural resources available in humanure.

Another system uses solar powered greenhouse-like technology to treat wastewater. This system uses hundreds of species of bacteria, fungi, protozoa, snails, plants and fish, among other things, to produce advanced levels of wastewater treatment. These solar aquatics systems are also experimental, but appear hopeful.²⁷ Again, the agricultural resources of humanure are lost when using this or any disposal method or wastewater treatment technique instead of a humanure recycling method.

AGRICULTURAL USE OF SEWAGE SLUDGE

Now here's where a thoughtful person may ask, "Why not put *sewage sludge* back into the soil for agricultural purposes?"

One reason: government regulation. When I asked the supervisor of my local wastewater treatment plant if the one million gallons of sludge the plant produces each year (for a population of 8,000) was being applied to agricultural land, he said, "*It takes six months and five thousand dollars to get a permit for a land application. Another problem is that due to regulations, the sludge can't lie on the surface after it's applied so it has to be plowed under shortly after application. When farmers get the right conditions to plow their fields, they plow them. They can't wait around for us, and we can't have sludge ready to go at plowing time.*" It may be just as well.

Sewage sludge is a lot more than organic human refuse. It can contain DDT, PCBs, mercury, other heavy metals, and the like.²⁸ One scientist alleges that more than 20 million gallons of used motor oil are dumped into sewers every year in the United States.²⁹ America's largest industrial facilities released over 550 million pounds of toxic pollutants into U.S. sewers in 1989 alone, according to the U.S. Public Interest Research Group. In 1987, 614 million pounds of toxic pollutants were released into sewers, and in 1988, another 570 million pounds were released, although the actual levels of toxic discharges are said to be much higher than these.³⁰ Of the top ten states responsible for toxic discharges to public sewers in 1991, Michigan took the cake with nearly 80 million pounds, followed in order by New Jersey, Illinois, California, Texas, Virginia, Ohio, Tennessee, Wisconsin and Pennsylvania (around 20 million pounds from PA).³¹

An interesting study on the agricultural use of sludge was done by a Mr. Purves in Scotland. He began applying sewage sludge at the rate of 60 tons per acre to a plot of land in 1971. After fifteen years of treating the soil with the sludge, he tested the vegetation grown on the plot for heavy metals. On finding that the heavy metals (lead, copper, nickel, zinc and cadmium) had been taken up by the plants, he concluded, "*Contamination of soils with a wide range of potentially toxic metals following application of sewage sludge is therefore virtually irreversible.*"³² In other words, the heavy metals don't wash out of the soil, they enter the food chain.

Other studies have shown that heavy metals accumulate in the vegetable tissue of the plant to a much greater extent than in the fruits, roots or tubers. Therefore, if one must grow food crops on soil fertilized with sewage sludge contaminated with heavy metals, one might be wise to produce carrots or potatoes instead of lettuce.³³ Guinea pigs experimentally fed with swiss chard grown on soil fertilized with sewage sludge showed no observable toxicological effects, however their adrenals showed

elevated levels of antimony, their kidneys had elevated levels of cadmium, there was elevated manganese in the liver and elevated tin in several other tissues.³⁴

Furthermore, *“the fact that sewage sludge contains a large population of fecal coliforms renders it suspect as a potential vector of bacterial pathogens and a possible contaminant of soil, water and air, not to mention crops. Numerous investigations in different parts of the world have confirmed the presence of intestinal pathogenic bacteria and animal parasites in sewage, sludge, and fecal materials.”*³⁵ (See chapter 6)

Another interesting study was published in 1989 indicating that the bacteria that survive in sewage sludge show a high level of resistance to antibiotics, especially penicillin, one of the most commonly used. The theory is this: because heavy metals are concentrated in sludge during the treatment process, the bacteria that survive in the sludge can obviously resist heavy metal poisoning. But these same bacteria also show an inexplicable resistance to antibiotics, suggesting that somehow the resistance of the two environmental factors are related in the bacterial strains that survive. The implication is that sewage sludge selectively breeds antibiotic-resistant bacteria, which may enter the food chain if the agricultural use of the sludge becomes widespread. The results of the study indicated that more knowledge of antibiotic-resistant bacteria in sewage sludge should be acquired before sludge is disposed of on land, as this method of disposal can be dispersing countless antibiotic resistant bacteria into the environment.³⁶

This poses somewhat of a problem. Collecting human excrement with wastewater and industrial pollutants seems to render the organic refuse incapable of being adequately sanitized. It becomes contaminated enough to be unfit for agricultural purposes. As a consequence, sewage sludge is not highly sought after as a soil additive. For example, the state of Texas sued the U.S. EPA in July of 1992 for failing to study environmental risks before approving the spreading of sewage sludge in west Texas. Sludge was being spread on 128,000 acres there by an Oklahoma firm, but the judge nevertheless refused to issue an injunction to stop the spreading.³⁷ Considering that the sludge was from New York City, who can blame the Texans?

Now that ocean dumping of sludge has been stopped, where's it going to go? Researchers at Cornell University have suggested that sewage sludge can be disposed of by surface applications in forests. Their studies suggest that brief and intermittent applications of sludge to forestlands won't adversely affect wildlife, despite the nitrates and heavy metals that are present in the sludge. They point out that the need to find ways to get rid of sludge is compounded by the fact that many landfills are expected to close over the next several years and ocean dumping is now banned. Some sources say that landfills in the U.S. are being closed permanently at the rate of

two per day.³⁸ In a report to congress by the EPA in 1989, 45% of the landfills then currently in operation were expected to be closed by 1991.³⁹

Under the Cornell model, one dry ton of sludge could be applied to an acre of forest each year.⁴⁰ New York state alone produces 370,000 tons of dry sludge per year, which would require 370,000 acres of forest each year for New York state sludge disposal. Then there are the other forty-nine states and the 7.6 million dry tons of sludge produced in the U.S.. Then there's figuring out how to get the sludge into the forests and how to spread it around. With all this in mind, a guy has to stop and wonder. The woods used to be the only place left to get away from it all.*

The problem of treating and dumping sludge isn't the only one. The costs of maintenance and upkeep of wastewater treatment plants is another. According to a report issued by the EPA in 1992, U.S. cities and towns need as much as \$110.6 billion over the next twenty years for enlarging, upgrading, and constructing wastewater treatment facilities.⁴¹

Ironically, when sludge is *composted*, it may help to keep heavy metals *out* of the food chain. According to a 1992 report, composted sludge lowered the uptake of lead in lettuce that had been deliberately planted in lead-contaminated soil. The lettuce grown in the contaminated soil to which composted sludge had been added had a 64% lower uptake of lead than lettuce planted in the same soil but without the compost. The composted soil also lowered lead uptake in spinach, beets and carrots by more than 50%.⁴² Three cheers for compost!

Some scientists claim that the composting process transforms heavy metals into benign materials. According to Joseph C. Horvath, a soil and compost scientist who designs facilities that compost sewage sludge, *"at the final product stage, these [heavy] metals actually become beneficial micro-nutrients and trace minerals that*

SEWER TROUBLE?

"Root Eliminator" KEEPS Sewers & Septic Tanks OPEN

Easy-to-use chemical prevents and frees stoppage of sewer by roots. Just drop one soluble briquette in your lavatory monthly.

A year's supply for only \$3.95

Show this ad to your local store, or mail your order direct to us. Sent promptly, postpaid.



BETTER LIVING THROUGH CHEMICALS

MONEY BACK GUARANTEE

Dripless toilets China's top priority

BEIJING, June 7 — With oceans of scarce water literally going down China's drains, Communist Party chief Jiang Zemin has made the dripless toilet a national priority. "If the country can send satellites and missiles into space, it should be able to dry up its latrines," today's China Daily quoted Jiang as saying. The Construction Ministry estimates leaky toilets sold by negligent manufacturers waste 200 million cubic meters of water a year. Vice Minister of Construction Ye Rutang launched a purge of leaky and sub-standard toilet hardware. Three hundred of China's 570 cities, including the capital, Beijing, face serious water shortages, China Daily said.

(From a Saudi Arabian newspaper, 1994)

add to the productivity of soil. This principal is now finding acceptance in the scientific community of the USA and is known as biological transmutation, or also known as the Kervran-Effect." Composted sewage sludge that is microbiologically active can also be used to detoxify areas contaminated with nuclear radiation or oil spills, according to Dr. Horvath. Clearly, the composting of sewage sludge is a grossly underutilized alternative to landfill application, and it should be strongly promoted.**

GLOBAL SEWERS AND PET TURDS

Let's assume that the whole world adopted the sewage philosophy we have in the United States: defecate into water and then treat the polluted water. What would that scenario be like? Well, for one thing it wouldn't work. It takes between 1,000 and 2,000 tons of water at various stages in the process to flush one ton of humanure. In a world of just five billion people producing a conservative estimate of one million metric tons of human excrement daily, the amount of water required to flush it all would not be obtainable.⁴³ When one adds to this equation the increasing landfill space that would be needed to dispose of the increasing amounts of sewage sludge, and the tons of toxic chemicals required to "sterilize" the wastewater, then one can

see that this system of human waste disposal is not sustainable and will not serve the needs of humanity in the long term.

As one person puts it, "Conventional 'Western' methods of waterborne sewerage are simply beyond the reach of most [of the world's] communities. They are far too expensive. And they often demand a level of water use that local water resources cannot supply. If Western standards were made the norm, some \$200 billion alone [early 1980's] would have to be invested in sewerage to achieve the target of basic sanitation for all. Resources on this scale are simply not in sight." (Barbara Ward, President of the International Institute for Environment and Development).

To quote Lattee Fahm, "In today's

TRICKLING ... NOISY? TOILET



GET THE GENUINE WATER MASTER

America's Largest Selling TOILET TANK BALL

Noisy running toilets can waste over 1000 gallons of water a day. Stop this annoying noise, waste and expense. The amazing patented Water-Master Tank Ball instantly stops the flow of water after each flushing, stops the flow everytime, not just some of the time.

75c at hardware stores EVERYWHERE
Higher in Canada

world [1980], some 4.5 billion people produce excretal matters at about 5.5 million metric tons every twenty-four hours, close to two billion metric tons per year. [Humanity] now occupies a time/growth dimension in which the world population doubles in thirty five years or less. In this new universe, there is only one viable and ecologically consistent solution to the body waste problems - the processing and application of [humanure] for its agronutrient content.”⁴⁴ In other words, we have to understand that humanure is a natural substance, produced by a process vital to life (human digestion), originating from the earth in the form of food, and valuable as an organic refuse material that can be returned to the earth in order to produce more food for humans. That’s where composting comes in.

But hey, wait, let’s not be rash. We forgot about incinerating our excrements. We can dry our turds out, then truck them to big incinerators and burn the hell out of them. That way, instead of having fecal pollution in our drinking water or forests, we can breathe it in our air. Unfortunately, burning sludge with other municipal waste produces *emissions* of: particulate matter, sulfur dioxide, nitrogen oxides, carbon monoxide, lead, volatile hydrocarbons, acid gasses, trace organic compounds and trace metals. The left-over *ash* has a high concentration of heavy metals, such as cadmium and lead.⁴⁵ Doesn’t sound so good if you live downwind, does it?

How about microwaving it? Don’t laugh, someone’s already invented the microwave toilet.⁴⁶ This just might be a good cure for hemorrhoids, too. But heck, let’s get serious and shoot it into outer space. Why not? It probably wouldn’t cost too much per fecal log after we’ve dried the stuff out. This could add a new meaning to the phrase “the Captain’s log”. Beam up another one, Scotty!

Better yet, we can dry our turds out, chlorinate them, get someone in Taiwan to make little plastic sunglasses for them, and we’ll sell them as pet turds! Now that’s a realistic entrepreneurial solution, isn’t it? Any volunteer investors out there?



REFERENCES - CHAPTER FOUR

- 1 - Mancini, K. *Septic Tank - Soil Absorption Systems*. Agricultural Engineering Fact Sheet SW-44. Penn State College of Agriculture Cooperative Extension, University Park, PA 16802.
- 2 - Mancini, K. *Mound Systems for Wastewater Treatment*. SW-43. Same as above.
- 3 - Stewart, J.G. (1990). Drinking Water Hazards: How to Know if There Are Toxic Chemicals in Your Water and What to Do If There Are. Envirographics: Hiram, Ohio. (pp.177-178).
- 4 - van der Leeden, F. et al. (1990). The Water Encyclopedia. Lewis Publishers Inc.: Chelsea, Michigan, 48118. (p.526).
- 5 - Ibid. (p.525).
- 6 - Stewart, John G. (as in #3 above, same pages).
- 7 - Ibid.
- 8 - *Environmental Reporter*. 2/28/92. The Bureau of National Affairs, Inc., Washington D.C., (pp. 2441-2).
- 9 - Gray, N.F. (1990). Activated Sludge Theory and Practice. Oxford University Press: New York. (p.125).
- 10 - van der Leeden, F. et al. (1990). The Water Encyclopedia Second Edition. Lewis Publishers, 121 South Main Street, Chelsea, Michigan 48118 (p. 541).
- 11 - *Journal of Environmental Health*. July/August 1989. "EPA Proposes New Rules for Sewage Sludge Disposal". (P.321).
- 12 - Logan, W.B. (1991). "Rot is Hot". *New York Times Magazine*. 9/8/91 Vol. 140, Issue 4871, p.46.
- 13 - *Garbage*. February/March 1993. Old House Journal Corp., 2 Main St., Gloucester, MA 01930. (p.18).
- 14 - Manahan, S.E. (1990). Hazardous Waste Chemistry, Toxicology and Treatment. Lewis Publishers, Inc.: Chelsea, Michigan. (p.131).
- 15 - Ibid. (pp. 148-49).
- 16 - Baumann, Marty. *USA Today*. Feb 2, 1994, p. 1A, 4A. USA Today (Gannet Co. Inc.) 1000 Wilson Blvd., Arlington, VA 22229.
- 17 - "The Perils of Chlorine". *Audubon Magazine*, 93:30-2. Nov/Dec 1991.
- 18 - Liptak, B.G. (1991). Municipal Waste Disposal in the 1990's. Chilton Book Co.: Radnor, PA. (pp.196-8).
- 19 - Stiak, J. "The Trouble With Chlorine". *Buzzworm*. Nov/Dec 1992. (p.22).
- 20 - *Environmental Reporter*. 7/10/92. (p.767).
- 21 - *Buzzworm*. March/April 1993. (p.17).
- 22 - *Environmental Reporter*. 7/10/92. (p.767).
- 23 - Ibid. 4/24/92. (p.2879).
- 24 - Ibid. 8/7/92. (p.1155).
- 25 - Burke, W.K. "A Prophet of Eden". *Buzzworm*. Vol. IV, Number 2, March/April 1992. (pp.18-19).
- 26 - *Environmental Reporter*. 8/7/92. (P.1152).
- 27 - Ibid. 5/15/92. (p.319).

- 28 - Ibid. 3/6/92 (p. 2474) and 1/17/92 (p.2145).
- 29 - Ibid. 1/3/92 (p.2109).
- 30 - Ibid. 11/1/91 (p.1657).
- 31 - Hammond, A. et al. (Eds.) (1993). The 1993 Information Please Environmental Almanac. Compiled by the World Resources Institute. Houghton Mifflin Co.: New York. (p.41).
- 32 - Purves, D. (1990). "Toxic Sludge". *Nature*. Vol. 346, 8/16/1990 (pp. 617-18).
- 33 - Rybczynski, W. et. al. (1982). Appropriate Technology for Water Supply and Sanitation - Low Cost Technology Options for Sanitation, A State of the Art Review and Annotated Bibliography. World Bank. (p. 124).
- 34 - Ibid. (p. 125).
- 35 - Fahm, L.A. (1980). The Waste of Nations. Allanheld, Osmun & Co.: Montclair, NJ (p.61).
- 36 - Radtke, T.M., and Gist, G.L. (1989). "Wastewater Sludge Disposal: Antibiotic Resistant Bacteria May Pose Health Hazard". *Journal of Environmental Health*. Vol 52, No.2, Sept/Oct 1989. (pp.102-5).
- 37 - *Environmental Reporter*. 7/10/92. (p.770).
- 38 - Daniel, J.E., et al. (Eds.). (1992) 1992 Earth Journal. Buzzworm Books: Boulder, CO. (p.131).
- 39 - Rivard, C.J. et al. (1989). "Waste to Energy". *Journal of Environmental Health*. Vol.52, No.2, Sept/Oct 1989. (p.99).
- 40 - *Environmental Reporter*. 11/1/91. (p.1653).
- 41 - Ibid. 1/17/92. (p.2154).
- 42 - Damsker, M. (1992). "Sludge Beats Lead". *Organic Gardening*. Feb, 1992, Vol. 39, Issue 2, p.19.
- 43 - Fahm. (1980). The Waste of Nations. (p.xxiv).
- 44 - Ibid. (p.40).
- 45 - Rivard, C.J. et al. (1989). "Waste to Energy". *Journal of Environmental Health*. Vol 52, No.2, Sept/Oct 1989. (p.100).
- 46 - See *Garbage*, Oct/Nov 1992, (p.14).

* **"All sewer sludge is not bad," according to Ancil Schmidt, West Virginia Division of Environmental Protection Extension Agent. Mr. Schmidt offers a very helpful packet of information about the use of sewage sludge for agricultural purposes ("Use and Disposal of Municipal Wastewater Sludge"), which is available from: West Virginia University Extension Service, 200 1/2 South Kanawha Street, Beckley, West Virginia, 25801-5616; Phone (304) 255-9321.**

** Contact JCH Environmental Engineering, Inc., 2730 Remington Court, Missoula, MT 59801-7121. Phone (406) 721-1164.

**YOU MAY HAVE NOTICED THAT THIS BOOK
HASN'T (YET) MADE IT TO THE NEW YORK
TIMES BESTSELLER LIST.**

**HERE'S YOUR MANUSCRIPT
BACK SIR. SORRY, WE DON'T
PUBLISH CRAP LIKE THIS.
PERHAPS YOU COULD USE IT
FOR EMERGENCY
TOILET PAPER.**



COMPOSTING TOILETS AND SYSTEMS

"Simplicity of life, even the barest, is not misery but the very foundation of refinement."

William Morris



The act of composting humanure can be done *actively*, with full and voluntary participation by the person(s) creating the refuse, or it can be done *passively*, with little or no participation in the composting process by the person(s) creating the refuse. Many people in the West who agree with the idea of composting humanure want to do so, but only if the process is passive. They don't want to be actively involved in the compost-making process. They want the toilet to do the work, although they may be willing to haul the finished compost off somewhere to be disposed of, usually desiring to do so as infrequently as possible. For many people, a composting toilet is another disposal system, one that doesn't require water (usually), and one that is not to be used in the human nutrient cycle.

Others, those who make compost through an aerobic, thermophilic process, know that there's a technique to building a compost pile that must be respected in order to achieve the desired result, i.e. good quality garden compost. These people use their finished compost to produce food for themselves to eat, therefore they want to be actively involved in the composting process in order to assure quality control over the finished product.

People who actively compost their organic refuse, including humanure, are as rare as hen's teeth in the West. The practice is so alien to Western culture that a person who thermophilically composts humanure may as well walk around with a bone through his or her nose. This is ironic because well-managed thermophilic composting ensures the destruction of human pathogens in the composted material and transforms organic refuse into humus in a relatively short period of time compared to passive composting, which is not thermophilic (the compost does not heat up). However, as pointed out in chapter three, Westerners gained a deep distrust of human excrement over the past several hundred years. This was largely due to terrible epidemic diseases during the Middle Ages and up to the late 1800's spread by fecal contamination of the environment, a condition caused by a cultural ignorance of both the

origins of disease and of the the benefits of composting in destroying human pathogens. That deeply entrenched bias against the use of humanure agriculturally, still currently prevalent in the West, will not be easily rooted out, although eventually it must be. I call the belief that humanure is unsafe for agricultural use: *fecophobia*.

People who are fecophobic can suffer from severe fecophobia or a relatively mild fecophobia, the mildest form being little more than a healthy concern about personal hygiene. Severe fecophobics do not want to use humanure for food growing, composted or not. They believe that it's dangerous and unwise to use such a material in their garden. Milder fecophobics may, however, compost humanure passively and use the finished compost in horticultural applications. People who are not fecophobic may thermophilically compost humanure and utilize it in their food garden. Some may even use it raw, a practice not recommended by the author.

In any case, humanure is best rendered hygienically safe by proper thermophilic composting. Passive, low-temperature composting is very unlikely to become thermophilic and usually does not focus on the destruction of possible human pathogens in the organic refuse being composted. Yet, even passive composting will eventually yield a relatively pathogen-free compost after a period of time, a period which, according to some sources, may be as long as five and a half¹ or even ten² years. This is in contrast to thermophilic composting which will destroy human pathogens in a matter of hours or days, or, for larger quantities, weeks or months.

Commercial composting toilets are, for the most part, passive. They are *mouldering* toilets, meaning that the compost moulders or decomposes slowly at temperatures lower than that of the human body. The consumer who buys a commercially distributed composting toilet can rest assured that s/he will have to do little more than use the toilet and then once a year (or two or three) empty out some compost. Often, a dry, organic cover material such as peat moss is recommended to be added to the contents of the toilet on a regular basis. Other than that, there's not much to it.

On the other hand, *non-commercial* mouldering toilets, or *toilets constructed by the users*, are in widespread use throughout the world since many people do not have the financial resources required to purchase commercially produced toilets. Non-commercial mouldering toilets usually require the separation of urine from feces when collecting the organic refuse. This is done by urinating in a separate container or into a diversion device which causes the urine to collect separately from the feces. The rationale for separating urine from feces is that the urine/feces blend contains too much nitrogen to allow for effective composting and the collected refuse gets too wet and odorous. Therefore, the urine is collected separately, thereby reducing the nitrogen, the liquid content, and the odor of the collected refuse.

However, there is a little known alternative method of achieving the same

result which does not require the separation of urine from feces. Organic material with too much nitrogen for effective composting (such as a urine/feces mixture) *can be balanced by adding sufficient carbon material such as cellulose in the form of sawdust or a similar material, rather than removing nitrogen.* The extra carbon material also absorbs excess liquids and can cover the collected refuse to eliminate odor completely. This alternative of adding a carbon material to humanure instead of segregating urine from it, also sets the stage for thermophilic composting because of the carbon/nitrogen balancing. However, almost all commercial and non-commercial composting toilets are designed to only achieve mouldering conditions in the compost and not to generate thermophilic conditions.

A *commercial* composting toilet such as a Clivus Multrum (see figure 5.4 on page 93 and the photos on pages 94 and 95) is a manufactured device including a toilet seat and a composting chamber whereby individuals can deposit their feces with little or no active involvement in a nutrient cycling process. In other words, you can take a shit and forget about it, and urine does not need to be segregated. Commercial composting toilets are convenient for that reason. The compost may or may not be suitable for a kitchen garden, as the composting process is usually slow and usually maintains a relatively low temperature which can allow some pathogens to survive. These toilets are popular among those who understand that defecating in water doesn't make sense, or among those who have no electricity or water in their summer cottages and can't use a water-based waste disposal system even if they wanted to. Commercial composting toilets often strive to dehydrate the organic refuse deposited in them so as to reduce bulk and minimize the quantity of compost being produced. This is done by blowing air through and over the organic refuse with fans, and/or by heating the refuse electrically, or by draining excess liquids out into the soil.

On the other hand, an *active, thermophilic composting system* (not a mouldering system) may only use a toilet for *collection* purposes. The humanure may be collected regularly, perhaps daily or weekly, in a simple, low-cost receptacle and deposited on a compost pile or in a compost pit away from the toilet area and layered with other organic materials so that a high aerobic decomposition temperature is generated in order to kill all potential pathogens. (By the way, *a pathogen is any microorganism or worm that can cause a disease.* See glossary or see next chapter.) In some cases, the humanure is deposited directly onto a compost pile in a basement or under an elevated toilet, and layered with other household organic refuse and organic cover materials. Those who use such an active composting system understand that the composting process is only one step in a larger cyclical system of nutrient transfer: soil produces food, we eat the food, we discharge organic refuse (feces, urine, food scraps, agricultural refuse), the humanure is composted with other veg-

etable or animal refuse, the compost turns back into soil, the soil produces more food, we eat the food, we discharge refuse, and so on. This never-ending human nutrient cycle, when humanure is composted and used to grow human food, maintains a harmonious balance between the human and the earth. It's an active process and requires diligent and conscientious involvement by the human participant(s). What's of value here is the entire, unbroken system, the process itself. The physical toilet may only be a small but important part of the entire cycle. When the actual composting takes place away from the toilet area, this approach requires little construction cost. An active composting system is more labor intensive, but requires little use of technology or natural resources, including water.

Thermophilic composting of humanure has not gained popularity among Westerners for three basic reasons: 1) You can't take a shit and forget about it. The organic refuse has to be dealt with on a regular basis, even if only covered after each deposit and the finished compost removed regularly. S/he who defecates and/or urinates must acknowledge and take responsibility for what comes out of his/her body. 2) Fecophobia. There seems to be a general fear that if you don't die outright from actively composting humanure, you'll die a slow, miserable and wretched death, or you'll surely cause an epidemic of something like the plague and everyone within two hundred miles of you will die, or you'll become so infested with worms that you'll no longer be recognized as human. 3) Misinformation. Much of the information in print concerning the recycling of humanure is confusing, erroneous or incomplete.

As chapter 6 deals with pathogens and chapter 7 deals with the subject of practical thermophilic composting, I won't go into either subject here in any great detail. Let's take a look at some commercial and/or passive composting toilets instead.

THE NON-COMMERCIAL (HOME-MADE) MOULDERING TOILET

The objectives of a moultering toilet are to achieve safe and sanitary treatment of fecal material, to conserve water, to function with a minimum of maintenance and energy consumption, to operate without unpleasant odors, and to recycle humanure for horticultural use in a form usable to nature (see figures 5.1, 5.2, and 5.3).

The decomposition process is akin to what happens on a forest floor, i.e. cool, slow decomposition. Because the temperature of the compost does not elevate high

enough to destroy all pathogens, the resulting compost, also known as duff, is considered suitable only for horticultural purposes, not for agricultural purposes, except, perhaps, for orchard use where the duff is covered or buried after application.

It is well known that humanure contains the potential to harbor disease-causing microorganisms, or pathogens. Compost temperatures must rise significantly *above the temperature of the human body* (98.6°F or 37°C) in order to begin eliminating disease-causing organisms, as human pathogens can live happily in temperatures similar to that of the human being. The human body attempts to destroy pathogenic infections by elevating its own temperature, thereby creating a fever, which pathogens don't like. Human fevers rarely rise above 104°F (40° C), and when they do, they rarely sustain that level of heat for more than a day or two. Compost must also generate heat in order to destroy human pathogens, and fortunately thermophilic composting will readily create temperatures much higher than the human body temperature and sustain them, perhaps for weeks.

However, mouldering toilets generally do not achieve thermophilic conditions and therefore do not achieve temperatures higher than that of the human body. Consequently, some human pathogens may smugly reside in the finished compost, perhaps for years. According to current scientific evidence, which is discussed at greater length in chapter six, a few months retention time in just about any compost toilet will result in the deaths of nearly all human pathogens. The most persistent pathogen seems to be the roundworm (*Ascaris lumbricoides*) however, and particularly the egg of the roundworm, which is pro-

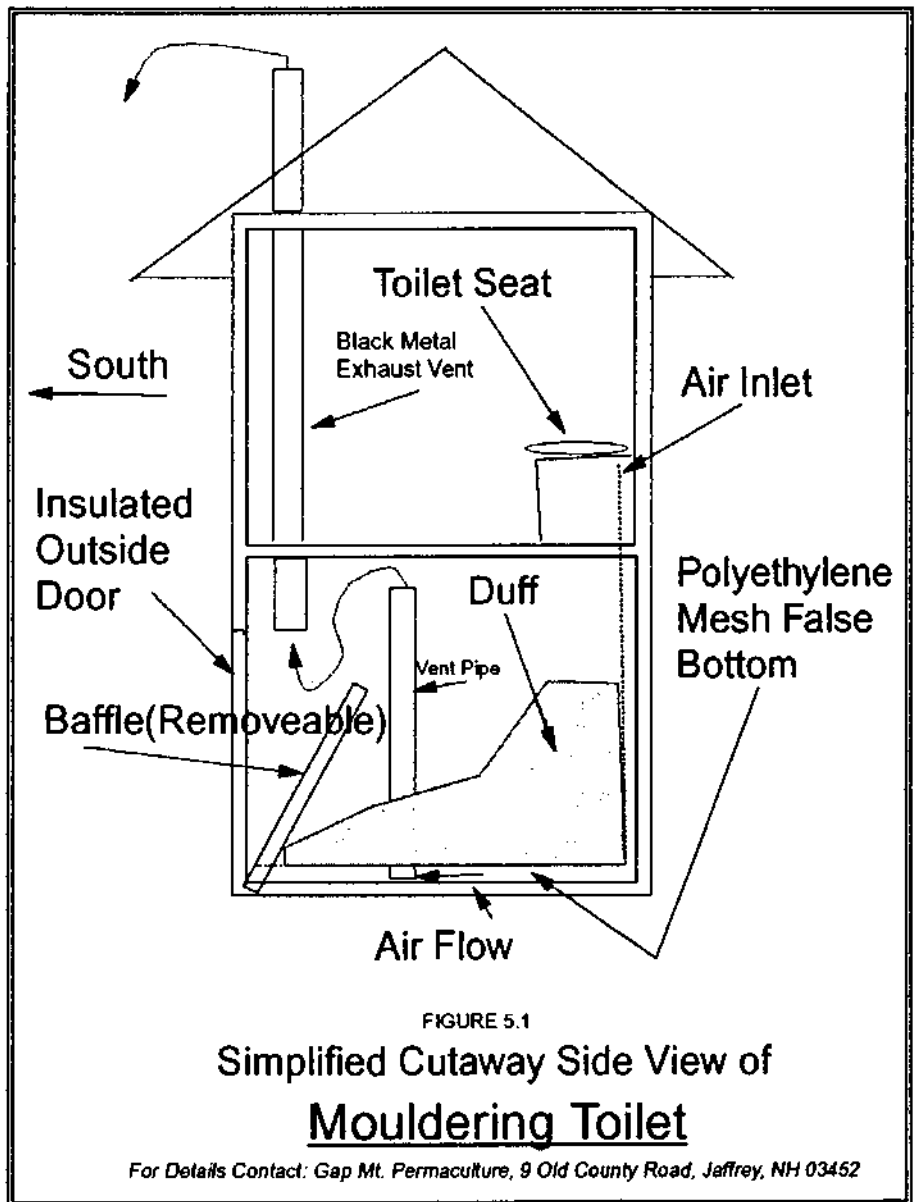

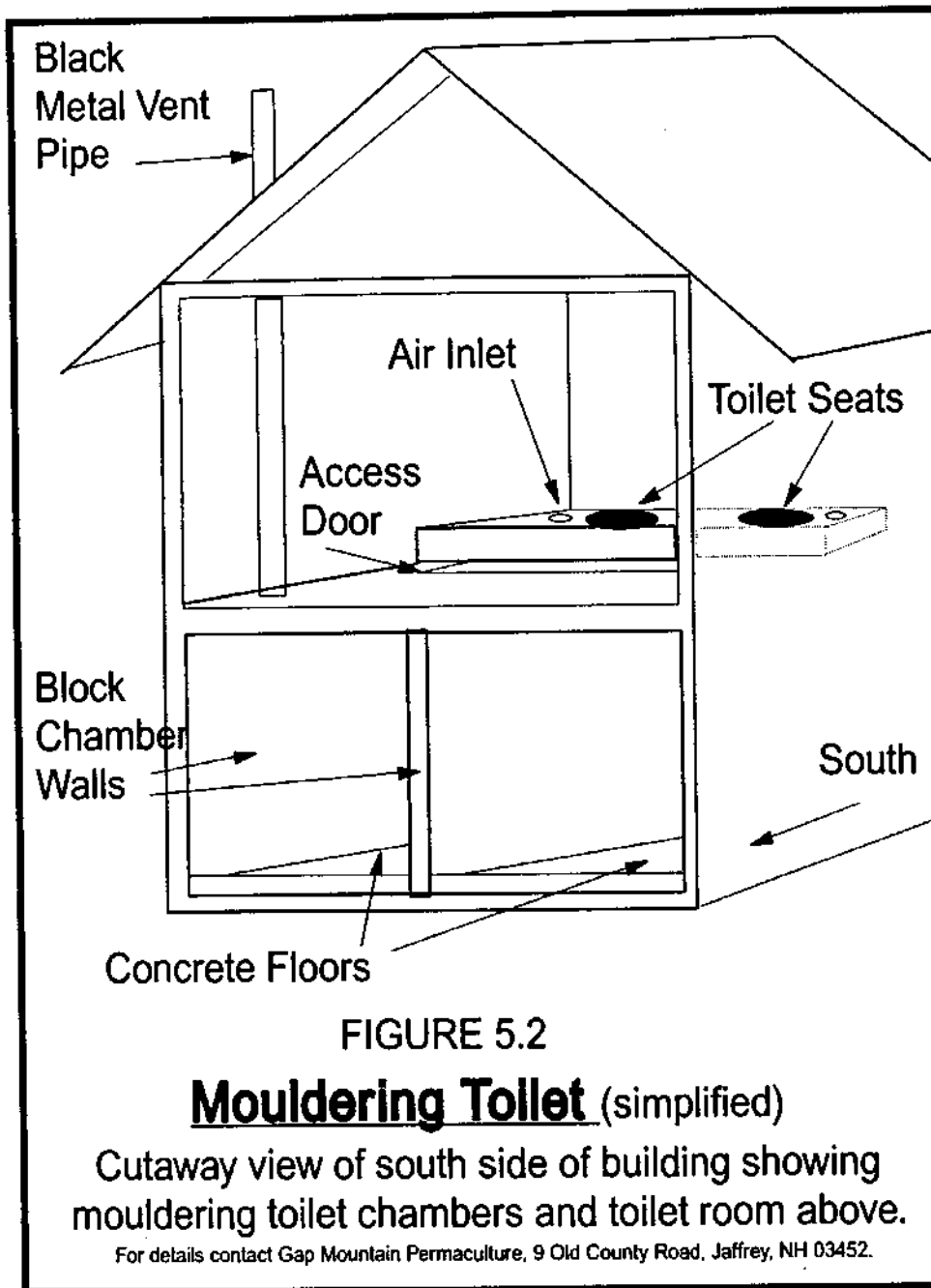

tected by an outer covering which renders the egg resistant to chemicals and adverse environmental conditions. Estimates of the viability of *Ascaris* eggs in soil range as high as ten years. Although the *Ascaris* and the eggs are readily destroyed by thermophilic composting, the eggs may survive in conditions generated by a mouldering toilet. This is why the compost resulting from a mouldering toilet is not recommended for human food production, and why mouldering toilets are only used as elements of the human nutrient cycle in groups of people who are willing to accept the possibility of a level of *Ascaris* infection in their population.

The primary advantage to this sort of toilet is the passive involvement of the user, as the toilet collection area need not be entered into more than every two or three years, unless to rake the pile flat. The pile that collects in the chamber must be raked and mixed somewhat every few months (which can be done through a floor access door), and the chamber is emptied only after nothing has been deposited in it for at least two years, although this time period may vary depending on the individual systems used.

In order for this system to work well, each toilet must consist of two chambers. The first is deposited into until it's full, then the second is used. By the time the

FIGURE 5.3

Guatemalan Mouldering Toilet

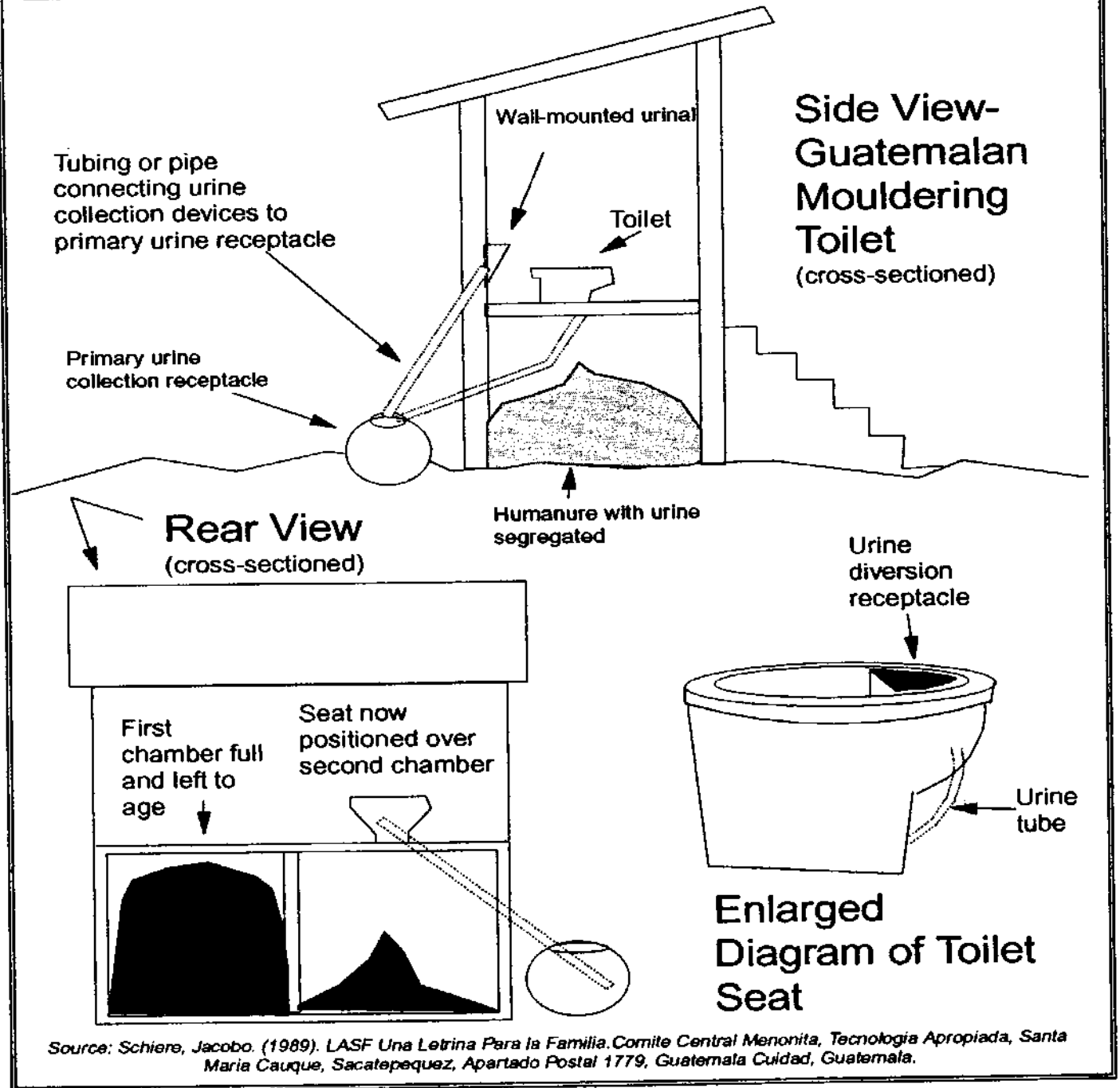

second side is full the first should be emptied. It may take five years to fill a side. In addition to feces, carbonaceous organic matter such as sawdust is regularly added to the chamber in use. One drawback to this system may be the desire to segregate urine from feces in order to minimize odors and waterlogging of the duff. Urination then takes place in a separate container and the collected urine is deposited on a garden or compost pile. Some toilets, such as one currently being used in Guatemala (see figure

5.3 on page 91), automatically separate urine from feces during defecation. However, an alternative to segregating urine to prevent waterlogging of the duff would be to simply add more dry cover material to soak up the excess moisture. Urine-soaked sawdust composts quite well.

An advantage to this system is that there are no moving parts or electrical devices. Air ventilation may take place through a large, black vertical pipe which passes indoors through the toilet room in front of a south-facing window (in the northern hemisphere) where it will be heated, passively causing the air to rise.

In short, the mouldering toilet seems to offer a method of composting humanure that would be attractive to persons wanting a low-maintenance, low-cost, passive approach to excrement recycling. However, urination in a separate receptacle seems to somewhat offset the passive nature of this type of toilet, as the urine must be dealt with on a regular basis. The other primary drawback, as I see it, aside from occasional fly infestations, is the low-temperature composting of the humanure rendering it unfit for growing human food, except for orchard application, until after a quite lengthy period of time. The total destruction of human pathogens should be the goal of anyone composting humanure. However, any effort which successfully returns organic refuse to the soil without polluting water or the environment and without using electricity certainly demands a high level of commendation.³

COMMERCIAL MOULDERING (OR MULTRUM) TOILETS

Commercial mouldering toilets have been popular in Scandinavia for some time, and at least twenty-one different mouldering toilets were on the market in Norway alone in 1975.⁴ One of the most popular types of commercially available composting toilets in the United States today is the multrum toilet, invented by a Swedish engineer and first put into production in 1964. These toilets have found their way into public buildings, banks, even universities. The concept is similar to that of a simple double-chambered mouldering toilet, although fecal material and urine are deposited *together* into a single chamber with a double bottom. The decomposition takes place slowly over a period of years, and the finished compost gradually falls down to the very bottom of the toilet chamber where it can be removed. Again, the decomposition temperatures remain cool, not usually climbing above 90° F, which is not high enough to kill all pathogens. Therefore, it is recommended that the finished compost be buried under one foot of soil or used in an ornamental garden.⁵

The advantages of this type of toilet include the passive nature of user partici-

pation. Anybody will happily use a multrum toilet because they know full well that *someone else* someday will have to empty it out. Also, no water is used or required during the operation of this toilet, thereby keeping human excrement out of the water supplies as well as conserving water. According to one report, a single person using a Clivus Multrum will produce 40 kg (88 lbs) of compost per year while refraining from polluting 25,000 liters (6,604 gallons) of water annually.⁹ Finally, the finished compost can be used as a soil additive where the compost will not come in contact with food crops.

Drawbacks include the cost, which can easily exceed two or three thousand dollars (1990's), and the fact that the composting chamber is usually made of plastic, which means that for every plastic multrum toilet purchased, a non-biodegradable plastic multrum toilet will probably end up someday in a landfill. If these toilets were made from recycled plastic, that would certainly be a bonus, but that currently doesn't seem to be the case. Also, the multrums require electricity to run both a fan-driven ventilation system and a pump for pumping excess liquid (urine) from the composting chamber. Finally, the composting process does not kill all pathogens in the manure by means of thermophilic composting, although the lengthy retention time of the compost undoubtedly contributes to the destruction of most pathogens that may exist in the excrement (see table 6.11 on page 127).

I'm aware of a couple of multrum toilets currently being used by friends of mine, and they both have had problems with odors, while one has had problems with flies and excess liquid buildup in the composting chamber.

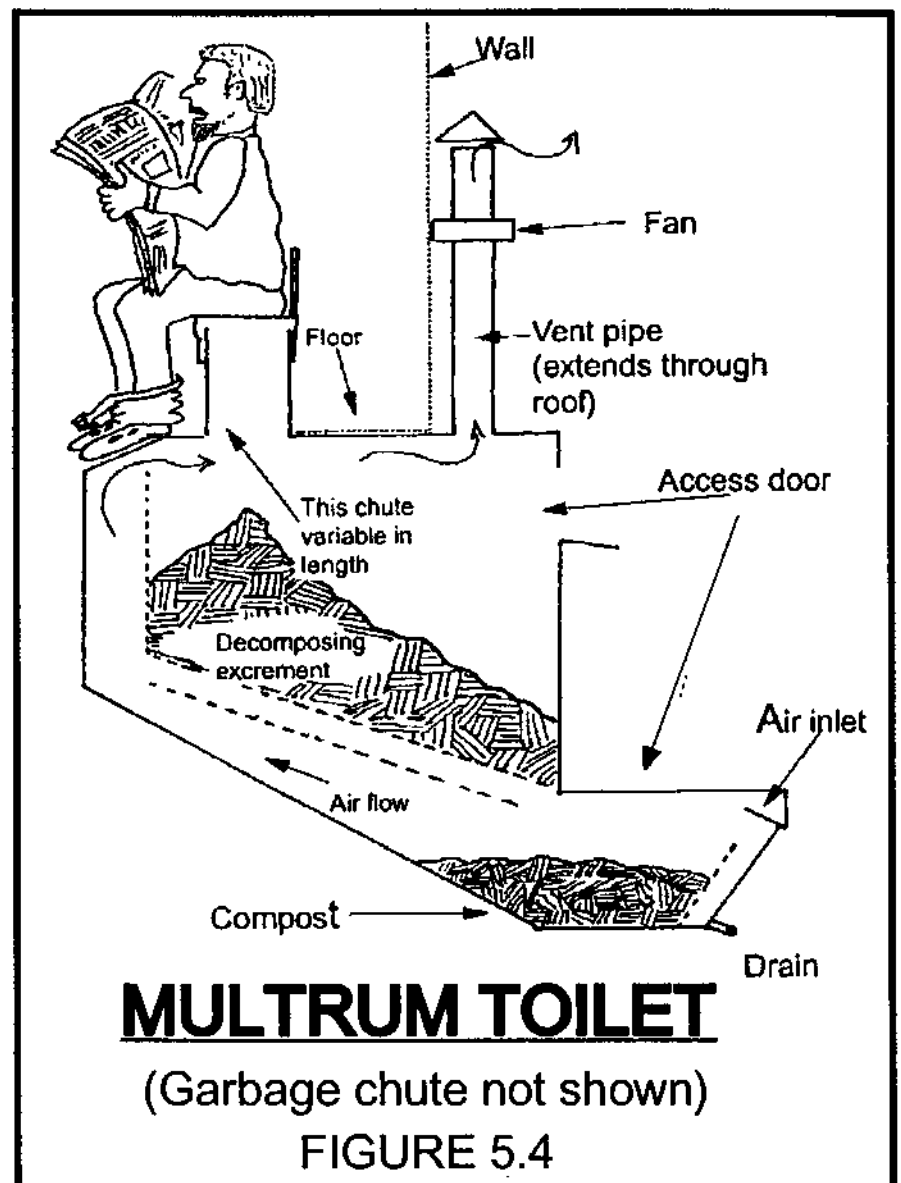

Now, it seems to me that these problems *are due to improper use of the toilet, not necessarily to the toilet itself*, as eventually both parties managed to get their toilets working well, without odors or flies. However, this indicates that some management of the composting toilet is required by someone using the toilet in order to avoid these kinds of problems. For example, organic bulking materials such as sawdust or fine wood shavings must be added regularly to the toilet to absorb excess liquids, aid the composting process, and minimize or eliminate odors. If a multrum toilet is managed properly, it should easily be odor and worry free. As always, a good understanding of the basic concepts of composting will help anyone who wishes to use a composting toilet. Nevertheless, the multrum toilets, when used properly, should provide a suitable alternative to flush toilets for people who want to stop defecating in their drinking water. You can probably grow a heck of a rose bed with the compost, too.

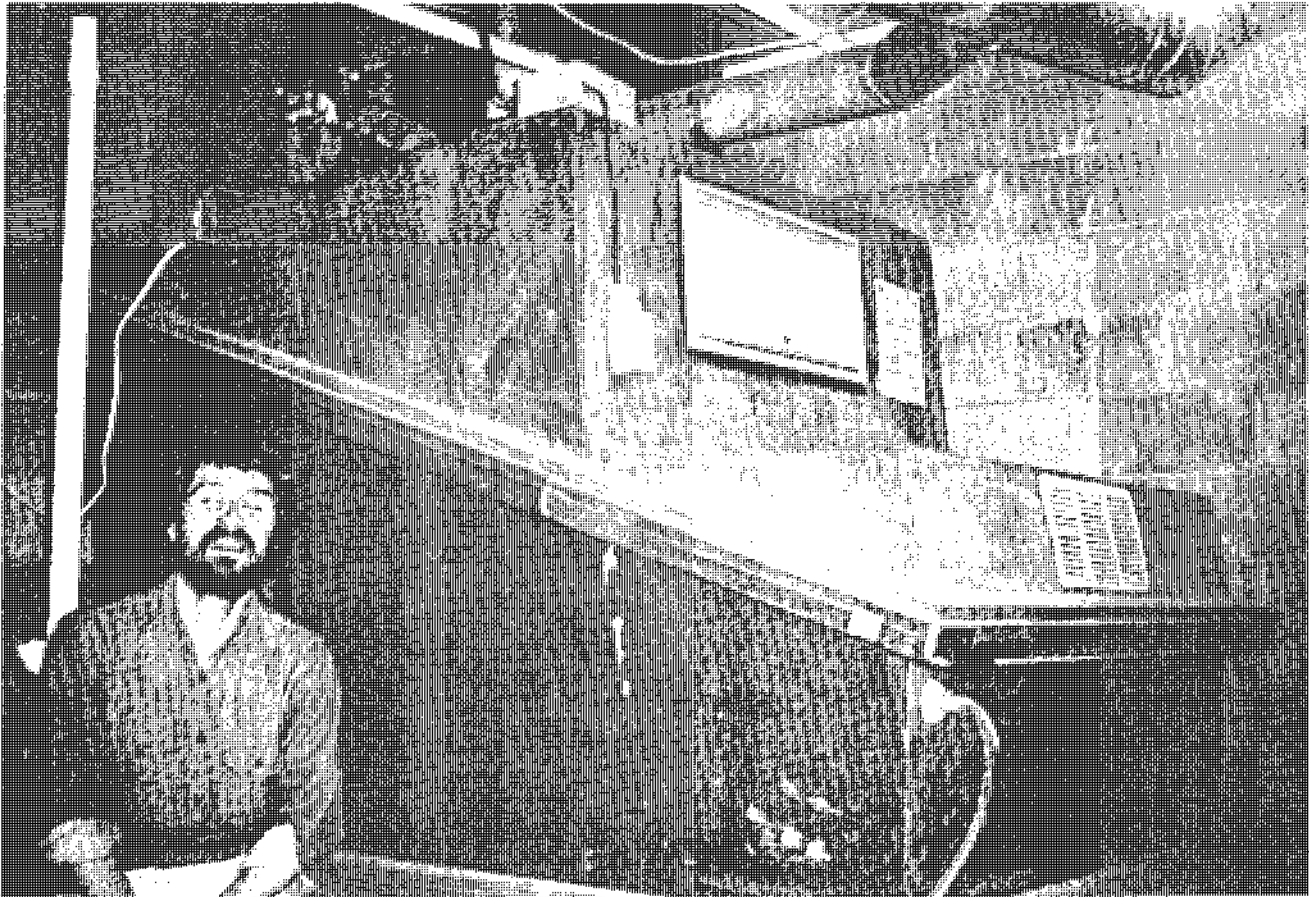

A CLIVUS MULTRUM IN THE BASEMENT OF SLIPPERY ROCK UNIVERSITY'S HARMONY HOUSE. THE TOILET AND THE KITCHEN COMPOST DISPOSAL CHUTE ARE ON THE FIRST FLOOR.

Finished compost from seven Clivus Multrum toilets which had been in use for 4 to 14 years was analyzed for nutrients, according to a report issued by Clivus Multrum USA in 1977. The compost averaged 58% organic matter, with 2.4% of nitrogen, 3.6% of phosphorous, and 3.9% of potassium,

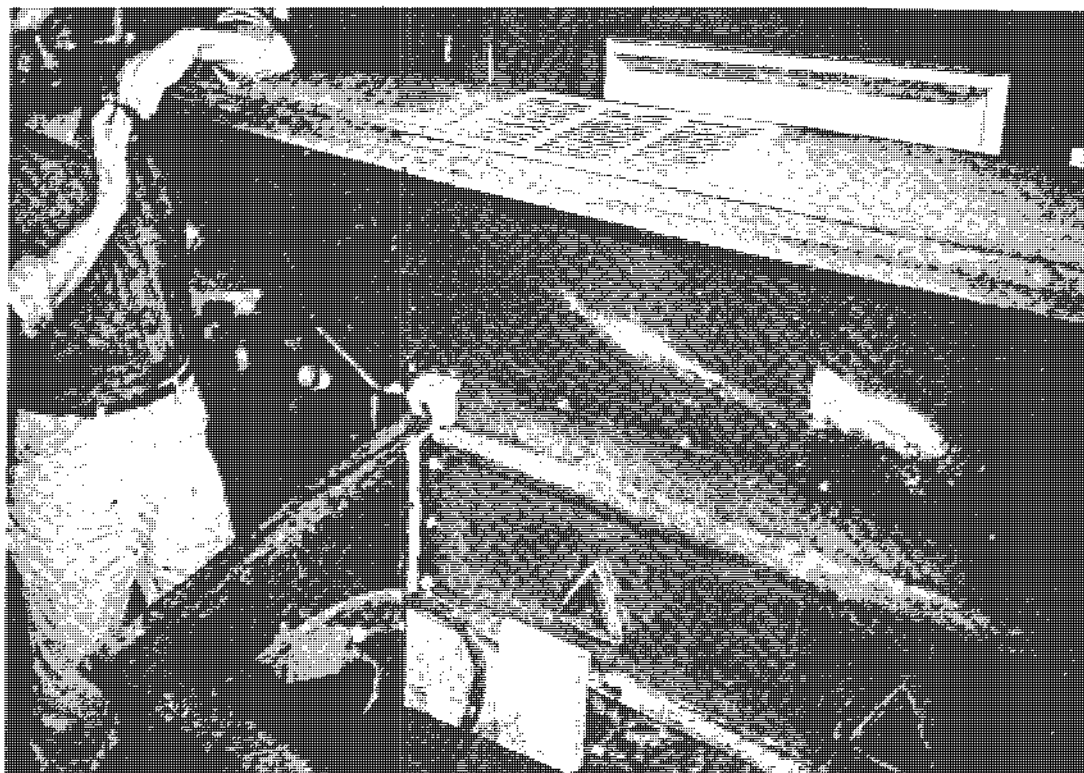

THE CONTENTS OF A CLIVUS MULTRUM ARE BEING EXAMINED THROUGH ITS MAIN ACCESS DOOR.

which is reportedly higher than composted sewage sludge, municipal compost, or ordinary garden compost. Suitable concentrations of trace nutrients were also found. Toxic metals were found to exist in concentrations far below recommended safe levels.⁹

MORE COMMERCIAL COMPOSTING TOILETS

There are a variety of other composting toilets available on the market today (see reference list and additional sources of composting toilets on pages 107-108). One manufacturer (*Sun Mar*) claims that over 200,000 composting toilets have been sold worldwide. The same manufacturer produces a fiberglass and stainless steel toilet which consists of a drum under the toilet seat or under the bathroom floor into which the feces and urine are deposited. The drum is rotated by hand in order to blend the ingredients, which should include garbage and a carbon material such as peat moss. The toilet can come equipped with an electric heating system and an electrical fan ventilation system. The compost is produced in small quantities which are

removed by pulling out a drawer beneath the drum. The compost is said to be suitable for garden purposes.

Drawbacks? Some of the models require water as well as electricity (although some require no electricity or water). Again, the cost may be prohibitive to some, although these smaller, more self-contained toilets seem to cost less than the multrums. 1993 price quotes ranged from \$1100.00 to \$1400.00. Also, for every fiberglass toilet unit purchased, someday a fiberglass toilet unit will undoubtedly end up thrown "out" somewhere when it wears out.

However, as the manufacturer insists that the toilet produces absolutely no odor and generates compost suitable for a food garden, it must be assumed that the heating element in the electric toilets in combination with the active compost blending create optimum composting conditions which kill all pathogens. The literature on these toilets doesn't discuss the pathogen issue in any detail though, and as some of the toilets aren't electrically heated, the destruction of pathogens in the finished compost remains a matter of speculation.⁶

Another composting toilet that is currently on the market (*AlasCan*) is even further up the ladder of technological sophistication. Made in Alaska and costing upwards of \$10,000 or more, the toilet is complete with an insulated tank, conveyers, motor-driven agitators, a pump and sprayer, and exhaust fan.⁷

Finally, another source of a composting toilet⁸ (*Composting Toilet Systems*) manufactures a fiberglass unit similar to a multrum toilet, and advertises it as a "waste disposal system". The 1993 price for this unit, which uses no water, but does require electricity, is \$3656.00. According to the manufacturer, waterless composting toilets reduce household water consumption by 40,000 gallons per year. This is significant when one considers that only 3% of the Earth's water is fresh, even more so when one realizes that two thirds of that fresh water is locked up in ice. That means that less than one percent of the Earth's water is available as fresh water. Why shit in it?

ASIAN COMPOSTING

As stated in chapter three, it is well known that Asians have *recycled* humanure for centuries, possibly millennia. However, historical information concerning the *composting* of humanure in Asia seems difficult to find. Rybczynski et. al.⁹ in fact state that such composting was only introduced to China in a systematic way in the 1930's, and that it wasn't until 1956 that compost toilets were used on a wide scale in Vietnam. On the other hand, Franceys et. al. tell us that composting, "*has been practiced by farmers and gardeners throughout the world for many centuries.*" They add

that, “ *In China, the practice of composting human wastes [sic] with crop residues has enabled the soil to support high population densities without loss of fertility for more than 4000 years.*”¹⁰

However, a book published in 1978 and translated directly from the original Chinese (Compost, Fertilizer and Biogas Production from Human and Farm Wastes in the People’s Republic of China, by M. G. McGarry and J. Stainforth, International Development and Research Center, Ottawa)¹³ indicates that composting has *not* been a cultural practice in China until only recently. An agricultural report from the Province of Hopei, for example, states that the standardized management and hygienic disposal (i.e. composting) of excreta and urine was only initiated there in 1964. The composting techniques being adopted and developed at that time included the segregation of feces and urine, which were later “*poured into a mixing tank and mixed well to form a dense fecal liquid*” before piling on a compost heap. The compost was made of 25% human feces and urine, 25% livestock manure, 25% miscellaneous organic refuse, and 25% soil.

Two *aerobic* methods of composting were reported to be in widespread use in China, according

to the 1976 report. The two methods are described as a) surface aerobic continuous composting, and b) pit aerobic continuous composting. The *surface* method involves constructing a compost pile around an internal framework of bamboo, approximately nine feet by nine feet by three feet high (3m x 3m x 1m).



A YOUNG LADY SETTING CEDAR POSTS IN THE GROUND FOR THE CONSTRUCTION OF A DOUBLE-CHAMBERED COMPOST BIN.

Compost ingredients include fecal material (both human and non-human), organic refuse, and soil. The bamboo is removed from the constructed pile and the resultant holes allow for the penetration of air into this rather large pile of refuse. The pile is then covered with earth or an earth/horse manure mix, and left to decompose for 20 - 30 days, after which the composted material is used in agriculture. The *pit* method involves constructing compost pits five feet wide and four feet deep by various lengths, then digging channels in the floor of the pits. The channels (one lengthwise and two widthwise) are covered with coarse organic material such as millet stalks, and a bamboo pole is placed vertically along the walls of the pit at the end of each channel. The pit is then filled with organic refuse and covered with earth, and the bamboo poles are removed to allow for air circulation.¹¹

Additional light is shed on the subject of Chinese composting by a report from a hygienic committee of the Province of Shantung, as published in the aforementioned work by McGarry and Stainforth. The report lists three traditional methods used in that Province for the recycling of humanure: 1) drying it (*"drying has been the most common method of treating human excrement and urine for years"*), 2) using it raw for agricultural purposes, and 3) *"connecting the household pit privy to the pigpen . . . a method that has been used for centuries"*, a method in which the excrement was simply eaten by a pig. No mention is made whatsoever of composting being a traditional method used by the Chinese for recycling humanure. On the contrary, all indications were that the Chinese government in the 1960's was *at that time* attempting to establish composting as preferable to the three traditional recycling methods listed above, mainly because the three methods were hygienically unsafe, while composting, when properly managed, would destroy pathogens in humanure while preserving agriculturally valuable nitrogen. Once again, the report describes composting techniques in which soil was being used as a main ingredient in the compost, or, to quote directly, *"Generally, it is adequate to combine 40-50% of excreta and urine with 50-60% of polluted soil and weeds"*.

For further information on Asian composting I must defer to Rybczynski et. al., whose World Bank research on low-cost options for sanitation considered over 20,000 references and reviewed approximately 1200 documents. Their review of Asian composting is brief, but includes the following information, which I have condensed:

There are no reports of composting privys (toilets) being used on a wide scale until the 1950's, when the Democratic Republic of Vietnam initiated a five-year plan of rural hygiene and a large number of *anaerobic* composting toilets were built. These toilets, known as the Vietnamese double vault (see figure 5.5), consisted of two, above ground water-tight tanks, or *vaults*, for the collection of humanure. For a

family of five to ten people, each vault was required to be 1.2 m wide, 0.7 m high, and 1.7 m long (approximately 4 feet wide by 28 inches high and 5 feet seven inches long). One tank is used until full then left to decompose while the other tank is used. The use of this sort of composting toilet requires the segregation of urine, which is diverted to a separate receptacle by means of a groove on the floor of the toilet. The fecal material is collected in the tank and covered with soil, where it anaerobically decomposes. Kitchen ashes are added to the fecal material for the purpose of reducing odor. Intestinal worm eggs, which are one of the most persistently viable forms of human pathogens, were found to be 85% destroyed after a two month composting period in this system.

Another anaerobic double-vault composting toilet in use in Vietnam includes the use of fecal material *and* urine, but the bottom of the vaults are perforated to allow drainage, and the urine is filtered through limestone to neutralize acidity. Other organic refuse is also added to the vaults, and ventilation is provided via a pipe.

In India, the composting of organic refuse and humanure is advocated by the government. A study of such compost prepared in pits in the 1950's showed that

intestinal worm parasites were completely eliminated in 3 months and pathogenic bacteria were also completely destroyed. The destruction of pathogens in the compost was attributed to the maintenance of a temperature of about 104°F for a period of 10-15 days. However, it was also concluded that the compost pits had to be properly constructed and managed, and the compost not removed until fully "ripe", in order to achieve the total destruction of human pathogens. If done properly, it is reported that *"there is very little hygienic risk involved in the use and handling of [humanure] compost for agricultural purpos-*

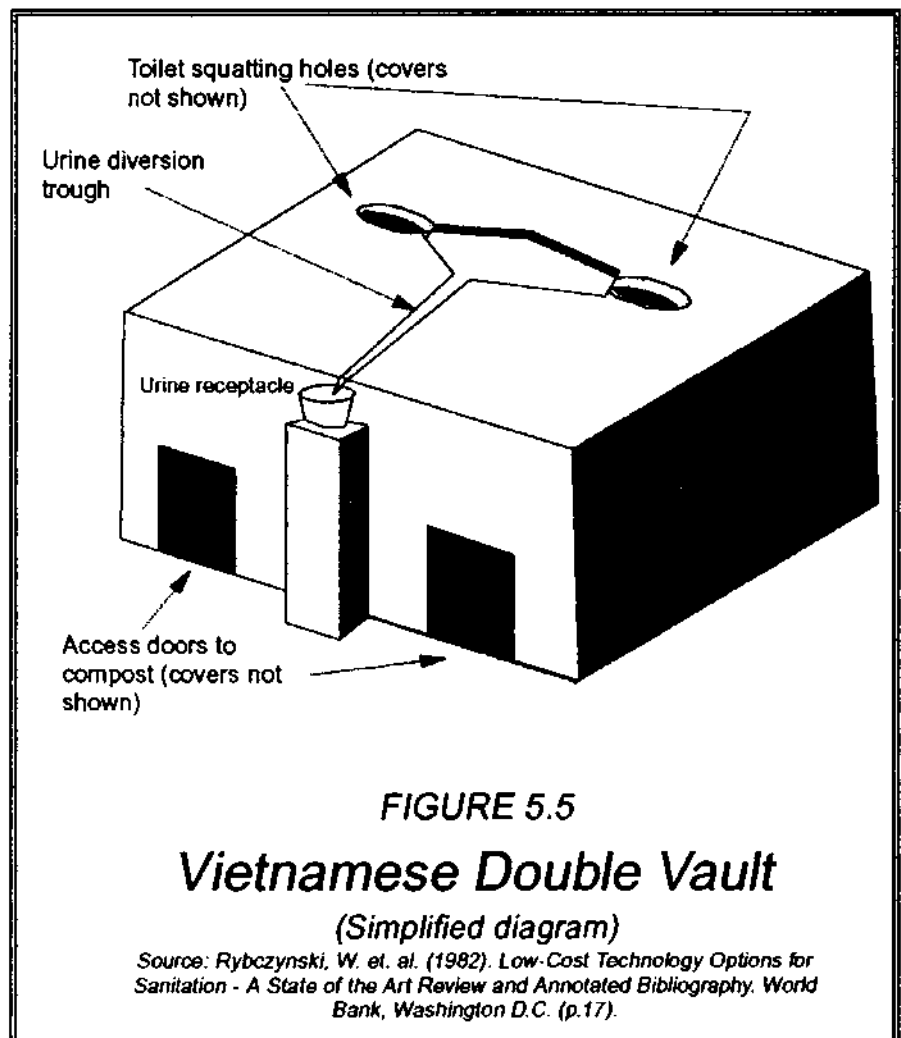

es". The issue of pathogens will be discussed at length in the next chapter.

SIMPLE, LOW-TECH HUMANURE COMPOSTING



A SAWDUST TOILET. HUMANURE IS COLLECTED IN THE FIVE-GALLON CONTAINER UNDER THE SEAT AND KEPT COVERED WITH ROTTED SAWDUST. WHEN FULL, THE ORGANIC MATERIAL IS DEPOSITED INTO A COMPOST BIN FOR THERMOPHILIC COMPOSTING (SEE NEXT PAGE). SUCH A TOILET COSTS VERY LITTLE TO INSTALL OR OPERATE AND REQUIRES NO WATER OR ELECTRICITY.

Simple, low-tech compost systems are traditionally used by people who do not have the luxury of buying expensive, electrically powered, plastic or fiberglass receptacles to defecate in. Instead, they develop simple methods of collecting their manure and composting it, often away from their living spaces. Sometimes these systems are called cartage systems or bucket systems, as the manure is carried to the compost pit, chamber or bin, often in buckets or other waterproof vessels. People who utilize such simple techniques for composting humanure simply take it for granted that feces recycling is one of the regular and necessary chores of sustainable human life on this planet.

How it works is a model of simplicity. One begins by depositing one's organic refuse (feces and urine) into a plastic bucket, clay urn or other non-corrodible waterproof receptacle with about a five gallon (approximately 20 liters) capacity. Food scraps may be collected in a separate receptacle. The humanure is kept covered with a clean, organic material such as sawdust, peat moss,

soil, etc. in order to prevent odors, absorb urine, and eliminate any fly nuisance, and a lid is kept on the receptacle when not in use. A standard, hinged toilet seat is quite suitable as a lid. This system of using an organic cover material works well enough in preventing odors to allow the toilet to be indoors, year round. When the bucket is full, it is carried to the composting area and deposited on the pile. The deposit is then immediately covered with a layer of clean, bulky, organic material such as straw or weeds, in order to eliminate odors and trap air. The bucket is then thoroughly scrubbed with a small quantity of water, which can be rain water or wastewater, and biodegradable soap, if available or desired. A long-handled toilet brush works well for this purpose. The soiled water is then poured on the compost pile. Rain water or wastewater is ideal for this purpose as its collection requires no electricity. The bucket is then replaced in the toilet area. The inside of the bucket can then be dusted with clean, dry sawdust and it's ready to "go".

Drawbacks to this system include the inconvenience of carting buckets of excrement on a regular basis; having to look at and smell the excrement (mixed in sawdust), no



THE FULL SAWDUST TOILET RECEPTACLE IS SIMPLY LIFTED OUT OF THE TOILET AND EMPTIED INTO A COMPOST BIN OUTDOORS. ALL URINE AND FECES IS COLLECTED IN SUCH A TOILET. A FAMILY OF FOUR CAN EXPECT TO FILL A SAWDUST TOILET OF THIS SORT IN THREE OR FOUR DAYS. THE SAWDUST COVER ELIMINATES ODORS AND FLIES, AND BALANCES THE NITROGEN OF THE HUMANURE WITH CARBON, THEREBY FACILITATING THERMOPHILIC COMPOSTING. SUCH A TOILET SHOULD BE LOCATED INSIDE, BUT NEAR AN OUTSIDE DOOR FOR EASE OF REMOVAL.

matter how briefly, when depositing it on the compost pile; having to clean the bucket after emptying; and having to keep a supply of clean, organic material (e.g. sawdust, peat or clean soil, and straw/hay, weeds or leaves) available to use as cover materials, which is absolutely essential to the success of this sort of humanure composting system. Furthermore, when the bucket gets full, it can't be used until it's been emptied, no matter how bad one has to go. There is a degree of conscientious and serious responsibility involved in this system of composting in order for it to work well.

The advantages to this system include low financial cost in the creation of the facilities and low, or no energy consumption in its operation. Also, such a simple system, when the refuse is thermophilically composted, has a low environmental cost, as little or no technology is required for the system's operation, and the finished compost is as nice and benign a material as humanure can ever hope to be. No large, non-biodegradable composting chambers are required, and no composting facilities are necessary in or near one's living space, unless by choice (the manure collection can and should be inside one's home and can be quite comfortably designed). No electricity is needed, and no water is required except a small amount for cleaning purposes. The compost, if properly managed, will heat up sufficiently to kill all pathogens and thereby be useful for gardening purposes. A complete natural cycle is maintained, unbroken. Finally, the composting process is fast, i.e. the humanure is converted quickly (within a few days if not frozen) into an inoffensive substance that will neither attract rodents nor flies. In cold winter months, the compost simply freezes until spring thaw, then heats up.

The thought of carrying humanure to a compost site away from one's living space is one that will cause most Westerners to immediately reject the idea of composting their manure in this manner. The Western culture is built upon the idea of convenience, which is one reason why commercial composting toilets are relatively popular in the West, and the inconvenience of carrying refuse (*any* refuse) to a compost pile on a regular basis is just unacceptable. It is more convenient to *discard* organic refuse, such as down a toilet or in a garbage can, and that's why Western cultures do so. However, there are still more than a few people on the planet who are happy to endure a small inconvenience in exchange for less waste, a cleaner environment, and for soil-building compost. Furthermore, there are many people who do not have the luxury of choosing the convenience of waste disposal, as they don't have electricity, running water, or garbage pick-up, and they are therefore prime candidates for the thermophilic composting of their manure.

Likewise, there are those who want to compost their manure, are willing to endure some inconvenience, and still don't want to have to carry it anywhere. Those are people who may want to try situating their toilets directly above their compost

piles, such as is done with a mouldering toilet. This may be best suited in warm climates where an outdoor toilet is acceptable, or in situations where an easily accessible basement is available for the location of the compost pile. There's no reason why this scenario would not work *if the compost is properly managed*. Proper management can be summed up simply with four requirements:



This sawmill shed is full of raw, hardwood sawdust. Large quantities of this carbon-rich organic material are typically available at numerous sawmills throughout any forested area, either free for the hauling, or at very little cost. The above sawdust is being protected from the weather so it won't freeze, however, for composting purposes it is best to leave the sawdust exposed to the elements so it will become damp and will more rapidly decompose. Rotted sawdust is better for a compost pile than raw sawdust; kiln-dried sawdust (from a lumber yard) is the worst due to its relatively inert dehydrated state which resists microbial decomposition (let it sit out in the rain to rehydrate it). Sawdust alone decomposes slowly and may take 15 years to fully decompose. However, when blended with nitrogen rich, moist humanure, it will decompose relatively rapidly, returning to humus in year or two.

An Important Note About Sawdust

Not all sawdust decomposes well. Some tree species contain antibiotic oils that retard the development of microorganisms, and sawdust from these trees does *not* make good compost. These trees include **CEDAR, REDWOOD, BLACK LOCUST, OSAGE ORANGE, CYPRESS, WHITE OAK**, and perhaps others. Some rot-resistant hardwoods such as white oak *will* make good compost if the sawdust is left to decompose outside for a year or two before using for compost. Although the author uses only hardwood sawdust for compost because he lives in a hardwood forest area, **softwood sawdust makes good compost too, and some say it's even better than hardwood**. You be the judge. Experiment!

1) *Use at least a double chambered, above ground compost bin.* Deposit in one chamber for a period of time (e.g. a year), then switch to the other for an equal period of time.

2) *Deposit a good mix of organic refuse into the compost pile, including kitchen scraps.*

3) *Always cover humanure deposits with an organic cover material such as sawdust, leaves or hay.* Make sure that enough cover is applied so that there is neither excess liquid build-up nor offensive odors escaping the compost pile. The trick to using cover material is quite simple: *if it smells bad, cover it.*

4) *Keep good access to the pile* in order to rake the top flat, to apply bulky cover material when needed, and to monitor the temperature of the pile, if desired. The advantage of aerobic composting, as is typical of an above-ground pile, over anaerobic composting typical of sealed pits, is that the aerobic compost will generate higher temperatures, thereby ensuring a more rapid and complete destruction of potential human pathogens. It is still widely reported today that the aeration of a compost pile is best achieved by manual methods, especially turning of the pile, such as with a shovel, although I dispute this. Because of the widespread encouragement to turn compost piles, I turned my compost every year for over a decade, until I started monitoring the temperature of my compost pile using a compost thermometer. That's when I discovered that when I turned my compost, the thermophilic activity of the pile immediately stopped, and the pile cooled down, which is just the opposite of what one would expect. Yet the explanation is simple.

Perhaps my composting technique is unique in that it is as simple as it can get. I build the same pile for a year in an above-ground wooden bin, then I leave it to age for another year as I build a second pile. After the second year, I remove the first pile, which is now finished, and I start over in the first bin with a new pile. I use an annual system because my growing season is based on an annual system. I apply compost to my garden once a year because I only plant a garden once a year. When one builds the same pile *continuously* for a year, one will find during the course of that year that the thermophilic area of the pile is on the top where the fresh deposits reside. The lower sections of the pile have already heated and are now undergoing a cooler decomposition by fungi, earthworms etc. The pile is constantly growing on top and constantly shrinking beneath, and the thermophilic layer is therefore constantly rising to digest the newer deposits. When a pile such as this is turned, the thermophilic layer on top becomes diluted with the cooler, thermophilically-spent lower layers, and the carbon/nitrogen balance consequently becomes disrupted. The thermophiles don't have the proper balanced diet, and they cool down and die off, oxygen or no oxygen. All the oxygen in the world isn't going to ensure a successful compost

pile when the other requirements for successful compost are not met.

When I came to understand this phenomenon as it relates to continuous composting, I realized that if the compost pile is heating sufficiently, it obviously has enough oxygen. There is no need to add more, and if one tries to do so by turning the pile, one instead runs the risk of disrupting the C/N ratio of the thermophilic layer of the compost, thereby putting out its fire. Since my compost heats more than adequately for the purposes of hygiene, I've been forced to come to the conclusion that the simple act of covering humanure deposits with coarse materials such as straw or weeds, actually helps to trap sufficient oxygen in the pile *to render any additional or manual aeration of the compost unnecessary.*

Furthermore, in my case, all human urine is collected with fecal material and composted in the same elevated pile. This is made possible and convenient by using an absorbent carbonaceous material in the toilet receptacle itself, which absorbs the urine and covers the humanure deposits, thereby eliminating odors, flies and any other problems. I use rotting sawdust from logs because it is a readily available and inexpensive local resource, and it works. I used to haul a free load home every so often in the back of my pick-up truck, but now I just have a fellow with a small dump truck deliver me a load every year or two. I have the sawdust dumped outside where it can remain exposed to the elements and thereby slowly decompose on its own, as rotting sawdust makes compost more quickly than fresh sawdust. The sawdust doesn't cost anything, but it usually costs about five dollars to have it loaded and another twenty or so to have it hauled. This is an expense I'm happy to pay in order to ensure for myself a functional compost toilet system. However, my guess is that any cellulose-based material or combination of materials would work, including perhaps ground newsprint, or even just plain soil, if collected and kept dry enough to be absorbent.

Anaerobic systems seem best suited in situations where large amounts of refuse need to be composted, such as in an anaerobic pit where municipal refuse is deposited. Compost microorganisms, in the absence of oxygen (anaerobic), convert organic nitrogen to ammonia, while carbon is reduced to methane, and sulfur to hydrogen sulfide. This results in rather severe odor problems, and the destruction of pathogens proceeds slowly due to the relatively low composting temperatures. Such destruction may take up to twelve months for roundworm eggs.¹²

When I read about all of the styles and techniques for composting humanure, including vaults, pits, segregation of urine, liming, ashing, sealing, turning, etc., I wonder if anyone has tried to simply collect humanure, with urine and a carbon cover material, and pile it in a bin with garbage and other local organic cover materials such as weeds. Such a simple system, although not glamorous or sophisticated, works.

And that's what really matters, doesn't it?

Simple, low-tech compost systems not only have a low negative impact on the Earth's ecosystems, but are proven to be sustainable. Westerners may think that any system not requiring technology is too primitive to be worthy of respect. However, when Western culture is nothing more than a distant and fading memory in the collective mind of humanity thousands (hundreds?) of years from now, the humans who will have learned how to survive on this planet in the long term will be those who have learned how to live in harmony with it. That will require much more than intelligence or technology - it'll require a sensitive understanding of our place as humans in the web of life. That self-realization may be beyond the grasp of our egocentric intellects. Perhaps what is required of us in order to gain such an awareness is a sense of humility, and a renewed respect for that which is simple.

Some would argue that a very simple system of humanure composting can also be the most advanced system known to humanity. It may be considered the most advanced because it works well *while consuming little, if any, non-renewable resources, producing no pollution, and actually creating a resource vital to life.*

Now others may argue that in order for a system to be considered "advanced", it must display all the gadgets, doodads and technology normally associated with advancement. The argument is that something is advanced if it's been created by the scientific community, by humans, not by nature. That's like saying the most advanced method of drying one's hair is using a nuclear reaction in a nuclear power plant to produce heat in order to convert water to steam in order to turn electric generators in order to produce electricity in order to power a plastic hair-drying gun in order to blow hot air on one's head. But that's only technological advancement. It reflects humanity's *intellectual* progress . . . (I think).

True advancement, others would argue, instead requires the *balanced* development of humanity's intellect with physical and spiritual advancement. We must link what we know intellectually with the physical effects of our resultant behavior, and with the understanding of ourselves as small, interdependent, interrelated life forms in relation to a greater sphere of existence. Otherwise, unbalanced technological advancement uses technology to excessively consume non-renewable resources and to create toxic waste and pollution in order to do a simple task such as hair drying, which is easily done by hand with a towel. If that's advancement, we're in trouble.

Perhaps we're really advancing ourselves when we can function healthfully, peacefully and sustainably without squandering resources and without creating pollution. That's not a matter of mastering the intellect or of mastering the environment with technology, it's a matter of mastering one's self, a much more difficult undertaking, but certainly a worthy goal.

REFERENCES - CHAPTER FIVE

- 1 - Crook, James. (1985). "Water Reuse in California", *Journal American Water Works Association*, v.77, no.7, as seen in The Water Encyclopedia (van der Leeden, et. al., 1990, Lewis Publishers, Chelsea, Mich. 48118).
- 2 - Boyd, Robert F. and Hoerl, Bryan G. (1977). Basic Medical Microbiology. Little, Brown and Co., Boston. (p.494).
- 3 - Clayton, D., and Jacke, D. (1992). The Gap Mountain Permaculture Mouldering Toilet. Published by Gap Mountain Permaculture, 9 Old County Road, Jaffrey, NH 03452, phone:(603) 532-6877. Cost of mouldering toilet publication is \$12.00.
- 4 - Rybczynski, W. et. al. (1982). Appropriate Technology for Water Supply and Sanitation - Low Cost Technology Options for Sanitation, A State of the Art Review and Annotated Bibliography. World Bank. (p. 63). [see below]
- 5 - See ***Clivus Multrum Maintenance Manual***, Clivus Multrum, Inc., 21 Canal St., Lawrence, Mass. 01840. (Also contact Hanson Assoc., Lewis Mill, Jefferson, MD 21755)
- 6 - Contact ***Sun Mar Corp.***, 900 Hertel Ave., Buffalo, NY 14216 USA; or 5035 North Service Road, Burlington, Ontario, Canada L7L5V2.
- 7 - Contact ***AlasCan, Inc.***, 3400 International Way, Fairbanks, Alaska 99701, phone/fax (907) 452-5257 [as seen in *Garbage*, Feb/Mar 1993, p.35].
- 8 - ***Composting Toilet Systems***, PO Box 1928 (or 1211 Bergen Rd.), Newport, WA 99156, phone: (509) 447-3708/ fax (509) 447-3753.
- 9 - Rybczynski, W. et. al. (1982). Appropriate Technology for Water Supply and Sanitation - Low Cost Technology Options for Sanitation, A State of the Art Review and Annotated Bibliography. World Bank. Transportation and Water Department, 1818 H Street N.W., Washington D.C. 20433 USA. [Note: This work contains a bibliography on compost toilets that the reader may find useful.]
- 10 - Franceys et. al. (1992). A Guide to the Development of On-Site Sanitation. World Health Organization, Geneva. (p. 213).
- 11 - Rybczynski, as above. (p. 114).
- 12 - Franceys, et. al., as above. (p.214).
- 13 - McGarry, Michael G., and Stainforth, Jill (eds.) (1978). Compost, Fertilizer, and Biogas Production from Human and Farm Wastes in the People's Republic of China. International Development Research Center, Box 8500, Ottawa, Canada, K1G 3H9 (pages 9, 10, 29, 32).

Additional Sources of Composting Toilet Plans and/or General Information:

- ***Appalachia Science in the Public Interest**. Route 5, Box 423, Lexington KY 40445. [ASPI has a technical bulletin on composting toilets which includes a schematic for a compost toilet which ASPI designed.]
- ***Water Conservation Systems, Inc.** Damonmill Square, Nine Pond Lane, Concord, MA 01742 (508) 369-3951 [A source of several brands of composting toilets, including Biolet, Sunmar, Carousel, Alascan, Ecos Soltran, Sealand, Pactosan, and Nepon, as well as a variety of toilet accessories.]

***EKAT**, Robert J. Fairchild, Executive Director, 150 Gravel Lick Branch Road, Dreyfus, KY 40426-9700, ph. (606) 986-6146. ["Big Batch Composting Toilet Plans" \$7. Describes the do-it-yourself construction of compost toilets built of large, rolling, polyethylene dump carts, or "tilt trucks".]

***Long Branch Environmental Education Center**. P.O. Box 369, Leicester, NC 28748 (704) 683-3662. ["Do-It Yourself Passive Solar Compost Toilet" (\$25.00 for blueprints); Goodbye to the Flush Toilet by Carol Stoner (\$18.00 postpaid); "Compost Toilets: A Guide for Owner Builders" (\$8.00 postpaid).]

***National Center for Appropriate Technology**. 3040 Continental Drive, PO Box 3838, Butte MT 59702 (406) 494-4572. ["Compost Toilets: Suggested Readings", 1992, 6 pages, \$2; and "Wastes to Resources: Appropriate Technologies for Waste Conversion", 1984, 28 pages, \$4.]

***Real Goods**. 966 Mazzoni St., Ukiah, CA 95482-9486 USA, (800)762-7325. [They sell compost toilets and many other things.]

* **Biolet** (International, Canada, and USA)

Biolet USA Inc., Damonmill Square, Nine Pond Lane, Concord, MA 01742; 1-8005BIOLET. In Canada: Biolet Toilets Ltd., 1177 West Hastings Street, Suite 1106, Vancouver, BC, V6E2K3; Ph: 604-685-5265.

***Jade Mountain** 717 Poplar Ave., Boulder, CO 80304, or PO Box 4616, Boulder, CO 80306-4616; Ph: 303-449-6601 or 800-442-1972. (They sell various toilets).

***Lehman Hardware**, Box 41, Kidron, Ohio 44636; Ph: 216-857-5441. (They have a selection of toilets).

***Soiltech** (Biolet distributor) 607 E. Canal St., Newcomerstown, Ohio 43832-1207; Ph: 614-498-5929 or 800-296-6026.

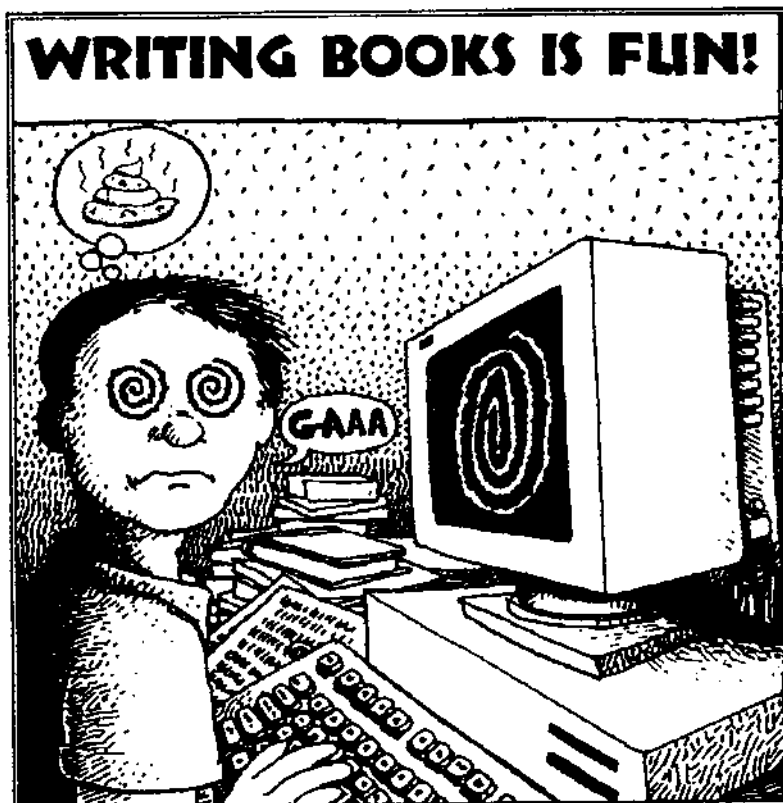

WORMS AND DISEASE

“Compost heaps. We built them regularly out of all the waste material we could find and watered them lavishly with liquid from the communal cesspool. I had, as chief composter, responsibility for seeing that they heated properly . . . A well-made compost heap steams like a tea kettle and gets hot enough to destroy all pathogens that may be present when one uses human sewage. An extraordinary device when one thinks about it. Thermophilic bacteria. Bacteria that can live and flourish in temperatures hot enough to cook an egg. How can they survive in such heat? Truly the tricks of nature are extraordinary!”

Robert S. deRopp



I well remember in 1979 when I first informed a friend that I intended to compost my own manure and grow my own food with it. *“Oh my God, you can't do that!”* she cried.

“Why not?”

“Worms and disease!”

Of course. What else would a fecophobe think of when one mentions using humanure as a fertilizer?

An English couple was visiting me one summer after I had been composting humanure for about six years. One evening, as dinner was being prepared, the couple suddenly understood the horrible reality they now found themselves faced with: the food they were about to eat was *recycled shit*. When this “fact” dawned upon them it seemed to set off some kind of instinctive English alarm in their minds, possibly inherited directly from Queen Victoria. *“We don't want to eat shit!”* they quite seriously informed me (that's an exact quote), as if in preparing dinner I was simply defecating on plates and setting them on the table. Never mind that the food appeared quite palatable. It was the *thought* of it that mattered.

Fecophobia is alive and well and currently residing in about a billion Westerners. Oh well, ignorance is a problem. I have no doubt that if I were living five hundred years ago, I'd be considered one of those “witches” of bygone days. What made a person a witch was their refusal to accept the intellectual constraints of the era, which forced them to be seen as nonconforming and threatening to the status quo. The solution at that time reflected the puny intelligences and spiritual destitution of the establishment leaders: they'd simply gather up the non-conformists and burn

them alive. Yes, ignorance is a chronic human problem.

One common misconception is that fecal material, when composted, remains fecal material. *It does not.* Humanure comes from the earth, and through the miraculous process of composting, returns to earth. When the composting process is finished, the end product is earth, not shit. That earth, or humus, is useful in growing food. My friends unfortunately didn't understand this, and they chose instead to continue clinging to their misconceptions, despite my attempts to clarify the matter for their benefit. Apparently, some fecophobes will always remain fecophobes.

THE HUNZAS

It's already been mentioned that entire civilizations have recycled humanure for thousands of years. That should provide a fairly convincing testimony about the usefulness of humanure as an agricultural resource. Nearly everyone's heard of the "healthy Hunzas", a people in what is now a part of Pakistan who live among the Himalayan peaks, and routinely survive to be 120 years old. The Hunzas gained fame in the United States during the 1960's health food era, at which time several books were written about the fantastic longevity of this ancient people. Their extraordinary health has been attributed to the quality of their overall lifestyle, including the quality of the natural food they eat and the soil it's grown on. Few people, however, realize that the Hunzas also compost their humanure and use it to grow their food. The Hunzas, who call themselves "Hunzakuts", have bronzed but Caucasian features like southern Europeans. They're said to have virtually no disease, no cancer, no heart or intestinal trouble, and they regularly live to be over a hundred years old while *"singing, dancing and making love all the way to the grave."*

According to Tompkins (1989), *"In their manuring, the Hunzakuts return everything they can to the soil: all vegetable parts and pieces that will not serve as food for humans or beast, including such fallen leaves as the cattle will not eat, mixed with their own seasoned excrement, plus dung and urine from their barns. Like their Chinese neighbors, the Hunzakuts save their own manure in special underground vats, clear of any contaminable streams, there to be seasoned for a good six months. Everything that once had life is given new to life through loving hands (emphasis mine)."*¹

Sir Albert Howard wrote in 1947, *"The Hunzas are described as far surpassing in health and strength the inhabitants of most other countries; a Hunza can walk across the mountains to Gilgit sixty miles away, transact his business, and return forthwith without feeling unduly fatigued."* Sir Howard maintains that this is illustra-

tive of the vital connection between a sound agriculture and good health, insisting that the Hunzas have evolved a system of farming which is perfect. He adds, *“To provide the essential humus, every kind of waste [sic], vegetable, animal and human, is mixed and decayed together by the cultivators and incorporated into the soil; the law of return is obeyed, the unseen part of the revolution of the great Wheel is faithfully accomplished.”*²

Sir Howard’s view is that soil fertility is the real basis of public health. A medical professional associated with the Hunzas claimed, *“During the period of my association with these people I never saw a case of asthenic dyspepsia, of gastric or duodenal ulcer, of appendicitis, of mucous colitis, of cancer. . .Among these people the abdomen over-sensitive to nerve impressions, to fatigue, anxiety, or cold was unknown. Indeed their buoyant abdominal health has, since my return to the West, provided a remarkable contrast with the dyspeptic and colonic lamentations of our highly civilized communities.”*

Sir Howard’s response to this is, *“The remarkable health of these people is one of the consequences of their agriculture, in which the law of return is scrupulously obeyed. All their vegetable, animal and human wastes [sic] are carefully returned to the soil of the irrigated terraces which produce the grain, fruit, and vegetables which feed them.”*³

PATHOGENS

[Much of the following information is adapted from Appropriate Technology for Water Supply and Sanitation, by Feachem, et. al., World Bank, 1980.⁴ This comprehensive work cites 394 references from throughout the world, and was carried out as part of the World Bank’s research project on appropriate technology for water supply and sanitation. The reader can assume that the following facts and figures for which no references are shown originated in the above work. Other sources used for reference are as indicated.]

Clearly, the recycling of humanure for agricultural purposes does not necessarily pose a threat to human health, as evidenced by the Hunzas. And yet, it can. Feces can harbor any of a host of disease germs which can make their way into the environment to infect innocent people, as was apparently the case in medieval Europe. In fact, even a healthy person apparently free of disease can pass potentially dangerous pathogens through the feces, simply by being a carrier. Even urine, usually considered sterile, can contain disease germs (see table 6:1).

Table 6.1 (Source: Feachem et. al., 1980)
POTENTIAL PATHOGENS IN URINE

Healthy urine on its way out of the human body may contain up to 1,000 bacteria, of several types, per milliliter. More than 100,000 bacteria per milliliter of a single type signals a urinary tract infection.²³ Infected individuals will pass pathogens in the urine that may include:

<u>Bacteria</u>	<u>Disease</u>
1. <i>Salmonella typhi</i>	<i>typhoid</i>
2. <i>Salmonella paratyphi</i>	<i>paratyphoid fever</i>
3. <i>Leptospira</i>	<i>leptospirosis</i>
4. <i>Yersinia</i>	<i>yersiniosis</i>
<u>Worms</u>	<u>Disease</u>
<i>Schistosoma haematobium</i>	<i>schistosomiasis</i>

The following information is not meant to be alarming. It's included for the sake of thoroughness, and to illustrate the need to *thermophilically compost* humanure, rather than to try to use it raw for agricultural purposes. Humanure has been used raw in farm fields and is still used in such a state at times in various places throughout the world, including China. This is where the danger lies, as the process of thermophilic composting is required in order to kill dangerous pathogens that may reside in human excrement. When the composting process is side-stepped and pathogenic organic material is distributed throughout the environment, various diseases and worms can infect the population living in the contaminated area. This fact has been widely documented in societies where members recycle their manure carelessly as well as in those that don't recycle at all.

For example, consider the following quote from Jervis (1990): "*The use of night soil [raw human fecal material and urine] as fertilizer is not without its health hazards. Hepatitis B is prevalent in Dacaiyuan [China], as it is in the rest of China. Some effort is being made to chemically treat human waste [sic] or at least to mix it with other ingredients before it is applied to the fields. But chemicals are expensive, and old ways die hard. Night soil is one reason why urban Chinese are so scrupulous about peeling fruit, and why raw vegetables are not part of the diet. Negative features aside, one has only to look at satellite photos of the green belt that surrounds China's cities to understand the value of night soil.*"²⁵

On the other hand, "worms and disease" are not spread by properly prepared compost, nor by healthy people. There is no reason to believe that the manure of a

healthy person is dangerous unless left to accumulate, pollute water with intestinal bacteria, and breed flies and/or rats, all of which are the results of negligence or bad customary habits. It should be understood that the breath one exhales can also be the carrier of dangerous pathogens, as can one's saliva and sputum. The issue is confused by the notion that if something is potentially dangerous, then it is always dangerous, which is not true. Furthermore, it is generally not understood that the carefully managed thermophilic composting of humanure kills all human pathogens in the manure. No other system of fecal material and urine recycling or disposal does this without the use of dangerous chemical poisons or a high level of technology and energy consumption.

The pathogens that can exist in human feces can be divided into four general categories: *viruses, bacteria, protozoa, and worms (helminths)*.

There are more than 100 types of **viruses** worldwide that can be passed through human feces, including polioviruses, coxsackieviruses (causing meningitis and myocarditis), echoviruses (causing meningitis and enteritis), reovirus (causing enteritis), adenovirus (causing respiratory illness), infectious hepatitis (causing jaundice), and others (see table 6:2).

Of the pathogenic **bacteria**, the genus *Salmonella* is significant because it contains species causing typhoid fever, paratyphoid, and gastrointestinal disturbances. Another genus of bacteria, *Shigella*, causes dysentery. *Mycobacterium* cause

Table 6.2 (Source: Feachem et. al., 1980)

POTENTIAL VIRAL PATHOGENS IN FECES

<u>Virus</u>	<u>Disease</u>	<u>Can Carrier Be Symptomless?</u>
1. <i>Rotaviruses</i>	Diarrhea.....	yes
2. <i>Hepatitis A</i>	Infectious hepatitis	yes
3. <i>Adenoviruses</i>	varies	yes
4. <i>Reoviruses</i>	varies	yes
5. <i>Coxsackievirus</i>	varies	yes
6. <i>Echoviruses</i>	varies	yes
7. <i>Polioviruses</i>	Poliomyelitis	yes

Rotaviruses may be responsible for the majority of infant diarrheas. Hepatitis A causes infectious hepatitis, but is often without symptoms, especially in children. Coxsackievirus infection can lead to meningitis, fevers, respiratory diseases, paralysis, and myocarditis. Echovirus infection can cause simple fever, meningitis, diarrhea, or respiratory illness. Most poliovirus infections don't give rise to any clinical illness, although sometimes infection causes a mild, influenza-like illness which may lead to virus-meningitis, paralytic poliomyelitis, permanent disability or death. It's estimated that almost everyone in developing countries becomes infected with poliovirus, and that one out of every thousand poliovirus infections leads to paralytic poliomyelitis.

tuberculosis (see table 6:3).

The pathogenic **protozoa** include *Entamoeba histolytica* (amoebic dysentery), and members of the Hartmanella-Naegleria group (meningo-encephalitis). The cyst stage in the life cycle of protozoa is the primary means of dissemination as the amoeba die quickly once outside the human body. Cysts must be kept moist in order to remain viable for any extended period (see table 6:4).⁶

Finally, a number of parasitic **worms** pass their eggs in feces, including hookworms, roundworms, and whipworms (see table 6:5). Various researchers have reported 59 to 80 worm eggs in sampled liters of sewage. This suggests that billions of pathogenic worm eggs may reach an average wastewater treatment plant daily. These eggs tend to be resistant to environmental conditions due to a thick outer covering.⁷

Now here's a good place to stop and do some calculations. If there are fifty-nine to eighty worm eggs in a liter sample of sewage, then we could reasonably estimate that there are 70 eggs per liter, or 280 eggs per gallon to get a ballpark average.

Table 6.3 (Source: Feachem et. al., 1980)
POTENTIAL BACTERIAL PATHOGENS IN FECES

<u>Bacteria</u>	<u>Disease</u>	<u>Symptomless Carrier</u>
1. <i>Salmonella typhi</i>	Typhoid fever.....	yes
2. <i>Salmonella paratyphi</i>	Paratyphoid fever.....	yes
3. Other <i>Salmonellae</i>	Food poisoning	yes
4. <i>Shigella</i>	Dysentery.....	yes
5. <i>Vibrio cholerae</i>	Cholera.....	yes
6. Other <i>Vibrios</i>	Diarrhea	yes
7. <i>E. coli</i>	Diarrhea	yes
8. <i>Yersinia</i>	Yersiniosis	yes
9. <i>Campylobacter</i>	Diarrhea	yes

Table 6.4 (Source: Feachem et. al., 1980)
POTENTIAL PROTOZOAN PATHOGENS IN FECES

<u>Protozoa</u>	<u>Disease</u>	<u>Symptomless carrier?</u>
1. <i>Balantidium coli</i>	Diarrhea	yes
2. <i>Giardia lamblia</i>	Diarrhea.....	yes
3. <i>Entamoeba histolytica</i>	Dysentery, colonic	yes
	ulceration, liver abscess	

Table 6.5 (Source: Feachem et. al., 1980)
POTENTIAL WORM PATHOGENS IN FECES

<u>Common Name</u>	<u>Pathogen</u>	<u>Transmission</u>	<u>Distribution</u>
1. Hookworm	<i>Ancylostoma doudenale</i> <i>Necator americanus</i>	Human-soil-human	Warm, wet climates
2. ———	<i>Heterophyes heterophyes</i>	Dog/cat-snail-fish-human	Middle east, S. Europe, Asia
3. ———	<i>Gastrodiscoides</i>	Pig-snail-aquat. veg.-human	India, Bangladesh, Vietnam, Philippines
4. Giant Intestinal fluke	<i>Fasciolopsis buski</i>	Human/pig-snail-aq. veg.-human	S.E. Asia, China
5. Sheep liver fluke	<i>Fasciola hepatica</i>	Sheep-snail- aq. veg.-human	Worldwide
6. Pinworm	<i>Enterobius vermicularis</i>	Human-human	Worldwide
7. Fish tapeworm	<i>Diphyllobothrium latum</i>	Human/animal-copepod-fish-human	Mainly temperate
8. Cat liver fluke	<i>Opisthorchis felineus</i> , <i>O. viverrini</i>	Animal-aq. snail-fish-human	USSR, Thailand
9. Chinese liver fluke	<i>Chlonorchis sinensi</i>	Animal/human-snail-fish-human	S.E. Asia
10. Roundworm	<i>Ascaris lumbricoides</i>	Human-soil- human	Worldwide
11. Dwarf tapeworm	<i>Hymenolepis spp</i>	Human/rodent-human	Worldwide
12. ———	<i>Metagonimus yokogawai</i>	Dog/cat-snail-fish-human	Japan, Korea, China, Taiwan, Siberia
13. Lung fluke	<i>Paragonimus westermani</i>	Animal/human- snail-crab/crayfish-human	S.E. Asia, Africa, S.America
14. Schistosome, bilharzia	<i>Schistosoma haematobium</i>	Human-snail- human	Africa, M. East, India
-----	<i>S. mansoni</i>	Human-snail- human	Africa, Arabia , Latin America
-----	<i>S. japonicum</i>	Animal/human- snail-human	S.E. Asia
15. Threadworm	<i>Strongyloides stercoralis</i>	Human-human (dog-human?)	Warm, wet climates
16. Beef tapeworm	<i>Taenia saginata</i>	Human-cow- human	Worldwide
Pork tapeworm	<i>T. solium</i>	Human-pig-human or human-human	Worldwide
17. Whipworm	<i>Trichuris trichiura</i>	Human-soil-human	Worldwide

That's approximately 280 pathogenic worm eggs per gallon of wastewater entering wastewater treatment plants. My local wastewater treatment plant serves a population of eight thousand people and collects about 1.5 million gallons of wastewater daily. That means there could be 420 million worm eggs entering the plant each day and settling into the sludge. In a year's time over 153 *billion* parasitic eggs can pass through my local small-town wastewater facility. Now let's look at the worst scenario: all the eggs survive in the sludge because they're resistant to the environmental conditions at the plant. Well, in a year's time, 30 tractor-trailer loads of sludge are hauled out of the local facility. Each truckload of sludge could then contain over 5 *billion* pathogenic worm eggs, en route to maybe a farmer's field, but probably a landfill. Now, if we were composting that manure instead of floating it downstream, we'd be killing those eggs. But there I go getting ahead of myself again.

INDICATOR PATHOGENS

Indicator pathogens are pathogens whose detectable occurrence in soil or water serves as evidence that fecal contamination exists.

The astute reader will have noticed that many of the pathogenic worms listed previously are not found in the United States. Of those that are, the *Ascaris lumbricoides* (roundworm) is the most persistent, and can serve as an indicator for the presence of pathogenic helminths in the environment.

A single female roundworm may lay as many as 27 million eggs in her lifetime.⁸ These eggs are protected by an outer covering that is resistant to chemicals and that can enable the eggs to remain viable in soil for long periods of time. The reported viability of roundworm eggs (*Ascaris ova*) in soil ranges from a couple of weeks under sunny, sandy conditions⁹, to 2 and a half years¹⁰, four years¹¹, five and a half years¹² or even ten years¹³ in soil, depending on the source of the information. Consequently, the eggs of the roundworm seem to be the best indicator for the determination of parasitic worm pathogens in compost. In China, current standards for the agricultural reuse of humanure require an *Ascaris* mortality of greater than 95 percent.

Ascaris eggs develop at temperatures between 15.5°C (59.90° F) and 35°C (95.00° F), but the eggs disintegrate at temperatures above 38°C (100.40° F)¹⁴. The temperatures generated during thermophilic composting can significantly exceed levels necessary to destroy roundworm eggs.

One way to determine if the compost you're using is contaminated with viable roundworm eggs is to have a stool analysis done at a local hospital. If your compost

is contaminated and you're using the compost to grow your own food, then there's a good chance that you've contaminated yourself. A stool analysis will reveal whether that is the case or not. Such an analysis cost about \$41.00 (1993). [*See page 135]

Indicator bacteria include fecal coliforms, which reproduce in the intestinal systems of warm blooded animals. If one wants to test a water supply for fecal contamination, then fecal coliforms, usually *Escherichia coli*, are looked for. The absence of *E. coli* in water indicates that the water is free from fecal contamination.

Water tests, however, often determine the level of *total coliforms* in the water, reported as the number of coliform/100 ml. Such a test measures *all* species of the coliform group and is not limited to species originating in warm-blooded animals. Since some coliform species come from the soil, the results of this test are not always indicative of fecal contamination in a *stream* analysis. However, this test can be used for *ground water* supplies, as no coliforms should be present in ground water unless it has been contaminated by a warm blooded animal.

Fecal coliforms do not multiply outside the intestines of warm blooded animals, and their presence in water is unlikely unless there is fecal pollution, They survive for a shorter time in natural waters than the coliform group as a whole, therefore their presence indicates relatively recent pollution. In domestic sewage, the fecal coliform count is usually 90% or more of the total coliform count, but in natural streams fecal coliforms may range from 10-30% of the total coliform density. Almost all natural waters have a presence of fecal coliforms, since all warm-blooded animals excrete them. Most states in the U.S. limit the fecal coliform concentration allowable in waters used for water sports to 200 fecal coliform/100ml.

Table 6.13

Average Density of Fecal Coliforms Excreted in 24 Hours (million/100ml)

Human	13.0
Duck	33.0
Sheep	16.0
Pig	3.3
Chicken	1.3
Cow	.23
Turkey	.29

Bacterial analyses of drinking water supplies are routinely provided for a small fee (in 1994 around \$20.00) by agricultural supply firms, water treatment companies, or private labs.

PERSISTENCE OF PATHOGENS IN SOIL, CROPS, MANURE AND SLUDGE

According to Feachem, et. al. (1980), the persistence of fecal pathogens in the environment can be summarized as follows:

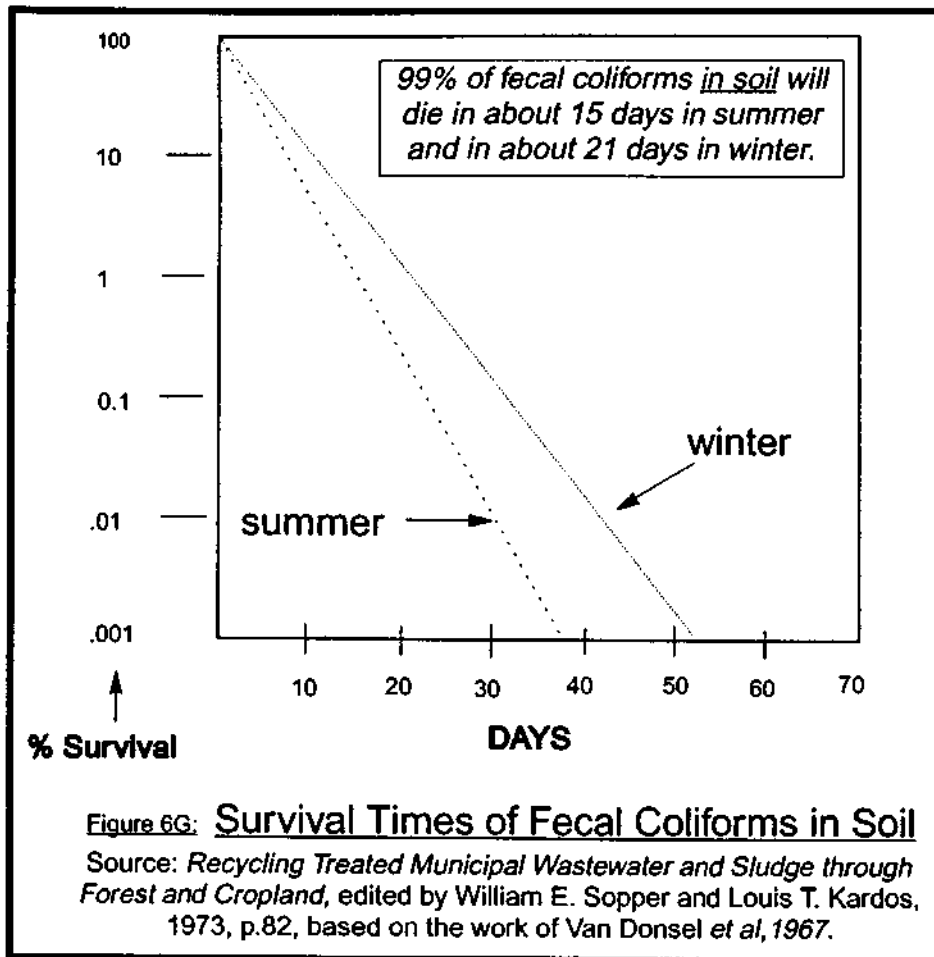

In Soil

Survival times of pathogens in soil are affected by soil moisture, pH, type of soil, temperature, sunlight, and organic matter. Although **fecal coliforms** can survive for several years under optimum conditions, a 99% reduction is likely within 25 days in warm climates (see Figure 6G). **Salmonella bacteria** may survive for a year in rich, moist, organic soil, although 50 days would be a more typical survival time. **Viruses** can

survive up to three months in warm weather, and up to six months in cold. **Protozoan cysts** are unlikely to survive for more than 10 days. **Roundworm eggs** can survive for several years.

The viruses, bacteria, protozoa and worms that can be passed in human excrement all have limited survival times outside of the human body. Let's take a look at their survival times when deposited raw into soil (refer to tables 6.6 through 6.10):

Survival of pathogens On Crops

Bacteria and **viruses** cannot penetrate undamaged vegetable skins. However, pathogens can survive on the surfaces of vegetables, especially root vegetables. Sunshine and low air humidity will promote the death of pathogens. **Viruses** can survive up to 2 months on crops but usually less than one month. **Indicator bacteria** up to several months, but usually less than one month. **Protozoan cysts** usually less than two days. **Worm eggs** usually less than one month.

For example, lettuce and radishes sprayed with sewage inoculated with poliovirus I showed a 99% reduction in pathogens after 6 days, 100% after 36 days (in Ohio). Radishes grown outdoors in soil fertilized with fresh typhoid feces four

Table 6.6 (Source: Feachem et. al., 1980)
SURVIVAL OF ENTEROVIRUSES IN SOIL

Viruses - These parasites, which are smaller than bacteria, can only reproduce inside the animal or plant they parasitize. However, some can survive for long periods outside of their host:

Enteroviruses - Enteroviruses are those that reproduce in the intestinal tract. They have been found to survive in soil for periods ranging between 15 and 170 days. The following chart shows the survival times of enteroviruses in various types of soil and soil conditions:

<u>Soil Type</u>	<u>pH</u>	<u>% Moisture</u>	<u>°C</u>	<u>Days of Survival</u> (less than)
Sterile, sandy	7.5-----	10-20%-----	3-10 -----	130-170 days
		"	18-23	90-110
	5-----	"-----	3-10 -----	110-150
		"	18-23	40-90
Non-sterile, sandy	7.5-----	"-----	3-10 -----	110-170
		"	18-23	40-110
	5-----	"-----	3-10 -----	90-150
		"	18-23	25-60
Sterile, loamy	7.5-----	"-----	3-10 -----	70-150
		"	18-23	70-110
	5-----	"-----	3-10 -----	90-150
		"	18-23	25-60
Non-sterile, loamy	7.5-----	"-----	3-10 -----	110-150
		"	18-23	70-110
	5-----	"-----	3-10 -----	90-130
		"	18-23	25-60
Non-sterile, sandy	7.5-----	"-----	18-23 -----	15-25

Table 6.7 (Source: Feachem et. al., 1980)
SURVIVAL TIME OF SOME PROTOZOA IN SOIL

<u>Protozoa</u>	<u>Soil</u>	<u>Moisture</u>	<u>Temp°C</u>	<u>Survival</u>
<i>E. histolytica</i>	loam/sand	Damp	28-34	8-10 days
"	soil	Moist	?	42-72 hr
"	"	Dry	?	18-42 hrs.

Table 6.8 (Source: Feachem et. al., 1980)
SURVIVAL TIME OF SOME BACTERIA IN SOIL

<u>Bacteria</u>	<u>Soil</u>	<u>Moisture</u>	<u>Temp. °C</u>	<u>Survival</u>
<i>Streptococci</i> -----	<i>Loam</i>	?	?	<i>9-11 weeks</i>
“-----	<i>Sandy loam</i>	?	?	<i>5-6 weeks</i>
<i>S. Typhi</i> -----	<i>various soils</i>	?	22	<i>2 days-400 days</i>
<i>Bovine tubercule bacilli</i>	<i>soil & dung</i>	?	?	<i>less than 178 days</i>
<i>Leptospire</i> s-----	<i>varied</i>	<i>varied</i>	<i>summer</i>	<i>12 hrs-15 days</i>

Table 6.9 (Source: Feachem et. al., 1980)

SURVIVAL OF POLIOVIRUSES IN SOIL

<u>Soil Type</u>	<u>Virus</u>	<u>Moisture</u>	<u>Temp. °C</u>	<u>Days of Survival</u>
<i>Sand dunes</i> -----	<i>Poliovirus</i>	<i>dry</i>	?	<i>Less than 77</i>
		<i>moist</i>	?	<i>" 91</i>
<i>Loamy fine sand</i> -----	<i>Poliovirus I</i>	<i>moist</i>	4	<i>90% reduction in 84 days</i>
		<i>moist</i>	20	<i>99.999% red. in 84 days</i>
<i>Soil irrigated w/</i> ----- <i>effluent, pH=8.5</i>	<i>Polioviruses</i> <i>1,2 &3</i>	<i>9-20%</i>	<i>12-33</i>	<i>Less than 8</i>
<i>Sludge or effluent</i> ----- <i>irrigated soil</i>	<i>Poliovirus I</i>	<i>180mm total</i> <i>rain</i>	<i>-14-27</i> -----	<i>96-123 after sludge applied</i>
			<i>-14-27</i> -----	<i>89-96 after effluent applied</i>
		<i>190mm total</i> <i>rain</i>	<i>15-33</i> -----	<i>less than 11 days after</i> <i>sludge or effluent applied</i>

Table 6.10 (Source: Feachem et. al., 1980)

SURVIVAL TIME OF SOME PATHOGENIC WORMS IN SOIL

<u>Worm</u>	<u>Soil</u>	<u>Moisture</u>	<u>°C</u>	<u>Survival</u>
Hookworm larvae	Sand	?	rm. temp.	less than 4 months
	Soil	?	open shade, Sumatra	less than 6 months
	Soil	Moist	Dense shade	9-11 wks
			Mod. shade	6-7.5 wks
			Sunlight	5-10 days
	Soil	Water covered	varied	10-43 days
	Soil	Moist	0°	less than 1 week
16	14-17.5 weeks			
27	9-11 weeks			
35	less than 3 weeks			
		40	less than 1 week	
Hookworm ova (eggs)	Heated soil with night soil	water covered	15-27	9% survival after 2 weeks
	Unheated soil with night soil	water covered	15-27	3% survival after 2 weeks
Roundworm ova	Sandy, shaded	25-36	31% dead after 54 days	
	Sandy, sun	24-38	99% dead after 15 days	
	Loam, shad	25-36	3.5% dead after 21 days	
	Loam, sun	24-38	4% dead after 21 days	
	Clay, shade	25-36	2% dead after 21 days	
	Clay, sun	24-38	12% dead after 21 days	
	Humus, shade	25-36	1.5% dead after 22 days	
	Clay, shade	22-35	more than 90 days	
	Sandy, shade	22-35	less than 90 days	
	Sandy, sun	22-35	less than 90 days	
	Soil irrigated with sewage	?	less than 2.5 years	
	Soil	?	2 years, 5.5 years ¹⁴ , even 10 years ¹⁵	

days after planting showed a pathogen survival period of less than 24 days. Tomatoes and lettuce contaminated with a suspension of roundworm eggs showed a 99% reduction in eggs in 19 days and a 100% reduction in 4 weeks. These tests indicate that if there is any doubt about pathogen contamination of compost, the compost should be applied to long-season crops at the time of planting, so that sufficient time ensues for the pathogens to die before harvest.

Pathogen survival In Sludge and Feces/Urine

Viruses can survive up to 5 months, but usually less than 3 months in sludge and night soil. **Indicator bacteria** up to 5 months, but usually less than 4 months.

Salmonellae up to 5 months, but usually less than one month. Tubercle bacilli up to 2 years, but usually less than 5 months. **Protozoan cysts** up to one month, but usually less than 10 days. **Worm eggs** vary depending on species, but roundworm eggs may survive for many months.

When I started writing this book, I'd been composting my own humanure for nearly fourteen years and using it to grow about 50% of my food (the other 50% I buy). My sawdust toilet was used by many other people during that time period, especially since I operated an alternative school for five years on my property with a peak enrollment of 23 kids, which involved frequent use of my composting toilet system. I had many gatherings of people at my homestead over the years, as many as 150 people during a weekend. Not long before I began writing this book, I had 130 people visit within a twenty-four hour period. The humanure receptacle had to be emptied onto the compost pile four times that day. I've had little control over who's been using my toilet. There may have been people infected with all manner of pathogens depositing their contaminated feces into my composting system. However, I've had faith that the thermophilic composting routine I use has been killing any human pathogens present in the compost. Nevertheless, for the sake of thoroughness I had two stool analyses conducted by the local hospital laboratory as I wrote this, and no intestinal worms or eggs were found.

ELIMINATING PATHOGENS FROM HUMANURE

It should be evident to the reader by now that humanure certainly possesses the capability of transmitting various diseases. For this reason, it should also be evident that the composting of humanure is a serious undertaking and should not be done in a frivolous, careless or haphazard manner. The pathogens that may be present in humanure have various survival periods outside the human body and maintain varied capacities for re-infecting people. This is why the *careful management* of a thermophilic compost system is so important. Nevertheless, there is no proven, natural, low-tech method for destroying human pathogens in organic refuse that is as successful and accessible to the average human as well-managed thermophilic composting.

The following information illustrates the various waste treatment methods and composting methods commonly used today and shows the transmission of pathogens through the individual systems:

Outhouses and Pit Latrines

Outhouses have odor problems, breed flies and possibly mosquitoes, and pollute groundwater. However, if the contents of a pit latrine have been filled over and left for a minimum of one year, there will be no surviving pathogens except for the possibility of roundworm eggs, according to Feachems. This risk is small enough that the contents of pit latrines, after twelve months burial, can be used agriculturally. Franceys, et. al. (1992) state, "Solids from pit latrines are innocuous if the latrines have not been used for two years or so, as in alternating double pits."¹⁵

Septic Tanks

It is safe to assume that septic tank effluents and sludge are highly pathogenic (see figure 6A).

Conventional Sewage Treatment Plants

The only sewage digestion process producing a guaranteed pathogen-free sludge is batch ther-

mophilic digestion in which all of the sludge is maintained at 50°C (122°F) for 13 days. All other sewage digestion processes will allow the survival of worm eggs and possibly pathogenic bacteria. Typical sewage treatment plants instead use a continuous process where wastewater is added daily or more frequently, thereby guaranteeing the survival of pathogens.

I took an interest in my local wastewater treatment plant when I discovered that the treated water it was discharging into our local creek had ten times the level of nitrates that unpolluted water has, and three times the level of nitrates acceptable for drinking water.¹⁶ In other words, the water being discharged from the water treatment plant was polluted with nitrates (we didn't test for pathogens or chlorine levels). Despite the pollution, the levels were within legal limits for wastewater discharges (see figure 6B).

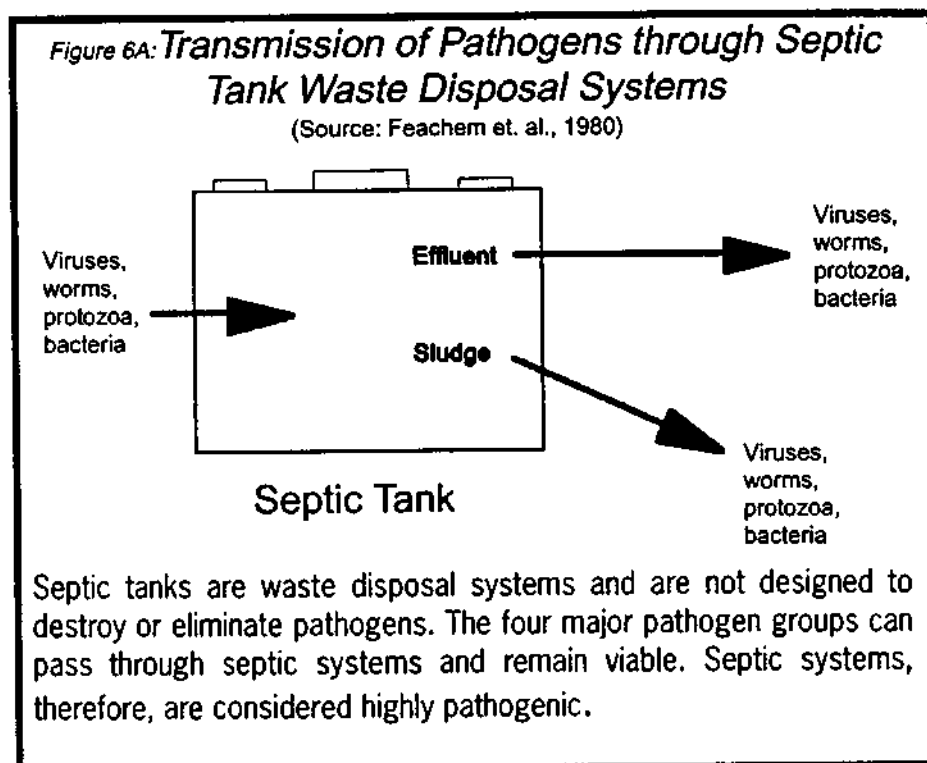
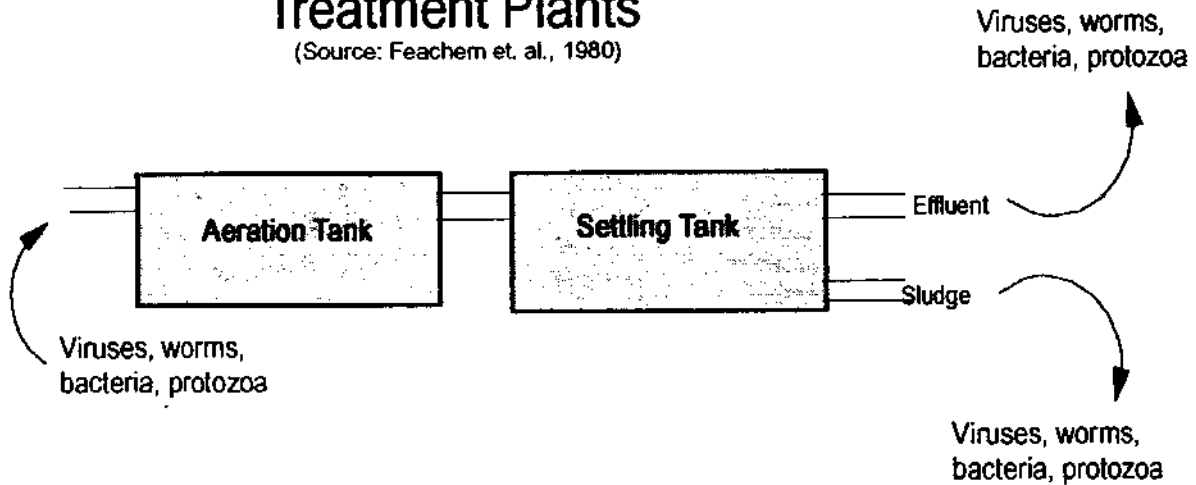

Figure 6B: Transmission of Pathogens through Conventional Sewage Treatment Plants

(Source: Feachem et. al., 1980)



Conventional sewage treatment plants allow the transmission of pathogens through them. Consequently, the effluent is commonly treated with chemical poisons such as chlorine, and the sludge is commonly buried in landfills.

Waste Stabilization Ponds

Waste stabilization ponds, large shallow ponds widely used in North America, Latin America, Africa and Asia, involve the use of both beneficial bacteria and algae in the decomposition of organic waste materials. Although they can breed mosquitoes, they can be designed and managed well enough to yield pathogen-free waste

Figure 6C: Transmission of Pathogens through Waste Stabilization Ponds

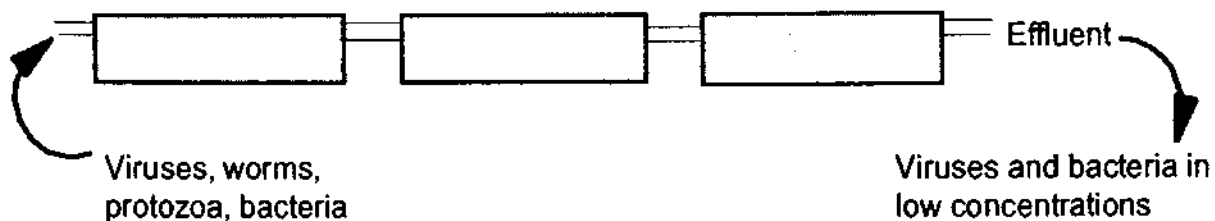

(Source: Feachem et. al., 1980)

water. However, they typically yield water with low concentrations of both pathogenic viruses and bacteria (see figure 6C).

Composting Toilets and Mouldering Toilets

Due to the relatively anaerobic conditions of the multrum and mouldering toilets and the consequently low decomposition temperatures, complete elimination of pathogens from the manure is not likely to be obtained.

However, according to Feachems, et. al., a minimum retention time of three months produces a compost

free of all pathogens except possibly some intestinal worm eggs. Also, the compost obtained from these types of toilets can conceivably be composted again in a thermophilic pile and rendered suitable for food gardens (see figure 6D and table 6.11).

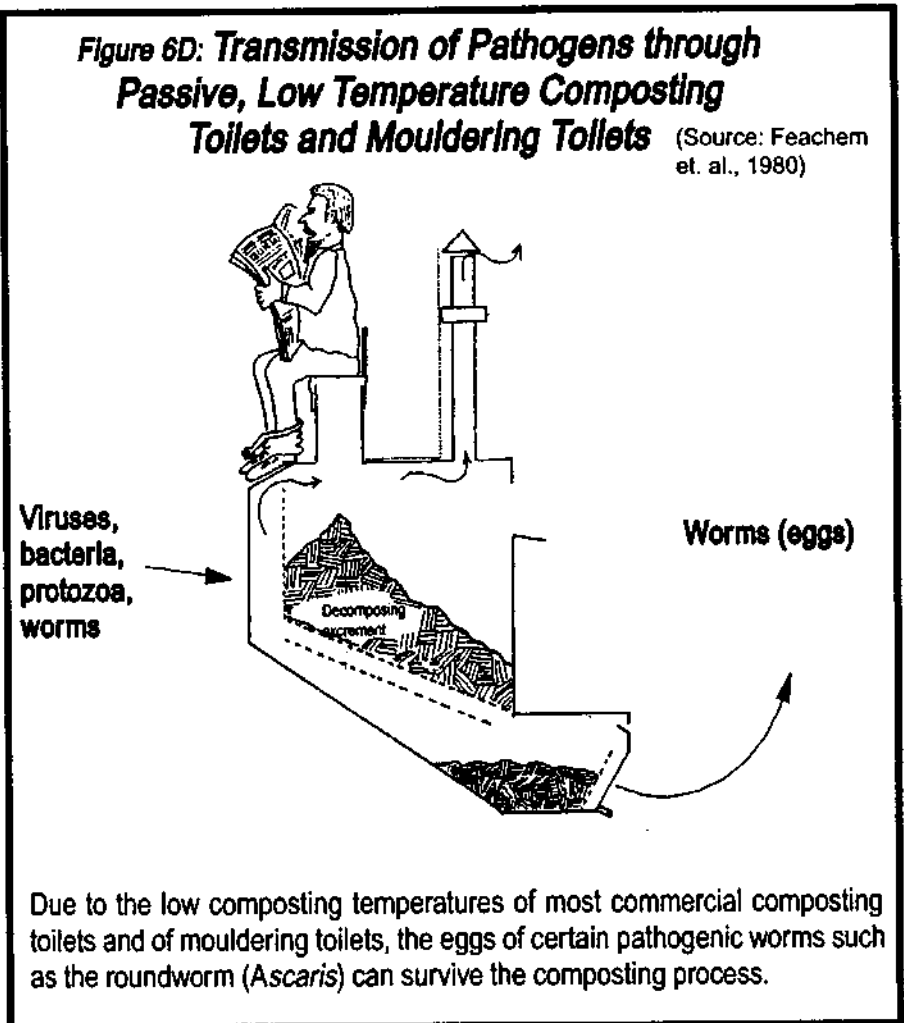

Well-managed Thermophilic Composting System

Complete pathogen destruction is guaranteed by arriving at a temperature of 62°C (143.6°F) for one hour, or 50°C (122°F) for one day, or 46°C (114.8°F) for one week, or 43°C (109.4°F) for one month. It appears that no excreted pathogen can survive a temperature of 65°C (149°F) for more than a few minutes. A compost pile containing entrapped oxygen may rapidly rise to a temperature of 55°C (131°F) or above, or will maintain a temperature hot enough for a long enough period of time to thoroughly destroy human pathogens (see figure 6E). Table 6.11 indicates survival times of pathogens in a) soil, b) anaerobic decomposition conditions, c) composting toilets and d) thermophilic compost piles.

*Figure 6E: Transmission
of Pathogens through
a Thermophilic
Composting System*

(Source: Feachem et. al., 1980)

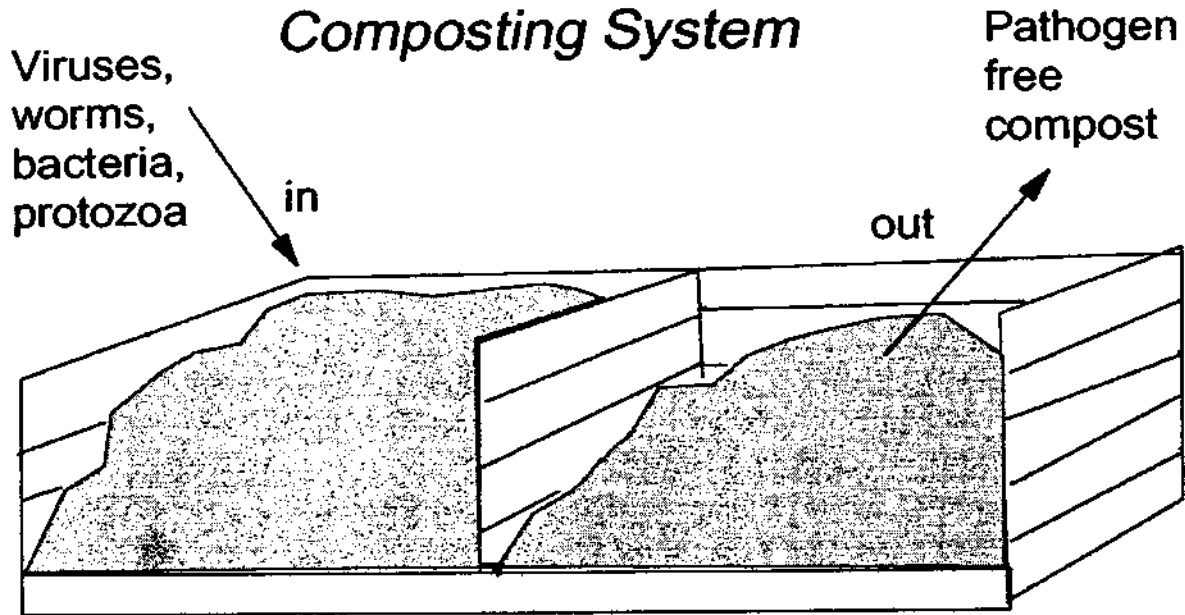

A properly managed thermophilic composting system will generate enough heat to destroy all four groups of human pathogens including parasitic worms and their eggs, viruses, bacteria and protozoa. The resulting finished compost is a hygienically safe, user friendly, soil-building humus.

MORE ON PARASITIC WORMS

This is a good topic to discuss in greater detail as most people know so little about it. Therefore, I'll take a few minutes here to discuss the most common of human worm parasites: pinworms, hookworms, whipworms and roundworms.

Pinworms

I confess, my kids had pinworms during childhood. I know exactly who they

Table 6.11 (Source: Feachem et. al. 1980)

PATHOGEN SURVIVAL BY COMPOSTING OR SOIL APPLICATION

<u>Pathogen</u>	<u>Soil Application</u>	<u>Unheated Anaerobic Digestion</u>	<u>Composting Toilets (3 mo. min. ret.)</u>	<u>Thermophilic Composting</u>
<i>Enteric viruses</i>	May survive 5 months	Over 3 months	Probably eliminated	Killed rapidly at 60°C
<i>Salmonellae</i>	3 months to 1 year	Several weeks	A few may survive	Killed in 20 hrs. at 60°C
<i>Shigellae</i>	Up to 3 months	A few days	Probably eliminated	Killed in 1 hr. at 55°C or in 10 days at 40°C
<i>E. coli</i>	Several months	Several weeks	Probably eliminated	Killed rapidly above 60°C
<i>Cholera vibrio</i>	1 week or less	1 or 2 weeks	Probably eliminated	Killed rapidly above 55°C
<i>Leptospire</i> s	Up to 15 days	2 days or less	Eliminated	Killed in 10 min. at 55°C
<i>Entamoeba histolytica</i> cysts	1 week or less	3 weeks or less	Eliminated	Killed in 5 min. at 50°C or 1 day at 40° C
<i>Hookworm eggs</i>	20 weeks	Will survive	May survive	Killed in 5 min. at 50°C or 1 hr at 45°C
<i>Roundworm (Ascaris) eggs</i>	Several years	Many months	Survive well	Killed in 2 hrs. at 55°C, 20 hrs. at 50°C, 200 hrs. at 45°C
<i>Schistosome eggs</i>	One month	One month	Eliminated	Killed in 1 hr. at 50°C
<i>Taenia eggs</i>	Over 1 year	A few months	May survive	Killed in 10 min. at 59°C, over 4 hrs. at 45°C

got them from (another kid), and getting rid of them was a simple matter. However, the rumor was circulated that they got them from our compost. We were also told to worm our cats to prevent pinworms in the kids (these rumors allegedly originated in a doctor's office). Yet, the pinworm life cycle does not include a stage in soil, compost, manure or cats. These unpleasant parasites are spread from human to human by direct contact, and by inhaling eggs.

Pinworms (*Enterobius vermicularis*) lay microscopic eggs at the anus of a human being, its only known host. This causes itching at the anus which is the primary symptom of pinworm infestation. The eggs can be picked up almost anywhere, and once in the human digestive system they develop into the tiny worms. Some estimate that pinworms infest or have infested 75% of all New York City children in the 3-5 year age group, and that similar figures exist for other cities.¹⁷

These worms have the widest geographic distribution of any of the worm parasites, and are estimated to infect 208.8 million people in the world (18 million in Canada and the U.S.). An Eskimo village was found to have a 66 per cent infection rate, a 60% rate has been found in Brazil, and a 12-41 % rate in Washington D.C.

Infection is spread by the hand to mouth transmission of eggs resulting from scratching the anus, as well as from breathing airborne eggs. In households with several members infected with pinworms, 92% of dust samples contained the eggs. The dust samples were collected from tables, chairs, baseboards, floors, couches, dressers, shelves, window sills, picture frames, toilet seats, mattresses, bath tubs, wash basins and bed sheets. Pinworm eggs have also been found in the dust from school rooms and school cafeterias.

Pregnant female pinworms contain 11,000 to 15,000 eggs. Fortunately, pinworm eggs don't survive long outside their host. At room temperature and 30% to 54% relative humidity more than 90% of the eggs will die within two days. At higher summer temperatures, 90% will die within three hours. Eggs survive longest (2-6 days) under cool, humid conditions; in dry air, none will survive for more than 16 hours.

A worm's life span is 37-53 days and an infection would self-terminate in this period, without treatment, in the absence of reinfection. *The amount of time that passes from ingestion of eggs to new eggs being laid at the anus is from 4 to 6 weeks.*¹⁸

Although dogs and cats do not harbor pinworms, the eggs can get on their fur and find their way back to their human hosts. In about one-third of infected children, eggs may be found under the fingernails.

In 95% of infected persons, pinworm eggs aren't found in the feces. Transmission of eggs to feces and to soil is not part of the pinworm life cycle, which

is one reason why the eggs aren't likely to end up in either feces or compost. Even if they do, they quickly die outside the human host.

One of the worst symptoms of pinworm infestation is the trauma of the parents, whose feelings of guilt, no matter how clean and conscientious they may be, are understandable. However, if you're composting your manure, you can be sure that you are not thereby breeding or spreading pinworms. Quite the contrary, any pinworms or eggs getting into your compost are being destroyed.¹⁹

Hookworms

Hookworm species in humans include *Necator americanus*, *Ancylostoma duodenale*, *A. braziliense*, *A. caninum*, and *A. ceylanicum*.

The small worms are about a centimeter long, and humans are almost the exclusive host of *A. duodenale* and *N. americanus*. A hookworm of cats and dogs, *A. caninum*, is an extremely rare intestinal parasite of humans.

The eggs are passed in the feces and mature into larvae outside the human host in favorable conditions. The larvae attach themselves to the human host usually at the bottom of the foot when they're walked on, and then enter their host through pores, hair follicles or even unbroken skin. They tend to migrate to the upper small intestine where they suck their host's blood. Within 5 or 6 weeks they'll mature enough to produce up to 20,000 eggs per day.

Hookworms are estimated to infect 500 million people throughout the world, causing a *daily blood loss of more than 1 million liters*, which is as much blood as can be found in all the people in the city of Erie, PA, or Austin, Texas. An infection can last 2 - 14 years. Light infections can produce no recognizable symptoms, while a moderate or heavy infection can produce an iron deficiency anemia. Infection can be determined by a stool analysis.

These worms tend to be found in tropical and semi-tropical areas and are

Table 6.12		
Hookworms:		
<i>Hookworm larvae develop outside the host and favor a temperature range of 23°C to 33°C (73°F to 91°F).</i>		
<u>Temperature</u>	<u>Survival Time of</u>	
	<u>Eggs</u>	<u>Larvae</u>
45°C (113°F).....	Few hours	less than 1 hour
0°C (32°F).....	7 days	less than 2 weeks
-11°C (12°F).....	less than 24 hours
Both thermophilic composting and freezing weather will kill hookworms and eggs.		

spread by defecating on the soil. Both the high temperatures of composting will kill the eggs and larvae, as will the freezing temperatures of winter. Drying is also destructive²⁰

Whipworm

Whipworms (*Trichuris trichiura*) are usually found in humans, but also may be found in monkeys or hogs. They're usually under two inches long and the female can produce 3,000 to 10,000 eggs per day. Larval development occurs outside the host, and in a favorable environment (warm, moist, shaded soil) first stage larvae are produced from eggs in 3 weeks.

Hundreds of millions of people worldwide, as much as 80% of the population in certain tropical countries, are infected by whipworms. In the U.S., whipworm is found in the south where there is heavy rainfall, a subtropical climate, and soil polluted with feces. The lifespan of the worm is usually considered to be 4 to 6 years.

Infection results from ingestion of the eggs, which can contaminate the hands of persons handling soil that has been defecated on by an infected person. Light infections may not show any symptoms. Heavy infections can result in anemia, and death. A stool examination will determine if there is an infection.

Cold winter temperatures of -8°C to -12°C (17.6°F to 10.4°F) are fatal to the eggs, as are the high temperatures of thermophilic composting.²¹

Roundworms

The roundworms (*Ascaris lumbricoides*) are fairly large worms (10 inches) which parasitize the human host by eating semi-digested food in the small intestine. The females can lay 200,000 eggs per day for a lifetime total of 26 million or so. The larvae develop from the eggs *in soil* under favorable conditions (21°C to 30°C or 69.8°F to 86°F). Above 37°C (98.6°F) they cannot fully develop.

Approximately 900 million people are infected with roundworms worldwide, one million of them in the U.S. The eggs are usually transmitted hand to mouth by people, usually children, who have come into contact with the eggs in his/her environment. Infected persons usually complain of a vague abdominal pain. Diagnosis is by stool analysis.²²

The eggs are destroyed by direct sunlight within 15 hours, and are killed by temperatures above 40°C (104°F), dying within an hour at 50°C (122°F). Roundworm eggs are resistant to freezing temperatures, chemical disinfectants, and other strong chemicals. Thermophilic composting will kill them.

Roundworms, like hookworms and whipworms, are spread by fecal contamination of soil. Much of this contamination is caused and spread by children who defecate outdoors within their living area. One sure way to eradicate fecal pathogens is to conscientiously collect and thermophilically compost *all* fecal material. Therefore, it is very important when composting humanure to be certain that *all* children use the toilet facility and do not defecate elsewhere. When changing soiled diapers, scrape the fecal material into the humanure receptacle with toilet paper or another biodegradable material. It's up to adults to keep an eye on kids and make sure they understand the importance of *always using a toilet facility*.

Fecal environmental contamination can also be caused by using raw fecal material for agricultural purposes. *Proper thermophilic composting of all fecal material is essential for the eradication of fecal pathogens.*

SUMMARY OF CONDITIONS NEEDED TO KILL PATHOGENS

There are two primary factors leading to the death of pathogens in humanure. The first is *temperature*. A compost pile that is properly managed in order to cultivate thermophilic organisms will destroy pathogens with the heat it generates.

The second factor is *time*. The lower the temperature of the compost, the longer the retention time needed for the destruction of pathogens. That period may be long if the pile doesn't heat at all, such as in a mouldered pile, as roundworm eggs have been known to survive for years in soil, and some bacteria can survive for two years in sludge and over a year in soil. Feachem, however, states that three months retention time will kill all of the pathogens in a low-temperature composting toilet except worm eggs, although table 6.11 (also from Feachem) indicates that some additional pathogen survival may occur.

A high-temperature thermophilic compost pile will destroy pathogens, including worm eggs, quickly, possibly in a matter of minutes. Lower temperatures require longer periods of time, possibly hours, days, weeks or months, to effectively destroy pathogens. One need not strive for extremely high temperatures (say 150°F or 65°C) in a compost pile to feel confident about the destruction of pathogens. Instead, it may be more realistic for one to strive to maintain lower temperatures in a compost pile for longer periods of time (say 120°F or 50°C for twenty four hours, or 115°F or 46°C for a week). For example, as one source puts it, "*All fecal microorganisms, including enteric viruses and roundworm eggs, will die if the temperature exceeds 46°C (114.80° F) for one week.*"¹⁵

A sound approach to pathogen destruction when composting humanure is to

thermophilically compost the organic refuse, then allow the compost to sit, undisturbed, for a lengthy period of time after the thermophilic heating stage has ended. The subject of thermophilic composting is discussed in greater detail in chapter seven.

In the words of Feachem (et. al.), *“The effectiveness of excreta treatment methods depends very much on their time-temperature characteristics. The effective processes are those that either make the excreta warm (55°C) [131°F], hold it for a long time (one year), or feature some effective combination of time and temperature.”*

In short, the combined factors of temperature and time will do the job of converting “turds into tomatoes” (The time/temperature factor of pathogen destruction is illustrated in figure 6F.)

CONCLUSIONS

Humanure is a valuable resource suitable for agricultural purposes and has been recycled for such purposes by large segments of the world’s human population for thousands of years.

However, humanure contains the potential for harboring human pathogens, including bacteria, viruses, protozoa and parasitic worms or their eggs, and thereby can contribute to the spread of disease. When pathogenic raw humanure is applied to soil, pathogenic bacteria may continue to survive in the soil for over a year, and roundworm eggs may survive for many years, thereby maintaining the possibility of human reinfection for lengthy periods of time.

However, when humanure is thermophilically composted, human pathogens are rapidly destroyed, and the humanure is thereby converted into a hygienically safe form suitable for soil applications for the purpose of human food production.

Finally, it must be added that thermophilic composting requires no electricity and therefore no coal combustion, no acid rain, no nuclear power plants, no nuclear waste, no petrochemicals, and no consumption of fossil fuels. The composting process produces no waste, no pollutants, and no toxic byproducts. Thermophilic composting of humanure can be carried out century after century, millennium after millennium, with no stress on our ecosystems, no consumption of resources, no garbage or sludge for our landfills. And all the while it will produce a valuable resource necessary for our survival while preventing the accumulation of dangerous and pathogenic waste. If that doesn’t describe *sustainability*, nothing does.

Figure 6 F (Source: Feachem et. al. 1980)

Safety Zone for Pathogen Death

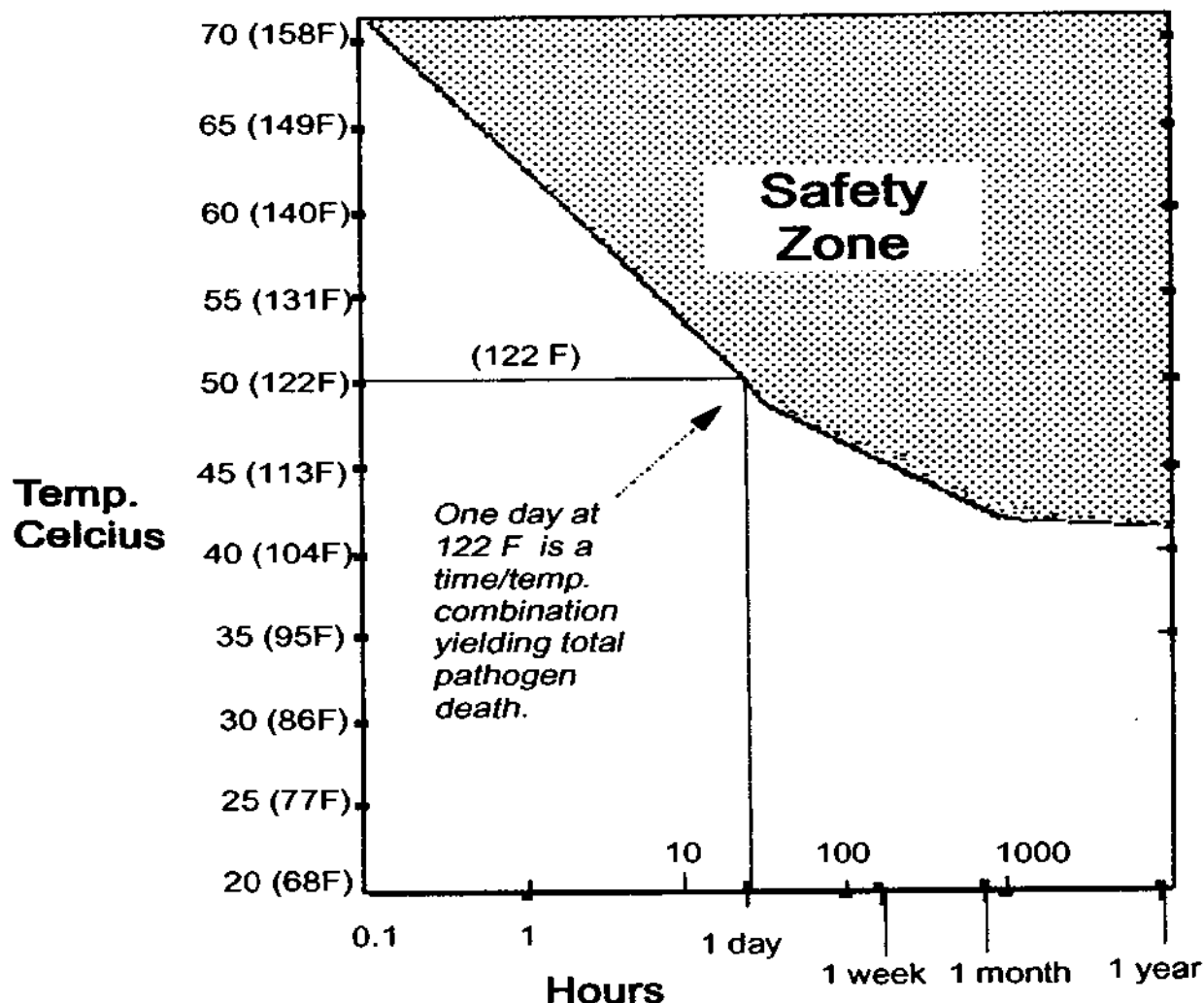

The above pathogen death boundaries include those for *enteric viruses*, *shigella*, *taenia*, *vibrio cholera*, *Ascaris* (roundworm), *salmonella*, and *entamoeba histolytica*. Source: Feachem, et. al., 1980.

Table 6.14- Parasitic Worm Egg Death

Eggs	Temp.(°C)	Time required to die
Schistosome	53.5	1 minute
Hookworm	55.0	1 minute
Roundworm	55.0	10 minutes
"	60.0	5 seconds
"	0	4 years
"	-30	24 hours

[Source: *Compost, Fertilizer, and Biogas Production from Human and Farm Wastes in the People's Republic of China*, (1978), M. G. McGarry and J. Stainforth, editors, International Development Research Center, Ottawa, Canada. (page 43)]

REFERENCES - CHAPTER SIX

- 1 - Tompkins, P., and Boyd, C. (1989). Secrets of the Soil. Harper and Row: New York. (pp.94-5).
- 2 - Howard, Sir Albert. The Soil and Health: A Study of Organic Agriculture. Schocken: New York. 1947. (pp. 37-38).
- 3 - Ibid. (p.177).
- 4 - Feachem, et al. (1980). Appropriate Technology for Water Supply and Sanitation. The World Bank, Director of Information and Public Affairs, Washington D.C. 20433 (see listing #9).
- 5 - Jarvis, N. "Waste Not, Want Not". *Natural History*. May, 1990 (p.73).
- 6 - Sopper, W.E. and Kardos, L.T. (Eds.). (1973). Recycling Treated Municipal Wastewater and Sludge Through Forest and Cropland. The Pennsylvania State University, University Park, PA (pp. 248-51).
- 7 - Ibid. (pp. 251-252).
- 8 - Cheng, Thomas C. (1973). General Parasitology. Academic Press, Inc., 111 Fifth Avenue, New York, NY 10003 (p. 645).
- 9 - Feachem, et. al. (1980). Appropriate Technology for Water Supply and Sanitation: Health Aspects of Excreta and Sullage Management. Energy, Water and Telecommunications Department of the World Bank, 1818 H Street N.W., Washington D.C. 20433.
- 10 - Ibid.
- 11 - Olson, O. W. (1974). Animal Parasites - Their Life Cycles and Ecology. University Park Press, Baltimore, MD (p. 451-452).
- 12 - Crook, James (1985). "Water Reuse in California". *Journal of the American Waterworks Association*. v77, no. 7. as seen in The Water Encyclopedia by van der Leeden et. al. (1990), Lewis Publishers, Chelsea, Mich. 48118.
- 13 - Boyd, R. F. and Hoerl, B. G. (1977). Basic Medical Microbiology. Little, Brown and Co., Boston Mass. (p. 494).
- 14 - Cheng, Thomas C. (1973) General Parasitology. Academic Press Inc., 111 Fifth Ave., New York, NY 10003. (p. 645).
- 15 - Franceys, R., et. al. (1992). A Guide to the Development of On-Site Sanitation. World Health Organization, Geneva (pit latrine info p. 212, quote on time/temperature factor, p. 214).
- 16 - Schoenfeld, M., and Bennett, M. (1992). Water Quality Analysis of Wolf Creek. (Unpublished manuscript). Slippery Rock University, Applied Ecology Course, PREE, Fall Semester. (Prof. P. Johnson), Slippery Rock, PA 16057
- 17 - Pomeranz, V.E. and Schultz, D., (1972). The Mother's and Father's Medical Encyclopedia. The New American Library, Inc., 1633 Broadway, New York, NY 10019. (p.627).
- 18- Chandler, A.C. and Read, C.P. (1961). Introduction to Parasitology. John Wiley and Sons, Inc.: New York.
- 19 - Brown, H.W. and Neva, F.A. (1983). Basic Clinical Parasitology. Appleton-Century-Crofts/Norwalk, Connecticut 06855. (pp.128-31).
- 20 - Ibid. (pp.119-126).
- 21 - Ibid. (page numbers uncertain).
- 22 - Ibid. (page numbers uncertain)

23 - Lewis, Ricki. (1992). *FDA Consumer*, September 1992 (p. 41).

24 - Crook, James. (1985). "Water Reuse in California". *Journal of the American Waterworks Association*, v.77, no.7. as seen in The Water Encyclopedia by van der Leeden et. al. (1990), Lewis Publishers, Chelsea, Michigan 48118.

*** A wide range of compost analyses and tests for pathogens and other contaminants such as pesticides and herbicides are available from Woods End Research Laboratory, Inc., Route 2, Old Rome Road, Box 1850, Mt. Vernon, ME 04352; Phone (207) 293-2457. In 1995, a helminth ova test cost \$145.00, and required a one gallon sample of compost.**

**WE DO IT EVERY DAY. BUT DO WE EVER
THINK ABOUT IT!**

I
DEFECATE,
THEREFORE I
AM . . .



THE TAO OF COMPOST

"Always bear this in mind, that very little indeed is necessary for living a happy life."

Marcus Aurelius

"Aspire to simple living? That means, aspire to fulfill the highest human destiny."

Charles Wagner



I will never forget the day I introduced my mother to my composting system. She came to visit me at my newly established homestead one spring day in 1980 and I gave her a tour of my garden, which was already quite vibrant. A fresh pile of finished compost had been dumped from a wheelbarrow onto one of the raised garden beds and, as we passed, I reached down and scooped up a big handful, thrusting it toward her. "Smell this," I said. So she put her nose right up to the black earth I held out before me and took a deep breath.

"Boy, that smells good!" she said, inhaling the rich, sweet-smelling aroma of fertile soil, and smiling.

"This is my alternative to a septic system!" I proudly informed her, still holding the compost out in front of me as I watched her smile suddenly freeze. I will always remember the look on her face when I caught her so completely by surprise in an unexpected, and perhaps awkward, situation. My dear mother, although very open-minded, had not, prior to that moment, had the experience of so intimately communing with composted humanure. But the compost did smell good, like a rich soil from the woods.

PRIMAL COMPOST

Try to imagine yourself in an extremely primitive setting, maybe sometime around 10,000 B.C. Imagine that you're just slightly more enlightened than your brutish companions and it dawns on you one day that your feces should be disposed of properly. Everyone else is defecating in the back of the cave, creating a smelly mess, and you don't like it. You're going to improve on the system.

Your first revelation is that *smelly refuse should be deposited in one place*, not spread around for everyone to smell or to step in, and it should be deposited away from one's living area somehow. You watch the wild cats and see that they each go to a special spot to defecate. But the cats are still one step ahead of the humans, as you soon find out, because they cover their excrement.

When you've shat outside the cave on the ground in the same place several times you see that you've still created a foul smelling, fly-infested mess. Your second revelation is that *the refuse you're depositing on the ground should be covered after each deposit*. So you scrape up some leaves every time you defecate and throw them over the feces. Or you pull some tall grass out of the ground and use it for cover.

Soon your companions are also defecating in the same spot and covering their fecal material as well. They were encouraged to follow your example when they noticed that you had conveniently located the defecation spot between two large rocks, and positioned logs across the rocks to provide a convenient perch, allowing for care-free defecation above the collecting refuse underneath.

A pile of dead leaves is now being kept beside the toilet area in order to make the job of covering it more convenient. As a result, the offensive odor of human feces and urine no longer foul the air. Instead, it's food scraps that attract flies and smell bad. This is when you have your third revelation: *food scraps should be deposited on the same spot and covered as well*. Every stinky bit of refuse you create is now going to the same spot and is being covered with a natural material to eliminate odor. This hasn't been hard to figure out, it makes good sense and it's easy to do.

You've succeeded in solving three problems at once: no more humanure scattered around your living area, no more garbage, and no more offensive odors assaulting your keen sense of smell and generally ruining your day. You also begin to realize that the illnesses that were prone to spread through the group have subsided, a fact that you don't understand, but you suspect may be due to the group's new found hygienic practices.

Quite by accident, you've succeeded in doing one very revolutionary thing: *you've created a compost pile*. You begin to wonder what's going on when the pile gets so hot it's letting off steam. What you don't know is that you've done exactly what nature intended you to do by piling all your organic refuse together, layered with natural, biodegradable cover materials. In fact, nature has "seeded" your excrement with a breed of microscopic animal that proliferates in and digests the pile you've created, and, in the process, heats the compost to such an extent that any disease-causing pathogens resident in the humanure are destroyed. The invisible microscopic animals, otherwise known as thermophilic bacteria, would not multiply rapidly in the discarded refuse unless you created the pile, and thereby the conditions,

which favor their rapid proliferation. By daring to be different, you stumbled upon a miracle of nature.

Finally, you have one more revelation, a big one. You see that the pile, after it gets old, sprouts all kind of vibrant plant growth. You put two and two together and realize that *the stinking refuse you carefully disposed of has been transformed into rich earth, and ultimately into food*. Thanks to you, humankind has just climbed another step up the ladder of evolution.

Yet there is one basic problem with this scenario: *it didn't take place 12,000 years ago. It's taking place now.*

THE EVOLUTION OF COMPOST

The hypothetical discovery of compost in a primal situation would be most likely to occur in a group of humans who had settled into an agricultural lifestyle rather than a nomadic, hunter-gatherer one. Nomadic people can walk away from the trash they leave behind, allowing nature to deal with it. Settled peoples don't have that luxury. The development of rooted human settlements and the development of agriculture go hand in hand, for it is the working of the land to grow food crops that forces a people to stay put year after year. Unless, of course, they deplete the soil of nutrients and are then forced to move on to find a new patch of fertile ground.

More enlightened peoples will develop an understanding of the human nutrient cycle instinctively, and will strive to maintain that cycle intact on a day-to-day basis as if it were a natural and necessary part of their lives, as natural and necessary as growing or cooking their food, or bathing, or nursing their children. For settled, agricultural peoples, there is an abundance of organic refuse materials needing to be recycled on a regular or daily basis, these materials may include potato peels, apple cores, crop residues, humanure, garden refuse and on and on. In most cases, those organic materials would be recycled without question, day in and day out, year in and year out, not as a chore or a burden, but as a necessary responsibility for human life on the planet Earth. Such is the Tao of compost, the balanced way, the natural way, not the glamorous way, not the exciting way, not the get-rich-quick way of contemporary pop culture. The Tao is the endless way.

Although such recycling has apparently been a common practice in the East for thousands of years, it is a relatively unknown phenomenon in the West. In fact, compost itself is a relatively new phenomenon in the West and perhaps even in the East, a phenomenon that never gained recognition throughout the ages in Europe, despite its potentially valuable utility. Perhaps people in Europe who developed an instinctive understanding of natural phenomenon were simply rounded up and burned

at the stake by religious fanatics. One can only speculate as to why the West has been so slow to catch on to humanure recycling, and in view of the religious extremism of the past ages in Europe, such speculation can be both gruesome and saddening.

Much of compost's current popularity in the West can be attributed to the work of Sir Albert Howard, who wrote An Agricultural Testament (1943) and several other works on aspects of what has become known as *organic* agriculture. Sir Howard's discussions of composting techniques focus on the Indore process of composting, a process developed in Indore, India between the years of 1924 and 1931. The Indore process was first described in detail in Sir Howard's work (co-authored with Y. D. Wad), The Waste Products of Agriculture, in 1931.

The two main principles underlying the Indore composting process include 1) mixing animal and vegetable refuse with a neutralizing base, such as agricultural lime, and 2) managing the compost pile by physically turning it. These Indore process composting techniques subsequently became adopted and espoused by composting enthusiasts in the West, and today one still commonly sees people turning and liming compost piles. For example, Robert Rodale wrote in the February, 1972 issue of *Organic Gardening* concerning composting humanure, "*We recommend turning the pile at least three times in the first few months, and then once every three months thereafter for a year.*"

However, as composting becomes more deeply looked into over the years by us Westerners, new information is bound to be brought forth that challenges the conventional wisdom. For years I also believed that compost should be turned, and perhaps limed or treated with rock dusts. Yet, after monitoring my own compost, I've come to understand differently. Now, due to my own experiences, I contend that compost piles need not be limed, and need not be turned at all. Turning is unnecessary unless one is perhaps trying to accelerate the composting process, trying to compost piles of refuse that are exceedingly large, or trying to stir the outer areas of a batch of compost into the center in order to subject all parts of the batch to the high inner temperatures. I discussed the liming issue in chapter 2 of this book, and I'll discuss the turning (aerating and mixing) issue later in this chapter. I realize now that compost-making is really simpler than I could have imagined, and the arduous task of turning a compost pile may actually do more harm than good *if the pile is being continuously added to*. This is by no means an attempt by me to disparage the work of anyone, including Robert Rodale or Sir Albert Howard, who both very justifiably remain held in high regard by proponents of organic gardening and farming.

The Tao of compost, however, requires that *compost-making be an integral part of normal and daily life*. Such compost-making is a natural and *bio*regional phenomenon. Organic refuse from a given population and geographic area is layered

together for the purpose of cultivating the microscopic organisms that convert the refuse into humus. As there are thousands of geographic areas on the earth each with its own unique human population, climatic conditions and available organic refuse materials, there will also be potentially thousands of composting methods and styles. What works in one place on the planet for one group of people may not work at all for another group in another geographic location. Where one group uses above-ground, continuous compost bins such as described in this book, another group will use below-ground pits sealed with clay. Where one group chooses to compost aerobically, as described in this book, another may choose to compost anaerobically such as in a sealed pit. Where a group only uses natural, organic materials in their compost, another may add chemical fertilizers or rock dusts. Where one group may compost each family's refuse separately, another group may compost the refuse of many people all together.

It is not my intention to unfairly promote certain methods of composting as superior over others. My intention is to describe my own experiences in the hope that others may benefit from such descriptions. I would hope that others with different experiences would also make their information available for the benefit of the general public. If I must insist upon anything, I would insist that the compost-maker be clear in understanding why s/he is making compost. If compost is being made in order to eliminate waste and pollution as well as recover resources, as it should be, then the compost-maker will strive to utilize local refuse resources in a wise and efficient manner. The availability of local, organic refuse materials in combination with local climatic conditions, and cultural predispositions toward the recycling of humanure, will determine the methods of composting for a given location, or bioregion.

When composting humanure, the additional factor of pathogen destruction must be taken into account and incorporated into the composting formula. The destruction of human pathogens occurs most readily under the conditions of aerobic, thermophilic composting, because of the heat generated by the process. This is the sort of composting in which I engage and which this book primarily entails. In short, humanure composting requires 1) a knowledge of accessible local refuse materials suitable for composting, 2) a sensitivity to and understanding of seasonal fluctuations in weather conditions, and 3) a willingness to combine the refuse materials in a manner that suits the climate and still promotes the growth of aerobic, thermophilic bacteria.

I would add to this formula one more thing: the technique one finally settles on for composting humanure should be sustainable. It should not be creating waste or pollution or squandering resources.

Bearing all this in mind, perhaps Sir Albert Howard's Indore process of com-

posting was the most appropriate for his purposes, in Indore, India in the 1920's. But that's no reason for anyone else to believe that the compost they are producing in their area of the world for their own purposes should utilize the same techniques that the Indore process calls for. This is especially important to understand when one realizes that if all compost required both liming and turning, many people would be unable to make compost. Agricultural lime is not available to everyone, everywhere, and turning compost can be quite an arduous task, especially for the frail or elderly. Whereas, *all people, everywhere, should be able to make compost.*

Additionally, people who recommend the frequent turning of humanure compost are people who have never engaged in humanure composting as a way of life. We simple humans of meager material resources who insist on recycling our daily refuse are aware of this one important fact: we produce organic refuse *continuously*, and therefore we must engage in *continuous composting*, which involves the continuous addition of organic refuse to a compost pile. Such a continuous compost pile requires the slow and constant upward movement of thermophilic organisms in the pile, which digest incoming refuse deposited on the pile above them, and abandon digested refuse below them. Such a pile of compost is always growing on top and always shrinking on the bottom, and does not need to be turned for aeration. In fact, such turning could be extremely disruptive.

This is in contrast to *experimental* composting, whereby large amounts of refuse are suddenly made available for the purpose of experimentation. Such experiments have a purpose and value all their own, but they may not reflect real situations in real life in the real world. When a person is suddenly faced with a large mass of raw organic material to be composted, perhaps turning the pile is a useful management technique. Certainly if the refuse is piled out in the open, the outer surfaces of the pile may remain unacceptably cool and will need to be turned into the center periodically. This can possibly be remedied by keeping the refuse in bins that hold in the heat, and covering the piles with insulating organic materials such as straw.

In other words, there is a big difference between the Tao of compost, which is composting *as a way of life*, and composting done for agricultural or academic experimentation. And although from an evolutionary standpoint we are slowly advancing our understanding of compost in the West, we are still back in the cave when it comes to incorporating composting into our daily lives.

In any case, I contend that not much has changed since ten thousand B.C. in the eyes of the compost pile. The thermophilic microorganisms that convert humanure into humus don't care what techniques we use today anymore than they cared what techniques were used eons ago, *so long as their needs are met.* And those needs haven't changed in human memory, nor are likely to change as long as humans roam

the earth. Those needs include: 1) *temperature* (compost microorganisms won't work if frozen); 2) *moisture* (they won't work if too dry or too wet); 3) *oxygen* (they won't work without it; and 4) *a balanced diet* (otherwise known as balanced carbon/nitrogen). In this sense, compost microorganisms are a lot like people, and, with a little imagination, we can think of compost microorganisms as a working army of microscopic people who need the right food, water, air and warmth.

The art of compost-making then, remains the simple and yet profound art of providing for the needs of these invisible workers so that they work as vigorously as possible, season after season. And although those needs may be the same worldwide, the techniques used to arrive at them may differ from time to time and from place to place.

THERMOPHILIC MICROORGANISMS

Converting humanure back into soil requires microorganisms that produce and thrive at high temperatures - high enough to kill the human pathogens that may be found in the excrement. The beneficial microorganisms are primarily thermophilic (heat-loving) microscopic bacteria, and they're extremely valuable to humanity. They ask for very little and they give a lot in return, and, for the most part, we ignore them. However, people interested in composting humanure need to know something about the little buggers and how to keep them happily working.

Bacteria are usually divided into three classes based upon the temperatures in which they grow best. The low temperature bacteria are the *psychrophiles*, which can grow at temperatures down to -10°C , but whose optimum temperature is above 20°C (68°F). The *mesophiles* live at medium temperatures, 20°C - 37°C (68°F - 98.6°F).

ESSENTIAL READING FOR INSOMNIACS



*A number of thermophilic microorganisms may be found in the composting process including bacteria: *Bacillus stearothermophilus*, and *Clostridium thermocellum*; fungi: *Geotrichum candidum*, *Aspergillus fumigatus*, *Mucor pusillus*, *Chaetomium thermophile*, *Thermoascus auranticus*, *Torula thermophila*, and *Humicola insolens*; and actinomycetes (a cross between a bacterium and an imperfect fungus): *Thermoactinomyces*, *Actinomyces thermophilis*, *Talaromyces (Penicillium) duponfi*, and *Thermomonospora*.³*

Thermophiles thrive above 40°C (104°F), and the optimum temperature for some thermophilic strains may be as high as 65°C (149°F) or higher. These bacteria occur naturally in hot springs, tropical soils and compost heaps, to name a few places. Some thermophilic bacteria have been found at temperatures as high as 89°C (192°F), and perhaps higher.

Thermophiles are responsible for the spontaneous heating of hay stacks which can cause them to burst into flame. When growing on bread, they can raise the temperature of the bread to 74°C (165°F). Heat from bacteria also warms germinating seeds, as sterile seeds are found to remain cool while germinating.¹

Thermophilic bacteria were first isolated in 1879 by Miquel, who found bacteria capable of developing at 72°C (162°F). He found these bacteria in soil, dust, *excrement*, sewage and river mud. It wasn't long afterward that a variety of thermophilic bacteria were discovered in soil - bacteria that readily thrived at high temperatures, but not at room temperature. These bacteria are said to be found in the sands of the Sahara Desert, but not in the soil of cool forests. Composted or manured garden soils may contain 1-10 percent thermophilic types of bacteria, while field soils may have only 0.25% or less. Uncultivated soils may be entirely free of thermophilic bacteria.²

The presence of thermophilic bacteria in garden soil to which compost has been added indicates that the use of garden weeds in one's compost pile, including soil clinging to roots, may help keep the pile inoculated with the necessary bacterial strains. However, it seems more likely that the bulk of the thermophilic bacteria enter the compost pile from the humanure itself. In which case, it would seem that mother nature has provided for the human race a built-in solution to the problem of getting rid of human excrement. The thermophilic bacteria are already in it; we just have to provide the conditions they need to do their thing, which is heating and digesting the manure sufficiently to render it hygienically safe. Nature provides us with seeds to grow our food too, but those seeds won't grow unless we create the right conditions for them. We've already figured *that* out.

Humanure is said to contain 100 *billion* bacteria per gram (there are 28.34 grams in an ounce).⁴ This means that *one gram of humanure contains a bacterial population twenty times greater than the entire human population of the earth*, which seems unbelievable. If the average excrement weighs about 40 ounces, then each stool could contain 113 *trillion* bacteria, a figure totally beyond human comprehension.

When a pile of organic refuse begins to undergo the composting process, the mesophilic bacteria proliferate, raising the temperature of the composting mass up to 44°C (111°F). These mesophilic bacteria can include *E. Coli* and other bacteria from

the human intestinal tract, but these soon become increasingly inhibited by the temperature as the thermophilic bacteria take over in the transition range of 44°C-52°C (111°F-125.6°F). Thermophilic growth can then continue up to about 70°C (158°F).⁵ These bacteria combine organic carbon with oxygen to produce carbon dioxide as well as to release energy. Some of the energy is used by the microorganisms to proliferate, the rest is given off as heat.

The heat produced by thermophilic bacteria kills the pathogenic microorganisms, viruses, bacteria, protozoa, worms and eggs that may inhabit humanure. A temperature of 122° F (approx. 50°C), if maintained for twenty-four hours, is sufficient to kill all of the pathogens. A lower temperature will take longer to kill pathogens (a temperature of 115°F may take nearly a week to kill pathogens completely), a higher temperature may only take minutes. For example, when Westerberg and Wiley composted sewage sludge which had been inoculated with polio virus, salmonella, roundworm eggs, and *Candida albicans*, they found that a temperature of 116°F to 130°F (46.66°C to 54.44°C) maintained for three days killed all of these pathogens (see *Applied Microbiology*, December 1969). This sort of phenomenon has been confirmed by many other researchers, not the least of which being Gotaas, who indicates that few organisms are able to survive temperatures of 120°F (48.88°C) for more than one hour. However, for safety's sake, a period of twenty-four hours at 122°F is generally recommended for the assurance of total pathogen destruction. Therefore, the first goal in composting humanure should be to create a compost pile that will heat sufficiently to kill all potential human pathogens that may be found in the manure (see figure 6F and table 6.14 on page 133, and table 6.11 on page 127).

It should be understood though, that *the heating process carried out by thermophilic bacteria occurs only in the initial stage of organic decomposition*. The heating stage takes place rather quickly and may only last a few days, weeks or months. The thorough decomposition of organic material, or the conversion of organic refuse into humus may take a year or two. After the initial thermophilic heating period, the humanure will appear to have been digested, but the coarser organic material will not. The fungi and macroorganisms that break the coarser elements down into humus wait for the heat to die down before they move in. Then they take their good old time, and I say "more power to them!" I only plant a garden once a year, so I only need compost once a year. No need to hurry the process.

FOUR NECESSITIES FOR GOOD COMPOST

1. Moisture

In order for the composting process to work properly, several conditions must be met. The first is proper moisture content. A correct moisture content is 50-60%. The pile should be quite moist, but not wet or water logged. How does one determine the moisture content of the compost? How does one regulate the moisture content? First, don't worry. Second, if the pile is getting too much moisture (not likely in an open topped pile with an earth bottom), add more dry materials such as hay, straw, weeds, leaves etc. These things soak up excess moisture.

In extreme cases, a roof over your compost pile may be needed to keep the rain out, or to keep the sun from drying the pile. You may want a roof over your pile so you can collect rain water to use for cleaning composting containers and utensils, then you can use the cleaning water to help keep your pile damp. In any case, the more you work with your compost, the easier you'll find the process to be.

I don't water my compost except to empty cleaning water on it after cleaning the toilet container, and I don't cover it to keep the rain out. Average annual rainfall where I live is about 35 inches per year. There is no apparent leaching from the compost pile into the surrounding environment, and no visible surrounding environmental deterioration whatsoever resulting from my humanure compost bin which has been situated in the same place for fifteen years. I do, however, have my compost bin under tree cover so it has protection from the pouring rain, and I keep the top of the pile flat to minimize water runoff. When monitoring the temperature of my compost pile during a period of drought, I found that the temperature rose dramatically after a heavy rain. This has led me to believe that rain water is good for compost, and provides a source of essential moisture. Compost tends to soak up rain water like a sponge, especially if the pile has a flat top.

On the other hand, much of the moisture in our compost pile comes from human urine. Urine not only provides needed moisture, but it also provides needed nutrients such as nitrogen, and it expedites the decomposition of the sawdust or other organic cover material used in the toilet. If one wants to use a cover material in one's toilet to eliminate odors (and one should), then one needs urine in the toilet to provide the extra moisture and nitrogen to balance the dry carbonaceous cover material so that it'll all compost together thermophilically. If one wants to compost urine as well as feces, then one will have to add a significant amount of relatively dry carbonaceous material to soak up the urine and balance its nitrogen. Cover materials and urine go hand in hand. You shouldn't have one without the other in a composting toi-

let system.

The segregation of urine from feces in composting systems has been promoted far and wide. I strongly disagree with this practice when applied to thermophilic composting systems, as the alternative of using a carbonaceous cover material is much more simple, pleasant and beneficial. People who segregate urine from feces claim that the urine creates foul odors and waterlogs the compost. However, it is a lack of cover material that allows for the creation of foul odors and waterlogging, not the existence of excess urine. Collecting urine (and feces) in a receptacle filled with sawdust or other organic and fairly dry material before depositing it on the compost pile will ensure that adequate carbonaceous material is added to the pile to balance the nitrogenous urine. The covering of such deposits again, *after application to a compost pile*, with additional organic cover materials such as grass or weeds will ensure an odor free system. This will be discussed in greater detail later in this chapter.

2. Oxygen

The second necessity for a good compost pile is oxygen. Thermophilic bacteria are aerobic bacteria, they need oxygen. One way to oxygenate your pile is by turning it, chopping it, running pipes through it with little holes in them, moving it on augers, blending, agitating, sweating, digging, etc. The belief that one must turn one's compost pile surely is the leading reason why many people don't have them. Especially little old ladies.

I also believed that turning was an essential step in the aeration of a pile and therefore essential in making good compost, and I turned my pile once a year for over a decade. It wasn't until I conducted the more detailed research for this publication when I discovered that turning the pile was not assisting the process of thermophilic decomposition. In fact, after I turned my pile, the bacterial activity slowed way down instead of speeding up as it was supposed to. The microorganisms continued to work, but not as earnestly, and the temperature of the compost dropped significantly (about 30°F) immediately after the pile was turned, then petered out altogether.

The reason this happened was a revelation to me at the time: The thermophilic bacteria in my compost were happily multiplying in the fresher, upper layers of the pile, which contained the proper conditions for vigorous microbial proliferation, namely fresh food, and that layer was around 120°F or 50°C. The lower, older layers of the pile had already been digested by the thermophilic bacteria and were "spent", or cool. When I turned the pile, I diluted the fresh, hot, upper half of the pile with the

spent lower half and left the thermophilic bacteria without enough food. Or, in other words, I disrupted their carbon/nitrogen balance. They had plenty of oxygen, but that wasn't good enough. So they quickly cooled down. Now I realize that if a compost pile is arriving at temperatures adequate for the destruction of human pathogens, the microorganisms are enjoying the proper conditions and should be left alone. Turning the pile after it has cooled down will reintroduce oxygen, but it won't refresh the food supply, so why bother? Now I don't turn my compost at all, and the process of compost-making has become that much more enjoyable.

It seems that the act of turning and artificially aerating compost piles is advocated for the purpose of accelerating the compost-making process so that it takes less time. There are many examples in the available literature showing compost piles finished and removed for agricultural application in a few weeks. This may be appropriate for the composting of large quantities of municipal refuse or something of that sort, but for individual families who produce compost for gardening purposes, such compost acceleration will provide little advantage. Furthermore, such tales of fast, hot, compost apply to situations where a sufficient quantity of organic refuse becomes immediately available for piling, turning, and composting. The reality for individual families is that compostable refuse is produced daily in small quantities, day after day, year after year, forever. Therefore, a sudden large heap of compost (a batch) cannot be readily created, and an alternative approach must be used. That approach requires the use of a continuous composting system (as mentioned earlier, but worthy of repeating), in which refuse is continuously added to a pile, and the thermophilic layer continually rises in the pile to digest the incoming refuse. This sort of system is not aided by manually turning the pile. Instead, the pile is aerated by providing it with a blend of ingredients which trap air space in the pile. For those of you who aren't in a hurry, turning or aerating compost manually will not be necessary. I produce compost to use in my food garden, which I plant annually. Therefore, I only need finished compost on an annual basis. An annual cycle works well in a temperate climate such as the one I live in, although shorter cycles may be useful in tropical climates with year-round growing seasons.

In many cases, batch composting piles (not continuous composting piles) are turned in order to insure that all parts of the pile are subjected to the high internal temperatures, thereby ensuring total pathogen destruction. However, small-scale composting by individual families, if done in wooden bins where the compost is kept covered by an insulating layer of organic refuse (such as straw), may be sufficient to retain the necessary temperatures throughout the pile, without turning.

Another reason why compost piles are manually turned or aerated is because they are just too big, and the inside of the pile is smothered. This can be remedied by

not making big compost piles. A workable bin size is 5'w x 5'd x 4'h (1.5m x 1.5m x 1.2m), or smaller. There are easy ways to oxygenate a pile this size sufficiently to allow for proper thermophilic decomposition to occur. The easiest way to get oxygen into your pile is by using coarse cover materials such as hay, straw, grasses, or weeds (a main crop in my garden) to cover over odorous compost deposits. These coarse materials trap air spaces in the pile, as well as trap odors. A pile constructed with layered materials including coarse cover materials would have to be under water to be starved of oxygen.

Finally, there is an abundance of evidence that the more compost piles are turned, the greater they suffer from a loss of nutrients, particularly nitrogen and organic matter. Unturned compost retains the highest nutrient value. It also costs much less to produce, as the need for equipment or labor is kept to a minimum.

3. A Balanced Diet

A good carbon-nitrogen balance (a good blend of materials) is required for a nice, hot compost pile (see page 38 to refresh your memory on the topic of carbon and nitrogen). Since most of the materials commonly added to a compost pile are very high in carbon, this means that a source of nitrogen must be incorporated into the blend of composting ingredients. This isn't as difficult as it may seem. You can carry bundles of weeds to your compost pile, add hay, straw, leaves and garbage, but you'll still need one thing: nitrogen. Of course the solution is simple - add manure. Where can you get manure? From an animal. Where can you find an animal? Look in a mirror.

And be sure to keep that kitchen garbage going into the compost. Variety is the spice of life, even for a microscopic critter.

4. Temperature

Compost ceases to be active when frozen, and may slow down considerably when the ambient air temperature is consistently below freezing. However, frozen compost can resume vigorous activity after thawing, providing that it has adequate moisture, oxygen and a balanced diet (see Figure 7.6 on page 164, and appendix 4 on page 187).

DOING IT

OK. You should know by now that anyone can compost humanure at little if any cost in money or resources. You know that, if done properly, the manure will be

rendered hygienically safe, no matter what pathogens were in it before composting. The next question is, *“How can I do it, considering our cultural predisposition against the idea, and my own personal circumstances?”* My guess is that if you’re living in downtown Pittsburgh, you won’t be composting humanure in the near future. On the other hand, if done properly, you could probably compost humanure almost anywhere else without causing a problem. Let me fill you in on my own experiences, and on some possibilities for adapting my experiences to different situations. Maybe this will give you some ideas.

In 1974, after graduating from a university, I set out to learn a thing or two. I soon learned that diet and lifestyle are keys to good health. I decided to experiment a little and eventually put money down on land for the purpose of establishing a homestead and growing my own food. My intentions were to proceed in a manner that was gentle on the Earth, so to speak, while maximizing my own self-reliance and independence.

I traded a wood-burning cookstove for a canvas tipi and set the tipi up on my newly acquired wooded land. I soon had an area cleared for a garden. The first obstacle I ran into was a lack of soil fertility. How was the soil to be built up? Obviously, I had to replace what I took from the land when I gardened. It occurred to me that I had to complete the human nutrient cycle by returning my manure to the soil in the form of compost. It was either that or truck in manure from nearby farms year after year, while my own manure collected underground in a septic tank as toxic waste, thereby threatening the quality of my spring water. So I started composting in a serious way.

I varied my techniques and methods of composting until I hit upon what seemed to work best for me, having now composted in the same bin since 1979. The system I use requires no electricity, running water or technology (although a little technology, such as a truck to haul sawdust, or a sawmill to create it, is useful). And it’s not very labor intensive. Most of the work involves regularly emptying organic materials into the compost bin (my sawdust toilet is usually used by four people and is usually emptied every three or four days), and occasionally (annually) removing finished compost from the bin. What’s important is that the system works well.

During the development of my composting experiences, I knew at least a dozen families who lived in my surrounding area and were also composting humanure. Today, half of them have converted to flush toilets and conventional septic systems. This is an indication of the obvious: that composting is not for everyone, even the well-intentioned. However, none of the families I knew had done their homework and understood the importance of thermophilic composting or its ability to destroy the pathogens in humanure. Perhaps they weren’t sure they were doing the right

thing, and in fact many of them were mouldering their compost rather than thermophilically composting it. One family who composts humanure by a mouldering process uses it to fertilize trees in a field, having banned it from their garden, which, of course, is better than shitting in drinking water. Ironically though, it is a simple matter to convert a mouldering system into a thermophilic one, thereby rendering the compost fit for food production.

I now have a house built primarily of bioregional and recycled materials. The tipi ended up at a local state-owned environmental center where it was used to teach kids environmental ethics until a wind storm blew it to shreds. I lived “off the grid”, without mainstream electricity, for the first ten years, eventually incorporating photovoltaics (solar electricity) into my home, then mainstream electricity, conservatively consumed. I added the mainstream electricity when I realized I would never want to pay for a photovoltaic system big enough to even light my house, not only because of the prohibitively high cost, but also because of the toxic lead-acid batteries I would have had to buy and eventually discard in order to store the solar power. Besides, the kerosene lamps we had to use were causing indoor air pollution and creating a fire hazard. I also married a woman who owned a freezer, which not only required electricity, but which proved itself to be very useful in preserving food for the winter. The woman’s pretty nice too.

In short, ideals carved in stone are eventually molded by the constant rain of reality, which transforms them into a practical wisdom.

On the other hand, my composting system has changed little. I’ve upgraded it by moving the original “outhouse” indoors, where it works much better and does not

A Tip From Mr. Turdley



Sawdust works best in compost when it comes from logs, not kiln-dried lumber. Although kiln-dried sawdust (from a wood-working shop or retail lumber yard) will compost, it is a dehydrated material and will not decompose as quickly as sawdust from “green” logs, which is a byproduct of sawmills. Kiln-dried sawdust may also contain sawdust from pressure treated lumber, a dangerous addition to any compost pile. Sawdust from logs makes a better cover material in a sawdust toilet, as it prevents the escape of odor more effectively than the lighter, airier, kiln-dried material. Sawdust from logs is an inexpensive and plentiful local resource in forested areas, and can be found at local sawmills, usually free for the hauling. Sawdust should be stored outside where it will remain damp and continue to decompose, although during the winter special provisions must be made to ensure a supply of unfrozen sawdust. Some people will tell you that sawdust will make your soil or your compost acidic. That’s not true. A comprehensive study of sawdust done between 1949 and 1954 by the Connecticut Experiment Station showed no instance of it making the soil more acidic.⁶ This is verified by the author’s experience.

create an odor problem at all. In fact, the most common remark visitors offer concerning the toilet is "Gee, why doesn't it smell?" The system itself is still the same model of simplicity that I've been employing all along, if not more so. People ask me when I'm going to get a septic system. They take one look at the compost toilet and say things like "I respect the way you're living, but I could never do it." Well, I could install a septic system, as I have the running water and the electricity. However, in doing so I'd likely create environmental pollution and threaten the quality of my ground water, which I drink. That's what septic systems do. They're *waste disposal* systems. They collect and store waste, allowing the waste to slowly seep into the



A SIMPLE, COMPACT, INDOOR SAWDUST TOILET IN A NEWLY CONSTRUCTED HOME.

environment. I'd rather engage in resource recovery instead of waste disposal. My compost is my reward, and that's too valuable for me to be willing to sacrifice. It helps me to grow my food.

Finally, I don't understand humans. We line up and make a lot of noise about big environmental problems like incinerators, dumps, acid rain, and pollution. But we don't understand that when we add up all the tiny environmental problems each of us creates, we end up with those big environmental dilemmas. Humans are content to blame someone else, like government or corporations, for the messes we create, and yet we continue doing the same things ourselves day in and day out that have created the problems. Sure, corporations create pollution. If they do, don't buy their products. If you have to buy their products (gasoline for example), keep it to a minimum. Sure, municipal waste incinerators pollute the air. Stop throwing trash away. Minimize your production of waste. Recycle.

Buy food in bulk and avoid packaging waste. Simplify. Take a few months off work each year and don't spend money. Turn off your TV. Grow your own food. Plant a garden. Be part of the solution, not part of the problem. If you don't, who will?

THE SAWDUST TOILET

By now the reader should realize that the thermophilic composting of humanure will render it hygienically safe for garden use. However, thermophilic composting requires managing a compost pile by ensuring that the composting microorganisms have their basic needs of oxygen, food and moisture met. That management process simply entails heaping a mix of organic refuse in a constructed bin on bare soil, using some coarse (but not woody) material in the heap, and making sure the pile doesn't dry out. An additional important management practice involves occasionally raking the exposed outer edges of the compost pile onto the top of the pile to ensure that no material is escaping the thermophilic process.

In any case, when composting humanure one may ask, "*How does one get the humanure to the compost pile?*" There are two basic answers to that question. First, the compost pile may be situated under the toilet. I have never used such a toilet and therefore cannot discuss such a system with any authority. I don't see why this sort of collection system would not work as long as the compost pile is readily accessible and closely managed to ensure thermophilic decomposition and to prevent odor and waterlogging. Secondly, the humanure may be collected in one location, then moved to the compost pile in another location on a regular basis. This is the sort of system I am most familiar with, therefore, it is the system on which I focus my discussion.

Another TIP FROM MR. TURDLEY



THE SECRET

**to composting humanure is
to keep it covered.**

Always cover toilet deposits thoroughly with a clean, organic cover material such as rotting sawdust. When depositing humanure onto a compost pile always cover the deposit with another cover material, preferably a coarse one such as straw or weeds. Proper cover materials eliminate odors and flies, and balance the nitrogen in the humanure.

Figure 7.1

The Tao of the Sawdust Toilet

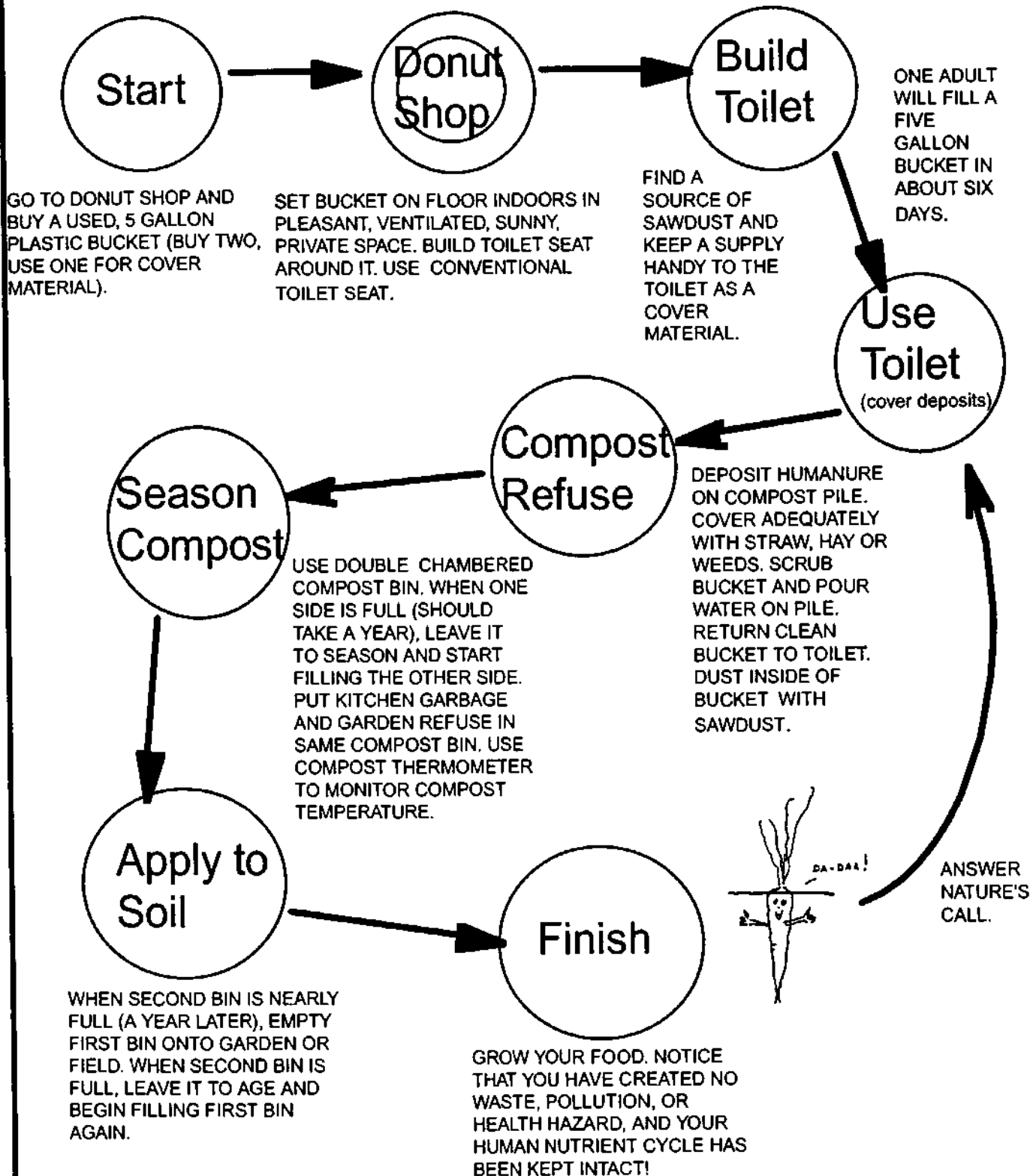
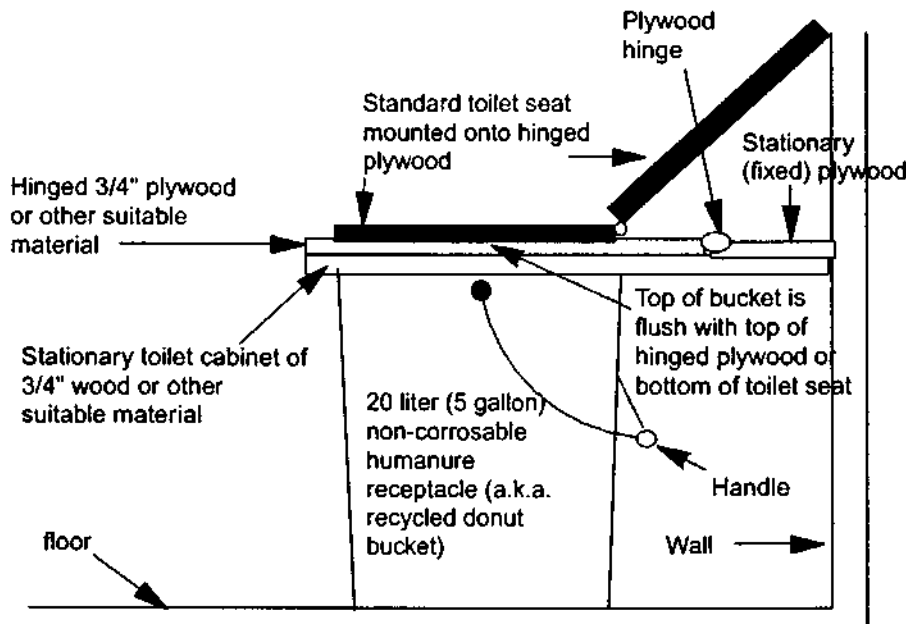

Figure 7.2

CUTAWAY VIEW OF SAWDUST TOILET HUMANURE RECEPTACLE



SAWDUST TOILET VITAL STATISTICS

100 pounds of human body weight will fill approx. 3 gallons (.4 cubic feet, or 693 cubic inches or approx. 11 liters) in a sawdust toilet *per week* - this volume includes the sawdust cover material. 100 pounds of human body weight will also require approximately 3 gallons of semi-dry, deciduous, rotting sawdust per week for use as a cover material in a toilet. This amounts to a requirement of approximately 20 cubic feet of sawdust cover material per 100 pounds of body weight per year for the proper functioning of a sawdust toilet. Human excrement tends to add weight rather than volume to a sawdust toilet as it is primarily liquid and fills the air spaces in the sawdust. Therefore, for every gallon of sawdust-covered excrement collected in a sawdust toilet, nearly a gallon of cover material will have been used.

Diagram of Simple Humanure Sawdust Toilet Arrangement

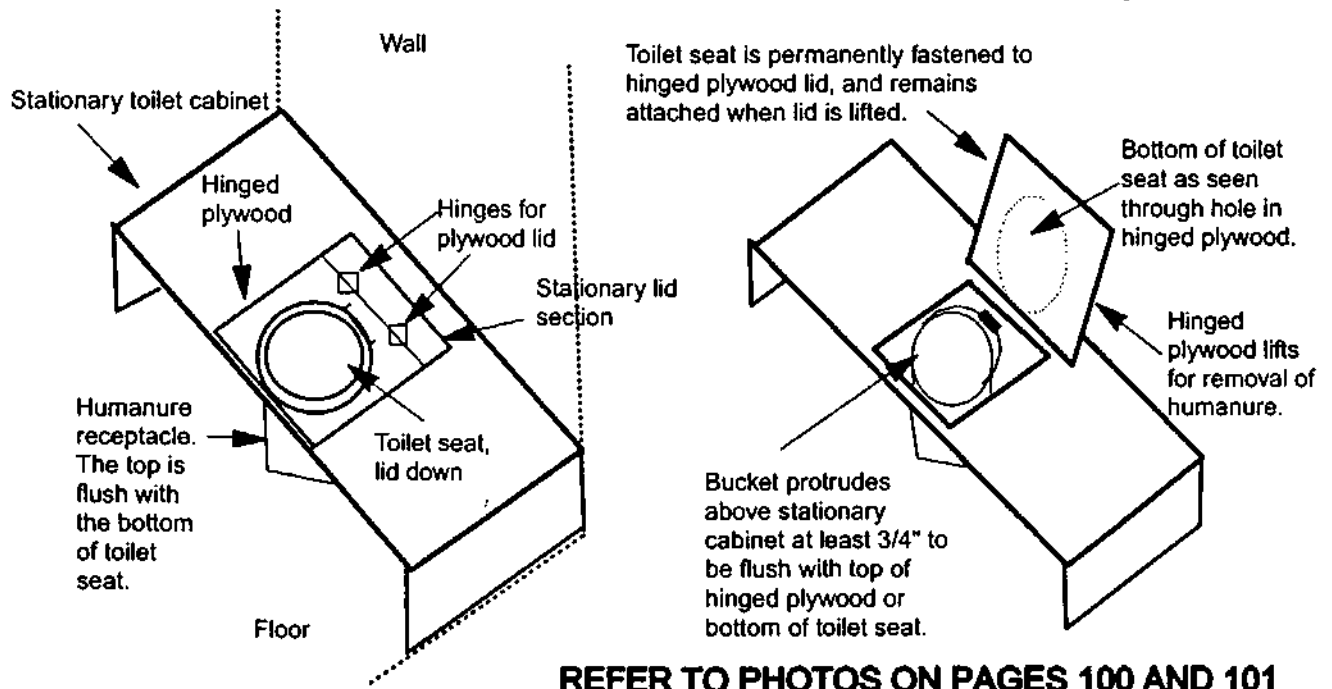

REFER TO PHOTOS ON PAGES 100 AND 101

A simple collection system whereby humanure is collected regularly, then moved to a compost pile has its advantages and disadvantages. The advantages include:

1) A very low cost is required to initiate such a system. The lower the cost of a system, the more universally available it is to humans on planet earth. A collection receptacle that is non-corrosable with a 20 liter or five gallon capacity is ideal. A larger capacity receptacle would be too heavy when full. Plastic, five-gallon food grade buckets with handles are available in the United States for a very small cost as discarded from donut shops and other food establishments. Such a receptacle will withstand many years of constant use with little or no degradation.

2) The toilet can (and should) be comfortably indoors, with no odor. In order to prevent odors, a cover material *must* be used in the collection receptacle. Sawdust from logs is ideally suited for this purpose, although other organic materials would also work. Not only does the cover material trap odor in the collection receptacle, but it also completely eliminates any fly or insect problems. If sawdust from logs is not available, the compost-maker will have to find an alternative that is available in his or her locality. The cover material should be natural, organic, clean and not wet, although it may be damp, and a slight dampness may actually be preferred for odor prevention purposes. Some people use peat moss. Other possibilities would include leaves (preferably dead or dried), ground corncobs or stalks, plain dirt, grain chaff,

Yet Another Tip from Mr. Turdley



PRESSURE TREATED LUMBER SHOULD NEVER BE USED FOR CONSTRUCTING COMPOST BINS, or for anything else. Pressure treated lumber is saturated with chromated copper arsenate. Both arsenic and chromium have been classified as human carcinogens (causing cancer) and are suspected mutagens (causing mutations). The poisons in pressure treated lumber will leach into your soil and into your compost, and may enter your food chain. You can't even safely burn pressure treated lumber to get rid of it - it produces highly toxic fumes and ash! When using sawdust in compost, don't use sawdust from a lumber yard as it may be made from pressure treated lumber! [See *Organic Gardening*, July/August, 1992. p. 8-10]

Figure 7.3

CONSTRUCTING A SIMPLE COMPOST BIN

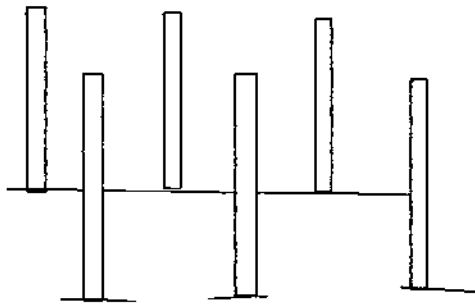

Set six posts into the ground. Use cedar, locust, redwood, or other wood resistant to rot. Do not use pressure treated lumber! Posts should be about five feet (1.5m) apart, about 40" (1m) out of the ground, and buried about two feet (.6m) deep.

(See photo, page 97.)

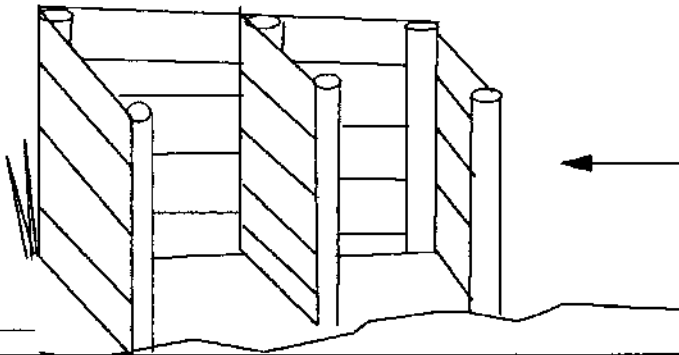

Close posts in so that two chambers are constructed, each about five feet square and 40" high. Recycled lumber without paint is ideal for this purpose. **Do not use pressure treated lumber.**

NOTE: A bin for only one or two people may need to have smaller chambers.

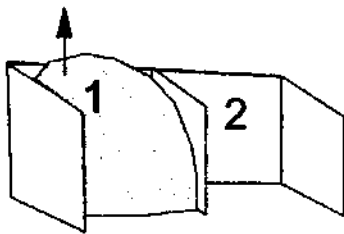

Fill one side to full (about a year), let it sit and age while the other side is filled. When filling the bin, layer the compost with weeds, hay, straw or similar coarse material.

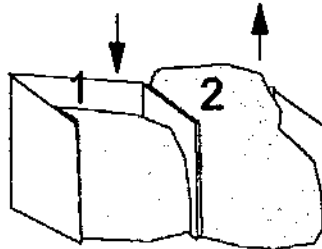

Fill second side. Notice that first side has shrunk considerably. When second side is nearly full, empty first side onto garden or field.

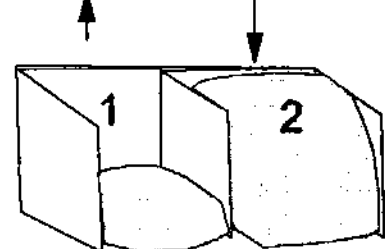

Begin filling first side again, as second side shrinks and ages. When side one is full, empty side two and start over.

THE CEASELESS CYCLE OF COMPOST MAKING

(Refer to page 159 for additional illustrations.)

possibly ground newsprint, perhaps even green leaves, etc. The cover material is an absolutely essential part of a thermophilic compost toilet - it not only eliminates odors and insects, but it also balances the nitrogen of the humanure by providing carbon, thereby setting the stage for the desired thermophilic decomposition.

3) No energy is required to operate such a system. No ventilation is necessary if the composting does not take place inside one's home. In which case, no fans or electricity are needed, and no running water is needed, although a small quantity of water is needed (a minimum of 2 quarts or 2 liters) to wash out the collection receptacle after emptying, which is also essential for maintaining an odor free system. The

soiled wash water can be dumped on the compost pile, or at the base of a fenced-off bush or shrub which is inaccessible to people, especially children. Or the water can be deposited into a standard septic system, or into a natural wetland wastewater treatment system.

4) The thermophilically composted organic refuse is transformed into a hygienically safe, valuable resource. The process eliminates sewage, fecal contamination of the environment, and the spread of disease by human pathogens resident in human excrement.

The disadvantages of a collection system requiring the regular removal of humanure to a compost pile are obvious. They include: 1) the inconvenience of carrying the organic refuse to the compost pile; 2) the inconvenience of keeping a supply of organic cover material available and handy to the toilet; 3) and the inconvenience of maintaining and managing the compost pile itself.

In researching the literature during the preparation of this book, I found it surprising that almost no mention is ever made of the thermophilic composting of humanure as a viable alternative to on-site sanitation. When “bucket” systems are mentioned, they are also called “cartage” systems, and are universally decried as being the least desirable sanitation alternative. For example, in A Guide to the Development of On-Site Sanitation by R. Franceys et. al., published by the World Health Organization in 1992, “bucket latrines” are described as *“malodorous, creating a fly nuisance, a danger to the health of those who collect or use the nightsoil, and the collection is environmentally and physically undesirable”*. This sentiment is echoed in Rybczynski’s (et. al.) World Bank funded work on low-cost sanitation options, where it is stated that *“the limitations of the bucket latrine*



A PEAT TOILET WITH A RECESSED CONTAINER HOLDING PEAT MOSS FOR USE AS A COVER MATERIAL.

include the frequent collection visits required to empty the small container of [humanure], as well as the difficulty of restricting the passage of flies and odors from the bucket.”

Now, I've personally used what could be called a bucket latrine (actually *sawdust toilet* or *biosolids toilet* would be more appropriate terms) for fifteen years and

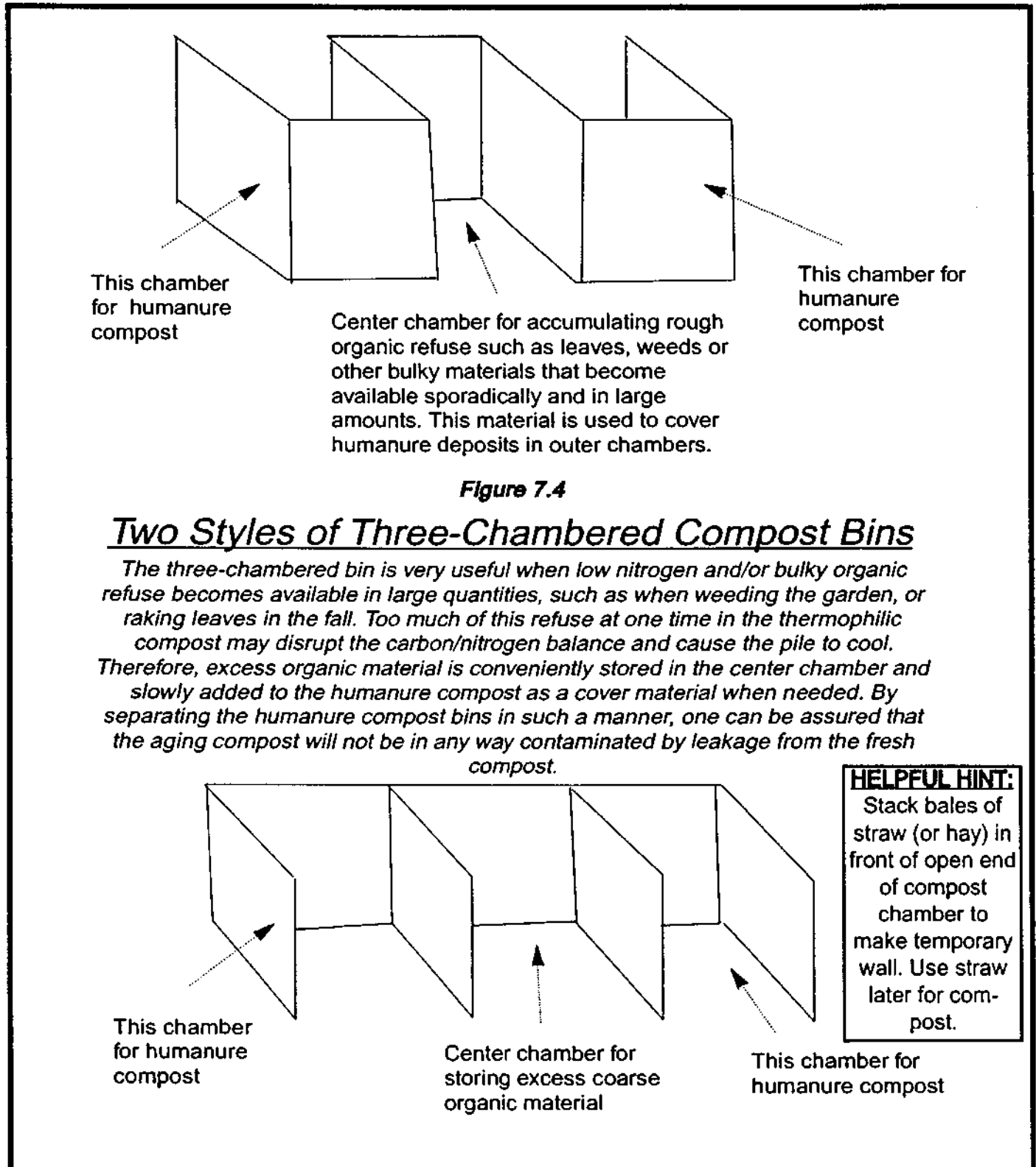

it has never given me odor problems, fly problems, health problems, or environmental problems. Quite the contrary. Nevertheless, Franceys et. al. go on to say that "[humanure] collection should never be considered as an option for sanitation improvement programmes, and all existing bucket latrines should be replaced as soon as possible." Say what?

Obviously Franceys et. al. are referring to the practice of collecting humanure in buckets without a cover material (which would surely stink to high heaven and attract flies) and without any intention of composting the humanure. Such buckets of feces and urine are presumably dumped raw into the environment. Naturally, such a practice should be decried and strongly discouraged, if not outlawed. However, rather than forcing people who use such crude waste disposal methods to switch to other more prohibitively costly waste disposal methods, perhaps it would be better to edu-

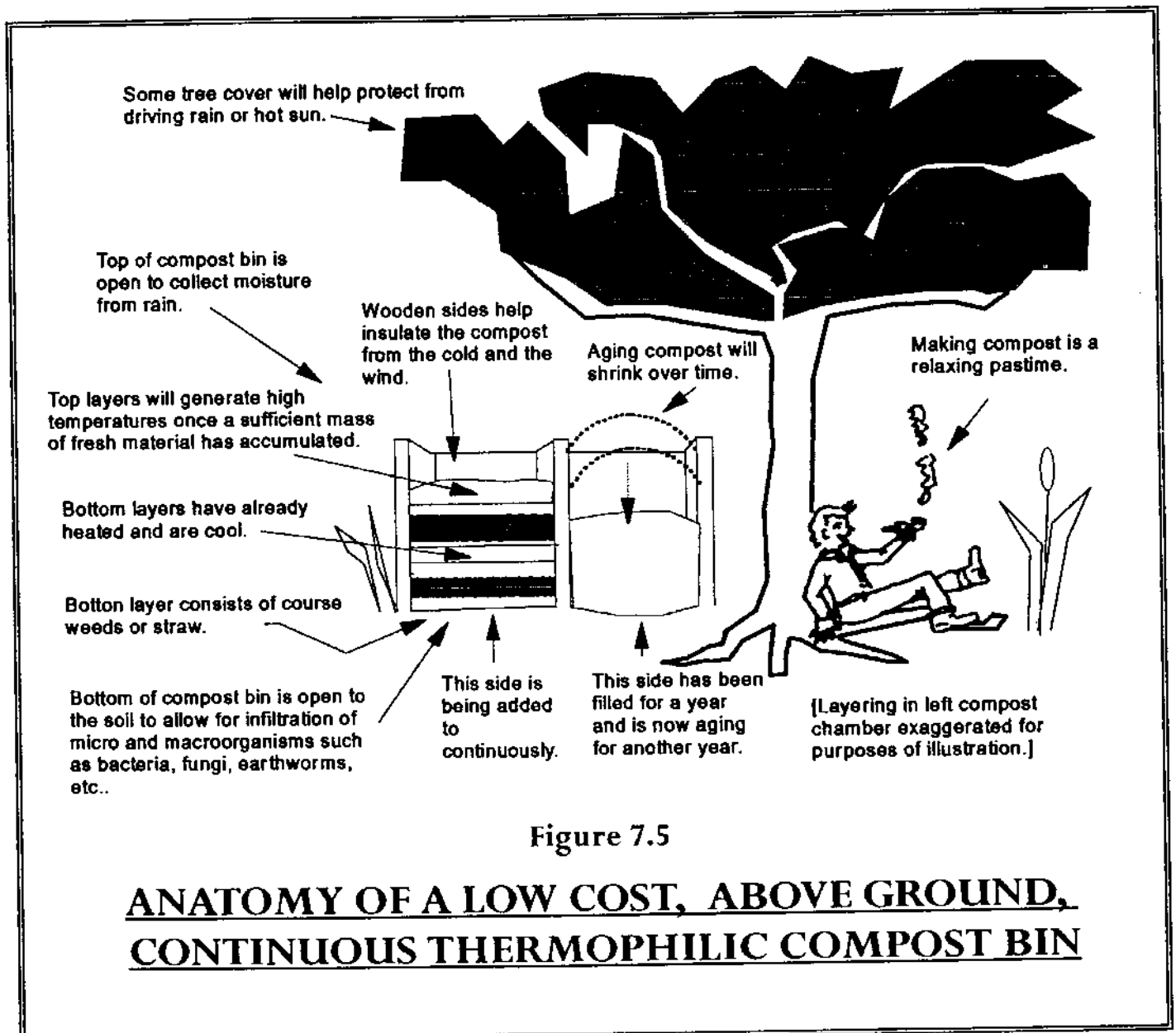

cate those people about *resource recovery*, about the *human nutrient cycle*, and about *thermophilic composting*, and help them acquire adequate and appropriate *cover materials* for their toilets, assist them in constructing *compost bins*, and thereby eliminate waste, pollution, odor, flies and health hazards altogether. I find it inconceivable that intelligent, educated scientists who observe bucket latrines and the odors and flies associated with them do not see that the simple addition of a clean organic cover material to the system would solve the aforementioned problems. Plus balance the nitrogen of the human feces and urine with carbon.

Franceys, et. al. state, however, in their aforementioned book, that "*Apart from storage in double pit latrines, the most appropriate treatment for on-site sanitation is composting.*" I would agree that composting, when done properly, is the most appropriate method of on-site sanitation available to humans. I would not agree that double pit storage is more appropriate than thermophilic composting unless it could be proven that all human pathogens could be destroyed using such a double pit system, and that such a system would not require the segregation of urine from feces. According to Rybczynski, the double pit latrine shows a reduction of *Ascaris ova* of 85% after two months, a statistic which does not impress me. When my compost is finished, I don't want *any* pathogens in it.

Ironically, the work of Franceys et. al. further illustrates a "decision tree for selection of sanitation" that indicates that the use of a "compost latrine" as being one of the least desirable sanitation methods, and one which can only be used if the user is willing to collect urine separately. Unfortunately, contemporary professional literature is rife with this sort of inconsistent and incomplete information which would surely lead a reader to believe that composting humanure just isn't worth the trouble.

On the other hand, Hugh Flatt, who, I would guess, is a practitioner and not an academic, in Practical Self-sufficiency tells of a sawdust toilet system he had used. He lived on a farm for more than thirty years which made use of "bucket lavatories". The lavatories serviced a number of visitors during the year and often two families in the farmhouse, but they used no chemicals. They used sawdust, which Mr. Flatt described as "absorbent and sweet-smelling." The deciduous sawdust was added after each use of the toilet, and the toilet was emptied on the compost pile daily. The compost heap was located on a soil base, the deposits were covered each time they were added to the heap, and kitchen refuse was added to the pile (as was straw). The result was "*a fresh-smelling, friable, biologically active compost ready to be spread on the garden.*"

Perhaps the "experts" will one day understand, accept, and advocate simple humanure composting techniques such as the sawdust or biosolids toilet. However, we may have to wait until Composting 101 is taught at the university.

ANALYSES

After nearly fourteen years of composting all of my family's and visitor's humanure on the same spot about fifty feet above my garden, and using all of the finished compost to grow the food in our single garden, I analyzed my garden soil, my yard soil (for comparison), and my compost, each for fertility and pH, using LaMotte test kits from the local university⁸. I also sent samples of my feces to a local hospital lab to be analyzed for indicator pathogenic ova or worms. The analyses are as follows:

The humanure compost proved to be adequate in nitrogen (N), and rich in phosphorus (P), and potassium (K), and higher than either the garden or the yard soil

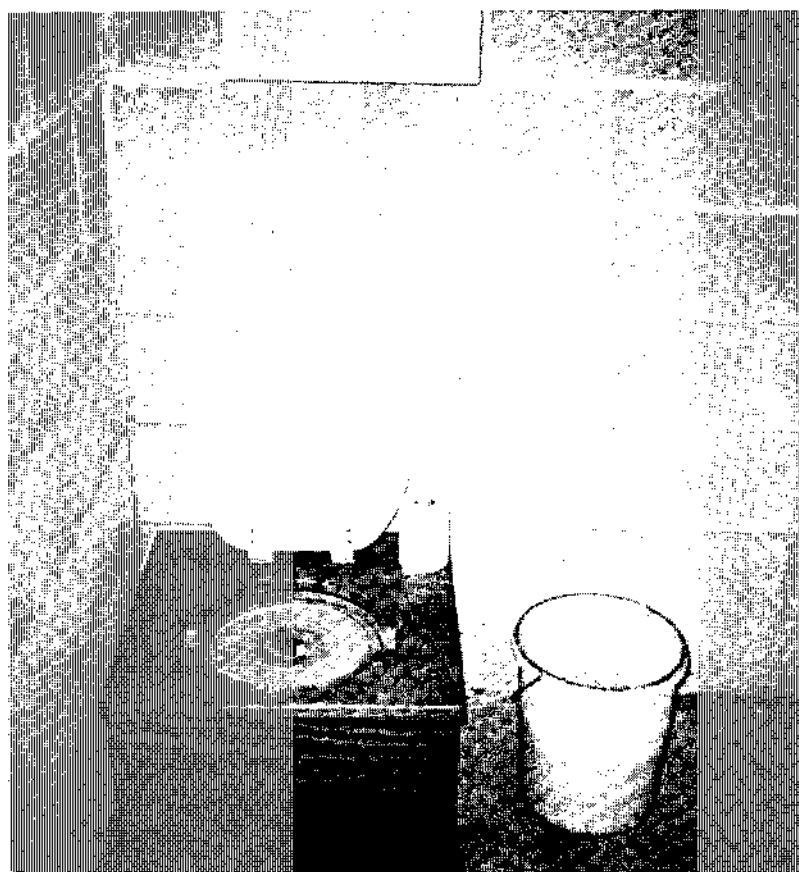

A SAWDUST TOILET IN A BASEMENT.

THIS TOILET IS USED AS AN EMERGENCY BACKUP IN A HOUSE WITH A SEPTIC SYSTEM. NOTE THAT THE HUMANURE RECEPTACLE EMPLOYS AN INNER LID, WHICH IS NOT NECESSARY WHEN ROTTED DECIDUOUS SAWDUST IS USED AS A COVER MATERIAL AND THE REGULAR TOILET SEAT FITS SNUGLY AGAINST THE TOP OF THE HUMANURE RECEPTACLE. THE BUCKET TO THE RIGHT CONTAINS CLEAN SAWDUST, WHICH IS ADDED TO THE TOILET AFTER EACH USE.

in these constituents as well as in various beneficial minerals. The pH of the compost was 7.4 (slightly alkaline), and no lime or wood ashes had been added during the composting process. This is one reason why I don't recommend adding lime (which raises the pH) to a compost pile. A finished compost would ideally have a pH around 7 (neutral).

The garden soil was slightly lower in nutrients (N, P, K) than the compost, and the pH was also slightly lower at 7.2. I had added lime and wood ashes to my garden soil over the years, which may explain why it was slightly alkaline. The garden soil, however, was still significantly higher in nutrients and pH than the yard soil (pH of 6.2), which remained generally poor.

My stool sample was free of pathogenic ova or worms. I used my own stool for analysis purposes because I had been exposed to

the compost system and the garden soil longer than anyone else in my family by a number of years. I had freely handled the compost year after year with no reservations (my garden is mostly hand-worked). I repeated the stool analysis a year later (after fifteen years of composting humanure) again with negative results (no ova or parasites observed).

These results indicate that the compost is a good soil builder, and that no intestinal parasites were transmitted from the compost to the compost handler. This wasn't a laboratory experiment; it was a real life situation conducted over a somewhat lengthy period of time. The whole process, for me, has been a success.

LOW-IMPACT COMPOSTING

It's very important to understand that *two* factors are involved in destroying pathogens in humanure. Along with heat, the *time* factor is important. Once the organic material in a compost pile has been heated by thermophilic microorganisms, it should be left to age or "season". This part of the process allows for the final decomposition to take place, decomposition that may be dominated by fungi and macroorganisms such as earthworms. Therefore, a good compost system will utilize at least two sections or chambers in a single bin, or two separate bins, one to fill and leave to age, and another to fill while the first is aging. One may want to have two separate single-chambered compost bins, or a three-chambered compost bin, or any variation of the double-chambered bin that meets the individual's needs.

When using two compost chambers, fill them one at a time. Stop filling the first one when it's full, which may take a year, and leave it alone. Don't turn it unless you want some exercise, however it should still be heating on the top layer, and turning it now may put out the fire. At that time start filling the second chamber. Then, when the second chamber is nearly full (a year later?), the first one can begin to be emptied onto the garden. The object is to let the compost rest for about a year after the pile has been fully constructed. Pure simplicity (see figures 7.3, 7.4 and 7.5).

A compost pile can accept a huge amount of refuse, and even though the pile may seem to be full, as soon as you turn your back it will shrink down and leave room for more material. So when I say fill the first chamber before filling the second, I mean *FILL* it. You'll know when it's getting full when nothing else will fit on the pile without trying to roll out of the bin.

The timing cycle I follow for compost-making is natural. Natural cycles of time include daily cycles, or "circadian rhythms". For humans that usually involves a daily defecation, a daily sleeping period, etc. For the planet it involves the daily rotation. This cycle of time connects us, as humans, to the other life forms on the earth. It's something we all share in common.

Monthly cycles include the waxing and waning of the moon, the monthly new and full moons, or the monthly revolution of the moon around the earth. This involves tidal cycles, menstrual cycles, and probably a heck of a lot more that I'm not aware of.

Seasonal cycles break up the annual revolution of the Earth around the sun. They're marked by the spring and fall equinoxes and the winter and summer solstices, and by the weather changes of the seasons. All of these cycles are included in the yearly cycle, which involves gardening, farming, planting, harvesting, and anything else done on an annual schedule, including an annual period of rest.

Figure 7.6

Temperature Curve of Frozen Humanure Compost Pile After Spring Thaw

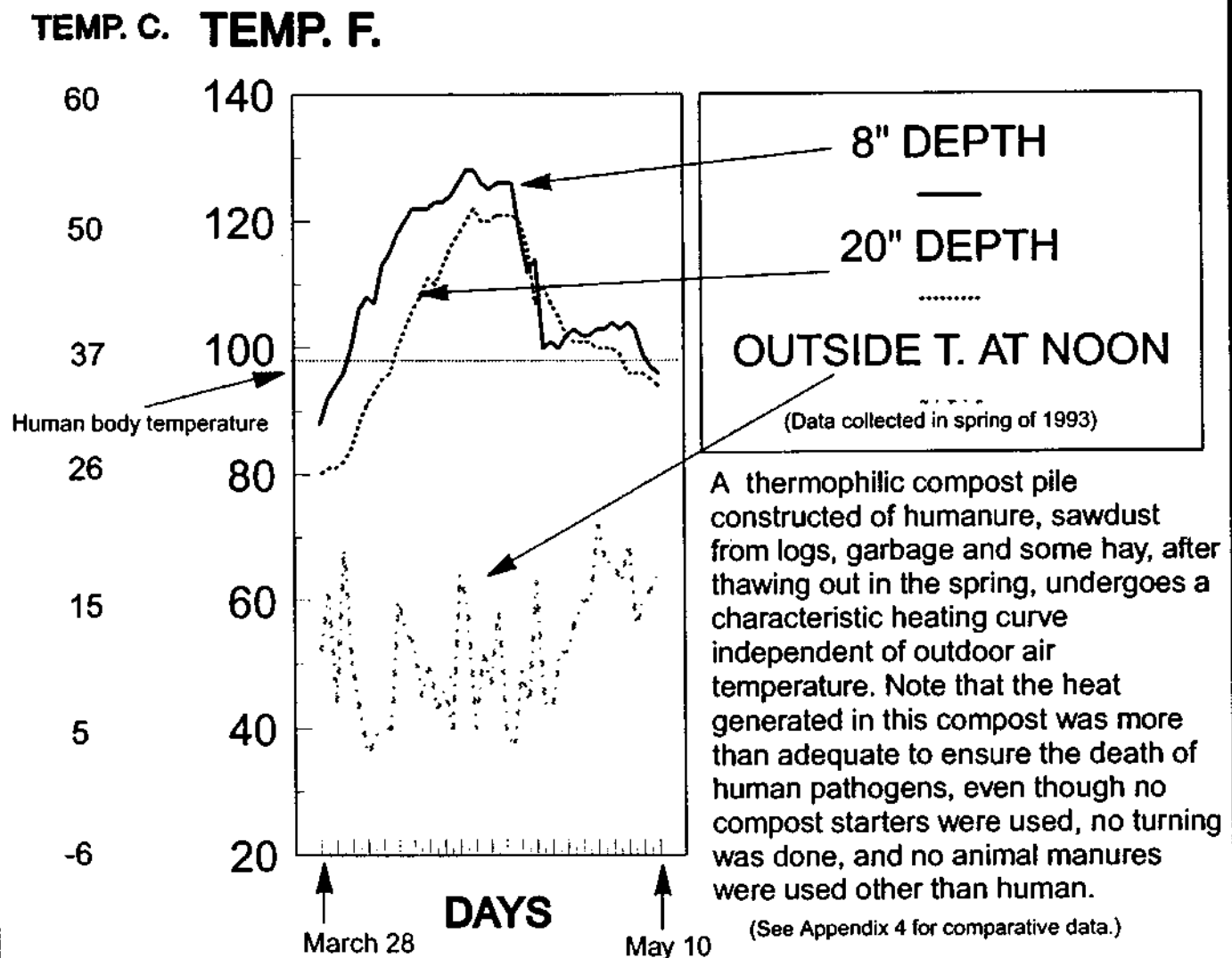

When working with natural cycles such as with the composting stage of the human-nutrient cycle, it's best, I believe, to follow natural cycles of time as well. They go hand in hand. Therefore, I've found a yearly cycle to work best for me in making compost. By late spring, the compost bin is full and it's time to leave it sit until the next spring, when the finished compost will be ready to be removed to the garden. The removal of the finished compost takes place in the spring prior to or during planting time.

MONITORING COMPOST TEMPERATURE

The preceding graph shows the rise in temperature of a humanure compost pile (feces, urine, and garbage) which had been frozen all winter. That particular spring was very cold, so the pile didn't thaw out until late March. Until then it was hard as a rock, a large pile of frozen mass, nearly filling a 5' x 5' x 4' bin.

The compost consisted primarily of deposits from the sawdust toilet, which contained raw hardwood sawdust (just enough to cover the material in the toilet), humanure including urine, and toilet paper. In addition to this material, kitchen garbage was added to the pile intermittently throughout the winter, and hay was used to cover the toilet deposits on the pile. Some weeds and whatnot may have been thrown in now and then, but garden material isn't available during the winter except in the form of

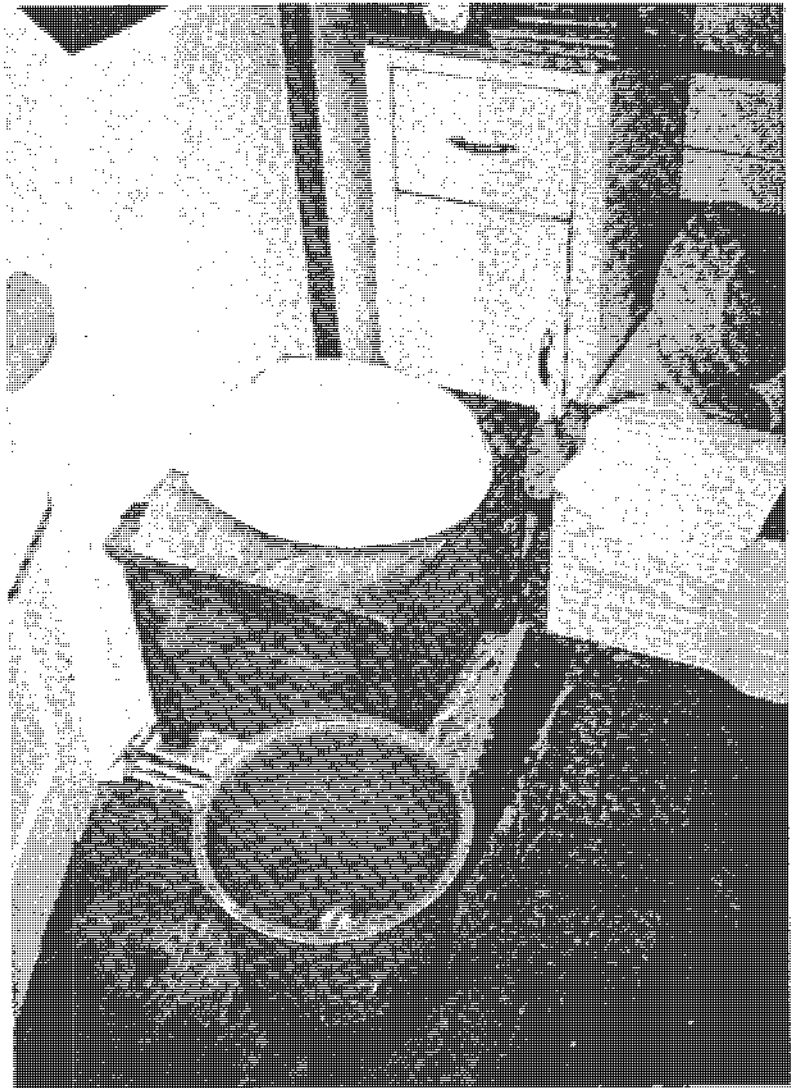

THIS SAWDUST TOILET CONSISTS OF A WOODEN BOX SITUATED OVER A FIVE GALLON, PLASTIC HUMANURE RECEPTACLE (NOT VISIBLE). THE BOX IS LIFTED OFF THE RECEPTACLE WHEN IT IS FULL, AND THE ORGANIC REFUSE IS THEN REMOVED TO THE COMPOST BIN OUTDOORS.

DO's and DON'T's of a thermophilic toilet composting system:

DO - Collect urine in the toilet. Urine provides essential moisture and nitrogen.

DO - Have a supply of cover material for the toilet to eliminate odor, absorb excess moisture and urine, and balance the C/N ratio. Examples: rotting sawdust, peat moss.

DO - Have another supply of cover material to cover the compost pile itself, for odor prevention, air entrapment, and C/N balance. Examples: Hay, straw, weeds, leaves, grass.

DO - Occasionally rake exposed outer surfaces of the compost pile onto the top of the pile.

DO - Add a mix of organic material to the compost pile, including organic garbage.

DO - Keep top of compost pile somewhat flat. This allows rain to be absorbed, and added organic material to stay on top.

DO - Use a compost thermometer. If the temperature of your compost does not seem adequate to you, use finished compost for berries, fruit trees, and ornamentals, instead of garden crops.



DON'T - Segregate urine from feces.

DON'T - Turn the pile if it is being continuously added to.

DON'T - Cover fresh compost deposits with lime or wood ashes. Put lime and wood ashes directly on soil. Cover compost with clean organic materials that will benefit the composting process, such as mentioned at left.

DON'T - Deposit urine/feces/sawdust into a compost bin without cover

materials and other organic refuse and expect it to thermophilically compost. The layering of a wider mix of materials traps air and provides nutrients that stimulate thermophilic activity.

DON'T - Worry if your compost does not reach an extremely high temperature quickly. Temperatures above 110° F indicate thermophilic activity, which may peak periodically in a continuous compost pile when sufficient organic mass has accumulated.

Temperatures above 104°F may be sufficient to kill pathogens (see page 99).

A compost bin may require some time to develop a resident thermophilic population. If your compost does not achieve thermophilic temperatures, after collecting it for a year and aging it for another year, use it to plant berries, fruit trees, or ornamental plants.

kitchen refuse, so not much in the way of garden weeds was in this pile.

The material was collected over a period of about four months from a family of four. Nothing special was done to the pile at any time. No unusual ingredients were added, no compost starters, no water, no animal manures other than human, and no turning whatsoever. The compost pile was situated in a three-sided, open-topped wooden bin on the dirt ground, outside. Only normal household organic refuse such as produced by any human being was added to the pile including human fecal material and urine. The only imported materials (not from the home) were sawdust, a locally abundant resource, and hay from a neighboring farm (one or two bales were used during the entire winter).

Notice that the outside of the pile was heated by thermophilic activity before the inside. The outside thawed first, so it started to heat first. Soon thereafter the inside thawed and also heated. By April 8th the outer part of the pile had reached 120°F (50°C) and the temperature remained at that level or above until April 22 (a two week period). The inside of the pile reached 120°F on April 16, over a week later than the outside, and remained there or above until April 23. The data suggest that the entire pile was at or above 120°F for a period of eight days before starting to cool. Two thermometers were used to monitor the temperature of this compost, one having an 8" probe, the other having a 20" probe. The 8" thermometer came from Edmund Scientific Co.; the 20" thermometer came from Real Goods, 966

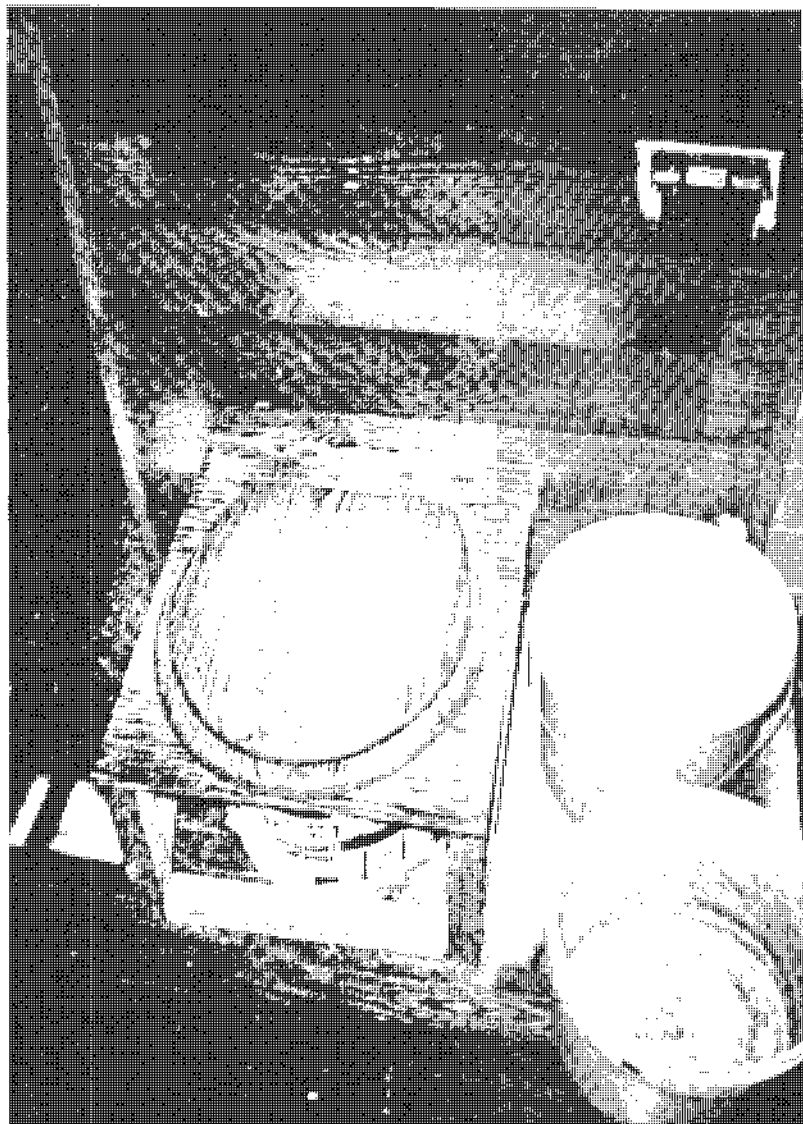

A SAWDUST TOILET IN A MOBILE HOME. THE FRAME IS HINGED TO THE WALL AND LIFTS UP OFF THE HUMANURE RECEPTACLE WHEN REMOVAL IS NECESSARY.

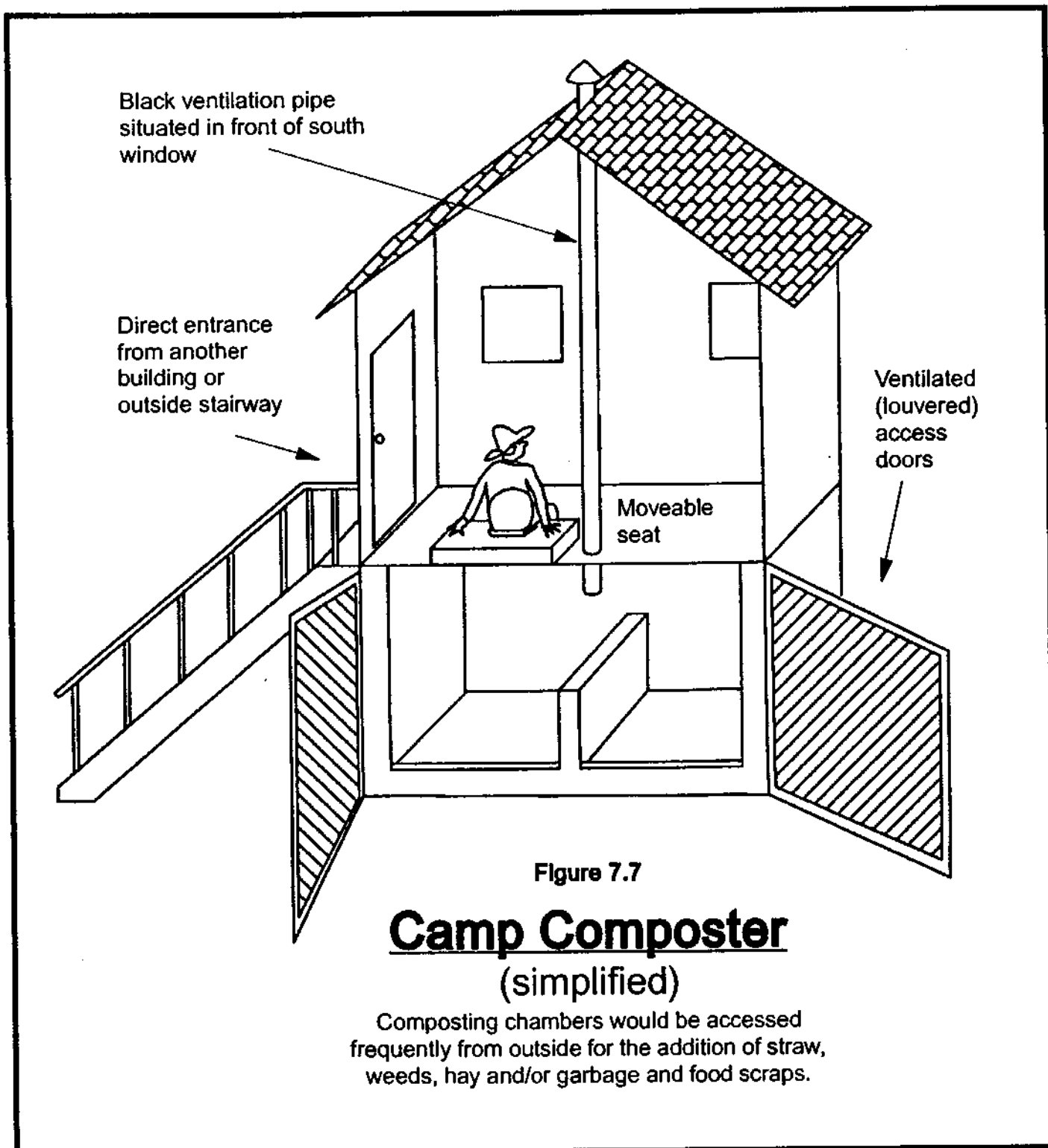

Mazzoni St., Ukiah, CA 95482-9292. The Real Goods thermometer was the best buy (see appendix 1 on page 185 for sources of compost thermometers).

According to Dr. T. Gibson, Head of the Department of Agricultural Biology at the Edinburgh and East of Scotland College of Agriculture, "All the evidence shows that a few hours at 120 degrees Fahrenheit would eliminate [pathogenic

microorganisms] completely. There should be a wide margin of safety if that temperature were maintained for 24 hours.” (See The Complete Book of Composting, 1960, J. I. Rodale, p. 650, Rodale Books, Emmaus, PA).

This opinion is corroborated by Feachem et. al. and many others, and is illustrated in figure 6F, page 133, titled “Safety Zone for Pathogen Death”, which is a diagram adapted from Feachem’s work (Appropriate Technology for Water Supply and Sanitation) extensively used as a reference in chapter 6. That diagram indicates that one day at 122°F will kill the human pathogens that can be resident in humanure. A week at 115°F will do the same thing. Higher temperatures kill things faster, lower temperatures take more time. A combination of heating the compost then retaining the heated and cooled compost in storage for a period of months seems to be a good bet for making fine kitchen-garden compost from humanure. That’s the sawdust or biosolids toilet system in a nutshell.

The significance of the aforementioned graph is that it shows the humanure required no coaxing to heat up sufficiently to be rendered hygienically safe. It just did it on its own, having been provided the simple requirements a compost pile needs.

A comparative temperature curve monitored the following spring indicated that the addition of a small amount of chicken manure improved the thermophilic activity of the compost (see appendix 4, p. 187).



AN OUTDOOR SAWDUST TOILET BUILT OF RECYCLED MATERIALS. A REMOVABLE BUCKET LINGERS UNDER THE TOILET SEAT, WAITING TO BE FILLED, EMPTIED AND COMPOSTED.

LEGALITIES

I knew of some local folks, Amish, who had a baby at home a couple of years ago. Babies born at home nowadays are no big deal; most of the Amish have a midwife deliver their babies. All of my six children were born at home. However, a local county health worker decided to put a stop to this practice and *charged the young Amish couple with child abuse for not having their baby born in a hospital.*

Here we have an otherwise happy young couple who just had a beautiful baby, and some poor, deluded authority figure was actually telling them he'd have their baby taken away and put in a foster home if they didn't tell him who delivered the kid. This is a true story. The couple gave him the name of their midwife, a highly respected and eminently qualified woman who has now delivered over one thousand babies. She was promptly arrested. To make a long story short, the local magistrate threw the charge (practicing medicine without a license) out, the authorities actually appealed, then the higher court threw the charges



THIS UNPRETENTIOUS STRUCTURE HOUSES A SAWDUST TOILET. ALTHOUGH CONSIDERED AN "OUT-HOUSE", THERE IS NO PIT UNDERNEATH AND NO LEACHING OF POLLUTION INTO THE GROUND. THE HUMANE IS INSTEAD COLLECTED AND COMPOSTED.

out.

What's that have to do with compost? Composting humanure, is like having babies where and how you want them, or educating your kids alternatively. It's behavior out of the mainstream of Western society. It may be something different, and different things can scare people when they don't know anything about them, especially

those people who have oatmeal for brains and have somehow gravitated into a position of authority. Whether it's legal or not often isn't the issue. The Amish story is one of many in which the basic rights of humans have been subverted by the ignorance and the misuse of authority by others.

Ideally, laws are made to protect society. Laws requiring septic, waste, and sewage disposal systems are supposedly designed to protect the environment, the health of the citizens and the water table. This is all to be commended,

and conscientiously carried out by those who produce *sewage*, a waste material. If you don't produce sewage, you have no need for a sewage disposal system, and laws pertaining to sewage disposal are not your concern. The number of people who produce compost instead of sewage is so minimal, that few, if any, laws have been enacted to regulate the practice. The thermophilic composting of humanure is not a threat to society, it produces no pollution, does not threaten the health of humans or contaminate the ground water or environment. Unfortunately, this fact is not understood by many people, and ignorance is a problem.

It would be hard to intelligently argue that a person who produces no sewage must have a costly sewage treatment system. What would they do with it? That would be like requiring someone who doesn't own a car to have a garage. And it would be very difficult to prove that composting humanure is threatening to society, especially given the facts as presented in this book. On the other hand, Galileo, the astronomer, was arrested as a heretic and forced to renounce his theory that the Earth revolves around the sun. Sure, that was three hundred years ago. But sometimes I think the consciousness of our society as it relates to human manure is still back in the middle

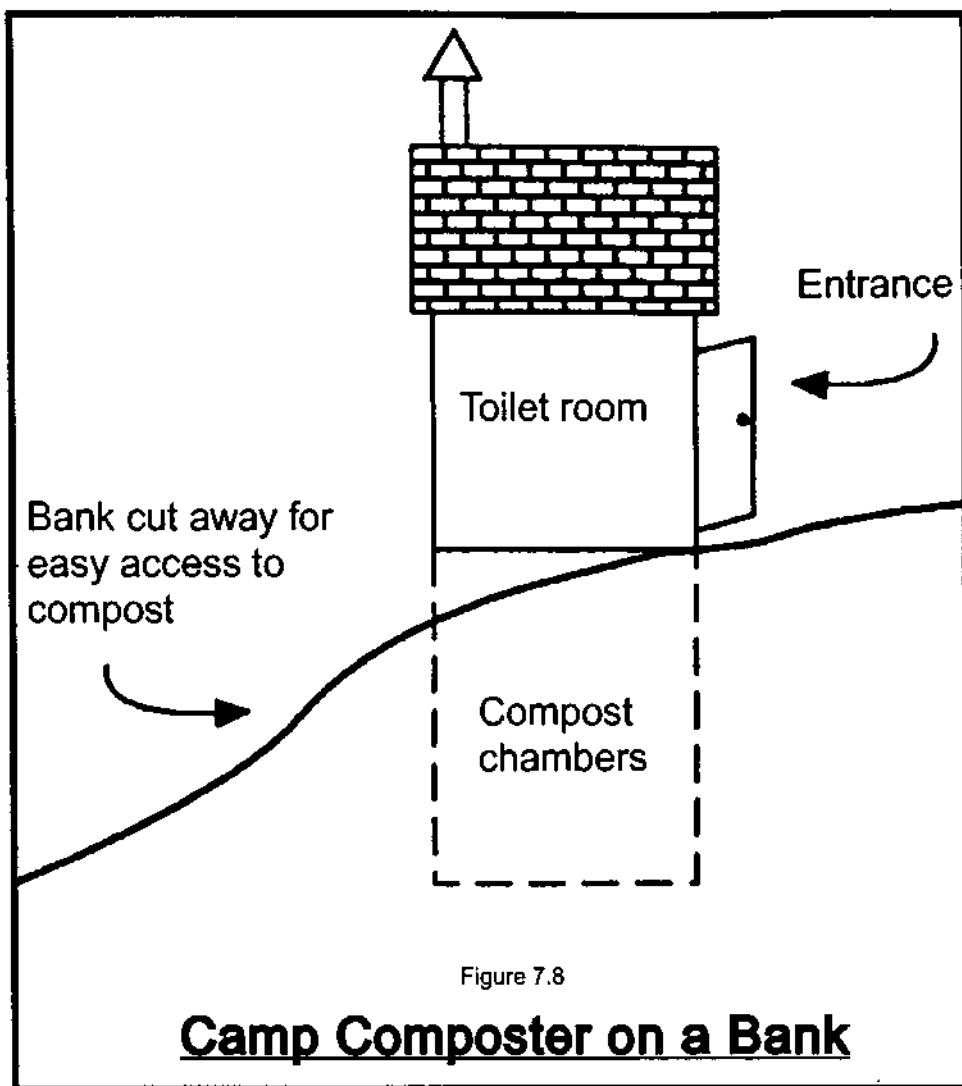

ages.

One way to dispel the darkness of ignorance is with the light of knowledge. Knowledge is best gained by experience. Therefore, I'd like to hear from any of you readers about your composting experiences. You may be able to add to the body of knowledge, and I may someday revise and update this book to include the experiences of others. So don't hesitate at any time to write to the address at the front of this book and let me know how it's going for you. I'd welcome *any* feedback at all.

If you're concerned about your local laws, go to the library and see what you can find about regulations concerning compost. Or also inquire at your county seat or state agency as statutes, ordinances, and regulations vary from locality to locality.* Where I live septic system permits aren't required for new home construction, but the next county is two properties over and people there are required to have septic system permits before they can build a new dwelling. This is largely due to the fact that the water table tends to be high in my area, and septic systems don't always work, so sand mounds are required by law for sewage disposal. Now, if you don't want to dispose of your manure but want to compost it instead (which will certainly keep it out of the water table, not to mention raise a few eyebrows at the local municipal office), you may have to stand up for your rights.

In Pennsylvania, the state legislature has enacted legislation "*encouraging the development of resources recovery as a means of managing solid waste, conserving resources, and supplying energy.*" Under such legislation the term "disposal" is defined as "*the incineration, dumping, spilling, leaking, or placing of solid waste into or on the land or water in a manner that the solid waste or a constituent of the solid waste enters the environment, is emitted into the air or is discharged to the waters of the Commonwealth*" (Pennsylvania Solid Waste Management Act, Title 35, Chapter 29A). Further legislation has been enacted in Pennsylvania stating that "*waste reduction and recycling are preferable to the processing or disposal of municipal waste,*" and further stating "*pollution is the contamination of any air, water, land or other natural resources of this Commonwealth that will create or is likely to create a public nuisance or to render the air, water, land, or other natural resources harmful, detrimental or injurious to public health, safety or welfare. . .*" (Pennsylvania Municipal Waste Planning, Recycling and Waste reduction Act (1988), Title 53, Chapter 17A). In view of the fact that the thermophilic composting of humanure involves recovering a resource, requires no disposal of waste, and creates no environmental pollution, it is unlikely that anyone who *conscientiously* engages in such an activity would be successfully convicted of criminal activity.

If there aren't any regulations concerning compost in your area, then be sure that when you're making your compost, you're doing a good job of it. It's not hard to do it right. The most likely problem you could have is an odor problem, and that's

simply due to not keeping your deposits adequately covered with clean organic material. If you keep it covered, it does not give off offensive odors. It's that simple. Perhaps shit stinks so people will be naturally compelled to cover it with something. That makes sense when you think that thermophilic bacteria are already in the feces waiting for the manure to be layered into a compost pile so they can get to work. Sometimes the simple ways of nature are really profound.

Few people understand that the composting of humanure is a benign method of recycling what would otherwise be a toxic waste material. For that reason, this book is recommended reading for people involved in municipal, county, or township waste treatment or permitting, or resource recovery.

What about gray water? You're still producing gray water and therefore you may still need a septic system or something of the sort as required by law, you may wonder. Maybe, maybe not. Gray water is relatively easy to deal with. A biological treatment system such as an artificial wetland, algae pond, or heck, a patch of woods can effectively absorb gray water, especially if you have sense enough to keep toxic materials and fecal material out of your drains. However, now we're getting beyond the scope of this book. Low-impact gray water treatment systems could involve another whole publication.

And what about flies, could they create a public nuisance? I have never had problems with flies on my compost. Perhaps the compost heats up so fast that flies don't have a chance to enjoy it. And rats? I've never seen one on my homestead. I guess steaming compost doesn't appeal to them. Nor does it appeal to raccoons, dogs or cats.

Concerning flies, F. H. King, who traveled through China, Korea and Japan in the early 1900's when organic material, especially humanure, was the only source of soil fertilizer, stated, *"One fact which we do not fully understand is that, wherever we went, house flies were very few. We never spent a summer with so little annoyance from them as this one in China, Korea and Japan. If the scrupulous husbanding of waste [sic] refuse so universally practiced in these countries reduces the fly nuisance and this menace to health to the extent which our experience suggests, here is one great gain."* He added, *"We have adverted to the very small number of flies observed anywhere in the course of our travel, but its significance we did not realize until near the end of our stay. Indeed, for some reason, flies were more in evidence during the first two days on the steamship out from Yokohama on our return trip to America, then at any time before on our journey."*⁹

If an entire country the size of the United States, but with twice the population (at that time), could recycle all of its organic refuse without the benefit of electricity or automobiles and not have a fly problem, surely we in the United States can recycle a greater portion of our own organic refuse with similar success today.

REFERENCES - CHAPTER SEVEN

- 1 - Thimann, K.V. (1955). The Life of Bacteria: Their Growth, Metabolism, and Relationships. The Macmillan Co., New York. (p.177).
 - 2 - Waksman, S.A. (1952). Soil Microbiology. John Wiley and Sons, Inc., New York. (p.70).
 - 3 - Atlas, R.M. and Bartha, R. (1981). Microbial Ecology: Fundamentals and Applications. Addison-Wesley Publishing Co., Reading, Mass. (p.392)
- also:
- Cooney, D.G. and Emerson, R. (1964). Thermophilic Fungi. W.H. Freeman and Company, San Francisco. (pp.129,142).
- also
- Waksman, Soil Microbiology, (p.71).
- 4 - Lewis, Ricki. (1992). FDA Consumer, September 1992 (p.37)
 - 5 - Lynch, J.M. and Poole, N.L. (Eds.). (1979). Microbial Ecology: A Conceptual Approach. Blackwell Scientific Publications, London. (p.238).
 - 6 - Rodale, R. I. (1960). The Complete Book of Composting. Rodale Books Inc.: Emmaus, PA. (p.192).
 - 7 - Kitto, Dick. (1988). Composting: The Organic Natural Way. Thorsons Publishers Ltd.: Wellingborough, England. (p. 103).
 - 8 - LaMotte Chemical Products Co., Chestertown, MD 21620
 - 9 - King, F.H. (1911). Farmers of Forty Centuries. Rodale Press, Inc., Emmaus, PA 18049. (pp.78, 202).

***Maryland residents (or anyone else) can obtain: "A Farmers' Guide to Maryland Compost Regulations", from Pickering Creek Environmental Center, 27370 Sharp Road, Easton, Maryland 21601.**

"The On-Farm Composting Handbook" is available from The Northeast Agricultural Engineering Service, 152 Riley-Robb Hall, Cooperative Extension, Ithaca, NY 14853-5701.

Two information packages on Farm Scale Composting and Yard Waste Composting are available free from the Appropriate Technology Transfer for Rural Areas, PO Box 3657, Fayetteville, AR 72702, phone: (800) 346-9140.

A journal of composting and recycling which may contain pertinent information is: Biocycle, JG Press, Inc., 419 State Ave., Emmaus, PA 18049.

The Agricultural Composter Newsletter is available from: The Agricultural Composting Association, PO Box 608, Belchertown, MA 01007.

THE END IS NEAR

"If you want to be free, learn to live simply. Use what you have and be content where you are."

J. Heider



Ladies and gentlemen, allow me to introduce you to a new and revolutionary literary device: the *Self-Interview!* [Applause heard in background. Someone whoops.] Today I'll be interviewing myself. In fact here I am now. [Myself walks in.]

Me: Good morning sir. Haven't I seen you somewhere before?

Myself: Cut the crap. It's too early in the morning for this. You see me every time you look in the mirror, which isn't very often, thank God. What, for crying out loud, would possess you to interview yourself anyway?

M: If I don't, who will?

MS: You do have a point there. In fact, that may be a point worthy of contemplation.

M: Well, let's not get off the track. The topic of discussion today is a material substance near and dear to us all. Shall we step right into it?

MS: What the hell are you talking about?

M: I'll give you a hint. It often can be seen with corn or peanuts on its back.

MS: Elephants?

M: Close, but no cigar. In fact, cigar would have been a better guess. We're going to talk about *humanure*.

MS: You dragged me out of bed and forced me to sit here in front of all these people to talk about CRAP?!

M: You wrote a book on it, didn't you?

MS: So what? OK, OK. Let's get on with it. I've had enough of your theatrics.

M: Well first off, do you expect anyone to take your *Humanure Handbook* seriously?

MS: Why wouldn't they?

M: Because nobody gives a damn about humanure. The last thing anyone

wants to think about is a turd, especially their own. Don't you think that by bringing the subject to the fore you're risking something?

MS: You mean like mass constipation? Not quite. I'm not going to put any toilet bowl manufacturers out of business. Like I said, I'd estimate that one in a million people have any interest at all in the topic of resource recovery in relation to human excrement. Nobody thinks of shit as a resource, it's just too bizarre a concept. When I've printed and distributed the 250th copy of the *Humanure Handbook* in the USA, I'll probably consider that market saturated.

M: Then what's the point?

MS: The point is that long-standing cultural prejudices and phobias need to be challenged once in a while by somebody, anybody, or they'll never change. Fecophobia is a deeply rooted fear in the American, and perhaps Western, psyche. But you can't run from what scares you. It just pops up somewhere else where you least expect it. We've adopted the policy of defecating in our drinking water and then piping it off somewhere to let someone else, if anyone, deal with it. So now we're finding that our drinking water sources are becoming increasingly contaminated. What goes around comes around.

M: Oh, come on. I drink water everyday and it's never contaminated. We Americans probably have the most abundant supply of safe drinking water of any country on the planet.

MS: Yes and no. Your water may suffer from no fecal contamination, true, and when I say fecal contamination I mean intestinal bacteria in water. But how much chlorine do you drink instead? Then there's beach pollution. But I don't want to get into all this again. I've already discussed human waste pollution in chapter one.

M: Then you'll admit that American water supplies are pretty safe?

MS: Yes, they are. Even though we defecate in our water, we go to great lengths and expense to clean the pollutants back out of it. We do a good enough job to keep most of our drinking water safe, albeit with chemical additives. However, drinking water supplies are dwindling all over the world, water tables are sinking, and water consumption is on the increase with no end in sight. That seems to be a good reason to not pollute water with our daily bowel movements. And still, that's only *half* the equation.

M: What do you mean?

MS: Well, we're still throwing away the agricultural resources that humanure should be providing us. We're not maintaining an intact human nutrient cycle. By piping sewage into the sea we're essentially dumping grain into the sea. By burying sludge, we're burying a source of food. That's a cultural practice that should be challenged. It's a practice that's not going to change overnight, but will change incremen-

tally if we begin acknowledging it now.

M: So what're you saying? You think everybody should shit in donut buckets?

MS: God forbid. Then you would see mass constipation!

M: Well then, I don't understand. Where do we go from here?

MS: I'm not suggesting a mass cultural revolutionary change in toilet habits. I'm suggesting a change in the way we *understand* our habits. Most people never heard of such a thing as a nutrient cycle. Recycling humanure is just not something anyone ever thinks about. I'm simply suggesting that we begin thinking about new approaches to the age-old problem of what to do with human excrement.

M: That's a beginning, but that's probably all we'll ever see in our lifetime, don't you think?

MS: Don't be so sure about that. Things are changing. I predict that compost toilets and toilet systems will be designed and redesigned in our lifetimes. Eventually, entire housing developments will utilize compost toilet systems. Some municipalities will someday install compost toilet systems in all new homes.

M: You think so? What would that be like?

MS: Well, each home might have a removable container made of recycled plastic that would act as both a toilet receptacle and a garbage disposal.

M: How big a container?

MS: You'd need about five gallons of capacity per person per week. A container the size of a fifty gallon drum should fill in two to three weeks for an average family. Every household will deposit all of its organic refuse except gray water into this glorified donut bucket, including maybe grass clippings and yard leaves. The municipality will provide a cover material for odor prevention of something like ground leaves or rotted sawdust, neatly packaged for each household and possibly dispensed automatically into the toilet after each use. *This would eliminate the production of all garbage and all sewage by human households*, as it would all be collected without water and composted at a municipal compost yard away from town.

M: Who'd collect it?

MS: Once every couple of weeks or so the *Resource Recovery Team* would stop by and take the compost receptacle from your house, sliding it out a side wall in a manner similar to the old coal chutes, using a hand-operated fork lift type machine specially suited for this purpose. A new compost receptacle would then be slid back in to replace the old, and the air-tight gasket joining it to the toilet seat and ventilation pipe would be locked into place. Your manure and your garbage, mixed together with ground leaves and other organic refuse or crop residues would be collected regularly just like your garbage is collected now. Except the destination would not be a landfill, it'd be the compost yard where the organic material would be converted, through

thermophilic composting, into an agricultural resource, and sold to farmers who'd use it to grow food. The natural cycle would be complete, immense amounts of landfill space would be saved, a valuable resource would be recovered, pollution would be reduced, and soil fertility would be enhanced. So would our long-term survival as human beings on this planet.

M: I don't know. . . , how long before Americans will be ready for that?

MS: In Japan today, a similar system is in use, except that, rather than removing the container and replacing it with a clean one, the truck that comes to pick up the humanure suctions it out of the container it's in. Sort of like a truck sucking the contents out of a septic tank. What they do with it after that I don't know. I also don't know whether they mix their garbage with it at home or not. (I need to travel to Asia.)

Such a truck system involves a capital outlay about a third of that for sewers. One study which compares the cost between manual humanure removal and waterborne sewage in Taiwan estimates the manual collection costs to be less than one fifth the cost of waterborne sewage treated by oxidation ponds. That takes into account the pasteurization of the humanure as well as the market value of the resultant agricultural soil additive.¹

We Americans have a long way to go. The biggest obstacle is in understanding and accepting humanure and other organic materials as resource materials rather than waste materials. We have to stop thinking of human excrement and garbage as waste. When we do, then we'll stop defecating in our drinking water and sending our garbage to landfills.

It's critical that we separate water from humanure. As long as we keep defecating in water we'll have a problem that we can't solve. The solution is to stop fouling our water, not to find new ways to clean it up. Don't use water as a vehicle for transporting human excrement or other waste. Humanure must be collected along with other solid (and liquid) organic refuse produced by human beings and composted. We won't be able to do this as long as we insist upon defecating into water. Granted, we can dehydrate the water-borne sewage sludge and compost that. However, this is a complicated, energy-intensive process, and then the sludge is contaminated with all sorts of bad stuff from our sewers which becomes concentrated in the compost.²

M: It'll never happen. Face it. Americans, Westerners, will never stop shitting in water. They'll never, as a society, compost their manure. It's unrealistic. It's against our cultural upbringing. We're a society of Howdy-Doody, hotdogs, hairsprays and Ho-Hos, not composted humanure fer christsake. We don't *believe* in balancing human nutrient cycles! We just don't give a damn. Compost making is unglamorous and you can't get rich doing it. So why bother?!

MS: You're right on one point - Americans will never stop shitting. But don't be so hasty. In 1988 in the United States alone, there were 49 operating municipal sludge composting facilities.³ In Duisberg, Germany, a decades-old plant composts 100 tons of domestic refuse daily. Another plant at Bad Kreuznach handles twice that amount. Many European composting plants compost a mixture of refuse and sewage sludge. A solid waste composting plant in Oregon is designed to handle 800 tons of refuse daily. There are at least three composting plants in Egypt. In Munich, a scheme was being developed in 1990 to provide 40,000 households with "biobins" for the collection of compostable refuse.⁴

It's only a matter of time before the biobin concept is advanced to collect humanure as well. As it is today, much of the compost being produced by the big plants is contaminated with such things as batteries, metal shards, wine bottle caps, paints, heavy metals and the like. As a result, much of it isn't useful for agriculture and has to be used for filler or for other non-agricultural applications, which, to me, is absurd. The way to keep the junk out of the compost is to value the compostable organic refuse enough to collect it separately from the other trash, and to keep the humanure out of the sewers. A household biobin would do the trick. The biobin could be collected regularly, emptied, its contents composted, and the compost sold to farmers and gardeners as a financially self-supporting service provided by independent businesses.

Some entrepreneurs have already got into the sewage composting business in the United States. In 1989, the town of Fairfield, Connecticut contracted to have its yard refuse and sewage sludge composted. The town is said to have saved at least \$100,000 in waste disposal costs in its first year of composting alone. The Fairfield operation, which is just one quarter mile from half million dollar houses, is reported to smell no worse than wet leaves from only a few yards away.⁵

Some say that as much as 50% of all municipal refuse could be converted into compost. However, the problem remains the same: contamination of the compost, largely due to sewage sludge contamination and inadequate or improper collection systems for organic refuse. Americans put someone on the moon in 1969, surely we can figure out the solution to making good compost today.

M: But still, there's the fear of humanure and its capability of causing disease and harboring parasites.

MS: That's right. But y'know, according to the literature, a temperature of 122°F for a period of twenty-four hours is sufficient to kill all of the human pathogens potentially in humanure. When my humanure compost pile thawed out last spring, I put two thermometers in it, one with a long (20") probe and one with a short (8") probe to see what happened with the temperature. Now this was a pile of human

manure, urine, sawdust, kitchen food scraps, and some weeds and hay. This was a pile that I never turned or worked manually in any way, except to occasionally rake the exposed outer surfaces of the pile on to the top of the pile to ensure inclusion of all the compost in the thermophilic process. I also occasionally raked the top of the pile flat, but I never manually aerated the compost. Nor did I add any compost starters or anything else. The pile was outside, exposed to the air and rain in a three sided wooden bin with an earth bottom. As soon as the pile thawed it began to heat. In a few weeks, the entire pile reached and maintained a temperature of over 120°F and stayed there for eight days. Parts of the pile stayed over 120°F for over two weeks. This spring I monitored my compost pile temperature again, after it thawed. This time it stayed above 122° for 25 days. I'm not worried about diseases or parasites in my compost at all. It doesn't seem to me that creating thermophilic compost is difficult or complicated, and that's what we need to do in order to sanitize human excrement without excessive technology and energy consumption. Thermophilic composting is something simple humans all over the world can do whether they have money or technology or not.

M: Why would the heat of a compost pile kill human pathogens anyway? I don't understand that.

MS: Human disease-causing organisms thrive in the human body, which has a temperature of about 98.6°F. They like this temperature. The natural way the body tries to destroy the pathogens is by elevating its own body temperature. That's called a fever, and the temperature rarely exceeds 104°F. Now I understand that the body raises its temperature not only to retard the growth of pathogens, but also to accelerate the growth of disease fighting components of the human bloodstream, such as white blood cells. However, the higher the temperature, the harder it is for human pathogens to survive. Not only does a high compost temperature destroy the pathogens, but it also indicates prolific microbial activity in the compost, and thereby a level of microbial competition that thwarts the growth and reproduction of microscopic animals that would rather be in someone's body than in an over-populated compost pile. When the temperature climbs to 110 or 120°F, the pathogens start rapidly dying off. Our bodies can't achieve that kind of temperature elevation, but thermophilic microorganisms can. A compost pile is like a mass of life that is having a huge fever. Pathogens are comfortable in the human body, but they can't take the heat of the compost. It's a harsh and unnatural environment for them. A killer.

Furthermore, just leaving a compost pile sit for a year will kill off almost all pathogens, *Ascaris* (roundworm) eggs being the exception. They're tough buggers, but heat will do them in. That's why I recommend letting compost heat, like a fever, then letting it sit and age. That's the one-two punch.

M: But how do you know that *all* parts of the compost pile are being subjected to temperatures sufficient to kill potential pathogens? If the pathogens are microscopic and a little piece of fecal material rolls off the pile, why wouldn't billions of pathogens in that little piece then escape the thermophilic process and live on to cause trouble another day?

MS: That's one of the most common questions I'm asked. Frankly, you *don't* know that *all* parts of the compost pile have elevated in temperature sufficiently to kill all pathogens. And you will never know for sure that every cubic centimeter of your finished compost is pathogen-free unless you analyze every cubic centimeter in a laboratory. Which few people can afford to do, and even fewer want to do. There will always be people who will not be convinced that thermophilically composted humanure is pathogen-free unless every tiny scrap of it is analyzed in a laboratory first, with negative results. On the other hand, there will always be people, like myself, who conscientiously compost humanure by maintaining a well-managed compost pile, and who feel that their compost has been rendered hygienically safe as a result. A layer of straw covering the finished compost pile, for example, will insulate the pile and help keep the outer surfaces from cooling prematurely. It's common sense, really. The true test comes with living with the thermophilic composting system for long periods of time. I don't know anyone who has done so besides myself, but after fifteen years I've found that the simple system I use works quite well for me. And I don't do anything special or go to any great lengths to make thermophilic compost other than the simple things I've outlined in this book.*

Perhaps Gotaas (*Composting*, 1956, p.101) hits the nail on the head when he says, "*The farm, the garden, or the small village compost operator usually will not be concerned with detailed tests other than those to confirm that the material is safe from a health standpoint, which will be judged from the temperature, and that it is satisfactory for the soil, which will be judged by appearance. The temperature of the compost can be checked by: a) digging into the stack and feeling the temperature of the material; b) feeling the temperature of a rod after insertion into the material; or c) using a thermometer. Digging into the stack will give an approximate idea of the temperature. The material should feel very hot to the hand and be too hot to permit holding the hand in the pile for very long. Steam should emerge from the pile when opened. A metal or wooden rod inserted two feet (.5 m) into the pile for a period of five to ten minutes for metal and 10-15 minutes for wood should be quite hot to the touch, in fact, too hot to hold. These temperature testing techniques are satisfactory for the smaller village and farm composting operations.*" [Emphasis mine.] In other words, humanure composting can remain a simple process achievable by anyone, and need not become a complicated, hi-tech, expensive process controlled and regulated

by nervous, bespectacled academics in white coats bending over your compost pile shaking their heads and wringing their hands while making nerdy clucking sounds.

I want to make it clear though, that I can't be responsible for what other people do with their compost. If someone who reads this book decides that s/he wants to compost humanure, but wants to go about it in an irresponsible manner, then s/he could run into problems. My guess is that the worst thing that could happen is that the person would end up with a mouldered compost pile instead of a thermophilic one (I see this happen a lot), and the remedy to that would be to let the mouldered pile age for a few years before using it agriculturally, or to use the mouldered compost horticulturally instead.

I can't fault someone for being fecophobic, and I believe that fecophobia lies at the root of most of the concerns about composting humanure. What fecophobes may not understand is that those of us who aren't fecophobes understand the human nutrient cycle and the importance of recycling organic refuse materials. We recycle organic refuse because we know it's the right thing to do, and we aren't hampered by irrational fears. We also make compost because we need it for fortifying our food-producing soil, and we consequently exercise a high degree of responsibility when making the compost. It's for our own good.

Then, of course, there's the composter's challenge to fecophobes: *show me a better way to deal with human excrement.*

M: Sounds to me like you have the final word on the topic of humanure.

MS: Hardly. The *Humanure Handbook* is only a tiny beginning in the dialogue about human nutrient recycling.

M: Well sir, this is starting to get boring and our time is running out so we'll have to wrap up this interview. Besides, I've heard enough talk about the world's most notorious "end" product. So let's focus a little on the end itself, which has now arrived.

MS: And this is it. This is the end?

M: "*This is the end,*" (sung like Jim Morrison). Whatd'ya say folks? [Wild applause, stamping of feet, frenzied whistling, audience members jumping up and down, yanking at their hair, rolls of toilet paper thrown confetti-like through the air, clothes being torn off, cheering and screaming. What's this!?! The audience is charging the stage! The interviewee is being carried out over the heads of the crowd! Hot dang and hallelujah!]

THE END

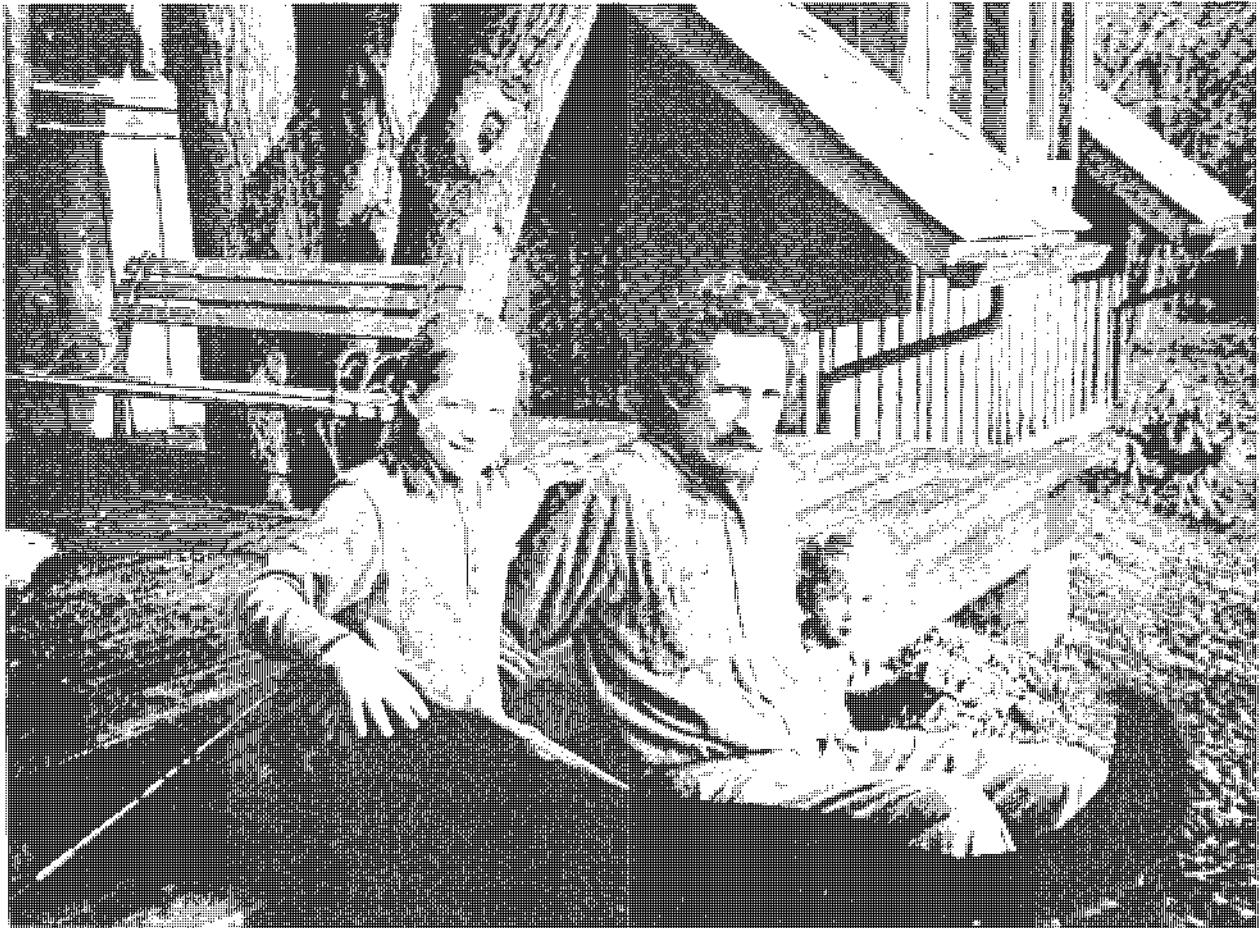

**THE AUTHOR RELAXING AT THE END OF THE DAY WITH TWO
OF HIS CHILDREN (AND A DOG).**

Photo by Jeanine Jenkins

REFERENCES - CHAPTER 8

- 1 - Rybczynski, W. et. al. (1982). Appropriate Technology for Water Supply and Sanitation - Low Cost Technology Options for Sanitation, A State of the Art Review and Annotated Bibliography. World Bank, Geneva. (p. 20).
 - 2 - Johnson, Julie. (1990). "Waste That No One Wants". *New Scientist*. 9/8/90, Vol. 127, Issue 1733. (p.50).
 - 3 - Benedict, Arthur H. et. al. (1988). "Composting Municipal Sludge: A Technology Evaluation". Appendix A. Noyes Data Corporation.
 - 4 - Johnson, Julie. (1990). "Waste That No One Wants". (p. 53) see above.
 - 5 - Simon, Ruth. (1990). "The Whole Earth Compost Pile?" *Forbes*. 5/28/90, Vol. 145, Issue 11. (p. 136).
- * For laboratory analyses of compost contact Woods End Research Laboratory, Inc., Old Rome Road, Rt. #2, Box 1850, Mt. Vernon, Maine 04352; Phone: (207) 293-2457.

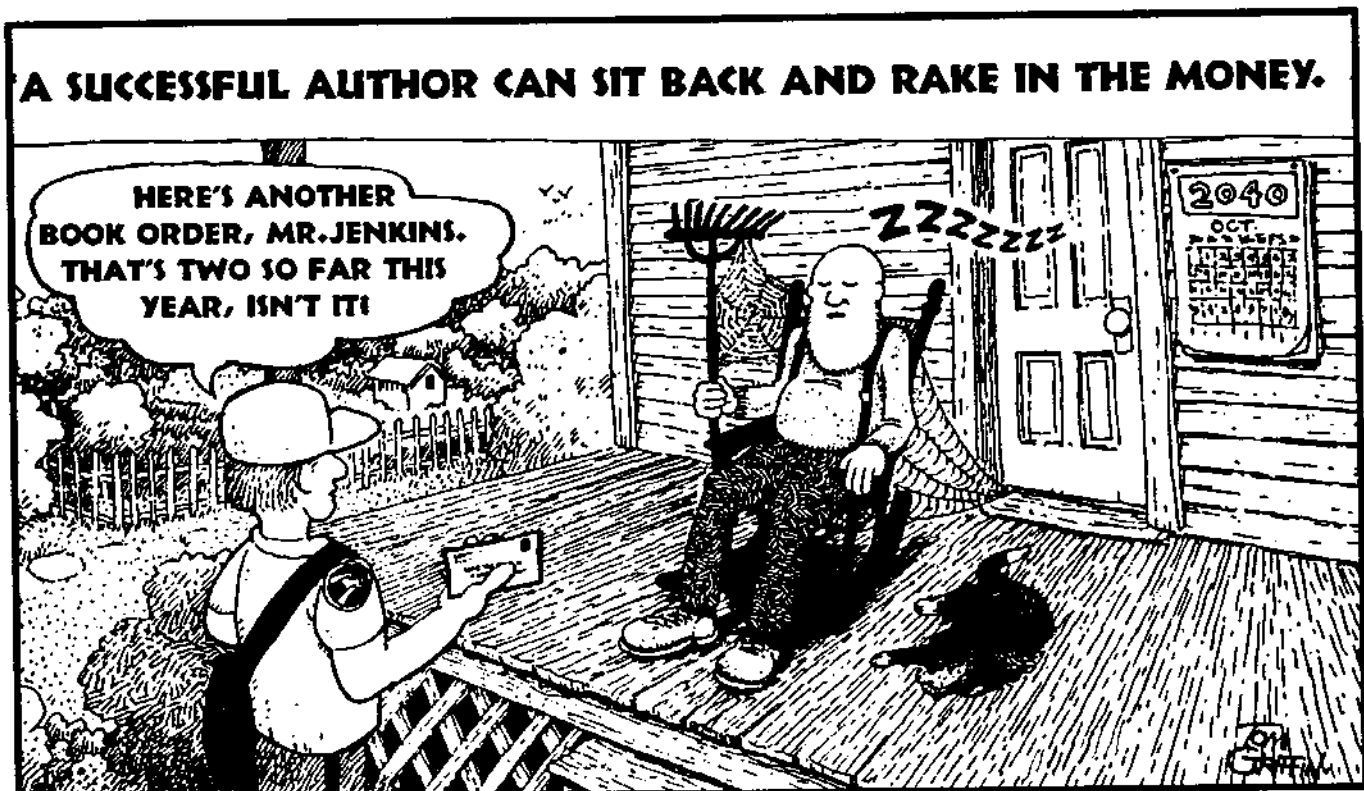

Appendix 1: Sources of Compost Thermometers

Real Goods - 966 Mazzoni St., Ukiah, CA 95482-9486 USA, (800)762-7325. [They offer a thermometer with a 20" probe.]

Pinetree Garden Seeds - Box 300, New Gloucester, ME 04260 USA, (207)926-3400. [20" probe.]

The Natural Gardening Co. - 217 San Anselmo Ave., San Anselmo, CA 94960 USA. (707)766-9303. [20" probe.]

Harris Seeds - 60 Saginaw Drive, P.O. Box 22960, Rochester, NY 14692-2960, USA, (716)442-0100. [12 1/2" long probe.]

Johnny's Selected Seeds - Foss Hill Road, Albion, Maine 04910-9731 USA, (207)437-4301. [12" probe.]

W. Atlee Burpee Co. - Warminster, PA 18974 USA, (800)888-1447. [5" probe.]

Edmund Scientific Co. - 101 East Gloucester Pike, Barrington, NJ 08007-1380 USA, (609)547-8880. [8" and 5" probes.]

A. M. Leonard Co. - 241 Fox Dr., P.O. Box 816, Piqua, Ohio 45356 USA. (800)543-8955. [13 1/2" probe.]

Appendix 2: Table of Linear Measures

1 meter =39.37 inches =3.2808 feet

1 foot (12 inches) =0.3048 meter

1 centimeter =1/100 (or 10^{-2}) meters =0.3937 inch

1 millimeter =1/1000 (10^{-3}) meters =0.03937 inch

1 micrometer =1/1,000,000 (10^{-6}) meters

1 mil =001 inch =0.0254 millimeters

1 inch =2.54 centimeters

1 yard (3 feet) =0.9144 meter

Appendix 3: Temperature Conversions

Fahrenheit	Celsius	F°	C°	Celsius	Fahrenheit
-40.....	-40	150	65.55	0	32.00°
-30.....	-34.44	140	60.00	5	41.00°
-20.....	-28.88	130	54.44	10	50.00°
-10.....	-23.33	120	48.8	15	59.00°
0.....	-17.77	110	43.33	20	68.00°
5.....	-15.00	100	37.77	25	77.00°
10.....	-12.22	90	32.22	30	86.00°
15.....	-9.44	80	26.66	35	95.00°
20.....	-6.66	70	21.11	40	104.00°
25.....	-3.88	60	15.55	45	113.00°
30.....	-1.11	50	10.00	50	122.00°
35.....	1.66	40	4.44	55	131.00°
40.....	4.44	30	-1.11	60	140.00°
45.....	7.22	20	-6.66	65	149.00°
50.....	10.00			70	158.00°
55.....	12.77			75	167.00°
60.....	15.55			80	176.00°
65.....	18.33			85	185.00°
70.....	21.11			90	194.00°
75.....	23.88			95	203.00°
80.....	26.66			100	212.00°
85.....	29.44				
90.....	32.22				
95.....	35.00				
98.6.....	36.99				
100.....	37.77				
105.....	40.55				
110.....	43.33				
115.....	46.11				
120.....	48.88				
125.....	51.66				
130.....	54.44				
135.....	57.22				
140.....	60.00				
145.....	62.77				
150.....	65.55				
155.....	68.33				
160.....	71.11				
165.....	73.88				

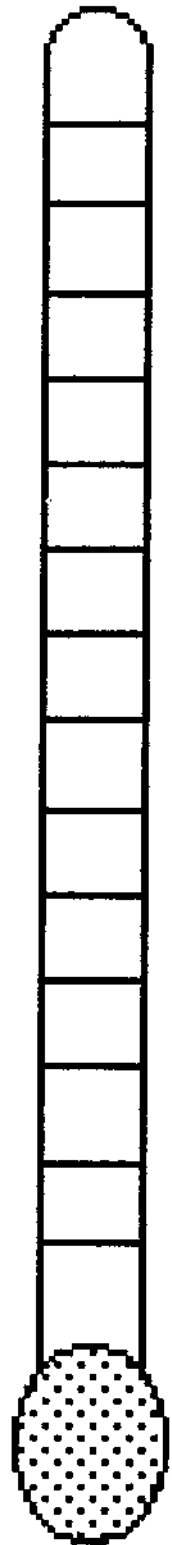

$$F = \frac{9}{5} C + 32$$

APPENDIX 4

Temperature Curve of Humanure Compost After Spring Thaw

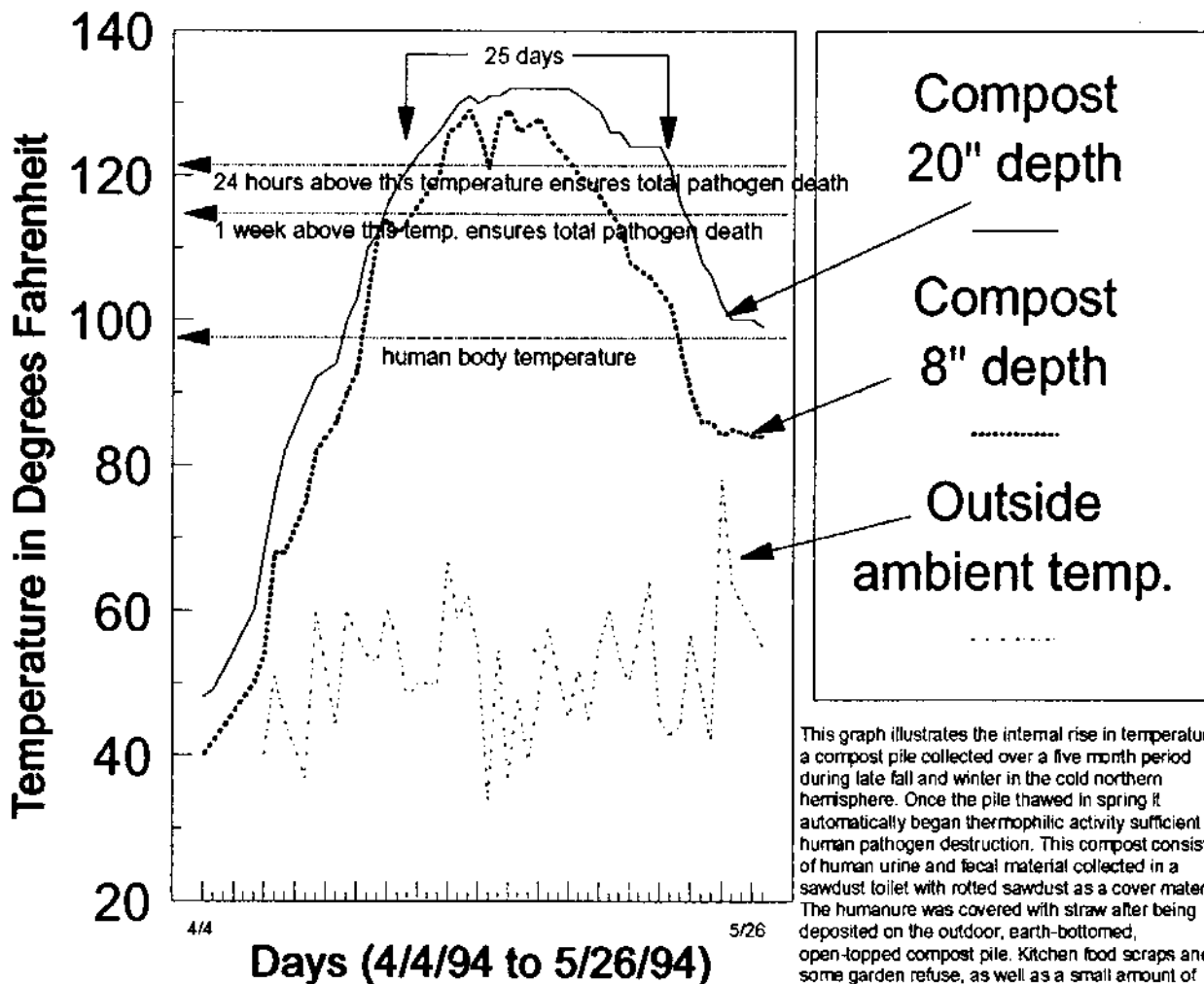

This graph illustrates the internal rise in temperature of a compost pile collected over a five month period during late fall and winter in the cold northern hemisphere. Once the pile thawed in spring it automatically began thermophilic activity sufficient for human pathogen destruction. This compost consisted of human urine and fecal material collected in a sawdust toilet with rotted sawdust as a cover material. The humanure was covered with straw after being deposited on the outdoor, earth-bottomed, open-topped compost pile. Kitchen food scraps and some garden refuse, as well as a small amount of chicken manure were also added to this compost. This pile was not turned or manually aerated in any way. No compost starters whatsoever were used.

The above graph provides an illustration that human fecal material and urine when collected in a sawdust toilet and layered on an outdoor, earth-bottomed, wooden compost bin open to the rain, covered with straw and additional food scraps, a small amount of garden refuse, and a small amount of chicken manure, will undergo thermophilic composting automatically, even after being frozen for months. No turning is necessary, although the pile should be covered with a layer of insulating material after it has thawed, such as straw, animal manures, or earth, to hold in heat. According to Gotaas (*Composting*, 1956, p. 20), disease causing bacteria are unable to survive temperatures of 55-60 degrees C (130-140F) for longer than thirty minutes to one hour. Dr. T. Gibson (*Complete Book of Composting*, J. I. Rodale, 1960, p. 650) states, "All the evidence shows that a few hours at 120 degrees Fahrenheit [approx. 50C] would eliminate [disease causing microorganisms] completely. There should be a wide margin of safety if that temperature were maintained for 24 hours." Franceys, et. al. (*A Guide to the Development of On-site Sanitation*, 1992, p.214) state, "All fecal [pathogenic] microorganisms, including enteric viruses and roundworm eggs, will die if the temperature exceeds 46 degrees C [115F] for one week. Fly eggs, larvae and pupae are also killed at these temperatures." According to Feachem, et. al. (*Appropriate Technology for Water Supply and Sanitation*, 1980), complete pathogen destruction is guaranteed by arriving at a temperature of 62 degrees C [144F] for one hour, 50 degrees C [122F] for one day, 46 degrees C [115F] for one week, or 43 degrees C [110 F] for one month. Westerberg and Wiley (*Applied Microbiology*, December, 1969) found that three days at 116 to 130 degrees Fahrenheit killed all of the polio virus, salmonella, roundworm eggs and *Candida albicans* in infected compost.

THE HUMANURE HANDBOOK PRODUCTION STAFF



GLOSSARY OF TERMS

activated sludge

Sewage sludge that is treated by forcing air through it in order to activate the beneficial microbial populations resident in the sludge.

aerobic

Able to live, grow, or take place only where free oxygen is present, such as *aerobic* bacteria.

anaerobic

Able to live and grow where there is no oxygen.

Ascaris

A genus of round-worm parasitic to humans.

bacteria

One-celled microscopic organisms. Some are capable of causing disease in humans, others are capable of elevating

the temperature of a pile of decomposing refuse sufficiently to destroy human pathogens.

carbonaceous

Consisting of or containing carbon.

C/N ratio

The ratio of carbon to nitrogen in an organic material.

combined sewers

Sewers that collect both sewage and rain water runoff.

compost

A mixture of decomposing vegetable refuse, manure, etc., for fertilizing and conditioning soil.

continuous composting

A system of composting in which organic refuse material is continuously or daily added to the

compost bin or pit.

cryptosporidia

A pathogenic protozoa which causes diarrhea in humans.

enteric

Intestinal

fecophobia

Fear of fecal material, especially in regard to the use of human fecal material for agricultural purposes.

green manure

Vegetation grown to be used as fertilizer for the soil, either by direct application of the vegetation to the soil, by composting it before soil application, or by the leguminous fixing of nitrogen in the root nodules of the vegetation.

heavy metal

Metals such as gold, platinum, lead, mercury, cadmium, etc., having more than five times the weight of water. Some heavy metals, when unnaturally concentrated in the environment, pose a significant health risk to humans.

helminth

A worm or worm-like animal, especially parasitic worms of the human digestive system, such as the roundworm or hookworm.

human nutrient cycle

The endlessly repeating cyclical movement of nutrients from soil to plants and animals, to humans, and back to soil.

humanure

Human feces and urine used for agriculture purposes.

humus

A dark, loamy, organic material resulting from the decay of plant and animal refuse.

hygiene

Sanitary practices, cleanliness.

indicator pathogen

A pathogen whose occurrence serves as evidence that certain environmental conditions, such as pollution, exist.

latrine

A toilet, often for the use of a large number of people.

macroorganism

An organism which, unlike a microorganism, can be seen by the naked eye, such as an earthworm.

mesophile

Microorganisms which thrive at medium temperatures (20-37C or 68-98.6F).

metric ton

A measure of weight equal to 1,000 kilograms or 2,204.62 pounds.

microhusbandry

The cultivation of microscopic organisms for the purpose of benefiting humanity, such as in the production of fermented foods, or in the decomposition of organic refuse materials.

moulder (also molder)

To slowly decay, generally at temperatures below that of the human body.

mulch

Organic material such as leaves or straw spread on the ground around plants to hold in moisture, smother weeds, and feed the soil.

naturalchemy

The transformation of seemingly value-

less materials into materials of high value using only natural processes, such as the conversion of humanure into humus by means of microbial activity.

night soil

Human excrement used raw as a soil fertilizer.

nitrates

A salt or ester of nitric acid, such as potassium nitrate or sodium nitrate, both used as fertilizers, and which show up in water supplies as pollution.

organic

Referring to a material from an animal or vegetable source, such as refuse in the form of manure or food scraps; also a form of agriculture which employs fertilizers and soil conditioners that are primarily derived from animal or vegetable

sources as opposed to mineral or petrochemical sources.

pathogen

A disease-causing microorganism.

pH

A symbol for the degree of acidity or alkalinity in a solution, ranging in value from 1 to 14, below 7 is acidic, above 7 is alkaline, 7 is neutral.

pit latrine

A latrine consisting of a hole or pit in the ground, into which human excrement is deposited. Known as an outhouse or privy when sheltered by a small building.

protozoa

Tiny, mostly microscopic animals each consisting of a single cell or a group of more or less identical cells, and living primarily in water. Some are human

pathogens.

psychrophile

Microorganism which thrives at low temperatures [as low as -10°C (14°F), but optimally above 20°C (68°F)]

schistosome

Any of a genus of flukes that live as parasites in the blood vessels of mammals, including humans.

septic

Causing or resulting from putrefaction (foul-smelling decomposition).

shigella

Rod shaped bacteria, certain species of which cause dysentery.

sludge

The heavy sediment in a sewage or septic tank.

sustainable

Able to be continued

indefinitely without a significant negative impact on the environment or its inhabitants.

thermophilic

Characterized by having an affinity for high temperatures, or for being able to generate high temperatures, such as in regard to thermophilic microorganisms.

virus

Any of a group of submicroscopic pathogens which multiply only in connection with living cells.

waste

A substance or material with no inherent value or usefulness, or a substance or material discarded despite its inherent value or usefulness.

wastewater

Water discarded as

waste, often polluted with human excrements or other human pollutants, and discharged into any of various wastewater treatment systems, if not directly into the environment.

Western

Of or pertaining to the Western hemisphere (which includes North and South America and Europe) or its human inhabitants.

I N D E X

a

- acid precipitation, 22
- activated sludge, 72-73, 189
- adenovirus, 113
- AlasCan toilet, 107
- aquaculture, 25
- Ascaris lumbricoides*, (see also roundworm,
pathogenic worms) 89-90, 105, 114-116,
131, 161, 189
- Survival in soil, 123, 132
- Viability of eggs, 116, 118

b

- bacteria, 32, 33, 113, 189
 - Aerobic, 37, 141, 189
 - Anaerobic, 37, 189
 - Fecal, 113-114
 - Indicator, 117, 118, 121
 - Survival in humanure, 122
 - Survival in soil, 118, 120
 - Survival on crops, 118
 - Thermophilic, 138
- BHT, 45
- bins, 36, 99, 148, 157
 - Three-chambered, 159
- biobins, in Germany, 179
- bioregionalism, 140
- Black Death, 59
- BOTVIP latrine, 67
- Brown, Lester, 22
- Buddhism, 56

c

- camp composter, 168, 171
- carbon dioxide, atmospheric, 21
- carbon/nitrogen ratio, 38, 40, 87
 - and Nitrogen loss, 39
- cartage systems, 157
- Celsius/Fahrenheit conversions, 186
- China, 51, 79, 96, 97, 98, 112, 116, 173
- chloramines, 75
- chlorine, 18, 73-74
- cholera, 59, 61, 114, 127
- Christianity, 58, 59
- circadian rhythm, 163
- Clivus Multrum, 87, 93-95, 107
 - Analysis of finished compost, 95
 - Quantity of compost produced, 93
 - Water conserved by, 93
- C/N ratio, 38, 40, 87, 104, 105, 149, 189
- coliforms
 - Fecal, 117, 118
 - Total, 117
- combined sewers, 72, 189
- compost, 32, 33, 189
 - Aeration, 105, 147
 - Asian, 96-99
 - Benefits of, 32-35
 - Bins, 36, 99, 148, 157
 - Capacity to hold water, 32
 - and Chernobyl, 35
 - Continuous, 104, 140, 142, 148, 160, 189
 - Control of plant diseases, 33, 34
 - Covering, 37, 138, 153, 173
 - Defined, 31, 189
 - and Diesel oil, 34
 - Flat-topped, 37, 166
 - Frozen, 37, 164, 187
 - Heavy metals, 79
 - Laboratory analysis of, 181, 184

Layering, 38
 Management of, 104, 152, 166
 Materials to avoid in, 45
 Moisture content of, 35-37, 146-147
 Mouldering, 87, 88-95, 150
 Necessities for, 146-149
 Nitrogen loss, 39
 Oxygen, 104, 105, 147-149
 Piling of, 35
 Pits, 36, 98, 99
 Shrinkage, 44
 Temperatures, 37, 89, 98, 125, 131,
 133, 145, 164-169, 180-81, 187
 Thermometers, 46
 Thermophilic, 85, 87, 88, 104, 127, 141,
 143-145
 Time factor, 131, 133, 163
 and TNT, 35
 Turning of, 104, 140, 142, 148
 and Uranium, 35
 Urine in, 105, 146
 Watering, 146
composting (see also compost), 24
 Active, 85
 Aeration, 105, 147
 Asian, 96-99
 Basement, 103
 Bin construction, 99, 148, 157, 159
 Cartage systems, 158
 Continuous, 104, 140, 142, 148, 160
 Experimental, 142
 Mouldering, 87, 88-95, 150
 and Oxygen, 104, 147-148
 Passive, 85, 90, 92
 Sources of information, 174
 Thermophilic, 85, 87, 88, 104, 112,
 127, 131, 138, 141, 143-145
 Time factor, 131, 133, 163
composting toilets,
 Aerobic, 98-99, 104
 Anaerobic, 98, 105
 Cartage systems, 158
 Low-tech, 100
 Pathogen transmission through, 125, 127
 Plans for, 107-108

Sawdust toilet, 100, 101, 152, 153, 154,
 155, 161, 162, 165, 167, 169, 170
 Sources of, 107-108

Confucius, 57
cover material, 87, 92, 101, 138, 146,
 148, 153, 173
coxsackievirus, 113
cryptosporidia, 189

d

deforestation, 22
diarrhea, 20, 113, 114
dioxin, 74
disposable diapers, 45
dysentery, 114

e

earthworms, 163
echovirus, 113
Egypt, composting of sludge in, 179
Escherichia coli, 114, 117, 144
Europe
 Diseases of the middle ages, 59
extinction of plants and animals, 21

f

Fahm, Lattee, 80
Fahrenheit/Celsius conversions, 186
farmland, loss of, 22
feces and urine
 Raw use of, 53, 86, 112, 131
 Separation of, 41-42, 86, 91, 147
 Weight of, 52
fecophobia, 41, 43, 86, 109, 189
fertilizers
 Chemical, 18, 19
 Pollution from, 19

Flatt, Hugh, 161
flies, 173
food
 Exports, 51
 Refuse generated by American cities, 15
fossil fuels, 22
fungi, 143, 145, 163
fusarium, 34

g

Germany, municipal composting,
 179
 Biobins, 179
Giardia lamblia, 114
Gibson, Dr. T., 168
global warming, 21-22
Gotaas, 43, 181
greenbelt around Asian cities, 112
green manure, 189
Guatemalan mouldering toilet, 91

h

heavy metals, 71, 77, 79-81, 190
 transmutation, 80
helminths, 113, 190
hepatitis A, 113
hepatitis B, 112
Hinduism, 56
hookworms, 121, 127, 129, 131
Horvath, Joseph C., 79-80
Howard, Sir Albert, 35, 36, 48, 140, 141
human nutrient cycle, 11, 12, 13, 88, 190
humanure, 7, 8, 14, 190
 C/N ratio of, 39
 Composition of, 39
 Dollar value, 16
 Per square mile of arable land, 15
human waste, 7, 14, 21, 24, 25, 53-54
humus, 31, 32, 145, 190
Hunzas, 35, 110

i

India, 99, 140, 142
indicator bacteria, 117, 118
 Survival in humanure, 121
indicator pathogens, 116, 190
Indore process, 140, 141
inks, 46, 50

j

jail fever, 59-60
Japan, 51, 173, 178
Jews, torture of, 59

k

Kervran-Effect, 80
King, Dr. F. H., 52, 173
Korea, 51, 65, 173

l

landfills, 15, 78-79
latrine, 190
 double pit, 161
 (see also Vietnamese double vault)
legalities, 170
Leptospires, 120, 127
lime, 38, 47-48, 140, 142, 162
Lovley, Derek, 35
Lubke, Sigfried, 35

m

macroorganisms, 145, 190
Marino toilet, 42

mesophile, 143, 144, 190
metric conversions, 185
 ton, 190
microwave toilet, 81
microhusbandry, 29, 190
Miquel, 144
moulder, 190
mouldering toilets, 29, 86-95
 Commercial, 86, 92, 95
 Guatemalan, 91
 Non-commercial, 86, 88-90
 Transmission of pathogens through, 125, 127
mulch, 30, 190
Multrum toilet, 92-94
 Transmission of pathogens through, 125, 127

n

Native Americans, 60
naturalchemy, 31, 190
newspapers, 45
night soil, 7, 25, 29, 51, 53, 58, 112, 158, 191
nitrates, 18-19, 123, 191
nitrogen, 52, 95, 162
 loss, 39
Norway, 92

O

odor elimination, 37, 87, 101, 151, 156, 172
oil reserves, 51
organic, 191
organic refuse, 31
outhouse, 66
 Pathogen transfer through, 123
oxygen, 38, 104, 105, 125, 147, 148
ozone, 21

p

Pakistan, 110
parasites (see pathogenic worms)
paratyphoid, 113
pathogen, 191
pathogenic worms, 113, 114-116, 118, 126-131, 161
 Eggs, 116, 118, 131
 Fecal, 114, 115
 Survival in humanure, 122
 Survival in soil, 118, 121
pathogens, 29, 111
 Defined, 87
 Eliminating from humanure, 122
 Indicator, 116
 Persistence in crops and humanure, 117
 Persistence in soil, 118
 Survival in thermophilic compost, 127
pH, 33, 47-48, 162, 191
phosphorous, 19, 53, 95, 162
phytophthora, 34
pinworms, 127, 128
 Eggs in feces, 128
pit latrine, 66, 191
 Ventilated improved, 67
 Pollution from, 66, 68
 Pathogen transfer through, 123
Plague, 59
poliovirus, 113, 120
population growth, 22
Postel, Sandra, 21
potassium, 19, 53, 95, 162
pour flush latrine, 67
pressure treated lumber, 156
protozoa, 113, 191
 Fecal, 114
 Survival in humanure, 122
 Survival in soil, 118, 119
 Survival on crops, 118
psychrophile, 143, 191
pythium, 34

r

recycling, 15
reovirus, 113
Rodale, J. I., 48
Rodale, Robert, 140
rotavirus, 113
roundworm, (see also *Ascaris*, pathogenic worms) 89-90, 98, 105, 121, 127, 130, 131, 161
Rumpelstiltskin, 31

s

Salmonella, 113, 114, 118, 127
sand mound, 69
sanitary napkins, 45
sawdust, 40, 41, 44, 151, 155, 156
sawdust toilet, 100-102, 153, 154, 155, 161, 162, 164-165, 167, 169, 170
Quantity of sawdust required for, 155
Scandinavia, 92
schistosome, 131, 191
septic, defined, 70
septic systems, 68-71, 171
Pollution from, 70
and Population density, 71
septic, 70, 191
septic tank
Capacity, 68
Cross-section, 68
Distribution system, 69
Pathogen transfer through, 123
sewage pollution, 16, 17
Beaches, 16
Ocean dumping, 17-18
sewers, (see also wastewater treatment)
Combined, 72
Pollutants in, 77
Cost comparison to manual collection, 178
shigella, 113, 114, 127, 191
Sides, S., 33

sludge, 73, 191
Activated, 72-73
Agricultural use of, 76-78, 83
Bacteria resistant to antibiotics in, 78
Composting in Egypt, 179
Composting in U.S., 178, 179
Forest disposal of, 78-79
Heavy metals in, 77, 79-80
Incineration of, 81
solar greenhouse wastewater treatment, 76
stool analysis, 116-117, 122, 129, 130, 162-163
Streptococci, 120
Sun Mar toilet, 107
sweating sickness, 59
sustainability, 9, 23, 55, 191
synthetic organic compounds, 70, 71

t

Tao, 57
of Compost, 139, 140
temperature conversions, 186
temperature of compost, 37, 89, 98, 125, 131, 133, 145, 164, 168, 169, 180, 181, 187
Required for pathogen death, 145, 125, 133, 187
Tester, Cecil, 48
thermometer
Compost, 46
Sources of, 185
thermophilic, 192
thermophilic bacteria, 138
In humanure, 144
thermophilic composting, 29, 38, 43-44, 58, 138, 143
Conditions required for, 142
Transfer of pathogens through, 125, 127
thermophilic microorganisms, 143, 144
Number in humanure, 144
time factor in compost, 131, 133, 162-163
toilets (see also multrum, mouldering)
Botvip latrine, 67
Double pit, 161

Guatemalan mouldering toilet, 91
Microwave, 81
Marino, 42
Multrum, 92-94
Outhouses (see pit latrines)
Pit Latrines, 66-68 (see also separate list
-ing)
Pour-flush latrines, 67
Sawdust, 100-102, 153, 154, 155, 161,
162, 164-165, 167, 169, 170
Transmission of pathogens through
composting toilets, 127
Water consumption of, 18
toilet paper, 44, 73
topsoil, 33
Loss, 22, 51
Tsu, Lao, 57
turning of compost, 140, 142, 147, 148
typhoid, 59, 113, 120

U

urine (see also feces/urine)
Pathogens in, 112
In compost, 105, 146

V

vaults, 98
vibrios, 114
Vietnam, 96, 98-99
Vietnamese double vault, 99, 161
viruses, 113, 127, 192
Fecal, 113
Survival in humanure, 121
Survival in soil, 118-120
Survival on crops, 128

W

Ward, Barbara, 80

waste, 7, 21, 192
Reduction, 23, 54
Solid waste generated in U.S., 14, 21, 23
waste stabilization ponds, 124-125
Transmission of pathogens through, 125
wastewater, 192
wastewater treatment plants, 72, 73, 123,
124
and Chlorine, 73
Solar greenhouse, 76
Transfer of pathogens through, 124
water
Consumption, 20
Pollution, deaths from, 20
Testing, 117
wetlands, constructed or artificial, 75, 76
whipworms, 130
White, Andrew D., 59
winemaking, 30-31
witches, 59, 109
wood ashes, 47, 162
Wood's End Laboratory, 46, 135, 184
worms (see pathogenic worms, also
Ascaris lumbricoides, hookworm,
roundworm, whipworm, pinworm,
helminths)

y

yeasts, 32
yersinia, 114
Yucatan, 65

Z

Zen, 57

THE ORGANIC WAY TO MULCHING

**by the Editors of
ORGANIC GARDENING and FARMING**

ROBERT RODALE, Editor

JEROME OLDS, Executive Editor

M. C. GOLDMAN, Managing Editor

MAURICE FRANZ, Managing Editor

Compilation Supervised by

GLENN F. JOHNS

The paper in this book has been made from waste paper that normally winds up at the city dump. This reclaimed paper is an example of how today's wastes can be converted into a worthwhile resource, thereby helping to solve the solid waste disposal crisis and preserving the quality of our environment.

RODALE PRESS, INC.

Emmaus, Pa.

CONTENTS

Introduction: There's More To Mulch Than Meets The Eye! . . .

CHAPTER

1. Mulch— Tool of the Best Doggone Organic Gardeners	1
2. Mulch and Your Soil	14
3. Mulch and Your Garden	34
4. Mulching Materials	52
5. Stone Mulching	81
6. Why We Reject One of the Most Common Mulches	101
7. There's Method in This Mulching	115
Appendix I	138
Appendix II	144
Index	187

Standard Book Number 0-87857-009-8
Library of Congress Catalog Card Number 70-170280
Copyright 1971 by Rodale Press, Inc.
All Rights Reserved
Printed in the United States
OB-50
First Printing 1972

INTRODUCTION

There's More To Mulch Than Meets The Eye!

Mulch is a layer of material, preferably organic material, that is placed on the soil surface to conserve moisture, hold down weeds, and ultimately improve soil structure and fertility.

There's more to mulch than meets the eye. Be it a fluffy blanket of hay, a rich brown carpet of cocoa bean shells, or a mantle of sawdust, that "topping" for the vegetable patch and flower bed serves as much more than frosting on the garden cake.

Mulch acts. It performs in several wondrous ways. It fills a role as protector of the topsoil, conserver of moisture, guardian against weather extremes and comfortable, bruise-saving cushioner under ripening produce. It prevents weed growth while enriching the soil and all but eliminates a lot of those time-consuming, back-aching jobs like plowing and cultivating always consid-

ered necessary for a productive garden.

Another important advantage of mulching is regulating the temperature of the soil. The mulch tends to be an insulator, which means that during many periods of the year it moderates the temperature of the soil beneath. In winter a mulched soil can be warmer than other ground, and in summer it can be cooler.

Mulching around trees prevents competition by grass for moisture and nutrients. Trees, and in fact most plants, need a tremendous amount of moisture during hot weather, especially. If grass and other plants are growing right up to the trunk, they will take the moisture first and leave less for the tree. Mulching is the easiest and most attractive way for the average gardener to keep that from happening.

If you're serious about your garden, you've long ago thrown away your bags of commercial fertilizer and have started to build real productivity into your soil. And the fertility of your soil depends upon how you're able to get humus into it. That's really what mulching is all about.

Most mulching benefits can be obtained by any kind of ground cover—even the plastic sheets which are such a detriment to the welfare of our environment. But when it comes to improving the soil, nothing can do it like an organic mulch—not aluminum foil, not plastic, not polyethylene film. Organic mulches have a plus—they decompose into the essential life-giving elements of a rich, dark humus.

Plants themselves literally demand to be mulched because that's the way they've been able to survive repeated disasters through the ages. Spontaneous mulch-

ing has been going on for a long time—millions of years—by the time man first began to raise a few favored crops about 15,000 years ago.

Snow is not the only mulch that Nature has been using for all those centuries. We also know that leaves cover forest and woodland areas to protect the soil and feed its inhabitants. As the leaves fall to the forest floor, forming the basis of nature's mulch protection, they also decompose into a compost that makes up a rich soil-rebuilding program of nature. Out in the open fields, dead tops and foliage of the annual plants fall over to cover the ground and protect it from the rigors of winter.

This fact is important: composting and mulching go hand-in-hand and are, in many instances inseparable. Remember that in dealing with your soil. The aim is to build and maintain nature's complete soil pattern as far as possible. That demands a good organic mulch. The soil in your garden, whether you know it or not, is a world teaming with living things, whose combined activity enables the soil to grow plants.

In nature's scheme of things, as the dead remains of once living things gradually decompose, they return to the earth to be used again in a continuous cycle of life. Our soil will find itself undergoing conservation much more extensively and will be used more efficiently when we see Nature's pattern of natural mulching with its benefits according to the levels of soil fertility concerned. Mulching alone, as a mechanical ministrations, cannot offset completely the shortage of fertility in the soil. Conversely, building up the fertility can be all the more reason for mulching also, a combination with dou-

bled benefits because of the more efficient use of both the soil and the mulch that covers it. Of course, Mother Nature doesn't till or disturb her soil, except by using earthworms, insects and plant roots.

So, it's pretty apparent today that you're missing out on a lot of good gardening if you don't mulch—and mulch with whatever is cheap and handy. Leaves contain twice as much plant food as barnyard manure—pound for pound. Buckwheat hulls are fine, but so is hay. Sawdust will keep the weeds down and the soil moist, but be sure you add some form of nitrogen if you're going to raise a crop right away.

Our cumulative experience—and we already have well over a quarter of a century of it—and the experience of our readers has taught us to use whatever is cheap and abundant locally, to use it to get practical results and to solve our own gardening problems. We have learned to be our own “experts” and to think for ourselves.

And we've learned to mulch!

So, keep on mulching with whatever comes to hand—leaves, straw, hay, grass clippings, weeds, crop residues. Remember that the more humus you get into your soil, the better the crops you grow—while you're knocking the pesticides and herbicides out of your soil that somebody else put there.

Better break out the organic covering and start mulching—*now!*

Chapter One

MULCH—TOOL of the BEST DOGGONE ORGANIC GARDENERS

Constant correspondence with people who garden the organic way tells us they all agree that mulch is a must—and each for his own reasons. A Michigan gardener discovered it prevents weed takeovers. Another likes the hardiness it gives her plants against storms, while a desert-dweller lauds its ability to retain moisture for his garden.

Harold Fleck, the Michigan resident, found he could leave his garden unattended for periods of time during the summer without adverse effect. His mulch prevented weeds from crowding out his plants.

He was fortunate in that his garden area lay adjoining a field that was combined for clover seed the previous fall. After passing through the combine, the hay lay on the ground over winter. Fleck decided to use this handy supply of material for mulching. Early in the spring the

garden was plowed as usual. Then it was worked with a rotary tiller. As the various seeds were planted, the hay was placed between the rows of planted seeds. When the small seedlings came up, the hay was moved nearer to them. Finally, the whole garden was covered with hay.

"This new type of gardening has restored my once flagging interest in gardening," Fleck said, "The benefits were far more numerous than I had dreamed. The following are a few of the advantages I discovered:

"Neatness. It was always a problem to have a neat borderline between the grass of the lawn and the garden. Mulching solved this. Running the rotary mower right up to the mulch leaves no line of unmowed grass between the grass and the mulch. That narrow line of unmowed grass was always a problem before mulching.

"No drought effects. Although we had some very dry weather last summer our mulched garden did not show the effects of it. Our sweet corn did not 'roll' during the hottest days of the dry-weather period.

"Pests subdued. Before mulching, the beetles would ruin our lima and string beans. Last summer it was different. There were a few beetles, but they were too few to damage our production. No chemicals were used.

"It is wonderful to be able to walk out into the garden without getting dirt and dust in your shoes. The mulch is a soft and clean carpet to walk on. It is also a blessed relief to be free from the battle with weeds."

Fleck's experience also taught him that his mulch offered protection for his plants during bad weather and frost. When he feared an early frost was in the offing, he merely covered his plants with some straw in the

evening, removing it in the morning. But Dorothy Schroeder's experience with mulch as a plant saver was more extensive. Hers involved a heavy storm.

"We should have known that it would happen after a completely rainless spring and early summer," she explained.

"Well, the day arrived when the rain came, a cloud-burst pouring down four inches of water in a little over an hour. It roared down the canyon east of the house in a white curtain, egged on by a 70-mile wind. During the worst of it, hail pelted the garden. Cracking branches of the old cottonwood trees were inaudible in the greater noise of the storm, so that we were surprised to find tree-sized limbs blocking both exits when the tempest stopped," she continued.

"After we had sawed a path through, we found what looked like complete devastation. The corn was flattened to the ground; the beautiful big crisp leaves of the summer squash and zucchini we'd been so proud of were broken and mud covered, soaked into the ground. The tomato supports had been broken or pulled out, and many tomato branches were broken off. Pepper plants were bent in the middle, their blooms stuck in the mud. The crisp green lettuce was reduced to mush.

"The first comfort I found in this devastation was that no water had run off my garden," Mrs. Schroeder said.

"Although our home is on a fairly steep hillside, the rain soaked into the mulch-covered soil while my neighbors's topsoil ran away in brown streams, clogging the drains and making extra work for the street department, and pointing out a valuable lesson. My neighbors

complained that the rain was like the pounding of hammers on their soil; nothing soaked in and the ground was left like asphalt. My soil was cushioned by the mulch and there was no pounding.

“In general I learned from that storm that what seemed like complete devastation could be only a few days’ setback if I moved in quickly”, she continued. “I learned, too, that the plants growing in the best soil, richest in compost and most heavily covered with mulch, suffered least. That was brought home to me by the two potato patches. I planted one in the ‘new’ part of the garden, not yet prepared organically. For the other I used decayed leaf mold, planting the potatoes in a heap of it 18 inches above the level of the garden, between two thick layers. These potato plants weren’t injured at all, but stood straight and tall after the storm. The others were beaten down to the ground,” Mrs. Schroeder said.

“I also learned a lesson from a stone-mulched tomato. I had set the plant in a slight depression in the ground, and instead of staking it I had killed two birds with one stone by piling around it the rocks that I would have otherwise had to cart away, both to mulch it and to keep the branches off the ground. That was the first of the tomatoes to recover, with more of its leaves returning to their former healthy condition than I’d have thought possible. I was surprised, too, at how little the injured leaves affected the fruit bearing. Fruit bore better with their leaves whole, it’s true, but production went on when they were ragged and full of holes,” she explained.

Even more telling, Mrs. Schroeder said, was something that didn’t immediately occur to her. “The roots weren’t hurt at all. That, of course, accounted for the quick recovery of so many of our injured plants.”

Ruth Tirell, a longtime organic gardener from Massachusetts, found through experience that a mulch works its wonders as well in the opposite extreme of weather—drought. Although the drought she experienced was unusually long and severe, no crop was a total loss. But the contrast between the plants that grew in bare, exposed soil and those that had been mulched was revealing. The favored crops which were mulched—tomatoes, summer squash, cucumbers and melons—all flourished and grew as if there were no drought.

The beans were another story. Compared to tomatoes, they have simple requirements—moderately good soil, some extra nourishment like compost in the furrow. She planted beans in late May. A little of the winter mulch was still visible; she didn’t add to it—her beans had always done well enough.

June that year brought scant rain, only sprinkles. While, for various reasons, Mrs. Tirell didn’t have much time for the garden, she did notice that the beans weren’t growing fast. Still, she didn’t water them. At maturity in July, the bean plants were stunted and the yield small, so she pulled them up. Usually her beans go into a second—and sometimes a third—blossoming and bearing.

Beets and carrots planted early in May were another example. Getting some quick growth before the drought

started, they then seemed literally to stand still in the dry, baked, unmulched ground. All she got at harvest time were stunted, tough beets.

By contrast, the tomato patch was lush and green. Under the permanent mulch, the soil actually felt moist. The beans, the beets and carrots had all been planted in the same small garden, got the same treatment as the tomatoes—up to a point. All her crops, when planted, were given compost in the hole or furrow. But to nourish a plant, compost must be made soluble. During that long period when there were practically no rains, only the few crops she had kept mulched were really being fed.

In mid-July Mrs. Tirell made a test planting with summer squash, which she always starts at that time to take over in September when the early-planted crop is pulled up. She has found the new plants bear better fruit. She made two hills, treating both alike at first, digging in plenty of dried manure and compost, soaking the hills thoroughly on the day before and again on planting day.

Sowing the Seneca Buttercrunch hybrid, she left one hill bare but mulched the other with grass clippings. The next day she watered again, lifting the mulch on the second hill. She continued to water until the seeds sprouted at about the same time for both hills.

The mulched hill got no water from then on, except when she added to the mulch, while the bare-soil hill was watered every other day. Despite this neglect, the mulched plant grew faster during a period of practically no rain than the unmulched-but-watered-hill. It matured sooner, was bigger, leafier and more prolific—7 to

8 little squashes forming at one time and growing into healthy, big but tender, maturity. By contrast, the fruit from the unmulched hill were rather small and stringy.

At the height of the drought, about August 1, she made another test planting, this time with lettuce seedlings. While all were dressed with compost and the soil was soaked, half the seedlings were mulched and half were not.

When the unmulched lettuce was watered every day, the encrusted soil had to be broken with a hoe—which meant lots more work—so it would absorb the water. But the mulched lettuce was practically no trouble. Grass clippings were added once or twice, first soaking the old mulch which was dry on top but moist underneath. The unmulched lettuce succeeded—after all the care it had received—but the mulched plants succeeded even more, forming bigger, thicker, and more tender hearts to live up to Buttercrunch's reputation.

Like other organic gardeners, Ruth Tirell had known that mulches conserve moisture, but until that summer of abnormal drought, she hadn't seen with her own eyes the difference mulches do make at harvest time. From now on, she's joining other converts, like Arizona dweller Harold Rawson, and keeping her garden mulched year-round. Rawson joined the corps of converts when he found a combination of composting and mulching to be the best solution to the problem of gardening in a desert.

"Our mulch performs best when moist," Rawson said. "Evaporation cools the soil and plants just as our inexpensive evaporators cool many homes. But the mulch loses its moisture quickly in the desert sun, and

this beneficial effect is lost. I've found that a screen wire held above smaller plants with a simple frame makes an excellent sun filter. The screen also offers considerable protection from the hot winds that blow in from the desert. Its only drawback is that it is not very attractive. Most of our garden takes a needed rest during the summer. Otherwise, we have no problems with our annual beds or the vegetable garden. During the enforced



A mulch of lawn clippings decomposes, converts to humus and enriches soil.

siesta, we thoroughly soak the soil to a depth of two or three feet, and then add compost, spading it in deeply and watering it. Anything that will add humus to the rather sparse earth is used—table scraps, composted crop residues and manure which we also use as a mulch. Thanks to our soil rebuilding program, the rows and beds are alive with earthworms most of the year," he added.

"With this preparation we have magnificent displays of flowers during March, April and May," Rawson continued, "And we do have delicious vegetables during the winter, plus some tomatoes and sweet corn in early summer.

"Growing roses and some shrubs creates perplexing problems here. Considerable composted material is used in the planting hole as a soil conditioner. Plants do very well for a couple years, then trouble starts. The acid reaction is lost as time passes, drainage may be impaired, and the leaves show salt damage. How do we restore healthy soil balance and functioning?

"We apply new mulch in liberal amounts, removing the old and spreading it around the garden," Rawson said. "Then we water deeply to wash the harmful salts down and out of the root zone. Since the bushes need more fertilizers to replace lost nutrients, I add manure and liquid fish solutions.

"When we came here five years ago, I was a bit confused by the problems confronting the desert gardener. While I may still be confused, one thing I'm firm about is this—mulching and composting combined is the surest way to gardening success in this hardpan country."

The grand old lady of mulching is without a doubt Ruth Stout. Ever since she moved to Redding, Connecticut back in 1929, Miss Stout has been dazzling her neighbors with her gardening technique. It's a unique one, because it succeeds despite the fact that she doesn't plow, harrow, spade, hoe, weed or cultivate.

Just what is this gal's secret? Very briefly, it's an over-all year-round mulch, and a thick one at that. Six to eight inches of hay, weeds, paper and garden wastes placed around every flower and vegetable, shrub and tree. It is never turned under, never disturbed; it is, in effect, a constantly decomposing compost pile spread over all the places where rich earth should abound.

"Right under the mulch you'll find earthworms crawling around in the moist earth in the driest weather," she said. "It defeats the drought; it does away with all the heavy work of gardening. And it can improve your garden's appearance.

"Now let's say you want to start a garden in a spot which is now sod, or full of perennial weeds," she explained. "If you mulch it heavily in early fall it will be rotted sufficiently by spring so that you can put in a garden without bothering to plow. It's possible that for small seeds you may have to do a bit of sod-shaking but nothing like what has to be done if one plows sod in spring and then tries to plant.

"For tomatoes, or any other crop which calls for putting in plants instead of seeds, nothing could be simpler," she said. "Pull back the mulch a bit and stick the plant in the ground. And for things grown from seed but which should be thinned to 12 or 18 inches apart, such as the cabbage family—well, you can plant these

in hills, a few seeds in each spot, thinning them later to one plant.

"Onion sets may just be scattered around on last year's mulch, then covered with a few inches of loose hay; by this method you can 'plant' a pound of them in a few minutes, and you may do it, if you like, before the ground thaws. Lettuce seeds, too, will germinate if merely thrown on frozen earth—but not on top of mulch. And this, of course, can't be done if you plow before planting.

"Many people," Miss Stout said, "have discovered that they can lay seed potatoes on last year's mulch, or on the ground or even on sod, cover them with about a foot of loose hay, and later simply pull back the mulch and pick up the new potatoes.

"A few weeds may come through your mulch here and there; this will be because you didn't apply it thickly enough to defeat them. They are easy to pull if you want to take the trouble, but the simplest thing is to just toss a bit of hay on top of them," she said. "And if a row of something needs thinning, this can be done effectively by simply covering the plants you want to get rid of with a little mulch."

There are other benefits, too. She hasn't sprayed her garden for years but hasn't had pest problems. The crows, she said, are nonplussed by the heavy layer of mulch over her corn. And she hasn't used fertilizer for years, either. "After you have mulched for a year to two," she said, "you will need no fertilizer of any kind except perhaps for a little meal (cottonseed, soybean—whatever you can buy) for nitrogen. The rotting mulch supplies all the nourishment your plants should have.

“A word of caution: after your soil has become so nearly perfect because of so much rotting mulch in it, you may be swamped with the quantity of your crops.”

It was just this sort of Ruth Stout warning that got Dorothy Anderson, a Wisconsinite, moving. She decided that if Ruth Stout could garden from her couch, so could she. At any rate, she had nothing to lose by giving it a try.

“In our garden, head lettuce was tennis-ball size; cucumbers, exhausted fending off the cucumber beetles, stretched only to fountain-pen length. And strawberries—well, it might take 50 to fill one English teacup,” Mrs. Anderson explained. But after she and her family started mulching, it seemed that she was merely replacing one evil with another.

“Pleasure driving through the country ceased to exist,” she explained. “My eye spied any spoiled hay within a block of the highway. After hectic dickering with the owner, we loaded the car with mulch. It’s heavy, dirty and scratchy—but what does that matter compared to salvaging two whole bales of spoiled hay?”

“The first two bales spread in the middle of the garden looked as lonesome as a fly in the middle of a duck pond. When we tried to cover our 30-by-80 foot garden with mulch, it suddenly expanded to city-park size.

“Mulching took on the attributes of a nightmare. The garden opened its jaws and gulped down mulch far faster than we could provide it. When we walked down the rows of mulch it snapped, crackled and shrank. When it rained, the mulch became soft and gushy and shrank. When the sun dried it, it shriveled and shrank. Under the winter snow it all but disappeared,” she said.

“In the spring the need for more mulch to cover the garden’s nakedness was renewed. The old nightmare chugged and chased our heels. If Ruth Stout could do it, why couldn’t we? We hauled in sawdust, spoiled hay, more sawdust, marshgrass, wood chips, spoiled hay. We salvaged the cut grass along the roadside. Every leaf that blew in the wind was gathered and added to the mulch. Every blade of grass, every weed, was pounced on for mulch.

“After 5 years of constant mulching my temperature has subsided to normal. I, too, lie on my couch by the window and anticipate the first head of lettuce sprouting a blue ribbon from its leaves, and I picture a new garden cart sturdy enough to haul to the house the 30-pound Blue Hubbard squash,” she continued.

“My anticipation of a beautiful garden has truly been realized. The giant heads of Boston lettuce actually did bring in a blue ribbon. With the drought we’ve had in Wisconsin for the last 7 summers, this would have been impossible without mulching.”

Dorothy spoke for all mulchers when she concluded, “The proof of its value is under the mulch. The earth is soft, moist and full of earthworms (just as Ruth Stout said). I have longed for a garden soil so soft that I could scoop out a trench for seeds with my hands.

“My dream has come true; *the mulch made it possible.*”

Chapter Two

MULCH and YOUR SOIL

Mulching will improve any type of soil, generally speaking. But before using fertilizers you should know something about the make-up of *your* soil.

What kind of soil do you have? That's an easy question to ask, a difficult one to answer. Replies could vary from "hard as a rock" or "a sandy loam with a pH of 6.5" to "a deep soil of podzolic origin."

To some people, soil is nothing more than dirt that's perfectly okay as long as it allows flowers and most of the lawn to grow, and when muddy, doesn't get the house or patio too messed up.

Fortunately, to the majority of us, our soil represents a great deal more than that. Unscientific as it may be, we still regard soil as a living, breathing organism with definite likes and dislikes. It has a personality all its own

—depending upon its past history, treatment and present environment.

In the *Yearbook of Agriculture*, published by the U.S. Department of Agriculture, Roy Simonson writes:

"Soil is related to the earth much as the rind is related to an orange. But this rind of the earth is far less uniform than the rind of an orange. It is deep in some places and shallow in others. It may be red, as soils are in Hawaii, or it may be black, as they are in North Dakota.

"Be it deep or shallow, red or black, sand or clay, the soil is the link between the rock core of the earth and the living things on its surface. It is the foothold for the plants we grow. Therein lies the main reason for our interest in soil.

"Every soil consists of mineral and organic matter, water and air. The proportions vary, but the major components remain the same."

All soils have a profile—a succession of layers in a vertical section down into loose, weathered rock. The individual layers are called horizons. The upper layers of the soil profile, known as the "A" horizon, generally contain the most organic matter, bacteria and fungi, and are darkened as a result. This upper layer is the surface soil with which we are most familiar.

The subsoil, or "B" horizon, lies directly below, and is also markedly weathered but usually contains little or no organic matter. In temperate-region soils, the subsoil layers average between three and four feet deep.

The layers where the subsoil merges into the original soil material is known as the "C" horizon. It's usually

weathered, and the upper portion is about to become a part of the lower subsoil.

Soil is a natural body; its formation depends mostly on climate, living organisms, parent rocks, topography and time. Because of the variations in these five factors, soils in any one region are far from identical.

Although soil composition is complex, regard it—and the entire process of soil formation—as a marvelous work of nature rather than saying: “It’s a mystery to

me, so let’s get on with the actual gardening work.” Once we have the attitude that we *can* learn more about our soils, we’ll be going a long way to finding out its needs, and what should be done to improve it.

Your home grounds probably consist of a lawn, shrubs, trees, flowers and vegetables—all supported by the soil beneath them. The goal is to learn what general type of soil you have, if it has enough of the major nutrient elements and whether it’s acid or alkaline. The answers to these questions will tell you how to plant an effective soil build-up program and what plants will grow best in it.

There are two ways to find out the nutritional deficiencies of the soil. A soil sample may be sent to a commercial laboratory or to a state agricultural experiment station. Or a home testing kit may be acquired and the necessary tests made on the spot.

A home test kit is particularly valuable since it makes periodic testing of the soil practical. Indeed, the more it is used, the less costly it becomes on a per-test cost basis. Most of the kits are simple to use and require no knowledge of chemistry or laboratory procedure. And they’ll quickly reveal the deficiencies of the soil.

All soils are composed of particles varying greatly in size and shape. In order to classify them by texture as well as physical properties, four fundamental soil groups are recognized: gravels, sands, loams and clays. (The last three make up most of the world’s arable lands.)

The sand group includes all soils of which the silt and clay make up less than 20 percent by weight. Its mineral particles are visible to the naked eye and are irregular

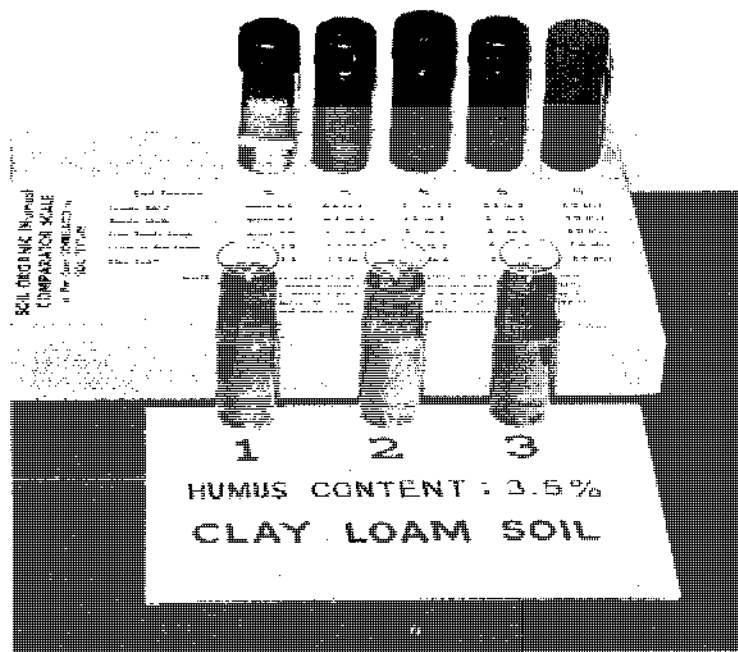

Soil type must be determined according to information provided in kits before the test for humus content is made.

in shape. Because of this, their water-holding capacity is low, but they possess good drainage and aeration and are usually in a loose, friable condition.

In contrast, particles in a clay soil are very fine (invisible under ordinary microscope) and become sticky and cement-like.

Texture of the loam class cannot be as clearly defined, since its mechanical composition is about midway between sand and clay. Professors T. Lyon and Harry Buckman in their excellent book, *The Nature and Properties of Soils*, describe loams “as such a mixture of sand, silt and clay particles as to exhibit light and heavy properties in about equal proportions . . . Because of this intermixture of coarse, medium and fine particles, usually they possess the desirable qualities both of sand and clay without exhibiting those undesirable properties, as extreme looseness and low water capacity on the one hand and stickiness, compactness, and very slow air and water movement on the other.”

Fortunately for the gardeners and farmers in the United States, most soils are in the loam classification. The majority of soils are mixtures; the more common class names appear below: (Combinations are given when one size of particles is evident enough to affect the texture of the loam. For example, a loam in which sand is dominant will be classified as a sandy loam of some kind.)

Sandy Soils

Gravelly sands
Coarse sands

Medium sands
Fine sands
Loamy sands

Loamy Soils

Coarse sandy loams
Medium sandy loams
Fine sandy loams
Silty loams and stony silt loams
Clay loams

Clayey Soils

Stony clays
Gravelly clays
Sandy clays
Silty clays
Clays

You can get a good idea of your soil’s texture and class by merely rubbing it between the thumb and the fingers or in the palm of the hand. Sand particles are gritty; silt has a floury or talcum-powder feel when dry, and is only moderately plastic when moist, while the clayey material is harsh when dry and very plastic and sticky when wet.

Professors Lyon and Buckman observe: “This method is used in all field operations, especially in soil survey, land classification and the like. Accuracy . . . can be acquired by the careful study of known samples.” If you’re interested in developing an ability to classify soils, we suggest your contacting the local

county agent for soil samples that are correctly classified.

While on the subject of soil characteristics, let's take a look at how the structure of your soil influences gardening results. Structure refers to the arrangements or groupings of the soil particles. The two extremes are "single-grained", as loose sand, and "massive", where the soil masses are very large, irregular and featureless.

The ideal structure is granular, where the rounded aggregates (or clusters) of soil lie loosely and readily shake apart. When the granules are especially porous, the term crumb is applied.

How can you change your soil's structure to a granular condition? The answer is clearly given by Lyon and Buckman:

"The major agency in the encouragement of granulation probably is organic matter, especially as it undergoes decay and is synthesized into humus. Not only does it bind but it lightens and expands, making possible the tremendous porosity so characteristic of individual soil crumbs. Plant roots probably promote granulation as much or more by the decay of the distributed organic matter as by the disruptive actions of the root material. The electrochemical properties of humus, no doubt, are fully effective in the organization and the later stabilization of the aggregates.

". . . At the same time organic matter promotes ready air and water movement and, not only does it lower the plasticity and cohesion of the soil mass, but it also localizes the influence of clay, since this constituent seems to be concentrated in the newly formed aggregates. . . . In fact, the granulation of a clay soil cannot

be promoted adequately without the presence of a certain amount of humus. The maintenance of organic matter, therefore, is of great practical concern . . ."

Of course, the two soil experts were speaking chiefly in terms of the physical characteristics of soil. But maintenance of organic matter in soil is beneficial chemically and biologically as well as physically. Soil scientists working for the U.S. Department of Agriculture have tested the effects of organic matter in soil. They tried it on rotation. They tried it on tillage. They tried it on fertility. In every case, they found that organic matter improves the soil and helps plants to grow fat and nutritious.

A number of interesting concepts on the value of organic matter in soil were suggested to the Nebraska Crop Improvement Association by T. M. McCalla, a bacteriologist with the agriculture department's Soil Conservation Service in Lincoln, Nebraska.

McCalla said that organic matter is indispensable to plant growth. However, he said most of our food is produced by plants grown on soils with organic matter in them. And soils with more organic matter in them produce higher yields than soils with less organic matter.

This is about the same as saying that humans don't have to have solid food to live on. We don't! But who wants to live on soup and milk for the rest of their lives, when such things as steak, mashed potatoes, gravy, and fresh fruit are available? And don't you feel like you can do a better day's work when you have a good meal in your stomach? The same way with plants. They have been found to do better when raised on soils with plenty

of organic matter present. Even such plants as tomatoes and gardenias which have been raised on nutrient solutions have been found to do better on a good soil.

Organic matter benefits the soil in numerous ways, McCalla pointed out, through its biological, chemical, and physical effects. One important benefit, he said, comes from its influence on the activities of soil microorganisms which release plant nutrients. Other benefits come from soil nitrogen tied up in organic matter, and the ability of organic matter to stabilize soil structure, increase aggregation, aeration, water-holding capacity, and decrease soil erosion and runoff. All of these increase crop yields.

Soil organic matter, he said, is that part of the soil which originates from plants, animals and microbes. Humus is the dark organic matter of the soil that has undergone decomposition until it can no longer be recognized as the original organic material. Mix any plant residue with soil and it becomes a part of the soil organic matter. When it decomposes it becomes humus.

This is the miracle substance that makes life possible. Without it there would be little or no plant life on earth. Proper use of humus can make soil more fertile, yields more abundant, and foods more nutritious.

One way humus builds up soil and brings abundant yields of healthy, nourishing vegetables and fruits to your dinner table is by making minerals available. Humus does this primarily by chelation, solvation, and storage.

Chelation is the word scientists use to describe the claw-like action of the organic compounds in humus. Some of these compounds stretch out like an earth-

worm. As they swim around in the soil water they come into contact with minerals in rocks. When they do, both ends swing close together and grab hold of the mineral. The claw that is formed is so strong that it can yank an atom of mineral right out of a piece of rock. This gets the mineral out in the open where plants can use it for food. Soil scientists in the University of Illinois' agronomy department have explained that "the availability of plant nutrients may be greatly affected by the chelating ability of organic matter."

They also explained another trick humus has for making soil minerals available to plants. It is called solvation. "During the decomposition of plant residues," the scientists explained, "certain acids, particularly carbonic acid, are formed that dissolve soil minerals and make the nutrients more available to the plant."

One of the most important properties of humus is its ability to store mineral nutrients. Department of Agriculture soil scientists have said that "humus is like a sponge in absorbing water and helps hold mineral elements in the upper soil layers. It is the seat of the greatest microbiological activity and acts as a nutrient reservoir." Agricultural experiments have shown that humus supplies plants with 95 per cent of the nitrogen they need, up to 60 per cent of the phosphorus, up to 80 per cent of the sulphur and similar amounts of other minerals. These minerals are supplied to the plant as the plant needs them for food.

But is it organic matter in itself or its decay that is important to soils?

As soon as organic matter is incorporated with soil

or applied to the surface of it, it is immediately attacked by a host of microbes of every kind and description. These are the microorganisms that cause the organic matter to decay and be dissipated in a short time under normal garden or field conditions. These microorganisms are so active that any average soil is able to handle easily many times the amount of organic matter usually applied to it.



A "packed", mud-pie soil can be made workable with mulch.

Since the microorganisms readily attack the organic matter and soon convert it into humus and other decay products, the question comes up of whether it is desirable to have at least some undecomposed organic matter in the soil. "Yes," is the answer to that. The undecomposed organic matter continues to furnish food for the microorganisms. It also acts as a rough conditioner to open up and aerate the soil. It allows rain to



Soil mulched consistently is well aerated, easily worked and full of nutrients.

soak down into the soil and helps to prevent wind and rain erosion. Hence, it is necessary to keep applying organic matter to soils, regardless of whether they are garden or farmland. And regardless of whether the organic matter is available or not, it is still needed by soil microorganisms.

But what about the benefits other than from the rough organic matter? There is no question about benefits. The principal benefit is the release of plant nutrients caused by the microbial action and the chelating action of the organic matter. Of particular importance are the nitrogen and phosphorous released during the decomposition of the organic matter. These help dissolve minerals in the soil such as phosphorous, potash, calcium, magnesium and other essential plant nutrients. Chelation occurring when decomposing organic matter comes into contact with the minerals in the soil make iron, copper and other metals available to plants.

Since microorganisms are most active during the period of plant growth due to warmer temperatures, essential plant nutrients are also made most available during this period. In other words, the dynamic life of the soil is most active when it is most needed.

Another little considered effect of the decomposition of organic materials in soil is the production of "auximones" and other growth-promoting substances. There is also the production of toxic or antibiotic substances when green manures are added to the soil. Strangely enough, these toxic substances do not harm the growing plants. They appear to help in controlling root-rot and damping-off fungi.

The benefits from organic matter, then, are due

primarily to the activity of the microorganisms which decompose the organic matter and to the products they form. But the organic matter is also important to the chemical composition of the soil.

"Soil organic matter contains the things that plants have taken from the soil, air and water, as well as products resulting from the decomposition of plants and animal materials by soil microorganisms," McCalla noted in his report. "It contains generally about 56 per cent carbon, 5 per cent nitrogen, and oxygen, hydrogen, phosphorus, sulphur, calcium, magnesium, potassium, iron, zinc, manganese, copper and boron. Organic matter also contains numerous organic compounds. A ton of wheat straw will produce about one and one-half tons of carbon dioxide. Decomposition of soil organic matter results in the gradual production of mineral elements in forms that are available to plants. A storehouse of plant nutrients, organic matter is almost a fool-proof fertilizer.

How much organic matter do good farm soils contain? The better farm soils, McCalla said, contain from four to five per cent organic matter. How to maintain this is the big problem. Continuous cropping to cultivated plants reduces the organic matter content of the soil. However, organic matter was maintained at about the same level or higher in experiments by the liberal use of manure, sod crops, and wise crop rotations, McCalla said.

Soil scientists recommend adding a generous supply of organic matter to soil at frequent intervals. This keeps biodynamic activity at its peak. Compost may be added any time. Undecomposed materials such as grass

clippings, leaves, shredded corn stalks, alfalfa, clover and so on are best turned under after the fall harvest. If you do three things—give plants plenty of sunshine, plenty of water and add generous amounts of compost—you will be sure of supplying the basic nutritional requirements of plants. The net result will be a better soil more capable of growing larger crops of more nutritious fruits and vegetables.

But how does mulch fit into the picture?

Well, most obviously, it is a constant supply of organic matter for the soil. As it decomposes, it provides the important microbiological activity. And as it decomposes, it becomes humus.

An important benefit of mulch is its improvement of soil structure and tilth. As the decaying organic matter works down into the soil, it becomes more friable, is better penetrated by water and its aeration is improved, thus stimulating root and biological activity. If organic mulch is mixed into the upper soil layer, it will dilute the soil and usually increase root growth. When mulches such as crushed corn cobs, sphagnum peat moss, or sawdust are used, the effect of the addition of this material to the soil is almost immediate. On clay soils, aeration is increased. Water holding capacity is increased in a sandy soil, an important function of mulch which is often overlooked. A mulch of leaves, grass or dead plant residues cuts down evaporation, helps to hold moisture in the soil and lowers the soil temperature. Sandy soils mulched with grass and leaves in November have shown 2 to 3 per cent more moisture the following May than unmulched soil. While this is a small amount, it is sufficient to make the difference

between good plant growth and little or no growth.

Plant roots extend down into the soil in search of moisture. In so doing, ordinarily, they grow away from the highest concentration of the mineral plant food elements. With a good mulch of organic matter the surface soil is kept moist, promoting the development of feeder roots near the surface of the soil, the zone of highest fertility. The improved moisture condition and increased plant food constituents result in increased vigor and better plant growth. A mulch will prove beneficial on heavy textured soils as well as on light textured ones, but the benefit from improved moisture conditions will be greatest on sandy soils.

Mulches improve and stabilize soil structure or the arrangement of soil articles. Because of the mulch layer, the soil structure is not disturbed by pelting rain, or coarse streams or drops of water from irrigation devices. Some gardeners do not realize that cultivation of the soil when it is too wet destroys good soil structure. When mulches are used, the danger of cultivation at the wrong time is eliminated since very little, if any, cultivation is necessary. Another way to harm the soil structure is walking on the soil when it is wet. If there is a mulch on the soil, this will serve as a cushion and the compaction of the soil is reduced.

If the mulch is not well-decomposed but is a decomposable material, it will promote granulation of soil particles just as Lyon and Buckman said. During decomposition of the organic material, soil microorganisms secrete a sticky material which promotes the granulation of the soil. This is especially true of heavy soil types. Materials like sphagnum peat moss, which

decompose slowly, have little effect on granulation. Straw, hay, fresh leaves, or manure, which decompose rather rapidly, do have an effect on granulation.

A valuable organic matter is formed during the decomposition or rotting of a mulch cover. Decomposition is not an undesirable process, but rather one that recirculates necessary plant food elements for additional crops. In addition to the release of mineral elements such as nitrogen, phosphorus, iron, carbon dioxide and water are released.

All mulch covers do not decompose at the same rate. More resistant substances in the mulch cover, such as lignin, undergo relatively slow change because of their complex nature. Lignin, together with cellulose, forms the chief part of woody tissue. Carbohydrates, such as plant sugars and cellulose, on the other hand, are rapidly attacked yielding carbon dioxide and water. The resistant materials like lignin are not wholly inert nor are they readily identified in the soil. If this were not so, organic mulch would accumulate until ultimately the surface of the earth would be covered by it.

When an organic mulch decomposes, it is similar to a wood fire which dies down from a bright blaze to smoldering embers, glowing for a long time.

The composition of organic matter from different locations is surprisingly uniform despite the wide variations in type of plants and microorganisms that are responsible for its formation. Recent investigations indicate that three classes of compounds dominate soil organic matter. They are substances produced by the alteration of lignin of plants, compounds related to carbohydrates (bacterial gums, slimes and molds) and

material probably derived from proteins. The last is probably the principal carrier of nitrogen.

The lignin of the organic mulch undergoes change when first mixed in the soil. After the initial attack a resistant portion remains that is so greatly altered as not to be properly spoken of as lignin. This portion is usually resistant to further degradation.

The carbohydrate-like materials in an organic mulch are largely substances of microbial origin, as, slimes, gums and organic salts of uronic, teichoic, muramic fulvic and humic acids.

There are, of course, many other benefits derived from mulching. Not all are as complex as those involving chelation and solvation and other processes in the soil. But they are vital to growth of nutritious fruits and vegetables. They are vital to the maintenance of a good, fertile soil. They can be stated briefly.

—Mulching conserves soil moisture by reducing the evaporation of water from the soil.

—Mulching prevents crusting of the soil surface, thus improving absorption and percolation of water to the soil areas where the roots are growing.

—Mulching maintains a more uniform soil temperature by acting as an insulator that keeps the soil warm during cool spells and cooler during the warm months of the year.

—Mulching reduces weed problems when the mulch material itself is weed-free and is applied thickly enough to prevent weed seed germination or smother existing smaller weeds. Mulching thus considerably reduces the time and labor expended in weeding garden areas.

—Mulching adds to the beauty of the landscape by

providing a cover of uniform color which can be neutral or non-detracting and may add an interesting texture to an otherwise drab surface.

—Mulching can prevent fruit and plants from becoming mud-splashed and reduce losses to soil-borne diseases.

—Mulching can prevent freezing injuries caused by late spring or early fall frosts if a light layer of mulch material is placed on top of the plants in the evening and removed in the morning.

It is important to remember that mulching should be done only with natural, organic materials. And for good reason. The soil, basically, is made up of weathered rock particles and organic matter, closely associated and intermixed.

In the organic method of gardening, we attempt to feed the soil so its natural constitution is not disturbed, basing our procedures and techniques on the study of the makeup of the soil. Knowing how it was originally formed, we can better understand what kind of food will suit it.

The soil's basic elements—inorganic minerals from rock fragments, organic matter, water and air—logically lead us to the best formula for its sustenance. If we restore the used-up mineral and organic matter, and if we see to it that there is an adequacy of water and air, the fertility of the soil will continue to maintain itself. The great forests, the huge groves of trees and masses of vegetation which we know exist unaided by man, are all growing within the scope of this simple formula—straight, unadulterated mineral matter, organic matter, water and air. The great redwood trees of the western

coast which tower into the clouds depend on nothing more than these four things.

Therefore, when we mulch the earth with only the elements of which it is naturally constituted, we are not gambling. And since the gardener will soon discover that he can secure a greater harvest of vegetables by following the organic system, he will realize how wrong the chemical method is.

Chapter Three

MULCH and YOUR GARDEN

Mulching will do as much for your garden as it will for your soil, for there are as many benefits of mulching above-ground as there are in-ground.

While the mulch is stimulating and feeding aeration, microbiological activity and granulation in your soil, it will be preserving moisture and soil structure, maintaining a fairly constant temperature, quelling weeds, disease and insects, making your garden something worth looking at and its produce worth eating.

Mrs. Robert Smith of Fort Wayne, Indiana, praises the mulch system. She and her husband, both practitioners of the organic way of gardening, tried the mulch system for the first time several years ago when they were planning a four-week vacation far from the vegetable patch. Mrs. Smith planted the garden to coincide

with their return and thoroughly mulched about three-quarters of the plot.

"My husband was rather disgruntled that I spent money for the mulch," she said, "but on our return he had to admit I had been wise. Needless to say, the area I did not mulch was stunted in growth although there was a great harvest of weeds. The rest of the garden was a veritable jungle of beans, corn, cucumbers, and a dozen other vegetables, with few weeds showing. Our yields were fantastic—the best year we'd ever had in growing a garden!" she continued.

"Later, in talking to my neighbors, they said not one drop of rain had fallen during our month's absence, and they couldn't understand why my garden had survived and was so luxurious and rich in color as well as crops while their gardens either dried up or were badly stunted.

"This year we plan to be gone again for 4 to 5 weeks, so we'll again be mulching heavily and expect a bumper crop waiting our return. It's really been a pleasure gardening organically and seeing our production outdo itself each year," she concluded.

Mrs. Smith's testimonial is typical for the mulch-it-and-virtually-forget-it way of gardening. Ruth Stout has been practicing it for years. And mulching has been around for many more years than Ruth Stout—and that's a lot of years.

The fact that the effects of mulching are seldom simple complicates the search for precise information. Certain patterns of behavior of soils and plants under mulch, however, have been observed in studies conducted in the United States and abroad. These studies

have determined the effects of mulch on the soil, as outlined in the previous chapter. They have determined that mulching affects such gardening conditions as moisture, soil structure, temperature, weed growth, plant disease and insect infestation. Further, mulch can be a factor in the appearance of a garden, although appearance isn't the sort of thing you pin down with a scientific test or study.

Temperature and moisture or a combination of the two frequently appear to be the most critical factors in determining the effect of mulch on crop yield. For Mrs. Smith, for example, the moisture holding qualities of a good mulch were critical not just to a good yield, but to the simple survival of her garden.

Farmers who use mulches generally do because it is the best way to make most efficient use of the available moisture in producing crops. In most cases, the moisture content of the surface soil under mulch is higher than when soil is clean-cultivated.

But where does this moisture come from if—as in Mrs. Smith's case—there is no rainfall for a substantial period of time? The moisture comes from the dew. Dew is the condensation of moisture from the air in the soil. Most of the dew is a complete waste as far as plant growth is concerned—unless there is something on the surface to catch it and prevent it from evaporating. A mulch is a wonderful dew-catcher. A mulch of rocks or wooden boards catches more dew than any other because no air or moisture can pass through it.

While much of the Northeast was enduring its fourth consecutive summer of searing drought several seasons ago, and worried communities began placing more re-

strictions on water use, the helpful role that a mulch can play became increasingly apparent. A notable instance was the attractive Brooklyn Botanical Gardens, where regular irrigation was curtailed completely in the midst of New York's drive to conserve water. Instead, mulching was employed around the many gardens and plantings. The dampness underneath could be felt as well as seen and an increase of earthworms resulted in the soil where areas were mulched.

Experiments in a number of states have shown the efficiency of mulch in holding down evaporation. The amount of moisture savings attributable to reduced evaporation under a straw mulch varied widely with climate and other varying test conditions. In experiments in Tennessee and Michigan, for example, indirect measurements showed that, in humid areas, evaporation losses may be reduced by the use of mulch. The reductions ranged from around 12 or 16 per cent to as much as 50 per cent or more.

Other experiments in North Carolina showed that wheat straw mulch at three tons per acre increased moisture in the soil and markedly increased corn yields during drought conditions. The increases averaged 21 bushels per acre in eight experiments, with a close ratio between corn yields and moisture content of the soil. In 10 experiments conducted under good moisture conditions, mulching did not greatly affect yields.

Similarly with tobacco, there is a close correlation between drought conditions and the effect of mulching on crop yields. Agricultural researchers working in Maryland found that tobacco grown under four to six tons of straw mulch per acre gave yields as good as

those from cultivated fields during five years when rain was normal or less than normal—but crop values were reduced during two years of above normal rainfall.

On land where excess moisture is a problem because of poor drainage and heavy rainfall, mulching could obviously have an adverse effect.

The second most critical factor appears to be temperature. A mulched plant is not subjected to the extremes of temperature that an exposed plant is. Unmulched roots are damaged by the heaving of soil brought on by sudden thaws and frosts. The mulch acts as an insulating blanket, keeping the soil warmer in winter and cooler in summer.

Soil heaving damage, brought on by a winter of sudden, deep freezes alternated with abrupt thaws, should be no threat. Safe under a protective mulch, plants and topsoil can wait out the severest winter weather with an absolute minimum of injury.

The penalty for not mulching can be high at any time. But the advent of winter can bring real trouble to the thinly mulched or unmulched flower beds and vegetable patch. Winter-hardy perennials can be lifted literally out of the ground by frost action and their roots exposed. Wheat plants are frequently completely heaved out of the soil, taprooted legumes such as alfalfa can be badly injured, while entire fall-planted beds of strawberries may be found dead or dying above the ground.

It generally is not known that the type of soil has more to do with soil heaving than the prevailing climate. Sandy soils rarely heave because they are well-drained and the free water is below the three-foot mark—which is as deep as the soil freezes. Soil heaving is not

caused by the expansion of water freezing in the soil but by the formation of more ice from water moving up through the soil.

Heaving occurs when the surface layer of the soil freezes and is pushed upward by pure ice columns of “lenses” which develop just below the layer of frozen earth. The pillars of ice are formed by water that swells upward from below to the lower side of the frozen layer, moving by capillary action through pores or voids in the soil structure.

Control of heaving may not be possible under really severe circumstances, but the place of mulching in maintaining control is nevertheless secure. Good drainage reduces the chances of heaving injury by removing free water near the surface. A good blanket of mulch further reduces the possibility of heaving by controlling the action of the water in the soil—preventing it from alternately freezing and thawing and freezing again.

A good mulch has a similarly tempering effect on the soil's reaction to the change of seasons. It soothes the swing into spring and blunts the first bitter blows of fall and winter weather.

In experiments using mulches on vegetables, researchers of the Pennsylvania State Agricultural Experiment Station concluded that reduced temperatures under mulches in the early spring might partly explain smaller early yields and greater total yields in midsummer when lower soil temperatures would have a favorable result. The mulch tempers day-to-day temperature changes and even the rise and fall of the temperature in the course of the day.

There are a number of factors which enter into the

mulch's ability to temper temperature, one of which is the color of the mulch material. Light-colored materials tend to reflect heat rays while dark-colored mulches tend to absorb them.

This was brought out in a Kansas study which showed that the darkening of a straw mulch by humification influenced the effect the mulch had on the soil's summer temperature. Under a light-colored, fresh mulch the soil temperature was 2.8° C. lower than in bare soil, while soil under a dark gray, partially decomposed mulch was only 0.2° C. lower than bare soil. Reflection from the fresh, light-colored mulch was about three times as great as from the dark, partially decomposed mulch: 32 candles of light per square foot as compared to 11 candles.

To a degree, the moisture preserving and temperature controlling characteristics of mulches are tied to their ability to maintain good soil structure. A mulch prevents—largely by preserving the moisture in the ground—crusting of the earth. A crusted earth is more subject to erosion by wind and rain and is less capable of absorbing the moisture of a brief shower. Indeed, such showers even contribute to the crusting of the earth by compacting it.

Mulches protect the soil from the direct impact of rainfall. Raindrops fall with tremendous force. When this force strikes on bare ground, much of the energy is expended by breaking up soil aggregates and sealing and compacting the surface soil. This decreases the infiltration capacity of the soil and increases runoff and erosion. By breaking the force and size of the falling

raindrops, surface mulches maintain soil porosity and conserve soil and water.

The preservation of porosity was demonstrated in U. S. Department of Agriculture tests in Ohio. The results of the tests indicated that the greater penetration of water generally occurring in mulched soils was primarily due to the protection that the cover affords to an existing favorable soil structure. But when the soil wasn't permeable to begin with, putting mulch on the surface did not cause the water to penetrate. After cultivating the soil to a one-inch depth to break surface crust, however, the infiltration rate under mulching after 60 minutes was 2.10 inches an hour as compared to 0.28 inches an hour on similar unmulched plots.

Similarly, the value of mulches in controlling erosion is widely recognized and has been test proven. Mulches do this by reducing runoff, by maintaining the porosity of the soil and by providing conditions favorable to the activity of organisms which can result in more stable soil aggregates. These all interrelate and all contribute to the soil-saving effect of the mulch.

The extent of this effect has been measured in numerous studies. In Illinois tests, for example, soil losses after an hour's rain of 1-3/4 inches were 3,225 pounds per acre from bare ground as compared to 205 pounds from ground mulched with cornstalks.

In studies recently conducted in cooperation with the Georgia Agricultural Experiment Station, researchers found that a mulch of pine needles, straw, or any other cheap mulching material applied at the rate of around two tons per acre could be used successfully to prevent

erosion on steep road banks until a cover of vegetation could be established. The chief landscape architect for the Ohio Department of Highways has said that mulch is a primary part of his state's successful seeding operation. He said that straw mulch was first used on highway seeding to protect sloping areas from erosion. Its use has been continued because the straw successfully extended the seeding season. As a result, seeding is done at any time of the year that a proper seed bed can be secured. Usually a thicker amount of straw is required if the project is to go through a dormant seeding period, he noted.



Soybeans on the right, grown with an oat straw mulch, are almost weed-free, in marked contrast to unmulched beans at left.

Public Works magazine observed that "the best thinking has found that mulch is of great benefit because it reduces erosion; it reduces the force of raindrops; it reduces evaporation; it keeps the seed bed loose and at a more even soil temperature; and it eventually adds organic matter to the soil. Mulch shades the seedlings, allowing some sunlight to penetrate and air to circulate, and it encourages and hastens native growth in areas that have not been seeded."

But there's even more of a case for mulching than that, because mulching protects plants from weeds, insects and soil-borne diseases.

Ruth Stout is most outspoken on the value of mulches for weed-control. In her recent book *The Ruth Stout No-Work Garden Book*, she explained why mulches are good for controlling weed growth.

"If the mulch is thick enough, the weeds can't come through," she wrote. "When I say this, people then invariably ask why it is that the vegetable seeds come through and weed seeds don't; this is because heavy mulch is on top of the latter, but not the former . . .

"A few weeds may come through your mulch here and there; this will be because you didn't apply it thickly enough to defeat them," she continued. "They are easy to pull if you want to take the trouble, but the simplest thing is to just toss a bit of hay on top of them."

A good mulch will also deter garden pests. Ruth Stout has reported that corn-hungry crows are "non-plussed" by her mulch. She and other mulchers, like Harold Fleck, have lauded the freedom from insects that a thick mulch brings. "Before mulching", Fleck said, "the beetles would ruin our lima and string beans.

Last summer it was different." He had mulched for the first time. "There were a few beetles, but they were too few to damage our production."

Or as Ruth Stout puts it, "I haven't sprayed for 18 years and have no bug problems at all except for a few Japanese beetles which go for soybeans and raspberries. No bean beetles, no aphids, not a potato bug, no corn worms."

Plants, fruits and vegetables are also protected from soil-borne diseases. Mud is less of a problem when walking on mulched rows. Low-growing plants aren't splashed with mud. Free from this, they are also apt to be free from diseases that mud splashed on them might carry.

At harvest time, vegetables which sprawl on the ground, such as cucumbers, squash or strawberries, often become mildewed, moldy or even develop rot. A mulch prevents this damage by keeping the vegetables clean and dry.

Tests have shown that mulches sometimes support microbiological life which fights organisms deleterious to plants. Several scientists made a study of a lemon grove which almost quadrupled its yield after being mulched with wood shavings.

Since healthy root systems are associated with high citrus yields, they tried to determine what factors were involved in bringing about such an improved yield. Their approach to the problem included a study of the soil flora to determine whether there was a build-up in the mulch of some organism known to be antagonistic or parasitic to citrus root pathogens.

They found there was a fungus in the wood shavings

that parasitized two other fungi, which together or separately can cause citrus root rot, crown rot and fruit rot. Following this lead, repeated attempts were made to recover the harmful fungi from roots and soil in this mulched grove. Although the grove had a history of brown rot, the fungus was difficult to locate, indicating that it did not prosper there.

During this study of the flora in the shavings mulch, the researchers encountered other fungi which were capturing, killing and digesting free-living nematodes. Since citrus nematodes are a serious problem in many groves, the men tried to determine if these helpful fungi were capable of attacking the citrus nematode. They found that the fungi, when grown in culture and fed the larvae of the citrus nematode, readily captured and killed these root parasites.

Studies like this one have demonstrated time and again the disease fighting qualities of mulches. But a tree, shrub or plant won't get sick in the first place if it is vigorously healthy. It is most susceptible to disease when it is poorly nourished and lacking in vigor.

Avid organic orchardist Alden Stahr has demonstrated this by saving nine of the last 10 orchards he's dealt with. Stahr has moved from farm to farm, and at many of his different homes he's struggled "with remnants of old orchards, given up in past seasons as being past bearing age. But because of sentimentality, or from sheer determination," he said, "I experimented with the old trees until at last I came upon what I believe is a fountain of youth for fruit trees."

He found his discovery was similar to that of researchers at the Beltsville (Md.) Agriculture Plant In-

dustry Station of the Department of Agriculture. In experiments there, 18-year-old apple trees with injured roots and in very poor condition made a phenomenal recovery after being mulched for two to three years with nitrogen-rich orchard hay grass.

Each tree received about 20 pounds of air dried hay, applied in June, which provided sufficient mulch to extend a foot or two beyond the spread of the branches and was about six inches in depth after being packed down by rain. No supplementary fertilizer of any kind was added to the hay-mulched trees.

High nitrogen hay mulches decompose rapidly, releasing nutrients to the roots and carbohydrates to the soil. Under these mulches, many tree roots grow in immediate contact with the decomposing hay and receive a continuous supply of nutrients. This is a dynamic process and although the mulch almost disappears each year the desirable changes have been effected.

Improvement in growth and foliage color in the Beltsville experiment was evident the year after the first application was made. Marked improvement was evident the second season; and during the third growing season after the experiment's beginning, the trees were outstandingly vigorous and productive. Unmulched trees in the same orchard location remained in poor vigor irrespective of fertilizer treatment. Trees receiving supplementary nitrogen in quantity equivalent to that supplied by the orchard grass were more vigorous than unmulched trees, but in no instance did they compare in vigor with those mulched with high-nitrogen orchard grass hay. The response to hay mulch was characterized

by luxuriant dark green foliage, increased terminal and spur growths, and heavy set of fruit.

“In conjunction with our studies on tree response,” the Beltsville researchers noted, “chemical analyses were made to determine the rate and total amount of the various nutrient elements released by the orchard grass mulch during the process of decomposition. These analyses showed that this mulch will provide a complete supply of nutrients for ideal growth and production, if the nitrogen content of the hay is relatively high and the rainfall adequate for decomposition and extraction.”

They were orchards that were saved, but they could easily have been rose gardens or vegetable patches. Mulching makes the difference.

But mulches are more than practical—they're like frosting on the cake. While they're keeping everything beneath them cool and moist and in the proper structural relationships they're providing taste and visual appeal. Without the frosting, you still have a cake, but it isn't as good as it could be. It doesn't look as good and it doesn't taste as good. So it is with mulches. There are gardens and orchards without them, but they don't look as good as they could. Nor does the produce of unmulched orchards and gardens taste as good as it could.

Several years ago, Lewis Hill tried some experiments in hopes of coming up with a method of producing cultivated raspberries with flavor comparable to wild ones. Initially, he believed that fertilizers and soils were the keys to flavor. The principal experiment lasted several years, Hill said. It consisted, he continued, “of a dozen or so of large established Latham raspberry

clumps, each of which was fertilized or mulched in a different way, to find how the different types of culture affected plant growth, and principally their influence on variances in flavor.

"In the spring, 6 clumps were treated with fertilizer as follows: (a) fresh cow manure, (b) well-age cow and horse manure, (c) finished compost, (d) dirt gathered from maple woods, (e) 5-10-10 chemical fertilizer, (f) liquid chemical fertilizer.

"Six clumps received various mulches: (g) coarse wood chips (maple), (h) sawdust (fir and spruce), (i) old hay, (j) green grass clippings, (k) maple leaves, and (l) paper mulch consisting of ordinary newspapers and magazines. The final clump, (m) received no mulch or fertilizer. None of the plants were irrigated or given additional plant food, organic or otherwise. Soil was ordinary, unimproved field soil not particularly high in humus or fertility," Hill continued.

"Results were quicker than we expected. Even the first summer there was a noticeable difference in fruit flavor, and subsequent years increased it. Since flavor cannot be measured like size or weight, and is only a matter of opinion, we called on numerous customers and visitors to our nursery to sample our berries, and compare flavor. Without knowing the details of our tests, nearly all confirmed our findings.

"The berries grown with fresh manure had a strong taste, and a handful of them together had an unpleasant smell. This was not too surprising. More than once, we had checked out complaints from customers concerning bad-flavored apples, only to find the trees had been planted near their septic tank drains!

"Berries grown with chemical fertilizers, both granular and liquid, had less fragrance, and a flat, duller taste. Well-rotted manure, woods dirt, and compost all had much better flavor and odor; but quite surprisingly ran second, in our opinion, to the mulch-grown ones," he said.

"Since the soil was not especially fertile, the quicker-rotting mulches—hay, grass, maple leaves, and paper—came closest to producing the flavor we were seeking. Soil under these mulches improved in texture much faster than in any of the other treatments, too; though in following years, those with the slower-rotting sawdust and wood chip mulch did well, falling only a little short of the others in producing vigorous plants with highly flavored fruit.

"For uniform comparison in all tests, berries were picked only when completely ripe, and nearly ready to fall off.

"The result? Mulches went on the currants, gooseberries, apples, cherries, plums, strawberries, and the rest of the raspberries. Our compost pile collected mostly garbage from then on; all else went into mulch material—like garden waste on the bottom, better-looking hay on top. Soil tilth improved vastly, staying loose and moist even during the driest part of the summer. All the trees and plants showed impressive increase in growth. Some of the young trees grew nearly twice as much in a year as before mulching, since they kept growing all season, not just after rains. Quality of fruit was much improved, too. Furthermore, now we never feel the large cultivated berries are playing second violin to any wild ones in flavor," he said.

“We found that mulching saves hard work, also. Applying mulch is certainly much easier than making and turning large compost piles, keeping them moist, and later having to work them into the soil. Now we let Nature, her bacteria, and earthworms do the job right on the spot!

“When we started our experiments, we fully expected to prove how compost produces superior flavor in berries. Instead we became convinced that to all the other arguments in favor of garden mulch, another may be added: mulching means better flavor.”

Mulch means better looks, too. A mulch is visually appealing.

Picture a garden section devoted to shrub roses or other flowering perennials. In bare, uncovered soil their appeal is limited to upper levels alone. But add a layer of auburn cocoa bean hulls nestling around them, and a whole new outlook comes into view—a vista of rich color, of eye-pleasing textures and tones. Then, too, a dimension of depth completes the comfortable “carpeted” look. In bloom and out, your plants—and garden—look better right from the ground up.

Or shift the scene to the vegetable patch, where backyard eye-appeal and practical benefits go hand in hand with a cushion of thick hay or straw. Glance over to the fruit trees, which cast a far more attractive spell on the homeground horizon when they’re circled with things like rough-grained bark and wood chips or ringed by a deep bed of crushed rock. And look at plantings set around the foundation of your home; invariably they fit more naturally and invitingly when a layer of pine needles, shells or leaves makes them snug.

Given a variety of mulches to work with, a gardener eager to do some “outdoor decorating” has a tool for being as creative as the fussiest of the indoor breed. At every turn of the yard and garden, mulch can help contrast the shapes and hues of plants or blossoms, highlighting backgrounds and vertical lines, or simply blending neatly with them where desirable. From a distance, the effect of certain mulches can be one that dramatically enhances any size or form of growing area. Up close, they easily perk up the mood of plant sites, transforming drab or detractive ground into handsome settings for every sort of growth.

Best of all, they prepare that handsome setting for some of the best growing you’ve ever seen. For while a mulch is working in the soil, sparking microbiological activity, promoting better aeration and granulation, it’s working atop the soil, too. It’s providing a cover to prevent the sun from baking out the moisture, creating a crust and making the land privy to runoff and erosion. It’s preventing the growth of weeds and other ground cover which would compete for the moisture and nutrients in the soil. It’s tempering the temperature, limiting the radical range of temperatures which beset plants.

“There is the secret”, said Alden Stahr. “Mulch will do the trick. Drainage and feeding are important, but mulch is the real fountain of youth.”

Or, as Mrs. Smith put it: “Our yields were fantastic. . . . so we’ll again be mulching heavily . . .”

Chapter 4

MULCHING MATERIALS

When you set out to mulch a home garden of any size, the first thing you ask is, what should I use?

There are almost as many different kinds of mulching materials as there are gardeners to use them. Mulch is a personal thing—if you ask 20 gardeners what their favorite material is and why, you may get 20 different answers. There is no one perfect mulch, but many good materials are suitable for mulching your garden. Perhaps the best way to start is to use what's easily available. There's not much sense spending hard-earned money for exotic mulches if easily found leaves will do the job you want done. Most gardeners solve their own individual gardening problems by using what is cheap and abundant locally and gets practical results for them. They have learned by experimenting to think for themselves.

Take Bob Wandzell, for example. He's a resident of Alaska where growing seasons are short and wet. Wandzell solved his gardening problems by tapping the ocean's resources. Seaweed combined with sawdust brought satisfying results in an otherwise marginal growing area.

Not long after moving to Wrangell, Alaska, Bob yearned for the fresh fruits and vegetables he had enjoyed so much in the continental United States. He decided to start his own garden. Upon checking around, he discovered that others had unsuccessfully attempted to garden in Alaska. They attributed their failure to heavy rainfall, short growing seasons, high-acid soils, non-existent local supplies of animal fertilizers, and high commercial fertilizer costs.

How did Wandzell overcome these problems to become the most successful berry and vegetable grower in southeast Alaska? Well, the first thing he did was to plot his garden on a hill, in hopes the sloped runoff would solve the excess moisture trouble. (Wrangell averages over 150 inches of rain every year.) His first garden did poorly, though—just as others had predicted. But pictures of ripe vegetables on the seed boxes, the sweat spent in preparing the patch, and the sight of weak plants struggling to mature fired up Wandell's determination and whetted his appetite for fresh produce.

The moisture problem licked, he tackled the soil deficiencies. There were no barnyard animals around Wrangell, so manure was out. He tried several commercial fertilizers without success. Then he thought waste materials from the fish canneries might do the job, but the canneries seemed to have a can for everything the

fish had to offer, and there was no waste.

Finally one spring, lacking anything else to try, Wandzell mixed some seaweed—found on the beach across the street from the garden—in with his soil and planted strawberries. Late that summer the family enjoyed their fill of fresh strawberries. For some reason unknown to him, the seaweed had given the soil what it needed.

He collected five soil samples from around the garden—one of which had a high seaweed content—and sent them to the Alaska Division of Agriculture to be tested for fertilizer needs. He soon received word that four of the samples were low in phosphorus and had too high an acid content. The fifth sample, he was informed, contained everything necessary for ordinary gardening!

That fall the Wandzells gathered a large crop of seaweed that had washed ashore above the high-tide mark and dried in the sun. Wet seaweed contains 70 to 80% water—which they didn't need—so they harvested in the fall when dry weed is abundant on the beaches. They stored their ocean "crop" like hay all winter, then added it to the soil in the spring. That summer the Wandzells' garden produced the best vegetables ever grown in Wrangell.

Their rhubarb is first-class evidence of how kelp influences green leafy plants. It grows like it's trying to push back the whole Alaskan rain forest. From one short row Wandzell sold 30 to 40 pounds before the first of June last year, which is something to brag about when one considers Alaska's late springs and short growing seasons.

Even without the seaweed, sawdust makes real good

mulch, if that's what is cheap and abundant locally. Such was the case for Morton Binder. He estimated the cost of manure, peat or beanstraw and mixed the wholesale use of it in his gardening program. But he needed something to aid his rock-hard soil.

Located on a coastal plain, his soil is an extremely compacted, very fine sand over an impervious yellow clay subsoil. When he started on the yard, he began to dig a post-hole and thought he had hit a rock. Even a pick refused to chip off more than bite-sized chunks. He filled the hole with water and the next day had to bail it out to continue digging.

Then he remembered that in a nursery where he had worked a lot of old shavings from the sawdust bins had been used. "A lumber mill is close by," Binder explained. "I went up to look over the situation. There were literally thousands of yards of coarse mill sawdust chips free for the taking. I carried sufficient back with me in a few trips to heap a foot deep over the entire future garden area. The deep surface mulch held the irrigation water without runoff, and within two or three days the fine sand was ready to spade. It took three times over to get a good mix. This could have been done much more simply with a hand tractor, but it was in an inaccessible position," he explained.

The upshot of his labors was a better soil. He said it became "increasingly friable and plants are responding well." He continued, "I ran a pH on the sawdust and found it to be 4.5, or about that of peat moss. In an alkaline soil this would be fine, but in my 5.5–6 soil I had to add lime.

"Weeds pull readily when the soil is mulched with

sawdust. The water bill has been negligible, even though our water rates are high. Humidity is maintained at all times. The ground looks and feels good, and caking is a thing of the past. Cultivation has been reduced to minimum and the angleworms are becoming more prevalent," he said.

"The amount of manure, organic matter, and lime used was no greater than if I had been working with a friable soil in the first place. I estimate my total soil-

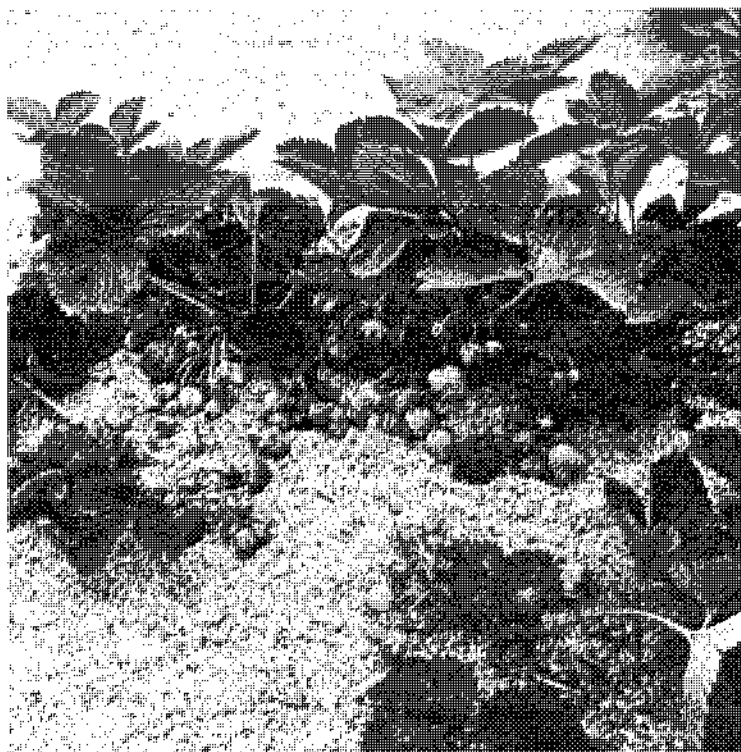

Sawdust, available free from the lumber yard, is one of the most inexpensive soil builders.

building cost at two gallons of gas, although it did take a lot of hard work," he concluded.

Another sawdust mulcher, Mary Leister, reaped similar benefits with a similar outlay. She was able to get sawdust to mulch her garden "at the expenditure only of time and physical effort." Unlike the variety Binder used, however, Mrs. Leister's sawdust was well rotted from having spent 20 years lying in a shady woods.

"This sawdust was," she explained, "moist and very heavy to handle, but its dark color was most pleasing to the eye. Even the lightest of rains seemed to go directly through to the garden soil and very little additional water was needed throughout the summer by the herbaceous annuals and perennials protected by it, nor did they show any overt need for additional fertilizers during the growing season. The vegetable garden grew lushly, and strawberries, raspberries and rhubarb all produced prodigiously surrounded and protected by this sawdust mulch.

"No replenishing of the mulch was necessary from spring to fall," she continued. "Not one garden weed penetrated the three inches of sawdust, and only an amazing few of the broken roots of the creeping woods plants gave rise to new growth that had to be pulled from the loose, unresisting medium.

"On the same July day when the soil beneath the dried grass registered 94 degrees F., that beneath the rotted sawdust registered only 82 degrees. These temperature readings were taken in the same test bed, in the same direct rays of the sun, and within four feet of each other.

"In early November, checking the decomposition

and/or loss of the sawdust, I found approximately two inches of loose mulching material, while the first inch or so of soil immediately beneath was so mixed with the sawdust as to be inseparable one from the other. It was, in effect, a rich, black, moist soil, brought about, probably, by the action of rain water, soil bacteria, and little earth animals," she said.

Mrs. Leister, in the course of her gardening, has had the opportunity to try some other mulch materials. She approached her mulching endeavors with these other materials with the same observant care she applied to her test of rotten sawdust. The others she tried were grass clippings, a material available to anyone with a lawn; shredded pine bark, a commercially-available mulch, and ground cork, a relatively little-used mulch. Each was spread on the Leister garden and "checked for its desirability as a mulch."

"Our lawn, green, healthy and practically devoid of weeds, has always provided a more than abundant supply of clippings to cover, thin layer by thin layer, every bed and border in our garden," she said. The pale gray-green color of the drying grass deepens to brown and is not unpleasant. It readily permits raindrops to penetrate to the soil beneath, while its decomposition enriches the soil, and its shady protection keeps the earth beneath it both cooler and damper than cultivated soil exposed to the elements. On a day in July when the air temperature was 98 degrees F. and the temperature, in direct sunlight, at the surface of the mulch registered 120, the surface of the soil beneath the dried grass mulch was 94 degrees.

"These grass clippings, however, require almost

weekly replenishment in order to keep the mulching depth a preferred 3 inches. This rapid decomposition necessitates the constant addition of organic fertilizers rich in nitrogen, to the soil; and the protected plants, even in a season of fairly normal rainfall, are very often in need of additional moisture. Furthermore, by freeze-up time very little dried grass is ever left for use as a winter mulch," she continued.

"One of the most striking things about shredded pine bark," she explained, "is the woody fragrance that rises when the bark is spread. It is," she said, "so heavenly that the gardener is apt to feel that even if its mulching capabilities are nil it is worth its price in nostril-tingling value alone. But, fortunately for the garden, it is an excellent mulch. Its pine-woods aroma vanishes after a few weeks' exposure to the elements, but its dark color remains pleasing to the eye for at least the two years I have used it," she reported.

"It does not rob the soil of moisture but instead appears to allow every falling drop to penetrate to the earth. Its fine, dusty particles are, of course, quickly absorbed by the soil, but this is such an extremely small percentage of the mulch that its disappearance is scarcely noted, either in the depth of the mulch on the ground or in the bulk recovered if it is raked up for storage during the winter months. The dust absorbed presumably increases, to a slight degree, the acidity of the soil, but does not noticeably increase the demand for nitrogen.

"Possibly because the larger pieces and consequent greater unevenness of the shredded pine bark mulch allow some moisture to escape, but more likely because

the foundation planting suffers from being in the rain shadow of the house, a considerable amount of additional moisture was required by these large evergreens. So, too, the smaller-rooted cuttings in the test bed required a great deal of additional water, but this need not necessarily be laid at the door of the pine bark mulch."

She continued, "When the surface temperature of this mulch was 120 degrees F., the temperature of the soil directly beneath it was 86 degrees, while a temperature of 90 degrees was registered in medium shade with the soil beneath it registering 82 degrees F.

"The other mulching material tested was ground cork—not yet, to my knowledge, on the open market.

"This material was so light and so easy to handle that a 90-pound woman could spread it with ease. It was also so light that I feared the first breeze would blow it across the countryside and that even the moderate force of an ordinary raindrop would dislodge it from place. But I was wrong.

"Scarcely had we spread this mulch when an early-summer thunderstorm raced across the land," she said. "Preceded by violent winds, it let loose a volley of pounding, outsize raindrops, and then sluiced down veritable waterfalls upon the earth. The storm passed, the sun shone, and we went out to view the end of the mulch test that had not yet fairly begun; and there lay the ground cork, smoothly and evenly spread upon the ground, completely unruffled by either wind or water. The cork itself was damp, the ground beneath it soaked, and from that moment through the entire growing season that section of the test garden relied solely on nature for its watering.

"This ground cork is reported, authoritatively, to test one per cent nitrogen, a fairly negligible amount; but its deterioration is so unbelievably slow that it appears almost to be an inert material and its effect for good or ill on the nitrogen content of the soil is not observable except probably by highly scientific testing methods. Measured by bulk, there appears to be exactly as much cork in November as there was in May.

"Well known for its insulating qualities, there should be no surprise that where its surface registered the same 120 degrees F. mentioned before, the temperature of the surface of the soil directly beneath was 82 degrees; and in light shade where the mulch surface showed 94 degrees, the soil beneath showed 78 degrees F.," she said.

"Dry or wet it is completely odorless. Its only drawback—and it is no doubt quibbling to mention it in view of its other excellences—is its pale-tan color which does not enhance the beauty of a planting as a darker color would do."

If a pale tan color is a drawback, you'd never know from listening to hay mulchers. These gardeners spread that pale tan substance over, around and through their gardens with nary a thought that it should be darker to best enhance the garden. For Fred Eaton, for example, hay mulching has too many practical advantages for him to be concerned about whether its color appeals to him. He's been using a hay-mulch for years and finds it a fine labor-saver.

"Make the right start in hay-mulch gardening by making the best choice of the hay itself," he recommended. "*Make every effort to get baled hay.* It's neater, and is much easier to manage than loose hay. It's a

better weed smotherer, and stays in place even in high spring winds.

“Don’t depend on a mulch for a complete soil nutrient provider” he continued. “It’s main value, after decomposition, is as a soil conditioner. It does contain some nutrient value, however, so try to get it organically-grown, if possible. Well-fed hay will return a greater percentage of nutrients to your soil and crops. A rich and early-cut grass hay often contains more nutrient value than a starved clover or alfalfa.

“Before you start to mulch, apply fertilizer in the usual way as you always do. Compost, manures, rock powders, and other organic materials will tend to decompose more quickly under a cooling, moisture-holding hay mulch, so even if you’ve never tried surface fertilizing (or sheet composting) before, don’t be afraid to try it now. We don’t hesitate to use lots of phosphate rock, granite stone meal (good for potash and mineral supply), and a magnesium limestone (only when needed to raise pH.) This general fertilizing program is far from scientific, but it works wonders with plants, probably because, unlike chemicals, it is ‘nature-balanced’ in its original form. All the many trace minerals lacking in straight chemical formulas are present in almost every organic and rock fertilizer,” Eaton continued.

It should be pointed out that such a program of fertilizing is the best, regardless of the nature of mulch you use. But there are some pitfalls in using unrotted organic materials and planting at the same time. These are explained in chapter seven.

“Fertilizing over and done, let’s start to plant. Again, there is nothing special here, and you may proceed to

plant as you have always done,” he explained. “First drop in or sow your first row of seeds. Then go to your bale of hay, and peel off a two-inch layer ‘book.’ Place it alongside of the seed row. Continue peeling off books, until the entire row is flanked by straw. Then repeat this process on the other side of the row. A medium to large field-baled bale should cover about 40 feet of row. Now, if you’ll stand back and look at the results of your efforts, you’ll see a newly-planted row of seed running parallel in between hay books, laid end to end. Who said mulching is untidy?

“Your second seed row should be placed just outside of the second row of books you laid for the first row. Confused? Just lay out seed rows and place one row of books between each seed row.

“By midsummer, the hay should be pretty well on the way to decomposition, and the books should have been compressed to half their original thickness. By this time, some weeds and grass will have fought their way through the hay. There’s no need to hand-weed, however. This is the time to apply a second layer right on top of the first. In late autumn, while closing out the garden season, you should re-cover any bare or thin spots in the mulch rows.

“Next year, you’ll really reap all the benefits of this system. Take a rake or a potato hook, and pull the remaining mulch to one side for a distance of half a book width, so that you expose the ground for a planting row right in the middle of where the path or row of hay was before. Get it? You are now to plant in the richest area, that was the middle of your mulch strip last year. And you are covering last year’s row space to

kill weeds and grass, and make rich soil for a third year," Eaton said.

"You'll find it unnecessary to dig or cultivate this ground before seeding. It will be loose, rich, humus-full, and abounding with earthworms. Just loosen enough ground with the corner of a hoe to get your seed in to proper depth, cover, and tamp. From now on, Mother Nature takes over many of your former duties.

"With this system," Eaton said, "we don't have to cultivate any more. We don't water, except in extreme drought; we do no weeding except at the first thinning or transplanting of the seedlings. Because we applied our minerals (granite dust and phosphate rock) liberally at first, we haven't been adding any fertilizing materials either.

"Only two and a half years of the book system has converted our depleted, packed, humus-lacking soil into a rich, soft, mellow garden that certainly does grow good vegetables. And this land has probably been used and abused for over 250 years.

"In only three years, we have seen our soil consistently in tilth and productivity. The hay mulch, constantly in contact with the soil, not only gives us the usual advantages of a mulch (which would be reason enough to use it), but actually conditions the soil with practically no effort on our part," Eaton said.

Another gardener who believes in a good hay mulch is John Krill. His garden is constantly covered with a mulch of old hay, weeds, straw and leaves. The mulch must be constantly renewed, however, because decomposition reduces its depth quickly. The Ohioan decided

that the best way to handle the renewal was "to grow my mulch right where I wanted it. That would be right over the mulch already spread out over the garden. I bought a bushel of oats and sowed them by broadcasting over the brown mulch," he explained. "Oats are cheap and a bushel sows one heck of a big area. I scattered the oats thickly because I wanted a good and heavy stand.

"What happened? I noticed next day that a few sparrows were gorging on the oats. So what? What could a few tiny birds do to all those oats scattered out there? Next day there were more, and on each succeeding day their numbers increased until I felt sure there were more birds than oats in the garden. I looked skyward for some signs of rain. A good wetting would cause the oats to sprout quickly with the sprouts preventing the birds from eating them. No rain. And very quickly there were no oats," he continued.

"When the rains came much later, the few handfuls of oats that had worked down out of reach deep in the mulch sprouted. They grew lushly, relishing the cool weather. But as I had planned, they never matured. Winter stormed over the land and the tender oats were killed by continuing freezing temperatures.

"The blades that had stood up so erectly were now flat on the surface of the mulch. Snow came and buried them. When spring arrived and the snow had vanished, I found a thick layer of flattened oat blades. This much of my idea had worked. I was determined to beat the birds the following fall. I used two methods, both of them good. Both are practical and may be used almost

anywhere that oats will grow. Oats like cool weather, hence for this purpose must be seeded in the fall.

“The following autumn turned out to be nearly as dry. It seemed to me the birds were already gathering in anticipation of more free oats. I did broadcast the oats, but the birds did not disturb them. There was one prime difference in them this time.

“I had emptied the oats into a tub. Then I poured enough water over them to give them a good soaking. The tub was covered with burlap and placed in a cool, shady place. A garage or cellar provides ideal conditions for this purpose. Everyday I would stir the damp oats, adding water if they appeared to be drying out,” Krill said.

“Then the oats showed signs of sprouting. I kept watering and stirring them to keep rot from setting in. Finally the tub was a tangle of greenish-white oat sprouts. When they were two or more inches long, I waited until evening and then broadcast them over the garden. True, the birds did come down and searched out every grain that they could swallow. But these were grains that had not sprouted for some reason. Those with the sprouts they left alone.

“The sprouts fell in every nook and cranny in the not yet compacted mulch. The blades turned a healthy green and shot upward rapidly. Late September became late October and the sprouts thickly covered the garden with a sturdy growth. But before the blades could set their heads of seed, the constantly intensifying cold slowly withered them.

“Snow buried the fallen oats. The weight of the snow, plus the hard beating of a number of rains flattened

them flush with the mulch out of which they grew. Spring found my garden already mulched with mulch right in place.

“I seeded oats by a second method without going through the process of sprouting them. It is equally good and equally simple to use. I had quite a quantity of old hay which was to be spread in the garden as mulch. Again you must wait until late September or the early weeks of October to use oats.

“I broadcast the oats thickly over the garden. (I must add that sprouting the oats will not interfere with gathering any vegetables which may be growing up until a killing frost arrives.) Over the scattered oats I spread the hay. It makes little difference how thickly the mulch is applied, for by the time it has compacted, the oats will have sprouted through it,” he continued.

“This method also defied the birds, for they could not poke deep enough in the protective mulch cover to reach the grains. A rain soaked the garden thoroughly and in a few days spears of green wove a mosaic over the brown mulch. Once started, the oats grew with a gratifying abandon. Soon they were so thick that the mulch could scarcely be seen.

“Before they could head, winter destroyed them and they fell wilted to the mulch, adding themselves to it. Again snows and rains beat the blades flat. Spring came and the garden was a mat of flattened and dense oat grasses that covered the original mulch,” Krill concluded.

Krill liked the results of his experiment. Years later, he's still using the method. But one man's passion is another's poison, or at least not his passion. Lee Shields,

an Indiana resident, uses another material for his mulch, a material abundant locally, and one he doesn't have to plant. Shields uses old leaves. He gets them from the city during each year's fall cleanup.

The city street department dumps from two to four truckloads on his garden each year when they are removing them from the streets in his neighborhood—all free. This may sound like a tremendous amount of leaves, but since they are wet when dumped by the trucks they immediately start to “heat” and break down. By the following summer, the “mountains” of leaves have been reduced to about one-third of the original bulk. He does not “turn” the piles—they are only handled once. (Other gardeners find that wet leaves tend to “wad” up into layers and resist bacterial action unless stirred and turned occasionally.)

Each year he takes leaves directly from the piles that were heaped up the previous fall, and works them into the soil to steadily improve its tilth and structure. Such application is usually made before the dry, hot summer days set in, preserving valuable growing moisture.

Shields likes to cultivate at least once before applying mulch, and give the soil a chance to warm up well. Then, a heavy application is made right up close to the plants, which will also help prevent them from blowing over during wind and rainstorms. By the following spring, most of the leaves are decayed enough so the rotary tiller effectively incorporates them with the soil.

Using leaf mulches is practical for the gardener since the supply is generally boundless in most communities. And it's practical for the community, which usually doesn't know what to do with its boundless supply of

leaves. In most areas, the leaves are simply burned, which wastes good mulch and puts more smoke into air which doesn't need it.

Waste is the key. Most mulches are waste, to everyone but the mulcher. Dave Shaw uses wood chips, for example. Wood chips would be a waste material to most people, but to Shaw they're nutrients in his soil.

Like Shields, Shaw, a southern New Jersey resident, likes to thoroughly turn his old mulch and sod into the soil each spring.

When first planting a new section of his garden that formerly was sod, Shaw goes back and forth with the



Wood chip mulch retains moisture, controls weeds and creates handsome background for rhododendron plant.

tiller about four times, working it down to about eight inches deep. He then applies a new four-inch layer of chips, adding cottonseed meal and dried chicken manure at the same time. Shaw tried mulching without tilling to break up new ground prior to planting, but discovered it took longer to eliminate weeds and grasses.

At spring planting time, Shaw moves the chips aside, makes a furrow with the hoe, drops in the seed, covers and tamps. As the plants grow, the chips are replaced around them. After crops are harvested in fall, the entire garden area gets several truckloads of chips to maintain the 4-inch depth.

When growing potatoes, Shaw plants them in about 12 inches of chips and straw, pressing the seed into the soil surface. Clean potatoes are picked merely by separating chips and breaking them off plants.

Although for most plants it makes no difference what kind of wood is used, Shaw does apply only pine chips and pine needles to his strawberry rows because of their acid reaction. Ordinary chips are close enough to neutral to cause no problem. The only potential problem with the constant chip mulch is an occasional nitrogen deficiency, evident when foliage begins to yellow. When this happens, Shaw applies cottonseed or bone meal, but, he said, "As long as you keep the chips above ground and don't mix them with the soil, you don't have nitrogen deficiency."

Shaw is proud of the lawn-building job he did at his Godparents' home along the Jersey shore. The soil there was just sand and gravel when he applied 3 inches of chips and 2 inches of old chicken manure. He worked

the mixture in well before planting. "Now that lawn is one of few in the area to have done so well with so little extra care."

He actually has sold so many people on the advantages of chips that "there's almost not enough to go around for everybody who wants to use the chips." In fact, he's glad to have his own chopper. Whenever his supply from tree-trimming crews gets low, he can always make his own chips from his farm's timber supply.

Shaw's primary source of the wood chips is a good source of mulching material for anyone: tree trimming operations. Utility companies and many cities have crews which annually trim branches which overhang their wires and other overhead facilities.

Ohio Edison Company, for example, does this. Instead of burning tree limbs that have been cut down, the Ohio Edison crews put them into chipping machines that shred leaves and limbs alike into small bits of material. This matter, when it decomposes, makes excellent mulch and top dressing. And Ohio Edison gives it away.

The leaves in the material contribute the most to its decomposition. They break down first and help to decompose the bits of wood, a process that does not occur quickly.

Archer Martin got a pile of the material in July. For several weeks it smelled like new ensilage and continued to be warm for two and a half months, showing that decomposition still was occurring. He expected that by the next summer they would be broken down completely and would do much to improve the consistency of the soil. Meanwhile, he used some of the material to

protect his roses and other perennials over the winter.

“I did not give the chips any special treatment,” Martin explained, “merely piling them in a mound with a depression at the top to catch rainfall. I wet down the pile frequently during dry periods and added wood ashes and grass cuttings atop it for no other reason than that the pile was a convenient place to put them. (To be truly effective, the ashes should have been mixed through the pile when I built it. I shall do that before I use it.)”

Ervin Steinmetz, an Ohio Edison tree foreman, has used the shredded material for winter protection of his

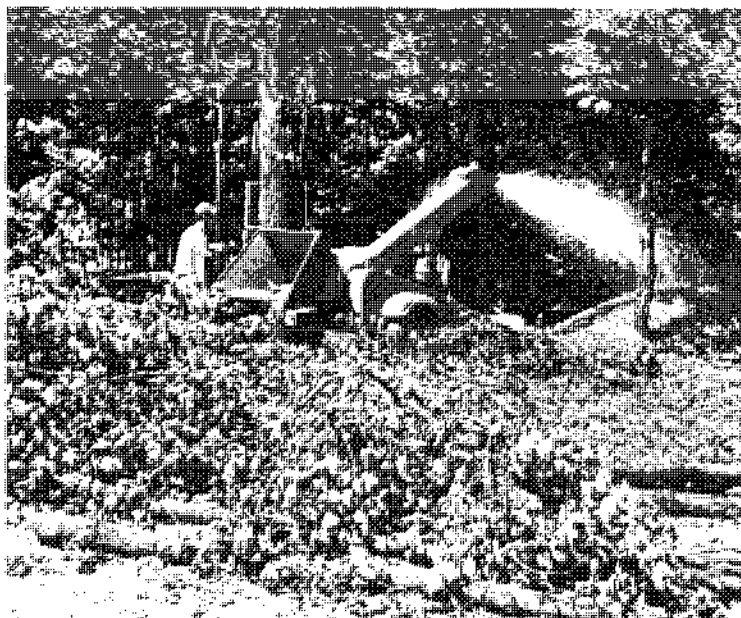

Utility company shredders quickly convert sawed-off limbs and leaves into free-for-the-asking mulch.

roses. He applied it after frost, though, and then spaded it into the soil early the next spring. The mulch shouldn't be put down while still green during the growing season, for it will rob the plants of nitrogen during its decomposition.

A farmer who lives near Steinmetz has been allowing the Ohio Edison Company to dump as many chips as it wants into an old gravel pit on his farm, with the idea in mind that he eventually will use the decomposed material for top dressing his fields.

Ohio Edison considers the use of chippers to be more economical than the old practice of piling whole limbs on trucks to be hauled away.

The utility firm almost always has men clearing limbs away from its lines during the growing season. If they are working in particularly heavy growth, they will fill a truck with shredded matter every hour or so. They haul the stuff to dumps, or to nurserymen and farmers who can use it in unlimited quantities.

The hauling, however, takes time and costs money, so Ohio Edison people are pleased when someone—usually a gardener—comes with truck or trailer to where the men are working and asks for the material. If your utility firm, whether electric or telephone, does not use chippers, a suggestion to the management might open up a new supply of free mulch for your community's gardeners.

And while you're checking the utilities, try calling other local industries, such as lumberyards, milling firms or food processing firms. Mulch is where you find it, and a little scouting around is generally worth the effort.

According to Robert Mead, thousands of tons of sawdust and shavings are used each year as bedding for the booming dairy industry in Vermont, for example. In addition to the natural fertilizer value of the sawdust and shavings, they absorb much of the fertilizer value from the cow manure that would otherwise be lost. Some mills gladly give this away to get it out of their way. At others there is a charge, a common cost being one cent a bushel. Some shavings are baled, with the usual price being 50 to 75 cents a bale.

Many other wood by-products are freely or cheaply available for use as mulch. In addition to the sawdust and wood chips and shavings that have already been mentioned, one can use bark and packing materials; such as shredded paper or excelsior. Peat moss, too, is good mulch.

The by-products of your own or others' gardening activities can be used as mulch. Use those weeds for mulch. And the grass clippings, pine needles, rotted pine wood, corn cobs and stalks and tobacco stems.

In Kentucky, for example, the tobacco remedy is the first thing people think of when their lawns are doing poorly. If it works for them, it should for anyone who has access to the tobacco stems. The remedy is really a mulch of tobacco stems. After the last leaves are raked in the fall, the Kentuckians spread a thick layer of tobacco stems over the lawn. Winter rains and snows leach the nutrients from the stalks into the soil. In the spring, the stalks are raked up. The tobacco farmers themselves use the stalks in some areas, usually tilling them into the soil.

In corn country, widely-used mulches are corn cobs

and corn stalks. Ground into one-inch bits, the cobs have many uses. The sugar content of them will benefit the microorganisms in the soil and will promote better soil granulation. Shredded corn stalks—provided the stalks weren't infested with borers—make a well-aerated winter mulch.

In the southern states, rice hulls, cotton burrs and hulls and pecan and peanut shells are readily available as mulch materials. Most of these materials are rich in nitrogen and potash. They are unusually attractive as a mulch, too. If you happen to live in the northern areas of the country, you may find the nut shells available commercially.

If you live near a brewery, check the availability of spent hops and grain used in the beer-making process. These are good as mulch.

Gardeners in Florida and Georgia often use excess hyacinth plants as mulch. The plants abound in these states. They can be used as is or ground to a pulp.

It all depends, again, on what is cheaply and abundantly available locally. In the Canary Islands, to use a far off example, an old custom, dating back 100 years or more, is to mulch with picon, which are small volcanic pebbles. Picon farming, as it is called, is a variation on stone mulching, which is covered more fully in the next chapter. Its biggest advantage, according to practitioners, is that it conserves, as do most mulches, fertilizer and water, both in short supply on the barren islands.

The custom dates back to the last major volcanic eruption in the islands. When they could get back to their homes, the farmers found their fields covered with

volcanic rock. But it was planting time, and they could do nothing else but dig holes through the pebbles and plant. To their amazement, they had record crops that year and in subsequent years developed the following procedure of protecting the ground with the small pebbles left by the lava flow.

First, furrows are cleared away, and animal manure placed in the soil is covered over, and a top layer of from one to three inches of picon is put on. The row is watered, and when it seasons well, it is planted through holes made in the picon for insertion of seeds or seedlings.

Farmers say a picon covering can be left undisturbed for 20 to 30 years, with only small additions of fertilizer needed from time to time, put in through the holes in the picon at planting time. Watering is unnecessary, for the picon not only holds in what moisture there is, but collects additional moisture from the atmosphere during the short rainy and foggy seasons, and stores it in the ground below. Weeding is minimal, another saving in time and labor.

Chief beneficiaries of the picon treatment are cactus farms, which produce sisal fibers for rope and cochineal insects for carmine and like dyes. But without picon, home gardeners would find it impossible to grow tomatoes, corn, melons, cucumbers, squash or potatoes.

Without a somewhat similar material, Ruth Bixler would have found it impossible to keep her flowers growing. Mrs. Bixler had had tremendous problems keeping anything growing in the shaley soil at her Pennsylvania home. An intensive mulch program saved her vegetable patch and stone mulches—explained in the

next chapter—saved her trees. Nothing worked for her flowers, however, until she discovered and tried a picon-like material.

“One Saturday,” she explained, “I stopped at the feed store to get some feed for our pet rabbit, and right in front of me I saw the answer—bags of ground oyster shell. I bought bag after bag and started shaking it over the beds. I really put it on thick and it was beautiful for the summer; not even a heavy shower disturbed it.

“To my surprise the few weeds that came up pulled right out as if the ground underneath was wet. It cut my weeding time down to once a month (before that every week). The roses were never more beautiful and bloomed until the first snow. I also used it thick on my Mimosa trees and they got through the severe winter without a single loss.”

What this all means is that to succeed in the mulching system of gardening, you have to be what Owen M. Voigt calls a “pack rat.” He figures that’s what he is. Voigt has toured and explored Virginia’s Shenandoah Valley countless times in search of mulch materials for his garden.

“I have become an expert in our county’s various industries, have memorized hundreds of miles of scenic back roads, and have made the acquaintance of many interesting people,” he said. “I now feel I am truly a citizen—almost a native—of the area to which we migrated several years ago.

“Luckily, mulching poses the need for more common sense than funds, so we were able to utilize our limited resources to good advantage. The nooks and corners where our search for material took us were fascinating,

and in the long run as educational and rewarding as the improvement wrought by our horticultural endeavors.

“People everywhere were considerate of our needs. They recognized the basic common sense behind our methods, and were always ready to give us what we needed.

“When I visited a furniture factory for sawdust, the manager took me on a tour of inspection and showed me the sawdust pile which loomed imposingly in an



Shredded pine bark mulch around fruit trees holds in moisture, promotes new root growth.

adjacent field. But he pointed out that it was an overfine residue of many woodworking operations and was prone to cake. He suggested a local sawmill which cuts logs and rough lumber—much better for my uses. I located the mill which was operated part-time by a genial farmer. Here, for just a few cents, I was able to acquire large amounts of good red oak sawdust—enough to mulch my lengthy 500-foot hedge, and to add to my compost heap.

“However, my farmer-sawmill operator passed me on to another and larger mill which uses a debarker system on their logs. They gave me a very generous amount of shredded bark, which I found to be the most successful evergreen mulch I have tried,” Voigt said.

“The soil beneath an inch or slightly more of this shredded bark never showed signs of extreme drying, although we had some very hot suns during the severe droughts. Through it all, the shrubs retained a healthy deep green, while the soil, unrobbed of nutrients and nitrogen, was alive with beneficial insects, fungi and earth worms. I would also like to add that it gives a very professional finish to your vegetable rows and ornamental beds and borders, very pleasing to the eye, while it keeps the weeds down rigorously.

“In the fall of the year, trucks of the sanitation department roam the streets collecting huge piles of leaves with a suction pump. I contacted the chief engineer of the town waste disposal system who told me they were dumped on a public fill project, and were available to all who chose to collect them. Here indeed was a bonanza overlooked by almost all of the local horticulturists, many of whom still burn their leaves. The action

of the pump in sucking up the leaves grinds them up into a powder, so I was able to collect close to a ton easily. Last year when I made the mistake of spreading them in the spring, the ground was very slow in heating up. So this year I plowed them under in the fall, letting the now-abundant worms and bacteria consume them through the winter.”

As Voigt toured the valley looking for mulch materials, he also kept his eyes open for organic fertilizers. “I consider a large supply of burlap bags in the car’s trunk an absolute necessity,” he said. “It’s also advantageous, I find, to keep a small notebook which lists places and areas cited by friendly advisers as possible sources for more and different organic complements.

“Trouble, and time-consuming? Yes, I guess it is if you mark down each moment to drudgery. But what are adventures into the back roads and bypassed nooks of your community? And what is that pioneer’s satisfaction that comes with building a really fine garden from a square of waste soil? Is this trouble, is it pleasure, or is it achievement?

“Two years ago, local gardeners considered my methods a little nutty—to say the least. But this fall I caught my neighbor quietly sneaking in a load of leaves to cover his garden.

“It looks as if being a pack rat is contagious!”

Chapter Five

STONE MULCHING

When “Pack rat” Owen Voigt first started roaming the Shenandoah Valley in search of mulching materials, one of his first specific desires was stones—big ones, little ones, round ones, jagged ones—just stones.

“If you have never used a rock mulch,” he said, “I heartily recommend it.” For Voigt, a big factor was that rocks aren’t too hard to find and are used just as they are found. All he had to do was find a rock, plunk it in place and he had mulch. Moreover, rocks are free.

Rock mulching is pretty much like every other kind of mulching. Rocks do everything that other mulches do. In some instances, they do it better. They are, for example, exceptionally good for conserving moisture and moderating daily temperature fluctuations and particularly good at maintaining soil structure. And when

was the last time you saw a weed sprout through a stone?

Most any vegetation can be stone mulched, but it works particularly well for trees and it looks particularly good with flowers and other decorative vegetation. L. T. Servais, a Green Bay, Wisconsin, gardener and rock collector, uses his functional stone mulches to show off his collection.

"I have been using rock mulches around fruit trees for 20 years now with good results," he said. "As a rock collector, I at first kept my collection of specimens from a dozen states and Canada in the house. But when they really began to get in the way, cluttering up closets,



A mulch of rocks combines neatness with moisture conservation while it discourages weeds.

shelves and cabinets, I moved them outdoors and put them to work around my trees. I have replaced the more drab stones now with rose quartz, gleaming obsidian, and shining feldspar to add a bit of glamour to my tree plantings while helping them to grow better."

While a rock mulch's ability to make a garden look better might be a matter of opinion, its ability to make plants grow better appears to be a historical fact. Evidence of stone mulching in ancient Rome has been found in the writings of Virgil, the great Roman poet. His agricultural directives included the following instructions:

"Finally, put your rooted grape cuttings firmly down in the ground, be sure to add sufficient earth and sprinkle rich manure over it. Also dig in some stones, perhaps pumice, perhaps rounded sea shells; for, between these, water will seep down and the air will gently penetrate and inspire growth in your plants. I have even found some who loaded heavy fieldstones on top or considerable weights of broken pots; this is protection against cloudbursts and against the hot summer heat which cracks the thirsty fields."

Columella, who was the best prose writer on agriculture in Roman times, related that stones were placed even between the roots. Similar practices prevailed in olive groves. The olives like lime stones particularly. The olive was planted in trenches four feet deep into which it was the custom to deposit stones for encouraging moisture around the roots.

Stone mulching has been used to great advantage on the Organic Gardening Experimental Farm. Author

and publisher J. I. Rodale did quite a bit of successful experimenting with stone mulches.

"Somewhere in the 1940's," he wrote some years ago, "I got the idea of growing vegetables in a stone garden, with alternate layers of soil and stone . . . For almost 20 years we have planted vegetables in this garden with excellent results. It seems that something about the stones communicates itself into the plants to make them grow faster and be healthy . . ."

"The one bad feature of this kind of a garden was that the weeds would grow between the stones and could not be cleaned out as with a weeding tool in a conventional garden. They would have to hand-picked. So one day . . . while my wife Anna and I stood looking at a stone section overgrown with weeds, she observed, 'Perhaps if we would put another layer of stones over the existing ones, it would be more difficult for the weeds to poke their way through them.' No sooner said than done."

That experiment turned out to be as successful as the original test of the stone-mulched garden itself. Rodale reported some of the more unusual and unexpected benefits of rock mulching. It is, for example, a good method of plowless farming, that is, farming in which the upper layer of soil isn't disturbed. He reported that plowing can be used, but that it isn't necessary to plow deeply. In the spring, the upper four or five inches of soil is merely stirred about a bit before seeding. This stirring is easy because the earth is soft and moist between the stones. If some organic fertilizer is being used, the shallow plowing keeps it close to the surface where it will be more accessible to oxygen and will decay faster.

"A stone mulch causes the earth under it to be well-aerated, usually more so than exposed soil, strange as it may seem," he wrote. "You can verify this by merely looking at a stone resting above the soil. The rain causes a shallow channel to form in the soil under the outer rim of each rock, permitting air to enter, whereas the baking action of the sun on exposed soil and blowing of wind over it harden the surface into crusts that can be lifted up bodily.

"The conditions under stones are ideal for bacteria, earthworms and other burrowing insects," he continued. "A dampened darkness prevails that is favorable for the working of bacteria and beneficial insects.

"Groves of sickly limes, citrus trees and other fruits have been revived when rocks were piled high around the trunks to help keep the bark from scorching and the roots from becoming dry and hot. The vigor and growth of both ornamental and fruit orchard trees is increased by rock mulching when teamed with sound organic care. Consistently better yields and quality of plums, peaches, apples and cherries have been reported by many gardeners and farmers using the rock-mulch system. Young fruit trees have been especially benefited in getting a strong start," he wrote.

Margaret L. Wood is a stone mulcher whose experience with the system tested it to an extreme. She had read about the system and its results at the Organic Gardening Experimental Farm and elsewhere. She viewed it as something of a last resort. Mrs. Wood and her family live in Arizona's Mojave Desert. Since every drop of water used by the Woods, their dogs and cats, horse, cattle and sheep and their plants must be trucked

in, the moisture conserving qualities of a good rock mulch were on the line.

“We took possession of our new home in a July following an unusually wet period in May and June,” Mrs. Wood explained. “The trees and shrubs were green and lovely. Then the weather returned to normal. In Arizona that means *hot* and *dry*. The ground baked until a hoe just bounced off it, and you couldn’t dig a hole without first soaking it for an hour or so. Hauling water became a daily, not weekly chore, but even so the shrubs and shade trees drooped and shed most of their leaves. The tips of branches on the fruit trees died back. The evergreens looked limp and actually seemed to shrink. Everything wilted, including us. The situation looked hopeless,” she said.

Then she remembered Rodale’s stone mulch. “If there was any one thing we had lots of on our desert land it was rocks—big rocks, little rocks, granite, quartz, turquoise, sandstone, limestone—we had them all. From then on, every morning and evening, and even some afternoons, found the children and me out hauling rocks in a wheelbarrow and garden cart. Judging by the expressions on their faces as they drove by, the neighbors must have been pretty certain that the sun had gone to our heads.

“The first thing we tackled was the shrubs and bedding plants against the west side of the house. Afternoons they were broiling and mornings, when it was shady, the seven kittens were literally tearing them to bits. We gave the whole bed a quick overall cover of fist-sized rocks which the contractor had obligingly left pushed up nearby, soaked the covered bed for a couple

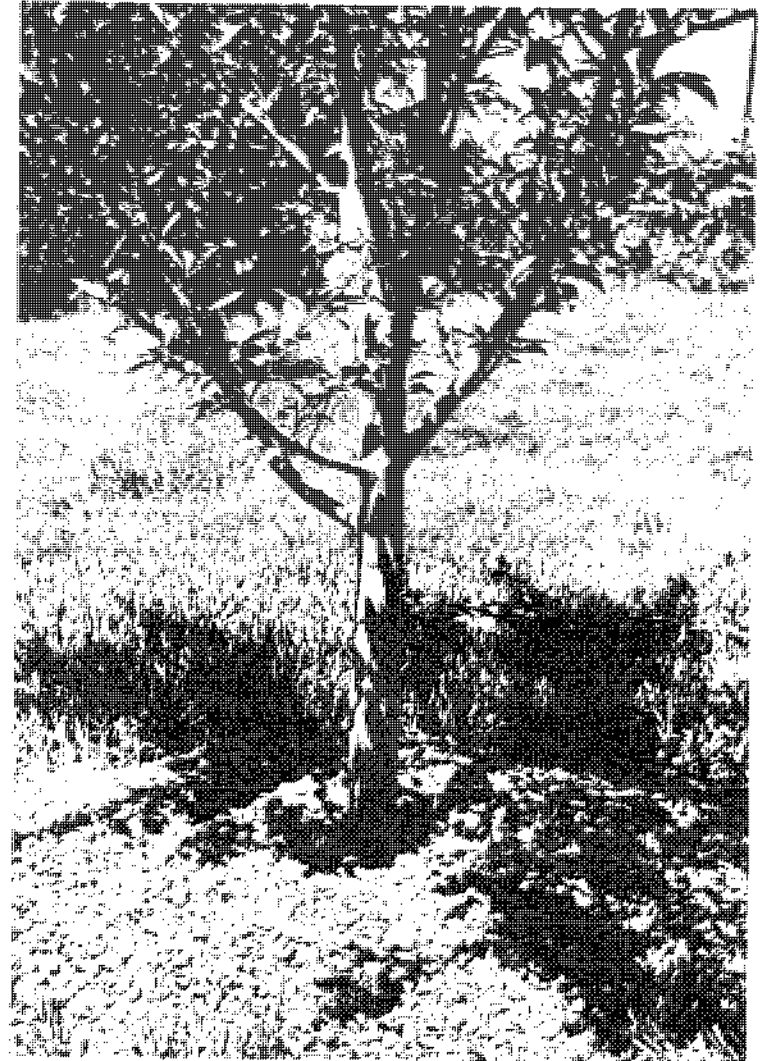

Stones in a rainbow of colors prove mulch can be decorative as well as protective.

of hours with a sprinkler hose turned upside down, and as simply as that the flowers and bushes stopped dying and actually began to grow. A few even bloomed. Now don't misunderstand me. I didn't say that suddenly we had a lovely flower bed. This was still the desert in July and the soil in the spot was hard and barren, but these plants were now at least holding their own, and they continued to do so if watered lightly with the sprinkler hose once a week," she continued.

"By now it was obvious that the foundation planting in the front (the east side) was losing its battle with the dogs and the heat, so we worked on it next. We were now able to scrape up a few wheelbarrow loads of manure in the corral, so we could do a more thorough rescue job here.

"First we made a manure dike a foot high, a foot across, and 18 inches from the plants the full length of the beds and across the ends. This was then shored up on both sides with the biggest rocks we could manage to get into the wheelbarrow. The top of the dike was covered with smaller rocks to keep it from weathering away.

"When we had finished, the two beds in front had become, in effect, two rock-bottomed reservoirs bounded on two sides by the manure-rock dikes and on the other two by the foundation and the cement steps," she explained. "We filled them with water to a depth of eight to 10 inches and let it soak into the ground, and these bushes grew and flowered and the little pyracantha set a full crop of large, well-colored berries.

"Again, this was no lovely flower bed. These were small shrubs two to three feet apart, and partially hid-

den this first year by the big rocks—but they grew, despite the heat, on only one watering a month from then on.

"Our next project was the rhubarb and shrubs along the north side of the house. They received the same treatment, and the rhubarb continued to send up new growth all summer," Mrs. Wood continued.

"By this time our backs were stronger and our manure pile bigger, and we decided to see what we could do for the trees, grapevines, and rose bushes which were too widely separated for that sort of treatment. Since we had finally run out of readily available rocks, we began by building circular manure dikes two to three feet from the tree trunks, wetting them down with the hose and letting them "bake" in the hot sun. These were then filled to the top with water every 10-14 days and the trees began to grow. Some of the Scotch pines grew more than a foot through August and September, and later the fruit trees began forming blossom buds for spring. The roses appeared blighted or diseased, so they were pruned back almost to the ground after diking, then responded with fresh, healthy new growth and a few perfect blossoms for Christmas.

"Meanwhile, we hauled in rocks whenever we could. As each tree was rocked up, a six to eight inch layer of trash from around the hay stack was placed between the tree trunk and the dike to make it easier to tuck in sprigs of myrtle and sweet alyssum and a few bulbs here and there," she said.

It took muscle, some perseverance and lots of a cheap and locally abundant material—rock—but the Woods finally got their little chunk of the desert blooming like

an oasis. And it wasn't a mirage, either.

Another stone mulcher is Georgia Montfort. She didn't find herself in a do-or-die situation such as the Woods. For her it was a matter of developing a rock garden for show and watching—somewhat amazed—as her plants slowly gravitated to the areas best suited to their health. Those areas happened to be on a 50-foot sandstone terrace located between the rock garden and the lawn.

“First, drifts of my favorite wild red poppy appeared in two or three places, blooming more vigorously and colorfully than they had before. Next, portulaca—normally quite difficult to establish in beds—put in a surprise appearance on the sunniest part of the terrace. Then alyssum cascaded onto the sunny terrace,” she said.

“By now the floral migration was on, and the penstemon, which had been unhappy in a well-tended bed, marched boldly out into the flat sandstone to flourish brilliantly. Evening primrose appeared, growing to fantastic proportions and far excelling anything found in its normal habitat, while another wild specimen—the little blue violet—became a permanent resident, cropping out between the cracks in blue masses.

“Since the development of the first terrace-dwellers far exceeded anything that had been planted in the nearby beds, I soon began to plan and regulate flower growth on the terrace, obtaining added beauty and color with practically no extra effort, and without interfering too much with what was going on. I also began to realize with increasing clarity the numerous advantages offered by the stone-mulched terrace and why my

plants were seeking them out without being particularly invited or encouraged.

“Contrary to my expectations, the terrace newcomers did not wither for lack of moisture, nor was their growth stunted during the hot season. Because the porous sandstone seems to reduce evaporation, I found it necessary to water only when flower growth was dense and tall. Sometimes, when a stone broke or chipped, I lifted it to find the soil moist and pliant, well-aerated and teeming with active angleworms beneath. Capillary root growth became so pronounced that, in many instances, the tiny but vigorous root systems penetrated the stones themselves. Another growth-promoting factor came from the slow disintegration of the rocks which deposited rich minerals in the soil. In addition, most of the wild flowers prefer the slightly acid condition created by the sandstone,” Mrs. Montfort said.

“Although I had long been aware of the many advantages of rock gardening, I now realized that a flat sandstone terrace offers the same benefits but on a much wider scale. Besides moisture storage and weed control, the stones moderate extremes of temperature, keeping the soil below them cool against the heat of the sun. Root growth is steady and vigorous, low foliage is protected against spattering when it rains, and a clean, attractive background is provided for creeping, low-lying blooms.

“It wasn't necessary to plant seeds deliberately on the terrace because other flower combinations occurred quite spontaneously as highly welcome additions. Among these, the delphiniums established themselves in thick profusion—their curled green crowns appear-

ing consistently between the cracks long before my regular beds even thawed.

“Such are the advantages of terrace gardening—however unintentional!—that early germination is now counted upon with confidence. Long before the frost was out of the ground in the garden, my poppies and portulaca put in a startlingly early appearance. Despite the freezing nights, cold winds and even intermittent snows, they continued to develop—hardy wild pioneers who know what’s best for them and where to find it. Anyway, the snow melted quickly on the sunheated terrace before it could do any lasting harm.

“So,” said Mrs. Montfort, “don’t be dismayed if some of your favorite plants insist on wandering through your garden, away from the spots you have prepared so carefully and lovingly for them. They know what they’re doing and what they’re looking for, so don’t fight ’em—encourage them. That’s what I did, and the entire garden benefitted when my wild flowers insisted on moving over to my stone-mulched terrace.”

Ruth Bixler’s trees benefitted when she turned to stone mulching. It was for her—like for the Woods—something of a last hope. After she and her husband acquired a small tract near Allentown, Pennsylvania, and constructed a home, she discovered their proposed garden plot was shale. A period of composting and mulching cured the gardening problems. But her flowers failed and her trees started to follow suit.

“When all my spruce trees died but one,” she said, “I decided to do something about it. My fruit trees had a struggle to get rooted, too. A Chinese walnut tree gave

up and died. I also realized then that the sprinkling system was not the answer.

“Why, I asked myself, does a tree grow high and handsome in the woods under the same sun, with no surplus water, and in my yard refuse to grow? Finally, I made a trip to the woods and the first thing I noticed was the stones under the trees. And then I knew that it was the stones that helped hold the moisture.

“In July of that year we spent our vacation along Lake Erie. The grade going down to the beach was full of round, flat stones. The day we started home, our car trunk was half full of these. That week I laid the last spruce thick with stone. In a month the tree started growing and stayed green all summer in spite of the hot, dry weather and few showers,” she continued. “It never stopped growing and is now a beautiful specimen. The next year I brought more stones home and started putting them around the fruit trees. A Yellow Transparent apple tree grew quickly after the stones were put around, and has been bearing very heavily ever since.”

Without realizing it, Mrs. Bixler may have been doing more for her trees than merely providing a handy reservoir. A. P. Thompson, a Shenandoah Valley orchardist, has been growing apples the organic way for years. Part and parcel of his method is mulching, with a generous number of stones included in the mulch. He cites not only the moisture conserving qualities of the stones as a reason, but others as well.

Thompson uses what he calls the “fortress method” of stone mulching, claiming it has four benefits. It gives the trees greater anchorage in strong winds. Further, it

acts as a heat sink by absorbing a great deal of the sun's heat during the day. On frosty nights, this heat sets off minor convection currents that provide some protection to bud and bloom. The fortress also provides protection for the tree's roots from burrowing mice, which oftentimes damage or kill trees. And finally, the rocks provide calcium and magnesium for the tree as they weather.

The fortress method, one of the most unusual of Thompson's many offbeat orchard management practices, involved erecting a six-inch high wall of half-inch dolomitic rock around the base of each tree. About 500 pounds of stone goes into each five or six foot diameter wall.

Servais, the Wisconsin rock collector, developed a similar technique for nurturing young trees. He explained his mulch, saying, "Last year I placed 100 pounds of rocks around two young pear trees and a blue plum as soon as I planted them, and then gave them a heavy soaking. I didn't want to lose them because of air pockets around their tender young roots—which has happened in the past.

"My trees all came through the summer in good, healthy condition, justifying my theory that the weight of the rocks gradually squeezes the air out of the newly worked, dampened soil," he said.

The experience of John S. MacManes with sick trees offers further evidence in support of J. I. Rodale's conclusion that rock mulches greatly benefit trees. Even the fertile ground of the Finger Lakes region of upstate New York couldn't do much for MacManes' sick peach tree.

"If we were going to save it all," MacManes decided, "we would have to rock-mulch it, we agreed, at the same time giving it plenty of compost, leaf mold and wood ashes in order to sustain its will to live. Otherwise, the tree looked bad on the following counts:

"1) It was too old, well past its prime;

"2) Leaf curl had blighted its foliage almost completely;

"3) It was suffering from gummosis, was ill-shaped and worm infested;

"4) The northwest wind hit it full blast throughout the winter.

" 'Cut it down,' the neighbors said, but we were stubborn. We had noted some timid and sparse new growth and felt that 'where there's life, there's hope.' So we pitched in, and I began my own private battle to save our tree," he continued.

"First I applied a booster dose of finely pulverized limestone right under the tree, and then added a generous top-dressing of good wood ashes. Next, starting at the drip line and working to within a few inches of the trunk, I heaped poultry droppings, leaf mold and compost. And finally, I worked over the entire area, setting a good ground cover of rock mulch to regulate soil temperature and moisture, to encourage extra bacterial growth in the soil, and also to supply the trace minerals which our tree obviously lacked. Then we sat back, eager with expectation, to see the results and reap our reward.

"Nothing happened. The tree didn't die and it didn't seem to be getting any better.

“But the spring and summer of the following year told a much different story, as the magic in stone mulching began to assert itself.

“The season came on extremely dry, which tended to slow up growth everywhere—what our tree needed was rain. But, despite the baking sun and drying winds, new growth took place before our eyes, and we were agreeably surprised and pleased with the richly vibrant bloom at blossom time. A beautiful green again enfolded our tree, leaf curl was reduced drastically, gummosis practically ceased.

“That harvest time we picked bushels of lusciously big peaches—each a handful in its own right—from our once-dying tree,” he concluded.

Michigan planter Walter J. Muilenberg discovered that even the frail Canadian Hemlock tree can survive out of its element with a good rock mulch. In Muilenberg’s area, the tree is never found in pure stands. It’s always mixed in with hardwoods which protect it from wind and sun.

It seems impossible to transplant them and make them grow under ordinary conditions. Muilenberg was clearing land and pulling out stumps when he came upon three hemlocks. He decided to let them grow and cleaned out everything else around them. A lot of stones accumulated and by sheer accident they were piled under one of the hemlocks. That is the only one that lived. The other two died in a few years. The peculiar thing is that the one with the stone mulch became a wonderful specimen, far superior to the twisted and scraggly hemlocks usually seen in the forest.

“It is my guess that the third hemlock survived be-

cause of the rock, a weight of several tons, which had been piled around it,” Muilenberg said. “It had grown up in heavy woods, which consequently helped to make it more shallow-rooted, and in heavy shade, which helped to keep the soil cool and moist. Later, when the rest of the trees were removed, rock gave the tree a good grip on the soil and made for a cool, moist root-run, as rock always does. It would seem that the top of the tree will get along in good shape so long as the roots have protection.”

Stone mulches, of course, needn’t be accidental, haphazard or last resorts. They can be tremendous additions to an existing garden or the center of a new one. A stone mulch can be exactly what you want it to be, because you can make the stones, as Robert Rodale once explained.

“My father, J. I. Rodale, has had the idea for many years that mulches don’t have to be dull, and they don’t have to be just organic either. Many a day in my youth was spent hauling rocks from quarry and fence row to make stone mulches for around trees, and even for lining the rows in a special vegetable garden. A stone mulch has certain advantages over any other kind. It lasts, for one thing. As the stone ‘decays’, it also adds minerals to the soil. But stone mulches have disadvantages, too. Their biggest problem is the odd sizes of stones, which make them difficult to fit together into a neat, flat surface. It can be done by an expert mason—but a person who isn’t a mason might have trouble making a geometric pattern out of rock.

“The idea of making different-shaped concrete segments that would fit together into unusual stone mul-

ches came to my father several years ago. He had some concrete molds made in square and rectangular shapes, and cast enough of the blocks to make several different beds. One of his concrete mulch variations is now an herb garden. The most-noticed one, though, is the round 'target' garden along the highway in front of my house.

"These concrete mulch gardens have turned out to be one of those unusual garden features which attract attention year after year. They are something you can make yourself, if you are handy with tools and can make the molds. The concrete work is simplicity itself, because no fine finishing is required. You can even make them in different colors by adding dye to the mix," he said.

The most commonly used shape in the Rodale garden is a triangle. In the mixture for the cement slabs are included some crushed rock and some mineral fertilizer powders like phosphate rock, granite dust and dolomite. These minerals slowly leach out into the soil. The recipe for the cement includes one part cement, one and a half part sand, one and a half part stone, a half part dolomite and a half part phosphate rock.

"We also add finely powdered coal dust to the mixture, not only for its minerals, especially sulphur, but also to darken the triangles, in order to make them retain heat better," J. I. explained.

"There are three different sizes of triangles, so that they can be made to fit together in a circular pattern. The sizes are 12 by 12 by 12 inches, 10 by 10 by 12 inches and 10 by 10 by 14 inches. The larger one is made with a pool-table billiard ball rack triangle. This was the

idea of John Keck, our farmer-technician, who went at this project with great enthusiasm and who practically worked the whole thing out by himself. He made the slabs a few at a time, in his spare time, but it's surprising how little by little things add up.

"One of the advantages of this method is that once a year the slabs can easily be taken up and the soil given a complete working over," J.I. continued. "The most interesting thing about it is its beauty, and the fact that a person with some imagination can vary the designs. Almost any shape of metal form for the molds can be made by a welder or blacksmith."

"A lot of people get in a mulch rut," said the younger Rodale. "Perhaps they have one kind of mulch material available to them, and use it year after year. While that is the easy way, it can't be counted on to give the maximum in beauty to a garden. We should think more that the mulch around trees, shrubs and flowers is a dynamic feature of the garden, and not just something to hold down weeds, preserve moisture and feed the soil. Of course, those are the big reasons for mulching, but we shouldn't forget beauty as well.

"Mulches of small stones and gravel are becoming more popular lately, spurred perhaps by the Japanese school of landscape architecture which features such things as raked areas of sand and boulders artistically scattered throughout a garden," he said. "One of the most popular of these mulches is river gravel, the small stones collected from stream beds, where they have been washed and rolled by the waters for perhaps hundreds of years. Those stones all have rounded edges and are of a variety of colors. Best application for them is

along a building or near areas of concrete such as walks or patios. They provide a welcome visual relief from flat, uninteresting pavement or big walls.”

A stone mulch is, as Servais the rock collector said, adding “a bit of glamour” to your plants, “while helping them to grow better.”

Chapter Six

WHY WE REJECT ONE of the MOST COMMON MULCHES

Extensive experimentation has shown marked increases in vegetable yields resulting from the use of black, polyethylene plastic mulches. Many gardeners have enthusiastically adopted the use of such mulches. It seems like such a good idea. But it's not.

Most people overlook one important fact. They see that plastic mulches are cheap, effectively control weeds and efficiently conserve moisture. And they fail to see that a plastic mulch contributes nothing to the fertility of the soil. It's only shelter, not food, too. An organic mulch is both.

When you stop to think about it, what could be more unnatural than a product like plastic mulch? Plastics are non-organic substances which add nothing to the soil except trouble if you try to grow crops where they

have been buried. There is, in fact, some reason to believe that the formaldehyde given off in small amounts by some plastics can actually kill soil bacteria and thus interfere with plant growth.

The durability of plastic, at first counted as its prime virtue, has become instead a monumental pollution problem, for unless it is burned, plastic is virtually indestructible. Since burning certain kinds of plastic, particularly polyvinyl chloride, gives off toxic fumes such as hydrochloric acid—labeled by the New York City Commissioner of Air Resources as a “serious environmental hazard”—burning is not a safe disposal method. Even the DuPont Company, famed for creating “Better Living Through Chemistry,” and a leading plastics manufacturer, has found no more satisfactory method of disposing of plastics than to bury them. Should we continue at our present pace, there will hardly be a square inch of land on the continent in which some form of plastic doesn’t lurk six inches beneath the surface.

Studies into methods of degrading plastics have been conducted in the United States, Sweden, Great Britain and the Netherlands. No answer has been found, and many authorities are beginning to recognize that we are coming face to face with a very serious problem.

Ironically, organic gardeners, dedicated to preserving a healthful and attractive environment, are nevertheless unwittingly contributing their share to the nation’s reputation as a plastic society. Without giving it a thought, most of us end up with at least half a dozen disposable but indestructible plastic packages every

time we go to the supermarket. But more than that, some actually use plastics deliberately in their gardening!

Plastics are convenient, quick and durable. That they are a labor-saving mulch is plausible. After all, they don’t have to be replaced periodically as do those organic mulches which keep disappearing into the soil. But the fact that the non-organic plastic mulch doesn’t disappear—ever—is its prime drawback.

It should be noted that another increasingly popular non-organic mulch—if handled properly—doesn’t have this drawback. That mulch is aluminum foil, which can be recycled. Aluminum foil mulch has many of the advantages of plastic mulch, plus some it doesn’t have—such as an insect-repelling, photosynthesis-boosting reflectivity. But, like plastic, it won’t ever boost the fertility or tone up the condition of your soil. If you must use a non-organic mulch, use aluminum foil. And when you’re through with it, recycle it.

But before you do, read what Ruth Stout, that mulching pioneer, has to say about plastic mulches. Most of what she says will apply to aluminum foil mulches as well. Despite the plausibility of claims that plastic mulches cut the labor in mulch gardening, Miss Stout plans to stick with her tried and true methods.

“A month or so after my first book about year-round mulch was published in 1955, I got a letter from a business firm in New Jersey, asking permission to send me a gift of black plastic, which was, of course, to be used for mulching my garden,” she said. “My reply was, in effect, as follows: ‘Thank you very much for your offer, and since I never refuse a present, I will

accept the plastic. However, I think it only fair to add that I may never use it. And if I do (just to try it out), I will almost certainly write about it and speak of it, not for it, but against it, comparing it unfavorably with the kind of mulch I use.'

"Needless to say, that New Jersey firm didn't send me any plastic.

"In writing about gardening, and giving talks on the subject, I try very hard to stick to my own experiences. However, all one needs, in my opinion, in order to be able to figure out what's wrong with plastic mulching is a little imagination and a little common sense.

"Let's say that a person who was rather short-changed when imagination was being passed around decides to use a plastic mulch instead of hay on a garden the size of mine (45 x 50); he figures that, for one thing, the plastic will cost less, since it lasts forever. Well, here's news for him. Plastic won't be cheaper because, since it doesn't supply the nourishment needed to keep a garden producing, he will also have to buy fertilizer each year to make sure that his plants get what a mulch of hay gives them; the hay rots and provides the soil with all the required nutrients" she continued.

"And of course all other vegetable and organic matter that rots—straw, leaves, corncobs, wood chips, kitchen garbage—will nourish your soil; cornstalks and the tomato, bean, asparagus plants should all be left on your plot, in order to do their share of providing nutrients.

"I have heard it said that there is less to do in a garden if you use a plastic mulch rather than an organic one, and I wonder how growers operate when using the

former. Since it seems to be less work, I suppose they just spread the plastic on their plot in strips, then ignore the whole thing.

"For the moment I am going to pretend that for some odd reason I've decided to use plastic for mulch on my 45-by-50 plot. Let's say that I put down strips of plastic, leaving a small space between, and I drop the seeds in the exposed area. But first I must do something about enriching the soil, and maybe buy some organic fertilizer. But what? Manure? And do I make a compost pile? I'll certainly skip that, for it's quite a lot of work to get the materials together. Then, when the pile has become rich soil, I'd have to load a wheelbarrow with it and distribute it all around. Well, that whole routine is 'out of bounds' as far as I'm concerned," she continued.

"Now I go ahead and put in the seeds in my plastic-mulched garden and the plants show up and so do the weeds—in the spaces between the plants right in the rows which have to be made rather far apart. That is, the corn does, and potatoes, and squash, and tomatoes and, in fact, almost all the plantings. The question of weeds isn't a problem, of course, if you use an organic mulch. The hay, or whatever you use, is lying there in the row, as well as alongside it, and will keep just about all weeds from getting anywhere.

"At last, the first summer of plastic-mulching my plot is over, and finally another spring shows up—time to plant early crops. But when I go out to the garden, I'm nonplussed; I can't get rid of the idea that the plastic which was supposed to save me a lot of work, should certainly be moved to other areas. Why do I feel that? Well, I keep thinking of that good earth under the

plastic, and it seems absurd not to make any use of it. And the small open space, which I used for planting last season, doesn't seem to be adequate now, so the only thing to do is to move those black strips to other spots, and that would certainly be a tedious job. (I will admit that maybe I am being unreasonable, and that it may be quite all right to cover up a lot of your soil with plastic and never produce anything in those areas, but the whole idea sounds goofy to me.)

"However, if a person is wise enough to use organic matter for mulch, all he has to do in early spring if he wants to plant some lettuce and parsley in whatever spot he may choose, is just pull the hay aside (if he hasn't already done that in the fall) and put in the seeds.

"About asparagus, I just can't believe that anyone at all familiar with how this vegetable operates would use plastic in that bed. Asparagus likes to wander around and come up wherever it pleases. And it likes a rich soil—just as weeds do, unfortunately. But an organic mulch will, as I said, dispose almost entirely of the latter. As you may know, asparagus stalks can, and will, push up through a hay mulch, which they could of course never be able to do if your plot is mulched with plastic.

"You also may know that air, rain, dew and sun reach the soil right through organic mulch. A plastic covering keeps all of these beneficial things from reaching the earth, although it's true that plastic will keep the ground damper than it would be if the soil stayed bare. But hay and leaves not only keep the earth moist, but also let dew and rain enter the soil, and help to hold the moisture in.

"Since I started to use organic mulch, we have had several seasons with long droughts—one summer no rain at all for three consecutive months. Although I can't water any plants in dry weather because my well is very shallow, yet I didn't lose one vegetable through those dry spells. Squash needs lots of water but despite that season with a three-months drought, I had an over-supply—one of the Blue Hubbards weighed 51 pounds," she said.

"When one of my neighbors (a confirmed organic gardener and mulcher) dropped in, I spoke of this plastic. Although I knew she didn't use it, I asked her if she could think of anything at all in favor of it as a mulch.

"My neighbor said that plastic is supposed to warm up the soil more quickly than hay. When I asked why she thought this, she hesitated for a moment then said that someone must have told her it did. 'Well, even if it does, what's so important about that?' I asked. 'You can, for instance, plant lettuce on frozen ground, and it doesn't seem to mind. After all, it's only early plantings that need warmed-up soil; the sun does the job for later crops. So for parsley, lettuce, peas, all you need do is take the hay off those areas in the fall and, in my experience, the ground is then never too cold to interfere with desired results.'

"She had one more suggestion which she thought might be favorable, and that was that since squash plants take up so much room in a garden, black plastic might make it easier to keep down weeds between the hills. However, I plant squash between my two rows of asparagus, and I've already said why I wouldn't use

plastic for the latter, even if I went a little haywire and wanted to do so," she concluded.

If you are concerned about producing those abundant, nutritional crops next year and next decade and next generation, you, like Ruth Stout, won't mulch with plastic. You'll find it cheaper to spend once—if at all—for a good organic mulch which will rot and fertilize your soil in time. You'll find you can do as well or better without plastic, the indestructible, non-nutritional mulch.

... AN ALTERNATIVE TO PLASTIC MULCH

So now the whole mulch idea has been ruined for you. Plastic mulch was all you were looking for in a mulch. Using it, you didn't have to scour the world for lumberyards with excess sawdust or farmers with spoiled hay or harrass your neighbors for leaves and grass clippings—they were beginning to think you daft, right?—or even continually spend money for more, since that organic stuff *did* keep disappearing. You could be completely respectable and order some from your local plastic mulch store, put it down in the garden and forget it. Well, maybe those shiny black indestructible strips in your garden lacked the visual appeal of a variety of rocks mulching away, or the warm richness of a layer of cocoa bean shells, some other natural mulch. But it could be acquired without people giving you funny looks and it didn't mess up the inside of the car and . . .

But it's ruined, right? Okay, try this. Use newspapers.

After you've read all the news, go out and throw it on the ground. It's one of the most effective ground coverings around. And it's organic. Even the ink provides trace elements vital to healthy plant life. Chances are, you have stacks of newspapers in your basement, just sitting there gathering dust and creating a fire hazard when they could be in the garden decomposing busily and creating good, rich soil.

Environmentally-minded mulchers have found that mulching with newspapers not only provides a great way to safely recycle as much as 50 per cent of our refuse but also to control weeds, improve soil texture and regulate moisture and temperature in the garden. They have been using newspapers for years to create a humus which is readily incorporated into the soil.

Here are some of the ways they've been doing it.

1) Laying them out in varying thicknesses of unfolded sheets, leaving space for rows or planting in holes punched through the paper;

2) Shredding or tearing the sheets into a fine aggregate which can be easily handled in beds and borders, also around trees and shrubs;

3) Using them as a liner under materials to conserve moisture;

4) Burying them with the family garbage in selected areas after tearing them into very small fragments;

5) Converting them into a highly mobile, flowing slurry by combining them with water in a pulping machine.

Mrs. Sherrelle Ault slides unfolded newspapers under "poultry netting" one foot wide. Number 9 wire or

coat-hanger wire cut about eight inches long, is bent into a "U" which goes on each side about three feet apart, and is pushed into the soil.



Newspapers eight layers thick keep trees and shrubs free from weeds.

"To renew the newspapers each year—and you must as they decompose underneath," the Missourian said, "take out the wire U's on one side, slide fresh newspapers under the wire, and replace the U's. I don't try to do the whole garden at once, but just go along—150 feet of wire costs \$5 here. But I don't need to buy it again because it lasts and lasts.

"The appearance is fine," she said. She also explained how she used newspaper and waste pulp to tame her stubborn hardpan garden soil.

"I have gumbo cement for a garden, and lots of luck to anyone who tries to plow on that site—no telling what else was buried there by a bulldozer. This was the only way to go ahead. Not being able to dig down deeper than one inch, and being on low ground which stands in water, the only thing to do was to build on top.

"This is also a great way to dispose of all your paper trash. Fold everything to about the size of a folded newspaper. This goes for cereal boxes and containers of all sizes (tear them open), wrappings—everything—because the wire holds them down and keeps them from blowing all over the landscape. Paper egg cartons—practically wood pulp—should be torn up and worked into the soil."

"I hope that mulching your garden with newspapers will be a continuing and growing movement," said Mrs. Margaret Hunter of Lake Worth, Florida. "I have been doing it for years, with more than one good result, the re-use of newspapers," she continued. She asserted that, "newspapers control some of the garden pests.

"I tried it with very good results on some pests including white fly, some scales and aphids. At first I just

put down three-or-four-inch-thick piles of folded papers, held down with just a piece of wood or rock around shrubs. With time, I began tearing the paper into strips, and covering the ground with them which permitted more uniform watering from the hose or the rain. I also found that the torn strips stayed put better and didn't blow around.

"As horticulture chairman of the garden club, I talked about the advantages of paper mulch to the members. After they came and saw my torn paper borders, many of them followed my example and I later received reports that they had obtained good results from using newspaper as a mulch."

Newspapers, dampened and torn into 30-inch long strips, will "tangle good when stirred lightly," Mrs. Hunter said. Method of dampening is not important just as long as the paper "flutters down in limp strips and no longer clings together in clumps.

"My garden is quite small," she reported. "I put the paper around the 'up' squash hills and along the newly planted okra row. When the okra was up and large enough to thin, I pulled the paper together with the plants. Considering the poor soil in this place, the okra is doing quite well as are most of the other vegetables and herbs. I am building up a good organic soil and the paper mulch is proving a big help."

Robert F. DeVoe, Sr., has followed organic gardening methods in eight different homesteads since he got started back in 1923. Today, he lives in Meadowvale, "a small town east of Louisville, Kentucky," where he mulches his vegetable garden and his strawberries with newspapers.

"I spread newspapers three to six thicknesses with

three-inch overlaps on all four sides over my vegetable garden," he said. "I covered this with the mulch pile which consisted of kitchen refuse, wood bark, weeds, grass clippings, flower and bush trimmings and cottonseed meal. I wet this down for several days before planting.

"I started with a few bush beans, and corn in peat pots, and placed them in rows. But at the east end I dug holes in the mulch and newspaper and placed the plants and seeds in the soil. Along the fence, I set out strawberry plants in newspapers with grass clippings on top and brick edging to make everything look neat and keep the papers from blowing."

Still another newspaper mulcher is Paul Graybill, who gathers grass cuttings, wood chips, fallen leaves, hay, weeds and vegetable refuse—garbage included—and then returns them to the soil together with a paper mulch.

"Without all the nutrients that organic materials add to the soil, my fruit and vegetables would have very little taste and practically no food value," said the Connecticut homesteader.

The surface mulching Graybill worked out overcomes many problems he's encountered in other methods. When plants reach a height of two or three inches and the ground is thoroughly warmed, he scatters fine organic material such as heap-prepared compost, grass clippings, shredded leaves or fine hay between the rows.

Next, he folds newspapers about four papers thick, places them in the rows and between or against the plants on each side, then scatters an inch or so of grass clippings, hay or other organic material on top to hold them in place. This type of mulch lasts through the

season—without further work. Additional fine material may be added during the growing period. Very few weeds come up, Graybill said, except a few now and then directly in the plant row, which can be easily pulled because the soil stays so moist and friable. Another advantage: the fruit and leaves of plants are kept clean, and the compost below the papers disintegrates fast. The paper itself decomposes by fall, ahead of preparations for the cover crop seeding.

When setting out young plants like tomatoes and cabbage, Graybill tears a slot in the paper, making it fit snugly around the stem, then covers the entire area about the plant before adding compost over the paper. He says he likes the paper-mulched method much better than plastic sheets, since it allows free moisture passage during rains and also allows some “breathing”, where plastic—unless perforated—allows no passage of water or air.

The paper-mulch plan is effective in the strawberry patch, Graybill said. Runners can be controlled by placing folded papers of 10 or more thicknesses between the rows in spring and covering this with hay. This leaves exposed a bed of strawberries about eight inches to a foot wide in the row itself. And it kills the runners which are covered, holds moisture, and keeps the strawberries clean during the bearing season. He thins these narrow beds by pulling out plants after picking season.

Newspaper mulching works two-fold wonders. It is a good organic mulch in the garden. It relieves the community of a portion of its increasingly heavy burden of solid waste. So send that plastic back to its maker and mulch instead with newspapers.

Chapter Seven

THERE'S METHOD in THIS MULCHING

Hopefully, you've been convinced. And you've run out and gathered up all the mulching materials you could lay your hands on. Now you're standing beside the garden, hay in hand, with a slightly quizzical expression. There're a couple of questions.

“When do I mulch? How much do I use? How often should I mulch?” you're asking. “What about fertilizers? Don't I need fertilizers at all? Are you sure this is as easy as it sounds? I'm going to goof it up, right? Because there's something you forgot to tell me, right?”

Just relax. Mulching is as easy as it sounds. You won't goof it up as long as you are careful and follow a few guidelines. We won't give you the steps of the perfect way to mulch your garden, because such a way doesn't exist. We will point out mulching guidelines and a few of the most common pitfalls. A good organic

gardener, of course, always likes to experiment a bit and develop a specially-adapted method. Thus the variations on when and how to mulch are as numerous as the materials you can use. We'll give you the maps. You'll have to select your own route.

The answer that Ruth Stout always gives to the first question—when should the mulching begin?—is “NOW, whatever the date may be.” That's as good an answer as you can expect. There are, basically, three kinds of mulching—summer, winter and continuous. Miss Stout is of the continuous school of mulching. Other experienced mulchers find fault with a continuous covering and opt for covering their garden soil only a part of the year.

The chief reason for a mulch in winter is to prevent damage to plants from alternate freezing and thawing which causes soil to heave and expose and break roots. Winter mulches, too, protect the more tender plants not perfectly suited to rougher climates. And they protect plants against rapid changes of temperature. In many sections the temperature often ranges from 15 to 20 degrees in 24 hours. Under a mulch the temperature remains more constant.

The mulch should be applied *after* the first hard frost to prevent alternate thaws and freezes from heaving soil, roots or bulbs. Its purpose once winter sets in is to hold the lower temperature *in* the soil, avoiding thaw and subsequent refreezing which shifts the earth and plants, often exposing enough roots to cause winter-killing. To protect young shrubs, and particularly roses, mound several inches of earth around them early in autumn, then mulch after the first freeze with several

more inches of leaves, straw, yard trimmings, or other mulch materials.

The winter carpet of organic matter also helps condition the whole garden area for the next spring.

A summer mulch, applied as soon as plants are established, allows the temperature under it to rise and fall gradually, to remain uniform and about 10 to 15 degrees cooler than that of unmulched areas close by during normal air temperatures.

The more even, cooler temperature under a mulch helps to maintain a better balance between the plant's loss of water (transpiration) and its absorption of water. It does this even during hot, dry days when transpiration exceeds absorption and causes unmulched plants to wilt. A mulch acts as a reservoir. It conserves water by providing a greater area for absorption and an uneven textured surface which prevents water from running off.

After you've planted most of your vegetables your primary concern will be how to protect these plants from the coming summer's hot, dry weather. What should you do? Mulch.

The third kind of mulch, the continuous mulch, serves the dual purpose of both the summer and winter mulch. It protects whatever plants are in the ground and steadily works to condition the soil. A mulch used the year around serves to control weeds, conserve moisture and provide plants with protection against the extremes of weather. If it is one of the coarse materials with rough, irritating surfaces, it will discourage slugs and snails from crawling over plants and damaging them.

A continuous mulch around thick-stemmed perenni-

als, shrubs, trees, evergreens should be of a coarse, heavy material not subject to rapid decay. Straw, hay or cotton bolls may not appeal to you for this purpose because they break down fast and must be replenished regularly.

Woody materials and coarsely ground cobs are ideal. They last from three to five years, when applied to a depth of three to four inches, and relieve the gardener of the chore of cultivation and worries concerning drought and heaving of soil. The only maintenance such mulches need is a nitrogenous fertilizer in spring and midsummer and a raking, when necessary, to open them up to air and water.

Most of the hard-core mulchers—like those whose experiences with mulching have been related—use a continuous mulch. But they generally have some reservations about the continuousness of the cover.

There *can* be too much of a good thing. There can be advantages to pulling back the mulch on certain occasions to allow the ground to warm. And while a year-round mulch does the job on sandy soil, it can defeat the purpose on heavy clay.

Most gardeners agree that mulch timing is important to produce bumper crops and have learned by their own mistakes or experiences to abide by a few general rules.

Seedlings planted in very moist soil should not be mulched immediately. The addition of any organic matter which keeps the soil at a high humidity encourages damping-off of young plants. Damping-off is a disease caused by a fungus inhabiting moist, poorly ventilated soil, and can be 90 per cent fatal. Allow seedlings to become established then, before mulching.

It is wise, too, to consider the danger of crown-rot in perennials. This disease is also caused by a fungus. If there have been especially heavy rains, postpone mulching until the soil is no longer water-logged. Do not allow mulches composed of peat moss, manure, compost, or ground corn cobs to touch the base of these plants. Leave a circle several inches in diameter. The idea here is to permit the soil to remain dry and open to the air around the immediate area of the plant.

Do not mulch a wet, low-lying soil, or at most, use only a dry, light type of material, such as salt hay or buckwheat hulls. Leaves are definitely to be avoided as they may mat down and add to the sogginess.

The heavy mulching method described by Ruth Stout stands a better chance of success if the soil contains some humus (well-decayed organic matter) and is fairly high in nitrogen content.

Where the soil is poor and mostly clay in composition, it is well to test the soil and apply the needed elements, as nitrogen, phosphate and potash, according to test results. Then spread the mulch in thin layers without packing, so as to permit air and moisture to start breaking down the raw materials. When the first layer of mulch shows signs of decay, sprinkle some cottonseed meal, blood meal or other nitrogen-rich material and apply another thin layer of mulch. By this method, any danger of the heavy mulch taking too much nitrogen from the soil is avoided.

Some vegetables, like tomatoes and corn, need a thoroughly warmed soil to encourage ideal growth. A mulch applied too early in the spring, before ground temperatures have had a chance to climb a little in

frost-zone areas, may slow up such crops. Once plants are well started, though, and the weather levels off, mulch is definitely in order to conserve needed water, stimulate topsoil microorganisms and generally condition the soil.

Author-gardener John Krill pinpointed the importance of logical mulch timing for tomatoes, for example. His experiments—and the experiences of others—show that early ripening of tomatoes cannot be expected if the spring-thawing ground is cloaked too soon.

“Mulch can be a hindrance instead of a benefit under certain conditions. The deeper the mulch, the greater the drawback,” he said. “I’m a mulch addict for more years than I care to name. If I named how many people would say ‘He’s too old to know better’. Yet I will venture that many mulch enthusiasts have undergone the same experiences I have.

“With the coming of the true spring weather, I’d be in the garden planting tomatoes. The plants were set properly and lovingly in their holes. Then I’d carefully mulch them with any suitable substance available,” he said. “The plants never failed to respond and grow sturdily. Their color was a green to delight the eye of the most critical gardener. As the mulch would compact itself, I would busily add more. There wasn’t a weed to be found because the mulch prevented them from coming up.

“Ah! That part of growing tomatoes was simply unbeatable. But guess who had the first *ripe* tomatoes? None other than the people across the street. They didn’t mulch because they had not yet learned of its tremendous value. They weren’t the only ones. Friends

living miles away and scattered in every direction also had ripe tomatoes sooner than I.

“What hurt me the worst was that I had given tomato plants to them from my hotbeds. Why did their tomatoes ripen ahead of mine since they were of the same identical stock? Sure, I couldn’t help noting that their unmulched plants did not produce as much. Nor did they last until frost finally destroyed them, as was the case with my own mulched plants. Hot and dry weather withered and destroyed their plants long before a frost came, while mine were just coming into heavy production of ripe fruit.

“There had to be a connection between mulched and non-mulched plants. A little serious thinking prompted me to conduct a simple, but extremely illuminating experiment. When spring once more arrived, I had my experiment ready to try. I set out three rows of tomatoes. All the plants came from the same hot-bed. The first row I covered with mulch as I had always done. I left the second row bare. No mulch was applied. And during the growing season I kept this row well cultivated. I did not water these unmulched plants because I had never watered those I did mulch. The only thing I did was keep the soil loose and weed-free. It turned out that it was a season of ample rains and watering would have been totally unnecessary. The natural moisture was a definite help in the experiment.

“The third row was also left unmulched—up to a point. As soon as the tomato blossoms appeared, I gave up clean cultivation of this row and covered it with a straw mulch. The other row which I had left clean and without mulch also showed a good set of blossom. But

the mulched row was just showing signs of developing buds. It would take 10 to 15 days to produce the blossoms that were already in bloom on the two unmulched rows.

“The mystery was clearing up. Sure enough, the unmulched row produced the first ripe fruit. Almost neck-and-neck with it ripened the fruit in the row I had mulched after flowers had appeared. The fruit was heavier, juicier and far better shaped than in the row which had been left unmulched. The mulched row? It was the same old story. The plants were beautifully

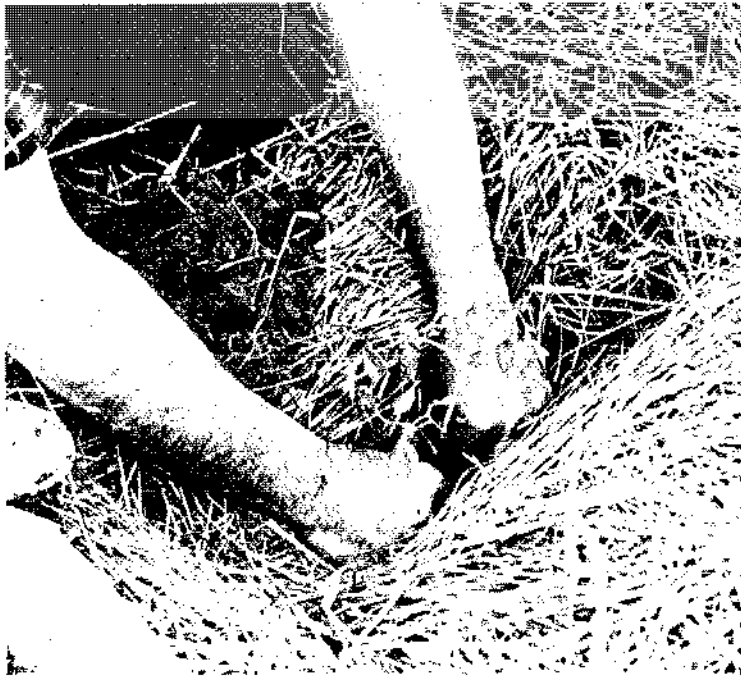

Mulching of tomato plants too early in the season can slow ripening.

green and just loaded with fine-shaped green tomatoes. There wasn't a single ripe tomato among them. It would be two weeks or more before there would be any ripe ones," he said.

“But I had the key to the whole thing. By mulching the tomatoes when I had set them out in the spring, I had slowed down their growth. It takes a lot of heat to warm the soil in the spring to where it will stay warm. The mulch I had applied so soon had simply insulated the soil against absorbing warmth from the sun and air. Tomatoes like plenty of warmth. With the mulch keeping the soil from warming thoroughly, the plants were late in setting their blossoms. Consequently the fruit developed and ripened tardily. That this was so was easily proved. I laid my hand on the bare ground. It felt warm. I thrust my hand under the mulch. The sensation was one of soft coolness, something that the plants would tolerate, but which would not accelerate rapid development.

“How about the row I had mulched after the blossoms appeared? It was a dandy. By the time the flowers had developed, the soil was thoroughly warmed by the advancing heat of summer. The thin mulch now acted to prevent the warmth from leaving if sudden cool days and nights arrived. With heat under the mulch and more heat beaming on top of the mulch, these plants set heavy and well-shaped fruit that ripened practically as soon as that of the unmulched row,” he said.

“About the middle of August the unmulched row began to shrivel and dry from a prolonged spell of heat and drought. The plants soon died. But the remaining two rows with their mulch coverings seemed to wax

even more vigorously, with the row that had been mulched from the very start now coming into full ripening. Both of these rows produced good tomatoes until frost.

"I have learned this lesson: that if mulch is applied before the earth is thoroughly warmed, it will delay the ripening of tomatoes. I apply mulch now only when flowers are profuse, or even wait until the fruit sets before mulching the plants. Then the mulch seals the heat in instead of sealing it out. Thus it pays to know when to mulch.

"For late-ripening tomatoes I mulch my plants heavily when I set them out. For the earliest possible I set out enough to get ripe fruit in unmulched soil until the juicier and better-flavored tomatoes are ripened in the mulched rows. By the wise use of mulch you can prevent tomatoes ripening all at one time.

Bart Burdick confirmed Krill's conclusion.

"My garden was located approximately four miles south of Cornucopia, Wisconsin, which is Wisconsin's northernmost village," he said. "Temperatures drop to 20 to 30 degrees below zero—and occasionally to 40 below in midwinter. In spring the ground is slow to warm up.

"I set out my tomato plants in peat pots. My brother-in-law set out his plants a week later, minus peat pots. I mulched mine; he didn't. His tomatoes ripened seven to 10 days before mine. His ran out faster due to frost. Mine kept ripening for another week," Burdick explained.

"My conclusion as to the difference in time of

maturity: the same as John Krill. I should have left the mulch off *until* the soil had warmed sufficiently, then applied my mulch" he said.

In North Carolina Vernon Ward plowed and harrowed, then mulched the ground with about six to eight inches of wheat straw. Then, using Rutgers plants, he set his tomato plants through the mulch at a distance of four feet apart each way. To set the plants he pulled the mulch apart and set the roots in the prepared ground, then pushed the mulch back together around the stems. This was the end of his work. He did nothing else the entire season but pick tomatoes. Dark green vines soon completely covered and obliterated the mulch. No weeds grew. There was an immense set of fine tomatoes which remained large, with hardly any culls throughout the growing season, and the vines were still full of tomatoes at frost.

Ruth Stout mulches continuously and heavily. Unlike some gardeners, she doesn't differentiate between summer and winter mulches. She doesn't plow under the winter covering in spring, although many gardeners do this successfully. She doesn't plow at all. She is a strong believer in the continuous mulch, but she doesn't quarrel with the likes of John Krill and even admits to pulling back the mulch from ground slated to receive certain plants—like tomatoes—in spring. She has advice on the best ways to use mulches around your plants at spring planting time.

For spinach, lettuce and peas you should place six to eight inches of mulch. Shade the lettuce if you can. For beets, carrots, parsnips and kohlrabi: first thin the

plants; then water thoroughly and put mulch all around them at once, six inches deep between rows. If the mulch is wet, so much the better. For bush beans: if already planted, thin, water and mulch. If you haven't planted them already, make a drill four inches deep; plant the beans sparsely; cover with two inches of soil; water; cover with a board or cardboard and mulch. Remove the board as soon as beans sprout. For corn: if planted already, thin to two plants in a hill instead of customary three. Water and put down six inches of mulch. (If you're running out of mulch, use as many layers of wet cardboard as you can collect. The cardboard is only an emergency measure; it is not as satisfactory as hay or leaves, because the latter provide more valuable nutrients to the soil as they decompose.) Each time you plant corn soak the seed overnight, make four-inch drills and cover the seed with two inches of soil. Water thoroughly, put a board over the seed and mulch immediately.

For late cabbage, broccoli, cauliflower, peppers, and tomatoes: if not planted yet, put very deep and four feet apart, mulching heavily. If peppers and tomatoes aren't in, put them very deep and farther apart than customary. If already planted, water and mulch heavily (six to eight inches).

For flowers: "All flower beds should be under a constant mulch, drought or no drought." Miss Stout said that you can easily do this without making them look ugly. Peonies can be mulched with dead leaves and their own tops. Well-rotted hay, mixed with crushed leaves, makes an excellent cover for roses. Put it on six inches deep and then scatter soil on top. It all looks like soil

then, but the mulch is so deep that weeds can't sprout. The same method works well for large annuals, such as zinnias.

For small, low-growing annuals, Miss Stout used a fine mulch. "Since I keep my whole vegetable garden mulched constantly, there is always material there, not quite rotted enough to be rich soil, but rotted enough to look like it. I put this round my small annuals. If you don't have such material, you can use crushed leaves mixed with a little soil and wood ashes. This may sound like quite a job, but you have to do it just once a season."

The catch in mulching—if really there is one—lies in deciding on the amount of mulch to use. Should a good mulch always be the same depth? Must it be measured to slide-rule accuracy to function right? Do any other considerations influence the proper quantity? In other words, how much mulch is enough?

Generally, gardeners mulch crops that are in the garden for most of the summer. How much? During the growing season, the thickness of the mulch should be sufficient to prevent the growth of weeds. A thin layer of finely shredded plant materials is more effective than unshredded loose material. For example, a four to six-inch layer of sawdust will hold down weeds as well as eight or more inches of hay, straw or a similar loose, "open" material. So will one or two inches of buckwheat or cocoa bean hulls, or a two-to-four inch depth of pine needles. Leaves and corn stalks should be shredded or mixed with a light material like straw to prevent packing into a soggy mass. In a mixture, unshredded leaves can be spread eight to 12 inches deep for the winter. To offset the nitrogen shortage in sawdust and

other low-nitrogen materials, add some compost, soybean or cottonseed meal.

Ground corncobs are highly recommended. Light and bulky, they help to “fluff up” the soil, thus preventing crust formation. Peat moss, an old stand-by, can be spread an inch or more in vegetable gardens and flower beds or used as a half-inch top-dressing twice a year on established lawns. Other good materials which can be used in the same manner include cotton gin wastes shredded cotton burrs, oat, rice and cottonseed shells and sphagnum moss.

How much mulch do you need? For her system of year-round mulching, Miss Stout says, you should put down, “more than you would think. You should start with a good eight inches of it. Then I’m asked: ‘How can tiny plants survive between eight-inch walls?’ And the answer to that is: the mulch is trampled on, rained on and packed down by the time you are ready to plant. It doesn’t stay eight inches high.”

Once you’ve put the basic mulch down, it is going to start decomposing and it will need replenishing periodically. How often do you replenish? That’s something you will have to determine by observing the breakdown and compaction of your mulch. According to Miss Stout, the time to add to the cover is “whenever you see a spot that needs it. If weeds begin to peep through, don’t bother to pull them; just toss an armful of hay on them.”

Speaking simply, the amount of mulch to use is the amount that does the best job for you, your soil and your plants. Working out an ideal mulch program takes some experimenting, some trials with various materials

and depths. It’s only common sense to check on the most plentiful free and reasonable sources, to test the effects of different mulches in your climate locale, your own soil type and timing.

Are mistakes ever made in mulching? Of course. But with simple precautions you can avoid them. Before tossing armfuls of hay around, remember to use a partly rotted mulching material. New mulch will sometimes rob the soil of nitrogen. If you have only a small amount of decomposed material, put just a thin layer of it on the ground, then sprinkle some nitrogen-rich fertilizer such as bone meal, manure, cottonseed meal or tankage on the topsoil first. Another important thing is that mulch will be more effective if put on after a good rain—for it is difficult for water to penetrate a thick covering. If the ground is dry to start with, it will stay dry the rest of the summer unless the skies really open up.

“As wonderful as mulching is, it must be done right or the results may be disappointing,” said Lucille Shade. “During my first few years I made many mistakes. For instance, I mulched corn with bright new hay and wondered why it didn’t do well—without realizing that this brought a temporary nitrogen shortage as the hay started to decompose. I mulched other crops with oat straw and got a fine but unwanted crop of green oats between the rows of vegetables. I used timothy hay as a winter mulch for strawberries—and the following spring I had timothy coming up all over the strawberry bed. Nothing is harder to discourage when it’s up close around the plants. I finally gave up and started a new strawberry patch,” explained the Ohioan.

“Over the years I’ve learned some techniques that

make for successful mulching every time.

“First, if it is at all possible, use partly rotted mulching material. New mulch will rob your soil of nitrogen, which explains why my corn did so poorly under a mulch the first time I tried it. If you have only a small amount of partly decomposed material, put just a thin layer of it on the ground, then cover it with a thick layer of new stuff. If you must use all new mulch, then sprinkle some nitrogen-rich fertilizer such as blood meal, manure, cottonseed meal or tankage on the topsoil first. The only place I use new mulch without extra nitrogen is in covering large areas of ground—such as in the melon, cucumber and tomato patches—with rotted mulch up close around the plants.

“To age baled hay or straw in a hurry, soak it thoroughly with water, then give it six to eight weeks to start decaying,” she said.

“A second important thing I’ve learned is that mulch will be much more effective if I wait until we’ve had a good rain, and then put it on—for it is difficult for water to penetrate a thick covering. If the ground is dry to start with, it will stay dry the rest of the summer unless the skies really open up. My spring gardening season is divided into dry and wet days. On wet days I concentrate on mulching, leaving all other chores for dry days.

“I’ve also discovered that simply pulling the mulch apart in the spring and planting my seed doesn’t work on my heavy clay soil. I must open up a space about a foot wide in order to let the sun warm up the soil. I’m especially careful not to hurry mulching of such warm-weather lovers as tomatoes and melons. I start at the outer edges of my melon patch, for instance, and keep

covering the ground until I get within about a foot of the vines. Then—once the weather is good and warm and the melons are off to a good start—I finish the job, mulching in close around the vines. In my climate, I’ve



Best time to mulch is after a shower. Small weeds are smothered out with hay.

found it's best to hold off close-up mulching of tomatoes until they have started to set fruit," she said.

"If your mulch starts sprouting—as my oat straw did—simply turn it over. It takes only a few minutes to walk down a row flipping it upside down.

"I am more careful now in selecting hay for a winter covering on strawberries. The trick is to use hay that was cut early, before the timothy became ripe enough to shed its seed. You can do this by opening up a bale and shaking it. If fine, chaff-like seed falls out, don't use it for this purpose.

"Nothing you can do to your garden will benefit it more than mulching," Mrs. Shade concluded. "It can substitute for the chemical gardener's watering, fertilizing, soil conditioning, and hours of weeding. What else can do so much for you?"

Morton Binder ran into nitrogen problems similar to those of Mrs. Shade. Binder, you may recall, turned to a mulching program to solve his soil problems. While still in the soil conditioning stage of his program, Binder wanted to set out some canned fuchsia without waiting.

"I dug the holes," he said, "and added two shovels of leaf mold from the woods to the sawdust soil mixture. As soon as the fuchsias were set out, I mulched them with manure to begin to offset the lack of available nitrogen during the rotting-down process of the sawdust. The results were as follows—and, I think the moral of the story and the lessons learned may prove valuable to others attempting the same trick:

"In spite of the manure, the fuchsias rather quickly developed nitrogen starvation symptoms. I gave them a handful of processed sewage and a tablespoon of blood

meal, but it wasn't until three months had elapsed that the color returned and the results became satisfactory.

"The other portion of the bed was not planted until four months after the first. These plants developed no chlorosis, and normal feeding brought out good color. Four months later both groups of plants appeared quite healthy, and no different in final results," Binder said.

"It proves again what has often been said. 'Don't plant immediately in freshly prepared soil where unrotted organic material has been used in large quantities. Wait until the breakdown process has had time to work.'"

The reason for these gardeners' woes is that substantial amounts of nitrogen are required for decomposing plant residues. When an organic mulching material does not contain all the nitrogen required for decomposition, the mulch tends to "borrow" nitrogen from the soil or fertilizer applied to the soil, leaving less nitrogen available for plant growth during the decomposition process. Consequently, signs of nitrogen deficiency are frequently observed in plants grown under heavy mulches, unless sufficient nitrogen fertilizer is added to compensate for the soil or fertilizer nitrogen required in the decomposition process. The amount of additional nitrogen fertilizer needed to compensate for the nitrogen tieup varies with the type of mulch and its state of decomposition.

Duration and severity of the nitrogen depression sometimes observed following application of organic mulches is affected by a number of factors in addition to the kind of mulching material used and its nitrogen content. Soil fertility—particularly the amount of nitro-

gen in the soil—is a significant factor in determining whether or not crop yields will be affected adversely under mulching. This is illustrated by studies of wheat grown in various sections of the west. Although yields grown under a system of mulch farming tended to be less than under moldboard plowing in most areas studied, no depressing effect on grain yields was observed in areas where the nitrate content of the soil was high.

Increases in the amount of soil nitrate following application of mulch occur under some conditions. In fact, such an increase has been reported in the majority of studies in which “inert” mulches such as plastic were used.

When decomposable mulches such as straw or hay or manure are used, the rate of decomposition and the proportion of carbon to nitrogen are significant factors in determining whether mulching will increase or decrease the nitrate content of the soil.

The point is that mulched crops must have an abundant nitrogen fertilizer supply, else the crop will show temporary nitrogen starvation. This is true because soil bacteria stimulated by the better growth conditions under the mulch tend to gobble up available soil nitrogen. Of course, these tiny motes of vegetable life soon die and decay, and give back to the soil quickly available higher-plant food. But there is a lag when you first mulch during which they need to be fed extra nitrogen.

This is why experienced mulchers like Ruth Stout sprinkle a bit of cottonseed meal or blood meal on the soil before planting. The soil can be treated with compost or manure, but Miss Stout doesn't go in for the

extra work and doesn't recommend the process unless the soil is deficient and really needs conditioning. The soil in her garden, for example, is in proper condition and is kept that way continually by her mulch. A soil test is a good way of determining whether or not your soil has deficiencies.

Another deficiency that'll do in your plants is a lack of water. As Mrs. Shade learned, the best time to mulch is after a rain. Or, failing that, after the soil has been watered. A mulch is a good moisture conserver, but it can't conserve what isn't there.

By the same token, however, too much water isn't good either. This is why good drainage is important. A too-wet soil is trouble for a garden, and mulching a too-wet garden is just compounding the problem. If you can't solve the problem of an overabundance of water naturally—as Bob Wandzell did by selecting a slope for his garden to promote runoff—a few drainage ditches might help. This is the solution Cynthia Williamson chose.

“Ruth Stout had been talking about mulching humus-rich sandy land,” said the Michigan mulcher, “and I was going to mulch humus-poor, heavy soil. Although I realized it would take two or three years for the mulch to condition the earth, I failed to realize that my heavily compacted soil was badly in need of drainage ditches in the lower end.

“Our part of Michigan has had extremely heavy rainfall. After a 4-inch downfall, when the water stood in pools around my transplants of lettuce, tomatoes, peppers and cabbages, it dawned on me I had problems. At

the site of an old compost pile, the soil crumbled like moist, light cake; but in the lower end of my 50-by-100-foot garden, the soil was extremely heavy and fell off the spade in tight, wet clods.

“This lower area of the garden had grown tomatoes for two years. The vines had been beautiful and lush with fruit, but frost had hit before a majority could ripen. Previously I had blamed their late maturity on a heavy layer of mulch, but after reading that tomatoes ripen faster on a light, humusy soil I began to wonder. Green peppers had the same trouble. There was plenty of fruit on the vines, but they just didn’t grow or ripen rapidly. Perhaps I was too hasty in mulching the entire garden without first enriching the soil’s humus content.

“Although tomatoes and peppers had plagued me, other vegetables did well in this area surrounded by mulch. Green peas planted in mid-July stretched up and bore heavily. Late cabbages did well, even though I fed them nothing but a little compost at the start. Now that the area is well-drained, my head lettuce and leaf lettuce grow in abundance, unaffected by the heavy soil, and mulched thickly,” she said.

Are there mistakes you can make? Sure there are. But the biggest one you can make is to refuse or to neglect to mulch your garden—or to give up on mulching after one less than abundantly successful try. There’s more to mulch than meets the eye. A successful mulch garden may not come overnight. Humus-poor soil won’t be rejuvenated in one growing season, so don’t expect too much that first year, or the second, for that matter.

Rather, weigh the experiences of others. Test your soil, study its strengths and weaknesses. Consider your climate. Investigate the various mulch material available to you locally in abundance. Then, observing the guidelines and existing conditions, set up a program.

Then get out there and mulch!!!

Appendix I

CALENDAR GUIDE for SEASONAL MULCHING

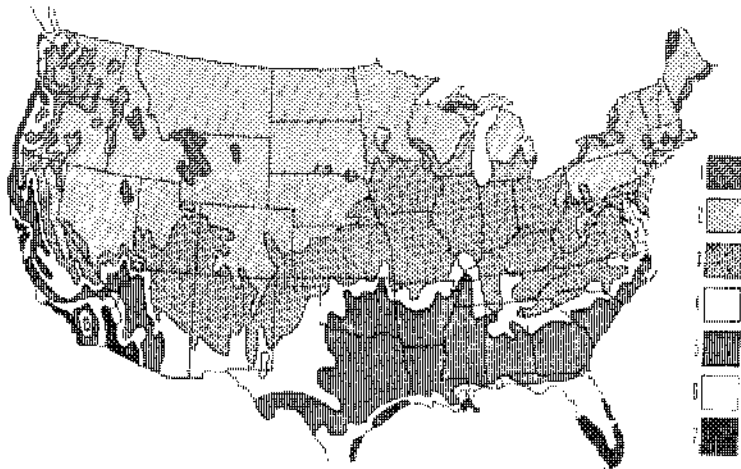

Average date of last expected spring frosts: Zone 1, June; zone 2, May 10-30; zone 3, April 10 to May 10; zone 4, March 20 to April 10; zone 5, February 28 to March 10; zone 6, February 8-23; zone 7, January 30 to February 8.

FEBRUARY: Turn over cover crops and spring weeds and cover the soil with mulch immediately if you are in an arid or drought area. In all other areas the spring

crop will grow faster if you leave the soil uncovered for a week or two to warm up before you apply the spring mulch.

After the snow melts in the northern areas, check the mulch in your flower gardens and loosen it where it has become packed down during the winter.

In Zones 2 and 3, start removing the mulch from spring-flowered bulb beds.

In Zone 6, remove mulch from roses, and allow the soil to bake for a couple of weeks before you apply a mulch of new materials. Use the old mulch to enrich the compost pile.

MARCH: In Zone 4 and northward, shred old asparagus plants with either the lawn mower or shredder and return them as a mulch. Mulch half the asparagus bed heavily with a fine material such as cocoa bean shells, well ground corncobs or partly broken down leaf mold. Let the other half of the bed unmulched until shoots begin to break through the mulched half. This extends the asparagus season, because the unmulched part of the bed will begin to bear one to two weeks earlier than the mulched part.

In orchards, pulverized rock fertilizers can be spread below the trees and berry bushes. Work the materials into the top layer of soil before covering it with the summer mulch.

In northern perennial beds, loosen the leaf mulch as soon as the snow has melted, but don't remove this winter mulch too soon. One of its purposes is to keep the ground frozen until it will remain permanently thawed. In Zone 4, work into the soil any manure that remains on the surface around roses, and allow the sun

to bake the soil for a couple of weeks before you apply the summer mulch.

APRIL: The winter mulch should be off your planting rows by now, even if you had a dry, snowless winter. Give the spring sun a chance to warm the soil and bring it to life. Later, as the season advances, pull this rather thin mulch back to the row, and add to it as much as you can.

Be shrewd about your mulching. Delay it as long as you safely can in order to warm the soil, without losing too much moisture.

Mulch is more important in the hot Southwest than possibly elsewhere. Residents there should mulch their azaleas and camellias thoroughly with compost or leaf mold, keeping them well watered, especially while they are putting forth new growth after flowering.

In Zone 3, when tomatoes can safely be set out without protection, draw a hay mulch up to the stem of each plant.

In all sections of the country, use the early grass clippings for mulch. These are very rich in nitrogen in this season.

In the orchard spread nitrogen-rich fertilizers around fruit trees and berry bushes if you have not already done so. Cover the fertilizer with a thick mulch of hay, preferably alfalfa.

MAY: Planting will be underway by now and your mulching should be, too. In Zones 4–7, planting must be done immediately for summer crops. When plants are four to five inches high, apply a mulch at least three inches deep. Use old sawdust, hay, leaves, pine needles, or rocks to hold moisture, lessen weed growth and cut

down on labor. For these zones, the importance of mulching cannot be overstressed. Continue to gather mulching materials to replenish the ground cover.

In Zones 1 and 2, the winter mulch will have come off a bit later, but the spring soil conditioning program should be nearing completion and some hardier plants should be planted by mid-month. Almost all planting should be done by the beginning of June.

JUNE: Vegetables should be mulched heavily before the dry summer days arrive. You can speed growth for hardier plants by sprinkling cottonseed meal before the new mulch goes on.

JULY: If weeds are starting to push up through your spring mulch, the time has come to spread a few extra bales of hay. The best time to do this is right after a thundershower, when you have fresh moisture to protect. Tiny weeds can be smothered out with hay—no need to pull them first. Draw the mulch up close to the stems of plants like tomatoes, peppers, eggplant and corn. When spreading it next to lettuce, cover the ground first with newspaper and save yourself an extra-difficult washing job later.

AUGUST: Even if you started with newspaper, you may find it pays now to tuck straw and hay around the plants in the row. As for the paths and middles, you can use whatever comes handy to keep the soil from crusting and becoming trodden.

In the vegetable garden, check the mulch in the planting rows and patches to make sure it is not running too thin. Shade the compost pile this month with a thick layer of straw mulch.

Tomatoes may need a fresh layer of mulch at this

time. In the orchard, if a thick mulch has been maintained under the trees all season, it might help the pest situation to rake it away and supply a fresh mulch.

SEPTEMBER: Start now to collect organic materials for winter mulching or for sheet composting. As fast as garden rows are emptied, cover them with layers of materials that will break down during the winter, and that can be turned under in spring. Shredded leaves, fresh manure, hops, apple and castor bean pomace, ground corn cobs, bean and peanut shells are among the materials obtainable in the fall.

OCTOBER: In the North, azaleas and rhododendrons should be mulched with leaves. Central states gardeners should haul back the mulch six to eight inches from the trunks of fruit trees and grapevines.

Mulch Jerusalem artichokes with a thick layer of leaves as soon as soil has a frozen crust. The leaves will prevent hard freezing, and you should be able to push back any snow and to dig tubers at any time during the coming winter. Fall carrot plantings may be treated the same way in all but the very coldest areas.

New strawberry beds can be started at any time from now until midwinter in Zones 5, 6, and 7. Mulch the rows with clean, new straw after planting.

In Zones 1 and 2, mulch peonies with rich manure as soon as the ground freezes. Also cover the rock garden with evergreen boughs as soon as cold weather arrives to stay. This will anchor the snow, so essential to the health of Alpines.

In the orchard, push back mulch six to eight inches from the bases of the fruit trees to discourage rodents that plan to build their winter nests there.

NOVEMBER: Mulch heeled-in fruit trees that have arrived too late from the nursery to be planted. Mulch with straw after the soil is frozen ringing hard, so that the mulch does not harbor field mice.

Clear up all fallen fruit and old leaves, before applying a new fall mulch of leaves. Allow the ground cover to extend beyond the drip-line, but leave a bare area one foot wide around the trunk of each tree to foil the mice. Weigh down the new mulch with large, flat rocks. This procedure is particularly recommended for stone fruits suffering from gummosis.

Otherwise, spread rich manure under the trees and shrubs when they are dormant, covering it immediately with straw, hay or wood-chip mulch. This prevents ammonia from escaping, and will also give winter rains or melting snow a chance to leach it down to the plant roots. Again, leave a one-foot center well open around each tree trunk to prevent damage.

Give the berry bushes a good layer of wood chips, manure, sawdust, or shredded leaves. Blueberries must have an acid mulch—oak leaves are fine—but the others are not so particular.

Compost piles in Zones 4 and 5 can be kept active all winter by mulching them heavily with hay or straw.

For roses whose hardiness may be doubtful, build an overcoat of burlap stretched around 4 posts to surround each bush, and fill the enclosure with a mulch of chopped corn cobs.

Be sure to inspect winter mulches after each heavy windstorm.

Appendix II

MULCHING SOME SPECIFIC PLANTS

Vegetables

ARTICHOKE

Artichokes, Jerusalem or otherwise, thrive under a good light mulch with lots of nitrogen and a moist, well-drained soil. Any nitrogen-rich mulch material will do. Its thickness should be increased as the growing season progresses. The tops can be used as a winter mulch after the vegetables are harvested.

ASPARAGUS

Like most garden plants, asparagus thrives when properly mulched. In the spring you might want to take your nitrogen-rich grass clippings and save them for the asparagus bed. Sometimes it's a good idea to divide your asparagus bed in half. Mulch half the bed heavily with a fine material such as cocoa bean shells, ground corn

cobs or partly decomposed leaf mold. Leave the other half unmulched until shoots begin to break through the mulched half. This technique will extend the asparagus season, because the unmulched part of the bed will begin to bear one or two weeks earlier than the mulched part.

At any rate, mulching your asparagus bed will keep it weed free if you use available organic material such as old hay, leaves, straw, salt hay and dried grass clippings—about eight inches for a season. If you want a steady, yearly supply of thick, delicious spears, you repeat that practice every spring.

When you finish your asparagus planting, sometime in late spring or early summer, weed the bed thoroughly, feed it and give it a thick mulch blanket. For the winter, mulch asparagus thickly with fresh manure or compost and allow the top to stand until spring.

One organic gardener, Brownson Malsch of Texas, tried experimenting with cotton-burr mulch on his asparagus beds. It's a material that's handy there and, like most natural materials, it breaks down readily and turns to a mellow compost. The material's obtained directly from the cotton gin, spread several inches deep making for easier maintenance of the planting site. It's rich brown appearance gives an attraction to the planting area while it controls weed growth at the same time.

BEANS

Like most plants in the garden, beans will respond favorably when mulched. Perhaps the most serious cultivating problem in growing beans is the control of weeds. The bean roots are often close to the surface and

any deep or extensive cultivation to halt the weeds will result in undesirable root pruning. But a heavy mulch will work for you in keeping down the weeds and give you an added plus in preserving moisture in times of drought. Gardeners have mulched beans successfully with grass clippings and oat straw. The result will be some healthy looking plants and some mighty good eating.

BEETS

Beets are alkaline soil plants, and won't grow in acid soil. It is wise, then, to load your mulch with alkaline materials or use some ground limestone. A light mulch should be applied immediately after planting to conserve moisture and prevent the sun from baking the soil. When sprouts appear, pull the mulch back somewhat. As the growing season progresses, increase the thickness of the mulch and tuck it in close to the maturing plants. Beets thrive in a humus-rich soil, and a continuous mulch will contribute to this condition in your soil.

BROCCOLI

Broccoli should be well-mulched to preserve moisture. Organic gardener Joan Pierson used matted leaves with excellent results. She applied forkfuls of the leaves between the rows of plants, checked a substantial weed and insect problem and produced superb broccoli. Another Joan—Lindeman in this case—uses hay mulch with similar results.

CABBAGE

Spread some mulch on your cabbage bed and watch the cabbage respond. Near the Grand River in Eaton

Rapids, Michigan, Charles Carter grew 18 jumbo heads of cabbage—one of them a real tape measure gem. Carter used rabbit manure as fertilizer and irrigated with river water he brought to his garden with a small electric pump. The mulching was supplied by a nearby sawmill which gave out sawdust just for the asking. When the Carters began harvesting their cabbages, they discovered one head measured 52 inches around and tipped the scale at 35 pounds.

Others have used grass clippings and hay on cabbages with good results.

One of the most surprising mulches that's good for cabbages is aluminum foil. Investigation at Connecticut and other university experimental stations indicated that cabbage mulched with strips of aluminum foil were able to repel disease-carrying aphids and return the increased yields over unprotected plants.

If you live in a warm climate location and one that normally experiences mild winters you might like to plant seeds of cabbages and cover the beds with a coarse mulch during the early winter months like November or early December. Recover the bed with a coarse mulch such as twigs or pine boughs as soon as seedlings appear. In spring when you uncover them, you will have some hardy babies for early transplanting.

CARROTS

When you sow carrots you will probably want to place some mulch over the beds to prevent the soil surface from crusting so that sprouting seeds can't break through. Cover the soil with a little loose hay or other mulch (not so deep as you might normally use it), and water it carefully so that the fine seeds will not wash

away. When the slender seedlings come up be certain the mulch doesn't interfere with them.

If you're tired of the pesky brown worm that spoils your carrots you might be able to foil it with a coffee break. Mix your package of carrot seed with one cup of fresh unused coffee grounds. Plant the coffee with your seeds. It percolates enough coffee odor during the growing season to foil the noisiest of carrot flies. And it won't flavor the carrots as sprays and other poisonous substances do. Because coffee grounds are acid, they are good for plants that like that kind of treatment. Often it is best to mix ground limestone with the grounds before using it as a mulch or top-dressing. They seem to have a remarkable effect on stimulating the growth and health of certain plants. Chemical analyses show that the grounds contain small amounts of all sorts of minerals—including trace elements—plus carbohydrates, sugars and even some vitamins, as well as caffeine.

One gardener has found that he likes to leave carrots in the ground during the winter months. By covering them well with a thick mulch he finds that the carrots may be kept that way. At any rate, he prefers it to the frozen or canned carrots that are available in most supermarkets.

CELERY

Ohio gardener Lucille Eisman reports that leaf celery protected with a deep mulch almost covering the plants, will produce crisp, tender hearts until Thanksgiving time or later. Recently she took eight or ten celery plants, complete with roots and a clump of soil and

stacked them upright in an unused cold frame. Dried leaves were packed around and between the big plants and gave full protection from the cold.

CORN

When it comes to planting delicious sweet corn, organic gardeners are of one accord—mulching is important. Often it may be best to mulch sparingly—if at all—early, because it's best to let the corn get a good start and allow the soil to warm up. However, if the weather is very dry at planting time you might want to mulch each hill with a handful of old hay or dry grass clippings and remove it as soon as there are signs of germination. Another reason for early mulching could be an abundance of crows in your vicinity. Crows will pull small corn plants nearly as fast as they show above ground. The solution is a thorough mulch that will give the plants a chance to get well started before the crows can spot them. By that time, any plant pulled will yield disappointing results to the average crow, who is after the tender young kernels below the plants.

C. E. Chamberlain of Tacoma, Washington is one of the advocates of mulching growing corn. Chamberlain uses grass clippings that have rotted all winter and mixes them with peat moss and foil. After planting the corn he tops the bed by filling it with a ring of fresh, green grass clippings. He surrounds the plants with 24" circles of inexpensive aluminum grass edging. Edward P. Morris uses a more standard technique of hilling the corn six to eight inches high. Then he uses baled or old spoiled hay which he has shaken out in the area to make a continuous mulch five to six inches deep. He claims

it is always wise to work with the wind at your back to keep the dust and seeds away. Sometimes the hay separates quickly and easily into one inch pads or slates which are equal to five or six inches of shaken hay.

CUCUMBERS

Leaves, grass clippings, old hay, leaf mold or other organic mulch all rank high in controlling cucumbers, as does aluminum foil. In fact, mulch could be the way to control the old cucumber nemesis, the cucumber beetle. E. M. Watson of Chardon, Ohio, knows the difference that mulching makes in that regard. "One year I was setting watermelon plants and was driven in by the rain before I could finish," he said. "I had all but one hill mulched with compost. I didn't get back for two days and the unmulched hill was literally destroyed by striped cucumber beetles. The others were not bothered. I had this experience with other things I have mulched; they appeared to be less susceptible to pests."

Down in Houston, Texas, Pat Patterson has found that cucumbers benefit greatly from an organic mulch. When the cucumbers are about three inches in height, Patterson spreads a reservoir of leaves around the tiny plants. Every few days he will add another thin layer of leaves until the mulch is about four inches thick. When an occasional indomitable weed pokes through the mulch, it is easily plucked from the loose soil. If you use lawn clippings as a mulch, let them dry a few days, then apply a four-inch thick layer down the whole row of cucumbers. Actually, any organic mulch will serve as well. It is a good idea to provide mulch wherever cucumber roots might extend, even on the other side of

a fence or tree. Look for big improvements in your cucumber patch after you begin to use an organic mulch.

EGGPLANT

Mulches are valuable to the eggplant because it cannot be disturbed if it is to have proper development. Besides smothering the weeds, a good organic mulch will help to conserve a uniform supply of moisture which in turn will enable the roots to feed in the top, moist two inches of soil with which they are surrounded.

GARLIC

Add garlic to the list of plants that get a boost from mulch. Harry Scoth of Corvallis, Oregon grows giant garlic, and he knows the value of using organic material. Scoth welcomes all the grass clippings, weeds and leaves his neighbors care to donate in the fall. Then he maintains two big piles of grass clippings available as mulch during the dry August months. When his garlic is six to eight inches high, Scoth works compost into the soil and mulches with grass clippings between the rows.

KOHLRABI

Moisture is of the greatest importance in feeding kohlrabi for the best growth. A thick mulch should be drawn up to the seedlings as soon as they are tall enough, and the soil beneath the mulch should be kept moist. One experienced kohlrabi grower, Dexter Raymond, uses hay, grass clippings and pulled weeds to

mulch his plants. Ruth Stout uses hay rather successfully.

LEEKs

Leeks profit from mulches of all sorts, including peat, straw, compost, wood shavings and autumn leaves. Be certain that when mulching young seedlings the mulch doesn't interfere with them as they sometimes come up rather thick in the seed bed.

LETTUCE

Lettuce is a plant which needs a coarse mulch material such as twigs or pine burrows in the seedling bed. If you already have a planting area that has seen the mulch break down a bit in early summer, scatter some lettuce seed there. The lettuce appreciates the semi-shade as well as the rich, rotting mulch.

If you have to plant your lettuce after the chill of early spring, apply a thin straw mulch around and right up underneath the lettuce leaves. This does three things: holds soil moisture; keeps the large leaves off damp soil to prevent rot; maintains the cool root run that many plants (especially cool season vegetables) require for best production. Aluminum foil also has been used successfully as a lettuce mulch.

OKRA

In growing okra, a good mulch is important if your soil is heavy and rain abundant. Before the plants bloom, work the aisles. Hill the growing plants and mulch between the rows heavily with straw, old hay or

well-rotted cow manure. Mulch the rows themselves lightly—just enough to discourage weeds but not the okra—since this plant needs plenty of warmth. Grass clippings are ideal for this light mulch. Other gardeners have found that leaves—even oak leaves—are good for mulching okra.

ONIONS

Mulch will aid the first stages of onion growth and maintain the plants during cold weather. Don't put much stock in the rumors that onions don't appreciate mulching. Mrs. Paul Gillette of Shelton, Washington reports that she put several inches of fresh fir sawdust on her onions and had the biggest and best she ever saw. Gordon Snyder of Glidden, Wisconsin plants his onions in spring—plowed ground under a two-inch mulch of kiln-dried hardwood shavings. That's all the work he does and he has been taking first prize for onions at the local country fair for several years. Ruth Stout has always claimed that her hay mulched onions are extremely mild and good eating. Walter Starns of Bethel, New York, echoes Mr. Snyder's statement on kiln-dried sawdust and shavings with Spanish onions. "It will", he says, "definitely produce larger winter onions."

PARSNIPS

To prolong the use of fresh garden parsnips, heap leaves high over the rows as cold weather moves in. These leaves will prevent the soil from freezing, and enable you to pull fresh vegetables from the ground long after the rest of the garden freezes solid.

PEAS

Trying to grow peas all summer is a rather hopeless gamble unless the most important growing principle is observed—mulch early and mulch deeply. Use straw or any material that's handy but be sure it is put on as soon as the seeds are sown—rather thin at first, then more heavily as the plants get started. Provide a deep buffer of mulch between the heat of the atmosphere and the soil. The cool, moist root run is the important difference between success or failure of summer-long peas.

Ruth Tirrell knows that peas must go in early, and the soil has to be ready to receive them. That's why an early mulching program includes plenty of organic material that gets incorporated into the soil usually the autumn before. Leaves or other clean debris are dug in and a mulch of similar material is put down for the winter. The result is enriched, productive soil that yields high quality vegetables. After the peas are planted she draws back the winter mulch to the furrow. It could cover the latter loosely. Because peas are a coarse plant they will come up through it. By the time the peas are pulled up the winter mulch will have just about disappeared. If you can, renew the mulch. Use grass clippings, hay, straw, weeds or the nitrogen-rich pea vines themselves. The mulch of organic material will prevent root rot, a disease to which peas on poorly drained land are susceptible.

PEPPERS

Peppers respond well to mulching. Most any good organic material, such as hay or grass clippings will do. But if you want early-ripening peppers, use a tar-paper

mulch in conjunction with glass cloches to permit planting the peppers two to three weeks earlier than you normally would. Use a good-quality tar paper since this will be a mulch to use and reuse for years. Cut 18-inch squares of the tar paper and put a five inch hole in the center of each. Place the tar paper over the ground with the plant growing through the hole. Cover the plant with the cloche, which can be made by cutting the bottoms of one-gallon clear glass jugs.

The tar paper mulch will collect the heat of the day and help maintain it through the night. It will keep the ground moist, although it won't contribute anything nutritional to the soil. The individual greenhouses will allow the peppers to get the sunlight and still be protected from late spring frosts.

When the pepper plant fills the cloche, remove it and the tar paper and put down an organic mulch.

POTATOES

Probably no other garden plant is more synonymous with mulching than potatoes. You can grow potatoes under mulch, in mulch, on top of mulch—almost any way in fact—and get satisfactory results.

Generally, planting potatoes on top of any mulch remaining from last season is effective. After they are set in rows, cover the eyed pieces with at least 6 to 8 inches of hay, straw or other loose material. If soil stays cold in your area during early spring, try a delayed mulch. To harvest early potatoes, remove hay or straw carefully when blossoms start falling, separate small potatoes from stems, and generally replace mulch. One organic gardener planted potatoes on top of the ground

in a cover of leaves. The leaves are piled over the potato patch the previous fall to a depth of three feet and left there for the winter. By spring they are packed down and earthworms are working through them. Potatoes are planted by laying the pieces directly on the leaves in rows where they are to grow. The seed is then covered with 12 to 14 inches of hay or straw. More mulch is added later, if tubers appear through the first. When harvest time comes, the mulch is pulled back and



Early potatoes are harvested from their thick bed of mulch, then covering is replaced.

potatoes are picked and put into their sacks with no digging necessary.

Don Tillung of Deerfield, Wisconsin, uses a method of raising potatoes on top of the ground which eliminates a lot of labor. His mulch cover is eight inches of marsh hay—usually the cheapest type. If the soil is high in nitrogen content, the hay on the bottom of the mulch will tend to decay rapidly which may require more to maintain a minimum of eight inches. Advantages are that you don't have to cultivate and you don't have bothersome potato bugs.

Edith Sarwell of Lake Forest, Illinois uses a straw mulch to plant her potatoes. The mulch keeps the soil cold and could cause a late maturity—if that's what you are after. Or, why not try two plantings—a very early one for a good head start and another in July for winter and spring harvesting. If hay or leaves are not available in your locality, try to cover each potato row with an eight-inch layer of pine needles. It makes a light, airy mulch and keeps moisture down under the needles. That will make the earthworms mighty happy and the potatoes mighty good eating.

There's one sure mulching method that controls the potato bug. It was conceived and tested at the Organic Gardening Experimental Farm. The potato seeds must be planted and the soil covered with a one-foot layer of hay or straw mulch. Through experiments it was determined that the hay is the better of the two. The plants, of course, will grow through this mulch, but the potato bug, whose egg winters in the soil, cannot climb up on the potato stem through the heavy mulch. This method of heavy mulching proved so effective that not a single

potato bug could be found on the potato plant. At the end of the season the mulch is plowed under, thus enriching the soil with valuable organic matter and giving it a better structure. The plants also benefit from this highly successful method, for they obtain a greater health and resistance to insects and disease.

Kenneth Polscer discovered that potatoes planted in soil and mulched with hay give better results than potatoes mulched with plastic. The hay keeps down the weeds, and can be turned under to decompose in the soil and provide added nutrients, something plastic can never do.

PUMPKINS

Pumpkins will profit from hay from a newly-mowed field. Mulch around each hill. Before laying down the mulch, work in a feeding of cow manure.

In Troy, New York a group of youngsters discovered that composted leaves, old hay, straw, cow manure and bone meal gave forth insect-free pumpkins that had no trouble from dryness. "From now on," says Joe Miller, "we're growing everything in the garden in organic compost."

RADISHES

Donald Shaw of Colona, Illinois planted white winter radishes on the Fourth of July, and mulched them with chopped, partly-decayed clover hay as soon as they were high enough. The results more than pleased Shaw, as one of the radishes scaled 6 pounds and measured 28 inches long.

"We ate the smaller ones—those that weighed only a pound or two each!" Shaw said.

RHUBARB

Thick stalks of rhubarb result from continuous heavy feeding. To keep the soil up to the standard necessary, spread a thick mulch of strawy manure over the bed after the ground freezes in winter. Nutrients will be leached into the soil during the winter. In spring, rake the residue aside to allow the ground to warm and the plants to sprout. Then draw the residue together with a thick new blanket of straw mulch up around the plants. Hay, leaves or sawdust also make excellent mulches for rhubarb. A side benefit of the sawdust and leaves is that they contribute to the acidity of the soil, and rhubarb thrives in an acid soil.

SPINACH

Spinach can be mulched with grass clippings, hay or ground corncobs and it will be the better for it. Inez Grant of Columbia, Maine has used hay successfully. Since spinach doesn't grow well in acid soil, acidic mulches such as sawdust or leaves shouldn't be used. Summer mulches shouldn't be applied until the leaves have made a good growth.

SQUASH

Squash needs an extra special dose of mulch, particularly during hot, dry summers. Try a heavy dousing of compost and rotted sawdust. Make your mulch as much

as four inches deep. Aluminum foil mulch has been found to repel aphids from squash plants.

SWEET POTATOES

Sweet potatoes are heavy feeders, and they grow well when they have sufficient moisture. A good mulch cover with compost will fill both of those requirements. Old leaves and grass clippings on the sides of the rows make an adequate mulch, as do the old standbys—hay and straw. If you make a hill for your sweet potatoes, be sure you mulch them well, allowing plenty of room for them to develop. At season's end, work the mulch deeply into the soil to build up humus content.

TOMATOES

Deep mulching and delicious tomatoes go hand in hand. Organic gardeners have been experiencing great results for years with mulching. Take the case of Robert E. English of Baltimore, Maryland. He mulches his plants when they reach sufficient size. If leaves are handy, they are used to a height of four inches or more, but with grass clippings or sawdust the plants may be somewhat smaller. Much of his mulching is done following a storm, using leaves, since they are not shredded. Either grass, sawdust or old rugs are used to hold the leaves in place. With every passing year English has found his soil easier to spade and the number of earthworms on the increase. He believes his use of mulch has contributed greatly to the soil fertility. Frank and Cecile Fiederlein of Cape Cod have found success in mulching their tomato plants with leaves and pine needles. "The tomatoes were the envy of the neighborhood. Besides having enough for our family and friends, my

wife put up fifty-five quarts for the winter," Fiederlein said.

Fruits

BANANAS

Oliver R. Franklin of Fort Myer, Florida, showed his neighbors that organic mulch methods could revive banana growing. "They told me that bananas did poorly here," he said, "and from the looks of those growing in nearby yards, it appears believable. However, I planted mine in the same kind of soil, but shocked the neighbors by capturing islands of water hyacinths floating by in the river, and pitching them ashore with a hay fork and mulching the bananas a foot deep with them. I figured that the rains had washed a lot of soluble minerals and trace elements into the river to be captured by the weeds, and I wanted some of it back.

"When the hyacinths decayed around the bananas, I mulched them deeply with the most aged shavings and sawdust I could find. The plants responded by growing twice as tall as their parent stock, with none of the usual root rot and no insect pests."

BLUEBERRIES

Although blueberry plants, like most other harborages of the garden, profit from mulch, it's best to be a bit wary about how much and what you use. When setting out blueberries, the soil pH should be between 4.5 and 5.0. By applying organic mulches—never any lime—you'll be able to keep it that way. Peat moss, hard wood, leaves, pine needles, and similar materials decompose into an acid compost-mulch. Also good is sphagnum moss or shredded oak leaves. If the pH is

unusually low, the mulch may be composed of shredded corn cob. Use saw dust as a mulch only if it has been composted with manure for at least a year.

Don't go hog wild mulching blueberries. When plants are first set out, a three to four inch mulch around the plant or about one inch over the whole plot is adequate. Increase the depth as the plants grow to a maximum of six to eight inches. Although mulching may prevent many bacterial and fungus diseases, over-mulching could open a Pandora's box of problems, particularly if the soil is poorly drained, making blueberries more susceptible to disease.

Frank Fiederlein of Cape Cod is a blueberry mulcher who has had success using pine needles, sawdust, some decayed leaves and sand. Around the roots he uses a mixture of sand, loam and peat moss. Each year he adds a two inch layer of pine needles. He reports that his yields are getting bigger all the time.

BOYSENBERRIES

Ethel M. Stephens of California has found that boysenberries profit from organic mulch. Because boysenberries are terrific feeders, a mulch of well rotted compost or leaves does a good job. Ethel has found that after many years of that treatment, her soil has become a deep, soft mass of organic material that holds moisture like a sponge. In hot, dry weather she mulches partially rotted sawdust to further conserve moisture and humus surrounding the roots.

CANTALOUPE

Cantaloupes and other melons need lots of moisture from the time they come up until they are nearly full-

grown. For this reason, they'll do better under a thick mulch. The best materials to use include hay, grass clippings, shells and hulls and newspapers. Stay away from sawdust and leaves, since these materials may add too much acid to the soil for the alkaline-loving melons.

The mulch should be put down before the fruit develops, since handling may damage the tender melons. Once the melons do develop, they'll be resting on a clean carpet of mulch and won't be prone to rot.

CITRUS TREES

Mulch under a citrus tree should be kept at least eight inches from the base of the tree so it doesn't foster root rot. Keep the mulch pulled well back and don't allow any irrigation water to stand at the foot of the tree.

Bearing this caution in mind, there are few things more beneficial for a citrus tree than a good mulch. One California orchardist allows the trees to mulch themselves. He just never rakes up the leaves that fall from the trees. Other orchardists grow the mulch material within the orchard itself. Summer cover crops that may be planted in the orchard and cut for mulching material include soybeans, cowpeas, millet, sudan grass and buckwheat. Winter cover crops that can be cut for mulching include rye, wheat, vetch, clover, alfalfa and kudzu beans.

Growing the mulching material in the orchard is a practice which stemmed from the large amount of material needed to properly mulch such an area. An orchardist thus doesn't have to reserve areas free of trees for cultivating mulching materials, nor does he have to purchase materials. Both of these practices con-

tinue, however. Besides the various grasses that may be used for mulching materials, you can use sawdust, weeds, peat, corncobs, brewery and canning wastes, rotten wood and leaves and, of course, stones.

Tests in New Zealand have indicated that citrus trees under mulch are healthier and produce better fruit than those not mulched. In addition, the mulched trees need only half as much fertilizer as unmulched ones. Similar tests in the United States have demonstrated that mulched trees come into bearing sooner than trees under clean cultivation. Mulches are particularly beneficial for trees between one and four years old, since these trees are most sensitive to competition from other vegetation.

FIGS

Like all fast-growing tropical plants, the fig responds quickly to a good mulch. A heavy mulch in summer to retain moisture, and in the winter to protect against the weather, plus a spring application of good compost, will usually guarantee even growth. A tree so treated needs no cultivation.

FRUIT TREES

Organic mulches are highly recommended in starting and growing fruit trees, particularly the dwarf variety. After the trees begin to grow, add a shovelful of well-rotted manure around each tree. Then mulch thoroughly. Apply the mulch to conserve moisture and aid new root growth. If you use straw, apply one half to one bale per tree. Other materials that can be used include compost and leaf mold or hay. Keep all mulches

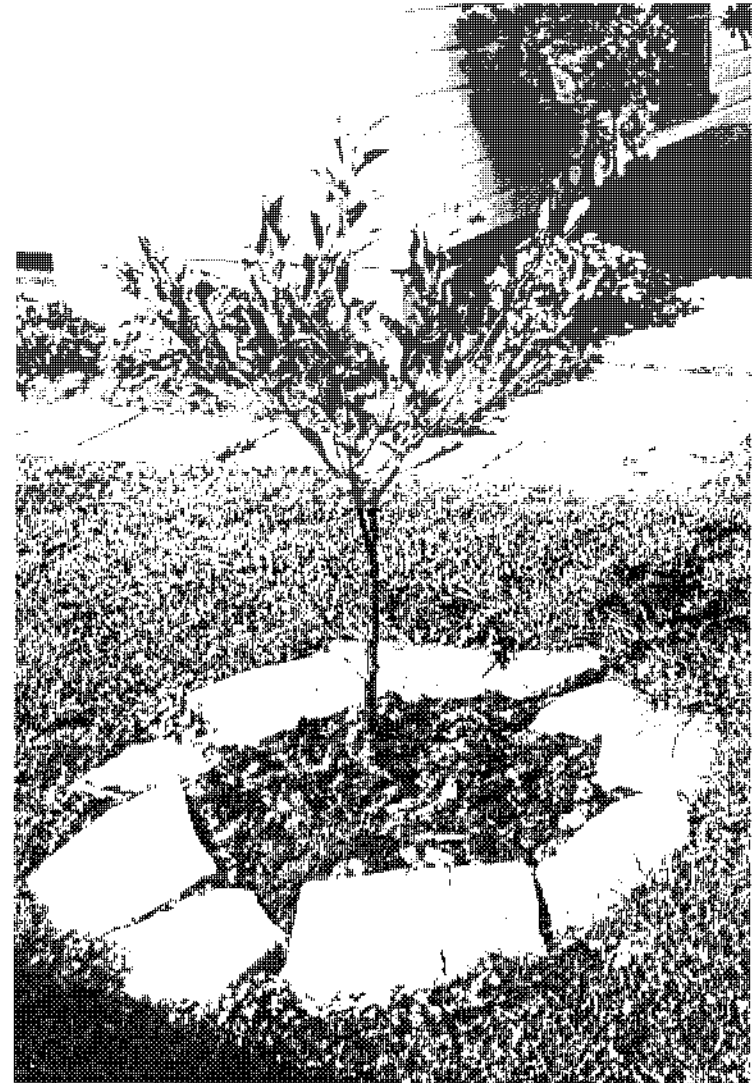

Flat stones should be used to anchor mulch around young fruit trees.

away from the base of the trunk to discourage rodents which can damage trees severely. Stone or stone chips might make an effective mulch, keep weeds down and deter animal pests. If your fruit trees are growing in a bare, recently pulled orchard, spread a mulch over the root area in late fall before temperatures tumble. You may not be able to regulate the winter blasts that sweep the branches and kill the bugs, but you can preserve your orchard for another year.

Keep in mind that your soil needs to be kept moist (not wet). A soil kept wet invites stagnation which leads to root rot. Water once, then get down to the business of mulching. The mulch is especially important during the first growing season, whether transplanting is done in autumn or spring. The mulch conserves soil moisture, but it also keeps the soil cool under the hot summer sun. Moisture and coolness are equally important in promoting vigorous root growth. Whenever rainfall is scant (naturally or unusually) a thorough soaking of the soil every two or three weeks will keep the trees growing as if there were no drought.

And if you have summer showers, you can make better use of them by mulching. This prevents thorough drying for a time. If you have scattered large rocks on top of the soil under the mulch, they act as condensers to return rising moisture to the depths. But the greatest soil moisture loss is through transpiration of the leaves, and this is one thing that you do not want to prevent, because it is necessary for their growth.

Mrs. C. F. Brock of Jay, Oklahoma has found that mulching her peach trees with maple leaves was just what they needed. "In the fall two years ago, I carried

six sacks of maple leaves and dumped them into the place I had spaded out along the peach trees, (mixing several spadefuls of rotted manure in the soil), and since I did not have rocks to cover the leaves, I used old brick on top and around the edges.

"My husband laughed at me—but when the peaches were ripe, he didn't laugh any more. He never saw such large well formed peaches and the nice part about it was there were no webs. Those mouth-watering luscious peaches made a believer out of him. He mulched all his fruit trees this fall."

GRAPES

Grapes deserve mulching, even the first year. Alfalfa hay and sand-straw-steer manure mixture rank high on the list of mulch-fertilizer combinations. Before the rainy season is the best time for the overall spread of mulches and various manures. If you choose hay or shredded leaves, work additional nutriment into the soil. It might be best to use compost, wood ashes or granite dust as fertilizer.

LOGANBERRIES

Sawdust mulching greatly increases cane growth and yields as compared to clean cultivation.

MOCK ORANGE

During the hot days of summer, it is well to use a mulch three to four inches thick for the mock orange tree. Put it on after a thorough watering and use different materials. Whether it be composed of vegetable matter from a compost pile, manure or leaf mold, all would

be suitable. Although some mulches are at the same time top dressings, they also prevent over-rapid evaporation, and enrich the soil by furnishing new food to the shrub.

PAPAYA

Edwin H. Avrimis saved an untreated papaya tree by using a large quantity of mulch. The tree had been uprooted by a heavy wind and it was decided to destroy the tree as its roots were largely out of the ground. But instead, the tree was propped up at an angle of some 30 or 40 degrees and loads of compost and garden soil placed over the roots until it was well covered. When it was found that the tree was still alive and even putting out new branches while burring heavily, more and more mulch was added from time to time, and it made a surprising comeback. It not only matured a large crop of food that it carried when overthrown, but actually put out several tree limbs and grew a large crop of good-sized fruit on these in addition.

RASPBERRIES

Sawdust and wood chips make an excellent mulch for raspberries and have increased production in Canadian tests as much as 50 per cent. Apply a sawdust or chip mulch about three or four inches thick to the base of the plants. The mulch will save moisture, cut down weeds and raise yields. Browned corn stalks and poultry litter also make a good raspberry mulch as do decomposed leaves when used as deep as five inches.

Jean Bowman of Pennsylvania says that she hasn't needed direct fertilizer applications in many years.

"But," she writes, "we have mulched at one time or another with pine needles, sawdust, grass clippings, oak leaves and wood chips. These have decomposed and have enriched the soil, conserved moisture, shaded the ground and smothered most of the weeds. Beth Criteser of Roseburg, Oregon uses grass clippings and leaves as a mulch and fertilizes all of her garden that way. She had berries more than nine feet up the vine and managed to pick enough for dessert on Thanksgiving Day.

STRAWBERRIES

The very nature of a strawberry makes it both responsive to organic methods and most sadly vulnerable to poisonous sprays. The root system fans out below the crown in a perpendicular pattern rather than a horizontal as so many other plants do. Tiny hair roots scatter in all directions from the main roots in search of nutrition and moisture. Mulch should be well dug in to keep the bottom leaves clear so air can circulate around the plants, otherwise berries will mold on the stem.

If the mulch is allowed to remain fairly late in the spring, the plants will be protected from starting into growth so soon that their blossoms may be frosted. When the weather starts to warm up, watch the plants under the mulch. They will show definite signs of wanting to grow, and the leaves will begin to yellow when they need the sun. This is the time when the mulch should be pulled back, leaving enough straw around the plants to cover the bare soil. Leaves will grow up through this light mulch, which will help to smother the weeds and to keep the berries clean. If a late frost threat-

ens after blossoms have begun to develop, draw the winter mulch back over the plants for the night and remove it in the morning.

The best materials for mulching strawberries are wheat straw, cotton hulls, crushed corncobs, peat moss, wood shavings, pine needles or spoiled hay. Leaves make a good mulching material, particularly if corn stalks or tomato vines are applied first to prevent matting.

Although a good thick mulch will prolong the growing season, all good things have to end sometime. When the pickings dwindle down, spread an inch of young, rich compost around the remaining plants and mulch the beds heavily with clean straw. Draw the mulch up to the plants and, as new runners develop, tuck the most promising under the mulch. When the ground is frozen in fall, recheck your mulch and be sure it is thick enough. If you are using straw or hay, a depth of six inches is not too much, particularly in north central states.

WATERMELON

Watermelon vines may be mulched to keep down the weeds and retain the large amounts of moisture needed by the maturing plants. The mulch shouldn't be applied before the soil has warmed, however. Hoeing will keep the weeds down until the soil is warmed sufficiently to permit mulching. Using straw, hay or chopped leaves, spread a six-inch mulch over the entire watermelon patch, drawing the covering up to the bases of the vines. This should be done before the fruit is formed, since it is tender and easily damaged. The best time to apply the

mulch is when the soil is thoroughly dampened. As the watermelons develop, they'll be kept dirt-free by the mulch and won't be prone to rot on the vines.

Ornamentals

ARBORVITAE

As every arborvitae lover knows, winter injury can be a real nemesis. It causes a browning of the previous season's growth in late winter or early spring due to drying winds or hot sun. Trees in exposed locations are more severely affected. This discoloration is due to evaporation of moisture from the leaves or needles faster than the roots can pick up water and it is very apt to occur on newly transplanted trees. A thorough mulching of some heavy material like straw or hay will maintain moisture in the ground and help prevent this disease.

AZALEAS

The importance of mulching azaleas cannot be over-emphasized. The roots are extremely shallow—most of them lie within three or four inches of the surface—and they must be kept moist at all times. Thus a mulch of at least four inches is necessary.

Pine needles, oak leaves and sawdust from oak, cypress or hemlock make excellent mulches. A mixture of materials is preferable since the mulch in decaying continually adds food to the soil. Many growers find that a combination of pine needles and oak leaves is especially good. The needles keep the leaves from blowing and are high in acidity but slow in decaying. The oak

leaves decay more rapidly and, while lower in acidity, are higher in food value. Seaweed added to the mulch from time to time adds trace minerals. Manure is not recommended for azaleas because of its alkaline reaction.

Some gardeners have found they're able to bring their azaleas through the winter with much less loss by applying winter mulch early in the fall. One gardener uses four inches of bark dust or sawdust and tills it under every spring. By adding mulch before freezing, he has found most of his plants come up from the roots even if peripheral ones are killed.

Victor A. Carley of Berryville, Arkansas, uses mold or shredded leaves—mostly oak—to revitalize his otherwise hard to handle azaleas and wild orchards. The finely shredded leaves keep the soil conditioned if they are packed around the roots. Robert Couldwig reports that azaleas can be transplanted after being mulched like that, "and you would hardly know they had been moved." The leaves are neat, have no weed seeds, and hold moisture like a sponge, keeping the growth zone cooler in hot weather.

Mulching can be a plus if you are stricken by azalea petal blight, a disease that produces small pale spots on the inner surfaces of the petals of the colored flowers and brown spots on the white flowers. The spots rapidly enlarge until the whole flower collapses. A good preventative technique is covering the azalea beds with several inches of mulching material. That helps keep the arresting structures free of the spores. Avoid overhead watering while the plants are in flower and rely upon the deep mulching instead.

BEGONIAS

Buckwheat hulls are an especially good mulch for tuberous begonias when these moisture-lovers are put into the open ground rather than pots. Tuberous begonias are tender, naturally cool-weather plants, and are heavy feeders. The soil should be cool and moist to make nutrition constantly available, but the soil should not be soggy, which may cause rotting of the tubers. Buckwheat hulls improve the appearance of the begonia bed, and prevent the blossoms from becoming mud-splattered.

BOXWOOD

Boxwood profits from mulching particularly in the fall. Like most evergreens, boxwoods prefer a straw, leaf mold or rotted manure mulch. Such mulches prevent wide fluctuation in soil temperature and help the soil hold moisture. The mulch can be left on all winter, and then worked into the soil in the spring. A newly-planted bush should be mulched to the same depth that prevailed in the nursery or woods.

CHRYSANTHEMUMS

If your winters are not too severe and your mums are hearty, you may want to mulch heavily with straw or hay and leave them out over the winter. The object of this protection is prevention of soil heaving and the resulting root damage. If you leave your mums outdoors over winter, do not confine them to pots, but allow them to bloom naturally in October and November.

DAHLIAS

Dahlias will profit from a mulch of dried grass clippings or old hay about six inches deep. Buds form quickly after mulch is applied, so keep that in mind for planting your garden color.

DAISIES

Some nurserymen claim you can carry daisies through the coldest winter if you mulch them with eight inches of straw after the ground freezes. It might be a good technique particularly for gardeners up north who have a tendency to lose these vibrant flowers.

DELPHINIUMS

Delphiniums need a thick mulch of straw and clipped grass to keep the roots cool through the hot summer and to conserve moisture. You might also like to apply a generous amount of wood ashes, particularly if slugs or snails seem overly fond of your new delphinium shoots.

DOGWOODS

Dogwoods profit from a pine straw or leaf mulch three or four inches thick. Avoid making a mound of mulch or soil around the plant, which will shed water away from it, as dogwoods can often use a good drink during dry summer months.

EVERGREENS

Small evergreens, like any other planting, benefit from regular watering, frequent cultivation, or most

important, a mulch to help control weeds. You probably will find a heavy mulch between the trees of either compost or rotted manure to be effective. Even as seedlings, evergreens are tough, but the first winter it might be a good idea to tuck a deep layer of straw around each tree. If the straw is sufficiently moist in the fall, they should come through the first winter in fine shape. One organic gardener has found that a heavy mulch of equal parts of leaf mold and cow manure does a good job of preventing deep freezing and also supplies adequate and continuous water. Normally, a heavy leaf mulch, preferably oak leaves which last longer and contribute more to an acid condition, will give your evergreen trees the shot in the arm they need.

FERN

A woody location, with shade, moisture, and an organic soil high in leaf mold is perfect for the majority of the ferns. Oak leaves and compost are good substitutes for the leaf mold. Peat moss is also an excellent choice because it contributes to the neatness of the beds and ferns just love its acidity.

FLOWERS

Flowers make up a big category, but generally you may use a mulch to alter the soil texture to suit specific plants. Bulbs like Alpines which require a gritty soil may be accommodated by spreading a fine rock chip mulch over the soil surface. Damp meadow conditions may be simulated by laying perforated water pipes below the surface of the soil. A chopped leaf compost mixed with plenty of rotted manure or cottonseed meal

has approximately the texture and nutrients of rich wood soil. If acid spring water is available on the site, a planting of sphagnum moss in it will bring a fine bed for picture plants or bogged orchids. During the June growing months you want to be certain that all your flowers are under mulch. Ground corn cobs are fine for roses, while coffee grounds mixed with about an inch of sawdust make a handsome flower bed mulch. The coarser screenings from the compost heap can also be spread evenly around the flowers.

Texas gardeners have found that cotton burr mulching makes the difference between success and failure. Of course, in that region the material is plentiful as well as effective and it produces humus on the spot. Spread the dried burrs several inches deep around the base of the plants. Cotton burr mulch is light in weight and sufficiently porous so that it will not smother. When spread on flowering plants, the rich brown composted burrs give a neat, attractive appearance to the beds, and control weed growth at the same time.

Most annuals like a late fall planting, even though they are particularly hardy. After the first thaw in your area has penetrated the ground about an inch or so, try a mulch three to six inches thick depending on the severity of your winters. It's probably best to make it a light mulch, such as compost, straw, manure, pine needles, fresh or partly decayed leaves, peat moss or salt hay.

In early spring give consideration to mulching your perennials. If there is plenty of spring rainfall in your area, rake back the mulch to allow the furrow to warm up. But if you are in an area of skimpy rainfall, leave

the mulch in place and content yourself with later warming. Before it gets too hot be sure to mulch your perennials with compost and rock fertilizers. To keep the weeds out you might use peat moss—a material which contributes to flower bed neatness as well as making the soil on the acid side.

GLADIOLUS

Do you want to experiment with materials to mulch gladiolus? Florence M. Chase has found that hay is the most satisfactory mulch material since it does not mat and allows the spikes to push through easily, eliminating their chance of being deformed. Normally she mulches to a depth of about five inches, and has had excellent results with discouraging thrip infestation. Cornell University experimenters at Farmingdale, New York have discovered that aluminum foil protects gladiolus from attack by aphids. The researchers have found it highly effective in combating the cucumber mosaic virus, a disease carried from plant to plant by aphids which cause "color break" in flowers and streaking of leaves.

HEATHS

Heaths demand an acid material mulch and will thrive in it. That means you probably should choose an oak leaf mold, sawdust or pine needle mulch and apply it during the early growing season.

HOLLY

Because hollies love water and moisture, be certain to apply a yearly surface mulch of well rotted oak leaf

compost or wood leaf mold. Hollies also benefit from a tobacco stem mulch placed over the root area underneath the entire branch spread of the tree. The tobacco stems are rich in nutrients and perhaps detrimental to insects. When fed with a mulch of tobacco stems, hollies respond with darker green leaves and more berries.

In New Jersey, Earl Dilatush reports that oak leaf mulches are essential in growing the bright red-berried holiday greenery. He reports many cases where a heavy mulch of oak leaves has revived and restored failing holly trees.

HYDRANGEA

Pearl Wright has found that plenty of mulch—enough to protect the entire root system of a hydrangea—will get even the most pampered house pet safely through the rigors of a Mid-Illinois winter. She first mulched her hydrangea heavily with straw, working it well along the stem and adding a heavy layer of cow manure. Figuring the manure would act “just as it does in a hot bed”, she then covered the whole thing with sacks. When her straw-mulched plant survived, she added potato, apple, pear and banana peelings—in fact, all the kitchen left-overs including meat and egg scraps. It was no wonder that hordes of earthworms could be seen in her hydrangea beds digging around the plant and aerating the soil. If you want to grow good hydrangeas, especially in an area where the temperatures drop to twenty below and stay there, put enough mulch around your plant so that you protect the entire root system. The results of Pearl Wright’s growings can’t be topped—one fabulous shrub bore 240 blossoms at once.

IRIS

Iris mulch should be applied to the base of the plant where it can control weeds growing in the flower beds. Use any organic matter on hand—sometimes strawberry plants from the old bed or just dry grass clippings. Ruth Stout disproved the old theory that bearded iris can’t be mulched. She mulched her iris with loose hay and had profuse blooms as beautiful as any around. If the sun’s rays can get through a layer of loose hay to make potatoes green, she concluded, it can obviously penetrate the same mulch on a bed of iris and give the rhizomes the needed treatment. It may be best not to use anything heavy—such as peat moss—she admits, but loose hay is a natural.

LAWNS

There seems to be little doubt that grass seed newly sown will benefit from a cover of mulch. Often straw or old hay maintains enough moisture to allow the seed to germinate. The covering shouldn’t be so thick as to prevent the grass from sprouting through as seedlings. Even a light covering of green grass clippings will help grass seed germinate.

The mulching status of already established lawns becomes more controversial, however, because a lawn can mulch itself as it is mowed and there is a great temptation to allow the grass clippings to deteriorate and turn into humus. The theory is that letting the grass clippings remain uncollected will provide for a more fertile soil and a more luxuriant bed of sod. Some gardeners argue, however, that the practice of not collect-

ing grass clippings produces a sick thatch that inhibits grass growth and development.

Actually, both schools of thought bear the seeds of truth. If you do the same thing with your grass clippings all the time, you're wrong. Occasionally allow your grass clippings to go back into the soil for added enrichment. But never allow them to accumulate so thickly as to form the underlying thatch.

LILACS

When spring rolls around, spread a six-inch layer of well rotted compost around the lilac bush and out far enough to take in most of the branch spread. Dig that in well, being careful not to injure the root, and cover with a mulch of hay or leaves with ashes, or pine needles if the soil is not acid enough. The lilacs, like most shrubs, grow best in slightly acid soil. If it is too acid, an application of agricultural lime is recommended. In the late fall work that mulch into the soil and remulch with leaves or grass clippings for the winter. That will prevent heaving of roots when the ground freezes and thaws.

LILIES

Lily bulbs must be kept well drained, and yet remain cool and moist. That condition demands a good mulch. Manure may be used over the top of the soil, if it is sufficiently decayed. A deep mulch of leaf mold over the lily bed will be appreciated during the hot weather, although the lilies may be planted among low growing annuals or bushes that will keep the soil shaded. After the first frost, cut your lily plants back to the ground

and cover with a light mulch of sawdust to protect new bulbs that are growing on the stem. Later, when the ground is frozen hard, cover with a very thick mulch of hay to pull them through the winter.

PANSY

Pansies want a cool, moist soil and a rich mulch, for they are gluttons. Use manure, compost, woods soil, leaf mold, or sawdust and shavings mixed with sheep or poultry manure. The mulch feeds them richly—they are surface feeders—and keeps the roots cool in summer and warm in winter.

PEONIES

Peonies can profit from a mulch of seaweed if it is available. If not, you might want to use a pine-bark mulch which will leave a nice, red-brown appearance. The pine bark will provide added nutrients to the soil and if you add pigeon manure over the winter you should have all the ingredients necessary for productive peonies.

POINSETTIAS

If you're transferring poinsettias out of doors, be sure you mulch them heavily. Be sure to keep them well mulched with lawn clippings or other good organic mulching material.

ORIENTAL POPPIES

Oriental poppies must be mulched in the fall. However, remove that mulch in the spring and stake them. By removing the mulch in springtime, you allow the soil

to warm up and the poppies to provide rich early blooms that will dot your spring garden.

RHODODENDRONS

Leaves and sawdust make excellent mulches for the rhododendron bed, chiefly because these plants need an acidic soil. These plants are subject to chlorosis, which stems from too basic a soil condition. The leaves will turn yellow or brown. An acidic mulch is an excellent preventative for this condition, or a good cure, should it occur.

It's usually best to add a winter mulch to rhododendrons before the temperature drops too far. By adding the mulch before freezing, you will help your plants to come up from the roots in spring. Rhododendron roots are fairly delicate and sensitive to soil heaving in winter. Add about four inches of sawdust or leaves in the fall and turn them under in spring.

ROSES

How important is mulch for roses? Frankly, it probably is rather foolhardy to attempt to grow roses without mulching. Horticulturist H. P. Rosen of Wright University in Arkansas says, "One cannot overemphasize the importance of a thick mulch, applied anew each spring as a sanitary measure. Such a mulch acts as an insulating layer that prevents soil-born infectious material from reaching new growth. Perhaps the best mulch is a thick layer of rotted cow manure."

Most roses will probably do twice as well with a mulch as without it, and often with roses a mulch may mean the difference between life and death.

Think about your mulching campaign early in the spring. Perhaps you will want to remove some of the old mulch that has been left to lie from last season. If you buried the top of the roses for winter protection under the mulch, resurrect them gradually. Then tear off the



Mulch can often mean the difference between life or death for roses, here being covered with a blanket of sugar cane.

old mulch entirely and work the tired old straw, leaves or whatever you used after it is half decayed into new compost heaps along with the winter's kitchen wastes and some fresh manure. Or if your rose soil is workable, turn the old mulch under right there. It will break down quickly, worked over by all the awakening and newly hatched soil animals, insects and bacteria. Earthworms begin to stir, slugs and snails chew up and break down any coarse mulch, and the spring cleaning of the rose bed is under way. When everything is operating efficiently, blanket the roses with a layer of fresh mulch, and the life of the soil continues to percolate under its brand new cover. Grass clippings from the earliest spring mowings will provide a nitrogen-rich cover. Freshly ground corncobs are fine for roses, while coffee grounds, mixed with about an inch of sawdust, make a handsome flower bed mulch. Shredded pine bark or cocoa bean hull, applied to approximately a two-inch level after spring pruning and seeding have produced excellent results. Even newspaper or sawdust on the rose beds has given excellent results.

Leaves are an excellent mulch for the rose beds, as they prevent alternate thawing and freezing that can destroy delicate root systems. But be careful they do not mat over the crowns, or crown rot will result. When leaves are used, the plants should be four or more inches in height; when using grass clippings or sawdust, the plants can be somewhat smaller. It's a good idea to mulch following a storm, using leaves, unless they are shredded. Use either grass, sawdust, or even old rugs to hold the leaves in place. Where sawdust is placed directly on the soil, pigeon manure should be put down

first to alleviate any nitrogen robbery by the sawdust. Some gardeners have experimented with mushroom compost and redwood sawdust. Others have used shredded pine bark or cocoa bean hull not more than two inches in depth. Put the mulch on after the soil has warmed up in the spring and keep it piled high during the growing season.

Gardeners have found that a well mulched bush doesn't invite predators. A good thick mulch and adequate ventilation are also the best preventative for the old nemesis, black spot.

When winter finally rolls around, you can prevent winter injury of roses from heaving and thawing. A proper application of a good mulch around the plants prevents the soil from freezing too deep and acts as an insulator. You might like to try a four to five inch mulch of ground corn cobs, manure, straw or peat moss. Put it on in the fall after the ground has been partially frozen, or not later than December. If your roses have been mulched during the summer, simply add two or three inches more of mulch material. That will keep the soil temperature more constant and prevent damage. Some rose growers prefer to mound their plants with soil to a depth of six to eight inches, but this is hard work and unnecessary.

SHRUBBERY

Established shrubs, like most other plants, should receive a good mulch during the growing season. Strawy manure makes an excellent mulching material during the early summer months. A leaf mulch under most shrubs will also replenish organic matter in the

soil. Unless fungus disease is a problem, leaves should be left where they fall and should be supplemented by liberal mulching with grass clippings, peat, corn cobs, straw, composted sawdust, or leaf mold. Leaves are an excellent mulch for shrubbery, and you might want to use it as a winter covering. Be sure to keep it well away from the trunk and apply only after the ground freezes to prevent the nesting of rodents.

INDEX

A

Acid, 17, 159, 161, 177
 Acid reaction, 9, 148
 Acids,
 carbonic, 23
 fulvic, 31
 humic, 31
 muramic, 31
 teichoic, 31
 uronic, 31
 Aeration, 18, 22, 25, 28, 34
 Aggregates, 20, 22, 40
 Alaska Division of Agriculture, 54
 Alfalfa, 28, 38, 140, 163, 167
 Alkaline, 17
 Aluminum foil, viii, 147, 149, 150, 152, 160, 177
 Anderson, Dorothy, 12-13
 Antibiotic substances, 26
 Apples, 46, 49, 85, 93
 Apple pomace, 142
 Arborvitae, 171
 Artichoke, 142, 144
 Asparagus, 104, 106, 139, 144-145
 Ault, Mrs. Sherreille, 109
 Auximones, 26
 Avrims, Edwin H., 168
 Azaleas, 140, 142, 172-172

B

Baterial gums, 30
 Bananas, 161
 Beans, 5, 35, 104, 113, 125, 145-146
 lima, 2, 43
 string, 2, 43
 Beets, 5, 6, 125, 146
 Begonias, 173

Beltsville, (Md.) Agriculture Plant Industry Station, 45-46
 Binder, Morton, 55, 132
 Biodynamic activity, 27
 Bixler, Ruth, 76, 92
 Blood meal, 119, 130, 132-133, 134
 Blueberries, 143, 161-162
 Bone meal, 70, 129, 158
 Boron, 27
 Bowman, Jean, 168-169
 Boxwood, 173
 Boysenberries, 162
 Broccoli, 126, 146
 Brock, Mrs. C.F., 166-167
 Brooklyn Botanical Gardens, 37
 Buckman, Professor Harry, 18-20, 29
 Buckwheat hulls, x, 119, 127, 173
 Burdick, Bart, 124

C

Cabbage, 126, 135, 136, 146-147
 Calcium, 26, 27
 Camellias, 140
 Canary Islands, 75
 Cantaloupe, 162-163
 Carbohydrates, 30
 Carbon, 27
 Carley, Victor A., 172
 Carter, Charles, 147
 Carrots, 5, 125, 147-148
 Carter, Charles, 147
 Castor bean pomace, 142
 Cauliflower, 126
 Celery, 148
 Cellulose, 30
 Chamberlain, C.E., 149
 Chase, Florence M., 177
 Chelation, 22, 26, 31

Cherries, 49, 85
 Chrysanthemums, 173
 Citrus trees, 44, 85, 163
 Clover, 28
 Cocoa bean shells, viii, 50, 139, 144
 Coffee grounds, 148, 176
 Columella, 83
 Commercial fertilizer, viii, 48, 49, 53
 Compost, ix, 6, 7, 9, 27, 28, 48, 49, 62, 95, 127, 135, 140, 141, 143, 150, 151, 152, 158, 162, 168, 176, 178, 180, 181, 184, 185, 186
 Copper, 26, 27
 Corn, 3, 9, 11, 35, 37, 113, 119, 125, 129, 130, 141, 147, 150
 cobs, 28, 74, 104, 118, 128, 139, 143, 144, 162, 164, 170, 176, 184, 185, 186
 shredded stalks, 28, 41, 74, 75, 127, 176
 Cotton burrs, 75, 128, 176
 Cottonseed meal, 11, 70, 119, 127, 129, 130, 134, 141, 175
 Couldwig, Robert, 172
 Criteser, Beth, 169
 Crop residues, 9
 Crows, 11, 43, 149
 Cucumbers, 5, 35, 130, 150-151
 Cultivation, 10, 29, 56, 118, 174
 Currants, 49

D

Dahlias, 174
 Daisies, 174
 Damping-off, 118
 Decay, 20, 23, 24, 28
 Decayed leaf mold, 4
 Decomposition, ix, 22, 23, 26, 27, 29, 30, 47, 57, 59, 62, 64, 71, 128, 133, 161
 Delphiniums, 174
 DeVoc, Robert F., 112
 Dew, 36, 106
 Dogwoods, 174
 Drainage, 18, 38, 39
 Drought, 2, 5, 7, 10, 13, 36, 37, 118, 123
 DuPont Company, 102

E

Earthworms, x, 9, 13, 22-23, 37, 50, 64, 79, 85, 157, 178, 184
 Eaton, Fred, 61
 Eggplant, 141, 151
 Eisman, Lucille, 148
 English, Robert E., 160
 Erosion, 22, 26, 41, 42, 43, 51
 Evergreens, 60, 86, 118, 142, 174-175

F

Fern, 175
 Fiederlein, Frank and Cecile, 160-161, 162
 Figs, 164
 Fleck, Harold, 1, 43-44
 Flowers, 9, 175-176
 Franklin, Oliver R., 161
 Frost, 2, 38, 67, 116, 119, 120, 136, 169, 180
 Fruits, 161-171
 Fruit trees, 50, 82, 85, 86, 92, 142, 143, 164-165
 Fungi, 15, 26, 44-45, 79, 118
 Fuschias, 132

G

Garlic, 151
 Georgia Agricultural Experiment Station, 41
 Gillette, Mrs. Paul, 153
 Gladiolus, 177
 Gooseberries, 49
 Grapes, 167
 Grass clippings, x, 7, 27-28, 48, 49, 58, 74, 144, 145, 147, 151, 153, 154, 160, 163
 Graybill, Paul, 113
 Ground cork, 58, 60, 61
 Gums, 31

H

Hay, vii, x, 10, 11, 12, 30, 46, 48, 49, 54, 61, 63, 67, 104, 125, 126, 128, 129, 130, 134, 140, 141, 143, 145, 146,

147, 150, 152, 158, 160, 163, 171, 174, 179

Heaths, 177
 Heaving, 38-39
 Hemlocks, 96-97, 171
 Herbaceous annuals, 57
 Herbicides, x
 Hill, Lewis, 47
 Holly, 177
 Hops, 75, 142
 Humus, viii, 20, 21, 25, 28, 48, 64, 135, 136, 146, 179
 Hunter, Mrs. Margaret, 111-112
 Hyacinth plants, 75, 161
 Hydrangea, 178
 Hydrogen, 27

I

Iris, 179
 Iron, 26, 27, 30

K

Keck, John, 99
 Kohlrabi, 125, 151-152
 Krill, John, 64-67, 120, 125

L

Lawns, 179
 Leaves, x, 9, 28, 30, 48, 49, 50, 64, 68, 71, 79, 80, 95, 117, 119, 125, 126, 127, 140, 142, 143, 145, 149, 150, 151, 152, 153, 154, 156, 158, 160, 162, 163, 164, 167, 169, 171, 173, 178, 182, 184, 186
 Leeks, 152
 Leister, Mary, 57
 Lettuce, 3, 7, 11, 12, 13, 107, 125, 135, 136, 141, 152
 Lignin, 30, 31
 Lilacs, 180
 Lilies, 180-181
 Lime, 56
 Lindeman, Joan, 146
 Liquid fish solutions, 9
 Loganberries, 167
 Lyon, Professor T., 18-20, 29

M

MacManes, John S., 94
 Magnesium, 26, 27, 62
 Malsch, Brownson, 145
 Manganese, 27
 Manure, 9, 26, 27, 30, 48, 49, 53, 55, 56, 62, 70, 76, 88, 89, 105, 129, 130, 134, 139, 142, 143, 147, 153, 159, 167, 172, 173, 175, 176, 180, 181, 182, 184, 185
 Marshgrass, 13
 Martin, Archer, 71
 McCalla, T.M., 21, 27
 Mead, Robert, 74
 Melons, 5, 130, 163
 Microbes, 22, 24
 Microbial action, 26, 34
 Microbiological life, 23, 44, 51
 Miller, Joe, 158
 Minerals, 17, 22, 23, 26, 30, 32, 62, 98
 Mock Orange, 167-168
 Molds, 30
 Montfort, Georgia, 90-92
 Morris, Edward P., 149
 Mulenberg, Walter J., 96-97
 Mulch,
 amount of to use, 127
 continuous, 10, 116, 117, 149
 dark, 40
 light, 40
 nature's, ix
 organic, viii, 23-33
 permanent, 6, 10
 spring, 139
 summer, 116, 117
 when to, 115-117, 130-132
 winter, 116, 140, 141, 143
 Mulching,
 benefits, of, 28-29, 31-33, 34, 43, 45
 book system of, 63-64
 materials, 52-80
 mistakes, 129, 136
 questions about, 115
 spontaneous, viii-ix
 Mulching specific plants, 144 (see plant name)

N

Nature and Properties of Soils, The, 18
 Nebraska Crop Improvement Association, 21
 Nematodes, Citrus, 45
 Newspapers, 48, 109-114, 141, 163, 184
 ways to use, 109
 New York City Commission of Air Resources, 102
 Nitrogen, x, 11, 22, 26, 27, 30, 31, 59,
 61, 75, 79, 119, 129, 130, 132, 140,
 144, 157, 185
 deficiency, 127-128, 133
 Nutrients, 9, 17, 22, 23, 26, 47, 62, 79,
 176

O

Oats, 65, 128, 129
 Ohio Department of Highways, 42
 Ohio Edison Company, 71, 73
 Okra, 152-153
 Onions, 11, 153
 Organic Gardening Experimental Farm, 83, 85, 157
 Organic material, vii, 20-24, 26, 27, 29,
 30, 32, 43, 56
 Organic salts, 31
 Oriental poppies, 181
 Ornamentals, 171-186
 Oxygen, 27
 Oyster shell, 77

P

Pansy, 181
 Papaya, 168
 Paper, 10, 48, 49
 Parsnip, 125, 153
 Patterson, Pat, 150
 Peaches, 85, 94, 95
 Peanut shells, 75, 142
 Peas, 125, 136, 154
 Peat moss, 55, 74, 128, 149, 152, 161,
 162, 164, 170, 175, 176, 179, 185,
 186
 Pennsylvania State Agricultural Experiment Station, 39
 Peonies, 126, 142, 181

Peppers, 3, 125, 135, 136, 141, 154-155
 Perennials, 50, 57, 72, 117-118, 119,
 139, 177
 Pesticides, x
 pH, 14, 55, 62, 161
 Phosphorous, 26, 27, 30
 Picon, 75-76
 Pierson, Joan, 146
 Pine chips, 58-59, 70
 Pine needles, 41, 50, 74, 127, 140, 157,
 161, 162, 169, 171, 176, 177
 Plant roots, x, 20, 29
 Plastic mulch, 101-108, 158
 drawbacks, viii, 101
 Ruth Stout on, 103-108
 toxic fumes from, 102
 Podzolic, 14
 Poinsettias, 181
 Polser, Kenneth, 158
 Potash, 26, 62, 75, 119
 Potassium, 27
 Potatoes, 4, 11, 70, 155-158
Public Works, 43
 Pumpkins, 158

R

Radishes, 158-159
 Raspberries, 44, 47-48, 49, 57, 168-169
 Rawson, Harold, 7-9
 Raymond, Dexter, 151
 Rhododendrons, 142, 182
 Rhubarb, 54, 57, 89, 159
 Rice hulls, 75, 128
 Rodale, J.I., 84, 94, 98, 99
 Rodale, Robert, 97-99
 Root zone, 9
 Rosen, H.P., 182
 Roses, 9, 50, 72, 77, 89, 139, 143, 176,
 182-185
 Rot, 152
 brown, 45
 crown, 45, 119
 fruit, 45
 root, 26, 45
 Rotation, 21, 27
 Ruth Stout No-Work Garden Book, The, 43

S

Salt damage, 9
 Sarwell, Edith, 157
 Sawdust, viii, 13, 28, 48, 49, 53, 54, 55-56,
 57, 58, 74, 78, 127, 132, 140,
 143, 147, 153, 159, 160, 161, 162,
 163, 164, 167, 168, 169, 171, 177,
 181, 182, 184, 186
 Schoth, Harry, 151
 Schroeder, Dorothy, 3
 Seasonal mulching calendar, 138
 Seaweed, 53, 54, 172
 Seneca Buttercrunch, 6
 Servais, L.T., 82, 94, 100
 Shade, Lucille, 129-130, 135
 Shaw, Dave, 69
 Shaw, Donald, 158
 Shields, Lee, 67
 Shrubbery, 9, 185-186
 Simonson, Roy, 15
 Slimes, 30, 31
 Smith, Mrs. Robert, 34-36, 51
 Snyder, Gordon, 153
 Sod, 10, 27
 Soil,
 balance, 9
 clays, 17, 18, 20, 28, 119
 composition of, 16-18
 crumb, 20
 flora, 44
 friability of, 18, 28, 55
 granular, 20, 29
 gravels, 17
 heaving, 38, 116, 118
 home testing kit for, 17
 horizons, 15
 loams, 17, 18
 microorganisms, 22, 24-25, 26, 27, 29
 nutritional deficiencies in, 17
 pattern, ix
 porosity, 41
 profile, 15
 sample, 17, 20
 sands, 17-19, 28, 38
 structure, vii, 20, 22, 29, 36, 81
 temperature, viii, 28, 34, 36, 38-40,
 43, 51, 57, 61, 81
 Soil Conservation Service, 21
 Solvation, 22, 23, 31

Soybean meal, 11, 128
 Soybeans, 44, 163
 Sphagnum peat moss, 28, 29, 128, 161
 Spinach, 125, 159
 Spoiled hay, 12, 13
 Squash, 3, 7, 13, 107, 159-160
 Stahr, Alden, 45, 51
 Starns, Walter, 153
 Steinmetz, Ervin, 72, 73
 Stephens, Ethel M., 162
 Stone mulching, 81-100
 as decoration, 83, 99-100
 concrete molds for, 98
 disadvantages of, 97
 fortress method, 93-94
 for sick trees, 85, 94
 Stout, Ruth, 10-13, 35, 43-44, 103-108,
 116, 119, 125, 134, 135, 153, 159,
 179
 Straw, x, 27, 41, 104, 117, 127, 129, 130,
 132, 134, 141, 143, 145, 151, 152,
 154, 155, 158, 160, 170, 171, 173,
 174, 175, 176, 178, 185, 186
 Strawberries, 49, 54, 57, 114, 129, 169-170
 Sulphur, 23, 27
 Sweet Potatoes, 160

T

Terrace gardening, 92
 Thompson, A.P., 93
 Tillage, 21
 Tilling, Don, 157
 Tilth, 28, 49, 64, 68
 Tirell, Ruth, 5-7, 154
 Tobacco, 37, 74, 178
 Tomatoes, 3-6, 9, 10, 22, 104, 119, 120-125,
 126, 130, 132, 135, 136, 141,
 160-161

U

University of Illinois, 23
 U.S. Department of Agriculture, 15, 21,
 23, 41

V

Vegetables, 144-161

INDEX

Virgil, 83
Voigt, Owen M., 77-81

W

Wandzell, Bob, 53
Ward, Vernon, 125
Watermelon, 150, 170-171
Watson, E.M., 150
Wood, Margaret L., 85-90
Wood chips, 13, 44-45, 48, 49, 69-74,
143, 152, 168, 169, 170

Wright, Pearl, 178
Wright University, 182
Williamson, Cynthia, 135-136

Y

Yearbook of Agriculture, 15

Z

Zinc, 27
Zinnias, 127

FENCE PLANNER

for the COMMON SENSE FENCETM

Fencing technology in the U.S. has evolved from the first use of barbed wire in the late 1800's and woven wire soon after. This, along with steel and wood posts were the main means of animal control until electric fencing was introduced in the 1940's. Electric fencing was a wonderful invention in that it kept livestock both contained and away from the fence. Unfortunately, steel and wood posts continued to be used and insulators needed to be added. The cost of the insulator was always an important consideration and in an effort to keep insulators for farm fences affordable materials were chosen that typically had a short life span plus if dirt and moisture collected

on the surfaces, shorts occurred. Thus electric fencing was only used for temporary fencing. In another development in the 1970's, high-tensile wire was developed to get away from barbed wire. This wire needed to be installed close together and at high tension which required both extremely strong corners and line posts spaced close together, thus high cost. In the 1980's, the "COMMON SENSE FENCE" product line was introduced which combined the advantages of high tensile wire and electricity with "never to short out" Fiberglass Posts that could now be spaced at greater intervals. THIS IS THE PRODUCT WE ARE PRESENTING HERE.

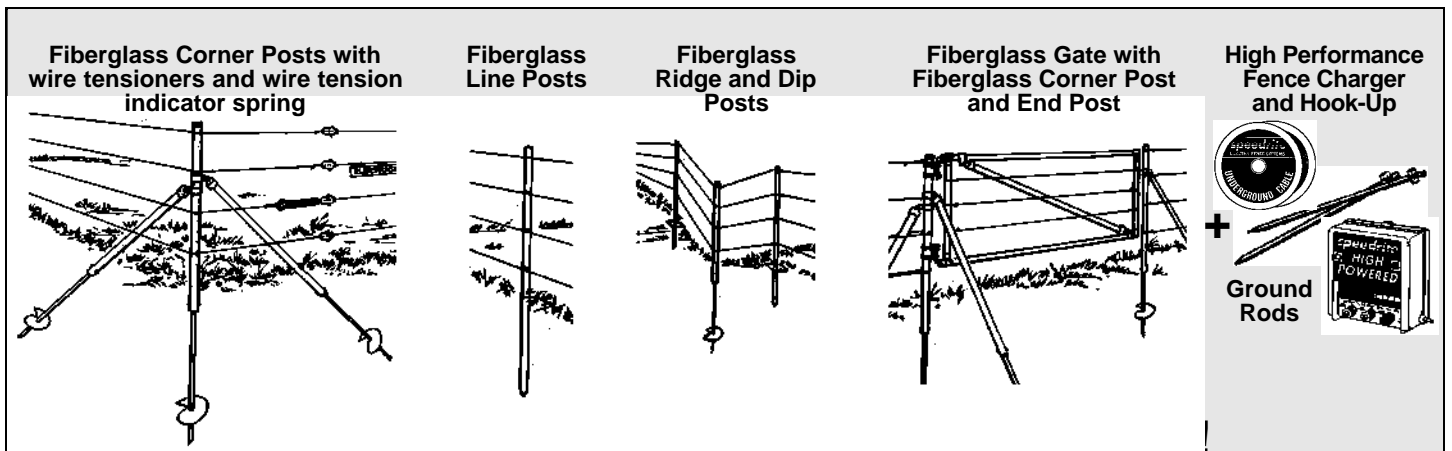

The easiest to install, safest, most dependable, longest lasting and most cost effective fence you can build, PERIOD!

TAKE TIME TO PLAN. The installation of any fencing system begins long before the first post is driven or wire is strung. The secret of getting the most from each dollar spent on fencing is to take the time to thoroughly plan, and then construct carefully. Any time that may be saved by incomplete planning, construction shortcuts or poor safety practices will only reduce the efficiency and life of the fence and will ultimately cost much more than is saved. NO ONE is better suited to plan the "Common Sense Fence" and construct it than the person who will use it...you. You know which animals are to be controlled and the lay of the land.

CHECK LOCAL LAWS AND ORDINANCES. Laws governing placement of fences and electric fencing vary from county to county. It is important to understand what your local ordinances have to say about electric fencing BEFORE you start. Questions such as: "How far must a fence be from a roadway?", "Can electric

fencing be used in suburban areas?" and "Are warning signs required?" must be answered. If in a rural area, check with your County Extension Office and if in town, check with the City Clerk's Office.

CHECK YOUR PROPERTY LINES. The first step in planning any fence is to check your property survey. In rural areas, adjoining fences are generally built on the property line with each owner paying half the cost. Within city limits, fences must generally be entirely on your own property and you pay all the costs. Again, check your local laws.

TALK WITH YOUR NEIGHBORS. It is a good idea to talk over fencing plans with the neighbor whose property will be next to the fence. Your neighbors may have questions about the "Common Sense Fence".

A. Sketch a Map and Choose your End, Corner, Dip and Ridge Posts

Begin by drawing a map of your property including all major features such as: buildings, roads, fields, swamps, woods, hills, gullies, streams and other features that might require special consideration during construction. Be sure to include: power and telephone lines, gas and oil pipelines and underground cables.

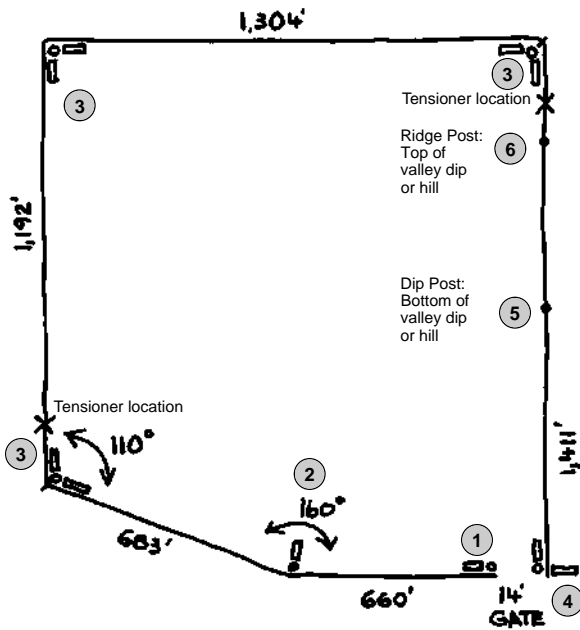

STEP 1.

Screw in anchors.

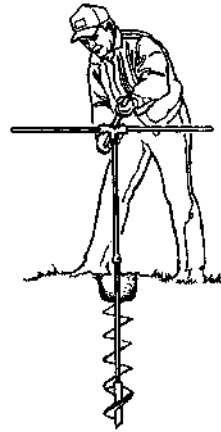

STEP 2.

Secure fiberglass corner posts and braces to anchors.

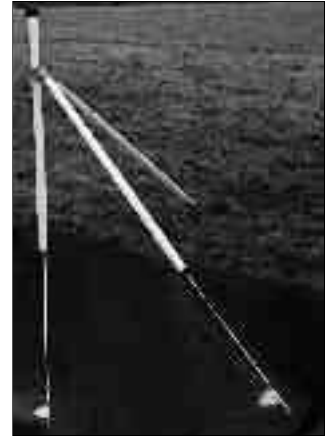

4, 5 & 6 FOOT HIGH MULE

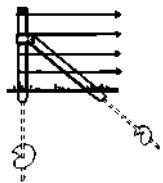

End Post - 1 Post, 1 brace and 2 augers to be used in two situations:

1. Where the fence will end and a gate will not be hung on that post.

2. For slight changes in wire direction and where a full corner is not required. Generally less than 60° and more than 120°.

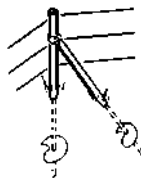

Corner and Gate Posts - 1 Post, 2 Braces and 3 Augers

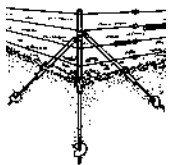

3. For all corners near 90° or

4. Where the fence will end and a gate will be hung on that post.

Note: Be sure to measure gate opening correctly to allow for gate hinges and latch.

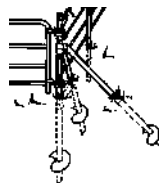

DIP AND RIDGE POSTS

5. Dip Post

To be used where the ground rises causing a lot of upward pull on the post. Use at the bottom of a valley dip or hill.

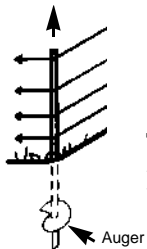

6. Ridge Post

To be used where the ground slopes down and tension on the wires will want to force the post into the ground. Use at the top of a valley dip or hill.

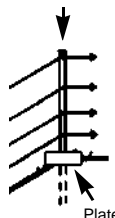

3 FOOT HIGH MULE

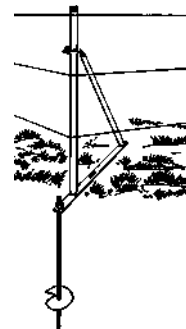

Single brace can be used as an end or a corner.

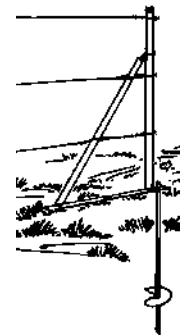

Install tool is built into bottom metal strap.



Double brace can be used for all ends and corners.

When pulling sideways on a gate post, you may prefer to use the double brace for more side stability.

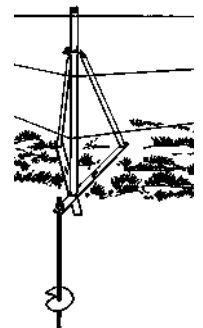

ANCHOR OPTIONS:

The 6" x 36" auger anchor is the standard and works in over 80 percent of the situations. However, for very hard, rocky ground, we have the 4" x 24" auger and for soft, deep sand, peat and swampy soils we have the 10" x 36" auger. In addition, 12" and 24" extensions are available to handle unexpected conditions that may require deeper penetration into the ground. We have not uncovered conditions to date that one of our Mule™ anchors can't handle. If one has solid rock, one can drill a 1¼" hole in the rock, insert the ¾" x 12"

extension, add grout, let it harden and install the corner system.



B. Wire, Tensioners and Crimp Sleeves

12½ gauge, 200,000 min. psi, high tensile, class III galvanized steel wire should be used. Its strength and elasticity will assure you of a fence that lasts for years. Care must be taken when uncoiling high tensile wire as it acts like a coiled spring and can easily become entangled. A "spinning jenny", as shown in the photo should be used to hold the wire in place as it's being uncoiled. Install in-line wire tensioners and secure wire as shown in illustrations below. Secure just ONE wire prior to driving line posts in. This should be the second wire up from the ground. Tighten wire with in-line wire tensioners so it stays straight and provides a guide for installing the line posts.



CRIMP SLEEVES

It is recommended that all wire connections be made using crimp splice sleeves and the special crimp tool. Use of the crimp sleeves will result in a splice equal to the strength of the wire.

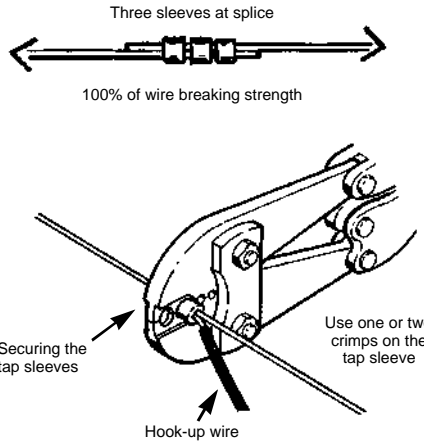
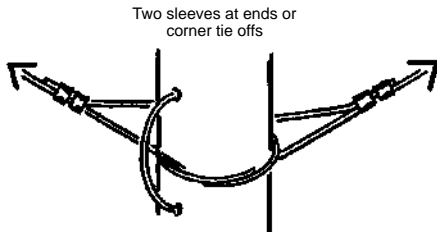

12½ gauge high tensile wire can be tied off as illustrated below. However, it is difficult to do and one does not achieve a splice strength equal to the strength of the wire.

SPLICE KNOTS

FIGURE EIGHT

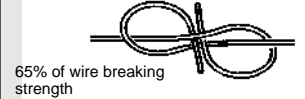

65% of wire breaking strength

DOUBLE LOOP

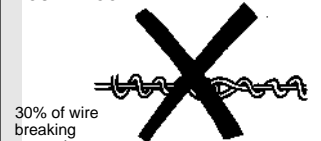

30% of wire breaking strength

THREADED THROUGH

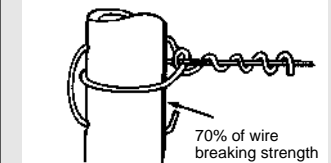

SIMPLE TWIST

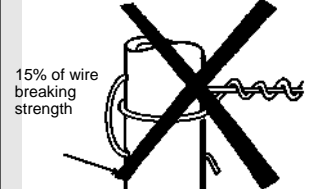

15% of wire breaking strength

IN-LINE WIRE TENSIONER

(X) shows location of wire tensioner	Maximum feet of wire per wire tensioner
STRAIGHT LINE 	5,000 ft. max. Additional wire tensioners per wire are required if braced ends are over 5,000 ft. apart.
ONE CORNER 	5,000 ft. max. each Use two wire tensioners for angles less than 45° (one on each straight line)
TWO CORNERS 	3,000 ft. max. You can pull around one corner in each direction.

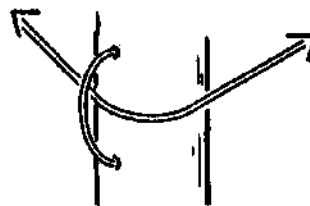

NOTE: Fence line wires may "flow" around corners allowing longer runs and the use of fewer tensioners. See chart.

(X) WIRE TENSIONER

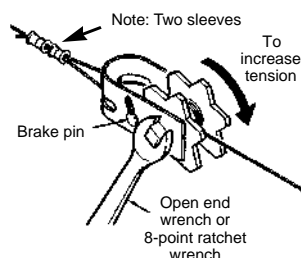

C. Drive in Line Posts and Install Clips

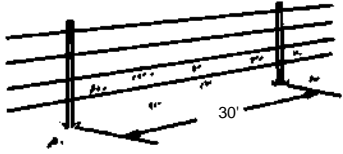

Suggested spacing for line posts is 30 feet.

See pages 6 and 7 for suggested wire spacing.

SECURE WIRE TO POSTS

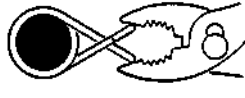

Squeeze hooks together. Slip clip onto post with longer hook down, release.



Pull wire up into bottom hook – rotate wire up and around until it is inside the upper hook. Release.

WIRE U-CLIPS

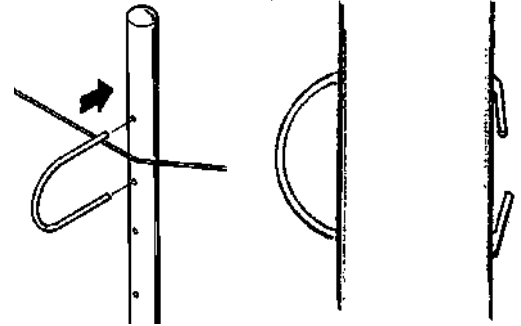

Push u-clip through two holes and use hammer for 2" posts to bend wires and pliers for other posts.

D. Tension Indicator Spring

Recommended wire tension is between 100 and 150 pounds for 12½ gauge wire. The springs are marked to show load. Generally, the wires need to be tightened so they do not have excessive sag and thus not likely to touch the wire above or below. Remember, **ITS THE ELECTRICITY THAT IS CONTROLLING THE ANIMALS**, not the wire tension.

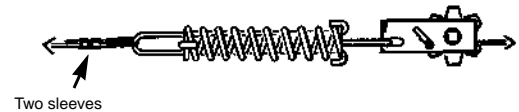

Gates

POLYETHYLENE TUBING

The "Common Sense Fence"™ System uses insulated hook-up wire inserted through polyethylene tubing to conduct fence line current underground. Polyethylene tubing provides additional insulation from the soil as well as protecting the insulation from the soil as well as protecting the insulation on the wires. The use of overhead wires is not recommended. Transfer wires that run overhead (conventional electric fencing) from controllers to fence lines and across gateways, are "high targets" for lightning strikes or may be damaged by farm equipment.

Underground use of insulated hook-up wire requires proper installation:

- Never have spliced insulated hook-up wires inside the polyethylene tubing.
- The ends of the polyethylene tubing must be made water resistant.
- Maximum distance recommended for underground wires is 200 feet. For longer distances, run a fence above the ground or install the controller closer to the fence. Spliced joints in the polyethylene tubing are not recommended.

WATER RESISTANT END FOR POLYETHYLENE TUBING

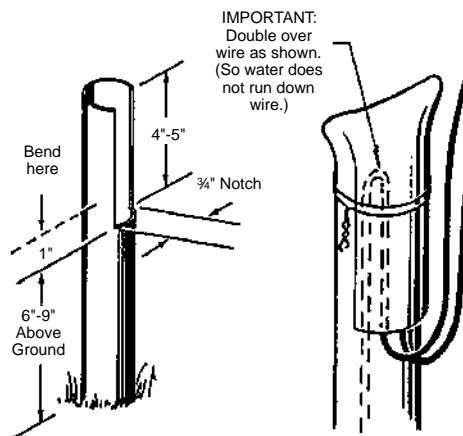

GATE BRACKET AND GATE HOOK PIN

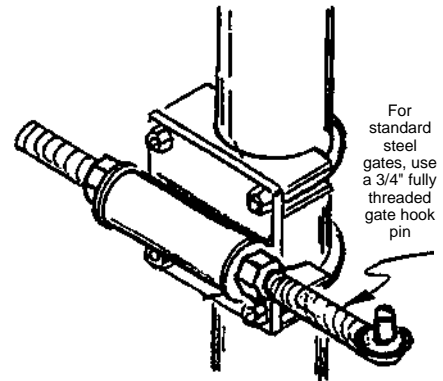

GATE LATCH BRACKET

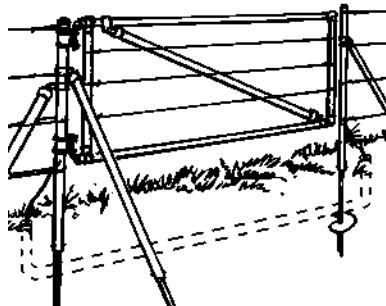
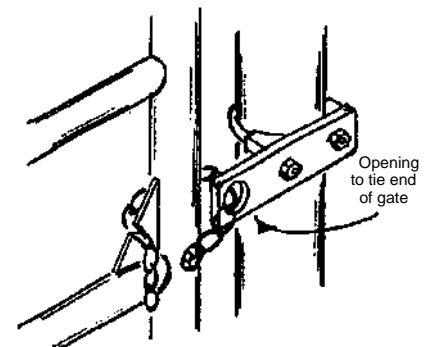

E. Fence Controller and Ground System

ALL HOT SYSTEM

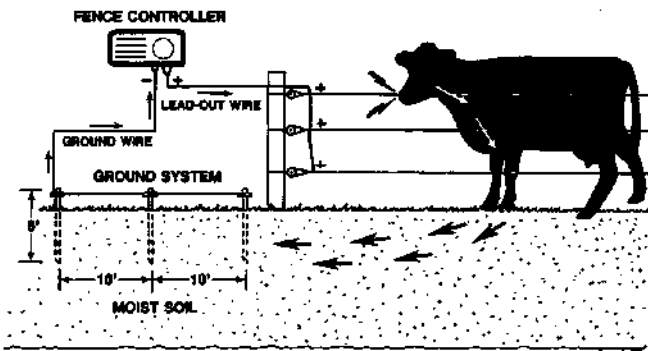

In an all hot system, the animal receives a shock by touching a hot wire which transfers the electrical charge through the animal, through the earth to the ground rods and back to the controller which completes the circuit. **This system relies on good ground rods and moist, unfrozen earth conditions.**

HOT/GROUND SYSTEM

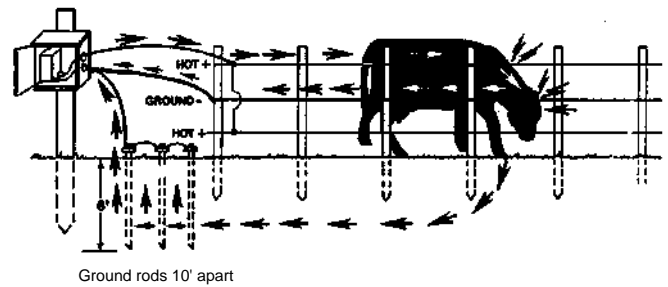

In the hot/ground system, the animal can receive a shock the same as the All Hot System and also by touching a hot (+) and ground (-) wire at the same time to complete the circuit. **For best results in all soil conditions, use a hot/ground system.**

DO NOT install ground rods within 50 feet of a utility ground rod, buried telephone line, or buried water-line (they may pick up stray voltage).

WARNINGS

SAFETY: Although modern fence controllers approved by recognized safety standard organizations pose no direct safety concern, indirect accidents can happen so it's important to be aware of the following WARNINGS before constructing your fence.

- WARN ALL PERSONS, ESPECIALLY CHILDREN, ABOUT YOUR ELECTRIC FENCE AND SHOW THEM HOW TO DISCONNECT THE CONTROLLER IN CASE OF EMERGENCY. If you permit hunters or other visitors to use your land, be sure they have been warned and that all of your electric fences are marked.
 - USE AMPLE WARNING SIGNS. This is especially true around buildings or locations where you expect people to be. Warning signs should be used every 300 feet or less. In some states warning signs are required by law.
-
- ONLY USE CONTROLLERS WHICH HAVE BEEN APPROVED BY NATIONALLY KNOWN AND RECOGNIZED SAFETY STANDARD ORGANIZATIONS.
 - BEFORE THUNDER OR ELECTRICAL STORMS, IT IS BEST TO DISCONNECT A CONTROLLER FROM THE FENCE WIRES AND REMOVE THE PLUG FROM THE LINE OUTLET.
 - DO NOT FENCE DURING ELECTRICAL STORMS.
 - NEVER GRASP A SUSPECTED LIVE FENCE WIRE.
 - DO NOT TAMPER WITH OR ATTEMPT TO REPAIR CONTROLLERS. Controllers must be sent back to the factory or an authorized service shop for repairs.
 - DO NOT USE MORE THAN ONE CONTROLLER FOR THE SAME SECTION OF FENCE.
 - ALWAYS DISCONNECT THE CONTROLLER BEFORE HANDLING FENCE WIRES.
 - WHEN WORKING NEAR OR TESTING ELECTRIC FENCES, KEEP FEET AND HANDS DRY.

- DO NOT USE BARBED WIRE WITH ELECTRIC FENCING.
 - DO NOT STRING ELECTRIC FENCE WIRES OVER OR CLOSE TO WATER TANKS OR ANY WATER THAT MIGHT BE USED FOR SWIMMING.
 - DO NOT ERECT AN ELECTRIC FENCE UNDER OR NEAR OVERHEAD POWER LINES. Because electric fence lines are well insulated from the ground, fallen power lines can send lethal amounts of electrical power for much greater distances than can non-electric fences. Check with your local power authority so see if this is a potential problem. The following illustration shows one method of safely passing under a power line with an electric fence.
-
- BE SURE THAT YOUR ELECTRIC FENCE WIRES (both wire return and hot) DO NOT COME IN CONTACT WITH YOUR BUILDING.
 - NEVER USE YOUR POWER LINE GROUND RODS OR YOUR PLUMBING SYSTEM AS A GROUND FOR YOUR ELECTRIC FENCE.
 - KEEP GROUND RODS FOR THE ELECTRIC FENCE AT LEAST 20 FEET AWAY FROM ANY:
 - Utility company rods.
 - Telephone company ground rods.
 - Underground metal pipes
 - Metal supports for structures which lie upon, or have been driven into, the earth.

Suggested Wire Spacings:

The designs shown are for general reference and may be modified for your own specific containment needs.

3 Foot High MULE

HORSES, CATTLE

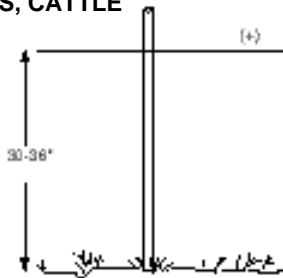

Figure 1

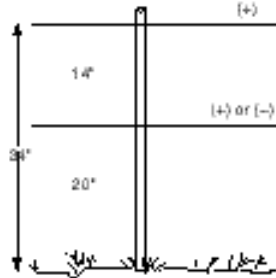

Figure 2

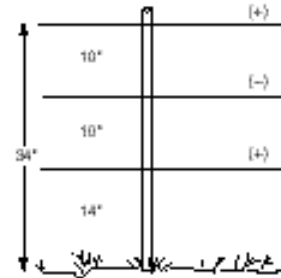

Figure 3

SHEEP, GOATS, HOGS

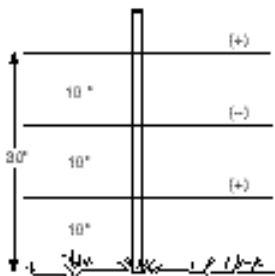

Figure 4

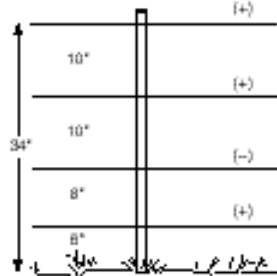

Figure 5

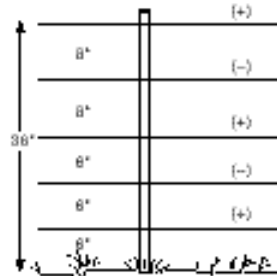

Figure 6

RABBITS, RACCOONS

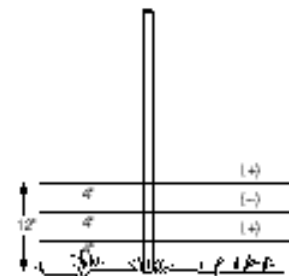

Figure 7

4 Foot High Heavy Duty MULE

HORSES, BEEF, DAIRY

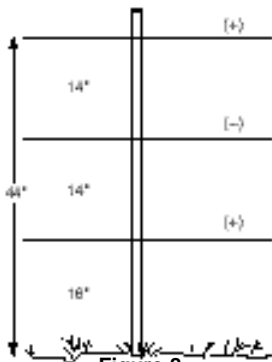

Figure 8

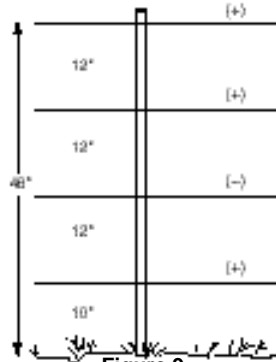

Figure 9

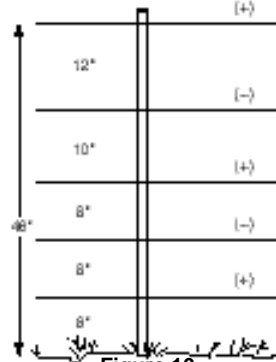

Figure 10

SHEEP, GOATS, HOGS

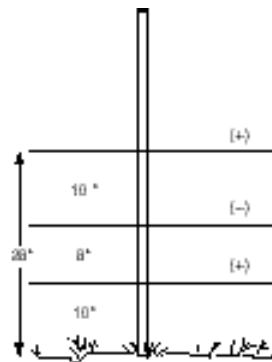

Figure 11

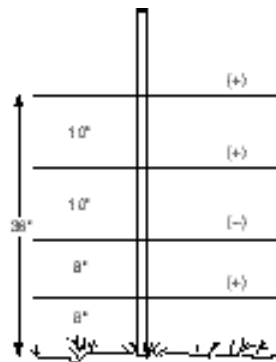

Figure 12

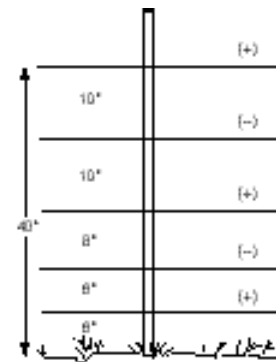

Figure 13

5 Foot High Heavy Duty MULE

BUFFALO, DEER, DAIRY, HORSES, BEEF, PREDATORS, LLAMA

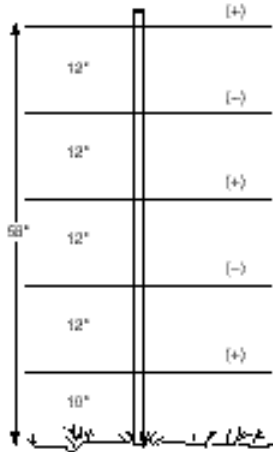

Figure 14

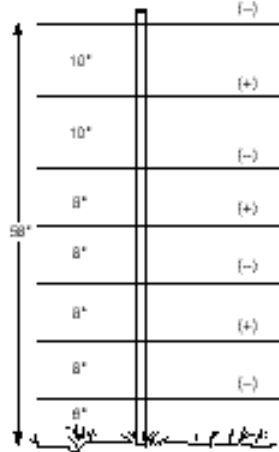

Figure 15

PREDATOR CONTROL – COYOTES, DOGS, WOLVES, ETC.

Fencing requirements are generally greater for the control of wild animals. This is because of their more aggressive behavior towards fences and barriers. Just as with livestock, it is important to consider the physical and behavioral characteristics of the wild animals which you are going to control. Dogs and their relatives are of particular interest because they have no sweat glands. This greatly reduces the moisture on their skins, making electrical flow more difficult and thus a less effective shock. A fence for these predators must be high enough to keep them from jumping over, wire spacing close enough to keep them from squeezing through. The 9-wire general-purpose predator fence shown in Figure 17 forces the predator to climb the fence. This insures simultaneous contact by two or more of its padded paws between the (+) hot and the (-) wire return producing the most effective shock to control these predators.

6 Foot High Heavy Duty MULE

BUFFALO, DEER, PREDATORS, BEAR

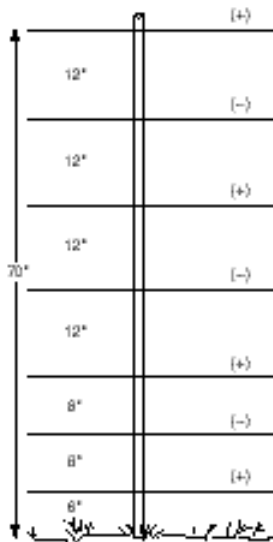

Figure 16

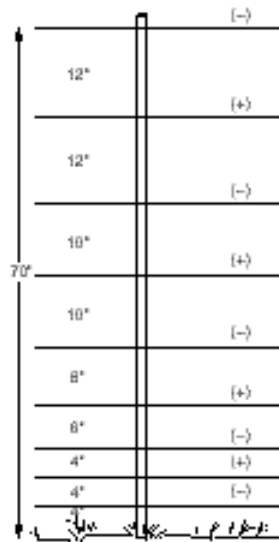

Figure 17

4 Foot High Electric Rail MULE

1 1/4" RAIL, 2" POST



Figure 18

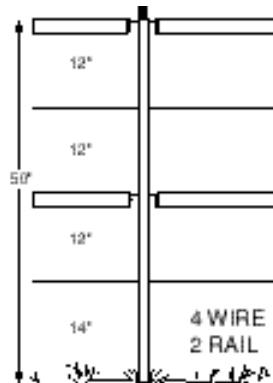

Figure 19

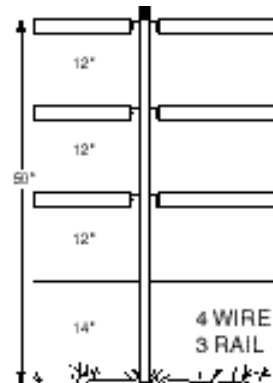

Figure 20

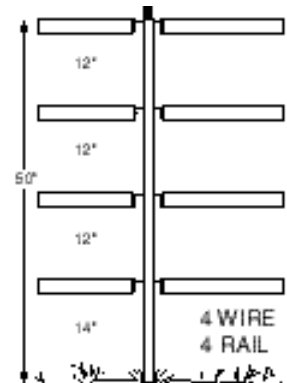

Figure 21

Embedded Secure Document

The file *file:///C:/CDROMs/SCDR-2/Prophecykeepers/POST-NUCLEAR-WAR/b_recovery/2_farm_recovery/ftpfiles/oilseed.pdf* is a secure document that has been embedded in this document. Double click the pushpin to view.



Simple Technology

Table of Contents:

Some of the information regarding Simplified Technology is presently in locked files because it is copyrighted information. The concept behind putting it on this site in that manner is to gather the information now and to archive it in a form that may possibly be disseminated later. Some of the information here could as well as have gone under farming or pioneering skills. There is so much information about using bicycles, that while they might have gone under simple machines, they have gotten a category of their own. The same applies to windmills and waterwheels. Some of the decisions as where to put information have been arbitrary but there is just too much to put it all under one category, so the reader needs to look under all the categories when studying the subject.

[Basic Machines: The Basic Principles of Machinery](#)

This 168 page .pdf book is open and available for downloading NOW. It covers levers, block and tackle, plane and wedge, and on up through hydraulic devices, and internal combustion engines, and more.

[Simple Machines: Descriptions of Simple Machines](#)

This 81 page .pdf book from MIT explains how to build dozens of primitive machines, drills, lathes, pumps, and all sorts of other useful devices. Currently a locked file because of copyright.

[Farm Devices: Patterns for Simple Farm Devices](#)

This 150 page .pdf book shows how farmers built their own devices in the 1700s and 1800s (and for perhaps centuries earlier). Practical ideas that are still used today.

[Scythes: A tool of the centuries](#)

This 63 page .pdf copyrighted and presently sealed book covers one of the most basic and essential tools of the centuries. Along with ax, hoe, hammer and shovel, it has been essential to the establishment of civilization. Largely displaced by modern harvesting methods it is a technology that may need to be at least temporarily "recovered".

[Blacksmithing: An essential technology](#)

This 132 page .pdf copyrighted and presently sealed book covers an essential technology that may have to be recovered. About a hundred years ago every village would have one or more blacksmiths, but then the

skill largely disappeared except as retained by farriers (horse shoeing is another subject) and some ornamental artists.

[Regulator:](#) [How to build your own alternator regulator](#)

[SEALED:](#) [How to build your own alternator regulator](#)

This is the SEALED mirrored version of this site that won't be opened until after The Great Catastrophe. The above open link is to the original Forcefield Site.

[Float Switch:](#) [How to build a float switch](#)

[SEALED:](#) [How to build a float switch](#)

This is the SEALED mirrored version of this site that won't be opened until after The Great Catastrophe. The above open link is to the original Forcefield Site.

[Propane Conversion:](#) [How to do a gas to propane conversion](#)

[SEALED:](#) [How to do a gas to propane conversion](#)

This is the SEALED mirrored version of this site that won't be opened until after The Great Catastrophe. The above open link is to the original Forcefield Site.

[LED Conversion:](#) [How to convert flashlights to use LEDs](#)

[SEALED:](#) [How to convert flashlights to use LEDs](#)

This is the SEALED mirrored version of this site that won't be opened until after The Great Catastrophe. The above open link is to the original Forcefield Site.

Click here to return to the
[Overview Table of Contents](#)

MENU: [HOME](#) » [Reconstruction](#) » [Recovery](#) » [Renewal](#) » [Survival](#)

BASIC MACHINES AND HOW THEY WORK

Prepared by Bureau of
Naval Personnel

Dover Publications, Inc.
New York

Published in Canada by General Publishing Company, Ltd., 30 Lesmill Road, Don Mills, Toronto, Ontario.

Published in the United Kingdom by Constable and Company, Ltd., 10 Orange Street, London WC 2.

This Dover edition, first published in 1971, is an unabridged and unaltered republication of the work originally published by the United States Government Printing Office in 1965, under the title: *Basic Machines*. This work was prepared by the Bureau of Naval Personnel, Department of the Navy, as Navy Training Course NAVPERS 10624-A.

International Standard Book Number: 0-486-21709-4
Library of Congress Catalog Card Number: 77-153739

Manufactured in the United States of America
Dover Publications, Inc.
180 Varick Street
New York, N. Y. 10014

PREFACE

Basic Machines is written as a reference for the enlisted men in the Navy whose duties require knowledge of the fundamentals of machinery.

Beginning with the simplest of machines—the lever—the book proceeds with the discussion of block and tackle, wheel and axle, inclined plane, screw and gears. It explains the concepts of work and power, and differentiates between the terms "force" and "pressure." The fundamentals of hydrostatic and hydraulic mechanisms are discussed in detail. The final chapters include several examples of the combination of simple mechanisms to make complex machines.

As one of several basic Navy Training Courses, this book was prepared by the Education and Training Support Service, Washington, D.C., for the Chief of Naval Personnel.

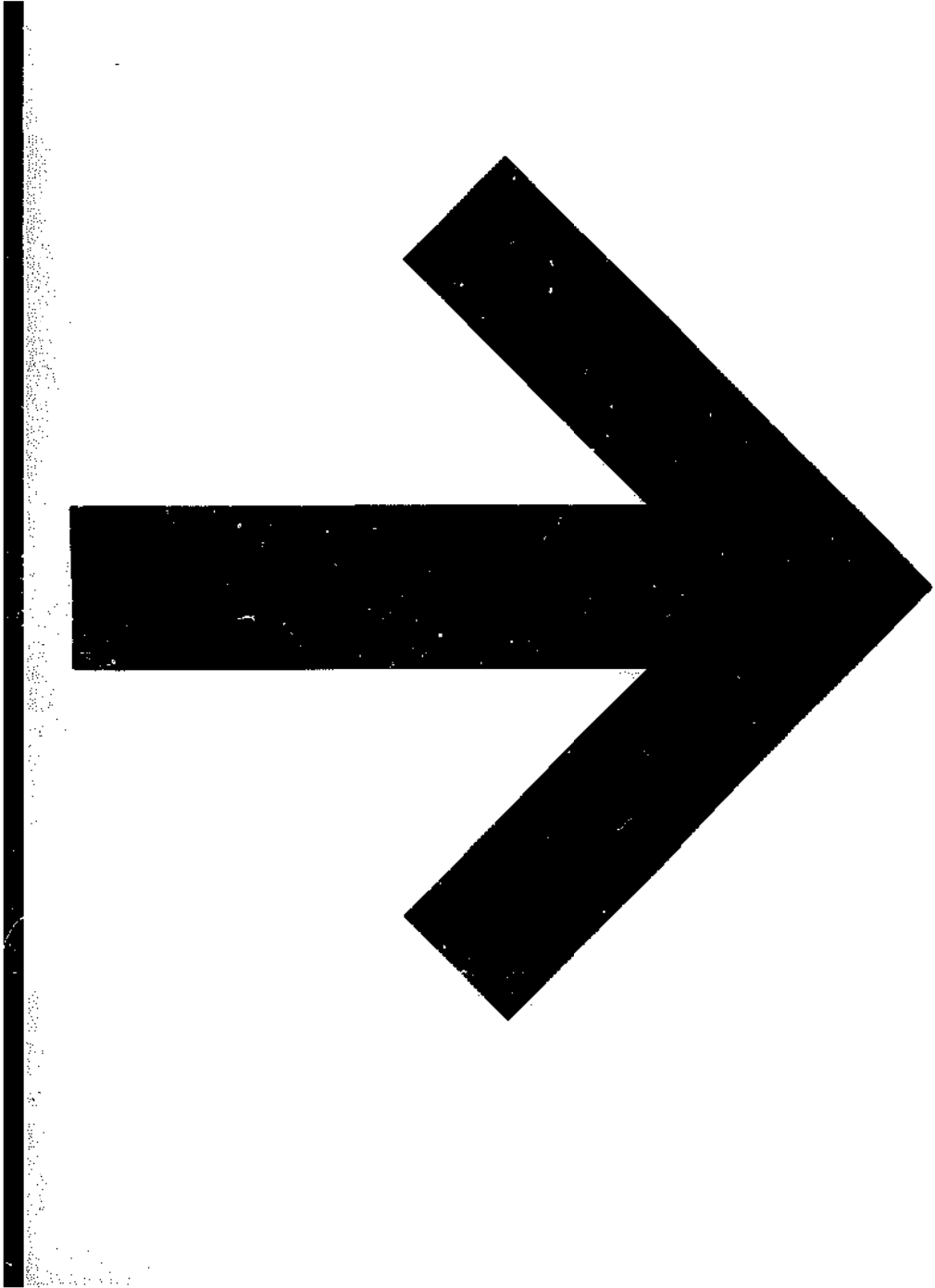

CONTENTS

CHAPTER	Page
1. Levers	1
2. Block and Tackle	10
3. The Wheel and Axle	16
4. The Inclined Plane and Wedge	23
5. The Screw	26
6. Gears	30
7. Work	39
8. Power	46
9. Force and Pressure	50
10. Hydrostatic and Hydraulic Machines	58
11. Machine Elements and Basic Mechanisms	69
12. Complex Machines	87
13. Internal Combustion Engine	106
14. Power Trains	130
15. Basic Computer Mechanisms	150
INDEX	158

CREDITS

<u>Source</u>	<u>Figures</u>
Underwood Corporation	Figure 12-4 through Figure 12-16
U. S. Naval Institute: Naval Auxiliary Machinery Naval Turbines	Figure 9-6 Figure 11-2

CHAPTER 1

LEVERS

YOUR HELPERS

Ships have evolved through the ages from crude rafts to the huge complex cruisers and carriers of today's Navy. It was a long step from oars to sails, and another long step from sails to steam. With today's modern nuclear-powered ships another long step has been taken. Each step in the progress of shipbuilding has involved the use of more and more machines, until today's Navy men are specialists in operating and maintaining machinery. The Boatswain operates the winches to hoist cargo and the anchor; the men in the engine room operate pumps, valves, generators, and other machines to produce and control the ship's power; men in the weapons department operate shell hoist, and rammers; elevate and train the guns and missile launchers; the cooks operate mixers and can openers; men in the CB rates drive trucks, operate cranes, graders, and bulldozers. In fact it is safe to say every rate in the Navy uses machinery some time during the day's work.

Each machine used aboard ship has made the physical work load of the crew lighter. You don't walk the capstan to raise the anchor, or heave on a line to sling cargo aboard. Machines have taken over these jobs, and have simplified and made countless others easier. Machines are your friends. They have taken much of the backache and drudgery out of a sailor's life. Reading this book should help you recognize and understand the operations of many of the machines you see about you.

WHAT IS A MACHINE?

As you look about you, you probably see half a dozen machines that you don't recognize as such. Ordinarily you think of a machine as a complex device—a gasoline engine or a typewriter. They are machines, but so is a

hammer, a screwdriver, a ship's wheel. A machine is any device that helps you to do work. It may help by changing the amount of the force or the speed of action. For example, a claw hammer is a machine—you can use it to apply a large force for pulling out a nail. A relatively small pull on the handle produces a much greater force at the claws.

We use machines to TRANSFORM energy. For example, a generator transforms mechanical energy into electrical energy. We use machines to TRANSFER energy from one place to another. For example, the connecting rods, crankshaft, drive shaft, and rear axle transfer energy from the automobile engine to the rear wheels.

Another use of machines is to MULTIPLY FORCE. We use a system of pulleys (a chain hoist for example) to lift a heavy load. The pulley system enables us to raise the load by exerting a force which is smaller than the weight of the load. We must exert this force over a greater distance than the height through which the load is raised; thus, the load moves more slowly than the chain on which we pull. A machine enables us to gain force, but only at the expense of speed.

Machines may also be used to MULTIPLY SPEED. The best example of this is the bicycle, by which we gain speed by exerting a greater force.

Machines are also used to CHANGE THE DIRECTION OF A FORCE. For example, the signalman's halyard enables one end of the line to exert an upward force on a signal flag as a downward force is exerted on the other end.

There are only six simple machines—the LEVER, the BLOCK, the WHEEL and AXLE, the INCLINED PLANE, the SCREW, and the GEAR. However, physicists recognize that there are only two basic principles in machines; namely, the lever and the inclined plane. The wheel and

axle, the block and tackle, and gears may be considered levers. The wedge and the screw use the principle of the inclined plane.

When you are familiar with the principles of these simple machines, you can readily understand the operation of complex machines. Complex machines are merely combinations of two or more simple machines.

THE LEVER

The simplest machine, and perhaps the one with which you are most familiar, is the LEVER. A seasaw is a familiar example of a lever in which one weight balances the other.

There are three basic parts which you will find in all levers; namely, the FULCRUM (F), a force or EFFORT (E), and a RESISTANCE (R). Look at the lever in figure 1-1. You see the pivotal point F (fulcrum); the EFFORT (E) which you apply at a distance A from the fulcrum; and a resistance (R) which acts at a distance a from the fulcrum. Distances A and a are the lever arms.

CLASSES OF LEVERS

The three classes of levers are shown in figure 1-2. The location of the fulcrum (the fixed or pivot point) with relation to the resistance (or weight) and the effort determines the lever class.

First-Class Levers

In the first-class lever (fig. 1-2A), the fulcrum is located between the effort and the resistance. As mentioned earlier, the seasaw is a good example of the first-class lever.

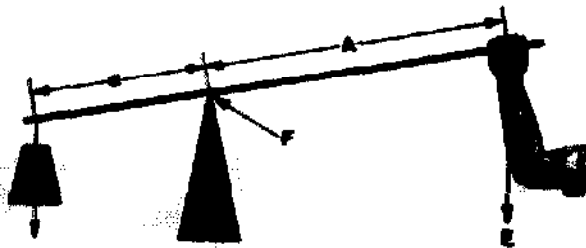

Figure 1-1.—A simple lever.

191.1

The amount of weight and the distance from the fulcrum can be varied to suit the need. Another good example is the oars in a row-boat. Notice that the sailor in figure 1-3 applies his effort on the handles of the oars. The oarlock acts as the fulcrum, and the water acts as the resistance to be overcome. In this case, as in figure 1-1, the force is applied on one side of the fulcrum and the resistance to be overcome is applied to the opposite side, hence this is a first-class lever. Crowbars, shears, and pliers are common examples of this class of lever.

Second-Class Levers

The second-class lever (fig. 1-2B) has the fulcrum at one end; the effort is applied at the other end. The resistance is somewhere between these points. The wheelbarrow in figure 1-4 is a good example of a second-class lever. If you apply 50 pounds of effort to the handles of a wheelbarrow 4 feet from the fulcrum (wheel), you can lift 200 pounds of weight 1 foot from the fulcrum. If the load were placed farther back away from the wheel, would it be easier or harder to lift?

Both first- and second-class levers are commonly used to help in overcoming big resistances with a relatively small effort.

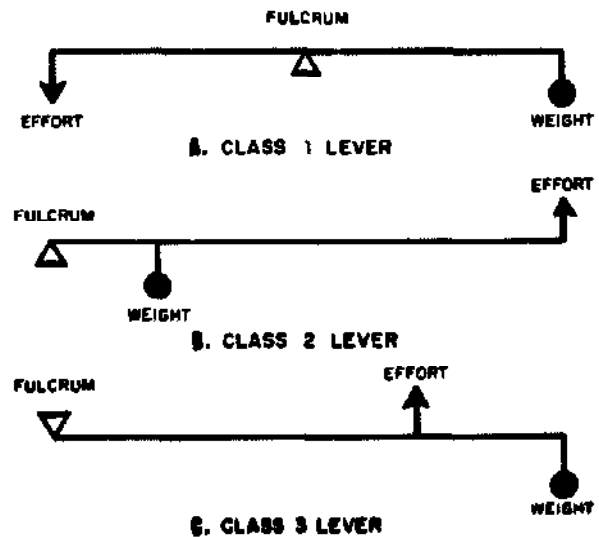

Figure 1-2.—Three classes of levers.

5.30

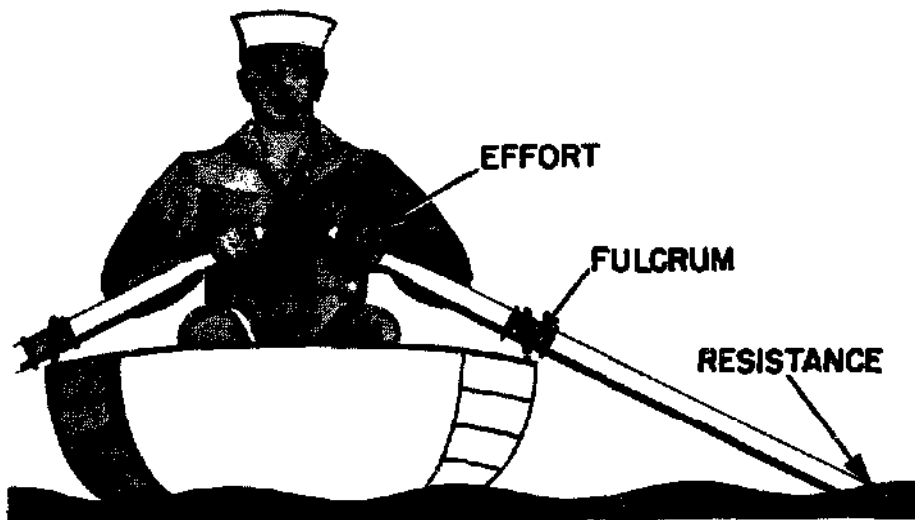

Figure 1-3.—Oars are levers.

131.2

Third-Class Levers

There are occasions when you will want to speed up the movement of the resistance even though you have to use a large amount of effort. Levers that help you accomplish this are third-class levers. As shown in figure 1-2C, the fulcrum is at one end of the lever and the weight or resistance to be overcome is at the

other end, with the effort applied at some point between the fulcrum and the resistance. You can always spot third-class levers because you will find the effort applied between the fulcrum and the resistance. Look at figure 1-5. It is easy to see that while point E is moving the short distance e , the resistance R has been moved a greater distance r . The speed of R must have been greater than that of E, since R covered a greater distance in the same length of time.

Your arm (fig. 1-6), is a third-class lever. It is this lever action that makes it possible for you to flex your arms so quickly. Your elbow is the fulcrum. Your biceps muscle,

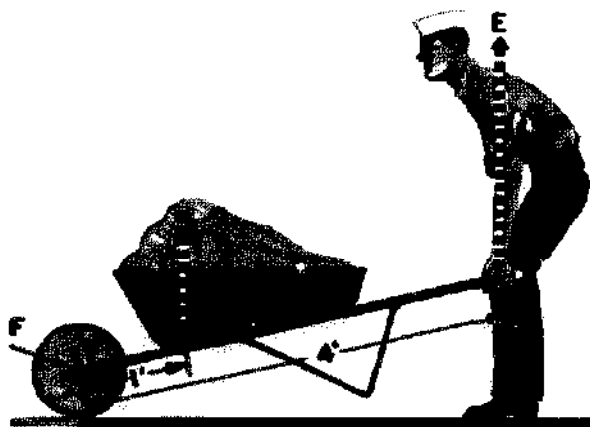

Figure 1-4.—This makes it easier.

131.3

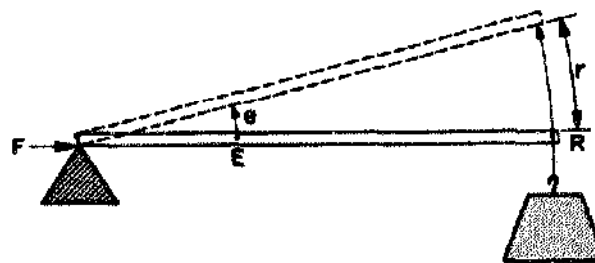

Figure 1-5.—A third-class lever.

131.4

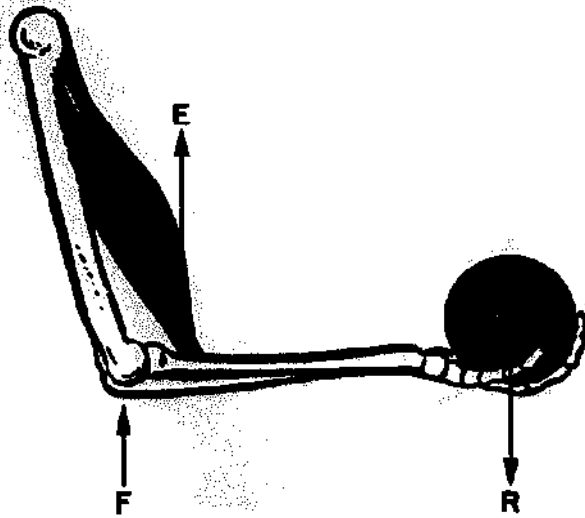

Figure 1-6.—Your arm is a lever.

131.5

which ties onto your forearm about an inch below the elbow, applies the effort; and your hand is the resistance, located some 18 inches from the fulcrum. In the split second it takes your biceps muscle to contract an inch, your hand has moved through an 18-inch arc. You know from experience that it takes a big pull at E to overcome a relatively small resistance at R. Just to remind yourself of this principle, try closing a door by pushing on it about three or four inches from the hinges (fulcrum). The moral is, you don't use third-class levers to do heavy jobs, you use them to gain speed.

One convenient thing about machines is that you can determine in advance the forces required for their operation, as well as the forces they will exert. Consider for a moment the first-class lever. Suppose you have an iron bar, like the one shown in figure 1-7. This bar is 9 feet long, and you want to use it to raise a 300-pound crate off the deck while you slide a dolly under the crate. But you can exert only 100 pounds to lift the crate. So you place the fulcrum—a wooden block—beneath one end of the bar, and force that end of the bar under the crate. Then you push down on the other end of the bar. After a few adjustments of the position of the fulcrum, you will find that your 100-pound force will just fit the crate when the fulcrum is 2 feet from center of the crate.

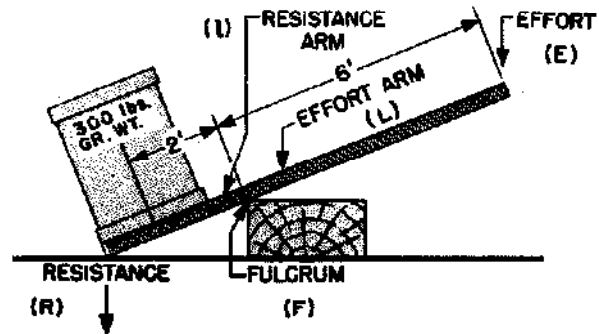

Figure 1-7.—Easy does it.

110.4

This leaves a 6-foot length of bar from the fulcrum to the point where you push down. The 6-foot portion is three times as long as the distance from the fulcrum to the center of the crate. But you lifted a load three times as great as the force you applied— $3 \times 100 = 300$ pounds. Here is an indication of a direct relationship between lengths of lever arms and forces acting on those arms.

You can state this relationship in general terms by saying—the length of the effort arm is the same number of times greater than the length of the resistance arm as the resistance to be overcome is greater than the effort you must apply. Writing these words as a mathematical equation, it looks like this—

$$\frac{L}{l} = \frac{R}{E}$$

in which,

- L = length of effort arm.
- l = length of resistance arm.
- R = resistance weight or force.
- E = effort force.

Remember that all distances must be in the same units—such as feet, and all forces must be in the same units—such as pounds.

Now take another problem and see how it works out. Suppose you want to pry up the lid of a paint can (fig. 1-8) with a 6-inch file scraper, and you know that the average force holding the lid is 50 pounds. If the distance from the edge of the paint can to the edge of

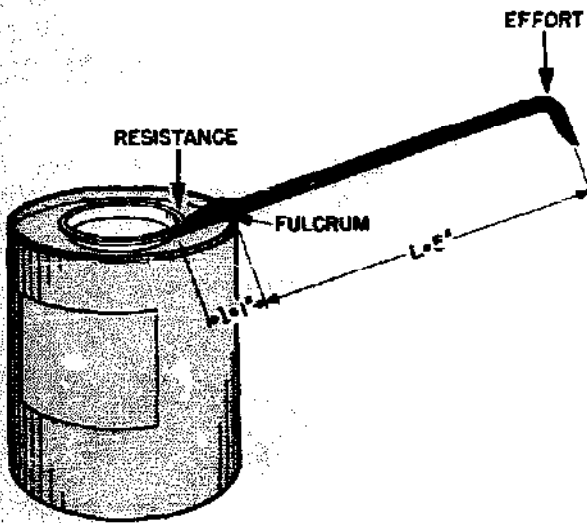

Figure 1-8.—A first-class job.

131.6

the cover is one inch, what force will you have to apply on the end of the file scraper?

According to the formula:

$$\frac{L}{1} = \frac{R}{E}$$

Here $L = 5$ inches; $1 = 1$ inch; $R = 50$ pounds, and E is unknown.

Substitute the numbers in their proper places, Then,

$$\frac{5}{1} = \frac{50}{E}$$

and

$$E = \frac{50 \times 1}{5} = 10 \text{ pounds}$$

You will need to apply a force of only 10 pounds.

The same general formula applies for second-class levers. But you must be careful to measure the proper lengths of the effort arm and the resistance arm. Looking back at the wheelbarrow problem, assume that the length of the handles from the axle of the wheel—which is the fulcrum—to the grip is 4 feet. How long is the effort arm? You're right, it's 4 feet. If the center of the load of sand is 1 foot from

the axle, then the length of the resistance arm is 1 foot.

By substituting in the formula,

$$\frac{L}{1} = \frac{R}{E}$$

$$\frac{4}{1} = \frac{200}{E}$$

and

$$E = 50 \text{ lb.}$$

Now for the third-class lever. With one hand, you lift a projectile weighing approximately 10 pounds. If your biceps muscle attaches to your forearm 1 inch below your elbow, and the distance from the elbow to the palm of your hand is 18 inches, what pull must your muscle exert in order to hold the projectile and flex your arm at the elbow?

By substituting in the formula,

$$\frac{L}{1} = \frac{R}{E}, \text{ it becomes } \frac{1}{18} = \frac{10}{E}$$

and

$$E = 18 \times 10 = 180 \text{ lb.}$$

Your muscle must exert a 180-pound pull to hold up a 10-pound shell. Our muscles are poorly arranged for lifting or pulling—and that's why some work seems pretty tough. But remember, third-class levers are used primarily to speed up the motion of the resistance.

Curved Lever Arms

Up to this point you have been looking at levers with straight arms. In every case, the direction in which the resistance acts is parallel to the direction in which the effort is exerted. However, all levers are not straight. You'll need to learn to recognize all types of levers, and to understand their operation.

Look at figure 1-9. You may wonder how to measure the length of the effort arm, which is represented by the curved pump handle. You do not measure around the curve—you still use a straight-line distance. To determine the length of the effort arm, draw a straight line AB through the point where the effort is applied and in the direction that it is applied. From point E on this line, draw a second line EF that passes through the fulcrum and is perpendicular to line AB. The length of the line EF is the actual length L of the effort arm.

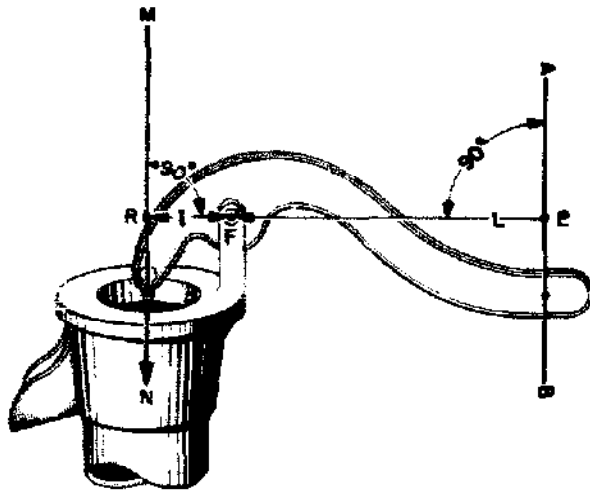

131.7

Figure 1-9.—A curved lever arm.

To find the length of the resistance arm, use the same method. Draw a line MN in the direction that the resistance is operating, and through the point where the resistance is attached to the other end of the handle. From point R on this line, draw a line RF perpendicular to MN so that it passes through the fulcrum. The length of RF is the length l of the resistance arm.

Regardless of the curvature of the handle, this method can be used to find the lengths L and l. Then curved levers are solved just like straight levers.

MECHANICAL ADVANTAGE

There is another thing about first-class and second-class levers that you have probably noticed by now. Since they can be used to magnify the applied force, they provide positive mechanical advantages. The third-class lever provides what's called a fractional mechanical advantage, which is really a mechanical disadvantage—you use more force than the force of the load you lift.

In the wheelbarrow problem, you saw that a 50-pound pull actually overcame the 200-pound weight of the sand. The sailor's effort was magnified four times, so you may say that the mechanical advantage of the wheelbarrow is

4. Expressing the same idea in mathematical terms,

$$\text{MECHANICAL ADVANTAGE} = \frac{\text{RESISTANCE}}{\text{EFFORT}}$$

or

$$M. A. = \frac{R}{E}$$

Thus, in the case of the wheelbarrow,

$$M.A. = \frac{200}{50} = 4$$

This rule applies to all machines.

Mechanical advantage of levers may also be found by dividing the length of the effort arm A by the length of the resistance arm a. Stated as a formula, this reads:

$$\text{MECHANICAL ADVANTAGE} = \frac{\text{EFFORT ARM}}{\text{RESISTANCE ARM}}$$

$$M. A. = \frac{A}{a}$$

How does this apply to third-class levers? Your muscle pulls with a force of 1,800 pounds in order to lift a 100-pound projectile. So you

have a mechanical advantage of $\frac{100}{1,800}$ or $\frac{1}{18}$, which is fractional—less than 1.

SUMMARY

Now for a brief summary of levers.

Levers are machines because they help you to do your work. They help by changing the size, direction, or speed of the force you apply.

There are three classes of levers. They differ primarily in the relative points where effort is applied, where the resistance is overcome, and where the fulcrum is located.

First-class levers have the effort and the resistance on opposite sides of the fulcrum, and effort and resistance move in opposite directions.

Second-class levers have the effort and the resistance on the same side of the fulcrum, but the effort is farther from the fulcrum than is the resistance. Both effort and resistance move in the same direction.

Third-class levers have the effort applied on the same side of the fulcrum as the resistance, but the effort is applied between the resistance and the fulcrum. Both move in the same direction.

First- and second-class levers can be used to magnify the amount of the effort exerted, and to decrease the speed of effort. First-class and third-class levers can be used to magnify the distance and the speed of the effort exerted, and to decrease its magnitude.

The same general formula applies to all three types of levers:

$$\frac{L}{l} = \frac{R}{E}$$

MECHANICAL ADVANTAGE (M.A.) is an expression of the ratio of the applied force and the resistance. It may be written:

$$M. A. = \frac{R}{E}$$

APPLICATIONS AFLOAT AND ASHORE

Doors aboard a ship are locked shut by lugs called dogs. Figure 1-10 shows you how these dogs are used to secure the door. If the handle is four times as long as the lug, that 50-pound heave of yours is multiplied to 200 pounds against the slanting face of the wedge. Incidentally, take a look at that wedge—it's an inclined plane, and it multiplies the 200-pound

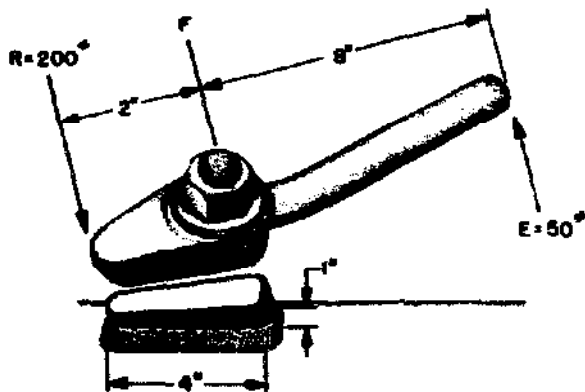

Figure 1-10.—It's a dog.

3.100

force by about four. Result—your 50-pound heave actually ends up as an 800-pound force on each wedge to keep the hatch closed! The hatch dog is one use of a first-class lever, in combination with an inclined plane.

The breech of a big gun is closed with a breech plug. Figure 1-11 shows you that this plug has some interrupted screw threads on it which fit into similar interrupted threads in the breech. Turning the plug part way around locks it into the breech. The plug is locked and unlocked by the operating lever. Notice that the connecting rod is secured to the operating lever a few inches from the fulcrum. You'll see that this is an application of a second-class lever!

You know that the plug is in there good and tight. But, with a mechanical advantage of ten, your 100-pound pull on the handle will twist the plug loose with a force of a half-ton.

If you've spent any time opening crates at a base, you've already used a wrecking bar. The blue-jacket in figure 1-12 is busily engaged in tearing that crate open. The wrecking bar is a first-class lever. Notice that it has curved lever arms. Can you figure the mechanical advantage of this one? Your answer should be M. A. = 5.

The crane in figure 1-13 is used for handling relatively light loads around a warehouse or a dock. You can see that the crane is rigged as a third-class lever. The effort is applied between the fulcrum and the load. This gives a mechanical advantage of less than one. If it's going to support that 1/2 ton load, you know that the pull on the lifting cable will have to be considerably greater than 1000 pounds. How much greater? Use the formula, and figure it out—

$$\frac{L}{l} = \frac{R}{E}$$

Got the answer? Right—E=1,333 lb.

Now, because the cable is pulling at an angle of about 22° at E, you can use some trigonometry to find that the pull on the cable will be about 3,560 pounds to lift the 1/2-ton weight! However, since the loads are generally light, and speed is important, it is a practical and useful machine.

Anchors are usually housed in the hawsepole and secured by a chain stopper. The chain

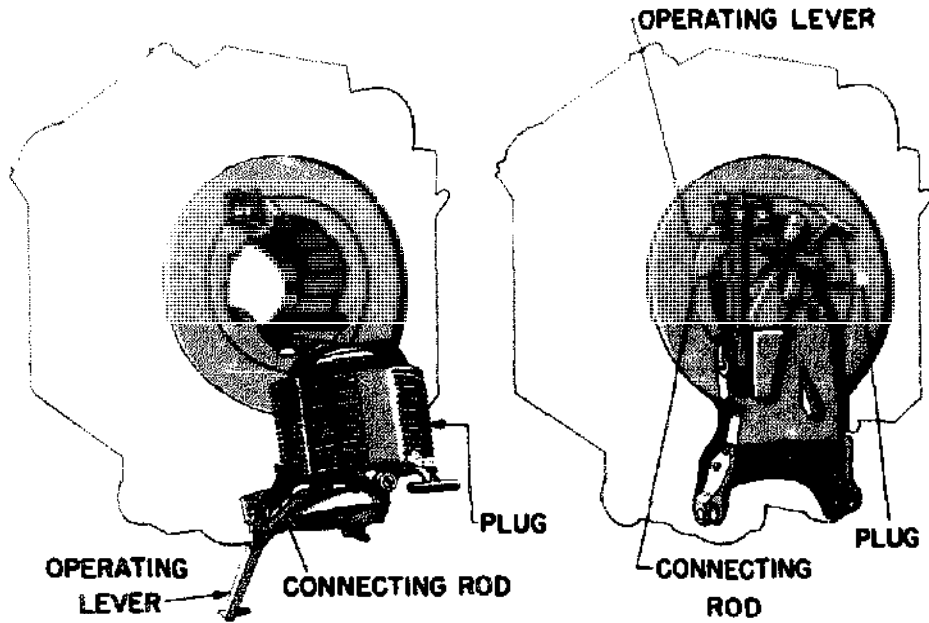

Figure 1-11.—An 8-inchers breech.

80.213:214

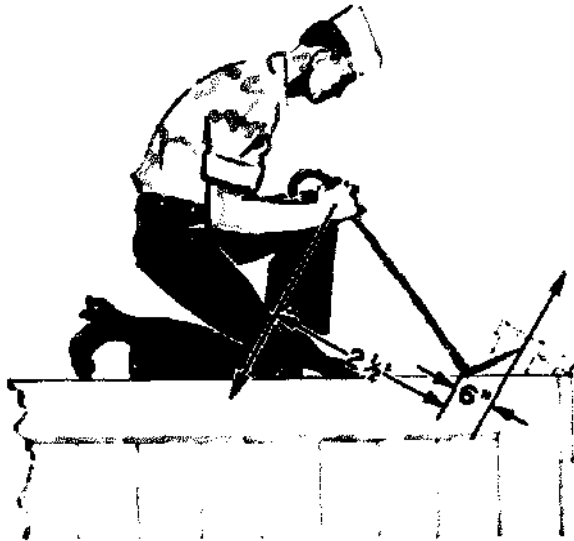

Figure 1-12.—Using a wrecking bar.

131.8

stopper consists of a short length of chain containing a turnbuckle and a pelican hook. When you secure one end of the stopper to a pad eye in the deck and lock the pelican hook over the anchor chain, the winch is relieved of the strain.

Figure 1-14A gives you the details of the pelican hook.

Figure 1-14B shows the chain stopper as a whole. Notice that the load is applied close

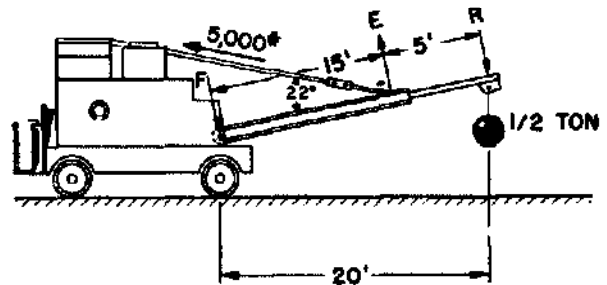
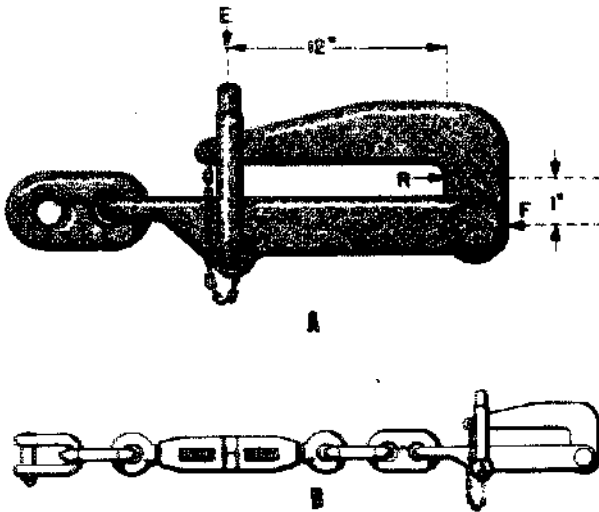

Figure 1-13.—An electric crane.

131.9



3.223

Figure 1-14.—A. A pelican hook;
B. A chain stopper.

to the fulcrum. The resistance arm a is very short. The bale shackle, which holds the hook secure, exerts its force at a considerable distance A from the fulcrum. If the chain rests against the hook one inch from the fulcrum, and the bale shackle is holding the hook closed $12 + 1 = 13$ inches from the fulcrum, what's the mechanical advantage? It's 13. A strain of only 1,000 pounds on the base shackle can hold the hook closed when a $6 \frac{1}{2}$ -ton anchor is dangling over the ship's side. You'll recognize

the pelican hook as a second-class lever with curved arms.

Figure 1-15 shows you a couple of guys who are using their heads to spare their muscles. Rather than exert themselves by bearing down on that drill, they pick up a board from a nearby crate and use it as a second-class lever.

If the drill is placed half way along the board, they will get a mechanical advantage of two. How would you increase the mechanical advantage if you were using this rig? Right. You move the drill in closer to the fulcrum. In the Navy, a knowledge of levers and how to apply them pays off.

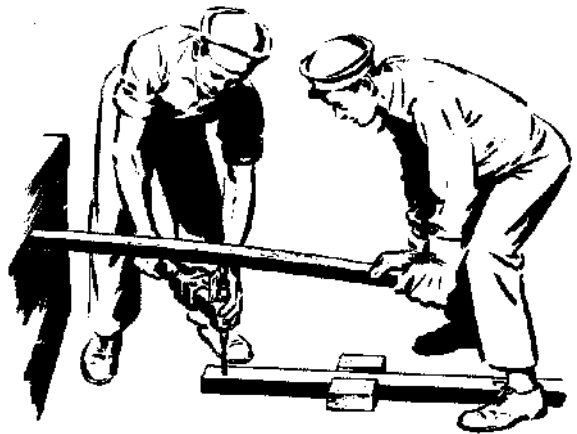

131.10

Figure 1-15.—An improvised drill press.

CHAPTER 2

BLOCK AND TACKLE

Blocks—pulleys to a landlubber—are simple machines that have many uses aboard ship, as well as on shore. Remember how your mouth hung open as you watched movers taking a piano out of a fourth story window? The fat guy on the end of the tackle eased the piano safely to the sidewalk with a mysterious arrangement of blocks and ropes. Or perhaps you've been in the country and watched the farmer use a block-and-tackle to put hay in a barn. Since old Dobbin or the tractor did the hauling, there was no need for a fancy arrangement of ropes and blocks. Incidentally, you'll often hear the rope or tackle called the fall. Block-and-tackle, or block-and-fall.

In the Navy you'll rig a block-and-tackle to make some of your work easier. Learn the names of the parts of a block. Figure 2-1 will give you a good start on this. Look at the single block and see some of the ways you can use it. If you lash a single block to a fixed object—an overhead, a yardarm, or a bulkhead—you give yourself the advantage of being able to pull from a convenient direction. For example, in figure 2-2 you haul up a flag hoist, but you really pull down. You can do this by having a single sheaved block made fast to the yardarm. This makes it possible for you to stand in a convenient place near the flag bag and do the job. Otherwise you would have to go aloft, dragging the flag hoist behind you.

MECHANICAL ADVANTAGE

With a single fixed sheave, the force of your down-pull on the fall must be equal to the weight of the object being hoisted. You can't use this rig to lift a heavy load or resistance with a small effort—you can change only the direction of your pull.

A single fixed block is really a first-class lever with equal arms. The arms EF and FR in figure 2-3 are equal; hence the mechanical advantage is one. When you pull down at A with a force of one pound, you raise a load of one pound at B. A single fixed block does not magnify force nor speed.

You can, however, use a single block-and-fall to magnify the force you exert. Notice, in figure 2-4 that the block is not fixed, and that the fall is doubled as it supports the 200-pound cask. When rigged this way, a single block-and-fall is called a runner. Each half of the fall carries one half of the total load, or 100 pounds. Thus, by the use of the runner, the bluejacket is lifting a 200-pound cask with a 100-pound pull. The

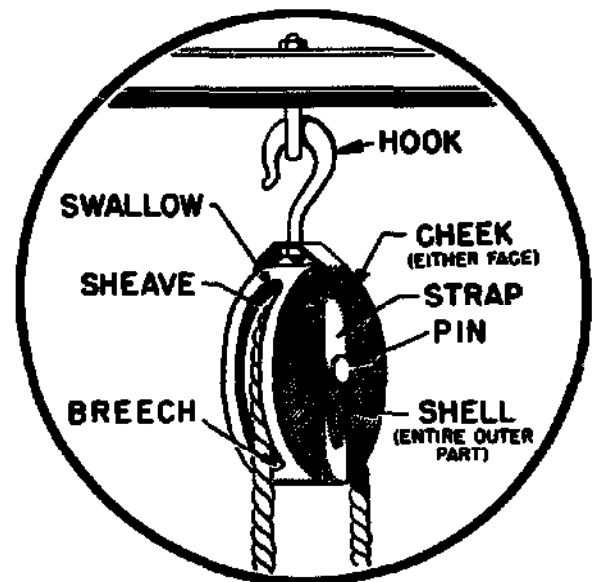

Figure 2-1.—Look it over.

29.184

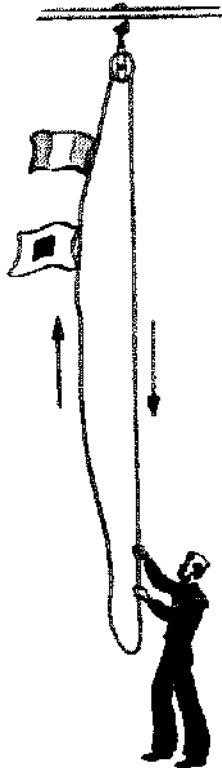

Figure 2-2.—A flag hoist.

69.122

mechanical advantage is two. Check this by the formula:

$$M. A. = \frac{R}{E} = \frac{200}{100}, \text{ or } 2$$

The single movable block in this setup is really a second-class lever. See figure 2-5. Your effort *E* acts upward upon the arm *EF*, which is the diameter of the sheave. The resistance *R* acts downward on the arm *FR*, which is the radius of the sheave. Since the diameter is twice the radius, the mechanical advantage is two.

But, when the effort at *E* moves up two feet, the load at *R* is raised only one foot. That's one thing to remember about blocks and falls—if you are actually getting a mechanical advantage from the system, the length of rope that passes through your hands is greater than the distance

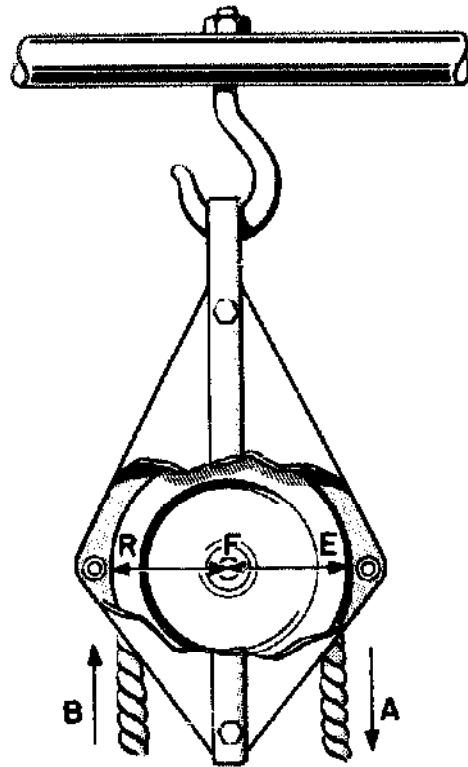

Figure 2-3.—No advantage.

29.187

that the load is raised. However, if you can lift a big load with a small effort, you don't care how much rope you have to pull.

The bluejacket in figure 2-4 is in an awkward position to pull. If he had another single block handy, he could use it to change the direction of the pull, as in figure 2-6. This second arrangement is known as a gun tackle purchase. Because the second block is fixed, it merely changes the direction of pull—and the mechanical advantage of the whole system remains two.

You can arrange blocks in a number of ways, depending on the job to be done and the mechanical advantage you want to get. For example, a luff tackle consists of a double block and a single block, rigged as in figure 2-7. Notice that the weight is suspended by the three parts of rope which extend from the movable single block. Each part of the rope carries its share of the load. If the crate weighs 600 pounds, then each of the three parts of the rope supports its share—200 pounds. If there's a pull of 200 pounds downward on rope *B*, you will have to pull downward

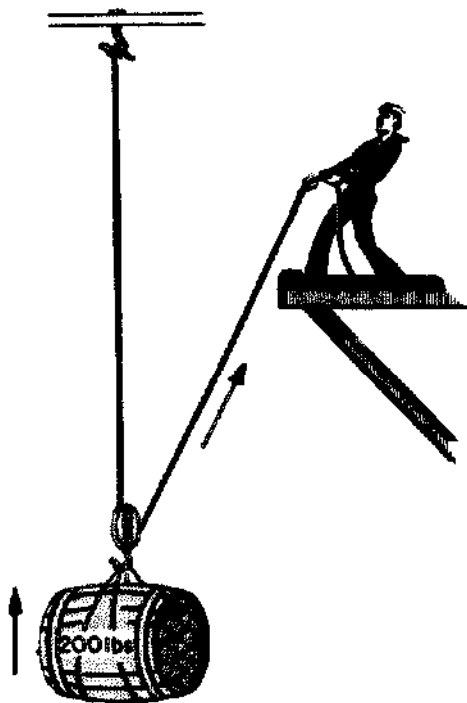

Figure 2-4.—A runner.

29.187

with a force of 200 pounds on A to counterbalance the pull on B. Neglecting the friction in the block, a pull of 200 pounds is all that is necessary to raise the crate. The mechanical advantage is:

$$M. A. = \frac{R}{E} = \frac{600}{200} = 3$$

Here's a good tip. If you count the number of the parts of rope going to and from the movable block, you can figure the mechanical advantage at a glance. This simple rule will help you to quickly approximate the mechanical advantage of most tackles you see in the Navy.

Many combinations of single, double, and triple sheave blocks are possible. Two of these combinations are shown in figure 2-8.

If you can secure the dead end of the fall to the movable block, the advantage is increased by one. Notice that this is done in figure 2-7. That is a good point to remember. Don't forget, either, that the strength of your fall-rope—is a limiting factor in any tackle. Be sure your fall will carry the load. There is no point in rigging a six-fold purchase which carries a 5-ton load with two triple blocks on a 3-inch manila rope attached to

a winch. The winch could take it, but the rope couldn't.

Now for a review of the points you have learned about blocks, and then to some practical applications aboard ship—

With a single fixed block the only advantage is the change of direction of the pull. The mechanical advantage is still one.

A single movable block gives a mechanical advantage of two.

Many combinations of single, double, and triple blocks can be rigged to give greater advantages.

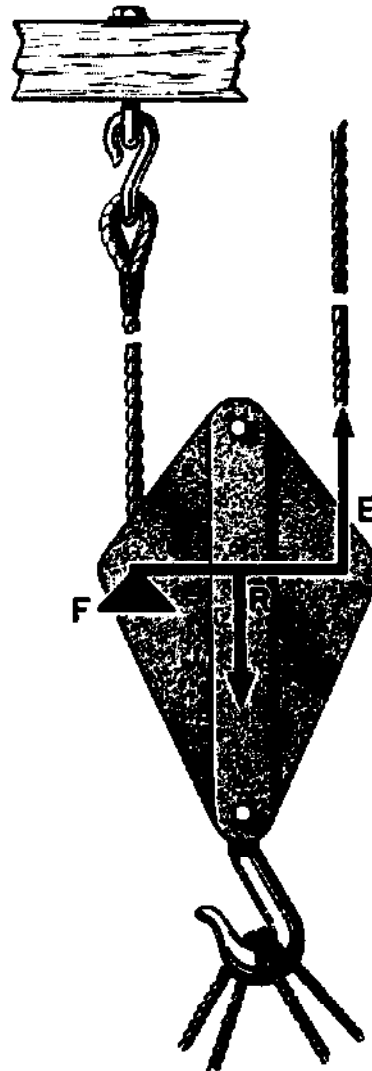
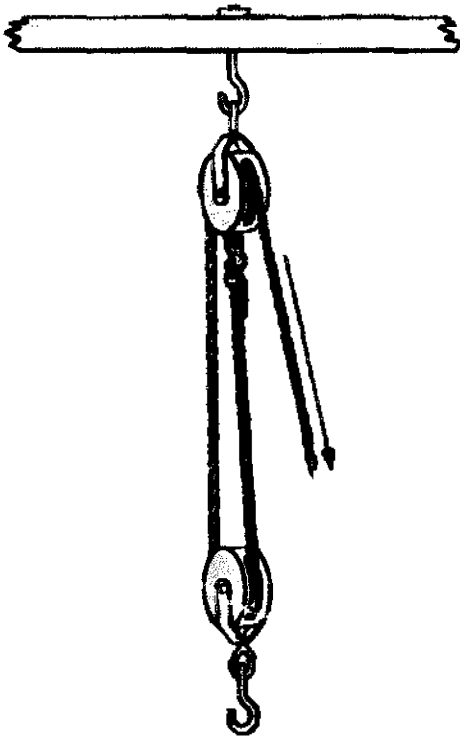

Figure 2-5.—It's 2 to 1.

29.187



29.187

Figure 2-6.—A gun tackle.

A general rule of thumb is that the number of the parts of the fall going to and from the movable block tells you the approximate mechanical advantage of that tackle.

If you fix the dead end of the fall to the movable block you increase the mechanical advantage by one.

APPLICATIONS AFLOAT AND ASHORE

Blocks and tackle are used for a great number of lifting and moving jobs afloat and ashore. The five or six basic combinations are used over and over again in many situations. Cargo is loaded aboard, depth charges are placed in their racks, life boats are lowered over the side by the use of this machine. Heavy machinery, guns, and gun mounts are swung into position with the aid of blocks and tackle. In a thousand situations, bluejackets find this machine useful and efficient.

Yard and stay tackles are used on shipboard when you want to pick up a load from the hold and

swing it onto the deck, or to shift any load a short distance. Figure 2-9 shows you how the load is first picked up by the yard tackle. The stay tackle is left slack. After the load is raised to the height necessary to clear obstructions, you take up on the stay tackle, and ease off on the yard fall. A glance at the rig tells you that the mechanical advantage of each of these tackles is only two. You may think that it isn't worth the trouble to rig a yard and stay tackle with that small advantage just to move a 400-pound crate along the deck. However, a few minutes spent in rigging may save many unpleasant hours with a sprained back.

If you want a high mechanical advantage, a luff upon luff is a good rig for you. You can raise heavy loads with this setup. Figure 2-10 shows you how it is rigged. If you apply the rule by which you count the parts of the fall going to and from the movable blocks, you find that block A gives a mechanical advantage of 3 to 1. Block B has four parts of fall running to and from it, a

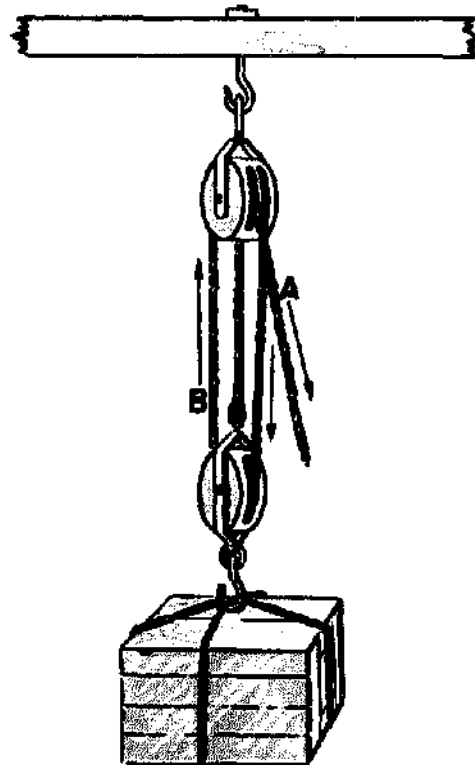

29.187

Figure 2-7.—A luff tackle.

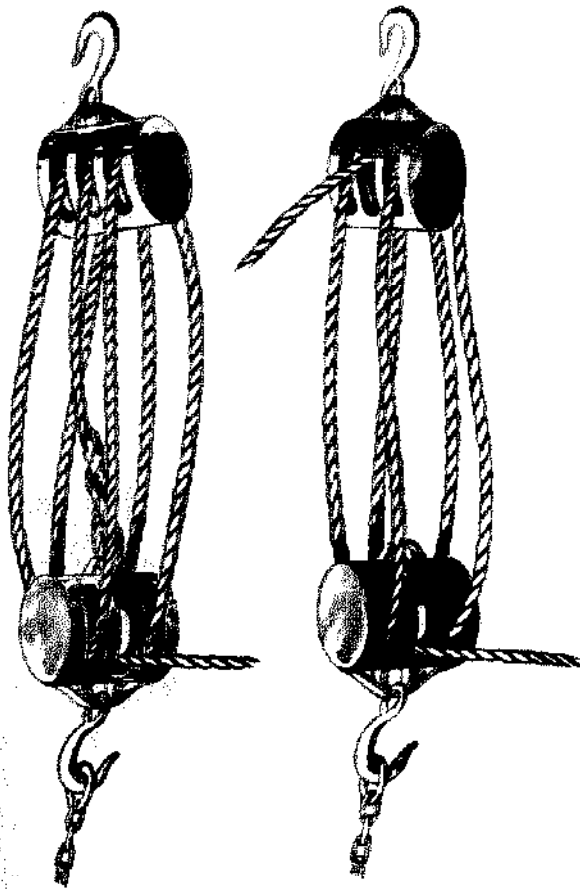

29.187

Figure 2-8.—Some other tackles.

mechanical advantage of 4 to 1. The mechanical advantage of those obtained from A is multiplied four times in B. The overall mechanical advantage of a luff upon luff is the product of the two mechanical advantages—or 12.

Don't make the mistake of adding mechanical advantages. Always multiply them.

You can easily figure out the M.A. for the apparatus shown in figure 2-10. Suppose the load weighs 1,200 pounds. Since it is supported by the parts 1, 2, and 3 of the fall running to and from block A, each part must be supporting one third of the load, or 400 pounds. If part 3 has a pull of 400 pounds on it, part 4 which is made fast to block B, also has a 400-pound pull on it. There are four parts of the second fall going to and from block B, and each of these takes an

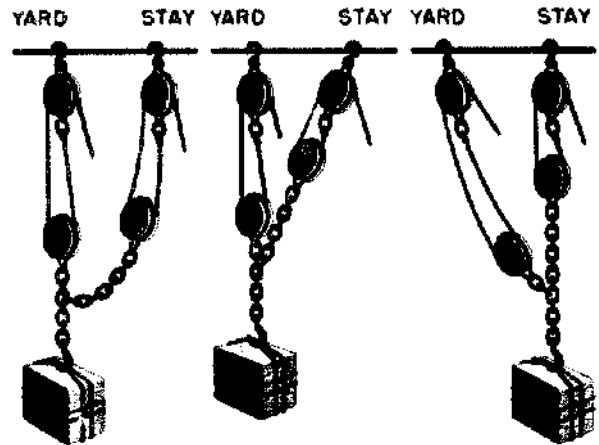

29.187

Figure 2-9.—A yard and stay tackle.

equal part of the 400-pound pull. Therefore, the hauling part requires a pull of only $1/4 \times 400$, or 100 pounds. So, here you have a 100-pound pull raising a 1,200-pound load. That's a mechanical advantage of 12.

In shops ashore and aboard ship you are almost certain to run into a chain hoist, or differential pulley. Ordinarily, these hoists are suspended from overhead trolleys, and are used to lift heavy objects and move them from one part of the shop to another.

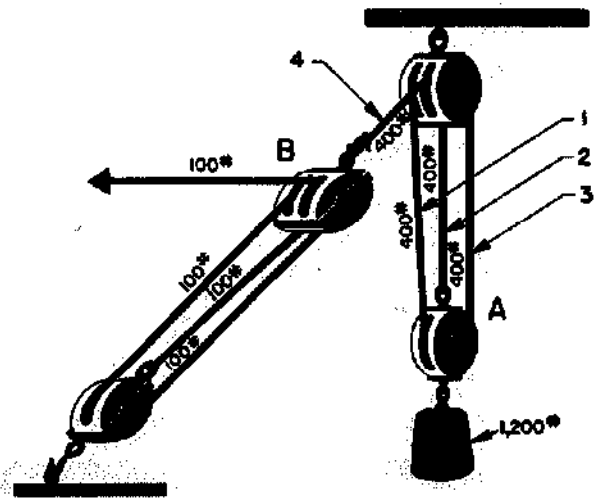

29.187

Figure 2-10.—Luff upon luff.

To help you to understand the operation of a chain hoist, look at the one in figure 2-11. Assume that you grasp the chain at E and pull until the large wheel A has turned around once. Then the distance through which your effort has moved is equal to the circumference of that wheel, or $2\pi R$. How much will the lower wheel C and its load be raised? Since wheel C is a single movable block, its center will be raised only one-half the distance that the chain E was pulled, or a distance πR . However, the smaller wheel B, which is rigidly fixed to A, makes one revolution at the same time as A does so B will feed some chain down to C. The length of the chain fed down will be equal to the circumference of B, or $2\pi r$. Again, since C is single movable block, the downward movement of its center will be equal to only one-half the length of the chain fed to it, or πr .

Of course, C does not first move up a distance πR and then move down a distance πr . Actually, its steady movement upward is equal

to the difference between the two, or $(\pi R - \pi r)$. Don't worry about the size of the movable pulley, C. It doesn't enter into these calculations. Usually its diameter is between that of A and that of B.

The mechanical advantage equals the distance through which the effort E is moved, divided by the distance that the load is moved. This is called the velocity ratio, or theoretical mechanical advantage. It is theoretical because the frictional resistance to the movement of mechanical parts is left out. In practical uses, all moving parts have frictional resistance.

The equation for theoretical mechanical advantage may be written—

Theoretical mechanical advantage =

$$\frac{\text{Distance effort moves}}{\text{Distance resistance moves}}$$

and in this case,

$$\text{T. M. A.} = \frac{2\pi R}{\pi R - \pi r} = \frac{2R}{R - r}$$

If A is a large wheel, and B is a little smaller, the value of $2R$ becomes large, and $(R - r)$ becomes small. Then you have a large number for $\frac{2R}{R - r}$ which is the theoretical mechanical advantage.

You can lift heavy loads with chain hoists. To give you an idea of the mechanical advantage of a chain hoist, suppose the large wheel has a radius R of 6 inches and the smaller wheel a radius r of $5\frac{3}{4}$ inches. What theoretical mechanical advantage would you get? Use the formula—

$$\text{T. M. A.} = \frac{2R}{R - r}$$

Then substitute the numbers in their proper places, and solve—

$$\text{T. M. A.} = \frac{2 \times 6}{6 - 5\frac{3}{4}} = \frac{12}{\frac{1}{4}} = 48$$

Since the friction in this type of machine is considerable, the actual mechanical advantage is not as high as the theoretical mechanical advantage would lead you to believe. For example, that theoretical mechanical advantage of 48 tells you that with a one-pound pull you should be able to lift a 48-pound load. However, actually your one-pound pull might only lift a 20-pound load. The rest of your effort would be used in overcoming the friction.

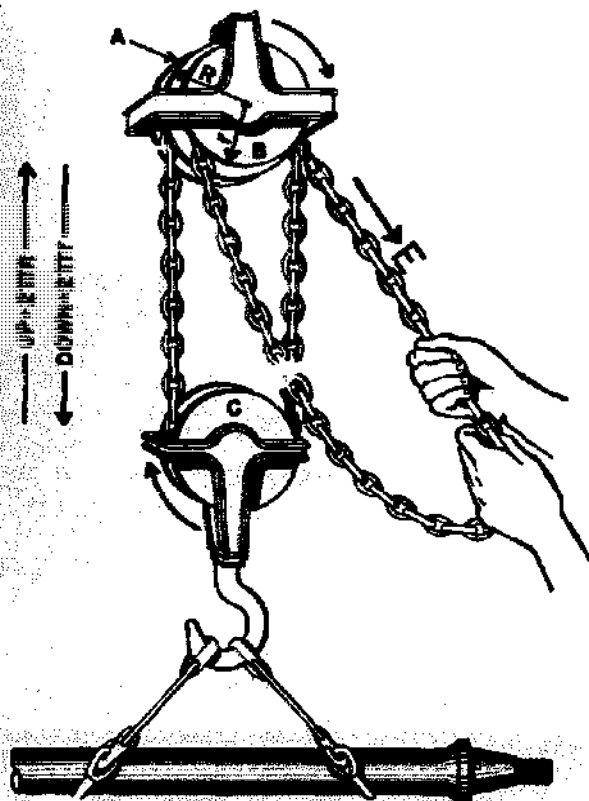

Figure 2-11.—A chain hoist.

29.187

CHAPTER 3

THE WHEEL AND AXLE

Have you ever tried to open a door when the knob was missing? If you have, you know that trying to twist that small four-sided shaft with your fingers is tough work. That gives you some appreciation of the advantage you get by using a knob. The door knob is an example of a simple machine called a wheel and axle.

The steering wheel on an automobile, the handle of an ice cream freezer, a brace and bit—these are familiar examples of this type of simple machine. As you know from your experience with these devices, the wheel and axle is commonly used to multiply the force you exert. If a screwdriver won't do a job because you can't turn it, you stick a screwdriver bit in the chuck of a brace and the screw probably goes in with little difficulty.

There's one thing you'll want to get straight right at the beginning. The wheel-and-axle machine consists of a wheel or crank rigidly attached to the axle, which turns with the wheel. Thus, the front wheel of an automobile is not a wheel-and-axle machine because the axle does not turn with the wheel.

MECHANICAL ADVANTAGE

How does the wheel-and-axle arrangement help to magnify the force you exert? Suppose you use a screwdriver bit in a brace to drive a stubborn screw. Look at figure 3-1A. Your effort is applied on the handle which moves in a circular path, the radius of which is 5 inches. If you apply a 10-pound force on the handle, how big a force will be exerted against the resistance at the screw? Assume the radius of the screwdriver blade is 1/4 inch. You are really using the brace as a second-class lever—see figure 3-1B. The size of the resistance

which can be overcome can be found from the formula—

$$\frac{L}{l} = \frac{R}{E}$$

In which—

L = radius of the circle through which the handle turns,

l = one-half the width of the edge of the screwdriver blade,

R = force of the resistance offered by the screw,

E = force of effort applied on the handle.

Substituting in the formula; and solving:

$$\frac{5}{1/4} = \frac{R}{10}$$

$$R = \frac{5 \times 10}{1/4}$$

$$= 5 \times 10 \times 4$$

$$= 200 \text{ lb.}$$

This means that the screwdriver blade will tend to turn the screw with a force of 200 pounds. The relationship between the radii or the diameters, or the circumferences of the wheel and axle tells you how great a mechanical advantage you can get.

Take another situation. The old oaken bucket, figure 3-2, was raised by a wheel-and-axle arrangement. If the distance from the center of the axle to the handle is 8 inches, and the radius of the drum around which the rope is wound is 2 inches, then you have a theoretical mechanical advantage of 4. That's why they used these rigs.

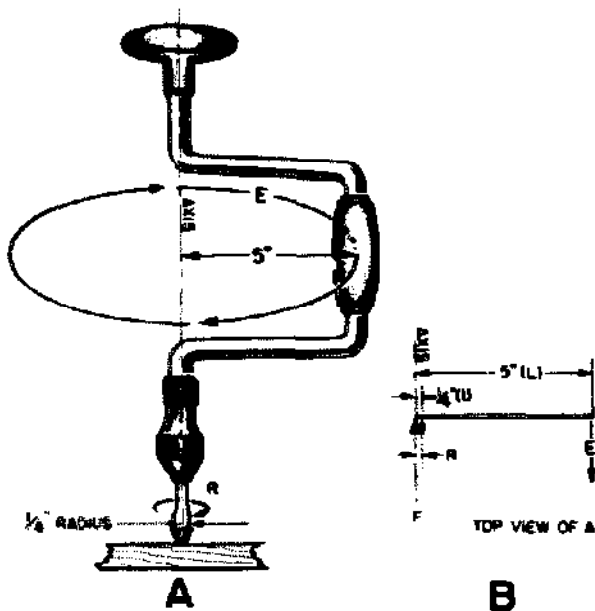

44.20
Figure 3-1.—It magnifies your effort.

MOMENT OF FORCE

In a number of situations you can use the wheel-and-axle to speed up motion. The rear-wheel sprocket of a bike, along with the rear wheel itself, is an example. When you are pedaling, the sprocket is fixed to the wheel, so the combination is a true wheel-and-axle machine. Assume that the sprocket has a circumference of 8 inches, and the wheel circumference is 80 inches. If you turn the sprocket at a rate of one revolution per second, each sprocket tooth moves at a speed of 8 inches per second. Since the wheel makes one revolution for each revolution made by the sprocket, any point on the tire must move through a distance of 80 inches in one second. So, for every eight-inch movement of a point on the sprocket, you have moved a corresponding point on the wheel through 80 inches.

Since a complete revolution of the sprocket and wheel requires only one second, the speed of a point on the circumference of the wheel is 80 inches per second, or ten times the speed of a tooth on the sprocket.

(NOTE: Both sprocket and wheel make the same number of revolutions per second so the speed of turning for the two is the same.)

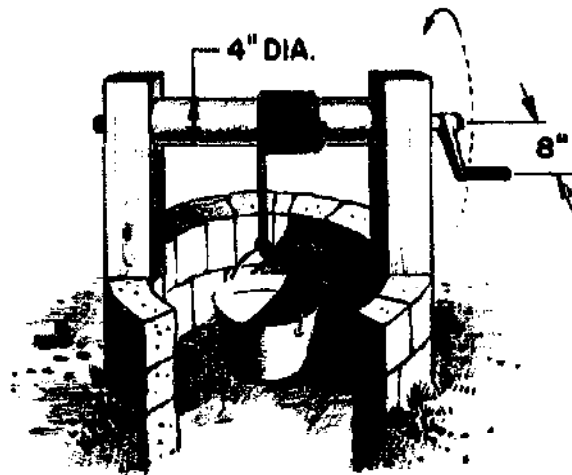

131.11
Figure 3-2.—The old oaken bucket.

Here is an idea which you will find useful in understanding the wheel and axle, as well as other machines. You probably have noticed that the force you apply to a lever tends to turn or rotate it about the fulcrum? You also know that a heave on a fall tends to rotate the sheave of the block and that turning the steering wheel of a car tends to rotate the steering column. Whenever you use a lever, or a wheel and axle, your effort on the lever arm or the rim of the wheel tends to cause a rotation about the fulcrum or the axle in one direction or another. If the rotation occurs in the same direction as the hands of a clock, that direction is called clockwise. If the rotation occurs in the opposite direction from that of the hands of a clock, the direction of rotation is called counterclockwise. A glance at figure 3-3 will make clear the meaning of these terms.

You have already seen that the result of a force acting on the handle of the carpenter's brace depends not only on the amount of that force but also on the distance from the handle to the center of rotation. From here on you'll know this result as a moment of force, or a torque (pronounced tork). Moment of force and torque have the same meaning.

Look at the effect of counterclockwise movement of the capstan bar in figure 3-4. Here the amount of the effort is designated E_1 and the distance from the point where this force is

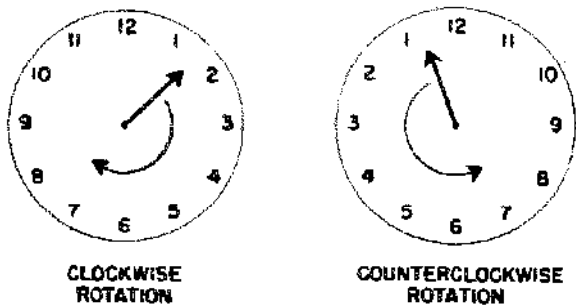

CLOCKWISE ROTATION

COUNTERCLOCKWISE ROTATION

131.12

Figure 3-3.—Directions of rotation.

applied to the center of the axle is L_1 . Then $E_1 \times L_1$ is the moment of force. You'll notice that this term includes both the amount of the effort and the distance from the point of application of effort to the center of the axle. Ordinarily, the distance is measured in feet and the applied force is measured in pounds.

Therefore, moments of force are generally measured in foot-pounds—abbreviated ft-lb. A moment of force is frequently called a moment.

By using a longer capstan bar, the bluejacket in figure 3-4 can increase the effectiveness of his push without making a bigger effort. But if he applied his effort closer to the head of the capstan and used the same force, the moment of force would be less.

BALANCING MOMENTS

You know that the bluejacket in figure 3-4 would land flat on his face if the anchor hawser snapped. But just as long as nothing breaks, he must continue to push on the capstan bar. He is working against a clockwise moment of force, which is equal in magnitude but opposite in direction to his counterclockwise moment of force. The resisting moment, like the effort moment, depends on two factors. In the case of the resisting moment, these factors are the force R_2 with which the anchor pulls on the hawser, and the distance L_2 from the center of

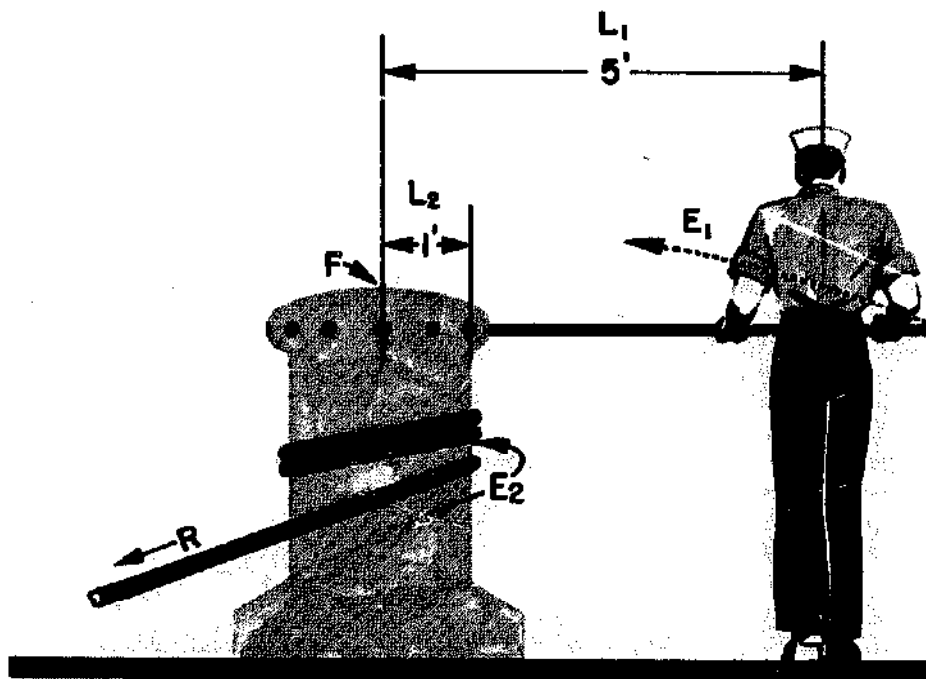

Figure 3-4.—Using a capstan.

131.13

the capstan to its rim. The existence of this resisting force would be evident if the blue-jacket let go of the capstan bar. The weight of the anchor pulling on the capstan would cause the whole works to spin rapidly in a clockwise direction—and good-bye anchor! The principle involved here is that whenever the counterclockwise and the clockwise moments of force are in balance, the machine either moves at a steady speed or remains at rest.

This idea of the balance of moments of force can be summed up by the expression—

**CLOCKWISE MOMENTS =
COUNTERCLOCKWISE MOMENTS**

And, since a moment of force is the product of the amount of the force times the distance the force acts from the center of rotation, this expression of equality may be written—

$$E_1 \times L_1 = E_2 \times L_2$$

In which—

- E_1 = force of effort,
- L_1 = distance from fulcrum or axle to point where force is applied,
- E_2 = force of resistance,
- L_2 = distance from fulcrum or center of axle to the point where resistance is applied.

EXAMPLE 1

Put this formula to work on a capstan problem. A single capstan bar is gripped 5 feet from the center of a capstan head with a radius of one foot. A 1/2-ton anchor is to be lifted. How big a push does the sailor have to exert?

First, write down the formula—

$$E_1 \times L_1 = E_2 \times L_2$$

Here $L_1 = 5$; $E_2 = 1,000$ pounds; and $L_2 = 1$. Substitute these values in the formula, and it becomes:

$$E_1 \times 5 = 1,000 \times 1$$

and—

$$E_1 = \frac{1,000}{5} = 200 \text{ pounds}$$

EXAMPLE 2

Consider now the sad case of Slim and Sam, as illustrated in figure 3-5. Slim has suggested that they carry the 300-pound crate slung on a

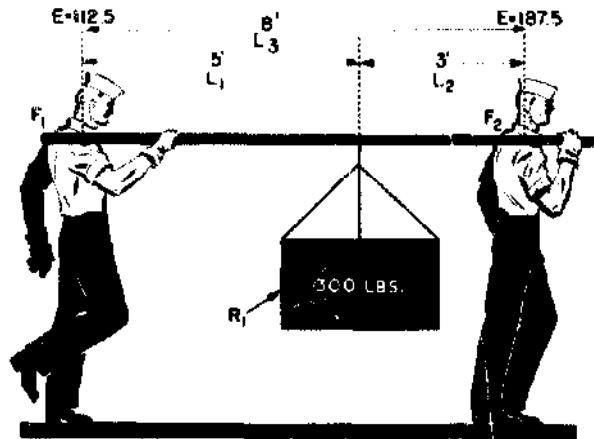

131.14

Figure 3-5.—A practical application.

handy 10-foot pole. He was smart enough to slide the load up 3 feet from Sam's shoulder.

Here's how they made out. Use Slim's shoulder as a fulcrum F_1 . Look at the clockwise moment caused by the 300-pound load. That load is five feet away from Slim's shoulder. If R_1 is the load, and L_1 the distance from Slim's shoulder to the load, the clockwise moment M_A is—

$$M_A = R_1 \times L_1 = 300 \times 5 = 1,500 \text{ ft.-lb.}$$

With Slim's shoulder still acting as the fulcrum, the resistance of Sam's effort causes a counterclockwise moment M_B acting against the load moment. This counterclockwise moment is equal to Sam's effort E_2 times the distance L_3 from his shoulder to the fulcrum F_1 at Slim's shoulder. Since $L_2 = 8$ ft., the formula is—

$$M_B = E_2 \times L_3 = E_2 \times 8 = 8E_2$$

But there is no rotation, so the clockwise moment and the counterclockwise moment are equal. $M_A = M_B$. Hence—

$$1,500 = 8E_2$$

$$E_2 = \frac{1,500}{8} = 187.5 \text{ pounds.}$$

So poor Sam is carrying 187.5 pounds of the 300-pound load.

the capstan to its rim. The existence of this resisting force would be evident if the blue-jacket let go of the capstan bar. The weight of the anchor pulling on the capstan would cause the whole works to spin rapidly in a clockwise direction—and good-bye anchor! The principle involved here is that whenever the counterclockwise and the clockwise moments of force are in balance, the machine either moves at a steady speed or remains at rest.

This idea of the balance of moments of force can be summed up by the expression—

**CLOCKWISE MOMENTS =
COUNTERCLOCKWISE MOMENTS**

And, since a moment of force is the product of the amount of the force times the distance the force acts from the center of rotation, this expression of equality may be written—

$$E_1 \times L_1 = E_2 \times L_2$$

In which—

- E_1 = force of effort,
- L_1 = distance from fulcrum or axle to point where force is applied,
- E_2 = force of resistance,
- L_2 = distance from fulcrum or center of axle to the point where resistance is applied.

EXAMPLE 1

Put this formula to work on a capstan problem. A single capstan bar is gripped 5 feet from the center of a capstan head with a radius of one foot. A 1/2-ton anchor is to be lifted. How big a push does the sailor have to exert?

First, write down the formula—

$$E_1 \times L_1 = E_2 \times L_2$$

Here $L_1 = 5$; $E_2 = 1,000$ pounds; and $L_2 = 1$. Substitute these values in the formula, and it becomes:

$$E_1 \times 5 = 1,000 \times 1$$

and—

$$E_1 = \frac{1,000}{5} = 200 \text{ pounds}$$

EXAMPLE 2

Consider now the sad case of Slim and Sam, as illustrated in figure 3-5. Slim has suggested that they carry the 300-pound crate slung on a

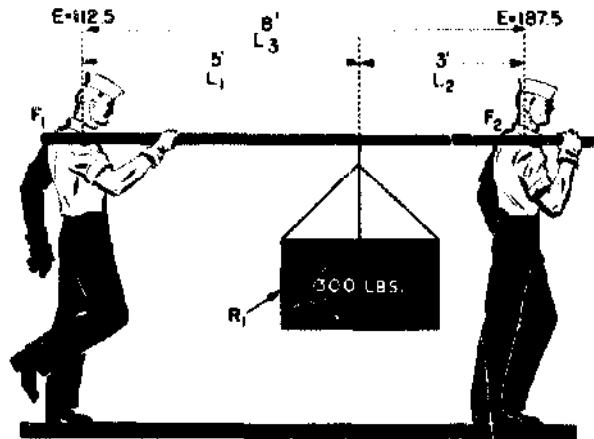

131.14

Figure 3-5.—A practical application.

handy 10-foot pole. He was smart enough to slide the load up 3 feet from Sam's shoulder.

Here's how they made out. Use Slim's shoulder as a fulcrum F_1 . Look at the clockwise moment caused by the 300-pound load. That load is five feet away from Slim's shoulder. If R_1 is the load, and L_1 the distance from Slim's shoulder to the load, the clockwise moment M_A is—

$$M_A = R_1 \times L_1 = 300 \times 5 = 1,500 \text{ ft.-lb.}$$

With Slim's shoulder still acting as the fulcrum, the resistance of Sam's effort causes a counterclockwise moment M_B acting against the load moment. This counterclockwise moment is equal to Sam's effort E_2 times the distance L_3 from his shoulder to the fulcrum F_1 at Slim's shoulder. Since $L_2 = 8$ ft., the formula is—

$$M_B = E_2 \times L_3 = E_2 \times 8 = 8E_2$$

But there is no rotation, so the clockwise moment and the counterclockwise moment are equal. $M_A = M_B$. Hence—

$$1,500 = 8E_2$$

$$E_2 = \frac{1,500}{8} = 187.5 \text{ pounds.}$$

So poor Sam is carrying 187.5 pounds of the 300-pound load.

When an object is at rest or is moving steadily, the clockwise moments are just equal and opposite to the counterclockwise moments.

Moments of the force, depend upon two factors—the amount of the force, and the distance from the fulcrum or axis to the point where the force is applied.

When two equal forces are applied at equal distances on opposite sides of a fulcrum, and move in opposite directions so that they both tend to cause rotation about the fulcrum, you have a couple.

APPLICATIONS AFLOAT AND ASHORE

A trip to the engine room makes you realize how important the wheel and axle is on the modern ship. Everywhere you look you see wheels of all sizes and shapes. Most of them are used to open and close valves quickly. One common type of valve is shown in figure 3-7. Turning the wheel causes the threaded stem to rise and open the valve. Since the valve must close water-tight, air-tight, or steam-tight, all the parts must fit snugly. To move the stem on most valves without the aid of the wheel would be impossible. The wheel gives you the necessary mechanical advantage.

You've handled enough wrenches to know that the longer the handle, the tighter you can turn a nut. Actually, a wrench is a wheel-and-axle machine. You can consider the handle as one spoke of a wheel, and the place where you

take hold of the handle as a point on the rim. The nut which is held in the jaws of the wrench can be compared to the axle.

You know that you can turn a nut too tight—and strip the threads or cause internal parts to seize. This is especially true when you are taking up on bearings. In order to make the proper adjustment, you use a torque wrench. There are several types. Figure 3-8 shows you one that is very simple. When you pull on the handle, its shaft bends. The rod on which the pointer is fixed does not bend—so the pointer indicates on the scale the torque, or moment of force, that you are exerting. The scale is generally stated in pounds, although it is really measuring foot-pounds of torque. If the nut is to be tightened by a moment of 90 ft-lb, you pull until the pointer is opposite the number 90 on the scale. The servicing or repair manual on an engine or piece of machinery generally tells you what the torque—or moment of force—should be on each set of nuts or bolts.

The gun pointer uses a couple to elevate and depress the gun barrel. He cranks away at a hand-wheel that has two handles. The right-hand handle is on the opposite side of the axle from the left-hand handle—180° apart. Look at figure 3-9. When he pulls on one handle and pushes on the other, he's producing a couple. But if he lets go the left handle to scratch himself, and cranks only with his right hand, he no longer has a couple—just a simple first-class lever! And he'd have to push twice as hard with one hand.

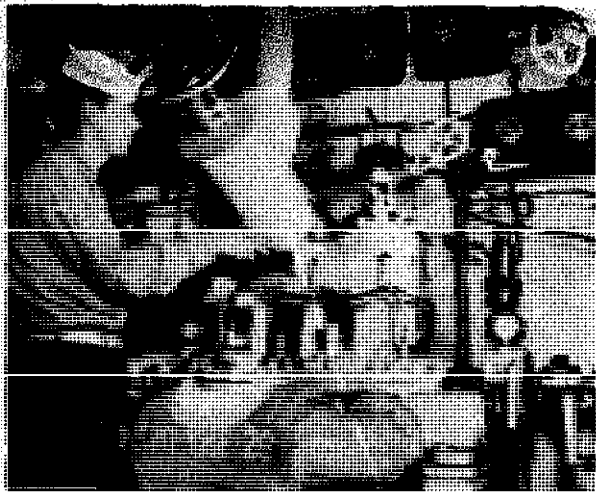

Figure 3-7.—Valves.

131.16

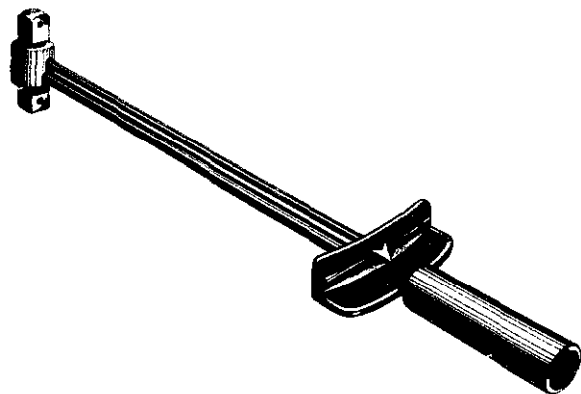

Figure 3-8.—A simple torque wrench.

5.9

BASIC MACHINES

A system of gears—a gear train—transmits the motion to the barrel. A look at figure 3-10 will help you to figure the forces involved. The radius of the wheel is 6 inches— $1/2$ foot—and each handle is being turned with a force of, say, 20 pounds. The moment on the top which tends to rotate the wheel in a clockwise direction is equal to 20 times $1/2 = 10$ ft-lb. The bottom

handle also rotates the wheel in the same direction with an equal moment. Thus the total twist or torque on the wheel is $10 + 10 = 20$ ft-lb. To get the same moment with one hand, applying a 20-pound force, the radius of the wheel would have to be twice as great—12 inches, or one foot. The couple is a convenient arrangement of the wheel-and-axle machine.

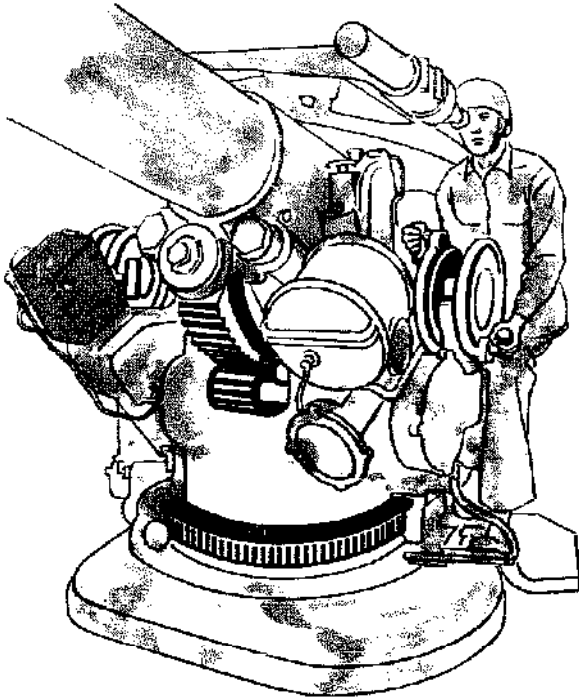

131.17

Figure 3-9.—A pointer's handwheel.

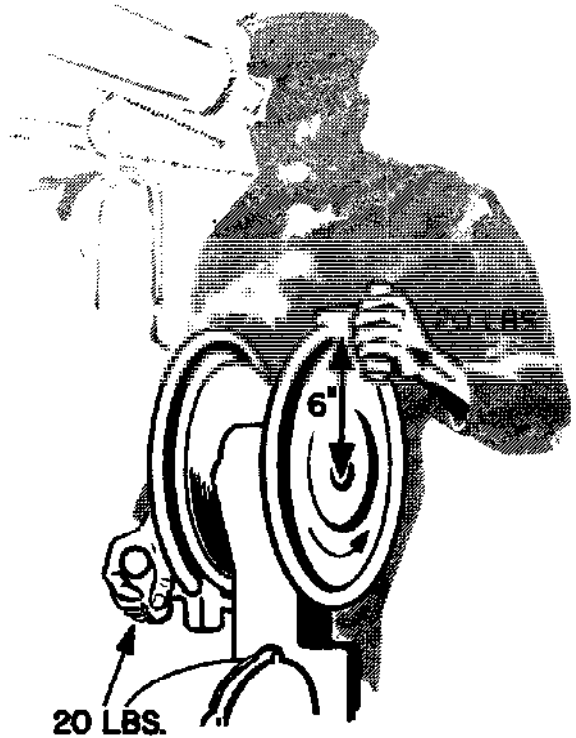

131.18

Figure 3-10.—Developing a torque.

CHAPTER 4

THE INCLINED PLANE AND THE WEDGE

THE BARREL ROLL

You have probably watched a driver load barrels on a truck. The truck is backed up to the curb. The driver places a long double plank or ramp from the sidewalk to the tail gate, and then rolls the barrel up the ramp. A 32-gallon barrel may weigh close to 300 pounds when full, and it would be quite a job to lift one up into the truck. Actually, the driver is using a simple machine called the inclined plane. You have seen the inclined plane used in many situations. Cattle ramps, a mountain highway, and the gangplank are familiar examples.

The inclined plane permits you to overcome a large resistance by applying a relatively small force through a longer distance than the load is raised. Look at figure 4-1. Here you see the driver easing the 300-pound barrel up to the bed of the truck, three feet above the sidewalk. He is using a plank nine feet long. If he didn't use the ramp at all, he'd have to apply a 300-pound force straight up through the three-foot distance. With the ramp, however, he can apply his effort over the entire nine feet of the plank as the barrel is slowly rolled up to a height of three feet. It looks, then, as if he could use a force only three-ninths of 300, or 100 pounds, to do the job. And that is actually the situation.

Here's the formula. Remember it from chapter 1?

$$\frac{L}{l} = \frac{R}{E}$$

In which—L = length of the ramp, measured along the slope,

l = height of the ramp,

R = weight of object to be raised, or lowered,

E = force required to raise or lower object

Now apply the formula to this problem—

In this case, L = 9 ft.; l = 3 ft.; and R = 300 lb. By substituting these values in the formula, you get—

$$\frac{9}{3} = \frac{300}{E}$$

$$9E = 900$$

$$E = 100 \text{ pounds}$$

Since the ramp is three times as long as its height, the mechanical advantage is three. You find the theoretical mechanical advantage by dividing the total distance through which your effort is exerted by the vertical distance through which the load is raised or lowered.

THE WEDGE

The wedge is a special application of the inclined plane. You have probably used wedges. Abe Lincoln used a wedge to help him split logs into rails for fences. The blades of knives, axes, hatchets, and chisels act as wedges when they are forced into a piece of wood. The wedge is two inclined planes, set base-to-base. By driving the wedge full-length into the material to be cut or split, the material is forced apart a distance equal to the width of the broad end of the wedge. See figure 4-2.

Long, slim wedges give high mechanical advantage. For example, the wedge of figure 4-2 has a mechanical advantage of six. Their greatest value, however, lies in the fact that you can use them in situations where other simple machines won't work. Imagine the trouble you'd have trying to pull a log apart with a system of pulleys.

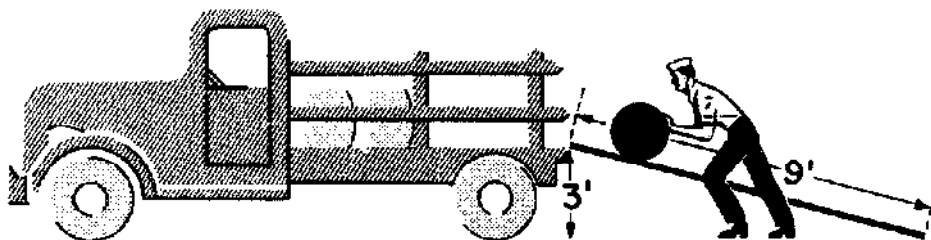

Figure 4-1.—An inclined plane.

110.4

SUMMARY

Before you look at some of the Navy applications of the inclined plane and the wedge, here's a summary of what to remember from this chapter—

The inclined plane is a simple machine that lets you raise or lower heavy objects by applying a small force over a relatively long distance.

The theoretical mechanical advantage of the inclined plane is found by dividing the length of the ramp by the perpendicular height that the load will be raised or lowered. The actual mechanical advantage is equal to the weight of the resistance or load, divided by the force that must be used to move the load up the ramp.

The wedge is two inclined planes set base-to-base. It finds its greatest use in cutting or splitting materials.

APPLICATIONS AFLOAT AND ASHORE

One of the most common uses of the inclined plane in the Navy is the gangplank. Going aboard the ship by gangplank, illustrated in figure 4-3 is certainly easier than climbing up a sea ladder. And you appreciate the M.A. of the gangplank even more when you have to carry your sea bag or a case of prunes aboard.

Remember that hatch dog in figure 1-10. The dog that's used to secure a door not only takes advantage of the lever principle, but—if you look sharply—you can see that the dog seats itself on a steel wedge which is welded to the door. As the dog slides upward along this wedge, it forces the door tightly shut. This is an inclined plane, with its length about eight times its thickness. That means you get a theoretical mechanical advantage of eight. You figured, in

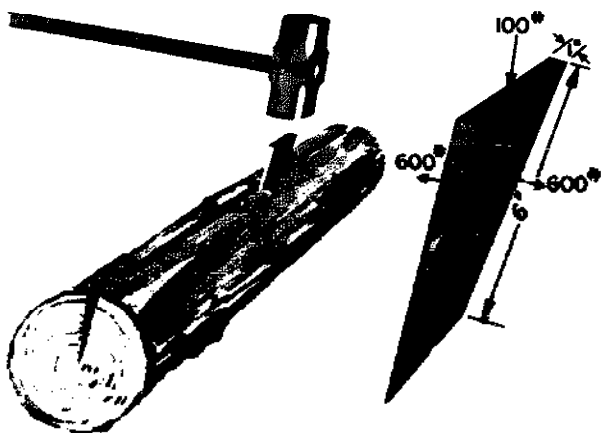

Figure 4-2.—A wedge.

131.19



Figure 4-3.—The gangplank is an inclined plane.

131.20

Chapter 4—THE INCLINED PLANE AND THE WEDGE

chapter 1, that you got a mechanical advantage of four from the lever action of the dog—so the overall mechanical advantage is 8 times 4 or 32, neglecting friction. Not bad for such a simple gadget, is it? Push down with 50 pounds heave on the handle and you squeeze the door shut with a force of 1600 pounds, on that dog. You'll find the damage-control parties using wedges by the dozen to shore up bulkheads and decks. A few

sledge-hammer blows on a wedge will quickly and firmly tighten up the shoring.

Chipping scale or paint off steel is a tough job. However, the job is made a lot easier with a compressed air chisel. The wedge-shaped cutting edge of the chisel gets in under the scale or the paint, and exerts great pressure to lift the scale or paintlayer. The chisel bit is another application of the inclined plane.

CHAPTER 5

THE SCREW

A MODIFIED INCLINED PLANE

The screw is a simple machine that has many uses. The vise on a workbench makes use of the great mechanical advantage of the screw. So do the screw clamps used to hold a piece of furniture together while it is being glued. And so do many automobile jacks and even the food grinder in the kitchen at home.

A screw is a modification of the inclined plane. Cut a sheet of paper in the shape of a right triangle—an inclined plane. Wind it around a pencil, as in figure 5-1. Then you can see that the screw is actually an inclined plane wrapped around a cylinder. As the pencil is turned, the paper is wound up so that its hypotenuse forms a spiral thread similar to the thread on the screw shown at the right. The pitch of the screw, and of the paper, is the distance between identical points on the same threads, and measured along the length of the screw.

THE JACK

In order to understand how the screw works, look at figure 5-2. Here you see a jack screw of the type that is used to raise a house or a piece of heavy machinery. The jack has a lever handle with a length r . If you pull the lever handle around one turn, its outer end has described a circle. The circumference of this circle is equal to 2π . (You remember that π equals 3.14, or $\frac{22}{7}$). That is the distance, or the lever arm, through which your effort is applied.

At the same time, the screw has made one revolution, and in doing so has been raised a height equal to its pitch p . You might say that one full thread has come up out of the base. At any rate, the load has been raised a distance p .

Remember that the theoretical mechanical advantage is equal to the distance through which

the effort or pull is applied, divided by the distance the resistance or load is moved. Assuming a 2-foot—24"—length for the lever arm, and a 1/4-inch pitch for the thread, you can find the theoretical mechanical advantage by the formula—

$$M. A. = \frac{2\pi r}{p}$$

in which

r = length of handle = 24 inches
 p = pitch, or distance between corresponding points on successive threads = 1/4-inch.

Substituting,

$$T. M. A. = \frac{2 \times 3.14 \times 24}{1/4} = \frac{150.72}{1/4} = 602.88$$

A 50-pound pull on the handle would result in a theoretical lift of 50×602 or about 30,000 pounds. Fifteen tons for fifty pounds.

But jacks have considerable friction loss. The threads are cut so that the force used to overcome friction is greater than the force used to do useful work. If the threads were not cut this way, if no friction were present, the weight of the load would cause the jack to spin right back down to the bottom as soon as you released the handle.

THE MICROMETER

In using the jack, you exerted your effort through a distance of $2\pi r$, or 150 inches, in order to raise the screw 1/4 inch. It takes a lot of circular motion to get a small amount of straight-line motion from the head of the jack. You will use this point to advantage in the micrometer, which is a useful device for making accurate small measurements, measurements of a few thousandths of an inch.

In figure 5-3, you see a cutaway view of a micrometer. The thimble turns freely on the

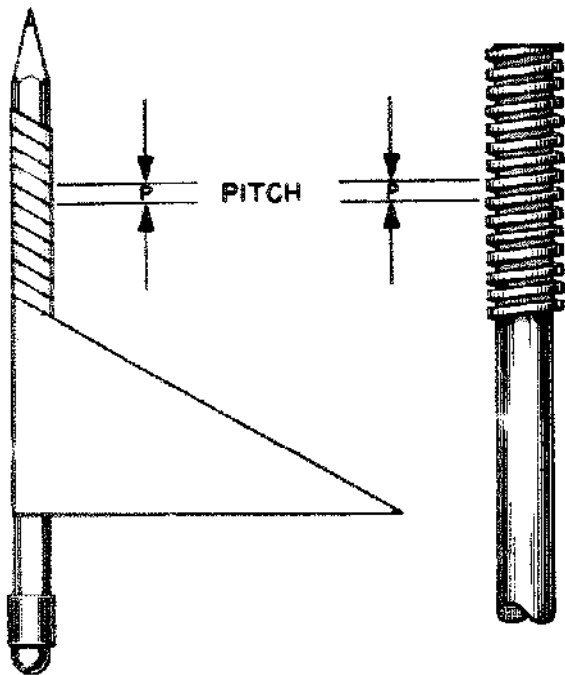

110.4
Figure 5-1.—A screw is an inclined plane in spiral form.

sleeve, which is rigidly attached to the micrometer frame. The spindle is attached to the thimble, and is fitted with screw threads which move the spindle and thimble to right or left in the sleeve when you rotate the thimble. These screw threads are cut 40 threads to the inch. Hence one turn of the thimble moves the spindle and thimble $1/40$ inch. This represents one of the smallest divisions on the micrometer. Four of these small divisions make $4/40$ of an inch, or $1/10$ inch. Thus the distance from 0 to 1 or 1 to 2 on the sleeve represents $1/10$ or 0.1 inch.

To allow even finer measurements, the thimble is divided into 25 equal parts laid out by graduation marks around its rim, as shown in figure 45. If you turn the thimble through 25 of these equal parts, you have made one complete revolution of the screw, which represents a lengthwise movement of $1/40$ of an inch. Now, if you turn the thimble one of these units on its scale, you have moved the spindle a distance of $1/25$ of $1/40$ inch, or $1/1000$ of an inch—0.001 inch.

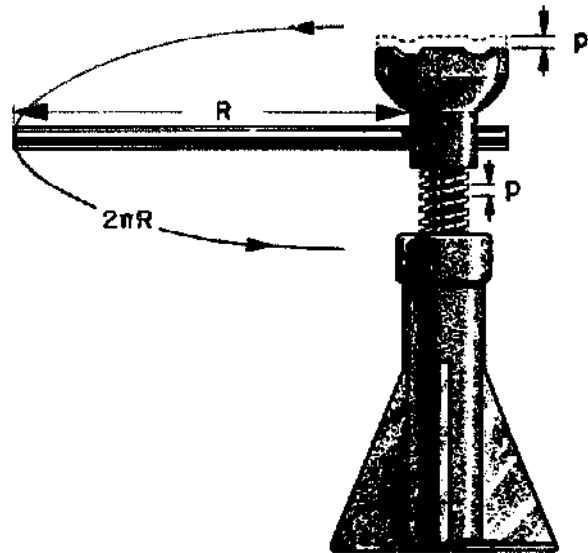

81.25
Figure 5-2.—A jack screw.

The micrometer in figure 5-4 reads 0.503 inch, which is the true diameter of the half-inch drill-bit shank being measured. This tells you that the diameter of this particular bit is 0.003 inch greater than its nominal diameter of $1/2$ inch—0.500".

Because you can make such accurate measurements with this instrument, it is indispensable in every machine shop.

SUMMARY

Look over the basic ideas you have learned from this chapter, and then see how the Navy uses this simple machine—the screw.

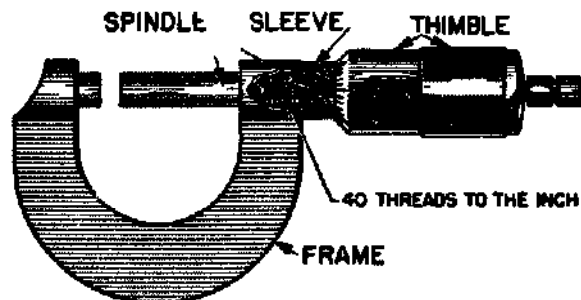

4.20
Figure 5-3.—A micrometer.

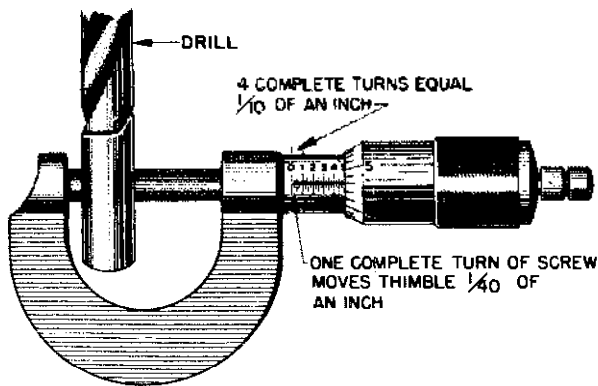

Figure 5-4.—Taking turns.

4.20

The screw is a modification of the inclined plane—modified to give you a high mechanical advantage.

The theoretical mechanical advantage of the screw can be found by the formula

$$M.A. = \frac{2\pi r}{p}$$

As in all machines, the actual mechanical advantage equals the resistance divided by the effort.

In many applications of the screw, you make use of the large amount of friction that is commonly present in this simple machine.

By the use of the screw, large amounts of circular motion are reduced to very small amounts of straight-line motion.

APPLICATIONS AFLOAT AND ASHORE

It's a tough job to pull a rope or cable up tight enough to get all the slack out of it. But you can do it. Use a turnbuckle. The turnbuckle is an application of the screw. See figure 5-5. If

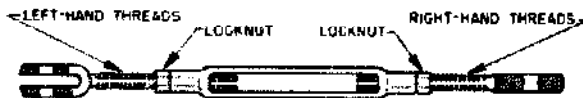

Figure 5-5.—A turnbuckle.

131.21

you turn it in one direction, it takes up the slack in a cable. Turning it the other way slacks off on the cable. You'll notice that one bolt of the turnbuckle has left-hand threads, and the other bolt has right-hand threads. Thus, when you turn the turnbuckle to tighten up the line, both bolts tighten up. If both bolts were right-hand thread—standard thread—one would tighten while the other one loosened an equal amount. Result—no change in cable-slack. Most turnbuckles have the screw threads cut to provide a large amount of frictional resistance to keep the turnbuckle from unwinding under load. In some cases, the turnbuckle has a lock nut on each of the screws to prevent slipping. You'll find turnbuckles used in a hundred different ways afloat and ashore.

Ever wrestled with a length of wire rope? Obstinate and unwieldy, wasn't it? Riggers have dreamed up tools to help subdue wire rope. One of these tools—the rigger's vise—is shown in figure 5-6. This rigger's vise uses the great mechanical advantage of the screw to hold the wire rope while the crew splices a thimble—a reinforced loop—onto the end of the cable. Rotating the handle causes the jaw on that screw to move in or out along its grooves. This machine is a modification of the vise on a work bench. Notice the right-hand and left-hand screws on the left-hand clamp.

Figure 5-7 shows you another use of the screw. Suppose you want to stop a winch with its load suspended in mid-air. To do this, you need a brake. The brake on most anchor or cargo winches consists of a metal band that



Figure 5-6.—A rigger's vise.

131.22

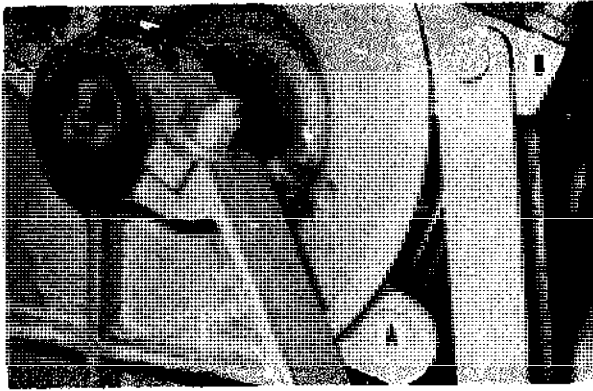

Figure 5-7.—A friction brake.

131.23

encircles the brake drum. The two ends of the band are fastened to nuts connected by a screw attached to a handwheel. As you turn the handwheel, the screw pulls the lower end of the band A up toward its upper end B. The huge M.A. of the screw puts the squeeze on the drum, and all rotation of the drum is stopped.

One type of steering gear used on many small ships—and as a spare steering system on some larger ships—is the screw gear. Figure 5-8

shows you that the wheel turns a long threaded shaft. Half the threads—those nearer the wheel end of this shaft—are right-hand threads. The other half of the threads—those farther from the wheel—are left-hand threads. The nut A has a right-hand thread, and nut B has a left-hand thread. Notice that the cross head which turns the rudder is connected to the nuts by two steering arms. If you stand in front of the wheel and turn it in a clockwise direction—to your right—arm A moves forward and arm B moves backward. This turns the rudder counterclockwise, so that the ship swings in the direction you turn the wheel. There is a great mechanical advantage to this steering mechanism.

Figure 5-9 shows you another practical use of the screw. The quadrant davit makes it possible for two men to put a large life boat over the side with little effort. The operating handle is attached to a threaded screw which passes through a traveling nut. If the operating handle is cranked in a counterclockwise direction (as you face outboard), the nut travels outward along the screw. The traveling nut is fastened to the davit arm by a swivel. The davit arm and the boat swing outboard as a result of the outward movement of the screw. The thread on that screw is the self-locking type—if you let go of the handle the nut remains locked in position.

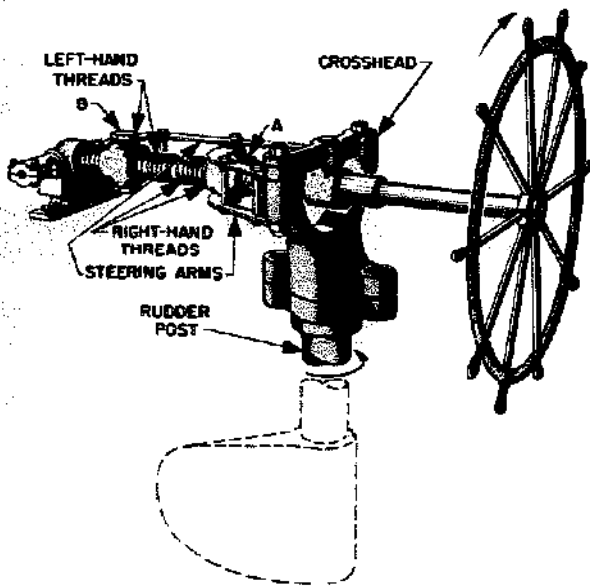

131.24

Figure 5-8.—The screw gives a tremendous mechanical advantage.

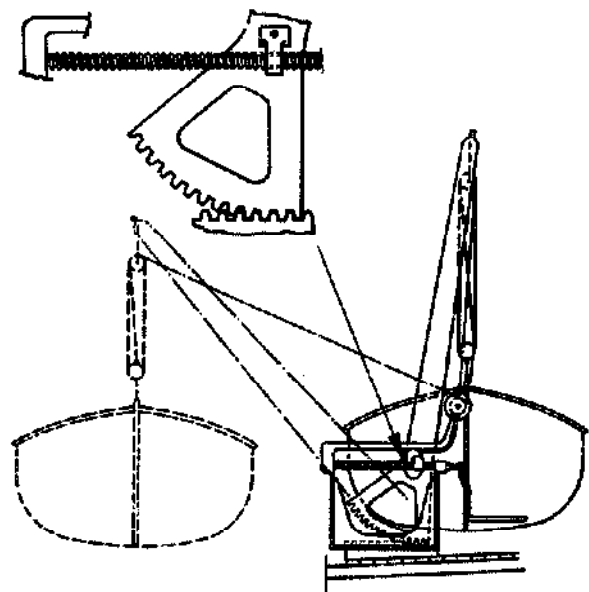

80.101

Figure 5-9.—The quadrant davit.

CHAPTER 6

GEARS

Did you ever take a clock apart to see what made it tick? Of course you came out with some parts left over when you got it back together again. And they probably included a few gear wheels. Gears are used in many machines. Frequently the gears are hidden from view in a protective case filled with grease or oil, and you may not see them.

An egg beater gives you a simple demonstration of the three things that gears do. They can change the direction of motion; increase or decrease the speed of the applied motion; and magnify or reduce the force which you apply. Gears also give you a positive drive. There can be, and usually is, creep or slip in a belt drive. But gear teeth are always in mesh, and there can be no creep and slip.

Follow the directional changes in figure 6-1. The crank handle is turned in the direction indicated by the arrow—clockwise, when viewed from the right. The 32 teeth on the large vertical wheel A mesh with the 8 teeth on the right-hand horizontal wheel B, which rotates as indicated by the arrow. Notice that as B turns in a clockwise direction, its teeth mesh with those of wheel C and cause wheel C to revolve in the opposite direction. The rotation of the crank handle has been transmitted by gears to the beater blades, which also rotate.

Now figure out how the gears change the speed of motion. There are 32 teeth on gear A and 8 teeth on gear B. But the gears mesh, so that one complete revolution of A results in four complete revolutions of gear B. And since gears B and C have the same number of teeth, one revolution of B results in one revolution of C. Thus the blades revolve four times as fast as the crank handle.

In chapter 1 you learned that third-class levers increase speed at the expense of force. The same thing happens with this egg beater. The magnitude of the force is changed. The force required to turn the handle is greater than

the force applied to the frosting by the blades. Therefore a mechanical advantage of less than one results.

TYPES OF GEARS

When two shafts are not lying in the same straight line, but are parallel, motion can be transmitted from one to the other by means of spur gears. This setup is shown in figure 6-2.

Spur gears are wheels with mating teeth cut in their surfaces so that one can turn the other without slippage. When the mating teeth are cut so that they are parallel to the axis of rotation, as shown in figure 6-2, the gears are called straight spur gears.

When two gears of unequal size are meshed together, the smaller of the two is usually called a pinion. By unequal size, we mean an unequal number of teeth causing one gear to be of a larger diameter than the other. The teeth, themselves, must be of the same size in order to mesh properly.

The most commonly used type are the straight spur gears, but quite often you'll run across another type of spur gear called the helical spur gear.

In helical gears the teeth are cut slantwise across the working face of the gear. One end of the tooth, therefore, lies ahead of the other. In other words, each tooth has a leading end and a trailing end. A look at these gears in figure 6-3A will show you how they're constructed.

In the straight spur gears the whole width of the teeth comes in contact at the same time. But with helical (spiral) gears contact between two teeth starts first at the leading ends and moves progressively across the gear faces until the trailing ends are in contact. This kind of meshing action keeps the gears in constant contact with one another. Therefore, less lost

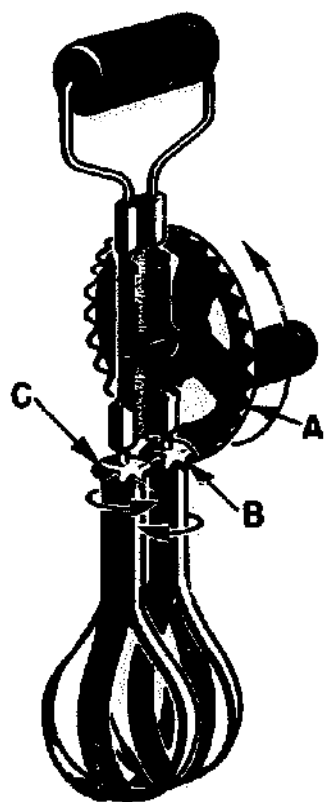

131.25
Figure 6-1.—A simple gear arrangement.

motion and smoother, quieter action is possible. One disadvantage of this helical spur gear is the tendency of each gear to thrust or push axially on its shaft. It is necessary to put a special thrust bearing at the end of the shaft to counteract this thrust.

Thrust bearings are not needed if herringbone gears like those shown in figure 6-4 are used. Since the teeth on each half of the gear are cut in opposite directions, each half of the gear develops a thrust which counterbalances that of the other half. You'll find herringbone gears used mostly on heavy machinery.

Figure 6-3 also shows you three other gear arrangements in common use.

The internal gear in figure 6-3B has teeth on the inside of a ring, pointing inward toward the axis of rotation. An internal gear is always meshed with an external gear, or pinion, whose

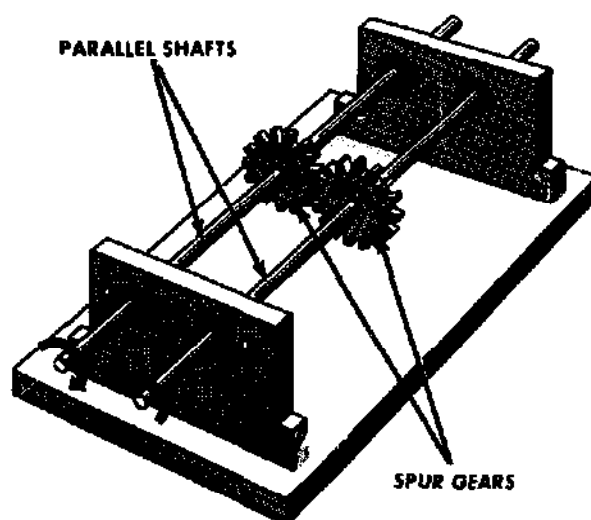

5.22.1
Figure 6-2.—Spur gears coupling two parallel shafts.

center is offset from the center of the internal gear. Either the internal or pinion gear can be the driver gear, and the gear ratio is calculated the same as for other gears—by counting teeth.

Often only a portion of a gear is needed where the motion of the pinion is limited. In this case the sector gear (fig. 6-3C) is used to save space and material. The rack and pinion in figure 6-3D are both spur gears. The rack may be considered as a piece cut from a gear with an extremely large radius. The rack-and-pinion arrangement is useful in changing rotary motion into linear motion.

THE BEVEL GEAR.—So far most of the gears you've learned about transmit motion between parallel shafts. But when shafts are not parallel (at an angle), another type of gear is used—the bevel gear. This type of gear can connect shafts lying at any given angle because they can be beveled to suit the angle.

Figure 6-5A shows a special case of the bevel gear—the miter gear. A pair of miter gears is used to connect shafts having a 90° angle, which means the gear faces are beveled at a 45° angle.

You can see in figure 6-5B how bevel gears are designed to join shafts at any angle. Gears cut at any angle other than 45° are called just plain bevel gears.

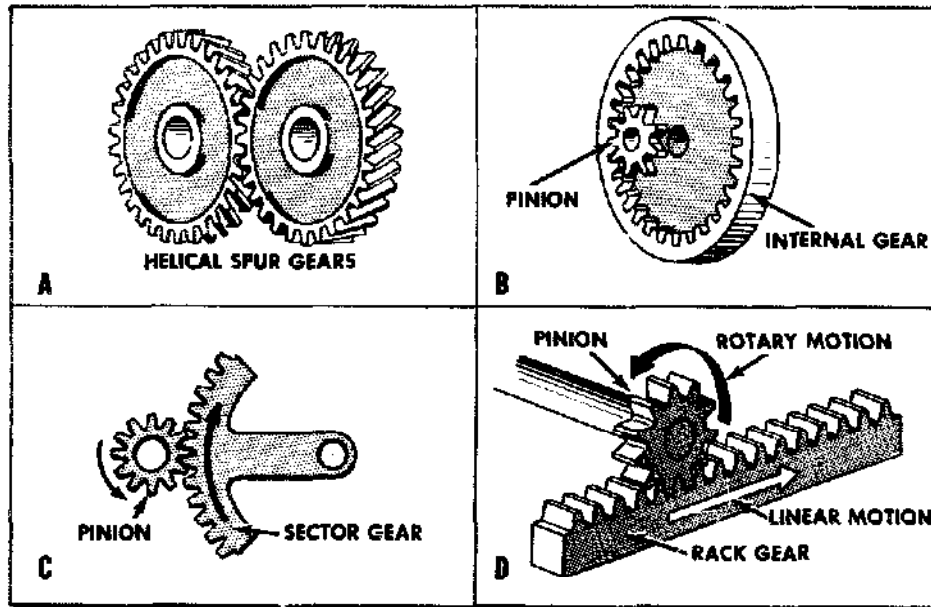

5.23:24

Figure 6-3.—Gear types.

The gears shown in figure 6-5 are called straight bevel gears, because the whole width of each tooth comes in contact with the mating tooth at the same time. However, you'll also run across spiral bevel gears with teeth cut so as to have advanced and trailing ends. Figure 6-6 shows you what spiral bevel gears look like. They have the same advantages as

other spiral (helical) gears—less lost motion and smoother, quieter operation.

THE WORM AND WORM WHEEL.—Worm and worm-wheel combinations, like those in figure 6-7, have many uses and advantages. But it's better to understand their operating theory before learning of their uses and advantages.

Figure 6-7A shows the action of a single-thread worm. For each revolution of the worm,

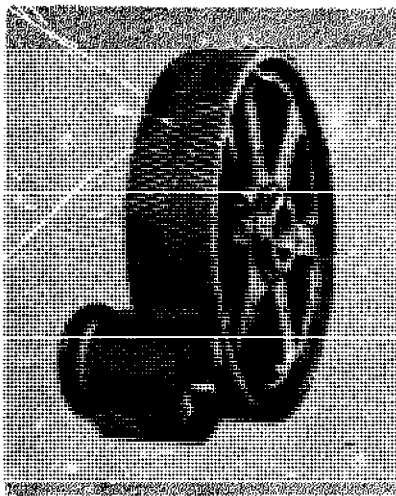
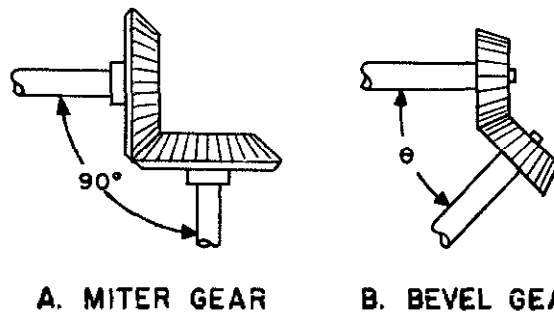

Figure 6-4.—Herringbone gear.

5.22.3



A. MITER GEAR

B. BEVEL GEAR

5.22.4

Figure 6-5.—Bevel gears.

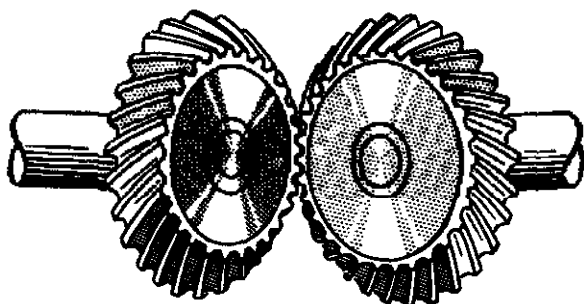

Figure 6-6.—Spiral bevel gears.

5.22.6

the worm wheel turns one tooth. Thus if the worm wheel has 25 teeth the gear ratio is 25:1.

Figure 6-7B shows a double-thread worm. For each revolution of the worm in this case, the worm wheel turns two teeth. That makes the gear ratio 25:2 if the worm wheel has 25 teeth.

Likewise, a triple-threaded worm would turn the worm wheel three teeth per revolution of the worm.

A worm gear is really a combination of a screw and a spur gear. Tremendous mechanical advantages can be obtained with this arrangement. Worm drives can also be designed so that only the worm is the driver—the

spur cannot drive the worm. On a hoist, for example, you can raise or lower the load by pulling on the chain which turns the worm. But if you let go of the chain, the load cannot drive the spur gear and let the load drop to the deck. This is a non-reversing worm drive.

CHANGING DIRECTION WITH GEARS

No doubt you know that the crankshaft in an automobile engine can turn in only one direction. If you want the car to go backwards, the effect of the engine's rotation must be reversed. This is done by a reversing gear in the transmission, not by reversing the direction in which the crankshaft turns.

A study of figure 6-8 will show you how gears are used to change the direction of motion. This is a schematic diagram of the sight mounts on a Navy gun. If you crank the range-adjusting handle A in a clockwise direction the gear B directly above it is made to rotate in a counter-clockwise direction. This motion causes the two pinions C and D on the shaft to turn in the same direction as gear B against the teeth cut in the bottom of the table. The table is tipped in the direction indicated by the arrow.

As you turn the deflection-adjusting handle E in a clockwise direction the gear F directly above it turns in the opposite direction. Since the two bevel gears G and H are fixed on the

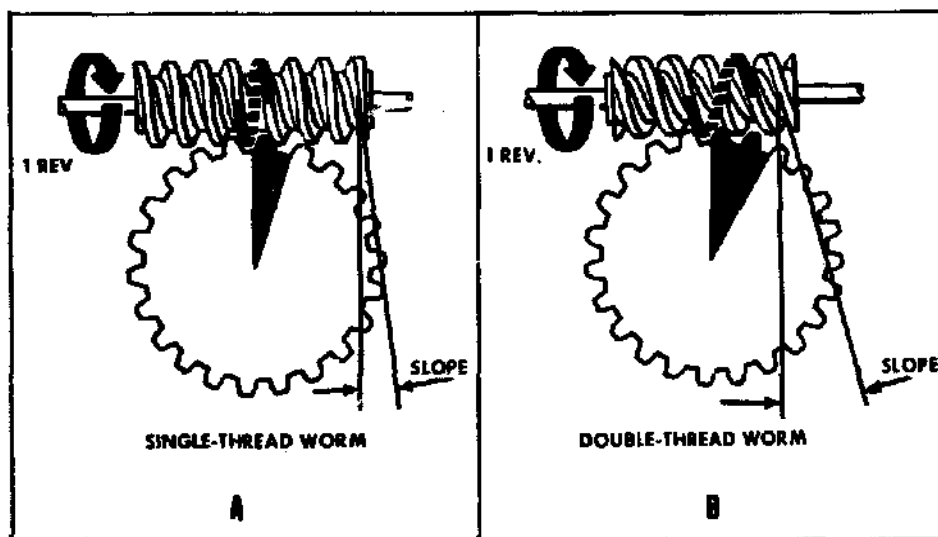
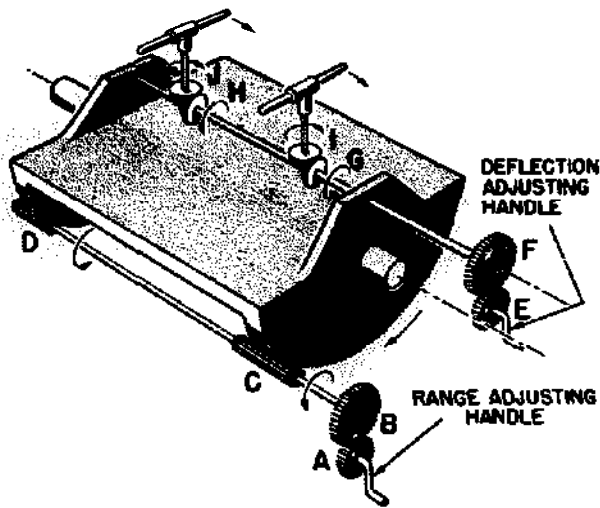

Figure 6-7.—Worm gears.

5.22.9



131.26
Figure 6-8.—Gears change direction of applied motion.

shaft with F, they also turn. These bevel gears, meshing with the horizontal bevel gears I and J, cause I and J to swing the front ends of the telescopes to the right. Thus with a simple system of gears, it is possible to keep the two telescopes pointed at a moving target. In this and many other practical applications, gears serve one purpose—to change the direction of motion.

CHANGING SPEED

As you've already seen in the egg-beater, gears can be used to change the speed of motion. Another example of this use of gears is found in your clock or watch. The mainspring slowly unwinds and causes the hour hand to make one revolution in 12 hours. Through a series—or train—of gears, the minute hand makes one revolution each hour, while the second hand goes around once per minute.

Figure 6-9 will help you to understand how speed changes are made possible. Wheel A has 10 teeth which mesh with the 40 teeth on wheel B. Wheel A will have to rotate four times to cause B to make one revolution. Wheel C is rigidly fixed on the same shaft with B. Thus C makes the same number of revolutions as B. However, C has 20 teeth, and meshes with wheel D which has only 10 teeth. Hence, wheel D turns twice as fast as wheel C.

Now, if you turn A at a speed of four revolutions per second, B will be rotated at one revolution per second. Wheel C also moves at one revolution per second, and causes D to turn at two revolutions per second. You get out two revolutions per second after having put in four revolutions per second. Thus the overall speed reduction is 2/4—or 1/2—which means that you got half the speed out of the last driven wheel that you put into the first driver wheel.

You can solve any gear speed-reduction problem with this formula—

$$S_2 = S_1 \times \frac{T_1}{T_2}$$

where

S_1 = speed of first shaft in train

S_2 = speed of last shaft in train

T_1 = product of teeth on all drivers

T_2 = product of teeth on all driven gears

Now use the formula on the gear train of figure 6-8.

$$S_2 = S_1 \times \frac{T_1}{T_2} = 4 \times \frac{10 \times 20}{40 \times 10} =$$

$$\frac{800}{400} = 2 \text{ revs. per sec.}$$

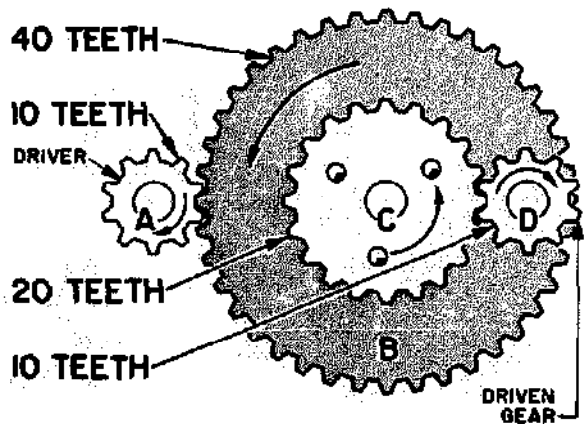

131.27
Figure 6-9.—Gears can change speed of applied motion.

Almost any increase or decrease in speed can be obtained by choosing the correct gears for the job. For example, the turbines on a ship have to turn at high speeds—say 5800 rpm—if they are going to be efficient. But the propellers, or screws, must turn rather slowly—say 195 rpm—to push the ship ahead with maximum efficiency. So, a set of reduction gears is placed between the turbines and the propeller shaft.

When two external gears mesh, they rotate in opposite directions. Often you'll want to avoid this. Put a third gear, called an idler, between the driver and the driven gear. But don't let this extra gear confuse you on speeds. Just neglect the idler entirely. It doesn't change the gear ratio at all, and the formula still applies. The idler merely makes the driver and its driven gear turn in the same direction. Figure 6-10 will show you how this works.

MAGNIFYING FORCE WITH GEARS

Gear trains are used to increase the mechanical advantage. In fact, wherever there is a speed reduction, the effect of the effort you apply is multiplied. Look at the cable winch in figure 6-11. The crank arm is 30 inches long, and the drum on which the cable is wound has a 15-inch radius. The small pinion gear has 10

teeth, which mesh with the 60 teeth on the internal spur gear. You will find it easier to figure the mechanical advantage of this machine if you think of it as two machines.

First, figure out what the gear and pinion do for you. The theoretical mechanical advantage of any arrangement of two meshed gears can be found by the following formula—

$$M. A. (\text{theoretical}) = \frac{T_o}{T_a}$$

In which, T_o = number of teeth on driven gear;

T_a = number of teeth on driver gear.

In this case, $T_o = 60$ and $T_a = 10$. Then,

$$M. A. (\text{theoretical}) = \frac{T_o}{T_a} = \frac{60}{10} = 6$$

Now, for the other part of the machine, which is a simple wheel-and-axle arrangement consisting of the crank arm and the drum. The theoretical mechanical advantage of this can be found by dividing the distance the effort moves— $2\pi R$ —in making one complete revolution, by the distance the cable is drawn up in one revolution of the drum— $2\pi r$.

$$M. A. (\text{theoretical}) = \frac{2\pi R}{2\pi r} = \frac{R}{r} = \frac{30}{15} = 2$$

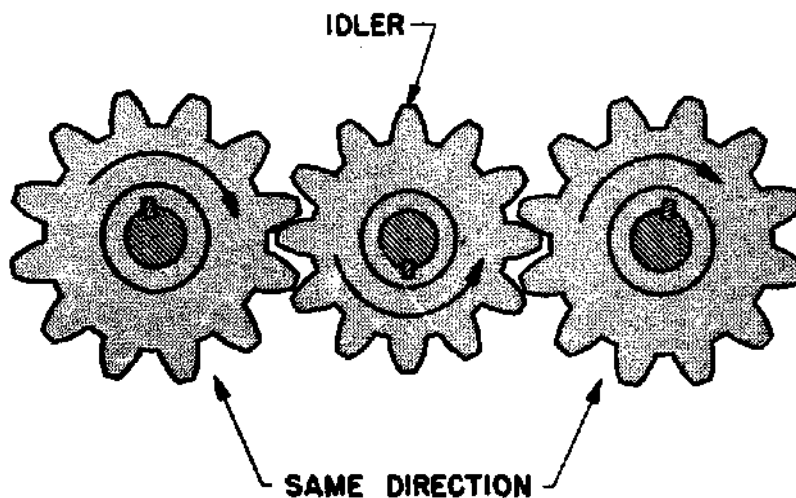
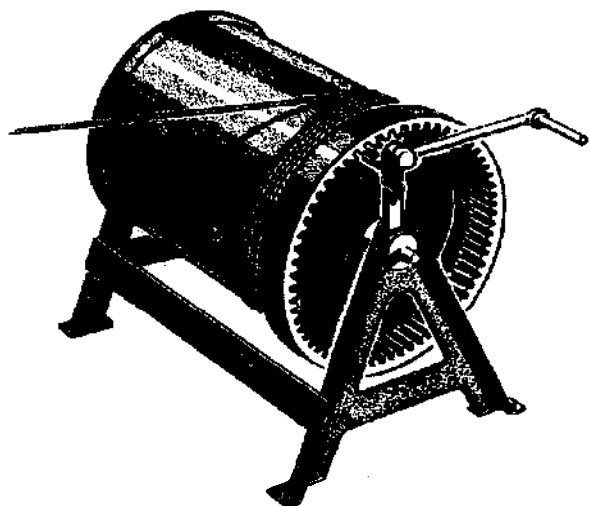

Figure 6-10.—An idler gear.

12.55



131.28

Figure 6-11.—This magnifies your effort.

You know that the total, or overall, theoretical mechanical advantage of a compound machine is equal to the product of the mechanical advantages of the several simple machines that make it up. In this case you considered the winch as being two machines—one having an M. A. of 6, and the other an M. A. of 2. Therefore, the over-all theoretical mechanical advantage of the winch is 6×2 , or 12. Since friction is always present, the actual mechanical advantage may be only 7 or 8. Even so, by applying a force of 100 pounds on the handle, you could lift a load of 700 or 800 pounds.

You use gears to produce circular motion. But you often want to change rotary motion into up-and-down or linear motion. You can use cams to do this. For example—

The cam shaft in figure 6-12 is turned by the gear. A cam is keyed to the shaft and turns with it. The cam has an irregular shape which is designed to move the valve stem up and down, giving the valve a straight-line motion as the cam shaft rotates.

When the cam shaft rotates, the high point—lobe—of the cam raises the valve to its open position. As the shaft continues to rotate, the high point of the cam is passed and the valve is lowered to closed position.

A set of cams, two to a cylinder, driven by timing gears from the crankshaft operate the exhaust and intake valves on the gasoline automobile engine as shown in figure 6-13. Cams are widely used in machine tools and other devices to make rotating gears and shafts do up-and-down work.

SUMMARY

These are the important points you should keep in mind about gears—

Gears can do a job for you by changing the direction, speed, or size of the force which you apply.

When two external gears mesh, they always turn in opposite directions. You can make them turn in the same direction by placing an idler gear between the two.

The product of the number of teeth on each of the driver gears, divided by the product of the number of teeth on each of the driven gears, gives you the speed ratio of any gear train.

The theoretical mechanical advantage of any gear train is the product of the number of teeth on the driven gear wheels, divided by the product of the number of teeth on the driver gears.

The overall theoretical mechanical advantage of a compound machine is equal to the product of the theoretical mechanical advantages of all the simple machines which make it up.

Cams are used to change rotary motion into linear motion.

One of the gear systems you'll get to see frequently aboard ship is that on the anchor winch. Figure 6-14 shows you one type in which you can readily see how the wheels go 'round. The driving gear A is turned by the winch engine or motor. This gear has 22 teeth, which mesh with the 88 teeth on the large wheel B. Thus, you know that the large wheel makes one revolution for every four revolutions of the driving gear A. You get a 4-to-1 theoretical mechanical advantage out of that pair. Secured to the same shaft with B is the small spur gear C, covered up here. The gear C has 30 teeth which mesh with the 90 teeth on the large gear D, also covered up. The advantage from C to D is

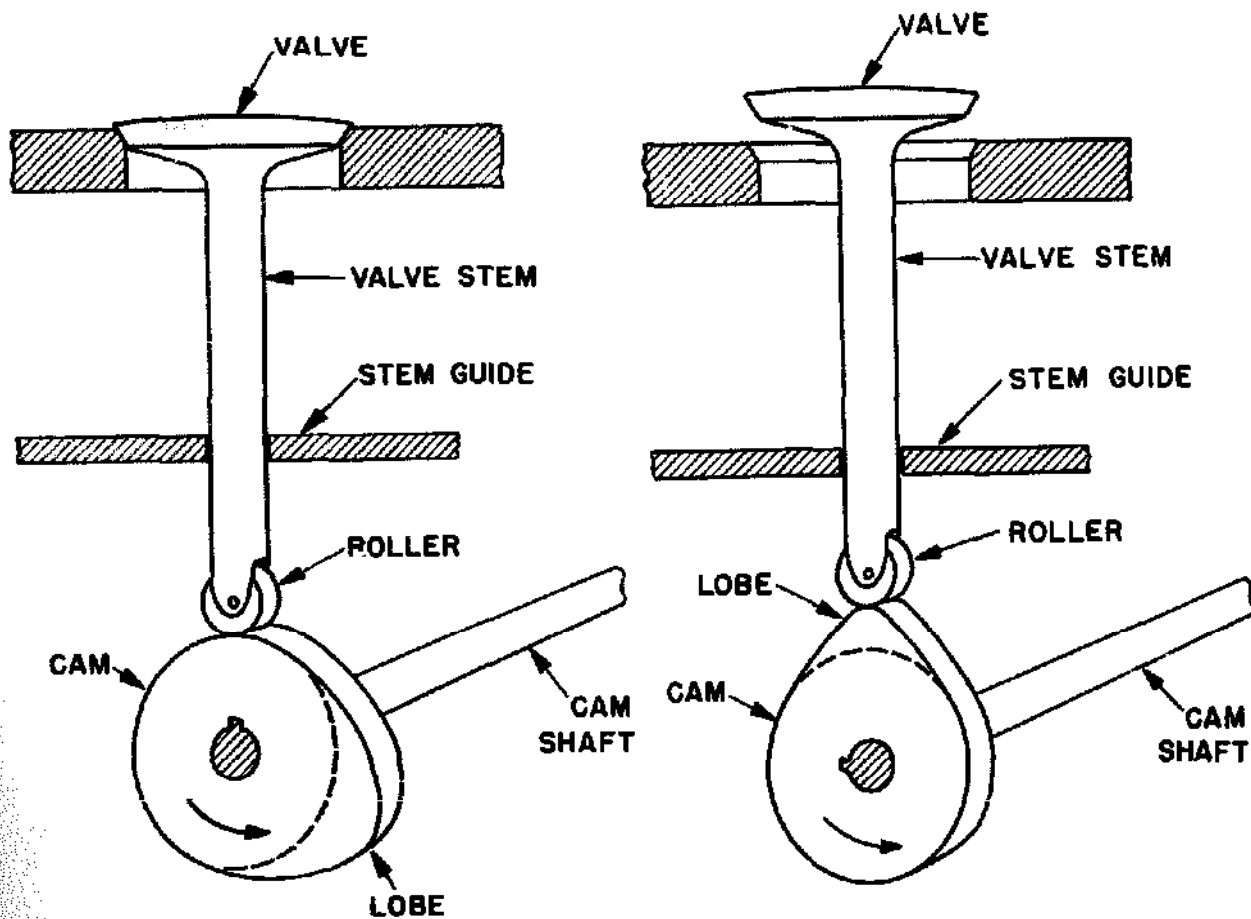

Figure 6-12.—Cam-driven valve.

131.29

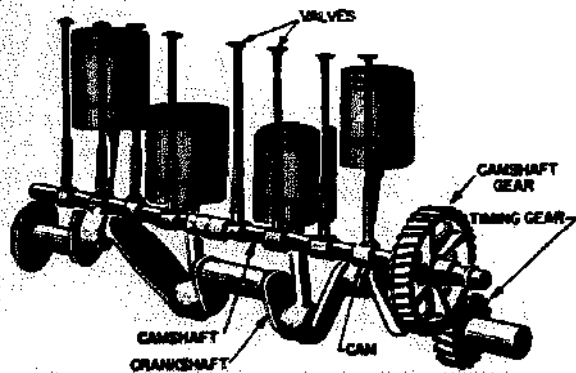

Figure 6-13.—Automobile valve gear.

131.30

3 to 1. The sprocket wheel to the far left, on the same shaft with D, is called a wildcat. The anchor chain is drawn up over this. Every second link is caught and held by the protruding teeth of the wildcat. The overall mechanical advantage of the winch is 4×3 , or 12 to 1.

Figure 6-15 shows you an application of the rack and pinion as a steering mechanism. Turning the ship's wheel turns the small pinion A. This pinion causes the internal spur gear to turn. Notice that there is a large mechanical advantage in the arrangement.

Now you see that center pinion P turns. It meshes with the two vertical racks. When the wheel is turned full to the right, one rack moves downward and the other moves upward to the positions of the racks. Attached to the bottom

of the racks are two hydraulic pistons which control the steering of the ship. You'll get some information on this hydraulic system in a later chapter.

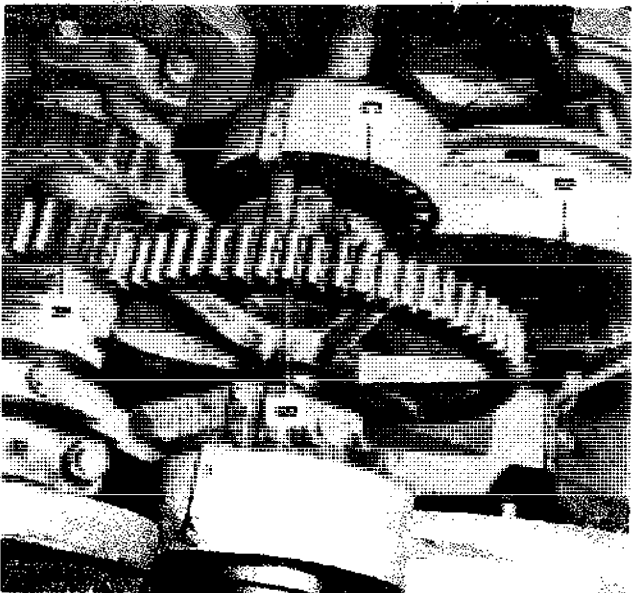

Figure 6-14.—An anchor winch.
131.31

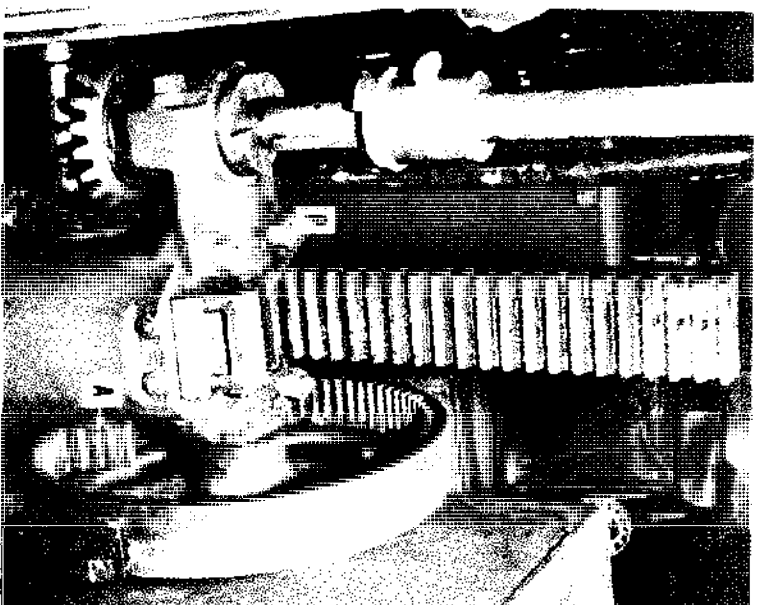

Figure 6-15.—A steering mechanism.
131.32

CHAPTER 7

WORK

MEASUREMENT

You know that machines help you to do work. But just what is work? Work doesn't mean simply applying a force. If that were so, you would have to consider that Big-Boy, busily applying his 220-pound force on the sea bag in figure 7-1 is doing work. But no work is being done!

Work, in the mechanical sense of the term, is done when a resistance is overcome by a force acting through a measureable distance. Now, if Big-Boy were to lift his 90-pound bag off the deck and put it on his bunk, he would be doing work. He would be overcoming a resistance by applying a force through a distance.

Notice that two factors are involved—force and movement through a distance. The force is normally measured in pounds, and the distance in feet. Work, therefore, is commonly measured in units called foot-pounds. You do one foot-pound of work when you lift a one-pound weight through a height of one foot. But—you also do one foot-pound of work when you apply one pound of force on any object through a distance of one foot. Writing this as a formula, it becomes—

$$\text{WORK} = \text{FORCE} \times \text{DISTANCE}$$

(foot-pounds) = (pounds) x (feet)

Thus, if the sailor lifts a 90-pound bag through a vertical distance of 5 feet, he will do—

$$\text{WORK} = 90 \times 5 = 450 \text{ ft-lb.}$$

There are two points concerning work that you should get straight right at the beginning.

First, in calculating the work done you measure the actual resistance being overcome. This is not necessarily the weight of the object being

moved. To make this clear, look at the job the bluejacket in figure 7-2 is doing. He is pulling a 900-pound load of supplies 200 feet along the dock. Does this mean that he is doing 900 times 200, or 180,000 foot-pounds of work? Of course not. He isn't working against the pull of gravity—or the total weight—of the load. He's pulling only against the rolling friction of the truck, and that may be as little as 90 pounds. That is the resistance which is being overcome. Always be sure that you know what resistance is being overcome by the effort, as well as the distance through which it is moved. The resistance in one case may be the weight of the object; in another it may be the frictional resistance of the object as it is dragged or rolled along the deck.

The second point to hold in mind is that you have to move the resistance to do any work on it. Look at Willie in figure 7-3. The poor guy has been holding that suitcase for the past 15 minutes waiting for the bus. His arm is getting tired; but according to the definition of work, he isn't doing any—because he isn't moving the suitcase. He is merely exerting a force against the pull of gravity on the bag.

You already know about the mechanical advantage of a lever. Now consider it in terms of getting work done easily. Look at figure 7-4. The load weighs 300 pounds, and you want to lift it up onto a platform a foot above the deck. How much work must you do on it? Since 300 pounds must be raised one foot, 300 times 1, or 300 foot-pounds of work must be done. You can't make this weight any smaller by the use of any machine. However, if you use the eight-foot plank as shown, you can do that amount of work, by applying a smaller force through a longer distance. Notice that you have a mechanical advantage of 3, so that a 100-pound push down on the end of the plank will raise the 300-pound crate. Through how long a distance will you have to exert that 100-pound push? Neglecting



131.33

Figure 7-1.—No work is being done.

friction—and in this case you can safely do so—the work done on the machine is equal to the work done by the machine. Say it this way—

Work put in = work put out.

And since Work = force x distance, you can substitute "force times distance" on each side of the work equation. Thus—

$$F_1 \text{ times } S_1 = F_2 \text{ times } S_2$$

in which,

F_1 = effort applied, in pounds

S_1 = distance through which effort moves, in feet

F_2 = resistance overcome, in pounds

S_2 = distance resistance is moved, in feet

Now substitute the known values, and you obtain—

$$100 \text{ times } S_1 = 300 \text{ times } 1$$

$$S_1 = 3 \text{ feet}$$



131.34

Figure 7-2.—Working against friction.



131.35

Figure 7-3.—No motion no work.

The advantage of using the lever is not that it makes any less work for you, but that it allows you to do the job with the force at your command. You'd probably have some difficulty lifting 300 pounds directly upward without a machine to help you!

A block and tackle also makes work easier. But like any other machine, it can't decrease the total amount of work to be done. With a rig like the one shown in figure 7-5, the bluejacket has a mechanical advantage of 5, neglecting friction. Notice that five parts of the rope go to and from the movable block. To raise the 600-pound load 20 feet, he needs to exert a pull of only 1/5 of 600—or 120 pounds. But—he is going to have to pull more than 20 feet of rope through his hands in order to do this. Use the formula again to figure why this is so—

Work input = work output

$$F_1 \times S_1 = F_2 \times S_2$$

And by substituting the known values—

$$120 \times S = 600 \times 20$$

$$S_1 = 100 \text{ feet.}$$

This means that he has to pull 100 feet of rope through his hands in order to raise the load 20 feet. Again, the advantage lies in the fact that a relatively small force operating through a large distance can move a big load through a small distance.

The sailor busy with the big piece of machinery in figure 7-6 has his work cut out for him. He is trying to seat the machine square on its foundations. The rear end must be shoved over one-half foot against a frictional resistance of 1,500 pounds. The amount of work to be done is $1,500 \times 1/2$, or 750 foot-pounds. He will have to do at least this much work on the jack he is using. If the jack has a 2 1/2-foot handle— $R = 2 1/2 \text{ ft}$ —and the pitch of the jack screw is 1/4 inch, he can do the job with little effort. Neglecting friction, you can figure it out this way—

Work input = work output

$$F_1 \times S_1 = F_2 \times S_2$$

In which

F_1 = force in pounds applied on the handle;
 S_1 = distance, in feet, that the end of the handle travels in one revolution;

F_2 = resistance to be overcome;
 S_2 = distance in feet that head of jack is advanced by one revolution of the screw.
 Or, the pitch of the screw.

And, by substitution,

$$F_1 \times 2R = 1500 \times 1/48,$$

since $1/4'' = 1/48$ of a foot

$$F_1 \times 2 \times 2 1/2 = 1500 \times 1/48$$

$$F_1 = 2 \text{ pounds}$$

The jack makes it theoretically possible for the sailor to exert a 1,500-pound push with a 2-pound effort, but look at the distance through which he must apply that effort. One complete turn of the handle represents a distance of 15.7 feet. That 15.7-foot rotation advances the piece of machinery only 1/4th of an inch—or 1/48th of a foot. Force is gained at the expense of distance.

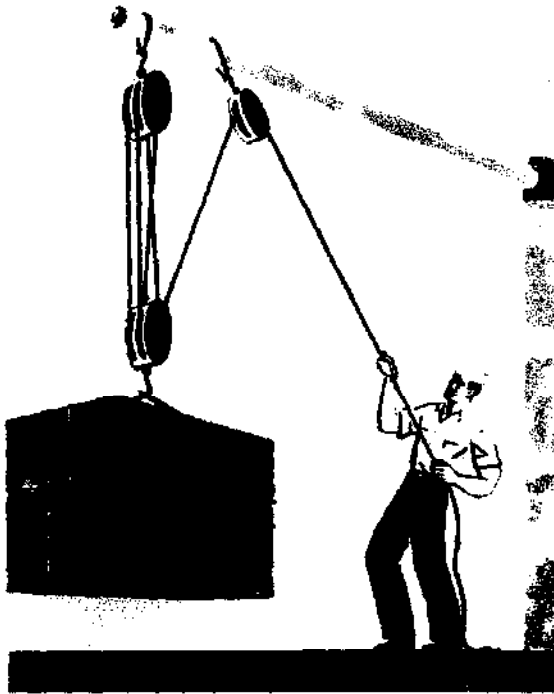

131.37

Figure 7-5.—A block and tackle makes work easier.

lump of sugar on a table and give each an equal push, the marble will move farther. This is because rolling friction is always less than sliding friction. You take advantage of this fact whenever you use ball bearings or roller bearings. See figure 7-7.

Remember that rolling friction is always less than sliding friction. The Navy takes advantage of that fact. Look at figure 7-8. This roller chock not only cuts down the wear and tear on lines and cables which are run through it, but—by reducing friction—also reduces the load the winch has to work against.

The roller bitt in figure 7-9 is another example of how you can cut down the wear and tear on lines or cable and also reduce your frictional loss.

When it is necessary to have one surface move over another, you can decrease the friction by the use of lubricants, such as oil, grease, or soap. You will use lubricants on flat surfaces, gun slides for example, as well as on ball and



131.38

Figure 7-6.—A big push.

roller bearings, to further reduce the frictional resistance and to cut down the wear.

Don't forget that in a lot of situations friction is mighty helpful, however. Many a blue-jacket has found out about this the hard way—on a wet, slippery deck. On some of our ships you'll find that a rough-grained deck covering is used. Here you have friction working for you. It helps you to keep your footing.

EFFICIENCY

Up to this point you have been neglecting the effect of friction on machines. This makes it easier to explain machine operation, but you know from practical experience that friction is involved every time two surfaces move against one another. And the work used in overcoming the frictional resistance does not appear in the work output. Since this is so, it's obvious that you have to put more work into a machine than you get out of it. In other words, no machine is 100 percent efficient.

Take the jack in figure 7-6, for example. The chances are good that a 2-pound force exerted on the handle wouldn't do the job at all. More likely a pull of at least 10 pounds would be required. This indicates that only 2 out of the 10 pounds, or 20 percent of the effort is usefully employed to do the job. The remaining 8 pounds of effort were consumed in overcoming the friction in the jack. Thus, the jack has an efficiency of only 20 percent. Most jacks are inefficient, but even with this inefficiency, it is possible to deliver a huge push with a small amount of effort.

Actually, $50 \div 0.60 = 83.3$ pounds. You can check this yourself in the following manner—

$$\begin{aligned} \text{Efficiency} &= \frac{\text{Output}}{\text{Input}} \\ &= \frac{F_2 \times S_2}{F_1 \times S_1} \end{aligned}$$

One revolution of the drum would raise the 600-pound load a distance S_2 of $2\pi r$ or 7.85 feet. To make the drum revolve once, the pinion gear must be rotated six times by the handle; and the handle must be turned through a distance S_1 of $6 \times 2\pi R$, or 94.2 feet. Then, by substitution—

$$0.60 = \frac{600 \times 7.85}{F_1 \times 94.2}$$

$$F_1 = \frac{600 \times 7.85}{94.2 \times 0.60} = 83.3 \text{ pounds.}$$

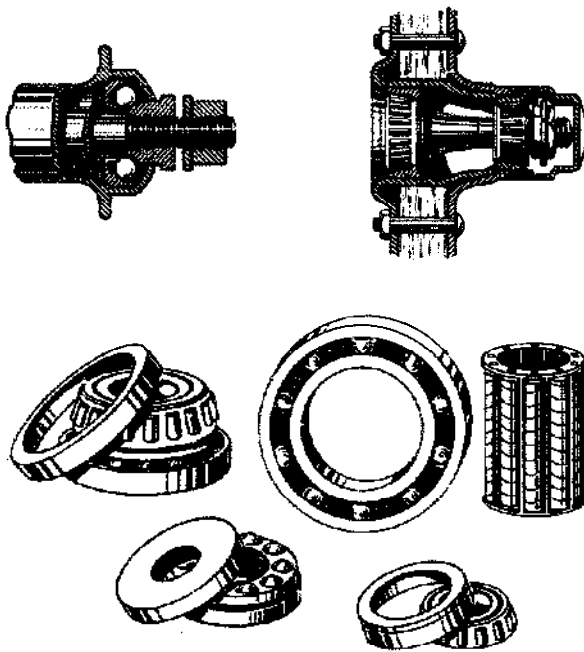

12.50

Figure 7-7.—These reduce friction.

A simple way to calculate the efficiency of a machine is to divide the output by the input—convert to percentage

$$\text{Efficiency} = \frac{\text{Output}}{\text{Input}}$$

Now go back to the block-and-tackle problem illustrated in figure 7-5. It's likely that instead of being able to lift the load with a 120-pound pull, the bluejacket would perhaps have to use a 160-pound pull through the 100 feet. You can calculate the efficiency of the rig by the following method—

$$\text{Efficiency} = \frac{\text{output}}{\text{input}} = \frac{F_2 \times S_2}{F_1 \times S_1}$$

and, by substitution,

$$= \frac{600 \times 20}{160 \times 100} = 0.75 \text{ or } 75 \text{ percent.}$$

Theoretically, with the mechanical advantage of twelve developed by the cable winch back in figure 6-11 you should be able to lift a 600-pound load with a 50-pound push on the handle. If the machine has an efficiency of 60 percent, how big a push would you actually have to apply?



131.39

Figure 7-8.—It saves wear and tear.

Because this machine is only 60-percent efficient, you have to put 94.2×83.3 , or 7,847 foot-pounds of work into it in order to get 4,710 foot-pounds of work out of it. The difference— $7,847 - 4,710$ 3,137 foot-pounds—is used to overcome friction within the machine.

SUMMARY

Here are some of the important points you should remember about friction, work, and efficiency—

You do work when you apply a force against a resistance and move the resistance. Since force—measured in pounds—and distance—measured in feet—are involved, work is measured in foot-pounds. One foot-pound of work is the result of a one-pound force, acting against a resistance through a distance of one foot.

Machines help you to do work by making it possible to move a large resistance through a small distance by the application of a small force through a large distance.

Since friction is present in all machines, more work must be done on the machine than the machine actually does on the load.

The efficiency of any machine can be found by dividing the output by the input.

The resistance that one surface offers to movement over a second surface is called friction.

Friction between two surfaces depends upon the nature of the materials and the magnitude of the forces pushing them together.

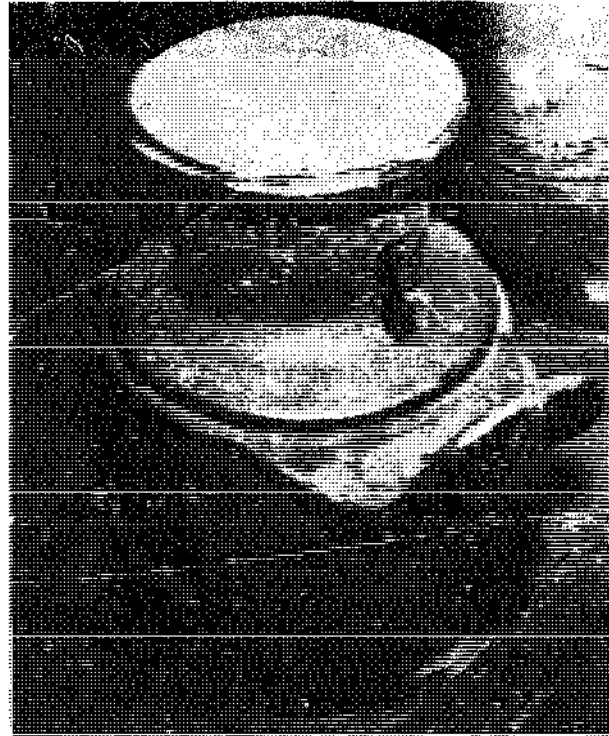

131.40
Figure 7-9.—Roller bitt saves line.

CHAPTER 8

POWER

It's all very well to talk about how much work a man can do, but the payoff is how long it takes him to do it. Look at "Lightning" in figure 8-1. He has lugged 3 tons of bricks up to the second deck of the new barracks. However, it has taken him three 10-hour days—1800 minutes—to do the job. In raising the 6000 pounds 15 feet he did 90,000 foot-pounds of work. Remember—force x distance = work. Since it took him 1800 minutes, he has been working at the rate of $90,000 \div 1800$, or 50 foot-pounds of work per minute.

That's power—the rate of doing work. Thus, power always includes the time element. Doubtless you could do the same amount of work in one 10-hour day, or 600 minutes—which would mean that you would work at the rate of $90,000 \div 600 = 150$ foot-pounds per minute. You then would have a power value three times as great as that of "Lightning."

By formula—

$$\text{Power} = \frac{\text{Work, in ft-lb}}{\text{Time, in minutes}}$$

HORSEPOWER

You measure force in pounds; distance in feet; work in foot-pounds. What is the common unit used for measuring power? The horsepower. If you want to tell someone how powerful an engine is, you could say that it is so many times more powerful than a man, or an ox, or a horse. But what man, and whose ox or horse? James Watt, the fellow who invented the steam engine, compared his early models with the horse. By experiment, he found that an average horse could lift a 330-pound load straight up through a distance of 100 feet in one minute. Figure 8-2 shows you the type of rig he used to find this out. By agreement among scientists, that figure of 33,000 foot-pounds of work done in one minute has been

accepted as the standard unit of power, and it is called a horsepower—hp.

Since there are 60 seconds in a minute, one horsepower is also equal to $\frac{33,000}{60} = 550$ foot-pounds per second. By formula—

$$\text{Horsepower} = \frac{\text{Power (in ft-lb per min)}}{33,000}$$

CALCULATING POWER

It isn't difficult to figure how much power is needed to do a certain job in a given length of time, nor to predict what size engine or motor is



Figure 8-1.—Get a horse.

131.41

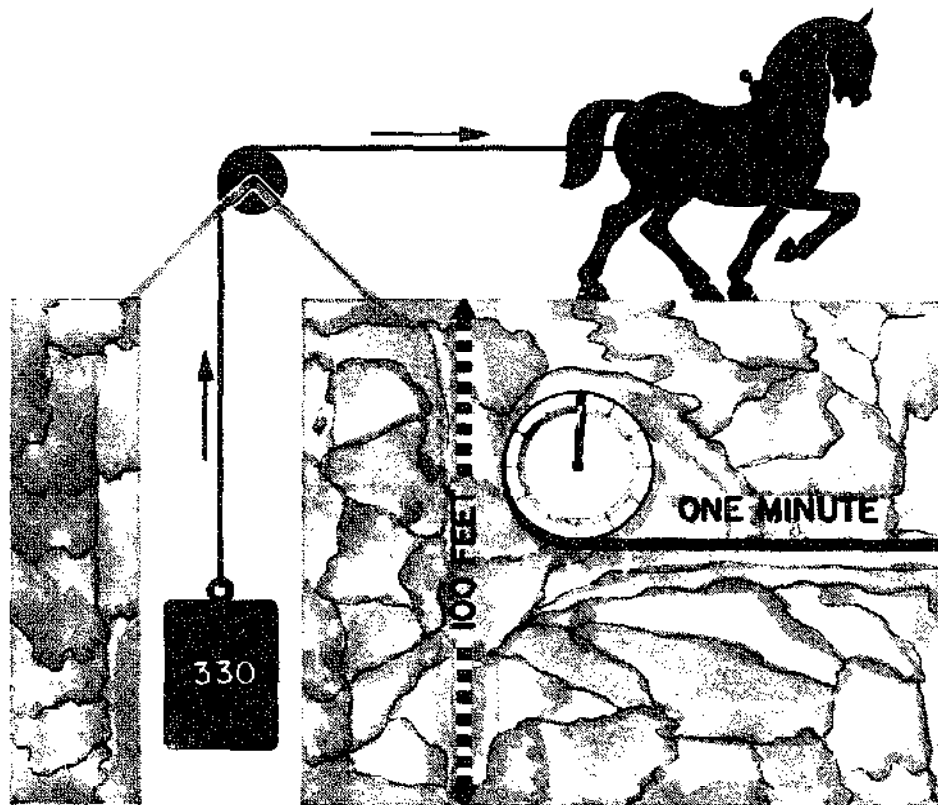

131.42

Figure 8-2.—One horsepower.

needed to do it. Suppose an anchor winch must raise a 6,600-pound anchor through 120 feet in 2 minutes. What must be the theoretical horsepower rating of the motor on the winch?

The first thing to do is to find the rate at which the work must be done. You see the formula—

$$\text{Power} = \frac{\text{work}}{\text{time}} = \frac{\text{force} \times \text{distance}}{\text{time}}$$

Substitute the known values in the formula, and you get—

$$\text{Power} = \frac{6,600 \times 120}{2} = 396,000 \text{ ft-lb/min}$$

So far, you know that the winch must work at a rate of 396,000 ft-lb/min. To change this rate to horsepower, you divide by the rate at

which the average horse can work—33,000 ft-lb/min.

$$\begin{aligned} \text{Horsepower} &= \frac{\text{Power (ft-lb/min)}}{33,000} = \\ &= \frac{396,000}{33,000} = 12 \text{ hp.} \end{aligned}$$

Theoretically, the winch would have to be able to work at a rate of 12 horsepower in order to get the anchor raised in 2 minutes. Of course, you've left out all friction in this problem, so the winch motor would actually have to be larger than 12 hp.

Planes are raised from the hangar deck to the flight deck of a carrier on an elevator. Some place along the line, an engineer had to figure out how powerful the motor had to be in order

to raise the elevator. It's not too tough when you know how. Allow a weight of 10 tons for the elevator, and 5 tons for the plane. Suppose that you want to raise the elevator and plane 25 feet in 10 seconds. And that the overall efficiency of the elevator mechanism is 70 percent. With that information you can figure what the delivery horsepower of the motor must be. Set up the formulas—

$$\text{Power} = \frac{\text{force} \times \text{distance}}{\text{time}}$$

$$\text{hp} = \frac{\text{power}}{33,000}$$

Substitute the known values in their proper places, and you have—

$$\text{power} = \frac{30,000 \times 25 \text{ ft}}{10/60 \text{ minute}} = 4,500,000 \text{ ft lb/min.}$$

$$\text{hp} = \frac{4,500,000}{33,000} = 136.4 \text{ hp.}$$

So, 136.4 horsepower would be needed if the engine had 100 percent overall efficiency. You want to use 70 percent efficiency, so you use the formula—

$$\text{Efficiency} = \frac{\text{Output}}{\text{Input}}$$

$$\text{Input} = \frac{136.4}{0.70} = 194.8 \text{ hp.}$$

This is the rate at which the engine must be able to work. To be on the safe side, you'd probably select a 200-horsepower auxiliary to do the job.

FIGURING THE HORSEPOWER RATING OF A MOTOR

You have probably seen the horsepower rating plates on electric motors. A number of methods may be used to determine this rating. One way that the rating of a motor or a steam or gas engine can be found is by the use of the prony brake. Figure 8-3 shows you the Prony brake setup. A pulley wheel is fixed to the shaft of the motor, and a leather belt is held firmly against the pulley. Attached to the two ends of the belt are spring scales. When the motor is standing still, each scale reads the same—say 15 pounds.

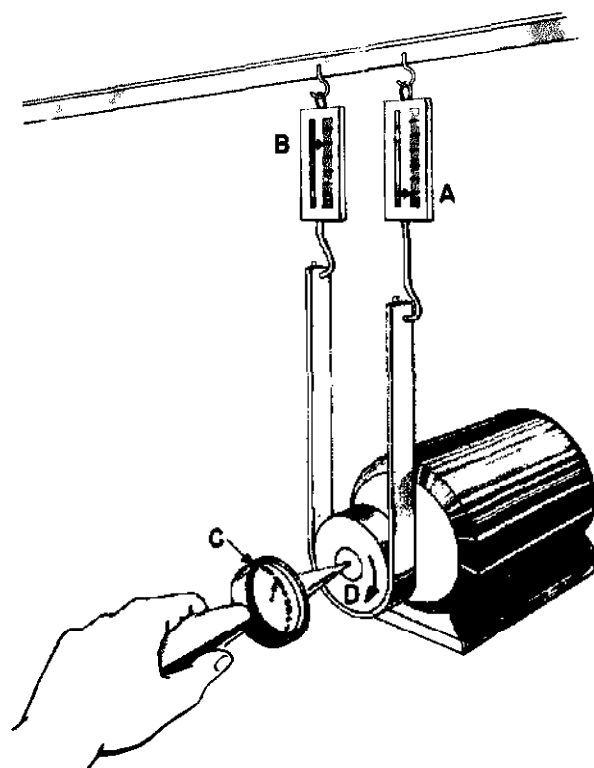

Figure 8-3.—A prony brake. 131.43

When the pulley turns in a clockwise direction, the friction between the belt and the pulley makes the belt try to move with the pulley. Therefore, pull on scale A will be greater, and the pull on scale B will be less than 15 pounds.

Suppose that scale A reads 25 pounds, and scale B reads 5 pounds. That tells you that the drag, or the force against which the motor is working, is 25-5=20 pounds. In this case the normal speed of the motor is 1800 rpm (revolutions per minute) and the diameter of the pulley is one foot.

The number of revolutions can be found by holding the revolution counter C against the end of the shaft for one minute. This counter will record the number of turns the shaft makes per minute. The distance D which any point on the pulley travels in one minute is equal to the circumference of the pulley times the number of revolutions— $3.14 \times 1 \times 1800 = 5652 \text{ ft}$.

You know that the motor is exerting a force of 20 pounds through that distance. The work done

in one minute is equal to the force times the distance, or work = $F \times D = 20 \times 5,652 = 113,040$ ft -lb/min. Change this to horsepower—

$$\frac{113,040}{33,000} = 3.43 \text{ hp.}$$

Here are a few ratings for motors or engines with which you are familiar—an electric mixer

has a 1/16-hp motor; a washing machine a 1/4-hp motor.

SUMMARY

There are two important points for you to remember about Power—

Power is the rate at which work is done.

The unit in which power is measured is the horsepower, which is equivalent to working at a rate of 33,000 ft-lb per min, or 550 ft-lb per sec.

CHAPTER 9

FORCE AND PRESSURE

By this time you should have a pretty good idea of what a force is. A force is a push or a pull exerted on—or by—an object. You apply a force on a machine, and the machine in turn transmits a force to the load. Men and machines, however, are not the only things that can exert forces. If you've been out in a sailboat you know that the wind can exert a force. Further, you don't have to get knocked on your ear more than a couple of times by the waves to get the idea that water, too, can exert a force. As a matter of fact, from reveille to taps you are almost constantly either exerting forces or resisting them. That's the reason you are pooped when you hit the sack.

MEASURING FORCES

You've had a lot of experience in measuring forces. You can estimate or "guess" the weight of a package you're going to mail by "hefting" it. Or you can put it on a scale to find its weight accurately. Weight is a common term that tells you how much force or pull gravity is exerting on the object.

You can readily measure force with a spring scale. An Englishman named Hooke discovered that if you hang a 1-pound weight on a spring, the spring stretches a certain distance. A 2-pound weight will extend the spring just twice as far, and 3 pounds will lengthen it three times as far as the 1-pound weight did. Right there is the makings of the spring scale. All you need to do is attach a pointer to the spring, put a face on the scale, and mark on the face the positions of the pointer for various loads in pounds or ounces.

This type of scale can be used to measure the pull of gravity—the weight—of an object, or the force of a pull exerted against friction, as shown in figure 9-1. Unfortunately, springs get tired, just as you do. When they get old, they don't always snap back to the original position. Hence an old spring or an overloaded spring will give inaccurate readings.

HONEST WEIGHT—NO SPRINGS

Because springs do get tired, other types of force-measuring devices are made. You've seen the sign, "Honest Weight—No Springs", on the butchershop scales. Scales of this type are shown in figure 9-2. They are applications of first-class levers. The one shown in figure 9-2A is the simplest type. Since the distance from the fulcrum to the center of each platform is equal, the scale is balanced when equal weights are placed on the platforms. With your knowledge of levers, you will be able to figure out how the steel yard shown in figure 9-2B operates.

PRESSURE

Have you ever tried to walk on crusted snow that would breakthrough when you put your weight on it? But you could walk on the same snow if you put on snowshoes. Further, you know that snowshoes do not reduce your weight—they merely distribute it over a larger area. In doing this, they reduce the pressure per square inch. Figure out how that works. If you weigh 160 pounds, that weight, or force, is more or less evenly distributed by the soles of your shoes. The area of the soles of an average man's shoes is roughly 60 square inches. Each one of those square inches has to carry $160 \div 60 = 2.6$ pounds of your weight. Since 2.6 pounds per square inch is too much for the snow crust, you break through.

When you put on the snowshoes, you distribute your weight over an area of approximately 900 sq in.—depending, of course, on the size of the snowshoes. Now the force on each one of those square inches is equal to only $160 \div 900 = 0.18$ pound. The pressure on the snow has been decreased, and the snow can easily support you.

Pressure is force per unit area—and is measured, in pounds per square inch—"psi." With snowshoes on, you exert a pressure of 0.18

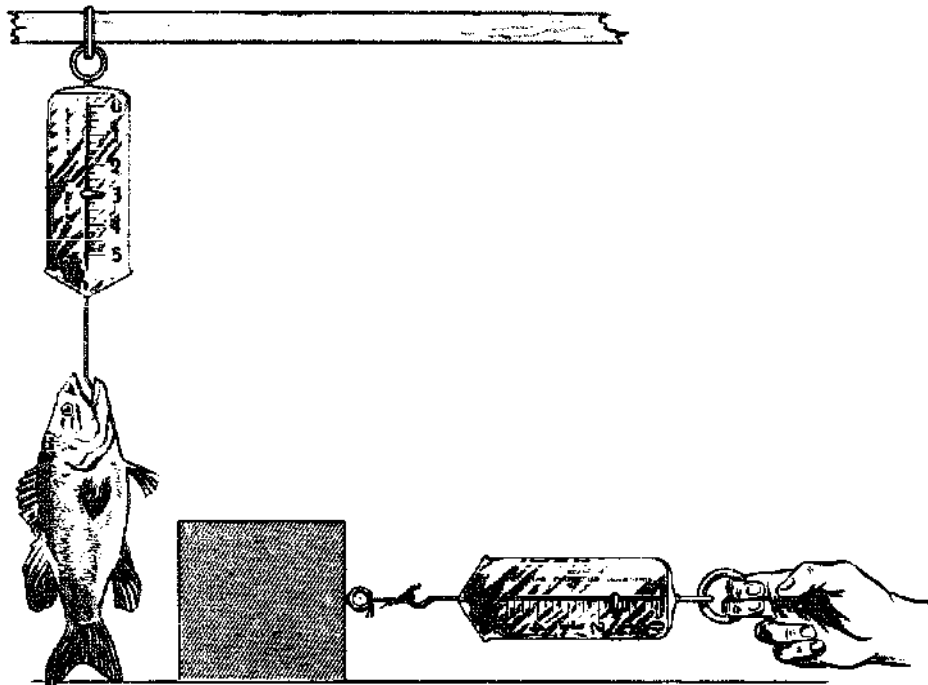

Figure 9-1.—You can measure force with a scale.

131.44

psi. To calculate pressure, divide the force by the area over which the force is applied. The formula is—

$$\text{Pressure, in psi} = \frac{\text{Force, in lb}}{\text{Area, in sq in}}$$

Or
$$P = \frac{F}{A}$$

To get this idea, follow this problem. A tank for holding fresh water aboard a ship is 10 feet long, 6 feet wide, and 4 feet deep. It holds, therefore, 10x6x4, or 240 cubic feet of water. Each cubic foot of water weighs about 62.5 pounds. The total force tending to push the bottom out of the tank is equal to the weight of the water—240x62.5, or 15,000 lb. What is the pressure on the bottom? Since the weight is evenly distributed on the bottom, you apply the formula $P = \frac{F}{A}$ and substitute the proper values for F and A. In this case, F=15,000 lb, and the area of the bottom in

square inches is 10x6x144, since 144 sq in.=1 sq ft.

$$P = \frac{15,000}{10 \times 6 \times 144} = 1.74 \text{ psi}$$

Now work out the idea in reverse. You live at the bottom of the great sea of air which surrounds the earth. Because the air has weight—gravity pulls on the air, too—the air exerts a force on every object which it surrounds. Near sea level that force on an area of 1 square inch is roughly 15 pounds. Thus, the air-pressure at sea level is about 15 psi. The pressure gets less and less as you go up to higher altitudes.

With your finger, mark out an area of one square foot on your chest. What is the total force which tends to push in your chest? Again use the formula $P = \frac{F}{A}$. Now substitute 15 psi for P, and for A use 144 sq. in. Then $F = 144 \times 15$, or 2160 lb. The force on your chest is 2160 lb per square foot—more than a ton pushing against an area of

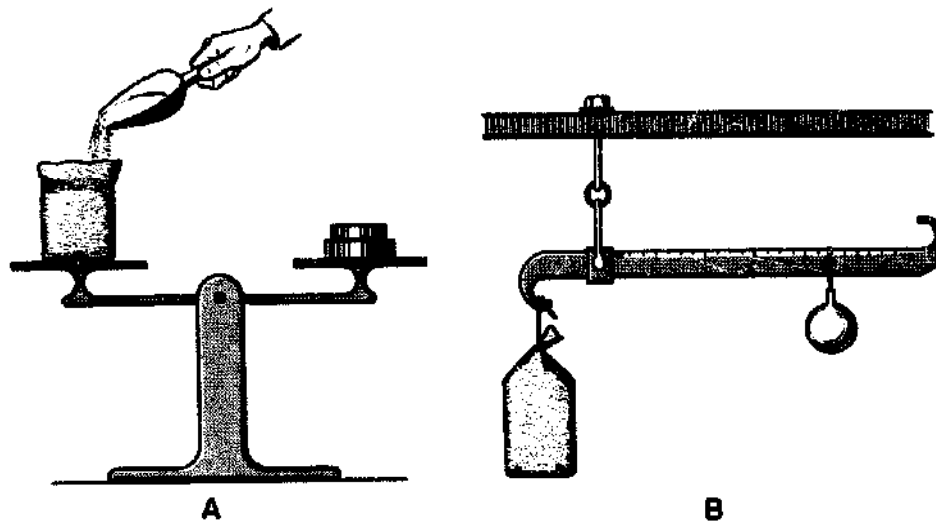

Figure 9-2.—Balances.

18.30

1 sq ft. If there were no air inside your chest to push outward with the same pressure, you'd be squashed flatter than a bride's biscuit.

MEASURING PRESSURE

Fluids—which include both liquids and gases—exert pressure. A fluid at rest exerts

equal pressure in all directions. Figure 9-3 shows that. Whether the hole is in the top, the bottom, or in one of the sides of a submarine, the water pushes in through the hole.

In many jobs aboard ship, it is necessary to know the pressure exerted by gas or a liquid. For example, it is important at all times to know

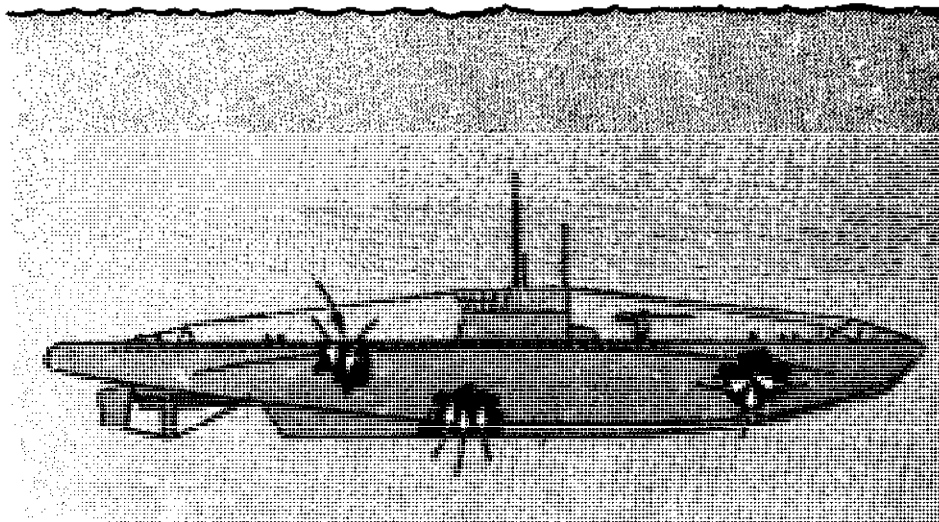

Figure 9-3.—Fluids exert pressure in all directions.

131.45

the steam pressure inside of a boiler. One device to measure pressure is the Bourdon gage, shown in figure 9-4. Its working principle is the same as that of those snakelike paper tubes which you get at a New Year's party. They straighten out when you blow into them.

In the Bourdon gage there is a thin-walled metal tube, somewhat flattened, and bent into the form of a C. Attached to its free end is a lever system which magnifies any motion of the free end of the tube. The fixed end of the gage ends in a fitting which is threaded into the boiler system so that the pressure in the boiler will be transmitted to the tube. Like the paper "snake," the metal tube tends to straighten out when the pressure inside it is increased. As the tube straightens, the pointer is made to move around the dial. The pressure, in psi, may be read directly on the dial.

Air pressure and pressures of steam and other gases, and fluid pressures in hydraulic systems, are generally measured in pounds per square inch. For convenience, however, the pressure exerted by water is commonly measured in pounds per square foot. You'll find more about this in chapter 10.

The Bourdon gage is a highly accurate but rather delicate instrument, and can be very easily damaged. In addition, it develops trouble where pressure fluctuates rapidly. To overcome this, another type of gage, the Schrader, was developed. The Schrader gage (fig. 9-5) is not as accurate as the Bourdon, but is sturdily constructed and quite suitable for ordinary hydraulic pressure measurements. It is especially recommended for fluctuating loads. In the Schrader gage a piston is directly actuated by the liquid pressure to be measured, and moves up a cylinder against the resistance of a spring, carrying a bar or indicator with it over a calibrated scale. In this manner, all levers, gears, cams, and bearings are eliminated, and a sturdy instrument can be constructed.

Where accurate measurements of comparatively slight pressures are desired, a diaphragm type gage may be used.

Diaphragm gages give sensitive and reliable indications of small pressure differences. Diaphragm gages are often used to measure the air pressure in the space between inner and outer boiler casings. In this type of gage, a diaphragm is connected to a pointer through a metal spring and a simple linkage system (fig. 9-6). One side

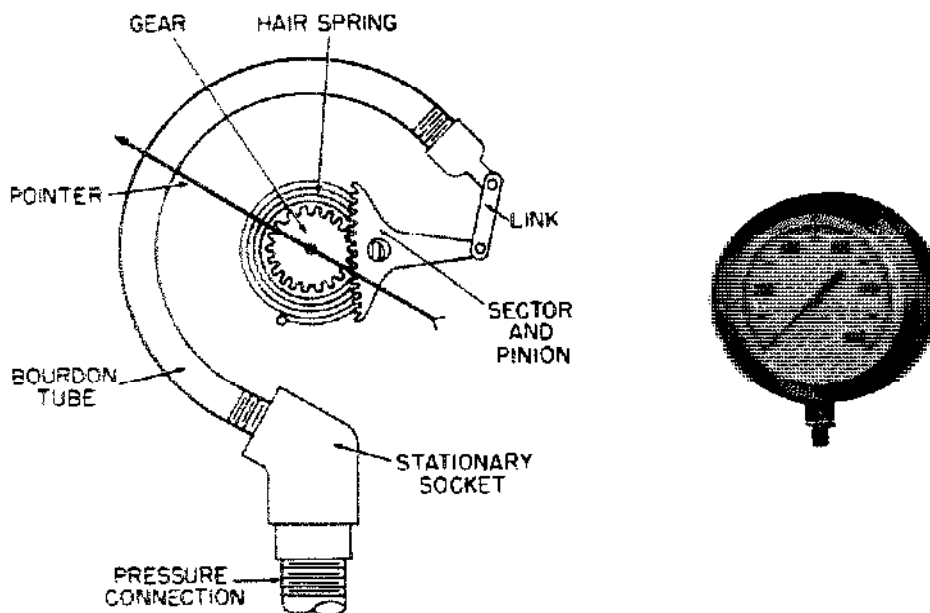

Figure 9-4.—The Bourdon gage.

38.211

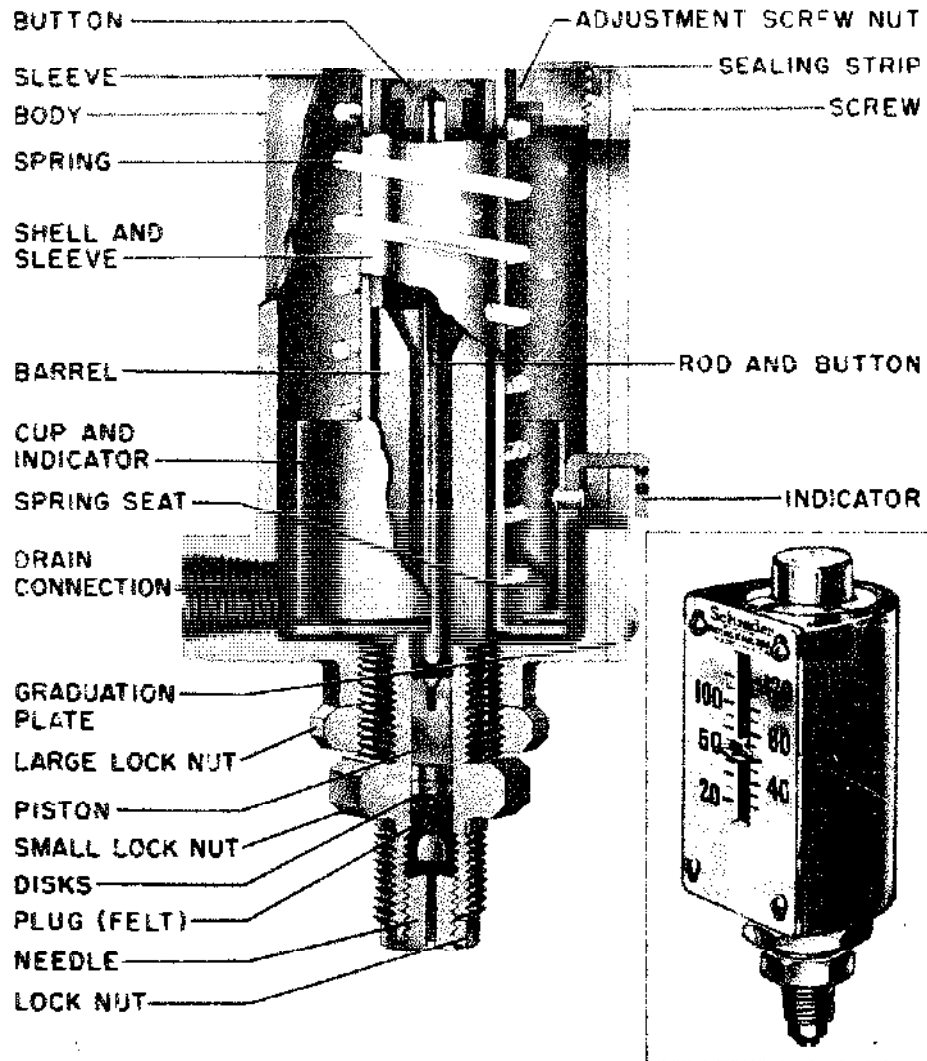

Figure 9-5.—The Schrader gage.

131.46

of the diaphragm is exposed to the pressure being measured, while the other side is exposed to the pressure of the atmosphere.

Any increase in the pressure line will move the diaphragm upwards against the action of the spring. The linkage system operates and the pointer rotates to a higher reading. When the pressure being measured decreases, the spring moves the diaphragm downward, rotating the pointer to a lower reading. Thus the position of the pointer is a balance between the pressure tending to push the diaphragm upward and the

spring action tending to push it down. When the gage reads "0" the pressure in the line is equal to the outside air pressure.

THE BAROMETER

To the average man, the chief importance of weather is as an introduction to general conversation. But at sea and in the air, advance knowledge of what the weather will do is a matter of great concern to all hands. Operations are

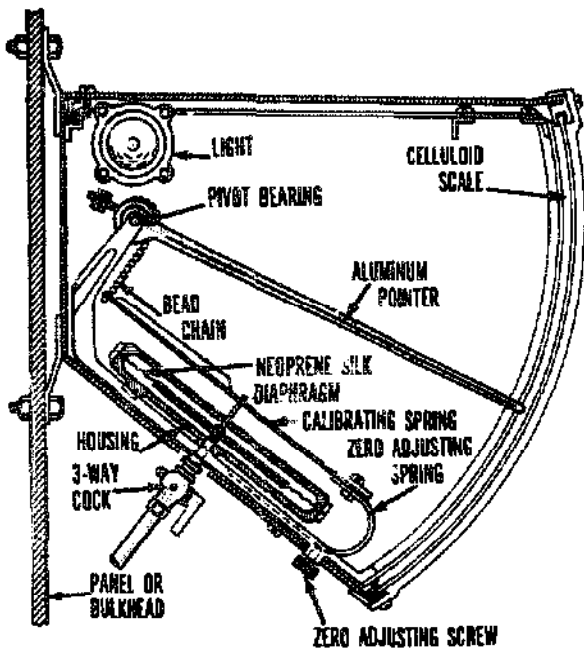

38.212X

Figure 9-6.—Diaphragm pressure gage.

planned or cancelled on the basis of weather predictions. Accurate weather forecasts are made only after a great deal of information has been collected by many observers located over a wide area.

One of the instruments used in gathering weather data is the barometer. Remember, the air is pressing on you all the time. So-called normal atmospheric pressure is 14.7 psi. But as the weather changes, the air pressure may be greater or less than normal. If the air pressure is low in the area where you are, you know that air from one or more of the surrounding high-pressure areas is going to move in toward you. Moving air—or wind—is one of the most important factors in weather changes. In general, if you're in a low-pressure area you may expect wind, rain, and storms. A high-pressure area generally enjoys clear weather. The barometer can tell you the air pressure in your locality, and give you a rough idea of what kind of weather may be expected.

The aneroid barometer shown in figure 9-7 is an instrument which measures air pressure. It contains a thin-walled metal box from which

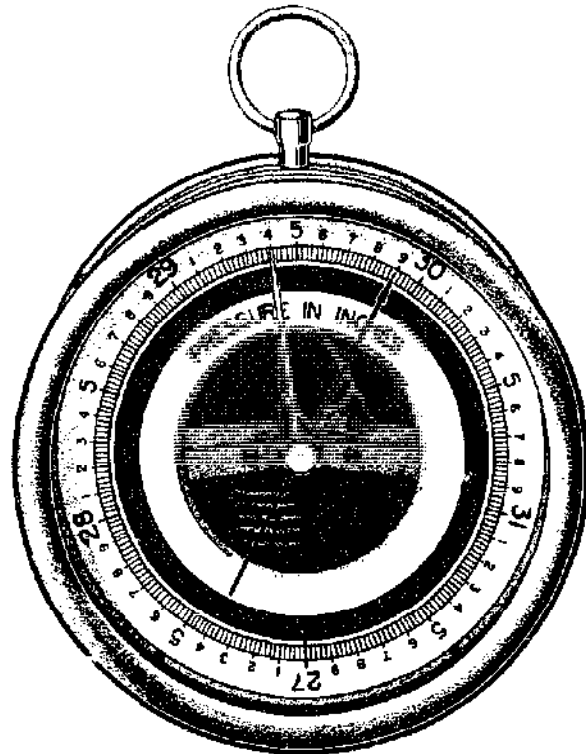

69.87

Figure 9-7.—An aneroid barometer.

most of the air has been pumped. A pointer is mechanically connected to the box by a lever system. If the pressure of the atmosphere increases, it tends to squeeze in the sides of the box. This squeeze causes the pointer to move towards the high-pressure end of the scale. If the pressure decreases, the sides of the box expand outward. This causes the pointer to move toward the low-pressure end of the dial.

Notice that the numbers on the dial run from 27 to 31. To understand why these particular numbers are used, you have to understand the operation of the mercurial barometer. You see one of these in figure 9-8. It consists of a glass tube partly filled with mercury. The upper end is closed. There is a vacuum above the mercury in the tube, and the lower end of the tube is submerged in a pool of mercury in an open cup. The atmosphere presses down on the mercury in the cup, and tends to push the mercury up in the tube. The greater the air pressure, the higher the column of mercury rises. At sea level, the

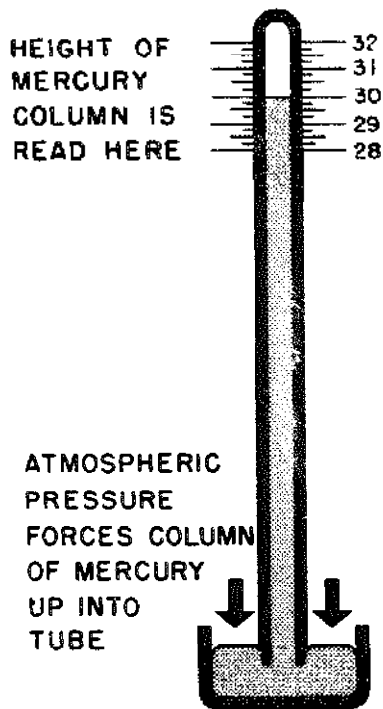

69.86

Figure 9-8.—A mercurial barometer.

normal pressure is 14.7 psi, and the height of the mercury in the tube is 30 inches. As the air pressure increases or decreases from day to day, the height of the mercury rises or falls. A mercury barometer aboard ship is usually mounted in gimbals to keep it in a vertical position despite the rolling and pitching of the ship.

Pressures indicated on dials of most gages are relative. That is, they are either greater or less than normal. But remember—the dial of an aneroid barometer always indicates absolute pressures, not relative. When the pressure exerted by any gas is less than 14.7 psi, you have what's called a partial vacuum. The condensers on steam turbines, for instance, are operated at pressure well below 14.7 psi. Steam under very high pressure is run into the turbine and causes the rotor to turn. After it has passed through the turbine it still exerts a back pressure against the blades. You can see that this is bad. Soon the back pressure would be nearly as

large as that of the incoming steam, and the turbine would not turn at all. To reduce the back pressure as much as possible, the exhaust steam is run through pipes which are surrounded by cold sea water. This causes the steam in the pipes to condense into water, and the pressure drops well below atmospheric pressure.

It is important for the engineer to know the pressure in the condensers at all times. To measure this reduced pressure, or partial vacuum, he uses a gage called a manometer. Figure 9-9 shows you how this simple device is made. A U-shaped tube has one end connected to the low-pressure condenser and the other end is open to the air. The tube is partly filled with colored water. The normal air pressure on the open end exerts a bigger push on the colored water than the push of the low-pressure steam, and the colored water is forced part way up into the left arm of the tube. From the scale between the two arms of the U, the difference in the height of the two columns of water can be read. This tells the engineer the degree of vacuum—or how much below atmospheric pressure the pressure is in the condenser.

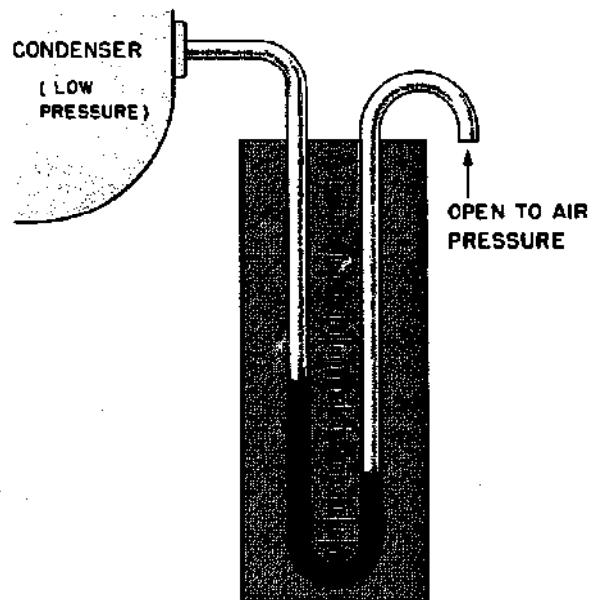

61.4

Figure 9-9.—A manometer.

SUMMARY

Here are seven points that you should remember—

A force is a push or a pull exerted on—or by—an object.

Force is generally measured in pounds.

Pressure is the force per unit area which is exerted on, or by, an object. It is commonly measured in pounds per square inch—psi.

Pressure is calculated by the formula $P = \frac{F}{A}$.

Spring scales and lever balances are familiar instruments you use for measuring forces. Bourdon gages, barometers, and manometers are instruments for the measurement of pressure.

The normal pressure of the air is 14.7 psi at sea level.

Pressure is generally relative. It is sometimes greater—sometimes less—than normal air pressure. When pressure is less than the normal air pressure, you call it vacuum.

CHAPTER 10

HYDROSTATIC AND HYDRAULIC MACHINES

HYDROSTATIC MACHINES

LIQUIDS AT REST

You know that liquids exert pressure. In order that your ship may remain afloat, the water must push upward on the hull. But the water is also exerting pressure on the sides. If you are billeted on a submarine, you are more conscious of water pressure—when you're submerged the sub is being squeezed from all sides. If your duties include deep-sea diving, you'll go over the side pumped up like a tire so that you can withstand the terrific force of the water below. The pressure exerted by the sea water, or by any liquid at rest, is called hydrostatic pressure. In handling torpedoes, mines, depth charges, and some types of aerial bombs, you'll be dealing with devices which are operated by hydrostatic pressure.

In chapter 9, you found out that all fluids exert pressure in all directions. That's simple enough. But how great is the pressure? Try a little experiment. Place a pile of blocks in front of you on the table. Stick the tip of your finger under the first block from the top. Not much pressure on your finger, is there? Stick it in between the third and fourth blocks. The pressure on your finger has increased. Now slide your finger under the bottom block in the pile. There you find the pressure is greatest. The pressure increases as you go lower in the pile. You might say that pressure increases with depth. The same is true in liquids. The deeper you go, the greater the pressure becomes. But, depth isn't the whole story.

Suppose the blocks in the preceding paragraph were made of lead. The pressure at any level in the pile would be considerably greater. Or, suppose they were blocks of balsa wood—the

pressure at each level wouldn't be so great. Pressure, then, depends not only on the depth, but also on the weight of the material. Since you are dealing with pressure—force per unit of area—you will also be dealing with weight per unit of volume—or density.

When you talk about the density of a substance you are talking about its weight per cubic foot—or per cubic inch. For example, the density of water is 62.5 lb. per cu. ft. This gives you a more exact way of comparing the weights of two materials. To say that lead is heavier than water isn't a complete statement. A 22-caliber bullet doesn't weigh as much as a pail of water. It is true, however, that a cubic foot of lead is lots heavier than a cubic foot of water. Lead has a greater density than water. The density of lead is 710 lb. per cu. ft., as compared with 62.5 lb. per cu. ft. for water.

Pressure depends on two factors—depth and density—so it is easy to write a formula that will help you find the pressure at any depth in any liquid. Here it is—

$$P = H \times D$$

in which

P = pressure, in lb. per sq. in., or lb. per sq. ft

H = depth of the point, measured in feet or inches.

and

D = density in lb. per cu. in. or in lb. per cu. ft.

Note: If inches are used, they must be used throughout; if feet are used, they must be used throughout.

What is the pressure on one square foot of the surface of a submarine if the submarine is 200 feet below the surface? Use the formula—

$$P = H \times D$$

and

$$P = 200 \times 62.5 = 12,500 \text{ lb. per sq. ft.}$$

Every square foot of the sub's surface which is at that depth has a force of over 6 tons pushing in on it. If the height of the hull is 20 feet, and the area in question is midway between the sub's top and bottom, you can see that the pressure on the hull will be at least $(200 - 10) \times 62.5 = 11,875$ lb. per sq. ft., and the greatest pressure will be $(200 + 10) \times 62.5 = 13,125$ lb. per sq. ft. Obviously, the hull has to be made very strong to withstand such pressures.

Using Pressure to Fire the Depth Charge

Although hiding below the surface exposes the sub to great fluid pressure, it also provides the sub with a great advantage. A submarine is hard to kill because it is hard to hit. A depth charge must explode within 30 to 50 feet of a submarine to really score. And that means the depth charge must not go off until it has had time to sink to approximately the same level as the sub. You use a firing mechanism which is set off by the pressure at the estimated depth of the submarine.

Figure 10-1 shows a depth charge and its interior components. A depth charge is a sheet-metal container filled with a high explosive and a firing device. A tube passes through its center from end to end. Fitted in one end of this tube is the booster, which is a load of granular TNT to set off the main charge. The safety fork is knocked off on launching, and the inlet valve cover is removed from an inlet through which the water enters.

When the depth charge gets about 12 to 15 feet below the surface, the water pressure is sufficient to extend a bellows in the booster extender. The bellows trips a release mechanism, and a spring pushes the booster up against the centering flange. Notice that the detonator fits into a pocket in the booster. Unless the detonator is in this pocket, it cannot set off the booster charge.

Nothing further happens until the detonator is fired. As you can see, the detonator is held in the end of the pistol, with the firing pin aimed

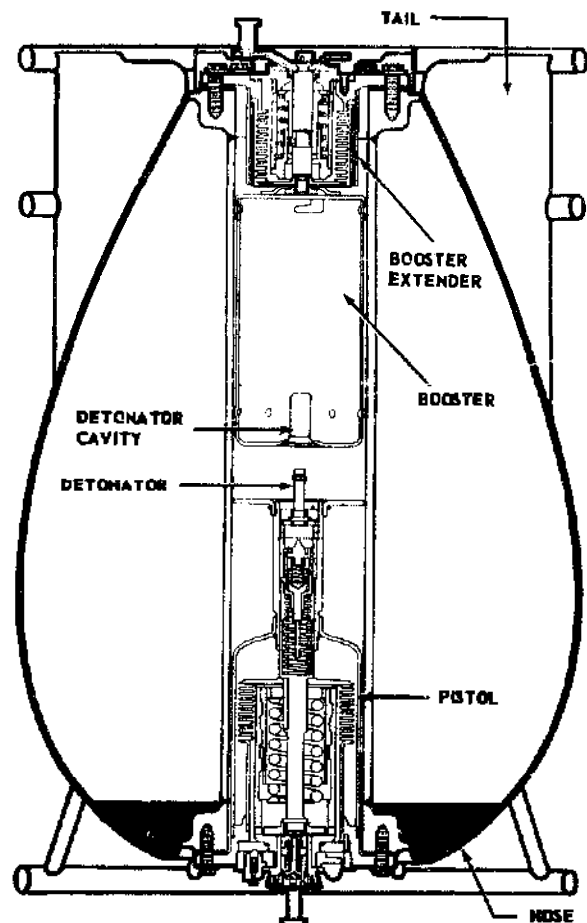

4.198

Figure 10-1.—A depth charge.

at the detonator base. The pistol also contains a bellows into which the water rushes as the charge goes down. As the pressure increases, the bellows begins to expand against the depth spring. You can adjust this spring so that the bellows will have to exert a predetermined force in order to compress it. Figure 10-2 shows you the depth-setting dials of one type of depth charge. Since the pressure on the bellows depends directly on the depth, you can arrange to have the charge go off at any depth you select on the dial. When the pressure in the bellows becomes sufficiently great it releases the firing spring, which drives the firing pin into the detonator. The booster, already moved into position, is fired, and this in turn sets off the entire load of TNT.

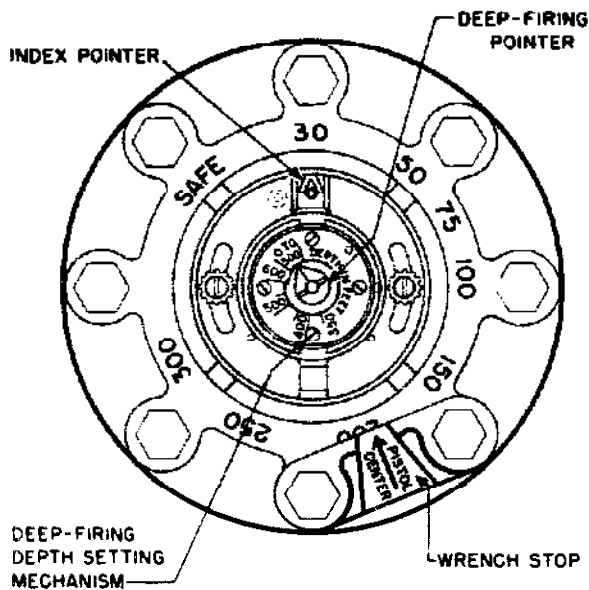

4.204
Figure 10-2.—You select the depth on these dials.

These two bellows—operated by hydrostatic pressure—serve two purposes. First they permit the depth charge to be fired at the proper depth; second, they make the charge safe to handle and carry. If the safety fork and the valve inlet cover should accidentally be knocked off on deck, nothing would happen. Even if the detonator went off while the charge was being handled, the main charge would not let go unless the booster were in the extended position.

To keep a torpedo on course toward its target is quite a job. Maintaining the proper compass course by the use of a gyroscope is only part of the problem. The torpedo must travel at the proper depth so that it will neither pass under the target ship nor hop out of the water on the way. Here again hydrostatic pressure is used to advantage.

As figure 10-3 indicates, the tin fish contains an air-filled chamber which is sealed with a thin, flexible metal plate, or diaphragm. This diaphragm can bend upward or downward against the spring. The tension on this spring is determined by setting the depth-adjusting knob.

Suppose the torpedo starts to dive below the selected depth. The water, which enters the torpedo and surrounds the chamber, exerts an increased pressure on the diaphragm and causes it

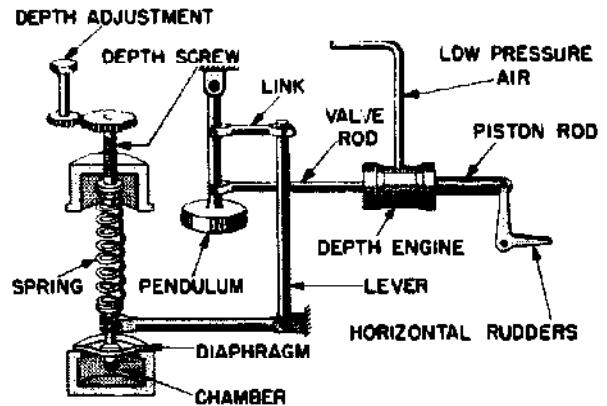

4.122
Figure 10-3.—Inside a torpedo.

to bend down. If you follow the lever system, you can see that the pendulum will be pushed forward. Notice that a valve rod connects the pendulum to the piston of the depth engine. As the piston moves to the left, low-pressure air from the torpedo's air supply enters the depth engine to the right of the piston and pushes it to the left. A depth engine must be used because the diaphragm is not strong enough to move the rudders.

The depth-engine's piston is connected to the horizontal rudders as shown. When the piston moves to the left, the rudder is turned upward, and the torpedo begins to rise to the proper depth. If the nose goes up, the pendulum tends to swing backward and keep the rudder from elevating the torpedo too rapidly. As long as the torpedo runs at the selected depth, the pressure on the chamber remains constant, and the rudders do not change from their horizontal position.

Pressure and the Deep-Sea Diver

Navy divers have a practical, first-hand knowledge of hydrostatic pressure. Think what happens to a diver who goes down 100 feet to work on a salvage job. The pressure on him at that depth is 6,250 lbs. per sq. ft.! Something must be done about that, or he'd be squashed flatter than a pancake.

To counterbalance this external pressure, the diver is enclosed in a rubber suit into which air under pressure is pumped by a shipboard

compressor. Fortunately, the air not only inflates the suit, but gets inside of the diver's body as well. It enters his lungs, and even gets into his blood stream which carries it to every part of his body. In that way his internal pressure can be kept just equal to the hydrostatic pressure.

As he goes deeper, the air pressure is increased to meet that of the water. In coming up, the pressure on the air is gradually reduced. If he is brought up too rapidly, he gets the "bends." The air which was dissolved in his blood begins to come out of solution, and form as bubbles in his veins. Any sudden release in the pressure on a fluid results in freeing some of the gases which are dissolved in the fluid.

You have seen this happen when you suddenly relieve the pressure on a bottle of pop by removing the cap. The careful matching of hydrostatic pressure on the diver by means of air pressure in his suit is essential if diving is to be done at all.

A Sea-Going Speedometer

Here's another device that shows you how your Navy applies its knowledge of hydrostatic pressure. Did you ever wonder how the skipper knows the speed the ship is making through the water? There are several instruments used to give this information—the patent log, the engine revolution counter, and the pitometer log. The "PIT. LOG" is operated, in part, by hydrostatic pressure. It really indicates the difference between hydrostatic pressure and the pressure of the water flowing past the ship—but you can use this difference to indicate ship's speed.

Figure 10-4 shows you a schematic drawing of a pitometer log. A double-wall tube sticks out forward of the ship's hull into water which is not disturbed by the ship's motion. In the tip of the tube is an opening A. When the ship is moving there are two forces or pressures acting on this opening—the hydrostatic pressure due to the depth of water above the opening, and a pressure caused by the push of the ship through the water. The total pressure from these two forces is transmitted through the central or white tube to the left-hand arm of a manometer.

In the side of the tube is a second opening B which does not face in the direction the ship is moving. Opening B passed through the outer wall of the double-wall tube, but not through the inner wall. The only pressure affecting this opening

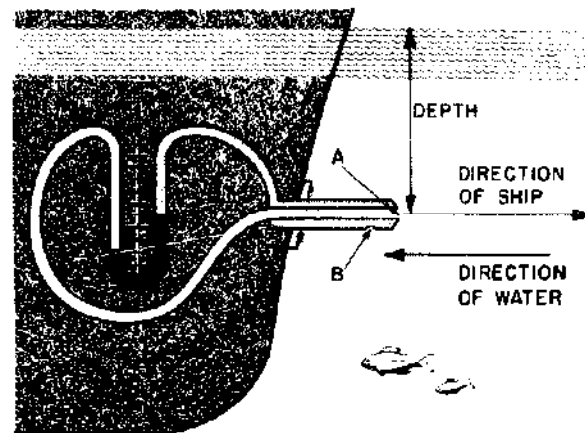

Figure 10-4.—A Pitometer log. 131.47

B is the hydrostatic pressure. This pressure is transmitted through the outer tube (shaded in the drawing) to the right-hand arm of the manometer.

When the ship is dead in the water, the pressure through both openings A and B is the same, and the mercury in each arm of the manometer stands at the same level. However, as soon as the ship begins to move, additional pressure is developed at opening A, and the mercury is pushed down in the left-hand arm and up into the right-hand arm of the tube. The faster the ship goes, the greater this additional pressure becomes, and the greater the difference will be between the levels of the mercury in the two arms of the manometer. The speed of the ship can be read directly from the calibrated scale on the manometer.

Incidentally—since air is also a fluid—the airspeed of an aircraft can be found by a similar device. You have probably seen the thin tube sticking out from the leading edge of a wing, or from the nose of the plane. Flyers call this tube a pitot tube. Its fundamental principle is the same as that of the pitometer log.

SUMMARY

The Navy uses many devices whose operation is dependent on the hydrostatic principle. Here are three points to remember about the operation of these devices.

Pressure in a liquid is exerted equally in all directions.

You use the term hydrostatic pressure when you are talking about the pressure at any depth in a liquid that is not flowing. Pressure depends upon both depth and density.

The formula for finding pressure is—

$$P = H \times D$$

HYDRAULIC MACHINES

LIQUIDS IN MOTION

Perhaps your earliest contact with a hydraulic machine was when you got your first haircut. Tony put a board across the arms of the chair, sat you on it, and began to pump the chair up to a convenient level. As you grew older, you probably discovered that the filling station attendant could put a car on the greasing rack, and—by some mysterious arrangement—jack it head-high. No doubt the attendant told you that oil under pressure below the piston was doing the job.

Come to think about it, you've probably known something about hydraulics for a long time. Automobiles and airplanes use hydraulic brakes. As a bluejacket, you'll have to operate many hydraulic machines, so you'll want to understand the basic principles on which they work.

Simple machines such as the lever, the inclined plane, the pulley, the wedge, and the wheel and axle, were used by primitive man. But it was considerably later before someone discovered that liquids and gases could be used to exert forces at a distance. Then, a vast number of new machines appeared. A machine which transmits forces by means of a liquid is a hydraulic machine. A variation of the hydraulic machine is the type that operates by the use of a compressed gas. This type is called the pneumatic machine. This chapter deals only with basic hydraulic machines.

Pascal's Law

A Frenchman named Pascal discovered that a pressure applied to any part of a confined fluid is transmitted to every other part with no loss. The pressure acts with equal force on all equal areas of the confining walls, and perpendicular to the walls.

But remember this—when you are talking about the hydraulic principle as applied to a

hydraulic machine, you are talking about the way a liquid acts in a closed system of pipes and cylinders. The action of a liquid under such conditions is somewhat different from its behavior in open containers, or in lakes, rivers, or oceans. You should also keep in mind that most liquids cannot be compressed—squeezed into a smaller space. Liquids don't "give" the way air does when pressure is applied, nor do liquids expand when pressure is removed.

Punch a hole in a tube of shaving cream. If you push down at any point on the tube the cream comes out of the hole. Your force has been transmitted from one place to another by the shaving cream—which is fluid—a thick liquid. Figure 10-5 shows what would happen if you punched four holes in the tube. If you press on the tube at one point, the cream comes out of all four holes. This tells you that a force applied on a liquid is transmitted equally in every direction to all parts of the container. Right there you have illustrated a basic principle of hydraulic machines.

This principle is used in the operation of four-wheel hydraulic automobile brakes. Figure 10-6 is a simplified drawing of this brake system. You push down on the brake pedal and force the piston in the master cylinder against the fluid in that cylinder. This push sets up a pressure on the fluid just as your finger did on the shaving cream in the tube. The pressure on the fluid in the master cylinder is transmitted through the lines to the brake cylinders in each wheel. This fluid under pressure pushes against the pistons in each of the brake cylinders and forces the brake shoes out against the drums.

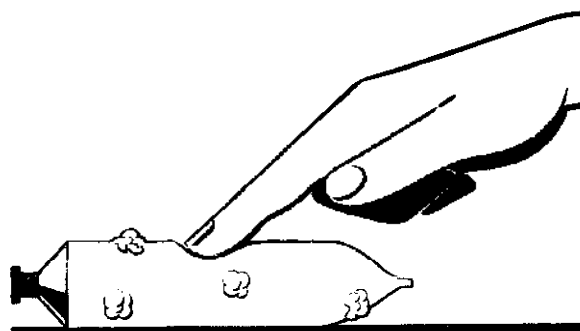

131.48
Figure 10-5.—Pressure is transmitted in all directions.

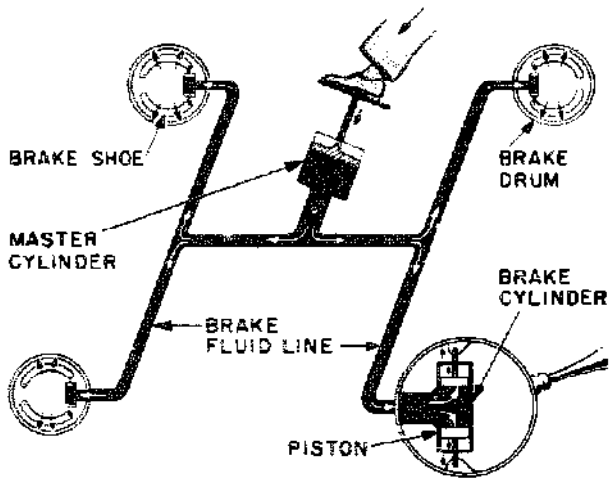

Figure 10-6.—Hydraulic brakes.

81.280

Mechanical Advantage Through Hydraulics

The next thing to understand about hydraulic machines is the relationship between the force you apply and the result you get. Figure 10-7 will help you on this. The U-shaped tube has a

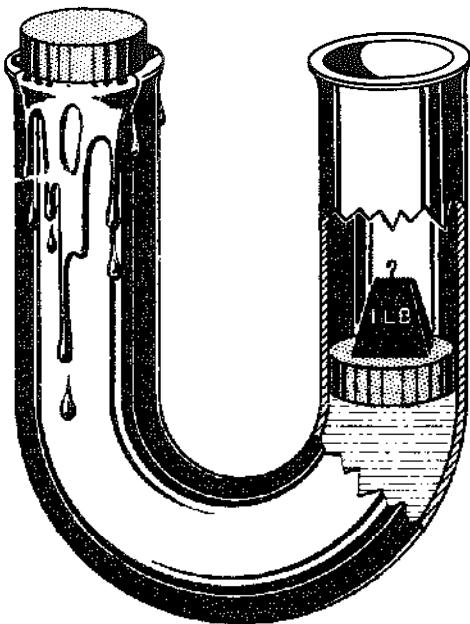

Figure 10-7.—The liquid transmits the force.

131.49

cross-sectional area of one sq. inch. In each arm there's a piston which fits snugly, but which can move up and down. If you place a one-pound weight on one piston, the other will be pushed out the top of its arm immediately. Place a one-pound weight on each piston, however, and they remain in their original positions, as shown in figure 10-8.

Thus you see that a pressure of one pound per sq. in. applied down on the right-hand piston exerts a pressure of one pound per sq. in. upward against the left-hand piston. In other words, not only is the force transmitted by the liquid around the curve, but the force is the same on each unit area of the container. It makes no difference how long the connecting tube is, or how many turns it makes. It is important, however, that the entire system be full of liquid. **Hydraulic systems will fail to operate properly if air is present in the lines or cylinders.**

Now look at figure 10-9. The piston on the right has an area of one sq. in., but the piston on the left has an area of 10 sq. in. If you push down on the smaller piston with a force of one pound, the liquid will transmit this pressure to every square inch of surface in the system. Since the left-hand piston has an area of 10 sq. in., and each square inch has a force of one pound transmitted to it, the total effect is to push on the larger piston with a total force of 10 pounds. Set a 10-pound weight on the larger piston and it will be supported by the one-pound force of the smaller piston.

There you have a one-pound push resulting in a 10-pound force. That's a mechanical advantage of ten. This is why hydraulic machines

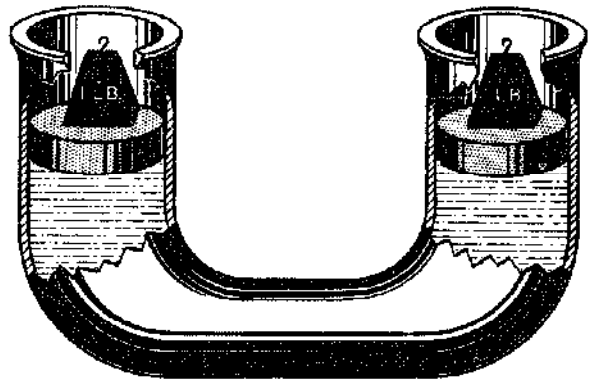
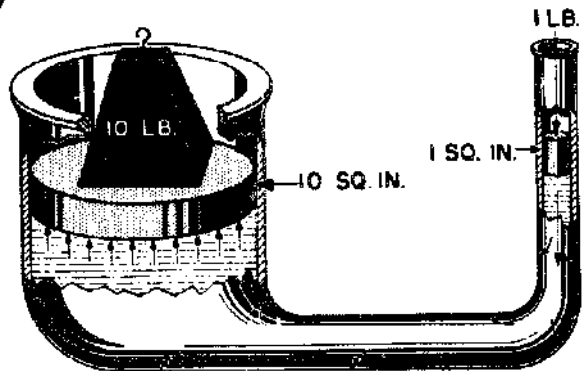

Figure 10-8.—Pressure is the same on all parts of an enclosed liquid.

5.181

166



4.7

Figure 10-9.—A mechanical advantage of 10.

Where's The Catch?

You know from your experience with levers that you can't get something for nothing. Applying this knowledge to the simple system in figure 10-9, you know that you can't get a 10-pound force from a one-pound effort without sacrificing distance. The one-pound effort will have to be applied through a much greater distance than the 10-pound force will move. If you raise the 10-pound weight through a distance of one foot, through what distance will the one-pound effort have to be applied? Remember—if you neglect friction, the work done on any machine equals the work done by that machine. Use the work formula, and you can find how far the smaller piston will have to move.

Work input = Work output

$$F_1 \times D_1 = F_2 \times D_2$$

By substituting— $1 \times D_1 = 10 \times 1$

and— $D_1 = 10 \text{ feet}$

are important. Here's a formula which will help you to figure the forces that act in a hydraulic machine—

$$\frac{F_1}{F_2} = \frac{A_1}{A_2}$$

- In which F_1 = force, in pounds, applied to the small piston,
- F_2 = force, in pounds, applied to the large piston,
- A_1 = area of small piston, in square inches,
- A_2 = area of large piston, in square inches.

Try out the formula on the hydraulic press in figure 10-10. The large piston has an area of 90 sq. in. and the smaller one an area of two sq. in. The handle exerts a total force of 15 pounds on the small piston. With what total force will the large piston be raised?

Write down the formula—

$$\frac{F_1}{F_2} = \frac{A_1}{A_2}$$

Substitute the known values—

$$\frac{15}{F_2} = \frac{2}{90}$$

and—

$$F_2 = \frac{90 \times 15}{2} = 675 \text{ pounds.}$$

There's the catch. The smaller piston will have to move through a distance of 10 feet in order to raise the 10-pound load one foot. It looks then as though the smaller cylinder would have to be at least 10 feet long—and that wouldn't be practical. Actually, it isn't necessary—if you put a valve in the system.

The hydraulic press in figure 10-10 contains a valve for just this purpose. As the small piston moves down, it forces the fluid past the check valve A into the large cylinder. As soon as you start to move the small piston upward, the pressure to the right of the check valve A is removed, and the pressure of the fluid below the large piston helps the check valve spring force that valve shut. The liquid which has passed through the valve opening on the down stroke of the small piston is trapped in the large cylinder.

The small piston rises on the up-stroke until its bottom passes the opening to the fluid reservoir. More fluid is sucked past a check valve B and into the small cylinder. The next down-stroke forces this new charge of fluid out of the small cylinder past the check valve into the large cylinder. This process is repeated stroke by stroke until enough fluid has been forced into the large cylinder to raise the large piston the required distance of one foot. The force has been applied through a distance of 10 feet on the pump handle,

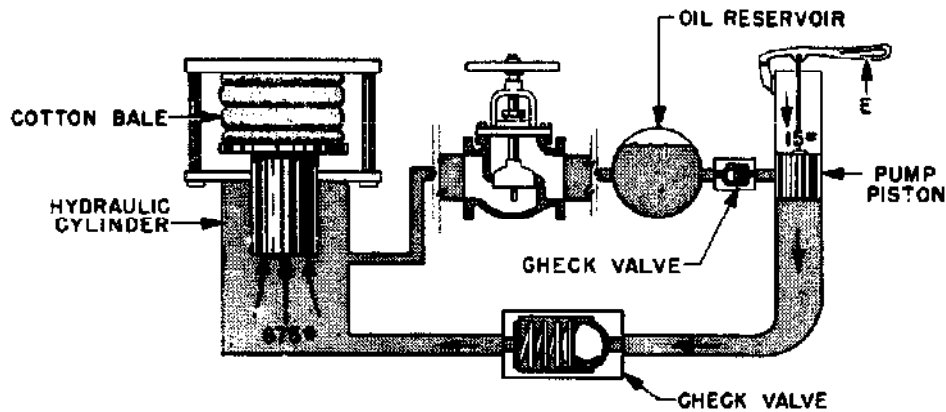

Figure 10-10.—Hydraulic press.

131.50

but it was done by making a series of relatively short strokes—the sum of all the strokes being equal to 10 feet.

Maybe you're beginning to wonder how the large piston gets back down after you've baled the cotton. The fluid can't run back past the check valve B—that's obvious. You lower the piston by letting the oil flow back to the reservoir through a return line. Notice that a simple gate valve is inserted in this line. When the gate valve is opened, the fluid flows back into the reservoir. Of course, this valve is kept shut while the pump is in operation.

Hydraulics Aid the Helmsman

You've probably seen the helmsman swing a ship weighing thousands of tons about as easily as you turn your car. No, he's not a superman. He does it with machines.

Many of these machines are hydraulic. There are several types of hydraulic and electrohydraulic steering mechanisms, but the simplified diagram in figure 10-11 will help you to understand the general principles of their operation. As the hand steering wheel is turned in a counterclockwise direction, its motion turns the pinion gear *g*. This causes the left-hand rack *r*₁ to move downward, and the right-hand rack *r*₂ to move upward. Notice that each rack is attached to a piston *P*₁ or *P*₂. The downward motion of rack *r*₁ moves piston *p*₁ downward in its cylinder and pushes the oil out of that cylinder through the line. At the same time, piston *p*₂ moves upward and pulls oil from the right-hand line into the right-hand cylinder.

If you follow these two lines, you see that they enter a hydraulic cylinder *S*—one line entering above and one below the single piston in that cylinder. In the direction of the oil flow in the diagram, this piston and the attached plunger are pushed down toward the hydraulic pump *h*. So far, in this operation, you have used hand power to develop enough oil pressure to move the control plunger attached to the hydraulic pump. At this point an electric motor takes over and drives the pump *h*.

Oil is pumped under pressure to the two big steering rams *R*₁ and *R*₂. You can see that the pistons in these rams are connected directly to the rudder crosshead which controls the position of the rudder. With the pump operating in the direction shown, the ship's rudder is thrown to the left, and the bow will swing to port. This operation demonstrates how a small force applied on the steering wheel sets in motion a series of operations which result in a force of thousands of pounds.

Getting Planes on Deck

The swift, smooth power required to get airplanes from the hanger deck to the flight deck of a carrier is supplied by a hydraulic lift. Figure 10-12 explains how this lifting is done. A variable-speed gear pump is driven by an electric motor. Oil enters the pump from the reservoir and is forced through the lines to four hydraulic rams, the pistons of which raise the elevator platform. The oil under pressure exerts its force on each square inch of surface area of the four pistons. Since the pistons are large, a

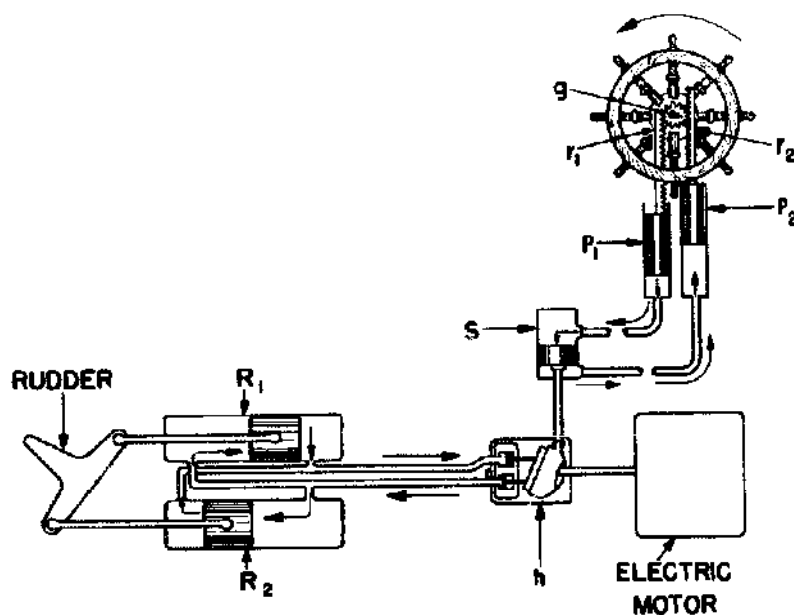

Figure 10-11.—Steering is easy with this machine.

131.51

large total lifting force results. The elevator can be lowered by reversing the pump, or by opening valve 1 and closing valve 2. The weight of the elevator will then force the oil out of the cylinders and back into the reservoir.

Submarines Use Hydraulics

Here's another application of hydraulics which you will find interesting. Inside a submarine, between the outer skin and the pressure hull, are several tanks of various design and purpose. These are used to control the total weight of the ship, allowing it to submerge or surface, and to control the trim, or balance fore and aft, of the submarine. The main ballast tanks have the primary function of either destroying or restoring positive buoyancy in the submarine. By allowing air to escape through hydraulically operated vents at the top of the tanks, sea water is able to enter through the flood ports at the bottom—replacing the air that had been holding it out. To regain positive buoyancy, the tanks are "blown" free of sea water with compressed air. Sufficient air is then left trapped in the tanks to prevent the sea water from reentering.

Other tanks, such as the variable ballast tanks and special ballast tanks like the negative tank, safety tank, and bow buoyancy tank, are used either to control trim, or stability, or for emergency weight compensating purposes. The variable ballast tanks have no direct connection to the sea. Therefore, water must be pumped into or out of them. The negative tank and the safety tank, however, can be opened to the sea through large flood valves. These valves, as well as the vent valves for the main ballast tanks and those for the safety and negative tanks, are all hydraulically operated. The vents and flood valves are outside of the pressure hull, so some means of remote control is necessary if they are to be opened and closed from within the submarine. For this purpose, hydraulic pumps, lines, and rams are used. Oil pumped through tubing running through the pressure hull actuates the valve's operating mechanisms by exerting pressure on and moving a piston in a hydraulic cylinder. It is easier and simpler to operate the valves by a hydraulic system from a control room than it would be to do so by a mechanical system of gears, shafts, and levers. The hydraulic lines can be readily led around corners and obstructions, and a minimum of moving parts is required.

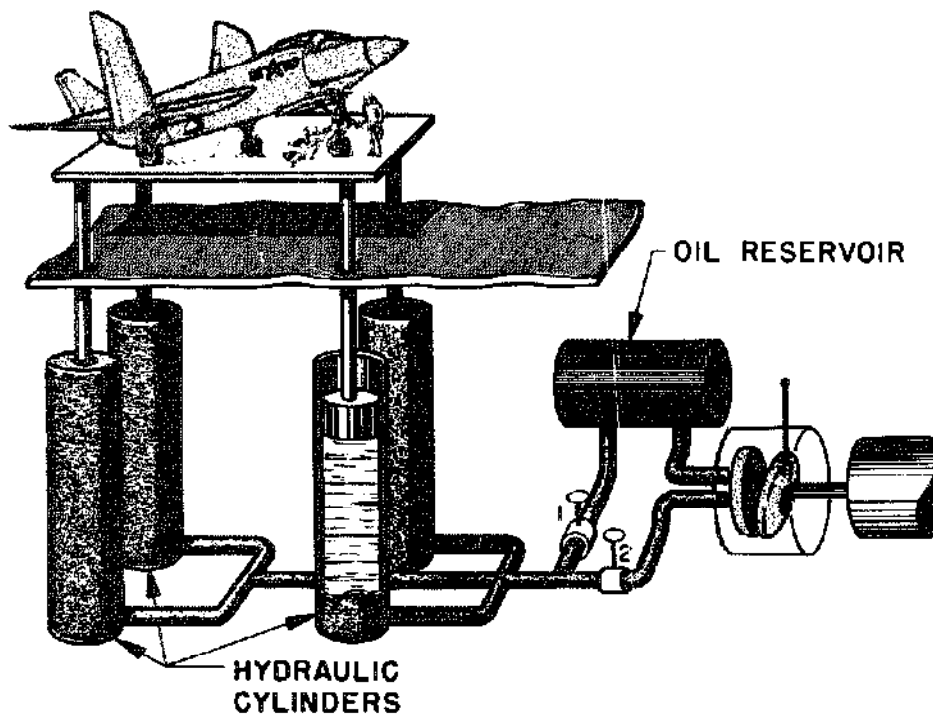

Figure 10-12.—This gets them there in a hurry.

131.52

Figure 10-13 is a schematic sketch of the safety tank—one of the special ballast tanks in a submarine. The main vent and the flood valves of this tank are operated hydraulically from remote control; although, in an emergency, they may be operated manually.

Hydraulics are also used in many other ways aboard the submarine. The periscope is raised and lowered, the submarine is steered, and the bow and stern planes are controlled by means of hydraulic systems. The windlass and capstan system, used in mooring the submarine, is hydraulically operated, and many more applications of hydraulics can be found aboard the submarine.

The Accumulator

In some hydraulic systems, oil is kept under pressure in a container called an accumulator. Figure 11-14 shows you this large cylinder, into the top of which oil is pumped. A free piston

divides the cylinder into two parts. Compressed air is forced in below the piston at a pressure of, say, 600 psi. Oil is then forced in on top of the piston. As the pressure above it increases, the piston is forced down, and squeezes the air into a smaller space. Air is elastic—it can be compressed under pressure—but it will expand as soon as the pressure is reduced. When oil pressure is reduced, relatively large quantities of oil under working pressure are instantly available to operate hydraulic rams or motors any place on the sub.

SUMMARY

The working principle of all hydraulic mechanisms is simple enough. Whenever you find an application that seems a bit hard to understand, keep these points in mind—

Hydraulics is the term applied to the behavior of enclosed liquids. Machines which are operated by liquids under pressure are called hydraulic machines.

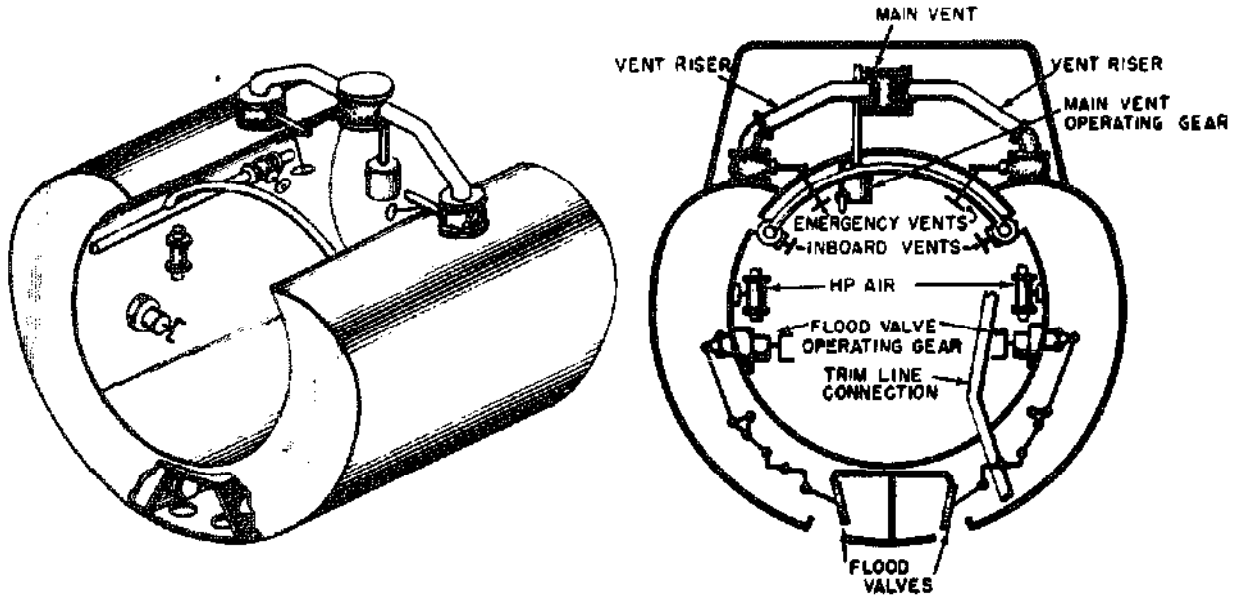

131.53

Figure 10-13.—Submarine special ballast tank (safety tank).

Liquids are incompressible. They cannot be squeezed into spaces smaller than they originally occupied.

A force applied on any area of a confined liquid is transmitted equally to every part of the liquid.

In hydraulic cylinders, the relation between the force exerted by the larger piston to the force applied on the smaller piston is the same as the relation between the area

of the larger piston and the area of the smaller piston.

Some of the advantages of hydraulic machines are—

Tubing is used to transmit forces, and tubing can readily transmit forces around corners.

Little space is required for tubing.

Few moving parts are required.

Efficiency is high, generally 80-95%.

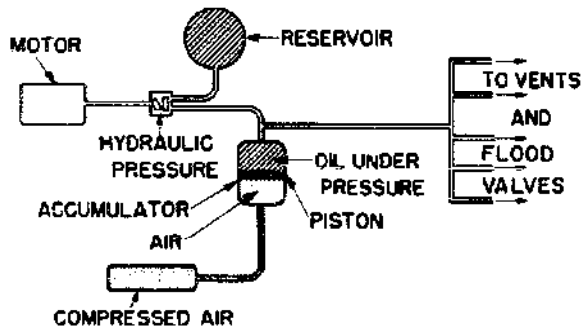

131.54

Figure 10-14.—This keeps pressure on tap.

CHAPTER 11

MACHINE ELEMENTS AND BASIC MECHANISMS

MACHINE ELEMENTS

Any machine, however simple, utilizes one or more basic machine elements or mechanisms in its makeup. In this chapter we will take a look at some of the more familiar elements and mechanisms used in naval machinery and equipment.

BEARINGS

In chapter 7 we saw that wherever two objects rub against each other, friction is produced. If the surfaces are very smooth, there will be little friction; if either or both are rough, there will be more friction. **FRICTION** is the resistance to any force that tends to produce motion of one surface over another. When you are trying to start a loaded hand truck rolling, you have to give it a hard tug (to overcome the resistance of static friction) to get it started. Starting to slide the same load across the deck would require a harder push than starting it on rollers. That is because rolling friction is always less than sliding friction. To take advantage of this fact, rollers or bearings are used in machines to reduce friction. Lubricants on bearing surfaces reduce the friction even further.

A bearing is a support and guide which carries a moving part (or parts) of a machine and maintains the proper relationship between the moving part or parts and the stationary part. It usually permits only one form of motion, as rotation, and prevents any other. There are two basic types of bearings: sliding type (plain bearings), also called friction or guide bearings, and anti-frictional type (roller and ball bearings).

Sliding Type (Plain) Bearings

In bearings of this type a film of lubricant separates the moving part from the stationary

part. There are three types of sliding motion bearings in common use: Reciprocal motion bearings, journal bearings, and thrust bearings.

1. **RECIPROCAL MOTION BEARINGS** provide a bearing surface on which an object slides back and forth. They are found on steam reciprocating pumps, where connecting rods slide on bearing surfaces near their connections to the pistons. Similar bearings are used on the connecting rods of large internal-combustion engines, and in many mechanisms operated by cams.

2. **JOURNAL BEARINGS** are used to guide and support revolving shafts. The shaft revolves in a housing fitted with a liner. The inside of the liner, on which the shaft bears, is made of babbitt metal or similar soft alloy (antifriction metal) to reduce friction. The soft metal is backed by a bronze or a copper layer, and that has a steel back for strength. Sometimes the bearing is made in two halves, and is clamped or screwed around the shaft (fig. 11-1). It is also called a laminated sleeve bearing.

Under favorable conditions the friction in journal bearings is remarkably small. However, when the rubbing speed of a journal bearing is very low or extremely high, the friction loss may become excessive when compared with the performance of a rolling surface bearing. A good example is the railroad car, now being fitted with roller bearings to eliminate the "hot box" troubles of journal bearings.

Heavy-duty bearings have oil circulated around and through them and some have an additional cooling system that circulates water around the bearing. Although revolving the steel shaft against babbitt metal produces less friction (and therefore less heat and wear) than steel against steel, it is still a problem to keep the parts cool. You know what causes a "burned out bearing" on your car, and how to prevent it. The same care and lubrication are necessary on all Navy equipment, only more so, because

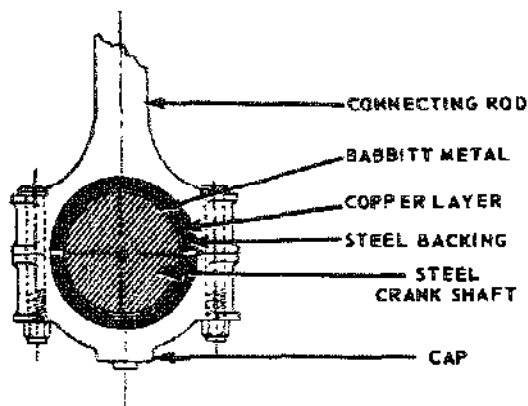

5.20
Figure 11-1.—Babbitt-lined bearing in which steel shaft revolves.

there is a lot of equipment, and many lives depend on its continued operation.

3. **THRUST BEARINGS** are used on rotating shafts, such as those supporting bevel gears, worm gears, propellers, and fans. They are installed to resist axial thrust or force and to limit

axial movement. They are used chiefly on heavy machinery, such as Kingsbury thrust bearings used in heavy marine propelling machinery (figs. 11-2 and 11-3). The base of the housing holds an oil bath, and the rotation of the shaft continually distributes the oil. The bearing consists of a thrust collar on the propeller shaft and two or more stationary thrust shoes on either side of the collar. Thrust is transmitted from the collar through the shoes to the gear housing and the ship's structure to which the gear housing is bolted.

Antifrictional Or Roller and Ball Bearings

You have had first-hand acquaintance with ball bearings since you were a child. They are what made your roller skates or bicycle wheels spin freely. If any of the little steel balls came out and were lost, your roller skates screeched and groaned. The balls or rollers are of hard, highly polished steel. The typical bearing consists of two hardened steel rings (called RACES), the hardened steel balls or rollers, and a SEPARATOR. The motion occurs between the race surfaces and the rolling elements. There

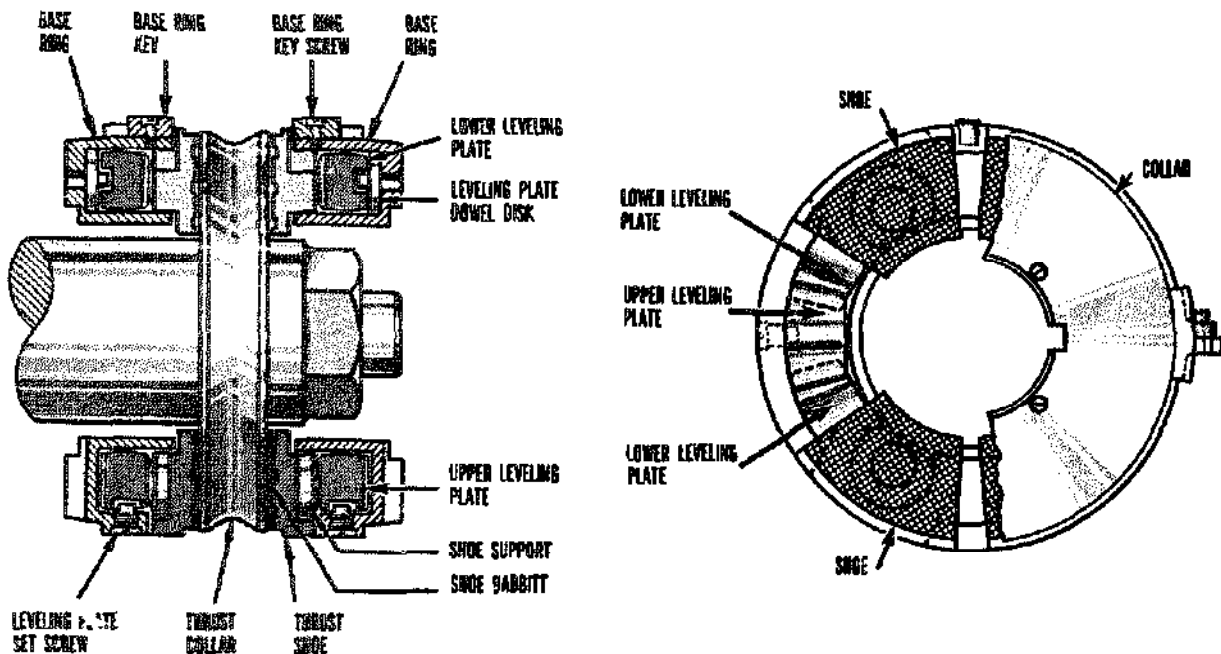
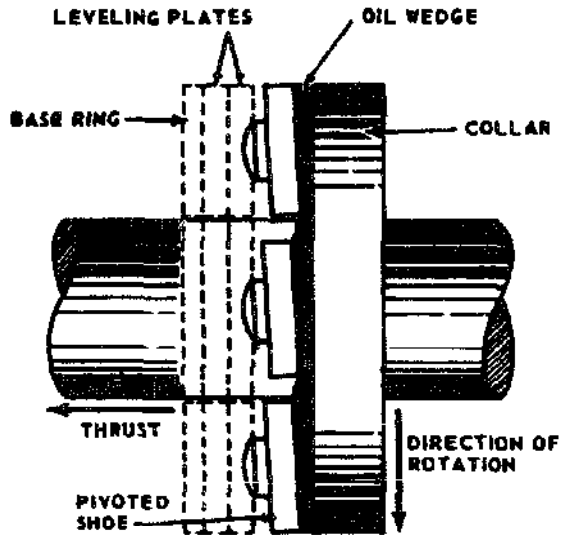

Figure 11-2.—Kingsbury pivoted-shoe thrust bearing.

38.85:.86X



38.86.1

Figure 11-3.—Diagrammatic arrangement of a Kingsburg thrust bearing, showing oil film.

are seven basic types of antifrictional bearings (fig. 11-4).

1. Ball bearings
2. Cylindrical roller bearings
3. Tapered roller bearings
4. Self-aligning roller bearings with spherical outer raceway
5. Self-aligning roller bearings with spherical inner raceway
6. Ball thrust bearings
7. Needle roller bearings

Roller bearing assemblies are usually easy to disassemble for inspection, cleaning, and replacement of parts. Ball bearings, however, are assembled by the manufacturer and installed, or replaced, as a unit. Sometimes maintenance publications refer to roller and ball bearings as being either thrust or radial bearings. The difference between the two depends on the angle of intersection between the direction of the load and the plane of rotation of the bearing. Figure 11-5A shows a radial ball bearing assembly. The load here is pressing outward along the radius of the shaft. Now suppose a strong thrust were to be exerted on the right end of the shaft, tending to move it to the left. You can see that the radial bearing is not designed to support this axial thrust. Even putting a shoulder between the load and the inner race wouldn't do. It would just

pop the bearings out of their races. The answer is to arrange the races differently, as in figure 11-5B. Here is a thrust bearing. With a shoulder under the lower race, and another between the load and the upper race, it will handle any axial load up to its design limit. Sometimes bearings are designed to support both thrust and radial loads. This is the explanation of the term **RADIAL THRUST** bearings. The tapered roller bearing in figure 11-6 is an example.

Antifriction bearings require smaller housings than other bearings of the same load capacity, and can operate at higher speeds.

SPRINGS

Springs are elastic bodies (generally metal) which can be twisted, pulled, or stretched by some force, and which have the ability to return to their original shape when the force is released. All springs used in naval machinery are made of metal—usually steel, though some are of phosphor bronze, brass, or other alloys. A part that is subject to constant spring thrust or pressure is said to be **SPRING LOADED**. (Some components that appear to be spring loaded are actually under hydraulic or pneumatic pressure, or are moved by weights.)

Functions of Springs

Springs are used for many purposes, and one spring may serve more than one purpose. Listed below are some of the more common of these functional purposes. As you read them, try to think of at least one familiar application of each.

1. To store energy for part of a functioning cycle.
2. To force a component to bear against, to maintain contact with, to engage, to disengage, or to remain clear of, some other component.
3. To counterbalance a weight or thrust (gravitational, hydraulic, etc.). Such springs are usually called equilibrator springs.
4. To maintain electrical continuity.
5. To return a component to its original position after displacement.
6. To reduce shock or impact by gradually checking the motion of a moving weight.
7. To permit some freedom of movement between aligned components without disengaging them. These are sometimes called **takeup springs**.

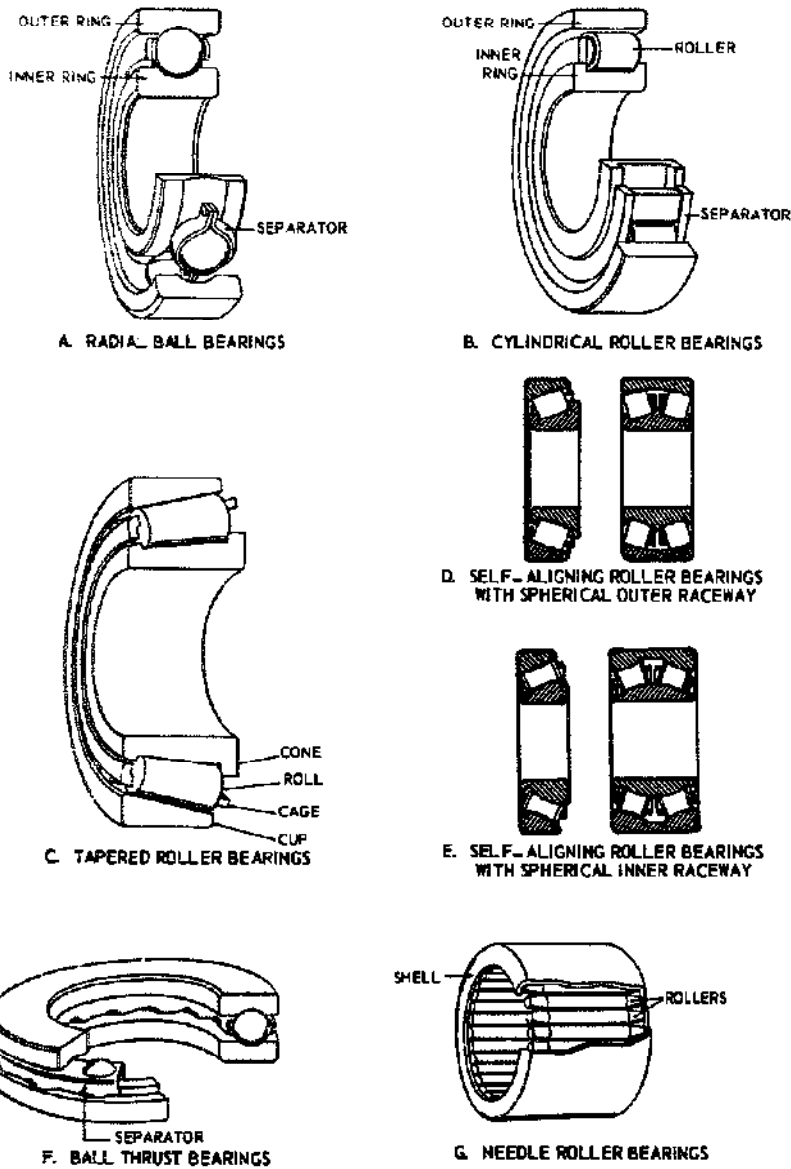

Figure 11-4.—The seven basic types of antifrictional bearings.

5.21

Types of Springs

As you read different books you will find that authors do not agree on classification of types of springs. The names are not as important as the types of work they can do and the loads they can bear. We may say there are three basic types: (1) flat; (2) spiral; (3) helical or coil.

1. **FLAT** springs include various forms of elliptic or leaf springs (fig. 11-7A (1&2)), made up of flat or slightly curved bars, plates, or leaves, and special flat springs (fig. 11-7A (3)). A special flat spring is made from a flat strip or bar, into whatever shape or design is calculated to be best suited for its position and purpose.

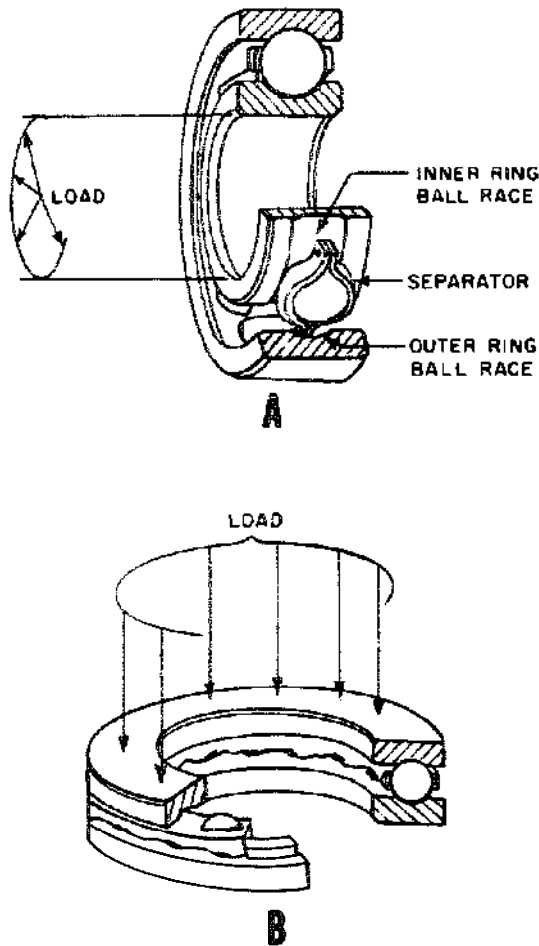

5.21
Figure 11-5.—Ball bearings. A. Radial type; B. Thrust type.

2. **SPIRAL** springs are sometimes called clock or power springs (11-7B), and sometimes coil springs. A well known example is a watch or clock spring, which is wound (tightened) and then gradually releases the power as it unwinds.

Although there is good authority for calling this spring by other names, to avoid confusion we shall consistently call it **SPIRAL**.

3. **HELICAL** springs, often called spiral, but not in this text (fig. 11-7D), are probably the most common type of spring. They may be used in compression (fig. 11-7D (L)), extension or tension (fig. 11-7D (2)), or torsion (fig. 11-7D (3)). A spring used in compression tends to shorten in action, while a tension spring

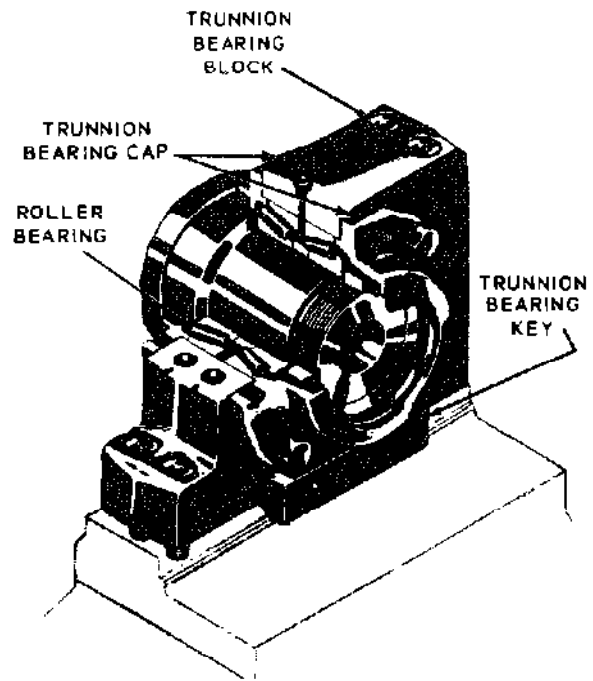

84.120
Figure 11-6.—Radial-thrust roller bearing.

lengthens in action. Torsion springs are made to transmit a twist instead of a direct pull, and operate by coiling or uncoiling action.

In addition to straight helical springs, cone, double cone, keg, and volute springs are also classed as helical. These are usually used in compression. A cone spring (fig. 11-7D (4)), often called a valve spring because it is frequently used in valves, is shaped by winding the wire on a tapered mandrel instead of a straight one. A double cone spring (not illustrated) is composed of two cones joined at the small ends, and a keg spring (not illustrated) is two cone springs joined at their large ends.

VOLUTE springs (fig. 11-7D (5)) are conical springs made from a flat bar which is so wound that each coil partially overlaps the adjacent one. The width (and thickness) of the material gives it great strength or resistance.

A conical spring can be pressed flat so it requires little space, and it is not likely to buckle sidewise.

4. **TORSION BARS** (fig. 11-7C) are straight bars that are acted on by torsion (twisting force). The bar may be circular or rectangular in cross

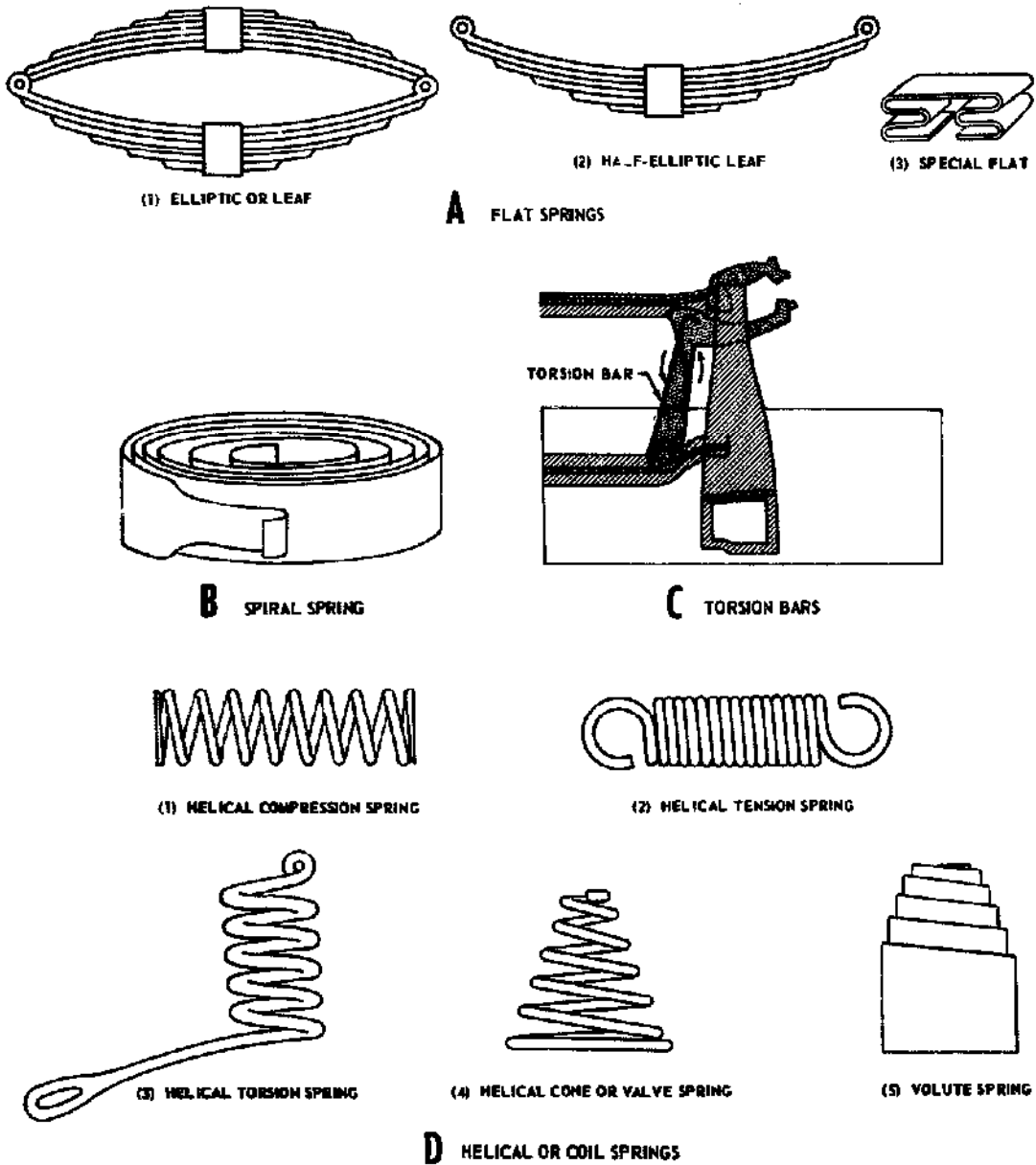

Figure 11-7.—Types of springs.

84.131

section, or less commonly in other shapes. It may also be a tube.

5. A special type of spring is a RING SPRING or DISC spring (not illustrated). It is made of a number of metal rings or discs that overlap each other.

BASIC MECHANISMS

THE GEAR DIFFERENTIAL

A gear differential is a mechanism that is capable of adding and subtracting mechanically. To be more precise, it adds the total revolutions

of two shafts—or subtracts the total revolutions of one shaft from the total revolutions of another shaft—and delivers the answer by positioning a third shaft. The gear differential will add or subtract any number of revolutions, or very small fractions of revolutions, continuously and accurately. It will produce a continuous series of answers as the inputs change.

Figure 11-8 is a cutaway drawing of a bevel gear differential showing all its parts and how they are related to each other. Grouped around the center of the mechanism are four bevel gears, meshed together. The two bevel gears on either side are called "end gears." The two bevel gears above and below are called "spider gears." The long shaft running through the end gears and the three spur gears is called the "spider shaft." The short shaft running through the spider gears, together with the spider gears themselves, is called the "spider."

Each of the spider gears and the end gears are bearing mounted on their shafts and are free to rotate. The spider shaft is rigidly connected with the spider cross shaft at the center block where they intersect. The ends of the spider shaft are secured in flanges or hangers, but they are bearing mounted and the shaft is free to rotate on its axis. It follows then that to rotate the spider shaft, the spider, consisting of the spider cross shaft and the spider gears, must tumble, or spin, on the axis of the spider shaft, inasmuch as the two shafts are rigidly connected.

The three spur gears shown in figure 11-8 are used to connect the two end gears and the spider shaft to other mechanisms. They may be of any convenient size. Each of the two input spur gears is attached to an end gear. An input gear and an end gear together are called a "side" of a differential. The third spur gear is the output gear, as designated in figure 11-8. This is the

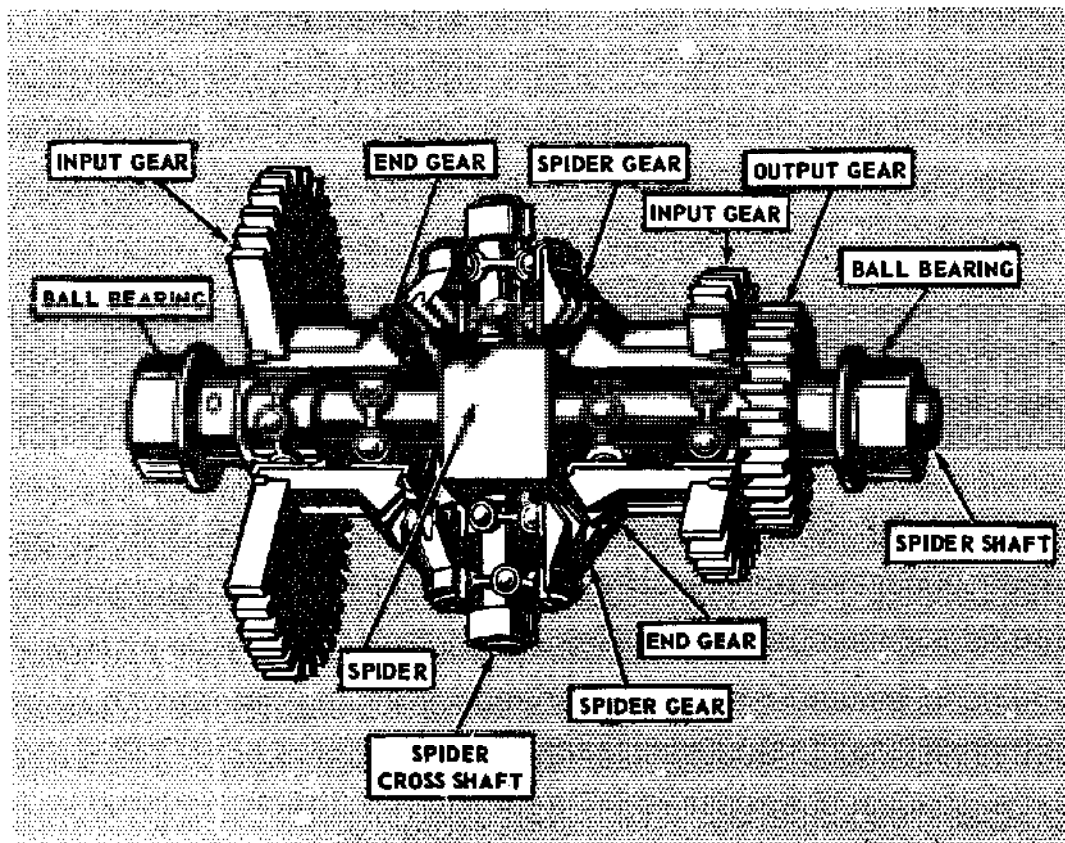

Figure 11-8.—Bevel gear differential.

12.87

only gear that is pinned to the spider shaft. All of the other gears, both bevel and spur, in the differential are bearing mounted.

Figure 11-9 is an exploded view of a gear differential showing each of its individual parts, and figure 11-10 is a schematic sketch showing the relationship of the principle parts.

How it Works

For the present we will assume that the two sides are the inputs and the gear on the spider shaft is the output. Later it will be shown that any of these three gears can be either an input or an output. Now let's look at figure 11-11. In this hookup the two end gears are positioned by the input shafts, which represent the quantities to be added or subtracted. The spider gears do the actual adding and subtracting. They follow the rotation of the two end gears, turning the spider shaft a number of revolutions proportional to the sum, or difference, of the revolutions of the end gears.

Suppose the left side of the differential is rotated while the other remains stationary, as in block 2 of figure 11-11. The moving end gear will drive the spider gears, making them roll on the stationary right end gear. This motion will turn the spider in the same direction as the input and, through the spider shaft and output gear, the output shaft. The output shaft will turn a number of revolutions proportional to the input.

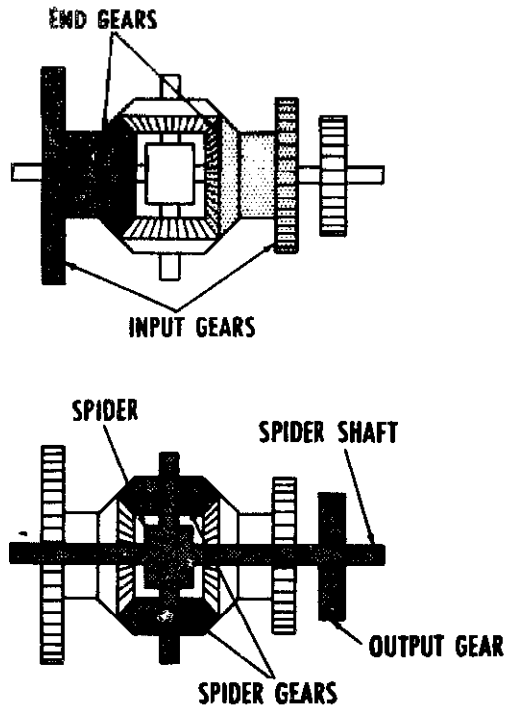

110.8

Figure 11-10. —The differential. End gears and spider arrangement.

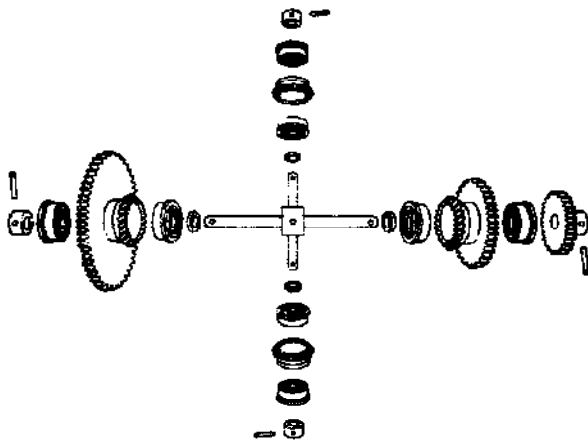

131.55

Figure 11-9. —Exploded view of differential gear system.

If the right side is now rotated and the left side held stationary, as in block 3 of figure 11-11, the same thing will happen. If both input sides of the differential are turned in the same direction at the same time, the spider will be turned by both at once, as in block 4 of figure 11-11. The output will be proportional to the sum of the two inputs. Actually, the spider makes only half as many revolutions as the sum of the revolutions of the end gears, because the spider gears are free to roll between the end gears. To understand this better, let's look at figure 11-12. Here a cylindrical drinking glass is rolled along a table top by pushing a ruler across its upper side. The glass will roll only half as far as the ruler travels. The spider gears in the differential roll against the end gears in exactly the same way. Of course, the answer can be corrected by

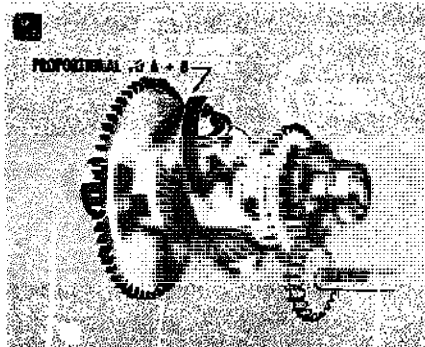
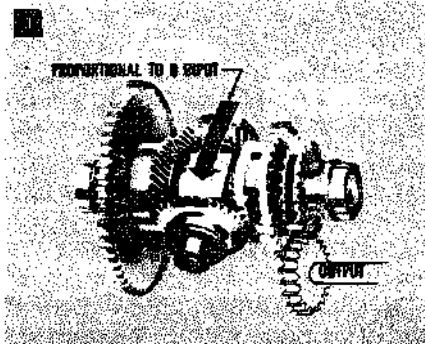
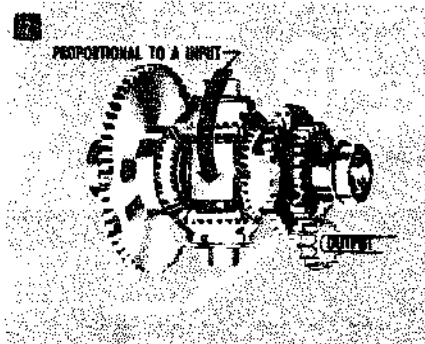
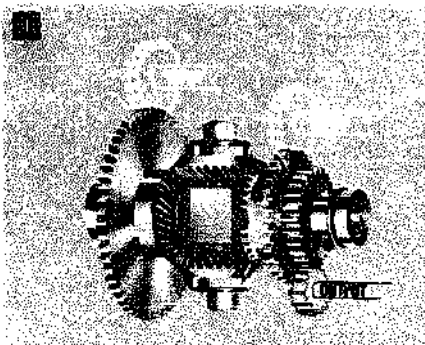

110.9 Figure 11-11.—How a differential works.

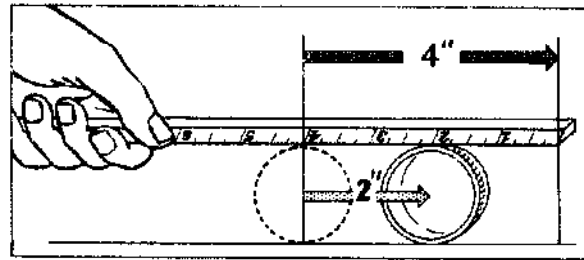

131.56 Figure 11-12.—The spider makes only half as many revolutions.

using a 2:1 gear ratio between the gear on the spider shaft and the gear for the output shaft. Very often, for design purposes, this gear ratio will be found to be different.

When the two sides of the differential move in opposite directions, the output of the spider shaft is proportional to the difference of the revolutions of the two inputs. This is because the spider gears are free to turn, and are driven in opposite directions by the two inputs. If the two inputs are equal and opposite, the spider gears will turn, but there will be no movement of the spider shaft. If the two inputs turn in opposite directions for an unequal number of revolutions, the spider gears roll on the end gear that makes the lesser number of revolutions, rotating the spider in the direction of the input making the greater number of revolutions. The motion of the spider shaft will be equal to half the difference between the revolutions of the two inputs. A change in the gear ratio to the output shaft can then give us any proportional answer we wish.

We have thus far been describing a hookup wherein the two sides are inputs and the spider shaft the output. As long as it is recognized that the spider follows the end gears for half the sum, or difference, of their revolutions, however, it is not necessary to always use this type hookup. The spider shaft may be used as one input and either of the sides used as the other. The other side will then become the output. This fact permits three different hookups for any given differential, as is illustrated in figure 11-13. Whichever proves the most convenient mechanically may be used.

In chapter 14 of this book, the differential as used in the automobile will be described. This differential is similar in principle, but, as you

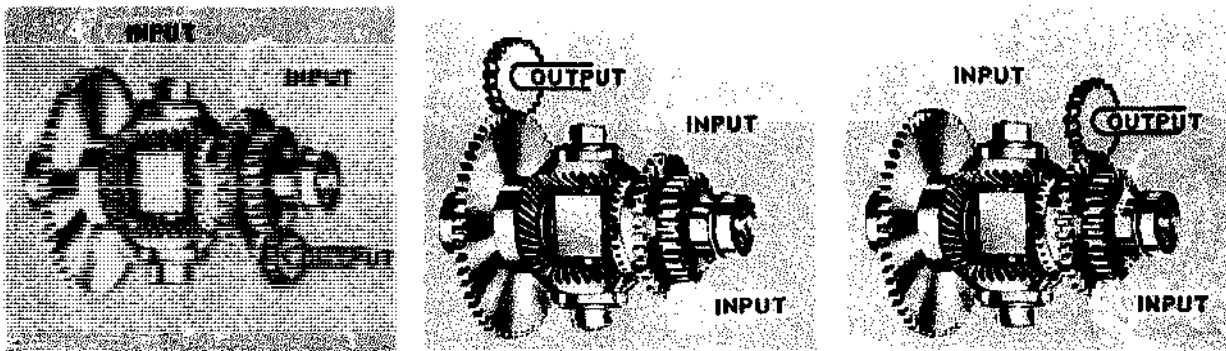

Figure 11-13.—Any of these three hookups can be used.

110.9

will see, is somewhat different in its mechanical makeup. In chapter 15 you will be given information on differentials as they are used in computers.

LINKAGES

A linkage may consist of either one or a combination of the following basic parts:

1. Rod, shaft, or plunger
2. Lever
3. Rocker arm
4. Bell crank

These parts combined are used to transmit limited rotary or linear motion. To change the direction of a motion, cams are used with the linkage.

Lever type linkages (fig. 11-14) are used in equipment which has to be opened and closed; for instance, valves in electric-hydraulic systems, gates, clutches, clutch-solenoid interlocks, etc. Rocker arms are merely a variation, or special use, of levers.

Bell cranks are used primarily to transmit motion from a link traveling in one direction to another link which is to be moved in a different direction. The bell crank is mounted on a fixed pivot, and the two links are connected at two points in different directions from the pivot. By properly locating the connection points, the output links can be made to move in any desired direction.

All linkages require occasional adjustments or repair, particularly when they become worn. To make the proper adjustments, a person must be familiar with the basic parts which constitute

a linkage. Adjustments are normally made by lengthening or shortening the rods and shafts by means of a clevis or turnbuckle.

COUPLINGS

In a broad sense, the term "coupling" applies to any device that holds two parts together. Line shafts which are made up of several shafts of different lengths may be held together by any of several types of shaft couplings. When shafts are very closely aligned, the sleeve coupling, as in figure 11-15, may be used. It consists of a metal tube slit at each end. The slitted ends enable the clamps to fasten the sleeve securely to the shaft ends. With the clamps tightened, the shafts are held firmly together and turn as one shaft. The sleeve coupling also serves as a convenient device for making adjustments between units. The weight at the opposite end of the clamp from the screw is merely to offset the weight of the screw and clamp arms. By distributing the weight more evenly, shaft vibration is reduced.

The Oldham coupling, named for its inventor, may be used to transmit rotary motion between shafts which are parallel but not necessarily always in perfect alignment.

An Oldham coupling (fig. 11-16), consists of a pair of disks, one flat and the other hollow. These disks are pinned to the ends of the shafts. A third (center) disk, with a pair of lugs projecting from each face of the disk, fits into the slots between the two end disks and thus enables one shaft to drive the other shaft. A coil spring, housed within the center and the hollow end disk,

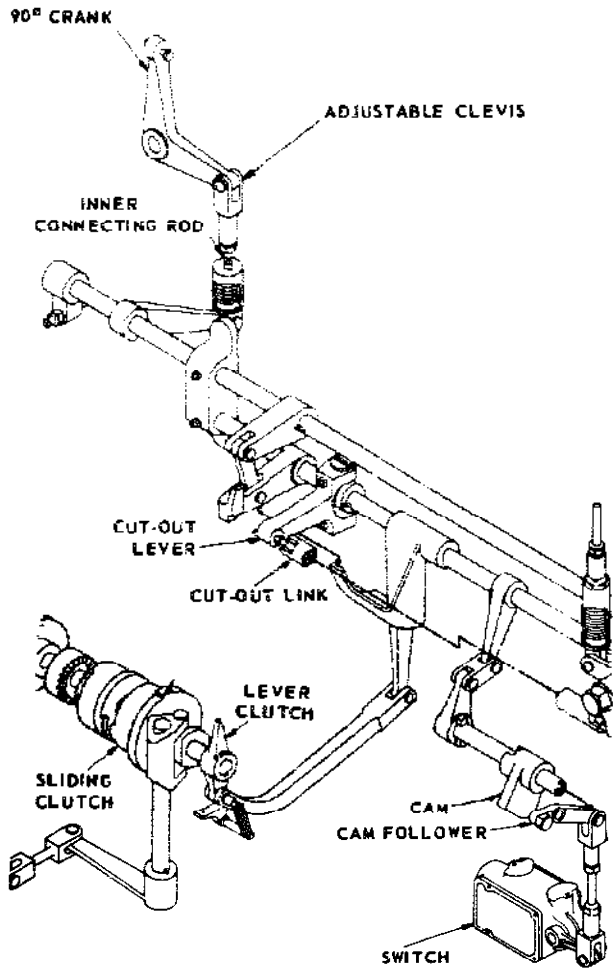

131.57

Figure 11-14.—Linkages.

forces the center disk against the flat disk. When the coupling is assembled on the shaft ends, a flat lock spring is slipped into the space around the coil spring. The ends of the flat spring are formed so that when the flat spring is pushed into the proper place, the ends of the spring are pushed out and locked around the lugs. A lock wire is passed between the holes drilled through the projecting lugs to guard the assembly. The coil spring compensates for any change in shaft length. (Shaft length may vary due to changes in temperature.)

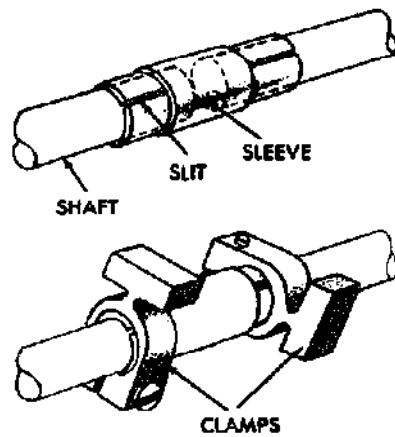

12.51

Figure 11-15.—Sleeve coupling.

The disks, or rings, connecting the shafts allow a small amount of radial play, and this allows a small amount of misalignment of the shafts as they rotate. Oldham type couplings can be easily connected and disconnected.

A universal joint is the answer when two shafts not in the same plane must be coupled. Universal joints may have various forms. They are used in nearly all types and classes of machinery. An elementary universal joint, sometimes called a Hooke joint (fig. 11-17), consists of two U-shaped yokes fastened to the ends of the shafts to be connected. Within these yokes is a cross-shaped part which holds the yokes together and allows each yoke to bend, or pivot, one with respect to the other. With this arrangement, one shaft can drive the other even though the angle between the two is as great as 25° from alignment. Figure 11-18 shows a ring and trunnion type of universal joint. This is merely a slight modification of the old Hooke joint. This type is commonly used in automobile drive shaft systems. Two, and sometimes three, are utilized. You will read more about these in chapter 14 of this book. Another type of universal joint is used where a smoother torque transmission is desired and less structural strength is required. This is the Bendix-Weiss universal joint (fig. 11-19). In this type of joint, four large balls transmit the rotary force, with a smaller ball as a spacer. With the Hooke type of universal joint, a whipping motion occurs as the shafts rotate—the amount of whip depending on the degree of shaft misalignment. The Bendix-Weiss joint does not have this disadvantage; it

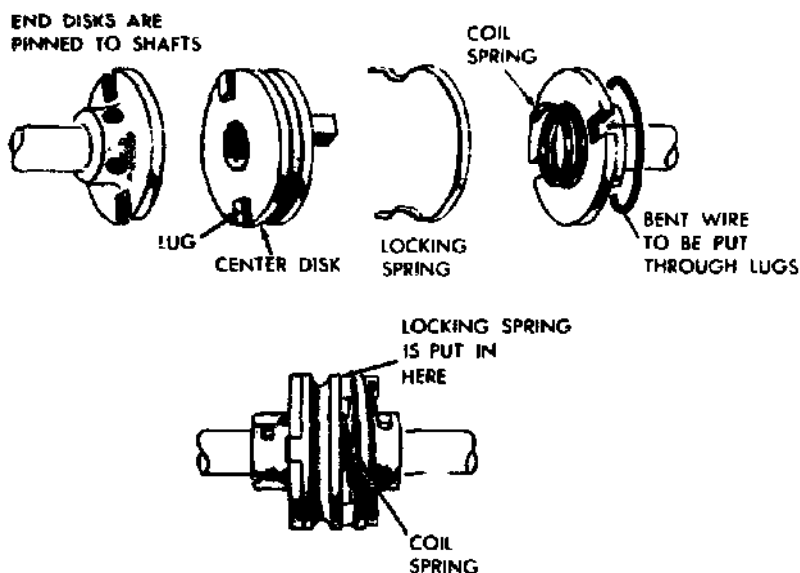

Figure 11-16.—Oldham coupling.

12.52

transmits rotary motion with a constant angular velocity. This type of joint is both more expensive to manufacture and of less strength than the Hooke types, however.

The following four types of couplings are also used extensively in naval equipment:

1. The fixed (sliding lug) coupling is non-adjustable; however, it does allow for a small amount of misalignment in shafting (fig. 11-20).

2. The flexible coupling (fig. 11-21), connects two shafts by means of a metal disk. Two coupling hubs, each splined to its respective shaft, are bolted to the metal disk. The flexible coupling provides a small amount of flexibility to allow for a slight axial misalignment of the shafts.

3. The adjustable (vernier) coupling provides a means of finely adjusting the relationship of two interconnected rotating shafts, (fig. 11-22). By loosening a clamping bolt and turning an adjusting worm, one shaft may be rotated while the other remains stationary. When the proper relationship is attained, the clamping bolt is retightened, locking the shafts together again.

4. The adjustable flexible (vernier) coupling (fig. 11-23) is simply a combination of the flexible disk coupling and the adjustable (vernier) coupling.

CAM AND CAM FOLLOWERS

A cam is a specially shaped surface, projection, or groove whose movement with respect to a part in contact with it (cam follower) drives the cam follower in another movement in response. A cam may be a projection on a revolving shaft (or on a wheel) for the purpose of changing the direction of motion from rotary to up-and-down, or vice versa. It may be a sliding piece or a groove to impart an eccentric motion. Some cams do not move at all, but cause a change of motion in the contacting part. Cams are not ordinarily used to transmit power in the sense that gear trains are. They are generally used to modify mechanical movement, the power for which is furnished through other means. They may control other mechanical units, or lock together or synchronize two or more engaging units.

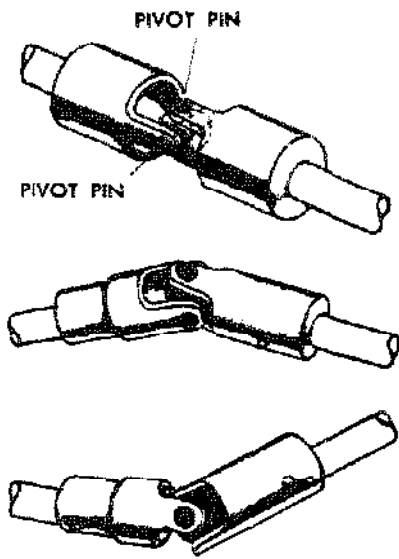

5.34

Figure 11-17.—Universal joint (Hooke type).

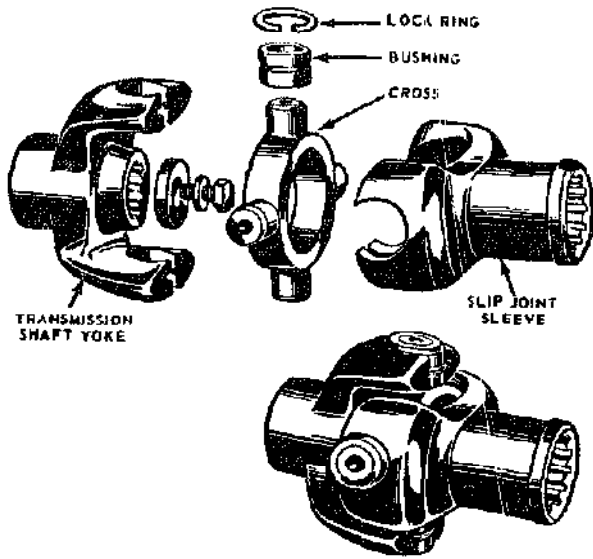

81.194

Figure 11-18.—Ring and trunnion universal joint.

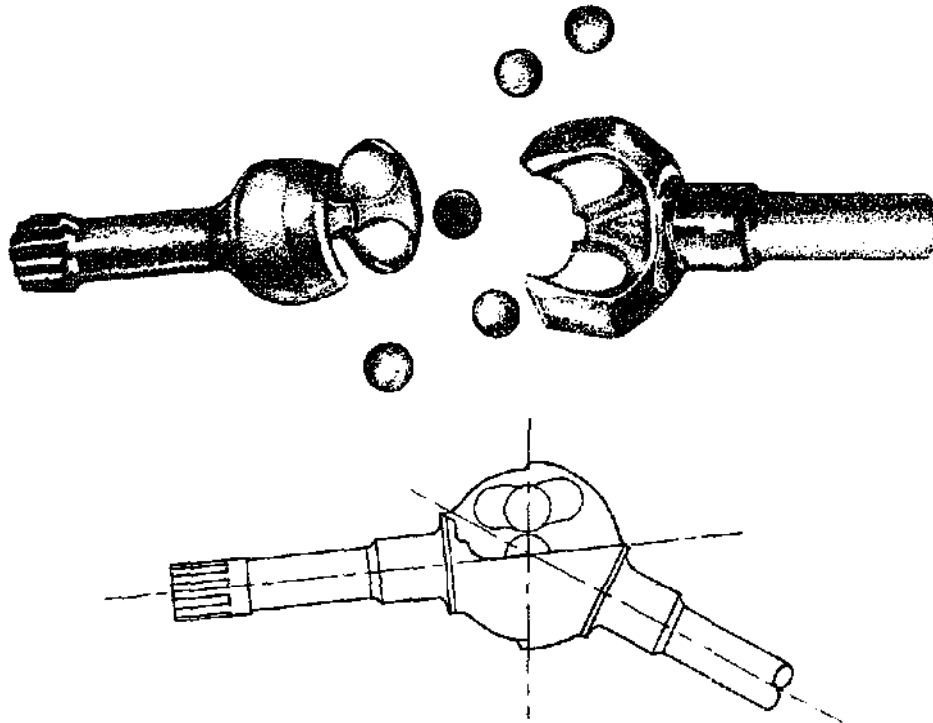
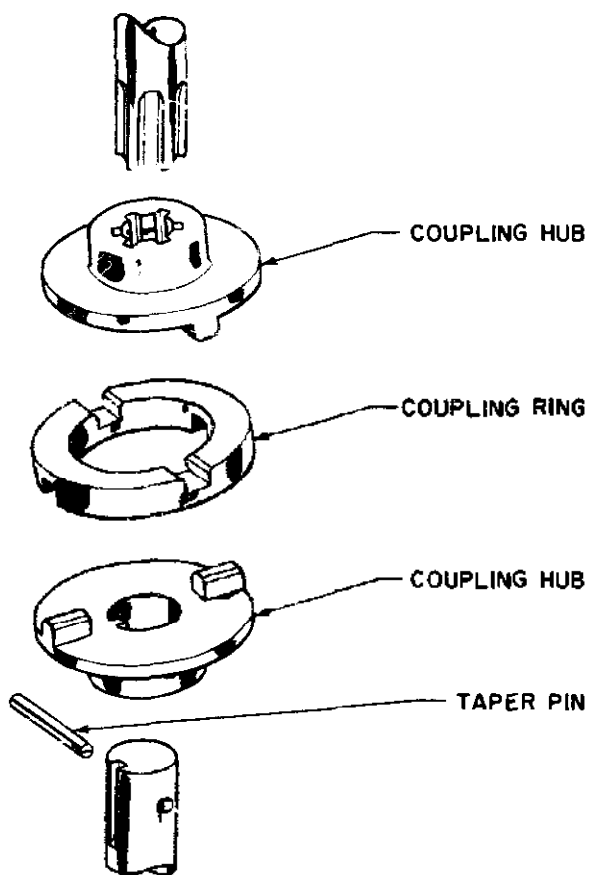

Figure 11-19.—Bendix-Weiss universal joint.

5.34



84.133.3

Figure 11-20.—Fixed coupling.

Types and Uses

Cams are of many shapes and sizes and are widely used in machines and machine tools (fig. 11-24). Cams may be classified as:

1. Radial or plate cams
2. Cylindrical or barrel cams
3. Pivoted beams

A similar grouping of types of cams is: Drum or barrel cams; edge cams; face cams.

The drum or barrel cam has a path for the roll or follower cut around the outside, and imparts a to-and-fro motion to a slide or lever in a plane parallel to the axis of the cam. Sometimes these cams are built up on a plain drum with cam plates attached.

Plate cams are used in 5"/38 and 3"/50 guns to open the breechblock during counter-recoil.

Edge or peripheral cams, also called disc cams, operate a mechanism in one direction only, gravity or a spring being relied upon to hold the cam roll in contact with the edge of the cam. The shape of the cam may be made to suit the action required, such as heart shape.

Face cams have a groove or roll path cut in the face and operate a lever or other mechanism positively in both directions, as the roll is always guided by the sides of the slot. Such a groove can be seen on top of the bolt of the Browning machine gun, caliber .30, or in fire control cams. The shape of the groove may give its name to the cam, as for example, constant lead cam, square cam, run-out cam.

The toe and wiper cam shown in figure 11-24 (d) is an example of a pivoted beam.

CLUTCHES

TYPES

A clutch is a form of coupling which is designed to connect or disconnect a driving and a driven member for stopping or starting the driven part. There are two general classes of clutches—positive clutches and friction clutches.

Positive Clutches. Positive clutches have teeth which interlock. The simplest is the jaw or claw type (fig. 11-25A), which is usable only at low speeds. The spiral claw or ratchet type (fig. 11-25B) cannot be reversed. An example of a clutch is seen in bicycles—it engages the rear sprocket with the rear wheel when the pedals are pushed forward, and lets the rear wheel revolve freely when the pedals are stopped.

Friction Clutches. The object of a friction clutch is to connect a rotating member to one that is stationary, to bring it up to speed, and to transmit power with a minimum of slippage. Figure 11-25C shows a cone clutch commonly used in motor trucks. They may be single-cone or double-cone. Figure 11-25D shows a disc clutch, also used in autos. A disc clutch may also have a number of plates (multiple-disc clutch). In a series of discs, each driven disc is located between two driving discs. You may have had experience with a multiple-disc clutch on your car. The Hele-Shaw clutch is a combined conical-disc clutch (fig. 11-25E). The groove permits circulation of oil, and cooling. Single-disc clutches are frequently dry clutches (no lubrication); multiple-disc clutches may be dry or wet (lubricated or run in oil).

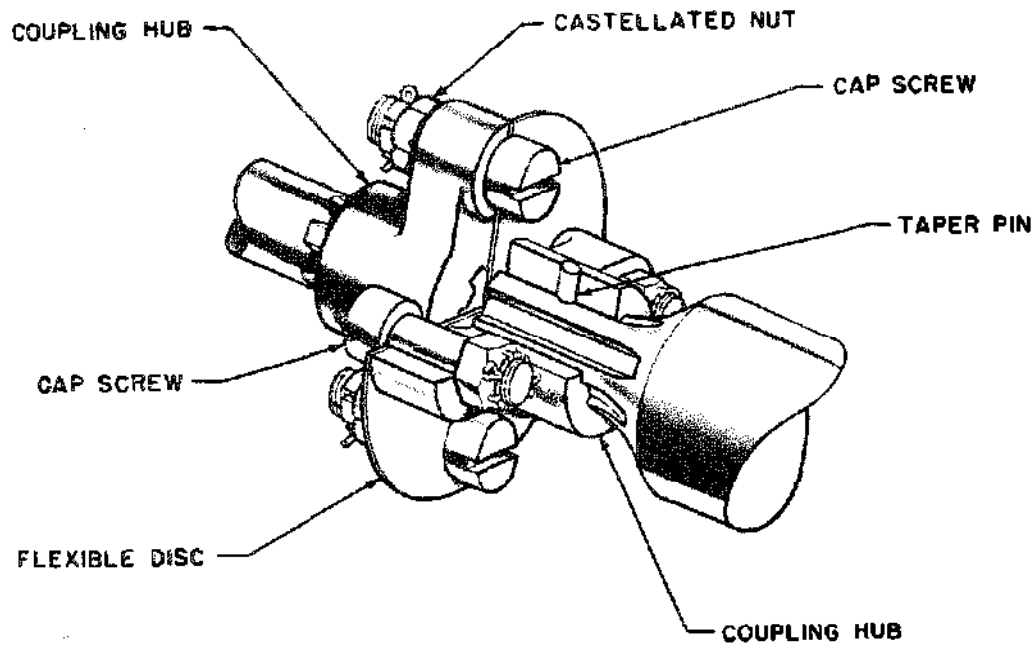

84.133.2

Figure 11-21.—Flexible coupling.

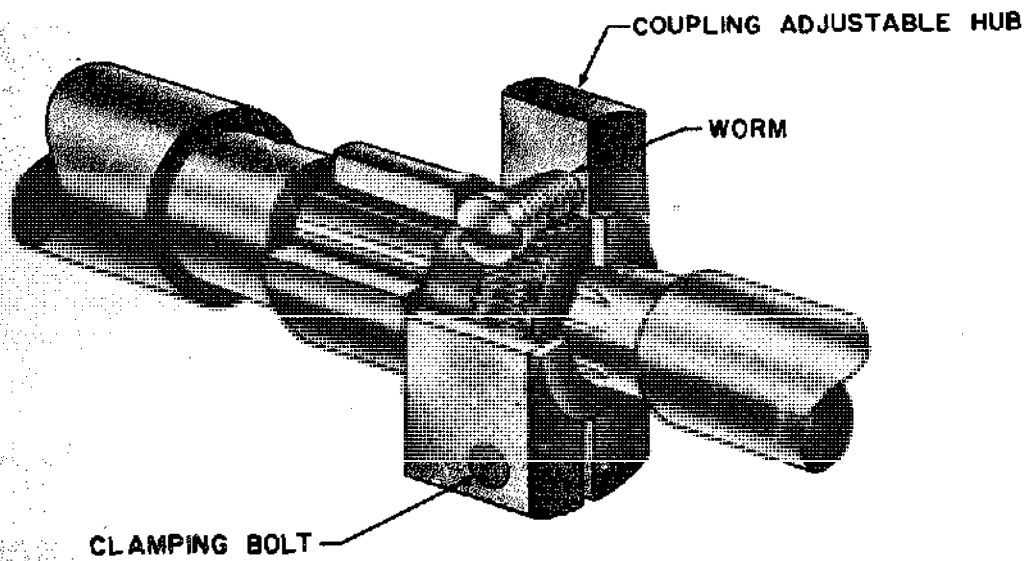

131.58

Figure 11-22.—Adjustable (vernier) coupling.

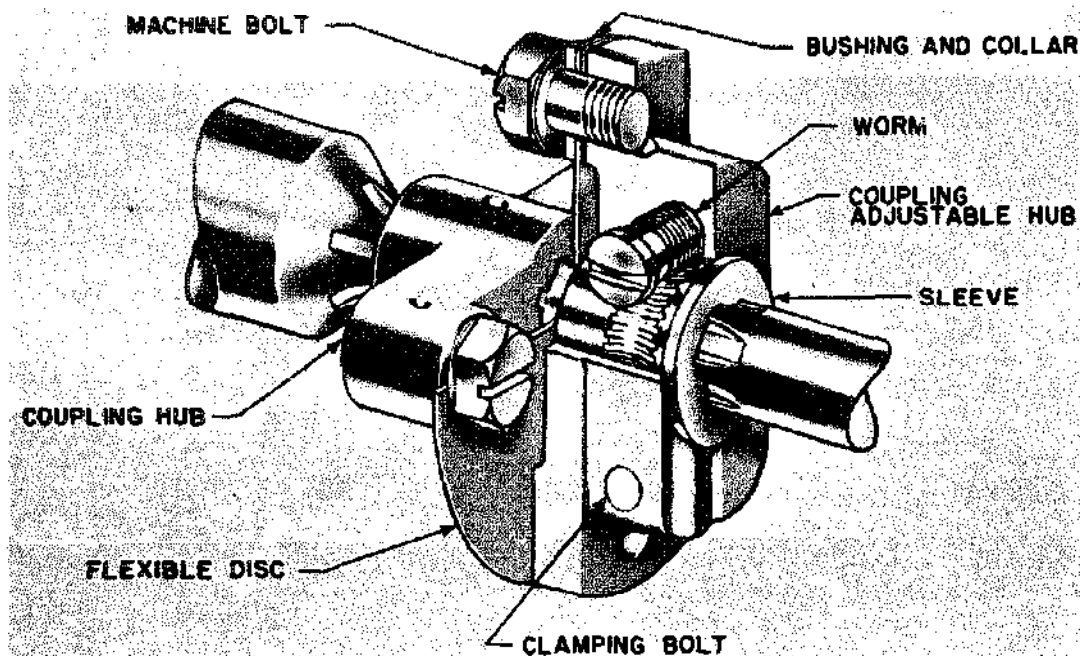

Figure 11-23.—Adjustable flexible (vernier) coupling.

11.133.4

Magnetic clutches are a recent development in which the friction surfaces are brought together by magnetic force when the electricity is turned on (fig. 11-25F). The induction clutch transmits power without contact between driving and driven members.

Expanding clutches or rim clutches are named according to the way the pressure is applied to the rim—block, split-ring, band, or roller. In one type of expanding clutch a powerful effect is gained by the expanding action of right-and left-hand screws as a sliding sleeve is moved along a shaft, and expands the band

against the rim. The centrifugal clutch is a special application of a block clutch.

Coil clutches are used where heavy parts are to be moved, as in a rolling mill. Great friction is caused by the grip of the coil when it is thrust onto a cone on the driving shaft, yet the clutch is very sensitive to control.

Pneumatic and hydraulic clutches are used on Diesel engines and transportation equipment. Hydraulic couplings (fig. 11-25G), which serve also as clutches, are used in the hydraulic A-end of electric-hydraulic gun drives.

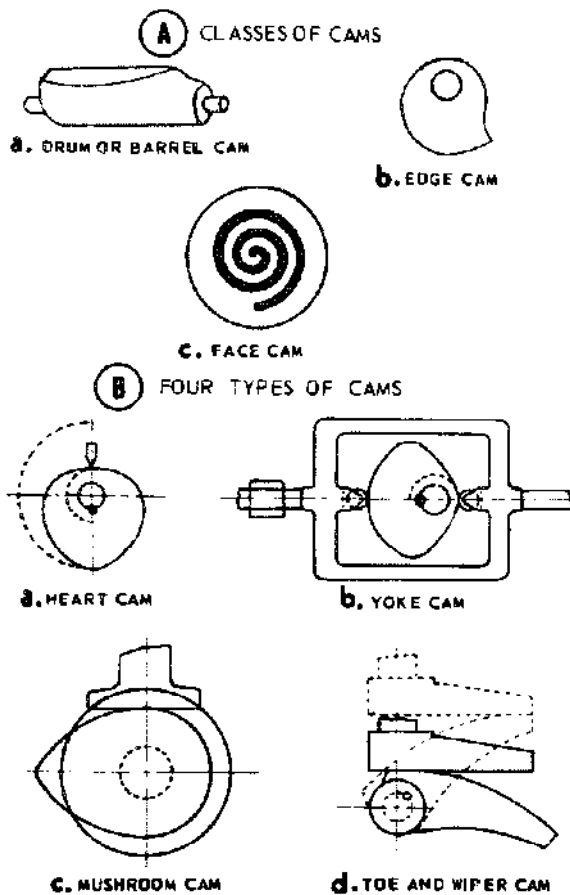

5.29

Figure 11-24.—Classes and types of cams.

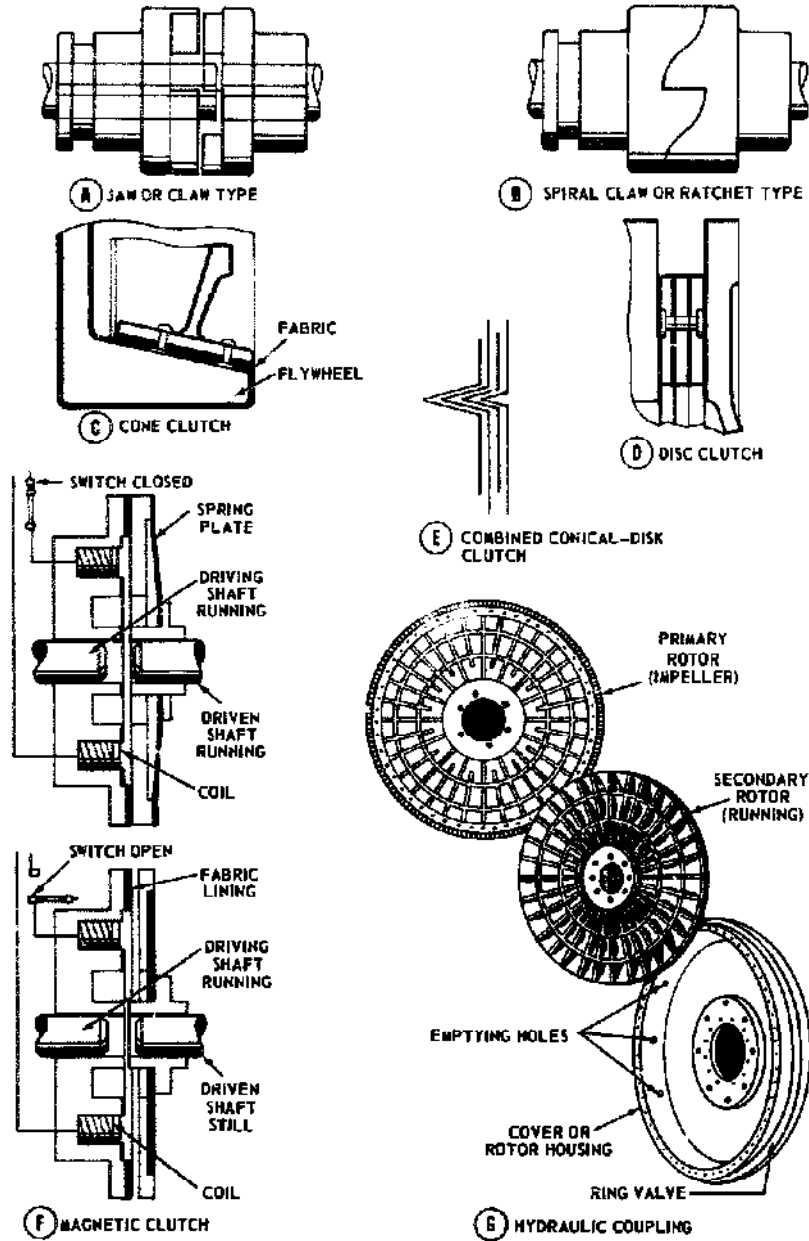

Figure 11-25. --Types of clutches.

CHAPTER 12

COMPLEX MACHINES

We've been studying only the more simple machines so far. Now that we've learned about them, let's take a look at some complex machines. One of the first things you should learn is to recognize the simple machines which make up a complex machine; for a complex machine is only a combination of simple machines. In the examples given in this chapter, look first for the simple machines. If you've been studying well, you should be able to predict what will happen when a force is applied at a given point in a simple machine. Make a step-by-step analysis, and you'll discover that complex machines are not as complicated or mysterious as they first appear to be.

PORTHOLE CLOSER-BLANKET PULLER-UPPER

Take a good look at figure 12-1 and read the directions for operation. This machine was invented by a guy named Oscar. Sea water entering open port is caught in helmet (1) hung on rubber band. Rubber stretches and helmet is pushed down against shaft of Australian spear (2). Head of spear tips over box of bird seed (3) which falls in cage (4) where parrot (5) bends over to pick it up. Board strapped on parrot's back pulls on string (6) which releases arrow (7) and slams the port shut. Breeze from closing port turns page on calendar (8) to new day.

In the meantime, water falling over water-wheel (9) turns gears (10) which wind string (11) on drum (12). This pulls blanket up over Oscar. Arm (13) pulls on cord (14) and raises board under alarm clock (15) sliding same into bucket of water.

In case of mechanical breakdown at any point in the system, helmet is tipped by off-center peg (16) emptying water into funnel (17). Pipe (18) directs water onto Elmer, who is sleeping below. The theory is that Elmer will get up and do something about that open port--or about Oscar.

You'll probably agree that this nightmare is a complex machine. But, if you look carefully, you can see that Oscar has put together several simple machines to make this complicated device. He has used a couple of levers, several blocks, a gear train, and you can even find an inclined plane under the alarm clock.

While this gadget is nonsensical, it does call attention to the important fact that a complex machine is nothing more than a combination of two or more simple machines, conveniently arranged to do the job at hand. It makes no difference how big or complicated the machine is, you can figure out how it works if you understand the operation of the simple machines from which it is made. Just as you did with Oscar's Goldberg, always start at the point where the energy is applied and follow the movement systematically, step-by-step, to the business end.

FUEL-OIL-HATCH COVER

Here's a complex mechanism that is easy to figure out. The hatch cover in figure 12-2 weighs a couple of hundred pounds; and the device which raises it is a complex machine. It is complex because it consists of two simple machines--a jackscrew and a first-class lever.

First locate the point where you apply a force to the machine. That wrench handle seems a likely spot. Remember that you can consider this handle as if it were the spoke of a wheel. Suppose you turn this handle in a counter-clockwise direction. That will cause the nut n to move upward along the threaded bolt. One complete turn of the handle will cause the nut to move upward a distance equal to the pitch of the thread on the bolt. The collar c follows the nut up and permits the lever arm I to rise. The other part of the lever arm L will move downward. Since I is much shorter than L, the downward movement of the cover will be much greater

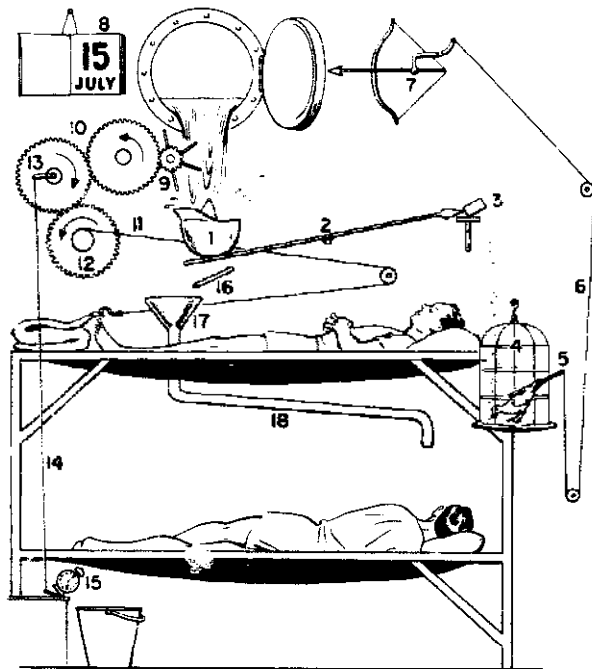

131.59
Figure 12-1.—A complex machine.

than the upward movement of the collar. It's a "speed-up" arrangement.

The hatch cover is closed by turning the handle counterclockwise, and is opened by turning the handle clockwise. This combination of two simple machines is better mechanically than one machine.

Here's how to go about figuring out how a complex machine works. Locate the point where the energy is applied and look over the part of the machine next in line. You say to yourself, "Oh, yeah, this is really a jackscrew"—or a wheel and axle, or whatever the machine happens to be. "If I turn it clockwise, then the piece right here will move so. That's going to cause this arm to move to the right. And since the arm is part of a first-class lever, the other end will move over to here to the left." In every case, you follow through in a similar manner from one part to another—carefully determining the direction and magnitude of the motion.

Perhaps you will want to know the size of the force that is exerted at some point in the machine, or perhaps the mechanical advantage up to a point. Remember that the mechanical advantage of a complex machine is equal to the

product of the mechanical advantage of each simple machine from which it is made.

Assume some numerical values for the hatch cover in figure 12-2 and see how you can calculate the mechanical advantage. For example, allow 18 inches for the length of the wrench from the end of the handle to the center of the bolt. Let the pitch of the thread be 1/4 inch. The collar is attached to arm 15 inches from the fulcrum, and the center of the cover lies 18 inches from the fulcrum along arm L.

The theoretical mechanical advantage of the jackscrew can be found by using the formula—

$$\begin{aligned} \text{M. A.} &= \frac{2\pi r}{p} \\ &= \frac{2 \times 3.14 \times 18}{1/4} = \frac{113}{1/4} = 452 \end{aligned}$$

Since jackscrews rarely have an efficiency of better than 30 percent, you'd be wise to multiply this theoretical mechanical advantage by 0.30, which gives an actual mechanical advantage of $452 \times 0.30 = 136$ for this part of the machine.

Now figure what the lever action does for you. The theoretical mechanical advantage of a lever system can be found by dividing the length of the resistance arm by the length of the effort arm.

$$\text{M. A.} = \frac{1}{L} = \frac{5}{18} = 0.278$$

Notice that the lever gives you a mechanical advantage of less than one. Whenever the M.A. is less than one, you know that either the speed or the distance of motion has been magnified at the expense of force. In this case, you can afford to sacrifice force for distance.

The overall mechanical advantage of the machine is equal to the product of the two mechanical advantages, or $136 \times 0.278 = 37.8$. This is the standard method for figuring the M. A. of complex machines.

A WATERTIGHT DOOR

Figure 12-3 shows you a watertight door—a complex machine that is a combination of a wheel-and-axle and a system of levers. That big center handle A is the point of input, which is the place to start. If you pull the handle to the right, point a on drive link 1 moves to the right. That's going to make point b on the same link move to the left. Now look at drag link 2.

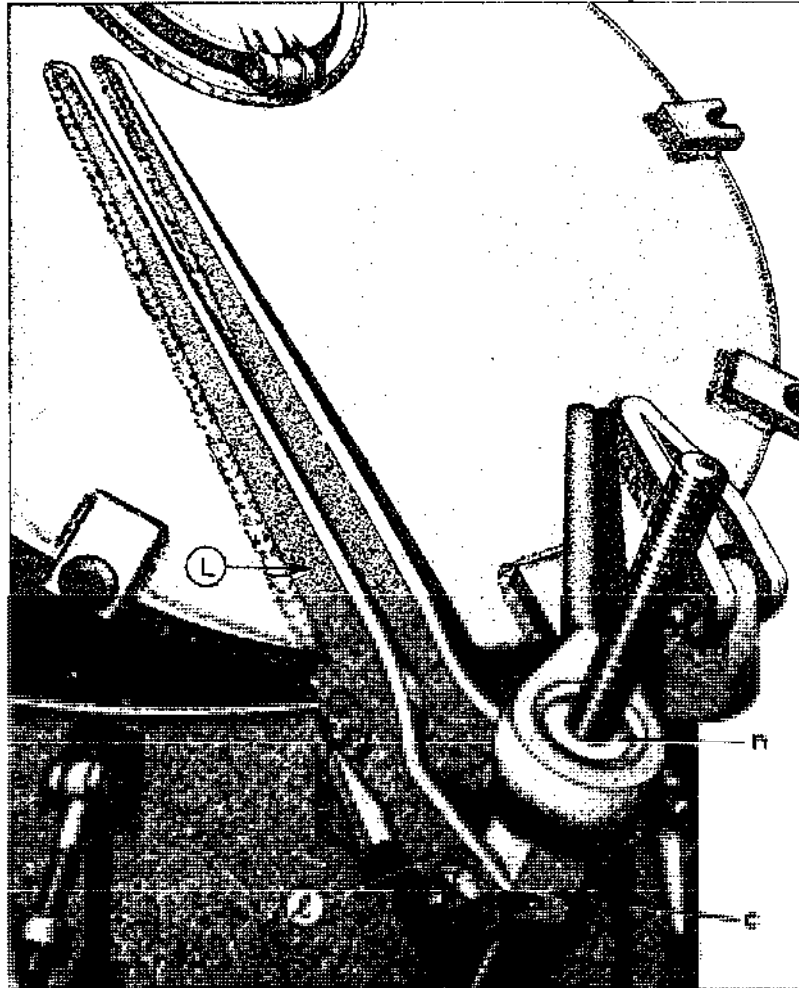

Figure 12-2.—A not-too-complex machine.

131.60

It will be moved to the left. Point a on drag line 2 moves in the direction indicated by the arrow. That action moves the outer—or right-hand—end of the bellcrank 3 upward, and the dog is extended to the locking position. At the same time drag link 4 moves downward—because it is pivoted to the left-hand end of bell-crank 3. If you follow the movement of link 4 you will see that as its end a moves down, it raises the end b of bellcrank 5 into the locking position.

Now come back to the end b of lever arm 2. Its motion is indicated by the arrow. End b moves lever 6 outward and into the locking position, and at the same time causes arm 7 to move

downward. This motion causes lever 8 to be swung in a clockwise direction until it too locks. You can see that lever arm 9 follows the movement of 8 and thus causes the dog at the top of the door to swing into the locked position.

Probably, at first glance, this mechanism looked highly complicated. But it isn't so tough to figure out, after all.

THE TYPEWRITER

The standard typewriter (fig. 12-4) is a good example of basic, or simple, machines combined

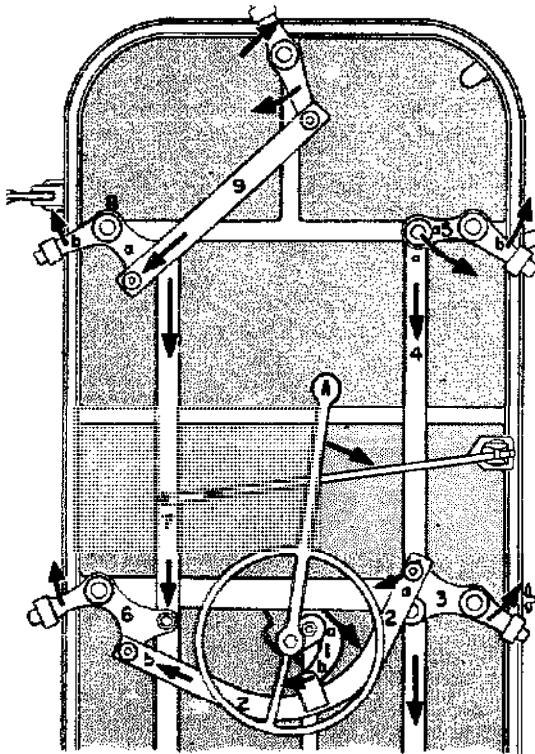

Figure 12-3.—It works too.

131.61

to make up a complex machine. In the following text and illustrations, see how many basic machines you can identify.

CONSTRUCTION AND OPERATION

The keyboard of a typewriter contains all the keys, bars, levers, etc., which are used when operating the machine.

Each type key operates a type bar with a type head having two characters (top and bottom). When a key is depressed, the type head is carried up by a system of levers into the type guide where it strikes a ribbon in front of paper on the platen (roller) and prints one of the characters (soldered on the type head).

The bar at the lower front position of the keyboard is for spacing the escapement mechanism. There is a SHIFT key on each side of the

keyboard for shifting the type bars and segments up and down, as necessary, in order to use characters in the upper and lower positions on the type heads. Other keys are for backspacing, setting and clearing the tabulator mechanism, margin releasing, and so forth. There is also a ribbon selector lever, and another lever for changing direction of the ribbon.

A typewriter carriage is positioned on or between rails, and rides upon some type of roller or ball bearings. This carriage includes the platen and all parts of the typewriter which ride with it. The energy which drives the carriage while the machine is being operated comes from a mainspring enclosed in a metal drum. A ratchet wheel and pawl hold the mainspring in the position desired for a certain amount of tension. A draw band connects the end of the mainspring to the right end of the carriage.

The carriage rack, through the escapement mechanism (explained later), controls the space-by-space movement of the carriage. The teeth of the rack mesh with the escapement wheel pinion. The rack and pinion are conventional spur gear and rack assemblies. The pinion, when turned by movement of the carriage rack, turns the escapement wheel. The movement of the escapement wheel is limited by the escapement rocker, which moves forward and backward each time a key or the space bar is depressed and released, moving the carriage one space. Thus the escapement rocker allows the carriage to move only one type space each time a key or the space bar is struck. Movement of the carriage for each type space is controlled by the escapement wheel held by the LOOSE dog of the escapement rocker. The escapement wheel may rotate during regular typing only by the disengagement of the loose dog from the escapement wheel. When the escapement wheel shaft turns, it also feeds the ribbon through the ribbon guide.

The platen holds and controls the paper in the typewriter carriage and serves as a backstop for the typeface when it strikes the paper. At the left end of the platen there is a ratchet, which is held in position by a detent (shown later), until it is moved by the carriage return lever on the left of the carriage. The function of this ratchet is to establish evenly spaced typed lines on the paper.

In the middle of the left platen knob in figure 12-4 a variable line spacer is indicated. This variable line spacer is actually a clutch between the ratchet and the platen; it holds the platen ratchet in a fixed, locked relation to the platen. By pushing the variable line spacer in with the

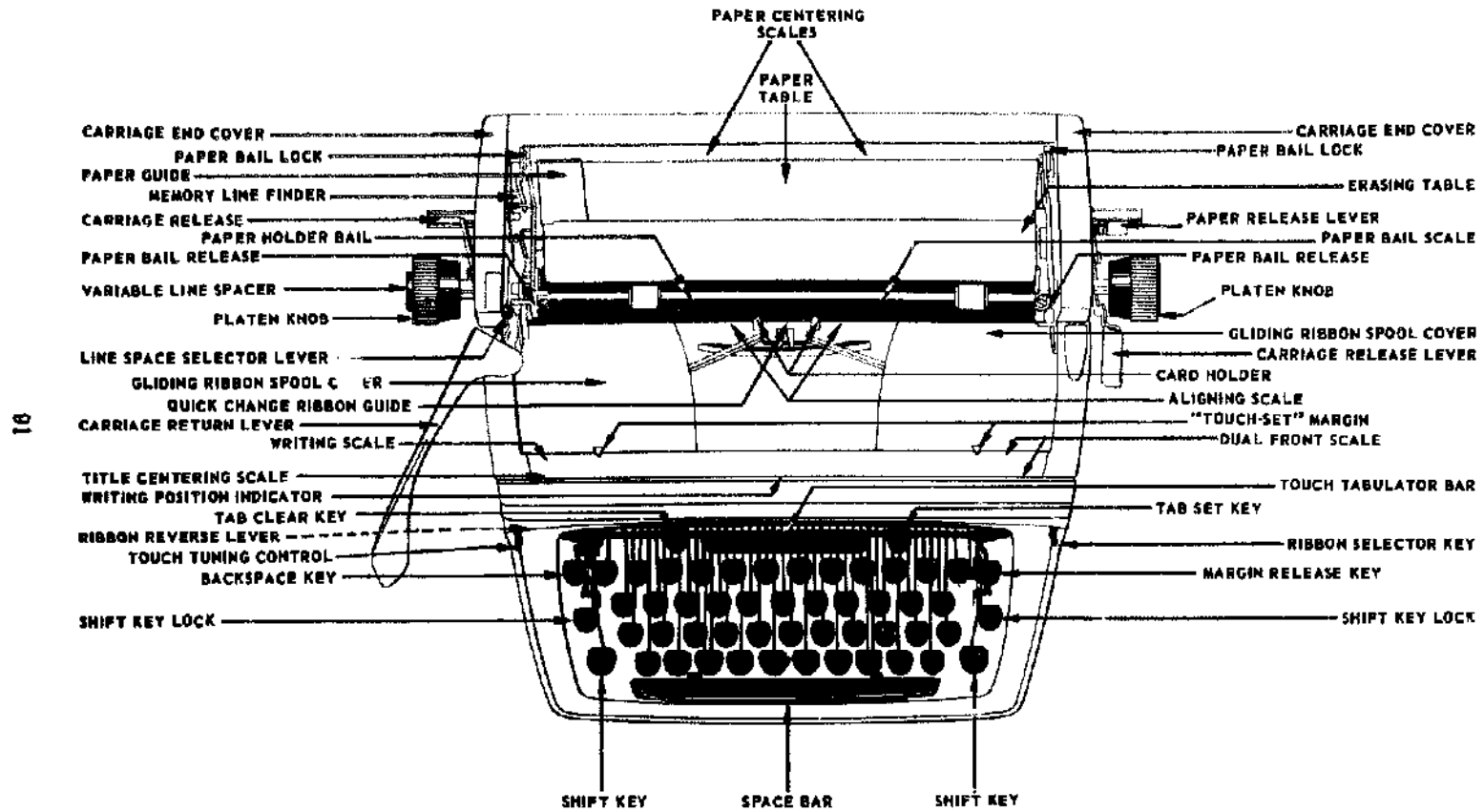

Figure 12-4.—External parts of a standard typewriter.

61.38X

left hand, the operator releases the clutch and can then turn the FREE platen to any desired position, forward or backward, with either hand. The line finder mechanism on a typewriter releases the ratchet detent and enables the operator to return the platen to an established writing line without using the variable mechanism.

ESCAPEMENT MECHANISM

The escapement mechanism (fig. 12-5) is the "heart" of a typewriter. It controls movement of the carriage during typing, allowing it to move a prescribed distance for each actuation of the escapement dogs (illustrated). The escapement is actuated once every time a type key is depressed and released, or once with each actuation of the space bar.

An escapement consists primarily of a wheel (with teeth on its perimeter) which works in conjunction with two holding dogs in a pivoted rocker mechanism. Study the illustration. As the dogs are moved back and forth, the wheel teeth contact the dogs alternately, resulting in the rotation of the wheel in EQUAL movements or steps.

The escapement rocker rocks forward and backward with respect to the front of the typewriter. This rocker contains the loose dog (catch) and the rigid (stationary) dog. As the escapement rocker pivots on a pivot pin and a pivot screw, it disengages the loose dog from an escapement wheel tooth and permits the escapement wheel to rotate. As the loose dog moves

off an escapement wheel tooth, the stationary dog moves between the teeth of the escapement wheel, limiting the rotation of the escapement wheel to the distance from one tooth to another.

When a typewriter is not in use, one tooth of the escapement wheel rests against the LOOSE DOG. Note the position of the loose dog in figure 12-5 (rear view). Tension of the carriage main-spring creates a force on the escapement wheel and overcomes the tension of the loose dog spring and forces the loose dog against a stop. When a key is depressed, or the space bar is depressed, the upper portion of the escapement dog body is rocked to the rear, moving the loose dog out of the path of the wheel tooth. At the same time, the rigid dog is moved into the path of the wheel tooth and the tooth stops against the rigid dog. When the loose dog is disengaged from an escapement wheel tooth, the loose dog spring pulls the loose dog to a position halfway between the next tooth and the one from which it was disengaged.

When the escapement mechanism returns to its normal position, the loose dog engages an escapement wheel tooth and is forced back against the loose dog stop by the pull of the main-spring on the carriage. The escapement is then completely restored and ready for the next cycle.

The sequence of mechanical action which takes place during typing is as follows:

1. When a key is struck (depressed) with sufficient force to type, the ribbon rises to cover the type.

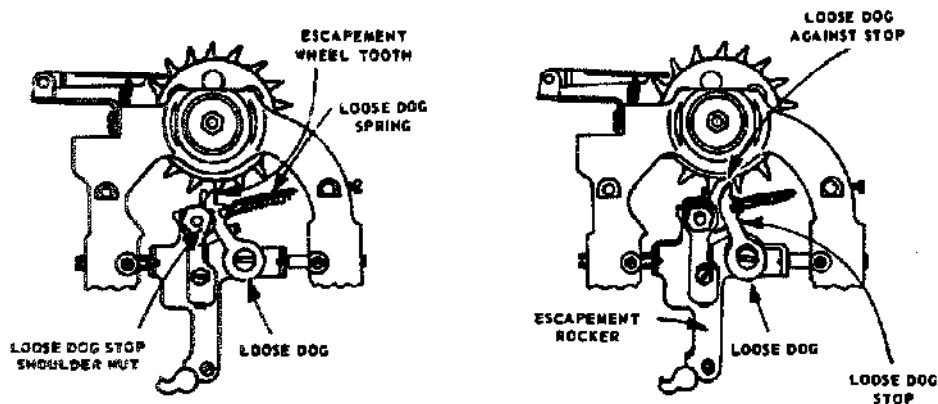

Figure 12-5.—Escapement mechanism.

61.39X

2. The type prints on the paper and the ribbon is advanced 1/2 space by the ribbon feed mechanism.
3. The escapement rocks, allowing the escapement wheel to advance 1/2 space; and the escapement wheel pinion and carriage feed rack allow the carriage to move 1/2 space.
4. The escapement returns to its original position, allowing the carriage to move 1/2 space and the ribbon to advance 1/2 space.

TYPE BAR MECHANISM

The type bar mechanism carries the type bar up to the platen when a key is depressed. The manner in which this mechanism works is illustrated in figure 12-6. When a type key is depressed, it pivots and depresses a spring beneath (key lever tension spring). At the same time, it pulls the bell crank forward and causes it to pivot on the fulcrum wire which passes through its base. A wire link between the bell crank and the type bar then pulls the base of the type bar forward, causing it to pivot on the fulcrum wire and move the type bar into the type guide (fig. 12-6). When the type bar goes into the type guide, the bar pushes the universal bar back, causing the hunter rod to trip the escapement dogs and allow the carriage to move one space. The segment stop ring (fig. 12-6), called the WHIP, prevents the type bar from springing, thus ensuring clear printing on the paper. When the key is released, the key lever tension spring (plus the weight of the type bar) forces the key lever up, returning the type bar action mechanism to its REST position.

While the type bar action mechanism is operating, the key lever and the ribbon universal bar also actuate the ribbon lift mechanism.

RIBBON DRIVE MECHANISM

The function of the ribbon drive mechanism is to move the ribbon from one spool to another in definite increments each time a key or the space bar is depressed, and to raise the ribbon to the line of type. Refer to figure 12-7 as you study how the ribbon drive mechanism works.

When the typewriter carriage moves one space to the left, the escapement wheel (fig. 12-7) rotates the distance of one tooth. A small gear on the escapement wheel shaft meshes with a small gear on the ribbon feed shaft, causing

a sprocket and chain on the other end of the shaft to rotate. The chain which passes over this sprocket drives another sprocket wheel on the right end of the ribbon drive shaft (fig. 12-7). Two idler pulleys guide the drive chain and maintain proper tension on it.

When the drive chain turns the large sprocket wheel on the ribbon drive shaft, a small gear on the drive shaft meshes with a ribbon spool shaft gear (right or left) and drives the ribbon spool shaft. When the ribbon spool shaft revolves, it turns a ribbon spool on top and winds the ribbon in small increments onto it. If the ribbon drive shaft is shifted to the right, automatically or manually, the right drive shaft gear meshes with the right ribbon spool shaft gear and revolves the ribbon spool shaft. When the ribbon drive shaft is shifted to the left, the gear on its left end drives the left ribbon spool shaft and winds the ribbon to the left.

Ribbon Drive Shaft Detent

You can change the direction of a typewriter ribbon by shifting a reverse lever (fig. 12-7) to the right or left. A slot in the lever limits the amount of space the lever may be moved, and a small spring retains it in the position to which it is moved. The rear arm of the reverse lever fits in a notch in the collar on the left end of the ribbon drive shaft, and moves the shaft to the right or left when the ribbon reverse lever is moved.

Ribbon Reverse Mechanism

The function of the ribbon reverse mechanism is to reverse the ribbon automatically from a full ribbon spool to the empty ribbon spool. The action of this mechanism ensures utilization of the ink in the full length of the ribbon and the same degree of brightness of color in every line of type. The ribbon reverse mechanism is illustrated in figure 12-7.

Note the ribbon spool, ribbon reverse trigger, ribbon reverse plunger, and the reversing cam on the ribbon drive shaft.

The end of the ribbon is attached to the ribbon spool by a catch. As long as there is one complete turn of ribbon on the ribbon spool, the ribbon reverse trigger is held in the IN position and the trigger holds up the plunger inside the ribbon spool shaft, so that the lower end of the plunger does not come into contact with the

BASIC MACHINES

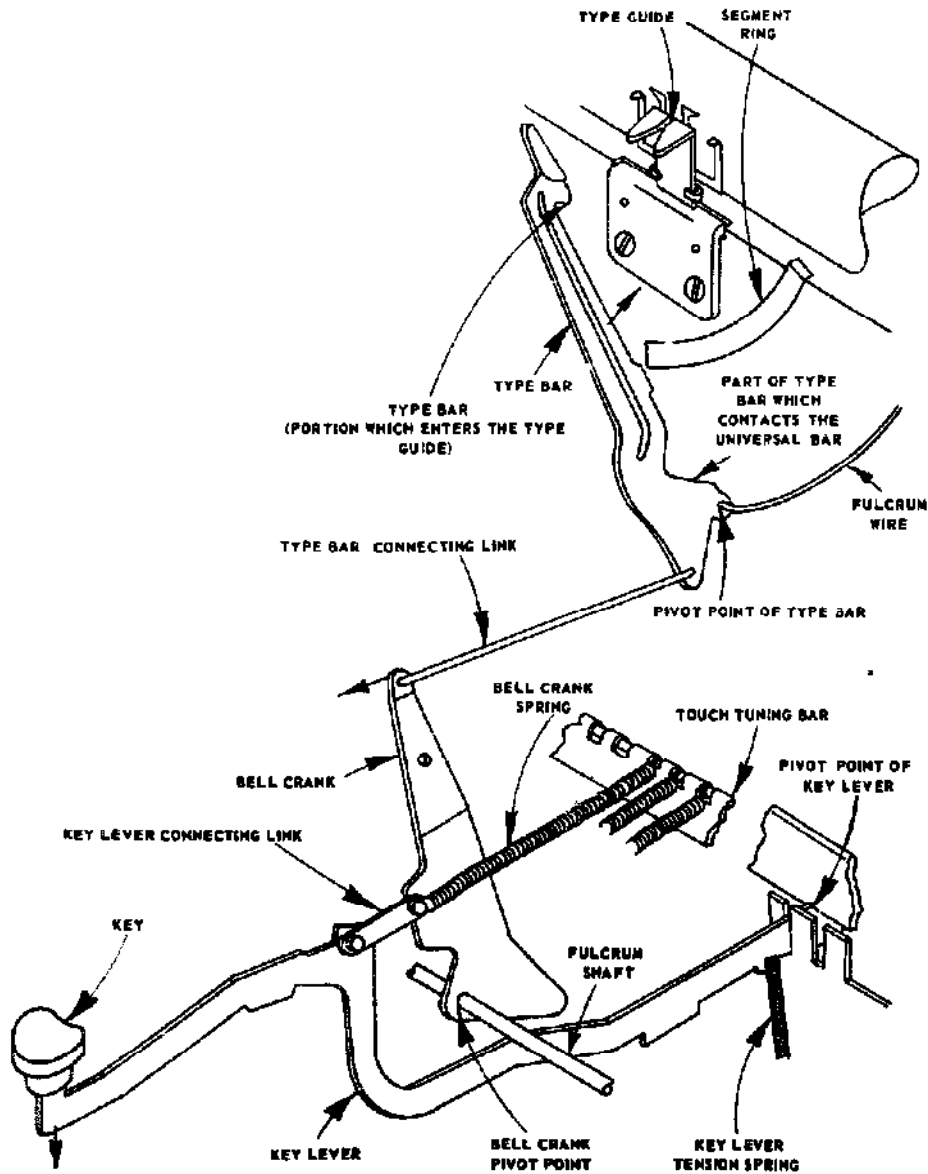

Figure 12-6.—Type bar action mechanism.

61.40K

reversing cam on the ribbon drive shaft as it rotates.

When a ribbon spool starts its last revolution before becoming completely empty, the ribbon reverse trigger which has been holding the ribbon reverse plunger up, moves OUT from the ribbon

spool and releases its hold on the top of the ribbon reverse plunger. As the ribbon reverse plunger drops down, it moves into the path of a reversing cam on the ribbon drive shaft, causing the drive shaft to move laterally, thereby disengaging the drive shaft gear from the ribbon spool

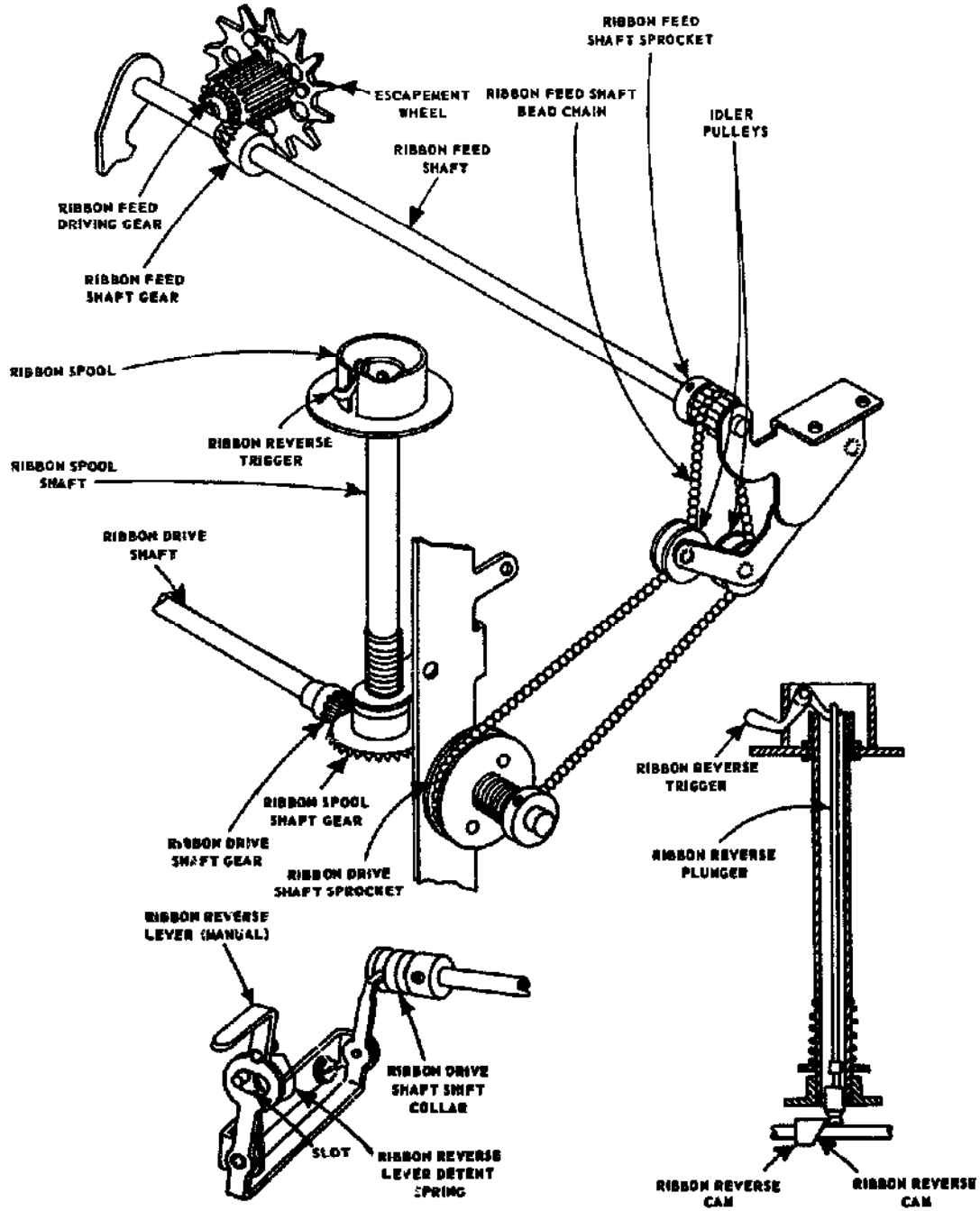

Figure 12-7.—Ribbon feed mechanism.

61.41X

BASIC MACHINES

shaft gear at one end and engaging the drive shaft gear and opposite spool shaft gear at the other end.

As the ribbon starts to wind onto the empty ribbon spool, it pushes the ribbon reverse trigger in, causing the other end of the trigger to engage the slot in the top of the ribbon reverse plunger and raise it above the reversing cam on the ribbon drive shaft.

Ribbon Lift Mechanism

The ribbon lift mechanism lifts the ribbon to a position in which it may be struck by the type when its presence is required, and to let it down when not required (to allow reading of a line that is being typed). Study illustration 12-8 as you follow the description of the operation of this mechanism.

When a type key is depressed, the key lever contacts a prong, immediately beneath, which is connected to the ribbon universal bar (U-bar), causing the U-bar to pivot its top forward. As the U-bar top pivots forward it raises the ribbon guide actuating lever link between the U-bar and the ribbon guide actuating lever. The ribbon guide actuating lever is connected to the ribbon guide (carrier) and raises it when the key is depressed, bringing the ribbon up in position to be struck by the type head. A spring provides tension to restore the ribbon guide actuating lever.

Note that the ribbon guide actuating lever has a horizontal slot in the middle, and the horizontal slot has an indentation in its upper surface. Then note the ribbon guide actuating lever link shift lever connected to the left end of the ribbon-shift shaft. On the right end of the ribbon shift shaft is the ribbon shift detent to which the ribbon bichrome shift lever is connected.

When the ribbon bichrome shift lever is in the BLACK position, the ribbon guide actuating lever link shift lever moves to position the ribbon guide actuating lever link at the front end (black position) of the horizontal slot in the ribbon guide actuating lever. Now, when a key is depressed, the ribbon guide actuating lever moves the ribbon guide in position for the type head to strike the upper (black) portion of the ribbon. If the ribbon bichrome shift lever is moved to the WHITE position (stencil), the ribbon guide actuating lever link shift lever moves the ribbon guide actuating lever link to the center of the horizontal slot in the ribbon guide actuating lever. When type keys are depressed, the ribbon

guide actuating lever link moves up and down in the vertical slot of the ribbon guide actuating lever without moving it, enabling the typist to print characters directly on the stencil because there is no ribbon in front of the type heads. If the ribbon bichrome shift lever is moved to the RED position, the ribbon guide actuating lever link shift lever moves the ribbon guide actuating lever link to the rear end of the slot in the ribbon guide actuating lever. If typing is done with the ribbon guide actuating lever link in this position, the ribbon guide actuating lever carries the ribbon guide high enough for the type heads to strike the lower (red) portion of the ribbon.

Having three positions for setting the ribbon lift mechanism permits efficient use of a standard two-color typewriter ribbon and allows the typist to cut a stencil by merely moving the ribbon bichrome shift lever to the WHITE position.

BACKSPACE MECHANISM

The function of the backspace mechanism is to enable a typist to move the carriage one or more spaces to the right whenever necessary. This mechanism is shown in figure 12-9. When the backspace key lever is depressed, the backspace key lever link causes the bell crank to pivot and transfer the PULL to a horizontal plane. The backspace slide is then moved to the left at the two guide slots shown in the illustration. This action causes a backspacing pawl to engage a tooth on the escapement wheel pinion and turn the pinion clockwise until the pinion pawl on the escapement wheel moves over one tooth on the pinion. Since the carriage rack is engaged with the escapement wheel pinion, the carriage is also moved back one space to the RIGHT.

TABULATOR MECHANISM

The tabulator mechanism of a typewriter enables the typist to move the carriage a definite, predetermined distance by depressing the tabulator bar (fig. 12-10). Refer to this illustration frequently as you study the manner in which the tabulator mechanism works.

If the tabulator stops are set as shown at left-center in figure 12-10 and the tabulator bar is depressed, the tabulator bar frame raises the key set tabulator (KST) stop blade and an arm on the KST stop blade contacts and raises

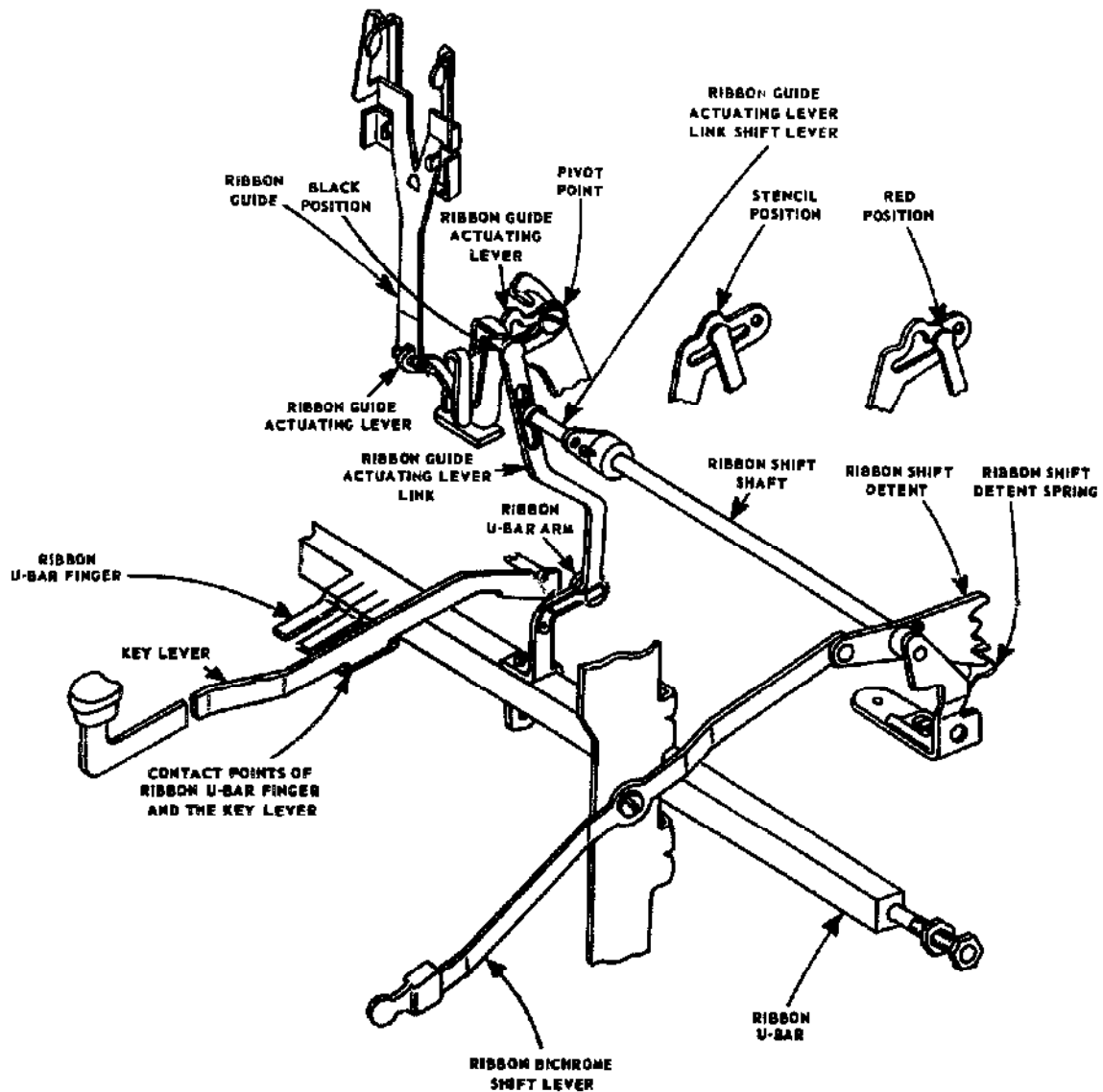

Figure 12-8.—Ribbon lift mechanism.

61.42X

the tabulator lever actuating plate in front of the KST frame, causing the shaft to rotate. A short arm (shaft arm) attached to the end of this shaft moves down and depresses the tabulator lever, which pivots, and a roller on front of the tabulator lever lifts the carriage feed

rack out of mesh with the escapement wheel pinion, allowing the carriage to move to the left.

By the time the carriage feed rack is raised out of mesh with the pinion, the KST stop blade has moved up into the path of a set tabulator stop, as shown in figure 12-10 (left-center).

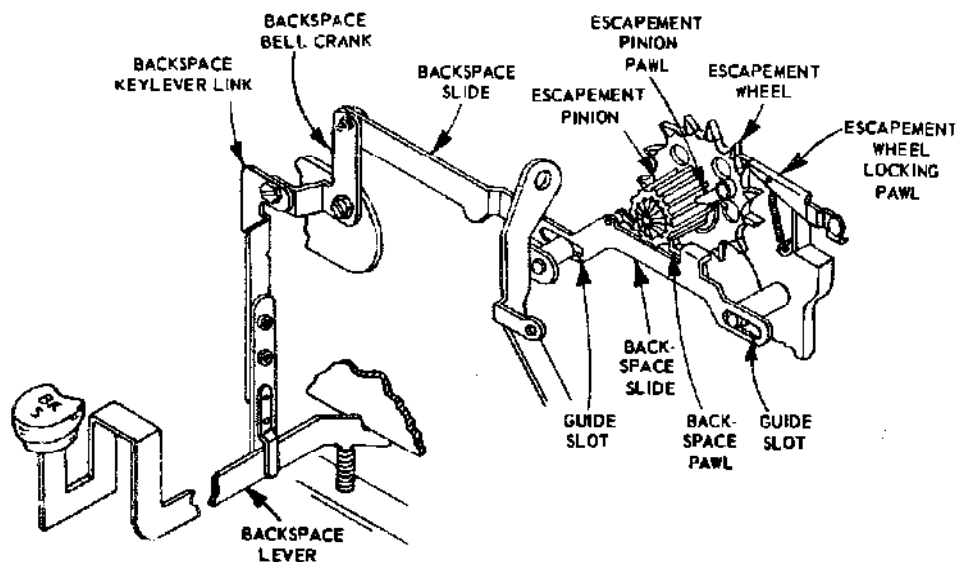

Figure 12-9.—Back spacer mechanism.

61.43X

The stop prevents the carriage from moving beyond this point.

The escapement wheel locking pawl, in conjunction with the escapement dogs, prevents the escapement wheel from moving out of position while the feed rack is disengaged. When the tabulator lever actuating plate in front of the KST frame is raised, a yielding device on the left end of the shaft moves against the spring drum brake arm and presses the brakeshoes against the side of the spring drum with enough force to regulate the speed of the carriage.

Tabulator Stop Setting Mechanism

The tabulator stop mechanism stops the carriage at the desired position. When the SET key is depressed with the carriage in any desired position, the key lever raises the stop setting link (lower link), shown in figure 12-11, moving the stop setting link (upper link) down against the stop immediately beneath it, and moves the stop to its lower or SET position. The stop remains in this position until it is cleared.

Tabulator Stop Clearing Mechanism

The tabulator stop clearing mechanism enables you to clear a set tabulator stop by

depressing the TAB-CLEAR key. To clear individual stops, tabulate to the stop which is to be cleared and depress the tab-clear key. The key lever then raises the clearing plunger, which contacts the bottom of the stop and raises it to the cleared or UP position.

To clear all stops which are set, move the carriage to the extreme left. Then depress the TAB-CLEAR key and hold it down while you move the carriage to the extreme right. The bottoms of the tabulator stops contact the beveled portion of the clearing plunger, which raises them to the top of the plunger.

SHIFT MECHANISM

The function of the shift mechanism (fig. 12-12) is to raise and lower the segment and type bars so that the typist may be able to type the upper and lower case characters on the type heads on a common line. When you depress a SHIFT key, the shift mechanism moves the segment and type bars to the DOWN position. By depressing a shift key LOCK next to the shift key, you can retain the segment and type bars in the down position as long as desired. The shift key lock lever is a simple, spring-loaded catch. When the lock is released, the segment returns to the rest position.

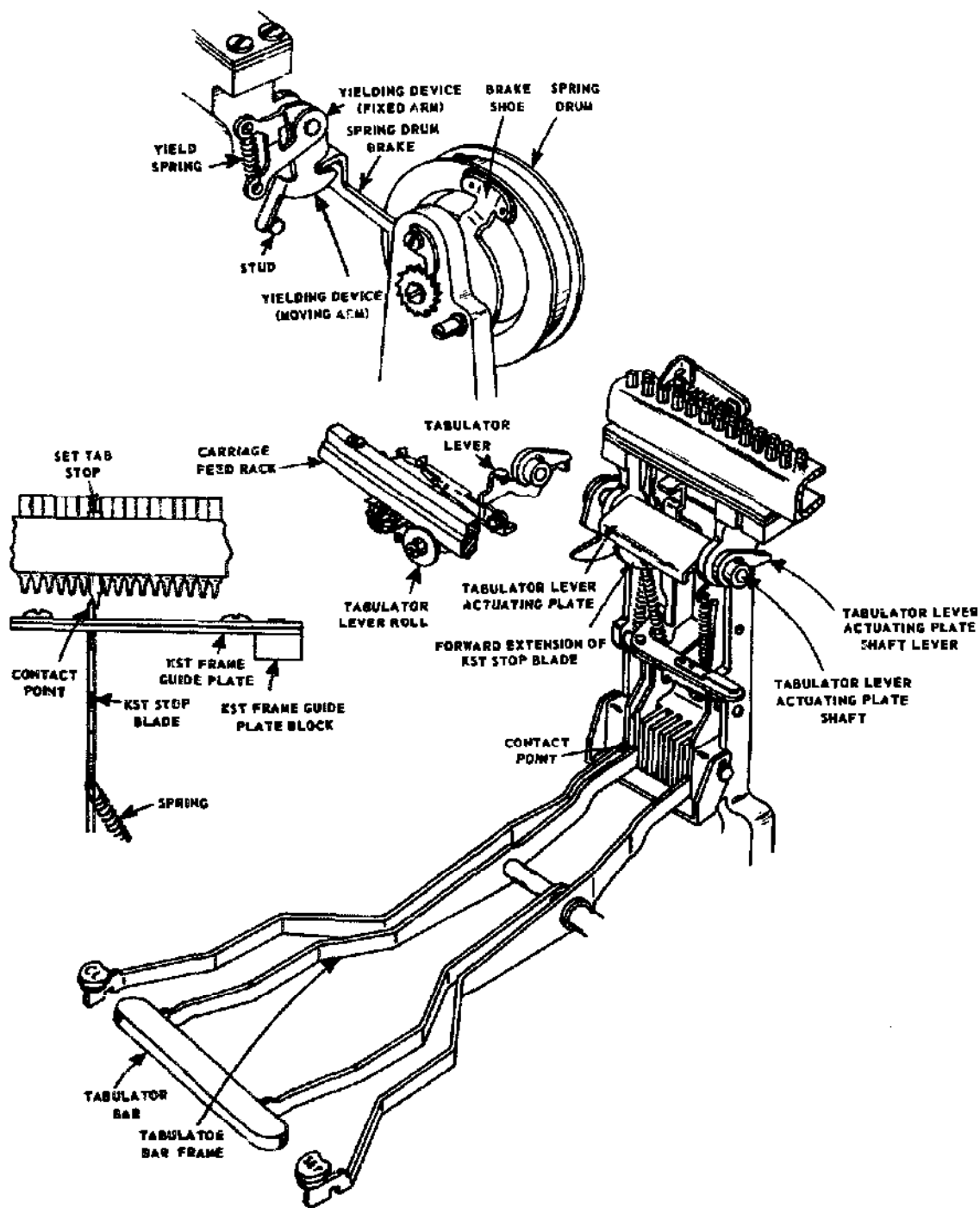

Figure 12-10.—Tabulator mechanism.

61.44X

BASIC MACHINES

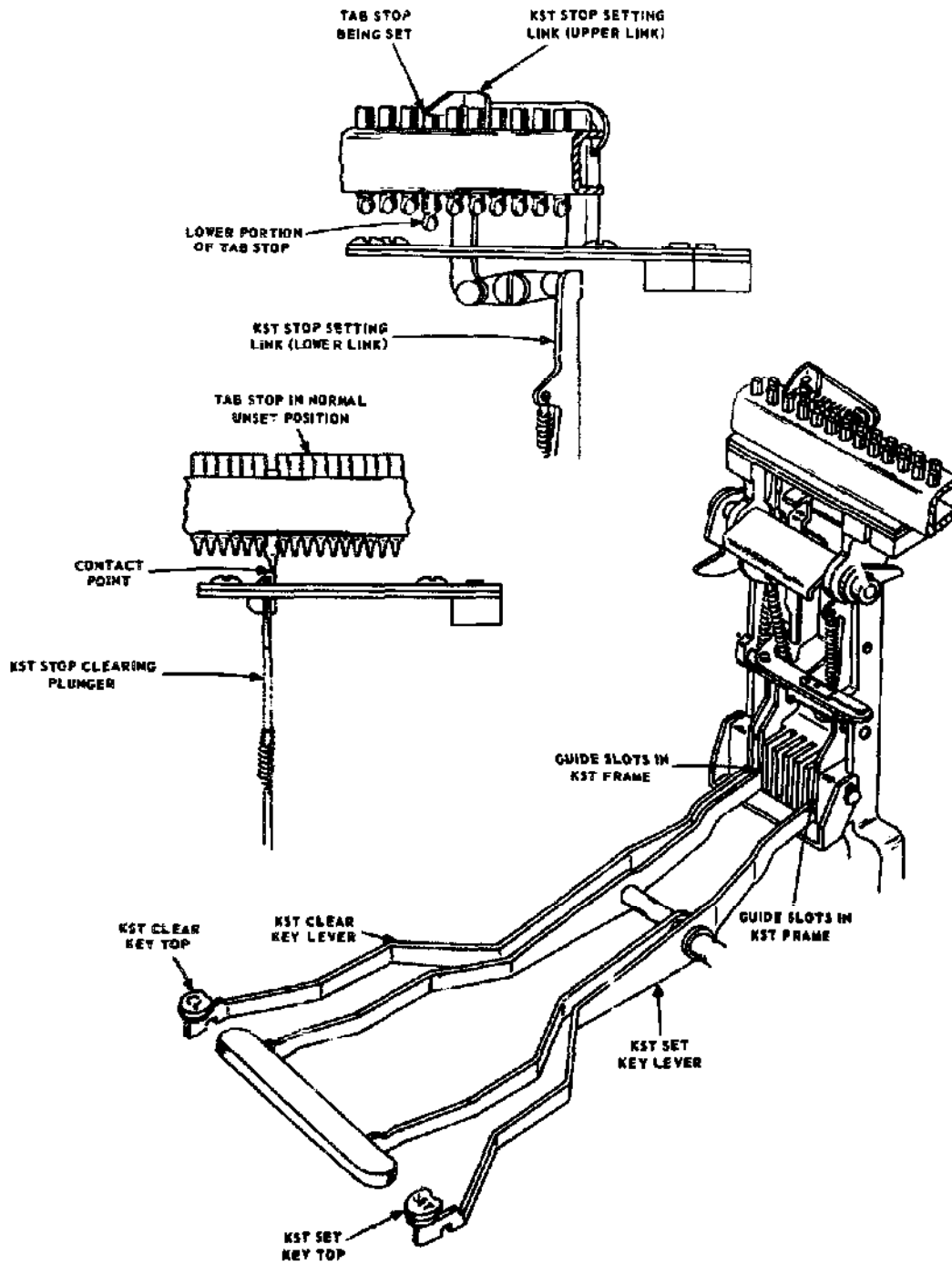
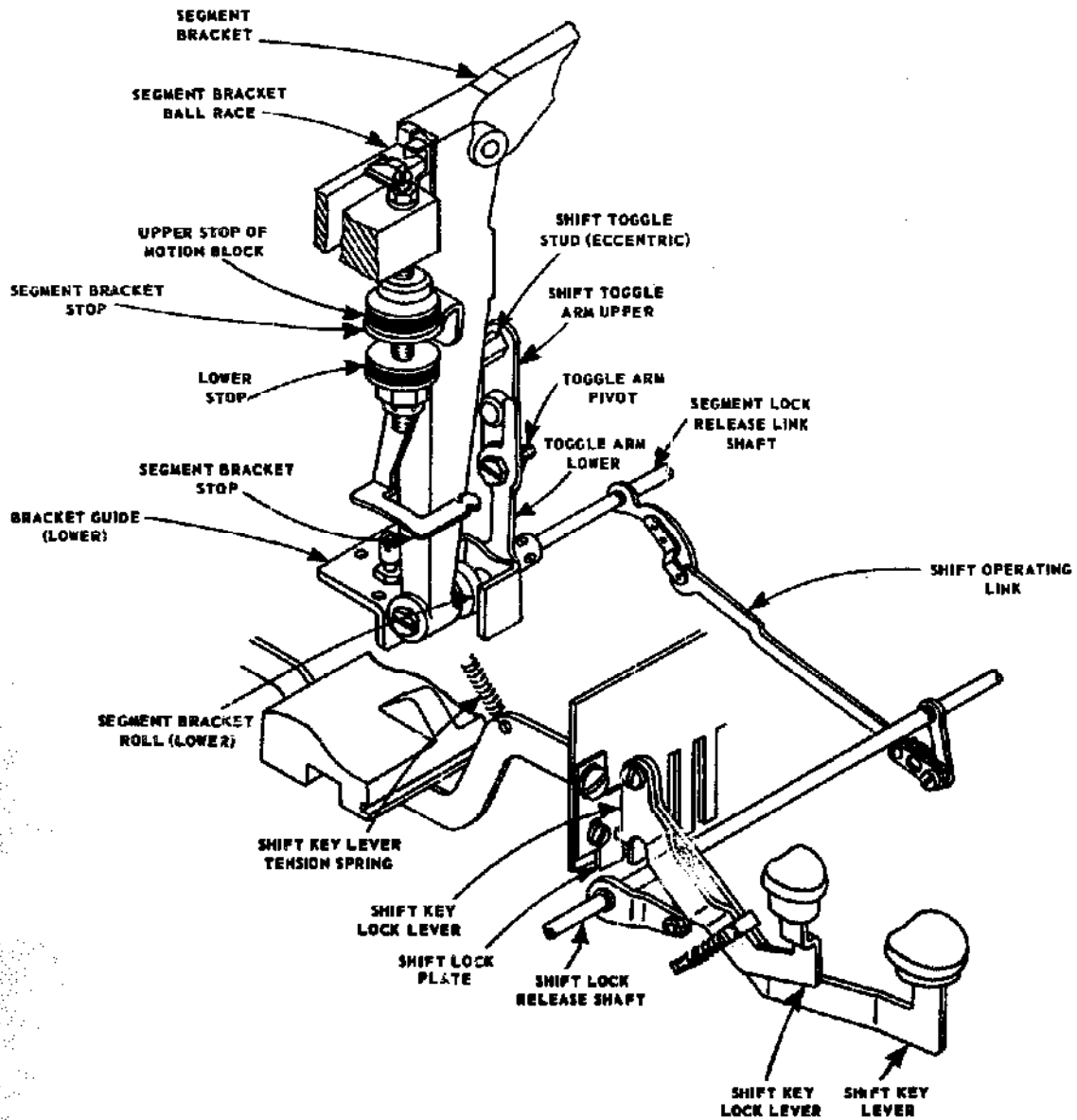

Figure 12-11.—Tabulator stop setting mechanism.

61.45X



61.46X

Figure 12-12.—Shift mechanism.

Depressing the shift key rotates the shift lock release shaft through a connecting link and an arm secured to the shaft. The shift lock release shaft, through the shift operating link, turns the segment lock release link shaft (illustrated). The

lower toggle arm is secured to the segment lock release link shaft and the upper toggle arm at the toggle arm pivot (fig. 12-12). The upper toggle arm is connected to an adjustment eccentric (shift toggle stud). As the lower toggle arm

BASIC MACHINES

pivots forward, the lock is released and the action of the lower and upper toggle arms pulls the segment bracket (carrying the segment and type bars) down until the upper stop rests against the lower stop.

When a shift key lever, right or left, is released, a spring raises the shift key lever. This reverse action helps to restore the entire mechanism, but the power required to raise the segment bracket is supplied by two springs, one right and one left, which are connected between the segment bracket and the ribbon spool shaft brackets.

When the segment bracket is in the extreme upper position and the key shift lever is up, the lower toggle arm moves slightly over center toward the rear of the machine, locking the segment bracket in the upper position, thus preventing it from bouncing and causing irregular printing on the line.

BELL RINGER MECHANISM

The bell ringer mechanism rings a bell to indicate that the carriage is approaching the tabular stop set for the right margin. Refer to figure 12-13 as you study this mechanism.

As the typewriter carriage moves to the left, the bell trip pawl on the right margin stop moves the bell hammer lever and the hammer away from the bell. When the bell trip pawl moves past the cam portion of the bell hammer lever, the bell

hammer lever is released, allowing the hammer to strike the bell under spring tension.

LINE LOCK MECHANISM

The margin stops arrest the movement of the carriage to the right or left. The line lock, actuated by the margin stop, locks the universal bar to prevent type keys from overtyping on the last letter when the carriage is stopped. The line lock lever also locks the escapement in position to prevent operation of the space bar while the line is locked, and to prevent overspacing when the margin release key is depressed.

When the carriage moves to the left, the margin stop contacts the margin release rod arm (center). See figure 12-14. As the margin release rod moves to the left, the margin release rod arm (right) on its right extremity contacts the line lock actuating lever and moves it to the left. The line lock actuating lever then pivots at the pivot point (fig. 12-14) and pulls the line lock lever comb link connected to the link lock lever to the right, causing the line lock lever to position itself behind the bunter plate and around the bunter rod.

If a key is depressed when the line lock mechanism is in this position, the type bar is prevented from making an impression on the paper by the universal bar bunter plate being stopped by the link lock lever adjusting screw. Because the

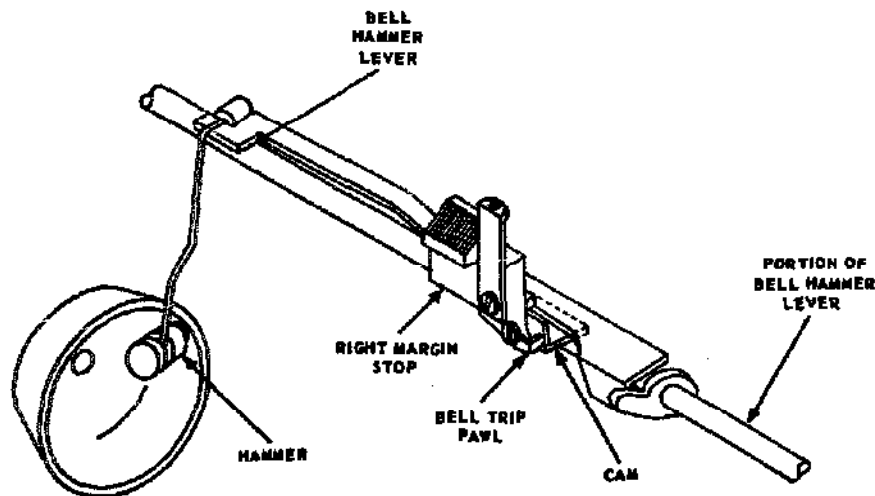

Figure 12-13.—Bell ringer mechanism.

61.47X

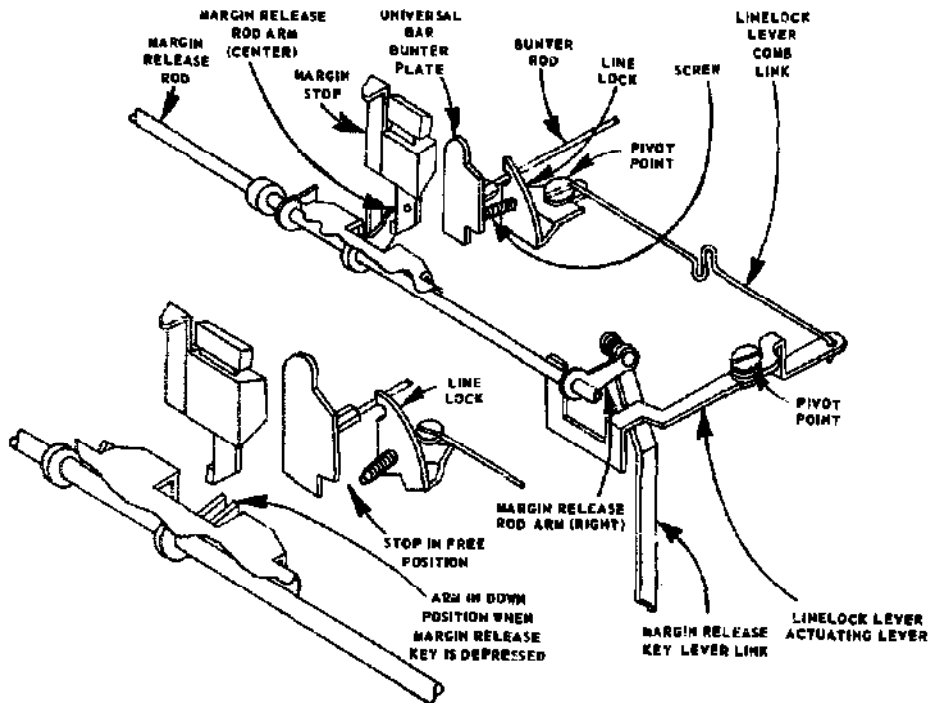

Figure 12-14.—Line lock mechanism.

61.48X

U-bar cannot move the bunter rod rearwards, this action also prevents the escapement from tripping. If the space bar is depressed with the line lock mechanism in this position, the line lock lever prevents actuation of the escapement by its contact with the bunter rod.

With the link lock mechanism in the position just explained, no more typing can be done on this line until the MARGIN-RELEASE key is depressed, causing the margin release rod to rotate and move the margin release rod arm fastened to it down below the margin stop. Study the illustration. The margin release rod then moves to the right and allows the line lock lever actuating lever to move to the right under spring tension, freeing the line lock lever from the bunter rod and the U-bar bunter plate.

LINE SPACE MECHANISM

A typewriter line space mechanism ensures the same amount of space between lines of type when the adjuster is set for a definite distance.

The manner in which this mechanism works is illustrated in figure 12-15.

There are three positions to which the line space adjuster of a typewriter may be set. The action of the line space pawl on the platen ratchet for all three positions is shown in figure 12-15. Study it carefully. The ratchet wheel in the illustration has 30 teeth (6 lines per inch).

When the line space lever is moved to the RIGHT, the line space pawl contacts a tooth on the platen ratchet and moves it rearwards the amount of space set (position 1, 2, or 3). After the ratchet is moved back to one of the three positions, a detent roller (fig. 12-15) which is engaged with the platen ratchet holds it in place.

PINION STOP SLIDE MECHANISM

The purpose of the pinion stop slide mechanism is to prevent overbanking at the left margin when the carriage is returned with excessive force or speed, and also to prevent underbanking when it is returned with little force. The pinion

BASIC MACHINES

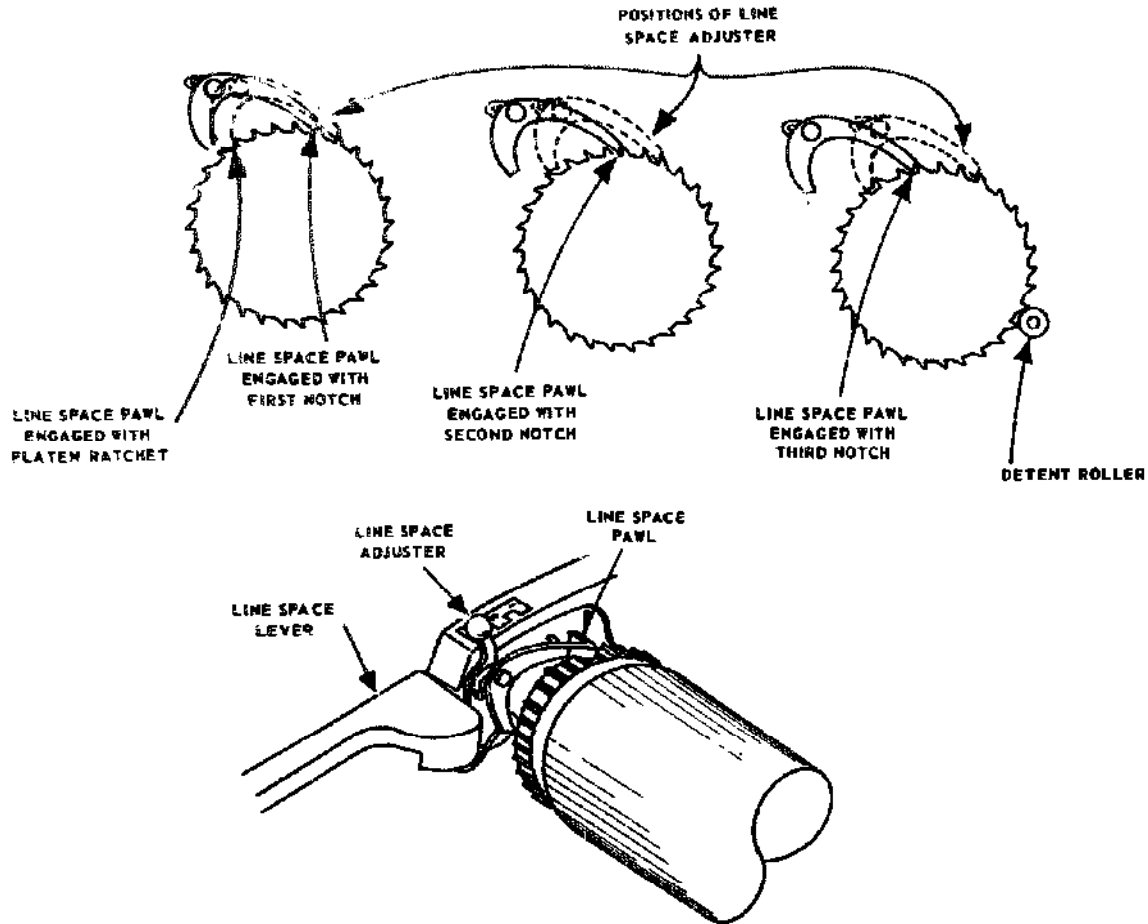

Figure 12-15.—Line space mechanism.

61.49X

stop slide (fig. 12-16) maintains the pinion in a fixed position as the carriage is banked. Any yielding of the carriage as a result of excessive force or speed when it banks is compensated for by the spring-loaded carriage feed rack.

As the carriage moves through the last space just before banking, the left margin stop contacts the pinion stop slide actuating slide and moves it to the right until it contacts and stops against the margin release rod arm. By means of the pinion stop slide intermediate lever, the pinion stop slide is moved to the left and the edge of the lip moves into the teeth of the escapement wheel pinion and prevents the pinion from turning. If

the carriage yields enough to equal one space, the yielding device and yield spring on the carriage feed rack (fig. 12-10) yields and allows the rack to remain at a correctly fixed relation with the pinion while the carriage continues until its momentum is expended.

SUMMARY

The operation of complex machines will be much easier for you to understand if you will keep in mind the following points:

A complex machine is nothing more than a combination of two or more simple machines.

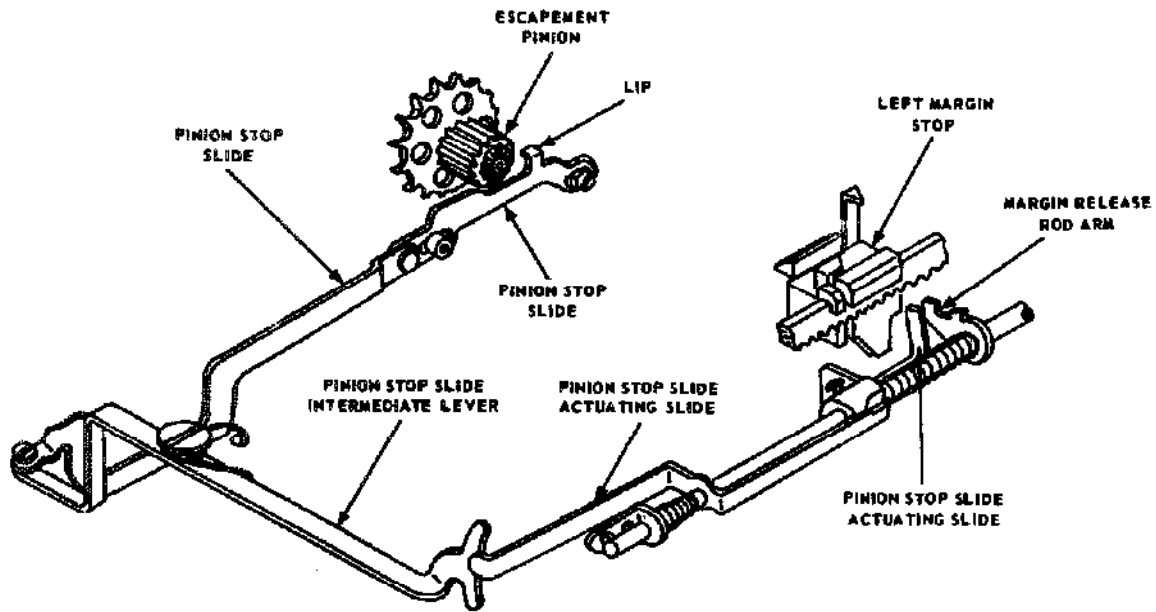

Figure 12-16.—Pinion stop slide mechanism.

61.50X

You can figure out how a complex machine works if you understand the operation of the simple machines from which it is made. Look first for the point where energy is applied, and follow the action through step-by-step—carefully determining the DIRECTION and MAGNITUDE of movement at each step.

The mechanical advantage of a complex machine is equal to the PRODUCT of the mechanical advantage of each simple machine from which it is made.

When a machine gives a mechanical advantage of MORE THAN ONE, it multiplies the FORCE of the applied energy. When it gives a mechanical advantage of LESS THAN ONE, it multiplies both the DISTANCE and the SPEED of the applied movement.

More examples of complex machines will be given in the following chapters of this book. None of them should be too difficult for you to understand if you analyze each of them carefully by the methods described in the foregoing.

CHAPTER 13

INTERNAL COMBUSTION ENGINE

The automobile is a familiar object to all of us; and the engine that makes it go is one of the most fascinating and talked about of all the complex machines we use today. In this chapter we will explain briefly some of the operational principles of this machine, and then break it down to its more basic mechanisms. In its makeup you will find many of the devices and basic mechanisms that you have studied earlier in this book. Look for these and the simple machines that make up the engine as you study its operation and construction.

COMBUSTION ENGINE

An engine is defined simply as a machine that converts heat energy to mechanical energy. To fulfill this purpose, the engine may take one of several forms.

Combustion is the act of burning. Internal means inside or enclosed. Thus an internal combustion engine is one in which the fuel burns inside; that is, burning takes place within the same cylinder that produces energy to turn the crankshaft. In external combustion engines, such as steam engines, the combustion takes place outside the engine. Figure 13-1 shows, in simplified form, an external and an internal combustion engine.

The external combustion engine requires a boiler to which heat is applied. This combustion causes water to boil to produce steam. The steam passes into the engine cylinder under pressure and forces the piston to move downward. With the internal combustion engine, the combustion takes place inside the cylinder and is directly responsible for forcing the piston to move downward.

The transformation of heat energy to mechanical energy by the engine is based on a fundamental law of physics which states that gas will expand upon application of heat. The law

also states that when a gas is compressed the temperature of the gas will increase. If the gas is confined with no outlet for expansion, then the pressure of the gas will be increased when heat is applied (as it is in an automotive cylinder). In an engine, this pressure acts against the head of a piston, causing it to move downward.

As you know, the piston moves up and down in the cylinder. The up-and-down motion is known as reciprocating motion. This reciprocating motion (straight line motion) must be changed to rotary motion (turning motion) in order to turn the wheels of a vehicle. A crank and a connecting rod change this reciprocating motion to rotary motion.

All internal combustion engines, whether gasoline or diesel, are basically the same. We can best demonstrate this by saying they all rely on three things—air, fuel, and ignition.

Fuel contains potential energy for operating the engine; air contains the oxygen necessary for combustion; and ignition starts combustion. All are fundamental, and the engine will not operate without any one of them. Any discussion of engines must be based on these three factors and the steps and mechanisms involved in delivering them to the combustion chamber at the proper time.

DEVELOPMENT OF POWER

The power of an internal combustion engine comes from the burning of a mixture of fuel and air in a small, enclosed space. When this mixture burns it expands greatly, and the push or pressure created is used to move the piston, thereby cranking the engine. This movement is eventually sent back to the wheels to drive the vehicle.

Since similar action occurs in all cylinders of an engine, let's use one cylinder in our development of power. The one-cylinder engine

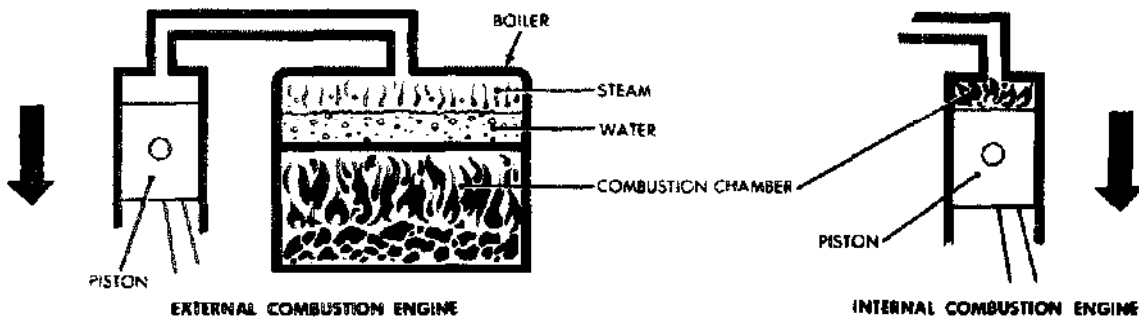

81.41

Figure 13-1.—Simple external and internal combustion engine.

consists of four basic parts as shown in figure 13-2.

First we must have a cylinder which is closed at one end; this cylinder is similar to a tall metal can.

Inside the cylinder is the piston, a movable metal plug, which fits snugly into the cylinder,

but can still slide up and down easily. This up-and-down movement, produced by the burning of fuel in the cylinder, results in the production of power from the engine.

You have already learned that the up-and-down movement is called reciprocating motion. This motion must be changed to rotary motion

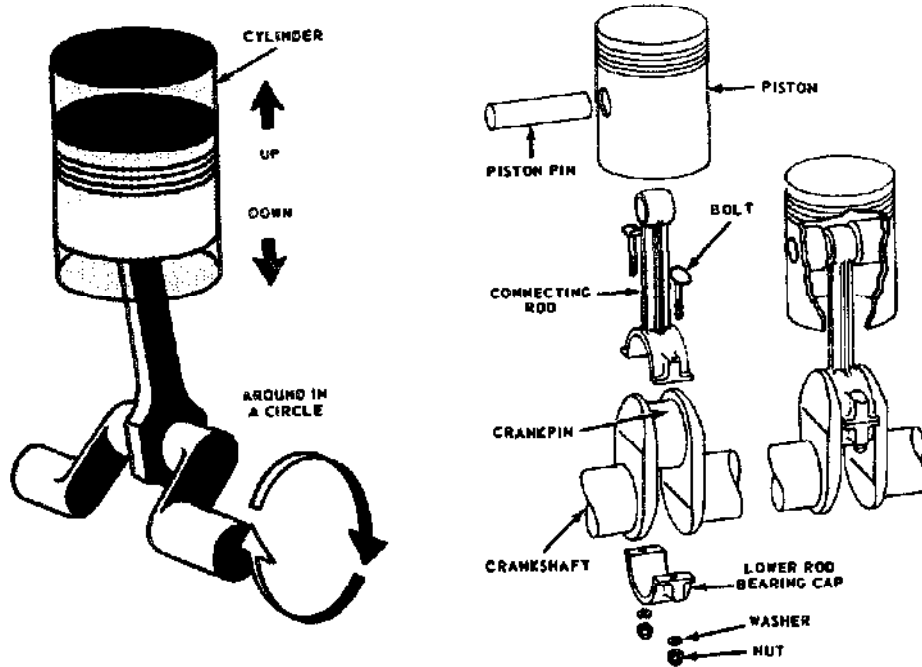

85.95

Figure 13-2.—Cylinder, piston, connecting rod, and crankshaft for a one-cylinder engine.

so the wheels or tracks of vehicles can be made to rotate. This change is accomplished by a crank on the crankshaft and a connecting rod which connects between the piston and the crank.

The crankshaft is a shaft with an offset portion, the crank, which describes a circle as the shaft rotates. The top end of the connecting rod is connected to the piston and must therefore go up and down. The lower end of the connecting rod is attached to the crankshaft. The lower end of the connecting rod also moves up and down but, because it is attached to the crankshaft, it must also move in a circle with the crank.

When the piston of the engine slides downward because of the pressure of the expanding gases in the cylinder, the upper end of the connecting rod moves downward with the piston, in a straight line. The lower end of the connecting rod moves down and in a circular motion at the same time. This moves the crank and in turn the crank rotates the shaft; this rotation is the desired result. So remember, the crankshaft and connecting rod combination is a mechanism for the purpose of changing straightline, up-and-down motion to circular, or rotary motion.

BASIC ENGINE STROKES

Each movement of the piston from top to bottom or from bottom to top is called a stroke. The piston takes two strokes (an upstroke and a downstroke) as the crankshaft makes one complete revolution. When the piston is at the top of a stroke, it is said to be at top dead center (TDC). When the piston is at the bottom of a stroke, it is said to be at bottom dead center (BDC). These positions are called rock positions and will be discussed further in this chapter under "Timing." See figure 13-3 and figure 13-7.

The basic engine you have studied so far has had no provisions for getting the fuel-air mixture into the cylinder or burned gases out of the cylinder. There are two openings in the enclosed end of a cylinder. One of the openings, or ports, permits the mixture of air and fuel to enter and the other port permits the burned gases to escape from the cylinder. The two ports have valves assembled in them. These valves, actuated by the camshaft, close off either one or the other of the ports, or both of them, during various stages of engine operation. One of the valves, called the intake valve, opens to admit a mixture of fuel and air into the cylinder.

The other valve, called the exhaust valve, opens to allow the escape of burned gases after the fuel-and-air mixture has burned. Later on you will learn more about how these valves and their mechanisms operate.

The following paragraphs give a simplified explanation of the action that takes place within the engine cylinder. This action may be divided into four parts: the intake stroke, the compression stroke, the power stroke, and the exhaust stroke. Since these strokes are easy to identify in the operation of a four-cycle engine, that engine is used in the description. This type of engine is also called a four-stroke-Otto-cycle engine, because it was Dr. N.A. Otto who, in 1876, first applied the principle of this engine.

INTAKE STROKE

The first stroke in the sequence is called the intake stroke (fig. 13-4). During this stroke, the piston is moving downward and the intake valve is open. This downward movement of the piston produces a partial vacuum in the cylinder, and air and fuel rush into the cylinder past the open intake valve. This is somewhat the same effect as when you drink through a straw. A partial vacuum is produced in the mouth and the liquid moves up through the straw to fill the vacuum.

COMPRESSION STROKE

When the piston reaches bottom dead center at the end of the intake stroke and is therefore at the bottom of the cylinder, the intake valve closes. This seals the upper end of the cylinder. As the crankshaft continues to rotate, it pushes up, through the connecting rod, on the piston. The piston is therefore pushed upward and compresses the combustible mixture in the cylinder; this is called the compression stroke (fig. 13-4). In gasoline engines, the mixture is compressed to about one-eighth of its original volume. (In a diesel engine the mixture may be compressed to as little as one-sixteenth of its original volume.) This compression of the air-fuel mixture increases the pressure within the cylinder. Compressing the mixture in this way makes it still more combustible; not only does the pressure in the cylinder go up, but the temperature of the mixture also increases.

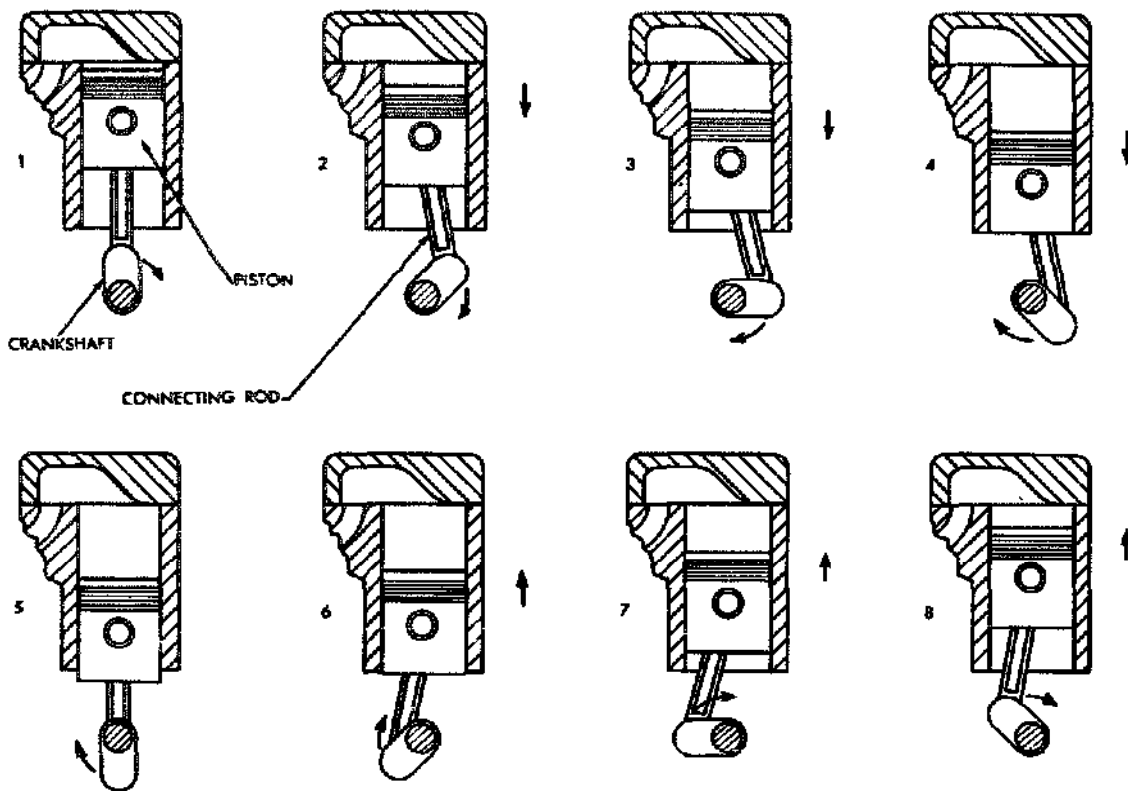

81.42
 Figure 13-3.—Relationship of piston, connecting rod, and crank on crankshaft as crankshaft turns one revolution.

POWER STROKE

As the piston reaches top dead center at the end of the compression stroke and therefore has moved to the top of the cylinder, the compressed fuel-air mixture is ignited. The ignition system causes an electric spark to occur suddenly in the cylinder, and the spark sets fire to the fuel-air mixture. In burning, the mixture gets very hot and tries to expand in all directions. The pressure rises to about 600 or 700 pounds per square inch. Since the piston is the only thing that can move, the force produced by the expanding gases forces the piston down. This force, or thrust, is carried through the connecting rod to the crankpin on the crankshaft. The crankshaft is given a powerful twist. This is called the power stroke (fig. 13-4). This turning effort, rapidly repeated in the engine and carried through gears and shafts, will turn

the wheels of a vehicle and cause it to move along the highway.

EXHAUST STROKE

After the fuel-air mixture has burned, it must be cleared from the cylinder. This is done by opening the exhaust valve just as the power stroke is finished and the piston starts back up on the exhaust stroke (fig. 13-4). The piston forces the burned gases out of the cylinder past the open exhaust valve. The four strokes (intake, compression, power, and exhaust) are continuously repeated as the engine runs.

ENGINE CYCLES

Now, with the basic knowledge you have of the parts and the four strokes of the engine, let

BASIC MACHINES

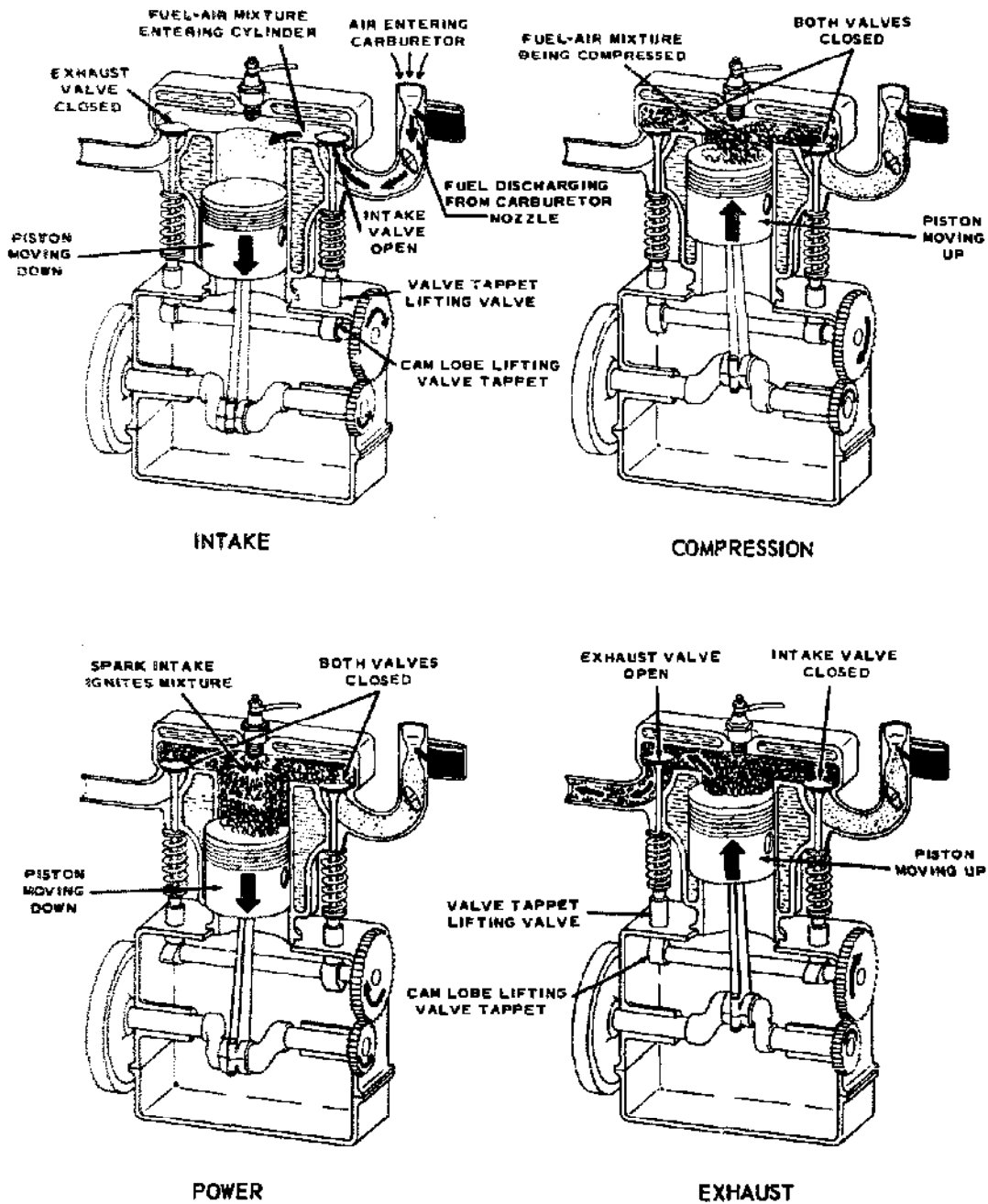

Figure 13-4.—Four-stroke cycle in a gasoline engine.

54.19

us see what happens during the actual running of the engine. To produce sustained power, an engine must accomplish a definite series of operations over and over again. All you have to do is follow one series of events—intake, compression, power, and exhaust—until they repeat themselves. This one series of events is called a cycle.

Most engines of today are called four-cycle engines. What is meant is four-stroke-cycle, but our habit of abbreviating has eliminated the middle word. Just the same, when you see four-cycle it means there are four strokes of the piston, two up and two down, to each cycle. Then it starts over again on another cycle of the same four strokes.

TWO-CYCLE ENGINE

In the two-cycle engine, the entire cycle of events (intake, compression, power, and exhaust) takes place in two piston strokes.

A two-cycle engine is shown in figure 13-5. Every other stroke in this engine is a power stroke. Each time the piston moves down it is on the power stroke. Intake, compression, power, and exhaust still take place, but they are completed in just two strokes. In figure 13-5 the intake and exhaust ports are cut into the cylinder wall instead of being placed at the top of the combustion chamber as in the four-cycle engine. As the piston moves down on its power stroke, it first uncovers the exhaust port to let

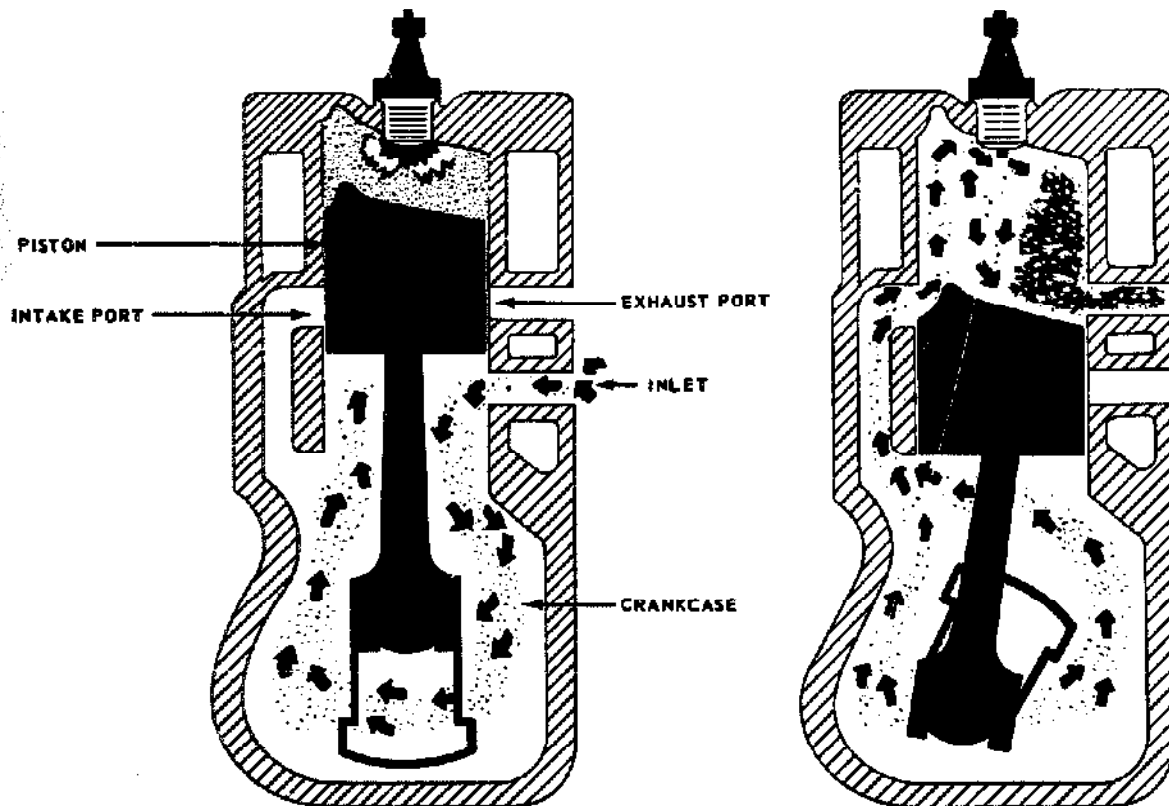

Figure 13-5.—Events in a two-cycle, internal combustion engine.

54.20

burned gases escape and then uncovers the intake port to allow a new fuel-air mixture to enter the combustion chamber. Then, on the upward stroke, the piston covers both ports and, at the same time, compresses the new mixture in preparation for ignition and another power stroke.

In the engine shown in figure 13-5 the piston is shaped so that the incoming fuel-air mixture is directed upward, thereby sweeping out ahead of it the burned exhaust gases. Also, there is an inlet into the crankcase through which the fuel-air mixture passes before it enters the cylinder. This inlet is opened as the piston moves upward, but it is sealed off as the piston moves downward on the power stroke. The downward moving piston slightly compresses the mixture in the crankcase, thus giving the mixture enough pressure to pass rapidly through the intake port as the piston clears this port. This improves the sweeping-out, or scavenging, effect of the mixture as it enters and clears the burned gases from the cylinder through the exhaust port.

FOUR-CYCLE vs TWO-CYCLE ENGINES

You have probably noted that the two-cycle engine produces a power stroke every crankshaft revolution; the four-cycle engine requires two crankshaft revolutions for each power stroke. It might appear then that the two-cycle could produce twice as much power as the four-cycle of the same size, operating at the same speed. However, this is not true. With the two-cycle engine some of the power is used to drive the blower that forces the air-fuel charge into the cylinder under pressure. Also, the burned gases are not completely cleared from the cylinder. Additionally, because of the much shorter period the intake port is open (as compared to the period the intake valve in a four-stroke-cycle is open), a relatively smaller amount of fuel-air mixture is admitted. Hence, with less fuel-air mixture, less power per power stroke is produced as compared to the power produced in a four-stroke cycle engine of like size operating at the same speed and with other conditions being the same. To increase the amount of fuel-air mixture, auxiliary devices are used with the two-stroke engine to ensure delivery of greater amounts of fuel-air mixture into the cylinder.

MULTIPLE-CYLINDER ENGINES

The discussion so far in this chapter has concerned a single-cylinder engine. A single cylinder provides only one power impulse every two crankshaft revolutions in a four-cycle engine and is delivering power only one-fourth of the time. To provide for a more continuous flow of power, modern engines use four, six, eight, or more cylinders. The same series of cycles take place in each cylinder.

In a four-stroke cycle six-cylinder engine, for example, the cranks on the crankshaft are set 120 degrees apart, the cranks for cylinders 1 and 6, 2 and 5, and 3 and 4 being in line with each other (fig. 13-6). The cylinders fire or deliver the power strokes in the following order: 1-5-3-6-2-4. Thus the power strokes follow each other so closely that there is a fairly continuous and even delivery of power to the crankshaft.

TIMING

In a gasoline engine, the valves must open and close at the proper times with regard to piston position and stroke. In addition, the ignition system must produce the sparks at the proper time so that the power strokes can start. Both valve and ignition system action must be properly timed if good engine performance is to be obtained.

Valve timing refers to the exact times in the engine cycle at which the valves trap the mixture and then allow the burned gases to escape. The valves must open and close so that they are constantly in step with the piston movement of the cylinder which they control. The position of the valves is determined by the camshaft; the position of the piston is determined by the crankshaft. Correct valve timing is obtained by providing the proper relationship between the camshaft and the crankshaft.

When the piston is at TDC the crankshaft can move 15° to 20° without causing the piston to move up and down any noticeable distance. This is one of the two rock positions (fig. 13-7). When the piston moves up on the exhaust stroke, considerable momentum is given to the exhaust gases as they pass out through the exhaust valve port, but if the exhaust valve closes at TDC, a small amount of the gases will be trapped and will dilute the incoming fuel-air mixture when the intake valves open. Since the piston has

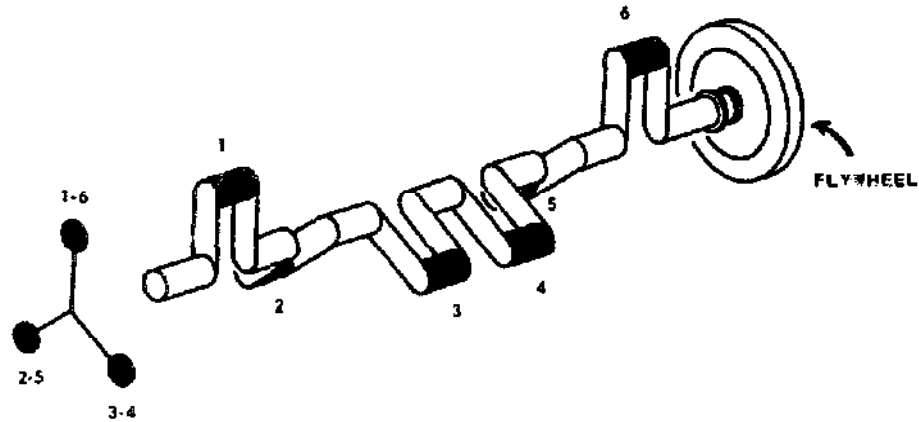

Figure 13-6.—Crankshaft for a six-cylinder engine.

81.42

little downward movement while in the rock position, the exhaust valve can remain open during this period and thereby permit a more complete scavenging of the exhaust gases.

Ignition timing refers to the timing of the spark at the spark plug gap with relation to the piston position during the compression and power strokes. The ignition system is timed so that the spark occurs before the piston reaches TDC on the compression stroke. This gives the mixture enough time to ignite and start burning. If this time were not provided, that is, if the spark occurred at or after TDC, then the pressure increase would not keep pace with the piston movement.

At higher speeds, there is still less time for the fuel-air mixture to ignite and burn. In order to compensate for this, and thereby avoid power loss, the ignition system includes an advance mechanism that functions on speed.

CLASSIFICATION OF ENGINES

Engines for automotive and construction equipment may be classified in a number of ways: type of fuel used; type of cooling employed; or valve and cylinder arrangement. They all operate on the internal combustion principle, and the application of basic principles of construction to particular needs or systems

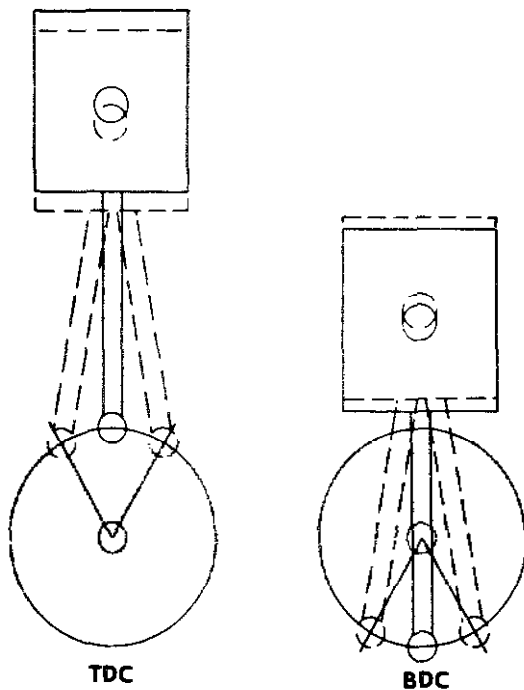

Figure 13-7.—Rock position.

81.45

BASIC MACHINES

of manufacture has caused certain designs to be recognized as conventional.

The most common method of classification is by the type of fuel used; that is, whether the engine burns gasoline or diesel fuel.

GASOLINE ENGINES VS DIESEL ENGINES

Mechanically and in overall appearance, gasoline and diesel engines resemble one another. However, in the diesel engine, many parts are somewhat heavier and stronger, so that they can withstand the higher temperatures and pressures the engine generates. The engines differ also in the fuel used, in the method of introducing it into the cylinders, and in how the air-fuel mixture is ignited. In the gasoline engine, air and fuel first are mixed together in the carburetor. After this mixture is compressed in the cylinders, it is ignited by an electrical spark from the spark plugs. The source of the energy producing the electrical spark may be a storage battery or a high-tension magneto.

The diesel engine has no carburetor. Air alone enters its cylinders, where it is compressed and reaches high temperature due to compression. The heat of compression ignites the fuel injected into the cylinder and causes the fuel-air mixture to burn. The diesel engine needs no spark plugs; the very contact of the diesel fuel with the hot air in the cylinders causes ignition. In the gasoline engine the heat from compression is not enough to ignite the air-fuel mixture, therefore spark plugs are necessary.

ARRANGEMENT OF CYLINDERS

Engines are classified also according to the arrangement of the cylinders: inline, with all cylinders cast in a straight line above the crankshaft, as in most trucks; and V-type with two banks of cylinders mounted in a "V" shape above the crankshaft, as in many passenger vehicles. Another not-so-common arrangement is the horizontally opposed engine whose cylinders are mounted in two side rows, each opposite a central crankshaft. Buses often are equipped with this type of engine.

The cylinders are numbered. The cylinder nearest the front of an in-line engine is No. 1. The others are numbered 2, 3, 4, etc., from

front to rear. In V-type engines the numbering sequence varies with the manufacturer.

The firing order (which is different from the numbering order) of the cylinders is usually stamped on the cylinder block or on the manufacturer's nameplate.

VALVE ARRANGEMENT

The majority of internal combustion engines also are classified according to the position and arrangement of the intake and exhaust valves—that is, whether the valves are in the cylinder block or in the cylinder head. Various arrangements have been used, but the most common are L-head, I-head, and F-head (fig. 13-8). The letter designation is used because the shape of the combustion chamber resembles the form of the letter identifying it.

L-Head

In the L-head engines both valves are placed in the block on the same side of the cylinder. The valve-operating mechanism is located directly below the valves, and one camshaft actuates both the intake and exhaust valves.

I-Head

Engines using the I-head construction are commonly called valve-in-head or over-head valve engines, because the valves are mounted in a cylinder head above the cylinder. This arrangement requires a tappet, a push rod, and a rocker arm above the cylinder to reverse the direction of valve movement, but only one camshaft is required for both valves. Some over-head valve engines make use of an overhead camshaft. This arrangement eliminates the long linkage between the camshaft and valve.

F-Head

In the F-head engine, the intake valves normally are located in the head, while the exhaust valves are located in the engine block. This arrangement combines, in effect, the L-head and the I-head valve arrangements. The valves in the head are actuated from the camshaft through tappets, push rods, and rocker arms (I-head arrangement), while the valves in the block are actuated directly from the camshaft by tappets (L-head arrangement).

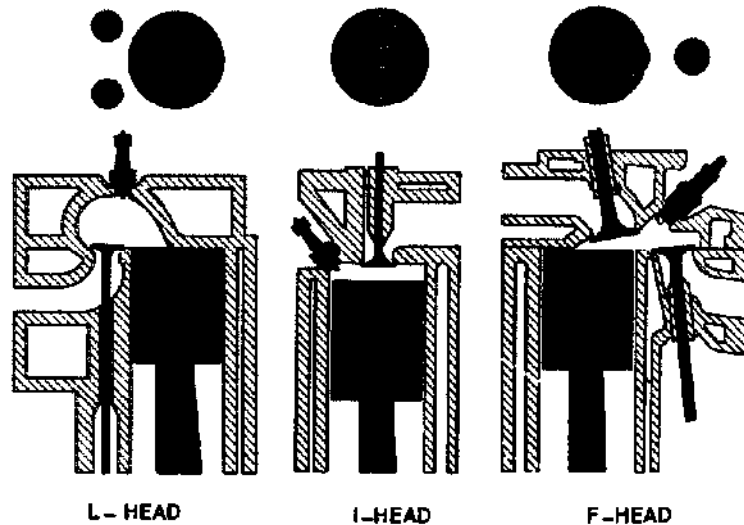

Figure 13-8.—L-, I-, and F-valve arrangement.

81.46

ENGINE CONSTRUCTION

Basic engine construction varies little, regardless of size and design of the engine. The intended use of an engine must be considered before the design and size can be determined. The temperature at which an engine will operate has a great deal to do with determining what metals must be used in its construction.

To simplify the service parts problem in the field, and also to simplify servicing procedures, the present trend in engine construction and design is toward what is called engine families. There must, of necessity, be many different kinds of engines because there are many kinds of jobs to be done. However, the service and service parts problem can be simplified by designing engines so that they are closely related in cylinder size, valve arrangement, etc. As an example, the GM series 71 engines can be obtained in 2, 3, 4, and 6 cylinders; but they are so designed that the same pistons, connecting rods, bearings, valve operating mechanisms and valves can be used in all 4 engines.

Engine construction, in this chapter, will be broken down into two categories: stationary parts and moving parts.

STATIONARY PARTS

The stationary parts of an engine include the cylinder block, cylinders, cylinder head or heads, crankcase, and the exhaust and intake manifolds. These parts furnish the framework of the engine. All movable parts are attached to or fitted into this framework.

Engine Cylinder Block

The engine cylinder block is the basic frame of a liquid-cooled engine, whether it be in-line, horizontally-opposed, or V-type. The cylinder block and crankcase are often cast in one piece which is the heaviest single piece of metal in the engine. (See fig. 13-9). In small engines, where weight is an important consideration, the crankcase may be cast separately. In most large diesel engines, such as those used in power plants, the crankcase is cast separately and is attached to a heavy stationary engine base.

In practically all automotive and construction equipment, however, the cylinder block and crankcase are cast in one piece. In this course we are concerned primarily with liquid-cooled engines, of this type.

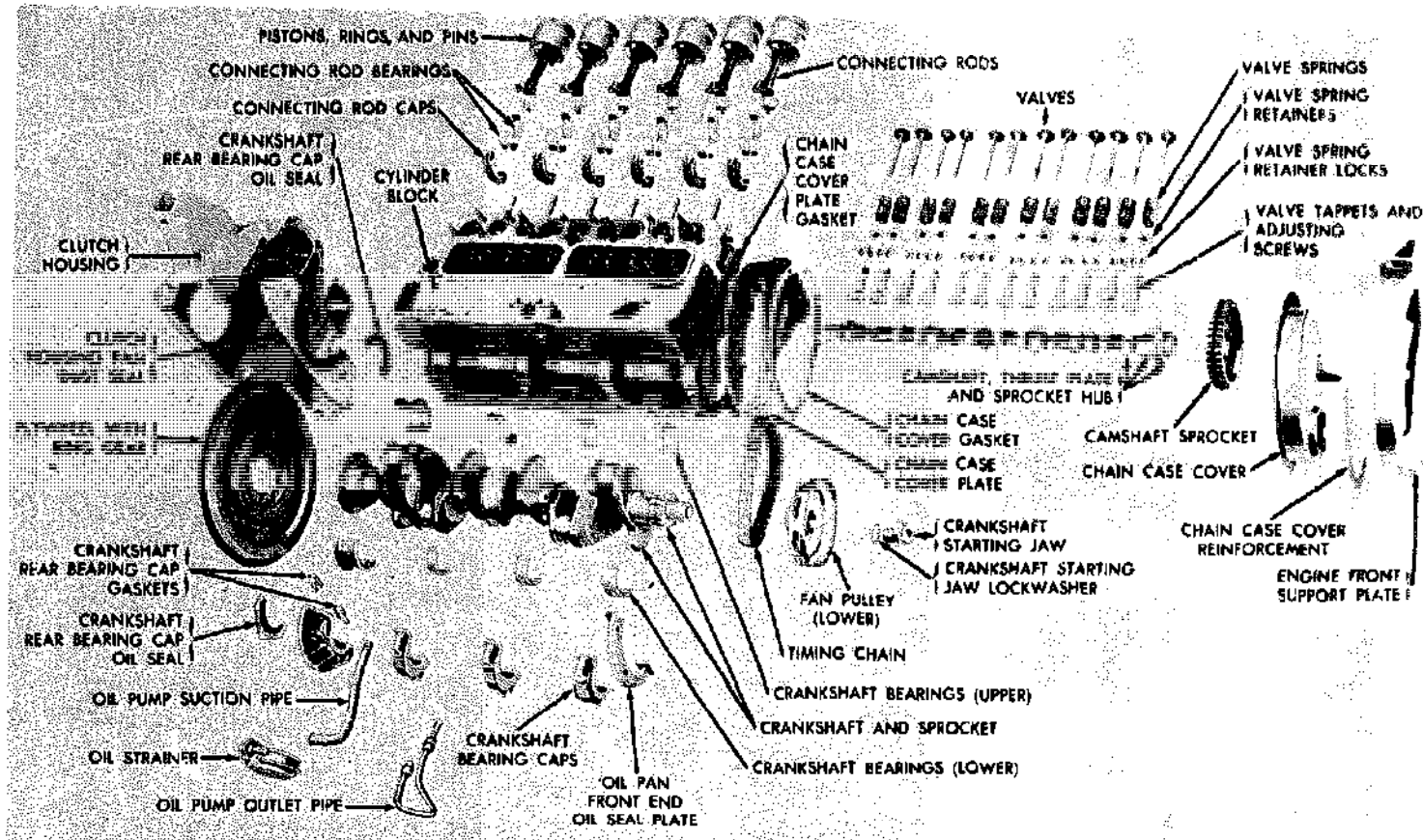

Figure 13-9.—Cylinder block and components.

The cylinders of a liquid-cooled engine are surrounded by jackets through which the cooling liquid circulates. These jackets are cast integrally with the cylinder block. Communicating passages permit the coolant to circulate around the cylinders and through the head.

The air-cooled engine cylinder differs from that of a liquid-cooled engine in that the cylinders are made individually, rather than cast in block. The cylinders of air-cooled engines have closely spaced fins surrounding the barrel; these fins provide a greatly increased surface area from which heat can be dissipated. This is in contrast to the liquid-cooled engine, which has a water jacket around its cylinders.

Cylinder Block Construction

The cylinder block is cast from gray iron or iron alloyed with other metals such as nickel, chromium, or molybdenum. Some light weight engine blocks are made from aluminum.

Cylinders are machined by grinding, and/or boring, to give them the desired true inner surface. During normal engine operation, cylinder walls will wear out-of-round, or they may become cracked and scored if not properly lubricated or cooled. Liners (sleeves) made of metal alloys resistant to wear, are used in many gasoline engines and practically all diesel engines to lessen wear. After they have been worn beyond the maximum oversize, the liners can be replaced individually permitting the use of standard pistons and rings. Thus you can avoid replacing the entire cylinder block.

The liners are inserted into a hole in the block with either a PRESS FIT or a SLIP FIT. Liners are further designated as WET TYPE or DRY TYPE. The wet type line comes in direct contact with the coolant and is sealed at the top by the use of a metallic sealing ring and at the bottom by a rubber sealing ring; the dry type liner does not contact the coolant.

Engine blocks for L-head engines contain the passageways for the valves and valve ports. The lower part of the block (crankcase) supports the crankshaft (with main bearings and bearing caps) and also provides a place for fastening the oil pan.

The camshaft is supported in the cylinder block by bushings that fit into machined holes in the block. On L-head in-line engines, the intake and exhaust manifolds are attached to the side of the cylinder block. On L-head V-8 engines, the intake manifold is located between the two banks

of cylinders. In this engine, there are two exhaust manifolds, one on the outside of each bank.

Cylinder Head

The cylinder head provides the combustion chambers for the engine cylinders. It is built to conform to the arrangement of the valves: L-head, I-head, or other.

In the water-cooled engine the cylinder head (fig. 13-10) is bolted to the top of the cylinder block to close the upper end of the cylinders. It contains passages, matching those of the cylinder block, which allow the cooling water to circulate in the head. The head also helps retain compression in the cylinders. In the gasoline engine there are tapped holes in the cylinder head which lead into the combustion chamber. The spark plugs are inserted into these tapped holes.

In the diesel engine the cylinder head may be cast in a single unit, or may be cast for a single cylinder or two or more cylinders. Separated head sections (usually covering 1, 2, or 3 cylinders in large engines) are easy to handle and can be readily removed.

The L-head type of cylinder head shown in figure 13-10 is a comparatively simple casting. It contains water jackets for cooling, and openings for spark plugs. Pockets into which the valves operate are also provided. Each pocket serves as a part of the combustion chamber. The fuel-air mixture is compressed in the pocket as the piston reaches the end of the compression stroke. Note that the pockets have a rather complex curved surface. This shape has been carefully designed so that the fuel-air mixture, in being compressed, will be subjected to violent turbulence. This turbulence assures uniform mixing of the fuel and air, thus improving the combustion process.

The I-head (overhead-valve) type of cylinder head contains not only water jackets for cooling spark-plug openings, and valve and combustion-chamber pockets, but it also contains and supports the valves and valve-operating mechanisms. In this type of cylinder head, the water jackets must be large enough to cool not only the top of the combustion chamber but also the valve seats, valves, and valve-operating mechanisms.

Crankcase

The crankcase is that part of the engine block below the cylinders. It supports and encloses the

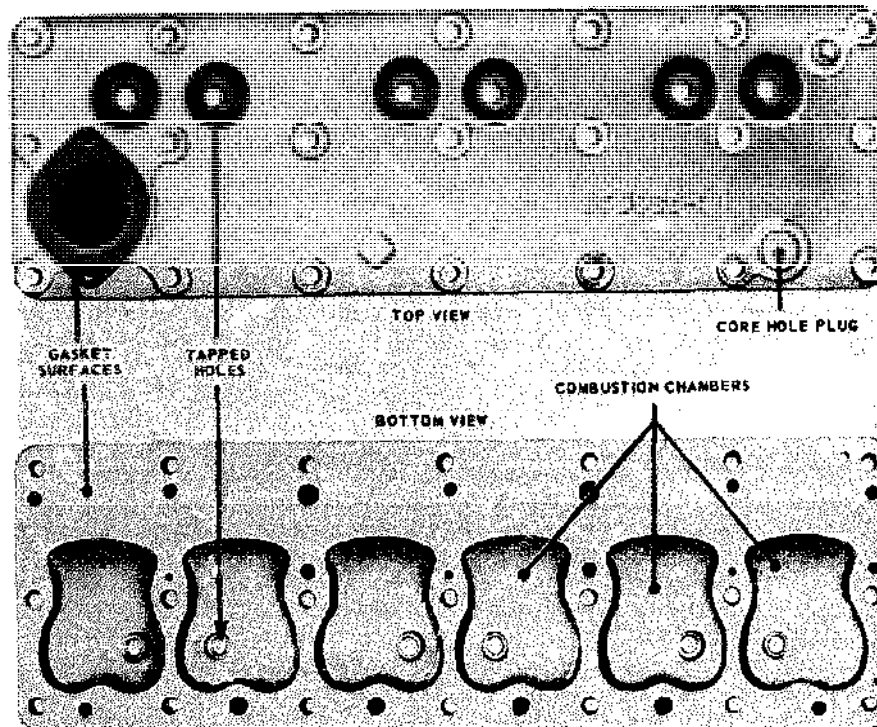

Figure 13-10.--Cylinder head for L-head engine.

81.50

crankshaft and provides a reservoir for the lubricating oil. Oftentimes there are places provided on the crankcase for the mounting of the oil pump, oil filter, starting motor, and the generator. The lower part of the crankcase is the OIL PAN, which is bolted at the bottom. The oil pan is made of pressed or cast steel and holds from 4 to 9 quarts of oil, depending on the engine design.

The crankcase also has mounting brackets which support the entire engine on the vehicle frame. These brackets are either an integral part of the crankcase or are bolted to it in such a way that they support the engine at 3 or 4 points. These points of contact usually are cushioned with rubber, which insulates the frame and body of the vehicle from engine vibration and therefore prevents damage to the engine supports and the transmission.

Exhaust Manifold

The exhaust manifold is essentially a tube that carries waste products of combustion from the cylinders. On L-head engines the exhaust manifold is bolted to the side of the engine block; on overhead-valve engines it is bolted to the side of the engine cylinder head. Exhaust manifolds may be single iron castings or may be cast in sections. They have a smooth interior surface with no abrupt changes in size. (See fig. 13-11.)

Intake Manifold

The intake manifold on a gasoline engine carries the fuel-air mixture from the carburetor and distributes it as evenly as possible to the cylinders. On a diesel engine the manifold carries only air to the cylinders. The intake

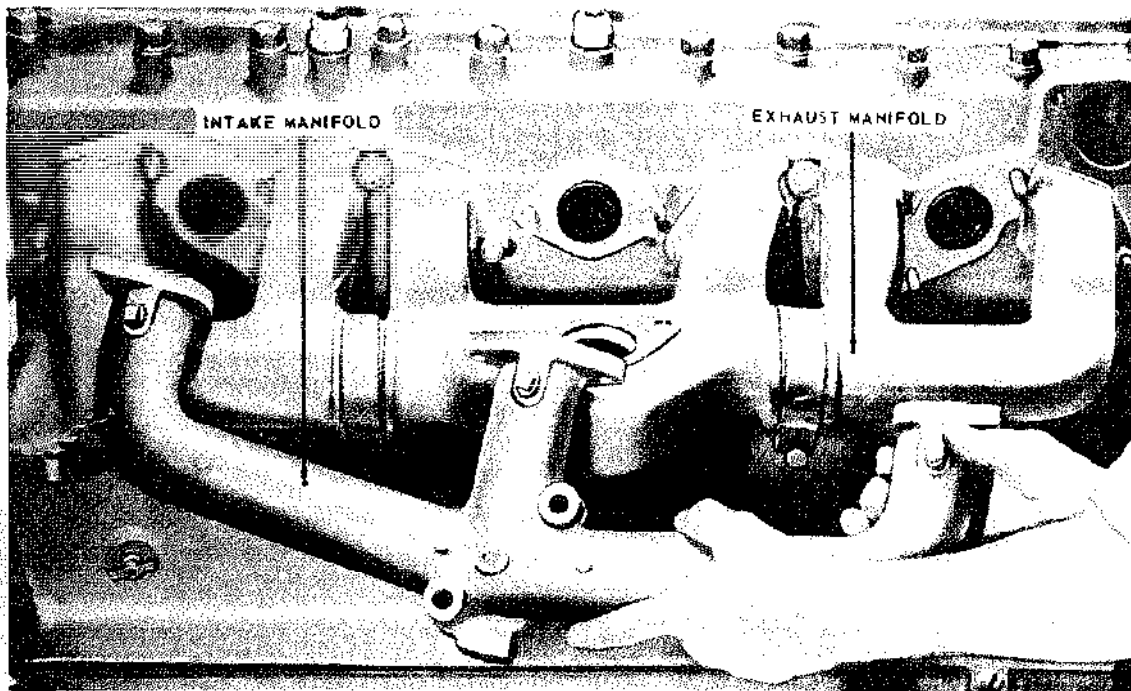

Figure 13-11.—Intake and exhaust manifolds.

65.93

manifold is attached to the block on L-head engines and to the side of the cylinder head on overhead-valve engines. (See fig. 13-11.)

In gasoline engines, smooth and efficient engine performance depends largely on whether or not the fuel-air mixtures that enter each cylinder are uniform in strength, quality, and degree of vaporization. The inside walls of the manifold must be smooth to offer little obstruction to the flow of the fuel-air mixture. The manifold is designed to prevent collecting of fuel at the bends in the manifold.

The intake manifold should be as short and straight as possible to reduce the chances of condensation between the carburetor and cylinders. To assist in vaporization of fuel, some intake manifolds are constructed so that part of their surfaces can be heated by hot exhaust gases.

Gaskets

The principal stationary parts of an engine have just been explained. The gaskets (fig. 13-12)

that serve as seals between these parts in assembly, require as much attention during assembly as any other part. It is impractical to machine all surfaces so that they fit together to form a perfect seal. The gaskets make a joint that is air, water, or oil tight; therefore, when properly installed, they prevent loss of compression, coolant, or lubricant.

MOVING PARTS OF AN ENGINE

The moving parts of an engine serve an important function in turning heat energy into mechanical energy. They further convert reciprocal motion into rotary motion. The principal moving parts are the piston assembly, connecting rods, crankshaft assembly (includes flywheel and vibration dampener), camshaft, valves, and gear train.

The burning of the fuel-air mixture within the cylinder exerts a pressure on the piston, thus pushing it down in the cylinder. The action of

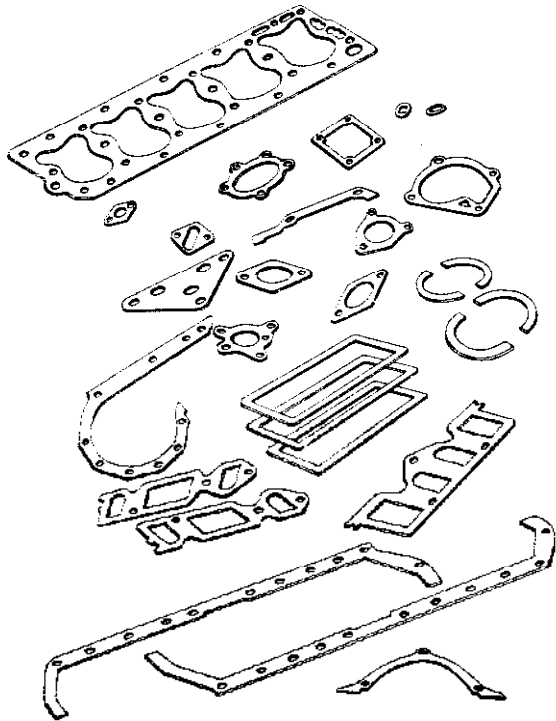

81.52

Figure 13-12.—Engine overhaul gasket kit.

the connecting rod and crankshaft converts this downward motion to a rotary motion.

Piston Assembly

Engine pistons serve several purposes: they transmit the force of combustion to the crankshaft through the connecting rod; they act as a guide for the upper end of the connecting rod; and they also serve as a carrier for the piston rings used to seal the compression in the cylinder. (See fig. 13-13.)

The piston must come to a complete stop at the end of each stroke before reversing its course in the cylinder. To withstand this rugged treatment and wear, it must be made of tough material, yet be light in weight. To overcome inertia and momentum at high speeds, it must be carefully balanced and weighed. All the pistons used in any one engine must be of similar weight to avoid excessive vibration. Ribs are used on

the underside of the piston to reinforce the head; the ribs also assist in conducting heat from the head of the piston to the piston rings and out through the cylinder walls.

The structural components of the piston are the HEAD, SKIRT, RING GROOVES, and LANDS (fig. 13-14). However, all pistons do not look like the typical one here illustrated. Some have differently shaped heads. Diesel engine pistons usually have more ring grooves and rings than the pistons of gasoline engines. Some of these rings may be installed below as well as above the WRIST or PISTON PIN (fig. 13-15).

Fitting pistons properly is important. Because metal expands when heated, and because space must be provided for lubricants between the pistons and the cylinder walls, the pistons are fitted to the engine with a specified clearance. This clearance depends upon the size or diameter of the piston and the material from which it is made. Cast iron does not expand as fast or as much as aluminum. Aluminum pistons require more clearance to prevent binding or seizing

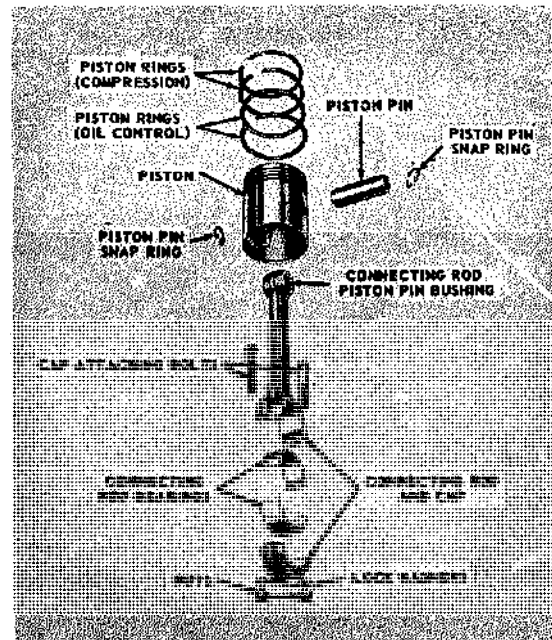

75.70

Figure 13-13.—Piston and connecting rod (exploded view).

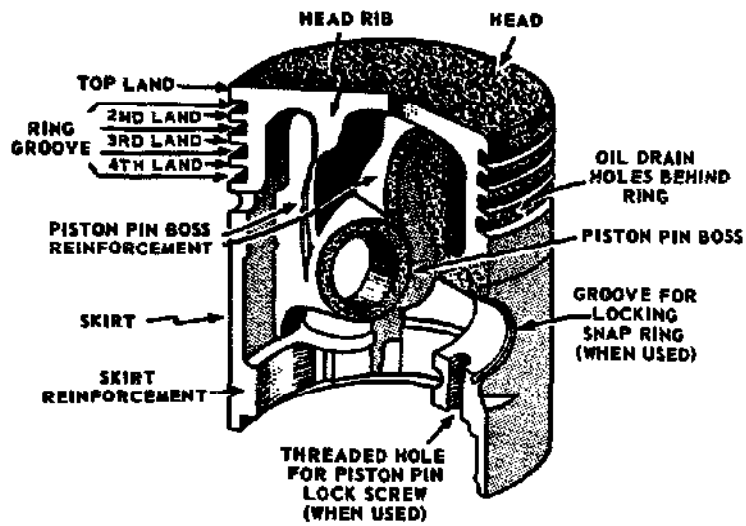

81.53

Figure 13-14.—The parts of a piston.

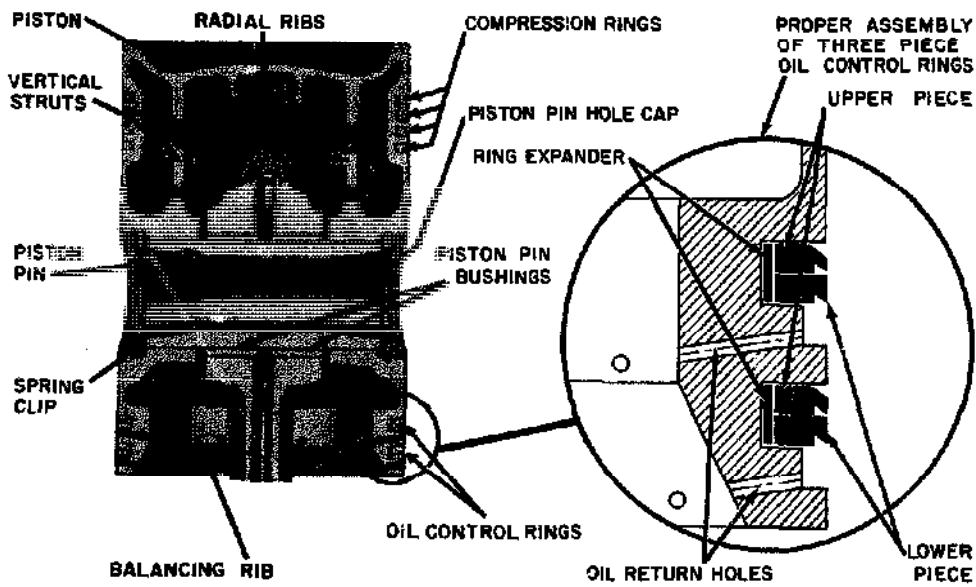

81.54

Figure 13-15.—Piston assembly of General Motors series 71 engine.

BASIC MACHINES

when the engine gets hot. The skirt or bottom part of the piston runs much cooler than the top; therefore, it does not require as much clearance as the head.

The piston is kept in alignment by the skirt, which is usually CAM GROUND (elliptical in cross section) (fig. 13-16). This elliptical shape permits the piston to fit the cylinder, regardless of whether the piston is cold or at operating temperature. The narrowest diameter of the piston is at the piston pin bosses, where the metal is thickest. At the widest diameter of the piston, the piston skirt is thinnest. The piston is fitted to close limits at its widest diameter so that piston noise (slap) is prevented during engine warm-up. As the piston is expanded by the heat generated during operation, it becomes round because the expansion is proportional to the temperature of the metal. The walls of the skirt are cut away as much as possible to reduce weight and to prevent excessive expansion during

engine operation. Many aluminum pistons are made with SPLIT SKIRTS so that when the pistons expand the skirt diameter will not increase. The two types of piston skirts found in most engines are the FULL TRUNK and the SLIPPER. The full-trunk-type skirt, which is more widely used, has a full cylindrical shape with bearing surfaces parallel to those of the cylinder, giving more strength and better control of the oil film. The SLIPPER-TYPE (CUTAWAY) skirt has considerable relief on the sides of the skirt, leaving less area for possible contact with the cylinder walls and thereby reducing friction.

PISTON PINS.—The piston is attached to the connecting rod by means of the piston pin (wrist pin). The pin passes through the piston pin bosses and through the upper end of the connecting rod, which rides within the piston on the middle of the pin. Piston pins are made of alloy steel with a precision finish and are case

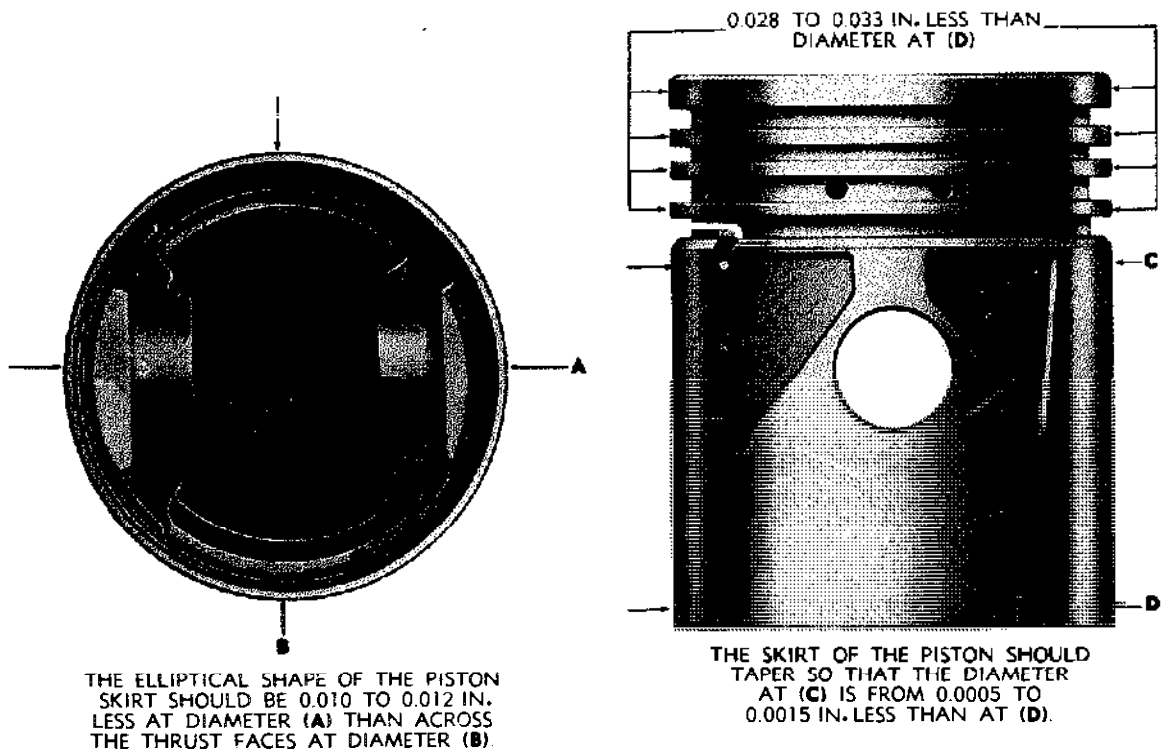

Figure 13-16.—Cam-ground piston.

81.55

hardened and sometimes chromium plated to increase their wearing qualities. Their tubular construction gives them a maximum of strength with a minimum of weight. They are lubricated by splash from the crankcase or by pressure through passages bored in the connecting rods.

There are three methods commonly used for fastening a piston pin to the piston and the connecting rod. (See fig. 13-17.) An anchored, or "fixed," pin is attached to the piston by a screw running through one of the bosses; the connecting rod oscillates on the pin. A "semifloating" pin is anchored to the connecting rod and turns in the piston pin bosses. A "full-floating" pin is free to rotate in the connecting rod and in the bosses, but is prevented from working out against the sides of the cylinder by plugs or snapping locks.

PISTON RINGS.—Piston rings are used on pistons to maintain gastight seals between the pistons and cylinders, to assist in cooling the piston, and to control cylinder-wall lubrication. About one-third of the heat absorbed by the piston passes through the rings to the cylinder wall. Piston rings are often quite complicated in design, are heat treated in various ways and are plated with other metals. There are two distinct classifications of piston rings: compression rings and oil control rings. (See fig. 13-18.)

The principal function of a compression ring is to prevent gases from leaking by the piston during the compression and power strokes. All piston rings are split to permit assembly to the piston and to allow for expansion. When the ring

is in place, the ends of the split joint do not form a perfect seal; therefore, it is necessary to use more than one ring and to stagger the joints around the piston. If cylinders are worn, expanders (fig. 13-15 and 13-18) are sometimes used to ensure a perfect seal.

The bottom ring, usually located just above the piston pin, is an oil regulating ring. This ring scrapes the excess oil from the cylinder walls and returns some of it, through slots, to the piston ring grooves. The ring groove under an oil ring is provided with openings through which the oil flows back into the crankcase. In some engines, additional oil rings are used in the piston skirt below the piston pin.

Connecting Rods

Connecting rods must be light and yet strong enough to transmit the thrust of the pistons to the crankshaft. Connecting rods are drop forged from a steel alloy capable of withstanding heavy loads without bending or twisting. Holes at the upper and lower ends are machined to permit accurate fitting of bearings. These holes must be parallel.

The upper end of the connecting rod is connected to the piston by the piston pin. If the piston pin is locked in the piston pin bosses, or if it floats in both piston and connecting rod, the upper hole of the connecting rod will have a solid bearing (bushing) of bronze or similar material. As the lower end of the connecting rod revolves with the crankshaft, the upper end is forced to

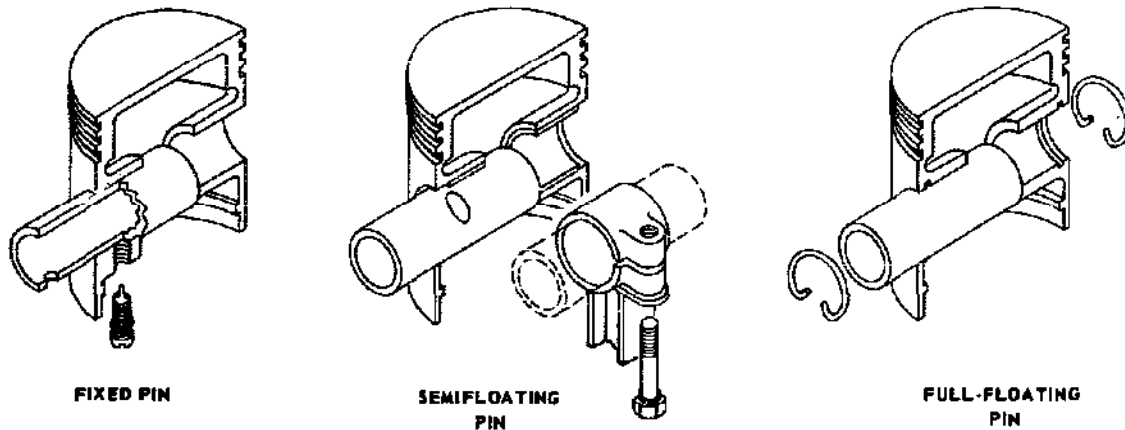

Figure 13-17.—Piston pin types.

81.56

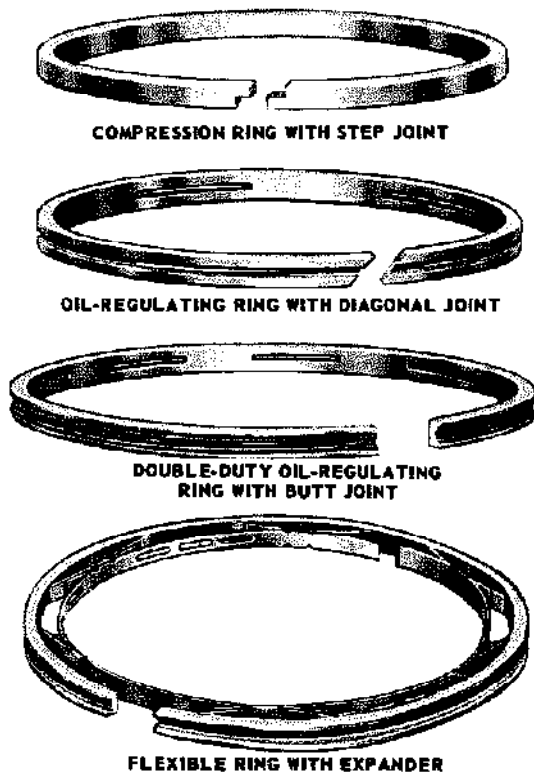

Figure 13-18.—Piston rings.

75.51

turn back and forth on the piston pin. Although this movement is slight, the bushing is necessary because the temperatures and the pressures are high. If the piston pin is semifloating, a bushing is not needed.

The lower hole in the connecting rod is split to permit it to be clamped around the crankshaft. The bottom part, or cap, is made of the same material as the rod and is attached by two or more bolts. The surface that bears on the crankshaft is generally a bearing material in the form of a separate split shell, although, in a few cases, it may be spun or die-cast in the inside of the rod and cap during manufacture. The two parts of the separate bearing are positioned in the rod and cap by dowel pins, projections, or short brass screws. Split bearings may be of the precision or semiprecision type.

The **PRECISION** type bearing is accurately finished to fit the crankpin and does not require further fitting during installation. It is positioned by projections on the shell which match reliefs in the rod and cap. The projections prevent the bearings from moving sideways and from rotary motion in the rod and cap.

The **SEMPRECISSION** type bearing is usually fastened to or die-cast with the rod and cap. Prior to installation, it is machined and fitted to the proper inside diameter with the cap and rod bolted together.

Crankshaft

As the pistons collectively might be regarded as the heart of the engine, so the **CRANKSHAFT** may be considered its backbone (fig. 13-19). It ties together the reactions of the pistons and the connecting rods, transforming their reciprocating motion into a rotary motion. And it transmits engine power through the flywheel, clutch, transmission, and differential to drive your vehicle.

The crankshaft is forged or cast from an alloy of steel and nickel, is machined smooth to provide bearing surfaces for the connecting rods and the main bearings, and is **CASE-HARDENED**, or coated in a furnace with copper alloyed with carbon. These bearing surfaces are called **JOURNALS**. The crankshaft counterweights impede the centrifugal force of the connecting rod assembly attached to the **THROWS** or points of bearing support. These

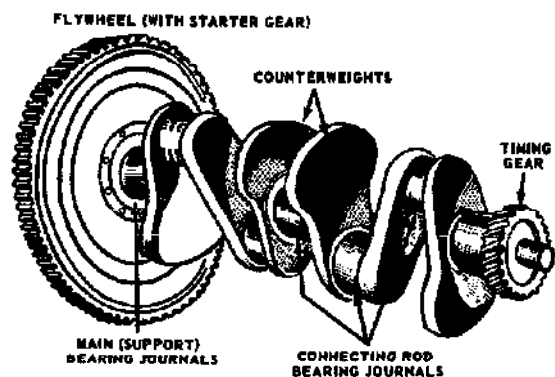

Figure 13-19.—Crankshaft of a 4-cylinder engine.

75.81

throws must be placed so that they counter-balance each other.

Crank throw arrangements for 4-, 6-, and 8-cylinder engines are shown in figure 13-20. Four-cylinder engine crankshafts have either 3 or 5 main support bearings and 4 throws in one plane. In figure 13-20 you see that the throws for No. 1 and No. 4 cylinders (4-cylinder engine) are 180° from those for No. 2 and No. 3 cylinders. On 6-cylinder engine crankshafts each of the 3 pairs of throws is arranged 120° from the other 2. Such crankshafts may be supported by as many as 7 main bearings, that is one at each end of the shaft and one between each pair of crankshaft throws. The crankshafts of 8-cylinder V-type engines are similar to those for the 4-cylinder in-line type or may have each of the 4 throws fixed at 90° from each other (as in fig. 13-20) for better balance and smoother operation.

V-type engines usually have two connecting rods fastened side by side on one crankshaft

throw. With this arrangement, one bank of the engine cylinders is set slightly ahead of the other to allow the two rods to clear each other.

Vibration Damper

The power impulses of an engine tend to set up torsional vibration in the crankshaft. If this torsional vibration were not controlled, the crankshaft might actually break at certain speeds; a vibration damper mounted on the front of the crankshaft is used to control this vibration (fig. 13-21).

Most types of vibration dampers resemble a miniature clutch. A friction facing is mounted between the hub face and a small damper flywheel. The damper flywheel is mounted on the hub face with bolts that go through rubber cones in the flywheel. These cones permit limited circumferential movement between the crankshaft and damper flywheel. This minimizes the

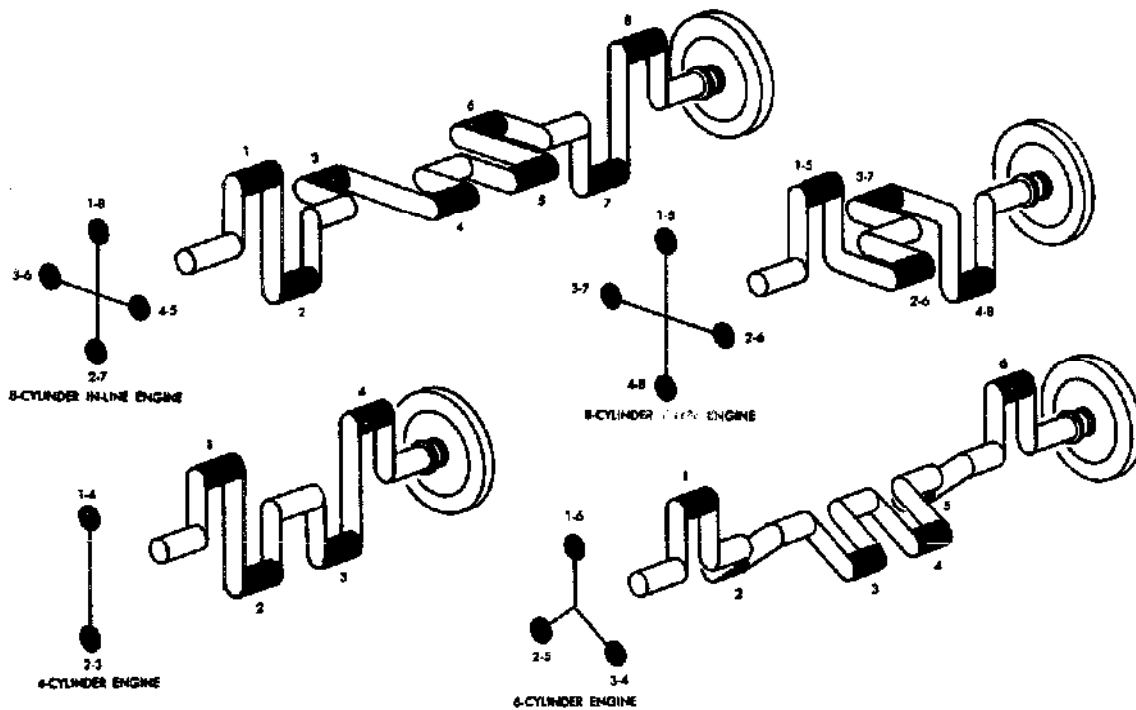
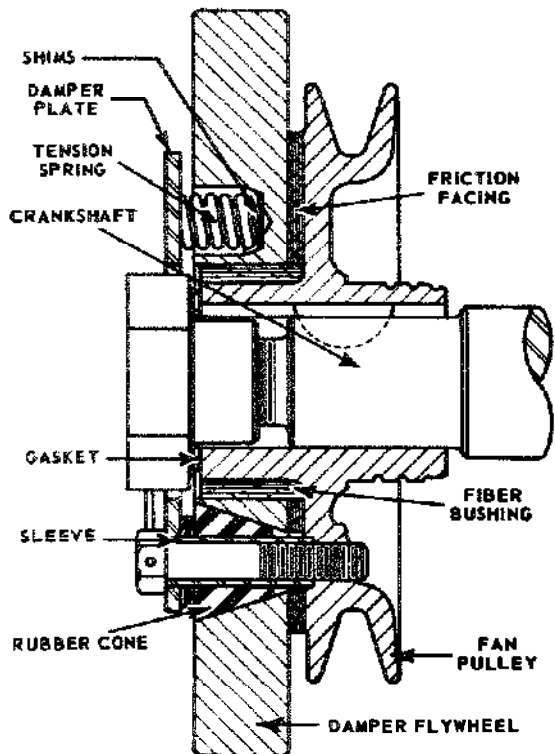

Figure 13-20.—Crankshaft and throw arrangements commonly used.

75.81



81.62

Figure 13-21.—Sectional view of a typical vibration damper.

effects of the torsional vibration in the crankshaft. Several other types of vibration dampers are used. However, they all operate in essentially the same way.

Engine Flywheel

The flywheel is mounted at the rear of the crankshaft near the rear main bearing. This is usually the longest and heaviest main bearing in the engine, as it must support the weight of the flywheel.

The flywheel (fig. 13-22) stores up energy of rotation during power impulses of the engine. It releases this energy between power impulses, thus assuring less fluctuation in engine speed and smoother engine operation. The size of the flywheel will vary with the number of cylinders and the general construction of the engine. With a large number of cylinders and the consequent

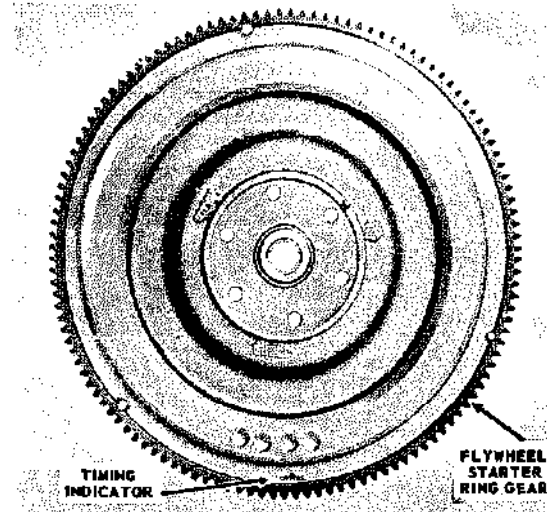

81.63

Figure 13-22.—Flywheel.

overlapping of power impulses, there is less need for a flywheel; consequently, the flywheel can be relatively small. The flywheel rim carries a ring gear, either integral with the flywheel or shrunk on, that meshes with the starter driving gear for cranking the engine. The rear face of the flywheel is usually machined and ground, and acts as one of the pressure surfaces for the clutch, becoming a part of the clutch assembly.

Valves And Valve Mechanisms

There are two valves for each cylinder in most engines, one intake and one exhaust valve. Since each of these valves operates at different times, it is necessary that separate operating mechanisms be provided for each valve. Valves are normally held closed by heavy springs and by compression in the combustion chamber. The purpose of the valve-actuating mechanism is to overcome the spring pressure and open the valves at the proper time. The valve-actuating mechanism includes the engine camshaft, camshaft followers (tappets), pushrods, and rocker arms.

CAMSHAFT.—The camshaft (fig. 13-23) is inclosed in the engine block. It has eccentric lobes (cams) ground on it for each valve in the

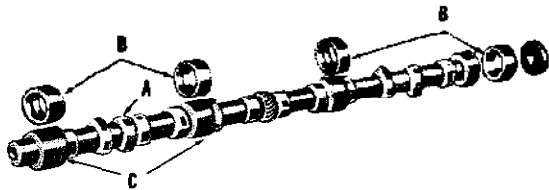

A - CAMSHAFT
B - CAMSHAFT BEARING
C - BEARING JOURNAL

81.61

Figure 13-23.—Camshaft and bushings.

engine. As the camshaft rotates, the cam lobe moves up under the valve tappet, exerting an upward thrust through the tappet against the valve stem or a pushrod. This thrust overcomes the valve spring pressure as well as the gas pressure in the cylinder, causing the valve to open. When the lobe moves from under the tappet, the valve spring pressure reseats the valve.

On L-, F-, or I-head engines, the camshaft is usually located to one side and above the crankshaft, while in V-type engines it is usually located directly above the crankshaft. On the overhead camshaft engine, such as the Murphy diesel, the camshaft is located above the cylinder head.

The camshaft of a 4-stroke cycle engine turns at one-half engine speed. It is driven off the crankshaft through timing gears or a timing chain. In the 2-stroke cycle engine the camshaft must turn at the same speed as the crankshaft in order that each valve may open and close once in each revolution of the engine.

In most cases the camshaft will do more than operate the valve mechanism. It may have extra cams or gears that operate fuel pumps, fuel injectors, the ignition distributor, or the lubrication pump.

Camshafts are supported in the engine block by journals in bearings. Camshaft bearing journals are the largest machined surfaces on the shaft. The bearings are usually made of bronze and are bushings rather than split bearings. The bushings are lubricated by oil circulating through drilled passages from the crankcase. The stresses on the camshaft are

small, therefore the bushings are not adjustable and require little attention. The camshaft bushings are generally replaced only when the engine requires a complete overhaul.

FOLLOWERS.—Camshaft followers (figs. 13-24 and 13-25) are the parts of the valve-actuating mechanism that contact the camshaft. You will probably hear them called valve tappets or valve lifters. In the L-head engine the followers directly contact the end of the valve stem and have an adjusting device in them. In the overhead valve engine the followers contact the pushrod that operates the rocker arm. The end of the rocker arm opposite the pushrod contacts the valve stem. The valve adjusting device, in this case, is in the rocker arm.

Many engines have self-adjusting valve lifters of the hydraulic type that operate at zero clearance at all times. The operation of one type of hydraulic valve tappet mechanism is shown in figure 13-26. Oil under pressure is forced into the tappet when the valve is closed, and this pressure extends the plunger in the tappet so that all valve clearance, or lash, is eliminated. When the cam lobe moves around under the tappet and starts to raise it, there will not be any tappet noise. As the lobe starts to

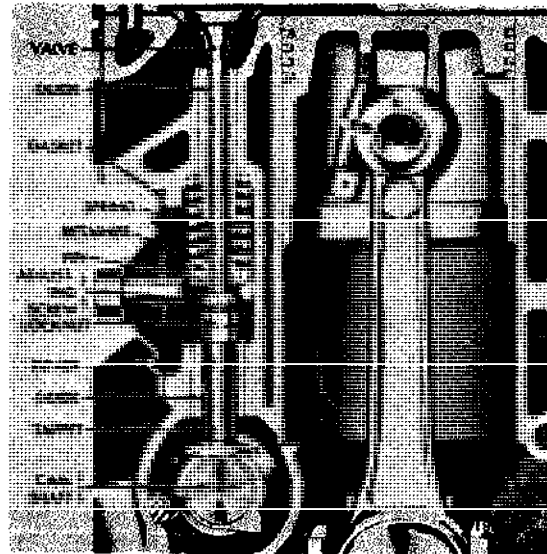

81.64

Figure 13-24.—L-head valve operating mechanism.

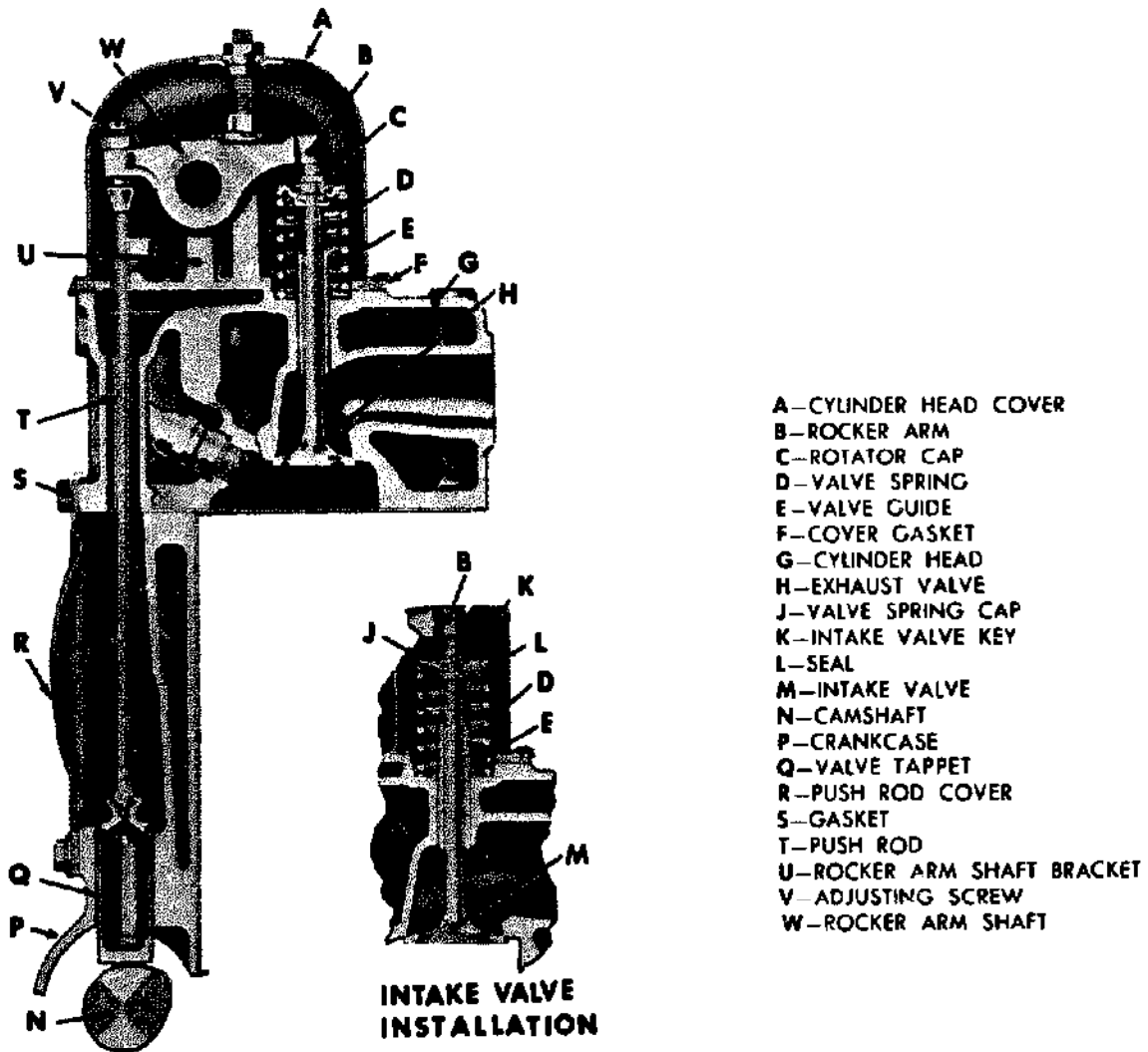

Figure 13-25.—Valve operating mechanism for an overhead valve engine.

81.65

raise the tappet, the oil is forced upward in the lower chamber of the tappet. This action closes the ball check valve so oil cannot escape. Then the tappet acts as though it were a simple, 1-piece tappet and the valve is opened. When the lobe moves out from under the tappet and the valve closes, the pressure in the lower chamber of the tappet is relieved. Any slight loss of oil from the lower chamber is then replaced by the oil pressure from the engine lubricating system. This causes the plunger to move up snugly

against the push rod so that any clearance is eliminated.

Timing Gears (Gear Trains)

Timing gears keep the crankshaft and camshaft turning in proper relation to one another so that the valves open and close at the proper time. In some engines, sprockets and chains are used.

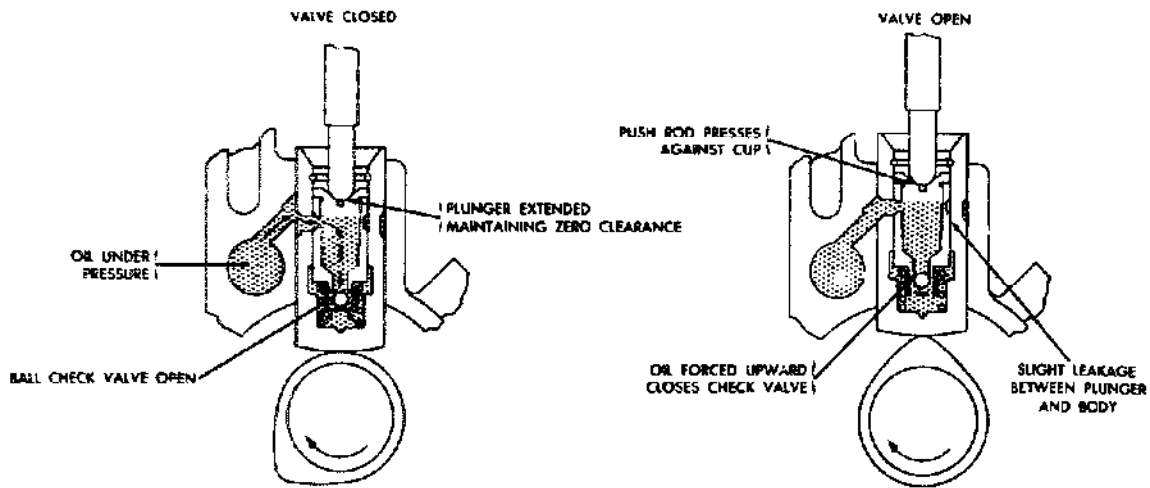

81.66

Figure 13-26.—Operation of a hydraulic valve lifter.

The gears or sprockets, as the case may be, of the camshaft and crankshaft are keyed in position so that they cannot slip. Since they are keyed to their respective shafts, they can be replaced if they become worn or noisy.

With directly driven timing gears (fig. 13-27), one gear usually has a mark on two adjacent teeth and the other a mark on only one tooth. To time the valves properly, it is necessary only to mesh the gears so that the two marked teeth of one gear straddle the single marked tooth of the other.

in air-cooled engines a blower is generally used to force cool air around the engine cylinders.

In addition, an exhaust system is provided to carry away the burned gases exhausted from the engine cylinders. These systems will not be discussed in this course, however. For further information on them refer to NavPers 10644D, Construction Mechanic 3 & 2.

AUXILIARY ASSEMBLIES

We have discussed the main parts of the engine proper; but there are other parts, both moving and stationary, that are essential to engine operation. They are not built into the engine itself, but, in most cases, are attached to the engine block or cylinder head.

The fuel system includes a fuel pump and carburetor mounted on the engine. In diesel engines the fuel injection mechanism replaces the carburetor. An electrical system is provided to supply power for starting the engine and also for ignition during operation. An efficient cooling system is necessary for operating an internal combustion engine. In water-cooled engines a water pump and fan are used, while

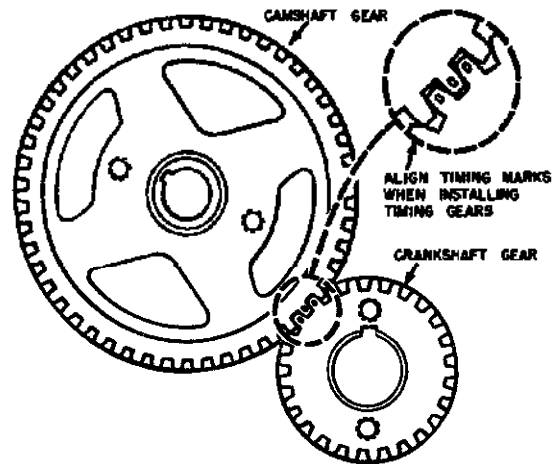

81.69

Figure 13-27.—Timing gears and their markings.

CHAPTER 14

POWER TRAINS

In chapter 13 we saw how a combination of simple machines and basic mechanisms were utilized in constructing the internal combustion engine. In this chapter we will go on from there to learn how the power developed by the engine is transmitted to perform the work required of it. To illustrate this, we will use the power train system as used by the automobile, and most trucks, as a familiar example. In this application, once again you are to look for the simple machines that make up each of the machines or mechanisms which are interconnected to make up the power train.

In a vehicle, the mechanism that transmits the power of the engine to the wheels and/or tracks and accessory equipment is called the power train. In a simple situation, a set of gears or a chain and sprocket could perform this task, but automotive and construction vehicles are not usually designed for such simple operating conditions. They are designed to have great pulling power, to move at high speeds, to travel in reverse as well as forward, and to operate on rough terrain as well as smooth roads. To meet these widely varying demands, a number of units have been added to the vehicles.

Automobiles and light trucks driven by the two rear wheels have a power train consisting of clutch, transmission, propeller shaft, differential, and driving axles (fig. 14-1).

In 4- and 6-wheel drive trucks, you will find transfer cases with additional drive shafts and live axles. Tractors, shovels, cranes, and other heavy-duty vehicles that move on tracks also have similar power trains. In addition to assemblies that drive sprockets to move the tracks, these vehicles also have auxiliary transmissions or power takeoff units which may be used to operate accessory attachments. The propeller shafts and clutch assemblies of these power trains are very much like those used to drive the wheels.

THE CLUTCH

The clutch is placed in the power train of motorized equipment for two purposes:

First, it provides a means of disconnecting the power of the engine from the driving wheels and accessory equipment. When the clutch is disengaged, the engine can run without driving the vehicle or operating the accessories.

Second, when the vehicle is started, the clutch allows the engine to take up the load of driving the vehicle or accessories gradually and without shock.

Clutches are located in the power train between the source of power and the operating unit. Usually, they are placed between the engine and the transmission assembly, as shown in figure 14-1.

Clutches generally transmit power from the clutch driving member to the driven member by friction. In the plate clutch, figure 14-2 the driving member or plate, which is secured to the engine flywheel, is gradually brought in contact with the driven member (disc). The contact is made and held by strong spring pressure controlled by the driver with the clutch pedal. With only a light spring pressure, there is little friction between the two members and the clutch is permitted to slip. As the spring pressure increases, friction also increases, and less slippage occurs. When the driver removes his foot from the clutch pedal and full spring pressure is applied, the speed of the driving plate and driven disc is the same, and all slipping stops. There is then a direct connection between the driving and driven shafts.

In most clutches, there is a direct mechanical linkage between the clutch pedal and the clutch release yoke lever. On many late model vehicles, and on some of the larger units which require great pressure to release the spring, a hydraulic clutch release system is used. A master cylinder (fig. 14-3), similar to the brake

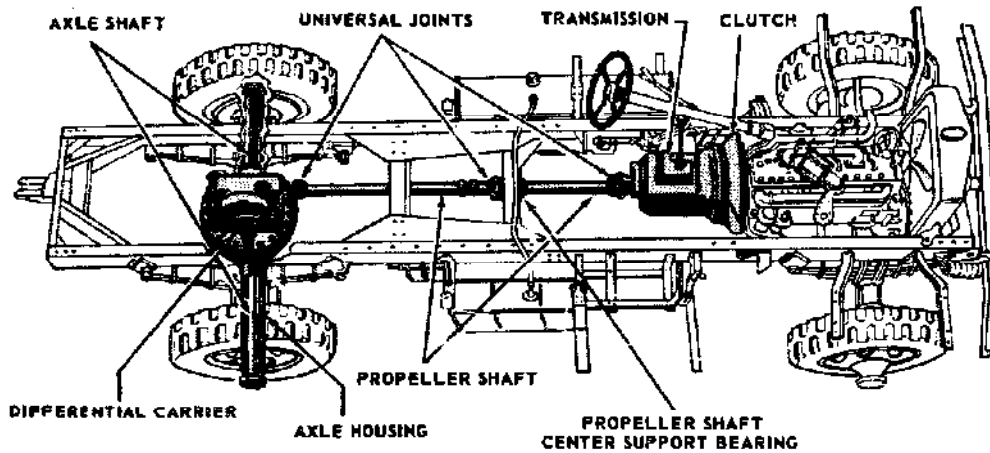

81.174

Figure 14-1.—Type of power transmission.

master cylinder, is attached to the clutch pedal. A cylinder, similar to a single-acting brake wheel cylinder, is connected to the master cylinder by flexible pressure hose or metal tubing (fig. 14-3). The slave cylinder is connected to the clutch release yoke lever. Movement of the clutch pedal actuates the clutch master cylinder. This movement is transferred

by hydraulic pressure to the slave cylinder, which in turn actuates the clutch release yoke lever.

TYPES OF CLUTCHES

There are various types of clutches. The type most used in passenger cars and light

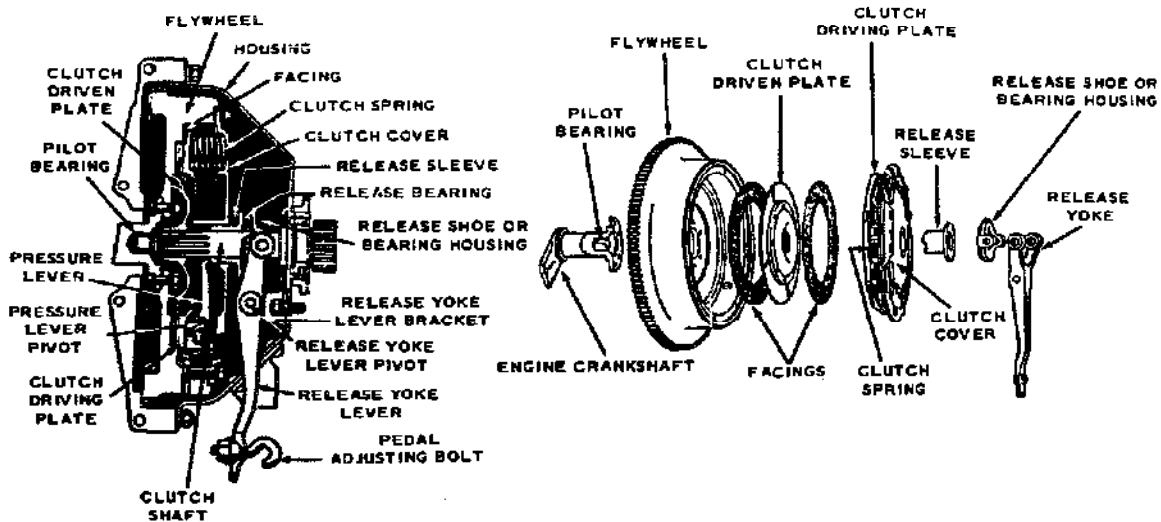

81.175

Figure 14-2.—Exploded and cross-section view of a plate clutch.

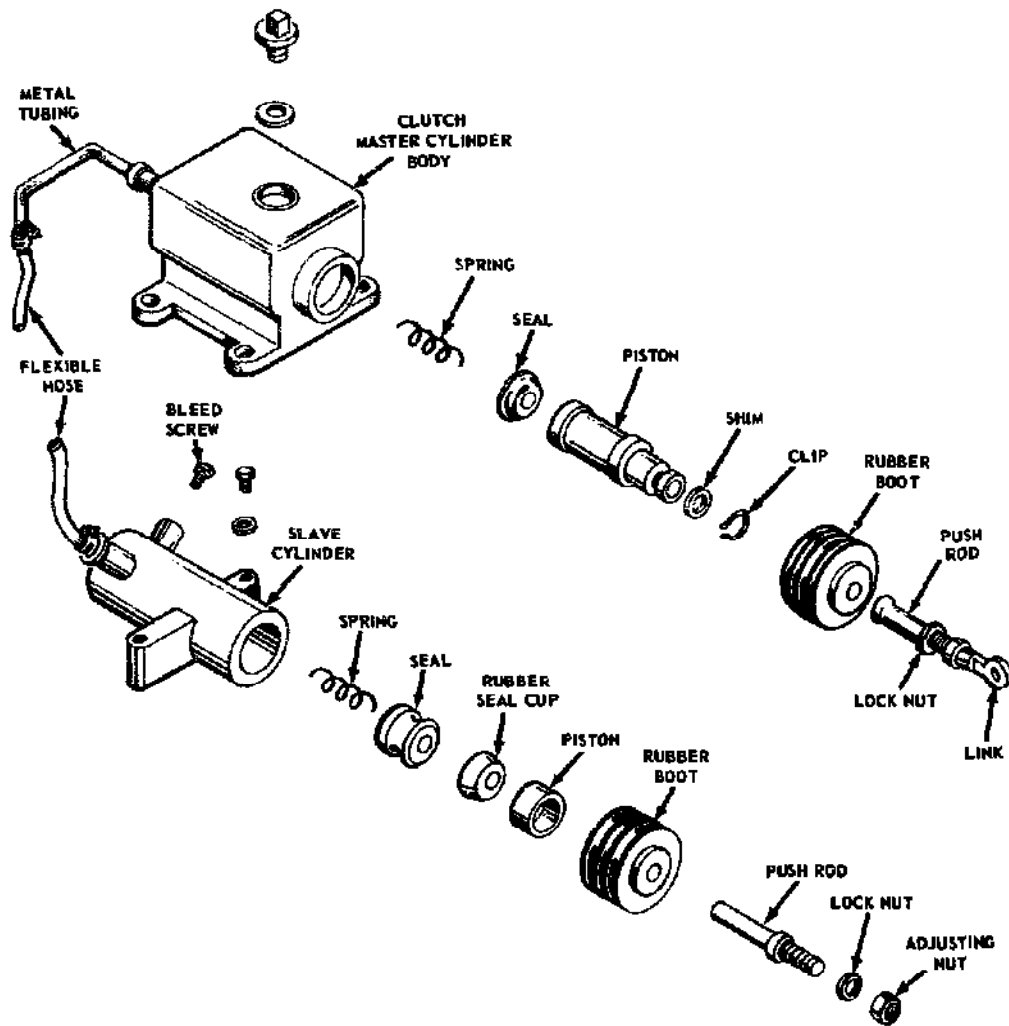

81.177

Figure 14-3.—Master cylinder, slave cylinder and connections for standard hydraulic clutch.

trucks is the previously-mentioned plate clutch. The plate clutch is a simple clutch with three plates, one of which is clamped between the other two. Exploded and cross-sectional views of a plate clutch are shown in figure 14-2.

Single Disk Clutch

The driving members of the single disk clutch consist of the flywheel and the driving

(pressure) plate. The driven member consists of a single disk, splined to the clutch shaft and faced on both sides with friction material. When the clutch is fully engaged, the driven disc is firmly clamped between the flywheel and the driving plate by pressure of the clutch springs, forming a direct, nonslipping connection between the driving and driven members of the clutch. In this position, the driven disc rotates the clutch shaft to which it is splined. The clutch shaft is

Chapter 14--POWER TRAINS

connected to the driving wheels through the transmission, propeller shaft, final drive, differential, and live axles.

The double disk clutch (fig. 14-4) is substantially the same as the single plate disk clutch except that another driven disk and intermediate driving plate is added.

Multiple Disk Clutch

A multiple disk clutch is one having more than three plates or disks. Some have as many as 11 driving plates and 10 driven disks. Because the multiple disk type has a greater frictional area than a plate clutch, it is best suited as a steering clutch on crawler type tractors. The multiple disk clutch is sometimes used on heavy trucks. In operation, it is very much like the plate clutch and has the same release mechanism. The facings, however, are usually attached to the driving plates rather than to the driven disks. This reduces the weight of the driven disks and keeps them from spinning after the clutch is released.

You may run into other types of friction clutches such as the lubricated plate clutch and the cone clutch. These types are seldom used on automotive equipment. However, fluid drive is largely replacing the friction clutches in automobiles and light trucks, and even in some tractors.

For information on fluid drives (automatic transmissions), refer to Construction Mechanic 3 & 2, NavPers 10644-D, chapter 11.

TRANSMISSION

The transmission is part of the power train. It consists of a metal case filled with gears (fig. 14-5), and is usually located in the rear of the engine between the clutch housing and the propeller shaft, as shown in figure 14-1. The transmission transfers engine power from the clutch shaft to the propeller shaft, and allows the driver or operator to control the power and speed of the vehicle. The transmission shown in figure 14-5 and 14-6 is a sliding gear transmission. Many late model trucks

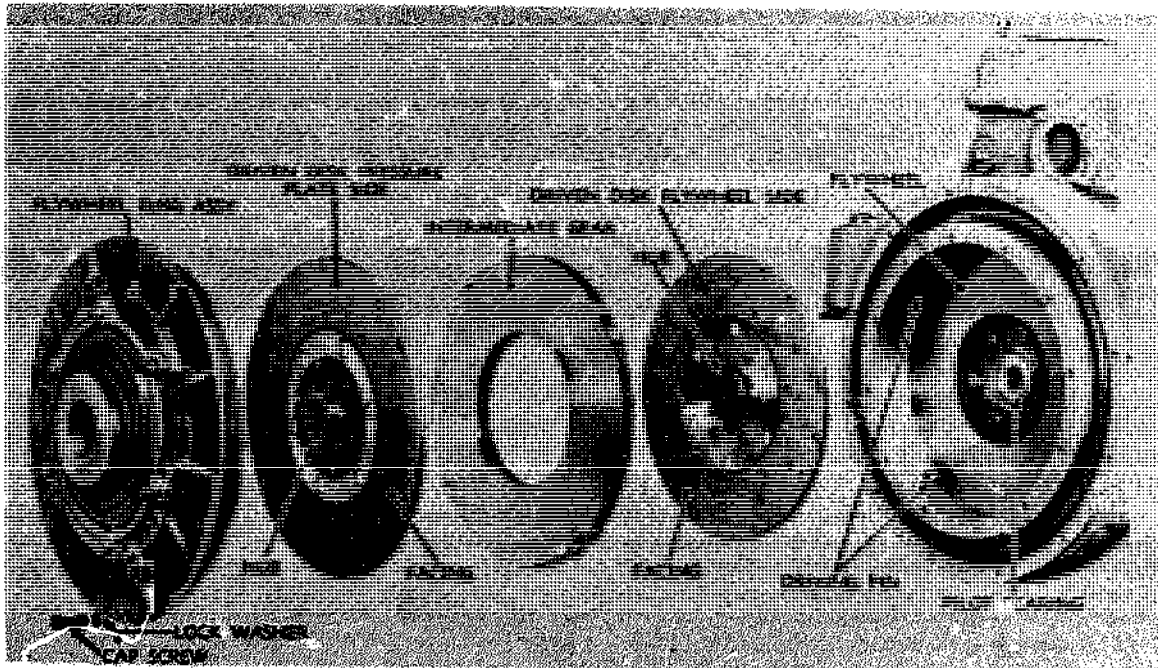

Figure 14-4.--Double disk clutch--exploded view.

81.179

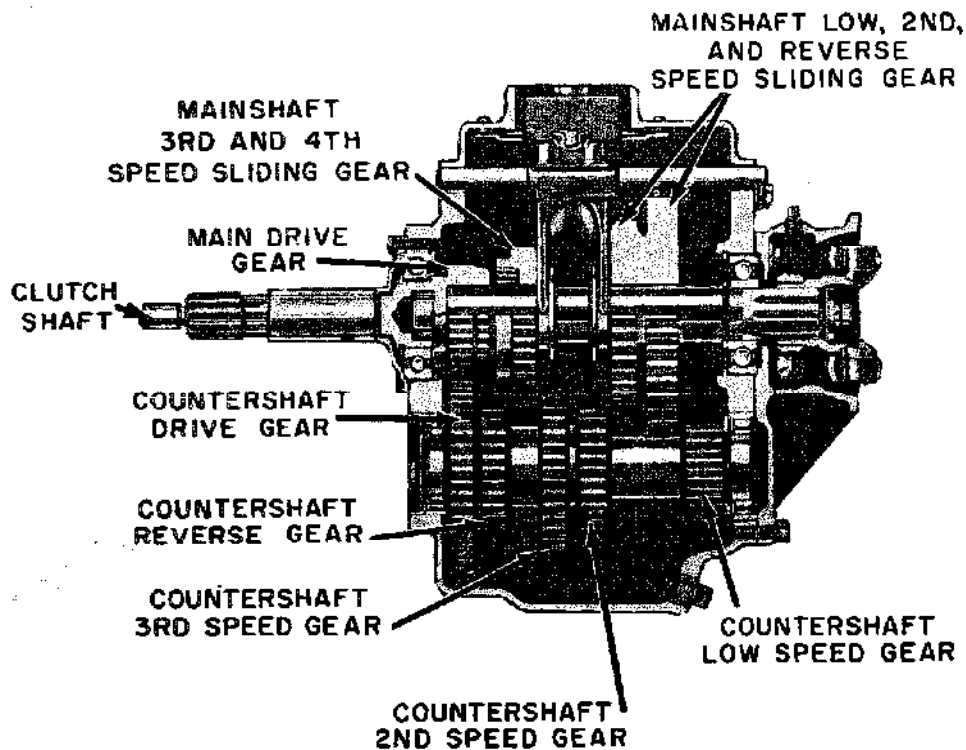

Figure 14-5.—Four-speed truck transmission.

81.181

have either constant mesh or synchromesh transmissions (explained later). However, the principles of operation and gear ratios are the same.

A review of chapter 6 of this book will help you to understand the transmissions and power transfer mechanisms described in this chapter.

FOUR-SPEED TRUCK TRANSMISSION

The gear shift lever positions shown in the small inset in figure 14-6 are typical of most four-speed truck transmissions. The gear shifting lever, shown at A, B, C, D, and E in the illustration, moves the position of the two shifting forks which slide on separate shafts secured in the transmission case cover. Follow the separate diagrams to learn what takes place in shifting from one speed to another. For example, as you

move the top of the gear shift lever toward the forward left position, the lower arm of the lever moves in the opposite direction to shift the gears. The fulcrum of this lever is in the transmission cover.

In shifting transmission gears it is necessary to use the clutch to disengage the engine. Improper use of the clutch will cause the gears to clash, and may damage them by breaking the gear teeth. A broken tooth or piece of metal can wedge itself between two moving gears and ruin the entire transmission assembly.

When you shift from neutral to first or low speed (A of fig. 14-6), the smallest countershaft gear engages with the largest sliding gear. Low gear moves the truck at its lowest speed and maximum power. The arrow indicates the flow of power from the clutch shaft to the propeller shaft.

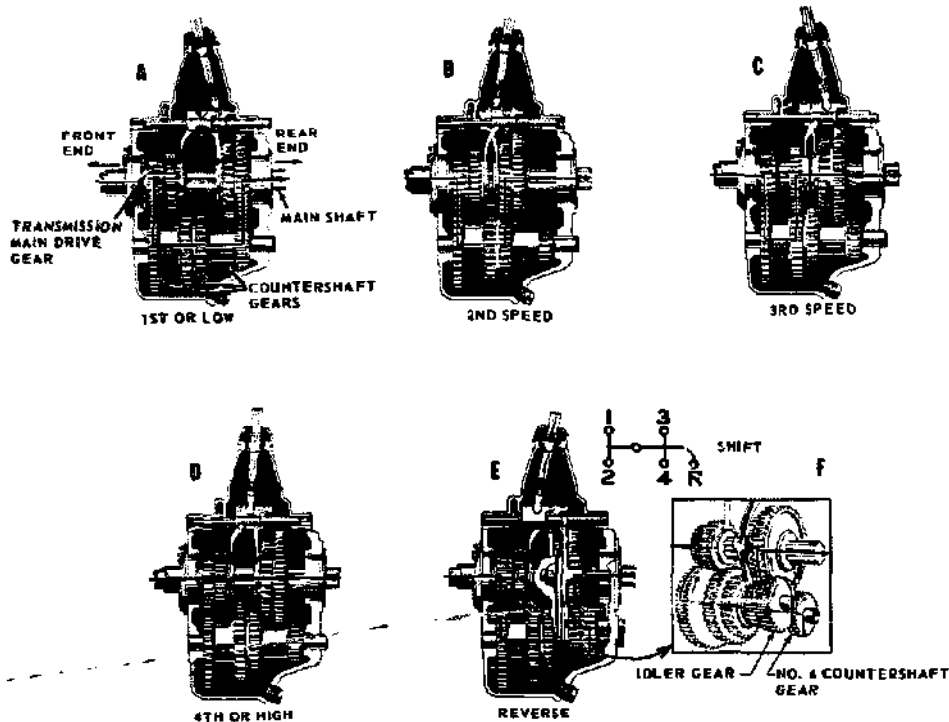

Figure 14-6.--Power flow through a 4-speed transmission.

81.182

The second speed position is obtained by moving the gear shift lever straight back from the low speed position. You will, of course, use the clutch when shifting. In B of figure 14-6 you will see that the next to the smallest countershaft gear is in mesh with the second largest sliding gear. The largest sliding gear (shift gear) has been disengaged. The flow of power has been changed as shown by the arrow. The power transmitted to the wheels in second gear (speed) is less, but the truck will move at a greater speed than it will in low gear if the engine speed is kept the same.

In shifting from the second speed to the third speed position, you move the gear shift lever through the neutral position. This is done in all selective gear transmissions. From the neutral position the driver can select the speed position required to get the power he needs. In C of figure 14-6 you will notice that the gear shift lever is in contact with the other shifting fork, and that the forward slide gear

has been meshed with the second countershaft gear. The power flow through the transmission has again been changed, as indicated by the arrow, and the truck will move at an intermediate speed between second and high.

You shift into fourth or high speed position by moving the top of the shift lever back and to the right from the neutral position. In the high speed position, the forward shift or sliding gear is engaged with the constant speed gear as shown in D of figure 14-6. The clutch shaft and the transmission shaft are now locked together and the power flow is in a straight line. In high, the truck propeller shaft revolves at the same speed as the engine crankshaft, or at a 1 to 1 ratio.

You shift to reverse by moving the top of the gear shift lever to the far right and then to the rear. Most trucks have a trigger arrangement at the gear shift ball to unlock the lever so that it can be moved from neutral to the far right. The lock prevents unintentional

shifts into reverse. Never attempt to shift into reverse until the forward motion of the vehicle has been completely stopped.

In F of figure 14-6, you can see how the idler gear fits into the transmission gear train. In E of figure 14-6, you can see what happens when you shift into reverse. An additional shifting fork is contacted by the shift lever in the far right position. When the shift to reverse is completed, this fork moves the idling gear into mesh with the small countershaft gear and the large sliding gear at the same time. The small arrows in the inset show how the engine power flows through the transmission to move the propeller shaft and the wheels in a reverse direction.

The different combination of gears in the transmission case makes it possible to change the vehicle speed while the engine speed remains the same. It is all a matter of gear ratios. That is, having large gears drive small gears, and small gears drive large gears. If a gear with 100 teeth drives a gear with 25 teeth, the small gear will travel four times as fast as the large one. You have stepped up the speed. Now, let the small gear drive the large gear, and the large gear will make one revolution for every four of the small gear. You have reduced speed, and the ratio of gear reduction is 4 to 1.

In the truck transmission just described, the gear reduction in low gear is 7 to 1 from the engine to the propeller shaft. In high gear the ratio is 1 to 1, and the propeller shaft turns at the same speed as the engine. This holds true for most transmissions. The second and third speed positions provide intermediate gear reductions between low and high. The gear ratio in second speed is 3.48 to 1, and in third is 1.71 to 1. The gear reduction or gear ratio in reverse is about the same as it is in low gear, and the propeller shaft makes one revolution for every seven revolutions of the engine.

All transmissions do not have four speeds forward, and the gear reductions at the various speeds are not necessarily the same. Passenger cars, for example, usually have only three forward speeds and one reverse speed. Their gear ratios are about 3 to 1 in both low and reverse gear combinations. You must remember, the gear reduction in the transmission is only between the engine and the propeller shaft. Another reduction gear ratio is provided in the rear axle assembly. If you have a common rear axle ratio of about 4 to 1, the gear reduction from the engine of a passenger car to the

rear wheels in low gear would be approximately 12 to 1. In high gear the ratio would be 4 to 1 as there would be no reduction of speed in the transmission.

CONSTANT MESH TRANSMISSION

To eliminate the noise developed in the old-type spur-tooth gears used in the sliding gear transmission, the automotive manufacturers developed the constant-mesh transmission which contains helical gears.

In this type of transmission certain countershaft gears are constantly in mesh with the main shaft gears. The main shaft meshing gears are arranged so that they cannot move endwise. They are supported by roller bearings so that they can rotate independently of the main shaft (figs. 14-7 and 14-8).

In operation, when the shift lever is moved to third, the third and fourth shifter fork moves the clutch gear (A, fig. 14-8) toward the third speed gear (D, fig. 14-8). This engages the external teeth of the clutch gear with the internal teeth of the third speed gear. Since the third speed gear is rotating with the rotating countershaft gear, the clutch gear must also rotate. The clutch gear is splined to the main shaft, and therefore the main shaft rotates with the clutch gear. This principle is carried out when the shift lever moves from one speed to the next.

Constant-mesh gears are seldom used for all speeds. Common practice is to use such gears for the higher gears, with sliding gears for first and reverse speeds, or for reverse only. When the shift is made to first or reverse, the first and reverse sliding gear is moved to the left on the main shaft. The inner teeth of the sliding gear mesh with the main shaft first gear.

SYNCHROMESH TRANSMISSION

The synchromesh transmission is a type of constant-mesh transmission that permits gears to be selected without clashing, by synchronizing the speeds of mating parts before they engage. It employs a combination metal-to-metal friction cone clutch and a dog or gear positive clutch to engage the main drive gear and second-speed main shaft gear with the transmission main shaft. The friction cone clutch engages first, bringing the driving and driven members to the same speed, after which the dog clutch engages easily without clashing. This process is accomplished

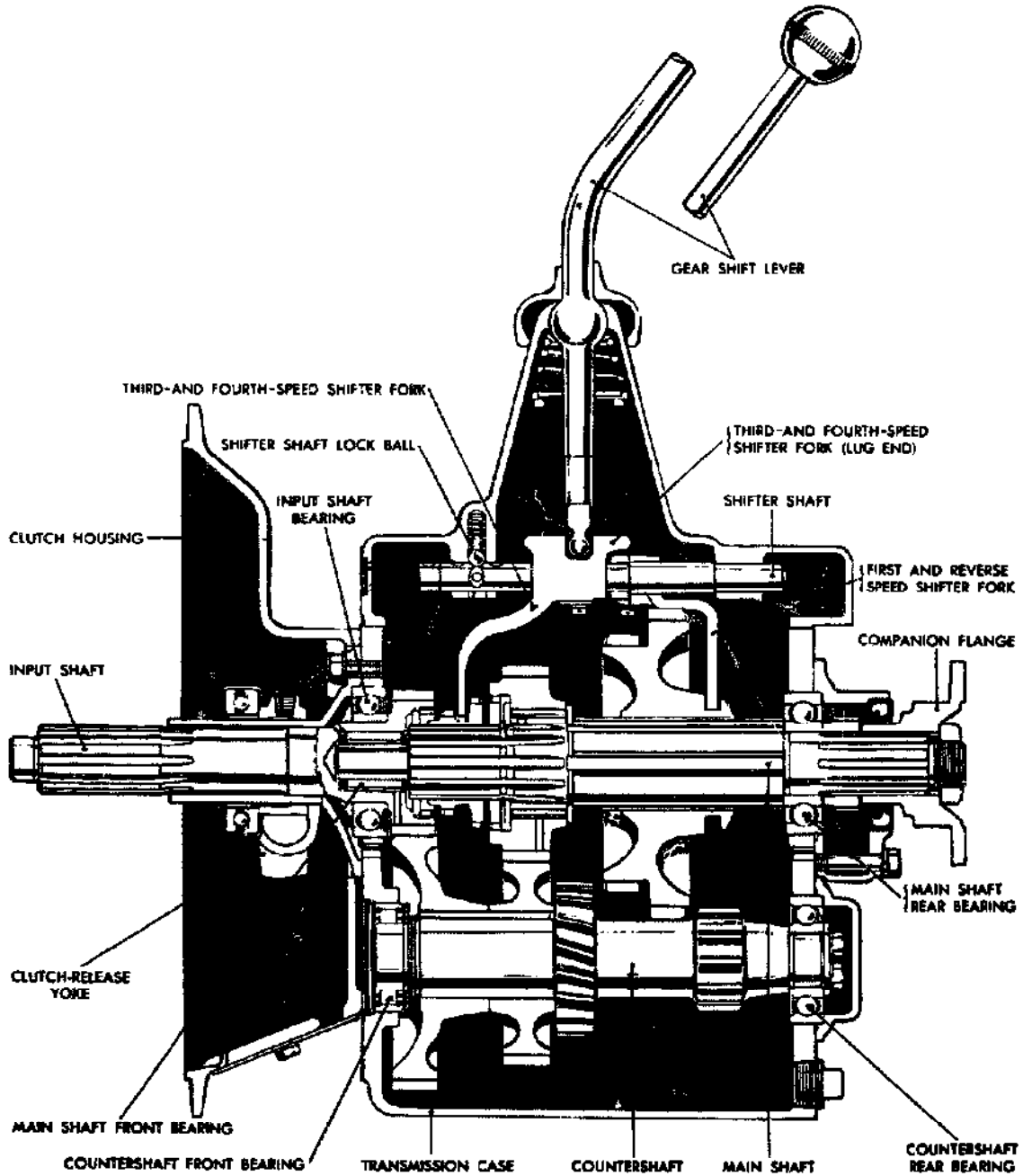
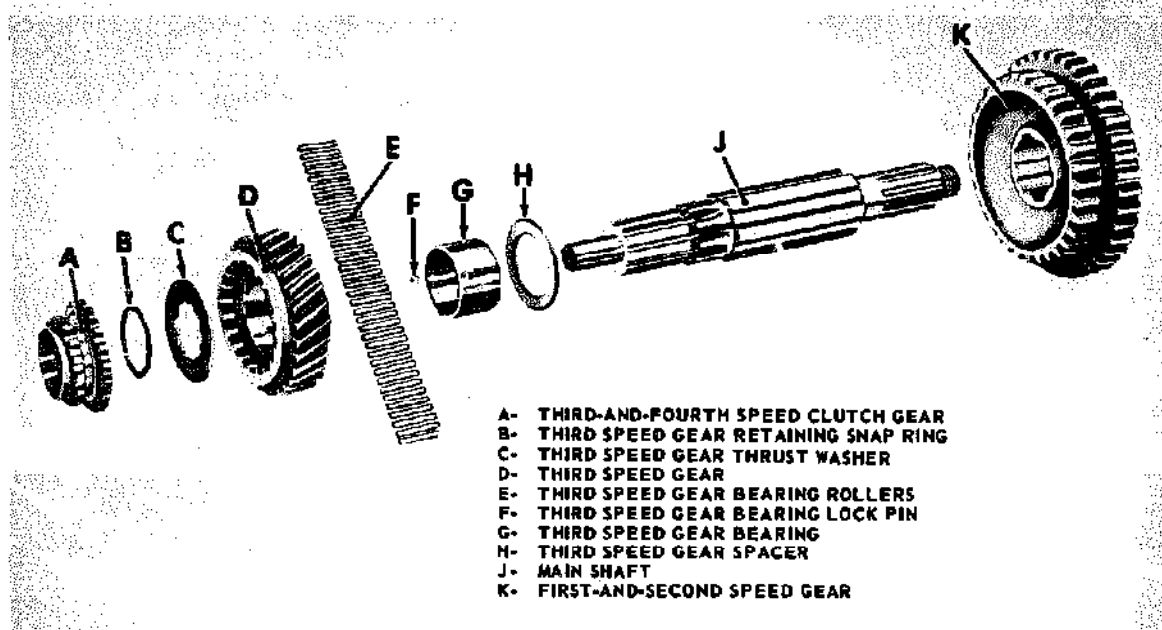

Figure 14-7.—Constant-mesh transmission assembly—sectional view.

81.183



- A- THIRD-AND-FOURTH SPEED CLUTCH GEAR
- B- THIRD SPEED GEAR RETAINING SNAP RING
- C- THIRD SPEED GEAR THRUST WASHER
- D- THIRD SPEED GEAR
- E- THIRD SPEED GEAR BEARING ROLLERS
- F- THIRD SPEED GEAR BEARING LOCK PIN
- G- THIRD SPEED GEAR BEARING
- H- THIRD SPEED GEAR SPACER
- J- MAIN SHAFT
- K- FIRST-AND-SECOND SPEED GEAR

81.184

Figure 14-8.—Disassembled main shaft assembly.

in one continuous operation when the driver declutches and moves the control lever in the usual manner. The construction of synchromesh transmissions varies somewhat with different manufacturers, but the principle is the same in all.

The construction of a popular synchromesh clutch is shown in figure 14-9. The driving member consists of a sliding gear splined to the transmission main shaft with bronze internal cones on each side. It is surrounded by a sliding sleeve having internal teeth that are meshed with the external teeth of the sliding gear. The sliding sleeve is grooved around the outside to receive the shift fork. Six spring-loaded balls in radially-drilled holes in the gear fit into an internal groove in the sliding sleeve and prevent it from moving endwise relative to the gear until the latter has reached the end of its travel. The driven members are the main drive gear and second-speed main shaft gear, each of which has external cones and external teeth machined on its sides to engage the internal cones of the sliding gear and the internal teeth of the sliding sleeve.

The synchromesh clutch operates as follows: when the transmission control lever is moved by the driver to the third-speed or direct-drive position, the shift fork moves the sliding gear and sliding sleeve forward as a unit until the internal cone on the sliding gear engages the external cone on the main drive gear. This action brings the two gears to the same speed and stops endwise travel of the sliding gear. The sliding sleeve then slides over the balls and silently engages the external teeth on the main drive gear, locking the main drive gear and transmission main shaft together as shown in figure 14-9. When the transmission control lever is shifted to the second-speed position, the sliding gear and sleeve move rearward and the same action takes place, locking the transmission main shaft to the second-speed main shaft gear. The synchromesh clutch is not applied to first speed or to reverse. First speed is engaged by an ordinary dog clutch when constant mesh is employed, or by a sliding gear; reverse is always engaged by means of a sliding gear. Figure 14-10 shows a cross section of a synchromesh transmission which uses constant-mesh helical gears for the

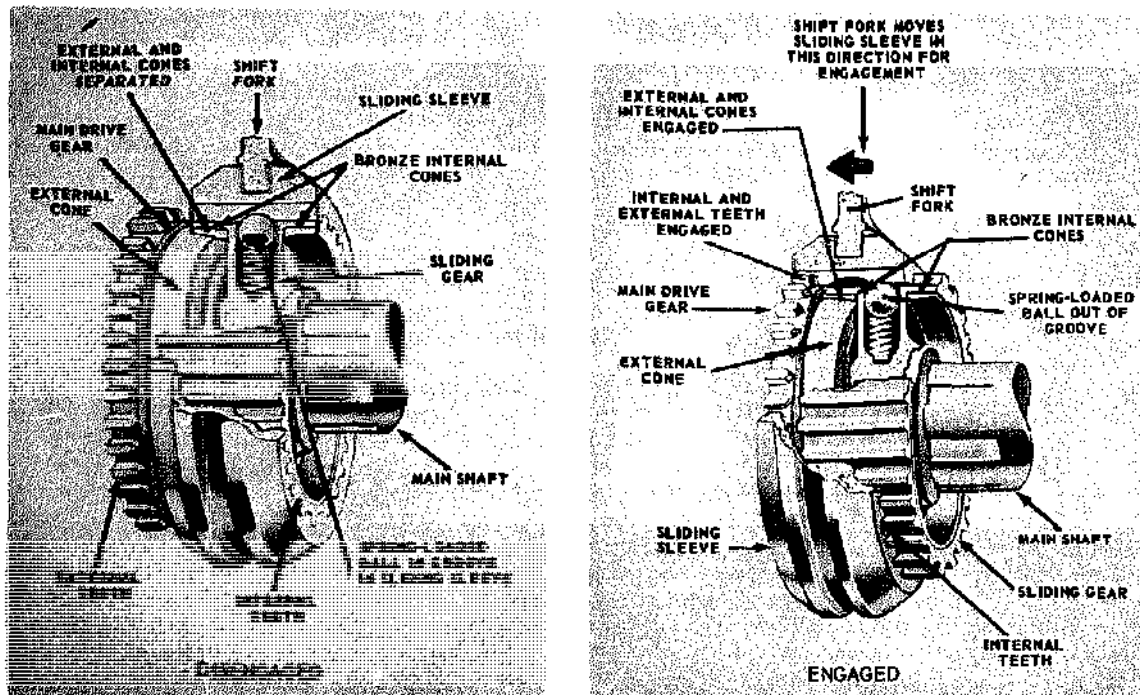

Figure 14-9.—Synchromesh clutch—disengaged and engaged.

81.185

three forward speeds and a sliding spur gear for reverse.

Some transmissions are controlled by a steering column control lever (fig. 14-11). The positions for the various speeds are the same as those for the vertical control lever except that the lever is horizontal. The shifter forks are pivoted on bellcranks which are turned by a steering column control lever through the linkage shown. The poppets shown in figure 14-10 engage notches at the inner end of each bell crank. Other types of synchromesh transmissions controlled by steering column levers have shifter shafts and forks moved by a linkage similar to those used with a vertical control lever.

AUXILIARY TRANSMISSION

The auxiliary transmission allows a rather small engine to move heavy loads in trucks by increasing the engine-to-axle gear ratios. The auxiliary transmission provides a link in the

power trains of construction vehicles to divert engine power to drive 4 and 6 wheels, and also to operate accessory equipment through transfer cases and power takeoff units. (See fig. 14-12).

Trucks require a greater engine-to-axle gear ratio than passenger cars, particularly when manufacturers put the same engine in both types of equipment. In a truck, the auxiliary transmission doubles the mechanical advantage. It is connected to the rear of the main transmission by a short propeller shaft and universal joint. Its weight is supported on a frame cross-member as shown in figure 14-12. The illustration also shows how the shifting lever would extend into the driver's compartment near the lever operating the main transmission.

In appearance and in operation, auxiliary transmissions are similar to main transmissions, except that some may have two and some three speeds (low, direct and overdrive).

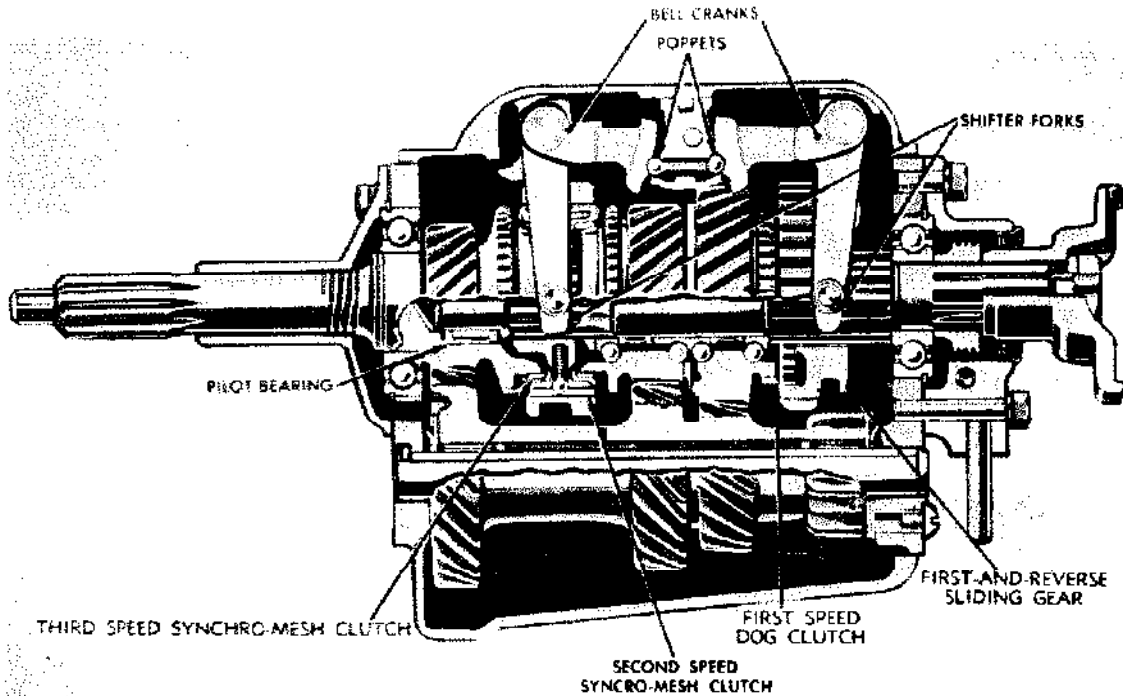

81.186

Figure 14-10.—Synchromesh transmission arranged for steering column control.

TRANSFER CASES

Transfer cases are placed in the power trains of vehicles driven by all wheels. Their purpose is to provide the necessary offsets for additional propeller shaft connections to drive the wheels.

Transfer cases in heavier vehicles have two speed positions and a declutching device for disconnecting the front driving wheels. Two speed transfer cases like the one shown in figure 14-13 serve also as auxiliary transmissions.

Some transfer cases are quite complicated. When they have speed changing gears, declutching devices, and attachments for three or more propeller shafts, they are even larger than the main transmission. A cross section of a common type of two-speed transfer case is shown in figure 14-14. Compare it with the actual installation in figure 14-13.

The declutching mechanism for the front wheels consists of a sliding sleeve spline clutch.

This same type of transfer case is used for a 6-wheel drive vehicle. The additional propeller shaft connects the drive shaft of the transfer case to the rearmost axle assembly. It is connected to the transfer case through the transmission brake drum.

Some transfer cases contain an overrunning sprag unit (or units) on the front output shaft. (A sprag unit is a form of overrunning clutch; power can be transmitted through it in one direction but not in the other.)

On these units the transfer is designed to drive the front axle slightly slower than the rear axle. During normal operation, when both front and rear wheels turn at the same speed, only the rear wheels drive the vehicle. However, if the rear wheels should lose traction and begin to slip, they tend to turn faster than the front wheels. As this happens, the sprag unit automatically engages so that the front wheels also drive the vehicle. The sprag unit simply provides an automatic means of engaging the

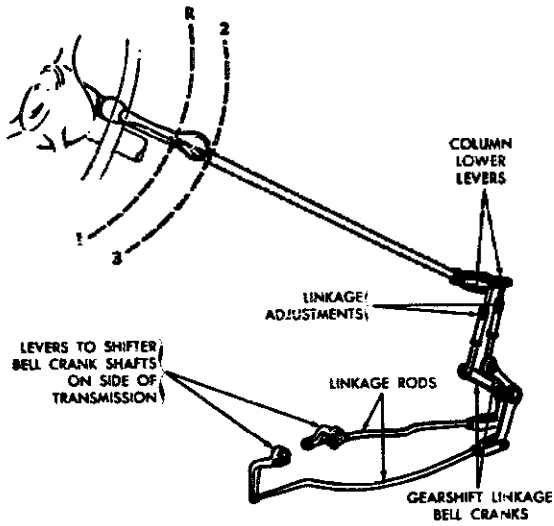

81.187
 Figure 14-11.—Steering column transmission control lever and linkage.

front wheels in drive whenever additional tractive effort is required. There are two types of sprag-unit-equipped transfers, a single-sprag-unit transfer and a double-sprag-unit transfer. Essentially, both types work in the same manner.

POWER TAKEOFFS

Power takeoffs are attachments in the power train for power to drive auxiliary accessories. They are attached to the transmission, auxiliary transmission, or transfer case. A common type of power takeoff is the single-gear, single-speed type shown in figure 14-15. This unit is bolted to an opening provided in the side of the transmission case as shown in figure 14-12. The sliding gear of the power takeoff will then mesh with the transmission countershaft gear. The operator can move a shifter shaft control lever to slide the gear in and out of mesh with the counter shaft gear. The spring-loaded ball holds the shifter shaft in position.

On some vehicles you will find power takeoff units with gear arrangements that will give

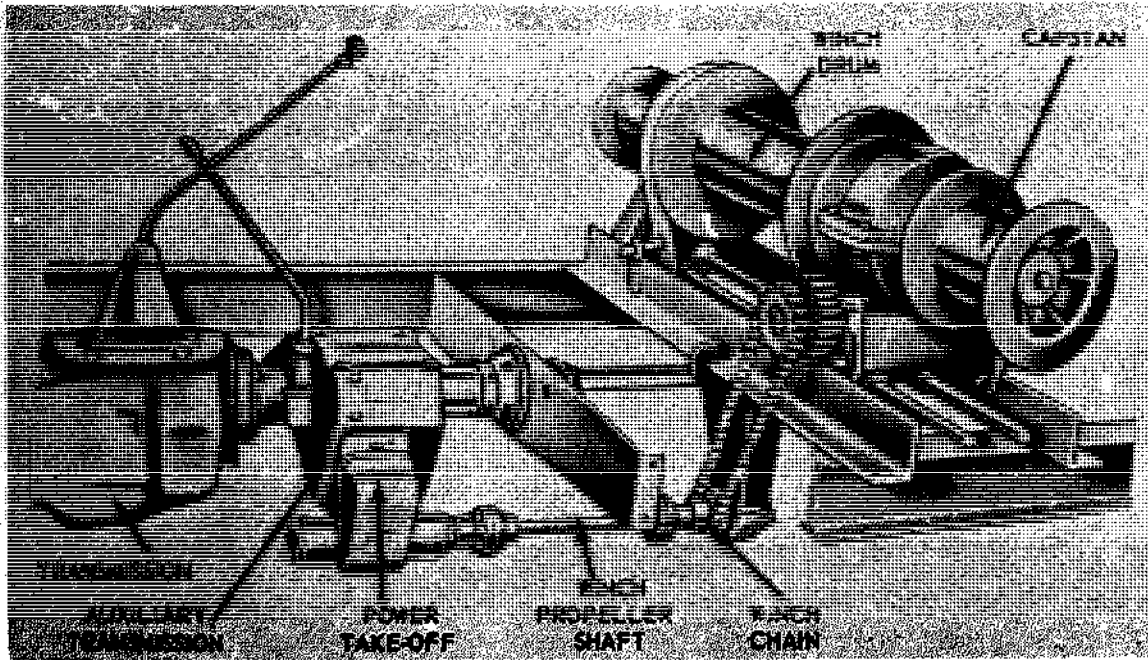

81.188
 Figure 14-12.—Auxiliary transmission power takeoff driving winch.

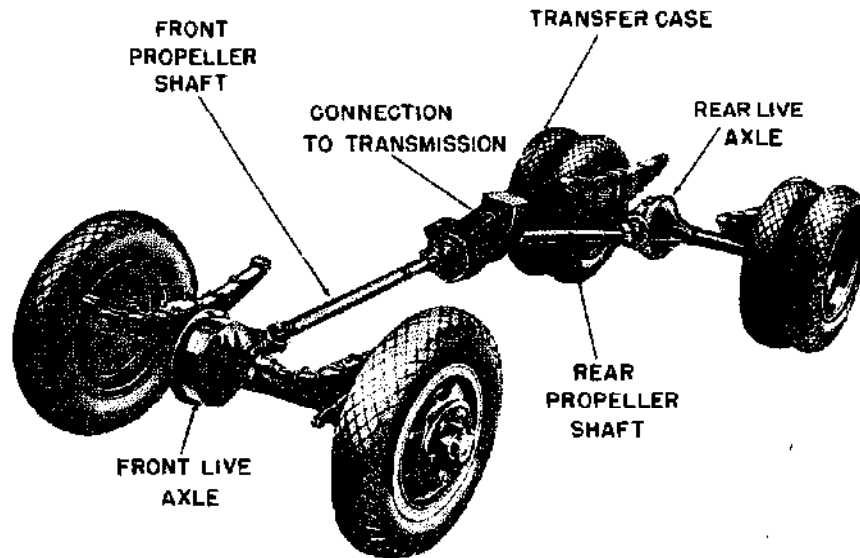

81.190

Figure 14-13.—Transfer case installed in a 4-wheel drive truck.

two speeds forward and one in reverse. Several forward speeds and a reverse gear arrangement are usually provided in power take-off units which operate winches and hoists. Their operation is about the same as the single speed units.

PROPELLER SHAFT ASSEMBLIES

The propeller shaft assembly consists of a propeller shaft, a slip joint, and one or more universal joints. This assembly provides a flexible connection through which power is transmitted from the transmission to the live axles.

The propeller shaft may be solid or tubular. A solid shaft is somewhat stronger than a hollow or tubular shaft of the same diameter, but a hollow shaft is stronger than a solid shaft of the same weight. Solid shafts are generally used inside of a shaft housing that encloses the entire propeller shaft assembly. These are called torque tube drives.

A slip joint is provided at one end of the propeller shaft to take care of end play. The driving axle, being attached to the springs, is

free to move up and down while the transmission is attached to the frame and cannot move. Any upward or downward movement of the axle, as the springs are flexed, shortens or lengthens the distance between the axle assembly and the transmission. To compensate for this changing distance, the slip joint is provided at one end of the propeller shaft.

The usual type of slip joint consists of a splined stub shaft, welded to the propeller shaft, which fits into a splined sleeve in the universal joint. A cross-sectional view of the slip joint and universal joint is shown in figure 14-16.

A universal joint is a connection between two shafts that permits one to drive the other at an angle. Passenger vehicles and trucks usually have universal joints at both ends of the propeller shaft.

Universal joints are double-hinged with the pins of the hinges set at right angles. They are made in many different designs, but they all work on the same principle. (See chapter 11.)

FINAL DRIVES

A final drive is that part of the power train that transmits the power delivered through the

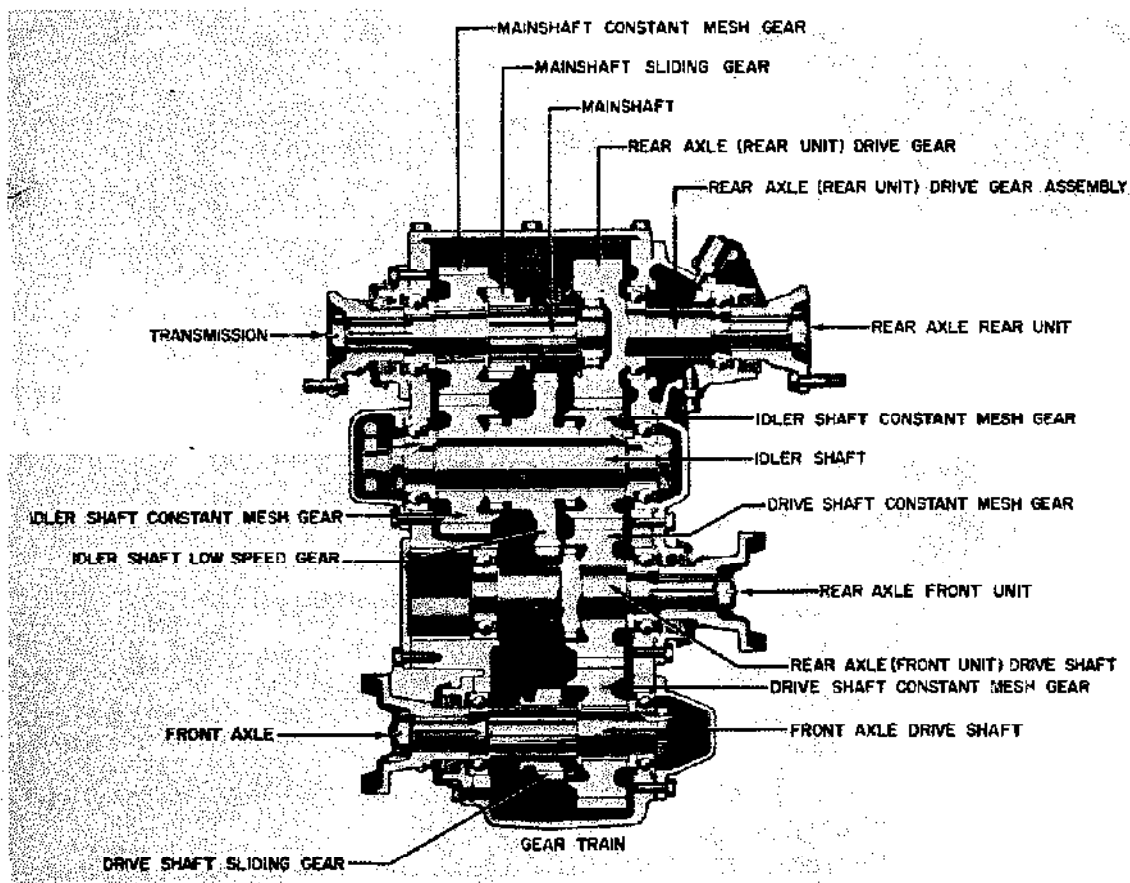

Figure 14-14.—Cross section of a 2-speed transfer case.

81.191

propeller shaft to the drive wheels or sprockets. Because it is encased in the rear axle housing, the final drive is usually referred to as a part of the rear axle assembly. It consists of two gears called the ring gear and pinion. These may be spur, spiral, or hypoid beveled gears, or wormgears, as illustrated in figure 14-17.

The function of the final drive is to change by 90 degrees the direction of the power transmitted through the propeller shaft to the driving axles. It also provides a fixed reduction between the speed of the propeller shaft and the axle shafts and wheels. In passenger cars this

reduction varies from about 3 to 1 to 5 to 1. In trucks, it can vary from 5 to 1 as much as 11 to 1.

The gear ratio of a final drive having bevel gears is found by dividing the number of teeth on the drive gear by the number of teeth on the pinion. In a worm gear final drive, the gear ratio is found by dividing the number of teeth on the gear by the number of threads on the worm.

Most final drives are of the gear type. Hypoid gears are used in passenger cars and light trucks to give more body clearance. They permit the bevel drive pinion to be placed below the center of the bevel drive gear, thereby

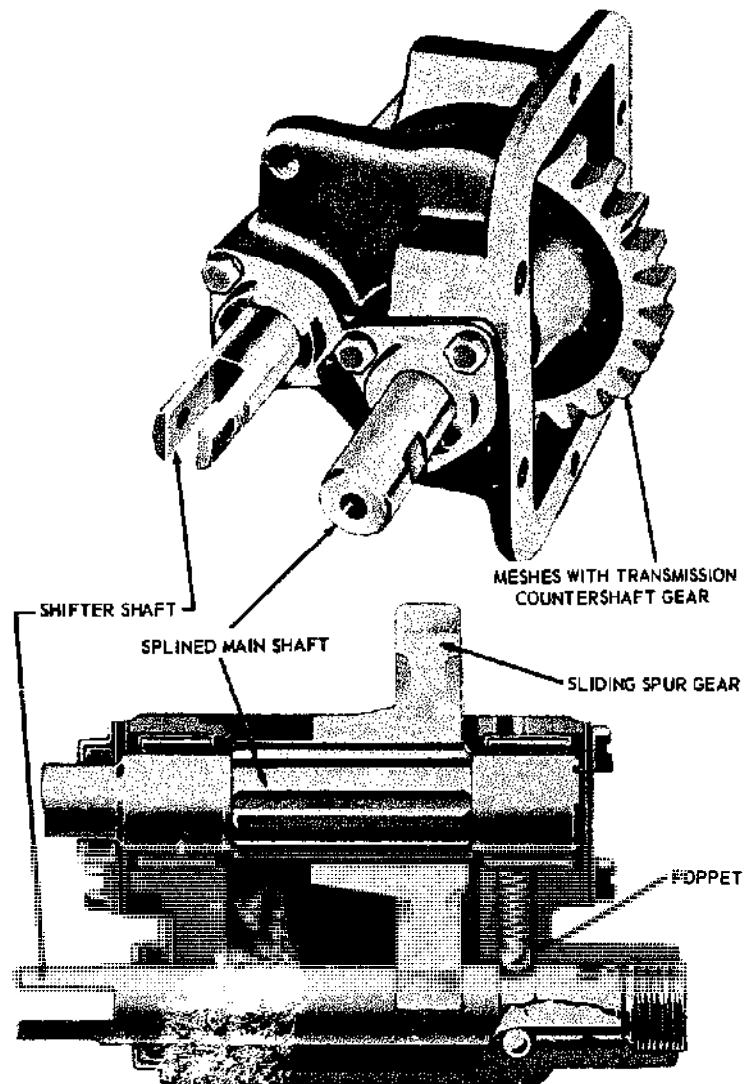

Figure 14-15.—Single speed, single gear, power takeoff.

81.192

lowering the propeller shaft (see fig. 14-17). Worm gears allow a large speed reduction and are used extensively in the larger trucks. Spiral bevel gears are similar to hypoid gears. They are used in both passenger cars and trucks to replace spur gears that are considered too noisy.

DIFFERENTIALS

The construction and principles of operation of the gear differential were described in chapter 11 of this book. We will briefly review some of the high points of that chapter here, and then go on to describe some of the more common types

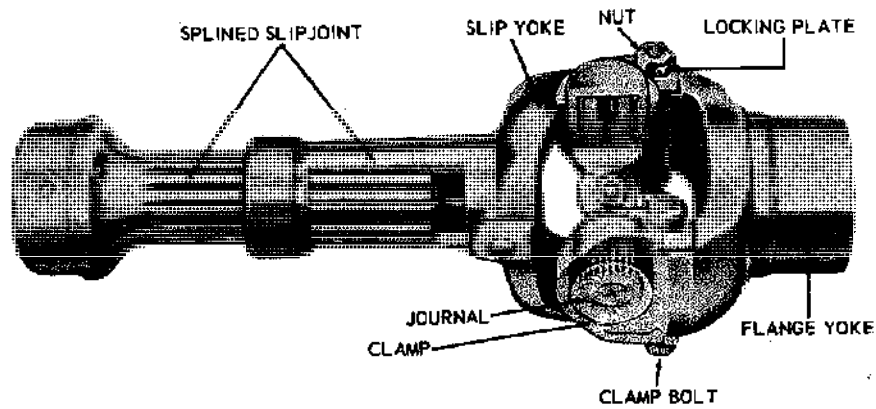

Figure 14-16.—Slip joint and common type of universal joint.

2.200

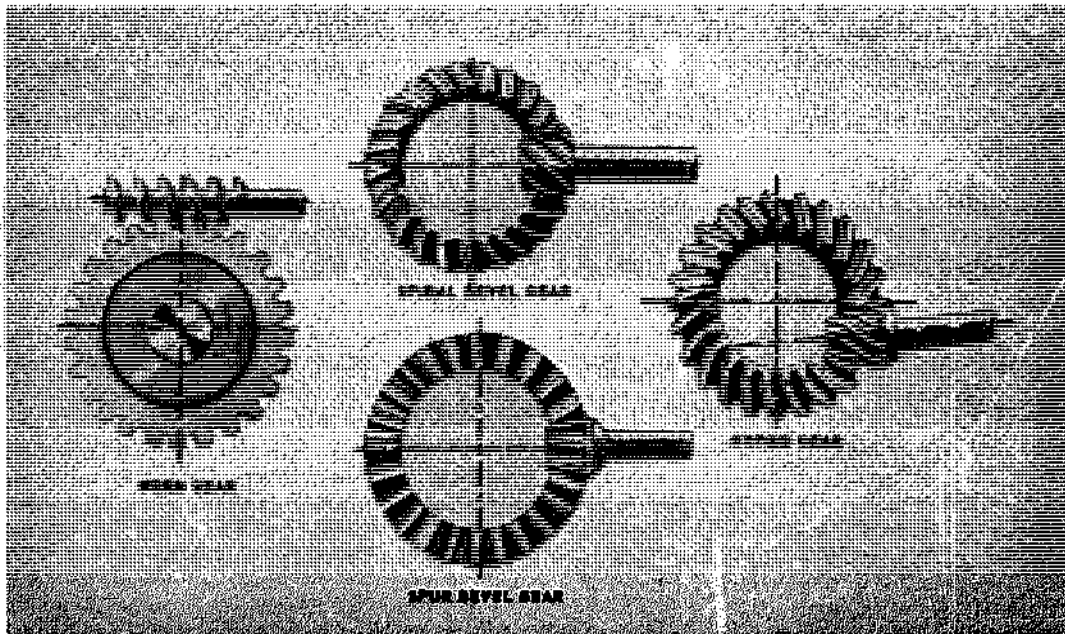
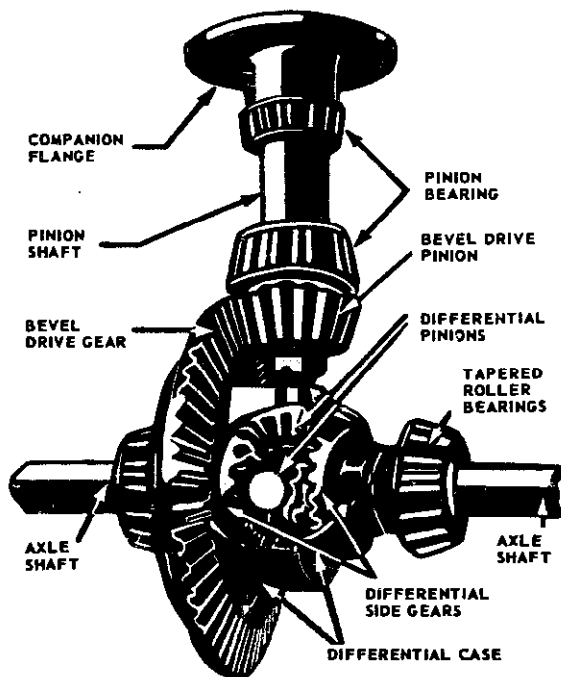

Figure 14-17.—Gears used in final drives.

81.195

of gear differentials as applied in automobiles and trucks.

The purpose of the differential is easy to understand when you compare a vehicle to a company of men marching in mass formation. When the company makes a turn, the men in the inside file must take short steps, almost marking time, while men in the outside file must take long steps and walk a greater distance to make the turn. When a motor vehicle turns a corner, the wheels on the outside of the turn must rotate faster and travel a greater distance than the wheels on the inside. This causes no difficulty for front wheels of the usual passenger car because each wheel rotates independently on opposite ends of a dead axle. However, in order to drive the rear wheels at different speeds, the differential is needed. It connects the individual axle shaft for each wheel to the bevel drive gear. Therefore, each shaft can turn at a different speed and still be driven as a single unit. Refer to the illustration in figure 14-18 as you study the following discussion on differential operation.



81.196

Figure 14-18.—Differential with part of case cut away.

The differential described in chapter 11 had two inputs and a single output. The differential as used in the automobile, however, has a single input and two outputs, the input being introduced from the propeller shaft, and the outputs going to the rear axles and wheels. In this discussion, the "spider gears" are referred to as "differential pinions," so don't let this confuse you.

The bevel drive pinion, connected to the propeller shaft, drives the bevel drive gear and the differential case to which it is attached. Therefore, the entire differential case always rotates with the bevel drive gear whenever the propeller shaft is transmitting rotary motion. Within the case, the differential pinions are free to rotate on individual shafts called trunnions. These trunnions are attached to the walls of the differential case, so that whenever the case is turning, the differential pinions must revolve—one about the other—in the same plane as the bevel drive gear.

The differential pinions mesh with the side gears, as did the spider and side gears in the differential described in chapter 11. The axle shafts are splined to the side gears and keyed to the wheels. Power is transmitted to the axle shafts through the differential pinions and the side gears. When resistance is equal on each rear wheel, the differential pinions, side gears, and axle shafts all rotate as one unit with the bevel drive gear. In this case, there is no relative motion between the pinions and the side gears in the differential case. That is, the pinions do not turn on the trunnions, and their teeth will not move over the teeth of the side gears.

When the vehicle turns a corner, one wheel must turn faster than the other. The side gear driving the outside wheel will run faster than the side gear connected to the axle shaft of the inside wheel. To compensate for this difference in speed, and to remain in mesh with the two side gears, the differential pinions must then turn on the trunnions. The average speed of the two side gears, axle shafts, or wheels is always equal to the speed of the bevel drive gear.

To overcome the situation where one spinning wheel might be undesirable, some trucks are provided with a differential lock. This is a simple dog clutch, controlled manually or automatically, which locks one axle shaft to the differential case and bevel drive gear. Although this device forms a rigid connection between the two axle shafts and makes both wheels rotate at

the same speed, it is used very little. Too often the driver forgets to disengage the lock after using it. There are, however, automatic devices for doing almost the same thing. One of these, which is rather extensively used today, is the high-traction differential. It consists of a set of differential pinions and side gears which have fewer teeth and a different tooth form from the conventional gears. Figure 14-19 shows a comparison between these and standard gears. These differential pinions and side gears depend on a variable radius from the center of the differential pinion to the point where it comes in contact with the side gear teeth, which is, in effect, a variable lever arm. As long as there is relative motion between the pinions and side gears, the torque is unevenly divided between the two driving shafts and wheels; whereas, with the usual differential, the torque is evenly divided at all times. With the high-traction differential, the torque becomes greater on one wheel and less on the other as the pinions move around, until both wheels start to rotate at the same speed. When this occurs, the relative motion between the pinion and side gears stops and the

torque on each wheel is again equal. This device assists considerably in starting the vehicle or keeping it rolling in cases where one wheel encounters a slippery spot and loses traction while the other wheel is on a firm spot and has traction. It will not work, however, when one wheel loses traction completely. In this respect it is inferior to the differential lock.

With the no-spin differential (fig. 14-20), one wheel cannot spin because of loss of tractive effort and thereby deprive the other wheel of driving effort. For example, one wheel is on ice and the other wheel is on dry pavement. The wheel on ice is assumed to have no traction. However, the wheel on dry pavement will pull to the limit of its tractional resistance at the pavement. The wheel on ice cannot spin because wheel speed is governed by the speed of the wheel applying tractive effort.

The no-spin differential does not contain pinion gears and side gears as does the conventional differential. Instead, it consists essentially of a spider attached to the differential drive ring gear through four trunnions, plus two driven clutch members with side teeth that are

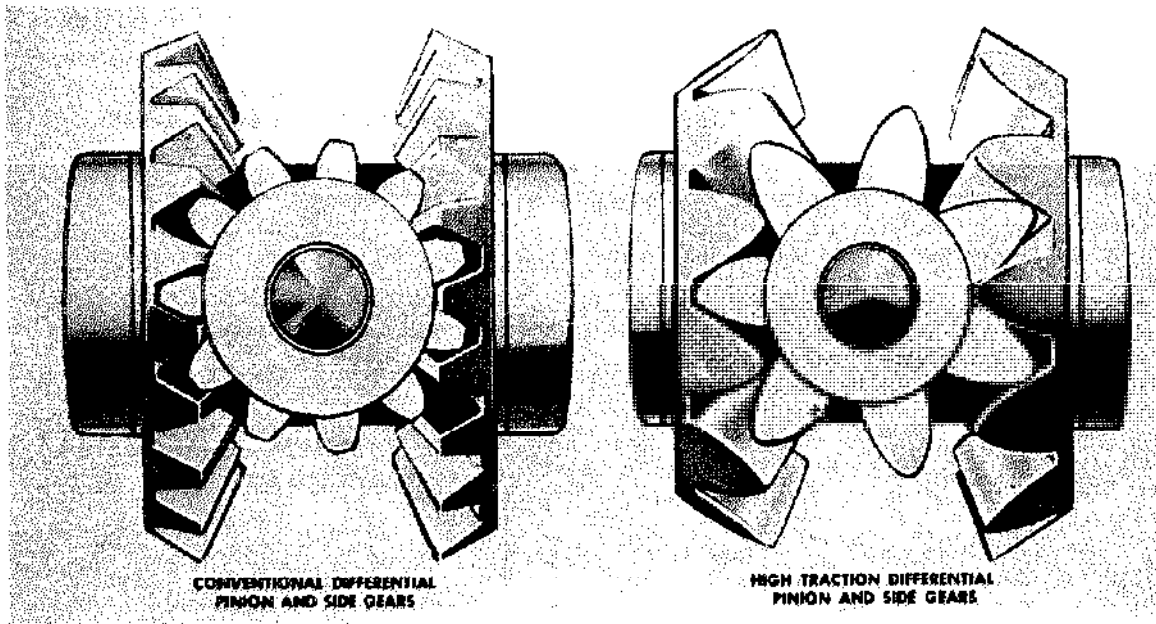

81.197

Figure 14-19.—Comparison of high-traction differential gears and standard differential gears.

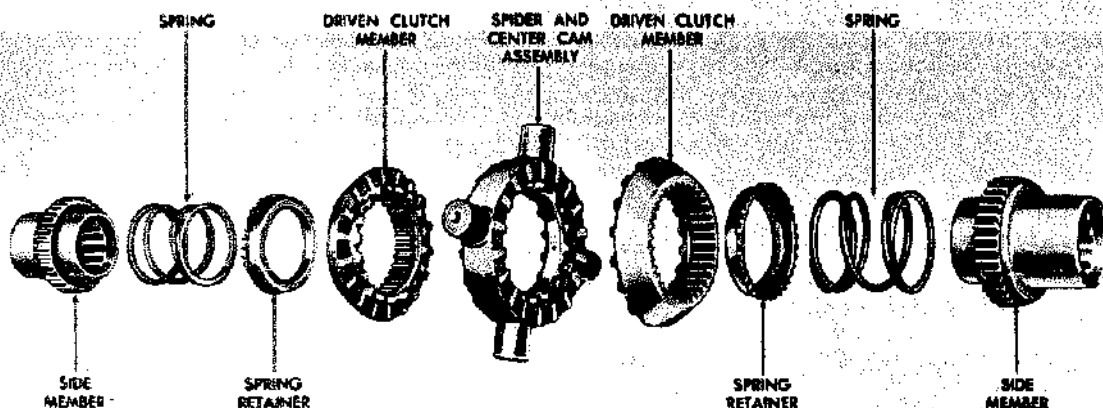

Figure 14-20.—No spin differential—exploded view.

81.198

indexed by spring pressure with side teeth in the spider. Two side members are splined to the wheel axles and in turn are splined into the driven clutch members.

axle shafts in this assembly are called nonfloating because they are supported directly in bearings located in the center and ends of the axle housing. In addition to turning the wheels, these shafts carry the entire load of the vehicle on their outer ends. Plain axes also support the weight of the differential case.

AXLES

A live axle is one that supports part of the weight of a vehicle and also drives the wheels connected to it. A dead axle is one that carries part of the weight of a vehicle but does not drive the wheels. The wheels rotate on the ends of the dead axle.

The semifloating axle (fig. 14-21) that is used on most passenger cars and light trucks

Usually, the front axle of a passenger car is a dead axle and the rear axle is a live axle. In 4-wheel drive vehicles, both front and rear axles are live axles, and in 6-wheel drive vehicles, all three axles are live axles. The third axle, part of a bogie drive, is joined to the rearmost axle by a trunnion axle. The trunnion axle is attached rigidly to the frame. Its purpose is to help in distributing the load on the rear of the vehicle to the two live axles which it connects.

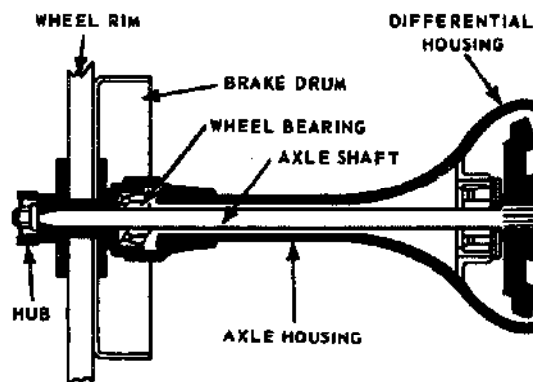

There are four types of live axles used in automotive and construction equipment. They are: plain, semifloating, three-quarter floating, and full floating.

The plain live axle, or nonfloating rear axle, is seldom used in equipment today. The

Figure 14-21.—Semifloating rear axle.

81.200

has its differential case independently supported. The differential carrier relieves the axle shafts from the weight of the differential assembly and the stresses caused by its operation. For this reason the inner ends of the axle shafts are said to be floated. The wheels are keyed to outer ends of axle shafts and the outer bearings are between the shafts and the housing. The axle shafts therefore must take the stresses caused by turning, skidding, or wobbling of the wheels. The axle shaft in a semifloating live axle can be removed after the wheel has been pulled off.

The axle shafts in a three-quarter floating axle (fig. 14-22) may be removed with the wheels, which are keyed to the tapered outer ends of the shafts. The inner ends of the shafts are carried as in a semifloating axle. The axle housing, instead of the shafts, carries the weight of the vehicle because the wheels are supported by

bearings on the outer ends of the housing. However, axle shafts must take the stresses caused by the turning, skidding, and wobbling of the wheels. Three-quarter floating axles are used in some trucks but in very few passenger cars. The full floating axle is used in most heavy trucks. (See fig. 14-23). These axle shafts may be removed and replaced without removing the wheels or disturbing the differential. Each wheel is carried on the end of the axle tube on two ball bearings or roller bearings and the axle shafts are not rigidly connected to the wheels. The wheels are driven through a clutch arrangement or flange on the ends of the axle shaft which is bolted to the outside of the wheel hub. The bolted connection between axle and wheel does not make this assembly a true full floating axle, but nevertheless, it is called a floating axle. A true full floating axle transmits only turning effort, or torque.

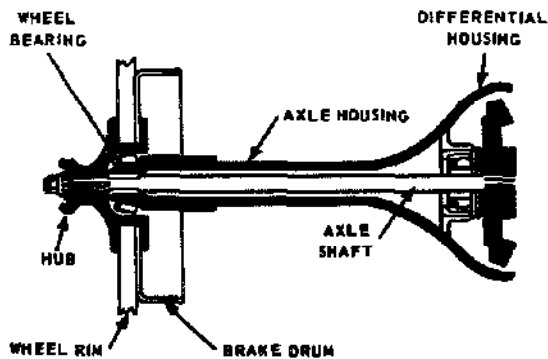

81.201

Figure 14-22.—Three-quarter floating rear axle.

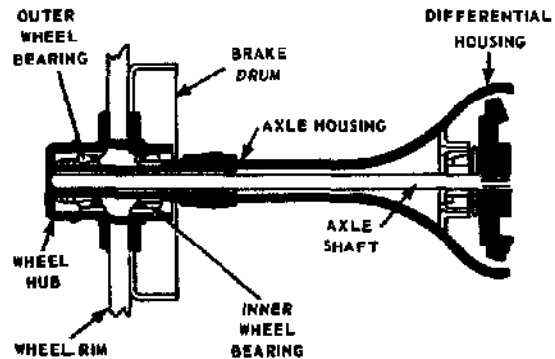

81.202

Figure 14-23.—Full floating rear axle.

CHAPTER 15

BASIC COMPUTER MECHANISMS

We have already studied several examples of complex machines in the preceding chapters to learn how simple machines and basic mechanisms are utilized in their design. The analog computer, of the kind used in modern fire control systems, is a complex machine in every sense of the word. We will not attempt in this book to break down and analyze a complete computer. We will, however, examine a few of the special devices commonly used in computers. These devices have come to be known as basic computer mechanisms. They are, however, quite complex machines in themselves—as you'll soon agree. Like the engine, the typewriter, and the other machines we've studied, these mechanisms are only combinations of simple machines cleverly designed to do a specific kind of work. As before, the watchword is *Look For the Simple Machines*.

DIFFERENTIALS

The differentials used in the analog computer are gear differentials similar to those described in chapter 11. They are different from the automobile differential in that instead of receiving a single input and delivering two outputs, they receive two inputs and combine them into a single output. Most of the differentials in a computer are quite small, averaging about 2" x 2 1/2" in size, and are designed for light loads. Some computers may have as many as 150 gear differentials in their makeup.

Figure 15-1 illustrates the symbol used to indicate the differential in schematic drawings. The cross in the center represents the spider. The arrows pointing inward represent inputs, and the arrow pointing outward is the output.

Figure 15-2 shows one of the many applications of the gear differential in a computer. In this case, the differential is being used as an integral part of a followup control. Computing mechanisms are not designed to drive heavy

loads. The outputs from such mechanisms often merely control the action of servomotors. The motors do the actual driving of the loads to be handled. The device which makes it possible for the comparatively weak output from a computing mechanism to control the action of a servomotor is called a followup control. In this device, the differential is used to measure the difference, or "error," in position between the input and the output. The input is geared to one side of the differential. The servo output is used to do two things: (1) to position whatever mechanism is being handled, and (2) to drive the other side of the differential. This second operation is known as the servo "response."

When there is a difference between the input and the output, the spider of the differential turns. As this happens, the spider shaft operates a set of controls which control the action of the servomotor in such a way that the motor drives its side of the differential in a direction opposite to that taken by the input. That is, the servo always drives to reduce the difference, or error, to zero.

LINKAGES FOR ADDING AND SUBTRACTING

Addition of two quantities is performed in the linkage mechanism by means of adding levers as shown in figure 15-3. In the example two quantities, designated X and Y, are to be added. Their values are represented by the movements of the two slide bars. The adding lever is pivoted at its center to another slide bar, and its opposite ends are connected through links to the X and Y slides. To illustrate the problem, scales showing the values of the quantities represented by movements of slides have been drawn in the figure, and index marks are placed on the slides. The units on the center scale are half as large as those on the other two.

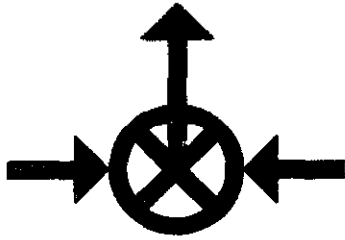

12.87

Figure 15-1.—This is the symbol used to indicate the differential in schematic drawings.

If the Y slide is held in place and the X slide is moved, the adding lever pivots about its lower end. The center slide, which is connected to the midpoint of the lever then moves half as far as the X slide. If the X movement is one unit, the center slide also moves one unit since the units on the center scale are half as large as those on the X scale. Similarly, movements of the Y slide with the X slide held in place add one unit on the center scale for each unit movement of

Y. At the left of figure 15-3, the parts are shown in zero position, with the three index marks opposite the zero points of the scales. At the right, the X slide has been moved one unit, and the Y slide has been moved three.

The center slide has traveled one unit in response to the X-travel and three more in response to the Y-travel, and so stands at a reading of four. Similarly, for any position of the X and Y slides, the reading on the center scale represents the quantity X plus Y.

There are several variations of the adding lever used in computing linkage, but their operating principles are the same.

MECHANICAL MULTIPLIERS

There are two basic types of mechanical multipliers—those using rotary gearing and those using linkages.

The rotary gearing type produces a solution through the use of similar triangles. There are four types of rotary multipliers in use—screw, rack, sector, and cam. Since they all operate in fundamentally the same manner, we will discuss the screw type multiplier and then compare the other types to it.

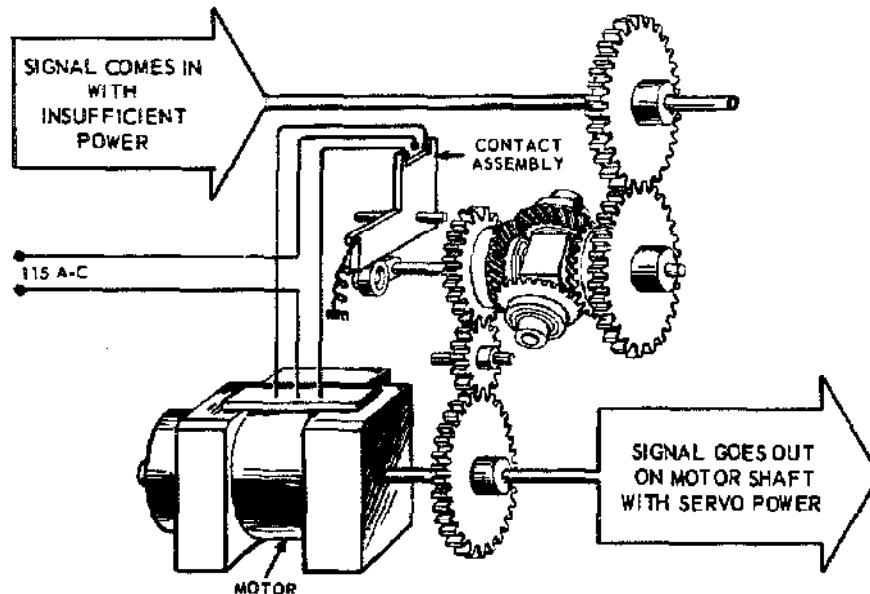

110.9

Figure 15-2.—Simplified sketch of a followup control showing application of a gear differential.

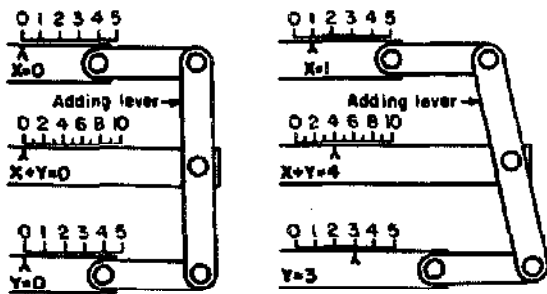

12.88

Figure 15-3.—Adding lever.

The screw multiplier, shown in figure 15-4, has two inputs and one output. The inputs are shaft values which position the input slide and input rack. The output appears at the output rack which positions the output shaft. Thus the output shaft value is always proportional to the product of the two inputs.

One input gearing is connected to two long screws. These screws pass through the threaded sleeve-like ends of the slotted input slide. As the input gears to the screws are rotated, the two screws turn to move the slide to the left or right. At the same time, the other input moves the input rack up or down, moving the slotted pivot arm around the stationary pin.

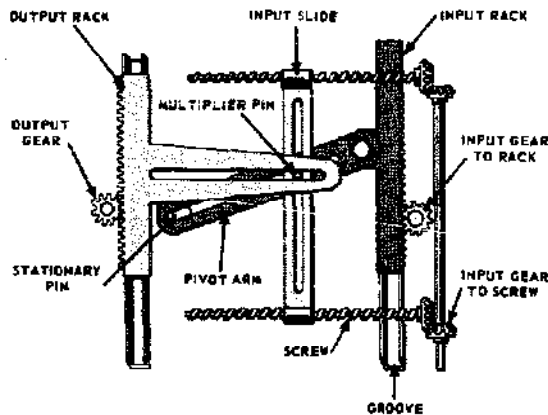

12.91

Figure 15-4.—Screw type multiplier.

The multiplier pin is mounted in the slots of the input slide, pivot arms, and output rack, connecting all three where the slots cross. As the multiplier pin moves the input slide and pivot arm, it positions the output rack and gear.

Now, consider the multiplier in the zero position shown in figure 15-5. If only the screws are rotated, the input slide moves to the right; but it will not affect the output rack. Similarly, if only the input rack is moved up or down from the zero position, the output rack will be unaffected. This is a reasonable result, for any number multiplied by zero is equal to zero.

From this we can conclude that both inputs must be removed from the zero position for an output. Such a condition is shown in figure 15-6. Notice the triangle superimposed on the device. The value a represents the amount of rack input. The value b represents the amount of slide input. K is a fixed distance, since the multiplier pin cannot move and the input rack travels in a machined guide.

Because the angles are equal, the triangles are similar. Thus the value of X can be determined if the other values are known.

$$\text{(Actually, } X = \frac{ba}{K}\text{)}$$

This equation shows that the output (X) is always proportional to the product of the two inputs. The constant value (K) can be compensated for by the proper choice of input and output gearing for the multiplier. These

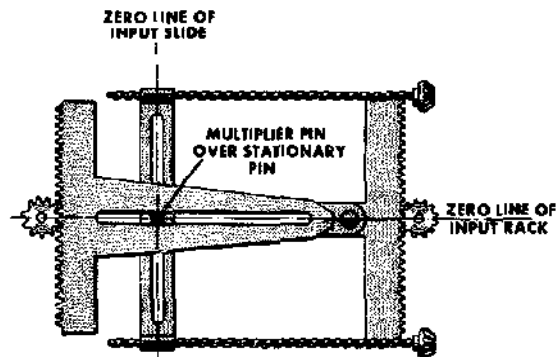

12.92

Figure 15-5.—Screw type multiplier—zero position.

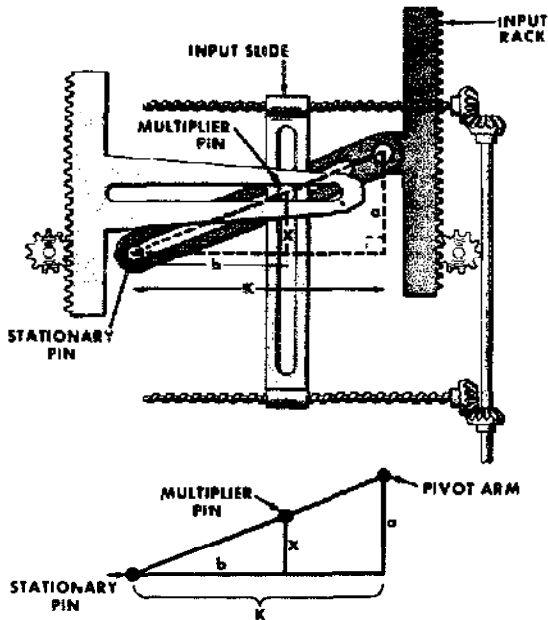

12.93

Figure 15-6.—Screw type multiplier—multiplying positive values.

multipliers can also determine the product of negative values.

The rack type multiplier in figure 15-7 performs the same task as the screw type multiplier. The differences are that (1) the screw input has been replaced with an input rack, and (2) the output rack is placed on the same side as the second input rack.

The sector type, although different in construction, also employs triangles for the multiplication of the two inputs. A sector type multiplier is shown in figure 15-8. One input positions the input sector arm and the other input turns a large screw that is mounted on the input sector arm. The bevel gear turns this lead screw through a universal joint. The use of the universal joint permits the input to drive the lead screw as the sector arm changes its angular position. Notice that the lead screw drives the multiplier pin up and down the sector arm. Thus the position of the input sector arm and the position of the multiplier on the lead screw represents the two values to be multiplied.

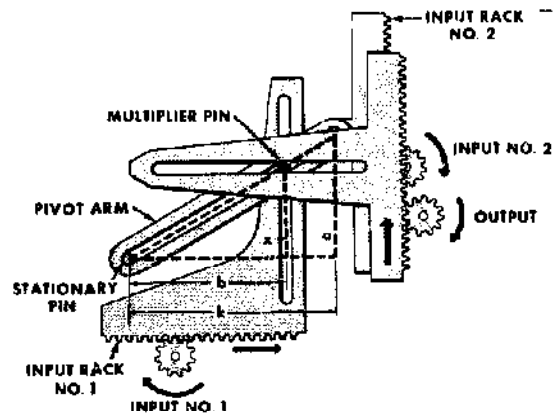

12.94

Figure 15-7.—Rack type multiplier.

A study of figure 15-9 along with figure 15-8 will reveal how the triangles are established. While the sector type multiplier can handle both positive and negative inputs on the input sector arm, the input to the lead screw must always be a positive quantity.

The cam computing multiplier is a dual operation device. It computes a function of one value on a cam and multiplies that function by a second value. It is a combination of a cam and a rack type multiplier.

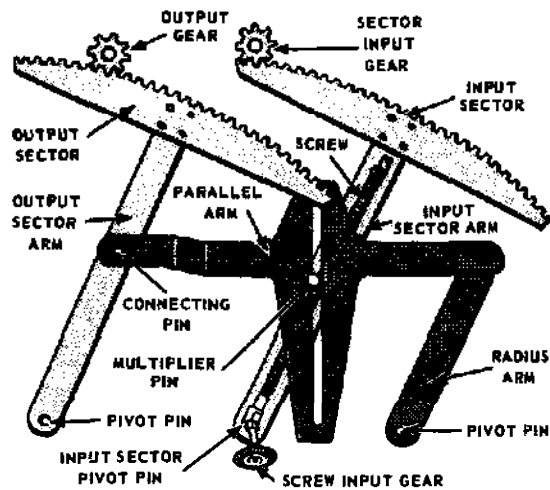

12.95

Figure 15-8.—Sector type multiplier.

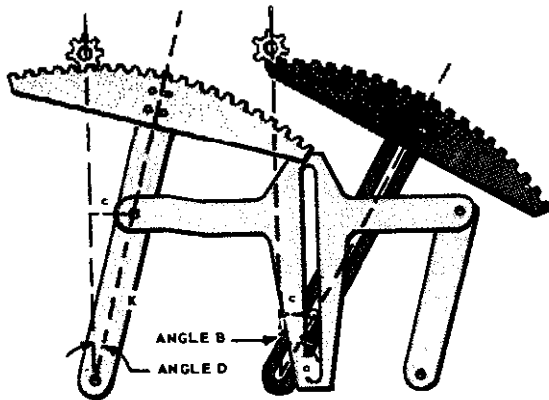

Figure 15-9.—Multiplying with the sector type multiplier. 12.96

A single cam computing multiplier is shown in figure 15-10. Notice it is like the rack type multiplier except that one of the inputs is positioned by a cam instead of a rack. The cam follower pin is mounted directly on the multiplier input slide. This cam may be cut to compute any desired function of the cam input.

One input drives the input rack through the rack input gear. The other input drives the cam

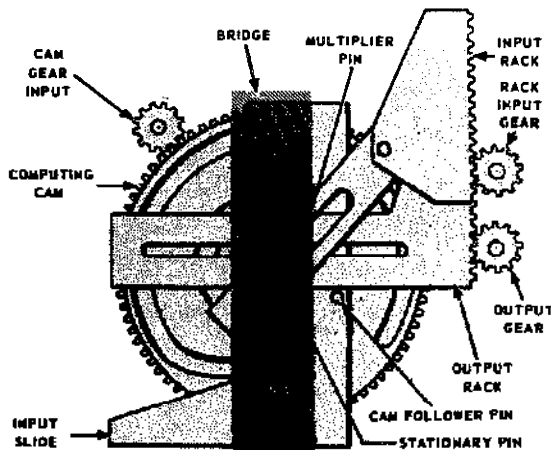

Figure 15-10.—Single cam computing multiplier. 12.97

directly. The cam positions the input slide according to the function for which the cam was cut. Thus the cam output becomes the slide input. The position of the output rack represents a value which is proportional to the product of the cam output and the rack input, just as in the rack type multiplier.

A two-cam computing multiplier computes the function of both inputs and multiplies these functions together. The output is proportional to the product of the functions of the two inputs.

Linkage multipliers of the type described here are used when one of the factors is a constant, as shown in figure 15-11. In this example we want to transform a movement representing the quantity X into one representing $1.5X$. One end of the multiplying lever is pivoted on the fixed frame of the computer, as indicated by the cross-hatched circle in the figure.

The input and output links are connected to the lever at different points, the connection of the output link being 1.5 times as far from the fixed pivot as the connection of the input link. The two scales shown in figure 15-11 have units of the same size; but because of the difference in lever arms, each one-unit movement of the input link moves the output link a unit and a half. Then, if the input movement represents the quantity X , the output represents $1.5X$.

In many cases the computing problem requires the multiplication of two variable quantities. The multiplying levers shown in figure 15-11 cannot be used for this purpose. Figure 15-12 shows a linkage designed to multiply two variables, X and Y . The levers AB and ED are pivoted on the fixed structure and are connected by links BC and CD , both of which have exactly the same length as AB . The X input is applied by a link connected at B . The Y input is applied by a link connected at C ;

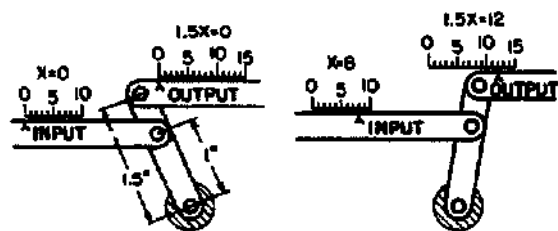

Figure 15-11.—Multiplying lever. 12.98

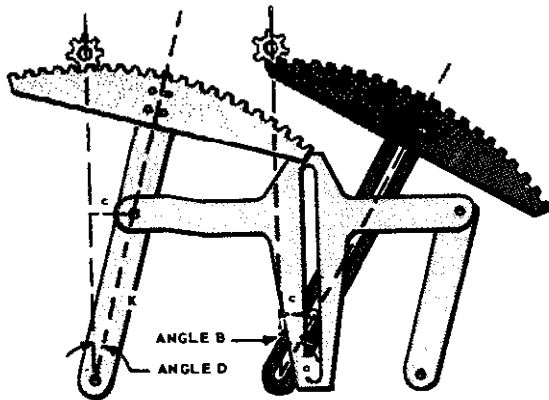

Figure 15-9.—Multiplying with the sector type multiplier. 12.96

A single cam computing multiplier is shown in figure 15-10. Notice it is like the rack type multiplier except that one of the inputs is positioned by a cam instead of a rack. The cam follower pin is mounted directly on the multiplier input slide. This cam may be cut to compute any desired function of the cam input.

One input drives the input rack through the rack input gear. The other input drives the cam

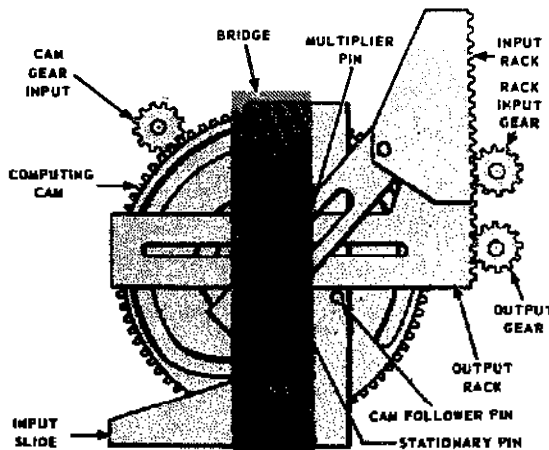

Figure 15-10.—Single cam computing multiplier. 12.97

directly. The cam positions the input slide according to the function for which the cam was cut. Thus the cam output becomes the slide input. The position of the output rack represents a value which is proportional to the product of the cam output and the rack input, just as in the rack type multiplier.

A two-cam computing multiplier computes the function of both inputs and multiplies these functions together. The output is proportional to the product of the functions of the two inputs.

Linkage multipliers of the type described here are used when one of the factors is a constant, as shown in figure 15-11. In this example we want to transform a movement representing the quantity X into one representing $1.5X$. One end of the multiplying lever is pivoted on the fixed frame of the computer, as indicated by the cross-hatched circle in the figure.

The input and output links are connected to the lever at different points, the connection of the output link being 1.5 times as far from the fixed pivot as the connection of the input link. The two scales shown in figure 15-11 have units of the same size; but because of the difference in lever arms, each one-unit movement of the input link moves the output link a unit and a half. Then, if the input movement represents the quantity X , the output represents $1.5X$.

In many cases the computing problem requires the multiplication of two variable quantities. The multiplying levers shown in figure 15-11 cannot be used for this purpose. Figure 15-12 shows a linkage designed to multiply two variables, X and Y . The levers AB and ED are pivoted on the fixed structure and are connected by links BC and CD , both of which have exactly the same length as AB . The X input is applied by a link connected at B . The Y input is applied by a link connected at C ;

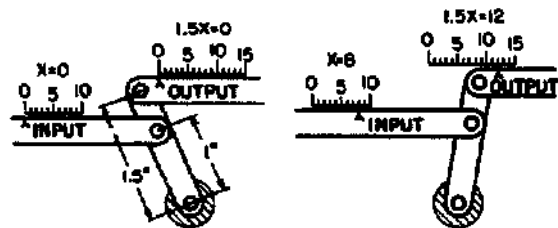

Figure 15-11.—Multiplying lever. 12.98

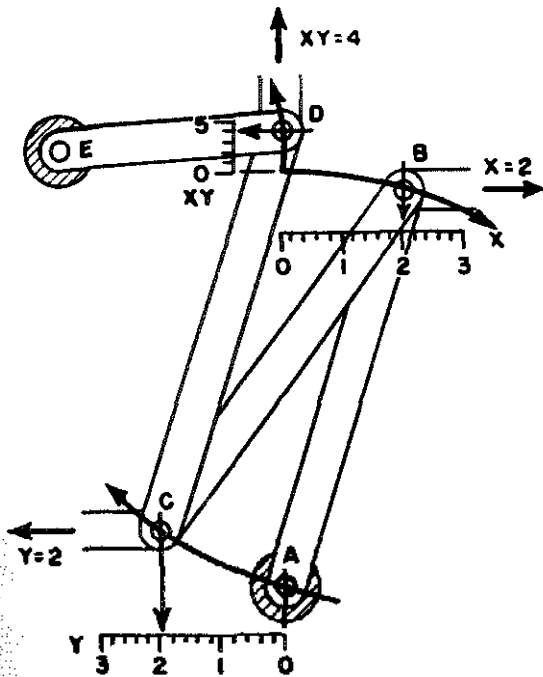

Figure 15-12.—Multiplying linkage. 12.99

and the output XY is taken off at D . In the position of the links shown in figure 15-12, X equals two units, Y equals two units, and XY equals four.

This type of linkage in the computer can be operated in reverse to serve as a divider instead of a multiplier. Two inputs are applied at the points corresponding to B and D in figure 15-12. The output taken off at C then represents the input at D divided by the input at B .

Component solvers are devices that are used in mechanical computers. The component solver takes a vector of a given magnitude and angular position, and resolves it into its two rectangular components.

There are several types of component solvers. However, this discussion will be limited to the screw type component solver. The device consists of a vector gear, two racks, two output gears, two input gears, and a screw and pin assembly. The speed input gear drives a gear train which causes the screw to turn. As the screw turns, it drives an assembly carrying the pin,

thus changing the length of the vector which is proportional to the input component, such as r (slant range). (See figure 15-13.)

In this type of component solver the pin can travel nearly the full width of the vector gear. From the pin's zero or center position it can be moved in either of two directions, which correspond to positive or negative.

The vector input gear drives the vector gear in the desired angular direction indicating target position. The pin positions the racks as it moves along the slot, thus resolving the vector into its components.

An angle resolver is a linkage mechanism which computes the sine and cosine of an angle. Figure 15-14A shows an angle resolver consisting of gear H with two crank pins M and N , mounted 90° apart and equidistant from the center of the gear. Attached to each crank pin is an output link which transmits the horizontal component of motion of the pin as the gear rotates. The horizontal component of the displacement of pin M is proportional to the sine of the angle through which gear H rotates. The horizontal component of pin N is proportional to the cosine of the angle through which gear H rotates.

Figure 15-14B shows the resolver in its zero position, with the radius OM perpendicular to the horizontal center line and the radius ON in the horizontal center line. Notice that link R (sine output) is at zero horizontal displacement, and that link S (cosine output) is at maximum

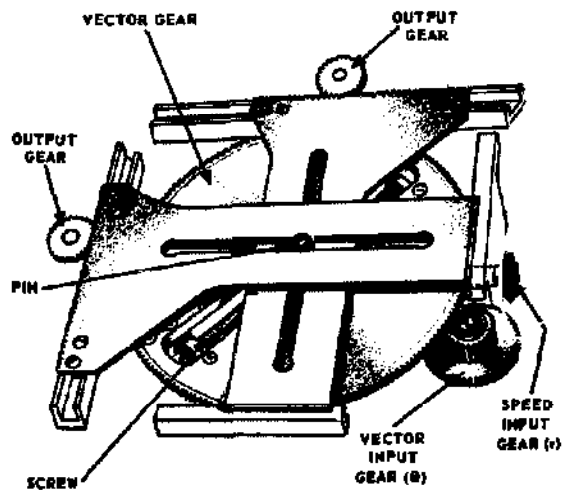

Figure 15-13.—Screw type component solver. 12.113

horizontal displacement. If we rotated gear H clockwise through an angle 30° , link R would move to the right and link S to the left along the horizontal center line. The linear displacement of the output links would be proportional to the sine and cosine function of the angle.

The outputs of the resolver of figure 15-14 are only approximate values. This is because the output links are not parallel to the horizontal center line. The output links have a slight angular movement that must be compensated for to eliminate distortion. This is accomplished by additional gearing, and by making the pins M and N eccentric.

Integrators, as used in computers, perform a special type of multiplication. In the disc-type integrator, illustrated in figure 15-15, a constantly changing value, such as time, is multiplied by a variable such as range rate, such as range (the rate that a target range is opening or closing), the output being a continuous value of their product which can be accumulated as shaft rotation.

The instrument consists of a flat circular disc revolved at constant speed by a motor equipped with a clock escapement; a carriage, containing two balls driven by friction with the surface of the disc, and themselves driving an output roller; and suitable shafts and gears for transmission of values to and from the unit. Rotation of the disc rotates the lower ball, which turns the upper ball, and this in turn

rotates the output roller. The balls are supported in a movable carriage so that the point of contact between the lower ball and the disc can be shifted along a diameter from the center of the disc to either edge. Spring tension on the roller provides sufficient pressure to prevent slipping. Two balls are used to reduce the sliding friction that results when only one is used.

The speed of roller rotation depends upon the speed at which the balls rotate. If the carriage is in the center of the disc, no motion is imparted to the roller. As the carriage is moved off center, the balls will begin to rotate, and will reach their maximum speed at the edge of the disc. The speed varies with the distance of the carriage from the center. Values of rotation on one side of center are considered positive, while if the carriage is moved to the opposite side, rotation will be in the opposite direction and will give negative output values.

SUMMARY

Of the many existing complex machines to choose from, you have been given only a few examples to study. The operational principles of some of them may have come to you quite easily—others may have been a bit harder to grasp. In any case, if you'll keep firmly in mind the following points that have been brought out in this book—you'll find all machines much easier to analyze and understand.

A machine is any device that helps you do work. It helps you by changing motion, magnitude, or speed of the effort you apply.

All machines consist of one or more of the six basic, or simple machines. These are the lever, the block and tackle, the wheel and axle, the inclined plane, the screw, and gears.

When machines give a mechanical advantage of more than one, they multiply the force of your effort. When they give a mechanical advantage of less than one, they multiply either the motion, or the speed of the force you apply.

No machine is 100 percent efficient. Some of your effort is always used to overcome friction. You always do more work on the machine than it does on the load.

You can figure out how any complex machine works by breaking it down into the simple machines from which it is made, and following the action through, step by step.

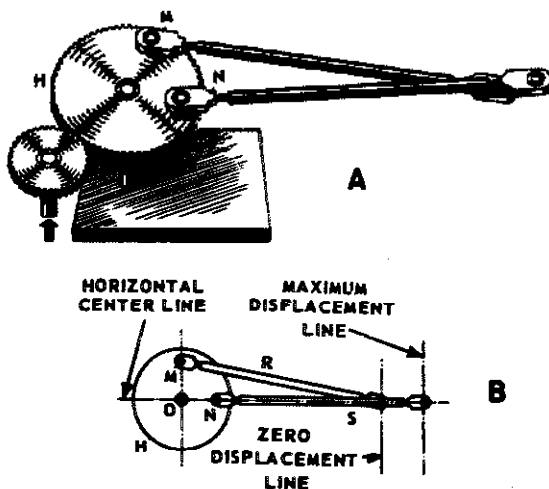

12.115
Figure 15-14.—Basic linkage angle resolver.

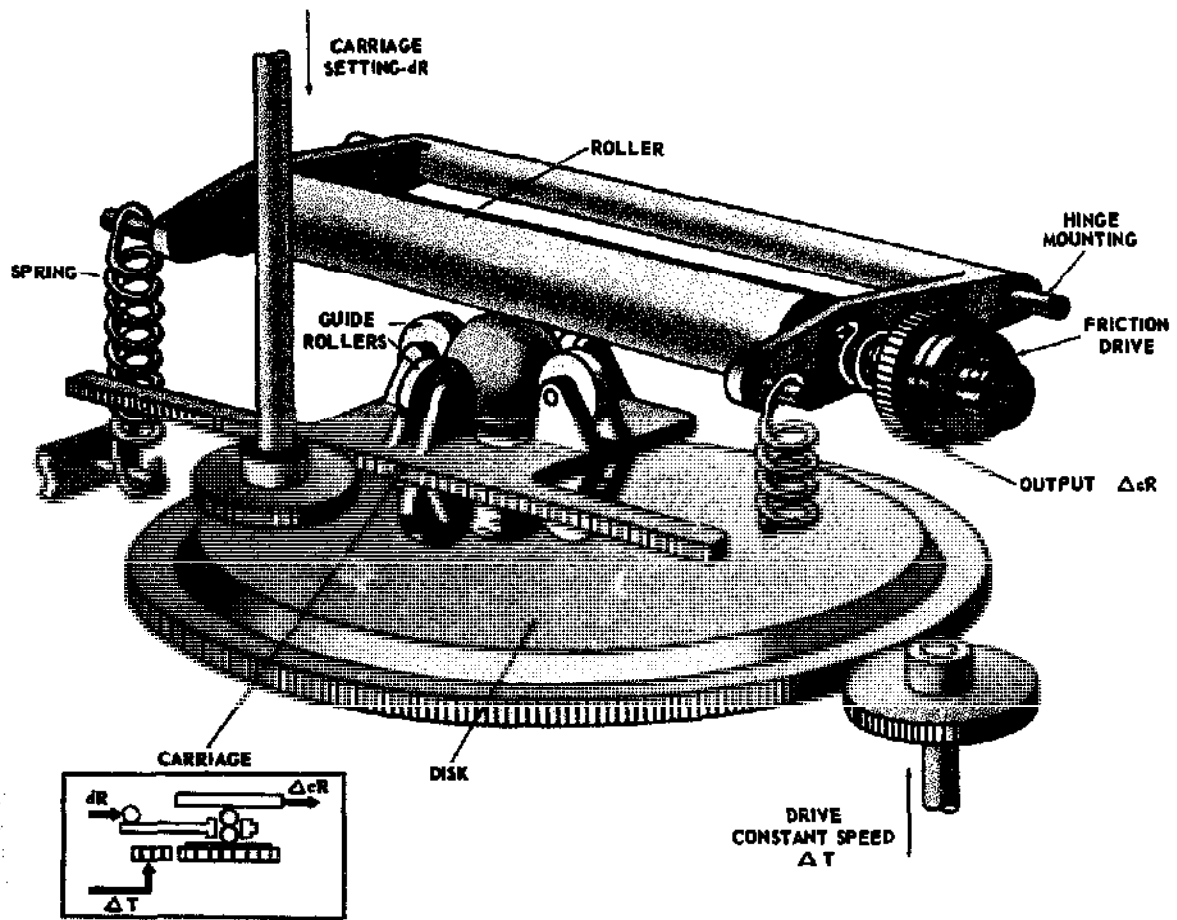

Figure 15-15.—The disc type integrator.

110.12

INDEX

- Accumulator, 67
- Anchor winch, 36, 38
- Automobile valve gear, 36
- Axles used in power trains, 148, 149

- Balancing moments of force, 18
- Ballast tank, 67, 68
- Ball bearings, 71, 73
- Barometer, 54-57
- Bearings, 69-73
- Bendix-Weiss universal joint, 79
- Bevel gear, 31
- Bevel gear differential, 75
- Block and tackle, 10-15, 41
 - applications afloat and ashore, 13
 - chain hoist, 15
 - flaghoist, 10
 - gun tackle, 11
 - luff tackle, 11
 - luff upon luff, 13, 14
 - mechanical advantage, 10, 15
 - runner, 10
 - yard and stay tackle, 13
- Bourdon gage, 53
- Brakes, 28, 63
 - friction, 28
 - hydraulic, 63
- Breech, 16-inch gun, 7

- Cams, 85
- Cam and cam followers, 80-82
- Cam-driven valve, 36
- Cam shaft, 36
 - of a 4-stroke cycle engine, 127
- Capstan bar, 17, 18
- Chain hoist, 15
- Chain stopper, 8
- Clockwise moments of force, 19
- Clutches, 82, 86, 130-133
 - power train, 130-133
- Combustion engines, 106-129
 - basic strokes, 108
 - classification of, 113
 - construction of, 115-129
 - auxiliary assemblies, 129
 - connecting rods, 123
 - crankcase, 117
 - crankshaft, 124
 - cylinder head, 117
 - engine cylinder block, 115
 - engine head, 126
 - exhaust manifold, 118
 - gaskets, 119
 - intake manifold, 118
 - moving parts, 119-129
 - piston assembly, 120
 - stationary parts, 115-119
 - timing gears, 128
 - valves and valve mechanisms, 126-128
 - vibration damper, 125
 - cycles, 109-112
 - development of power, 106
 - diesel engines, 114
 - gasoline engines, 114
 - multiple-cylinder engines, 112
 - one-cylinder engine, 106-112
- Complex machines, 87-105
 - computer mechanisms, 150-157
 - fuel-oil-hatch cover, 87
 - porthole closer-blanket puller-upper, 87, 88
 - typewriter, 89-105
 - watertight door, 88
- Computer mechanisms, 150-157
 - differentials, 150-151
 - linkages for adding and subtracting, 150-156
 - adding lever, 152
 - angle resolver, 156
 - component solver, 155
 - integrators, 156
 - multipliers, 151-156
 - multiplying linkage, 155
 - screw type multipliers, 152
- Constant mesh transmission, 136
- Counterclockwise moments of force, 19
- Couple, 20
- Couplings, 78-84
- Crane, electric, 7
- Curved lever arms, 5
- Cylinders used in power trains, 131

- Deep-sea diver, 60
- Depth charge, 59

INDEX

- Diesel engine, 106, 114
Differentials, gear, 144-148
Dogs, 7
Drill press, 9
- Electric crane, 7
External combustion engine, 106, 107
External mesh gears, 35
- Final drives, 142
Flaghoist, 10
Fluids, pressure exerted by, 52
Force and pressure, 50-57
 force, measurement of, 50
 pressure, measurement of, 50-56
 barometers, 54-56
 exerted by fluids, 52
 gages, 53
 manometer, 56
 scales, 50, 51
Four-speed truck transmission, 133
Friction, 40, 42-45
Friction brake, 28
Fuel-oil-hatch cover, 87
Fulcrum, 17, 19-21
- Gages used to measure pressure, 53
Gangplank, 24
Gasoline engine, 106, 114
Gear differential, 74-78, 144-148
 used in automobiles and trucks, 144-148
Gears, 30-38
 anchor winch, 36, 38
 automobile valve gear, 36
 cam-driven valve, 36
 cam shaft, 36
 changing speed, 34
 external mesh gears, 35
 idler gear, 35
 internal gear, 31
 magnifying force with, 35
 pinion gear, 30
 rack and pinion as a steering mechanism, 37
 spur gear, 30
 types of, 30-34
 worm gears, 32
Gear trains, 128
Gun tackle, 11
- Helical gears, 30
Herringbone gears, 31
Hooke joint, 79
Horsepower, 46-48
- Hydraulic machines, 62-68
 advantages of, 63
 brakes, 63
 liquids in motion, 62
 Pascal's law, 62
 press, 64
 steering with, 65
 used on submarines, 66
Hydraulic valve lifter, 127
Hydrostatic machines, 58-61
- Idler gear, 35
Incined plane, 23-26
 applications afloat and ashore, 24
 barrel role, 23
 gangplank, 24
 in spiral form, 26
 ramp, 23
 wedge, 23
Internal combustion engines, 106-129
 basic strokes, 108
 classification of, 113
 construction of, 115-129
 auxiliary assemblies, 129
 connecting rods, 123
 crankcase, 117
 crankshaft, 124
 cylinder head, 117
 engine cylinder block, 115
 engine head, 126
 exhaust manifold, 118
 gaskets, 119
 intake manifold, 118
 moving parts, 119-129
 piston assembly, 120
 stationary parts, 115-119
 timing gears, 128
 valves and valve mechanisms, 126-128
 vibration damper, 125
Internal gear, 31
- Jack, 41
Jack screw, 26, 27
- Levers, 1-9
 chain stopper, 8
 classes of, 2
 curved lever arm, 5
 dogs, 7
 drill press, 9
 electric crane, 7
 oars, 2
 pelican hook, 6
 wrecking bar, 7

BASIC MACHINES

- Linkages, 78
- Luff tackle, 11
- Machine elements and basic mechanisms, 69-86
 - basic mechanisms, 74
 - bearings, 69-73
 - ball bearings, 73
 - cams, 80-82, 85
 - and cam followers, 80-82
 - clutches, 82, 86
 - couplings, 78-84
 - gear differential, 74-78
 - linkages, 78
 - radial-thrust roller bearing, 73
 - springs, 71-74
 - types of, 74
 - universal joints, 79-81
- Manometer, 56
- Micrometer, 27
- Moment of force, 17, 20
- Multiple-cylinder engines, 112
- Oars, 2
- Oldham coupling, 78, 80
- One-cylinder engine, 106
- Pelican hook, 8
- Pinion gear, 30
- Pointer's handwheel, 21
- Power, 46-57
 - calculation of, 46-48
 - horsepower, 46
 - motor, 48
 - Prony brake, 48
- Power takeoffs, 141
- Power trains, 130-149
 - axles, 148, 149
 - clutch, 130-133
 - differentials, 144-148
 - final drives, 142-144
 - joints, 142, 145
 - propeller shaft assemblies, 142
 - transfer cases, 140-142
 - transmission, 133-139
- Pressure and the deep sea diver, 60
- Pressure, measurement of, 50-56
 - balances, 50, 52
 - barometers, 54-56
 - exerted by fluids, 52
 - gages, 53
 - manometer, 56
 - scales, 50, 51
- Prony brake, 48
- Quadrant davit, 29
- Rack and pinion, 37
- Radial-thrust roller bearing, 71, 73
- Ramp, 23
- Rigger's vise, 28
- Roller bearing, 71, 73
- Roller bitt, 43
- Runner, 10
- Scales, 50, 51
- Schrader gage, 53
- Screw applications, 26-29
 - friction brake, 28
 - inclined plane in spiral form, 26
 - jack screw, 26, 27
 - mechanical advantage of, 29
 - micrometer, 26
 - quadrant davit, 29
 - rigger's vise, 28
 - turnbuckle, 28
- Sleeve coupling, 78
- Spider gears, 76
- Spiral bevel gears, 144
- Springs, 71-74
- Spur gears, 30
- Steam engine, 106
- Synchromesh clutch, 138
- Synchromesh transmission, 136
- Timing gears in engines, 128
- Torpedo, 60
- Torque, 17, 21, 22
 - wrench, 21
- Transfer cases, 140-142
- Truck transmission, 133
- Turnbuckle, 28
- Typewriter, 89-105
 - backspace, 96
 - bell ringer, 102
 - construction and operation, 90
 - escapement, 92
 - external parts, 89
 - line lock, 102
 - line space, 103
 - pinion stop slide, 103-105
 - ribbon drive, 93-96
 - shift, 98, 101, 102
 - tabulator, 96-99
 - type bar, 93
- Universal joints, 79-81
- Valve lifters, 127
- Valves and valve mechanisms, engine, 126-128

INDEX

Watertight door, 88

Wedge, 23

Wheel and axle, 16-25

balancing moments of force, 18

capstan bar, 17, 18

clockwise moments of force, 19

counterclockwise moments of
force, 19

couple, 20

fulcrum, 17, 19, 20, 21

mechanical advantage, 16

pointer's handwheel, 21

rotation, 17

torque, 17, 21, 22

wrench, 21

Work, friction, and efficiency, 39-45

block and tackle, 41

friction, 42-45

jack, 41

measurement of, 39-41

roller bitt, 43

Worm and worm wheel, 32

Worm gear, 32

Wrecking bar, 7

Yard and stay tackle, 13

BASIC MACHINES AND HOW THEY WORK

BUREAU OF NAVAL PERSONNEL

Covering thoroughly basic theory, ranging from the lever and inclined plane up through basic computer mechanisms, this extraordinarily clear book leaves nothing to be desired in its presentation. Nothing more than the most elementary mathematics is required to follow it.

Beginning with the simplest of machines—the lever—the course proceeds with the discussion of the block and tackle (pulleys and hoists), the wheel and axle, the inclined plane and the wedge, the screw, and different types of gears (simple, spur, bevel, herringbone, spiral, worm, etc.). A chapter on the concept of work discusses the measurement of work, friction, and efficiency; this is followed by investigations of power, force and pressure, explaining the uses of scales, balances, gauges and barometers. The fundamentals of hydrostatic and hydraulic machines (such as the hydraulic braking system and the hydraulic press) are discussed in detail. The remaining chapters cover machine elements (bearings and springs), basic mechanisms (gear differential, couplings, cam and cam followers, clutches), complex machines (water-tight door, typewriter), the internal combustion engine (its components and how it works), power trains (including explanations of various transmission systems—synchronesh, auxiliary, etc.), and basic computer mechanisms (linkages, multipliers, integrators, etc.).

Every concept is clearly defined and the discussions always build easily from elementary theory to particular applications that are familiar to anyone with the slightest interest in mechanics. Important concepts, machine components and techniques are clearly illustrated in more than 200 diagrams and drawings, cross-sections that reveal inner workings—all of these help to clarify even further an already clear and well-organized presentation. Although it was originally designed for use in U.S. Naval Training Schools, this book can be used to great advantage as a basic text in mechanical engineering in standard technical schools, and it will be immensely valuable even to the layman who desires a basic knowledge of machines.

Unabridged republication of Navy Training Course NavPers 10624-A (1965). 204 figures. Preface. Index. viii + 161pp. 6½ x 9¼.

21709-4 Paperbound

A DOVER EDITION DESIGNED FOR YEARS OF USE!

We have made every effort to make this the best book possible. Our paper is opaque, with minimal show-through; it will not discolor or become brittle with age. Pages are sewn in signatures, in the method traditionally used for the best books, and will not drop out, as often happens with paperbacks held together with glue. Books open flat for easy reference. The binding will not crack or split. This is a permanent book.

Handy Farm Devices

and How to



Make Them

HANDY FARM DEVICES AND HOW TO MAKE THEM, a classic from the Golden Age of American Farming, is as useful and pertinent for homesteaders and small-scale farmers today as it was when it was first published more than seventy-five years ago. A wealth of labor- and money-saving projects fills its pages: spill-proof chicken waterers; a portable chicken coop; a lightweight orchard ladder; a small truss bridge; an easy fence-post and stump-puller; gates that don't sag; gates that lift over snowdrifts; a handy wood splitter—even a bicycle-powered washing machine.

HANDY FARM DEVICES AND HOW TO MAKE THEM is a rare and engaging combination of nostalgic Americana and helpful instruction, sure to appeal to everyone inclined toward self-sufficiency and the country life.

Write for a complete list of other books on country living and the outdoors from Lyons & Burford, Publishers.



Lyons & Burford, Publishers
31 West 21 Street • New York, New York 10010

Cover design by Lynne Amft
Printed in the United States of America

A CLASSIC OF
AMERICAN INGENUITY

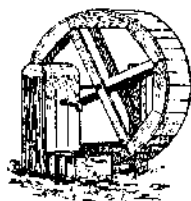

dog power pump

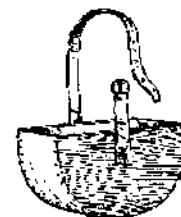

feed basket

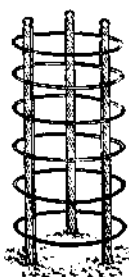

trellis



rack



pipe twister



dumb waiter

Rolfe Cobleigh

Handy Farm Devices and How to Make Them

By Rolfe Cobleigh

681
.763
Cob
18

Cobleigh, Rolfe.
Handy farm devices and how to make them / by
Rolfe Cobleigh. --New York : Lyons & Burford, 1996
288 p. : ill.

Originally published: New York : Orange Judd Co.,
1909. With new foreword.
Includes index.
753053 LC: 95038426 ISBN:1558214321 (pbk.)

1. Farm equipment - Design and construction

Foreword to the 1996 Edition

IN 1972, after a brief and unsuccessful experiment with urban living, I moved to a small hardscrabble homestead in midcoast Maine—as one of many in my generation who migrated to places like Oregon and Montana, determined to live apart from a society that seemed to value us only as producers and consumers of goods. We came to get a living with our hands, to become latter-day Thoreaus, working the soil and communing with nature—with, of course, the Grateful Dead blaring reassuringly in the background.

That few of us had been closer to nature than dozing in the sun on Boston Common or Golden Gate Park troubled us not a whit: We were brilliant, clever, omniscient. We were baby boomers.

Mother Earth News would show us the way. *The Whole Earth Catalog*. *Living on the Earth*. All we needed were the right books and a pair of low-back overalls. How hard could country life be?

Pretty hard, as it turned out. The hands-on experience of our generation's back-to-the-land authors could most charitably be described as recent and shallow—a fact that quickly became evident when our hand-crafted homesteads needed essentials about which our gurus knew only basics, not details: chicken coops, grain storage bins, cistern filters. So our chickens didn't stay cooped, grains didn't stay binned, and cisterns were filtered only through rose-colored granny glasses.

I had a bit more experience in country living than most, having come from farm country. But I soon found that dozing in VocAg class doesn't properly equip one for running a homestead in Maine.

Then I found *The Book*, dust-covered and neglected in a crossroads junk store, and my homestead creations quickly assumed a more professional air: the chickens stayed cooped, the grain stayed binned.

Foreword copyright © 1996 by James R. Babb

All inquiries should be addressed to Lyons & Burford,
Publishers, 31 West 21 Street, New York, New York 10010.

First published 1909 by Orange Judd Company
Printed in the United States of America

10 9 8 7 6 5 4 3 2 1

Library of Congress Cataloging-in-Publication Data

Cobleigh, Rolfe.

Handy farm devices and how to make them /
by Rolfe Cobleigh.

p. cm.

Originally published: New York : Orange Judd Co., 1910

Includes index.

ISBN 1-55821-432-1 (pbk.)

1. Farm equipment—Design and construction—Handbooks, manuals, etc.
2. Agricultural implements—Design and construction—Handbooks, manuals, etc.
3. Farm buildings—Design and construction—Handbooks, manuals, etc.
4. Agriculture—Handbooks, manuals, etc.
5. Do-it-yourself work. I. Title.

S676.C7 1996

681'.763—dc20 95-38426 CIP

More important, the grain dried fast and stayed rodent-free; the chickens were healthier and produced more eggs with less feed.

Handy Farm Devices and How to Make Them dates from The Golden Age of American Farming, when farmers were truly self-sufficient, making what they needed from what they had. It is recent enough to be technologically pertinent and old enough to be free from the baleful influences of advertising and its artificial demands. It is both helpful instruction and nostalgic Americana.

In its pages you will find detailed instructions for building the things without which a small farm or homestead simply cannot exist, as well as valuable insights into building things in general, including the best treatise I've seen on the most useful but least appreciated tool in the box: the carpenter's square.

The projects range from the merely curious—a bicycle-powered washing machine; or a dog-powered water pump—to the absolutely essential—an improved stone boat; a portable chicken coop; a light-weight orchard ladder; a small truss bridge; an easy fence-post and stump-puller; gates that don't sag; gates that lift over snowdrifts; and—the handiest farm device I've ever found: the accurately described Handy Wood Splitter, which has saved me countless hours trying to balance a lopsided chunk of wood long enough to whack it with an ax.

Farming and homesteading are hard work, and long-term success lies in minimizing both the amount of work needed to produce a desired result and outside expenditures. *Handy Farm Devices and How to Make Them*—as succinct and accurate a book title as was ever writ—will help you do that and more.

James R. Babb

By Way of Introduction

SUCCESS comes to the man who so works that his efforts will bring the most and the best results—not to the man who simply works hard. It is the know-how, things-to-do-with and economy that count. Labor-saving machinery has revolutionized many a trade and industry. It has made farming an industry and a science of possibilities undreamed of and unattainable a hundred years ago. But it is not enough for the modern farm to be equipped with the best tools and machinery that shops and factories turn out, to know how to use them and keep them in repair. There are many handy devices, not made in any factory and not sold in any store, that every intelligent man can make himself, which save money and labor and time. Inventive men are constantly contriving simple but valuable things to meet the needs of their own practical experience. We are all the time hunting after and gathering these ideas. Now we are putting a lot of the best ones into this book. We are trying, by words and pictures, to explain clearly just how to make each device. Everything described is tried and practical. Some are old, many are new, all are good for the purpose intended. They represent the practical, successful experience of farmers and other wide-awake workers all over the United States.

This book is broader than its title. The overflow of good measure includes a valuable chapter on the steel square and its uses. Nowhere else has this subject been handled in a way so easily understood, with confusing mathematics cut out. We especially commend this chapter to our readers. We also present some good house and barn plans, that will be appreciated by those who contemplate building.

In addition to the direct benefit to be derived from doing what the book tells how to do, we have in mind the larger purpose of education toward putting more thought into our work and doing what we have to do the easiest, the cheapest and the quickest way. Out of it all, we trust our readers will make progress toward greater prosperity, greater happiness and greater usefulness.

CONTENTS BY CHAPTERS

	Page
Workshop and Tools	7
The Steel Square	19
In and Around the House	37
Barns and Stock	83
Poultry and Bees	115
Garden and Orchard	131
Field and Wood	154
Gates and Doors	174
When We Build	189
Worth Knowing	233



· WORK · SHOP · · AND · TOOLS ·

THE FARMER'S WORKSHOP



THERE is no doubt that of all the handy farm devices good tools head the list. So, in this book, we are going to start with carpenter tools and the place to keep and use them. Every farmer ought to have a workshop in which he can do odd jobs and make things when the weather prevents out-of-door work, or at times when there is little to do on the farm. Economy and thrift demand that a farmer should have and keep in good condition a few essential carpenter tools. First of all he should have a long, strong, smooth-top bench and, either on racks above the bench or in a tool chest, he should keep in order, and where he can easily find them when wanted, his stock of carpenter tools. Some of the tools that will be found useful are the following:

A rip saw, a crosscut saw, a back saw, and a compass saw; a jack plane, a fore plane, and a smoothing plane; a shave or drawing knife; two or three chisels of different sizes for woodworking and a cold chisel for metal; a gouge or two; a good hatchet; two or three hammers, including a tack hammer and a bell-faced claw hammer; a brace or bit stock with a set of half a dozen or more bits of different sizes; one or more gimlets; a mallet; a nail set, a large screw driver and a small one; a gauge; a spirit level; a miter box; a good carpenter's square—No. 100 is a good standard size;

compasses or dividers; cut nippers, a pair of small pincers and a pair of large ones; a rasp; a large, flat file; at least one medium-sized three-cornered file and a half-round file.

It is poor economy to buy cheap tools. Of course extravagance is to be avoided, but be sure that you get first-class material in every tool you buy. It is a good plan to get a good practical carpenter to assist you in selecting your tools. Keep on hand in the shop a variety of nails, brads and tacks, screws, rivets, bolts, washers and nuts, and such small articles of builders' hardware that are likely to be needed occasionally, including hinges, hasps and staples and some sand-paper. Have a good plumb line, chalk and pencils. Keep in a handy place a jar of a good liquid glue, and some cement. See to it that the shop contains a good stock of well-seasoned lumber, both hard wood and soft.

Attached to the bench should be a bench screw or vise. This need not be an expensive one, but should be of good size and strong. There should also be a pair of carpenter's saw benches, a shaving horse, a small anvil and a grindstone. Every farmer has a grindstone somewhere about the buildings, but it is a great convenience to have a good one in the workshop.

A corner of the shop should be devoted to painting supplies, including several colors of good standard ready-mixed paints and stains, raw linseed oil, boiled linseed oil, turpentine, varnish, putty, points for setting glass, several brushes of different sizes, a good putty knife and panes of glass of different sizes ready for emergency.

A farmer ought to be able to do occasional little jobs of soldering. He needs soldering iron, a bar of solder, resin, a little bottle of soldering fluid,

which can be purchased already prepared, also a small sheet-iron furnace in which to heat the soldering iron.

It would cost quite a tidy sum to buy all these things at once, but they can be gradually accumulated as one is able to purchase them, and then the outfit should be kept complete. Whenever anything in the shop is broken, worn out, or disappears it should be replaced.

Whenever farm implements or anything about the barn or house are broken or out of order, they should be properly fixed. Often a few minutes spent at the right time will make a thing almost as good as new, while, if neglected, it may soon get beyond repair and have to be thrown away. A thrifty farmer always keeps his farm implements well housed and in repair. It is not what we earn, but what we save, that makes us rich. It is quite as important to stop the leaks as it is to figure on big profits directly.

RUNNING THE GRINDSTONE

If the face of the grindstone is hard and glazed pour a little sand on the stone every few minutes until the glaze is worn off and the stone will cut like a new one. This condition is caused by exposing the stone to the weather. It is best to keep the stone in a shed under cover, but if this is not possible, set it under a tree and put a box over it when not in use. It is surprising how easy a little oil on the bearings will make the stone run. A few drops of kerosene will cut the gum if it runs hard and then some oil or axle grease will make it go easy.

It is hard to stand on one foot and work the

treadle with the other. The job can be made easy by bolting two boards to the grindstone frame, and extending it 2 feet, on which place a seat as shown

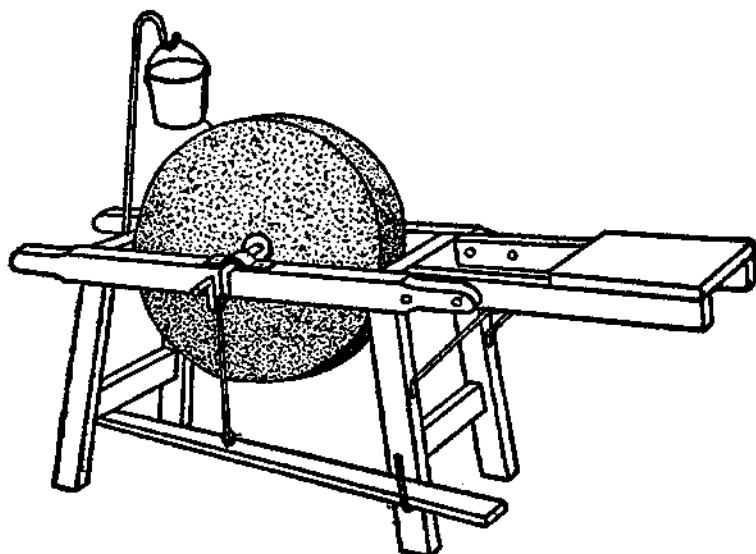

HANDY GRINDSTONE RIG

in the cut. An uneven stone needs to be cut down and toned up. This can be done by grinding against the end of a piece of pipe, having the stone dry.

Good nature is as contagious as the measles. Put on your best smile when you get up in the morning and observe how everybody will greet you with a sunny face.

A HOMEMADE ANVIL

A homemade anvil can be constructed from a 4-foot piece of railroad rail mounted on a trestle, as shown in the sketch. This affair will stand a lot

of heavy pounding, and comes in handy in many ways. The rail is just about the right shape to make an anvil.

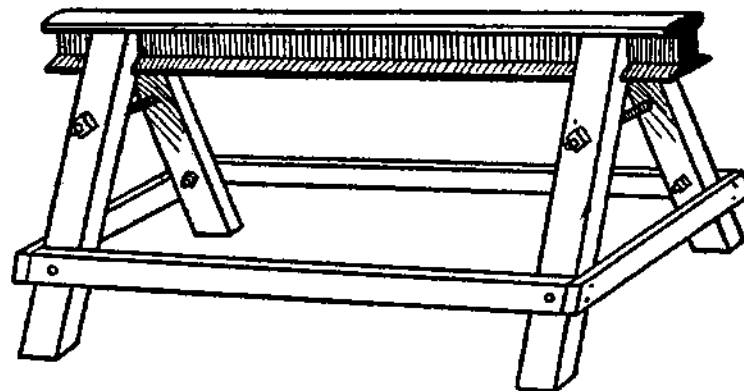

RAIL ANVIL

MAKING A NEW TOOL

A very handy wrench for many kinds of work, such as making gates and contrivances, where small bolts are used, is shown in the cut. From a small monkey wrench remove the wooden handle, and weld the metal part to an old bit-stock, as shown in the cut. This permits of very rapid work in screwing up small bolts. Where there are so many things to do as there are on a farm, it pays to do things in the easiest and quickest way. This is one of the real time-savers.

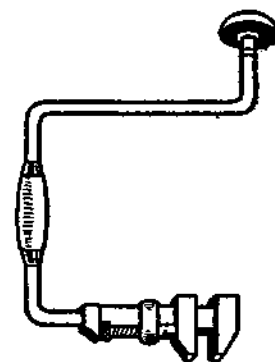

BIT-STOCK WRENCH

Learn to live, and live to learn,
Ignorance like a fire doth burn,
Little tasks make large return.—Bayard Taylor.

HOW TO MAKE A SHAVING HORSE

One of the most useful devices on a farm is a shaving horse. Make a bench 18 feet high of a good 2-inch plank, *c*, level off the edges so that it will make a comfortable seat. Upon this place a slanting platform, *b*, through which is cut a hole in which the clamp, *a*, works.

The clamp must be made of heavy hard wood that is tough and will not split. The shank, *f*, must

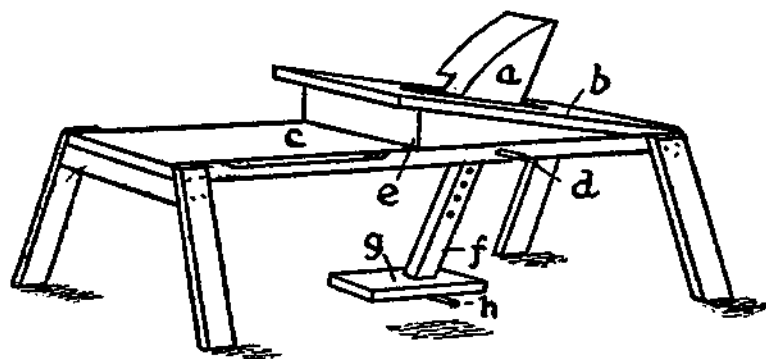

SHAVING HORSE

be an extension of the clamp, *a*. Several holes in the plank will allow the clamp to be raised so as to take in larger pieces of wood. The treadle, *g*, is kept in place by a peg at *h*. To operate this horse the workman places his foot upon the treadle, inserts the wood to be clamped under the edge of *a*, and pushes backward upon the treadle. This clamps the wood and the drawing knife can be used readily and much more rapidly than with a vise.

A CONVENIENT FARM HORSE

On the farm there is continual use for such a horse as is shown in the drawing. Not only when

doing little jobs of carpentering, but also in many other operations, such a support is found necessary. This little horse is an improvement over the ordinary stiff affair, in that it shuts together when not in use, and so can be packed out of the way.

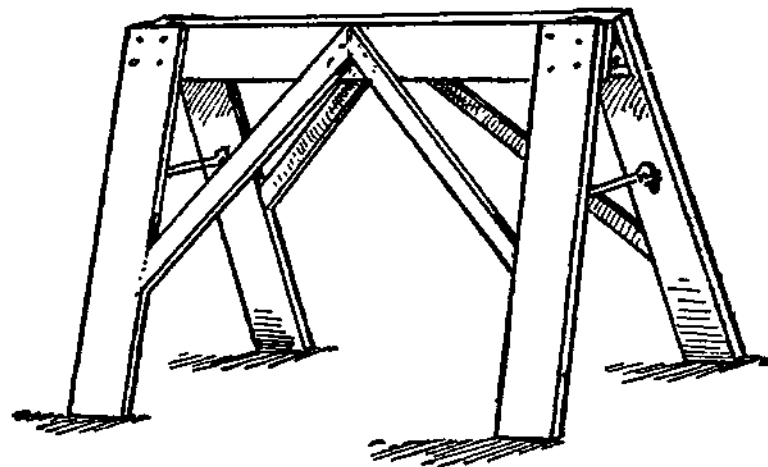

HORSE READY FOR USE

It is made of boards cut in strips, the two horizontal boards at the top being hinged together, as shown herewith. While in use the legs are kept apart by long hooks, as may be plainly seen in the picture.

When tillage begins, other arts follow. The farmers, therefore, are the founders of human civilization.—Daniel Webster.

A WIRE SPLICER

The neatest and strongest splice can be made with this little instrument. It is a strip of iron 1 inch wide and $\frac{1}{8}$ inch thick. One end is cut narrow and is bent into a hook large enough to fit

neatly the largest wire to be spliced. At the sides of this two notches are filed, as shown at the left. At the right the splicer is seen in position on the wire. The splicer should be turned backward, as it appears in the right-hand drawing, to make the splice. A pair of large pincers or a vise should be used to hold the two wires between the coils while turning the splicer. The

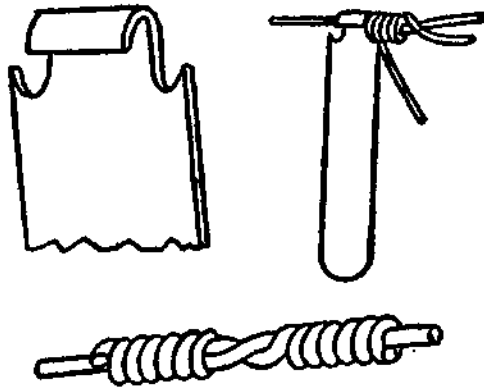

WIRE SPLICING

splice as finished appears above. The length of the handle may vary. If the splicer is to be used for net wire, of course the handle cannot be longer than the width of the mesh. Otherwise, 6 or 7 inches is about right for No. 8 wire. If it is to be used only for small wire, the length of the handle should be reduced for the sake of convenience.

SERVICEABLE HOMEMADE LEVEL

A serviceable level is shown in the illustration. Take two 1-inch boards of rather hard wood, well-seasoned, 2 to 3 feet long, bolt or screw them together at right angles. This union must be so strong as never to be moved by ordinary pressure. At the top of the perpendicular piece cut a slit and insert a piece of strong thread. To the bottom of the thread tie a thin circular

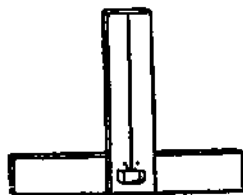

LEVEL

of the thread tie a thin circular

weight. Lay the device across two trestles of nearly the same level. Just above the weight mark the place where the string hangs. Reverse the position of the instrument by turning it end for end, and again mark the position of the string. Half way between the two marks place a third. When the string hangs over this mark the lower board will be level. A shield of tin may be placed over the weight. A nail on each side of the string, just above the weight, will keep it from swinging far out of place. It must be allowed to swing freely.

A simple level may be improvised by filling a small flat bottle with water, so that only a bubble of air remains, and attaching it lengthwise and near the middle of a straight stick or narrow board.

TO MAKE A HANDLE STAY ON

To secure the handle of a hammer or ax is often quite a bothersome problem. A special wedge made with a piece of wood as at *a*, in the sketch, held in place by a fence staple, *b*, has been devised to meet the need for a wedge that really holds. The prongs of the staple should be bent slightly outward before it is driven in, so that they will spread in the handle. There is little danger of handles coming loose when they are attached in this manner, and

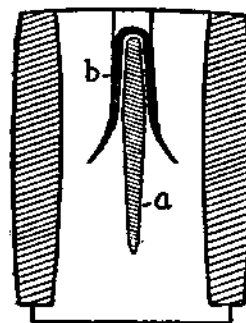

HOLDS WEDGE

it is little more difficult to set a handle as indicated than in the old-fashioned way.

A TOOL BOX REQUISITE

Among the handiest things to have in the tool box are some small bolts about 2 inches long with thumb nuts. A dozen or so of these will prove their value many times over in the course of a year. In making tables for fairs or suppers or in any sort of knock-down arrangement, or temporary convenience where strength is essential, nothing surpasses a bolt of this description. With a brace and a bit the right size, one may be entirely independent of nails and screws.

A farmer friend of ours was once called upon to make a fence about a child's crib without any marring nails. A slot in the fence post with a thumb bolt just above the crib line gave an alligator jaw result which was very satisfactory. On another occasion a knock-down stage was carried from the storeroom in pieces and put together by two men in 20 minutes. An actual computation of its strength showed that a locomotive might safely run over it.

The man referred to above has 100 feet of tables for hall purposes, depending entirely upon the 2-inch bolt and thumb nut for their fastenings and braces. There is never any trouble about knocking out nails. To one having a brace and bit these handy things will suggest of themselves many satisfactory uses. A supply of iron washers should be kept in hand, and in time a collection of various sizes of wooden washers will accumulate.

SOLDERING

Soldering may be done by anyone having a very simple outfit. All that is required is a copper sol-

dering iron, some solder, a vial of muriatic acid and some resin. A fairly successful job of soldering a tin dish may be done by scraping the surface bright where the hole is, sprinkling on a little finely powdered resin, laying on a bit of solder and holding the dish over a flame, which may be from an alcohol lamp, until the solder melts. It will cover the hole and stick. If the dish is rusty or badly tarnished use muriatic acid in place of resin. Resin works best when tin is bright, but usually solder sticks most successfully when the acid is used.

For soldering large breaks or doing important jobs of soldering the iron must be used. In order to work well the iron has to be kept coated with solder. When it gets blackened it should be filed until bright and then rubbed upon a smooth board while hot in a mixture of melted solder and resin. When the hot iron is taken from the fire wipe it on a damp cloth before trying to use it to lift the melted solder. A soldering iron is best heated in charcoal or the coals of a wood fire. The copper should never get red hot, as that causes the coating of the point to be burned off. The metal to be soldered must always be heated before the solder will unite it.

Solder may be obtained in bars at any tin shop. It can be made by melting together 2 parts of lead and 1 of bar tin. This is the usual proportion for most purposes. Soft solder that will melt quickly and can be easily used for mending tinware can be made of pure lead and tin in equal parts. A hard solder is made by melting together 2 parts of copper to 1 of tin. Brazing solder is made by melting together brass and one-sixth its weight of zinc. When cool it should be granulated by pounding

with a hammer. For soldering steel and iron to brass the following combination of metal is melted together, 3 parts tin, $39\frac{1}{2}$ copper, and $7\frac{1}{2}$ zinc. Before it is applied, all the metals to be jointed together must be heated to the same temperature as the soldering alloy. Gold solder is made of 24 parts gold, 2 parts silver and 1 part copper. A hard silver solder is made of 4 parts silver to 1 of copper. A soft silver solder is made of 2 parts silver to 1 of brass.

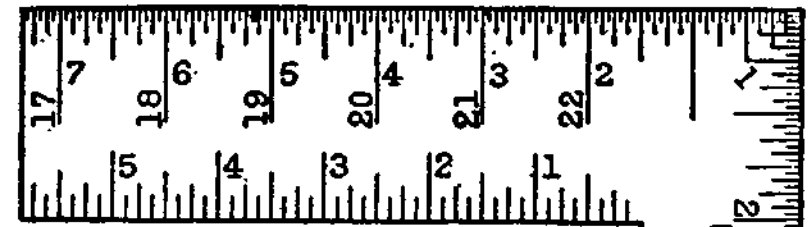

Use of the Steel Square

BY J. HAMILTON ELLIOT

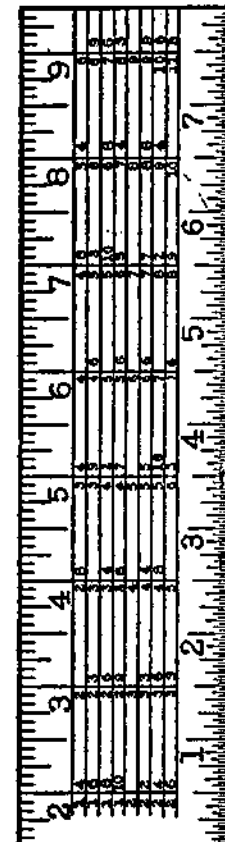

A steel square, often called a carpenter's square, can be found in almost any kit of mechanic's tools and a little knowledge of this instrument will aid the user to perform many problems easily and quickly that otherwise might prove difficult. Squares of different kinds and materials have been used by mechanics in all ages. The first were made of wood and were used in the construction of the earliest buildings of which we have historic record. The squares of today are made of steel, finely polished and stamped with many



figures, tables and rules, according to the taste of the manufacturer and the special mechanic for whom they are designed.

We will not attempt to deal with the several special kinds or makes, taking up only a few of the possibilities of the standard 2-foot square. This is 2 feet long on the blade, which is two inches wide, and it is 16 or 18 inches on the tongue or angular leg. The latter is $1\frac{1}{2}$ inches wide. Beginning at the heel or corner of the square, inches and fractions of inches are marked. It is necessary that the marking be in this way, in order to form the different combinations desired in connection with the different problems which have to be solved. A few of these problems are explained in the following pages.

LUMBER RULE

On the side of the blade of the square that is divided into inches and eighths is placed the lumber rule or scale. This is used for computing the number of feet in board measure contained in a given board or piece of lumber. We show a picture of a section cut from the center of the lumber rule. The space running lengthwise of the blade between the parallel lines contains the number of feet board measure for a given width of board. The first space is for boards 8 inches wide, the second for those 9 inches wide, the third for those 10 inches wide and so on. To determine the space which should be used for any given width, look under the 12-inch mark on the outside edge of the blade. These numbers give the width of the board, also the number of feet board measure. If a board is 10 inches wide and 12 feet long, it contains 10 feet board measure.

Now let it be required to find the number of feet board measure in a board 13 inches wide and 11 feet long. Find the space for boards 13 inches wide under the 12-inch mark on the square, follow this space to the left and under the 11-inch mark on the square will be found the answer desired: 11—11. This is read 11 feet and $\frac{1}{12}$, and is the number of feet board measure contained in a board

11	12	13	14
7-4	8-	8-8	9-4
8-5	9-	9-9	10-6
9-2	10-	10-10	11-8
10-1	11-	11-11	12-10
11-11	12-	12-1	13-2
12-10	13-	13-2	14-4
13-9	14-	14-3	15-6

LUMBER RULE

13 inches wide and 11 feet long. With a little practice, anyone can measure lumber or timber and check up his bills for this kind of material.

Do not confound foot board measure with square feet. Square feet are in surface measure, with no reference to thickness, while a foot board measure is the equivalent of a foot square and 1 inch in thickness. The square feet of a 3-inch plank would contain 3 feet board measure.

After becoming familiar with the use of the lumber rule, as described above, you will discover that the space may be taken to contain the amounts for a given width and the different lengths in feet as represented in the different columns, or the space may be taken as containing the amounts for a

given length and the different widths arranged in columns; therefore, find either length in feet or width in inches under the 12-inch mark and follow this space until under the inch mark representing the other measurement. In this space will be found the feet board measure.

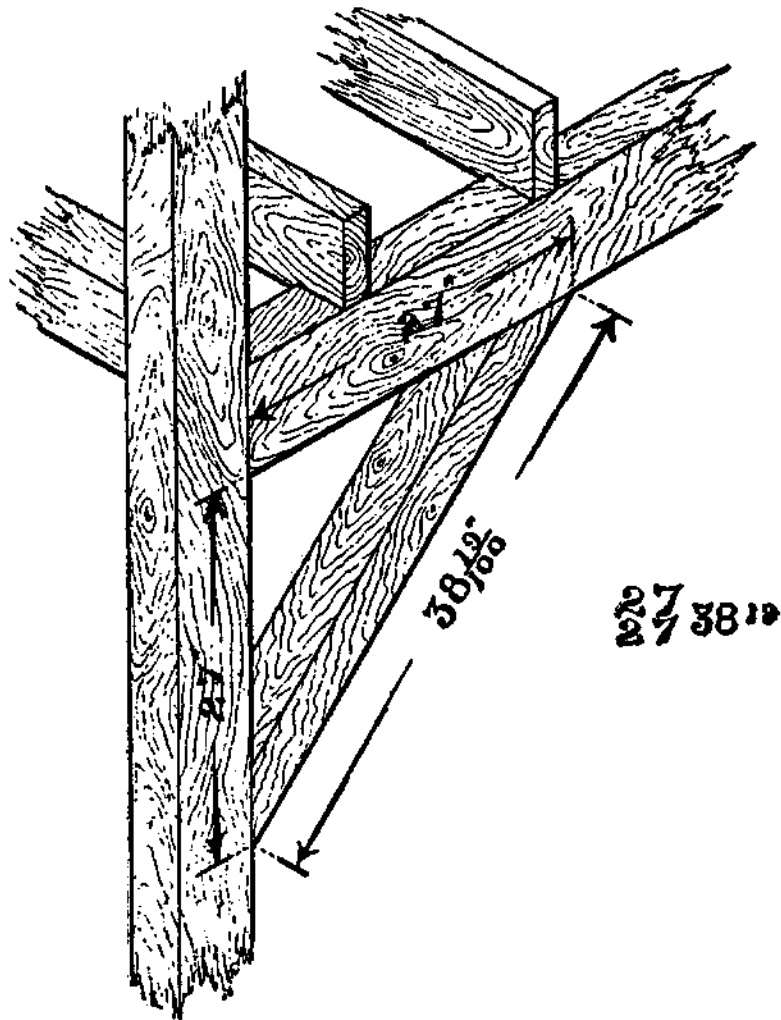

BRACE RULE

THE BRACE RULE

The brace rule is on the tongue of the square, and has a series of figures representing the rise or vertical height, the run or horizontal reach and the true length of a brace. For example, they are written $27/27$ 38^{19} and $45/45$ 63^{64} . These would be read 27 inches run, 27 inches rise and a length of 38 and $19/100$ inches, and 45 inches run, 45 inches rise and a length of 63 and $64/100$ inches.

A glance at the illustration on page 22 will give a good idea of the application of the brace rule as it appears on almost any modern make of square.

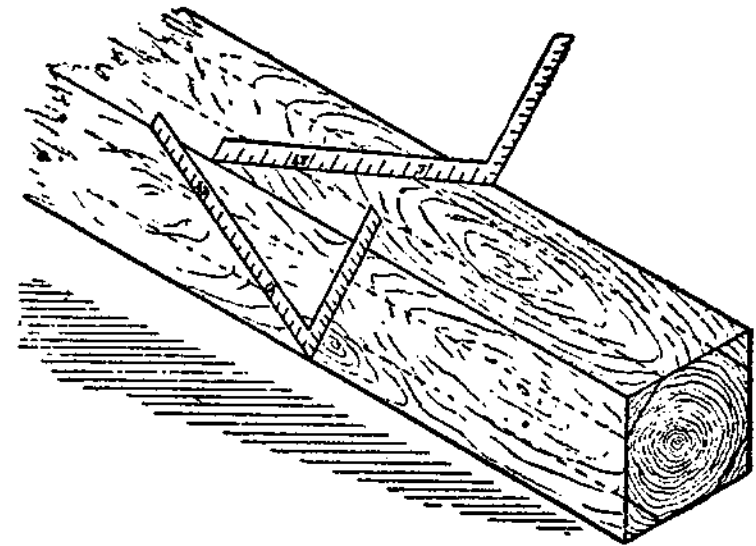

FIGURE I

THE OCTAGON SCALE

There is an octagon scale on one side of the tongue of the square, but we will not attempt to explain its use, as there are easier and simpler methods of obtaining the same result.

One method is shown in Figure 1. To obtain the lines on a square stick where the corners should come when converted into an octagon or eight-sided stick: Lay the square on the one side of the square stick at such an angle that the end of the square will come exactly at the edges or corners of the stick, make a dot on the 7-inch mark and at the 17-inch mark. Through these dots gauge or mark a line parallel with the edge of the stick. Continue this operation on all of the four sides. This gives the lines for the corners of an octagon. In making a flag-pole or spar for a boat or to round any large stick this is the operation used by all mechanics doing the work by hand.

THE MITER BOX

Of all homemade devices, one of the most frequently used in the shop is the miter box. After the box is put together it is a simple problem, with the use of a steel square, to make the cuts necessary to intersect two pieces of wood, as shown in Figure 2. First, the box must be straight and true and the sides form a perfect right angle or square with the bottom. Lay the steel square on the top

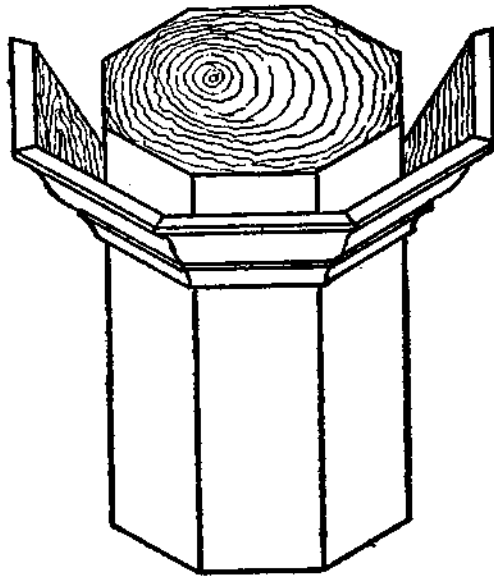
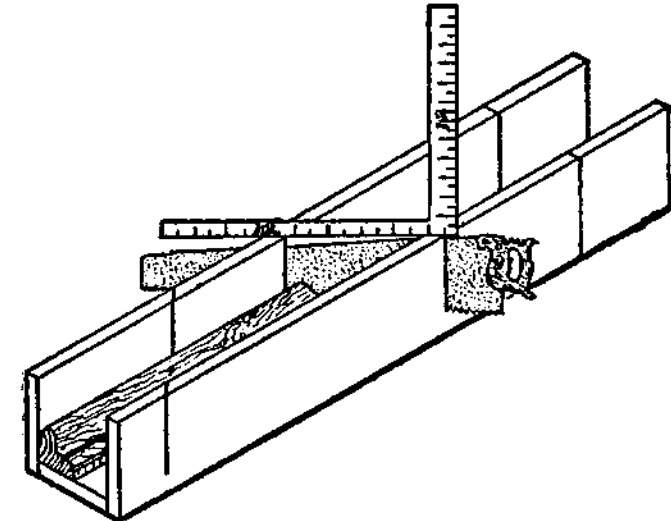
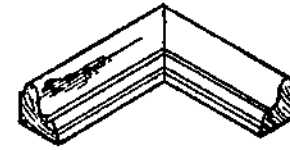
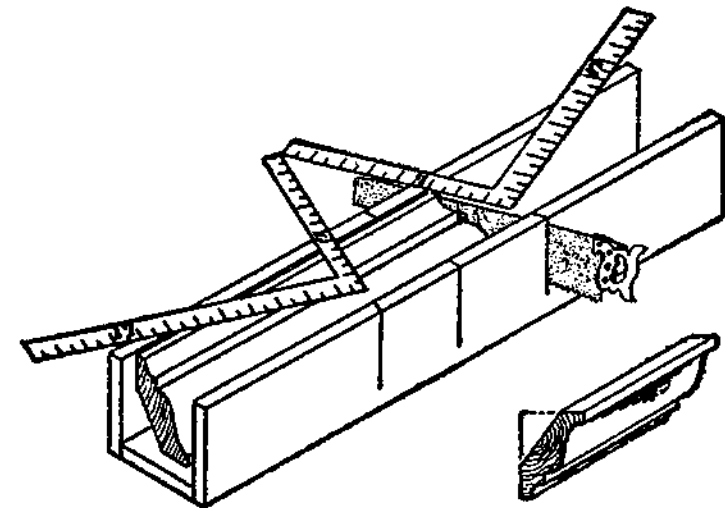

FIGURE 5A

of the box so that the 12-inch mark on the blade and the 12-inch mark on the tongue will both come



FIGURES 2 AND 3



FIGURES 5 AND 4

exactly on the edge of the box. This gives the miter cut of the intersection of the angle of a perfect square, as shown in Figure 2. Figure 3 shows the manner of placing the square on the box to give the desired angle.

A sprung molding, which is a molding not solid on the back, as shown in Figure 4, must be placed in the box bottom side up as shown in Figure 5, so as to get a solid bearing to hold it. Cuts in the box to miter around an eight-sided figure or an octagon, as shown in 5A, can be obtained by using 7 inches and 17 inches, marking the cut on the 7-inch side, as shown in Figure 5.

TRUING THE SQUARE

After obtaining a steel square, the first and most essential thing is to test or prove it to see that it is accurate, forming the angle of a perfect square.

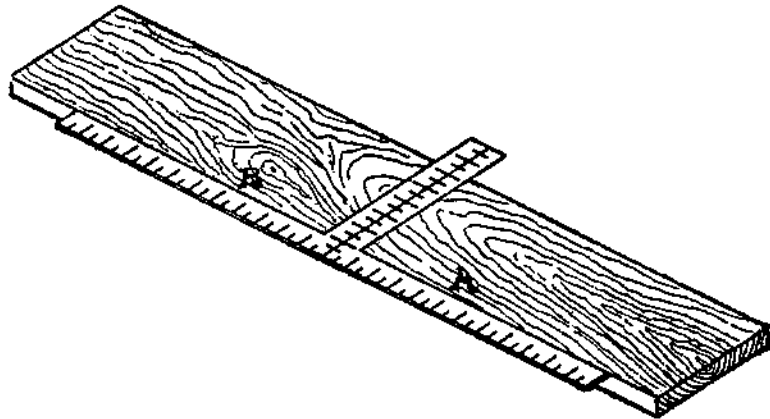

FIGURE 6

Take a board planed on one side and straighten one edge of it perfectly as described under Making a Straight Edge. Make a mark across this board

with the square, as shown in Figure 6, Position A, then reverse the square to Position B. If the square is true it should exactly fit the mark made. It is necessary to work very accurately, making the mark with the point of a knife and having the edge of the board absolutely straight.

If the square is found to be out or inaccurate, it is not necessary to throw it away; it can be made true by a simple method by any handy mechanic. If you do not possess an anvil, make a substitute by

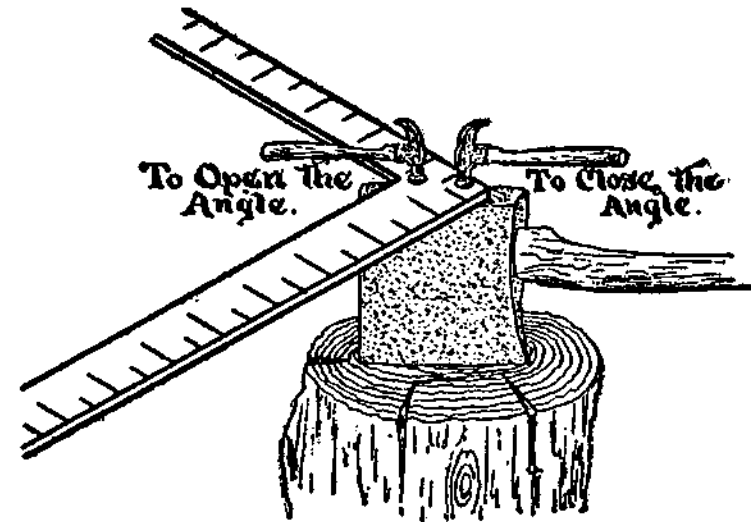

FIGURE 7

sticking the ax into a chopping block, lay the square on the head of the ax so that the bearing will come from the throat or inside angle to the heel or outside of the square. To close up the angle, strike with a hammer a sharp blow at a point near the heel; to open the angle, strike near the throat at a point indicated in Figure 7. Don't strike too hard. Use a bell-face nail hammer and the dent will not be noticed.

A STRAIGHT EDGE

In connection with the work with the steel square a straight-edged board is necessary to have ready for immediate use. Procure a board 8 or 10 feet long of good, dry pine, free from knots and 6 to 8 inches wide. Plane the edge until it seems

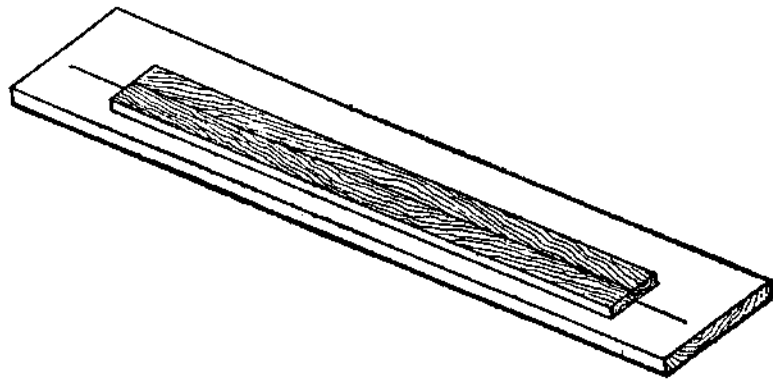

FIGURE 8

straight to the eye, then lay it on the bench or on another board and make a mark along the edge, just straight with a fine lead pencil; reverse it or turn it over and fit it to the other side of the pencil line. This multiplies any inaccuracy or deviation from a straight line. Make a new line each time you plane the edge. Work with as long a plane as you have and set the blade to take a fine shaving. When the edge will fit both sides of the line made from it while in one position, it is straight. Figure 8 will give a clear idea of this operation.

RAFTERS

The common rafter for a pitch roof is easily laid out with the steel square. There are many methods,

but the easiest and most simple is by spacing. Two dimensions, half the width of the building and the height of the roof, are divided into an equal number of parts. The width of half the building is called the run and is usually divided into parts of 12 inches or a foot for convenience. The height is called the rise, and is divided into an equal number of parts. A glance at Figure 9 tells us that the run there shown is 10 inches rise to 12 inches run.

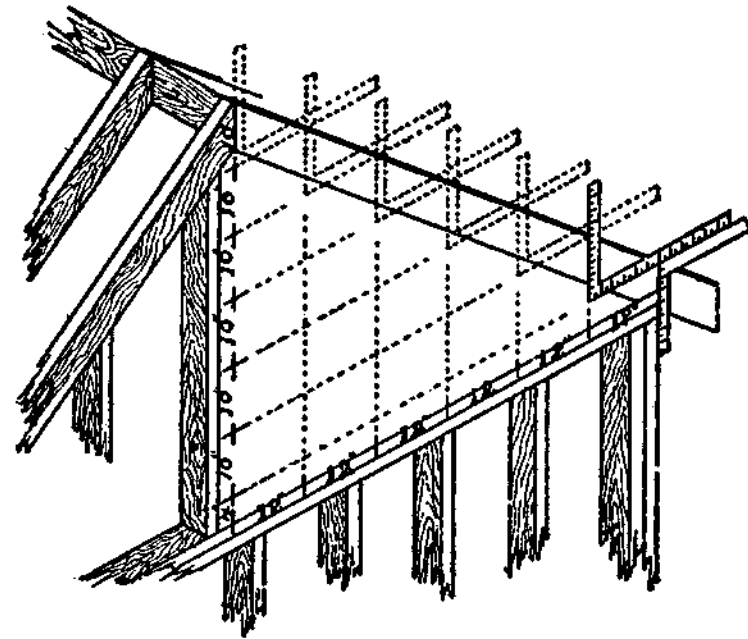

FIGURE 9

When the square is laid on the stick to be cut into a rafter, the 10-inch mark on the tongue and the 12-inch mark on the blade are held so that they come exactly even with the outside edge. The blade then takes a level position and the tongue a vertical position or plumb position. This gives the proper level for the cut at the top of the rafter and

the level cut at the top of the plate. As the square now lies on the stick make a fine mark and move the square along, marking another space. Mark as many of these spaces as the parts into which the rise and run were divided. This gives the length of a rafter from the ridge to a point exactly over the outside of the plate.

Where the rafter overhangs the plate, it is necessary to square down or in to form the notch for the plate. By studying Figure 9 you can readily see the different positions taken by the square, also, how and why the rise and run are divided into an equal number of spaces. By this method the length of the rafter is obtained without use of mathematics.

STAIR STRINGER

The stair stringer is laid out in much the same manner as the common rafter. The total rise of height to go up is divided into parts of about $7\frac{1}{2}$ inches, as near as possible. This makes the easiest step. The run is always divided into one less space than the rise. The reason for this can be easily understood by examining Figure 10. Lay the square on the stick to be used as a stair stringer, taking the numbers into which the rise and run have been divided, mark, and slide the square along until the required number of spaces are marked. A little experience, with allowance made for the surrounding conditions, and any handy mechanic can lay out stringers for an ordinary flight of stairs. To get an easy flight of stairs for the person of average size where plenty of room can be used, experience teaches that $7\frac{1}{2}$ inches rise and 10 inches run or tread makes an easy flight.

From this some stair-building experts have put together the following rule, which works very well for the average stair: When the rise multiplied by the tread equals 75, the run will be an easy one, as $7\frac{1}{2}$ inches rise by $10\frac{1}{2}$ inches tread equals 75; $8\frac{1}{3}$ inches rise by 9 inches tread equals

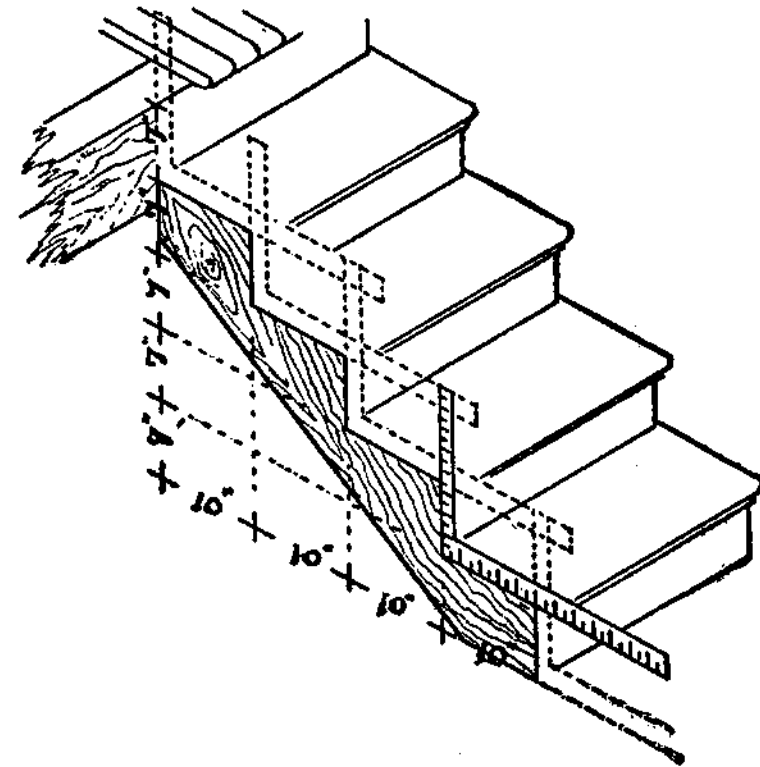

FIGURE 10

75; 8 inches rise by $9\frac{1}{2}$ inches tread equals 76, which is very near the desired result. When the rise is 9 inches or over, the rule is not good, as the tread must be shortened up much more, and the rise should never be more than 11 inches—that is about the rise in an ordinary ladder leaning against a house.

THE 47TH PROBLEM OF EUCLID

The problem shown in Figure 11 is known as the 47th Problem of Euclid, and is an invention by an ancient Greek geometer who sought many years for a method of finding the length of the hypotenuse of a right angle triangle in mathematics, and when the method was discovered, history tells us there was great rejoicing. Pythagoras is credited with having first proved the rule successfully applied to the problem.

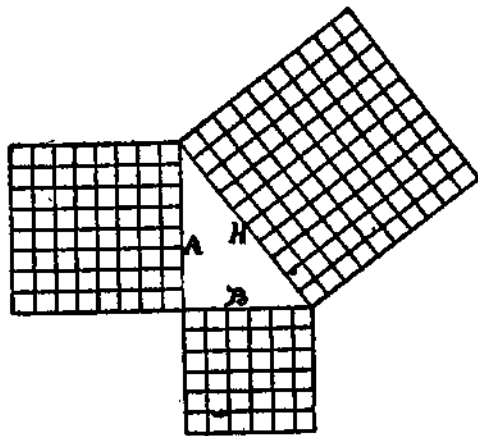

FIGURE 11

The rule is that the square of the base added to the square of the altitude equals the square of the hypotenuse. The base of a right angle triangle is the side on which it rests, marked B in Figure 11. The altitude is the height and is marked A in Figure 11. The hypotenuse is the connecting side of the triangle, marked H in Figure 11. The base, 6, squared or multiplied by itself, equals 36. The altitude, 8, squared, equals 64. By adding these together we have 100, which is the square of the hypotenuse. It remains but to extract the square root of 100, which we know is 10, therefore 10 is the length of the hypotenuse or third side of this right angle triangle. All right angle triangles can be figured in the same manner, but only multiples of the

length of the three sides come even—such as 3, 4, 5 and 12, 16, 20, as shown in Figure 12; and many others, of course.

length of the three sides come even—such as 3, 4, 5 and 12, 16, 20, as shown in Figure 12; and many others, of course.

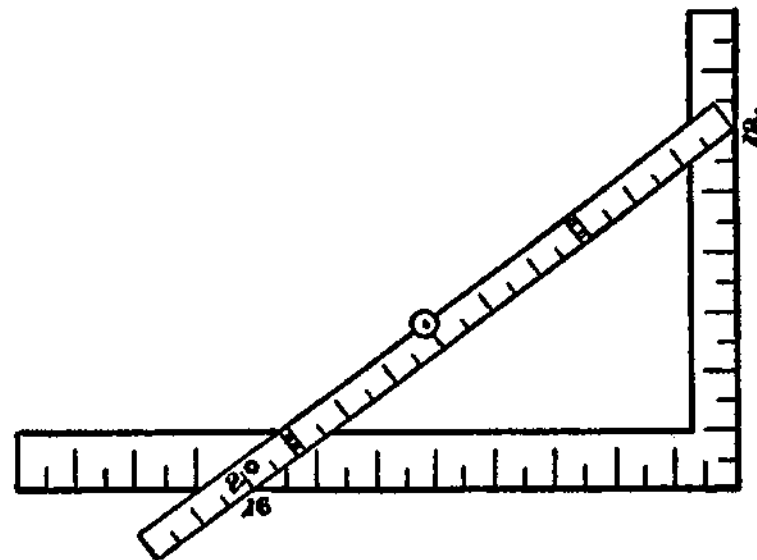

FIGURE 12

THE RULE OF 6, 8 AND 10

This is a rule so extensively used in the building trades and others that it has finally come to be known by the above name. It is derived from the 47th Problem of Euclid, and is used in the manner shown in Figure 13.

Measure 6 feet on the end sill of a building and 8 feet on the side sill. If it measures 10 feet across the angle the building is square. This is a very useful rule and easily remembered. It is always available in running lines for batter boards for masonry or lines for walks. By starting from a corner stake into which a nail is driven, measure off on the string or line used and insert a stake to mark the place. Drive a nail into this stake and

proceed in like manner on the other side. With a little care and practice, quite a job of surveying can be done by using a few stakes, a ball of string and a tape or 10-foot pole.

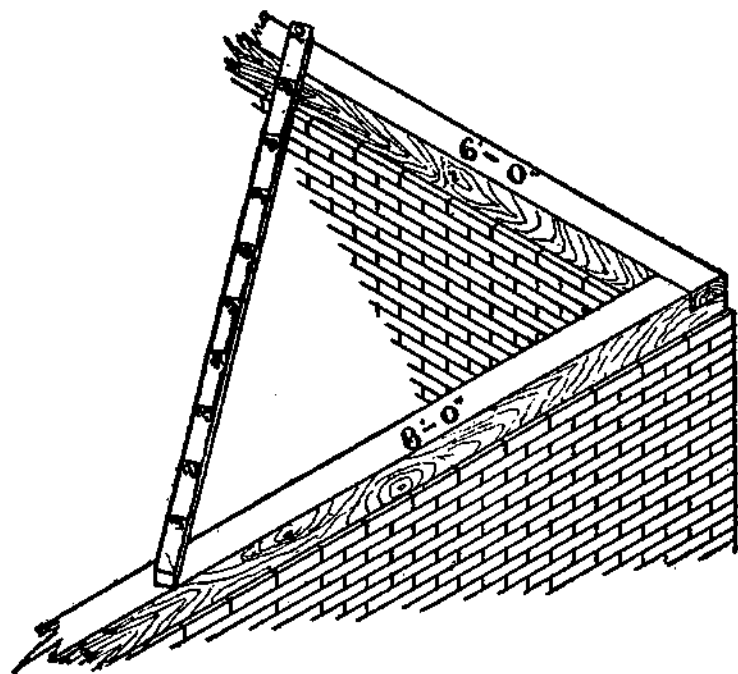

FIGURE 13

ANGLES

An angle is the opening between two lines meeting at a point. Angles are usually spoken of as being of a number of degrees. The degrees are measured on the circumference, the center of which is on the point of the angle. There are 360 degrees of the circumference of a circle. The surface of the earth is so divided north and south by the parallels of latitude, which are numbered from the equator each way; also east and west by the meridians of longi-

tude, which are numbered from Greenwich, England. They can be seen on any map.

By the use of a protractor, the number of degrees of any angle can be obtained. Figure 14 shows one-half of a circle or 180 degrees.

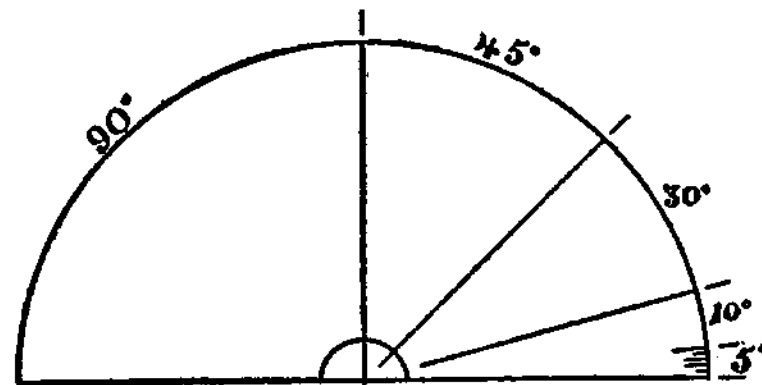

FIGURE 14

PLOTTING ANGLES

To strike an angle in a field on a large scale where one line is given or can be obtained, measure off from the point of the angle $57\frac{3}{10}$ feet; lay one

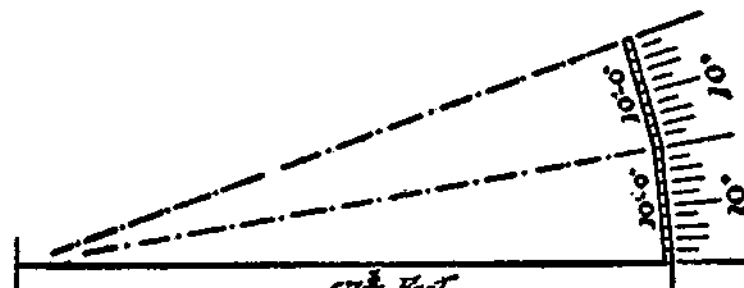

FIGURE 15

end of a 10-foot pole at this point. The other end should be swung around so that it also will be $57\frac{3}{10}$ feet from the starting point. Each foot marks

off 1 degree on the circumference of a circle whose radius is $57\frac{3}{10}$ feet. If more than 10 degrees are required, continue as before, keeping the ends of the 10-foot pole always on the circumference of the circle from the starting point. A clear idea of this operation can be obtained from Figure 15.

Labor is rest from the sorrows that greet us;
 Rest from all petty vexations that meet us,
 Rest from sin-promptings that ever entreat us,
 Rest from world-sirens that hire us to ill.
 Work—and pure slumbers shall wait on thy pillow;
 Work—thou shalt ride over Care's coming billow;
 Lie not down wearied 'neath Woe's weeping willow!
 Work with a stout heart and resolute will!
 —Frances S. Osgood.

IN and the HOUSE AROUND

THE STEP-SAVING DUMB WAITER



ONE may save many steps in every house where the kitchen is situated over the cellar, to say nothing of other considerations, with a small outlay of time, and perhaps, without the expenditure of a single dollar, by means of a dumb waiter, which may be placed in any convenient corner out of the way. A handy size for an ordinary family is 2 feet square with four shelves, counting the top, 1 foot apart. These shelves may be hung from the corners, the center or the middle of the sides, by means of manila sash cord over pulleys placed close to the ceiling of the kitchen and nearly balanced with weights, which should be confined in a little case. They should be guided in ascending and descending by means of grooves in the middle of the sides extending from top to bottom of the inclosed case. In the cellar the case may have a fine

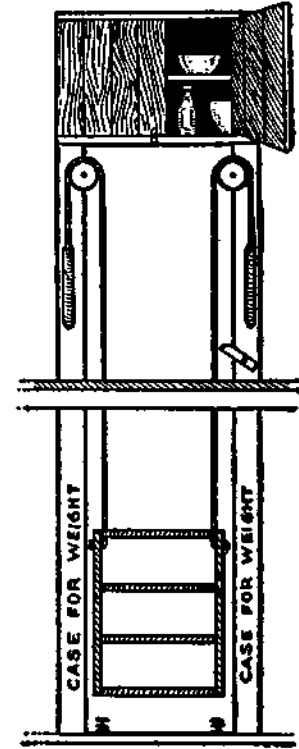

DUMB WAITER

wire screen door and in the kitchen an ordinary cupboard door or one with a glass front, as desired.

The doors should slide upward and be balanced like an ordinary window with sash weights and pulleys. In order to prevent the waiter from descending when being overloaded a pivoted wooden latch, as shown on the right-hand side, should engage with the ends of the shelves, and to prevent any shock from too quick descent some coiled springs should be placed at the bottom of the case. If desired a small cupboard may be built at the top of the case for storing little-used articles.

Some advantages of such a waiter are that food may be placed on the shelves and lowered into the cool cellar and either allowed to stay there or removed to the refrigerator. Thus it will be unnecessary to carry anything to or from the cellar, and this will often mean a saving of several trips up and down. If the cellar is clean and cool there may be no need to use a refrigerator or an ice box.

RACK FOR PRESERVES

A convenient rack for preserves may be made just at the turn of the cellar stairs in a house, so that the housewife need not step off the stairs, when she descends for a can of preserves. Several circular pieces of wood are pierced through the centers and nailed to a kind of wooden shaft that runs through the entire rack. Nail barrel hoops of the thick, wide variety around the edge of the shelves, so that the contents cannot fall off. The barrel hoops are soaked in water for several hours to make them pliable, so they can be fitted around the shelves.

In a socket at the bottom, the middle shaft slips,

the upper end working in a socket in the end of a stout piece of wood nailed to the beam overhead. The sockets may be purchased at the hardware store. The glass cans are arranged on the shelves, and the housewife can stand in one spot and turn the rack around until she finds the jar for which she is looking.

From the covers of large cheese boxes anyone could make a similar rack, using it in attic or kitchen, anywhere where one wants a rack which will hold an extra large number of articles for the amount of space involved.

Ill husbandry braggeth
To go with the best:
Good husbandry baggeth
Up gold in his chest.—Tusser.

TRANSFORMING A WASHSTAND

The kitchen cabinet here shown was made from an antiquated washstand and table, using old lumber, odds and ends of varnish, nails and screws, the finished article costing less than 50 cents. The only tools used were a saw, hammer, plane and square, such as can be found in any farmer's collection.

First, the shelf shown in Figure I was made, it being wide enough to reach each end of the table and deep enough for the washstand to set on it flush. To the right end was screwed a board of the same width, the shelf being so placed that it would be 2 feet above the

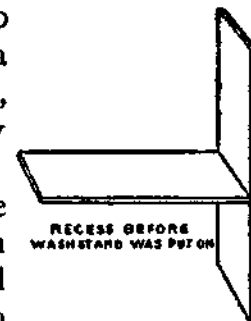
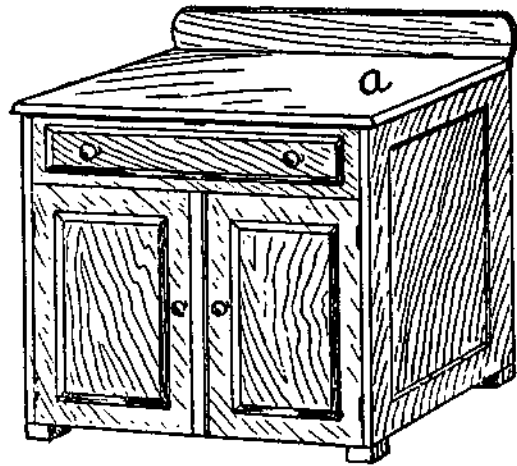

FIGURE I



WASHSTAND AS IT WAS

of the shelf, and the two were securely fastened together. This left a narrow open space between the right end of the washstand and the right support of the shelf. A board was then nailed on top from one end to the other, and a back added.

The drawer of the washstand had to be fixed so that it would slide the other way, as it was now upside down. That necessitated a shelf inside the washstand above the drawer. Old lumber was used, and

table. A board of equal width formed the support at the other end.

Then the washstand, from which the top had been removed, was placed upside down on the shelf (*bbb*), one end of the washstand reaching to the extreme left end

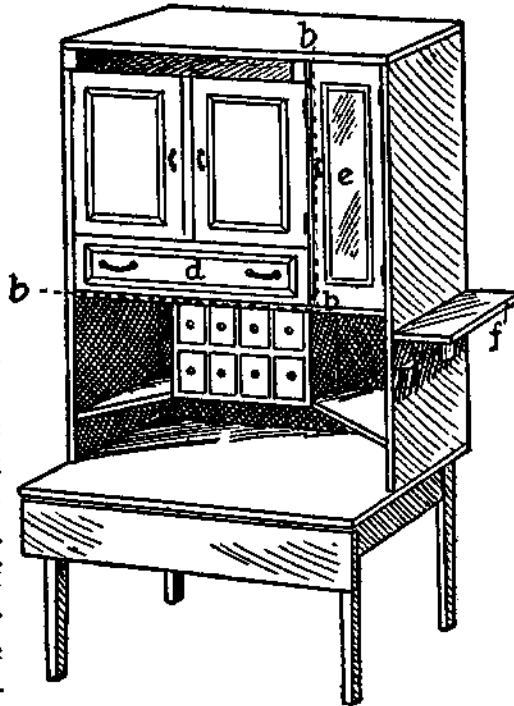

THE COMPLETED CABINET

this was smoothed with a plane, then sandpapered and holes and cracks filled with putty. When the putty was dry it was sandpapered again.

A support was then nailed to the back of the recess for a spice cabinet. This left the cabinet about 4 inches from the table. This support also did for two shelves, one in each corner of the recess. The spice cabinet contained eight small drawers and added much to the whole. A door with a glass sash (*e*) was then made for the narrow space to the right of the washstand above the recess. This made a little china closet with two shelves and containing over a dozen brass cup hooks. The space near the top on the left-hand side, between the short legs of the washstand, was left open for the crumb and draining trays. A piece of batten was nailed around the top as a finishing touch.

A leaf, which could be raised when required, added to the table room. The cabinet being placed in a corner left the front and one end free. On this end or side were placed two salt boxes, one for salt, and the other for kitchen cloths. Directly above these and reaching the length of the end was a shelf (*f*) for the clock, etc. Finally, walnut varnish stain, two coats, was applied. In each side of the recess were screwed two large cup hooks. Similar hooks were screwed on the inside of the washstand doors, to hang up biscuit cutter, corkscrew, nutmeg grater, etc.

HOMEMADE DRESSER

Sometimes it is necessary to use homemade makeshifts in the house furnishing, and sometimes it is done through a desire to exercise one's in-

geny in fashioning simple affairs. The accompanying illustration shows a plan for making a simple dresser that when finished will not only be very useful in itself, but will also add a useful bit of furnishing to the room.

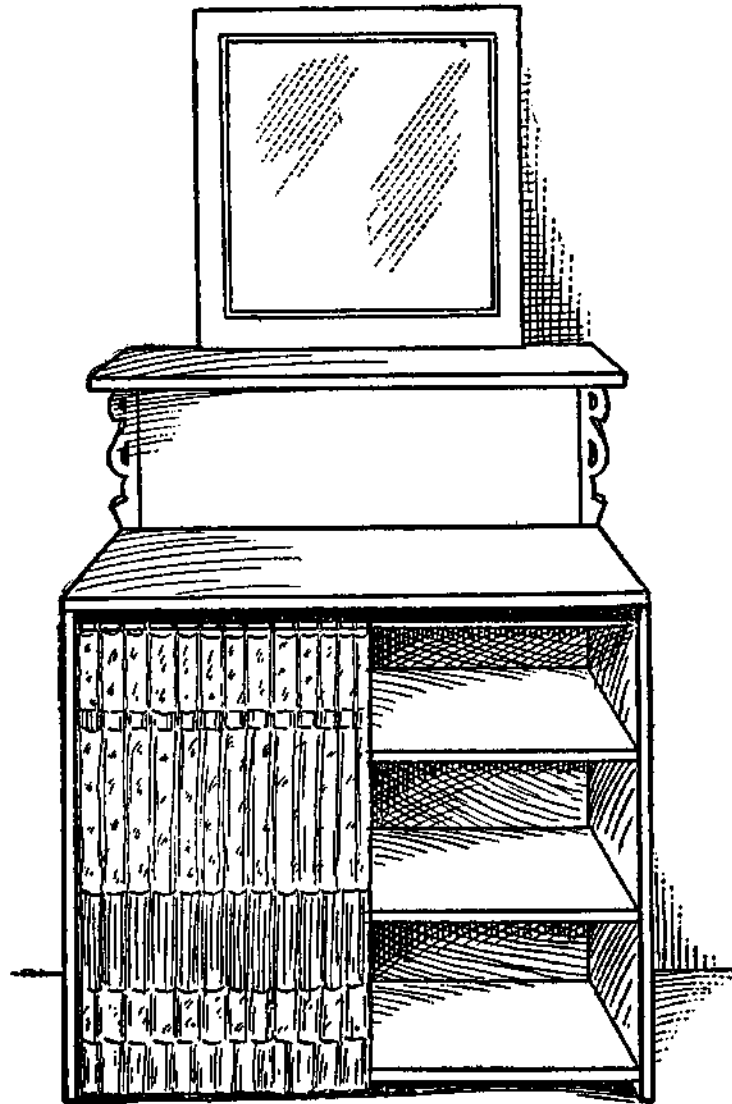

DRESSER MADE FROM A BOX

Select a drygoods box of the right size to fit well into the space to be utilized, then fit two shelves to the interior, as suggested. The whole box should be covered on the outside with some pretty cloth, the edges being drawn over and around the front edges of the box, and neatly tacked inside. Make a shelf with a length equal to the width of the box and fasten it to the wall above the box with some pretty nickel brackets, as shown in illustration. Cover the shelf with cloth, also. Now place a looking-glass above the shelf and have a curtain like the covering in front of the opening. This curtain can have little brass rings sewed to the upper edge, which will slide on a small brass rod.

Dost thou love life? Then do not squander time, for that is the stuff life is made of.—Benjamin Franklin.

Earth is here so kind, that just tickle her with a hoe and she laughs with a harvest.—Douglas Jerrold.

Blest is the man whose wish and care
Is just to be happy anywhere.

KITCHEN WINDOW CABINET

Nothing lightens labor so much as cheerfulness, and cheerfulness may often be secured by very simple means. In the accompanying picture is shown one way that works well. Instead of the usual kitchen table a cabinet is built below and at the sides of the kitchen window and the top made large enough to serve as a table. In this way the

wife may have a pleasant view when she looks up from her kitchen work. It is not necessary to go into details concerning the construction of such a cabinet, because no two people would be satisfied

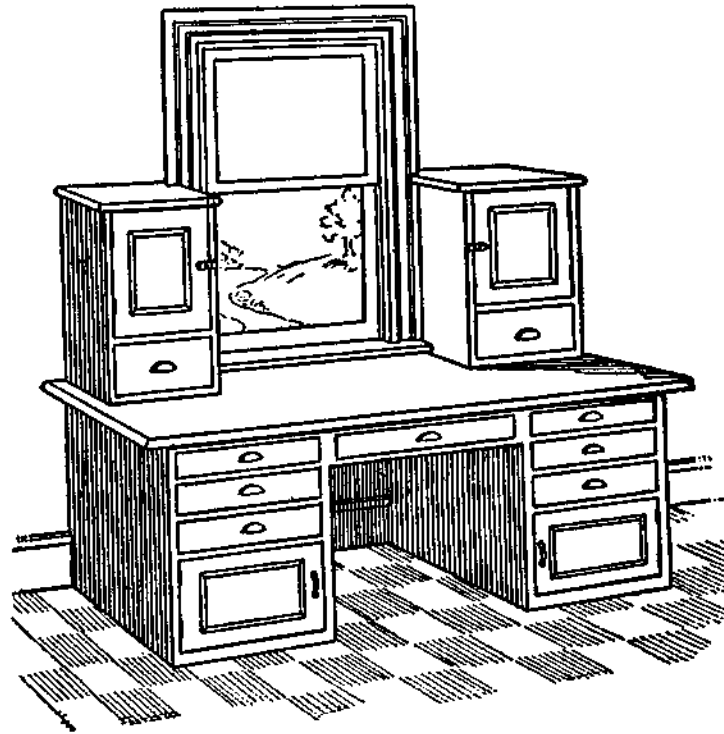

CABINET AT WINDOW

with the same plan. The plan shown is merely suggestive for the thoughtful wife and the handy man to work out to suit their own particular needs.

TO LET IN MORE LIGHT

Many farm kitchens and dining rooms are dark and gloomy. It is not an easy matter to cut new windows in the outside wall, though this can often

be done to great advantage; but where there is an outside door in a dark room, conditions can very easily be improved, and that, too, at small expense. Doors vary greatly in the manner of construction, some having wide panels at the top and some having two narrow ones of varying lengths. But almost every panel door that was ever constructed can be treated in the way which we will describe. The two upper panels can be removed, and their place filled with two lights of glass. If the door is of modern make it will be found that the wooden panel is held in place by a narrow molding all about it, both inside and out. Remove the molding on one side, and take out the panel. Put in the glass and replace the molding, and the work is done. If, however, the door is of older manufacture the molding on either side may be found to be a part of the door frame. In this case, cut the molding away on one side, neatly and evenly, and remove the panel. Then insert the glass, and having made, or bought, a little strip of molding, fasten it neatly in place around the glass with brads.

In the case of some doors the two panels could be removed, and also the upright between them, leaving a large rectangular opening, into which a single sash of four, or nine, lights could be inserted, the joints being made tight about it with putty and white lead. Then tack a narrow bit of molding about the sash, both inside and out, and a door that will give light to the room will be the result. An outside door looks better with glass in the upper half, and the interior will certainly be made more cheerful and healthful because of it.

We know what we are, but know not, what we may be.—Hamlet.

A BARREL CRADLE

Anyone who can use a hammer and nails and needle and thread can make this inexpensive, accessible, easily moved, and cool yet sheltering cradle.

Secure a nice white sugar barrel, clean it thoroughly and remove half of both heads. Place the barrel on its side, removing half the staves, and leaving the other half to form the bed of the cradle.

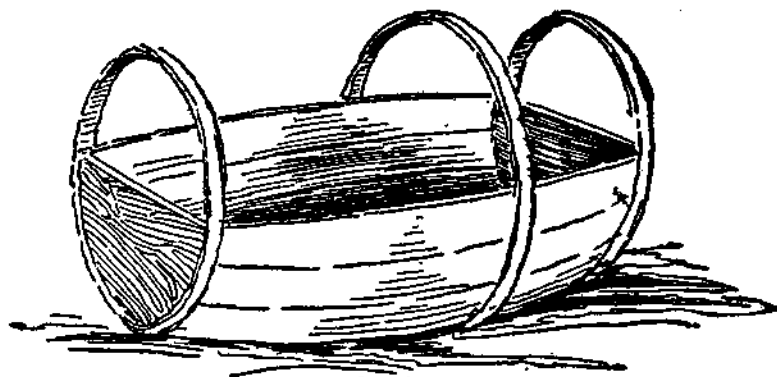

BARREL READY TO TRIM

Next remove the hoop that is second from the bottom, and then two hoops will be left at the top to form the frame for the hood, and one hoop at the bottom to form the foot. (See illustration.) Carefully nail the remaining staves to the hoops, clinching each nail securely.

Now cover the frame thus formed, as shown in the accompanying illustration. Any thin cotton goods that may be laundered can be used. Figured lawn would be very pretty, and if economy is an item, a worn bleaching sheet will do. Place a little mattress or pad and a tiny pillow within, or

the usual cradle furnishings may be used. One yard of mosquito netting stretched over the opening of the cradle will prevent insects from bothering, and the netting itself cannot touch and awaken the baby.

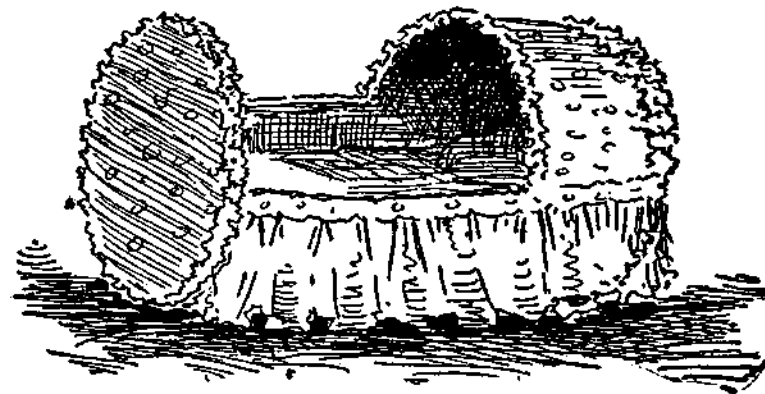

FINISHED CRADLE

TO PROTECT BABY FROM HOT STOVE

Winter months mean extra care for the mother of a baby, but possibly the greatest of the additional cares that winter brings in this regard is that of keeping the curious tot from the hot stove. Build a pen around the stove to protect him from it. The pen is a simple affair. It consists of four little gates, made just large enough to surround the stove, and covered with netting. The wire netting does not interfere with the free passage of heat and is very effective in keeping baby from getting burned. The gates are made of 1¼-inch strips, mortised or neatly fitted. For netting use ordinary poultry wire of 2-foot width. The gates are held in place by hooks and screw eyes. This arrangement is better than hinges, as it makes the

taking down of the affair, for sweeping or cleaning the stove, much easier.

In the summer you may use the gate at the foot of the stairs, across the porch door, and in other places where baby is determined to go, and where he is in danger of falling and getting hurt unless protected in this way. For this pen, the lumber costs 25 cents, the netting 25 cents, and the hook and screw eyes 15 cents, making a total of only 65 cents.

A BOX FOR CLOTHES

In many of the furniture stores one may see pretty cloth-covered boxes that are used in bedrooms as a receptacle for various articles of apparel, the inside, as well as the outside, being covered with pretty figured cloth. The inside of the cover is fitted with pockets for slippers and slumber shoes. These little chests are so light that they may be lifted about with one hand.

To make such a chest, select one of the very light and well-made grocery boxes in which cereals and various brands of breakfast foods are shipped, which may be had at any grocery store. See that the corners and the bottom are nailed securely. The top will be composed of at least two pieces of board, and these can be made into a solid cover by nailing two cleats beneath them. But these will not look very attractive when the covering is being put on, so a more workmanlike plan will be to saw off a couple of inches from each end of the top boards and supply the place of the wood removed by nailing along the ends a 2-inch strip of the same thickness. This gives a cleat at each end, but the cleats in this way form part of the cover itself.

Use long wire nails to secure these end pieces in place.

It will be a simple matter to cover and line the box when the covering material is at hand. Use very small tacks and carry the outside covering up over the top and down over the inside, which will make the use of tacks along the top unnecessary. The lower edge of the cover can be tacked on the bottom of the box, so the tacks will not be seen on the outside at all.

SCOOPS FROM TIN CANS

Scoops for handling sugar and flour are among the most convenient utensils that one can have about the pantry; and in a short time a good supply may be made from materials that are going to waste about almost every home.

Take an ordinary tin can and either melt or cut off the top. With a pair of tinner's shears (a strong pair of household shears may be used), begin at the open end and split the side of the can to within about an inch of the bottom. Opposite this one make a similar slit. Parallel to the bottom of the can, cut from the lower end of one slit to that of the other. Round the corners of the remaining half, and the body of your scoop is finished.

For a handle, about 4 inches off the end of an old broomstick is just the thing. If this is not available, a handle may easily be shaped with a knife from a piece of soft wood. To attach the handle, from the inside drive a small nail through the center of the bottom of the can and into the center of the handle.

Some additional strength is obtained by planning so that the seam of the can will run down the middle of the lip of the scoop, thus stiffening it. A salmon or corn can makes a very convenient sized scoop for the sugar, while tomato cans serve very nicely for flour and meals, and half-gallon paint buckets may be thus utilized for handling light materials.

A HOMEMADE FOLDING TABLE

A handy game or sewing table may be made as follows: Take two planed boards 12 inches wide and 3 feet long. Fasten them together with two

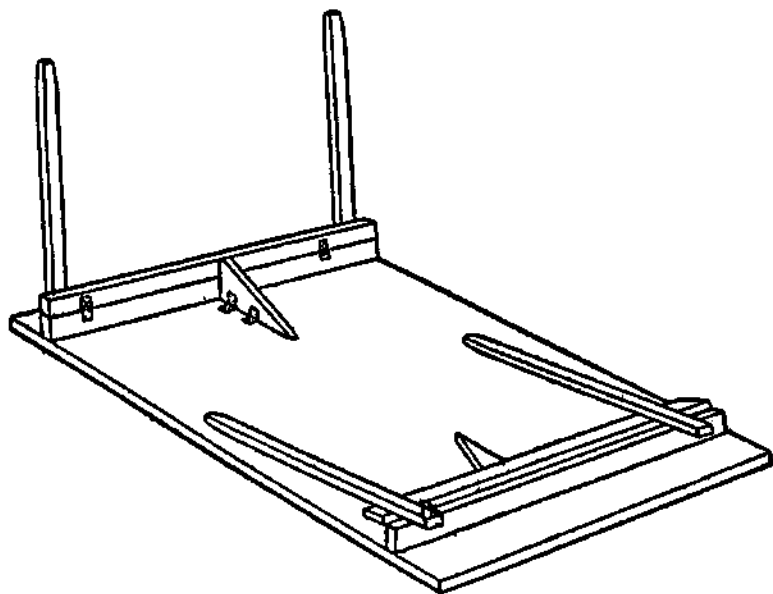

SIMPLE HANDY TABLE

strips 2 inches wide and 24 inches long. Fasten these strips by strong screws in upright position. Now take two similar strips and fasten them by

hinges to the pieces screwed on the boards. Fasten four stout legs to these in the manner shown in the cut. Take two three-cornered boards large enough to hold the legs stiff when dropped into position, and fasten them by hinges, as shown.

The same general plan may be followed in making a much larger and heavier table or a lighter one.

A HOMEMADE BUTTER WORKER

A butter worker is one of the handy devices that should be upon every farm. A good type is shown in the drawing. It is made of close-grained hardwood—maple or birch are recommended—tight-jointed, free from knots and perfectly smooth in size. It slopes enough to drain readily at the narrow end through a short piece of lead pipe inserted

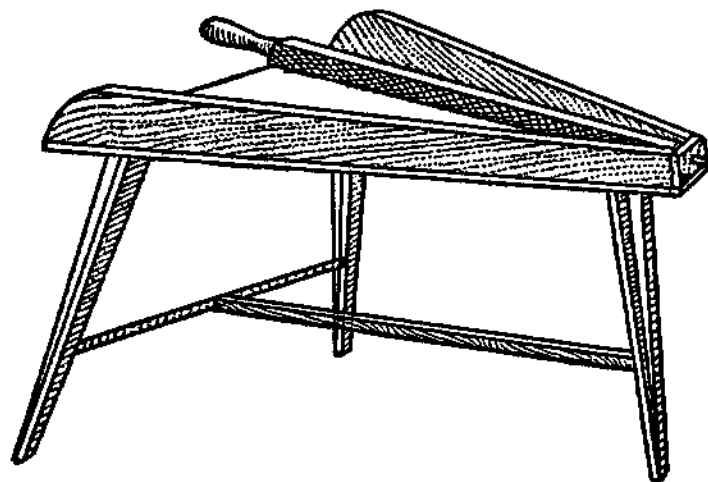

BUTTER WORKER

at the bottom. The working bar has a strong, smooth iron rod or spike at its lower end, which is easily inserted into or removed from the hole in

which it works. The part of the bar that comes in contact with the butter is half-round on one side and two flat sides meet at a right angle. Of course, it must be as smooth as possible.

HOME CHEESEMAKING

Nearly every farm home contains, or may easily be supplied with, the necessary appliances to make cheese, and it is not a difficult task when one is once familiar with the process. For a small batch of about 12 gallons of milk the following method is a good one: Take about 6 gallons of the evening's milk and leave it covered with a cloth in a

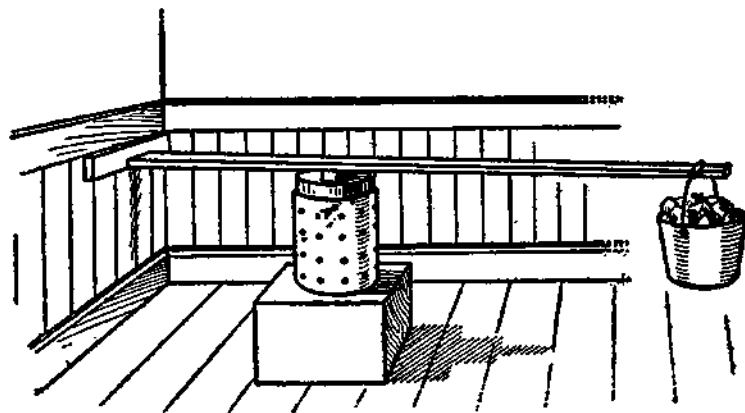

CHEESE PRESS

temperature of 65 to 70 degrees until morning and then mix 6 gallons of morning's milk with it in a large tub or boiler. All milk may then be heated together to 80 to 90 degrees. Care must be used not to get it too hot or to expose it to a draft so that it will cool quickly.

Another good method preferred by some is to use 11 gallons of perfectly sweet morning's milk and

to this add 1 gallon of milk that has soured and thickened. The sour milk should be stirred well to get out all the lumps and left for about 15 minutes before the rennet is put in. The easiest way to heat the milk is to place it in a wash boiler right on the stove until it gets up to 86 to 90 degrees and then raise it from the stove by placing it on two bricks. The stove must not be too hot.

Rennet in the form of tablets is most convenient and useful for home cheesemaking. Dissolve one tablet in half a glass of cold water and add to the milk after it has been heated and stir well for two minutes. Some cheesemakers use two or three tablets, as it saves time, but for beginners two are usually enough. If you have liquid rennet extract, use about two tablespoonfuls.

Cutting the Curd

The rennet will curdle the milk and the curd will be ready to cut in 20 to 40 minutes. This can be determined by noting if the curd breaks clean like jelly when raised on a knife blade. The cutting can be done with a wire toaster, a long knife or a heavy wire. Cut lengthwise of the vessel and then crosswise until the curd is in nearly uniform pieces of $\frac{1}{2}$ -inch squares. After cutting, leave the curd on for five minutes, then heat slowly to 100 degrees, stirring all the time. Cook for about 40 minutes at as near 90 degrees as possible, stirring occasionally to prevent the curd from sticking together. Keep the heat up and do not allow the mass to cool.

To determine when the curd is ready, take a handful and squeeze it in the hand firmly and if it feels elastic and does not stick together, it has been cooked long enough. If the milk is good, the curd

should have a pleasant, slightly acid odor. As soon as the curd is cooked, draw off the whey or dip off the curd with a sieve and place in another vessel. After the curd is well drained and before it sticks together, add $\frac{1}{4}$ pound of fine salt and mix well. After salting, let it cool for 15 minutes, stirring occasionally, when it is ready for the hoop.

Pressing and Curing

For a cheese hoop, one can use a tin hoop 7 inches in diameter and 12 inches deep or an old peck measure without a bottom if holes are punched in the sides for drainage. For a press a device shown in the sketch will serve well, the pail at the end of the lever being filled with stones. Before the curd is placed in the hoop, line it with cheesecloth, one piece the size of the bottom and another around the side. Turn the upper edge of the cloth over the edge of the hoop and fasten it tight. When the curd is packed firmly, put a piece of cloth on the upper end and fold it over tight. Make the pressure slight at first, but after an hour rearrange the cloth and make the pressure heavier. The pressing should be finished by the next day. Do not press in too cool a place, but keep the temperature about 50 degrees.

For curing, set the cheese in a damp room or cellar which has an even temperature. Turn it around daily, and if it shows signs of molding, rub occasionally with butter. It should be ready to eat in three or four weeks. Cheese will cure at 40 degrees, but it takes longer than when warmer. Twelve gallons of milk should make about 10 pounds of cheese, according to richness of milk.

After one or two attempts any housekeeper should be able to make good cheese by this method. It is necessary to keep all utensils very clean and the liberal use of boiling water with a little soda will accomplish this purpose.

WASHES WHILE READING

Here is a way of making play of wash day. Perhaps some of our bright boys will try this to help mother. A friend of ours had an old bicycle unfit for use. He made a frame to raise the hind wheel from the floor, wound the rim with twine (tire being off) and reversed the seat. In place of the form he inserted a piece of pipe (a stick would do as well). Then he took some old belting, cut it

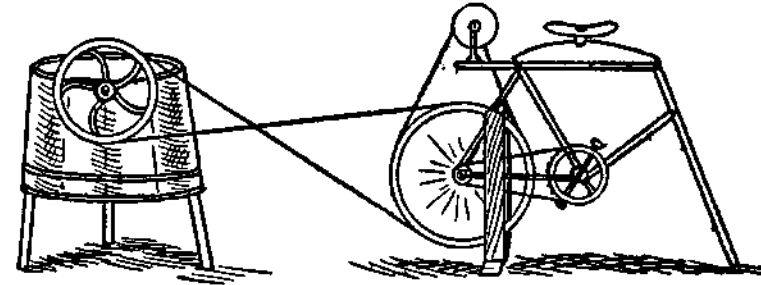

PEDAL POWER DEVICE

to $1\frac{3}{4}$ inches wide and about 10 feet long, and with that he runs the washing machine for his wife. He can read the paper while he washes, and he does not lose much time from field work either. An emery wheel can also be run with it by bolting 1-inch strips to the top part of the frame extending over the wheel and mounting a polishing head on same.

Knowledge is power.—Bacon.

TREAD POWER IN THE DAIRY

While the small gasoline engines adapted to running cream separators have been hailed with delight by many dairymen, the old tread power is still a very economical and reliable source of power. With a heavy sheep, dog or the dairy herd bull

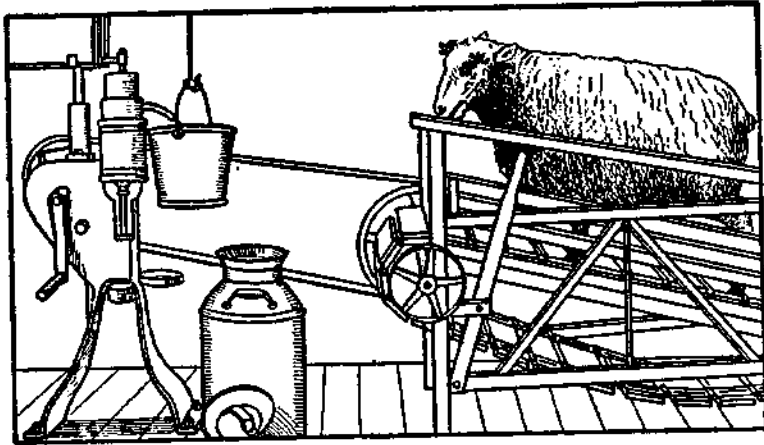

SEPARATOR RUN BY RAM POWER

enough power can be produced to run the separator and churn at practically no cost except for the tread.

One difficulty has been to secure a uniform rate of speed, but this is solved if a heavy flywheel is attached to the tread. While the sketch shows a direct drive from tread to separator, a more desirable arrangement is to have the tread located in a room adjoining the separator room, where the milk will not be exposed to the breath of the animal.

A great many men wear themselves out devising schemes to sidestep honest work.

A LAMP FOR COOKING

A lamp may be utilized for cooking purposes in the following way: Make a tripod by taking three strips of wood of equal length, putting in one end a headless nail and making slightly slanting holes in the corners of a 6-inch triangular piece of board in which to fit them. A screw hook in the center of the board, on the under side, completes the device, which has only to be stood over a lighted lamp to be ready for work. A small stew kettle, or tin pail, hung on the hook, within a half inch of the lamp chimney, enables one to have a "pot boiling" in short order. If you have a large lamp, with a round wick, it will give the heat of two or three common ones, and you can cook almost as rapidly as over a stove.

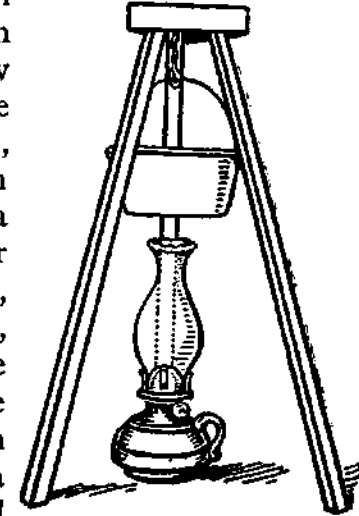

LAMP HEATER

With an ordinary lamp, food can be heated, eggs boiled, or coffee made very quickly, helping wonderfully in the getting of a meal. This is also an easy and convenient way to heat baby's milk, or water, in the night, in case of sickness. Stood on a chair by the table, the device can be used to keep the coffee or chocolate hot during meal time. A round piece of sheet iron, with chains attached to suspend it from the hook, is an additional help, to hold a steeper for tea.

As this tripod can be taken apart readily, when not in use, it will be found a good adjunct to a

camping outfit, even though you carry a camp stove, for there will be times when nothing will be wanted but a hot drink, which can be made over the lamp with less trouble than it would be to make a fire in the stove.

HOT WATER ALL NIGHT

One of the things that must be had quickly when medicine is needed, and still more often for a bottle baby, is hot water at night. The following contrivance has been found to be worth many times the trouble to make it, for it saves annoyance at a time when baby's worrying may mean hours of sitting up.

Place the socket of a wall bracket lamp just high enough above a table so that the top of a hand lamp chimney will be 5 or 6 inches below it. Make an arm of round iron or small piping long enough to extend out over the lamp and to this hang a hook, on which hang a small teakettle or pail. In this enough water for the needs of a night can be kept hot without boiling, and will be ready at an instant's notice. As a night lamp is a necessity in a house where there is a youngster, the cost of this device will be nothing, for the blaze of a small burner will provide sufficient heat. The proper height for the socket on the wall can be determined by measuring the hook and the kettle to be used. The lamp chimney should not be nearer than 2 inches to the bottom of the kettle, or the water will boil and steam away.

HOW TO CUT BREAD EVEN

Here is one of the most useful devices to which the handy man can give his attention. It is very

rarely that a housekeeper can cut even and handsome slices of bread, however much she may desire to have the bread plate look attractive. One slice will be thin, another thick, while another will be thick on one edge and thin on the other. The drawing shows a simple arrangement by which all the slices of bread can be cut of an even thickness without any slant.

Cut a piece of pine board to about 9 x 13 inches. Near one end, on either side, insert firmly two

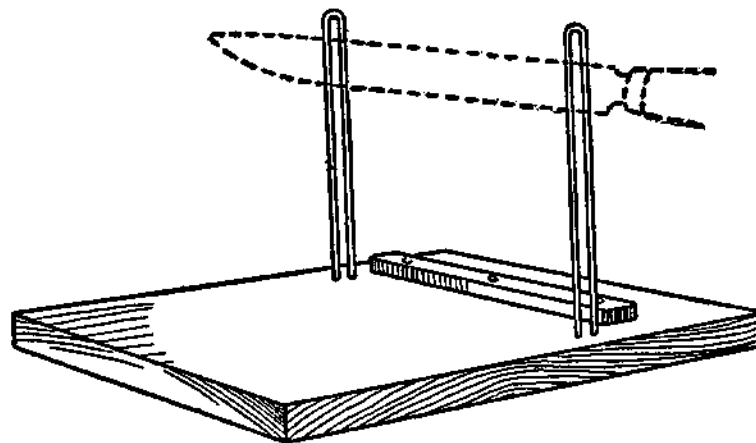

BREAD CUTTING BOARD

pieces of very stout wire, bent double, as suggested in the cut. These wire supports should be at least 7 inches high, and should have another inch of length firmly inserted in the wood. The wire should be as stout as No. 12, or larger still, and should stand exactly at right angles to the board. Put them far enough apart so the largest loaf will readily go between them, and have the opening in each wire standard just wide enough so the knife will slide up and down without "wobbling." The dotted lines show the position of the knife when

in place. Screw a little strip of wood in front of the wire, just far enough ahead to make the slice of bread the right thickness. Press the loaf up against this guide and cut off a slice, then press the shortened loaf up again, and repeat the process.

HOMEMADE WATER COOLER

It's a mighty nice thing to have a good supply of cold water at the barn when threshers, corn

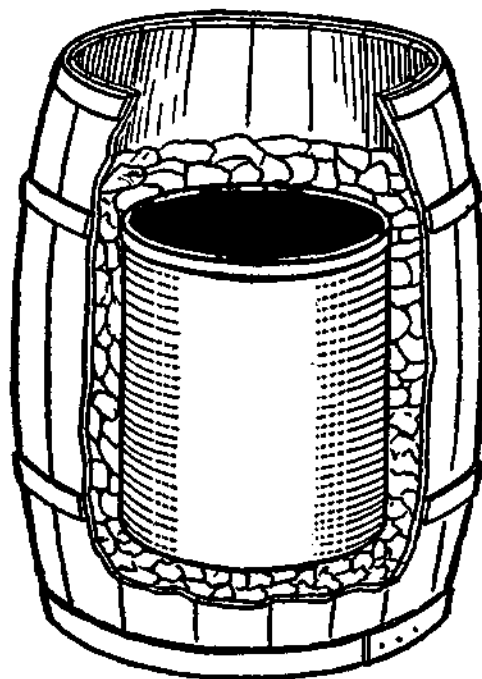

WATER COOLER

huskers, or hay harvesters are at work. A simple and effective arrangement can be made by using a flour barrel and a 10-gallon stone jar. Place the jar inside the barrel and surround it with charcoal, sawdust, or chaff, if nothing else is available. With a tight lid and a wet cloth spread over the top, water will keep ice cold in this arrangement.

KEEP FOOD COOL IN SUMMER

A very convenient and serviceable place to keep dairy products may be formed by sinking a large

barrel in the ground. A shady spot should be chosen, or the heat of the sun will affect the temperature. Fill in around the barrel with small stones, gravel and sand, dampened in order to maintain coolness.

Construct a box around and above the top of the barrel, and bank up with solid earth, preferably

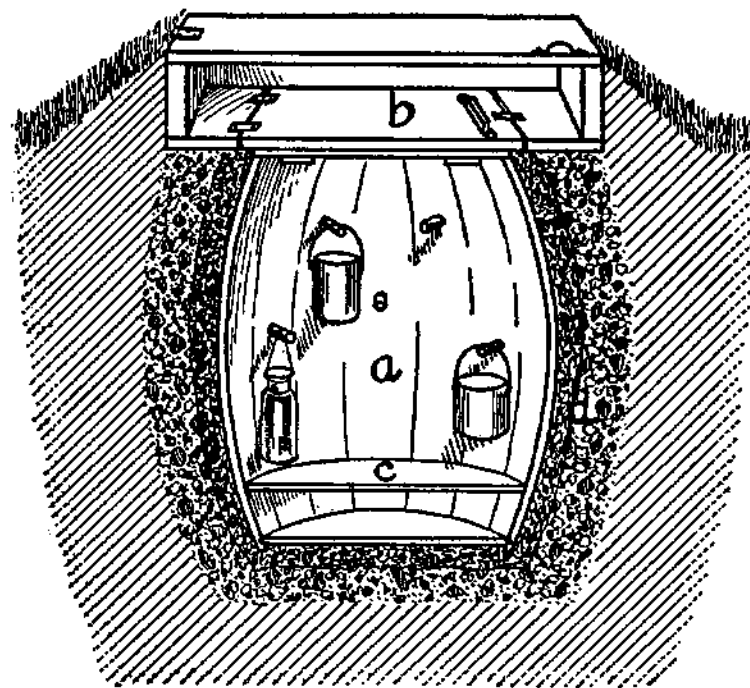

FOOD COOLER

clay. This drains off the water when it rains. It also makes the bottom of the barrel farther down from the top of the opening, which further promotes coolness. Next shape a light, inner lid to place on top of the barrel, and then make a strong, hinged lid for the box, and arrange it so it may be fastened down tightly.

Sprinkle a little dampened sand on the bottom of the barrel, and your little barrel cellar is ready for use. By being careful several vessels may be arranged one above the other in this handy little receptacle. Air out occasionally to prevent mold and odors from collecting.

A COOLER DUMMY

Where a deep, cool well is located near the house an arrangement may be devised that will serve the purpose of a refrigerator. Construct a frame of strong boards with a groove in which a board on the side of the box of shelves can run. Attach a rope to the top of the box of shelves, pass it over a wheel on the crank shaft and balance with a counter weight.

If the frame is 16 feet long and extended down near to the surface of the water the lowest temperature may be secured. A nice looking top may be constructed for the arrangement, with a door opening into the shelves when they are drawn to the top. Most wells are almost as cool as a refrigerator, and this sort of an arrangement serves the purpose with a great deal less expense.

A wire clothesline will serve as a cable. Any old pieces of iron will do for the counter weight, and it is well to have a ratchet wheel, such as are found on old chain pumps, to prevent the elevator dropping when it is well filled. Make as many parts as possible of wood to prevent rusting. One such elevator is 42 inches high and 18 inches square.

Turning the grindstone is hard work; but if you use it as a muscle developer it will help out.

AN OUTDOOR CLOSET

When the housewife has baked a pie or a pudding for dinner and wishes to cool it quickly in winter it has to be set out of doors; but there the trouble begins. It cannot be set upon the snow, since that would melt and engulf the hot dish. Moreover, the cat or dog, or some neighbor's cat or dog, is likely to be lurking about the door, ready for pie. Let the handy man make a little out-of-door cupboard for the use of the housekeeper, locating it beside the kitchen door. Get an empty grocery box of the right size and hinge the cover to the top, placing a knob on the other edge. Make a support for this closet by driving two strips of wood into the ground and screwing two crosswise strips of board to the tops. Lay the grocery box on its side on these supports and nail it to them from the inside.

Here anything hot can be placed to cool quickly, and with the cover down there will be no danger from cats or dogs or hens. If desired to give a freer access to the cold air, several holes can be bored in each end and in the bottom before putting the box in position on the supports. If the ground is frozen too hard to insert the strips of board, the closet can be placed against the side of the house, close to the kitchen door, and supported in place by two wooden brackets. Another plan to secure the same result would be to make the closet and screw a wooden handle to the middle of the top, with holes bored in ends and back. When it is to be used put the dish, or dishes, inside and set the closet out onto the snow beside the door.

Taste the joy
That springs from labor.—Longfellow.

HOMEMADE REFRIGERATOR

Take two large boxes, one 2 inches smaller than the other every way, and bore two 1-inch holes in the bottom of each box for drainage. Fill up 2 inches in the large box with powdered charcoal or coal ashes. Put the smaller box inside and fill the space all around with the charcoal or ashes. Fix the lids to both boxes to fit tightly. Put shelves on both sides of inner box. Leave a place in the center of the box of ice. A rack, made of lath, can be laid at the bottom for ice to rest on.

ICELESS BUTTER AND MILK COOLER

The accompanying picture shows how a well may be utilized during the warm months for cooling

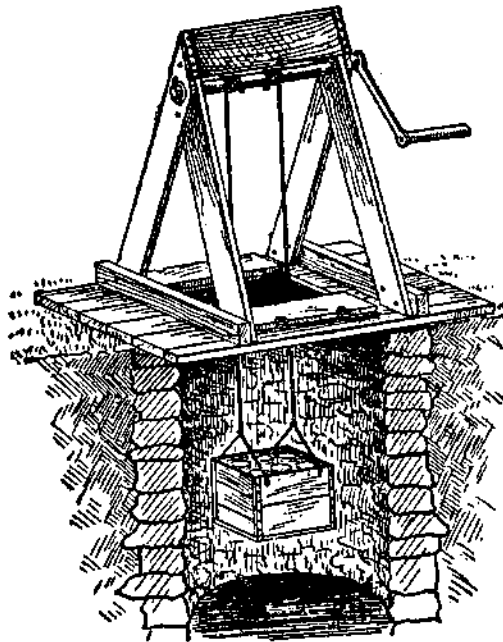

COLD STORAGE FOR MILK

butter, milk and other perishable articles. It will be found very handy as a substitute for a refrigerator when the farmer has no ice supply. Anyone can make a triangular-shaped frame for the windlass, which is placed above the well; and anyone can also put the trap doors in the platform of the well. These doors should be pro-

vided with a lock, so children cannot fall in. A pin may be placed on the handle side of the windlass to prevent the crank from turning around when the box is lowered to the desired depth.

The picture is only suggestive. The shape and size of the various parts will depend upon the style of the well. Preferably, the box should be made of galvanized iron and have perforations in the bottom, so it may be lowered right into the water. Of course, this would not be feasible if the materials to be kept cold were not first placed in sealed receptacles. Where a well with a bucket pump or the ordinary wooden pump is the only available place to put such a cooler, the cooler may be at one side of the well. If necessary, the position of the pump may be shifted.

Knowledge is of two kinds. We know a subject ourselves, or we know where we can find information upon it.—Samuel Johnson.

Every addition to true knowledge is an addition to human power.—Horace Mann.

But now my task is smoothly done,
I can fly, or I can run.—Milton.

A VENTILATED PUMP PLATFORM

Here is a way to keep the well clean and pure at all times. Make the frame of the platform of 2 x 4's, allowing a space 2 to 6 inches between the top and bottom parts of the sides. This space is covered on the inside with a fly screen to keep out dirt and

insects, and outside of this with a larger meshed screen to keep out large vermin. This gives good ventilation to the well, which never becomes foul. In the winter cover the platform with straw and snow.

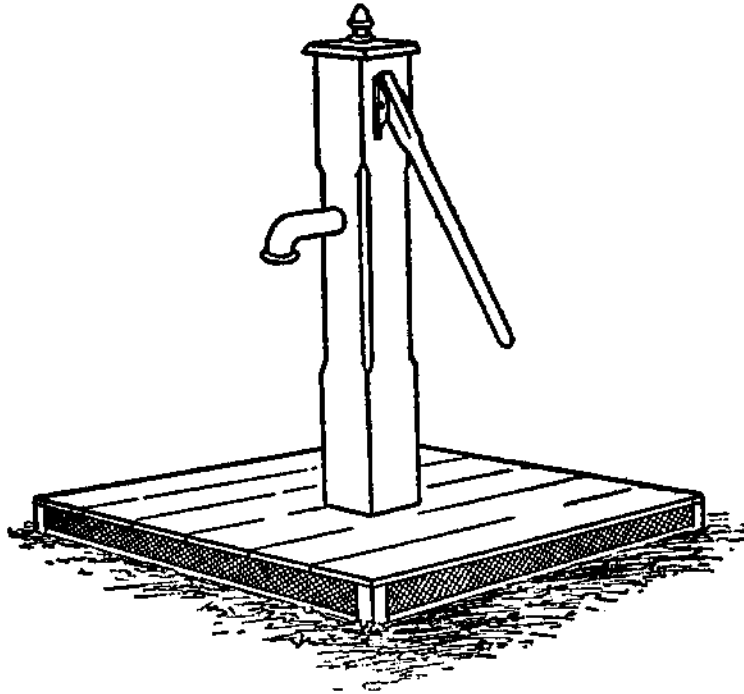

HELPS TO KEEP WATER PURE

CLEANING A WELL

To remove floating litter from a well, take an ordinary sand sieve, and, after marking off the rim into three parts, attach a wire to any of the two points and to this improvised handle attach a rope. Fasten the end of the rope to the third point in the rim and a weight to the sieve, so that it can be lowered into the well and will sink. When used, sink the sieve edgewise into the water and pull the

rope with a single attachment and it may be lifted out with all the floating sticks and timber on the surface of the water.

DOG POWER FOR PUMP

This sketch shows an arrangement for making use of the dog for carrying water. It simply consists of a wheel 8 feet in diameter and 18 inches

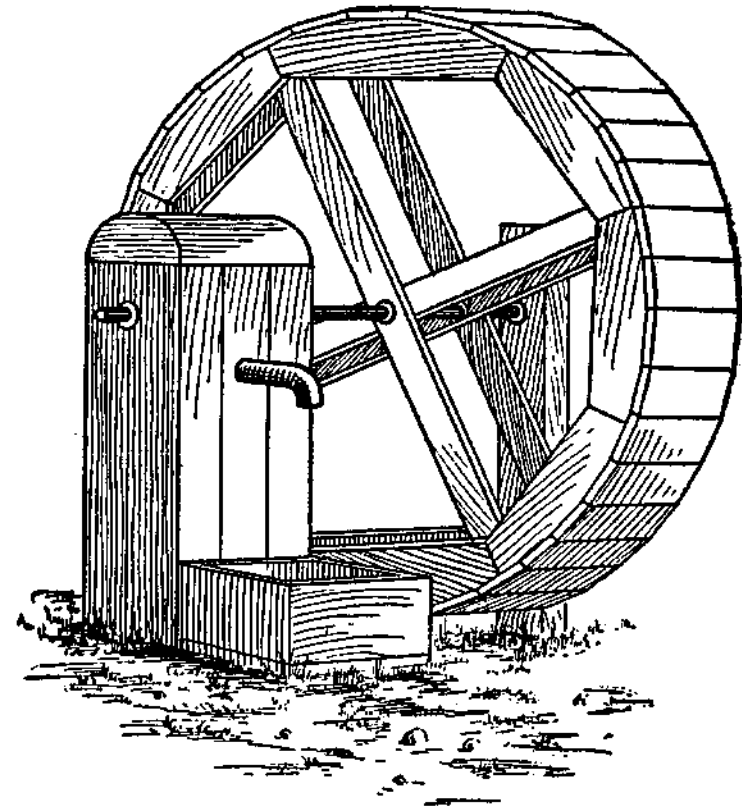

DOG POWER PUMPING DEVICE

wide, with room enough inside for the dog to walk around, where he acts as a tread power, which causes the pump to revolve. In southern Califor-

nia there are a number of these dog-power pumps, which cost less than \$15. A good-sized dog can easily earn his living in an arrangement of this kind.

FILTER FOR CISTERN WATER

The problem of keeping water in a cistern clean is most easily solved by not allowing it to get dirty, as can be done by the device shown in the drawing on page 69. Two barrels, each with a perforated false bottom, are set side by side beneath the water spout from the roof and connected with a pipe leading to the cistern. Above the false bottoms fine gravel and then sand are packed to the depth of 8 or more inches. On top of the sand rest stout floats as large as can be let down into the barrels. From near the margin of the floats two heavy wires extend vertically upward about 2 feet to engage loosely near their centers with a tilting spout by means of knobs on both the ends of the spout and the wires.

When the barrels are empty the floats rest on the sand. As the water begins to pour in one barrel it strikes the float, but is prevented from gouging a very deep hole at the outside of the barrel by striking a strip of wood about 1 inch high, 2 inches wide and 1 foot long. This spreads the flow. A layer of gravel at this place would also help prevent gouging. If the flow is too great to filter away readily, the float will rise and the knob on the wire will engage with the spout, which will be tilted until the flow will suddenly start into the other barrel. If the delivery pipe to the cistern be large enough there should be no danger of either barrel overflowing. When the sand becomes dirty

a few minutes will serve to remove it and put in fresh. This will insure clean water in the cistern, and greatly reduce the number of times the disagreeable job of cleaning out the cistern must be done.

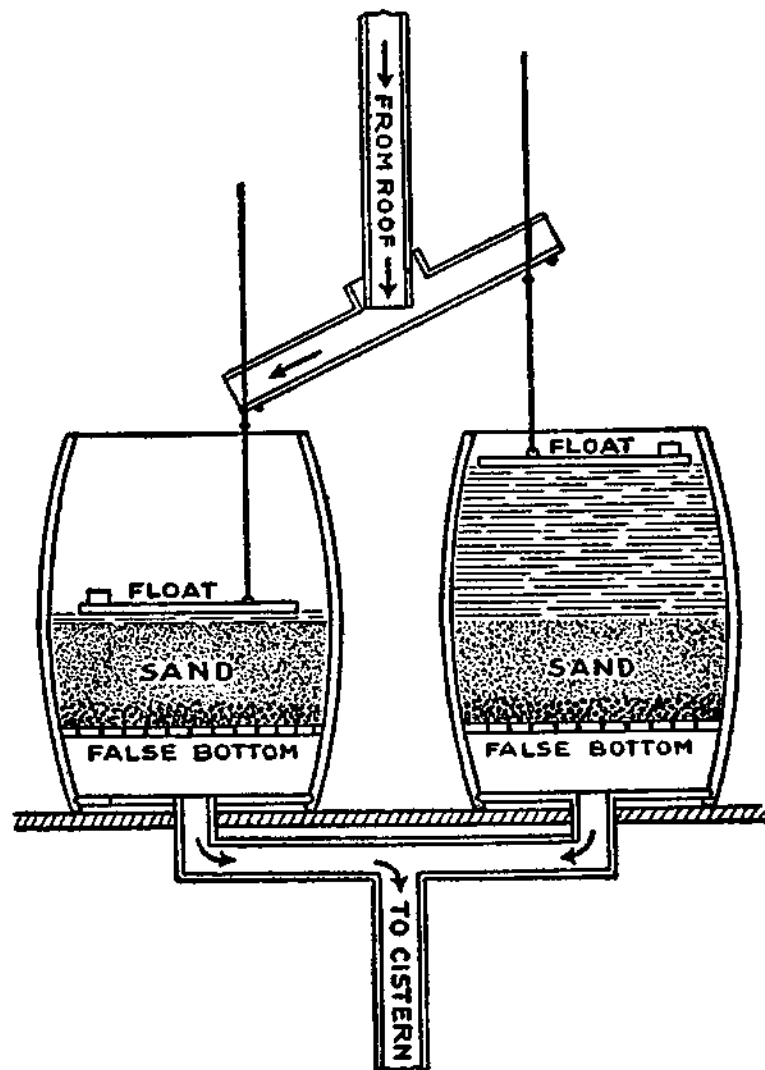

TWO-BARREL FILTER

A HANDY WATER FILTER

Nearly every farm can boast of good water, but no water, either from well, spring or stream, is pure, as it all contains more or less animal or vegetable matter. The only way to make it pure is to filter it, just as is done in city supply reservoirs, or private filtering tanks.

A simple water filter is very easily made that answers all purposes for domestic use. The plan of its operations is identical with that employed in large reservoirs where water is filtered on a large scale for general distribution. This filter consists, primarily, of two flower pots, set one above the other. In the bottom of the upper pot is stuffed a large sponge. A sponge is also stuffed in the bottom of the lower pot, but it is more adequately supplied with filtering material by placing above the sponge a layer of smooth pebbles, then a layer of coarse sand, and still above this a layer of pounded charcoal 3 or 4 inches in depth. It is also best to place another layer of smooth pebbles above the charcoal, to prevent it from being stirred up during the circulation of the water.

The upper pot should be the largest, and if the lower one is strong, the upper one may stand in it, or two strips of wood will serve as a base support. The two pots thus arranged are placed on a three-legged stool with a hole in it, through which the water drips through the bottom of the lower pot into the mouth of a jug set underneath. The upper pot serves as a reservoir, and its sponge stops the coarser impurities, and thus the filtering layers of the lower one may be used for a year without being renewed, though it is necessary frequently to clean the sponge of the upper pot.

The layers of sand and charcoal of the lower pot are positively effective in stopping all animal and vegetable matter, as well as many smaller impurities in the water. The only trouble one may experience with it is in neglecting the upper sponge for too long a time, or in stuffing it in too loosely, thus allowing the water to pass from the upper pot faster than it can filter through the lower one. Only a little attention, once or twice a month, is sufficient to keep this simple filter in perfect running order.

DELIVERING MAIL BY TROLLEY

Where the house stands some distance back from the highway a trolley can be rigged up to save steps in getting the mail. The box is hung on two pulley door hangers, as shown in cut. A strong post, with a bent arm, is set next the highway,

a, suspended between it and the house, on which the box runs. A pulley is fastened in or to, the post, and over it runs a cord, *b*, *c*, to pull the box back and forth between the house and the road. The box is sent down to meet the carrier, who places the mail in it, and then it is quickly pulled back to the house.

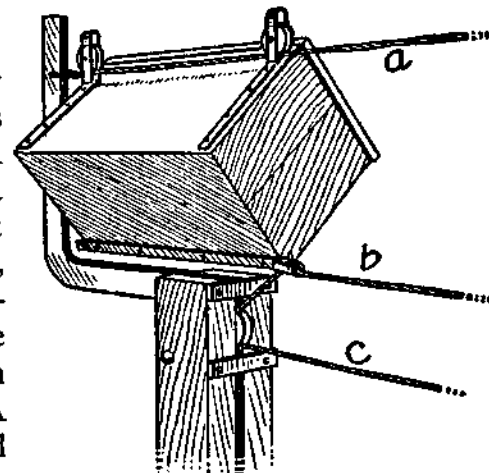

TROLLEY MAIL BOX

BEAUTY IN A BARREL

A very nice ornamentation for the lawn is shown in the picture. It is made by sawing an oil barrel



HALF-BARREL PLANT HOLDER

in two as shown, and mounting it on legs. Paint it and set one-half of the barrel on each side of the walk and use them for growing flowers in during the summer. Care should be taken to have the hoops thoroughly nailed to the staves and to have the heads solid. Dark green or dark red are good colors for the painting. If preferred,

the barrel may rest upon the ground, but should be securely braced or blocked to prevent rolling.

STORAGE BIN FOR VEGETABLES

Instead of keeping the vegetables in barrels or boxes scattered all over the cellar, have a set of storage bins. Take six drygoods boxes and bolt them together as shown in the drawing. Put legs on them to hold them off the floor and a cover on the top. Then paint on the boxes the names of the

vegetables. It is most convenient to have the vegetables most frequently used in the upper boxes, which would not be true of the bin shown in the picture. If the upper row of boxes is attached to each other, but not to the lower ones, the top section can easily be moved enough to make filling the lower boxes a simple matter. Otherwise, the vegetables

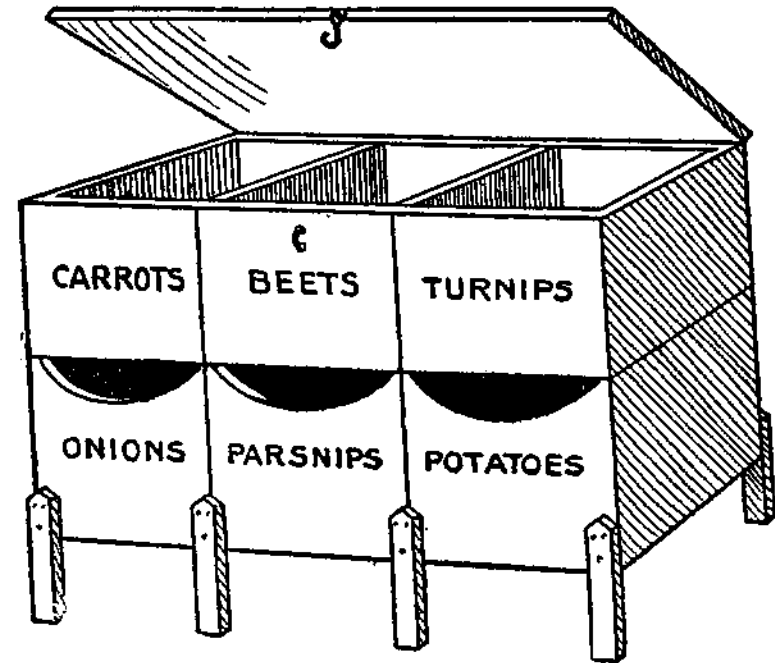

VEGETABLE BIN

would have to be put in through the openings at the top of each box a few at a time by hand, instead of pouring them in.

Many people would not care to keep their potatoes in such a sectional bin, preferring a large separate bin. It certainly is all right for other root vegetables, and many other products of the farm that are stored might well be kept handy for use in such a labeled sectional bin.

AN INEXPENSIVE CELLAR

A temporary cellar is sometimes necessary in cold countries where that under the house is not sufficient for storing vegetables. A very effective and useful temporary cellar may be constructed after the following method, as shown by the drawings: Dig a pit 15 feet long, 10 feet wide, 4 feet deep in a solid, dry place where the drainage is good. Put a gable roof of 1-inch board over the hole, supported by 2 x 4-inch strips at the eaves, gable and half way up the sides. Strengthen by crossbeams and a central support if the lumber is not first class. Over this place 8 to 10 inches of dry straw

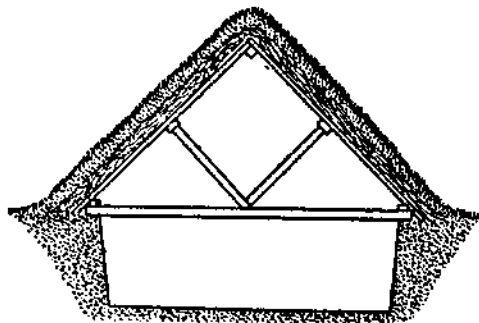

CROSS-SECTION

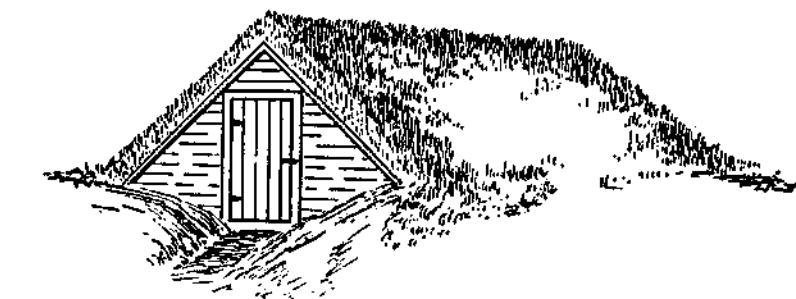

TEMPORARY CELLAR

well packed and over the entire structure, excepting one end, pack earth 12 to 14 inches deep. The surface should be smooth to shed water. It is better if plastered with mud covered with sods.

The door end must be double-walled and the space filled with straw. The door must also be double and its margin packed with cloth strips, so as to be practically airtight. If possible, the pit should be drained by a tile, the end of which is covered with a piece of wire netting to prevent the entrance of rodents. Such a cellar will prevent freezing during usual winter weather. The door should be opened on mild days and the interior aired thoroughly. The size and depth of the pit may be varied according to needs.

CLOTHESLINE UP AND DOWN

Heavy posts should be set for the ends, 3 feet in and 3 feet out of the ground. It is not necessary for the center post to be as heavy as the end ones. Have the posts clean and smooth, so they will not soil the clothes when blown against them. Take a

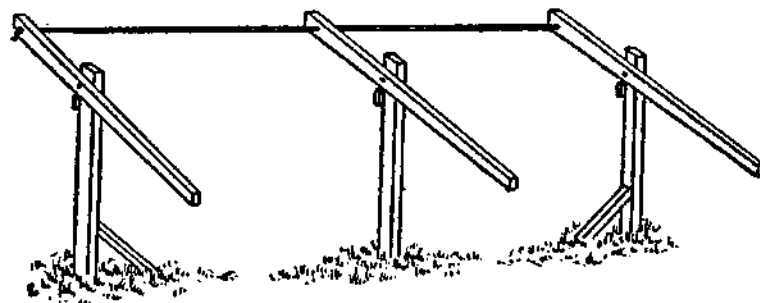

ELEVATED CLOTHESLINE

piece of 2 x 4-inch hard wood 5 feet long for the lever. Fasten to the post near the top with a $\frac{3}{4}$ -inch bolt, 2 feet next to the line and 3 feet for the lever. A block holds the lever in position while the clothes are being put on. A button holds the lever upright when the line is hoisted.

A CLOTHES HORSE

There is no little thing that will save the household so much as a revolving clothes horse, so near the back stoop that the clothes may be hung on it without stepping out in the snow. A solid post should have a hole bored in the top and the arms may be beveled and spiked to a piece of plank through which a bolt passes into the post, or each arm may be bored to let the bolt pass through it. Three, four or five arms may be used as desired, and of any length, provided all are of one length. No skill is required in making it, as the rope holds the arms up simply by being tight enough. It is well to set the post before measuring for the arms, so that they may be sure to reach the veranda. Some laths may be nailed together at first to make a model, if you are not sure of your ability as a carpenter.

A TOILET CLOSET

A small closet in a home, for keeping medicines and toilet articles, is a great convenience. One consists of $\frac{1}{2}$ -inch pine, 4 inches wide, planed and put together so as to be 2 x 3 feet. It has four shelves. The door is of thin pine, free from knots, planed, hinged and with a back catch. The outside of frame and door is varnished. Being in the toilet room, it is indeed a very useful as well as ornamental piece of furniture. It has no back casing or boards; simply rests against the wall. It is held in place by four short pieces of band iron, one end of each band being fastened to back of frame, the other end fastened to the wall by a screw. All

kinds of medicines, shaving materials, soaps, wash rags, can there be kept. If there is no other looking-glass in the room, one may be fastened on the outside of door.

REVOLVING CELLAR SHELF

A handy cellar shelf that will save the housekeeper many steps may be arranged at the side of the cellar stairs, within easy reach upon descending a few steps. The shelf is contrived from an old axle and wheel. The axle is fastened to hang from the nearest beam to the stairway. The wheel is covered with thin, smoothly planed boards and the axle is kept well oiled, so the wheel will revolve readily, bringing all parts of the shelf within reach at need.

WATER SUPPLY FOR FARMHOUSE

Farmers can have running water, hot or cold, in their dwelling houses at a cost of fifty dollars and up, depending upon the size of the house and the kind of equipment needed. This makes possible the bath and toilet room, protection from fire, the easy washing of windows and walks, the sprinkling of lawns, the irrigating of gardens, and all the other conveniences which a few years ago were thought possible only in cities, where big water systems were available. This is one of the things that makes farm life attractive. It lessens the work in the house, insures a fine lawn and garden, reduces danger from fire, adds greatly to comfort and convenience in every direction.

The way to secure this is to install a water supply system, with a pressure tank in the basement.

This pressure tank is so arranged that by pumping it full under strong air pressure the water is forced all over the house, and is available for the bathroom, toilet room and the garden or fire hose. The water is distributed about the house exactly as it is in city homes, by means of galvanized iron pipes. Where a small building is to be supplied and the

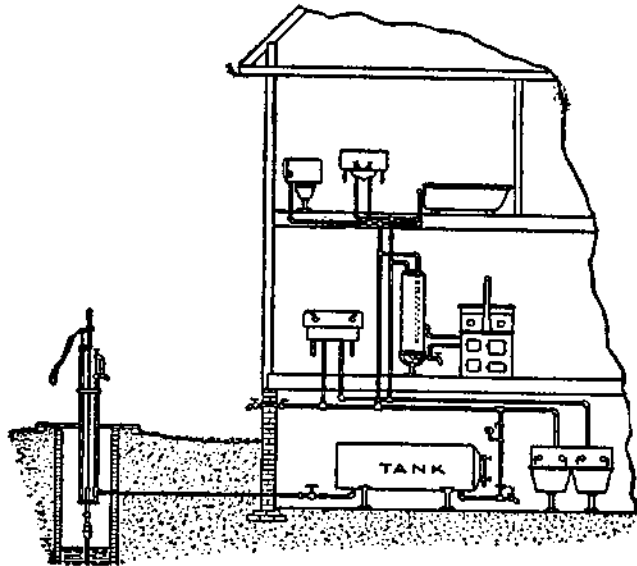

HOUSE WATER SYSTEM

amount of water to be used is not large, the system can be installed for \$50. For the average house \$90 is a better figure. Where the house is large, and where considerable amounts of water are needed for the lawn and garden, and possibly also for washing carriages, automobiles and horses, a larger system should be installed, costing up to \$150.

Installation and Operation

Its installation is easy, and its operation is exceedingly simple. Any pipe fitter or plumber can

put in the plant so that it will work perfectly. All that is needed for operating is to keep the tank pressure up to the desired point. This may be 20, 40, 60 or 100 pounds. A few strokes of the pump, if the work is done by hand, is sufficient. If a lot of water is used, of course the amount of pumping will increase. By being economical in the use of water, that is to say, wasting none, this matter of pumping is not at all a serious problem.

The most satisfactory method of pumping, however, is to use a windmill, or what is much better, a gasoline engine. Every up-to-date farm ought to have a small gasoline engine, which can be utilized not only for operating this water supply system, but for churning, sawing wood, cutting feed and doing a dozen and one other jobs about the farm. It would take only a few minutes of pumping to raise the pressure in the tank the desired height. With the engine it will not be necessary to be economical in using water, provided the well is a good one, and the supply of water large.

Experience with Water Supply System

C. A. Shamel of Illinois, editor of the Orange Judd Farmer, has a system of this kind in his country home. It cost \$75. He put in a bathroom, a toilet, has a hot water tank in connection with the kitchen range, and no money ever expended on that farm has given anything like the amount of satisfaction and comfort as that paid for this water supply system. Arrangement is made to take care of the waste water and sewage by running a large tile from the bathroom, one-quarter of a mile distant, to a large cistern, located in the center of a big field. This is disinfected about

twice a year, and is easily handled. There is never any trouble with the water pipes, even during the coldest weather. Neither has there been any difficulty with the waste system. In fact, the water supply is practically perfect, and the people on that farm don't see how any farmer who can get together \$75 or \$100 can afford to be without it.

Up to date all the pumping has been done by hand. With the pump in perfect condition, this is not a laborious problem. On two occasions the pump valve became slightly defective through wear, and it was not convenient to fix it for a few weeks, being somewhat distant from the factory. With this condition it required a great deal more labor to do the pumping, but even with this disadvantage, it was not a serious proposition.

The illustration indicates the arrangement of a water supply system, and as can be readily seen, it is very simple. Notice the hand force pump tank in the basement to hold the water under pressure, and the arrangement of lavatories, bath and kitchen hot water service. The system can also be used for supplying water to stock tanks, and these may be located anywhere on the farm. The pressure developed in the tank is sufficient to force the water anywhere wanted. This use will, of course, depend entirely upon the wishes of the owner and is simply a matter of cost of pipes. It can very readily be used for delivering water to dairy or other stock barns, where it can be run into water troughs in the stalls, or elsewhere, as desired.

WARNING AGAINST FIRE

A handy device that will give an alarm in case the roof catches fire close to the chimney is shown

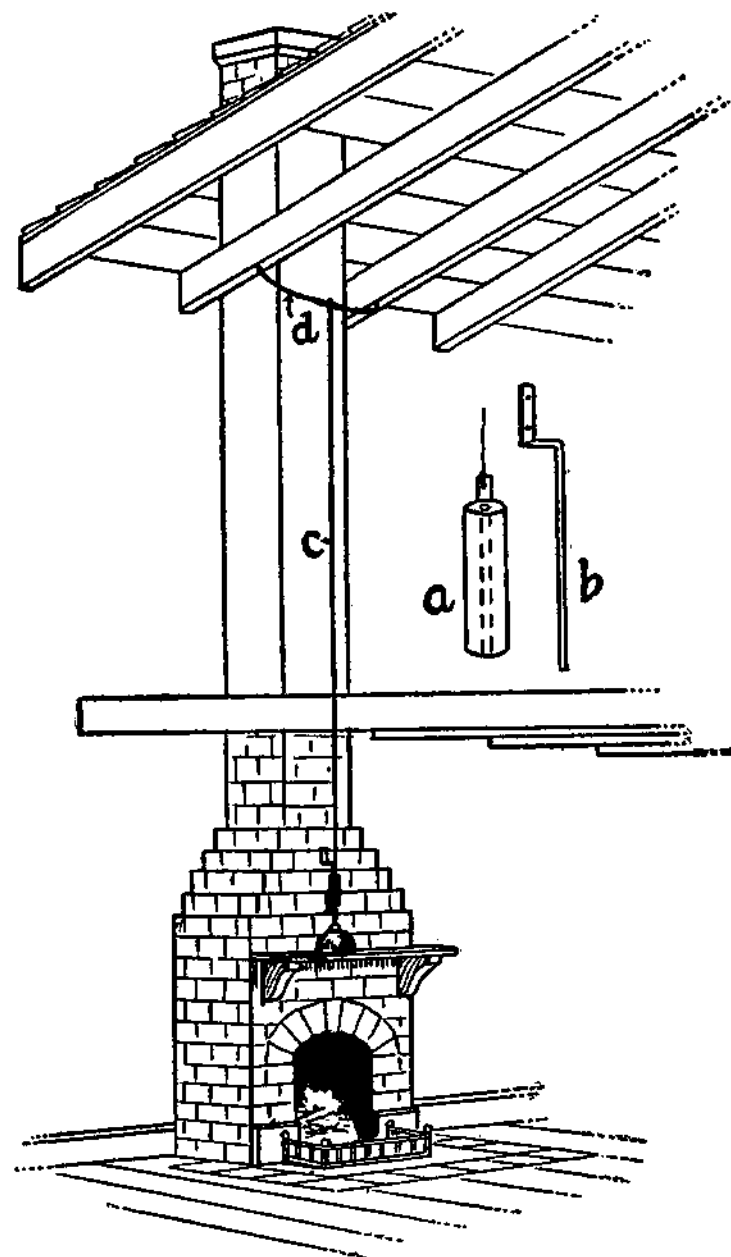

A FIRE ALARM

on the opposite page. Drive a nail in two rafters on a line with the face of the chimney, to which stretch a cord close to the chimney, so that, in case of fire, the cord will burn off and release the weight hanging to it, which in turn will drop on an electric button and ring a bell. A dry battery will cost 20 cents and a bell 50 cents. Place these on a shelf above the fireplace. Place a piece of heavy wire, *b*, 10 inches long, as shown, and fasten to the wall or chimney for the weight, *a*, to slide on. The weight need be suspended only an inch or two above the bell.

WHERE TO HANG A FIRE LADDER

A necessity on all farms and near all farm buildings are ladders and other means of getting on the roofs, and in and out of upper story windows in time of emergency. A scuttle should be left or made in the highest part of the house roof and a ladder should be at hand that will reach the eaves of the highest roof. A good place to store a ladder of this kind is under the eaves of the L or along the rear wall of the house. Have two hooks to hang it on. Make a good ladder and keep it painted.

If your cellar is dark, there is danger of accidents when going down the stairs. Have the last step whitened so that you may easily know when you are at the bottom. You can see this step plainly even in a dim light.



A HANDY FEED BASKET



PROVIDE a feed basket like this to strap upon the nose of a horse when giving the animal feed while away from the stable. It is simpler to make than the round basket, and has an added advantage. When not in use, the two sides press together and occupy scarcely any room. Cut out two semi-circular pieces of wood from a $\frac{3}{4}$ -inch board in the shape suggested in the cut. Setting them at the proper distance apart, tack a strip of canvas, or other stout cloth, around the curved partition, as shown in the accompanying picture. Nail a strap and a buckle at the sides, to go over the head, and the feed basket will be complete.

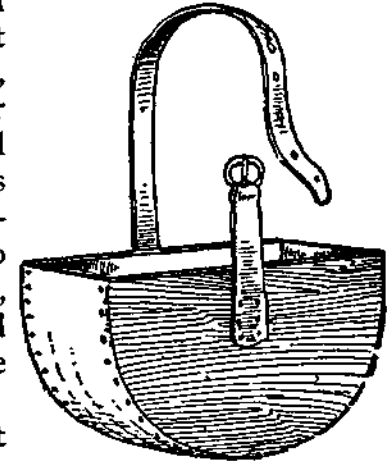

FEED BASKET

The form of this basket more nearly fits the shape of a horse's head, and besides, because of its oblong shape, gives the horse more freedom in opening his mouth than does the close-fitting round basket.

He who will not be counseled cannot be helped.

MAKE THE HORSE EAT SLOWLY

If your horse has the habit of bolting his feed you can easily remedy it by making a self-feeder on his box. The accompanying drawing shows how a feeder may be made similar to a poultry feed hopper. The contrivance may be made of inch boards large enough to hold one feed. The horse can get the grain only in small quantities and so cannot eat it more rapidly than he should. The bottom must be made with enough slant to insure all of the feed coming out in the trough.

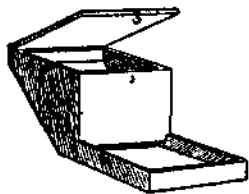

HOLDS ONE FEED

I am only one,
 But I am one.
 I cannot do everything,
 But I can do something.
 What I can do I ought to do;
 And what I ought to do
 By the grace of God I will do.

STALLS BETTER THAN STANCHIONS

The only point in favor of stanchions is that they take up less room than stalls, but the increase in milk is a reward for allowing more space and convenience to each cow. The cut shows one kind of stall. The rack, *a*, is of hardwood 30 inches high, with the slats wide enough so the cow can thrust her nose through up to her eyes.

The bottom of the rack is 18 inches wide, extending into the stall toward the cow. The feed

box, *b*, slides through an opening in the stall on the barn floor. It can be drawn into the feedway, cleansed out and a new feed put in without being disturbed by the cow. The halter strap, *c*, is just long enough to allow the cow to lie down comfortably. The gutter, *d*, is 8 inches lower than the

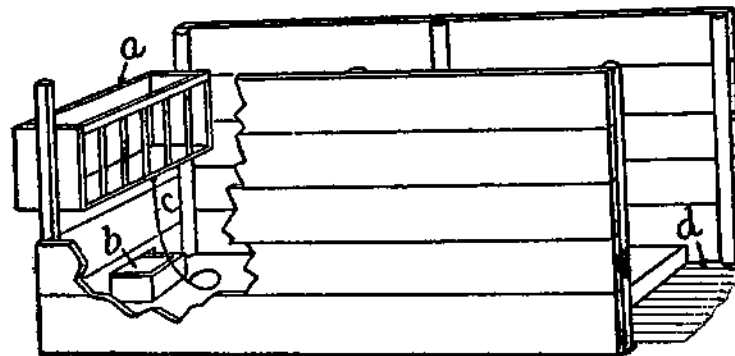

PLAN OF COW STALL

stall floor. When she lies down she will put her head under the rack in kneeling and when she gets up, she will move backward so that she can look through the rack. The length and width of stall can be made to suit the cows. Small breeds, like Jerseys and Ayrshires, will need about 6 inches less each way than Holsteins and Shorthorns.

Knowledge is proud that he has learned so much;
 Wisdom is humble that he knows no more.

—Cowper.

The man who is always poking his nose into other folks' business rarely has any of his own worth attending to.

There is no knowledge that is not power.—
 Emerson.

GOOD TIES FOR COWS

The merits of stanchions and other forms of cow ties have been debated by dairymen for a long time.

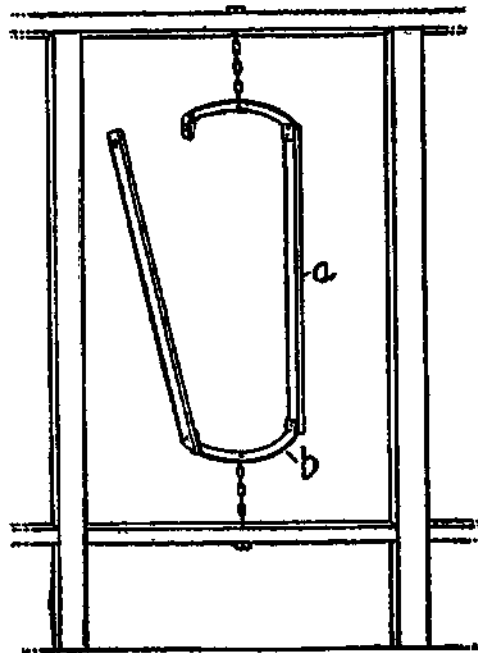

SWINGING STANCHIONS

The mass of experience is in favor of the tying arrangement which will give the cow the most freedom of movement. The old-fashioned solid stanchion fails in this respect. In many cases it is difficult for the cow to lie down or get up with her head fast in one of these stanchions. The heavy swinging stanchions have advantages over this, but it also must be criticised in many cases, because of its weight and of the consequent lack of freedom on the part of the cow. A very light swinging stanchion is the best type of that form. It is easy to fasten, as the cows will in most cases put their heads in position as they go into the stall. There is not so much danger of the dairyman being struck by the horns of the cow in fastening these stanchions. Many modern barns are equipped with this kind.

The chain tie is favored in many sections. This consists simply of a crosschain with considerable slack, attached to a ring at each end which runs over a perpendicular iron rod about 18

inches long. In the center of this chain is a loop with a snap which goes around the cow's neck. This arrangement gives the greatest freedom, and allows the cow to lie down and get up without difficulty. If light partitions are used between the heads of the cows no difficulty will be experienced in their striking each other with their horns. This is by far the least expensive of cow ties, and is at the same time one of the most satisfactory.

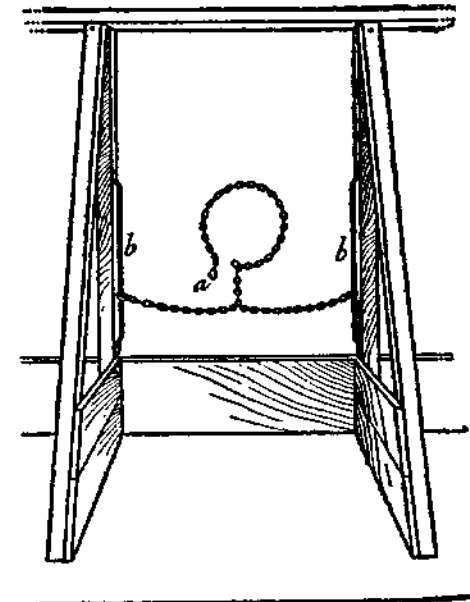

NECK CHAIN

HANDY CALF-FEEDING DEVICE

To feed a half-dozen calves at once is entirely possible if one uses the device shown here. A man

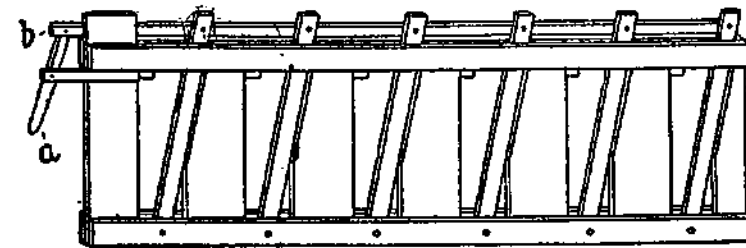

STANCHIONS FOR CALVES

who has one reports no more trouble with calves since he has used this. He rattles a couple of

buckets together, the calves come running up to the fence and soon have all their heads through the stanchions, to which they are easily fastened by throwing down lever, *a*, which draws the bar, *b*, into position. Then one may feed each calf without difficulty.

Leave a 4-inch space for the calves' heads. Make the rack of 1-inch lumber and it can be moved from one pasture to another and attached to the fence or a couple of posts. It can also be used for holding ewes at lambing time.

MANAGEMENT OF KICKING COWS

Make a slatted stall just high enough so the cow can't jump out, and wide enough to hold her comfortably, with nothing to spare, and narrower at the end, where her feed box should be placed as high from the ground as is comfortable for her to eat out of. This slatted stall should be long enough to have cleats through which a bar or two should be run behind the cow to keep her from backing out, and also places to run a bar in front of her hind legs about the hock joint, or as high up as possible so as not to interfere with milking. A hole about 18 or 20 inches wide is left open for this purpose from the ground up to the cow's flank, which allows easy and safe access to the udder, while the cleat and post prevent the cow from kicking outwardly at the milker, thus insuring safety.

A HANDY MILKING STOOL

Milkers who have trouble with restless cows that invariably either upset the pail or get a quantity of

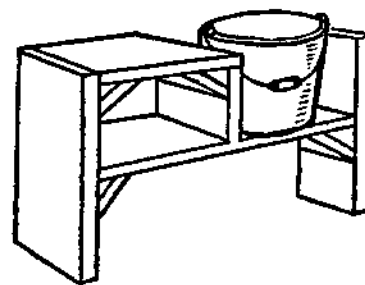

STOOL TO HOLD PAIL

dirt in it will find the stool shown here a remedy for their troubles. It is also very serviceable in fly time. The upright pieces forming the legs and ends of stools are made of 2 x 8-inch pieces about 1 foot long. The supports for the bucket and the seat are made of inch boards. To secure rigidity it is well to put three-cornered blocks under the seat and bucket board as brace stays. The most restless cow is not likely to upset the bucket from this stool.

THE EVER READY STOOL

A very convenient stool for use in milking the cow in yard or field is shown in the cut. It is merely a one-legged stool to which is attached four straps connecting with a broad strap that is buckled around the waist. The stool is quickly fastened to the milker and is always in a position so one can sit down anywhere. Such a stool with a short leg would also be useful in the garden. Of course, if one pre-

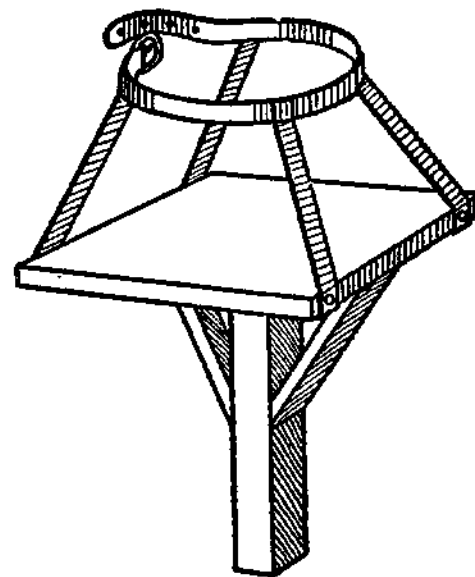

MILKING STOOL

ferred four legs instead of one, the stool could be so made, but experience proves that the one-legged kind serves well.

CHEAP MILKING STOOL

A cheap and very useful milking stool is made of the reel from which barbed wire has been removed. Saw off the ends so it will set level and

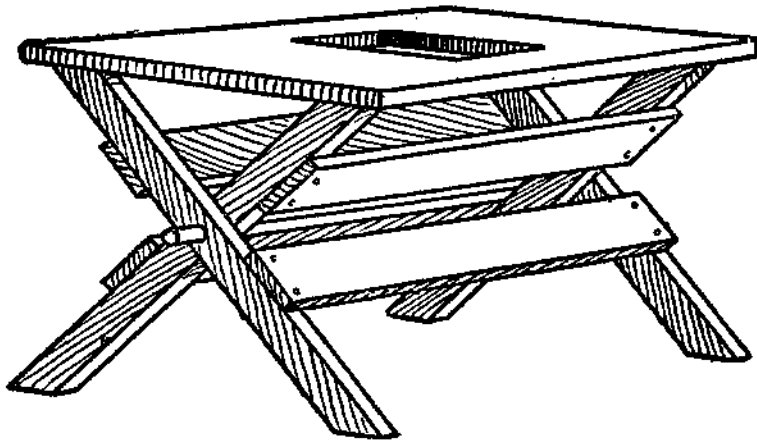

REEL STOOL

cut a board to fit on top. Make a hand hole through the board as shown in the illustration and the stool is ready for use.

KEEP STOOLS CLEAN

Much milk contamination is undoubtedly due to the careless handling of the milk stools. When the milker is through milking one cow he gives the stool a toss, then he picks it up again when he starts to milk the next cow and his hands become more or less contaminated from the stool and from

them the dirt drops into the milk pail during the milking.

When the milking is over, the stool is left in the yard or on the barn floor. It is so easy to make a small rack and to bore holes in the legs of the

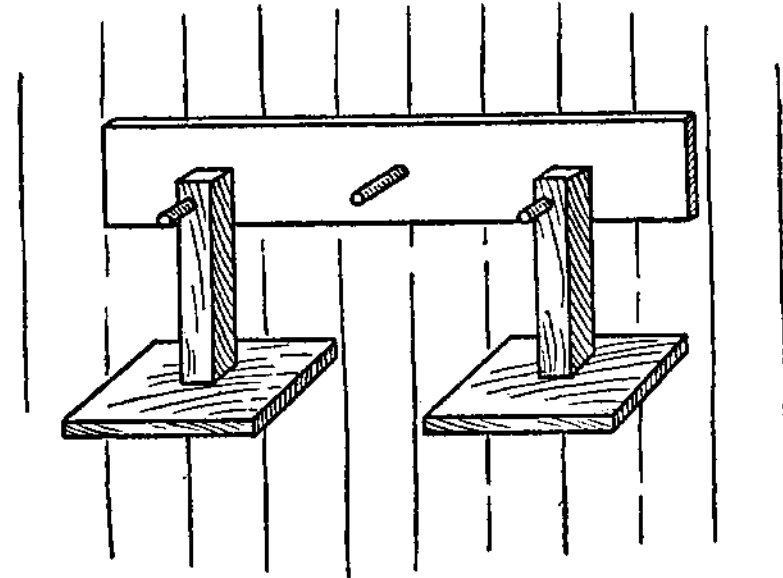

STOOL RACK

stool, so that they may be hung up. This keeps them out of the dirt and it is only necessary to brush them off carefully once in a while to keep them scrupulously clean.

The man who is constantly changing his mind usually has little to change.

A USEFUL STOCK CART

Here is a handy transfer cart, made with wheels and crossarch of an old corn plow to carry a hog

or sheep, pigs or a calf. Raise the tongue, which lets the rear end on ground, then drive in the animal,

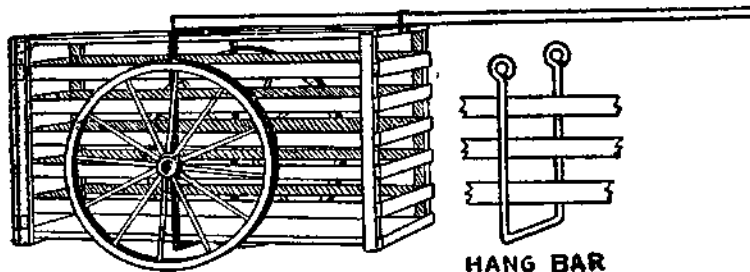

TRANSFER CART FOR SMALL ANIMALS

shut the gate, pull tongue down and you have your load ready to fasten to a wagon.

HOW TO STAKE OUT STOCK

A convenient and simple contrivance so that no harm can come to the animal is to drive two stakes several feet apart and stretch a rope or wire on

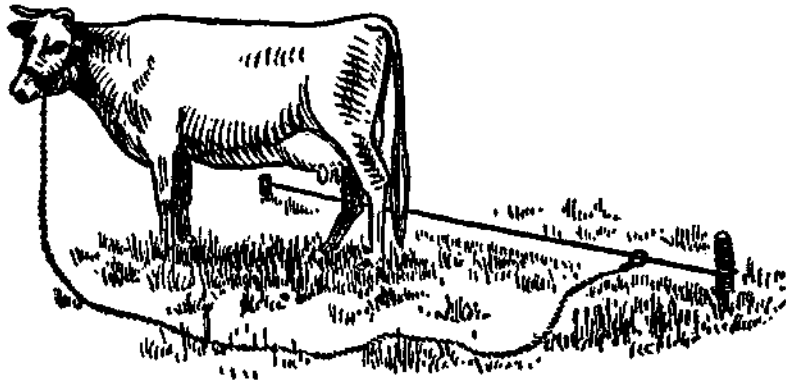

COW TIED OUT TO FEED

which a ring is placed. To this ring fasten halter strap. The animal can graze up and down on both sides without tangle or injury. The ring slides, and the stretched wire will give some.

FEED BOX FOR FIELD

A handy feed box for use in open lots or when steers are being fed upon grass is shown in the

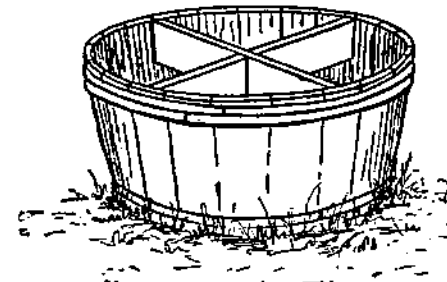
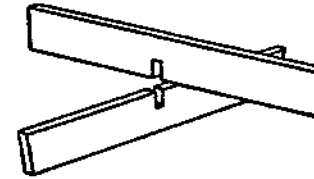

TUB FEED BOX

cut. Cut a barrel in two and strengthen the halves by placing a frame of two boards across the inside, as shown in this sketch. This will prevent the tub being smashed and will allow four animals to eat out of the trough without bothering each other unnecessarily.

It is important that a very strong barrel be selected and that the hoops be nailed to each stave.

Be advis'd;

Heat not a furnace for your foe so hot
That it do singe yourself: we may outrun,
By violent swiftness, that which we run at,
And lose by over-running.—Henry VIII.

Have more than thou showest,
Speak less than thou knowest,
Lend less than thou owest,
Ride more than thou goest,
Learn more than thou trowest,
Set less than thou throwest.—King Lear.

Use or practice of a thing is the best master.

CHEAP SHEDS OF STRAW

It would pay every farmer to put up in the pastures some kind of protection for his sheep, hogs and cattle. Where labor is scarce and hay and straw is plentiful and cheap, a condition which prevails in many large sections, straw sheds and barns are very profitable. Put up a framework of posts 8 feet high, 16 feet wide and as long as needed; 30 feet is a good length.

The posts are hewed evenly on two sides and set so that a bale of straw will fit snugly between them. They are cut off at a uniform height and a 2 x 6 spiked securely on top. Rafters are nailed to this and covered loosely with poles. Baled straw is used for the sides.

After the sides are up the roof is covered 2 feet deep with loose straw held in place with a few poles that are tied together in pairs and placed over the ridge. Several of these sheds have been built for five years and have not needed any attention.

Life is made up not of great sacrifices or duties, but of little things, in which smiles and kindness, and small obligations given habitually, are what win and preserve the heart and secure comfort.—
Sir H. Davy.

You must cut your coat according to your cloth.

FEED TROUGH FOR SHEEP

For a sheep trough procure two 6-inch boards, *a*, about 3 feet long and at the bottom of each fasten another board, *b*. Make a flat trough and let the

ends project above the top. Bore a hole through each end and also through the standards, *a*, and hang the trough on bolts. After the sheep eat and

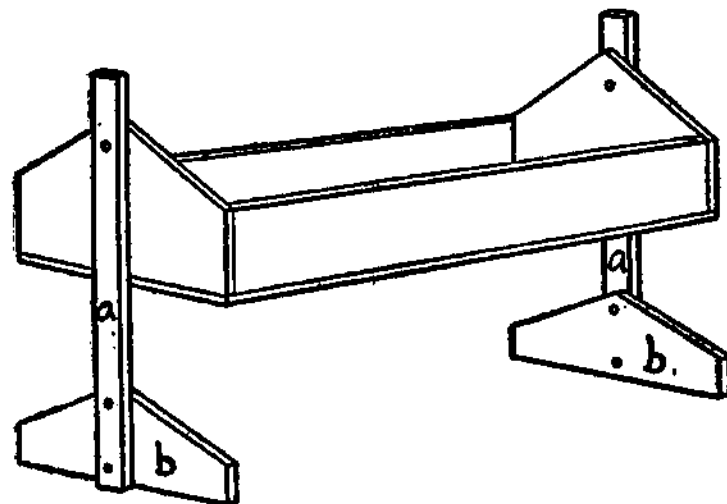

SWINGING SHEEP TROUGH

leave the cobs, or if it rains, the trough can be turned bottom side up and quickly cleaned.

The luck that I believe in
Is that which comes with work,
And no one ever finds it
Who's content to wish and shirk.
The men the world calls lucky
Will tell you, every one,
That success comes, not by wishing,
But by hard work, bravely done.

A NOVEL FEED RACK

An overhead manger, as shown in the sketch, is excellent for sheep or calves. It should hang just high enough so that they will pass under with-

out rubbing their backs. When filled with hay from above they will eat of it at their pleasure, and at the same time it will not take up floor space.

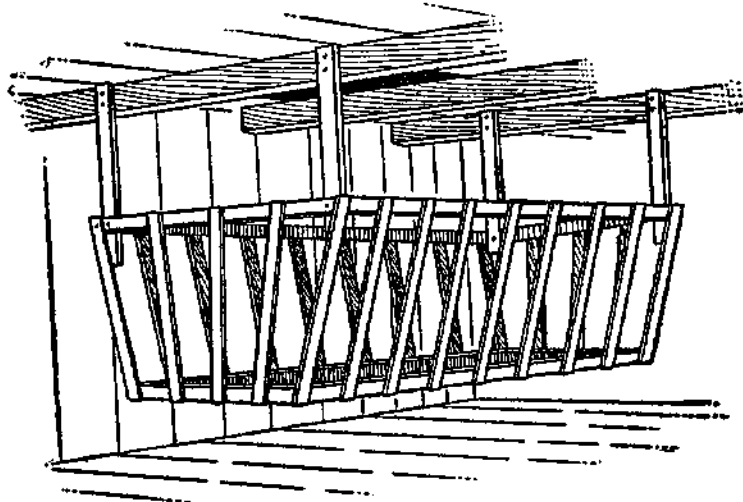

HANGING RACK

Such a manger is not suitable for grains or fine cut fodders, as too much may be wasted.

A WHEELBARROW SHEEP TROUGH

It very often happens that one wishes to run the sheep on several different pastures during the

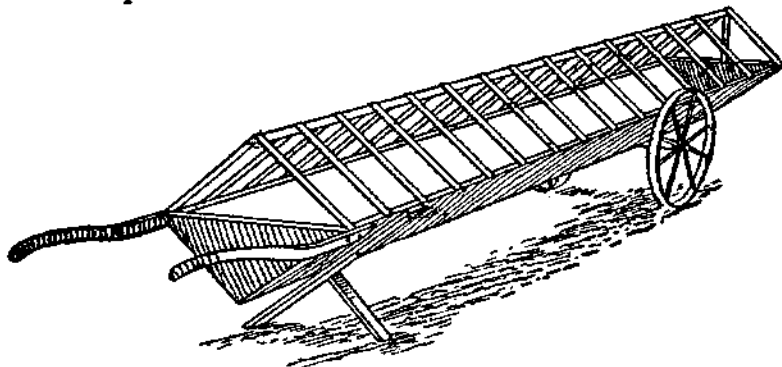

PORTABLE RACK FEEDER

season. If heavy feed racks are used it is quite a task to move them. The drawing shows a rack that can be easily moved from one field to another by one person. It is simply mounted upon a pair of wheels and has handles on the other end.

If the rack is made very large, it can be easily attached to a wagon, and thus drawn from place to place. The one shown is mounted on old cultivator wheels.

PACKING THE FLEECE

One of the best ways to pack a fleece is to lay it upon a table, turn in the head and tail, then the

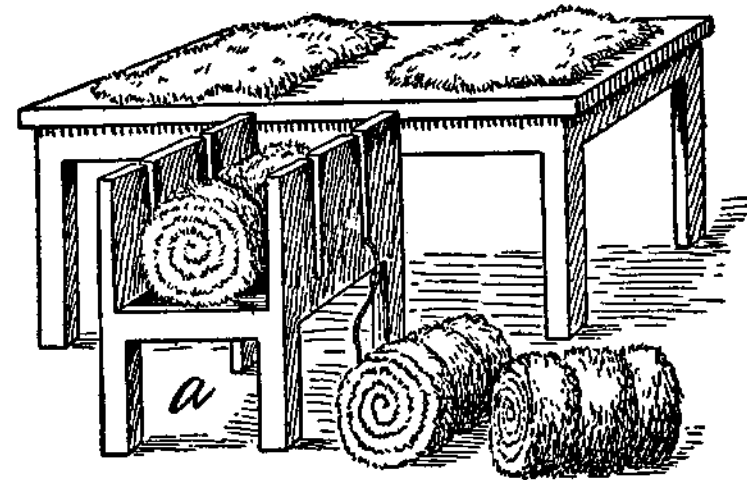

FLEECE TYING BOX

flanks. After this roll it up into a neat roll and tie firmly, using such a device as here illustrated.

The tying box is made from light lumber with slots, as shown, through which the rope is passed. The fleece is placed upon this rope and the roll easily tied. Wool buyers prefer to have the fleece

loose, light to handle and elastic and tied up so that it can be opened if needed.

EASY TO HANDLE HEAVY HOGS

The old fashion of having a lot of help around at hog-killing time is going out, owing to the use of better appliances for handling the animals after killing. You may rig up a simple arrangement so

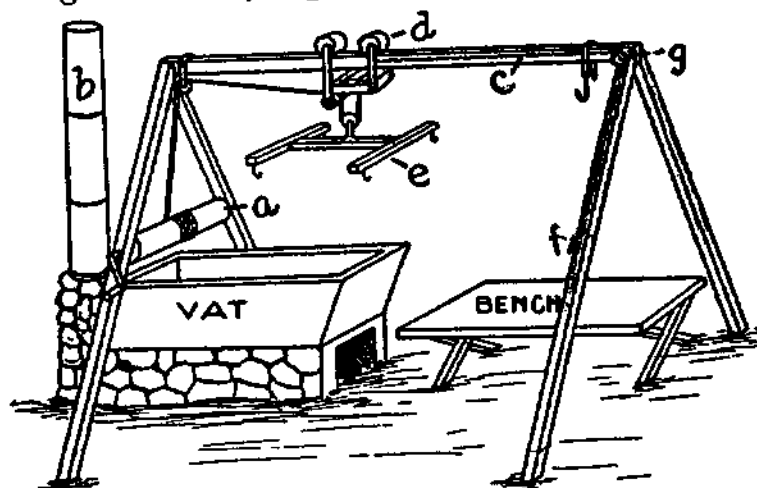

ONE-MAN BUTCHERING RIG

that you can handle heavy hogs without assistance. Build a fire box with a flue, *b*, of three joints of old stovepipe. The vat is made of heavy galvanized iron 4 feet long by 2 feet wide and 18 inches deep.

Over this erect a frame of 2 x 4-inch strips, upon which place an old traveler from a hay carrier, or construct one similar to *d*. With the windlass arrangement, *a*, and the tackle, *e*, to which are attached the four feet of the hog, you can convey it from the vat to the bench. A rope, *c*, passing over the pulley at *g*, serves to pull the carrier, *d*, over the bench from the vat.

HEATING WATER FOR HOG KILLING

A device which is superior to the old iron kettle for heating water is shown in this sketch. Take a piece of 2-inch iron pipe 8 feet long and have it securely screwed into the bottom of a stout vinegar barrel. In the other end of the pipe screw a large wooden block.

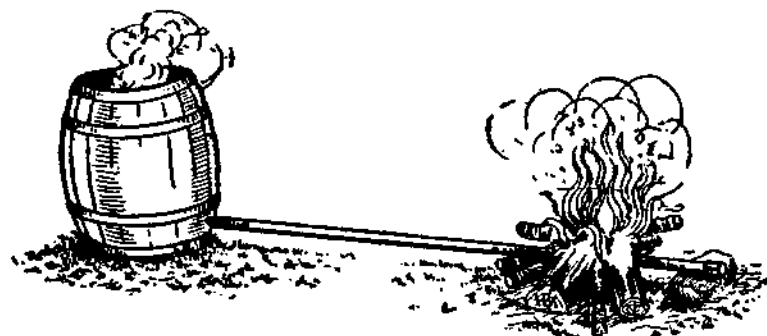

SIMPLE WATER BOILER

By arranging the affair as shown in the sketch water in the barrel will be heated rapidly and can be removed as desired without bothering the fire. Do not make the mistake of putting a metal cap on the end of the pipe, or the steam may sometimes burst the piping before the cap will come off. The wooden block acts as a safety valve and will fly out if pressure is too great.

A FARM SLAUGHTERHOUSE

If one butchers his own stock on the farm he would do well to fix up a small building for a slaughterhouse. This can be done so easily and at such small expense that almost any farmer can afford one. It is generally most convenient to have

it near the hog yard, for then the refuse can be easily conveyed to the hogs. Indeed it would not be a half bad idea to have it in some instances a part of the hog house. The room in which to kill

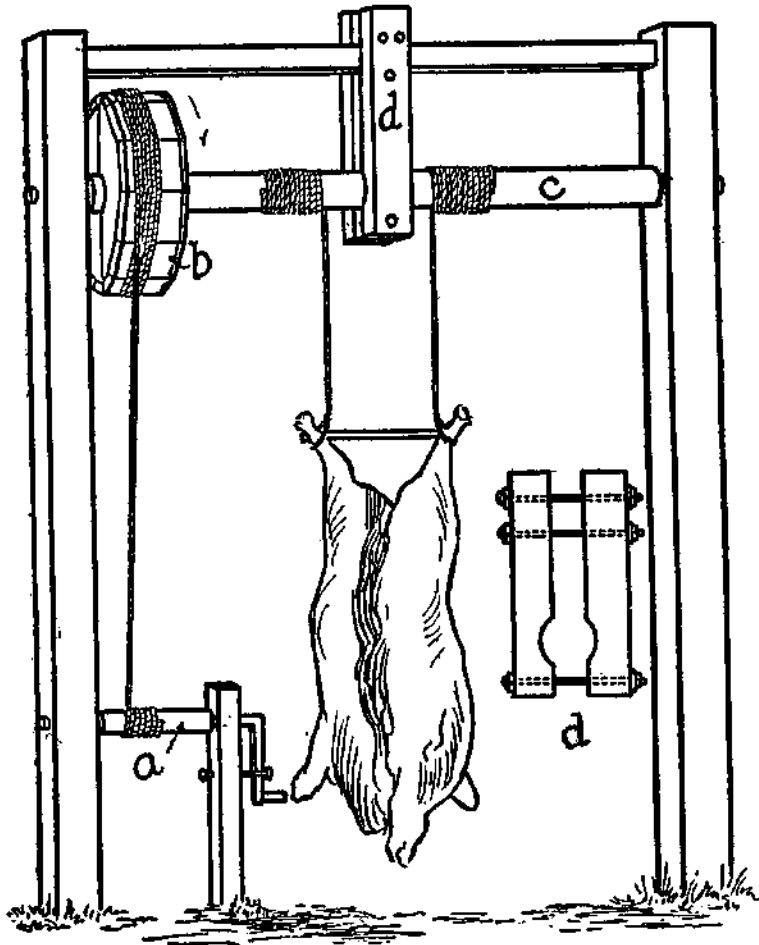

CARCASS DERRICK

cattle and hogs should not be less than 15 feet square. This will give plenty of space for the work. As much of the room should be kept clear from fixtures as possible.

The floor should be made of concrete graded so that it will all drain to a central opening. A pipe should carry the liquid from this opening to a trough in the hog yard. The ideal way would be to make the walls of concrete for about 3 feet from the ground. This will make it much easier to keep the place clean. It is quite necessary that a good supply of water be close at hand. If possible, a water pipe with hose attached should be in the house. This will enable one to flood the floor at any time.

On page 99 is a picture of a very good device for handling the carcasses. It is made of a heavy roller, *c*, 5 to 6 inches thick, and long enough to reach across the width of the room. It is supported in the middle by a bracket, *d*, detail of which is shown in the drawing. This makes it possible to lift a carcass of any weight. A drum, *b*, is attached to the roller at one end, over which is run the rope that communicates with the crank, *a*, at the floor. Any man handy with tools can make this derrick.

In order to simplify matters one may use a barrel cart water heater. This barrel has a valve attached at the bottom. To this is fastened a rubber hose that communicates with a small coil of pipes. This coil of pipes in turn communicates with the top of the barrel by another rubber hose. The coil of pipes is placed over a fire built in a hole in the ground, and the valve is opened.

As soon as the water in the coils becomes hot it is forced through the rubber hose, and a circulation is started. This device will heat water very rapidly and easily. When the water is heated the rubber hose is detached and the barrel wheeled under the

derrick on which the hog is hung. By means of a crank the carcass is let into the water to be scalded.

With simple devices one man can very easily do the butchering alone. It will be found convenient to have a table that folds up against the side of the building on which to cut up the meat.

KEEP PIGS OUT OF FEED TROUGH

To prevent hogs crowding and getting in the trough with their feet the accompanying plan will be found practical. You can nail the Vs, or rick-

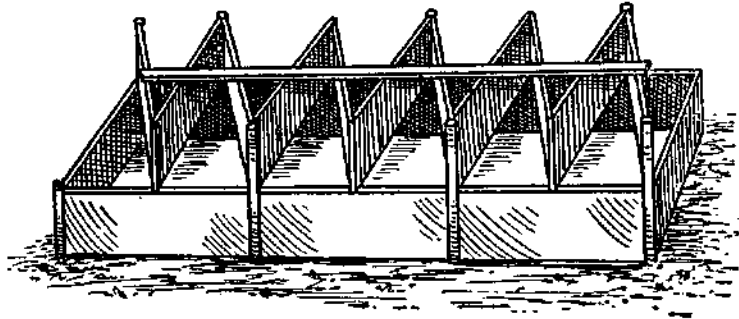

PARTITIONED HOG TROUGH

rack work, on any shaped trough. They fit on a pointed or flat-bottomed trough equally well. Nail a strip lengthwise along the top of the Vs to strengthen them. Stakes driven at intervals and nailed securely to the angles will hold the Vs and trough both solid.

MOVABLE HOUSE FOR BREEDING SOWS

Individual hog houses may be constructed with four upright walls and a shed roof, as shown below. The walls and the roof are separate and can be easily taken down and replaced. These small

houses can be moved about very easily. The size of the house will depend upon conditions. The

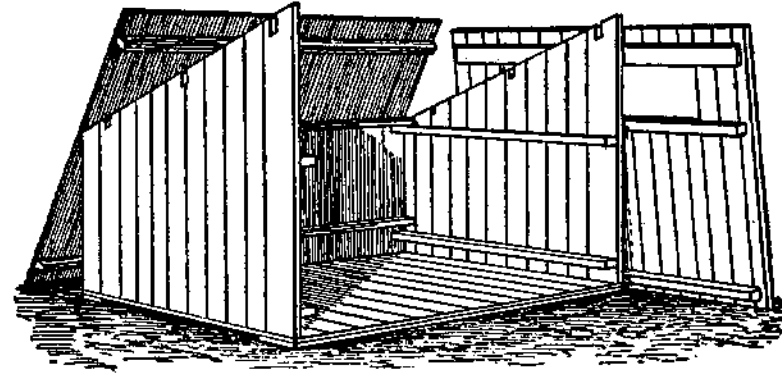

CONSTRUCTION OF THE HOUSE

construction is shown, so that any farmer with tools can easily put up one of these houses. With the individual houses the sow at farrowing time may be kept alone and away from all disturbance and there will not be too large a number of pigs in a

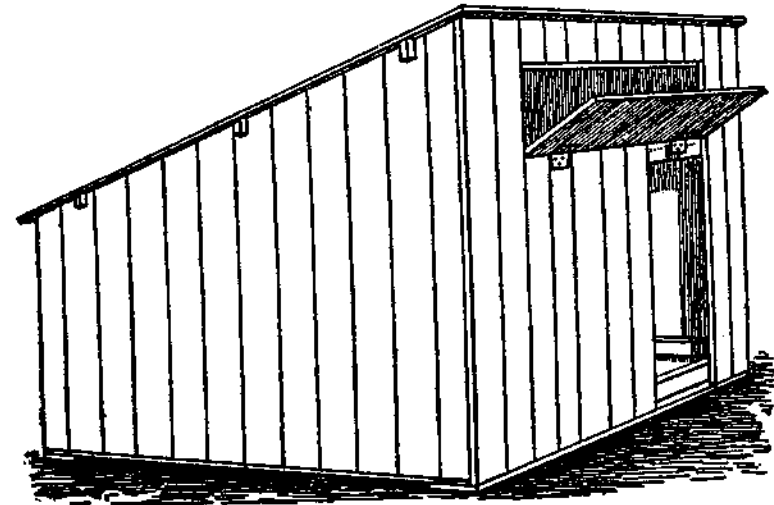

THE HOUSE SET UP

small lot if kept in this way. The danger of spreading diseases among the animals is also reduced to a minimum where swine are kept more isolated. When properly bedded and cared for no disastrous disease need be feared. Much depends upon the sanitary conditions.

WELL-ARRANGED HOG LOTS

An Indiana farmer keeps his pigs in long houses which are divided into compartments opening into small lots. The sketch shows how they stand. Breeding hogs and fattening shotes are allowed the run of their own lots, as well as occasional

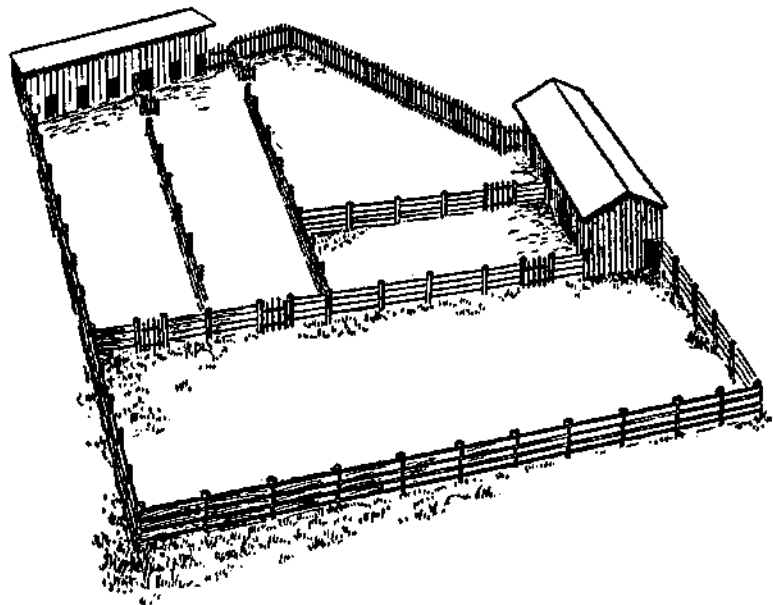

PIG HOUSES AND PENS

changes into the larger field, shown at the bottom of the sketch, which is a timothy and clover pasture. It is better to have pigs in separate quarters in small bunches, for in this way they can be better attended to and the growths are more uniform.

HANDY PIG CATCHER

Here is a homemade device for catching small pigs which saves much time and annoyance. The net may be made from a discarded lawn tennis net, the rim from a bicycle wheel, and the handle is a heavy rake handle. The net is securely fastened to the rim with some copper wire, while the rim is fastened to the handle with two pieces of band iron. Small pigs caught in the net will not squeal and struggle as when chased around the pen and caught by one leg. The element of excitement is greatly reduced by use of the net, and some would find less fun in the net method. On the whole, however, we recommend it.

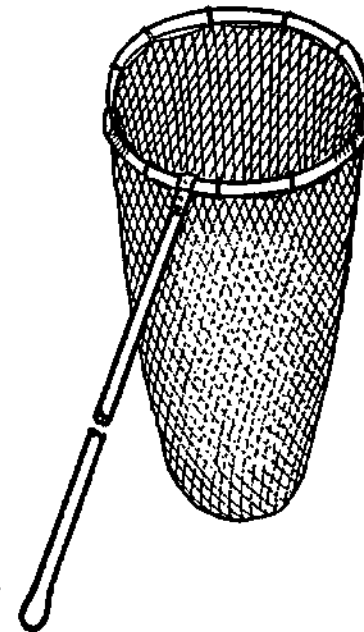

PIG NET

The weakest arm is strong enough that strikes with the sword of justice.

Our knowledge is the amassed thought and experience of innumerable minds.—Emerson.

STAIRS FOR THE BARN

A lot of time is saved if one has handy stairs which can be used for throwing down hay as well as a passageway. These steps are made of light

material and instead of putting on a lower step, use a block, *c*, and attach the stringers of the stairs to it at each end with a pin. A rope passes over the

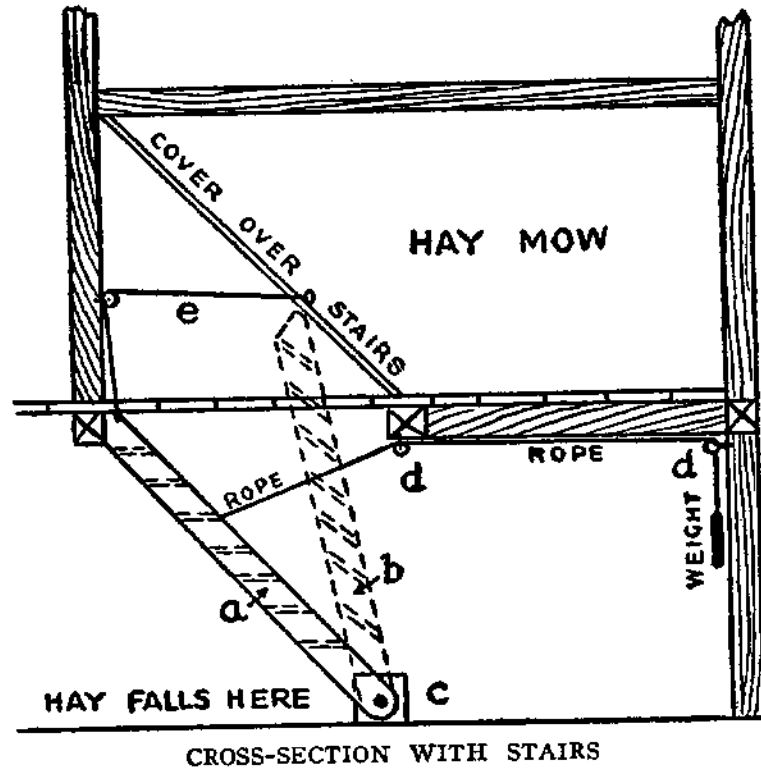

pulleys at *d*, to a weight, which allows the stairway to be held upright while the hay is being put down. The rope, *e*, is handy to pull the stairs into position.

HANG UP THE LANTERN

Here is a good idea for hanging a lantern over the barn floor. Get two pulleys with screw stems, and screw on in beam over head, the other at top of post. Have a bracket lower on the same post. Take a piece of small but strong cord, and at

one end fasten a snap and pass the other end through the pulleys. Put your lantern on the snap and draw it high enough so it will be out of reach of forking hay, and you can see all over the barn floor. You can raise the lantern high enough to pitch hay from the top of the mow with no danger of turning the light over and burning the building and contents.

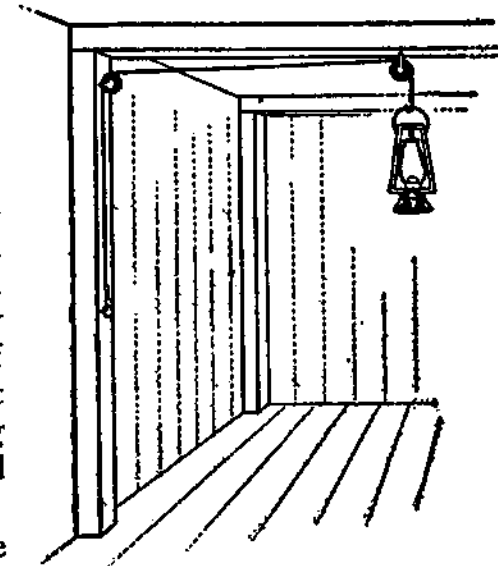

PULLEY-HUNG LANTERN

The end of the cord opposite the lantern may be fastened with a snap, or more length may be allowed for adjusting the height of the lantern, and the cord may be secured by a hitch or a few turns around a button or two spikes driven halfway in and bent over in opposite directions.

ARRANGEMENT FOR WEIGHING

A homemade balance may be constructed with a joist loosely attached, so as to just balance over the rounded top of a heavy block. It will be useful in weighing hay and other bulky substances for feeding purposes. For weights, use small wooden boxes or bags of stone and sand which have been weighed on other scales. Place the required weight upon the balance and then place feed on the other

end until it balances the weight, and it will be accurate enough for all ordinary purposes.

A BARN WINDLASS

It is easily made of iron pipe or a bar fastened to the ladder or other suitable support by means of eyebolts or stout staples, as shown at *a* in the drawing. It may be used for raising grain, wagon boxes and other heavy things to the upper part of the barn, and, if desired, may be rigged with block and falls, so as to increase the power without increasing the effort. A loose bolt placed in a hole will prevent unwinding. The picture shows how simple this device is. Every farmer knows how useful a barn windlass may be.

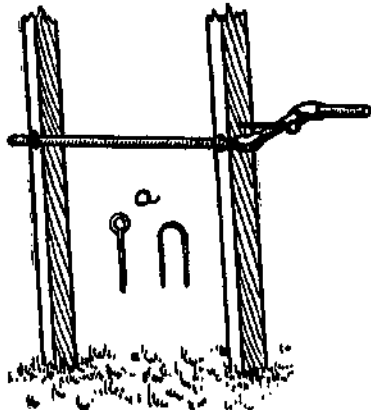

WINDLASS

GRAIN BOX EASY TO EMPTY

The trouble with most grain boxes is to get out the last third of the grain. Bending over the edge jackknife fashion is neither pleasant nor healthful. A box or bin may be made with half its front on hinges, so that it can be let down and all the contents scooped out without difficulty. The bin may be made from a piano box with a partition in the middle for two kinds of grain.

Leave your son a good reputation and an employment.

EASILY CONSTRUCTED GRAIN BINS

Grain bins with compartments for different kinds of feed are handy in barn or stable. By procuring a number of dry-goods boxes, all of the same size and shape, and nailing them together side by side, so that they will appear as one, the bin is easily made. The cover should extend the entire length of the bin, and though leather hinges will answer, it is better to attach it with iron ones, for then, with a good staple and hasp, the contents can be kept under lock and key if desired.

A CONVENIENT BARN TRUCK

No dairyman can afford to ignore that which will lighten his labor in any way whatever. Be his stable ever so conveniently constructed, he has enough to do. Hence the importance of his considering a feeding truck or car if he does not have one. Made of good lumber, the only iron about it need be the handle at each end, by which to push or pull it along the feeding alley in front of the cows which are to be fed, and the small trucks on which it is mounted. The wheels procured, any good blacksmith can make these, so that the truck is by no means difficult to construct. The box body should be about 2 feet wide, 20 inches deep and 4½ feet long. Silage can be conveyed in it from the silo to the mangers very readily. If the silo is some distance away, it will save much hard work.

If little labor, little are our gains:
Man's fortunes are according to his pains.

—Herrick.

TAKES A MAN'S PLACE

In most cases it takes two men to fill a sack of

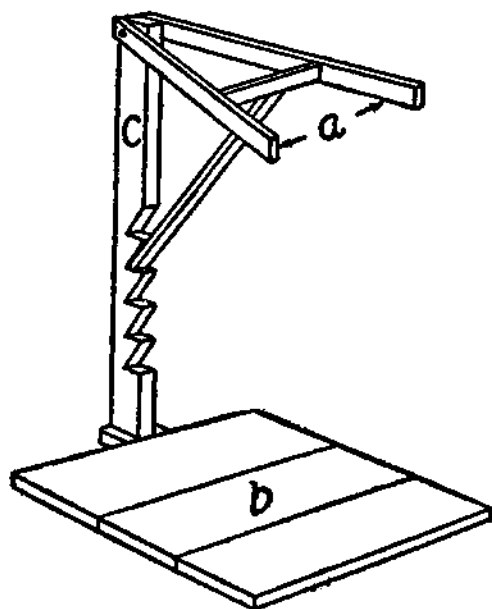

SACK HOLDER

man or enables a man to work twice as fast as he could without it is worth while.

A wise old owl sat on an oak,
The longer he stayed the less he spoke.
The less he spoke the more he heard.
Why are not more of us like that wise old bird?

There are but two ways of paying debt: increase of industry in raising income, increase of thrift in laying out.—Carlyle.

If it were done, when 'tis done, then 'twere well
It were done quickly.—Macbeth.

A HANDY BAG HOLDER

It is constructed with two good boards 1 inch thick and 15 inches wide. The perpendicular one is 3½ feet long, and the horizontal one 2 feet long. These are joined together and braced as

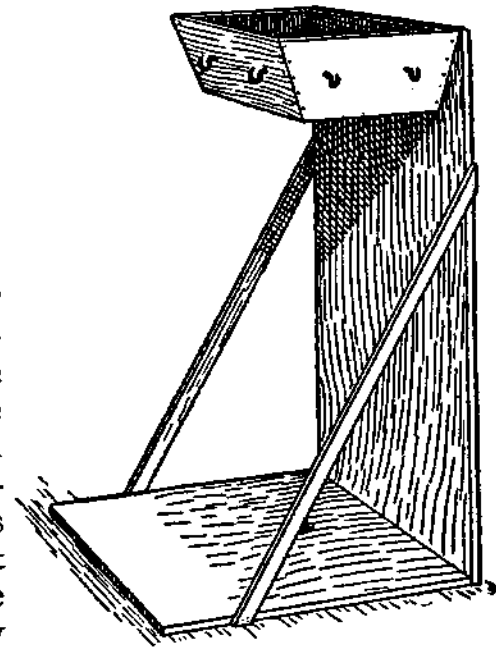

BAG HOLDER

shown in the drawing, and the hopper is attached, wedged out from the perpendicular board so the bag may wrap it all the way round. The hooks for holding the bag in place can be secured at a hardware store. As the whole affair, if composed of thoroughly seasoned lumber is light to handle, it can easily be carried to any spot where grain is to be put up.

Here is another scheme that saves time and labor and makes it possible for one man to do the work that usually requires two. This one is as good and perhaps better than any device that has been invented in the bag-holder line. In making it, an important point is to attach all parts very securely where they come together, especially the hopper and the braces. Otherwise, with hard usage the holder will get loose and break down.

A CORN HUSKING RACK

Many who husk their corn by hand find it very tiresome to sit on the floor or ground in a cramped position. A rack made as shown in the drawing

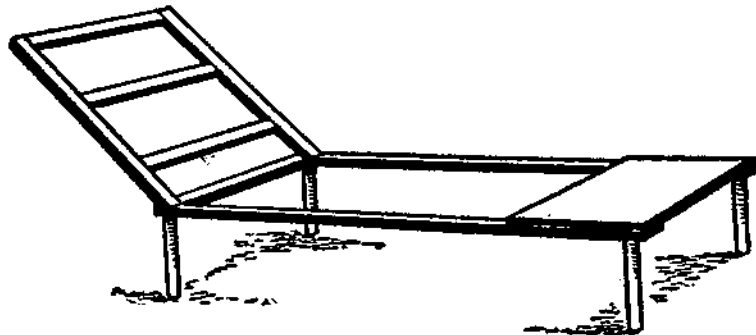

RACK FOR CORN HUSKING

will hold two or three shocks and gives a better place for the husker to sit. Place the stalks cross-wise of the bench in front of you.

A HOMEMADE FEED CUTTER

An old lawn mower can be arranged to make a fairly satisfactory straw or feed cutter. One must

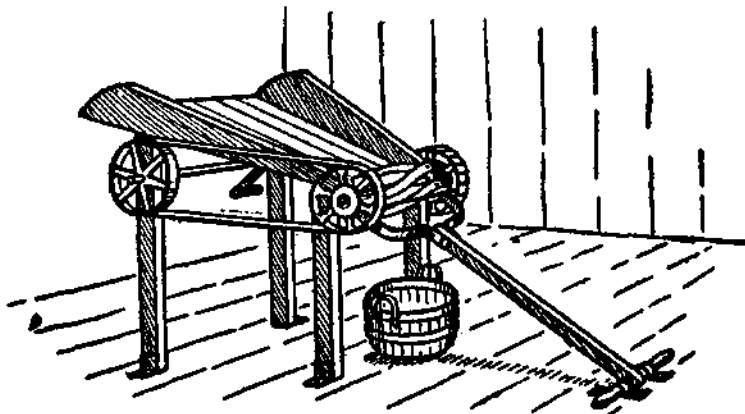

WORKING THE LAWN MOWER

rig up a hopper, as shown in the sketch, and attach the mower to the lower end of it so that the straw or grain will just strike the knives where the grass usually comes into the mower. A crank and a belt arrangement makes it easy for one man to feed and turn the cutter. This is a good use for a lawn mower in the winter time when it is not working outdoors.

SAW ROOT CUTTER

Those who have cut roots in the winter time with a butcher knife or hatchet will fully appreciate something better for a root cutter.

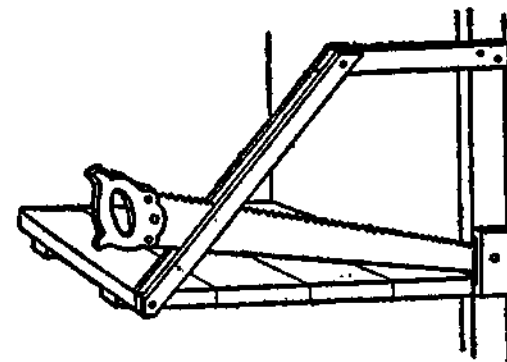

ROOT CUTTER

A Wisconsin farmer has found a serviceable homemade lever cutter very efficient for all roots. For hard ones, like rutabagas, it is about the best thing available.

His is made out of an old hand saw, sharpened on the back, fastened by means of a bolt passing through a hole punched at the small end, and held by a guide formed of two pieces of wood secured upright, so as to have a slit for the saw to work in. This contrivance is a success, and with a little practice the roots may be cut very rapidly. See accompanying illustration. The cutter may be mounted upon the wall wherever it will be most convenient. The bench or platform should be at about the height of a common table.

HOMEMADE CABBAGE CUTTER

A cheap and easily made cabbage and root cutter is shown in the drawing. Take two

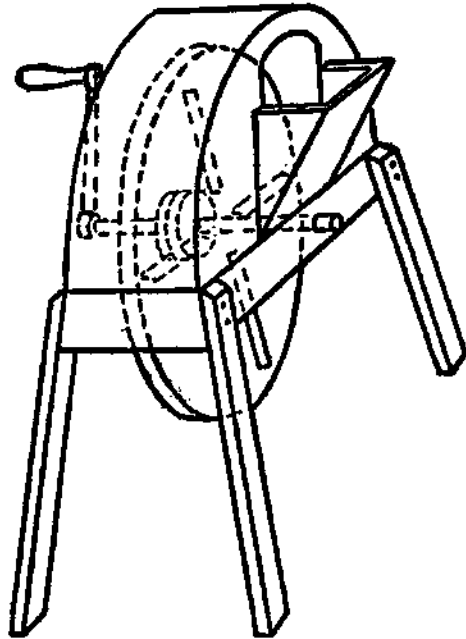

CABBAGE CUTTER

12-inch boards and nail them strongly together. With dividers mark around a circle, then saw out and mark in quarters. Cut four slots 7 inches long on a slant, as shown by dotted lines, so the cabbage will fall through easily. Next cut two circles 4 inches in diameter. Nail one to the large wheel on the back and leave the other loose on the shaft to act as a bearing.

Make a frame to admit the wheel, leaving 2 inches clear, and just wide enough so the knives do not strike the side. Make a top over the wheel and put a hopper on the opposite side from the crank. The knives are 8 inches long and can be made from an old bucksaw and ground down sharp, with a bevel on one side. Screw these on the wheel at a slant according to the thickness the cabbage is wanted. A square hole should be cut through the center of the wheel for the shaft.

A SUBSTANTIAL DRIVEWAY

A plank driveway to the barn is usually made steep in order to save planks. It is continually wearing out and breaking. A substantial driveway with an easy grade can be made by driving down stakes close together on either side, and filling in between with stones, rubbish and earth, packing all down firmly. When full to the top, pack some earth against the outside of the stakes and sod over the sides. This driveway will form an easy rise and will prove very durable.

Kindle not the fire that you cannot extinguish.



FEEDING DRY GROUND GRAIN



SOME of our friends have found that a poultry feed hopper for feeding ground grain has proved very satisfactory. Make a box 18 x 18 inches and 6 inches deep, then take off one end and fasten to the back with hinges, which forms the cover.

Nail a strip, *a*, 3 inches wide across the open side at bottom, which forms the box for the poultry to eat from. Take a board, *b*, the width of inside of box, 14 inches long, and insert in front of box, nailing as shown in cut, with the upper end even with front edge of box and slanting in until a space of 2 inches is left between bottom of board and back of box to allow the feed to pass through.

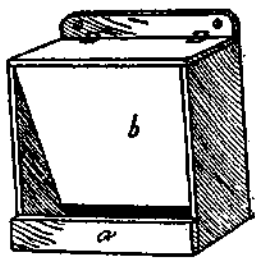

FEED HOPPER

The feed is poured into this hopper and runs down into the box at the bottom as fast as needed. The size of the hopper can be varied to suit the size of the flock. It should be screwed to wall of poultry house about 12 inches from floor. By using this hopper one may keep a dry mixture consisting of wheat bran and middlings and occasionally corn meal, or a small amount of linseed meal, always before the fowls. In addition, some people feed a mixture of whole corn, oats and wheat in the litter morning and evening, also ground green bone and beef scraps.

KEEPING THE WATER CLEAN

Few drinking fountains are more successful than a large bottle or jug filled with water and inverted. It can be fastened wherever convenient with straps. If a small pan is placed close beneath it the water will flow out as it is used and will remain clean and cool. Place it high enough above the floor of the house so the fowls will not scratch litter into the pan.

A WATERING RACK FOR HENS

Build a crate of lath 2 feet square, 3 feet high, with a slanting cover to keep the hens off the top. Then tack an 8-inch board in front, level with floor of crate. Nail the rack to post or side of henhouse about 2½ feet from floor, and put your water pan in crate. The hens will quickly learn to fly up and drink by putting corn on the lighting board. This contrivance keeps the hens from spilling their water or scratching dust or chaff into it. Be sure to nail the rack securely to the wall or post where it is put up.

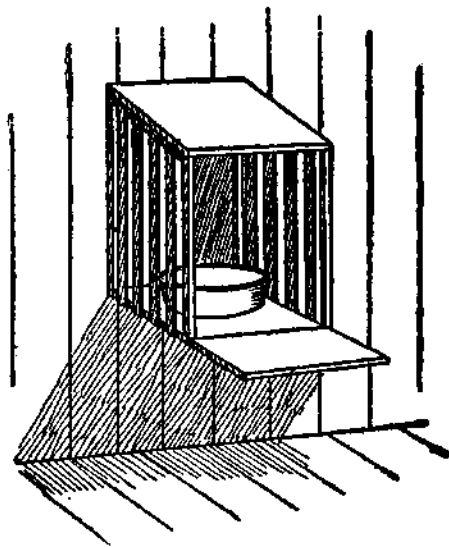

RACK IN PLACE

Keep your shop and your shop will keep you.

DRINKING FOUNTAIN

The best drinking fountain, in that it is impossible for small chicks to get drowned, and they cannot stand in the water to befoul it, is made by inverting a can or pail in a pan a trifle larger. Tomato cans with the edges pounded down, leaky pails with the ears bent up, in fact anything with a smooth top and in which a hole can be made, can be used. Punch a hole or holes in the side just a little less distance from the top than the depth of the pan to be used. Fill with water, invert the pan over the top, and turn over quickly.

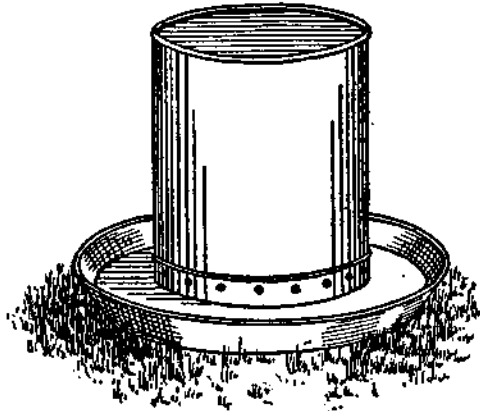

CHICKEN FOUNTAIN

FOLDING CHICKEN ROOST

This roost is made of 3-inch boards cut any desired length. A small bolt fastens the upright

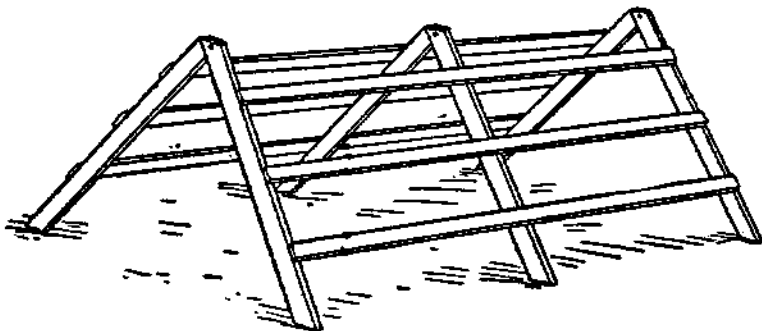

MOVABLE ROOST

pieces at their top ends, and the horizontal pieces are fastened on with nails. This roost can be kept at any angle, and may be quickly taken out of the house when it is time to clean up. This sort of roost will accommodate more fowls in the same space than the flat kind, but it should not be made very high.

A GOOD POULTRY NEST

A useful trap nest can be made of grocery boxes. They should be at least 12 inches each way. The illustration shows how they are made.

In the cut the trap is set ready for the hen to enter. A cleat, *c*, is fastened to a small piece of cord, which is tied to a nail on the side of the box. Set the trap by raising it and resting the cleat on the nail, with the other

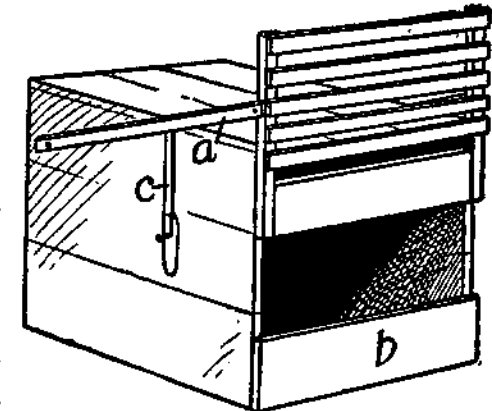

TRAP NEST

end under the arm marked *a*. This leaves an opening from 4 to 6 inches wide, which is not enough for the hen to enter. In going into the nest she will be obliged to raise the trap door, which will let the cleat fall, thus closing the trap after the hen has gone in.

The trap door, the arms and the cleats may be made out of lath. Leave a little space between the boards in the walls, so the heat can escape, otherwise it will be too warm in summer. The bottom

board, *b*, in front should be 3 or 4 inches wide, and the lower piece of the trap door should rest against this so the hen cannot get her head through, raise the trap and get out.

TWO COOPS FROM A BARREL

Very good coops can be made at small cost from empty barrels, as shown in this picture. First, drive shingle nails through the hoops on both sides of each stave and clinch them down on the inside. Then divide the barrel in halves, if it is big enough, by cutting through the hoops and the

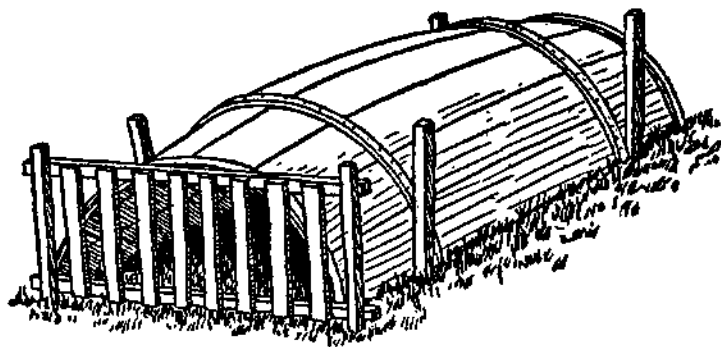

BARREL CHICKEN COOP

bottom. Drive sticks into the ground to hold the coop in place, and drive a long stick at each side of the open end just far enough from coop to allow the front door to be slipped out and in. The night door can be made of the head from the barrel or any solid board, and the slatted door, used to confine the hen, by nailing upright strips of lath to a crosslath at top and bottom.

Weak men wait for opportunities; strong men make them.—Marden.

A BOX CHICKEN COOP

The diagram shows a convenient way to make a coop for the poultry yard, of which the special feature is its door. Procure a box of the right dimensions and saw a hole, *d*, in one end. Then strengthen the box with narrow strips of wood, *b*, *c*, on each side of the hole *b*, *c*. This acts as a

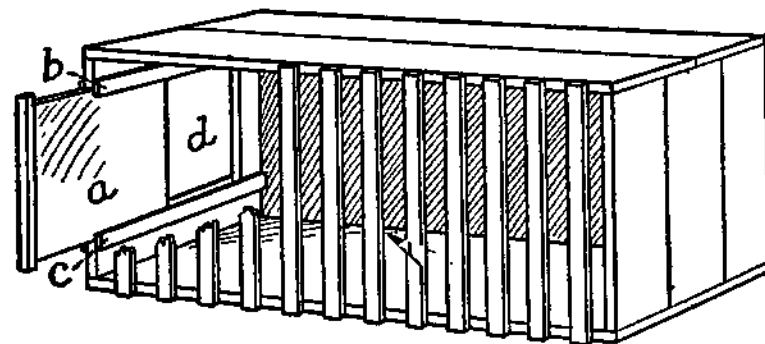

HINGELESS DOOR IN COOP

groove for the door, *a*, to slide in. Thus you have a sliding door, which opens and shuts with the greatest ease. The front of the coop is inclosed with lath, or narrow strips, placed $2\frac{1}{2}$ to 3 inches apart. The top should be covered with a good grade of roofing paper to make it waterproof. A coop of this sort should be 2 to $2\frac{1}{2}$ feet long, 16 inches deep and 2 feet high.

A LOW POULTRY RUN

A safe and secure run that requires less material than a high pen can be made from laths sawed in two, which would make the sides 2 feet high, making the frame of scantlings and the top of sawed laths, box boards or similar material. The top of

the run should consist almost entirely of trap doors, using bits of old harness for hinges, which will look well if cut neatly. The picture shows one of the doors propped up to show the construction more plainly. The doors are 4 feet long, the length of a lath, and may be 8 to 10 feet the other way and still not be clumsy, being constructed of such light material. This trap door is an important feature,

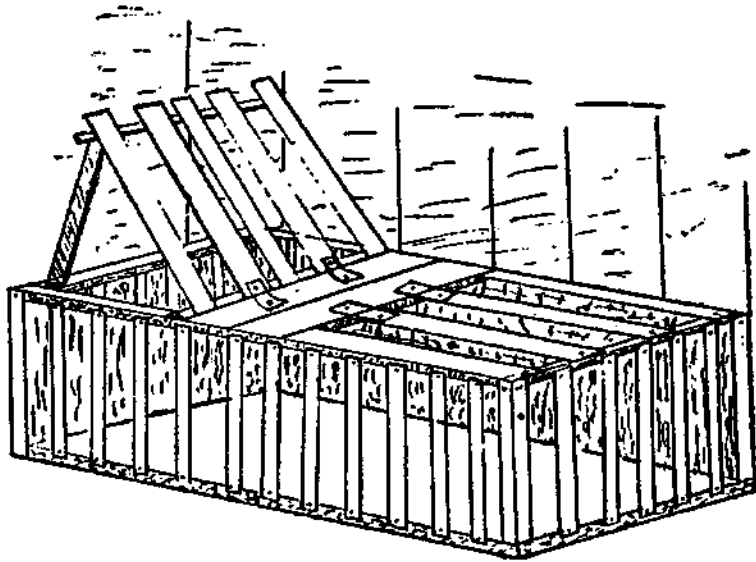

TRAP-DOOR POULTRY COOP

as it permits the tender to enter easily for removing top soil and replacing with fresh earth, or otherwise caring for the birds. The frame material is of 2 x 2-inch scantling at the corners, while the side strips are made of inch boards sawed 2 inches wide. The earth under this run should be slightly mounded for the sake of dryness.

Whatever is worth doing at all is worth doing well.—Earl of Chesterfield.

A PORTABLE CHICKEN COOP

One of the annoyances about an ordinary chicken coop is that it is not easily moved from place to place, nor provided with a yard. To obtain a yard the coop must be moved separately, and thus require the loss of more or less time. In the drawing shown herewith is a simple, homemade coop,

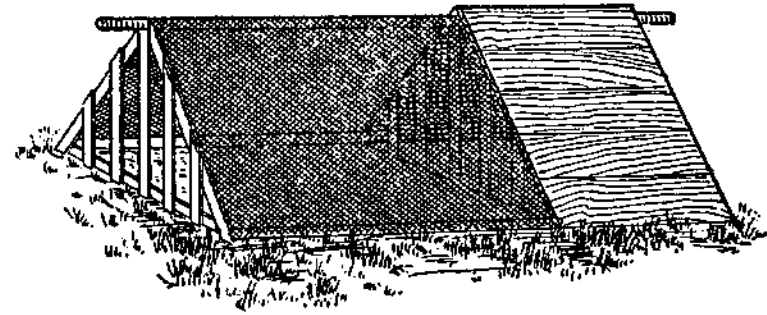

COOP EASILY MOVED

which can very easily be moved by the aid of the handles at the apex at each end. The coop is built of ordinary material on a base frame, and with a V-shaped roof and side frames. The ridge pole is extended, as shown at each end, to form a handle. A convenient length is about 2 feet for the coop and 3 or 4 feet for the yard. If desired, the hen may be allowed the freedom of the yard or may be held in by slats, as shown in the drawing.

A HOMEMADE BROODER

The material costs about \$2 and a handy person can build one in a day. The gas from the lamp does not go into the chick apartment at all, but filters around under the floor, making it dry and warm. The lamp flame is about 3 inches from the

sheet iron. The heat flows up gently through the drum, *f*, which is perforated with holes in the side, thus letting part of the heat out into the hover and the balance in the brooder above. The heat reservoir, *g*, between the sheet iron, *k*, and the floor, *c*, is about 1 inch deep. The tube, *f*, should not touch the sheet iron, merely extending through the floor, *c*. It takes very little oil.

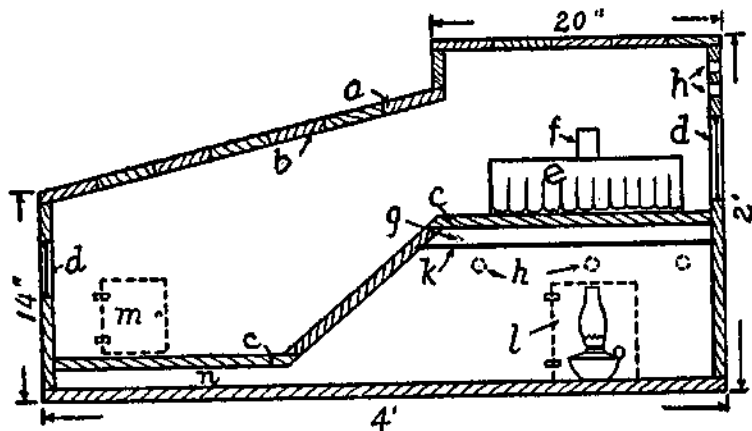

DETAILS OF BROODER

In the cut, *a*, is the paper roofing over inch-matched boards, *b*; *c* is board floor of same material; *d* are small windows, *e* is the hover, *h* are holes in each side of the brooder for the escape of gas and fumes, *l* shows door to reach the lamp, *n* air space below the floor.

MOVABLE BROODER HOUSE

The type of house shown in the cut is one of the best for raising poultry. It may be built on runners, with a tight board floor of matched boards. A convenient size is 6 feet wide and 10 feet long, 6 feet high in front and 4 feet at the rear. The

door is in the middle, and there is a window on each side, with two openings below. The roof should be covered with a good quality of prepared roofing.



HOUSE ON RUNNERS

The same material used to cover the sides will make the house warmer. Roosts may be put in after the brooders are taken out, and the chickens easily protected from foxes and other animals.

A VERY CHEAP HENHOUSE

It was built by a "down east" Yankee. The studs and rafters were made of two pieces of 1 x 2-inch stuff nailed together T shape. These were set up 2 feet 10 inches apart on centers and covered with wire netting drawn taut. This was then covered with tarred paper, which made the only material between the fowls and the outside air. They have wintered in these houses without discomfort, and gave a good egg yield. The wire netting prevented the paper from sagging when the house was covered with snow.

They can who think they can.

A DAYLIGHT CHICKEN CATCHER

Do you, when you want fried chicken on short notice, run it down, provided it doesn't run you down? Here is a better way. Fasten a barrel hoop securely to a handle about 6 feet long, and to it fasten a bag about 3 feet deep. A piece of an old hammock is fine for a bag, or horse net or fish net—anything the chicken cannot get out of. Lay it on the ground, call the chicken and throw the corn over the bag, and when one suitable goes on lift up the hoop and you have it. If the bag is made not over 1 foot deep it can be dropped down over the chicken while eating.

A SIMPLE HAWK TRAP

Make a box 4 inches deep, 6 inches square and nail to a 4-foot pole with cleats at the bottom to keep from turning over. Cover top of box with 1-inch mesh wire. Place a little chicken in the box; then put a steel trap on top of box and set it out under the trees where the hawks lodge to watch for the chickens. If there are hawks around, it is pretty sure to catch them.

SCARE AWAY CROWS AND HAWKS

For keeping hawks and crows away from the poultry yards, get a few bright tin shingles, link them together with wire, and hang upon an arm extending from the top of a high pole, where sun and wind strike fairly. The jingle and glitter is sufficient to keep these pests at a safe distance. You will also find them useful in the corn and melon fields where crows are troublesome.

PRACTICAL HIVES AND HIVE MAKING



EVERY apiarist knows that there is no item in bee keeping of more practical importance than the hive and brood frame. The Langstroth, or Simplicity size of frame has become almost standard, for there are more frames of this size in use than all others combined. The frame proper is $17\frac{5}{8}$ inches long, $9\frac{1}{8}$ inches deep, and the top bar is 19 inches long. There are several styles made, but many prefer what is known as the Hoffman. This has a heavy top bar in depth, as well as width. The ends, or end bars, are made $1\frac{3}{8}$ inches wide for about 3 inches down and one side is worked off to a knife edge, which comes against the square edge of the next frame, making them self-spacing, but not a closed-end frame, and allowing the proper bee space between the top bars. This works fairly well without the use of the honey board, though one is preferable.

The hive for this frame, to be best adapted to the production of comb or extracted honey, should contain 10 frames, the inside dimensions being 15 inches wide, 10 inches deep and $18\frac{3}{8}$ inches long. A follower can be used at one side to assist in removing frames by first removing the follower or division board. This arrangement leaves $\frac{3}{8}$ inch between the top of the frames and the top of the brood nest, so that when the surplus cases are put on the proper bee space is

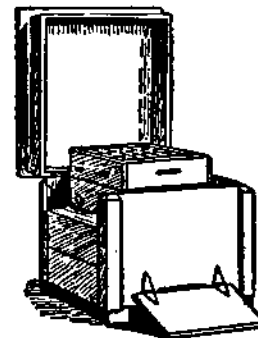

DOUBLE-WALLED
HIVE

preserved. This hive is made of scant $\frac{1}{2}$ -inch lumber for the outside, ship-lapped together in a manner to make a perfect joint. It is 20 inches wide, 24 inches long, about 20 inches high to the eaves, or roof, outside measurements, and weighs complete about 50 pounds. The inside dimensions of the brood nest should be the same as any 8 or 10-frame hive, as the bee keeper may prefer. The brood nest is raised sufficiently to admit of packing between it and the hive proper, also a space for packing at ends and sides.

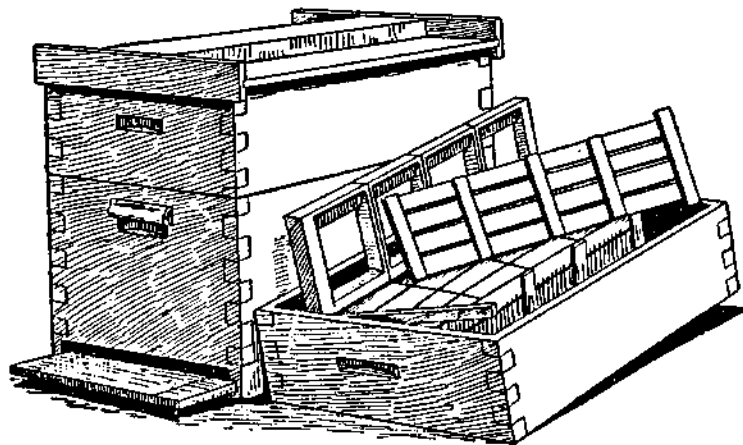

DOVETAILED HIVE

The lower portion of the hive being well protected against the cold, the warmth of the bees will care for the upper portion. To avoid condensation cover the brood nest after removing the surplus cases with a porous substance, or chaff cushion. Make a wooden rim about 4 inches deep, covering the top and bottom with burlap and filling with wheat chaff or cut straw. Many prefer the cut straw both for cushions and packing the

hives. This rim should be made a little smaller than the inside of the hive.

In extremely warm weather the cover can be raised a few inches in front, giving a circulation of air all around the surplus department, and shading it at the same time. The cover is hinged at the back end, and when raised, as shown in cut, makes two shelves for the use of the operators, which are highly appreciated; besides, there is no lifting on or off of covers, as is the case in other hives. The alighting board is hinged and can touch the ground, which is of great advantage to the bees during a heavy flow of honey.

Perhaps there are more single-walled hives used in the United States than double-walled or chaff hives, but in northern states a double-walled hive is preferable.

DEVICE FOR EXTRACTING BEESWAX

Wax, as produced by the bees and worked into comb, is almost pure white, but, on being melted

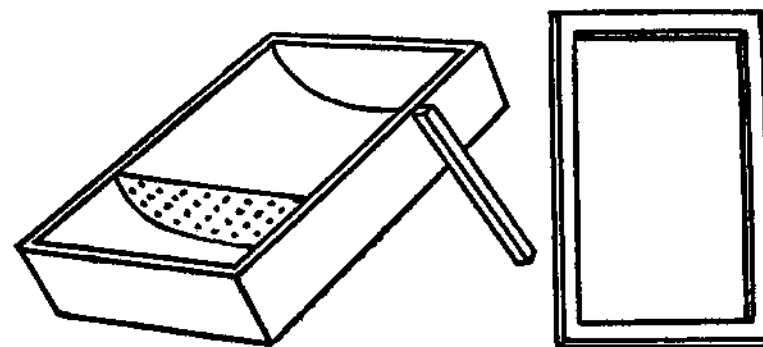

SOLAR WAX EXTRACTOR

and cooled, is yellow. A man who knows advises every beekeeper to use the solar wax extractor.

All that is necessary is to have a box with glass to fit over it, as shown in the drawing. To melt combs, put in the box an old dripping-pan, having a hole at one corner, and that corner the lowest, with some kind of a dish set under to catch the wax. Set in the sun. To get the most out, break up the combs into fine pieces, then soak in water for a day or two longer before rendering.

SELF-FEEDER FOR BEES

A very simple device for feeding bees on syrup may be made if you take an ordinary fruit can, fill it full of syrup and over the top tie a thick rag with a string. Then invert the can in a small pan or dish. The syrup will seep out through the rag around the edges of the jar just fast enough for the bees to keep it cleaned up.



A HANDY DEVICE OF THE ORIENT

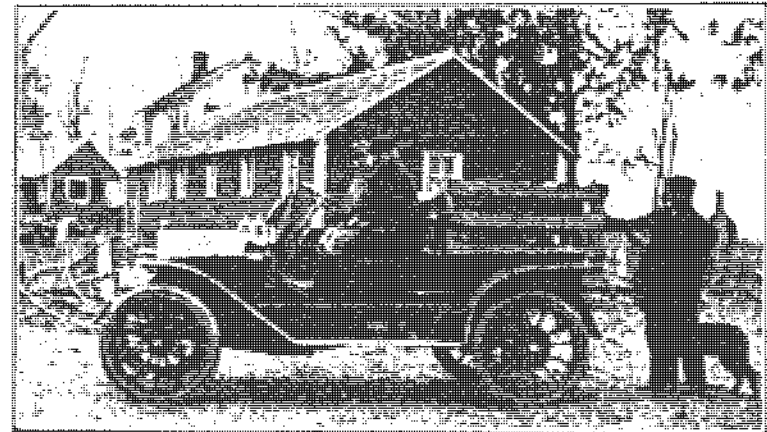

QUICK DELIVERY FROM THE FARMS

Hundreds of farmers are today making profitable use of automobiles, although their first appearance upon country roads caused only fear and anger.



SAVE THE BARRELS

Barrels, barrel hoops and barrel staves may be worked into many useful things upon a farm. From the few described in this book your ingenuity will lead you to others.

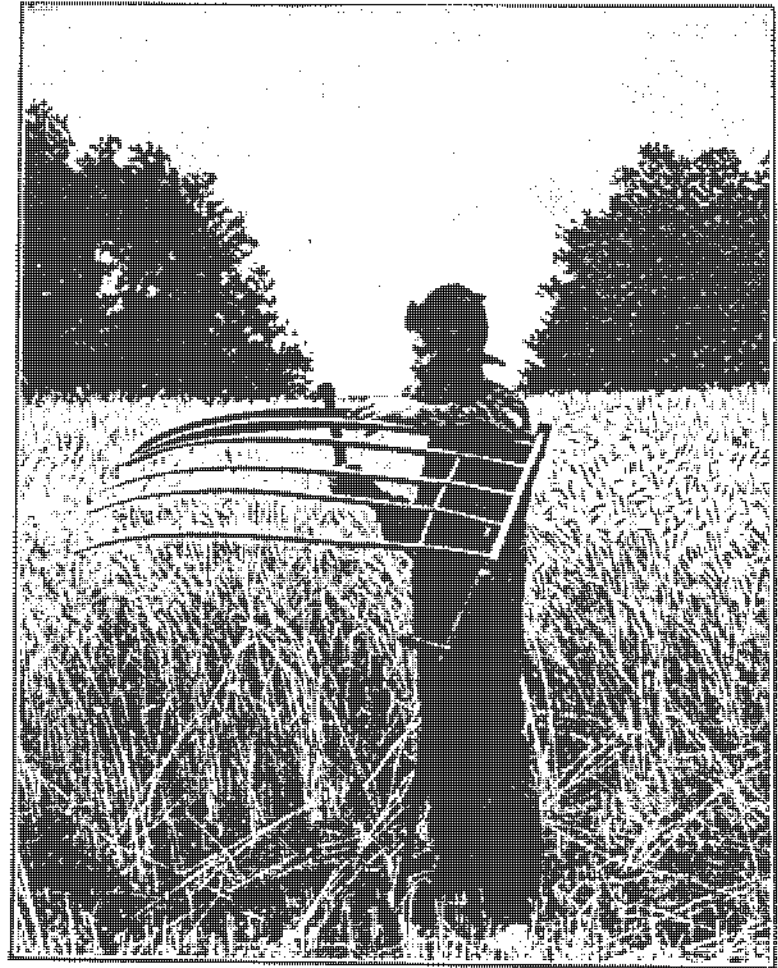

AS IN DAYS OF YORE

Modern harvesting machinery has come to take the place of old-time hand tools on the big farms; but many a reaper of the ancient type still swings through the golden grain, a relic of the days when men worked harder and accomplished less than they do today.

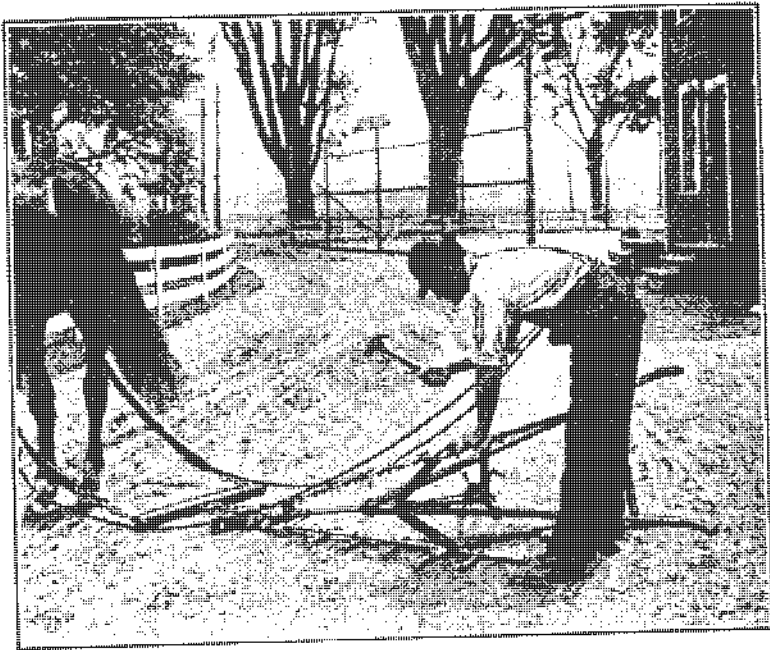

KEEP THE HAMMER BUSY

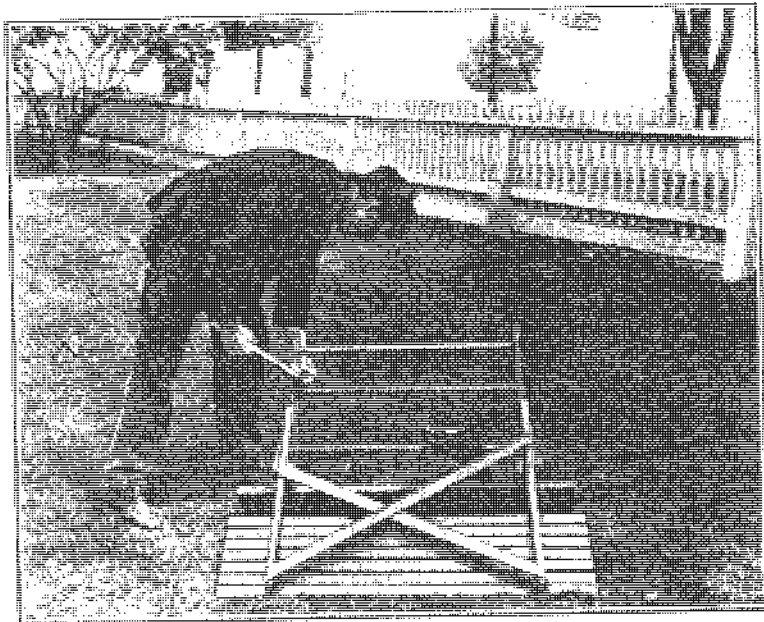

A NAIL IN TIME

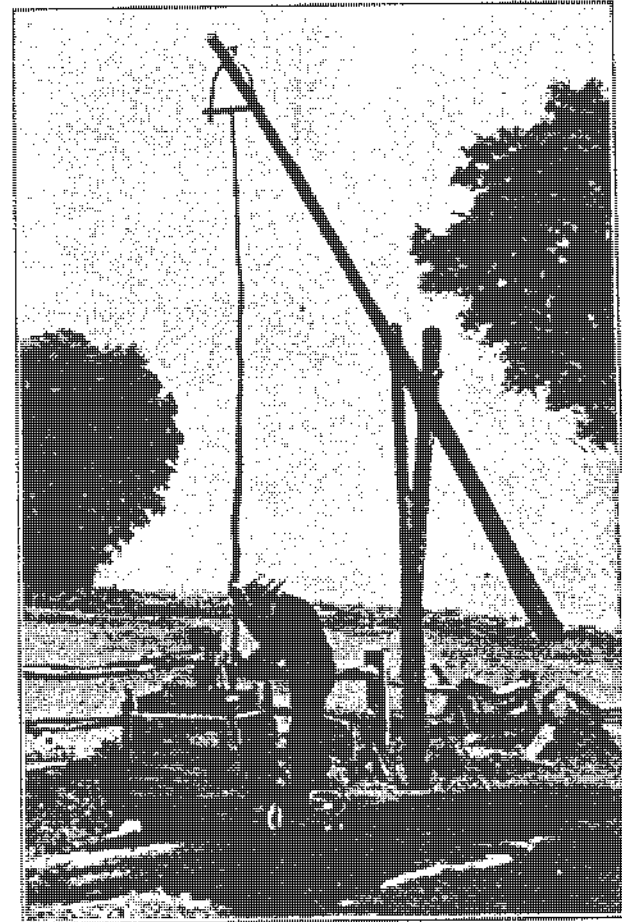

A TIME-HONORED HANDY DEVICE

AN IRON HOOP TRELLIS



THE BIG BROTHER TAKES A HAND

He's a city chap now, but when he comes home, he proves that his early training has not been forgotten. Teach your boy to use tools and use them right.



THIS trellis is made of the iron hoops that are now used so commonly upon sugar and other barrels. They are of stout wire, welded into a complete circle, and, as barrels are constantly going to pieces, one can get together quite a collection of these, when they can be assorted into uniform sizes.

An attractive trellis is shown. Three strips of wood, pointed at the lower end and finished with a knob at the top, are provided, the length being a matter for individual taste. A trellis for tomato plants will need not more than two hoops, while one for sweet peas may require a half dozen. The strips of wood should be of inch board, 2 inches wide. The hoops are secured to the uprights by small staples made for putting up wire fencing. The wooden posts may be oiled or painted some attractive color. This trellis will be greatly appreciated both in the vegetable and flower gardens, for its strength and attractiveness.

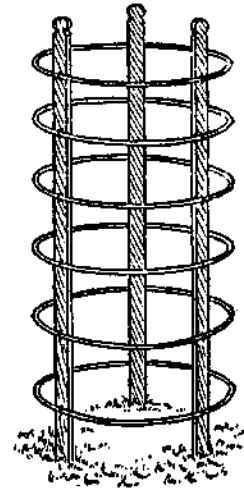

THE TRELLIS

Diligence is the mother of good luck.—Franklin.

PLANT SUPPORTS OF BARREL HOOPS

The ordinary wooden hoops from barrels may be made into an attractive trellis for grapes or a support for smaller twining plants by being arranged

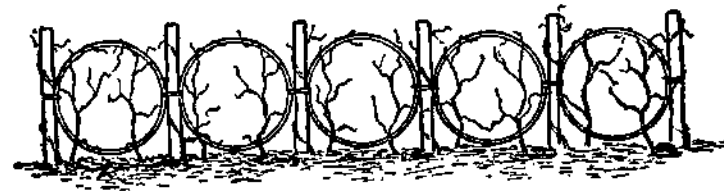
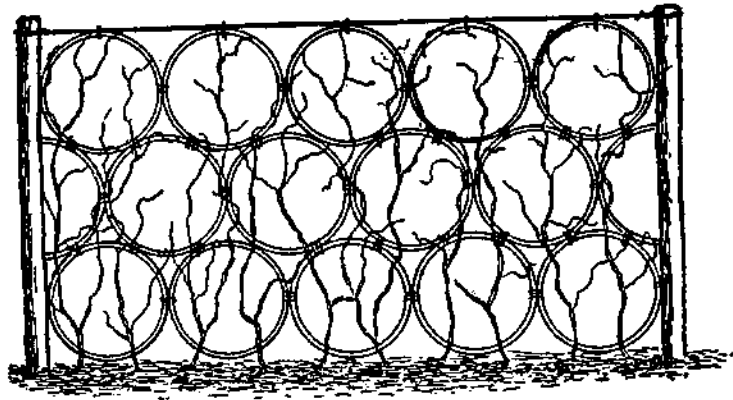

HOOP TRELLISES

as shown in the sketch. Attach them firmly to heavy stakes with some No. 7 smooth wire and you have an arrangement which will last for several years and is not unattractive to the eye.

A FOLDING TRELLIS

A good way to pole beans is to make a folding trellis out of plastering lath, as shown in the cuts.



TRELLIS FOLDED

Bore three small holes through each lath, as shown in the first cut and fasten them together with common wire nails well clinched.

Five-foot posts are set 1 foot in the ground and a wire strung at top and bottom. The lath are fastened to the wires with string, as shown in the second cut. The trellis is made in sections so as to be

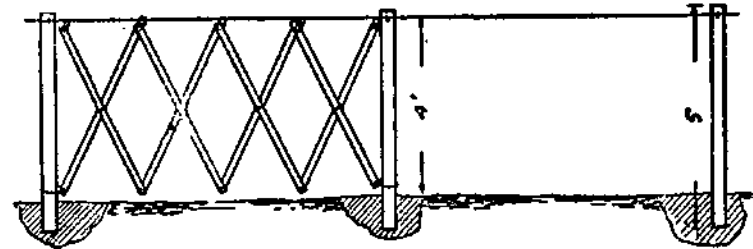

TRELLIS IN PLACE IN THE GARDEN

easily handled. When not in use it is folded up and laid away under shelter. The posts are spaced evenly so that one section of trellis will just go between two posts.

EASY WAY TO POLE BEANS

Set posts at convenient distances apart and stretch a wire at the top. This may be done as soon as ground is plowed. Plant and cultivate one row each side of line until beans begin to vine, then



TRELLIS FOR BEANS

set poles slanting, tying them together where they cross at the wire. This braces the whole row and beans can be cultivated with hoe. Hills 3 feet apart in row with one vine to hill are better than two vines.

TRELLIS THAT STANDS ALONE

A plant support or garden trellis, such as shown in the drawing, is very handy in the garden. This

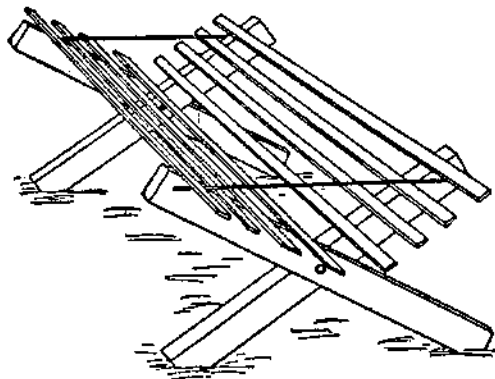

DOUBLE FORM OF TRELLIS

double form of trellis can be folded up and takes very little room in storage. All trellises and stakes should be gathered as soon as the crop is harvested and stored under cover until the next season.

They are useful for tomatoes, beans, peas, cucumbers and other plants that need some support. The double trellis is built of narrow $\frac{1}{2}$ -inch slats and pieces of 2 x 3, which are bolted together for the legs. The top may be held in place by pieces of string or wire attached at the points indicated in the drawing. The length, width and height of this trellis should depend upon the use to be made of it. A large one will be wanted for a large spreading plant and a small one for a small plant. It is important to have trellises just the right size to give proper support.

PROTECTING NEWLY SET PLANTS

Plants newly transplanted always demand more or less protection from the blighting effects of too much sun and wind. It is best achieved by making a shelter such as is shown in the cut. Two 10-

foot poles and two 3-foot pieces of any convenient thickness for the crosspieces, with four 14-inch weather-strips for the legs, constitute the frame. In the middle of it two hooks should be inserted on each side, and upon these the covering fastened, which can thus be adjusted very quickly. The covering may consist of burlap or any kind of rough sacking.

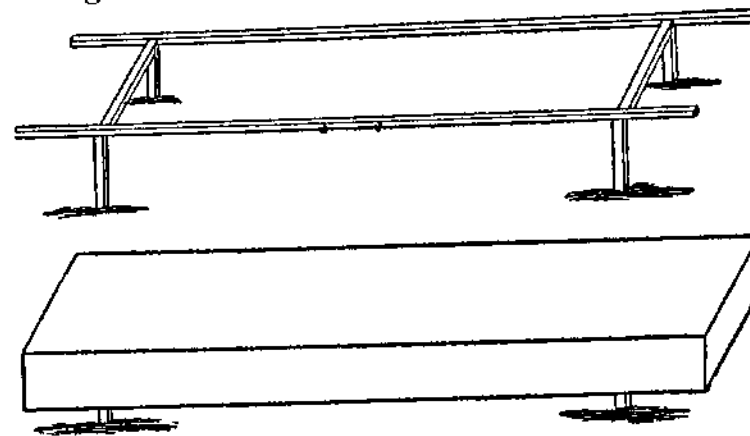

FRAME OPEN AND COVERED

Being so simple and economical to make, it is advisable to have enough frames to protect the number of tender plants that are set out in a garden at one time. They possess other advantages than sheltering the young things from the direct rays of the sun. They allow slow evaporation, and so keep newly watered ground moist for hours, whereas if exposed to the sun and wind it would soon become dry and caked. On windy days it is only necessary to let the sacking down on the windward side of the shelter. In case of frost the protection that they afford is of inestimable value.

Love thy neighbor, yet pull not down thy hedge.

MAKING THE HOTBED

The value of every vegetable garden can be greatly increased and the time during which a supply of fresh vegetables may be secured for the table greatly lengthened by the use of the common manure hotbed and the cold frame. These indispensable adjuncts of the good garden are so easily made and cost so little that it is surprising they are not more common. A good hotbed made the latter part of February or in March can be made to yield an abundant supply of lettuce, radishes, spinach, etc., for table use by the time such crops are being planted out of doors, and the supply of cabbage, tomatoes and other plants for the home garden can be secured ready to transplant several weeks earlier than if plants grown in the open were depended upon.

As a source of heat fresh horse manure is used. About half manure and half fine straw mixed together should be piled in square piles 2 or 3 feet in depth, and 4 or 5 feet in width and long enough to contain the amount necessary for the beds desired. After heating has well started, the piles should be forked over, turning the outside of the old pile to the inside of the new, and when heating again is well under way the material is ready for use. In the meantime select a well-drained spot, sloping to the south, if possible.

Dig a trench $6\frac{1}{2}$ feet wide, 2 feet deep and as long as desired, running east and west. Now place the manure in the trench, tramping and packing in thin, even layers until level with the surface. Make a frame 6 feet wide and as long as desired, but some multiple of three, because the hotbed sash are always made 3 feet wide. The end piece should

be 9 inches high in front and 15 inches high in the back. The front side board should be 9 inches wide and for the rear it will require two boards, preferably 12 and 3, with the wide one at the top.

A frame 12 or 15 feet in length will be quite large enough for the ordinary farm garden. Set this frame on top of the manure with the slope facing the south and secured by stakes. On top of the manure put 6 inches of good garden soil and cover the frame with common sash or windows 6 feet long by 3 feet wide. At first the heat will run very high, but in a few days it will fall to 80 or 90 degrees, when it is safe to plant the seeds.

MAKING PERMANENT HOTBEDS

Hotbed sash should be constructed of white pine or of cypress, and the sash bars should run in one direction only, and that lengthwise of the sash. The bars may be braced through the middle by a transverse bar placed through the long bars below the glass. The two ends of the sash should be made of sound timber, 3 inches wide at the top and 4 inches wide at the bottom end, mortised to receive the ends of the sash bars, and with a tenon at the ends to pass through the side pieces, which should be $2\frac{1}{2}$ inches wide.

A permanent hotbed should be so constructed as to be heated either with fermenting manure or by radiating pipes from the dwelling or greenhouse heating plant. For a permanent bed, in which manure is to supply the heat, a pit 2 to $2\frac{1}{2}$ feet deep, according to the latitude in which the work is to be done, should be provided.

The sides and ends may be supported by a lining of plank supported by posts 4 feet apart, or, what

is better still, a brick wall 9 inches thick, as shown in the drawing, may be used. In either case the pit lining should come flush with the surface of the soil. The site for the pit should be on naturally well-drained land, and a tile drain from the bottom of the excavation should be provided to prevent the

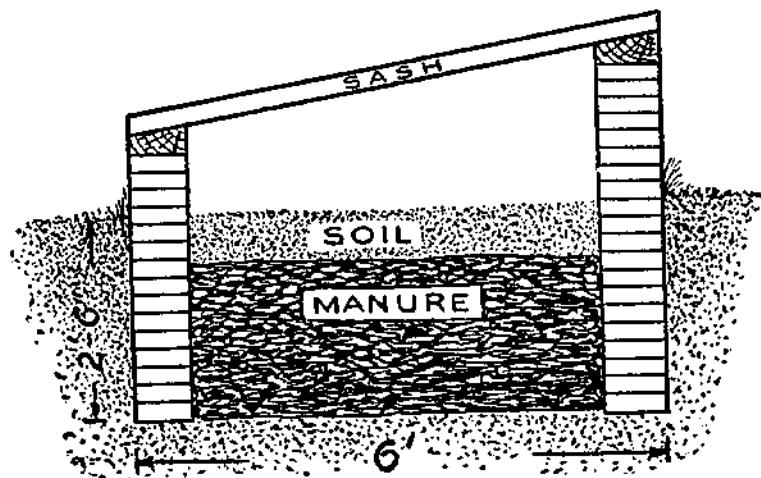

HOTBED WITH BRICK WALLS

water from accumulating in the pit and stopping the fermentation of the manure during the period the hotbed is in use.

Standard hotbed sashes are 3 by 6 feet. The pit, therefore, should be some multiple of 3 feet in length, and the width should be the same as the length of the sash, 6 feet. The plank frame, or the brickwork of the pit, may be extended above the surface of the ground sufficiently to allow for placing the sash immediately upon these permanent structures.

HEAT FOR HOTBEDS

Make an excavation 5 x 16 feet on the surface, and about a foot deep. Lengthwise along this

space lay three rows of tiling, one along the center and one about a foot from each side. The tiles should be 4 inches inside measure, and 1 foot long. These are placed end to end so as to fit closely, and earth is pressed around them so as to hold every piece exactly in place. Then the excavation is filled with rich soil until level with the surface, excepting at the end the tiles are left bare for a few inches. The board frame, 5 x 15 feet, is next put in place so as to leave 6 inches of each row of tiles projecting beyond the ends of the frame.

At the east ends of the bed, a hole should be dug 3 x 4 feet on surface and 2 feet deep; in this hole a crude fireplace may be made of loose brick and the flue connected with the three ends of projecting tile. At the west end of the frame a brick chamber should be made into which the three tiles enter, giving them a common flue for outlet. Cover the top of this chamber closely, excepting a 6-inch circular hole, into which a single length of stovepipe is fitted. A sloping door is hung over the fireplace cavity to keep out the rain; and the earth raised high enough around to prevent surface water from running into the hole. Bank soil about the frame. You may happen to have on hand six old storm window sashes of that size. Of course the sashes slope to the south in the usual way.

When the fire is kindled in the fireplace the smoke comes freely from the stovepipe. The tiles are covered with soil to a depth of about 6 inches. With a good fire, you can quickly warm up the earth on the coldest days of spring. And when once well heated, the earth and tiling hold the heat for a long time, provided the draft is closed. Unlike beds heated with manure, the heat supply can thus

be regulated to suit the demand of the prevailing weather.

COLD FRAMES AND THEIR MANAGEMENT

In the South cold frames are in use all winter. The principal winter crops grown are lettuce, radishes, beets, cauliflower and occasionally cabbage, while these crops are commonly followed in spring by cucumbers, cantaloups and sometimes Irish potatoes. The frames are easily made. Rough inch lumber (heart pine is best in the South, and hemlock in the North) and 2 x 4 or 2 x 3-inch scantling are all that is required. For the double frames, strips 3 inches wide and $\frac{3}{4}$ or $\frac{1}{2}$ inch thick, long enough to extend across the frame, should be provided for rafters. The back or north side of the single frame should be 12 or 15 inches high, while the front should slope down to 8 inches. In Southern practice, where canvas covers are used, the back should be $2\frac{1}{2}$ feet and all cracks should be well covered with building paper, held in place by laths tacked over it.

Good treatment for the posts used in construction is to dip them in kerosene over night. This will preserve them indefinitely. Drive the posts into the ground 18 inches and let them extend upward to the top of the boards, putting a post at the union of each pair of boards and nailing them to it. All ends and rafters may be made so that they can be quickly removed, so that the frames can be plowed and the ground prepared with a mule. The sides of the double frames are best made 1 foot high, with the ends sloping upward to $2\frac{1}{2}$ feet. Down the center of the frame, a row of 2 x 4-inch posts $2\frac{1}{2}$ feet above ground are set 8 feet apart.

Over each one of these a rafter is bent and fastened to the sides of the frames.

For cold frames in the North, glass is the only covering to be thought of. By all means, put the frames up facing the south or southeast and to afford protection against the north and northwest winds, cold the country over, a high wall, a thick hedge, or a piece of thick woodland should be close at the back of them.

The soil in the frames should be thoroughly prepared, rich and pulverized thoroughly. An abundance of well-rotted stable manure should be used; if thoroughly decomposed, at the rate of 75 to 100 tons an acre is not excessive, unless the soil is already very rich. Whether glass or canvas is used as a covering great attention must be given to water and ventilation. The land should be well drained that no water will stand, or the soil become water logged; that is one side of the water question, but in addition, the plants should be carefully watered from time to time to provide sufficient for their needs.

If the coverings are kept down too constantly, the growth of the plants will be weak and spindling and such diseases as damping off, Botrytis and drop will work havoc with them. Careful attention to watering, ventilation and keeping the surface of the ground stirred are the genuine secrets of controlling these pests. Watch the temperature, do not let it rise too high, lower it by raising the sash or drawing back the covers. The canvas covers should be drawn back a portion of every day when the temperature is not too low, and at other times the ends may be raised, to allow the air to circulate under them. A sharp eye must be kept on the

frost item. Sometimes steam heat is provided, oil stoves may be used and glass covered frames should be covered with burlap or straw mats, securely held down either by tying them in place or by weighting them down. Both canvas and the glass covering should be well fastened to prevent their being lifted off by strong winds.

The upper end of glass sash may be held down with a hook and staple, a hook being placed on the back of the frame at the center of each sash with the staple in the end of the sash. Canvas covers are best held down by nailing along the center to a board run lengthwise on the center of the rafters, in the case of double coverings, or along the back in the case of single ones and by placing marbles or small pebbles in the cloth and tying about these every 4 or 5 feet, along the ends and sides, slipping the looped ends of the twine used in tying them over nails driven into the ends and sides of the frame.

A HAND GARDEN CULTIVATOR

Now that garden crops are planted almost exclusively in rows a tool that will clean out the weeds, stir the soil around the plants, and, by making a good surface mulch, prevent the loss of moisture to some extent, is essential for the proper care of the garden. The wheel hoe of our cultivator is usually used for this purpose by the professional gardener, but the price is generally considered rather high by the ordinary farmer or amateur.

This machine, although homemade and not very handsome in appearance, does the work as well as a \$6 or \$8 tool, and cost not more than 40 cents

to make. For a wheel, take the fly wheel of an old sewing machine, about 1 foot in diameter, and put a round bolt tightly through the axle. Then a piece of plank, *a*, 20 x 10 inches, and cut as shown, boring holes for the axle where marked. After the wheel is set in place, it should turn easily and steadily, if balanced properly. For the handle, *c c*, cut out and round from a piece of plank two pieces, or use any that may be otherwise obtained. Then get a blacksmith to make three teeth, *b*, out of a

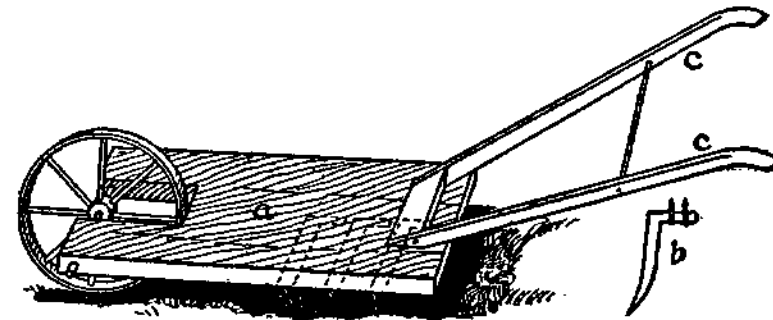

HAND CULTIVATOR

piece of spring steel 1 inch wide and 8 inches long, bent as shown. Two-inch holes are drilled through them for screws.

One tooth should be placed about 6 inches behind the wheel and directly in the center, the other two being 4 inches behind the first, and the same distance from the center tooth. When this cultivator is pushed through the rows it should run with little pressure from the operator, clearing out the weeds and stirring the soil at the same time. This contrivance does the work well, and if given two coats of brown and green paint it will be improved in appearance.

Know thy opportunity.—Pittacus.

A CONVENIENT GARDEN STOOL

This device will prove useful in doing hand work in the garden. It is made from two barrel staves upon which is mounted a low stool. This should be narrow, so that it may be drawn between the rows of vegetables. The holes in the seat are large enough for the fingers to go through and render the stool more easily handled. The device is especially convenient for the women.

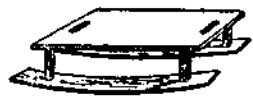

WEEDING STOOL

WATERING SEED SOIL MADE EASY

To avoid disturbing small seeds by watering, when planted in forcing boxes, a plan has been devised which not only insures against the disturbance of the seed, but keeps the soil of the entire box in a moderate state of moisture, which is an essential feature in early growth.

Make a box of any desired size to suit the occasion, and about 3 inches deep. Then get a few small unglazed flower pots and place same on stove until quite hot. With a short piece of candle, seal drain hole in bottom of pots, taking care not to put wax over the entire bottom of pot. Place pots in box about 9 inches apart on a thin layer of sand, and overlap pieces of broken pots, to convey by capillary attraction the water to the entire soil of the box, which soil should be sifted and box filled to within $\frac{1}{4}$ inch of the top of the pots.

Cover the box with glass, and heat from above will draw the water up to the roots. By this method you will not have surface baking, which is so troublesome with surface watering. If so desired,

you can cover the pots with circular pieces of paste-board or tin, and avoid surface evaporation from the pots. Always fill pots with warm water.

CATCHING OWLS AND HAWKS

A friend of ours captured a large owl and fastened him securely with a small chain to a stake in the middle of an open field. He set three posts 5 feet tall and 4 to 5 inches in diameter 20 to 30 yards from the owl, and on each post placed a small steel trap with a bunch of hay or grass tied to the post just under the trap, to hide it, as shown in cut. At night, the owl called. Others came, and seeing nothing near, alighted in the trap on the post. During the day hawks came, and were caught in the same way. In two months two owls and 17 hawks were caught. In some places a bounty is paid, so there is a profit in two ways. The owl may be fed on the hawks caught and on rabbits or chickens that may die around the premises. The most difficult part of this scheme is often the capture of the first owl, but if you are a good hunter you will find a way.

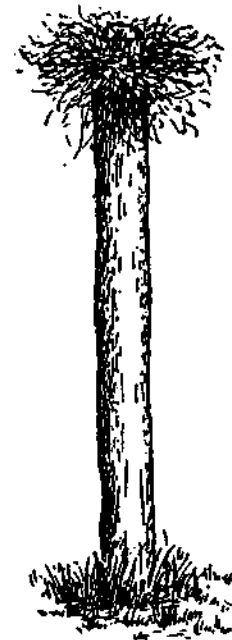

TRAP ON POST

Make no absolute promises, for nobody will help you to perform them.

Money is a good servant, but a bad master.

MOVING A LARGE TREE

To move a large tree one may find it very satisfactory to use a rig similar to that shown in the picture. Make a three-sided standard of 2 x 4-inch stuff. Loosen the dirt around the roots of the tree



RIG FOR MOVING TREE

and wrap the tree firmly at the base with old carpet or burlap to prevent injury. Place the standard firmly in the ground and tie the cross-piece to the body of the tree with strong rope to each side of the standard and hitch a horse to the

other end. With a slow pull the tree can be drawn onto the drag and then hauled to the new location. It can be placed in the ground again by using the standard in the same way it was used to load it upon the drag.

A penny saved is two pence clear,
A pin a day's a groat a year.—Benjamin Franklin.

The man who builds, and wants wherewith to pay,
Provides a home from which to run away.—Young.

TRANSPLANTING TREES

Here is a way to transplant large trees that is not so difficult as such transplanting is by many supposed to be. The first move to make is to dig all round the tree, leaving a large ball of soil, which is carefully wrapped in sacking or canvas to hold it on the roots and prevent drying. When this is well tied in place a chain is passed round the ball two or three times and hooked, as shown in Figure 1.

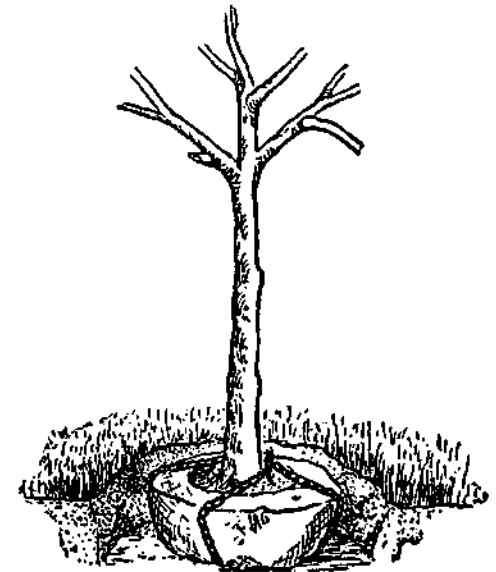

FIGURE 1—BALLED

Then with a pair

of heavy wheels on a short axle and a strong pole laid across it, with a massive iron hook fastened to the pole, it is easy to back up to the tree. The sketch, Figure 2, shows the truck with its lever raised ready to hook into the chain. The rope at the end of the pole brings it down and the tree up, when the pole is fastened under a second pair of wheels. The young trunk must be kept from contact with the machinery by the free use of blankets and bags. The secret of success in transplanting trees is to injure the roots as little as possible.

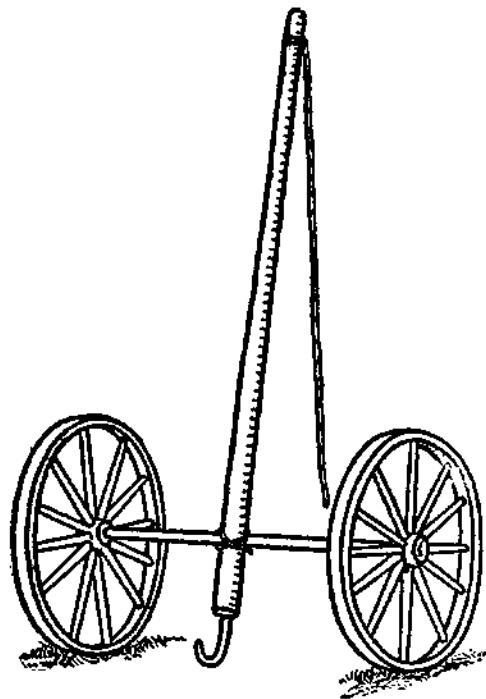

FIGURE 2—HOOK AND TRUCK

The manly part is to do with might and main what you can do.—Emerson.

Many things difficult to design prove easy to performance.—Samuel Johnson.

HOMEMADE FRUIT PICKER

This is a device that is hard to beat for reaching fruit at the top of tall trees. After a little

practice, a man can operate it rapidly, far outstripping hand pickers and at the same time not

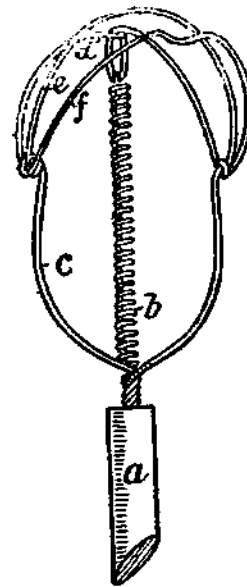

WIRE DETAILS

injuring the fruit. The construction is shown in the upper drawing. The main frame is of heavy copper wire, to which is attached the strong spring, *d*. The end, *a*, is inserted into a wooden handle as long as

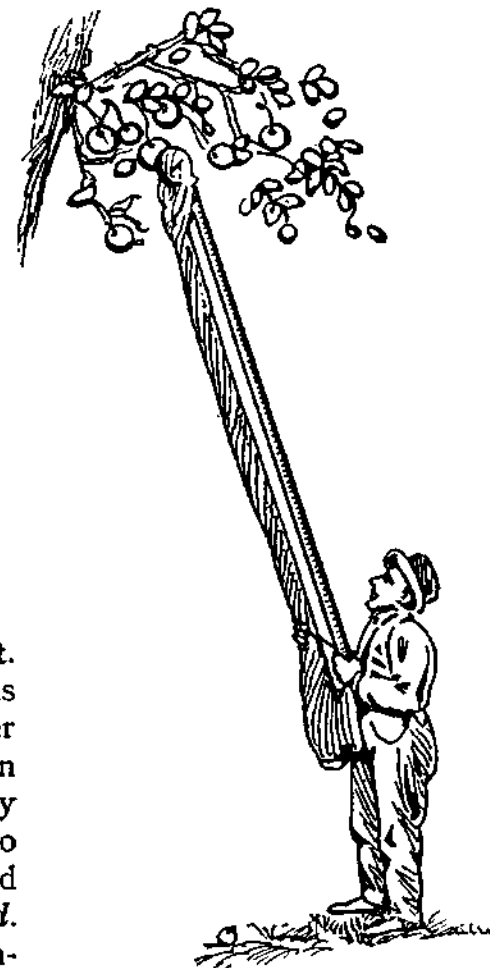

THE PICKER IN USE

needed. When the muslin sack is attached, as shown in the picture of the picker in use, the jaws of the picker are easily closed by pulling slightly on the cloth. The fruit falls through the sack or long cloth tube into the hand of the operator. Many

devices have been made for this sort of service, but it will be hard to find one that works better than this one if constructed in the exact shape indicated.

A TRUSS LADDER

For a 14-foot ladder select four pieces of 1 x 2 hard wood, using two pieces for each side. Place rungs of 1 x 2 between the side pieces. Make ladder 12 inches wide at top, 14 inches at center, and 30 inches at the bottom. Put a 1/4-inch bolt through the side pieces just below the rungs, and a 6d nail through the end of each rung to prevent them from slipping out. Keep all bolts tight. A ladder made as above, of Oregon pine, 14 feet long, supported on trestles at each end, deflected but 1 inch when 150 pounds were placed on the center. It is light, yet strong, and it is almost impossible to spring it. The special advantage of a truss ladder is lightness, which is a very great advantage, when strength is combined, as in the case of this particular ladder.

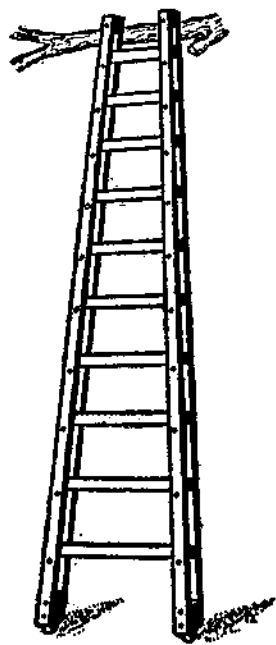

THE LADDER

Let us have faith that right makes might; and in that faith let us to the end do our duty as we understand it.—Lincoln.

Never spend your money before you've earned it. Never buy what you do not want; it is not cheap.

ORCHARD LADDER ON WHEELS

The accompanying sketch shows the manner of construction. Any farmer or orchardist can build it. Secure two old mower wheels and one piece of 2 x 4 scantling for an axle. Place the ladder upon this scantling. To keep it upright use poles, two at the bottom and one near the top of the ladder, extending to the ground. The upper one should be forked at the top so as to hold the ladder firmly. This ladder is 18 feet high, and as the foundation is broad, there is no danger of it falling over. The brace is so made that it can be adjusted, thus enabling one to place the ladder at any angle.

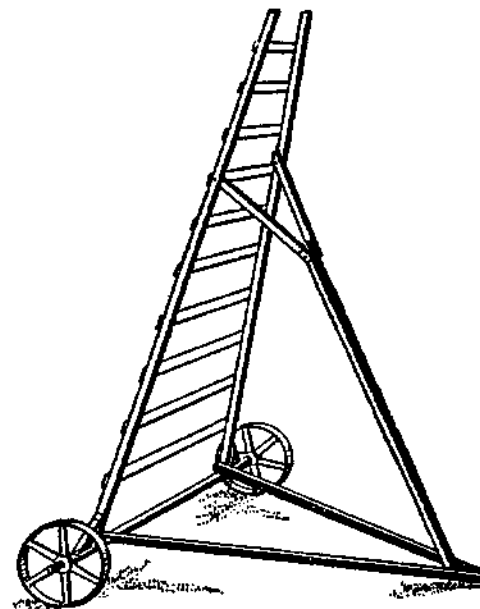

LADDER FOR FRUIT TREES

CONVENIENT SORTING TABLES

Where fruit is packed from the trees a sorting table will always be found convenient. It generally saves time and labor to do the packing right in the orchard. A handy table is one mounted on wheels which may be of any size desired and should be large enough to hold at least four barrels. The

wheels can be picked up from discarded machinery or quickly made by nailing together crosswise two boards to prevent them from splitting, boring a hole in the center for the axle and rounding them off with a key hole saw. One end of the table should be made several inches higher than the other, so that the culls will roll into a pile at the lower end.

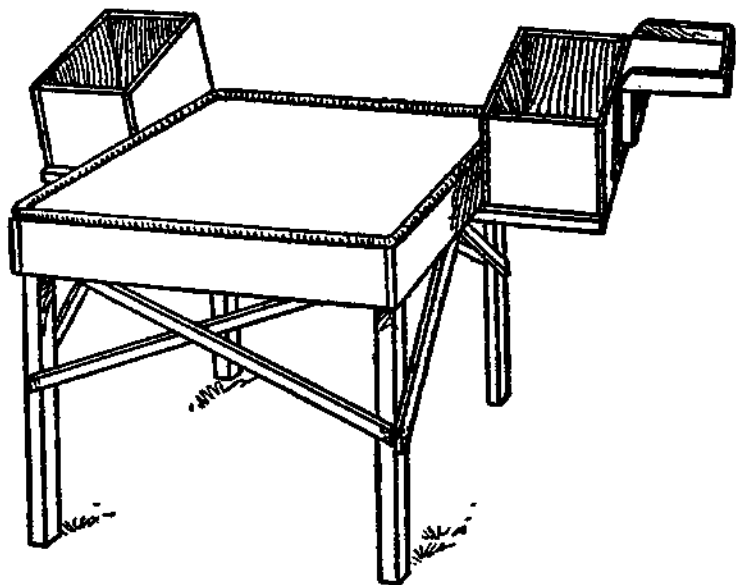

OREGON SORTING TABLE

In the Hood river district of Oregon a table such as shown here is commonly used. This is made to accommodate two packers. To make such a table take four standards about 3 feet high. It is made 3 x 4 feet in size, the top covered with strong burlap or canvas and allowed to hang rather loosely. Saw off the tops of the legs on a bevel so as not to have the sharp corners push into the burlap, and make points that will bruise or cut the fruit.

A piece of old garden hose is generally nailed around the top of the table to protect the fruit. Besides the braces shown in the cut it is also well to wire the legs and braces together firmly, as there is a heavy load to support. The shelves on each side are for holding the boxes, as all the good fruit in this region is boxed. The height is only relative, the point being to construct it so each packer can work with the greatest comfort, avoiding back bending in all cases. The top should not be greater than 3 x 4 feet, as anything larger would not allow two packers to reach all points of it without unnecessary stretching.



PORTABLE HAY DERRICK



A VERY satisfactory derrick for stacking hay is shown in the sketch. The base pieces are 6 x 6 inches by 16 feet. For the center pole we use a straight round pole 7 inches in diameter at the base and 5 inches at the top about 24

feet long. We put an iron band around the base and insert the peg upon which it turns. About half-way to the top is an iron collar, which has three loops to it that form an attachment for the braces, which are fastened about 15 feet from the bottom of the central pole. This allows the pole to turn readily when in upright position. The top framework is made of 2 x 6-inch pieces

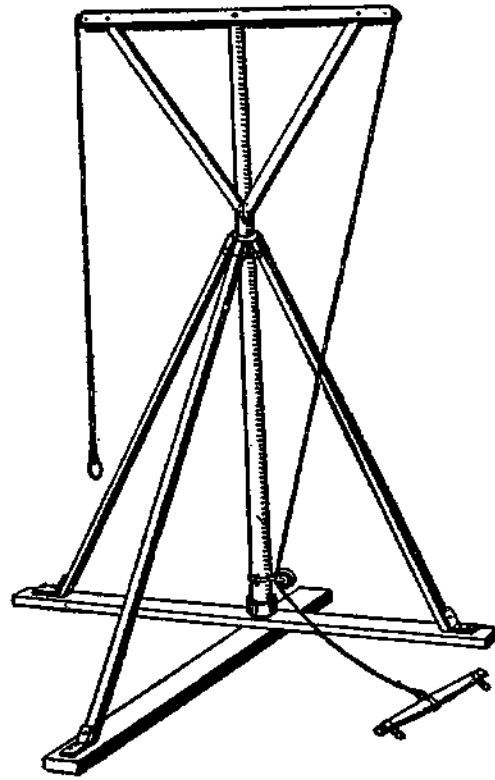

HAY DERRICK

12 feet long. The rigging, consisting of three pulleys and the hay rope, is attached as shown in sketch. By having the lower pole attached near the base of the upright the arms will make half a turn when the hay fork is lifted, thus swinging around from the ground or wagon onto the stack.

A WIRE TIGHTENER

Here is a device easily made and very convenient to use in tightening barbed wire when stringing it upon the posts. Cut out a piece of inch board in the shape shown in the picture with a notch to let in the face of a hammer. Insert a long bolt at the point indicated by the light dotted lines, to prevent splitting. Fasten on the hammer with leather straps. The sharp brads should stick out about half an inch. Carefully finish the handle so that it will be smooth and not hurt the hands when you are using the device. It should be made of tough hardwood.

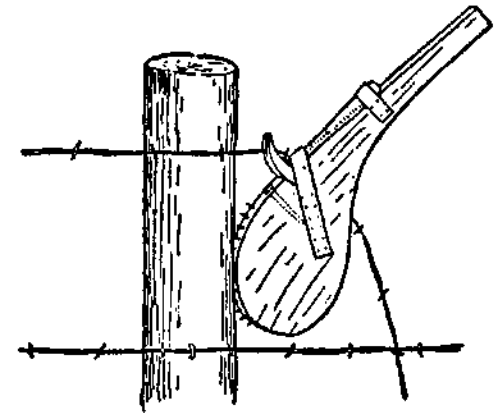

TIGHTENER IN USE

FENCE WIRE REEL

Here is a device on which one can wind barbed wire that is much better than an old barrel. The reel is mounted on a truck made of old buggy wheels with short shafts. The cart may be drawn

along by a man while a boy steadies the reel to keep it from unwinding too rapidly. For winding up wire, the machine is best pushed just fast enough

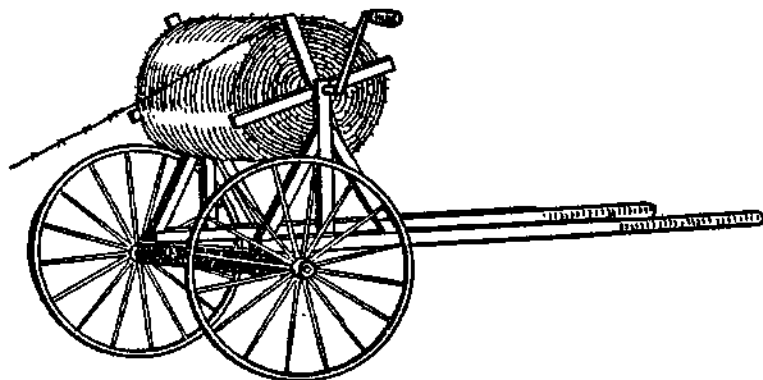

WIRE REEL ON WHEELS

to keep up with the wire as it is being wound on the reel. A crank placed upon the reel proves serviceable in winding up.

Never sign a writing till you have read it; neither drink water till you have seen it.

One part of knowledge consists in being ignorant of such things as are not worthy to be known.

Get the work habit.

SAFE WAY TO STRING BARBED WIRE

One of the most satisfactory ways to unreel barbed wire is to make a contrivance similar to the one shown on page 157. Fasten a short piece of plank to the front end of a stone boat. Bore a 2-inch hole in this plank and set the spool

of barbed wire on top. Run a piece of gas pipe about 5 feet long through the spool and let the bottom end rest in the hole made in the plank.

Attach the stone boat to the rear end of the wagon and have an assistant sit in the wagon and hold the top end of the pipe. If the wire becomes kinked the assistant simply lets go of the pipe and the spool rolls off the boat without breaking the wire.

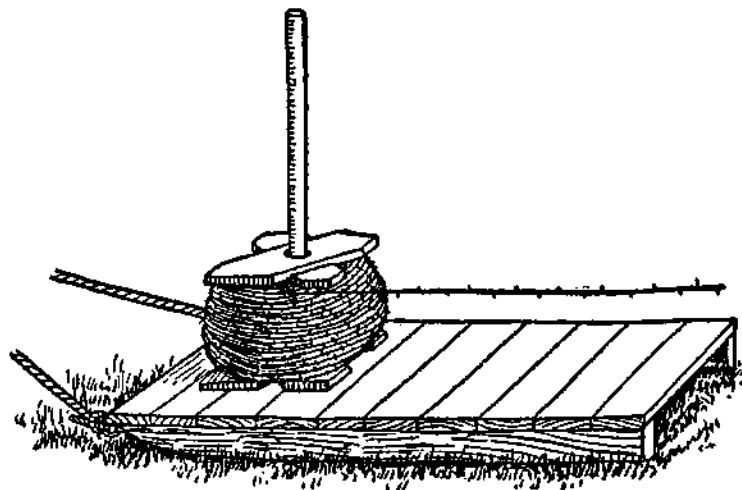

WIRE REEL ON BOAT

A BOXED STONE BOAT

A flat stone boat or drag is convenient for many purposes, but its uses are limited because it has no great capacity. On page 158 is shown an arrangement for increasing the utility of a stone boat 100 per cent. It is made of plank and has sides 1 foot high. It may be used for the purpose for which the ordinary drag is employed, and in addition is very convenient for hauling apples, potatoes, or other root crops from the field.

By increasing the size of the box, manure can be

hauled out from stables as it is dumped into it from wheelbarrows without having to reload or wheel up an incline. It is low on the ground and very convenient for loading. All light, bulky articles, as well as heavy stones, bags of fertilizers and seed, can easily be hauled on this contrivance.

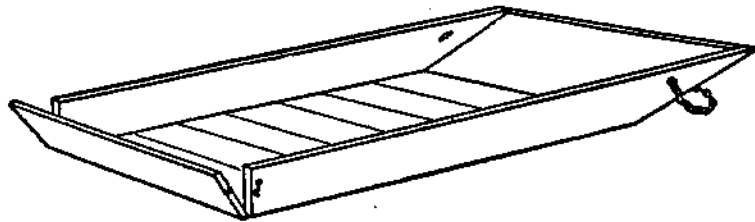

CAPACIOUS DRAG

A HOMEMADE ROAD ROLLER

If you need a road roller get a heavy sheet iron cylinder, stand it on end and place a length of $1\frac{1}{2}$

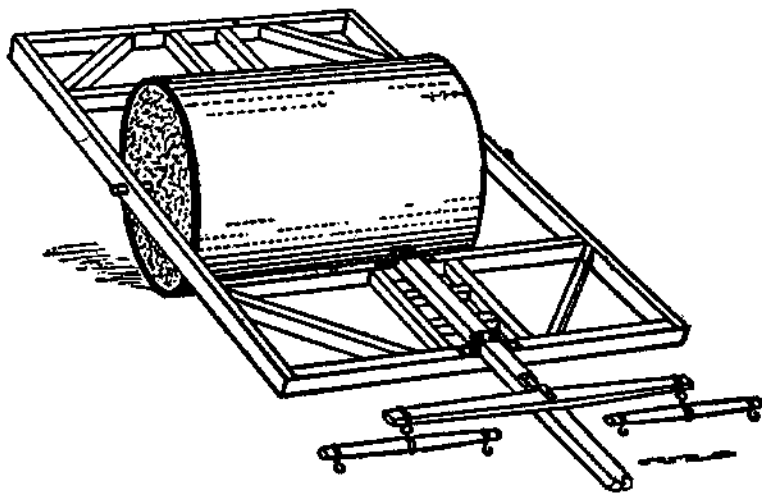

ROAD ROLLER

or 2-inch pipe through the center. The end should be placed on planks which are well soaked or are

well oiled, and the pipe braced to keep it exactly in the center. Fill the cylinder with good concrete, and when it has set tip it over and build a frame for it, so you can hitch a removable tongue at either side. The frame should be made of good strong hardwood well braced. The cuts show plainly just how the roller is made and put together.

AN OLD-FASHIONED DROGUE

Drogue is an old-fashioned word applied to a low drag or sled, something like the stone boat in general use now. The word is seldom heard today.

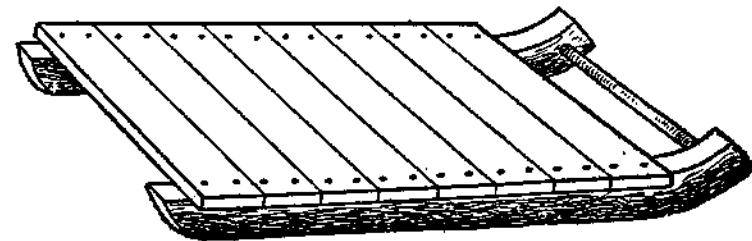

HOMEMADE HANDY DROGUE

So accustomed are we to the regulation stone boat that most of us do not know that there is still a more handy arrangement that is fully as easy to build and better to use, because it cannot slide sidewise on a hill. Select a small tree that has a bend in it the shape of a sled runner and split it with a sharp saw while it is green. It saws fastest and easiest while frozen. Saw or hew the bottom and top flat, so planks about 4 feet long may be pinned to it. Bore the front ends so a heavy stake with a shoulder may be inserted to prevent the runners from drawing together, and the drogue is done. It is handy for all work, but may need side rails spiked to it, if small stones are to be drawn.

Regular boat planks are not easy to obtain now that the old up and down saws are not in use.

A DITCHING SCRAPER

There should be a ditching scraper on every farm. They can be purchased made of steel, but a homemade one costs little and is quite serviceable. Take two planks, each 10 inches wide and 3 feet long, of good 2-inch hardwood. Bolt to them securely a pair of old plow handles. To the bottom bolt an old crosscut saw blade which will make a sharp edge. Let this project about an inch at the bottom. Attach two singletree hooks near each end of the lower board and your scraper is ready to use. With this scraper and two men a ditch can be cut one-quarter mile long and as deep as it could be plowed with a turning plow in two days' time. It is also very useful in filling holes in the highway.

BRIDGE FOR A SMALL STREAM

For crossing a small creek or deep ditch a cheap bridge can be built as shown in the illustration. The lumber used is 6 inches wide and 2 inches thick, except for the floor and four side braces.

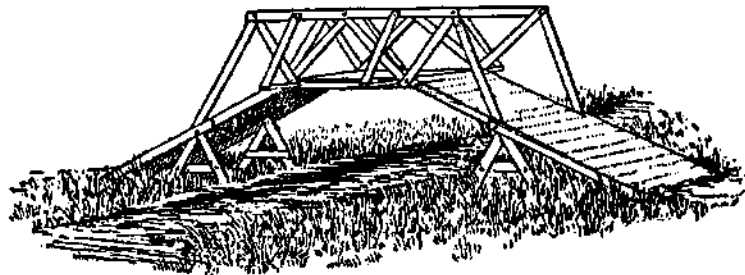

A BRIDGE OF TRIANGLES

Saw 11 pieces the length required for each of the two sides, then bore bolt holes $1\frac{1}{2}$ inches from each end. Use $\frac{5}{8}$ -inch bolts $8\frac{1}{2}$ inches long where four pieces come together and $6\frac{1}{2}$ -inch bolts where

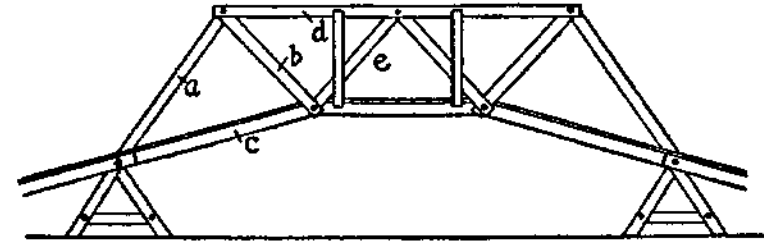

FRAMEWORK OF BRIDGE

three pieces meet. The A-shaped supports and the pieces for the approaches are bolted on at once, and then the side braces are put on. The sides of the bridge are made entirely of triangles. The first triangle is made of pieces, *a*, *b* and *c*. The second triangle of the pieces, *b*, *d* and *e*. The piers may be posts, stone or concrete.

DAM FOR FARM POND

A small pond held by a good-sized hydraulic dam supplies water for house, barn and two acres

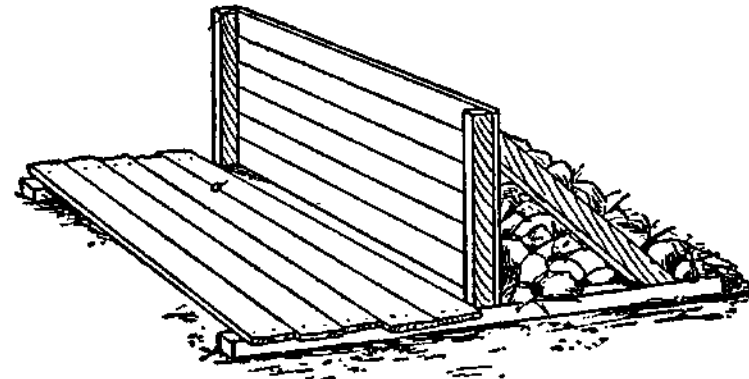

EASILY BUILT DAM

of garden and fruit, also floods a cranberry meadow when needed. A section of the dam is placed 6 feet apart and covered with plank fitted tight. The apron is of 12-foot plank spiked to the sills so as to break joints. The bottom is made tight with brush and clay. Stones are piled in behind the plank coverings, as shown in cut.

SOWING SEED EVENLY

These drawings show the construction of a wheel seeding device that can be easily made at home.

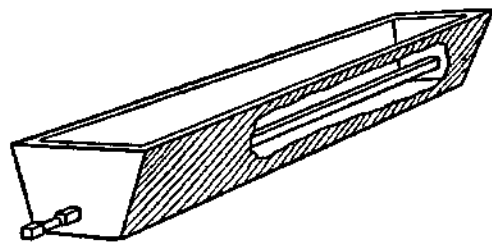

THE SEED BOX

The axle is tightly fitted into the wheels so that it turns when the wheels do. This agitates the grain or other seed and helps to keep the seed running out of the holes at the lower back side of the box. The quantity of flow may be regulated at pleasure by making the holes large or small and increasing or diminishing the number of holes.

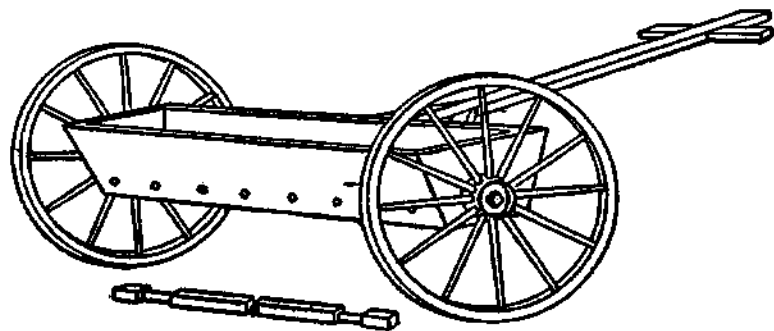

A SOWING MACHINE

It may be found desirable to have a considerable number of holes and then having plugs, for alternate ones, perhaps, which may be removed to make the seeding thicker. From 4 to 6 feet is suggested for the length of the box. Any old wheels will do if they are not too heavy to be easily drawn by hand.

BERRY CRATE CARRIER

One of the most convenient appliances for use in the strawberry field is illustrated in the picture shown herewith. It shows a novel use for the old-fashioned yoke used so commonly on the old-

time farms. The picture is so readily understood that no description need be given. This also suggests the many purposes for which a yoke may be used on a farm. Every farmer ought to have one, to make more easy the task of carrying things. In

some places yokes may be found for sale, but if you cannot buy one, make one yourself. Take a piece of strong, tough wood, shape it out to fit around the neck and shoulders and taper off the ends to what you consider the right size. Usually a groove is cut around about $1\frac{1}{2}$ inches from each end and

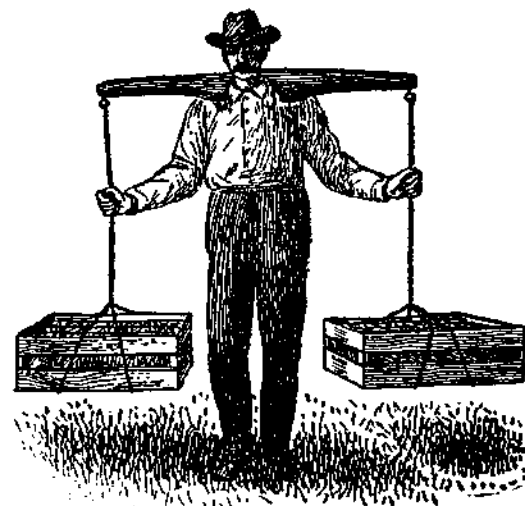

YOKE CRATE CARRIER

a rope is securely tied. At the other end of the rope a hook is attached the right size to go around the bail handle of any ordinary pail. The hook may be iron or may be formed from a strong, branched stick.

HANDY LOADING DEVICE

Here is a rig simple and strong that works well for loading corn in the field. The picture shows

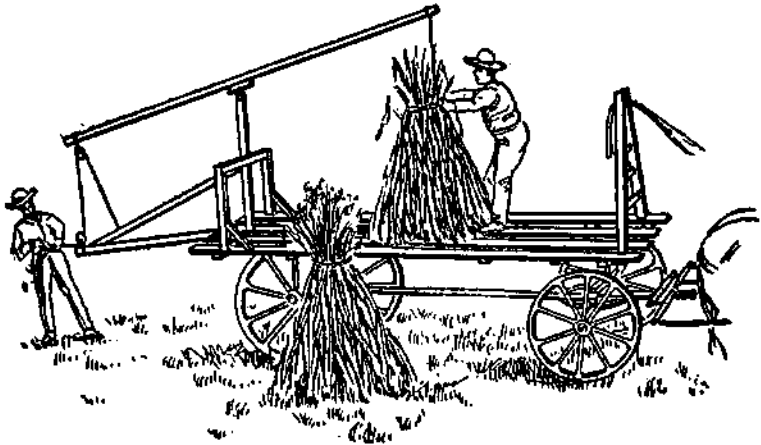

LOADING RIG IN USE

the construction of the rack and hoisting device with pulley attachment. Such a rig will be found useful for loading many things on a farm.

RACK FOR HAULING FODDER

A handy rack for hauling fodder from the field is shown in the drawing. It may be used for any kind of corn, of course, for sorghum, and may be found useful in moving brush. Each end of the

rack is hung from the axles by two straps of iron that can be obtained from any blacksmith at very little expense.

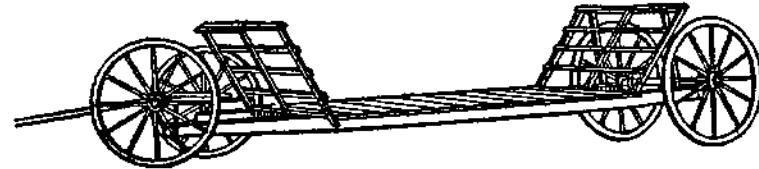

FODDER RACK

PULLING FENCE POSTS

An easy and practical method of pulling fence posts, by which all digging and hand labor is eliminated, is here shown. Take a plank 4 feet long,

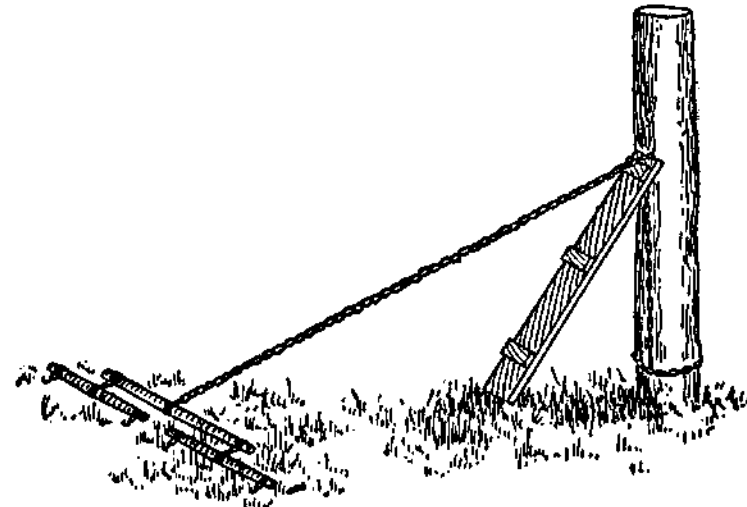

POST PULLER IN POSITION

1 foot wide and make a V-shaped notch in one end, nailing on several crosspieces to prevent splitting. This plank is used to change the horizontal draft to the vertical.

Place one end of chain around the post close to ground. Incline the plank against the post so the lower end of the plank will be about $1\frac{1}{2}$ or 2 feet from the base of the post. Place the chain in the notch of the plank, start the team and the post in a few seconds will be clear of the ground.

In moving fences the chain should be attached to the rear axle of the wagon, so the posts may at once be loaded and hauled to the new location of the fence.

ONE WAY TO PULL STUMPS

A Connecticut man has a very handy device for pulling peach stumps from old orchards, and can

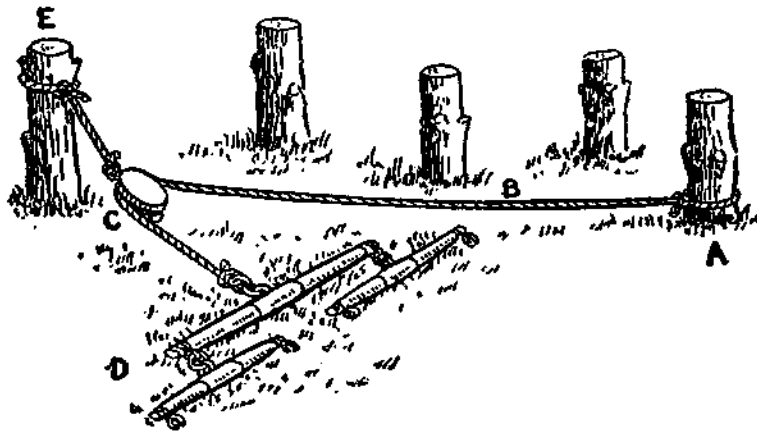

TACKLE FOR STUMP-PULLING

pull 200 or more a day by this means. The limbs are cut off and the stumps, E, left as long as possible. A short rope or chain with a single pulley is attached to the top of the stump. The anchor rope, B, which runs through the pulley, is fastened to the bottom of a stout stump, A.

A pair of steady horses is attached to the rope and always pull toward the anchor stump. With

a steady pull there is no jumping or jerking, and they will walk right off as if pulling a loaded wagon. Use about 60 feet of 1-inch rope, which costs \$2.40, and the pulley, \$1.75, making a total cost of \$4.15.

SIMPLE LAND MEASURE

Having much land measuring to do that requires greater accuracy than just "stepping it off," make a simple affair like this.

The manner of construction is made plain. Use hardwood pieces; $\frac{5}{8}$ or $\frac{3}{4}$ x 1 inch is heavy enough. Have lower points exactly 5 feet 6 inches apart. Make a round head on the handle. Grasp the top lightly in hand, holding at the side, whirl handle to bring rear point to front, moving off in direction to be measured. Continue to revolve measure, changing points in advancing. It takes three lengths to the rod.

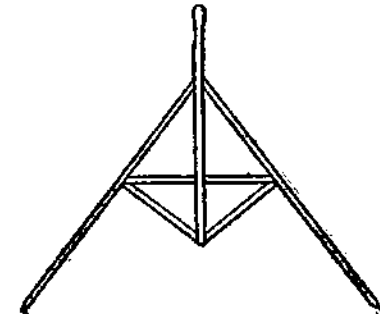

THE MEASURE

STORING WATER

An easy way to make a reservoir at the spring is to throw up a bank, perhaps laying a wall first, founding it below the surface. Should the soil be such that water percolates through it, face the soil with loam on top and puddle it well. If this leaks, face it with clay and puddle the clay. These rules apply to all dams made of stone and earth.

Pipes entering reservoirs should enter at the bottom and the soil be well puddled around them

to prevent the water working through beside the pipe. Each pipe must have a strainer over its supply end and have no air holes in its entire length.

A good strainer can be made from a piece of large lead pipe punched full of holes. One end may be flattened or turned over and the other drawn on over the end of the water pipe. Let nobody suppose that simple, inexpensive arrangements are faulty because primitive. If constructed correctly and in line with natural laws, they are not only all right, but are preferable to fancy, complicated devices that get out of order easily or in a year or two and require a master mechanic to put them into working condition again.

GETTING A SUPPLY OF FUEL



A PLAN for getting up the year's supply of fuel is suggested as follows: Fell the trees on the ground with a small sapling under them, so a log chain can be passed beneath. Then a logging bob (Figure 1) is tipped up on its side near the end of the log; a chain is hooked to the bolster near the ground, passed under the log and over the top runner of the bob and the team hitched to the end of the chain. A quick pull of the team and the bob comes down on both runners, with the log on the top of the bolster.

The log is now drawn to some sheltered place near the woodhouse and sawed into stove lengths with a 6-inch crosscut saw on the skidway shown in Figure 2. The limbs are trimmed in the woods, drawn on a pair of bobs to the shop, where there

is a three-horse power boiler and two-horse power engine, and are sawed at the rate of $1\frac{1}{2}$ cords an

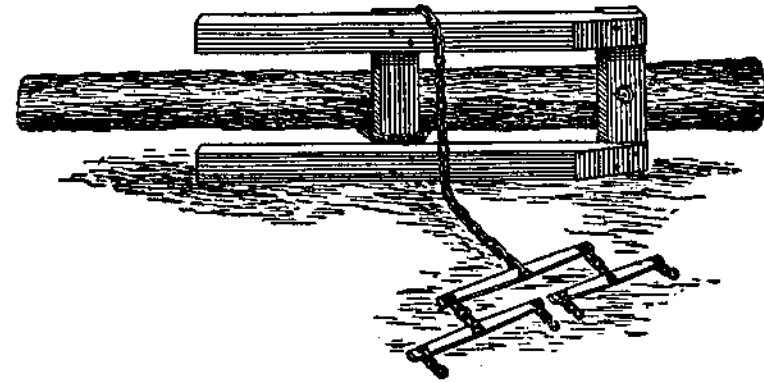

FIGURE 1—LOGGING BOB

hour with a buzz saw. A handy device can be made of two crotched limbs, as shown in Figure 3, to saw large limbs on. A 2-inch auger hole is

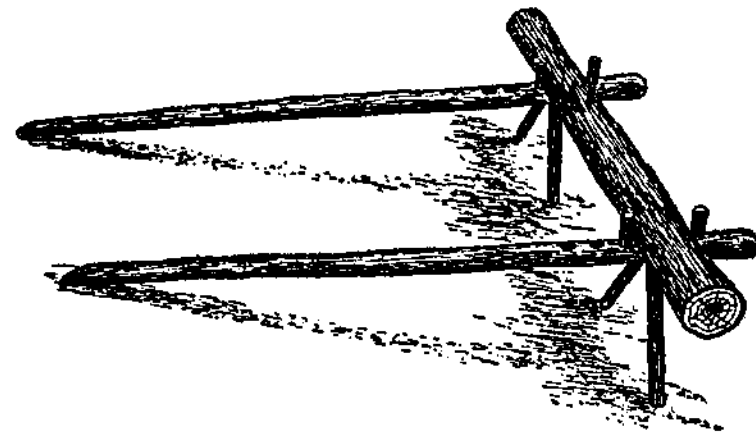

FIGURE 2—SKIDWAY

bored where the limbs branch, and a hardwood limb driven tightly into the hole.

The following described device (Figure 4) is very handy to hold and lower the tree after sawing

the stump off. [*a*, planks with holes bored in them; *b*, log; *c*, chain; *d*, crotched limb; *ee*, lever; *f*, iron pins.] It is made of two hardwood planks about 8 x 5 inches and 1½ inches thick bolted together at the top and bottom, with a 2-inch space between

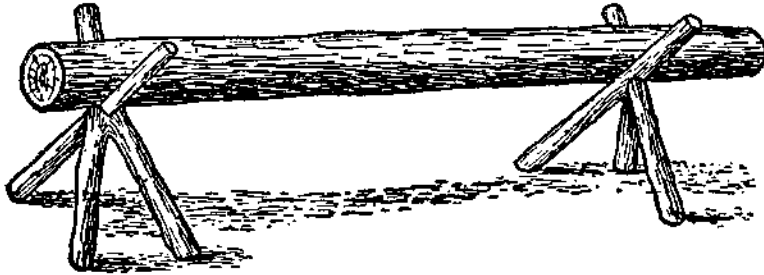

FIGURE 3—HANDY SAWHORSE

for the lever to work in. One-inch holes are bored through the sides of both planks, in which iron pins are placed for the lever to pry over. The lever is made of white ash, and has two notches near the large end, with a chain link attached midway be-

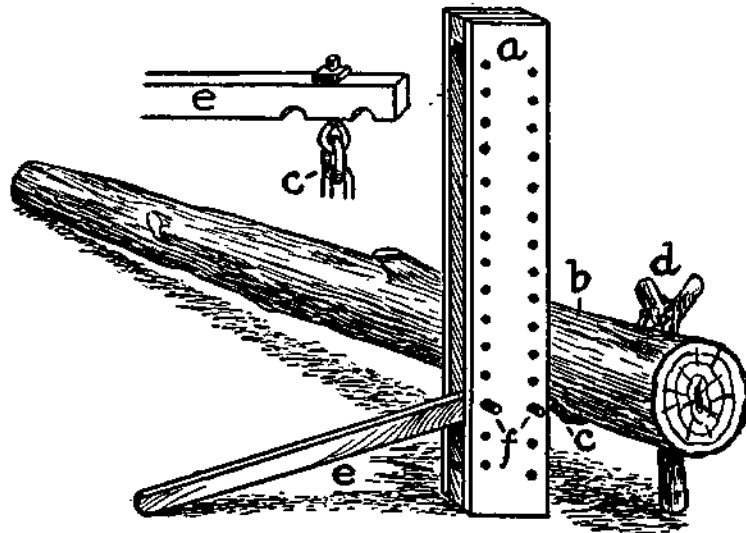

FIGURE 4—LOG JACK

tween notches. A stout chain is hooked in the link, passed under the log, and attached to a crotched limb leaning slightly against the opposite side of the log. By working the small end of the lever up and down and moving the pins up one hole at a time, a good-sized tree can be raised from the ground high enough to be sawed easily without a backache.

SIMPLEST OF ALL CAMPING TENTS

The great trouble with camping-out tents is the weight of the frame, but the weight of the latter in

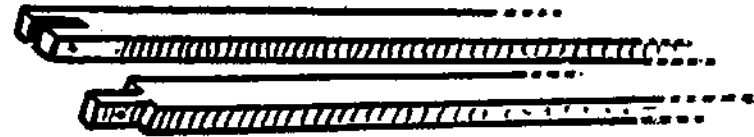

Fig 1

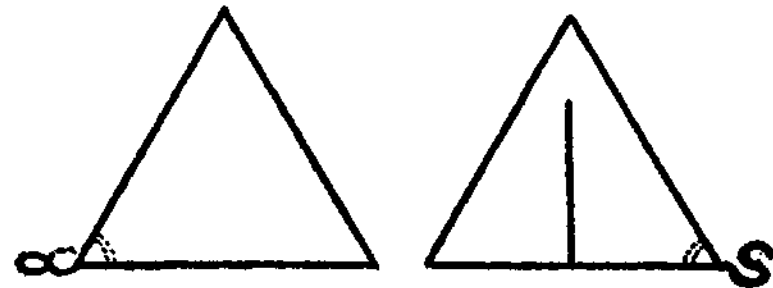

Fig 2

DETAILS OF TENT

the case of the tent figured herewith will hardly prove a burden to anyone, as only two light sticks are used, such as are shown in Figure 1. These

are pressed into the ground 8 or 10 feet apart, according to the size of the tent, and brought together and fastened at the upper ends with such a joint as is shown, or with a string passing through a screw-eye in each pole, if a simpler method is preferred.

The tent is made from four triangular pieces of cloth, as suggested in Figure 2. One of these is cut up the center and hemmed, to afford an entrance to the tent. The triangular pieces are sewed together at the edges and at two of the opposite



THE TENT SET UP

corners pieces of stout cord are sewed into the corners of the cloth, the cloth being reinforced as suggested in the cut.

Two stout pegs of wood and two lighter ones are provided. To pitch the tent, put up the two frame poles A-fashion and draw the tent cloth over them, opposite seams and corners fitting over the poles. Draw out the other two corners and tie by the ropes to the stout pegs which have been driven into the ground. The two lighter pegs are

used to fasten back the flaps of the front. It may be found well to hem a light cord into the bottom of the side having the opening, leaving the flaps free from the cord. The position of the cord is shown by the dotted line. It will not be in the way when lying across the opening of the tent on the ground and will strengthen the whole when the outer corners are drawn tightly up to the stout pegs.

This makes a practically square tent and the size can be as large or small as may be desired. To cut the side pieces, decide on the width of the sides and the height you wish the tent to be. Then draw a triangle (Figure 2), having the base as long as desired for the side of the tent, and a perpendicular 2 feet longer than the height desired for the tent, since the four sides of the tent are to be inclined, and must, therefore, be enough longer to make up for this.

This will prove a very satisfactory tent for boys who are camping out, and it has the merit of being easily made and very easy to carry about.



KEEPING A GATE FROM SAGGING



THE average farm gate is heavy, and after a little time it sags. When they get this way it takes a strong man to open and shut one. Here is a remedy. Get a wheel, either big or little, from an old piece of machinery, and bolt it to the front end of the gate in such a way that the gate will be held level. Now the smallest child can open

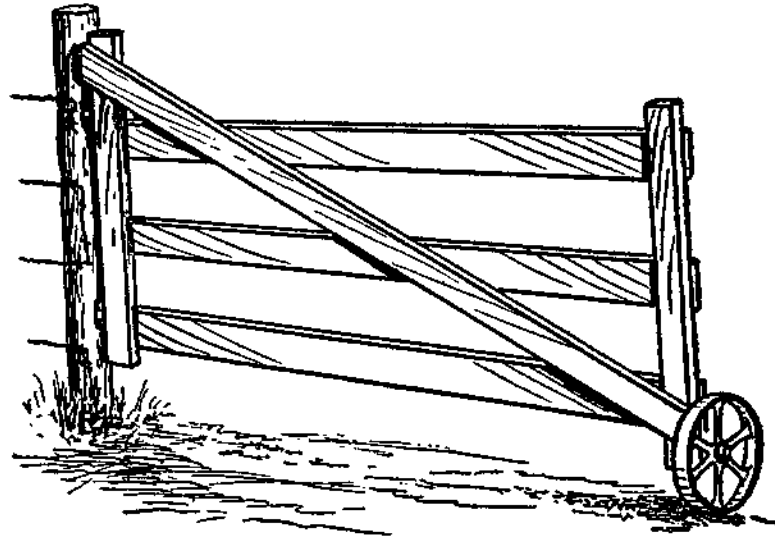

OLD PLOW WHEEL DOES THE TRICK

the gate for you. Try it, for it is a saver—saves your patience, your back and the gate.

AN EASILY OPENED GATE

Take an old buggy wheel and fasten it as shown in the drawing to the gates that are opened often. The piece of board indicated by *c* drops between

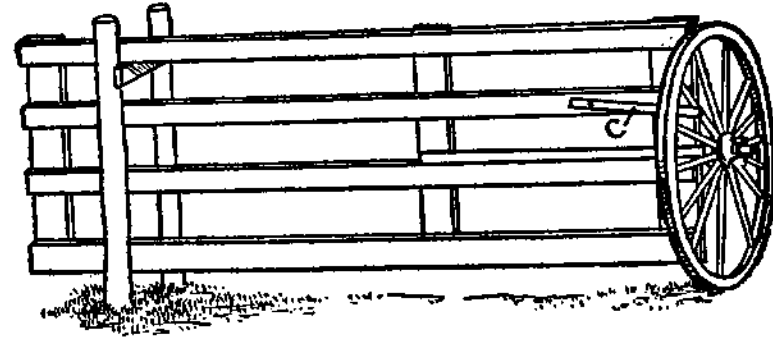

GOOD USE FOR A WHEEL

the spokes of the wheel and holds the gate either open or closed. A child can easily operate the heaviest gate with this attachment.

A GATE THAT NEVER SAGS

A farmer has used this gate for many years and never spent five minutes repairing it. Countersink



CROSSPIECE

two pieces and pin them together. Then set up two 2 x 4 pieces 2 feet higher than the gate so it can be raised in winter. Mortise and set in between the crosspieces, which are 12 inches apart, the board, *a*, and fasten a cap to the top of the frame. The gate is 16 feet long, 12 feet being for the gateway and 4 feet for the weights to balance it. The frame is of 2 x 4s. Cover the 4-foot end with boards and fill with enough stones to balance it when hung.

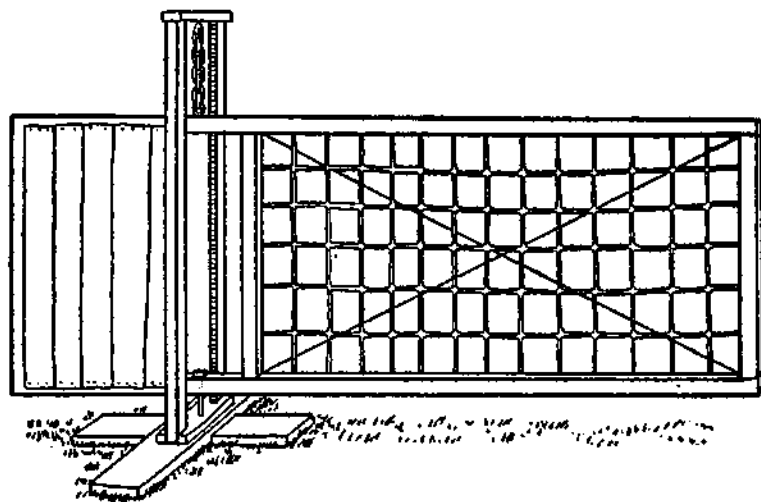

BALANCED WIRE GATE

Cover the gate with wire fencing and hang by a chain. Put a bolt through the lower part of the frame into the crosspiece, *a*.

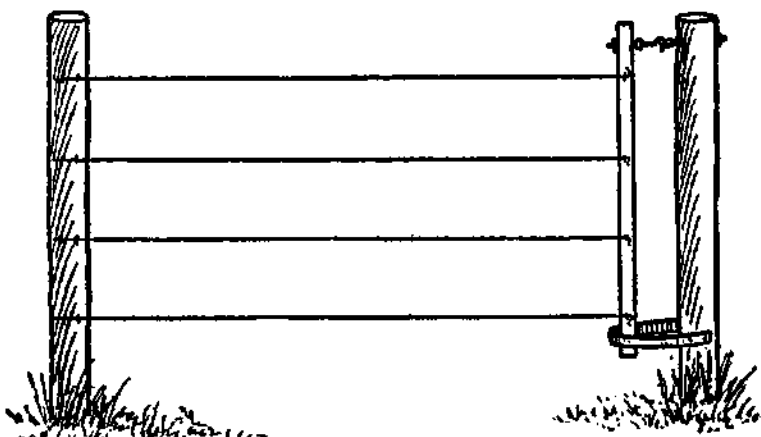

WIRE GATE THAT SPEAKS FOR ITSELF

A CHEAP GATE

A light, useful and durable gate can be made of sassafras poles and barbed wire, as shown in the

cut. Set a strong post 4 feet in the ground in the middle of the gateway and balance the gate on it.

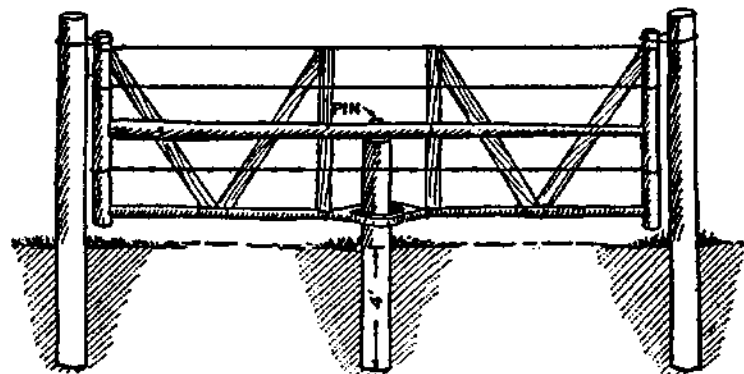

POLE AND WIRE GATE

The lower rail is made of two forked sassafras poles securely nailed together so as to work around the post.

A SIMPLE FARM GATE

Many like such a gate as that shown in the cut. Material to be used depends largely on the purpose for which the gate is made. For a paddock or pasture gate, make it out of seasoned boards 1 x 6 inches, 12 or 14 feet long. The posts supporting

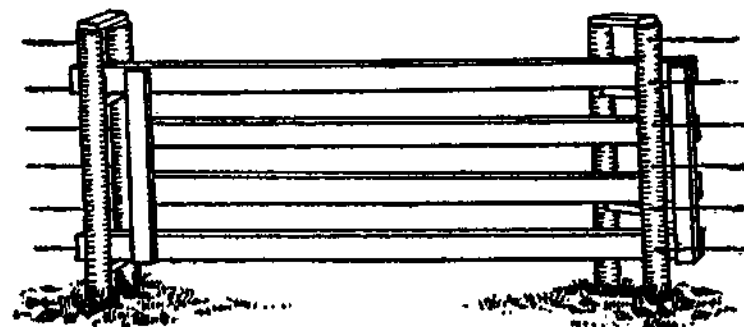

GATE SIMPLE AND STRONG

the gate are about 5 inches apart, the one on the inside being about 8 inches ahead of the other. They are joined together by cleats or rollers which support the gate and allow it to be pushed back and swing open. If rollers are not obtainable, cleats made of any hard wood are good. They need not be heavier than 1 x 4 inches. If the gate is to be used for a hog pasture, the lower cleats on both sets of posts should be placed just above the lower board to prevent the hogs from lifting it up.

AN EASILY REGULATED GATE

The gate hanger illustrated in the drawing is very handy for use where it is desired to let hogs

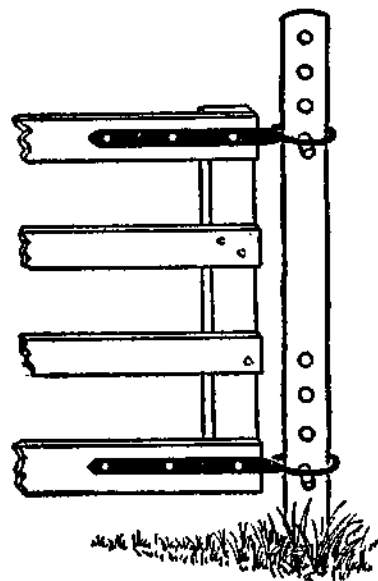

ADJUSTABLE HANGER

pass from one pasture to another while cows are confined to one. As shown, the hanger is a piece of strap iron bent around the post and supported by pegs. These pegs may be inserted in holes at varying heights. Raise the gate to let the hogs through and lower it to keep them in, of course. This is also a good device for raising the gate above the snow in winter. Many would find this use of the adjustable hanger prefer-

able to the gates made to raise only one end for snow. Of course it is desirable that there should be the least play as possible while the hanger

slides up and down freely, and special care should be taken to set the post firmly. Otherwise the gate would sag.

GATE TO OVERCOME SNOWDRIFTS

In the picture is shown a gate which can be readily adjusted to swing over snowdrifts. It is easily made from ordinary lumber. A 1 x 6-inch upright is used for the lower boards, 1 x 4 for the upper ones. The uprights at the hinge post are double 1 x 4, one piece outside and the other inside

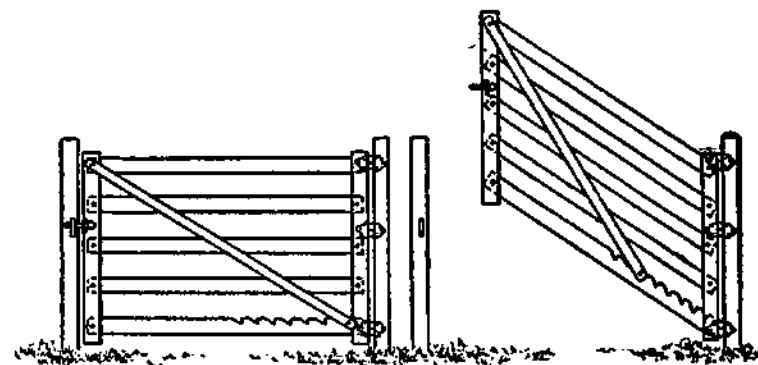

GATE SHUT AND OPEN

the bars. The upright at the latch side may be the same weight of stuff or slightly lighter, and fastened in the same way. Instead of nailing the bars to these uprights, bolts are used, one for each bar at each end. The lowest board is notched as shown, and the double brace used from the top of the latch post to the bottom of the hinge post. For the brace, 1 x 3 stuff is strong enough. They are joined near the bottom with a bolt, which engages with the notches when the gate is raised, as shown at the right.

A TIME SAVER

To open and close gates that stock may be kept within bounds the year round is one thing which uses up a great deal of time, and makes no return. Every gate should be so made that it will fall into

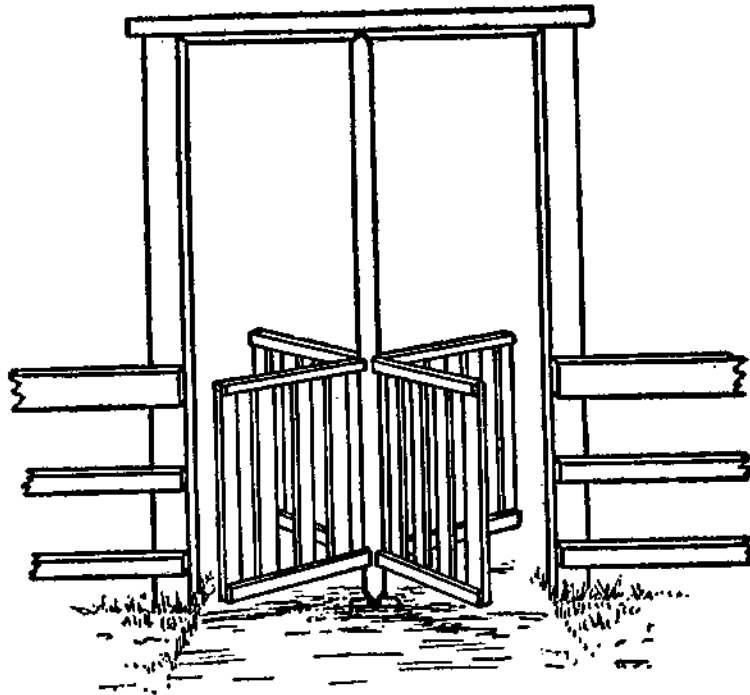

TURNSTILE GATE

place of its own weight and stay closed and open without hitch or bother. The cut illustrates a convenient thing that should be in larger use on farms. It is always open and always closed against stock. Put up and well painted, it will last for many years.

He who keeps company with great men is the last at the table and the first at any toil or danger.

KEEP THE GATE OPEN

A simple and handy device which serves to hold the gate open is shown in the cut. To make it, procure a board, *a*, 1 x 4 x 12 inches and saw out a portion in the center, leaving a space on each side $\frac{1}{2}$ inch wide, and bore holes for a bolt. Next get an 8-inch stick, *b*, and bore a hole through it 3 inches from the top. Bevel the top so that the gate will pass over it, and it will then fall back and hold the gate open. When one's hands and arms are full of things, as they often are on a farm, it is a great convenience to have a gate or door held open automatically. No simpler or more effective device for the purpose can be found. A similar device can be adapted to use as a latch to catch and keep a gate or door closed.

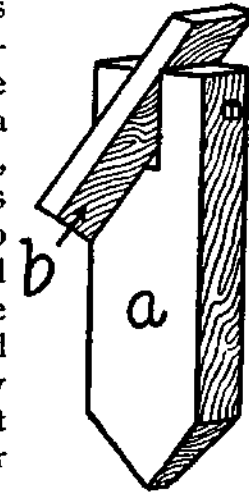

GATE CATCH

GOOD BARS FOR THE FARM

It is an important matter to the farmer that his farm should be well equipped with good, substantial bars. Some farmers go to as much trouble in a year's time in moving a poor gate or bars back and forth as they drive in and out of fields, and in chasing cattle about, as making dozens of such bars as are represented here. Use round poles about $2\frac{1}{2}$ or 3 inches in diameter. Set two good-sized posts one on either side of the barway, and to each one, an equal distance apart, nail large horseshoes, al-

lowing the round part to stand out far enough from posts to admit the bar poles easily.

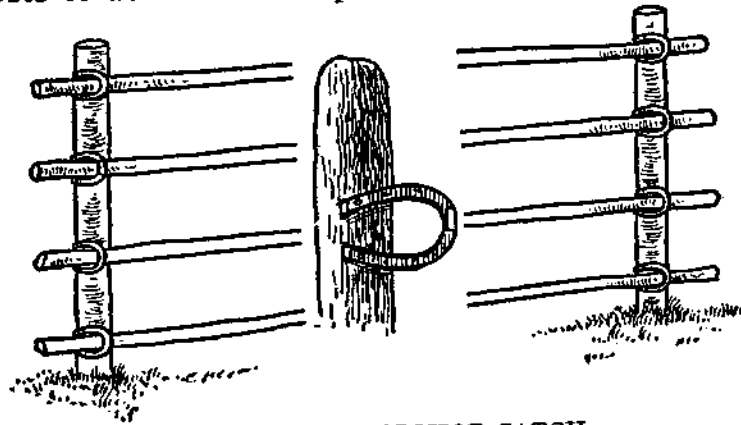

BAR WITH HORSESHOE CATCH

DURABLE FLOATING FENCE

This is a cheap and easy way to make a good, strong cable on which to hang a water gate, when it becomes necessary to have a fence cross a stream: Set two good, large posts about 3 feet deep in the ground and about 6 feet from the banks of the stream. Get a piece of wire (barbed wire will do, but smooth wire makes a much better looking job), long enough to go from one post around the other and back again about six times, being careful to fasten each end securely at the proper height from the ground. Then get a strong piece of wood about 1 x 3 inches and about 4 feet long, stand as near the middle of the space between the two posts as possible, and place the stick between the two sets of wires. Turn around until all the wires are well twisted together, being careful not to twist too much.

On withdrawing the stick, the wires will only untwist two or three times. After the gate is hung, the stick may be again inserted in the same place

and several more twists given to take up the sag caused by the weight of the gate. Then fasten one end of the stick to the top of gate and it will be im-

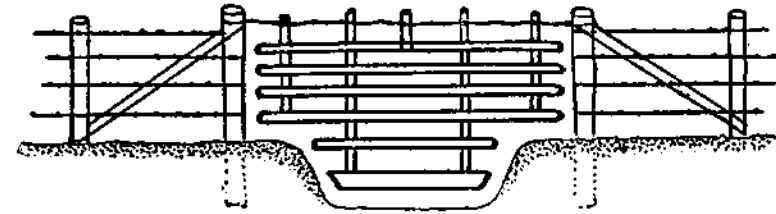

SUSPENDED GATE

possible for the cable to untwist any more. This has been found to answer all the purposes of an expensive cable and looks and lasts just as well.

FENCE ACROSS A STREAM

To construct a fence across a creek or small stream, set a post on each bank and brace well. If a tree happens to be near at the right place, so much the better. Then fasten wire securely on posts, leaving enough slack so a weight in the middle will draw the wires toward the bed of the stream, thus making it impossible for stock of any size to get through. A large stone makes a good weight. It can be blocked up to desired height and fastened in position with smooth wire.

TEMPORARY SHEEP FENCE

One of the best portable fences for use in soiling sheep is made in panels with supports, as shown on next page. Panels are 10 feet long, made of 4-inch board solidly nailed together. After this fence is once put up, sheep are not likely to overturn it. A fence 3½ feet high will turn most flocks.

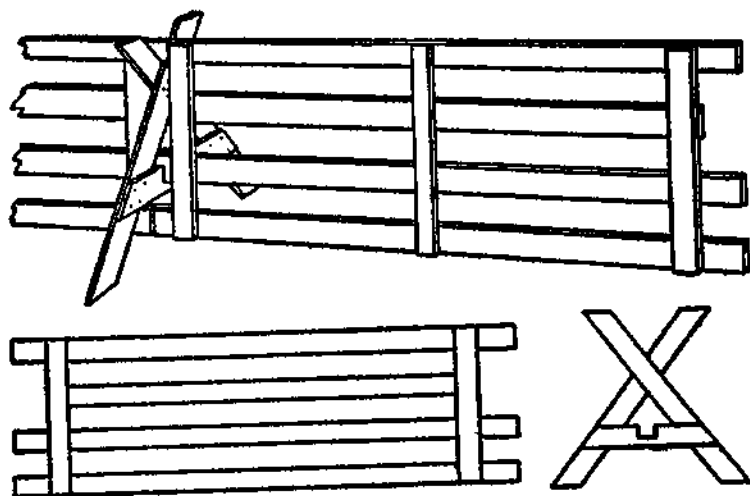

MOVABLE FENCE AND PARTS

FASTENING HEAVY DOORS

There is little difference in the effectiveness of these two locks for heavy doors. The left-hand

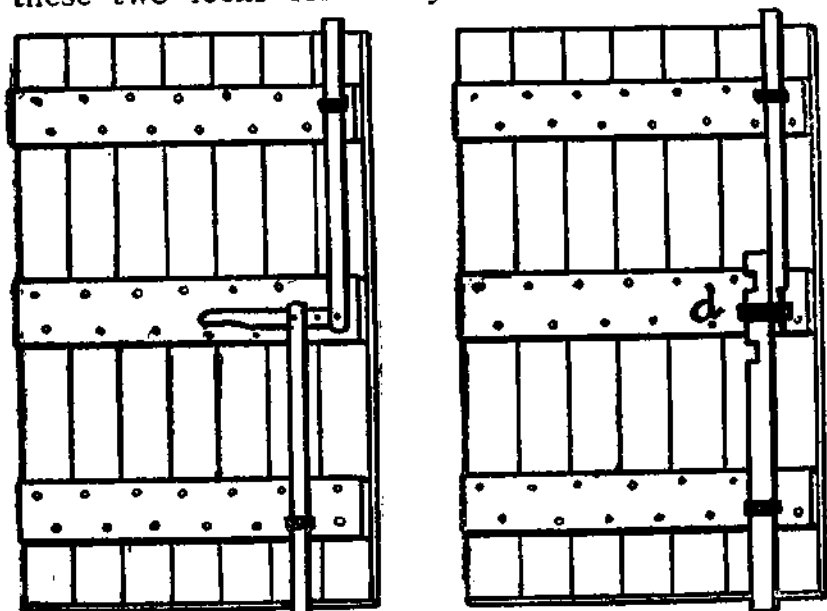

TWO BIG DOOR LOCKS

device is extremely quick and handy; the other very neat and substantial. The lock to the left has both bars pivoted to a lever handle, which is pivoted to the door midway between the ends of the arms. Moving the lever handle up moves both arms out of slots above and below the doors. The fastening may be also worked from the inside by cutting a slot through the door and setting a pin in one of the arms, so that it can be moved in the slot.

The right-hand fastening is worked by raising the lower arm so that the notch incloses the middle staple at *d*. Then the upper arm can be pulled down. Both arms stay firm and snug whether the door is shut or open.

HOLD THE BARN DOORS SHUT

A latch that will hold double doors shut is shown in the cut. This is put on the inside of the door that is closed first. It is made of hardwood 4

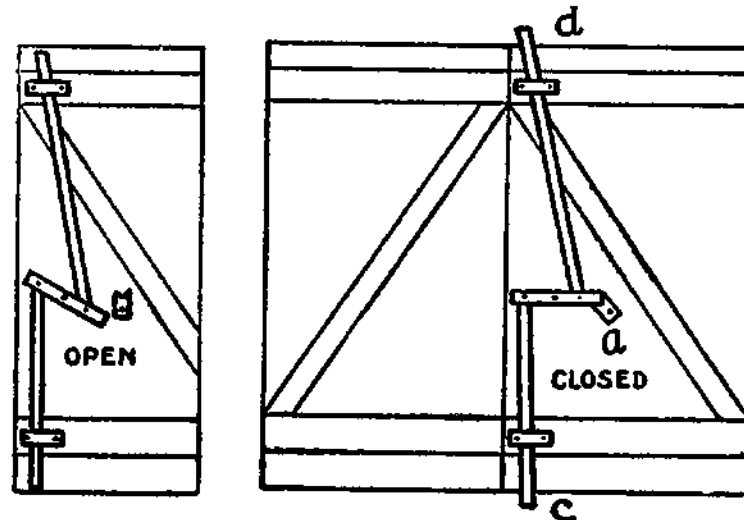

LATCH FOR DOUBLE DOORS

inches wide and 1 inch thick. To open the door, turn the piece, *a*, to the right and pull down on the crosspiece which is fastened to the door by a bolt in the middle. This will raise the latch, *c*, and lower the latch, *d*, as shown in the cut to the right.

Open your doors to a fine day, but make yourself ready for a foul one.

Prosperity is the thing in the world we ought to trust the least.

FASTENING THE STABLE DOOR

A handy stall door fastener is shown in Figure 1. It consists of a piece of oak or other hard wood 4 inches wide by $\frac{7}{8}$ inch thick and 2 inches longer than the width of the door. It is fastened to the door by a $\frac{3}{8}$ -inch bolt through the middle and it works like a button. Cleats, *b*, are sawed out and fastened to the door jamb on each side to hold the fastener in place. Another handy fastener that can be worked from either side of the door is shown in Figure 2.

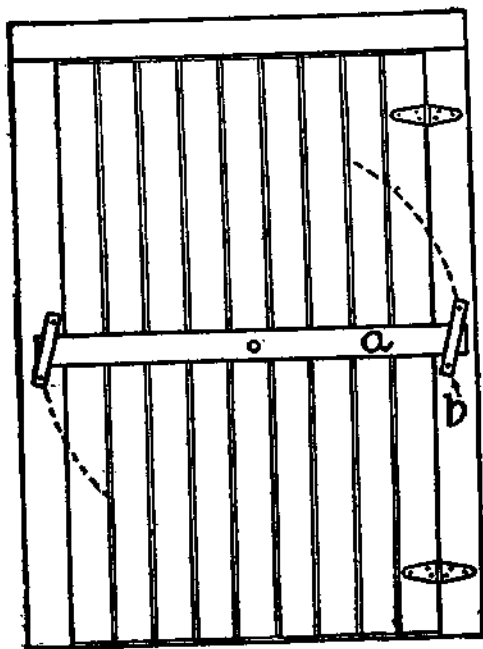

FIGURE 1—LONG FASTENER

There are three upright pieces, *a*, two of which are on the door and one on the door jamb or casings. Another piece, *b*, slides through these and holds the door shut. A pin, *c*, goes through the bolt and through the door to open or shut it from the opposite side. The bolt is kept shut by the spring, which can be made from a piece of hickory, or other tough hardwood, whittled down to the proper thickness. The spring feature is the chief advantage, and a very important one it is, of this excellent fastener. It is also a good point that the fastener works nicely from the opposite side of the door.

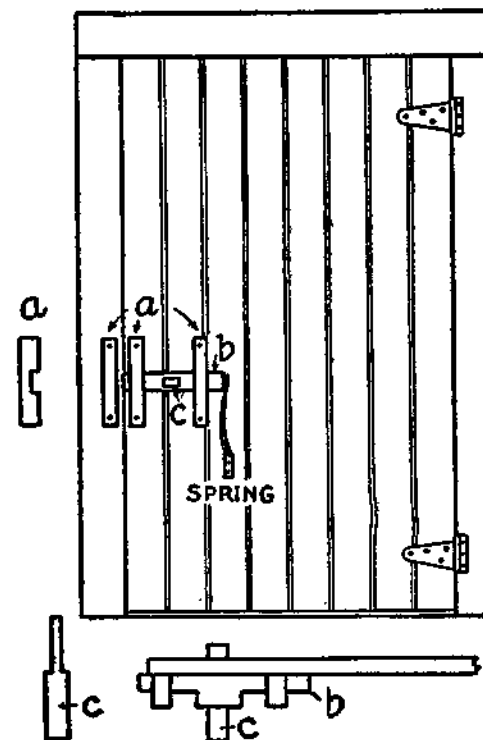

FIGURE 2—SPRING FASTENER

Sell cheap and you will sell as much as four others.

They must hunger in frost that will not work in heat.

'Tis easier to build two chimneys than to maintain one.

HOMEMADE DOOR LATCH

This consists of three pieces of oak or other good hardwood, as shown in the drawing. For the handle use a piece 8 x 2 x 1 inches. Shape a flattish knob on one end 3 inches long. Work down the rest so as to pass through a 1-inch auger hole. Shape a knob on the other end by flattening the sides. The latch is made of a piece 5 x 1 x $\frac{3}{8}$ inches. The catch is 8 x 2 x $\frac{3}{4}$ inches. Bore a 1-inch hole for the handle 3 inches



DETAILS OF LATCH

from the edge of the door. Push the handle through the hole and mark on it the thickness of the door; then bore in the handle a $\frac{3}{8}$ -inch hole for the latch. Now assemble the parts according to the finished figure, which shows the latch thrown back. A little peg may be used to keep the latch from falling down when the door is open. By taking pains to shape and finish this latch nicely it will look well enough to please the artistic eye of the most fastidious.

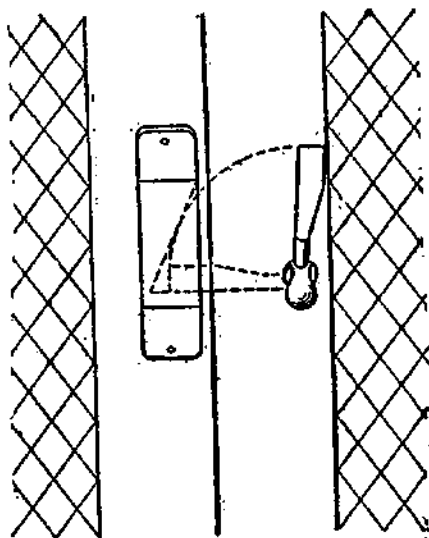

LATCH IN PLACE



IMPORTANT POINTS IN HOUSE BUILDING



THE following points in building a house are considered of the greatest importance by a well-known architect: Carefully watch that the foundation walls are substantially laid, and accurately leveled on their upper surfaces, so that the doors shall not strike the floor or carpets in opening, nor the tables, chairs, or other furniture be obliged to stand on three legs.

The framework, when raised, should be plumb, so that all on or in the building can be cut square, and applied without tedious fitting. The siding should be thoroughly seasoned in the open air before using, and carefully applied with close joints, and well nailed. The edges of all water tables, corner boards, and window frames should be painted before setting.

The shingles should be carefully laid, breaking their joints at one-third of their width and double nailed. The flooring should be dry, close laid, and nailed with two nails to each beam. The partitions should be set with studding of selected width, and their angles or corners should be anchored firmly together to prevent the walls from cracking in those parts when finished. The chimneys should be carefully constructed, all points between the brickwork should be well filled with mortar to prevent sparks from passing through to the framework.

All mortar for plastering should be properly mixed, and allowed sufficient time (at least a week) for the thorough slacking of the lime, and a complete permeation of the caustic properties. Thin coats of plastering are better than heavy ones. A mortar that does not crack in setting or drying is sure to be good.

The interior wood finish should not be begun until the plastering is completely dried out, and all loose mortar is removed from the building. All woodwork usually painted should be primed as soon as in position.

A VERY CONVENIENT HOUSE

The accompanying picture and plans show the outside and interior arrangements of a very convenient home built the past year by one of our

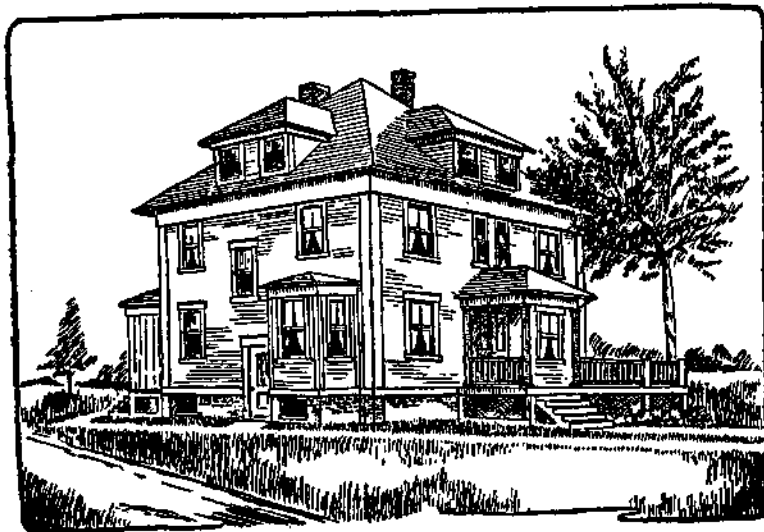

AN ATTRACTIVE HOME

agricultural editors. It is 34 feet wide by 30½ feet deep, with a 7-foot cellar underneath. The house

contains 10 rooms, including two in the attic, besides a storeroom in addition to those shown. All the rooms are of good size and have two or more large windows, which make them light and sunny and supply plenty of good air.

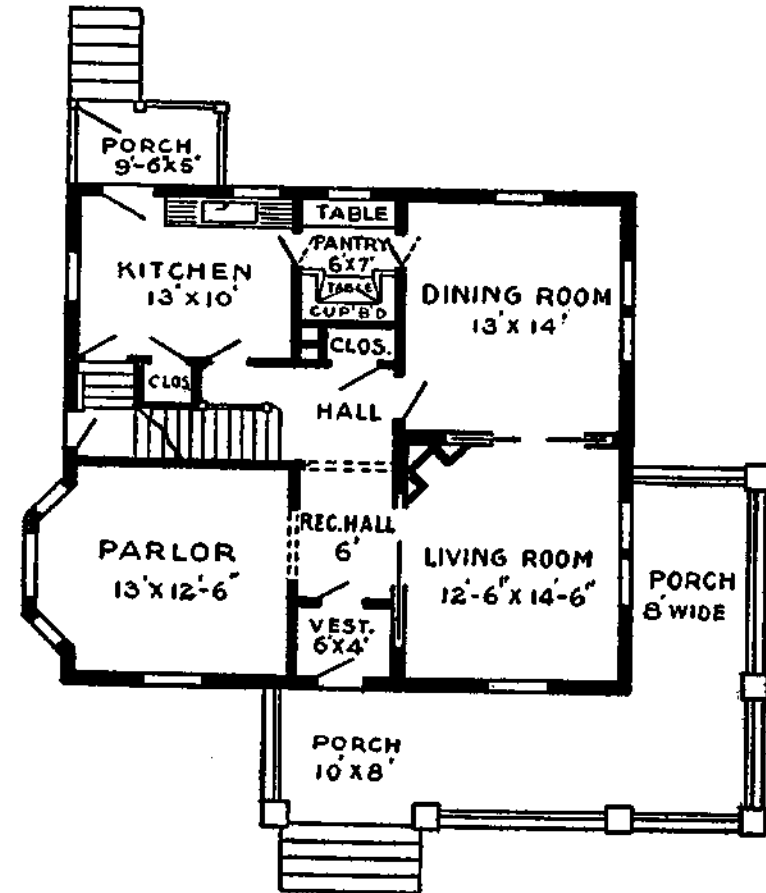

PLAN OF FIRST FLOOR

Economy of construction, as well as of doing the work, was kept in mind in the planning. The location of the stairs is somewhat unusual in a house of this sort, but is such that only one light

is necessary from first to second floor. There are plenty of large closets on the second floor, which are greatly appreciated.

The porch is not roofed except over the door, but

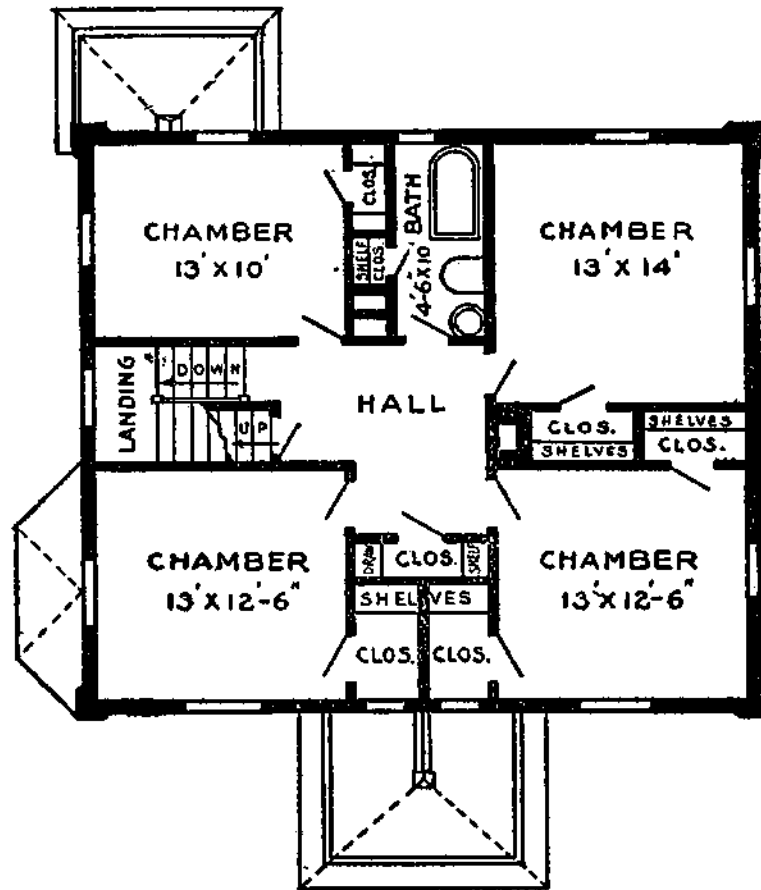

PLAN OF SECOND FLOOR

an awning, which is taken down in the fall, makes it cool and shady in summer, and allows the sunshine to reach the living room in winter. The first story is 9 feet from floor to ceiling, the second 8 feet and the third 7 feet 6 inches. The house

is piped with gas and wired for electricity, provided with the best quality of sanitary plumbing

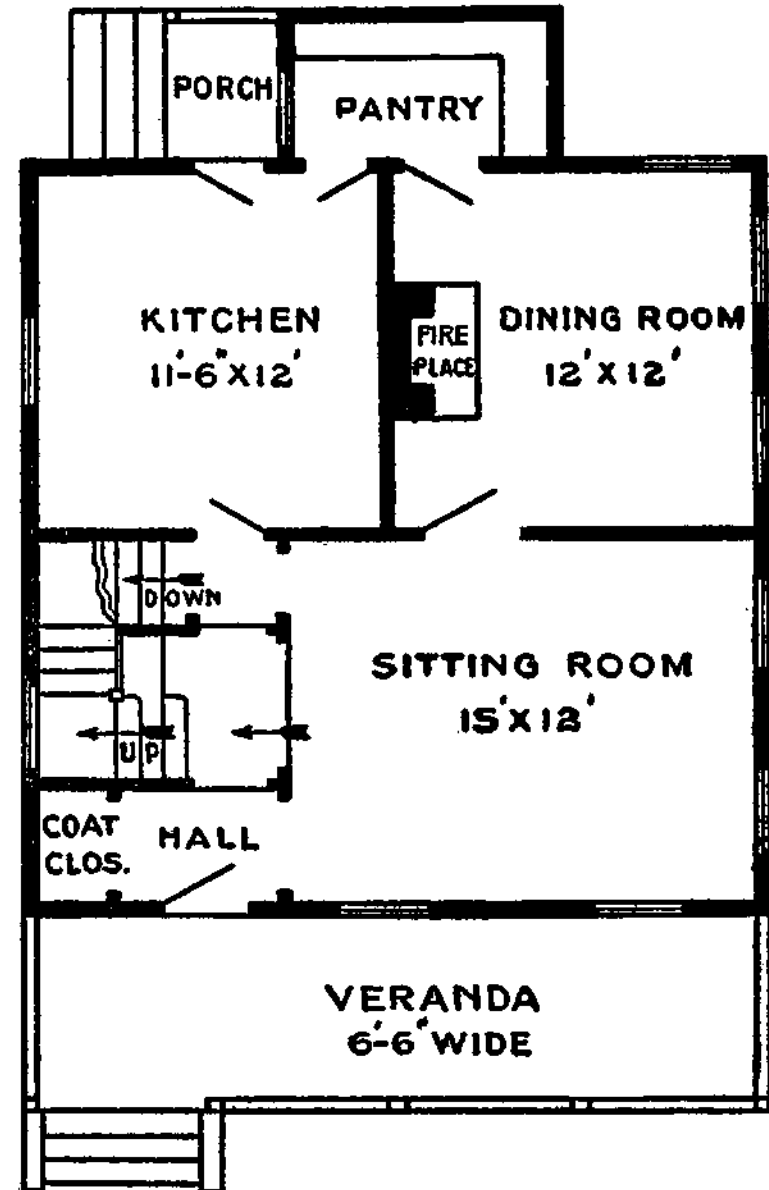

FIRST FLOOR COTTAGE PLAN

and heated with hot air furnace. A similar house can be built for about \$4,000, more or less, according to finish and locality. Occupancy proves it to be a model of convenience.

If a bigger kitchen is desired, it can be obtained by going back farther. Many would prefer a

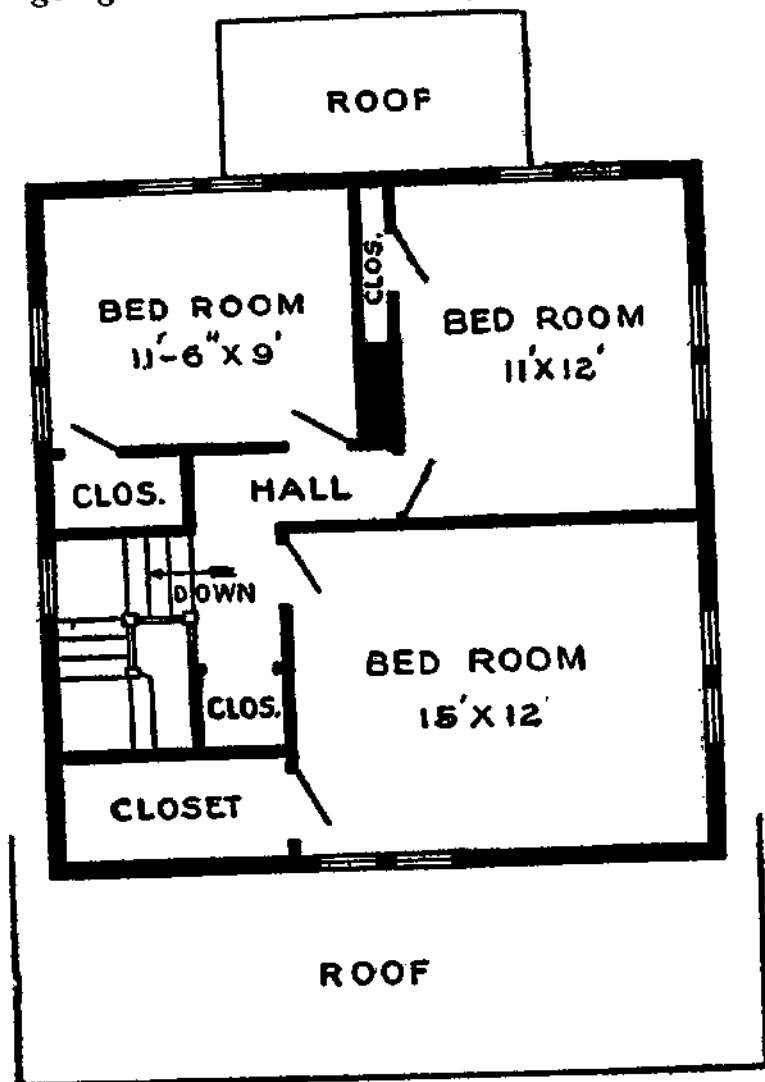

SECOND FLOOR COTTAGE PLAN

wider bathroom. A foot taken from the back chamber on the right would greatly improve the bathroom and still leave a large chamber. If desired, a large roofed piazza can be added.

BUILDING A BLOCK HOUSE

A Kansas farmer needed a house on his farm, but had very little money. He found that only a little was needed for a cement block house. He ordered a cement block machine and bought 12 boards 10 inches wide and 12 feet long, which were cut in seven pieces of equal length. Two cleats were

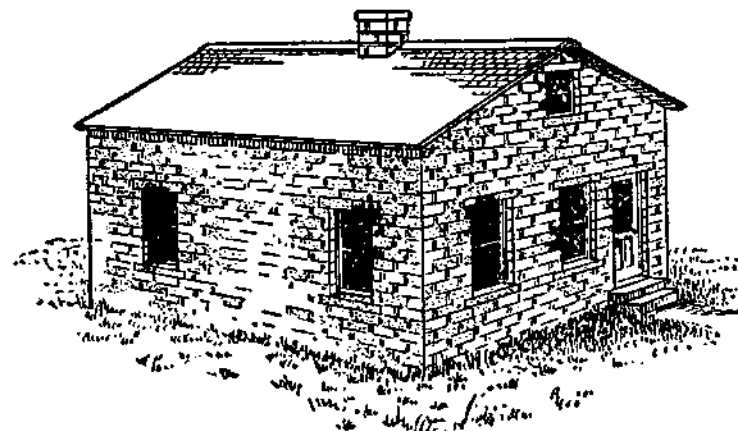

\$400 CEMENT BLOCK HOUSE

nailed on each, about 3 inches from the ends. These were for pallets and cost about 7½ cents each. The cement blocks were 8 x 9 x 18. As the block machine had no attachments, some contrivances were made for making half stone, three-quarter and others.

For caps and sills for doors and windows 9-inch boards were taken, using three for each mold, and

two holes 2 inches from the edges and 3 or 4 inches from the ends of two of them were bored. Then the farmer made cement blocks for the ends 9 x 8 inches, laid the other board on the ground, placed one of the others on each side of it edgewise, put in the end blocks, and through the holes put long bolts and bolted it tight together. Then it was ready to fill with concrete. These boards were as long as were needed to make the caps or sills. A sprinkler, sand shovel, plasterer's trowel, and a wire sieve of $\frac{1}{4}$ -inch mesh were obtained.

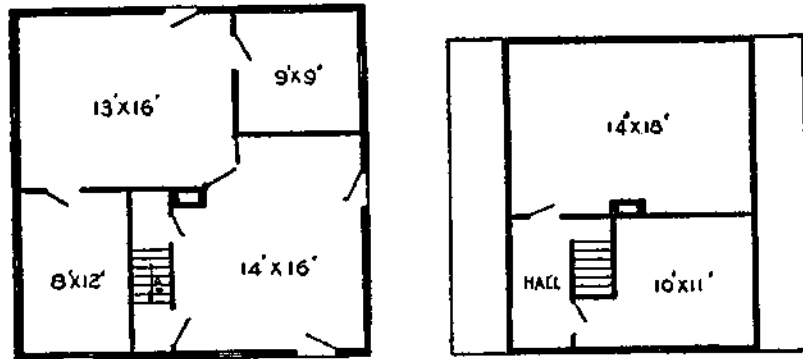

FIRST AND SECOND FLOOR PLANS

The sand cost nothing except hauling. The machine was set up near a spring. A box something like a wagon bed with both ends out was made of boards, the block machine placed in one end and the pile of sand at one side. Three shovels of sand and one of cement were placed in a tub and mixed thoroughly. Then a boy took the sprinkler and sprinkled it while another mixed, until it was dampened evenly all through. Then they spread 35 shovels of sand in the mixing box and shook one sack of cement over it, which made a five-to-one mixture. This was thoroughly mixed

by shoveling and sprinkling until it was good and damp, but not wet. This quantity made ten blocks.

A pallet was placed on the open machine, the machine closed, and some of the richer mixture of concrete placed on the face about 1 inch thick. The mold was then filled with the five-to-one mixture, while one of the boys tamped it, put in the core, and smoothed off the top with a trowel. The core was then carefully lifted out, the machine opened, and the pallet with the stone on it placed on a level piece of ground.

In three or four hours the blocks were ready to sprinkle. When 30 hours old they were placed on end and the pallets used for more stone. After standing for two days, during which time they were sprinkled frequently to keep them damp, they were dumped in the creek, where they were left until ready for use. The foundations were made by first putting into a trench about 6 inches of broken rock, then 4 inches of concrete.

The house is 26 feet square, the walls 12 feet high, with gables north and south. The picture of the house and arrangement of the two floors are shown in the illustrations. We used 12,400 pounds of cement, which cost 60c per 100, or \$74.40. Doors and windows were brought at a cost of \$33.75. Chimney, plastering and lumber for floors, roof, partitions and finishing, all of the best, cost \$240. The hardware was \$30, making the total cost of house \$378.15, not counting cement machine or labor, all of which was done by the family.

Art imitates nature, and necessity is the mother of invention.—Richard Franck.

Consider the end.—Chilo.

A PRACTICAL ROUND BARN

There is no economy in building a round barn, that is, strictly round. The barn here illustrated has 26 sides nearly 12 feet long, making a barn 94 feet in diameter. The sills, plates and roof in a strictly round barn are very expensive, and the work will not last as well as when built as shown. The floor space of the first floor is nearly the same as if round, and the hay loft is very little smaller. If the building is round, the walls should be lathed

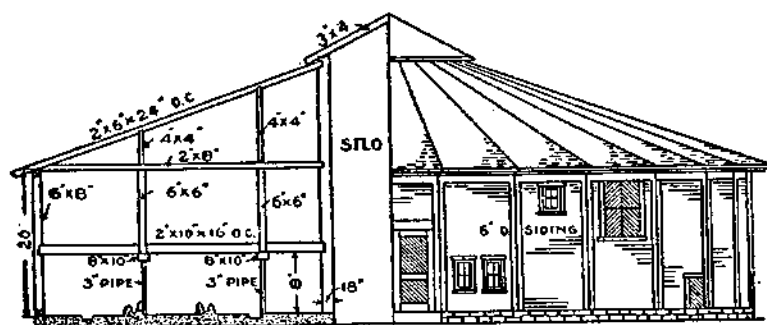

CROSS-SECTION OF BARN

with metal lath, over rough boxing, and plastered with two coats of portland cement. In fact, this finish is to be preferred in building any shaped barn, as it requires no paint and practically no repairs.

The floor plan of the barn shown is self-explanatory. It has stalls for 40 milch cows, three bull pens, two hospital stalls, pen for baby beef that will accommodate about $2\frac{1}{2}$ cars of calves, stalls for seven horses, including the two box stalls, and the feeding room and silo. The silo is 16 x 34 feet, will hold about 140 tons of silage, and requires about ten acres of average corn to fill.

The hay loft has 166,500 cubic feet of space, and deducting the silo and bins for ground feed will hold 300 tons of loose hay. The ground feed is stored in hopper-shaped bins above the feed room, and drawn down through small spouts as wanted. The hay is handled with hay forks, and to locate

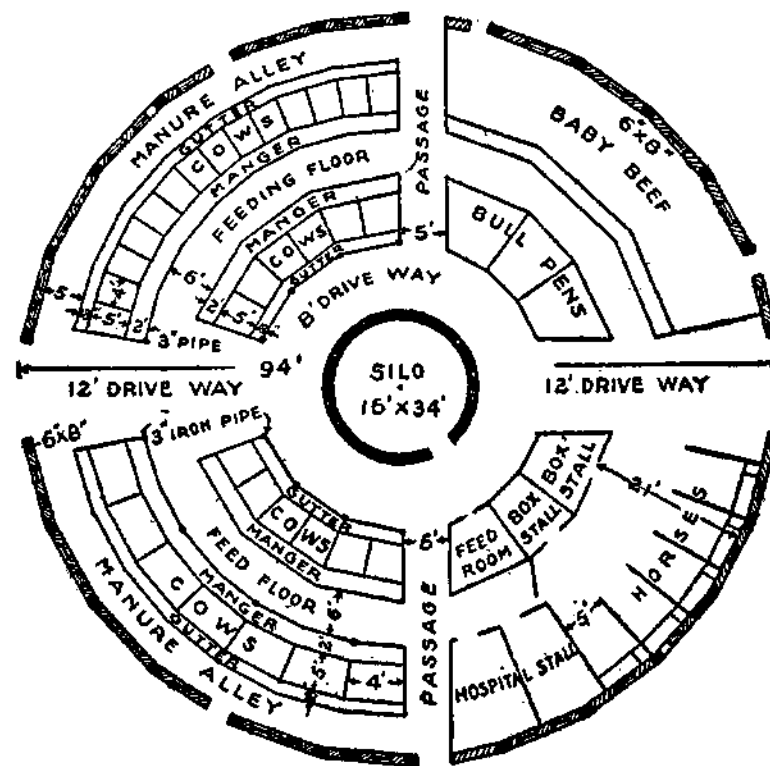

FIRST FLOOR PLAN

the trolleys as near the roof as possible, trap doors are left in the loft floor, and the hay hoisted from the driveways. A circle trolley may be installed, or two straight ones. Several large hay doors are also built in the outside walls above the loft floor. The silo, the floors of the cow stalls, including

the gutters and mangers, also the 8-foot driveway around the silo, are of cement, and, while it is intended to install litter and feed carriers, it is also intended to drive around the entire barn, or the feed floor with a cart if desired. The interior arrangement of first floor may, of course, be changed in several ways, and the cows faced in the opposite direction, etc., or stalls and other equipment arranged for different stock.

The barn, as shown, has about the same floor space as a barn would have 36 feet wide and 180 feet long. The ventilation is always much better in the round barn, the work of caring for and feeding may be accomplished with less labor, there are never any drafts on the stock, the building may be built for less money, and is much stronger. As shown, the barn has a stone foundation, the roof is covered with asbestos roofing felt, and the walls covered with 6-inch drop siding. Everything is of the best, and all exposed woodwork painted two coats. This building would cost about \$4700 without the cow stanchions. Where home labor is used, and the lumber can be secured for less than \$30 per thousand, the barn may, of course, be erected for less.

A WELL-ARRANGED BARN

This Kentucky barn has a frame of oak, 6 x 6 inches. Center posts 23 feet 9 inches; shed posts 16 feet tall; studding and braces 2 x 6-inch poplar; joists 2 x 10-inch poplar, oak and pine. The sheeting is of poplar, beech and ash. The bevel siding is select poplar. Cornice and base, white pine. All doors are two thicknesses, front is dressed cypress and the back dressed white pine. The

lower windows are 10 x 12-inch, 12 lights and upper ones inside the building. The joists are set 20 inches from center to center. The loft is 8½ feet from lower floors.

The floor plan shows the arrangement as follows: Number 1, icehouse, 18 feet deep, walled up with stone; 2, carriage house, 16 x 18 feet; 3, stairs, leading to lumber room over carriage room; 4, corn

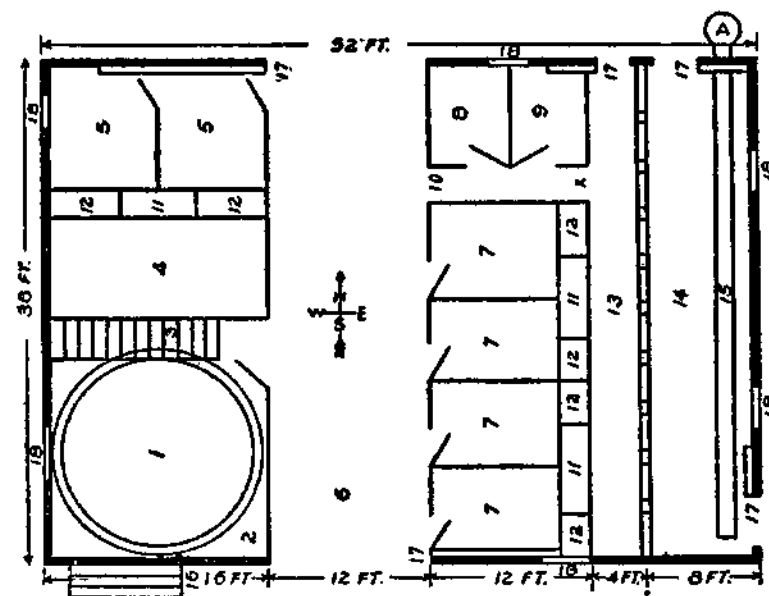

GROUND PLAN OF A KENTUCKY BARN

crib, 8 x 16 feet, over which are the grain bins for wheat and oats. These bins have chutes running down into the corn crib, from which grain is filled into sacks. Numbers 5, 5, are box stalls, 8 x 12 feet; 6, driveway, 12 x 38 feet; 7, 7, 7, 7, box stalls, 6½ x 12 feet; 8, harness room, 6 x 8 feet; 9, feed mixing room, 6 x 8 feet, with spouts running from cutting box and bran bins overhead; 10, alleyway running from driveway to feed alley; 11, 11, 11, hay

chutes, with openings near the bottom, 1 x 2 feet. These openings are directly over the feed boxes and any hay that falls while horses are feeding goes into the boxes and none is wasted. Number 12, feed boxes, 1 x 2 x 2 feet; 13, feeding alley, 4 x 38 feet.

Overhead at X is an opening from the hay loft where alfalfa, clover, cowpeas and hay are kept for the cows; 14, cow shed, 8 x 38 feet. Cows are fastened with stanchions and fed out of boxes on alley floor. The cow shed has concrete floor, with a fall of 2 inches from stanchion to Number 15, the drain basin, which is 1 foot 2 inches wide and 1 foot deep at A, where it runs into a basin made of concrete, 6 x 6 feet and 2 feet deep; 16, driveway into carriage room; 17, openings in which siding doors hang when open; 18, windows.

The roof is of tin, standing seams, with Yankee gutters made on the lower edge of the roof. An opening 10 x 10 feet in the center of the driveway loft is allowed for hay and other feed taken up by an unloader that runs on a track in comb of roof. The barn will cost about \$1500—more or less, according to cost of building material where it is erected.

A HANDY SMALL BARN

This barn is arranged to meet the needs of a small farm. It can be built in most localities at a cost not to exceed \$500, and if a farmer has his own timber, at even less cost. The outside dimensions are 36 x 48 feet, and it is 16 feet to the eaves, with a curb roof. The stables should be about 8 feet high, which allows plenty of loft room above for hay.

In the floor plan the cow stalls, A, can be made of any width desired, 3½ feet being best for general purposes. At B are two large box stalls for cows with young calves. The mangers, C, are 18 inches wide, with a rack for hay or fodder above. At D is the feed room and alley, which is 8 feet wide. At E are the mangers for the horses, with

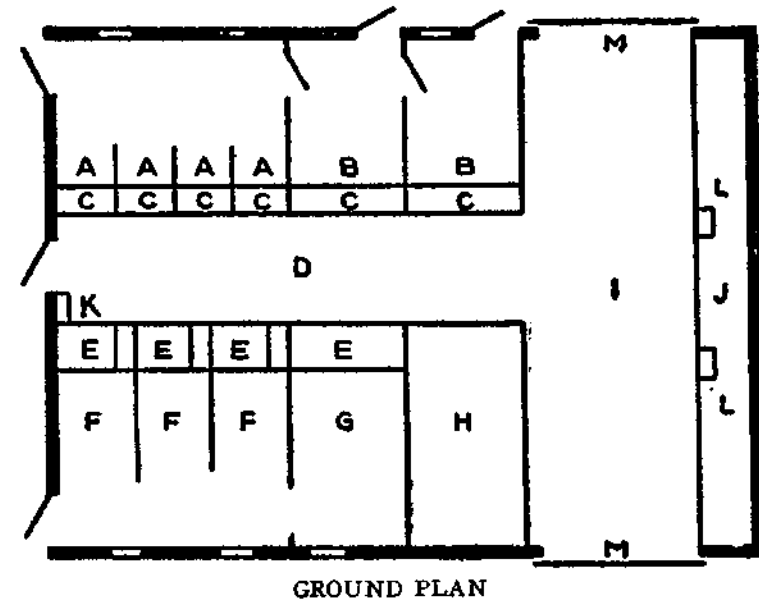

a feed box at the right side. At F are three horse stalls 4 feet wide, in which horses can be tied. At G is a large box stall for mares and colts.

At H is provided the granary, which can be subdivided into bins as necessary. The portion I is the driveway, which affords ample storage space for tools, wagons, etc., and is used as a driveway when hay is being elevated into the loft above.

There is a large corn crib, J, at the end, which can be filled from the outside and emptied from the inside. It is narrow and so arranged that the

corn will dry out quickly. Chutes from this bin should be provided at L. A ladder to the hay loft at K is a convenience which should not be omitted.

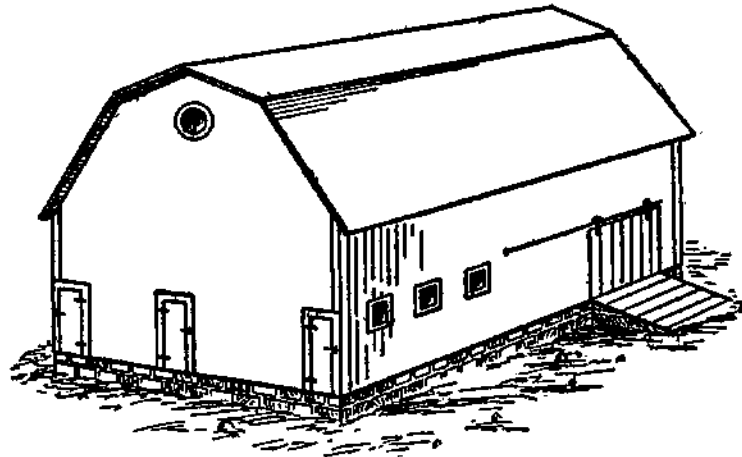

VIEW OF COMPLETED BARN

THE FARMER'S ICEHOUSE

In a properly constructed icehouse, and when the ice is properly packed and cared for, no waste should take place from the inside of the pile of ice. The melting from the sides, bottom and top is caused by insufficient insulation. The waste from the bottom is generally the greatest. The amount of ice melted in the bottom of the icehouse varies from 1 to 6 feet during the year, depending upon the construction of the floor. If the icehouse is provided with an airtight floor, with the ice laid on at least 18 inches of dry sawdust, the bottom waste rarely exceeds 12 inches during the year; on the other hand, if the ice is piled in the icehouse on the bare ground without any insulation under it, or any provision made for drainage, the meltage fre-

quently is 6 feet. The side and top meltage is not so great, but it frequently ranges from 1 to 3 feet, depending upon the insulation.

Location and Building

The location should be where the ice can be removed and delivered with the least amount of labor; however, it is very important that the icehouse should be located in the coolest place, in as dry a place as possible, and always above ground. The lowest layer of ice should always be at least 6 inches above the outside level of ground.

The size of the building must be determined by the amount of ice used during the year. For instance, a dairy farm upon which 35 cows are kept, and from which the milk is sold, needs an icehouse 16 x 16 and 14 feet high. If the cream is to be sold and skim milk fed to the calves, immediately from the separator, an icehouse 14 x 14 and 12 feet high is of sufficient size. In both cases we make allowance for the use of 25 pounds of ice per day during the summer months for household purposes. For a man who keeps about 20 cows and sells the milk, an icehouse 14 x 14 and 12 feet high is of sufficient size; however, in no case should an icehouse be smaller than 12 x 12 and 10 feet high, because the outside surface is too great, compared with the volume, and, therefore, too much ice is wasted in proportion to the amount used.

The building should be as near the shape of a cube as possible, for the cube contains the greatest amount of volume with the least amount of surface exposed other than circular forms. It is not always practical to build as high as we build square,

owing to the amount of labor and the inconvenience of storing the ice; therefore, the dimensions given are really the most practical.

If the icehouse is not built upon a sandy surface and where rapid drainage is natural, it is

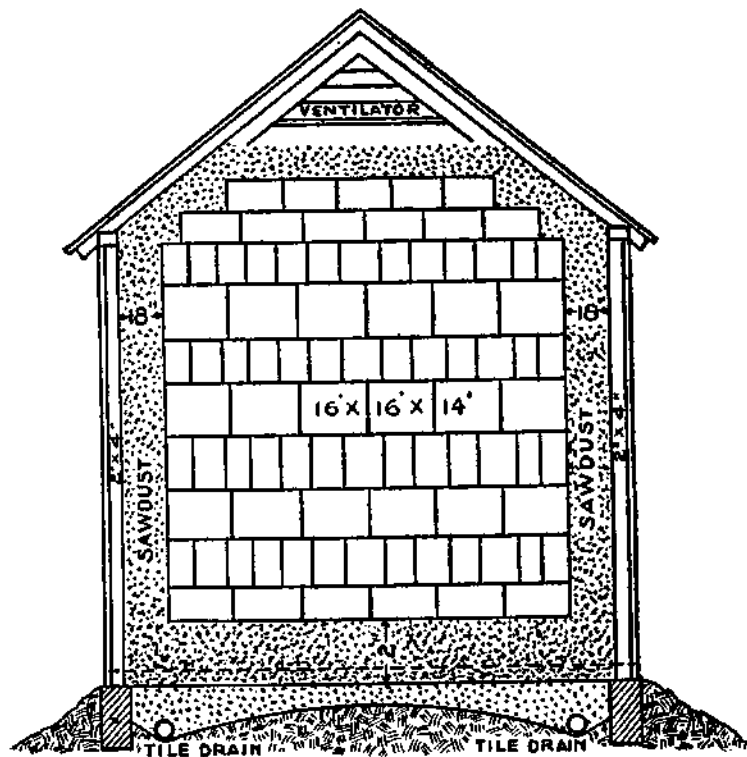

CROSS-SECTION OF ICEHOUSE

necessary to cut a space to a depth of 12 to 18 inches, where the icehouse is to be located, lay a tile drain to drain this, and fill it with sand or finely crushed stone. Put a 6-inch foundation of concrete of the size you wish to build your icehouse in this pit, and fill around the outside.

Framing the Icehouse

The framework is made by laying 2 x 4-inch sill on the concrete foundation; fasten this to the foundation by cementing a few bolts into the concrete and allowing them to extend through the sill; 2 x 4 studding are then placed upon the sill, 16 inches apart from center to center. The rafters for the roof are likewise made of 2 x 4's, placed the same distance apart as the studding, but the purlin plate upon the studding should be at least 6 inches wide. The outside of studding may be boarded either with common sheeting and paper, upon which poplar siding is nailed, or with patent siding or ship-lap siding, the latter being the cheapest and requiring only a single thickness of board.

The roof should be made with not less than one-half to one-third pitch, and preferably covered with shingles, for shingles are better insulators than either slate or metal. Paper may sometimes be used to good advantage. A cupola or flue should be built upon the roof to allow for the removal of the warm air from the top of the ice. A ventilator may be placed in the gable end,

A continuous door should be cut in one end to allow the ice to be put in. This door may extend from the gable down to within 5 feet of the bottom.

Before putting in the ice place from 18 inches to 2 feet of sawdust or dry peat upon the floor. The ice should be harvested in regular shape, oblong, rather than square, and not less than 18 inches in width and 30 inches in length.

Ice and Milk Houses Combined

The side elevation of an icehouse with milkhouse attached is presented in the drawing. It shows the

advantage of utilizing the water from the icehouse for cooling the milk. No ice needs to be removed from the icehouse. It operates automatically. If the weather is warm the ice melts more rapidly and keeps water in the tank at the required temperature.

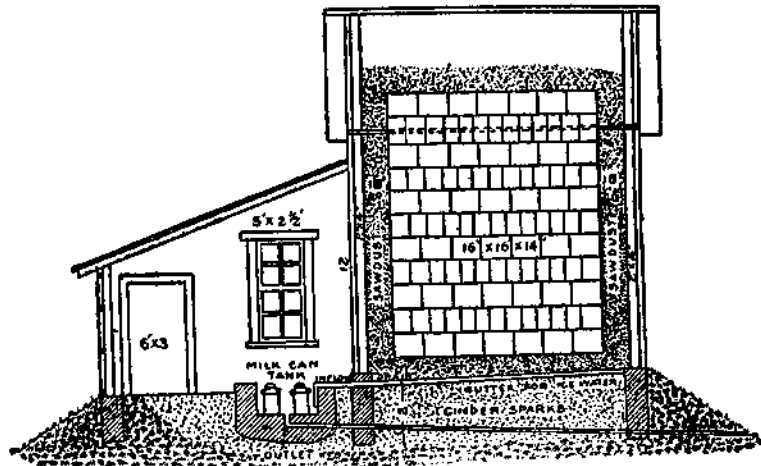

A GOOD COLD COMBINATION

SMALL GREENHOUSES

The farmer who would make his crops of vegetables most profitable, or the small gardener who would have an early supply of early vegetables for home use or market must employ some kind of glass structures to hasten these crops. The hot-bed or cold frame have been much in use in the past, but the cost of sash, shutters and mats is nearly as much as the materials needed for a permanent structure, while the labor of caring for cold frames or hotbeds is often much more than that of the small greenhouse. In the latter one may work with comfort no matter what the weather may be outside. It requires much more skill to run hotbeds successfully.

Small greenhouses may be built against the south side of the house or stable, Figures 1 and 2, or they may be built entirely away from other buildings, but the shelter of larger buildings on the north or west will be found of great advantage. If one has a basement to the house or stable, a lean-to house may be built, and heat from the open cellar in a large measure will heat the greenhouse in the mild weather of fall and spring.

Material for Construction

A cheap and efficient house may be made by setting chestnut or cedar posts in the ground, covering the sides with lining boards, then two thicknesses of tarred building paper and sheathing

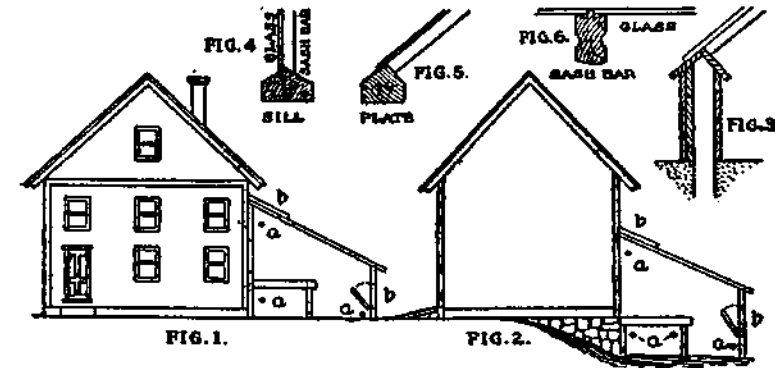

DETAILS FOR SMALL GREENHOUSES

outside, Figure 3. Cement, stone or brick will be cheaper in the end. The durability of glass structures will depend much upon the form of the materials. Clear cypress is now more used than any other material. Sills should be of the form shown in Figure 4. Plates may be made of plank as in

Figure 3, or as in Figure 5. Sash bars should have grooves along the sides to catch the drip from the glass, as in Figure 6.

The glass for ordinary work may be No. 2 double thick, large sizes, 16 x 20 inches or 20 x 24 inches, being much used. Smaller sizes will be cheaper in price, but more sash bars will be needed, and they cut off much of the sunlight. The glass should be put in with putty, made with about one-third white lead in it, and firmly tacked with triangular zinc tacks of large size, or the double-pointed tacks, which are so bent as to prevent the glass from slipping down.

Set Glass in Warm Weather

Glazing should be done during the summer or early fall, as putty will soon become loose if frozen before well hardened.

In building there should be no mortises, but all joints be made by toeing in with long, slender nails. All woodwork should be thoroughly painted before fitting, and all joints filled with white lead paint. After all is done the frame should be painted before the glass is put in.

The most important and expensive feature of the small greenhouse is the heating. If one has a hot water or steam heater in the house, to which the glass house is attached, it will be a very simple matter to carry pipes through, as at *a, a*, Figures 1 and 2. Hot air also may be let into such houses, or a small kerosene heater in very cold weather may be used, if the house is built opening into the cellar.

Ventilators must be located as shown in Figures 1 and 2, at *b, b*. Very small structures may be

run without much heat if opening into cellars or other heated rooms by having shutters or curtains to draw down at night and in very cold, cloudy weather.

Covering with Hotbed Sash

Houses of small size may be made by building a frame upon which hotbed sash may be screwed. If one has the sash this is a cheap way of building, and such a house has the advantage that the sash may be entirely removed during the summer, but it is very difficult to make a close house with such sash.

The woodwork of greenhouses and hotbed sash should have a coat of thin linseed oil paint every second year. Much of the success to be obtained from any glass structure will depend upon the skill of the operator, and the thermometer, both outside and in, must be watched very closely. The temperature should be maintained as nearly as possible like that in the open air under which the plants grown thrive the best.

WIRE FENCE CORN CRIB

In the drawing is shown a handy, inexpensive corn crib, which possesses several advantages not possessed by the ordinary slat corn crib. It is made on 4 x 4-inch posts, with pans at their tops, to prevent rats from climbing in. The sills are 4 x 4-inch, the scantlings 2 x 4, and 2 feet apart. The fencing is nailed to these on all sides, and the door frame is similarly covered. The roof is made wide, so as to shed all possible water. The height, length

and width may suit the farmer's convenience. A convenient width is about 5 feet at the floor, widening to 7 feet at the eaves. Owing to the very open

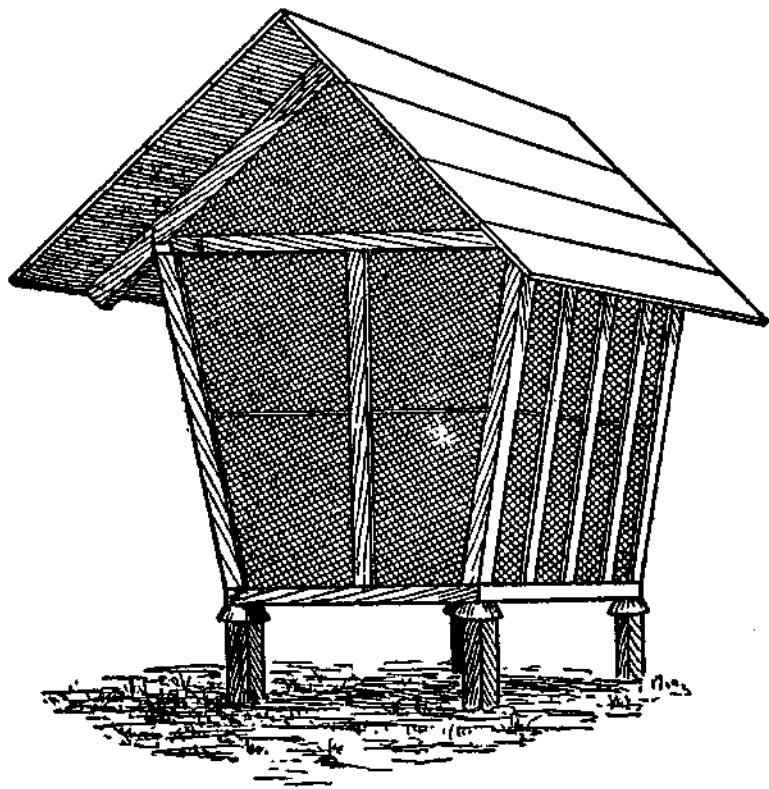

THE CORN CRIB

nature of this crib, corn dries more quickly than in a slat crib, and as there is less chance for water to lodge in the cracks, the crib will be more durable than if built entirely of wood.

Want of cure does us more damage than want of knowledge.

HOW TO LAY A FLOOR

To lay a floor or board ceiling just right, and do the work fast, use a good lever, as in the illustration, taking for the supports two 1 x 4-inch pieces as long as the width of the room. The upright arm is 4 feet long with a hole 4 inches from the lower end and through which it is pinned loosely between the ends of the supports. With a little practice, a good carpenter's job can be done on floor or ceiling.

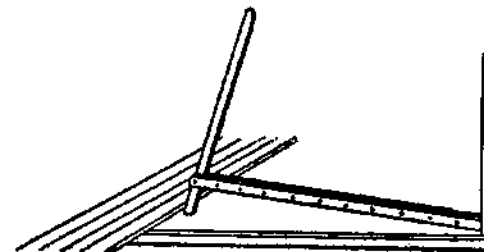

FLOORING LEVER

AN INEXPENSIVE VERANDA

A vine-covered veranda is a great comfort, but in many cases the expense seems greater than the owner of the plain little farmhouse feels able to stand. A farmer in Arkansas wanted one, and he set to work in this fashion. First he went to the woods and got a load of straight poles about 1½ inches in diameter and from 8 to 12 feet long. He next procured a number of nice, smooth boards for the flooring of the veranda, making it about 6 feet wide and 10 feet long and strengthening it with the necessary timbers. He securely nailed the poles about 8 inches apart around the flooring to form an inclosure, leaving an opening in front about 5 feet wide.

The poles in front were 7 feet from the floor to the roof and 12 feet at the house. About midway of their height the poles were straightened by a row

of poles nailed horizontally and another row was placed at the top. To make all secure against rain, the slanting roof poles were next carefully covered with overlapping rows of bark. All this required but small outlay of cash and even less of work. It was then ready for the vines.

Being in haste for immediate results, the builder planted some roots of the hard native woodbine, which will soon cover any space with its rapid growth. It is an easy matter to sow seed of the morning glory, hardy annual gourd, or any one of several hardy climbers and the result will soon be a mass of shade and lovely blossoms besides, all of which makes the summer evenings pass far more pleasantly.

CONCRETE ON THE FARM

The progressive farmer must not overlook the economic value of portland cement concrete. Today is the age of concrete. It is crowding wood and steel into the background, and bids fair to become the most universal of building materials. Concrete is extensively used by the largest landholders, and can be used by the men of more moderate means to equal advantage. It is to be recommended for general use by reason of its durability, sanitary qualities and moderate cost. Molded solid, it has no joints nor seams to afford a lodging for dirt and foster the growth of noxious fungi; it can be swept, washed, scrubbed and scalded, without injury to its texture. Further, it does not possess the disagreeable quality of absorbing gases and odors. Add to these qualities, coolness in summer, warmth in winter and we have one

of the most logical building materials in present-day use.

Concrete is not expensive when compared with other materials of construction, such as stone, brick and wood. To be sure, the initial cost of wood is less than that of concrete, but when we consider the life and quality of the finished product, concrete is easily cheaper than wood.

Portland cement of the most approved brands costs about \$1.60 per barrel, $1\frac{1}{4}$ barrels of cement being required for each cubic yard of concrete. Sand and gravel may be had from the farm or bought nearby at 10 cents a load. Add the cost of the forms and the labor of mixing and laying the concrete, which should be done at an expense not exceeding 75 cents per yard, and we have a total expense ranging from \$2.75 to \$3 per cubic yard, but under very favorable circumstances the cost may be reduced close to \$2. Experience both in practical work and in the laboratory has proved beyond a doubt that the best brands of cement, as in all other goods, are the cheapest in the end, and should be insisted upon by all prospective purchasers. Atlas, Alpha, Saylor's, Edison and Giant cements are among the leading brands. The sand should be clean, coarse and sharp and free from all foreign matter that would in any way tend to weaken the concrete. Broken stone with sand and cement makes an ideal mixture, but it is objected to on account of the cost of the broken stone. Gravel may be substituted for the stone, however, with excellent results. The gravel should be washed and cleaned, and, if very coarse, passed through a screen. The gravel should range from $\frac{1}{4}$ inch to $2\frac{1}{2}$ inches in diameter, but should not exceed $2\frac{1}{2}$

inches and to obtain the very best results the major portion should be between the limits of 1 and 1½ inches.

MIXING THE CEMENT

In mixing concrete for general use the following proportions are perhaps the best: One barrel cement to 3 barrels sand and 5 barrels gravel. In this mixture the spaces between the stones are entirely filled and when hardened the concrete virtually becomes a solid monolith.

To secure the best results mix the concrete as follows: Have the gravel washed and in readiness, usually on a platform of planking or boards, to permit easy shoveling and insure against waste. Add enough water to the cement and sand, which have been thoroughly mixed in a mortar bed, to make a thin mortar, not too thin, however, to permit easy shoveling. Spread the mortar on the gravel and thoroughly mix by turning with shovels. Then, without delay, shovel the batch of concrete into the forms or spread it on the floors as the case may be, being careful not to exceed layers of 8 inches at each filling. Each layer must be tamped and rammed till water flushes to the top.

Proceed in this manner till the forms are filled. In hot weather damp cloths or boards should be placed over the top of the concrete to keep it from checking after the final layer has been placed in the forms. The forms must necessarily be water tight and the concrete worked back from the boards with a spade, so the softer material may flow to the outside and insure a smooth surface. If this last is not done holes will surely result and the work will be disappointing. Let the concrete rest four to six days before removing the planking, concrete

being somewhat brittle until thoroughly hardened, and while in the "green" state easily broken.

MAKING CONCRETE BLOCKS

Concrete building blocks are ideal as building material on the farm. The cost to purchase these blocks has been beyond the reach of the farmer who desired to use them for all purposes; but by the use of the simple machine or mold described anyone can make the best quality of hollow concrete building blocks at an average cost of less than 6 cents each, the mere cost of sand and cement.

As the standard size block is 20 x 8 x 7½ inches, instructions are given for making the machine to build that size, but it can be constructed to turn out any size of block by changing the dimensions accordingly.

Take two boards 20 inches long by 7½ inches wide and 1 inch thick. These are for the sides. For the ends use lumber 10 inches long by 7½ inches wide. Care must be used to have the boards free from large knots and with an even grain, so as to avoid warping.

The above four boards were joined at three corners with six hinges; two hinges at top and bottom of each corner. In putting together have the two end boards set up against the sides as shown in Figure 1. At the fourth corner place a strong hook and eyelet to hold the machine together when making block, and by unhooking this allows the machine to be folded back away from the finished work, etc.

This makes a mold or form that is, inside measurements, 20 inches long, 8 inches wide and 7½ inches high, with top and bottom open.

For the core, take two boards of 1-inch lumber, cutting them 13 inches at the top and slanting to 11½ inches at the bottom with a width of 7½ inches. These make the sides of core. For the ends, use 2-inch strips cut 7½ inches long. These are fastened together,

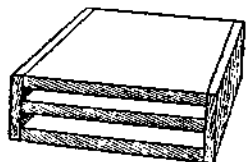

as shown in Figure 1. This makes a slanting box which is set inside of the machine, as illustrated in Figure 2, and forms the hollow in the block. To the top of the core a round stick is fitted into place the length of the core, so it will set down level with the top for a handle to lift the core from the block when operating the same.

To Operate the Machine

First set it on a board somewhat larger than the machine, as shown in Figure 2. This makes the bottom of machine and holds the block until dry. Enough of these boards must be provided for the

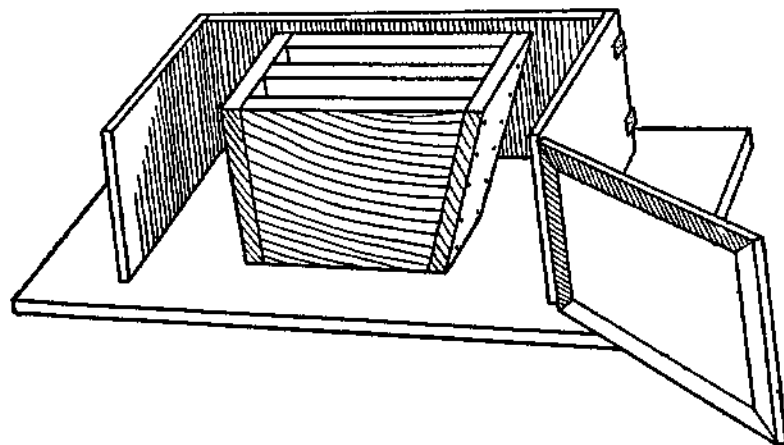

FIGURE 2—CEMENT BLOCK MACHINE OPEN

blocks made each day. Close the machine and fasten catch, then set the core in the center and fill the space around the same with the concrete mixture, tamping it in thoroughly. When full level off the top with a flat stick and carefully lift out the core, setting it on another board ready for the next block, unhook the catch and fold the machine back away from the finished block and you have the completed block ready to dry and cure. This method requires no handling and so has no danger of breaking while the block is yet "green," as it remains on the board or "pallet" until dry enough to be piled up, which they will be in three or four days.

When the blocks are to be laid in a side wall, between corners, take two 1½-inch strips 7½ inches long and attach with screws to the center of each end of machine on the inside. This molds a groove in the block, which is filled with mortar when laying the block in the wall and so securely ties it. By fastening with screws these strips can be easily removed when molding corner blocks.

Blocks of Different Shapes

A neat panel block can be molded by taking the common half-round strips, cutting to the right lengths and fastening to the outside of the face of machine, as shown in Figure 1. For corner blocks they can be attached to either end of machine. By using small screws these can be removed when not desired and also enable you to panel either right or left end of block as needs require.

For making half-size blocks, have a piece of board that is exactly 8 inches wide and 7½ inches high, or so it will just fit into machine when core

is removed. Set this in place in the middle half-way between the ends and fill with material. This will make two half-size blocks for use in breaking joints when laying wall. If desired to have these hollow, two small cores of proper size can be made to set in place when molding blocks of this size.

Rock face effects can be produced very easily by taking a 2-inch plank the size of the face of machine or the end as desired. On this draw a border $1\frac{1}{2}$ inches all around, then take several irons, heat them red-hot and burn out the center in irregular shape, at least $1\frac{1}{4}$ inches deep. By making ridges and hollows in this burning process of different depths and as broken as possible, you will secure a face plate that will mold a very excellent imitation of a rock face. This, of course, can be made to suit any fancy.

One may follow the practice of making several faces and ends from plain and panels down to different rock effects, having these extra face plates the same size as given for the machine above. Then by using hinges as used on doors or any pin hinge, you can easily change the style of block by putting one face plate or end on machine in a moment's time. One machine can thus be used for any style of block and a great amount of time be saved in changing from one style to another.

This machine, in addition to being simple in construction and operation, is very rapid. With but little practice one man can make from 75 to 100 blocks daily and have each one perfect, as he does not break any by handling them after they are molded

According to her cloth she cut her coat.—Dryden.

ANOTHER STYLE OF MOLD

All the lumber necessary to make this mold should be selected white pine or hardwood, free from knots and sap. The platform on which this mold rests should be 14 x 24 inches and be well battened together. The sides are made as shown

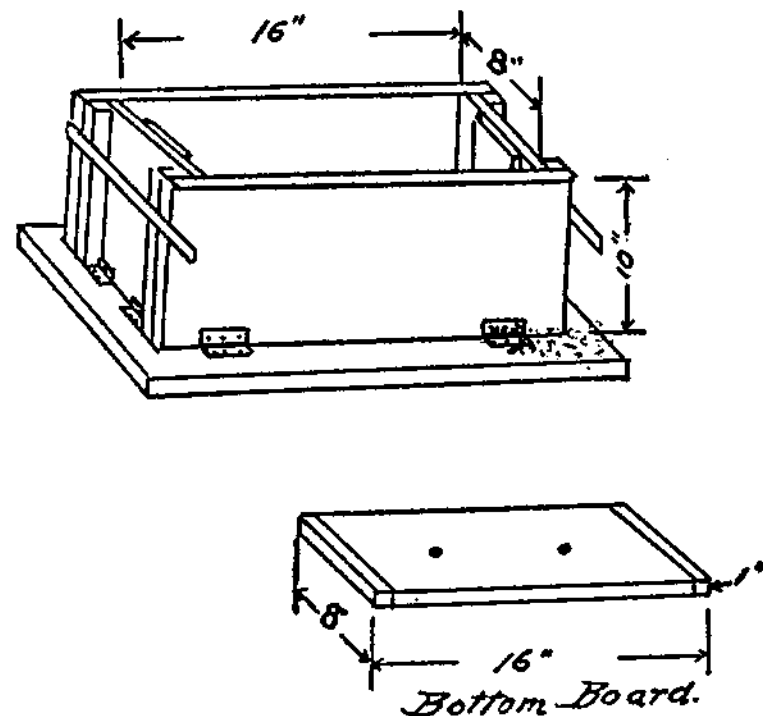

THE FINISHED MOLD

by the drawings, with a cleat on each end, which overlaps the end pieces and holds them in place. Both ends and sides are fastened to the platform as shown, with hinges, which permit them to be turned down to take out the completed block.

On each end is placed a flat iron bar with a notch in to fasten the whole mold together. These

bars are the same as hooks, only the ends are prolonged to act as handles for convenience.

Regulating the Height of the Blocks

The bottom board is intended to be fitted in the bottom of the mold loosely and should be blocked up from the bottom to give the required height of

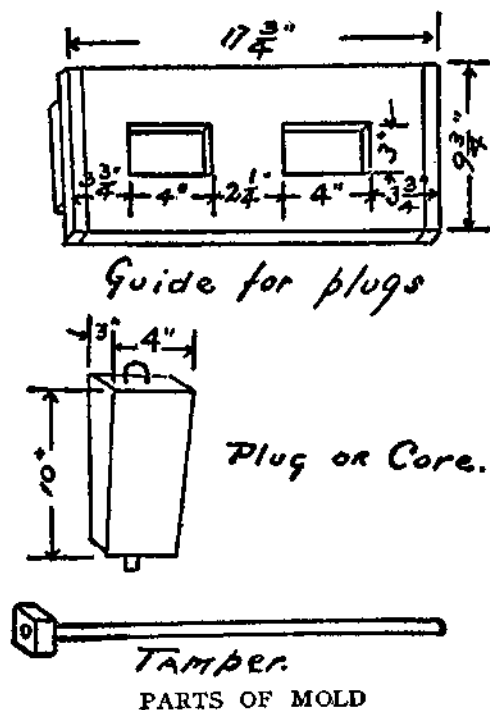

the finished block. The end pieces of mold have a thin piece of board running up and down to form a key between blocks and should run down to top of bottom board.

The plugs are made as shown, with a taper both sides, so that when they are removed they clear all the way out. The pins in the bottoms of the plugs

are to fit in the holes in the bottom board, which will steady them and hold them in place.

When the plugs are removed the board with the two square holes is placed over the top of mold and the handle of tamper is run through the rings in top of plugs and they are lifted up. This board is used as a guard and prevents the block from being broken when plugs are removed, and should not be used until the block is finished and ready to take out of mold. The tamper is made of a large iron nut and a piece of iron rod about 18 inches long.

Filling the Molds

To make these blocks use one part of portland cement and three parts of good sharp sand, mix well and put enough water on to simply dampen the whole. Now close up the mold, put plugs in place, fill the mold one-fourth full and tamp down hard. Repeat this until the mold is filled. Scrape off surplus material, remove the plugs, then turn down sides and lift out finished block which is to remain on the bottom board until hard enough to lift off.

It will be necessary to have a number of these bottom boards. After a number of blocks are made they should be sprinkled from day to day for from 15 to 20 days to properly cure them before using. A barrel of cement will make about 50 blocks and one man can make a block in 12 minutes.

MIXING CEMENT FOR BRICK

Many have found mixing the sand and cement the hardest part of cement brick making. An old

vinegar barrel may be put to use by placing a grindstone crank on one end and a pinion on the other. Two strong posts are set in the ground and the barrel hung over two pieces of round iron driven into the posts. A square hole is cut on side of barrel and covered with a piece of sheet iron hinged and a bottom to fasten.

The sand and cement are dampened, shoveled into the barrel and a boy may turn the crank. The mixing is done as fast as two men can mold, with a boy to sprinkle the brick to prevent drying too fast.

REINFORCEMENT FOR CONCRETE

For heavy construction work involving beams and columns, reinforcement with steel rods is needed. Reinforced concrete is rapidly coming to be the most approved kind of construction of large

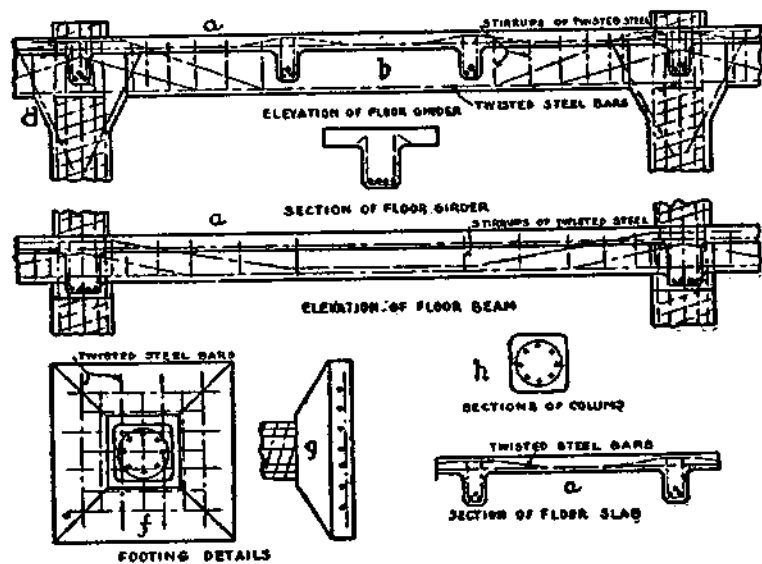

DETAILS OF REINFORCEMENT

buildings. Our own great building is one of the most noteworthy examples, being of reinforced concrete throughout. For any building where reinforcement seems desirable the following details will be found useful:

Plan of the footing or foundation of each column is shown in *f*; *g*, side view of footing and part of column above. The steel rods that run up through column are shown by dots in *h*, and the wire spiral by diagonal lines in *g*. *h* is cross-section of column filled with cement, the shaded part being the concrete. *a*, section of floor slab, $4\frac{1}{2}$ inches thick; it is also shown on top of the floor girder and floor beam (crossbeams between girders). *b*, girder; *c*, cross-section of girder, the dots showing twisted steel bars that take up the tensile stress—compression stress is carried by the concrete. The steel bars, *d*, stuck into the column at an angle, are to prevent the girders from breaking off or “shearing” at column.

MAKING A FROSTPROOF CELLAR

Some farmers build their own concrete cellar walls and chimneys with inexperienced help. Lay out your foundation the same way you would for any building. Have outside line of excavation plumb. Then use 2 x 4-inch studs the length required. Point one end, drive in ground, on line of inside of cellar wall, brace top of stud by driving stake in ground, and nail brace to stake and each stud. You must make everything firm. Then take square edge boards and place horizontally against the studs. (See illustration.)

Do not try to go around the whole cellar wall, take one side at a time to the height of earth sur-

face, but turn your corner. Pay no attention to outside, let the stone and cement push up against the earth. It is the best plan to finish the whole wall up to the earth surface line before making the elevation above the ground line.

Above the earth surface line do just the same on the outside as you have been doing on the inside, but now you must use boards and studs, as up to

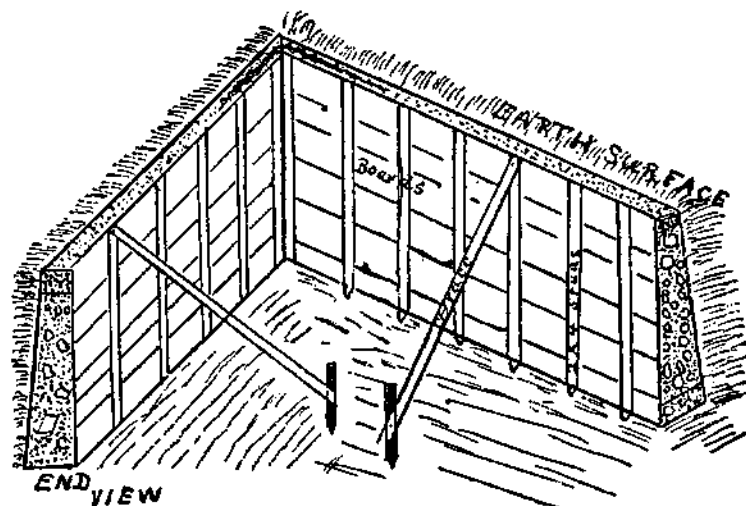

CONCRETE CELLAR WALL

this point the earth took the place of them. Plumb every stud you drive, and place them 24 inches apart. Have cellar window frames ready and place them as you come to them. Be sure and make extension for hatchway when building your main wall. For the corners use baled hay wire in wads, bending it around the center of wall, and a reinforced concrete corner will be the result.

Get cobblestones or any stone from the size of a goose egg to the size of your head, and put them in bottom of wall to depth of 1 foot. Make a mixing bed, say, about 12 x 36 x 72 inches. One man

used an old wooden sink as near watertight as possible. Use one water pail of cement to three of fine gravel sand. Put one and one-half pails water in the mixing bed, then add the cement. Be sure and mix water and cement well before using sand. Throw sand in one shovelful at a time. Have one person mixing with a good-sized hoe, while another throws in the sand. Mix well.

Have it about the same as thin mortar, so it will leave the pail easily when pouring into the foundation. Cover the stones and then put in another lot and do the same to height of wall up to within a couple of inches. Do not put stones to full height of wall. To bring wall up to line, mix cement and water together (or one part sand and one cement) so it will run, and after wall is hard pour it on top and it will find its own water level and your sills will fit exactly. It is a good plan to have wall thicker at bottom than at top—perhaps 18 inches at bottom and 12 inches on top.

Now for hatchway steps. Put in the stones, as they save cement. Before the cement gets hard, drive in some large spikes, leaving them projecting about 2 inches on line of hatchway sills. Your hatchway doors will stay in place if sills are well-fitted on to spikes. One of the most important things is to be sure of the sand you use. If there is more than 10 per cent loam in the sand, your work will be a failure.

A SUMMER COOL ROOM

A simple method of constructing a cool, outdoor cellar in localities where the common house cellars are too warm for use during the summer time, is shown in the accompanying sketch. It is a cellar

made under the pump, so that the water pumped by the windmill has a very cooling effect. In places where it is difficult to obtain ice, it will prove indispensable to the dairyman who keeps a few cows. Another important item is the fact that a man does not have to pull up all of the pipes every

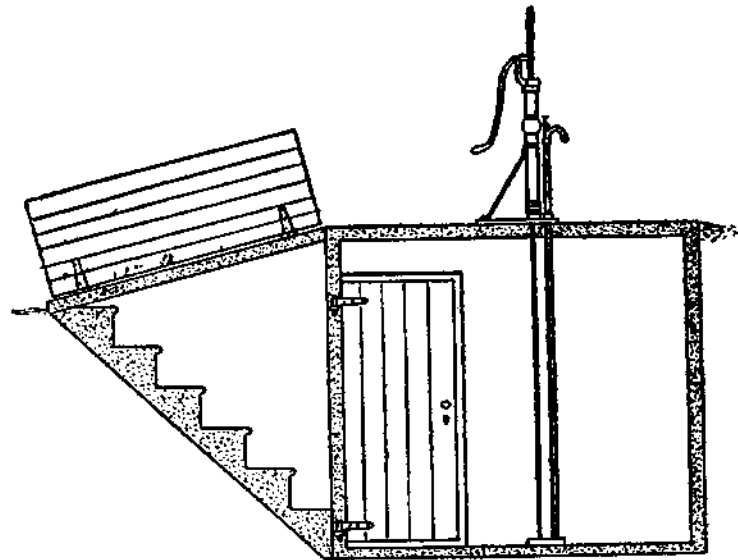

CONCRETE OUTDOOR CELLAR

time that he finds it necessary to repair the pipes and pump.

It is constructed of concrete. The top is reinforced with $\frac{1}{2}$ -inch steel rods placed 1 foot apart each way and the concrete work is about 6 inches thick. The sides are made by using a form, and the stairs are also made of concrete and are reinforced by small steel rods. The cost, including the labor, is about \$50. In the west and southwest it will also answer the purpose of a storm cave, which is considered a fixture on all farms.

A CONCRETE SMOKEHOUSE

The structure is about 8 x 10 feet and 7 feet high. It will keep the meat inside and thieves out. For a building of this sort 8-inch walls will be thick enough. Excavate to the proper depth below frost, which will be two feet or less, and use a mixture of one part portland cement, three parts sand and six parts gravel or broken stone.

Make the forms of matched boards, although square-edged boards could be used for this purpose. The forms must be well braced and may be raised as the work of laying the wall progresses. Space for a doorway must be left and two eye-bolts inserted in the concrete for the door to swing on. The door jamb can be molded in cement if it is desired. An eyebolt for the lock and latch should also be placed in the wall.

The roof will no doubt be of boards or shingles. The plates should be placed on the concrete and held to it with bolts properly imbedded. An arched concrete roof can be made if desired, in which case it will be necessary to leave suitable vents in each end, or build a small flue to allow the smoke to escape. To make the house absolutely proof against fire a steel or iron door should be used.

LAYING A CONCRETE FLOOR

A concrete floor should be level with the top of the sill, where there is much passing in and out with stock or wagons. There should be about 4 inches of concrete. If the earth is leveled off and tamped down hard, it would be unnecessary to put any crushed stone under the concrete in a building

where frost or water does not get underneath. It is generally recommended to put several inches of stones, gravel or cinders on top of the earth, but many floors are laid without such a bottom. Partitions for horse stalls and cattle stanchions can be held in place on a cement floor by putting down iron belts or pieces of gas pipe when the floor is laid. Let them project 2 or 3 inches above the floor.

MAKING A CONCRETE WALK

The best way is to dig a trench 16 inches deep, put in a foot of loose gravel or stone, leveling it off with fine material. On top of this spread 3 inches of concrete made of one part portland cement, two parts sand and four parts crushed stone or gravel. On this put a granolithic finish 1 inch thick mixed in the proportions of 1-2-3. Trowel it down smooth and hard. Joints $\frac{1}{4}$ inch thick and filled with sand should be left every 5 feet to prevent walk from cracking

CEMENTING A CISTERN WALL

In making a surface waterproof, a mixture of about one part portland cement to two of sand will shed water from a roof or wall, but to make a surface perfectly watertight, so that it will keep out standing water, it is better to use neat cement only, that is, cement with no other material but the water with which it is mixed, and it will cost less to put on a coat $\frac{1}{4}$ inch thick of neat cement than one 1 inch thick, one-half or two-thirds sand, as the neat cement mixed with plenty of water is waterproof.

SPECIAL USES FOR CEMENT

A sack of portland cement is a very useful thing to have for making quick repairs about the farm. A hole in a drain pipe can be stopped in a few minutes with a little cement, mixed with water, thick as putty. A crack in a barrel can be stopped this way. Hardwood floors may be patched and nail holes filled so they will not leak.

A waterproof floor can be laid over an old board floor in a short time. Sweep the old floor clean and dry and nail down all loose boards. Cover with a layer of heavy wire netting, tacking it down occasionally. Over this lay a layer of concrete of one part portland cement, three parts clean sand, mixed with water to a thin paste.

Smooth thoroughly, but if it is to be used by stock, brush with an old broom to make it rough, then let it dry thoroughly before using the floor. Gutters may be put in where necessary. Holes in an old shingled roof can be quickly stopped by forcing a little cement putty under the shingle where the leak appears.

Some special uses to which cement is being put are the making of bee hives, brick for pavement and ordinary foundations, cement shingles for roofing, grain bins in the form of square boxlike and round barrel-like receptacles. The use of this excellent material for farm structures is only just opening up and it is destined to become the most important material for general farm building.

A wooden reinforcement in the center of a concrete fence post is worse than useless. It does not make a bond with the concrete, and thus weakens,

instead of strengthens, the post. Of course, the same is true of wooden reinforcement of any concrete work.

A TIME-HONORED HANDY DEVICE

(SEE FRONTISPIECE)

How dear to my heart are the scenes of my childhood,
 When fond recollection presents them to view!

The orchard, the meadow, the deep-tangled wild-wood,
 And every loved spot that my infancy knew!

The wide-spreading pond and the mill that stood by it;

The bridge, and the rock where the cataract fell;
 The cot of my father, the dairy-house nigh it;

And e'en the rude bucket that hung in the well—
 The old oaken bucket, the iron-bound bucket,
 The old moss-covered bucket that hung in the well.

How ardent I seized it with hands that were glowing,
 And quick to the white-pebbled bottom it fell!

Then soon, with the emblem of truth overflowing,
 And dripping with coolness, it rose from the well.

—Samuel Woodworth.



FREEZING ICE IN BLOCKS



HERE a pond or stream is not handy from which to get the year's supply of ice, blocks can be frozen in forms with comparatively little labor. A supply of pure water is essential. The forms are best made of galvanized iron of any size desired. A convenient size is 16 inches wide, 24 inches long and 12 inches deep inside measure. The sides and ends should be made to taper $\frac{1}{4}$ inch, so

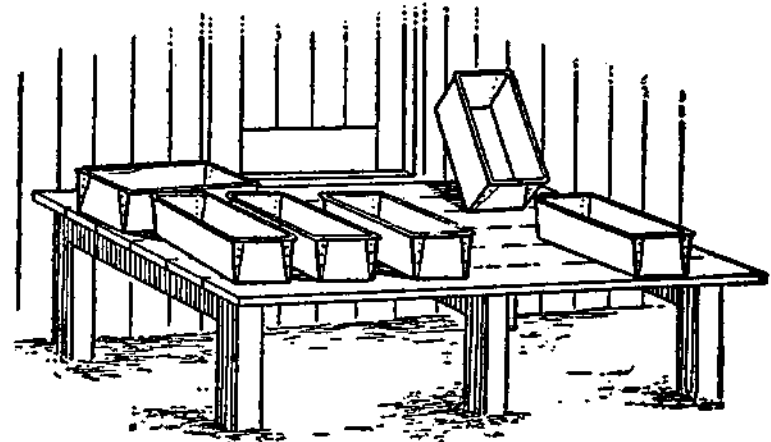

HOMEMADE ICE MOLDS

that the frozen block will drop out easily. The top of the mold should be reinforced with wire for the sake of strength and durability.

With a dozen or 20 forms one can put up quite a supply of ice during the winter. The forms should

be set level on joists or boards and placed a few inches apart. Fill them nearly full with pure water and let them freeze, which they will do in one or two days and nights in suitable weather. When frozen solid, turn the forms bottom side up and pour a dipper of warm water on them, which will release the cake of ice. The form can then be lifted off, the ice put away in the icehouse and the form filled with water again.

SAVING THE SEED CORN

Here is a handy device for preserving select ears of seed corn. It consists of a wide board

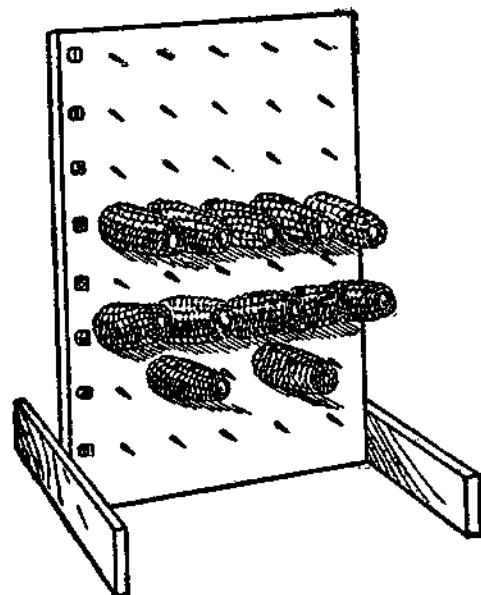

SEED CORN RACK

fastened between two supports nailed to the edges. The board stands upright on one end and may be as long as desired. Drive heavy spikes through it from the opposite side and stick an ear of corn upon each spike. This allows for the passage of air, and the ears can be examined without removing them from the rack. It

is much to be preferred to expensive wire racks, as each nail may be numbered and a record kept of the ears in this way. This rack was designed at the Idaho experiment station.

RACK FOR SEED CORN

Here is a simple arrangement for keeping choice ears of seed corn. Take a 2-inch square timber for the upright, and make a solid base by boring a hole through the two base pieces, then drive the timber into it. Drive 4-inch spikes through the upright at intervals of 6 inches from four sides, and stick the ears of corn on these spikes by thrusting the same into the butt of the cob. Numbers may be placed above each spike, so that records can be kept of all of the corn. The corn should be placed on this rack as soon as picked and husked, and may be left there until planting time if the rack is placed in a dry room where rats and mice cannot get at it. A large post strongly mounted on a heavy pedestal may be used in a manner similar to the small upright described above. The bigger the post and the larger the number of spikes used, the greater the capacity of the rack, of course. It is a good plan to make the pedestal heavy and strong in order that it may not be tipped over too easily.

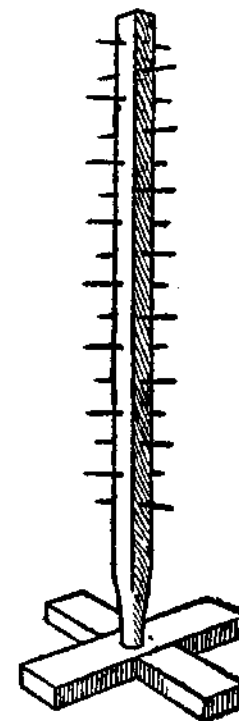

RACK

The first years of man must make provision for the last.—Samuel Johnson.

Put your trust in God, my boys, and keep your powder dry.—Colonel Blacker.

DRYING AND KEEPING SEED CORN

Never let it freeze before it is dry. Farmers have had seed corn exposed to a temperature of 30 degrees below zero without injuring its vitality, and have had it ruined at 10 degrees above zero. We would not recommend kiln-drying for the general farmer, as this is only practicable where a grower is in the seed business. A very convenient way is to take

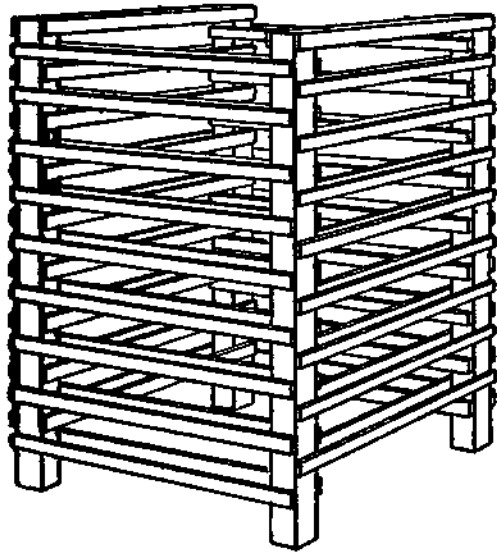

CORN DRYING RACK

four pieces 4 x 4 6 feet long, set them up in a square, and nail laths on them two and two opposite. Leave a 6-inch space between the laths, so the corn will have plenty of ventilation. Lay your corn on this to dry, and if thoroughly dry it can lay there all winter.

Knowledge is worth nothing unless we do the good we know.

It is better to give one shilling than to lend twenty.

Keep your mouth shut and your eyes open.

FIG. 1



FIG. 2

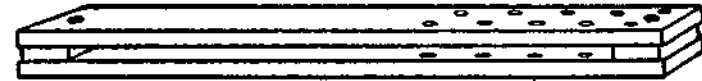

FIG. 3

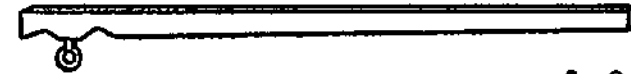
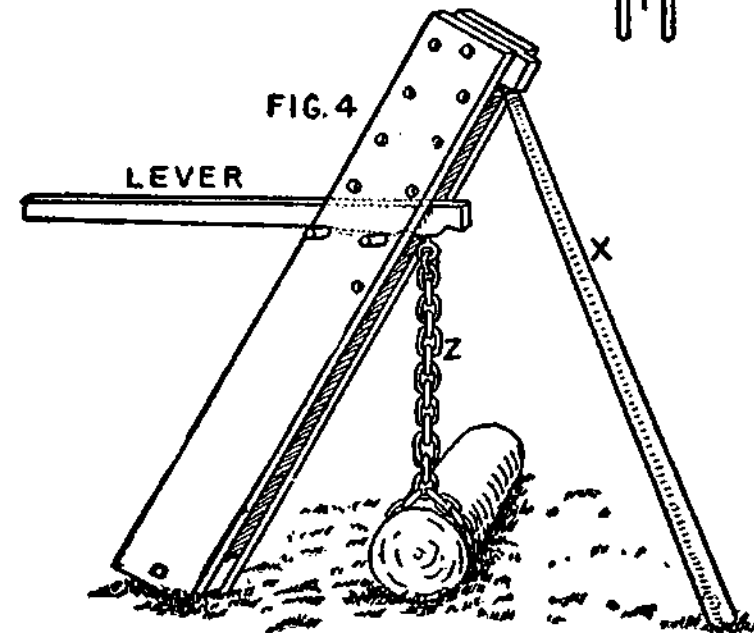

FIG. 4



WEIGHT LIFTER AND DETAILS

The drawings show the different parts and one of the many uses of this device.

STRONG AND SIMPLE WAGON JACK

Here is a good, practical wagon jack suited to almost all kinds of vehicles. The whole thing is made of wood with the exception of the curved piece, *b*, which is of iron and hooks over an iron bolt, *e*. It is well to have a strong $\frac{1}{2}$ -inch bolt at *f*, so as to support the heavy weight on the lever, *a*. The bottom, *d*, and the piece, *c*, are each 2 inches thick. In using the jack, the axle is lifted by simply pressing down on the handle of the lever. The teeth of *b* catch and hold on *e* automatically. The height of lever is regulated by moving *f* up and down.

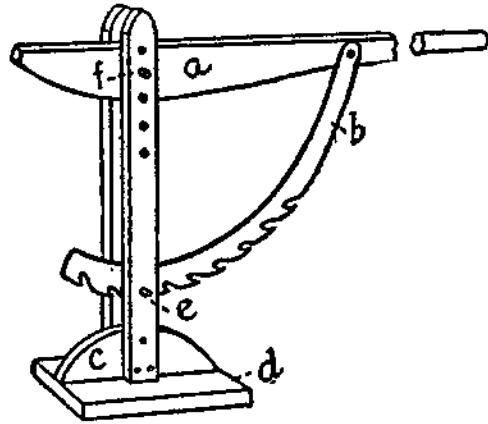

WAGON JACK

Write down the advice of him who loves you, though you like it not at present.

A JACK FOR HEAVY WAGONS

Many lifting jacks which are designed for light vehicles would not work well in the case of a heavy log wagon. Here is one that will stand a lot of hard usage and is simple and effective. Make the base and upright of heavy 2-inch oak plank and insert a $\frac{3}{4}$ -inch bolt through the lever for a support. Have a good, strong hemp rope attached to the base, pass-

ing over the handle end of the lever, so that as it is drawn down and the wagon is lifted it can be hooked in a notch to hold it in position.

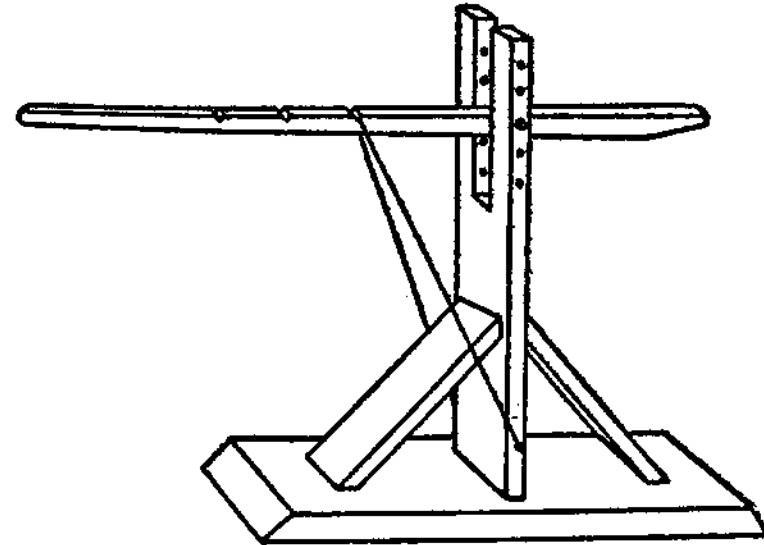

HOMEMADE WAGON JACK

A CHEAP WHEELBARROW

The construction of this barrow is very simple. Get a pair of old plow handles, two gate hinges about 1 foot long, and a wheel, which may be found at the junk dealer's. The legs of the wheelbarrow

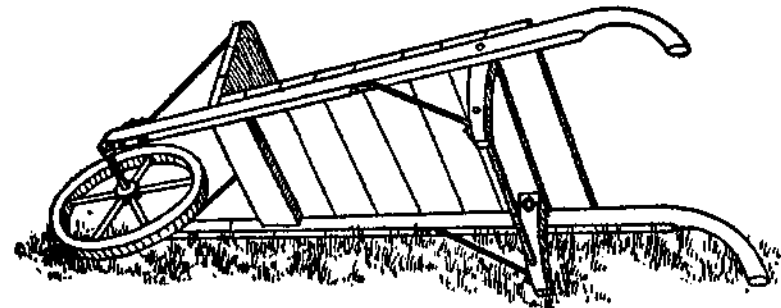

MADE FROM OLD MATERIAL

are those of an old chair, braced with a piece of iron. These articles in themselves are worthless, but in their combination we create something very useful.

A WHEELBARROW CHEAP AND STRONG

Here is a picture of a handy, strong wheelbarrow that any farmer can make on a rainy day. Take a dry-goods box 30 inches long, 24 or 26 inches wide and 20 inches deep, and two sticks $5\frac{1}{2}$ to 6 feet long and $3 \times 3\frac{1}{2}$ inches for handles. Nail or screw

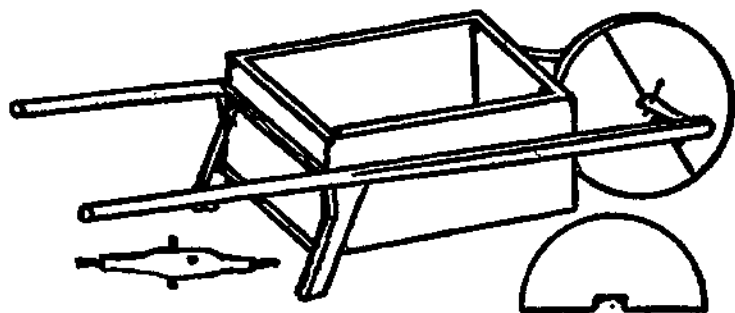

BOX WHEELBARROW

on crossbrace in front and rear, and pieces with brace as shown for legs. Cut four half circles from inch hardwood board and a notch in center to fit around axle. Nail these securely together for the wheel.

For the axle, take a stick $3\frac{1}{2}$ inches square. Trim and band each end or wrap with wire. Bore holes and drive a 6d. wire nail in each end. Just 2 inches apart in center, bore two 1-inch holes on opposite sides to hold the wheel in place. A band of hoop iron around the wheel will make it last longer. When it is put together, you have a very substantial wheelbarrow that cost but little.

HOW TO HANG A KETTLE

Using stones for a kettle support seems handiest oftentimes, but let the heat crack one of the stones and tip the kettle over, as it frequently will, does not tend to improve a man's language, let alone the loss sustained. It is much better to make a support such as is presented in the cut. The three uprights, of suitable length to correspond with the size of the kettle, may consist of any good wood. Through the top of these a hole is bored for the bolt to hold them together, which

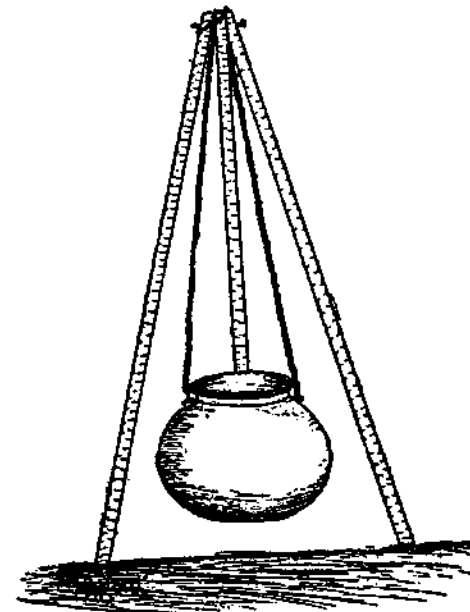

TRIPOD-HUNG KETTLE

must be long enough so they will have play to set up easily. All that is necessary then is to suspend two chains from the top and letting them extend downward to the proper distance, attach the ears of the kettle into the hooks on them. When not in use, the device can be folded together and laid away.

A SNOW PLOW

No person not owning a snow plow can appreciate how useful one is after every storm. A horse, or if the snow be a heavy one, a span or a yoke of cattle and this simple homemade arrangement, and

in less time than is required to tell it there is a path, and no back-breaking work either. It is only a big V braced so the snow is pushed both ways by it. It must be made of 2-inch planks at least 1 foot wide and not less than 6 feet long. If shorter it wobbles and does not stay on the ground well.

To make a good road for teams, chain it to one side of the wood sled and drive up and down. It spreads 2 feet, and will make your farm front look as if somebody of pluck lives there. For foot-paths draw it from a ring at the top of the front so it will root.

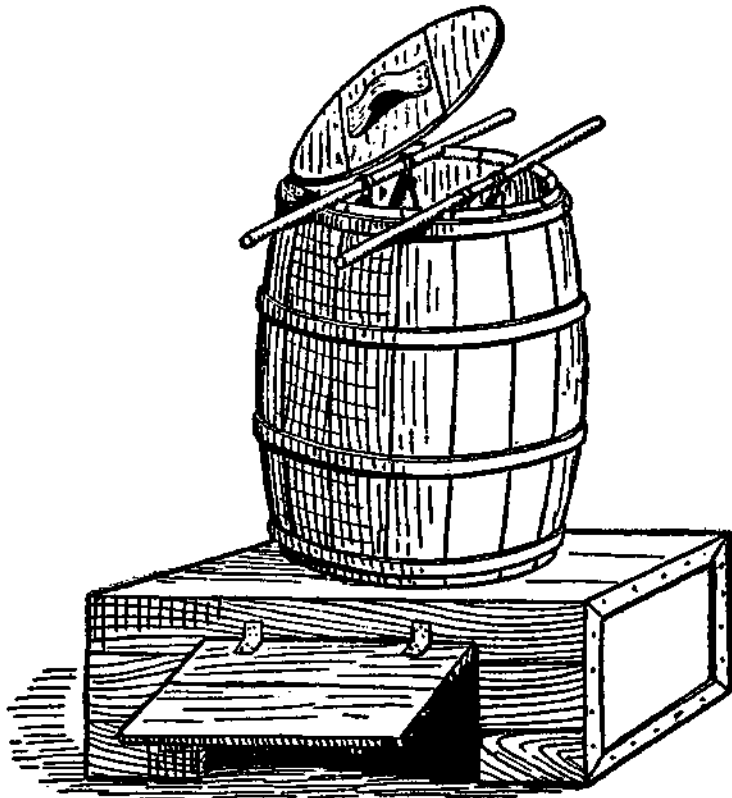

SMOKEHOUSE SUBSTITUTE

TEMPORARY SMOKING DEVICE

If one butchers only once a year it is not necessary to build an expensive smokehouse, for almost as good results can be obtained from a device such as that shown on page 242. It is made by taking both ends out of a barrel and mounting it upon a box or above a fireplace in the ground. The meat to be smoked is hung from the sticks laid across the top of the barrel, the fire built underneath and the lid put on.

HOMEMADE HEATER AND COOKER

A cheap and economical heater may be of home construction. Make a frame of 2 x 8-inch pine 7 feet long and 27 inches wide. Put a bottom on

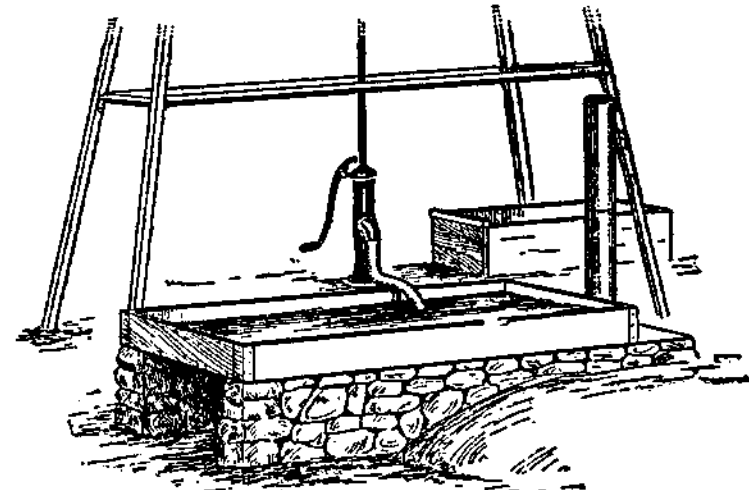

TANK AND COOKER

this of No. 18 galvanized iron, letting it project $\frac{1}{2}$ inch on each side and 14 inches at one end for a stovepipe fitting. Spike the frame together and

cover the corners with heavy tins to prevent any leaking. Nail the bottom on with two rows of nails.

Make a fireplace on the ground of stone and blue clay or brick and cement of mortar if preferred, 2 feet wide by 3 feet long and 18 inches high. Pile up dirt 1 foot high and 3 feet wide at the end of the fireplace for a flue, put stone on the earth the length of the galvanized iron, place the tank on this foundation and bank it up with dirt. In cutting a hole for the stovepipe, turn up strips of the galvanized iron for a collar, then drive an iron rod into the ground, put on two lengths of stovepipe and wire it fast to the rod.

A piece of sheet iron should be set up before the fireplace to control the draft and keep the fire. Such a heater, on one farm, is located near the windmill and storage tank and can be filled from either. The water can be heated quickly with cornstalks, straw, cobs or brush. One may boil pumpkins and small potatoes for fattening the pigs, and cook ground feed by pouring scalding water on the meal in barrels and covering with old blankets or carpets. A light fire will take the chill from ice water for the milch cows.

USE FOR A TOUGH LOG

Most farm wood piles have two or three old logs lying about which nobody cares to tackle with an ax or blasting powder, and are too short for the sawmill. If straight, they will make good water troughs. Square the ends, mark off about 10 inches from each end, chop out the inside and trim the edges. An inside coat of oil or pitch tar will increase wearing qualities.

A HANDY WOOD SPLITTER

For splitting wood a farmer in eastern Massachusetts uses a device as shown in the cut. Take a 2 x 8-inch plank about 3 feet long and an upright of the same material about 20 inches long. Set this upright at an angle of 20 degrees and use a brace of

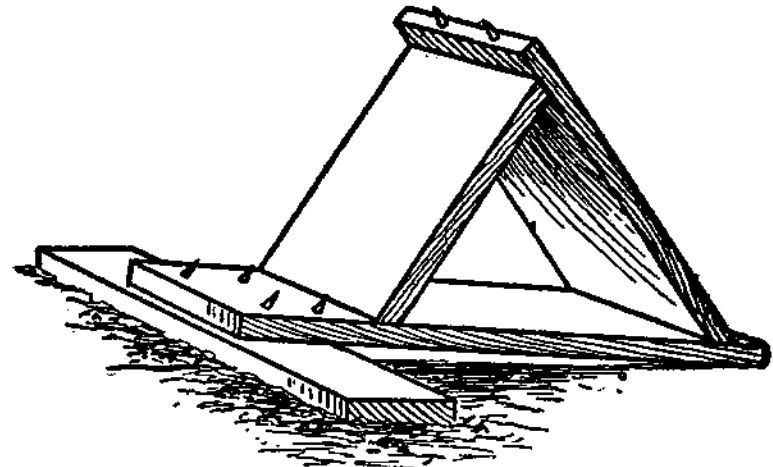

WOOD SPLITTING DEVICE

the same material. The sharp points shown in the cut are 40d wire nails. Set the wood against these spikes in splitting it.

HOW TO SPLIT WOOD

Wood splits much more readily in the direction up from the root of the tree than when the blow of the ax is downward. In other words, to split a chunk place it upside down—contrary to the direction in which it grew. It is much easier to split by slabs than to try to cleave through the center. This means to split off pieces near the edge.

A PULLING HAMMER

If you want to make your old claw hammer do more work and do it better and easier, have the handle projecting a little beyond the head. You will find it much more convenient in drawing a nail, as it makes a right angle for pulling the nail without bending it to one side. It takes the place of a block and is always on hand and ready in the right place for immediate use. The handle is simply whittled a little more than usual and driven through to the required distance. Don't drive it through too far, but about as shown at *a* in the picture. If it sticks out too much, it will be in the way when driving nails. Whittle it off rounding, and give it a finished appearance.

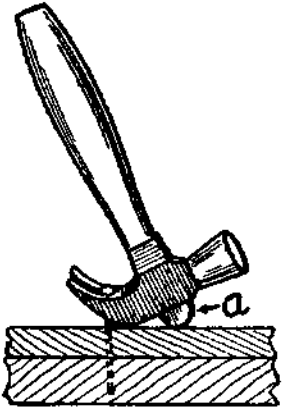

MOUNTING THE FARM ANVIL

To make a solid foundation for an anvil, build a form of boards 14 x 18 inches square at the base, 18 inches high, tapering to 8 x 10 inches at the top. Fill this mold with rich concrete and fix a bolt in the center of the top of it to fasten the anvil. Afterward, melted lead can be poured around the base of the anvil, completing a very nice pedestal.

SORTING POTATOES QUICKLY

The sketch shows a homemade potato cleaner and sorter. It consists of a number of hoops to which are fastened 1/2-inch slats so as to make holes

1 1/2 inches square. Two heavy pieces, *a*, are placed inside the cylinder to hold the axle, *b*, which extends entirely through the machine and is turned by a crank, *c*. The frame made is 4 inches lower at the opening end of the cylinder so that the potatoes will run through freely.

At the crank end is a hopper, *f*, into which the potatoes are poured. The cylinder is 25/8 feet long

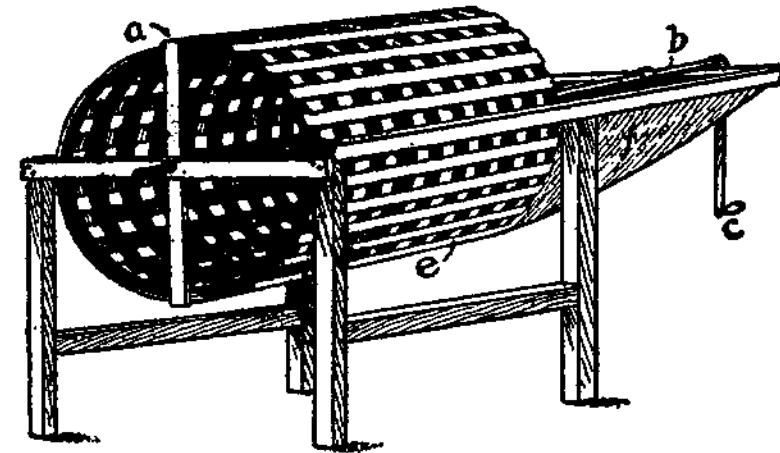

POTATO SORTER AND CLEANER

and 3 feet in diameter. It will not bruise the potatoes, and the dirt and small ones run through on to the floor or crate and the marketable ones run out at the open end of the cylinder into another crate. With one man to turn the crank and another to fill the hopper, from 700 to 800 bushels can be sorted in a day.

An indiscreet man is more hurtful than an ill-natured one; for as the latter will only attack his enemies, and those he wishes ill to, the other injures indifferently both friends and foes.—Addison.

HANDLING POTATOES EASILY

A bushel crate is often more convenient to use in handling ear corn, potatoes or other vegetables

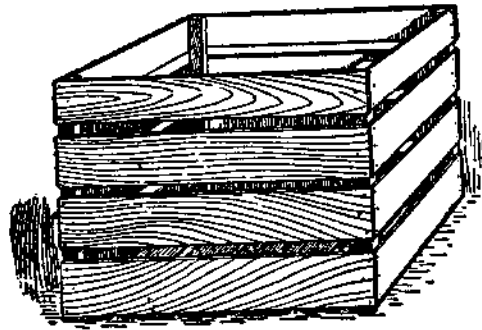

STORAGE BOX

than a basket. Crates that will hold a bushel when level full may be piled upon one another and thus stored in less space than baskets. At the same time they can be just as easily and just as quickly

moved. They may be of light material. Pieces of wood 2 inches square are used for the corner posts. The slats may be made of $\frac{1}{2}$ -inch boards 3 inches wide nailed securely to the corner posts. There should be just room enough between the two upper slats so that the fingers can be inserted when lifting the box. The box will be more durable if the upper slats are an inch thick. A handy size for the completed box is 16 inches long, 14 inches wide and 12 inches deep, outside measurements.

CUTTING SEED POTATOES

In the principal potato growing sections, medium to large seed is used for planting and cut to two eyes. In the famous Greeley district of Colorado, cutting is done by hand. Potatoes are shoveled into a bin or hopper, made of a dry-goods box raised on legs. The back is made higher than the front, so that potatoes will run down to the open-

ing and the bottom is slatted to let out the soil shoveled up with the potatoes.

The cutting is simple. An old case knife, *a*, is fastened to the end of a plank or board, *b*, in such

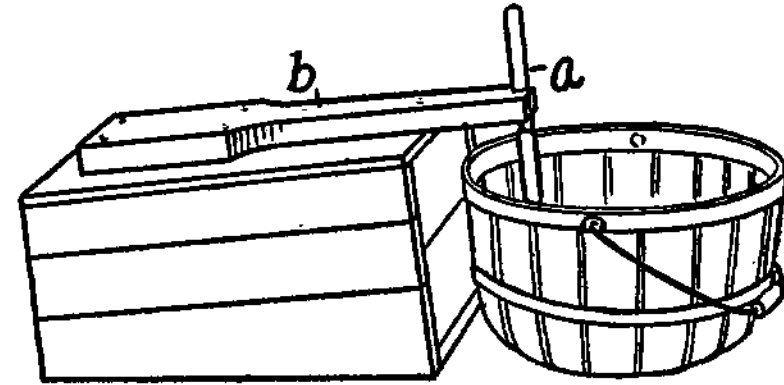

SEED POTATO CUTTER

a way that potatoes can be pushed against the knife and fall from it into the basket beneath. The operator sits on the box to which the board is fastened and can work very rapidly.

ANOTHER SEED POTATO CUTTER

A wide bench is boxed in on both ends and one side. It is divided into two or three compartments, these being open in the front which corresponds to the side boxed in. To each of the compartments is attached a sack on hooks, and along one side of the bench in the middle of each compartment and right over the opening of the sack is fixed, in an upright position, a shoemaker's or common steel table knife.

Potatoes to be cut for planting are shoveled into the compartments of the box and in front of each compartment a man takes his position, being seated

on a box or stool for comfort's sake. He seizes the tubers in rapid succession and by pulling them against the blade quickly cuts each one into as many pieces as desired; the pieces are then dropped into the open sack. It is claimed that by this indirect method of using the knife two fairly good cutters can cut each day all the potatoes ordinarily required for the use of one planter.

HOW TO TEST SEED CORN

Of the different methods for testing seed corn, the most convenient and satisfactory is a shallow box provided with wet sawdust to furnish the moisture and a marked cloth on which to lay the kernels. The most convenient box is one 2 feet square. This will accommodate 100 ears. It is best to make it about 6 inches deep. Fill a sack half full of clean sawdust and soak it for three or four hours in water. Then spread this sawdust in the bottom of the test box to the depth of 1 inch. Take a smooth brick and pack the sawdust down all over the box, making it as level as possible. Be sure to get it packed firmly around the edges and in the corners.

Then take a piece of white muslin 25 inches square. Stretch this tight on a table so that it can be marked. Rule off on this cloth with a heavy blue pencil 100 squares 2 inches each way. Beginning at the upper left-hand corner number these squares in rotation from left to right. When the ruling is done, pack the cloth in the germination box so that it will rest firmly on the sawdust. This can be done by pointing the tacks in the edge of the box downward, and as the tack is driven in it will draw the cloth tight over the sawdust.

Of course, there is no advantage testing any ears that are of undesirable shape or conformation, therefore the first step is to pick out those nearest to the type wanted. Lay these out in rows upon a plank or upon the floor, separating each ten ears with a nail driven into the plank or floor. Starting at the left-hand end of the row call the first ear No.

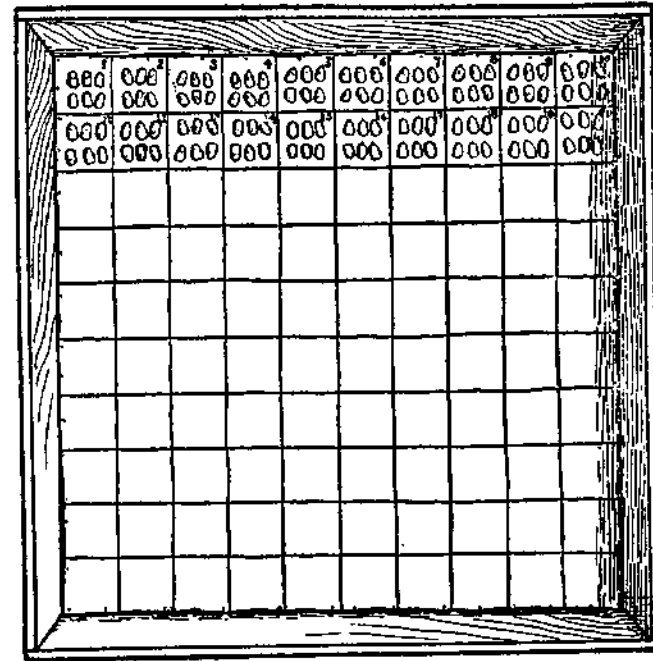

GERMINATION BOX

1, then the first ear beyond the first nail will be No. 11, the one beyond the second nail No. 21 and so on.

Remove six kernels from ear No. 1 and place them in square No. 1 in the test box. Put six kernels from ear No. 2 in square No. 2 and so on through the row. In removing the kernels from the ear take a pocketknife in the right hand and the ear in the left. Place the blade at the side of the

kernel you wish to remove and pry it gently. The kernel will come out easily and should be caught in the palm of the left hand. First remove a kernel from near the butt of the ear; turn the ear a quarter turn in the hand and remove a kernel from the center; turn the ear another quarter turn and remove a kernel from near the tip; another quarter turn and remove a second kernel from near the butt; another quarter and remove the second kernel from the center; another quarter turn and remove a second kernel from the tip. This makes six kernels from six different rows and representing the butt, middle and tip.

In placing the kernels in the box it will be found of advantage to point the tips all in the same direction, and also to lay the kernels with the germ uppermost. If the kernels are laid in the squares promiscuously, they may be thrown out of their places when the sprouts begin to grow. When the kernels are all in place, take a second piece of white cloth fully 24 inches square, moisten it and lay it carefully over the kernels. This will hold them in place while the top layer of sawdust is being put on. Take a third piece of cloth about 48 x 30 inches and lay it over the box so that the edges lap about equally. Then in this cloth put another inch of wet sawdust and pack it down firmly, especially around the edges. When this is done turn the edges of the cloth over the sawdust to keep it from drying out too rapidly and place the test box where it will not be subjected to cold below a living-room temperature.

Reading the Results

After seven days carefully roll back the cloth containing the top layer of sawdust and lift the

second cloth off the kernels. This must be done with care, because sometimes the sprouts grow through the cloth and the kernels will cling to it.

Observe the results in square No. 1. If all six of the kernels have vigorous sprouts, from $\frac{3}{4}$ to 2 inches long, you can be sure that ear No. 1 is thoroughly good. If in square No. 2 only two of the kernels have sprouted, you may know that ear No. 2 will make much better hog feed than seed corn. As soon as you have determined that ear No. 2 is really bad, pull it out from the row about half its length, leaving the other ears in place. After you have gone through the whole line, you may then go back and pick out the bad ears and discard them.

Of course, we would all prefer to use only those ears that gave a perfect germination, and if one has enough, that is the thing to do. But experience has taught that it is quite safe to use an ear, four of whose kernels grow strong sprouts. Or, if seed corn is scarce, one should not hesitate to use one that gave three strong sprouts and two weaker ones.

This testing may be done at any time after the ears are dry. It is generally more convenient to do it in winter, when there is not much outside work to be done. The box may be set behind the stove or any other convenient place, where it is sufficiently warm; in many cases, where there is an attic above the kitchen that room is a sufficiently warm place for testing.

Some put sand in an ordinary dinner plate, flood with water, and then drain the excess water off, place the seed on top of the sand, and cover with another dinner plate. Others use a saucer made

of porous clay. The seeds are placed in this, the saucer set in a pan of water, and the pan covered.

These methods may be used for other grains as well as corn. In case of sowing grasses, alfalfa or wheat, it is often of great advantage to test the seed.

Every man has two educations—that which is given to him and the other, that which he gives to himself. Of the two kinds, the latter is by far the most valuable. Indeed, all that is most worthy in a man he must work out and conquer for himself. It is that that constitutes our real and best nourishment. What we are merely taught, seldom nourishes the mind like that which we teach our selves.—Richter.

KILLING INSECTS IN GRAIN

If one has not time to make a substantial box for fumigation of seed grain for insect destruction, barrels may be utilized for the purpose. Get two tight, strong barrels, such as coal oil barrels, and make water tight. Put in the seed to be fumigated, cover with a blanket and close-fitting cover. Before covering pour carbon bisulphide, which is explosive, over the grain, at the rate of 3 to 4 ounces for 5 bushels of grain. If it is not desirable to pour this poison on grain, set a saucer on it, and pour the poison in the saucer. Place a small block near the saucer to hold up the blanket 1 or 2 inches higher, lay blanket over the

barrel, and place cover securely in place and weight with stone. This will kill the weevil in peas and beans.

BINDING PINS FOR HAY

Every person moving hay ought to have a set of binding pins. They are made in a minute and serve an excellent purpose for a lifetime. The sketch shows a rope stretched over the top of a load of hay or straw. The upright pin is worked down into the load and the other twisted in the rope and turned around the upright until the load

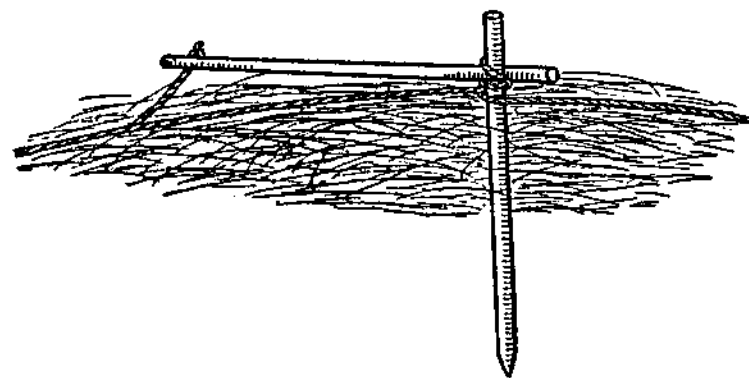

BINDING LOAD OF HAY

is tightly bound. Then a small rope that is kept tied in end of the horizontal pin is tied to the binding rope and the pressure is held. Each pin is $3\frac{1}{2}$ feet long. One is sharpened and the other has a $\frac{1}{2}$ -inch hole bored through one end. Old fork handles are just the thing to make them of. One pin only may be made and a fork used to bind in the manner shown after the load is on.

Nothing is impossible to industry.—Periander.

COMBINED DRAG AND HARROW

This road drag is all right. The front piece consists of a 4 x 4 oak strip, *b*, 10 feet long, through which are driven ordinary harrow teeth about 3 inches apart. This is attached to the rear piece, *a*, which is a 2 x 6 oak timber 10 feet long faced with

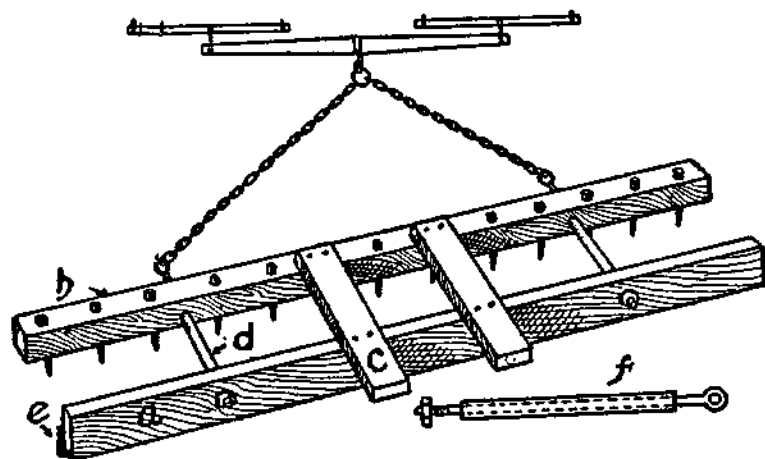

HARROWS AND LEVELS AT ONCE

3 inches of $\frac{1}{4}$ -inch metal on the bottom, *e*, which projects 1 inch. These pieces are kept apart by wooden blocks, *d*, upon the bolts, *f*, and by the top strips, *c*, each 2 x 6. This makes a fine level road, as it harrows it and scrapes it at the same time.

HOW TO HANDLE A ROPE

A rope is one of the most useful articles that are constantly needed about the farm; but too many farmers are not familiar with the many uses to which the rope may be put. The various sailors' knots may often be used to great advantage. To sling a plank for painting or other purposes make

a bight of rope as shown in Figure 1, bringing the rope entirely around the plank, so as to prevent its turning and throwing the workman down. One-half to $\frac{3}{4}$ -inch rope is usually sufficient for all practical purposes. A hemp rope is more generally used and stands wear better than other kinds.

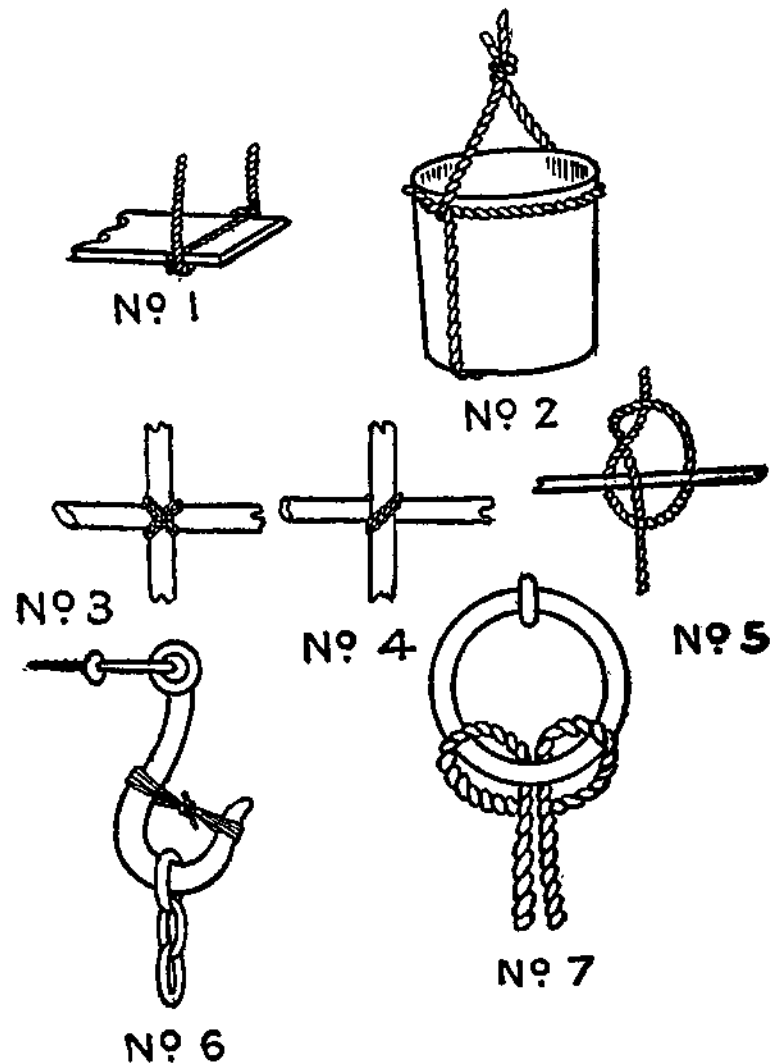

SOME ROPE HITCHES

A useful way to sling a can or pail from the end of a rope is shown in Figure 2. Prepared in this way the vessel is secure so long as the rope is not slipped off from the bottom. Secure the knot firmly at the top to allow no slipping and so that the pail may not become lopsided.

Scaffolding may often be erected by tying poles together as shown in Figure 3. This sort of lashing will not slip if made tight. In many cases a chain may be used as shown in Figure 4, in which case the weight should be on the side of the upright where the chain is lowest. All of these lashings must be drawn very tight so as not to allow any play, which may result disastrously.

An excellent hitch knot is shown in Figure 5, readily made, easily loosened and valuable for many purposes on the farm. This knot is readily untied by slackening up the drawing strand. It does not become tight and hard as many ordinary knots after heavy usage.

In many cases where heavy hooks are used they are liable to come unfastened unless a cord is affixed, as shown in Figure 6. A few turns of heavy twine or light wire in the middle will frequently prevent any loosening of the chain.

A ring hitch, shown in Figure 7, is a very effective and safe method, which may be made on short notice. The loose end of the rope is allowed to hang free or may be tied with a slip knot to the drawing strand.

TYING SOME USEFUL KNOTS

A sailor judges knots for their holding qualities and also their ability to be quickly unfastened, without regard to the strain they have been sub-

jected to. A knot's main office is to hold, without working loose or slipping, yet they do occasionally fail absolutely to accomplish this, when made by inexperienced hands. The accompanying diagrams show some of the simpler knots that may be of everyday use. In these, the mode of formation can be readily discerned, because the rope's position is shown before tightening. The overhand knot, Figure 1, is probably the simplest of all. It is used only for making a knot at the end of a rope to keep it from fraying or to prevent another knot from slipping. If a slight change in formation is

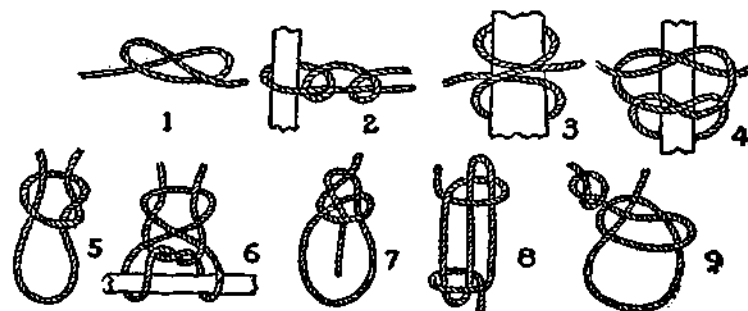

A FEW GOOD KNOTS

made, as in Figure 5, it develops into a slip knot or, as it is sometimes called, a single sling, and its purposes are obvious. A double sling is represented in Figure 6, and though it is slightly more complicated, it is considerably more useful for any purpose where a rope is to be attached to a bar or beam and stand a steady strain.

Probably for convenience and emergencies no knots equal the bow-line, Figure 7, because it will not slip or give, no matter how great the tension; in fact, the rope itself is no stronger, and the instant the strain ceases it can be untied as easily as

a bow. When the end of a rope is to be secured, the two half-hitches or clove hitch, Figures 2 and 3, are of great importance, for either of these bends can be attached instantly to almost anything, and their holding powers are exceeded by none. The square knot, Figure 4, can be used for infinite purposes, from reefing a sail to tying a bundle, the advantage being, if made properly, of resisting any separating strain on either cord, and yet can be untied immediately by pulling one of the short ends.

One of the best and safest slip knots is shown in Figure 9, made with the overhand at the end, which, until loosened by the hand, maintains its grip. When a rope requires shortening temporarily the sheep shank, Figure 8, affords a means of so doing. This knot can be applied to any part of the rope without reducing its strength of rectilinear tension.

CARRYING A BARREL MADE EASY

In the cities the ash collectors use a simple device, which farmers might make and often find handy, as barrels often become dried, weak and will not stand rough handling. The device is made of six pieces of wood; four pieces are about 2 feet long and 4 inches in thickness and width. Handles may be whittled on one end of each. About 10 inches from the other end, boards about 2 feet long and 8 inches wide are nailed as shown at *c, c*, in figure. Pieces *c, c*, are then cut in circular form so as to fit the outside of a barrel.

An old wheel tire may be straightened and four pieces cut to be fastened to the ends of each of the four handle pieces, as at *d*. These are then riveted

together so as to make hinges as shown at *d, d*. The tire need be only long enough to fasten securely to the handle pieces. Of course, the blacksmith should drill holes in them, that they may be securely riveted.

To use this device, drop it over the barrel. One man lifts on the two front handles and another

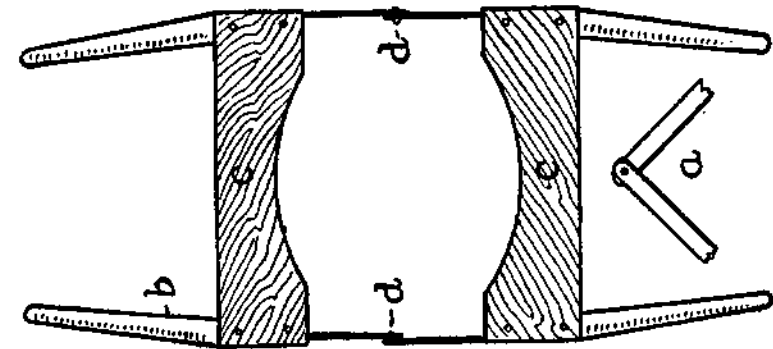

BARREL CARRIER

man on the rear handles. Boards *c, c*, close up in circular form, just beneath the lowest hoop round the upper end of the barrel, and cling tightly. The barrel is then lifted and readily carried without jar to its contents or straining the barrel. Of course, if all the barrels on the farm are of uniform size, the device could be made without hinges, and the barrels headed up could be rolled on pieces *c, c*.

The best part of one's life is the performance of his daily duties. All higher motives, ideals, conceptions, sentiments, in a man are of no account if they do not come forward to strengthen him for the better discharge of the duties which devolve upon him in the ordinary affairs of life.—Henry Ward Beecher.

HARNESS CLAMP

The accompanying drawing represents a very handy harness mender which anyone who can use

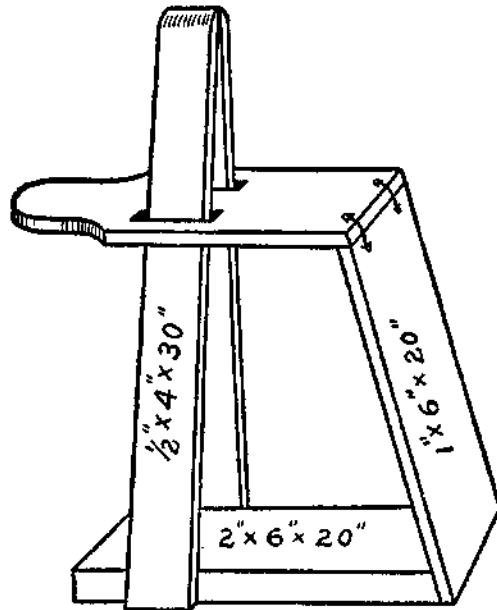

THE CLAMP

a saw and hammer can make in a few minutes. It is made of lumber of the dimensions indicated in the drawing. The clamp is tightened by the worker sitting upon the seat, which should extend at least 2 feet from the clamps. The drawing shows the device with a shorter seat than that. It would doubtless be better to have the seat extended to twice the length shown from the left of the clamps and to have the base extended in a similar manner, so that the device will not tip over too easily. The joint at the upper right-hand corner may be hinged with heavy wire run through holes and twisted together underneath, or real strap hinges of iron may be attached.

They who provide much wealth for their children, but neglect to improve them in virtue, do like those who feed their horses high, but never train them to the manage.—Socrates.

a saw and hammer can make in a few minutes. It is made of lumber of the dimensions indicated in the drawing. The clamp is tightened by the worker sitting upon the seat, which should extend at least 2 feet from the clamps. The drawing shows the device with a shorter seat than that. It would doubtless be better to have the seat extended to twice the length shown from the left of the clamps and to have the base extended in a similar manner, so that the device will not tip over too easily. The joint at the upper right-hand corner may be hinged with heavy wire run through holes and twisted together underneath, or real strap hinges of iron may be attached.

SUBSTITUTE FOR PIPE WRENCH

The drawing shown here illustrates a useful device for twisting pipe off or on its connections.

Three or 4 feet of new rope is frayed out at both ends, which are put together and wound tightly around the pipe to be turned, so that the first coil twists over the loose ends and continues around the pipe, two or three times, ending in a loop, through which a bar of iron is slipped, to be used as a lever. This simple plan will be found very effective in ordinary requirements for the pipe wrench, and is worth a trial. A more durable wrench may be made by using wire instead of rope. The loop can be formed by closely twisting the ends of the wire with pincers. The rope is rather easier to handle because more flexible.

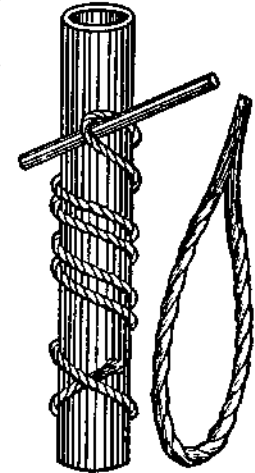

PIPE TWISTER

MARKET WAGON CONVENIENCES

Farmers who regularly haul produce to market or deliver direct to customers will find the conveniences described to be of much value.



REIN CLIP

They save much time and considerable trouble and cost but little effort to make them. Instead of wrapping the reins about the whip, or letting them lie over the dashboard, a hook, such as shown in the first sketch, may easily be made of stiff fencing wire and secured to the top of the wagon or the dashboard.

Two other hooks may be arranged at the sides of the wagon to hold an umbrella, which would be kept there rain or shine, and never forgotten and left at home. This will save a drenching some time and perhaps some valuable produce.

Another convenience is a rear curtain of oilcloth stretched over a light board frame and hinged at

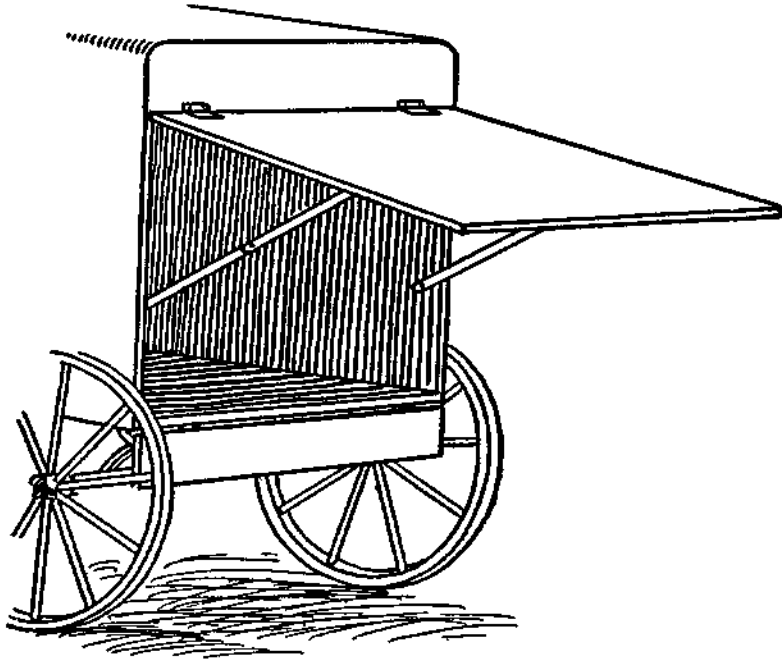

REAR SHADE FOR WAGON

the top, as illustrated. Two old stays from a buggy top will serve to support it, when it must be left open, and it will protect the driver from sun and rain while taking things from the wagon.

CARRYING BUTTER TO TOWN

A refrigerator that one farmer uses in which he takes butter to town nine miles away in hot weather

is made thus: Get two clean, tight boxes of some odorless wood, one 12 x 15 x 13 inches deep, and the other 9 x 12 x 10 inches deep. Slip one inside the other with a notched block in each corner to hold the inside box in place. Fasten the covers together so as to leave an air space of about 1 inch between them all around. The inner box will hold 20 pounds of butter nicely. It will carry butter solid in wagon all day in 90-degree weather.

TO SHARPEN SCISSORS

Do you know that you can sharpen scissors, and easily, by passing the blades over glass jars? Take a bottle or jar, make believe you are trying to cut it (have one blade in and the other outside of the top of the bottle) and then allow the scissors to glide off the hard surface naturally, just as if you were trying to cut the glass. Use firm but not too hard pressure, and repeat the operation several times.

HOW TO PAPER A ROOM

If a room has been papered several times, tear off all the loose parts you can and with a sponge and water loosen what remains on the walls, removing as much as possible, so as to have a smooth, even surface. If the room has never been papered, first go over it and fill all large cracks and holes with a paste made of whiting and water, or plaster of paris and water. When using the latter, mix only a little at a time, have it rather thin, and use quickly. Then, give the room a coat of sizing, which is made of common glue, three or four handfuls dissolved in a pail of boiling water. The sizing is applied with a large brush and should be allowed to dry overnight.

Choose Judiciously

For very sunny rooms, select cool-looking papers, such as blues, greens and browns in various shades,



HANGING WALLPAPER

while for dark rooms pinks, reds, terra cottas and yellows are best. When selecting papers, pay care-

ful attention to the color scheme of your room, and don't have an inharmonious mixture, which will offend good taste. Small, plain patterns are the most economical, and the easiest to match. The cheap, trashy papers, costing only a few cents a roll, are not worth the trouble of putting up. Gold paper is not to be recommended for wear.

No borders should be used for rooms having a low ceiling. For such, a striped paper of pretty design running right up to the ceiling is best. The ceiling may be papered in a plain or very small-patterned design, to harmonize with the side walls, or treated with several coats of tinted kalsomine or paint. A picture molding of appropriate color is used to finish the side walls, being placed scarcely 1 inch from the ceiling. The ceiling whether papered, painted or kalsomined, should be done first. It is a very difficult matter to paper the ceiling, and, unless you can have help, it would be better not to attempt it. Plain tints in paint or kalsomine are always pretty and in good taste. If, however, you want to risk papering the ceiling yourself, get some handy body to help you.

Paste and Tools

The paste is made by simply boiling flour and water together, and adding a very little alum, salt and glue—about a tablespoon of each to a pound of flour. It should be of a consistency thick enough to apply easily, and not so thin that it will run.

Provide yourself with a good-sized paste brush, another one (a whitewash brush will do) to use dry over the paper, sharp scissors and a knife,

plenty of clean rags, two barrels, two long, smooth, clean boards, each about 10 inches wide, and a step-ladder.

Make a long table by placing the two barrels about 8 or 9 feet apart and on top of these the boards.

Trimming and Cutting

The first thing to do is to cut the necessary number of strips of paper long enough to allow for waste in matching, and lay them all face downward on the "operating" table, one on top of the other. Next spread the paste evenly over the top or first strip of paper, being very sure to have the edges well pasted. Then turn top and bottom parts down, bringing pasted sides together, so that they meet, and none of the paste part is exposed, and carefully trim off edge on one side, with large, sharp scissors. Lift up the part thus trimmed and folded, and mount the ladder, which should previously have been placed convenient to the place where you intend to begin operations—the largest wall space is best, next to a door or window.

Hanging the Paper

Now take hold of the top end which was doubled over (it will open and hang by its own weight) and adjust to its proper place on the wall. Then, with a large clean rag in your hand, rub downward, never up or sideways, and take great care to keep the edge straight. If you find that you didn't start straight from the top, loosen paper and do it over again. A "straight eye" is needed to do the work neatly. Don't rub too hard and always rub down-

ward, doing a little part at a time, and lifting paper occasionally, so that no air bubbles are left under it. When the upper part is done, dismount from ladder, undo the folded part at the bottom of the width, and proceed in the same manner to adjust to the wall. When you are sure it is on straight and smooth, trim with a sharp knife along the base-board. Then give the strip another smoothing by going all over it again with a dry, clean brush. Proceed in this way until all the full length parts are covered, and then match in the small spaces over and below windows and doors. All the matching must be done with great care.

Practical and Economical

Wainscoting in living or dining rooms are nice, and very practical, especially where there are small children. For this purpose burlap, or the less expensive dark, heavy papers that come in wood-grain imitation are good. Matting is sometimes used with very good effect, too. A narrow wooden molding is used to finish the top of the wainscoting, and in that case the work of papering the side walls is so much easier, the lengths being short.

THE FARM BLACKSMITH SHOP

A blacksmith shop is of immense practical value on a farm. To those who have one it is almost as essential as live stock, farm tools and crops. One does not need to be a professional blacksmith. The elementary practice in welding, upsetting and tempering is easily learned with a little practice. Nor is it necessary to have many tools. An entire equipment may cost but a few dollars.

An old railroad rail will do for an anvil. But after getting the real article one is better satisfied and can do the work with greater ease. The forge should be obtained at the start. With it almost anyone can heat any small iron to welding point with as much ease as a regular blacksmith.

In the equipment of an Ohio farmer are a pair of tongs that he made himself, two other tongs and a large pair of pinchers picked up in a junk shop. He got the hammer and sledge from a hired man who had worked in a car shop. The anvil and vise also came from the junk shop, and both were in good repair. These cost \$8, the hammer and sledge, \$1.15, and an old, second-hand forge, \$1.80. Not a large outlay to be sure, but a wise expenditure. If purchased at first hand the cost would be greater, but cheap at any price when you consider what you can do in the way of making and repairing with such a list of blacksmith tools.

In addition to the above list this man, Frank Ruhlen, has chisels, pinchers, fullers and other small tools, all of which he has made out of old pieces of steel taken from old worn-out machines. By figuring and planning just a little, any farmer can make the greater part of his own tools and at a very small cost for materials and labor.

Why the Shop Pays

Mr. Ruhlen says: My shop was not started to replace the town blacksmith shop; and it will never do so. But it does serve for repair work, and it saves many trips to town. It is helpful in other ways, also. Last winter a sudden ice spell came on, so severe that I could not get the horses out to the field to feed the flock. Only one thing was

possible: to have sharpened shoes put on the horses. But it was a disagreeable trip ahead to walk and lead the horses to town; so I decided to do the work myself. I had never set a shoe myself, but that trip before me quickly decided. The horses were brought into the shop, the old shoes pulled off and sharpened, and within an hour the feeding was done. Had I gone to town for the work it would have required time going and coming, and then, maybe a long wait ahead for my turn at the shop.

Last year I sharpened the shoes on the corn planter, and both cultivators, six shovels each. We wore out a steel point or shear, and never had it to shop but once, and then it was to get a new nose or point. I do not try to put steel points on anything, as it is too particular work for anyone who just picks tools up when something breaks. A sharp harrow is a luxury on most farms, because the average smith does not draw the teeth out enough, and they are dull in a few days.

And I do not believe the average smith can harden the farm tools as good as a farmer who has had some experience in tempering, as the farmer is the one who works with the tools, and soon learns when they are too hard or not hard enough. I sharpened my smoothing harrow last year before we commenced on our corn crop of 64 acres, used it on all the land, on some more than once, and my harrow is sharper now than my neighbor's, who paid \$1.50 at the shop for the same work. We never use a dull mattock or pick now as we did before we had a forge. Welding chains, making chain hooks, open rings, clevises, are all easy to do on rainy days. I could not tell all the different uses I make of my shop.

Blacksmithing Not Hired Man's Work

I do the work in the shop myself, finding other chores for hired men. You cannot afford to break them in, for the reason that they may soon leave and all the teaching and trouble would be for nothing. By doing the work myself, I have learned a little more each year, have acquired the knack of it, and really enjoy doing what is to be done. Had we had a shop when I was a boy all of the repair work could have been done by the boys, and I would at the same time have had splendid training for my own needs now.

My experience is all in favor of the shop on the farm. It pays well. Get the forge first, and then gradually add other tools as you can. I used a claw hammer for some time before getting a smith's hammer. I did not equip my shop all at once. Start in a small way, build up gradually, learn slowly, and the shop will develop itself. Get a shop, and you will believe in it because of its help to you.

HORSESHOE LEVER

A handy lever for prying up boxes or barrels may be made by nailing an old horseshoe on the end of a 2 x 4, letting the ends of the horseshoe extend about an inch or two beyond the end of the timber. A more finished device may be constructed by cutting the upper part of the lever down to the form of a rounded handle. A horseshoe should be selected with fairly long and well-sharpened heel calks.

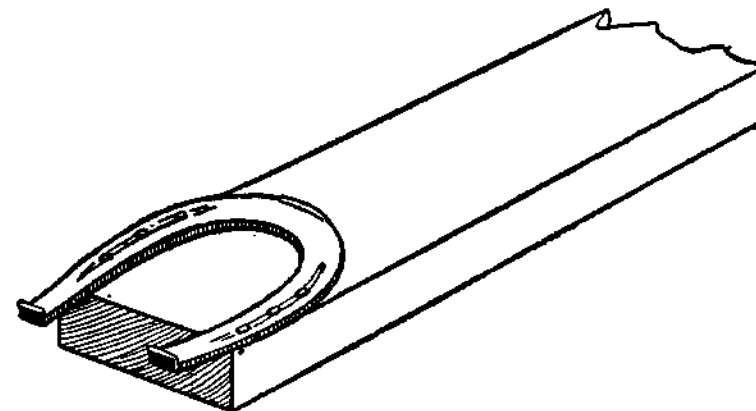

HORSESHOE FOR A TOOL

HOW TO PAINT TIN ROOFS

Remove all rosin and other loose substances from seams and have roof clean. Paint immediately after laying is finished; do not allow the tin to rust—you coat the base plate with tin and lead to prevent rust, and paint the finished goods to prevent oxidation of the coating. Use only the best red or brown oxide of iron, mixed with pure linseed oil all raw, or half raw and half boiled. Use litharge only as a drier. Litharge makes paint adhere hard to coating, so that when thoroughly dry you cannot scrape it off. Don't use any turpentine or patent driers.

Apply all paint with hand brushes and rub in well. This is very important. Don't put paint on thick—one coat that covers well, and is thoroughly rubbed in, is better than three put on thick. Let roof stand two weeks to a month before applying second coat. Six months or so after applying second coat put on a third coat. After this you do not have to paint roof more than once every two or three years. Too much paint injures a tin roof.

Keep paint well stirred up; put on thin and rub well in. By following these directions you will have a roof that will last many years.

PRESERVING WOOD

Creosote, or sulphate of copper or iron, are effective for preserving wood. There are objections, however, to their use for floorings or ornamental woodwork. Creosote leaves a permanent, disagreeable smell. The sulphates discolor the wood. Borax is excellent for keeping wood from decay. The preparation of it is simple, and consists in immersing the wood in a saturated solution of borax, which is then heated to 212 degrees Fahrenheit. The wood is left for 10 or 12 hours, the time depending upon the density and size of the pieces of wood. When taken out, the wood is stacked until dry, then reimmersed in a weaker solution of the borax for a brief time, dried again, and are then ready for use. Boards thus prepared are practically indestructible from rot, and are nearly incombustible.

Another preservative is a compound of one part silicate of potassa and three of pure water—the wood to remain in the solution 24 hours, then dried for several days, then soaked and dried a second time and afterward painted twice with a mixture of one part water-cement and four of the first-mentioned mixture. Thus prepared, it will not decay in the ground, and will be incombustible out of it.

Another process for preventing decay of wood is by use of a paint which possesses the advantages of being impervious to water. It is composed of 50 parts of tar, 500 parts of fine white sand, 4 parts

of linseed oil, 1 part of the red oxide of copper in its native state, and 1 part of sulphuric acid. The tar, sand and oil should be first heated in an iron kettle; the oxide and acid are then added very carefully. The mass is thoroughly mixed and applied while hot. When dry, this paint is as hard as stone.

Decay in wood may be prevented by the following method: Take 20 parts of resin, 46 parts of finely powdered chalk, some hard sand, and a little linseed oil and sulphuric acid; mix and boil for a short time. If this is applied while hot, it forms a kind of varnish, thereby preserving the wood.

TO PRESERVE SHINGLES

Following is an effective method to prevent the decay of shingles: Take a potash kettle or large tub and put into it one barrel of lye of wood ashes, 5 pounds of white vitriol, 5 pounds of alum, and as much salt as will dissolve in the mixture. Make the preparation quite warm, and put as many shingles in it as can be conveniently wet at once. Stir them up with a fork, and, when well soaked, take them out and put in more, renewing the preservative solution when necessary. Then lay the shingles in the usual manner.

After they are laid, take more of the preservative, put lime enough into it to make whitewash, and, if any coloring is desirable, add ocher, Spanish brown, lampblack, or other color, and apply to the roof with a brush or an old broom. This wash may be renewed from time to time.

Salt and lye are excellent preservatives of wood. Leach tubs, troughs and other articles used in the

manufacture of potash never rot. They become saturated with the alkali, turn yellowish inside and remain impervious to the weather.

TO RENDER WOOD FIREPROOF

Rendering the woodwork of houses secure against catching fire can be done at an insignificant cost, and with little trouble. Saturate the woodwork with a very delicate solution of silicate of potash as nearly neutral as possible, and when this has dried, apply one or two coats of a stronger solution.

Another method is simply to soak the wood with a concentrated solution of rock salt. Water-glass will act as well, but it is expensive. The salt also renders the wood proof against dry rot and the ravages of insects. Still another method is to immerse the wood in a saturated solution of borax, heat being gradually applied until the solution reaches 212 degrees Fahrenheit. It is then left for 10 or 12 hours, according to the nature and size of the wood.

FIREPROOF WASH FOR SHINGLES

A preparation composed of lime, salt and fine sand or wood ashes, put on like whitewash, renders the roof 50 per cent more secure against taking fire from falling cinders, in case of fire in the vicinity. It pays the expense a hundredfold in its preserving influence against the effects of the weather. The older and more weather-beaten the shingles, the more benefit derived. Such shingles generally become more or less warped, rough and cracked; the application of the wash, by wetting

the upper surface, restores them at once to their original form, thereby closing up the space between the shingles, and the lime and sand, by filling up the cracks and pores in the shingle itself, prevents warping.

PETRIFIED WOOD

Mix equal parts of gem salt, rock alum, white vinegar, chalk and Peebles' powder. After the mixture becomes quiet, put into it any wood or porous substance, and the latter becomes like stone.

HOW TO SEASON WOOD

Boiling small pieces of non-resinous wood will season them in four or five hours—the process taking the sap out of the wood, which shrinks nearly one-tenth in the operation. Trees felled in full leaf in June or July, and allowed to lie until every leaf has fallen, will then be nearly dry, as the leaves will not drop off themselves until they have drawn up and exhausted all the sap of the tree. The time required is from a month to six weeks, according to the dryness of the weather.

BLEACHING WOOD

Sometimes it is more feasible to bleach a small part of a wood surface, especially in repairing, than to darken a larger portion of the work. This can be done by brushing over the wood a solution composed of 1 ounce oxalic acid in a pint of water, letting it remain a few minutes and then wiping dry. The operation may be repeated if necessary. A few drops of nitric ether, or a quarter of an ounce of tartaric acid, will assist the operation; or

a hot solution of tartaric acid may be used alone. Lemon juice will also whiten most woods. Cut the lemon in half and rub the cut face upon the wood.

When the bleaching has been done and the wood is dry, give a thin coat of shellac or French polish, as the light and air acting upon the bare wood will bring back the original color.

If the wood obstinately resists bleaching, it may be lightened by mixing a little fine bismuth white, flake white or ball white (the cleansing balls sold by druggists) with the shellac, and give it a thin coat. This whitens, but it also somewhat deadens or obscures the grain and is, therefore, not so good as the bleaching method.

WOOD POLISH

Rub evenly over the wood a piece of pumice stone and water until the rising of the grain is cut down; then take powdered tripoli and boiled linseed oil and polish to a bright surface.

FURNITURE POLISH

Take equal parts of sweet oil and vinegar, mix, add a pint of gum arabic finely powdered. This will make furniture look almost as good as new and can be easily applied, as it requires no rubbing. The bottle should be shaken, and the polish poured on a rag and applied to the furniture.

SIZE STAINS

By the aid of glue in the solution, the colors are fixed in size stains. They are employed for the

purpose of giving a color to cheap work in soft woods, such as chairs, bedsteads and common tables and ordinary bookcases. The colors usually wanted are walnut, mahogany, cherry color, oak and even a rosewood.

For Mahogany—Dissolve 1 pound of glue in a gallon of water, and stir in $\frac{1}{2}$ pound venetian red, and $\frac{1}{4}$ pound chrome yellow, or yellow ocher. Darken with the red and lighten with yellow, as desired. If the venetian red does not give a sufficiently dark look put in a pinch of lampblack. Apply hot.

For Rosewood—Same as mahogany, omitting the yellow, and using $\frac{3}{4}$ pound venetian red (or more) instead of $\frac{1}{2}$ pound. Give one coat of this and then add lampblack, one pinch, or more, to the color; with the latter put in the figure or dark parts of the rosewood.

For Oak—In a gallon of glue size (as above) put $\frac{3}{4}$ pound powdered burnt umber. Lighten with yellow (chrome or ocher), if need be. Hot.

DARK WOOD STAIN

White woods may be given the appearance of walnut by painting or sponging them with a concentrated warm solution of permanganate of potassa. Some kinds of wood become stained rapidly, while others require more time. The permanganate is decomposed by the woody fiber; brown peroxide of manganese is deposited, which afterward may be removed by washing with water. The wood, when dry, may be varnished, and will be found to resemble very closely the natural dark woods.

RED STAIN FOR WOOD

Boil chopped Brazil wood thoroughly in water, strain it through a cloth. Then give the wood two or three coats, till it is the shade wanted. If a deep red is desired, boil the wood in water in which is dissolved alum and quicklime. When the last coat is dry, burnish it with the burnisher and then varnish.

LIQUID GLUE

Dissolve 1 pound of best glue in $1\frac{1}{2}$ pints of water, and add 1 pint of vinegar. It is ready for use.

CEMENT FOR METAL AND GLASS

Take 2 ounces of a thick solution of glue, and mix it with 1 ounce of linseed-oil varnish, and half an ounce of pure turpentine; the whole is then boiled together in a close vessel. The two bodies should be clamped and held together for about two days after they are united to allow the cement to become dry. The clamps may then be removed.

CEMENT FOR BROKEN CHINA

Stir plaster of paris into a thick solution of gum arabic till it becomes a viscous paste. Apply it with a brush to the fractured edges, and draw the parts closely together.

CEMENT FOR CROCKERY AND GLASS

Take 4 pounds of white glue, $1\frac{1}{2}$ pounds of dry white lead, $\frac{1}{2}$ pound of isinglass, 1 gallon of soft water, 1 quart of alcohol, and $\frac{1}{2}$ pint of white

varnish. Dissolve the glue and isinglass in the water by gentle heat if preferred, stir in the lead, put the alcohol in the varnish and mix the whole together.

MENDING GLASSWARE

Broken dishes and glassware may be easily mended as follows: Fit the pieces in their proper places and tie a string around the vessel to keep the parts from slipping out. Then boil the entire dish for two or three hours in sweet milk. This will firmly glue the vessel together and it will last for years with proper care.

ARMENIAN CEMENT

This will strongly unite pieces of glass and china, and even polished steel, and may be applied to a variety of useful purposes. Dissolve five or six bits of gum mastic, each the size of a large pea, in as much rectified spirits of wine as will suffice to render it liquid; and, in another vessel, dissolve as much isinglass, previously a little softened in water (though none of the water must be used), in French brandy or good rum, as will make a two-ounce vial of very strong glue, adding two small bits of gum galbanum of ammoniacum, which must be rubbed or ground till they are dissolved. Then mix the whole with a sufficient heat. Keep the glue in a vial closely stopped, and when it is to be used set the vial in boiling water.

JAPANESE CEMENT

Thoroughly mix the best powdered rice with a little cold water, then gradually add boiling water until a proper consistence is acquired, being par-

ticularly careful to keep it well stirred all the time; lastly it must be boiled for one minute in a clean saucepan or earthen pipkin. This glue is white, almost transparent, for which reason it is well adapted for fancy paper work, which requires a strong and colorless cement.

ROOFING PREPARATION

Take 1 pint of fine sand, 2 of sifted wood-ashes, and 3 of lime ground up with oil. Mix thoroughly, and lay on with a painter's brush, first a thin coat, and then a thick one. This composition is not only cheap, but it strongly resists fire.

FIRE KINDLERS

Take 1 quart of tar and 3 pounds of resin, melt them, bring to a cooling temperature, mix with as much sawdust, with a little charcoal added, as can be worked in; spread out while hot upon a board, when cold break up into lumps of the size of a large hickory nut, and you have, at a small expense, kindling material enough for one year. They will easily ignite from a match and burn with a strong blaze, long enough to start any wood that is fit to burn.

MENDING PIPES WITH WATER ON

Many farmers have had trouble in repairing pipes where the water could not be shut off conveniently. A lead pipe which has been cut off accidentally in making an excavation, for instance, may be repaired by the following plan: The two ends of the pipe are plugged, and then a small pile of broken ice and salt are placed around them; in five minutes the water in the pipe will be frozen, the

plugs removed, a short piece of pipe may then be inserted and perfectly soldered. In five minutes the ice in the pipes may be thawed and the water set to flowing freely again.

TO JOIN WATER PIPES

Water pipes may be united by using a preparation made by combining four parts of good portland cement and one part of unslaked lime mixed together in small portions in a stout mortar, adding enough water to permit it to be reduced to a soft paste.

WELDING METALS

Welding together two pieces of metal of any kind can be accomplished only when the surfaces to be joined are equally heated, and both surfaces must be brought to such a temperature that the particles will form a perfect continuity between the pieces united. This embraces the entire theory of welding, soldering or brazing metallic substances of any kind. In addition, however, to the equal and adequate heating of the surfaces to be united, every particle of coal dust, cinders or scales of oxide must be removed, so as to present two perfectly clean surfaces at the very moment when the union is to be effected.

The piece of metal that would fuse at the lower temperature must be the guide, when bringing the surfaces of conjunction up to the proper heat. If, for example, two pieces of wrought iron are to be welded, the part that will melt at the lower temperature must be brought just to a welding heat, and the surface of the other piece must be heated quite

as hot, or a trifle hotter than the first piece. Then, if the surfaces are clean when the parts are brought together, the union will be satisfactory. The degree of heat aimed at must be, not to produce a fluid, but simply to bring the metal into a condition between the fluid and plastic.

GRINDING TOOLS

All steel is composed of individual fibers running lengthways in the bar and held firmly together by cohesion. In almost all farm implements of the cutting kind the steel portion which forms the edge, if from a section of a bar, is welded to the bar lengthwise, so that it is the side of the bundle of fibers hammered and ground down that forms the edge. So, by holding on the grindstone all edge-tools, as axes, scythes and knives of strawcutters, in such a manner that the action of the stone is at right angles with the edge, or, this is to say, by holding the edge of the tools square across the stone, the direction of the fibers will be changed, so as to present the ends instead of the side as a cutting edge. By grinding in this manner a finer, smoother edge is set, the tool is ground in less time, holds an edge a great deal longer, and is far less liable to nick out and to break.

Plane irons should be ground to a level of about 35 degrees—chisels and gouges to 30. Turning chisels may sometimes run in an angle of 45. Molding tools, such as are used for ivory and for very hard wood, are made at from 50 to 60 degrees. Tools for working iron and steel are beveled at an inclination to the edge of from 60 to 70 degrees, and for cutting gun and similar metal range from 80 to 90.

INDEX

	Page		Page
A			
Angles, Measuring.....	34	Carrier, Barrel	260
Angles, Plotting.....	35	Carrier, Yoke	163
Anvil, Mounting.....	246	Cart for Stock.....	91
Anvil, Rail	10	Catch, Gate.....	181
Ax Handle, How to Secure.....	15	Catcher, Pig	105
B			
Bag Holder.....	110, 111	Cellar, Concrete Outdoor	227
Balance for Weighing	107	Cellar, Temporary.....	74
Barn Driveway.....	115	Cellar Shelf, Revolving.....	77
Barn Plans	200	Cellar Stairs, Hint for.....	82
Barn, Round.....	198	Cellar Wall, Concrete	225
Barn, Small.....	202	Cement Block House.....	195
Barn Stairs.....	105	Cementing Cistern Wall	230
Barn Truck.....	109	Cements for Mending.....	280
Barn Windlass.....	108	Cement, Mixing for Brick.....	223
Barrel Carrier.....	260	Cement, Special Uses for.....	231
Barrel Coolers.....	60	Chain Tie	87
Barrel Coop.....	120	Cheese Making.....	52
Barrel Cradle	46	Cheese Press.....	52
Barrel Hoop Trellis.....	132	Chicken Catcher.....	126
Barrel Plant Holder.....	72	Chicken Coop, Box	121
Bars with Horseshoe Support	181	Chicken Coop, Portable.....	123
Bee Feeder	130	Chicken Fountain	118
Bee Hives.....	127	Chicken Roosts	118
Beeswax Extractor.....	129	China Cement.....	280
Bench, Corn Husking	112	Cistern Wall, Cementing.....	230
Bicycle for Power.....	55	Clamp, Harness	262
Binding Pins for Hay.....	255	Cleaning a Well	66
Bin for Vegetables.....	72	Closet for Toilet Articles.....	76
Bins, Grain.....	109	Closet, Outdoor	63
Bin, Hinged Grain.....	108	Clothes Box	48
Blacksmith Shop, Farm.....	269	Clothes Horse	76
Bleaching Wood.....	277	Clothes Line Elevator.....	75
Boat, Boxed Stone.....	157	Cold Frames.....	140
Bolts, Use for.....	16	Concrete Anvil Foundation.....	246
Box for Clothes	48	Concrete Block Machine.....	218
Box for Potatoes.....	248	Concrete Blocks.....	217
Box for Tying Fleece.....	97	Concrete Cellar Wall.....	225
Box Wheelbarrow	240	Concrete Mixing.....	216
Brace Rule	23	Concrete Floor.....	229
Bread Cutting Board.....	59	Concrete On the Farm.....	214
Brooder	123	Concrete Outdoor Cellar.....	227
Brooder, House.....	124	Concrete Reinforced with Wood.....	231
Bridge, Small.....	160	Concrete Reinforcement.....	224
Building, House.....	189	Concrete Smokehouse.....	229
Butchering Derrick.....	100	Concrete Walk.....	230
Butchering Rig.....	98	Cooker, Tank	243
Butter Wagon Refrigerator.....	264	Cooler in Well	62, 64
Butter Worker.....	51	Cooler, Water.....	60
C			
Cabbage Cutter	114	Coop, Barrel	120
Calf Stanchions.....	87	Coop, Box.....	121
Camping Tent.....	171	Coop, Portable Chicken	123
Cans, for Scoops.....	49	Coop, Trap Door	121
		Corn Crib, Wire.....	211
		Corn Drying Rack.....	236
		Corn Husking Rack.....	112
		Cottage Plans.....	193
		Cow Stall.....	84

	Page	G	Page
Cow Stanchions	86		
Cows, How to Stake Out	92		
Cows, Stalls for Kicking	88		
Cradle, Barrel	46		
Crate, Vegetable	248		
Crows, How to Scare	126		
Cultivator, Hand Garden	142		
Cutter, Feed	112		
Cutter, Seed Potato	248		
Cutter, Root	113		
Cutter, Vegetable	114		
D			
Dam	161		
Derrick, Carcass	100		
Derrick, Portable Hay	154		
Ditching Scraper	160		
Dog Power for Pump	67		
Door Fastener, Stall	186		
Door Fasteners	184		
Door Latch	188		
Doors, Glass Panels for	44		
Doors, Double Latch for	185		
Drag and Harrow Combined	256		
Dresser	41		
Drinking Fountain for Chicks	118		
Drinking Fountain, Poultry	117		
Drogue	159		
Dumb Waiter	37		
E			
Euclid, 47th Problem of	32		
Extractor, Solar Wax	129		
F			
Fastener, Stall Door	186		
Fasteners for Doors	184		
Feed Basket	83		
Feed Box	84		
Feed Box, Partitioned	93		
Feed Cutter	112		
Feed Hopper, Poultry	116		
Feed Rack	95		
Feed Rack, Portable	96		
Feeder for Bees	130		
Fence, Movable	183		
Fence, Over Stream	182		
Fence Wire Reel	155		
Filter	70		
Filter for Cistern	68		
Fire Alarm	80		
Fire Kindlers	282		
Fire Ladder	82		
Fireproofing Shingles	276		
Fleece Tying Box	97		
Floating Fence	182		
Floor, Concrete	229		
Floor, How to Lay	213		
Flowers in Barrel	72		
Fodder Rack	164		
Folding Table	50		
Food Cooler	60		
Fruit Picker	148		
Fruit Sorting Table	151		
Fuel, How to Haul	168		
Fumigating Seed Grain	254		
Furniture Polish	278		
G			
Garden Stool	144		
Gate, Adjustable	179		
Gate, Balanced Wire	175		
Gate Catch	181		
Gate Hanger, Adjustable	178		
Gate, Pole and Wire	176		
Gate, Sliding	177		
Gate, Suspended	182		
Gate, Turnstile	180		
Gate with Wheel	175		
Germination Box	250		
Glass Cement	280		
Glass in Doors	44		
Glue, Liquid	280		
Grain Bins	109		
Grain Box, Hinged	108		
Grain, Killing Insects in	254		
Grain Sack Holder	110, 111		
Greenhouses	208		
Grinding Tools	284		
Grindstone Rig	9		
H			
Hammer, Pulling	246		
Harness Clamp	262		
Harrow and Drag Combined	256		
Hay Derrick	154		
Hay Binding Pins	255		
Hawks, How to Scare	126		
Hawk Trap	126		
Hawks, Trap for	145		
Heat for Hotbed	138		
Heater, Lamp	57		
Heating Water	99		
Hen House	125		
Hitches, Rope	256		
Hives, Bee	127		
Hog Butchering Rig	98		
Hog House, Movable	102		
Hog Pens	104		
Hog Trough, Partitioned	102		
Holder, Grain Sack	110, 111		
Hoop Trellis	131		
Horse, Feed Basket	83		
Horse Feed Box	84		
Horse, Folding	12		
Horse, Shaving	12		
Horseshoes for Bars	181		
Horseshoe Lever	272		
Hotbed, Heat for	138		
Hotbed, How to Make	136		
Hotbed, Permanent	137		
House Building, Hints for	189		
House, Cement Block	195		
House, Plans for	190		
Houses, Hog	104		
I			
Ice House	204		
Ice House and Milk House	207		
Ice Molds	233		
J			
Jack, Log	170		
Jack, Wagon	238		

	Page	K	Page	L	Page	M	Page
Kettle Tripod	241			Ladder on Wheels	151	Mail Box, Trolley	71
Kindlers, Fire	282			Ladder, Place for	82	Market Wagon Conveniences	263
Kitchen Cabinet	39			Ladder, Truss	150	Measure, Land	167
Kitchen Cabinet at Window	43			Lamp Heater	57	Measuring Angles	34
Knots, How to Tie	258			Land Measure	167	Medicine Closet	76
L							
Lantern Hanger	106			Mending Water Pipes	282	Metal Welding	283
Latch, Door	188			Milk and Houses Combined	207	Milking Stool	88, 89, 90
Latch for Double Doors	185			Miter Box	24	Mold for Concrete Blocks	221
Lawn Mower Feed Cutter	112			Molds, Ice	233		
Level, Homemade	14			N			
Light, More for Rooms	44			Neck Chain for Cattle	87		
Liquid Glue	280			Nests, Trap	119		
Loading Rig	164			O			
Logging Bob	169			Octagon Scale	23		
Log Jack	170			Old Oaken Bucket	232		
Log Water Trough	244			Outdoor Closet	63		
Logging, Rig for	168			P			
Lumber Rule	20			Painting Tin Roof	273		
M							
Painting Tin Roof	273			Papering a Room	265		
Papering a Room	265			Petrified Wood	277		
Pickering Fruit	148			Picker, Fruit	148		
Plans, Barn	200			Plans, Cottage	193		
Plans for Cottage	193			Plans for House	190		
Plans for House	190			Plant Protector	134		
Plant Protector	134			Platform for Pump	65		
Platform for Pump	65			Porch, Vine-Covered	213		
Porch, Vine-Covered	213			Preserving Wood	274		
Preserving Wood	274			Pig Net	105		
Pig Net	105			Pipe Twister	263		
Pipe Twister	263			Plotting Angles	35		
Plotting Angles	35			Plow, Snow	241		
Plow, Snow	241			Pole and Wire Gate	176		
Pole and Wire Gate	176			R			
P							
Rack, Corn Husking	112			Rack, Corn Hauling	164		
Rack, Fodder Hauling	164			Rack for Corn	236		
Rack for Corn	236			Rack, Hanging Feed	95		
Rack, Hanging Feed	95			Rack for Milking Stool	90		
Rack for Milking Stool	90			Rack for Preserves	38		
Rack for Preserves	38			Rack for Seed Corn	235		
Rack for Seed Corn	235			Rack, Portable Feed	96		
Rack, Portable Feed	96			Rack, Water for Hens	117		
Rack, Water for Hens	117			Rafters, How to Lay Out	28		
Rafters, How to Lay Out	28			Reel, Clothes	76		
Reel, Clothes	76			Reel, Wire on Boat	156		
Reel, Wire on Boat	156			Reel, Wire on Wheels	155		
Reel, Wire on Wheels	155			Refrigerator	64		
Refrigerator	64			Rein Clip	263		
Rein Clip	263			Reinforced Concrete	224		
Reinforced Concrete	224			Reservoir, Storage	167		
Reservoir, Storage	167			Right Angles, How to Figure	32		
Right Angles, How to Figure	32			Roller, Road	158		
Roller, Road	158			Rope, How to Handle	256		
Rope, How to Handle	256			Roof, Painting Tin	273		
Roof, Painting Tin	273			Roofing Preparation	282		
Roofing Preparation	282			Roosts, Folding	118		
Roosts, Folding	118			Root Cutter, Saw	113		
Root Cutter, Saw	113			Round Barn	198		
Round Barn	198			S			
S							
Saw Horse	170			Seasoning Wood	277		
Seasoning Wood	277			Seed Corn Rack	234		
Seed Corn Rack	234			Seed Corn Testing	250		
Seed Corn Testing	250			Seed Potato Cutter	248		
Seed Potato Cutter	248			Seed Sower	162		
Seed Sower	162			Seed, Watering	144		
Seed, Watering	144			Separator, Run by Tread Power	56		
Separator, Run by Tread Power	56			Scissors, How to Sharpen	265		
Scissors, How to Sharpen	265			Scraper, Ditching	160		
Scraper, Ditching	160			Scoops from Tin Cans	49		
Scoops from Tin Cans	49			Sharpening Scissors	265		
Sharpening Scissors	265			Shaving Horse	12		
Shaving Horse	12			Sheep Fence, Movable	183		
Sheep Fence, Movable	183			Sheep Feed Trough	94		
Sheep Feed Trough	94			Sheds, Straw Covered	94		
Sheds, Straw Covered	94			Shelf, Revolving	77		
Shelf, Revolving	77			Shelter, Plant	134		
Shelter, Plant	134			Shingles, Preserving	275		
Shingles, Preserving	275			Size Stains	278		
Size Stains	278			Skidway	169		
Skidway	169			Slatted Stall	88		
Slatted Stall	88			Slaughter House	99		
Slaughter House	99			Smokehouse, Concrete	229		
Smokehouse, Concrete	229			Smoking Device	243		
Smoking Device	243						

	Page		Page
Snow Plow	214	V	
Solder, How to Make	17	Vat, Butchering	98
Soldering	16	Vegetable Storage Bin	72
Sorter, Potato	246	Veranda, Vine-Covered	213
Sorting Table	151	W	
Sowing Machine	162	Wagon Jack	238
Square, How to True	26	Wagon, Market	263
Square, the Steel	19	Walk, Concrete	230
Stall for Cows	84	Wall, Cementing	230
Stains, Wood	279	Wall Paper, How to Hang	265
Stair Stringer, How to Lay Out ..	30	Washing Machine, Pedal Power ..	55
Stairs, Barn	105	Water Bottle, Poultry	117
Staking Out Stock	92	Water Cooler	60
Stanchions, Swinging	86	Water Filter	70
Stanchions for Calves	87	Water Filter for Cistern	68
Steel Square, Use of	19	Water Heating for Butchering ...	99
Stock Cart	91	Water Pipes, Mending	282
Stone Boat, Boxed	157	Watering Rack for Hens	117
Stool, Garden	144	Watering Seed	144
Stool, Milking	88, 89, 90	Water Stove	167
Stool Rack	90	Water Supply for House	77
Stove, Fence Around	47	Water Trough	244
Straight Edge, How to Make	28	Wedge Staple	15
Straw-Covered Sheds	94	Weighing Balance	107
Stream, Fence Across	183	Weight Lifter	237
Stump Pulling	166	Welding Metals	283
Surveying, Rule for	33	Well	Frontispiece
Suspended Gate	182	Well Cooler	62, 64
Swinging Sheep Trough	94	Well, How to Clean	66
T		Wheelbarrow	239
Table, Folding	50	Wheelbarrow Sheep Trough	96
Table, Fruit Sorting	151	Wheel Gate	174
Tank Heater	243	Windlass, Barn	108
Tent, Camping	171	Windlass for Butchering	98
Testing Seed	250	Wire Gate	176
Tool Grinding	284	Wire Reel on Boat	155
Tools Needed for Workshop	7	Wire Reel on Wheels	155
Transplanting Large Tree	146	Wire Splicer	13
Trap for Owls	145	Wire Tightener	155
Trap, Hawk	126	Wood Bleaching	277
Trap Nests	119	Wood Fireproofing	276
Tread Power for Separator	56	Wood, Hauling	168
Trees, How to Move	146	Wood, How to Split	245
Tree, Transplanting	147	Wood, Petrified	277
Trellis, Folding	132	Wood Polish	278
Trellis, Barrel Hoop	132	Wood, Preserving	274
Trellis for Beans	133	Wood, Seasoning	277
Trellis, Iron Hoop	131	Wood Splitter	245
Trellis, Self-Supporting	134	Workshop, The Farmer's	7
Trolley Mailbox	71	Wrench, Bit-Stock	11
Trough, Sheep	94	Y	
Trough, Partitioned Hog	102	Yoke Crate Carrier	163
Truck for Barn	109		
Truing the Square	26		
Tub Feed Box	93		
Turnstile Gate	180		

Pioneer Methods

The "Good Old Days" were those of just recent decades past. In the 1800s and centuries previous the pioneer folk had it unimaginably difficult. People grew soft - and had no idea. City folk could not even begin to do the work of the real farmers who still ran small farms.

A US candidate for president once promised 40 acres and a mule. I always said that the only way I would have possibly made it through the first winter was to eat the mule. The pioneers were survivalists and had survival skills beyond any that we can imagine.

In addition to not having the "toughness", work habits and skills of the early pioneers - we do not have their resources. There are no buffalo herds and there is nowhere near that the deer and antelope play in sufficient number to support most survivors. Those who have taken survival courses that have taught them to go out into the woods and survive will be sorely disappointed. Such animals that have survived the radiation will be in very short supply relative to the survivors that would be in competition for them.

One will not have the horses, wagons or other implements that were necessary to pioneer survival. There will be a far larger population survive than there were pioneers a few centuries ago and there will be far fewer resources of the kind that sustained them. The early settlers of our village were confident in their ability to find in a few minutes enough fish in the stream to make supper. Even in my early days in the village a person could promise the night before that they would go out on the bridge out our back door and get fresh fish for breakfast - and make good their promise. But those days are gone. Fished out and poisoned out by salt on the roads and pesticide run-off from the farmer's fields. At this writing fish no longer come safe even from the farmer's markets without warnings that they are hazardous to expectant mothers.

No, we can't return to the old days - even if we want to. But fortunately we have many, many other advantages. We don't have to cut the forests to gain agricultural ground. We know many things the pioneers did not. Childbirth was a great hazard to pioneer women - simply because people did not know to wash their hands. We have a great advantage in modern knowledge - but we may well need to supplement that, at least for a while, with some of the pioneer knowledge and skills that we have forgotten about. That is the purpose of this page.

This page does not stand by itself, anymore than do any of the others. There may be some duplication on some items that will be found in the pages on simplified machinery and small farming but all that information will probably be just as important to know - if not more so.

The files on this page are all locked until after the nuclear war. Those who have to wisdom to gather the information ahead of time will have to go to other sources but all these pages can be thought of as a

checklist of types of information one may wish to gather together.

Table of Contents:

[SEALED: Making the Best of Basics.](#)

This is a SEALED 188 page .pdf file that won't be opened until after The Great Catastrophe. This 1975 book is by James Talmadge Stevens. It covers sprouting, food drying, game cleaning, recipes for different home products and a variety of similar subjects.

[SEALED: Cloudburst - Handbook of Rural Skills and Technology.](#)

This is a SEALED 126 page .pdf file that won't be opened until after The Great Catastrophe. The book is edited by Vic Marks and is Published in the US by: Cloudburst Press of America, Inc. 2116 Wetern Avenue, Seattle, Washington 98121 and in Canada by: Cloudburst Pres Ltd., Mayne Island British Columbia V0N 2J0 - The book covers a variety of technologies including overshot and undershot waterwheels, juice presses, beehive management, cheese making, a hand operated washing machine, a solar drier, and many other things.

[SEALED: Cloudburst Two.](#)

This is a SEALED 128 page .pdf file that won't be opened until after The Great Catastrophe. This is a second volume of the above book and is also edited by Vic Marks and is Published in the US by: Cloudburst Press of America, Inc. 2116 Wetern Avenue, Seattle, Washington 98121 and in Canada by: Cloudburst Pres Ltd., Mayne Island British Columbia V0N 2J0 - This volume covers a many, many additional technologies including various forms of construction, hand and foot operated machinery, kilns, hydraulic rams, spinning wheels, looms and associated machinery, and many, many other pioneer subjects.

[SEALED: Foxfire One.](#)

This is a SEALED 388 page .pdf file that won't be opened until after The Great Catastrophe. This series of books is edited by Eliot Wigginton and is published by Anchor Press | Doubleday 501 Franklin Avenue - Garden City, NY 11530. Volume One covers many subjects from hog dressing to cabin building.

[SEALED: Foxfire Two.](#)

This is a SEALED 410 page .pdf file that won't be opened until after The Great Catastrophe. This series of books is edited by Eliot Wigginton and is published by Anchor Press | Doubleday 501 Franklin Avenue - Garden City, NY 11530. Volume Two covers many subjects from midwifery to burial.

[SEALED: Foxfire Three.](#)

This is a SEALED 512 page .pdf file that won't be opened until after The Great Catastrophe. This series of books is edited by Eliot Wigginton and is published by Anchor Press | Doubleday 501 Franklin Avenue - Garden City, NY 11530. Volume Three covers many subjects from animal care to hide tanning and making musical instruments.

SEALED: Foxtire Four.

This is a SEALED 480 page .pdf file that won't be opened until after The Great Catastrophe. This series of books is edited by Eliot Wigginton and is published by Anchor Press | Doubleday 501 Franklin Avenue - Garden City, NY 11530. Volume Four covers many subjects from gardening to traps to knife making and horse trading.

SEALED: Foxtire Five.

This is a SEALED 515 page .pdf file that won't be opened until after The Great Catastrophe. This series of books is edited by Eliot Wigginton and is published by Anchor Press | Doubleday 501 Franklin Avenue - Garden City, NY 11530. Volume Five covers many subjects from iron making and blacksmithing to gun making and hunting.

SEALED: Foxtire Six.

This is a SEALED 513 page .pdf file that won't be opened until after The Great Catastrophe. This series of books is edited by Eliot Wigginton and is published by Anchor Press | Doubleday 501 Franklin Avenue - Garden City, NY 11530. Volume Six covers many subjects from shoe making to wooden locks and toy making.

MENU: [HOME](#) » [Reconstruction](#) » [Recovery](#) » [Renewal](#) » [Survival](#)
