

# **AT** MICROFICHE REFERENCE LIBRARY

A project of Volunteers in Asia

The Power Guide: A Catalogue of Small Scale Power  
Equipment

by: Peter Fraenkel

Published by:  
Intermediate Technology Publications, Ltd.  
9 King Street  
London WC2E 8HN  
United Kingdom

Paper copies are 7.50 British pounds.

Available from:  
Intermediate Technology Publications, Ltd.  
9 King Street  
London WC2E 8HN  
United Kingdom

Reproduced by permission of Intermediate  
Technology Publications, Ltd.

Reproduction of this microfiche document in any  
form is subject to the same restrictions as those  
of the original document.

# The Power Guide

A Catalogue of Small Scale Power Equipment

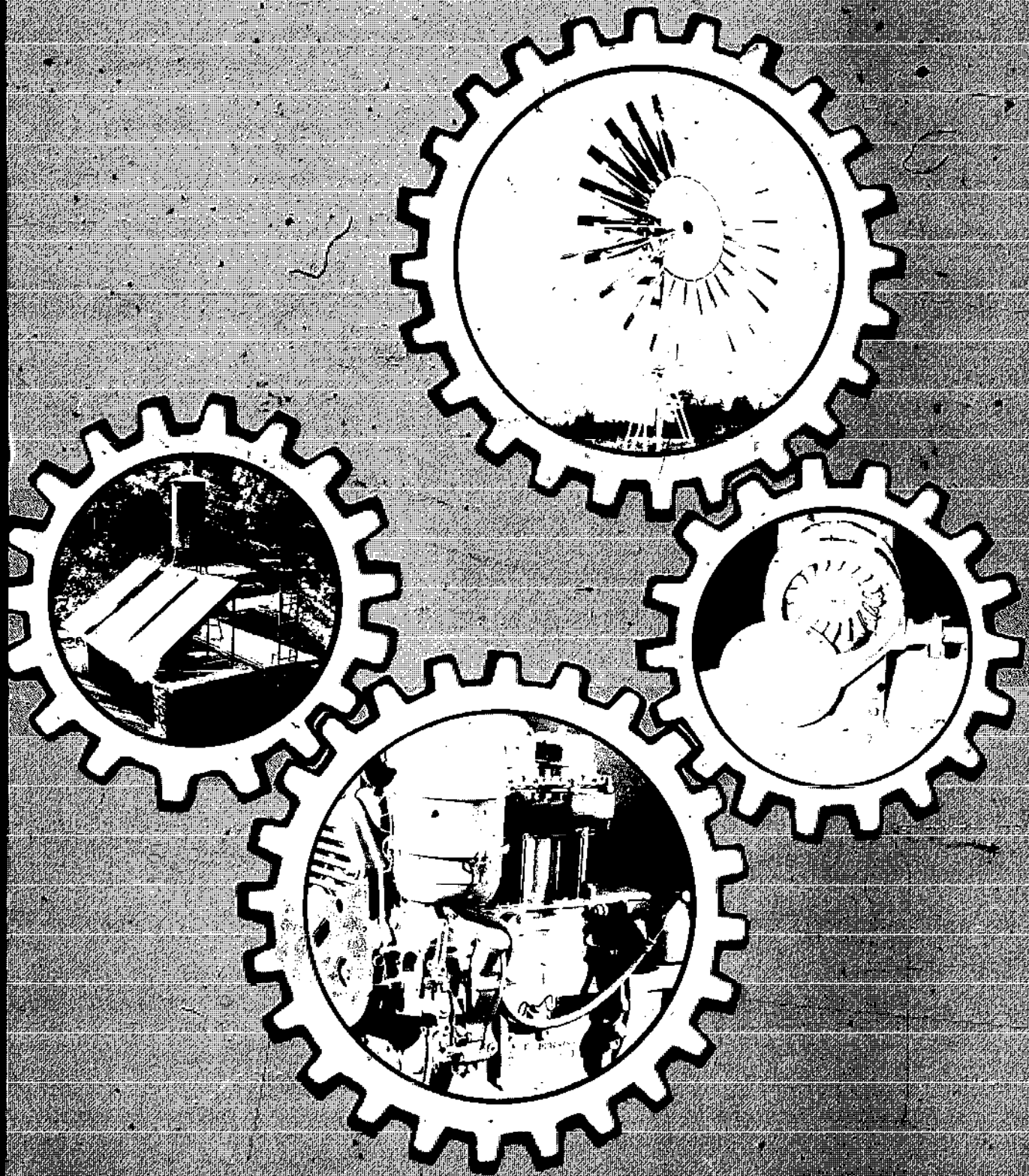

Compiled by Peter Fraenkel

An Intermediate Technology Publication

# The Power Guide

Compiled by Peter  
Fraenkel

A CATALOGUE OF SMALL SCALE  
POWER EQUIPMENT

An Intermediate Technology Publication

# Contents

Acknowledgements	4
Foreword	5
<b>Introduction</b>	<b>7</b>
Scope of the guide	7
Energy, power production and development	8
Economics of energy converters	10
Notes on units and tables of conversion factors	12
<b>1. Solar Energy</b>	<b>*15</b>
Solar energy (photo-voltaics)	21
Solar engines (power, pumping and cooling)	24
Solar heating	26
<b>2. Wind power</b>	<b>43</b>
Wind-electric systems	47
Wind-pumping systems	56
<b>3. Water power</b>	<b>65</b>
Hydro-electric systems	68
Hydro-mechanical and pumping systems	74
<b>4. Bio-mass and thermal energy</b>	<b>77</b>
Stoves and water heaters	83
Heat pumps and regenerators	87
Methane digesters	88
Burners and steam raising plant	91
Gasification plant	93
<b>5. Internal combustion engines</b>	<b>94</b>
Compression ignition (diesel) engines	97
Spark ignition engines (petrol and gas fuelled)	111
Gas turbines	116
<b>6. External combustion engines</b>	<b>117</b>
Steam engines	120
Stirling engines	123
Thermo-electric converters	123
<b>7. Electricity generation</b>	<b>125</b>
Alternators and generators	128
Generating sets	133
Miscellaneous electrical equipment (batteries, inverters etc.)	150
<b>8. Instrumentation, monitoring and control equipment</b>	<b>154</b>
<b>9. The Intermediate Technology power programme</b>	<b>158</b>
<b>10. Information sources; research and development institutions; consultants</b>	<b>163</b>
<b>11. List of agents and distributors and their addresses by country</b>	<b>173</b>
<b>12. Index of manufacturers</b>	<b>238</b>

## Acknowledgements

This publication would not have been possible without the help of Christine Marsden, Max Ewens and Roger Doyle. My thanks also to my other colleagues in the Intermediate Technology Development Group who have been involved in this work.

The co-operation of the numerous manufacturers and other bodies who supplied information for this guide is much appreciated, and it is hoped this collaboration will continue in the compilation of future editions.

On behalf of the Group, I would like to thank the Ministry of Overseas Development for providing the funds for the project and a loan for the printing of this publication. Their assistance is gratefully acknowledged.

*Peter Fraenkel*  
Power Project Officer  
Intermediate Technology Development Group

## Foreword

If other countries are to attain the standard of living enjoyed by the industrialised nations, then availability of energy is an essential requirement to enable them to do so. If industrialised countries are to enjoy the same per capita growth and the same increase in the standard of living as hitherto achieved the supply of energy must continue to grow.

Now that signs of shortages in the supply of fossil fuels are apparent there is an accelerated and widespread move towards exploring other possible sources of supply, not only of fossil fuels but also of renewable and natural sources. These range from wind and water to solar and biomass, as well as towards recycling the waste from our cities which could be converted to useful energy.

While research investigation will obviously take time, an examination of the state of the art in regard to all the various small scale sources of power available at the present time is a vital first step in the development of alternatives. In this respect this volume could not be more timely, providing as it does an account of both conventional and unconventional small scale energy converters and a catalogue of commercially available equipment in this range.

It is important to appreciate that in the developing countries the problem is not one of substituting one source of energy for another but of increasing the total per capita energy availability. Currently biomass, mainly in the form of wood and dung, constitutes the major source of energy in many developing countries and even in world terms is of great importance, amounting to around 10-15% of the total world energy use. The internal combustion engine, both diesel and petrol, is widely used in the developing world and will continue to be required for some time to come. Solar energy, either in the form of direct radiation or indirectly in the form of wind, water power or biomass, has a number of attractive features. It is continuously renewable, free, universally available, and does not have harmful ecological effects. Although converters using renewable energy are not cheap, fuel is free, and there are already a number of applications where renewable energy sources are economically competitive with conventional plant. These include windmills for water pumping, small hydro-generators for electricity supply, methane generation using dung or vegetation to provide gas for cooking, and solar crop driers.

This book lists manufacturers of such equipment, provides a brief summary of the characteristics of the equipment and the criteria which should be borne in mind in its selection. There is no doubt that this well-researched and wide-ranging catalogue of small scale power equipment will provide a powerhouse of information for anyone wishing to find a source of energy to suit his purpose. *The Power Guide* is an important and timely contribution to the literature of appropriate technology.

*Professor P.D. Dunn  
Department of Engineering  
University of Reading*

# Introduction

**SCOPE OF THIS GUIDE  
ENERGY, POWER PRODUCTION  
AND DEVELOPMENT  
ECONOMICS OF ENERGY CONVERTERS  
NOTE ON UNITS AND TABLES  
OF CONVERSION FACTORS**

## Scope of Guide

This guide is intended to help those seeking to buy small-scale power equipment, particularly for use in remote and underdeveloped parts of the world, by indicating a selection of appropriate commercially-available power sources. It gives basic information on the pros and cons and the criteria for choosing a variety of different energy conversion systems, together with a selection of internationally available items of equipment, and the names and addresses of their manufacturers and agents. Additional material on related consultancy and information services, plus a listing of organisations concerned with research and development in small-scale power production is also included.

The product information is based entirely on that supplied by manufacturers. The Intermediate Technology Development Group, (ITDG), has no facilities for testing machinery and therefore cannot take responsibility for manufacturers' claims — the object of this Guide is for it to be used as a means to identify sources of supply. *Therefore the inclusion of any particular item of equipment or manufacturer does not signify any specific recommendation by ITDG.* We should of course be interested to have from readers either endorsements or criticisms of companies or equipment in this edition and would value information on useful products that are missing for possible inclusion in future editions.

It should be explained that ITDG has no commercial interest in any of the equipment listed, since we are a non-profit research organisation, registered as a charity in the UK. The preparation of this Guide was financed by a grant from the UK Ministry of Overseas Development. All the entries were provided at no charge to the manufacturers concerned and the choice of the entries was at ITDG's discretion. The Group exists to help people, particularly in underdeveloped parts of the world, to advance and improve their level of self-sufficiency through the use of technically and economically appropriate equipment. We do this by seeking to diffuse information on equipment that has proved useful in the field in many parts of the world, and in some cases where appropriate devices are lacking, we develop, test and encourage others to manufacture new devices. Further details of our activities in the field of energy and power production are given in Section 10).

This book represents an attempt to satisfy the flood of enquiries we (and similar organisations) continuously receive on where one can obtain small-scale power producing equipment. Some of the entries, particularly for the engine manufacturers, refer to world-famous multinational corporations, others are quite small and little-known specialised companies in many parts of the world. In particular we have included a wide selection of manufacturers of renewable energy conversion devices (that use energy from the sun, wind, rivers, bio-mass) since the increasing cost of fossil fuels, particularly in remote underdeveloped areas, has caused a great deal of interest world-wide in such devices. Manufacturers of renewable energy systems are often small, and the merits and weaknesses of their products and often not as well understood as they might be. We have, of course included a large section on conventional diesel and petrol (gasoline) engines, as these will remain the most effective power source for many applications for the nearer future, but have limited the descriptive details on these to a basic specification on the assumption that potential users will write for precise and up-to-date information to the manufacturers.

## Energy, Power Production and Development

### *What is energy?*

Energy is required, by definition, to do any kind of work: the rate at which it is used is measured as power, (see page 12 for units and their relationships). We can do a certain amount of work slowly, using little power or quickly using more power, involving the use of a similar total amount of energy in either case.

Virtually all human activity requires work to be done: ploughing fields, lifting water, transporting ourselves, mining for minerals, manufacturing, cooking food, and so on. Even lazing around and doing nothing involves "work" in the technical sense, as our bodies consume a minimum amount of energy to keep our heart, lungs and other vital organs functioning at a rate thermally equivalent to burning about a pound (500gm) of coal a day. So there is an obvious minimum energy requirement for human survival, represented by a minimum food need to prevent malnutrition and starvation.

Our own muscles, or the muscles of domesticated animals, were for centuries the primary source of power behind human industry, and this remains true to this day for the majority of the human race (of the order of 2,000,000,000 people). However, man or woman power alone is hopelessly unproductive as a primemover — our brains are far more impressive than our muscles — for example, one man-year of hard labour represents a mere 150kWh, which is the energy in about 15 litres of kerosene (3½ gallons). You can buy 150kWh as electricity, one of the most expensive forms of power, for under £5 (\$9.00) in most countries, and who would offer a year of hard labour, even in the poorest of countries, for that? Muscle power alone is therefore unproductive and very expensive compared with even the costlier sources of artificial power.

### *Energy in under-developed regions*

It is quite clear that all human productive activity can benefit from a certain amount of power-assistance, so much so that energy conversion or power production is an almost essential prerequisite for progress. Unfortunately this belief has stretched so far that in certain quarters it is accepted that energy consumption and wealth are tied together by a rigid correlation as binding as a law of nature, a belief that has led certain industrialised countries to extrapolate historical energy "growth" curves and then plan enormous nuclear power programmes, while less developed countries, fearful of being left even further behind in a world of unbalanced wealth and unbalanced energy consumption often seek to do the same thing on a smaller scale. However, energy consumption per capita in the industrialised countries and to some extent in the urban, developed sectors of less developed countries too, has in most cases passed the level at which further additions are important to improve the quality of life — diminishing returns have set in to such an extent that in some places more energy consumption even spells a decline through the effects of added pollution. Today, the United States uses more power just to run the nation's air conditioners for a minority of its population, than is consumed by all 800 million Chinese for all essential and non-essential purposes put together. Air conditioning is of course desirable (although the human race evolved successfully without it until quite recently) but the industrial nations will obviously cease to air-condition rooms which are simultaneously solar heated through

enormous picture windows once the price of energy reaches a level where alternative less energy-intensive "solutions" become more economically attractive. Similarly, much of the energy consumption in poor tropical countries is to air-condition government offices — increasing that kind of consumption increases energy per capita as well as GNP per capita, but does nothing for the underdeveloped predominantly rural areas.

It is often thought that rural electrification might be the solution, since the most efficient form of electricity production (and most easily manageable from a centralised administration) is to use large power stations generating hundreds of megawatts. However it is not economical to distribute electricity to small distant consumers. Large thermal stations and the huge dams in Africa and Asia, such as Kariba, Cabora Bassa, Aswan, Volta, Mangla and so on, are only capable of feeding power to a few urban and industrial areas — in most cases the rural areas in the vicinity of such schemes are still without electricity because the potential market is too diffuse to allow economic distribution. Rural electrification has proved expensive and of limited success in most less developed countries. For example, only 2% of the electricity generated in Latin America goes to the rural areas, while India, with one of the most extensive rural electrification programmes, which has been in hand for thirty years, today supplies only 10% of its electricity to the rural areas inhabited by 80% of the population.\* In the end, such schemes, useful as they may be to the general economies of their host countries, serve to boost the already-developed sector of the economy rather than the under-developed parts. As a result, centralised electrification schemes almost inevitably lead to a further increase in the differential between the developed and under-developed areas, with further polarisation between rich and poor, more migration from the countryside to the cities and all the usual consequences of continued rural lack of productivity leading to chronic poverty in rural areas and urban wealth and squalor in close juxtaposition.

Most technology has been developed in response to market forces, in other words to be economic and marketable at a price level which suits the already wealthy, (and it is apparent that this observation applies equally in socialist as well as in capitalist economies — since technology has followed similar patterns and trends throughout the world). As a result, power-production machinery, in common with most other types of machinery, is generally not ideal for use in under-developed areas. It is usually too expensive in capital requirements, too expensive in fuel costs (fuel is nearly always priced higher in under-developed areas due to transport costs) and above all, often requires skills that have to be imported at a higher than normal cost in order to provide maintenance and continuity of operation. Also, due to the small initial market for power in such regions, it must be generated on a small scale, generally from systems of under 100kW, which as a result often involves the use of less efficient or less long-lasting equipment. Therefore it would be wrong to pretend that decentralised, small-scale power production can be easily and economically arranged — but without it any significant improvement in the productivity and standard of life in the least developed parts of the world will be no more than a vain hope.

This Guide gives an indication of the variety of energy converting machines that can be considered for small-scale decentralised applications. At the present time, half

\*Energy Policy for the Rural Third World by Arjun Makhijani, International Institute for Environment and Development, London, 1976.



a century of declining petroleum costs followed by less than half a decade of reversal has placed the internal combustion engine in such a dominant position for most applications that it is likely to remain the most commonly used small-scale mechanical prime-mover for the immediately foreseeable future. The i.c. engine is unlikely to improve significantly in future as such tremendous efforts have already been devoted to it in connection with its development for motor vehicles. As a result, many diesel and petrol engines for use as stationary power plants are thinly disguised adaptations of car or lorry engines. In some respects such engines are not ideal (a motor vehicle spends much less of its life with its engine running than the average power plant) but on the other hand, the mechanics of such engines are well-understood everywhere that motor vehicles are to be found and the infrastructure to provide spares and maintenance tends to accompany that for motor vehicles. First costs can also be quite low due to high volumes of production. Other power plants have been specially developed to run for the much larger number of hours normally expected of a stationary plant — such machines are invariably heavier, slower and more expensive in first cost (as is discussed more fully in the introduction to the section on i.c. engines).

Increasing petroleum costs (which have hit hardest at many of the least developed countries lacking sufficient hard currency to pay the higher prices), have caused a revival of interest in machines that can utilise non-petroleum-based energy sources; steam and hot air engines that can burn wood or coal and, of course, devices such as windmills, small hydro-turbines and solar heaters that use freely available natural energy. Since these energy resources are more diffuse than oil or petrol, and in some cases are only intermittently available, the conversion devices tend to be larger and more expensive in terms of first cost per kilowatt. They have also had more limited development (especially in recent years), their volume of production is smaller and they are generally not so well understood by prospective purchasers and users. However, even with all these handicaps, many are economically competitive with internal combustion engines at current prices and increased usage and development combined with further escalations in the price of oil will move the economic factor further away from the i.c. engine towards the windmill and the solar heater or the steam engine and the photocell. It is hoped that this Guide will indicate something of the variety of equipment that is available on the world market and that the introductory sections will provide some guidance on their pros and cons and how the different devices can most appropriately be applied.

In the end the ultimate criterion for any energy converting machine is not its power output, its life or even its efficiency — but its economics. How much does it cost to guarantee sufficient power for the required end-purpose. Whether it is intended to make decentralised rural energy production a "paying proposition" (an aim which historical trends even in developed industrial countries, let alone in the less developed ones, indicated as being unlikely to be successful) or whether rural energy is subsidised or even given away for nothing in the interests of rural development or aid, it is obviously desirable to minimise energy costs and to maximise its effectiveness.

To maximise the effectiveness with which energy is applied, it is important to assess energy end-uses carefully. It is likely that power used for pumping irrigation water or driving workshop machines is going to be more useful for the local economy than power used for lighting or for television sets, (although the latter two applications are not unimportant in terms of redressing the balance of

attractions between the rural and urban areas).

Variation of demand and variability of load are other important considerations; for example, a large generator is inherently more efficient at full load than a small one, but a number of small generators may be cheaper to run than one big one that is on part-load for most of the time. Also, a number of small generators would be unlikely to fail simultaneously whereas a single large one may need a standby unit. Small generators are also likely to need a smaller and simpler power distribution system and they are also often more readily repaired and maintained by local people. But smaller generators are, of course, more expensive per unit of output at a given load factor.

Sometimes power must be available at any time or all the time, for example to drive a lathe or milling machine or to run a refrigeration plant, but sometimes the need is not very time-dependent — for example to pump water into a reservoir or storage tank or for heating water in an insulated tank. The latter uses can easily make use of intermittent and less predictable energy sources such as the wind or the sun, but the former will generally need a more controllable prime-mover.

Another important consideration is energy grade. Just like currencies, energy can be exchanged or converted and in this case natural constraints, defined under the laws of thermodynamics, dictate that every transaction causes a percentage of the energy converted to be lost as waste heat. Some transactions are inherently more efficient than others — it is more efficient to convert from a higher grade of energy to a lower, while considerable losses are involved in going from a low grade to a high. As a result, electricity or mechanical shaft power are said to be of high grade, because they can be efficiently converted to lower grade heat, but heat is a variable but lower grade of energy — the lower the temperature of the end-use the lower the grade. Therefore, raising steam from a boiler demands a higher grade of heat than is needed for domestic water heating. As a result, low grade solar heat can be used quite efficiently and cheaply for domestic water heating but it is more difficult and less efficiently utilised to run a steam engine. The diagram below shows typical energy exchange rates and it can be seen how high-grade electricity yields 1000W of heat, but in reverse it takes 20,000W of heat to produce 1000W of electricity directly, or if heat is converted first to mechanical and then to electrical power — 3,600 watts of heat to produce 1000 watts of electricity. This shows why motor-generator sets are more popular than thermo-electric converters, despite their greater complexity and maintenance requirements.

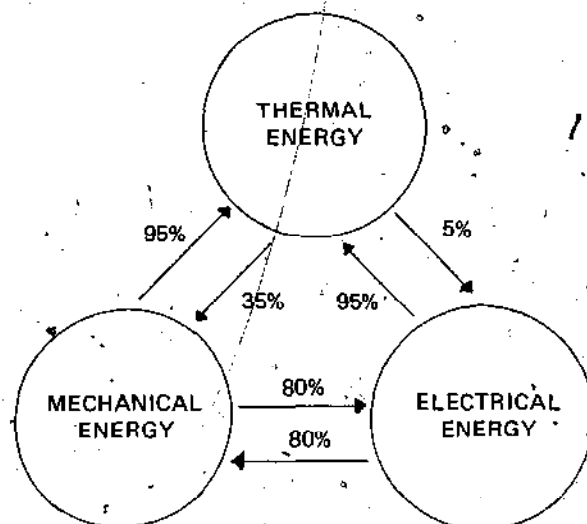

Figure 1. Some typical energy exchange rates

It follows from consideration of energy exchange rates that it would be wasteful to use, say, a diesel generator to produce electricity for heating water, and quite ridiculous to use a thermo-electric converter for such a purpose! Although convenient, electricity is hard-won energy and should not normally be used for low-grade applications (except perhaps in conjunction with hydro-electric plants when it can sometimes be very cheaply generated). Indeed, since a lot of normally wasted heat is associated with any type of heat engine, including diesel generators (in the cooling water or cooling air) it may be worth considering ways that the heat could be used as a by-product (particularly in the case of larger fixed installations). This is very rarely done, although waste heat could readily be used for crop or hay drying, water heating, desalination or space heating. It may become possible to utilise waste heat for cooling purposes in hot countries once suitable refrigeration and air-conditioning equipment is developed to make use of low grade heat inputs (it is currently technically feasible to do this but suitable equipment is not readily available).

## Economics of Energy Converters

Before considering the factors that affect the cost of energy conversion using different types of machine, or what might be called the micro-economics of energy conversion, it is worth keeping in mind the macro-economic effects of any larger-scale rural energy policy. An individual device has an operating cost determined by the *de facto* first cost, fuel price and other variables. However, in situations where the choice is not for one or a few but for a larger number of energy converters, it would be a mistake to ignore how existing costs might be deliberately changed sufficiently to favour a different energy conversion process. For example, local manufacture might become feasible and greatly reduce both first costs and foreign currency requirements — so suitability for local manufacture may be a valid criterion when considering widespread usage. (And of course, small scale local manufacture offers other benefits to an under-developed area). Just as with centralised power production, centralised machinery production gives low unit costs (at the power station bus-bar or the factory gate respectively), but distribution costs can lead to diseconomies compared with small-scale local manufacture just as much as with decentralised power production. Increasing energy prices will lead to increased distribution costs both for mass-produced engines and for centralised, grid-distributed electricity, so this effect should become increasingly important in future.

However, most readers of this Guide will not be in a position to influence the criteria that effect the economics of energy conversion. They will have to weigh up the relative merits of whatever happens to be available to deliver the required power to their envisaged end-use, and hopefully, future editions of this Guide will help to keep them aware of any newly available devices that may be worthy of consideration.

### Assessing the annual costs of different devices

The main elements in costing any energy converter are:

1. Cost of purchasing and replacement finance
2. Cost of fuel
3. Cost of maintenance and repairs

In order to evaluate these costs, it will be necessary to obtain quite a number of figures from manufacturers' literature or from local manufacturers' agents, as follows:

### 1. Cost of purchasing and replacement finance

A number of formulae are conventionally used to assess the annual charges relating to a fixed capital investment, most of which require knowledge of the capital sum or first-purchase cost,  $C$ ; the expected life of the machine (amortisation period) in years,  $n$ ; and at least a notional interest rate based on the value of the interest to be gained if the same sum were invested or the actual interest to be paid if it is borrowed,  $r$ . If  $r$  is expressed as a decimal percentage (i.e. 0.10 represents ten per cent, 0.08 is eight per cent, etc.), then:

$$\text{Annual charge } R = C \frac{r(1+r)^n}{(1+r)^n - 1}$$

### 2. Fuel costs

These depend on:

- i. the type of machine (obviously fuel costs will be zero with a windmill and will vary depending on fuel type with steam, petrol or diesel engines);
- ii. the rated power output,  $P$  — ideally chosen so as to operate at as high a power rating as possible without unduly overloading it and shortening its life — (a heavily loaded machine runs efficiently but wears out fast and vice-versa);
- iii. efficiency of conversion which governs the fuel consumption per unit of power output (specific fuel consumption),  $c$ ; here it is important to assume a fuel consumption in line with typical load factors and not the manufacturer's proudly quoted optimum fuel consumption. A typical figure for a small diesel engine will be around 0.3 litres/hp.h or .07 gall/hp.h (which is 250 gm/hp.h or 0.6 lb/hp.h) under fairly well controlled conditions;
- iv. the number of hours of operation per year,  $h$ ;
- v. and finally, the unit price (per litre or gallon or kg) of fuel including delivery and storage,  $f$ ; (here the trade-off is between size of storage and frequency of delivery).

Therefore  $P.c.h$  litres or gallons (depending on units) are needed per year so, fuel costs  $F = \{P.c.h\} f$ .

### 3. Maintenance and repairs

This depends very much on the type of machine. In general, the frequency of maintenance and repairs tends to increase in relation to the operational speed of the machine; small fast machines need more maintenance than big slow ones; while non-moving devices like thermo-electric generators and photo-voltaic cells need practically no maintenance and rarely go wrong. However, while small, high-speed engines need rather a lot of maintenance, the skills required are often locally available and spares are mass-produced and relatively inexpensive, while a larger, more specialised engine, a gas turbine or any unconventional machine or device may need less attention, but the maintenance and repair skills may be rare and spares may also be harder to obtain and more expensive.

A rough rule of thumb with small engines is that the lubricant consumption rate is 2% of the fuel consumption rate and that servicing and routine replacements will cost an additional 2% or more of the capital cost of the machine per annum.

**Typical worked examples**

a. *5 hp diesel engine and pump set* (for irrigation). Let the first cost be £700, the annual utilisation 1000 hours, and on the basis of an assumed 10,000 hour useful life, the amortisation period will be a maximum of 10 years. Lastly let us assume a notional interest rate of 10%, which gives:-

$$\text{Annual charge } R = £700 \frac{0.1(1+0.1)^{10}}{(1+0.1)^{10}-1} = £114 \text{ p.a.}$$

Let us assume that the engine is derated by 60% and delivers an average of 3 bhp (i.e. 3000hp-h/y). The specific fuel consumption is likely to be around 0.3 litre/hp-h, or 900 l/y. Suppose the delivered fuel cost is £0.21/l (£0.90/imp. gallon) - (i.e. around double a typical refined product production cost), then:-

$$\text{Fuel costs } F = 3000 \times 0.3 \times £0.20 = £180 \text{ in the first year}$$

If we assume lubricant consumption at 2% of fuel, or 18 l/y and lubricant cost (typically) to be around three times fuel cost (£0.60/l) and maintenance and repairs cost an additional 2% of the cost of the engine (£14), we must add:-

$$\text{Maintenance and repairs } M = (18 \times £0.60) + £14 = £24.80 \text{ in the first year}$$

However, it would generally be unreasonable to suppose that fuel and maintenance costs will remain constant throughout the life of the engine. If for example inflation is taken as being 10% per annum, then these costs will increase over the ten year life of the unit to such an extent that the average annual cost for the period will be the first year's cost multiplied by a factor of 1.59, (see Table 1 for multiplying factors for other inflation rates and periods).

As a result, combined fuel and maintenance costs of £205 in the first year would average £326 over ten years at 10% inflation. (At 5% inflation the average annual fuel and maintenance cost would be £258, while at 15% inflation the annual average would be £416.) Obviously inflation is neither constant nor predictable, and due to inflation the inflated values are not worth the same by the time they occur as present day currency - however it is worth noting the effect as it is a factor when comparing with devices that do not require fuel and which in real terms become cheaper after inflation.

Therefore, for the diesel engine, the following costs apply:-

	1st year	average	10th year	
annual running costs:	£320	£440	£560	(10% inflation)
average cost per bhp-h:	10.7p	14.7p	18.7p	

b. *16ft diameter (5m) water pumping windmill* (for irrigation). Let the first cost be £3000 including tower, storage tank and all accessories. Assuming a life of 30 years, then the annual charge for the investment will be:-

$$R = £3000 \frac{0.1(1+0.1)^{30}}{(1+0.1)^{30}-1} = £318 \text{ per annum}$$

Fuel costs are zero.

Maintenance involves one oil change per annum, say £10.

Therefore total average annual cost = £328.

Average cost per hp-h depends on the wind regime of the location. Calculations based on an average wind speed of 8 mph (12 kmph) suggest that such a windmill would pump 500 million ft. gallons per annum, which is roughly equivalent to 2500 hp-h.

Hence, average cost per hp-h is approximately 13p in the first year.

On the same basis as before, at a 10% inflation rate for maintenance.

	1st year	average	10th year
annual running costs:	£328	£334	£341
average cost per hp-h:	13.1p	13.4p	13.7p

On the face of it, there is little to choose between these two power sources, at present day prices with the chosen wind regime. In a windier location the windmill would be cheaper and vice-versa.

What is illustrated is that certain energy converters are predominantly influenced by day-to-day running costs, which are subject to inflation, while others involve one large capital investment, so that the annual charges are substantially fixed.

In practice, high capital-cost devices with low or zero running costs tend to be less economical where high interest rates apply, while low capital cost devices (such as engines) with relatively high running costs become progressively less competitive in times of high fuel and maintenance cost inflation.

**Table 1**

**Variation of annual average fuel and maintenance costs over various periods at various inflation rates**

*Multipliers to apply to current annual average price to obtain mean annual average over the periods shown*

	5 years	10 years	20 years	30 years
<i>inflation @</i>				
1%	1.02	1.05	1.11	1.17
5%	1.10	1.26	1.66	2.22
10%	1.22	1.59	2.86	5.47
15%	1.35	2.03	5.12	14.49
20%	1.49	2.60	9.33	

e.g. average annual cost over a ten year period with 10% inflation will be 1.59 times present annual cost.

formula:

average annual cost  $F_{av}$   
 present annual cost  $F_1$   
 interest rate  $i\%$   
 period  $n$  years

$$F_{av} = \frac{100 \cdot F_1 (1 + i/100)^n - F_1}{i}$$

## Notes on Units and Tables of Conversion Factors

Unfortunately a wide variety of different measuring systems are in current usage internationally (and the UK is almost like the world in microcosm in this respect, since we are in the midst of a slow conversion process from our own traditional system which is still generally used in modified form in the USA, to the SI (Système Internationale) metric system). As a result the information supplied by manufacturers can be in all kinds of units.

We have generally sought to show SI units (or sometimes other non-SI metric units), in conjunction with British units where possible. However it proves very

difficult to abandon some non-SI units such as the ubiquitous horsepower, which usually means more to people in terms of mechanical shaft power than kW. Although SI prefers either mm or m, we have given engine capacities in cc, which should of course be written as cc<sup>3</sup>! Again, we would plead that this is what people are generally familiar with and it is certainly the most common engine capacity unit used by manufacturers.

The following tables of units and conversion factors may help in sorting out any confusion which may arise from the selection of different units quoted in this Guide.

### A. Methods used for indicating multiples of ten and their standard prefixes

<i>name</i>	<i>numeric</i>	<i>exponent</i>	<i>prefix</i>	<i>standard symbol</i>
millionth	$\frac{1}{1,000,000}$	10 <sup>-6</sup>	micro-	$\mu$
thousandth	$\frac{1}{1,000}$	10 <sup>-3</sup>	milli-	m
hundredth	$\frac{1}{100}$	10 <sup>-2</sup>	centi-	c
times thousand	x 1,000	10 <sup>3</sup>	kilo-	k
times million	x 1,000,000	10 <sup>6</sup>	mega-	M
times billion	x 1,000,000,000	10 <sup>9</sup>	giga-	G

### B. Principal units in common usage; names and symbols (alternatives in brackets).

	<i>Metric</i>		<i>British/US</i>	
<i>length</i>	*millimetre centimetre metre kilometre	mm cm m km	inch foot yard mile	in ("") ft ('') yd m.
<i>area</i>	square metres hectare	m <sup>2</sup> ha	sq.ft. acre	ft <sup>2</sup> acre
<i>volume</i>	cubic cm litre cubic metre	cm <sup>3</sup> (cc) l m <sup>3</sup>	cubic inch gallon cubic feet	in <sup>3</sup> (cu in) gal ft <sup>3</sup> (cu ft)
<i>mass</i>	gramme kilogramme tonne	g kg t	ounce pound ton	oz lb ton
<i>velocity</i>	*metres/second kilometres/hour	ms <sup>-1</sup> (m/s) kmh <sup>-1</sup> (km/h)	feet/second miles/hour knots	ft/s mph (m/h) kt
<i>rotation/frequency</i>	*herz revolution/min. radsam/sec.	Hz rev/min (rpm) $\Omega$	cycles/second revolution/min. radian/sec	c/s rev/min (rpm) $\Omega$
<i>flow rate</i>	litre/minute cu.metre/second	l/min m <sup>3</sup> s <sup>-1</sup> (m <sup>3</sup> /s)	gallon/minute cu.ft/second cu.ft/minute	gal/min (gpm) ft <sup>3</sup> /s (cusec) ft <sup>3</sup> /min (cfm)
<i>force</i>	*newton *kilonewton kilogramme-force tonne	N kN kgf t	pound force ton	lbf ton
<i>torque</i>	newton-metre kilonewtonmetre	Nm kNm	pound-feet	lbf ft

	Metric		British/US	
<i>work/heat/energy</i>	*calorie kilocalorie *joule *megajoule gigajoule watthour *kilowatthour	cal kcal J MJ GJ Wh kWh	British Thermal Unit Therm footpoundforce horsepower-hour	BTU (B.Th.U.) therm ft lbf hp h
<i>power</i>	*watt *kilowatt *megawatt metric horsepower	W kW MW CV (PS)	foot-pound/second horsepower brakehorsepower	ft.lbf/s hp bhp
<i>electrical</i>	*amps milliampère ampères/hour *volts ohms	A (current) mA Ah V (potential difference) $\Omega$ (resistance)	volt-amps kilovolt-amps	VA kVA
<i>pressure</i>	*pascal megapascal *bar kilogram per square centimetre	Pa MPa bar kgcm <sup>2</sup> (kg/cm <sup>2</sup> )	pounds/square inch gauge pounds/square inch atmospheric atmosphere foot water	psig psia atm ftH <sub>2</sub> O

\*Preferred units are indicated by an asterisk.

#### C. Conversion factor tables

<i>length</i>	mm	m	km	in	ft	mile
	1	.001	10 <sup>-6</sup>	.0394	.0033	5.4x10 <sup>-7</sup>
	1000	1	.001	39.4	3.28	5.4x10 <sup>-4</sup>
	10 <sup>6</sup>	1000	1	39360	3280	.539
	25.4	.025	2.5x10 <sup>-5</sup>	1	.083	1.4x10 <sup>-5</sup>
	305	.305	3.0x10 <sup>-4</sup>	12	1	1.9x10 <sup>-4</sup>
	1.6x10 <sup>6</sup>	1609	1.609	63360	5280	1

<i>area</i>	m <sup>2</sup>	ha	km <sup>2</sup>	ft <sup>2</sup>	acre	sq. mile
	1	10 <sup>-4</sup>	10 <sup>-6</sup>	10.76	2.5x10 <sup>-4</sup>	3.9x10 <sup>-7</sup>
	10000	1	.01	1.1x10 <sup>5</sup>	2.471	3.9x10 <sup>-3</sup>
	10 <sup>6</sup>	100	1	1.1x10 <sup>7</sup>	247.1	0.386
	.0929	9.3x10 <sup>-6</sup>	9.3x10 <sup>-8</sup>	1	2.3x10 <sup>-5</sup>	3.6x10 <sup>-8</sup>
	4047	.4047	4x10 <sup>-3</sup>	43560	1	1.6x10 <sup>-3</sup>
	2.6x10 <sup>6</sup>	259	2.590	2.8x10 <sup>7</sup>	640	1

<i>volume</i>	l	m <sup>3</sup>	in <sup>3</sup>	gal (US)	gal (Imp)	ft <sup>3</sup>
	1	10 <sup>-3</sup>	61.02	.264	.220	.0353
	1000	1	6102	264	220	35.31
	.0164	1.6x10 <sup>-5</sup>	1	4.3x10 <sup>-3</sup>	3.6x10 <sup>-3</sup>	5.8x10 <sup>-4</sup>
	3.785	3.8x10 <sup>-3</sup>	231.1	1	.833	.134
	4.546	4.5x10 <sup>-3</sup>	277.4	1.201	1	.160
	28.32	.0283	1728	7.47	6.23	1

<i>mass</i>	g	kg	t	lb	ton
	1	.001	10 <sup>-6</sup>	2.2x10 <sup>-3</sup>	9.8x10 <sup>-7</sup>
	1000	1	.001	2.205	9.8x10 <sup>-4</sup>
	10 <sup>6</sup>	1000	1	2205	.984
	453.6	.4536	4.5x10 <sup>-4</sup>	1	4.5x10 <sup>-4</sup>
	10 <sup>6</sup>	1016	1.016	2240	1

<i>velocity</i>	m/s	km/h	ft/s	mph	kt
	1	3.60	3.28	2.237	1.768
	.278	1	.912	.621	.539
	.305	1.097	1	.682	.592
	.447	1.609	1.467	1	.868
	.566	1.853	1.689	1.152	1

rotation	Hz (or c/s)	rpm	rad/s
	1	60	6.283
	.0167	1	.1047
	.159	9.549	1

flow rate	l/min	m <sup>3</sup> /s	(imp) gal/min	ft <sup>3</sup> /s
	1	1.7x10 <sup>-5</sup>	.220	5.9x10 <sup>-4</sup>
	60000	1	13206	35.315
	4.546	7.6x10 <sup>-5</sup>	1	2.7x10 <sup>-3</sup>
	1699	.0283	373.7	1

force	N	kN	kgf	t	lbf	ton
	1	.001	.102	1x10 <sup>-4</sup>	.225	1x10 <sup>-4</sup>
	1000	1	102	.102	225	.100
	9.807	.010	1	.001	2.205	9.8x10 <sup>-4</sup>
	9807	9.807	1000	1	2205	.984
	4.448	.004	.5436	4.5x10 <sup>-4</sup>	1	4.5x10 <sup>-4</sup>
	9964	9.964	1016	1.016	2240	1

torque	Nm	kNm	lbf.ft
	1	.001	.738
	1000	1	738
	1.356	1.4x10 <sup>-3</sup>	1

work/heat/energy (smaller units)	cal	J	Wh	BTU	ft.lbf	hp.h
	1	4.184	1.2x10 <sup>-3</sup>	3.9x10 <sup>-3</sup>	3.088	1.6x10 <sup>-6</sup>
	.239	1	2.8x10 <sup>-4</sup>	9.4x10 <sup>-4</sup>	.7376	3.7x10 <sup>-7</sup>
	860.4	3600	1	3.414	2655	1.3x10 <sup>-3</sup>
	252	1055	.293	1	778	3.9x10 <sup>-4</sup>
	.324	1.356	3.8x10 <sup>-4</sup>	1.3x10 <sup>-3</sup>	1	5.0x10 <sup>-7</sup>
	6.4x10 <sup>5</sup>	2.6x10 <sup>6</sup>	745.7	2546	2.0x10 <sup>6</sup>	1

(larger units)	kcal	MJ	kWh	BTU	hp.h
	1	4.2x10 <sup>-3</sup>	1.2x10 <sup>-3</sup>	3.968	1.6x10 <sup>-3</sup>
	239	1	.2778	947.8	.3725
	860.4	3.600	1	3414	1.341
	.252	1.1x10 <sup>-3</sup>	2.9x10 <sup>-4</sup>	1	3.9x10 <sup>-4</sup>
	641.6	2.685	.7457	2546	1

power	W (or J/s)	kW	CV	ft.lbf/s	hp	BTU/min
	1	.001	1.4x10 <sup>-3</sup>	.7376	1.3x10 <sup>-3</sup>	.0569
	1000	1	1.360	737.6	1.341	56.9
	735	.735	1	558	1.014	41.8
	1.356	1.4x10 <sup>-3</sup>	1.8x10 <sup>-3</sup>	1	1.8x10 <sup>-3</sup>	.077
	746	.746	.9860	550	1	42.44
	17.57	.0176	.0239	12.96	.0236	1

power flux	W/m <sup>2</sup>	kW/m <sup>2</sup>	hp/ft <sup>2</sup>
	1	.001	1.2x10 <sup>-4</sup>
	1000	1	.1246
	8023	8.023	1

calorific values	cal/gm	MJ/kg	BTU/lb
	1	4.2x10 <sup>-3</sup>	1.80
	239	1	430
	.556	2.3x10 <sup>-3</sup>	1



# Solar Energy

SOLAR ELECTRICITY  
SOLAR ENGINES  
SOLAR HEATING

The sun is indirectly responsible for most of our existing energy production, millions of years of solar radiation having produced the fossil fuels which we are so rapidly consuming. It is also the heat of the sun which evaporates enough sea water to produce the streams and rivers from which we tap hydro-electric power and of course it is the radiation from the sun that is essential to the photosynthesis process which is the basis for plant growth on which all life on earth ultimately depends.

Despite the obvious importance of the sun, recognised by mankind from earliest times, the direct use of solar energy (other than for naturally occurring processes such as crop-growing), has proved difficult. This is partly because of the intermittent nature of sunlight and also partly due to its diffuseness as an energy source compared with the concentrated energy in fossil fuels.

The sun emits about  $3.8 \times 10^{23}$  kW and is expected to continue doing this for 4 billion years or so to come (according to current scientific thinking). A minute proportion of this strikes the Earth, averaging around  $1.7 \times 10^{14}$  kW, of which nearly a third gets reflected back into space, giving an average daily energy supply from the sun of about  $2.9 \times 10^{15}$  kWh reaching the earth's surface. Total world daily energy consumption during 1974 averaged around  $1.8 \times 10^{11}$  kWh — so our current energy needs are only around one sixteenthousandth (1/16000) of what the earth receives every day; put differently — the earth receives every six seconds more energy from the sun than the entire human race consumes in 24 hours. Clearly there is no shortage of solar energy if we can find effective ways of harnessing it.

However the problems of using low-grade heat efficiently and of storing energy during the night or cloudy periods, economically, have made it difficult to tap much of this enormous energy supply. Hopefully, the combination of increasing technical skill and the fact that fossil fuels are being depleted will lead to a great increase in the use of this benign and pollution-free energy source. Certainly, if the equipment listed in the following section provides any indication, we are at the beginning of a mushrooming international solar energy industry, as very many of the devices listed (and their manufacturers) have only appeared within the last few years. Even the oldest established manufacturers of solar water heaters have only been in business for 25 years or so, (solar water heaters were in fact used in California and Florida during the early part of this century but these "prehistoric" designs disappeared when cheap natural gas killed the industry off until the recent revival of the 1970s).

This is not the place to go into any great detail on the technicalities of using solar energy, but a number of basic principles apply and are worth bearing in mind when reviewing the equipment listed.

### *Some characteristics of solar energy*

Obviously the economics of any solar energy utilisation system will depend on the available solar energy at the proposed location. Just under  $1\text{kW/m}^2$  is the maximum solar energy received at ground level on a surface perpendicular to the sun's rays. If the atmosphere is clear, the humidity low, the energy flow per unit area of a surface perpendicular to the sun's rays received near the North Pole can be similar to those near the equator. The main reason why the tropics are so hot is that the ground is more nearly perpendicular to the sun's rays, so the average energy intensity as it hits the ground is considerably greater. Also, of course, the number of hours of unobstructed sunlight available at any location will greatly influence the viability of any solar-powered device. As with wind-power, the availability may vary considerably

from day to day and with the seasons, but the total annual energy received at any particular place will not vary greatly from year to year. Therefore the outputs from solar-powered devices over a period of time such as a season are reasonably predictable.

For example, the UK, not one of the sunniest parts of the world, receives a maximum of about  $900 \text{ W/m}^2$  on a horizontal surface at midday in mid-summer in clear weather, while at midday in mid-winter in clear sunny weather this figure falls to  $200 \text{ W/m}^2$ . Hence the best that can be expected from a wholly clear summer day in the UK is around  $8.5 \text{ kWh}$ , while the worst possible result on an overcast, short winter day might be around  $0.8 \text{ kWh}$ . Britain in fact receives a total of around  $900 \text{ kWh/m}^2$  per year, which averages a power supply of  $100 \text{ W}$  per square metre if calculated over every hour of an  $8760$  hour year. By contrast, one of the more favourable areas for collecting solar energy, such as the desert regions straddling the Tropics of Cancer and Capricorn, receive some  $2000 \text{ kWh}$  per year, giving an all-the-year-round hourly average of  $230 \text{ W/m}^2$ . These figures of course apply only to a horizontal surface — if a surface is inclined to track the sun and remain perpendicular to its rays, greatly increased amounts of energy may be received. Since tracking the sun continuously involves complicated and expensive mechanisation, a good compromise is to site solar collector surfaces at an angle close to that of the latitude of the location, facing south in the northern hemisphere and vice-versa in the southern. This gives the optimal direction from which to receive the sun's rays as near to perpendicular as possible for the maximum possible time. In practice it is usual to set fixed collectors at an angle more like the latitude plus  $10$  or more degrees to make the optimisation relatively better in winter when greater efficiency of collection is more important. In some cases it is worth adjusting the angle seasonally in order to gain a slight increase in received energy per unit area of collector.

#### *Utilisation of solar energy.*

The main problems of using the sun's energy are its rather low concentration and intermittent nature. We have processes to convert solar radiation directly into heat or into electricity, or we can use the heat to power a heat engine to produce mechanical power. This section therefore considers the available solar energy conversion devices in three subdivisions — solar electricity, solar engines and solar heaters.

It is possible to overcome the problem of the diffuse nature of sunlight by concentrating it with systems of lenses or, more often, with mirrors, which are cheaper for larger applications. Just as with the well-known example of a magnifying glass, this creates a more intense energy flux which can achieve the temperatures commonly reached with fossil fuels. However, there are major disadvantages inherent in solar concentrators — firstly they can only focus direct sunlight and they therefore cease to function effectively under cloudy conditions and secondly, they need to track the sun in order to be kept in the correct alignment with the rays of sunlight, which inevitably introduces mechanical problems that can greatly add to the cost of such a system compared with a passive non-concentrating solar collector. As a result, most solar energy conversion systems are set up to use unconcentrated solar energy at the optimum angle for the location. Many of these can benefit from diffuse sunlight received through clouds. For example, if a clear sky yields  $800 \text{ W/m}^2$ , slight haze can reduce this to  $600 \text{ W/m}^2$ , light overcast conditions to  $300 \text{ W/m}^2$  and heavy overcast would typically be  $150 \text{ W/m}^2$ .

The intermittent nature of sunlight raises different problems. Obviously it can readily be applied for end-uses which are not very time-dependent — for example solar distillation — but a solar cooker may be inconvenient if its owner wants a hot lunch on a cloudy day and it is useless for cooking supper. It is technically feasible to provide energy storage to permit energy derived from sunlight to be available on cloudy days or at night, but in many cases it is difficult to do this at an economic price compared with the energy stored in fossil fuels. This is why solar cookers have been generally unsuccessful, even in hot sunny climates, but simple solar distillation systems where the product can be cheaply stored, have been economically applied for many years in a number of countries. Similarly, solar water heating is readily economic even in quite cold countries, as hot water can be stored at low cost in an insulated tank, but solar space heating in a cold country is more difficult (as is solar air conditioning in hot countries) as much larger quantities of energy require storage to cover nights and extended cloudy periods. One of the most common applications for solar-mechanical outputs is for pumping water for irrigation, since the need is greatest under sunny conditions, and water can be stored at low cost. Solar generated electricity, on the other hand, can only conveniently be stored in batteries, which is only economic for low output applications where limited quantities of stored electrical energy are sufficient. These problems will be discussed in more detail in the introductory passage to each of the categories of solar energy in which this section is sub-divided.

#### *Solar energy economics*

Obviously, the energy that can be converted from solar radiation at a particular location by a particular device will be proportional to the area of collector surface (or of concentrator surface) (assuming the collector is at the optimum alignment to maximise the received solar radiation). The efficiency of conversion and of storage will then govern what is usefully available from the system. The collector tends to be the most critical part of a system in terms of achieving reasonable efficiency and it is also generally the largest and most expensive component. Almost all solar energy conversion devices involve compromises aimed at minimising the cost per square metre of collector area while maintaining acceptable efficiencies. The most efficient energy converters are generally less cost-effective in most applications due to a disproportionately high cost per unit area, while very inefficient devices are also not cost-effective as they require excessive areas of collector to produce a given output. Some of the most economic solar energy systems are ones where the collector serves a dual purpose — for example where it forms the actual roofing for a building (rather than being placed on top of the roof to convert an existing building).

Another important aspect of any solar-powered device is its likely life expectancy. Since the running costs are very low, consisting of nothing more than whatever minor maintenance might be needed, (the sun being free), the main cost elements are whatever notional interest charge is payable on the capital investment involved in the installation and of course a depreciation allowance to permit eventual replacement. Hence the life-expectancy, capital cost and the consequent interest charges are the primary elements of the cost of converting solar energy. Therefore a low cost system may not be economic if it has too short a life, while on the other hand a system with an almost indefinite life might be feasible, but it may not be economical as its high cost would never be compensated



by its value in the distant future (and it may outlive its usefulness and be overtaken by improved lower-cost technology within its long lifetime, raising the question of whether to replace prematurely). Therefore, much of the design decision-making in solar energy technology consists of finding appropriate compromises between cost and efficiency and cost and life expectancy to suit the technical requirements as well as the economics of the end use.

These elements will be briefly described in conjunction with some of the technicalities of the different solar energy conversion processes in the three subsections dealing with solar-electric, solar-mechanical and solar-thermal conversion.

#### *Solar Electricity (photo-voltaics)*

A physical phenomenon known as the "photo-voltaic effect" allows light energy to interact with electrons present in suitably arranged semi-conductor combinations, and produce a voltage across two terminals. If an electrical load is connected across the terminals, a d.c. electricity flows and light energy is converted into electrical energy. Devices that produce this effect are called photocells, and a variety of different materials have been found to be active in this respect.

The most commonly produced type of photocell is based on silicon (one of the most abundant elements, being a primary constituent of sand — but used in an extremely refined form for photocells). Others commonly available are based on cadmium sulphide, gallium arsenide, and a number of other materials. Probably one of the best known applications of photocells is in the exposure meters of photographic cameras — since most photocells generate a voltage proportional to the intensity of the light falling on them, they are very suitable for measuring light intensity in conjunction with a voltmeter.

Unlike most other electrical generators, solar cells are normally not damaged by being short-circuited or open-circuited — they simply develop a voltage to suit the load and the availability of electrons motivated by the amount of incident light energy. Their output is roughly proportional to the received light energy intensity and the active area of the cell. Typical conversion efficiencies are of the order of 5 to 10% of received solar energy, depending on cell type and construction and assuming that the load and photocell array are suitably matched to permit output at the optimum voltage to maximise the electrical power.

As there are no moving parts and it is possible to encapsulate the delicate cell surfaces and contacts in a robust synthetic resin, very good reliability coupled with a long active life, of the order of 20 years or so, is normal. Also, if one solar cell fails it does not normally affect the functioning of its neighbours, and the output can be easily adjusted by adding or removing cell modules.

The main problem with photocells is their high price. This results largely from the high cost of developing and manufacturing them rather than from the intrinsic value of their materials (particularly in the case of silicon solar cells). Originally the only "power" applications were for milli-watt sized loads such as the voltmeter part of a light-meter — but the development of space satellites gave a great boost to solar cell development as they were applied to quite large power applications to run electronic systems in space. Some of the large space satellite installations involved 100 watt plus outputs, and of course the high cost of the solar arrays in relation to their output was unimportant in that application as there were no "conventional" alternatives that could be applied. In the early 1960s, photocells cost hundreds of pounds per peak

watt. Increased production and the improvement of manufacturing techniques had brought the price to large buyers down to around £15/peak watt in 1977 (i.e. peak watt means the output in bright sunlight with a solar radiation of around  $1\text{kW/m}^2$ ) and £10/peak watt by 1978.

Just as the price of electronic pocket calculators and transistor radios dropped enormously once large-scale production began, so it is anticipated that photo-voltaics will come down to around £1/peak watt during the early 1980s and it is thought they may be down to prices of the order of £0.25/peak watt within 20 years. As their price falls, the range of economic applications increases, which allows a higher production rate with accompanying further economies, and so on.

A few years ago photocells were only viable for ultra-low power applications (such as cameras) or for "expense no object" applications like space satellites. Today they are available in modules offering outputs in the 1 to 100 watt range, where their reliability, long-life and freedom from any maintenance requirements make them economic for a variety of specialised remote applications such as keeping batteries charged in inaccessible places, (e.g. for microwave repeaters, navigational aids for ships and aircraft, remote emergency equipment, telephones, railway signals, etc.). A typical module rated at 10 watts peak (in full sunlight), will on average produce 270 watt hours per week under a Mediterranean type of climate — this would be down to an average of only 160 watt hours per week in the UK, but might be as high as 400 watt hours per week in a favourable Middle East location. Its 1979 price would be under £100, and it could be expected to last up to 20 years and involve virtually no running costs or maintenance.

Once the price falls by another factor of ten, as is possible during the next decade, it will become economic to use much larger arrays of solar cells to produce power outputs of several kilowatts peak in order to pump water, power remote dwellings, hospitals or schools and to generally replace small petrol and diesel engines in remote areas.

A price drop of another magnitude to a probable minimum of the order of £0.20 (1977 values), possibly by the late 1980s or 1990s may allow larger scale electricity generation from solar energy — perhaps using decentralised local electrical systems in preference to centralised systems.

Energy storage with solar cells would normally be through the use of batteries; (this subject is discussed in more detail under the section dealing with electrical equipment). Sealed lead-acid batteries or nickel-cadmium cells tend to be better suited for most solar-electric applications, as their low (or zero) maintenance requirements match the similar characteristics of photo-voltaic cells, and so long as solar cells are so expensive and they are only used for rather low powered applications, the battery cost element is quite small compared with the photocell costs.

Optimisation of solar-cell and battery combinations in order to ensure sufficient storage capacity combined with sufficient charging capability is a specialised skill for which most of the manufacturers have developed computer programmes. Accurate records of sunshine hours and intensity are an important input requirement if system costs are to be minimised. Several manufacturers market monitoring devices, often based on a single solar cell, which can be set up in order to measure the radiation received over predetermined periods of say one month, which aid the correct specification of photo-voltaic power systems.

### *Solar engines*

In the nineteenth century some of the first attempts to utilise solar energy actively involved the use of small steam engines, with boilers heated by solar concentrators. One of these successfully ran a printing press at the great Paris exhibition of 1878. A solar steam engine producing 50hp (37kW) ran successfully in Egypt as long ago as 1913. Yet, ironically, today little is commercially available (as can be seen from the following section) although a number of interesting devices are under development (one or two of which are indicated in section 10 on R&D).

The main problem when using solar energy to drive a heat engine is to achieve optimum economics for the system. Heat engines work most efficiently from a high temperature source, while solar collectors are most efficient supplying heat at low temperatures. Early solar engines tended to run at high temperatures so as to use reasonably conventional engines and consequently needed large areas of solar concentrator which had in turn to be constantly oriented to track the sun. Modern developments, such as that by Sofretes, involve the use of special low temperature engines running on heavy organic vapours rather than on steam which can operate at lower temperatures that permit the use of non-tracking, more efficient, flat-plate collectors.

One of the primary applications for solar-powered engines is for pumping irrigation water, where the needs are closely matched to the availability of solar energy. Other applications might be to drive solar cooling (air conditioning or refrigeration) systems, where again the needs are closely matched to the energy availability. It seems likely that there will be considerable development in this field during the coming years, although in the long run it may be difficult for solar heat engines to compete with photo-voltaics driving electric motors once the price of solar cells comes down for small-scale applications. Various large-scale solar power stations are being investigated, including one based on a space satellite in stationary orbit which could beam its power to earth as microwaves and which would operate 24 hours/day. Other systems using indirect solar heat, such as is present in ocean thermal gradients (the difference in temperature between the surface and the depths of the oceans) are under evaluation — obviously such developments are well outside the scope of this guide, but they do indicate how important solar energy is likely to be as a primary source of energy in the future.

### *Solar Heating*

It can be seen from the large number of solar heating designs in the following section that this is one of the most common applications for solar energy.

Solar water heating is quite widely in use in some of the sunnier parts of industrial countries, such as the southern USA, northern Australia and Japan and it is becoming a growth industry even in less sunny regions such as northern Europe.

Solar space heating is more difficult to arrange as the needs tend not to coincide with the times when solar energy is most available, hence heat storage becomes a major element of solar space heating systems and these are best designed into the structure of a building rather than added to a conventional building.

As a result, it is solar water heating that offers the best prospects for being economic. In many cases solar water heaters may be used in conjunction with thermostatically controlled electric water heating in order to save electricity and reduce the running costs. In any case it is normal to

evaluate solar water heating economics in terms of what it would cost to heat the same amounts of water using fossil fuels or electricity or whatever is being substituted for by using solar energy.

Solar water heaters are passive devices; the only mechanical component needed, and then only in some cases, is a small electric pump needing very little power. As this is not an essential, solar water heating can be used in locations away from an electricity supply. Unlike photo-cells or solar engines, solar water heaters can readily be manufactured on a small-scale with low cost conventional workshop equipment, and as a result, many small manufacturers all over the world are now making them. There are probably many more manufacturers, particularly in the USA, than have been included in this edition. It is also encouraging that a number of engineering companies in Third World countries are also beginning to manufacture solar water heaters. It is hoped particularly to include other Third World manufacturers in future editions and any who are not included are invited to get in touch with us. It is well worth seeking a nearby manufacturer, because solar water heaters are relatively bulky and it is not very economic to import them in quantities from distant industrial countries due to high transport costs. Hence it is likely that a local manufacturer, even producing quite a small output, can compete with an overseas supplier quite successfully. In view of this a number of established manufacturers in industrial countries expressed interest in negotiating licenses to permit overseas manufacture of their products. Also a number of small engineering companies in non-industrial tropical countries have found it worthwhile to carry out some research and development to develop their own designs. Both these trends can be expected to continue.

### *Technical aspects of solar water heaters*

As with most solar energy systems, the solar collector is generally the largest and most expensive element of a water heating system. In general it consists of a blackened absorber plate which is heated by the sun's rays. The absorber carries water pipes or channels which are either integral with it or attached in such a manner as to obtain good thermal contact to allow heat to flow from the absorber into the water.

A blackened absorber with water flowing through it, or containing water is the simplest form of solar water heater. If it is intended to heat the water to temperatures significantly above ambient, and to keep it warm once it has been heated, even after dark, then various steps must be taken to prevent heat loss. This is because the temperature attained by the absorber will cease to increase once the rate of heat loss equals the rate of heat input. Obviously, the more the heat losses can be cut down the hotter and more efficient the absorber will get. Therefore it is normal to insulate the back and sides of the absorber to minimise heat losses, and to have a glass or plastic transparent cover over the side facing the sun. The latter serves two purposes — it traps solar energy by the so-called "green-house effect" under which glass readily passes short visible light wave lengths but is opaque to longer heat wave lengths. As a result, a glass cover is like a one-way valve — it lets in light-energy easily, but obstructs the departure of heat-energy. The other function of the glass is to trap a layer of air near the absorber to prevent the cooling effects that would be present if wind or convection could cool the surface. Multiple layers of glass allow higher temperatures to be attained. So-called "selective surfaces" consisting of various metallic oxides can be applied to metallic absorber surfaces which have a similar function to a glass cover in that they absorb light

energy readily but do not readily allow heat to radiate — certain solar absorbers have this feature which improves the overall efficiency of the system.

The solar collector is normally connected by two pipes to an insulated storage tank — one pipe leads hot water to the top of the tank while the other, running from the bottom of the tank, lets cooled water return for reheating in the absorber. Sometimes the hot water from the absorber does not mix with the water in the tank, but is circulated through a copper (or other metal) heat exchanger in the tank. Then the hot water to be drawn from the tank does not actually pass through the solar heater but is indirectly heated, and the liquid in the solar heater remains unchanged — which is an advantage as it allows anti freeze and anti-corrosive additives to be added to the water in the solar heater. In some cases liquids other than water may be used in certain types of solar water heater offering indirect heating of the water in the storage tank.

If the storage tank can be sited at a point higher than the top of the solar water heater, it is possible to take advantage of the fact that hot water is less dense than cold water to allow the hot water to "thermo-syphon" up to the tank and displace colder water down to the solar water heater via the second return pipe. Systems such as this do not require any pumps or mechanical moving parts, as when there is no sun, thermosyphoning stops and the hot water remains at the highest part of the system inside the insulated tank. However, in some cases it is not easy to arrange for the tank to be above the solar water heater, in which case small electric circulating pumps of the kind used for central heating systems are generally used — these have to be controlled by an electronic temperature sensing system which switches the pump on automatically whenever the temperature at the absorber exceeds the temperature at the top of the storage tank, and vice versa. Most of the smaller low cost systems try and use the thermosyphon effect to keep the costs down.

A few types of solar water heater consist of a complete combined solar collector and tank. The capacities of such systems are usually quite small, although they can of course by inter-connected in many cases to increase the availability of hot water.

A few systems heat air rather than water at the absorber. Systems using air do not suffer from the same corrosion and freezing problems that can affect water-fired absorbers, but for water heating an air to water heat exchanger is needed and fans are also usually needed to drive the air.

Many of the solar water heaters marketed in industrialised countries are intended for heating swimming pools, as the fuel bills for heating even quite a small swimming pool with electricity or oil are very high due to the large volumes of water involved. Swimming pool heaters usually need to heat a lot of water with only a small temperature rise, so they are designed to be of low cost per square metre and less efficient than the heaters designed for domestic hot water supplies. Some of these might be useful for domestic water heating in hot countries where the temperature increase required is not as great as in the colder parts of the world and a lower efficiency would therefore be acceptable. They would also be applicable to preheat water for other systems.

Many different types of absorber are offered by different manufacturers, some being aluminium, some copper, some steel and some plastic. Technically copper has a lot of advantages, being both a very good conductor of heat and also resistant to corrosion; unfortunately it is by far the most expensive absorber material generally used and may in some cases be "too good" to be economic. Aluminium "roll-bonded" absorber panels have been

marketed by a number of firms, but they cannot operate with ordinary water inside as they corrode too quickly — instead inhibitors have to be used in the water or else special oils are used as heat carrying fluids instead of water. Steel does not conduct heat as well as copper or aluminium, but is much cheaper than either. It is less corrosion prone than aluminium, particularly if it is used in an indirect system with a corrosion inhibitor. Alternatively thick steel pipes or stainless steel panels may be used. Composite systems in which copper pipes are mounted into an aluminium absorber are also sometimes used. Plastic absorbers have been quite widely introduced, particularly for lower temperature applications — care must be taken with most of these that they cannot accidentally be drained of water while exposed to sunny conditions as this can lead to overheating which may distort the plastic. Obviously plastic is completely corrosion resistant, but it may eventually degrade under strong sunlight.

Other uses for solar heaters are solar distillation, crop-drying, timber seasoning, etc. As most of these applications require installations that are constructed on site, complete systems are not normally available ready-built, but advice or plans for their construction may possibly be obtained from some of the organisations who offer consultancy services (listed in section 10).

#### *Solar heater economics*

In common with most devices using renewable energy resources and consequently not having any significant "running costs", the economics of solar water heaters depend on achieving the optimum compromise between the conflicting requirements of achieving good efficiency, low cost per unit area of energy absorbing surface and an adequate life expectancy for the system. The other important element in the economic calculations is the value of the energy produced, which generally depends on the cost of the energy being substituted for, such as fuel oil or electricity.

The following table indicates approximate payback periods when solar heating is valued against different fuel costs. The calculations assume unchanging fuel costs during that period (which is most unlikely) so they are rather pessimistic. Typical UK solar energy figures amounting to 900kWh/m<sup>2</sup> per year are compared with a hotter country receiving 1400kWh/m<sup>2</sup> per year. The payback periods are referred to a 4m<sup>2</sup> collector having three possible initial costs for the system, namely £200, £300 and £400; the lower value would relate to a thermosyphoning simple system installed on a do-it-yourself basis, while the higher level relates to an electrically pumped system, with electronic temperature sensing, that is professionally installed. For convenience, £5 per annum is deducted in all cases to cover pumping costs, whether or not a pump is used, making the figures for a thermosyphon system even more pessimistic.

This table shows how the unit cost of the heating source being replaced greatly affects the pay-back period. Obviously if inflation of fuel costs is taken into account, shorter pay-back times would be achieved.

Although solar water heaters can pay for themselves in a reasonable period with electricity prices at the levels that they are in many countries, and they can also save valuable fossil fuels in many countries where mains electricity is produced by diesel or thermal power stations, it has often needed political action to help establish them in the few countries where they are widely used. This is because the capital cost of an electric immersion heater is much lower than that of a solar heating system and the decision as to which system to install is usually

in the hands of the building contractors, rather than of the future residents who would need to pay for the electricity that will be used. A solar heated house tends to be slightly more expensive to build but is a lot cheaper.

to run, both for the residents and for the economy of the area in which it is located. Solar heating can also offer significant local job creating possibilities since the equipment lends itself to small scale manufacture.

Payback periods in years for systems with different first costs

Fuel costs p/kWh 1p = £0.01	a) Received energy 900kWh/m <sup>2</sup> /yr			b) Received energy 1400kWh/m <sup>2</sup> /yr		
	£200	£300	£400	£200	£300	£400
0.5	65	97	129	26	39	53
1.0	18	27	36	10	15	20
1.5	10	16	21	6	9	12
2.0	7	11	15	4	7	9
2.5	6	8	11	3	5	7
3.0	5	7	9	3	4	6
3.5	4	6	8	2	4	5

# Solar Electricity

**BRIAU S.A.**  
B.P. 43  
37009 Tours Cedex  
France

Telex: 750729 F  
Phone: (47) 61 38 17

Suppliers of solar pumping installations driven by photo-voltaic modular array. The number of solar collector modules, inclined to the optimum position for the latitude where the unit is installed, can be varied to suit the required power output. Units can raise water from 50m or more and can discharge to any required height. Automatic start/stop units are incorporated to guard against no load pumping and water loss through over filled tanks. The inclusion of a battery bank allows continuous running even during periods of zero insolation.

**SOLAPAK PRODUCTS**  
14 Brookfield Rd  
London W4 1DQ  
U.K.

School House  
Covent Usworth  
Washington  
Tyne & Wear  
NE37 1NF  
U.K.

Telex: c/o 53374  
Victor,  
Wallsend  
Phone: 01-994 8173  
Telex: 537681  
ALWRLD  
Phone: (0632)  
464646

Large selection of modular arrays (Solarex USP) producing up to 300 watts/module. The constituent Solapak panels come in a variety of sizes from 1 to 9 watts of 1.5 to 14V.

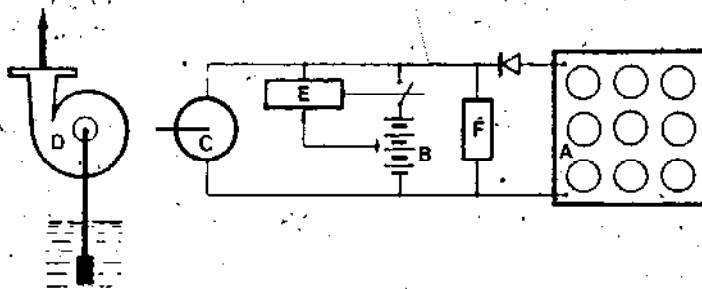

- A: Solar Panels
- B: Accumulator battery
- C: Motor
- D: Pump adapted to needs of installation
- E: Electric control cabinet
- F: Limit switch for charge

## Briau Photopile Generator for Pumping

**LUCAS SERVICE  
OVERSEAS LTD**  
Thame House  
Windmill Road  
Haddenham  
Aylesbury  
Bucks HP17 8JB.  
U.K.

Telex: 83615  
Phone: Haddenham 291681

Supply silicon solar cells encapsulated in silicone rubber. Various modular arrays are available to suit different demands from 1 to 30W and 2 to 12V. The basic modules available are:

Model	Charging point data			Peak output data			No. of cells
D0206	—	—	—	0.6A	2.2V	1.3W	5 of 55mmØ
E1215	1.53A	13.5V	20.7W	1.45A	17.5V	25.4W	36 of 90mmØ
E1206	0.61A	13.5V	8.2W	0.56A	17.0V	9.5W	36 of 55mmØ

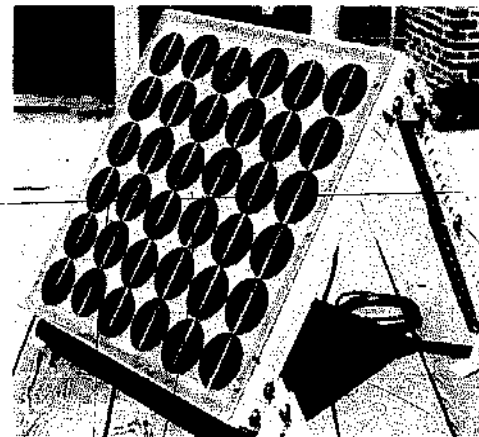

Series "E" Solar Array

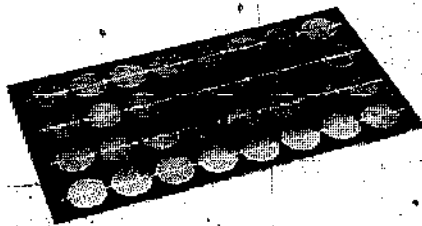

Solar Power Module MST 102

**FERRANTI LTD**  
Gem Mill  
Fields New Road  
Chadderton  
Oldham OL9 8NP  
Lancs  
U.K.

Telex: 668038 Ferem G  
Phone: (061 624) 0515

Manufacturers of silicon solar cell modules suitable for charging 12V batteries. The cells are encapsulated in silicon resin with an optional polycarbonate cover for harsh environments. Two models are available:

Model No.	Maximum power point			No. of cells	Shipping weight
	Volts	Amps	Watts		
MST 102	13.0	0.54	7.00	32	1kg
MST 103	—	—	—	36	1.1kg

A new range based on larger cells is under development.

**SOLAR ENERGY COMPANY** Cables: Solenco  
 World Wide Energy Systems  
 P.O. Box 649  
 Gloucester Point  
 Virginia 23062  
 U.S.A.

This company offers a range of individual silicon solar cells ranging from 2mA at 0.45V up to 2000mA at 0.45V (optimum) for the customer to assemble and in addition there is a wide range of modular cell assemblies as follows:

Suncharger	236	1.5V	250mA	0.375W
"	296	14V	650mA	9.1W
"	346	14V	250mA	3.5W
"	348	12V	150mA	1.8W
"	372	12V	250mA	3.0W
"	421	12V	580mA	6.96W
"	704	14V	250mA	3.5W
"	1626	2.5V	250mA	0.625W
"	1270	6.5V	1.2A	7.8W
"	2938	14V	650mA	9.1W
"	2700	28V	750mA	21W
Super	"	3348	12V*	1.8A 21.6W
"	"	6348	12V*	3.5A 42W
"	"	8348	12V*	4.7A 56.4W
Solar power pack	S6348PP			(200Wh/day)*

\*These are available with optional voltage outputs of 12, 24 or 36V to order.

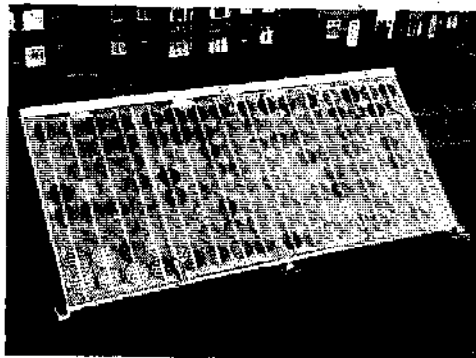
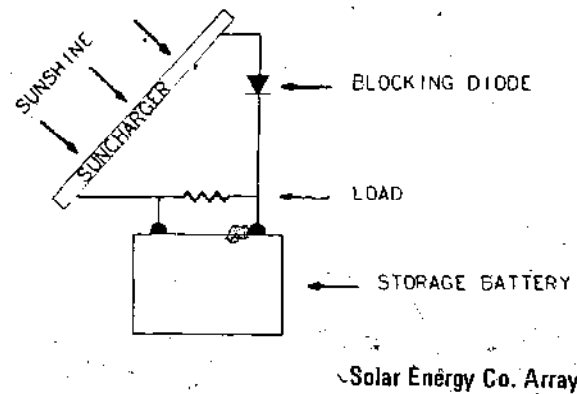

Solarex Unipanel

**SOLAREX CORPORATION** Telex: 710 828 9709  
 1335 Piccard Drive Cables: Solarex  
 Rockville Phone: 301 948 0202  
 Maryland 20850  
 U.S.A.

U.K. Distributor: SOLAPAK PRODUCTS, 14 Brookfield Road, London W4 1DQ (Phone: 01-994 8173).

This company manufactures a wide selection of individual silicon solar cells as round, rectangular and quadrant shapes for customer assembly, plus a range of modular silicon cell panels with the cells encapsulated in silicon rubber, the trade name for the assemblies being "Solarex Unipanel".

Model No.	Nominal Voltage	Output at 100mW/cm <sup>2</sup> Amps	Watts	Watt hr/week (US average)	watt/ft <sup>2</sup> (min)	weight lb	kg
215	12	0.125	1.5	45	4.0	0.7	0.3
230	12	0.25	3.0	100	4.0	1.3	0.59
260	12	0.5	6.0	200	4.0	2.3	1.06
1260	12	0.5	6.0	200	5.0	2.0	0.905
1270	12	0.58	7.0	220	5.8	2.0	0.905
280	12	0.62	8.0	240	5.2	2.3	1.06
615	6	0.25	1.5	45	3.7	0.7	0.3
950	9	0.5	5.0	160	5.3	1.8	0.8
435	14	0.25	3.5	105	4.2	1.4	0.64
470	14	0.5	7.0	220	4.4	2.5	1.15
480	14	0.62	8.0	270	5.0	2.5	1.15
1470	14	0.5	7.0	220	5.0	2.1	0.97
1480	14	0.58	8.0	260	5.8	2.1	0.97
670	7	1.0	7.0	220	4.4	2.5	1.15
770	7	1.0	7.0	220	4.9	2.3	1.06
785	7	1.2	8.5	280	6.0	2.3	1.06

Also a "Solar Electric Monitor" type 203.

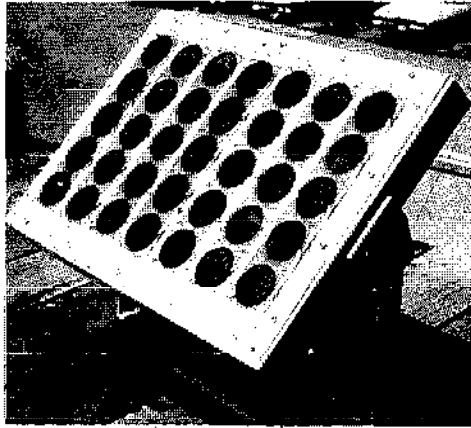

Solar Power Corp. Array

**SOLAR POWER CORPORATION**  
 5 Executive Park Drive  
 North Billerica  
 Massachusetts 01862  
 U.S.A.  
 110-111 Strand  
 London WC2E 0DA  
 U.K.

Telex: 710 347 6792  
 Phone: 617 667 8376  
 Phone: 01-386 8918

This company is a subsidiary of the giant Exxon Oil Group and produces a series of silicon solar cell modules encapsulated in UV stabilised silicon rubber and available with various types of carrying frame or legs incorporating different combinations of the basic modules to give various output voltages. Some examples of basic modules available are:

Model No.	Charging point		Peak power point		
	Volts	Amps	Volts	Amps	Watts
1002	—	—	2.3	0.6	1.4
E4-125-0.6	4.5	0.64	4.9	0.6	2.9
E6-185-0.6	6.8	0.64	7.7	0.6	4.6
E6-365-1.2	6.8	1.29	7.7	1.2	9.2
E6-369-3.0	6.8	3.22	7.9	3.04	24.0
E12-365-0.6	13.6	0.65	16.0	0.6	9.6
E12-369-1.5	13.6	1.62	16.5	1.52	25.0
G12-361	13.6	2.00	16.5	1.90	31.3

The last model, prefixed G, has a tempered glass cover which is claimed to be of lower cost, good weathering resistance and durability and to keep the cells cooler.

This company offers computerised system design to match cells and batteries optimally and a single cell solar insolation monitoring unit is also available.

**SOLAR SYSTEMS INC.**  
 Division of Silicon Sensors, Inc.  
 Highway 18 East  
 Dodgeville  
 Wisconsin 53533  
 U.S.A.

Phone: (608) 935 2707

This company produces a wide selection of individual silicon, cadmium sulphide and selenium photo-voltaic cells suitable for the customer to assemble, and in addition offers the following purpose-built modular arrays of silicon photo cells for power production: (data applies with 100mW/cm<sup>2</sup> and 25°C standard).

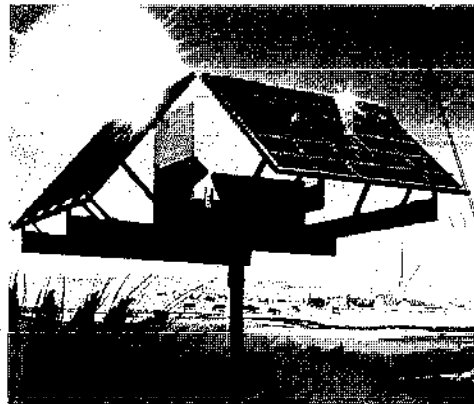

Solar Systems Array

Model designation*	Nominal output data†			Alternative voltage at same power
	Volts	Amps	Watts	
SPM-75-2	2	.32	.64	2, 4, 8 and 16
SPM-100-2	2	.48	.96	2, 4, 8 and 24
SPM-150-2	2	.72	1.44	2, 6, 12, 18 and 36 (& 3.6 economy)
SPM-200-6	6	.18	1.08	6 and 18 (also derated at 2V)
PCM-510 Power-Mod	2	.044	.09	
PCM-540 Power-Mod	2	.10	.20	

\*the final suffix number gives the voltage; for example the 6V version of SPM-75 is SPM-75-6.

†the output data for the lowest voltage version is given as an example.

**SPECTROLAB INC.**  
 (Subsidiary of Hughes  
 Aircraft Corp.)  
 12500 Gladstone Avenue  
 Sylmar  
 California 91342  
 U.S.A.

Telex: 910 496 1488  
 Phone: (213) 365 4611

Spectrolab produce the "Solectric" series of modular silicon solar cell arrays. The silicon cells are embedded in clear silicon rubber and covered with a glass faceplate with an extruded aluminium "I" beam backing.

Five basic modules which can readily be linked by bus bars are available. Their nominal outputs with 100mW/cm<sup>2</sup> light intensity at 28°C are as follows:

Nominal voltage	Minimum test performance			Length*		Weight	
	current	voltage	power	in cm		lb	kg
4V	1.0A	5.4V	5.4W	29	73	3.6	1.63
6V	1.0A	8.1V	8.1W	42	107	5.2	2.36
6V	0.5A	8.1V	4.05W	22	57	2.8	1.27
12V	0.5A	16.2V	8.1W	42	107	5.2	2.36
14V	0.5A	18.9V	9.4W	49	124	6.0	2.72

\*the lengths are to nearest whole inch or cm.

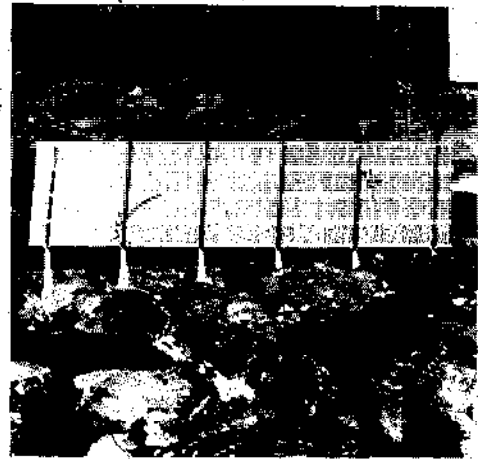

3kW Solectric Array

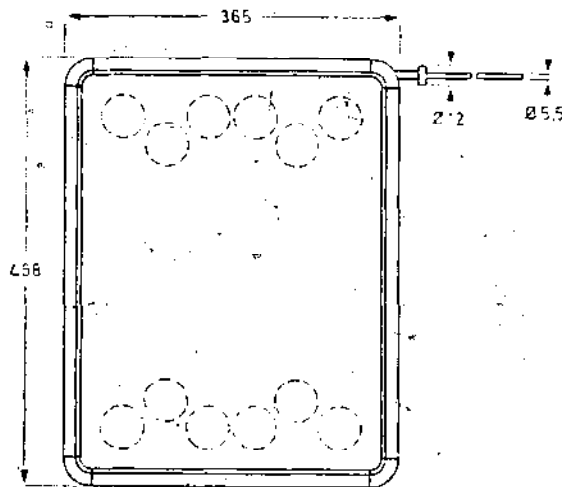

Solar Cell Module BPX47A

**Philips Nederland BV**  
 Afd. Elonco  
 Boschdijk 525,  
 Eindhoven  
 Netherlands

Phone: (040) 79 33 33

also:

ELCOMA Philips Electronics Components and Materials, P.O. Box 50, Lane Cove 2066, New South Wales, Australia.

MULLARD LTD., Mullard House, Torrington Place, London WC1E 7HD U.K. Phone (01) 580 6633.

NORTHAMERICAN PHILIPS, 230 Duffy Avenue, Hicksville, NY 11802, U.S.A. Phone (516) 931 6200 and numerous other Philips subsidiaries, worldwide.

The Philips solar cell module consists of 34 series connected 57mmØ silicon solar cells, moulded in transparent resin and laminated between two glass sheets.

Performance data at 100mW/cm<sup>2</sup> insolation and 25°C ambient: Optimum power 10.7W with voltage 15.5V and current 0.69A.

## Solar Engines

**ORMAT TURBINES LTD**  
 Szydowski Road  
 Yavne  
 P.O.B. 68  
 Israel

Phone: 055 95461  
 Telex: 31902  
 Cables: ORMATURB  
 TELAVIV

Manufacturer of a range of solar-powered turbines for a variety of applications including water pumping, electricity generation, etc.

Turbine runs on organic heavy vapour working fluid and has only one major moving part. Over a thousand units have been installed in a variety of continents and these have been in production for some ten years.

Solar powered systems can be supplied with the possibility of an optional fuel burner to guarantee power at night or during cloudy periods.

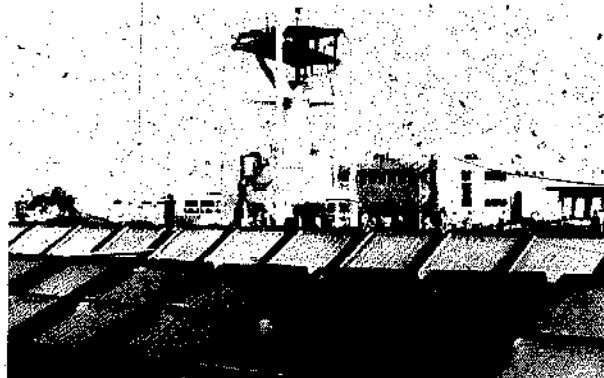

Ormat Turbines Installation



**SOLAR PHYSICS CORPORATION**  
 1350 Hill Street  
 El Cajon  
 California 92020  
 U.S.A.

Phone: (714) 440 1625

Manufacturers of a solar power unit utilising the sun via tracking mirrors to heat a working fluid in a receiving tower. This working fluid is used to power an engine which drives a generator. Electrical output of up to 5kW currently offered, but larger models offering outputs up to 100kW are at the planning stage. This company is well known for its pioneering work in the field of "power towers", which have been postulated as a likely configuration for future large scale power production. Consultancy services in this field are also offered.

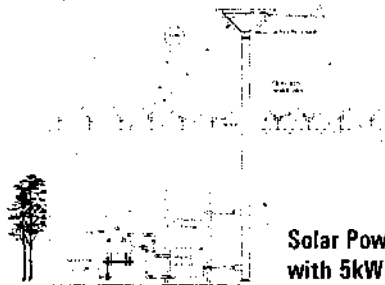

**Solar Power-Tower with 5kW Electrical Generating Plant**

**YAZAKI CORPORATION**  
 International Division  
 6th Floor Tokyo Ryutsu Center  
 1-1 6 chome  
 Heiwa Jima  
 Ota-Ku  
 Tokyo  
 Japan

Telex: J24437, 246 8395  
 Cables: Yazaki Tokyo  
 Phone: Tokyo (03) 767 3960

This group manufactures a newly developed solar heated absorption refrigeration unit producing chilled water for building cooling by the absorption cycle.



**Yazaki Solar Heated Absorption Refrigeration Unit**

**RENAULT MOTEURS DEVELOPPEMENT**  
 R.N. 186  
 La Boursidiere  
 92350 Le Plessis-Robinson  
 France

Telex: Reno 200288 F  
 Phone: 630 21 03

Renault Motors are now marketing a novel type of solar heat engine developed by Sofretes in France. Quite a large number of these machines are now in use in countries such as Senegal, Mexico, Upper Volta, Mauritania, Niger, Mali, Cameroon, Chad, Abu Dhabi and Sudan. Since they are relatively expensive machines, they depend on intense sunlight for the best return.

Two versions in various sizes are available, these and solar pumping stations designated by the prefix MS and solar power stations prefixed TS, which can also be used as pumping stations.

The following performance data assumes average ambient temperatures over 25°C, average solar radiation of 700W/m<sup>2</sup>, pumped water temperature 28°C.

Model No.	Water output at 25m head	Nominal power (pumping)	Daily Average running time	Nominal power (shaft)
MS 8	3.5m <sup>3</sup> /hr	240W	4-6 hr/day	—
MS 5	5.75m <sup>3</sup> /hr	392W	4-6 hr/day	—
MS 7	8.9m <sup>3</sup> /hr	545W	4-6 hr/day	—
TS 25	1200m <sup>3</sup> /day	17.2kW	5-6 hr/day	25kW
TS 50	2400m <sup>3</sup> /day	34.8kW	5-6 hr/day	50kW



**Sofretes Panel Collectors for Solar Pump**

**SPILLING CONSULT AG**  
 Sonnenweg 4  
 CH-5610 Wahlen  
 Switzerland

Telex: 57 939  
 Cables: Spill Ch  
 Phone: 057 6 73 57

Spilling solar energy plant consisting of a solar collector and a steam motor generator set with outputs from 2kW upwards.

This was all the information available to us at the time of going to press.

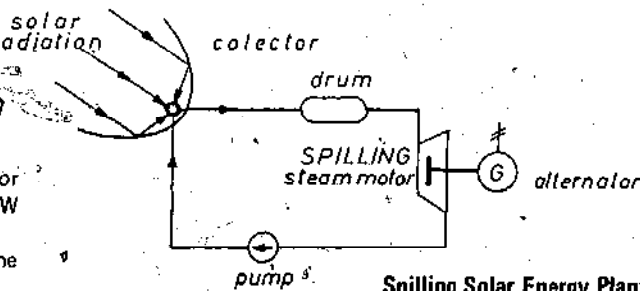

**Spilling Solar Energy Plant**

# Solar Heating

**AIR DISTRIBUTION  
EQUIPMENT (M & W) LTD**  
64 Whitebarn Road  
Llanishen  
Cardiff CF4 5HB  
U.K.

Phone: 0222  
754677

Manufacturers of solar water heating systems for home water heating. Systems incorporate solar panels plus a differential temperature controller to control the flow of water through the panels.

- Solar panel module of 2ft x 2ft (0.37m<sup>2</sup>).
- GRP/aluminium case to glass cover.

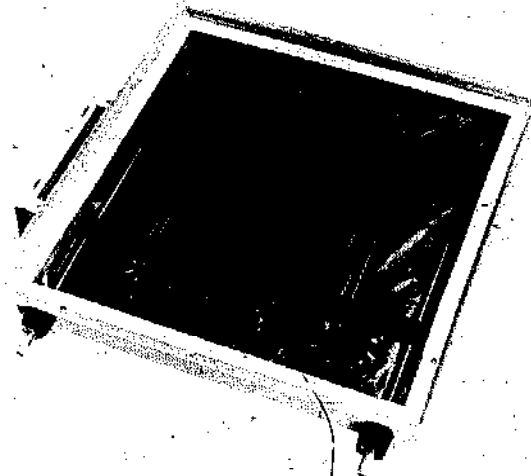

Solar Panel

**ARC SOLAR CENTRE LTD**  
176 Ifield Road  
London SW10 9AF  
U.K.

Phone: 01-370 4804

Manufacturers of a range of solar panels under the tradename "Sunstor":

**a. Sunstor domestic collector**

Size: 1524mm x 610mm x 76mm, weight 28lb (12kg) empty, area of collector 0.92m<sup>2</sup>.

Absorber: Copper pipes soldered to copper absorber plate.

Casing: Aluminium sheet (18 swg) with fibreglass wool and polyurethane insulation.

Glazing: 4mm single sheet of glass to be supplied by customer.

Installation: Either thermosyphon for simplicity or electric pumped.

**b. Sunstor industrial collector**

Size: 2000mm x 1000mm x 76mm, absorber area 1.9m<sup>2</sup>, weight 17.5kg empty.

Absorber: Copper plate with copper pipes bonded by patented heat fusion process.

Surface coating: 3M Nextel with reduced infra-red emission.

Casing: Aluminium sheet with fibreglass wool and polyurethane foam.

Glazing: 4mm glass.

Installation: Intended for large installation for industrial/commercial premises.

**c. Sunstor "Waterfall 2" low cost, low temperature collector**

Size: 1830mm x 1220mm (2.16m<sup>2</sup>).

Construction: All metal unglazed collector with copper waterways clamped to an aluminium absorber plate.

Applications: Preheating cold water for other solar or non-solar water heating systems or for heating swimming pools.

**d. Sunstor miniature demonstration panel**

This is a novel miniature complete thermosyphoning solar collector and storage tank to demonstrate solar water heating or for heating small quantities of water. It is intended mainly for educational purposes or for studies.

Effective absorber area: 0.1m<sup>2</sup> (426mm x 335mm).

Construction: Similar to domestic collector described in paragraph a.

Storage tank capacity approximately 2 litres. It is claimed that it will heat two litres of water to 55°C in strong sunlight quite rapidly.

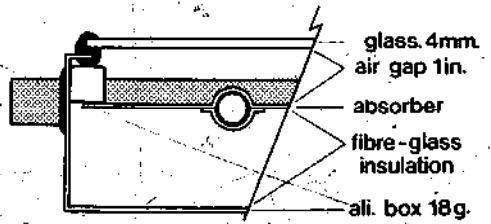
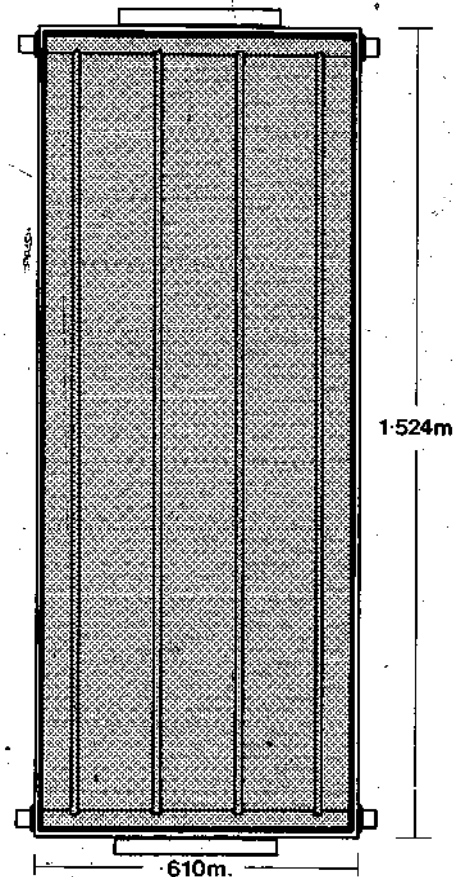

Sunstor Flat Plate Collector

**ASAHI TRADING CO LTD**  
 Asahi House  
 Church Road  
 Port Erin  
 Isle of Man  
 U.K.

Phone: (062 483)  
 3347/  
 3758

Manufacturers of a glazed solar panel using glass tubes as the collector pipes in which the heating water runs.

This is a Japanese system and it is claimed that 2½ million units are in use in Japan.

The unit is quite heavy when filled with water and does not require a separate storage tank as it is for direct rather than indirect systems. Having glass water channels there is no corrosion problem. The channels are claimed to be efficient as collectors, particularly at absorbing solar energy when the sun is not due south or conditions are cloudy.

The case is of steel and the unit is glazed with plastic.

Size: 1460mm x 1670mm x 190mm.  
 Weight: Empty 75kg; full 255kg.  
 Capacity: 180 litres.

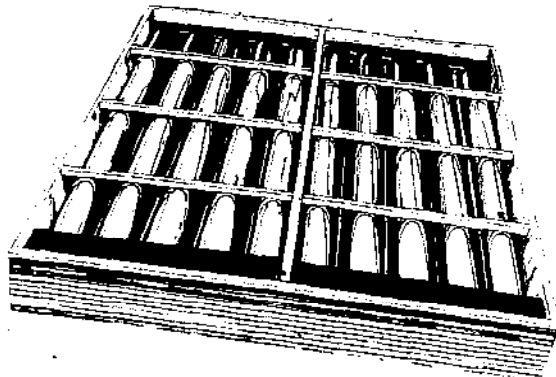

Asahi Solar Panel

**BURKE RUBBER COMPANY**  
 2250 South Tenth Street  
 San José  
 California 95112  
 U.S.A.

Phone: (408) 297  
 3500

A simple unglazed trickle flow solar panel for low temperature gain water heating, (i.e. used in the U.S.A. mainly for swimming pool applications).

Module areas are: 8ft x 8ft, 12ft or 16ft (2.44m x 2.44m, 3.66m or 4.88m).

Construction material: Du Pont "Hypalon" (Chloro-sulphonated polyethylene) with a copper sparge pipe.

Surface temperature limits: 40°F to 250°F (-40°C to 121°C).

- |   |                          |
|---|--------------------------|
| 1. Water Out                                | 6. Black Hypalon Panel   |
| 2. Installation Grommets                    | 8 ft. Wide x 8 ft. Long  |
| 3. Water in at top                          | 8 ft. Wide x 12 ft. Long |
| 4. Copper Distribution Pipe                 | 8 ft. Wide x 16 ft. Long |
| 5. Water Distribution Material Inside Panel | 7. Overflow Relief Valve |

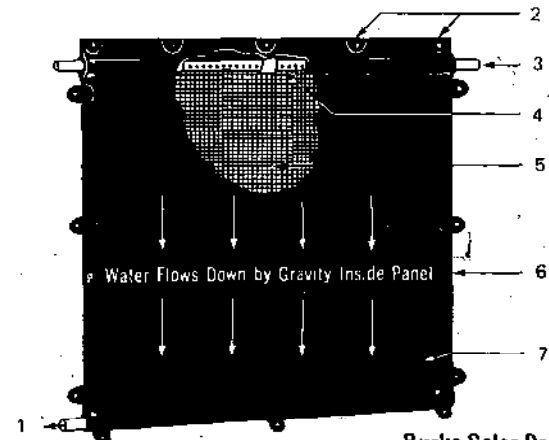

Burke Solar Panel

**CALOR SOL LTD**  
 Lancaster Road  
 Shrewsbury SY1 3NG  
 U.K.

Phone: (0743) 51578

This company offers a variety of water and air heating solar collectors. The following are all in glass reinforced plastic casing with polyurethane insulation and glass reinforced plastic glazing.

Mark 1: Cascade water heating corrugated metal plate - stove-enamelled matt black, 15mm copper sparge pipe and 25mm UPVC outlet collector. For low temperature applications. 2.92m x 0.97m = 2.83m<sup>2</sup> effective area.

Mark 2: Warm air ventilation corrugated metal plate stove-enamelled matt black, size as above.

Mark 3: For indirect water supply with aluminium roll-bonded absorber, size as mark 1.

Mark 4: Similar size to above units, but with pressed steel radiator absorbers interconnected with copper pipes.

Some further low cost models are also offered, which have 20g galvanised steel cases and thinner GRP glazing and the insulation is expanded polystyrene.

Mark 5: Roll bonded aluminium absorber of 2.05m<sup>2</sup>.

Mark 6: Corrugated galvanised cascade collector of 2.3m<sup>2</sup> effective area.

Mark 7: Similar to Mark 6, but designed for air heating rather than water heating and having suitable inlet and outlet ducts.

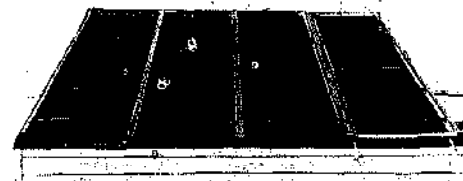

Calorsol Solar Heat Collector Plate

**CSI SOLAR SYSTEMS  
DIVISION**  
12400 49th Street  
Clearwater  
Florida 33520  
U.S.A.

Phone: (813) 577  
4228/4489

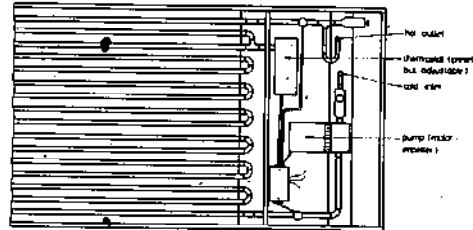

**CSI Solar Panel**

Manufacturers of a range of solar heater modules with integrated controls and an electric circulating pump.

Model No.	Size	Weight	Water Channels	Absorber Material	Frame	Insulation
250	2ft x 8ft	80lb			Stained red-wood	Polyethylene
500	2ft x 11ft	100lb	Copper tube	Aluminium		
1000	4ft x 11ft	220lb				

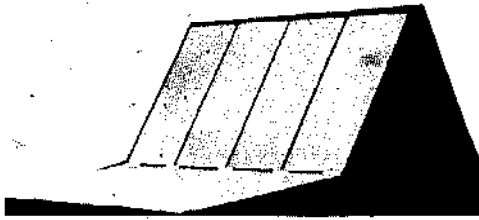

**Champion "Solar Furnace"**

**CHAMPION HOME  
BUILDERS CO**  
5573 North Street  
Dryden  
Michigan 48428  
U.S.A.

Phone: 313 796  
2211

Manufacturers of a solar heater for hot air domestic heating. The unit is a free standing unit using a rock fill heat store. The system is easily installed in conjunction with any conventional warm air heating system.

Sizes: Three models of 108, 144 and 180ft<sup>2</sup> collector area (10.1, 13.4, 16.7m).

Absorber: Aluminium with double glass cover and urethane insulation. Heat store: 9, 12 or 15 cu.yds of gravel.

Fitted with circulating fans and electronic controller.

**DIY-SOL INC**  
P.O. Box 614  
Marlboro  
Massachusetts 01752  
U.S.A.

Phone: 617 877 6018

claimed to be a low cost method of installing solar heating.

Hot water can be provided through the use of a heat exchanger between the solar heated air and the water supply.

The collector is glazed with Dupont's "Tedlar" and incorporates a special type of efficient absorber called "Xsoletherm" — both are included in the kits.

This system might be useful for crop drying or timber drying processes, etc.

This company supplies a kit and instruction book to allow a sophisticated and effective hot air solar heating system to be built. The kit includes only the special equipment necessary and ordinary construction materials are supplied from local sources by the customer. This is

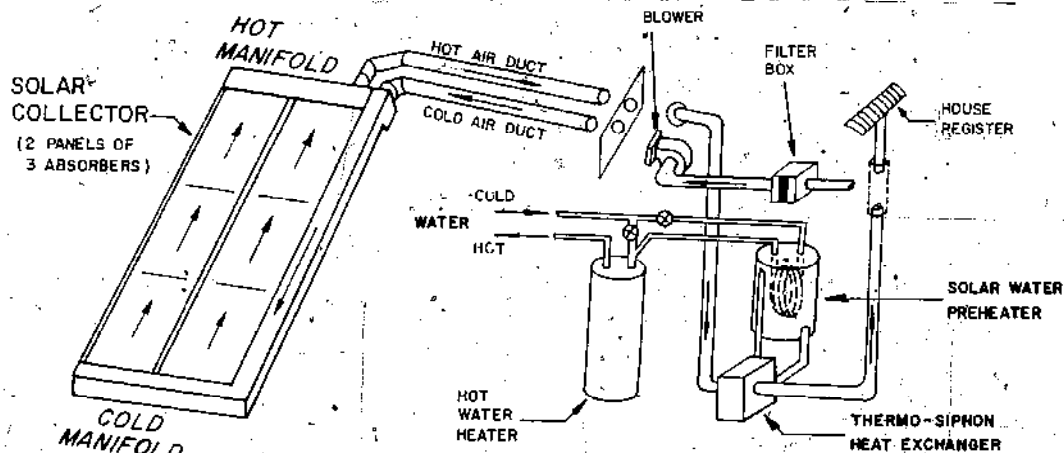

**DIY-SOL "Hot  
Water Plus" System**

**E.I. DU PONT DE NEMOURS  
& CO INC**  
 Film Department  
 Speciality Markets Division  
 Wilmington  
 Delaware 19898  
 U.S.A.

Manufacturer of a wide range of plastic materials including "Tedlar" PVF film which is particularly suited for the glazing of solar flat plate collectors. "Tedlar" is available in various grades; 100BG30TR passes UV wavelengths and some infra red. "Tedlar" is partially selective in that it blocks infrared in the 7 to 12 micron wavelength range partially.

**E.A. HYDRAULICS &  
METAL INDUSTRIES LTD**  
 P.O. Box 30730  
 Nairobi  
 Kenya

Phone: Nairobi  
 559273  
 28918  
 28907

This is a solar water heating panel made in Kenya with a glazed cover and combined galvanised tank of 120 litres capacity. It is claimed to heat the contents of the tank to 70°C after two hours of Kenyan sun.

Overall dimensions of the installation are 5ft x 4ft x 3ft and net weight (empty of water) is 240lb. A 1.5kW electrical immersion heater can be included as an optional extra to guarantee hot water during periods of limited sunshine.

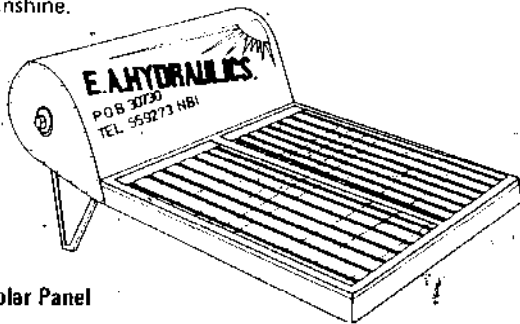

**Solar Panel**

**EDWARDS ENGINEERING  
CORP.**  
 101 Alexander Avenue  
 Pompton Plains  
 New Jersey 07444  
 U.S.A.

Telex: 130131  
 Cables: Edengco  
 Phone: (201) 835  
 2808

The Edwards Completely Packaged Solar System provides a complete assembly of related heat transfer units to accomplish the heating and cooling of residential/commercial spaces.

**Solar Collectors:** The solar collector panels are 2ft or 3ft in width and of any specified length to fit the building design. The panels are so designed that they will take the place of the normal roofing material such as the shingles. The panels consist of 1 inch of aluminium covered fibre-glass insulation, heat absorbing aluminium plates, copper or aluminium tubes, one or two layers of transparent plastic sheeting, and an aluminium frame for fastening and holding the parts to the roofdeck.

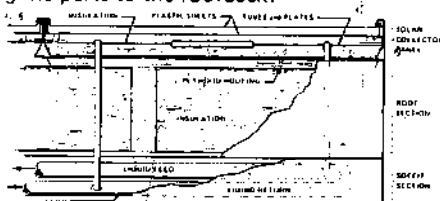

**Edwards Engineering Solar Collector**

**E & K SERVICE COMPANY**  
 16824 - 74th Avenue N.E.  
 Bothell  
 Washington 98011  
 U.S.A.

Phone: 206 486  
 6660

Manufacturers and licencees of an unusual wooden framed solar collector claimed to minimise heat loss by conduction which can be a problem with some metal-cased collectors.

Panel Sizes: 2ft x 4ft, 4ft x 4ft, 4ft x 8ft, 4ft x 12ft.

Absorber: Aluminium sheet with copper tubes.

Glazing: GRP plastic or  $\frac{3}{16}$ " glass or can be supplied unglazed.

Weight: Approx 6.5lb/ft<sup>2</sup> (glazed) or 4.25lb/ft<sup>2</sup> (unglazed).

A miniature version of the above panels, size 1ft x 2ft is available for educational purposes or as a sample.



**E & K Service Company  
SOL-R panel**

**GRUMMAN CORPORATION**  
 Energy Systems Division  
 4175 Veterans Memorial Highway  
 Ronkonkoma  
 New York 11779  
 U.S.A.

Telex: (516) 575  
 6555  
 Phone: (516) 575  
 6205

Manufacturers of direct and indirect solar heating systems which include solar panels and all ancillary equipment for domestic water heating, for use in conjunction with other heating systems or on their own.

Typical unit size: 24.58ft<sup>2</sup> (2.28m<sup>2</sup>) of absorber area.

Weight: 87 or 122lbs depending on absorber.

Absorbers: Aluminium Rollbond for closed circuit indirect systems. Aluminium-Finplank with copper water passages for direct or indirect systems.

Glazing: Arched acrylic covers or single/double tempered glass.

Insulation: Foil enclosed fibreglass.

Casings: Aluminium alloy with baked enamel finish.

N.B. Finplank absorbers are available separately for building into "home made" cases. Weight 56.5lb for 24.95ft<sup>2</sup> absorber.

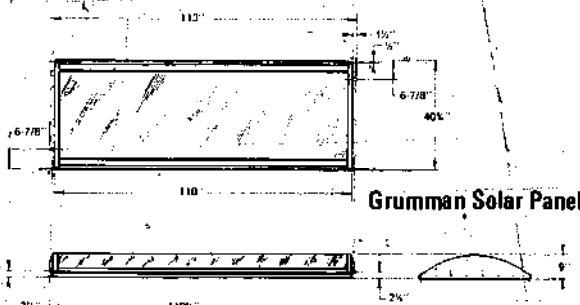

**Grumman Solar Panel**

**ENERGY DYNAMICS CORPORATION**  
 6062 East 49th Avenue  
 Commerce City  
 Colorado 80022  
 U.S.A.

Phone: 303 321 3314

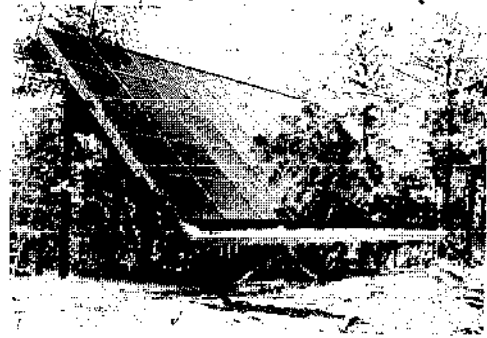

"Solaris" Collector

Designers and suppliers of solar systems using the "Solaris" solar heating module. Systems include designs for domestic water heating and space heating as well as the incorporation of a heat pump connected system.

"Solaris" collectors are to the following specifications:

Dimensions:	Model	Width	Nominal Height	Depth
	308	4' - 0	8'	4"
	312	4' - 0	12'	4"
	316	4' - 0	16'	4"

Additional space is required at top and bottom for plumbing connections.

Weight: 2.5lb/sq.ft dry; 3.25lb/sq.ft wet.

Absorber: Aluminium.

Absorptive coating: Flat black epoxy coating.

Cover: 1/8" tempered glass - single layer - transmittance - 88%.

Transfer fluid: Water.

Plumbing connections: Top: 3/8" OD copper tubing. Bottom: 1" CPVC pipe.

**Fafco Solar Heat EXCHANGERS**  
 138 Jefferson Drive  
 Menlo Park  
 California 94025  
 U.S.A.

Phone: 415 321 6311

Manufacturers of an unglazed, low temperature solar water heating system using polyolefin (plastic) tubular extrusion absorbers between header pipes.

Standard panel sizes are 4' x 10' and 4' x 8'. Electronic controllers and associated equipment are available.

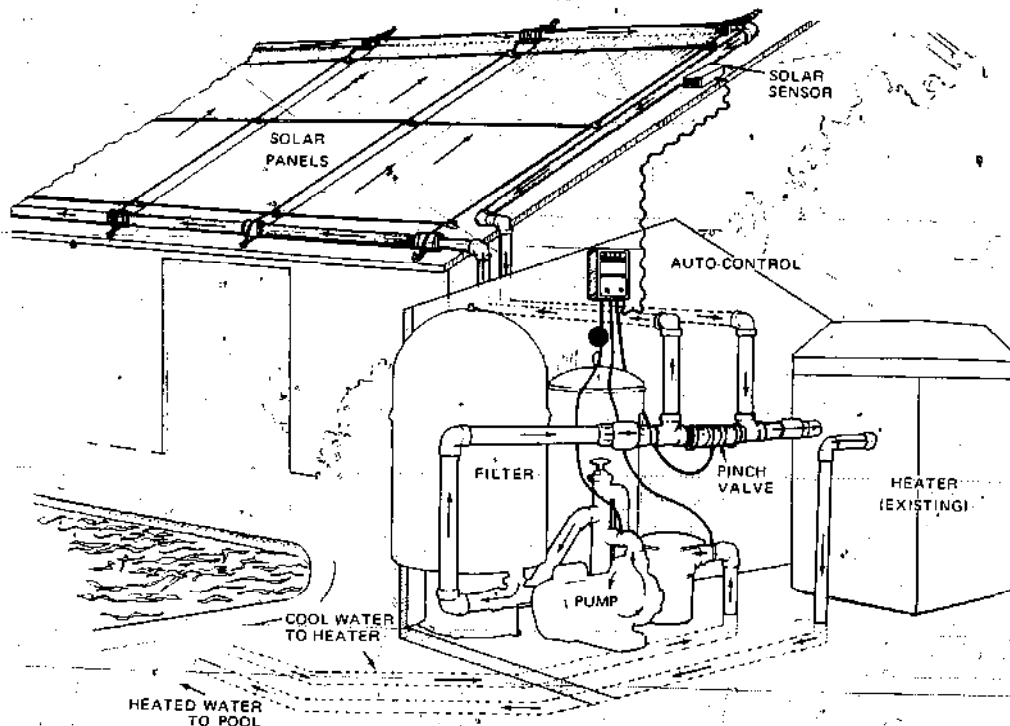

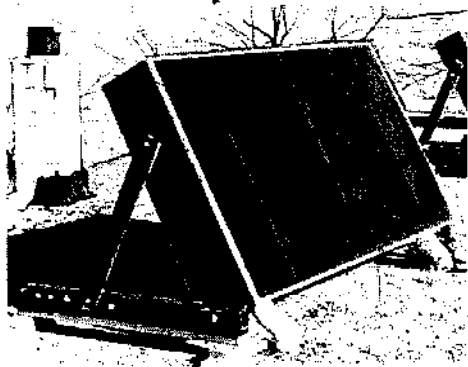

Hadley Home Built Solar Panel

**HADLEY SOLAR ENERGY**  
 Box 1456  
 Wilmington  
 Delaware 19899  
 U.S.A.

Phone: 215 444 3618

Publishers of a booklet and plans for construction of do-it-yourself solar heating panels for both air heating and water heating.

Specifications:	Water heater	Air heater
Size	4 x 8ft = 32ft <sup>2</sup> (2.97m <sup>2</sup> )	4 x 8ft = 32ft <sup>2</sup> (2.97m <sup>2</sup> )
Absorber	galvanised steel	galvanised steel
Water channels	copper pipe	
Glazing	acrylic or glass	acrylic or glass
Insulation	fibreglass	fibreglass

**HELION**  
 P.O. Box 4301  
 Sylmar  
 California 91342  
 U.S.A.

Phone: 213 367 8291

Helion solar panels are offered as kits and are claimed as an easily fitted low-cost system.

Overall dimensions: 45 x 96in = 30ft<sup>2</sup> (2.79m<sup>2</sup>).

Weight: 55lb.

Absorber: Aluminium sheet with copper tube water channels.

Glazing: Tedlar coated fibreglass.

Insulation: Polyurethane foam/fibreglass.

Casing: Aluminium.

**FILON DIVISION, VISTRON CORPORATION**  
 12333 Van Ness Avenue  
 Hawthorne  
 California 90250  
 U.S.A.

Phone: (213) 757 5141

Manufacturers of fibreglass reinforced (GRP) panels for use in solar collectors and passive glazing installation. Units are guaranteed to retain 90% light transmission for 15 years. Licenses for manufacture apparently granted in Africa, Asia and South America.

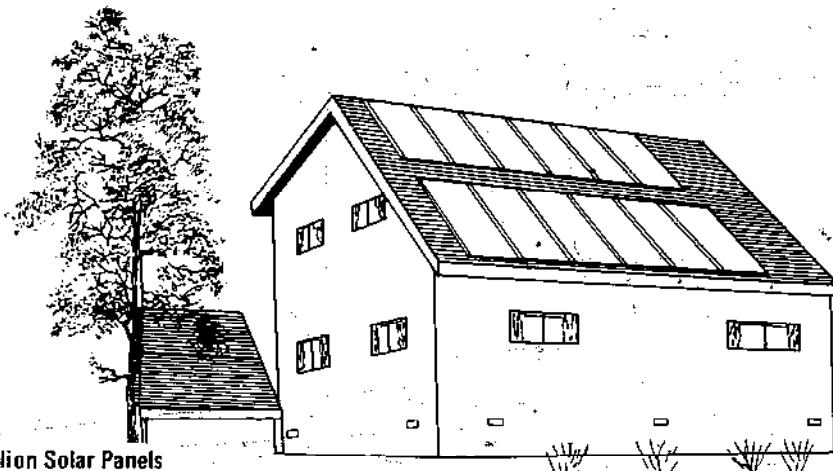

Helion Solar Panels

**IMI RANGE LTD**  
 P.O. Box 1  
 Bridge Street  
 Stalybridge  
 Cheshire SK15 1PQ  
 U.K.

Phone: 061 338 3353

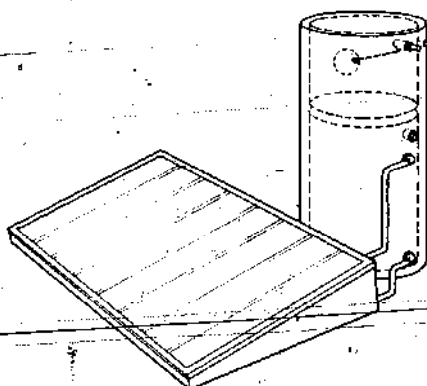

IMI Solar Collector Unit Plus Hot Water Cylinder

A large company which offers mainly components for trade use or export in quantity. Manufacturers of "Solaric" absorber panels.

Sizes: 3 widths and 3 lengths available giving 9 areas ranging from 0.21 to 2.82m<sup>2</sup>. Favoured size is 1.75 x 0.86m = 1.6m<sup>2</sup>.

Absorber: All copper consisting of copper water tubes fitted with copper absorbing fins treated with black selective coating.

Casing: The absorbers are recommended to be built into the roof structure of a building and glazed over, but plastic cases for the 1.6m<sup>2</sup> size are available if independent "detachable" units are needed.

Other items: Copper heat exchanger tanks, with optional sprayed on insulated surface are also available.

McKee SOLARONICS LTD  
12 Queenborough Road  
Southminster  
Essex CM0 7AB  
U.K.

Phone: 0621  
772477

Manufacturers of a range of plastic solar collectors for water heating:

**Industrial/Domestic heat exchanger:** collector 2050mm x 1230mm (2.4m<sup>2</sup>). The absorber is a polypropylene extrusion in translucent plastic with a metalised reflecting sheet behind it and this system is novel in that it uses a dark fluid to transfer heat from the collector which is claimed to give good efficiency. The unit is single glazed with a tough polycarbonate plastic window. It is claimed that these units will withstand temperatures in the range from -40°C up to +120°C without damage (and can tolerate the effect of water freezing within the channels). Maximum water pressure is 0.6MPa (90 psi). Insulation is by transparent cellular plastic either side of the absorber panel. In situations where direct solar heating of water is required, the panel can be obtained with the internal polycarbonate absorber painted matt black to avoid the need for using a dark liquid.

**Swimming pool heat exchanger:** collector 1886mm x 1240mm (2.4m<sup>2</sup>). This is to a similar specification to the above system, but is slimmer as it does not include the insulating voids filled with cellular plastic since it is not intended to achieve such a high temperature increase above ambient. Applications such as pre-heating or low temperature increase processes such as crop or wood drying may be appropriate in addition to the intended application of swimming pool heating.



McKee Solaronics Industrial/  
Domestic Solar Heater

METALCO (HEATERS) LTD  
P.O. Box 1307  
Nicosia  
Cyprus

Telex: 2776  
Metalco-Cy  
Cables: Metalco-  
Nicosia  
Phone: 32101/2

Manufacturers of a complete water filled solar domestic hot water system. System is free standing and relies on the thermosyphon principle for its operation. An electric heating element may be incorporated to provide hot water during sunless periods.

Absorber area: approximately 131 x 92cm (2x) = 2.4m<sup>2</sup>.  
Construction material: not specified.

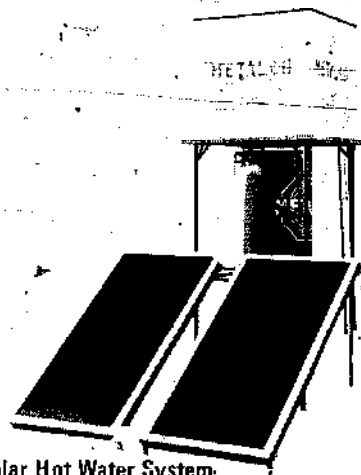

Metalco Solar Hot Water System

DISTRIMEX LIMITED  
88 The Avenue  
London NW6 7NN  
U.K.

Cables: Imexhouse  
London NW6  
Phone: 01 459 1391  
U.K.

Distrimex produces the Miromit solar energy collector, which was developed in Israel over 20 years ago and incorporates a unique selective surfacing known as "Tabor Selective Black" after its inventor, the well known solar energy researcher, Dr. H. Tabor.

Collector module surface area: 1.428m<sup>2</sup>.

Collector absorber material: Mild steel electroplated with "Tabor Selective Black".

Insulation: Rockwool 40mm thick.

Outer casing: 0.6mm galvanised steel, 1850mm x 960mm x 95mm.

Glazing (not supplied): Recommend 3mm or 4mm glass.

Weight: 60kg.

Claimed life expectancy: "Well in excess of 15 years".

Other products from Distrimex include the "Sunsource Solar Controller" which operates at 240V (or 110V by request) to switch on a pump for a pumped solar heating system.

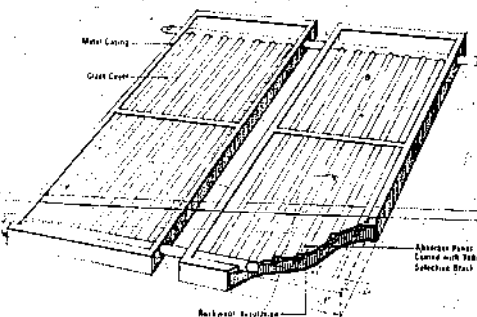

Miromit Solar Energy Collector



**NATURAL ENERGY SYSTEMS INC**  
 1654 Pioneer Way  
 El Cajon  
 California 92020  
 U.S.A.

Phone: 714 440 6411

Manufacturers of solar panel heating systems for domestic space heating or water heating installations. The company also produce a solar distillation system (illustrated) for purifying water.

Precise technical specifications were not known at the time of going to press.

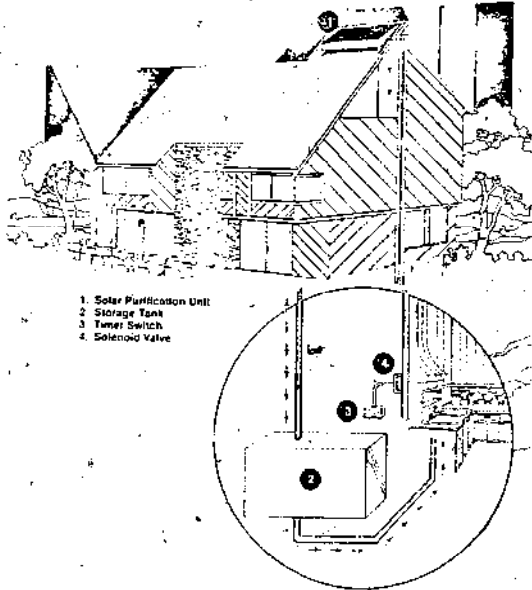

**Natural Energy Systems  
 Solar Water Purification System**

**THE PEOPLE/SPACE COMPANY**  
 Division PAC  
 49 Garden Street  
 Boston  
 Massachusetts 02114  
 U.S.A.

Phone: 617 261 2064

Manufacturers of an open flow collector in which the water flows over the fibreglass collector surface beneath a translucent fibreglass cover. Due to its simplicity, this system is claimed to be of low cost and the construction materials are certainly long-lasting and durable.

One module size is available 4ft x 8ft x 4ft (2.97m<sup>2</sup>) which can be obtained either double glazed or single glazed.

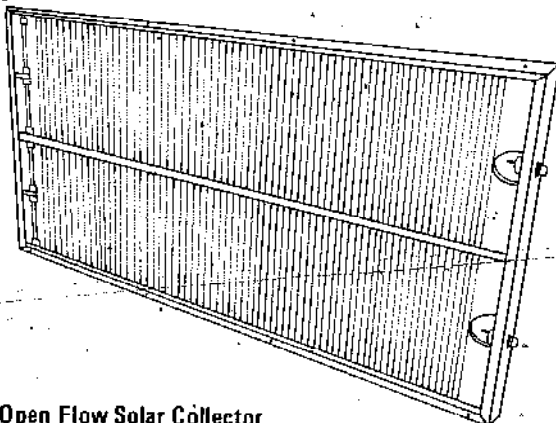

**Open Flow Solar Collector**

**NORTHRUP INC.**  
 302 Nichols Drive  
 Hutchins  
 Texas 75141  
 U.S.A.

Phone: (214) 225 4291

This company is a major solar energy developer and claims the world's largest solar heating/air conditioning installation of 16,000ft<sup>2</sup> (1487m<sup>2</sup>) at Trinity University in Texas.

Main product is a concentrating solar collector which tracks the sun using electric drive motors and concentrates the sunlight through an acrylic linear fresnel collector lens onto a copper selectively coated absorption tube; this system is claimed to be of high efficiency in terms of energy collection per unit area compared with flat plate collectors. It is claimed that it can supply water at 200°F (93°C) under 90°F ambient conditions with an efficiency of 65%. Effective collecting area per module is 9.7ft (0.901m<sup>2</sup>).

Other systems available include a low cost (claimed) integral thermosyphon water heater and storage (which has no moving parts at all). This has a 21.78ft<sup>2</sup> absorber of extruded aluminium with copper water tubes coated with 3M Nextel selective surface and with a Tedlar plastic cover. It has a 40 gallon (150 litre) storage tank with anodic corrosion protection and insulation is a fibreglass blanket.

This collector is also available without the storage tank as a normal flat-plate collector module and glass can be used (customer supplied) for glazing as an option. Storage tanks, pumps and other components are also available.

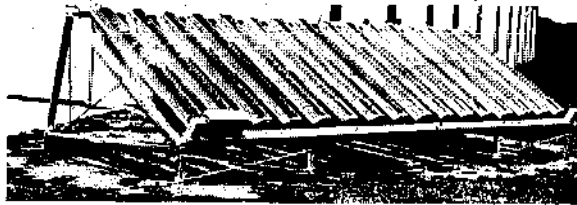

**Northrup Solar Concentrator Array**

**RAYOSOL**  
 Apartado 21  
 Torreimolinos  
 Malaga  
 Spain

Phone: 320432

Manufacturers of a glazed solar water heater using a copper absorber with copper water tubes. The case is of fibreglass/polyester with unspecified insulation material behind the absorber. Standard absorber area is approximately 1.5m<sup>2</sup>.

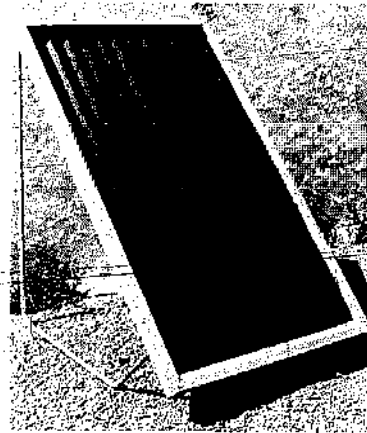

**Rayosol Solar Panel**

**PIPER HYDRO INC**  
 2895 East La Palma  
 Anaheim  
 California 92806  
 U.S.A.

Phone: (714) 630  
 4040

Designers and manufacturers of complete solar water heating systems for individual dwellings or industrial estates. Units are solar/gas heated for constant hot water and space heating.

This company is one of 36 U.S. manufacturers whose products were approved by ERDA in 1976 for use in the Federal Solar Heating and Cooling Demonstration Programme.

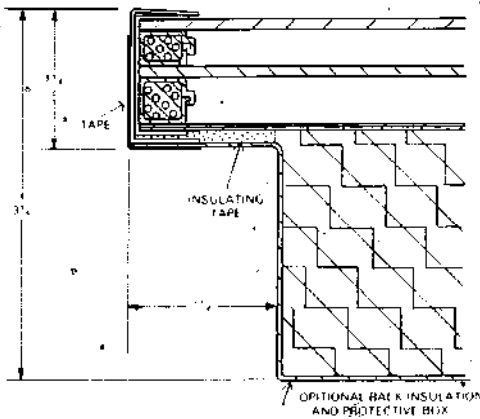
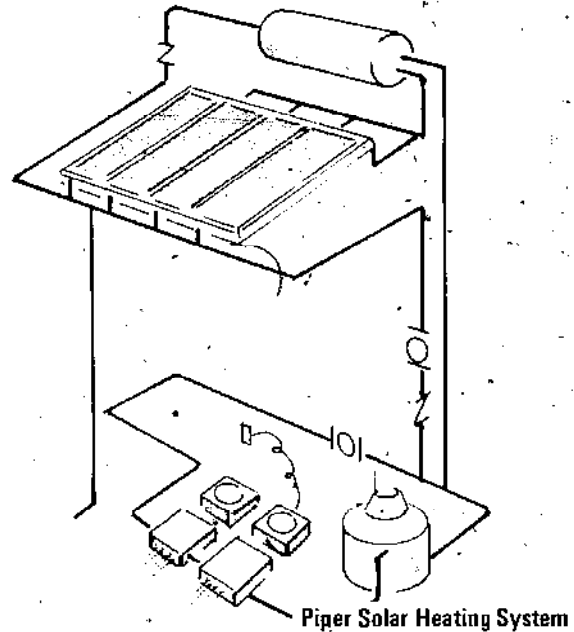

**PPG Solar Collector**

**PPG INDUSTRIES INC**  
 One Gateway Center  
 Pittsburgh  
 Pennsylvania 15222  
 U.S.A.

Telex: 866570  
 Cables: Glasplit  
 Phone: 412.434 2045

and:  
**BOMERT, TEVES &  
 BLANKLEY LTD**  
 (Agents)  
 Pembroke House  
 44 Wellesley Road  
 Croydon  
 Surrey CR9 9PD  
 U.K.

Manufacturers of solar collectors for water and space heating. These systems can include heat storage units for periods of little sunshine. Standard collectors are as follows:

Size	Absorber	Casing	Glazing
34 <sup>3</sup> / <sub>16</sub> " x 76 <sup>3</sup> / <sub>16</sub> " x 1 <sup>5</sup> / <sub>16</sub> "	Copper alloy bonded to copper water tubes with semi-selective PPG Duracron black coating.	Painted or galvanised steel with fibre-glass insulation.	Single or double pieces of 1/8" tempered glass

**REYNOLDS ALUMINUM  
 EXPORT CORPN.**  
 6603 West Broad Street  
 Richmond  
 Virginia 23261  
 U.S.A.

Telex: 827-358  
 Cables: Reyfor Rich  
 Phone: 281 2000

Manufacturers of an all aluminium water heating solar panel using one piece extruded water tubes and fins enclosed in an aluminium frame. A double layer of Tedlar glazing is shrunk onto the glazing frame over the unit. Standard panel is 4ft x 8ft = 32ft<sup>2</sup> = 2.97m<sup>2</sup>.

**CROSS SECTION THROUGH FRAME**

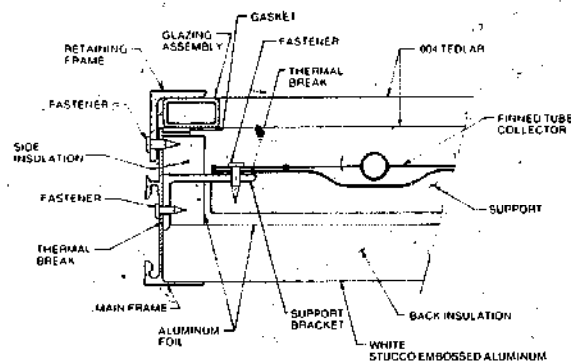

**Reynolds Solar Collector**

RAYPAK INC  
 31111 Agoura Road  
 Westlake Village  
 California 91359  
 U.S.A.

Telex: 67 3308  
 Phone: 213 889 1500

Manufacturers of a range of solar panels for high, medium and low temperature increase applications as follows:

Raypak Solar Panel

Model	Size	Area	Absorber	Glazing	Case
SG18P	950 x 2095mm	1.99m <sup>2</sup>	Copper tubes in aluminium	Single glass	Enamelled steel
DG18P	950 x 2095mm	1.99m <sup>2</sup>	" " "	double glass	" "
SK800	1090 x 2440mm	2.66m <sup>2</sup>	" " "	unglazed	no case
SK1000	1090 x 3050mm	3.33m <sup>2</sup>	" " "	" " "	" " "

Also supply controllers, pumps and associated equipment.

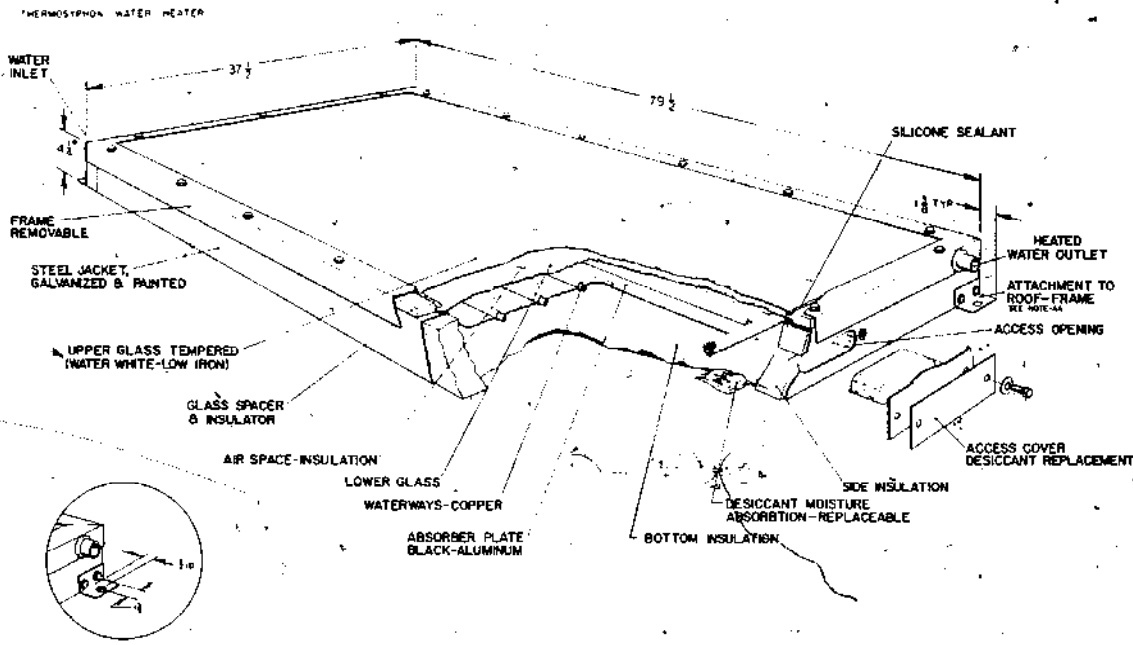
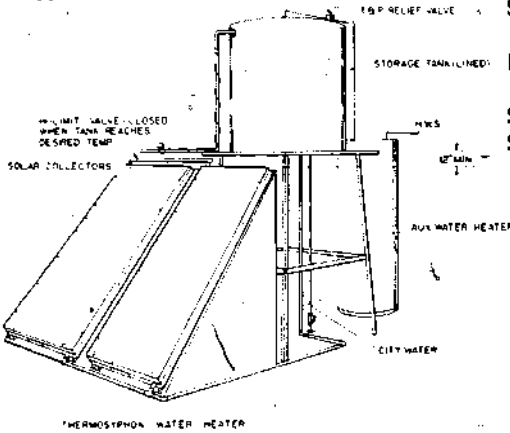

SATA Solar Collector and Tank

SATA/BALAJU YANTRA  
 SHALA (P) LTD  
 (Swiss Association for Technical Assistance)  
 P.O. Box 113  
 Kathmandu  
 Nepal

Cables: SATA  
 Kathmandu  
 Phone: 21205

This group produces solar water heating systems and provides detailed plans for home construction of units. Designed for conditions existing in Nepal using low cost materials; similar conditions probably prevail in a number of other developing countries where solar heaters might be useful.

- Size of typical module: 180 x 89cm (1.6m<sup>2</sup>).
- Absorber: Aluminium sheet or galvanised mild steel sheet with steel water pipes.
- Cover: Glass.
- Insulation: Fibreglass.
- Case: Mild steel sheet 1.2mm thick.

**REDPOINT ASSOCIATES LTD** Telex: 449543  
 Lynton Road Phone: 0793 28440  
 Swindon SN2 2QN  
 Wiltshire  
 U.K.

Manufacturers of a 1.75m<sup>2</sup> solar collector module. The unit is designed for fast response to variations in insolation.

Absorber: Selectively surfaced with refrigerent-filled heat pipes to copper heat exchanger to water.

Frame: Light alloy.

Glazing: 1 glass sheet.

Insulation: Fibreglass back.

This is an unconventional system in that the absorber uses heat pipes to transfer heat to the water. It is available as an absorber and heat exchanger alone for overseas manufacturers who would like to fabricate the case and glazing locally.

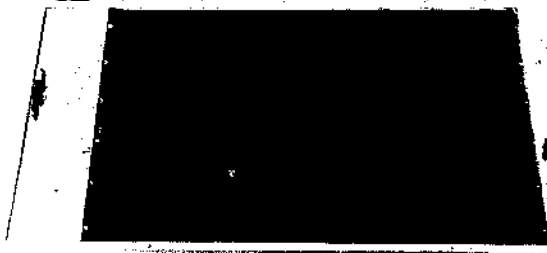

\$175 Solar Panel

**FRED RICE PRODUCTIONS**

INC.  
 P.O. Box 643  
 48-780 Eisenhower Drive  
 La Quinta  
 California 92253  
 U.S.A.

Phone: 714 564  
 4823

Publishes quarterly *Sunergy* newsletter. Offers consultancy services on a variety of solar energy applications and markets Sav Cylindrical Solar Hot Water System.



Sav Cylindrical Solar Hot Water System

**ROBINSON OF WINCHESTER LTD** Telex: 477149  
 Robinson House Cables: Robinsons  
 Winnall Industrial Estate Winchester  
 Winchester SO23 8LH Phone: (0962) 61777  
 Hants.  
 U.K.

Manufacturers of polypropylene plastic solar panels under the trade name "Suncell". These units are unglazed and work at temperatures up to 70°C. Other versions with single glazing are also available.

Two sizes of absorber are available; 1.2 x 2m; 1.2m x 3m.

These units are for low temperature-rise applications and are low cost and of light weight.

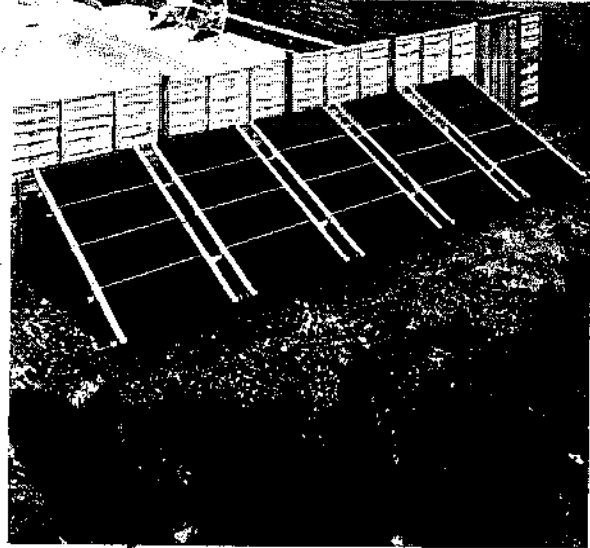

Suncell Swimming Pool Solar Heater

**SENIOR PLATECOIL LTD**

Otterspool Way  
 Watford  
 Herts WD2 8HX  
 U.K.

Telex: 935574 Setl  
 Cables: Senthern  
 Watford  
 Phone: Watford  
 26091  
 35571

Manufacturers of a wide range of plate type heat exchangers for process industries and including "Solar-miser" solar collector absorber plates available in carbon steel and in stainless steel from 20swg thickness upwards in various dimensions and arrangements.

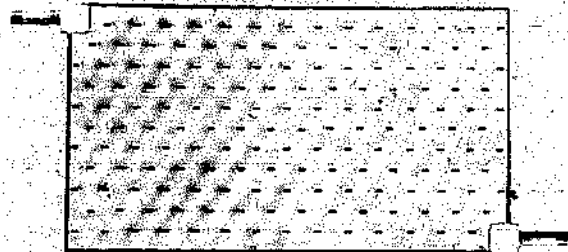

Solar-miser

**SOLAHART PTY. LTD**  
 112 Pilbara Street  
 Welshpool  
 Western Australia 6106

Cables: Hartmet  
 Phone: 686211

Some 10,000 of these systems are claimed to be in use in Australia. The main system offered is the "Solahart" model 240L (illustrated). This consists of a complete solar hot water system of two collectors and an insulated storage tank. The collectors have copper water tubes in an aluminium absorber panel. The effective area is 1.9m<sup>2</sup> each (3.8m<sup>2</sup> for the complete system). The cover is aluminium with single glass glazing and a combination of polystyrene foam and glassfibre insulation. Tank capacity is 240 litres (54 gallons) with 75mm of polyurethane insulation. An 1800 watt electric booster element can be fitted to guarantee hot water even under adverse solar conditions. Total weight of this system is approximately 160kg. A booster system with only eight gallons of storage (36 litres) and a single 1.74m<sup>2</sup> absorber is also available, construction being similar to that described above.

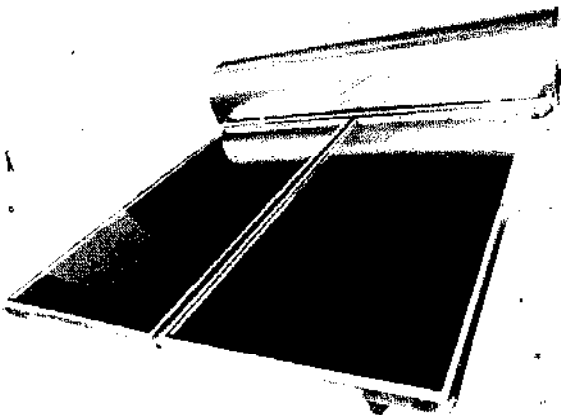

**Solahart 240L Unit**

**SOLAR EQUIPMENT DIVISION** Telex: NZ 31368  
 Monorail Chairlift Ltd Phone: "Opinion"  
 P.O. Box 10368 720 306  
 Wellington  
 New Zealand

Manufacturers of an unusual cylindrical solar water heater with internal water storage. Unit consists of a double clear plastic outer skin with the tubular inner water heater using a double pass system. Units can be connected in series or parallel. It is claimed that the cylindrical collector offers advantages over flat plate collectors by being able to accept solar energy from all directions equally well, including heat reflected from the roof and that less light is reflected back by the glazing. As a result it is claimed to be particularly efficient.

Agents in the U.S.A. for this system are:  
 Fred Rice Productions Inc., P.O. Box 643, La Quinta,  
 California 92253, U.S.A. (see previous page).

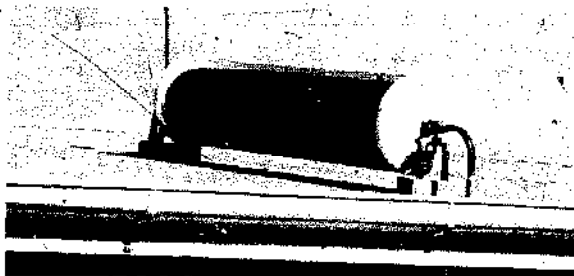

**Cylindrical Solar Water Heater**

**KALWALL CORPORATION** Phone: 603 668  
 Solar Components Division 8186  
 Kalwall Corporation  
 88 Pine Street  
 P.O. Box 237  
 Manchester  
 New Hampshire 03105  
 U.S.A.

A variety of solar collectors is offered:

"Fes Delta Focussing Collector" - Model 54A. 54ft<sup>2</sup> (5m<sup>2</sup>) collector area with two dimensional focussing reflecting surface and aluminium "Roll-Bond" absorber.

"Aquarius 1" all copper absorber with copper oxide selective coating and double glazed with "Sunlite" GRP. System will raise 42 gallons of water (160 litres) approx. 60-70°F per day above ambient.

"Solar-Kal Airheater" is a very simple but effective flat plate air heater with aluminium (flat or 'V') absorber panel and "Sun-lite" glazing in GRP.

Sizes of standard module:

47<sup>3</sup>/<sub>8</sub>" x 95<sup>1</sup>/<sub>2</sub>" (1.2m x 2.42m).

59<sup>3</sup>/<sub>8</sub>" x 107<sup>1</sup>/<sub>2</sub>" (1.5m x 2.73m).

This company manufactures a selection of materials that can be bought in bulk for constructing solar panels as integral parts of buildings or in other purpose-built applications. Products include:

"Sun-lite" collector glazing material. This is thin translucent fibreglass plastic sheet, which is strong, light in weight, easily cut and of low cost and transmits 85-90% of incident solar energy. Available in rolls 4ft x 10ft, 20 or 50ft and 5ft x 50ft. Thicknesses .025" and .040" (0.635mm and 1.02mm).

Various absorber panels - e.g. black coated aluminium sheet, flat and 'V' corrugated. Copper "Roll-bond" panels for solar water heaters and aluminium "Roll-bond" preferably used with non-corrosive liquids as heat exchange media.

Insulation materials, sealants, control equipment, absorber paints, air blowers, water pumps, insulated storage tanks, etc. also available.

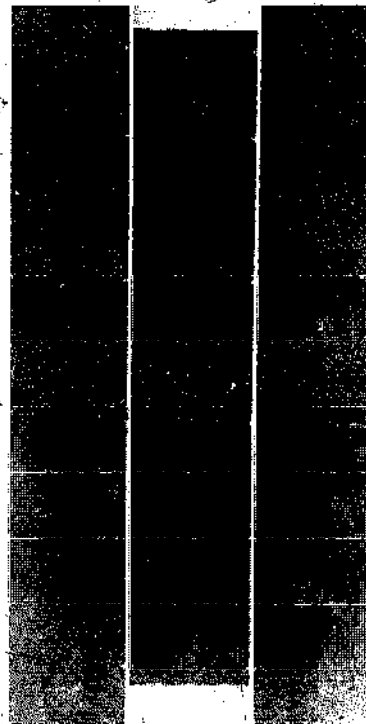

**Solar-Kal Air Heater**

**SOLAR CORPORATION OF AMERICA**  
 P.O. Box 399  
 Warrenton  
 Virginia 22186  
 U.S.A.

Phone: (703) 347 0550

Main product is a high efficiency solar collector module, as follows:  
 Absorber area: 32.16ft<sup>2</sup> (2.99m<sup>2</sup>).  
 Absorber Spec: Eleven aluminium extrusions enclosing copper water tubes and coated with black chromium selective surface.  
 Glazing: Single 3/16" tempered glass.  
 Insulation: Fibreglass blanket plus unspecified plastic foam.  
 Outer casing: Galvanised steel plate.

Another model to a similar specification has optional double glazing and is about half the area of the above unit in size.

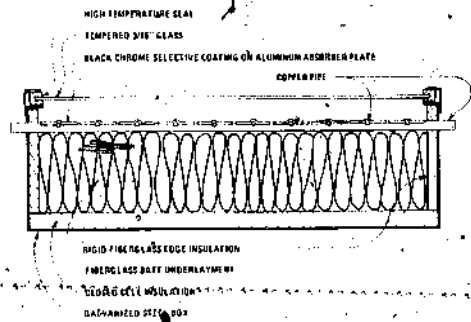

Solar Collector

**SOLARIS INDUSTRIES LTD**  
 Bruce McLaren Road  
 Henderson  
 Auckland  
 New Zealand

Cables: Solaris  
 Phone: HSN 68 408  
 HSN 68 470

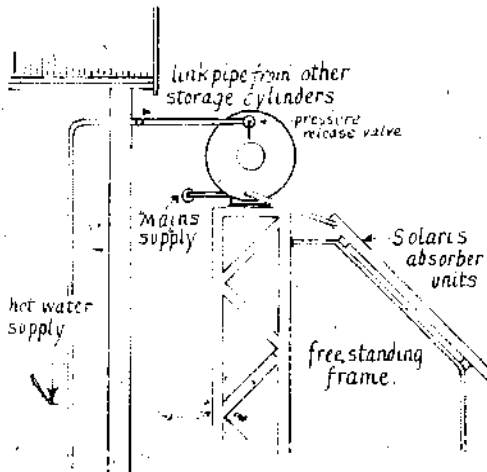

Manufacturers of two sizes of solar panel of 40ft<sup>2</sup> and 21ft<sup>2</sup> (3.72m<sup>2</sup> and 1.95m<sup>2</sup>). The absorber is of copper sheet coated with "thermal black" and has copper water tube arranged in a serpentine embossed into it. The outer case is of fibreglass with fibreglass wool insulation and the unit is glazed with a single pane of 5.5mm float glass (supplied by customer). The system follows the Australasian popular and effective pattern of using a horizontal water cylinder which collects the hot water by thermosyphon effect. Cylinders insulated with urethane and including facility for electric standby heating are available in a choice of sizes from 136 to 546 litres. A single panel with a 60 gallon (270 litre) tank is claimed to yield an average of 8.69kWh per day in Sidney, Australia (highest monthly average per day was 12.43kWh and lowest was 4.32kWh).

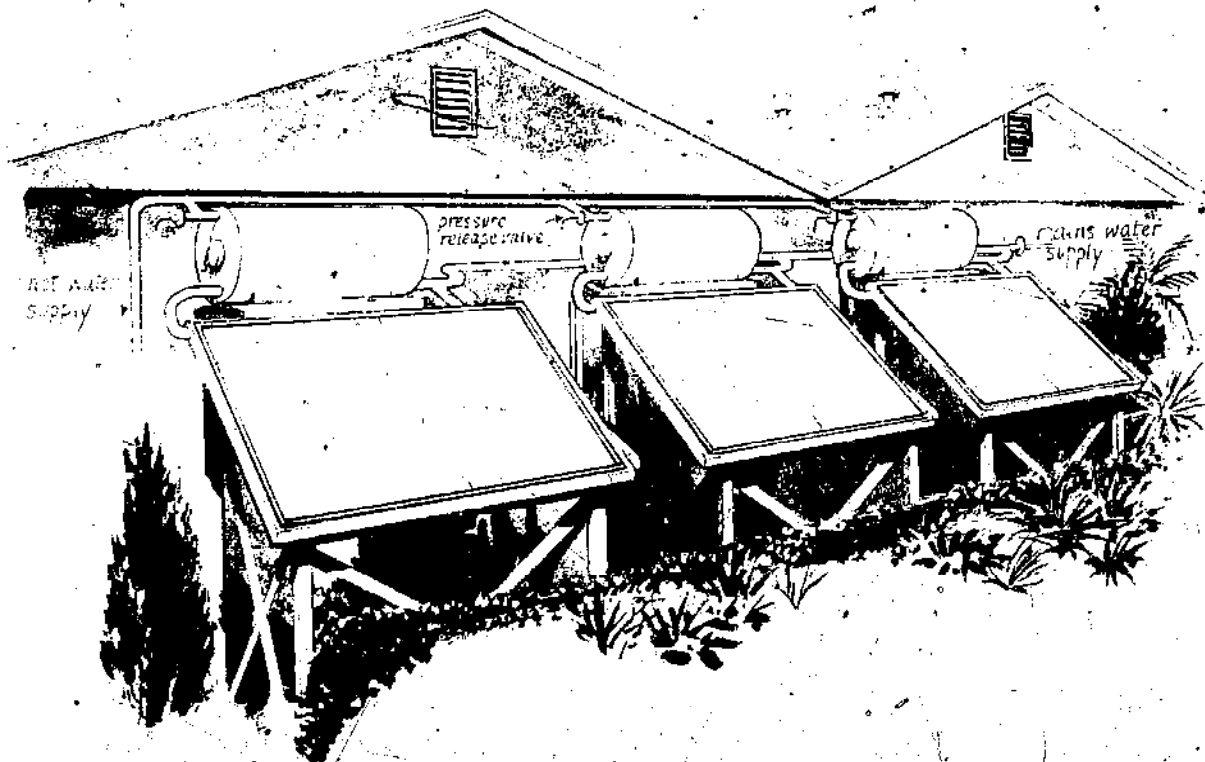

**SOLAR WATER  
HEATERS LTD**  
153 Sunbridge Road  
Bradford  
Yorkshire BD1 2PA  
U.K.

Telex: 51170  
Phone: (0274)  
24664

This system is based on the Solarex polypropylene plastic absorber panel consisting of plastic moulded sandwich structure containing a host of integral water channels. Each absorber unit is 10ft x 4ft (3.05m x 1.22m) giving a total of 40ft<sup>2</sup> (3.72m<sup>2</sup>). These have been widely used in the U.S.A. mainly as swimming pool heaters.

The absorbers are available unglazed for low temperature applications or pre-heating water for other systems. They are also available in an aluminium frame with polyurethane insulation and double glazing. Pumps, supplementary tanks, automatic control units, etc. are also available.

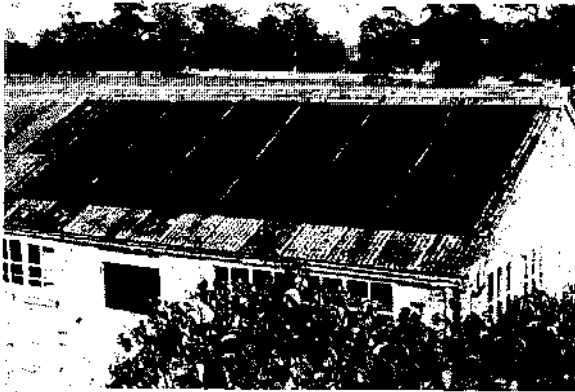

Solar Panels

**SUNDU COMPANY**  
3319 Keys Lane  
Anaheim  
California  
U.S.A.

Phone: 714 828  
2873

Manufacturers of low temperature unglazed plastic solar panel. The basic modules are assembled from 6in (150mm) wide plastic rectangular sections containing integral water tubes and made from ABS material, similar to that used for many types of plastic water pipe. Two sizes are available of 4ft x 10ft and 4ft x 8ft (3.72m<sup>2</sup> and 2.97m<sup>2</sup>).

This system is for low temperature applications such as preheating for other systems of swimming pools.

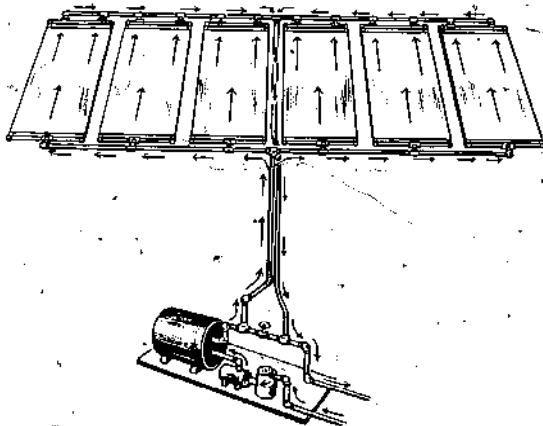

Sundu Swimming Pool Panel Assembly

**SONNENENERGIE-HEIZUNGS  
GENERATOREN PRODUKTIONS  
UND VERTRIEBS GMBH**  
7919 Buck  
German Federal Republic

also:

Intermarketing Paris  
25bis Avenue Brezin  
92380 Garches  
France

Phone: 970 52 95

Designers and manufacturers of a complete solar water heating system for domestic and swimming pool applications. It is a fairly sophisticated modular system involving heat exchangers and temperature-sensing switches, and is normally installed by heating engineers. The manufacturers' information is available in German or French, but not English.

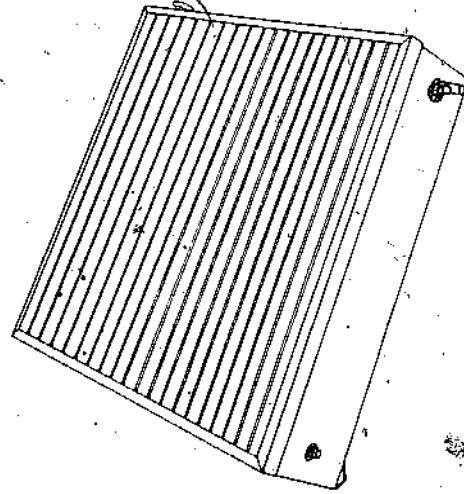

**SUNEARTH INC.**  
Progress Drive  
Box 515  
Montgomeryville  
Pennsylvania 18936  
U.S.A.

Phone: 215 699  
7892

This company offers two alternative collector modules for water heating. Both have absorber areas of approximately 19sq.ft. (1.77m<sup>2</sup>).

Absorber for both in aluminium with copper water passages and selective black surface.

One is single glazed with tempered glass, the other is double glazed with an acrylic outer cover and Teflon (PTFE) inner.

Aluminium frame for both models with fibreglass insulation.



Sunearth Solar Panel

**SOLARON CORPORATION**  
 4850 Olive Street  
 Commerce City  
 Colorado 80022  
 U.S.A.

Phone: 303 289 5971

TYPICAL COLLECTOR INSTALLATION

This company offers solar heaters using air as the circulating medium with the ability to heat water as well as applications involving space heating. This avoids the problems with liquid filled systems of freezing and corrosion.

- Typical size per unit: 3 x 6.5ft = 19.5ft<sup>2</sup> (1.81m<sup>2</sup>).
- Weight: 153lb (69kg).
- Absorber: 28swg steel with ceramic enamel surface.
- Glazing: Double glazed, hermetically sealed tempered glass.
- Casing: 24swg steel.
- Insulation: Fibreglass.

Numerous accessories are offered, including a pebble-bed heat store, air to water heat exchangers, etc.

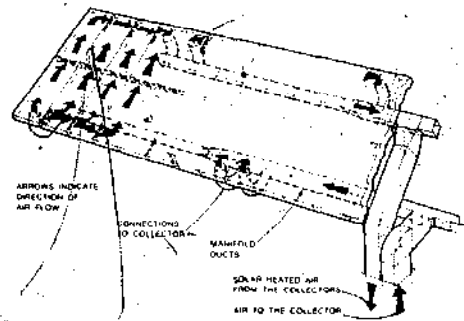

**Solaron Air Type Solar Collector Series 2000**

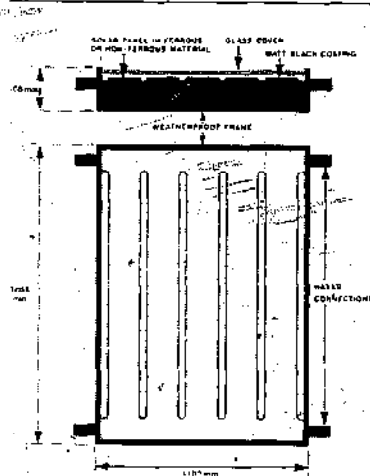

**Sundwell Solar Panel**

**SUNDWELL ENERGY SYSTEMS**

Hawker Siddeley —  
 Washington Engineering Ltd  
 Solar Heating Division  
 Industrial Road  
 Washington  
 Tyne and Wear NE37 2SB  
 U.K.

Telex: 53674  
 Cables: Trafo Washington  
 Phone: 0632 463001

- Collector module surface area: 2m<sup>2</sup> (approx.).
- Collector absorber material: Mild or stainless steel.
- Back and edge insulation: Polyurethane foam 'Quelflam'.
- Glazing: 4mm float glass.
- Water content: 8.22 litres.
- Weight of panel (drained): 56kg (approx.).
- Pressure: Tested to 0.7kg/m<sup>2</sup>.
- Frame: 0.9mm mild steel, powder coated and stove enamelled.

**SUNPOWER DISTRIBUTORS**

Phone: 446570

LTD  
 P.O. Box 172  
 Taradale  
 Napier  
 New Zealand

Manufacturers of a glazed chlorinated PVC plastic solar collector for domestic water heating applications. Units have a surface area of 1.28m<sup>2</sup> and are encased in galvanised cases. Approximately 1050kWh per year per panel can be collected in New Zealand. Typical installations are indirect by thermosyphon to a special holding tank.

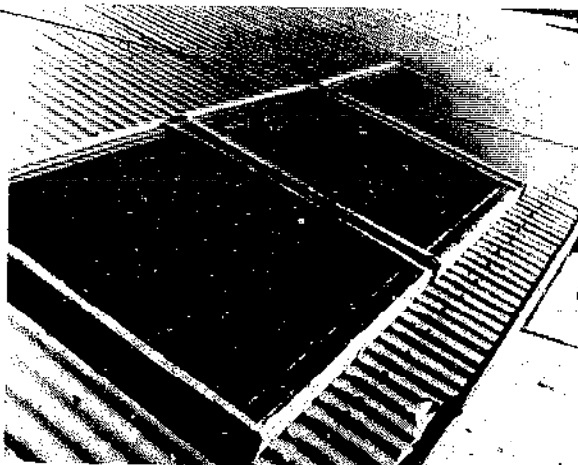

**Sunpower CPVC Solar Panel**

**SUNMASTER**

Phone: (052 785)

Foster House —  
 Redditch Road  
 Studley  
 Warwickshire B80 7AX  
 U.K.

3833  
 2454

Manufacturers of flat plate solar collectors that can be delivered to the purchaser in a knocked down form for home assembly. The group also manufactures a controller for electric control of circulation pumps in a solar heating system by sensing the temperature differential between the collector and storage.

Panels are 4ft x 4ft (1.48m<sup>2</sup>) or 5ft x 3ft (1.4m<sup>2</sup>). The absorber is galvanised steel with a copper water tube serpentine soldered to it.

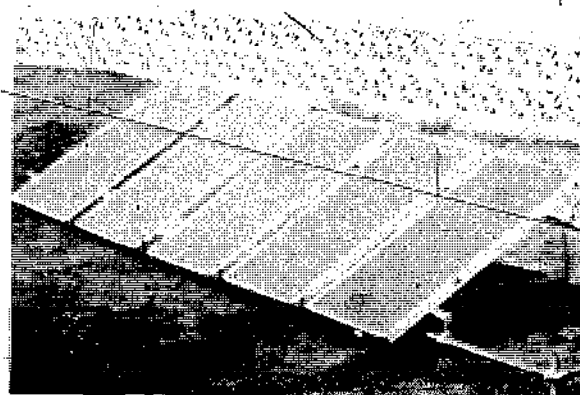

**Sunmaster Solar Collector**



**SUNRAY SOLAR HEAT INC** Phone: (212) 857 0193  
 202 Classon Avenue 638 6540  
 Brooklyn  
 New York 11205  
 U.S.A.

An 18sq.ft. (1.67m<sup>2</sup>) flat plate, single glazed, solar collector.

Absorber: All copper with "Solar Selective Black" selective coating.

Glazing: "Shatter resistant" glass.

Casing: Aluminium.

Insulation: Fibreglass blanket plus polyurethane foam.

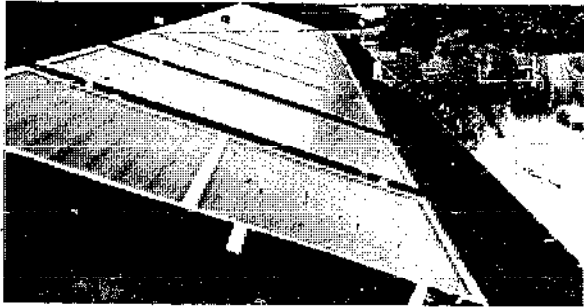

Sunray Solar Panel Array

**SUNSENSE LTD** Phone: 0733  
 1 Church Street 252672  
 Northborough  
 Peterborough  
 U.K.

A manufacturer with a range of solar products as well as an agency for Elektro wind generators.

Main type of solar panel is supplied unglazed (customer adds own 4mm glass).

Size: 0.675 x 1.46m = 0.98m<sup>2</sup> with a copper absorber, copper water tubes, at 150mm centres, fibreglass wool insulation, aluminium sheet casing, weight empty and unglazed = 12kg per panel.

Manufacturer claims 0.018 to 0.024m<sup>2</sup> of panel is required per litre of hot water storage under British conditions.

Also offer electronic solar panel pump controller.



Sunsense Solar Panel

**J.M. SOLAR HEATERS** Phone: Gaborone  
 P.O. Bag 004 4389  
 Gaborone  
 Botswana

A range of low cost solar water heaters from this manufacturer has recently been introduced. These generally have galvanised water pipe water tubes attached to a galvanised steel absorber panel. A galvanised steel case has fibreglass insulation and single glass covering. The system can be supplied complete with storage tank, as illustrated and is normally installed to thermosyphon to avoid the need for an electric pump.

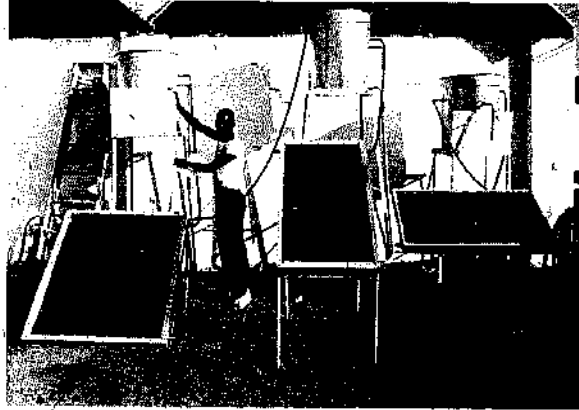

**SUNWORKS**  
 Division of Enthone Inc.  
 P.O. Box 1004  
 New Haven  
 Connecticut 06508  
 U.S.A.

Manufacturers of both liquid and air heating solar panels with mainly copper absorbers. Typical specifications:

Absorber area: 18.68ft<sup>2</sup> (1.74m<sup>2</sup>).

Absorber construction: Copper sheet with selective black (Enthone) surface and copper tubes for liquid versions.

Casing: Aluminium with fibreglass blanket insulation.

Glazing: Tempered glass, 3/16".

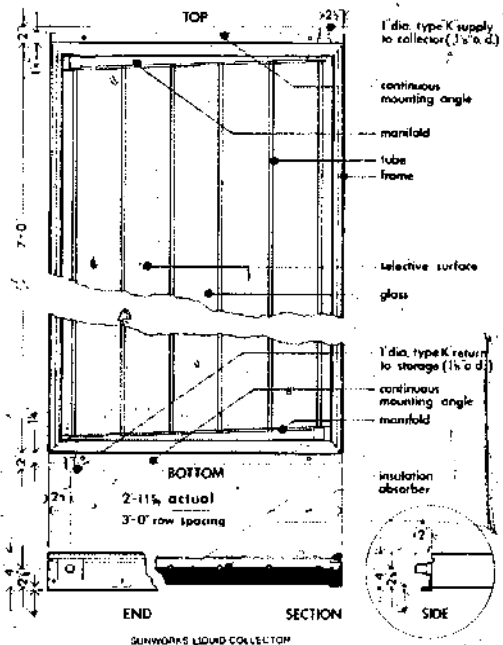

Sunworks Liquid Collector

**SUNSHINE MANUFACTURING COMPANY** Phone: 503 643 6172  
 4870 SW Main Highway  
 Beaverton  
 Oregon 97005  
 U.S.A.

Manufacturers of a tracking solar concentrator for water heating, or for producing steam at up to a temperature of 550°F. Tracking is automatic by differential solar heating of gas which works a servo system.

The company also produces a heat store that stores up to 100,000 BTU (29.3kWh) at 400°F (205°C) for use in conjunction with the collector.

**Specifications:**

- Physical dimensions: 48" x 96"
- Collection area: 25 sq.ft.
- Concentration ratio: 6.
- Operating temperature: 550°F.
- Operating pressure: 25 psig.
- \*Power output: 6kWh/day.
- Shipping weight: 180lbs (82kg).

**Features:**

Automatic sun tracking: Electronic temperature control: Weather-proof construction: 15 year minimum useful life.

\* (thermal).

Also manufacturers of a solar power cell for storage of solar heat for use in periods of low insolation and to smooth out the variations in solar output due to weather conditions.

- Physical dimensions: 60" x 60" x 60" (1.5m x 1.5m x 1.5m).
- Thermal storage capacity: 550kWh.
- Charge rate: 360kWh/day (input at 500°F = 260°C)
- Maximum discharge: 250kWh/hour (output at 400°F = 204°C)
- Leakage rate: 25kWh/day.
- Shipping weight: 1200lb (544kg).
- Minimum life (claimed): 15 years.

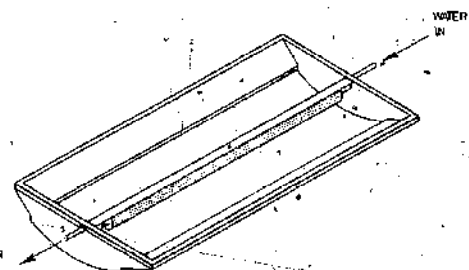
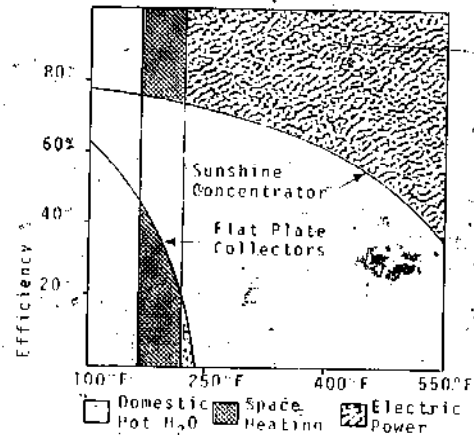

**Instantaneous Collector Performance**

**TUNNEL COMPANY LTD** Phone: Fort Ternan  
 P.O. Fort Ternan 7Y7  
 Kenya  
 East Africa

This company has been manufacturing a low cost type of solar water heater for a number of years, based on a corrugated steel absorber panel treated with suitable internal coatings to prevent corrosion. The glazing consists of a uv-resistant polyester envelope which surrounds both sides of the absorber; this needs replacing at intervals from 1½ to 4 years, but is of relatively low cost. Water temperatures of 65°C are claimed for sunny days in Kenya, while 40°C can be obtained on overcast days. The standard absorber module is 10ft x 2ft 3in. (3.05m x 0.69m) giving an area of 22.5ft<sup>2</sup> (2.09m<sup>2</sup>).

Complete systems, including hot water storage tanks, with optional electric, cylinder gas or charcoal booster heating capability are available to provide hot water for 5 or 10 showers per day or for 1, 2, 3 or 4 baths per day.

A larger absorber element 20ft x 2ft 3in is also offered for institutional or industrial use.

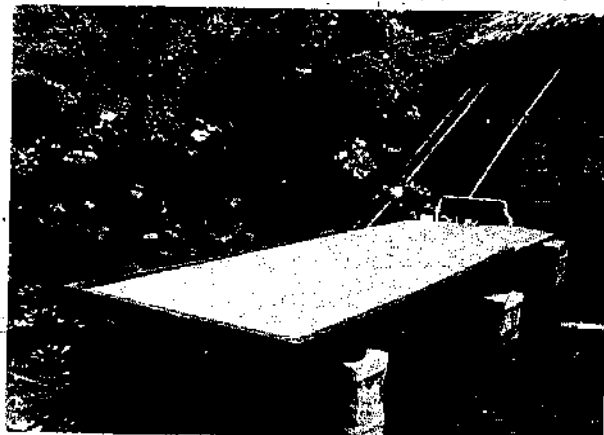

**Hutchinson Solar Shower**

# 2

## Wind Power

WIND-ELECTRIC SYSTEMS  
WIND-PUMPING SYSTEMS

The energy in the wind has been used throughout man's history in many parts of the world and was developed to such an extent that up to the time of the industrial revolution it was the most powerful and widely used energy source under human control. The fossil-fuel-burning heat engines that came with the industrial revolution led to the decline of windpower due to a better power/weight ratio and more predictable availability of power from first, the steam engine and later, the internal combustion engine.

However, even during the huge growth of fossil fuel based energy consumption in the industrialised areas, wind has continued to be used — primarily for pumping water — in remote regions where fuel supplies or maintenance facilities are difficult to arrange for internal combustion engines. The cattle and sheep raising industries of the arid central USA and even more so in central Australia still rely today on water-pumping windmills. As many as a million of these windmills are still in use in the world, predominantly in Australia and the USA. Indeed, it is true that the windmill, rather than the six-gun, was more important, if less dramatic, in "opening up the Wild West" for ranching. Windmills were also quite widely used in large numbers for generating small outputs of electricity in the 1920s and 1930s in the more remote parts of the industrialised countries, until subsidised rural electrification allowed their replacement by mains electricity.

Today, with greatly increasing oil prices, there is a considerable revival in interest in wind power, both for water pumping and for electricity. Major research programmes are also in hand to develop large windmills with megawatt-sized outputs for feeding electrical grid systems and saving fossil fuels. The few surviving manufacturers of traditional small wind pumps and generators are enjoying a revival of sales and have been joined by a number of new competitors offering in some cases novel designs incorporating recent technical innovations. It can be expected that both the quality and the variety of wind machines appearing on the market will continue to grow during the next few years, as we hope will be indicated by future editions of this publication.

### *The wind*

It is not intended to go into a great deal of detail on the complex subject of wind behaviour and wind energy extraction; however there are a number of important factors which can greatly affect the output of a particular wind machine and which consequently have an important bearing on whether the use of a windmill for a particular application in a chosen location will be economic or not. Just as the economics of running an engine will be closely tied to the cost of fuel, so the economics of windmills depend closely on the availability of wind energy at a particular site.

The energy available in the wind is not at all proportional to its speed — in fact the output of a windmill will vary with the *cube* of the windspeed. In other words, doubling the wind speed has the effect of increasing the available energy by a factor of *eight* ( $2^3 = 8$ ), while a halving of the windspeed reduces the energy to one eighth. So the energy availability is very much more variable than the windspeed. The result of this is that it is generally not practicable to make use of winds with speeds lower than about 5 to 7 mph (8 to 11 km/h) while winds higher than about 30 mph (or 50 km/h) tend to be too powerful to be conveniently used. Therefore, most windmills are designed to make use of winds in the range mentioned; they do not function in lower windspeeds and invariably either furl themselves or deliberately shed a lot of the available power in higher windspeeds with the aid

of an automatic governing or furling system to prevent any damage. Hence it is obviously important that there are reasonably frequent winds available at a proposed windmill site in the range preferably above 10 mph or 16 km/h and certainly above 5 mph (8 km/h).

Although the wind is variable in an unpredictable manner from day to day (not even the most well-equipped forecaster could predict the exact windspeed at a certain time in a particular location on a particular day), the total wind energy passing over a particular site remains surprisingly constant if measured over the years. It may vary considerably seasonally in many places, but the total for any particular year generally only varies by a moderate amount. Obviously some sites are very much better than others and of course there are many places where wind speeds are so low on average that it would be quite unrealistic to try and use windmills. On the other hand, some only moderately windy locations offer the prospect of wind energy for certain applications at a lower cost than any other alternative.

Wind behaviour is governed by a combination of global, regional, seasonal and diurnal weather patterns. Globally there are a series of wind belts of varying intensity and prevailing direction, that used to be of great importance in the days of sailing ships, and which are described in detail in most school geography books and world atlases. There are mobile regional effects caused by atmospheric depressions (cyclones and anti-cyclones), and more constant regional effects caused by hills or mountain ranges and the effect of lakes or sea shores. Seasonal changes such as Monsoon or Harmatan winds are caused by the heating and cooling of a large continental land mass in summer and winter. Lastly there is commonly a diurnal wind pattern caused by temperature differences between night and day. All these factors combine to produce varying winds which particularly on land are modified further by surface irregularities and "hot spots" which give the wind its irregular gusty character with which we are all familiar.

In general the latitudes within  $10^\circ$  either side of the equator tend to have lower average wind speeds than most other regions. On the other hand, the coastal regions of hot countries or areas around large lakes in hot sunny regions tend to have marked diurnal winds caused by the temperature differences between the air over the land and that over the water. So, very approximately, coastal regions (by the sea or a large lake) and islands in a marine trade-wind belt often offer the best wind conditions for windmill operation, while inland regions near the equator tend to be poorer.

Choice of site in a given area is also important. Wind speed increases with height above the ground according to the formula  $\left(\frac{H_1}{H_2}\right)^{0.17} = \left(\frac{V_1}{V_2}\right)$  where  $V_1$  is the wind speed

at height  $H_1$  and  $V_2$  at height  $H_2$ . The exponent 0.17 is an approximate figure for "average" ground surfaces — over a smooth surface like water the variation of wind speed with height is less marked and a lower exponent applies, while any obstructed surface covered with trees or buildings creates vertical eddies which have the effect of interfering with the wind motion higher up. Because the power in the wind is related to the cube of the wind speed, putting a windmill on a higher tower can have a more impressive effect on its output than might be expected — for example the wind speed is generally recorded by weather stations at a standard height of 10m above the ground (33 ft) — therefore if a windmill is placed 20m (66 ft) above the ground it will feel a wind speed  $(2)^{0.17} = 1.125$  times that at 10m, an increase of 12%. Bearing in mind that the power available is related

to wind-speed cubed, there will be  $(1.125)^3 = 1.424$  — in other words 42% more power available than at a wind speed recorded at 10m. Obviously placing the windmill higher still will improve the wind power availability still further, but this has to be paid for in terms of a more expensive tower. In the end a compromise is generally sought in which the minimum tower height which will give the rotor unobstructed access to the wind is used — most manufacturers specify that the lower part of the rotor disc should be at least 6m (20 ft) above the highest level of any obstructions such as trees or buildings within 200m (600 ft) of the windmill, if possible. If there are any obstructions nearer to the windmill than this, it is better to allow an even greater clearance than 6m. In practice, this ideal cannot always be achieved and some obstructions may be tolerated.

### Sizing of windmills

There are of course two main applications for windmills; pumping water and generating electricity. This section of the Guide has been divided into two parts dealing with the two main windmill types. A glance at each part will show that, in general, water pumping windmills have multi-bladed rotors, while most electricity generating machines have two or three bladed rotors, more like an aircraft propeller in appearance. The reason for this is that a high starting torque (turning force) is needed to get a water pump started, and the provision of many blades eases starting against a heavy load in light winds. Unfortunately a multi-bladed rotor is less efficient at converting wind energy once it gets going, so that many of the multi-bladed water pumps are actually only about half as powerful in a given wind as an "airscrew" type electricity generating windmill of the same diameter. Also, it is of course generally more expensive to build a multi-bladed rotor due to its greater material content. The other main characteristic of the two main types of rotor is that multi-bladed rotors run slowly in a given wind while propeller-like ones run fast — a good analogy is to think of water pumps as "low geared" in their interaction with the wind, while electricity generators are "high geared" — this is another reason for the choice of rotor, as reciprocating well pumps need to be driven at quite low speeds (up to around 60 strokes per minute) while electricity generators need to run at 1500 rpm or so, so that the faster the rotor speed the less gearing is required to drive the generator at the optimum speed.

The principles involved in using the wind are generally very similar for both major types of windmill. The output of electricity generators would be proportional to wind speed cubed, but the output of pumping units would correspond to windspeed itself. The relative power of different sized windmills in a given wind is proportional to the area of their rotors, or the square of their diameters (since the area of a disc is  $\pi d^2/4 = 0.785d^2$  — where  $d$  is the diameter). An efficiency factor will also apply which is a measure of the effectiveness of the rotor at using wind power — with most water pumps the overall efficiency or power coefficient ( $C_p$ ) is around the 0.10 to 0.25 level (10 to 25% of the energy in the wind intercepted by the rotor usefully applied) while many electricity generators can achieve  $C_p$  values of between 0.3 and 0.4. A further complication is that the  $C_p$  varies considerably with any windmill at different wind speeds, usually being best in low windspeeds where it is most important to use the wind as efficiently as possible, and tailing off to a low level in higher windspeeds.

Manufacturers generally give the outputs of their windmills at various wind speeds in their sales literature. Electricity generators are often quoted as giving a certain

rated output at a certain *rated speed* — this is usually quite a high windspeed above which the windmill is governed to give no increase in output, but below which the output is related to windspeed cubed. Wind-pumps on the other hand are sensitive to the size of pump fitted — fitting a smaller pump will allow the windmill to start in a lower windspeed, but it will produce less water in a high windspeed than with a bigger pump. Good judgement is required to fit a pump which will maximise the output from the windmill in a given wind régime.

Care must be taken when reading manufacturers' brochures not to be fooled by "Rated Power Outputs". If a windmill is rated by the manufacturer for a high wind speed, say 25 mph or 40 km/h, then it may appear to be much more powerful than a rival rated at a more realistic speed of say 15 mph or 24 km/h, because there is  $(\frac{40}{15})^3 = 4.6$  times as much power in the wind at the higher of the two rated speeds. In other words, a wind generator rated at 25 mph, all other things being equal, should be expected to be 4.6 times more powerful at its rated speed than one rated at 15 mph. What matters more is the output at average speeds prevailing in the proposed wind generator location and the most important thing is the total amount of energy at all windspeeds that can be converted — i.e. the number of kWh per year that a system can produce. It is to be hoped that manufacturers will stop the misleading practice of publishing "rated output" figures for unrealistically high windspeeds, but will publish actual amounts of energy converted in typical wind régimes — in the meantime the reader is cautioned to note carefully the windspeed at which any quoted rated power output is deemed to apply and to make the necessary allowances.

Generally, to obtain optimum matching of a wind-rotor and generator, the correct rated wind speed shall be not much more than twice the mean windspeed of the chosen location.

To allow the reader to arrive at an approximate estimate of the size of windmill likely to be needed for any application, the following table has been compiled to illustrate the relative outputs from various sizes of electricity generating windmill. The electrical outputs are estimated at a  $C_p$  fixed at 0.3 and given purely in kW for different windspeeds. A certain amount of rounding of numbers has been done, for clarity, as these tables are of course only intended as an approximate guide.

An indication of the output of various sizes of wind-

pump can be obtained by studying the figures given by manufacturers in several of the entries that follow.

Table 2 shows typical figures for a 16 ft diameter wind-pump. Because  $C_p$  declines as wind speed increases, the output only goes up in proportion to  $V$  rather than  $V^3$ . The wind-pump starts at 5 mph.

#### Windmill specification

In order to arrive at reasonably accurate predictions of likely windmill performance in a given location, regular wind records are needed, ideally for several years, from as close a meteorological station as possible. There are usually three main levels of wind data recorded by different categories of weather station. The most elaborate (and useful) consist of continuous or hourly records of wind speed; such detailed information as this is only usually recorded at major weather stations such as those attached to international airports. The next level consists of "run of wind" figures (that is the number of miles or kilometres of wind that have gone past a cup anemometer), recorded twice or three times each twenty-four hours; this information allows the average windspeed to be estimated for each day and each night, or in some cases for the morning, afternoon and night. Lastly, the crudest wind data consists of run of wind figures for longer periods, such as daily or monthly; these give no indication of diurnal variations in wind speed, but do give an indication of the relative windiness of a place compared with other places, which can allow at least a vague assessment of the suitability of the wind regime.

If run of wind figures taken regularly, three times per day are available, or, better still, hourly figures, it is possible to produce a velocity/duration chart from which the annual output of a windmill may be predicted. What is required is the frequency with which a particular wind-speed occurs. If records are taken only three times a day, say at 0800, 1200 and 1800 — suppose the wind run

The formulae used to calculate Table 1 are:

$$P = 0.00000125d^2V^3 \quad (P \text{ in kW, } d \text{ in ft, } V \text{ in mph})$$

$$P = 0.00000323d^2V^3 \quad (P \text{ in kW, } d \text{ in m, } V \text{ in Kmph})$$

Where:  $P$  = Power

$d$  = Diameter

$V$  = Velocity

Table 1  
Electricity generating windmills with  $C_p = 0.3$ . Output table

rotor diameter		6	8	12	14	16	20	24	30	ft
		1.8	2.4	3.7	4.3	4.9	6.1	7.3	9.2	m
wind speed										
5	8	.005	.010	0.22	.029	.038	.060	0.86	1.35	kW
10	16	.043	.077	.173	.235	.307	.480	.691	1.08	kW
15	24	.146	.259	.583	.794	1.04	1.62	2.33	3.64	kW
20	32	.346	.614	1.38	1.88	2.46	3.84	5.53	8.64	kW
25	40	.675	1.20	2.70	3.67	4.80	7.50	10.8	16.9	kW
mph	kmp/h									

Table 2  
Typical 16 ft (4.9 m) dia. water pumping windmill

Wind speed		Output x head	
5	8	45000	61
10	16	90000	122
15	24	135000	183
20	32	180000	244
25	40	225000	305
mph	km/h	ft.gall/h	m.m <sup>3</sup> /h

between 0800 and 1200 was 30km, then the average wind speed for those four hours was  $30/4 = 7.5$  km/h and we would say that a frequency of 7.5 km/h had occurred four times; between 1200 and 1800 suppose the run was 36km, giving an average of 6km/h occurring 6 times, and so on. Then to make use of the windmill data given in Table 2 we would record all wind averages below 5km/h, as being of no use to the windmill, all between 5 and 11 are taken as producing the output corresponding to 8km/h, all between 12 and 20 are taken as producing an output similar to 16km/h and so on. Obviously if hourly figures are available they need not be averaged over a whole morning, afternoon or night, but they would be grouped within the speed bands given for the windmill as just described.

Therefore by knowing from Table 1 or 2 what the windmill will produce in a certain windspeed in 1 hour, and by knowing how many hours in the year that windspeed tends to occur, we can calculate the annual output due to winds of that speed. This can be repeated for each speed range and the results can be added to give the total for the year as indicated in Table 3.

Obviously this calculation can be considerably refined by taking more averages over narrower wind-speed ranges and by averaging figures for several different years (assuming suitable windmill and meteorological data are

location to be representative of its wind regime, then annual average wind-run figures of the crudest kind can be used as a very rough guide to whether a location could be used for wind powered pumping or generation. In general, places with average annual wind runs less than about 44000 miles or 70000 kilometres, (i.e. average speeds below 5 mph or 8 mph) are unlikely to be very satisfactory, while over 90000 miles or 144000 km suggests a promising location. Anything in between will probably be adequate especially if experience suggests considerable diurnal variability (e.g. sea or lake breezes) and if a good exposed location can be used or the windmill is raised on a high tower.

Where limited meteorological data is available another useful indicator might be the performance of any windmills already in your area, or, if planning to introduce a number of units for the first time, it may be justifiable to set up one small unit initially and use it over a year or so to provide a measure in itself of the possible output. There is nothing better than a windmill for measuring the suitability of the wind regime — although they cost much more than just an anemometer.

In cases where the wind regime was misjudged, providing the error was not too great, it is possible to improve the low wind performance with pumping windmills by reducing the stroke or fitting a smaller diameter pump,

Table 3  
Velocity/duration chart example for a 16 ft diameter water pumping windmill

Wind speed ranges	No. of times speed within range recorded (hours p.a.)	Windmill output at this speed range for head of 100 ft (30m) from Table 2		Cumulative total outputs	
		(Imp.gal/h)	(m <sup>3</sup> /h)	(Imp.gal)	(m <sup>3</sup> )
under 3 mph under 5 km/h	2765	—	—	—	—
3 to 7 mph 5 to 11 km/h	2644	450	2	1189800	5288
8 to 12 mph 12 to 19 km/h	2272	900	4	2044800	9088
13 to 17 mph 20 to 27 km/h	882	1350	6	1190700	5292
18 to 22 mph 28 to 35 km/h	137	1800	8	246600	1096
over 22 mph over 35 km/h	60	2250	10	135000	600
Total for year				4806900	21364

available). This calculation will tend to under-estimate the windmill output if it is set up under comparable conditions to the anemometer used for recording the wind data, especially if the windmill rotor is considerably higher than the anemometer. The figures used apply to Leicester in the UK, which has quite a low average wind speed (by UK standards) of 6.2 mph (9.9 kmph) but which corresponds quite well to typical annual averages for many tropical locations.

It is interesting that if we take the output per hour corresponding to the annual average wind speed and then multiply it by the number of hours in the year (8760) we obtain a much lower apparent output. This is because a steady low wind (implied by taking an annual average) has much less total power than a fluctuating wind of the same average (the average of the cubes of a series of numbers is greater than the cube of their average).

Obviously the same process can be applied using Table 1 in order to estimate the likely output from an electricity-generating windmill in the same wind regime.

If detailed meteorological data is not available from any weather station that is near enough to the proposed

and vice-versa.

#### Storage

Due to the variability of the wind, if a supply of electricity or water must be guaranteed, it becomes necessary either to provide a storage capable of covering the longest likely windless periods, or to provide a standby capability using some other energy source such as a small engine. Obviously, the windier the location the smaller the storage needs to be. Water storage is of course considerably cheaper than electrical storage in batteries, and it becomes feasible to provide for windless periods of a week or more in some cases. The capital cost of electricity storage becomes rather high if kilowatt sized loads are to be supplied, and it is often cheaper to use a small standby diesel or petrol engine generator in such situations. The combination of windmill and generator can be considerably more economical in the long term than either system considered alone, since the windmill greatly extends the life of the engine, reduces the costs of maintenance and saves a large proportion of the fuel that would otherwise be needed.

# Wind-Electric Systems

**AERO-POWER**  
2398 - 4th Street  
Berkeley  
California 94710  
U.S.A.

Phone: (415) 848  
2710

Model "A" wind generator is rated at 1000W and delivers 12V for battery charging. Rated output is reached at 25 m.p.h. (40km/h) and the machine starts at approximately 6 m.p.h. (10km/h).

The rotor is of 8.5ft (2.6m) diameter with three spruce blades with governing by pitch change. A 14.5V 75A maximum alternator is fitted (3-phase rectified to d.c.).

Various towers from 30 to 80ft (9m to 24m) are available and so are voltage regulators, inverters and batteries. This manufacturer also offers a Super-8 film about their wind plant.

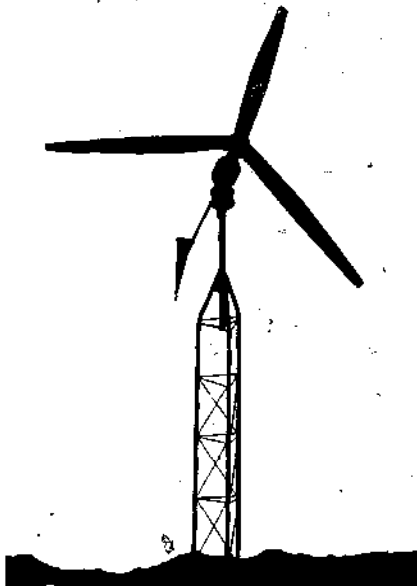

Aero-Power Model A Wind Generator

**BOSMAN:**  
Waterbeheersing En  
Milieverbetering B.V.  
Steegjesdijk 4  
Postbus 3518  
3364 Piershil (Z.-H.)  
Netherlands

Télex: 24475  
Phone: (01869)  
1316

Manufacturers of a small wind generator set for battery charging operations at 350 to 400W at outputs of 12 or 24V. The twin bladed rotor is made of fibreglass and automatically feathered. Storm protection is effected normally by turning the unit out of the wind. Unit can be supplied on a 7 metre tower.

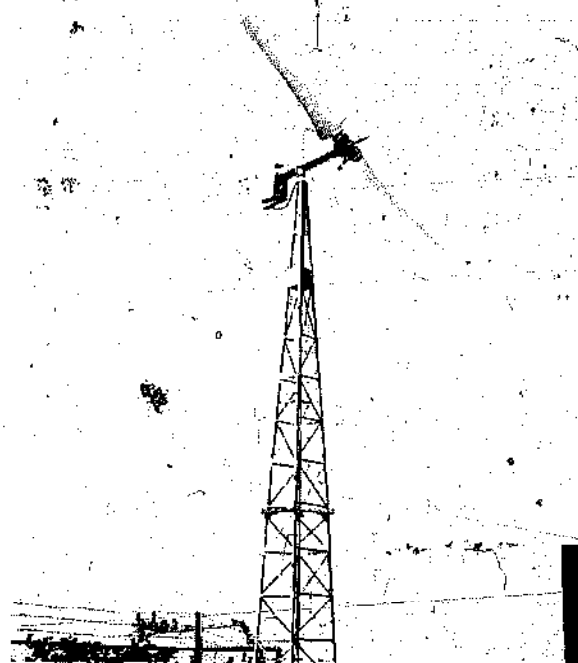

Bosman Wind Generator Set

**ALSTHOM-NEYRPC-**  
**TECHNIQUES DES FLUIDES**  
B.P. 75  
38041 Grenoble Cedex  
France

Telex: 320750  
Cables: Neyrpc Grenoble  
Phone: (76) 96-48-30

Manufacturers of two electricity generating windmills rated at 15 and 40hp which can be fitted with different rotors to suit different wind régimes:

Wind speed		15hp Mechanism		40hp Mechanism	
		Rotor of 8m (26ft)	Rotor of 10m (33ft)	Rotor of 13m (43ft)	Rotor of 16m (52ft)
m/s	m.p.h.	hp	hp	hp	hp
6	13	—	5.8	—	16.3
7	15	5.2	9.3	16.5	25.8
8	18	8.7	14.7	24.5	38.4
9	20	12.5	—	34.9	—
9.5	21	14.7	—	41.1	—

Orientation and speed control are by an auxiliary fan tail rotor and centrifugal pitch change of the rotor blades respectively. Various outputs are possible, typically 110V and this machine is normally supplied with either a 12 or a 15m (40 or 50ft) tower.

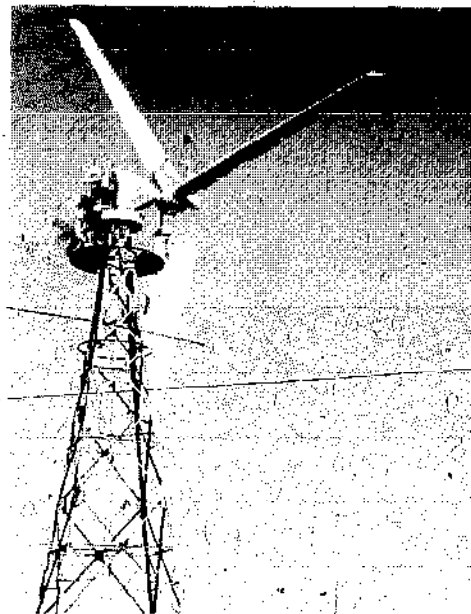

Alsthom-Neyrpc Windmill

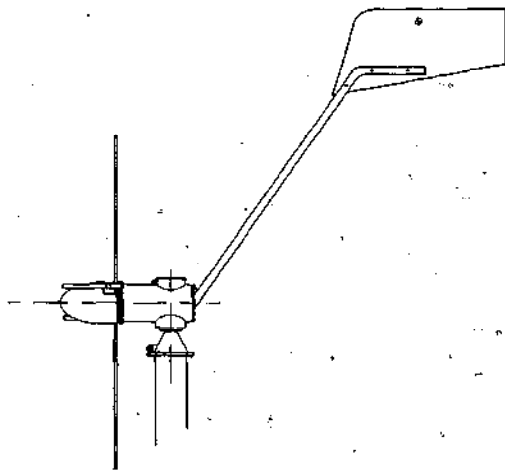

### Wind Generator-24 FP7 E

Model	Starting wind speed		Rated wind speed		Rated power output	Rotor dia.		Nominal voltage of battery bank
	(m/s)	(mph)	(m/s)	(mph)		(m)	(ft)	
24 FP7	4	9	7	16	24	1.2	3.9	24
100FP5	2	4.5	5	11	100	3.2	10.5	24
150FP7D	3	6.7	7	16	130	2.0	6.5	24
300FP7B	3	6.7	7	16	350	3.2	10.5	24
*1100FP5	2	4.5	5	11	1125	9.2	30	24
*1100FP7B	3	6.7	7	16	1125	5.0	16.5	24
4100FP7	3	6.7	7	16	4100	9.2	30	48

**AEROWATT COMPANY**  
37 rue Chanzy  
75011 Paris  
France

Telex: Sysna  
680160F  
Phone: 371 35 78  
371 36 21

This is a well established manufacturer in this field with a range of generators offering rated outputs from 24 to 4100W. These machines are conservatively rated and designed to be of high quality and the manufacturer offers special rotors for extreme conditions such as freezing or wind-blown sand.

The principal characteristics of their wind generators are given below.

All these machines run up-stream of the tower with centrifugal governing via blade pitch variation, giving protection automatically in wind speeds up to 125 m.p.h. or 200km/h.

Larger machines are available to special order up to a maximum of 100kW.

\*These models can be used to drive a 380V 3-phase, 50Hz submersible pump directly.

**CHLORIDE TRANSPACK LTD** Telex: 896071 code  
Stanley Road Transipack  
Bromley BR2 9JF London  
Kent Cables: Trahsipack  
U.K. Bromley  
Phone: 01 460 9861

Standard model of wind generator the Transwind 1.1kW machine starts generating at wind speeds of 7.5kt and reaches its rated output at 10kt. Rotor diameter is approximately 2m with variable pitch control to maintain a constant 50Hz 240/110V output.

A similar 3.5m rotor machine rated at 4kW is also available to special order.

See also this company's wide range of static inverter systems.

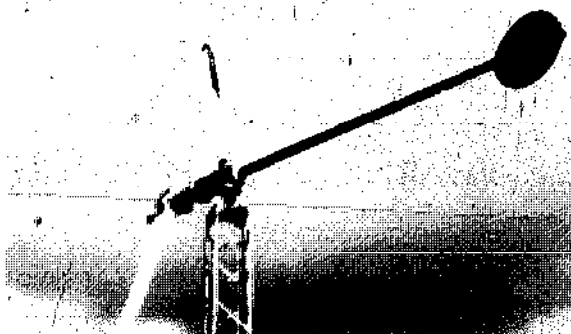

### 1200 and 2500W Wind Generator Units

**COULSON WIND ELECTRIC** Phone: 515 984  
RFD 1 Box 225 6038  
Polk City  
Iowa 50226  
U.S.A.

Retailer of reconditioned, second-hand and new wind

well known Jacobs generators.

Stocks: reconditioned and second-hand Jacobs Winchargers. New Winco 200W units.



**DAVEY DUNLITE**  
 (Division of PYE Industries  
 Sales Pty Ltd)  
 P.O. Box 120  
 Oakleigh  
 Melbourne  
 Australia 3166

Telex: 32542  
 Cables: Daylite  
 Melbourne  
 Phone: 544 6666

The main model is a 2kW rated wind generator (in 25 m.p.h. or 40km/h windspeed, starting speed 10 m.p.h. 16km/h), which has been in production for many years. It has a 13ft (4m) three-bladed rotor with galvanised steel aerofoils. Governing by centrifugally actuated pitch-change and a brake is fitted to stop the rotor manually. A version with a 10ft 6 in (3.2m) rotor is available capable of withstanding 120 m.p.h. winds in very windy locations (some have been used in the Antarctic).

The generator is a brushless machine with an integral gearbox, claimed to be able to run without any maintenance attention for intervals of five years. Outputs of 24V or 110V optional.

A new 5kW model is also available. Specification details were not available at the time of going to press.

U.K. Agents are Pye Telecommunications, Newmarket Road, Cambridge.

U.S. Agents are Independent Power Developers Inc., Box 1467 Noxon, Montana 59853.

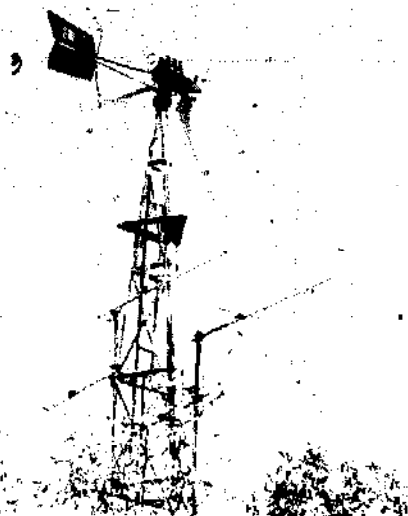

**2000 Watt Wind Generator**

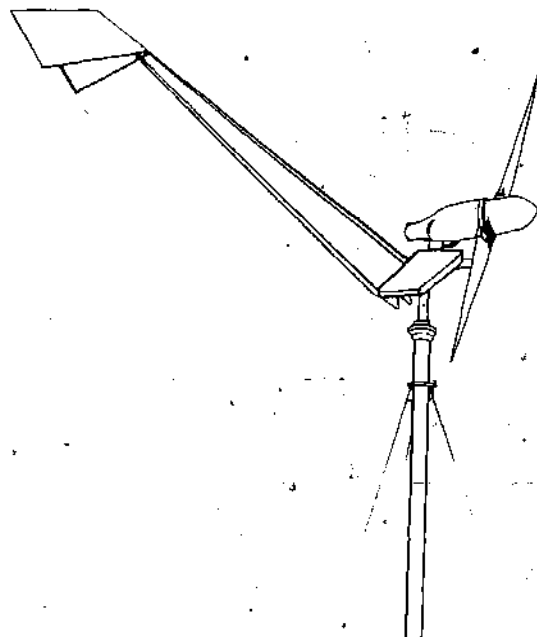

**Forces Motrices Neuchateloises Wind Generator**

**FORCES MOTRICES**  
**NEUCHATELOISES S.A.**  
 Rue Pourtales 13  
 CH-2000  
 Neuchatel  
 Switzerland

Telex: Ensa 35 140  
 Phone: 038 25 77 51

This wind generator is supplied as a complete system consisting of the windmill, tower, servicing console and storage batteries designed to produce an output of 220V, 50Hz, via an inverter.

The wind generator is nominally rated at 5kW and apparently achieves its rated output at 10m/s (22 m.p.h.). It cuts in at 2.5m/s (6 m.p.h.) and governs by turning out of wind above 15m/s (34 m.p.h.). It has a fixed pitch fibreglass two-bladed rotor of 5m diameter and has an overspeed device to prevent speeds in excess of 500 r.p.m.

The alternator is brushless with permanent magnets offering high efficiency through the speed range used, producing 3-phase alternating current at 380V. Its output is rectified to 60V d.c. and a static inverter then produces 220V +5% or -10% at 50Hz  $\pm$ 5% sinusoidal. The normal installation comes with a battery storage of 160AH consisting of 5 batteries in series.

**DOMINION ALUMINUM**  
**FABRICATING LTD.**  
 3570 Hawkestone Road  
 Mississauga  
 Ontario  
 Canada

Telex: 06-961482  
 Cables: Dafcol  
 Phone: 416 275 5300

This is an unusual turbine, being of vertical-axis configuration known as a "Darrieus" rotor. Two models are available with a choice of voltage for the smaller one:

Rotor dia. (ft)	Output voltage	Rated output Power	Rated output windspeed	Average monthly output			(av. wind)
				9 m.p.h.	11 m.p.h.	13 m.p.h.	
15	24V	4kW	23 m.p.h.	110	190	290	420kWh/month
15	110V	4kW	23 m.p.h.	110	210	360	560kWh/month
20	110V	6kW	23 m.p.h.	210	400	680	1070kWh/month

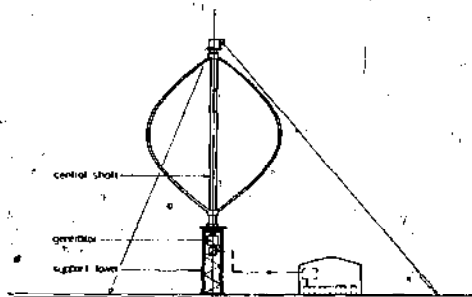

**Vertical Axis Wind Turbine**

EDMUND SCIENTIFIC  
COMPANY  
101 East Gloucester Pike  
Barrington  
New Jersey 08007  
U.S.A.

Telex: 831-564  
Phone: 609 547  
3488

Manufacturers of a 12V d.c. portable wind generator producing 196W at 14 m.p.h. and 600W at 25 m.p.h. 3-blade, 9ft diameter rotor on tubular pipe tower driving 12V generator via timing belt. Wind load governing with rotor pivoting against spring-loaded tail. Shipping weight 51 lb (23kg).

Also can supply "Wincharger" generators (9V), (200W @ 12V d.c.).

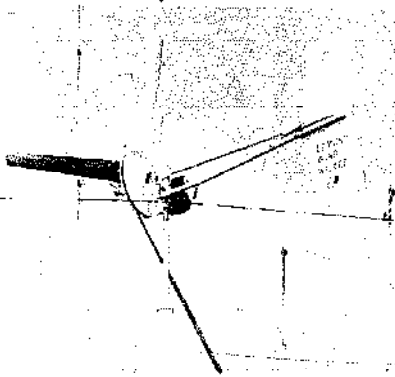

Edmund Portable Wind Generator

GRUMMAN CORPORATION  
Energy Systems Division  
4175 Veterans Memorial Highway  
Ronkonkoma  
New York 11779  
U.S.A.

Telex: (516) 575-  
6555  
Phone: 516 575  
6205

The Windstream 25 Unit is rated at 15kW in winds of 26 m.p.h. Voltage outputs available at 110V, 220V, and 440V a.c. and at 110 or 220 V d.c. Cut-in speed is 8 m.p.h.

Annual energy output from this system estimated by manufacturers as:

Average wind speed for site:	10	12.5	15 m.p.h.
Yearly energy production:	14,000	22,000	37,500kWh

Rotor diameter 25ft (7.6m) with centrifugal overspeed brakes and automatically controlled pitch angle. Rotor weight 340kg nacelle weight 575kg and centrifugally cast concrete tower weighing 4080kg.

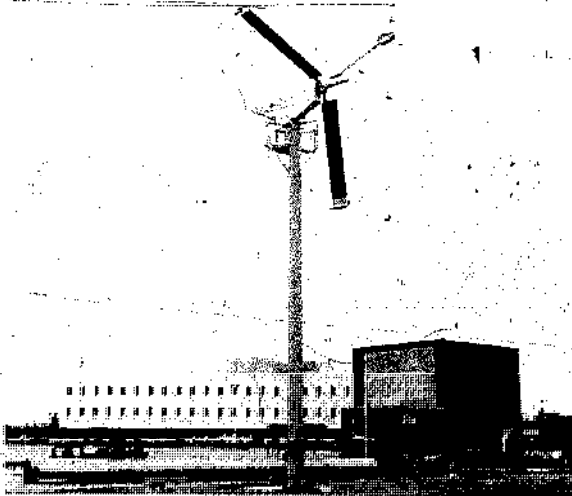

50 Windstream 25 Unit

ENAG SA  
Route de Pont-l'Abbé  
F 29000 Quimper  
Finistère  
France

Phone: 95 44 25

Model 1 "Super-Enag": two-bladed governed rotor generating up to 250 watt 12V or 24V output.

Model 2 "Super-Enag": three-bladed governed rotor generating rated output up to 1000 watt at 24V or to 1200 watt at 30V.

Model 3 "Super-Enag" special: similar to Model 1 in output, but fully automatic for remote operation without any kind of supervision.

Model 4 "Super-Enag": three bladed rotor with rated output of 2000 watt at 110V.

Batteries and control equipment can also be supplied, plus towers or stub-towers to suit the various models of 1.1m, 2.2m, and 1.5m.

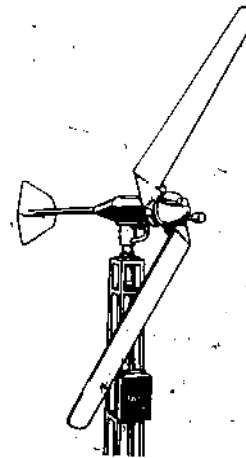

Enag Wind Generator

ÉOLIENNES-HUMBLLOT  
8 Rue d'Alger  
Coussey  
88300 Neufchateau  
France

Phone: (29) 94 09 09

This firm mainly manufactures windpumps but produces one wind generator called Aerogenerateur Ideolec, to the following specifications.

Rotor diameter: 4.20m (13.8ft), two bladed in polyester.

Starting speed: 3m/s (7 m.p.h.) giving 60W output.

Middle range: 6m/s (14 m.p.h.) giving 800W output.

Rated speed: 10m/s (22 m.p.h.) giving rated output of 1100W.

Tower: 9, 12 or 15m (29, 40 or 50ft) angle steel frame.

Generator: 24V, 1100W maximum.

Extras: Regulator, inverter, battery bank, etc.

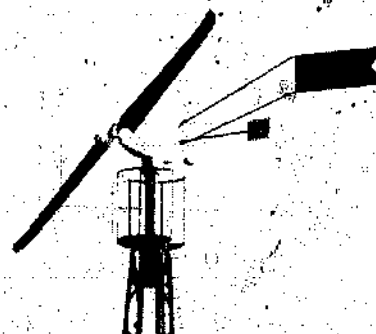

"Ideolec" Wind Generator

ELEKTRO GMBH  
 St. Gallerstrasse 27  
 8400 Winterthur  
 Switzerland

Telex: 76-299  
 Elektro  
 Phone: 052 22 34 34

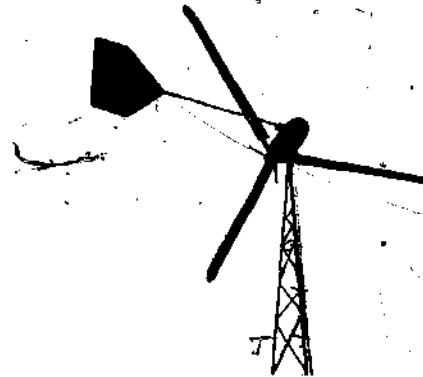

Manufacturers of a range of windmill generators (for well over 30 years) with outputs from 50 watts to 10kW, using aerofoil section blades on lattice-frame towers.

**Elektro Wind Generator Installation**

Model	Rotor diameter blades		Rated output	Rated windspeed		Available voltages				Net weight (kg)
	(m)	(no.)		(m.p.h.)	(km/h)					
W50	vertical axis	.45m	50	40	60	6	12	24	-	35
W250	vertical axis	.66m	50	20	30	12	24	36	-	70
WV05	2.5	2	750	20	30	12	24	36	48	65
*WV15G	3	2	1200	23	37	12	24	36	48	135
*WV25G	3.6	2	2200	22	36	24	36	48	110	180
*WV35G	4.4	3	4000	23	37	48	60	110	-	235
*WVG50G	5	3	5500	26	42	60	110	-	-	265
*WVG120G	6	3	9000	-	-	110	-	-	-	315

\*These models also available with 3-phase a.c. generators for heating applications.



Jacobs/North Wind Generator

**NORTH WIND POWER COMPANY INC**  
 P.O. Box 315  
 Warren  
 Vermont 05674  
 U.S.A.

Phone: 802 496 2955

This company reconditions and rebuilds Jacobs wind generators, a very successful and innovative design in its time (production started in 1931) and still known as one of the most reliable systems available. North Wind have introduced a number of improvements, such as electronic control. All the Jacobs/North Wind generators have three-bladed wooden rotors with aerofoil blades and centrifugal pitch change. Special direct drive generators have been developed which are claimed to match the rotor characteristic particularly well.

The following *Jacobs* machines are offered:

- apc J47 3000W @ 120V
- apc J45 2500W @ 120V
- apc J80 2000W @ 32V
- apc J46 2800W @ 32V
- apc J49 2500W @ 32V
- apc J51 1800W @ 32V

Full rated power is obtained at the relatively low wind speed of 20 m.p.h. (9m/s).

North Wind also offer the following *Aeropower* generator:

Rotor: 6ft diameter spruce, twin aerofoil with pitch change feathering.

Generator: 1000W @ 14V maximum direct drive (max. output in 32 m.p.h. 14.3m/s wind).

The following complete systems are offered:

*Jacobs 1.8-30kW 32/120V d.c. or 120V a.c.*

Average wind speed for site:	8	10	16	m.p.h.*
Monthly output in kWh	150-250	200-450	500-850	

*Aeropower 1kW 12V d.c. or 120V a.c.*

Average wind speed for site:	10	12.5	15	m.p.h.*
Monthly output in kWh	33	70	110	

\*Note: 1 m.p.h. = 1.6km/h

Also available is a wide selection of different towers in aluminium or galvanised steel, both free-standing and guyed with heights from 20ft (6m) to 100ft (30m). Batteries, inverters, wind measuring equipment, woodstoves and windpumps are also available.

**RALPH HOWE  
MARKETING LTD**  
New Orchard and High Street  
Poole  
Dorset  
U.K.

Telex: 41495  
Cables: Ralphowe Poole  
Phone: Poole (02013) 77377/8

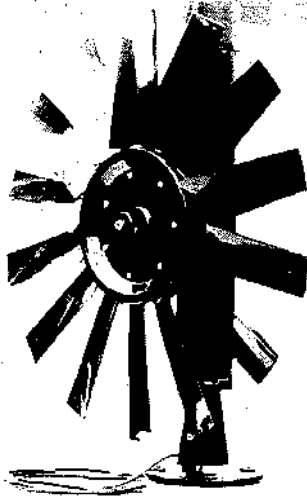

Small units for trickle charging electric storage batteries. Intended mainly for marine applications on sailing ships or for remote buoys and harbour beacons, but ideal for any similar application needing small power levels delivered with minimum supervision and maximum reliability.

Model	Rotor diameter	Rated output	Cut-in speed m.p.h.	Net speed m.p.h.	weight kg
Selectromarine					
5W12	432mm (17")	5W @ 12V	25	10	10
5W24	432mm (17")	5W @ 24V	25	10	10
10W12	432mm (17") (2 rotors)	10W @ 12V	25	10	15
10W24	432mm (17") (2 rotors)	10W @ 24V	25	10	15
Ampair 50MK3	670mm (26.4")	50W @ 12V	35	12	8.2
Aerocharge 3	432mm (17")	5W @ 12V or 24V	25	10	4

Complete wind-powered marine buoys and navigation aids intended for reliable unattended operation also available.

**SENCEBAUGH WIND  
ELECTRIC**  
P.O. Box 11174  
Palo Alto  
California 94306  
U.S.A.

Phone: 415 964 1593

This company offers two designs by the well known American wind energy expert Jim Sencenbaugh, as follows:

Model	Rotor diameter	Rated output	Maximum output	Cut-in speed	Weight
1000-14	12ft (3.7m)	100W at 23 m.p.h.	1200W at 30 m.p.h.	7-8 m.p.h.	300lb shipping
24-14	20in (51cm)	24W at 21 m.p.h.	30W at 30 m.p.h.	8-9 m.p.h.	18lb net.

Also available are Dunlite windmills, towers, storage batteries, wind recording equipment, inverters, etc.

Catalogue \$5 — including postage to overseas enquirers.

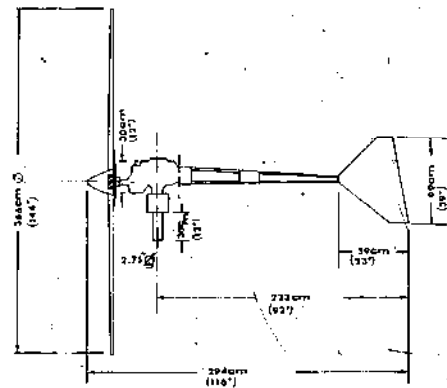

**Sencenbaugh Model 1000-14**



**Kedco 1200 Unit**

**KEDCO INC**  
9016 Aviation Boulevard  
Inglewood  
California 90301  
U.S.A.

Phone: 213 776 6636

Kedco offer a range of four aerogenerators based on the Jack Parks design offered by Helion as drawings or by Topanga Power as a kit.

These machines have three-bladed light alloy rotors with variable pitch centrifugally activated governing. The models 1200 and 1600 have 14V (28V optional) d.c. outputs for battery charging, while the 1210 and 1610 have a variable (180V max) voltage permanent magnet alternator rated at up to 2000W. Further details are summarised as follows:

Model	Rotor dia.	Rated power	Rated speed	Cut-in speed
1200	12ft 3.7m	1200W	22 m.p.h.	7 m.p.h.
1600	16ft 4.9m	1200W	17 m.p.h.	8 m.p.h.
1210	12ft 3.7m	2000W	26 m.p.h.	11 m.p.h.
1610	16ft 4.9m	2000W	22 m.p.h.	10 m.p.h.

Note that the model 1600 in particular is very conservatively rated compared with most machines on the market. "Tropicalising" is offered as an optional extra and towers and a suitable synchronous inverter are available.

**LUBING MASCHINENFABRIK** Phone: 05442 625/7.  
 D-2847 Barnstorf  
 Postfach 110  
 German Federal Republic

The single Lubing 400W wind generator design results from 25 years experience and is an expensive machine but said to be of good quality. It has six blades made from fibreglass, three smaller ones of fixed pitch to aid starting and three longer variable-pitch, centrifugally governed ones which produce most of the power.

The generator is brushless with an output of 24V a.c. which is rectified to 24V (nominal) d.c. via silicon diodes and an electronic regulator. Drive is via an integral gearbox and the windmill comes on a hinged aluminium pole tower which can be winched down horizontal to facilitate servicing.

Performance claimed is as follows:

Wind velocity	m/s	4	5	6	7	8	9	10	11	12
	m.p.h.	9	11	13	16	18	20	22	25	27
Output	Watts	24	72	136	220	325	375	400	400	400

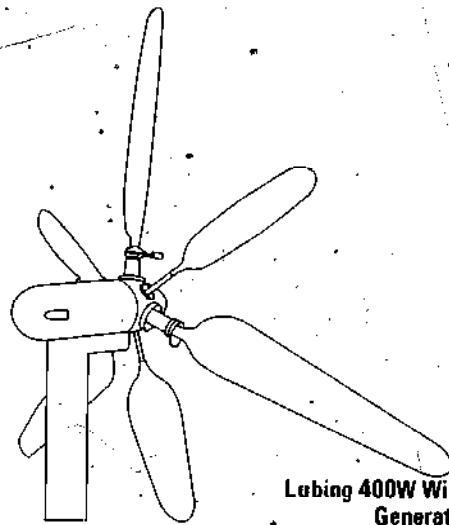

**Lubing 400W Wind Generator**

**PINSON ENERGY CORPORATION**  
 P.O. Box 7  
 Marstons Mills  
 Massachusetts 02648  
 U.S.A.

Cycloturbine Model C2E is supplied to the following specifications:

- Rotor diameter: 12ft (3.6m).
- Blade length: 8ft (2.5m).
- Swept area of rotor: 96ft<sup>2</sup> (8.9m<sup>2</sup>).
- Overspeed control: Centrifugal.
- Starting windspeed: 5 m.p.h. (13.5m/s).
- Governing windspeed: 30 m.p.h. (13.5m/s).
- Governing r.p.m.: 200
- Electrical output: 2kW @ 24 m.p.h. (11m/s). 4kW @ 30 m.p.h. (13.5m/s).

This machine is a very recent development having a vertical-axis configuration (Darrieus) with cyclic pitch variation to achieve self-starting and to limit the speed.

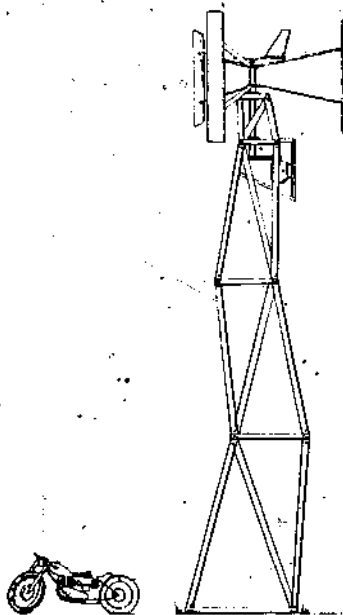

**Cycloturbine C2C**  
 Atop 33ft Octahedron Tower

**NOAH ENERGIE SYSTEME**  
 GmbH  
 Mühlenstr 11  
 D-53 Bonn  
 W. Germany

Telex: 889445 d  
 Glahn  
 Phone: 02242 2543

&  
 Wippenhohnerstrasse 31  
 D5202 Hennef 1  
 W. Germany

Single and double rotor units with power outputs from 15kW to 130kW depending on size and wind speed, as follows:

Type 30/90kW: 12m diameter, 6 bladed rotor, rated output 30kW and maximum output 90kW.

Type 15/45kW: 12m diameter, 3 bladed rotor with rated and maximum outputs of 15 and 45kW respectively.

Type 45/130kW: 16m diameter, 3 bladed rotor of 45 and 130kW rated and maximum outputs.

Larger double rotor machines with outputs from 200kW up to one with a maximum output of 1800kW are offered as special projects on request.

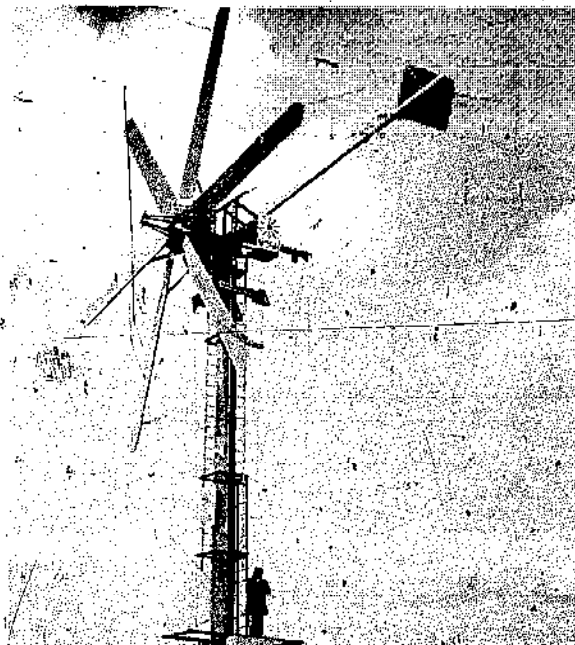

**Noah 30/90kW Plant**

**P.J. SPECIALIST ENGINEERS LTD**  
 The Dean  
 Alresford  
 Hants  
 U.K.

Telex: 447152  
 PICOR G  
 Phone: 096 273  
 3242  
 Tele-grams: PICOR

This windmill embodies another version of the vertical axis principal often attributed to Darrieus, but has a novel feature of "variable geometry" developed by Dr Peter Musgrove of Reading University. This allows the blades to fold outwards if the turbine overspeeds and thereby effectively governs it.

The manufacturer has just begun production, with a primary application intended as cathodic protection of pipelines and other steel structures. However, the system could equally be employed for any low voltage d.c. application such as battery charging.

In common with other Darrieus-type windmills, it is not self-starting. This machine incorporates an electric starter which is activated by an electronic wind-sensing system whenever adequate wind conditions for operation are felt.

Rotor diameter: 9.5m (14ft 9in).  
 Blade length: 3m (20ft)  
 Swept area of rotor: 13.5m<sup>2</sup> (148ft<sup>2</sup>)  
 Overspeed control: Centrifugal.  
 Starting windspeed: 4m/s (9 m.p.h.) (adjustable).  
 Governing windspeed: 10m/s (22 m.p.h.) (adjustable).  
 Operational speed range: 80 to 160 r.p.m.  
 Electrical output: 50-100W @ 5m/s (11 m.p.h.).  
 500W @ 7m/s (16 m.p.h.). 100W @ 10m/s (22 m.p.h.).

Electrical output via CAV alternator and diode rectifier to 12, 24 or other voltages. Performance figures given depend on choice of output and alternator.

Work on a 6m (19ft 6ins) diameter self-starting version of the windmill is now well advanced. It is hoped it will be available shortly after publication of this Guide.

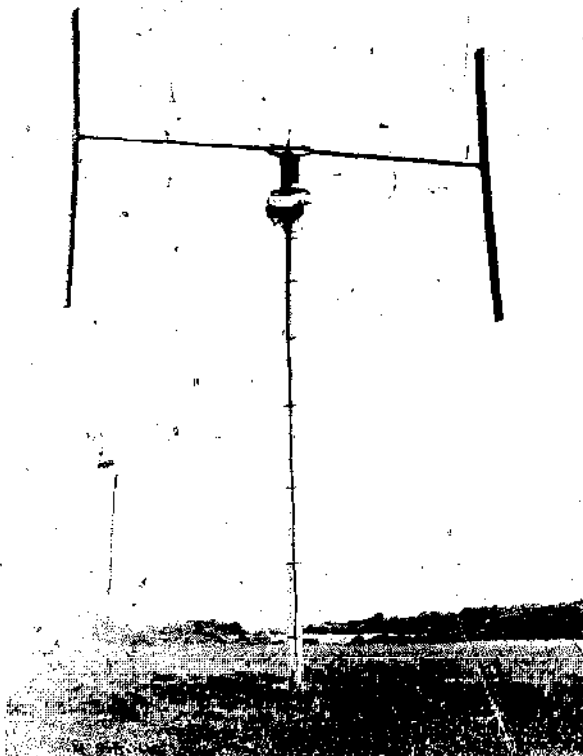

54 4.5m Variable Geometry Wind Generator

**QUIRK'S VICTORY LIGHT CO. PTY LTD**  
 33 Fairweather Street  
 Bellevue Hill  
 New South Wales 2023  
 Australia

Cables: Quirklite  
 Sydney  
 Phone: 36 6630

A 12V or 110V unit supplying 3kW in a 25 m.p.h. wind. Generation starts in a 6-8 m.p.h. wind and plants are designed to withstand wind speeds of 140 m.p.h. Brushless generator with integral gearbox. Centrifugal governor with variable pitch galvanised steel rotor blades. Designed for 5 year operation without maintenance.

Manufacturer also offers batteries, inverters, various towers, etc.

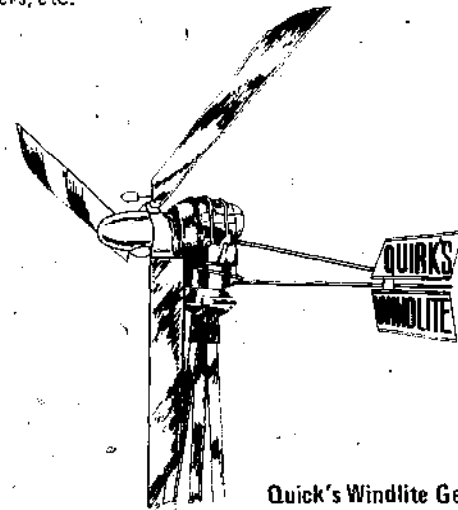

Quirk's Windlite Generator

**ZEPHYR WIND DYNAMO COMPANY**  
 P.O. Box 241  
 Brunswick  
 Maine 04011  
 U.S.A.

Phone: 207/25  
 6534

The Zephyr Wind Dynamo is a sophisticated design with a low speed, high frequency, permanent magnet alternator direct coupled to a three bladed 20ft diameter (6m) downwind rotor. The reinforced plastic rotor blades are of light weight with tip spoilers for overspeed protection. A servo turns the rotor at right angles to the wind if overspeed or vibrations occur beyond the control of the spoilers.

Rated output of 15kW is achieved in a 30 m.p.h. (13.4m/s) wind. Cut-in is at 8 m.p.h. (3.5m/s) and 500W is produced at 10 m.p.h. Shut down takes place at 45 m.p.h. (20m/s). Weight on tower = 600lb (272kg).

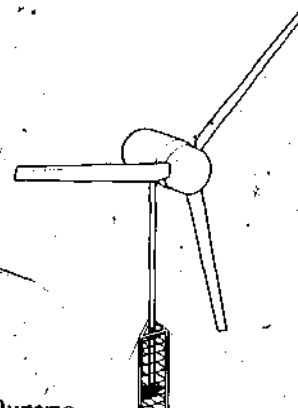

Zephyr Wind Dynamo

**TRIMBLE WINDMILLS**  
 Crimble Grange  
 Beckwithshaw  
 Harrogate  
 North Yorkshire HG3 1QU  
 U.K.

Phone: 0423 56006

Manufacturers of the 'Trimblemill' wind generator, a new windmill due to come onto the market at about the date of publication. Specification is given as:

- Rotor diameter: 16ft (5m) 8 bladed (3 front, 5 rear).
- Tower: 30ft (9.3m) Ductile Iron pipe.
- Control: Electrical overload cut out, automatic furling in 53 m.p.h. winds, limited stress sail lashings, emergency mechanical brake.
- Output: 22 m.p.h. (10m/sec) 5 kW 240V. 53 m.p.h. (23.6m/sec) 12.5kW 565V.
- Generator: Designed specifically for windmill use by N.E.I. Clark, Chapman Engineering Ltd., (see generator section), it is integral in the hub and carries the blades. Power collection is via slip rings.
- Extras: Optional control system for battery storage to give constant 240V 50Hz.

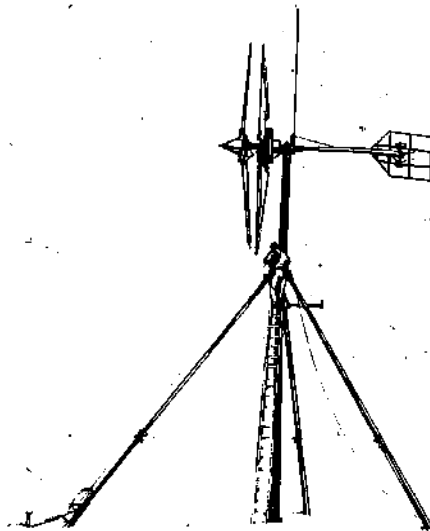

Trimblemill

**TOPANGA POWER**  
 Box 712  
 Topanga  
 California 90290  
 U.S.A.

Phone: 213 455 2458

This company manufactures a kit of parts to build the Helion windmill. The kit is to a high level of completeness and it is claimed that a competent builder can complete it in two days or less.

Alternatively, plans alone can be obtained from Helion, P.O. Box 4301, Sylmar, California 91342, U.S.A. (Phone 213 367 8291).

Specification as follows:

- Rotor diameter: 12ft or 16ft (to choice) (3.6 or 4.9m).
- Rated wind speed: 25 m.p.h. (11m/s).
- Rated output: 1300W (12V system) or 1600W (24V system) at 18 m.p.h. (16ft) or at 25 m.p.h. (with smaller 17ft rotor).
- Rotor type: Three aerofoils from aluminium sheet with centrifugal pitch change governing system. Rotor operates downwind of tower.
- Transmission: Oil bath gears generator to 8.6 times rotor r.p.m.
- Overall weight: 200lb (91kg).

Note that the illustration shows a prototype Helion windmill, similar in arrangement but differing in detail from the production model.



Helion Windmill

**WINCO**  
 Division of Dyna Technology,  
 Inc.  
 East Seventh at Division Street  
 P.O. Box 3263  
 Sioux City  
 Iowa 51102  
 U.S.A.

Telex: 487110  
 Phone: 712 252 1821

This small 12\* volt unit has been in production for some time and produces a maximum of 200 watts in a wind velocity of 23 m.p.h. Charging starts in a breeze of 7 m.p.h. When wind speeds exceed 23 m.p.h. the governor flaps deploy to safeguard the unit. Rotor diameter 6ft. Comes complete with 10ft stub tower.

*Average usable energy per month*

- 10 m.p.h. average - 20kWh
- 12 m.p.h. average - 26kWh
- 14 m.p.h. average - 30kWh\*

\*24, 28, 32 or 36V available at extra cost.

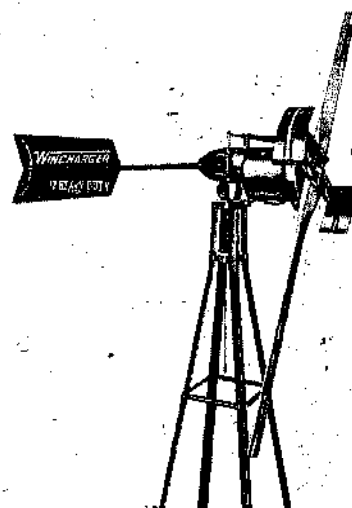

12ft Wincharger Unit

**THE WIND ENERGY SUPPLY  
CO. LTD (WESCO)**  
Iroko House  
Bolney Avenue,  
Peacehaven  
Sussex BN9 8HQ  
U.K.

Telex: 877623  
ContecG  
Phone: Peacehaven  
(07914) 5051

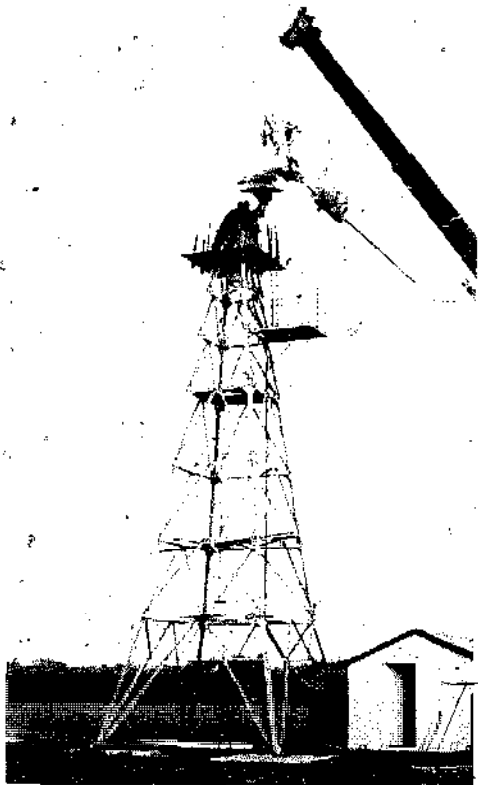

Wesco 18m Prototype

Have so far mainly been involved in sophisticated windpower research and development, particularly in the field of combined heat and mechanical outputs from windpower. Have built an 18m (60ft) prototype (see photo) with a maximum output of around 190kW in a wind-speed of 13.5m/s (30 m.p.h.) and are bringing the following series of machines onto the market:

- 5m (16ft) rotor suitable for a variety of applications.
- 5.5m (18ft) system for battery charging; designed for low wind operation and beacon/repeater station duty.
- 7m (23ft) system similar to the 5m one above but offering improved cost/performance (see detailed specification below).
- 18m (60ft) development of prototype mentioned above, with thermal/electric output via hydraulic transmission.

A more detailed specification of the 7m windmill follows:

Rotor diameter: 7m Number of blades - 3 (downwind of tower).

Furling method: pitch change by torsion flexure/centrifugal weights.

Rated wind speed: 13.4m/s (30 m.p.h.).

Rated rotor speed: 311 r.p.m.

Output at rated wind speed: 15kW (415V 50Hz a.c. three-phase).

Tower: Square section, tubular steel lattice, 7.2m (24ft) high.

Optional extras include priority load controller, 380V three-phase alternator, economy and professional battery chargers, and low temperature spec. (-20°C).

## Wind-Pumping Systems

**AGRO-AIDS**  
27 Shrungar Shopping Centre  
Mahatma Gandhi Road  
Bangalore - 560001  
India

Phone: 56149  
Cables: INDEX  
BANGALORE

Agro-Aids are manufacturing the WP-2 windmill originally developed by the Indian National Aeronautical Laboratory. Its specification is as follows:

Rotor: 12 bladed, 16ft (4.88m) diameter.

Transmission: Direct acting, self-lubricating with 5in (125mm) stroke.

Governing: By moving tail vane.

Tower: Four post all-steel, 32ft (10m) high.

Output: 21m lift with 100mm pump in 20km/h (12 m.p.h.) winds = 2000 l/h. 4.6m lift with 200mm pump in 20km/h wind = 7500 l/h.



WP-2 Windmill

**BOSMAN**  
Waterbeheersing En  
Milieverbetering B.V.  
Steggjesdijk 4  
Postbus 3518  
3364 Piershil (Z.-H.)  
Netherlands

Telex: 24475  
Phone: (01869) 13 16

Manufacturers of a small water pumping system to control water levels. The system, suitable for small pump drainage schemes, monitors the water level in the drainage ditch and, when the wind is available, will pump water from the ditch until it reaches the desired level, where the unit will automatically cut out.

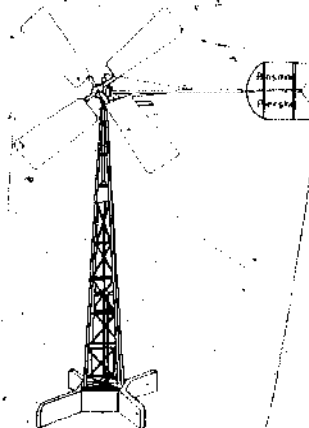

Bosman Water pumping system



S.A. BRUNO  
 Route du Mans  
 Bonchamps-les-Laval  
 53210 Argentre  
 France

Phone: (43) 53 65 90

also available from:

BRIAU S.A.  
 B.P. 43  
 37009 Tours Cedex  
 France

Telex: 750729F  
 Phone: (47) 61 38 17

"Le Mistral" is a relatively simple wind pump intended for small water supplies. It requires virtually no maintenance. It is available with a choice of rotor sizes to cater for different applications as follows:

- Rotor diameter: 2.00, 2.24, 2.50 metre.
- Output in 24 hours: 3100, 4900, 8800 litre.
- Maximum head: 30 to 40m.
- Tower sizes: 4.5m, 6.0m, 8.0m, 10.0m.

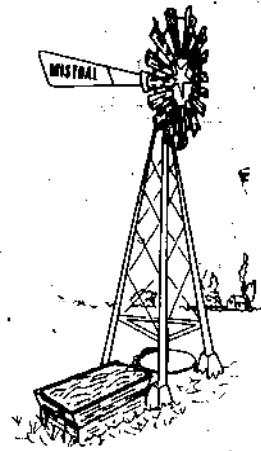

Mistral Wind pumping unit

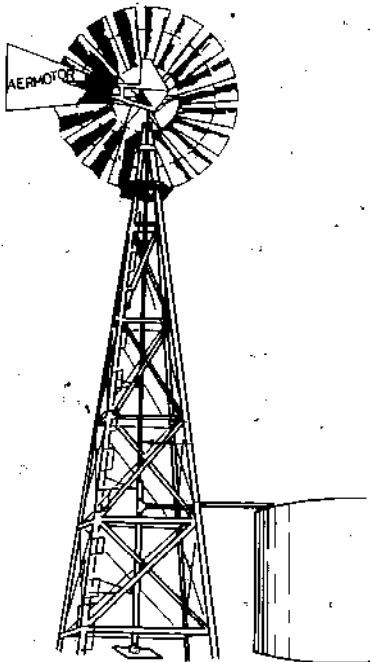

Aermotor Wind Pumping Unit

AERMOTOR  
 (Division of Braden Industries  
 Inc.)  
 P.O. Box 1364  
 Conway  
 Arkansas 72032  
 U.S.A.

Phone: (501) 329 9811

Also:

W.D. Moore & Co  
 3 Keegan Street  
 O'Connor  
 West Australia 6163

Cables: Clippglaze  
 Phone: 374766

Aermotor have been in the water-lifting business since 1888 and apart from windmills, manufacture electric borehole pumps. The current windmill range, model 702, was first introduced in 1933. Versions are licence manufactured in Australia and Argentina as well as in the U.S. It is available with 6, 8, 10, 12, 14, and 16ft diameter rotors with towers in five heights from 21 through to 47ft. All models have oil filled gearboxes, automatic furling plus manual furling with a brake. Manufacturers figures for output are given below in U.S. gallons (1 U.S. gallon = 3.8 litre = 0.84 Imp.gall.).

**AERMOTOR PUMPING CAPACITY**

Cylinder dia: (inches)	Capacity (g.p.h.)		SIZE OF AERMOTOR Total elevation in feet					
	6ft	8-16ft	6ft	8ft	10ft	12ft	14ft	16ft
1 1/4	105	150	130	185	280	420	600	1,000
1 7/8	125	180	120	175	260	390	560	920
2	130	190	95	140	215	320	460	750
2 1/4	180	260	77	112	170	250	360	590
2 1/2	225	325	65	94	140	210	300	490
2 3/4	265	385	56	80	120	180	260	425
3	320	470	47	68	100	155	220	360
3 1/4	-	550	-	-	88	130	185	305
3 1/2	440	640	35	50	76	115	160	265
3 3/4	-	730	-	-	65	98	143	230
4	570	830	27	39	58	86	125	200
4 1/4	-	940	-	-	51	76	110	180
4 1/2	725	1,050	21	30	46	68	98	160
4 3/4	-	1,170	-	-	-	61	88	140
5	900	1,300	17	25	37	55	80	130
5 1/4	-	1,700	-	-	-	40	60	100
6	-	1,875	-	17	25	38	55	85
7	-	2,550	-	-	19	28	41	65
8	-	3,300	-	-	14	22	31	50

Manufacturers note: Capacities shown in the above table are approximate, based on the mill set on the long stroke, operating in a 15 to 20 mile-an-hour wind. The short stroke increases elevation by one-third and reduces pumping capacity one-fourth.

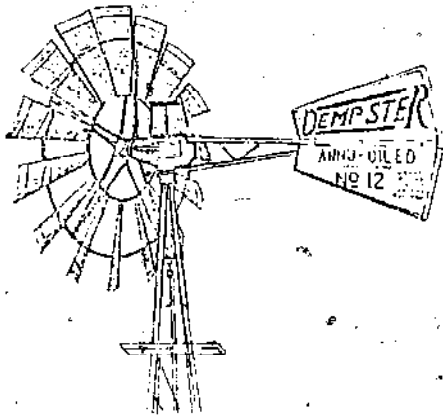

Dempster Wind Pump

**DEMPSTER INDUSTRIES INC.** Phone: (402) 223 4026  
 P.O. Box 848  
 Beatrice  
 Nebraska 68310  
 U.S.A.

Manufacture a range of windmills for water pumping with rotor diameter of 6ft to 10ft on towers of 22ft to 60ft:

Performance claimed is indicated as follows, in U.S. Gallons/hr. These capacities are based on a 15-mile per hour wind. Capacities are based on longest stroke of Dempster mills. If shorter stroke is used capacities will be reduced in proportion to length of stroke used.

Cylinder size	6ft		8ft "A"		10ft	
	5" Stroke Elev.	g.p.h.	7½" Stroke Elev.	g.p.h.	7½" Stroke Elev.	g.p.h.
1 7/8	120	115	172	173	256	140
2	95	130	135	195	210	159
2 1/4	75	165	107	248	165	202
2 1/2	62	206	89	304	137	248
2 3/4	54	248	77	370	119	300
3	45	294	65	440	102	357
3 1/4	39	346	55	565	86	418
3 1/2	34	400	48	600	75	487
3 3/4	29	457	42	688	65	556
4	26	522	37	780	57	635

If the wind velocity be increased or decreased, the pumping capacity of the windmill will also be increased or decreased. Capacities will be reduced approximately as follows, if wind velocity is less than 15 miles per hour: 12 mile per hour wind, capacity reduced approximately 20%; 10 mile per hour wind, capacity reduced approximately 38%.

**THE HELLER-ALLER COMPANY**  
 P.O. Box 29  
 Corner Perry &  
 Oakwood Streets  
 Napoleon  
 Ohio 43545  
 U.S.A.

Cables: Helaler  
 Phone: (419) 592  
 1856

Heller-Aller have manufactured Baker Windmills, pumps, water systems, tanks and allied goods since 1886. Performance of the current range of models of windmill is indicated in the following table, (note that 1 U.S.-gallon = 3.8 litre).

Pumping Capacities of Back-Geared "Baker" Windmills  
 (in 15 mile-per-hour wind)

Total elevation (ft)	6 FOOT BAKER		8 FOOT BAKER		10 FOOT BAKER		12 FOOT BAKER	
	Cylinder diameter (")	Capacity (U.S. g.p.h.)	Cylinder diameter (")	Capacity (U.S. g.p.h.)	Cylinder diameter (")	Capacity (U.S. g.p.h.)	Cylinder diameter (")	Capacity (U.S. g.p.h.)
25	3	350	3 1/2	900	4	1250	6	2400
35	2 1/2	240	3	720	3 1/2	925	5	1625
50	2 1/4	200	2 1/2	450	3	700	4 1/2	1425
75	2	160	2 1/4	350	2 1/2	475	4	1125
100	2	150	2	250	2 1/2	460	3	680
125	1 5/8	120	1 7/8	240	2	280	2 1/2	525
150	—	—	1 1/4	220	2	280	2 1/2	525
200	—	—	—	—	1 7/8	260	2	325
250	—	—	—	—	1 1/4	215	2	325
300	—	—	—	—	—	—	1 1/4	200

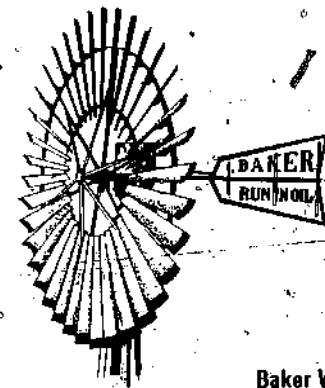

Baker Windmill

Manufacturer's note: The above capacities are approximate. By the total elevation in feet we do not mean the depth of the well, but the distance to the cylinder.

M.B.P. (S.A.) PTY LTD  
P.O. Box 2047  
Adelaide  
South Australia 5001

Cables: Modmaid  
Phone: 43 6241

7-25 Manchester Street  
Mile End South  
South Australia 5031

M.B.P. manufacture windmills, syphon and borehole pumps, plus various tanks and other agricultural water supply equipment, until recently under the trade name of 'Meters'.

The windmills are conventional farm windmills with all normal facilities such as automatic and manual furling in wheel sizes from 6 to 14ft as indicated below.

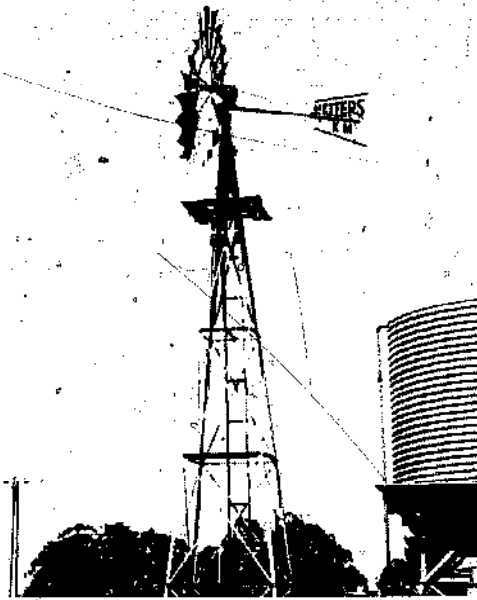

Metters Windmill Installation

		PUMP SIZE						
		2	2 <sup>3</sup> / <sub>8</sub>	2 <sup>1</sup> / <sub>2</sub>	2 <sup>3</sup> / <sub>4</sub>	3	3 <sup>1</sup> / <sub>2</sub>	4
Inches		50.8	60.3	63.5	69.8	76.2	88.9	101.6
Millimetres								
<b>6 feet wheel</b> 1.828 m								
Maximum head:	Feet	71	61	49	40	34	28	25
	Metres	21.64	18.59	14.94	12.19	10.37	8.53	7.62
Average daily output:	Galls	1,110	1,530	1,750	2,110	2,475	3,410	4,400
	Litres	5,001	6,955	7,956	9,592	11,251	15,502	20,002
<b>8 feet wheel</b> 2.438 m								
Maximum head:	Feet	127	102	86	72	62	44	35
	Metres	38.71	31.09	26.2	21.95	18.90	13.41	10.67
Average daily output:	Galls	1,320	1,860	2,090	2,540	2,970	4,125	5,280
	Litres	6,001	8,456	9,501	11,547	13,502	18,752	24,003
<b>10 feet wheel</b> 3.048 m								
Maximum head:	Feet	265	233	206	161	139	99	73
	Metres	80.77	71.02	62.79	49.07	42.37	30.18	22.25
Average daily output:	Galls	1,540	2,145	2,420	2,970	3,465	4,785	6,160
	Litres	7,001	9,751	11,001	13,502	15,752	21,753	28,003
<b>12 feet wheel</b> 3.658 m								
Maximum head:	Feet	292	255	233	199	169	139	112
	Metres	89.00	77.72	71.02	60.65	51.51	42.37	34.14
Average daily output:	Galls	1,650	2,287	2,585	3,180	3,700	5,115	6,500
	Litres	7,501	10,397	11,751	14,456	16,820	23,253	29,549
<b>14 feet wheel</b> 4.267 m								
Maximum head:	Feet	385	314	282	245	201	169	134
	Metres	117.35	95.71	85.95	74.68	61.26	51.51	40.84
Average daily output:	Galls	1,705	2,385	2,668	3,285	3,828	5,280	6,820
	Litres	7,751	10,842	12,129	14,934	17,379	24,003	31,004

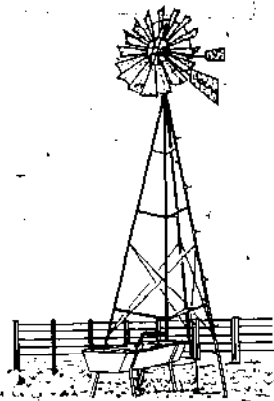

L'Idéale Wind pumping unit

**EOLIENNES HUMBLLOT**  
 8 rue d'Alger  
 Coussey  
 88300 Neufchateau  
 France

Phone: (29) 94 09,09

Manufacturers of direct drive wind pumping units intended for animal drinking trough supply and consequently rather smaller and less expensive than some of the American and Australian farm windmills. There are two main types and various permutations of rotors, head mechanisms and towers can be combined for different purposes. There is one large model listed last.

Model name	Rotor sizes	Transmissions	Pumping head	Maximum output	Tower heights
Cadeteol	1.75m	same for both	0 to 6m	500 l/h	4.4m
Supercadeteol	1.75m			600 l/h	4.4m
Junioreol	1.75m	choice*	0 to 15m	[ 600 to 2000 ] l/h	[ 4.4m 5.25m 6.55m 8.85m ] choice
	2.0m		15 to 20m		
	2.25m		20 to 30m		
	2.5m		30 to 40m		
	2.75m	40 to 55m			
Geanteol	3.50m	same (geared)	[ 80m well (100m total) ]	8000 l/h	[ 9.30m 13.30m ]
	4.0m				

\*These transmissions are first two of fixed output, second two variable and numbers one and three are grease lubricated, the others oil bath. Spring shock absorbers are an optional extra to protect against iced up pumps damaging the drive train.

**ETS PONCELET & CIE**  
 B.P. No. 1  
 10380 Plancy L'Abbaye  
 France

Manufacturers of a range of small, relatively inexpensive, water-pumping windmills intended for filling cattle troughs, under the trade name "Oasis".

Model	Rotor diameter	Tower height	Head range	Output
1	1.60m	4.0m )		
1 "bis"	1.75m	4.0m )	0 to 30	200 to
1 "ter"	1.75m	6.0m )	(0 to 100ft)	1000
2	2.00m	6.0m )		l/h
2 "bis"	2.25m	6.0m )		(44 to
3	2.25m	7.5m )		220
4	2.50m	7.5m )		gall/hr)
5	2.50m	10.0m )		

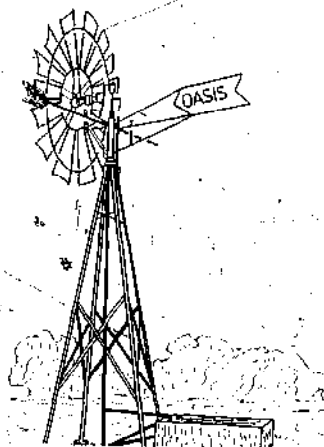

Oasis Windmill

**SOUTHERN STEEL  
 WORKS LTD.**  
 Ballyhale  
 Co. Kilkenny  
 Ireland

Phone: 056 28633

The Ballyhale range of windpumps is available as follows:

Model	Maximum hourly output*		Rotor diameter	
	(Galls)	(Litres)	(ft)	(m)
SS 1	300	1350	9	2.74
SS 2	800	3600	12	3.66
SS 3	1600	7200	15	4.57
SS 4	3000	13500	18	5.49

\*The head at which this output occurs was not stated in the manufacturer's literature.

A water storage tank of 1100 gallons (4950 litres) can be supplied if required. These windmills furl automatically in a windspeed of 25 m.p.h. (40km/h).



**REYMILL STEEL PRODUCTS** Phone: 641

Sta. Rosa  
Neuva Ecija  
Philippines

Manufacturers of locally designed and developed steel wind-pumper with built-in governing and braking system. Three sizes available as follows:

- Regular size: tower height 40-50ft windwheel diameter 10ft (3.05m)
- Medium size: tower height 40-50ft windwheel diameter 12ft (3.6m)
- Large size: tower height 40-50ft windwheel diameter 14ft (4.3m)

Pump stroke in all cases is 6 to 9 ins (150 to 225mm).

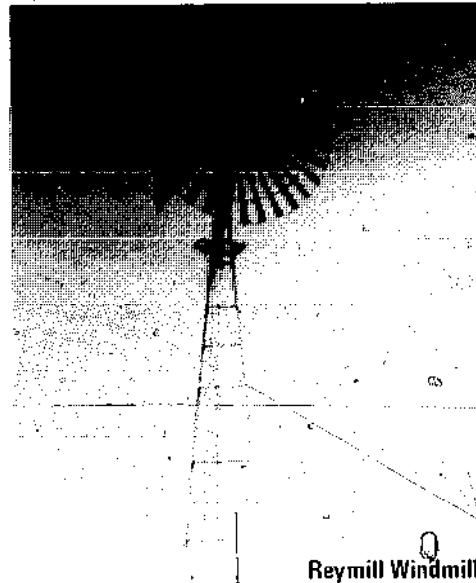

Reymill Windmill



S & L No.18 Windpump

**STEWARTS & LLOYDS**  
P.O. Box 74  
1930 Vereeniging  
South Africa

Telex: 8-0480  
Cables: Tubes Vereeniging  
Phone: (016) 45133

This manufacturer offers a range of six sizes of windpump incorporating modern, PTFE bearing, bushes. The largest machine, which is direct drive, requires no maintenance as it has sealed for life ball-bearings and PTFE self-lubricating bushes. The smaller machines require occasional oil changes for their gearboxes. Automatic furling in storms plus manual furling from ground level is provided. The following models are available:

Model	Rotor diameter		Pump stroke	Pump size	Head range	Flow range (max.)
	(ft)	(m)	(in)	(in)	(ft)*	(Imp.gall/hr)
6	6	1.83	5	1½ - 6	11 - 176	89 - 1430
8	8	2.44	5½	1½ - 6	13 - 209	83 - 1331
10	10	3.28	7	1½ - 8	12 - 396	75 - 2157
12	12	3.66	9¼	1½ - 12	10 - 522	118 - 5549
14	14	4.27	9¼	2¼ - 12	18 - 554	161 - 4582
18	18	5.49	6	2 - 6	92 - 882	138 - 1828

\*Note that the head range is for total head; the maximum depth of borehole is around two-thirds of the maximum total head given.

Basic 6m towers (20ft) can be extended to 9, 12 or 15m (30, 40 or 50ft).

**THAI U Sa INDUSTRIAL FACTORY**  
No. 5g/15 M007  
2 Pracharaj 2 Road  
Dusit  
Bangkok  
Thailand

Phone: 585 2560  
585 4815

Manufacturers of a range of direct drive, locally designed, multi-bladed water pumpers of relatively low cost.

Rotor dia.		Tower height		Pump dia.		Output per hour*	
(ft)	(m)	(ft)	(m)	(in)	(mm)	(Imp. galls)	(litres)
6	1.82	40	12	2.5	63	267	1200
8	2.44	40	12	2.75	70	356	1600
10	3.05	40	12	3.0	76	444	2000
12	3.66	40	12	4.5	114	667	3000
14	4.27	40	12	5.0	127	888	4000

\*Output in windspeed 10km/h (6 m.p.h.) for unspecified lift:



Thai Windpump Installation

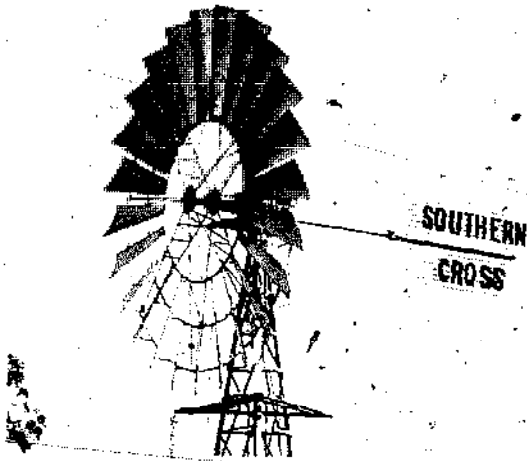

Southern Cross Wind Pump

**TOOWOOMBA FOUNDRY**  
 PTY Ltd  
 259 Ruthven Street  
 Toowoomba  
 Australia 4350

Telex: 40046  
 Cables: Foundfact  
 Phone: 32 3122

Toowoomba Foundry products under the "Southern Cross" tradename are widely known in Australia; other than windmills they include a very wide product range covering diesel engines, turbine and other pumps, irrigation machines, sprinklers, storage tanks, towers and aerial masts, etc. There are two ranges of windmills, the smaller, geared "IZ Pattern" and the larger, direct-drive "Seneschal". The following tables illustrate their performance according to the manufacturer in winds of 18 m.p.h. (29km/h). In winds of 12-16 m.p.h. (approx. 21km/h) the outputs would be reduced by 25% and in light winds of 8-10 m.p.h. (approx. 14km/h) the outputs would be reduced by about 50%.

Choice of pump cylinder diameter for various lifts and resulting flows

Size Mill		1 1/2 in.	2 in.	2 1/2 in.	2 3/4 in.	3 in.	3 1/2 in.	3 3/4 in.	4 in.	4 1/2 in.	4 3/4 in.	5 in.	6 in.	8 in.	
6ft. "IZ"	Total lift in feet	73	60	51	43	37	32	27	24	19	17	15	12		
	Gallons per hour	90	120	155	180	230	275	320	370	485	545	610	755		
8ft. "IZ"	Total lift in feet	132	109	92	77	66	57	50	44	34	31	28	23	16	
	Gallons per hour	100	120	170	210	250	300	350	405	530	600	670	830	1200	
10ft. "IZ"	Total lift in feet	236	197	166	141	121	105	92	81	64	57	51	42	30	
	Gallons per hour	100	125	160	200	240	290	340	390	510	580	650	800	1150	
12ft. "IZ"	Total lift in feet	315	263	222	189	162	140	123	108	85	78	68	56	40	23
	Gallons per hour	105	140	175	215	260	310	365	420	550	620	695	860	1240	2200
14ft. "IZ"	Total lift in feet	443	370	312	265	228	197	172	151	119	107	96	79	56	32
	Gallons per hour	90	120	150	185	225	260	305	360	460	520	590	720	1040	1880

Size Mill	"Seneschal"	1 1/2"	2"	2 1/2"	2 3/4"	3"	3 1/2"	4"	4 1/2"	5"	6"	8"	10"	12"	14"		
17ft. "R"	Total lift in feet	480	415	360	315	275	240	205	175	135	120	105	85	60	34	-	
7in. Stroke	Galls. per hour	170	220	280	350	420	500	590	685	895	1010	1130	1400	2000	3600	-	
17ft. "R"	Total lift in feet	420	360	310	270	240	210	180	155	120	105	95	75	53	30	-	
8in. Stroke	Galls. per hour	195	255	320	400	480	575	675	780	1020	1150	1290	1600	2300	4080	-	
21ft. "R"	Total lift in feet	-	-	575	500	440	390	345	310	240	210	190	155	105	60	38	27
8 1/2 in. Stroke	Galls. per hour	-	-	270	330	400	480	560	650	850	960	1080	1330	1920	3400	5320	7660
21ft. "R"	Total lift in feet	-	-	470	410	360	320	285	250	200	175	155	125	88	50	32	22
10in. Stroke	Galls. per hour	-	-	325	405	490	580	680	790	1030	1165	1310	1615	2320	4120	6440	9300
25ft. "R"	Total lift in feet	-	-	710	635	575	515	460	350	310	280	225	155	88	55	39	28
9 1/2 in. Stroke	Galls. per hour	-	-	320	390	465	545	630	825	930	1045	1290	1860	3300	5160	7440	10200
28ft. "R"	Total lift in feet	-	-	530	475	425	385	350	280	245	220	180	125	70	45	31	23
12in. Stroke	Galls. per hour	-	-	410	490	590	690	800	1045	1180	1320	1630	2350	4180	6520	9400	12900

**WINDPUMPEN-ZENTRALE** Phone: (04351)  
 Luetthoern 51 42024  
 D 2330 Eckernfoerde  
 West Germany

"Pumpomat Windpumpen" is a series of unconventional paddle-bladed windpumps with an unusual governing system for water pumping windmills of variable pitch blades on smaller models and a vertical windvane which applies a brake on the large ones.

Model No.	Rotor diameter	No. of blades	Water head	Nominal output
1, 2	n/a	2	4m	200 l/hr
3	n/a	2	10m	180 l/hr
11, 22	n/a	4	4m	500 l/hr
33	n/a	4	10m	280 l/hr
44	n/a	4	16m	200 l/hr
55	n/a	4	22m	200 l/hr
111, 222	n/a	6	4m	750 l/hr
333	n/a	6	10m	300 l/hr
444	n/a	6	16m	300 l/hr
P360	2.5m	4	3.5m	10000 l/hr
P500	n/a	n/a	3.5m	30000 l/hr

Most of these pumps are intended for low lifts and there is a choice of diaphragm or piston pump with most models.

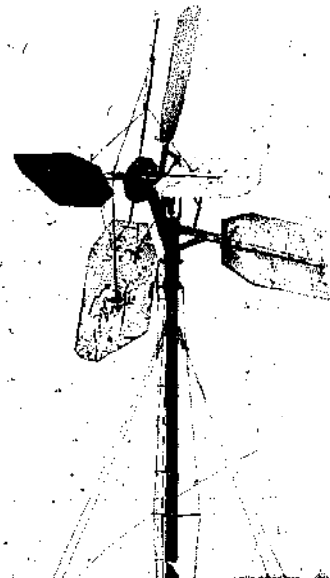

Pumpomat P360 Windmill

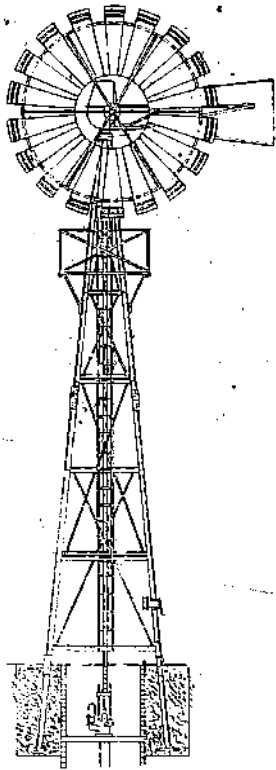

Climax Wind Pump

WYATT BROTHERS  
(WHITCHURCH) LTD  
Wayland Works  
Whitchurch  
Salop ST13 1RS  
U.K.

Phone: (0948)  
2526-7

Wyatt Bros. manufacture the "Climax" range of windmills, pumps and well-heads. The windmills are conventional geared farm machines with automatic and manual furling and wheel sizes available from 6ft to 18ft (1.83 to 5.49m). The following table outlines their performance in a "good wind of 20-22 m.p.h." and in a 12 m.p.h. wind the manufacturer states that these figures will be reduced to about 65% of those indicated. A rule of thumb recommended for assessing daily output is to assume 65% of the figures indicated for 10 hours per day. The output is given in Imperial gallons = 4.5 litres or 1.2 U.S. gallons.

Size of mill	Strokes per minute	Cylinder dia. (inches) and Actual gallons per hour	Total head in feet												
			10	50	75	100	125	150	175	200	250	300	350	400	
6ft	45	Cylinder g.p.h. @ 5" stroke	3¾	2½	2	1¾	—	—	—	—	—	—	—	—	—
		Cylinder g.p.h. @ 5" stroke	420	250	155	120	—	—	—	—	—	—	—	—	—
8ft	42	Cylinder g.p.h. @ 5" stroke	3¾	3¾	2¾	2¾	2	—	—	—	—	—	—	—	
		Cylinder g.p.h. @ 7" stroke	500	380	275	182	145	—	—	—	—	—	—	—	
10ft	37	Cylinder g.p.h. @ 8" stroke	4¾	3¾	2¾	2¾	2¾	2	1¾	1¾	—	—	—	—	
		Cylinder g.p.h. @ 9" stroke	800	530	337	275	228	177	138	138	—	—	—	—	
12ft	31	Cylinder g.p.h. @ 10" stroke	7	5	4	3¾	3¾	3	2¾	2¾	2¾	2	1¾	—	
		Cylinder g.p.h. @ 11" stroke	2260	1150	750	625	555	412	360	285	240	187	144	—	
14ft	29	Cylinder g.p.h. @ 11" stroke	8	6½	5	4¾	4	3¾	3¾	3	2¾	2¾	2	—	
		Cylinder g.p.h. @ 13" stroke	3115	1980	1210	980	780	600	510	410	372	250	200	—	
16ft	21	Cylinder g.p.h. @ 12" stroke	12	8	7½	6	5½	5	4¾	4	3¾	3¾	3	2¾	
		Cylinder g.p.h. @ 15" stroke	5400	2400	2125	1330	1120	930	855	600	525	392	336	284	
18ft	17	Cylinder g.p.h. @ 12" stroke	15	12	10	8	7	5¾	5¾	4¾	4¾	3¾	3¾	3¾	
		Cylinder g.p.h. @ 15" stroke	6800	4360	3000	1920	1480	1000	920	665	544	425	368	320	

Galvanized steel towers to carry "Climax" windmills are supplied in heights from 15 feet to 60 feet in multiples of 5 feet.



WAKES & LAMB LTD  
Millgate Works  
Newark-on-Trent  
Notts NG24 4XB  
U.K.

Phone: (0636) 4464

Manufacture the Newark series of conventional farm water pumping windmills with rotor sizes from 8ft (2.44m) up to 16ft (4.88m). Output range for the series is quoted as 475 gall/hr (2137 l/h) up to 2720 gall/hr (12,240 l/h) at an unspecified wind.

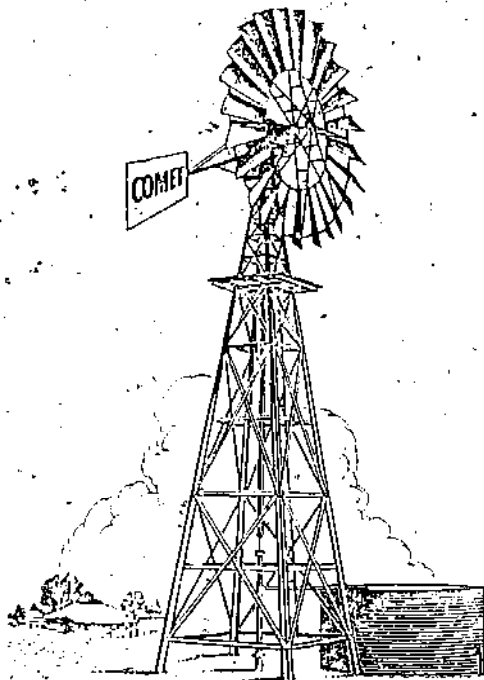

**SIDNEY WILLIAMS & CO.**  
**(PTY) LTD**  
P.O. Box 22  
Dulwich Hill  
New South Wales  
Australia 2203

Phone: 56 2491

Manufacturers of the "Comet" range of Windmills from 8ft to 35ft diameter mounted on towers of 20ft to 60ft height. The manufacturers say these units are of a well tried design and will pump water with a minimum of maintenance for many years.

The larger "Comet" sizes are believed to be the largest water-pumping windmills currently available anywhere.

#### Comet Windmill

**MÁQUINAS AGRÍCOLAS  
FORTUNA LTDA**  
Divisão International  
Rua João Adolfo, 118  
conj. 710/711  
C.E.P. 01050  
São Paulo  
Brasil

Phone: 36-5160/  
4497  
Telex: OU 21724  
Cables: BR-Fortuna

Manufacturers of the 'Aerogerador' wind generator. This machine is rated at 20 amps, 40 volts. No further details were available at press date.



**Aerogerador Wind Generator**



# 3

## Water Power

HYDRO-ELECTRIC SYSTEMS  
HYDRO-MECHANICAL AND  
PUMPING SYSTEMS

### *Background*

Historically, water power was one of the first energy sources to be exploited by mankind. Water wheels and crude, wooden, vertical-axis Norse or bucket turbines have been in use in many parts of Europe and Asia since long before the Industrial Revolution, (and 2000 years or more in some places). By the time of the Industrial Revolution, water-wheel technology had been developed to a fine art and efficiencies approaching 70% were being achieved from the best machines.

Improved metallurgical skills, the need for higher-speed devices in order to generate electricity and a better understanding of fluid flow led to the development of turbines during the nineteenth century, which gradually supplanted the water wheel. Up until the 1930s, small water turbines were quite extensively used both in the developed and in the developing world to provide electrical power for places remote from a main electricity grid. However, the more developed industrial countries extended their electricity grids during the subsequent period and set an impossible example for larger, poorer and less densely populated countries to follow. As a result, low-cost mains electricity (usually heavily subsidised in the remoter extremities of the grid) pushed hydro-electric technology development towards large multi-megawatt systems designed to feed the new national grids. Most of the manufacturers of small turbines, faced with a contracting market for their wares, either went out of business or turned to pump manufacturing instead. So small turbine design remained substantially frozen at the 1930s level of advance until quite recently, when rapidly increasing fossil fuel costs created a new interest in such renewable energy sources as water power.

### *Current developments*

Within the last few years, the few surviving manufacturers of small turbines have in many cases taken a new interest in what had generally become a minor sideline, while a number of new small turbine building enterprises are appearing, often utilising electronic controllers to obtain a great saving in cost combined with an improvement in reliability compared with the traditional hydro-mechanical governing of the 1930s and before.

The great attractions of hydro-power are:-

- i. it is generally continuously available
- ii. given a reasonable head, it is a concentrated energy source
- iii. the available energy is readily predictable
- iv. water-powered machines can be extremely cost-effective in the sense that they:-
  - a. have a high power/weight ratio (i.e. power/cost ratio)
  - b. have long working lives
  - c. require little maintenance and have low running costs.

Against this are the disadvantages:-

- i. suitable sites where a useful head of water can be engineered economically are not very common (although very many suitable sites are not being used).
- ii. there is always a maximum power output available from a given site which limits further expansion of energy-consuming activities in the area.

The one example of a country which has set out to exploit as many as possible of its potential small-scale hydro-power sites in recent years is the People's Republic of China. Not only have the conventional large-scale grid-feeding hydro-projects common in other countries been

implemented, but a very extensive small-scale hydro-electric programme has been set up. In 1949 there were only 50 small hydro-stations in China with a combined capacity of 5.6MW. Extensive river surveying was initiated in the mid 1950s, and the first major power station building programme began during the Great Leap Forward which fell short of its target but resulted in about 4500 small plants with a total capacity of the order of 200MW by 1959. This may seem a remarkable increase in ten years, but the period since is even more spectacular, as according to the New China News Agency there were some 60,000 small hydro-electric stations completed in China by 1975 (20,000 in the Yangtse basin alone). The average output of these stations is 36kW and total capacity of the small hydro-stations by 1973 was of the order of 1800MW. Small Chinese power plants are based on 1930s European designs, but have been refined to suit Chinese conditions. Chinese turbines do not as yet appear to be generally available on the international market (mainly because there has been little demand), but details will be given in future editions if this situation changes.

According to V. Smil writing in the journal *Water Power and Dam Construction* in March 1976 . . . "the well established guidelines for China's water power development — build large, medium and small plants simultaneously and most of them should be small and medium sized ones — will certainly continue to be implemented in the future. Small stations requiring limited investments operating at a low cost and yielding quick returns seem to be, when developed with a modicum of planning and staffed with trained personnel, a very sensible acquisition for a vast, overwhelmingly rural and relatively poor developing country."

Recognising the utility of small scale hydro-electric power in many of the hillier regions of the world (which are so often less developed than the more populated low lands), ITDG is working on a small turbine development programme in conjunction with Evans Engineering Ltd and Leisure Services Ltd., (see the following section), as described in more detail in Section 9.

Farmers and others in the more remote parts of the UK, USA and other industrial countries are coming to similar conclusions as a result of a great increase in diesel generation costs combined with the reduction or withdrawal of subsidies for mains connections coupled with greatly increased costs per kWh of electricity. As a result there is a great revival of interest in small-scale water power and many formerly disused water mill sites in the UK and other industrial countries are being investigated by their owners for possible small-turbine installations. Naturally, planners and others concerned with providing energy in the developing world are also interested in this possibility and it is hoped that the manufacturers listed in this section may be able to help satisfy this demand.

#### *Water power sites and equipment*

Virtually all water power applications depend on a head of water falling to a lower level. Figure 1 is a chart showing the power available (assuming a conversion efficiency of 70%) for a range of heads and flow rates. The greater the head the less the flow required for a given output, and vice-versa. The chart can be used to indicate the potential of a given site, although different efficiencies will effectively raise or lower the output proportionately (60% would yield 6/7 of the power indicated).

For various reasons, different types of equipment are needed to cope with different heads and end-uses of the mechanical power. Water wheels are obviously restricted to heads of half the diameter for undershot, or equal to the diameter for overshot while different types of turbine are best suited to different head ranges.

Low head turbines are generally of the propeller type and high head devices are usually impulse turbines such as the Pelton or similar Turgo wheel. The traditional medium head turbine, (still used on large-scale applications) is the Francis turbine, but its complex shape is very expensive to reproduce under modern conditions as a casting, so the Mitchell alias Crossflow alias Banki turbine (see the Ossberger-Turbinenfabrik turbine entry, which is slightly less efficient, is becoming popular for medium heads as it lends itself to fabrication from standard steel stock. However, propeller turbines and Pelton wheels can also be used for medium heads, although the former tend to run faster than is convenient while the latter can need multiple nozzles to make use of the full flow.

Water wheels turn relatively slowly and are therefore unsuitable for use with standard electricity generators requiring rotational speeds of 1500 r.p.m. or more. Gearing can be used (or belts or chains) to step the speed up, but the very high torque in the low speed end of the train requires large and expensive transmission components unless a rim drive is used. The water wheel is also extremely heavy and material-intensive in terms of its output, and requires a large and expensive shaft and bearings to cope with its high weight and torque. However it is still valuable for applications such as milling or driving low speed machinery via a belt and pulleys. Hydraulic transmission (using oil or water) may be another modern option in conjunction with a water wheel to achieve a higher speed step-up.

One of the main advantages of small-scale electricity generation is that it can involve the minimum of transmission and control equipment, by generating electricity at the voltage it is to be used at near to the point of use. Control may be by manual adjustment in response to the reading of a voltmeter or automatic control can be achieved by a mechanical/hydraulic governor or by an electronic "black box". The latter is a very cost-effective and reliable modern development that has only recently been possible with the advent of thyristors (see Evans Engineering's entry).

Another use for water power is to pump a small amount of water to a higher level, so that a hillside may be cultivated, or a village at a high level might have an on-the-spot piped water supply or a watering point might be provided for grazing animals. The traditional and simplest solution to this problem is to use a ram pump or hydram, several of which are included later in this section; a device such as this induces a water hammer effect caused by the sudden closure of an automatic clack valve and the sudden rise in pressure so caused forces a small proportion of the water flowing through it to a considerable height, (typically up to 40 times the supply head). However the greater the ratio of supply head to delivery head, the smaller the volume of water delivered. Hydrams need little attention and have extremely long useful lives, having only a single moving component, the clack valve. Turbines can also be used to pump water, and the Plata Pump (included) is a unique device specially developed for this purpose, which can operate at a very low head.

There are many places with fast flowing rivers but where no head can conveniently be engineered (since damming the river would be too great an expense or the hydraulic gradient is inadequate to allow a head to be contoured). As a result the Intermediate Technology Development Group is developing a turbine that is mounted on a floating pontoon and operates submerged in a stream at zero-head. This is a kinetic energy converter analogous to a submarine windmill (see also Section 9) for further details of the ITDG project). We expect our device and others will become available for widespread use within the

next five years and that this will permit river energy to be tapped at very many more points than are possible at present. It may also become economic to apply this principle to tap the energy of marine coastal currents

and tidal currents. At the moment the only commercial system of this kind is the Aquadyn (see the Natural Energy Centre entry).

Figure 1 Flow and head requirements for various power outputs at a conversion efficiency of 70%

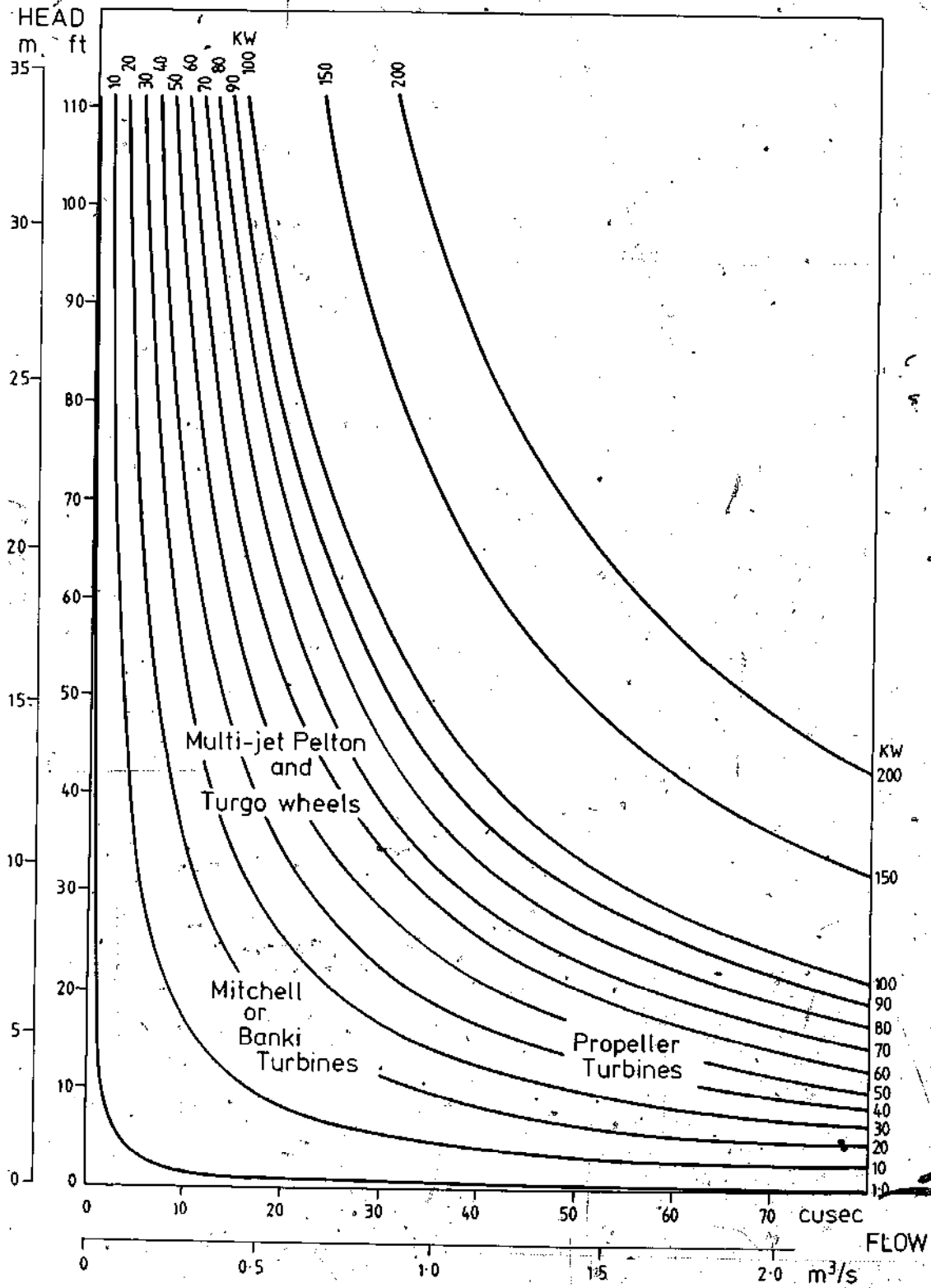

# Hydro-electric Systems

**ALLIS-CHALMERS**  
 Hydro-Turbine Division  
 Box 712  
 York  
 Pennsylvania 17405  
 U.S.A.

Phone: 717 792 3511

Manufacture a range of standardised hydroelectric generating units, all intended for use with heads of up to 15m (50ft). All units are horizontal shaft propeller turbines and outputs of from 50 to 50,000kW can be catered for. Obviously all but the smaller systems in this range are outside the general power range considered by this Guide, so only the smallest models in this range of ten sizes are included (the remaining sizes go up to 3000mm Ø).

For these models the following parameters apply (approx. figures).

Runner diameter	Head range	Flow range	Power range
750mm	2-15m	2-3.5m <sup>3</sup> /s	30- 400kW
1000mm	2-15m	3-6 m <sup>3</sup> /s	50- 700kW
1250mm	2-15m	5-9 m <sup>3</sup> /s	80-1000kW

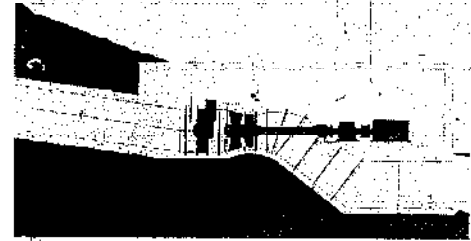

Allis-Chalmers Generating Unit

**AB BOFORS-NOHAB**  
 S-46101 Trollhättan  
 Sweden

Telex: 42084  
 Cables: Nohab  
 Phone: 0520 18000

A range of horizontal and vertical turbines with power outputs ranging from 100kW to 2000kW. Runner diameters vary between 700mm and 2000mm for heads from 5m to 25m. Units are supplied complete with alternator and switch gear.

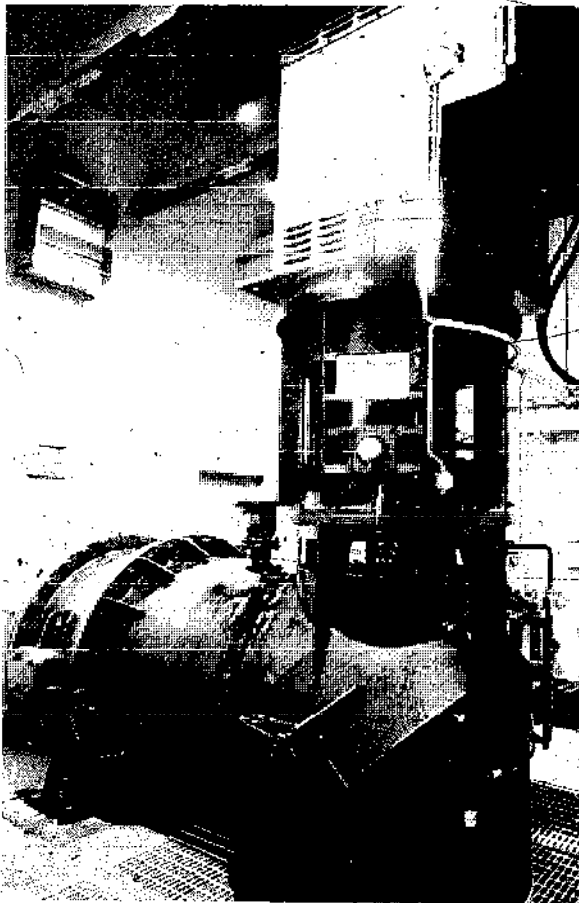

68 Bofors Vertical Shaft Turbine

**BRIAU S.A.**  
 B.P. 43  
 37009 Tours Cedex,  
 France

Telex: 750729 F  
 Phone: (47) 61 38 17

Manufacture a packaged low head turbine/generator system with outputs in the range 4 to 50kVA. Either Francis or Propeller type runners are used, depending on head.

Performance envelope as follows:

Heads: from 2 to 20m (6 to 60ft)

Flows: from 200 to 4000 l/s (7 to 140ft<sup>3</sup>/s)

They quote a rule of thumb for estimating the power of their system as follows:

$$P(\text{kW}) = \frac{5.5}{1000} Q (\text{l/s}) \cdot H (\text{m})$$

A self-regulating brushless alternator is used, three-phase with output at 500V at a choice of 50 or 60Hz.

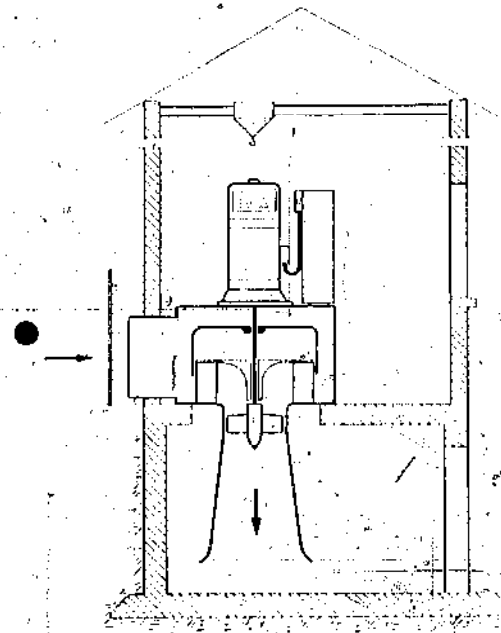

Briau Hydro Electric Unit

**CANYON INDUSTRIES**  
 5346 Mosquito Lake Road  
 Deming  
 Washington 98244  
 U.S.A.

Manufacture a miniature low head package turbine system called "Hydromite". The turbine and generator are integrated and designed for easy connection to a 4in (100mm) PVC/ABS standard plastic pipeline.

The output is at low voltage and can be used in conjunction with a storage battery bank. The performance envelope lies within the following limits:

Head: 8 to 34ft (2.4 to 10.4m)  
 Flow: 22 to 34ft<sup>3</sup>/min (0.6 to 1m<sup>3</sup>/min)  
 Power: 50 to 750 watts

The system is so small that its shipping weight is only 48lb (22kg).



**Hydromite W/55 Amp Alternator**

**DREES & Co. GmbH**  
 4760 Werl/Westf.  
 Postfach 43  
 Germany

Telex: 8 421 404  
 dres d  
 Cables: Dreesco  
 Werl  
 Phone: 02922  
 5071/72

Manufacturers of a range of hydro-electric systems from small micro plants to full size hydro-electric stations. The range includes Kaplan turbines, Francis Spiral turbines, and Pelton turbines.

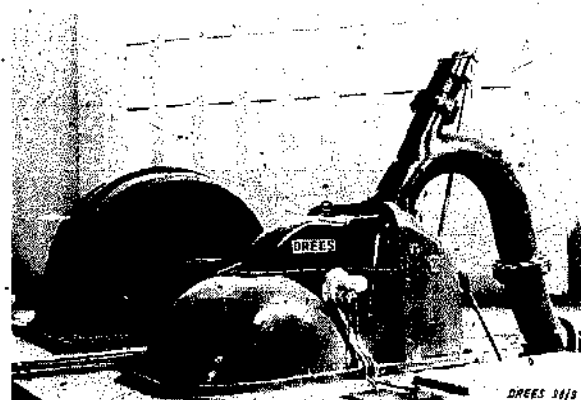

**Pelton Wheel Installation**

**GILBERT GILKES & GORDON** Telex: 65125  
 LTD Cables: Gilkes  
 Kendal Kendal  
 Cumbria LA9 7BZ Phone: 0539-20028  
 U.K.

Long established manufacturers (over 100 years) of a wide range of different types of turbine.

*'Hydec' Range*

Small relatively low-cost, one or two jet Turgo impulse wheel with belt driven governor:

Net head: 30 to 300ft (10 to 100m)  
 Output (shaft): 10 to 200 b.h.p.  
 Nominal electrical outputs: 10, 25 and 50kW

*Spiral cased Francis turbines for small outputs*

This series are usually fitted with oil pressure governors to adjust the ring of gates built into the turbine casing.

Power range: 100 to 150 b.h.p.  
 Heads: 25 to 200ft (7.5 to 60m)

*Open type Francis turbines*

This series is usually fitted with oil pressure governors to vanes surrounding the runner. Runner sizes vary from 6in (150mm) up to 60in (1500mm).

*Pelton Wheels and water motors*

A wide selection of Pelton wheels is available, the smaller sizes being generally intended for use in water motors for use from ship's pressure mains (Butterworth line).

Water motors based on Pelton, Turgo, Francis and Propeller runners are available designed to operate at water pressures from 30lb/in<sup>2</sup> (2 bar) up to 150lb/in<sup>2</sup> (10 bar). The Axial Flow (propeller) motors operate at low pressures of 1lb/in<sup>2</sup> (0.1 bar) up to 13lb/in<sup>2</sup> (0.9 bar); all these pressures being "gauge" pressures.

The power range covered by the various water motors over their permissible pressure range is from 0.1 up to 42 b.h.p. (0.1 to 29kW). Obviously water motors could be applied for electricity generation.

*Larger turbines*

A comprehensive selection of large turbines with multi-megawatt capability is also available from this manufacturer.



**Gilkes "Hydec" Impulse Water Wheel Installation**

**INDEPENDENT POWER DEVELOPERS INC.**  
 Box 1467  
 Noxon  
 Montana 59853  
 U.S.A.

Phone: 406 847 2315

Manufacturers of a range of small turbines, and distributors of a variety of other small-scale power equipment including Dunlite wind generators storage batteries and inverters.

Two types of turbine are offered, a high head 3hp maximum Pelton wheel (min. head 60ft or 20m) and a low head 6hp maximum propeller turbine for heads from 5ft to 60ft (2m to 20m). Both are quite small units with direct coupled 32V generators. The system is intended for use in conjunction with a battery bank and inverter to provide considerably higher peak power surges than the generator can provide on its own; for example a peak output of 3kW, 6kW, 9kW, or 12kW can be provided by units rated for continuous outputs of 300W, 700W, 1700W and 8500W respectively. Monthly outputs from these systems would be 200kWh, 500kWh, 1200kWh, and 6000kWh respectively.

The output is converted from 32V d.c. to 115V, 60Hz a.c. by an inverter.

The system is made to high specifications and comes with a two year warranty.

I.P.D. also offer custom designed larger systems using Pelton wheels with outputs up to as much as 1000 b.h.p.



I.P.D. Impulse Turbine.

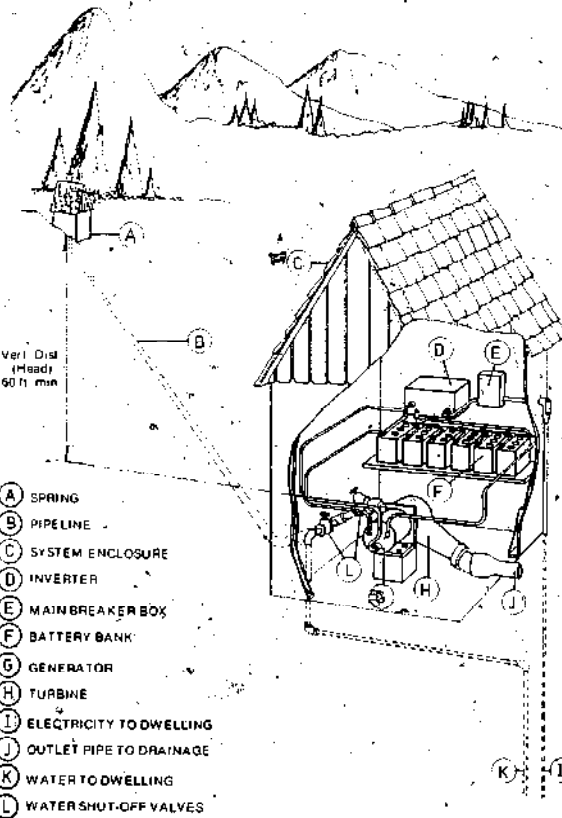

- (A) SPRING
- (B) PIPELINE
- (C) SYSTEM ENCLOSURE
- (D) INVERTER
- (E) MAIN BREAKER BOX
- (F) BATTERY BANK
- (G) GENERATOR
- (H) TURBINE
- (I) ELECTRICITY TO DWELLING
- (J) OUTLET PIPE TO DRAINAGE
- (K) WATER TO DWELLING
- (L) WATER SHUT-OFF VALVES

I.P.D. Hydroelectric Installation

**Performance details**  
 (Selected heads showing min. and max. flow)

Head ft	m	Flow		Continuous power W	Monthly power kWh/ month	Model
		gall/min	m <sup>3</sup> /hr			
46	14	15	4.1	102	74	4P MA
80	24	10	2.7	119	86	..
80	24	25	6.8	301	216	..
103	31	11	3.0	168	120	..
103	31	27	7.4	417	300	..
161	49	34	1.1	100	72	..
161	49	54	9.3	826	594	..
184	56	4	1.1	109	79	4P SA
184	56	37	10.1	1015	730	..
230	70	5	1.4	172	123	..
230	70	43	11.7	1484	1168	..
288	88	6	1.6	258	185	..
288	88	46	12.5	1981	1426	..

**ELEKTRO GMBH**  
 St Gallerstrasse 27  
 8400 Winterthur  
 Switzerland.

Telex: 76-299 Elektro

Model	Type of Turbine	Head	Flow	Generator
222	Pelton turbine	20-70m	0.5-2 /sec	W50 50 to 400 W
222	Pelton turbine	40-120m	1-3 /sec	W250 200 to 1500 W
Bu 242	Francis turbine	8-20m	10-30 l/sec	U286 500 to 2000 W
542,548	Pelton turbine	100-200m	15-30 l/sec	258 10 to 25W

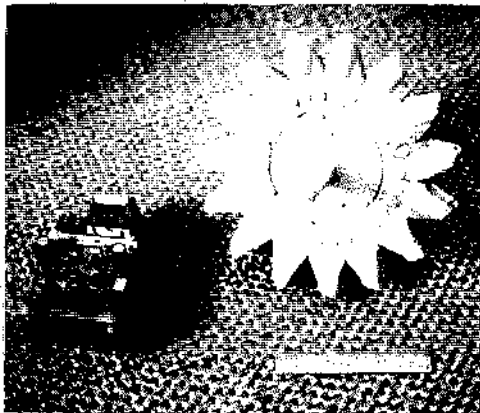

**Pelton Wheel and Electronic Controller**

**EVANS ENGINEERING**  
 Land & Leisure (Services) Ltd  
 Priory Lane  
 St. Thomas  
 Launceston PL15 8DQ  
 Cornwall  
 U.K.

Phone: 0566 3982

This company acts as building contractors for micro-hydro stations in the U.K. and as consultants to the Intermediate Technology Development Group (see Section 9).

Products offered are:

1. Simple bare-shaft turbines of up to 5 b.h.p.
2. Packaged reaction and impulse turbines with brushless alternators and completely electronic controllers of up to 100kW.
3. Electronic control units applicable to any other turbine using the load control concept (involving a ballast circuit).
4. Instrument and control panels made to order.
5. Simple and duplex hydraulic rams (Hydrams) for pumping water.
6. Plywood/GRP tanks, sluice units; etc.
7. Reconditioned second-hand turbines of various sizes.

**JYOTI LIMITED**  
 Industrial Area  
 P.O. Chemical Industries  
 Baroda 390 003  
 India

Telex: 0175-214  
 Cables: Jyotipumps  
 Phone: 8352/8641

A range of turbines suitable for generating power from 25kW to 100kW where medium heads are available. The group also produces larger units for higher head installations.

**5kW Micro-Hydel Units** (Francis turbine vertical shaft)

Head	Flow
3m (10ft)	205 l/s (7.25ft <sup>3</sup> /s)
6m (20ft)	150 l/s (5.28ft <sup>3</sup> /s)
9m (30ft)	93 l/s (3.28ft <sup>3</sup> /s)
12m (40ft)	73 l/s (2.6ft <sup>3</sup> /s)

**10kW Micro-Hydel Units** (Francis turbine vertical shaft)

6m (20ft)	256 l/s (9.05ft <sup>3</sup> /s)
9m (30ft)	170 l/s (6.0ft <sup>3</sup> /s)
12m (40ft)	133 l/s (4.69ft <sup>3</sup> /s)

**25kW Micro-Hydel Units** (Turgo type impulse wheel, horizontal shaft)

60m (197ft)	70 l/s (2.5ft <sup>3</sup> /s)
130m (425ft)	31 l/s (1.1ft <sup>3</sup> /s)

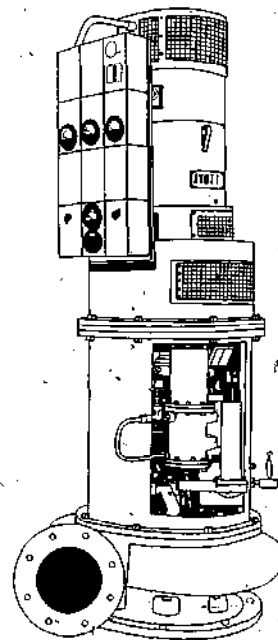

**Micro-hydel Units**

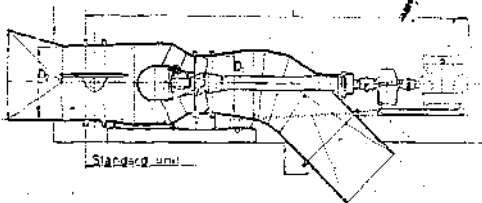

**Type SH Water Turbine**

**KARLSTADS MEKANISKA  
 WERKSTAD**  
 Fack. S-681 01  
 Kristinehamn  
 Sweden

Telex: 66050 Kmwksn S  
 Cables: Verkstaden  
 Kristinehamn  
 Phone: 0550 15200

Manufacturers of a range of turbines from micro to large multi-megawatt units. The small systems consist of propeller turbines available for either vertical or horizontal shaft installation as follows:

Runner diameters	= 0.7, 0.9, 1.15 and 1.5m
Heads	= 4 to 25m
Flow rates	= 1 to 15m <sup>3</sup> /s
Outputs	= 50 to 1800kW

These units generally are supplied to feed a larger grid system through an a.c. asynchronous generator and therefore are non-adjustable but a version with adjustable blades controlled by the upstream water level is also available.

**JAMES LEFFEL & COMPANY**  
**Springfield**  
**Ohio 45501**  
**U.S.A.**

Cables: Leffel Springfield Ohio  
 Phone: 513 323 6431

Long-established manufacturers of water turbines (since 1862). Current production ranges from units having outputs of 5000hp down to quite small machines coming within the scope of this guide. The main small machines are the Hoppes hydro-electric system, the Samson turbine and a very small unit intended for laboratory use with either a miniature Francis or a propeller runner.

*Hoppes Hydro-electric Units (integral turbine and generator sets)*

Nominal elect. power output	Minimum head & corres. flow	Maximum head & corres. flow	Penstock diameter for flow range
0.5kW (d.c. only)	8ft 104cfm	12ft 68cfm	12in to 6in
1.0kW	8 190	25 68	12 6
2.0kW	8 330	25 110	16 6
3.0kW	8 470	25 158	18 10
5.0kW	8 760	25 260	20 12
7.5kW	11 800	25 380	20 16
10.0kW	12 980	25 480	20 16

Standard electrical rating is 3-phase, 60Hz at 120, 240, or 480V but also available at 50Hz.

*Improved Vertical Sampson Turbine (turbine supplied with vertical shaft)*

Model	Min. head & corres. power flow-rate & speed				Max. head & corres. power flow-rate & speed				Penstock dia.
	ft	hp	cfm	rpm	ft	hp	cfm	rpm	
17E	3	1.1	252	161	26	29.5	741	474	24in
17D	3	1.5	328	161	26	38.5	967	474	26
17C	3	2.0	433	161	26	50.7	1273	474	28
17B	3	2.4	533	161	26	62.6	1571	474	30
17A	3	3.2	697	161	26	81.8	2053	474	36
20	3	4.2	914	140	26	107.0	2691	415	42
23	3	5.5	1209	127	26	141.0	3559	361	48
26	3	7.1	1545	108	26	180.0	4549	319	54
30	3	9.4	2057	94	26	241.0	6056	276	60
35	3	12.8	2789	81	26	327.0	8210	237	72
40	3	16.8	3657	70	26	428.0	10767	207	84
45	3	21.2	4629	63	26	542	13626	184	96
50	3	26.2	5714	56	26	669	16822	166	108
56	3	32.9	7168	50	26	839	21102	148	120
62	3	40.3	8787	45	26	1030	25868	134	
68	3	48.5	10570	41	26	1238	31115	122	
74	3	57.5	12517	38	26	1466	36848	112	

*Laboratory Model Hydraulic Turbines*

Turbine Model No 4W supplied with a 4in Francis and 4in propeller runner,

Head (ft)	hp	rpm	Discharge cu. ft. sec.
5	.29	990	.685
7	.50	1170	.810
10	.83	1390	.972
12	1.10	1530	1.050
15	1.50	1712	1.160
17	1.81	1822	1.230
20	2.34	1977	1.325

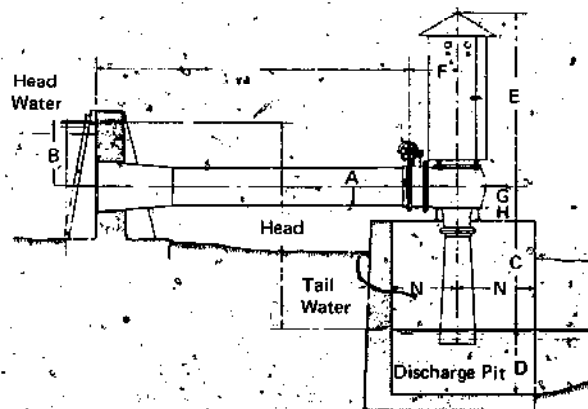

**Leffel Turbine**



**MASCHINENFABRIK  
KÖSSLER GmbH**  
A-3151 St. Polten  
St. Georgen  
Austria

Telex: 015652  
Cables: Turbinekossler  
Phone: (0 27 46) 82 72

Manufacturers of two types of small scale hydro-electric sets, one with a horizontal shaft and the other with a vertical shaft configuration. Both systems are fully integrated generating systems. Outputs vary from 12kVA at 20m head and 70 l/s flow up to 1250kVA at 100m head and 1270 l/s flow. Outputs of 400/231V 50Hz are normally supplied, but can be varied to order.

The company also designs/manufactures/install larger Impulse, Francis and Kaplan turbines of up to 50MW.

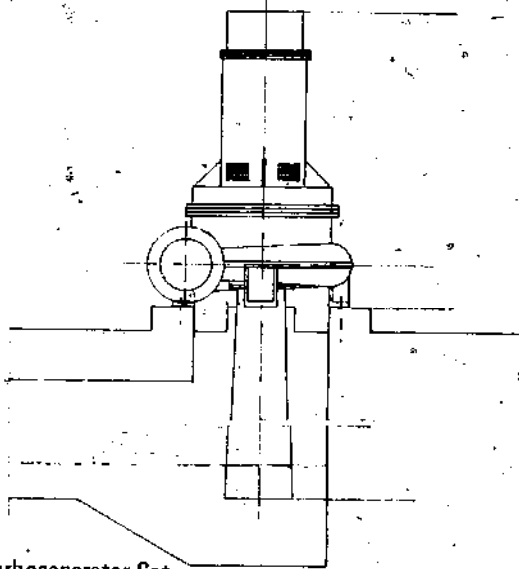

Turbogenerator Set

**SMALL HYDROELECTRIC SYSTEMS** Phone: 206 366 7203  
P.O. Box 124  
Custer  
Washington 98240  
U.S.A.

Supply small impulse (Pelton) hydro-electric systems producing 5kW to 25kW from heads of 50ft to 350ft. The turbines are fitted with a Lima brushless alternator mounted on top of the turbine casing.

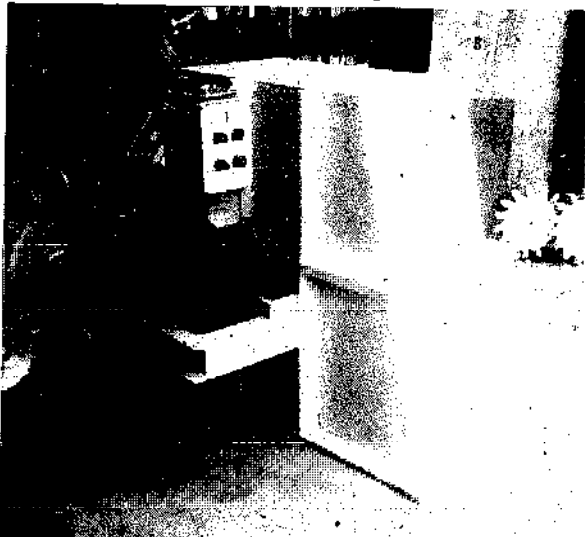

Peltex Unit

**THE NATURAL ENERGY CENTRE**  
161 Clarence Street  
Kingston upon Thames  
Surrey KT1 1QT  
U.K.

Telex: 21887  
MONCO G  
Phone: 01 549  
5888/9

Distributors of a variety of power producing equipment from numerous sources. A unique item is the Aquadyn 12V charger. This is a small electric generator designed for charging the batteries and running electrical systems on yachts and small boats; it is capable of continuously running a small refrigerator, an automatic pilot and for trickle charging batteries, running general lighting, etc.

Power is produced by a propeller which is immersed under the boat and which drives a generator using the kinetic energy of the passing water. It could equally be immersed in the current of a river or stream as a free-stream turbine.

The only maintenance required is one oil change annually. Weight is 20kg and output is 15 amp at 12 volt with a 5kt current.

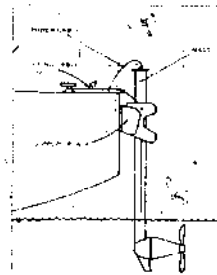

15 Amp/12V Aquadyn

**OSSBERGER-TURBINENFABRIK**  
D-8832 Weissenberg  
Postfach 425  
Bayern  
German Federal Republic

Telex: 06 24672  
Phone: 09141  
4091/2

Manufacturers of a range of Mitchell (Banki) cross-flow turbines. Units are self-contained, automatic, hydroelectric generating sets which only need be shut down once a year for an oil change and a grease. The units have automatically controlled output to cope with varying loads.

Power range = 1kW to 1000kW  
Head range = 10ft (3m) to 800ft (240m)  
Flow range = 1ft<sup>3</sup>/s (0.03m<sup>3</sup>/s) to 250ft<sup>3</sup>/s (7m<sup>3</sup>/s)

A questionnaire is available for prospective customers.

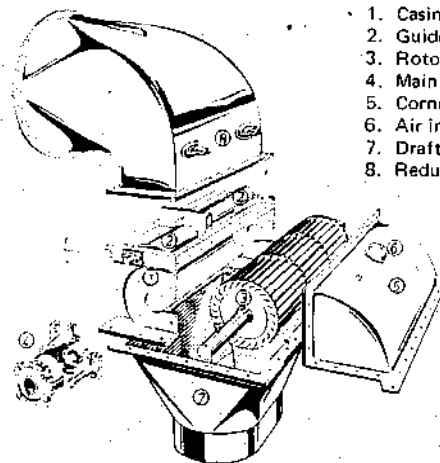

1. Casing
2. Guide vanes
3. Rotor
4. Main bearing
5. Corner casing
6. Air inlet valve
7. Draft tube
8. Reducer

Ossberger Turbine

**NORTHERN WATERPOWER  
INC**  
P.O. Box 49  
Harrisville  
New Hampshire 03450  
U.S.A.  
**NIAGARA WATERWHEELS  
LTD**  
706 East Main Street  
Welland  
Ontario L3B 3Y4  
Canada

Telex: 710 366  
6762  
Phone: 603 827  
3367  
  
Phone: 416 734,  
7418



**Northern Waterpower Turbine  
and Generator Set**

These two related companies supply six models of horizontal-axis axial flow propeller turbine package, with outputs in the 20 to 300kW range.

The turbines incorporate a high specific speed runner with an inlet butterfly valve which is normally hand operated (motor operation optional). Flow control is by radial guide vanes actuated by servo motor controlled either by electro-hydraulic speed sensing or by tachometer relay governing, (the latter being for use when paralleled with larger systems).

Typical performance envelope for these models is:-

Head range: 10 to 60ft      3 to 20m  
Flow range: 10 to 100ft<sup>3</sup>/s    0.3 to 3m<sup>3</sup>/s

Larger versions with outputs of up to 500kW at heads up to 30m are also available.

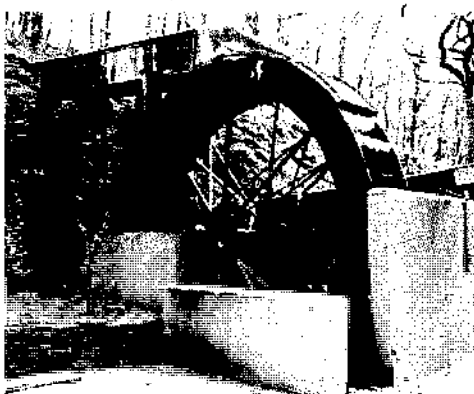

**16ft Wheel Producing 20 b.h.p.**

**WESTWARD MOULDINGS  
LTD**  
Greenhill Works  
Delaware Road  
Gunnislake  
Cornwall  
U.K.

Phone: Gunnislake (0822) 832120

Manufacturers of fibreglass water wheels to order. Units can be overshot or breast wheels with diameters of 8ft, 16ft, and 20ft. Wheels can be built to any width and can be shipped in sections and erected on site.

Typical power outputs as follows:

Diameter	Width	Nominal Power (max)
8ft (2.4m)	2.5ft (0.76m)	6 b.h.p.
16ft (4.8m)	3.0ft (0.91m)	25 b.h.p.
20ft (6.0m)	4.5ft (1.4m)	35 b.h.p.

## Hydro-Mechanical and Pumping Systems

**CECOCO CHUO BOEKI  
GOSHI KAISHA**  
P.O. Box 8  
Ibaraki  
Osakafu  
Japan 567

Cables: Cecoco Ibaraki  
Phone: (0726) (22) 2442-3

The Ce-Co-Co Hydro-Hi-Lift series of hydraulic ram pumps can lift water up to fifty times the head available from the driving water source. Minimum driving head of 0.5m is necessary.

Pump Type No.	No. 1	No. 2	No. 3	No. 4	No. 6	No. 8
Outputs at:						
4X drive head	10	22	38	85	200	400 l/min
8X drive head	5	11	20	43	100	200 l/min
15X drive head	2	5	9	23	55	100 l/min
Driving flow	25	60	150	300	600	1200 l/min
Supply pipe dia.	40	50	75	100	150	200 mm

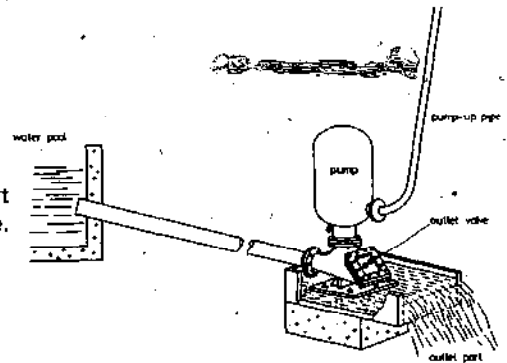

**Ce-Co-Co Hydro-Hi-Lift Pump**

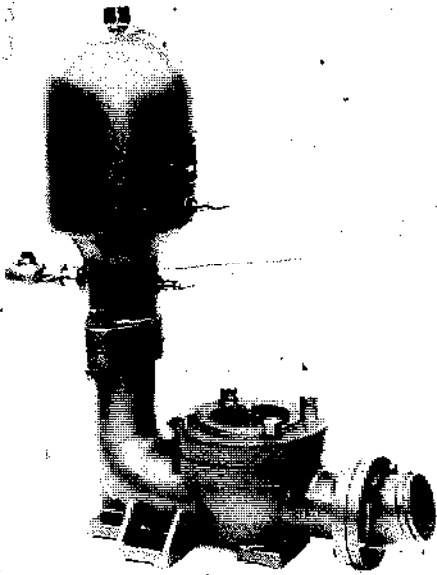

Blake's Hydram

**JOHN BLAKE LTD**  
 Royal Works  
 P.O. Box 43  
 Clayton-le-Moors  
 Accrington  
 Lancs. BB5 5LP  
 U.K.

Telex: 63242  
 Cables: Rams Accrington  
 Phone: (0254) 35441

A long established manufacturer of a range of hydraulic ram pumps, as follows.

Size of Hydram	1	2	3	3½	4	5X	6X	6Y	6Y
Driving flow from	7	12	27	45	68	136	180	136	180
required (l/min) to	16	25	55	96	137	270	410	270	410
Max delivery height poss. m	150	150	120	120	120	105	105	105	105

Quantity of water raised in litres per 24 hours for each litre per minute of driving flow, for different delivery heads and driving water heads:

Delivery head (m)	10	30	60	100	125
Driving head (m)					
1	65	19.5			
2	156	53	19.5		
4		115	53	23	16
8			125	69	55
16			250	150	110

**BRIAU S.A.**  
 B.P. 43  
 37009 Tours Cedex  
 France

Telex: 750729 F  
 Phone: (47) 61 38 17

This company manufactures a range of 8 models of hydraulic ram in addition to small turbines, windmills, etc.

Output in % for water-fall height  $\geq 1.50$  m  
 For lower height: consult BRIAU SA.

Type	Absorbed flow in l/min	Ratio of delivery head to fall height								Pipe sizes	
		4	6	8	10	12	15	20	Drive	Delivery	
A1	4 to 7	50	54	54	48	40	30	12	20/27	15/21	
B2	8 to 15	52	56	56	50	44	33	16	26/34	20/27	
C3	15 to 25	55	59	59	54	48	37	20	33/42	20/27	
Do 3 A	25 to 45	55	60	60	55	49	38	22	40/49	26/34	
D4	45 to 80	58	63	63	60	55	47	30	50/60	33/42	
E6	80 to 160	60	65	65	64	60	55	42	66/76	33/42	
G10	250 to 450	63	68	68	66	64	59	46	100	50/60	
J12	750 to 1200	65	70	70	69	68	60	50	150	80	

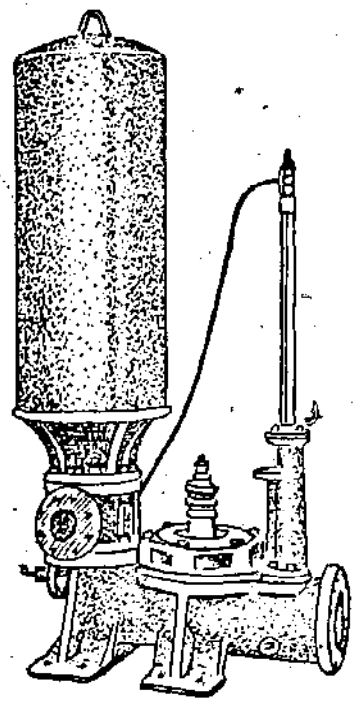

Briau Hydram

Calculation of Ram-flow

- q: delivered flow in l/min
- Q: absorbed flow by the ram in l/min
- fh: fall height in m
- DH: delivery height in m
- n: output in % according to the above table

Example

Q: 50 l/min  
 fh: 4 m  
 DH: 32 m

Ratio  $\frac{DH}{fh} = \frac{32}{4} = 8$  output = 63%

Effective flow:  $q = 50 \times \frac{4}{32} \times 63\% = 4$  l/min

**GREEN & CARTER LTD**  
 Vulcan Iron Works  
 Kingsworthy  
 Nr. Winchester  
 Hants SO23 7QF  
 U.K.

Phone: (0962) 880846

Manufacturers of the Vulcan series of hydraulic ram pumps (Hydrams) for over 56 years. Capable of pumping water driven by as small a fall of water as 2½ft (0.75m) and of delivering water to heights of 400ft (122m). Special rams delivering up to 1000ft (300m) to special order.

Model No. (Drive pipe diam. (in.))	Driving Flow (Imp. gall/min)	Diameter of delivery pipe (in) (mm)		Delivery flow in 24 hours (Imp. gall)
1¼	1 to 4	¾	22	100 to 600
1½	2 to 6	¾	22	400 to 1000
2	5 to 10	1	25	600 to 2000
2½	8 to 25	1	25	750 to 3000
3	12 to 30	1¼	25	1000 to 5000
4	20 to 45	1¼	30	2000 to 10000
6, 7	50 to 100	2	50	6000 to 30000

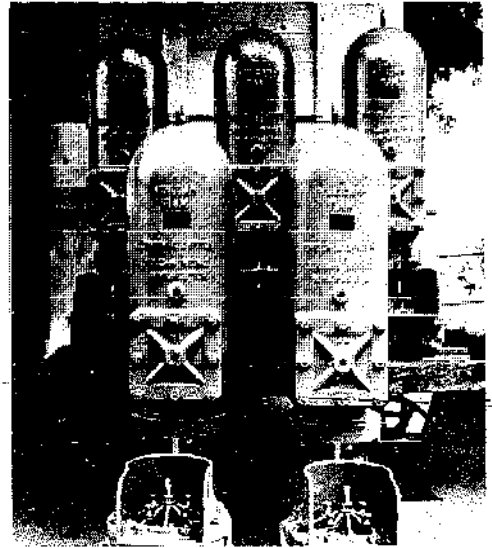

**Vulcan Hydraulic Ram**

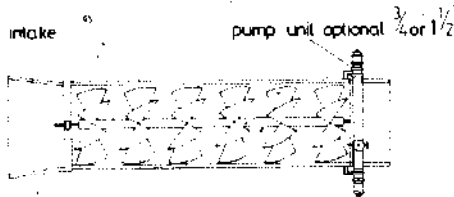

6 impellers each with 8 blades  
**The Plata Pump** 380

**PLATA POWER LTD**  
 P.O. Box 221  
 Dunedin  
 New Zealand

Cables: Nespat  
 Phone: 78 694

This new water-powered pumping system, developed in New Zealand, consists of a plastic tube with a series of propellers mounted on a shaft inside it. It can operate on very low heads of water from 9in (0.23m) up to 2ft (0.6m) and operates best when the tube is running only half full with water. The shaft drives a choice of ¾in or 1½in pumps (20mm or 40mm pumps).

*Performance envelope:*

Driving flow required: 0.5ft<sup>3</sup>/s (0.014m<sup>3</sup>/s) up to 3ft<sup>3</sup>/s (0.085m<sup>3</sup>/s).

Head range for delivery: up to 125ft (38m) with 1½in pump; up to 300ft (90m) with 3in pump.

Outputs (typical): 68 gall/hr at 10ft head or 16 gall/hr at 300ft head, with 2ft<sup>3</sup>/s driving flow and 15in driving fall (¾ pump). 316 gall/hr at 10ft head and 53 gall/hr at 100ft head with 2ft<sup>3</sup>/s driving flow and 15in driving head (1½ pump).

Although the Plata Pump performs a similar function to a Hydrum, it can operate with a much greater driving to delivery head ratio and it can also usefully handle much larger driving volumes of water than most ram pumps.

# 4 Bio-Mass and Thermal Energy

STOVES AND WATER HEATERS  
HEAT PUMPS AND REGENERATORS  
METHANE DIGESTERS  
BURNERS & STEAM RAISING PLANT  
GASIFICATION PLANT

"Bio-mass" is modern jargon for the oldest human energy resource. It means biologically derived material of any kind, all of which is potentially useful as a source of heat energy, since life on Earth is based on combustible compounds of carbon. The chain of life begins with photosynthesis, or the use of solar energy by plant life to synthesise organic matter from atmospheric carbon dioxide and water, and other life-forms in turn depend on this starting point in their food chain.

Dried organic matter is invariably capable of being burnt and the heat produced in this process represents released solar energy stored chemically. One of the main end-products of this combustion or oxidation is carbon dioxide, which is returned to the atmosphere. Fuels such as petroleum and coal consist of fossilised remains of ancient bio-mass. They are a more concentrated energy source, since the fossilisation process effectively compresses the combustible components of the original wood or marine organisms into a denser form.

The main forms of bio-mass in general use are of course wood, (and its derivatives such as charcoal) and dried animal dung. It is not generally realised by the minority of the human race within the world's moneyed economy (whether they are in so-called "developed" or "developing" countries) how important non-commercial or semi-commercial fuels are to the world's rural poor. Between 50 and 60 per cent of all people in the world spend a significant proportion of their time gathering twigs and firewood or drying the dung of their animals to provide for their basic energy needs such as cooking their food. Although the energy consumption of individual families in this way is small compared with the energy consumption of families in industrialised societies, the total firewood, charcoal and dung energy consumption for more than 2,000,000,000 people is of course substantial. It is hard for energy statisticians to obtain reliable figures, since gathered firewood is not registered by governments in the same way as commercial fuels, but a number of studies have been made. For example, using FAO figures, Earl<sup>1</sup> has shown that world energy consumption in 1970, given in millions of tonnes of coal equivalent (MTCE) was as follows:

World Energy Consumption in 1970 in MTCE

<i>Coal</i>	2419	<i>Geothermal</i>	1
<i>Oil</i>	2850	<i>Wood</i>	487
<i>Gas</i>	1418	<i>Dung</i>	90
<i>Uranium</i>	10	<i>Agricultural wastes</i>	10
<i>Hydro</i>	150		
		<b>TOTAL</b>	<b>7435</b>

In other words, wood and dung combustion accounted for an energy consumption equivalent to more than one fifth of the world's total oil consumption in that year and nearly four times the world's total hydro-electric output. Nuclear power, the greatest absorber of energy R&D expenditure in the industrialised world, is not in the running by comparison.

Earl also shows in the same reference that the populations of certain countries are heavily dependent on wood and dung for their fuel requirements. The table on the following page illustrates this by contrasting selected non-industrialised and industrialised countries.

As far as dung consumption is concerned, India is almost certainly the primary consumer. Serious studies<sup>2</sup> have shown that dung consumption in India in 1972 was approximately 100,000,000 tonnes which is the equivalent of 58MTCE in heating value.

Country	Energy consumption per capita from all sources (1973) (kg coal equivalent)	Fuel wood energy consumption per capita (1973) (kg coal equivalent)	Percentage of fuel wood based energy (%)
Malawi	376	335	89
Nepal	259	248	96
Tanzania	1042	999	96
India	274	83	30
Kenya	447	299	67
Nigeria	480	435	91
Zambia	900	391	43
Brazil	1176	695	59
Libya	569	87	15
Algeria	479	9	2
USSR	4356	157	4
UK	5143	4	0
France	3570	52	1
USA	10817	43	0

Unfortunately, the main users of these energy resources are in the poorest section of the human community, precisely the section with the highest rate of population growth. Hence there is a severe crisis developing as demand for subsistence fuels exceeds supply in very many parts of the world. There is often a narrow gap between a sustainable rate of firewood collection and the catastrophic removal of vegetation followed by desertification which occurs when excessive demands are made. Dung is of course far better if used as a fertiliser rather than as a fuel, so that the continued use of dung as a fuel is causing severe deterioration of the quality of the soil for agriculture or replanting of trees and is therefore contributing to the problem. The so-called "oil crisis" which afflicts the wealthy is nothing by comparison with the "firewood crisis" that is beginning to afflict the poor.

Fortunately in the longer term there are good possibilities for alleviating the subsistence fuel crisis by a two-pronged attack; firstly the existing methods of combustion are invariably highly inefficient and low-cost more efficient burners could greatly reduce demand; secondly, the managed cultivation of fuel crops could add to the available supply, but this approach would only be economically viable given more efficient usage. In the short term there is little hope because of the magnitude of the problem and the severe neglect of the necessary technology. Here we have the world's fourth largest existing energy resource absorbing a negligible proportion of development effort compared with other much less significant energy conversion processes of value to the wealthier sections of the human race (whether they are in rich or poor countries). What R&D effort there is at present is mainly aimed at re-introducing wood fuel (or other solid fuels) into the wealthier sections of the community as a petroleum substitute, and is therefore motivated by the oil crisis of the "rich" rather than the wood crisis of the "poor".

Inevitably, most of the devices listed in this section, being commercial products, have been developed with other markets than the poorer half of humanity in mind, but nevertheless some may well find application in areas where they are not to be found at present. Other sections of this Guide, including Section 10 on information sources, consultants and R&D institutions will point to lower cost "non-commercial" devices (such as mud stoves) that could usefully be applied under various development and extension schemes in areas where subsistence fuels are proving to be in short supply. There are also other methods than direct burning by which bio-mass may be utilised, involving a variety of processes, and there are of course numerous alternative bio-mass fuels which can compete

with the main fossil fuels of oil and coal.

As far as heat production is concerned, the relative merits of various fuels are perhaps best summarised in terms of the calorific values or total heat released when they are burnt. These can be expressed in terms of their weight or their volume, or for that matter, when sufficient data are available, in terms of their cost. The commonly used SI unit of heat is the MJ (Mega-joule) which is equal to 0.278kWh (kilowatt-hours), or 950 BTU (British Thermal Unit), or 0.0095 therms, or for that matter 0.373 hp-h (horsepower-hour), and the relative energy density of various fossil and bio-mass fuels is given in the table on the following page.

Also of interest is the productivity of various bio-mass fuels. Obviously this depends considerably on factors such as location, soil quality, etc. The most productive areas for photosynthetic material are the forested regions; agricultural land is generally less than half as productive in terms of bio-mass production. Earl (*ibid*) quotes the following perannum rates:

#### Photosynthetic Carbon Production Rates

Type of land	Net primary production (tonne/ha)	Total world annual natural production (giga-tonnes)*
<b>A. Forest</b>		
temperate deciduous	10	8.0
conifer and mixed	6	9.0
temperate rain forest	12	1.2
tropical rain forest	15	15.0
dry woodlands	2	2.8 = 36.0 GT
<b>B. Non-forest</b>		
agricultural	4	6.0 (man-made)
grasslands	3	7.8
tundra	1	1.2
deserts	1	3.2 = 18.2 GT
		Total: 54.2 x 10 <sup>9</sup> tonnes

\*total fixed carbon, including leaves, grass, roots, barks, etc.

Also given is the small proportion of this natural resource that is utilised (1970 figures); 6,700 million tonnes of coal equivalent just rots each year!

Clearly the firewood energy crisis is a crisis of geography; there is a considerable surplus of firewood available in regions other than where it is currently needed. Indeed the heat value of the unused fraction of the annual increment, at some 6,700 MTCE represents an energy surplus of around 90% of the world's total energy consumption in 1970. Which is not to say it could all be used, much of this wood would need more energy in its

**Relative Heat Value of Various Fuels (Approximate Values)**

	Calorific value/unit wt.		Calorific value/unit vol.	
	(MJ/kg)	(BTU/lb)	(MJ/m <sup>3</sup> )	(BTU/ft <sup>3</sup> )
<b>A: Fossil fuels</b>				
petrol/gasoline	44	19,000	32,000	860,000
fuel oil	44	19,000	39,000	1,050,000
paraffin/kerosine	45	19,500	36,000	970,000
diesel/gas oil	46	20,000	38,000	1,020,000
coal tar/asphalt	40	17,000	40,800	1,100,000
anthracite coal	35	15,000	56,000	1,500,000
bituminous coal	33	14,000	42,900	1,150,000
lignite (brown) coal	30	13,000	37,500	1,010,000
peat	20	9,000	18,200	490,000
coke	28	12,000	22,400	600,000
natural gas (methane)	56	24,000	40*	1,020
coal gas (methane)	9	4,000	20*	490
propane (cylinder gas)	48	21,000	90*	2,400
butane (cylinder gas)	47	20,000	120*	3,100
<b>B: Bio-Mass fuels</b>				
wood (oak)	18	8,000	14,400	390,000
wood (pine)	20	9,000	10,000	270,000
wood (acacia)	16	7,000	11,000	300,000
charcoal	28	13,000	11,000	300,000
sunflower stalks	20	9,000	10,000	270,000
wheat straw	18	8,000	—	—
beef cattle manure	14	6,000	—	—
methanol (methyl alcohol)	20	8,600	19,000	500,000
ethanol (ethyl alcohol)	28	12,000	28,000	700,000
biogas (65% methane)	20	8,600	23*	600
wood gas (typical)	—	—	11*	280

\*Since these fuels are normally gaseous, the calorific value per unit volume is relatively low compared with liquid and solid fuels.

**Use of Fuel Wood Stocks**

Area	Growing* stock (m <sup>3</sup> x 10 <sup>9</sup> )	Annual increment (m <sup>3</sup> x 10 <sup>9</sup> )	Used by industry (m <sup>3</sup> x 10 <sup>9</sup> )	Used as fuel (m <sup>3</sup> x 10 <sup>9</sup> )	Total used (m <sup>3</sup> x 10 <sup>9</sup> )	Unused increment (m <sup>3</sup> x 10 <sup>9</sup> )	Heat value of unused (TCE x 10 <sup>9</sup> )
developed countries	242	8.8	1.1	0.3	1.4	7.4	3.2
developing countries	382	9.0	0.2	0.8	1.0	8.0	3.5
total	642	17.8	1.3	1.1	2.4	15.4	6.7

\*above ground wood in areas classified by the FAO as "forest".

**Potential Bio-mass Values of Selected Crops**

Species	Location	Annual dry matter yield		Heat value		Tonne oil equiv. per ha./yr.
		(ton/acre)	(tonne/ha)	(10 <sup>6</sup> BTU/ acre/yr)	(GJ/ha/yr)	
sunflower	USSR	13.5	30	200	530	12
forage sorghum	Puerto Rico	30.6	69	460	1210	28
hybrid corn	USA (Miss)	6	13	90	250	6
water hyacinth	USA (Fla)	16	36	240	630	14
sugar cane (average)	USA (Fla)	17	39	260	680	16
sugar cane (experiment)	USA (Cal)	32	72	480	1250	29
sudangrass	USA (Cal)	16	36	240	630	15
bamboo	S E Asia	5	11	70	210	5
eucalyptus	USA (Cal)	20	45	300	790	19
eucalyptus	India	17	39	260	678	16
eucalyptus	Ethiopia	21	48	320	834	19
american sycamore	USA (Ga)	3.7	8	60	160	4
algae (pond)	USA (Ca)	39	88	580	1520	36
tropical rainforest (typical)		18	41	270	710	17
subtropical deciduous forest (typical)		11	24	160	420	10

collection than it would be worth, but obviously there is a lot of potential that is not being applied because of a shortage of technology of the kind described in this section, to exploit it.

Since much of the non-exploited bio-mass is inconveniently located, the question arises of growing fuel crops where they are needed. Some figures for the poten-

tial value of a selection of crops that might be used as fuel on account of their high growth rates appear above.<sup>3</sup>

There are two primary mechanisms for oxidising bio-mass and releasing its energy content. The easiest and most widely used method is to burn it, or in some cases to apply heat, often by partial combustion, and thereby drive off gases (which might be burnt separately but

usually are wasted) so as to leave charcoal which is a fuel that gives more consistent and controllable heat production. Another method is to use bacteria to carry out a process to yield combustible products. The various methods are summarised below:

Direct heat process	Bacterial process
complete combustion	methane (bio-gas) fermentation
pyrolysis (gasification)	alcohol by fermentation
carbonisation (charcoal)	
destructive distillation	

Burning processes are generally wasteful, in the sense that the only product is heat which is often used inefficiently, or even in the case of charcoal production, the wood volatiles are deliberately driven off and lost as the objective is to produce a more concentrated and smokeless fuel. Also, wet wood absorbs a large proportion of the available energy in producing steam. Pyrolysis plants

processes, although relatively slow, can yield a "digested" sludge of value as a fertiliser for reapplication to the land in addition to a fuel output as gas or alcohol.

It is perhaps of interest to note the products present in a typical sample of tropical hardwood,<sup>4</sup> all of which have potential uses:

*In 1000kg of dry wood:*

charcoal	200kg (= 8400MJ)
gas (calorific value 10.5MJ/m <sup>3</sup> )	140m <sup>3</sup> (= 1470MJ)
methyl alcohol	14l (= 260MJ)
acetic acid	53l
esters (methyl acetate, etc.)	8l
acetone	3l
wood oil and light tar	76l
creosote oil	12l
pitch	30 kg

The general lack of commercial technology for exploiting bio-mass is reflected by the make up of the following section of this Guide — clearly there is much potential for new products and it is known that there has been some increase in R&D in this area, although mainly orientated towards finding petroleum substitutes for industrialised societies. The most readily available technology consists of wood and other solid fuel burning stoves and heaters and a number of methane digesters (bio-gas) plants and wood gasification plants have appeared within recent years. Also, a few steam raising plants for use with steam engines are included. Some further comments on the type of equipment included follows.

### Stoves and Water Heaters

All the stoves included are completely enclosed systems with full control of the air supply in order to achieve efficient and controlled combustion.

Open fires, traditionally used in many parts of the world for cooking and heating are notoriously inefficient — often needing ten times or more fuel than a good enclosed stove to perform the same function.

Benjamin Franklin is often credited with having developed the first efficient stove. In fact he reinvented what was already widely used in the Orient for many centuries. In 1740 he developed his so-called 'Pennsylvanian Fire-Place' to try and combat a serious firewood shortage by improving the efficiency of combustion — in his own words<sup>5</sup> "by the help of this saving invention our wood may grow as fast as we consume it . . ." Today the

so-called Franklin Stove, widely used in the USA, bears little resemblance to the original invention it developed from, but at least Franklin stated the important objective that led Americans to give up the wasteful open fireplace they and their ancestors had brought with them from Europe.

A number of heat reclaimers are also included, which allow surplus heat in the flue gases to be used for heating either convected air or water, and thereby improve the efficiency of fuel combustion still further.

As explained in Section 9, the Intermediate Technology Development Group is investigating improved cooking stove designs as part of its Power Project activities.

### Heat pumps and regenerators

These devices are generally used to move heat around, and since the energy required to move heat is often considerably less than the heat that is actually transferred

appearing to deliver more heat than they use.

This is not the place to describe the principle of the heat pump in detail (almost any textbook on thermodynamics will do this). The principle of the heat pump is the same as that of a refrigerator, although the object is to take heat at low temperature from the outside air, the ground or a river and to raise the same heat to a higher temperature via a compression-heat exchange-expansion process; a refrigerator uses the same process to take heat out of food at a low temperature and to transfer it to the outside air at slightly above ambient temperature (hence the heat that is emitted from the back of a fridge).

The attractive feature of a heat pump is that the only power required is to drive a compressor which pumps the refrigerant fluid used for the heat transfer. Commonly the actual heat transferred can be over twice the energy needed to drive the compressor, so that a heat pump delivering say 6kW of heat can often require less than 3kW to drive it. Another feature of heat pumps is that sometimes they are reversible so that they can be used as air-conditioners in summer and heaters in winter.

Although the principle of the heat pump has been known for many years, it is only in recent years that they have begun to gain ground as viable heating equipment as a result of climbing electricity prices. While electricity was cheap in most countries it was always much simpler to heat using normal electrical resistance heaters.

Regenerators are systems that recover heat that would otherwise be wasted, through the use of a small energy input. Typical sources of waste heat are the flue gases of a stove or boiler or even the heat emitted in the stale air expelled by a ventilation system. Although some heat must usually be lost with flue gases (it is this heat which is needed to create a draught), many systems lose more heat than necessary, so the provision of a heat exchanger in the flue allows some surplus heat to be extracted either for space heating or to provide hot water; examples of such devices are included in this section and they are generally extremely cost effective. Also included is a heat regenerator which extracts heat from stale air being expelled from a building and transfers it to the fresh incoming air. An interesting application of this may be to transfer "cold" in the case of air conditioned buildings, where warm incoming air could be cooled from the stale outgoing flow.

This section includes only a limited selection of equipment in this category since heat reclamation is not strictly power generation. However it is generally cheaper to save energy than to generate power and it is hoped to expand this section in future editions of this Guide.



## Methane digesters

Many organic materials can be fermented in a sealed container (with air excluded). Under these conditions anaerobic bacteria can break down the bio-mass and yield in the process a fuel gas (similar to naturally occurring "Marsh gas") consisting of about 60% methane and the rest mainly carbon dioxide. This gas, often called "Bio-gas" or in India "Gobar gas" has reasonably good qualities for cooking or for running internal combustion engines.

Other merits of this process are that the digested sludge makes a useful fertiliser, so that unlike when bio-mass is totally burnt, it is possible to return much of the original material to the land and preserve the soil quality. In fact, the digestion process makes the nitrogen and various other chemicals present in the original bio-mass more accessible for plant growth than the normal aerobic (in air) rotting process. Also, unlike artificial N fertilisers the sludge contains humus which can greatly improve soil structure.

In addition to its use for fertiliser production, this process can be used for treating sewage and other potentially dangerous wastes, because the anaerobic process kills most pathogens harmful to people. Hence it can be applied as a small scale sewage processing system. It also has the advantage of producing an effluent without a seriously offensive smell.

At present the anaerobic process finds its main application in large process plants for municipal sewage treatment. Often, the considerable volumes of gas produced by this process are not effectively used by the municipalities concerned and surplus gas is simply "flared" off.

Small scale methane production was practised by French farmers and others during the Second World War when they were totally without petroleum fuel, but the subsequent "cheap petrol era" caused the process to be abandoned in industrialised societies (except for large-scale sewage treatment) until quite recently. On the other hand, considerable efforts to popularise the use of small-scale anaerobic digesters have been made in Asia, particularly in India and China, since the 1960s and onwards. It was realised in those countries that the anaerobic process had considerable merits in the rural economy if all its three uses for fuel production, fertiliser production and waste treatment could be combined on a small-scale at sufficiently low cost. The main difference between typical Indian and Chinese methane plants is that the Indian system requires a steel gas holder which rises as its fills, while the Chinese system traps the gas under a fixed masonry or concrete dome. The Chinese use the system to process human sewage as well as any other suitable wastes, but the Indians generally use cow dung (or Gobar) as the main input. It is claimed<sup>6</sup> that over a million houses in the Chinese province of Szechuan alone use bio-gas and that in one year the county of Yunghsing in the same province saved the use of 1,100 tons of coal, 15 tons of kerosene and over 800,000 work days formerly spent getting wood and coal. Experience in India has shown that the larger Gobar plants, generally attached to institutions such as Ashrams, are more successful than small "family-size" units and there have been difficulties in popularising the smaller plants.

There is a technical reason for the difficulty in obtaining such good results with small plants, as the process depends on steady temperatures for good gas production and the optimum rate of gas production occurs as a temperature of around 35°C. Larger plants have a greater thermal inertia, giving steadier temperatures in the digester and they also have a smaller surface area relative to their volume (since area goes up with L<sup>2</sup> and volume with L<sup>3</sup>)

<sup>6</sup>"Gobar" means cow dung.

so that heat losses are lower and a higher temperature is more easily maintained in a large plant. To be effective smaller plants need to be insulated, except where they are used in hot tropical regions having night temperatures not much lower than day ones. Obviously the same constraints apply to the commercially manufactured plants described in the following section.

This is not the place to give a detailed account of this complex biological process but it is worth giving a brief outline of the characteristics of the process. Figure 1 shows a schematic view of the digester system illustrating a number of end uses and optional additional processes. The following table<sup>7</sup> indicates typical gas yields from various input materials, (the gas being in all cases from 60 to 70 per cent methane).

Material	Gas yield per unit dry matter	
	(m <sup>3</sup> /kg)	(ft <sup>3</sup> /lb)
cow dung	1 - 3	1 - 5
chicken droppings	3	5
pig dung	4 - 5	6 - 8
farm wastes	3 - 4	5 - 7
elephant grass	4 - 6	7 - 9
chicken droppings and paper pulp	4 - 5	7 - 8
chicken droppings and grass clippings	4	6
sewage sludge	6	10

In most cases the process requires from 20 to 30 days for completion (depending on temperature and other factors) — hence the digester capacity will require to be such that it can hold the requisite number of days' input. The input generally requires to be around 5-10% solids, the rest water; since many inputs are already wet, this does not necessarily mean that nine parts of water per part of input are added, just that in many cases some water must be added to achieve the optimum solids to water ratio. A critical factor is the ratio of carbon to nitrogen in the feed material, which ideally should be in the range 10 to 30 for good operation. In many cases with excessively carbon-rich inputs (e.g. vegetation or paper pulp), the process benefits if nitrogen is added (this can be in the form of ammonia, urea, urine, etc). Similarly, nitrogen-rich inputs (like chicken droppings or urine-rich stable or pig-sty wastes) can benefit from extra carbon in the form of grass clippings or paper (this being evident from the above table).

## Burners and steam-raising plant

Unfortunately the limited number of entries in this section reflects the decline of steam power during the last few decades of increasing internal combustion engine usage, to the extent that small steam engines and steam-raising plants are today very rare. Also, many of the more recently developed types tend to be fuelled with oil rather than solid wastes, for convenience. There is a marked revival of interest in steam power, particularly to exploit non-petroleum fuels, and it is hoped that future editions of this Guide will include a wider choice of equipment in this section as work appears to be in hand in a number of countries. New technology such as fluidised bed combustors and heat pipes promise improved steam raising plant in future, with potentially high efficiency at relatively low cost.

An important element in the use of steam raising plant is safety. Virtually all countries have regulations governing the use and inspection of boilers and pressure vessels and it is as well to ensure that any equipment that you plan to use will comply (although most commercially available

products are almost bound to comply since the countries of manufacture impose their own regulations on the manufacturers). Obviously no attempt should be made to modify commercially bought equipment by tampering with the design as such actions could make a boiler dangerous. Modern mono-tube boilers are particularly safe, however, as the steam is raised in a single coil of tube and any accident, (and designs are such that they are usually fail-safe), will merely cause minor internal damage to the boiler. Mono-tube boilers have the additional advantage of being quick to reach working pressure since the water capacity of the heated volume is small.

Another factor to bear in mind with steam raising plant is the need for water softening in many locations to prevent excessive "furring" of the boiler tubes, although in installations involving the condensing and recycling of exhaust steam (essential for reasonable efficiency), this problem only arises for small quantities of make-up water that may occasionally be needed.

### Wood Gasification

This is another old technology, popular at the beginning of this century, and then later in times of emergency in some industrialised countries (e.g. during the Second World War) when petroleum was not available, but subsequently forgotten. The few commercial systems included in this issue stem from war-time experience in their respective countries of manufacture, but have been brought up-to-date in the face of the "oil crisis".

The attraction of these devices is that they enable internal combustion engines, particularly spark ignition (petrol) engines, to be run on wood and even on saw mill wastes, coconut shells or agricultural wastes.

The main problems are the accumulation of tars from certain wastes, and the need to scrub the gases to remove corrosive components. However these problems have been tackled in commercially available equipment, and again it is to be hoped and expected that wider variety of gasification plants will appear on the market as petroleum prices increase.

### Footnotes

1. *Forest Energy & Economic Development*, D.E. Earl, Clarendon Press, Oxford, 1975.
2. Earl quoting from National Commission on Agriculture, India.
3. *Energy for Rural Development*, National Academy of Sciences, Washington, 1976.
4. Earl - *Forest Energy & Economic Development*.
5. *Heating with Wood*, Larry Gay, Garden Way Publishing, Charlotte, Vermont, U.S.A.
6. *China Reconstructs*, May 1977, "Home-Made Gas for China's Countryside", article by Tai Mei-Tien.
7. *Methane Generation by Anaerobic Fermentation - an Annotated Bibliography*, Leo Pyle & Christina Freeman, Intermediate Technology Publications.

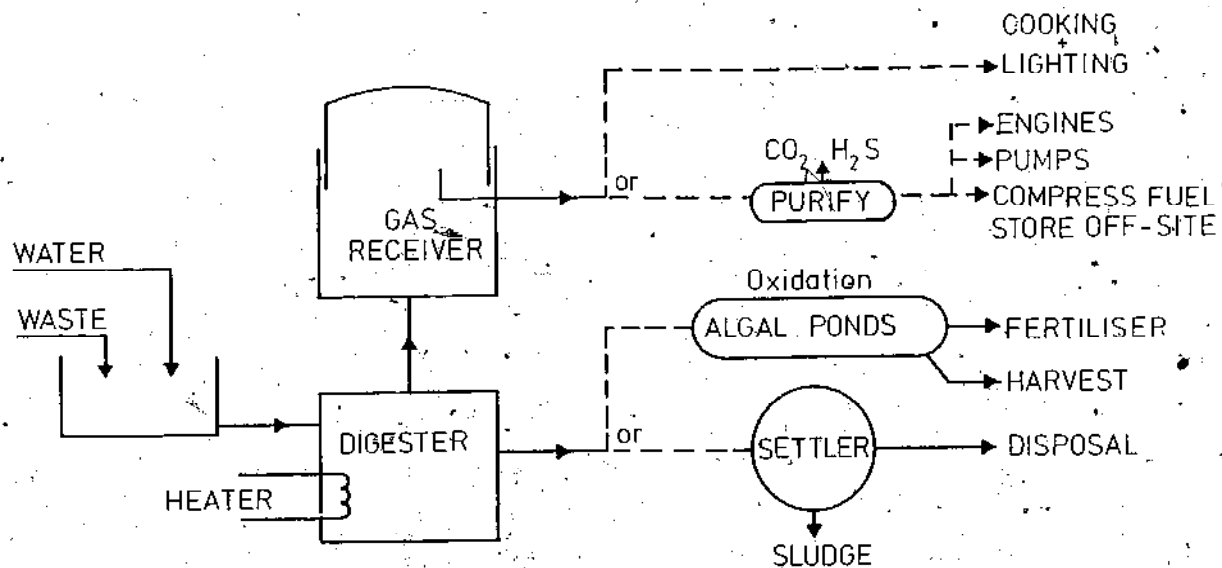

Schematic Diagram of Biogas System

# Stoves & Water Heaters

**AGAHEAT APPLIANCES** Phone: (0952) 3973  
 Glynwed Domestic & Heating  
 Appliances Ltd  
 Aga Works  
 P.O. Box No.30  
 Ketley  
 Telford  
 Salop TF1 1BR  
 U.K.

Manufacturers of a range of domestic cooking and heating boilers using solid fuel. Some of these incorporate heat storage to give consistent cooking conditions. The model CB illustrated, has two hot plates, one fast and one slow and two ovens, one for roasting and baking and the other for slow cooking or warming.

This group also offers the well known "Rayburn" series of solid fuel cookers and boilers.

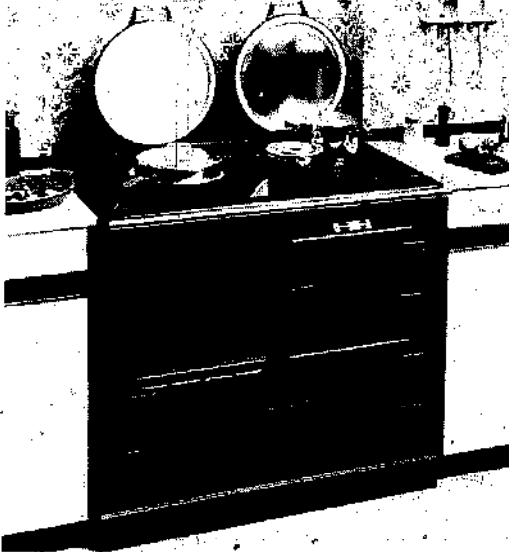

**Aga Kitchen Range**

**BIRMINGHAM STOVE & RANGE COMPANY** Phone: 205 322 0371  
 Box 2647  
 Birmingham  
 Alabama  
 U.S.A.

Manufacturers of a selection of stoves and ranges, and fires for burning coal and wood for home heating and cooking. Cooking stoves are in cast iron and models are available for wood and coal burning. A number of designs is also available for room heating.



**Bonanza - Model 8316 Wood Range**

**THE ENTERPRISE FOUNDRY CO LTD** Telex: 014 2288  
 Phone: 506 536 1160  
 Lorna Street  
 Sackville  
 New Brunswick  
 Canada

Long established manufacturers (since 1872) of a range of wood or coal burning and oil fired stoves and cooking ranges.

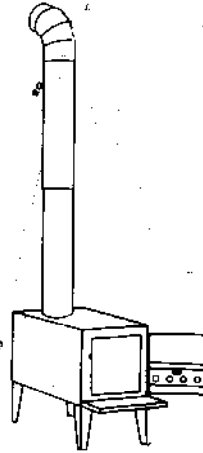

**Enterprise BH-25 Wood Heater**

**FATSCO** Phone: 616 926 7795  
 251-3 N Fair Avenue  
 Benton Harbor  
 Michigan 49022  
 U.S.A.

Long-established manufacturers of a range of small solid fuel stoves for heating and cooking purposes.

These stoves can burn almost any solid fuel and are quite small and relatively inexpensive. The smaller ones can be despatched from the manufacturers by ordinary postal delivery. All stove parts are individually replaceable and some stoves are available with a choice of black or stainless steel bodies. Most stoves have heat shields and are suitable for use in small boats as well as for land-based applications.

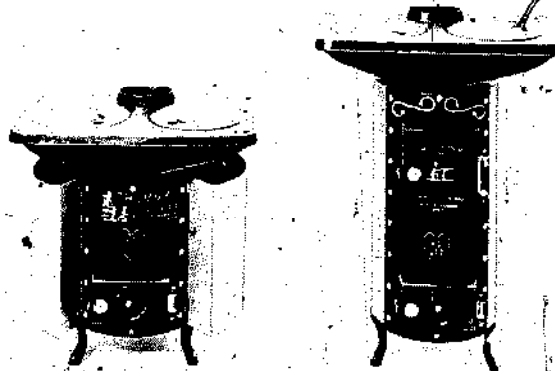

**Fatsco Small Solid Fuel Stoves**

**JØTUL WOODSTOVES**

Simon Thorpe  
New Road  
Newcastle Emlyn  
Dyfed SA38 9BA  
U.K.

Phone: 0239 710100

Agents and suppliers of a range of Norwegian-built wood burning stoves for space heating and cooking purposes. Some models can be provided with a water heating kit for limited supplies of hot water. High efficiency is claimed for this range.

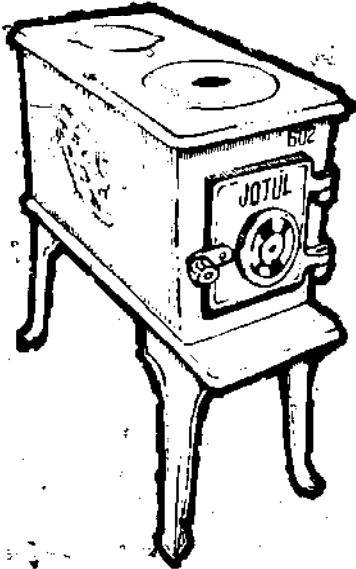

Jøtul 602

**MALLEABLE IRON  
RANGE COMPANY**  
715 North Spring Street  
Beaver Dam  
Wisconsin 53916  
U.S.A.

Phone: 414 887 8131

Manufacturers of a range of cooking stoves for burning wood, coal or oil.

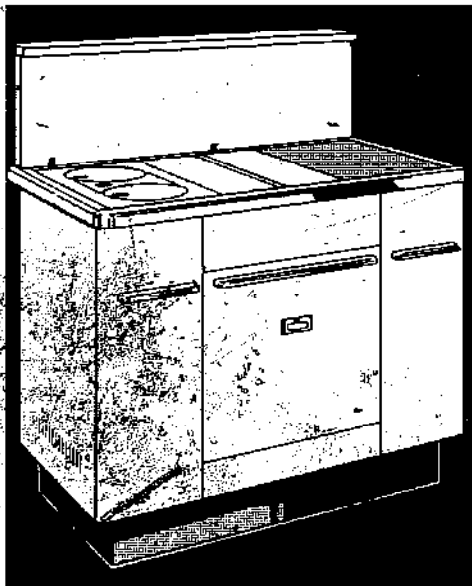

Monarch Wood-Coal Kitchen  
Range Model R9CW

**ETS LARROQUE**  
401 Route de Seysses  
31300.Toulouse  
France

Phone: 40 22 47

Manufacturers of wood burning stoves in a range of sizes. Unit is suitable for workshop or garage situation and due to simplicity is relatively cheap. It can be used for space heating or water heating.

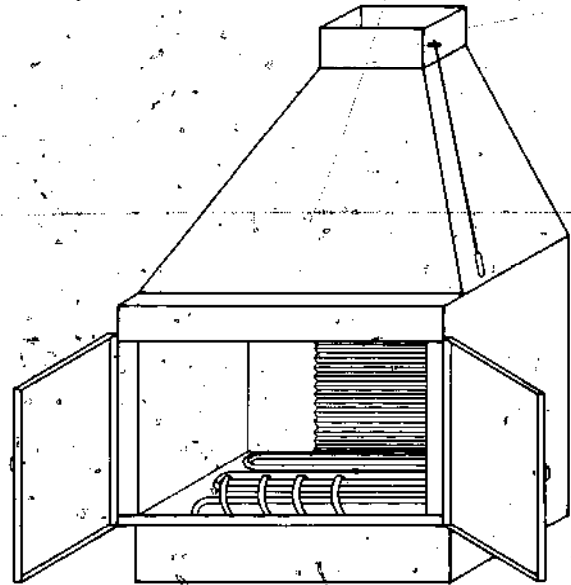

Larroque Wood Burning Heater

**SCANDINAVIAN-STOVES  
INCORPORATED**  
Box 72  
Route 12-A  
Alstead  
New Hampshire 03602  
U.S.A.

Phone: 603 835 6029

Suppliers of a range of solid fuel (wood or coal) stoves, some of traditional Scandinavian cast iron design and some of modern design.

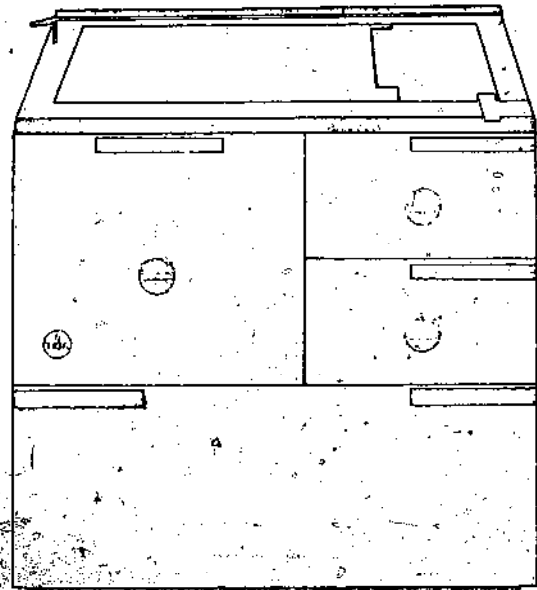

Tiba

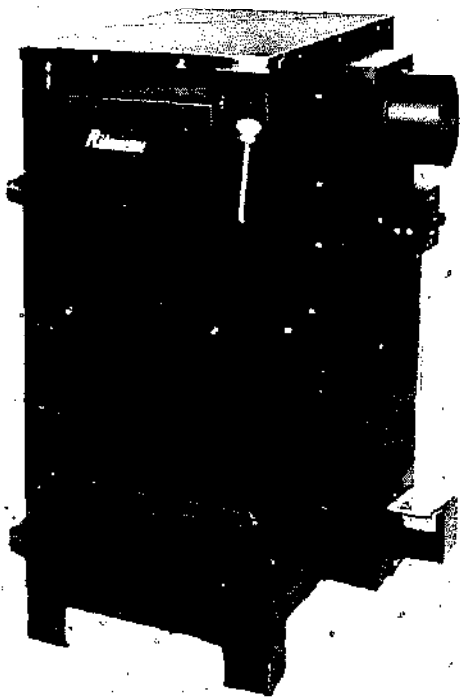

Riteway Wood and Coal Heater

**RITEWAY MANUFACTURING COMPANY** Phone: (703) 434 7090  
 P.O. Box 6  
 Harrisonburg  
 Virginia 22801  
 U.S.A.

Manufacturers of a range of efficient wood burning and dual fuel stoves and furnaces for space and water heating.

Model	Fuel Capacity	Rating	Shipping Weight	Comments
2000	4 cu.ft.	50 000 BTU/hr	200lb	Burns logs up to 24" long
37	7½ cu.ft.	73 000 BTU/hr	400lb	Burns 24" logs or coal

Plus a range of furnaces and boilers from 160 000 to 350 000 BTU/hr ratings.

**TORRID MANUFACTURING CO. INC** Phone: 206 324 2754  
 1248 Poplar Place South  
 Seattle  
 Washington 98144  
 U.S.A.

Manufacturers of a wood burning stove for cooking and water heating. Unit is a traditional style and can be incorporated with a flue oven for baking or flue space heater for room heating.

**SHENANDOAH MANUFACTURING CO INC.** Phone: 703 434 3979  
 Box 386  
 Harrisonburg  
 Virginia 22801  
 U.S.A.

Manufacturers of various solid fuel stoves and heaters with thermostatic control to minimise fuel consumption. Models for mixtures of fuels or for wood and for coal/coke are available.

Model R75 (illustrated) has a fire-brick lining and will burn for 12 hours on a single charge (when damped down). Shipping weight is 178lb (81kg).

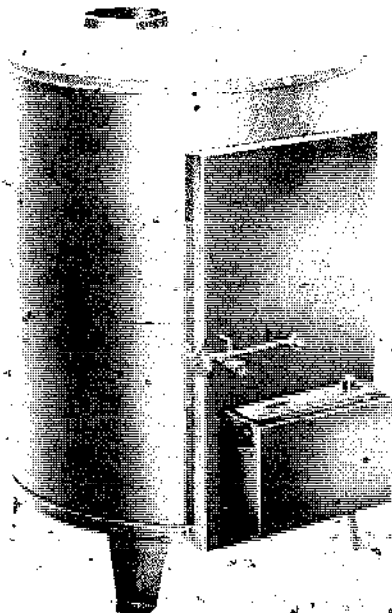

Model R75

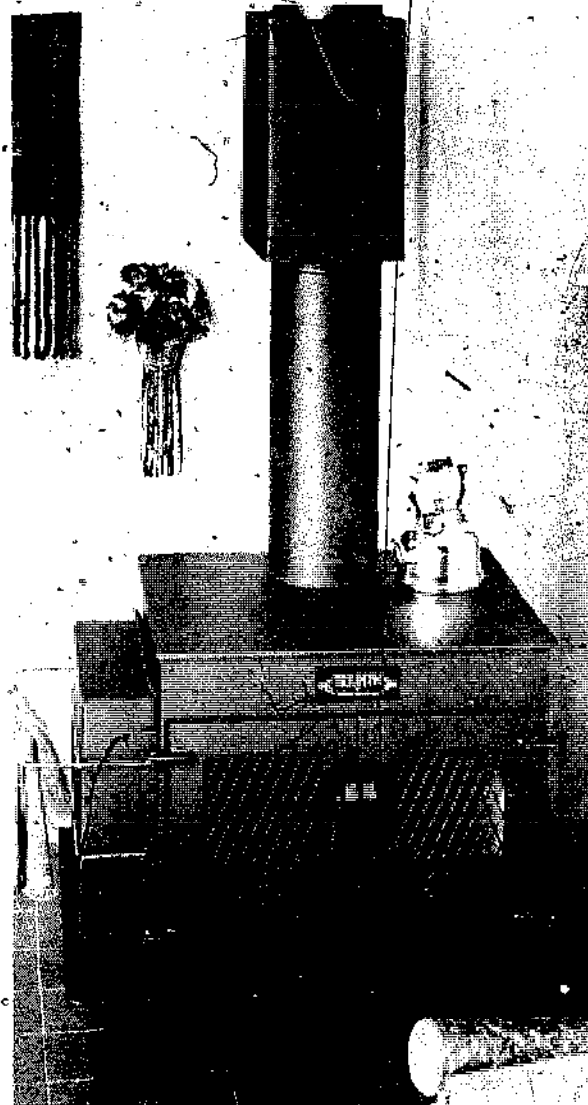

Triumph Wood Stove

**UNITED STATES,  
STOVE COMPANY**  
P.O. Box 151  
South Pittsburg  
Tennessee 37380  
U.S.A.

Phone: (615) 837  
8631

Manufacturers of a large selection of stoves for heating and cooking purposes.

Models can be run on wood, coal, charcoal, oil, kerosene.

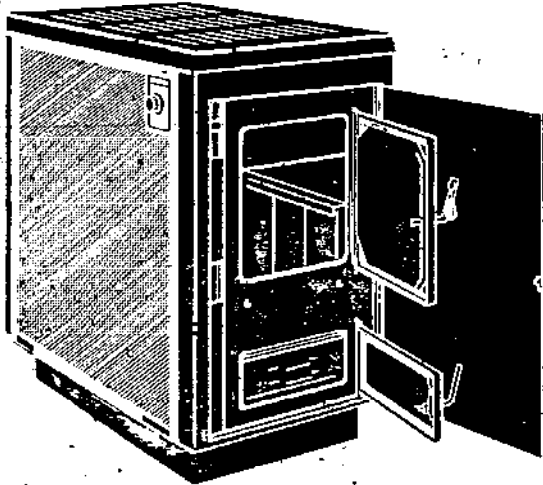

Wonderwood Stove

**WATER MASTER  
SYSTEMS LTD**  
Coroglen Via Thames  
New Zealand

Phone: Whenuakite  
858

Manufacturers of a water heater using any fuel, be they waste oil, wood or any combustible waste. Claimed to heat 40-160 gallons per hour and a half. Also supply solar heating systems:

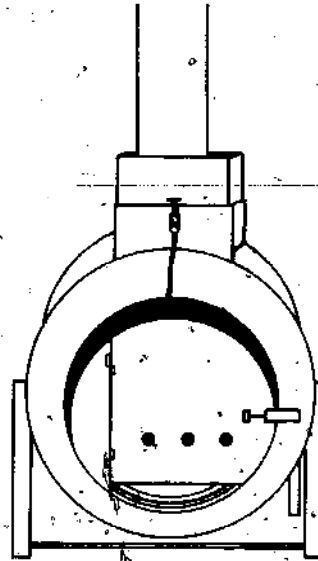

Water Master Heater

**VALLEY COMFORT**  
Winlaw B.C.  
Canada VOG 2JO

Phone: 604 226 7221

Manufacturers of cased wood burning stoves for home heating by radiation, natural convection or forced convection.

Model No.	Fuel	Log Size (ft)	Chamber Lining	Max heat output BTU	Weight (lb)
C26	Wood	1.5	Stainless steel	-	170
C31	"	2	" "	-	195
F51	"	2½	Fire brick	80-100 000	850
F71	"	3	" "	100-130 000	1050
RB3D	"	2½	" "	90 000	475
FB4D	"	2½	" "	120 000	550

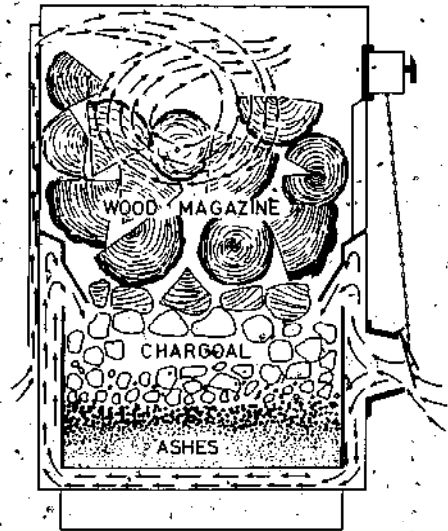

Valley Comfort Wood Stove

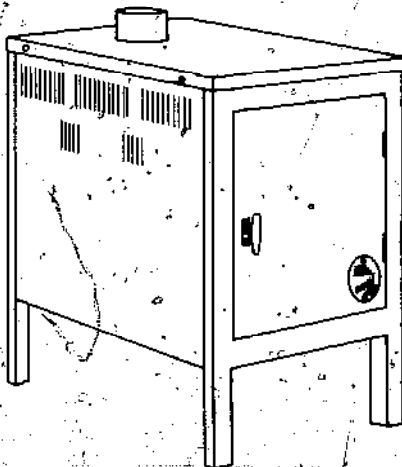

**WAVERLY HEATING  
SUPPLY COMPANY**  
117 Elliott Street  
Beverly  
Massachusetts 01915  
U.S.A.

Phone: 617 922 0581

Manufacturers of a wood burning, totally enclosed stove, of a modern design. Units will accept 20" logs. The steel combustion chamber is encased in cabinet to provide convectional movement of heating air.

# Heat Pumps and Regenerators

**BLAZING SHOWERS**  
P.O. Box 327  
Point Arena  
California 95468  
U.S.A.

Phone: 707 882 9956

Manufacturers of a water heater utilising the waste heat in the flue of a stove.

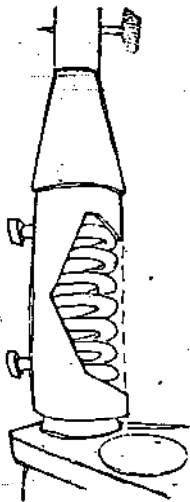

Flue Pipe Water Heater

**DOLIN METAL PRODUCTS INC.**  
475 President Street  
Brooklyn  
New York 112115  
U.S.A.

Phone: 212 596 1400

Manufacturers of a flue heat reclaimer for recovery of heat that otherwise is lost up the chimney. Fan blown air is blown out of the unit and can be ducted to where required.

The fan requires a 110V, 60Hz electricity supply, (a transformer can allow use on 240V systems or motor can be changed to one suitable for local conditions). Power consumption for the fan is 80W. Heat output is 11 000 to 16 000 BTU/hr (3.2 to 4.7kW).

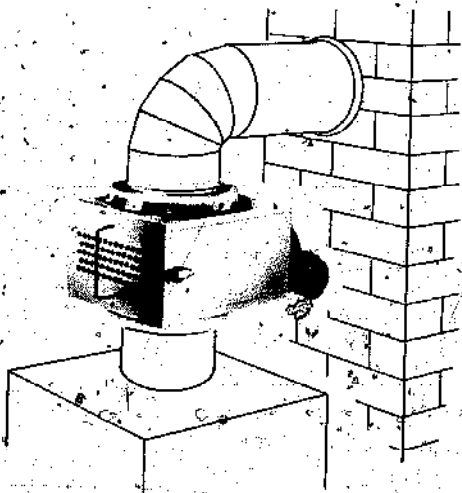

Dolin Flue Heat Reclaimer

**CHIMNEY HEAT RECLAIMER CORPORATION**  
53 Railroad Avenue  
Southington  
Connecticut 06489  
U.S.A.

Phone: 203 628 4738

Manufacturers of a flue heat reclaimer to utilise heat normally lost up the chimney and also a wood fired boiler that incorporates the same system. The heat reclaimer incorporates an 80W electric motor to drive its fan for air circulation.

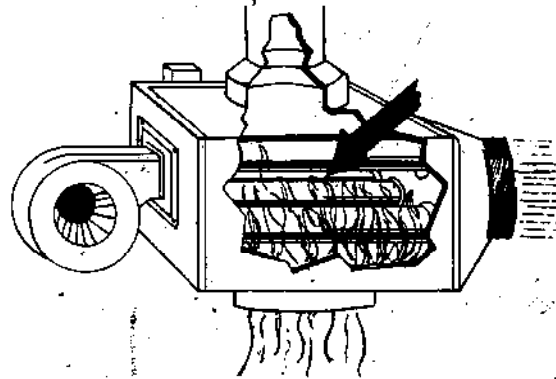

Chimney Heat Reclaimer

**CURWEN & NEWBURY LTD**  
Westcroft Works  
Alfred Street  
Westbury  
Wiltshire BA13 3DZ  
U.K.

Phone: (0373)  
823646

Manufacturers of an air to air heat recovery system to reduce the heat lost from buildings due to forced ventilation. The unit extracts the heat from the outgoing air and warms the incoming fresh air. The unit can also be used in the reverse direction to minimise the loss of cool air from air conditioned buildings.

(Models available for high temperatures)

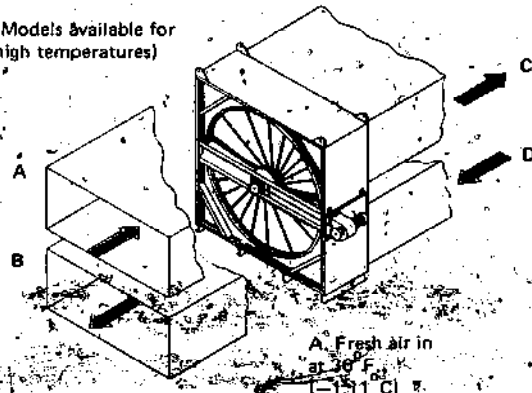

A Fresh air in at 40°F (4.4°C)

B To outside at 39°F (3.89°C)

C Fresh air with regenerated heat at 66°F (18.9°C)

D Contaminated exhaust air at 75°F (23.9°C)

C.N. Heat Regenerator

**ISOTHERMICS INC**  
 P.O. Box 86  
 Augusta  
 New Jersey 07822  
 U.S.A.

Telex: 710 988  
 2292  
 Phone: 201 383  
 3500

Air to air heat recovery system for exhaust flows up to 600°F and ventilation rates of 750 cfm to 12500 cfm. Some units are produced for liquid to air heating. Air conditioning units and stove flue pipe heat recovery systems are also produced.

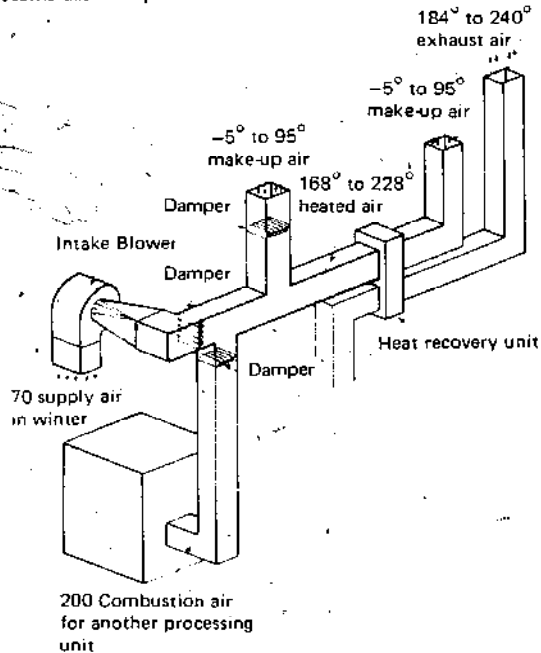

**Iso-Vent**

**LENNOX INDUSTRIES LTD.**  
 P.O. Box 43  
 Lister Road  
 Basingstoke  
 Hants. RG22 4AR  
 U.K.

Telex: 858675  
 Phone: 0256 61261

This company is a major manufacturer of heat pumps (with additional branches in Germany, the Netherlands, France, the U.S.A. and Canada).

Heat pumps transfer heat from one temperature to another and therefore can be used either for heating or for cooling. The heating and cooling effect in terms of energy transfer is invariably considerably greater than the driving power needed since the heat source/sink is normally the atmosphere. Systems are available for the efficient heating and/or cooling of a variety of spaces ranging from private homes and small offices to large commercial/industrial premises. This is a much more efficient method of heating than the direct conversion of energy into heat.

Eleven heat pump models are available with nominal cooling capacities ranging from 7 to 39kW and nominal heating capacities from 6 to 32kW. The actual performance depends on a wide variety of factors, not least being the ambient conditions. The power requirement is generally between 0.25 and 0.5 of the actual output, again depending on specification and ambient conditions.

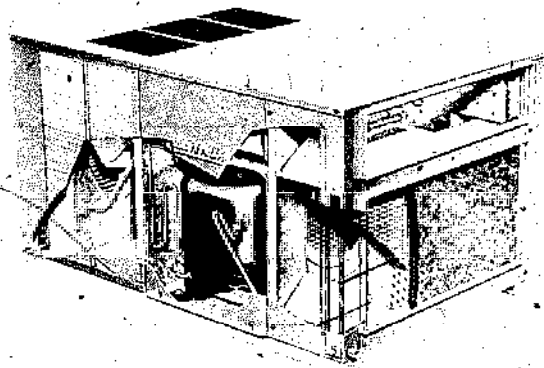

**Lennox Unit**

## Methane Digesters

**BIO GAS OF COLORADO INC.**  
 5620 Kendall Court,  
 Unit G  
 Arvada  
 Colorado 80002  
 U.S.A.

Phone: 303 422  
 4354

Designers of bio-gas systems for a range of installations. This organisation offers consultancy and design services in the field of bio-gas systems. These are developed for the American farmer and they include larger systems — for example a set of workshop plans are available for four digestion units sized from 2,250 to 18,000ft<sup>3</sup> capacity.

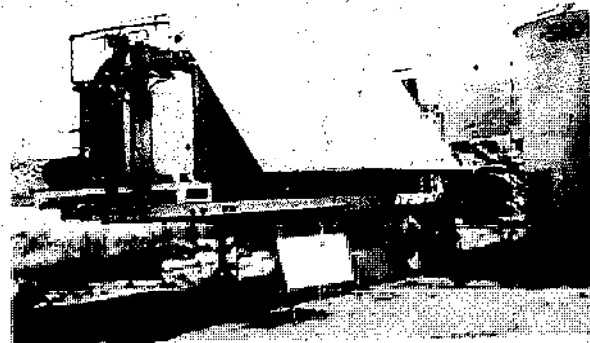

**Colorado Demonstration Bio-Gas Unit**



**FARM GAS LTD**  
 Heath Workshop  
 Lydham  
 Bishops Castle  
 Salop SY9 5HB  
 U.K.

Phone: (05883)  
 348

Manufacturer of two main types of methane digester, a 2500 gallon (11.25m<sup>3</sup>) capacity system for farms and a small 400 gallon (1.8m<sup>3</sup>) system for domestic wastes, garden wastes or for experimentation.

Specification: Model FG25, capacity 2500 gallons. Can handle slurry from 125 pigs, 16 cows or 2000 laying hens (slurry contains washing water as well as wastes). Gas production from 600ft<sup>3</sup> (16.8m<sup>3</sup>) down to 400ft<sup>3</sup> (11.2m<sup>3</sup>) per day depending on input and conditions. 400ft<sup>3</sup> output represents a 3kW gas heater running 24 hours/day, running a generator producing 1kW of electricity 24 hours/day or producing 200 gallons (900 litres) of hot water per day.



Farm Gas Ltd Digester System

**SANAMATIC TANKS**  
 PTY LTD  
 P.O. Box 119  
 Bendigo  
 Australia 3550

Cables: Sanamatic  
 Bendigo  
 Phone: 267 1464  
 (Melbourne)

Manufacturers of a range of bio-gas plants developed over a thirty year period by John Coulthard, for utilizing 500lb to 120 tons of effluent per day. The smaller unit comes complete with all necessary fittings and instructions for use for domestic purposes. This manufacturer is prepared to negotiate license manufacturing arrangements overseas.

The Sanamatic Tank is claimed to be of sufficiently low cost to pay for itself in one to two years when used in Australia. It consists of a specially developed butyl rubber liner suspended in a metal supporting frame, and is relatively portable and easily erected.

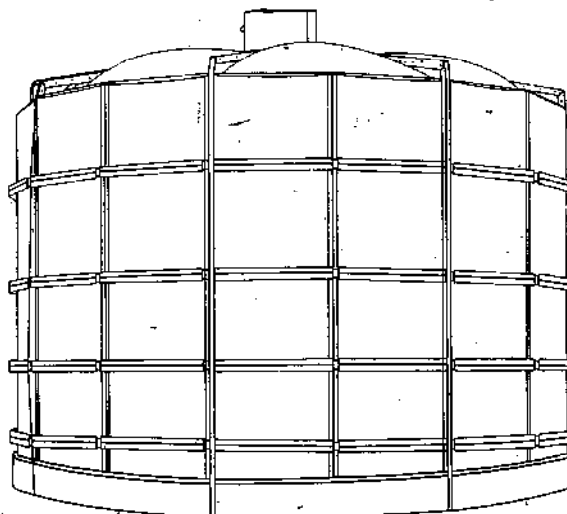

Sanamatic tank

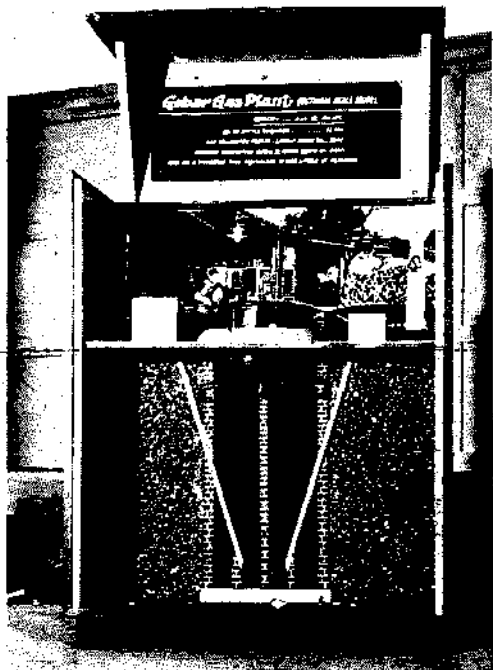

Sectional View of Khadi and Village Industries Commission Model Gas Plant

**KHADI & VILLAGE INDUSTRIES COMMISSION**

Cables: Khadigram  
 Phone: 571323-9

Gramodaya  
 3 Irla Road  
 Vile Parle (West)  
 Bombay 400 056  
 India

Designers of bio-gas plants for construction by approved makers. These plants consist generally of a brick-lined pit with a fabricated steel gas holder suspended over it. Detailed drawings are also provided for people, or groups who wish to construct their own units. Technical personnel to aid in such ventures can also be provided on a consultancy basis.

The following sizes of plant are available:

Capacity (m <sup>3</sup> )	2	3	4	6	8	10	15	20
Approx. No. of cows required	2-3	3-4	4-6	6-10	12-15	16-20	25-30	35-40
Capacity (m <sup>3</sup> )	25	35	45	60	80	140		
Approx. No. of cows required	40-45	45-55	60-70	85-100	100-140	400-450		

**TUNNEL CO LTD**  
 Tunnel Estate  
 P.O. Fort Ternan  
 Kenya

Phone: Fort Ternan 7Y7

Manufacturers of the 'Hutchinson' methane plant which has been developed over a period of twenty years. This manufacturer is interested in licensing arrangements to allow its products to be manufactured in other countries, since local manufacture is generally likely to be most economic for large and bulky systems such as methane digesters.

The following systems are available:

**A. Continuously fed systems**

Livestock requirements	Plant	Bio-gas output per day (ft <sup>3</sup> )	Size of gas holder (ft <sup>3</sup> )	Comments
5 cows	Mk III No.1	25	50	Supplied complete plus gas light.
10 "	Mk III No.2	50	50	Complete plus cooker and light.
15 "	Mk III No.3	75	100	Complete plus cooker and light.
20 "	Mk III No.4	100	100	Complete plus cooker and light.
40 "	2x Mk III No.4	200	200	Complete plus cooker and light.
50 "	Mk II Domestic	450	300	Kit and plans supplied.
80 "	Mk II Large	750	400	Kit and plans supplied.
150 "	Mk II 2 Lid	1500	400	Kit and plans supplied.
200 "	Mk II 3 Lid	2000	400	Kit and plans supplied.

It is stressed that gas is a by-product and that the sludge from 5 cows will, in addition to producing the equivalent of 2 x 30lb propane cylinders per year, fertilise one acre (= 0.4 ha).

**B. Batch fed plants**

Each plant consists of a number of compartments each of which holds 300ft<sup>3</sup> of organic wastes and yields on average 75-100ft<sup>3</sup> of bio-gas per day. Each compartment is recharged every eight weeks. The residues from each compartment will treat 5 acres per year (= 2 ha). It is suggested that batch plants be used in conjunction with one of the continuous ones listed above in order to provide a supply of the active inoculum (active bacteria) to start the batch when a fresh load is introduced.

Mk I Plant 3 compartment 300ft<sup>3</sup> gas holder, supplied as kit plus plans.

Mk I Plant 4 compartment 300ft<sup>3</sup> gas holder, supplied as kit plus plans.

Mk IV Plant is a small batch plant, supplied ready built with an output of 30ft<sup>3</sup> gas per day.

This company also produces solar water heaters (see Section 11 section).



'Hutchinson' Methane Plant

# Burners & Steam Raising Plants

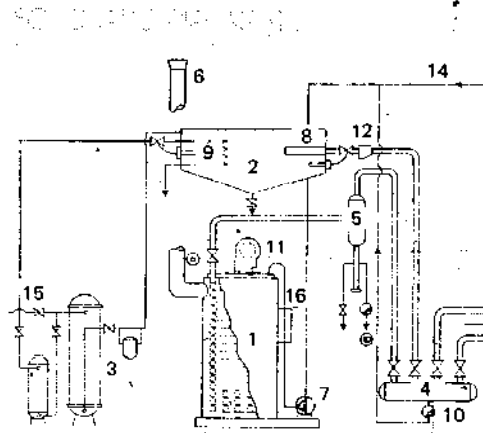

Dunlop Rapid Steam Generator

**DUNLOP LTD**  
 Energy Equipment Division  
 Holbrook Lane  
 Foleshill  
 Coventry CV6 4AA  
 U.K.

Telex: 31677  
 Phone: 0203 88733

Manufacturers of a range of steam generators to produce dry saturated steam at up to 120 atmospheric pressure. Units are gas, oil or dual fuel fired. Air requirements are less than 0.6m<sup>3</sup>/hr and the unit runs at 80% thermal efficiency.

- |                          |                     |
|--------------------------|---------------------|
| 1. Steam Generator       | 9. Cooling Coil     |
| 2. Feed Water Tank       | 10. Steam Traps     |
| 3. Water Treatment Plant | 11. Burner          |
| 4. Flow Distributor      | 12. Filter          |
| 5. Water Separator       | 13. Steam for use   |
| 6. Chimney               | 14. Condense Return |
| 7. Feed Water Pump       | 15. Water Supply    |
| 8. Steam Lance           | 16. Control Box     |

**STONE-PLATT CRAWLEY LIMITED**  
 Boiler Products  
 Gatwick Road  
 P.O. Box 5  
 Crawley  
 West Sussex RH10 2RN  
 U.K.

Telex: 877481  
 Cables: Stonelec crly  
 Phone: 0293 2711

A series of modern gas or oil-fired coil tube steam raising boilers giving 5 minute start up and quick response to load variations, complete with automatic control system. The manufacturers say the modular construction allows easy replacement of boiler tubes and other components, and that the various units are compact in arrangement.

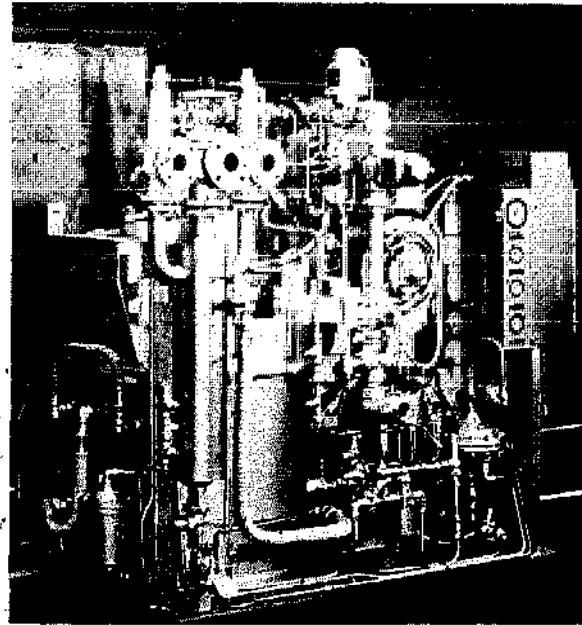

Stone Vapour Boiler

Model	Output nominal hp	Steam production at 100°C (212°F)	Fluid capacity	Heating surface	Dimensions L/W & H	Weight (kg)
7211	35	545 Kg/hr	36.8 l	8.0m <sup>2</sup>	1686mm 1110mm 1550mm	952
7217	60	948 Kg/hr	43.2 l	9.7m <sup>2</sup>	2100mm 1356mm 1940mm	1520
7227	100	1490 Kg/hr	75.0 l	14.4m <sup>2</sup>	2266mm 1220mm 2010mm	1950
7245	150	2440 Kg/hr	126 l	23m <sup>2</sup>	2860mm 1415mm 2120mm	3100
7260	200	3130 Kg/hr	207 l	29m <sup>2</sup>	2910mm 1650mm 2330mm	3774

Design pressures in the range 13 to 79 bars (188 to 1150lb/in<sup>2</sup>).

**SEMPLE ENGINE CO. INC**  
 Box 6805  
 St. Louis  
 Missouri 63144  
 U.S.A.

Phone: 314 961 6244

Vertical tubular boilers burning coal or wood intended for use with steam engines.

Model	FT-40	FT-80	FT-160	FT-240	FT-480
Horsepower	5	10	20	30	60
Height (cm)	107	127	152	163	183
Shell diam. (cm)	46	63	81	99	120
Heating surface (m <sup>2</sup> )	3.7	7.9	15.9	22.8	45.6
Operating (psig)	200	185	185	185	185
Pressure (bar)	13.8	13	13	13	13
Weight (kg)	304	508	980	1501	2485

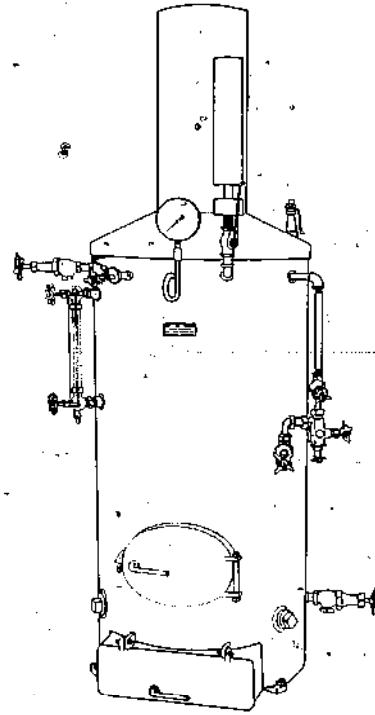

**Simple Boiler**

**FREEHEET BURNERS**

c/o Steam Power  
 106a Derby Road  
 Loughborough LE11 OAG

Manufacturers of an oil burner suitable for any oil from waste oil, such as old engine oil, to light fuel oils. Unit uses compressed air atomisation of the fuel (or steam atomisation if neither electricity or compressed air are available). There are five sizes of burner providing 7 000 to 1 925 000 BTU per hour. The company also produces warm air convectors for space heating and grain drying.

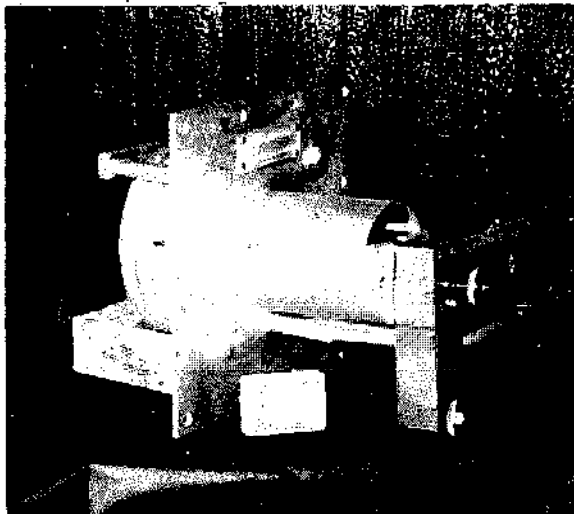

**Freeheet Oil Burner**

**O'CONNOR ENGINEERING**  
**LABORATORIES INC**  
 100 Kalmus Drive  
 Costa Mesa  
 California 92627.  
 U.S.A.

Telex: 685 641  
 Phone: 714 979  
 3993

Watertube boilers with outputs of 300-10,000 pounds of steam per hour. The 1,000 pound per hour unit operates at 350 psig and 550°F with an overall thermal efficiency of 80%. Units are suitable for marine or industrial use.

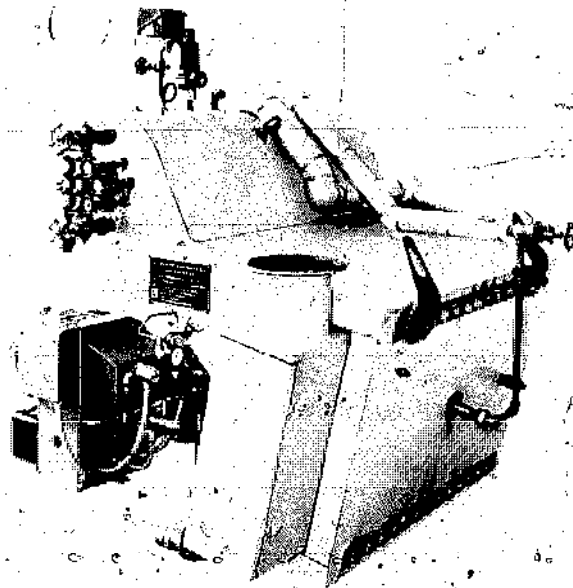

**O'Connor Boiler**

# Gasification Plant

## CECOCO AGRICULTURAL & SMALL INDUSTRIAL CENTER

Chuo Boeki Goshi Kaisha  
P.O. Box 8  
Ibaraki City  
Osaka Pref  
Japan 567

Cables: CECOCO Ibaraki

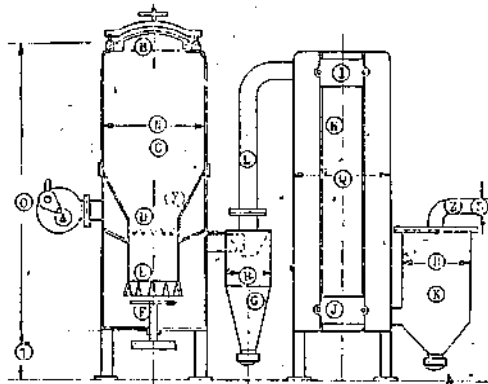

Cecoco Gas Producer

Suppliers of two gas producer plants developed in the early 1950's. These units can be used to power a specially adapted car engine. Stationary units have an output of up to 100hp while the smaller units have an output of about 10hp and are suitable for motor transport. These systems may be fuelled with wood chips, charcoal, coconut shells or other similar materials.

### Dimension of Gas Producer (mm)

Type	N	O	P	Q	R	S	T	Avail. Engine
1	350Ø	900	1500	350	2000	40A	150	18-20HP
2	300Ø	900	1500	300	2000	40A	150	12-15HP
3	300Ø	700	1200	300	1800	32A	100	10-12HP
4	250Ø	650	1200	250	1800	32A	100	4- 8HP

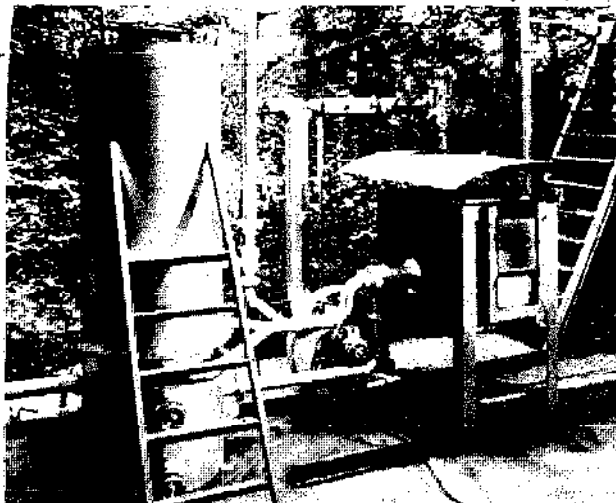

Thalopat Wood Gas Producing Plant

THALOPAT A.G.  
51 Feldstrasse  
CH - 8400 Winterthur  
Switzerland

Cables: Thalopat  
Phone: 052 22 32 22

Manufacturers of a range of wood gas producing systems with outputs of 50,000 to 1,500,000 kcal/h using waste wood or other volatile wastes as fuel. Furnaces using oil firing can be changed to wood gas fired operation simply by changing the burner.

1kg of fuel oil is approximately 10,000 kcal which is equivalent to 3kg of waste wood. The largest systems have automatic or semi-automatic fuel feed.

Applications of systems include electricity generation using specially adapted engines, saw mill operation (using wastes as fuel), ploughing (with special cable-drawn plough), etc.

# 5

## Internal Combustion Engines

DIESEL (COMPRESSION IGNITION)  
ENGINES  
SPARK IGNITION ENGINES  
(PETROL AND GAS FUELLED)  
GAS TURBINES

By far the most common power source in the 5 to 500 hp range is the internal combustion (i.c.) piston engine in either of its two main forms, the diesel (compression ignition) (c.i.) engine or the petrol (spark ignition) (s.i.) machine. Various rotary internal combustion engines (without pistons) and gas turbines have appeared in recent years, but remain relatively rare in this power range. And only one — a gas turbine — is included in this edition.

The main reasons for the success of the i.c. engine are its relatively high power/weight ratio, compact size and its "instant" startup capability, which led to its universal adoption for powering road vehicles, smaller ships and boats and small and mobile agricultural and industrial machinery. Mass production for these purposes made i.c. engines cheap, so they also became the primary power source for stationary applications such as electricity generating or pumping, where compactness and light weight are less important.

The internal combustion process, in which the fuel is burned inside the engine's power cylinder(s) was responsible for allowing compactness and light weight, as it eliminated the large boiler, with extensive heat transfer surface built into it, that is needed for the i.c. engine's primary predecessor, the external combustion (e.c.) steam engine. The other main external combustion engine, known as the Stirling engine after its inventor, uses air rather than steam as its working medium, but also requires sizeable heat transfer surfaces. However the internal combustion engine's main virtue is also its weakness, as in order to arrange easy combustion within the working cylinder it is necessary to use a clean and readily ignited fuel such as oil or gas; therefore i.c. engines are invariably dependent on petroleum-based fuels which are becoming increasingly expensive and scarce in many parts of the world. Therefore, hitherto almost extinct external combustion rivals described in the next chapter may be at the beginning of a period of revival for certain applications due to their ability to run on anything which burns such as wood, coal or agricultural wastes.

### Some general characteristics of i.c. engines

This is not the book to describe the technicalities of engines in any detail. However, when comparing different commercially-available engines it soon becomes apparent that there is a lot of variation in types available even of one particular power output.

The two main categories which are differentiated in separate parts of the following section are diesels and petrol/gas engines. The former rely on the temperature increase caused by the sudden compression of air in the cylinder(s) to ignite a jet of fuel droplets sprayed into the cylinder at the appropriate instant (compression ignition), while the latter generally have the fuel mixed with the air prior to entering the cylinder and the mixture is ignited in the cylinder by an electrical discharge at a spark plug (spark ignition). Diesel engines therefore tend to be relatively heavier and more robust in construction in order to allow the high pressures required for compression ignition to be sustained and they also require a high-precision injection pump capable of metering and injecting the fuel into the cylinder at high pressure. Petrol engines tend to be lighter and more compact for their power output and they are also somewhat cheaper to manufacture. However the diesel is inherently more efficient and often has a longer life and better reliability than a spark ignition engine of comparable power. Their greater efficiency is because the ignition method allows the engine to operate reliably with a weaker mixture (a spark ignition system requires a minimum concentration of fuel to allow the flame to spread from the spark plug).

and in addition, the higher compression ratio of the diesel effectively allows it to "breathe more deeply". The compression ratio for a petrol or s.i. engine must be limited to prevent premature ignition caused by the heat of compression, so it cannot breathe so "deeply", to use a valid human analogy.

Therefore, the petrol engine tends to be cheaper, lighter, more compact but thirstier for fuel than a diesel of the same power. As a result, private cars have petrol engines which allow a sportier performance and lower first cost, while commercial vehicles usually are diesel powered to give them better fuel economy, a longer working life and higher reliability. For stationary applications, the main virtue of petrol engines is where light weight is important to allow easy portability, or low initial cost and simplicity are important.

A general characteristic following from this for both types of piston i.c. engine is that the smaller and lighter it is for a given power output the cheaper will be its first cost and the shorter will be its life. Obviously long-life equipment generally requires better-quality materials and manufacturing, which invariably cost more, but the simplest way to get more power from a smaller engine is to design it to run at a higher speed. The faster a given size of engine runs, the more air it can breathe and the more fuel it can burn — consequently as the power is closely related to fuel consumption, the more power it will produce. However, the life of an engine both between major overhauls and *in toto* is related to the total number of revolutions — so a fast revving engine will obviously wear itself out faster than a larger, slower revving one of the same power.

The consequence of this is that it is best to use a large, heavy, slow-running engine for any applications requiring continuous reliable operation for long periods, while a cheap, compact high speed machine may be appropriate for intermittent applications or where portability is important. It will be shown later that it is a mistake to consider first or capital cost as a primary choice criterion in many cases, as the actual running costs depend equally or even more on such aspects as total engine life (amortization period), maintenance costs and fuel costs.

It follows from this that it is also better to run an engine at a lower power than its "maximum rated power" to prolong its life — indeed in many cases such as high altitude or hot locations, it is essential to "de-rate" the engine to a lower power by using an engine of greater maximum rated power than the load requires. A typical rating factor might be 0.8, implying that to obtain a horsepower of  $P$  we must use an engine of  $\frac{P}{0.8}$  rated output, = 1.25 $P$ . Another reason to derate the engine is that the maximum efficiency (that is the minimum fuel consumption relative to the power output) is usually obtained at a power output and speed two thirds approximately of that corresponding with the peak power output — so as well as extending the life of the engine, much better fuel economies may be obtained. Manufacturers will generally advise on optimum rating factors to suit your requirements, but if in doubt, it is wiser to derate too much rather than too little.

Other factors that become apparent when studying the various engine options available are as follows:

#### a. Four-stroke or two-stroke

Both s.i. and c.i. engines can be designed to run in such a way that ignition takes place either every other revolution (four-stroke or four-cycle) or once per revolution (two-stroke cycle). Four stroke engines tend to be more efficient and slower revving while two-strokes are simpler to build and have a high power/weight ratio that makes them

suitable for small-scale low cost applications. Many s.i. two-strokes are lubricated by mixing oil with the petrol supply — this removes the need for oil changes but is rather wasteful, tends to cause a smoky exhaust and there is a risk of an inexperienced operator trying to run it on neat petrol and thereby damaging it.

#### b. Air cooled or liquid cooled

All types of internal combustion engines require some form of cylinder cooling to prevent overheating. This can be arranged either via a water jacket and radiator (as used for most cars) or by blowing air past a series of cooling fins (as on most motor-cycles). Each method has its pros and cons. Water cooling is more compact in many cases for higher powered engines and the water jacket tends to deaden the engine noise and allow slightly quieter running — also the running temperature is readily controllable by a thermostat which can regulate the water flow. However water can leak out or freeze (the latter can be prevented by using anti-freeze in winter) and it is obviously an important regular maintenance function to check coolant levels with a liquid cooled engine. As loss of coolant generally causes severe engine damage if the machine is allowed to continue running, various safety devices can be fitted to warn of overheating for that or any other reason; obviously they are worth fitting to unattended engines and are often supplied as standard. Air cooled engines cannot lose their coolant, but it is important to ensure that the cooling fins do not get clogged with dust or dirt and they generally require a large and powerful fan to drive sufficient cooling air. This fan is often belt-driven — so the belt needs to be kept correctly tensioned and in good condition. Small light-weight portable engines tend to be air cooled as this allows a simpler more compact design. Therefore air cooling is more common with small engines. There is little to choose between air and liquid cooling for medium engines and most large machines are liquid cooled.

#### c. Cylinder arrangement

Most engines have vertical cylinders with the crankshaft below. For various reasons, generally dictated by the need for compactness when engines were developed for automotive use, certain multi-cylinder engines have horizontal cylinders opposing each other in pairs, or a vee arrangement. Multi-cylinder engines tend to run more smoothly and quietly than ones of the same power with fewer cylinders, but they also tend to be more expensive (having more components), to be harder to maintain but to be rather more compact.

#### d. Special features

Many of the engines described can be supplied just as a basic engine lacking essential accessories (which can then be chosen from other sources). More often they are supplied complete with a starter motor, electrical system for charging a starter battery (or this can be done via a mains voltage battery charger where the engine drives a mains voltage generator), cooling radiator (with liquid cooled machines), etc. They are often offered mounted on skids and in many cases as a complete generating or pumping set. A number of generating sets of this kind is described in Section 7. In such cases a choice of generator, electrical output, instrumentation and other ancillaries is commonly offered and described in detail in the manufacturers' brochures. A common optional extra with larger diesels in the range considered is supercharging. This artificially forces a greater volume of air and fuel through

the engine to boost the power output of a given size of engine and it can be useful at high altitude locations.

*e. Other important criteria to consider*

Probably the most important point when choosing an engine is the availability of spare parts and servicing skills — the most efficient machine to an ideal specification is useless when you cannot get spares for it and very expensive if an enormous spares inventory is required due to its rarity locally. Hence the presence of an efficient and helpful local agent should usually be a vital first consideration. The section at the end of this book on agencies, while not totally comprehensive, will, it is hoped, give some guidance in this direction. If no agent is listed for a certain engine in your country, it may well still be worth enquiring of the manufacturer in case one exists that we were not aware of. It is worth seeking the opinion of other engine users in your country as agents have a vested interest in praising their wares — and many have agencies for several rival engines and may for good or bad reasons favour one or other type.

*The economics of internal combustion engines*

The i.c. engine has two major disadvantages in most non-industrial countries, namely (a) it and its spares usually have to be imported and (b) it uses petroleum-based fuel, so obviously it is a heavy consumer of hard currency which is often scarce. Consequently, its widespread use does more for the economies of the industrial and the OPEC countries than for the economies of the poorer nations. This book indicates that in certain circumstances other alternatives which are less well-known might be worthy of consideration. However, for many years to come, in most parts of the world, it will be difficult to find other power sources in the range under consideration that are quite as convenient or well understood as i.c. engines. In the long run further depletion of oil reserves and increasing oil prices will make the alternatives increasingly attractive. Meanwhile, the main components of engine running costs are:

- Fuel consumption — (related primarily to power output) and fuel purchase, delivery and storage costs.
- Capital cost which is related to size and power output and interest rates governing the annual charge on the investment.
- Lubricant consumption (generally from 1 to 5% of fuel consumption) and lubricant purchase, delivery and storage costs.
- Operational life of engine — this varies from as little as 1000 hours for very small, high-speed, light weight two-stroke engines, to perhaps 2000 to 3000 hours for medium spark ignition and small diesels, to five or ten years for the heavier duty medium-sized petrol and diesels, to decades for some of the larger, slow-speed diesels if they are carefully maintained. Calculations can be badly upset if bad maintenance causes premature destruction of an engine.
- Repair and maintenance charges.

Vinod Mubayi and Tien Le\* have shown in a detailed comparative analysis of the costs of various alternative energy sources when applied to pumping irrigation water,

\*Irrigation in Less Developed Countries, Vinod Mubayi & Tien Le, Policy Analysis Division, Brookhaven National Laboratory, Upton, NY 11973 USA, March 1977.

that an equation can be derived to estimate the approximate costs of operating small diesel engines in early 1977 as follows:

$$e = \frac{16.275}{4h} \left( \frac{700}{P} + 110 \right) + 0.322C_f + \frac{3}{P} \text{ US cents hp-h}$$

where

h = hours operation per year

P = maximum rated power output in hp

C<sub>f</sub> = total delivered cost of fuel in US cents per litre

Obviously this is a gross approximation based on numerous assumptions described in the paper concerned, but it does allow certain interesting points about the relative effects of various cost elements to be seen. Notably, that even at low fuel prices, fuel costs become dominant compared with capital costs when engines are utilised for periods in excess of about 1500 to 2000 hours per year (there is a total of 8760 hours in a year); obviously this applies even more so with higher fuel costs more common outside the USA. Hence an apparently "cheap" engine in capital terms is often more expensive to run than a higher first cost alternative, if fairly heavy utilisation is envisaged, while a low cost machine may be best for rare operation such as for stand-by duty.

In order to give an initial indication of the character of the various engine models, offered by each manufacturer listed in this guide, in addition to the major sub-division of engines into compression (diesel) and spark (petrol/gas engine) ignition categories, the reader will find a note of special features such as which are two-stroke (to distinguish them from the majority which are four-stroke). Also, the range of models from each manufacturer is tabulated to show the model number or name, cylinder arrangement, type of cooling, cylinder capacity in cubic cm (a measure of engine size), maximum power output, typical rated output at a speed appropriate for continuous operation, and lastly the weight of the engine which may give an indication both of the first cost and the life of the engine (both being generally related to weight, first cost being roughly proportional to weight and life being proportional to  $\frac{\text{weight}}{\text{horsepower}}$ ).

Lastly, mention should be made of the sole internal combustion engine in this edition which is in the rotary class. This is a small gas turbine, having its primary value in its extremely high power to weight ratio, a factor common to engines of this kind (which makes them so suitable for aircraft propulsion). Small gas turbines have not been very successful in the past due to difficulties in scaling down larger units and the high cost of rather sophisticated components. However, new materials and manufacturing techniques and larger manufacturing volumes as more are produced for aircraft auxiliary power units and ground starters, may lead to further units of the kind described becoming available for small-scale power production. The unit described is in use in a number of places for ordinary electricity generation.

Pros and cons of small turbines are:

Pro: high power, little vibration, light weight, small size, good reliability given correct maintenance.

Con: expensive first cost, poor fuel economy compared with diesel, rather unusual maintenance skills and spaces needed.

Other rotary i.c. engines include the Wankel produced by NSU and Mazda. These are not in widespread use and like the turbine are not as economical as piston engines, but are lighter in relation to their power output.



## Diesel (compression ignition) Engines

ALLIS CHALMERS  
P.O. Box 563  
Harvey  
Illinois 60426  
U.S.A.

Telex: 910-257-2135  
Cables: Founders—Milwaukee  
Wisconsin  
Phone: (312) 339 3300

Water-cooled, turbocharged engines with power output from 60 b.h.p. to 450 b.h.p. Designed for industrial heavy plant irrigation pumping, electricity generation and marine use. Can be supplied as complete generating sets including 75 and 100kW continuous rating.

Smaller sizes of engine include:

Model	Cylinder	Cooling	Gross Power (b.h.p.)		Nett Weight (kg)
			Max.	Cont. @ r.p.m.	
D-262	4	water	77	60 2000	363
2800 Mk1	1	water	85	75 2200	476
2900 Mk2	1	water	135	100 2400	499
3500 Mk2	1	water	175	136 2200	646

Plus five further sizes up to 450 b.h.p.

Various three-phase generating sets available 94kVA/60Hz, 77kVA/50Hz up to 340kVA.

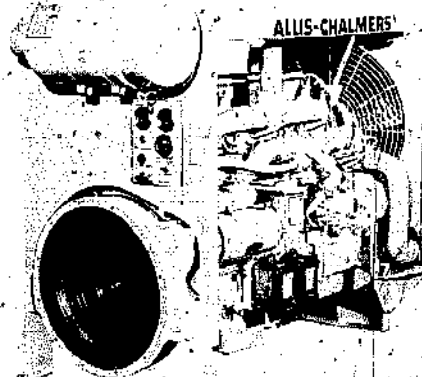

2800 Cased Stationary Diesel Unit

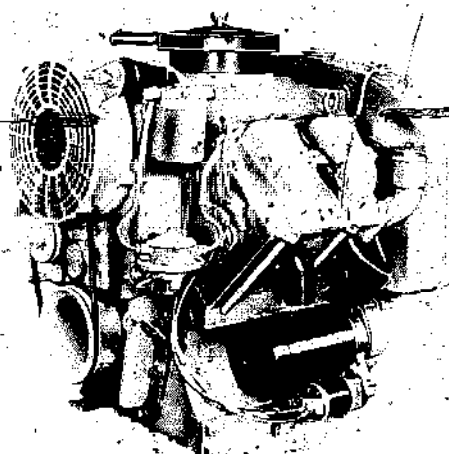

W44 Air-cooled V4 Diesel Engine

BERMOTOR LIMITED  
21 London Road  
Tunbridge Wells  
Kent TN1 1PA  
UK

Telex: 95446 —  
Phone: (0892) 37588

This is a Renault Company offering the following range of air and water-cooled industrial engines.

Model	Cylinder	Cooling	Cont. @ r.p.m.		Nett Weight (kg)
21	1	air	4	3000	51
51	1	air	6	3000	68
71	1	air	11	3000	100
42	2V	air	20	3000	142
44	2V	air	20	3000	197

Water-cooled equivalent industrial power units are also available with power outputs of 10 b.h.p. to 70 b.h.p. Units can be supplied as complete pumping sets.

CHRYSLER CORPORATION  
P.O. Box 1  
Marysville  
Michigan 48040  
U.S.A.

Cables: Chrymarine

Water-cooled diesel engines suitable for industrial and automotive installations. Some units are specifically designed for marine power use or electricity generation.

Model	Cylinder	Cooling	Cap. (cc)	Gross Power (b.h.p.)		Nett Weight (kg)
				Max.	Cont. @ r.p.m.	
IN-433	4	water	2180	61 36	2600	215
IN-633	6	water	3270	92 53	2600	300
CI641-100	6	water	4030	110 83	2800	360
CI655-100	6	water	5460	130 95	2500	427

Model CI641-100 available with brushless generator 60kW @ 3000 r.p.m.

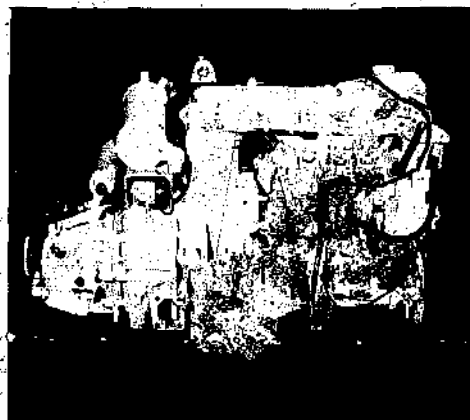

Model IN433

**BRITISH LEYLAND U.K. LIMITED**  
Leyland  
Preston PR5 1SN  
U.K.

Telex: 67655  
Cables: Leymotors Leyland  
Phone: (07744) 21400

A range of water-cooled engines designed for automotive, marine and construction-machinery use. Can be supplied as complete engine-gearbox and axle units. A variety of gearboxes and transmissions also available.

Model	Cylinder	Cooling	Cap. (cc)	Gross Power (b.h.p.)		Nett Weight (kg)	
				Max.	Cont. @ r.p.m.		
100	4	water	1490	37	27	2750	186
120	4	water	2520	60	41	2250	268
4/98	4	water	3770	75	62	2200	391
6/98	6	water	5655	115	94	2200	490
401†	6	water	6540	138	122	2600	567
AV505†	6	water	8180	171	110	2000	760
410*	6	water	6540	155	136	2600	580
500	6	water	8200	170	150	2600	753
680†	6	water	11100	202	178	2200	953
AV760†	6	water	12470	212	170	2000	1156
510*	6	water	8200	220	184	2200	835
690*	6	water	11100	240	210	220	968

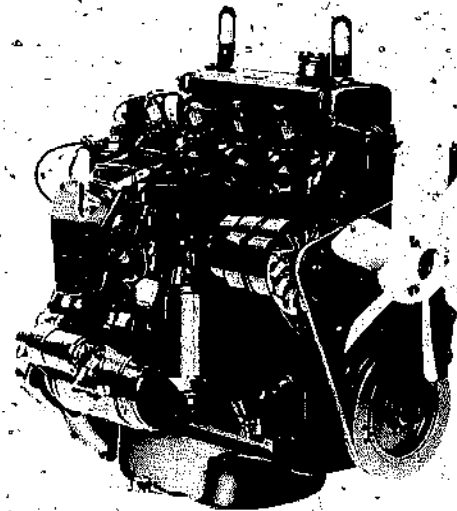

100 Series

\*turbocharged  
†available in horizontal configuration (all the rest are vertical)

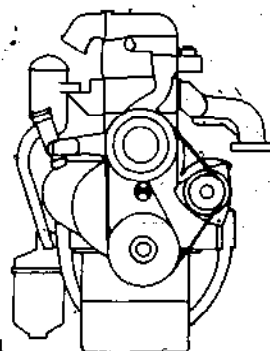
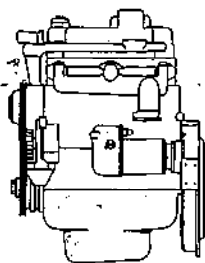

Diesel Engine OM314

**DAIMLER-BENZ A.G.**  
7000 Stuttgart 60  
West Germany

Telex: 07-23901  
Phone: 07-23901

Water-cooled units with power outputs ranging from 28 b.h.p. to 430 b.h.p. Units are designed for automotive, industrial and marine use.

Model	Cylinder	Cooling	Cap. (cc)	Gross Power (b.h.p.)		Nett Weight (kg)	
				Max.	Cont. @ r.p.m.		
OM615	4	water	2200	60	38	2600	184
OM616	4	water	2400	65	43	2600	189
OM314	4	water	3780	85	56	2200	302
OM352	6	water	5680	130	68	1800	400
OM352A*	6	water	5680	168	83	1800	410
OM360	6	water	8720	192	119	1800	640
OM346	6	water	10810	210	93	1500	778
OM355	6	water	11580	240	147	1500	857
OM401	6V	water	9570	192	81	1500	616
OM402	8V	water	12760	256	148	1500	756
OM403	10V	water	15950	320	180	1500	915
OM404	12V	water	20910	430	230	1500	1064

\*turbocharged

**CATERPILLAR OVERSEAS SA**  
118 Rue du Rhone  
P.O. Box 408  
1211 Geneva  
Switzerland

Telex: 22706  
Cables: Catoversea-Geneva  
Phone: (022) 206222

Range of water-cooled engines 64kW to 970kW. Units can be supplied suitable for truck, marine, agricultural and pumping applications. Most of the range have higher outputs than covered by the scope of this guide.

Model	Cylinder	Cooling	Cap. (cc)	Gross Power (b.h.p.)		Nett Weight (kg)	
				Max.	Cont. @ r.p.m.		
3304NA	4	water	7000	100	85	2000	718
*3304T	4	water	7000	165	125	2000	736

\*Turbocharged

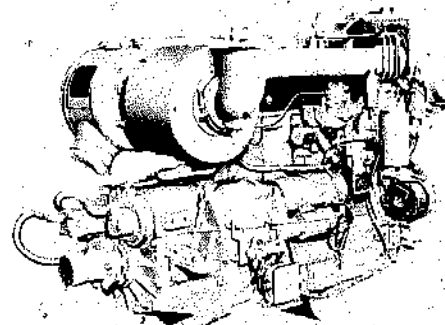

3304 Marine Propulsion Engine

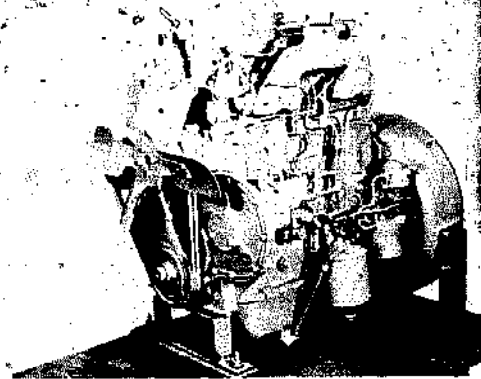

**GM Bedford 220 Fan to Flywheel Diesel Unit**

**DETROIT DIESEL ALLISON  
INTERNATIONAL-EUROPE**  
P.O. Box 6  
London Road  
Wellingborough  
Northants NN8 2DL  
U.K.

Telex: 31329  
Cables: Germopower Welling-  
borough  
Phone: (0933) 71122

Water-cooled engines with power outputs from 40 b.h.p. to 1600 b.h.p. Units designed for automotive industrial or marine use and can be supplied as complete (brushless) generating sets, rated at 30, 35, 44 and 71kW, 50 or 60Hz.

*Detroit-Diesel Allison fan to flywheel two-stroke diesels with integral injector/pump units*

Model	Cylinder	Cooling	Cap. (cc)	Gross Power (b.h.p.)			Nett Weight (kg)
				Max.	Cont.	@ r.p.m.	
2-71	2	water	2300	68	40	1500	436
3-53	3	water	2610	78	64	2200	438
3-53*	3	water	2610	97	64	2200	438
3-71	3	water	3496	106	75	1800	693
3-71*	3	water	3496	113	82	1800	693
4-53	4	water	3480	108	87	2200	623
4-53*	4	water	3480	123	87	2200	623
4-71	4	water	4660	160	117	1800	954

\*Denotes 4-valve version. Numerous larger models available, plus versions with torque converter and 35, 50, 55, 75 105kVA and larger generator sets.

*GM Bedford Diesels (four-stroke)*

220F/F	4	water	3614	65	56	2500	356
330F/F	6	water	5420	100	82	2500	460
500F/F	6	water	8200	164	95	1600	600

These models available as fan to flywheel suffix (F/F), complete power unit (P) and marine (M).

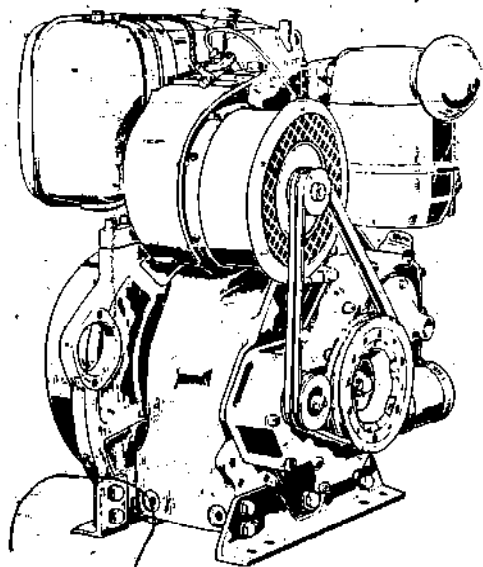

**Hatz Diesel Engine**

**MOTORENFABRIK HATZ KG**  
P.O. Box 20  
D-8399 Ruhstorf/Rott  
W. Germany

Telex: 057260  
Cables: Hatzmotor  
Phone: 08531-3022

Manufacturers of a range of four-stroke air-cooled diesel engines with power outputs of 1.5 hp to 80 hp. Units are suitable for automotive or stationary installations.

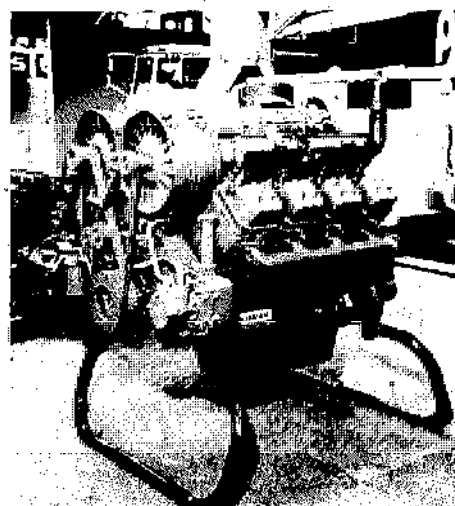

**DA Series Air Cooled Engine**

**DORMAN DIESELS LIMITED**  
Tixall Road  
Stafford ST16 3UB  
U.K.

Telex: 36156  
Cable: Dorman Stafford  
Phone: (0785) 3141

A series of robust, medium speed, four-stroke diesel engines as follows:

Model	Cylinder	Cooling	Cap. (cc)	Gross Power (b.h.p.)			Nett Weight (kg)
				Max.	Cont.	@ r.p.m.	
4DA	4	air	4150	75	46	1500	470
6DA*	6	air	6230	112	69	1500	572
8DA	8V	air	8310	144	86	1500	711
8F*	8V	water	9120	177	107	1500	685
6LD*	6	water	9882	145	124	1500	859
6LE*	6	water	11340	170	147	1500	859

\*Turbocharged variants available.

Other models up to approximately 950 b.h.p. are available.

**ELVE CORPORATION**  
 Elve Chambers  
 Green Street (off Bank Street)  
 Fort  
 Bombay 400023  
 India

TeleX: Elve Oly 3856  
 Cables: Elbuscon  
 Phone: 263981/2/3

Water-cooled slow speed diesel engines with power outputs of 7.8 b.h.p. and 11 b.h.p. Units can be supplied as complete pumping units.

Model	Cylinder	Cooling	Cap. (cc)	Gross Power (b.h.p.)		
				Max.	Cont.	@ r.p.m.
6/1	1	radiator or tank	553	7.4	5	600
8/1	1	radiator or tank	622	14	8	850

Manufacturers claim 5 year operational life.

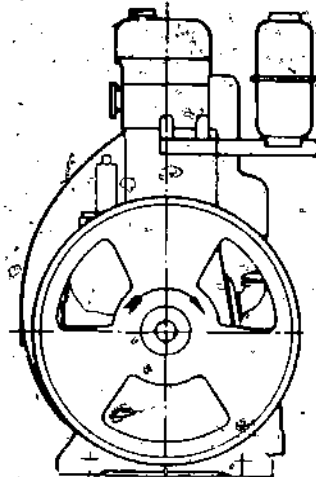

Brand Diesel Engine Type 8/1

**FARYMANN DIESEL**  
 P.O. Box 100  
 684 Lampertheim  
 West Germany

Telèx: 465710  
 Cables: Farymann diesel  
 Phone: (6206) 2001

Air-cooled and water-cooled diesel engines with outputs ranging from 1hp to 26hp. The units are aimed at the small industrial and the marine auxiliary engine market and those at the lower end of the range are very small and compact. Model K50 is claimed to be the smallest industrial diesel in the world.

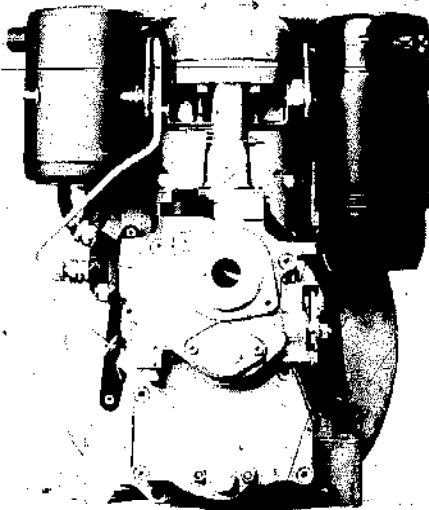

K Series Single Cylinder Air-Cooled Diesel Engine

Model	Cylinder	Cooling	Cap. (cc)	Gross Power (b.h.p.)			Nett Weight (kg)
				Max.	Cont.	@ r.p.m.	
K50	1	air	200	3.5	3	2500	33
K54	1	air	242	4.5	3.8	2500	33
K14	1	air	298	6.0	5.2	2500	51
L14	1	air	412	8.0	6.8	2500	60
A10	1	air	582	11.0	9.5	2500	68
A12	1	air	618	12.0	10.0	2500	69
L20	1H	air	412	8.0	6.8	2500	62
A20	1H	air	582	11.0	9.5	2500	70
A22	1H	air	618	12.0	10.0	2500	71
G20	1H	air	1625	14.0	14.0	2000	180
R10	2V	air	1160	18.0	14.5	2000	130
R12	2V	air	1236	21.0	15.5	2000	132
P10	2V	air	1276	22.0	17.0	2000	150
S10	2V	air	1558	26.0	21.0	2000	160
A40	1H	water	582	12.0	10.0	2500	75
A30	1	water	582	12.0	10.0	2500	73
R30	2V	water	1160	24.0	18.0	2500	130
S30	2V	water	1560	32.0	25.0	2500	170

**ENFIELD INDUSTRIAL ENGINES LIMITED**  
 Somerton Works  
 Cowes  
 Isle of Wight  
 U.K.

Cables: Diesels Cowes  
 Phone: Cowes 4711

Hand started units suitable for use in stationary, automotive and marine installations. Centrifugal governor speed control for factory setting between 1200 r.p.m. and 2000 r.p.m. An over-riding control can be fitted varying the speed from maximum to 800 r.p.m.

Model	Cylinder	Cooling	Cap. (cc)	Gross Power (b.h.p.)			Net Weight (kg)
				Max.	Cont.	@ r.p.m.	
85 single	1	air	568	7.5	5.5	1500	121
85 twin	2	air	1135	14.9	11	1250	147

Marine versions available; all models with hand or electric start options.

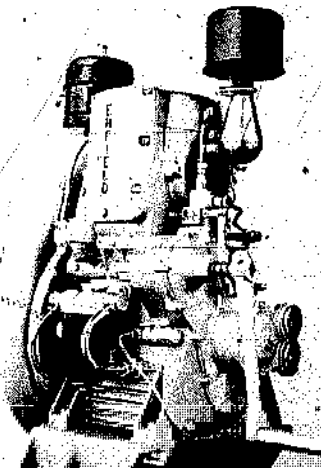

Model '85' Single Cylinder Unit



**2401E Industrial Diesel Engine**

**FORD MOTOR COMPANY LIMITED**  
 Royal Oak Way South  
 Daventry  
 Northants NN11 5NT  
 U.K.

Telex: 311552  
 Phone: (032 72) 71111  
 Cables: Fordparts, Daventry  
 Fordparts, Daventry

Model	Cylinder	Cooling	Cap. (cc)	Gross Power (b.h.p.)		Nett Weight (kg)	
				Max.	Cont. @ r.p.m.		
2504E	3	water	2868	41.5	30	1500	311
2512E	3	water	3294	57	39	1500	324
2514E	4	water	4196	69.5	53	1600	401
2711E	4	water	4150	71	58	2000	340
2712E	4	water	4150	80	63	2000	340
2713E	6	water	5950	100	78	2000	442
2714E	6	water	6220	108	85	2000	442
2715E	6	water	6220	120	93	2000	442
2704ET*	6	water	5945	150	116	2000	455

High speed range

2401E	4	water	2360	58	42	2750	215
2402E	6	water	3540	87	63	2750	292

\*available for marine use with or without intercooler.

**KLOCKNER-HUMBOLDT-DEUTZ-AG**  
 P.O. Box 900 509  
 Deutz-Mulheimer-Strasse 111  
 5000 Cologne  
 W. Germany

Telex: 08 873 201  
 Cables: Deutzmotor Köln  
 Phone: (0221) 8221

Wide range of air cooled engines as indicated. Two stage combustion version offers low exhaust emissions to California 1977 standard.

Model	Cylinder	Cooling	Cap. (cc)	Gross Power (b.h.p.)		Nett Weight (kg)	
				Max.	Cont. @ r.p.m.		
Air cooled direct injection engines.							
F1L208	1	air	410	8	7	3000	65
F1L210	1	air	670	14	12.5	3000	80
F1L411D*	1	air	690	14	8.75	2500	110
F2L411D*	2	air	1390	28	23	2500	146
F2L912*	2	air	1880	32	20	2300	235
F3L912*	3	air	2830	58	47	2300	270
F4L912*	4	air	3770	80	63	2300	300
F5L912*	5	air	4710	100	79	2300	380
F6L912*	6	air	5660	120	95	2300	410
BFL6L913	6	air	6128	160	123	2000	485
F5L413R	5	air	7350	136	113	2300	623
*F6L413R	6	air	8820	163	136	2300	740
F6L413*	6V	air	8480	163	136	2300	595

Plus larger units up to 455 b.h.p.

\*Denotes variants with two-stage combustion, offering reduced exhaust emissions. Water cooled series from 20Q to 9000 b.h.p. also available.

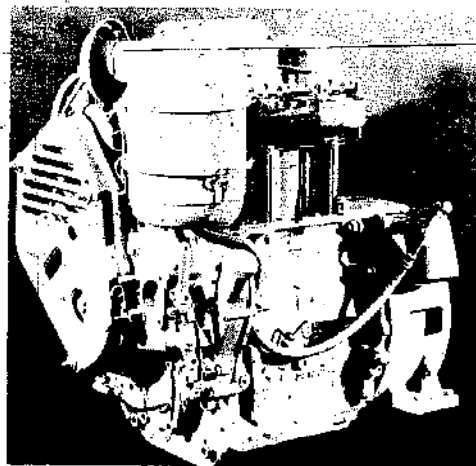

**F2L411W**

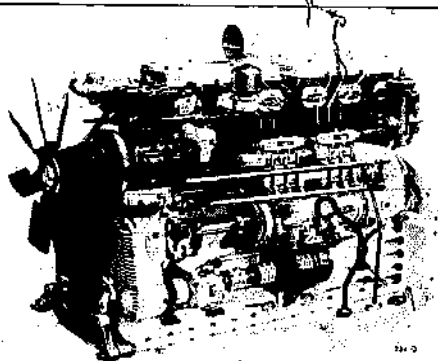

**6LXB 10.45 Litre Diesel Engine**

**L. GARDNER & SONS LIMITED**  
 Barton Hall Engine Works  
 Patricroft  
 Eccles  
 Manchester M30 7WA  
 U.K.

Telex: 668023  
 Cables: Gardworks Eccles  
 Manchester  
 Phone: 061 789 2201

Water cooled four-stroke diesel engines for automotive, marine and industrial purposes.

Model	Cylinder	Cooling	Cap. (cc)	Gross Power (b.h.p.)		
				Max.	Cont. @ r.p.m.	
6LXB	6	water	10450	180	120	1500
8LXB	8	water	13938	240	160	1500
8L3B	8	water	24138	260	214	1150

**R.A. LISTER & COMPANY LIMITED**  
 (Member of Hawker Siddeley Group)  
 Dursley,  
 Gloucester GL11 4HS  
 U.K.

Telex: 43261  
 Cables: Machinery Dursley  
 Phone: Dursley 4141

Air and water cooled diesel engines with a power range from 2.5 b.h.p. to 250 b.h.p. Small units have hand starting, larger units are started electrically. Numerous accessories are available for most models for a wide variety of applications, plus a very comprehensive international distribution network. A wide selection of marine engines and auxiliary engines based on these power units is also available.

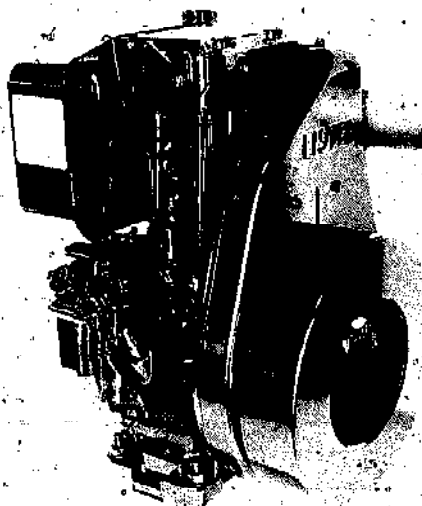

**Lister Diesel Engines**

Model	Cylinder	Cooling	Cap. (cc)	Gross Power (b.h.p.)			Nett Weight (kg)
				Max.	Cont.	@ r.p.m.	
8/1	1	water	—	8	6	650	—
16/2	2	water	—	16	12	650	—
LT1	1	air	408	5.25	4	1800	80
ST1	1	air	633	12.5	7.3	1800	107
ST2	2	air	1266	25.0	14.6	1800	170
ST3	3	air	1900	37.5	21.9	1800	215
HR2	2	air	2090	37	21.5	1500	280
HR3	3	air	3135	55	32	1500	370
HR4	4	air	4180	73	43	1500	432
HR6	6	air	6270	111	64	1500	560
HRS6	6	air	6270	—	80	1500	626
JA6	6	air	10620	173	109	1500	950
JAS6	6	air	10620	—	122	1500	975
HRW2	2	water	2090	37	21	1500	306
HRW3	3	water	3135	55	32	1500	419
HRW4	4	water	4180	73	43	1500	507
HRW6	6	water	6270	111	64	1500	652
HRW56	6	water	6270	—	80	1500	684
JW6	6	water	10620	173	109	1500	1180
JWS6	6	water	10620	—	140	1500	1200

**PETTERS LIMITED**  
 Power Generation Division  
 Hamble Lane  
 Hamble  
 Southampton SO3 5NJ  
 U.K.

Telex: 47626  
 Cables: Petter Hamble  
 Phone: (042) 122 2061

This manufacturer is part of the Hawker Siddeley Group and offers air and water cooled diesel engines with power outputs ranging from 2 b.h.p. to 50 b.h.p. Power off-take via a clutch at the machined flywheel housing end on the larger units, or by pulley attached to an extension of the crankshaft on the small units. Various units are available as a generating and refrigeration or pumping set.

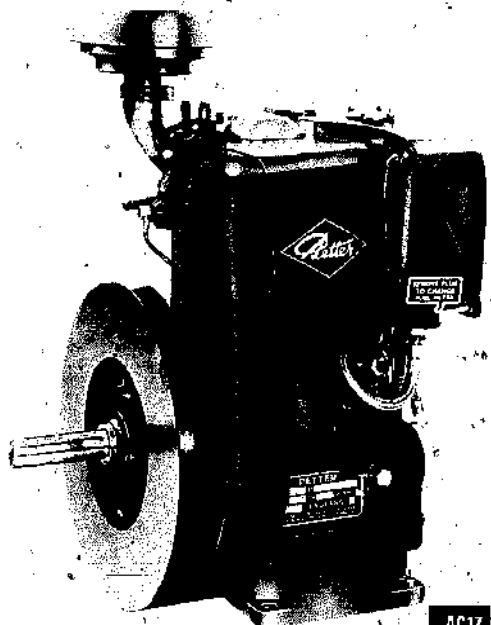

**AC1Z Single Cylinder**

Model	Cylinder	Cooling	Gross Power (b.h.p.)			Nett Weight (kg)
			Max.	Cont.	@ r.p.m.	
<b>Compact range</b>						
AA1	1	air	3.8	2.8	2500	42.6
AB1	1	air	5.5	3.8	2500	44.5
AB1W	1	water	5.5	3.8	2500	46.8
AC1	1	air	7.2	5.0	2500	47
AC1W	1	water	7.2	5.0	2500	46
AC1Z	1	air	6.0	5.0	2500	49
BA1	1	air	11.0	7.5	2000	105
BA2	2	air	22.0	15.0	2000	147
AC2	1	air	13.2	11.0	3000	78
<b>Standard range</b>						
PAZ1	1	air	3.3	2.5	1500	108
PH1*	1	air	9.0	6.3	1500	185
PH2*	2	air	18.0	12.5	1500	252
PJ1*	1	air	12.4	8.5	1500	210
PJ2*	2	air	24.7	17.0	1500	276
PJ3*	3	air	37.1	25.5	1500	362
PJ4*	4	air	49.5	34.0	1500	435

\*Water cooled variants available with suffix W to model number.

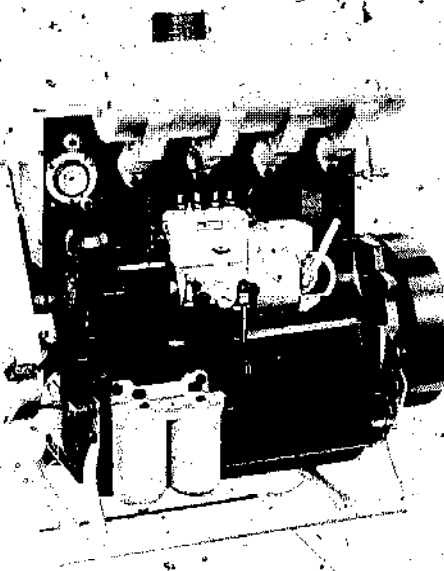

**PRAGOVEST**  
Foreign Trade Corporation  
P.O. Box 890  
Praha 9  
Czechoslovakia

Telex: 122 379  
Cables: Pragoinvest-Praha

A range of air cooled medium speed, four-stroke diesel engines with one, two, three or four cylinders. Units are suitable for various light industrial uses, generating electricity, etc.

**Slavia S 95 Type Diesel Engine**

**MECCANICA S.p.A**  
CP 313  
Via A.C. Ducati 3  
Borgo Parigale  
40100 Bologna  
Italy

Telex: 51492  
Phone: (051) 405049

A range of Italian built Ducati four-stroke diesel engines with forced air-cooling via a flywheel blower. Starting normally by a rope but units can be supplied for hand crank starting or electric dynastart.

Model	Cylinder	Cooling	Cap. (cc)	Gross Power (b.h.p.)		@ r.p.m.	Nett Weight (kg)
				Max.	Cont.		
1S7	1	air	345	7	5.5	2500	48
1S9	1	air	345	9	6.2	2500	48
1S11	1	air	432	11	7.8	2500	50
1S16	1	air	673	18	13	2500	86
1S20	1	air	746	20	14.2	2500	88
2IS22	2	air	864	22	15.2	2500	86

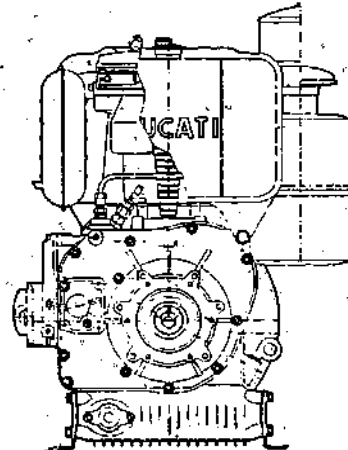

**IS16 Four-stroke Diesel Unit**

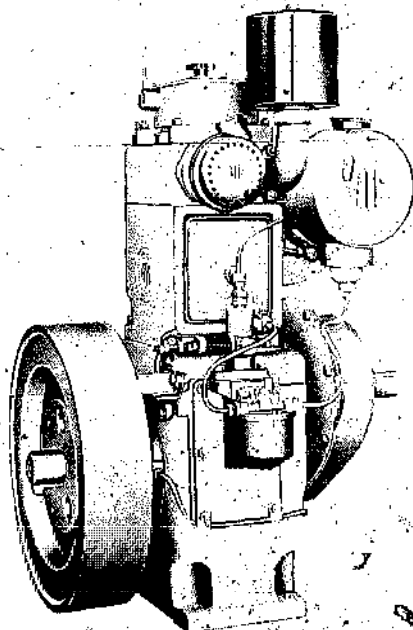

**Model VRS5**

**H.T.C. DIESEL ENGINES**  
**PRIVATE LIMITED**  
Beaumont Chambers  
27/33 Nagindas Master Road  
Bombay 400 023  
India

Telex: 011-3242  
Cables: Hotraco  
Phone: 272188

Single-cylinder, open-flywheel, hand-cranked engines, which can be supplied with clock-wise or anti-clockwise rotation.

Model	Cylinder	Cooling	Cap. (cc)	Gross Power (b.h.p.)		Nett Weight (kg)
				Max.	Cont. @ r.p.m.	
AAVRS-5	1	air	553	5	1500	155
RVRS-5	1	water	553	5	1500	—
VRS-5	1	water	553	6.5	1500	—

Engines offered as pumping set on base-plate, trolley or skids.

INDIAN NATIONAL DIESEL  
ENGINE CO. LIMITED  
6 Little Russel Street  
Calcutta 700071

Telex: 7211, 3283  
Cables: Innatdec  
Phone: 43-1938

Registered Office:  
Hall & Anderson  
Buildings  
Park Street  
Calcutta 700016  
India

Manufacturers of four-stroke diesel engines which can be supplied as pumping or generating sets.

Model	Cylinder	Cooling	Cap. (cc)	Gross Power (b.h.p.)			Nett Weight (kg)
				Max.	Cont.	@ r.p.m.	
PH1	1	air	659	8.2	6.25	1500	188
PH1W	1	water	659	8.2	6.25	1500	178
PH2	2	air	1318	16.4	12.5	1500	255
PH2W	2	water	1318	16.4	12.5	1500	250

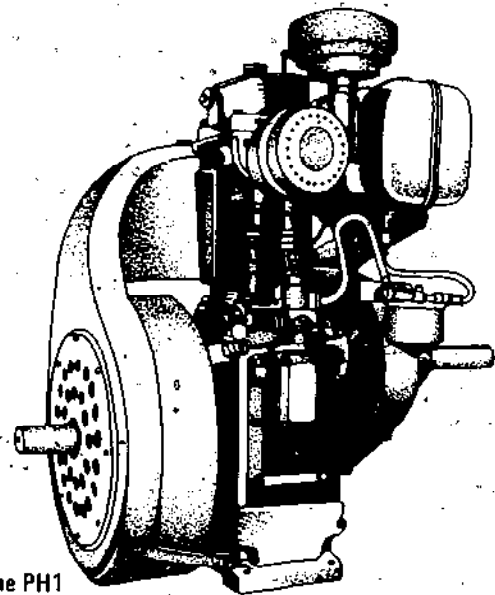

Air Cooled Diesel Engine PH1

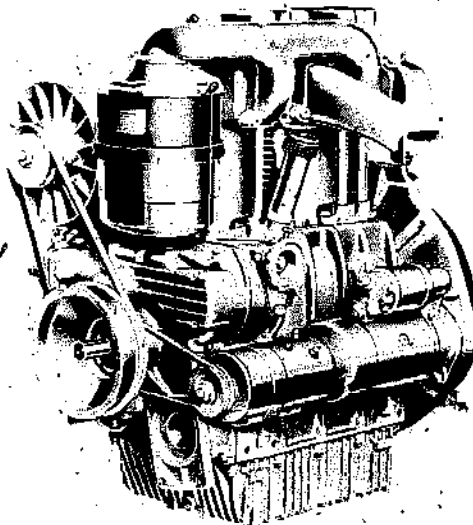

RUGGERINI MOTORI S.p.A.  
42040 Villa Bagno  
Reggio Emilia  
Italy

Telex: 51137  
Cables: Ruggenerini Motori Rubiera  
Phone: (0522) 55221

All models can be equipped with cables and control panel for dynastart and electric start and fuel cut-off switch for remote control. Both horizontal and vertical shaft models are available.

Model	Cylinder	Cooling	Cap. (cc)	Gross Power (b.h.p.)			Nett Weight (kg)
				Max.	Cont.	@ r.p.m.	
RD80	1	air	375	8.0	6.3	3000	42
RD850	1	air	482	10.3	9.0	3000	49
RD901	1	air	540	14.2	12.6	3000	60
RD920	1	air	565	16.0	13.5	3000	65
P101	1	air	746	20.6	17.7	3000	95
RD901/2	2	air	1080	26.0	23.0	3000	88
P101/2	2	air	1492	40.0	36.0	3000	143
P105/2	2	air	1750	45.0	40.0	3000	150
RD80V	1H	air	375	8.0	6.3	3000	42
RD850V	1H	air	485	10.3	9.0	3000	49
RD920V	1H	air	565	16.0	13.5	3000	65

Ruggenerini P101/2 (40 h.p.)

Various clutches, reduction gears, starters, etc., are available.

NISSAN DIESEL MOTOR  
COMPANY LIMITED  
Kowa Building  
3-7-1 Kanda Nishiki-cho  
Chiyoda-ku  
Tokyo  
Japan 101

Telex: J24905 Nideko  
Cables: Nissandiesel Tokyo

Model	Cylinder	Cooling	Cap. (cc)	Gross Power (b.h.p.)			Nett Weight (kg)
				Max.	Cont.	@ r.p.m.	
SD226							
marine	4	water	2164	46	40	2600	375
SD22	4	water	2164	66	36	2600	190
SD33	6	water	3246	99	53	2600	300
ED30	4	water	2956	91	39	2000	295
ED6	6	water	5654	152	85	2200	470
ND6	6	water	6842	140	87	2000	600
PD60	6	water	10308	190	122	1800	822

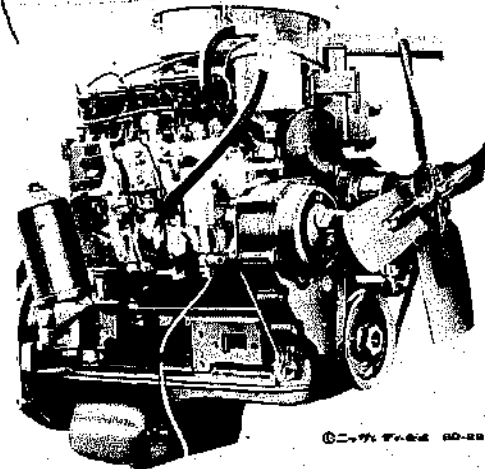

SD22 Diesel Unit

Various other models up to 350 b.h.p. are also available, and some units are supplied as an enclosed power-pack as an optional extra.



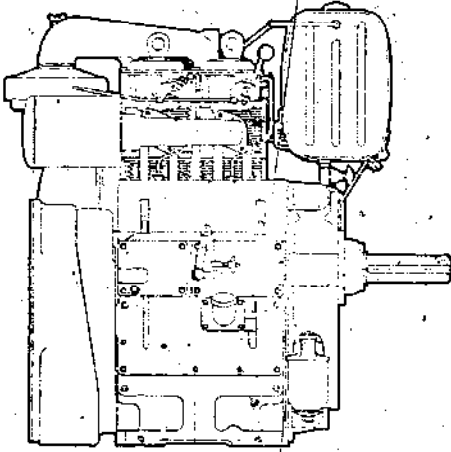

Ruston 'YWA' Air-Cooled Diesel

**RUSTON & HORNSBY  
(INDIA) LIMITED**  
Chinchwad  
Poona - 411 019  
India

Telex: 303 Greaves (PN)  
Cables: Rustonind  
Phone: 82601/2/3/4/5

Medium speed engines of unitary construction to allow easy maintenance and repair of individual cylinders and pistons. Industrial and marine versions with the facility of power off-take being from either end of the crankshaft.

Model	Cylinder	Cooling	Cap. (cc)	Gross Power (b.h.p.)		Nett Weight (kg)
				Max.	Cont. @ r.p.m.	
2YDA	2	air	2463	42	22 1500	480
3YDA	3	air	3695	68	46 1600	557
4YDA	4	air	4928	92	63 1600	620
6YDA	6	air	7391	135	92 1600	793
1YWA	1	air	-	15.5	9.8 1500	245
2YWA	2	air	-	31.5	19.6 1500	308
3YWA	3	air	-	51	29.4 1500	372
2YD	2	water	2463	42	27.5 1500	524
3YD	3	water	3695	65	42 1500	584
4YD	4	water	4928	90	55 1500	673
6YD	6	water	7391	135	84 1500	876
6YDX	6	water	7391	182	-	-

Slow speed horizontal engines with exposed flywheel

Model	Cylinder	Cooling	Cap.	Gross Power (b.h.p.)		Nett Weight (kg)
				Max.	Cont. @ r.p.m.	
1HR	1H	water	1900	6	5.5 550	367
1XHR	1H	water	1900	9	8 800	367
1YHR	1H	water	4300	11	10 450	635
1ZHR	1H	water	4300	12	11 475	635
2XHR	1H	water	6000	15.5	14 475	839
3HRO	1H	water	9300	20	18 400	1270
HRY	1H	water	9300	28.6	26 430	1283

**MEDALIST UNIVERSAL  
MOTORS**  
1552 Harrison Street  
P.O. Box 2508  
Oshkosh  
Wisconsin 54901  
U.S.A.

Telex: 262-717  
Cables: Unimot  
Phone: (414) 231 4100

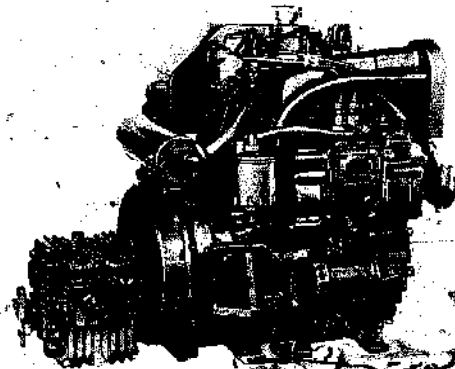

17 h.p. Universal Marine Diesel

Manufacturers of a range of three water cooled, four-stroke diesel engines with rated power outputs of 12, 17 and 25 b.h.p. at 2800 r.p.m. Specifically designed for marine applications, but can be supplied with or without a final drive reduction. Closed system fresh water cooling can be supplied on some models for sea water use.

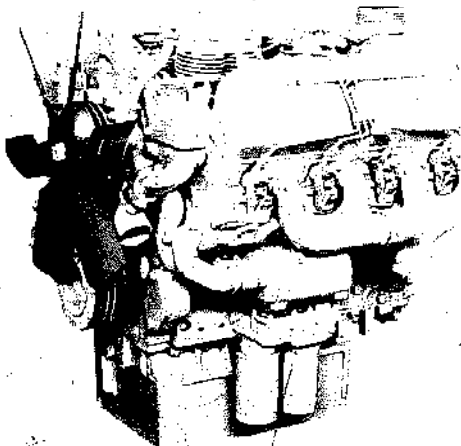

V8.640 Diesel Engine

**PERKINS ENGINES LIMITED**  
Eastfield  
Peterborough PE1 5NA  
U.K.

Telex: 32501  
Cables: Perkoil Peterborough  
Phone: (0733) 67474

Model	Cylinder	Cooling	Cap. (cc)	Gross Power (b.h.p.)		Nett Weight (kg)
				Max.	Cont. @ r.p.m.	
D3.152	3	water	2500	49	38 1800	210
4.108	4	water	1760	45	26 1800	150
4.203	4	water	3300	61	52 1800	236
4.236	4	water	3860	81	64 1800	249
4.248	4	water	4070	84	65 1800	249
6.354	6	water	5800	114	87 1800	390
T6.354*	6	water	5800	137	117 1800	417
V8.540	8V	water	8830	180	135 1800	623

\*Turbocharged.

Two further V8's up to 250 b.h.p. are also available.

These engines are widely used in industrial, earth moving and agricultural machinery, and for powering generator sets.

**KIRLOSKAR OIL ENGINES LIMITED**  
 13. Laxmanrao Kirloskar Road  
 Kirkee  
 Pune - 411 003  
 India

Telex: 9014-245-Koel Pa  
 Cables: Koel Pune (India)  
 Phone: 55346/7/8

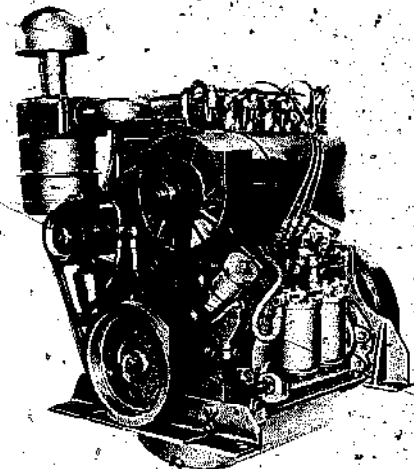

**Kirloskar RA3 Diesel Unit.**

Air and water cooled engines with a power range of 5 to 370 b.h.p. Manufactured for automotive, marine, agricultural and industrial use. Can be supplied as complete generating or pumping sets.

Model	Cylinder	Cooling	Cap. (cc)	Gross Power (b.h.p.)			Nett Weight (kg)
				Max.	Cont.	@ r.p.m.	
TA1	1	air	660	9.38	6.0	1500	164
TA2	2	air	1320	18.75	12.0	1500	250
TV1	1	water	660	10.88	7.0	1500	166
TV2	2	water	1320	21.76	14.0	1500	247
KA27	1	air	276	4.5	2.7	2000	91
CA1	1	air	580	6	5	1500	172
CA2	2	air	1160	12	10	1500	248
AV1	1	water	553	8.1	5	1500	166
AV2	2	water	1106	16.2	10	1500	247
RA2	2	air	1728	21	16.5	1500	323
RA3	3	air	2592	31.5	24.7	1500	433
RA4	4	air	3456	42	33	1500	475
RA6	6	air	5184	63	48.5	1500	595
RDA2	2	air	1930	26.5	19	1500	325
RDA3	3	air	2900	36	28.5	1500	435
RDA4	4	air	3870	47	37	1500	475
RDA6	6	air	5800	70	55	1500	595
RV2	2	water	1728	27.5	16.8	1500	328
RV3	3	water	2592	41.25	25.2	1500	438
RV4	4	water	3456	55	33.6	1500	480
RV6	6	water	5184	82.5	50.4	1500	600
RBV2	2	water	2090	30.8	25.8	1650	338
RBV3	3	water	3135	46.2	38.7	1650	448
RBV4	4	water	4180	61.5	51.6	1650	490
RBV6	6	water	6270	92.5	77.4	1650	610
RE4	4	water	2700	55	31.25	2000	235

Kirloskar also manufacture a selection of 1 to 45kVA generating sets and 16 to 61 b.h.p. pumping sets. Also, marine variants and larger units.

**VOLVO PENTA**  
 P.O. Box 392  
 401 26 Goteborg 1  
 Sweden

Telex: 20755  
 Cables: Penta  
 Phone: 23 54 60

Range of units with power outputs ranging from 44kW to 201kW, designed for industrial machinery, marine auxiliary use, as power packs, and can be supplied complete with a large range of ancillary equipment.

Model	Cylinder	Cooling	Cap. (cc)	Gross Power (b.h.p.)			Nett Weight (kg)
				Max.	Cont.	@ r.p.m.	
D70B	6	water	6730	165	100	1800	670
TD70B*	6	water	6730	215	139	1800	680

\* Denotes turbocharged version - a range of larger units up to 329 b.h.p. is also available.

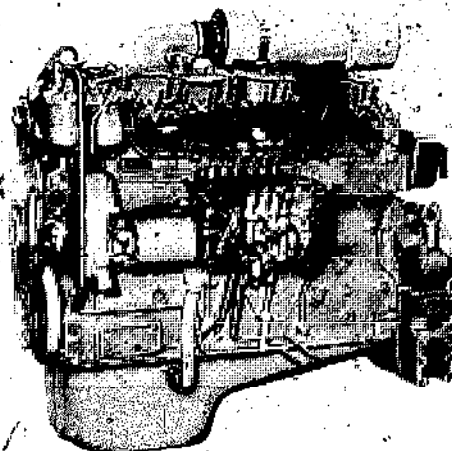

**Volvo Penta D70B**

Inboard marine engines:

MD5A	1	water	440	7.5	-	-	111
MD7A	2	water	740	13	-	-	175
MD11C	2	water	1120	-	20	2300	230
MD17C	3	water	1680	-	30	2300	290
MD70B	6	water	6730	139	106	2000	800

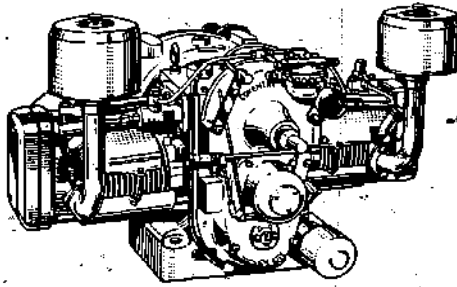

Model HDA

**A.N. WEAVER (COVENTRY VICTOR) LIMITED**  
 Smiths Industrial Estate  
 Humber Avenue  
 Coventry CV3 1JL  
 U.K.

Cables: Precision Coventry  
 Phone: 0203-452625

A range of air and water cooled general purpose engines as follows:

Model	Cylinder	Cooling	Cap. (cc)	Gross Power (b.h.p.)		Nett Weight (kg)	
				Max.	Cont. @ r.p.m.		
WD3	1	water	636	11	7.3	1500	125
AD3	1	air	636	9	6	1500	154
HDA	2H	air	1448	23	15.4	1500	207
HDW	2H	water	1448	30	17.8	1500	197

Some of these units are available adapted for marine and other specialised uses.

**VOLKSWAGENWERK AG**  
 Heinrich Nordoff Strasse  
 D-3180 Wolfsburg 1  
 Germany

Telex: 09586-0 vwwd  
 Cables: Volkswagenwerk/Wolfsburg  
 Phone: 22-3535

1500 cc water cooled diesel engine producing 33 kW at 4000 r.p.m. Unit based on engine used for Volkswagen Golf car, and is intended for industrial applications.

Model 068.2, 1471 cc, water-cooled, 4 cylinder in-line. Maximum power 50 b.h.p. Maximum continuous rating (typical) 25 b.h.p. @ 2000 r.p.m. Weight (dry) 129 kg. 12V electrical system complete with starter.

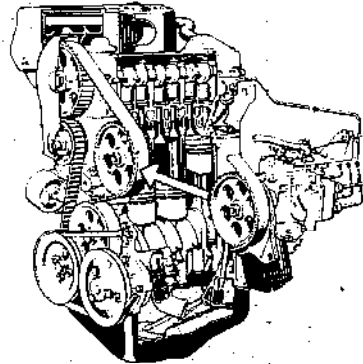

Volkswagen 1500cc Diesel Engine

**SPILLING CONSULT AG**  
 Sonnenweg 4  
 CH-5610 Wohlen  
 Switzerland

Telex: 57 939  
 Cables: Spill Ch.  
 Phone: 057-6 73 57

Manufacturers of modular diesel engine with multi-fuel capability consisting of a single cylinder module which can be assembled in any combination from 1 to 8 units in line.

	Cylinder	Cooling	Capacity	Gross Power (b.h.p.)	
				Cont.	@ r.p.m.
each module	1	water	13200cc	100	1000
supercharged				180	1000

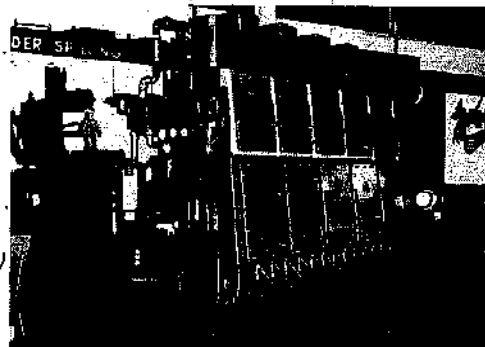

Spilling Six-cylinder Diesel Engine

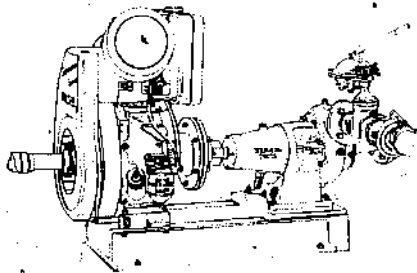

Southern Cross 6 h.p. Air-cooled Diesel Engine

**TOOWOOMBA FOUNDRY PTY LTD**  
 P.O. Box 109  
 Toowoomba  
 Queensland 4350  
 Australia

Telex: Socross 40046  
 Cables: Foundfact Toowoomba  
 Phone: 076 32 3122

Manufacturers of "Southern Cross" slow to medium speed diesel engines. A series of air cooled, four-stroke cycle engines as follows:

Model	Cylinder	Cooling	Cap. (cc)	Gross Power (b.h.p.)		Nett Weight (kg)	
				Max.	Cont. @ r.p.m.		
EF-D	1	air	316	3.5	2.5	1500	85
EF-E	1	air	591	6.0	5	1500	139
EF-H	2	air	1182	12	10	1500	236
ED-C	1	air	1104	12	11	1500	326
ED-E	2	air	2092	24	20	1500	388
ED-G	4	air	4184	50	44	1500	572

**GRAHAME PUTTICK  
LIMITED**  
Sandwich  
Kent  
U.K.

Telex: 96336  
Cables: Puma Sandwich  
Phone: (03046) 2901

A range of exposed flywheel water cooled single cylinder engines designed for slow speed operation and simplicity of maintenance.

Model	Cylinder	Cooling	Capacity (cc)	Gross Power (b.h.p.) Cont. @ r.p.m.	Nett Weight (kg)
PZ3	1	water	1950	7 600	420
PZ4	1	water	1950	8 700	420
PZ10	1	water	1950	10 800	425

These engines are available as complete pumping and generating sets.

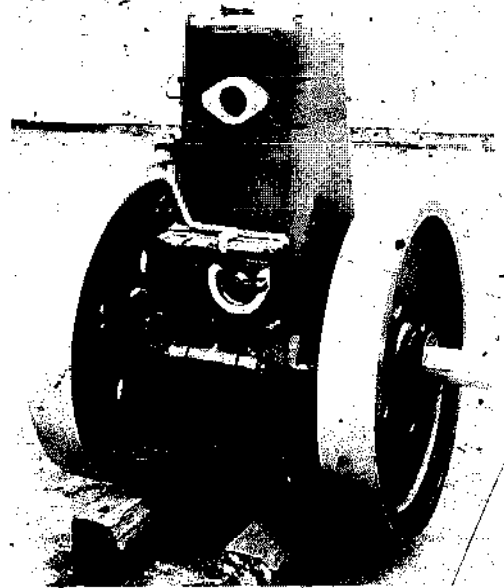

**Puma 10 b.h.p. Diesel Engine**

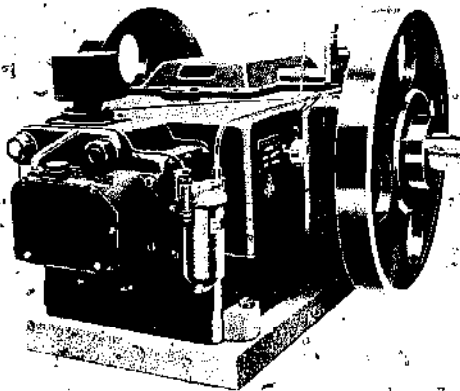

**Robson RC Diesel Engine**

**JOHN ROBSON (SHIPLEY)  
LIMITED**  
P.O. Box 31  
Ives Street  
Shipley  
Yorkshire  
U.K.

Telex: 517386  
Cables: Robson Shipley  
Phone: Shipley 52041

Single cylinder, water cooled, low speed, totally enclosed, horizontal diesel engines. Starting is by hand for which purpose an automatic decompressor is fitted and a starting handle is provided. Drive may be taken from either side from a pulley that bolts to the flywheel, and the units can be supplied as complete pumping sets.

Model	Cylinder	Cooling	Cap. (cc)	Gross Power (b.h.p.) Max. Cont. @ r.p.m.	Net Weight (kg)
RB	1H	water	1800	14 13 1100	457
RC	1H	water	3850	24 22 880	1016
R16	1H	water	2150	18 16 1100	476
R26	1H	water	4600	29 26 880	1057

Total operational life of up to 20 years claimed.

**ROLLS ROYCE MOTORS  
LIMITED**  
Diesel Division  
Shrewsbury  
Salop SY1 4DP  
U.K.

Telex: 35171/2  
Cables: Roycar Shrewsbury  
Phone: (0748) 52262

A range of water cooled diesel engines with outputs from 100kW to 690kW. Units are supplied on skids or mounting feet and as generating sets.

Model	Cylinder	Cooling	Cap. (cc)	Gross Power (b.h.p.) Max. Cont. @ r.p.m.	Nett Weight (kg)
C6N	6	water	12170	180 150 1500	1133
C8T	8	water	16200	340 294 1500	1470

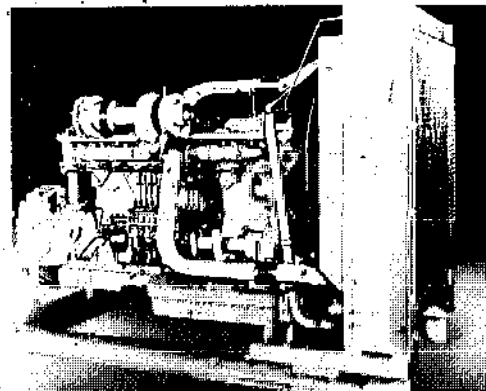

**Rolls Royce C8T Diesel Engine**

Plus a variety of other models up to 730 b.h.p. nett.

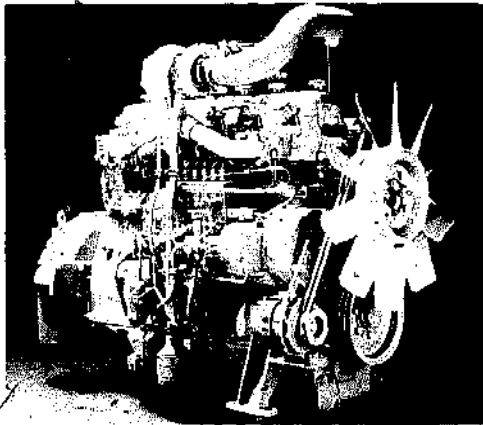

Saab-Scania DS8

SAAB-SCANIA  
S-151 87 Södertälje  
Sweden

Telex: 10200 Scania s  
Cables: Scania Södertälje  
Phone: 0755-341 40

Prime Mover Engines

Model	Cylinder	Cooling	Cap. (cc)	Gross Power (b.h.p.)		Nett Weight (kg)
				Max.	Cont. @ r.p.m.	
D8	—	water	—	167	99 1500	—
DS8	6l	water	—	210	130 1500	—
D11	6l	water	—	215	144 1500	—

D8 engine available as 73kW generating set, 131 hp marine engine or 99 hp (continuous) at 1500 r.p.m. prime mover.  
Other engines also available up to 400 hp.

YANMAR DIESEL ENGINE  
COMPANY LIMITED  
1-11-1 Marunouchi  
Chiyoda-ku  
Tokyo  
Japan 100

Telex: 0222-2310, 0222-4733  
Cables: Yanmar Tokyo  
Phone: 03-213-8111

Water cooled engines designed for use in marine, industrial and agricultural applications.

Model	Cylinder	Cooling	Cap. (cc)	Gross Power (b.h.p.)		Nett Weight (kg)
				Max.	Cont. @ r.p.m.	
TS50C	1H	water	270	5	4 2000	52
TS60C	1H	water	335	6	5 2000	70
TS70C	1H	water	380	7	6 2200	82
TS130C	1H	water	635	13	11 2200	130
TS105C	1H	water	515	10.5	9 2200	96
TS115C	1H	water	750	15.5	13 2200	150
TS180C	1H	water	870	18	15 2200	170
TS80C	1H	water	435	8	7 2200	88

This series available in generating sets of 1.5, 2, 3, 5, 7.5, 10, and 12kVA (various voltages) and as marine auxillary engines.

Marine engines (fitted with clutch and various reduction gear arrangements).

YSB8	1H	water	330	8	5 2200	107
YSB12	1H	water	510	12	8 2200	135
SB8	1	water	330	8	5 2200	114
SB12	1	water	510	12	8 2200	137
SKE	1	water	664	13	12 2400	170
2SE	2	water	1134	18	16 2200	250
2QM	2	water	1100	22	20 2600	225
3QM	3	water	1650	33	30 2600	280
2TE	2	water	1650	25	22 2000	380
3TE	3	water	2475	37	33 2000	490
1SME	1	water	1050	15.5	14 1800	240
2SME	2	water	2100	33	30 2200	430
3SME	3	water	3150	50	45 2200	530
3ESDE	3	water	4600	63	56 1800	680
4ESDE	4	water	6130	84	74 1800	800
3BNE	3	water	10200	132	115 1600	1480
4BNE	4	water	14960	175	150 1600	1730
6BNE	6	water	20400	260	240 1600	2550
3KDE	3	water	8500	90	82 1450	1240
4KDE	4	water	11350	121	110 1450	1701

Plus a range of larger engines up to 1980 b.h.p.

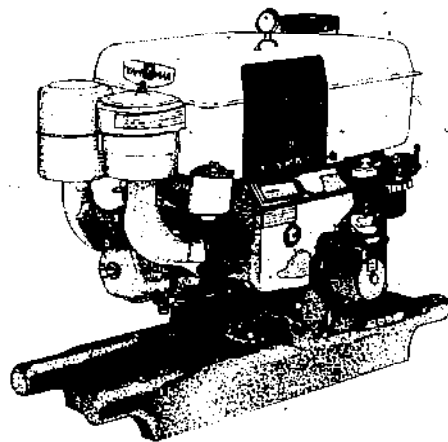

TS (C) Series Engine

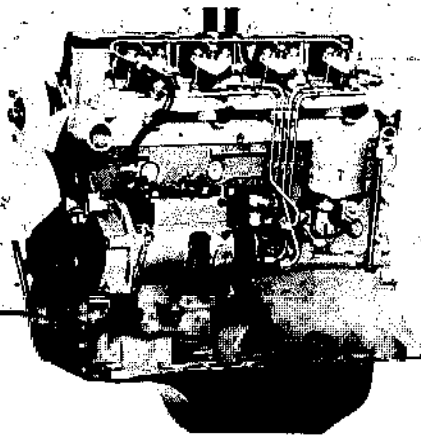

XDP 4.88 Diesel

SOCIÉTÉ COMMERCIALE DE  
MOTEURS - C.L.M.  
B.P. 420  
49 rue Noël Pons  
92000 Nanterre  
France

Telex: 620162  
Cables: Cogemot-Nanterre  
Phone: 780 7211

This manufacturer is a subsidiary of the PSA-Peugeot-Citroën group producing a range of water cooled four-stroke diesel engines (as used in Peugeot and Citroën vehicles), with outputs from 68 b.h.p. to 106 b.h.p.

Model	Cylinder	Cooling	Cap. (cc)	Gross Power (b.h.p.)			Nett Weight (kg)
				Max.	Cont.	@ r.p.m.	
XDP 4.88	4	water	1946	55	40	3000	153
XDP 6.90	6	water	3168	90	61	2500	246
XDP 4.90	4	water	2112	61.5	40	2500	172
CRD 90B	4	water	2175	61.5	41	2500	205

WITTE ENGINE  
CORPORATION  
(A Hawker Siddeley Company)  
P.O. Box 386  
555 East 56th Highway  
Olathe  
Kansas 66061  
U.S.A.

Telex: 0426262  
Phone: (913) 764 3512

A range of diesel engines, the 120/HS being a hand cranked, slow speed unit, with an output of 26 b.h.p. Speed regulation is to  $\pm 5\%$  no load to full load and it is designed for continuous 24 hour running conditions. Units are also available for marine applications for boats up to 45ft.

Model	Cylinder	Cooling	Cap. (cc)	Gross Power (b.h.p.)			Nett Weight (kg)
				Max.	Cont.	@ r.p.m.	
120M	2H	water	1966	30	22	1500	398
120	2H	water	1966	33	26	1800	545

This heavy duty four-stroke diesel engine is available as a complete generating set and there is also the Model G-260 natural gas spark ignition engines with many common components.

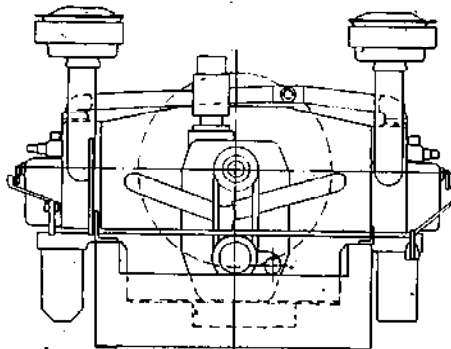

120/HS Unit

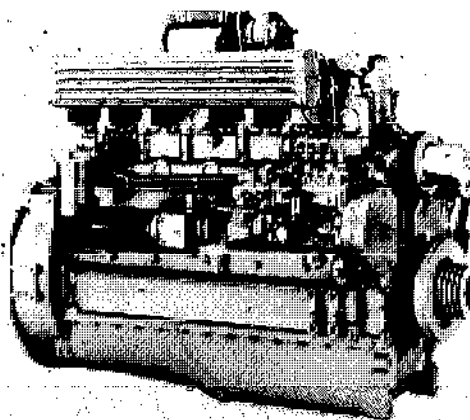

SDMTW 6, 7 Litre Unit

MOTORENFABRIK ANTON  
SCHLÜTER  
Münchner Strasse 32  
D-8050 Freising  
Germany

Telex: 0526515  
Cables: Schlüterwerke Freising  
Phone: (08161) 13051/55

Water cooled diesel engines with power outputs from 30 hp to 200 hp, suitable for vehicle power, construction machines and stationary installations. Units can be supplied with a variety of power take-off assemblies on the flywheel casing.

Model	Cylinder	Cooling	Cap. (cc)	Gross Power (b.h.p.)			Nett Weight (kg)
				Max.	Cont.	@ r.p.m.	
SDMW2	2	water	2376	38	34	1800	227
SDMW3	3	water	3564	57	50	1800	325
SDMW4	4	water	4752	76	68	1800	420
SDMW6	6	water	7128	114	100	1800	595
SDMW8	8	water	9504	152	136	1800	775

**WHITE ENGINES  
INCORPORATED**  
101 Ely Street S.E.  
Canton  
Ohio 44705  
U.S.A.

Telex: 98-3439  
Cables: Hercano  
Phone: 74 979 3993

Water cooled engines designed for automotive and industrial use.  
Can be supplied as enclosed generators or open power units.

Model	Cylinder	Cooling	Cap. (cc)	Gross Power (b.h.p.)		Nett Weight (kg)	
				Max.	Cont. @ r.p.m.		
D-2000	4	water	3250	68	53.5	1800	435
D-2300	4	water	3710	72	61	1800	500
D-3000	6	water	4880	114	80	1800	500
D-3000T*	6	water	4880	117	105	1800	510
D-3000T*	6	water	4880	111	96	1800	510
D-3400	6	water	5860	115	92	1800	438
D-4800	6	water	7850	150	127	1800	870
D-4800T*	6	water	7850	180	180	1800	870

\*T denotes turbocharged version.

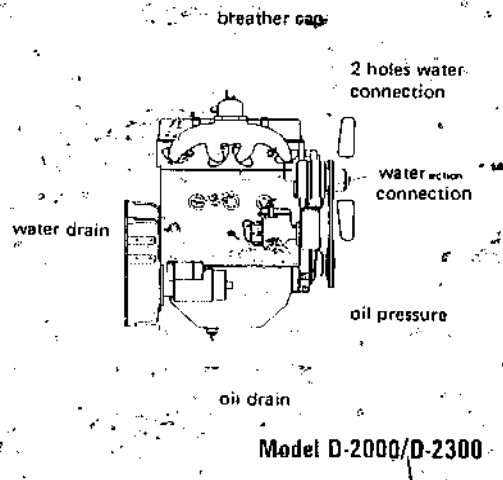

## Spark Ignition Engines (petrol and gas fuelled)

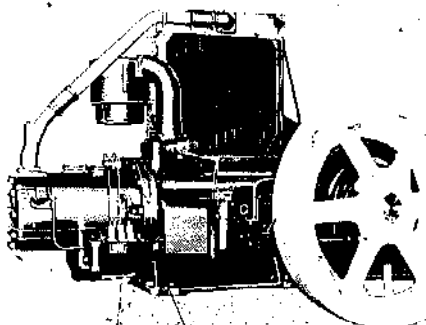

DP-60 Engine

**COOPER ENERGY SERVICES** Telex: 91-4554  
19 North Center Street Phone: (814) 665 8281  
Corry  
Pennsylvania 16407  
U.S.A.

A range of heavy duty, low-speed, horizontal, two-stroke engines, developed for pumping oil in oilfields but well-suited for driving reciprocating water pumps. Very little maintenance required — engines have particularly long operational life.

Model	Cylinder	Cooling	Cap. (cc)	Gross Power (b.h.p.)		Nett Weight (kg)	
				Max.	Cont. @ r.p.m.		
EA-22	1H	water	4340	22	17	450	1317
EA-30	1H	water	5410	30	22	450	1340
E-42	1H	water	9290	42	35	400	1961
DP-60	1H	water	13930	60	40	350	2813
DP-80A	1H	water	21800	80	60	300	3691
DP-125	1H	water	36150	125	100	280	6143
DP-165	1H	water	46330	165	125	260	6347
DP-250	2H	water	72300	250	175	250	8111
DP-325	2H	water	92660	325	230	250	8467

**JLO MOTORENWERK GMBH** Telex: 02 189 113  
P.O. Box 1620 Cables: Jlo Pinneberg  
D-2080 Pinneberg Phone: (04101) 2141  
W. Germany

\* Two stroke engines.

Model	Cylinder	Cooling	Cap. (cc)	Gross Power (b.h.p.)		Nett Weight (kg)	
				Max.	Cont. @ r.p.m.		
L35	1	air	35	1.7	1.1	3600	4.5
L77	1	air	73	2.6	2.3	3600	7.5
L97	1	air	98	4.0	3.0	3600	8.1
L101	1	air	98	4.3	3.8	3600	11.8
L152	1	air	148	6.0	5.4	3600	14.2
L197	1	air	198	7.3	6.7	3600	16.6
L252	1	air	247	8.0	7.9	3600	27.2
L253	1	air	247	9.5	9.1	3600	24.1
L372	1	air	372	14.3	13.5	3600	32.6

There is also a series of specialised models specifically designed for various applications including spraying and lawnmowers.

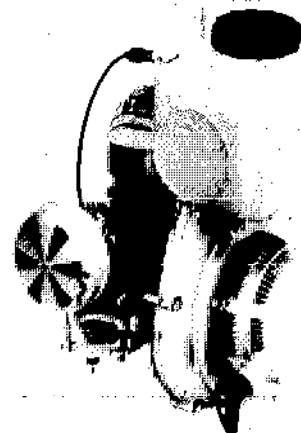

L152 Engine

**BRIGGS AND STRATTON  
CORPORATION**  
P.O. Box 702  
Milwaukee  
Wisconsin 53201  
U.S.A.

Telex: 02-6776  
Cables: Basco  
Phone: (414) 461 1212

Vertical Shaft  
Series 170700

Range of four-stroke air cooled engines available with wide choice of accessories, mountings and shaft sizes.

Model	Cylinder	Cooling	Cap. (cc)	Gross Power (b.h.p.)			Nett Weight (kg)
				Max.	Cont.	@ r.p.m.	
92500	1H	air	148	3	2.3	3000	8.8
92900	1H	air	148	3	2.4	3000	8.9
110900	1H	air	187	4	3.0	3000	11.0
100900	1H	air	170	4	2.9	3000	13.8
130900	1H	air	205	5	3.7	3000	13.9
170700	1H	air	274	7	5.3	3000	19.7
191700	1H	air	318	8	6.0	3000	22.2
251700	1H	air	399	10	7.9	3000	26.9
60100	1	air	109	2	1.5	3000	10.1
80100	1	air	127	2.5	2.0	3000	10.1
80200	1	air	127	3	2.3	3000	10.9
80300	1	air	127	3	2.3	3000	11.5
100200	1	air	170	4	2.9	3000	13.4
130200	1	air	205	5	3.7	3000	13.9
170400	1	air	274	7	5.3	3000	20.0
190400	1	air	318	8	6.0	3000	20.4
251400	1	air	399	10	7.9	3000	28.7
233400	1	air	376	9	7.3	3000	41.4
243430	1	air	392	10	7.9	3000	43.5
302430	1	air	494	13	10.2	3000	48.1
326430	1	air	531	16	12.2	3000	48.3

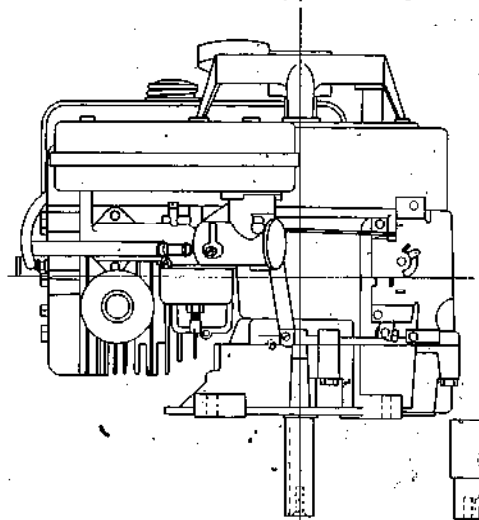

Series 170700

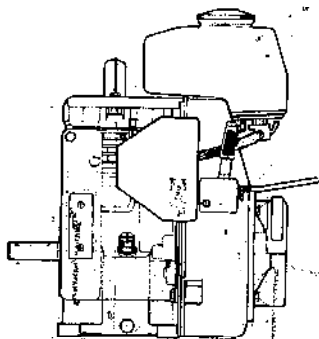

MAG1014\*SRL

**VILLIERS MAG ENGINES LTD**  
Factory 47  
Pensnett Trading Estate  
Brierley Hill DY6 7NA  
U.K.

Telex: 338558  
Cables: Vilmag  
Phone: (038 44) 6553

**MOTOSACOCHE S.A.**  
CH-1211 Geneva 26  
Switzerland

Telex: 23139  
Phone: (022) 42 01 60

Model	Cylinder	Cooling	Cap. (cc)	Gross Power (b.h.p.)			Nett Weight (kg)
				Max.	Cont.	@ r.p.m.	
MAG1014 SRL	1	air	141	3.5	2.8	3000	17
MAG1026 SRL	1	air	258	7.0	5.5	2600	28

**036.1 Water-cooled 1100cc Industrial Engine**

**VOLKSWAGENWERK AG**  
Heinrich Nordhoff Strasse  
D-3180  
Wolfsburg 1  
Germany

Telex: 09586-0 vww d  
Cables: Volkswagenwerk/  
Wolfsburg  
Phone: 22 3535

Four-stroke industrial engines

Model	Cylinder	Cooling	Cap. (cc)	Gross Power (b.h.p.)			Nett Weight (kg)
				Max.	Cont.	@ r.p.m.	
036.1	4	water	1093	49	50	3600	107
049.6	4	water	1588	61	46	3000	111
122	4H	air	1192	34	28	3000	94
126A	4H	air	1584	46	36	2800	100

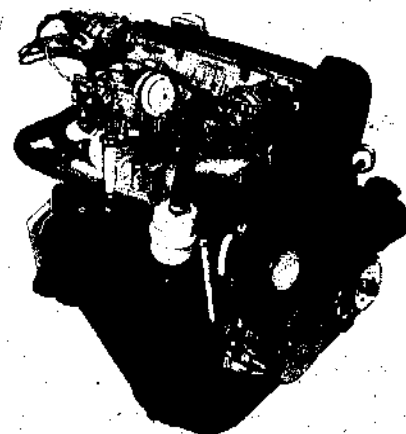



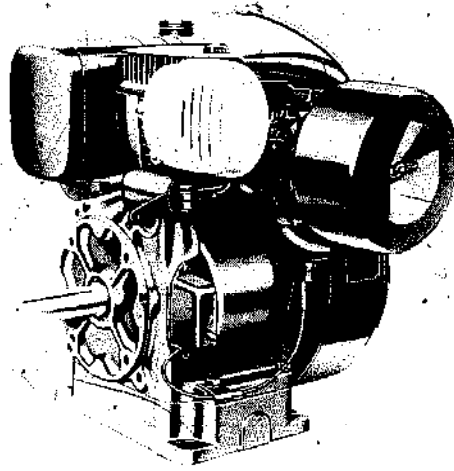

**K181 (8hp) Unit**

**KOHLER INTERNATIONAL LIMITED.**  
High Street  
Kohler  
Wisconsin 53044  
U.S.A.

Telex: 2.688  
Cables: Kohlerint  
Phone: (414) 457 4441

Range of four-stroke, single and twin cylinder, air cooled petrol engines with power take-off.

Model	Cylinder	Cooling	Cap. (cc)	Gross Power (b.h.p.)		Max. Cont. @ r.p.m.	Nett Weight (kg)
				Max.	Cont.		
K91	1	air	145	4.0	3.6	3400	19.5
K141	1	air	278	6.25	5.6	3000	29.5
K161	1	air	278	7.0	6.2	3000	29.5
K181	1	air	305	8.0	7.4	3000	29.5
K241	1	air	391	10.0	8.6	2800	53.5
K301	1	air	476	12.0	11.2	2800	53.5
K321	1	air	512	14.0	12.3	2800	53.5
K341	1	air	588	16.0	14.9	2800	55.3
K532	2	air	880	20.0	18.5	2600	85.0
K582	2	air	946	23.0	19.8	2600	85.0

Purpose-built generating sets are also available.

**KIRLOSKAR OIL ENGINES LIMITED**  
Laxmanrao Kirloskar Road  
Poona 411 003  
India

Telex: 014-245  
Cables: Koel-Poona  
Phone: 55341

Small air cooled two-stroke engines.

Model	Cylinder	Cooling	Cap. (cc)	Gross Power (b.h.p.)		Max. Cont. @ r.p.m.	Nett Weight (kg)
				Max.	Cont.		
KP70	1	air	72	3.0	3.0	5000	4.4
KP75	1	air	35	1.7	1.5	4800	3.75

Engines available with optional recoil starter.

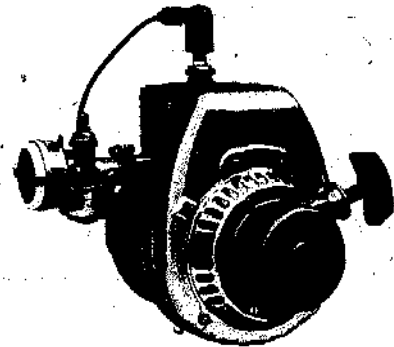

**KP75/1 Petrol Unit**

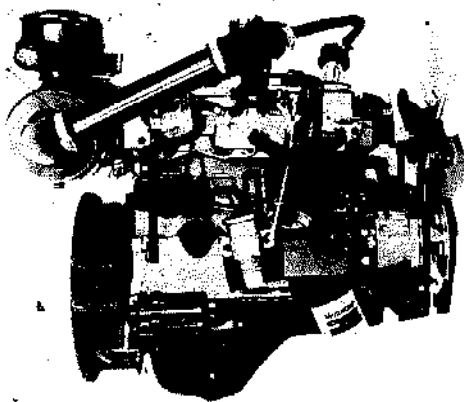

**Ford 1599cc Natural Gas Engine**

**FORD MOTOR COMPANY LIMITED**  
Royal Oak Way South  
Daventry  
Northants NN11 5NT  
U.K.

Telex: 311552  
Phone: (032 72) 71111  
Cables: Fordparts, Daventry

Range of water cooled petrol engines with power outputs as indicated below.

Model	Cylinder	Cooling	Cap. (cc)	Gross Power (b.h.p.)		Max. Cont. @ r.p.m.	Nett Weight (kg)
				Max.	Cont.		
2261E	4	water	1093	47	30	3000	110
2262E	4	water	1298	55.5	38	3000	115
2263E	4	water	1298	68	37	3000	115
2264E	4	water	1599	65.5	47	3000	120
2265E	4	water	1599	84.5	51	3000	120
BDA	4	water	1600	114	93	4500	114
2503E	3	water	2590	46	31	1500	310
2511E	3	water	3294	57	41	1500	323
2513E	4	water	4496	74	53	1500	402
2606E	4V	water	1996	80	63	3000	150
2613E	6V	water	2495	117	77	3000	181
2614E	6V	water	2994	136	99	3000	181
2652E	4V	water	1498	60	45	3000	128
2653E	4V	water	1699	74	55	3000	130
2655E	6V	water	2293	108	76	3000	160
2656E	6V	water	2551	124	85	3000	163

**KAWASAKI HEAVY  
INDUSTRIES LIMITED**  
World Trade Centre Building  
4-1 Hamamatsu-cho  
2-chome  
Minato Ku  
Tokyo  
Japan

Telex: J22672/J26888  
Cables: Kawasakiheavy Tokyo  
Phone: Tokyo (03) 4352516

Air cooled four-stroke and two-stroke engines with power outputs ranging from 12 b.h.p. to 28 b.h.p. Typical applications include stationary power units and vehicle motor units.

**Four-stroke cycle models**

Model	Cylinder	Cooling	Cap. (cc)	Gross Power (b.h.p.)			Nett Weight (kg)
				Max.	Cont.	@ r.p.m.	
KF24*	1	air	98	2.3	1.6	1800	9.6
KF34*	1	air	132	3.4	2.3	1800	13
KF53*	1	air	181	5.0	3.5	1800	16
KF64*	1	air	244	6.5	5.0	1800	20.5
KF81*	1	air	324	8.2	6.0	1700	32
KF100*	1	air	397	10.0	7.5	1600	40
KF140*	1	air	552	14.0	10.5	1600	60
KF160*	2H	air	680	16.0	12.0	1600	85
KF200*	2H	air	794	20.0	15.0	1600	85

\*two versions available — low speed, rated output quoted

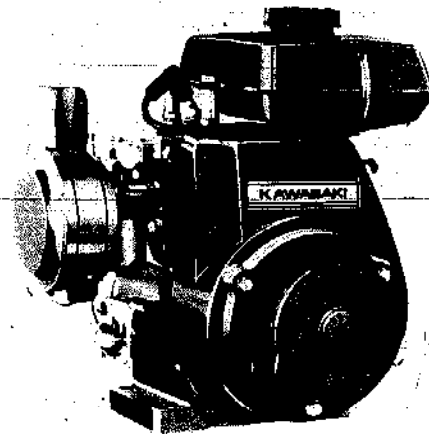

**KF24**

**Two-stroke cycle models**

KT12	1	air	23	1.2	0.8	7000	2.2
KT15	1	air	27	1.5	1.0	7000	2.5
KT18	1	air	35	1.5	1.0	5000	3.7
KT30	1	air	50	2.4	1.7	6000	6.5
KT33	1	air	80	3.3	2.2	1750	12
KT43	1†	air	110	4.3	3.0	1600	13
KT60	1	air	169	6.0	4.5	1750	27
KT300	2†	air	554	28.0	28.0	4500	48

†this model is available in a vertical shaft option, intended for grass cutting machines.

Main uses for these engines are for small pumps and generators. See also the range of Kawasaki purpose-built generating sets in Section 7.

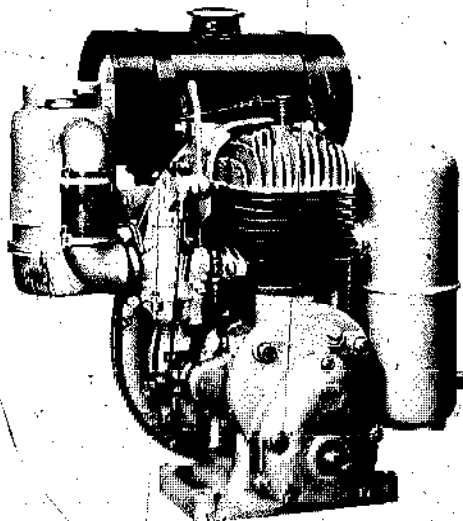

**BOMBARDIER-ROTAX GMBH**  
P.O. Box 5  
A-4623 Gunskirchen  
Austria

Telex: 25546 bomrot a  
Cables: Bombrotax Gunskirchen  
Phone: (07246) 271

Magneto ignition industrial engines. 2 stroke cycle.

Model	Cylinder	Cooling	Cap. (cc)	Gross Power (b.h.p.)			Nett Weight (kg)
				Max.	Cont.	@ r.p.m.	
75	1	air	75	3	2.54	4500	9
95	1	air	95	4.75	4.25	4500	9.5
125	1	air	125	4.5	3.3	3000	16
150	1	air	150	5.8	4.2	3000	16
151	1	air	151	7.4	6.2	4000	16
161	1	air	165	7.6	4.5	3000	15
185	1	air	185	9.2	5.2	3000	15
200	1	air	199	7.5	6.0	3000	23
250	1	air	247	9.7	7.2	3000	23
250AS	1	air	247	14.3	11.0	4000	23
300	1	air	299	12.0	9.0	3000	23
500	2	air	494	16.2	14.2	3000	38
635	2	air	635	38.5	38	5000	40
640	2	air	635	38.5	38	5000	40
373	2	air	368	24	23.5	5250	33
637	2	air	635	40	39	5250	45

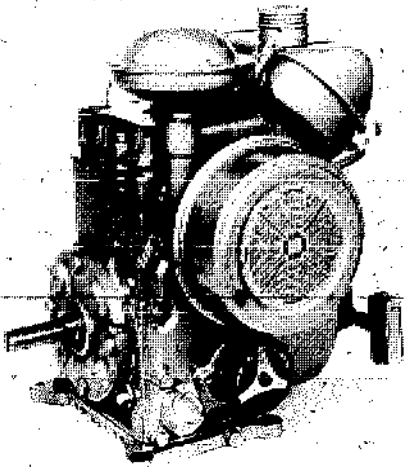

**BERMOTOR LIMITED**  
 21 London Road  
 Tunbridge Wells  
 Kent TN1 1SY  
 U.K.

Telex: 95446  
 Cables: Bermotor Tunbridge Wells  
 Phone: (0892) 37588

Multi-fuel spark ignition engines, four-stroke, fuelled with petrol (gasoline), paraffin (kerosene) or propane (l.p.g.). Power figures given for petrol-fuelled versions.

Model	Cylinder	Cooling	Cap. (cc)	Gross Power (b.h.p.)			Nett Weight (kg)
				Max.	Cont.	@ r.p.m.	
18A	1	air	—	1.5	1.0	2500	11.3
318A	1*	air	—	2.0	1.3	2500	11.3
117B	1*	air	—	3.3	2.2	2500	14
217	1*	air	—	4.0	2.8	2500	14
239A	1*	air	—	4.5	3.3	2500	20
610A	1	air	—	6.0	4.0	2000	36
810	1	air	—	8.0	5.0	2000	36
112	1	air	—	10.0	8.0	1600	70

\*vertical shaft variants available in these sizes

**W217 Air-cooled 4 b.h.p. Unit**

800-45	4	water	845	24.0	15.0	2500	98
688-45	4	water	1108	37.0	22.0	2500	108
810-45	4	water	1289	42.5	27.0	2500	108
821-45	4	water	1565	70.0	60.0	4200	—

Various engines available as generating sets, battery chargers, site welders, self-priming irrigation and drainage pumps, etc.

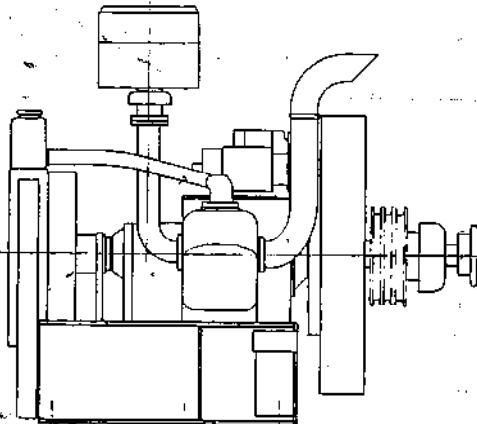

**WITTE ENGINE CORPORATION**  
 (A Hawker Siddeley Company)  
 P.O. Box 386  
 555 East 56th Highway  
 Olathe  
 Kansas 66061  
 U.S.A.

Telex: 042-6262  
 Phone: (913) 764 3512

Model G-260 natural gas or propane engine:

Model	Cylinder	Cooling	Cap. (cc)	Gross Power (b.h.p.)			Nett Weight (kg)
				Max.	Cont.	@ r.p.m.	
G-260	2H	water	1966	17	8	600	545

This engine is available as a single or three-phase generating set and there is also the Model 120 diesel engine (see page 26) with many common components.

**G-260 Engine (Oilfield) Unit**

**WHITE ENGINES INCORPORATED**  
 101 Eleventh Street S.E.  
 Canton  
 Ohio 44707  
 U.S.A.

Telex: 98-3439  
 Cables: Hercano  
 Phone: 216 454 5631

Water cooled engines with power outputs 35 b.h.p. to 140 b.h.p. Can be supplied as closed generator power units, with housing, instrument panel, governor, etc.

Model	Cylinder	Cooling	Cap. (cc)	Gross Power (b.h.p.)			Nett Weight (kg)
				Max.	Cont.	@ r.p.m.	
G1600	4	water	2670	77	55	2000	190
G2000	4	water	3240	84	69	2000	270
G2300	4	water	3700	89	76	2000	270
G3000	6	water	4880	130	100	2000	360
G3400	6	water	5550	144	115	2000	360

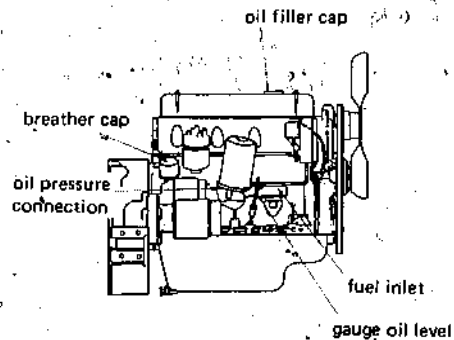

**Model D-2000**

# Gas Turbines

**RADICAL ENGINE GROUP**  
 (Subsidiary of International  
 Harvester)  
**Solar Division**  
 2200 Pacific Highway  
 San Diego  
 California 92138  
 U.S.A.

Telex: 695045  
 Phone: (714) 238 5551

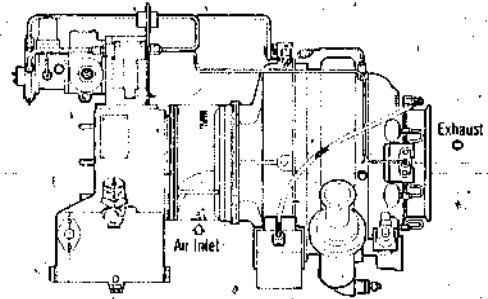

**Solar Titan Gas Turbine Engine T-64T-40**

A series of small gas turbines designed for aircraft auxiliary power unit and ground starter applications, but suitable for other generating applications, mechanical applications and for the production of pneumatic power simultaneously if required. All with single-stage centrifugal compressor and radial inflow turbine mounted back-to-back. All fuelled with aviation turbine fuels.

Model	Max. Power Rating (hp)	Max. fuel consumption (lb/hr)	Output speeds (r.p.m.)	Environmental limits		Weight (kg)
				Temp. (°F)	Altitude (ft)	
T-62T-16B1	75	82	8000	-65 to 125	15000	34
T-62T-11	75	92	(8000/ 7788)	-65 to 130	6000	32
T-64T-40	90	140	(11760/ 12240)	-65 to 130	30000	41
T-62T-16A1	95	108	8000	-65 to 125	15000	32
T-62T-2A1	95	114	6000	-65 to 125	15000	32
T-62T-12	105	115	(8216 & 8000)	-65 to 130	20000	34
T-62T-27	150	140	(8216 & 8000)	-65 to 130	20000	38

All of these operate for 2000 hrs between overhauls and have an expected service life of 10000 hrs. Typical start-up time to full power is 16 seconds.

# 6 External Combustion Engines

STEAM ENGINES  
STIRLING ENGINES  
THERMO-ELECTRIC CONVERTERS

In common with the internal combustion engines described in the previous section, external combustion (e.c.) engines convert heat into mechanical (or electrical) energy. The primary difference which characterises e.c. engines is that the heat is applied externally (and continuously) and transferred via suitable heat exchange surfaces to a working fluid within the engine.

There are three primary types of working fluid, a liquid/vapour combination (the steam engine), gas/hot air (Stirling engines) and electrons (thermoelectric generators). The first two systems formed the basis of the technological advances which led to the Industrial Revolution, while the latter is a relatively new development based on principles known for some time but not well understood until recently.

It is relevant to consider briefly the advantages and disadvantages of this category of heat engines, as they may in future come into increasing use again for small power applications.

The primary disadvantage of e.c. engines in general is that due to the fuel being burnt externally, considerable heat exchange area is required to transmit the heat into the working space(s) and to reject the waste heat at the end of the cycle. This normally implies numerous boiler tubes to transmit the heat from the flue gases to the water in a steam engine boiler, and a similar arrangement in the condenser which cools the exhaust steam. The same problem applies to the Stirling (or Erikson) engine which uses expansion and contraction of alternately heated and cooled air (or some other gas in some cases) to drive a piston. Thermoelectric generators, which utilise temperature differences to move free electrons across junctions between dissimilar metals (thermocouples) also require a large heat exchange area in order to admit sufficient heat flux from the burner or other sources of heat to the hot end and to keep the cold end cool.

The result is that e.c. engines are generally bulky and consequently expensive to construct compared with i.c. engines of the same power output. They also have considerable thermal inertia so that they cannot be switched on or off quite as quickly as an i.c. engine. As a result, i.c. engines rapidly became the primary autonomous power source early this century, largely replacing steam engines in medium power applications while Stirling engines which tended to be used in the nineteenth century for fractional horsepower applications, were rapidly replaced by electric motors once widespread electrification became the norm in industrialised countries. Steam engines succeeded in remaining dominant for railway and marine use until the middle of this century, as weight and bulk were less important in those applications. However, less labour intensive and more convenient installations became economically desirable and petroleum prices fell in real terms, so steam engines were superseded by the diesel in those roles too. The only area where steam engines are still favoured is for large-scale centralised electric power production and for propelling large ships requiring 10,000's of horsepower. Here steam turbines are used, as they can achieve better efficiencies than any other type of heat engine. In the lower power ranges, diesel engines have tended to reign supreme as a result of their efficiency and lower first cost resulting from mass-production.

However, the main disadvantage of diesel and other i.c. engines is that they are usually fed with petroleum-based fuels, which for the first time since the start of the industrial revolution are becoming more expensive in real terms. Since fuel costs are a primary expense with any heat engine used for anything other than very intermittent or stand-by applications, this development is likely to offer a better future to external combustion engines

which have the characteristic of requiring heat rather than fuel — in other words, they can be run on anything that burns providing suitable combustion and heat exchange facilities are designed in. Coal and other solid fuels are becoming relatively cheaper than oil, and this trend is likely to continue due to depletion of oil reserves at a far faster rate than the world's far larger coal reserves. In the very long run, e.c. engines are the only heat engines that can readily make direct use of solar energy once all fossil fuels become scarce — Section 1 includes examples of solar heat engine systems of this kind developed for pumping water in desert areas.

Having listed the major shortcomings of steam and other e.c. engines, it is worth noting that they offer a number of advantages in addition to their multi-fuel capability. The main ones are that they tend to be longer-lasting than equivalent i.c. engines (which goes a long way to make up for their intrinsically higher capital costs); they are possibly better suited to small-scale manufacture — so that a suitable design could more likely be manufactured economically in small numbers within less developed countries; they are much quieter and more vibration-free than diesels in particular; and their exhaust emissions are much cleaner in terms of poisonous carbon monoxide and oxides of nitrogen than i.c. engine exhaust. Technical maintenance requirements and spare part inventories tend to be reduced with e.c. engines compared with i.c. machines, but (depending on the fuel), a considerable amount of routine ash removal and other low level maintenance may be required.

The general demise of e.c. engines throughout the first half of this century has meant that relatively little effort (or funding) has been invested in improving the technology. However, various new developments offer some prospect that much improved e.c. engines will emerge within the next few years — for example, heat pipes may be used to transfer heat much more cheaply and rapidly, small fluidised bed burners may improve the ease and efficiency with which fuels may be burnt, solid-state electronics offer the possibility of reliable, low-cost control, and so on. Work is in hand in many research centres on this kind of development, and in the meantime, a number of well-tried traditional steam engines have enjoyed a bit of a comeback, particularly for use in small boats, because of their quietness and reliability.

It remains to give a brief description of the principles and features of the three main categories of e.c. engines.

#### *Steam engines*

The steam engine's initial development in the 18th century, mainly for pumping water out of coal mines, led directly to the Industrial Revolution. In the engine water is boiled to produce steam under pressure, which is then allowed to expand either in a cylinder or through the rotor of a turbine, to do work. In traditional railway and traction engines the steam was then exhausted to the atmosphere doing nothing more useful on the way than to create a good draught for the fire by inducing the flue gases to flow more effectively out of the chimney. This is very wasteful, as a lot of heat is lost in the exhaust system; as a result the overall efficiency of steam engines of this kind tends to be less than ten per cent, which with present day fuel prices (even for coal) is generally unacceptable. The other disadvantage is that the lost steam has to be replaced with fresh water, which ideally needs to be softened and filtered to prevent boiler corrosion or scaling. Therefore it is preferable to recycle the exhaust system through a condenser (the latter of course adds to the weight, size and cost of the system). This allows a limited pure water supply to be used (which reduces boiler maintenance)

and, more important, the efficiency is greatly improved as the condensate can be readmitted to the boiler at closer to boiling temperature. Engines of this kind can be from 15 to 30% efficient, comparing favourably with i.c. engines in this respect. However, fans or high smoke stacks are required to create a good draught.

Most of the units in this section are conventional reciprocating engines of traditional design, but there are also some steam turbines. The latter are particularly appropriate for direct electricity generation as they can couple directly to a standard alternator, whereas the reciprocating piston engines tend to be slow speed devices which would need a lot of gearing up to achieve synchronous speeds.

Small steam turbines are quite widely used to generate electricity from the waste products of such tropical industries as sugar refining and palm oil production, while reciprocating steam engines are best used for applications demanding high torque and slow speeds, such as for driving small boats, slow-speed machinery, etc. It is believed that a number of new products may be appearing in this field within the next year or two, and it is hoped to include details in future editions of this publication.

The principles of the steam engine can be applied using working fluids other than water. A number of engines have been developed which run on organic heavy vapours of the kind often used in refrigerators in order to operate efficiently at lower temperatures than is possible with a water boiling engine. Engines of this kind are of course always of the condensing type so that there is no loss of working fluid. Low temperature vapour engines using organic fluids or ammonia are of particular interest for solar powered applications as they can use the low-grade heat from flat-plate solar collectors or low concentration factor solar collectors. Although low temperature heat engines are inherently inefficient, low temperature solar collectors are the most efficient. As a result, the best system efficiency is often obtained with a low temperature vapour engine, rather than by trying to concentrate solar energy sufficiently to run a normal water-based steam engine. Renault/SOFRETES offer systems of this kind — see Section 1.

#### *Stirling engines*

This engine, originally developed by the Rev. Robert Stirling, in 1816, uses the pressure changes caused by alternatively heating and cooling air (or some other gas) to do work. A variety of different configurations have been developed. The primary advantage over the steam engine is that no boiler with its dangerous contents of high pressure steam is involved, but nevertheless, early Stirling engines tended to be bulky and heavy in terms of their power outputs and they were readily superseded by electric motors once electricity became more widely available.

In recent years a number of sophisticated new devices utilising the Stirling hot air (or more often another gas) cycle have been under development. Only one of these, the Aga Harwell Thermo Mechanical Generator, has appeared on the market, but as can be seen from the section on equipment under development, United Stirling in Sweden and Sunpower Inc. in the USA are in the process of developing Stirling engines which will eventually also be commercially available.

The main attractions of the Stirling engine are that being an e.c. engine it can operate on almost any heat source (the Sunpower version can be run on solar heat) and, if worked with a pressurised working gas, high efficiencies and a compact and reasonably light weight design can be

achieved that appears competitive or even superior in some respects to diesel engines. To achieve this, however, the working gas needs to be at quite high pressures and until recently it was technically impossible to achieve effective sealing under the temperatures and conditions prevailing. Modern technological advances have made these problems soluble. The other major attractions are relatively quiet operation, less vibration and a cleaner exhaust (depending on fuel used) than comparable i.c. engines. It is difficult for Stirling engines to compete economically with i.c. engines initially, except in applications where their unique advantages, such as multi-fuel capability, give them an edge. This is because the engine has in many cases a more complex mechanism; the sealing problems already mentioned; and until now its development has been limited. Obviously, a coal or wood fuelled Stirling engine of comparable thermal efficiency to an i.c. engine would seem to be potentially very useful in areas where petroleum based fuels are particularly expensive and it is expected that machines of this kind will be developed within the next few years.

#### *Thermo-electric generators*

These are not external combustion engines in the strictest sense of the word, although they do convert heat energy directly into electricity, which is a more desirable and versatile energy form compared with a mechanical output. Obviously a mechanical output can be arranged simply by using an electric motor or servo.

The thermo-electric generator depends on a principle known since about the time when the steam and Stirling engines were invented, namely the thermocouple or Seebeck effect. That is, a voltage develops when the junctions of an electrical circuit consisting of dissimilar metals are maintained at different temperatures. The reasons for this phenomenon were only understood quite recently with the development of solid-state physics, and this knowledge has allowed the process to be optimised to some extent.

Two ranges of devices of this kind that are commercially available are listed in this section (from Teledyne Energy Systems in the USA and Global Thermoelectric Power Systems of Canada. These are designed for similar unattended remote low power applications as the previously mentioned Aga Harwell TMG and produce outputs in the range up to 90 watts while running on gaseous hydrocarbon fuels such as propane, butane or natural gas. The units can of course be combined to satisfy larger power requirements. As the power output is proportional to the temperature difference between the hot and cold end, these devices tend to give greater power outputs in cold ambient conditions.

The main advantages of the thermo-electric generator are that it has no moving parts at all (being a solid-state electronic device). So it is completely silent and vibrationless and the only maintenance needed is in connection with the burner or heat sources. Hence one example (from Teledyne Energy Systems) is claimed to have been operated without maintenance for 6 years and the claimed operational life is of the order of 75 years. Obviously like the other external combustion devices it potentially has a multi-fuel capability or could be solar heated, although currently available models generally run on propane or natural gas (methane).

Its disadvantages are that it has a high capital cost for its power output and the thermal efficiency is rather poor, so the fuel consumption tends to be high. Obviously, where long life, freedom from attendance or maintenance and great reliability are essential the high first and running costs become worthwhile. It is claimed that thermo-

electric generators become economic in competition with other devices in remote applications where a continuous, reliable power source is needed in the range from 1 to 300 watts.

There is some hope that if thermo-electric devices become more widely used so that they can be manufactured in larger quantities, the first cost may come down and further technical improvement may well lead to better thermal efficiencies. But even now there is little doubt that the existing commercially-available devices can be applied more economically than any other alternative in a number of specialised remote small-power applications.

# Steam Engines

**APE-ALLEN LTD**  
 P.O. Box 43  
 Queens Engineering Works  
 Bedford MK40 4JB  
 U.K.

Telex: 824686  
 Cables: Apeng Bedford Telex  
 Phone: (0234) 67400

A major steam turbine manufacturer with a wide range of multi-megawatt steam plant, the following represent the very smallest end of the range and many units are in use generating power from the heat of waste products of various tropical industries, such as the palm oil industry, or from sugar cane bagasse.

Model	Max. Output (bhp)	Temp. limit (kW)	Temp. (°C)	Max. inlet steam pressure (psi)	Max. inlet steam pressure (kg/cm <sup>2</sup> )	Max. exhaust steam pressure (psi)	Max. exhaust steam pressure (kg/cm <sup>2</sup> )	Drive
BF2.5	60	45	500	1800	125	70	5	direct
BF3.5	60	45	420	570	40	70	5	..
BF4	270	200	500	640	45	70	5	..
AF3.5D	410	300	500	1425	100	230	16	..
AF3.5G	410	300	500	1425	100	230	16	geared
AF4D	820	600	500	1425	100	140	10	direct

AF4G is a geared version of AF4D and AF4GV is a vertical shaft geared version.

All the above machines have overhung, single-stage rotors and all are fitted as standard with hydraulic overspeed and control governors. Some systems can be supplied as purpose built alternator sets.

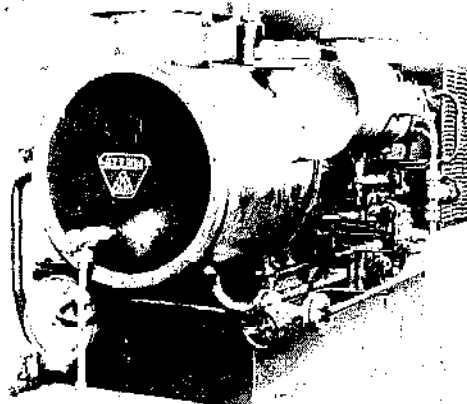

A typical 500kW ALLEN-KKK Turbine Generator

**PETER BROTHERHOOD LTD** Telex: 32154  
 Lincoln Road Cables: Brotherhood  
 Peterborough PE4 6AB Peterborough  
 U.K. Phone: (0733) 71321

Manufacture a range of small to medium steam turbines and turbo-alternators intended for waste process heat, marine waste heat and similar waste heat utilisation as well as for direct power production.

Smallest range of single-stage turbines are type SS MD. These are intended for any industrial mechanical drive application.

**Power range:** 200 to 3000 b.h.p. at speeds from 800 to 200 r.p.m.

**Rotor:** Impulse type, overhung.

**Gearing:** Built-in reduction gearing.

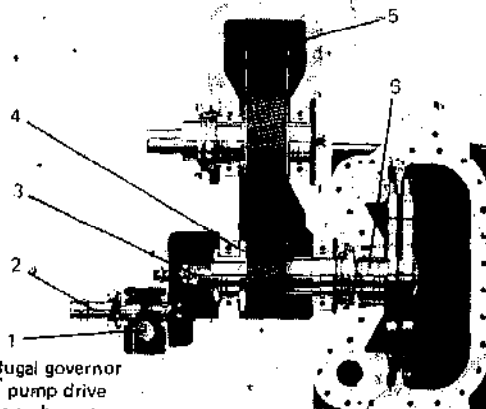

1. Centrifugal governor and oil pump drive
2. Electric tachometer
3. Overspeed trip
4. Gear thrust collar
5. Hardened and ground reduction gearing
6. Labyrinth gland seal

Overhung Turbine with Integral Geared Drive

**M.B. ENGINE COMPANY** Phone: (055) 381  
 Watlington 282  
 King's Lynn  
 Norfolk  
 U.K.

Single-cylinder double-acting engine weighing 26kg (with flywheel). Uses steam at 85psi to produce 2 b.h.p. at 500 r.p.m. from a monotube boiler.

Suggested for combined domestic heating/lighting (to 1½kVA), small boats, pumping water, etc.

Available complete with monotube boiler as portable power unit weighing approximately 100kg.

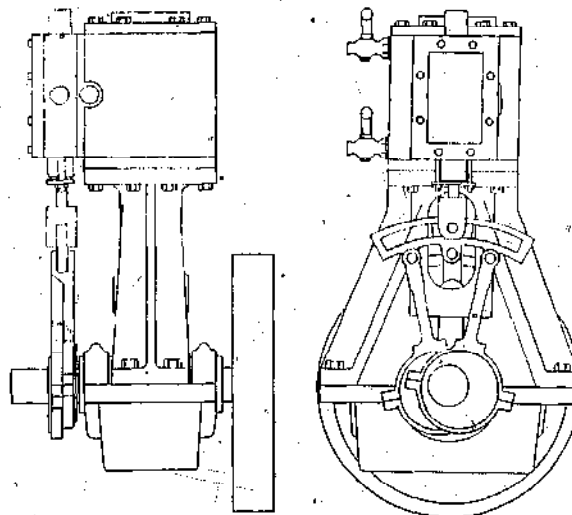

Single Cylinder Steam Engine



**O'CONNOR ENGINEERING  
LABORATORIES INC.**  
100 Kalmus Drive  
Costa Mesa  
California 92627  
U.S.A.

Telex: 685-641  
Phone: 714 979  
3993

Two and three cylinder steam engines. Power range from 5 to 25hp. Suitable for marine or industrial use. (See also for boilers).

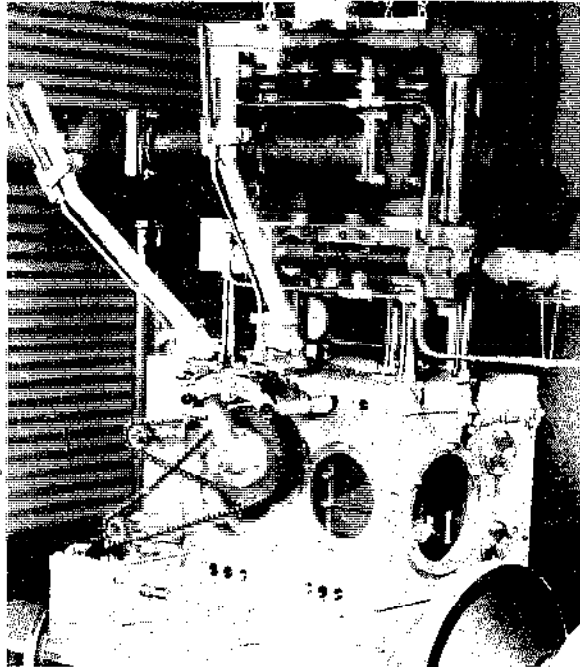

Uniflow Steam Engine

**PONTIS STEAM PLANT**  
The Gate  
Cotterstock  
Dundle  
Peterborough PE8 5HD  
U.K.

Phone: (083) 26 277

Manufacturers of small steam boilers and steam engines, most suitable for marine applications. Also adaptable, with suitable modifications, for stationary situations.



Vertical Coal Fired Boiler

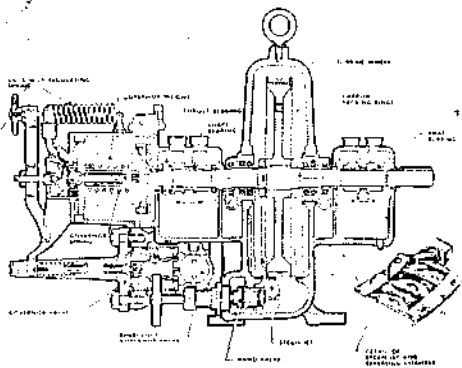

Sectional Arrangement: T100 Turbine

**HAYWARD TYLER &  
CO. LTD**  
P.O. Box 2  
Luton  
Bedfordshire  
U.K.

Telex: 82158  
Phone: (0582) 31144

A range of simple, single-wheel steam turbines of well proven design. All units are fitted with a governor (various types available) and a hand synchroniser allowing 20% manual variation in the constant speed setting.

The makers claim that poor condition steam can be used for some models and a wide range of operating pressures and speeds are possible. As power depends on both steam pressure and speed of rotation, the use of a reduction gearbox to permit higher wheel speed often results in both a higher power output and improved efficiency.

Typical applications include pumps, mixers, alternators, compressors, blowers, etc. Immediate start up is possible.

Model	Inlet psi.	Temp. Limit °C	Exhaust Press psi	Power Range h.p.	Max. Output h.p.	Max rpm	Net. Weight kg
T100	200	274	50	5-150	250	4500	318
TS200	450	400	90	5-200	250	4500	354
T400	250	274	50	75-450	750	4500	795
TS600	450	400	90	75-650	750	4500	886
TC18	450	260	90	5-150	250	3600	375
TC18H	640	400	90	5-200	250	3600	450
TC24	450	260	90	75-450	750	3600	886
TC24H	640	400	90	75-650	750	3600	977

**SEMPLE ENGINE COMPANY** Phone: (314) 961 6244  
**INC.**  
 P.O. Box 6805  
 St. Louis  
 Missouri 63144  
 U.S.A.

Range of small steam engines ranging from 5 to 20hp. Suitable for steam boats of 18 to 35ft. Units are either single or compound, operating at 600 r.p.m.

Units can also be used in stationary applications but the boiler may need an additional firebox if used with low grade fuels. The engine may also require a governor.

34-DW	Double-acting, single-cylinder	5hp at 600 r.p.m.	Weight 39kg
34-DL	Double-acting, single-cylinder	5hp at 600 r.p.m.	Weight 42kg
354-DL	Two-cylinder vee compound	10hp at 600 r.p.m.	Weight 84kg

FT-40 Vertical tubular boiler, operates at 150psi, steams in 14 minutes from cold; produces 245lbs/steam hr. weight 304 kg (suitable for above engines). Complete marine power units available comprising above engines/boiler complete with pump, heater and condenser. Other boilers available to suit engines of 10, 20, 30, 60 and 120hp. The 354-DL engine can be twinned to produced a four-cylinder 20hp power unit.

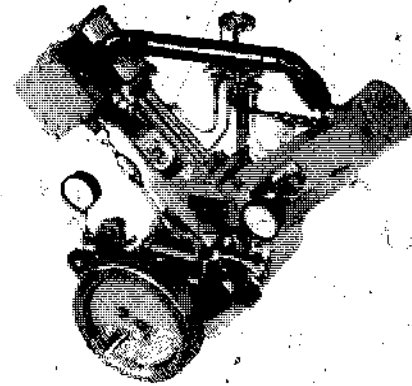

**354DL (10hp) Compound Unit**

**SPILLING CONSULT AG** Telex: 57 939  
 Sonnenweg 4 Cables: Spill Ch  
 CH-5610 Wohlen  
 Switzerland

Manufacture two different single-cylinder steam engine modules which can be assembled into multi-cylinder compound units, allowing a large number of power outputs from 10 through to 1200hp. These modules are designed to run at 750, 1000 and 1500 r.p.m. The units may be used for multi-fuel or waste-burning installations.

A consultancy service is available to ensure the most efficient use of basic resources.

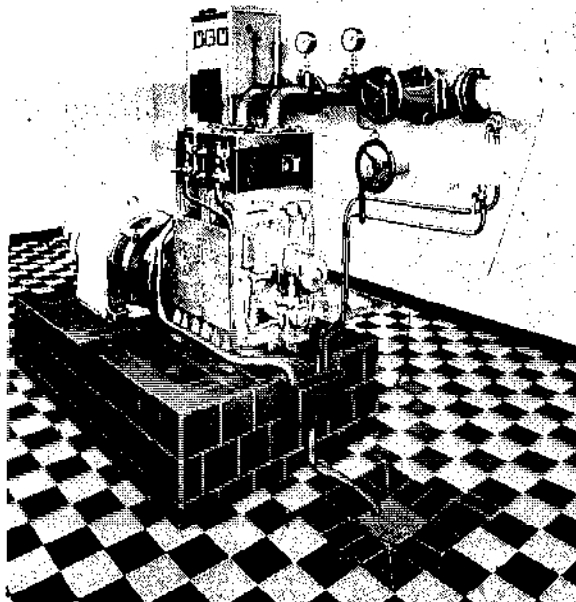

**Spilling 2-Cylinder Steam Motor**

**"STEAM POWER"**  
 106a Derby Road  
 Loughborough LE11 0AG  
 U.K.

This organisation publishes a quarterly magazine on steam power, plus numerous plans of different types of steam engine and associated equipment. They also offer the "Panther" Steam Engine to the following specification:

*"Panther" Steam engine:* 90° Vee twin cylinder double-acting compound expansion engine.  
*Maximum power:* 35 b.h.p. at 2000 r.p.m. with steam at 100 psig (approx. 70 bar)  
 Minimum steam pressure 40 psig (approx. 3.5 bar) for continued operation.  
*Overall weight:* 76.2kg (168lb)

It is understood that a comprehensive brochure is available for £1.70 or US \$5.00.

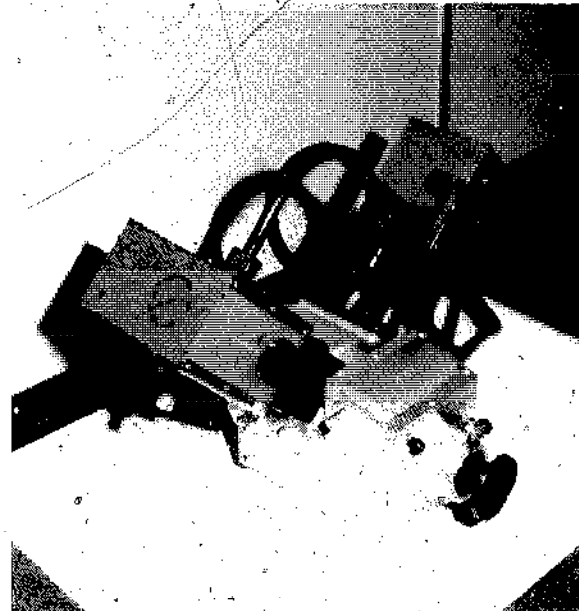

**Panther Steam Engine**

## Stirling Engines

Harwell TMG  
AGA Navigation Aids  
77 High Street  
Brentford  
Middlesex  
U.K.

Telex: 935956  
Cables: Agafaros  
Hounslow  
Phone: 01-950  
6465

The Aga Harwell Thermo Mechanical Generator is an unconventional device invented at the Harwell nuclear research centre. It works on the Stirling engine principle, but has no rotating parts. The output is via a linear, oscillating electric generator that produces a 25 watt, 100Hz AC electrical primary output which is then rectified to maintain 10 12V nickel cadmium cells capable of sustaining a 36 watt electrical load for a mean duty of 14 hours in each 24.

Its function is to produce a reliable electrical output from a propane (or other heat) energy input source, consumption being 200kg of propane per year. The device is intended to run for ten years without maintenance other than cleaning the propane burner annually when the fuel supply is replenished. Typical applications are remote unattended low power electrical devices such as marine buoys, microwave repeaters.

It is likely that further, higher powered models of this device will become available later.

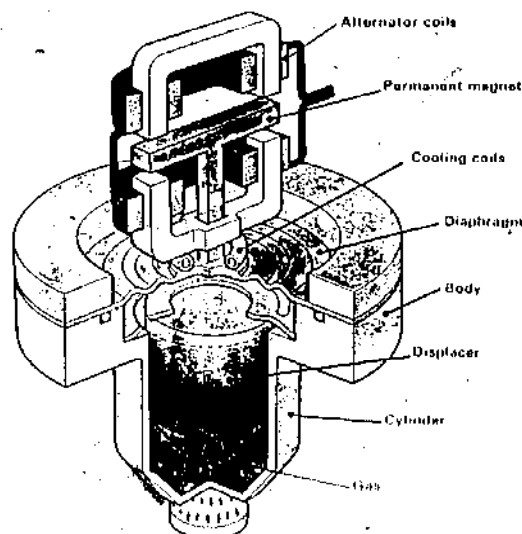

Aga Harwell Thermo Mechanical Generator

## Thermo-Electric Converters

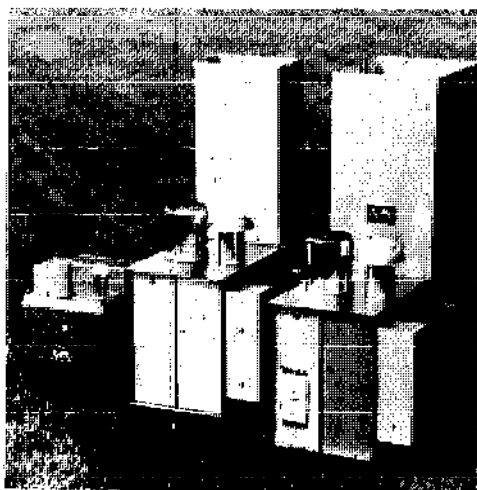

Global Thermoelectric Units

GLOBAL THERMOELECTRIC POWER SYSTEMS LTD  
P.O. Box 459  
Bassano  
Alberta Canada T0J 0B0

Telex: 03 848141  
Phone: 403 472 3512

Manufacturers of thermoelectric generators for use in remote and unattended locations — recommended preventive maintenance operations for these systems average ½ man-hour per year. With no moving parts, these systems are claimed to last for over 20 years of continuous operation.

The following models are available:

Model	Voltage*		Current*		Power*	Fuel consumption		Weight of unit (kg)
	(volt)	(amp)	(watt)	(kg/day)	(m <sup>3</sup> /hr)			
5020	1.8	11.1	20	0.90	0.05		19.5	
5020-12	12	1.3	15					
5020-24	24	.65	15					
5030	1.8	16.7	30	1.50	0.087		19.5	
5030-12	12	2.0	24					
5030-24	24	1.0	24					
5060	6.5	9.2	60	2.9	0.18		41	
5060-12	12	4.2	50					
5060-24	24	2.1	50					
5060-48	48	1.0	50					
5120	7	17.2	120	5.8	.36		64	
5120-12	12	9.0	108					
5120-24	24	4.5	108					
5120-48	48	2.25	108					

\*Matched load @ 24°C.

Voltage adjustments 12-18, 24-30 or 48-60V DC; regulation ± 0.25% no load to full load.

Voltage ripple peak to peak under 250mV; ripple frequency 400Hz.

TELEDYNE ENERGY  
SYSTEMS  
110 W. Timonium Road  
Timonium  
Maryland 21093  
U.S.A.

Telex: 8 7780  
Cables: Telises  
Phone: 301 252 8220

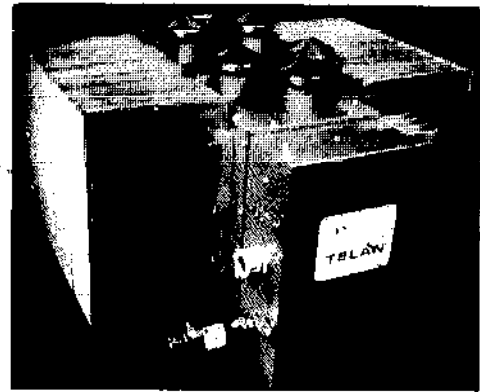

Telan Thermoelectric Generator

Model	Voltage*		Power*	Fuel consumption		Weight of unit (kg)
	(volt)	Current* (amp)		propane (kg/day)	natural gas (m <sup>3</sup> /week)	
Telan	12	.67	8	5.1	0.52	15
2T1	24	.33	8			
	48	.17	8			
Telan	12	1.58	19	10.2	13.00	24
2T2	12	1.41	17			
	24	.71	17			
	48	.35	17			
Telan	12	2.50	30	15.3	19.55	33
2T3	24	1.05	25			
	48	.52	25			
Telan	12	3.0	36	20.4	26.1	42
2T4	24	1.5	36			
	48	.7	34			
Telan	12	4.16	50	25.4	32.6	51
2T5	24	2.08	50			
	48	.87	42			
Telan	12	5.0	60	30.5	39.1	59
2T6	24	2.5	60			
	48	1.06	51			
Telan	12	5.67	68	35.6	45.6	68
2T7	24	2.83	68			
	48	1.23	59			
Telan	12	6.58	79	40.7	52.2	77
2T8	24	3.08	74			
	48	1.52	73			
Telan	12	7.50	90	45.8	58.7	86
2T9	24	3.71	89			
	48	1.85	89			

\*Matched load @ 21°C.

# 7 Electricity Generation

ALTERNATORS & GENERATORS  
GENERATING SETS  
OTHER ELECTRICAL EQUIPMENT

This, of course, is not the only section in this Guide to deal with electricity generation, since many of the devices in the specialised sections on energy conversion produce electricity as an end product. Also, as the main prime-mover for small-scale electricity generation is the diesel engine, (and likely will remain so for the next decade or two at least), it is inevitable that a lot of diesel engine manufacturers offer their products with an alternator attached, while a lot of alternator manufacturers offer theirs with a diesel engine attached. As a result, quite a number of the entries in this section consist of alternators with diesel engines, while quite a number of the diesels in Section 5 are listed as being available with alternators. In fact there are so many different diesel generating sets available on the international market, from such a wide variety of manufacturers, representing an enormous number of permutations and combinations of different makes of engine and electrical equipment, that it would be quite impossible in a book of this scope to attempt to be comprehensive. It is hoped that the selection included provides a good cross-section of typical products and shows most of the more widely used machines; we will of course welcome suggestions from readers and manufacturers who would like to recommend further generating sets and associated equipment for inclusion in future editions.

Also, it is beyond the scope of this book to go into detail on internationally-available electrical transmission and control equipment. Agents, and suppliers of this kind of equipment are well established and well known in most parts of the world and the best practice will generally be to use equipment that is locally available and which will, no doubt, conform to local electrical standards.

## *Electricity*

This is not the place to discuss the technicalities of electricity generation — but a number of fundamental points are worth a brief mention as they affect the choice of equipment that might be used.

Electricity is primarily of course an energy transmission medium possessing the virtue of being readily convertible, with high efficiency and at low cost, into mechanical, light or heat energy. It can be easily transmitted some distance, but the greater the distance of transmission the higher are the voltages required to prevent undue losses in the transmission lines. High voltage lines need well-spaced conductors on large insulators carried by high towers — so long distance electricity lines are expensive and need to carry a heavy load to be economic. As a result it is not economic to send electricity to distant small communities — it is usually cheaper to send diesel fuel in drums and generate it locally — which is what is normally done in such situations.

Most electricity generation for anything other than battery charging involves the production of alternating current (a.c.), mainly because a.c. generators (alternators) are simpler, cheaper and more reliable than direct current (d.c.) generators (sometimes known as dynamos). In recent years, even cars have generally been fitted with alternators to save cost and improve reliability — the a.c. current then being rectified to d.c. to charge the battery.

Direct current (d.c.) consists of a steady flow of electric current at a fixed voltage, analogous to a steady stream of water flowing down a pipe, while a.c. fluctuates in voltage, changing polarity either 50 times a second (under most European standards) or 60 times a second (U.S. standards). The frequency of a.c. current is controlled by the speed of the generator — most generators produce 50 cycles/second (or 50 Herz) at a driven speed of 1500

rpm, while American machines are often driven at 1800 rpm to produce the US normal output of 60 Herz. Most European electrical appliances are designed for voltages in the range 210 to 240, (50hz) while American equipment tends to be 110V. A lot of equipment on the international market tends to be dual standard and can be adjusted before being put into operation to use either type of supply, or it can be ordered in the first place to suit either type.

Therefore the most basic decision in choosing a generating set is the voltage and frequency that will be required. Here it is probably best to use whatever is normal for the areas of your country with mains electricity for two reasons; firstly appliances and electrical equipment, cables, etc., will be readily available to suit and secondly, if mains power is ever extended to wherever the local generating set is located, then the local wiring and appliances will all be immediately usable.

With direct current, the current (electron flow) and voltage (motive force that moves the electrons) are constant and in the same direction, and the power being transmitted is simply calculated by the product of the voltage and the current; i.e. volts x amps = watts, (for example, a current of 5 amps (A) at a voltage of 240 volts (V) =  $5 \times 240 = 1200$  watts (W) or 1.2 kW). With a.c., this is only true if the voltage and current fluctuate simultaneously, or in phase with each other — in practice, for reasons that need not be detailed here, any electrical appliances with electro-magnetic components (i.e. electric motors, transformers, relays) will have the effect of making the current tend to lag behind the voltage, whereas any components with capacitance (i.e. electrical circuitry that can store an electrical charge) will have the reverse effect and tend to make the current variations lead the voltage ones. Long transmission lines are capacitive and a lot of electric motors in the load are inductive — the two could cancel each other out and make the voltage and current vary in phase, but in practice they are usually a little out of phase. The effect of this is to reduce the transmitted power by a certain amount which is measured by the Power Factor. For example, if the phase difference is such that the transmitted power is 90% of the product of amps times volts, we say that the power factor is 0.9 and the actual power available will be the volts times the amps times the power factor. As a result, it is normal to specify the output of a generator in kilovolt-amps written as kVA and the actual power in kW delivered will be the kVA times the power factor of the circuit; often perhaps 0.8 or 0.9 times the kVA.

Obviously it is desirable to get the power factor as near to unity as possible. The economics of the equipment necessary usually dictate that this is only done with reasonably large, continuously running generating sets — it is hardly worth bothering with a small intermittently used portable set or stand-by unit. The manufacturers of larger, more sophisticated generating equipment (i.e. generators of 5 to 10kVA and upwards, rated for continuous operation) will usually specify in some detail what kind of circuitry should be used in conjunction with their equipment for different purposes and will often supply any special items as a package deal.

Another feature of a.c. electrical power generation is that it is common practice to generate three electrical pulses of voltage and current on the same machine, but equally-spaced, out-of-phase with each other — these voltages and currents are sent down three separate live conductors, but the return (neutral) lines are combined into one conductor. This is known as three-phase transmission (and it is almost universally used for all electrical transmission systems of any significant power and size).

The reason is economic — three-phase generators and motors are smaller and cheaper than single-phase ones of the same output. On the other hand, it is far simpler to connect ordinary, small domestic appliances, fractional-horsepower motors and lights to a single-phase, two-wire circuit — so most three-phase generating systems supplying a large number of small loads tend to have as evenly balanced a collection of small single-phase loads as possible on separate circuits connected to each of the three phases. Large motor loads, on the other hand, are usually three-phase as well and have four terminals to allow connection direct to four-conductor, three-phase systems.

The connecting up of three-phase equipment can be quite complicated, as there are several different methods for linking the terminals on a three-phase generator or motor. It should be noted that the voltages between the three lines are considerably higher than between each line and the neutral return. It is of course essential that installations of this kind are completed, or at least supervised, by a qualified electrician or electrical engineer, so no attempt will be made here to instruct in the details of connecting up electrical circuits.

It must of course be stressed that electricity is extremely dangerous if mishandled, and the smallest low-powered generating sets with tiny 49cc two-stroke power units can administer a fatal electric shock if of 240V-output, while even a 110V output can be dangerous for someone with a weak heart if touched with wet hands or in some other careless way that ensured a good electrical connection. Therefore, always switch off the generator or at least isolate all circuits before undertaking any maintenance, repairs or modifications.

#### *Alternators and generators*

As already explained, almost all electricity generation is in a.c. using alternators. There are two primary types of alternator; so-called rotating armature slip-ring machines and fixed armature, rotating field, brushless machines. Slip-ring machines have a lower first cost but they need more maintenance as they have carbon brushes running on brass slip rings which eventually wear out and need replacement. Brushless machines are really two alternators in one (which explains their greater cost) as they have a small rotating armature which activates a rotating d.c. field coil (via built in rectifiers) on the same shaft, which in turn generates the output within the stator armature. As a result no electrical connections are needed between rotating and static components and brushes can be eliminated from the design. This makes brushless machines almost maintenance free, the bearings being the only wearing components.

Dynamos for d.c. generation are relatively unusual except for low-power battery charging applications such as in motor vehicle electrical systems, and a few of the smaller windmills intended for low voltage, low power outputs. These have brushes and brass commutators (which resemble segmented slip rings) which tend to wear faster than slip rings and generally need slightly more maintenance.

Most modern electrical machines are enclosed sufficiently to be "drip proof" — (early machines tended to be exposed and vulnerable to damage from any water splash or drips). Control equipment is sometimes built in, but can usually be supplied when it is not, for regulating the voltage and frequency within close enough limits to permit the use of standard electrical equipment that might be sensitive to voltage or frequency "excursions". This applies particularly to electronic devices, but excessive voltage can burn out almost all electrical appliances, light bulbs in particular.

### Generating sets

An enormous variety of different types of generating set is available. They range from very small portable units with a pull-start and outputs of only a few hundred watts, for use with portable electrical equipment that is used intermittently, such as small power tools or temporary lighting, to large permanent installations that are in effect miniature power stations, complete with automatic control equipment and designed for continuous operation.

Many of the larger diesel generating sets are available either as standby units to provide power during periods of mains supply failure, or as continuous power units. Standby machines have automatic start-up facilities which activate them if the mains voltage falls below some preset limit.

A lot of the remarks in the introductory passages to Section 5 on internal combustion engines apply to the choice of power units for generating sets. It is particularly important to make sure that the chosen unit is sufficiently derated for the operation envisaged. It is invariably cheaper in the long run to use a machine which is slightly too powerful for the job than to use one that has a struggle to deliver sufficient power to satisfy the demand. A vital factor, of course, is the availability of spare parts and service, particularly for the engine, so before looking too closely at technical features, it is often as well to investigate whether a reliable agency is close at hand.

When choosing a power unit it is particularly important to consider the likely load demands and their nature. A generator used to drive electric motors capable of absorbing a significant proportion of the generator output must be capable of sustaining a quite heavy over-load for a few seconds when starting an electric motor, as motors draw a much increased current while running up to speed. Even refrigerators and other domestic appliances with electric motors can cause an appreciable extra load when their motors start up. Obviously it would be very wasteful to use electricity from a generating set for heating purposes (either for space heating, water heating or cooking) as the same or similar fuel that is used to run the engine could be used much more efficiently and cheaply by burning it in suitable appliances directly, and renewable resources such as solar heating or wood fuels (where available) will often be still more economical. If heat is required for space or water heating and a water cooled generating set is in use, it is possible to use engine waste heat, via a heat exchanger, to heat water or to space-heat using equipment similar to a car's heater. Indeed, an interesting challenge for all who use regularly operated generating sets is to find use for the waste heat.

A number of generators intended for continuous operation can be supplied with extra silencing and sound-proofing. This can be worthwhile specifying in many cases as in addition to the environmental improvement, it may permit the generator to be located nearer to its load and save on the costs of transmission lines and save transmission losses.

### Other electrical equipment

This section includes a number of items connected indirectly with electricity generation, such as batteries and inverters.

Batteries are at present only generally available as lead-acid or nickel-cadmium for most practical and economic purposes. Other types exist, and some quite promising new types are under development, but none of these are yet economically competitive. Lead-acid batteries, as used for most motor vehicle electrical systems, tend to cost around £25 to £30/kWh, which makes them much cheaper

than their only real rival, nickel-cadmium at around £100/kWh. Nickel cadmium batteries are worth the extra cost for some applications, as they can withstand deep discharge and overcharging much better than lead-acid batteries, and they can be short-circuited or deliver very heavy currents for a brief time with less likelihood of damage occurring.

Batteries in their more common form require regular replenishment of the electrolyte with distilled water. However, nickel cadmium batteries have been available for some time in a maintenance-free sealed version and new lead-acid batteries of a similar kind, with a jellied electrolyte that needs no topping up, are coming onto the market. It is quite important to ensure that the capacity of a lead-acid battery or batteries allows them to avoid excessively deep discharge between recharging intervals, which may necessitate a greater storage capacity having to be provided in certain circumstances when lead-acid are chosen than if nickel cadmium had been used, which could partially offset some of the cost differential.

For heavier power applications, lead-acid batteries would normally be used for cost reasons, while for specialised small power applications (such as in conjunction with solar cells) the lower maintenance requirement of sealed lead acid or of nickel cadmium batteries can justify their extra expense.

For power applications involving energy storage in excess of a few kWh, it generally becomes uneconomic to use batteries, and a standby diesel or petrol engine with a fuel supply is likely to be cheaper. The running costs for the standby engine in such situations will be higher, but its lower capital cost could more than outweigh this.

In any case, where energy storage by battery is being contemplated, it would be well to write to the manufacturers' technical advisory services to seek advice on correct sizing to suit the need. This is particularly important with lead-acid batteries to avoid excessive discharging which could greatly shorten their life.

Where batteries are required for storage, but a conventional a.c. output is needed to run mains voltage equipment such as domestic electrical appliances, the modern method for performing the conversion from d.c. to a.c. is via a solid-state electronic inverter, some examples being included in this section. A number of suppliers of electricity-generating windmills also supply inverters, since batteries are commonly used with small and medium-sized windmills as an energy store for use in windless periods.

Once an a.c. output is obtained, different voltages can be produced using a suitable transformer, although most inverters are designed to convert to normal domestic a.c. voltages. To go from a.c. to d.c. requires a rectifier; modern practice being to use solid-state diodes to perform this function. It is beyond the scope of this book to detail suppliers of transformers and rectifiers; they are fairly readily available from most wholesalers of general electrical equipment.

### Note on code letters in the following section:

B	= brushless
S	= slipring
4	= 4-stroke engine
2	= 2-stroke engine
D	= diesel engine
P	= petrol engine (spark ignition)
G	= gas engine
W	= Water (liquid) cooled engine
A	= air cooled engine
T	= turbo-charged engine
P.T.O.	= power take off drive

# Alternators & Generators

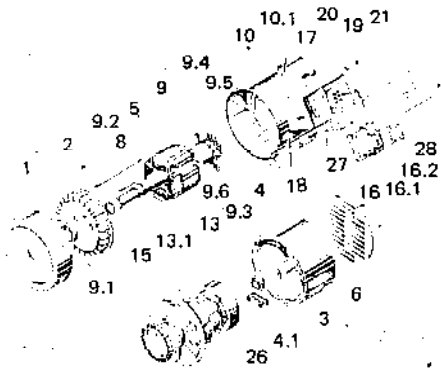

## Type 4221-4230/04

- |  |                         |
|--|-------------------------|
| 1. bearing plate (driving end - AS)      | 19. terminal strip L1   |
| 1.1 (ouvre) plate (driving end - AS)     | 20. main terminal board |
| 1.2 air baffle                           | 21. condenser           |
| 2. bearing (driving-AS)                  | 26. series resistor     |
| 3. bearing plate (non-driving end - NAS) | 27. cover plate         |
| 4. bearing (non-driving end - NAS)       | 28. terminal box cover  |
| 5. stud bolts                            |                         |
| 6. cover plate                           |                         |
| 8. feather                               |                         |
| 9. rotor, complete                       |                         |
| 9.1 fan                                  |                         |
| 9.2 spacer ring                          |                         |
| 9.3 diode assembly                       |                         |
| 9.4 exciter rotor                        |                         |
| 9.5 rotating diode (+)                   |                         |
| 9.6 rotating diode (-)                   |                         |
| 9.7 varistor, complete                   |                         |
| 10. stator complete                      |                         |
| 10.1 eyebolt                             |                         |
| 13. exciter stator                       |                         |
| 13.1 exciter support                     |                         |
| 15. pilot exciter stator                 |                         |
| 16. regulator, complete                  |                         |
| 16.1 terminal strip L2                   |                         |
| 16.2 terminal strip L3                   |                         |
| 17. reference voltage adjuster           |                         |
| 18. locking screw                        |                         |

**AEG-TELEFUNKEN**  
(U.K.) LTD  
202 Kensington Church Street  
London W8 4DP  
U.K.

Telex: 22795  
Phone: 01 229 9244

**Mounting:** Flanged feet  
**Range:** 64 models in 2 ranges from 30 to 2520kVA.  
**Connections:** Keyways are standard, conical and optional.  
**Control Options:** Automatic voltage control, with overload and over-speed protection. Parallel running facility is optional.  
**Voltage options:** 400V 50Hz and 450V 60Hz three-phase are standard, others on request.  
**Power factor:** 0.8  
**Protection:** Drip proof and screen protected.  
**Agencies:** Subsidiaries world wide.

Type	kVA		V.	Gen. Spec.	Weight (kg)
	Single-phase 50Hz	3-phase 60Hz			
DKBH4221/04	Not applicable	30	400/450	B	290
.. 4222/04	..	35	..	B	300
.. 4223/04	..	40	..	B	320
.. 4224/04	..	45	..	B	330
.. 4225/04	..	51	..	B	350
.. 4226/04	..	60	..	B	380
.. 4227/04	..	70	..	B	420
.. 4228/04	..	80	..	B	450
.. 4229/04	..	90	..	B	460
.. 4230/04	..	97	..	B	510
.. 4254/04	..	120	..	B	575
.. 4255/04	..	140	..	B	655
.. 4256/04	..	150	..	B	735

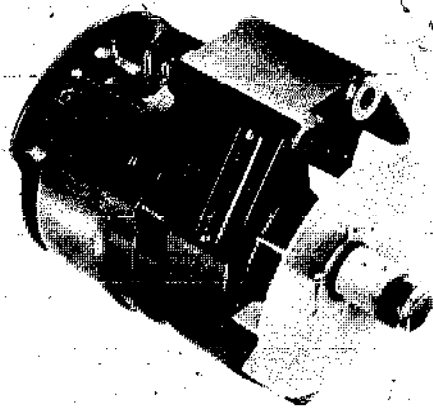

AC5-24 Alternator

**CAV LTD**  
P.O. Box 36  
Warpole Way  
London W3 7SS

Telex: 27881  
Cables: Vanteria London  
Phone: 01 743 3111

**Mounting:** Cradle mount or wing mount (as per vehicle generator)  
**Range:** 7 models in 3-ranges from 0.78kVA to 1.2kVA  
**Connections:** Keyed output shaft  
**Alternator make:** CAV  
**Control options:** Automatic full wave regulation to give d.c. output.  
Solid state regulator for voltage options  
**Voltage options:** 12.24 or 32V d.c.  
**Power factor:** 1  
**Protection:** Corrosion resistant  
**Special features:** Small range of electrical control and protection devices. Different models in the same range have varying cut-in speeds.

Type	Engine power absorbed (kW)	Single-phase	3-phase (kVA)	V d.c.	Gen. Spec.	Weight (kg)
AC512	1.8	65-100 amps	0.78-1.2	12	S	5.9
AC524	1.8	33-50	0.79-1.2	24	S	5.9
AC532	1.8	23	0.74	32	S	5.9

@ 3500 r.p.m.



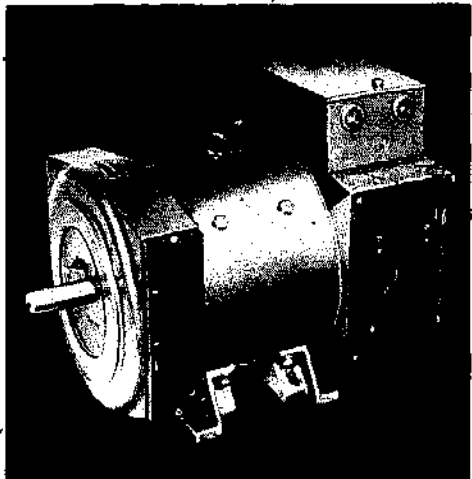

**Brush SCA/SDA Generator**

**BRUSH ELECTRICAL  
MACHINES LTD**  
Light Machines Division  
P.O. Box 18  
Loughborough  
Leicestershire LE11 1HJ  
U.K.

Telex: 341091  
Cables: Brush Loughborough  
Phone: Loughborough 63131

Export address:  
Hawker Siddeley Electrical  
Export Ltd.  
P.O. Box 18  
Loughborough  
Leicestershire LE11 1HJ  
U.K.

*Mounting:* Flanged feet

*Range:* 6 models in 2 ranges from 1.2kVA to 14.4kVA

*Connections:* Keyed shaft output suitable for V belt drive

*Control options:* Self regulating, top mounted terminal box. Loose leads optional

*Voltage options:* Specify from 115/230/240 single-phase, 210/380/420/440, 3-phase. 2 to 4 outputs available from each frame.

*Power factor:* 0.8

*Protection:* Drip proof and screen protected

*Special features:* Regulation and radio suppression may be omitted.

*Agencies:* Through Hawker Siddeley and Lister agents

Type	kVA				V	Gen. Spec.	Weight (kg)
	Single-phase		3-phase				
	50Hz	60Hz	50Hz	60Hz			
SCA 117	1.2-	1.2-	2.4-	2.4-	115	S	59
	3.2	3.6	4.0	4.8	up		
SCA 225	3.2-	4-	4.8-	5.6-	440	S	105
	6	7.2	8	9.6			
SCA 320	6.4-	8-	8.8-	11.2-	in	S	181
	8.8	10.4	12	14.4			
SEA 1A	1.2-	1.4-	2-	2.4-	S	S	55
	2.4	2.9	3.2	3.8			
SEA 1B	3.2-	3.6-	4-	4.8-	S	S	59
	4.8	6	6.4	7.7			
SEA 2	6.8-	8-	8-	10.-	S	S	105
	8	9.6	10.4	12.4			

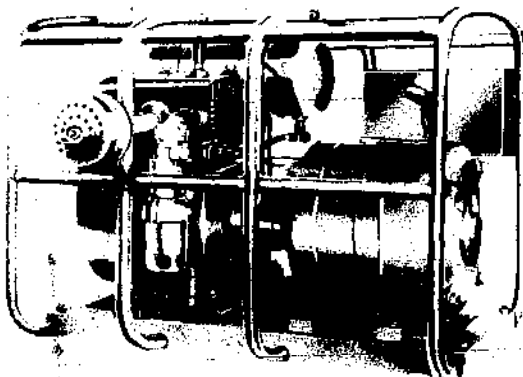

**Portable Gensets Petrol and Diesel Engine**

**ELMOT ENGINEERING CO.  
PRIVATE LTD.**  
2 Udyog Nagar  
Swami Vivekanand Road  
Goregaon (West)  
Bombay 62 NB  
India

Telex: 011-3389  
Cables: Alternator  
Bombay  
400 023  
Phone: 696351,2

*Mounting:* Smaller units are frame mounted, larger ones are skid mounted. Trolley and trailer options are available

*Range:* From 0.5kVA to 250kVA

*Engine make:* Made in India, diesel and petrol types available

*Engine features:* Hand or electric start available.

*Connections:* Keyed output shaft on generators supplied separately

*Control options:* Machine mounted as standard. Mains failure and parallel running facilities are available.

*Voltage options:* 230V single-phase, 415V three-phase, or to order, 50Hz

*Protection:* Drip proof Class A insulation. Canopies are optional

*Special features:* All spare parts manufactured in India.

*Agencies:* Branches through India

No detailed specifications available.

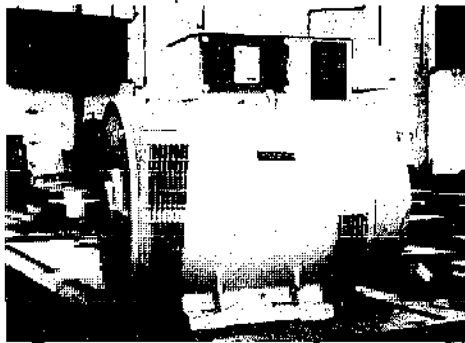

**BRP-280 Drip-proof Machine**

**ELECTRIC CONSTRUCTION (W'TON) LTD**  
 (Hawker Siddeley Group)  
 Bushbury Engineering Works  
 Wolverhampton W10 9LE  
 U.K.

Telex: 339618  
 Cables: Electric Wolverhampton  
 Phone: 0902 21455,  
 27831

*Mounting:* Flange mounted  
*Range:* 12 models from 15kVA to 1200kVA.  
*Connections:* As specified or with SAE or Ford flanged end bracket  
*Alternator make:* Electric Construction  
*Control options:* Built in voltage regulator, machine mounted terminal box.  
*Voltage options:* 415/240 option is standard. Specify phase and other voltages.  
*Power factor:* 0.8  
*Protection:* Tropical insulation. Drip proof or screen protected as specified.  
*Special features:* Machine or wall mounted control panel optional  
*Agencies:* Concessionaires in 36 countries.

Type	Single-phase		kVA 3-phase		V	Gen. Spec.	Weight (kg)
	50Hz	60Hz	50Hz	60Hz			
200	15	18	25	31	415/	B	225
200L	21	25	37	44	240	B	310
225	24	29	40	50	..	B	310
225L	30	35	50	60	..	B	360
250	42.5	51	72	86	..	B	450
250L	58	68	100	120	..	B	535
280	70	84	120	150	..	B	600
280L	100	120	170	204	..	B	715
355	120	144	210	250	..	B	1090
up to 500L			1000	1200	..	B	3390

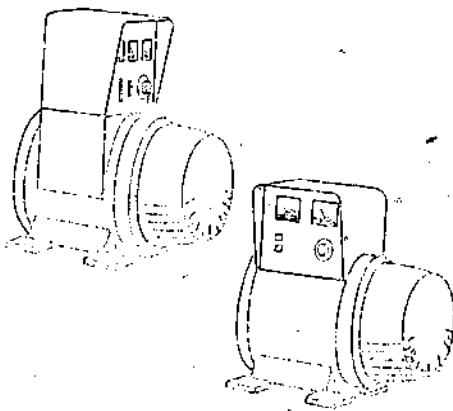

**Model H Loadster Brushless Generator**

**FIDELITY ELECTRIC COMPANY**  
 332 N. Arch Street  
 Lancaster  
 Pennsylvania 17603  
 U.S.A.

Phone: 717 397-8231

*Mounting:* Flange feet  
*Range:* 7 models from 5kVA to 50kVA  
*Connections:* SAE 2, 3, 4, and 5 are standard, others available.  
*Control options:* Inherent voltage regulation. Machine mounted terminal box as standard. Variety of control options available.  
*Voltage option:* 120 to 480 in steps by connecting terminal box  
*Power factor:* 0.8  
*Protection:* Drip proof. Tropical insulation and sustained short circuit protection available.  
*Special features:* Limited range of control and instrumentation options available. The generator is lightweight and (it is claimed) has good electric motor starting characteristics.  
*Agencies:* U.S.A.

Frame size	Single-phase		kVA 3-phase		V	Gen. Spec.	Weight (kg)
	50Hz	60Hz	50Hz	60Hz			
284	5	7.5	6.25	9.4	120	B	not
284	7.5	10	9.4	12.5	up	B	avail-
284	10	12	12.5	18.75	to	B	able
284T	12	15	18.75	25	480	B	
286T	15	20	25	31.25	..	B	
286T	20	25	31.25	37.5	..	B	
286T	25	30	37.5	50	..	B	

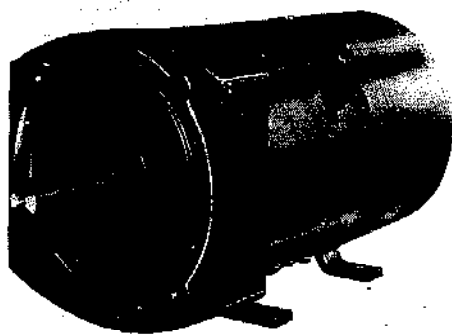

"D" Range D8 Alternator

**NEWAGE ENGINEERS  
LIMITED**  
P.O. Box 17  
Barnack Road  
Stamford  
Lincolnshire PE9 2NB  
U.K.

Telex: 32268  
Cables: Leopower  
Phone: 0780-2552

*Mounting:* Flange mounted

*Range:* 20 models in 2 ranges from 2kVA up to 630kVA

*Connections:* Standard range of flange adaptors available

*Alternator make:* Newage

*Control options:* Automatic voltage regulation, output is loose wires or terminal box

*Voltage options:* Most standard voltages available by connection

*Power factor:* 0.8

*Protection:* Drip proof on larger range. Optional on small range. Tropical insulation

*Special features:* Short circuit protection and parallel running units are available

*Agencies:* Comprehensive world wide agency list

Type	Engine Input h.p.	kVA		V		Gen. Spec.	Weight (kg)
		single-phase 50Hz	60Hz	3-phase 50Hz	60Hz		
D8A	5	3.5	4	5	6	220 S	59
D8B	6.5	4	5	6	8	up S	81
D8C	12-17	7.5	9	11	13.5	to S	102
D11A	15-27	10	12	15	18	440 S	145
D11B	20-37	13.5	16	20	24	.. S	159
C20A		12.5	16	20	25	100 B	216
C20B		20	25	31	37.5	up B	254
C30A		30	44	50	62.5	to B	381
C30B		50	62.5	80	94	600 B	457
C40A		65	81	100	125	.. B	622
C40B		85	106	137.5	162.5	346 B	686
C434A				150	180	up B	775
up to C634B				630	750	to 600 B	2123

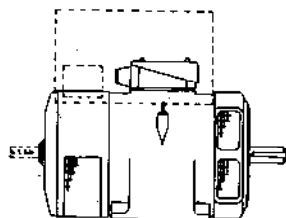

GEC Industrial A.C. Generators

**GEC MACHINES LTD**  
Diesel Generator and Machine  
Sales  
Mill Road  
Rugby  
Warwickshire CU21 1BD  
U.K.

Telex: 31671  
Cables: Assoelect Rugby  
Phone: (0788) 2121

*Mounting:* Flanged feet

*Range:* 22 models in 6 frames from 6.25kVA to 162.5kVA

*Connections:* Variety of splined output shafts to order

*Alternator make:* GEC (as used on Dorman Diesels)

*Control options:* Self-regulating, machine or wall mounted switchboards can be supplied. Parallel running, short circuit protection and voltage build up accessories are available.

*Voltage options:* Any standard voltage up to 480V by reconnection

*Power factor:* 0.8

*Protection:* Tropically insulated

*Special features:* A variety of control units are available specially suited to a more industrial use

*Agencies:* Through Dorman agents

Type	Engine	kVA		V		Gen. Spec.	Weight (kg)
		single-phase 50Hz	60Hz	3-phase 50Hz	60Hz		
C20A	16	7.5	6.25	12.5	12.5	up B	216
C20B	35	17.5	22	25	31	to B	254
C30A	50	27.5	37.5	45	56	480 B	381
C30B	80	45	50	70	81	.. B	457
C40A	100	60	81	100	125	.. B	622
C40B	175		106	137.5	162.5	.. B	686

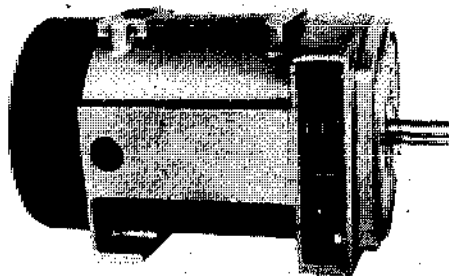

**B Range Series 2 Alternator.**

**MARKON ENGINEERING CO. LIMITED**  
 Long Row  
 Oakham  
 Leicestershire LE15 6LW  
 U.K.

Telex: 34472  
 Cables: Markon Oakham  
 Phone: (0572) 3811/5

*Mounting:* Flanged base  
*Range:* Various ranges 0.5kVA to 1125kVA. 1 range listed  
*Connections:* 3/8" or 7/8" standard SAE taperbore shafts. Turning @ 3000 r.p.m.  
*Alternator make:* Markon  
*Control options:* In-built automatic voltage control  
*Voltage options:* Specify 220-240 or 110-220V  
*Power Factor:* 0.8  
*Protection:* Drip proof  
*Agencies:* World wide manufacturers, subsidiaries and agencies

Type	Engine Input h.p.	kVA				V	Gen. Spec.	Weight (kg)
		single-phase		3-phase				
		50Hz	60Hz	50Hz	60Hz			
SC21a	4-5	2	2.5	Not applicable		110	S	20.5
SC21b	4.5-7	3	3.75			up to	S	23
SC21c	6-8.5	4	5			to	S	27
SC21d	7-10	5	6			240	S	30

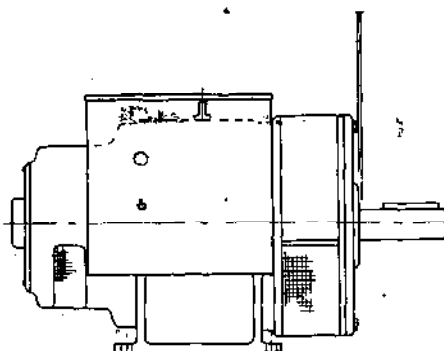

**Brushless A.C. Generator**

**NEWTON DERBY LIMITED**  
 Alfreton Road  
 Derby DE2 4AG  
 U.K.

Telex: 37580  
 Cables: Dynamo Derby  
 Phone: 0332 47676

*Mounting:* Skid mounted (generators have flanged feet).  
*Range:* 24 models in 2 ranges from 7.5kVA to 400kVA. 3 ranges (generator only) 1.5kVA to 330kVA. Full range not shown.  
*Engine make:* Smaller range uses Lister, larger uses Cummins  
*Engine features:* Crank start for smallest engines, remainder are self starting.  
*Connections:* Smallest generators have a female taper output shaft. Larger ones are spigotted to accept a range of SAE adaptors.  
*Alternator make:* Newton Derby  
*Control options:* Machine mounted control box for complete sets. Generators have automatic voltage control.  
*Voltage options:* 380/440 Volts for complete sets. Generators offer 115/230, 220/440 or 380/440 or others as specified.  
*Power factor:* 0.8  
*Protection:* Drip proof and tropically insulated.  
*Special features:* Limited accessory range of basic items (e.g. fuel tank)  
*Agencies:* Agencies in the Middle East, North Africa and Far East Asia.

Type	Engine	kVA				V	Gen. Spec.	Weight (kg)
		Single-phase		3-phase				
		50Hz	60Hz	50Hz	60Hz			
RC3LA6	4DA	5	6	7.5	9	380/	S	Not
RC3LA7.5	4DA	7.5	9	10	12	440	S	avail-
RC3LA11.5	4DA	10	12	15	18	..	S	ble at
RC3LA15	4DA	12.5	15	18.75	22.5	..	S	time
RC3LA20	4DA	17.5	21	25	30	..	S	of
RC3LA28.8	4DA			36	..	..	S	print-
RC3LA32	4DA			40	48	..	S	ing.
RC3LA40	4DA			50	60	..	S	
RC3LA48	4DA			60	72	..	S	
SER3CW56	4DW	36	40	70	80	..	B	
SER3CW64	4DW	40	47	80	90	..	B	
SER3CW80	4DW	50	60	100	110	..	B	
SER3CW104.5	4DW	70	80	135	156	..	B	
SER3CW124.8	4DW	80	90	156	175	..	B	
SER3CW140	4DW	90	100	175	200	..	B	
up to								
SER3CW320	4DW			400				

# Generating Sets



**Type PBF Generating Set**

## ALLAM GENERATORS

Arterial Road  
Eastwood  
Leigh-on-Sea,  
Essex  
U.K.

Telex: 995127  
Cables: Epaltrical Southend  
Phone: 0702 526551

*Mounting:* Petrol engines are frame mounted, diesel engine is skid mounted. A Barrow mount is available for the diesel.

*Range:* 5 models in 2 ranges, from 1.5kVA to 7.5kVA

*Engine make:* Petrol engines are Briggs and Stratton, diesel engine is Petter.

*Engine features:* All engines are hand started and run at higher r.p.m.

*Control options:* Self regulating with machine mounted panels. Short circuit protection is standard.

*Voltage options:* Each unit offers 1 or 2 voltages from a range of standard voltages.

*Power factor:* 0.8

*Protection:* Drip proof

*Special features:* Long run fuel tank available for diesel set

*Agencies:* Middle East, Africa and Indian sub-continent.

Type	Engine	kVA		V	Gen. Weight Spec. (kg)		
		Single-phase				3-phase	
		50Hz	60Hz			50Hz	60Hz
PBD1.5	4DA	1.5	1.5	115/230	B 35		
PBE3	4DA	3	3	.. / 415	B 70		
PBF5	4DA	5	5	.. ..	B 124		
PBF7	4DA	7	7	.. ..	B 128		
DPF7.5	4DA	7.5	7.5	.. ..	B 176		

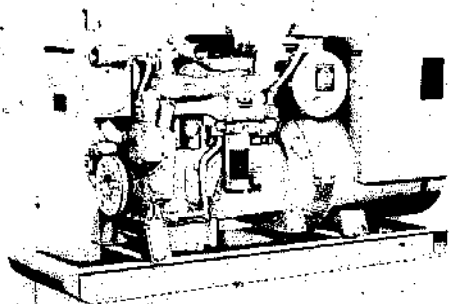

**3304 Generator Set**

## CATERPILLAR OVERSEAS

S.A.  
118 Rue du Rhone  
P.O. Box 408  
1211 Geneva  
Switzerland

Telex: 22706, 22833  
Cables: Catoversea Geneva

*Mounting:* Skid mounted

*Range:* 20 types, 63kVA to 1125kVA

*Engine make:* Caterpillar

*Engine features:* Variety of cooling options, self-start, all sets are test run.

*Control options:* Machine mounted, variety of control board configurations, automatic start and remote monitoring available. Parallel running facility

*Voltage options:* Short steps from 115 to 600

*Power factor:* 0.8

*Protection:* Drip proof

*Special features:* Small accessory range (includes parts of starting equipment)

*Agencies:* World wide, plus printed guides to aid generator selection.

Type	Engine	kVA		V	Gen. Weight Spec. (kg)		
		Single-phase				3-phase	
		50Hz	60Hz			50Hz	60Hz
3304	4DW	63	63	115	B 1200		
3304	4DWT	75	75	to	B 1204		
3304	4DWT	100	106	600	B 1259		
3306	4DW	125	131	..	B 1905		
3306	4DWT	163	163	..	B 2000		
up to							
0399	4DWT	875	1063	..	B 10297		

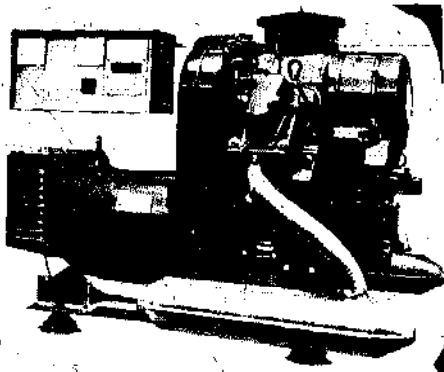

44T28 - 28kVA Diesel Generator

**BERMOTOR LIMITED**  
 21 London Road  
 Tunbridge Wells  
 Kent  
 U.K.

Telex: 95446  
 Cables: Bermotor  
 Tunbridge Wells  
 Phone: 0892 37588

**Mounting:** Frame and skid mounted, larger units on trailer or trolley as option.

**Range:** 30 models in 6-ranges from 0.5kVA d.c. to 28kVA a.c. Specifications are given for a part of the range only.

**Engine make:** Barnard (a Renault Company)

**Engine features:** Recoil starting on smaller engines, larger ones are self starting. All engines turn at 3000 r.p.m.

**Control options:** Smaller engines have integral control panels, larger ones use wall mounting. Remote start and stop. Automatic start and mains failure facilities are available.

**Voltage options:** Voltage to be specified on larger sets from 400/230, 380/220 or 220/127.

**Power factor:** Given as 1 for smaller alternators; 0.8 for larger

**Protection:** Most models are drip proof

**Special features:** Propane may be used as fuel on some models

**Agencies:** Through Renault agents.

Type	Engine	kVA		V	Gen. Spec.	Weight (kg)
		Single-phase 50Hz 60Hz	3-phase 50Hz 60Hz			
18ACB66	4DA	0.3 d.c.		6/12	C	16
117CBD68	4DA	0.75 d.c.		12/24	C	37
21CB305	4DA	1.5 d.c.		12/24	C	97
318AMAP502	4DA	0.75 d.c.		110	B	32
318AMAP603	4DA		1	up to	B	32
117-6M16	4DA	1.6		220	S	48
217M2	4DA		2.4	220	S	85
217M24	4DA	2		220	S	50
810M4	4DA	4		220	S	100
71M5	4DA	5		220	S	165
112TM553	4DA	5		220	B	160
71M491	4DA	6		up to 110	B	165
239AM606	4DA	1.8		220	S	70
610AM606	4DA	2.5		220	S	51
810M606T	4DA	3.3		220	S	53
610AT	4DA		3.75	400/		120
112T	4DA		6.25	230		205
71T495	4DA		7.5	380/		230
				220		
42T497	4DA		12.5	220/		290
44T28	4DA		28	127		490

**DAWSON-KEITH ELECTRIC LTD**  
 Deekay House  
 North Street  
 Havant  
 Hants PO9 1QH  
 U.K.

Telex: 86491  
 Cables: Autogen Havant  
 Phone: (07012) 74122

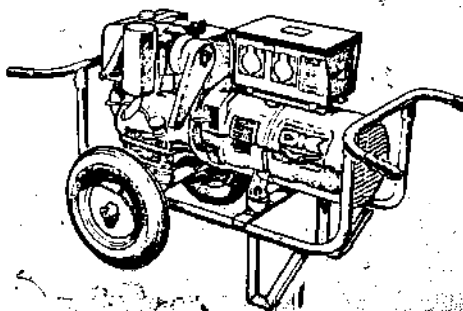

D-K Generating Plant

Manufacturers of a wide range of generating plant as follows:

	Base-load plant	Transportable Plant	Auto-standby plant
<b>Power range:</b>	12.5 to 1125kVA	20 to 1125kVA	12.5 to 1125kVA
<b>No. of models:</b>	37	34	37
<b>Engine types:</b>	Lister, Perkins, Ford, Dorman, Rolls, Cummins and GM	Perkins, Ford, Dorman, Rolls, Cummins and GM	Lister, Perkins, Ford, Dorman, Rolls, Cummins and GM
<b>Alternators:</b>	Brushless self-exciting, self-regulating — all to BS2613		
<b>Special features:</b>	A wide range of extras available for control, silencing mounting, enclosing, etc. A 24-hour round the clock advice service is offered to customers.		

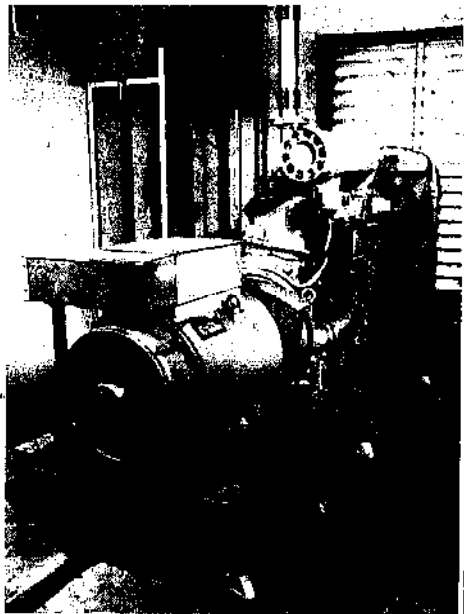

Model ADV100

**AUTO DIESELS BRABY LTD**  
 Cowley Mill Road  
 Uxbridge  
 Middlesex UB8 2QG  
 U.K.

Telex: 263835  
 Cables: Audodiesels Uxbridge  
 Phone: 0895 38262

*Mounting:* Skid mounted. Trailer mounting optional  
*Range:* 40 models in 3 ranges from 20 to 700kVA. Full range not shown.

*Engine make:* Volvo, Cummins, and Dorman, in ascending size order.

*Engine features:* Self starting industrial engines.

*Control options:* Machine or wall mounted controls. Self regulating. Comprehensive range of starting, control and protection controls are available.

*Voltage options:* Any standard voltage in the limits specified can be obtained.

*Power Factor:* 0.8

*Protection:* Drip proof, screen protected

*Special features:* Standard specification includes many 'options'.

Comprehensive list of control and mechanical extras

*Agencies:* Distributors in nearly 50 countries.

Type	Engine	kVA		V	Gen. Spec.	Weight (kg)	
		Single-phase 50Hz 60Hz	3-phase 50Hz 60Hz				
ADP20	4DW	Not available	20 24	380	B	726	
ADF30	4DW		30 40	up	B	907	
ADP37	4DW		37 45	to	B	930	
ADF50	4DW		50 60	440	B	1021	
ADF69	4DW		69 85	..	B	1265	
ADP80	4DW		80	..	B	1261	
AS/F85	4DW		85	..	B	1265	
ADV100	4DW		100	..	B	2000	
AS/V120	4DW			120	..	B	2000
ADL107	4DW		107	..	B	1987	
AS/L130	4DW			130	..	B	1987
ADS160	4DW		160 167	..	B	2404	
ADC130	4DW		130	220	B	2550	
ADC165	4DWT		165	up	B	2800	
ADC700	4DWT		700	to	B	7706	
ADC280	4DWT		280	650	B	4536	
ADC700	4DWT		700	..	B	9304	

**KAWASAKI HEAVY INDUSTRIES LIMITED**  
 World Trade Centre Building  
 Hamamatsu-cho  
 Minatoku  
 Tokyo  
 Japan

Telex: J-22672J26888  
 Cables: Kawasakiheavy:Tokyo



Kawasaki KG700B Generator

*Mounting:* Smaller units on feet, larger units in tube frames

*Range:* 4 types from 0.5 to 2.3kVA

*Engine make:* Kawasaki

*Engine features:* Recoil start, engine runs at high r.p.m.

*Alternator make:* Kawasaki

*Control options:* None, comes as complete unit

*Voltage options:* Either 110 or 220 volts available

*Power factor:* 1.0

*Protection:* Unit totally enclosed, no external moving parts. Small d.c. output for battery charging.

*Special features:* Smaller units may be carried by one man

*Agencies:* As for motorcycles.

Type	Engine	kVA		V	Gen. Spec.	Weight (kg)
		Single-phase 50Hz 60Hz	3-phase 50Hz 60Hz			
KG600	4PA	0.5 0.6		110	B	25
KG900	4PA	0.8 0.9		to	B	30
KG1300	4PA	1.1 1.3		220	B	42
KG2300	4PA	2 2.3		..	B	53

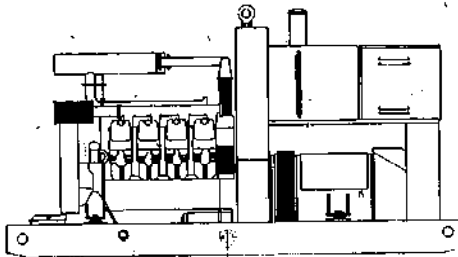

Model 22J

**CGE INTERNATIONALE  
U.K. LIMITED**  
Castle Works  
Station Road  
Hampton  
Middlesex TW12 2BY  
U.K.

Telex: 928735  
Cables: Electexpel Hampton  
Phone: 01 941 2525

*Mounting:* Skid base standard. Road and handling trailers optional  
*Range:* 10 models from 14kVA to 210kVA  
*Engine make:* Alsthom-Tarbes (division of CGE)  
*Engine features:* Self-starting  
*Alternator make:* Unelec (Alsthom subsidiary)  
*Control options:* Machine mounted with built in safety cut-out. Automatic voltage control  
*Voltage options:* 380 or 220V  
*Power factor:* 0.7  
*Protection:* Drip proof. Tropical insulation. All weather cover optional  
*Special features:* Optional starter motor and cold start equipment. Silent running cover available  
*Agencies:* World wide

Type	Engine	kVA		V	Gen. Spec.	Weight (kg)
		3-phase				
		50Hz	60Hz			
22J	4DA	14	23	220/	B	1065
..	4DA	32	50	380	B	1125
..	4DA	70	85	..	B	1155
..	4DA	110	140	..	B	1350
..	4DA	170	210	..	B	1730
..	4DA	..	..	..	B	2250
..	4DA	..	..	..	B	2850
..	4DA	..	..	..	B	3250
..	4DA	..	..	..	B	3700
..	4DA	..	..	..	B	3900

**DIPL.-ING. HITZINGER &  
COMPANY**  
Helmholtzstrasse 56  
4020 Linz  
Austria

Telex: 021769  
Cables: Tebehi Linzdonau  
Phone: 07222/81681

*Mounting:* Skid mounted, covered and trailer versions available.  
*Range:* Large range up to 500kVA  
*Engine make:* Hatz, UW Lister, MWM Jenbacher, MAN and Deutz engines all used  
*Engine features:* Electric start  
*Alternator make:* Hitzinger  
*Control options:* Machine or wall mounted, manual or automatic start synchronising equipment for parallel operation available.  
*Power factor:* 0.8  
*Protection:* Drip proof — complete cover optional  
*Special features:* Range of accessories and equipment for emergency power plant erection. Continuous supply models available.  
*Agencies:* Africa, N. Africa, Mid-East Asia, Far East, Pacific, Central America and Caribbean.

No specifications available at time of printing.

### Ventilated and Sound-proofed Hitzinger Installation

1. grille
2. outgoing air-sound absorber
3. tank
4. flap for outgoing air
5. bellows
6. generating set
7. switch-panel
8. silencing door
9. flap for ingoing air
10. ingoing air-sound absorber
11. exhaust-silencer
12. rain protection cap
13. exhaust-pit

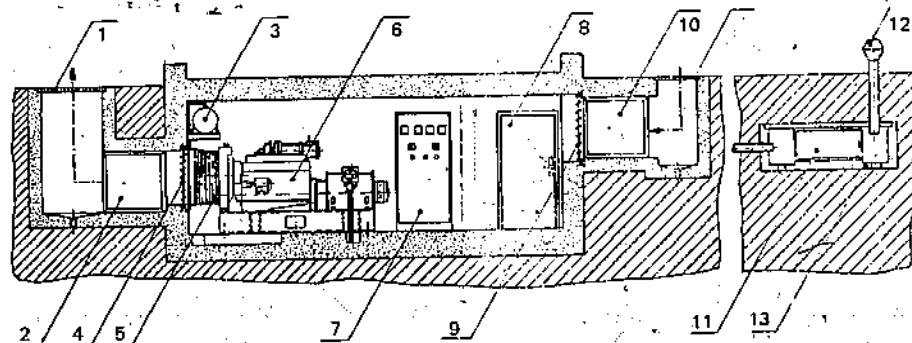



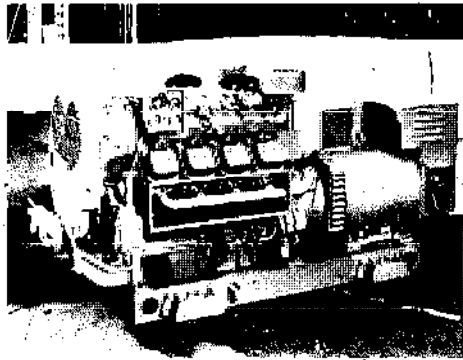

DA Series Generating Set

**DORMAN DIESELS LTD**  
 Tixall Road  
 Stafford ST16 3UB  
 U.K.

Telex: 36156  
 Cables: Dorman Stafford  
 Phone: 0875 3141

*Mounting:* Skid mounted. Trailer mount available on some models  
*Range:* 27 types in 4 ranges from 18.5 to 573kVA. Full range not shown

*Engine make:* Dorman

*Engine features:* Self start, sets may be run slow

*Control options:* Control panel mounted on or off machine. Machine mounted single/parallel running, auto start/stop, alarm shutdown available.

*Voltage options:* Any single standard voltage up to 480V; 4-wire

*Power factor:* 0.8

*Protection:* Drip proof, overall cover available

*Special features:* Refer to manufacturer for special requirements

*Agencies:* World wide

Type	Engine	kVA				V	Gen. Spec. #	Weight (kg)
		Single-phase		3-phase				
		50Hz	60Hz	50Hz	60Hz			
4DA	4DA			37	44	120	B	934
4DA	4DA			55	66	up to	B	1161
6DAT	4DA			66	77	480	B	1184
8DA	4DA			70	82	..	B	1447
4LD	4DL			61	71	..	B	1691
5LD	4DL			76	89	..	B	2011
6LD	4DL			89	100	..	B	2385
6LE	4DL			110	124	..	B	2385
4LDT	4DLT			88	100	..	B	1863
6LDT	4DLT			137	156	..	B	2476
up to								
6LETCA	4DLT			188	211	..	B	2958
6QK	4DL			184	204	..	B	4355
8Q	4DL			237	264	..	B	6096
up to								
12QBTCW	4DLT			658	515	..	B	8709

Alternators are available on their own. (See xxxx)

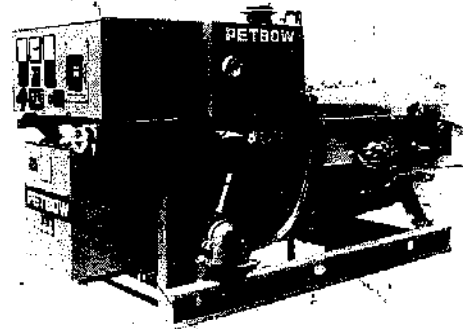

Model ZA9

**PETBOW LTD**  
 Ramsgate Road  
 Sandwich  
 Kent  
 U.K.

Telex: 96329  
 Phone: (030 46) 3311

*Mounting:* Skid mounted as standard. Site or main road trailers are optional.

*Range:* 4 models from 25 to 93.75kVA

*Engine make:* Deutz

*Engine features:* Self-starting

*Control options:* Automatic voltage regulation with set mounted controls are standard, mains failure and other start options available. Also various safety stopping options. Parallel running control panel available.

*Voltage options:* From 110V to 550V in steps, as specified.

*Power factor:* 0.8

*Protection:* Tropical insulation. Weatherproof canopies are optional. Drip proof.

*Special features:* Small accessory range. Heavy motor starting option.

*Agencies:* In Middle East, Africa, West, Central and East Asia.

Type	Engine	kVA				V	Gen. Spec. #	Weight (kg)
		Single-phase		3-phase				
		50Hz	60Hz	50Hz	60Hz			
ZA5	4DA			25	31	120	B	704
ZA6	4DA			35	42.5	up	B	795
ZA8	4DA			54	65	to	B	950
ZA9	4DAT			79	94	550	B	1090

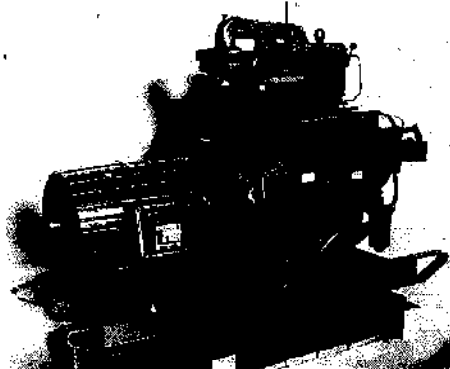

**Ruston/Dunlite Generating Set**

**DUNLITE**  
 (Div. of PYE Industries Sales  
 PTY Ltd)  
 28 Orsmund Street  
 P.O. Box 100  
 Hindmarsh  
 South Australia 5007

Telex: 82893 Aust  
 Cables: Daylite  
 Phone: 46 3832

*Mounting:* Small range in tube frame, larger ranges on skids with canopy and trailer options

*Range:* 3 ranges, 12 models, 2.5kVA to 185kVA (with engines) plus range of alternator only.

*Engine make:* Briggs & Stratton, Ford and Volvo (range each)

*Engine features:* Small range: recoil start and high r.p.m.: larger ranges: self-start

*Alternator make:* Dunlite

*Control options:* Machine mounted, local/remote control; mains failure auto start (on larger ranges)

*Voltage options:* Either 240 or 415 volts

*Power factor:* 0.8

*Protection:* Drip proof, weatherproof canopy available

*Special features:* Various voltage options on request, short circuit protection, tropicalised insulation

*Agencies:* Covering Australia

Type	Engine	kVA				V	Gen. Spec.	Weight (kg)
		Single-phase		3-phase				
		50Hz	60Hz	50Hz	60Hz			
31311	4PA	2.5				240	C	65
31335		5				240	C	88
020B3FDE	4DW			20			B	824
030B3FDE	4DW			30		415	B	830
035B3FDE	4DW			35		up to	B	335
055B3FDE	4DW			55		240	B	1207
070B3FDE	4DW			70		..	B	1243
075B3UP-E	4DW			75		..	B	1794
090B3UP-E	4DW			90		..	B	1931
130B3UP-E	4DW			130		..	B	1950
150B3UP-E	4DW			150		..	B	2083
185B3UP-E	4DW			185		..	B	2767
BLF10		7.5				110	B	
BLF13		10				up to	B	
B3F13				20		440	B	
B3F11				30		in	B	
B1F11	40					small	B	
B3F12				90		steps	B	
B3F14				200		..	B	

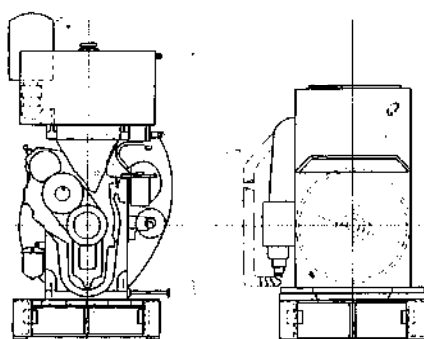

**Ruston YWAK Alternator Set**

**RUSTON & HORNSBY**  
 (INDIA) LIMITED  
 Chinchwad  
 Poona-411 019  
 India

Telex: 303 Greaves (PM)  
 Cables: Rustonind

*Mounting:* Skid mounted

*Range:* 3 machines in 1 range 5 to 16 kVA

*Engine make:* Ruston & Hornsby (India) Ltd.

*Engine features:* Crank starting, self starting optional.

*Control options:* Cubicle mounted separately, mains failure control and parallel running are optional

*Voltage options:* 240 volts single-phase, 415 volts 3-phase.

*Power factor:* 0.8

*Protection:* Drip proof

*Special features:* Basic accessories available

*Agencies:* Dealers across India.

Type	Engine	kVA				V	Gen. Spec.	Weight (kg)
		Single-phase		3-phase				
		50Hz	60Hz	50Hz	60Hz			
1YWAK		5.2		5.3		240		570
2YWAK		10.6		11.3		or		710
3YWAK		16		17.2		415		900

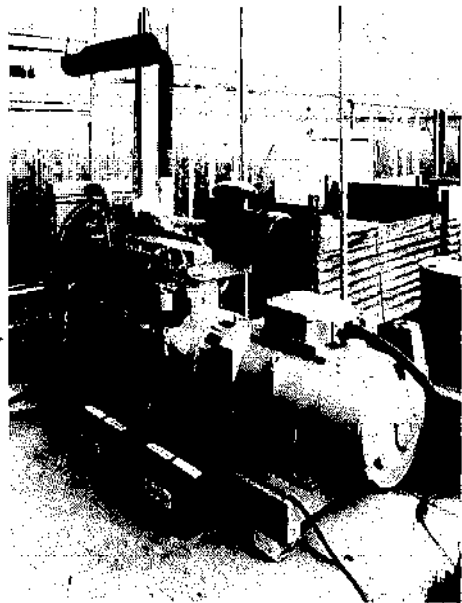

Buffalo 'E' Range

DALE ELECTRIC OF  
GREAT BRITAIN LTD  
Filey  
Yorkshire YO14 9PJ  
U.K.

Telex: 52163  
Cables: Dalelectric  
Phone: 0723 514141

*Mounting:* Smaller units are frame mounted. Larger units are skid mounted with trailer options.

*Range:* Over 100 models in 15 ranges, from 0.5kVA to 2585kVA. Neither all models nor all ranges shown.

*Engine make:* Engines include, in ascending order of power, Villiers, Briggs and Stratton, Petter, Dorman, Ford, Volvo and Deutz

*Engine features:* Smaller engines are recoil or rope start and run fast. Larger ones are self starting

*Connections:* 1 range is specifically designed for tractor p.t.o. operation

*Control options:* Automatic voltage regulation is standard. Controls are machine mounted on smaller units; and wall mounted on larger ones. Larger models have safety shut down switches as standard mains failure and other control options are available.

*Voltage options:* A variety of standard voltages is available, specify phase and voltage when ordering.

*Power factor:* 0.8

*Protection:* Drip proof, all weather protection is optional

*Special features:* Small standard accessory range, refer to factory for comprehensive options range.

*Agencies:* Distributors world wide.

Type	Engine	kVA				V	Gen. Spec.	Weight (kg)
		Single-phase		3-phase				
		50Hz	60Hz	50Hz	60Hz			
T15/7/SR	For tractor	7				200 up to 480	—	—
T16/8.5/SR		8.5				220 up to 440	—	—
T35/12.5/SR	p.t.o. use			12.5		200 up to 480	—	—
T36/15/SR					15	200 up to 480	—	—
T16/12/SR	..		12			200 up to 480	—	—
T15/20/SR	..	20				220 up to 480	—	—
T35/30/SR	..			30		12/24 d.c.	C	41
T36/40/SR	..				40	230/115	S	41
DM/0.5/PUB	4DA	0.5				115	S	43
DM/0.8/PUH	4DA	1	1			115 up to 415	S	28
DM/1.5/PUF	4DA	1.9	1.9			115/230	S	120
DM/3.5/PUF	4DA	3.5	3.5	3.5	3.5	115/230	S	115
DM/S/PBSF	4DA	5	5	5	5	115/230	S	117
DM/2.25/DPT	4DA	2.25	2.25			115 up to 415	S	116
DM/3/DPF	4DA	3	3			115 up to 415	S	116
DM/4/DPT	4DA	4	4	4	4	115 up to 415	S	116
EM/DDZX	4DA			14	17.5	220 up to 440	B	594
EM/25.5/DDZX	4DA			25.5	30.5	220 up to 440	B	699
EM/44.5/DDZX	4DA			44.5	53	..	B	965
EM/80/DDZX	4DA			80	93	..	B	1420
EM/157.5/DDZX	..			157.5	191	..	B	2071
EM/35/DFE	4DW			35	..	..	B	827
EM/50/DFE	4DW			50	..	..	B	1018
EM/68/DFE	4DW			68	..	..	B	1127
EM/37/DDX	4DA			37.5	44.5	..	B	981
EM/65/DDX	4DA			65	77.5	..	B	1190
EM/72/DDX	4DA			72	85	..	B	1325
EM/62/DD	4DW			62	70	..	B	1542

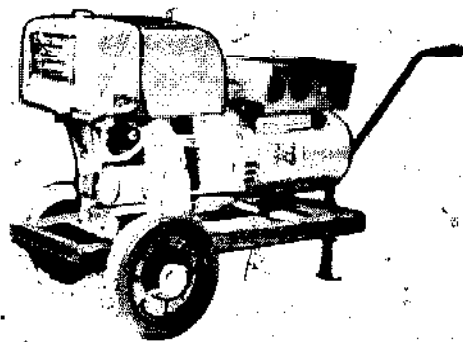

**BM Type Portable Diesel  
Generating Set**

**GEORGE COHEN  
MACHINERY LTD**  
600 Wood Lane  
London W12 7RL  
U.K.

Telex: 21288  
Cables: Omniplant London  
Phone: 01 743 2070

*Mounting:* Smaller sets mounted in a frame, larger sets are trolley mounted.

*Range:* 21 models in 3 ranges from 1kVA to 15kVA

*Engine make:* Petrol engines are Norton Villiers and smaller diesels are Petter. Larger diesels are Lister or Ruston.

*Engine features:* Small engines are rip starting and run at high r.p.m. Larger engines are rip start or hand cranked. Self starting is optional.

*Alternator make:* Newton Derby, Brush or Stamford

*Control options:* Self regulating with machine mounted control panel standard. Safety shutdown and mains failure start are optional.

*Voltage options:* 110V or 240V or both

*Power factor:* 0.8

*Protection:* Drip proof, tropically insulated. Weatherproof canopies are optional

*Special features:* Small accessory range

*Agencies:* Agents in Middle East and North Africa

Type	Engine	kVA				V	Gen. Weight Spec. (kg)
		Single-phase		3-phase			
		50Hz	60Hz	50Hz	60Hz		
AMF1503	4DA	1				110/	S Not
AMF1506	4DA	1.5				240	S avail-
AMC3009	4DA	2				..	S able
AMC3012	4DA	2.5				..	S
AMC3015	4DA	3				..	S
BM/AA1/02	4DA	1.5				..	S
BM/AB1/06	4DA	2				..	S
BM/AB1/09	4DA	2.5				..	S
BM/AC/12	4DA	3				..	S
CM/ST1	4DA	4.38				..	S
CM/ST2	4DA	8.75				120/	S
CM/ST3	4DA	13.13				240	S
CM/SR1	4DA			3		..	S
CM/SR3	4DA			12.5		..	S
CM/HR2	4DA			16.25		..	S
CM/HR3	4DA			25		..	S
CM/HR4	4DA			34.4		..	S
CM/HR6	4DA			52.2		..	S
CM/HRS6	4DA			65.5		..	S
CM/IA6	4DA			90		..	S
CM/IAS6	4DA			117		..	S

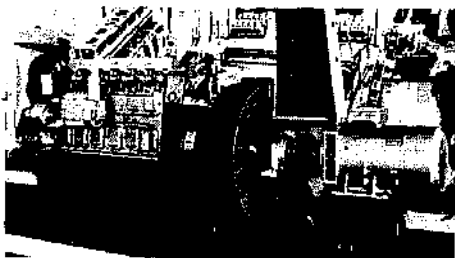

**Model 6S110**

**PRAGOINVEST**

Foreign Trade Corporation  
Ceskomoravská 23  
180 56 Praha 9  
Czechoslovakia

Telex: 122 379  
Cables: Pragoinvest Praha  
Phone: 822 741-6

*Mounting:* Skid mounted

*Range:* 1 model shown, refer to manufacturers for details of others

*Engine features:* Self starting from continuously running flywheel

*Control options:* The machine is built to give automatically an uninterrupted power supply in the case of a mains failure.

*Voltage options:* 231 or 400

*Power factor:* 0.8

*Special features:* Generator driven as a motor by the mains under normal conditions

*Agencies:* Refer to manufacturer.

Type	Engine	kVA				V	Gen. Weight Spec. (kg)
		Single-phase		3-phase			
		50Hz	60Hz	50Hz	60Hz		
6S110	4DW			50		231/	S
						400	

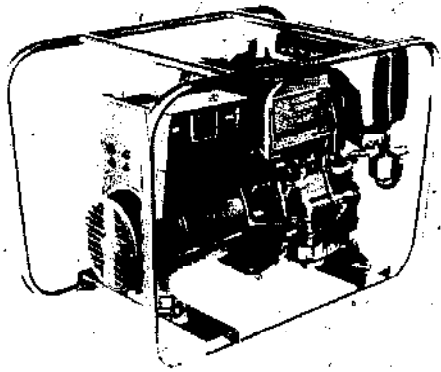

Flyweight Dieselite AC1 Series Generator

G & M POWER PLANT LTD  
Magnet Works  
Whitehouse Road  
Ipswich  
Suffolk  
U.K.

Telex: 98216  
Cables: Green Acre Ipswich  
Phone: 0473 41795

**Mounting:** Smaller one frame mounted, larger one skid mounted. Trailer options available.

**Range:** Over 50 models in 4 ranges from 0.3kVA to 231kVA. Full range not shown. Also similar choice in military generators and marine generators — not shown here.

**Engine make:** Briggs & Stratton, Onon, Pettef, Lister, Perkins, British Leyland, Volvo.

**Engine features:** Smaller engines are recoil started and high revving. Larger ones are self starting.

**Control options:** Smaller machines machine mounted, larger models machine mounted as standard, wall mounting, remote control, demand starting and mains failure options are available.

**Voltage options:** 120/240 on small machines. 120/440 in steps on larger ones.

**Power factor:** 0.9

**Protection:** Small models drip proof, larger are screen protected only, weatherproof canopies are optional. Tropical insulation.

**Special features:** Limited range of protection equipment available.

**Agencies:** World wide (except S. America), especially in Europe, Middle East, and Australia.

Type	Engine	KVA				V	Gen. Spec.	Weight (kg)
		Single-phase		3-phase				
		50Hz	60Hz	50Hz	60Hz			
03B80-2QE	4DA	0.3d.c.				12/15	C	27
06B80-224E	4DA	0.6				24/30	C	34
105B10-224E	4DA	1.5				24/30	C	55
015AA1-232E	4DA	1.5				32/40	C	74
2B17-53P	4DA	2				120/240	S	59
3B17-53P	4DA	3				120/240	S	65
305B17-63P	4DA	3.5				120/240	S	106
2AB1-53P	4DA	2				120/240	S	90
3AC1-53P	4DA	3				120/240	S	106
305AC1-63P	4DA	3.5				120/240	S	106
ST1	4DA	3.5	4	4	4.8	220/415	S	244
ST2	4DA	7	8	8	9.5		S	290
ST3	4DA	10.5	12.5	12.5	15	220/415	S	405
MR2	4DA	15	17.5	16	19	220/415	S	549
MR3	4DA			25	29.5	220/415	S	648
MR4	4DA			34.5	40	220/415	S	843
MR6	4DA			52.5	61	220/415	S	1103
JA6	4DA			90	103.5	220/415	B	1615
JAS6	4DA			117.5	125		B	1710
10RDP	4DW	10				120/440	B	483
12RDP	4DW	12	12	12		120/440	B	488
15RDP	4DW	15	15	15		120/440	B	493
24/42RDP4	4DW	24/35	29/42	25/38	31/42	110/440	B	766
45/62RDP6	4DW			45/54	52/62	110/440	B	920
70/82RDP6T	4DW			70	82	110/440	B	1125
RDL4	4DW	33.5	39	35	40.5	120/480	B	1000
RDL	4DWT			72	86	120/480	B	1474
RDV100B	4DW			100	115	127/440	B	2117
RDVT100A	4DWT			150	166	127/440	B	2390
RDVT120A	4DWT			200	231	127/440	B	3043

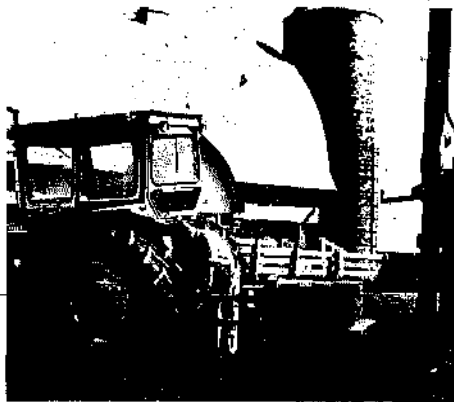

Trailer-mounted Tractor Drive Unit

**KATOLIGHT CORPORATION**  
 3201 Third Avenue  
 P.O. Box 3229  
 Mankato  
 Minnesota 56001  
 U.S.A.

Telex: 290787  
 Cables: Interkato - NY  
 Phone: 507-625-7973

**Mounting:** Basic machines are skid mounted, small units are frame mounted and P.T.O. drive generators have flanged feet with a trailer option.

**Range:** Over 30 models in 5 ranges from 2kVA to 1250kVA, full range not shown.

**Engine make:** Wisconsin, Hercules, International Moline, Cummins, Wausessa, General Motors, Allis Chalmers, Briggs & Stratton, Lister

**Engine features:** Small units are rip start and faster running. Larger units are self starting. Diesel, petrol and liquid petroleum gas are optional fuels.

**Connections:** 1 range is designed for operation by a tractor P.T.O.

**Control options:** Machine mounted as standard with safety cut outs.

Wall mounting, mains failure remote and automatic start are optional

**Voltage options:** Order from 120/208, 277/480 or 115/230, or connect output to suit.

**Power factor:** 0.8

**Protection:** Screen protected, weatherproofed canopies are optional.

**Special features:** Fuel conversion and improved silencing are available.

**Agencies:** Middle East, N. Africa, and Far East.

Type	Engine	kVA		V	Gen. Spec.	Weight (kg)
		Single-phase 50Hz 60Hz	3-phase 50Hz 60Hz			
10FW4CEP	4GA	12.5		115/230	S	590
15FW4CEP	4GA	18.8		..	S	658
25FW4CEP	4GA	31.5		..	S	794
35FH4CEP	4GW			43.7 120/240	S	1067
55FH4CEP	4GW			68.6 ..	S	1112
140FM4CEP	4GW			175 ..	S	2860
10FW4	4PA	12.5		12.5 120 up	S	431
15FW4	4PA	18.75		18.75 to 480	S	522
23FH4	4PW	29	29	..	S	522
55FH4	4PW	68.6	68.6	..	S	1089
8SF14	4PW	106	106	..	S	1633
N140FM4	4PW	175	175	..	S	2359
D15FL4	4DA	18.8		..	S	522
D35FH4	4DW	43.7	43.7	..	S	817
D60FH4	4DW	75	75	..	S	1270
D110FH4	4DW	137	137	..	S	1860
D1000FX4	4DW	1250	1250	..	S	9271



Model 100N3 Generating Set

**GRAHAME PUTTICK LIMITED** Telex: 96366 Puma UK G  
 Sandwich. Cables: Puma Sandwich  
 Kent Phone: 03046 2901  
 U.K.

**Mounting:** Skid mounted as standard. Trailer mounting is optional on all except the smallest range.

**Range:** Over 100 models in 10 ranges. From 3.5kVA to 1430kVA. Full range not shown.

**Engine make:** Rolls Royce, Cummins, Perkins, Kirloskar, Ford, Deutz, Bedford, Dorman, G.M. (Detroit)

**Engine features:** Smallest range by crank. All others are self-starting.

**Alternator make:** Grahame Puttick

**Control Options:** Set mounted as standard. Wall mounting optional.

Also available are parallel running, auto starting, short break mains standby and mains failure control options.

**Voltage options:** Choice from 346/440V or 190/240V.

**Power factor:** 0.8

*Protection:* Drip proof. Tropical insulation. Weatherproof canopy optional

*Special features:* Comprehensive accessory range

*Agencies:* World wide.

Type	Engine	kVA		V	Gen. Spec.	Weight (kg)		
		Single-phase					3-phase	
		50Hz	60Hz				50Hz	60Hz
M3.551	4DA	3.5		220/	S	230		
M7.552	4DA	7.5		240	B	370		
20U1	4DA		20	208/	B	780		
25U1/J	4DA		25	25 240	B	780		
30U1J	4DA			30	B	960		
30U2	4DA		30		B	960		
40U2J	4DA			40 346/	B	1010		
50U3	4DA		50	440	B	1160		
55U3J	4DA		55	55	B	1160		
65U4	4DA		65		B	1385		
80U4J	4DA			80	B	1385		
80U8	4DA		80		B	1516		
200U11	4DA		200		B	3680		
225U10G/J	4DA		225	225	B	2815		
20F1	4DW		20		B	870		
25F1/J	4DW		25	25	B	870		
40F1	4DW		40		B	1040		
45F1J	4DW			45	B	1040		
60F3	4DW		60		B	1320		
83F4J	4DW			83 208/	B	1325		
80F3G/J	4DW		80	83 240	B	1360		
30G1	4DW		30		B	736		
55G2J	4DW			55	B	1059		
70GS	4DW		70		B	1100		
100G5G/J	4DW		100	100 346/	B	1281		
100N3	4DW		100	440	B	2170		
137N3J	4DW			137	B	2300		
145N4	4DW		145		B	2130		
160N4J	4DW			160	B	2130		
up to 1550P22	4DW		1550		B			

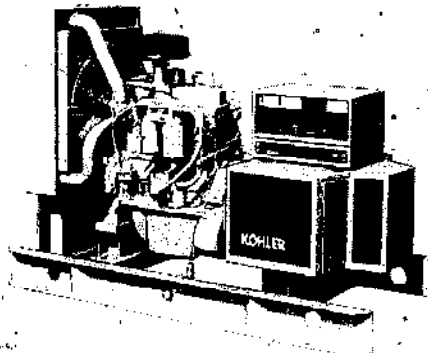

**Kohler Fast Response Generator**

**KOHLER INTERNATIONAL LTD**  
High Street  
Kohler  
Wisconsin 53044  
U.S.A.

Telex: 2 6888  
Cables: Kohlerint  
Phone: 414 457 4441

*Mounting:* Skid mounted as standard. Trailer options available.

*Range:* Over 60 models in 8 ranges, from 1.5kVA to 1000kVA. Full range not shown.

*Engine features:* Hand starting on smallest models, which are higher revving. Most models are self starting.

*Control options:* Machine mounted controls as standard. Variety of remote controls available.

*Voltage options:* 120/240 on small machines. 120 up to 500 on larger ones.

*Power factor:* 0.8

*Protection:* Weatherproof and soundproof covers are available

*Special features:* Larger models feature rapid response to load change

*Agencies:* Dealers through N. America.

Type	Engine	kVA		V	Gen. Spec.	Weight (kg)		
		Single-phase					3-phase	
		50Hz	60Hz				50Hz	60Hz
1.5MM25	4DA	1.5		120	B	44		
3MMV55	4DA	3		120/	B	72		
4CM021	4DA	4		240	B	136		
6.5CM021	4DA	6.5			B	197		
10CM021	4DA	10			B	316		

Type	Engine	kVA		V	Gen. Spec.	Weight (kg)		
		Single-phase					3-phase	
		50Hz	60Hz				50Hz	60Hz
15CM021	4DA	15		..	B	457		
8.5CM021	4DA	8.5		..	B	364		
12CM021	4DA	12		..	B	451		
-	4DW	7.5		120	B	245		
-	4DW	12.5		up	B	341		
-	4DW	20		to	B	457		
-	4DW	30		600	B	709		
-	4DW	45		..	B	926		
-	4DW	55		..	B	926		
-	4DW	70		..	B	907		
-	4DW	85		..	B	1205		
-	4DW	115		..	B	2290		
-	4DW	170		..	B	3050		
-	4DW	12.5		..	B	421		
-	4DW	20		..	B	515		
-	4DW	30		..	B	841		
-	4DW	45		..	B	897		
-	4DW	60		..	B	1025		
-	4DW	100		..	B	1357		
-	4DW	125		..	B	1936		
-	4DW	150		..	B	2341		
-	4DW	170		..	B	2611		
-		up to		..	B	10832		
-		1000		..	B	10832		

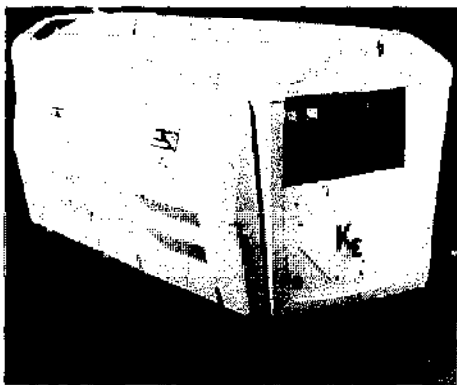

-Single Sentry in Vibration Isolated and Noise Suppressed Cabinet -

**KING ENGINEERING LTD**  
 -Greenland Mills  
 Bradford-on-Avon  
 Wiltshire BA15 1BZ  
 U.K.

Telex: King Bradonavon  
 Phone: (02216) 2709

**Mounting:** Complete units are skid mounted with a trailer option, tractor driven units have flanged feet with a tractor mounting frame optional.

**Range:** 30 models in 2 ranges from 5kVA to 70kVA. Full range not shown.

**Engine make:** 1 range is powered by British Industrial Diesels

**Engine features:** Self starting

**Connections:** 1 range is driven by a tractor P.T.O. through special shaft

**Control options:** Controls are machine mounted as standard, complete units feature automatic voltage regulation. Speed drift warning safety shut down, mains failure, auto start, remote start are optional.

**Voltage options:** 110/220 on P.T.O. units. 240/480 single phase, 240/415 three phase on complete units. 60Hz on request.

**Power factor:** 0.8

**Protection:** Drip proof, anti-condensation and tropical insulation as standard. Various stages of protection up to noise-proof, weather-proof, vibration-proof and dust-proof.

**Special features:** Control and environment options available also P.T.O. output. Any particular requirement considered by the factory.

**Agencies:** Order from factory.

Type	Engine	kVA		V	Gen. Spec.	Weight		
		Single-phase					3-phase	
		50Hz	60Hz				50Hz	60Hz
6S	P.T.O.	5.5	5.5	110/220	B	-		
10S	..	10		240	S	-		
15S	..	15		..	S	-		
19S	..		19	240/415	S	-		
25S	..		25	..	S	-		
25SBP	..	25		240/480	S	-		
40SBP	..	40		..	S	-		
38SBT	..		37.5	240/415	S	-		
65SBT	..		65	..	S	-		
N6BS/T/P	4DA	5.5	5.5	..	S	-		
10SS/T	4DA	10	10	..	S	-		
15SS/T	4DA	15	15	..	S	-		



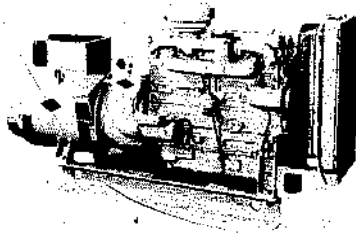

'P' Type Generating Set

Type	Engine	kVA				V	Gen. Weight Spec. (kg)
		Single-phase		3-phase			
		50Hz	60Hz	50Hz	60Hz		
19ST	4DW			19		S	—
25S/BT	4DW	25		25		B or S	—
33BS	4DW	33				B	—
38BT	4DW			38		B	—
50BT	4DW			50		B	—
70BT	4DW			70		B	—
D25ST	4DW			25	240/480	S	—
D30BS	4DW	30		30		S or B	—
D38ST	4DW			38		S	—
D40BT	4DW			40		B	—
D50ST	4DW			50		S or B	—

**PETTERS LTD**  
 Hamble  
 Southampton SO3 5NJ  
 U.K.

Telex: 47626  
 Cables: Petter Hamble  
 Phone: 042 122 2061

**Mounting:** Smaller units have flanged bases as standard with skid bases and frames as optional. Larger units have skid mounting as standard.

**Range:** 32 models in 8 ranges from 1.5kVA up to 860kVA. Full range not shown.

**Engine make:** In size order. Petters, Perkins, Dorman and Cummins

**Engine features:** Smallest engines are higher revving and rope started as standard. Larger units are self starting. Most air cooled units have a water cooling option.

**Control options:** Smaller units have machine mounted control boxes. Larger ones are wall mounted. All alternators are self regulating. Automatic start, mains failure and remote start/stop are optional. Larger units have safety shutdown devices.

**Voltage options:** 110 or 220 single phase, 127/220 or 230/400, 3-phase, specify frequency and phase where ordering.

**Power factor:** 0.8

**Protection:** Screen protected, tropical insulation

**Special features:** Refer to factory for optional extras. High level of parts standardisation in the range.

**Agencies:** Through associated agents.

Type	Engine	kVA				V	Gen. Weight Spec. (kg)
		Single-phase		3-phase			
		50Hz	60Hz	50Hz	60Hz		
AA1	4DA	1.5	1.8			230/110	S 78
AB1	4DA	2.5	2.75			.. ..	S 78
AC1	4DA	3.2	3.5			.. ..	S 78
PH1	4DA/W	3.5	4	4.5	5.5	110 up	S 356
PH2	4DA/W	7.2	8.7	9	11	to 400	S 483
PJ1	4DA/W	4.9	5.8	6.25	7.25	.. ..	S 368
PJ2	4DA/W	10	11.6	12.5	15	.. ..	S 630
PJ3	4DA			20	23.75	127 up	S 703
PJ4	4DA			27	32	to 400	S 976
P4.236	4DW			35	42.5	127/220	S 821
P6.354	4DW			52.5	60	or	S 1043
PT6.354	4DWT			72.5	85	230/400	S 1139
6LD	4DW			90	102.5	127/200	S 2563
6LE	4DW			110	122.5	or	S 2586
6LDT	4DWT			147.5	160	230/400	S 2812
8JT	4DWT			187.5	210	127/220 or	S 3107
8JTCA	4DWT			250	287.5	230/400	S 3155
N855-G	4DW			127.5	152.5	240/415	B 2550
NT855-G1	4DWT			186	187.5	.. ..	B 2700
up to						or 220/127	
KTA2300-G	4DWT			720	860	240/415	B 6100
						or 220/127	

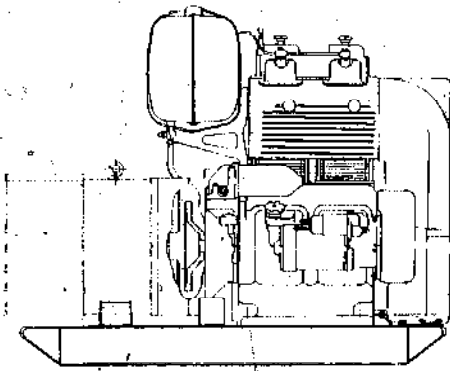

**Model DE12P4 Generating Set**

**WINPOWER CORPORATION**  
 P.O. Box 99  
 Newton  
 Iowa 50208  
 U.S.A.

Telex: TWX 910 520 1557  
 Cables: Winpower  
 Phone: 515 792 1301

*Mounting:* Skid mounted, carrying frames and carts optional.  
*Range:* 28 models in 3 ranges from 1.5. to 25kVA. Full range not shown.  
*Engine make:* Includes Petter, Briggs & Stratton, and Wisconsin  
*Engine features:* Smaller units are higher revving. Most units are hand started, others self start.  
*Connections:* 1 range is designed to be driven by a tractor P.T.O.  
*Control options:* Machine mounted, remote start is optional.  
*Voltage options:* 120 or 120/240  
*Power factor:* 0.8  
*Protection:* Drip proof, high quality insulation.  
*Special features:* Starting battery and equipment is optional. Automatic idling facility available.  
*Agencies:* North, Central and South America.

Type	Engine	kVA				V	Gen. Spec.	Weight (kg)
		Single-phase		3-phase				
		50Hz	60Hz	50Hz	60Hz			
GM105B2	4PA		1.9			120	S	39
GM2B2	4PA		2.5			120/ 240	S	43
GM205B2	4PA		3.1				S	49
GM4W2	4PA		4.7		4.7		S	91
GM5B2	4PA		6.25				S	101
GM6W2	4PA		6.9				S	111
GM205B4	4PA		3.2			120	S	97
GM308W4	4PA		4.7			120/ 240	S	134
GE6W4	4PA		7.5				S	261
GR10W4	4PA		12.5				S	285
GR15W4	4PA		18.75				S	427
GR20W4	4PA		25				S	536
DE12P4	4DA		15		15		S	481

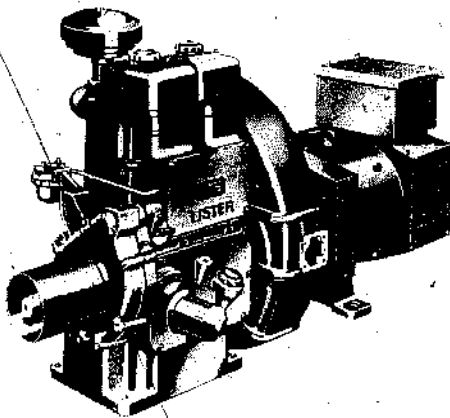

**12hp Air-cooled Diesel Engine**

**R.A. LISTER POWER PLANT LIMITED**  
 Thrupp  
 Stroud  
 Gloucestershire GL5 2BW  
 U.K.

Telex: 43559  
 Cables: Machinery Dursley  
 Phone: 045-388 5166

*Mounting:* Skid mounted, with trolley option on smaller models.  
*Range:* 32 models in 3 ranges from 2.5kVA to 119kVA. Full range not shown.  
*Engine make:* Lister (Hawker Siddeley subsidiary)  
*Engine features:* Crank start on smaller models. Self start is optional on smaller, and standard on larger models.  
*Alternator make:* Brush (Hawker Siddeley subsidiary)  
*Control options:* Machine or wall mounted. Comprehensive range of remote automatic and mains failure control available.  
*Voltage options:* Voltage choice to be specified on larger sets from 220/380, or 400/230, or 415/240, or 220/127, or 230/133  
*Power factor:* 0.9  
*Protection:* Drip proof, tropical insulation. Canopy available on smaller models.  
*Special features:* Silencers, mountings, fuel pumps and control accessories. Large selection. Advice available in booklet.  
*Agencies:* World wide.

Type	Engine	kVA				V	Gen. Spec.	Weight (kg)
		Single-phase		3-phase				
		50Hz	60Hz	50Hz	60Hz			
ST1	4DA	3.5	4	4	5	133	S	244
ST2	4DA	7	8	8	10	up	S	290

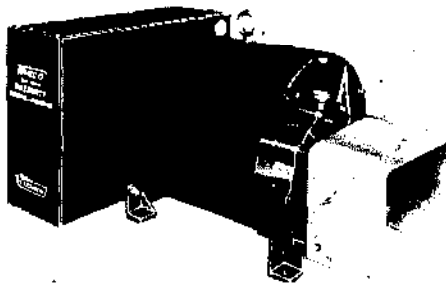

Series PTOC Generator

Type	Engine	kVA				V	Gen. Weight Spec. (kg)
		Single-phase		3-phase			
		50Hz	60Hz	50Hz	60Hz		
ST3	4DA	10.5	12.5	12.5	15	to	S 405
HR2	4DA	15	17.5	16	19	415	S 549
HR3	4DA			25	29	..	S 648
HR4	4DA			34	40	..	S 843
HR6	4DA			52.5	62	..	S 1103
HRS6	4DA			66	78	..	S 1196
IA6	4DA			90	104	..	S 1615
IAS6	4DA			117	125	..	S 1710
HRW2	4DW 14	17	15	18	..	..	S 450
HRW3	4DW			24	28	..	S 620
HRW4	4DW			33	38	..	S 784
HRW6	4DW			50	58	..	S 1082
HRWS6	4DW			62.5	75	..	S 1167
IW6	4DW			86	99	..	S 1684
IWS6	4DW			111	119	..	S 1734

WINCO  
 Division of Dyna Technology  
 Incorporated  
 East 7th and Division Streets  
 P.O. Box 3263  
 Sioux City  
 Iowa 51102  
 U.S.A.

Telex: 487110  
 Phone: (712) 252-1821

*Mounting:* Frame and skid mounted as standard. Trailer mounting is optional.

*Range:* Over 70 models in 20 ranges from 1.9kVA to 100kVA. Full range not shown.

*Engine make:* In size order for complete units, Briggs and Stratton, Wisconsin, Lister, Petter.

*Engine features:* Smaller engines are recoil or rope start with self starting options and run at higher speeds. Larger ones are self starting and run at normal speeds.

*Connections:* 1 range of generators specifically designed for operation from a tractor P.T.O. 1 range has a keyed shaft connection.

*Control options:* Machine mounted as standard. All units have built in overload protection. Mains failure is available on some larger models.

*Voltage options:* 115/230

*Power factor:* 0.8

*Protection:* Drip proof

*Special features:* Automatic idling when off load, optional use of 2 voltages simultaneously and exceptional ability for heavy motor starting load. 180 cycle generators and fire fighter generators are available.

*Agencies:* Agents in Africa, Middle East, Central and South America.

Type	Engine	kVA				V	Gen. Weight Spec. (kg)
		single-phase		3-phase			
		50Hz	60Hz	50Hz	60Hz		
15PTOF	from			15		240/	B 124
20PTOF	tractor			20	20	240	B 138
30PTOC	P.T.O.			30		..	B 224
35PTOC	..				35	..	B 234
50PTOC	..			50		..	B 307
65PTOC	..				65	..	B 311
P1TH-1M	4DA			1		115	B 27
P205BH-1M	4DA			2.5		..	B 39
C109BH-1M	4DA			1.9		..	B 41
C202WRH-1M	4DA			2.25		..	B 48
305BH-FE	4DA			3.5		115/	B 64
P307BH-3E	4DA			3.7		230	B 55
403WH-FM	4DA			4.3		..	B 122
P503BH-3M	4DA			5.3		..	B 88
P703WH-3E	4DA			7.3		..	B 133
10WH-3E	4DA			10		..	B 221
6WS-3E	4DA			6		..	B 188

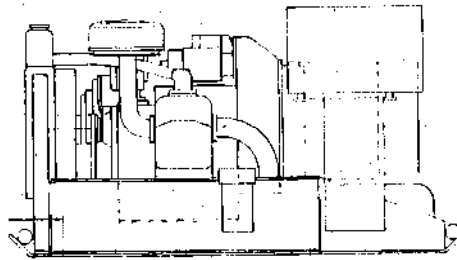

Model 120/RDP

Type	Engine	kVA				V	Gen. Weight Spec. (kg)
		Single-phase		3-phase			
		50Hz	60Hz	50Hz	60Hz		
1205WS-4R	4DA			12.5		120/208	B 290
305LDS-1E	4DA			3.5		115	B 195
7LDS-3E	4DA			7		115/230	B 316
1005LDS-4E	4DA				10.5	120/208	B 365
6PDS-3E	4DA			6		115/230	B 324
1205PDS-17E	4DA				12.5		B 427

**WITTE ENGINE CORPORATION**  
 P.O. Box 386  
 555 East 56th Highway  
 Olathe  
 Kansas 66061  
 U.S.A.

Telex: 042-6262  
 Phone: 913 764 2512

*Mounting:* Skid mounted. Trailer mounting is optional.

*Range:* 6 models in 2 ranges

*Engine make:* Witte (Hawker Siddeley subsidiary)

*Engine features:* Self starting. Engines available without generator. 260 model available with propane gas fuel conversion (2nd range belt driven).

*Alternator make:* Hawker Siddeley subsidiary

*Control options:* External voltage regulator in machine mounted control box. Automatic and mains failure starting optional.

*Voltage options:* 120/240V single-phase or 120/208V 3-phase

*Power factor:* 0.8

*Protection:* Drip proof

*Special features:* Close voltage regulating requirements can be met. Tropical cooling and cold weather starting equipment optional.

*Agencies:* A Hawker Siddeley Company, U.S.A. subsidiary.

Type	Engine	kVA				V	Gen. Weight Spec. (kg)
		Single-phase		3-phase			
		50Hz	60Hz	50Hz	60Hz		
100	4DW			12.5		120/208	B -
120	..			16.5		208	B -
G260	..			15		..	B -
100	..	10		10		120	B 590
120	..	15		15		up to	B 590
G260	..	15		15		240	B 590

**YANMAR DIESEL ENGINE CO. LIMITED**  
 1-11-1 Marunouchi  
 Chiyoda-ku  
 Tokyo  
 Japan

Telex: 0222-2310  
 Cables: Yanmar Tokyo

*Mounting:* Skid mounted

*Range:* Over 100 models in 9 ranges from 12.5kVA to 1600kVA. Full range not shown.

*Engine make:*

*Engine features:* Self-starting. Engines originally designed as marine diesels. Larger models are slower running.

*Control options:* Machine or wall mounted control. Parallel running, auto start, load shedding, remote control and protection devices available.

*Voltage options:* Specify on ordering

*Power factor:* 0.8

*Protection:* Drip proof

*Special features:* Cooling and fuel supply options available

*Agencies:* Service depots in 130 countries.

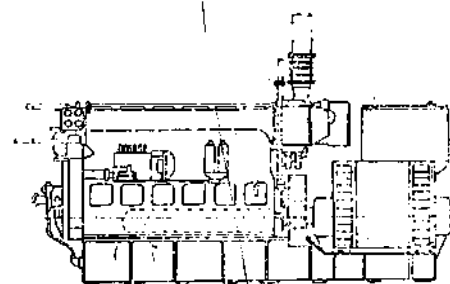

Model 6RK Series

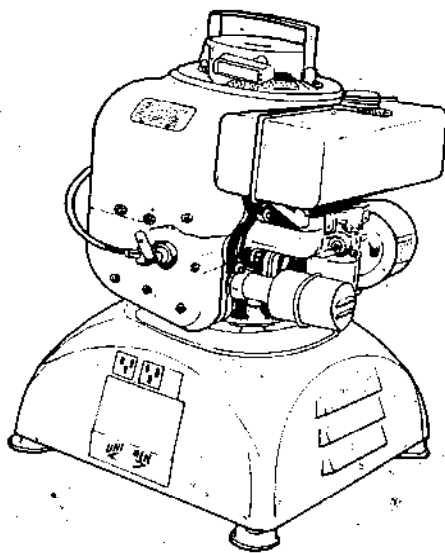

Unigen Model 420

Type	Engine	kVA				V*	Gen. Weight Spec. (kg)
		Single-phase		3-phase			
		50Hz	60Hz	50Hz	60Hz		
2TLE	4DW			12.5	15	not	—
3TLE	4DW			20	20	yet	—
3ESDL	4DW			30	40	known	—
4ESDL	4DW			50	56	at	—
3KDL	4DW			65	56	time	940
4KDL	4DW			90	75	of	1150
5KDL	4DW			100	90	print-	1345
6KDL	4DW			140	120	ing	1500
6KDL-T	4DW			187.5	150		1610
6KFL	4DW			140	120		1780
6KFL-HT	4DW			225	185		1930
6RL	4DW			140	130		3360
6RL-T	4DW				160		3340
6RAL	4DW			200	187.5		3510
up to							
12GLET	4DW			1600	1600		18650

\*As specified by purchaser

**UNIGEN INCORPORATED**  
 194 West Stone Street  
 Almont  
 Michigan 48003  
 U.S.A.

Telex: 810-235-1100  
 Phone: (313) 798 3150

**Mounting:** Smaller units are free standing, larger units are skid mounted. All feature carrying handles.

**Range:** 15 models in 3 ranges from 0.8kVA to 4kVA

**Engine features:** Rip start with electric or remote options on larger models. All models are higher revving. Small units only have a vertical axis of rotation with engine over alternator.

**Control options:** Machine mounted controls

**Voltage options:** 12 or 24 d.c. on battery chargers. 115 or 230 on a.c. models. 60Hz frequency shown, 50Hz available on request

**Power factor:** 1

**Protection:** Drip proof tropicalised insulation

**Special features:** Instrumentation, battery charging facility and automatic voltage regulating are optional

**Agencies:** Write to factory.

Type	Engine	kVA				V	Gen. Weight Spec. (kg)
		Single-phase		3-phase			
		50Hz	60Hz	50Hz	60Hz		
712	4DA	0.85 d.c.				12	B 19
720	4DA	0.85 d.c.				12/24	B 34
1412	4DA	1.7 d.c.				12	B 32
724	4DA	1.7 d.c.				24	B 32
1224	4DA	1.7 d.c.				12/24	B 34
410	4DA	1 a.c. 400Hz				110	B 19
		or d.c.					
420	4DA	2 a.c. 400Hz				110	B 34
		or d.c.					
LA12			1.2			115/230	B —
LA20			2			115/230	B —
LA30			3			115/230	B —
LA40			4			115/230	B —

## Other Electrical Equipment

**C & D BATTERIES  
DIVISION**  
3043 Walton Road  
Plymouth Meeting  
Pennsylvania 19462  
U.S.A.

Phone: (215) 828  
9000

This company claims to be the largest manufacturer of lead-acid batteries in the U.S.A. and has a very comprehensive product range covering almost every type of lead-acid battery, plus an assortment of industrial battery chargers. Applications include batteries for industrial trucks, switchgear, communications equipment, mine locomotives, railroad loco starters, all kinds of engine starters, electric vehicles, photovoltaic and wind energy storage systems, etc. Various lead-calcium and lead antimony batteries are included in the range.

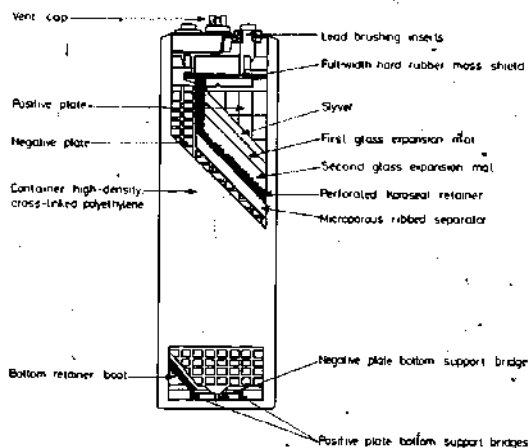

**C & D Battery**

**CHLORIDE ZAMBIA LTD**  
Corner Dr Agrey Ave/North  
End Road  
P.O. Box 1892  
Kitwe  
Zambia

Telex: Clorid  
ZA52170  
Cables: Chloride  
Kitwe  
Phone: 2200/2209/  
3631

Manufacturers of a wide range of lead acid batteries and ancillary equipment for automotive, traction and other purposes. Also suppliers of nickel cadmium battery cells, battery chargers, rectifiers, and emergency lighting sets.

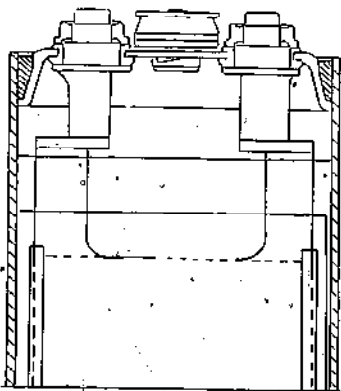

150 **Kathanode Battery**

**CHLORIDE ALCAD**  
P.O. Box 4  
Union Street  
Redditch  
Worcs. B98 7BW  
U.K.

Telex: 33816  
Cables: Alcad Redditch  
Phone: Redditch  
(0527) 62351

Manufacturers of a wide range of nickel cadmium batteries (companies in the group produce other types of batteries and there are world wide distribution channels and associated companies).

RV and RVP series for deep cycle applications in 16 – 1040Ah sizes.

EP series for low rate discharge and float charging in 5 – 1040Ah sizes.

DLS and DLP for high rate discharge in 11 900Ah sizes. 'Unibloc' types for low rate discharge requiring virtually maintenance free operation in sizes from 7.5Ah up to 27Ah. PS series of sealed cell batteries require no maintenance in 7-27Ah sizes.

A choice of steel or plastic containers is available for many of the above batteries.

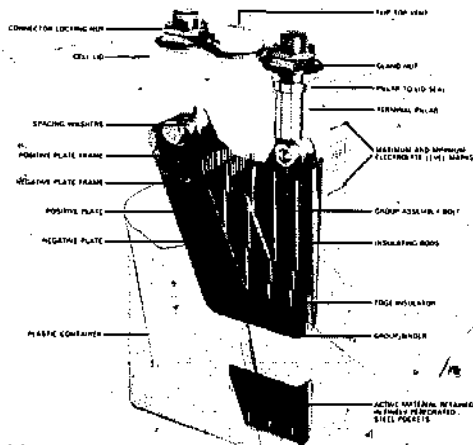

**Alcad battery**

**QUIRK'S VICTORY LIGHT  
COMPANY PTY LTD**  
33 Fairweather Street  
Bellevue Hill  
New South Wales 2023  
Australia

Cables: Quirklite  
Sydney

Sets of 2V or 6V cells, either rubberoid or polystyrene case made up to a size to meet requirements from 130 amps to 330 amps. Heavy duty house lighting batteries with an effective working life of from 10-15 years. 13 to 29 – Plate.

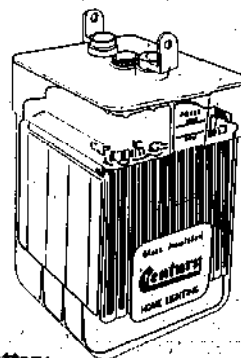

**Glass Insulated Battery**

**DELATRON SYSTEMS CORPORATION**  
553 Lively Boulevard  
Elk Grove Village  
60007  
U.S.A.

Phone: (312) 593 2270  
(312) 438 9235

Manufacturers of lead acid deep discharge, 6V at either 245Ah or 375Ah rating, batteries and d.c. to a.c. inverters. The inverters are specifically designed for application in wind, hydro and solar electric generating systems and are up to 6kVA with 90% efficiency. The batteries are sold with a 60 month warranty on a pro-rata basis after 12 months.

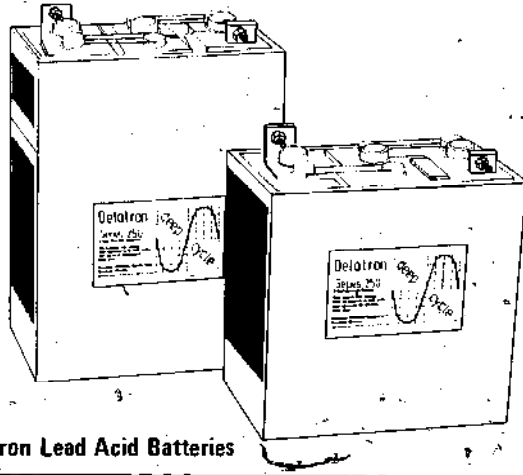

**Delatron Lead Acid Batteries**

**ITT MERIDIAN**  
West Road  
Harlow  
Essex CM20 2BP  
U.K.

Telex: 817202  
Phone: (0279) 35351

Supplier of 'Gelyte' sealed and spillproof lead/lead dioxide batteries with gelled acid electrolyte as follows:

Model	20hr rating Amp. hr @ 20°C	Nominal voltage	Weight lb
PB626	2.6	6	1.4
PB1226	2.6	12	2.8
PB645L	4.5	6	1.9
PB660L	6.0	6	2.8
PB660	6.0	6	2.3
PB1260	6.0	12	4.6
PB690	9.0	6	3.7
PB1290	9.0	12	7.4
PB6180	18.0	6	7.4
PB12180	18.0	12	14.8
PB6270	27.0	6	11.1
PB12270	27.0	12	22.2
PB2300	30.0	2	4.2

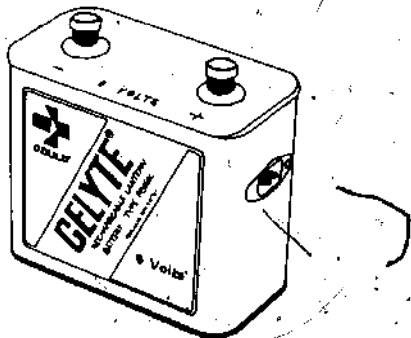

**Model PB660L Battery**

**SAFT-SOCIETE DES ACCUMULATEURS FIXES ET DE TRACTION**  
Storage Battery Division  
156 Avenue de Metz  
93239 Romainville  
France

Telex: 220100  
Cables: Saftalcalin-Paris  
Phone: (1) 843 93 61

Manufacturers of a large range of steel or plastic cased nickel-cadmium storage batteries and associated crates and stands for high power applications.

For example:

KPM steel cased cells range from 30 to 520Ah at 5 hour discharge.

KPMP plastic cased cells from 10 to 320Ah at 5 hour

KPH series steel cased cells range from 30 to 310Ah at 5 hour

KPHP plastic cased cells from 14 to 250Ah at 5 hour

Crated battery assemblies in a variety of sizes are available.

Completely sealed miniature and small nickel cadmium batteries requiring no maintenance are also available, some as replacements for non-rechargeable dry-cells. These are as follows:

Sealed cylindrical cells 0.1 to 10Ah (20 different sizes)

Sealed button cells 40 to 600Ah (5 sizes)

Sealed rectangular cells 3.8 to 26Ah (8 sizes)

All the above ratings being taken over a 5 hour discharge cycle.

#### SAFT Crated Battery Assembly

This assembly is particularly suitable for mobile applications (railway, marine ...). The crates are made from impregnated timber.

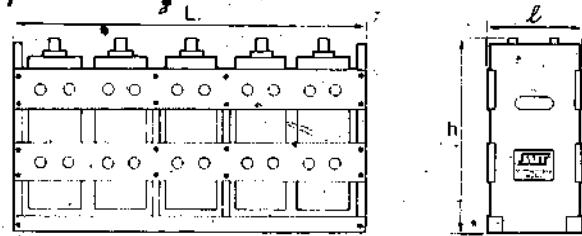

**ACCUMULATORENFABRIK SONNENSCHNEIN GmbH**  
D 6470 Buedingen/Hessen  
Federal Republic of Germany

Telex: Sonnenschein Export  
No. 4184 637  
Cable: Accusonne

U.K. Distributor:  
F.W.O. Bauch Ltd  
49 Theobald Street  
Boreham Wood  
Herts WD6 4RZ  
U.K.

Phone: (0 60 42) 91  
Telex: 27502  
Phone: 01 953 0091

Manufacturer of Dryfit range of maintenance-free portable lead-acid storage batteries and Ulimatic power supply units and battery chargers.

A wide variety of Dryfit batteries are available with nominal voltages of 2, 4, 6, 8 and 12V and capacities of 1.0 up to 36Ah (20hr discharge rate). Many of these have high power/weight ratios compared with standard cells.

Two versions are available, the A200 and A300 series. The A200 is designed for high cyclic applications; the A300 for use in stand-by and float service applications.

The Ulimatic chargers come in four sizes, 0.8, 2.5, 5 and 10A nominal for use with 110 or 240V, 50 or 60Hz mains supplies and are designed for use under ambient conditions from -20°C up to 45°C.

Dryfit batteries would be particularly useful in conjunction with unattended solar photovoltaic systems due to their maintenance free specification.

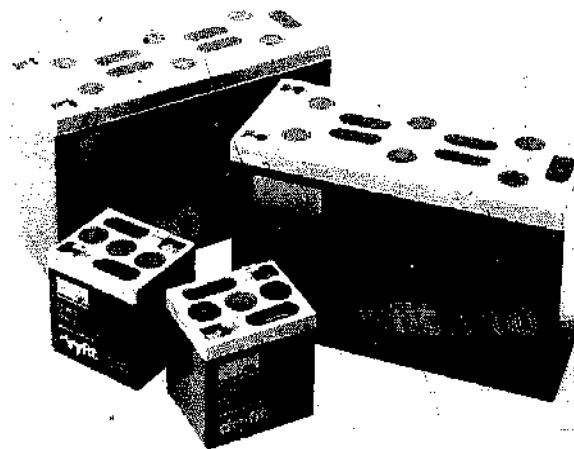

**Dryfit A300**

**CHLORIDE TRANSPACK LTD**  
Stanley Road  
Bromley  
Kent BR2 9JE  
U.K.

Telex: 896071 code:  
Transpack  
London  
Cables: Transpack,  
Bromley  
Phone: 01 460 9861

This company's main product line is a range of static inverters and battery chargers many of which are intended to provide continuity to essential electrical equipment during mains failure or to provide a good quality voltage and frequency with fluctuating supplies. Some are also designed for military applications to run communications equipment in the field and are therefore particularly robust. Some typical products of interest are:

*Transpack 200D:* Low cost domestic battery charger/inverter which charges two 12V car batteries while mains power is available and provides 240V at 50Hz sinusoidal up to 200VA when mains is off.

*Transpack 350:* Similar to above but 350VA capacity and in carrying case.

*Transpack 606:* 350VA unit in military Creeth case or for Post Office rack.

A wide selection of other inverters and stabilised power supplies up to as much as 14kW or more are produced.

Also available is the Alcos range of general purpose nickel-cadmium batteries with capacities from 2 to 500Ah per unit. Member of same group as Chloride Zambia and Chloride Alcad.

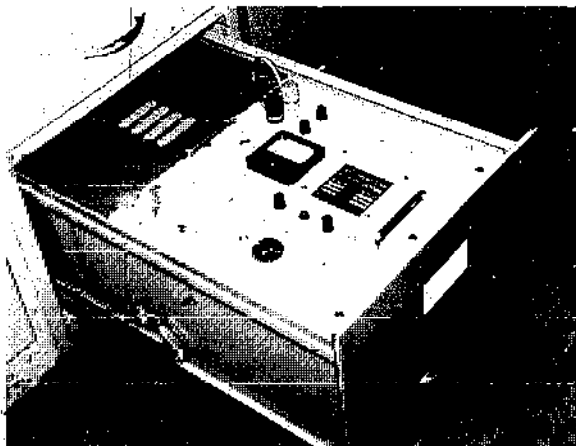

**Transpack 200D**

**VARLEY DRY ACCUMULATORS LTD**  
Alfred's Way  
Barking  
Essex IG11 0TB  
U.K.

Telex: 8951668  
Phone: 01 594 3346

Manufacturers of a range of lead-acid batteries with the electrolyte absorbed in a porous separating medium. This allows the batteries to be used in any position and renders them spill-proof. Other advantages are that bridging of the cells cannot occur, which allows much thinner plates to be used, so size-for-size they have a greater capacity and short-circuited current capability than free-acid counterparts.

Batteries in this range are available at voltages of 2, 6 and 12V with capacities ranging from 5 to 28Ah over a 20 hour cycle. An encased "Shoulder Pack" battery and a "Mini Power Pack" of 12V and 12Ah capacity (20hr) is also offered.

**Typical Varley System Battery construction**

- High impact polystyrene vent stopper
- Terminal - 28A terminal screw
- Perforated separator protector
- A.B.S. plastic case
- Negative plate
- Highly porous separator
- Positive plate
- Fibre glass outer protector

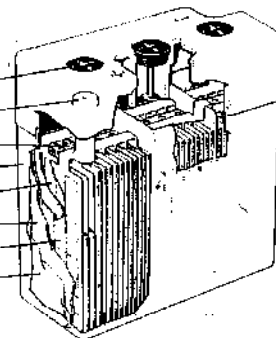

**NORTH WIND POWER COMPANY INC.**  
P.O. Box 315  
Warren  
Vermont 05674  
U.S.A.

Phone: 802 496  
2955

This company distributes the Gemini Synchronous Inverter System developed by the Windworks research group.

The Gemini inverter is designed to interface between a variable voltage d.c. power source such as a windmill generator and an a.c. grid system. All the d.c. is converted to a.c. and any excess available after supplying the local load is fed into the grid, while if insufficient is available for the load from the wind-generator or variable source, the necessary balance is taken from the grid.

Synchronous inverters are less expensive than most conventional inverters and they allow a wind system to be fully utilised to yield the maximum possible output. In some American states the electricity utilities are prepared to credit the system with any power fed in to the grid and the system could equally be applied in conjunction with a small grid powered by say a diesel generating set as a fuel saving device, since any surplus from a windmill appears on the grid as a load reduction.

The basic Gemini unit is rated at 8kW, with d.c. inputs of 0-200V and 0-40A, a.c. connection being 120 or 240V, maximum efficiency 95%. Units of up to 20kW single-phase or up to 1500kW three-phase are possible.



**EARLE ENGINEERING**  
P.O. Box 850  
Alpine  
California 92001  
U.S.A.

The Watchman regulator combines an electronic voltage regulator with switching and charge sensing circuits to provide automatic battery charging for wind driven generators fitted with automotive alternators. The group also produce a.c. servo regulators for use with waterwheels.

The Watchman regulator incorporates a special delay to allow a windmill to free-wheel until the alternator reaches sufficient speed to sustain a charge to the battery and prevents continuous "hunting". The system can carry a maximum of 70A at 14V (980W). It is available at a reduced price in kit form for self-assembly and weighs 2lb (1kg).

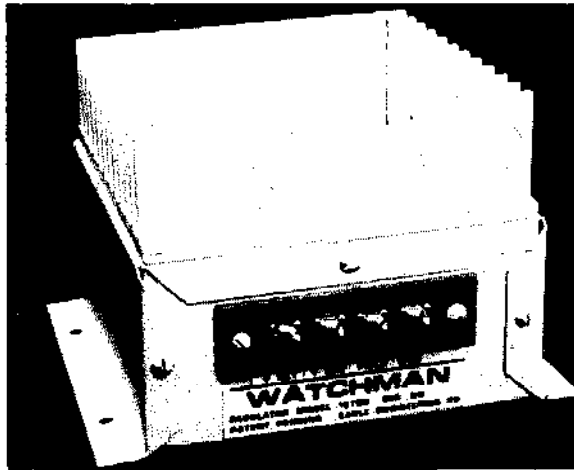

**Watchman 1270B Regulator**

**RATELCO INC**  
610 Pontius Avenue N  
P.O. Box C-19080  
Seattle  
Washington 98109  
U.S.A.

Telex: 32 1200  
**RATELCO**  
SEA  
Phone: 206 624  
7770

Manufacturers of an extensive range of d.c. to a.c. inverters with standard input voltages of 24, 32, 48 and 120V d.c. (others available to special order). Output voltages are regulated 120V  $\pm$  5% at 60Hz to  $\pm$  0.5% and 240V  $\pm$  5% is also available. The manufacturers claim less than 15% harmonic distortion on all loads and less than 7% for loads from 75 to 100%. Models available with outputs from 500VA up to 5000VA.

Also offer an extensive range of battery chargers for single-phase 120 or 240V a.c. operation and for three-phase 208, 240 or 480V a.c. Normal outputs available as follows:- 12V 10 models from 3 to 150A; 24V 12 models from 3 to 200A; 32V 9 models from 3 to 100A; 48V 11 models from 3 to 300A; 120V 11 models from 3 to 250A and 240V 10 models from 3 to 150A.

Other products include ranges of uninterruptible power supplies, a.c. to d.c. converters, various communication power equipment systems and components,

transistorised voltage regulators, battery testers, battery balancers, etc.

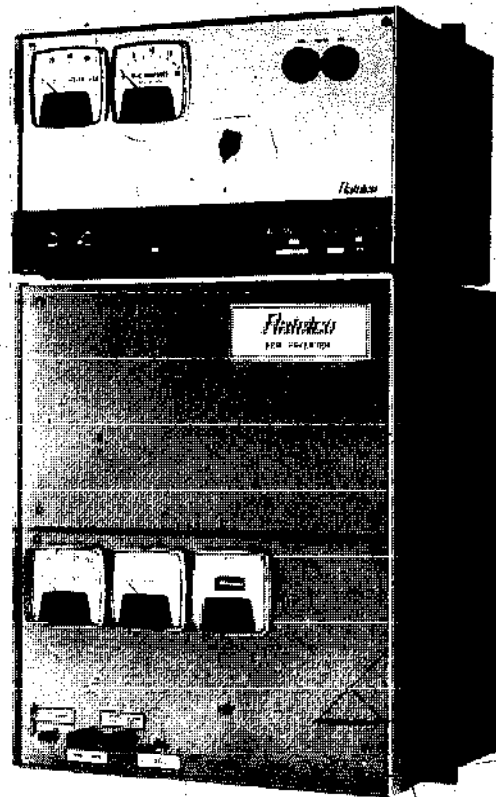

**Ratelco SCR Inverter**

**INDEPENDENT POWER DEVELOPERS**  
Box 1467  
Noxon  
Montana 59853  
U.S.A.

Phone: (406) 847  
2315

Distributors of Creative Electronics inverters intended for use in conjunction with wind-electric and small hydro-electric systems. These inverters have a very low "idle current" and are claimed to be over 90% efficient from a load of 275W up to maximum, reaching a mid-load efficiency of as high as 98%. They can handle 500% overload to cope with starting electric motor loads.

These inverters are available in seven different models from 1kW up to 12kW.

This company also markets their own model of small turbine, Dunlite wind generators and Delatron deep cycle storage batteries.

# 8

## Instrument- ation, Monitoring and Control Equipment

There is an enormous variety of monitoring and control equipment available to suit mass-produced conventional power plants. As already mentioned in the introductions to the engine sections and generator section, it is obviously advisable to install sufficient control equipment to protect a plant from damage by loss of coolant, overheating, or other possible catastrophic malfunctions. However this section will not deal with this kind of equipment since information on what is recommended and available is readily available from the suppliers of engines and it is generally best to adhere to their advice.

Renewable energy conversion devices, such as wind-mills, solar heaters or hydro-turbines generally require a lower level of monitoring since these devices are usually relatively less complex than engines and less susceptible to the kind of damage that might have been prevented by some form of automatic monitoring device. However, a major unknown with many of these devices is the potency or otherwise of the energy resource being tapped at a particular locality. How much solar, wind or water energy is actually available? This is a very important question to resolve, since the choice of equipment and its economic viability will often hinge on the energy availability.

Therefore, we have included mainly a selection of meteorological equipment that would be applicable in particular for the assessment of wind and solar energy availability. At present, much of the equipment on the market has been developed purely for conventional meteorological applications and it tends to be incidentally useful for energy assessment, but it is expected that increasing usage and research into the application of solar-based energy will result in the development of more specialised equipment requiring a lower level of interpretation of their data to arrive at a reliable conclusion.

Since this section at present is also a place to present the odd items that would be of interest but which do not fit into other categories, it also includes controllers for wind and water turbines.

**BELFORT INTERNATIONAL  
CORP.**  
P.O. Box 5268  
Baltimore  
Maryland 21224  
U.S.A.

Cables: BELF  
Phone: 301 342 2626

A full range of meteorological measuring and recording equipment including anemometers, chart drives, liquid level recorders, barometers, rain gauges, including many specialised items of equipment such as dew balances, evaporation recorders, pyranographs (for measuring and recording variations in solar radiation), etc.

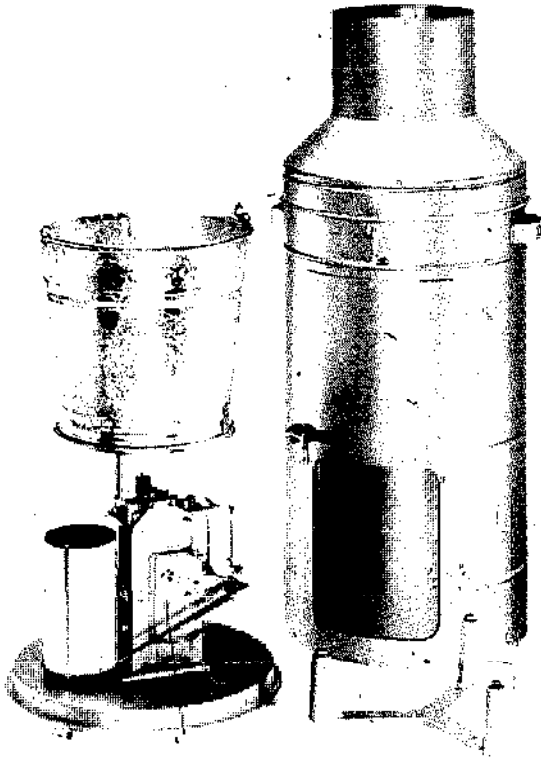

**Belfort Raingauge**

**C.F. CASELLA & CO LTD\***  
Regent House  
Britannia Walk  
London N1 7ND  
U.K.

Telex: 26 16 41  
Phone: 01 253 8581

Manufacturers of a variety of meteorological instruments including several alternative types of high accuracy anemometer that are widely used by weather stations throughout the world.

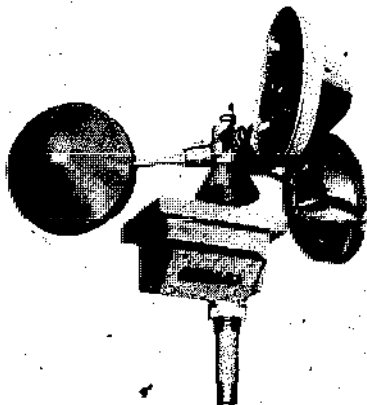

**Casella Cup Counter Anemometer**

**LULL MARINE LTD**  
1 1/2 Suckling Green Lane  
Codsall  
Wolverhampton WV8 2BL  
U.K.

Phone: (09074)  
2700

This company offers a range of instruments as follows:  
Sims hand-held anemometers (ranges available from 0-15 knots up to 0-60 knots in units of knots, m.p.h. m/s, k.p.h. or Beaufort force).

Sims remote reading anemometer (ranges 0-30kt or 0-80kt).

Sims depthometer — a depth sounder which measures water depths from 0-10 or 0-100ft (could be used for investigating flow rates of a river). Requires 12V battery but draws only 40mA.

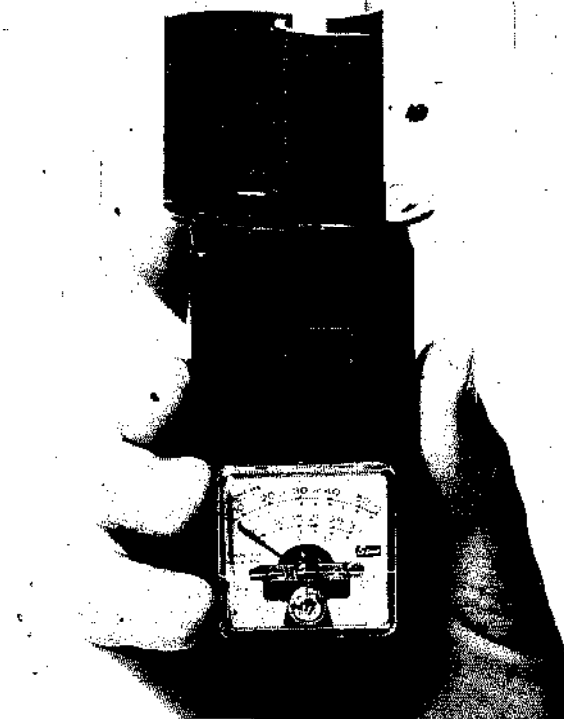

**Sims Hand-held Anemometer**

**SMITHS INDUSTRIES LTD**  
50 Oxgate Lane  
Cricklewood  
London NW2 7JB  
U.K.

Telex: 22671  
Cables: Speedofac  
London  
Phone: 01.452 3333

Manufacturers of a range of marine and engine monitoring instruments. Products include oil pressure gauges, tachometers, temperature gauges, voltmeters, ammeters, engine vacuum gauges, speedometers (vehicle and marine), engine hours counters, fuel level gauges, windspeed indicator, stop watches, etc.

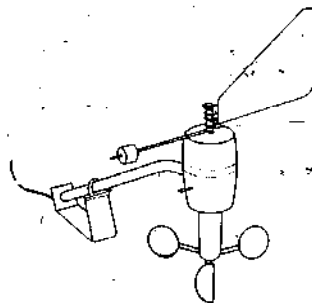

**Smiths Wind Speed Indicator**

SCIENCE ASSOCIATES INC Phone: 609 924 4470  
 Box 230  
 230 Nassau Street  
 Princeton  
 New Jersey 08540  
 U.S.A.

Suppliers of a wide selection of instrumentation for the measurement of wind and solar energy. The products available from this company range from cup anemometers with dial indicators or automatic chart recorders, to hot wire type windspeed recorders. Numerous forms of solar radiation measuring equipment are also available together with sophisticated chart recorders and integrators. The range offered includes equipment intended for marine, airport and meteorological departments as well as experimenters and educational establishments.

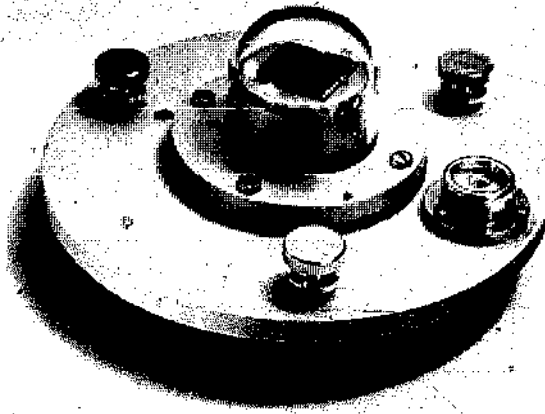

Weather-proof Pyranometer

SOLAR POWER CORP  
 5 Executive Park Drive  
 N Billerica  
 Massachusetts 01862  
 U.S.A.

Telex: 710 347  
 6792  
 Phone: 617 667  
 8376

and:

SOLAR POWER LTD  
 110-111 Strand  
 London WC2E 0AA  
 U.K.

Telex: 975247  
 Phone: 01 386 8918

A new device on the market for measuring solar radiation. The idea is that a large number of sun stations could be put out in an area where there is little or no insolation data and, using only one portable readout unit, all the sun station records could be monitored.

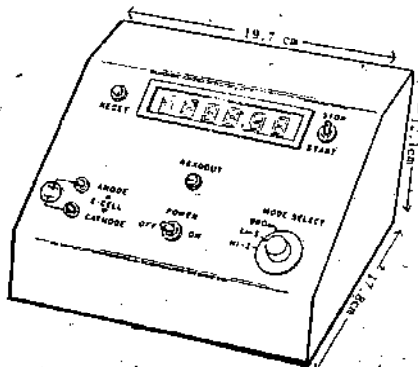

Model 3B Sunstation

TECNICO ELECTRONICS  
 53 Carrington Road  
 P.O. Box 12  
 Marrickville  
 New South Wales 2204  
 Australia

Telex: AA21490  
 Phone: 55 0411

This battery powered device is designed to monitor solar radiation, outputs from solar panels, wind generators, etc. It is intended for long unattended operation away from mains electricity supplies.

It has two separate integrator channels each having two input ranges of 10mV and 100mV and the readout is displayed on two six digit counters. A 12V battery supply such as two 509 lantern batteries will last in excess of 12 months operation.

Model R 2TL/101A/WP/B dual recorder integrator has a similar function to Model 2TL but has an additional chart recorder built in to give a continuous record of variations in weather conditions, solar cell output, etc. Hence overcast periods or windless periods, in the case of solar or wind monitoring respectively, can be clearly identified.

The integrator battery requirements are as for the other model. The chart recorder requires four No.509 cells per month of operation and the paper runs 31 days at 1in/hr with 1000 counts per hour.

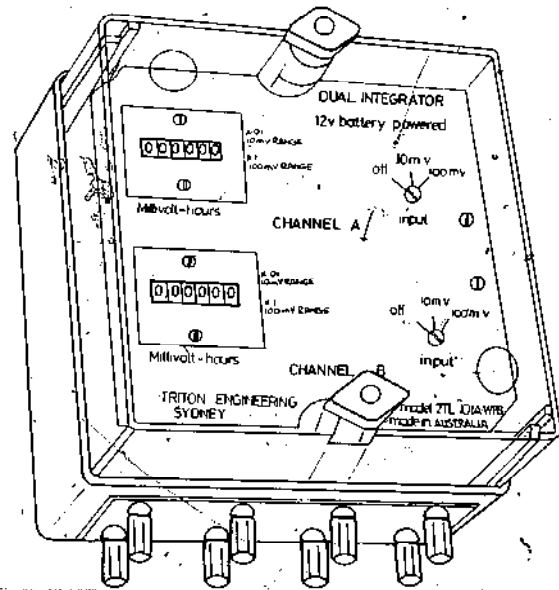

Model 2TL/101A/WP/B  
 Dual Integrator

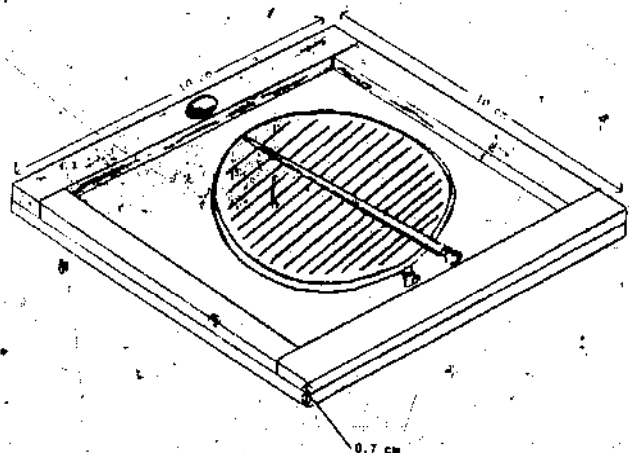

**CONTROL TECHNOLOGY LTD** Telex: 877623  
Bolney Avenue Phone: (079 14)  
Peacehaven 5841  
Sussex BN9 8HQ  
U.K.

This company, which is associated with the Wind Energy Supply Co., (WESCO), offers various items of electrical control equipment and instrumentation. It has made notable developments including induction generators, for use with wind powered systems. Its products are also designed for usage with other intermittent and variable power supplies.

In particular its products include "Self Powered DC voltage transformers"; AC and DC current transformer; AC and DC voltage and current relays; automatic voltage regulators, battery chargers, main injection units; inverters etc..

It can also supply, by quotation, windmill instrumentation for controlling and monitoring performance, together with a statistical wind analyser for use in site location. Also available is a new "Load Priority Controller" which enables loads to be added in individual priority as increased power becomes available from aerogenerators.

In addition, the company offers, by enquiry or quotations, a comprehensive advisory service on all electrical controls and applications associated with wind powered systems!

Enquiries from Europe & N. America to:

**EVANS ENGINEERING** Phone: (0566)  
Land & Leisure Services Ltd 3982  
Priory Lane  
St. Thomas  
Launceston  
Cornwall PL15 8DQ

Enquiries from rest of the world to:

Intermediate Technology Phone: 0788 70126  
Industrial Services Cables: ITIS Rugby  
3rd Floor Myson House  
Railway Terrace  
Rugby CV21 3HT  
U.K.

Electronic load controller to provide a continuous stabilised power supply from small hydro-electric plants, and other generating systems by switching unrequired power into a ballast circuit to keep the alternator load correct for the required voltage and frequency. This is a much less expensive and more reliable control system than traditional mechanical or hydraulic governing systems for a variety of applications.

Available to handle up to 100kW or more, single or three-phase with a variety of safety devices to suit customer's needs.

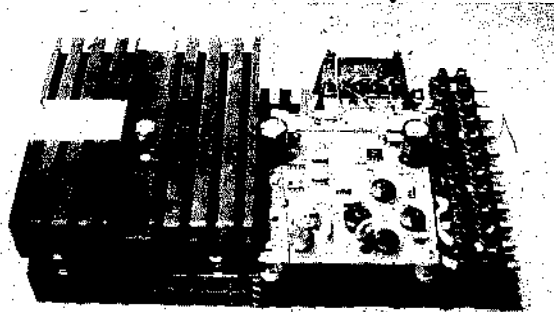

**Evans Electronic Load Controller**

# 9

## ITDG Power Project

### THE INTERMEDIATE TECHNOLOGY DEVELOPMENT GROUP'S POWER PROGRAMME

ITDG exists to try and transfer technology appropriate to the needs of people in the underdeveloped parts of the world so that it can be instrumental in reducing poverty in those regions. In effect the Group seeks to redistribute technology as a means towards the redistribution of wealth.

Market forces dictate that equipment is developed for people who can afford to pay for it, so its scale and cost is geared to suit the needs of the customer with money. Sometimes, equipment developed by the purchasing pressures from the affluent market will, by chance, be suitable and helpful if applied in the poorer regions using aid or development money to subsidise its movement there. So one function of ITDG is to communicate knowledge of available technology that might be useful in development — this book being part of that function.

However, another function of our Group is to develop new equipment to fill specialised technological gaps in the under-developed world. Since the Group is a non-profit Registered Charity we are not motivated by any need to produce profit-making products. Indeed, our aim, with most of our own technology, is to see it transferred and taken over, perhaps in modified form in some cases, by the people whom it might benefit. As lack of job opportunities is one of the major sources of poverty in underdeveloped areas, job creation as well as end-use inevitably affects our choice of technology, and most of the equipment we develop is intended for local manufacture at or near the place of usage, using local skills and resources. In many cases appropriate local skills and resources are initially absent, in which case the aid element involves the setting up of the necessary manufacturing unit and the training of local people to run it, as soon as possible, independently and self-sufficiently. An important criterion of whether or not aid is effective is the question of how it affects the self-sufficiency of the receivers — arguably, technology that undermines their self-sufficiency by making them more dependent on outside help is generally counter productive in all except the short-term.

To this end the Group is actively promoting a number of R&D programmes, usually with the backing of various aid donor organisations, and often in co-operation with other organisations both in the U.K. and overseas. The Group's R&D effort is implemented mainly by its Project Officers, who at the time of writing include staff engineers with experience in agricultural engineering, water supplies, rural transport, building, building materials and of course energy and power and they are supported by numerous panels of specialists operating voluntarily as advisors and who occasionally serve as consultants for short-term projects. In addition, a newly formed wing of the Group called Intermediate Technology Industrial Services exists to develop and transfer the technology for small-scale industrial processes by advising on and setting up small industries in under-developed parts of the world.

This section contains a brief outline of the Power Project's current research and development work.

#### *Windmill system for pumping water*

Water lifting is clearly a highly appropriate application for wind power. Many arid regions where the need is greatest have adequate or even good wind regimes, and usually water lifting is not time-dependent, so that the intermittent nature of the wind poses no great problem. Where it is a problem, water storage is relatively cheap compared with other forms of energy storage. As already explained in the section on wind power, windpumps have been vital to the development of the livestock industries of the arid USA and Australia.

Many developing countries have contemplated licence

manufacturing of American, Australian or other industrial countries' windpumps, but most of those products require sophisticated and expensive manufacturing facilities which would be prohibitively expensive in terms of the small initial market for the product. As a result, ITDG has developed a windpump specifically intended to be suitable for small-scale low-volume production using no more than basic machine shop facilities of the kind that are commonly available throughout the world. It is however designed to technical specifications competitive with equipment available in the industrial countries and bearing in mind that the main running cost of a windmill is the interest on the investment, it is intended to have a long life to permit a long amortisation period.

Two distinct applications for windpumps have become apparent to the Group. Low-lift, high volume pumping for irrigation purposes and high-lift small volume pumping (from tube wells) for village and live-stock water supplies. These two applications require different rotor and pump combinations to obtain optimum outputs, so the ITDG windmill system consists of a common tower, transmission, tail and governing system, with two alternative rotors and pumps. The low lift version has a relatively high speed rotor, with a special pump designed to obtain better than usual windmill to pump matching for the conditions. The high speed rotor for the prototype can exploit the advantages (structural and aerodynamic) of using agrofoil section blades (aluminium filled with polyurethane foam), as it only needs six blades on account of its low solidity, but the high lift version carries 24 "paddle" blades of sheet metal (or fibreglass) to obtain the necessary high starting torque and low speed of operation for a deep well pump. Both versions have 6m (20ft) diameter rotors.

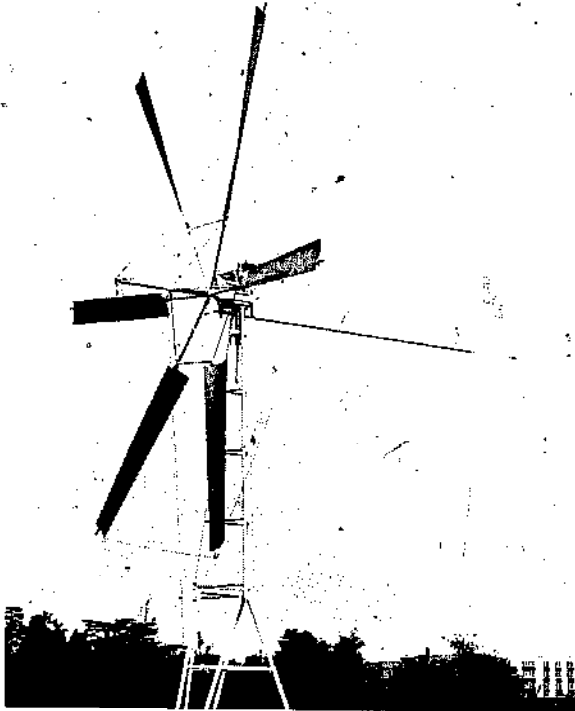

*ITDG prototype fast-rotor windpump.*

ITDG developed the UK prototype for this system with the support of the Engineering Department of Reading University. The U.K. charity Christian Aid has funded this work and nine institutions (some commercial, and some R&D orientated) in eight countries having appropriate applications for the system are participating in the overseas development phase as a joint venture with ITDG. The plan is that a variety of production prototypes adapted from the UK prototype are to be produced in

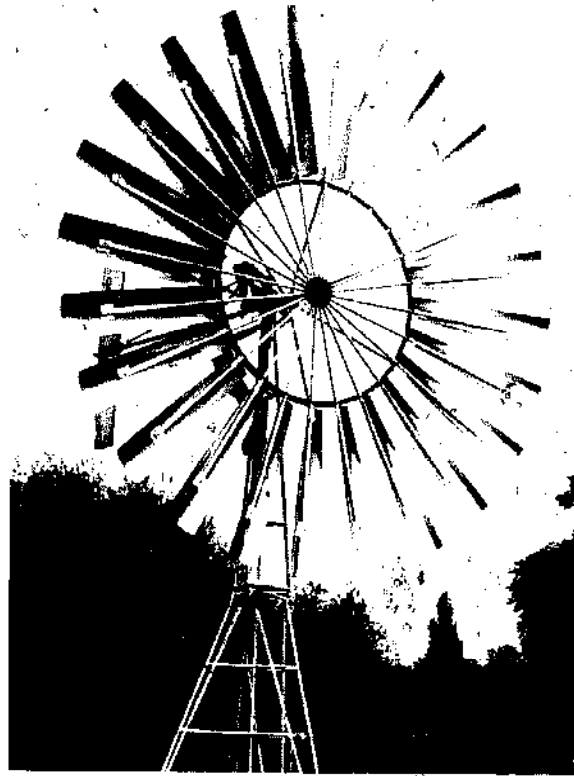

*ITDG prototype multi-bladed windmill.*

Botswana, Kenya, Egypt, Oman, Pakistan, Sri Lanka, Zambia and Antigua in order to evaluate and improve the design both for ease and economy of local manufacture and for operational reliability and performance. After this phase it is planned that it will go into production in those and any other countries wanting it, probably around 1980.

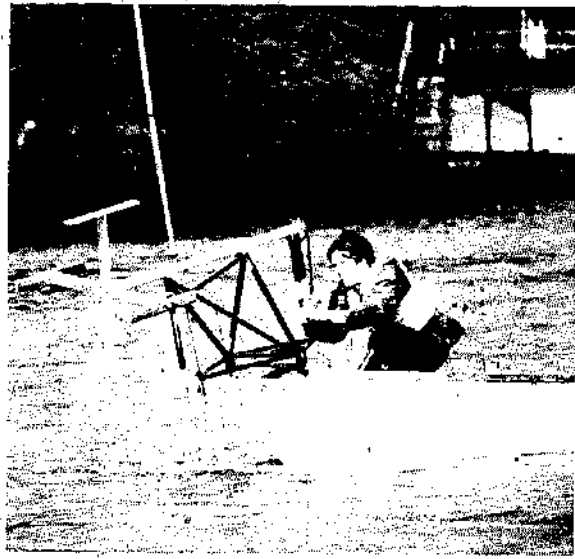

*Lowering the vertical axis river turbine into the water for a test run.*

#### *Run-of-stream river turbine*

There is a substantial energy flux present in moving water. A 3 knot river current represents an energy flux of  $1.8\text{kW/m}^2$  ( $0.23\text{hp/ft}^2$ ) available 24 hours per day. Conventional engineering practice for tapping river energy is to dam the entire river in order to create sufficient head to allow the use of traditional encased turbines. With any

sizeable, well-developed river this is an enormously expensive proposition only justified economically if there is a large market for electricity such as for an aluminium smelter (e.g. Volta) or a copper industry (Kariba), since "all or nothing" of the river flow energy must be used.

Traditionally, large undershot waterwheels were used in parts of the Middle East and the Sudan to tap small quantities of river current energy, but these are massive and material-intensive in relation to their power output, and therefore uneconomic. With this in mind, the ITDG Power Project has developed a "low solidity" device which runs completely submerged in a river current and is therefore potentially quite efficient yet does not need much construction material. Initial work indicates that it can convert up to 40% of the energy flux, amounting to  $720\text{W/m}^2$  ( $0.1\text{hp/ft}^2$ ) from a 3kt current.

This device is the same in principle as a Darrieus vertical-axis windmill or a Voith-Schneider ship propeller. The initial prototype tested over the front of a motor boat on the river Thames is only 1m in diameter by 0.5m deep. It is planned to develop a larger version, to be suspended beneath a pontoon, for pumping irrigation water from rivers passing through arid regions (such as the Nile, Niger, Euphrates, Indus, etc.). At the time of writing the Power Project is working on a design for a unit with a cross-sectional area of  $3\text{m}^2$  which could lift approximately  $61\text{m}^3$  (13500 UK gall) per hour against a 5m (16ft) head if submerged in a 3kt (1.5m/s) current. Large areas of fertile alluvial but arid soil that cannot at present be exploited economically for agriculture (due to the high cost of imported energy sources such as diesel or electric pumps) will become accessible to a device of this kind. We are hoping to test this prototype in Juba, Southern Sudan, in late 1979 or early 1980.

Later work will, it is hoped, result in a variant for electricity generation to permit village electrification along well-developed rivers with adequate currents.

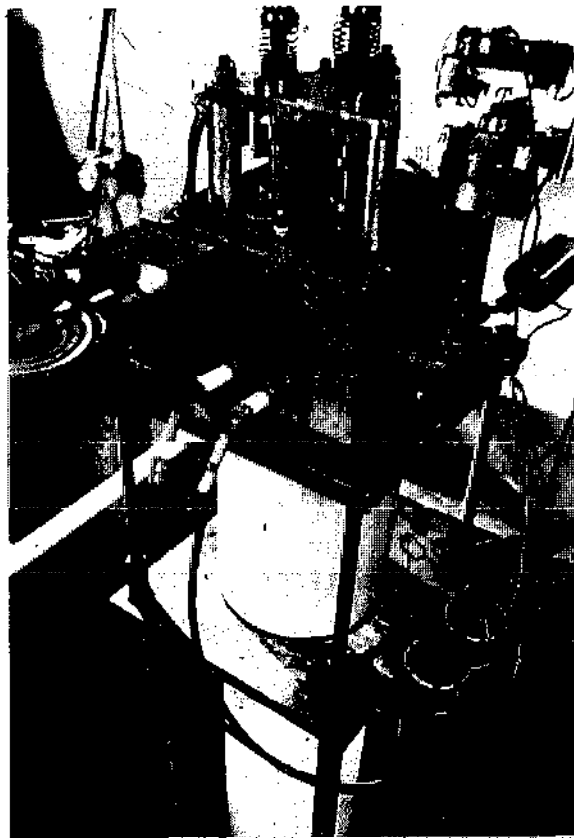

The Humphrey pump.

#### Liquid piston Humphrey Pump

This is a four-stroke spark ignition engine which has no piston or mechanical output; instead, the cylinder is open to water and a column of water behaves as a piston so that the ignition and expansion of the charge drives water directly from one level to another. ITDG developed an initial prototype at Reading University and the University Engineering Department then took the work further under a Ministry of Overseas Development grant. ITDG has now commissioned the manufacture of two field prototypes at Reading which have been sent for testing to Egypt and Nepal.

The present level of development only allows the use of gaseous fuels (such as methane, propane, bio-gas or wood-gas), but work is proposed to develop methods of utilising liquid fuels. The prototype machine functions reliably with a conventional coil ignition system, but work is also planned to find alternatives not requiring a battery for irrigation; considerable promise is offered by a piezo-electric ignition system which has been under test with some success, although it is not yet as reliable as coil ignition.

This machine is suitable for small-scale manufacture, needs virtually no maintenance and has an almost indefinite life since there are no loaded moving parts. The Reading prototype has achieved an overall system efficiency of 10% maximum (which is not bad for a small system (i.e. engine plus pump) of this power — around 500w), and lifts about  $25\text{m}^3/\text{hr}$  (5500 gall/hr) through 6m (20ft).

One attractive application is as an irrigation pump powered by bio-gas generated from agricultural wastes, sewage, animal dung and/or water weeds. The effluent from the bio-gas digester provides fertiliser in addition to the irrigation water. Efforts are being made in Nepal to test this concept in practice and it is hoped that a system working on water hyacinth may be evaluated in Egypt, where this water weed is currently a pest which could for this purpose form a combined fuel and fertiliser.

#### Micro-hydro-electric systems

Most of the power projects have been preoccupied with lifting water, one of the most basic prerequisites for improved agricultural production in most parts of the world. However, rural electrification is another important need.

To this end, ITDG has supported work by an innovative hydro-power engineer in the West of England, Mr Rupert



The Evans 6kW propeller turbine pilot installation (the belt guards are not yet fitted).

Armstrong Evans, to develop further some promising small-scale hydro-electric equipment he has evolved.



Some of this equipment is on the UK market and in use (see page 151), but the Group and Mr Evans have identified a need for low head turbines to succeed the Francis turbine, used traditionally for such applications in the 1930s and before. Mr Evans has also developed an electronic control system which eliminates many of the most expensive components in traditional turbines (e.g. no gates, spear valve, governor or mechanical linkage are needed) and which is more reliable and maintenance free with a quicker response than conventional hydro-mechanical control systems. For high and medium heads he has developed a family of Pelton Wheels which can also be electronically controlled.

As a result of identifying this need, ITDG has at its disposal a newly developed propeller turbine which can readily be machine-shop fabricated, economically in small quantities. Initial prototype testing gave an overall efficiency in the 65-70% range at a head of 4m (12ft), with a machine having an output of 6kW. It is planned to test-manufacture and field-test prototypes overseas in the near future and several electronic controllers have already been sent by the Group to places such as Fiji, Nepal and Pakistan. At the time of writing about 30 are in regular use in U.K. installations.

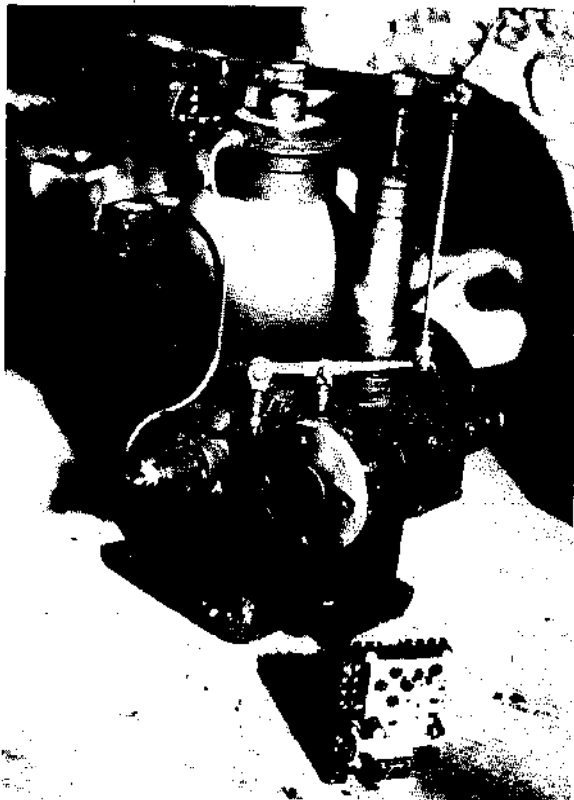

*The Evans electronic turbine load controller (foreground) shown with a traditional hydro-mechanical turbine flow controller.*

#### *Solar energy*

The Power Project is beginning work, in consultation with the Chairman of the Group's Solar Sub-panel, Mr Costis Stambolis, on several direct applications of solar energy.

These will include a simple basin solar still to be installed in conjunction with the windmill project in Oman. It is hoped that this work will lead later to the development of more sophisticated types of still utilising solar and/or wind energy in order to desalinate brackish and sea water.

It is proposed that the Group should develop specialised expertise in advising on the setting up of small manufac-

turing units in less developed countries to produce solar water heaters, a primary objective is the job creating aspect as well as that of energy saving. To this end we have made a financial contribution to a small project to develop suitable hardware at the University of Fourah Bay in Sierra Leone.

#### *Improved stoves*

The Power Project has recently commissioned an Australian engineer, Mr Stephen Joseph, to investigate the current situation with respect to "subsistence fuel" cooking stoves and to initiate a research and development programme aimed at the identification of improved efficiency low-cost cooking stoves. In terms of human needs, this is probably by far the most important project in the power field being undertaken by our group (as explained earlier in the section on bio-mass).

At the time of writing, Mr Joseph has received an encouraging response to a questionnaire from numerous institutions and individuals in developing countries. He has also developed a number of prototype stoves and is particularly interested in developing a type of light clay stove which can be turned on a potter's wheel and fired for strength prior to use. Also under investigation are small metal stoves with refractory linings that could be made and marketed in bazaars and small workshops in competition with mass-produced kerosene stoves.

This is such an important field for development that we hope and expect this programme to continue for some time. It should result in publications of stoves as well as collaborative field projects with other institutions in developing countries.

#### *Steam engines*

We have initiated investigative work in collaboration with staff from Reading University Engineering Department with a view to developing a 10kW steam powered electricity generating set. This system is to be developed to run on such fuels as wood, low grade coal, lignite, agricultural and other wastes, etc. At the time of writing a project proposal is being circulated in order to find funding to allow prototype construction and testing to proceed. It is expected that this work will get under way during the course of 1979.

#### *Future projects and the new Energy Centre at Reading*

The Engineering Department at Reading University has recently set up an Alternative Energy Research Centre off the main university campus, to conduct R&D into a number of new energy conversion systems, many of which are applicable for small-scale decentralised power production of the kind that is appropriate in under-developed areas. The department also proposes initiating post-graduate research and training courses in the fields of "alternative energy" based on the centre, particularly aimed at teaching technology relevant to the needs of the under-developed regions. Obviously the department is keen to attract engineering and science graduates who are nationals of countries that could benefit from this kind of expertise and to co-operate with universities and similarly-minded institutes in such countries.

ITDG has an office and a staff member of the Power Project based at the new Centre and will of course be closely involved with the work there, which is directed by Professor Peter Dunn. Some of the work going on at the centre in addition to that involving ITDG includes development of heat pipes, fluidised bed combustors, sterling engine development, Dr Musgrove's vertical axis

windmill (see page 54 for production model), small steam engines that could use solar energy, testing of solar collectors and work on bio-gas. Test facilities for reciprocating pumps, windmills and solar devices are also available. A permanent appropriate technology exhibition is being established at the Energy Centre by Intermediate Technology Industrial Services.

# 10

## Information Sources

RESEARCH AND DEVELOPMENT  
INSTITUTIONS, CONSULTANTS, &  
GENERAL SUPPLIERS OF  
EQUIPMENT

The technology of small-scale decentralised energy conversion is in the transition period to a new epoch, in the sense that for several decades the internal combustion engine running on petroleum-based fuel was the only serious contender for the purpose. The i.c. engine superseded the previous generation of steam engines, small turbines and windmills that started back in the nineteenth century, and is now, for the first time, under serious challenge due to the threat of future (rather than present) petroleum shortages and price rises.

As a result, the new technology of small-scale energy conversion is in a relatively embryonic state, particularly so far as the economic exploitation of solar, wind and biomass energy is concerned. A healthy bit of evidence for this assertion is the large number of research institutions throughout the world that are actively looking for alternative solutions, (including of course ourselves at the Intermediate Technology Development Group). The first part of this section includes a far from exhaustive list of various institutions and consultants who may be able to offer technical advice on aspects relevant to the subjects covered by this Guide.

At the risk of seemingly stating the obvious to some readers, it should be emphasised that many of the organisations listed are small and their resources are stretched to the limit, so it is recommended that readers should send International Reply Coupons to cover expenses when writing to them and be patient if in some cases a reply is a few weeks coming. Obviously some organisations are better geared to coping with enquiries than others and this will not apply to all. From our own experience it is a great help if enquirers are as specific as possible as to what they ask — obviously it is not possible to do more than answer very specific technical questions in the space of a letter, or to recommend a reference that might provide a detailed answer.

It is believed that the consultants listed are prepared to undertake on-the-spot consultative commissions in their various specialisations.

# Information Sources and General Suppliers of Equipment

Addresses, and where available, brief descriptions of organisations that can supply information, consultancy services or hardware, plus a selection of institutions active in research and development in fields related to the scope of this Guide. We should be grateful for suggestions and corrections for inclusion in the next edition of this Guide.

## a

**ALTERNATIVE ENERGY GROUP - READING UNIVERSITY** Phone: 0734 81269  
Department of Engineering  
(Shinfield Centre)  
Whitknights  
Reading RG6 2AY  
U.K.

Research and development work is in hand in such fields as windpower, stirring engines, biomass conversion, direct use of solar energy, heat pipes, fluidised bed combustion, etc. Much of ITDG's own power programme is being carried on at this centre (see Section 9 giving details).

**THE AMERICAN WIND ENERGY ASSOCIATION** Phone: 219 848 4360  
54468 CR 31  
Bristol  
Indiana 46507  
U.S.A.

The primary purpose of the American Wind Energy Association is to promote the use of wind as a renewable energy source. It provides regular publications in the form of a newsletter and a technical journal and also organises conferences.

**J. HILBERT ANDERSON, INC.** Phone: 717 741 0884  
2422 South Queen Street  
York  
Pennsylvania 17402  
U.S.A.  
& SEA SOLAR POWER INC.

Specialists in vapour turbine development (Rankine Cycle) for applications such as geothermal energy utilisation and ocean thermal energy conversion. A variety of publications is available on various aspects of sea solar power and its applications, mainly describing the results of technical investigations. A publications list is available on request.

**APPROPRIATE TECHNOLOGY DEVELOPMENT ORGANISATION** Phone: 42327  
P.O. Box 1306  
I-B, F-7/1 St. No. 57th  
Islamabad  
Pakistan

A government sponsored AT organisation with experience of constructing experimental methane digesters (Chinese types), wind-pumps and mini-hydroelectric plants, plus numerous activities in other non-energy fields.

**APPROPRIATE TECHNOLOGY DEVELOPMENT UNIT** Cables: Aptech  
Phones: 43451  
P.O. Box 311  
Gandhi Bhawan  
Lucknow  
U P 226001  
India

An independent AT organisation with particular interests in small industry development and small scale processes such as small cement and sugar production units.

**APPROPRIATE TECHNOLOGY DEVELOPMENT UNIT** Cables: Utech  
Phone: 42 4999  
University of Technology Ext. 130  
P.O. Box 793  
Lae  
Papua New Guinea

Working on various items of AT hardware and particularly active in conjunction with the University Department of Electrical Engineering on developing small-scale hydro-electric systems. Publishers of the admirable *Lik Lik Buk* on appropriate technology in rural Papua New Guinea.

**APPROPRIATE TECHNOLOGY GROUP SRI LANKA**  
c/o P.O. Box 352  
Colombo 1  
Sri Lanka

A group with general interests in promoting small-scale industries and appropriate technology for development purposes.

**ASIAN INSTITUTE OF TECHNOLOGY** Cables: AIT Bangkok  
Phone: 796415 or 796418  
Division of Community and Regional Development  
P.O. Box 2754  
Bangkok  
Thailand

Studying solar radiation in Thailand, solar distillation systems, solar powered water pumps and solar refrigeration.

**ASSOCIATION OF BRITISH GENERATING SET MANUFACTURERS** Phone: 01 839 6171  
21 John Adam Street  
London WC2N 6JH  
U.K.

This is an association of some of the major British generating set manufacturers and can offer specialised technical advice, particularly with respect to generator set specifications and claims a comprehensive, impartial generating set consultancy service.

**ASSOCIATION OF  
VOLUNTARY AGENCIES  
FOR RURAL  
DEVELOPMENT**

Phone: 678642

C-6 Safdarjang Development  
Area  
Community Centre  
New Delhi 110016  
India

This group provide a consultancy service and information on the construction and operation of bio-gas plants in India.

**ASTRA**

Phone: 30481

Cell for the Application of  
Science & Technology to  
Rural Areas  
Dept. of Inorganic and  
Physical Chemistry  
Indian Institute of Science  
Bangalore 560012  
India

Research and development work at a very practical level on simple low cost energy converters, including windpumps, methane generators, etc.

**b**

**BELYEA COMPANY INC**  
31-45 Howell Street  
Jersey City  
NJ 07306  
U.S.A.

Phone: 201 653  
3334  
212 732  
7150

This company rebuilds electrical power equipment and machinery and carries a wide selection of reconditioned stock, much of which is in the mega-watt size range but there is usually a reasonable selection of motor-generating sets in the 25 to 100kW range.

**BRACE RESEARCH  
INSTITUTE**  
Macdonald College of  
McGill University  
Ste. Anne de Bellevue  
Quebec HOA 1C0  
Canada

Phone: (514)  
457 6580

Publishers of articles in English and French with some translations into Arabic, on the full range of solar heated appliances. They have a publications list available.

Some selected publications are:

<i>How to Make a Solar Still</i>	US\$1.25
<i>How to Make a Solar Steam Cooker</i>	US\$1.25
<i>How to Build a Solar Water Heater</i>	US\$1.25
<i>How to Construct a Cheap Wind Machine for Pumping Water</i>	US\$1.25
<i>How to Make a Solar Cabinet Dryer for Agricultural Produce</i>	US\$1.25
<i>Instructions for Making a Simple 8ft Square Solar Still</i>	US\$1.25
<i>Plans for a Glass and Concrete Solar Still</i>	US\$4.50
<i>Production Drawing for a Solar Cabinet</i>	

**Dryer**

US\$2.50

*Notes on the Development of the Brace  
Aircscrew Windmill as a Prime Mover*

US\$0.50

**BUNDESVERBAND  
SOLARENERGIE e.V. (BSE)**  
Kruppstrasse 5  
D-4300 Essen 1  
German-Federal Republic

Telex: 0857 851  
Phone: 0201  
1853392

Numerous firms in the Federal Republic of Germany have developed techniques — especially in the field of solar energy for utilisation of regenerative sources of energy in different fields.

With the aim of promoting the investigation, testing and development of different possibilities for utilizing solar energy, these firms have founded the Bundesverband Solarenergie e.V. These aims also include working on technical problems of common interest, promoting co-operation with foreign countries and informing the public of the possibilities of using solar energy.

**C**

**CECOCO**  
(Chuo Boeki Goshi Kaisha)  
P.O. Box 8  
Ibaraki City  
Osaka  
Japan

Cables: Cecoco  
Ibaraki  
Phone: 0726 22  
2441

This organisation develops and markets a wide selection of equipment for small-scale agriculture, energy conversion, cottage industries, etc. Their hydrams and wood gasification plants are listed in the relevant sections of this Guide; other products include a wide selection of pumps, small powered cultivators, plus small-scale manufacturing equipment that is too numerous to list here. Detailed lists are available from them (in English) and they also publish a booklet entitled *Guide Book for Small, Medium and Rural Cottage Industries, Paddy Rice Cultivation*.

**CENTRO DE TECNOLOGIA  
PROMON (CTP)**  
Praia do Flamengo 154  
20000 Rio de Janeiro  
RJ Brasil

Phone: 021 205  
0112

This major research centre is studying solar energy, fuel alcohols, fluidized combustion, coal conversion, fuels from wastes, etc. Various publications are available on these subjects, mainly in Spanish, although a few are in English.

**COPPER DEVELOPMENT  
ASSOCIATION**  
Orchard House  
Mutton Lane  
Potters Bar  
Hertfordshire EN6 3AP  
U.K.

Telex: 27711  
Phone: Potters Bar  
50711  
Cables: CLUDA  
Potters Bar

Advice and publications available to those who wish to use copper in any form, for any purpose for solar collectors and for other power applications.

# d

**DESERT SUNSHINE  
EXPOSURE TESTS INC.**  
P.O. Box 185  
Black Canyon Stage  
Phoenix  
Arizona 85020  
U.S.A.

Telex: TWX910  
950 4681  
Phone: (602) 465  
7525

Well instrumented and experienced outdoor exposure testing station, for the performance testing of solar devices (including photo-voltaics).

Also test any products particularly for weathering characteristics such as adhesives, building materials, paints, plastics, textiles, mirrors, etc.

**DEVELOPMENT TECHNOLOGY CENTRE** Phone: 82051 or 82055  
Documentation Centre  
Institute of Technology  
P.O. Box 276  
Jalan Ganesha 10  
Bandung  
Indonesia

A series of simple designs for the construction of a simple solar dryer, a solar water heater and a simple water treatment system are available.

# e

**THE EAST-WEST CENTER** Cables: Easwescen  
177 East-West Road  
Honolulu  
Hawaii 96822  
U.S.A.

This centre is a private, non-profit, educational institution intended to promote better relations and understanding between the nations and peoples of the Pacific area, Asia and the U.S.A. It is engaged in co-operative research, training and education in the field of development technology. It is not engaged in the production of equipment or provision of consultancy services in technology.

A quarterly newsletter called *Infotech* is produced and various seminars, conferences and training courses on specialised subjects are organised from time to time.

**ECOTOPE GROUP** Phone: (206) 322  
747 16th East 3753  
Seattle  
Washington 98112  
U.S.A.

The group offers a wide range of consulting, demonstration and research services in the field of "appropriate technologies" including solar, wind bio-conversion and energy conservation.

Also produce various publications and present workshops to teach people how to build solar collectors.

Publications include:

*Methane Feasibility Study; Solar Retrofit Feasibility Study; Solar and Wind Power as Energy or Water Conservation Measures in the Columbia River Basin.*

**THE ELECTRICAL RESEARCH ASSOCIATION (ERA) LTD** Telex: 264045  
Cleeve Road Phone: 03723  
Leatherhead 74151  
Surrey KT22 7SA (from London  
U.K. 537 4151)

This association carries out research and development programmes on behalf of industry or government in a wide variety of electrical specialisations. They have long been associated with research into large scale wind-power usage and they have published numerous technical papers on aspects of wind-energy conversion. They also publish *Electrical Power Plant International*, which is a very comprehensive 700 page reference source on generating equipment, static inverters, generators and prime movers in the range from 1kVA to 1000mVA and would be particularly useful for readers of this Guide seeking higher powered equipment than covered here and for those seeking more detailed technical advice specifically on electrical generating plant and equipment. The ERA guide is US\$60.00 or £35.00 surface mail included at the time of going to press of our Guide.

**ENERTECH CORPORATION** Cables: Enertech  
Norwich Norwich  
Vermont 05072 Phone: 802 649  
U.S.A. 1145

This company specialises in wind energy systems and offers systems design services in connection with wind or solar energy applications. They have agencies for Elektro, Dunlite, and Sparco windmills and also market Dwyer and Stewart wind measuring instrumentation.

They produce their own publication *Planning a Wind Powered Generating System* (US\$2.00) and can offer various other useful publications on wind energy.

**ENVIRONMENTAL ENERGIES INCORPORATED** Phone: 616 378  
Box 73 2000  
Copernish  
Michigan 49625  
U.S.A.

A group who conduct feasibility studies for solar heating and wind electric power systems on an international basis.

# f

**FICHES ECOLOGIQUES** Phone: (68) 59 40 59  
Vingrau Village  
66600 Rivesaltes  
France

Publishers of over 400 leaflets many on health care, but some technical and general on aspects of self sufficiency. Leaflets are written in either French, or English. Energy related topics include: *Autogas Conversion, Methane Fermentation, Solar Cabinet Dryer, Solar Water Heaters (200 litre and 50 litre versions), Wind Machines, etc.*

**g****GOBAR GAS RESEARCH STATION**Ajitmal  
Etawah (U.P.)  
India

Cables: Gas Research

This organisation developed the Gobar Gas system of methane production for village and small farmers' use. They publish various information booklets and plans, notably:

<i>Bio Gas Plant Generating Methane from Organic Wastes</i>	US\$5.00
<i>Bio Gas Plant Designs with Specifications</i>	US\$7.00

The above are in English, but there are also various Hindi publications.

**GOODMAN ASSOCIATES**4 Berryville Pike  
Summit Point  
West Virginia  
U.S.A.Phone: 703 667  
7175

Publishers of information sheets and plans on *Vertical Windmill, Electric Car, Home Power Plant, Electric Bicycle, Electric Mini Bike, Fireplace, Log Splitter, Solar Heat, Water Wheel, Burn Waste Oil in Your Home Burner.*

These plans cost US\$3.00 each or any four for US\$10.00 or all for US\$15.00.

**GROUP SOCIALLY APPROPRIATE TECHNOLOGY**Afd. der Bedrijfskunde  
Technische Hogeschool Eindhoven  
Postbus 513  
Eindhoven  
NetherlandsPhone: 972443  
(040)

Research is carried out at the University on various projects related to energy conversion in underdeveloped areas, e.g. water power, wind power, solar energy, methane gas, water pumping equipment, water supplies, small industries, food processing and building and construction.

The group corresponds with other similar institutes and with field workers in many parts of the world and contributes to other Dutch groups working in this field such as TOOL and SWD.

**h****HELIO ASSOCIATES INC**Interstate 10 & Vail Road  
P.O. Box 17960  
Tucson  
Arizona 85731  
U.S.A.Telex: 666490  
Phone: 502 792  
2800

This company offers energy system analysis and management studies as well as consulting and design services for solar heating systems, particularly systems for use in buildings.

**i****INSTITUTE OF SOLAR ENERGY**P.O. Box 6094  
Khartoum  
Sudan

Research centre currently active with research and development work.

**INTERMEDIATE TECHNOLOGY DEVELOPMENT GROUP** Cables: IT/DEV  
9 King Street London WC2  
London WC2E 8HN Phone: 01 836 9434  
U.K.

The parent organisation of Intermediate Technology Publications, publishers of this Guide. Specialises in all fields of development technology; operates a technical enquiry service; publishes; carries out research and development and organises field projects and consultancies. An independent, non-profit-making U.K. registered charity. See Section 9 describing our energy related activities in detail.

**INTERMEDIATE TECHNOLOGY INDUSTRIAL SERVICES** Cables: ITIS Rugby  
3rd Floor Myson House Phone: 0788 70126  
Railway Terrace  
Rugby, CV21 3HT  
U.K.

Newly formed wing of Intermediate Technology Development Group (above) specialising in the provision of technical, managerial and financial support for small industries in under-developed parts of the world. This organisation is run by ITDG staff and funded by the U.K. Ministry of Overseas Development.

**INTERNATIONAL INSTITUTE FOR ENVIRONMENT & DEVELOPMENT (IIED)** Phone: 01 580 7656  
10 Percy Street  
London W1  
U.K.

also:

1302 Eighteenth Street NW Phone: (202)  
Washington D.C. 20036 462 0900  
U.S.A.

Research institute specialising in aspects affecting policy decisions in energy both in industrial and in under-developed regions. Areas studied include economic aspects of renewable energy technologies, tradeoffs between centralised and decentralised energy sources, energy costs of various agricultural systems, etc. Publishes papers and reports.

**THE INTERNATIONAL RICE RESEARCH INSTITUTE (IRRI)** Telex: 7425365  
P.O. Box 933 via ITT  
Manila 7222456  
Philippines via RCA  
Cables: Ricefound  
Manila  
Phone: 88 48 69

IRRI designs and develops a selection of agricultural equipment which is subsequently manufactured in a

number of Asian countries; drawings and other technical information are provided free, subject to a simple agreement. Although their designs are primarily agricultural, a number of energy-related developments are under way, including research into simple windpumps, steam engines, a kerosene fuelled batch dryer, pumps and water lifting equipment, etc.

**INTERNATIONAL INSTITUTE OF TROPICAL AGRICULTURE** Phone: Ibadan 23741  
Lagos 33931  
PMB 5320  
Ibadan  
Nigeria

Practical research and development work on systems for reducing the energy inputs into tropical agriculture, while taking into account the needs of the tropical small farmer as well as larger farming systems.

**INTERNATIONAL SOLAR ENERGY SOCIETY (ISES)** Phone: 03 347 491  
Headquarters:  
P.O. Box 52  
Parkville  
Melbourne  
Victoria  
Australia 3052

**U.K.-ISES** Phone: (01) 493  
c/o The Royal Institution 6601  
19 Albemarle Street  
London W1X 3HA  
U.K.

ISES has branches in numerous countries and organises seminars and conferences on technical aspects of using solar energy and publishes various publications which are available to ISES members at a considerably reduced rate. This is the primary organisation promoting solar energy on an international scale, and its publications include contributions from most of the more prominent workers in this field.

## k

**KAJIMA INSTITUTE OF CONSTRUCTION TECHNOLOGY** Cables: Kajima  
Tokyo  
Phone: (0424) 85 1111  
19-1 Tobitakyu 2 Chome  
Chofu-Shi  
Tokyo 182  
Japan

This group is doing research into the operations of a solar heated heat pump. This is a dual system that absorbs heat from solar radiation via an outdoor solar panel during winter, and radiates heat from the building via the same panel, during the summer nights. The unit has not yet come into production, as research into it has not been completed. It is reported to have a C.O.P. of 400-500% with the compressor absorbing a power input of 2.6kW. It is likely to be commercially available once development is completed.

**KINGSTON REYNOLDS THOM & ALLARDICE LTD**  
44 Wakefield Street  
Auckland  
New Zealand

Telex: NZ 21385  
Cables: Kingsdice  
Phone: 30189

Consultants in development of geothermal resources, reconnaissance, geophysical, geochemical investigation, exploratory drilling management, feasibility studies for development of resource. Operations in South East Asia.

## m

**MIDDLETON ASSOCIATES** Phone: (416) 961  
5136  
6 Crescent Road  
Suite 28  
Toronto  
Canada M4W 1T3

A firm of Consultants who provide supporting service to organisations interested in establishing themselves in renewable energy development or implementation. Will locate designers, developers and people with specialised technical expertise in resource assessment, planning, engineering and execution.

## n

**NATIONAL ACADEMY OF SCIENCE/NATIONAL RESEARCH COUNCIL**  
Board on Science and Technology  
for International Development  
Commission on International Relations  
2101 Constitution Avenue  
Washington D.C. 20418  
U.S.A.

Publishes various booklets on development, including *More Water for Arid Lands*, and *Energy for Rural Development*, which are overviews of the current 'state of the art' in small scale energy and water lifting. These are available free from the above address.

**NATIONAL CENTRE FOR ALTERNATIVE TECHNOLOGY** Phone: 0654 2400  
Llywngwn Quarry  
Machynlleth  
Powys  
Wales  
U.K.

This is an important experimental centre where a variety of commercially-developed and experimental "ambient energy" systems can be inspected by the public. NCAT also publish useful Do-it-Yourself plans and leaflets on equipment they have developed which do not gloss over



some of the problems that were discovered and explains solutions that were tried. This organisation has an extensive book list of publications from other sources, e.g. *Practical and Philosophic Approaches to Alternative Technology, Ecological and Environmental Issues, Growing and Cooking Food, Crafts*, etc. They have a large collection of useful information sheets available at 5p each, plus 15% postage and packing. Their own plans include a *5W Wind Generator, Water Pump, Pumping Windmill, Solar Water Heater, Sail-Windmill (Cretan)* - most of these cost £0.20 plus 15% postage. Write, enclosing SAE or Reply Coupons for details of air-mail postage and complete list, (they are a non-profit charity and request a SAE with correspondence). Some of their plans are stocked by IT Publications.

**NATIONAL RESEARCH CENTRE**  
Sh. El-Tahrir  
Dokki  
Cairo  
Egypt

Cables: Research  
Cairo  
Phone: 982433

This major government-run establishment has an active solar energy research centre running research and development programmes on a variety of aspects of solar energy conversion. The NRC is also active in the field of wind energy research and a number of other energy related fields.

**NATIONAL RESEARCH DEVELOPMENT CORPORATION OF INDIA**  
61 Ring Road  
Lajpatnagar III  
New Delhi 24  
India

Telex: 031 3214  
Cables: Natredveco  
Phone: 625608

This group is not a commercial organisation but develops designs for equipment for local manufacture in the country. The corporation deals with advances in all fields of technology and is available to people in other countries as an information source for any specific problems.

**THE NATURAL ENERGY CENTRE**  
161 Clarence Street  
Kingston upon Thames  
Surrey KT1 1QT  
England

Telex: 21887  
MONCO G  
Phone: 01 549  
5888/9

This company markets commercially available energy equipment utilising renewable energy resources and actively promotes the use of renewable resources with a newsletter and various useful publications. The Centre in effect supplies hardware, designs and installs and acts as consultants and it also houses the Natural Energy Association which publishes books, holds seminars and provides advice for its members.

The following principal hardware is available from this source:-

a. *solar collectors*. Solarex, Solaray, Maxsum, Liebi, solar air conditioner, plus various other kits and items.

b. *wind generators*. Elektro, Dunlite, Wescó, Noah and others.

c. *wind pumps*. Oasis, Sparco.

d. *water turbines*. Osberger.

Also available are inverters, wood and waste-burning stoves, heat pumps, electronic energy monitors, methane digesters, instrumentation, etc., etc.

They offer a useful publication *How to Use Natural Energy* (price £1.75 net) which gives a good broad overview of the various systems available and catalogues products available from the Natural Energy Centre.

**BROCK WINDMILL SALES**  
Route 1 12 St  
North Benton  
Ohio 44449  
U.S.A.

Suppliers of windmills and spare parts for windmills including Heller-Aller, Dempster, Aermotor, and also Davey hydraulic rams.

**PRAIRIE SUN AND WIND COMPANY**  
4408 62nd Street  
Lubbock  
Texas 79414  
U.S.A.

Phone: 806 795 1412

This company offers a wind power consultancy service and it is preparing designs for various wind machines. They also have agencies for a number of windmill manufacturers including Aeropower, Heller Aller "Baker" Windpumps, Wincharger (wind generator and selection of engine powered generating sets plus "loose" generators) from Dyna Technology's Winco Division, Dwyer and Maximúm wind measuring instruments, Surrette lead-acid storage batteries plus various other similar products.

**THE ROYAL SCIENTIFIC SOCIETY**  
P.O. Box 6945  
Amman  
Jordan

The Mechanical Engineering Department of the RSS is active in solar energy, with a particular interest in desalination systems. They publish a newsletter and research reports.

**RURAL INDUSTRIES INNOVATION CENTRE (RIIC)**  
P.O. Box 138  
Kanye  
Botswana

Telex: 435 BD  
Phone: Gaborone  
2942

A research organisation specialising in development technology which is active in a number of fields such as small industries, improved low cost housing construction, as well as small-scale energy conversion. Experimental bio-gas, mud stoves, solar stills and wind-pumps and generators are being developed.

## S

**SKYTHERM PROCESSES  
AND ENGINEERING**  
2424 Wilshire Boulevard  
Los Angeles  
California 90057  
U.S.A.

Phone: (213) 389  
2300

This consultancy group specialise in natural heating and cooling of buildings using their patented Skytherm water blanket system developed by Harold Hay. They act as consultants to architects, engineers and governments to provide temperature control in buildings.

**SOFRETES**  
(Société Française d'Etudes  
Thermiques et d'Énergie Solaire)  
B.P. 163  
45203 Montargis  
France

A pioneering institution working in the field of solar power heat engines (see entry for Renault Moteurs Development) and on a variety of other solar energy conversion systems.

**SOLAR ENERGY COMPANY** Phone: 603 424 4000  
Deerwood Drive  
Merrimack  
New Hampshire 03054  
U.S.A.

Developers of simple concepts in the energy field embracing solar energy, waste energy and wood energy systems.

**SOLAR USAGE NOW (SUN)** Phone: 419 937 2226  
Box 306  
450 E Tiffin Street  
Bascom  
Ohio 44809  
U.S.A.

This company stocks a very comprehensive range of solar energy equipment and components. A 120 page catalogue is available for US\$2.00 and includes a wealth of clearly detailed entries too numerous to list here. The catalogue also includes a wide selection of books and journals on alternative energy and on energy saving that can be ordered from SUN.

**STEERING COMMITTEE ON  
WIND-ENERGY FOR  
DEVELOPING COUNTRIES (SWD)** Cables: Dehave  
Amersfoort  
P.O. Box 85  
Amersfoort  
The Netherlands

This group exists to try and stimulate the use of wind energy in developing countries. Its membership is drawn mainly from Dutch technical universities and an active research and development programme to develop suitable equipment is in hand both in the Netherlands and in a variety of overseas countries. This group can offer training in wind energy related specialisations and also carries out consultancy work in this field. A number of publications are available on technical aspects of windmill design; one copy of each publication is available free of charge to research institutes in third world countries and many of these would be invaluable to serious students or pro-

pective researchers in this field. Typical titles available include *Wind Energy Utilisation in Sri Lanka - Potentialities and Constraints*, *Construction Manual for a Cretan Windmill*, *Rotor Design for Horizontal Axis Windmills*, etc. Virtually all publications are available in English, and some are in French.

**SUNPOWER INC.**  
48 West Union Street  
Athens  
Ohio 45701  
U.S.A.

This group have produced prototype stirling engines using solid fuel or solar power as the heat source.

Currently under development are:

- Solar powered stirling engine system of 1kW electrical output.
- Solid fuel powered stirling engine of 500W electrical output.
- Solar powered water pumps.

W.T. Beale, a noted pioneer in developing free piston Stirling engines is associated with this work.

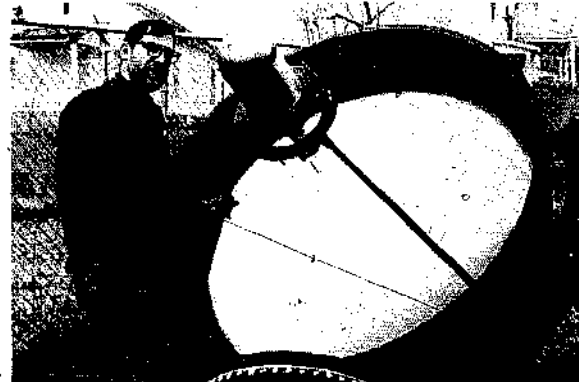

**SUN POWER SYSTEMS** Phone: 813 366 3050  
1121 Lewis Avenue  
Sarasota  
Florida 33577  
U.S.A.

Specialists in low temperature heat engines using freon vapour as a working fluid. Developing various prototypes.

**SURPLUS CENTER**  
1000 W O St  
P.O. Box 82209  
Lincoln  
NB 68501  
U.S.A.

Stock a wide range of bits and pieces useful for those involved in building their own energy conversion systems.

## t

**TECHNOLOGY CONSULTANCY** Phone: Kumasi  
**CENTRE** 5351  
University of Science and 5360  
Technology  
University Post Office  
Kumasi  
Ghana

A centre with extensive experience in the setting up

and provision of support to small businesses and industries in Ghana.

**TOOL (Technische Ontwikkeling Ontwikkelings Landen)** Phone: (020) (92) 6892  
Mauriskade 61a  
Amsterdam  
The Netherlands

TOOL is a joint organisation formed by groups from seven Dutch universities, which operates a technical enquiry service on problems of rural development. They also publish a periodical in Dutch called *Vraagbaak*, and various information leaflets and plans in English and Dutch, for example *Simple Methods of Soap Manufacture*; *The Salawepump*: how to build a simple hand pump.

**TROPICAL PRODUCTS INSTITUTE** Phone: 01 242 5412  
56-62 Gray's Inn Road  
London WC1X 8LU  
U.K.

TPI gives information on renewable resources (plant and animal products, solar energy, etc.) of less developed countries and provides expert advice on the scientific, technological and economic problems arising post harvest. TPI also carries out research, provides consultants, offers specialist training and publishes numerous technical and economic reports.

## U

**UNITED STIRLING (SWEDEN) AB & CO.** Telex: Stirlin S 32379  
Fack  
201 10 Malmo 1  
Sweden

This group have developed prototype stirling engines of 40kW, 75kW and 150kW which it is hoping to market in 1982. The expected efficiency in vehicles is hoped to be in excess of 35% and the 75kW unit shown weighs 350kg while the 40kW unit weighs 180kg.

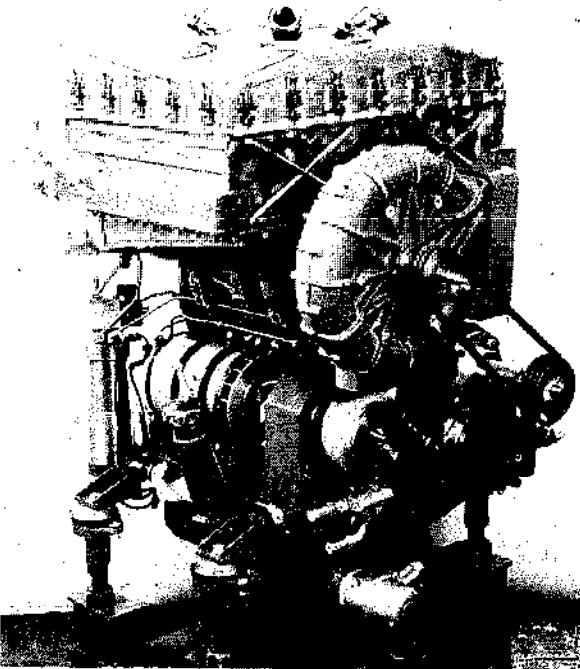

## V

**VITA (VOLUNTEERS IN TECHNICAL ASSISTANCE)**  
3706 Rhode Island Avenue  
Mt. Rainier  
Maryland 20822  
U.S.A.

Phone: (301) 277 7000

Publishers of a range of leaflets and books on most aspects of rural development. Most publications are written for application by technical assistance people in developing countries.

VITA Technical Bulletins: (selection on energy related topics)

<i>1kw River Generator</i>	US\$1.00
<i>Wood Burning Oven</i>	US\$1.00
<i>Solar Water Heater</i>	US\$1.00
<i>Double Drum Sawdust Stove</i>	US\$1.00
<i>Hydraulic Ram Pump</i>	US\$3.00
<i>Low Cost Development of Small Water Power Sites</i>	US\$2.95
<i>Hydraulic Ram Pump</i>	US\$1.95
<i>Low Cost Windmill for Developing Nations</i>	US\$2.95
<i>Design Manual for Water Wheels</i>	US\$4.50
<i>Tanzanian Windmill</i>	US\$3.00
<i>Savonius Rotor Construction</i>	US\$3.25
<i>Pedal Power</i>	US\$4.95
<i>Evaluation of Solar Cookers</i>	US\$5.95

A few available in other languages.

**VOLUNTEERS IN ASIA**  
Appropriate Technology Project  
Box 4543  
Stanford  
CA 94305  
U.S.A.

Phone: (425) 497 3228

This is a group which consists of volunteers who are associated with three American universities and who work on AT projects in co-operation with institutes and organisations in Asia. Publishers of the *Appropriate Technology Source Book*.

## W

**WINDWORKS**  
P.O. Box 329  
Route 3  
Mukwonago  
Wisconsin 53149  
U.S.A.

Phone: 663 4408

Windworks offer consultancy services in the fields of wind energy, load management, etc., and produce various publications and plans as follows:

<i>25ft diameter Sail Windmill with 42ft tower set of plans</i>	\$25.00
<i>Wind Energy Bibliography</i>	\$ 3.00
<i>Educational Wind Energy Display Chart</i>	\$ 3.25

They also stock various other publications on wind energy from other sources and they are agents for 'Gemini' Inverters.

**WEST WIND COMPANY**

Phone: 728 9940

Wilson Mesa  
Telluride  
Colorado 81435  
U.S.A.

This company offers information and consultancy on wind energy systems, plus various components including a temperature differential electronic controller for solar water heating systems, a voltage controller for battery charging systems, and an automatic load sensing switch. They are developing various inverters and permanent magnet alternators for use with wind generators.

**WORLD BANK**  
1818 11 Street  
Washington D.C. 20433  
U.S.A.

Cables: Intbafrad,  
Washington  
D.C.  
Phone: (202) 477  
1234

Has departments specialising in economic assessments of LDC energy prospects, which carries out individual studies of LDC's energy needs, and finances LDC energy projects (normally at government level only).

**WORLDWATCH INSTITUTE**  
1776 Mass. Avenue NW  
Washington D.C. 20036  
U.S.A.

Phone: (202)  
452 1999

This institute is concerned with renewable energy sources for developing countries and has a special interest in the "Firewood Crisis". Publications available.

**THE WHOLE EARTH TRUCK  
STORE**

Phone: 415 323 0313

558 Santa Cruz Avenue  
Menlo Park  
CA 94025  
U.S.A.

This is primarily a book store specialising in alternative energy, ecological, self-sufficiency and related publications. They also operate a world-wide mail order service which sells hard-ware as well as books.

# List of agents and distributors by country

The information given here is as supplied by the manufacturers.

## Abu Dhabi

CATERPILLAR OVERSEAS SA  
Mohamed Abdulrahman  
Al-Bahar  
P.O. Box 441  
Abu Dhabi

Telex: 259 AH  
Cable: Moatasim  
Phone: 22387

KOHLER INTERNATIONAL  
LIMITED  
Sadiq Brothers  
P.O. Box 169  
Abu Dhabi

KLOCKNER-HUMBOLDT-  
DEUTZ AG  
Bruno Company Trading  
Electric & Mechanic  
P.O. Box 4264  
Abu Dhabi

Telex: AH 2464  
Cable: Bruno  
Phone: 42363

LUCAS SERVICE OVERSEAS  
LIMITED  
Automotive Parts Company  
P.O. Box 2647  
Abu Dhabi

Phone: 22373

NISSAN DIESEL MOTOR  
COMPANY LIMITED  
Mohammed Bin Massood  
& Sons  
P.O. Box 322  
Abu Dhabi

PERKINS ENGINES LIMITED  
Technical Services &  
Supply Company  
(Arabian Gulf) Limited  
P.O. Box 277  
Abu Dhabi

Cable: Techserve  
Phone: 22331-22332

JOHN ROBSON (SHIPLEY)  
LIMITED  
Abdulla Bin Ahmed Zarouni  
& Bros.  
P.O. Box 1020  
Al-Ain  
Abu Dhabi

VOLVO PENTA  
Mohammad Bin Masood  
& Sons  
P.O. Box 322  
Abu Dhabi

Telex: Mastor AH 249  
Phone: 41167, 41236

## Afghanistan

DETROIT DIESEL ALLISON  
Peiwar Motors Incorporated  
Khushhal Khattack Road  
P.O. Box 243  
Kabul

Cables: Pemotor  
Phone: 23857

DORMAN DIESELS LIMITED  
Afghanistan Commercial  
Company Limited  
P.O. Box No. 3044  
Charshi-Sedarat  
Shahri Nau  
Kabul  
Kabul

Cables: Comerco  
Phone: 20081

KIRLOSKAR OIL ENGINES  
LIMITED  
Dwarkadas Kalyanji  
P.O. Box 39  
Kabul

Cables: Raj  
Phone: 21915/16

LEYLAND INTERNATIONAL  
Indamer Motor Division  
P.O. Box 202  
Kabul

Cables: Atbaldini

LUCAS SERVICE OVERSEAS LIMITED  
Shaffi Automobile Company Limited  
P.O. Box 142  
Outside Lahori Gate  
Kabul

Cables: Shaffi Auto  
Phone: 20364

PERKINS ENGINES LIMITED  
The Afghan Motor Service and Parts Company  
Zenda-Banon Workshops  
P.O. Box 86  
Kabul

Cables: Service Kabul  
Phone: Kabul 20920, 20925

PETTERS LIMITED  
Anglo Afghan Trade Centre  
P.A. Box 363  
Jade Sadar Mohd Hashim Khan  
Kabul

Cables: Anglat  
Phone: 21193

### Algeria

DETROIT DIESEL ALLISON  
Detroit Diesel Allison International Europe  
c/o General Motors France  
Louis Roche  
55 à 58 Avenue  
Gennevilliers  
92231  
France

Telex: Genlmp 62050  
Cables: Parautexap  
Gennevilliers  
Phone: 790-70-00  
Gennevilliers

DORMAN DIESELS LIMITED  
(Oran Province only)  
A Magnol & Cie  
Boite Postal 8020  
(Oran Saint Michel)  
5 rue Sidi-Ferruch  
Oran

Cables: Magnol Oran  
Phone: 412-95, 449-21

KLOCKNER-HUMBOLDT-  
DEUTZ AG  
BCA  
Bureau Consultatif de la Société  
Klockner-Humboldt-Deutz AG  
5 Impasse de la Revolution  
B.P. El Mouradia 181  
El Mouradia  
Alger

Telex: 52835  
Cables: Deutzmotor  
Phone: 604970, 602475/76

LEYLAND INTERNATIONAL  
Sonacome  
B.P. No. 15  
Rouiba  
Algiers

Telex: Sondoc 52773 Alger  
Cables: Sonacome  
Phone: 664160/64  
664180/84

LUCAS SERVICE OVERSEAS LIMITED  
DIAL (Diesel Algérie)  
47 Boulevard Rouchai, Boualem  
Algiers

Telex: 52356 DIAL  
Cables: Dial-Alger  
Phone: 662055, 662057

PERKINS ENGINES LIMITED  
Diesel Algérie Dial  
47 Boulevard Capitaine Rouchai  
Boualem  
Alger

Telex: 52356 DIAL  
Cables: Dial-Alger  
Phone: 662055, 662057

PETBOW LIMITED  
Sovesta (Soc. de Services Techniques)  
Vilmain  
20 Chemin des Sept Merveilles  
Algiers

PETTERS LIMITED  
Sonacome D.C.E.I.  
P.O. Box 72  
Avenue De L'Ain (Cinq Maisons),  
El Harrach  
Alger

Telex: 52.938  
Phone: 76.64.06/10

### American Samoa

KOHLER INTERNATIONAL LIMITED  
G.H.C. Reid & Company Limited  
P.O. Box 1269  
Pago Pago  
96799

### Andorra

LEYLAND INTERNATIONAL (Agent of Tugs & Lighters Ltd.  
Garatge Central S.A. Trinidad)  
Les Escaldes P.O. Box 120  
Principat

### Angola

ALLIS CHALMERS  
Maquinas E. Equipamentos  
Technicos De Angola  
S.A.R.L. (META)  
Caixa Postale 3175-C  
Luanda

Telex: 3386 META AN  
Cables: Meta  
Phone: 6701 through 6705

BRIGGS & STRATTON CORPORATION  
Agro Technica, Lda,  
P.O. Box 10,100  
Luanda

Cables: Agrotechnica  
Phone: 25671/2

CATERPILLAR OVERSEAS SA  
Sorel S.a.r.l.  
P.O. Box 408  
Luanda

Telex: 3229  
Cables: Sorel Luanda  
Phone: 7-22-81/2/3/4/5

DETROIT DIESEL ALLISON  
Casa Americana Commercial S.A.R.L.  
P.O. Box 1208C  
Luanda

Telex: 998-3039 Caci An  
Cables: Americana  
Phone: 35190 through 35194

DORMAN DIESELS LIMITED  
Friauto S.A.R.L.  
Divisao de Maquinas  
Rua Paiva Couceiro Nos 373/375  
C Postal 1255  
Luanda

Telex: Friauto 3229  
Sorel An  
Cables: Friauto  
Phone: Angola 80214,  
80191/2

KLOCKNER-HUMBOLDT-  
DEUTZ AG  
P.O. Box 6157  
Luanda

Telex: 3245  
Cables: Vega  
Phone: 32481

LEYLAND INTERNATIONAL  
Uniauto-Organizacoes Tecnicas  
S.A.R.L.  
Caixa Postal 1236  
Luanda

Telex: 3053 Uniao-An  
Cables: Uniao  
Phone: 27631/5

LUCAS SERVICE OVERSEAS LIMITED  
Motores De Angola S.A.R.L.  
Caixa Postal 2622C  
Luanda

Cables: Motorang  
Phone: 81900/81901

PERKINS ENGINES LIMITED  
Motores De Angola (S.A.R.L.)  
Caixa Postal 2622-C  
Luanda

Cables: Motorang  
Phone: 23577/81900

RUGGERINI MOTORI S.p.A.  
Agro-Tecnica LDA  
P.O. Box 10100  
Rua Direita de Luanda 114-116,  
Luanda

VOLVO PENTA  
Samil  
Caixa Postal 5065  
Luanda

Telex: 3074 Tecnil AN  
Cables: Samil  
Phone: 70174/5/6/7/8  
70180/1/2

**Anguilla**

PETTERS LIMITED  
Expan Company Limited  
Anguilla

Cables: Expan

**Antigua**

DETROIT DIESEL ALLISON  
Stephen R. Mendes (Antigua)  
Limited  
(Agent of Tugs & Lighters Ltd.  
Trinidad)  
P.O. Box 120  
The Colonial House  
18 Thames Street  
St. Johns

Telex: WB 113  
Cables: Mendesteph  
Phone: 21224

LEYLAND INTERNATIONAL  
George W. Bennett, Bryson &  
Company  
P.O. Box 162  
St. Johns

Cables: Bennet Antigua

PETTERS LIMITED  
Stephen R. Mendes Limited  
P.O. Box 120  
Colonial House  
18 Thames Street  
St. Johns

Cables: Mendesteph

**Argentina**

ALLIS CHALMERS  
Compañia Subamericana De  
Industria Y Comercio S.A.  
25 de Mayo 460  
Casilla de Correo 5083  
Buenos Aires

Telex: 122064 AR INMAQ  
Cables: Insdmaq  
Phone: 32-3661/32-3669

BRIGGS & STRATTON  
CORPORATION  
Autocam S.A., C.I. F.a.I.,  
Rivadavia 3872  
Buenos Aires

Cables: Autocarnion  
Phone: 811-0041

CATERPILLAR OVERSEAS SA  
Macrosa Crothers Maquinarias  
S.A.C.I.F.  
Av. Fondo de a Legua 1232  
Martinex (Partido San Isidro)  
Buenos Aires

Telex: 012-1739  
Cables: Macrosa Baires  
Phone: 792-0021 through  
29

DETROIT DIESEL ALLISON  
c/o General Motors Argentina S.A.  
Oswaldo Cruz 2900  
1293 Capital Federal

Telex: 012-1609 Buenos  
Aires  
Cables: Bairautoex  
Phone: 755-6949

DORMAN DIESELS LIMITED  
C.I.T.I.R. S.A.  
Casilla Correo  
41-Suc 46  
Buenos Aires

Telex: 122621 Ar Raimp  
Cables: Raimport Baires  
Phone: 37-8115

FORD MOTOR COMPANY  
LIMITED  
Ford Motor Argentina S.A.  
Casilla Correo 696  
Correo Central  
Buenos Aires

Telex: 012 1175  
Phone: 392 4112

L. GARDNER & SONS LIMITED  
Banham Hermanos y Compania S.A.  
Calle Peru 362  
Buenos Aires

Phone: 33-1325, 33-9044

KATOLIGHT LIMITED  
Ing. Iglesias S.R.L.  
Blas Parere 6979  
Santa Fe

KLOCKNER-HUMBOLDT-  
DEUTZ AG  
Sociedad Argentina  
de Maquinas y Motores S.A.C.I.  
Belgrano 685 - 5  
RA Buenos Aires

Telex: SAMM 121038 AR  
Cables: Motores  
Phone: 309472

LEYLAND INTERNATIONAL  
A.G. Pruden & Company S.R.L.  
Calle Bouchard 680 (R.90)  
Buenos Aires

Telex: 390-12-1887  
Cables: Prudante

LUCAS SERVICE OVERSEAS  
LIMITED  
Lucas Service Argentina S.R.L.  
Avenida San Martin 4200  
Casilla Correo 17,  
Lomas del Mirador  
Partido de la Matanza  
PCA  
Buenos Aires

Cables: Lucaserve Lomas  
Mirador Baires  
Phone: 740-9046, 68-9815/  
9086

PERKINS ENGINES LIMITED  
Perkins Argentina S.A.I.C.  
Bolivar 368  
Buenos Aires

Telex: 121162  
Cables: Perkins  
Phone: 33-8231/36

PETTERS LIMITED  
Alpomet Motors S.A., (Offices)  
Venezuela 1292  
Buenos Aires

Phone: 38 0210

VOLVO PENTA  
Volvo Sudamericana S.A.C.I.  
Moreno 1142  
Buenos Aires

Telex: Public Booth 3909  
Buenos Aires  
Cables: Sudvolvo  
Phone: 38-4135, 38-4160

WHITE ENGINES  
INCORPORATED  
Buxton  
Calle Florida 683 - 10th Floor  
Buenos Aires

Telex: 012-1861  
Phone: 396-9851 (Int'l Div)

**Australia**

ALLIS CHALMERS  
Diesel Engine & Transmission  
Company  
2 South Street  
P.O. Box 176  
Rydalmere  
2116 New South Wales

Telex: AA20604  
Cable: Detroitco  
Phone: 638-0133

ALLIS CHALMERS  
Westfarmers Tutt Bryant PTY.  
Limited F/A  
174-184 Railway Parade  
P.O. Box 21  
Bassendean  
6054 Western Australia

Telex: 92443  
Cables: Westutt Perth  
Western Australia  
Phone: 79-1616/19  
1103

BRIGGS & STRATTON  
CORPORATION  
A.N.I. Perkins  
A division of the ANI  
Corporation Limited  
16 Parramatta Road  
P.O. Box 117  
Lidcombe  
New South Wales 2141

Telex: 20238  
Cables: Perkaust  
Phone: 648-4088

CATERPILLAR OVERSEAS SA  
Caterpillar of Australia Ltd.,  
P.O. Box 35  
Niddrie  
Melbourne  
Victoria 3042

DETROIT DIESEL ALLISON  
c/o General Motors  
Holdens PTY. Limited  
Princes Highway  
P.O. Box 163  
Dandenong  
Victoria 3175

Telex: 30168, or 30212  
Melbourne  
Cables: GMP & IP  
Melbourne  
Phone: 03-792-0111

**DORMAN DIESELS LIMITED**  
GEC Diesels Australia Limited  
1 Winterton Road  
P.O. Box 135  
Clayton 3168  
Victoria

Telex: AA 30994  
Cables: Eedust Melbourne  
Phone: 554-8344

**FORD MOTOR COMPANY LIMITED**  
Ford Motor Co. of Australia Limited

Telex: 30624  
Phone: 359 0211

**NISSAN DIESEL MOTOR CO. LIMITED**  
U.D. Australia Pty. Ltd.  
P.O. Box 91  
Rosebery  
New South Wales 2018

**PERKINS ENGINES LIMITED**  
Perkins Engines Australia PTY. Limited  
P.O. Box 156

Telex: 30816  
Cables: Perkoil Melbourne  
Phone: 792-0431

Victoria 3061

**L. GARDNER & SONS LIMITED**  
Knox Schlapp PTY. Limited  
Corner Milford and Banks Street  
East Victoria Park  
Western Australia 6101

Telex: 92704  
Phone: 61-6822

**L. GARDNER & SONS LIMITED**  
Knox Schlapp PTY. Limited  
135-139 McEvoy Street  
P.O. Box 67  
Alexandria 2015  
New South Wales

Telex: 20483  
Phone: 699-8333

**KATOLIGHT LIMITED**  
Westinghouse Brake and Signal Company  
Australia PTY Rectifier Division  
P.O. Box 4  
Newport  
Victoria 3015

**KIRLOSKAR OIL ENGINES LIMITED**  
Winsland & Co. PTY. Limited  
P.O. Box 195  
Bentley 6102  
Western Australia 6106

Telex: AA-27370 Barpump  
Phone: 686166

**K.A.B. Projects PTY. Limited**  
322 Pacific Highway  
Hornsby  
New South Wales 2077

Telex: AA 27370  
Cables: Veebee Sydney  
Phone: 47 1863  
47 3307  
47 3329

**KLOCKNER-HUMBOLDT-DEUTZ AG**  
Deutz Australia PTY. Limited  
P.O. Box 241  
Cochranes Road  
Moorabbin 3189  
Victoria

Telex: Deutzmo  
Melbourne AA 324  
Cables: Deutzmotor  
Melbourne  
Phone: 957688 (6 lines)

**KLOCKNER-HUMBOLDT-DEUTZ**  
Tutt Bryant Limited  
2-8 South Street  
Rydalmere  
New South Wales 2116

Telex: Leotutt 20140  
Sydney  
Cables: Tutbry Sydney  
Phone: 638-0133

**LEYLAND INTERNATIONAL**  
Leyland Motor Corporation of Australia Ltd.  
(Head Office)  
P.O. Box 346  
332/342 Oxford Street  
Bondi Junction  
New South Wales 2022

Telex: 20222  
Cables: Leyaust Sydney  
Phone: 387 0233

**LUCAS SERVICE OVERSEAS LIMITED**  
Lucas Industries Australia Limited  
1156 Nepean Highway  
Cheltenham  
Victoria 3192

Telex: 30.453  
Cables: TLX 30.453  
Lucasaust  
Melbourne  
Phone: 93.0311

Correspondence to  
Lucas Industries Australia Limited  
Private Bag 3  
Cheltenham  
Victoria 3192

**PETERS LIMITED**  
A.N.I. Australia PTY. Limited  
A.N.I. Perkins Division  
P.O. Box 117  
16 Parramatta Road  
Lidcombe  
Sydney  
New South Wales 2141

Telex: 20238  
Cables: Perkaust, Sydney  
Phone: 648-4088

**RUGGERINI MOTORI S.p.A.**  
Engine Powered Equipment  
P.O. Box 29  
Carnegie  
Victoria

Telex: 32817 Volkvic

**VOLVO PENTA**  
Volvo Penta (Australia) Pty. Limited  
40 Hilly Street  
Mortlake  
New South Wales 2137

Telex: 21414  
Cables: Volvaust  
Phone: 736 2666

**Volvo Australia Pty. Limited**  
24 Viking Drive  
Dacra 4076  
Brisbane  
Queensland

Telex: 40403  
Phone: 722144

**Volvo Australia Pty. Limited**  
Cherry Lane  
Brooklyn 3025  
Melbourne  
Victoria

Telex: 32231  
Phone: 3992933

**VOLVO PENTA**  
Morton Industries  
80/88 Port Road  
Hindmarsh  
Adelaide  
South Australia

Cable: Mortonsaw  
Phone: 465971

**Sandmac Engineering**  
Hay Street  
P.O. Box 63  
Subiaco WA 6008  
Perth  
Western Australia

Telex: 92498  
Cable: Sansu Perty W.A.  
Phone: 813733

**WHITE ENGINES INCORPORATED**  
B.W.S. Properties PTY. Limited  
21 Meeks Road  
Marrickville 2204

Cable: Hobaustr Sydney  
Phone: 51-5013  
51-1896

Mailing address  
P.O. Box 62  
Marrickville 2204

**Austria**

**BRIGGS & STRATTON CORPORATION**  
A & M Bucek  
Krausegasse 8  
Postfach 11  
A 1112 Vienna XI

Cables: Bucekmotor  
Phone: 741101



**CATERPILLAR OVERSEAS SA**  
Eisner Baumaschinen GmbH  
Postfach 100  
Strasse No. 1,  
Objekt 27  
Industriezentrum No. Sud  
A-2351 Wr. Neudorf  
Vienna

Telex: 07-9213  
Cables: Eisnerbaumages  
Phone: (2236) 83-5-45

**DORMAN DIESELS LIMITED**  
Ing Franz Schmachtl K.G.  
4021 Linz-Donau 11,  
Ehrentetzbergerstr 2  
Postfach 362

Telex: (0) 21373  
Cables: Schmachtl-Linz  
Phone: 21974 Linz

**FORD MOTOR COMPANY LIMITED**  
Ford Motor Company  
(Austria) K.C.  
Rainerstrasse 27  
P.O. Box 2  
5021 Salzburg

Telex: 63201  
Phone: 74551

**KATOLIGHT LIMITED**  
Ferdinand Berger  
Stadtplatz 50 A-4960  
Schwanenstadt

Telex: 5229126  
Phone: 2371

**KLOCKNER-HUMBOLDT-DEUTZ AG**  
F.M. Tarbuck & Company  
St. Ulrichstr 19  
A - 6840 Gotzis

Telex: 5229126  
Phone: 2371

**KOHLER INTERNATIONAL LIMITED**  
Prochaska & Cia GmbH  
9 Strasse  
Sudbahnhof-Frachten-bahnos  
1100-Vienna

**LEYLAND INTERNATIONAL**  
British Leyland Austria K.G.  
Wasserfeldstrasse 15  
A 5020 Salzburg

Telex: 063479

**PERKINS ENGINES LIMITED**  
Indukont Technische Handelsges  
M.B.H.  
Kolingasse 19  
A-1092 Wien  
Fach 200

Telex: 07-4022  
Cables: Industriekontor  
Phone: 34 74 76

**PETTERS LIMITED**  
Karl I. Hoffman K.G.  
A 4600 Wels  
Boschstrasse 44  
P.O. Box 247

Telex: 025 - 422  
Phone: (07242) 7422, 4247

**RUGGERINI MOTORI S.p.A.**  
H. Leithmayer K.G.  
A. Wenzel Pragergasse 7-9  
A-3002 Purkersdorf

Telex: 01-3441

**VOLVO PENTA**  
Schweden-Bootsmotor-Import  
Gesellschaft mbH  
Donaustrasse 22  
1195 Wien

Telex: 75961  
Phone: 371679

#### Azores

**CATERPILLAR OVERSEAS SA**  
Sociedade Tecnica de Equipamentos  
e Tractors S.A.R.L.  
Apartado 1351  
Lisbon  
Portugal

Telex: 12778  
Cables: Streta Sacavem  
Phone: 251-1011

**LEYLAND INTERNATIONAL**  
Varela & Cia. LDA  
Ponta Delgada  
St. Miguel

**PERKINS ENGINES LIMITED**  
Leacock & Cia LDA  
Caixa Postal 416  
Funchal  
Madeira\*  
Rua Major Reis Gomes 13

Cables: Leacock  
Phone: 22101

**VOLVO PENTA**  
Motores e Automoveis Jotacor Lda  
Rua do Mercado 17  
Ponta Delgada-S  
Miguel-Azores

Cables: Jotacor  
Phone: 22696

#### Bahamas

**BRIGGS AND STRATTON CORPORATION**  
Bahama Engines Limited  
P.O. Box 6170  
Nassau

**CATERPILLAR OVERSEAS SA**  
Bahamas Tractor & Equipment  
Limited  
P.O. Box N-3238  
Nassau

Telex: NS125  
Cables: Bahtrac  
Phone: (809) 323-5701

**DORMAN DIESELS LIMITED**  
Bahamas Tractor & Equipment  
Limited  
P.O. Box N-3238  
Nassau

Cables: Bahtrac Nassau  
Phone: (809) 323-5701

**LEYLAND INTERNATIONAL**  
Nassau Motor Company Limited  
P.O. Box N-8165  
Shirley and Dowdeswell Streets  
Nassau

Cables: Nasmu

**LUCAS SERVICE OVERSEAS LIMITED**  
Bay Street Garage Limited  
Dowdeswell Street  
P.O. Box N3916  
Nassau

Cables: Bay Street Garage  
Phone: 80932, 22604

**PERKINS ENGINES LIMITED**  
Earthmovers Limited  
Wulff Road  
P.O. Box N-4894  
Nassau

Cables: Earthmovers  
Phone: 3-4343

**PETTERS LIMITED**  
Earthmovers Limited  
P.O. Box 4894  
Nassau

Telex: 1675  
Cables: Earthmovers Nassau  
Phone: Nassau 3-4343

#### Bahrain

**CATERPILLAR OVERSEAS SA**  
Ahmed & Essa Al-Jafahema  
P.O. Box 5357  
Manama

Telex: 299GJ  
Cables: Bahar  
Phone: 713-607

**L. GARDNER & SONS LIMITED**  
Abdulla Yusuf Fakhro  
P.O. Box 39  
Lulu Road  
Manama

Telex: 8211. GAC CH  
Phone: 53531

**KATOLIGHT LIMITED**  
Mohamed Jalal & Sons Co. Limited  
P.O. Box 747  
Bahrain

**KIRLOSKAR OIL ENGINES LIMITED**  
Salman A. Kaiksow  
P.O. Box 80  
Bahrain

Telex: 8349 TYLHTL GJ  
Cables: Kaiksow  
Phone: 3735

KLOCKNER-HUMBOLDT-  
DEUTZ AG  
Gray MacKenzie & Co. Ltd.  
P.O. Box 210  
Bahrain

Telex: GJ 8212  
Cables: Gray  
Phone: 50804

LEYLAND INTERNATIONAL  
Ahmed & Abdulla Fakhro  
P.O. Box 39  
Bahrain

Cables: Fakhro  
Phone: 5908, 3531

LUCAS SERVICE OVERSEAS  
LIMITED  
Gray, Mackenzie & Co. Limited  
P.O. Box 210  
Bahrain

Telex: Gray BHN GJ 8212  
Cables: Gray  
Phone: 53537

NISSAN DIESEL MOTOR CO. LIMITED  
Y.K. Almoayyed & Sons  
P.O. Box 143  
Manama

PERKINS ENGINES LIMITED  
Yusuf Bin Ahmed Kanoo  
P.O. Box 45  
Bahrain

Telex: 6215 GJ  
Cables: Kanoo  
Phone: 4081-9

PETTERS LIMITED  
Khalil M.K. Alsharif  
Bahrain Workshop  
P.O. Box 404  
Manama

Cables: Bahworks  
Phone: 51730

JOHN ROBSON (SHIPLEY) LIMITED  
Y.K. Almoayyed & Sons  
P.O. Box 143  
Bahrain

#### Bangladesh

BRIGGS & STRATTON  
CORPORATION  
Auto Equipment  
58, Motijheel Commercial Area  
Dacca 2

Cable: Autoquip  
Phone: 251708

CATERPILLAR OVERSEAS SA  
Greenland Engineers & Tractors  
Co. Ltd.  
7 Shantibagh  
P.O. Box 541  
Dacca 17

Cables: Mechanical

DORMAN DIESELS LIMITED  
Hives Engineering Limited  
P.O. Box 865  
American Life Insurance Building  
4th Floor (Pent House)  
18-20 Motijheel Commercial Area  
Dacca 2

Cables: Hives  
Phone: 246183, 246184,  
252867

KIRLOSKAR OIL ENGINES  
LIMITED  
Dacca Fibres Limited  
125/A Motijheel Commercial Area  
Dacca 2

Telex: 843 Dacfib  
Cables: Dacfib  
Phone: 282191/3

KLOCKNER-HUMBOLDT-  
DEUTZ AG  
Deutz-Bangladesh Limited  
31, Bangabandhu Avenue  
P.O. Box 249  
Dacca 2

Telex: Res. 302905  
Cables: Deutzmotor  
Phone: 280959, 250279

LEYLAND INTERNATIONAL  
Macneill & Kilburn Limited  
PSL Building  
(Hotel Inter Continental)  
P.O. Box 36  
Dacca 2

Cables: Macneills  
Phone: 255434/5/6

LUCAS SERVICE OVERSEAS  
LIMITED  
Levatus (Bangladesh) Limited  
Globe Chamber  
104 Motijheel Commercial Area  
Dacca

Cables: Levatus  
Phone: 257226 254868

PERKINS ENGINES LIMITED  
Shahnawaz (Bangladesh) Limited  
9/C Motijheel  
Dacca 2

Cables: Autoshez  
Phone: 245482, 246011,  
246012

PETBOW LIMITED  
Blackwood Hodge (Bangladesh) Limited  
P.O. Box 453  
Dacca 2

PETTERS LIMITED  
M.E.T.C.O.  
(Machinery & Equipment  
Trading Co.)  
P.O. Box 541  
7 Shantibagh  
Dacca 17

Phone: 25 1217, 25 3497

WHITE ENGINES  
INCORPORATED  
S.M. Bazlool Huq & Company  
Hossain Chamber (2nd Floor)  
105, Agrabad Commercial Area  
P.O. Box 350  
Chittagong

Cables: Bazlool Co  
Chittagong  
Phone: 83838

#### Barbados

CATERPILLAR OVERSEAS SA  
USI West Indies Limited  
Bosvigo  
Eagle Hall  
P.O. Box 178  
Bridgetown

Telex: WB258  
Cables: Usiwil Bridgetown  
Phone: 6-5072

KOHLER INTERNATIONAL LIMITED  
Central Foundry Ltd  
P.O. Box 240  
Pierhead Lane  
Bridgetown

LEYLAND INTERNATIONAL  
Dowding Estates & Trading Co. Ltd.  
1372-1376 Bay Street  
Bridgetown

Cables: Detco Barbados  
Phone: 64697

LUCAS SERVICE OVERSEAS  
LIMITED  
Harrisons Electrical Co. Limited  
Lucas House  
Tudor Street  
P.O. Box 304  
Bridgetown

Telex: 301  
Cables: Harrison  
Bridgetown

PERKINS ENGINES LIMITED  
Alstons Marketing Company  
Limited  
P.O. Box 24 (Fontabelle)  
Bridgetown

Cables: Wiljohn  
Barbados  
Phone: 93143 93432

PETTERS LIMITED  
Central Foundry Limited  
P.O. Box 240  
Bridgetown

Cables: Cenfoundry  
Phone: 64365

#### Belgium

ALLIS CHALMERS  
Societe Anonyme Hilaire Van  
Der Haeghe E  
Boomssteenweg 174  
B2610 Wilrijk

Telex: (3) 566  
Cables: VDH WIL b  
Phone: 031/38.10.80

BRIGGS & STRATTON  
CORPORATION  
S.A. Mertens & Straet  
50-54 Rue du Printemps  
1050 Brussels

Telex: 25754  
Cables: Ametradox  
Phone: (02) 6486445  
(10L)

CATERPILLAR OVERSEAS SA  
Treceo - Tractor & Equipment  
Company S.A.  
Steenweg op Brussels 340  
B-1900 Overijse

Telex: 23386 BRU  
Cables: Trecoosa Brussels  
Phone: (02) 687-60-20

DORMAN DIESELS LIMITED  
Constructiewerkhuis  
E Van Wingen PVBA  
Terneuzenlaan 23  
9000 Gent

Telex: 11 071  
Phone: (91) 51 12 33

FORD MOTOR COMPANY  
LIMITED  
Ford Motor Company (Belgium) S.S.  
P.O. Box 27  
B2030 Antwerp

Telex: 31460  
Phone: 410080

L. GARDNER & SONS LIMITED  
Automobiles Miesse S.A.  
42-44 Rue des Goujons  
Brussels

Phone: 02/522.03.45

KLOCKNER-HUMBOLDT-  
DEUTZ AG  
S.A. Magirus-Deutz N.V.  
12-14 Place de la Gare  
Berchem-Ste-Agathe  
B1080 Brussels

Telex: Deutz Bru 21597  
Cables: Magirus-Deutz  
Phone: 4656566  
4657178

LEYLAND INTERNATIONAL  
British Leyland (Belgium) S.A.  
1 Eggestraat  
B-2800 Mecheien

Telex: 25159 Britbe or  
22487 Flywheel  
Phone: 45833

NISSAN DIESEL MOTOR COMPANY  
LIMITED  
Maternaco, S.A.  
710-718 Ch de Louvain  
Brussels

PERKINS ENGINES LIMITED  
Ets Hunter & Co. P.V.B.A.  
St. Bernardsteenweg 858/864  
B2710 Hoboken  
Antwerp

Telex: 31 958 Perkun B  
Cables: Perkhunt  
Phone: 031-27 39 70

RUGGERINI MOTORI Sp.A  
Marine Motors Agencies  
Verbindingsdok W.K. 12A  
2000 Antwerp

Telex: 31488 Marimo B

WHITE ENGINES  
INCORPORATED  
Marine Motors Agencies  
Verbindingsdok W.K. 12a  
Antwerp

Telex: Marinmotor  
Antwerp 31488  
Cable: Marinmotors  
Phone: (02) 15-73-53

#### Belize

CATERPILLAR OVERSEAS SA  
R.H. Eyles & Sons Limited  
North Front Street  
P.O. Box 8  
Belize City

Cables: Eyles Belize  
Phone: 2369

DORMAN DIESELS LIMITED  
The Belize Electricity Board  
P.O. Box 327  
Belize City

Cables: Electricity  
Phone: 3404 and 2141

LEYLAND INTERNATIONAL  
Belize Distributors Limited  
77 North Front Street  
P.O. Box 145  
Belize City

Cables: Distribution  
Phone: 2500, 2501, 2514

LUCAS SERVICE OVERSEAS  
LIMITED  
Belize Distributors Ltd  
77 North Front Street  
P.O. Box 145  
Belize

Cables: Distribution Belize  
Phone: 2500, 2501, 2514

PERKINS ENGINES LIMITED  
Hofius Limited  
P.O. Box 226  
19 Albert Street  
Belize City

Cables: Hofius  
Phone: 2231/2

#### Benin

CATERPILLAR OVERSEAS SA  
Soger A.O.  
B.P. 33  
Cotonou

Telex: 5232  
Phone: 31 33 59

LEYLAND INTERNATIONAL  
Cie Francaise De l'Afrique  
Occidentale  
Agence Centrale  
P.O. Box 908  
Cotonou

Cables: Senafrika Cotonou

PERKINS ENGINES LIMITED  
Sogre-Ao  
B.P. 33  
Akpakpa

Telex: Ergenep 232  
Cables: Gastonegre Cotonou  
Phone: 23-77/23-80/33-18

#### Bermuda

BRIGGS & STRATTON  
CORPORATION  
Masters Limited  
Front Street  
Hamilton

Telex: 3430  
Cables: Mastand  
Phone: 5-4321

KOHLER INTERNATIONAL  
LIMITED

The Bermuda Motor & Cycle  
Accessories Co. Ltd.  
P.O. Box 1005  
Dundonald Street West  
Hamilton

LEYLAND INTERNATIONAL  
Pearman Watlington & Company  
P.O. Box 840  
Hamilton

Telex: 3246  
Cables: Triton  
Phone: 809-29-53232

LUCAS SERVICE OVERSEAS  
LIMITED

The Bermuda Motor & Cycle  
Accessories Co. Ltd.  
The Lucas House  
P.O. Box 1005  
Hamilton

Cables: Accessories  
Phone: 50736

PERKINS ENGINES LIMITED  
The Bermuda Motor & Cycle  
Accessories Co. Ltd.  
P.O. Box 1005  
The Lucas House  
Hamilton

Cables: Accessories  
Phone: 1-3186

PETERS LIMITED  
Burland Conyers & Marirea  
Limited  
P.O. Box 292  
St. John's Road  
Pembroke

Cables: Burlandco  
Phone: 2-2067

#### Bhutan

KIRLOSKAR OIL ENGINES  
LIMITED  
Tashi Commercial Corporation  
P.O. Phuntsholing

Cables: Tashi  
Phone: 63

**Bolivia**

**BRIGGS & STRATTON CORPORATION**  
Hansa Ltda  
Cajon Postal No. 1402  
La Paz

Telex: BX 5261  
Cables: Hansa  
Phone: 54426

**CATERPILLAR OVERSEAS SA**  
International Machinery Co.  
(Bolivia) S.A.  
Casilla 852  
La Paz

Telex: 5227  
Cables: Intermaco  
Phone: 40972, 53787

**DORMAN DIESELS LIMITED**  
MacDonald & Co. (Bolivia) S.A.  
Casilla 879  
La Paz

Telex: BX 5262  
Cables: Donal  
Phone: 54 380-12

**KATOLIGHT LIMITED**  
Cablebol  
P.O. Box 394  
Cochabamba

**KLOCKNER-HUMBOLDT-DEUTZ AG**  
Hansa Ltda.  
Mercado  
esquina Yanacocha  
Cajon Postal 1402  
La Paz

Telex: BX 5261  
Cables: Hansa  
Phone: 54426

**KOHLER INTERNATIONAL LIMITED**  
Tecna Limitada  
Casilla 4360  
Avenida Montes 437, Esq  
Batallon Ilimany  
La Paz

**LEYLAND INTERNATIONAL**  
Linale & Weiss SA.  
Avenida Montes 603/605  
Castilla de Correo 216  
La Paz

Cables: Linale

**LUCAS SERVICE OVERSEAS LIMITED**  
Hansa Ltda  
Cajon Postal 1402  
Calle Mercado Esquina Yanacocha,  
La Paz

Telex: 5261  
Cables: Hansa  
Phone: 54425, 54445,  
53661

**NISSAN DIESEL MOTOR CO. LIMITED**  
Compania Comercial Industrial  
Bolivia  
P.O. Box 954  
La Paz

**PERKINS ENGINES LTD**  
S.A.C.I. (Sucs) De Simon F. Bedoya  
Ingavi 1058  
La Paz

Telex: 3560009-5311  
Cables: Saci  
Phone: 55114-53706-55075

**PETERS LIMITED**  
Sociedad Anonima Comercial  
Industrial  
Calle Ingavi 1058  
Casilla 346  
La Paz

Telex: ITT 3560009  
Cables: Saci  
Phone: 55075, 55797,  
53706

**WHITE ENGINES INCORPORATED**  
Martin Cia S.A.  
Casilla 1467  
La Paz

Telex: Martin BX 5269  
Cables: Martin

**Botswana**

**CATERPILLAR OVERSEAS S.A.**  
Botswana Earthmoving Machinery  
Co. (Pty) Ltd.  
Dumela Industrial Sites  
P.O. Box 137  
Francistown

Telex: 212BD  
Cables: Tractors  
Phone: 547

**KATOLIGHT LIMITED**

K.G. Council Ltd  
P.O. Box 879  
Gaborone

**Brazil**

**BRIGGS & STRATTON CORPORATION**  
Borghoff S/A  
Rua Riachuelo 243  
Caixa Postal 6-19  
Rio de Janeiro

Cables: Borgmagneto  
Phone: 242-3720

**CATERPILLAR BRAZIL S.A.**  
Av. des Nacoes Unidas 1516  
Mail address: Caixa Postal  
8239 01.000  
Sao Paulo SP

Telex: 391-21132  
Cables: Caterpillar-SP  
Phone: 247-1011/5919/  
1100.

**DORMAN DIESELS LIMITED**  
Cobrel Maquip S.A.  
Comercio e Engenharia  
Avenida Rio Branco 138  
7th Floor Bozano Simonsen  
Building  
Rio de Janeiro  
ZC-21-CE P20-000

Telex: (38) 31505 Boznes  
Phone: Rio de J 2241422

**FORD MOTOR COMPANY LIMITED**  
Ford Willys Do Brazil S.A.  
Caixa Postal 8610  
Sao Paulo

Phone: 63-5151

**KLOCKNER-HUMBOLDT-DEUTZ AG**  
Otto Deutz S.A.  
Motores e Motores  
Mailing address  
Caixa Postal 841  
09700 Sao Bernardo do Campo

Telex: 114179 Deut BR  
Cables: Ottodeutz

**KOHLER INTERNATIONAL LIMITED**

Eximport/Importacao e  
Exportacao Ltda  
P.O. Box 76  
Rua Marechal Deodoro 75-A Sala 10  
Manaus  
Amazonas

**LEYLAND INTERNATIONAL**  
Phillippe Daou S.A.  
Rua Marcilio Dias 134  
Caixa Postal 254  
Manaus

**LUCAS SERVICE OVERSEAS LIMITED**  
CAV do Brasil S.A. Ind. e. Com.  
Rodovia Raposo Tavares  
Km 30  
Cotia Sao Paulo

Telex: 1121412  
Cables: Lucasbrasil and  
Vanteri  
Phone: 211-7576

**PERKINS ENGINES LIMITED**  
Motores Perkins S.A.  
Caixa Postal 30 028 c  
Sao Paulo  
CEP 09700  
Estado de Sao Paulo

Telex: 114013  
Cables: Perkoil  
Phone: 448-1499

**PETERS LIMITED**  
Moto Importadora  
P.O. Box 94  
Free Zone  
Manaus  
Amazonas

Telex: 922188 Moto BR  
Cables: Motoimportadora  
Phone: 25060 27008

**VOLVO PENTA**  
Carbrasmar S.A. Industria  
e Comercio  
Av. Brasil 14936  
Caixa Postal 1449  
Rio De Janeiro 91

Telex: Public Booth  
031903 for  
Carbrasmares  
Cables: Carbrasmares  
Phone: 30-9830  
30-9955

**British Virgin Islands**

**PERKINS ENGINES LIMITED** Phone: 42268  
 Diesel Marine Supply (Tortola)  
 Limited  
 P.O. Box 61

**Brunei**

**CATERPILLAR OVERSEAS SA**  
 Tractors Malaysia Berhad -  
 Jalan Setia Di-Raja  
 P.O. Box 268  
 Kuala Belait

**LEYLAND INTERNATIONAL** Telex: RS 400 (for Champ-  
 Champion Motors (Singapore) motora)  
 Pte. Ltd. Cables: Champmotor  
 P.O. Box 627 Phone: 283619  
 31 Leng Kee Road  
 Singapore 3

**LUCAS SERVICE OVERSEAS SA** Telex: 21772 Wearnes  
 Far East Motors (Pt.) Ltd Cables: Ignition  
 54 Orchard Road Phone: 328341/8  
 P.O. Box 2697  
 Singapore 9

**Bulgaria**

**DORMAN DIESELS LIMITED** Telex: 95531 Guestelx  
 Guest Industrials Limited SVKS  
 Engineering Division Cables: Guestind Sevenoaks  
 Tubs Hill House Phone: Sevenoaks 59311  
 London Road  
 Sevenoaks  
 Kent  
 U.K.

**PETTERS LIMITED** Telex: 284 BG  
 Interpred Pirin Phone: 87.14.41  
 Room 401  
 2 Stara Post Street  
 Sofia

**Burundi**

**CATERPILLAR OVERSEAS SA** Cables: Chanusa  
 Chanic Phone: 3284  
 B.P. 930  
 Bujumbura

**LEYLAND INTERNATIONAL** Cables: Broche  
 Compagnie De L'Afrique Orientale Phone: 2692/3  
 'Old East' S.A.R.L.  
 Bp. 330  
 Bujumbura 37

**Burma**

**ALLIS CHALMERS** Telex: Ubrmeic BM 2005  
 Myanmar Export Import Corporation Cables: Myanagent  
 (Agency Division) Phone: 13420, 18164  
 77/91 Sule Pagoda Road  
 P.O. Box 404  
 Rangoon

**CATERPILLAR OVERSEAS SA** Telex: HX3305 CFEL  
 Caterpillar Far East Ltd. Cables: Catfareast HKG  
 P.O. Box 3069  
 Hong Kong

**DETROIT DIESEL ALLISON** Telex: 31476  
 Blackwood Hodge Group Cables: Suntract  
 Services Ltd. Phone: 0604-61111  
 Hunsbury Hill Avenue  
 Northampton  
 NN4 9QT  
 U.K.

**DORMAN DIESELS LIMITED** Telex: Ubrmeic BM 2005  
 Myanmar Export Import Corporation Cables: Myanagent Rangoon  
 (Agency Division) Phone: 13420, 18164  
 77/91 Sule Pagoda Road  
 P.O. Box 404  
 Rangoon

**KLOCKNER-HUMBOLDT-DEUTZ AG** Telex: Ubrmeic BM 2005  
 Myanmar Export Import Cables: Myanagent Rangoon  
 Corporation Phone: 13420, 18164  
 (Agency Division)  
 77-91 Sule Pagoda Road  
 Rangoon

**LEYLAND INTERNATIONAL** Cables: Autocars  
 Autocars (Burma) Limited  
 55 Barr Street  
 P.O. Box 257  
 Rangoon

**LUCAS SERVICE OVERSEAS LIMITED** Telex: 2017  
 Myanmar Export Import Corporation Cables: Myanagent  
 (Agency Division) Phone: 11258  
 77/91 Sule Pagoda Road  
 Rangoon

**PERKINS ENGINES LIMITED** Telex: VBMEIC BM 2005  
 Myanmar Export & Import Cables: Myanagent  
 Corporation Phone: Rangoon 13429,  
 (Agency Division) 18164  
 P.O. Box 404  
 77/91 Sule Pagoda Road  
 Rangoon

**WHITE ENGINES INCORPORATED** Telex: 232886  
 Dodge & Seymour Cables: Eximco Newyork  
 XM World Trade Incorporated Phone: (212) 432-5200  
 Ona World Trade Center  
 Suite 4501  
 New York 10048  
 U.S.A.

**Cameroon**

**CATERPILLAR OVERSEAS SA** Telex: 5217 KN  
 S.H.O. Cameroun Departement Cables: Tractaftric  
 Tractaftric Phone: 42-40-83  
 B.P. 4017  
 Douala

**DETROIT DIESEL ALLISON** Telex: 842-650043 Paris  
 Division Matforce Diesel France  
 C.I.A.C.A.M. Cables: Nigarfrin Paris  
 P.O. Box 4025 8 France  
 Douala Phone: 256-72-00 Paris  
 France

**DORMAN DIESELS LIMITED** Telex: 5207 A/B Zochonis  
 Paterson Zochonis & Co. Ltd. DLA  
 P.O. Box 4009 Cables: Zochonis  
 Avenue R Poincare Phone: 42-18-78  
 Douala

**KLOCKNER-HUMBOLDT-DEUTZ AG** Telex: 5237  
 Valcke Freres Phone: 42507  
 Unterverretang: Dacam  
 Route du Docteur Jamot  
 B.P. 4028  
 Douala

**LEYLAND INTERNATIONAL** Cables: Zochonis Douala  
 Paterson Zochonis & Co. Ltd.  
 B.P. 4009  
 Douala

**LUCAS SERVICE OVERSEAS LIMITED** Telex: 5320  
 S.O.C.O.M.I. Phone: 42.46.66.42.31.81  
 P.O. Box 4025  
 Douala

**PERKINS ENGINES LIMITED**  
Socomi  
Rue Jarnot  
B.P. 609  
Douala

Telex: 5272  
Cables: Somatin  
Phone: 42.35.40

#### Canada

**BOMBARDIER-ROTAX GmbH**  
Bombardier Limited  
Valcourt

Telex: 5832550 —  
Purchasing Dept.  
5832551 —  
Research Dept.  
Phone: (514) 532-2211

**JOE ZLO**

Phone: (514) 532-2211

**CATERPILLAR OVERSEAS SA**  
Caterpillar of Canada Limited  
1550 Caterpillar Road  
Mississauga  
Ontario

Telex: 06-961149/961151  
(from U.K.)  
Phone: (416) 279-9901

**DORMAN DIESELS LIMITED**  
Ruston Diesels Limited  
2 Paxman Road  
Etobicoke  
Ontario  
M9C 1B6

Telex: 06-967542  
Spares/Depot  
06-967721  
Cables: Ruston Toronto  
Phone: Toronto 622  
3060/3 (Area  
Code 416)

**FORD MOTOR COMPANY LIMITED**

Ford Motor Company of  
Canada Limited  
Industrial Products Dept.  
National Parts Dept.  
8000 Dixie Road  
Bramalea  
Ontario

Telex: 0229161  
Phone: 459 2210

**L. GARDNER & SONS LIMITED**  
Western Diesel Sales & Manufacturing  
Limited  
25 Victoria Drive  
Vancouver B.C.

**KLOCKNER-HUMBOLDT-  
DEUTZ AG**  
Deutz Diesel (Canada) Ltd.  
90 Montee de Liesse  
Montreal  
Quebec H4T 1N4

Telex: 5-826776  
Cables: Airdiesel MTL  
Phone: 5-826776

**LEYLAND INTERNATIONAL**  
British Leyland Motors Canada  
Limited  
P.O. Box 5033  
4445 Fairview Street  
Burlington  
Ontario L7R 4A3

Telex: 061 8678  
Cables: Leymotcan  
Burlington  
Phone: (416) 632-3040

**LUCAS SERVICE OVERSEAS LIMITED**  
Lucas Industries Canada  
Automotive Equipment Division  
280 Yorkland Boulevard  
Wilowdale  
Ontario M2J 1R9

Telex: Lucas Tor  
06-966552  
Cables: Lucasparts Toronto  
Phone: 416-491-3520

**PERKINS ENGINES LIMITED**  
Perkins Engines Canada Ltd  
7 Meridian Road  
Rexdale  
Ontario

Telex: 0221225  
Cables: Perkoil Toronto  
Phone: 677/4960

**PÉTTERS LIMITED**  
Scona Electric Limited  
9950-75th Avenue  
Edmonton  
Alberta

Phone: 403-433-7779

**VOLVO PENTA**  
Atlas Polar Company Limited  
60 Northline Road  
P.O. Box 160  
Toronto 374  
Ontario

Telex: 0696-3580  
Cables: Atlaspolar  
Phone: 757-5131

#### Canary Islands

**DETROIT DIESEL ALLISON**  
Miquel Ortega S.A.  
Carlos Maurício Blandy  
44-48 Las Palmas de Gran Canaria

Telex: 22456 Madrid Spain  
Cables: Mitega Madrid Spain  
Phone: 20.13.35

**DORMAN DIESELS LIMITED**  
Blandy Brothers Y Cia S.A.  
Apartado No. 176  
Santa Cruz de Tenerife

Telex: Ten 92341 Blande  
Cables: Blandybros  
Phone: 2264.40/4

**KLOCKNER-HUMBOLDT-  
DEUTZ AG**  
Talleres Venequeras  
C/Gordillo, s/n Q  
Espigón del Castillo  
Puerto de la Luz

Phone: 263615  
261858

**LEYLAND INTERNATIONAL**  
Blandy Brothers & Co. S.A.  
Leon Y Castillo 535  
P.O. Box 24  
Las Palmas

Cables: Blandy Bros.  
Las Palmas  
Phone: 26.33.40-4

**PERKINS ENGINES LIMITED**  
Blandy Brothers Y Cia S.A.  
Carretera del Rosario  
Km.5 TACO  
Santo Cruz de Tenerife

Telex: 92341 Blan-E  
Cables: Blandybros  
Phone: 226440/5

**RUGGERINI MOTORI SpA**  
Inesa S.A.  
Imeldo Seris 51 alto  
Santa Cruz de Tenerife

**VOLVO PENTA**  
Macmor S.A.  
Edificio Doramas  
Avda de Escaleritas Num 70  
Las Palmas de Gran Canaria

Cables: Macmor  
Phone: 25 30 44, 25 09 55  
25 43 02, 25 32 89.

#### Cape Verde

**CATERPILLAR OVERSEAS SA**  
Sociedade Tecnica de Equipamentos  
e Tractores S.A.R.L.  
Apartado 1351  
Lisbon  
Portugal

Telex: 12778  
Cables: Stetra Sacavem  
Phone: 251-1011

**LEYLAND INTERNATIONAL**  
C. De Vasconcelos (Herdeides) Ltda  
Caixa Postal 4  
Praia  
Cape Verde Islands

Cables: Tamu Praia

#### Central African Republic

**CATERPILLAR OVERSEAS SA**  
S.H.O. Centrafrique Département  
Tractafric  
B.P. 959  
Bangui

Telex: 5252 (014)  
Cables: Tractafric  
Phone: 2420

**LEYLAND INTERNATIONAL**  
SIMA Service Autos  
B.P. 820  
Bangui

**PERKINS ENGINES LTD.**  
Somecal  
B.P. 294  
Bangui

Telex: Penteco 5228  
Phone: 27.63

#### Chad

**CATERPILLAR OVERSEAS SA**  
S.H.O. Tchad  
Département Tractafric  
B.P. 450  
N'djamena

Telex: 5214 KD  
Cables: Tractafric N'djamena  
Phone: 24-51

DETROIT DIESEL ALLISON  
Nouvelle Societe Commerciale, du  
Kouitou Niari  
P.O. Box 476  
Fort Lamay

Cables: Unasedec  
Phone: 2800

LEYLAND INTERNATIONAL  
SCOA Service Autos  
B.P. 474  
Fort Lamay

LUCAS SERVICE OVERSEAS  
LIMITED  
Tchadis Auto  
B.P. 474 M'Djamena

Telex: 5241  
Phone: 2664

PERKINS ENGINES LTD.  
N.S.C.K.N.  
P.O. Box 476  
Fort Lamay

Telex: 5210  
Cables: Sedec  
Phone: 28 07

#### Chile

ALLIS CHALMERS  
SALFA S.A.C.I.  
Avenue Rondizzoni 2130  
Casilla 1089  
Santiago

Telex: 3520063  
Cables: Salfa  
Phone: 93031, 93032,  
93033

BOMBARDIER-ROTAX GmbH  
Fabrica de Cerraduras  
y Candados POLI  
Casilla 129  
Buin

BRIGGS & STRATTON  
CORPORATION  
Lanz y Cia Ltda  
Casilla 16389 - Correo 9  
Santiago

Telex: 40637 CL  
Cables: Lanz  
Phone: 74 06 73

CATERPILLAR OVERSEAS SA  
Gildemeister S.A.C.  
Agustinas - Esquina Amunategui  
Casilla 99-D  
Santiago

Telex: 392, 40588  
Cables: Gildemeist  
Phone: 82525

DETROIT DIESEL ALLISON  
Jaras y Cia Ltda.  
Sucesores de Raul Jaras Barros  
y Cia. Ltda.  
Av. Baron de Juras Reales 5250  
P.O. Box 10114  
Santiago

Telex: Jarasca SG0334 or  
RCA 332-334  
Cables: Jarasca  
Phone: 777-807

DORMAN DIESELS LIMITED  
Cia Minera y Comercial Sali  
Hochschild  
Casilla 3127  
Santiago

Telex: Public Booth  
Santiago 260 - for  
Sali Hochschild  
Section Equipos  
Cables: Hochschild  
Phone: 713118

KLOCKNER-HUMBOLDT-  
DEUTZ AG  
Estudiantes 150  
(Loreta Altura 400)  
Portugal 160  
Casilla Correo 2116  
Santiago

Telex: Sgo.369  
Cables: Socoa  
Phone: 770475

KOHLER INTERNATIONAL  
Distribuidora Industrial Y Agrícola  
Del Sur A.  
P.O. Box 1625  
San Antonio 1625  
Santiago

LEYLAND INTERNATIONAL  
Javier Echeverría y Cia Saci  
Avda San Francisco 121  
Santiago

Cables: Echev

LUCAS SERVICE OVERSEAS S.A.  
Servicio Lucas-Blandford S.A.  
General Mackenna 1238  
P.O. Box 4D  
Santiago

Cables: Blandford  
Phone: 711420

PERKINS ENGINES LTD.  
Distribuidora Perkins Chilena Ltda  
Avenida Espana 69  
Casilla 14931  
Santiago

Telex: Cummhile SG0  
260 for Perkchile  
Cables: Perkchile  
Phone: 82113/4/5

PETTERS LIMITED  
E. Thurston & Cia Ltda  
Avenida Gral Buines 204  
Casilla 9032  
Santiago

Telex: SG0 260  
Edplumpton  
Cables: Edplumpton  
Phone: 66476

VOLVO PENTA  
Divolvo S.A.  
Echaurren 11 esq. Alameda  
Casilla 14085  
Santiago

Telex: SG0-260 (with  
address)  
Cables: Divolvo  
Phone: 68530, 82174,  
80900

WHITE ENGINES  
INCORPORATED  
Alberto Grunwald S.  
Casilla 9931  
Santiago

Phone: 94331

#### China

DORMAN DIESELS LIMITED  
Biddle Sawyer & Co. Limited  
32 St Mary at Hill  
London EC3R 8DH  
U.K.

Telex: 887971 Bidrouplat  
Cables: Bidsawya London  
Phone: 01-623 9333

L. GARDNER & SONS LIMITED  
Dodwell & Co. Limited  
P.O. Box 36  
Hong Kong

Telex: Dodco HX 3204  
Phone: H237011

LEYLAND INTERNATIONAL  
Biddle Sawyer & Co. Limited  
Plantation House  
Mincing Lane  
London EC3  
U.K.

Telex: 28266/28221  
Cables: Bidsawya  
Phone: 01-623 9333

#### Colombia

ALLIS CHALMERS  
Colombiana del Caribe S.A.  
(Colcaribe)  
Carrera 43 No. 12.8.61  
Apartado Aereo 80317  
Bogota

Telex: 044-676 Holunie  
Phone: 47-11-12, 47-74-28,  
47-25-72

BRIGGS & STRATTON  
CORPORATION  
Larsen, Vargas & Cia Ltda  
Apartado Aereo 5199  
Av. 5 No. 9-30  
Bogota

Cables: Larco  
Phone: 419-481

CATERPILLAR OVERSEAS SA  
General Electric de Colombia S.A.  
Km 7 Carretera a Bosa  
Apartado Aereo 3644 y 6799  
Bogota

Telex: 044-704  
Cables: Gécolsa  
Phone: 384020, 384032,  
304452, 704

DETROIT DIESEL ALLISON  
Motores S.A.  
Avenida Las Americas 39A-95  
Apartado Aereo 80040  
Zona Postal No. 6  
Bogota

Telex: 396-044887  
Cables: Motores  
Phone: 693066

DORMAN DIESELS LIMITED  
Tracey & Compania S.A.  
Apartado Aereo 3597  
Calle 13 No. 23-60  
Bogota

Telex: Bog 44675  
Cables: Tracey  
Phone: 43.94.72

FORD MOTOR CO. LIMITED  
Mr. Stewart  
Calle 19 No.7-30  
Room 807  
Bogota 1

KATOLIGHT LIMITED  
Electrointerandina Ltda  
Apartado Aereo 1237  
Bogota

KLOCKNER-HUMBOLDT-  
DEUTZ AG  
Held & Cia S.A.  
Edificio de la Bolsa.  
Calle 14 No. 8-79  
Oficinas 718  
Bogota

Telex: 44785  
Cables: Pluto  
Phone: 414202, 416025

KOHLER INTERNATIONAL  
Boza & Cia Ltda  
Carrera 13 No. 16-66  
Bogota

LEYLAND INTERNATIONAL  
Praco Limitada  
Calle 13 No. 3236  
Bogota

Cables: Praco

LUCAS SERVICE OVERSEAS  
LIMITED  
Laboratorios Electro-Diesel Ltda  
Calle 47 No. 43-70  
Apartado Aereo 21-26 (Airmail)  
Barranquilla

Cables: Eldiesel  
Phone: 25150, 23284

PERKINS ENGINES LIMITED  
Casa Inglesa Ltda  
Via 40 No.53-59  
Apartado Aereo No. 13 (Airmail)  
Barranquilla

Cables: Ivor  
Phone: 12-072, 15019,  
11810, 11

PETERS LIMITED  
C.J. Jacobsthal  
Resident Regional Executive  
Apdo Aereo 91105 Chico  
Bogota

Cables: Teediesel  
Phone: 567662

RUGGERINI MOTORI Spa  
Industrias Forestales S.A.  
Apartado Aereo 53039  
Bogota

WHITE ENGINES  
INCORPORATED  
Corporacion de Repuestos y  
Maquinaria Ltda  
(Corema Ltda)  
Carrera 30 No. 22C-19  
Bogota

Telex: Holo Co 44676  
Cables: Corema  
Phone: 69-56-03

#### Congo

CATERPILLAR OVERSEAS SA  
S.H.O. Congo  
Département Tractafric  
B.P. 697  
Pointe Noire

Telex: 8217 (014)  
Cables: Tractafric  
Phone: 2867, 2869

DETROIT DIESEL ALLISON  
Société Commerciale Du  
Kouilou Niari-Congo  
P.O. Box 34  
Brazzaville

Cables: SCKN  
Phone: 28-01

KLOCKNER-HUMBOLDT-  
DEUTZ AG  
Davum Outre-Mer  
B.P. 691  
Pointe Noire

Telex: 8201  
Cables: Davum  
Phone: 2593/4

LEYLAND INTERNATIONAL  
Cie Francaise De L'Afrique  
Occidentale  
Agence Centrale  
B.P. 247  
Brazzaville

Cables: Senafrica

LUCAS SERVICE OVERSEAS  
LIMITED  
Marforce Diesel (Div. of SCKN)  
B.P. 146  
Pointe Noire

Telex: 403  
Cables: Sedec  
Phone: 28-01, 28-05

PERKINS ENGINES LIMITED  
S.A. Pierre Gonthier  
Mécanique Générale  
B.P. 205  
Brazzaville

Telex: 5254 KG  
Phone: 29.09

#### Cook Islands

LEYLAND INTERNATIONAL  
The Cook Islands Trading  
Corporation Ltd.  
P.O. Box 92  
Haratonga

Telex: Citco RG 2013  
Cables: Donald

#### Costa Rica

ALLIS CHALMERS  
Tractomotriz S.A.  
Avenida 10-Calle 36 2244  
Apartado 10255  
San Jose

Telex: 2244  
Cables: Tractosa San Jose  
Phone: 22.48.94,  
22.49.94

BRIGGS & STRATTON  
CORPORATION  
Ortiz & Cia Ltda  
Apartado 4194  
San Jose

Cables: Zitro  
Phone: 22.43:07

CATERPILLAR OVERSEAS SA  
Machinery & Tractors Ltd.  
La Uruca  
P.O. Box 426  
San Jose

Telex: C.R.110  
Cables: Matra  
Phone: 21.00:01

DETROIT DIESEL ALLISON  
Tractomotriz S.A.  
Apartado No. 10255  
San Jose

Telex: 3032244  
Cables: Tractosa  
Phone: 224894

DORMAN DIESELS LIMITED  
Aceinca Ltda  
Apartado 203  
Puntarenas

Cables: Aceinca  
Phone: 61.01.28

KATOLIGHT LIMITED  
Equipos Nieto S.A.  
Apartado 1353  
San Jose

KLOCKNER-HUMBOLDT-  
DEUTZ AG  
Franz Amrhein & Co. Limited  
FACO  
Apartado 1766  
CR - San Jose

Cables: Amrhein  
Phone: 229188

KOHLER INTERNATIONAL  
LIMITED  
Apartado 66  
San Pedro Montes De Oca  
San Jose

Cables: Kohlerint  
Phone: 25.94.10, 24.13.71

LEYLAND INTERNATIONAL  
Auto Europeos S.A.  
P.O. Box 10030  
Paseo Colon v Calle 38  
San Jose

Cables: Autoro



**LUCAS SERVICE OVERSEAS LIMITED**

Electro-Diesel Ltda  
Avenida Central  
Calle 19/21  
P.O. Box 4112  
San Jose

Cables: Eldiesel  
Phone: 223518, 223618

**NISSAN DIESEL MOTOR CO. LIMITED**

Autopista General Canas  
Apartado 10223  
San Jose

**PERKINS ENGINES LIMITED**

Almacen El Estre S.A.  
P.O. Box 730  
San Jose

Telex: CR-2143  
Cables: Alesa  
Phone: 21-43-92

**PETERS LIMITED**

Ferreteria Miguel  
Macaya & Cia Ltda  
Apartado 268  
San Jose

Cables: Macaya  
Phone: 22.20.20/21

**WHITE ENGINES INCORPORATED**

Alberto Arco S.A.  
Apartado 296  
Calle 3 Norte No.150  
San Jose

Telex: CR-181  
Cable: Larce  
Phone: 22.45.55

**Crete (Greece)**

**BOMBARDIER-ROTAX GmbH**  
Eleftheris Hatzidakis  
1 Daedalus Street - 3rd Floor  
P.O. Box 146  
Iraklion

Phone: 223-357/284-420

**CATERPILLAR OVERSEAS SA**

Avras S.A.  
P.O. Box 1250  
Omonia  
Athens

Telex: 21-4661/4662  
Cables: Avratrac  
Phone: 571-6611

**Cuba**

**LEYLAND INTERNATIONAL**  
c/o The Cuban Commercial Office  
54 Conduit Street  
London W.1.  
U.K.

**Cyprus**

**ALLIS CHALMERS**  
General Engineering Company  
Limited  
Ledra Street  
P.O. Box 1208  
Nicosia

Telex: 2434  
Cables: Genco  
Phone: 3034

**CATERPILLAR OVERSEAS SA**

Cyprus Trading Corporation  
Limited  
8 Arnalda Street  
P.O. Box 1083  
Nicosia

Telex: 2415  
Cables: Cytraco  
Phone: 6.20.21/22

**DETROIT DIESEL ALLISON**

Kaisis Engineering Ltd.  
M.Georgalla Street  
P.O. Box 4708  
Nicosia

Telex: 2519 Kaigroup  
Cables: Kaiplant  
Phone: 44348

**DORMAN DIESELS LIMITED**

Ledra Engineering Co. Limited  
Pindarus Street  
No. 5L MNX  
P.O. Box 2255  
Nicosia

Telex: 2363 Promitheus  
Cables: Leco  
Phone: 74180

**L. GARDNER & SONS LIMITED**

G.C. Pierides Limited  
P.O. Box 1011  
Nicosia

Phone: 72024/5/6

**INDIAN NATIONAL DIESEL ENGINE CO. LTD**

Sarvas C. Charalambous  
P.O. Box 1473  
Nicosia

**KATOLIGHT LIMITED**

Fahed Khoury  
Isfa Supplies Ltd.  
P.O. Box 4913  
Nicosia

**KLOCKNER-HUMBOLDT-DEUTZ AG**

Char. Pilakoutas & Sons Limited  
Alexandria Road  
P.O. Box 1168  
Nicosia

Telex: 2245  
Cables: Pilakoutas  
Phone: 76312/3/4

**LEYLAND INTERNATIONAL**

D.J. Demades & Sons Limited  
P.O. Box 1104  
Nicosia  
Cyprus

Telex: Nicosia 2463  
Cables: Didemades  
Phone: 32111/2/3/4

**PERKINS ENGINES LIMITED**

Char. Pilakoutas & Sons Limited  
P.O. Box 1168  
Larnaka Street  
Nicosia

Telex: 2245 Nicosia  
Cables: Pilakoutas  
Phone: 76312/3/4

**PETBOW LIMITED**

Middle East Sales Promotion  
P.O. Box 262  
Larnaca

**PETERS LIMITED**

General Engineering Co. Limited  
P.O. Box 208  
Ledra Street 171-9  
Nicosia

Telex: 2434  
Cables: Genco  
Phone: 3034

**RUGGERINI MOTORI SpA**

Agrararia Limited  
P.O. Box 348  
Limassol

**VOLVO PENTA**

The Amazon Enterprise Limited  
57 Archbishop Makarios 111 Avenue  
P.O. Box 173  
Larnaca

Cables: Amazon  
Phone: 3478  
4027

**Czechoslovakia****CATERPILLAR OVERSEAS SA**

Phoenix Praha A.S.  
Pod Plynojemem  
18000 Prague 8  
Liben

Telex: 122591  
Cables: Phoenix  
Phone: 83.87.90

**PETERS LIMITED**

Intersim Limited  
Topolova 14  
Prague 10  
Zahradni Mesto

Telex: 121963, 121971  
Phone: 753-067, 753-068

**Dalfoamey**

**LUCAS SERVICE OVERSEAS LIMITED**  
John Walkden  
B.P. 24  
Contonou

Telex: 5214  
Phone: 31 30 06

**Denmark**

**BRIGGS & STRATTON CORPORATION**  
Ketner Teknik  
23 Fabriksparken  
DK-2600 Glostrup

Telex: 22211  
Cables: Motorketner  
Phone: (02) 451122

**CATERPILLAR OVERSEAS SA**  
Enmaco A/S  
363 Park Alle  
P.O. Box 138  
2600 Glostrup  
Copenhagen

Telex: 16795  
Cables: Earthmover  
Phone: (01) 45-22-11

**DETROIT DIESEL ALLISON**  
c/o General Motors International  
Borgmester Christiansens Gade 40  
DK-2450 Copenhagen

Telex: 16727  
Cables: Copeautoex  
Phone: 01.302211

**DORMAN DIESELS LIMITED**  
A/S Dorman Diesels (Salg og Service)  
Frydensbergvej 8  
DK 3660 Stenløese

Telex: 42538 Dorman Dk  
Cables: Dorman  
Phone: 03.171455

**FORD MOTOR COMPANY LIMITED**  
Ford Motor Company A/S  
Sluseholmen 1  
2450 Copenhagen S.V.

Telex: 22218  
Phone: 310510

**L. GARDNER & SONS LTD.**  
Dansk Gardner Diesel A/S  
Naerum Hovedgade 1  
2850 Naerum

Telex: 37337  
Phone: (03) 19 22 88

**KLOCKNER-HUMBOLDT-DEUTZ AG**  
Ingeniørfirmaet  
Viggo Bendz A/S  
Roskildevej 519-523  
DK - 2600 Copenhagen - Glostrup

Telex: 22985  
Cables: Viggobendz  
Phone: 964222

**KOHLER INTERNATIONAL**  
Danpower APS  
Houmannsgade 53  
8700 Horsens

**LEYLAND INTERNATIONAL**  
Dansk Oversøisk Motor Industri A/S  
Søndre Ringvej 35  
2600 Glostrup  
Copenhagen

Telex: 33125  
Cables: Domimotors  
Phone: 961410

**PERKINS ENGINES LTD.**  
Fred Rasmussen-Odense  
Pjentedamsgade 21  
Post Box 368  
DK 5100 Odense

Telex: 59866 Freras DK  
Cables: Fredras  
Phone: (09) 112216

**PETERS LIMITED**  
A/S Nordan  
25 Vallensbaekvej  
DK-2600 Glostrup  
Copenhagen

Telex: 33218  
Cables: Nordan  
Phone: (02) 45.88.86

**RUGGERINI MOTORI S.p.A.**  
Fred Rasmussen  
Pjentedamsgade 21  
P.O. Box 368  
DK 5100 Odense

Telex: 59866 Freras DK  
Cables: Fredras  
Phone: (09) 112216

**VOLVO PENTA**  
Firma Johs Thornam  
Indstribuset  
Kalvebod Brygge 20  
1560 Copenhagen V

Telex: 27491  
Cables: Thornam  
Phone: (01) 14 07 82

**WHITE ENGINES INCORPORATED**  
Fred Rasmussen  
Pjentedamsgade 21  
Postigiro 8042  
5100 Odense

Telex: 59886  
Cables: Fredras  
Phone: (09) 112216

**Djibouti**

**CATERPILLAR OVERSEAS SA**  
Anciens Comptoirs Ries  
B.P. 2106  
Djibouti

Telex: 223  
Cables: Ries  
Phone: 2467/2455

**LEYLAND INTERNATIONAL**  
Societe Commerciale de La Mer Rouge  
(SOCOMER)  
B.P. 676  
Djibouti

Cables: Socomer

**PERKINS ENGINES LIMITED**  
T.F.A.I.  
Anciens Comptoirs Ries  
B.P. 2106  
Djibouti

Telex: 823FS  
Cables: Ries  
Phone: 2467/2455

**Dominica**

**DETROIT DIESEL ALLISON**  
A.C. Shillingford & Co. Limited  
Agent of Tugs & Lighters Ltd.,  
Trinidad  
Cross Street  
Roseau

Telex: 387284 Trinidad  
Cables: Tuglighter Port-of-Spain Trinidad  
Phone: 2481 Dominica

**LEYLAND INTERNATIONAL**  
H.H.V. Whitchurch & Co. Limited  
P.O. Box 71  
Roseau

Telex: Whitdom D0614  
Cables: Whitchurch Roseau  
Phone: 2181

**LUCAS SERVICE OVERSEAS LIMITED**  
Smith & Co. Limited  
P.O. Box 9  
Roseau

Cables: Smithco Roseau

**PERKINS ENGINES LTD**  
P. Mallalieu Limited  
P.O. Box 70  
Roseau

**PETERS LIMITED**  
A.C. Shillingford & Company  
P.O. Box 123  
Roseau

Cables: Shillingford,  
Phone: 2481

**Dominican Republic**

**ALLIS CHALMERS**  
Atlas Commercial Co.  
Apartado 107  
Calle 30 De Marzo 22  
Santo Domingo R.D.

Telex: 3460024 Atlas  
Com Co.  
Phone: 682-6230

**BRIGGS & STRATTON CORPORATION**  
Transco S.A.  
Apartado 1205  
Santo Domingo

Cables: Transco  
Phone: 682-7262/689-9576

**CATERPILLAR OVERSEAS SA**  
Implementos y Maquinarias C por A  
Carratera Duarte Kilometre 5  
Apartado 171  
Santo Domingo.

Telex: RCA 4183 IMCA  
Phone: 566-5171  
Cables: Imca

**DETROIT DIESEL ALLISON**  
Quisqueya Motor C por A  
P.O. Box 54  
Santo Domingo

Telex: 3460106  
Cables: Quiquemato  
Phone: 9-7021

**DORMAN DIESELS LIMITED**  
Atlas Commercial Co C Por A  
Apartado 107  
Santo Domingo

Telex: 3460024  
Cables: Atlas Comcp  
Phone: 2-6230

KLOCKNER-HUMBOLDT-  
DEUTZ AG  
Jaime Mendex Succs C por A  
Apartado 1127  
Zona Postal 2  
Avenida San Martin 98  
Santo Domingo R.D.

Telex: ITT 3460377  
Cables: Jamendex  
Phone: 5658861

KOHLER INTERNATIONAL  
Ferreteria Americana C por A  
Apartado 1181  
Avenida San Martin 175  
Santo Domingo

LEYLAND INTERNATIONAL  
Cia Anglo Americana C Por A  
Avenida San Martin No.18  
P.O. Box 856  
Santo Domingo

Cables: Anamco

LUCAS SERVICE OVERSEAS  
LIMITED  
Mercantil Antillana C por A  
30 de Marzo No. 110  
Apartado 791  
Santo Domingo

Telex: 3460229  
Cables: Mercantil  
Phone: 689-8166/7

NISSAN DIESEL MOTOR CO.  
LIMITED  
Motorambar S.A.  
Avenue Abraham Lincoln 206  
Apartado 1381  
Santo Domingo

PERKINS ENGINES LIMITED  
Mercantil Antillana C por A  
Apartado 791  
30 De Marzo No.110

Telex: 3460229  
Phone: 689-8166/7  
565-2391  
565-2655

PETTERS LIMITED  
Importadora Tropical C por A  
Avenue San Martin v Leopold  
Navarro  
Apartado 750  
Santo Domingo

Telex: ITT 3460253  
REA 326198  
Cables: Tropical  
Phone: 689-8353, 682-7704,  
682-002

WHITE ENGINES  
INCORPORATED  
Atlas Commercial Co. C por A  
P.O. Box 107  
Calle 30 De Marzo 22  
Santo Domingo

Cables: Atlascomco  
Phone: 2-2921 (2)

#### Dubai

BRIGGS & STRATTON  
CORPORATION  
Mona Trading Company  
P.O. Box 5012  
Dubai

Telex: 5727  
Cables: Monatco  
Phone: 26361

CATERPILLAR OVERSEAS SA  
Mohamed Abdulrahman  
Al-Bahar  
P.O. Box 1170  
Deira

Telex: 5445 DB  
Cables: Behar Dubai  
Phone: 60255

DETROIT DIESEL ALLISON  
General Navigation and Commerce  
Company  
Zabeel Palace Road  
P.O. Box 1911  
Dubai

Telex: 958-5504-Genaco  
Du  
Cables: Genavco  
Phone: 31065

DORMAN DIESELS LIMITED  
Abdulla Haji Kamber Awazi  
P.O. Box 42  
Dubai

Telex: DB 531  
Cables: Kamber  
Phone: 21303

INDIAN NATIONAL DIESEL  
ENGINE CO. LIMITED  
Ahmed Ramjan Juma  
P.O. Box 2574  
Dubai

KATOLIGHT  
Ohamanmal Keshavdas  
P.O. Box 2068  
Dubai

KIRLOSKAR OIL ENGINES  
LIMITED  
Saeed & Mohammed Al-  
Naboodah  
P.O. Box 1200  
Deira

Telex: 5511 SMA DB  
Cables: Alnaboodah

KLOCKNER-HUMBOLDT-  
DEUTZ AG  
Arabian Gulf Mechanical  
Center Ltd.  
P.O. Box 1145  
Sharjah

Telex: 8086 Batha SH  
Phone: 23378

LEYLAND INTERNATIONAL  
Ali Bin Adbulla Al Owais  
P.O. Box 4  
Dubai

Telex: DB 450  
Cables: Aliowais  
Phone: 4556 4555

LUCAS SERVICE OVERSEAS  
LIMITED  
P.O. Box 275  
Dubai

Telex: 5527 Bhatia DB  
Cables: Bhatiabros  
Phone: 23245

PERKINS ENGINES LIMITED  
Yusuf Bin Ahmed Kanoo  
P.O. Box 290  
Dubai

Telex: 5451 DB  
Cables: Kanoo  
Phone: 24861/21462

PETTERS LIMITED  
Nasser Abdullatif  
P.O. Box 1219  
Dubai

Telex: 5540 Nasser DB  
Cables: Nasser  
Phone: 21374

RUGGERINI MOTORI S.p.A.  
Al Amodi Stores & Company  
P.O. Box 1274-5090  
Deira

Telex: 6859 Amoodi DB

#### Ecuador

ALLIS CHALMERS  
Delta-Delfini & Cia Ltda  
9 de Octubre 2303  
Apartado 4893  
Guayaquil

Telex: 043203 Delta Ed  
Cables: Delta  
Phone: 361737

BRIGGS & STRATTON  
CORPORATION  
Ivan Bohman Compania Ltda  
Casilla 1317  
Guayaquil

Telex: 3205  
Cable: Boman  
Phone: 307060

CATERPILLAR OVERSEAS SA  
Importadora Industrial  
Agricola S.A.  
Avda. Otto Arosemena G.Km3  
P.O. Box 562  
Guayaquil

Telex: 3215 Rosal Ed  
Cables: Rosal  
Phone: 384-700

DETROIT DIESEL ALLISON  
Fincom-Servicio C.A.  
Avenida Rocafuerte 752  
P.O. Box 1217  
Guayaquil

Telex: 393043355  
Cables: Fincomser  
Phone: 304367/7

DORMAN DIESELS LIMITED  
Mecanos S.A.C.  
Casilla 5608  
Guayaquil

Telex: 3264 Mecano Ed  
Cables: Mecano  
Phone: 16626

KATOLIGHT LIMITED  
Cotrac  
Cuero y Caicedo 224  
Quito

KLOCKNER-HUMBOLDT-  
DEUTZ AG  
Electro Ecuatoriana S.A.  
Avenida Colon 1011  
Apartado 1123  
Quito  
Telex: 22115 Electr. ED  
Cables: Electro  
Phone: 525800

KOHLER INTERNATIONAL  
Arthur Fried Cie Ltda  
P.O. Box 2680  
Calle Mejia 347  
Quito

LEYLAND INTERNATIONAL  
Morisaenz S.A.C.  
Apartado 625  
Panamericana  
Norte La 'Y'  
Quito  
Telex: 2158 Morisa ED  
Cables: Morisaenz

LUCAS SERVICE OVERSEAS LTD  
Gustavo A Lopez  
Apartado 3369  
Guayaquil  
Cables: Dunlopez  
Phone: 39-0004 639-5133

NISSAN DIESEL MOTOR CO. LTD.  
MYTSA Maquinas y Tractores S.A.  
Panamericana Norte Km 2.6  
Casilla 3941  
Quito

PERKINS ENGINES LTD  
Organizacion Commercial Vallejo  
Araujo S.A.  
P.O. Box 717  
Avenida 9 de Octubre 721-723  
Guayaquil  
Cables: Vallarjo  
Phone: 5-26960

PETTERS LIMITED  
Rectificadora Botar S.A.  
P.O. Box 3344  
Avenida 10 de Agosto 5980  
Quito  
Telex: 308 02 2176  
Cables: Recticiguenal  
Phone: 241-544

JOHN ROBSON (SHIPLEY)  
LIMITED  
Superagencias C.A.  
P.O. Box 666  
Avenida 9 de Octubre 822  
Guayaquil

RUGGERINI MOTORI SPA  
Superagencias C.A.  
P.O. Box 666  
Avenida 9 de Octubre 822  
Guayaquil  
Telex: 308 043222  
Super ED

VOLVO PENTA  
Fincom Guayaquil SA  
Avenida de Las Americas  
Casilla de correo 5557  
Guayaquil  
Telex: 43312  
Cable: Fincomquil  
Phone: 51 56 12  
51 44 10  
51 30 72

WHITE ENGINES  
INCORPORATED  
B. Aviles Alfaro & Cia  
Attn. White-Hercules Dept  
Apartado Postal 354  
Guayaquil  
Telex: 3531051  
Cable: Bavites  
Phone: 391-100

#### Egypt

CATERPILLAR OVERSEAS SA  
The Tractor & Engineering Co. Ltd  
Agriculture & Earthmoving Dept.  
23 Boustan Street  
P.O. Box 1400  
Cairo  
Telex: 2286 Tecu LIN  
Cables: Aziz  
Phone: 21704

DETROIT DIESEL ALLISON  
Carlin Middle East  
1103 Corniche El Nil Street  
Apt. 2 Garden City  
Cairo  
Telex: 927-2366 Extension  
085 CME  
Cable: Cocarlin  
Phone: 27451/2

DORMAN DIESELS LIMITED  
Getco  
2 Sherif Pacha Street  
Lewa Building  
Cairo  
Telex: 2113 Altfai-UAN  
ATT.006/Mec  
Cables: Kamelkof  
Phone: 43967/53436

FORD MOTOR CO. LIMITED  
Ford Motor Co. (Egypt) S.A.E.  
Avenue Victor Emmanuel III  
Alexandria

L. GARDNER & SONS LTD  
Alexandria Marine Equipment Co.  
Mikhail Abadeer Street  
Rushdy  
Alexandria

INDIAN NATIONAL DIESEL  
ENGINE CO. LTD  
Md. Khalil El Kewefi  
28 Talat Herb Street  
9th Floor  
Cairo

KATOLIGHT LIMITED.  
Delta Export & Import  
20 Salah Salem Street  
Alexandria

KLOCKNER-HUMBOLDT-  
DEUTZ  
Extra Egyptian Consulting Trading  
Co. Ltd  
12A Hassan Sabry Street  
Zamalek  
Cairo

LEYLAND INTERNATIONAL  
M.I.S.R. Car Trading Co.  
28 Talaat Herb Street  
Cairo  
Cables: Automisr

LUCAS SERVICE OVERSEAS  
LIMITED  
Missr Car Trading Company  
12 Abdel Khalek Sarwar  
Cairo  
Telex: 362  
Cables: Automiser  
Phone: 43655, 45598,  
908 19

NISSAN DIESEL MOTOR CO. LTD  
General Trade Co.  
P.O. Box 720  
Cairo

PERKINS ENGINES LIMITED  
The Engineering General Co. S.A.A.  
P.O. Box 588  
9-11 Orabi Street  
Cairo  
Telex: 2249  
Cables: Egici  
Phone: 49291/4

PETBOW LIMITED  
Tractor & Engineering Co. S.A.E.  
23 Sh Pres Abdel-Salam Aref  
P.O. Box 1400  
Cairo

PETTERS LIMITED  
Tractor & Engineering Co. S.A.E.  
18 Rue Emad El Dine  
P.O. Box 366  
Cairo  
Cables: Crocodile  
Phone: 32724

RUGGERINI MOTORI Spa  
S.A. Ashmawy B.Sc.  
14 El-Bohtory Street  
Kubba Gardens  
Cairo

#### El Salvador

ALLIS CHALMERS  
Tecnica Universal Maegli S.A.  
(Tecun S.A.)  
3a Avenida 3-21  
Zona 9  
P.O. Box 590  
Guatemala City  
Telex: 275 Tecun GU  
Cables: Tecunsa (Tecunsael-  
San Salvador,  
El Salvador)  
Phone: 66783/4/5/6/7

BRIGGS & STRATTON  
CORPORATION  
Almacenes Saprissa  
Alameda Roosevelt 2419  
San Salvador

Cables: Maquinaria  
Phone: 23-3178, 23-3367

CATERPILLAR OVERSEAS SA  
Compañia General de Equipos S.A.  
de C.V.  
Km.5 Carretera a Sta. Tecla  
Apartado (06) 1000 #  
San Salvador

Telex: Cogesa-20074  
Area Code 301  
Cables: Cogesa  
Phone: 23-23-23

DETROIT DIESEL ALLISON  
Compañia Importadora De  
Maquinaria S.A.  
Alameda Roosevelt y 53  
Avenida Norte  
San Salvador

Telex: 301-20126  
Cables: Cidema  
Phone: 23-1144

DORMAN DIESELS LIMITED  
Promarca Alvarado y Cia  
Apartado 506  
San Salvador

Cables: Promarca  
Phone: 21-9081

KATOLIGHT LIMITED  
Goldtree Lieves S.A. de C.V.  
Apartado Postal (06) 195  
San Salvador

KLOCKNER-HUMBOLDT-  
DEUTZ AG  
Representaciones Caribia S.A.  
Septima Avenida Norte Nr.222  
Apartado 268  
San Salvador

Cables: Caribia  
Phone: 219547

KOHLER INTERNATIONAL  
Distribution Tecnica S.A.  
7A Calle Poniente 527  
San Salvador

LEYLAND INTERNATIONAL  
Auto Commercial Grange  
Alameda Roosevelt y 43 Avenida  
Norte  
San Salvador

Cables: Grane

LUCAS SERVICE OVERSEAS  
LIMITED  
Automotriz Sabater S.A.  
Alameda Roosevelt 35 Avenida Sur  
San Salvador

Cables: Ponsaba  
Phone: 231600

NISSAN DIESEL MOTOR CO.  
LIMITED  
Distribuidora Mejia Delgado S.A.  
25 Avenida Norte y 3<sup>ra</sup>  
Calle Poniente  
San Salvador

PERKINS ENGINES LTD.  
Salvador Machinery Company S.A.  
Apartado Postal 125  
Boulevard Ejercito Nacional  
San Salvador

Cables: Sijmac  
Phone: 21-8410

PETTERS LIMITED  
Siman S.A.  
Alameda Roosevelt 3114  
Apartado Postal 161  
San Salvador

Telex: 20165 Simansa  
Cables: Simansa  
Phone: 23-6333

WHITE ENGINES  
INCORPORATED  
Almacenes Saprissa  
Alameda Roosevelt 2419  
San Salvador

Cables: Maquinaria  
Phone: 23-3178, 23-3367

#### Equatorial Guinea

CATERPILLAR OVERSEAS SA  
Finanzauto S.A.  
Plaza de las Cortes 6  
Madrid 14  
Spain

Telex: 27752  
Cables: Finanzauto Madrid  
Phone: (91) 448-2700

LEYLAND OVERSEAS SA  
Casa Amilivia Ltda  
Santa Isabel  
Fernando Poo.

Cables: Akonibe

#### Ethiopia

CATERPILLAR OVERSEAS SA  
Ries Engineering Share Co.  
P.O. Box 1116  
Addis Ababa

Telex: 151133  
Cables: Riestract  
Phone: 21082

DETROIT DIESEL ALLISON  
The Motor & Engineering Co. of  
Ethiopia Ltd.  
P.O. Box 1767  
Addis Ababa

Telex: 976-21019  
Cables: Moenco  
Phone: 45708

DORMAN DIESELS LIMITED  
Petram Company  
Negash Oda Building  
Addis Ababa

Cables: Petram  
Phone: 121557/  
117162

KLOCKNER-HUMBOLDT-  
DEUTZ AG  
Seferian & Co. (Ethiopia) Ltd. S.C.  
Near Mexico Square  
P.O. Box 64  
Addis Ababa

Telex: 21070 Seferian  
Cables: Seferco  
Phone: 488100/444719  
152197

LEYLAND INTERNATIONAL  
Mitchell Cotts & Co. (Ethiopia) Ltd.  
P.O. Box 527  
Addis Ababa

Cables: Mitcotts  
Phone: 47160-4

LUCAS SERVICE OVERSEAS  
LIMITED  
Auto Accessories & Components  
Dept.  
Mitchell Cotts & Co (Ethiopia) Ltd.  
P.O. Box 527  
Addis Ababa

Telex: 21036  
Cables: Mitcotts  
Phone: 44716015

PERKINS ENGINES LTD.  
Ries Engineering Share Company  
P.O. Box 1116  
Addis Ababa

Telex: 21082  
Cables: Riestrac  
Phone: 51133

RUGGERINI MOTORI SpA  
Giuseppe Selicato  
P.O. Box 100  
9 Jubilee Street  
Asmara

#### Falkland Islands

LEYLAND INTERNATIONAL  
Estate Louis Williams  
Port Stanley

Cables: Williams

LUCAS SERVICE OVERSEAS  
LIMITED  
The Falkland Islands Trading Co. Ltd  
Stanley

PETTERS LIMITED  
Falkland Islands Co. Limited  
Port Stanley

#### Faroe Islands

LEYLAND INTERNATIONAL  
Dansk Oversoisk Motor Industri As.  
Sondre Ringvej 35  
2600 Glostrup  
Copenhagen  
Denmark

Telex: 22252  
Cables: Domimotors  
Copenhagen  
Phone: 961410

PETTERS LIMITED  
William Holm-Jacobsen  
Torshavn

Telex: 81242 WHJ  
Phone: 2360

VOLVO PENTA  
Firma Alfred Johannesen  
Tingshúsvegur 44-46  
P.O. Box 101  
Torshavn

Cables: Alf  
Phone: 1735

#### Fiji Islands

BRIGGS & STRATTON  
CORPORATION  
Coral Island Motors  
G.P.O. Box 48  
Walu Bay, Suva

Phone: 311655

CATERPILLAR OVERSEAS SA  
Carpenters Tractor and Equipment  
154 Queens Road  
Private Mail Bag  
Suva

Cables: Carptrac, Suva

DETROIT DIESEL ALLISON  
Clyde Engineering (Pacific) Ltd  
6 Lami Street  
P.O. Box 1068  
Lami  
Suva

Telex: NZ2377  
Cables: Clypac Suva Fiji  
Phone: 361382

LEYLAND INTERNATIONAL  
Motor Corporation (Fiji) Ltd.  
71 Moala Street  
P.O. Box 418  
Suva

Phone: 383144

Suva Motors Ltd.  
P.O. Box 34  
Lami P.O. Box 1068  
Suva

LUCAS SERVICE OVERSEAS  
LIMITED  
Burns Philp (South Sea) Co. Ltd.  
P.O. Box 355  
Suva

Telex: FJ2127  
Cables: Burnsouth

NISSAN DIESEL MOTOR CO.  
LIMITED  
Suva Motors  
P.O. Box 34  
Suva

PERKINS ENGINES LTD  
Clyde Engineering (Pacific) Ltd.  
P.O. Box 1068  
6 Lami Street  
Lami  
Suva

Phone: 361382

PETTERS LIMITED  
Suva Motors Limited  
P.O. Box 34  
Victoria Parade  
Suva

Cables: Motors  
Phone: 22634

JOHN ROBSON (SHIPLEY) LTD  
Wainiyaku Ltd.  
Vuna  
Taveuni

#### Finland

BRIGGS & STRATTON  
CORPORATION  
Oy Promotor Ab  
Ormustie 14  
00700 Helsinki 70

Telex: 122205  
Cables: Promotor  
Phone: 354144

CATERPILLAR OVERSEAS SA  
Wilhuri Oy Witraktor  
01530 Helsinki-Lento

Telex: 12-618  
Cables: Witraktor Helsinki  
Phone: 826-311

DORMAN DIESELS LIMITED  
Dieselkeskus Oy  
Fredrikinkatu 43B  
00120 Helsinki 12

Telex: 121382  
Cables: Dieselkeskus  
Phone: 648426

FORD MOTOR CO. LIMITED  
O/Y Ford A/B  
Henry Fordinkatu 6  
Postifokero 4B  
Helsinki

Telex: 12743  
Phone: 12161

KLOCKNER-HUMBOLDT-  
DEUTZ AG  
Oy Grönblom AB  
Postfach 370  
Mekaanikonkatu 6  
00101 Helsinki 10

Telex: 12542  
Cables: Grönbloms  
Phone: 80-7654411

LEYLAND INTERNATIONAL  
Oy Suomen Autoteollisuus AB  
Henkilöautot  
Lauttasaarentie 52  
P.O. Box 129  
00201 Helsinki 20

Telex: 121473 Sisul SF  
Cables: Voimavaunu  
Phone: 673283

PERKINS ENGINES LIMITED  
Oy Hans Palsbo AB  
Puhtitie 20  
SF 00810 Helsinki 81

Telex: 12434 Palsb SF  
Cables: Palsbos  
Phone: (90) 782100

PETTERS LIMITED  
Oy Mercantile AB  
P.O. Box 29  
Mannerheimintie 12B  
Helsinki

Telex: 12-416  
Cables: Mercantile  
Phone: 60-981

RUGGERINI MOTORI SpA  
Enon Teollisuus  
Koivumaentie 14  
SF-00680 Helsinki 68

Telex: 123213 Masi SF

VOLVO PENTA  
Oy Volvo Auto AB  
Marinavdelningen  
Batbyggarevägen 9  
SF-00210 Helsingfors 21

Telex: 12736  
Cables: Volvoauto  
Phone: 711 311

WHITE ENGINES  
INCORPORATED  
Oy Suomen Autoteollisuus AB  
Fleminginkatu 27  
P.O. Box 10307  
Helsinki 40

Telex: 121176 Sisue-SF  
Cables: Autoteollisuus  
Phone: 70101

#### France

BRIGGS & STRATTON  
CORPORATION  
2 & 4 Rue Guy Moquet  
95100 Argenteuil

Telex: 695 109

CATERPILLAR OVERSEAS SA  
Hy. Bergerat, Monnoyeur SA  
6 Rue Christophe Colomb  
75008 Paris

Telex: 660-811  
Cables: Tibi  
Phone: 723.61.32-  
723.61.34

DETROIT DIESEL ALLISON  
INTERNATIONAL EUROPE  
c/o General Motors France  
56 a 58 Ave. Louis Roche  
92231 Gennevilliers

Telex: Genmot 62050  
Cables: Parautexap  
Phone: 790-70-00

DORMAN DIESELS LIMITED  
Ets E Anduze & Cie  
47 Rue Servan  
75 Paris 11 e

Telex: Obertin 22259  
Phone: (805) 90-76, 90-77

FORD MOTOR CO. LTD.  
Ford (France) SA  
344 Avenue Napoleon Bonaparte  
92 Rueil Malmaison  
B.P. 90

Telex: 69963  
Phone: (01) 977 0505

L. GARDNER & SONS LIMITED  
Navigair  
5 Avenue Du 11 Novembre  
Antibes-06

Phone: 34.70.26

**KIRLOSKAR OIL ENGINES LIMITED**  
Société Grossol  
14 Rue Chaptal  
92 Levallois Perret  
B.P. 104  
Paris

Telex: 620207  
Phone: 757 82 90

**LEYLAND INTERNATIONAL**  
British Leyland France SA  
Rue Ambroise Croizat  
Z1 Argenteuil  
B.P. 32  
F-95 Argenteuil

Telex: 60875 60866  
Phone: 982-09-22

**PERKINS ENGINES LIMITED**  
Moteurs Perkins SA  
55 Boulevard Ornano  
93203 Saint Denis

Telex: 620 251 Saint Denis  
Cables: Perkoll Paris  
Phone: 243-04-40

**PETTERS LIMITED**  
N. Rey  
Resident Regional Executive  
1 Rue Schlumberger  
92430 Marnes la Coquette

Phone: 9262937

**RUGGERINI MOTORI SpA**  
Nauder  
P.O. Box 46  
22 Avenue Barthelemy Thimonnier  
69300 Caluire

Telex: 310843 Noderalp  
Calui

**VOLVO PENTA**  
Volvo Perita France SA  
Chemin de la Nouvelle France  
78130 Les Mureaux

Telex: 60722  
Phone: 474.72.01

**WHITE ENGINES**  
Bell International  
10 Rue des Oziers  
95 - Pierrelaye

Telex: Belinter 69573 - F  
Phone: 464-24-13

#### French Polynesia

**JOHN ROBSON (SHIPLEY) LIMITED**  
RC Papeete No.32B  
B.P. Box 628  
Papeete  
Polynesie Française

#### Gabon

**CATERPILLAR OVERSEAS SA**  
S.H.O. Gabon  
Département Industriel  
Tractafric  
P.O. Box 2147  
Libreville

Telex: 5210 (014)  
Cables: Tractafric  
Phone: 2070/2309

**DETROIT DIESEL ALLISON**  
Division Matforce Diesel  
Hatton & Cookson Ltd.  
P.O. Box 10075  
Libreville

Telex: Hatton 5224 GO  
Phone: 2331

**KLOCKNER-HUMBOLDT-DEUTZ AG**  
Valcke Frères  
Z.J. d'Oloumi  
P.O. Box 53  
Bd. Jules Rémy Isembé  
Libreville

Telex: 5234  
Phone: 22104, 22383

**LEYLAND INTERNATIONAL**  
Cie Francaise de L'Afrique Occidentale  
Agence Centrale  
P.O. Box 1181  
Libreville

**LUCAS SERVICE OVERSEAS LIMITED**  
Matforce Diesel (Div. of Hatton & Cookson Ltd.)  
P.O. Box 1075  
Libreville

Telex: 5216  
Cables: Hatton  
Phone: 2303

**NISSAN DIESEL MOTOR COMPANY LIMITED**  
Hatton et Cookson  
B.P. 4052  
Libreville

**PERKINS ENGINES LIMITED**  
Diesel Gabon  
B.P. 205  
Libreville

Telex: 6223 Diesel-Gabon  
Cables: Diesel Gabon  
Phone: 21.18

**PETTERS LIMITED**  
Hamelle-Afrique S.A.  
B.P. 31  
Route de l'Aviation  
Libreville

Telex: Hamelaf 5292  
Cables: Hamelaf  
Phone: 325.38

#### Gambia

**LEYLAND INTERNATIONAL**  
Cie Francaise de L'Afrique Occidentale  
P.O. Box 297  
Bathurst

Telex: GV 213  
Cables: Senafrika  
Phone: 473

**PERKINS ENGINES LTD.**  
S. Madi Ltd.  
11 Russell Street  
Bathurst

Telex: Madi GV 209  
Cables: Madi  
Phone: 372/373/282/559

**PETTERS LIMITED**  
Cie Francaise de L'Afrique Occidentale  
Technical Dept.  
P.O. Box 297  
Banjul

Cables: Senafrika  
Phone: 472

#### Gaza

**DORMAN DIESELS LIMITED**  
Mourtaga Engineering & Trading Co.  
Omer El-Moukhtar Street  
P.O. Box 4  
Gaza

Cables: Mourgaza  
Phone: 1473/522

**L GARDNER & SONS LIMITED**  
Saamir Commercial Agencies  
P.O. Box 23  
Gaza

Telex: 341938 Saamr II  
Cables: Saamr  
Phone: 177

**PETTERS LIMITED**  
Saamir Commercial Agencies  
P.O. Box 23  
Omer El Moukhtar Street  
Gaza

Telex: 341938 Saamir II  
Cables: Saamr  
Phone: 177

#### Germany

**BRIGGS & STRATTON CORPORATION**  
Ernst Hahn  
Postfach 1520  
Ringstrasse 12-18  
Fellbach 7012

Telex: 7254431  
Cables: Hahn D  
Phone: 0711/5003402, 5003274

**CATERPILLAR OVERSEAS SA**  
Zeppelin-Metallwerke GmbH  
Zeppelinstrasse 1-5  
Postfach 2003  
8046 Garching bei Munchen

Telex: 5215-821/606/607  
Cables: Zeppelinmetall  
Phone: (089) 32-00-01

**DORMAN DIESELS LIMITED**  
Elna GmbH  
2084 Rellingen Bei Hamburg  
Siemensstrasse 35

Telex: 02-189123  
Cables: Elektronautik  
Phone: (04101) 301-1

FORD MOTOR CO. LIMITED  
Ford Werke AG  
Parts Operations  
5 Koeln 71  
Industrie Strasse  
Postfach 714444

Telex: 885410  
Phone: (0221) 7191

KATOLIGHT LIMITED  
Kaptan  
6 Frankfurt/Main  
Kaiser Str 70/IV  
Frankfurt

KOHLER INTERNATIONAL  
LIMITED  
J. Wizemann & Co.  
7-9 Quellenstrasse  
P.O. Box 501260  
D-7000 Stuttgart

LEYLAND INTERNATIONAL  
A. Bruggemann & Co. GmbH  
P.O. Box 1940  
Harffstrasse 53  
4000 Düsseldorf

Telex: 1939

PERKINS ENGINES LIMITED  
Perkins Motoren GmbH  
8752 Kleinostheim,  
Postfach 12

Telex: 4188869  
Phone: 06027/8081

PETTERS LIMITED  
Siegfried Schumacher GmbH  
5252 Runderoth/RHt.D  
Muhlenberg 6

Telex: 88476  
Phone: 02263-5081/2

RUGGERINI MOTORI SpA  
Goebler-Hirthmotoren  
Postfach 20  
Max Eyth Strasse 10  
7141 Benningen/Neckar

VOLVO PENTA  
Volvo Penta Deutschland GmbH  
Redderkoppel 5  
Postfach 9069  
2300 Kiel-Friedrichsort

Telex: 02-92764  
Phone: 0431/39096-9

WHITE ENGINES  
INCORPORATED  
Ern Motorenteile K.-G.  
Schinkelstrabe 46-48  
4-Dusseldorf

Telex: 0858-2618  
Cables: Ern Dusseldorf  
Phone: (0211) 35-35-38

#### Ghana

ALLIS CHALMERS  
Paterson, Simons & Co.  
(Ghana) Ltd  
Korle Lagoon  
Guggersburg Road  
P.O. Box 480  
Accra

Telex: 883771  
Cables: Paterson London  
(England)

CATERPILLAR OVERSEAS SA  
Tractor & Equipment  
Division of the UAC of Ghana Ltd.  
P.O. Box 5207  
Accra-North

Cables: Machtrac  
Phone: 21900

DETROIT DIESEL ALLISON  
Blackwood Hodge (Ghana) Ltd.  
Ring Road  
P.O. Box 126  
Accra

Telex: 974-2147  
Cables: Suntract  
Phone: 21255 Accra

DORMAN DIESELS LIMITED  
The Ghana Consolidated Machinery  
& Trading Co. Ltd.,  
P.O. Box 3400  
Swanmill  
Accra

Telex: 2008 Accra  
Unamerch  
Cables: Machsuper  
Phone: 63921/2, 64822

L. GARDNER & SONS LTD.  
IKQ Motors & Co. Ltd.,  
P.O. Box 227  
Accra

Phone: 26278

INDIAN NATIONAL DIESEL  
ENGINE CO. LTD.  
The C.F.A.O. Service Transit  
P.O. Box 154  
Tema

KIRLOSKAR OIL ENGINES  
LIMITED  
Agricultural Engineers Limited  
P.O. Box 3707  
Ring Road West  
Accra

Cables: Agrico  
Phone: 28260/28292

KLOCKNER-HUMBOLDT-  
DEUTZ AG  
Firma Rowedder, Delmenhorst  
Uber Firma Reiss & Co.,  
D 757-4 Clement Papatio Avenue  
P.O. Box 3074  
Accra

Telex: 2040  
Phone: 65105-8

KOHLER INTERNATIONAL  
LIMITED  
Interassociates Ghana Ltd.  
Ring Road Central  
P.O. Box 5238-5269  
Accra

LEYLAND INTERNATIONAL  
Leyland Motors (Ghana) Ltd.  
P.O. Box 2969  
Accra

Cables: Leymotors  
Phone: 28806

LUCAS SERVICE OVERSEAS  
Lucas House  
P.O. Box 5731  
Ring Road  
Accra North

Cables: Unalucas  
Phone: 28774 28789

NISSAN DIESEL MOTOR CO.  
LIMITED  
Trans Africa Eng. & Motor  
Industry (Ghana) Ltd.  
P.O. Box 7269  
Accra

PETTERS LIMITED  
Pasico (Ghana) Ltd.  
P.O. Box 480  
Accra

Cables: Pasico  
Phone: 64658

RUGGERINI MOTORI SpA  
Japan Motors  
P.O. Box 2516  
Accra

#### Gibraltar

DETROIT DIESEL ALLISON  
H. Sheppard & Co. Ltd.  
P.O. Box 130  
Waterport

Cables: Marina Gibraltar  
Phone: 2183

L. GARDNER & SONS  
LIMITED  
H. Sheppard & Co. Ltd  
P.O. Box 130  
Waterport

Phone: 2183

LEYLAND INTERNATIONAL  
A.M. Capurro & Sons Ltd.,  
20 Line Wall Road  
P.O. Box 130  
Gibraltar

Telex: GK 258  
Cables: Capurro Gibraltar

#### Grand Cayman

PETTERS LIMITED  
Kirkconnel Bros. Ltd.  
P.O. Box 72

Telex: CP 232  
Cables: Kirk B  
Phone: 9-2521



**Greece**

**ALLIS CHALMERS**  
 Technical and Commercial  
 of Greece SA  
 61 Academias Street  
 P.O. Box 727  
 Athens

Telex: 21-5760 Cris GR  
 Cables: Tecellas  
 Phone: 625629

**BOMBARDIER-ROTAX GmbH**  
 P.N. Evmirides  
 12, Rue Paparrigopoulou  
 Thessaloniki

Phone: 204934

**BRIGGS & STRATTON  
 CORPORATION**  
 Catopodis Triantaphyllos &  
 Co. Inc.,  
 63 Stournara Street  
 Athens 102

Cables: Autoserve  
 Phone: 541-511, 541-512

**CATERPILLAR OVERSEAS SA**  
 Avras SA  
 Athinon and Kiffissou Aves  
 P.O. Box 1250  
 Omonia

Telex: 21-4661/4662  
 Cables: Avratrac  
 Phone: 571-6611/17  
 571-1401

**DETROIT DIESEL ALLISON**  
 Technica S. Malcotsis SA  
 14 Marni Street  
 Athens 103  
 Mail: 50 Papastratou Street  
 Piraeus

Telex: 863-215362 TSM GR  
 Cables: Mapeca, Athens  
 Phone: 831-577, 816-759  
 Athens

**DORMAN DIESELS LIMITED**  
 General Enterprises SA  
 43A, 3rd Septemvriou Street  
 Athens 103

Telex: 219395 GPGE GR  
 Phone: 822 6645

**FORD MOTOR CO. LIMITED**  
 Ford of Europe Inc.,  
 Athens Area Office  
 118c Kifissia Avenue  
 Athens 614

**L. GARDNER & SONS  
 LIMITED**  
 Dion Drossos & Co. Ltd.,  
 28, Carolou Street  
 Athens 107

Telex: 215058  
 Phone: 530-565

**KATOLIGHT LIMITED**  
 Cable Engineering Ltd  
 Piraeus 246  
 Athens (310)

**KLOCKNER-HUMBOLDT-  
 DEUTZ AG**  
 Magirus-Deutz Hellas A.E.  
 Leoforos Kifissou 94  
 P.O. Box 629  
 Athen-Egalao

Telex: 1-5356 Athen  
 Cables: Ottomoto  
 Phone: 5616960-66

**KOHLER INTERNATIONAL  
 LIMITED**  
 Andrew Apostolopoulos Co.  
 Successors  
 3-1 Paparrigopoulou Street  
 Athens 124

**LEYLAND INTERNATIONAL  
 KENTAVROS SA**  
 131 Tera Odos  
 Athens

Telex: 216089  
 Cables: SO Fosti  
 Phone: 3467201-209

**NISSAN DIESEL MOTOR CO. LTD**  
 NIC J. Theocarakis S.A.  
 169 Athinon Ave.  
 Athens

**PETTERS LIMITED**  
 The Alson Engineering Co.,  
 Leonidhopoulos Works  
 12b K.Mavromichali Street  
 Piraeus 24

Telex: 212835 Leo GR  
 Cables: Xenmas  
 Phone: (21) 411 3817/8

**RUGGERINI MOTORISpa**

A.B.E. R.H.  
 P.O. Box 17  
 Chalkis

**VOLVO PENTA**  
 Saracakis Brothers SA  
 71 Leoforos Athinon  
 P.O. Box 410  
 Athens 301

Telex: 215420, 215988  
 Cables: Saracal  
 Phone: 0030-21-365320,  
 367011

**WHITE ENGINES  
 INCORPORATED**  
 Ergex Ltd.,  
 35 Deligiorgi Street  
 Athens 107

Cables: Telergex  
 Phone: 535.946

**Greenland**

**VOLVO PENTA**  
 Godthab Autoservice  
 Rasmussen & Knudsen  
 Box 24  
 3900 Gadthab

Phone: 1263

**Grenada**

**DETROIT DIESEL ALLISON**  
 Grenada Yacht Services  
 Agent of Tugs & Lighters Ltd.  
 Trinidad  
 P.O. Box 183  
 St. George's

Telex: 387284 Trinidad  
 Cables: Tuglighter, Port-of-  
 Spain, Trinidad  
 Phone: 2508 St. George's

**LEYLAND INTERNATIONAL**  
 Jones Browne & Hubbard  
 (Grenada) Ltd.  
 P.O. Box 25  
 St. George's

Cables: Hubbard Grenada  
 Phone: 2087 (2 lines)

**LUCAS SERVICE OVERSEAS  
 LIMITED**  
 Gomez & Western Service Limited  
 Lowthers Lane  
 P.O. Box 373  
 St. George's

Cables: Gowest, St. George's  
 Phone: 3022

**PETTERS LIMITED**  
 W.E. Julien & Co., Ltd  
 Young Street  
 P.O. Box 76  
 St. George's

Cables: Julian Granada

**Guadeloupe**

**CATERPILLAR OVERSEAS SA**  
 Yves Massel and Cie  
 Route de Raizet  
 Box 210  
 97156 Pointe-A-Pitre

Telex: 791GA  
 Cables: Massely Pointeapitre  
 Phone: 82-15-36

**KLOCKNER-HUMBOLDT-  
 DEUTZ**  
 Valcke Freres  
 Untervertretung:  
 ARG Puech - Socomi  
 B.P. 896  
 Morne Vergain  
 Point-A-Pitre

Telex: 029869  
 Phone: 82-52-59

**LEYLAND INTERNATIONAL**  
 Etablissements Succes  
 Maurice Deher-Lesaint  
 34 Rue Bebian  
 Pointe-A-Pitre

Cables: Mauher  
 Phone: 82-00-99

**LUCAS SERVICE OVERSEAS  
 LIMITED**  
 L. Loret et Cie  
 P.O. Box 610  
 113 Rue de Noziales  
 Pointe-A-Pitre

Telex: 029745GL  
 Cables: Deslo  
 Phone: 82-07-18, 82-38-20,

PETTERS LIMITED  
Etablissements Philippe Vivies  
Zone Industrielle de Jarry  
B.P. 187  
Pointe-A-Pitre

Telex: Agmoli 029719/GL  
Cables: Fivi  
Phone: 82-11-17, 82-10-28

#### Guam

ALLIS CHALMERS  
F.L. Moylan Company  
Moylan Building  
Marine Drive-Agana  
Guam

Telex: 721118 RCA  
Cables: Fimco  
Phone: 772-6738

BRIGGS & STRATTON  
CORPORATION  
Mid-Pac Far East Inc.  
P.O. Box 7420  
Tamuning

Telex: M-PAC-GM RCA  
721-207  
Phone: 646-5447

DETROIT DIESEL ALLISON  
Mid Pac Far East Inc.  
P.O. Box 7420  
Tamuning 96911

Telex: M-Pac-GM RCA  
721207  
Phone: 746-5447

KOHLER INTERNATIONAL  
LIMITED  
Atkins Kroll (Guam) Ltd.  
P.O. Box 428  
Tamuning  
Guam 96910

Telex: M-Pac-GM RCA  
721207  
Phone: 746-5447

LEYLAND INTERNATIONAL  
Overseas Enterprises Limited  
P.O. Box 6096  
Tamuning  
Guam 96911

Cables: Paulsung  
Telex: 246-6638

#### Guatemala

ALLIS CHALMERS  
Técnica Universal Maegli  
SA (TECUN SA)  
3a Avenida 3-18  
Zona 9  
P.O. Box 590  
Guatemala City

Cables: Tecunsa (Tecunsael-  
San Salvador,  
El Salvador)  
Phone: 65783, 4, 5, 6, 7.

BRIGGS & STRATTON  
Almacenes Concordia  
18 Calle 6-85  
Zona 1  
Guatemala

Cables: Concordia  
Phone: 26-345, 24-534

CATERPILLAR OVERSEAS SA  
Mayatrac SA  
Kilometroll  
Carretera a Amatitlan  
Apartado Postal 1793  
Guatemala City

Telex: 273 Matrac CU  
Cables: Mayatrac  
Phone: 481061, 2, 3, 4, 5.

DETROIT DIESEL ALLISON  
CIDE Agro  
10A Avenue 30-57  
Zona 5  
Guatemala City

Telex: 305-254 - Cideg -  
GU  
Cables: Cidea  
Phone: 61531

DORMAN DIESELS LIMITED  
Felix Montes y Cia SA  
8a Calle 3-27  
Zona 1  
Guatemala CA

Telex: 4195 femco GU  
Cables: Remontes  
Phone: 20136

FORD MOTOR COMPANY  
LIMITED  
Caterias Espana  
7a Avenida 11-95  
Oficina 3  
Zona 9  
Guatemala City

KATOLIGHT  
Galmar Importaciones y  
Exportaciones  
Central Comercial  
Zona 4  
Guatemala City

KLOCKNER-HUMBOLDT-  
DEUTZ AG  
Auto Marina SA  
Calzada  
Raul Aguilar Batres 23-82  
Zona 11  
Guatemala D.C.

Telex: A Guatelgu para  
Automasa  
Cables: Automasa  
Phone: 460008, 480397,  
460383  
332, 334, 335

KOHLER INTERNATIONAL  
LIMITED  
Felix Montes & Cia Ltda  
8a Calle 3-38  
Guatemala City

LEYLAND INTERNATIONAL  
Almacenes 'Concordia'  
Calle 18 de Septiembre 6-85  
Zona 1  
Guatemala City

Cables: Concordia

LUCAS SERVICE OVERSEAS  
LIMITED  
Figueroa y Cia Ltd.  
La Calle 1-51  
Zona 9  
Guatemala City

Telex: 305358  
Cables: Fatcoa  
Phone: 61025

NISSAN DIESEL MOTOR  
CO. LIMITED  
Auto Mercantil S.A.  
Apartado Postal 2643  
Calzada Aguilar Batres 23-16  
Zona 11  
Guatemala City

PETTERS LIMITED  
Almacén de Maquinaria Topke  
Via 4 No. 5-52  
P.O. Box 678  
Zona 4  
Guatemala City

Cables: Etopke City  
Phone: 64056 & 64190

JOHN ROBSON (SHIPLEY) LTD.  
Orion  
Maquinaria Y Accesorios Industriales  
5a Calle 3-21  
Zona 9  
Apartado Postal 919  
Guatemala C.A.

WHITE ENGINES  
INCORPORATED  
Equipos Mecánicos de  
Guatemala SA  
Apartado Postal 472  
Guatemala C.A.

Cables: GIMAC  
Phone: 63326, 63859

#### Guiana (French)

CATERPILLAR OVERSEAS SA  
Yves Massel & Cie  
B.P. 171  
Cayenne

Telex: 527 FG  
Cables: Masselco  
Phone: 312948

KLOCKNER-HUMBOLDT-  
DEUTZ AG  
Valcke Frères  
Untervertretung: Agence Guyanaise  
de Mécanique A.G.M.  
Angle routes de Cabasson et de  
la Madeleine  
8.P. 350  
Cayenne

Telex: AGM 549 FG  
Phone: 311469

**LEYLAND INTERNATIONAL**  
Cie Commerciale des Antilles  
Francaises  
F. Tanon & Cie  
B.P. 225  
Cayenne

Cables: Tanon

**PETTERS LIMITED**  
P.P.D.E.G.  
B.P. 170  
Le Larivot  
Cayenne

Phone: 615

### Guinea

**CATERPILLAR OVERSEAS SA**  
Manutention Guinéenne  
B.P. 336  
Conakry

Phone: 621-42

**LEYLAND INTERNATIONAL**  
Paterson Zochonis Guinea SA  
Conakry

Cables: Zochonis

### Guinea Bissau

**CATERPILLAR OVERSEAS SA**  
STET  
Sociedade Tecnica de Equipamentos  
e Tractores S.a.r.l.  
Apartado 1315  
Lisbon  
Portugal

Telex: 12778  
Cables: Stetra Sacavem  
Phone: 251-1011

**DETROIT DIESEL ALLISON**  
Sociedade Tecnica De  
Equipamentos  
Industriais E Acessorios Ltda  
P.O. Box 159  
Bissau

Cables: Steia  
Phone: 2742

**LEYLAND INTERNATIONAL**  
Barbosa & CTA  
Rua Das Pedras Negras  
35E 41  
Lisbon 2  
Portugal

Cables: Guicolim Lisbon

**PETTERS LIMITED**  
Sociedade Commercial  
Untramarina  
S.A.R.L.  
Apartado 23  
Bissau

Cables: Ultra

### Guyana

**CATERPILLAR OVERSEAS SA**  
Guyana Tractor & Equipment  
Company  
P.O. Box 604  
Georgetown

Telex: GY238  
Cables: Guytrac  
Phone: 61130, 67181

**DETROIT DIESEL ALLISON**  
Associated Industries Ltd.  
Ruimveldt 5  
P.O. Box 77  
Georgetown

Telex: 312-241  
Cables: Ainlim Guyana  
Phone: 6729-67295

**DORMAN DIESELS LIMITED**  
Vernon H Gibson Ltd  
P.O. Box 424  
Georgetown

Telex: CY211  
- starting each  
message with  
"please pass to  
Vergil phone 2812  
or 5404"  
Cables: Vergil Demerara

**LEYLAND INTERNATIONAL**  
Guyana Gajraj Limited  
13 Water & Benjinck Streets  
P.O. Box 440  
Georgetown 2

Cables: Gadwhite  
Phone: 2606

**LUCAS SERVICE OVERSEAS  
LIMITED**  
13-15 Water Street  
Georgetown

Telex: GY212  
Cables: Boost  
Phone: 66171

**PETTERS LIMITED**  
Bookers Stores Limited  
49-53 Water Street  
Georgetown

Telex: GY212  
Cables: Campcult Demerara  
Phone: Central 1136/66171

### Haiti

**CATERPILLAR OVERSEAS SA**  
Haytian Tractor & Equipment  
Company SA  
Ave. Haile Selassie  
P.O. Box 1318  
Port-Au-Prince

Telex: 3490074  
Cables: Haytractor,  
Phone: 2-1750, 2-3837

**DETROIT DIESEL ALLISON**  
Haitian Marine & Industrial Co.  
Rue Lowverture  
Gonaives

Telex:  
Cables: Haimarine  
Phone: 3-3226

**KOHLER INTERNATIONAL  
LIMITED**  
Charles Fequirer & Cie  
B.P. 398  
84 Rue Dantes Destouches  
Corner of Rue Du Center  
Port-Au-Prince

**LEYLAND INTERNATIONAL**  
Auto SA  
360 Boulevard J.J. Dessalines  
P.O. Box 147  
Port-Au-Prince

Cables: AutoSA  
Phone: 2772

**LUCAS SERVICE OVERSEAS  
LIMITED**  
Compagnie Haitienne de  
Moteurs SA  
P.O. Box 162  
Port-Au-Prince

Cables: Haimo  
Phone: 22230

**NISSAN DIESEL MOTOR CO.  
LIMITED**  
Autorama S.A.  
P.O. Box 1046  
Rue de Peuple  
Port-Au-Prince

**PETTERS LIMITED**  
Commercial Francisco Oliver  
P.O. Box 356  
Port-Au-Prince

Cables: Oliver  
Phone: 3193

**JOHN ROBSON (SHIPLEY) LTD.**  
Commercial Francisco Oliver  
P.O. Box 356  
Port-Au-Prince

**WHITE ENGINES  
INCORPORATED**  
Charles Fequiere & Cie  
B.P. 398  
84 Rue Dante Destouches  
Port-Au-Prince

Telex: 3490094  
Cables: Fequiere Port-Au-  
Prince  
Phone: 2-2149

### Honduras

**ALLIS CHALMERS**  
Distribuidora De Requeros SA  
3a Avenida 11 y 12 Calles  
Comayagua  
Apartado Postal 46  
Tegucigalpa

Telex: 4148 Diresahu  
Cables: Diresa, Tegucigalpa  
(Honduras)  
Phone: 2-7492

**BRIGGS & STRATTON CORPORATION**

Soc. General de Comercio  
Empresa Alvaraz  
Apartado 568  
San Pedro  
Sula

Cables: Sogema  
Phone: 52-18-10

**CATERPILLAR OVERSEAS SA**  
Casa Commercial Mathews, SA  
Barrio La Bolsa  
Cormayaguela, D.C.  
P.O. Box 39  
Tegucigalpa

Telex: 1109 Cemcol, HT  
Cables: Cemcol  
Phone: 22-3164

**DETROIT DIESEL ALLISON**

Corporacion Commercial SA de C.V.  
La Avenida 111  
Cormayaguela D.C.  
P.O. Box 207  
Tegucigalpa

Cables: Motz  
Phone: 22-67-90, 22-51-95

**DORMAN DIESELS LIMITED**  
(Diresa)  
Distribuidora de Repuestos SA  
Apartado Postal No.46  
Tegucigalpa D.C.

Cables: Diresa  
Phone: 2-4437, 2-8482

**KOHLER INTERNATIONAL LIMITED**

S.E.M.P.E. SA  
Apartado Postal No.219  
Boulevard Kennedy  
Tegucigalpa

**LEYLAND INTERNATIONAL**

Sociedad De Equipos Mecanicos Y  
Productos Especializados SA,  
De C.V.  
(S.E.M.P.E.)  
Apartado 219  
Tegucigalpa

Cables: 1134 SEMPE - HT

**LUCAS SERVICE OVERSEAS LTD.**

G.L. Schofield  
Apartado 1488  
Tegucigalpa C.A.

**NISSAN DIESEL MOTOR CO. LIMITED**

Sociedad de Equipos Mecanicos  
y Productos Especializados S.A.  
Apartado 219  
Tegucigalpa D.C.

**PERKINS ENGINES LIMITED**

Agencia Rene Sempe  
Apartado Postal 219  
Tegucigalpa D.C.

Telex: 1134 Sempe HT  
Cables: Sempe  
Phone: 2-5101

**PETTERS LIMITED**

Empresa de Servicios Agricola  
SA de C.V.  
Apartado 278  
7a Avenida S.O. No.62  
San Pedro  
Sula

Telex: 5522 ESA SA HT  
Cables: ESA  
Phone: 520025  
522185

**WHITE ENGINES INCORPORATED**

Fomento Internacional  
SA de C.V.  
P.O. Box 337  
Tegucigalpa D.C.

Cable: Fomento  
Phone: 2-2433 or 2-8015

**Hong Kong**

**BRIGGS & STRATTON CORPORATION**

King Tah Steel Ball &  
Bearing Co.  
P.O. Box 2120  
Kowloon Central Post Office  
959 Canton Road  
Mongkok  
Kowloon

Telex: 75028 HKBRG HX  
Cables: HKBRGS  
Phone: 3-300231

**CATERPILLAR OVERSEAS SA**

Caterpillar Far East Limited  
P.O. Box 3069  
Hong Kong

Telex: HX3305 CFEL  
Cables: Catfareast HKG

**DETROIT DIESEL ALLISON**

American Engineering Corp.  
(Hong Kong) Ltd.  
1207-1213 Princes Building  
Ice House Street  
Hong Kong

Telex: 780-83116 Inten  
HX  
Cables: Amengg  
Phone: H 239081-239085

**DORMAN DIESELS LIMITED**

WorldWide Engineers Ltd.  
Room 503  
Landwide Building  
118-120 Austin Road  
Kowloon

Telex: 84761 HX  
Cables: Lalchuli  
Phone: 3-691985

**L. GARDNER & SONS LIMITED**

Dodwell & Co. Ltd.  
P.O. Box 36  
Hong Kong

**KLOCKNER-HUMBOLDT-**

Hongkong United Dockyards Ltd.  
Hung Horn  
Hong Kong

Telex: 73547 Hudhkh X  
Cables: Hudrep  
Phone: 33411

**KOHLER INTERNATIONAL LIMITED**

Industrial Engineers Ltd.  
P.O. Box 1838  
311 Windsor House  
42 Desvoeux Road Central  
Hong Kong

**LEYLAND INTERNATIONAL**

Metro Dodwell Motors Ltd.  
42 Floor  
Connaught Centre  
Hong Kong

Telex: HX 75696  
Cables: Metcar  
Phone: 5-702381

**LUCAS SERVICE OVERSEAS LIMITED**

Auto-Electric Ltd  
Lucas House  
231-235 Gloucester Road  
P.O. Box 20641  
Hong Kong

Telex: Dodwell  
73204  
Cables: Lucaserve  
Phone: 5-738241-4

**NISSAN DIESEL MOTOR CO. LIMITED**

Dah Chong Hong, Ltd.  
Commercial Vehicles Department  
152A-D Prince Edward Road  
Kowloon

**PERKINS ENGINES LIMITED**

M.K. Gilman & Co Ltd.  
World Trade Centre  
24th Floor  
280 Gloucester Road  
Causeway Bay  
Hong Kong

Telex: 73358 Gilman HK  
Phone: 5-793083

**PETBOW LIMITED**

Reiss Bradley & Co. Ltd.  
P.O. Box 78  
701-704 Realty Buildings  
Hong Kong

**PETTERS LIMITED**

Autodiesel Trading Corporation  
55 Gloucester Road  
Hong Kong

Cables: Autodiesel  
Phone: 5-272091,  
5-276739,  
5-278373

**RUGGERINI MOTORI SpA**

Wai Gin Ltd.  
P.O. Box 8642  
Mongkok Post Office  
711-713 Nathan Road  
3rd Floor  
Mongkok  
Kowloon

Telex: 75878 Waigi

**Hungary**

**CATERPILLAR OVERSEAS SA** Telex: 22-5347  
 Universal Co. Ltd. Cables: Universal  
 P.O. Box 54 Phone: 424-514, 882-318  
 Budapest 1135

**DORMAN DIESELS LTD** Telex: 23465  
 I. Bier & Son (Overseas) Ltd. Cables: Ironsteel London  
 Kemp House Phone: 01-2537815/6  
 152/160 City Road 01-2536173  
 London EC1V 2PE  
 U.K.

**KLOCKNER-HUMBOLDT-DEUTZ AG** Telex: 22-4971  
 Nikex Ungarisches Phone: 475-903, 475-140  
 Csérkesz Str. 7  
 H-1809 Budapest X

**Iceland**

**BRIGGS & STRATTON CORPORATION** Telex: 2042  
 Gunnar Asgeirsson Ltd Cables: Volver IS  
 Sudurlandsbraut 16 Phone: 35200

**CATERPILLAR OVERSEAS SA** Telex: 2018  
 Hekla Ltd. Cables: Hekla  
 Laugavegur 170-172 Phone: 21240-21250  
 P.O. Box 5310  
 Reykjavik

**DETROIT DIESEL ALLISON** Telex: 11682  
 Detroit Diesel Allison International Phone: 02 713860, 715860  
 - Europe Lillestrom  
 c/o General Motors Norge A/S  
 P.O. Box 205  
 2001 Lillestrom  
 Norway

**DORMAN DIESELS LIMITED** Cables: Stefansson  
 S. Stefansson Ltd Phone: 1-5579 Reykjavik  
 P.O. Box 1006  
 Grandagardi 5  
 Reykjavik

**L. GARDNER & SON LTD.** Telex: 2074  
 Jonsson & Juliusson Phone: 25430  
 P.O. Box 731  
 Tryggvagata 4  
 Reykjavik

**KLOCKNER-HUMBOLDT-DEUTZ AG** Telex: 2070  
 Hlutafelag Hamar Cables: Hamar  
 Posthof 1444 Phone: 22123-6  
 Reykjavik

**LEYLAND INTERNATIONAL** Telex: 2151  
 P. Stefansson Ltd Phone: 26911  
 P.O. Box 5092  
 Hverfisgata 103  
 Reykjavik

**RERKINS ENGINES LTD.** Telex: 2124  
 Drattarvelar H.F. Cables: Ictractors  
 Sundurlandsbraut 32 Phone: 86500  
 Reykjavik

**PETTERS LIMITED** Cables: Velskip  
 Velar & Skip Ltd. Phone: 27544  
 P.O. Box 1006  
 Gradagardi 5  
 Reykjavik

**WHITE ENGINES INCORPORATED** Cables: Blar  
 Bergur Larusson, HF Phone: 81050  
 P.O. Box 634  
 Armula 14  
 Reykjavik

**VOLVO PENTA** Telex: 42  
 Valtir HF Phone: 35200  
 Gunnar Asgeirson Ltd Cables: Volver  
 Sudurlandsbraut 16  
 Reykjavik

**India**

**BRIGGS & STRATTON CORPORATION** Telex: 021-7883 Spares.  
 Aeicorp Pvt Ltd Cables: Eagerness  
 10 Lall Bazar Street Phone: 23-5120, 23-0879  
 Calcutta 700001

**CATERPILLAR OVERSEAS SA** Telex: 2246  
 Larsen & Toubro Ltd Cables: Larsenbro  
 L & T House  
 Ballard Estate  
 P.O. Box 278  
 Bombay 400 038

**Tractors India Limited** Cables: Diesels  
 1 Taratolla Road  
 Garden Reach  
 P.O. Box 323  
 Calcutta 700 024

**DETROIT DIESEL ALLISON** Telex: 953-312599  
 Pram Nath Diesels Private Ltd Premotnd  
 7 Scindia House Cables: Premdiesel  
 Kasturba Gandhi Marg Phone: 45891  
 New Delhi 1

**DORMAN DIESELS LIMITED** Telex: 2517  
 Greaves Cotton & Co Ltd Cables: Greaves  
 P.O. Box 91 Phone: 259771  
 1 Forbes Street  
 Bombay

**L. GARDNER & SONS LIMITED** Phone: 251337  
 W.H. Brady & Co Ltd  
 Brady House  
 12-14 Veer Nariman Road  
 P.O. Box 26

**KATOLIGHT**  
 E. Krishna Rao & Brothers  
 Visakhapatnam 530 002  
 Bombay

**KLOCKNER-HUMBOLDT-DEUTZ AG** Telex: 11-2181 DIL  
 Deutz India Ltd Cables: Aircooled  
 3-D-2 Court Chambers Phone: 298247  
 35 Sir Vithaldas Thackersey Marg  
 Bombay 400 020

**LEYLAND INTERNATIONAL** Telex: 41271  
 Ashok Leyland Ltd Cables: Leyind Madras  
 11/12 North Beach Road Phone: (Ennore Works)  
 Madras 1 59340/9  
 (City Office)  
 24674

**Austin Distributors (Prvt) Ltd** Cables: Ausdis  
 19 Chowringhee Road  
 Calcutta

**Automobile Products of India Ltd**  
 Tractor Division  
 8 Eastern Avenue  
 Maharani Bagh  
 New Delhi 14

**LUCAS SERVICE OVERSEAS LTD.** Telex: 41-439  
 Lucas Indian Service Ltd Cables: Lucasind  
 9 Patullo Road Phone: 812176-9  
 Mount Road  
 Madras 600 002

**Aeicorp Private Ltd**  
 Mercantile Buildings  
 2nd Floor  
 10 Lall Bazaar Street  
 Calcutta 700001

PERKINS ENGINES LIMITED  
Simpson & Co Ltd  
P.O. Box 303  
202-203 Mount Road  
Madras 2  
Telex: 41-538  
Cables: Simpsons  
Phone: Madras 83091

PETBOW LIMITED  
William Jacks & Co  
(India) Private Ltd  
Hamilton House  
P.O. Box 335  
Ballard Estate  
Bombay 1BR

PETTERS LIMITED  
Parry & Co Ltd  
Dare House  
P.O. Box 12  
Madras 1  
Cables: Distimato  
Phone: 24101/29251

WHITE ENGINES  
INCORPORATED  
Salgaocar Engineers Pvt Ltd  
805 New Delhi House  
27 Barakhamba Road  
New Delhi 1100011

#### Indonesia

ALLIS CHALMERS  
John D. Hutchinson & Co  
(Indonesia) Ltd  
Hutchison House  
17th Floor  
P.O. Box 43  
Hong Kong  
Telex: 74798  
Cables: Alltrakhk  
Phone: 5-233081

BRIGGS & STRATTON  
CORPORATION  
P.T. Unimas Motor Wasta  
3 Jalan Batu Ceper  
P.O. Box 2911 Dkt  
Jakarta  
Telex: Unimas 46238  
Cables: Unimotor  
Phone: 56497, 50499

CATERPILLAR OVERSEAS SA  
P.T. Trakindo Utama  
Kompleks KKO Cilandak  
P.O. Box 2282  
Jakarta  
Telex: 011 44393  
Cables: Traktama

DÉTROIT DIESEL ALLISON  
P.T. Garuda Diesel (Ltd)  
Jl Letjen Haryono M.T.33  
Jakarta  
Telex: 796-44100  
Cables: Garudadiesel  
Phone: 81204, 81097,  
84117

DORMAN DIESELS LTD  
Berca Indonesia P.T.  
1st Floor JL  
Cikini Raya 61  
P.O. Box 496/JKT  
Jakarta  
Telex: 2895 Bercacon JKT  
Cables: Bercacon  
Phone: 40369

KATOLIGHT  
P.T. Speed Indonesia Ltd  
P.O. Box 2346  
Jakarta

KIRLOSKAR OIL ENGINES LTD  
Rutan Trading Coy  
Djalan Srompretan 16-18  
Surebaya  
Telex: 3497  
Cables: Rutan  
Phone: 2841, 3620, 2151,  
2502

KLOCKNER-HUMBOELDT-  
DEUTZ AG  
P.T. Lindeteves Indonesia  
Jl Yos Sudarso  
P.O. Box 2651  
Sunter 11  
Jakarta Utara  
Cables: Lindeteves  
Phone: 290409, 290934

LEYLAND-INTERNATIONAL  
P.T. Java Motors  
17 Djalang Raya Kramat  
Tromolpos 161  
Jakarta 1V/4  
Cables: Javamotors  
Phone: 40693/5

LUCAS SERVICE OVERSEAS LTD  
P.T. Fakta Jaya Motor  
Tromol Pos 3032/JKT  
97 Jalan Lautze  
Jakarta  
Cables: Factsmot  
Phone: 25927

NISSAN DIESEL MOTOR CO.  
LIMITED  
P.T. Imermotors  
Djalan Melawai VIII No.10  
Kebejoran Baru  
Jakarta

PERKINS ENGINES LTD  
P.T. Traktor Nusantara  
Jalan Gajah Mada 80  
Jakarta  
Telex: JKT 42844  
Cables: Traknusa  
Phone: 270919/20062

PETBOW LIMITED  
P.T. Porodisa Equipment  
Ground Floor  
Arthaloko Building  
Jalan Jenderal Sudirman  
Kav-2  
Jakarta

PETTERS LIMITED  
P.T. Patindo Permanent V.A. Ltd  
Jalan Hayam Wuruk No. A1-3  
Pasar Lindeteves  
Jakarta  
Barat  
Cables: Indopermanent  
Phone: 22651, 21882

VOLVO PENTA  
P.T. Benua United Trading &  
Engineering Corporation  
Jalan Gajah Mada No.209  
Jakarta  
Telex: 42869  
Cables: Betrab  
Phone: 21288, 24504

WHITE ENGINES  
INCORPORATED  
P.T. Sumber Mesin Raya  
Jl: Gajah Mada No.176-177  
P.O. Box 1298/JAK  
Jakarta  
Barat  
Telex: 46111  
Cables: Summesra  
Phone: 22016 20-417

#### Iran

ALLIS CHALMERS  
Diesel Auto Part SA  
247 Abassabad Avenue  
P.O. Box 687  
Tehran  
Telex: 212658 Yasa Ir  
Cables: Fouladi  
Phone: 851021-8

BRIGGS & STRATTON  
CORPORATION  
Sabet-Pasal Co. Incorporated  
Eisenhower Avenue  
Jeyhoun Street  
Telex: 2519  
Cables: Sabetpasal  
Phone: 954051-53

CATERPILLAR OVERSEAS SA  
Mashinaye Rahsazi Co Ltd  
Av. Saadi 168  
P.O. Box 3390  
Tehran  
Telex: 212357  
Cables: Marcoll  
Phone: (021) 314001/10

DORMAN DIESELS LTD  
Partt Motor Co  
Saadi Avenue 588  
Tehran  
Cables: Parttmotor  
Phone: 303207/9

L. GARDNER & SONS LTD  
H.G. Mollahzadeh & Bros  
Avenue Arvand  
P.O. Box 49  
Abadan  
Phone: Abadan 3778

**KATOLIGHT**  
Karteman Company  
No.90 Ramsar Street  
Shahreza Avenue  
Tehran

**KIRLOSKAR OIL ENGINES LTD** Telex: 212261 IMTC IR  
Iran Margó Trading Co. Ltd Cables: Iranmargo  
P.O. Box 373 Phone: 921082/83/84  
216-222 Eisenhower Avenue  
Tehran

**KLOCKNER-HUMBOLDT-  
DEUTZ AG** Telex: 213239 Varn Ir  
Varnco Co Ltd Phone: 899585  
Avenue Sepahbad Zahedi  
P.O. Box 41-2166  
No.6 Naser Street  
Shahdad Building  
Tehran 14155

**LEYLAND INTERNATIONAL** Cables: Leymotors  
British Leyland Motor Corporation  
P.O. Box 1111545  
11 Avenue Sepahbad  
Avenue Sepahbad  
Tehran

**LUCAS SERVICE OVERSEAS LTD** Telex: 212075  
Tundar Distribution & Service Co. Cables: Irantundarco  
P.O. Box 66139 Phone: 547688  
Ghazvine Avenue No. 682  
Tehran

**NISSAN DIESEL MOTOR CO.  
LIMITED**  
Romco Co. Limited  
Ave. Iranshahr North  
Koucheh Hoza No.13  
Tehran

**PERKINS ENGINES LTD** Cables: Ferromatex  
Ferromatex Technical & Phone: 310085-89  
Trading Corporation  
Aftab Shargh Building  
Avenue Ferdowsi  
Tehran

**PETBOW LIMITED**  
Iran Electrical Engineering  
249 Avenue Shahreza  
Tehran

**PETTERS LIMITED** Telex: 212511 Mahyar  
The Mahyar Industrial Company THN  
Mahyar Building Cables: Mahyar  
634 Saadi Avenue, Phone: 217093  
Tehran

**JOHN ROBSON (SHIPLEY) LTD**  
Sherkat Tazamoni Farijoun  
Zartoshty va Baradar  
Zartoshty Building  
Kooche Morntaz Saadi Avenue  
Tehran

**RUGGERINI MOTORI SpA**  
Farland Company Ltd  
642 Saadi Avenue  
Tehran

**WHITE ENGINES  
INCORPORATED** Telex: IEC IR 21-2607  
Iran Equipment Co Cables: Taymour  
17 Mellat Avenue Phone: 311301-311820  
Tehran

#### Iraq

**ALLIS CHALMERS** Cables: Diesel  
Technical Works W.L.L. Phone: 90018  
Muaskar Al-Rashid  
Baghdad

**DORMAN DIESELS LIMITED** Cables: Rustengine Baghdad  
The Iraqi Diesel Engine Company Phone: 94799  
P.O. Box 2211  
Alwiyah

**KATOLIGHT**  
Nabeel Jewaideh  
26/3/26 Muasker St Rashid Road  
Baghdad

**KLOCKNER-HUMBOLDT-  
DEUTZ AG** Cables: Faryaf  
Faris Trading & Contracting Phone: 99215  
Alexander Iskander Building  
Bustan Kubbah Sa'addon Street  
P.O. Box 5681  
Baghdad

**LEYLAND INTERNATIONAL** Cables: Automobile  
General Automobile Company Phone: 89711  
Al-Andalus Square  
P.O. Box 3270  
Saadoun  
Baghdad

**LUCAS SERVICE OVERSEAS  
LIMITED** Cables: Automobile  
Automobile State Enterprise Phone: 95071  
P.O. Box 3270  
Al-Andalus Square  
Baghdad

**PERKINS ENGINES** Telex: 2342 Auto I.K.  
Automobile State Enterprise Cables: Automobile  
P.O. Box 3270 Phone: 95071  
Al-Andalus Square  
Baghdad

**PETERS LIMITED**  
State Machinery Import Company  
Sa'Adon Street  
Baghdad

**JOHN ROBSON (SHIPLEY) LTD**  
J.J. Moukhtar  
Numaan Street 25G/1/197  
Baghdad

#### Ireland

**DETROIT DIESEL ALLISON** Telex: 851-3 1329  
Detroit Diesel Allison International Wellingborough  
— Europe Cables: Genmopower  
Division of General Motors Ltd Phone: (0933) 71122  
London Road  
P.O. Box 6  
Wellingborough  
Northamptonshire NN8 2DL  
U.K.

**FORD MOTOR CO LIMITED** Telex: 6121  
Henry Ford & Son Limited Phone: 26881  
Cork

**KLOCKNER-HUMBOLDT-  
DEUTZ AG** Telex: 5122  
Blackwood Hodge Limited Cables: Suntract  
Long Mile Road Phone: 503666  
Dublin 12

**NISSAN DIESEL MOTOR CO.  
LIMITED**  
William P. Ryan Ltd.  
52 Thorncastle Street  
Ringsend  
Dublin 4

**PERKINS ENGINES LTD** Telex: 5320  
McNeill (Ireland) Ltd Phone: 371801  
Collinstown Cross  
Cloughram  
Co. Dublin

PETERS LIMITED  
M & G Limited  
Cooksdown Industrial Estate  
Belgard Road  
Tallaght  
Co. Dublin

Telex: 4486 (Mags)  
Phone: 511144

VOLVO PENTA  
Western Marine Ltd  
Bulloch Shipyard Dalkey  
Dublin

Telex: 4839  
Phone: 800321

#### Israel

BRIGGS & STRATTON  
CORPORATION  
Moise Carasso Sons Limited  
26 Rival Street  
P.O. Box 991  
Tel Aviv

Telex: 32-114  
Cables: Mocarasso  
Phone: 33241-6

CATERPILLAR OVERSEAS SA  
The Israel Tractors &  
Equipment Co. Ltd  
New Industrial Area  
8 Hamanor Street  
P.O. Box 214  
Holon

Telex: 32447  
Cables: Israelquip  
Phone: 856-125

DETROIT DIESEL ALLISON  
David Argamany Limited  
36 Yitzhak Sade Street  
P.O. Box 14161  
Tel Aviv

Telex: 922-03-2470  
Coin IL  
Cables: Agradiesel  
Phone: 03-30172

JLO  
Reses Limited  
12 Harakeyeth Street  
P.O. Box 941  
Tel Aviv

Telex: 34118/9bxtv il for  
5141 resses  
Cables: Resses  
Phone: 625-634

KATOLIGHT  
C.N.E.C. Telecoms Limited  
P.O.B. 1707  
Tel Aviv

LEYLAND INTERNATIONAL  
Israel Motor Agency Limited  
65 Derech Petach Tikva  
P.O. Box 20029  
Tel Aviv

Telex: 03-2283  
Cables: Isomotor

RUGGERINI MOTORI SpA  
N. Feldman & Son Limited  
P.O. Box 33181  
71 Giborey Israel Street  
Tel Aviv

Telex: 32276 Felta

VOLVO PENTA  
Mayer's Cars and Trucks Co.  
Limited  
23 Carelbach Street  
P.O. Box 16164  
Tel Aviv

Telex: 32230  
Cables: Carsmayer  
Phone: 269191

WHITE ENGINES  
INCORPORATED  
Ardini Limited  
P.O. Box 1033  
3 Levontin Street  
Tel Aviv

Cables: Arditi  
Phone: 61118/2, 621533

#### Italy

ALLIS CHALMERS  
Cav. Tonino Cerioli + C.S.A.S.  
Via Bentini 9  
40013 Castelmaggiore  
Bologna

Telex: 51209 Cerioli  
Cables: Ceriolo Castel-  
maggiore  
Phone: 700442/3/4

Via Isonzo 34  
Rome

Telex: Reitaly 62037  
Cables: Powerhouse  
Phone: 8440351

BOMBARDIER-ROTAX GmbH  
Cantiere Jet-Craft  
Quartiere ind. Mirabilia  
1-20081 Abbiategrasso (MI)

Phone: 94.92.17

BRIGGS & STRATTON  
CORPORATION  
R.A.M.A. Snc  
Via Agnoletti (Zona Annonaria)  
Reggio Emilia 42106

Telex: 53396  
Cables: Ranga R.E.  
Phone: (0522) 71852-  
72631

CATERPILLAR OVERSEAS SA  
Compagnia Generale Trattori S.p.A.  
Direzione Generale  
Via San Vittore 37  
Milan

Telex: 39073  
Cables: Cogetrattori  
Phone: (01) 49-94

Macchine Agricole Industriali  
Automezzi MAIA S.p.A.  
Via Nomentana 995  
00137 Rome

Telex: 61463  
Cables: Maiarom  
Phone: 820-241/4  
824-841/4  
823-901

DETROIT DIESEL ALLISON  
Detroit Diesel Allison International  
- Europe  
c/o General Motors Suisse SA  
Salzhausstrasse 21  
2501 Biel-Bienne  
Switzerland

Telex: 34217 Gms-Ch  
Cables: Gms-Ch, Bienne  
Phone: 032-215111  
Bienne

DORMAN DIESELS LIMITED  
Officine Meccaniche Ing.  
Contaldi (OMLC)  
Strada Padana Superiore 307  
20090 Vimodrone (Milano)

Telex: 35193 Comavim  
Cables: Contaldi  
Phone: 2500441/2/3/4/5

FORD MOTOR COMPANY  
LIMITED  
Ford Italiana S.p.A.  
Parts Distribution Centre  
Via Appia Nuova 1157  
00178 Rome

Telex: 62106  
Phone: (06) 799 3015

L. GARDNER & SONS LIMITED  
Cantiere Navale Dell'Argentario  
s.r.l.  
58019 Porto S. Stefano  
(Grosseto)

Phone: (05 64) 81.29.75,  
81.41.15

KLOCKNER-HUMBOLDT-  
DEUTZ AG  
Industrie Meccaniche  
Lombarde S.p.A.  
via Garcia Lorca 25  
22050 Lomagna  
(Como)

Telex: 37606 Imellom  
Cables: Imelombarde  
Phone: 587291

LEYLAND INTERNATIONAL  
B.L. Italia  
Via Paolo di Dono Angolo  
Via Baldovinetti  
00144 Rome

Telex: 79284 (Leylita)  
Phone: 546811

PERKINS ENGINES LIMITED  
Motori Perkins S.p.A.  
22100 Como-Camerlata  
Via Pasquale Paoli 9/A

Telex: 38063  
Cables: Perkoil Camerlata  
Phone: 504885

PETERS LIMITED  
Volpi & Bottoli  
Via Altobello Ferrara  
26034 Piacenza (Cr)

Telex: 30421 Combanca  
Mastora  
Phone: (0375) 98128/  
98434

VOLVO PENTA  
Volvo Perita Italia S.r.l.  
Via Lomellina 18  
Casella Postale 30  
I-20094 Buccinasco-Milano

Telex: 35323  
Cables: Volvopenta  
Phone: 02-447 97 05  
02-447 80 57



**Ivory Coast**

**ALLIS CHALMERS**  
Compagnie Africaine D'Equipement  
Industrial  
(C.A.E.I.)  
30 Rue Thomas Edison  
P.O. Box 836  
Abidjan

Telex: 768  
Cable: Afequip  
Phone: 357039

**CATERPILLAR OVERSEAS SA**  
Manutention Africaine  
P.O. Box 1299  
Abidjan

Telex: 675  
Cables: Mea  
Phone: 37-33-66  
37-33-86/7/8/9/  
90/91

**DETROIT DIESEL ALLISON**  
Blackwood Hodge (Cote d'Ivoire)  
S.a.r.l.  
25 Boulevard Angoulvant  
P.O. Box 14066  
Abidjan

Telex: 969-Abidjan 2207  
Cable: Suntract  
Phone: 324083

**KOHLER INTERNATIONAL  
LIMITED**  
Ets. Peyrissac Cote D'Ivoire  
P.O. Box 1272  
Abidjan

**LEYLAND INTERNATIONAL**  
Cie Francaise de l'Afrique,  
Occidentale  
Agence Centrale  
P.O. Box 2114  
Abidjan

Telex: 777  
Cables: Senafrica  
Phone: 226.51, 262.26

**LUCAS SERVICE OVERSEAS  
LIMITED**  
Matforce Diesel (Div. of CFCIT)  
6 Rue Thomas Edison  
Zone 4  
P.O. Box 1844  
Abidjan

Telex: Tecofra  
640435  
Phone: 35 58 69

**NISSAN DIESEL MOTOR CO.  
LIMITED**  
Comafrique  
B.P. 20817  
Abidjan

**PERKINS ENGINES**  
Carena  
P.O. Box 453  
Abidjan

Telex: Carena 323  
Cables: Carena  
Phone: 22.22.27, 32.13.36

**PETERS LIMITED**  
Hamelaf-Afrique SA  
Km3 Autoroute Sud  
P.O. Box 1326  
Abidjan

Telex: Hamelaf 401  
Cables: Hamelaf  
Phone: 35.67.43, 63.28

**Jamaica**

**ALLIS CHALMERS**  
Kingston Industrial Agencies  
Limited  
381 Spanish Town Road  
P.O. Box 80  
Kingston 11

Telex: 01042 - Indage  
Cables: Indage  
Phone: 933-7121, 933-7123

**BRIGGS & STRATTON  
CORPORATION**  
Will's Battery Co. Limited  
66 Slipe Road  
Kingston 5

Cables: Battery  
Phone: 936-5921

**CATERPILLAR OVERSEAS SA**  
Jamaica Tractor &  
Equipment Company  
379 Spanish Town Road  
P.O. Box 213  
Kingston

Telex: 2135 Alprojam  
Cables: Jamtrac  
Phone: 923-9251

**DETROIT DIESEL-ALLISON**  
Industrial Equipment Company  
22 Bell Road  
P.O. Box 22  
Kingston 11

Telex: 381-2213 Haultrax  
Cables: Powerload  
Phone: 927 36519, 36529

**DORMAN DIESELS LIMITED**  
Caribbean Industrial Equipment  
Limited  
7 South Avenue  
Rest Pen  
Kingston 10

Cables: Indquip  
Phone: 926-1240

**KATOLIGHT**  
Specialist Agencies Limited  
P.O. Box 657  
Spanish Town

**KLOCKNER-HUMBOLDT-  
DEUTZ AG**  
The Technical Supply Co. Limited  
44 Hagley Park Road  
P.O. Box 75  
Kingston 10

Telex: 2271 Servocomp JA  
Cables: Kemtex  
Phone: 9367744

**KOHLER INTERNATIONAL,  
LIMITED**  
Abdulla C. Marzouca Limited  
157 Orange Street  
Kingston

**LEYLAND INTERNATIONAL**  
Cars & Commercial Limited  
6799 Harbour Street  
Kingston

Cables: Garancom  
Phone: 23121, 26821

**LUCAS SERVICE OVERSEAS  
LIMITED**  
John Crook Limited  
Lucas House  
86-88 Tower Street  
P.O. Box 21  
Kingston

Cables: Lucasjam  
JCA  
Phone: 5227/8/9

**PERKINS ENGINES LIMITED**  
Reginald Aitken Limited  
437 Spanish Town Road  
P.O. Box 280  
Kingston 11

Telex: 2170 Marco  
Cables: Marco  
Phone: 933/6737/9  
933/6730; 933-  
8538, 933-8411

**PETERS LIMITED**  
Will's Battery Co. Limited  
P.O. Box 440  
66 Slipe Road  
Kingston 5

Cables: Battery  
Phone: 936-5921

**Japan**

**ALLIS CHALMERS**  
Denyo Co. Limited  
No.2, 4-Chome  
Nakano-Ku  
Kamitakada  
Tokyo

Telex: 232-2936 Denyo J  
Cables: Denwelyo  
Phone: 03-552-1201

**BRIGGS & STRATTON  
CORPORATION**  
Yanase & Co. Limited  
Trading Division  
Minato-ku,  
Tokyo

Telex: 78102422551  
Cables: Yanaseco  
Phone: 452-4311

**CATERPILLAR OVERSEAS SA**  
Caterpillar Mitsubishi Limited  
3700 Tana  
Sagamihara-Shi  
Kanagawa-Ken 229

Telex: J222877  
Cables: Caterbishico  
Sagamihara

**DETROIT DIESEL ALLISON**  
Tominga & Co. Limited  
Ibasen Building  
No.5 Nichome Kobunacho  
Nihombashi  
Chuo-Ku  
Tokyo 103

Telex: 781-22435 Tompo  
Cables: Tomdiesel  
Phone: 662-1851

DORMAN DIESELS LIMITED  
Kyotkuto Boeki Kaisha Limited  
Secoind Industrial Machinery Dept  
CPO Box 330  
Tokyo 100-91

Telex: 22440 Kyokubo  
Cables: Mercantile  
Phone: 244-3511

FORD MOTOR CO. LIMITED  
Ford Motor Company of Japan  
Limited  
Checker Building  
5-29 Akasaka 8 Chome  
Minato Ky  
Tokyo-107

Cables: Fomoja

KLOCKNER-HUMBOLDT-  
DEUTZ AG  
Mitsui Deutz Diesel Engine Co.  
Limited  
Daini Toyo Kaiji Building  
3rd Floor  
4-8-24 Shinbashi  
Minato-ku  
Tokyo

Telex: 02842-109  
mdeutz j  
Cable: Demitsui Deutz  
Phone: 4331666

KOHLER INTERNATIONAL  
LIMITED  
Tominaga & Co. Limited  
8 Kinugasa-cho  
Kita-ku  
Osaka

LEYLAND INTERNATIONAL  
Shintoyo Motors Company Limited  
P.O. Box 581  
Hatanodai  
Shingawa-ku  
Tokyo

Telex: 246/6638  
Cables: Shintoprise

LUCAS SERVICE OVERSEAS  
LIMITED  
Nihon-Lucas (Sales & Service)  
Limited  
7-5 Iwamotochu 1-chome  
Chiyoda-ku  
Tokyo 101

Telex: 285-5888  
Cables: Lucastyo  
Phone: 863-5187

PERKINS ENGINES LIMITED  
Perkins Engines (North Pacific) Ltd.  
6th Floor  
Heianzaka Building  
14-2 Akasaka 1-chome  
Minato-ku  
Tokyo 107

Telex: 24292  
Phone: (03) 586-7377

PETBOW LIMITED  
Mikuni Kikai Kogyo Company Limited  
No. 2-2 Kajicho  
2-chome  
Chiyoda-Ku  
Tokyo

PETERS LIMITED  
Dodwell & Company Limited  
Industrial Department  
P.O. Box 297  
Kowa Building No 16 Annex  
9-20 Akasaka 1-chome  
Minato-ku  
Tokyo

Telex: International:  
J22274, J22602  
Domestic: 222 2842  
Cables: Dodtrade  
Phone: (03) 584-2351

VOLVO PENTA  
The Penta Japan Limited  
Room No. 316  
Azabu Heights  
5-10, 1-chome  
Roppongi  
Minato-ku  
Tokyo

Telex: J24692  
Cables: Volvopentajap  
Phone: 03-586-3801/5

#### Jordan

CATERPILLAR OVERSEAS SA  
Jordan Tractor &  
Equipment Co. Limited  
Salt Road  
P.O. Box 313  
Amman

Telex: 1226  
Cables: Jallad  
Phone: 383-63/64/65

DETROIT DIESEL ALLISON  
Farradj & Company  
Jabel El Wejbedeh  
P.O. Box 974  
Amman

Telex: 925-1317 Farradj  
Cables: Farradj  
Phone: 21662

DORMAN DIESELS LIMITED  
Nagib Baki & Sons (Jordan) Ltd.  
P.O. Box 572  
King Hussein Street  
Basharat Building  
Amman

Cables: Nagib Baki  
Phone: 36121

INDIAN NATIONAL DIESEL  
ENGINE CO. LIMITED  
Ramadhan Trading Company  
P.O. Box 12067  
Amman

KATOLIGHT  
Modern Trading Agency Company  
P.O. Box 1377  
Amman

KIRLOSKAR OIL ENGINES  
LIMITED  
Nicolas C. Peridakis & Company  
P.O. Box 441  
King Hussein Street  
Amman

Cables: Perico  
Phone: 23789

KLOCKNER-HUMBOLDT-  
DEUTZ AG  
Adnan Kassim  
P.O. Box 5210  
Amman

Telex: 1474 ask jo  
Phone: 42378

KOHLER INTERNATIONAL  
LIMITED  
The Commercial & Industrial Co.  
Limited  
Station Street  
P.O. Box 379  
Amman

LEYLAND INTERNATIONAL  
Sulaiman Tannous & Sons  
P.O. Box 102  
Amman

Cables: Tours

LUCAS SERVICE OVERSEAS  
LIMITED  
Suleiman Tannous & Sons Ltd.  
Amir Mohammed Street  
P.O. Box 102  
Amman

Telex: 1324 Sultan Jo  
Cables: Tours  
Phone: 36180, 36188,  
36189, 24768

NISSAN DIESEL MOTOR CO.  
LIMITED  
The Commercial & Industrial  
Co. Ltd.  
P.O. Box 379  
Amman

PETERS LIMITED  
The United Engineering &  
Mechanical Co.  
(Modaco)  
P.O. Box 1400  
Mahatta Road  
Amman

Cables: Modaco  
Phone: 55354

PERKINS ENGINES LIMITED  
Transjordan Engineering Company  
P.O. Box 1  
Amman

Telex: 1300  
Cables: Tec  
Phone: 24198/9, 23354

JOHN ROBSON (SHIPLEY)  
LIMITED  
Nagib Baki & Sons (Jordan) Limited  
P.O. Box 572  
King Hussein Street  
Amman

**Kenya**

**ALLIS CHALMERS**  
Hokman Bros (East Africa) Ltd  
Buckleys Road  
P.O. Box 42044  
Nairobi

Telex: 22510 Homanea  
Cables: Airdrift  
Phone: 555388

**BRIGGS & STRATTON CORPORATION**  
Car & General (Kenya) Limited  
Cargen House  
13 Government Road  
P.O. Box 20001  
Nairobi

Telex: 22046  
Cables: Cargen  
Phone: 31570

**CATERPILLAR OVERSEAS SA**  
Construction Equipment  
(Div. of Gailley & Roberts Ltd.)  
P.O. Box 30331  
Nairobi

Cables: Afritrak  
Phone: 55-71-88

**DETROIT DIESEL ALLISON**  
Wigglesworth & Co. Kenya Limited  
Kingston Road  
Industrial Area  
P.O. Box 30092  
Nairobi

Telex: 963-22241  
Cables: Pettinato  
Phone: 57022

**DORMAN DIESELS LIMITED**  
Mackenzie (Kenya) Ltd.  
Likoni Road  
P.O. Box 30010  
Nairobi

Telex: 22205  
Phone: 555333 (Office)

**KIRLOSKAR OIL ENGINES LIMITED**  
Marina Machineries Co.  
(Kenya) Limited  
P.O. Box 43266  
Nairobi

Cables: Marina  
Phone: 22059

**KLOCKNER-HUMBOLDT-DEUTZ AG**  
Achelis (Kenya) Limited  
P.O. Box 30378  
Kijabe Street  
Nairobi

Telex: 22556  
Cables: Achelissos  
Phone: 559766, 559485

**LEYLAND INTERNATIONAL**  
Leyland Kenya Limited  
P.O. Box 18052  
Connaught House  
Haili Selassie Avenue  
Nairobi

Cables: Leyalb

**LUCAS SERVICE OVERSEAS LIMITED**  
Lucas House  
Delta Limited  
Uhuru Highway  
P.O. Box 30519  
Nairobi

Telex: 22248  
Cables: Delta  
Phone: 557422

**NISSAN DIESEL MOTOR CO. LIMITED**  
Ryce Motor Ltd.  
P.O. Box 49729  
Nairobi

**PERKINS ENGINES LIMITED**  
Century Tractor & Implements  
(Kenya) Limited  
P.O. Box 30192  
Roland Ngala Street  
Nairobi

Telex: 22641  
Cables: Centrac  
Phone: 23035-6, 24940

**PETTERS LIMITED**  
Mackenzie (Kenya) Limited  
P.O. Box 30010  
Mercantile House  
Koinange Street  
Nairobi

Telex: 22205  
Cables: Mackenzies  
Phone: 555333

**Khmer Republic**

**DORMAN DIESELS LIMITED**  
Societe Commerciale Khmere  
(E. Rondon & Co)  
P.O. Box 231  
61 Maha Vithei Preah-Bat Norodom  
Phnom Penh

Cables: Rondon  
Phone: 24078

**LEYLAND INTERNATIONAL**  
Societe Des Garages Charner  
Au Cambodge  
215 Vithei Pau Kampo  
P.O. Box 274  
Phnom Penh

Cables: Fareast St Germain  
Franc  
Phone: 963.48-83,  
973.07-15

**PETTERS LIMITED**  
Etablissements Maha-Boepa  
250 Maha Vithei Preah Monivong  
P.O. Box 446  
Phnom Penh

Cables: Moha  
Phone: 32024

**Korea**

**ALLIS CHALMERS**  
Woodward & Dickerson  
(Korea) Limited  
1601 Korean Air Lines Building  
118-2K a Namdong-gu, P.O. Box 1218  
Chung-Ku  
Seoul

Telex: 2252  
Cables: Woodward  
Phone: 24-3551/4

**CATERPILLAR OVERSEAS SA**  
Hae Nin Tractor Co. Limited  
Dong Bang Building  
18th Floor  
250, 2-Ka Taipyong-ro  
Chung-Ku  
Central P.O. Box 1201  
Seoul

Cables: HN Tractor

**DETROIT DIESEL ALLISON**  
Summit Industrial Corporation  
Hae Nam Building  
No.90 2-KA  
Taepyong-No  
Chung-Ku  
I.P.O. Box 1078  
Seoul

Cables: Sumiting  
Phone: 28-5338

**DORMAN DIESELS LIMITED**  
Ewkor Trading Co. Limited  
901 International Insurance Building  
No.8 Yang Dong  
I.P.O. Box 1162  
Chung-Ku  
Seoul

Telex: 2365  
Cables: Ewkor  
Phone: 22-2124, 22-5349

**KATOLIGHT**  
European American Corporation  
P.O. Box 1467  
Seoul

**KLOCKNER-HUMBOLDT-DEUTZ AG**  
Lee-Gee Industrial Corporation  
I.P.O. Box 2232  
Seoul

Telex: 28548 Sesil K  
Cables: Leegee  
Phone: 766259

**LEYLAND INTERNATIONAL**  
The Seoul Kyo Tonh Corporation  
Limited  
185 Setongro  
I.P.O. Box 1154  
Seoul

Cables: Seoul Kyotong

**LUCAS SERVICE OVERSEAS LIMITED**  
Hyundai Motor Service Company  
113-25 4KA Wonhyo Ro  
Yongsan Ku  
Seoul

Telex: 2338  
Phone: 43-3171/6  
43-7901

**PERKINS ENGINES LIMITED**  
Hyundai Motor Co. Limited  
Hyundai Building  
178 Sejong-Ro  
Jongro-Ku  
Seoul

Telex: Hdmoco K2391  
Phone: 74-8311, 75-6511

**PETTERS LIMITED**  
Shriro (International) Ltd.  
9th Floor  
Jaban Building  
5 Yang Dong  
Choong-Ku  
Seoul

Telex: Shriroco 23515  
Phone: 22.6131/3

**WHITE ENGINES  
INCORPORATED**  
Pan-A International Co.  
Room 1200 Samyun Building  
63-2, 2-KA Chungmu-Ro  
Joong-Ku  
Seoul

Cables: Panabyun, Seoul  
Phone: 76-1588

#### Kuwait

**BRIGGS & STRATTON  
CORPORATION**  
Khalid Yousuf Al-Homaizi, Corp.  
P.O. Box 252  
Kuwait

Telex: 2488  
Cables: Homaizico  
Phone: 812321

**CATERPILLAR OVERSEAS SA**  
Mohamed Abdulrahman Al-Bahar  
Machinery General Office  
P.O. Box 148 Safat  
Kuwait

Telex: 2302 KT  
Cables: Moatasim  
Phone: 810-855/56

**DETROIT DIESEL ALLISON**  
Yusuf Ahmad Alghanim & Sons  
W.L.L.  
Construction Equipment and  
Engine Division  
Fourth Ring Road  
Rai Industrial Area  
Shuwaikh  
P.O. Box 223  
Kuwait

Telex: 9592069 Autoarabi  
Cables: Autoarabi  
Phone: 719772 or 730105

**L. GARDNER & SONS  
LIMITED**  
Al-Sabah & Fakhro Company  
Limited W.L.L.  
Commercial Centre No.3  
P.O. Box  
Safat 319  
Kuwait

Phone: 34138

**INDIAN NATIONAL DIESEL  
ENGINE CO. LIMITED**  
Abdulaziz Abdullah  
Al-Murshed & Brothers  
P.O. Box 1874  
Kuwait

**KATOLIGHT**  
Yusuf A. Aighanem  
P.O. Box 223  
Kuwait

**KLOCKNER-HUMBOLDT-  
DEUTZ AG**  
Ateeq  
Trading & Engineering Enterprises  
P.O. Box 699  
Kuwait

Telex: 3007 KT  
Cables: Ateeq  
Phone: 717945/6/7

**KOHLER INTERNATIONAL LIMITED**  
Bader Al Mulla & Brothers  
P.O. Box 177 Safat  
Kuwait

**LEYLAND INTERNATIONAL**  
Kuwait Automobile & Trading  
Company  
P.O. Box 41  
Kuwait

Telex: 3005 Automobile  
KT  
Cables: Automobile  
Phone: 24132-34215

**LUCAS SERVICE OVERSEAS  
LIMITED**  
Ajmar Mechanical Engineering  
Company  
P.O. Box 392  
Kuwait

Telex: 2152 Omarco Kwt  
Cables: Omarco  
Phone: 819555/7/8/9

**NISSAN DIESEL MOTOR CO.  
LIMITED**  
Boudai Trading Co. Ltd.  
P.O. Box Safat 1287  
Kuwait

**PERKINS, ENGINES  
LIMITED**  
The Trading & Industrial  
Equipment Co. W.L.L.  
P.O. Box Safat 2459  
Kuwait

Telex: Success 2224 KWT  
Cables: Success  
Phone: 819179/819188/  
819190

**PETBOW LIMITED**  
Morad Yousuf Behbehani  
P.O. Box 146  
Kuwait

**PETTERS LIMITED**  
Yousif Ibrahim Hizami  
P.O. Box 733  
Kuwait

Cables: Hizami  
Phone: 434645

**JOHN ROBSON (SHIPLEY)  
LIMITED**  
Al-Humaidan Kuwait Trading &  
Contracting Est.  
Hilali Street  
Mohd. N. Al-Hajeri Building  
Kuwait

#### Laos

**LEYLAND INTERNATIONAL**  
Ets. Lath Nhouyvanisvong  
Enterprises  
Commerciales Et Constructions  
P.O. Box 33  
Vientiane

Cables: Lath-Pakke  
Phone: 35

#### Lebanon

**ALLIS CHALMERS**  
Merican-Curtis International  
Limited  
Al Ghanem Building  
Rue Verdun  
P.O. Box 11-4986  
Beirut

Telex: 20829LE Penyon  
Cables: Engracting  
Phone: 353-670

**BRIGGS & STRATTON  
CORPORATION**  
Michel Andraos & Co.,  
S.A.L.  
P.O. Box 447  
Beirut

Cables: Micandros  
Phone: 220300

**CATERPILLAR OVERSEAS SA**  
M. Ezzat Jallad & Fils  
P.O. Box 110208 and 112556  
Beirut

Telex: 21624  
Cables: Jamla Beirut  
Phone: 932-522

**DETROIT DIESEL ALLISON**  
Levant Diesel  
Matta Building  
Makdesi Street  
P.O. Box 11-2867  
Beirut

Telex: 20680  
Cables: Levandiesel Beirut  
Phone: 350180 or 350181

**DORMAN DIESELS LIMITED**  
Nagib Bakj & Sons  
P.O. Box 11-828  
Patriarch Hoyek Street  
Khan Antoun Bay  
Beirut

Cables: Bakson  
Phone: 234618, 271395

**L. GARDNER & SONS LIMITED**  
Saamir Commercial Agencies  
P.O. Box 11-2891  
Beirut  
Telex: 20680 Le Joe Int  
Cables: Trancomage  
Phone: 295240-238001

**INDIAN NATIONAL DIESEL  
ENGINE CO. LTD.**  
Abourrousee & Company  
P.O. Box 1500  
Beirut

**KIRLOSKAR OIL ENGINES  
LIMITED**  
Abdel Massih Commercial  
Company  
St. Joseph Hospital Street  
P.O. Box 80260 Dora  
Bourj Hammoud  
Beirut  
Cables: Amcco  
Phone: 262388/264615

**KLOCKNER-HUMBOLDT-  
DEUTZ AG**  
Emile Acar & Fils  
Rue Arz  
B.P. 115834  
Beirut  
Telex: 22218 Rocomy  
Cables: Emilacarfils  
Phone: 225797, 293774

**KOHLER INTERNATIONAL  
LIMITED**  
Demetrius Stephanou & Company  
P.O. Box 127  
Port Street  
Fattal Building  
Beirut

**LEYLAND INTERNATIONAL**  
Phillippe & Adib Fata  
P.O. Box 5309  
Beirut  
Cables: Fatabros  
Phone: 280860, 281533

**LUCAS SERVICES OVERSEAS  
LIMITED**  
Michel Andraos & Co.,  
S.A. Lebanese  
Andraos Building  
Al Arz Street  
P.O. Box 447  
Beirut  
Cables: Micandros  
Phone: 220300

**PERKINS ENGINES LIMITED**  
Abourrousee & Company  
P.O. Box 1500  
Beirut  
Cables: Edrouss  
Phone: 227345/235784

**RUGGERINI MOTORI SpA**  
Antoine Hajjar & Fils  
P.O. Box 11-1705  
Saliba Building  
Dora-Beirut

**VOLVO PENTA**  
S. Sadaka & Sons  
P.O. Box 4  
Zahle  
Telex: 21211  
Cables: Sadaka  
Phone: 823333

#### Lesotho

**CATERPILLAR OVERSEAS S.A.**  
Barlow's (D.F.S.) Ltd.  
Nuffield Street  
Hamilton  
Bloemfontein 9301  
South Africa  
Telex: 2-632  
Cables: Shipments  
Bloemfontein  
Phone: 82721

#### Liberia

**CATERPILLAR OVERSEAS SA**  
Liberia Tractor & Equipment  
Company  
United Nations Drive  
P.O. Box 299  
Monrovia  
Telex: 4282  
Cables: Libtraco  
Phone: 22279/22057

**DETROIT DIESEL ALLISON**  
Blackwood Hodge (Liberia) Inc.  
United Nations Drive  
P.O. Box 105  
Monrovia  
Telex: 937-4223 Suntract  
Cables: Suntract  
Phone: 21039

**KATOLIGHT**  
United States Trading Company  
P.O. Box 140  
Monrovia

**KLOCKNER-HUMBOLDT-  
DEUTZ AG**  
United Liberia Rubber  
Corporation  
Randall Street  
P.O. Box 51  
Monrovia  
Telex: 4243  
Cables: Unilibru  
Phone: 21506, 21708

**LEYLAND INTERNATIONAL**  
Swiss Africa Trading Corporation  
P.O. Box 115  
Bushrod Island  
Monrovia  
Telex: 4271  
Phone: 21668

**PERKINS ENGINES LIMITED**  
Oost Afrikaansche Compagnie  
(O.A.C.)  
P.O. Box 281  
Water Street  
Monrovia  
Telex: Monrovia 4233  
Cables: Jupiter  
Phone: 21010, 22655

#### Libya

**ALLIS CHALMERS**  
Hajmohammed M. Sheibany  
& Co (SHEBCO)  
Sciara Haiti 2  
Alitalia Building  
P.O. Box 626  
Tripoli

**CATERPILLAR OVERSEAS SA**  
General Company for Farm  
Equipment & Agricultural  
Necessities  
(GISMET-EMÉ)  
Sidi Mesri  
P.O. Box 148  
Tripoli  
Telex: 20022  
Cables: Metrade  
Phone: 32520/41237

**DETROIT DIESEL ALLISON**  
Belashbar GM Power  
P.O. Box 2238  
Tripoli  
Telex: 929.40031 Mobilely

**DORMAN DIESELS LIMITED**  
Mahdi Bettamer & Sons  
P.O. Box 66  
8 Omar Mukhtar Street  
Benghazi  
Telex: 20017  
Cables: Bettamer  
Phone: 3135

**KATOLIGHT**  
Gharabel Trading Agency  
P.O. Box 1541  
Tripoli

**KIRLOSKAR OIL ENGINES  
LIMITED**  
Omar Ali Adballa Elhuni &  
Brothers  
P.O. Box 2232  
146 Omar Mukhtar Street  
Tripoli  
Cables: Elhuni  
Phone: 36295

**KLOCKNER-HUMBOLDT-  
DEUTZ AG**  
A. Bramley  
P.O. Box 68  
Tripoli  
Phone: 40588

**LEYLAND INTERNATIONAL**  
Mahari Trading Co. SpA  
Sciara Haiti  
P.O. Box 2361  
Tripoli  
Cables: Airam

LUCAS SERVICE OVERSEAS  
LIMITED  
Mahari Trading Company  
P.O. Box 2361  
Tripoli

Cables: Alram  
Phone: 31171/5

NISSAN-DIESEL MOTOR CO.  
LIMITED  
The National Company for Trade &  
Vehicles  
P.O. Box 8456  
Tripoli

PERKINS ENGINES LIMITED  
Libyan Electronics Company  
P.O. Box 3680  
Sidi Et-Masri  
Tripoli

Cables: Electronco  
Phone: 31840, 39462

PETTERS LIMITED  
Libyan Anglo Agencies  
(Shebco) Ltd  
Darnis Building,  
Avenue Emile San Lot  
P.O. Box 242  
Benghazi

Telex: 40047 Laally  
Cables: Laal  
Phone: 2320-3509

JOHN ROBSON (SHIPLEY)  
LIMITED  
Libyan Development & Investment  
Company  
P.O. Box 3294  
Tripoli

RUGGERINI MOTORI SpA  
Agricoltura Shop  
Ramadam Misillati  
P.O. Box 2999  
Tripoli

VOLVO PENTA  
I.L.C.O.  
Suani Road Km 2  
P.O. Box 60  
Tripoli

Cables: Entesar  
Phone: 30726, 32108/9

#### Liechtenstein

CATERPILLAR OVERSEAS SA  
Ulrich Ammann Baumachinen AG  
Langenthal  
Switzerland

Telex: 68446  
Cables: Ammaning  
Langenthal  
Phone: (063) 2-27-02  
2-51-22

#### Luxembourg

CATERPILLAR OVERSEAS SA  
Bergerat Dutry S.A.  
Zone Industrielle  
Howald  
Luxembourg

Telex: 2543  
Cables: Bedutry  
Phone: 48-12-21/22

KLOCKNER-HUMBOLDT-  
DEUTZ AG  
Garage Magirus Deutz  
Arthur Schmitz  
243 route d'Esch  
Luxembourg

Telex: 2346  
Cables: Garagedeutz-  
luxemburg  
Phone: 487474

#### Madagascar

CATERPILLAR OVERSEAS SA  
Société Henri Fraise Fils & Cie  
Route des Hydrocarbures  
B.P. 28  
Tananarive  
Malagasy Republic

Telex: 22218  
Cables: Fraisenri  
Phone: 227-21/24

#### Madeira

CATERPILLAR OVERSEAS SA  
STET  
Sociedade Tecnica de Equipamentos  
e Tractores S.A.r.l.  
Apartado 1351  
Lisbon  
Portugal

Telex: 12778  
Cables: Stetra Sacavem  
Phone: 251-1011

DORMAN DIESELS LIMITED  
Madeira Engineering Co. Lda  
Arsenal de S. Tiago  
Rua D. Carlos 1,2A  
Caixa Postal 528  
Funchal

Cables: Arsenal  
Phone: 20191/2

LEYLAND INTERNATIONAL  
Leacock & Cia Ltd  
Rua Major Reis Gomes 13  
Caixa Postal 24  
Funchal

Cables: Leacock

PERKINS ENGINES LIMITED  
Leacock & Cia Lda  
Rua Major Reis Gomes 13  
Caixa Postal 416  
Funchal

Cables: Leacock  
Phone: 22101

VOLVO PENTA  
Mendes Gomes & Ca Lda  
Rua do Visconde de Anadia 3-4  
P.O. Box 556  
Funchal

Cables: Svea  
Telex: 72144  
Phone: 29191/3, 28118

#### Malagasy

CATERPILLAR OVERSEAS SA  
Société Henri Fraise Fils & Cie SA  
Route des Hydrocarbures  
P.O. Box 28  
Tananarive

Telex: 22218  
Cables: Fraisenri  
Phone: 227-21/24

KLOCKNER-HUMBOLDT-  
DEUTZ AG  
5 Rue Dr Rasamimanana  
P.O. Box 1248  
Tananarive

Telex: 22216  
Cables: Darrimax  
Phone: 20611, 23741

LEYLAND INTERNATIONAL  
Societe Industrielle &  
Commerciale de L'Emyrne  
(SICE)  
P.O. Box 1078  
Rue Clemenceau  
Tananarive

Telex: 216  
Cables: Sicegar  
Phone: 237-41

LUCAS SERVICE OVERSEAS  
LIMITED  
Ateliers De Mechanique  
Automobile A.Mec A  
Lalana Ravoninahitriariavo  
P.O. Box 392  
Tananarive

Telex: 22271  
Cables: Ameca  
Phone: 230-16

PERKINS ENGINES LIMITED  
AMECA  
Ateliers De Mechanique Automobile  
Routes Des Hydrocarbures  
P.O. Box 392  
Tananarive

Telex: 222-71 Ameca Tana  
Cables: Ameca  
Phone: 230-16

PETTERS LIMITED  
Ets Modrin & Cie  
P.O. Box 23  
Tananarive

Cables: Modrin  
Phone: 01-47

#### Malawi

CATERPILLAR OVERSEAS SA  
Cesco Ltd.  
Stadium Road  
P.O. Box 526  
Blantyre

Telex: 240  
Cables: Cesco  
Phone: 30166

**DETROIT DIESEL ALLISON**  
Detroit Diesel Allison International  
c/o General Motors South African  
(Pty) Ltd  
Aloes Plant (near Port Elizabeth)  
P.O. Box 4137  
Port Elizabeth 6000

Telex: 74-7684  
Cables: Portautoex  
Phone: 6-2384, 6-1131 Port  
Elizabeth

**DORMAN DIESELS LIMITED**  
Brown & Clapperton Limited  
P.O. Box 52  
Blantyre

Cables: Beance  
Phone: 2352/4

**LEYLAND INTERNATIONAL**  
The Leyland Motor Corporation  
(Malawi) Ltd  
P.O. Box 581  
Blantyre

Telex: Blantyre 4138  
Cables: Leymotor  
Phone: 30477

**LUCAS SERVICE OVERSEAS LIMITED**  
Brown and Clapperton Ltd  
P.O. Box 52  
Blantyre

Telex: 4243  
Cables: Beance  
Phone: 34677

**PERKINS ENGINES LIMITED**  
Farming & Engineering Services  
Limited  
Hanover Street  
P.O. Box 918  
Blantyre

Cables: Dixie  
Phone: 2923

**PETTERS LIMITED**  
Farming & Engineering Services  
Limited  
Hanover Street  
P.O. Box 918  
Blantyre

Cables: Dixie  
Phone: 35044

#### Malaysia

**BRIGGS & STRATTON CORPORATION**  
United Motor Works (M)  
Sdn. Bhd  
Batu Tiga Industrial Estate  
P.O. Box 52  
Sungei Rengam  
Shah Alam  
Selangor

Telex: MA 38649  
Cable: Unity  
Phone: 361911

**CATERPILLAR OVERSEAS SA**  
Tractors Malaysia Berhad  
Bangunan Sharidah  
Jalan Yong Shook Lin  
Section 7  
P.O. Box 2465  
Petaling Jaya

**DETROIT DIESEL ALLISON**  
General Diesel Malaysia Sdn. Bhd  
(Main Office)  
2 Jalan President Kennedy  
Lahat Road  
Ipoh

Telex: Genreco RS: 786-  
21962 Singapore  
Cable: Gedes  
Phone: 76455

**DORMAN DIESELS LIMITED**  
The General Electric Company  
of Malaysia  
Sendirian Berhad  
Diesel Division  
P.O. Box 256  
Kuala Lumpur

Telex: KL335  
Cables: Geclumpur  
Phone: 84291/5

**FORD MOTOR CO. LIMITED**  
Ford Motor Co. Pte. Ltd  
Malaysia Branch  
Sub Lot 11  
Jalan Paku 2/6  
Kawasan Miel Phase 11  
Batu Tiga  
Selangor  
W. Malaysia

Phone: 361900, 361909

**INDIAN NATIONAL DIESEL ENGINE CO. LIMITED**  
Chop Lim Hup Choon  
Sibu  
Sarawak

**KATOLIGHT**  
NEB  
P.O. Box 1003  
Kuala Lumpur 22-06

**KLOCKNER-HUMBOLDT-DEUTZ AG**  
Industrial Agricultural Div.  
Borneo Motors Sdn. Bhd  
Lot 1, Jn 13/2  
Petaling Jaya

Telex: Borneo MA 30334  
Phone: 51716, 51715,  
772629

**KOHLER INTERNATIONAL LIMITED**  
Sandilands Sdn. Bhd  
P.O. Box 159  
3 Jalan 13/2  
Petaling Jaya Selangor

**LEYLAND INTERNATIONAL**  
Wearne Bros. Malaysia Sdn. Bhd.  
P.O. Box 2323  
Kuala Lumpur

Telex: Wearne MA 30604

**LUCAS SERVICE OVERSEAS LIMITED**  
Far East Motors  
P.O. Box 81  
3 Jalan Robertson  
Kuala Lumpur

Telex: Wearnes 30604  
Cables: Ignitron  
Phone: 80381/3

**NISSAN DIESEL MOTOR CO. LIMITED**  
Malaysia Tractor & Equipment  
Sdn. Bhd.  
P.O. Box 1206  
Sandakan  
Sabah

**PERKINS ENGINES LIMITED**  
Perkins Engines Eastern  
(Malaysia) Sdn. Bhd.  
35 Jalan Segambut  
Tengah  
Kuala Lumpur 12-07

**PETTERS LIMITED**  
William Jacks & Co.  
(Malaysia) Sdn. Bhd.  
Jalan Bersatu Road 13/4  
Petaling Jaya  
P.O. Box 286  
Kuala Lumpur

Telex: 8430319  
Cables: Expanded  
Phone: 564121

#### Mali

**CATERPILLAR OVERSEAS SA**  
Manutention Africaine  
P.O. Box 443  
Bamako

Telex: 565  
Cables: Mea  
Phone: 22957, 22549

**KLOCKNER-HUMBOLDT-DEUTZ AG**  
Valcke Frères  
Untervertretung: Sté Sofica  
P.O. Box 1783  
KN 4 - Route de Rufisque  
Dakar

Telex: 663 Sofica SG  
Phone: 50063, 50537

**LEYLAND INTERNATIONAL**  
Etaperu Soudan  
5 Rue Mohamed  
P.O. Box 83  
Bamako

Cables: Etaperu

**PERKINS ENGINES LIMITED**  
Etabs. Simaga  
P.O. Box 27  
Segou

Phone: Agence 247.69  
Escale 241.47

**Malta**

**DETROIT DIESEL ALLISON** Cables: Mariner  
 Malta Marine Repairs & Services Ltd Phone: 20556  
 Mariner 1 Hay Wharf  
 Pieta Creek  
 Pieta  
 SA Maison

**DORMAN DIESELS LIMITED** Cables: Repairs  
 T. Pace & Co. Phone: Central 24139  
 Malta Marine Engineering Works  
 20/24 Zerafa Street  
 Marsa

**KLOCKNER-HUMBOLDT-DEUTZ AG** Cables: 813 Ronaso MT  
 Untervertretung I.M.L. Phone: 20072, 22956  
 Ronasons International Ltd  
 P.O. Box 50  
 113 Britannia Street  
 Valletta

**LEYLAND INTERNATIONAL** Telex: MW 232  
 Murray's Garage Ltd Cables: Automobile  
 Rue D'Argens Phone: 33041  
 Msida

**PERKINS ENGINES LIMITED** Cables: Interauto  
 International Automobiles Phone: 30001/2/3  
 20 Republic Street  
 Valetta

**PETTERS LIMITED** Cables: Darmzeb  
 Joseph Bezzina & Co. Ltd Phone: 139  
 44/45 Jetties Wharf  
 Marse

**RUGGERINI MOTORI SpA**  
 Michael Galea  
 41 Fisher Road  
 Magat

**Martinique**

**CATERPILLAR OVERSEAS SA** Telex: 02935 MR  
 Garage Americain Cables: Amgarage  
 Ets. Louis Crocquet Phone: 71-54-54  
 38 Avenue Duparquet 38  
 P.O. Box 579  
 Fort-De-France

**DETROIT DIESEL ALLISON** Cables: Pamaru Martinique  
 Manufactures Reupies Phone: 35-28  
 37 Rue Bertin  
 Fort-De-France

**DORMAN DIESELS LIMITED** Telex: Fort-De-France 665  
 Guy Vieules Phone: 54-69  
 P.O. Box 233  
 Fort-De-France

**KLOCKNER-HUMBOLDT-DEUTZ AG** Telex: 029633 MR  
 Valcke Freres Chemco  
 Untervertretung: Phone: 719363  
 SMR - SOCOMI  
 Zone de Jagbette Lamentin  
 P.O. Box 213  
 Fort-De-France

**KOHLER INTERNATIONAL LIMITED**  
 Ets. Rene & Henry Dormoy  
 P.O. Box 472  
 Pointe Simon  
 Fort-De-France

**LEYLAND INTERNATIONAL** Telex: 29631 Mr. Traser  
 Givva Garage Austin Phone: 74.16.28  
 Zone Industrielle Voie No.2  
 Lamentin  
 Martinique

**LUCAS SERVICE OVERSEAS LIMITED**

Antillas Mecanica  
 P.O. Box 497  
 Zone Industrielle  
 Lamentin  
 Fort-De-France  
 Telex: 029663  
 Cables: Monplasin  
 Phone: 741338, 741692

**PERKINS ENGINES LIMITED** Telex: 635 Amgarage  
 Ets. Louis Croquet Cables: Amgarage  
 P.O. Box 579 Phone: 71-54-54  
 38 Avenue Duparquet  
 Fort-De-France

**PETTERS LIMITED** Telex: Hermay 029648 MR  
 Ets. Rene & Henry Dormoy Cables: Remoy  
 P.O. Box 472 Phone: 71.95.16  
 Fort-De-France 12.033

**PERKINS ENGINES LIMITED** Telex: 635 Amgarage  
 Ets. Louis Croquet Cables: Amgarage  
 P.O. Box 579 Phone: 71-54-54  
 38 Avenue Duparquet  
 Fort-De-France

**Mauritania**

**CATERPILLAR OVERSEAS SA** Telex: 571  
 Somatrac Phone: 2188  
 P.O. Box 164  
 Nouakchott

**KLOCKNER-HUMBOLDT-DEUTZ AG** Telex: 420 ACD SG  
 Valcke Freres Phone: 50558  
 Untervertretung: ACD  
 Atelier Chantier de Dakar  
 P.O. Box 170  
 Av. Felix Eboué  
 Dakar

**LEYLAND INTERNATIONAL**  
 Cotema  
 P.O. Box 313  
 Nouakchott

**LUCAS SERVICE OVERSEAS LIMITED** Telex: 88  
 Compagnie Technique Cables: Unamotors  
 Mauritanienne Phone: 23-52  
 (Cotema)  
 P.O. Box 313  
 Nouakchott

**PERKINS ENGINES LIMITED** Telex: Cotema NKC 88  
 Cotema Phone: 23.52  
 Rte du Ksar  
 P.O. Box 313  
 Nouakchott

**PETTERS LIMITED** Telex: Locembe 556  
 Hamelle R.I.M. Cables: Hamelaf  
 Route d'Akjoujt Phone: 5.25.38  
 P.O. Box 382  
 Nouakchott

**Mauritius**

**CATERPILLAR OVERSEAS SA** Telex: IW 211  
 Blyth Brothers & Co. Ltd Cables: Ibel Mauritius  
 P.O. Box 341 Phone: 2-0265  
 Port Louis

**DETROIT DIESEL ALLISON** Cables: Ybrat Mauritius  
 Doger De Speville & Co. Ltd  
 P.O. Box 100  
 Port Louis

**DORMAN DIESELS LIMITED** Cables: Ireland  
 Ireland Fraser & Co. Ltd Phone: 2-2811  
 P.O. Box 58  
 Port Louis



**KLOCKNER-HUMBOLDT-DEUTZ AG**  
MECOM Mechanisation Co. Ltd  
13 Eugene Laurent  
P.O. Box 694  
Port Louis

Telex: 317 IW  
Phone: 2-4879/4

**LEYLAND INTERNACIONAL**  
Rogers & Co. Ltd  
P.O. Box 60  
Port Louis

Telex: IW 2217  
Cables: Finance  
Phone: 1281

**LUCAS SERVICE OVERSEAS LIMITED**  
Rey and Lanferna Ltd  
10 Edith Cavell Street  
Port Louis

Telex: 297  
Cables: Reyfer  
Phone: 2-0261

**PERKINS ENGINES LIMITED**  
Hall Genevieve Ltd  
P.O. Box 7  
Port Louis

Telex: IW 245  
Cables: Hagelan  
Phone: Port Louis 2-0211/

**PETTERS LIMITED**  
Forges Tardieu Ltd  
P.O. Box 20  
31 Route Nicolay  
Port Louis

Cables: Tardieu Port Louis  
Phone: Port Louis 194

**WHITE ENGINES INCORPORATED**  
Harel, Mallac & Co. Ltd  
P.O. Box 36  
Port Louis

Telex: 219 Port Louis  
Cables: Lerca

#### Mexico

**ALLIS CHALMERS**  
Standard Machinery & Supply  
Co. S.A.  
Boulevard Manuel Avila Comacho  
No. 112  
Apartado Postal 139  
Nancalpan de Juarez  
Estado de Mexico.

Phone: 5-76-35-42  
5-76-35-46

**BRIGGS & STRATTON CORPORATION**  
Sociedad Electro Mecanica SA  
Manuel Ma. Contreras 25  
Apartado Postal 42-164  
Mexico 4, D.F.

Telex: 017-71-137  
Cable: Selmex  
Phone: 5-66-36-00

**CATERPILLAR OVERSEAS SA**  
Maquinaria S.A.  
Carretera a Avalos y Calle 2A  
Apartado Postal 394  
Chihuahua

Telex: Maqsa Chi-034837  
Phone: 5-00-49, 5-00-51

**CATERPILLAR OVERSEAS SA**  
Caterpillar Mexicana S.A. de CV  
P.O. Box 2781  
Monterrey, N.L.

Telex: 038-794 (from U.S.)  
Phones: 46-45-32/3/4/5

**DETROIT DIESEL ALLISON**  
Detroit Diesel Allison International  
- Mexico  
c/o General Motors de Mexico,  
SA de CV  
Emerson 432 3rd Floor  
Mexico 5, D.F.

Telex: 7717-73835  
Cables: Genmotomex.  
Phone: 531-25-21,  
531-94-57

**FORD MOTOR COMPANY LIMITED**  
Ford Motor Company SA  
Paseo de la Reforma 333  
Apartado 39 Bis  
Mexico IDF

Telex: 7860  
Phone: 625 9200

**KLOCKNER-HUMBOLDT-DEUTZ AG**  
Dr. Rio de la Losa 68  
Apartado Postal 31-505  
MEX - Mexico 7, D.F.

Telex: Otto-Motor/ME  
Cables: Ottomotor  
Phone: 5787310  
1775604

**LEYLAND INTERNATIONAL**  
Refacciones Inglesas De Mexico  
SA  
Dinamarca 64-86  
Mexico 6, D.F.

Cables: Refinsa  
City  
Phone: 546-67-27,  
535-12-42

**LUCAS SERVICE OVERSEAS LIMITED**  
Electro Diesel de Mexico SA  
Arenal 110  
Apartado Postal 22-164  
Mexico 22, D.F.

Cables: Edamsa  
Phone: 5-73,51-00

**PERKINS ENGINES LIMITED**  
Motores Perkins SA  
Tiber No 68 1er Piso  
Mexico 5, D.F.

Telex: Perkoil-Mex  
017-71-347  
Cables: Perkoilmex  
Phone: 528-61-67

**PETTERS LIMITED**  
Cummins de Mexico SA  
Norte 35 No.1015  
Col. Industrial Valljo  
Mexico City 14, D.F.

Cables: Cummins, Mexico  
City  
Phone: 5-67-37-00

**VOLVO PENTA**  
Motor-Equipos SA  
Alemania 14  
Mexico 21, D.F.

Telex: 017-7-960  
Cables: Motesa  
Phone: 49 32 65

**WHITE ENGINES INCORPORATED**  
Sociedad Electro Mecanica SA  
Manuel Maria Contreras 25  
Apartado Postal 42-164,  
Mexico 4, D.F.

Telex: 017-71-137 Selmec  
Mex  
Phone: 566-36-00

#### Montserrat

**LEYLAND INTERNATIONAL,**  
United Motors Limited  
Empire House  
P.O. Box 224  
Plymouth  
Montserrat

**PETTERS LIMITED**  
O.R. Kelsick & Co. Ltd  
P.O. Box 166  
Plymouth  
Montserrat

Cables: Orkel  
Phone: 2205

#### Morocco

**BRIGGS & STRATTON CORPORATION**  
Etablissements Frenco  
Societe Marocaine De Construction  
de Matériel Agricole  
96 Boulevard de Khouribga  
Casablanca

Telex: 21617  
Cables: Agricultore-Casa  
Phone: 63411-634-12

**CATERPILLAR OVERSEAS SA**  
Societe Marocaine des Ets.  
P. Parrenin  
145 Bd. de la Resistance  
Casablanca

Telex: 21733  
Cables: Paragri  
Phone: 24-06-75

**DETROIT DIESEL ALLISON**  
Detroit Diesel Allison International  
- Europe  
c/o General Motors France  
56 a 58 Ave. Louis Roche  
92231 Gennevilliers  
France

Telex: Genimot 62050  
Cables: Parautexap  
Gennevilliers  
Phone: 790-70-60  
Gennevilliers

**DORMAN DIESELS LIMITED**  
Technical Equipments  
121 Bd Emile Zola  
P.O. Box 612  
Casablanca

Telex: 21860 Techequip  
Casa  
Cables: Techequip  
Phone: 406-21/22

**KATOLIGHT**  
Soreco  
19 Rue Hadjamar Riffi  
Casablanca

**KLOCKNER-HUMBOLDT-  
DEUTZ AG**  
Novelle Societe  
Magideutz SA  
4-8 Rue Layris Varger  
P.O. Box 24  
Casablanca

Telex: 21690  
Cables: Magideutz  
Phone: 2415-44  
243022-23,  
2416-98-99

**KOHLER INTERNATIONAL  
LIMITED**  
Societe Fenié Brosette  
650 Bou-Mohammed V  
Casablanca

**LEYLAND INTERNATIONAL**  
Afric Auto  
147 Rue Mustafá El Meani  
Casablanca  
Mr. José Ballesteros Velasco  
Borras Y Ballesteros  
Calvo Sotelo 60  
Ceuta  
Spanish Territories  
North Africa

Phone: 51-16-60

**LUCAS SERVICE OVERSEAS  
LIMITED**  
Standard-Auto-Accessoires SA  
149 Rue Mohamed Smiha  
Casablanca

Telex: 21859 SAA  
Cables: Standard  
Phone: 2786.23/24

**PERKINS ENGINES LIMITED**  
Calpe Garage Exploitation SA  
23 Rue Victor Hugo  
Tangier

Cables: Garagecalpe  
Phone: 376-77

**Dimateq**  
83 Boulevard de la Resistance  
Casablanca

Telex: 21907  
Phone: 24.48.96/97

**PETTERS LIMITED**  
Hamelie-Maroc SA  
35 Boulevard Hassan-Seghir  
P.O. Box 682  
Casablanca

Telex: Hamelaf 23841  
Phone: 620.51/2/3/4

**Technical Equipments SA**  
P.O. Box 612  
121 Boulevard Emile Zola  
Casablanca

Telex: 21860  
Cables: Techequip. R.C.  
Casa 26.0

**JOHN ROBSON (SHIPLEY)  
LIMITED**  
Technical Equipments  
P.O. Box 612  
121 Boulevard Emile Zola  
Casablanca

**WHITE ENGINES  
INCORPORATED**  
F. Pignal  
21/29 Boulevard Girardot  
Casablanca

Telex: 21.815  
Cables: Piradio  
Phone: 702-61

#### Mozambique

**CATERPILLAR OVERSEAS SA**  
Sociedade Tecnica de  
Equipamentos Industriais  
e Agricolas Lda. (STEIA)  
P.O. Box 2864  
Maputo

Telex: 6241 (393)  
Cables: Remoterra Maputo.  
Phone: 24187/88

**DETROIT DIESEL ALLISON  
INTERNATIONAL**  
c/o General Motors South  
African (Pty.) Ltd.  
Aloes Plant (near Port Elizabeth)  
P.O. Box 1137  
Port Elizabeth 6000

Telex: 74-7684  
Cables: Portautoex Port  
Elizabeth  
Phone: 6-2384 or 6-1131  
Port Elizabeth

**DORMAN DIESELS LIMITED**  
F. Bridler & Ca Ltda  
P.O. Box 65  
Can Phumo

Telex: 6-440FBC MO  
Cables: Bridler Can Phumo  
Phone: 23031

**L. GARDNER & SONS LIMITED**  
The Beira Engineering Co. Ltd  
(Marine)  
P.O. Box 363  
Beira

Phone: 2587-2687

**KATOLIGHT**  
Sadem  
Av. 31 de Janeiro 70  
Caixa Postal 2447  
Maputo

**KLOCKNER-HUMBOLDT-  
DEUTZ AG**  
Comel  
Consorcio de Maquinas &  
Electricidade Ltda  
P.O. Box 459  
Maputo

Telex: 6-388 Comel Mo  
Cables: Comela  
Phone: 27110, 27114

**LEYLAND INTERNATIONAL**  
Companhia Distribuidora de  
Automoveis SARL  
(Codauto)  
Caixa Postale 2510  
Maputo

Cables: Camiauto  
Phone: Camiauto  
No.6-225

**LUCAS SERVICE OVERSEAS LTD**  
Agencias Modernas Ltda  
P.O. Box 1066  
Avenida de Angola 3016  
Maputo

Telex: 6-268  
Cables: Agmod  
Phone: 733175

**PERKINS ENGINES LIMITED**  
Agencias Modernas Lda  
Caixa Postal No. 1066  
Av. de Angola 3016  
Maputo

Telex: 01-268 Penco Mo  
Cables: Agmod  
Phone: 733175

**PETTERS LIMITED**  
Breyner & Wirth (Beira) Lda  
Caixa Postal 293  
Rue Costa Serrao 158/166  
Beira

Cables: Produce  
Phone: 3154

**RUGGERINI MOTORI SpA**  
Inagrico Lda  
Caixa Postal 1809  
Avenida General Machado 1230  
Maputo

**VOLVO PENTA**  
Bonanza  
Del Ré & Velloza L da  
Av. Paiva Mansp 343/347  
Caixa Postal 2480  
Maputo

Cables: Delvemar  
Phone: 26507  
28798

#### Namibia

**BRIGGS & STRATTON  
CORPORATION**  
M & Z Motors & Engineering Ltd.,  
P.O. Box 192  
Windhoek

Telex: 56-720  
Cables: Emznetmotor  
Phone: 25401

**CATERPILLAR OVERSEAS SA**  
Barlow's S.W.A. Tractor Company  
Republiek Road  
Windhoek 9100

Telex: 56-725, 56-875  
Cables: Shipments  
Phone: 32026

**DETROIT DIESEL ALLISON**  
Detroit Diesel Allison International  
c/o General Motors South  
African (Pty.) Ltd.  
Aloes Plant (near Port  
Elizabeth)  
P.O. Box 1137  
Port Elizabeth 6000  
Republic of South Africa

Telex: 74-7684  
Cables: Portautoex  
Phone: 6-2384 or 6-1131

KLOCKNER-HUMBOLDT-  
DEUTZ AG  
Magirus-Deutz (Southern Africa)  
(Pty.) Ltd.  
P.O. Box 365  
Wrench Road  
Isando Travsvaal 1600

Telex: 86433  
Cables: Deutzmotor  
Phone: 365381/7

PETTERS LIMITED  
Barswa Motors Agric. Dept.  
P.O. Box 1708  
Windhoek

Telex: 56-871WK  
Cables: Barnmech  
Phone: 2-326J

#### Nepal

CATERPILLAR OVERSEAS SA  
Tractors India Limited  
1 Taratolia Road  
Garden Reach  
P.O. Box 323  
Calcutta 700 024

Cables: Diesels

KATOLIGHT  
Timber Corporation of Nepal Ltd.  
Babar Mahal  
Kathmandu

KIRLOSKAR OIL ENGINES  
LIMITED  
Kalpana Trading Co. Ltd.  
P.O. Box 83  
Kathmandu

Telex: NP 205 AAPU  
Cables: Kalpana  
Phone: 42-335

LEYLAND INTERNATIONAL  
Nepal Construction & Engineering  
Corporation (Priv.) Ltd.  
Dwalkha Chhen  
8/324 Pyukha Tole  
P.O. Box 156  
Kathmandu

Cables: Necoenco

LUCAS SERVICE OVERSEAS  
LIMITED  
Bhajuratra Engineering &  
Sales (P) Ltd.  
P.O. Box 133  
Moti Bhawan  
Kantipath  
Kathmandu

Cables: Himaliron  
Phone: 11490 and 14327

NISSAN DIESEL MOTOR CO.  
LIMITED  
Nepal Impex (P) Ltd  
Ramshah Path  
Kathmandu

#### Netherlands

BOMBARDIER-ROTAX GmbH  
Bonenkamp B.V.  
Castellumlaan 2-4-6  
De Meern

Phone: 03406-1246/2324

BRIGGS & STRATTON  
CORPORATION  
Motor Snelco B.V.  
HJE Wenckebachweg 137-139  
Amsterdam 0

Telex: 15272 Mosco  
Cables: Motor Snelco  
Phone: (020) 932808

CATERPILLAR OVERSEAS SA  
Geveke Motoren en Grondverzet  
B.V.  
Spaklerweg 45  
Industrieterrein Amstel  
Postbus 4091  
Amsterdam 0

Telex: 13106  
Cables: Globetract  
Phone: (020) 94-32-32

DETROIT DIESEL ALLISON  
INTERNATIONAL - EUROPE  
c/o General Motors Continental  
S.A. Nederland  
Parmentierplein 1  
P.O. Box 5061  
NL-Rotterdam 22

Telex: 21355 or 23018  
Cables: Cartruck  
Phone: Rotterdam 29-00-00

DORMAN DIESELS LIMITED  
BV Ingenieursbureau de Roos  
Beheer  
P.O. Box 1813  
Koninginnegracht 92  
Den Haag.

Telex: 31215 A/B Roos  
NL  
Cables: Abezet  
Phone: (070) 649830

FORD MOTOR CO. LIMITED  
N.V. Nederlandsche Ford  
Automobil Fabrik  
Postbus 795  
Amsterdam

Telex: 12303  
Phone: 5869111

L. GARDNER & SONS  
LIMITED  
Geveke Elektronica en  
Automatie N.V.  
Nautical Dept.,  
P.O. Box 5232  
Rotterdam

Telex: 22225  
Phone: (010) 29 24 44

KATOLIGHT  
MRC Zuid Hollandse Motoren  
Revisie B.V.  
P.O. Box 63008  
Rotterdam

KLOCKNER-HUMBOLDT-  
DEUTZ AG  
Deutz Motoren B.V.  
Sluisdijk 145  
Postbus 267  
Rotterdam

Telex: 28079  
Cables: Deutzmotor  
Phone: 298544

LEYLAND INTERNATIONAL  
British Leyland Nederland CV  
P.O. Box 204  
Nieuwe Gouwe OZ 40  
Gouda

Telex: 21553  
Cables: Britleyneq  
Phone: 1820-11122

PERKINS ENGINES LIMITED  
Kemper En Van Twist Diesel B.V.  
P.O. Box 156  
Mijlweg 33  
Dordrecht

Telex: 22-124 KVT NL  
Cables: Diesel  
Phone: 078-30155

PETTERS LIMITED  
Petters Continental B.V.  
Bunschotenweg 122-126  
Rotterdam

Telex: 22344  
Cables: Petters  
Phone: 010-290333

RUGGERINI MOTORI SpA  
Sim Holland B.V.  
Antwerpseweg 10  
Postbus 60  
Gouda

Telex: 26099 Simwo NL

VOLVO PENTA  
Nebim Handelmaatschappij B.V.  
Zwarteweg 77  
P.O. Box 3  
Aalsmeer

Telex: 10555  
Phone: 02977-24652

WHITE ENGINES  
INCORPORATED  
Petters Continental B.V.  
Bunschotenweg 124-126  
Rotterdam 3022

Telex: 22344 Petters  
Phone: 010-29 03 33

#### Netherlands Antilles

CATERPILLAR OVERSEAS SA  
PBC Machines & Services Inc.  
P.O. Box 157  
Curacao

Telex: 1159 Pbaiz NA  
Cables: Equipment  
Phone: 13981, 13866

DETROIT DIESEL ALLISON  
N.B. Winkel's Handel Maatschappij  
P.O. Box 8  
Oranjestad

Cable: Winruba

**DORMAN DIESELS LIMITED** Telex: CU6  
Kusters Trading Co. (Curacao) Inc. Cables: Kusters  
P.O. Box 41 Phone: 11853-11129  
Concordia Street No.30  
Curacao

**KATOLIGHT**  
Ferreira Sales and Service  
Siouxweg 5  
Willemstad,  
Curacao

**KOHLER INTERNATIONAL LIMITED**  
S.E.L. Maduro & Sons (Aruba) Inc.  
P.O. Box 36  
Orenjestad  
Aruba

**LEYLAND INTERNATIONAL** Cables: Vanderree  
N.V. Warenhuis Van Der Ree  
30 A.L. Boulevard  
Aruba

**LUCAS SERVICE OVERSEAS LIMITED** Cables: Vasco  
Viana Auto Supply Co. Inc. Phone: 5120/1  
P.O. Box 362  
San Nicholas  
Aruba

**PERKINS ENGINES LIMITED** Cables: Wellman  
Wellman Auto Supplies N.V. Phone: 54012/54354/  
P.O. Box 64 54289  
Schottegatweg Oost 156-158  
Willemstad

**PETERS LIMITED** Cables: Tackling  
Emile Tackling Phone: 2327-9  
P.O. Box 17  
Phillipsburg  
St. Maarten

**WHITE ENGINES INCORPORATED** Cables: Belicarib  
Bell Caribbean N.W. Phone: 93082  
P.O. Box 136  
Curacao

#### Nevis

**DETROIT DIESEL ALLISON** Telex: 387284 Trinidad  
S.L. Horsford & Co. Ltd. Cables: Tuglighter  
Agent of Tugs & Lights Ltd. Phone: 2085  
Trinidad  
Basseterre  
P.O. Box 45  
St. Kitts

#### New Caledonia

**CATERPILLAR OVERSEAS SA** Cables: Penocean, 051 NM  
Societe Caledonienne des Tracteurs  
Caltrac S.A.  
Complexe Edward Pentecost - PK5  
Magenta  
B.P. C2 Noumea Cedex  
Noumea

**DETROIT DIESEL ALLISON** Telex: 714-078  
Cemic S.A. Cables: Cemic  
Societe Commerciale d'Equipelement Phone: 739-48  
Mechanique  
P.O. Box 2059  
Noumea

**KLOCKNER-HUMBOLDT-DEUTZ AG** Phone: 73101  
Joseph Cheval & Cie  
3 Rue de Jean Jaurès  
B.P. 100  
Noumea

**LEYLAND INTERNATIONAL**  
Societe Commerciale d'Equipelement  
Mechanique  
CEMIC  
Lot 121, Duocos,  
Noumea

**LUCAS SERVICE OVERSEAS LIMITED**  
Groupement des Entreprises Barton  
B.P. 309  
Noumea

**NISSAN DIESEL MOTOR CO. LIMITED**  
Royal Motors  
P.O. 981

**PERKINS ENGINES LIMITED** Telex: Penocean 051 NM  
Pacific Motors S.A. Cables: Penocean  
24 Rue General Gallieni Phone: 757.44 & 757.45  
P.O. Box C2  
Noumea

**PETERS LIMITED** Phone: 20-49  
ABC Imports  
P.B. 617  
Noumea

#### New Hebrides

**DETROIT DIESEL ALLISON** Cables: Trade,  
D.J. Gubbay & Co. (New Luganville  
Hebrides) Pty. Ltd.  
P.O. Box 223  
Vila

**LEYLAND INTERNATIONAL** Telex: Satma BP 94  
Societe Des Automobiles Tracteurs Cables: Pacific Real  
& Materiel Agricole - Nouvelle Estates Villa New  
Hebrides,  
(SATMA - NH)  
Rue Higginson  
Lieu dit Thebakor  
Port. Villa  
New Hebrides

#### New Zealand

**ALLIS CHALMERS** Telex: NZ3438  
Cable-Price Corporation Limited Cables: Caprice  
C.P.D. House, Phone: 46-835  
108 The Terrace  
P.O. Box 10042  
Wellington

**BRIGGS & STRATTON CORPORATION** Telex: 4941  
Brown Brothers Ltd., Cables: MAZDA  
P.O. Box 548 Phone: 65-195  
Christchurch C.1.

**CATERPILLAR OVERSEAS SA** Cables: Goughs NZ 4889  
Gough Gough and Harmer Ltd.  
24-28 Armes Road  
P.O. Box 16-168  
Hornby

**DETROIT DIESEL ALLISON** Telex: NZ3521  
Detroit Diesel Allison International Cables: Genmotor  
c/o General Motors New Zealand Ltd. Phone: 2-7055  
Railway Avenue  
Parts Power & Appliances Dept.  
Private Bag  
Upper Hutt

**DORMAN DIESELS LIMITED** Telex: NZ 2481  
John Burras (Engineering) Ltd. Cables: Burnseng  
P.O. Box 14445 Phone: 576-119, 576-604,  
Carbine Road 575-055  
Panmure  
Auckland 6

FORD MOTOR CO. LTD.  
Ford Motor Company of  
New Zealand Limited  
Private Bag  
Auckland  
New Zealand

L. GARDNER & SONS LIMITED Telex: NZ 4277  
Andrews & Beaven Limited Phone: 60-599  
Private Bag  
203-205 Cashel Street  
Christchurch

KLOCKNER-HUMBOLDT- Telex: 2340  
DEUTZ AG Phone: 662119, 665139  
Mason Masco Ltd.  
Head Office  
P.O. Box 3485  
17 Maurice Road  
Penrose  
Auckland

KOHLER INTERNATIONAL  
LIMITED  
Agency Distributors  
(International) Ltd.  
P.O. Box 61-133  
Apirana Avenue  
Otara  
Auckland

LEYLAND INTERNATIONAL Telex: NZ 3432  
New Zealand Motor Cables: Mocerho  
Corporation Ltd. Phone: 844 039  
P.O. Box 2599  
89 Courtenay Place  
Wellington 1

LUCAS SERVICE OVERSEAS Cables: Aukas Auckland  
LIMITED  
Lucas Industries New Zealand Ltd.  
309-321 Broadway  
Newmarket  
Private Bag  
Auckland 1

NISSAN DIESEL MOTOR CO.  
LIMITED  
Nissan Motor Distributors (N.Z.) Ltd.,  
P.O. Box 61133  
Otara  
Auckland

PERKINS ENGINES LIMITED Telex: NZ 3387  
Clyde Engineering Ltd. Cables: Clydering  
P.O. Box 30480 Phone: 698-169  
415-427 Hutt Road  
Lower-Hutt

PETTERS LIMITED \* Telex: NZ 3455  
Richardson McCabe & Co. Ltd. Cables: Dredger  
P.O. Box 792 Phone: 557-728  
216/218 Willis Street  
Wellington

VOLVO PENTA Telex: NZ 2991  
Scandinavian Motors Limited Cables: Volpower  
115 Beach Road Phone: 362-797/8  
P.O. Box 1903  
Auckland 1

#### Nicaragua

ALLIS CHALMERS Telex: 342/0025  
Casa Commercial McGregor A.A. Cables: McGregor  
3A Calle S.E. No. 104 Phone: 6726  
Apartado 448  
Managua

BRIGGS & STRATTON Telex: 1336  
CORPORATION Cables: Ludeca  
Maquinaria Ludeca S.A. Phone: 40973-77 & 4611  
Apartado 861  
Managua

CATERPILLAR OVERSEAS SA Telex: 5811  
Nicaragua Machinery Company Cables: Nimac  
P.O. Box 469 Phone: 3151, 3159  
Managua

DETROIT DIESEL ALLISON Telex: 3021015  
Automotive & Industrial Cables: Automotive  
Equipment Co., Phone: 60092  
P.O. Box 323  
Managua

DORMAN DIESELS LIMITED Cables: Cross  
H.F. Cross S.A. Phone: 60114-6  
Apartado Postal 1169  
Managua D.N.  
Nicaragua

KATOLIGHT  
Samqui y Asociados  
Consultores S.A.  
Apartado 1005  
Managua

KOHLER INTERNATIONAL  
LIMITED  
Casa Cross S.A.  
Apartado 1169  
Managua

LEYLAND INTERNATIONAL Telex: 1237 H.F. Cross  
H.F. Cross S.A. Cables: Cross  
P.O. Box 1169 Phone: 60114-6  
Managua D.N.

LUCAS SERVICE OVERSEAS Telex: 3421327  
LIMITED Cables: Cross  
H.F. Cross S.A. Phone: 60114/5  
Apartado 1169  
Managua

NISSAN DIESEL MOTOR CO.  
LIMITED  
Distribuidora Datsun S.A.  
Boulevard Kennedy  
Carretera Norte Km 4½  
Apartado Postal 3680  
Managua D.N.

PERKINS ENGINES LIMITED Cables: Cross  
H.F. Cross, S.A. Phone: 3485-6-7  
Apartado Postal 1169  
Galle 15 de Septembre  
Managua D.N.

PETTERS LIMITED Telex: 1025 McGregor  
Casa Commercial McGregor S.A. Cables: McGregor,  
Apartado 448 Phone: 2-5306-07  
Carretera Sur, Kilometre 4, Phone: 2-5306-07  
Managua

#### Niger

CATERPILLAR OVERSEAS SA Telex: 5234  
Maintenance Africaine Phone: 72-20-11/12  
B.P. 136  
Niamey

KLOCKNER-HUMBOLDT- Telex: Nigretia 5227 NI  
DEUTZ AG Phone: 723319  
Valcke Frères  
Matforce Diesel  
B.P. 165  
Niamey

LEYLAND INTERNATIONAL Cables: Torfymot  
Societe Commerciale De L'Ouest  
Africain  
Niamey

LUCAS SERVICE OVERSEAS  
LIMITED Phone: 33.17, 30.38  
Niger Afrique  
B.P. 62  
Niamey

PERKINS ENGINES LIMITED  
Compagnie Transafricaine  
Boite Postale 246  
Niamey  
Telex: 237 Transacit  
Niamey  
Cables: Transacit  
Phone: 29.25/6

RUGGERINI MOTORI S.p.A  
El Hadji Nagnou Amadou Bonkougou  
B.P. 323  
Niamey

#### Nigeria

ALLIS CHALMERS  
Scoatrac - A Division of  
Scoa (Nigeria) Ltd.  
Dual Carriage Way  
Isolo Industrial Estate  
Isolo  
P.M.B. 1108  
Ikeja  
Lagos  
Telex: 21376 Torfymot  
Cables: Torfymot  
Phone: 48144-45249

BOMBARDIER-ROTAX GMBH  
African Afronic Merchants Co.  
P.O. Box 1541  
Lagos

BRIGGS & STRATTON  
CORPORATION  
Reiss & Co. (Nigeria) Ltd.  
71 Apapa Road  
Ebute Metta  
P.O. Box 678  
Lagos  
Telex: 21161  
Cables: Reico  
Phone: 44348 & 21258  
20956

CATERPILLAR OVERSEAS SA  
Tractor & Equipment Division of the  
UAC of Nigeria Ltd.  
P.M.B. 1015  
Ebute-Metta  
Lagos

DETROIT DIESEL ALLISON  
Diesel Sales & Service  
(Nigeria) Ltd.  
15 Burma Road  
P.O. Box 109  
Apapa  
Telex: 961-21393 Suntra  
Cables: Suntract Lagos  
Phone: 47107 or 47049

DORMAN DIESELS LIMITED  
Machinery & Electrical Equipment  
Div. of U.A.C. (Technical) Ltd.  
P.M.B. 1015  
Taylor Road  
Iddo  
Ebute Metta  
Lagos  
Cables: Mecquip  
Phone: 43310

J.L.O.  
Western Nigerian Technical Co. Ltd.  
P.M.B. 5148  
Ibadan  
Dugbe  
Telex: 31111  
Cables: Wenitra  
Phone: 22361/2

KATOLIGHT  
D. Nhilene (Pty) Ltd.  
23 Capt. Amangala  
Port Harcourt

KLOCKNER-HUMBOLDT-  
DEUTZ AG  
Nigerian Technical Comp. Ltd.  
Head Office  
11-13 Warehouse Road  
P.O. Box 356  
Apapa  
Lagos  
Telex: 21476 Niteco  
Cables: Niteco  
Phone: 45131, 45542,  
48074

KOHLER INTERNATIONAL  
LIMITED  
R.T. Briscoe (Nigeria) Ltd  
Technical Dept.  
P.O. Box 2104 Lagos  
22 Creek Road  
Apapa Lagos

LEYLAND INTERNATIONAL  
Bewec Ltd.  
P.M.B. 1016<sup>23</sup>  
1 Commercial Road  
Apapa  
Cables: Bewec

LUCAS SERVICE OVERSEAS  
LIMITED  
Lucas House  
Division of UAC of Nigeria Ltd.  
P.O. Box 344  
19 Creek Road  
Apapa  
Cables: Unalucas  
Phone: 46997

NISSAN DIESEL MOTOR CO.  
LIMITED  
CFAO Motors  
P.M.B. 2344  
Lagos

PERKINS ENGINES LIMITED  
Stokvis (Nigeria) Ltd.  
Perkins Department  
P.O. Box 136  
1 Dawodu Lane  
Ebute Metta  
Cables: Toolco  
Phone: 44609/43391

PETBOW LIMITED  
Holt Engineering,  
24 Creek Road  
P.O. Box 217  
Apapa

PETERS LIMITED  
Nigerian Motors Industries Ltd.  
P.M.B. 1032  
26 Wharf Road  
Apapa  
Cables: Nigermot  
Phone: Lagos 46848

VOLVO PENTA  
R.T. Briscoe (Nigeria) Ltd.  
Technical Department  
22 Creek Road  
Apapa  
P.O. Box 2104  
Lagos  
Telex: 21249  
Cables: Briscoe  
Phone: 46470/1, 46479

#### Norfolk Islands

LEYLAND INTERNATIONAL  
Southern Cross Motors Ltd.  
P.O. Box 218  
Norfolk Island  
Phone: 2022

#### Northern Ireland

KLOCKNER-HUMBOLDT-  
DEUTZ AG  
Blackwood Hodge Ltd.  
(Northern Ireland)  
Dennison Industrial Estate  
Ballyclare  
Co. Antrim  
Cables: Suntract Belfast  
Phone: Ballyclare 3171

#### Norway

BOMBARDIER-ROTAX GmbH  
Colbjørnsen & Co. A/S  
P.O. Box 80  
N-1341 Bekkestua  
Phone: 02-53 94 60

BRIGGS & STRATTON  
CORPORATION  
Weswitco A/S  
Olaf Schous Vei 4  
Oslo 5  
Telex: 18231  
Cable: WESWI  
Phone: (02) 351080

CATERPILLAR OVERSEAS SA  
Pay & Brihck A/S  
Brøbekkeveien 62B  
Postboks 65  
Risløkka  
Oslo  
Telex: 11631  
Cables: Fabrimas  
Phone: (2) 15-92-60

DETROIT DIESEL ALLISON Telex: 11682  
Detroit Diesel Allison International. Phone: 02 713860, 715860  
— Europe  
C30 General Motors Norge A/S  
P.O. Box 205  
2001 Lillestrom

DORMAN DIESELS LIMITED Telex: 19979 Thomo N  
Otto Thoresen & Moen A/S Cables: Ottot  
Faberborggt 12, Phone: (02) 46,69, 47,89.  
P.O. Box 5080 52.80  
Majorstua  
Oslo 3

FORD MOTOR CO. LIMITED Telex: 11659  
Ford Motor Co. (Norge) A/S Phone: (02) 801560  
1410 Kolbotn

L. GARDNER & SONS LIMITED  
Norsk Gardner Diesel A/S  
6715 Vaagsvaag

KLOCKNER-HUMBOLDT- Telex: 11309 Wilknud  
DEUTZ AG Cables: Wilknud  
William Knudsen A/S Phone: 423910  
Fred Olsensgt. 1  
P.B. 721 Sentrum  
Oslo 1

LEYLAND INTERNATIONAL Telex: 18276 BLN N  
British Leyland Norge A/S Cables: Britleynor  
Trondheimsveien 275 Phone: 225500  
P.O. Box 55-Arvoll  
Oslo 5

NISSAN DIESEL MOTOR CO.  
LIMITED  
A/S INOR  
Postboks 1239  
3001 Drammen

PERKINS ENGINES LIMITED Telex: 16855 Unidi  
Universal Diesel A/S Cables: Unidiesel  
Osterdalsgt 17 Phone: 19 32 00  
Oslo 6

PETTERS LIMITED Telex: 11613 Pindu  
Polytex A/S Cables: Polytex  
Trondheimsveien 139 Phone: Oslo 357780  
Oslo 5

RUGGERINI MOTORI SpA Telex: 16316 Agent N  
Gentrade A/S  
P.O. Box 297  
Sandefjord

VOLVO PENTA Telex: 16647  
Volvo Norge A/S Phone: (02) 22 60 60  
Lorenvangen 41  
Postboks 31, Økern  
Oslo 5

WHITE ENGINES Cables: Prosperity  
INCORPORATED  
B.M. Heede A/S  
P.O. Box 4231  
Sandakerveien 74  
Oslo 4

#### Oman

CATERPILLAR OVERSEAS SA Telex: 329 Alfaiha MB  
Oasis Trading & Equipment Phone: 2160  
Company  
P.O. Box 1002  
Muttrah  
Muscat

KATOLIGHT  
Oman Technical Centre  
P.O. Box 1079  
Muttrah

KIRLOSAR OIL ENGINES Telex: MB 245 Motorco  
LIMITED MB 294 Hashar  
Saeed Bin Nasser Al-Hashar Cables: Al-Hashar  
P.O. Box 331  
Muscat

LEYLAND INTERNATIONAL Telex: Lujaina.MB-230  
Darwish & Bros. Muscat  
P.O. Box 75 Cables: Areej  
Muscat Phone: 2703 2826

LUCAS SERVICE OVERSEAS Telex: MN214  
LIMITED Cables: Towell  
W.J. Towell & Co. Phone: 772131/3/65  
P.O. Box 1061 772261  
Muttrah  
Muscat

NISSAN DIESEL MOTOR CO.  
LIMITED  
Al-Hashar & Co.  
P.O. Box 1028  
Muttrah  
Muscat

PERKINS ENGINES LIMITED Telex: Waleed MB 270  
Waleed Associates Cables: Waleed  
P.O. Box 437 Phone: 722495 & 722692  
Muscat

PETBOW LIMITED  
Zubair Enterprises (Electronics)  
P.O. Box 127  
Muscat

PETTERS LIMITED Telex: MB 375  
Nasser Abdullatif & Co. Cables: Nasser  
P.O. Box 3636 Phone: Muttrah 2807  
Ruwi  
Muscat

JOHN ROBSON (SHIPLEY)  
LIMITED  
Nasser Abdullatif & Co.,  
P.O. Box 3636  
Ruwi  
Muscat

#### Pakistan

ALLIS CHALMERS Cables: Crawler  
Marghar Industries Ltd. Phone: 290111-19  
Hab Chauki Road S.I.T.E.  
P.O. Box 2706  
Karachi

BRIGGS & STRATTON Phone: 230342  
Peerless Industrial Engineering Co.,  
501, 5th Floor Qamar House  
M.A. Jinnah Road  
P.O. Box 5394  
Karachi 2

CATERPILLAR OVERSEAS SA Cables: Repmotors  
Republic Motors Ltd. (Tractor & Phone: 29-01-02/3/4/5  
Machinery Division)  
D-2 S.I.T.E.  
Manghopir Road  
Karachi - 1

DETROIT DIESEL ALLISON Cables: Lesscost  
Consolidated Equipment Co., Phone: 223529  
805 Muhammadi House  
1,1 Chundrigar Road  
P.O. Box 4093  
Karachi

DORMAN DIESELS LIMITED Cables: Greaves  
Greaves Cotton & Co. Phone: 512576/7/8/9  
(Pakistan) Ltd.  
P.O. Box 4908  
Volkswagen House  
Beaumont Road  
Karachi 4

L. GARDNER & SONS LIMITED  
Brady & Co. of Pakistan Ltd.,  
Shernaz House  
West Wharf Road  
Karachi 2

J.L.O.  
Sibtain Brothers  
Room No. 43 to 48  
Ghafur Chambers  
Abdullah Haroon Road  
P.O. Box 4225  
Karachi 3

KATOLIGHT  
Platinum Traders  
P.O. Box 4334  
Karachi 2

KLOCKNER-HUMBOLDT-  
DEUTZ AG  
Adamjee-Deutz (Pakistan) Ltd.  
P.O. Box 4405  
Adamjee House  
4th Floor  
J.J. Chundrigar Road  
Karachi

KOHLER INTERNATIONAL  
LIMITED  
Sai & Company  
P.O. Box 3109  
245-D/6 P.E.C.H.S.  
Karachi 29  
Pakistan

LEYLAND INTERNATIONAL  
Republic Motors Limited  
D-2 S.I.T.E.  
Manghopir Road  
Karachi-16

LUCAS SERVICE OVERSEAS  
LIMITED  
Lucas Service (Pakistan) Ltd.  
Al-Farid Centre  
Moulvi Tamizuddin Khan Road  
P.O. Box 506  
Karachi 4

PERKINS ENGINES LIMITED  
Shahnawaz Ltd.  
P.O. Box 4766  
19 West Wharf  
Karachi-2

PETBOW LIMITED  
Blackwood Hodge (Pakistan) Ltd.  
19 West Wharf Road  
Karachi

PETERS LIMITED  
Sibtain Brothers  
P.O. Box 4225  
43-48 Ghafur Chambers  
Abdullah Haroon Road  
Karachi 3

WHITE ENGINES  
INCORPORATED  
International Steel &  
General Agencies  
125 Block "A"  
S.M.C.H.S.  
Karachi 6

Panama

ALLIS CHALMERS  
25-45 Justo Arosemena Avenue  
P.O. Box 2140  
Zone 1  
Panama

BRIGGS & STRATTON  
CORPORATION  
Cardoze & Lindo S.A.  
P.O. Box 7342  
Panama 5

Telex: 715  
Cables: Carlindo

CATERPILLAR OVERSEAS SA  
Cardoze & Lindo S.A.  
Calle 85 y Transistematica  
Apartado 7342  
Panama

Telex: FRT-PA2106  
Comsa/Uwi 368715  
Cables: Carlindo  
Phone: 60-1155

DETROIT DIESEL ALLISON  
Transporte Y Equipo S.A.  
Boyd-Roosevelt Avenue  
P.O. Box 2145  
Panama 1

Telex: 3480089  
Cables: Tesa  
Phone: 60-2100

DORMAN DIESELS LIMITED  
Maquinarias y Equipo Romero S.A.  
Apartado U  
Panama 4

KATOLIGHT  
Motores Electricos  
Apartado 10628  
Panama 4

KLOCKNER-HUMBOLDT-  
DEUTZ AG  
Servinaves Panama S.A.  
Ave. Justo Arosemena  
Calle 44  
Bellevista  
Apartado 031  
Panama 5

Telex: 3689-75  
Cables: Servinpan  
Phone: 47 - 9663  
9704  
262

KOHLER INTERNATIONAL  
LIMITED  
F. Icaza & Co. Inc.  
P.O. Box 2140  
Avenida Justo Arosemena  
No. 25-45  
Panama City 1

LEYLAND INTERNATIONAL  
Motores Britannicos S.A.  
Apartado 1057  
Panama 1

Cables: Heurtemette  
Phone: 253900  
250 644

LUCAS SERVICE OVERSEAS  
LIMITED  
Motores Nacionales S.A.  
Avenida Once No. 26, 93  
P.O. Box L  
Panama 4

Cables: Diesefco  
Phone: 54510, 54514,  
54592

NISSAN DIESEL MOTOR CO.  
LIMITED  
Smoot y Paredes S.A.  
Transistematica Ave.  
Bolivar  
Apartado "C"  
Zona 4

PERKINS ENGINES LIMITED  
Maquinarias y Equipo Romero S.A.  
Apartado U  
Panama 4

Telex: 368675  
Cables: Romermaq  
Phone: 25-5133/25-5134

PETERS LIMITED  
Distribuidora Cummins Diesel  
de Panama S.A.  
Apartado 6-1394  
El-Dorado

Telex: 368690  
Cables: Cumpan  
Phone: 60.0666

VOLVO PENTA  
Maquinarias y Equipo Romero S.A.  
Apartado U  
Panama 4

Telex: 368675  
Phone: 25 51 30

WHITE ENGINES  
INCORPORATED  
Agro S.A.  
Calle Felipe Cleman  
Apartado 3417  
Panama 4

Telex: 3480146  
Cables: Agrosa  
Phone: 25-3245, 25-1446



**Papua New Guinea**

**DETROIT DIESEL ALLISON** Telex: 30168 or 30212  
 Detroit Diesel Allison International Cables: G.M.P. & I.P.  
 c/o General Motors Holden's Pty. Ltd. Phone: 792-0111  
 Princess Highway  
 P.O. Box 163  
 Dandenong  
 Victoria 3175  
 Australia

**LEYLAND INTERNATIONAL**  
 Burns Phillip (New Guinea) Ltd.  
 Musgrave Street  
 Port Moresby  
 Papua New Guinea

**LUCAS SERVICE OVERSEAS LIMITED** Telex: 116  
 Ela Motors Ltd. Cables: Elamot  
 Scratchley Road Phone: 54088  
 Bardali  
 P.O. Box 75  
 Port Moresby

**PERKINS ENGINES LIMITED** Cables: Tutby  
 Tutt Bryant Pacific Limited Phone: 53522  
 P.O. Box 326  
 Port Moresby

**PETTERS LIMITED (New Guinea, British)**

A.N.I. Australia Pty. Ltd.  
 A.N.I. Perkins Divisions  
 P.O. Box 117  
 16 Parramatta Road  
 Lidcombe  
 New South Wales

**PETTERS LIMITED (Indonesia)** Cables: Stompwals Den Haag  
 Technische Handelmaatschappij, N.V. Phone: 390275-331277  
 Akkerman & Company  
 Leekweg 17 (Binckshorst)  
 Gravenhage, Netherlands

**Paraguay**

**BRIGGS & STRATTON CORPORATION** Cables: Villalonga  
 Phone: 49-1719  
 Villalonga Hermanos Comercial e Industrial, S.A.  
 Casilla de Correo 274  
 Asuncion

**CATERPILLAR OVERSEAS SA** Cables: Pargtrade  
 S.A.C.I. H. Petersen Phone: 44-124/5/6  
 Pte Eligio Ayala 175/f  
 Casilla de Correo 592  
 Asuncion

**DETROIT DIESEL ALLISON** Telex: 99144 Metalpy  
 Automotores Comercial Cables: Acisa Asuncion  
 Industrial S.A. Phone: 41-838  
 P.O. Box 5  
 Asuncion

**DORMAN DIESELS LIMITED** Cables: Artaza  
 Phone: 44-493  
 Artaza Hermanos Comercial e Industrial S.A.  
 Casilla Postal 235  
 Asuncion

**KLOCKNER-HUMBOLDT-DEUTZ AG** Cables: Juvico  
 Phone: 45-989  
 Juan Wiské  
 Palma 573  
 Casilla Correo 51  
 Asuncion

**KOHLER INTERNATIONAL LIMITED**  
 Agropecuaria F. Arza Encina  
 Casilla Correo 793  
 25 De Mayo No. 865  
 Asuncion

**LEYLAND INTERNATIONAL** Cables: Gomal  
 Gomal S.A.C.  
 Casilla de Correo 1201  
 Azara 172/6  
 Asuncion

**LUCAS SERVICE OVERSEAS LIMITED** Cables: Perersenco  
 Phone: 4-1272  
 Ipa Sociedad Anonima de Comercio e Industrias 4-6803  
 Calle Chile 911/23 4-3351  
 Casilla de Correo 211 4-8391  
 Asuncion 4-8765

**NISSAN DIESEL MOTOR CO. LIMITED**  
 15 de Agosto Esq.  
 Presidente Franco  
 Asuncion

**PERKINS ENGINES** Cables: Pargtrade  
 H. Petersen S.A.C.I. Phone: 4-4124/5/6  
 Pt Elicio Ayala 481/483  
 Asuncion

**PETTERS LIMITED** Cables: Villalonga  
 Phone: 4408/09 - 8889-7298  
 Villalonga Hnos C.E.I.S.A.  
 Estrella 702  
 Casilla de Correo 274  
 Asuncion

**Peru**

**ALLIS CHALMERS** Telex: 3540081  
 Empeco S.A. Cables: Empeco  
 Parque Internacional D.E. Phone: 510920  
 Industria Y Comercio  
 Calle 11 No 203 CDRA  
 8 Ave Oscar R.  
 Benavides (Colonial)

**BRIGGS & STRATTON CORPORATION** Cables: Dest  
 Phone: 31-4766  
 Cia Importadora Derteano & Stucker, S.A.  
 Apartado 1663  
 Lima

**CATERPILLAR OVERSEAS SA** Telex: 35447 20102  
 Enrique-Ferreyros & Cia S.A. Cables: Ferreyco  
 Ave. Industrial 675 Phone: 52-0-70  
 Apartado 150  
 Lima

**DETROIT DIESEL ALLISON** Telex: 394-25333 Pu Milne  
 CIPSA - Commercial Peruana S.A. Cables: Aspica  
 Av. Nicolas Ayllon No. 1928 Phone: 313070  
 Carretera Central KM 1.5  
 P.O. Box 2 94  
 Lima 3

**DORMAN DIESELS LIMITED** Telex: Somerin PX5529  
 Somerin S.A. Cables: Somerin  
 La Colmena Phone: 287715  
 Oficina Colmena  
 Lima

**FORD MOTOR COMPANY LIMITED**  
 Ford Motor Co. del Peru S.A.  
 Apartado 4690  
 Lima

**KATOLIGHT**  
 Technocom  
 P.O. Box 11120  
 Lima 14 (Santa Beatriz)

**KLOCKNER-HUMBOLDT-DEUTZ AG** Telex: 25782  
 Diesel Centro S.A. Cables: Dicesa  
 Avenida Venezuela 2720 Phone: 238712, 320820  
 Casilla No. 789  
 Lima 1

KOHLER INTERNATIONAL  
LIMITED  
Empeco S.A.  
P.O. Box 5692  
Omega 203-Cuadra 38  
Oscar Benevides  
Lima

LEYLAND INTERNATIONAL  
British Leyland Del Peru  
1647 Ave. Republica de Panama  
Balconcillo  
Lima 13

LUCAS SERVICE OVERSEAS  
LIMITED  
Compania Importadora  
Derteano & Stucker S.A.  
Casilla 1663  
Avenida Mexico No. 363-373  
Lima

PERKINS ENGINES LIMITED  
Motores Diesel Andinos S.A.  
Carolina Vargas 275  
San Isidro  
Lima

PETTERS LIMITED  
Industrial Lima S.A.I. L.S.A.  
P.O. Box 4946  
Calle Omega 265  
Parque Internacional Industrial  
Lima

JOHN ROBSON (SHIPLEY) LTD  
Comercial Gutierrez S.A.  
Panamericana Norte s/n  
Apartado 77  
Pacasmayo  
Peru

VOLVO PENTA  
Volvo del Peru S.A.  
Volvo Penta Division  
Depto de Servicio  
P.O. Box 815  
Lima

WHITE ENGINES  
INCORPORATED  
Luis Schydrowsky, S.A.  
Casilla 2146  
Avda. Benavides 195  
Of. 101, Miraflores  
Lima

#### Philippines

ALLIS CHALMERS  
Chindisco (Phil) Inc.  
2288 Pasong Tamo Ext  
P.O. Box 1066 Commercial Center  
Makati Rizal

BRIGGS & STRATTON  
CORPORATION  
Asia/Pacific Regional Office  
P.O. Box 7417  
Air Mail Exchange Office  
M.I.A. 3120

CATERPILLAR OVERSEAS S.A.  
Usiphil Inc  
P.O. Box 55cc  
Makati  
Rizal

DETROIT DIESEL ALLISON  
General Diesel Power Corp.  
6305 South Xway  
P.O. Box 2311 MCC  
Makati  
Rizal

DORMAN DIESELS LIMITED  
Jardine Davies Incorporated  
Jardine Davies Building  
222 Buendia Avenue  
P.O. Box 561  
Makati Commercial Centre  
Rizal

FORD MOTOR COMPANY  
LIMITED  
Ford Philippines Inc.  
P.O. Box 415  
Makati Commercial Centre  
Makati  
Rizal

INDIAN NATIONAL DIESEL ENGINE  
CO. LTD.  
Warner Burnes & Co Ltd  
Makati  
Rizal

J.L.O.  
American Factors (Phil) Inc.  
2310 Pasong Tamo Extension  
P.O. Box 660  
Makati  
Rizal  
D708

KATOLIGHT  
VS Energetics, Inc.  
P.O. Box 1195  
Makati  
Rizal

KLOCKNER-HUMBOLDT-  
DEUTZ AG  
Makati Machinery & Equipment  
Company Inc. (MMECI)  
1120 Pres. Quirino Avenue  
P.O. Box 1526  
Makati CC  
Paco  
Manila

KOHLER INTERNATIONAL  
LIMITED  
Atkins Kroll & Co. Inc.  
P.O. Box 308  
7232 Malugay Street  
Makati  
Rizal

LEYLAND INTERNATIONAL  
Amalgamated Motors  
(Philippines) Inc.  
P.O. Box PA 413  
Port Area South 2803  
Manila

LUCAS SERVICE OVERSEAS LTD  
Electro Diesel Sales & Service Inc.  
Lucas House  
1108 Pres. Quirino Ave  
Malate  
Manila P.O. Box 311

NISSAN DIESEL MOTOR CO.  
LIMITED  
Columbian Motors Corp.  
Subangdaku  
Mandaue City

PERKINS ENGINES LTD  
Clindisco (Phi.) Inc.  
P.O. Box 1006 M.C.C.  
2288 Pasong Tamo Ext.  
Makati  
Rizal

PETTERS LIMITED  
Muller & Phipps Inc. Corp.  
Pioneer Street  
Mandaluyong  
Rizal

Telex: 7425170 via ITT  
7222192 via RCA  
Cables: Dracoman  
Phone: 89-30-61

Telex: through Williams  
Equipment Co.  
Ltd - WECCO  
742530  
Cables: Amfacphil  
Phone: 88-89-31

Telex: Resulto 7420318  
Manila  
Cables: Resolute  
Phone: 587630, 587622

Telex: Leyampi 3439  
Cables: Leyampi  
Phone: 407041/51

Telex: 2350, 3422, 5138  
2300  
Phone: 50.36.67

Telex: Eastern Ext. -  
PN3598  
ITT 7425193  
RCA 7222360  
Phone: 89-15-26, 89-55-06

Cables: Mulphico  
Telex: RCA 8228657  
Phone: 70-06-11, 78-19-12

JOHN ROBSON (SHIPLEY) LTD.  
Schmid & Oberly Inc.  
P.O. Box 1916  
Manila

RUGGERINI MOTORI SpA  
Newmark Commercial &  
Industrial Corp.  
855A & B de Los Santos Ave.  
Cor. Panay Ave.  
Quezon City

VOLVO PENTA  
The Edward J. Nell Company  
Makati Commercial Center  
Makati  
Rizal  
Manila

WHITE ENGINES  
INCORPORATED  
Warner Barnes & Co Inc  
P.O. Box 1191  
Makati Commercial Center  
Makati

#### Poland

CATERPILLAR OVERSEAS SA  
Bowmaker (Plant) Ltd.  
Polish Operations Division  
Watling St.  
Cannock  
Staffs.  
U.K.

CATERPILLAR OVERSEAS SA  
Osrodek Informacji Technicznej  
(Technical Information Center)  
Bowmaker (Plant) Ltd.  
Ul. Stawki 2  
Warsaw

KLOCKNER-HUMBOLDT-  
DEUTZ AG  
Unitex S.A.  
Import-Export  
Stawki 2  
00-950 Warszawa

#### Portugal

ALLIS CHALMERS  
Casa Americana Comercial  
S.A.R.L.  
Avenida de Republica 27  
Caixa Postale 1219  
Lisbon

BOMBARDIER-ROTAX GMBH  
Antonio Marques Boavida  
Almofala de Baixo  
Avelar

BRIGGS & STRATTON  
CORPORATION  
Mendes de Almeida  
Comercio de Industria de  
Maquinas e Equipamentos S.A.R.L.  
Av. 24 de Julho  
52, A-G  
Lisbon 2

CATERPILLAR OVERSEAS SA  
Sociedade Tecnica de Equipamentos  
e Tractores S.A.R.L.  
Apartado 1351  
Lisbon

DETROIT DIESEL ALLISON  
Detroit Diesel Allison International  
Europe  
c/o General Motors de Portugal Ltda  
Av. Marechal Gomes Da Costa 33  
Caira Postal 2484  
Lisbon 6

DORMAN DIESELS LIMITED  
Turbodiesel  
Sociedade Importadora de Maquinas  
Ltda  
Largo do Mastro 29-2°  
Lisbon 2

Telex: 12622 Rotiv P -  
attention Turbog-  
diesel  
Cables: Turbodiesel Lisboa  
Phone: 53 96 63, 5572 67

FORD MOTOR CO. LIMITED  
Ford Lusitania S.A.R.L.  
Apartado 2248  
Rua Rose Araujo 2  
Lisbon 2

Telex: 12218  
Phone: 53914

L. GARDNER & SON LIMITED  
Conde Barao,  
Industrias Metalicas e Comercio  
de Representacoes S.A.R.L.  
Avenida 24 de Julho  
62-64 Lisbon 2  
Apartado 2734

Phone: 671011/8

KLOCKNER-HUMBOLDT-  
DEUTZ AG  
Motope  
Motores Oleos Pesados S.A.R.L.  
Rua da Vitoria 88-3°  
Apartado 2565  
P - Lisbon 2

Telex: Motope P 16582  
Cables: Deutzmotor  
Phone: 327195/6/7

LEYLAND INTERNATIONAL  
British Leyland de Portugal  
Automoveis Ltda  
Avenida do Brasil 45  
Apartado 5090  
Lisbon

Telex: 12185 Sancin P +  
Cables: Brileypor Lisbon 5  
Phone: 251 0171/2  
251 0508  
251 0984  
251 0622

NISSAN DIESEL MOTOR CO.  
LIMITED  
Entrepoto Comercial de  
Automoveis S.A.R.L.  
Praca de Moscavide  
1-Olivais Sul  
Lisboa 6

PERKINS ENGINES LIMITED  
Auto-Industrial S.A.R.L.  
Estrada da Circunvalacao  
Portela da Ajuda  
Lisbon 2

Telex: 12444 Auto LP  
Cables: Automoveis Lisbon  
Phone: 210021/21016,17

PETTERS LIMITED  
E. Pinto Basto e Cia Ltd.  
Apartado 2200  
1 Avenida 24 de Julho  
Lisbon 2

Telex: Basto Lisbon 12201  
Cables: Pinto Lisbon  
Phone: 361536/261581

RUGGERINI MOTORI S.p.A.  
Centro de Comercio Agricola  
de Santarem  
Apartado 72  
Rua. Sergio Pinto 84  
Santarem

VOLVO PENTA  
Agencia Maritima Transatlantica Lda  
Rua do Alecrim 20-F-1° 9-1  
P. Box 539  
Lisboa

Telex: Amatra 18325  
Cables: Transmara  
Phone: 324351/2

CATERPILLAR OVERSEAS SA  
Sorel S.A.R.L.  
P.O. Box 40  
Luanda

Telex: 3229  
Cables: Sorel  
Phone: 7-22-81/2/3/4/5

#### Puerto Rico

ALLIS CHALMERS  
Gonzalez Trading Inc.  
San Patricio & De Diego Avenues  
URB Industrial La Reviera  
P.O. Box 13067  
Rio Piedras  
Puerto Rico 00921

Telex: Gontra  
Cables: Gontra  
San Juan P.R.  
Phone: (809) 783-9380

**BRIGGS & STRATTON CORPORATION**  
Badrena & Perez Inc.  
P.O. Box 1839  
Carpenter Road 225  
Hato Rey 00919

Telex: 9047  
Cable: Ferbad  
Phone: 767-2455

**CATERPILLAR OVERSEAS SA**  
USI Puerto Rico Inc.  
John F. Kennedy Eve.  
G.P.O. Box 2529  
San Juan 00936

Telex: 325-330 (RCA)  
Cables: Usipri Sanjuan Via  
RCA  
Phone: (809) 762-4100

**DETROIT DIESEL ALLISON**  
Diesel de Puerto Rico Div.  
Truck Fleets Inc.  
G.P.O. Box 4008  
San Juan 00936

Telex: 3252367  
Cables: Diesel San Juan  
Phone: 809-764-5330

**KATOLIGHT**  
Western Gas Products Corp.  
P.O. Box 1270  
Mayaguez 00708

**KOHLER INTERNATIONAL LIMITED**  
Garcia Machinery Inc.  
G.P.O. Box 3368  
Road 2 KM 4-8  
(Pueblo Viejo)  
San Juan  
Puerto Rico 00936

**LEYLAND INTERNATIONAL**  
British Car Distributors Inc.  
KMB.8 Carrera  
Militar Numero 2  
Bayamon  
Puerto Rico 00620

**PERKINS ENGINES LIMITED**  
Halco Sales Inc.  
Ave. San Marcos  
El Comandante Industrial Park  
Carolina Heights 00122

Phone: 809/769-7575

#### Qatar

**CATERPILLAR OVERSEAS SA**  
Mohamed Abdulrahman Al-Bahar  
P.O. Box 2171  
Doha

Telex: 4225 DH  
Cables: Bahar  
Phone: 21026

**DETROIT DIESEL ALLISON**  
Mannai Trading Company  
P.O. Box 76  
Doha

Telex: 957-4208  
Cables: Mannai  
Phone: 26251

**KOHLER INTERNATIONAL LIMITED**  
Al Khalaf Trading & Construction Co.  
P.O. Box 226  
Doha

**LEYLAND INTERNATIONAL**  
Darwish Automobiles  
P.O. Box 40  
Doha

Telex: DH211 Aldarwish  
Cables: Autodar  
Phone: 23133

**LUCAS SERVICE OVERSEAS LIMITED**  
Al Nasr Machinery Division  
P.O. Box 28  
Doha

Telex: 4242 Al Nasr  
Cables: Alnasr  
Phone: 22284, 24451/2/3

**NISSAN DIESEL MOTOR CO. LTD.**  
Jaidah Motors & Trading Co.  
P.O. Box 160

**PERKINS ENGINES LIMITED**  
Alnasr Machinery Division  
P.O. Box 28  
Doha

Telex: 4401 Macdir D.H.  
Cables: Alnasr  
Phone: 24451, 22284

**PETTERS LIMITED**  
Oriental Trading Co.,  
P.O. Box 96  
Doha

Telex: D.H. 286  
Cables: Oriental

**JOHN-ROBSON (SHIPLEY) LIMITED**  
Abdulrehman Bin Abdulla Abidan  
Fakhroo & Sons  
P.O. Box 254  
Doha

#### Reunion

**CATERPILLAR OVERSEAS SA**  
Ets Camille Macé & Cie  
46 rue de la Bourdonnais  
B.P. 57  
St. Denis 97462

Telex: 38RE  
Cables: Cemace  
Phone: 216-700

**KLOCKNER-HUMBOLDT-DEUTZ AG**  
Valcke Frères  
Brousseau  
B.P. 511  
Z.1. Le Chaudron  
Sainte Clotilde

Telex: REB St. Denis  
Phone: 213588

**LEYLAND INTERNATIONAL**  
Ländis Madagascar  
5 Rue Robert Ducrocq  
Behorirka  
P.O. Box 633  
Tananarive  
Malagasy

Cables: Lanbrocomp  
Tananarive

**LUCAS SERVICE OVERSEAS LIMITED**  
Electro-Diesel Reunion S.A.  
Route Nationale 2  
St. Clotilde 97-4  
B.P. 600  
97473 St. Denis

Cables: Eldire

**PERKINS ENGINES LIMITED**  
Electro Diesel Reunion S.A.  
B.P. 600  
97473 Saint Denis  
La Reunion

Telex: 50 Re Ste-clotilde  
Cables: Eldire  
Phone: 21.07.78

**PETTERS LIMITED**  
Sorequip  
51 Rue Labourdonnais  
S.P. 714  
Saint Denis  
Ile de la Reunion

#### Rio Muni

**CATERPILLAR OVERSEAS SA**  
Finanzauto S.A.  
Plaza de las Cortes 6  
Madrid 14  
Spain

Telex: 27752  
Cables: Finanzauto Madrid  
Phone: (91) 448-2700

#### Rwanda

**CATERPILLAR OVERSEAS SA**  
Chanic  
B.P. 930  
Bujumbura  
Burundi

Cables: Chanusa Bujumbura  
Phone: 3284

**DORMAN DIESELS LIMITED**  
S.A.R.L. Compagnie Industrielle  
et Commerciale Du Rwanda "Circa"  
B.P. 234  
Kigali

**KLOCKNER-HUMBOLDT-DEUTZ AG**  
Somirwa  
B.P. 266  
Kigali

Telex: 27  
Phone: 5421

LEYLAND INTERNATIONAL  
Compagnie De l'Afrique  
Oricentrale  
'Old East' S.A.R.L.  
Rue de la Revolution  
P.O. Box 711  
Kigali

Cables: Broche  
Phone: 5240/5290

PETTERS LIMITED  
N.A.H.V.  
B.P. 626  
Kigali

#### Sabah

LEYLAND INTERNATIONAL  
Champion Motors (SABAH)  
SDN. BHD  
16 Prince Phillip Drive  
Kota Kinabalu

PETTERS LIMITED  
William Jacks & Co.  
(Borneo) Ltd.  
P.O. Box 278  
8 Praya Road  
Kota Kinablu

#### Sao Tome

CATERPILLAR OVERSEAS SA  
Sorel S.A.R.L.  
P.O. Box 408  
Luanda  
Angola

Telex: 3229  
Cables: Sorel  
Phone: 7-22 81/2/3/4/5

LEYLAND INTERNATIONAL  
Champion Motors (Sarawak)  
SDN. BHD.  
Jalan Tunku Abdul Rahman  
Padungan  
Kuching

#### Saudi Arabia

ALLIS CHALMERS  
General Machinery Agencies  
P.O. Box 139  
Jeddah

Telex: 40178 Saladin SJ  
Cable: Trust  
Phone: 29501/2

BRIGGS & STRATTON  
CORPORATION  
Sami Kutbi & Co.  
Medina Street  
P.O. Box 247  
Jeddah

Cables: Sami  
Phone: 29057 C.R. 470

DETROIT DIESEL ALLISON  
General Machinery Agencies  
P.O. Box 139  
Jeddah

Telex: 92-40178  
Cable: Trust  
Phone: 29501/2

DORMAN DIESELS LIMITED  
Yusuf Bin Ahmed Kanoo  
Airport Road  
P.O. Box 753  
Riyadh

Cables: Kanoo  
Phone: 27132, 28942

Hussein M Fayed & Sons  
P.O. Box 11  
Jeddah

Cables: Fayed  
Phone: 2575

L. GARDNER & SON LIMITED  
General Engineering Trading Co.  
P.O. Box 4586  
Jeddah

KATOLIGHT  
Mohamed Ali Maghrabi & Sons  
P.O. Box 61  
Jeddah

KIRLOSKAR OIL ENGINES  
LIMITED  
Abdullah & A.M. Bahamdein  
P.O. Box 13

Cable: Albahamdein  
Phone: 26784

KLOCKNER-HUMBOLDT-  
DEUTZ AG  
A.S. Bugshan & Bros  
P.O. Box 378  
Jeddah

Telex: 40179 Bugshan SJ  
Cables: Bugshan  
Phone: 25250

KOHLER INTERNATIONAL  
LIMITED  
Sami Kutbi & Co.  
P.O. Box 247  
Jeddah

LEYLAND INTERNATIONAL  
Darwish Ben Abdullah Darwish  
Darwish Building  
P.O. Box 153  
Dammam

Cables: Aldarwish

LUCAS SERVICE OVERSEAS  
LIMITED  
Alissa  
Alissa Building  
Street No. 7  
P.O. Box 192  
Alkhobar

Telex: 67022 Alissa SJ  
Cables: Lateef  
Phone: 41510

NISSAN DIESEL MOTOR CO. LTD.  
Rolaco Trading & Contracting  
P.O. Box 222  
Jeddah

PERKINS ENGINES LIMITED  
Abdulaziz & M.A. Alhomaih  
Aljomaih Building  
P.O. Box 132  
Riyadh

Telex: 20023 Jomaih S.J.  
Cables: Aljomaih

PETBOW LIMITED  
Abdul Rahman Dawood Al-Gilani  
P.O. Box 1159  
Dammam

PETTERS LIMITED  
Ali Baobeid  
Ben Qubos Establishment  
for Trading & Imports  
P.O. Box 5440  
Jeddah

Cables: Luckytravel  
Phone: 24033

JOHN ROBSON (SHIPLEY)  
LIMITED  
Baghanem Corporation for  
Agric. & Commerce  
P.O. Box 14  
Jeddah

RUGGERINI MOTORI S.p.A.  
Ghaleb Abdullah Obeid  
P.O. Box 484  
Riyadh

Telex: 20112  
Tricorp SJ

WHITE ENGINES  
INCORPORATED  
Mohamed Ali Maghrabi & Son,  
P.O. Box 61  
Jeddah

Telex: Mamtex 400766  
Phone: 22636, 22870

#### Senegal

KLOCKNER-HUMBOLDT-  
DEUTZ AG  
Valcke Frères  
Sté Sofica  
B.P. 1783  
KM 4 - Route de Rufisque  
Dakar

Telex: 663 Sofica SG  
Phone: 50063  
50537

KOHLER INTERNATIONAL  
LIMITED  
Senegal Agricole Material (S.A.M.)  
Km 7 Route de Rufisque  
B.P. 229  
Dakar

LEYLAND INTERNATIONAL  
Societe Commerciale De L'Ouest  
Africain  
P.O. Box 50  
Dakar

LUCAS SERVICE OVERSEAS  
LIMITED  
Nouvelle Societe Commerciale  
Africaine (NOSOCO)  
2 Rue Faïdherbe  
B.P. 791  
Dakar

PERKINS ENGINES LIMITED  
Matforce Nosoco  
B.P. 791  
Dakar

PETTERS LIMITED  
Hamelle-Afrique S.A.  
KM 3-Route de Rufisque  
B.P. 162  
Dakar

#### Seychelles

LEYLAND INTERNATIONAL  
British Motors (Seychelles)  
Pty. Ltd.  
P.O. Box 83  
Victoria  
Mahe

PERKINS ENGINES LIMITED  
Engineering Supplies Ltd  
P.O. Box 340  
New Port  
Victoria  
Mahe

#### Sierra Leone

DETROIT DIESEL ALLISON  
Blackwood Hodge (Sierra  
Leone) Ltd  
P.O. Box 1456  
Freetown

DORMAN DIESELS LIMITED  
Holman Brothers Ltd.  
P.O. Box 465  
Freetown

LEYLAND INTERNATIONAL  
Compagnie Francaise de l'Afrique  
Occidentale  
Motors Dept.  
P.O. Box 823  
Freetown

LUCAS SERVICE OVERSEAS  
LIMITED  
The United Africa Co. of  
Sierra Leone Ltd.  
Lucas House  
8 Wilberforce Street  
P.O. Box 418  
Freetown

PERKINS ENGINES LIMITED  
African Commercial and  
Agricultural Enterprises Ltd.  
P.O. Box 1058  
18 Light-Foot Boston Street  
Freetown

PETTERS LIMITED  
Cie Francaise de l'Afrique  
Occidentale  
Technical Dept.  
P.O. Box 823  
Freetown

Cables: Senafrika  
Phone: 3088

#### Singapore

BRIGGS & STRATTON  
CORPORATION  
United Motor Works (S) Pte Ltd.  
12 Jurong Town  
Singapore 22

Telex: RS 21547  
Cables: Unity  
Phone: 653155

CATERPILLAR OVERSEAS SA  
Tractors Malaysia Berhad  
10km Bukit Timah Road  
G.P.O. Box 2977  
Singapore 21

DETROIT DIESEL ALLISON  
General Diesel Supplies (S)  
Pte. Ltd.  
32 Jurong Pier Road  
Singapore 22

Telex: 786-21962  
Cables: Gedes  
Phone: 655222

DORMAN DIESELS LIMITED  
The GEC Company of  
Singapore Pte. Ltd.  
Diesel Division  
Magent House  
P.O. Box 4046  
Bukit Timah  
Singapore 21

Telex: RS 21508 A/B  
Cables: Gecsing  
Enelectico or  
Gecsingapore  
Phone: 663011

FORD MOTOR CO. LIMITED  
Ford Motor Co. Private Ltd.  
P.O. Box 4047  
8½ Mile Bukit Timah Road  
Singapore

Telex: R.S. 21616  
(Sinford)  
Phone: 666111

L. GARDNER & SONS LIMITED  
Malayan Motors (Pte) Ltd.  
14-20 Orchard Road  
P.O. Box 394  
Singapore 9

Phone: 332085 (Auto-  
motive & Rail  
Traction)

INDIAN NATIONAL DIESEL ENGINE  
CO. LIMITED  
K.S.M. International  
15-B/4 Amber Mansion  
Orchard Road  
Singapore 9

KATOLIGHT  
Industrial Machinery & Electric Ltd.  
65 Namly Road  
Singapore 10

KLOCKNER-HUMBOLDT-  
DEUTZ AG  
Deutz Far East (Pte) Ltd.  
Jurong Town Hall (1st Fl.)  
Jurong Town Hall Road  
P.O. Box 98  
Jurong  
Singapore 22

Telex: RS 21961 DFE  
Cables: Deutzmotor  
Phone: 654044

KOHLER INTERNATIONAL LTD.  
Tanglin  
P.O. Box 12  
Singapore 10

Telex: 23946  
Cable: Kohlering Singapore

LEYLAND INTERNATIONAL  
Malayan Motors (Pte) Ltd.  
45 Orchard Road  
P.O. Box 441  
Singapore

Telex: RS 21772  
Cables: Malaymotor  
Phone: 332085

LUCAS SERVICE OVERSEAS SA  
Far East Motors (Pt.) Ltd.  
54 Orchard Road  
P.O. Box 2697  
Singapore 9

Telex: 21772 Wearnes  
Cables: Ignition  
Phone: 328341 to 8

**NISSAN DIESEL MOTOR CO. LTD.**

SM Mechanical (S) Pte Ltd.  
9 & 11 Sin Ming Road  
Bik 23  
Singapore 20

**PERKINS ENGINES LIMITED**

Perkins Engines Eastern Ltd.  
549 Upper Thomson Road  
Singapore 20

Telex: Perkoil R23360  
Phone: 594471/2/3

**PETTERS LIMITED**

William Jacks & Co.  
(Singapore) Ltd  
11 km Milestone  
Bukit Timah Road  
P.O. Box 4049  
Singapore 21

Telex: 8721324  
Cables: Expanded  
Phone: 660011

**JOHN ROBSON (SHIPLEY) LTD**

Inter-Golden Wood Pte. Ltd.  
5616, 5th Floor  
Woh Hup Complex  
Beach Road  
Singapore 7

**RUGGERINI MOTORI S.p.A.**

Bm Benh Meyer & Co.,  
P.O. Box 2000  
100 Pasir Panjang Road  
Singapore 5

Telex: 21390 Oldarno

**VOLVO PENTA**

Wearne's Equipment and Land  
Company (P) Ltd  
No. 3 Gul Circle  
Jurong  
Singapore 22

Telex: 21772 (Wealco  
Singapore)  
Cables: Wealco  
Phone: 65 57 44  
65 50 87  
65 54 32

**Solomon Islands**

LEYLAND INTERNATIONAL  
British Solomons Trading Co. Ltd.  
P.O. Box 114  
Honiara

Cables: Trade

**PERKINS ENGINES LIMITED**

Solomon Motors Limited  
P.O. Box A61  
Honiara

Cables: Solmot  
Phone: 313.374

**PETTERS LIMITED**

E.V Lawson Ltd.  
P.O. Box A144  
Honiara

**Somalia**

DORMAN DIESELS LIMITED  
Islah Commercial Agency  
P.O. Box 1035  
Mogadishu

Cables: Busharo  
Phone: 391932

**KLOCKNER-HUMBOLDT-  
DEUTZ AG**

Zustandig  
IML  
Via G. Lorca 25  
22050 Lomagna (Como)  
Italy

Telex: 37606 Imellom  
Cables: Imelombarde  
Phone: 587291

**LEYLAND INTERNATIONAL**

Government Trading Agency  
for Vehicles and Accessories  
P.O. Box 390  
Mogadishu

Telex: 607 Fiat  
Cables: Wadda'a Muqdisho  
Phone: 3666-3135-2785

**LUCAS SERVICE OVERSEAS SA**

Firma S.P.A.  
Casella Postale 344  
Mogadishu

Cables: Firma  
Phone: 3803, 2089

**PETTERS LIMITED**

Prattelli Loche  
P.O. Box 359  
Mogadishu

Cables: Loche  
Phone: 142

**RUGGERINI MOTORI S.p.A.**

Gibril Ali Abdulle  
C.P. 303  
Afgoi  
Mogadishu

**South Africa****BRIGGS & STRATTON  
CORPORATION**

Autolec Ltd.  
Corner La Rochelle &  
Crystal Roads  
Springfield (Eloff St.  
Ext. South)  
P.O. Box 2964 (Johannesburg  
2000)  
Johannesburg 2001

Telex: 43-7516  
Cables: Lecauto  
Phone: 838-3111

**CATERPILLAR OVERSEAS SA**

Caterpillar (Africa) (Pty) Ltd.  
Anvil Road  
P.O. Box 11481  
Johannesburg

Telex: 43-7878/9  
Cables: Isacat  
Phone: 36-10-11

**CATERPILLAR OVERSEAS SA**

Barlow's (O.F.S.) Ltd.  
Nuffield Street  
Hamilton  
Bloemfontein 9301

Telex: 2-632  
Cables: Shipments  
Phone: 82721

**DETROIT DIESEL ALLISON**

Detroit Diesel Allison International  
c/o General Motors South Africa  
(Pty) Ltd.  
Aloes Plant (near Port  
Elizabeth)  
P.O. Box 1137  
Port Elizabeth 6000

Telex: 74-7684  
Cables: Portautoex, Port  
Elizabeth  
Phone: 6-2384, 6-1131 Port  
Elizabeth

**DORMAN DIESELS LIMITED**

Ruston Dorman Diesels  
(Pty) Ltd  
P.O. Box 6001  
Dunswart  
Transvaal 1508

Telex: 8-0267 S.A.  
Cables: Kopelrail,

**FORD MOTOR CO. LTD.**

Ford Motor Co. of South  
Africa (Pty) Ltd.  
P.O. Box 788  
Ford House  
Port Elizabeth

Telex: 74 7411  
Phone: 2 7011

**L. GARDNER & SON LIMITED**

Gardner Engines South Africa  
(Pty) Ltd.  
350 Main Reef Road  
P.O. Box 25619  
Denver  
Transvaal

Telex: 87353  
Phone: 616.2130

**J.L.O.**

Diesel Installations (Pty) Ltd.  
Brewery Street & Anvil Road  
P.O. Box 104  
Isando  
Transvaal

Telex: 43-0572sa  
Cables: MoSems  
Phone: 36-5235

**KOHLER INTERNATIONAL  
LIMITED**

Hessen Engineering Co.  
(Pty) Ltd.  
P.O. Box 39066  
Bramley  
Johannesburg 2018

LEYLAND INTERNATIONAL  
Leyland South Africa Ltd.  
(Car and Light Commercial  
Vehicle Division)  
P.O. Box 190  
Goodwood 7460  
Cape Town

Telex: 57-7587  
Cables: Brimocor  
Phone: Cape Town  
938 3661

LUCAS SERVICE OVERSEAS  
LIMITED  
Lucas Industries South Africa  
(Pty) Ltd.  
Head Office  
8/10 Simmonds Street South  
P.O. Box 360  
Johannesburg

Telex: 8-7795  
Cables: Lucassa  
Phone: 836.3044

PERKINS ENGINES LIMITED  
Perkins Engines (Pty) Ltd.  
P.O. Box 31285  
6th Floor  
Noswal Hall  
Braamfontein  
2017 Johannesburg

Telex: 8-00375A  
Cables: Perknol  
Phone: 725-5715

PETTERS LIMITED  
Northfield Engineering  
(Pty) Ltd.  
P.O. Box 3119  
13/15 Dobson Street  
Port Elizabeth

Cables: 4-13805  
Phone: 4-13644/5/6

PETTERS LIMITED  
Vincent & Pullar (Pty) Ltd.  
P.O. Box 1146  
5 Eaton Road  
Durban  
Natal

Telex: 6-7444DN  
Cables: Electrical  
Phone: 357166

RUGGERINI MOTORI S.p.A.  
Industrial Units Ltd.  
P.O. Box 5945-2000  
7 Heidelberg Road  
Village Main  
Johannesburg

Telex: 43-7772 Induna

VOLVO PENTA  
Lawson's Marine &  
Industrial (Pty) Ltd.  
59 Beaumont St.  
Booyens  
P.O. Box 10599  
Johannesburg

Telex: 95-437638  
Cable: Lavolvo  
Phone: 32-6201/2/3/4

VOLVO PENTA  
Lawson's Autodiesels  
P.O. Box 93  
Sanlamhof  
Cape Province

Telex: 570258  
Cables: Lavolvo Cape Town  
Phone: 970032

VOLVO PENTA  
Lawson's Autodiesels  
P.O. Box 3460  
Durban  
Natal

Telex: 67474  
Cables: Lavolvo Durban  
Phone: 333771

WHITE ENGINES  
INCORPORATED  
Mosethals Engineering Co.  
(Pty) Ltd.  
P.O. Box 104  
Corner Brewery Street &  
Anvil Road  
Isando

Cables: Mathner  
Phone: 36-5235

#### South West Africa

LUCAS SERVICE OVERSEAS  
LIMITED  
Lucas Service SWA (Pty) Ltd.  
28 Bell Street  
P.O. Box 5015  
Windhoek

Cables: Lucassa  
Phone: 5973

#### Spain

BRIGGS & STRATTON  
CORPORATION  
Industrias Fita S.A.  
Calle San Lazaró, 54  
Figueras  
Gerona

Telex: 57177  
Cables: Fita  
Phone: 241300

CATERPILLAR OVERSEAS SA  
Finanzauto S.A.  
Dos Hermanas  
Sevilla

Telex: 72230  
Phone: (954) 721-350

Finanzauto S.A.  
Plaza de las Cortes 6  
Madrid 14

Telex: 27752  
Cables: Finanzauto  
Phone: (91) 448-2700

DETROIT DIESEL ALLISON  
Detroit Diesel Allison  
International - Europe  
c/o General Motors France  
56a 58 Ave. Louis Roche  
92231 Gennevilliers  
France

Telex: Genlmot 62050  
Cables: Parautexap.  
Phone: 790-70-00  
Gennevilliers

DORMAN DIESELS LIMITED  
Guascor S.A.  
Guascor Building  
P.O. Box 30  
Zumaya

Telex: 36310 Guazo E  
Cables: Guascor Sa Zumaya  
Phone: (43) 86 12 48  
(43) 86 12 49

KATOLIGHT  
Atlantic Industries S.L.  
Buenos Aires 12 - 1° Local Núm. 5  
Bilbao

KLOCKNER-HUMBOLDT-  
DEUTZ AG  
Cia. Española de Motores Deutz  
Otto Legitimo S.A.  
Av. Pio XII, No. 100  
Apartado 50.938  
Madrid 16

Telex: 43739  
Cables: Deutzmotor  
Phone: 2022240, 2023240

KOHLER INTERNATIONAL  
LIMITED  
Coprma Ltd.,  
Zurbano 56-2  
Madrid 10

LEYLAND INTERNATIONAL  
Leyland España S.A.  
Apartado 14.845  
Madrid

Telex: 22840-E  
Cables: Leyesp  
Phone: 675 01 50  
675 29 50  
675 16 50

PERKINS ENGINES LIMITED  
Motor Iberica S.A.  
(Division Zona 2)  
Carretera del Aero-Club  
Carabanchel Alto  
Madrid

Telex: 27324  
Cables: Perki-e  
Phone: 208 52-40  
208-96-40  
208-98-40

PETTERS LIMITED  
Alton S.A.  
Avenida Generalísimo 84  
Madrid 16

Cables: Caralton Madrid  
Phone: 2592557, 2500046

RUGGERINI MOTORI S.p.A.  
L. Zabala S.A.  
Astola 6  
Abadiano (Vizcaya)

VOLVO PENTA  
Volvo Concesionarios S.A.  
Avda Generalísimo 20  
Madrid 16

Telex: 23296 volco e  
Cables: Volvosa  
Phone: 262 22'07

#### Sri Lanka

DETROIT DIESEL ALLISON  
C.I.A.S. Ltd.  
150 Ward P1.  
P.O. Box 610  
Colombo

Cables: Ciastri  
Phone: 94191



**DORMAN DIESELS LIMITED**  
Brown & Co. Ltd.  
P.O. Box 200  
481 Darley Road  
Colombo 10

Telex: 1111  
Cables: Metal  
Phone: 91171

**L. GARDNER & SONS LIMITED**  
Taps Ltd.  
Kew Road  
Colombo 2

Phone: 79629

**J.L.O.**  
Mackwoods Limited  
38 D.R. Wijewardena Mawatha  
P.O. Box 91  
Colombo

Telex: 1153  
Phone: 32941-5

**KIRLOSKAR OIL  
ENGINES LTD.**  
Samuel Sons & Co. Ltd.  
P.O. Box 46  
Colombo 12

Cables: Echiron  
Phone: 32341

**LEYLAND INTERNATIONAL**  
Walker Sons & Co. Ltd.  
P.O. Box 166  
Colombo

Cables: Walkers  
Phone: 28441

**LUCAS SERVICE OVERSEAS  
LIMITED**  
Walker Sons & Co. Ltd.  
P.O. Box 166  
Colombo

Telex: Colombo 1118  
Cables: Walkers  
Phone: Fort No. 28441/9

**NISSAN DIESEL MOTOR CO.  
LIMITED**  
Associated Motorways Ltd.  
185 Union Place  
Colombo 2

**PETBOW LIMITED**  
Blackwood Hodge (Ceylon) Ltd  
Nadaraja Building  
Galle Road  
P.O. Box 688  
Kollupitiya  
Colombo 3

**PERKINS ENGINES LIMITED**  
The Ceylon Motor Transit Co.  
(1955) Ltd.  
P.O. Box 299  
101 D.S. Senanayake Mawatha  
Colombo 8

Cables: Bonanza  
Phone: 96101/5, 93401

**PETTERS LIMITED**  
Sri Lanka State Trading  
(General) Corporation  
P.O. Box No. 1686  
No. 119 Wekande Road  
Colombo 2

Cables: Rajawasa  
Phone: 36233/4/5

#### St. Helena

**LEYLAND INTERNATIONAL**  
Soloman & Co. (St. Helena) Ltd.  
Jamestown  
Island of St. Helena

Cables: Solomon  
St. Helena

#### St. Kitts

**DETROIT DIESEL ALLISON**  
S.L. Horsford & Co. Ltd.  
Agent of Tugs & Lighters Ltd.  
Trinidad  
P.O. Box 45  
Basseterre

Telex: 387284 Trinidad  
Cables: Tuglighter,  
Port-of-Spain  
Phone: 2085 St. Kitts

**LEYLAND INTERNATIONAL**  
S.L. Horsford & Co. Ltd.  
P.O. Box 45  
Basseterre

Cables: Horsford

**PERKINS ENGINES LIMITED**  
TDC  
P.O. Box 142  
Basseterre

Cables: Tadco  
Phone: 2511

**PETTERS LIMITED**  
S.L. Horsford & Co. Ltd.  
P.O. Box 45  
Marshal House  
Basseterre

Cables: Horsford  
Phone: 2085

#### St. Lucia

**DETROIT DIESEL ALLISON**  
St. Lucia Yacht Services  
Agent of Tugs & Lighters Ltd.  
Trinidad  
Castries

Telex: 387284 Trinidad.  
Cables: Tuglighter, Port-of-  
Spain, Trinidad  
Phone: 2879 St. Lucia

**LEYLAND INTERNATIONAL**  
J.O. Charles Ltd.  
P.O. Box 279  
Castries

Cables: Jayco St. Lucia  
Phone: 2721-4.

**LUCAS SERVICE OVERSEAS  
LIMITED**  
Peter & Co. Ltd.  
P.O. Box 84  
Castries

Cables: Peters

**PERKINS ENGINES LIMITED**  
Universal Services Limited  
Castries  
P.O. Box 463

Phone: 4109-2797 St. Lucia

**PETTERS LIMITED**  
Morne Dudon Industries Ltd.  
P.O. Box 397  
Castries

Telex: LC 317  
Cables: Witeco  
Phone: 8657

#### St. Martin

**PERKINS ENGINES LIMITED**  
Caribbean Supply Co. N.V.  
Pointe Blanche  
P.O. Box 18  
Phillipsburg  
St. Maarten

Telex: 8000/1  
Cables: Carsucon

#### St. Vincent

**DETROIT DIESEL ALLISON**  
St. Vincent Motors  
Agent of Tugs & Lights Ltd.  
Trinidad  
Arnos Vale

Telex: 387284 Trinidad  
Cables: Tuglighter Port-of-  
Spain, Trinidad  
Phone: 61557 St. Vincent

**LEYLAND INTERNATIONAL**  
Hazells Ltd.  
P.O. Box 108  
Kingstown

**LUCAS SERVICE OVERSEAS  
LIMITED**  
St. Vincent Sales & Services Ltd.  
P.O. Box 699  
Kingstown

Cables: Saleserve  
Phone: 71820

**PERKINS ENGINES LIMITED**  
St. Vincent Sales & Service  
P.O. Box 599  
Kingstown

Phone: 71820  
Cables: Saleserve St.

**PETTERS LIMITED**  
Hazells Ltd.  
Kingstown

Telex: BOAC WB512  
Cables: Hazel

#### Sudan

**CATERPILLAR OVERSEAS SA**  
Sudanese Tractor Company Ltd.  
74 Barlamen Avenue  
P.O. Box 1840  
Khartoum

Cables: Tractors  
Phone: 72828

CATERPILLAR OVERSEAS SA  
Sudanese Tractor Company Ltd  
P.O. Box 301  
Wad Medani

Cables: Tractors  
Phone: 639

DETROIT DIESEL ALLISON  
Taha El Sayed El Roubi & Co.  
P.O. Box 467  
Khartoum

Telex: 970-293  
Cables: Telroubi  
Phone: 71308, 76449,  
33145 or 31923

DORMAN DIESELS LIMITED  
Sharaf Modern Engineering Agencies  
P.O. Box 1701  
Khartoum

Telex: 280 Sharaf KM  
Cables: Engincom  
Phone: 75192 & 81773

L. GARDNER & SONS LIMITED  
El Laboudi Commercial House  
P.O. Box 1338  
Khartoum

Phone: 41204

KATOLIGHT  
Asim Trading Enterprises  
P.O. Box 1354  
Khartoum

KIRLOSKAR OIL ENGINES  
LIMITED  
Jamnadas Odhavji Sheth  
P.O. Box 648  
Omdurman

Cables: Jaytex  
Phone: 52308/56951

KLOCKNER-HUMBOLDT-  
DEUTZ AG  
Dalia Commercial Enterprises  
El Lew El Abiad Building  
Flat 29  
P.O. Box 2477  
Khartoum

Telex: 401 Dalia  
Cables: Yawadalla  
Phone: 72965, 80042,  
72557

LEYLAND INTERNATIONAL  
El Gezira-Automobile Co.,  
P.O. Box 232  
Khartoum

Telex: 455 Gezcar  
Cables: Gezcar  
Phone: Khartoum 78555-  
41867

LUCAS SERVICE OVERSEAS  
LIMITED  
Angelo & Co. Spare Parts  
P.O. Box 582  
Khartoum

Phone: 43026

NISSAN DIESEL MOTOR CO.  
LIMITED  
Hassouna Auto Work Shops  
& Stores  
P.O. Box 380  
Khartoum

PERKINS ENGINES LIMITED  
Aboulela Engineering Co. Ltd.  
P.O. Box 1341  
Aboulela Building  
U.N. Square  
Khartoum

Telex: 421 Handasiya  
Cables: Handasiya  
Phone: 77257/9

PETERS LIMITED  
Birtar Engineering Co. Ltd.  
P.O. Box 1011  
407 Gamhuria Avenue  
Khartoum

Telex: 285  
Cables: Engbox  
Phone: 70952, 71245,  
71045

JOHN ROBSON (SHIPLEY)  
LIMITED  
J.N. Valvis Ltd.,  
P.O. Box 247  
Khartoum

#### Surinam

CATERPILLAR OVERSEAS SA  
Surinaamse Machinehandel N.V.  
P.O. Box 1808  
Paramaribo

Telex: PBO 42 CKC SME  
182 Surmac  
Cables: Surmac  
Phone: 82222

DETROIT DIESEL ALLISON  
N.V. Ingenieursbureau  
H.N. Vag. Dijk  
Industrieweg 300N  
P.O. Box 347  
Paramaribo

Telex: 397-160 SME VAN  
DYK  
Cables: Vandijk  
Phone: 89163

KATOLIGHT  
George H. Knoppel  
P.O. Box 222  
Paramaribo

KLOCKNER-HUMBOLDT-  
DEUTZ AG  
N.V.C.E. Vervuurt  
Handelssonderneming  
Beekhuizenweg No. 211-212  
Livorno  
Paramaribo

Telex: 151  
Cables: Fructomel  
Phone: Paramaribo 81515

LEYLAND INTERNATIONAL  
NV Handelmaatschappij H.J.  
de Vries  
P.O. Box 1849/1850  
Waterkant 90/94  
Paramaribo

Cables: Petzoldt  
Phone: 4242

LUCAS SERVICE OVERSEAS  
LIMITED  
Handelmaatschappij I Fernandes  
& Son N.V.  
Corner Keizer en Klipsteenstraat  
2-3-4-6-8-10  
P.O. Box 1834  
Paramaribo

Cables: Ferson  
Phone: 76844, 71313,  
74844

NISSAN DIESEL MOTOR CO.  
LIMITED  
N.V. Reli  
Steenbakkerijstrat 56-60  
P.O. Box 632  
Paramaribo

PERKINS ENGINES LIMITED  
N.V. Handelmaatschappij  
H.J. de Vries  
P.O. Box 1848-1850  
Saramaccastraat  
Paramaribo

Telex: 128  
Cables: Petzoid  
Phone: 71222-

PETERS LIMITED  
F.E. Van Der Jagt Agencies  
Saramaccastraat 92  
Paramaribo

Cables: Najagt  
Phone: 71734-71117

VOLVO PENTA  
H. Bromet  
Dominiestraat 34.  
P.O. Box 2924  
Paramaribo

Telex: 141  
Cables: Bromet  
Phone: 73512/3

#### Swaziland

CATERPILLAR OVERSEAS SA  
Barlow's (Swaziland) (Pty) Ltd.  
P.O. Box 120  
Manzini

Telex: SMX63  
Cables: Shipments  
Phone: 2363

#### Sweden

BOMBARDIER-ROTAX GmbH  
AB E. Fleron  
P.O. Box 186  
S-201 21 Malmo

Telex: 32112  
Phone: 040-160000

BRIGGS & STRATTON  
CORPORATION  
Axelson & Engwall K/B  
P.O. Box 42036  
S12612 Stockholm 42

Telex: 10606  
Cables: Greiffcomp  
Phone: 08-188460

CATERPILLAR OVERSEAS SA  
Engson  
Engström & Nilson Maskin AB  
Fack  
17220 Sundbyberg

Telex: 1544 (General)  
1506 (Par)  
Cables: Engson Stockholm  
Phone: (8) 28-25-60  
8

DETROIT DIESEL ALLISON  
Detroit Diesel Allison  
International - Europe  
c/o General Motors Nordiska A.B.  
Motorvagen 1  
Fack  
S-104-60 Stockholm

Telex: 1569  
Cables: Genmotnord  
Phone: 08-44-01-08

DORMAN DIESELS LIMITED  
Eivind K. Son Sylvan A.B.  
St. Badhusgatan 20  
41121 Goteborg C.  
Sweden

Telex: 20731  
Cables: Sylvano  
Phone: Goteborg  
(031) 17 12 30

FORD MOTOR CO. LIMITED  
Ford Motor Company A.B.  
Fack  
S102-50 Stockholm 27  
Sweden

Telex: 19451  
Phone: (08) 679800

KLOCKNER-HUMBOLDT-  
DEUTZ AG  
Svenska Deutz A.B.  
P.O. Box 6037  
S-17506 Jaerfaella 6

Telex: Stockholm 17284  
Cables: Deutzmotor  
Phone: 08/7600400

LEYLAND INTERNATIONAL  
British Leyland Sweden A.B.  
Gamla Tuvevaegen 15B  
Fack  
402 70 Gothenburg 8

Telex: 20941 Leyscan S  
Cables: Leyscan  
Phone: 51.38.00

PERKINS ENGINES LIMITED  
Malte Manson A.B.  
Fack  
S-58101 Linkoping

Telex: 50049 Manson S  
Cables: Motorverktyg  
Phone: 013/150000

PETTERS LIMITED  
Aktiebolaget Transfer  
Reserve Power  
Prastgardsgatan 9  
Postfack  
172-20 Sundbyberg 1

Telex: 19339  
Cables: Transfer-Stockholm  
Phone: 98-16-20

RUGGERINI MOTORI S.p.A.  
AB Sterner Blomouist  
N. Grangesbergsgatan 28  
S-214 50 Malmo

Telex: 32127 Sterner

VOLVO PENTA  
Volvex Motor AB  
Rundbacksgatan 1-5  
417 05 Goteborg

Phone: 031/51 39 80

#### Switzerland

ALLIS CHALMERS  
Aksa AG Ingenieur Bureau -  
012787  
CH-5430  
Wettingen 3

Telex: 55307  
Cables: Aksa  
Phone: 056-6-36 58

BOMBARDIER-ROTAX GMBH  
Ernst Messer AG  
CH-4704  
Niederbipp BE

Telex: 62806  
Phone: 065-732363

BRIGGS & STRATTON  
CORPORATION  
European Office  
Steinenring 12  
4051 Basel

Telex: 62616  
Cables: Brigs  
Phone: 061/39 11 29

CATERPILLAR OVERSEAS SA  
118 Rue Du Rhone  
1211 Geneva 3

Telex: 22706 & 22833  
Cables: Catoversea  
Phone: (022) 20-62-22

DETROIT DIESEL ALLISON  
Detroit Diesel Allison  
International - Europe  
c/o General Motors Suisse S.A.  
Salzhausstrasse 21  
2501 Biel-Bienne

Telex: 34217 GMS-CH  
Cables: GMS-CH  
Phone: 032-215111

DORMAN DIESELS LIMITED  
Ulrich Rohrer-Marti AG  
3052 Zollikofen  
Berne

Telex: 32262  
Cables: Rohrer Marti  
Phone: 031 571157

FORD MOTOR CO. LIMITED  
Ford Motor Co.  
(Switzerland) S.A.  
Kurvenstrasse 35  
CH 8021 Zurich

Telex: 52230  
Phone: 601110

KLOCKNER-HUMBOLDT-  
DEUTZ AG  
Hans F. Wurgler  
Ing.-Buro  
Rautistr. 31  
CH-8047 Zurich-Albisrieden

Telex: 53868  
Cables: Maschine  
Phone: 526655/6

LEYLAND INTERNATIONAL  
British Leyland (Switzerland) AG  
Herostrasse 7  
Postfach  
8048 Zurich

Telex: 56762 55114  
Cables: Motofrey  
Phone: 010 4151 62  
9090

PERKINS ENGINES LIMITED  
Promot A.G.  
CH-5745 Safenwil

Telex: 68134 (pmot.ch)  
Cables: Promot  
Phone: 062-679211

PETTERS LIMITED  
Kofet A.G.  
Baumaschinen  
Aegerstrasse 11  
CH-8305 Industria Sued  
Dietlikon

Telex: 54242  
Phone: 01-833 1077

RUGGERINI MOTORI S.p.A.  
Agrido S.A.  
P.B. 166  
Chemin du Devin 51  
Ch-1012 Lausanne

Telex: 25398 Agrid

VOLVO PENTA  
Elektro Mechanik  
Hans Moughtry  
Gibraltarstrasse 13  
6000 Luzern

Telex: 78256  
Phone: 041/221222/23

#### Syria

BOMBARDIER-ROTAX GMBH  
Rinaldo Draghi  
B.P. 521  
Alep

Phone: 14070-19120-26144

CATERPILLAR OVERSEAS SA  
M. Ezzat Jallad & Fils  
Pour le Commerce et la  
Representation  
(M. Dureid Jallad & Cie)  
Aleppo Street  
Al-Qaboun  
P.O. Box 23  
Damascus

Cables: Jallad  
Phone: 550-321  
555 012

DORMAN DIESELS LIMITED  
Nagib Baki Trading Co. S.A.  
Fardoss Street  
Baki Building  
P.O. Box 135  
Damascus

Cables: Baki  
Phone: 11 343-4

INDIAN NATIONAL DIESEL  
ENGINE LIMITED  
Hijjar & Massamari  
Damascus

KATOLIGHT  
Mouhamed Al-Khouja  
P.O. Box 4911  
Damascus

KIRLOSKAR OIL ENGINES  
LIMITED  
Mohamed Ali (Mardini)  
P.O. Box 2601  
Damascus  
Cables: Molimar  
Phone: 223442  
448422 - R

KLOCKNER-HUMBOLDT-  
DEUTZ AG  
Dajani u. Farra AG  
P.O. Box 109  
Fardoss Street  
Damascus  
Cables: Tasada  
Phone: 115678

KOHLER INTERNATIONAL  
LIMITED  
Siedco  
P.O. Box 363  
Damascus

LEYLAND INTERNATIONAL  
Aftomachine  
P.O. Box 3130  
Fardous Street  
Damascus  
Telex: Aftoma 11036SY  
Cables: Aftoma Machine

LUCAS SERVICE OVERSEAS  
LIMITED  
Automotive and Industrial  
Equipment Co. Inc.  
El Fourat Street  
P.O. Box 789  
Damascus  
Telex: 11357  
Cables: Indeco  
Phone: 111044-221961

PERKINS ENGINES LIMITED  
Roy David Homsi  
P.O. Box 295  
Damascus  
Cables: Dagsi

PETTERS LIMITED  
Paysir Khaldi  
Fardoss Street  
Balkis 43  
P.O. Box 3371  
Damascus  
Cables: Taldico  
Phone: 113722

JOHN ROBSON (SHIPLEY)  
LIMITED  
Consulting Engineering &  
Trading Bureau  
P.O. Box 3526  
Fardoss Street  
Damascus

RUGGERINI MOTORI S.p.A.  
Mahmoud Chaaban  
B.P. 813  
Alep

#### Tahiti

ALLIS CHALMERS  
Etablissements Philippe J. Lucas  
Boite Postale 483  
130 Avenue De Marechal Foch  
Papeete  
Cables: Phillucas

DETROIT DIESEL ALLISON  
Ets Bredin Freres  
P.O. Box 21  
Papeete  
Phone: 20258

KLOCKNER-HUMBOLDT-  
DEUTZ AG  
René Solari  
7 Rue du Général de Gaulle  
B.P. No. 2  
Papeete  
Phone: 259

KOHLER INTERNATIONAL  
Lassere Industrie S.A.R.L.  
B.P. 487  
Avenue Georges Clemeneau  
Papeete, Tahiti

LEYLAND INTERNATIONAL  
Intercar S.A.R.L.  
P.O. Box 12  
Papeete  
Cables: Intercar  
Phone: 2.04.35

LUCAS SERVICE OVERSEAS  
LIMITED  
Ets René Solari et Fils  
7 Rue du General de Gaulle  
B.P. 2  
Papeete  
Telex: Soldo 055 FP  
Cables: Soldo  
Phone: 2.53.59

PERKINS ENGINES LIMITED  
Monsieur H. Lombard  
P.O. Box 6  
Papeete  
Phone: 20484

RUGGERINI MOTORI SpA  
Sablage Metallisation  
Peinture du Pacifique  
P.O. Box 596  
Papeete

#### Taiwan

ALLIS CHALMERS  
112 Hsin Sheng South Road  
Section 1  
P.O. Box 1-41  
Taipei  
Telex: 11731 Chiaoldt  
Cables: Chiaoldt  
Phone: 350220-2

BRIGGS & STRATTON  
CORPORATION  
William Chang & Co. Ltd.  
293-911 Sung Kiang Road  
P.O. Box 577  
Taipei  
Telex: 11743 Goldgate  
Wmchang  
Cables: Wmchang  
Phone: 522330, 522336

CATERPILLAR OVERSEAS SA  
TTC Equipment & Service Ltd.  
79 Chung Shan Road North  
Section 2  
P.O. Box 68-245  
Taipei  
Cables: Taitradco

DETROIT DIESEL ALLISON  
Summit Engineering Co. Ltd.  
Room C 3rd Floor  
Morrison Plaza  
No. 25 Jen Ai Road  
4th Section  
P.O. Box 53-5  
Taipei  
Telex: 785-11156  
Sumiteng  
Cables: Sumiteng  
Phone: 722111

DORMAN DIESELS LIMITED  
Winston & Co. Ltd.  
Room 702 Traders Building  
65 Nanking E Road  
Section 3  
P.O. Box 59826  
Taipei  
Cables: Winstoncol  
Phone: 321373

KATOLIGHT  
A1-Reliable Industries Inc.  
P.O. Box 9-086  
Taipei

KLOCKNER-HUMBOLDT-  
DEUTZ AG  
Cosa Liebermann Taiwan Ltd.  
107 Section 2  
Chungshan N. Road  
2nd Floor  
P.O. Box 1756  
Taipei  
Telex: 11312 Cosaco  
Cables: Cosaco  
Phone: 51171218

**KOHLER INTERNATIONAL LIMITED**

Solomon Enterprises Co. Ltd.  
P.O. Box 7-154  
Room 703  
129 Sung Chiang Road  
Taipei

**LEYLAND INTERNATIONAL**

Yung Wei Tung Trading Co. Ltd.  
No. 141 Tun Hua North Road  
P.O. Box 80  
Taipei

Telex: 22545 Weitung  
Cables: Weitungmo  
Phone: 755611, 730188  
743511, 743998

**NISSAN DIESEL MOTOR CO. LIMITED**

The Chinese Automobiles Trading Co. Ltd.  
169 Section 2  
Nanking East Road  
Taipei

**PERKINS ENGINES LIMITED**

Golden Gate Engineering &  
Development Co. Ltd.  
123 Nanking East Road  
3rd Section  
P.O. Box 762  
Taipei

Telex: 1174 Goldgate  
Phone: 551 6733  
571 9216  
511 8397

**RUGGERINI MOTORI S.p.A.**

Fuh Yang Trading Co.  
P.O. Box 9-086  
93 Shao-Tsuang Street  
Kaohsiung

Telex: 71174 Unitrade

**WHITE ENGINES INCORPORATED**

Solomon Enterprise Co. Ltd.  
Room 703  
P.O. Box 7-154  
129 Sung-Chiang Road  
Taipei

Telex: 22218 Padobebe  
Cables: Solo  
Phone: 560368/69

**Tanzania****ALLIS CHALMERS**

Holman Bros. (East Africa) Ltd.  
P.O. Box 1938  
Dar-Es-Salaam

**CATERPILLAR OVERSEAS SA**

Construction Equipment Division  
of the UAC of Tanzania Ltd.  
P.O. Box 2568  
Dar-Es-Salaam

Cables: Afritrak  
Caressalaam  
Phone: 63355

**DETROIT DIESEL ALLISON**

Blackwood Hodge Group  
Services Ltd.,  
Hunsbury Hill Ave.,  
Northampton NN4 9QT  
U.K.

Telex: 31476  
Cables: Suntract,  
Phone: 0604-61111

**DORMAN DIESELS LIMITED**

Agricultural & Industrial  
Supplies Co. Ltd.  
P.O. Box 4797  
Dar-Es-Salaam

Cables: Agrind  
Phone: 25201

**KLOCKNER-HUMBOLDT-DEUTZ AG**

Achelis (Tanganyika) Ltd.  
Karim Latha Mansion  
P.O. Box 9003  
Makunganya Str.  
Dar-Es-Salaam

Telex: 41067  
Cables: Achelissions  
Phone: 21078, 24011

**LEYLAND INTERNATIONAL**

Leyland Albion (Tanzania) Ltd.  
P.O. Box 2388  
Dar-Es-Salaam

Cables: Leyalb  
Phone: 63439, 63449

**LUCAS SERVICE OVERSEAS LIMITED**

Delta (Tanzania) Ltd.  
Pugu Road  
P.O. Box 44  
Dar-Es-Salaam

Telex: 41011  
Cables: Delta  
Phone: 20129, 22338

**PERKINS ENGINES LIMITED**

Century Tractor & Implements  
(Tanzania) Ltd.  
P.O. Box 21011  
Dar-Es-Salaam

Telex: 41058  
Phone: 27727/8

**PETTERS LIMITED**

Agricultural & Industrial Supplies Co. Ltd.  
P.O. Box 4797  
Upanga Road  
Dar-Es-Salaam

**Thailand****ALLIS CHALMERS**

89 Khor  
Super Highway 17½km  
Bangkok 9

Telex: BK 2740 ItalThai  
Cables: Titrac  
Phone: 791136-8

**BOMBARDIER-ROTAX GMBH**

Jones Company Ltd.  
P.O. Box 686  
Bangkok

Phone: 31267, 38628

**BRIGGS & STRATTON CORPORATION**

United Motor Works (Siam) Ltd.  
156 Suriwongse Road  
P.O. Box 370  
Bangkok

Telex: 7882629  
Cables: Yeesoh  
Phone: 32987-88-89

**CATERPILLAR OVERSEAS SA**

The International Engineering  
Co. Ltd.  
614 Sukhumvit Road  
P.O. Box 39  
Bangkok

Telex: Intenco Th2626  
Cables: Gysom

**DETROIT DIESEL ALLISON**

Borneo Engineering Co. Ltd.  
226 Nares Road  
Bangkok

Telex: 788-2826  
Cables: Deceja  
Phone: 38981/38989

**DORMAN DIESELS LIMITED**

Term Engineering Co. Ltd.  
P.O. Box 1513  
No. 302/2 Therd Thai Road.  
Bangkok 6

Telex: BK 2588 Nuclear  
Bk  
Cables: Nuclear  
Phone: 667055, 665335,  
665422-3

**L. GARDNER & SONS LIMITED**

Khin Nam Huat Limited  
Partnership  
P.O. Box 255  
361/363 Mahaputtarum Road  
Bangkok

Telex: Khinam Bk 2560  
Phone: 33542 39211

**INDIAN NATIONAL DIESEL ENGINE CO. LTD.**

Siamlester & Co. Ltd.  
Uchuliang Foundation Building  
6th Floor,  
968 Rama IV Road  
Bangkok

Cables: Hamlet  
Phone: 927478-9, 92251

**J.L.O.**

Hamlet & Co. Ltd.  
1999 Petchburi Road, Extension  
P.O. Box 122  
Bangkok 10

**KATQLIGHT**

Siri Sakol Co. Ltd.  
132-134 Samyod New Road  
Bangkok

**KIRLOSKAR OIL ENGINES LIMITED**  
Mechanical Equipment Co.  
295 Siphya Road  
Mequip Building  
P.O. Box 550  
Bangkok

Telex: BK 2509  
Cables: Mequip  
Phone: 37961-5

**KLOCKNER-HUMBOLDT-DEUTZ AG**  
B. Grimm & Co.  
1643/4 Petchburi Road (Extension)  
P.O. Box 66  
Bangkok

Telex: BK 2614 Thagrirm  
Cables: Thagrirm  
Phone: 2524081

**KOHLER INTERNATIONAL LIMITED**  
The East Asiatic Co.  
Oriental Machinery Stores  
60/1 Super Highway Route 31  
Bangkok

**LEYLAND INTERNATIONAL**  
Ley-Thai Motors Limited  
144 Sukhumvit Road  
Bangkok

Cables: Leythai  
Phone: 54061-7

**LUCAS SERVICE OVERSEAS LIMITED**  
Oriental Machinery Stores  
Worachakr Dept.  
539 Worachakr Road  
Bangkok

Telex: Asiatic TH 2615  
Cables: Machineco  
Phone: 218161, 225102

**NISSAN DIESEL MOTOR CO. LTD.**  
Siam Motors Co. Ltd.  
865 Rama 1 Road  
Bangkok

**PERKINS ENGINES LIMITED**  
Mechanical Equipment Co. Ltd.  
Perkins Engines Division  
28 Soi Asoke Sukumvit Road  
Bangkok

Telex: TH 2509  
Cables: Mequip  
Phone: 3912680, 3925571

**PETBOW LIMITED**  
Loxley (Bangkok) Ltd.  
G.P.O. Box 214  
Loxley Building  
304 Suepah Road  
Bangkok

**PETTERS LIMITED**  
Loxley (Bangkok) Ltd.  
G.P.O. Box 214  
Loxley Building  
304 Suepah Road  
Bangkok

Telex: TH2808 Castrol & 2627 Castrol  
Cables: Loxley  
Phone: 26641

**JOHN ROBSON (SHIPLEY) LIMITED**  
Lampangchai Co. Ltd.  
46/7-14 Petchburi Road  
Bangkok

**RUGGERINI MOTORI S.p.A.**  
Saha Thai Machinery  
133-135 Sam Yod. New Road  
Bangkok

**VOLVO PENTA**  
The East Asiatic Company Ltd.  
Super Highway Branch  
Oriental Machinery Stores  
60/1 Highway Route 31  
Din Daeng-Ladprao  
Bangkok 4

Telex: BK 2615  
Cables: Industreac  
Phone: 770176, 770183,  
770185, 770214,  
771784, 773227

**WHITE ENGINES INCORPORATED**  
Dodge & Seymour (Far East) Inc.  
P.O. Box 192  
942/16 Rama IV Road  
4th Floor, S.C. Building  
(Opposite Chulalongkon Hospital)  
Bangkok

Cables: Eximco  
Phone: 33557

## Timor

**PETTERS LIMITED**  
Sociedade Oriental de Transportes  
E. Armazens Lda.  
Avenida Marginal sa da Bandeira  
Dili

## Togo

**CATERPILLAR OVERSEAS SA**  
Gastonegre S.A.  
B.P. 134  
Lome

Telex: 5231  
Phone: 22-81/82, 32-70

**LEYLAND INTERNATIONAL**  
Cie Francaise de L'Afrique  
Occidentale  
Agence Centrale  
Agence Centrale  
B.P. 1246  
Lome

Cables: Senafrica

**LUCAS SERVICE OVERSEAS LIMITED**  
U.A.C. Togo  
B.P. 345  
Lome

Telex: 5219  
Phone: 55.82, 58.15

**PETTERS LIMITED**  
DTG (Departement Hamelle  
Afrigue) S.A.  
14 Avenue de la Liberation  
B.P. 129  
Lome

Telex: Detege 5241  
Departement 9  
Cables: Hamalaf  
Phone: 62.45

**PERKINS ENGINES LIMITED**  
Ets Gastonegre S.A.  
14 bis  
rue de Commerce  
B.P. 134  
Lome

Telex: 231 Gastonegre  
Cables: Gastonegre  
Phone: 22.81

## Tonga

**LEYLAND INTERNATIONAL**  
E.M. Jones Ltd.  
P.O. Box 4  
Nuku'alofa

Cables: Jones Nuku'alofa

Suva Motors Ltd.  
P.O. Box 4  
Suva  
Fiji

## Tuvalu Islands

**LEYLAND INTERNATIONAL**  
Millers Motors  
P.M.B.  
Suva  
Fiji

Telex: 2195  
Cables: Millmot  
Phone: 23031

## Trinidad

**BRIGGS & STRATTON CORPORATION**  
West Bend Sales Ltd.  
P.O. Box 978  
Port of Spain

Cables: Wends  
Phone: 62-24057/62-23245

**CATERPILLAR OVERSEAS SA**  
Tractors and Machinery  
(Trinidad) Ltd.  
P.O. Box 945  
Port of Spain

Telex: 308  
Cables: Tracmac Port-of-  
Spain Trinidad  
Phone: 62-1545,  
62-31431

DETROIT DIESEL ALLISON  
Tugs & Lighters Ltd. (Main Office)  
69 Independence Square  
P.O. Box 600  
Port of Spain

Telex: 387284 Alston WG  
Cables: Tuglighter Port-of-  
Spain  
Phone: 62-24127

DORMAN DIESELS LIMITED  
Alstons Marketing Co. Ltd.,  
(Wilson & Johnstone Division)  
P.O. Box 431  
Port of Spain

KATOLIGHT  
Tatec  
P.O. Box 355  
Port of Spain

KOHLER INTERNATIONAL  
Kirkconnell Brothers Ltd.  
P.O. Box 72  
School House Road  
Kirk Plaza  
Grand Cayman  
West Indies

Thomas Peake & Co. Ltd.  
P.O. Box 301  
76 Henry & 2a Charlotte St.  
Port of Spain

LEYLAND INTERNATIONAL  
Trinity Motors (Robinsons) Ltd.  
32 South Quay  
P.O. Box 241  
Port of Spain

Cables: Trinmot Port-of-  
Spain

LUCAS SERVICE OVERSEAS  
LIMITED  
Laughlin & De Gannes Ltd.  
37 Dundonald Street  
P.O. Box 1254  
Port of Spain

Cables: Bengaston Trinidad  
Phone: PBX 51712/17

NISSAN DIESEL MOTOR CO.  
LIMITED  
Neal & Massy Ltd.  
P.O. Box 1298  
Port of Spain

PERKINS ENGINES LIMITED  
Tractors and Machinery  
(Trinidad) Ltd.  
Eastern Main Road  
Laventille  
Trinidad

Telex: Tracmac 308  
Cables: Tracmac  
Phone: Laventille 62-31431  
San fernando  
65-78840

PETTERS LIMITED  
Charles McEneaney & Co. Ltd.  
25 Richmond St.  
P.O. Box 178  
Port of Spain

Telex: CMCE 256  
Cables: McEneaney  
Phone: 32731-9

#### Tunisia

CATERPILLAR OVERSEAS SA  
Ets. P. Parrenin S.A.  
91 Avenue de Carthage  
Tunis

Telex: 12422  
Cables: Parnin  
Phone: 256577

DETROIT DIESEL ALLISON  
Detroit Diesel Allison International  
- Europe  
c/o General Motors France  
56 à 58 Ave. Louis Roche  
92231 Gennevilliers,  
France

Telex: Genlmot 62050  
Cables: Parautexap  
Phone: 793-3450  
Gennevilliers

KLOCKNER-HUMBOLDT-  
DEUTZ AG  
Societe Tunisienne  
Sotradies  
16 Rue Ahmed Tlili  
Tunis

Telex: 12255 Tunis\*  
Cables: Sotradies  
Phone: 247033  
243340

LEYLAND INTERNATIONAL  
Societe de L'automobile et  
du Materiel  
10 bis Avenue de Ghana  
Tunis

Telex: Sami 2252 TN  
Cables: Sama  
Phone: 242 156

LUCAS SERVICE OVERSEAS  
LIMITED  
Soudiem  
35 Rue de Marseille  
Boite Postale 773  
Tunis

Telex: 12180  
Cables: Soudiem  
Phone: 241090 245113

PERKINS ENGINES  
Ets Louis Montenay  
49 Avenue de Carthage  
Tunis

Telex: 743  
Cables: Secfa  
Phone: 240-312/240-324

PETTERS LIMITED  
Agrimotor S.A.  
30 Rue Ali Dargouth  
B.P. 415  
Tunis

Telex: Agrimo 12014  
Cables: Etaboulaire  
Phone: 247.060

RUGGERINI MOTORI S.p.A.  
Societe de L'Automobile et  
du Materiel  
10 Bis  
Avenue de Ghana  
Tunis

Telex: 12252 SAM TN

WHITE ENGINES  
INCORPORATED  
Ets Louis Montenay  
49, Avenue de Carthage  
Boite Postale 862  
Tunis

Telex: 743  
Cables: Secfa  
Phone: 240.324, 240.312

#### Turkey

ALLIS CHALMERS  
Kutsi Begdas, Murgessillik  
Ithalat-Ihracat  
Barbaros Bulvari  
Ikinci Yol-Besiktas  
P.O. Box 125 Besiktas  
Istanbul

Telex: 22391 Kuba Tr  
Cables: Kutsi-Besiktas  
Phone: 47 89 50

BOMBARDIER-ROTAX GmbH  
Sefik Soyuyuce  
Sitam Ticaret  
Karanfil Sokak 30/5-6  
Yenisehir  
Ankara

Phone: 17 49 09

BRIGGS & STRATTON  
CORPORATION  
Alagoz ve Ort. Alem Kol. Sti.  
Persembepazari-Omeraga  
Sokak No. 4/3  
Karakoy  
Istanbul

Telex: 23472  
Cables: Alempomp  
Phone: 449433

CATERPILLAR OVERSEAS SA  
Cukurova Ithalat ve Ihracat T.A.S.  
Buyukdere Caddesi  
P.O. Box 124  
Sisli

Telex: 22693  
Cables: Cukurtas  
Phone: 47-48-30

DETROIT DIESEL ALLISON  
Kurt Basakinci Co.  
Vali Dr. Resit Cad, 52  
Cankaya  
P.O. Box 55  
Bakanliklar  
Ankara

Telex: 821-42289, Kurt,  
TR

DORMAN DIESELS LIMITED  
Ahmet Buldanlioglu & Co.  
Gazi Bulvari 26.  
P.O. Box 1  
Izmir

Telex: Istanbul 22603  
Nakitr  
Cables: Ehem  
Phone: 23991, 36392

**KATOLIGHT**  
Kopsan  
Makine Sanayi ve Ticaret Ltd. Sti.  
Buyudere Caddesi No. 66  
Daire 6 Mecidiyeköy  
Istanbul

**KLOCKNER-HUMBOLDT-  
DEUTZ AG**  
Deutz Humboldt  
Makina Ticaret Ltd., Sti  
P.K. 226 Beyoglu  
Siraselviler Caddesi Soganci Sokak  
No. 19/2 İttihad Sigorta Apt.  
Cihangir  
Istanbul

Telex: 22239 dhit tr.  
Cables: Deurzhumboldt  
Phone: 459166

**LEYLAND INTERNATIONAL**  
B.M.C. Sanayi Ve Ticaret AS  
Gazi Bulvari 47/49  
P.K. 260  
Izmir

Telex: 52320 BMCE TR  
Cables: Bemece  
Phone: 39780

**LUCAS SERVICE OVERSEAS  
LIMITED**  
Elektro-Dizel Motor Sanayi ve  
Ticaret A.S.  
Elmadag Caddesi No. 54-56  
Harbiye  
Istanbul

Telex: 23435  
Cables: Simpar

**PERKINS ENGINES LIMITED**  
Dizel Makina Ltd., Sirketi  
Cumhuriyet Caddesi No. 10/c  
Sisli  
Istanbul

Telex: Eligold 22357  
Istanbul  
Cables: Dizilimited  
Phone: 473675, 460941

**PETBOW LIMITED**  
Tarmo Tarim Motor  
Sanayi ve Ticaret A.S.,  
Necatibey Cad  
54 Karakoy  
Istanbul

**PETTERS LIMITED**  
Aziz Isvan Ticaret Ltd.  
P.O. Box 82  
Sishane Mesrutiyet Caddesi 184  
Beyoglu  
Istanbul

Cables: Arlim  
Phone: 4.419.77

**RUGGERINI MOTORI S.p.A.**  
Alveris  
Kurekciler Caddesi No. 50  
Karakoy  
Istanbul

**VOLVO PENTA**  
Erk Mühendislik Sanayi ve  
Ticaret Ltd.  
Yildiz Caddesi Akdogan Sokak  
No. 27  
P.K. 535 Karaköy  
Istanbul

Telex: 22711 Orya TR  
Cables: Erklimitsan  
Phone: 40 31 36

**WHITE ENGINES  
INCORPORATED**  
Metyä Limited Sirketi  
Methatpasa Caddesi No. 39/7  
Ankara

Cables: Metyaticaret  
Phone: 17.87.04

#### Uganda

**ALLIS CHALMERS**  
Holman Bros. (East Africa) Ltd.  
P.O. Box 2790  
Kampala

**CATERPILLAR OVERSEAS S.A.**  
Construction Equipment Division  
of Gailey & Roberts (Uganda) Ltd.  
P.O. Box 123  
Kampala

Cables: Afritak  
Phone: 98441

**DETROIT DIESEL ALLISON**  
Wiggleworth & Co. Ugand Ltd.  
P.O. Box 7127  
Kampala

Cables: Pettinato, Mombasa

**KLOCKNER-HUMBOLDT-  
DEUTZ AG**  
Achelis (Uganda) Ltd  
24 Seventh Street (Industrial Area)  
P.O. Box 7198  
Kampala

Cables: Achelissions  
Phone: 53751

**LEYLAND INTERNATIONAL**  
Leyland Albion (Uganda) Ltd.  
P.O. Box 3778  
Kampala

Cables: Leyalb

**LUCAS SERVICE OVERSEAS  
LIMITED**  
Delta Ltd.  
P.O. Box 28  
Kampala

Cables: Delta  
Phone: 42421/2

**PERKINS ENGINES LIMITED**  
Farm Machinery Distributors (U)  
Ltd.  
P.O. Box 5763  
Kampala

Cables: Farmec  
Phone: 41237

**PETTERS LIMITED**  
Mackenzie Technical Services Ltd.  
43 Roseberry Road  
P.O. Box 7011  
Kampala

Telex: 61080  
Phone: 43326/7

#### United Kingdom

**ALLIS CHALMERS**  
Deekay House  
North Street  
P.O. Box 14  
Havant PO9 1QH  
Hampshire  
England

Telex: 86491 Deekay  
Havant  
Cables: Autogen  
Phone: Havant  
74122 0712

**BRIGGS & STRATTON  
CORPORATION**  
Autocar Electrical Equipment  
Co., Ltd.  
16 Rippleside Commercial Estate  
Ripple Road  
Barking Essex  
England

Telex: 885060  
Cables: Autodulbee  
Phone: 01-592 2112/3/4

**DETROIT DIESEL ALLISON**  
Detroit Diesel Allison  
International - Europe  
Div. of General Motors Ltd.  
London Road  
P.O. Box 6  
Wellingborough  
Northamptonshire NN8 2DL  
England

Telex: 851-31329  
Wellingborough  
Cables: Genmopower,  
Phone: 71122  
Wellingborough

**KATOLIGHT LIMITED**  
Tatton Electric Co. Ltd.  
501 Staines Road West  
Ashford  
Middlesex, TW15 2AB  
England

**KATOLIGHT LIMITED**  
W.S.M. Electric and Electronic  
Services  
12 Campbell Street  
Hamilton ML3 6AS  
Scotland

**KIRLOSKAR OIL ENGINES  
LIMITED**  
P.M. Engine Ltd.  
35 Piccadilly  
London W1V 0JD  
England

Telex: 266250  
Cables: Dieselpicc  
Phone: 734-1066/7/8



KLOCKNER-HUMBOLDT-  
DEUTZ AG  
Deutz Engines Limited  
Riverside Road  
Wandsworth  
London SW17  
England

Telex: 928373  
Cables: Deutz  
Phone: 9469161

KOHLER INTERNATIONAL  
LIMITED  
J.H. Hancox Ltd.  
Wood Lane  
Earlswood  
Softhull  
Warwickshire B94 6JW  
England

KOHLER INTERNATIONAL  
LIMITED  
Hydraulic Cranes (Scotland) Ltd  
57-61 Vere Road  
Blackwood JL 11 9 RR  
Lanarkshire  
Scotland

LEYLAND INTERNATIONAL  
Leyland House  
174 Marylebone Road  
London NW1 5AA  
England

PERKINS ENGINES LIMITED  
Peterborough PE1 5NA  
England  
Telex: 32501  
Cables: Perkoil  
Phone: 67474

PETBOW LIMITED  
Marketing Advisory Services  
329 Grand Building  
Trafalgar Square  
London W.C.2  
England

PETTERS LIMITED  
Hamble  
Southampton SO3 5NJ  
England  
Telex: 47626  
Phone: Hamble 2061

RUGGERINI MOTORI S.P.A.  
Glanfield Lawrence Concessions  
Victoria Road  
Portslade  
Brighton  
Sussex BN4 1XY  
England

VOLVO PENTA  
Bolinders Co. Ltd.  
150/8 Kings Cross Road  
London WC1X 9DN  
England  
Telex: 24768  
Phone: 01-278 2711

VOLVO PENTA  
Robert Craig & Sons Ltd.  
Great George's St.  
Belfast  
Northern Ireland BT15 1BW  
Phone: Belfast (0232)  
32971

WHITE ENGINES  
INCORPORATED  
Diamond T. Motors  
411 London Road  
Isleworth  
Middlesex U.K.  
England  
Telex: 935576  
Cables: Diamond Isleworth  
Hauhslow  
Phone: Isleworth 71534

#### Uppel Volta

CATERPILLAR OVERSEAS SA  
Manutention Africaine  
B.P. 636  
Ouagadougou  
Telex: 5230  
Phone: 2155

LEYLAND INTERNATIONAL  
Dima -HV  
B.P. 25  
Ougadougou

LUCAS SERVICE OVERSEAS  
LIMITED  
Scoa  
Service Auto  
B.P. 32  
Ougadougou

#### Uruguay

ALLIS CHALMERS  
Cassarino Hermandos S.A.  
Galica 1069  
Casillad de Correo 153  
Montevideo  
Telex: Public Booth  
No. 702  
Cables: Casarihnos  
Montivideo  
Phone: 9122-22

BRIGGS & STRATTON  
CORPORATION  
Manuel Guelfi y Cia  
Av. Agraciada 1777  
Montevideo  
Telex: 398220  
Cables: Maguel

CATERPILLAR OVERSEAS SA  
General Machinery Co. S.A.  
Avenida Joaquin Suarez 2856  
Montevideo  
Telex: 398.730 Gemcosa  
UY730  
Cables: Gemcosa  
Montevideo  
Phones: 20-99-21/2/3/4/5

DETROIT DIESEL ALLISON  
Mapelli Ltda  
Cerrito 352  
P.O. Box 441  
Montevideo  
Telex: 398-330  
Cables: Mapelli  
Phone: 840223

DORMAN DIESELS LIMITED  
Maquinas & Materiales SA  
18 de Julio 2302  
Montevideo  
Cables: Maquinas  
Montevideo  
Phone: 46171, 414336

FORD MOTOR CO. LIMITED  
Ford (Uruguay) S.A.  
Casilla de Correo 296  
Montevideo  
Telex: 298 096  
Phone: 207521

KLOCKNER-HUMBOLDT-  
DEUTZ AG  
Arfil S.A.  
Casilla Correo 21  
Tala 2270  
U-Montevideo  
Telex: Arfil SA UY 387  
Cables: Micarta  
Phone: 293814

KOHLER INTERNATIONAL  
LIMITED  
Hidrotecnica Sociedad Anonima  
General San Martin 2505/07  
Montevideo

LEYLAND INTERNATIONAL  
Frank Surgey S.A.  
Casilla de Correo 704  
Montevideo  
Cables: Fransur

LUCAS SERVICE OVERSEAS  
LIMITED  
Automotive Accessories S.A.  
Cuareim 2179  
Montevideo  
Cables: Socra Montevideo  
Phone: 27849, 20.62-10

PERKINS ENGINES LIMITED  
Perkins Rio de la Plata S.A.  
Av. Juan Carlos Gomez 1492  
Montevideo  
Telex: 278  
Phone: 916254/88844

PETTERS LIMITED  
Horacio Torrendel S.A.  
Cuareim 2050 al 2082  
Montevideo  
Cables: Horatorsa  
Montevideo  
Phone: 20.13.01

**U.S.A.**

**ALLIS CHALMERS**  
P.O. Box 563  
Harvey  
Illinois 60426

Telex: 910-2572135  
Hvyilep  
Phone: (312) 339-3300

**BRIGGS & STRATTON CORPORATION**  
Milwaukee  
P.O. Box 702  
Wisconsin 53201

Telex: 02-8776  
Cables: Basco  
Phone: (414) 461-1212

**CATERPILLAR AMERICAS CO.**  
Peoria  
Illinois 61629

**DORMAN DIESELS LIMITED**  
Hemisphere Engine Sales Co. Inc.  
P.O. Box 12385  
Fort Worth  
Texas 76116

**DORMAN DIESELS LIMITED**  
Bay Engine & Parts Co.  
1640 Evans Avenue  
San Francisco  
California 94124

Phone: (415) 826-7400

**FORD MOTOR CO. LIMITED**  
Parts and Service Division  
Industrial Engine Operations  
P.O. Box 3080  
Livonia  
Michigan 48151

Phone: 32 32808

**L. GARDNER & SONS LIMITED**  
L. Klindt  
186 Venus Lane  
Tamarac Park  
Key West  
Florida 33040

Phone: (Area code)  
305 294 9434

**KLOCKNER-HUMBOLDT-DEUTZ AG**  
Deutz Corporation  
7585 Ponce de Leon Circle  
Atlanta  
Georgia 30340

Telex: 0707478  
Cables: Oilengine  
Phone: (404) 4496140

**KOHLER INTERNATIONAL LIMITED**  
Kohler  
Wisconsin 53044

Telex: 26888  
Cables: Kohlerint  
Phone: (414) 457-4441

**LEYLAND INTERNATIONAL**  
British Leyland Motors Inc.  
600 Willow Tree Road  
Leonia  
New Jersey 07605

**LUCAS SERVICE OVERSEAS LIMITED**  
Lucas Industries America Inc.  
Two Northfield Plaza  
Troy  
Michigan 48084

Telex: 8102321644  
Phone: 3138791920

**NISSAN DIESEL MOTOR CO. LIMITED**  
Chrysler Corporation  
Marine and Industrial Products Div.  
P.O. Box 1  
Marysville  
Michigan 48040

**PERKINS ENGINES LIMITED**  
P.O. Box 283/24175 Research Drive  
Farmington  
Michigan 48024

Telex: 023.5300  
Cables: Perkoil Farmington  
Phone: 313-477-3900

**PERKINS ENGINES LATIN AMERICA INC.**  
2600 Douglas Road  
Suite 600  
Coral Gables  
Florida 33134

Telex: 515880  
Cables: Perklac  
Phone: (305) 4484884

**PETTERS LIMITED**  
Onan Division  
Onan Corporation  
1400 73rd Avenue N.E.  
Minneapolis  
Minnesota 55432

Telex: 29-0476  
Phone: (612) 574-50000

**VOLVO PENTA**  
Volvo Penta of America Inc.  
P.O. Box 12758  
Koger Executive Center  
Building No. 18  
Suite 106  
Norfolk  
Virginia 23502

Telex: 823661  
Phone: (804) 461-1552

**WHITE ENGINES INCORPORATED**  
XM World Trade Inc.  
One World Trade Center  
Suite 4501  
New York  
New York 10048

Telex: 232886  
Cables: Eximco  
Phone: (212) 432-5200

**U.S.S.R.**

**CATERPILLAR OVERSEAS SA**  
Pokrovsky Boulevard 4/17  
Apartment 13  
Moscow 101000

Telex: 7802 SU  
Phone: 207-5658  
207-1007  
207-2625  
207-2982

**Venezuela**

**ALLIS CHALMERS**  
Sanchez & Cia S.A.  
Avda Rossevelt - Prado de Marie  
Apartado 1006  
Caracas 101

Telex: 21235  
Phone: 62.99.11 A1 19

**BRIGGS & STRATTON CORPORATION**  
Sanchez y Cia S.A.  
Apartado Postal 1006  
Caracas

Telex: 21235  
Cables: Sanchez  
Phone: 62.99.11  
62.45.01

**CATERPILLAR OVERSEAS S.A.**  
General Electric de Venezuela S.A.  
Calle Real - Sabana Grande  
Apartado 1666  
Caracas 101

Telex: 22724  
Cables: Ingenetric  
Phone: 71-98-11

**DETROIT DIESEL ALLISON**  
Stewart & Stevenson De  
Venezuela S.A.  
Apartado 1809  
Av. 2 (El Milagro) No. 86A-27  
Maracaibo

Telex: 395-81140  
Savenmex  
Phone: 223966 or 223251

**DORMAN DIESELS LIMITED**  
Edificio Halven Est. Monroy  
Avenida Universidad  
Aparto 808  
Caracas

Telex: 22567 A/B Halven  
Cables: Halven  
Phone: 54 312 1/25

**FORD MOTOR CO (VENEZUELA) S.A.**  
Avenida Henry Ford  
Zona Industrial Sur  
Apartado 354  
Valencia

Telex: Caracas 765377

**KATOLIGHT**  
Electronica Osorio S.R.L.  
Apartado 75776  
Caracas 107

**KOHLER INTERNATIONAL LIMITED**  
Lorenzo M. Bustillos &  
Cia. Sucs. C.A.  
Apartado No. 234  
Av. Romulo Gallegos - Boleita  
Caracas 10

**KLOCKNER-HUMBOLDT-DEUTZ AG**  
Navimeca  
Calle Comercio 103  
YV. - Punto Fijo - Edo. Falcón

Telex: 54164  
Cables: Navimeca  
Phone: 2343

**LEYLAND INTERNATIONAL**  
Compania Anonima De Automoviles  
Y Repuestos  
Apartado 6561  
Pilita A. Mamey 95-1  
Caracas

Telex: 21337 Tedesur  
Cables: Cadayr  
Phone: 429371 & 73

**LUCAS SERVICE OVERSEAS LIMITED**  
Core Compania Anonima  
Apartado 3969  
Caracas

Telex: 21322  
Cables: Core  
Phone: 62.46.62/3/4/5

**PERKINS ENGINES LIMITED**  
Corporacion Venezolana Del Motor  
Division de Maquinarias  
Apartado Postal No. 74  
Avenida Principal de los Ruices  
Caracas

Telex: 22741 Sacco  
Cables: Luap  
Phone: 34.75.71

**PETTERS LIMITED**  
Corporacion Mercantil  
Venezolana S.A.  
(Comersa)  
Apartado 20  
Avenida Diaz Moreno  
c/c Cantaura  
Con Antiguas Telares Karam  
Valencia

Cables: Comersa  
Phone: 89091/4

**JOHN ROBSON (SHIPLEY) LIMITED**  
Corporacion Mercantil  
Venezolana S.A.  
Av. 100 (Constitucion) No. 92-20  
Apartado No. 20  
Valencia

**RUGGERINI MOTORI S.p.A.**  
Befransa  
Apartado de Correos  
Los Ruices 70029  
Final Segunda Transversal de  
Los Ruices  
Caracas

Telex: 25208 Befransa

**VOLVO PENTA**  
Nautiven  
Nautica Venezolana CA  
Av. Los Samanes  
Apartado 50925  
Caracas

Telex: 21252  
Cables: Nautiven  
Phone: 74 05 15  
74 17 91

**WHITE ENGINES INCORPORATED**  
Servicios Tecnomat  
Calle Branger No. 14  
Los Rosales  
Apartado (P.O. Box) 10.294  
Caracas

Cables: Temaser  
Phone: 61-12-24 or  
61-12-25

#### Vietnam

**LEYLAND INTERNATIONAL**  
Societe Des Garages Charner  
131-133 Boulevard Nguyen Hue  
Saigon

Cables: Charnerco

**Societe D'Exploitation Industrielle Commerciale**  
Saigon-Garaga  
P.O. Box 47  
Saigon

Cables: Losseic  
Phone: 20.603

**Vietnam KY-XA Cong-TY**  
155 Bd. Hue  
Saigon

**Societe Indochinoise de Transports SA**  
4 Rue Nguyen  
Trung Truc  
B.P. 422  
Saigon

Cables: S.I.T.

#### Virgin Islands

**BRIGGS & STRATTON CORPORATION**  
Midwest Corp.  
4 Strand Street  
Box 1107  
Frederiksted  
St. Croix 00840

**KOHLER INTERNATIONAL LIMITED**  
Spesco  
P.O. Box 3127  
St. Thomas  
Virgin Islands

**LEYLAND INTERNATIONAL**  
Hayes & Co.  
P.O. Box 430  
Christiansted  
St. Croix  
Virgin Islands 00820

**LEYLAND INTERNATIONAL**  
Motor Holdings Ltd.  
Quay Motor Co. Ltd.  
P.O. Box 117  
Tortola

Telex: Anebank VB 918  
Cables: Quaymo  
Phone: 2470

**PETTERS LIMITED**  
J.R. O'Neal  
P.O. Box 127  
Road Town  
Tortola

Cables: O'Neal

#### Western Sahara

**LEYLAND INTERNATIONAL**  
Metalurgica de Santa Ana S.A.  
Delegacion En El Aaiun  
Apartado 8  
El Aaiun

#### Western Samoa

**L GARDNER & SONS LIMITED**  
I.H. Carruthers Ltd.  
P.O. Box 578  
Apia

Phone: Apia 88

**LEYLAND INTERNATIONAL**  
Motor-Distributors (Samoa) Ltd.  
Main Beach Road  
Apia

Cables: Modist

#### Yemen Arab Republic

**CATERPILLAR OVERSEAS SA**  
The Tehama Trading Co. Ltd.  
P.O. Box 337  
Hodeidah

Telex: For the Tehama  
Trading Co. Ltd. c/o  
Cwbooth 501/502  
Hodeidah  
Cables: Tradco

DORMAN DIESELS LIMITED  
Salem Saleh Bahaj  
P.O. Box 895  
Hodeidah

Cables: Bahaj  
Phone: 2224

KIRLOSKAR OIL ENGINES  
LIMITED  
Adhban Trading Corporation  
Republican Palace Street  
P.O. Box 1105  
Sanaa

Telex: 260 Adhban YE  
Cables: Adhban  
Phone: 2918

KLOCKNER-HUMBOLDT-  
DEUTZ AG  
Tihama Tractors and  
Engineering Co. Ltd.  
P.O. Box 49  
Sanaa

Telex: 217 ye  
Cables: Tiham  
Phone: 2462

LEYLAND INTERNATIONAL  
Amin Kassem M. Sultan & Co.  
P.O. Box 888  
Taiz

Cables: Alamin Hodeida

NISSAN DIESEL MOTOR CO.  
LIMITED  
Adhban Trading Corporation  
P.O. Box 1105  
Sanaa

PERKINS ENGINES  
The Tehama Trading Co Ltd.  
P.O. Box 3337  
Hodeidah

Telex: 218 Hoship ye  
(Sanaa)  
Cables: Tradco  
Phone: 2406

PETTERS LIMITED  
Awadh Salem Baobeid & Sons  
P.O. Box 3786  
Hodeidah

Telex: 513 Ye Baobeid  
Cables: Bin Awadh  
Phone: 2742

JOHN ROBSON (SHIPLEY) LTD  
Alwataary General Trading &  
Agricultural Development Co.  
P.O. Box 61-2207  
Maidan Altahrin  
Sanaa

RUGGERINI MOTORI S.p.A.  
Abduillah H. Alsonidar & Sons  
P.O. Box 11  
Sanaa

Telex: 226 Snidar

#### Yemen (Peoples Democratic Republic of)

CATERPILLAR OVERSEAS SA  
National Company for Home Trade  
P.O. Box 90  
Crater  
Aden

Telex: ADN 211  
Cables: Hometrade  
Phone: 51133-9, 51632-3

DORMAN DIESELS LIMITED  
Salem Saleh Bahaj  
P.O. Box 379  
Aden

Cables: Bahaj Aden  
Phone: Crater 52533,  
535909

L. GARDNER & SONS LIMITED  
The Arab General Trading  
Company  
P.O. Box 4195  
Aden

Phone: 52479, 53450,  
22976, 82266

LEYLAND INTERNATIONAL  
National Company for  
Foreign Trade  
Crater  
Aden

Telex: ADN 211  
Cables: Hometrade  
Phone: 51134-8

LUCAS SERVICE OVERSEAS  
LIMITED  
National Company for Foreign  
Trade  
P.O. Box 90  
Crater  
Aden

Telex: ADN 211  
Cables: Foreigntrade  
Phone: 51133-9, 51632-3

PERKINS ENGINES LIMITED  
National Company for Home Trade  
Crater  
Aden

Telex: ADN 211  
Phone: 51134

#### Yugoslavia

BRIGGS & STRATTON  
CORPORATION  
Elektrotehna  
Sektor Zastopstev  
Titova 51

Telex: 31-184  
Phone: 061-311233/  
320241

CATERPILLAR OVERSEAS SA  
Omnikomerc  
Batajniski put bb  
B.P. 637  
Belgrade

Telex: 12223  
Cables: Omnikomerc  
Phone: 608-322/3/4

DETROIT DIESEL ALLISON  
INTERNATIONAL - EUROPE  
c/o General Motors Suisse S.A.  
Salzhausstrasse 21  
2501 Biele Bienne  
Switzerland

Telex: 34217 GMS CH  
Cables: GMS CH Bienne  
Phone: 032.26161

KLOCKNER-HUMBOLDT-  
DEUTZ AG  
TAM Tovarna  
Avtomobilov in Motorjev  
Maribor

Telex: 33111  
Cables: Avtoma Maribor  
Phone: 32321

LEYLAND INTERNATIONAL  
Interpromet  
P.O. Box 328  
11001 Belgrade

Telex: 11164  
Phone: 435-132, 435-193  
435-931, 435-834  
435-895, 434-226  
435-980

PERKINS ENGINES LIMITED  
Industrija Motora Rakovica  
Partijarha Dimitriha 7-13  
Rakoyica  
Belgrade

Telex: 11341, YU, IMR  
Cables: Indmotor Beograd  
Phone: 562-043/322/992

PETTERS LIMITED  
Interkomerc  
Terezij  
1100 Belgrade

Telex: 11 434 Uy Intercom  
Phone: 340-301

RUGGERINI MOTORI S.p.A.  
Agroservis Export-Import  
Amruseva 8.  
Zagreb

Telex: 21498 Agros

VOLVO PENTA  
Jugoslavenska Tankerska  
Plovidba  
Oour Jugotanker  
Borisa Kidrica 3  
57000 Zadar

Telex: 27127  
Phone: 22-377  
24-255

#### Zaire

CATERPILLAR OVERSEAS SA  
Chanic  
Direction Générale  
B.P. 8512  
Kinshasa

Telex: 300  
Cables: Chamat Kjnshasa  
Phone: 59815, 59819

KLOCKNER-HUMBOLDT-  
DEUTZ AG  
Magirus-Deutz-Zaire S.Z.A.R.L.  
10me Rue  
B.P. 8616  
Kinshasa - Limete

Telex: 23058  
Phone: 77588

KOHLER INTERNATIONAL  
LIMITED  
Diomi Imports  
B.P. 2499  
Kinshasa

LEYLAND INTERNATIONAL  
Industrie Nationale Zairoise Des  
Automobiles Leyland (Inzal)  
B.P. 7121  
Kinshasa 1

Telex: 382 Inzal Kin.,  
Cables: Inzal Kinshasa  
Phone: 77748, 77768

LUCAS SERVICE OVERSEAS  
LIMITED  
Industrie Nationale Zairoise des  
Automobiles Leyland  
(Inzal)  
B.P. 7121  
Kinshasa

Telex: 382 Inzal Kinshasa  
Phone: 77748, 77768

NISSAN DIESEL MOTOR CO.  
LIMITED  
A.C.A.  
B.P. 1997  
Kinshasa 1

PERKINS ENGINES LIMITED  
Sedec Marforce  
B.P. 13599  
Kin. 1  
Kinshasa

Telex: 348  
Phone: 23972

PETTERS LIMITED  
Affima  
17 Avenue de l'Industrie  
B.P. 2200  
Kinshasa

Telex: Immarkin 974-38  
Cables: Afrima Kinshasa  
Phone: 22338/22194

WHITE ENGINES  
INCORPORATED  
Africauto-Zaire  
B.P. 2999  
Kinshasa

Telex: 223  
Phone: 22548-49

#### Zambia

CATERPILLAR OVERSEAS SA  
Mazembe Tractor Co. Ltd.  
Chibote House  
ChaChaCha Road  
P.O. Box 3450  
Lusaka

Telex: ZA 4292 Lusaka  
Cables: Assail Lusaka  
Phone: 75168/75941

DETROIT DIESEL ALLISON  
Velebilt Import-Export (Branch)  
P.O. Box 870  
Marsala Totbuhina 79/1  
YU 11000 Beograd.  
Yugoslavia

Telex: 11499  
Phone: 444847, 443538

DORMAN DIESELS LIMITED  
Northland Engineering Ltd.  
P.O. Box 1640  
Ndola

Telex: ZA 3331 A/B  
Raminje  
Cables: Northland Ndola  
Phone: 3712/3/4/5

L. GARDNER & SONS LIMITED  
Samuel Osborn (Zambia) Ltd.  
P.O. Box 1496  
Kitwe

Phone: 2473

KIRLOSKAR OIL ENGINES  
LIMITED  
Transocean Ltd.  
P.O. Box 1778  
Ndola

Telex: ZA 3368  
Cable: Transocean  
Phone: 4017/2422

KLOCKNER-HUMBOLDT-  
DEUTZ AG  
Eimco (InterAfrica) Ltd.  
Arkwright Road  
P.O. Box 885  
Ndola

Telex: ZA 33621  
Cables: Eimco  
Phone: 4257/8/9

LEYLAND MOTORS  
(ZAMBIA) LIMITED  
P.O. Box 1238  
Lusaka

Cables: Leymotors Lusaka  
Phone: 76082

LUCAS SERVICE OVERSEAS  
LIMITED  
Stansfield Ratcliffe Ltd.  
P.O. Box 780  
Chachacha Road  
Lusaka

Cables: Stancliffe  
Phone: 72016-7

NISSAN DIESEL MOTORS LIMITED  
National Transport Corporation  
(Zambia) Ltd.  
P.O. Box 2607  
Lusaka

PERKINS ENGINES LIMITED  
Power Equipment Limited  
P.O. Box 2699  
Cairo Road (North End)  
Lusaka

Telex: ZA 4174  
Phone: 74951

PETTERS LIMITED  
Power Equipment Ltd.  
P.O. Box 2699  
Cairo Road  
Lusaka

Telex: ZA 4174  
Phone: 74951/2/3/4

#### Zimbabwe-Rhodesia

CATERPILLAR OVERSEAS SA  
Barlow's Tractor & Equipment  
Co. Ltd.  
Cnr. Harrow Road & Martin Drive  
Beverley East  
Msasa  
P.O. Box 1537

Telex: 3152  
Phone: 67781

CATERPILLAR OVERSEAS S.A.  
Barlow's Tractor & Equipment  
Co. Ltd.  
5 Dunlop Road  
Donnington  
Bulawayo

Telex: 3152  
Phone: 67781

# 12

## Index of Manufacturers

This index refers to the main entries for manufacturers' equipment and excludes references in Section 10 to miscellaneous suppliers and in Section 11, the list of manufacturers' agents and distributors by country.

a

AB Bofors-Nohab, 68.  
AEG-Telefunken (U.K.) Ltd, 128.  
Aermotor, 57.  
Aero-Power, 47.  
Aerowatt Co., 48.  
AGA Harwell, 118, 123.  
Agahat Appliances, 83.  
Agro Aids, 56.  
Air Distribution, Equipment (M & W) Ltd, 26.  
Allam Generators, 133.  
Allis Chalmers, 68, 97.  
Alsthom-Neyric-Techniques des Fluides, 47.  
Ape-Allen Ltd, 120.  
Arc Solar Centre Ltd, 26.  
Asahi Trading Co. Ltd, 27.  
Auto Diesels Braby Ltd, 135.

b

Belfort International Corp., 155.  
Bermotor Ltd, 91, 115, 134.  
Bio Gas of Colorado Inc., 88.  
Birmingham Stove and Range Co., 83.  
Blake Ltd, John, 75.  
Blazing Showers, 87.  
Bombardier-Rotax GmbH, 114.  
Bosman, 47, 56.  
Briau S.A., 21, 68, 75.  
Briggs & Stratton Corp., 112.  
British Leyland U.K. Ltd, 98.  
Brotherhood Ltd, Peter, 120.  
Bruno S.A., 57.  
Brush Electrical Machines Ltd, 129.  
Burke Rubber Co., 27.

c

Calor Sol Ltd, 27.  
Canyon Industries, 69.  
Casella, C.F., & Co. Ltd, 155.  
Caterpillar Overseas S.A., 98, 133.  
C & D Batteries, 150.  
CAV Ltd, 128.  
CeCoCo, 74, 93.  
CGE International U.K. Ltd, 136.  
Champion Home Builders Co., 28.  
Chimney Heat Reclaimer Corp., 87.  
Chloride Alcad, 150.  
Chloride Transipak Ltd, 48, 152.  
Chloride Zambia Ltd, 150.  
Chrysler Corp., 97.  
Cohen Machinery Ltd, George, 140.  
Control Technology Ltd, 157.  
Cooper Energy Services, 111.  
Coulson Wind Electric, 48.  
CSI Solar Systems Division, 28.  
Curwen & Newbury Ltd, 87.

d

Daimler Benz AG, 98.  
Dale Electric of Great Britain Ltd, 139.  
Davey Dunlite, 49.  
Dawson-Keith Electric Ltd, 134.  
Delatron Systems Corp., 151.  
Dempster Industries Inc., 58.  
Detroit Diesel Allison International-Europe, 99.  
Distrimex, 32.  
DIY - Sol Inc., 28.  
Dolin Metal Products Inc., 87.  
Dominion Aluminium Fabricating Ltd, 49.

Dorman Diesels Ltd, 99, 137.  
Drees & Co. GmbH, 69.  
Dunlite, 138.  
Dunlop Ltd, 91.

e

E.A. Hydraulics & Metal Industries Ltd, 29.  
Earle Engineering, 153.  
Edmund Scientific Co., 50.  
Edwards Engineering Corp., 29.  
E.I. Du Pont de Nemours & Co. Inc., 29.  
E & K Service Co., 29.  
Elcoma Ferranti Ltd, 21.  
Electric Construction (W'ton) Ltd, 130.  
Elektro GmbH, 51, 70.  
Elmot Engineering Co. Private Ltd, 129.  
Elve Corp., 106.  
Enag S.A., 50.  
Energy Dynamics Corp., 30.  
Enfield Industrial Engines Ltd, 100.  
Enterprise Foundry Co. Ltd, 83.  
Eoliennes Humblot, 50, 60.  
Evans Engineering, 66, 71, 157, 160, 161.

f

Fafco Solar Heat Exchangers, 30.  
Farm Gas Ltd, 89.  
Farymann Diesel, 100.  
Fatsco, 83.  
Ferranti (see Elcoma Ferranti)  
Fidelity Electric Co., 130.  
Filon Division, Vistron Corp., 31.  
Forces Motrices Neuchateloises S.A., 49.  
Ford Motor Co. Ltd, 101, 113.  
Freeheat Burners, 92.

g

Gardner & Sons Ltd, L, 101.  
GEC Machines Ltd, 131.  
Gilbert Gilkes & Gordon Ltd, 69.  
Global Thermo-electric Power Systems Ltd, 119, 123.  
G & M Power Plant Ltd, 141.  
Green & Carter Ltd, 76.  
Grumman Corporation, 29, 50.

h

Hadley Solar Energy, 31.  
Harwell TMG (see Aga Harwell)  
Hat2, Motorenfabrik KG, 99.  
Hayward Tyler & Co. Ltd, 121.  
Helion, 31.  
Heller-Aller Co., 58.  
Hitzinger, Dipl.-Ing. & Co., 136.  
Howe Marketing Ltd, Ralph, 52.  
H.T.C. Diesel Engines Private Ltd, 103.

i

IMI Range Ltd, 31.  
Independent Power Developers, 70, 153.  
Indian National Diesel Engine Co. Ltd, 104.  
Isothermics Inc., 88.

JLD Motorenwerk GmbH, 111.  
J.M. Solar Heaters, 41.  
Jétel Woodstoves, 84.  
Jyoti Ltd, 71.

Kalwall Corporation, 37.  
Karlstads Mekaniska Werkstad, 71.  
Katalight Corporation, 142.  
Kawasaki Heavy Industries Ltd, 114, 135.  
Kedco Inc., 52.  
Khadji & Village Industries Commission, 89.  
King Engineering Ltd, 144.  
Kirloskar Oil Engines Ltd, 106, 113.  
Klockner-Humboldt-Deutz AG, 101.  
Köhler International Ltd, 113, 143.  
Kössler Maschinenfabrik GmbH, 73.

Larroque Ets, 84.  
Leffel & Co., James, 72.  
Lennox Industries, 88.  
Lister & Co. Ltd, F.A., 102, 146.  
Lubing Maschinenfabrik, 53.  
Lucas Service Overseas Ltd, 21.  
Lull Marine Ltd, 155.

Malleable Iron Range Co., 84.  
Maquinas Agricolas Fortuna Ltd, 64.  
Markon Engineering Co. Ltd, 132.  
M.B. Engine Co., 120.  
M.B.P. (SA) Pty. Ltd., 59.  
McKee Solaronics Ltd, 32.  
Meccanica S.p.A., 103.  
Medalist Universal Motors, 105.  
Metalco (Heaters) Ltd, 32.  
Monorail Chairlift Ltd, 37.

The Natural Energy Centre, 67, 73.  
Natural Energy Systems Inc., 33.  
Newage Engineers Ltd, 131.  
Newton Derby Ltd, 132.  
Nissan Diesel Motor Co. Ltd, 104.  
Noah Energie Systeme GmbH, 53.  
Northern Waterpower Inc., 74.  
North Wind Power Co. Inc., 51, 152.  
Northrup Inc., 33.

O'Connor Engineering Laboratories Inc.,  
92, 121.  
Ormat Turbines Ltd, 24.  
Ossberger-Turbinenfabrik, 73.

The People/Space Co., 33.  
Perkins Engines Ltd, 105.  
Petbow Ltd, 137.  
Pettars Ltd, 102, 145.

Philips Electronics Components and  
Materials, 24.  
Pinson Energy Corporation, 53.  
Piper Hydro Inc., 34.  
P.I. Specialist Engineers Ltd, 54, 162.  
Plata Power Ltd, 76.  
Poncellet & Cie, 60.  
Pontis Steam Plant Ltd, 121.  
PPG Industries Inc., 34.  
Pragoinvest, 103, 140.  
Puttick Ltd, Graham, 108, 142.

Quirk's Victory Light Co., 54, 150.

Radical Energy Group, 116.  
Ratelco Inc., 153.  
Rayosol, 33.  
Raypak Inc., 35.  
Redpoint Associates Ltd, 36.  
Renault Moteurs Developpement, 25, 118.  
Reymill Steel Products, 67.  
Reynolds Aluminium Export Corporation,  
34.  
Rice Productions Inc., F., 36.  
Riteway Manufacturing Co., 85.  
Robinson of Winchester Ltd, 36.  
Robson (Shiple) Ltd., J., 108.  
Rolls Royce Motors Ltd, 108.  
Ruggerini Motori S.p.A., 104.  
Ruston & Hornsby (India) Ltd, 105, 138.

Spab-Scania, 109.  
SAFT - Societe des Accumulateurs Fixes  
et de Traction, 151.  
Sanamatic Tanks Pty Ltd, 89.  
Sata/Balagu Yantra Shala (P) Ltd, 35.  
Scandinavian Stoves Inc., 84.  
Schluter Motorenfabrik, Anton, 110.  
Science Associates Inc., 156.  
Semple Engine Co. Inc., 92, 122.  
Sencebaugh Wind Electric, 52.  
Senior Platecoil Ltd, 36.  
Shenandoah Manufacturing Co. Inc., 85.  
Small Hydroelectric Systems, 73.  
Smiths Industries Ltd, 155.  
Societe Commerciale de Moteurs - CLM,  
110.  
Solahart Pty Ltd, 37.  
Solapak Products (see also Solarex), 21.  
Soifretes, 118.  
Solar Corporation of America, 38.  
Solar Energy Co., 22.  
Solarex Corporation, 22.  
Solaris Industries, 38.  
Solaron Corporation, 40.  
Solar Physics Corporation, 40.  
Solar Power Corporation, 23, 156.  
Solar Systems Inc., 23.  
Solar Water Heaters Ltd, 39.  
Sonnenschein Accumulatorenfabrik GmbH,  
151.  
Sonnenergie-Heizungs Generatoren  
Produktions und Vertriebs GmbH, 39.  
Southern Steel Works Ltd, 60.  
Spectrolab Inc., 24.  
Spilling Consult AG, 25, 107, 122.  
Steam Power, 122.  
Stewarts & Lloyds, 61.  
Stone-Platt Crawley Ltd, 91.

Sundu Co., 39.  
Sundwell Energy Systems, 40.  
Sunearth Inc., 39.  
Sunmaster, 40.  
Sunpower Distributors Ltd, 40, 118.  
Sunray Solar Heat Inc., 41.  
Sunsense, 41.  
Sunshine Manufacturing Co., 42.  
Sunworks, 41.

Technico Electronics, 156.  
Teledyne Energy Systems, 119, 124.  
Thalopat AG, 93.  
Thai Usa Industrial Factory, 61.  
Toowoomba Foundry (Pty) Ltd, 62, 107.  
Topanga Power, 55.  
Torrid Manufacturing Co. Inc., 85.  
Trimble Windmills, 55.  
Tunnel Co. Ltd, 42, 90.

Unigen Inc., 149.  
United States Stove Co., 86.  
United Stirling, 118.

Valley Comfort, 86.  
Varley Dry Accumulators, 152.  
Villiers Mag Engines Ltd, 112.  
Vistron Corporation (see Filon)  
Volkswagenwerk AG, 107, 112.  
Volvo Penta, 106.

Wakes & Lamb Ltd, 63.  
Water Master Systems Ltd, 86.  
Waverly Heating Supply Co., 86.  
Weaver (Coventry/Victor) Ltd, A.N., 107.  
Westward Mouldings Ltd, 74.  
White Engines Inc., 111, 115.  
Williams & Co. (Pty) Ltd, Sidney, 64.  
Winco, 55, 147.  
The Wind Energy Supply Co. Ltd.  
(WESCO), 56.  
Windpumpen-Zentrale, 62.  
Winpower Corporation, 146.  
Witte Engine Corporation, 110, 115, 148.  
Wyatt Brothers (Whitchurch) Ltd, 63.

Yanmar Diesel Engine Co. Ltd, 109, 148.  
Yazaki Corporation, 25.

Zephyr Wind Dynamo Co., 54.

This book provides the basic information on a wide variety of internationally available small-scale power equipment. It discusses the pros and cons and the criteria for selecting an appropriate energy conversion system to meet a special need.

Some of the entries, particularly for the engine manufacturers, refer to world famous multi-national corporations; others are quite small and little known specialist companies operating in various parts of the world. Attention has been given to a wide range of manufacturers of renewable energy equipment, i.e. devices that use the sun, wind and biomass to produce energy.

Addresses of manufacturers and their agents, material on related information services, and a list of organisations concerned with research and development of small scale power equipment are also included.

This book, which contains a mine of carefully assembled material, should prove invaluable for anyone looking for ways to produce small-scale power by providing information in a handy catalogue form on which the reader can base his judgement.

Peter Fraenkel is a mechanical engineer who has had considerable experience in various industries and in research and development. For the last 15 years he has been involved in projects in developing countries. He is a skilled photographer and writer and many of his articles have been published as well as a book entitled *Food from Windmills*. During the past five years he has been employed as Power Project Officer by the Intermediate Technology Development Group and has been involved in developing small-scale hydro-electric power, a low-cost windmill and a revolutionary run of stream river turbine.

£7.50

ISBN 0 903031 59 0

Intermediate Technology Publications Ltd,  
9 King Street, London WC2E 8HN.