

Enhanced production of Syngas

from

*catalysis,*

*plasma,*

*egg-shells.*

by

Nauman Mithani (#301016320)

Chem 372

2008-3-7

# Section 1: *Low-temp. catalytic gasification of cellulosic biomass* [ref. **P**]

## *Overview:*

---

Due to the massive anthropogenic addition of CO<sub>2</sub>, NO<sub>x</sub>'s and SO<sub>x</sub>'s to the atmosphere, global warming, at present, occurs at a faster rate than at any other point in the past millennium. These additions, mostly, are made in the name of energy production, consumption by combustion of fossil fuels [ref. **P.1**]. *The myriad and severity of ill-effects shall not be discussed here; suffice to say*, for our future well-being, the energy sources that succeed petroleum must be "*clean for the environment, renewable and sustainable, efficient*", economical, convenient and no more dangerous than petrol [ref. **P.2, .3, .4**]

H<sub>2</sub>, in itself, for fuel cells and internal combustion engines, syngas for clean(er) liquid fuels such as Fischer-Tropsch liquids, methanol and dimethyl ether, are the most promising potential successors. These potential fuels yield significantly lesser pollutants and greenhouse gases as by-products/exhaust/waste [ref. **P.5, .6**]

• ***The complication:*** Production of large amounts of tar, even at temperatures as high as 800 - 1000 °C. A "nickel"-based catalyst efficiently converts the tar in a secondary reactor

(700 - 800 °C), removing ~98% of it from the product gas [ref. **P.17**]. The nickel-based catalyst is also efficient at tar removal in the primary reactor (> 750 °C) [ref. **P.17**, .18], though the catalyst (and other standard catalysts) abruptly and utterly deactivates due to the deposition of carbon on its surface [ref. **P.20**]. Thus, a catalyst is needed such as that which can perform and resolve the tar formation in the primary reactor at as low as 500 - 600 °C during the cellulose gasification.

The experimental trials focus on the evaluation of a range of catalysts in the production of H<sub>2</sub> and syngas (CO + H<sub>2</sub>) by the gasification of biomass; lower temperatures and less extreme reaction conditions being the crux of the matter.

## ***Experimental intro and reaction setup:***

---

*"... the use of biomass to produce syngas is the most promising option to share renewable energy sources"*

[ref. **P**].

The basic chemistry at the heart of this whole affair is the reforming and partial oxidation of hydrocarbons [ref. **P.7, .8, .9**].

Extensive research during the past two decades has proven the reaction setup of fluidised- or fixed-bed reactors using air, steam and oxygen to be most advantageous; and so, for this experiment, the gasification of cellulose powder was conducted in a continuous feeding, fluidised-bed reactor [ref. **P.21**]. The feeding rate was  $\sim 85$  mg/min (C:  $3148 \mu\text{mol}/\text{min}$ , H:  $5245 \mu\text{mol}/\text{min}$ , O:  $2622 \mu\text{mol}/\text{min}$ ). Following calculations made for 25-minute reactions.

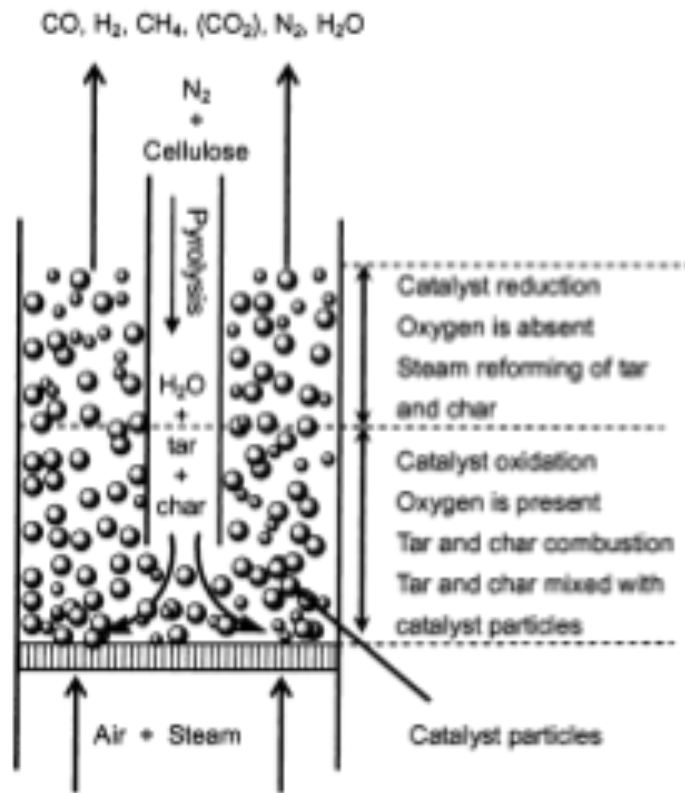

FIGURE 7. Function of Rh/CeO<sub>2</sub>/SiO<sub>2</sub>(35) catalyst and fluidized bed reactor in the catalytic gasification of cellulose with air and steam.

- Carbon conversion (C-conv) was calculated as follows,

$$\frac{\text{formation rate of carbon in } CO + CO_2 + CH_4}{\text{total carbon feeding as cellulose}}$$

- The quantity of char formed =

$$\frac{\text{carbon in the formation of } CO_2 \text{ after feeding was stopped}}{\text{total carbon feeding as cellulose}}$$

- The quantity of tar formed =

$$100 - \text{C-conv \%} - \text{char \%}$$

## ***Results and discussion:***

---

In order for efficient and economical production of hydrogen and syngas, total biomass-to-gas conversion is needed, along with high selectivity of useful gases at low temperatures. A Rh-CeO<sub>2</sub> catalyst was developed and fared well but suffered from the common problem of limited catalyst life during biomass gasification [ref. **P**.21, .22, .23]. This occurs due to the sintering of the CeO<sub>2</sub> during the reaction, and so the catalyst has been altered to CeO<sub>2</sub>-M (where M is SiO<sub>2</sub>, Al<sub>2</sub>O<sub>3</sub>, ZrO<sub>2</sub>) to increase the surface area and prevent sintering.

Figure 1 {shown below} presents the variation of the formation rate of gases with time. Figure 1a, depicting Rh-CeO<sub>2</sub>(35%)-SiO<sub>2</sub> shows the rates to be steady and stable, the rates are also second-highest, after those of Rh-CeO<sub>2</sub> (Figure 1d). The former catalyst system is still the best since, as mentioned previously, the latter catalyst is prone to deactivation but not the former. Other catalyst systems do not match the formation rates of aforementioned.

• ***A bonus:*** The product gas contains 50% N<sub>2</sub> (from the air that was used as the gasifying agent and N<sub>2</sub> that was used for cellulose transportation). *This diluted gas may be used for ammonia production* [ref. **P**].

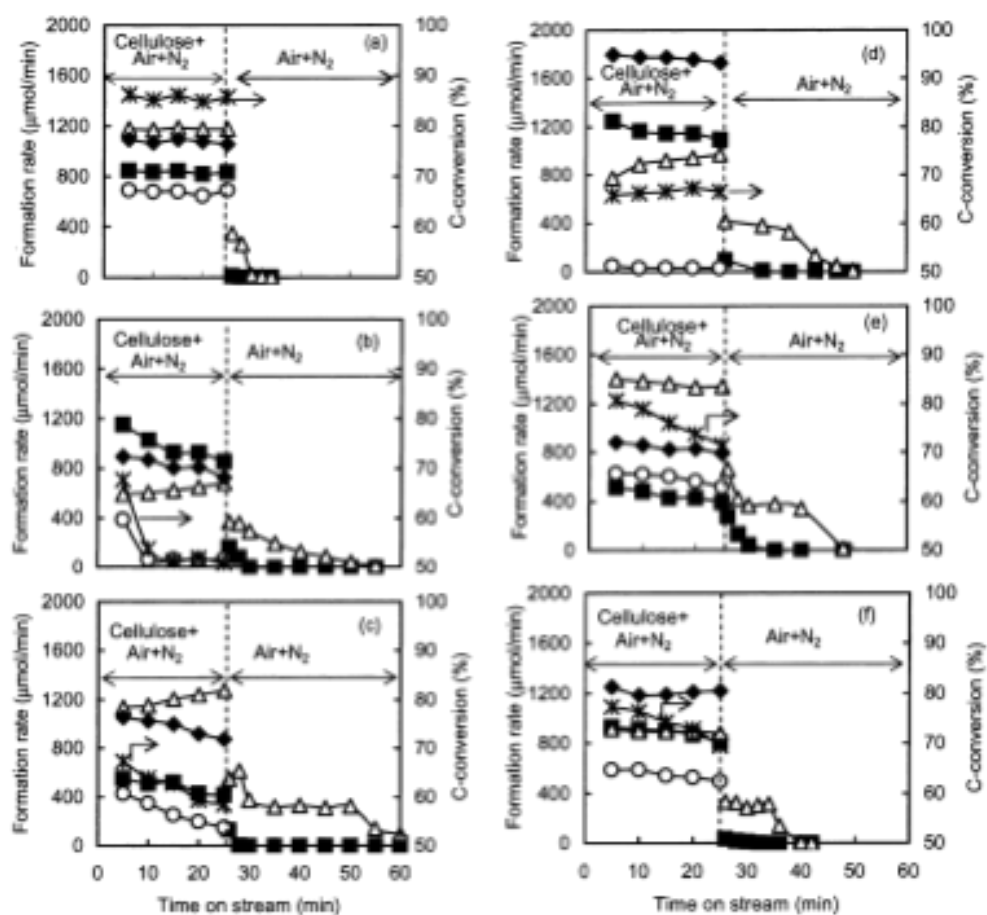

FIGURE 1. Dependence of time on stream on C-conversion and product distribution in cellulose gasification on (a) Rh/CeO<sub>2</sub>/SiO<sub>2</sub>(35), (b) Rh/SiO<sub>2</sub>, (c) G-81, (d) Rh/CeO<sub>2</sub>, (e) Rh/CeO<sub>2</sub>/Al<sub>2</sub>O<sub>3</sub>(30), and (f) Rh/CeO<sub>2</sub>/ZrO<sub>2</sub>(50) at 500 °C. +: C-conversion, ■: CO, ◆: H<sub>2</sub>, △: CO<sub>2</sub>, and ○: CH<sub>4</sub>.

As Table 1 also attests, the Rh-CeO<sub>2</sub>(35%)-SiO<sub>2</sub> catalyst system wins in terms of stability and formation rate; it provides high quantities of H<sub>2</sub> and CO, and its surface area remains fairly undiminished. It may not provide the highest C-conv., nor the largest quantity of syngas constituents but it is not far off, and all this, such high performance in nearly **all aspects** and at reduced temperatures proves its *overall* merit.

TABLE 1. Performance of Various Catalysts in the Gasification of Cellulose

| catalyst <sup>c</sup>                                    | T (°C) | formation rate (μmol/min) |                |                 |                 |     | H <sub>2</sub> /CO | C-conv (%) | char (%) | tar (%) | surface area (m <sup>2</sup> /g) |      |
|--|--------|---------------------------|----------------|-----------------|-----------------|-----|--------------------|------------|----------|---------|----------------------------------|------|
|  |        | CO                        | H <sub>2</sub> | CH <sub>4</sub> | CO <sub>2</sub> |     |                    |            |          |         | fresh                            | used |
| none   | 500    | 152                       | 24             | 5               | 569             | 0.2 | 23                 | 9          | 68       |         |                                  |      |
|  | 550    | 240                       | 76             | 15              | 562             | 0.3 | 26                 | 7          | 67       |         |                                  |      |
|  | 750    | 1536                      | 456            | 357             | 457             | 0.3 | 65                 | 4          | 31       |         |                                  |      |
|  | 800    | 1714                      | 505            | 462             | 417             | 0.3 | 82                 | 3          | 15       |         |                                  |      |
|  | 900    | 1943                      | 592            | 499             | 455             | 0.3 | 92                 | 2          | 6        |         |                                  |      |
| dolomite   | 550    | 414                       | 112            | 72              | 747             | 0.3 | 39                 | 34         | 25       |         |                                  |      |
|  | 700    | 1149                      | 892            | 294             | 336             | 0.8 | 57                 | 14         | 29       |         |                                  |      |
|  | 800    | 1383                      | 1072           | 410             | 833             | 0.8 | 83                 | 4          | 13       |         |                                  |      |
|  | 900    | 1656                      | 1442           | 515             | 750             | 0.9 | 93                 | 2          | 5        |         |                                  |      |
| Rh/CeO <sub>2</sub>                                      | 500    | 1158                      | 1764           | 35              | 898             | 1.5 | 67                 | 11         | 22       | 59      | 13                               |      |
| G-91   | 500    | 477                       | 964            | 284             | 1202            | 2.0 | 62                 | 18         | 20       |         |                                  |      |
| Rh/SiO <sub>2</sub>                                      | 500    | 970                       | 838            | 128             | 632             | 0.9 | 55                 | 9          | 36       | 312     | 310                              |      |
| Rh/CeO <sub>2</sub> /SiO <sub>2</sub> (10)               | 500    | 546                       | 777            | 377             | 1255            | 1.4 | 69                 | 11         | 20       | 285     | 277                              |      |
| Rh/CeO <sub>2</sub> /SiO <sub>2</sub> (20)               | 500    | 516                       | 742            | 648             | 1253            | 1.4 | 77                 | 7          | 16       | 250     | 247                              |      |
| Rh/CeO <sub>2</sub> /SiO <sub>2</sub> (35)               | 500    | 845                       | 1077           | 676             | 1178            | 1.3 | 86                 | 6          | 8        | 208     | 206                              |      |
| Rh/CeO <sub>2</sub> /SiO <sub>2</sub> (50)               | 500    | 927                       | 1200           | 750             | 999             | 1.3 | 85                 | 6          | 9        | 183     | 176                              |      |
| Rh/CeO <sub>2</sub> /SiO <sub>2</sub> (80)               | 500    | 975                       | 1370           | 625             | 912             | 1.4 | 79                 | 5          | 16       | 82      | 77                               |      |
| Rh/CeO <sub>2</sub> /SiO <sub>2</sub> (30) <sup>a</sup>  | 500    | 1189                      | 1684           | 141             | 1049            | 1.3 | 76                 | 15         | 9        | 180     | 177                              |      |
| Rh/CeO <sub>2</sub> /SiO <sub>2</sub> (10) <sup>b</sup>  | 500    | 1321                      | 1295           | 170             | 710             | 1.0 | 70                 | 13         | 17       | 62      | 58                               |      |
| Rh/CeO <sub>2</sub> /ZrO <sub>2</sub> (10)               | 500    | 842                       | 816            | 506             | 949             | 1.0 | 73                 | 16         | 11       | 87      | 86                               |      |
| Rh/CeO <sub>2</sub> /ZrO <sub>2</sub> (50)               | 500    | 886                       | 1212           | 548             | 897             | 1.4 | 74                 | 14         | 12       | 74      | 76                               |      |
| Rh/CeO <sub>2</sub> /Al <sub>2</sub> O <sub>3</sub> (20) | 500    | 399                       | 613            | 574             | 1177            | 1.2 | 68                 | 17         | 15       | 66      | 61                               |      |
| Rh/CeO <sub>2</sub> /Al <sub>2</sub> O <sub>3</sub> (30) | 500    | 448                       | 836            | 585             | 1364            | 1.8 | 76                 | 14         | 10       | 63      | 56                               |      |

<sup>a</sup> SiO<sub>2</sub>, 200 m<sup>2</sup>/g. <sup>b</sup> SiO<sub>2</sub>, 50 m<sup>2</sup>/g. <sup>c</sup> Values in parentheses are the mass% of CeO<sub>2</sub> in the support.

At 500 °C, in the un-catalysed system, C-conv. is 23% and H<sub>2</sub> production is *almost negligible* [ref. **P**], and the major products are tar + char; raising the temp. to 900°C raises the C-conv. to 92% and raises the CO production as well but not H<sub>2</sub> production (ratio). Other catalysts raise the



C-conv. ratios as well but are produce tar + char waste.

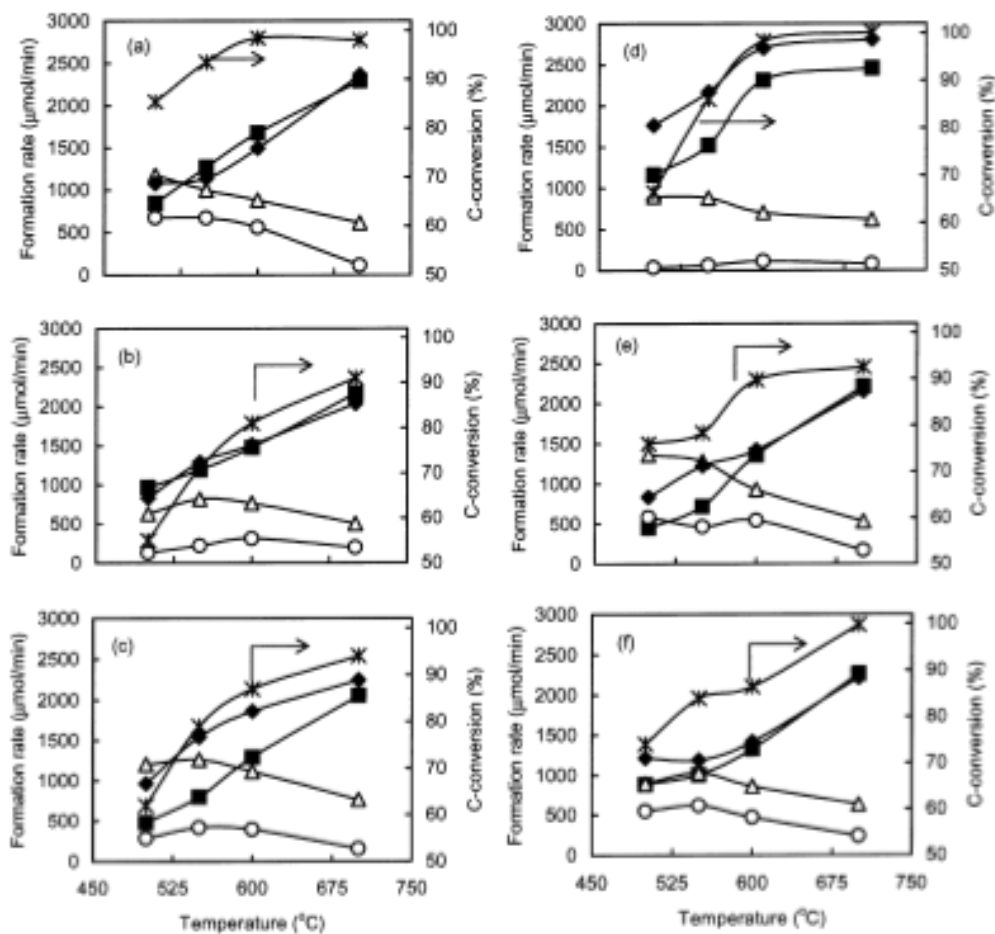

FIGURE 2. Effect of temperature on the C-conversion and product distribution in cellulose gasification on (a) Rh/CeO<sub>2</sub>/SiO<sub>2</sub>(35), (b) Rh/SiO<sub>2</sub>, (c) G-91, (d) Rh/CeO<sub>2</sub>, (e) Rh/CeO<sub>2</sub>/Al<sub>2</sub>O<sub>3</sub>, and (f) Rh/CeO<sub>2</sub>/ZrO<sub>2</sub>. \*: C-conversion, ■: CO, ◆: H<sub>2</sub>, △: CD<sub>2</sub>, and ○: CH<sub>4</sub>.

Figure 2 and Table 2 depict temperature dependence.

**TABLE 2. Reaction Temperature for 90% C-conv by Various Catalysts Expected from the Results of Figure 2**

| Figure 2 | catalyst   | temp (°C) |
|----------|--|-----------|
| a        | Rh/CeO <sub>2</sub> /SiO <sub>2</sub> (35)               | 522       |
| b        | Rh/SiO <sub>2</sub>                                      | 687       |
| c        | G-91   | 632       |
| d        | Rh/CeO <sub>2</sub>                                      | 572       |
| e        | Rh/CeO <sub>2</sub> /Al <sub>2</sub> O <sub>3</sub> (30) | 602       |
| f        | Rh/CeO <sub>2</sub> /ZrO <sub>2</sub> (50)               | 627       |

Production of syngas constituent rises with temperature for all catalyst systems but since the goal is to do so at lower temperatures, catalyst system (a) fares best again. The temperature required for 90% C-conv. with the Rh-CeO<sub>2</sub>(35%)-SiO<sub>2</sub> catalyst system is lowest, as shown by Table 2

•  $CeO_2$  (?? %):

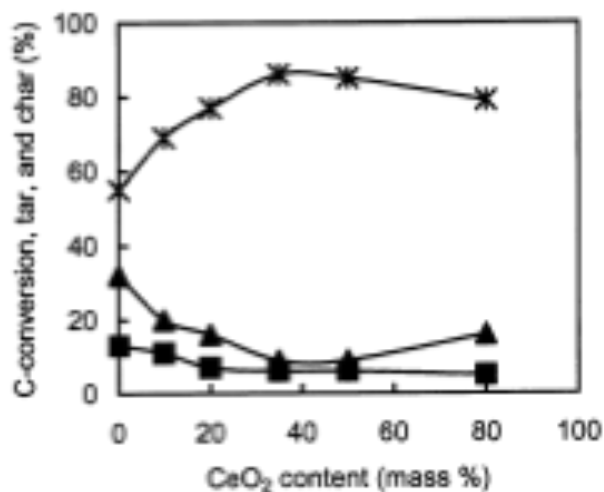

FIGURE 3. Effect of the amount of  $CeO_2$  loading in the  $Rh/CeO_2/SiO_2$  catalyst with respect to the C-conversion as well as tar and char formation. x: C-conversion, ▲: tar-formation and ■: char-formation. Reaction time was 25 min.

This figure shows the rationale behind the 35%  $CeO_2$  by mass in the catalyst system, it is at this value that tar + char conversion is at its highest. Specifically,  $CeO_2$  contributes to the char conversion, as its quantity produced decreases with increasing % of  $CeO_2$  added; the rising % of tar formation suggests that it is dependant on  $CeO_2$  surface area, as higher the  $CeO_2$  %-concentration rises, its ratio to the (constant) Rh surface area decreases.

• *Steaming:*

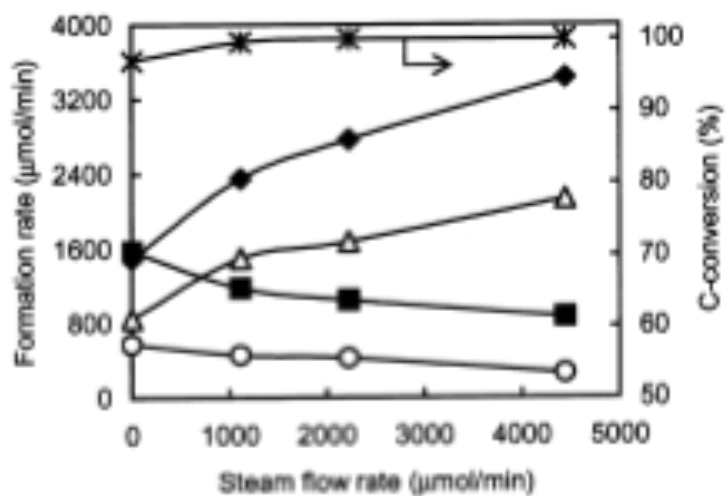
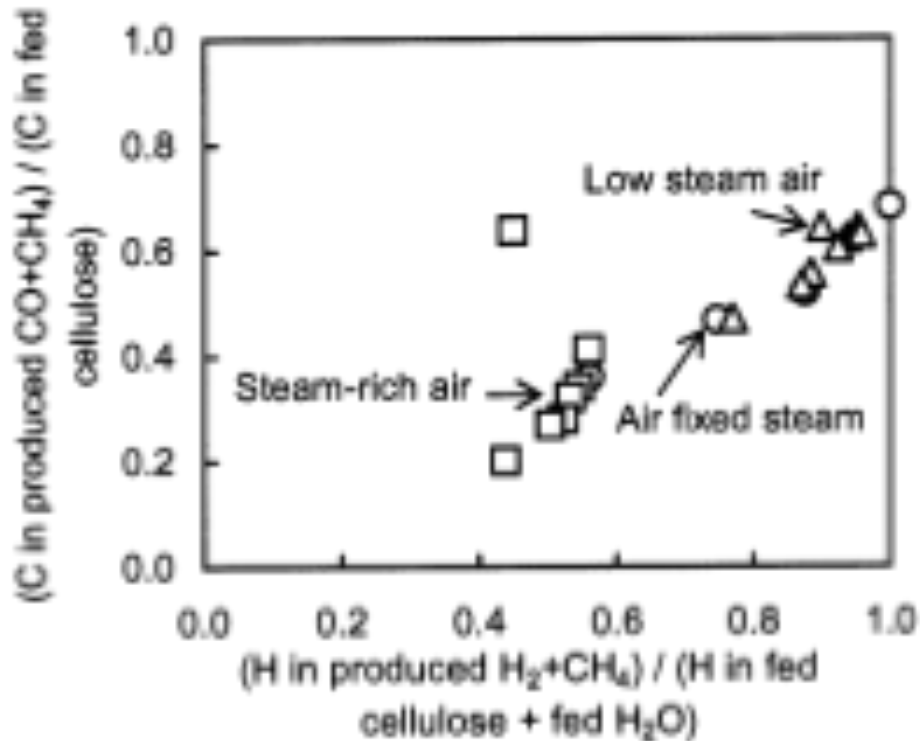

FIGURE 4. Performance of steam in the Rh/CeO<sub>2</sub>/SiO<sub>2</sub> (35) catalyzed gasification of cellulose at 600 °C. \*: C-conversion, ■: CO, ◆: H<sub>2</sub>, Δ: CO<sub>2</sub>, and ○: CH<sub>4</sub>.

Addition of calculated quantities of steam does not greatly enhance the C-conv. but it does boost H<sub>2</sub> production, though at the cost of CO production. This is explained by the water-gas-shift reaction,  $\text{CO} + \text{H}_2\text{O} \rightarrow \text{CO}_2 + \text{H}_2$  [ref. **P**]

• **Product distribution ratios:**



**FIGURE 8. Relation between hydrogen yield and C yield in useful products in the gasification of cellulose over Rh/CeO<sub>2</sub>/SiO<sub>2</sub>(35) under various reaction conditions. ○: Figure 4, △: Figure 5a and □: Figure 5b.**

Here, the relationship between four product gas ratios is shown in differing conditions over the Rh-CeO<sub>2</sub>(35%)-SiO<sub>2</sub> catalyst. Under certain conditions, H<sub>2</sub> yield approaches unity, implying complete pyrolysis of cellulose and negligible yield of tar + char (since these are aromatic compounds); thus conversion to H<sub>2</sub> may be achieved at lower temperatures. C-conv. is also high.

**Summary:**

Cellulose, a model compound of biomass, is the object of gasification in a fluidised bed reactor at 500 - 700 °C. Of the catalysts tested, including the standard Ni and dolomite, the Rh-CeO<sub>2</sub>-SiO<sub>2</sub> (35% CeO<sub>2</sub> by mass) fared best in terms of conversion of carbon to gas and the distribution of the product. The concept and execution of employing cellulosic biomass for the generation of H<sub>2</sub>+syngas may not be novel but the stumbling block of resolving (the catalyst-deactivating) tar+char formation and depositon at lower temperatures was not yet overcome. The aforementioned catalyst, emphatically, renders that possible (consequent effectively negligible tar+char formation). Controlled addition of steam allowed for complete conversion of the cellulose at temperatures as relatively low as 600 °C, providing syngas and upon greater supply, H<sub>2</sub> as the major product. Overall, for economic viability, high efficiency is needed, which cannot be achieved without either high temperatures or preferably, catalysts; of these catalysts, only one performs (and excels) consistently and reliably.

---

Section 2: *Gasification of biomass in water / gas-stabilised plasma for SYNGAS production: Absolute prevention of tar + char + CO<sub>2</sub> [ref. S]*

*Overview:*

---

This series of experiments employed the hybrid gas-water equipped PLASGAS reactor. The plasma was of low density, high temperature and high enthalpy. This high enthalpy was advantageous in providing high reaction temperatures and consequent high efficiency. Homogeneous heating of the plasma reactor and thorough mixing of plasma and treated material allowed for obliteration of the substance under test. In the end, a high percentage of syngas was obtained, moreover, formation of tar was not detected.

The model biomass in this experiment was wood.

## ***Experimental:***

---

The high temperatures from the thermal plasma decompose the organic substances to their constituent atoms and then converted to syngas. The inorganic substances "*are melted and coagulate into a dense, inert, non-leachable vitrified slag that does not require controlled disposal*" [ref. **T**]. The thermal plasma enables decomposition of biomass by only anaerobic pyrolysis or aerobic (calculated oxygen quantities - gasification) to yield syngas. The critical suppression of higher hydrocarbons is brought about by the high temperatures in the plasma reactor. Since all the energy is supplied by the plasma, there is no combustion to provide energy for decomposition, hence formation of CO<sub>2</sub> is also prevented. Such a reaction system allows for tighter controls of product composition, reduction of undesirable substances by acting as an energy storage, converting the supplied electrical energy to plasma to the syngas.



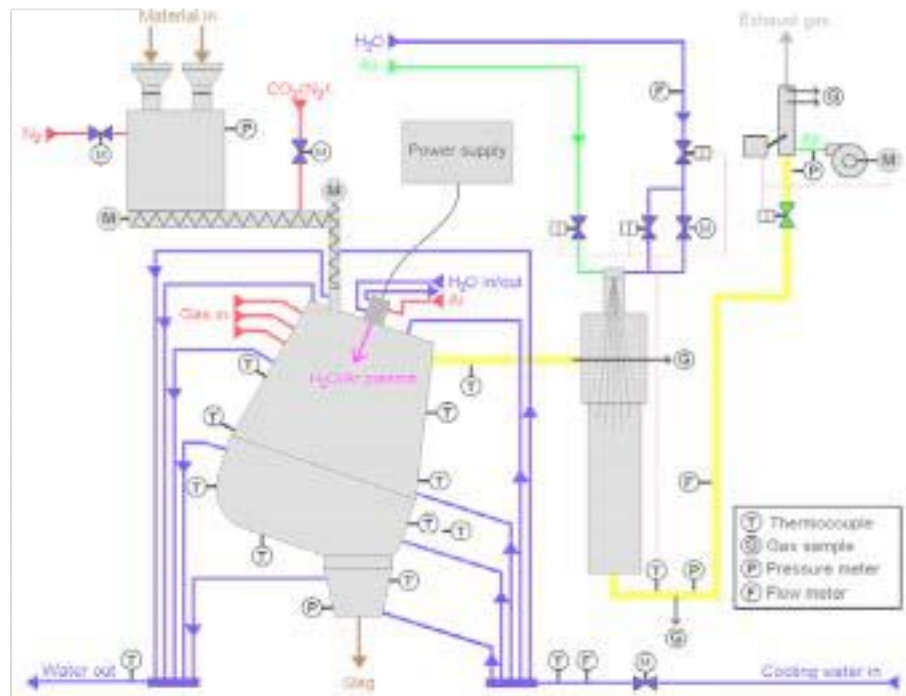

Fig. 1. Schematics of the experimental reactor PLASGAS.

The gas produced in the reactor flowed through the connecting tube to a quenching chamber in a shape of a cylinder with the length of 2 m. At the upper entrance of the cylinder the gas was quenched by a water spray from the nozzle positioned

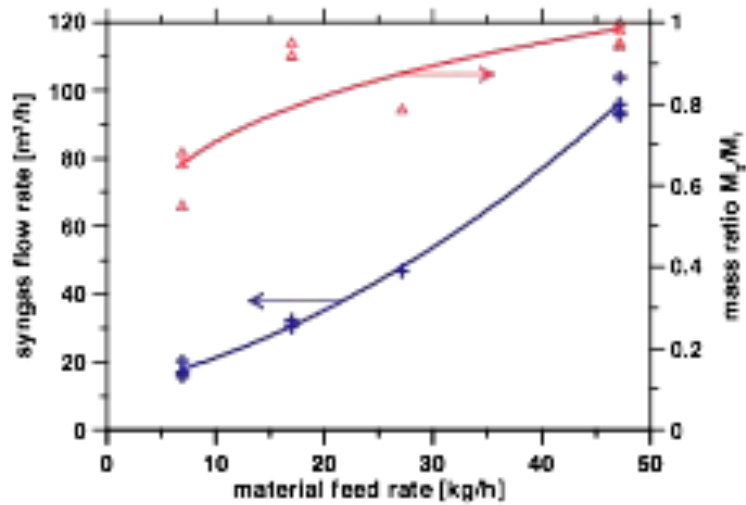

Fig. 4. Flow rate of syngas and ratio of syngas mass flow rate to material feed rate in dependence on material feed rate.

Orange: CO

Blue: H<sub>2</sub>

Higher feeding rates result in near complete gasification, lower rates may be explained by poor mixing due to lesser volume of plasma thus lesser energy transfer.

| torch power | feed rate | CO <sub>2</sub> | O <sub>2</sub> | T,   | syngas              | H <sub>2</sub> | CO   | CO <sub>2</sub> | O <sub>2</sub> | Ar  | CH <sub>4</sub> | calorific value |
|-------------|-----------|-----------------|----------------|------|---------------------|----------------|------|-----------------|----------------|-----|-----------------|-----------------|
| [kW]        | [kg/h]    | [slm]           | [slm]          | [K]  | [m <sup>3</sup> /h] | %              | %    | %               | %              | %   | %               | [kW]            |
| 104         | 6.9       | 43              | 10             | 1360 | 7.13                | 27.7           | 60.8 | 5.4             | 0.7            | 4.9 | 0.5             | 21.11           |
| 104.3       | 6.9       | 20              | 10             | 1355 | 7.65                | 33.7           | 57.1 | 3.3             | 0.4            | 5.6 | 0.05            | 23.6            |
| 105.3       | 17        | 115             | 0              | 1345 | 30.42               | 31.5           | 59.5 | 4.9             | 0.1            | 2.3 | 1.6             | 92.2            |
| 106.1       | 17        | 115             | 30             | 1463 | 32.16               | 28.4           | 59.7 | 7.7             | 0.4            | 2.2 | 1.6             | 94.7            |
| 106.3       | 27.1      | 115             | 30             | 1417 | 34.41               | 22.3           | 68.3 | 2.4             | 4.8            | 1.4 | 0.8             | 105.4           |
| 152.5       | 27.1      | 115             | 30             | 1452 |                     | 32.3           | 61.3 | 4.7             | 0.1            | 0.6 | 0.9             |                 |
| 95          | 28        | 16              | 0              | 1150 | 37.6                | 46.3           | 45.2 | 1.9             | 1.6            | 5.1 | -               | 111.7           |
| 138         | 28        | 16              | 0              | 1200 | 32.6                | 42             | 44.3 | 3.4             | 2.5            | 7.8 | 0               | 101.6           |
| 107.7       | 47.2      | 115             | 30             | 1406 | 71.04               | 36             | 59.9 | 2.3             | 0.1            | 0.6 | 1.1             | 225.9           |
| 107.7       | 47.2      | 115             | 30             | 1364 | 76.36               | 37.3           | 60.1 | 1.8             | 0.1            | 0.2 | 0.4             | 246.3           |

Table 1. Basic operation parameters, composition, flow rate and calorific value of produced syngas.

### **Summary:**

---

The gasification of wood as biomass by argon/steam plasma proves the capability of this method too in producing syngas with negligible waste products or interfering substances. The flow within the reactor is virtually controlled by the gasification of the biomass and so its rates are high. The generated syngas is of great calorific value, ~twice the input energy.

---

## Section 3: *Syngas "sunny-side up": a more "organic"*

*way to produce syngas* [ref. **T**]

In an eye-brow raising development, a patented process has been developed to produce H<sub>2</sub> from **EGG-SHELLS** (indirectly). The process, an improvement upon the water-gas-shift reaction,  $\text{CO} + \text{H}_2\text{O} \rightarrow \text{CO}_2 + \text{H}_2$ , seeks to economically remove or separate out the CO<sub>2</sub> from the product mixture.

The egg-shells are firstly treated with an "organic acid" to remove and isolate the membrane layer, 10% of which is the collagen (worth \$991 CDN per gram); then shells are then ground up. The experiments performed saw upto 78% absorption of equal mass of CO<sub>2</sub> by the ground-up egg-shells, the highest absorption efficiency recorded for CO<sub>2</sub>.

***A drop in the ocean:*** Though, a hydrogen infrastructure cannot be setup solely by way of the egg-shells, it is quite exciting and could in future put thousand of tonnes of would-be egg-shell rubbish to use (455,000 tonnes of egg-shells were produced in 2006 in the US).

---

---

## REFERENCE **P.**: Environ. Sci. Technol. 2002, 36, 4476-4481

- (1) Intergovernmental Panel on Climate Change, *Climate Change 2001*; Houghton, J. T., Ding, Y., Griggs, D. J., Noguer, M., van der Linden, P. J., Xiaosu, D., Eds.; The Scientific Basis Cambridge University Press: Cambridge, UK, 2001; pp 944, 2001.
- (2) Chum, H. L.; Overend, R. P. *Fuel Proc. Technol.* 2001, 71, 187.
- (3) Scarpellini, S.; Romeo, L. M. *Energy Conv., Management* 1999, 40, 1661.
- (4) Lynch, M. C. *Appl. Energy* 1999, 64, 31.
- (5) Ogden, J. M. *Annual Rev. Energy Environ.* 1999, 24, 227.
- (6) Steinberg, M. *Int. J. Hydrogen Energy* 1999, 24, 771.
- (7) Pena, M. A.; Gomez, J. P.; Fierro, J. L. G. *Appl. Catal. A: General* 1996, 144, 7.
- (8) Armor, J. N. *Appl. Catal. A: General* 1999, 176, 159.
- (9) Steinberg, M.; Cheng, C. H. *Int. J. Hydrogen Energy* 1989, 14, 797.
- (10) Gil, J.; Corella, J.; Aznar, M. P.; Caballero, M. A. *Biomass Bioenergy* 1999, 17, 389.
- (11) van der Drift, A.; van Dorn, J.; Vermeulen, J. W. *Biomass Bioenergy* 2001, 20, 45.
- (12) Blasi, C. D.; Signorelli, G.; Portoricono, G. *Ind. Eng. Chem. Res.* 1999, 38, 2571.
- (13) Rapagna, S.; Jand, N.; Kiennemann, A.; Foscolo, P. U. *Biomass Bioenergy* 2000, 19, 187.
- (14) Warnecke, R. *Biomass Bioenergy* 2000, 18, 489.
- (15) Caballero, M. A.; Corella, J.; Aznar, M. P.; Gil, J. *Ind. Eng. Chem. Res.* 2000, 39, 1143.
- (16) Garcia, L.; Salvador, M. L.; Arauzo, J.; Bilbao, R. *Fuel Processing Tech.* 2001, 69, 157.
- (17) Caballero, M. A.; Corella, J.; Aznar, M. P.; Gil, J. *Ind. Eng. Chem. Res.* 2000, 39, 1143.
- (18) Rapagna, S.; Jand, N.; Foscolo, P. U. *Int. J. Hydrogen Energy* 1998, 23, 551.
- (19) Arauzo, J.; Radlein, D.; Piskorz, J.; Scott, D. S. *Ind. Eng. Chem. Res.* 1997, 36, 67.
- (20) Baker, E. G.; Mudge, L. K.; Brown, M. D. *Ind. Eng. Chem. Res.* 1987, 26, 1335.
- (21) Asadullah, M.; Tomishige, K.; Fujimoto, K. *Catal. Commun.* 2001, 2, 63.
- (22) Asadullah, M.; Fujimoto, K.; Tomishige, K. *Ind. Eng. Chem. Res.* 2001, 40, 5894.
- (23) Baker, E. G.; Mudge, L. K.; Wilcox, W. A. *Catalysis of gas-phase reactions in steam gasification of biomass. In Fundamentals of Thermochemical Biomass Conversion*; Overend, R. P., et al., Eds.; Elsevier Applied Science: London, 1985; p 863.
- (24) Bensalem, A.; Bozon-Verduras, F.; Delamar, M.; Bugli, G. *Appl. Catal. A: General* 1995, 121, 81.
- (25) Tomishige, K.; Matsuo, Y.; Sekine, Y.; Fujimoto, K. *Catal. Commun.* 2001, 2, 11.
- (26) Tomishige, K.; Matsuo, Y.; Yoshinaga, Y.; Sekine, Y.; Asadullah, M.; Fujimoto, K. *Appl. Catal. A: General* 2002, 223, 225.

REFERENCE **S.**: Czechoslovak Journal of Physics, Vol. 56 (2006), Suppl. B

#### References

- [1] P.G. Rutberg, A.N. Bratsev, A.A. Ufimtsev: *J. of High Temp. Mat. Process.*, **8(3)** (2004) 433.
- [2] B. Mikhailov: *Thermal Plasma and new Materials Technology*. Ed. O.P. Solonenko, M.F. Zhukov, Cambridge Interscience Publish., Vol. 2, 1995, 345–369.
- [3] I.M. Zasyrkin, G.V. Nozdrenko: *Thermal Plasma Torches and Technologies*. Ed. O.P. Solonenko, Cambridge Interscience Publish., Vol. 2, 2001, 234–243.
- [4] R. Kezelis, V. Mecius, V. Valinciute, V. Valincius: *J. of High Temp. Mat. Process.* **8(2)** (2004) 273.
- [5] Z.L. Zhao, H.T. Huang, C.Z. Wu, H.B. Li, Y. Chen: *Chem. Engineering & Technology* **24(11)** (2001) 197.
- [6] Z.L. Zhao: Abstract of Papers of the American Chemical Society 226: U536–U536 048–FUEL Part 1, SEPT 2003.
- [7] V. Brezina, M. Hrabovsky, M. Konrad, V. Kopecky, V. Sember: *Proc. 15th Int. Symp. on Plasma Chemistry*. Orleans, France, July 9–13 (2001) Vol.III, 1021–1026.
- [8] M. Hrabovsky, V. Kopecky, V. Sember: *Proc. of 16th Int. Symp. on Plasma Chemistry*, Taormina, Italy, June 22–27 (2003) (ed. R. d'Agostino et al.) – CD.
- [9] M. Hlina, M. Hrabovsky, V. Kopecky, M. Konrad, T. Kavka: *Czech. J. Phys.* **56** (2006) Suppl. D, in this issue.

REFERENCE **T.**: Fan, L.S.; Iyer, M. *University of Ohio*