



An internet resource for indigenous ethno-technology focusing on the arts of Eastern Woodland Indian Peoples, providing historical & contemporary background with instructional how-to's & references.



...revising use of the term "primitive" with respect to Native American Technology and Art

ARTICLES

- [Beads & Beadwork](#)
- [Birds & Feathers](#)
- [Clay & Pottery](#)
- [Leather & Clothes](#)
- [Metalwork](#)
- [Plants & Trees](#)
- [Porcupine Quills](#)
- [Stonework & Tools](#)
- [Weaving & Cordage](#)

SPECIAL

- FEATURES**
- [Games & Toys](#)
- [Food & Recipes](#)
- [Poetry & Stories](#)
- [Virtual Woodland Tour](#)

OTHER

- RESOURCES**
- [Contemporary](#)
- [Issues in Art](#)
- [Seminole Clothing](#)
- [Ojibwe Culture & Language](#)
- [Discussion](#)
- [Forums](#)
- [Instructional Pamphlets](#)
- [Internet Links](#)

NATIVETECH NEWS

[Click >>>> More Native News Sources](#)

Tribal News

[Click >>>> More Tribal News](#)

Please reload this page to view the headlines

In the Arts

[Click >>>> More Native Arts News](#)

Please reload this page to view the headlines

Powwows & Festivals

[Click >>>> More Powwow News](#)

Please reload this page to view the headlines

[Powered by Moreover.com](#)

NativeTech BOOKPAGES

 [Article Bibliographies & Books to Buy On-Line](#)

Please visit my personal page, [Waaban Aki Crafting](#)

[NativeTech VIRTUAL POSTCARDS](#)

NativeTech POLL

What is your view on the Indian Arts and Crafts Act?

NativeTech SEARCH



Can't find it?

Try looking in the
[Site Index](#)

ALL GRAPHICS AND
TEXT ON THE
NATIVETECH
WEBSITE

© 1994 - 2003 [Tara](#)

[Prindle](#) (unless
specifically cited
otherwise)

[CLICK HERE for](#)
[copyright restrictions &](#)
[use policy](#)

[This site is hosted by](#)
[NativeWeb. Your](#)
[donations to](#)
[Nativeweb help them](#)
[to promote Indigenous](#)
[resources, inform the](#)
[public about](#)
[Indigenous cultures](#)
[and issues, and to](#)
[facilitate](#)
[communications](#)
[between Indigenous](#)
[peoples and](#)
[organizations](#)
[supporting their goals](#)
[and efforts. Please see](#)
[their donation page](#) to
find out ways you can
help.

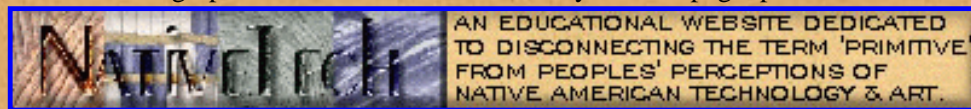
For a graphical link
to NativeTech from
your web page,
Please use: [Banner](#)
[image](#) or [Button](#)
[image](#) or [Small](#)
[Button image](#)



NativeTech: Native American Technology & Art

About NativeTech

For a graphical link to NativeTech from your web page, please use:



or [Button image](#) or [Small Button image](#)

Across this vast Turtle Island, different Peoples develop and express their own complex technology. Types of craft specialization are influenced by the different environments people live in, and by trade and information networks -- these technologies are the product of thousands of years of expertise, oral traditions and continuity.

NativeTech is an educational web site that covers topics of Native American technology and art with an emphasis on the Eastern Woodlands region. The web site is organized into categories of Beadwork, Birds & Feathers, Clay & Pottery, Leather & Clothes, Metalwork, Plants & Trees, Porcupine Quills, Stonework & Tools, and Weaving & Cordage. Instructional information about how some of these materials are used by Natives is coupled with detailed background on the history and development of these kinds of Native technologies. NativeTech hopes to show both change and continuity from pre-contact times to the present. NativeTech is dedicated to revising the term 'primitive' with respect to peoples' perceptions of Native American technology and art.



[~>>><<~ Click here to see other awards NativeTech has received ~>>><<~](#)



The presentation of NativeTech, made possible through my volunteered efforts and by webspace and support provided by [NativeWeb](#), is my way to thank all those individuals who have helped me to learn the little bit that I know. The best way I know to thank a teacher is to share that knowledge with others in a good way.

[WHAT IS NATIVE AMERICAN TECHNOLOGY AND ART?](#)

I've tried my best to illustrate as many topics as I can; my learning is continually ongoing and new sections will eventually make their way to NativeTech. The information at this website has been gathered using museum and archaeological collections, published literature, and personal communications with contemporary Native Americans. The material presented at NativeTech so far doesn't even come close to representing all the different technological aspects of Native American Indian peoples; this website represents only one person's efforts to build an internet resource for indigenous 'ethnotechnology'.

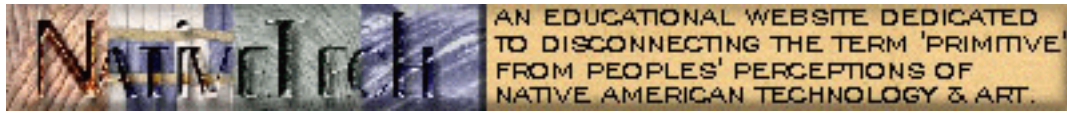
[WHAT IS ETHNOTECHNOLOGY?](#)

My experience is limited primarily to the geographic region of southern New England. I sincerely welcome contributions to the NativeTech pages of information or images of traditional or contemporary Native American technology and art. Please feel free to [contact me](#) to submit material for your own web presentation at NativeTech.

Thank you ~ [Tara Prindle](#).



Text and Graphics
© 1994 - 103 [Tara Prindle](#)
unless otherwise cited.







AWARDS NativeTech HAS RECEIVED

Because NativeTech is completely unfunded and built entirely of volunteer efforts, my greatest reward is the wonderful positive feedback from you, my internet community. I am very thankful to have had my work formally recognized with several web site awards:



Lycos Top5% Most Popular Sites on the Web. NativeTech recieved a high grade in all three categories: Content: 90, Design: 90, Overall: 90 (All ratings are based on a scale from 0 - 100). Their Review: "Explore Native American art and its technology. No, this site does not deal with Native American computer artists, but rather the technological roots of ancient native art. Everything from beadwork to porcupine quills is fully analyzed with histories, techniques, and meaning in Native American life. You will also find a series of essays on Native American life by author Longtrail Snowbird along with poetry and stories by other Native Americans. Not satisfied with simply reading about Native art? Then post a message to the board or try it yourself with the help of numerous craft sources. Overall, an excellent and in-depth exploration of Native American art". (29 Jan 1998).



NativeTech-- is awarded the Web of Culture Choice logo. The Web of Culture seeks to educate and entertain you on the topic of cross-cultural communications. (31 Jan 1998).



NativeTech-- is selected and linked as a "Classy Site Pick", and received the 'Duke of Url Classy Site Pick Award', Each month the Duke of Url voluntarily designs a page for the seniors of the net-- The 50+ Friends Club. With over 35,000 hits and growing fast, this site features several popular pages, one being The Duke of Url (1 Dec 1997).



NativeTech--has been chosen as a Super Site of the week for the Online Educator, NativeTech was added (10 Nov 1997) to their database of "Super Sites" and useful educational "hot links".

Scout Report

NativeTech--has been chosen as one of the Selections for the Scout Report, (9/27/96) the premier weekly collection of useful Internet sites for discerning Internauts. Care is taken in the selection of items included in the Scout Report. Basic criteria include depth of content, author, information maintenance, and presentation. The content of each resource is briefly described.

WebCrawler SELECT

Native Tech, has is deemed an outstanding Web site by the WebCrawler Select Editorial Team. A review of NativeTech appears in the October '96 edition of their catalog. The Select Editors are kind of like Internet prospectors, sifting through all the rubble and hand-selecting the only best sites they can find for their Internet directory.



NativeTech graciously accepts the Proud Eagle Award. This award is for those who's homepage's are designed to better understanding between the races of this Spaceship Earth, and to those pages of outstanding excellence in page design.



The Golden Feather Award

The Golden Feather Award, a new symbol of honor and respect is offered to NativeTech and other sites which are dedicated to the sharing of information and resources which enlighten and educate the general public. The award calls attention to those sites that exhibit their concerns for, and their interests in, the Tribe of Man; both of the inner world of the personal spirit, and the outer world of this planet we call home.

Who's Hot

NativeTech is presented with the Native American Who's Hot Award. For pride in Native American culture, the award recognizes Native American Homepages that exhibit the Health of the Indian Nations.



NativeTech's Web pages have recieved the coveted Cornerstone Foundation Award for "Excellence in Education". No more than the top 2% of the total sites nominated qualify to receive this honor. This prestigious award was created to showcase and give recognition to extraordinary sites throughout the World Wide Web. Those nominated for the Cornerstone Foundation Award do not compete against each other - but are judged against a high standard of excellence.



NativeTech is honored with the Wynterhawk's Award of Excellence. The Spirit of the Wynterhawk With the essence of flight, The strength of the Firewalk, With the wisdom of experience, Comes the spirit of Wynterhawk And the insight of intuition, The knowledge of desire, The eyes of discernment And the vision to go higher... ..The absolutes of anger And awareness of all talk, Lie bleeding in the clutches Of the spirit of Wynterhawk. ---written by Ira Green, 12/93.



NativeTech is selected for the Crafty Link of the Day for August 23, 1996 by CKS-INFO Information On-line (Crafts / Bargain bulletin / Local businesses). All the Crafty Link Award Winners have one thing in common. They are dedicated artisans, sharing their talents for arts and crafts with the world. All levels of sites are chosen, from the simple in design and product, to the elaborate in high quality graphics and award winning photos.



NativeTech is chosen officially as a member of Who's Cool In America Project and, for our international friends, Who's Cool International. by the American Association for the Advancement of Cool (A3C), the cornerstone of national and international education and program service efforts to promote the attributes of COOL.

... some other awards NativeTech has received:



[Return to About NativeTech](#)



Text and Graphics
© 1994 - 103 [Tara Prindle](#)
unless otherwise cited.



... since the last update on Sept. 7, 2003

New Additions

- Dynamic overhaul of [Overview of Native American Basketry](#)
With new pages, animations, photographs, slideshows and information on Coiling, Woodsplint and Sweetgrass basketry 9/7/03
- The Food & Recipes section has been reorganized by [Type of Dish](#) and also by [Tribe & Region!](#)
... And... more than forty New Recipes submitted by NativeTech visitors over the last few months. Thank you!!
3/28/03
- A photographic overhaul of [Indigenous Plants used in the Northeast](#)
Its a good time of year to take the [Virtual Hike on the Gathering Walk](#) 2/23/03
- Updates to various sections including [Wampum History](#)
[Try your hand at weaving a Virtual Wampum Belt](#) 2/11/03
- [New Poems and Stories, and two new contributing authors ...](#)
... [Rite of Passage](#) ~ Pierre Girard 10/14/02
... [A Grandfather Story](#) ~ Pierre Girard 10/10/02
... [Unsent Letter](#) ~ by Susan Marie Smith-Kennedy 10/10/02
... [The End?](#) ~ by Edward Ivan Madahbee 10/10/02
- [Multiquill Plaiting Techniques](#)
Another wonderful contribution of Porcupine Quill Embroidery from Nancy Fonicello. 1/22/02
- [Matching Game: Natural Dyes & Porcupine Quills](#)
See the porcupine fly, dont get stuck with his quills ! 10/13/01
- [NativeTech Virtual Postcards](#)
Send a fun message to a friend today! 10/12/01
- Interactive Game [Ojibwemowin!](#)
Ojibwe Language Picture Match 9/28/01
- Rick Obermeyer's [19th Century Seminole Men's Clothing](#)
... is now complete! 30 new articles 7/15/01
- [The Seminole Long Shirt](#)
Another chapter available from Rick Obermeyer's [19th Century Seminole Men's Clothing](#) 7/10/01

- [Projectile Point Types in New England](#)
An online catalogue... finally completed 6/22/01
- [POINT](#)
Projectile point classification software ... Updated 6/22/01
- [Concentration Game - Play it on-line](#)
... Match the New England Ash Splint Basket Designs. 6/19/01
- [What's In the News](#)
... Current news stories relating to Native American Technology & Art. 6/16/01
- [Planting a Three Sisters Garden](#)
... it's time to start planting! 5/27/01
- [Shuttlecock and Battledoor!](#)
...Another Interactive NativeTech game! 4/24/01

In August, 1998, [NativeTech](#) moved to the NativeWeb server.
Many, many thanks for the invitation to be hosted by [Nativeweb](#).



[NativeTech's Web Awards](#) -
recognizing my *volunteer* efforts!

[Links to Native American Art Resources](#)

Moved to NativeWeb's Resources in January 2000.

Links to Art Native Overviews, Beads & Beadwork, Birds & Feathers, Clay & Pottery, Leather & Clothing, Metal Work, Plants, Wood Twigs & Branches, Porcupine Quillwork & Hair, Stone & Tools, Weaving & Cordage, Food & Recipes, Games & Toys, Music & Performance, Powwows & Calendars, Stories & Oral History, History, Issues & Anthropology, Reenacting & Living History, Museums & Exhibits, Workshops in New England, Craft Supplies & Sources, and Links to Galleries on the Web.

Be sure to check out the pages for the
[Nipmuc Indian Association of Connecticut](#).

Children will find some fun games & activities in the [Kids Corner](#)!
... excerpts from [Quinnehtukqut Nipmuc News](#) NIAC's quarterly newsletter
... make connections in the [NIAC Guestbook](#) AND a [Community Callendar](#)
with a great link that answers the question "[What is a Powwow?](#)"
Don't miss the [NIAC FAQ](#) for with some answers to *frequently asked questions*
and a [growing list of links to genealogy resources](#).

The last updates were made for NIAC in February, 2002.



Text and Graphics
© 1994 - 2003 [Tara Prindle](#)
unless otherwise cited.

Cover Page	Coil Basketry	Woodsplint Baskets	Sweetgrass Uses	Play Basket Concentration	Basketry References	Internet Links
----------------------------	-------------------------------	------------------------------------	---------------------------------	---	-------------------------------------	--------------------------------

Weaving Life

Welcome to a glimpse into the world of indigenous basketmakers.

Begin your journey by exploring the topics through the bookmark tabs at the top of the page or through the links below.

 [Coil Baskets](#)

 [Woodsplints](#)

 [Sweetgrass](#)

 [Basket Game](#)

 [References](#)

 [Internet Links](#)



© 1994 - 103 Tara Prindle
[NativeTech.org](#) and
[Waaban Aki Crafting](#)

Introduce yourself to a variety of Native American [coiled](#), [woodsplint](#), and [sweetgrass](#) basketry forms. Within these topics you can play a slide-show, learn some basket making techniques and follow basket makers through several centuries of weaving traditions to the present day.

For an entertaining memmory-challenge, try your hand at playing the [Basket Design Concentration](#) game.

Peruse the books and articles cited in this presentation through the [Basketry References](#), which includes Internet links to books you can buy On-Line.

On the internet, additional history, techniques, galleries and craft supply resources are at



**your fingertips
through the lists
of [Internet links](#)
to basketry and
weaving
Resources.**

Native American Basketry

A Presentation of [NativeTech: Native American Technology and Art](#)

Cover	Coil	Woodsplint	Sweetgrass	Play Basket	Basketry	Internet
Page	Basketry	Baskets	Uses	Concentration	References	Links

[Background](#)

[Techniques](#)

[Pine Needles](#)

[Instructions](#)

[Splicing](#)

[Forms](#)

[Stitches](#)

[Sheathes](#)



© 1994 - 103 [Tara Prindle](#)
[NativeTech.org](#) and
[Waaban Aki Crafting](#)



Coiling is one technique of basketry used by Native Americans across North America. Coil baskets of different regions have various styles of construction depending upon the materials used in the coil, and the type of stitch used to fasten or interlock the coils together. All coiled containers use a flexible 'coil' which begins from the center at the bottom of a basket, or sometimes begins around a flat disk of bark or wood. The coil is spiraled outward and upward, placed on top of the coil in previous round, and fastened to former rounds



by some
stitching
material.

*Mouse over
the center of
the photo to
watch an
animated coil
basket emerge
~~~>*



[Coiling Cover Page](#)

[Coiling Background and History](#)





|                            |                               |                                    |                                 |                                           |                                     |                                |
|----------------------------|-------------------------------|------------------------------------|---------------------------------|-------------------------------------------|-------------------------------------|--------------------------------|
| <a href="#">Cover Page</a> | <a href="#">Coil Basketry</a> | <a href="#">Woodsplint Baskets</a> | <a href="#">Sweetgrass Uses</a> | <a href="#">Play Basket Concentration</a> | <a href="#">Basketry References</a> | <a href="#">Internet Links</a> |
|----------------------------|-------------------------------|------------------------------------|---------------------------------|-------------------------------------------|-------------------------------------|--------------------------------|

-  [Background](#)
-  [Traditions](#)
-  [Weaving Baskets](#)
-  [Splint Industry](#)
-  [Decorations](#)

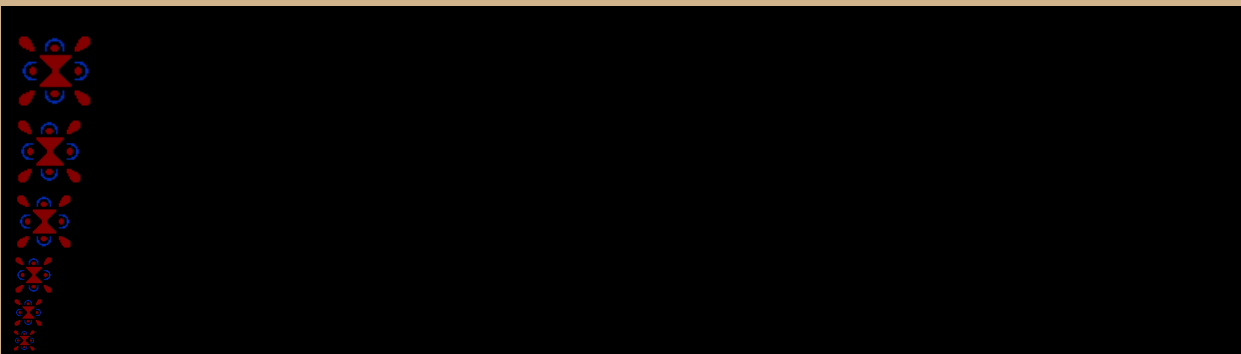
-  [Pigments](#)
-  [Designs](#)
-  [Domes](#)
-  [Dots](#)
-  [Leaves](#)
-  [Trails](#)
-  [Stockades](#)
-  [Berries](#)
-  [Bars](#)
-  [Vases](#)

-  [Acknowledgment](#)

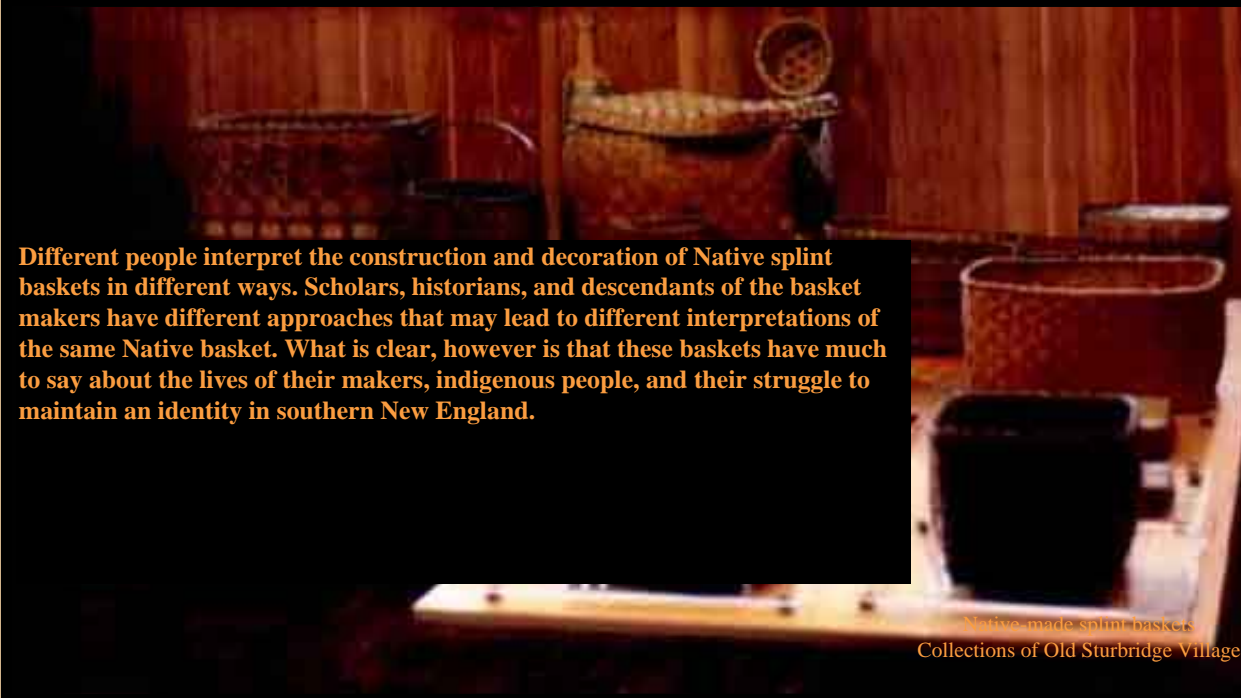
[Watch Slide Show](#)



© 1994 - 103 Tara Prindle  
[NativeTech.org](#) and  
[Waaban Aki Crafting](#)



## Splint Baskets of the Northeast



Different people interpret the construction and decoration of Native splint baskets in different ways. Scholars, historians, and descendants of the basket makers have different approaches that may lead to different interpretations of the same Native basket. What is clear, however is that these baskets have much to say about the lives of their makers, indigenous people, and their struggle to maintain an identity in southern New England.

Native-made splint baskets  
 Collections of Old Sturbridge Village

*"Artists might add representations of their own primary considerations - family, tribal members, plants for food and medicine, or the trails and paths traveled" ~ quote by Tantequidgeon & Fawcett*

[Woodsplint Cover Page](#)

[Woodsplint Background & History](#) 



|                            |                               |                                    |                                 |                                           |                                     |                                |
|----------------------------|-------------------------------|------------------------------------|---------------------------------|-------------------------------------------|-------------------------------------|--------------------------------|
| <a href="#">Cover Page</a> | <a href="#">Coil Basketry</a> | <a href="#">Woodsplint Baskets</a> | <a href="#">Sweetgrass Uses</a> | <a href="#">Play Basket Concentration</a> | <a href="#">Basketry References</a> | <a href="#">Internet Links</a> |
|----------------------------|-------------------------------|------------------------------------|---------------------------------|-------------------------------------------|-------------------------------------|--------------------------------|

 [Background](#)

 [Basketry](#)

 [Traditions](#)

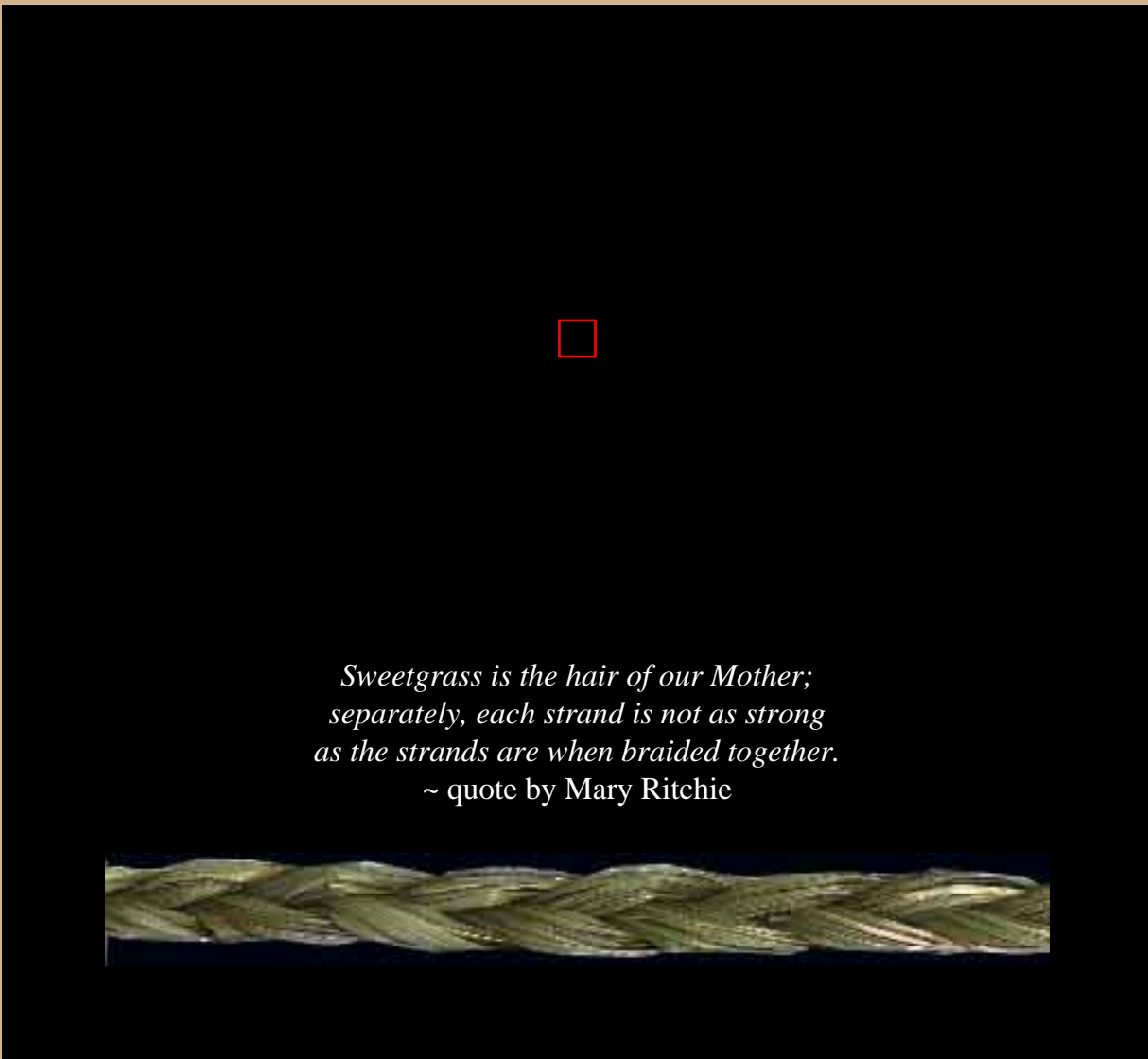
 [Medicine](#)

 [Sources](#)

 [References](#)



© 1994 - 103 [Tara Prindle](#)  
[NativeTech.org](#) and  
[Waaban Aki Crafting](#)



*Sweetgrass is the hair of our Mother;  
separately, each strand is not as strong  
as the strands are when braided together.*  
~ quote by Mary Ritchie



[Sweetgrass Cover Page](#)

[About Sweetgrass](#)



# Native American Basketry

A Presentation of [NativeTech: Native American Technology and Art](#)

|                            |                               |                                    |                                 |                                           |                                     |                                |
|----------------------------|-------------------------------|------------------------------------|---------------------------------|-------------------------------------------|-------------------------------------|--------------------------------|
| <a href="#">Cover Page</a> | <a href="#">Coil Basketry</a> | <a href="#">Woodsplint Baskets</a> | <a href="#">Sweetgrass Uses</a> | <a href="#">Play Basket Concentration</a> | <a href="#">Basketry References</a> | <a href="#">Internet Links</a> |
|----------------------------|-------------------------------|------------------------------------|---------------------------------|-------------------------------------------|-------------------------------------|--------------------------------|

## Match the New England Ash Splint Basket Designs

A classic memory game. All the basket designs begin face down.

Click on one to turn it over. Try to find the second basket design that matches the first.

If the second does not match, both designs return to a face down position.

If they do match, the two designs are removed to reveal part of a whole basket.



### [NativeTech's Game Index](#)

© 1994 - 103 [Tara Prindle](#)  
[NativeTech.org](#) and  
[Waaban Aki Crafting](#)

## Learn more about these [Native Designs](#)

If you don't see the instructions to the left, [click here to reload the page](#)

## Native Designs

Indians of the Northeast assigned meaning to the symbols on their baskets. Shapes like domes, dots, triangles, leaves, curls and bars were beautifully arranged into designs we call medallions, strawberries, trails, stockades and vases. Basket designs represented communities of people, places, territories; stories of the Nipmuc people.

*"Artists might add representations of their own primary considerations - family, tribal members, plants for food and medicine, or the trails and paths traveled"* (Tantequidgeon & Fawcett)



**Medallions** are four domes or other shapes placed around an open central space.

Nipmucs and other Natives had unique ways that they made their medallions. To many, these medallions represent groups of people, or family strength. This design is a traditional way to depict sky-domes that represent the "four directions that guide the traveler or call the winds" (Tantequidgeon & Fawcett).



[Stains, Dyes and Paints](#)

[Native Designs - Domes](#)





## Stains, Dyes and Paints



Covered Ash Splint Storage Basket with Hand Painted Design

Stains were swabbed onto the surface of splints with a fiber or cloth wrapped stick, sometimes before and sometimes after the basket was assembled. Usually swabbed baskets are only stained on their exterior. Because dyes are meant to soak completely through woodsplints, splints had to be steeped in dye before they are woven. Paints, or dry pigments mixed with water, oil, size, or whitewash were either applied with brushes, pointed sticks, chewed twigs, or a block stamp made from a piece of carved potato or wood.

Stamped decorations traditionally decorated Native clothing and pottery, but the printed text of the Bible in the 1600's may have inspired block stamp decoration on splint baskets (Speck 1947). As traditional lands were surrendered, some Native communities were destroyed while others were re-assembled, often through the efforts of Christian missionaries, such as John Eliot who established several Nipmuc Praying Towns in Connecticut and Massachusetts in the 1650's.

Although some Natives decorated their baskets with dyed or swabbed splints, southeastern New England Natives usually hand-painted their baskets with specific colors in geometric or floral designs. One Nipmuc woman, Sarah Maria Arnold Cisco, painted her designs on with a home-made cows-hair brush.



Splint Work Basket with Block Stamp Design

Nipmuc baskets were usually painted in two colors, using combinations of either brown or blue with orange, pink or red. Of the groups who used painted designs, the Pequot and Nipmuc were the only ones to use a different color to fill in their designs. Nipmucs traditionally prepared their paints from plants. Poke berry made a blue color, cranberries for red, wild indigo for brown, walnut bark for yellow, and green was made using both walnut bark and wild indigo. By the 1800's commercial colors, like laundry bluing and artists pigments sometimes replaced traditional paints of a similar color.



[Splint Basket Decorations](http://www.nativetech.org/basketry/splintstains.html)

[Native Designs](#)





## Splint Basket Decorations



Baskets are like a signboard where Natives could communicate their feelings about their surroundings and their changing existence; they can help us understand the lives of their makers. Because Natives of southern New England shared so many aspects of their culture with neighboring groups, they were probably able to understand or 'read' the designs on the baskets of others. Shared basket styles and designs among two groups may mean those groups view their world in similar ways, or that they have other social and political connections. If two groups that live right next to each other have very different designs, it may mean that they want to set themselves apart, stressing their differences.

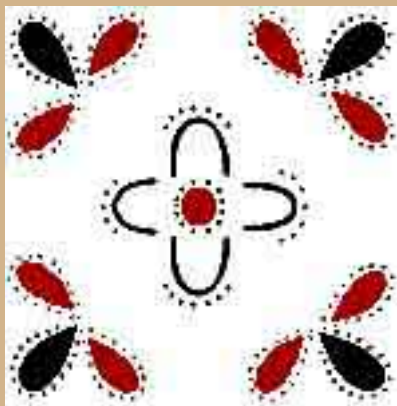




## Splint Basket Industry

Traditionally, Nipmuc people would have made baskets for their own family use, but European colonization and the fur trade changed the way Nipmucs had to support their families. With the growing dependence on European goods and a cash economy through the 1700's and 1800's, many families chose to earn money making and selling splint baskets.

*"Once the basket tradition entered these communities, it never left"* (McFeat)



Baskets were more easily made with metal tools that Natives bought from Europeans. Hand gauges, made of small metal blades or wires set into a wooden handle, were used by both Native and European basket makers to cut splints into even widths. As Natives traded more with Europeans, it made the job of preparing splints for baskets easier. By the 1700's when more and more splint baskets were being made, but other traditional craftwork, such as stitched birch bark baskets were becoming quite rare (Turnbaugh & Turnbaugh). Splint baskets were more time and money-saving; a single ash tree could yield a hundred baskets or more, while a birch tree might only produce a dozen (McFeat).

Carved wooden blocks were eventually used as forms to weave baskets over. By the 1800's many New England Natives used basket blocks, made in all shapes and sizes, to ensure even, standard baskets (Lester). Some baskets were made to resemble acorns, strawberries or ears of corn. Many kinds of baskets were made just for Europeans: 'wall pockets' were hung next to looms and used to store spools of thread, European style woven splint cradles and even tiny woven coverings for European sewing accessories like thimbles, scissors, pincushions.



One weaver's accessory made was the Yarn-Ball Ash Splint Basket

Many individuals sold their baskets 'door to door' in their local communities; some Nipmucs probably set up arrangements with certain European families to buy their baskets. Using tools like hand gauges and carved blocks saved time and labor, and made it easier to create standardized basket forms; they also helped turn Native basket making into an industry.

Victorian resort areas popping up in the Northeast in the 1800's changed how splint baskets were bought and sold. Natives no longer had to travel door to door. "Instead Indian basket weavers and their families traveled to the summer resorts and set up shop right there" (McFeat). Eventually, non-Native middlemen produced wholesale commercial catalogues for Native-made splint baskets. Mass production for a European market standardized basket forms, but some families developed their own unique forms and decorations based on their individual reputation and for the recognition of their baskets.



[Splint Basket Weaving](#)

[Splint Basket Decorations](#)





## Weaving Splint Baskets

Natives of the northeast made their woodsplints from the trees of Brown, Black Ash (*Fraxinus nigra*) and Oaks. In addition to these splints, sweetgrass, (sometimes braided) and in much later historic times, twisted Hong Kong cord (an imported twisted grass) are sometimes woven in. Ash is the preferred material for fine woodsplint basket making. Some sturdy workbaskets were made with oak for their durability but the time-enduring silky appearance of woodsplint baskets comes from ash. The best ash trees for basket making are those which grow vigorously during the summer months, creating the dense growth rings which are separated by pithy winter layers. When these porous layers of the ash tree's rings are pulverized, the wood comes apart into separate dense layers used for woodsplints



Interpreter pounding an ash log to remove splints at Old Sturbridge Village



Tantaquideon Splitter

Before pounding an ash log to remove the splints, it must be selected, cut and emersed in a body of water, swamp, bog or pond for at least a year. Once thoroughly soaked the ash log must be quickly debarked using a drawknife or a spud specifically designed for the task. While it still retains it's moisture, the log is scored along it's length and the width of the splints following the natural grain of the wood. The scored log is then pounded down it's length at close intervals with a wooden maul to separate the layers and lift the woodsplints.

If the raw woodsplints were thick they could be further slit down with a device called a splitter, of two lengths of wood, using one's knees to apply pressure to the splints, which are pulled apart with one's hands. The splints would be coiled up, dried and stowed for later finishing. Splints were soaked again and refined with planes, drawshaves, crooked knives, and basket gauges to trim splints to the proper thickness and width needed. At first Native woodsplints were made freehand, without using special knives or gauges. Some basket tools have Native beginnings, such as the crooked knife used to thin woodsplints (and for woodworking in general). Crooked knives originally had a beaver incisor for a blade (Speck 1915), but by the 1600's it had a metal blade, set at an angle, into a wooden handle (Snow 1980).



Beaver Incisor

Nipmucs, Mohegans, Pequots, Niantics, and Wampanoags living in region east of the Connecticut River eventually used a draw knife, (a blade with a handle at either end held with both hands), to shave down woodsplints; so the splints from this region resulted squared edges. Other Native groups such as the Schaghticoke, Mahican, Paugusset, and Tunxis living in the western region of southern New England used the crooked knife (held in one hand) to thin the wood, leaving the splints with tapering, beveled edges.



Large, bold 'curly-que' twists on a basket from southern New England



Small, intricate porcupine 'curly-que' twists on a basket from northern New England

The baskets of groups living to either side of the Connecticut River were also woven in different ways. Nipmucs, in imitation of Pequot basketry, often wove in a band of narrow-fitting splints or they painted 'bar' designs that have the same visual effect. Baskets of the western region of southern New England are noted for the 'porcupine twist'; a

way of twisting the splint weft into a 'curlicue' as it is woven over the splint warps. The Schaghticoke associate the splint 'curlicue' with the form of a shell, and similar techniques are used in traditional porcupine quill work (Speck 1915).



[Splint Basket Traditions](#)



[Splint Basket Industry](#)

## Splint Basketry Traditions

The Native people of southern New England have always been known for their beautifully decorated baskets. Inside a wigwam in 1643, these baskets were used instead of shelves to store all kinds of food and household supplies (Roger Williams 1973). A European traveling In 1674 described these traditional baskets as "very neat and artificial, with the portraitures of birds, beats, fishes and flowers, upon them in colors" (Gookin 1970). Long before European contact, Native people made baskets from materials including: birchbark, bulrush, cattail, cornhusk, sweetgrass, dogbane, cedarbark.

New England Natives began making baskets out of prepared wood splints in the 1600's. Natives in the Delaware River area may have first learned the preparation of wood splints for baskets from the Swedes (Snow 1980). Some of the earliest known woodsplint baskets were made in the mid-1600's by the Iroquois in what is now western New York.



1800s Painted Splint Covered Storage Basket in the collections of Old Sturbridge Village



[Splint Basket Background & History](#)

[Weaving Splint Baskets](#)







Dr. Handsman holding a 1830s painted Nipmuc storage basket

# Woodsplint Baskets of New England

Originally prepared by Tara Prindle in conjunction with  
*A Special Talk and Exhibition of Nipmuc Baskets*

*"Remembering Nipmuc Homelands in Histories"*

led by Dr. Russell G. Handsman

at The Connecticut Historical Society, Hartford. *sponsored by The Nipmuc Indian Association of Connecticut, Inc. on June 30, 1996*

If we only ask *how* or *when* a basket is made or decorated, we will find out little about the lives of Native basket *makers*. If we ask *Who* made Indian baskets? and *Why?*, we may glimpse into the lives of the basket makers, and understand a little of their histories.

*"Splint baskets therefore can be about society, people, and history, yet it is often difficult to realize this when we look at a basket on a pedestal and read a label with little more than names" ~ quote by Handsman and McMullen.*



[Woodsplint Cover Page](#)

[Splint Basket Traditions](#)



## *Native Designs*

# Domes



Made with a simple curved line possibly representing a wigwam. Domes are often used in medallion designs the way wigwams are grouped in a village.



[Native Designs](#)

[Native Designs - Dots](#)



# Native Designs

## Dots



Circles used by themselves or in lines, probably represent individual people, plants, animals or spiritual forces. In the center of the medallion design there is a space "that is of the spirit", which "could be represented as a presence unseen, or symbolized as a dot, circle, or a combination of these elements" (Tantequidgeon & Fawcett).



[Native Designs - Domes](#)

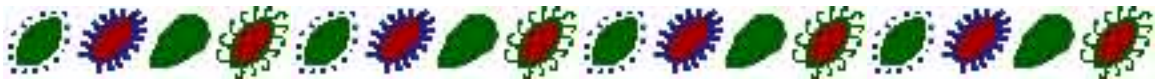


[Native Designs - Leaves](#)



## *Native Designs*

# Leaves and Curls



were also used just by themselves, with medallions, or combined with curls to make plants and vines. Leaves may be a literal symbol of the land.



[Native Designs - Dots](#)



[Native Designs - Trails](#)

# Native Designs

## Trails



Lines of domes, leaves, or curls linked together in a line or chain. By the late 1800's these trails were not just used as borders, but as the main figure on baskets. Trails may record the records kept by Native families during the 1800's.



*"The trail suggests the path one travels through life. Along that trail, one encountered other people and certainly many plants" (Tantequidgeon & Fawcett).*



[Native Designs - Leaves](#)

[Designs - Splint Stockades](#)



## Native Designs

### Stockades



Chains or lines that delineate design lay-outs, were common on baskets made before 1840. The chains used in stockades seem to represent borders on the landscape or between people. Stockade designs showed how Natives felt about what remained of their traditional territory. On a Mohegan basket, inside the stockade design (within ancestral lands), the villages are represented by medallions - while outside stockade the villages are represented by plants. "The message was that people would lose their Mohegan identity when they left the tribal lands" (McMullen). On another Mohegan basket, medallions were painted both inside and outside the stockade design and the maker probably felt that "Mohegan people were Mohegan people wherever they lived" (McMullen).



[Native Designs - Trails](#)

[Native Designs - Strawberries](#)





## *Native Designs*

# Strawberries



Groups of three leaves, are an early design on Nipmuc baskets. Medallion and stockade designs were often accompanied by strawberries, in groups, alone or on vines, which probably represented particular people, plants or areas of land.

*"A boundary of strawberries is a reference to a physical boundary"*  
[Handsman and McMullen]



[Native Designs - Stockades](#)



[Native Designs - Bars](#)

# *Native Designs*

## Bars



**A series of short parallel lines, may have been originally used to mimic the band of narrow splints used by Pequot and Nipmuc basket makers. Later in the historic period, bars are fully incorporated into basket designs.**



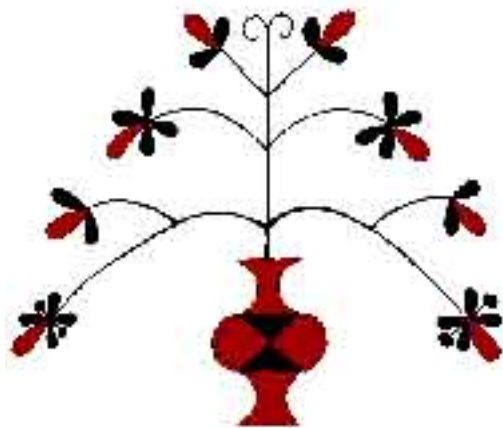
[Native Designs - Strawberries](#)



[Native Designs - Vases](#)

# Native Designs

## Vases



Unique to the Nipmuc people, were first painted during the early 1800's. Vases were painted on Nipmuc baskets by the Arnold family who lived at Hassanimisco, near Grafton, Massachusetts. Nipmucs also began using different colors at this time, blue instead of brown, either for particular buyers or because that paint was easier to get. Though older designs were still painted, the floral vase design had great commercial appeal to European buyers, as well as traditional meaning to Nipmucs. The 'tree of life' is represented by flowers made from curls and leaves growing from a medallion-like vase.

*"The construction of a family tradition of vase painting on baskets..., would suggest the growing importance of kin networks in Native American societies" (Handsman & McMullen)*



Lid of Splint Storage Basket with Vase Motif



[Native Designs - Bars](#)

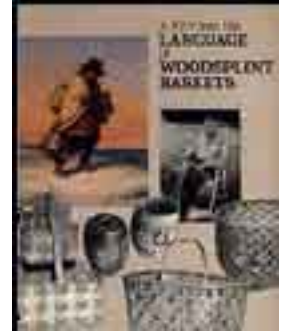
[Article Acknowledgements](#)





## Acknowledgments:

This article is based on a text prepared by Tara Prindle for a program on splint basketry sponsored by NIAC, Inc at the Connecticut Historical Society, where they shared a viewing of several Nipmuc baskets in their collection. Some interpretations and designs in this article, like the original text, are gratefully adapted from the authoritative source on Native splint basketry: *A Key into the Language of Woodsplint Baskets*, edited by Russell G. Handsman and Ann McMullen, published in 1987 by the American Archaeological Institute in Washington, CT. The articles authored therein by Lester, McFeat, McMullen, Tantequidgeon & Fawcett, and Turnbaugh & Turnbaugh were particularly useful in preparing this article.



*A Key into the Language of Woodsplint Baskets*

I am indebted to Joan Luster, Nipmuc Indian and to Dr. Russel G. Handsman, anthropologist, for giving me a cherished appreciation for the unique qualities of Native American Basketry.

See the [Bibliographic References](#) for more books about basketry

Gookin, Daniel

1970 *Historical Collections of the Indians in New England*. J.H. Fiske, ed. London: Towaid. (First published 1674).

Speck, Frank G.

1915 *Decorative Art of Indian Tribes of Connecticut*. Anthropological series 10. Memoirs of the Canadian Geological Survey 75. Ottawa, Ont: Canadian Department of Mines.

Speck, Frank G.

1947 *Eastern Algonkian Block-Stamp Decoration: A New World Original or an Acculturated Art*. Addendum by Eva Butler. Trenton: Archaeological Society of New Jersey.

Snow, Dean R.

1980 *The Archaeology of New England*. New York: Academic Press.

Williams, Roger

1973 *A Key into the Language of America*. J.J. Teunissen and E.J. Hinz, ed.s. Detroit: Wayne State University Press. (First printed 1643).



[Native Designs: Vases](#)

[Go to Woodsplint Cover Page](#)

## About Sweetgrass

Sweetgrass (*Hierochloa odorata*) has a sweet, long-lasting aroma that is even stronger when the grass has been harvested and dried and is then moistened or burned. In the Great Lakes region, Sweetgrass was historically referred to with the Latin name *Torresia odorata* (Densmore 1974). There is also a western species of Sweetgrass (*Hierochloa occidentalis*) that grows in redwood areas. Other common names for Sweetgrass are Holy Grass (or Mary's Grass), Vanilla Grass, Bluejoint, Buffalo Grass, and Zebrovka.

Sweetgrass is a circumboreal plant which is common above 40 degrees north latitude in Asia, Europe, and North America (Walsh 1994). In North America this fragrant grass grows regionally from Labrador to Alaska, and south to New Jersey, Ohio, Illinois, Iowa, South Dakota, Arizona and Washington (Larson 1993). Sweetgrass can be found growing wild in wet meadows, low prairies, the edges of sloughs and marshes, bogs, shaded streambanks, lakeshores, and cool mountain canyons. Sweetgrass rhizomes and roots form a dense mat beneath the soil surface (Walsh 1994).

Sweetgrass flowers from June through August and is easily identified by the sweet vanilla-like fragrance of its leaves, its 3-flowered spikelets about 1/4 inch long, and its hairy lemmas. The stems of the grass are upright and hollow, growing up to 2 feet tall, without hairs. The leaves are elongated, narrow and flat (up to 1/4 inch wide, and are also hairless). The Sweetgrass flowers are borne in 3-flowered spikelets, which are arranged in a panicle up to 4 inches long. The spikelets themselves are about 1/4 inch long (the lower 2 flowers are male only, while the upper flower has both stamens and pistils (USDA n.d.).

Sweetgrass usually grows among other grasses or shrubs; it is seldom found in pure stands. Dried Sweetgrass foliage is fragrant because of its coumarin content (Walsh 1994). Sweetgrass is traditionally harvested in late June or early July. Sweetgrass harvested after exposure to frost has little scent. Care should be taken to cut Sweetgrass leaves and not to pull the grass up by its roots so it can grow again the next year. Weeding Sweetgrass areas lessens competition from other plants.



Mouse-over Photo for Close-up

[Sweetgrass Cover Page](#)

[Basketry and Crafts](#)





*Sweetgrass is the hair of our Mother;  
separately, each strand is not as strong  
as the strands are when braided together.*  
~ quote by Mary Ritchie



[Sweetgrass Cover Page](#)

[About Sweetgrass](#)





## Uses for Sweetgrass in Baskets & Crafts

All of the northeastern Native peoples use sweetgrass in their splint basketry and craft work. Abenaki, Mi'kmaq, Maliseet, Penobscot, Passamaquoddy and the Iroquois nations all contribute to sweetgrass basketry traditions of the 1800s through today. By the height of the basket-making industry, these baskets were being made in innumerable shapes and for a myriad of uses, and continue to be woven by today's modern masters.



Larger Sewing Baskets of Braided Sweetgrass

Not all baskets are made entirely of sweetgrass. Sometimes sweetgrass is used only as a decorative accent on the lids, rims or handles of baskets. In some regions, especially around the Great Lakes, strands of sweetgrass were made into coiled basketry using cotton embroidery thread, taking the form of round bowls and flat mats. Sometimes a birch bark disk formed the base of these baskets, with coils of sweetgrass sewn on spiraling up (in Densmore 1974). Porcupine quill decorated birch bark boxes also employ sweetgrass in their construction to bind their seams and rims.



Arm Basket, Smaller Hair & Trinket Baskets

Some baskets have quite practical uses, such as the flat wide arm baskets (so named because they fit comfortably under one's arm). Arm baskets, having a lid and bottom the same size and shape, are extremely sturdy and were originally constructed to travel in a person's trunk or suitcase.



Trim on a Birch Bark Lid



Sewing Accessories

Whole sets of sweetgrass baskets were made for women's sewing accessories, including tight-fitting cases for thimbles, scissors, needle packs and velvet pin cushions. These tiny sewing trinkets, complete with lids and loops, were often strung together for the sewer's convenience.

Popular baskets included picnic accessories such as lidded baskets for shot-glasses or napkin rings accented with sweetgrass.



Shot Glass Basket



Suspended Bark Canoe, Pin

There are small round sweetgrass baskets to hold rings and notions, wallet-shaped baskets for handkerchiefs, woven spheres for dispensing yarn or string, and other baskets with small holes in their lids to ladies to save their strands of hair. Many other kinds of sweetgrass baskets and crafts survive to this day, including those more for whimsy, miniature rocking cradles, bookmarks and even decorative pins to wear.



Miniature Baskets, Pin



[About Sweetgrass](#)

[Sweetgrass Traditions](#)





## Sweetgrass Traditions

Though generally smaller than their woodsplint cousins, sweetgrass baskets had a similar often dyed or swabbed ash splint spoke base. Long exposed to light and weather these delicate baskets may seem to have lost their scent and have a faded exterior. However, a glimpse beneath their lids into their protected interiors will often reveal a surprising rainbow of colored splints. A misting with water is known to entirely restore their odorous scent.



Braided Decorative Accent



Brighter Colors Revealed Inside

Sweetgrass blades were gathered, dried, then soaked again before use in basketry. The fine yet sturdy leaves can be individually twined, working in pairs, around the basket spokes, or the blades of grass could be braided together first and then woven onto the ash splints. Some of these braided ropes of sweetgrass were as thin as string, while others were more boldly braided into thicker ropes. In later times as an aid to increase production, many Natives began to incorporate imported Hong Kong cord in their sweetgrass baskets. This commercially available twisted cord completely supplants the use of sweetgrass in some baskets. As the pre-processed cord was not as popular in the market, it fell out of use with many weavers.



Small Basket in Production

Because, like other special plants such as tobacco and cedar, sweetgrass has long standing traditional uses for medicine and ceremony it has always been afforded special respect and care; gifts and thanks are offered to gather or use it.

Trudie Lamb Richmond, Schaghticoke, describes an interview with a modern Mohawk basket maker who uses sweetgrass. Trudie explains: *"She told me she had thought about this meaning and that was why she always talked to her baskets as she made them. She said that she asked forgiveness for having to sell the baskets, but that she needed the money to survive. Using the sweetgrass would keep the baskets strong and alive, and she hoped that the people who bought them would appreciate their significance."* (in McMullen & Handsman 1987)





**Baskets and Crafts**

**Medicine and Ceremony**



## Uses for Sweetgrass in Medicine & Ceremony

Many Native tribes in North America use sweetgrass in prayer, smudging or purifying ceremonies and consider it a sacred plant. It is usually braided, dried, and burned.

Sweetgrass braids smolder and doesn't produce an open flame

when burned. Just as the sweet scent of this natural grass is attractive and pleasing to people, so is it attractive to good

spirits. Sweetgrass is often burned at the beginning of a prayer or ceremony to attract positive energies.



Densmore (1974) describes that among the Chippewa (Ojibwa), *"young people, chiefly young men, carried a braid of sweet grass and cut off 2 or 3 inches of it and burned it for perfume. Young men wore two braids of sweet grass around their necks, the braids being joined in the back and falling on either side of the neck like braids of hair."*



Sweetgrass is used to "smudge"; the smoke from burning sweetgrass is fanned on people, objects or areas. Individuals smudge themselves with the smoke, washing the eyes, ears, heart and body. Natives of the northeast have long used sweetgrass as a smudging ingredient, often mixed with other botanicals.

*"Sweetgrass is one of the four medicines which comprise a group of healing plants used by the people in Anishinabe, Bode'wad mi, and Odawa societies. The other three are tobacco, cedar, and sage"* (Mary Ritchie 1995).

Among the Chippewa *wicko'bimucko'si*, or wingashk (sweetgrass), is braided and used in pipe-smoking mixtures along with red willow and bearberry, when it is burned, prayers, thoughts and wishes rise with the smoke to the creator who will hear them. Densmore (1974) describes the story of *"a hunting incident in which a party of men placed sweet grass on the fire when the camp was in danger of starving and they were going again to hunt. Medicine men kept sweet grass in the bag with their medicinal roots and herbs"*.

A tea is brewed by Native Americans for coughs, sore throats, chafing and venereal infections. It is also used by women to stop vaginal bleeding and to expel afterbirth. It is warned that because the roots contain coumarin, that sweetgrass tea may be considered a carcinogenic. (Foster & Duke 1990)



[Sweetgrass Traditions](#)

[Sources for Sweetgrass](#)



## Sources for Sweetgrass Plants



For more information about growing Sweetgrass or to find out how to purchase plugs of sweetgrass, *and if you are On-Line*, you can visit the pages of [Craig and Sue Dremann](#)

[Redwood City Seed Co.](#)

[Box 361](#)

[Redwood City, California 94064.](#)

[Phone: \(650\) 325-7333](#)

Sweetgrass plants are also available on the website of the [Richters Herb Catalogue](#):

or you can write to:

Richters Herbs

Goodwood, Ontario, Canada

L0C 1A0

Tel. +1.905.640.6677

Fax. +1.905.640.6641



[Medicine and Ceremony](#)

[References for Sweetgrass](#)



## Specific References for Sweetgrass

Densmore, Frances

1974 *How Indians Use Wild Plants for Food, Medicine and Crafts*. New York: Dover Publications, Inc.

Foster, Steven and James A. Duke

1990 *A Field Guide to Medicinal Plants; Eastern and Central North America*. Peterson Field Guide Series. Houghton Mifflin Company: Boston/New York.

Larson, Gary E.

1993 *Aquatic and wetland vascular plants of the northern Great Plains*. Gen. Tech. Rep. RM-238. Fort Collins, CO: U.S. Department of Agriculture, Forest Service, Rocky Mountain Forest and Range Experiment Station. Northern Prairie Wildlife Research Center Home Page. <http://www.npwrc.usgs.gov/resource/1999/vascplnt/species/hier.htm> (Version 02FEB99).

McMullen & Handsman

1987. *A Key into the Language of Woodsplint Baskets*. American Indian Archaeological Institute: Washington, CT.

NATIVE-L Archive

1995 (October). Subject: Sweetgrass. Lyn Dearborn - Ojibwe /Louis Annance - Western Abenaki / Capucine Plourde - Mi'kmaq / Mary Ritchie, Ojibwe <http://bioc09.uthscsa.edu/natnet/archive/nl/9510/>

U.S. Department of Agriculture

No date *Western wetland flora: Field office guide to plant species*. U.S.D.A. Soil Conservation Service, West National Technical Center, Portland, Oregon. Jamestown, ND: Northern Prairie Wildlife Research Center Home Page. <http://www.npwrc.usgs.gov/resource/othrdata/westflor/species/2/hierodor.htm> (Version 16JUL97).

Walsh, Roberta A.

1994 *Hierochloe odorata*. In: Fischer, William C., compiler. *The Fire Effects Information System [Data base]*. Missoula, MT: U.S. Department of Agriculture, Forest Service, Intermountain Research Station, Intermountain Fire Sciences Laboratory. Magnetic tape reels; 9 track; 1600 bpi, ASCII with Common LISP present. <http://www.fs.fed.us/database/feis/plants/graminoid/hieodo/>



[Sources for Sweetgrass](#)

[Go to Sweetgrass Cover Page](#)



# Native American Basketry

A Presentation of [NativeTech: Native American Technology and Art](#)

[Cover  
Page](#)

[Coil  
Basketry](#)

[Woodsplint  
Baskets](#)

[Sweetgrass  
Uses](#)

[Play Basket  
Concentration](#)

[Basketry  
References](#)

[Internet  
Links](#)

[Manual Slides](#)



[Repeat Show](#)



Welcome to the Woodsplint Basketry Slide Show. The splint baskets presented are all from the Eastern Woodlands, many from Connecticut and Massachusetts tribes, and some fancy splint baskets from Northern New England peoples. Enjoy the show!

- [1. Painted Vase Motif](#)
- [2. Trail & Dome Designs](#)
- [3. Painted Leaves](#)
- [4. Stockade Motif w/ Medallion](#)
- [5. Medallions](#)
- [6. Geometric Stockade](#)
- [7. Bars and X's](#)
- [8. Medallions & Strawberries](#)
- [9. Covered Storage Basket](#)
- [10. Cloth Lined Sewing Basket](#)
- [11. Block Stamped Dots](#)
- [12. Handled Work Basket](#)
- [13. Medallions w/ Domes](#)
- [14. Miniature w/ curlieques](#)
- [15. Miniature - Dots & Leaves](#)
- [16. Miniature - Stockade Motif](#)
- [17. Traditional Fish Trap](#)
- [18. Baskets for Tourists](#)
- [19. Yarn-Dispensing Basket](#)
- [20. Nipmuc w/ Medallion](#)
- [21. Trinket & Arm Baskets](#)
- [22. Miniature Hamper Basket](#)
- [23. Oak Work Basket](#)
- [24. Miniature Pack Basket](#)
- [25. Bold Porcupine Twist](#)
- [26. Intricate Porcupine Twist](#)
- [27. Block Print - Potato Stamp](#)
- [28. Basket Vase](#)
- [29. Wall Pocket](#)
- [30. Mohegan Baskets](#)



1. Ash Splint Storage Basket Lid with Painted Vase Motif  
Collections of Old Sturbridge Village



2. Hand Painted Ash Splint Covered Storage Basket  
Collections of Old Sturbridge Village



3. Hand Painted Ash Splint Covered Storage Basket  
Collections of Old Sturbridge Village





4. Hand Painted Ash Splint Covered Storage Basket  
Collections of Old Sturbridge Village



5. Round Hand Painted Ash Splint Storage Basket  
Collections of Old Sturbridge Village



6. Hand Painted Ash Splint Covered Storage Basket  
Collections of Old Sturbridge Village



7. Hand Painted Ash Splint Storage Basket  
Collections of Old Sturbridge Village





8. Hand Painted Ash Splint Covered Storage Basket  
Collections of Old Sturbridge Village



9. Hand Painted Ash Splint Covered Storage Basket  
Collections of Old Sturbridge Village



10. Ash Splint Sewing Basket with Remnants of Cloth Lining  
Collections of Old Sturbridge Village

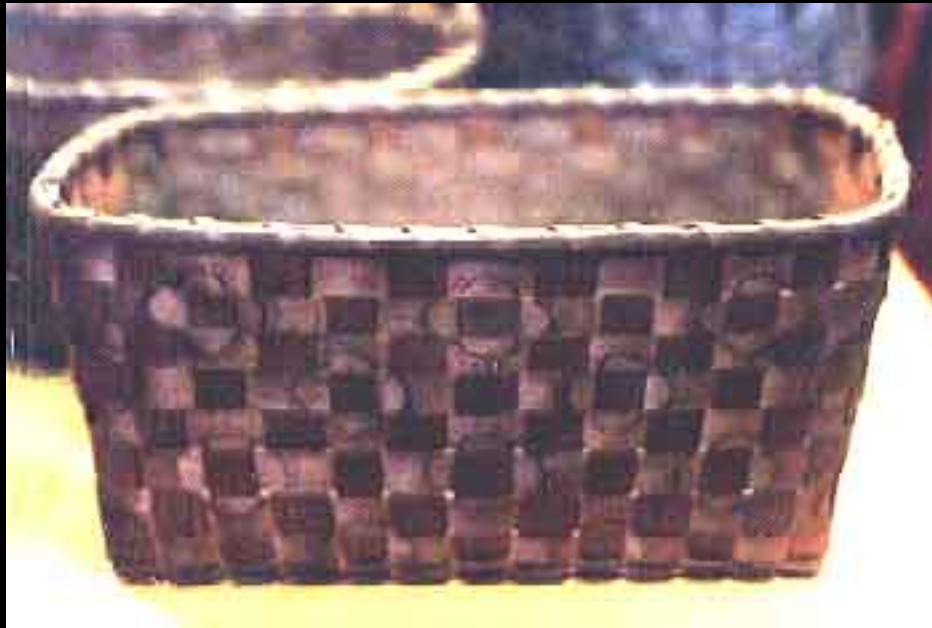


11. Hinged Ash Splint Trinket Basket with Handle  
Collections of Old Sturbridge Village





12. Round Lidded Splint Work Basket with Handle  
Collections of Old Sturbridge Village



13. Smaller Square Ash Splint Work Basket  
Collections of Old Sturbridge Village



14. Miniature Square Ash Splint Work Basket  
Collections of Old Sturbridge Village



15. Miniature Square Ash Splint Work Basket  
Collections of Old Sturbridge Village





16. Miniature Square Ash Splint Basket  
Collections of Old Sturbridge Village



17. Traditional Ash Splint Basket 2-piece Fish Trap  
Collections of Old Sturbridge Village



18. Small Native-made Tourist Baskets, Handkerchief box, string basket and pin cushions.  
Brimfield, Massachusetts Antique Market



19. Finely-made Splint Yarn-dispensing Basket  
Brimfield, Massachusetts Antique Market





20. Painted Nipmuc Splint Basket held by Dr. Handsman  
Connecticut Historical Society Collections



21. Trinket & "Arm" Baskets with splints, sweetgrass & imported Hong-Kong cord.  
Personal Collection



22. Miniature Hamper Basket 7 inches tall, signed - Enid Sylvie Palmer  
Personal Collection



23. Oak Splint Work Basket, Painted with Yellow Lead and Mohegan Pink paint  
Personal Collection





24. Modern Miniature "Pack" Basket - penny for scale  
Personal Collection



25. Ash Splint Basket using Bold Porcupine Twist Technique  
Personal Collection



26. Ash Splint Basket using Intricate Porcupine Twist Technique  
Personal Collection



27. Ash Splint Basket with Block Stamp Decoration  
Personal Collection





28. Ash Splint, Sweetgrass and Hong-Kong Grass made for 1900s Tourist Industry  
Personal Collection



29. Ash Splint Wall-Pocket Basket made to hold a Weaver's Loom Accessories  
Personal Collection



30. Early Mohegan Splint Baskets  
in the Tantiqidgeon collections

Hope you enjoyed the slide show!

## Coiling History and Background

Coil baskets using plant fibers such as willow twigs, blades of sweetgrass, or pine needles have a 'bundle' foundation. Long leaf pine needles (10-12 inches) are used extensively along the southeast coast of North America, while northeastern Native Americans often coil 'sweet grass' (*Hierochloe odorata*) into baskets. European-made baskets and bee skeps often have bundle foundations of grass, such as rye or wheat. Almost any plant material (yucca, sumac, cattail, sedges, corn husks, etc.) can be used in a bundle-foundation coil basket. The bundle foundation provides a flexible support for the basket and allows the individual coils in the basket to be easily stitched together. Solid rod foundations are also used by Native Americans in other regions. The diameter of the bundle or rod foundation is determined by the material used and the size of the baskets.

Tiny baskets a few inches high having bundle foundations tend to have coils only 1/16 in. to 1/8 in. in diameter. Much larger work or storage baskets might have bundle diameters up to an inch thick.



Apache still life Library of Congress, Prints and Photographs Division, LC-USZ62-130198 Curtis 1907



Wedding Basket

Native Americans of the Southwest are well renowned for their variety of plaited and coiled basketry. In addition to the many types of wicker carrying and gathering baskets, the coiled baskets of the Navajo (Dine') often appear as water jugs, trays and low bowls. Boiled down Pinion pitch was applied to coiled water jugs to seal them from leaks.

Navajo baskets are usually made from Three Leaf Sumac, sometimes substituting yucca or willow was (but not preferred by basketmakers). Starting the coil process with a central knot, these baskets are created with what is called a two-rod and bundle technique. In later times a three-rod bundled formation is used. The flexible bundled rods of sumac twigs are spiraled around and bound together by strips of sumac, poked through with the aid of an awl. When the basket is complete, the bundled twigs beneath can not be seen; the covering strips are placed so close together. The finished rims have a braided herringbone

appearance.

The strikingly beautiful Wedding Baskets, in their circular stepped designs in natural, black and red colors, are made to contain cornmeal for the couple and guests to consume at their ceremony. Starting with the couple, and having been shared with each guest, it is said that the last to eat from the basket may keep it.

The light tan background of Wedding Baskets is simply the color natural dried sumac. The red color is achieved by boiling down a dye of Alder-Leaf Mountain Mahogany roots sometimes mixed with Juniper ashes and Black Alder. The Navajo word for Mountain Mahogany (*Cercocarpus montanus*) means "wood heavier than stone", it can only be gathered in the winter while sumac is collected in the spring. The dye for the black color in these baskets is made from pinion pitch with crushed sumac leaves, coal or ochre.

The light center of the basket represents the emergence of the people from a cave into the pure world, and a



pathway is drawn from the center to the baskets braided rim, like the journey through a Navajo's world. First through the black ring of steps or mountains representing life's darker trials, into the red area characterizing one's earthly celebrations like marriage and family, and while there may be more trials and darker times represented in the mountains of the outer dark band, the light colored perimeter of the basket reminds us the joy at the opening of the pathway.



Papago Yucca Basket

The Tohono O'odham (Papago), descendants of Hohokam people, are also renowned for their basketry. These Piman-speaking people from southwestern Arizona and northern Mexico create beautiful durable coiled basketry from bundled willow twigs, wrapped with strips of Yucca (*Yucca elata*) and Devil's Claw (*Proboscidea parviflora*). These bold coiled forms usually have colors of black, green, white and red. The black elements in the basket are actually strips of the dried devil's claw seed pods. These curiously shaped hard black seed capsules are aptly named for their appendages resembling a set of two 'horns'. Green elements are Yucca strips left to dry in the shade, but if left to dry in the sun with bleach the yucca leaves white. A red dye can be simmered from the roots of the yucca.



Papago Indian, Luzi, with basket tray on head  
Library of Congress, Prints and Photographs  
Division, LC-USZ62-105389 Curtis 1907

Coil baskets are made around the world by indigenous people. Sometimes strikingly similar forms and designs are found in widely separated places. In Uganda, intricately woven coil baskets made by the Tooro Ndiiro coil have been frequently confused with those by Native Americans. The Ugandan baskets, for holding bread, herbs, medicine and even coffee beans, are distinguished by their brilliantly colors patterns and tight-fitting lids.



African Coffee Bean  
Basket



[Coiling Cover Page](#)

[Coiling Techniques](#)





## Coiling Techniques

There are a variety of techniques, called a 'stitch', used to wrap around and fasten together coils in a basket. There are a number of stitching techniques and materials used in Native American coil baskets that give the baskets of each region their own unique style. After European contact, Colored embroidery thread often supplanted natural fibers that had been used in coil basketry. When coils are joined tightly together with simple stitches, leaving no horizontal space, it is referred to as 'close-coiling'. When coils are separated by an intricate stitch, leaving an open space between subsequent coils, it is referred to as 'open-coiling'. The open space between coils is determined by the size and complexity of the basketmakers stitch. Sometimes close- and open-coiling are combined in the same basket to create a pattern.



Mission Indian baskets Library of Congress, Prints and Photographs Division, LC-USZ62-98667 Curtis 1924



Coiling with Artificial Sinew

The technique used to stitch together or wrap coils will determine any surface texture and visible pattern. A variety of 'simple' stitches are usually used by Native Americans along the eastern seaboard of North America. Combinations of 'simple', 'intricate' and 'wrapping' stitches are often used by Native Americans in other areas.

Simple stitches go around the bundle being added and then penetrate the former coil, only to be brought around the bundle being added again, repeated over and over. Simple stitches may be 'separate', 'interlocking', and 'split' in a variety of ways. Intricate stitches involve various knots made between the bundle or rod being added and the bundle below it, creating

open spaces between coils. Wrapping stitches only go around the coil being added. Wrapping stitches do not penetrate previous coils and are often used in certain combination with intricate stitches to create a varied texture.

Using different dyed colors, tightly spaced simple stitches or wrapping stitches often hide the bundle or rod foundation, and create designs on a basket surface. Bundles of pine needles and sweet grass in Native American coil baskets were always left visible, using widely spaced simple stitches.



Lake Mono basket-maker Library of Congress, Prints and Photographs Division, LC-USZ62-118771 Curtis 1924



Horsehair Basket

Native American techniques to splice in new stitching string vary not only from region to region, but also from one basketmaker to another. Unique splicing techniques are often the fingerprint of particular basketmakers. Some finely made baskets have well over one hundred thousand individual stitches!



Coiling begins on Bark Base



## Eastern Pine Needle Baskets



Pine Needle Baskets

Pine needles, or any other plant material, should be gathered and dried thoroughly in the sun (for bleached colors) or in the shade (to retain green color). Before the basket can begin dried vegetal material should be soaked in warm water for at least a half an hour to regain its flexibility. Over-soaking for hours may damage some basket materials.

Embroidery thread or waxed nylon string is very suitable for coil basket stitching, and can be easily threaded onto a needle. Natural materials, such as split roots, birch paper, basswood inner bark strips, or raffia may also be used, but you will probably have to splice in new strands quite often.

The instructions provided here apply to right handers for which the direction of work usually spirals counter-clockwise, (clockwise for left handers). The 'best side' of a basket can be depend upon which side is stitched into; from the outside - in, or from the inside - out. Generally the side of the basket which the needle and string enters into is the 'best side', although careful attention to where the needle enters and exits can result in a neat, orderly appearance on both sides of a basket.



Coiling with Embroidery Thread



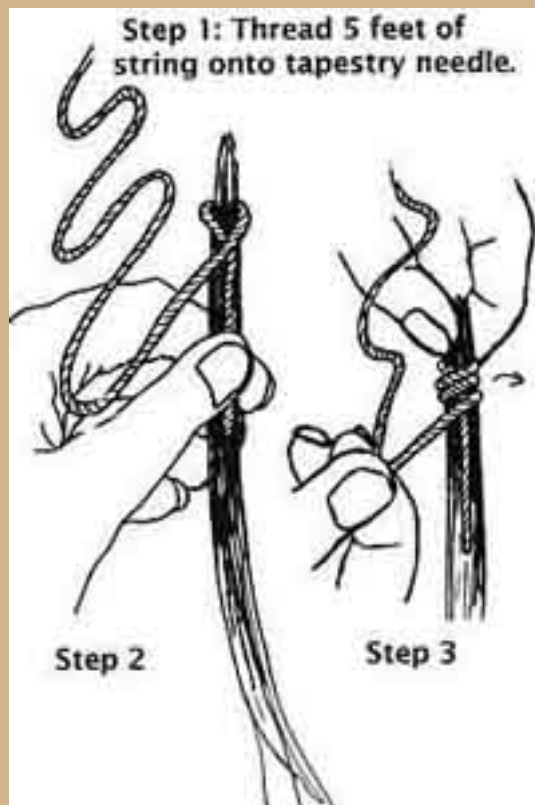
[Coiling Techniques](#)

[Instructions for Coiled Pine Needle Baskets](#)





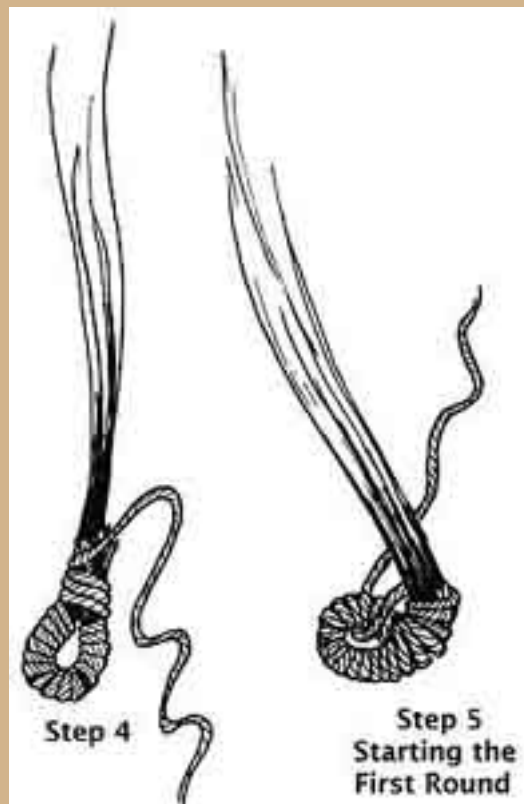
## Instructions for Round-bottom Pine Needle Coil Baskets



1. Cut a piece of stitching string about five feet long to start the basket. Thread one end of the stitching string through a needle, (Do NOT double thread, instead use a single thickness of string in wrapping and stitching).

2. Use 4 to 6 individual pine needles (stripped of the sheath that joins needles together) to produce the foundation at the bottom center of the basket. Lay a couple of inches of the loose end of the string alongside the end of the pine needles (and extending in the opposite direction.)

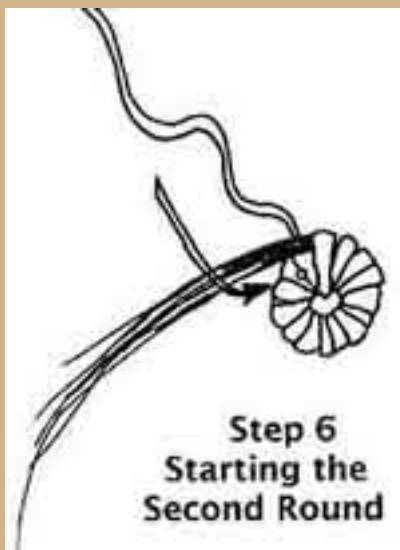
3. With one hand hold the short end of the string in place, and with the other hand wrap the long stitching string around both the string's end and the pine needle bundle (wrap about 10 - 15 times), producing a coil about  $\frac{3}{4}$  of an in. long. (Be sure to leave an initial  $\frac{1}{4}$  in. of pine needle unwrapped at the start.)



4. Bend the wrapped  $\frac{3}{4}$  inch bundle of needles (with extreme gentleness) into a 'U' shape and bind both the long and short ends of the pine needles together (wrap 6 or 8 times). This will form an elliptical circle or ring foundation. (Try to make the hole in the center of the ring as small as possible). This piece forms the center of your spiraling basket.

5. Start the coiling process. Bend the loose end of the wrapped pine needle bundle around. The bundle of loose needles should lay snugly along side the ring foundation. Stitch around the bundled needles and through the hole at the center of the ring. Use a standard whip stitch. Keep stitches close and adjacent to each other in this first round. Continue wrapping around the pine needle bundle and through the center of the ring one full time around (this should be about 10 to 20 stitches). The first round of the basket bottom is now joined to the central ring.





6. For the second round of stitches, do NOT stitch through the hole at the center of the ring any more. Now stitch around the bundle being added, and then through middle of the bundle making up the ring. Keep in mind the 'best side' of the basket.



7. In the second round, make small even spaces between the stitches so you can see the bundled needles in between. Uneven stitches at the bottom of a basket get amplified as the coiling progresses, and are hard to correct farther along. The second round should also have 10 to 15 stitches, depending upon the thickness of the string. The initial stitches secure the start of the coiling process, try to maintain a nice circular disk for the bottom of the basket. Also try not to let the bundled pine needles twist as they are coiled around.

8. In the second round of the basket bottom start adding pine needles to the bundle. Hold the bundle of needles with the thumb and fingers of the left hand, while the coil is stitched around with the right hand. Three or four individual needles may have to be added every other stitch, have patience, the finished product is worth it.

9. Continue adding needles to gradually increase the diameter of the bundle to that of a pencil (about 16 individual pine needles) for a medium sized basket. Add foundation material as needed while coiling the basket, maintain a consistent bundle width.

10. Select a type of stitching to use from those provided here for the third and subsequent rounds of the basket. Experiment with coming several rows of different types of stitching.

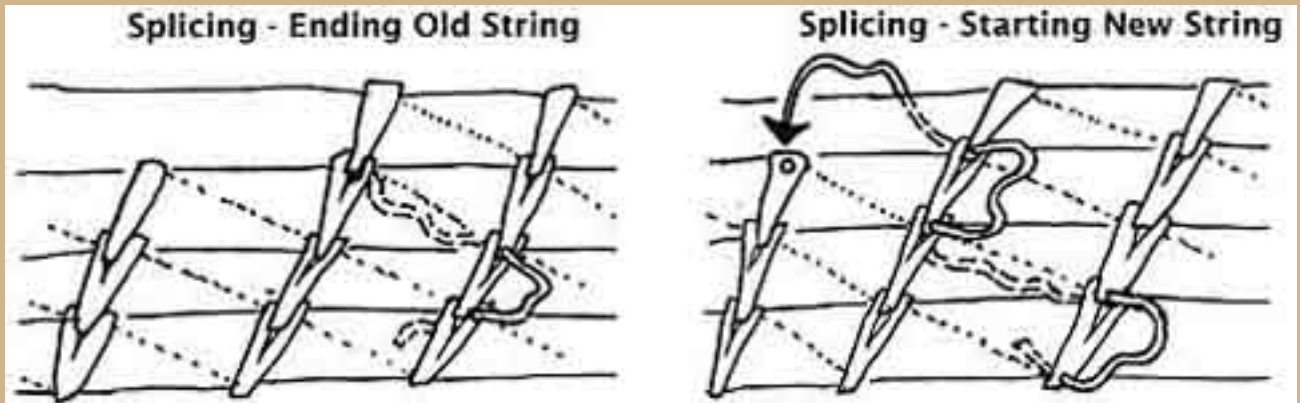


[Eastern Pine Needle Baskets](#)

[Splicing in new string to stitch with](#)



## Splicing in new string to stitch with



The simplest way to splice is to weave the short end back down through the coils, following the path of previous stitches, and cutting of the excess flush with the 'worst side' of the basket. Thread a new string on the needle, starting 2 or 3 coils below the one being added, weave the new string up along the path of previous stitches to the bundle being attached.

Increase the number of stitches when stitches become too widely spaced to hold the bundle together securely (3/4 in.). This can be accomplished by making two separate stitches where there would normally be one, or increase the number of stitches with a round of 'V'stitches.



[Coiling Instructions](#)

[Coil Basket Forms](#)



## Coil Basket Forms



Basket form is determined by the specific placement of the coil being added. The basket flat basket bottom is achieved by joining each coil directly to the side of the last coil added, spiraling in an outward direction. When the desired diameter of basket bottom is reached (3-4 in. for a medium sized basket) then the added coil is joined, at almost a 45 degree angle, on top of the last coil added. This 'turns the corner' (a hard angle) from the basket bottom to building up the wall of the basket.

If a cylinder shaped basket is desired, then each coil is added exactly on top of the last coil. If you wish the basket wall to expand gradually into a bowl shape, then the new coils should be placed the tiniest bit to the outside of the previous coils. If a

vase or constricted form is desired then the coils added should be placed the tiniest bit to the inside of previous coils.



Coil basket rims are finished using the same stitch the basket walls used. When the desired size of the basket is reached, taper the coil of pine needles, with each element in the bundle a different length, and continue stitching until the bundle runs out and tapers to nothing. You may stitch back through the same holes in the reverse direction around the rim, resulting in a 'double-wrapped' rim. This not only adds strength to the basket rim, but also creates a pleasing 'X' design on the basket rim.

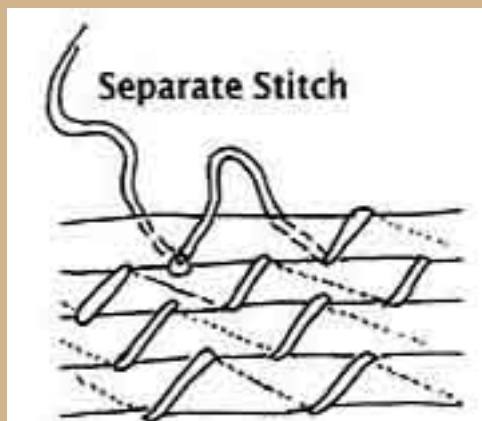


[Splicing in new string](#)



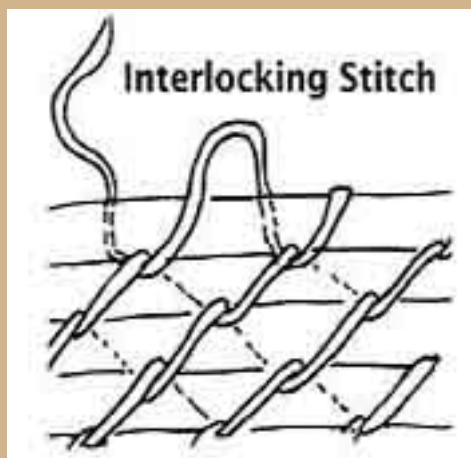
[Closed-coiling Stitches](#)

## Variations of Simple Closed-coiling Stitches



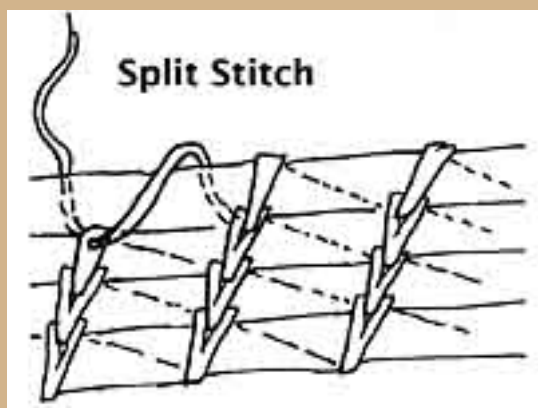
Separate:

Whip stitch around the coil being added, and insert the needle through the bundle of needles below it midway between the stitches in that last round. Be careful not to pierce the stitch from a previous coil. The stitches should appear separate, often as if placed on top of one another, on the basket wall.



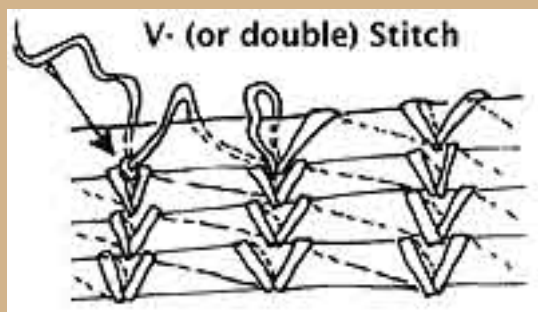
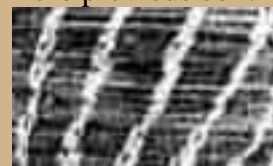
Interlocking:

A stitch where the needle is inserted diagonally through the top of the stitch just below it in the previous coil. The stitches spiral up the basket wall and appear interlocked resembling a chain.



Split:

Sew around the coil being added and through the center of the stitch in the previous round. This creates a split or bifurcate design where the needle and string goes through the stitch below it in the previous coil.



V-stitches:

After producing a single simple stitch, sew through the same spot a second time, creating v-shaped forms. V-Stitches can be continued for additional coils by passing the needle through middle of a previous round of V-stitches.



Split stitches can also be used in combination with V-stitches, the slant of the spiraling pattern depending upon whether the left or right side of a 'V' is split.



*Basket images adapted from Johnson: 1989*



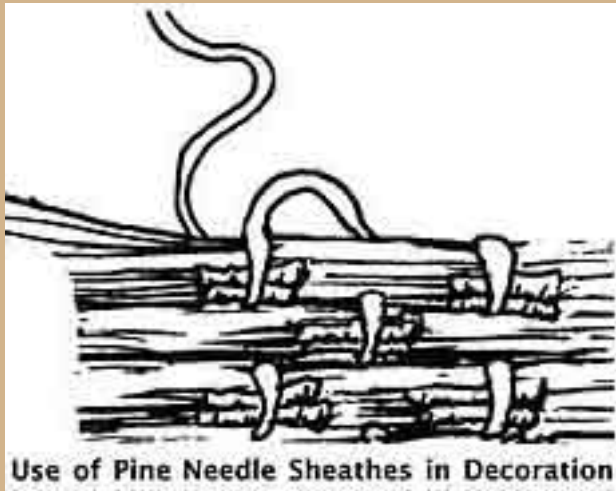
[Coil Basket Forms](#)

[Sheathes that hold pine needles in bunches](#)



## Pine needles and the sheathes that hold them in bunches

Unsheathed pine needles are tucked, hiding the short ends, into the middle of the existing coil at the bottom where it joins with the previous coil.



Sheathed pine needles, carefully positioned, can also be used to create patterns in baskets. Sheathed pine needles are added singly every stitch or so, or in small bunches every two or three stitches. The sheathed portion of the needle is positioned on the outside of the basket at the bottom of the coil being added. Stitch over the middle of the sheath, leaving about 1/4 inch projecting from the basket wall.



[Closed-coiling Stitches](#)

[Go to Coiling Cover Page](#)



Coiling is one technique of basketry used by Native Americans across North America. Coil baskets of different regions have various styles of construction depending upon the materials used in the coil, and the type of stitch used to fasten or interlock the coils together. All coiled containers use a flexible 'coil' which begins from the center at the bottom of a basket, or sometimes begins around a flat disk of bark or wood. The coil is spiraled outward and upward, placed on top of the coil in previous round, and fastened to former rounds by some stitching material.

*Mouse over the center of the photo to watch an animated coil basket emerge ~~~>*



[Coiling Cover Page](#)

[Coiling Background and History](#)





## Food & Recipes

[Check out these Books about Native Foods!](#)

Ok, this section is up to you, the faithful visitors of my web pages...

[Submit your own Native American recipe - click here!](#)

---

\*\*\* Recipes by **Type of Dish** are broken down into three categories: \*\*\*

1. [Bold Font] **All Indigenous Ingredients & Preparation**
2. [Normal Font] Traditional Recipes with Contemporary Ingredients
3. [Italics Font] *Today's Native Dishes*

OR [Click here to Sort by Region & Tribe](#)

Please do not reproduce these recipes without permission ~ thank you.

---

### ✂ Beverages & Teas

- [Berry Spritzer](#) prairie
- [Chaparral Tea](#) Coquille
- [Conk Tea](#) Cherokee **NEW!**
- [La Follette Thunder Milk](#) Menominee
- [Lichen Tea](#) Mohawk
- [Manzanita Juice](#) Miwok
- [Mint Leaf Tea](#) Maliseet
- [Orchata \(Ground Rice Drink\)](#) southwest
- [Pine Needle Tea](#) Cumash
- [Pine Needles for Stomach Cramps](#) Cherokee
- [Sagebrush Tea](#) Shoshone Bannock
- [Sassafras Tea](#) southeast
- [Snowberry / Mint Tea](#) Montagnais **NEW!**
- [Spring or Mint Tonic](#) Cree
- [Spruce Tea for coughs](#) northeast
- [Staghorn Sumac Tea](#) Cherokee
- [Yerba Buena Tea](#) Ohlone - Miwok- Costanoan
- [Wild Peppermint Tea](#) Lower Brule Sioux

### ✂ From the Four Legged

- [Aunt Margaret Tawatoy's Elk Steak](#) Umatilla
- [Baked Raccoon](#) Odawa
- [BBQ Sauce For Venison & Beef](#) Soix **NEW!**
- [Baked Jicima w/ Beef](#) Potawatomi

### ✂ Plants, Fruit & Vegetables

- [Anasazi Beans](#) southwest
- [Blueberry Wojapi](#) Lower Brule Sioux
- [Boiled Dry Corn](#) Umatilla
- [Butter Fried Morels](#) Odawa
- [Broccoli & Wild Rice Casserole](#) Ojibwe
- [Cactus Pear & Raspberry Syrup](#) Cherokee
- [Cactus Salad](#) southwest **NEW!**
- [Cattail/Poke Salad Stir Fry](#) prairie **NEW!**
- [Chitimacha Corn Soup](#) Chitimacha
- [Corn Balls \(Wahuwapa Wasna\)](#) Dakota
- [Corn Chowder](#) Cherokee
- [Corn Soup](#) Abenaki
- [Cherokee Fried Hominy](#) Cherokee
- [Cherokee Succotash](#) Cherokee, SE Kituwah
- [Choke Cherry Pudding](#) Lakota - Crow
- [\(more\) Choke Cherry Pudding](#) Shoshone Bannock
- [\(another\) Chokecherry Pudding](#) Aztec **NEW!**
- [Currant Pudding](#) Shoshone Bannock
- [Dandelion Stir Fry](#) Cree
- [Dried Sweet Corn Soup](#) Oneida
- [Fiddlehead & Cattail Salad](#) Mohawk - Metis
- [Floral Green Salad](#) Squamish
- [Fried Corn](#) Comanche
- [Fried Corn Mush](#) Pequot - Maidu



- [Beaver Ball Soup](#) Metis, Duck Bay
- [Better Than Grilled](#) Choctaw
- [Buffalo Stew](#) Lakota, Hunkpapa
- [Buffalo Stew \(Tanka-me-a-lo\)](#) Cherokee
- [Camp Side Stew](#) Choctaw **NEW!**
- [Chicken Fried Venison](#) Cherokee - Chickasaw - Choctaw
- [Choctaw Possum](#) Choctaw
- [Chokecherry Pemmican](#) Cree, Alberta Plains **NEW!**
- [Chorizo & Rice](#) southwest
- [Crock Pot Venison](#) Cherokee, Oklahoma
- [Curlies](#) Navajo
- [Easy Venison Roll Ups](#) Odawa
- [Fireside Stew](#) prairie **NEW!**
- [Gesatho](#) Apache, Gabrillino
- [Good Deer](#) northeast **NEW!**
- [Grilled Prairie Dog](#) Navajo
- [Hatteras Grilled Venison](#) Cherokee **NEW!**
- [Jerky Soup & Dumplings](#) northeast
- [Menudo](#) southwest
- [Moosemeat Chinese Style](#) Shoshone Bannock
- [Moose Steak Sandwich](#) Carrier Nation, CA
- [Mesquite Grilled Rabbit](#) Passamaquoddy
- [Mutton Stew](#) Navajo **NEW!**
- [Pit Roasted Venison](#) Miwok
- [Porcupine Balls](#) Yaqui **NEW!**
- [Pork Stuffed Fry Bread](#) Mohawk
- [Porky Bake](#) Cherokee/Choctaw **NEW!**
- [Roast Moose](#) Shoshone Bannock
- [Rock Chuck](#) Shoshone Bannock
- [Redeye Gravy](#) Cherokee
- [Sacho Seasoning For Steak](#) Mojave **NEW!**
- [Saponi Beef Empanadas](#) Saponi
- [Survival Sausage](#) Mohawk
- [Tanica](#) Lakota, Oglala
- [Too Tall Tail Meat Salad](#) Inuit
- [Venison & Barley Soup](#) Arikara - Hidatsa
- [Venison Chili](#) Nause - Waiwash
- [Venison "Ragout"](#) Nes Perce **NEW!**
- [Wampanackali](#) Wyandot
- [Woodchuck Chuck](#) Mohawk, Ontario

### ✂ From the Bird

- [Bar B.Q. Dove](#) Comanche
- [Cat's Butter noodle soup](#) Mohawk
- [Chicken Soup](#) Creek

- [Fried Sage & Mushroom Sause for Pasta](#) Haida - Tlingit
- [Fried Yucca Petals](#) Cherokee
- [Gluckaston](#) northeast
- [Greens Salad "Guhitligi"](#) Cherokee, SE Kituwah
- [Guacomole](#) southwest
- [I-Ya \(Dried Pumpkin Rings\)](#) Cherokee
- [Jac's Wildberry Crisp](#) Blackfoot
- [Jellico \(Wild Greens\)](#) Cherokee
- [Ma'at Salad](#) Powhatan **NEW!**
- [Macque Choux](#) Chitimaca, LA
- [Mohawk Corn Soup](#) Mohawk, Awkwesasne
- [Nopalitos Con Arror](#) southwest
- [Nopalitos \(Prickly Pear 1\)](#) Comanche
- [Napalitos \(Prickly Pear 2\)](#) Yaqui - Apache
- [Nopalitos & Pork](#) Yaqui
- [Parched Corn](#) Choctaw
- [Prickly Pear Cactus Jelly](#) Navajo
- [Prickly Pear Surprise](#) Cherokee
- [Red Clover & Sour Grass](#) Sioux **NEW!**
- [Seneca Corn Soup](#) Seneca
- [Squash Blossoms](#) Pequot - Maidu
- [Steamed Cattail](#) northeast
- [Steamed Lambsquarters](#) northeast
- [Succotash](#) Nipmuc
- [Succotash N' Nuts](#) northeast
- [Totti's Three-Stock Soup](#) Cherokee, SE Kituwah
- [Vegan Rice Pudding](#) Mohican
- [Veggy](#) southwest
- [Wagunabuie \(Lichen\) Soup](#) northeast
- [Wild Tumbleweed Greens](#) Choctaw
- [Wojapi \(Pudding\)](#) Lakota - Cree

### ✂ Breads, Nuts, Seeds & Grains

- [Acorn Breakfast](#) northeast **NEW!**
- [Acorn Mush](#) Miwok
- [Bannock - La galette](#) Ile-a-la-Crosse, Saskatchewan
- [Bay Nuts](#) Miwok
- [Calming Winds Creek Fry Bread](#) Creek
- [Cheyenne Batter-Bread](#) Cheyenne **NEW!**
- [Corn Cakes](#) Cherokee
- [Cranberry Bread](#) Iroquois
- [Easy Wild Rice Soup](#) Ojibwe
- [Frybread Pizza with a Twist](#) Cree - Mohawk
- [Fry Bannock Dessert](#) Carrier Nation, Nazko BC **NEW!**
- [Fry Bread Power!!](#) Nez Perce

- [Chitimacha Baked Duck](#) Chitimacha
- [Eggs & Wild Onions](#) Cherokee
- [Pheasant Under Plastic](#) Shoshone Bannock
- [Rav'in Raven](#) Choctaw
- [Roasted Mallard](#) Ile-a-la-Crosse, Saskatchewan
- [Smoked Chicken](#) Cherokee
- [Stuffed Chicken](#) Ile-a-la-Crosse, Saskatchewan
- [Stuffed Quail \(Guhgwe\)](#) Cherokee, Eastern Band

### ✂ **From the Fish**

- [Alex's Beer Battered Halibut](#) Aleut **NEW!**
- [Bass Cayo](#) southwest
- [B.B.O. Tuna](#) Lakota, Rosebud
- [Bluegail Supreme](#) northeast **NEW!**
- [Candy Salmon](#) Ojibwe **NEW!**
- [Deep Fried Salmon Chips](#) Fountain Indian Band, BC
- [Fire Baked Fish](#) Mohawk
- [Fire Baked Trail Fish](#) Huron
- [Fish Dinner](#) Passamaquoddy
- [Fish Head Stew](#) Yurok
- [Fried Fish](#) southwest **NEW!**
- [Great Lakes Smoked Salmon](#) great lakes **NEW!**
- [Grilled Buffalo \(Rough Fish\)](#) Cherokee **NEW!**
- [Grilled Salmon](#) Shoshone Bannock
- [Kallmeh Fish](#) northwest
- [Lake Trout & Wild Leek Bake](#) Odawa
- [Miracle Whipped Fish](#) Shoshone Bannock
- [Native American Bacon](#) Cherokee
- [Rainy Day Fish Chowder](#) Haida - Tlingit
- [Salmon on a Stick](#) Tuliap Indian, WA
- [Salmon Stuffed Frybread](#) Anishinaabe, MI
- [Shrimp & Corn Soup](#) Comanche
- [Skok Salmon Cheeks](#) Skokomish
- [Smoked Bucket Chicken](#) Blackfoot **NEW!**
- [South Texas Potatoes & Fried Minnows](#) southeast
- [Stuffed Salmon - Tahitian Style](#) Tahltan **NEW!**

### ✂ **Recipes that Defy Categorization**

- [Aztec Indian Omlette](#) Meshica - Aztlan
- [Baked Grindle](#) Choctaw - Cherokee
- [Beans & Bacon](#) Lakota, Oglala
- [Blanket Dog](#) Menominee
- [Bologna McMuffin](#) Cherokee
- [Four-Leaf Clover Salad](#) northeast **NEW!**
- [Goulosh With A Zest](#) Chickasaw **NEW!**

- [Fry Bread Recipe](#) Cherokee
- [Frybread Recipe Addition](#) Sauk - Fox
- [Good Frybread](#) Tulalip Tribes
- [Grape Dumplings](#) Comanche
- [Guyanna Moto](#) Cherokee **NEW!**
- [Hot Bread](#) Shoshone Bannock
- [Indian Bread Pudding](#) Cherokee
- [Indian Cake](#) Lenape
- [Indian Flat Bread](#) Choctaw
- [Indian Fry Bread](#) Lenape
- [Indian Pogo](#) Algonquin, Long Point First Nation
- [Indian Tacos](#) Ojibwe, Alderville First Nation
- [Indian Tacos](#) Port Gambal Skallam
- [Kahkewistahaw Indian Taco's](#) Kahkewistahaw, Sask. **NEW!**
- [Kiowan Frybread](#) Kiowa
- [Kush](#) Cherokee
- [Maxine & Kayla's Own Frybread](#) Prince Rupert, BC
- [Menominee Pilaf](#) Menominee
- [Mesquite Cakes](#) Lakota **NEW!**
- [Mohawk Corn Bread](#) Mohawk, Six Nations
- [Navajo Fry Bread](#) Navajo
- [New Native Frybread](#) Lower Brule Sioux
- [Nupa \(Acorn\) Soup](#) Miwok
- [Ojibwa Bannock](#) Ojibwa, Lac Seul Band, Ontario **NEW!**
- [Ojibwe Fry Bread](#) Chippewa, Bay Mills **NEW!**
- [Ojibwe Fry Bread \(2\)](#) Ojibwe, White Earth Rez **NEW!**
- [Ojibwe Style Fried Bread](#) Ojibwe, Mille Lacs
- [Pemmican](#) plains
- [Pinto Bean Fry Bread](#) Apache - Cherokee
- [Rao's Fried Bread Biscuits](#) Cherokee, SE Kituwah
- [SaSaKah's Potawatomie Fry-bread](#) Potawatomi **NEW!**
- [Slammin' Frybread](#) Noonsack
- [Spoon Bread](#) Cherokee
- [Stuffed Fry Bread](#) Cherokee
- [Taco Rice](#) Lower Brule Sioux **NEW!**
- [Wild Rice](#) Passamaquoddy
- [Wild Rice Breakfast](#) Ojibwe
- [Wild Rice Casserole](#) Chippewa, Lac du Flambeau
- [Wild Rice Delux](#) Ojibwe, Long Plain First Nation
- [Wild Rice Pancakes](#) northeast
- [Wild Rice Soup](#) Ojibwe, Fond du Lac, MN **NEW!**
- ["Western" Pemmican](#) Lenape

- [Horse Tea](#) Chippewa
- [Hungry Man Stew](#) Penobscot
- [Indian Goolosh](#) Sioux
- [Michelle's Recipe](#) Sioux
- [Minnesota Mac](#) Ojibwe, Leech Lake
- [Moth Tea](#) Sioux
- [Navajo Bacon Surprise](#) Navajo **NEW!**
- [Oakis' Favourite Big Mac](#) Oneida - Ojibway
- [Popcorn's On Me!](#) northeast
- [Pow-Wow Soup Lakota Style](#) Lakota
- [Roast Turtle](#) plains
- [Rock Chuck Extravaganza](#) Shoshone Bannock
- [Rushing Pie](#) Sioux, Rosebud **NEW!**
- [Silly Willy's Home Brew](#) Tuscarora
- [Stick Bread & Moose](#) northwest
- [Sun-Cooked Salsa](#) southwest
- [Yum Yums](#) Inuit

---

A lot of people have written to me suggesting I have a section on indigenous foods & Native American recipes. Admittedly, I am a terrible cook... and if left up to my own experiences this page would either be empty (or singed around the edges)! Rather than copying from the pages of books, I thought we could build a more interesting (and perhaps amusing) collection of our own. So I'm petitioning the more experienced and knowledgeable cooks out there to send me their own Native American recipes to be shared here on these pages. Contribution in any of the suggested categories is welcomed... humor is especially appreciated (as long as it's in good taste)!! Please do not submit recipes copied from other sources without the author's permission. *Note: I am not responsible for any cooking accidents or unpredicted results of these recipes.*

**Come on guys, make me proud! [Submit your own recipe](#)**

NOTE: Some people write to me to seek permission to reproduce recipes in NativeTech's Food and Recipes section. In general, NativeTech materials are free and may be reproduced for (non-internet) personal use and public non-profit classroom (or scouting) use. The original recipe contributor retains joint copyright with NativeTech, and recipes may not be re-sold, used for advertising purposes, or included in other commercially sold cookbooks.



**Text and Graphics**  
© 1994 - 2003 [Tara Prindle](#)  
unless otherwise cited.





## FOOD & RECIPES BIBLIOGRAPHY

Click on the links below for the books you can order on-line in affiliation with [barnesandnoble.com](http://barnesandnoble.com)

---

*Be sure to visit NativeTech's [Food & Recipes](#) section for original delicious dishes submitted by NativeTech's visitors.*

---

**Carolyn Niethammer**

[American Indian Cooking: Recipes from the Southwest](#)

**Constance M. Arzigian, William Green (Editor)**

[Agricultural Origins and Development in the Midcontinent](#)

**Karen Halderson**

[Alaska Native Food Practices, Customs, and Holidays](#)

**Imogene Dawson**

[American Indian Food: Sixty-One Indian Recipes](#)

**Jay Miller**

[American Indian Foods](#)

**James A. Brown (Editor), James L. Phillips (Editor), James Bennett Griffen (Editor)**

[Archaic Hunters and Gatherers in the American Midwest](#)

**Barbara Harjo (Compiler), Designed by Julie Pearson-Little Thunder**

[Artistic Tastes: Favorite Recipes of Native American Artists](#)

**Bernard R. De Montellano, Bernard R. Ortiz De Montellano**

[Aztec Medicine, Health, and Nutrition](#)

**E. Barrie Kavasch**

[Earthmaker's Lodge: Native American Folklore, Activities, and Foods](#)

**Richard I. Ford**

[An Ecological Analysis Involving the Population of San Juan Pueblo, New Mexico](#)

**Paul Anthony Vestal, Richard Evans Schultes**



**[The Economic Botany of the Kiowa Indians](#)**

**E. Barrie Kavasch, Mitzi Rawls (Illustrator)**

**[Enduring Harvests: Native American Foods and Festivals for Every Season](#)**

**Mick Johnsson**

**[Food and Culture among Bolivian Aymara: Symbolic Expressions of Social Relations](#)**

**George Erdosh**

**[Food and Recipes of the Revolutionary War](#)**

**Nancy J. Turner**

**[Food Plants of Coastal First Peoples](#)**

**Nancy J. Turner, Royal British Columbia Museum**

**[Food Plants of Interior First Peoples](#)**

**Sally M. Hunter, Carly Bordeau (Illustrator), Joe Allen (Photographer)**

**[Four Seasons of Corn a Winnebago Tradition](#)**

**Patricia B. Mitchell**

**[Good Land: Native American and Early Colonial Food](#)**

**Edmundo Morales**

**[The Guinea Pig : Healing, Food, and Ritual in the Andes](#)**

**Juanita Tiger Kavena**

**[Hopi Cookery](#)**

**Barb Marchand, Okanagan Native Band**

**[How Food Was Given, Vol. 2](#)**

**Frances Densmore**

**[How Indians Use Wild Plants for Food, Medicine, and Crafts](#)**

**Joseph A. Ezzo**

**[Human Adaptation at Grasshopper Pueblo, Arizona](#)**

**Joanne Dennee, Jack Peduzzi, Julia Hand, Carolyn Peduzzi**

**[In the Three Sisters Garden : Native American Traditions, Myths, and Culture around the Theme of the Garden](#)**

**Katherine A. Spielmann**

**[Interdependence in the Prehistoric Southwest: An Ecological Analysis of Plains-Pueblo Interaction](#)**

**Beverly R. Ortiz,Julia Parker**

**[It Will Live Forever: Traditional Yosemite Indian Acorn Preparation](#)**

**Carol Cunkle**

**[Kokopelli's Cookbook](#)**

**Travis Hudson,Thomas C. Blackburn**

**[Material Culture of the Chumash Interaction Sphere: Food Procurement and Transportation](#)**

**Native Womens Association,David Hunt (Editor)**

**[Native Indian Wild Game, Fish and Wild Foods Cookbook: Recipes from North American Native Cooks](#)**

**Suzanne Pelican,Karen Bachman-Carter**

**[Navajo Food Practices, Customs, and Holidays](#)**

**Ron Hirschi,Deborah Cooper (Illustrator),Edward S. Curtis (Photographer)**

**[People of Salmon and Cedar](#)**

**Phyllis Hughes (Compiler),Adapted by Pricilla Vigil**

**[Pueblo Indian Cookbook: Recipes from the Pueblos of the American Southwest](#)**

**Keewaydinoquay,Keewaydinoquay Peschel**

**[Pubpohwee for the People: A Narrative Account of Some Uses of Fungi among the Ahnishinaabeg](#)**

**Gordon Regguinti,Dale Kakkak (Photographer),Foreword by Michael Dorris**

**[The Sacred Harvest: Ojibway Wild Rice Gathering](#)**

**Marina Polvay**

**[Seminole Indian Recipes](#)**

**Beverly Cox,Martin Jacobs**

**[Spirit of the Harvest: North American Indian Cooking](#)**

**Harriet V. Kuhnlein,Nancy J. Turner**

**[Traditional Plant Foods of Canadian Indigenous Peoples: Nutrition, Botany and Use, Vol. 8](#)**

**Thomas Jr. Vennum**

**[Wild Rice and the Ojibway People](#)**

**Frank Hamilton Cushing**

**[ZuäNi Breadstuff](#)**



**Additional book list being compiled.  
In the meantime,**

**[Click here to Search for Books about Native American Recipes](#)**

**[Search for Books at  
barnesandnoble.com](#)**

Search by:

---

**[Return to Food & Recipes Menu](#)**



**Text and Graphics  
© 1994 - 103 [Tara Prindle](#)  
unless otherwise cited.**

## NativeTech: Native American Technology & Art

# NativeTech Bookpages

In affiliation with [barnesandnoble.com](http://barnesandnoble.com)

---



NativeTech's Bookpages brings together in one area all the separate bibliographies which list the various books cited in NativeTech's articles. Many of the articles at this website were researched using museum and archaeological collections, published literature as well as personal communication with contemporary Native Americans. I would like to share those sources with you. I have linked as many of my references as possible to the Barnes and Noble booksellers website, so you can have these on your own bookshelf. I've also found a few other noteworthy books they offer and have appended these to my bibliographies.

---

### *NativeTech's Bibliographies*

- |                                                                                                                                        |                                                                                                                                    |
|----------------------------------------------------------------------------------------------------------------------------------------|------------------------------------------------------------------------------------------------------------------------------------|
|  <a href="#"><u>Beadwork</u></a>                    |  <a href="#"><u>Leather &amp; Clothes</u></a>  |
|  <a href="#"><u>Birds &amp; Feathers</u></a>        |  <a href="#"><u>Metalwork</u></a>              |
|  <a href="#"><u>Birchbark</u></a>                   |  <a href="#"><u>Plants &amp; Trees</u></a>     |
|  <a href="#"><u>Branches, Twigs &amp; Roots</u></a> |  <a href="#"><u>Porcupine Quills</u></a>       |
|  <a href="#"><u>Cattails &amp; Grasses</u></a>      |  <a href="#"><u>Pottery &amp; Clay</u></a>     |
|  <a href="#"><u>Cornhusks</u></a>                   |  <a href="#"><u>Stonework &amp; Tools</u></a>  |
|  <a href="#"><u>Food &amp; Recipies</u></a>         |  <a href="#"><u>Weaving &amp; Cordage</u></a>  |
|  <a href="#"><u>Games &amp; Toys</u></a>            |  <a href="#"><u>Art &amp; Other Crafts</u></a> |



---

The articles presented at NativeTech, and the book lists above, don't come close to representing the myriad of Native American technologies; but after all, it's just one person's (perhaps obsessive) efforts to build a resource (and perhaps a better understanding) for the 'ethnotechnology' of Native Americans. The NativeTech website was born in 1994 with a single page on plants. Since that time NativeTech has grown to over 500 pages, through my volunteered efforts and by space provided by [NativeWeb](#). With your purchase of a book from Barnes and Noble through one of my links, I receive a small commission which helps me in the time I spend developing NativeTech as an educational resource.

---



© 1994-2000 [Tara Prindle](#).

NativeTech: Native American Technology & Art



## BEADWORK BIBLIOGRAPHY

Click on the links below for the books you can order on-line in affiliation with [barnesandnoble.com](http://barnesandnoble.com)

---

### *References cited in NativeTech's [Beadwork articles](#):*

**Anonymous**

**1967 'Narrative of a Journey into the Mohawk and Oneida Country' [1634-1635]. In Narratives of New Netherland, 1609-1664.**

F.J. Jameson, ed. Pp. 135-162. New York: Barnes and Noble.

[Order this book through barnesandnoble.com](#)

**Barth, Georg J.**

**1993 Native American Beadwork: Traditional Beading Techniques for the Modern-Day Beadworker.**

Stevens Point WI.

[Order this book through barnesandnoble.com](#)

**Bradley, James W.**

**1983 'Blue Crystals and Other Trinkets: Glass Beads From 16th and Early 17th Century New England'.**

In Proceedings of the 1982 Glass Trade Bead Conference, C.F. Hayes III, ed. New York: Rochester Museum and Science Center.

**Bradford, William**

**1981 Of Plimoth Plantation, 1620-1647.**

New York City, New York: Random House.

[Order this book through barnesandnoble.com](#)

**Ballantine, Betty**

**1993 The American Indians.**

Turner Publishing Inc.: Atlanta, Ga.

**Beauchamp, William M.**

**1903 Metallic Ornaments of the New York Indians.**

New York State Museum Bulletin 73.

[Order this book through barnesandnoble.com](#)



**Billings, Katherine**

**1980 Beads of Shell and Glass. In Burr's Hill, A 17th Century Wampanoag Burial Ground in Warren, Rhode Island.**

S.G. Gibson, ed. Pp. 118-127. Brown University, RI: Haffenreffer Museum of Anthropology.

**Ceci, Lynn**

**1982 The Value of wampum among the New York Iroquois: A case study in artifact analysis.**

**In Journal of Anthropological Research.**

**38(1): 97-107.**

**Brain, Jeffry P.**

**1979 Tunica Treasure.**

Peabody Museum of Archaeology and Ethnology, Harvard University, Cambridge, MA And the Peabody Museum of Salem, Salem, MA.

**Ceci, Lynn**

**1990 "Native Wampum as a Peripheral Resource in the Seventeenth-Century Word-System." In The Pequots in Southern New England, The Fall and Rise of an American Indian Nation.**

L.M. Hauptman and J.D. Wherry, ed.s. Pp. 48-63. Norman, Oklahoma: University of Oklahoma Press.

[Order this book through barnesandnoble.com](http://www.barnesandnoble.com)

**Church, Colonel Benjamin**

**1975 Diary of King Philip's War 1675-1676. Introduction by Alan and Mary Simpson. Published for the Little Compton Historical Society; Tiverton, RI: Lockwood Publications.**

[This book is Unavailable. But here are some related books.](#)

**De Forest, John W.**

**1852 History of the Indians of Connecticut from the Earliest Known Period to 1850.**

Hartford, CT: W. J. Hamersley.

[Order this book through barnesandnoble.com](http://www.barnesandnoble.com)

**Fogelman, Gary L.**

**1991 Glass Trade Beads in the Northeast and Including Aboriginal Bead Industries.**

Fogelman Publishing Co.: Turbotville, PA.

[Order this book through barnesandnoble.com](http://www.barnesandnoble.com)

**Fowler, William S.**

**1976 A Handbook of Indian Artifacts from Southern New England.**

Reprinted: 1983. Massachusetts Archaeological Society, Inc.

**Gibson, Susan G.**

**1980 Catalogue of the Collection. In Burr's Hill, A 17th Century Wampanoag Burial Ground in Warren, Rhode Island.**



**S.G. Gibson, ed. Pg. 128-174. Brown University, RI: Haffenreffer Museum of Anthropology.**

**Gookin, Daniel**

**1970 Historical Collections of the Indians in New England.**

J.H. Fiske, ed. London: Towaid. (First published 1674).

[Order this book through barnesandnoble.com](http://barnesandnoble.com)

**Groce, Nora**

**1980 Ornaments of Metal: Rings, Medallions, Combs, Beads and Pendants. In Burr's Hill, A 17th Century Wampanoag Burial Ground in Warren, Rhode Island.**

S.G. Gibson, ed. Pp. 108-117. Brown University, RI: Haffenreffer Museum of Anthropology.

**Hamell, George R**

**1983 'Trading in Metaphors: The Magic of Beads.' In Proceedings of the 1982 Glass Trade Bead Conference.**

C.F. Hayes III, ed. New York: Rochester Museum and Science Center.

**Hammett, Julia E. and Beverly A. Sizemore**

**1989 "Shell beads and Ornaments: Socioeconomic Indicators of the Past". In Proceedings of the 1986 Shell Bead Conference: Selected Papers.**

C.F. Hayes III, ed. Pp. 125-138. Research Records No. 20. New York: Rochester Museum and Science Center.

**Hayes, Charles F. III**

**1989 "An Introduction to the Shell and Shell Artifact Collection at the Rochester Museum and Science Center". In Proceedings of the 1986 Shell Bead Conference: Selected Papers.**

C.F. Hayes III, ed. Pg. 37-44. Research Records No. 20. New York: Rochester Museum and Science Center.

**Heath, Dwight B., ed.**

**1986 Mourt's Relation: A Journal of the Pilgrims at Plymouth.**

Cambridge: Applewood books. (First published in 1622).

[Order this book through barnesandnoble.com](http://barnesandnoble.com)

**Jennings, Francis**

**1976 The Invasion of America: Indians, Colonialism, and the Cant of Conquest.**

New York: W. W. Norton & Company, Inc.

[Order this book through barnesandnoble.com](http://barnesandnoble.com)

**Josselyn, John**

**1972 New-Englands Rarities Discovered.**

Meriden: Meriden Gravure Co. (First published 1672).

[Order this book through barnesandnoble.com](http://barnesandnoble.com)



**Juet, Robert**

**1967 From "The Third Voyage of Master Henry Hudson" [1610]. In Narratives of New Netherland, 1609-1664.**

F.J. Jameson, ed. Pp. 11-28. New York: Barnes and Noble.

[Order this book through barnesandnoble.com](http://www.barnesandnoble.com)

**King, J.C.H.**

**1991 "Wooddland Artifacts from the Studio of Benjamin West 1738-1820. In American Indian Art.**

Vol. 17, No 1. Pg. 34-47.

**Krepcio, Marion**

**2001 Personal Communication in reference to a talk on Wampum presented to the Boston Malacological Club. Donation of shells.**

**Leavitt, Robert M and David A Francis, eds.**

**1990 Wapapi Akonutomakonol ~ The Wampum Records: Wabanaki Traditional Laws. (68 pp., illustrated) Fredericton: Micmac-Maliseet Institute, UNB . For information about availability: Micmac-Maliseet Institute, University of New Brunswick, Fredericton, NB, Canada E3B 6E3**

**Monture, Joel**

**1993 The Complete Guide to Traditional Native American Beadwork. A definitive Study of Authentic Tools, Materials, Techniques, and Styles.**

New York: Macmillian Publishing Co.

[Order this book through barnesandnoble.com](http://www.barnesandnoble.com)

**Morgan, Lewis H.**

**1993 League of the Iroquois.**

New York: Carol Publishing Group.

[Order this book through barnesandnoble.com](http://www.barnesandnoble.com)

**Orchard, William C.**

**1975 Beads and Beadwork of the American Indians. New York: Museum of the American Indian / Heye Foundation.**

[Order this book through barnesandnoble.com](http://www.barnesandnoble.com)

**Pendergast, James F.**

**1983 The Significance of Some Marine Shell Excavated on Iroquoian Archaeological Sites in Ontario. In Proceedings of the 1982 Glass Trade Bead Conference.**

C.F. Hayes III, ed. New York: Rochester Museum and Science Center.

**Radin, Paul**

**1990 The Winnebago Tribe.**

Lincoln & London: University of Nebraska Press.



[Order this book through barnesandnoble.com](http://www.barnesandnoble.com)

**Ritzenthaler, Robert E. and Pat Ritzenthaler**  
**1970 The Woodland Indians of the Western Great Lakes.**  
Garden City, NY: Natural History Press.  
[Order this book through barnesandnoble.com](http://www.barnesandnoble.com)

**Russell, Howard**  
**1980 Indian New England Before the Mayflower.**  
Hanover: University Press of New England.  
[Order this book through barnesandnoble.com](http://www.barnesandnoble.com)

**Salisbury, Neal**  
**1982 Manitou and Providence, Europeans & the Making of New England, 1500-1643.**  
New York City, New York: Oxford U P.  
[Order this book through barnesandnoble.com](http://www.barnesandnoble.com)

**Simmons, William S.**  
**1970 Cautantowwit's House: An Indian Burial Ground on the Island of Conanicut in Narragansett Bay.**  
Providence, RI: Brown University Press.  
[Order this book through barnesandnoble.com](http://www.barnesandnoble.com)

**Snow, Dean R.**  
**1980 The Archaeology of New England.**  
New York: Academic Press.

**Speck, Frank G.**  
**1976 Penobscot Man: The Life History of a Forest Tribe in Maine.**  
New York: Octagon Books.  
[Order this book through barnesandnoble.com](http://www.barnesandnoble.com)

**Speck, Frank G.**  
**1919 The Functions of Wampum Among the Eastern Algonkian.**  
Lancaster, Pennsylvania: American Anthropological Association.

**Speck, Frank G.**  
**1915 Decorative Art of Indian Tribes of Connecticut. Anthropological series 10.**  
Memoirs of the Canadian Geological Survey 75. Ottawa, Ont: Canadian Department of Mines.

**Tehanetorens (Ray Fadden)**  
**1972 Wampum Belts.**  
Onchiota, NY.: Six Nations Indian Museum. Reprinted 1983. Ontario, Canada: Irocrafts Ltd.

[Order this book through barnesandnoble.com](http://www.barnesandnoble.com)

**Thomas, Peter Allen**

**1979 In the Maelstrom of Change. The Indian Trade and Cultural Process in the Middle Connecticut River Valley 1635-1665.**

Ann Arbor, Michigan: University Microfilms International.

[Order this book through barnesandnoble.com](http://www.barnesandnoble.com)

**Trigger, Bruce G. ed.**

**1978 Handbook of North American Indians, Vol. 15.**

W. Sturtevant, gen. ed. Washington, D.C.: Smithsonian Institution.

[Order this book through barnesandnoble.com](http://www.barnesandnoble.com)

**Turnbaugh, William A.**

**1984 A Mid-17th Century Narragansett Indian Burial Site in North Kingstown, Rhode Island.**

University of Rhode Island, Kingstown: Rhode Island Dept. of Sociology and Anthropology.

**Turnbaugh, William A. and Sarah P. Turnbaugh**

**1986 Indian Baskets.**

West Chester PA: Schiffer Publishing Company.

[Order this book through barnesandnoble.com](http://www.barnesandnoble.com)

**van der Donck, Adrien**

**1968 A Description of the New Netherlands.**

T. O'Donnell, ed. Syracuse: Syracuse University Press. (First published 1656).

**van Wassenaer, Nicolase**

**1967 From the "Historisch Verhael" [1624-1630]. In Narratives of New Netherland, 1609-1664.**

F.J. Jameson, ed. Pp. 61-96. New York: Barnes and Noble.

[Order this book through barnesandnoble.com](http://www.barnesandnoble.com)

**Vaughan, Alden T.**

**1979 New England Frontier; Puritans and Indians 1620-1675.**

Revised edition. New York: W. W. Norton and Company.

**Williams, Roger**

**1973 Key into the Language of America.**

J.J. Teunissen and E.J. Hinz, ed.s. Detroit: Wayne State University Press. (First printed 1643).

[Order this book through barnesandnoble.com](http://www.barnesandnoble.com)

**Wood, William**



**1977 New England's Prospect.**

London, England: 1634. Ed. Alden T. Vaughn. Amherst, Massachusetts: University of Massachusetts Press.

[This book is Out of Print. But used copies are available here.](#)

**Wray, Charles F., Martha L. Sempowski, Lorraine P. Saunders, Gian Carlo Cervone**  
**1987 The Adams and Culbertson Sites. The Charles F. Wray Series in Seneca Archaeology,**  
**Vol.I, No.15.**

New York: Rochester Museum and Science Center.

**Wray, Charles F.**

**1983 Seneca Glass Trade Beads C.A.D. 1550-1820. In Proceedings of the 1982 Glass Trade**  
**Bead Conference.**

C.F. Hayes III, ed. New York: Rochester Museum and Science Center.

**Wroth, Lawrence C., ed.**

**1970 The Voyages of Giovanni da Verrazzano, 1524-1528.**

New Haven and London: Yale University Press.

My most heartfelt appreciation goes to Nunya Ageya (Shelley Smith), Quapaw,  
for teaching me beadwork, for giving me a most enjoyable case of 'bead fever' and the incentive to learn.

---

*Other Books relating to Beadwork you can buy on-line through* [barnesandnoble.com](http://barnesandnoble.com):

**Ben W. Hunt, J. F. Burshears**

[American Indian Beadwork](#)

**Joyce Mori**

[Applique Patterns from Native American Beadwork Designs](#)

**Pamela Stanley-Millner**

[Authentic American Indian Beadwork and How to Do It: With 50 Charts for Bead Weaving and 21 Full-Size Patterns for Applique](#)

**Peggy Sue Henry**

[Beads to Buckskins: Beading Patterns and Illustrated Techniques of the Native American Indian, and Introducing How to Sew Buckskin Garments, Vol. 2](#)

**Jean Heinbuch**

[A Beadwork Companion: A Step by Step Illustrated Workbook for Beading Projects](#)



**Kay Doherty Bennett**

**[Big Book of Indian Beadwork Designs](#)**

**William Wildschut, John C. Ewers**

**[Crow Indian Beadwork: A Descriptive and Historical Study](#)**

**May A. Owen**

**[Folk-Lore of the Musquakie Indians of North America and Catalogue of Musquakie Beadwork and Other Objects in the Collection of the Folk-Lore Society](#)**

**Preston E. Miller and Carolyn Corey Carloyn Corey**

**[The Four Winds Guide to Indian Trade Goods and Replicas: Including Stone Relics, Beads, Photographs, Indian Wars, and Frontier Goods](#)**

**Gloria A. Lomahaftewa, Barbara Loeb**

**[Glass Tapestry: Plateau Beaded Bags from the Elaine Horwitch Collection](#)**

**Horace R. Goodhue, Jim Dochniaik (Editor), M. Barich (Illustrator), J. Szelka (Illustrator), T. Schwab (Illustrator), S. Skjold (Illustrator), Terry Schwab (Photographer)**

**[Indian Bead-Weaving Patterns: Chain-Weaving Designs, Bead Loom Weaving, and Bead Embroidery - an Illustrated how-to Guide](#)**

**Pamela Stanley-Millner**

**[North American Indian Beadwork Patterns](#)**

**James E. Byrd and Linda Byrd (Illustrator)**

**[Olde Bead Monger's Trade Bead Sketchbook](#)**

**Z. Susanne Aikman**

**[Primer: The Art of Native American Beadwork](#)**

**Carrie A. Lyford, Ca**

**[Quill and Beadwork of the Western Sioux](#)**

**Kate C. Duncan, Eunice Carney**

**[A Special Gift : The Kutchin Beadwork Tradition](#)**

**Monte Smith, Ralph L. Smith (Illustrator)**

**[The Technique of North American Indian Beadwork](#)**

**Lynn Harrison**

**[Traditions: Beadwork of the Native American](#)**

**Michael H. Logan, Douglas A. Schmittou**

**[With Pride They Made These: Tribal Styles in Plains Indian Art](#)**

**Additional book list being compiled.  
In the meantime,**

**[Click here to Search for Books about Beads & Beadwork](#)**

**[Search for Books at  
barnesandnoble.com](#)**

Search by:

---

**[Return to NativeTech's Main Beadwork Menu](#)**







---



© 1994-1999 **[Tara Prindle.](#)**



## BEADS AND BEADWORK

-  [Beads and Pendants ~ Meaning in Native American Life](#)
-  [Bead and Pendant Types of the Northeast](#)
-  [Bead Weaving Techniques and Analysis](#)
-  [Woven Wampum Beadwork ~ History & Background](#)
-  [Glass Beads ~ Introduction, Use & Techniques](#)
-  [Seminole Beads ~ by Michael R. Brown](#)



**NativeTech**  
**HOME PAGE**

Text and Graphics  
© 1994 - 2003 [Tara Prindle](#)  
unless otherwise cited.

## NativeTech: Native American Technology and Art. NATIVE AMERICAN BEADWORK

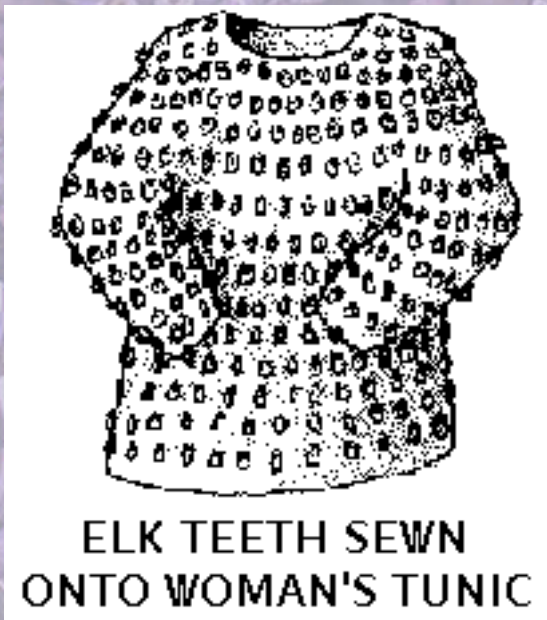
---

### Beads and Pendants of the Eastern Forest

#### ~Meaning in Native American Life~

Beauty aside, wearing or presenting jewelry had many social, economic, political and religious implications for the Native Americans of the 1600ís in southern New England. Jewelry was used to show connection with a particular group. Beads validated treaties and were used to remember oral tradition, as well as for exchange and currency. There were many ritual aspects of beads and pendants used in ceremonies of dance, curing and sacrifice. Jewelry was also used in many rites of passage which individuals passed through in their lives.

#### Personal Aesthetics:



Native Americans in New England, especially young women, enhanced their dress with beads and pendants. Wampum beads were treasured possessions and elaborate types and large amounts of jewelry were worn. Native American women, however, were considered less vain than European women. Besides jewelry, beads decorated clothing or were inlaid into objects of wood for aesthetic beauty. Wampum inlaid wooden items included tomahawk handles, pendants, and native bread mixing bowls.

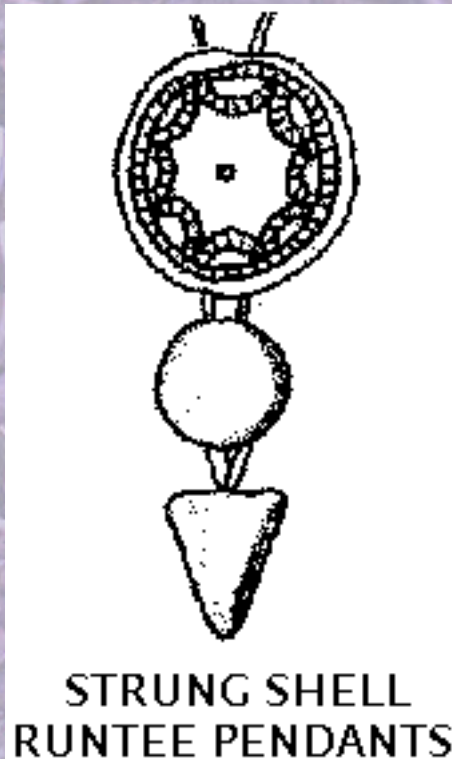
#### Group Identity:

Among many northeastern tribes, individuals acquired a spiritual totem at adolescence, often a mammal, snake, bird, claw, tooth or other animal part which was henceforth carried with that individual. Personal totems



often coincided with those of a person's family, clan or society. Jewelry was a means for Native Americans to show they belonged to that group. A male cat's head wrapped in trade cloth was one such totem. Totems were used in divination and to ensure opportunity. Native Americans wore beads and pendants to show ingredients in their social lives, economic and political concerns, and in beliefs of cosmology and religion.

### Exchange and Currency:



In New England, wampum beads were part of an economy of reciprocity and gift exchange. Reciprocal gift giving cemented ties between Native Americans. Wampum beads and pendants adorned high status men and young women of a tribe. The similarity in design, and abundance of shell pendants, at both coastal and inland areas attests to Native American networks of regional trade.

With the volume of trade after European contact, eastern Native Americans traded wampum inland to Wisconsin and the Dakotas, and as far south as Virginia. Using shell, glass and metal beads, early colonists and Native Americans could barter for the products of the other. European traders and politicians, using beads and trinkets, often exploited gift exchange to gain Native American favor or lands. Wampum quickly evolved into a formal currency. A fathom of white beads was worth 10 shillings and double that for purple beads. The wampum embroidered clothing of King Philip was valued at twenty



**pounds. Metal coins were scarce and wampum became currency for both colonists and Native Americans. Wampum was even mass-produced by the Dutch, and remained in use until the American Revolution.**

### **Ceremonies:**

**Native Americans in New England integrated beads and pendants into many of their ceremonies. Beads and pendants of natural materials were often used in ritual expression because of Native American esteem placed upon minerals and metals of the earth, and the association of shells with water. Dance ceremonies celebrated the change in seasons, harvest, births, marriages, or commemorated less fortunate events, and were often accompanied by chanting. Native Americans took great pains in the preparation of their appearance and accessories. Dances were often accompanied by throwing out wampum to onlookers. Beads were often distributed and redistributed during Native American dance ceremonies.**

**Ceremonies of healing and curing often required the use of specific types of jewelry or ornamentation. Shells of many animals, including turtles, were utilized in healing ceremonies. Some New England Native American necklaces provided protection from particular disorders. Face-painting using red, and hair ornaments of that color are also associated with curing ceremonies. Jewelry worn and other personal objects used in southern New England dance ritual were often relinquished or destroyed in sacrifice.**

### **Rites of Passage:**

**Jewelry was worn or exchanged by Native Americans to indicate that individual had passed through an important physical or social change. These transformations are called rites of passage. Such a change was after a Native American woman had her first menses, when she wore a**



garment which covers head and body for several months. After this time the women may remove the veil and dress themselves with necklaces, belts, and wampum headbands. Beads were also used in marriage rituals. Bridal presents, including wampum, Dutch glass and other beads were given to a woman for bridal present, which if she accepts, conceded to marry the man. Some bridal presents consisted of five to ten fathoms of wampum. Beads were also incorporated into Native American funeral and mortuary customs in southern New England. The deceased often wore necklaces, bracelets, rings, headband, and other ornaments provided by relatives.

---

[Continue Reading about Beads and Pendants; Display in the Eastern Forests](#)

[Beadwork Bibliography and Books to Buy On-Line](#)

---



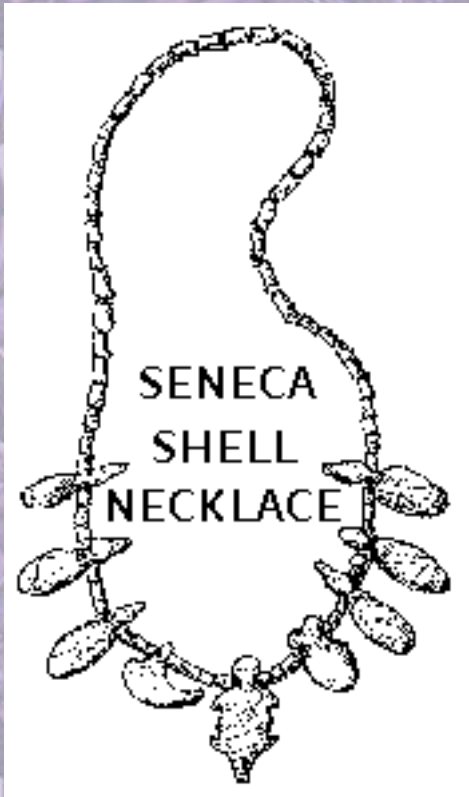
© 1994-2001 [Tara Prindle.](#)

# DISPLAY OF NATIVE AMERICAN BEADWORK

---

## ~Types of Jewelry and Ornaments in the Eastern Forests~

### Neck Ornaments



Prehistoric Native American necklaces were made of shell, bone, teeth, claws, pottery and other natural materials. A traditional Penobscot necklace consists of deer antler prongs and deer hoofs bored and strung on leather. Pendants or bags, some containing tobacco, were suspended from necklaces. One curative necklace had a pouch containing tree frogs said to 'stop womenís overflowing courses.' Another necklace of fawns teeth helped teething children. Native Americans often hung bunches of deerís hair dyed red from their neck.

Shell necklaces were made of wampum and various ornaments which were highly esteemed by Native American women. Wampanoag wore strands of tubular and discoidal purple and white shell beads. Narragansett wore strings of



**SENECA  
SHELL  
NECKLACE**



long and short whelk shell beads hung around the neck, while women wore shell beads both white and purple, long and short, strung alternately in a double rope. Shell necklaces worn by Seneca include effigy pendants separated by smaller tubular and other shaped shell beads, similar in arrangement to necklaces from southern New England. Symmetry in the arrangement of pendants was not essential and possibly not even desired.

**SHELL,  
CATLINITE &  
TRADE BEAD  
NECKLACE**



After Europeans contact, beads, pendants and brooches of metal and glass were used for neck ornaments. Penobscot girls wore necklaces of glass beads fastened to ribbons. Wampanoag wore necklaces of European round copper beads, or strands of glass chevron beads. Narragansett had necklaces of blue and white glass beads with bells and thimbles.

## **Woven Bands**

Woven beadwork is distinguished from strands in necklaces and bracelets. Woven beads are oriented in rows of beads placed side by side, not end to end; the result being a wide strip of beads with a geometric design. The bow loom, (similar to an archers bow), was the only type of formal loom used by Natives of New England. The bow loom was used exclusively with



wampum or small glass beads, needle and thread, commonly exchanged during the time of European contact. Before use of the bow loom, Native Americans probably secured only one end of a belt for weaving. Using a hand-held finger weaving technique, beads were interwoven one at a time using a doubled thread, into the loose end of the forming belt. Many of the existing use both leather thongs and vegetal fibers for cords and strings. Some fibers used were dogbane (*Apocynum cannabinum*), sometimes called armyroot or black Indian hemp; swamp milkweed (*Asclepias incarnata*), and the hairy milkweed (*A. pulchra*), also called white Indian hemp; toad flax (*Linaria linaria*), and Indian mallow (*Abutilon abutilon*) also known as velvet leaf.

By the late 1500ís, wampum was being woven into strips and belts containing white beads. The first purple wampum was used in such weaving by the early 1600ís. An early engraving depicts a Delaware family dressed in belts, headbands, bracelets, strings, and medallions of black and white wampum beads. Glass and metal beads were eventually woven into strips that were at one time made only of wampum. Wampanoag woven beadwork from this time uses blue and white glass pony beads. Wampanoag leader, King Philip, wore a wampum belt or bandolier (over the shoulder sash) that was nine inches wide and five feet long, with designs of flowers, birds and animals.



WOVEN WAMPUM BAND FROM NEW ENGLAND.



DELAWARE FAMILY WEARING WOVEN WAMPUM BELTS AND BANDS.

**Headbands in southern New England were narrow strips of woven wampum five to seven**



rows wide. These smaller bands have geometric designs in two or three colors of diagonal lines, triangles, nested-squares, crosses or a central figure. King Philip's headband was secured at the back of his head with two "flags" which hung down his back, perhaps long thong ties or decorations appended to them. Some beaded headbands were edged with red-dyed moose hair obtained from Mohawk territory. Northeastern Native Americans also wore bead collars, which used shorter beads than those in used in making bandoliers. Penobscot and Wampanoag collars used a diagonal weaving technique called the bias-weave in designs of thin diagonal lines and diamond shapes.

## Ear Ornaments



Earrings of all kinds were worn by both Native American men and women. Some ear ornaments were carved from bone, shells and stone in the form of birds, animals and fish, some obtained in trade from Europeans such as little bells and blue crystals. North Carolina Algonquian men wore in his ears two long bi-conical beads of rolled sheet brass decorated with etched lines. Native Americans in Massachusetts wore copper ear pendants. The earliest metallic earrings in use by Seneca were observed to be those of copper wire coiled and flattened. Brass and copper wire spirals and hoops were worn in the ears of Seneca. Onondaga also wore copper earrings, bent into a double-curve. Narragansett men wore two striped tubular glass beads in each ear. Narragansett woman wore whelk ear pendants.

## Anklets and Garters

Native Americans, including the Narragansett and Wampanoag wore anklets of strung beads and pendants. Women often wore tiny flushloop bells, brass rattles, small sheet metal cones and even perforated thimbles on their anklets. Deer toes and dew claws were used as prehistoric pendants. The pendants jingled or made a tinkling noise when they walked or danced, intended to draw attention. Garters were also worn, just below the knee by men and above the knee by women, to secure their leggings, garters were often decorated with embroidery, beads, animal hair and tinkling cones.

[Return to NativeTech's Beadwork Menu](#)

[Beadwork Bibliography and Books to Buy On-Line](#)





© 1994-2001 [Tara Prindle.](#)

## BEAD AND PENDANT TYPES OF THE NORTHEAST

-  [Bone and Antler](#)
-  [Ceramic](#)
-  [Metal](#)
-  [Shell](#)
-  [Stone](#)

[Return to NativeTech's Main Beadwork Menu](#)

**Note: Some beads and pendants were also drawn from items in the collection of the Office of the Connecticut State Archaeologist and from the collection of the Rhode Island Historic Preservation Office.**



**NativeTech  
HOME PAGE**

Text and Graphics  
© 1994 - 2003 [Tara Prindle](#)  
unless otherwise cited.

# NATIVE AMERICAN BEADWORK

## Bone and Antler Beads and Pendants of the Eastern Forest

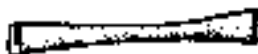
Some of the earliest tubular beads were undoubtedly made from long bones of mammals and birds, or from the bones of other animals, fish or reptiles. Claws, hoofs and teeth were occasional ornaments. Breech clouts, or loincloths, were decorated, sometimes with pieces of whales' fins, whale-bones, or wampum. Sea-horse teeth [Walrus teeth], were readily available, their walrus ivory was considered valuable to the Europeans. The walrus survived in Micmac territory until 1761. Native Americans manufactured articles ivory and antler. Bone beads and ear pendants were carved in the form of animals, birds and fish. Some pendants from southern New England were made from whole bones like turtle femurs, fox mandibles, or teeth and claws, drilled or grooved for suspension.



Bone Tubes



Fish  
Vertebra



Bird Bone



Bone Hair Pipe



Turtle Femurs



Bear



Teeth

Fox  
Mandible



Bear



Bobcat



Claws

Wolf



Coyote

Coyote



Porcupine



Eagle



Elk



Raccoon

Beaver







**Antler Maskettes**



**Bone Pendants**



[Return to Types of Beads and Pendants](#)

[Return to NativeTech's Beadwork Menu](#)

[Beadwork Bibliography and Books to Buy On-Line](#)

**NATIVE TECH  
HOME PAGE**

© 1994-1999 [Tara Prindle](#)

# NATIVE AMERICAN BEADWORK

## Ceramic Beads and Pendants of the Eastern Forest

Clay bead forms included spheres, large barrels, ovals and tubular shapes. The small number of surviving examples of ceramic beads, maskettes, or effigies suggests they were rarely produced or were too fragile to survive the centuries. Narragansett made small clay balls or beads. A late prehistoric period clay maskette from the Delaware/Jersey area is perforated for suspension near the bottom. Another clay maskette made by Northern Iroquois resembles a tiny face, perforated on either side for suspension. Other fired clay pendants include effigies of people, animals or fish.



Ceramic Beads



Ceramic Maskettes



Ceramic Figurine



Wooden Bird Pendant  
(inlaid with brass strips  
and shell bead for eye)

[Return to Types of Beads and Pendants](#)

[Return to NativeTech's Beadwork Menu](#)

[Beadwork Bibliography and Books to Buy On-Line](#)

---



© 1994-1999 [Tara Prindle.](#)



# NATIVE AMERICAN BEADWORK

## Metal Beads and Pendants of the Eastern Forest

Early Native American metal work in New England includes the manufacture of copper and brass ornaments, as well as wire inlay and lead casting to make beads and pendants. Most copper used along the east coast at the time of contact was European in origin, excepting some rare items made of native copper. Native copper of the northeast is found in the Lake Superior region and Nova Scotia. Native Americans of northern New England occasionally used indigenous copper to make beads, frequently small spheres of metal. These beads were made from copper nuggets, repeatedly hammered flat and rolled into shape. The limited use of native copper in the New World did not hinder Native American metal work once European trade copper and sheet brass reached the coast during the 1500ís. Manufacturing techniques of later brass beads and pendants suggest an aboriginal acquaintance with working native copper.

Although some metal beads were produced and traded by Europeans, many other copper and brass ornaments were worked up from broken kettles. When metal vessels became too worn for use as a container, the metal was often cut-up, and recycled into other items, including beads and pendants. The Seneca and other Native Americans wore rolled tubular and tapering oval-shaped brass beads. Native Americans of New York bent strips of copper sheet, probably supplied by Europeans, into tubes and often used the beads in headbands with shell beads. Copper beads and earrings were also made of wire, hammered flat and twisted into a spiral. Tubular brass beads of native manufacture were wrapped around reeds or sticks of wood with spongy centers. European-manufactured brass beads had no core and were likely wound around metal mandrels.

Among Native Americans in the 1600ís, metal pendants imitating teeth, claws, or effigies may have become popular as authentic beads of teeth or bone became unavailable, because the animals were not easily hunted. Native American men across the northeast wore huge breastplates, which hung from the neck, of flattened sheets of copper or brass which often measured a foot long and six inches wide. Such large pendants of sheet metal include a copper éthunderbirdí design gorget from New Hampshire, and Wampanoag sheet brass pendants representing fish or whale effigies. Smaller pendant shapes in sheet metal include triangles and roughed out rectangles and plain perforated brass disks that were slightly domed and probably attached to clothing. Other Native American copper or brass ornaments (sometimes European-made for tobacco or tinder) were small boxes or rattles containing strung wampum or tiny quartz pebbles.



**Rolled Brass**



**Tinkling Cone**



**Cast Brass**



**Copper Coil**



**Twisted Brass Wire**



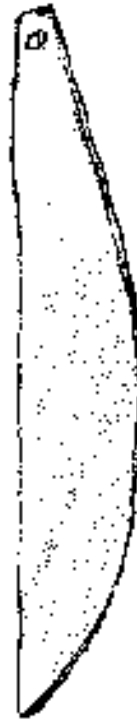
**Rolled Brass Tube**



**THUNDERBIRD**



**WHALE**

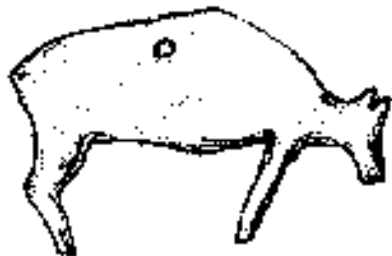


**BEAR CLAW**



**Hammered Brass Effigy**

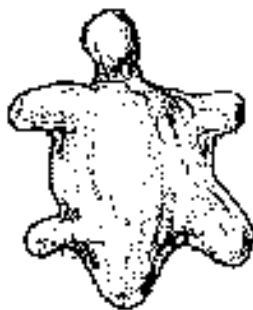
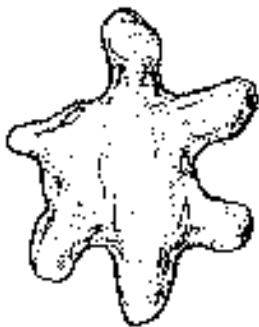
**Brass and Copper Sheet Metal Cut-outs**



**Lead Cut-out**



**Cast Lead Effigies**



[Return to Types of Beads and Pendants](#)

[Return to NativeTech's Beadwork Menu](#)

[Beadwork Bibliography and Books to Buy On-Line](#)

---



**NativeTech  
HOME PAGE**

© 1994-1999 [Tara Prindle.](#)



# NATIVE AMERICAN BEADWORK

---

## Shell Beads and Pendants of the Eastern Forest

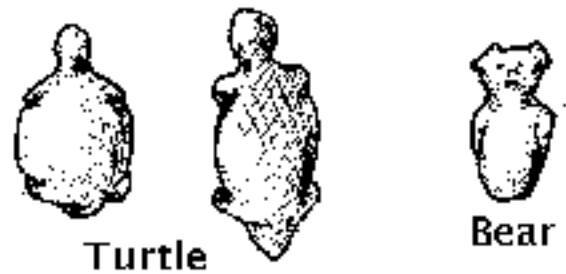
**Before European contact and at least 1500 years ago Native Americans produced barrel-shaped and discoidal shell beads, as well as perforated small whole shells. Prehistoric beads were more robust and had a larger, tapering drilled hole than that of historic wampum. Adoption of slender iron drills over the wider prehistoric stone drills made bead making much more efficient.**

**Wampum "Mints" were located among the Narragansetts and other Native Americans of the southern New England coast. Narragansett called the white shell beads Wûmpam (from the whelk) and called the purple shell beads Sucka<sup>TM</sup>hock (made from the quahog shell). Narragansett bead makers were buried with wampum supplies and tools to finish work in progress elsewhere.**

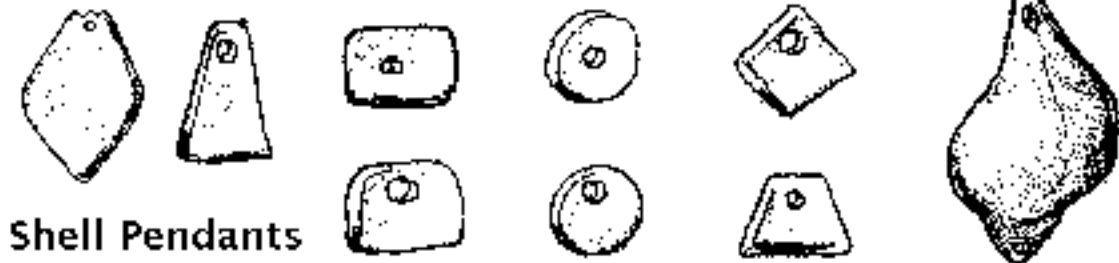
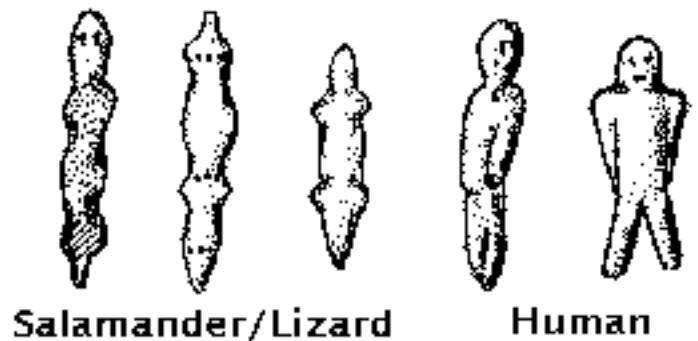
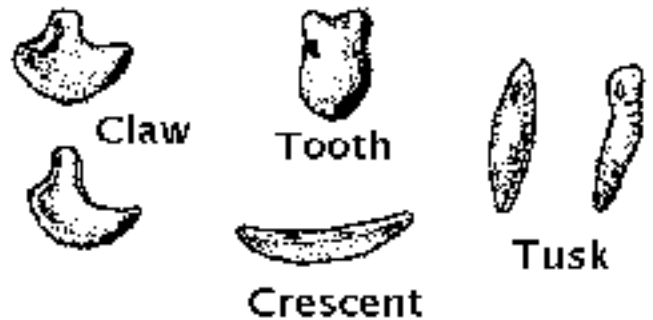
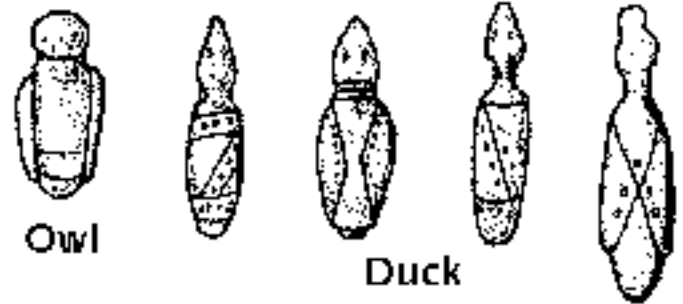
**Shell bead manufacture occurred in winter for employment. Finished wampum was strung onto cord with great attention to quality and sorting. Quahog shell was more scarce and less easily worked than whelk shell, so purple wampum was worth twice the value. Although attempts at imitations included beads of stone and other materials, Native-made wampum was so distinct that it was not easily counterfeited. Narragansett, Wampanoag and other coastal Native American women had huge shell tubes three to four inches and longer, smaller beads were made in the shapes of ovals, barrels, circles, cones, diamonds, triangles, squares, and wavy edge shaped beads.**



### Shell Effigy Pendants

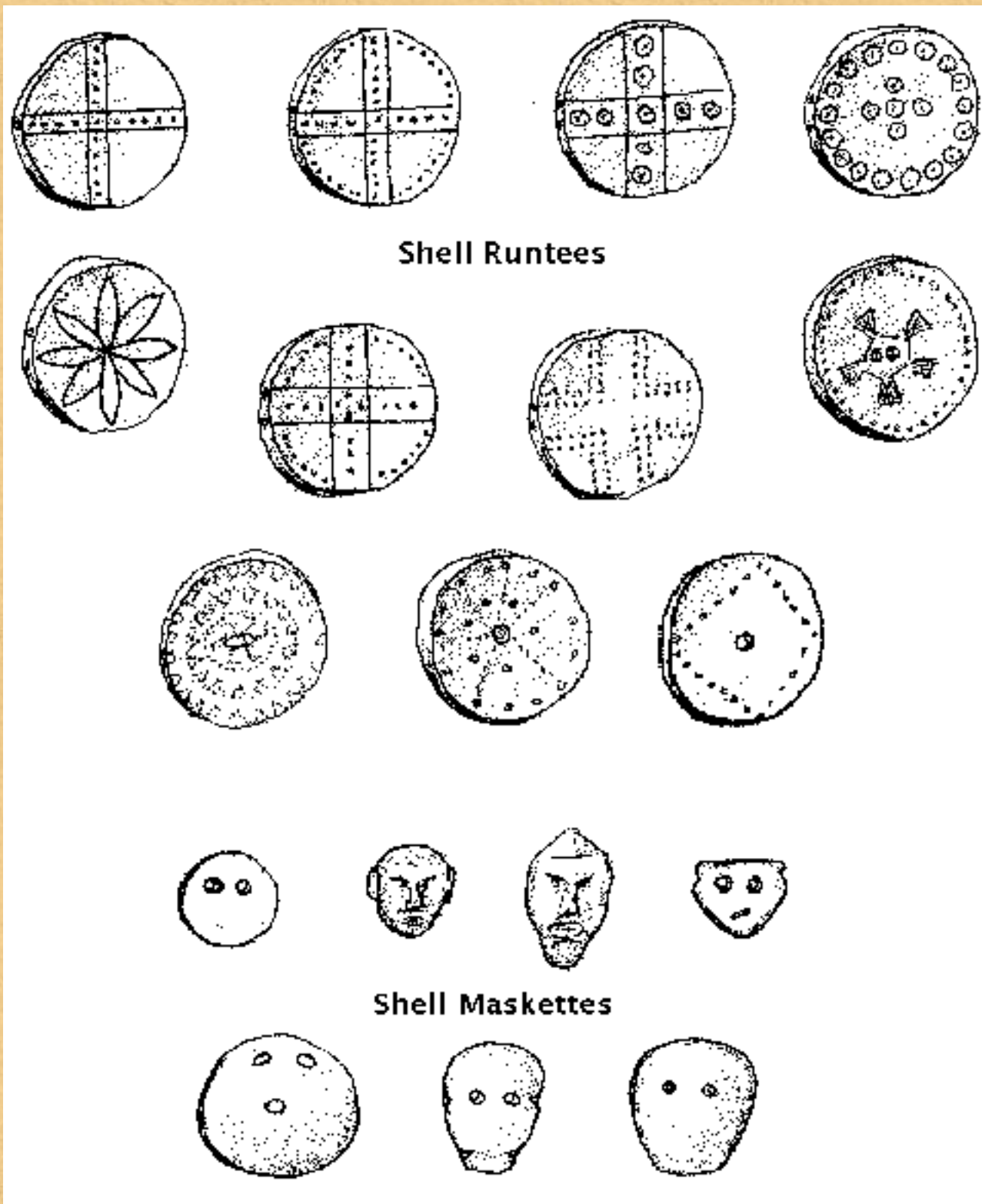


### Whelk and Quahog Beads



Pendants depict effigies of animals, turtles, birds, ducks, bear claw or bird talon forms, and drilled crescent shaped pendants. Narragansett wore teardrop shaped shell pendants. Purple shell claw pendants were worn by Seneca, in the Hudson Valley, in the Middle Connecticut

River Valley and were worn by coastal New England tribes as well. Seneca wore whole drilled columnar shell pendants, large and small, as well as decorated circular, disk-shaped shell *erunteesi*.



[Return to Types of Beads and Pendants](http://www.nativetech.org/bean/shell.html)



[Return to NativeTech's Beadwork Menu](#)

[Beadwork Bibliography and Books to Buy On-Line](#)

---

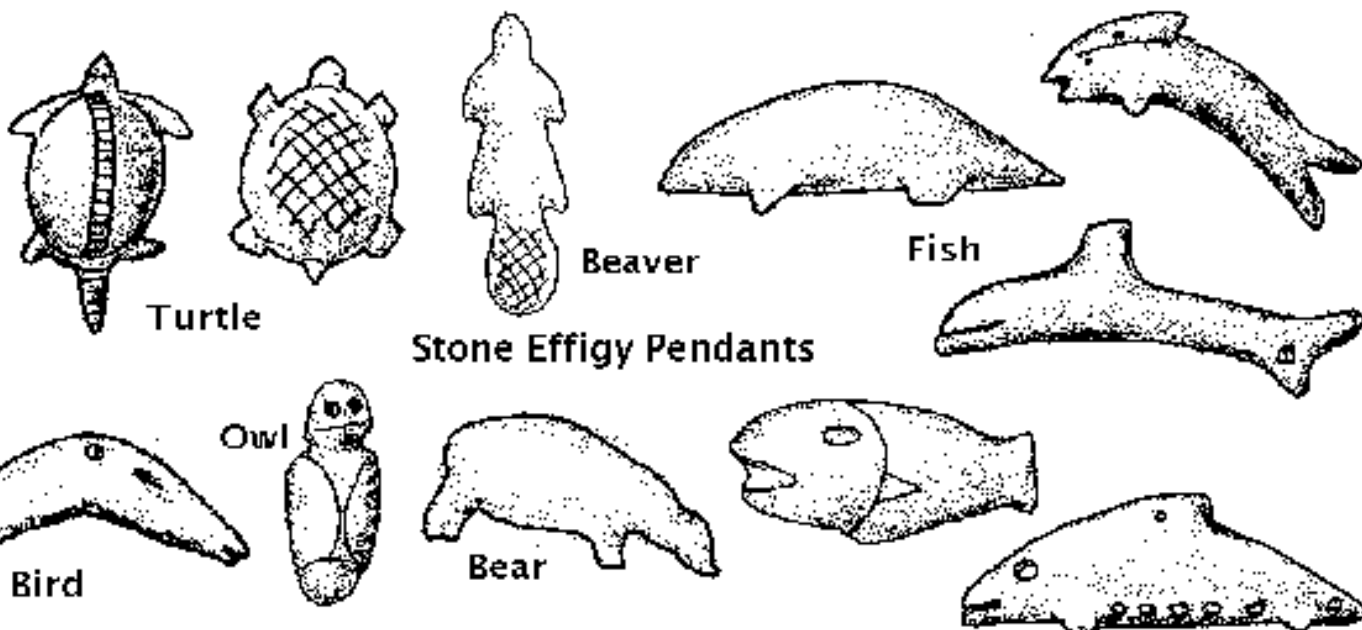
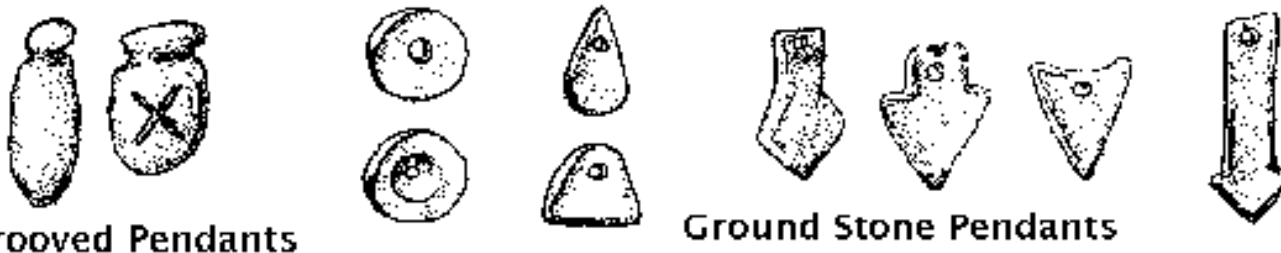
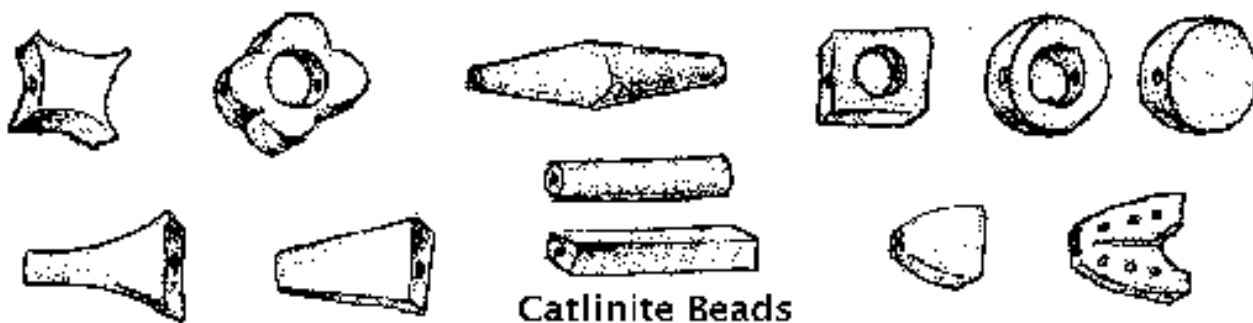


© 1994-1999 [Tara Prindle](#).

# NATIVE AMERICAN BEADWORK

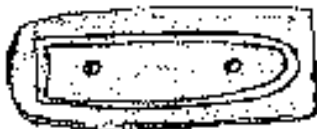
## Stone Beads and Pendants of the Eastern Forest

Native American ground stone combined decorative and utilitarian elements. Stone beads, ground slate pendants, gorgets worn around the neck and other ornamental stones were produced by Native Americans from archaic times through the period of European contact. Stone pendant shapes included ovals, rectangles and diamond shapes with serrated edges, arrows, triangles, animal figures and elongate polished pebbles with full grooves for suspension. Some engraved pendants and gorgets were incised with hatched or zig-zag lines, or figures.





Carved Stone Maskettes



Slate Pendants

Gorgets



Snake



Maize



Thunderbird

4 Directions

Bird

Cross



4 Directions

Bird

Cross

Thunderbird

[Return to Types of Beads and Pendants](#)

[Return to NativeTech's Beadwork Menu](#)

[Beadwork Bibliography and Books to Buy On-Line](#)



**NativeTech  
HOME PAGE**

© 1994-1999 [Tara Prindle.](#)

## NativeTech: Native American Technology & Art Behind the scenes



**Tara Prindle**  
**PO Box 73**  
**Storrs, CT 06268**

[To E-Mail Tara](mailto:tara@nativetech.org)

### Web page design & development:

- [NativeTech: Native American Technology and Art](#)  
[Read more about the NativeTech website.](#)
- [Waaban Aki Crafting](#)  
Traditional Crafts of the Eastern Woodlands.
- [A Line in the Sand, Co-Developer](#)  
A website about issues of cultural property and cultural theft.
- [NIAC ~ Nipmuc Indian Association of Connecticut](#)  
A social organization in Connecticut promoting preservation of Nipmuc Indian and Native American history, material culture, crafts and language, sacred and historical sites.
- [Stroudsburg Fur & Leather](#)  
A commercial website for fur apparel and craft supplies for nature centers, environmental educators, Native American craftspeople and hobbyists.
- [papergraphix.com](#) ~ J.P. Haydock; Distinctive Art Cards & Reproductions  
Combining the beauty of a frameable fine art reproduction with a recycled note card that can be sent for any occasion.

### Past Workshop Leader:

- [Connecticut State Museum of Natural History](#)
- [NIAC ~ Nipmuc Indian Association of Connecticut](#)
- [Mt. Kearsarge Indian Museum, New Hampshire](#)
- [National Audubon Center, Sharon Connecticut](#)
- [Native American Cultural Society](#), University of Connecticut
- Mashantucket Pequot Cultural Resources Department, Ledyard Connecticut
- Glastonbury Garden Center, Glastonbury Connecticut
- Camp Sloan, Lakeville Connecticut
- Rudolf Steiner School, Gt. Barrington Massachusetts



## Formal Education:

- Ph.D. Candidate Anthropology (1988 - discontinued 1997) ~ University of Connecticut
- M.A. Anthropology (1988) ~ University of Connecticut
- B.A. Anthropology (1986) ~ University of Vermont



## Ethnohistory and Archaeology Interests:

- [Projectile Point Classification Software](#)
- [Appropriation & imposition of technology between Natives & Europeans](#)
- [Wampum and the Evolution of Beadweaving](#)

I am not Native American. I am primarily of Scottish descent, my ancestor on my father's side, William [Pringle](#) came to New Haven, CT in 1654 and married Mary Desborough. Pringle was changed to Prindle, the Prindles married into the families of Brown, Goodrich, Sizer (DeSouza), Abbott, Wilcox, Woodward, Dewy, Baird, Sherman, Atwood, Ward, Starr, Weld, Catlin, Roeper, Bule, Baldwin, Bishop, Peck ... among other's unknown... all before the 1700s came to a close. Surnames on my mother's side include Hunter, Garfield, Bailey, Webster, Chapman, Stanton, Fowler, Dean, Reel, Odell, Pitcher, Strong, Clapp, Sheldon, Bullard, Brewer, Bigelow, Bridge, Danforth, Warren, Flag (Flegg), Underwood, Curtiss, Ives, Pierce, Marrison, Abernathy ... and so many more.

---

## Please Read This Before Contacting Tara:

Please contact me if you have articles or material about Native American technology and art you would like to contribute to these pages, or if you have suggested revisions for my topics covered on NativeTech. If you are a student, parent or teacher with a deadline for a school project, I can not answer e-mails I receive asking questions which require research. The search engine on NativeTech's home page may help you find are looking for. I believe more is learned when research is accomplished by the student.

If you're looking for specific information about Native Peoples, genealogy information, homework questions or if you have other questions about Native crafts or indigenous technologies, please post your questions on one of the various [Native-related Message Boards](#) and perhaps those reading the boards may be of help. Please remember to [have patience and keep an open mind](#).

[Please, do not attach files or graphics to an email without warning me first ... otherwise I won't open them.]

**E-mail address:** [tprindle@nativetech.org](mailto:tprindle@nativetech.org)

---

## Notice Concerning Copyright Restrictions and the NativeTech Web Site:

Please be aware that all text and images on the NativeTech website are © 103 Tara Prindle, unless



specifically cited otherwise.

**I encourage classroom use of my NativeTech web site. Students and teachers may print-out text and/or images without restriction for use in a non-internet classroom setting. The following statement should be included on each copy:**

**Copyright © Tara Prindle 103 , NativeTech: Native American Technology and Art.  
Internet URL: <http://www.nativetech.org>**

Any reproduction/transmission of NativeTech's text and/or images (excluding not-for-profit classroom use, or single printing of articles for non-commercial personal use) requires written permission. Any reproduction of NativeTech materials to be stored or displayed on other websites requires written permission. **If you are requesting permission for ANY COMMERCIAL USE of NativeTech materials be prepared to [MAKE A DONATION TO NATIVEWEB, INC.](#)**

NativeWeb hosts NativeTech at no charge, and they deserve to be compensated for the commercial use of one of their hosted sites. To request use of any material from the NativeTech web site, contact Tara Prindle [tprindle@nativetech.org](mailto:tprindle@nativetech.org), the author, designer and developer of NativeTech. Content of the NativeTech web site may not be used for commercial purposes without prior permission.

The copyright law of the United States (Title 17, United States Code) governs the making of reproductions of copyrighted material, including but not limited to downloading, printing, and performance (i.e. display.) Any individual who uses copies of NativeTech's web site text and/or images (<http://www.nativetech.org>) for purposes in excess of "fair use" as defined by the [copyright law](#) may be liable for copyright infringement.

*Note: I have included among the NativeTech pages some text that is copyrighted to others -- it will always be cited as such. I have scanned & hand colored some images from books copyrighted to others -- they will always be cited as such. Text/images attributed to others have either been contributed to NativeTech by the author/artist, or the text/image has been used under copyright laws relating to educational [Fair Use](#). I can not grant permission for the use of text/images attributed to others, permission for their use must be granted by the original author/artist.*

Permission has **\*not\*** been granted for 'Public Domain' use of NativeTech's text/backgrounds/images. If you have found any of my material on another web site without a 'permission granted' statement, or in a collection of web clip art, it has been placed there without my permission. I would be very grateful to be informed of the use of my text/images on other web sites.



**Text and Graphics  
© 1994 - 103 [Tara Prindle](#)  
unless otherwise cited.**

# Nipmuc Indian Association of Connecticut

*The Nipmuc Indian Association of Connecticut is dedicated to our Nipmuc ancestors, to our future seven generations, and to all who have helped our People.*



Nipmuc Indians are the original people of central New England, and are among the "Eastern Woodlands" or Algonquian Indians of the Eastern United States. Before the arrival of European settlers in the 1600s, the Nipmuc (or "Fresh Water People") lived in numerous band encampments, or *ëvillagesí*, near bodies of fresh water in a territory (called *ëNipnetí*) which extended from the present day Vermont and New Hampshire borders, through Worcester County in Massachusetts, into northern Rhode Island, and into northeastern Connecticut as far south as Plainfield.



[NATIVEWEB RESOURCES  
FOR NATIVE AMERICANS  
ON THE INTERNET](#)

Quinnehtukqut Nipmuc  
News

[NEW ENGLAND  
NATIVE AMERICAN  
TECHNOLOGY & ART](#)

*TODAY nearly 2,000 people are certified to be of Nipmuc heritage; most still live in those parts of Massachusetts, Rhode Island and Connecticut where ancestors of the Nipmuc Indians have lived for over 10,000 years.*



*NIAC, Inc. is the only Native American organization in the federally-designated Quinebaug and Shetucket Rivers Valley National Heritage Corridor.*

For additional information, you may write to:

N.I.A.C., Inc.  
Box 411  
Thompson, CT 06277-0411

---

© 1996-2002 *The Nipmuc Indian Association of Connecticut, N.I.A.C., Inc.*, a nonprofit, federally tax-exempt membership organization formed in 1994, and based Thompson, CT.



---

E-Mail the people at NIAC at: [NipmucNIAC@juno.com](mailto:NipmucNIAC@juno.com)

The NIAC Web Site is maintained by [Tara Prindle](#).

The N.I.A.C. website is hosted on the NativeWeb Server





## Nipmuc Indian Association of Connecticut

*The Nipmuc Indian Association of Connecticut*, a nonprofit, federally tax-exempt membership organization based Thompson, CT., was formed in 1994 for the principal purposes of:



NIPMUC DRINKING CUP

- promoting preservation of Nipmuc Indian and Native American history, material culture, crafts and language, sacred and historical sites;
- providing educational, social and economic opportunities for its membership;
- representing the interests of Nipmuc Indian people who reside in the State of Connecticut;
- providing a forum for the exchange of ideas and information among Nipmuc Indians and between Native American and non-Native people; and
- advancing efforts to obtain recognition that the Nipmuc Indians are aboriginal people of the State of Connecticut.

---

**For additional information, write to: N.I.A.C., Inc.  
Box 411  
Thompson, CT 06277-0411**



[NIAC Home Page](#)

---

© 1996-2002 N.I.A.C., Inc. [NipmucNIAC@juno.com](mailto:NipmucNIAC@juno.com)

The NIAC Web Site is maintained by [Tara Prindle](#).

**Nipmuc Indian Association of Connecticut**  
**N.I.A.C.**  
**COMMUNITY**  
**CALENDAR**  
**2001**



[What is a Powwow?](#)

---

[Wandering Bull's Callendar of Indian Social Events](#)

[Northeast Wigwam Powwow Schedule](#)

---

**Some Links Off-Site...  
to Other Nipmuc-related Organizations, Groups, News and Information:**

[Nipmuc Nation](#)

[Council of Chaubunagungamaugg](#)

[Nipmucspohke](#)

[Nipmucnet](#)

[Nipmuc History by Lee Stultzman](#)

[From a descendant of the Nipmuck Indians](#)

[Indians of Grafton](#)

*Note: These are all off-site links to websites  
-- NIAC does not guarentee the accuracy of any off-site information about the Nipmucs.*

---



[Return to NIAC Home Page](#)

---

**For additional information, write to: N.I.A.C., Inc.  
Box 411  
Thompson, CT 06277-0411**

---

© 1996-2002 N.I.A.C., Inc. [NipmucNIAC@juno.com](mailto:NipmucNIAC@juno.com)

The NIAC Web Site is maintained by [Tara Prindle](#).

## Nipmuc Indian Association of Connecticut

***N.I.A.C.***

### ***WHAT IS A POWWOW ?***



***Traditional Dancers  
Mid-Summer Powwow  
~East Hampton, CT***



***Wolf's Den Powwow  
~ Mashmoquet/Pomfret, CT***

To some Native peoples of northeastern North America, a 'powwow' was originally a man with special abilities to cure or offer advice from the spirit world. Eliot's Natick Dictionary translation of word 'pauwau' was recorded as "a wizard, witch, magician, etc.", but this is a poor translation. Pow wows, as individuals, were revered for their knowledge; the Narragansett word for "a wise speaker" is 'taupowaw'. Powwow's were needed to help to drive away sickness, ensure success in battle, interpret dreams, or to help individuals or tribes in other ways. Prayers, singing, dancing and drumming were all used by pow wows in those ceremonies; and wherever Native American people gathered there was feasting, socializing and trading. So, the gatherings themselves came to be called Powwows.

ALL people are welcome at Powwows! At times there is an entry fee, and you will often find a wide variety of Native American crafts, trade goods and food for sale; even demonstrations and story telling as well. It's a great place for your entire family to spend the day. Drugs and alcohol are not permitted; pets must be on a leash at all times.

The spiritual center of a Powwow is THE CIRCLE; a place to be respected and honored, it is a sacred place that is blessed by a spiritual leader. The circle is entered only from the East (where



***Connecticut River Powwow  
~ Sommers, CT***

there is an opening) and dancers travel in the same direction as the sun.

The singing is a gift and praise to the Creator; and the drum is the heartbeat of our People. The



***Fort Shantok Powwow  
~ Montville, CT***

singers and drummers together are called THE DRUM.

Ceremonies start with a "Grand Entry" of the dancers to pay respects to our Creator and to greet one another. Honoring songs, and dances for veterans and our ancestors follow. You will be asked to stand and remove your hat for these ceremonies. Please don't take photos or videos if you're asked not to do so; and please don't touch the clothing or personal belongings of anyone in Native American dress -- much of what is worn is sacred, expensive and/or irreplaceable. But do feel free to ask if you want to take individual pictures, or if you have a question about a particular item that someone is wearing. Most Native People will be pleased to assist you if they're asked first.



***Drum at a Powwow  
~ Mashpee, MA***



***Light the Lodge Powwow ~ Storrs, CT***

You will see many types of dances at the Powwow. When you hear a 'Round Dance' announced, EVERYONE will be invited to participate. Proceed to the East opening of the circle and join in -- a Round Dance is easy to learn and fun to do.

It's Powwow season now! We hope you'll attend one -- we think you'll enjoy the experience.



**[NIAC: Native American Music & Performance](#)**

---

**[Return to NIAC Home Page](#)**

---

© 1996-2002 N.I.A.C., Inc. **[NipmucNIAC@juno.com](mailto:NipmucNIAC@juno.com)**

The NIAC Web Site is maintained by **[Tara Prindle](#)**.

# ***N.I.A.C.* Nipmuc Indian Association of Connecticut, Inc.**

## **Native American Music & Performance**

### **Full Circle Drum**



© 1993 *Full Circle Drum Society*

The Full Circle Drum Society of Quinnehtukqut, the name given to Connecticut by its first peoples, is made up of many Nations unified in an effort to mend our part of the sacred hoop. Our songs are written in the Natick dialect of the Algonquin language, in an effort to refitalize the disappearing knowledge of the language and give hope to its continuance through times to come.

**Listen to these WAV Files from Full Circle Drum**  
(click on link, select 'open file' - file will download and play)

*Note: these files may not be copied, redistributed or reproduced*

#### **[Opening Prayer: Chief Strong Horse](#)**

(Narragansett Nation) (83 kb file)

Read the [Opening Prayer translation](#) below.

#### **[Grand Entry Song](#)** (608 kb file)

#### **[Closing Prayer: Litte Crow](#)**

(Nipmuc Nation) (1,151 kb file)

---

**Many of the members from the original Full Circle Drum Society are now with:**

**Heartbeat of the Land  
&  
StrongHeart Singers**

**These two drums can be heard at powwows around Connecticut, Massachusetts and Rhode Island.**

#### **[What is a Powwow?](#)**

**It's Powwow season now! We hope you'll attend one -- we think you'll enjoy the experience.**

---

**We would like to thank the Creator first for his blessings and teachings, and for keeping us safe on our journeys. Special thanks to our Elders who have inspired and supported us. We give thanks to our Ancestors who fought long and hard to protect our land, customs, and traditions. This tape is dedicated to them with gratitude and admiration so that we may in some way promote the continuance of tradition.**

**~Full Circle Drum Society**

---

### **Opening Prayer Translation**

**We greet all  
Greetings now from the Great One  
To all of you.  
We give thanks to the Great Spirit  
We give thanks to all wherever you are  
We thank you....  
- *Chief Strong Horse ~ Narragansett Nation***

---

### **Full Circle Poem**

**I draw the line between need and greed  
And sort the dilemmas of heart,  
Test the waters, bury remains,  
Dodge the poisoned dart.**

**How did my feet come to light  
On such a cluttered path?  
No crossroads warned of treacherous trails,  
Of impending bitter wrath.**

**I look to the Sun to find my way,  
To the Moon and winged friends,  
They Trace the circle I've come to know  
Will bring me home again.**

**With quiet heart I dance this path  
Hear the strong and steady Drum,**



**Certain that soon, when the Creator wills,  
Full Circle I'll have come.**

*- Cheryl A. Magos, Nipmuc Nation 10/92*

---

[NIAC: What is a powwow?](#)

---

[Return to NIAC Home Page](#)

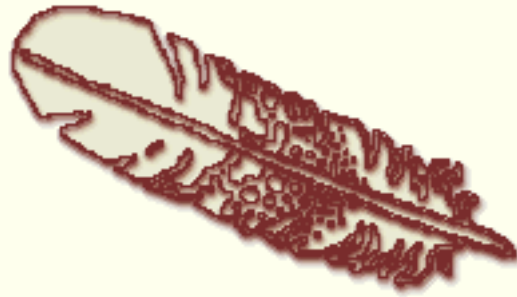
---

© 1996-2002 N.I.A.C., Inc. [NipmucNIAC@juno.com](mailto:NipmucNIAC@juno.com)

The NIAC Web Site is maintained by [Tara Prindle](#).

## Nipmuc Indian Association of Connecticut

# *N.I.A.C. ACTIVITIES*



[ [PROGRAM ACTIVITIES](#) | [THE YEAR IN REVIEW](#) | [KID'S CORNER](#) ]

● Membership meetings are held on Saturday or Sunday afternoons and include an educational program and a pot luck supper. [Program activities](#) include free lessons in Native American crafts, educational demonstrations, talks and materials, archaeological digs and group trips. Members have an opportunity to voice their personal interests on a [Member Survey form](#). *Minor children of members are encouraged to participate in NIAC activities.*



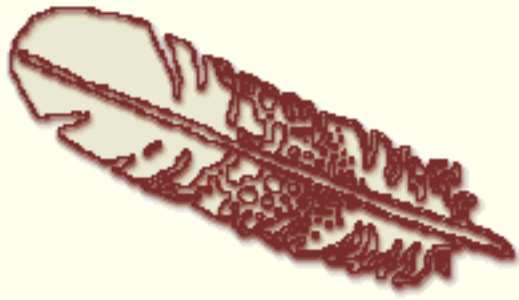
[NIAC Home Page](#)

---

For additional information, write to: **N.I.A.C., Inc.**  
**Box 411**  
**Thompson, CT 06277-0411**

---

© 1996-2002 N.I.A.C., Inc. [NipmucNIAC@juno.com](mailto:NipmucNIAC@juno.com)  
The NIAC Web Site is maintained by [Tara Prindle](#).



# Program Activities of the Nipmuc Indian Association of Connecticut

---

**Apr. 94 Women's Welcoming Dance Workshop led by Shelley Smith in Glastonbury, CT**

**Jun. 94 Birchbark Dish Workshop led by Tara Prindle at Mashamoquet State Park**

**Jul. 94 Indigenous Plants and and Native Uses; toured walk led by Tara Prindle in Mansfield CT**

**Aug. 94 Healing Ointments - Workshop led by Donna Johnson in Jewett City, CT**

**Sep. 94 Willow Dreamcatcher and Smudge Feather Workshop led by Tara Prindle & Shelley Smith in Thompson, CT**

**Oct. 94 Public Archaeological Dig 'Voices From The Past' for CT Arch. Awareness Day in Tolland, CT**

**Nov. 94 Participation at the UConn Native American Cultural Society Craft Fair in Storrs, CT**

**Dec. 94 NACS Winter Social at the UConn Student Union in conjunction with the Native American Cultural Society in Storrs, CT**

**Jan. 95 Talk and display of Eastern Woodlands Regalia led by Tara Prindle and Shelley Smith in Plainfield, CT**

**Feb. 95 Video with Dr. Nick Bellantoni speaking on CT Archaeology in Glastonbury, CT**

**Apr. 95 Crafts and Book Display at the 4th Annual Light the Lodge Pow Wow at UConn in Storrs, CT**

**Apr. 95 Talk and Display of Woodland Indian Paintings at the Killingly Historical Soc. Presented by David Wagner in Danielson, CT**

**May 95 Woven Wampum Beadwork Workshop led by Tara Prindle in Storrs, CT**

**Jun. 95 Talk and Slide Show on 'Prehistoric Pottery of Southern New England' presented by Dr. Jon Lizee in Mansfield Center, CT**

**Jul. 95 New England Native American Pottery Making Workshop led by Tara Prindle at the Sober Camel Studio in Woodstock, CT**



**Aug. 95 Wetu Tour & Mat Making Workshop led by Tara Prindle in Chaplin, CT**

**Sep. 95 Cattail Duck Decoy Workshop led by Tara Prindle in Thompson, CT**

**Oct. 95 Public Archaeological Dig 'Voices From The Past' for CT Arch. Awareness Day - with Flintknapping demonstrations by Jim Dina and others - in Tolland, CT**

**Nov. 95 Pottery and Crafts Exhibit at Archaeology Family Day/UConn hosted by CT Mus. of Natural History in Storrs, CT**

**Dec. 95 Talk and Slide Show on The 'Indian Tract' presented by Robert Gradie in Thompson, CT**

**Jan 96 Leather Pouch and Beadwork Workshop led by Nancy Harris, Tara Prindle & Shelley Smith in Glastonbury, CT**

**Mar. 96 Naming Ceremony directed by Tom Flanders (Cherokee) for Amber Smith (Quapaw) at Chaplin Kalpuli in Chaplin, CT**

**Mar. 96 Crafts and Book Display at the 5th Annual Light the Lodge Pow Wow at UConn in Storrs, CT**

**Apr. 96 Making Rope, Cord and String; led by Laurie Flegert in Danielson, CT**

**May 96 Twined Cornhusk Bottle Workshop led by Tara Prindle in Glastonbury, CT**

**Jun. 96 [Nipmuc Basketry Program](#) at the CT Historical Society led by Dr. Russel Handsman in Hartford CT**

**Jul. 96 Herbal First Aid Kits presented by Dr. Geraldine Hall-Horowitz in Vernon/Rockville, Connecticut**

**Aug. 96 Tinkling Cones led by Tara Prindle with Jerry Houle in Bozrah, Connecticut**

**Sep. 96 Porcupine Quill Work on Birchbark led by Tara Prindle in Storrs, Connecticut**

**Oct. 96 Native American Games presented by Tara Prindle in in Glastonbury, Connecticut**

**Nov. 96 Display of Native American Splint Baskets at Archaeology Family Day sponsored by the CT State Museum of Natural History in Storrs, Connecticut**

**Dec. 96 No meeting - Happy Holidays!**

**Jan. 97 Porcupine Quill Jewelry presented by Tara Prindle in in Glastonbury, Connecticut**

**Feb. 97 Native Wintertime Foods presented by Charlene Fuller in Chaplin, Connecticut**

**Apr. 97 Crafts and Book Display at the 5th Annual Light the Lodge Pow Wow at UConn in Storrs, CT**

**Apr. 97 Fingerweaving workshop led by Thomas Flanders in Chaplin, CT**

**May. 97 Native American Regalia workshop led by Shelley Smith, Brad Pafford and Tara Prindle in Glastonbury, CT**

**Jun. 97 Sweet Grass Baskets workshop led by Tara Prindle in Storrs, CT**

**Jul. 97 Camping - hosted by Johanna & Tom Bazzolo in Lebanon, CT**

**Aug. 97 Clay Pots, Pipes and Beads workshop led by Tara Prindle in Woodstock, CT**

**Sep. 97 Leather Bags & Pouches workshop led by Tara Prindle in North Grosvenor Dale, CT**

**Oct. 97 Lower Nipmuc Trail Hike in Mansfield, CT**

**Nov. 97 "Media Madness" at Duane & Alice Luster's in Glastonbury, CT**

**Dec. 97 - Feb. 98: Mid-winter Break**

**Mar. 98 Fundraiser at 7th Annual Light the Lodge Pow Wow in Storrs, CT**

**Apr. 98 Soapstone Carving; at Duane & Alice Luster's in Glastonbury, CT**

**May 98 Membership meeting in Woodstock, CT**

**Jun. 98 Birch Bark Baskets; at Susan Morissette's in Woodstock, CT**

**Jul. 98 & Aug 98: Mid-summer Break**

**Sep. 98 The Water Drum at by Susan Morissette in Woodstock, CT**

**Oct. 98 Lower Nipmuc Trail Hike, Mansfield, CT**

**Nov. 98 & Dec. 98 - No Meetings - Happy Holidays!**

**Jan. 99 Native American Splint Baskets; at Duane & Alice Luster's in Glastonbury, CT**

**Feb. 99 Bark Rattles hosted by Susan Morissette in Woodstock, CT**

**Mar. 99 Gardening with Native Plants hosted by Duane & Alice Luster in Glastonbury, CT**

**Apr. 99 NIAC Fundraiser at the 8th Annual Light the Lodge Pow Wow at UConn in Storrs, CT**



**Apr. 2000 Annual Meeting; Geneological Research with keynote speaker Marcella Pasay at the Civillian Conservation Corps Historical Museum in Staford, CT**

**May 2000 Beadwork with Jan Us at the Audubon Nature Center in Glastonbury, CT**

**Jul. 2000 Spiritual Workshop with Darla Pidgeon (Navajo) at James L. Goodwin State Forest, Hampton, CT**

**Feb. 2001 (Imitation) Wampum & Leather Bracelts led by Tara Prindle at the Brooklyn Community Center, CT**

**Mar. 2001 Pottery Workshop led by Tara Prindle at Susan Morissette's in Woodstock, CT**

**April 8, 2001 NIAC Fundraiser at the 10th Annual Light the Lodge Powwow, UCONN, Storrs, CT**

**Apr. 2001 Annual Meeting; Lasting of the Wabbaquassets: Nipmuc People at Hatchet Pond with guest speaker Thomas L. Doughton at the Brooklyn Community Center, CT**

**Jul. 2001 Learn to Make Infant Moccasins, Hair Ties and Clothing for Barbie Dolls, presented by Jean ('Kicks Twice') Sforza at the Brooklyn Community Center, CT**

**Aug. 2001 Learn to Make a Traditional Southern New England Style Ash Splint Basket, presented by Alice Luster at the Brooklyn Community Center, CT**

**Oct. 2001 Hike on the Nipmuc Trail, Mansfield, CT**

**April 7, 2002 NIAC Fundraiser at the 11th Annual Light the Lodge Powwow, Gampel Pavalion, UCONN, Storrs, CT 860-427-3180**



**[NIAC Home Page](#)**

---

© 1996-2002 N.I.A.C., Inc. [NipmucNIAC@juno.com](mailto:NipmucNIAC@juno.com)

The NIAC Web Site is maintained by [Tara Prindle](#).



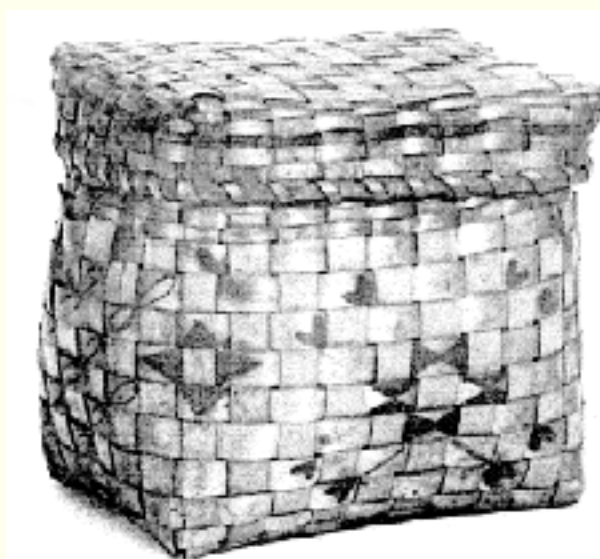
# QUINNEHTUKQUT NIPMUC NEWS

## Exerpts from *Quinnehtukqut Nipmuc News* The Nipmuc Indian Association of Connecticut's Quarterly Newsletter

---

Display of Nipmuc Indian Baskets ~ June 30, 1996  
sponsored by the Nipmuc Indian Association of Connecticut  
at the Connecticut Historical Society in Hartford.

Quinnehtukqut Nipmuc News Vol.3 No.3 - July 1996



**Many were left breathless at the sight of Nipmuc baskets made over a hundred years ago. Thanks to Richard Malley, registrar for The Connecticut Historical Society, 16 well-preserved pre-1850 Nipmuc Baskets of various shapes and sizes, and with a variety of hand-painted designs were on exhibit for our program!**

**The talk and slide show given by our guest speaker, Dr. Russell Handsman, included information about the area of Connecticut with which he is currently most familiar ñ Weantinock (Schaghticoke), as well as information on the Nipmuc baskets. We were extremely fortunate to have film maker Jeff Holda taped the program for us; it will be presented as a 1-hour show on cable TV later this year.**

**Joan Luster and Tara Prindle prepared two leaflets especially for the program: Nipmuc Splint Baskets contains information on our basket-making tradition and on Nipmuc basket designs; Nipmuc Continuity in Woodstock, CT, tells about some of the Nipmuc living in Woodstock in the 1700s and 1800s, including basket-makers who undoubtedly made some of the baskets that were on exhibit.**

**Refreshments, generously donated by Duane & Alice Luster, amounted to a feast! We are truly grateful to each and every person**

**who contributed to the success of this very special program.**

---

**You can order a copy of the book A Key into the LANGUAGE of WOODSPLINT BASKETS, which includes a wealth of information & photos of baskets & designs made by Nipmuc, Mohegan, Schaghticoke, Pequot, and other Natives of New England, from: The Institute for American Indian Studies, PO Box 1260, Washington, CT 06793. Price: \$25.20 (including postage & handling).**

[Details of NIAC Program Activities](#)

---

[Return to Index for Quinnehtukqut Nipmuc News](#)

[Return to NIAC Home Page](#)

---

© 1996-2002 N.I.A.C., Inc. [NipmucNIAC@juno.com](mailto:NipmucNIAC@juno.com)

The NIAC Web Site is maintained by [Tara Prindle](#).

# QUINNEHTUKQUT NIPMUC NEWS

Exerpts from *Quinnehtukqut Nipmuc News*  
The Nipmuc Indian Association of Connecticut's Quarterly Newsletter

---

- [Native Americans of Quinnehtukqut](#)  
Vol.6 No.1 - January 1999
  
  - [NIAC Scholarship Fund](#)  
Vol.4 No.3 - July 1997
  
  - [NIPMUC SPLIT](#)  
Vol.3 No.4 - October 1996
  
  - [PAUGUSSETT TRIBE IS DENIED FEDERAL RECOGNITION](#)  
Vol.3 No.4 - October 1996
  
  - [DISPLAY OF NIPMUC BASKETS AT THE CONNECTICUT  
HISTORICAL SOCIETY](#)  
Vol.3 No.3 - July 1996
- 

For upcoming events... Check [NIAC's Community Calendar](#)  
[Return to NIAC Home Page](#)

---

© 1996-2002 N.I.A.C., Inc. [NipmucNIAC@juno.com](mailto:NipmucNIAC@juno.com)  
The NIAC Web Site is maintained by [Tara Prindle](#).



# QUINNEHTUKQUT NIPMUC NEWS

## Exerpts from *Quinnehtukqut Nipmuc News* The Nipmuc Indian Association of Connecticut's Quarterly Newsletter

---

### Native Americans of Quinnehtukqut

Quinnehtukqut Nipmuc News Vol.6 No.1 January 1999  
Historical Sketches

This will begin a series of historical sketches on Native Americans of the area we know as Connecticut (alternative spelling: Quinnehtukqut - "place of the long river"). Our information is based on the writings of the late historian Mathias Spiess.

#### **Background:**

Our Connecticut Native Americans are part of the great Algonquian family of tribes which extends from the Carolinas to Canada north of the Great Lakes and on into the western plains. It should be understood that New England Native Americans: (1) did not have a name for themselves (tribal names are European designations), (2) do not have 'proper' names in their languages (each word has a meaning), (3) do not have written languages and (4) spoke dialects of a common 'Algonquian' language. Native American words herein (which are italicized) are merely English spellings of our language sounds.

The first Europeans to record encounters with Native Americans in Connecticut were the Dutch. We will cover the 16 tribal groups known to exist when the Dutch arrived in the early 1600s, beginning with the *Podunk* -- the first Native American group to welcome these newcomers to our homelands when Dutch navigator Adrian Block sailed up the *Quinnehtukqut* River and landed at a *Podunk* village just north of Hartford.

The *Podunk* - Hartford County.

*Podunk* or *Pautunke*, means "where you sink in mire", a boggy place, in the *Nipmuc* dialect. But the *Podunk* called their homeplace *Nowashe*, "between" rivers. Their lands are marked *Nowass* (perhaps the Dutch equivalent of *Nowashe* on Dutch maps of hte early 1600s.

The *Podunk* tribe consisted of three bands: the *Namferoke* (*Podunk*, "fishing place"), who lived near the village of Warehouse Point; the *Hockanum* (*Podunk*, "a hook", or "hook shaped"), led by *Tantonimo*, who lived near the village still known as *Hockanum*; and the *Scanticook* (*Nipmuc*, "at the river fork"), who lived on the north bank of the *Scantic* River near the section called Weymouth -- their leader was called *Foxen* (or *Poxen*). *Foxen*, a.k.a. *Poxen*, witnessed land deeds in 1640. He became the great councilor of the *Mohegan* (*Mohegan*, "wolf people") and his name appears repeatedly in early records.

Dutch accounts relate that the river tribes were beaten in three encounters with the *Pequot* (*Pequot-Mohegan*, "the destroyers"), who then claimed the entire country by right of conquest. After the Pequot sold land to the Dutch at *Squikiog* (*Wangunk*, "the ground is dark"), the *Podunk* conceived the idea of inviting the English to settle in Connecticut. The earliest written record regarding this tribe is in 1631 when a sachem, called *Wahginacut*, journeyed to Massachusetts and Plymouth Colonies to try to convince<sup>3</sup> their governors to encourage the English to emigrate to the Connecticut Valley. In 1632, "the year before the Dutch began in the River", sachem *Natawanute*, (a.k.a. *Attawanyut*) presented Governor Winslow of Plymouth, MA with a tract of land in South Windsor. The following year, Plymouth Trading Company rewarded *Natawanute* by restoring him as one of the great sachems of the river tribes.

Within traditional *Podunk* homelands in Connecticut today are the towns of East Hartford, East Windsor, South Windsor, Manchester, part of Ellington, Vernon, Bolton, Marlboro and Glastonbury.

---

[Return to Index for Quinnehtukqut Nipmuc News](#)

[Return to NIAC Home Page](#)

---

© 1996-2000 N.I.A.C., Inc. [NipmucNIAC@juno.com](mailto:NipmucNIAC@juno.com)

The NIAC Web Site is maintained by [Tara Prindle](#).

# QUINNEHTUKQUT NIPMUC NEWS

## Exerpts from *Quinnehtukqut Nipmuc News* The Nipmuc Indian Association of Connecticut's Quarterly Newsletter

---

### ANNOUNCING NIAC'S NEW SCHOLARSHIP FUND

Quinnehtukqut Nipmuc News Vol.4 No.3 - July 1997

Your Board of Directors worked long and hard to create a Scholarship Fund which will begin to help meet the needs and desires of ALL NIAC members and their minor children -- wherever they live. The document by which our Scholarship Fund will operate is included in this newsletter. Your comments are welcome.



We're counting on your help in growing funds to support this important program!!

We're asking members and friends of NIAC, to raise money or donate personal funds to our Scholarship Fund. Donations are deductible as charitable contributions on federal tax returns, so everyone can save on taxes too. Checks should be made payable to: NIAC

Scholarship Fund and mailed to  
NIAC, Inc., Box 411, Thompson, CT 06277.



**PURPOSE**  
The NIAC  
Scholarship  
Fund will  
provide  
financial

assistance to  
members of the Nipmuc Indian Association of Connecticut, Inc. and

their minor children.

NATURE AND AMOUNT OF SCHOLARSHIPS Scholarships may be granted for scholastic research projects, to promote higher education, for attendance at educational programs on Native American culture and history, to facilitate preparation and dissemination of information on Native American culture and history, and to enhance leadership skills. Grants shall be made as gifts. Preference for grants will be given to members who have not received a scholarship within the last 12 months.

---

Here are some ways you can help:

☞ Donate money you receive from returning cans and bottles, or conduct a can and bottle drive in your area.

☞ Conduct a yard sale and donate the proceeds.

☞ Ask your friends and family members to make a contribution -- if they write a check, they're entitled to the tax deduction.

☞ Enlarge our logo, glue it to a container with the words Scholarship Fund, and ask a storekeeper where you regularly shop if you can set it on their counter.

☞ Sell your craft items and donate the funds.

*The more you give,  
the more good things come to you.  
(Crow)*

We're sure you have even better ideas, and we hope you'll drop us a line so that we can share them with everyone! All contributions will be acknowledged in Quinnehtukqut Nipmuc News.

---

[Return to Index for Quinnehtukqut Nipmuc News](#)

[Return to NIAC Home Page](#)

---

© 1996-2000 N.I.A.C., Inc. [NipmucNIAC@juno.com](mailto:NipmucNIAC@juno.com)

The NIAC Web Site is maintained by [Tara Prindle](#).



# QUINNEHTUKQUT NIPMUC NEWS

## Exerpts from *Quinnehtukqut Nipmuc News* The Nipmuc Indian Association of Connecticut's Quarterly Newsletter

---

### NIPMUC SPLIT

Quinnehtukqut Nipmuc News Vol.3 No.4 - October 1996  
(Source: *Sunday Telegram* - 9/22/96)

The Chaubunagungamaug and Hassanamisco bands, based in Massachusetts, are no longer working together on a single petition for federal recognition of the Nipmuc tribe. Instead, each band intends to file its own application for federal recognition. A decision will be made by the federal Bureau of Indian Affairs within the next six months as to whether or not either of the petitioning Nipmuc bands constitutes a tribe.

---

[Return to Index for Quinnehtukqut Nipmuc News](#)

[Return to NIAC Home Page](#)

---

© 1996-2000 N.I.A.C., Inc. [NipmucNIAC@juno.com](mailto:NipmucNIAC@juno.com)

The NIAC Web Site is maintained by [Tara Prindle](#).

# QUINNEHTUKQUT NIPMUC NEWS

## Exerpts from *Quinnehtukqut Nipmuc News* The Nipmuc Indian Association of Connecticut's Quarterly Newsletter

---

### PAUGUSSETT TRIBE IS DENIED FEDERAL RECOGNITION

Quinnehtukqut Nipmuc News Vol.3 No.4 - October 1996

(Source: *Norwich Bulletin* - 9/18-96)

Denial of federal recognition of the Golden Hill Paugussett Tribe in Connecticut appears to be based on the federal Bureau of Indian Affairs conclusion that: (1) there is no evidence that the Paugussett are descended from an historic American Indian tribe, and (2) that they have failed to prove that the one common ancestor from whom they claim their tribal members are descended was a member of an Indian tribe or had Indian ancestry. The Paugussett will appeal the decision to the Board of Indian Appeals.

According to historian Mathias Spiess, writing in a 1993 booklet prepared for Connecticut's Tercentenary Commission, the Paugussett tribe considered of the Wipawaug, Unkowa, Potatuck, Pomeraug and Naugatuck clans. Their homelands included the present-day towns of Orange, Milford, Stratford, Fairfield, Bridgeport, Weston, Easton, Trumbull, Shelton, Ansonia, Woodbridge, Derby, Seymour, Monroe, Redding, Bethel, Danbury, Bridgewater, Southbury, Newtown, Oxford, Beacon Falls, Bethany, Naugatuck, Middlebury, Waterbury, Woodbury, Roxbury, and part of Wolcott, Prospect, Plymouth and New Fairfield.

The Golden Hill Paugussett are recognized by the State of Connecticut; they have reservations in Colchester and Trumbull.

Visit the [Paugussett's News Page](#)

---

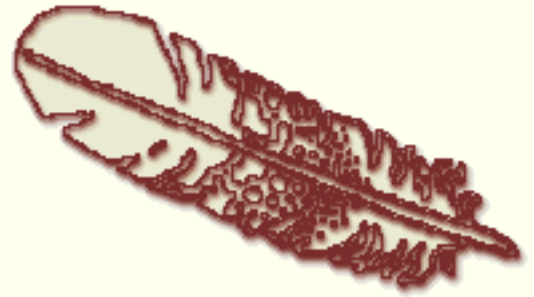
[Return to Index for Quinnehtukqut Nipmuc News](#)

[Return to NIAC Home Page](#)

© 1996-2000 N.I.A.C., Inc. [NipmucNIAC@juno.com](mailto:NipmucNIAC@juno.com)

The NIAC Web Site is maintained by [Tara Prindle](#).

**Nipmuc Indian Association of Connecticut**  
***N.I.A.C.***  
***The Year in Review***  
***2000-2001***



Since members have joined NIAC at different times, we wanted to let everyone know just what we were up to in the past year:

● **To Our Members and Friends:**

It's hard to believe, folks, but NIAC will be entering it's **eighth** year in April of 2001!! We have endeavored to bring you quality programs and well-documented information about Native American history and crafts (particularly those of the Algonquian people) ... and an opportunity to get together to learn, and to socialize. It is as we had hoped, *niac*, "a point" at which we are reviving Native American culture and re-forming a community where **all** our relations are included.

As you may know, NIAC is run by a volunteer Board of Directors; we do not have paid staff. Last year, two Board positions were vacated by the resignations of Alice Luster (who served as Program & Events Committee Chair) and Pam Silvestri (who served as Membership & Fundraising Chair.) While we sincerely regret those resignations, NIAC must plan for the future by enlisting volunteer participation of more of its members. Your **work** as a volunteer adds up to **fun** for our group.

In the belief that there is something each of our members and friends can do to participate in NIAC's continued success, we are enclosing a **Member Survey** in our current mailed Newsletter. We hope to enlist your participation in our continued growth. Survey results will be published in our next printed newsletter.

**BE A**





**VOLUNTEER!!**

---

[A past 'Year in Review' 1995 - 1996](#)

[Return to NIAC Activities Page](#)

[Return to NIAC Home Page](#)

---

© 1996-2002 N.I.A.C., Inc. [NipmucNIAC@juno.com](mailto:NipmucNIAC@juno.com)

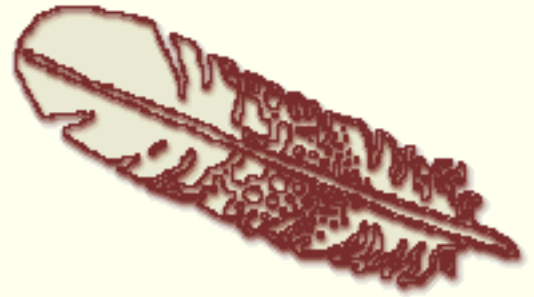
The NIAC Web Site is maintained by [Tara Prindle](#).

## Nipmuc Indian Association of Connecticut

*N.I.A.C.*

*The Year in Review*

*April 1995 - April 1996*



Since members have joined NIAC at different times, we wanted to let everyone know just what we were up to in the past year:

### ● **Archaeological Preservation:**

In October, 1995 we submitted a proposal to the Mashantucket Pequot Tribal Nation requesting funds to purchase an historic Nipmuc site in Woodstock, CT. Our request has been met with silence. For the 2nd year, we participated in CT Archaeology Week



by conducting a public exhibit and scientific archaeological dig called *Voices From the Past -- What Native American Artifacts Tell Us*. The event was sponsored by the Office of State Archaeologist and held at a site in Tolland, CT which will be destroyed so that an elderly housing complex can be built. The dig was professionally supervised by archaeologists. Artifacts from the site were turned over to the State Archaeologist for cataloging and analysis so that the 'story' of Native American activities there can be recorded.

### ● **Educational Programs:**

During the past year, members have had opportunities to learn: what wampum was, its significance to Native Americans in New England, and how to weave with (imitation) wampum beads; when New England Native Americans began making pottery, what styles and decorating techniques were used, and how to make our own pots using that knowledge; to make a duck decoy out of cattails; where Nipmuc lived in northeastern CT, with specific information on an historic site called the "Indian tract" in Woodstock, CT; how the frame for a wetu (a.k.a. wigwam) was constructed, and how to weave the mats that were used to cover the frame; what plants and techniques Native Americans used to make thread and cord.

- NIAC participated in: the CT Museum of Natural History's *Family Archaeology Day* with an exhibit of ancient and contemporary Native American pottery; and the Association of Northeastern Connecticut Historical Societies' Heritage Hall exhibit at the Brooklyn Fair, where our book *Nipmuc Place Names of New England* was for sale as well as our free membership brochure and flier on the "Praying Towns" of northeastern CT.



- NIAC achieved federal tax-exempt status, which will enable expansion of the organization and its programs.
- NIAC was the first Native American organization in Connecticut to make cultural information on a New England tribe available on the Internet.
- Our quarterly "Quinnehtukqut Nipmuc News" continued to be published, bringing news on upcoming programs and events, community news, a Native American History quiz question/answer, articles on Native American culture, and occasionally poetry and recipes.

---

[Return to NIAC Activities Page](#)

[Return to NIAC Home Page](#)

---

© 1996-2001 N.I.A.C., Inc. [NipmucNIAC@juno.com](mailto:NipmucNIAC@juno.com)

The NIAC Web Site is maintained by [Tara Prindle](#).

## Nipmuc Indian Association of Connecticut

# *N.I.A.C.* *KIDS CORNER*



---

**Enjoy these fun activities for kids!**  
Collected from past issues of NIAC's *Quinnehtukqut Nipmuc News*.

[Find Things in a Wetu](#)

[Find Tribes in the Northeast](#)

[Match the Animal with their Tracks](#)

[Can you String these 9 beads?](#)

[Woven Wampum Maze](#)

[Native American or European Foods?](#)

[Help the Chipmunk find his Acorn!](#)

[Finger Puppets](#)

[Crossword Puzzle](#)

[NIAC: What is a Powwow?](#)

[NIAC: Native American Music & Performance](#)

[More online indigenous amusements through NativeTech](#)

---

[Return to NIAC Home Page](#)



© 1996-2002 N.I.A.C., Inc. [NipmucNIAC@juno.com](mailto:NipmucNIAC@juno.com)

The NIAC Web Site is maintained by [Tara Prindle](#).

# Nipmuc Indian Association of Connecticut

## N.I.A.C. KIDS CORNER



### CIRCLE THE HIDDEN WORDS

Words go down & across

|   |   |   |   |   |   |   |   |
|---|---|---|---|---|---|---|---|
| B | A | G | F | U | R | S | N |
| A | B | A | S | K | E | T | I |
| C | O | R | N | B | A | R | K |
| W | W | R | O | O | H | I | N |
| A | P | O | T | S | I | N | I |
| M | H | W | O | O | D | G | V |
| P | P | R | O | O | T | L | E |
| U | D | O | L | L | S | U | S |
| M | A | T | S | U | N | E | T |

### "THINGS IN A WETU"

ARROW DOLLS POTS

BAG FURS ROOT

BARK GLUE TOOLS

BASKET KNIVES STRING

BOW MATS WAMPUM

CORN NET WOOD

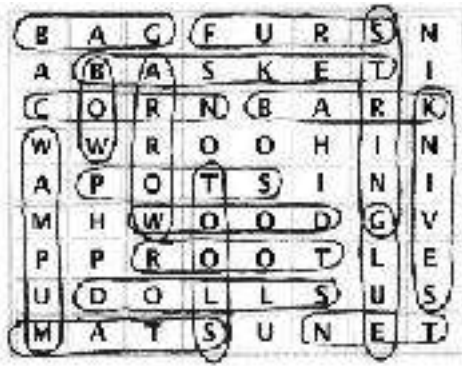
[solution](#)

[Return to NIAC's Kids Corner](#)

[Return to NIAC Home Page](#)

© 1996-2000 N.I.A.C., Inc. [NipmucNIAC@juno.com](mailto:NipmucNIAC@juno.com)

The NIAC Web Site is maintained by [Tara Prindle](#).



# Nipmuc Indian Association of Connecticut

## N.I.A.C. KIDS CORNER



### CIRCLE THE HIDDEN WORDS

Words go down & across, (some backwards)

|   |   |   |   |   |   |   |   |   |   |
|---|---|---|---|---|---|---|---|---|---|
| X | L | M | A | C | E | N | E | S | I |
| C | M | A | D | I | E | N | O | I | K |
| U | C | A | Y | U | G | A | Q | X | A |
| M | C | I | T | N | A | H | E | N | N |
| P | I | M | O | H | A | W | K | U | E |
| I | P | E | Q | U | O | T | K | T | B |
| N | S | N | A | G | E | H | O | M | A |

### Find Tribes in the Northeastern Woodlands

Abenaki Nipmuc

Cayuga Oneida

Mohegan Pequot

Mohawk Seneca

Nehantic Tunxis

[solution](#)

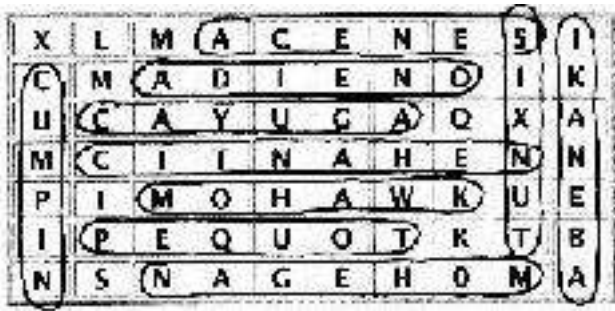
[Return to NIAC's Kids Corner](#)

[Return to NIAC Home Page](#)

© 1996-2000 N.I.A.C., Inc. [NipmucNIAC@juno.com](mailto:NipmucNIAC@juno.com)

The NIAC Web Site is maintained by [Tara Prindle](#).





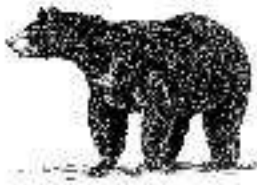


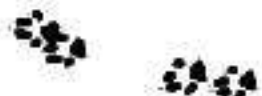








# Nipmuc Indian Association of Connecticut

## *N.I.A.C.* *KIDS CORNER*



### Match the Animal with their Tracks

Can you draw lines to connect the animals with their tracks left behind in the snow?

|                |                                                                                     |                                                                                       |
|----------------|-------------------------------------------------------------------------------------|---------------------------------------------------------------------------------------|
| <b>BEAR</b>    |    |    |
| <b>BEAVER</b>  |    |    |
| <b>RACCOON</b> |  |  |
| <b>DEER</b>    |  |  |
| <b>MOUSE</b>   |  |  |
| <b>WOLF</b>    |  |  |

*solution*

---

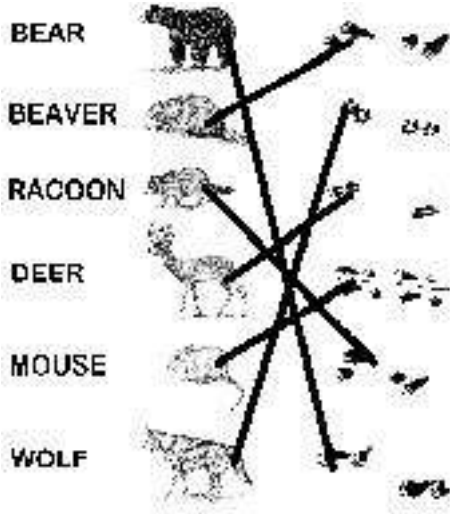
**[Return to NIAC's Kids Corner](#)**

**[Return to NIAC Home Page](#)**

---

© 1996-2000 N.I.A.C., Inc. **[NipmucNIAC@juno.com](mailto:NipmucNIAC@juno.com)**

The NIAC Web Site is maintained by [Tara Prindle](#).





## Nipmuc Indian Association of Connecticut

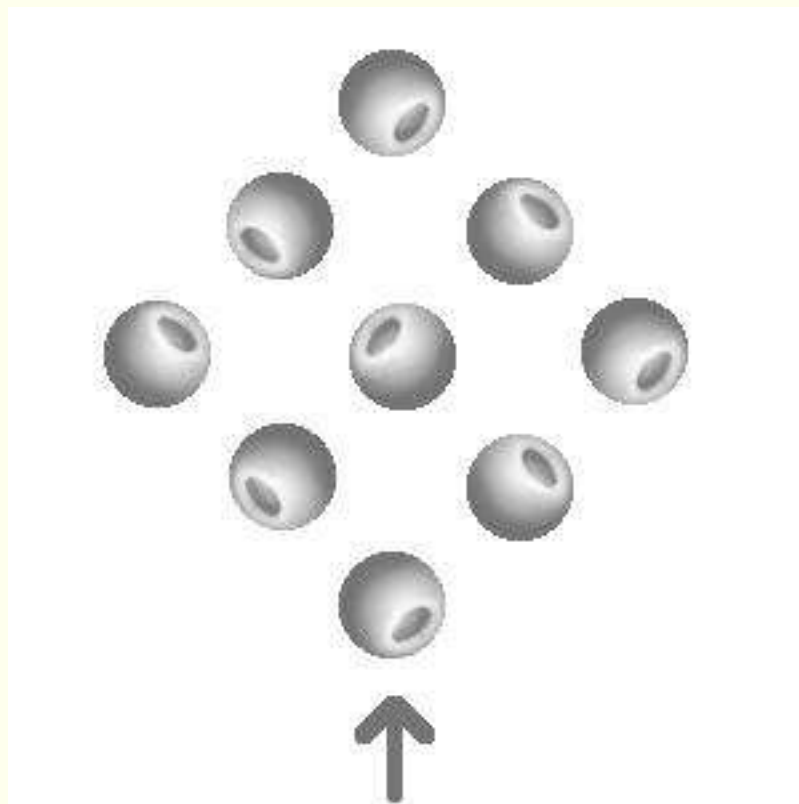
# *N.I.A.C.* *KIDS CORNER*



---

### Can you String these 9 beads?

... without lifting your pencil from the paper, can you draw \*only four straight lines that will 'string all 9 beads together?



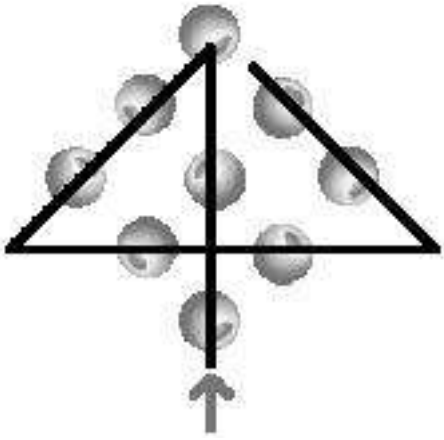
*solution*

---

[Return to NIAC's Kids Corner](#)  
[Return to NIAC Home Page](#)

---

© 1996-2000 N.I.A.C., Inc. [NipmucNIAC@juno.com](mailto:NipmucNIAC@juno.com)  
The NIAC Web Site is maintained by [Tara Prindle](#).



# Nipmuc Indian Association of Connecticut

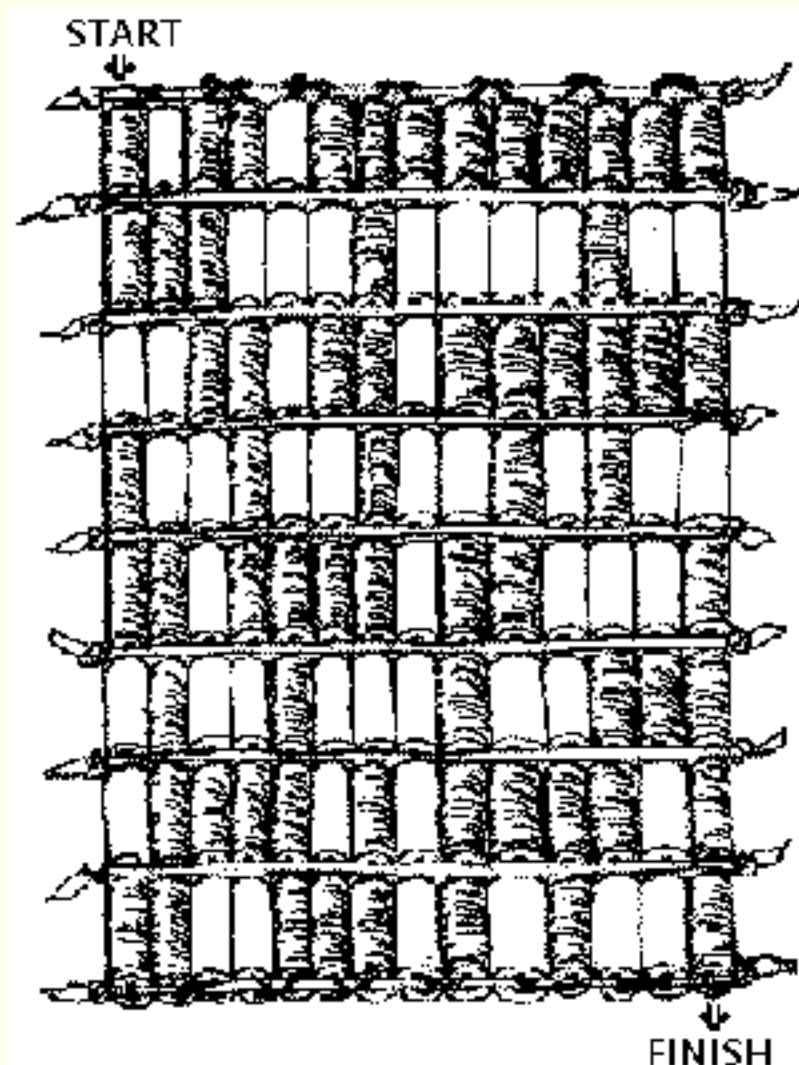
## *N.I.A.C.* *KIDS CORNER*



---

### Woven Wampum Maze

... find the path of dark quahog wampum beads from start of the belt to the finish!  
(you can only move down & across... no moving diagonally)



[solution](#)

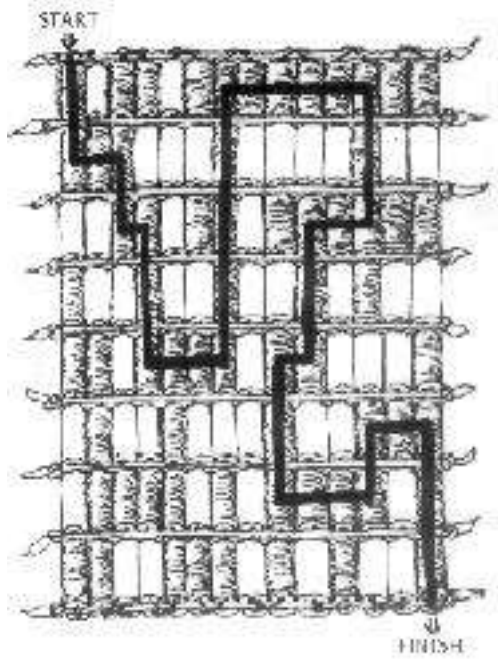
---

[Return to NIAC's Kids Corner](#)  
[Return to NIAC Home Page](#)

© 1996-2000 N.I.A.C., Inc. [NipmucNIAC@juno.com](mailto:NipmucNIAC@juno.com)

The NIAC Web Site is maintained by [Tara Prindle](#).





# Nipmuc Indian Association of Connecticut

## *N.I.A.C.* *KIDS CORNER*



---

### Native American or European Foods?

... which of these foods are Native American in origin?

... which of these foods are European in origin?

|                        |                                   |                                          |
|------------------------|-----------------------------------|------------------------------------------|
| <b>Cranberry Sauce</b> | <input type="checkbox"/> European | <input type="checkbox"/> Native American |
| <b>Hot Chocolate</b>   | <input type="checkbox"/> European | <input type="checkbox"/> Native American |
| <b>Maple Syrup</b>     | <input type="checkbox"/> European | <input type="checkbox"/> Native American |
| <b>Peanuts</b>         | <input type="checkbox"/> European | <input type="checkbox"/> Native American |
| <b>Pumpkins</b>        | <input type="checkbox"/> European | <input type="checkbox"/> Native American |
| <b>Sweet Potatoes</b>  | <input type="checkbox"/> European | <input type="checkbox"/> Native American |
| <b>Tomato Soup</b>     | <input type="checkbox"/> European | <input type="checkbox"/> Native American |
| <b>Turkey</b>          | <input type="checkbox"/> European | <input type="checkbox"/> Native American |
| <b>White Potatoes</b>  | <input type="checkbox"/> European | <input type="checkbox"/> Native American |
| <b>Zucchini Squash</b> | <input type="checkbox"/> European | <input type="checkbox"/> Native American |

*[solution](#)*

---

**[Return to NIAC's Kids Corner](#)**

**[Return to NIAC Home Page](#)**

---

© 1996-2000 N.I.A.C., Inc. **[NipmucNIAC@juno.com](mailto:NipmucNIAC@juno.com)**

The NIAC Web Site is maintained by **[Tara Prindle](#)**.

|                        |                                   |                                                     |
|------------------------|-----------------------------------|-----------------------------------------------------|
| <b>Cranberry Sauce</b> | <input type="checkbox"/> European | <input checked="" type="checkbox"/> Native American |
| <b>Hot Chocolate</b>   | <input type="checkbox"/> European | <input checked="" type="checkbox"/> Native American |
| <b>Maple Syrup</b>     | <input type="checkbox"/> European | <input checked="" type="checkbox"/> Native American |
| <b>Peanuts</b>         | <input type="checkbox"/> European | <input checked="" type="checkbox"/> Native American |
| <b>Pumpkins</b>        | <input type="checkbox"/> European | <input checked="" type="checkbox"/> Native American |
| <b>Sweet Potatoes</b>  | <input type="checkbox"/> European | <input checked="" type="checkbox"/> Native American |
| <b>Tomato Soup</b>     | <input type="checkbox"/> European | <input checked="" type="checkbox"/> Native American |
| <b>Turkey</b>          | <input type="checkbox"/> European | <input checked="" type="checkbox"/> Native American |
| <b>White Potatoes</b>  | <input type="checkbox"/> European | <input checked="" type="checkbox"/> Native American |
| <b>Zucchini Squash</b> | <input type="checkbox"/> European | <input checked="" type="checkbox"/> Native American |

**ALL THESE FOODS ARE  
NATIVE AMERICAN IN ORIGIN!!**

## Nipmuc Indian Association of Connecticut

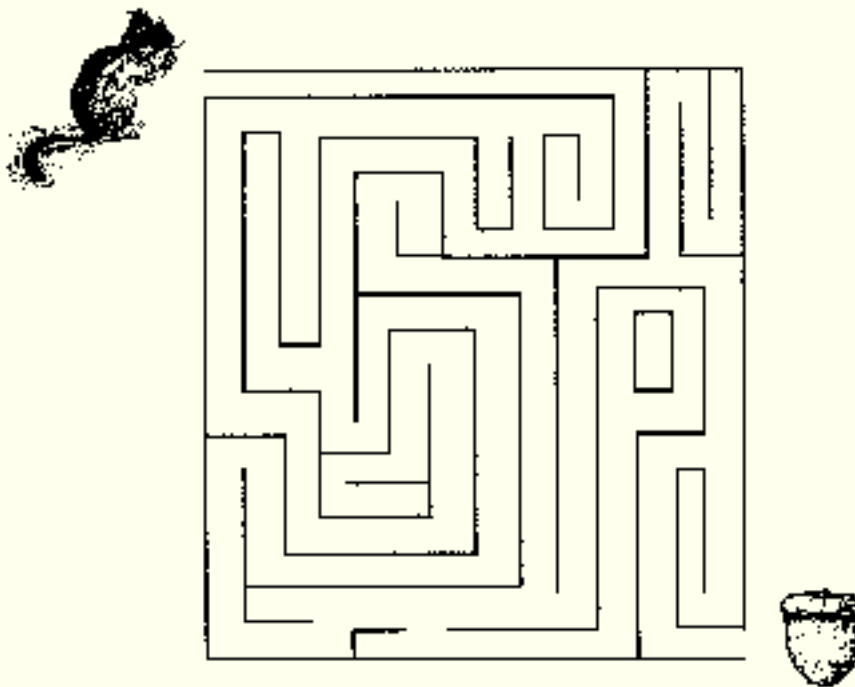
# *N.I.A.C.* *KIDS CORNER*



---

### Help the Chipmunk find his Acorn!

... find the path the chipmunk must take through the maze to find his acorn.



*[solution](#)*

---

[Return to NIAC's Kids Corner](#)

[Return to NIAC Home Page](#)

---

© 1996-2000 N.I.A.C., Inc. [NipmucNIAC@juno.com](mailto:NipmucNIAC@juno.com)

The NIAC Web Site is maintained by [Tara Prindle](#).





## Nipmuc Indian Association of Connecticut

# *N.I.A.C.* *KIDS CORNER*



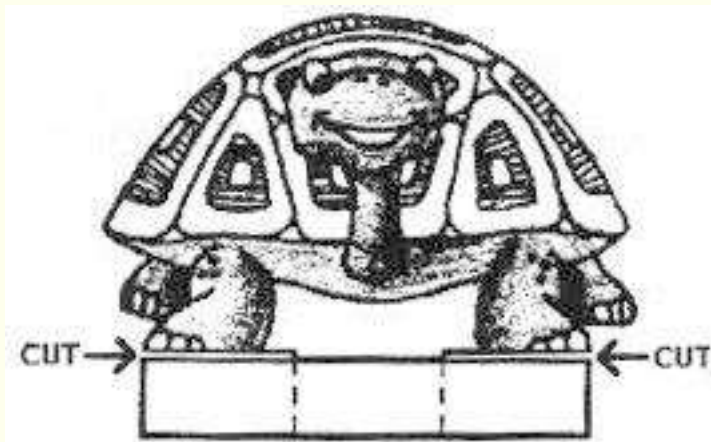
---

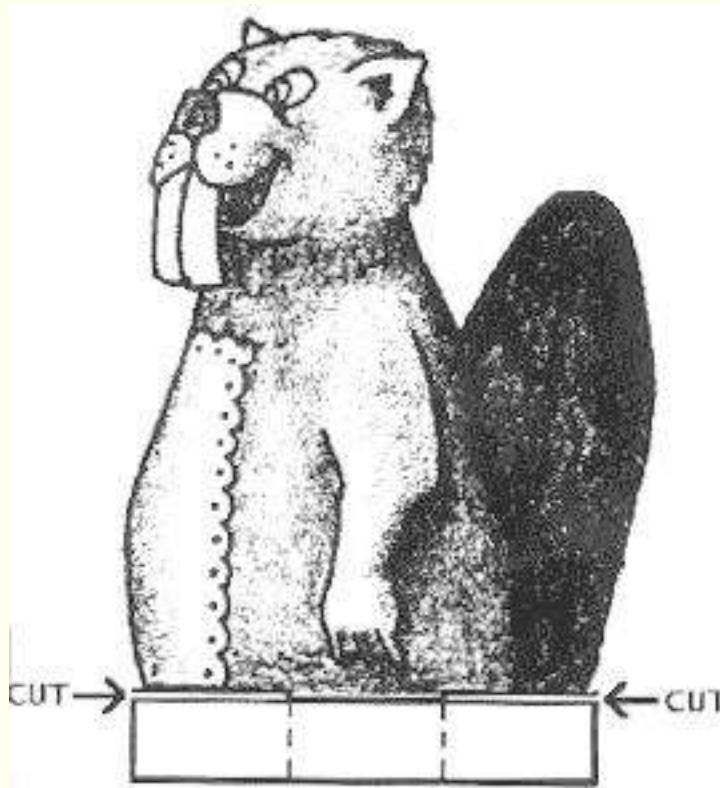
### Turtle and Beaver Finger Puppets

Cut out shapes, cut lines marked cut and fold along dotted ines.

Tape or glue the flaps together in the back.

*What do you think Turtle and Beaver would talk about?*





---

[Return to NIAC's Kids Corner](#)  
[Return to NIAC Home Page](#)

---

© 1996-2000 N.I.A.C., Inc. [NipmucNIAC@juno.com](mailto:NipmucNIAC@juno.com)  
The NIAC Web Site is maintained by [Tara Prindle](#).

# Nipmuc Indian Association of Connecticut

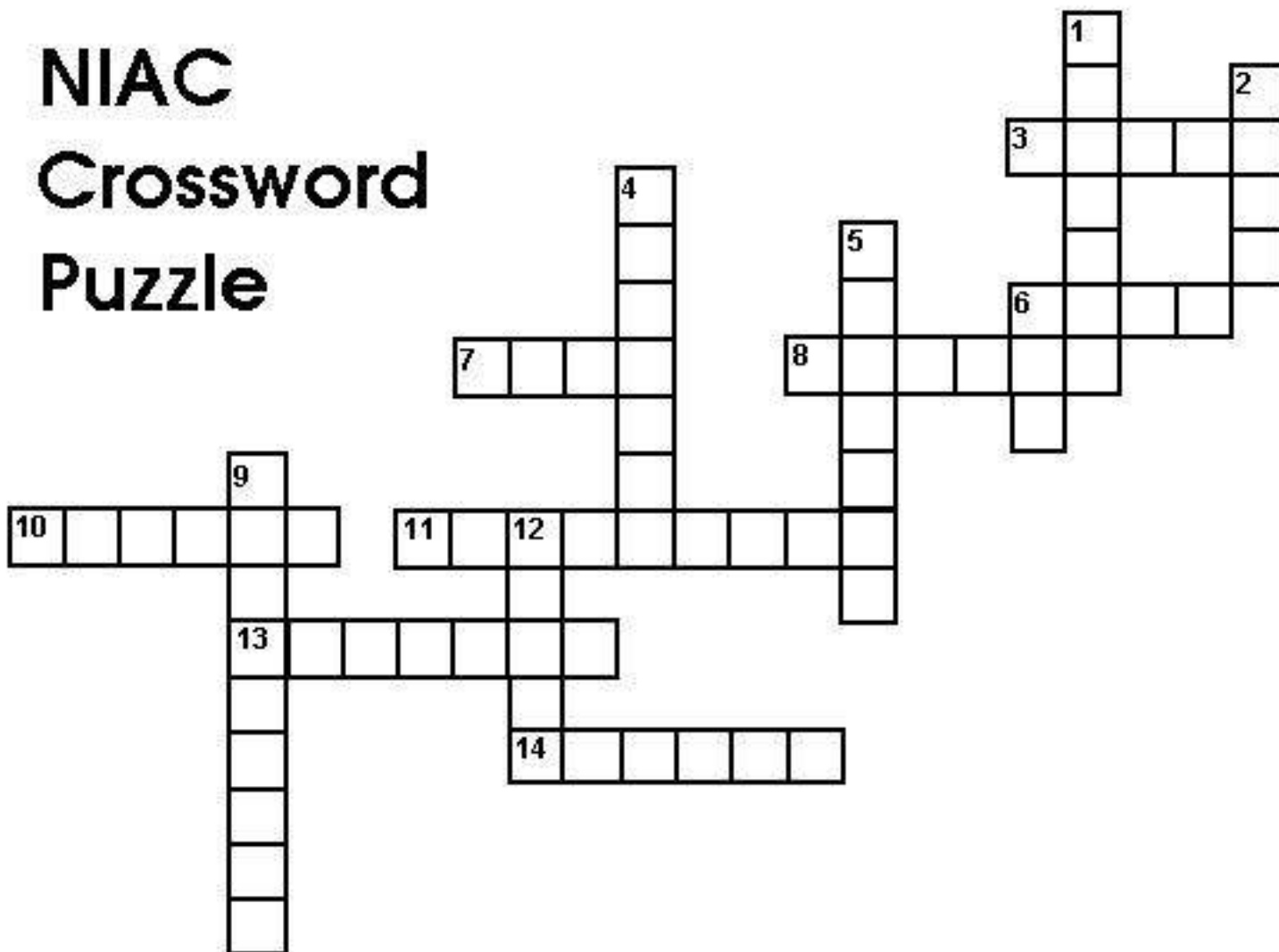
## *N.I.A.C.* *KIDS CORNER*



Can you solve this

Crossword Puzzle?

### NIAC Crossword Puzzle





**DOWN**

1. A covering made of skin, fur or wool
2. Another name for wigwam
4. A tribe of Native Americans inhabiting CT, RI & MA
5. Part of a bird used in headdresses or to fan smudge
6. A foxes home
9. Hunter - \_\_\_\_\_
12. Bow and \_\_\_\_\_

**ACROSS**

3. A log boat
6. A fad running animal
7. A rhythmic instrument
5. A container used to carry food and supplies
10. Another name for wetu
11. Sturdy containers used to cook were made fmm this
13. \_\_\_\_\_ and gatherers
14. Made from shells, this highly prized item was exchanged as a permanent reminder of intertribal agreements

---

***[solution to crossword puzzle](#)***

---

**[Return to NIAC's Kids Corner](#)**

**[Return to NIAC Home Page](#)**

---

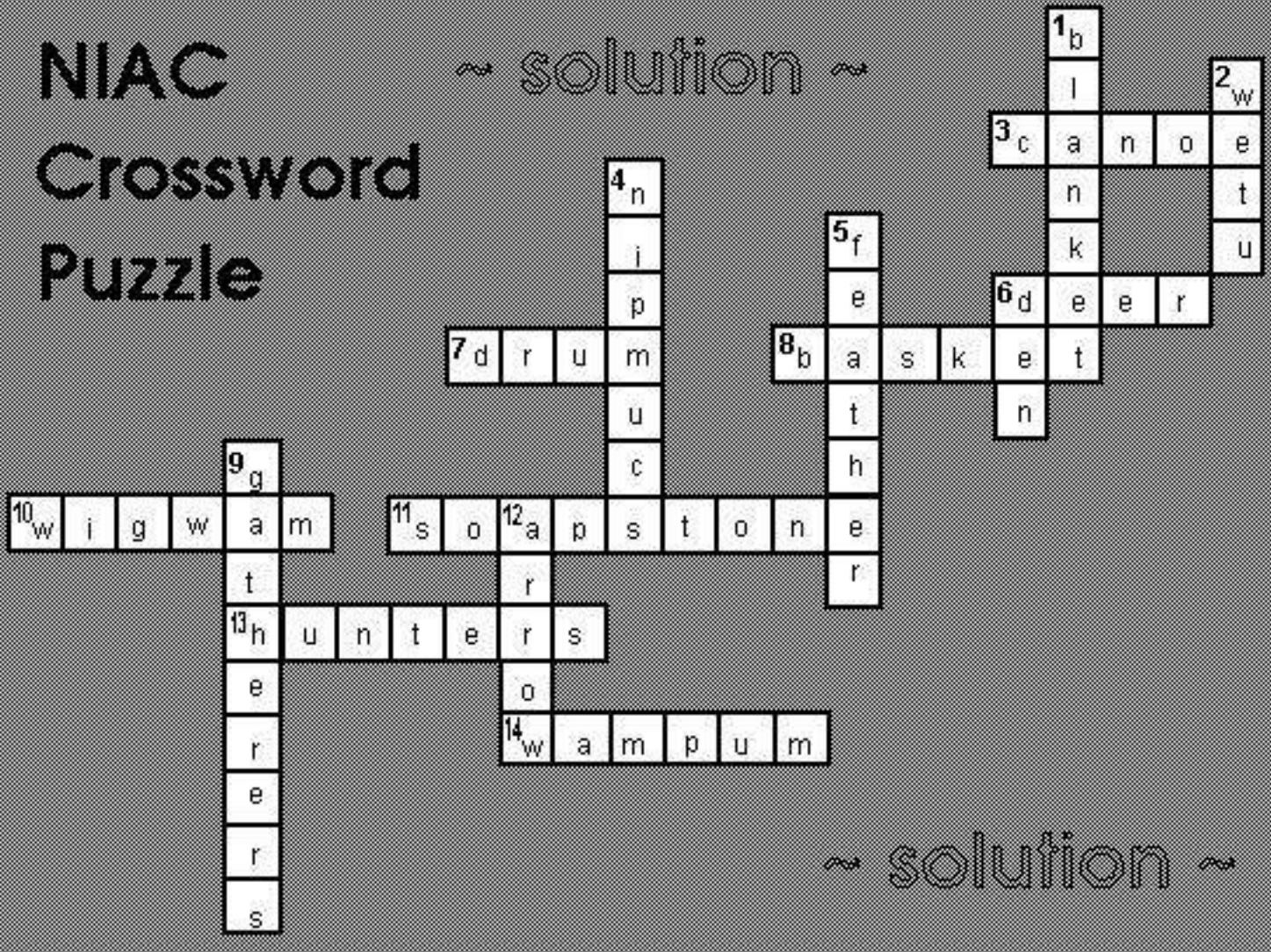
© 1996-2000 N.I.A.C., Inc. **[NipmucNIAC@juno.com](mailto:NipmucNIAC@juno.com)**

The NIAC Web Site is maintained by [Tara Prindle](#).

# NIAC

## Crossword Puzzle

~ solution ~



~ solution ~

## GAMES AND TOYS

Have Fun with NativeTech's Online Interactive Games!



[Virtual Wampum Belt](#)



[Picture Match](#)



[Match the Designs](#)



[Keep it in the air!](#)



[Virtual Coloring Book](#)



[Interactive Bead Graph](#)



[Traditional Gambling](#)



[Find His Acorns](#)



[Guess the Plant Name](#)










[Virtual Paper Dolls](#)



[Match the Dyes and Quills](#)



## Find out more about these Native American games!

-  [Ring and Pin](#)
-  [Bundle and Pin](#)
-  [Ball and Triangle](#)
-  [Buzzers](#)
-  [Shuttlecock](#)
-  [Little Pines](#)
-  [Hoop and Dart](#)
-  [Bowl and Dice](#)

==>> [Other Native American Games](#)<<==

==>> [More fun at NIAC's Kid's Corner](#)<<==



Text and Graphics  
© 1994 - 2003 [Tara Prindle](#)  
unless otherwise cited.



# Weave A Virtual Wampum Belt

*Note: Your browser must be JavaScript enabled, please be patient while the script loads...*

## 1. SELECT BEAD TO WEAVE:



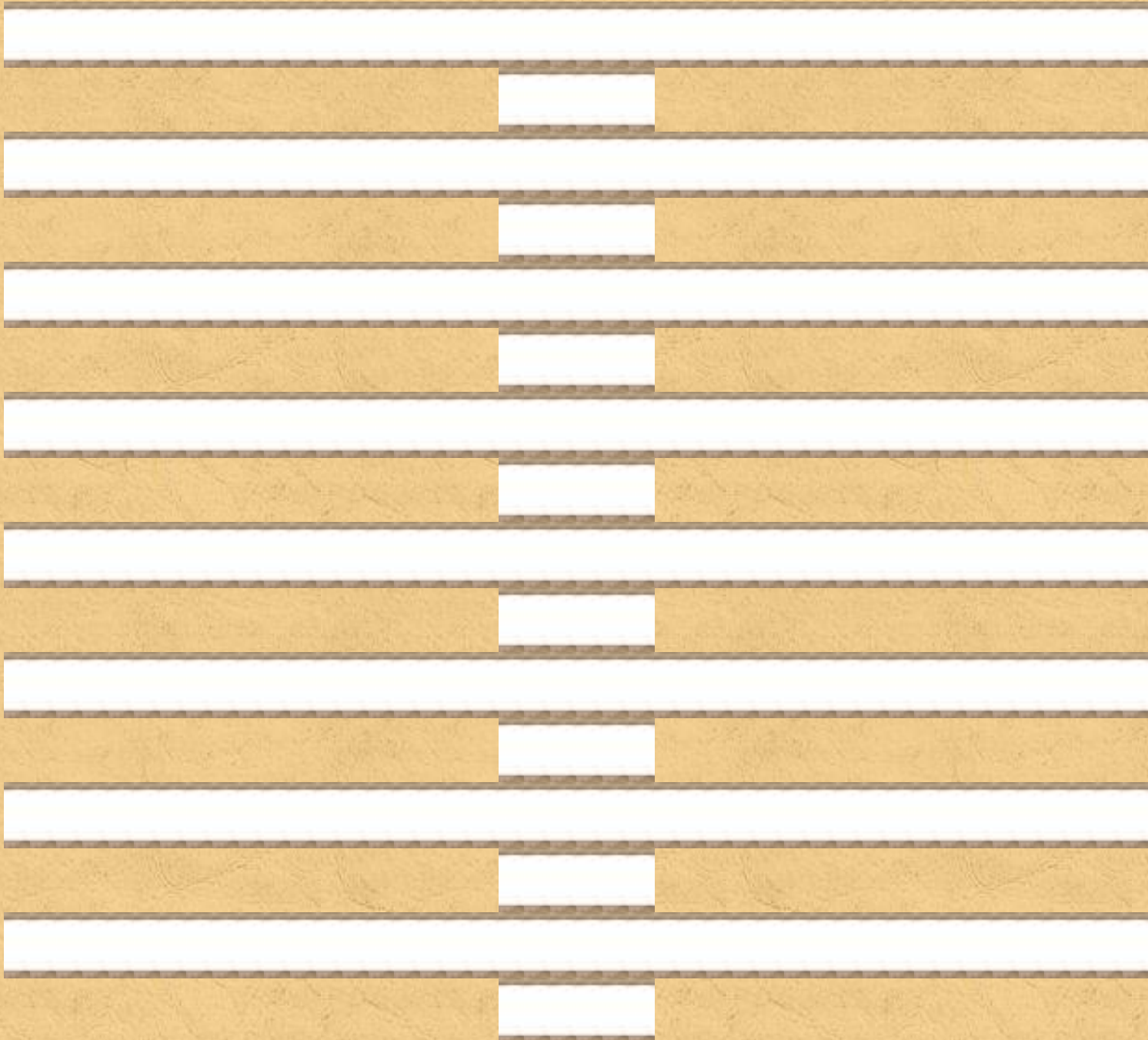
[Click Here for some Wampum Examples, History & Background](#)

*(opens in new window)*

## 2. SELECT WEAVING METHOD:

**Color single beads with each click.**

**Let the beads follow your cursor.**





Reproduction wampum beads used here are from [Waaban Aki Crafting](#)

"Virtual Wampum Belt" is based on the PebblePaint Script by Nicholas Alston

---

[Other Interactive Games on NativeTech](#)

[Return to NativeTech's Main Beadwork Menu](#)

---



Text and Graphics  
© 1994 - 103 [Tara Prindle](#)  
unless otherwise cited.





## WAMPUM HISTORY AND BACKGROUND



Shell beads have long had cultural significance to the Native Americans of southern New England; shell beads in the Northeast have been found which are 4500 years old. These shell beads were larger and relatively uncommon because drilling the material was difficult with stone drill bits. This earlier bead, proto-wampum, was traded within ceremonial contexts, in part for the connections of shell with water and its life giving properties.



Shell beads come in many traditional shapes and sizes, including small discs or hishi beads. Before contact with Europeans, shell beads were either disk shaped, or barrel shaped, usually made from the whelk's spiraling inner columnela. Other shapes of shell beads include tubes, and other forms resembling a ball, cone, diamond, square, or hourglass.

Wampum from Middle and Late Woodland periods (beginning around AD 200) had a robust shape, about 8mm in length and 5mm in diameter, with larger stone-bored holes of more than 2mm. Wampum beads of the mid-1600's average 5mm length and 4mm diameter with tiny holes were bored with European metal awls average 1mm. Seneca's in New York after European contact during the late 1600's had increasing numbers of shell beads which measured approximately 7mm length and 5mm diameter, having metal-drilled holes with a diameter of just under 2mm.



The word "Wampum" comes from the Narragansett word for 'white shell beads'. Wampum beads are made in two colors: white ("Wõmpi") beads ("Wompam") from the Whelk shell ("Meteaûhock"), and purple-black ("Súki") beads ("Suckáuhock") from the growth rings of the Quahog shell ("Suckauanaûsuck").





The quahog shell used to produce purple wampum and other shell pendants is exclusively the species with the Latin name 'Mercinaria mercinaria'

There are several types of Whelk used to make the white beads and pendants with the Latin name 'Busycon'. In southern New England beads are often manufactured from two local species: Busycon canaliculatum (Channeled Whelk) and Busycon carica (Knobbed Whelk), which both inhabit the waters from Cape Cod southwards to Florida. Early historic Iroquois wampum also originates from the species Busycon



sinistrum (Lightening Whelk) along the coast from New Jersey through Florida around through the Gulf, and also from the species Busycon Laeostomum (Snow Whelk) who's habitat ranges from New Jersey down to Virginia (Pendergast 1983: 97-112).

Some early historic documents contain inaccurate references to the shells being of periwinkle or muscle shell, sometimes mistaking the beads themselves for porcelain or bone. The periwinkle shell was not even introduced to the New England coastline until the late 1800's (Krepcio 2001: personal communication).

European traders and politicians, using beads and trinkets, often exploited gift exchange to gain Native American favor or territory. With the scarcity of metal coins in New England, Wampum quickly evolved into a formal currency after European/Native contact, its production greatly facilitated by slender European metal drill bits. Wampum was mass produced in coastal southern New England. The Narragansetts and Pequots monopolized the manufacture and exchange of wampum in this area.

The intense hardness and brittleness of the materials made it impossible to wear, grind, and bore the shell by machinery alone. First the thin portions were removed with a light sharp hammer, and the remainder was clamped in a scissure sawed in a slender stick, and was then ground into an octagonal figure, an inch in length and half an inch in diameter. This piece being ready for boring was inserted into another piece of wood, sawed like the first stick, which was firmly fastened to a bench, a weight being so adjusted that it caused the scissure to grip the shell and to hold it securely.

*The drill was made from an untempered handsaw, ground into proper shape and tempered in the flame of a candle. Braced against a steel plate on the operator's chest and nicely adjusted to the center of the shell, the drill was rotated by means of the common hand-bow. To clean the aperture, the drill was dexterously withdrawn while in motion, and was cleared by the thumb and finger of the particles of shell. From a vessel hanging over the*





[Tools for making "Dutch" wampum \(Orhard 1975: 84\).](#)

[Click for closer view.](#)

*closely clamped shell drops of water fell on the drill to cool it, for particular care was exercised lest the shell break from the heat caused by friction (Jennings 1976: 93-94).*

A fathom (six feet of strung beads) of white wampum was worth ten shillings and double that for purple beads. A coat and *Buskins* "set thick with these Beads in pleasant wild works and a broad Belt of the same (Josselyn 1988: 101)" belonging to King Philip (Wampanoag) was valued at Twenty pounds. Even in the 1600s there was noted distinctiveness of Native-made wampum and the inability of others to counterfeit it, although attempts at imitations included beads of stone and other materials.

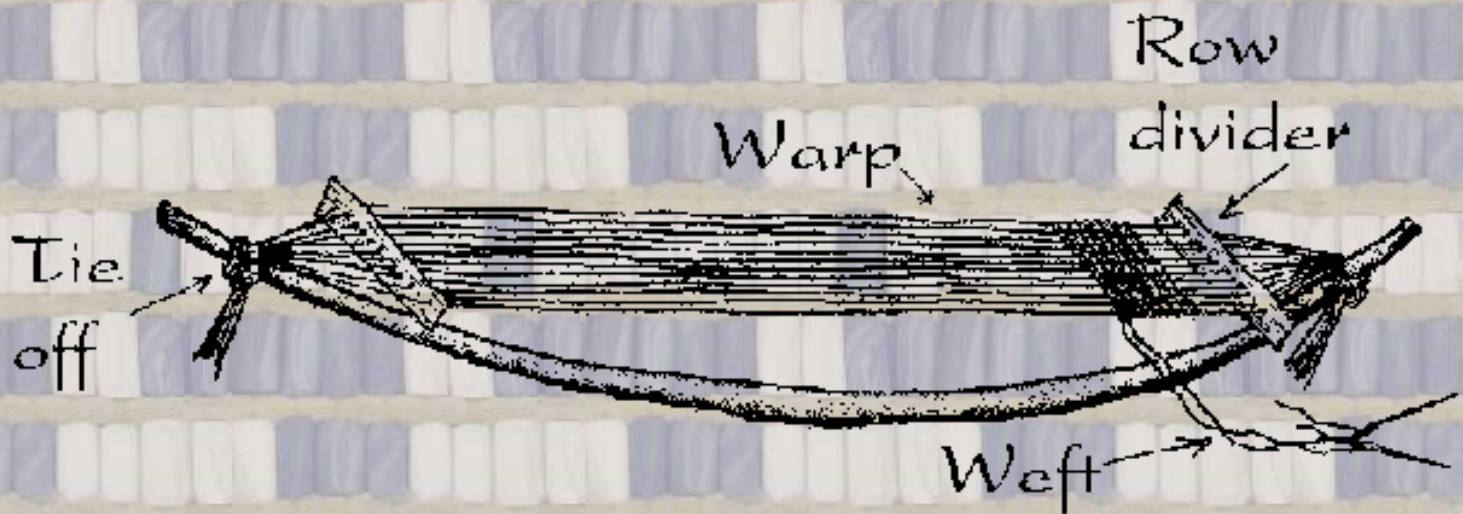


*King Philip, Wampanoag [from a lithograph by T. Sinclair appeared in Events in Indian History, 1842].*

*"Strung money was known as wampumpeage, or merely peage. Customarily arranged in lengths of one fathom (6 feet), which contained anywhere from 240 to 360 individual beads, depending not only on the size of the beads but on their current worth, for "fathom" soon came to denote a specific monetary value. Individual strands were then worked into bands from one to five inches wide, to be worn on the wrist, waist, or over the shoulder, ... Occasionally the Indians fashioned great belts containing over ten thousand beads" (Vaughan 1979: 120 - 124).*

With the increased manufacture after European contact, these beads were carried inland along indigenous trade routes as far as the Great Plains and as far south as Virginia. By the 1700's the Dutch Europeans began to fabricate vast quantities in factories such as the Campbell wampum factory New York.

*"The use of wampum as money, even among the English, continued until the American Revolution. Important matters such as treaty agreements were likely to be marked by an exchange of Wampum belts, with designs in two colors, which thereafter served as visual reminders of the event itself, and to call to memory the arrangements agreed on" (Russel 1980: 185).*



*Bow Loom used in New England  
to weave wampum belts.*

Wampum belts consist of rows of beads woven together. Belts were made using the techniques of both hand-held and loom-woven beadwork, often on a simple loom made from a curved stick resembling an archer's bow. Weaving traditionally involves stringing the beads onto twisted plant fibers, and securing them to animal sinew or leather thong warp.

Inner fibers stripped from milkweed, dogbane (a close relative of milkweed), toad flax, velvet leaf, and nettle plants were twisted into fine threads. By the 1700's a multitude of Native American weaving techniques had developed for wampum belts, bracelets, necklaces and collars. By the 1700's in New England, tubular glass beads and small round pony beads were being woven into belts and bands.

Long, wide belts of wampum were not produced by Native Americans until after European contact. However, the methods and techniques used in making large wampum belts probably developed from the ancient Native American traditions of finger-weaving. Some of the earliest post-European contact wampum belts were worn as collars around the neck. These early wampum collars are made without the use of a loom, much like prehistoric finger-weaving, with one end of the belt anchored and the other end left free to weave the warp and weft elements on a bias (diagonal). The very first woven wampum most likely incorporated single beads strung onto twine while finger-weaving sashes, garters, burden-straps or other bands. The belt weaving technique known as 'double-strand square weave' appears earlier (late 1500's and early 1600's) than the 'single-strand square weave' technique.



*Penobscot Wampum Collars & Belt (Speck 1976)*

Although a loom is helpful, but not necessary, the [double-strand square weave](#) technique does not require the use of metal needles, as the beads can be strung one at a time onto the two wefts and then the wefts passed



under and over the next warp string. The [single-strand square weave](#), used by most bead-workers today, probably developed in the late 1600's and early 1700's with the florescence of the Native wampum industry.



***Reproduction of the "Belt Carried by the Penobscot Delegate to Caughnawauga"***

*"The white ground color symbolizes its peaceful mission, the blue rectangle in the center represents the four Wabanaki tribes grouped about their council fire, while the four small crosses ranged at the sides again denote the four tribes. Another somewhat variant interpretation may be given in which the central rectangle represents the council fire of the confederacy at Caughnawaga, to which the four tribes indicated by the crosses owe their allegiance."* (Leavitt & Francis 1990: 17).



***Reproduction of the "Belt Representing the Union of the Four Eastern Tribes"***

*"...with a dark background denoting former or potential hostility among the tribes, lightened on the margins with white borders denoting the bonds of friendship that now surround them. The alternating panels of blue and white at the ends are evidently a convention imitated from the Iroquois. The four white triangles are tribal "wigwams," the Penobscot, Passamaquoddy, Malecite, and Micmac. In the center is the pipe which is the symbol of peace by which the allies re joined"* (Leavitt & Francis 1990: 17-18).



*Reproduction Bias-weave wampum collar by Prindle 2003*

Aside from beauty, wearing or presenting jewelry had many social, economic, political and religious implications for the Native Americans of the 1600's in southern New England. White wampum is the emblem of health, peace or purity. Purple and black wampum are color variants of the same bead, and were used for serious or civic affairs, sometimes indicating dis-ease, distress or hostility, at least in referring to the background colors in belt patterns. The meanings in the designs can become very complicated, for example a belt may have white designs on a purple background but be surrounded by a white border, indicating a relationship that was once hostile is now peaceful. A wampum belt painted red (with red ochre or vermilion) was sent as a summons for war.

Personal headbands and bracelets might combine shell with glass or metal beads. Many Native American headbands and bracelets in the 1600's in southern New England incorporated squares, triangles, diagonal lines, crosses, people, animals and other geometric shapes. Belt designs might show kinship or connection with a particular group. Belts and beads validated treaties and were used to remember oral tradition. Ceremonies of dance, curing, personal



sacrifice incorporate religious and ritual aspects of beads. Jewelry was also used to display many physical or social "rites of passage", and shows that a person has gone through a certain transformation in their life, like maturity or marriage. Wampum could be presented by the family of a prospective husband to the family of a potential wife, and if accepted, granted approval for the marriage.



Delaware family, 1653 wearing belts, bands, strings, & medallions (Trigger 1978:218).

*"The young man, when he had settled his mind upon marrying some special girl, would appoint an uncle, or some elderly man to be his go-between. Extra dignity was lent to the occasion by having two old men for negotiators. He would then procure some wampum, if he were rich enough a collar or necklace, if not, just a string. Next he would compose a message, the main points of which would be represented by the arrangement of white and purple beads. This message, accompanied by the mnemonic wampum, would be forthwith entrusted to the go-between's care, and he would go to the home of the girl's parents carrying the wampum in a rolled-up red handkerchief or other gaudy cloth. Here his message would be delivered, and the wampum left, to be debated upon by the girl's family. The negotiator would depart for a while to allow time for deliberation. Before long he would return for an answer. Now should the girl's family have decided negatively, the wampum would be returned to the old man, who would deliver it to the sender. And the matter was dropped. But should the suitor be favorably regarded, the wampum would be retained and upon the negotiator's next visit he would be answered in the affirmative or asked to defer a little longer. The retention of the wampum was considered a sign of consent. It often happened that the husband, after the wedding, would buy back the wampum" (Speck 1976: 254-255).*

---

[Some pictures adapted from published sources on wampum](#)

[Single-Strand Square Weave Technique](#)

[Double-Strand Square Weave Technique](#)

[Other Internet Links for Wampum and Woven Beadwork](#)

[Return to NativeTech's Beadwork Menu](#)

[Beadwork Bibliography and Books to Buy On-Line](#)

[Reproduction wampum beads are available from Waaban Aki Crafting](#)

---





Text and Graphics  
© 1994 - 103 [Tara Prindle](#)  
unless otherwise cited.

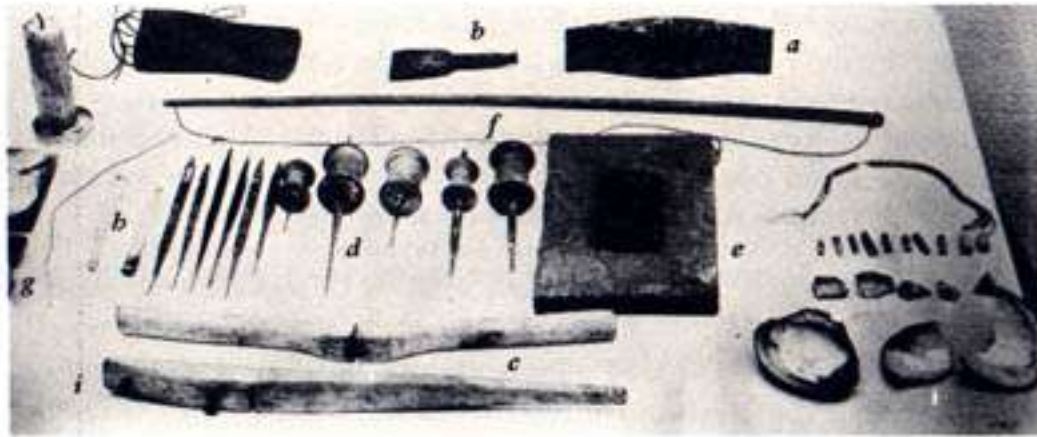


FIG. 73.—Tools for making "Dutch" wampum.



FIG. 74.—Wampum making: Roughly shaping a piece of shell before drilling.

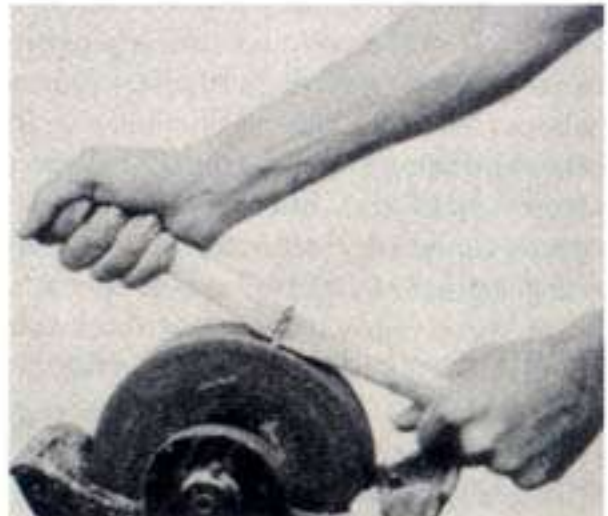


FIG. 75.—Wampum making: Squaring the ends of the shell by grinding.



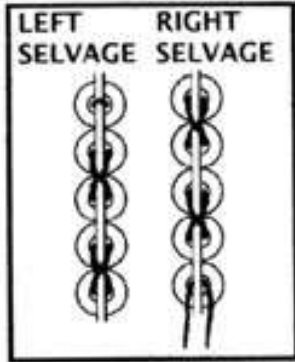
FIG. 76.—Wampum making: Perforating a roughly shaped bead.

FIG. 76.—Wampum making: Perforating a roughly shaped bead.

From: **Beads and Beadwork of the American Indians** by William C. Orchard, 1975,  
Museum of the American Indian, Heye Foundation. (pgs. 84-86.)

NativeTech: Native American Technology & Art  
Woven Wampum Beadwork

# Double-Strand Square Weave Technique



**BASIC PRINCIPLE:** For each column of weaving: The first needle and weft thread, with beads strung on it, passes under the looms warp strings. Then the second needle and weft passes over the warps in the same direction through the beads already in place.

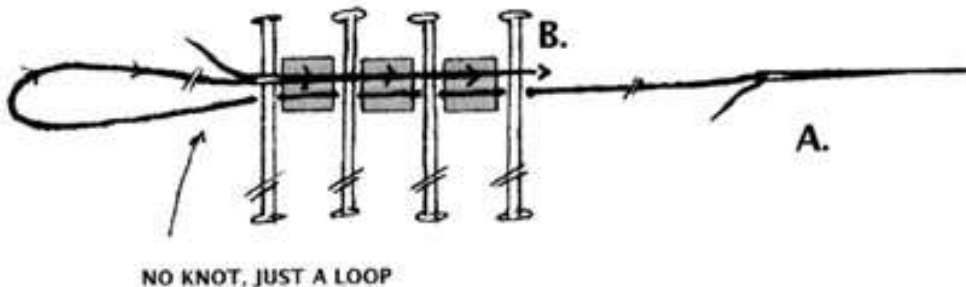
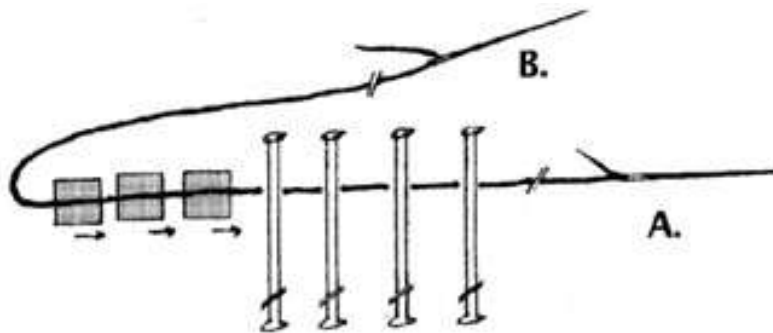
### TYING ON:

1. No knot is needed to start. Use 2 needles.

Thread both ends of a 3 yd. (nylon) string weft.

Slip appropriate number of beads to middle of weft.

Pass beads and weft (A) to right *under* warp. (So there is one bead between each pair of warps.)

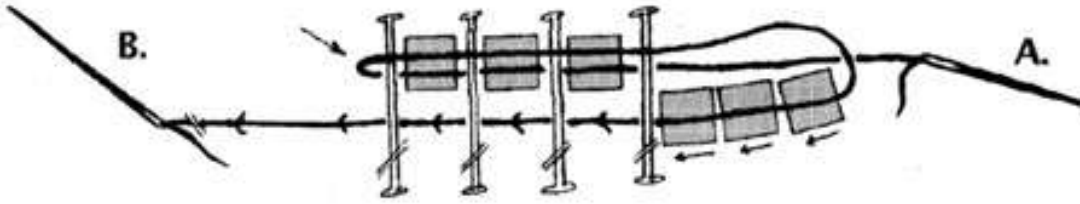


2. Pass the second needle and weft (B) from left to right through the column of beads held in place [*over* the remaining warps].

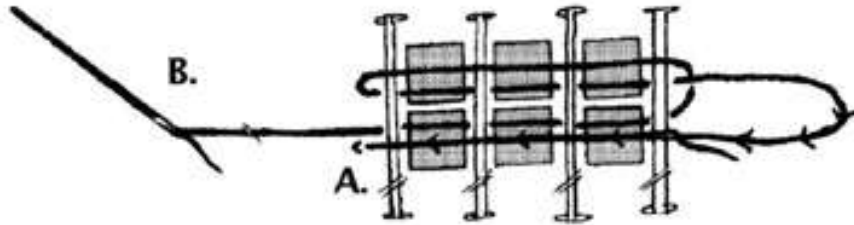


**CONTINUE WEAVING:**

**3. Now weave from right to left. Put the appropriate number of beads onto the weft (B) and pass the needle and weft *under* all the warps.**



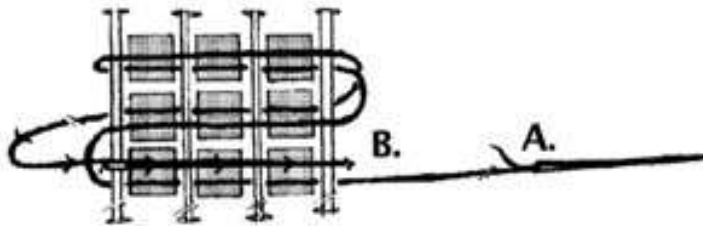
**4. Hold the beads in place between the warps, as you thread the other needle and weft (A) right to left [*over* the warps] through the same column of beads.**



**5. Repeat 3. and 4. until thread is short (5").**

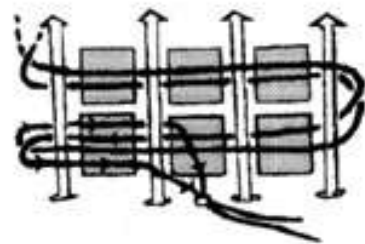
**Add new length of wefts in square knots to old wefts and weave ends back into beadwork.**

**[Try not to let the ends of the two wefts run out at the same time, so the knots are not right next to each other.]**



**TIE OFF:**

**6. End weaving by passing one weft *under* a warp, and the other weft *over* a warp, and through a bead. Knot the two wefts together around a warp. Weave ends back in.**



[Return to History and Background of Wampum](#)

[Some pictures adapted from published sources on wampum](#)

[Return to NativeTech's Beadwork Menu](#)

[Beadwork Bibliography and Books to Buy On-Line](#)

[Reproduction wampum beads are available from Waaban Aki Crafting](#)

---



**Text and Graphics**  
© 1994 - 103 [Tara Prindle](#)  
unless otherwise cited.

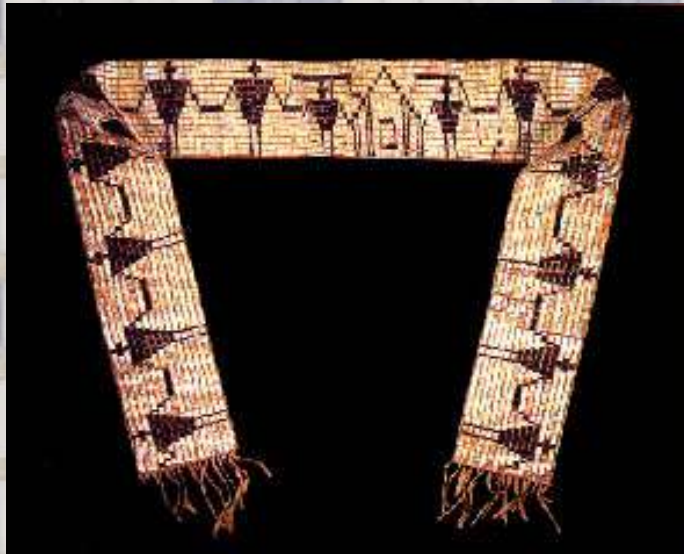
## Native American Technology & Art Pictures Adapted from Published Sources on Wampum

---



**The Huron Wampum Belt commemorates the 1683 agreement between the Hurons and Jesuit missionaries for the construction of the first wooden church on Huron Lands.** Adapted from *The Native Americans*. Edited by B. & I. Ballantine. 1993.

---



**The Great Chain, or Covenant Belt, is generally thought to be a belt presented by the U.S. government to the Iroquois in 1794 at the Pickering Treaty at Canandaigua, N.Y. The human figures, each linked by a wampum belt, form a chain of friendship, representing the alliance between the thirteen states and the Iroquoian confederacy.** Adapted from *The Native Americans*. Edited by B. & I. Ballantine. 1993.

---





**Wampanoag Chief Metacom, son of Massasoit, was known to his European contemporaries as "King Philip."** Adapted from a lithograph by T. Sinclair appeared in *Events in Indian History*, 1842.



**Unprovenanced Wampum Belt and Headbands from Southern New England.** Adapted from *Diary of King Philip's War 1675-1676* by Col. B. Church. 1975.

[Return to History and Background of Wampum](#)

[Return to NativeTech's Beadwork Menu](#)

[Beadwork Bibliography and Books to Buy On-Line](#)

[Reproduction wampum beads are available from Waaban Aki Crafting](#)

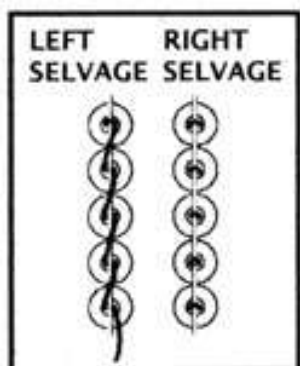




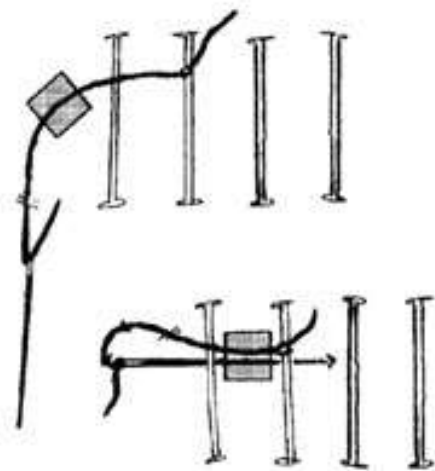
Text and Graphics  
© 1994 - 103 [Tara Prindle](#)  
unless otherwise cited.

## NativeTech: Native American Technology & Art Woven Wampum Beadwork

# Single-Strand Square Weave Technique



**BASIC PRINCIPLE:** For each column of weaving: A needle and weft thread, with beads strung on it, passes under the looms warp strings. Then the weft passes back over the warps through the beads already in place.

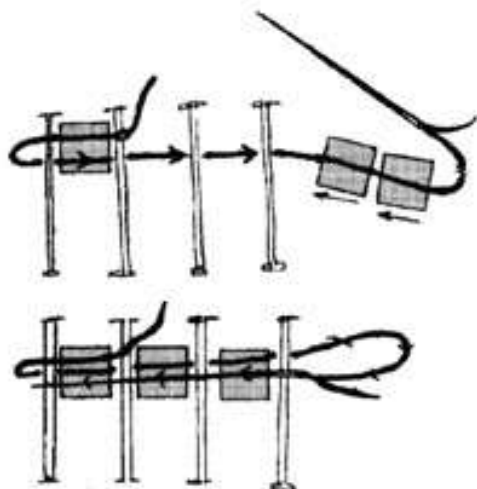


### TYING ON:

1. Use 1 needle and 1 1/2 yd. (nylon) string weft. Knot on 2nd warp from left.

Slip one bead up to knot and pass weft to left *over* warp.

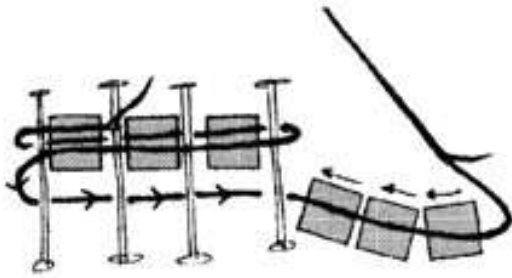
Pass needle and weft to the right under warp and go through the bead in place.



2. Slip the remaining number of beads [in the column] onto the weft.

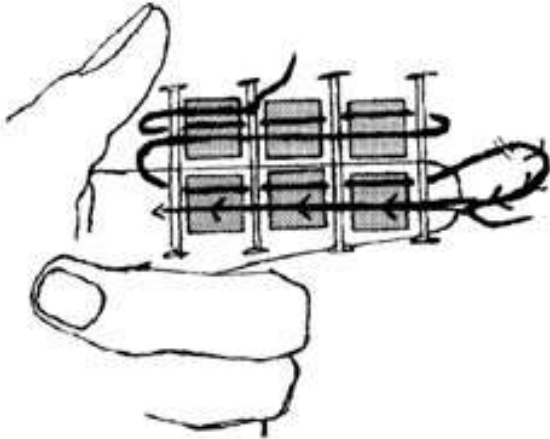
Pass the needle and weft to the right [*under* the remaining warps].

Thread the needle and weft [*over* the warps] back through the same column of beads.



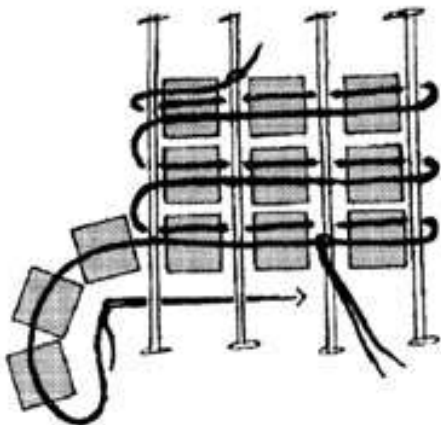
**CONTINUE WEAVING:**

**3. Slip the appropriate number of beads onto the weft and pass the needle and weft *under* all the warps.**



**4. Use the pointer of your left hand to hold the beads in place between the warps, as you thread the needle and weft [*over* the warps] back through the same column of beads.**

**[pull weft straight out from the column of beads, or beads/thread may break.]**

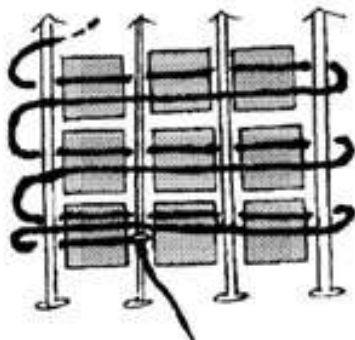


**5. Repeat 3. and 4. until thread is short (5").**

**Add new length of weft in middle of column of beads.**

**Tie new weft in square knot to old weft and weave ends back into beadwork.**

**[If nylon, the string can be trimmed short (1/4") and melted to the knot.]**



**TIE OFF:**

**6. End weaving by passing the weft *under* a warp and through a bead. Knot around a middle warp. Weave end back in.**

[Return to History and Background of Wampum](#)

[Some pictures adapted from published sources on wampum](#)

[Return to NativeTech's Beadwork Menu](#)

[Beadwork Bibliography and Books to Buy On-Line](#)

[Reproduction wampum beads are available from Waaban Aki Crafting](#)

---



**Text and Graphics**  
© 1994 - 103 [Tara Prindle](#)  
unless otherwise cited.



You are being redirected to NativeWeb's Resource Database for Beads and Beadwork

## Resources for Indigenous Cultures around the World

[Resources](#) [Books & Music](#) [Community](#) [Services](#) [About Us](#)

### Resource Center

- [Internet Links](#)
- [Nations Index](#)
- [Geographic Region Index](#)
- [Search the Site](#)
- [New Sites this Week](#)
- [Submit a Site!](#)
- [Top 5 Percent](#)

### Hosted Resources

- [Hosted Pages](#)
- [Book & Music Center](#)
- [Law & Legal Issues](#)
- [NativeLaw News](#)
- [NativeTech](#)

### Site Information

- [Get your FREE EMAIL @NativeWeb.Net!](#)
- [Community](#)
- [About Us](#)
- [Hosting Information](#)

[Resource Database](#) / [Crafts & Indigenous Technology](#) / **Beads & Beadwork**

### Beads & Beadwork Sub-Categories:

- [Woven Beadwork & Wampum](#)

**Resources: 37 listings**

| Name and Description                                                                    | Nation | Location | Hits |
|-----------------------------------------------------------------------------------------|--------|----------|------|
| <a href="#">Aunt Molly's Beadwork Projects: Brick Stitch Beaded Earrings</a>            |        |          | 5343 |
| Teardrop shaped earring project.<br><a href="#">More sites on www.flash.net</a>         |        |          |      |
| <a href="#">Bead Fairies Page</a>                                                       |        |          | 3728 |
| Illustrated Glossary of Bead Terms A-Z<br><a href="#">More sites on members.cox.net</a> |        |          |      |
| <a href="#">Beaded Bead</a>                                                             |        |          | 3522 |
| Bonnie Brook's techniques for covering a sphere in peyote stitch.                       |        |          |      |
| <a href="#">Beadesigner International</a>                                               |        |          | 2567 |

Donate to  
NativeWeb!  
Tax Deductible!



**The New England Area Bead Society - is a non-profit organization devoted to the study, design and research of beads, beaded jewelry and beaded objects. Our membership consists of beadmakers, jewelry designers, collectors, shop owners, gemologists, anthropologists, researchers and generally anyone interested in beads.**

**More sites on [www.geocities.com](http://www.geocities.com)**

**Beading Tips 3166**

**Mary J. Winters-Meyer, The Beading Banshee**

**Beadweaving Basics 3769**

**Using a bead loom plus tips on beads and beading threads.**

**Beadwork Designs - Iroquois US - 4848  
through Martin's Craft Northeast  
Shop**

**A Few Sample Designs of Beadwork (trimmed at bottom of leggings and/or skirt/wrap)**

**Beginner's Peyote 4016**

**Earring Project**

**How to make a peyote tube earring with looped fringe.**

**More sites on [www.flash.net](http://www.flash.net)**

**Beltana's Beads Main 6582**

**Page -- Patterns,  
Instructions, Links and  
more!**

**Learn Tubular Peyote; Learn Cheyenne Brick; Learn to Loom; Learn Net Stitch; Learn Spiral Rope Chain; My Patterns; My Gallery; Great Beading Links; Tools and Materials; Beading Tips**

**More sites on [www.angelfire.com](http://www.angelfire.com)**

## Early Bead Trade in North America 2391

Cherokee Messenger- Aug. 1995 Prior to settlement by Europeans, all North American Indians seem to have shared an appreciation for beads. At least eight thousand years before Europeans crossed the Atlantic, Indians were making, wearing, and trading beads of shell, pearl, bone, teeth, stone, and fossil crinoid stems.

[More sites on www.powersource.com](http://www.powersource.com)

## Easybeadpatterns.com 3081

A free service which allows you to generate bead patterns using digital images of type .jpg or .png.

## Even-Count Tubular Peyote 1537

Even count peyote instructions from Suzanne Cooper.

[More sites on suzannecooper.com](http://suzannecooper.com)

## Flat Round Peyote 2471

Anne Hawley's technique for making peyote rounds that lay flat every time!

[More sites on rogue.northwest.com](http://rogue.northwest.com)

## Free Designs 6421

Patterns for a variety of unique earrings from The Beading Banshee, Mary Winters-Meyer.

[More sites on www.staff.uiuc.edu](http://www.staff.uiuc.edu)

## Gourd Stitch Beadwork 2308



The purpose of this site is to provide resources for people interested in gourd stitch style net beadwork. The following links will take you to slide shows that have detailed instructions on how to get started doing gourd stitch beadwork as well as another presentation for folks who need more advanced help.

**Guide to Beadwork -** 4719  
**The Online Version**

Basic Beading, Supplies, Techniques, Fringe, Chevron Chain, Daisy Chain, Flower Stitch, Twill Stitch, Gourd Stitch, Brick Stitch, Lace Stitch, Glossary and Search Engine

[More sites on www.guidetobeadwork.com](http://www.guidetobeadwork.com)

**Hair Pipes in Plains** US - 2473  
**Indian Adornment** Central

Students of the American Indians and of Western history are familiar with the elaborate breastplates of long, light-colored, tubular beads worn by many prominent Plains Indian men that have been depicted in photographs taken since about 1870. Yet the story of how, when, and where these picturesque ornaments originated and how the custom of wearing them was diffused widely among the Plains Indians and their neighbors has never been told.

[More sites on www.sil.si.edu](http://www.sil.si.edu)

**Hair Pipes in Plains** 1600  
**Indian Adornment**

A Study in Indian and White Ingenuity By John C. Ewers Hairpipe Breastplate Anthropological Papers, No. 50 From Bureau of American Ethnology BULLETIN 164, pp. 29-85, pls. 13-37. United States Government Printing Office, Washington : 1957 Smithsonian Institution Libraries Electronic Edition 1996

**More sites on [www.sil.si.edu](http://www.sil.si.edu)**

**[handthoughts](#)** Cherokee United States 479

HandThoughts is an educational, scholarly research resource site and magazine about beads, beadwork, beaded objects. Our mission emphasizes a poly-cultural perspective. Our links pages, now being revised, include extensive resources about Native Peoples' beadwork and beads, including early trade, contemporary bead art, and museum/gallery exhibitions of Native American/First Nations bead-related topics. We are also building links pages on archaeological looting, racism, and social action.

**[Hecuba's Bead Graphics](#)** 3930

Bead It Free - The emphasis is mainly Native American loomwork patterns. They are free to download.

**[Index of beading techniques](#)** 1542

Instructions for beading techniques including Peyote Stitch, Brick Stitch, Loom Beadwork, Vertical Netting, Oglala Butterfly, Single Needle Embroidery, and other tips and tricks.

**[More sites on \[members.tripod.com\]\(http://members.tripod.com\)](#)**

**[Indigenous Beadwork at Delphi Forums](#)** United States 1771

A Delphi Forum/Chat Discussion area for Indigenous Beadwork artists and those who wish to learn from them. Hosted by two Cherokee cousins, Indigenous Beadwork welcomes any and all interested in honoring, celebrating, and respecting the craft.

**[More sites on \[forums.delphiforums.com\]\(http://forums.delphiforums.com\)](#)**

**Iroquois Beadwork - Cultural portraits of the past & present**      Iroquois US - Northeast      1265

Many First Nations in Québec and Canada have long practiced beadwork. This art has become a very real tradition for two Iroquois nations in particular, the Mohawks, who live near Montreal, and the Tuscaroras, who live on the American side of Niagara Falls. This website and the McCord Museum exhibition that inspired it - **Across Borders: Beadwork in Iroquois Life** - are based mainly on the beadwork of these two nations. ... Be sure to visit the Kid's Zone here!

**Janies Notebook**      1758

I hated starting peyote stitch--string on the number of beads in the pattern for the first two rows, add a bead, skip a bead, go through the next bead, add a bead, skip a bead, go through the next bead, add a bead, skip a bead, go through the next bead...and fight the taped up paper tube if working in the round. My first rows were always too tight, skewed, weird, and generally unsatisfactory. So-o-o-o-o-o...

**[More sites on www.geocities.com](http://www.geocities.com)**

**Lane Stitch**      1680

When, where, and how to use lane (lazy) stitch.

**Linked Chain Stitch**      866

**Supplement**

Mary Winters-Meyer's linked chain stitch.

**[More sites on www.staff.uiuc.edu](http://www.staff.uiuc.edu)**

**Native American Cybernetics**      US - Northeast      643

Virtual Bead Loom - mathematics education from indigenous knowledge





The Society was formed in 1981 to foster research on beads of all materials and periods, and to expedite the dissemination of the resultant knowledge. Membership is open to all persons involved in the study of beads, as well as those interested in keeping abreast of current trends in bead research. The Society publishes a biannual newsletter, The Bead Forum and an annual journal, Beads. Contents of the newsletter include current research news, requests for information, responses to queries, listings of recent publications, conference and symposia announcements, and brief articles on various aspects of bead research.

[More sites on www.mindspring.com](http://www.mindspring.com)

### Spiral Rope Chain 2386

Showing a spiral cord technique for bracelets, necklaces or straps.

[More sites on rogue.northwest.com](http://rogue.northwest.com)

### Thunder Bay Historical Ojibwe US - 572 Museum Society Northeast

Swampy Cree and Ojibway beadwork and embroidery.

### Trade Beads of the 1631 Indian Trade

When the Spanish explorer Hernando Cortez landed on the coast of Mexico in the spring of 1519, he had glass beads along with other European trade goods. In 1622, a glass factory was built near Jamestown, Virginia. Less than a year later, the factory was destroyed by a raiding party of Indians. Very few of the beads made in the Jamestown factory are believed to exist today.

[More sites on www.thefurtrapper.com](http://www.thefurtrapper.com)

### Virtual Bead Design 1402

**Online beadwork designer for brick-stitch or  
gourd stitch.**

---

© [NativeWeb, Inc.](#) 1994-2003 || [Disclaimer Statement](#) || [Copyright Statement](#) || [Contact Us](#) || [Visitors](#) || [Donations](#)

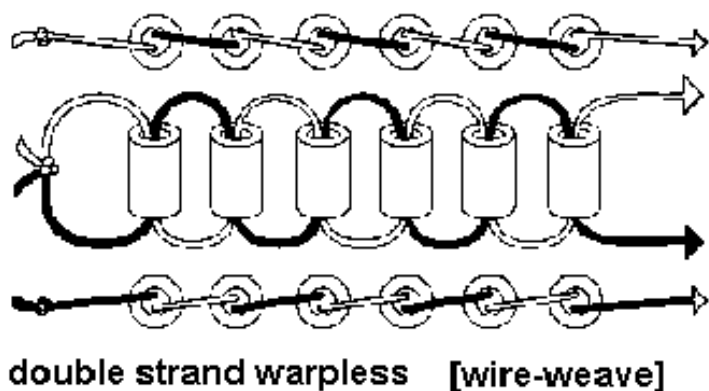
NativeTech: Native American Technology and Art  
NATIVE AMERICAN BEADWORK

## Bead Weaving Techniques and Analysis

© 1996 - 1999 [Shelley M. Smith](#) and [Tara Prindle](#).

**Beads are perhaps one of the earliest forms of Native American art. Beads are by their nature, intended to be strung on cord and various techniques have developed and evolved over the millennia in the eastern Woodlands. Some methods of stringing beads are similar to those used in textile and basket weaving. Beadweaving shares many technical traits with woven mats and twined baskets, and it may have developed alongside these other industries.**

**Woven Beadwork consists of two things: beads and string. The string used can range from animal proteins such as twisted sinew or hide thong to twisted cord from numerous plants, bark and roots. Twisted cordage needed to be made from otherwise short fibers for beadweaving, as it requires a string long enough to go through a great length of beads. Dogbane stalks, basswood bark and cedar bark or roots are commonly made into cord for beadweaving. Though European threads were available during early contact, Natives continued to use their own cordage, which was also deemed of superior quality by Europeans.**

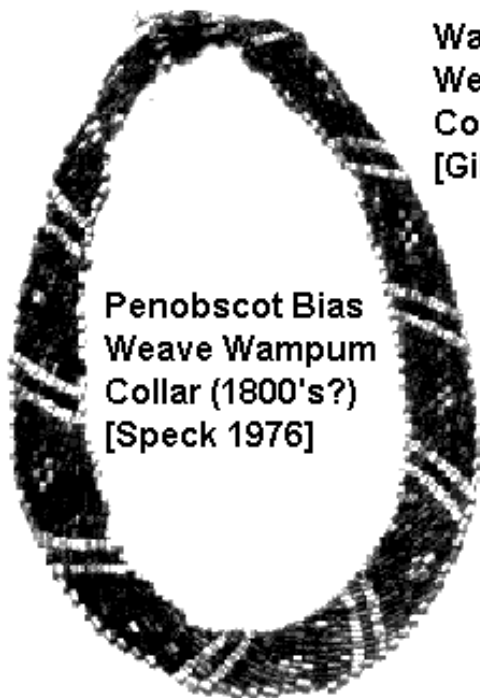


In weaving, as opposed to knotting or looping strings around each other, the bead represents an alternate way to secure strings together. Without the beads, loomwork would fall apart! The earliest forms of weaving by Natives of North America were probably hand-held 'finger-woven' techniques, developed from simple forms of braiding in which one end of a length of strings is anchored. The free end of the lengths are held in the hands and interwoven by taking the elements from the outer edges and bringing them to the center. There is no separate warp or weft with hand-held methods of 'finger-weaving', as the outer warps are each in turn then used as wefts as the work progresses.



**Wire-weave (or wire work) ring made from glass beads and wire, 20th century**

The simplest and perhaps the earliest form of beadweaving is hand-held, using techniques similar to braiding. This technique is often referred to as 'wire-work'. Ironically, though 'wire-work' is perhaps the first type of woven beadwork, the term comes from a 20<sup>th</sup> century type of beadwork using glass seed beads on thin wire to make rings and other commercial jewelry.



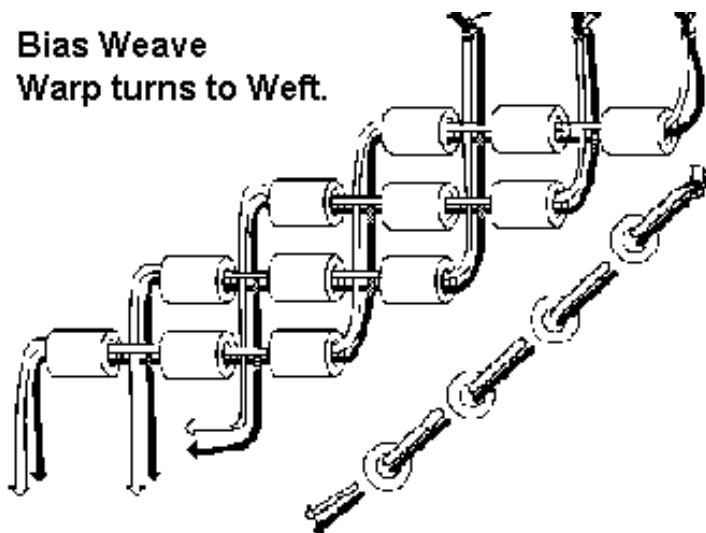
**Penobscot Bias Weave Wampum Collar (1800's?) [Speck 1976]**

**Wampanoag Bias Weave Wampum Collar (1600's) [Gibson 1980]**



Building on the same principles in 'wire-work', bias-weaving was used to produce many wampum collars in the Northeast during the 17<sup>th</sup> and 18<sup>th</sup> centuries. Bias-weaving beadwork techniques are nearly identical to those used for Native-made textiles such as basswood burden straps and yarn belts and garters in 17<sup>th</sup> century New England.

**Bias Weave  
Warp turns to Weft.**



When archaeologists or ethnotechnologists are analyzing fragments of very old beadwork, they must be very careful to observe the selvages of woven fragments. Being unaware of 'false fringe' effects produced by broken warps and missing rows of beadwork can lead to erroneous interpretations of beadwork techniques.





**Penobscot Bias Weaving, drag strap and tumpline (mid-1900's) [Speck 1976]**



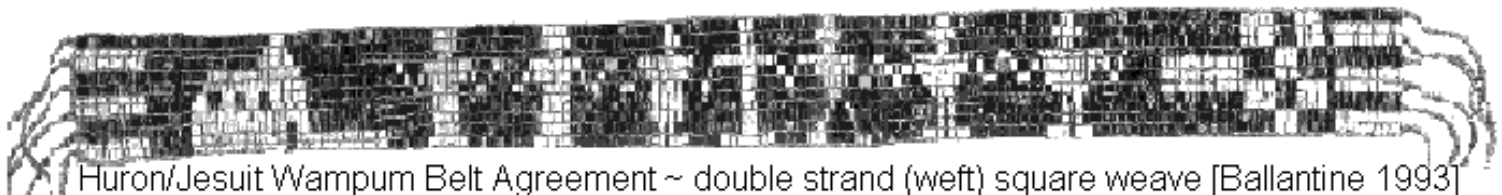
**Schematic Diagram of Eastern Woodland bias weaving of straps or belts**

European contact introduced metal tools, enabling the Native production of smaller shell beads, and also made available a flood of glass trade beads and iron needles. Native Americans developed ways to weave larger pieces of beadwork using smaller tools and supplies. It is more practical to anchor both ends of the long strings, the warp, and to use a separate element, a weft, to secure on the beads. Separating the strings in two weaving elements, warp and weft, required the use of a loom. The bow loom is the most elemental form of free-standing loom (meaning no part of the work is attached to the weaver).

**Eastern Great Lakes Garter Drop of bias weaving with glass beads woven in (late 1700's) [King 1991]**



Using a bow loom, beads can be individually strung on a doubled weft, which is parted and passed around each warp string, paired again and passed through a bead, and so on. This technique is called 'double-strand square-weave'. The weave is 'square' because it progresses across each row to the next column, in a square direction.

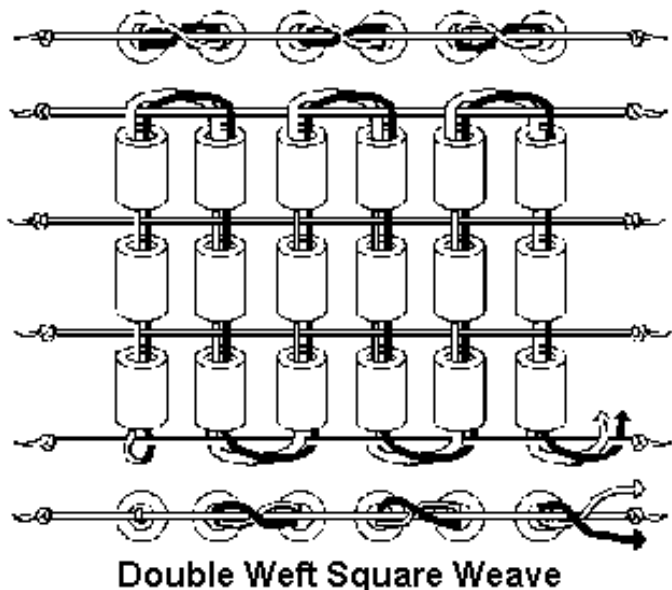


**Huron/Jesuit Wampum Belt Agreement ~ double strand (weft) square weave [Ballantine 1993]**

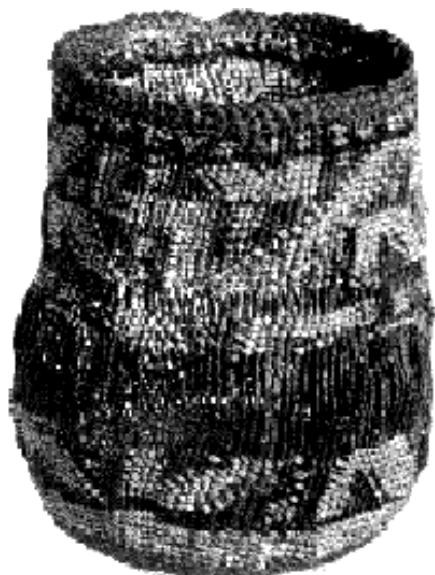


**E. Woodlands Schematic of Open Twining Cord & bark mat**

The technique has parallels with Native American twined mats and baskets. The weft makes a pattern of X's on the outer warps of the beadwork, showing how each weft crosses it mate as it moves to string on the next row of beads.



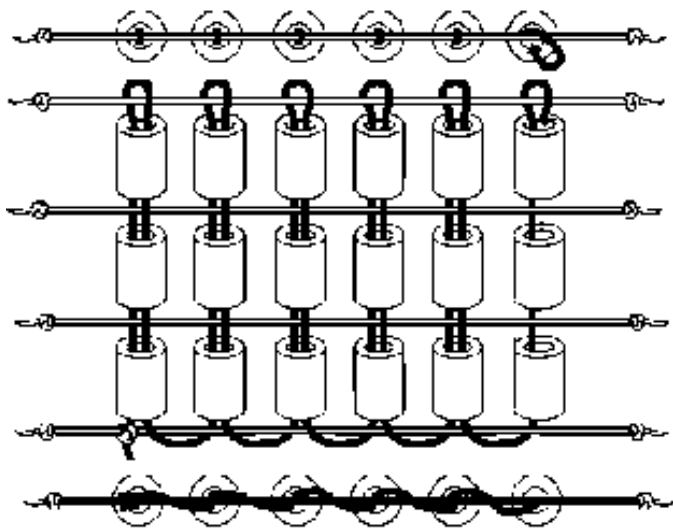
It is possible, though not time-effective to do double-strand square-weave without the use of a loom, by anchoring one end of the beadwork as in bias-weaving. Double-strand square-weave does not absolutely require the use of a needle, as the beads for each row can be placed on the doubled thread on at a time.



**Narragansett (1675)  
Closed Twining Bark,  
wool & husk Bag**  
[Turnbaugh &  
Turnbaugh 1986]

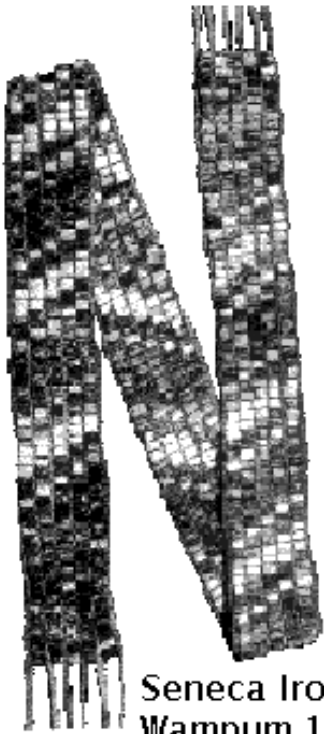
Because of the similarities of double-strand square-weave to bias-weaving, and because it doesn't require a needle, it was probably the first technique of loomed beadwork used by Natives of the Eastern Forests for the large wampum belts in the 1600's.

Another beadwork technique for the loom, commonly used today by many Native Americans, is 'single-strand square weave'. With this technique, a single weft is used that passes through



**Single strand Square weave**

the same row of beads twice, before progressing to the next row. Because weft cannot secure the beads on either side of the warp one at a time, a needle must be used to get the weft through back through the entire row of beads. This method of beadwork has obviously been used for a long time, as wampum belts from the 1600's through the 1800's also use the 'single-strand square-weave' technique.



**Seneca Iroquois  
Wampum 1670-1687 -  
Single Weft Square  
Weave [Hayes 1985]**

For each of the basic hand-held and loomwork methods, there are innumerable variations. An infinite number of effects can be achieved by wrapping or varying the number of warps, or by changing the way the weft goes around the warp. On a very local level, as the degree an intensity of European contact varied from area to area, there appears to be a chronological sequence from hand-woven multi-strand beadwork to needle-loomed single-strand beadwork, coming full circle back to a revival of hand-woven 'wire work' in this century.

---

[Index to Techniques of Woven Beadwork using Diagrams](#)

[Return to NativeTech's Beadwork Menu](#)

[Beadwork Bibliography and Books to Buy On-Line](#)

---



© 1994-1999 [Tara Prindle](#).



## NativeTech: Native American Technology & Art



# A Message from Nunya Ageya

---

Shelley M. Smith  
Department of Anthropology  
University of Connecticut  
E-mail:  
[ssmith02@snet.net](mailto:ssmith02@snet.net)  
[sms93003@uconnvm.uconn.edu](mailto:sms93003@uconnvm.uconn.edu)

---

### Research Interests:

Experimental archeology, primitive technology, [beadwork](#) analysis in archeological contexts, human and forensic osteology, textural qualities of disturbed soils in archeological settings, [Native American women's dance](#), paleoethnobotany, cultural resource management, [adaptive responses to adverse conditions](#).

---

B.A Anthropology (1993); M.A. Anthropology currently in progress.

---

[Back to the Poems and Stories Menu](#)

---

Text © 1996-2002 Shelley M. Smith. E-mail: [ssmith02@snet.net](mailto:ssmith02@snet.net)

---



[NativeTech Home Page](#)

Web Design & Graphics © 1994-2002 [Tara Prindle](#).





## NativeTech: Native American Technology and Art Poetry & Stories

*Story telling is a living breathing creature.  
It thrives, grows & adapts in the heart of each new generation of story teller.*

### Caribou Rock

Series authored by [Pierre Girard](#)

✕ [A Grandfather Story](#)

✕ [Rite of Passage](#)

✕ [Sugar Bush](#)

© 1999-2002 Pierre Girard  
E-mail: [pjjgirard@yahoo.com](mailto:pjjgirard@yahoo.com)

### Medicine Dreams

Series authored by [Nunya Ageya](#)

✕ [Black Rock](#)

✕ [Four Dreams](#)

✕ [Just Passin'](#)

✕ [Over Under](#)

✕ [Fireflies on Summer Nights](#)

✕ [Reminiscences](#)

✕ [Song of the Earthdream](#)

✕ [Time-warp Mountain Man](#)

✕ [Waiting for the Moon](#)

© 1996-2002 Shelley M. Smith  
E-mail: [ssmith02@snet.net](mailto:ssmith02@snet.net)

### Beavers and Beyond

Series authored by [Longtrail Snowbird](#)

✕ [The Gift](#)

✕ [The Ghost Woman and Heavy Collar of the Bloods](#)

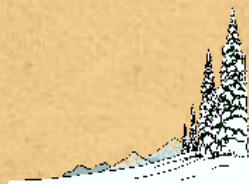
✕ [Eagle Hunter](#)

✕ [Shin'in Times Beyond](#)

✕ [The Sun Dogs of Winter](#)

✕ [Buffalo as a Food Source](#)

© 1996-2002 Victoria Dinsmore  
E-mail: [ezra@midrivers.com](mailto:ezra@midrivers.com)



Authored by [Susan Marie Smith-Kennedy](#)

✕ [Unsent Letter](#)

© 2002 Susan Marie Smith-Kennedy  
E-mail: [gersuekennedy@aol.com](mailto:gersuekennedy@aol.com)

Series authored by [T. W. Martindale](#)

Series authored by [Les Tate](#)

✕ [Season of Cheer](#)

✕ [Crystal Tears](#)

✕ [For Those Who Cried](#)

✕ [Whispers In The Wind](#)

✕ [Cry Freedom](#)

✕ [Quiet Companion](#)

✕ [Enter The Butterfly](#)

✕ [Kiss The Wind](#)

✕ [Vapors](#)

© 1998-2002 T. W. Martindale  
E-mail: [clueless1812@hotmail.com](mailto:clueless1812@hotmail.com)

✕ [The Shelter](#)

✕ [Time Walker Trilogy](#)

✕ [Are You An Indian?](#)

© 1998-2002 Les Tate  
E-mail: [lrtate@comcast.net](mailto:lrtate@comcast.net)

Authored by [Edward Ivan Madahbee](#)

✕ [Be Strong](#)

✕ [The End?](#)

✕ [I Miss You](#)

✕ [Never Mine](#)

© 2000 - 2002 Edward Ivan Madahbee  
E-mail: [wiiyas@hotmail.com](mailto:wiiyas@hotmail.com)

Series authored by [Ted Wilburn](#)

✕ [Little Two-Hands, Talking](#)

✕ [My Cherokee Rosetta Stone](#)

✕ [Faces in My Dreams](#)

✕ [Who Are You?](#)

© 1999-2002 Ted Wilburn  
E-mail: [clueless1812@hotmail.com](mailto:clueless1812@hotmail.com)

Series authored by [Tara Prindle](#)

✕ ['Twas the Night Before Ojibwe Christmas](#)

✕ [Anishinaabe and Ma'iingan \(Original Man and Wolf\)](#)

© 2000 - 2002 Tara Prindle  
E-mail: [Tara's\\_email](mailto:Tara's_email)

**From a Cyber Rez**

[Click here and read "Mr. Rock"](#), as told in NAC by an extremely talented young person nicknamed 'Thunder-God'.

Also visit [The Mormon and the Mohawk](#)

for Poems and Stories authored by Kiiskeen'tum



---

The poetry and stories here at NativeTech have all been submitted to NativeTech by different authors over the last several years. The writings in each series are presumed to be original and are accompanied by a little auto-biography for the author. The authors are Native, mixed-blood Native as well as non-Native ... inclusion here does not imply tribal representation.

Thank you all, for your invaluable contributions to NativeTech!

---

[Other Internet links to Native American Poems and Stories](#)

---



Text and Graphics  
© 1994 - 2003 [Tara Prindle](#)  
unless otherwise cited.

## NativeTech: Native American Technology & Art



# A Message from Pierre Girard

---

Pierre Girard lives with his wife, "Wing" and two youngest children in NE Minnesota on a lake connected to the Cloquet River system, one of the prominent arterials during the fur trade era.

His interests include: canoing, camping, fishing, hunting, wild rice harvesting, maple sugar harvesting, living his life by the seasons, and telling stories, as his ancestors did

---

[Back to the Poetry and Stories Menu](#)

---

Text © 2002 Pierre Girard. E-mail: [pjjgirard@yahoo.com](mailto:pjjgirard@yahoo.com)

---



[NativeTech Home Page](#)

Web Design & Graphics © 1994 - 2002 [Tara Prindle](#).





## A Grandfather Story

By

[Pierre Girard](#)

Grandfather would never admit we were Indian. Sometimes he would say we were French Canadian - sometimes not. They'd made him ashamed of his heritage. I would ask him, "If your brothers and sisters are Indian - why aren't you?" He'd tell me I asked too many questions. He was lighter skinned, was able to pass, and they'd made him ashamed of his heritage.

I lived in a different time and place. There were Finns in our small town, mostly all Finns. Finns are most often very fair and often white blond. There were some darker people too. I got on well with them - I obviously wasn't Finn. I don't recall ever thinking too much, one way or the other, about the darker people. There was one nice girl named Carol. She was very sweet. When I learned about books and read about the history of our area, I always meant to ask her if she knew there was an Indian tribe by the same name. Her name was Carol Ojibway. It never crossed my mind she might be of the Ojibwe nation. She didn't look like the Indians pictured in my books.

Grandfather was serious about taking care of his family. He'd moved down from the woods and took a job driving truck. He worked all through the depression, keeping the same job for 40 years, but his heart was always in the lakes and forests he'd left behind. Every chance he had to be in the woods - well, there was never a question where he'd be. I was often with him - the only grandchild who knew forests were "right" and cities were "wrong."

This time of year, he would look at me, with a twinkle in his eye, and say, "When the leaves of the tag alder are the size of a mouse's ear - the trout are biting," and off we'd go. Grandfather could "tickle" trout. If it was too warm and they weren't biting, he would wade along the shores of creeks and, with



infinite patience, flip the trout up on the bank. We would roast them and eat them whole - without cleaning them. They always tasted like heaven.

Often Joe Artichone, grandpa's cousin, was along. Joe was Ojibwe, and proud of it. Sometimes he would give grandfather a hard time about his reluctance to admit his lineage. Being young, most of this went over my head at the time. Joe's knuckles were always covered with scars as he would not put up with one derogatory word about Ojibwes or Indians in general. There was a story about Joe loosing out on the Navy Cross, or some such medal, during his time in the service because an officer had said his bravery was pretty incredible "for an Indian." Joe decked him. I should say, I'm not sure I have this story right, and now no one seems to know for sure. All those folks are dead.

Joe would sometimes tell me I was a "good little Indian," high praise from him, and it would make me beam with pleasure - as I knew it was the highest compliment. He and grandfather gave me a name.

One thing I remember about trips with Grandfather, Joe, and all their cronies, was we almost never ended up doing what we'd come to do. If we were going for fish, and blueberries were ripe - we picked blueberries. If we came to pick nuts, and ducks were in a pond - we hunted ducks. Grandfather never really hunted, he just always carried a gun. He had no particular need of a shotgun as he was well able to hit flying things with a rifle. Though he sometimes had fishing rods, he was never without a pocket tin containing line and hooks. He didn't try to bend nature to his ways, only accustomed himself to the ways of nature.

As I think back on it, the longer time we spent in the woods, the more grandfather's native heritage and upbringing came to the fore. We became more and more silent and at peace. He would start referring to "what the deer think" and "what the fish think," and even on occasion, to "what the trees think," and "what the winds think."

Some of the best times I remember were after he retired. He was always in the woods. You could often find Grandmother. She stayed around camp, and after so many years you knew about where camp would be. Grandfather usually showed up after a while and we would paddle into some other lake and he'd show me some new way in which nature had delighted him. He never said much, but his eyes would twinkle when you saw what had caught his eye. After we'd been out for a few days he would start gathering stones. They had to be just the right stones. Sometimes it would take a couple of days to gather the right stones. Then he would build a sweat lodge, draping it with tarps, and



we would heat the stones and lift them into the lodge with deer or moose sheds. You had to be careful of the hot stones. The lodge was so small, there would only be room for grandfather and me. Grandmother had to stay away. After we were hot, we ran to the water, or in winter, into the snow, then back in the lodge and then the steam. I don't remember feeling quite so free or clean since.

---

\*\*\*\*\*

*Over the portage of Ogichkemuncie we come carrying.*

*Over the hills of Ogichkemuncie we come carrying our canoes*

*Onto the waters of Gabbimichigami, the grandfather lake, we come carrying  
our canoes*

*Out of the morning mists on the waters, grandfather comes to me,*

*On Gabbimichigami, he comes to me and asks me, "Who are you?"*

*He walks on the waters of Gabbimichigami and asks me, "Who are you?"*

*"Do you do good to your neighbors?"*

*"Do you catch only what you need and eat all that you catch?"*

*"Do you feed the stranger and care for your family?"*

*"Is your heart sweet toward all men?"*

*Grandfather comes to me and asks, "Who are you?"*

\*\*\*\*\*

---

**[Return to the Poems and Stories Menu](#)**

---

**Text © 2002 [Pierre Girard](#). E-mail: [pjjgirard@yahoo.com](mailto:pjjgirard@yahoo.com)**

*Image credit: Photo close up of Ojibwe woman's leggings.*



*(from "Beads: Their Use By Upper Great Lakes Indians" exhibition produced by the Grand Rapids Public Museum and the Cranbrook Academy of Art (1977/1981).*

---



[NativeTech Home Page](#)

Web Design & Graphics © 1994-2002 [Tara Prindle](#).





## Rite of Passage

By

[Pierre Girard](#)

Wednesday Pa came by - said he'd heard we we'd been ricing Silver Isle and said he and Uncle Jean were headed for the grandfather river, close by, in the morning to fish brookies - wondered if I wanted to come. I told him we weren't ricing until Friday. I called work and took a comp day - I knew this would be an opportunity I wouldn't want to pass up.

I was at Pa's place at 5:30 AM, we left Jean's at 6:00 AM and pulled into the landing at 7:30 AM. Jean and Pa strapped on creels that were old when they were born and attached their worm cans to their belts. I used a canvas shoulder bag and a birchbark worm "can" that grandfather had made for me. Jean and I each carried small Duluth packs.

We followed the hogsback ridge west, took a couple of jogs north and south through swamp, caught another hogsback ridge and came up on the river under the cedars about 9:00 AM.

We each picked a hazel switch for a pole, tied on ten or twelve feet of line and a #4 hook. We soon dug a dozen worms, or so, apiece and, throwing our shoes in our packs, waded into the water. My knee breeches seemed like about the right thing to wear as most places the water was only about knee deep, though I knew I'd be wet all over before the day was through. I started working the nearest pool, while Jean and Pa started off downstream.

I got action almost right away and soon had three 10 to 12 inchers out of the first pool. I worked upstream until I had eight, two of really decent size, stood stock still at the sight of a full antlered bull moose - who didn't seem to notice me, and began working back downstream to see how Jean and Pa were doing.



They'd worked down quite a ways, and I barked my shins a couple times catching up to them. The rocks hadn't gotten any smoother since the last time I was there and the cold rushing water numbed my legs.

Pa was having trouble with his hook, it had bent straight, and he felt his pole was too supple - not keeping tension on the fish and letting them spit out the hook. Jean had 21 already - he takes after grandfather that way.

We kept working our way downriver, first one of us - then the other working alone while the other two worked a pool together, talking in low murmers so as not to scare the fish. Two hawks flew by down the river at shoulder height, one to the right of me and one to the left - each so close I could have touched them.

I enjoy these outings with folks from the family who know the woods. They are the kind of people who can teach you much if you are listening close, but who swear they don't know a thing worth knowing if you ask them straight out. Ask Pa anything about the family or woodcraft and he gets an embarrassed grin. Jean is even worse. Work along side of them awhile though and their mind is on the moment doing the job, whatever it may be, and gems of wisdom, observation, and experience fall from their lips without conscious thought.

I missed Grandfather. I think we all did. So many times we'd trekked through the swamp with him - never leaving by the same route - never leaving a trail. "Think like a fish," he would say to me, "You must learn to think like a fish, Wagidy (little turtle)." He would work a pool for an hour after the rest of us had moved on, showing up later with brook trout larger than anyone would think possible out of such a diminutive stream.

I asked him once why he bothered with brook trout when he was able to get so much larger fish in lakes. He told me brook trout were to fish as diamonds were to stones - that he was a poor man, but not even a king in europe could eat as well as he, toasting brook trout over an open fire.

By 1:00 PM we'd worked our way to the beaver dams - where the bigger fish lay. Before getting into them, Jean suggested we eat. We sorted all the fish by size and I cleaned them while Jean went for moss and Pa built a fire. I cooked the fish while Jean returned with blueberries and moss and Pa buttered toast and made coffee. We laid out a blanket and ate 31 fish in almost less time than it takes to tell.



We worked north and west through the beaver dams as the afternoon progressed and each took a dunking once or twice. I marveled at Pa and uncle Jean's resilience.

I started to wonder, out loud, if we shouldn't be heading back. The two of them grinned at each other, like mischievous school boys, and uncle Jean said they'd been thinking about hiking through the woods to Silver Isle to see our rice camp. I was floored. I told uncle Jean, and Pa too, that they must be getting senile in their old age, that it must be ten miles through rough country and it would be getting dark before too long. They assured me they didn't intend to get there before dark - and kept grinning. I began to realize this felt just like another "rite of passage" such as I and my cousins had been subjected to when I was young. I laughed and told them that at almost 50 years of age I'd learned a few things about sleeping in the woods.

We left the river on the north bank and trudged through alder swamp and low lands for several miles. Pa kept looking at the sun and reminding us to keep it over our left shoulder. Jean advised me to keep an eye for a "Bull" pine (a large white pine standing all alone). When we reached it, we took a hard right into tamaracks, then gradually climbed into birch and popple. A bobcat hissed from about 25 feet and ran off. After another mile or two, as the sun was about to set, Jean said we should be seeing a low rock cliff extending from one side of the horizon to the other. When we reached it we walked along the base and Jean said we had to climb it at some big slash piles. We finally found the piles, almost by accident. They'd shrunk even with the surrounding terrain in the years since Jean had last been over this country. We climbed to the top of the rock and made our camp for the night.

We built a huge fire on the rock, where grandfather'd built many fires before, against a large "reflector" rock and dried our wet clothes. I stretched out my wool blanket in front of the fire, where it was soon steaming, and hung my shoes on pegs beside the fire. We gathered boughs and blankets of dry rock moss and leaves for a mattress. With two blankets for the three of us - we'd be sleeping spoon fashion tonight.

Uncle Jean began making fry bread in a pan over the fire and swore a long, thoughtful, and colorful oath when he realized he'd left all the large brookies behind at the river when he'd sorted them out. We only had 52 left, leaving just 22 to eat if we wished to come out with ten apiece, the legal limit.

We assured him it was no big deal, and it wasn't. We managed to fill up just fine on fry bread and the trout we had left. We set around the fire for several



more hours becoming warmer and more lethargic as we fed the fire, told all the old tales, revisited the family history, and sang the old family songs, some of them hundreds of years old.

*"Alas, my love you do me wrong  
to cast me off discouragously.  
For I have loved you oh so well  
- delighting in thy company."*

*"I am a soujourner traveling around and round,  
but not from town to town.  
Travel the lakes and streams  
- follow my distant dreams."*

*"There were prunes, plums, and cherries,  
cinnamon, nutmeg, cloves and berries  
and the crust it was nailed on with glue  
- t'would kill a man twice  
after eating a slice  
of Miss Fogarty's Christmas Cake."*

It got me to thinking, as we set around the fire, this hadn't been a rite of passage for me - the way it was when I was young - it was a rite of passage for them, Pa and uncle Jean. At age 77 and 79, there won't be too many more trails like this ahead for them and they are out proving they still have what it takes to spend time in the woods. Or maybe they didn't have anything to prove - they just loved being out. Grandfather's last trip to the river had been at age 86, and that wasn't far off for Pa and Jean.

I slept like a dead man. I remember waking once to see Jean feeding the fire with wood he'd gathered the evening before, then I rolled over and woke just before dawn to see both of them up, tending the fire and giving me a hard time about sleeping in. Pa's gimp leg bothered him for a while until he'd worked the kinks out, but both of them insisted they'd slept fine and their smiles and jokes corresponded to their words.

Jean made more fry bread with lard and I produced a little bottle of maple syrup to sweeten it with. We soaked the fish and moss with water from the spring and knew they'd keep for at least two more days - long as we kept them wet.

We started up the rise above the cliff and, after an hour, Jean kept sniffing



and looking around until I asked him what he was looking for. He said we should be more to the right and we all moved over a bit, though it took us down slope. He said we should move off a bit more and I soon came out on a grade. Jean and Pa stepped through the brush onto the grade, grinning, and Pa said, "It's the old Alger Grade - goes straight on through to Kinny's Crossing." I should have known they didn't expect to walk the whole way right through the brush. This would still be no picnic - the grade hadn't been in use since the 1930s, but at least we wouldn't be walking through swamps.

We kept up the pace as best we could - taking a detour on a stretch where balsam fir had taken hold of the right of way to such an extent you couldn't push through them, but otherwise sticking to the grade until about 10:30 AM Jean began sniffing and looking around and finally said we should take another right. We were on high ground now, and we hadn't walked more than a couple hundred yards before we could see the lake. Canny, how that man knows his way by sense of smell!

When we reached the reeds at the edge of the lake, we could see a canoe poling off a ways, and I recognized Matt poling the canoe. A couple of shouts and they were soon close to us. We were able to wade to the canoe as Silver Isle, unlike many rice lakes, has a fairly hard bottom.

They took us back to the rice camp and Jean and Pa and I riced out of my canoe for the rest of the day. We cut another set of knockers and together with Matt and his Pa, had 95 pounds by 3:00 PM when ricing closed.

---

[Return to the Poems and Stories Menu](#)

---

Text © 2002 [Pierre Girard](#). E-mail: [pjjgirard@yahoo.com](mailto:pjjgirard@yahoo.com)

*Image credit: Photo of an Ojibwa man ricing from a canoe, by Frances Densmore, Smithsonian Institution. (cover photo from "A dictionary of the Ojibway Language" by Frederic Baraga (1992), Minnesota Historical Soc. Press, St. Paul.*

---



[NativeTech Home Page](#)



**Web Design & Graphics © 1994-2002 [Tara Prindle](#).**



# Sugar Bush

*iswi-baakwa-togan*

An Ojibwe/Metis Account of  
Maple Sugaring

by Pierre Girard

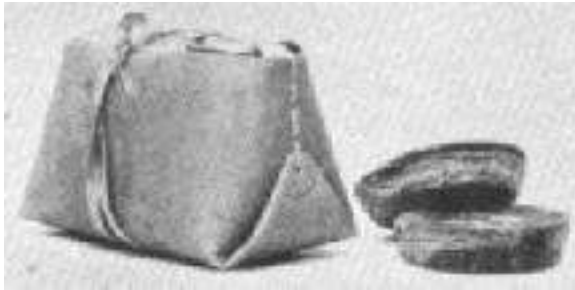
(AKA Bemosi Mukwa or Walking  
Bear)



*Making Maple Sugar at Mille Lac, Minnesota (Densmore 1979)*

---

It is that time of year again. Nights are cold and days are warm and the sap is running. For the Ojibwe this was always a time of renewal. Family groups reunited with their band and relations and friends who'd not seen each other over the winter could gather for the work of sugaring which seemed more like a festival than work.



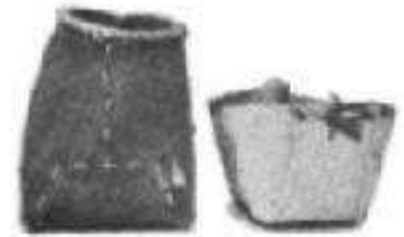
*Cakes of Maple Sugar and Makuk Filled with the Same  
(Densmore 1974)*

I have not sugared in several years. In my grandfather's time, when my mother was young, there was a family "sugar bush" or iswi-baakwa-togan. When Wing and I were first married we had land up north, 20 acres of which were prime ancient sugar maples. Some years we put out 200 buckets. Gathering buckets morning and night kept us running.

Boiling the sap down in an old copper corn boiler kept one of us constantly feeding the fire or stirring the boiling sap to keep it from burning as it became syrup. Forty gallons of sap were needed to make one gallon of syrup. Making the syrup into sugar required even further evaporation, though we only went as far as hardening the syrup by dropping the hot syrup into the snow. Put up this way it is known as "wax sugar."

I'd spent some time during the winter drilling and whittling spiles from sumac. I tried to make some Ojibwe sap containers, but did not have very good luck, only making five, as these are best made of newly harvested bark (corners are folded, not sewn) and all of the bark I had at home was old.

I'd picked out a sugar bush close to Hunter Lake last fall while hunting. It was off a trail north of us, but when I checked it two weeks ago I found the trail had been blocked and no entrance was possible. I put the idea on the back burner for a while, but yesterday as I compared night temperatures to day temperatures I realized I needed to get moving if I was going to get any sugar this year.



*Birch Bark Containers  
(Densmore 1974)*



*Stacked Dishes and Empty Cones, the Latter to be filled with Sugar  
(Densmore 1974)*

Early this morning I set out to the northwest, scouting the only other area I felt might be high enough close to Hunter Lake (sugar maples are almost always found on high ground). There is still enough snow in the woods to require snowshoes and the going is tough where the hazel brush is thick. In my pack were the five bark containers I'd been able to manufacture, five spiles, a bit, a brace, a hand axe, canoe cup, coffee, and small kettle.

The first bit of a way is on a trail I'm well familiar with and there were no surprises. Eventually I left the trail and set out across a swampy "moose pasture." On the far side the land climbs through birches, balsams and aspen. This is nice high land and I have a hope of seeing some maple. After following the ridge for some time I am able to see the next low spot, more moose pasture. On the far side I can see what I am sure is a good size maple among the birches and ash trees. Crossing this moose pasture is more of a problem than the first as there seems to be a small stream in the center. I am able to cross safely but my mogasins come away a little damp.

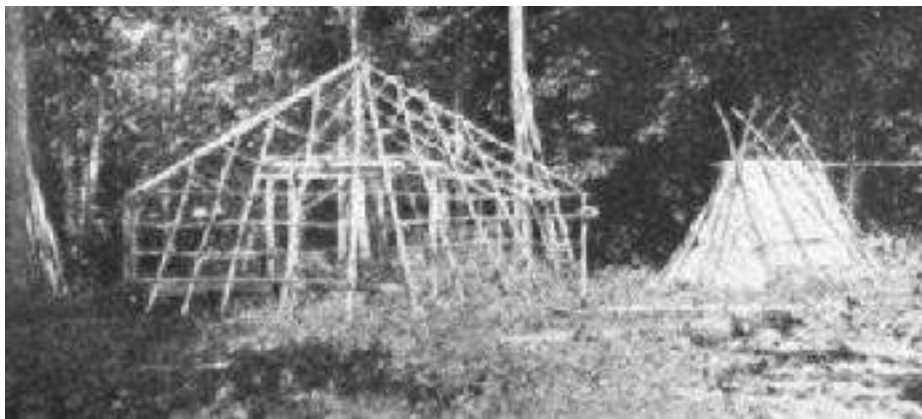
When I reach the maple I am happy to see it is a very large one with a double trunk coming from the same root system. I drill a hole in each trunk and pound in the spiles. I find I've made the top opening on my spile longer than it should have been. I make a mental note to bring a saw with tomorrow and saw the spiles shorter. After placing the bark sap makuk or box below the spile I set off looking for other maples.

hear noise in the brush several times, but I can not find the source of it. Everytime I look up the noise ceases. Finally I set off to the east toward higher ground. I travel for a mile or more through small aspens and larger birch. At last I come to a large network of ridges. There is much less snow here where the trees are deciduous and the sunlight is better able to make its warmth felt. Here and there I see a maple, but I am not ready to make the same mistake I'd made with the first maple. I decide to look for a real "sugar bush" where I may put out many spiles close together.



*Maple Trees Tapped (Densmore 1974)*

In the distance I see what looks like a good stand of maples. They are close together and appear to be just what I am looking for. When I get closer I can see that some of the trees are basswoods, but still there are many maples. When I get right up to them I can see that some do not look just right. I look at the leaves near the base of one and I am surprised to realize it is an oak. We do not have many oaks so far north. These are red oaks and look surprisingly like a maple this time of year, at least from a distance. Still, there are enough maples and I drill and tap three large trees and place the sap gathering makuks. The sap begins to run as soon as I drill the holes. I could make a "V" and pound in a wood chip like the old Ojibwes, like the "gete" or old ones, but I think it would do more harm to the trees. I boil coffee over a small fire and thank the Creator for his kindness to me.



*Frame of Lodge in which Maple Sap was Boiled, and Storage Lodge for Utensils (Densmore 1974)*

The view from here is fine. Many large birch grow on the sides of the ridge. Off in the distance I

can see several moose pastures and far to the west, what is probably the Us-kab-wan-ka River. This is an Ojibwe word, but I don't know what it means. It is one of the few rivers locally which retained its Ojibwe name. It occurs to me as I stand and enjoy the brisk spring breeze, that I am in one of those historical Deja-vu moments. West of the Us-kab-wan-ka, on the far bank, is the great east-west trail of the Fond-du-Lac Ojibwe. Close by where I stand it dips to the Cloquet River where the old fur post stood, then north and west again toward the St. Louis River and beyond that to the Mississippi. To the east it goes to Island Lake, a man made lake which now covers the main village of the Fond-du-Lac Band. At that point it intersects with the Vermillion Trail, which

connects the front of Lake Superior (Fond-du-Lac), 25 miles away to the south, with Lake Vermillion, the gateway to the Boundry Waters and western Ontario, Canada, 70 miles north.

For just a moment I am looking to the past and I realize this close to the trail this sugar bush was likely used by many Ojibwe and belonged to a clan, band and family, now long unknown and forgotten. For just a second I see them through the mists, laughing and joyful as they climb the ridge, happy for the spring and the end of another winter, but it is just a second, then they are gone and I am turning back to the trail.



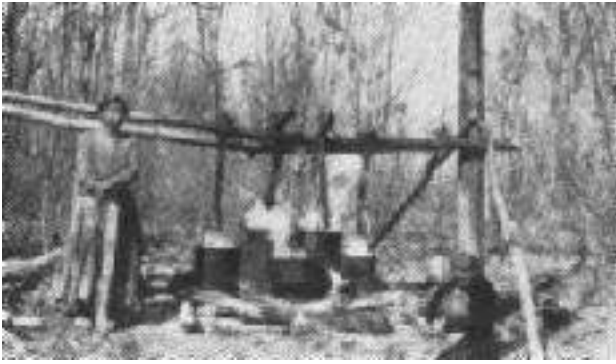
On the far side of this grove, looking through the birches, I see what appears to be another grove of maples further along the same ridge. This grove appears to be much larger and I head toward it. *Storage Lodge for Sugaring Utensils (Densmore 1974)*

Following the ridge I can see a well worn game trail, wherever it peeks though the snow, and plenty of deer sign, though none immediately fresh until I've gone a little ways. There I see where a young deer has come onto the trail from the south. Other tracks, also new, are over the deer tracks in spots. I can see they were made within the hour, because the sun has not bothered them yet. They are not chasing the deer, just following it. I cast about and locate two other sets of tracks. They appear to be timber wolves, Mainga. One set of tracks is very large. The other two would be normal for any mid-size dog. The warm fur filled piles of wolf scat clinches it. Not dogs. As always I feel the hair raise on the back of my neck. I know the wolf is the friend of the Ojibwe, but I am just a little bit Ojibwe, probably not enough for the wolf to recognize.

I enjoy living in an area that can support loons, Canada jays, eagles and wolves, for their presence means I am still in the wilderness, and I am only aware of one wolf attack on a human recently (and that seems to have been a mistake), but I've watched them kill deer and it was done so fast and efficiently that I have little doubt several of them together could kill me if they decided to. In the morning I will bring the children here. I resolve to bring my gun with, just to have something more to carry, in the morning.

I follow the tracks of the wolves, which are following the tracks of the deer, to the next maple grove. It is as it appeared. In this grove I would be able to tap enough trees to keep the syrup kettle boiling for a week. I decide that on the days I am not able to take much time I will cart the sap out. I gauge all five containers at about four gallons total. I have a hope that I can still carry four gallons in a container in a duluth pack back to Hunter Lake where we will boil the sap on the stove. On days when I am able to spend more time I will bring Wing and the children and we will boil the sap in the grove. It is much closer to Hunter Lake from this grove than it was from the area where I tapped the first tree. I will retrieve those spiles and containers tomorrow and plug the holes I bored in the tree.





Heading due south I find myself cutting across my outgoing trail sooner than I expected. It is amazing how many things hide in the forest. Twelve years I've lived at Hunter Lake, hunting and snowshoeing these woods, but I never suspected such fine maple ridges so close by.

*Boiling Maple Sap (Densmore 1974)* Had a good time today. Like those old Ojibwe, I'm tired of the winter; I'm ready for the spring. It was a good day, today, to be alive in the great north woods!

We later put out 15 more spiles. We have got an amazing amount of sap for the few taps and little time we could devote to this. So far we have about two gallons of syrup. Not a lot, but good for a start. Next year we will do 100 taps.

Gi-ga-wa-ba-mim-ba-ma

(see you later)

Pierre Girard

(AKA Bemosi Mukwa or Walking Bear)

---

[Return to the Poems and Stories Menu](#)

[Return to Plants & Trees Menu](#)

---

Text © 1999-2002 [Pierre Girard](#). E-mail: [pjjgirard@yahoo.com](mailto:pjjgirard@yahoo.com)

*Image credits: Photographic images scanned from the works of Frances Densmore in the early 1900s:*

*1974 How Indians Use Wild Plants for Food, Medicine & Crafts. Dover Publications, New York. First published in 1926-1927 by the Smithsonian Institution Bureau of American Ethnology as 44th Annual Report.*

*1979 Chippewa Customs. Minnesota Historical Society Press, St. Paul. First published in 1929 by the Smithsonian Institution Bureau of American Ethnology as Bulletin 86.*




---



[NativeTech Home Page](#)

*Web Design & Graphics © 1994 - 2002 [Tara Prindle](#).*

## PLANTS AND TREES

-  [Birchbark](#)
-  [Branches, Twigs & Roots](#)
-  [Cattails](#)
-  [Cornhusks](#)
-  [Indigenous Plants Gathered in the Northeast](#)
-  [Gathering Hike in Mansfield, CT](#)
-  [Mi'kmaq Medicines, Foods and Teas](#)
-  [Sugar Bush](#) An Ojibwe/Metis Account of Maple Sugaring
-  [Sweetgrass Uses](#)



Text and Graphics  
© 1994 - 2003 [Tara Prindle](#)  
unless otherwise cited.

## NativeTech: Native American Technology and Art

### Birchbark

-  [Native American Uses for Birchbark](#)
-  [Containers and Utensils](#)
-  [Canoes](#)
-  [Fans](#)
-  [Other Uses for Birchbark](#)



Text and Graphics  
© 1994 - 103 [Tara Prindle](#)  
unless otherwise cited.



NativeTech: Native American Technology and Art.

## USES FOR BIRCHBARK



**Paper Birch**  
(*Betula papyrifera*)



**Gray or Wire Birch**  
(*Betula populifolia*)



**Sweet or Black Birch**  
(*Betula Lenta*)

---

[Click here to read the Ojibway Legend: Winabojo and the Birch Tree.](#)

---

For as long as there have been birch trees in New England, Native Americans have recognized the special uses to which the bark of this tree could be put. Native Americans of the Northeastern Forests made wide use of the outer bark of white (or paper) birch for canoe construction and wigwam coverings. Long before the arrival of Europeans and even before the development of ceramic vessels 3000 years ago, bark containers were used to collect, store, cook and consume food or other products. Birch bark was also used to make hunting and fishing gear; musical instruments, decorative fans, and even children's sleds and other toys. Birch bark designs were also used in beadwork. Although few Native Americans in southern New England still make these items from birch bark, more recent decorative arts, such as splint basket decoration, draw upon many patterns developed in birch bark.

Removing the bark from a live birch threatens the health of that tree. If the dark inner bark of the birch tree is damaged this can kill the tree. Harming a tree only for pieces of its bark is not advised. Fortunately because of the remarkable preservative properties of birch bark, it is possible to use the bark from dead or fallen trees to make containers and other items.

There are several types of birch trees and the best type of bark for items from canoes to containers is the paper birch, sometimes called white birch. Do not confuse this bark with that of the gray or wire birch which is often referred to as white birch but is not as suitable for craft work. The bark from the sweet or black birch is rough and completely unsuitable for craft work but is the source of wintergreen, and from which Native Americans brewed a tea high in vitamin C.

Although the bark from fallen trees may be gathered at any time, the best time for gathering live birch bark was spring up until the month of June. This bark is the thickest, retaining the dark brown inner bark which formed from flowing sap in winter. In this season the bark will recoil easily from the tree and almost peels itself. To peel bark sheets from the tree, a vertical slit is made down the trunk. For smaller projects, sections about two feet long can be peeled from around the trunk by prying up using your hands between the dark bark on the interior of the birch sheets and the hard inner wood of the tree.

To store bark for later use, lay out the sheets and gently press them flat. Put weights on top of the bark sheets to prevent them from curling up, as birch has a tendency to do on its own. Fresh bark can be worked without special preparation. If stored bark or bark from fallen trees is used, the bark should be heated by soaking in warm water, or by steaming over a fire. Heat warm the sap retained in birch bark even after several months in storage and will render even old bark pliable and flexible to be cut and bent. If the bark is very thick, several layers of white paper may be peeled away to make the remaining sheet easier to cut or fold.

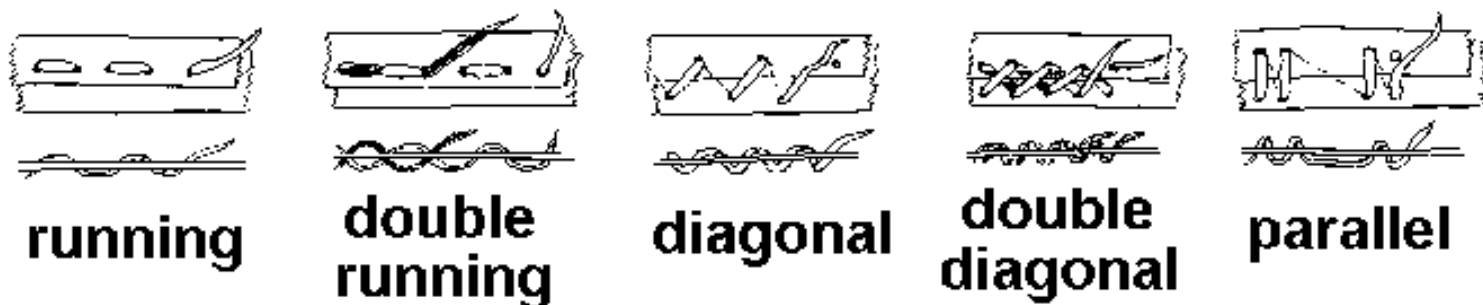
Paper patterns are ideal to practice with. To assure a symmetrical pattern and to practice the folding methods, cut a pattern from heavy paper and "stitch" the item with a modern stapler. Paper patterns can be made larger or smaller, scaled to fit the available piece of bark.

To ensure straight, even folds, it may be necessary to score along the fold with a dulled point that creases but does not cut the bark on the inside of the container.

Holes for stitching or lacing may be made by piercing the layers of bark with an awl or large needle with a triangular point. Holes made along seams where bark overlaps may be temporarily held in place using small wooden pegs or splinters of wood. Clothes pins and large paper clips are also useful in holding rims in place as they are stitched.

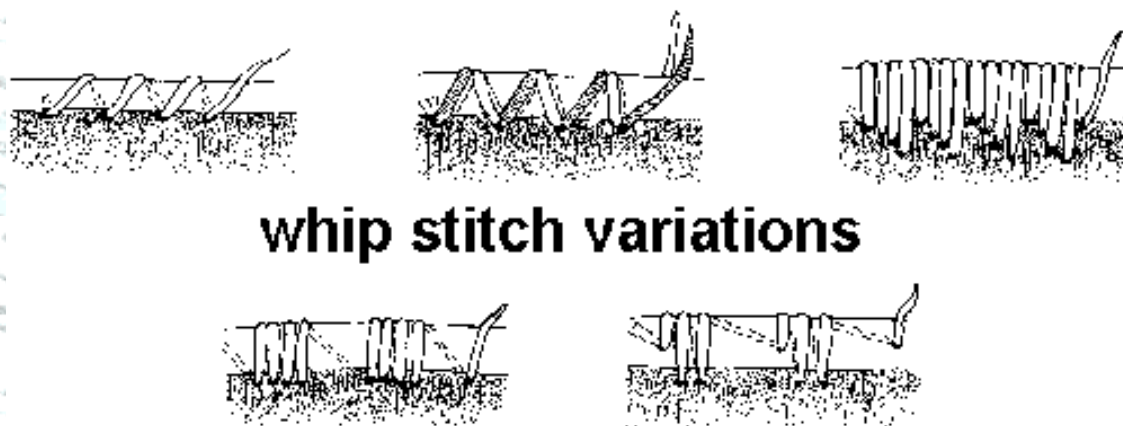
Seam stitching and rim wrapping are accomplished using lacing. Modern lacing may be heavy waxed nylon thread strung through a needle. Using natural material available to Native Americans, lacing would be made of basswood or dogbane cord, of thin strips of inner cedar bark, or from stripped pieces of black spruce roots. Natural lacing should be soaked in warm water before use to make it more flexible.

Stitching together seams:



Rims for containers are not only decorative, but also add reinforcement to an otherwise brittle area on birch bark vessels. Rims may be solid wood like white cedar, split spruce root, or basketry splints. Rims may also be made using a skinny bundle of plant material like sweetgrass. Rims are attached to a vessel by wrapping lacing around the rim material through evenly spaced holes pierced in the bark at the mouth of a vessel. Holes can be patched with a warmed mixture of white pine pitch and charcoal.

Wrapping the reinforced rim:



[Return to NativeTech's Main Birchbark Menu](#)

[Birchbark Bibliography and Books to Buy On-Line](#)

---



Text and Graphics  
© 1994 - 103 [Tara Prindle](#)  
unless otherwise cited.



**NativeTech: Native American Technology and Art.  
Ojibway Legend: Winabojo and the Birch Tree.**



---

**Once there was a spirit-boy named Winabojo who taught the Ojibway how to live in the natural world.**

**One day he asked his grandmother what was the biggest fish in the lake. She replied that there was an enormous fish that lived by a rock ledge but it was very powerful and would harm Winabojo. No one could kill the fish because no one could get down there where it lived.**

**Winabojo thought about how to hunt this fish, so he got some wood to make a bow and arrows. Then he asked his grandmother if there were any birds whose feathers could be put on the arrows to make them effective. She told Winabojo the only feathers strong enough come from a bird that lives in the sky, at the opening of the clouds. One would have to go there to get these feathers.**

**Winabojo climbed to the highest cliff and discovered a nest of the Thunderbirds and saw their babies. Winabojo turned into a rabbit so the Thunderbirds would bring him to their nest for their babies to play with. Winnabojo stayed in the nest for a long time; the babies were cruel to him and tossed him around. Eventually Thunderbirds went away to hunt for more food for their babies. Winabojo turned back to a boy; he clubbed the baby Thunderbirds and pulled out their feathers. Before their parents could return, Winabojo jumped from the high nest with the bundle of feathers but he was knocked out, but he was not killed because he was a manido.**

**When they returned to their nest, the angered Thunderbirds flew after Winabojo!! Thunder rolled from their beaks and lightning flashed from their eyes. Winabojo ran for his life clutching his bundle of feathers, but soon grew so tired he began to fear he would be caught. As the Thunderbirds reached for him with their claws, Winabojo saw an old fallen birch that was hollow inside. Winabojo crept into the hollow in the nick of time. The Thunderbirds ended their attack because they knew they could not reach Winabojo through the birch bark. Winabojo was safe. After the Thunderbirds went away, Winabojo came out and proclaimed that the birch tree would forever protect and benefit the human race.**

**You can still see the short marks on the birch tree to made by Winabojo to commemorate the sharp claws of the Thunderbirds which almost killed him. The Thunderbird parents put "pictures" of their baby birds with out-stretched wings into the birch bark so the sacrifice of their children would always be remembered.**



**Winabojo fixed his arrows and went home. With these arrows he was able to kill the great fish that lived under the rock ledge.**

**Winabojo has blessed the birch tree for the good of the human race. And this is why lightning never strikes the birch tree, and why anything wrapped in the bark will not decay. Birchbark is useful for house coverings, canoes, containers, utensils, tinder and in many other ways. Native Americans traditionally honor the tree by offering a gift, such as tobacco, when they use this tree.**

*(adapted from The Legend of Winabojo and the Birch Tree, in *How Indians Use Wild Plants for Food, Medicine and Crafts*, by Frances Densmore. Dover Publications Inc., New York, 1974).*

---

[Return to Birchbark Background](#)

[Return to NativeTech's Main Birchbark Menu](#)

[Birchbark Bibliography and Books to Buy On-Line](#)

---



Text and Graphics  
© 1994 - 103 [Tara Prindle](#)  
unless otherwise cited.

NativeTech: Native American Technology and Art.  
**BIRCHBARK CONTAINERS AND UTENSILS**



---

Follow these links to see varieties and patterns of Birchbark containers:

[Birchbark Seamless Containers](#)

[Birchbark Sewn Containers](#)

[Birchbark Sewn Makak Containers](#)

[Birchbark Utensils](#)

---

The durability and preservative properties of birchbark endowed this material with legendary properties of protection, and earned the bark a place in oral tradition at the center of many Native American myths from the Great Lakes and northern New England regions. These weatherproof properties made birchbark, as well as bark of elm and spruce, the perfect material for Native Americans to use not only for panels to cover houses and to build canoes to travel water, but also to contain and store food and drink.

Makak's were specialized containers made by several northern tribes to store maple sugar. Traditionally, containers and spoons were stitched or laced together with split spruce roots or with strips of inner bark of the basswood tree. Rims were often reinforced with wood splints or sweet grass, and handles were constructed with willow or other branches.

More simple utensils included trail-side dippers or ladles to be left hanging near a spring for the thirsty traveler.

---

[Return to NativeTech's Main Birchbark Menu](#)

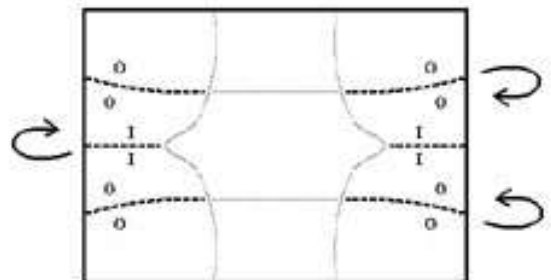
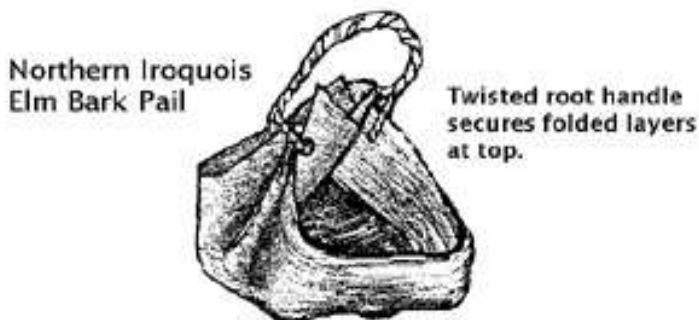
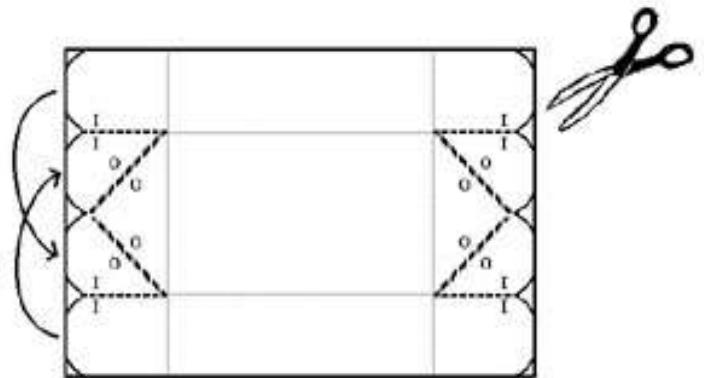
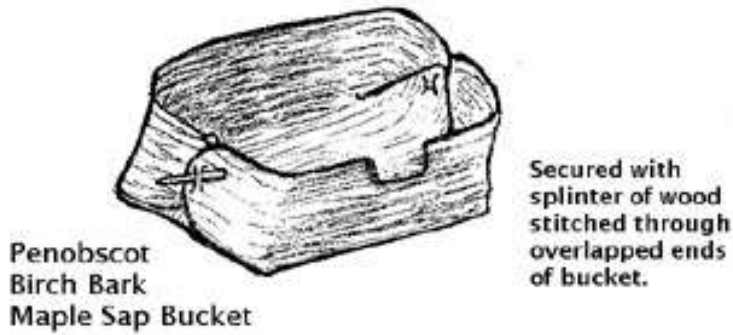
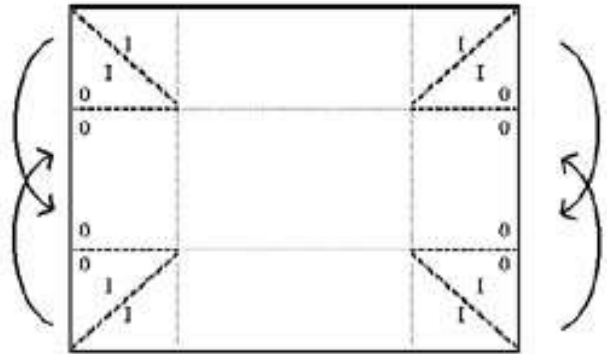
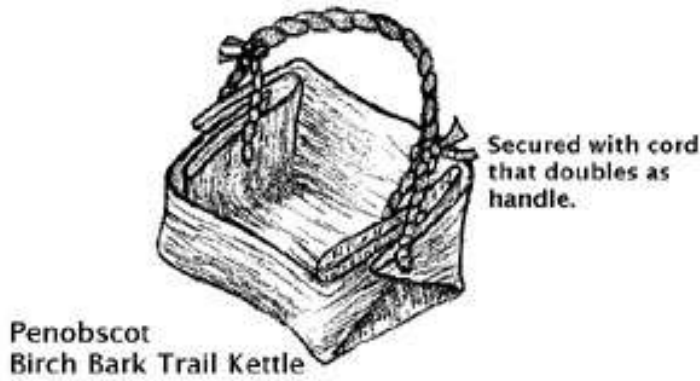
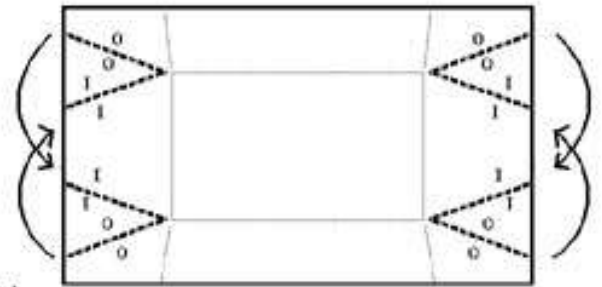
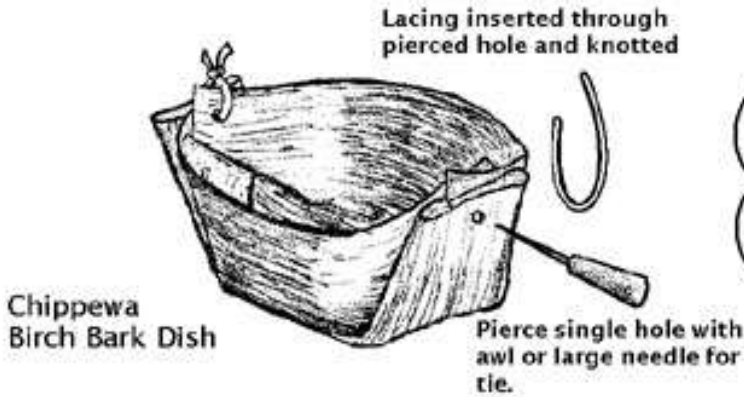
[Birchbark Bibliography and Books to Buy On-Line](#)

---



Text and Graphics  
© 1994 - 103 [Tara Prindle](#)  
unless otherwise cited.

# NativeTech: Native American Technology and Art. BIRCHBARK SEAMLESS CONTAINERS

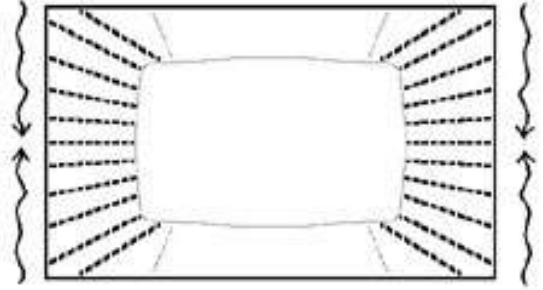






New England Algonquian  
Basswood Bark Sap Bowl

Bunched ends  
are tied with  
cord or lacing.



---

[Return to Birchbark Containers and Utensils](#)

[Return to NativeTech's Main Birchbark Menu](#)

[Birchbark Bibliography and Books to Buy On-Line](#)

---



Text and Graphics  
© 1994 - 103 [Tara Prindle](#)  
unless otherwise cited.



## BIRCHBARK BIBLIOGRAPHY

Click on the links below for the books you can order on-line in affiliation with [barnesandnoble.com](http://barnesandnoble.com)

### *References cited in NativeTech's [Birchbark articles](#):*

**Coe, Ralph T.**

**1986 Lost and Found Traditions, Native American Art 1965-1985.**

New York: University of Washington Press in Association with the American Federation of Arts.

[Order a used copy of this Out of Print book](#)

**Densmore, Frances**

**1974 How Indians Use Wild Plants for Food, Medicine and Crafts.**

New York: Dover Publications, Inc.

[Order this book through barnesandnoble.com](#)

**De Forest, John W.**

**1852 History of the Indians of Connecticut from the Earliest Known Period to 1850.**

Hartford, CT: W. J. Hamersley.

[Order this book through barnesandnoble.com](#)

**Dina, James Voyage of the Ant.**

Stackpole Books 1-800-READ-NOW for ordering information.

... Written and experienced by a friend of mine who lives in South Windsor, CT. you can call the publisher: has photographs and line drawings depicting 'A Stone Age quest in a birch bark canoe built with tools of stone and bone' with which he 'completed an arduous canoe trip up the Connecticut River, against both wind and current'. I know that everything Jim does is not only perfect and perfectly functional - but is also done \*completely\* using traditional tools and techniques. He built this canoe over 15 years ago and it still floats as well as it did he day it was made!

**Gidmark, David**

**1995 Birchbark Canoes of the Algonquin.**

In American Indian Art Magazine: Vol.20, No.3. pg.s 54-63. Scottsdale, Arizona.

**Gookin, Daniel**

**1970 Historical Collections of the Indians in New England.**

J.H. Fiske, ed. London: Towaid. (First published 1674).

[Order this book through barnesandnoble.com](#)

**Hall, Edward (editor)**

**1986 A Way of Life.**

Northwest Territories, Department of Renewable Resources: Yellowknife, NWT ISBN: 0-7708-7146-1

... This book has an excellent section on making a one-two person spruce bark canoe with great photographs and detailed drawings for making a canoe using the 1983 description from Johnny Klondike, Fort Laird.



**Josselyn, John**

**1972 New-England's Rarities Discovered.**

Meriden: Meriden Gravure Co. (First published 1672).

[Order this book through barnesandnoble.com](http://www.barnesandnoble.com)

**Ritzenthaler, Robert E. and Pat Ritzenthaler**

**1970 The Woodland Indians of the Western Great Lakes.**

Garden City, NY: Natural History Press.

[Order this book through barnesandnoble.com](http://www.barnesandnoble.com)

**Russell, Howard**

**1980 Indian New England Before the Mayflower.**

Hanover: University Press of New England.

[Order this book through barnesandnoble.com](http://www.barnesandnoble.com)

**Speck, Frank G.**

**1976 Penobscot Man: The Life History of a Forest Tribe in Maine.**

New York: Octagon Books.

[Order this book through barnesandnoble.com](http://www.barnesandnoble.com)

**Wilbur, C. Keith**

**1990 Indian Handcrafts; How to Craft Dozens of Practical Objects Using Traditional Indian Techniques.**

Chester, CT: Globe Pequot Press.

... has simple instructions for making an eastern Woodlands dug-out canoe using some 'modern conveniences'

[Order this book through barnesandnoble.com](http://www.barnesandnoble.com)

**Wilbur, C. Keith**

**1978 The New England Indians.**

Pequot Press: Chester, CT.

... has simple instructions for making an eastern Woodlands birchbark canoe

[Order this book through barnesandnoble.com](http://www.barnesandnoble.com)

---

*Other Books relating to Birchbark you can buy on-line through [barnesandnoble.com](http://www.barnesandnoble.com):*

**Massie, Larry B.**

[Birchbark Belles: Women on the Michigan Frontier](http://www.barnesandnoble.com)

**Gidmark, David**

[Birchbark Canoe: The story of an apprenticeship with the Indians](http://www.barnesandnoble.com)

**Kent, Timothy J.**

[Birchbark Canoes of the Fur Trade](http://www.barnesandnoble.com)

**Erdrich, Louise**  
**[The Birchbark House](#)**

**Additional book list being compiled.  
In the meantime,**

**[Click here to Search for Canoes & Canoeing](#)**

**[Search for Books at  
barnesandnoble.com](#)**

Search by:

---

**[Return to NativeTech's Main Birchbark Menu](#)**

---

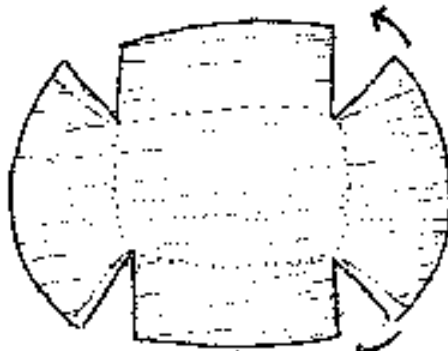


**Text and Graphics**  
**© 1994 - 103 [Tara Prindle](#)**  
**unless otherwise cited.**



# NativeTech: Native American Technology and Art. BIRCHBARK SEWN CONTAINERS

Trays and dishes often had wrapped rims reinforced with sweet grass, white cedar, basket splint, or other carved wood.

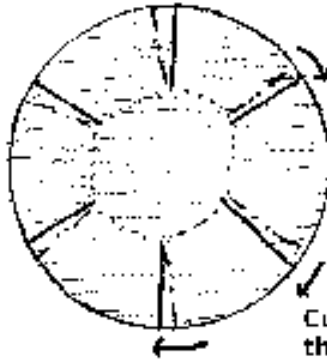


Cut out small triangle at corner, overlap and stitch



Penobscot Winoing Tray

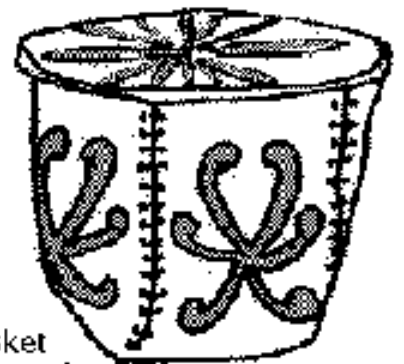
## CORNER SEAM



Cut in even distances from the edge, overlap and stitch



Penobscot Serving Dish



Cree Corner Sewn Basket Etched Design in Bark.

## CONICAL



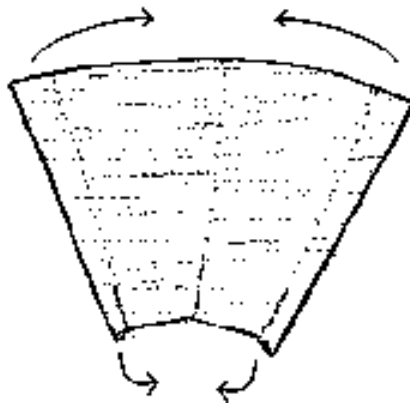
Wrap into tight cone and stitch single seam, leaving loop of string out bottom of cone.



Chippewa Maple Sugar Cone String for Hanging.

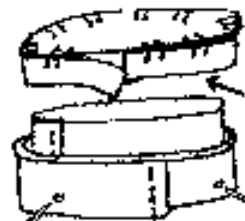


New England Algonquian Berry Picking Basket

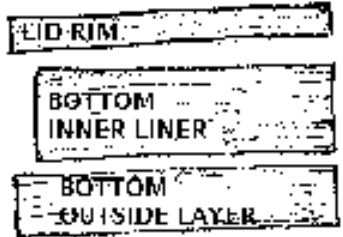


Penobscot Porcupine Quill Decorated Box

Sweet grass rims.



Tiny pegs hold inner liner to outside layer

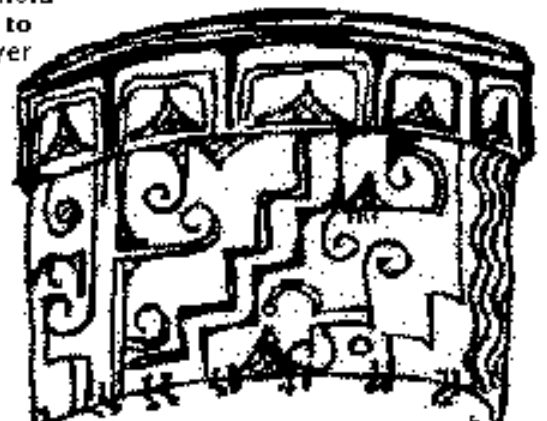


Lid liner (hides quill ends)

2 FOR LID AND 1 FOR BOTTOM

CUT 3 PIECES

## CYLINDRICAL





New England Algonquian  
Berry Picking Basket  
Single Stitched Seam.

Fold around and overlap edges of conc. Stitch  
bottom and side seam. Stitch on handle up sides.



Penobscot Storage Basket with Painted Design

note: Dark inner bark is always turned to the outside of the container.

---

[Return to Birchbark Containers and Utensils](#)

[Return to NativeTech's Main Birchbark Menu](#)

[Birchbark Bibliography and Books to Buy On-Line](#)

---



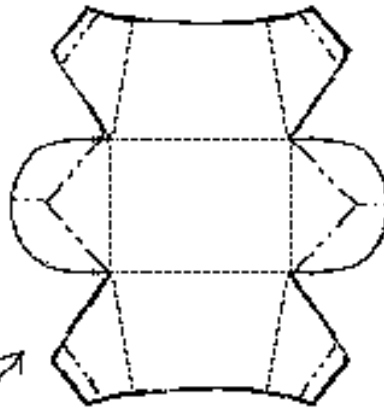
Text and Graphics  
© 1994 - 103 [Tara Prindle](#)  
unless otherwise cited.

# NativeTech: Native American Technology and Art. BIRCHBARK MAKAKS

## Birch Bark Maple Sugar Containers [Makak]



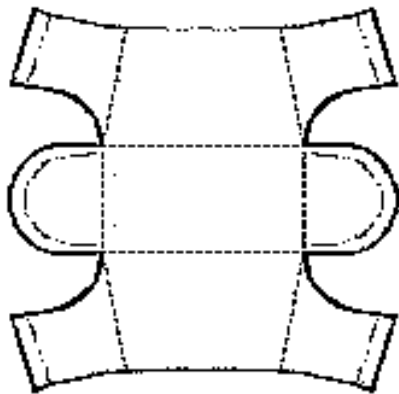
Penobscot



Penobscot

Individual patterns often varied.

Note etched designs where the dark inner bark is scraped away to let the lighter colored papery bark show through.



Splint Rim

Penobscot

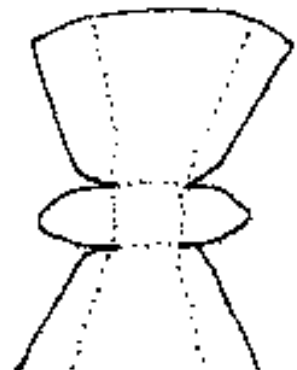
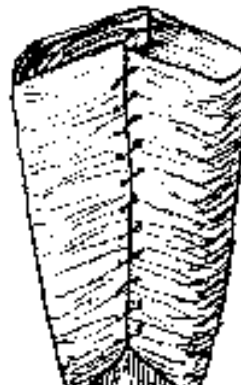
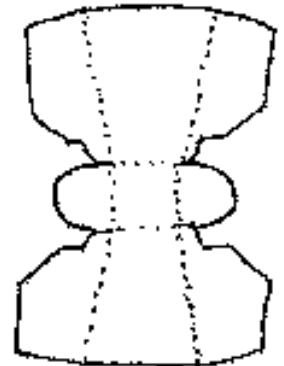


Folded cover with slanted sides.

## Beothuck (Newfoundland) Birch Bark Drinking Cups



Serrated edges.





**Chippewa**



---

[Return to Birchbark Containers and Utensils](#)

[Return to NativeTech's Main Birchbark Menu](#)

[Birchbark Bibliography and Books to Buy On-Line](#)

---

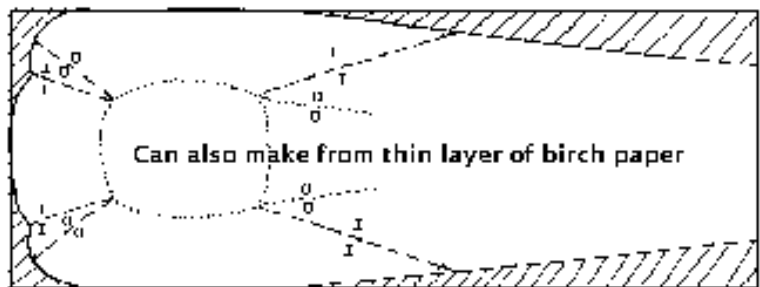
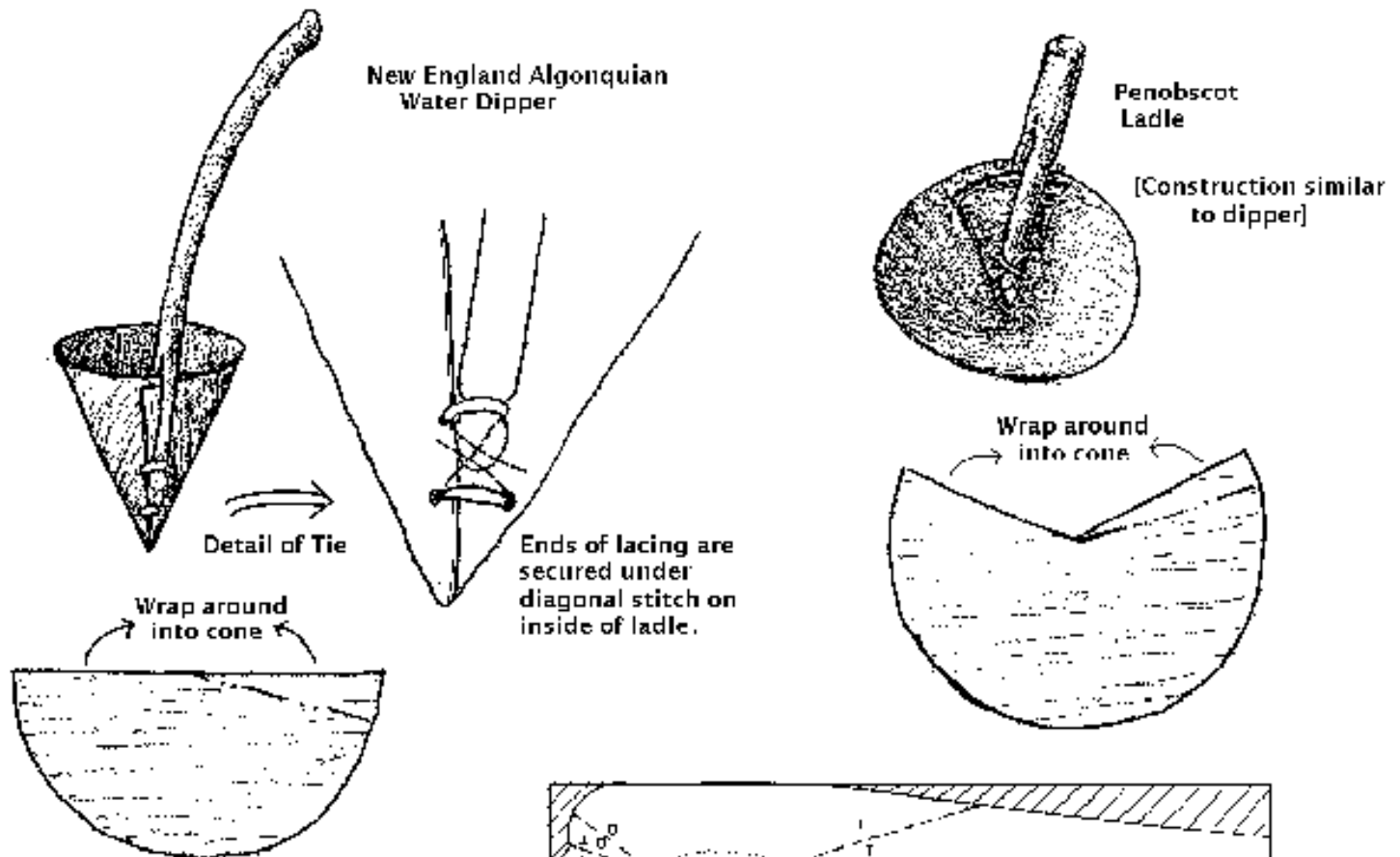


Text and Graphics  
© 1994 - 103 [Tara Prindle](#)  
unless otherwise cited.



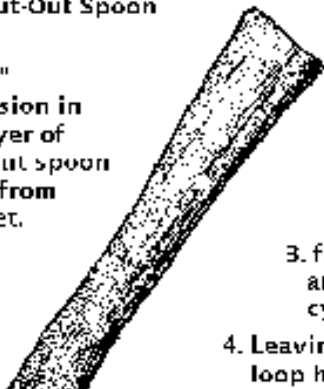


## BIRCHBARK UTENSILS



**Penobscot Cut-Out Spoon**

From sturdy "eye" forming a depression in the dark inner layer of birch bark. Cut out spoon bowl and handle from surrounding sheet.



**Massachusetts Algonquian Scraped Elm Bark Spoon**



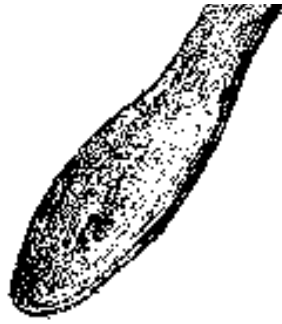
1. cut out shape from bark

2. fold corners of spoon bowl.

3. fold back of spoon bowl and wrap handle into cylinder.

4. Leaving 3" for eventual loop handle, use a long





4. Leaving 3" for eventual loop handle, use a long lacing and start by wrapping down handle.
  5. Insert one end of splint rim support into hollow handle from back of spoon, and begin sewing onto top of spoon bowl.
  6. Insert other end of splint support into handle and finish sewing around onto spoon bowl.
  7. spiral excess lacing back up the handle in the opposite direction, making a series of X's.
- B. Tie loose ends of lacing at top of handle to make loop for fastening to your belt.

---

[Return to Birchbark Containers and Utensils](#)

[Return to NativeTech's Main Birchbark Menu](#)

[Birchbark Bibliography and Books to Buy On-Line](#)



Text and Graphics  
© 1994 - 103 [Tara Prindle](#)  
unless otherwise cited.



## NativeTech: Native American Technology and Art BIRCHBARK CANOES

---

[See a cut-away view of a Traditional Full-Size Birchbark Canoe](#)

[See how to make a miniature birchbark canoe model.](#)

[See how to make a birchpaper canoe edged with sweetgrass.](#)

---

Birchbark canoes are most commonly associated with Native Americans of northern New England regions, but were probably produced where ever the birch tree grew to sufficient diameter. Early European written records indicate that birchbark canoes were built in all sizes, made small for a single person or fashioned in an incredible size to carry an amazing 50 paddlers. These canoes ranged in length between 10 and 24 feet.

Larger canoes required an amazing amount of work, although all the materials were readily available from the surroundings. The task involves: gathering the bark and root lashings, carving the manboards and laminating the prowpieces, bending and lashing the gunwales and inserting the hand-carved thwarts, stitching up the seams and gores, ripping and laying the cedar planking, bending and inserting the 30 or more ribs, and caulking the seams and holes with pine gum, and finally decorating by etching or painting the bark. *Much more* than a casual day's work!

Smaller birchbark or spruce bark canoes for hunting or warring parties could be made more expediently, being built for only one or two men. There was no planking or elaborate prowpiece in small canoes. The small canoes were not as durable nor as intricate as larger bark canoes, but with proper storage the little canoes could last five years or longer. Bark canoes could be stored in two ways: either kept from excessive light and moisture (elevated upside-down in the shade under a cover), or completely submerged in a lake or pond with rocks used as weights.



Canoes off Block Island, RI in 1635.  
Detail from *Nova Belgica et Anglina Nova* by Willem J. Blaeu, Amsterdam.

---

[Return to NativeTech's Main Birchbark Menu](#)

[Birchbark Bibliography and Books to Buy On-Line](#)

---



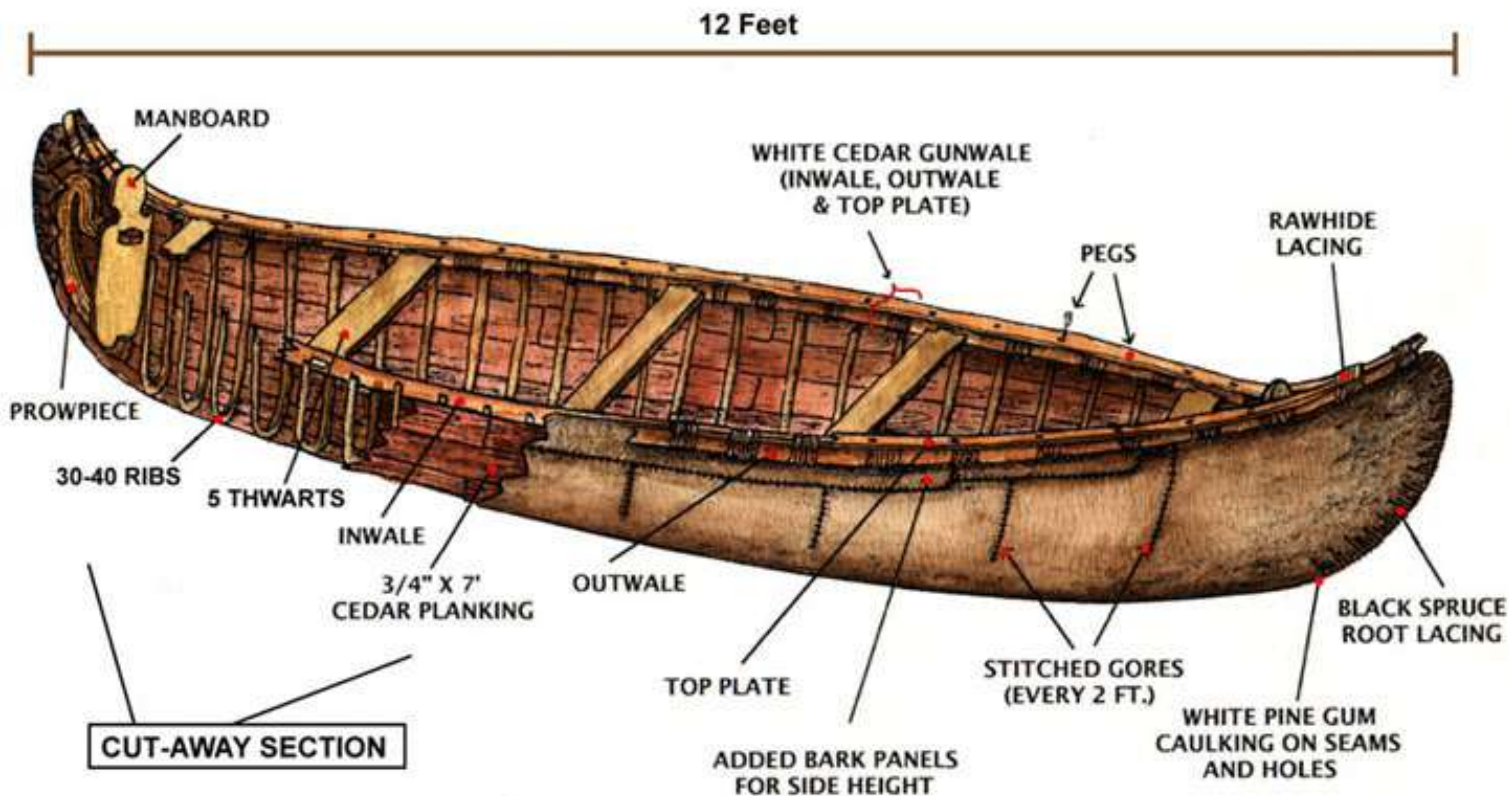
Text and Graphics  
© 1994 - 103 [Tara Prindle](#)  
unless otherwise cited.



NativeTech: Native American Technology and Art.  
Cut-Away View of a Full-Sized Canoe

Northeastern Native American Birchbark Canoe  
[from 6-7 Ft. circumference *Betula Papyrifera* tree]

© Tara Prindle 2000



[Return to Birchbark Canoe Background and History](#)

[Return to NativeTech's Main Birchbark Menu](#)

[Birchbark Bibliography and Books to Buy On-Line](#)



Text and Graphics  
© 1994 - 103 [Tara Prindle](#)  
unless otherwise cited.

## NativeTech: Native American Technology and Art. Making a Miniature Birchbark Canoe Model

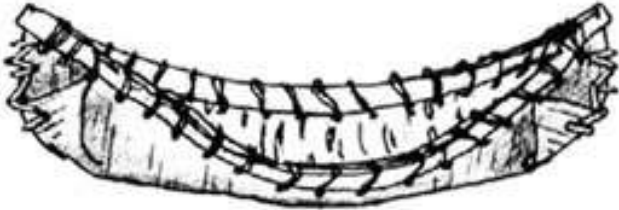
---

[Also See how to make a birchpaper canoe edged with sweetgrass.](#)

---

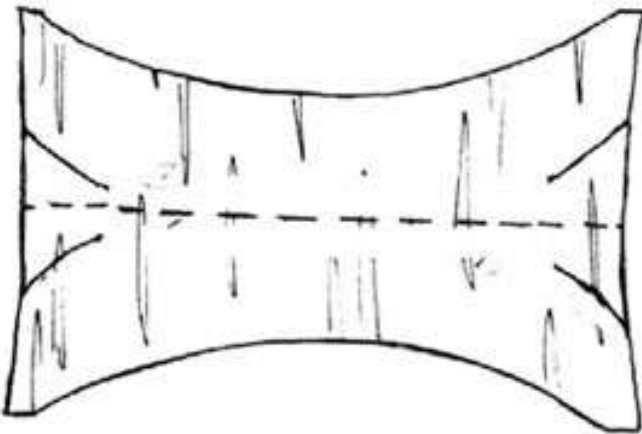
.

**1. Cut out pattern in soaked bark with woody side intact. .**



.

**2. Carefully cut slits as shown. .**



.

**3. Bend [do not crease] in half (length wise) so woody side faces out. .**

.

**4. Pinch one end and fold up the small tab; repeat with other end. .**



.

**5. Whip-stitch up and then down the seam on each end. .**

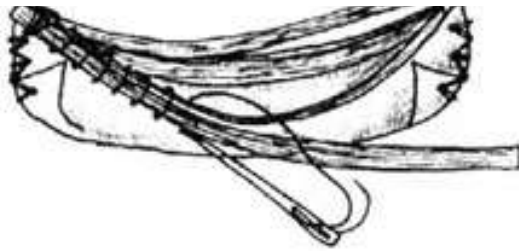
.

**[make sure one stitch goes through the small tab].**

.

**6. Whip-stitch a small basket splint around the canoe rim (gunwale)..**





.  
**7. Spread center of canoe to a 1" diameter (so it will float)..**  
.

**Fill holes and cracks with waterproof glue or pitch so the canoe will float.**

---

[Return to Birchbark Canoes](#)

[Return to NativeTech's Main Birchbark Menu](#)

[Birchbark Bibliography and Books to Buy On-Line](#)



Text and Graphics  
© 1994 - 103 [Tara Prindle](#)  
unless otherwise cited.

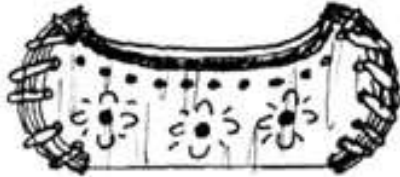
NativeTech: Native American Technology and Art.  
**Making a Miniature Birchpaper Canoe Edged with Sweetgrass**

---

[See how to make a miniature birchbark canoe model.](#)

---

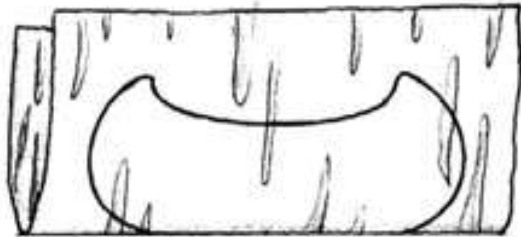
**1. Cut out pattern along the fold of a soaked piece of thin but stiff birch paper.**



**2. Fold up a blade of sweetgrass into two segments [about 1 1/2 " long & 4-5 blades thick].**

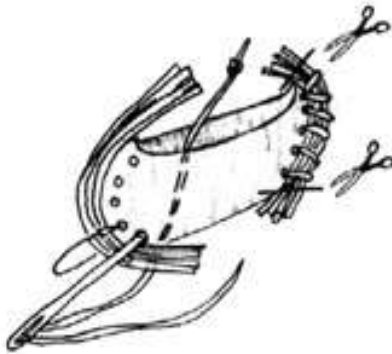
**3. Knot a thread on a needle and at the bottom of the canoe next to the seams.**

**Stitch from the inside out (so the knot is hidden inside the canoe.)**



**4. Hold folded sweetgrass along the seam at each end of the canoe.**

**Whip-stitch from the bottom of the canoe to the rim (knot at top on back of canoe.)**



**5. Trim off excess sweetgrass flush with bottom and top edges of the canoe. 6. Paint or use markers to decorate the canoe.**

---

[Return to Birchbark Canoes](#)

[Return to NativeTech's Main Birchbark Menu](#)

[Birchbark Bibliography and Books to Buy On-Line](#)

---





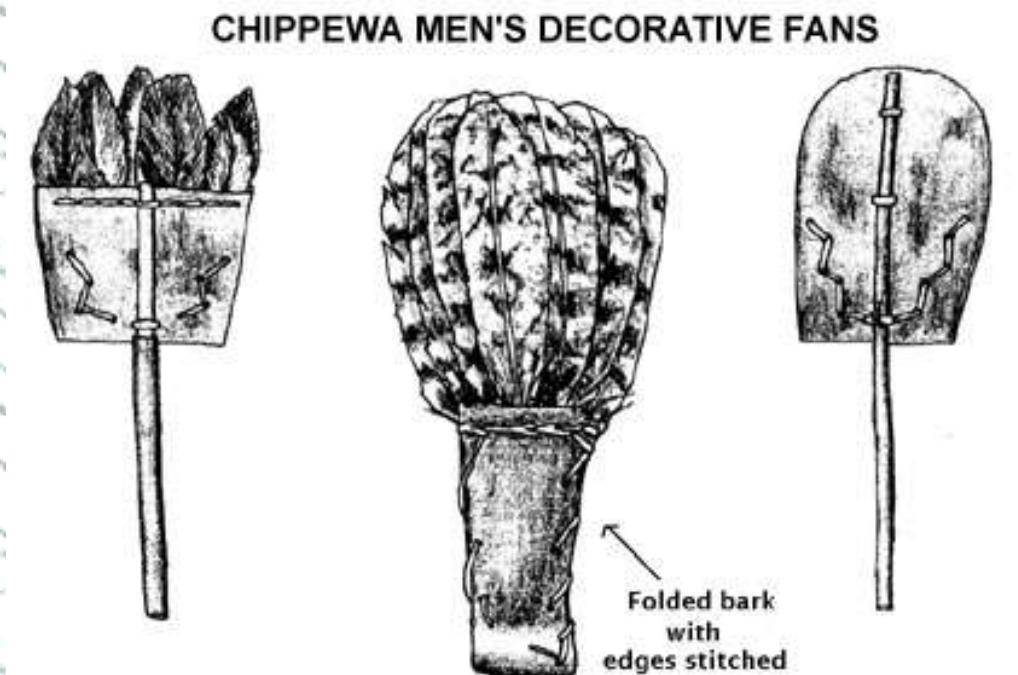
**Text and Graphics**  
© 1994 - 103 [Tara Prindle](#)  
unless otherwise cited.

## NativeTech: Native American Technology and Art. BIRCHBARK FANS

---

[See Instructions for Full-size Birchbark Fans](#)  
[See Instructions for Miniature Birchbark Fans](#)

---



Native Americans use fans for many purposes. Some uses for fans are merely practical: fans provide a deserving cool breeze; fans can motivate the flames of a diminishing fire; as well as protect eyes from the harsh glare and heat of the flames. Some old fans were even used in house cleaning. However, many fans had social and spiritual uses as well. Both men and women of most Native American tribes use fans for dancing. Some fans are passed down from one dance leader to the next. Feathers or markings used to decorate the fans can also display a man's leadership status or indicate the family to which he belongs. Fans are also used in medicine ceremonies and purifying rituals.

When desired, Native Americans in the Northeast and Great Lakes regions could quickly make birchbark fans from materials easily found in the woods. Several styles of fans are made from birchbark. Birchbark sheets could be folded in half or separate flat pieces could be slipped into a split stick handle. Stitched together with split spruce roots or with strips of inner bark of the basswood tree, these fans often incorporated the feathers of turkeys, owls, or other large birds. The fans are made to show the sturdy dark inner bark of the birch tree. This tough, dark surface can be ornamented with designs etched through to expose the lighter, more papery layers of bark. Ornamented fans among the Great Lakes Chippewa were usually reserved for men to carry, while women used more simple forms.

---

[Return to NativeTech's Main Birchbark Menu](#)

[Birchbark Bibliography and Books to Buy On-Line](#)

---



Text and Graphics  
© 1994 - 103 [Tara Prindle](#)  
unless otherwise cited.

NativeTech: Native American Technology and Art.



**INSTRUCTIONS FOR FULL-SIZE BIRCHBARK FANS**

[Also See the Instructions for Miniature Birchbark Fans](#)



**PAPERY SIDE**



**WOODY SIDE**

1. Use heavy scissors and cut 2 pieces of flattened stiff bark [about 6 " square]. Cut a paper pattern first to ensure both pieces are the same size and shape.

\* remove any badly damaged or peeling layers from the papery side of both pieces.

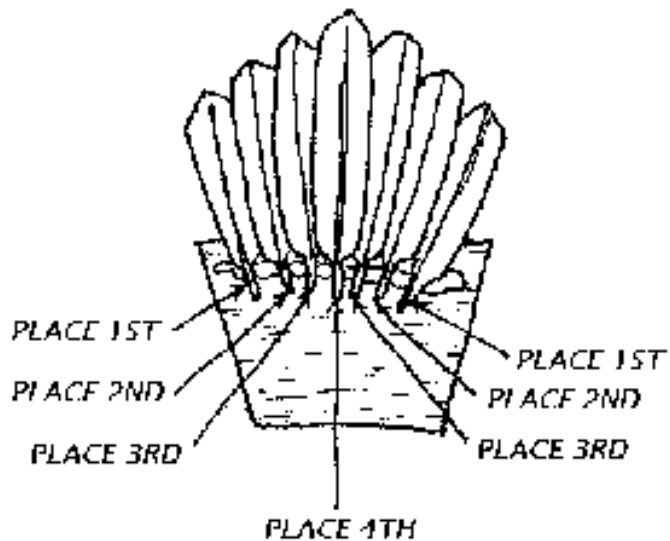
**GLUE**



2. Apply a generous strip of white glue on the papery side, near the top edge of both pieces of bark.

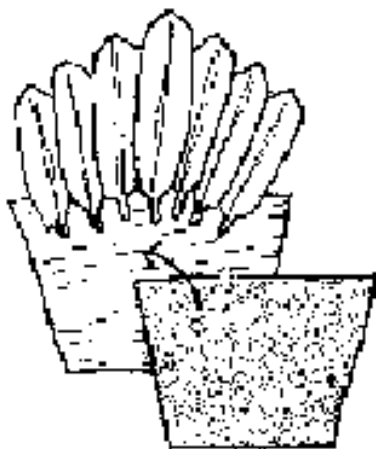
3. Select 5 to 7 large or medium size [game bird] feathers to ornament the fan. Bird-of-prey and song-bird feathers are illegal to own without a special



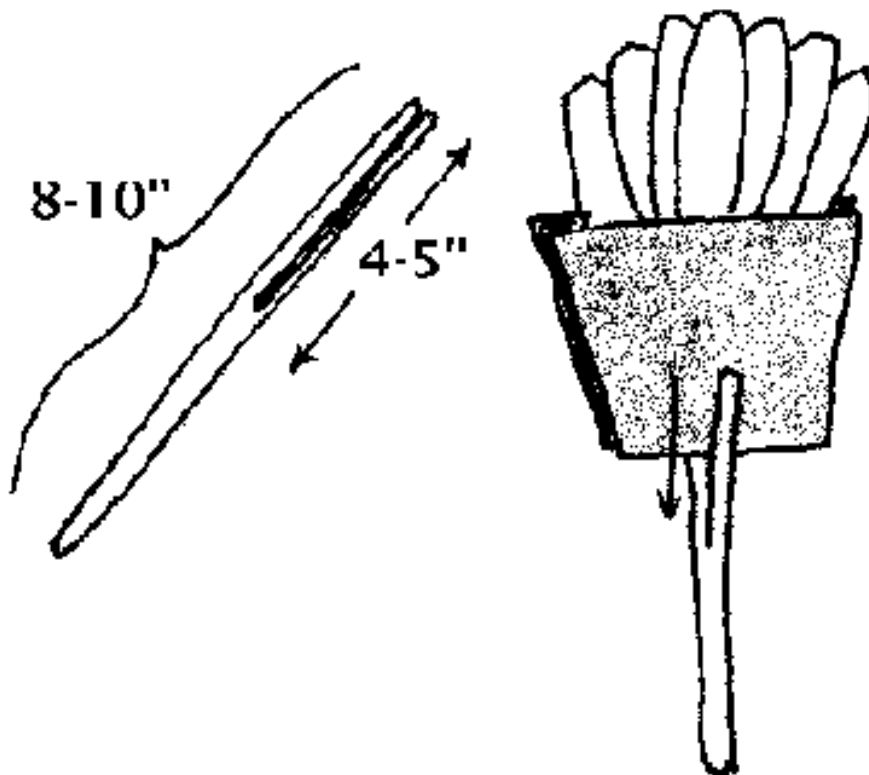


government permit.

4. Arrange feathers, smallest to largest, and place on the fan, so the feathers overlap only slightly, in the order shown. Place the largest feather last in the center of the fan.



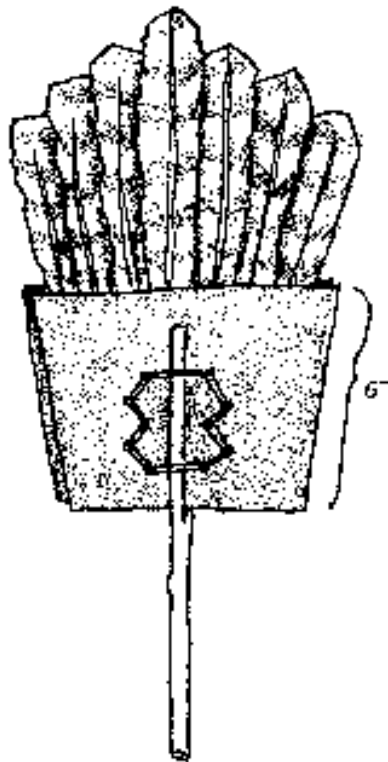
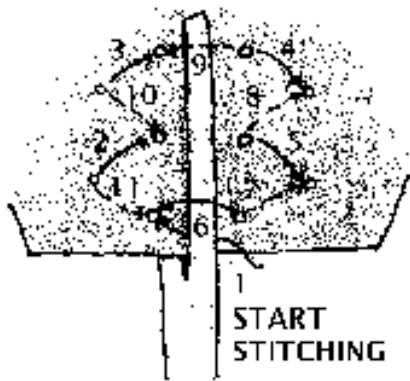
5. Lay the second sheet of bark, [woody side showing], over the first sheet with the feathers secured between the two layers with glue.



6. For the fan's handle, use an 8-10 in. stick. With a coping saw or knife, carefully make a 4-5 in. split from one end down the center of the stick. [Make sure the split is wide enough to accommodate the thickness of the two sheets of bark].

7. Carefully insert the glued bark sheets into the split in stick.

8. Use an awl or large pointed yarn needle to poke 10 holes through both layers of bark so the holes form a sideways "w" pattern on either side of



the stick handle.

**9. Knot the end of a 16" string or secure the string end between the bark and the split handle. Use a needle and stitch around through the holes and back to where the first stitch was made. Then stitch back around in the opposite direction, [to make the stitches appear continuous].**

**10. Finish by knotting the string or securing the end of the string between the bark and the split in the handle.**

---

[Return to Birchbark Fan Background](#)

[Return to NativeTech's Main Birchbark Menu](#)

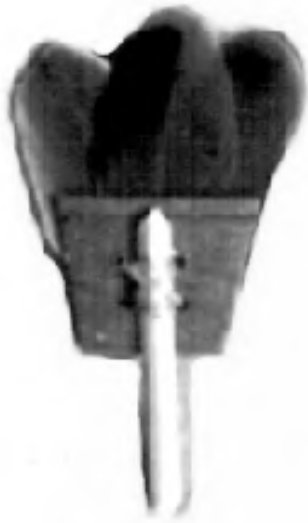
[Birchbark Bibliography and Books to Buy On-Line](#)

---



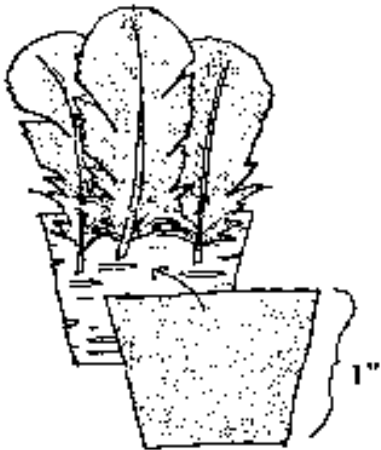
**Text and Graphics**  
© 1994 - 103 [Tara Prindle](#)  
unless otherwise cited.

**NativeTech: Native American Technology and Art.**



**INSTRUCTIONS FOR MINIATURE  
BIRCHBARK FANS**

[Also See the Instructions for Full-size Birchbark Fans](#)

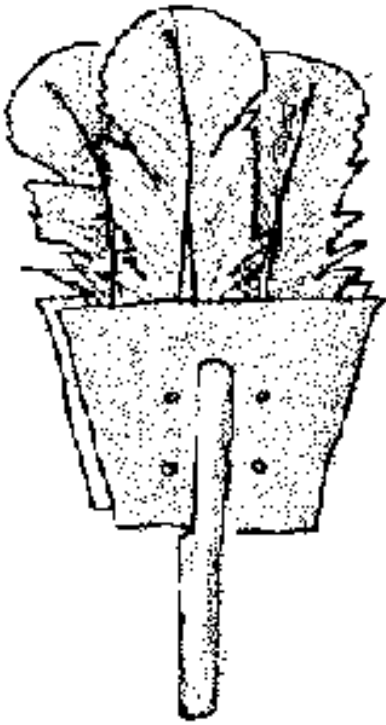


**1. Glue feathers in place on papery side.**

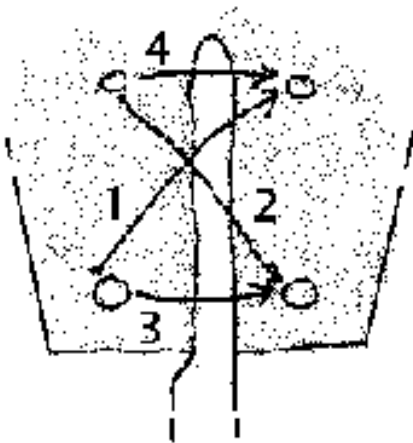


**2. Shave down 1/2 of tiny 1 1/2 '' stick.**





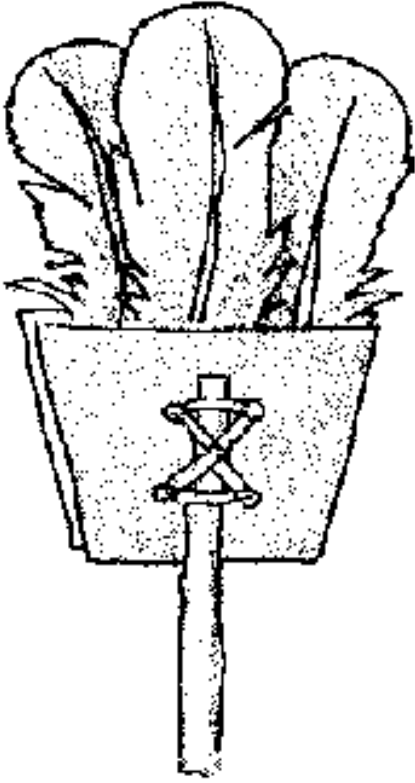
**3. Glue top sheet of bark (woody side showing) over feathers.**



**4. Glue shaved 1/2 of stick in center of bark.**

**5. Punch 4 holes through both layers for stitching.**

6. Stitch through holes in order shown (knot in back).



---

[Return to Birchbark Fan Background](#)

[Return to NativeTech's Main Birchbark Menu](#)

[Birchbark Bibliography and Books to Buy On-Line](#)

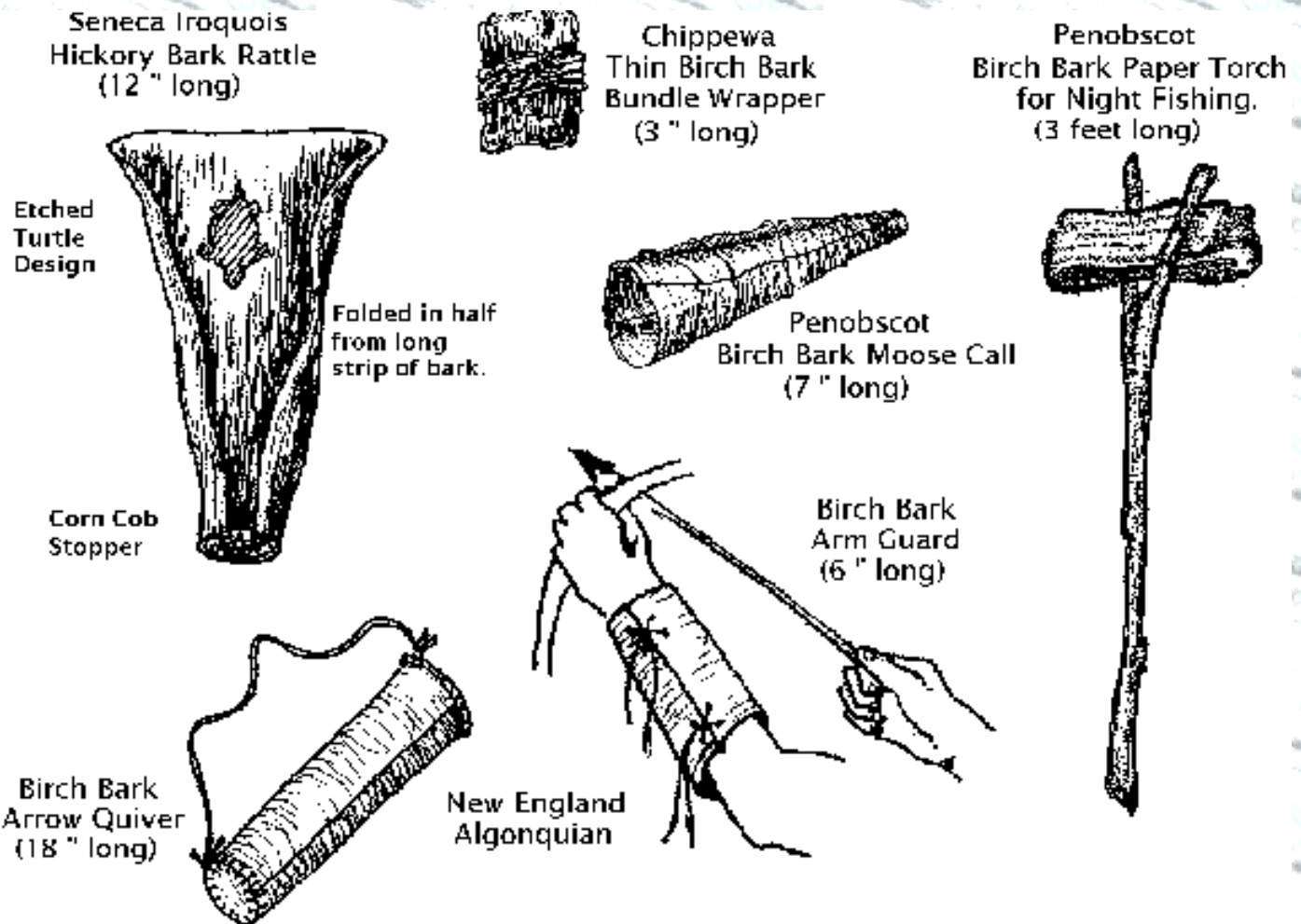
---



Text and Graphics  
© 1994 - 103 [Tara Prindle](#)  
unless otherwise cited.

NativeTech: Native American Technology and Art.  
**OTHER ITEMS MADE FROM BIRCHBARK**

In the northern reaches of the Eastern Forests, birchbark was an essential resource for Native American survival. Besides canoes, containers, utensils and fans, there are many less commonly known items made from birchbark. For a rattle, the bark is folded over, filled with pebbles or seeds, wrapped with a string and plugged with a corn cob stopper. A rigid sheet of bark can be peeled to the desired thickness, torch tinder and especially for wrapping and preserving food or medicine in packets. In addition to animal calls, weapons accessories such as quivers and archers arm guards are also made from birchbark. Penobscot made a [birchbark ball and triangle game](#) for their children. Ojibway (Chippewa) women made beautiful [birchbark transparensies and cutouts](#) both for amusement and for use in beadwork design.



[Return to NativeTech's Main Birchbark Menu](#)

[Birchbark Bibliography and Books to Buy On-Line](#)



Text and Graphics  
© 1994 - 103 [Tara Prindle](#)  
unless otherwise cited.



## NativeTech: Native American Technology and Art. BIRCHBARK TRIANGLE AND BALL GAME

---



A traditional toy used by Penobscot children consisted of a stiff piece of birch bark cut into a triangular shape, with a hole in the center. To one corner of the bark triangle is attached a string, and a ball is attached to the other end of the string. The circular hole in the center of the bark triangle is made only slightly larger than the ball attached to the string. Children grasp a corner of the triangle opposite the string, toss the ball into the air, and the object of the game is to get the ball to drop through the hole in the bark.

---

[Return to Other Uses for Birchbark](#)

[Return to NativeTech's Main Birchbark Menu](#)

[Birchbark Bibliography and Books to Buy On-Line](#)

---



Text and Graphics  
© 1994 - 103 [Tara Prindle](#)  
unless otherwise cited.

NativeTech: Native American Technology and Art.  
**BIRCHBARK TRANSPARENCIES AND CUTOUTS**

---

[Birchbark Transparencies](#)

[Birchbark Cutouts](#)

---



Birch bark bitten patterns, also called dental pictographs, are made by Native American women and children of the Great Lakes and northern New England regions. Made from the carefully peeled layers of the inner bark of the *Betula papyrifera*, or paper birch, the sheets are folded into quarters or eights. The folded sheet is bitten, or indented, using the eye and side teeth using fingers to help guide the placement of the pattern. When the paper is unfolded and held up to the light the translucent paper becomes transparent and luminous where the symmetrical bite marks appear.

Transparencies were often used to guide beadwork patterns sewn onto clothing; one bite mark for each bead would ensure the symmetrical placement of the pattern. When beadwork was completed and sewn on to the article, the birch paper could be easily torn away from the beads sewn over it.

---

[Return to Other Uses for Birchbark](#)

[Return to NativeTech's Main Birchbark Menu](#)

[Birchbark Bibliography and Books to Buy On-Line](#)

---



Text and Graphics  
© 1994 - 103 [Tara Prindle](#)  
unless otherwise cited.

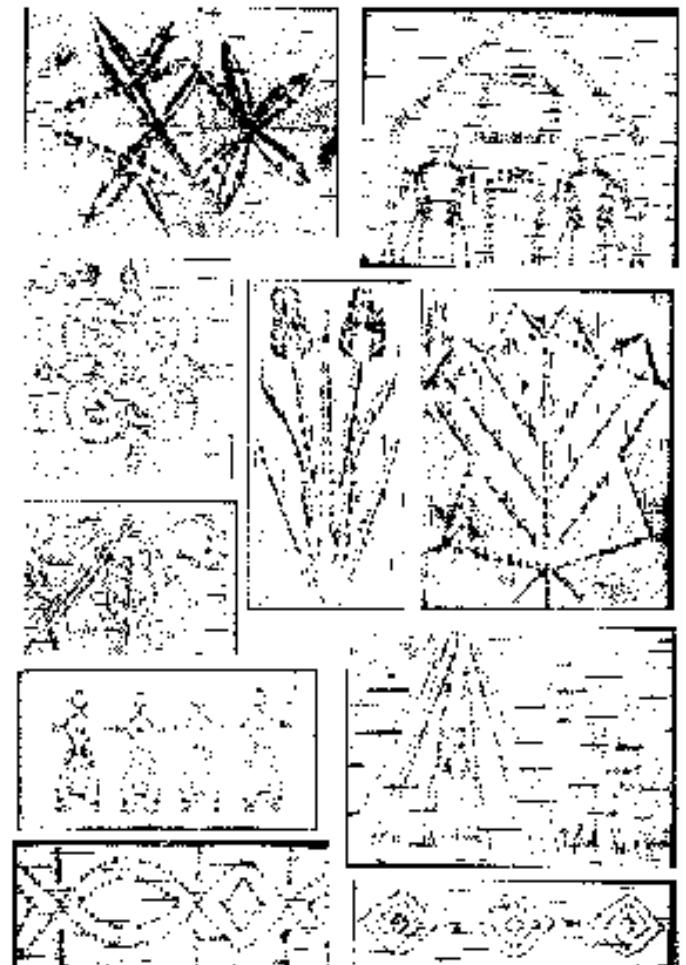
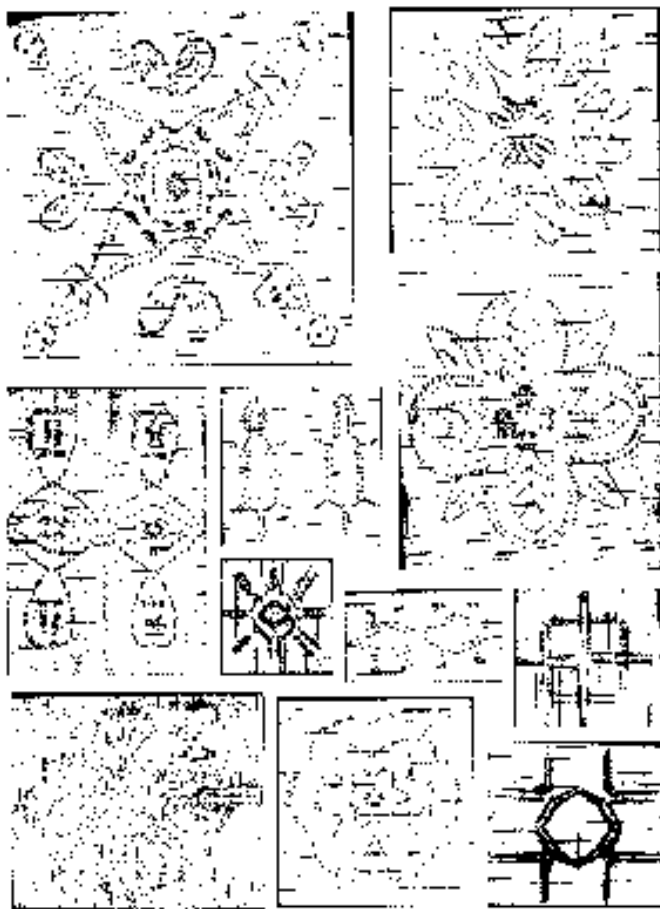
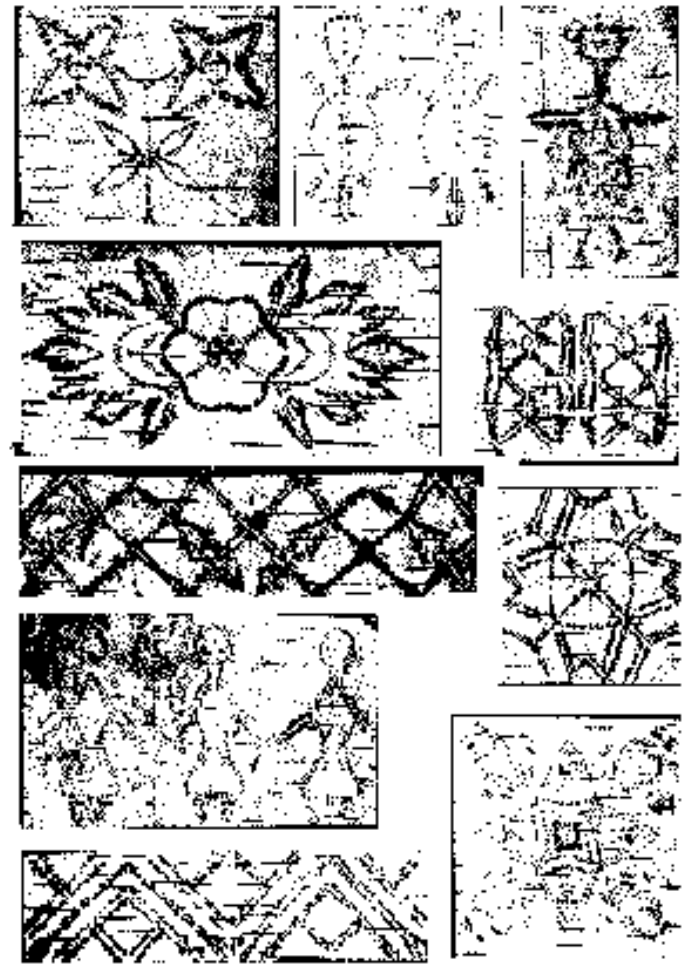
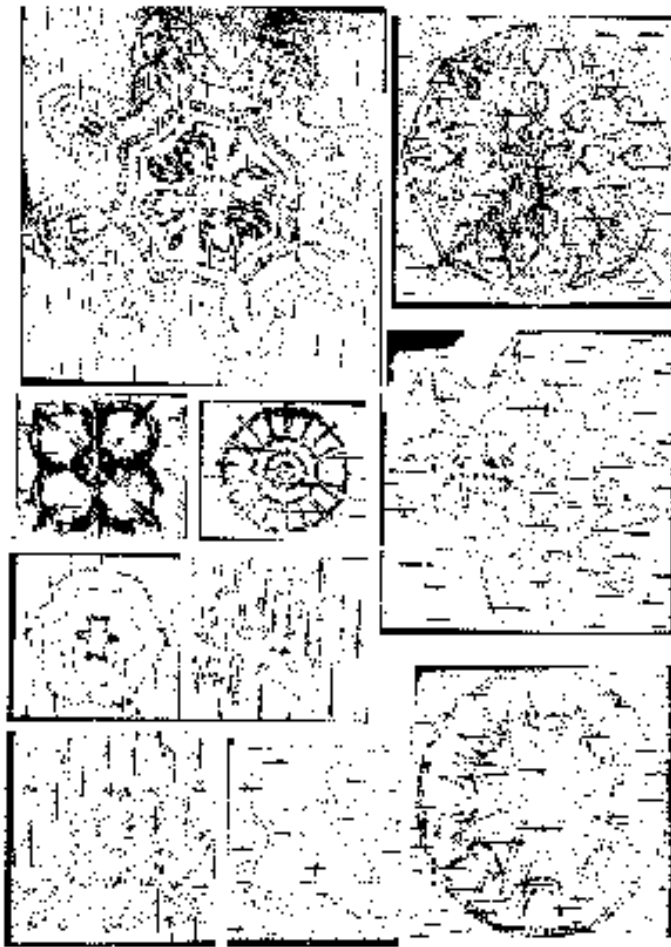


NativeTech: Native American Technology and Art.  
**BIRCHBARK TRANSPARENCIES**



**These 'bitten' patterns are beautiful when held up to the light and were probably used in developing beadwork patterns. 1. Carefully split moistened birch into the thin layers that make up the papery bark. There doesn't seem to be any easy way to do this except slowly and gradually. 2. Fold the thinnest possible layer of birch paper, in halves, quarters, or on a diagonal. 3. When holding the bark, place fingers in positions that will help guide where you want to bite. 4. Bite along the folded edges with eye and side teeth making indentations without cutting through the bark. Unfold and discover your pattern. Hold up to a bright light for another surprise.**







**Black & white images adapted from Densmore 1974**

---

[Return to Transparencies and Cutouts Background](#)

[Return to NativeTech's Main Birchbark Menu](#)

[Birchbark Bibliography and Books to Buy On-Line](#)

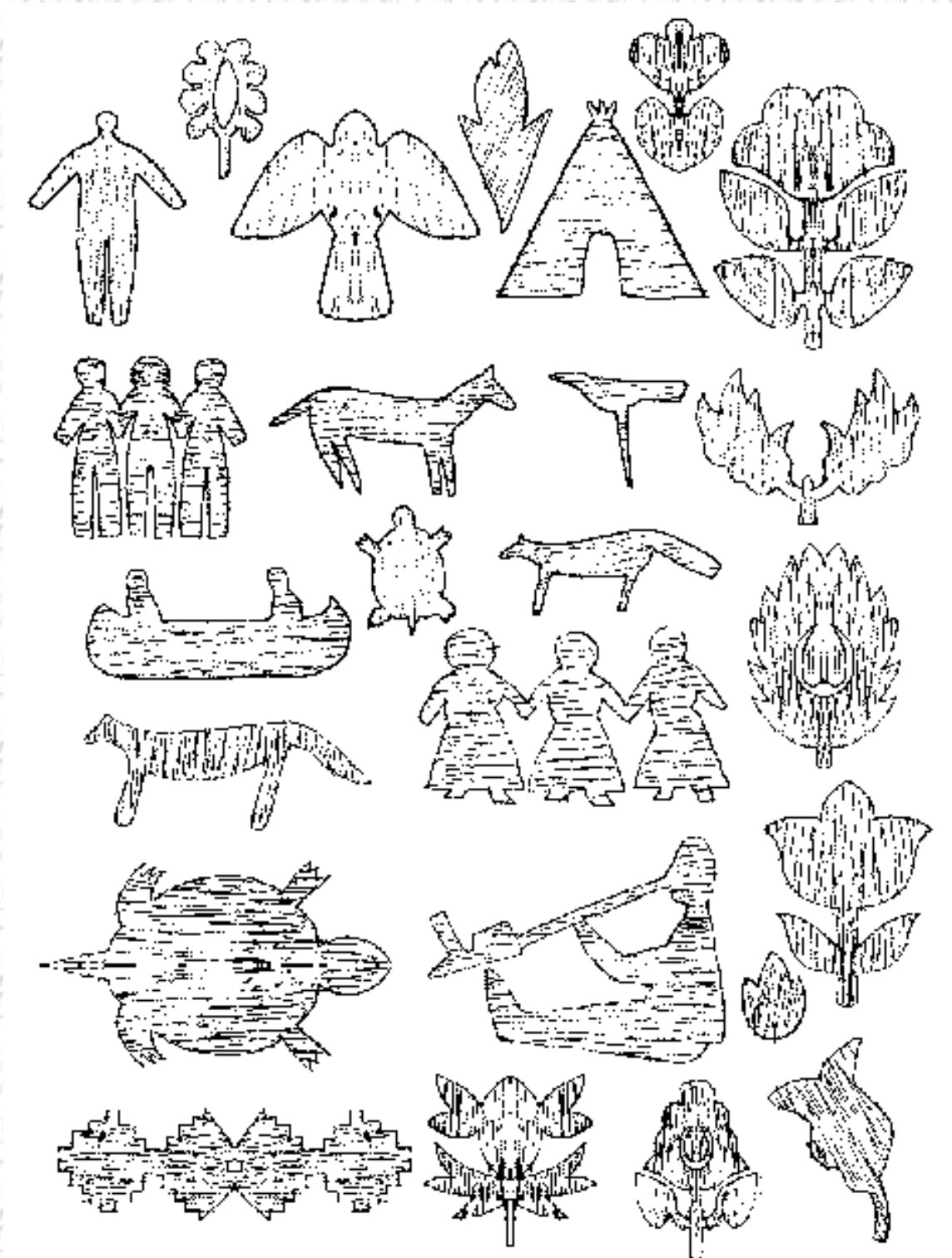
---



Text and Graphics  
© 1994 - 103 [Tara Prindle](#)  
unless otherwise cited.

## NativeTech: Native American Technology and Art. BIRCHBARK CUTOUTS

These cut out designs represent plants, animals or dream scenes important to the northeastern woodland Native American. Cut-outs were used as templates in bark container etching. Cut-outs were also used in combination with beadwork. Cutouts were made from thin but stiff pieces of birch bark paper. Symmetry is achieved by first moistening and folding the bark before cutting it.



Images adapted from Densmore 1974

---

[Return to Transparensies and Cutouts Background](#)

[Return to NativeTech's Main Birchbark Menu](#)

[Birchbark Bibliography and Books to Buy On-Line](#)

---



Text and Graphics  
© 1994 - 103 [Tara Prindle](#)  
unless otherwise cited.



## NativeTech: Native American Technology and Art

### Branches, Twigs and Roots

- [Dream Catchers](#)
- [Tamarack Trees & Traditions](#)
- [Wigwams History, Construction, and Virtual Tour](#)
- [Willow, Pine, Spruce & Cedar](#)
- [Willow Toys and Figures](#)
- [Branches, Twigs & Roots Bibliography and Books to Buy On-line](#)

[Other Internet Resources for Branches, Twigs and Roots](#)



© 1994-2000 [Tara Prindle](#).



## Native American Technology and Art

### Dream Catchers

#### Asubakacin

(Ojibwe - White Earth Band  
- meaning "net-like, looks like a net")

#### Bwaajige Ngwaagan

(Ojibwe - Curve Lake Band  
- meaning "dream snare")



*Photograph of an Ojibwe 'dream catcher' from the early 1900's [From Densmore 1979].*

---

Today dream catchers are made by Native American artists from many Nations; a great deal of people are under the impression that the Lakota/Dakota/Nakota (called Sioux by others) originated the dreamcatcher... There are many Native American stories and legends about spiders and webs, but the Ojibwe (called Chippewa by others) originated the dream catcher. A look at the long tradition of storytelling, oral histories, passed down parent to child, generation after generation, clears up any confusion about the origin of dream catchers.

Frances Densmore conducted an extensive study of material culture of the Ojibwe/Chippewa living in Minnesota, Wisconsin and Ontario, Canada in the early 1900's and the information is presented in the book, *Chippewa Customs*, published by Minnesota Historical Society Press (St. Paul) in 1979. Densmore describes that articles representing spider webs were usually hung from the hoop of a child's cradle board, and it was said that 'they catch and hold everything evil as a spider's web catches and holds everything that comes into contact with it'. These 'dream catchers' were wooden hoops with a 3 1/2 in. diameter, filled with a web made of nettle-stalk cord that was dyed red with bloodroot and wild plum inner bark. It is interesting to note that the 'weave' of the dream catcher photographed in Densmore's work is different from that usually done today. By the early 1900's, dark red yarn had been substituted for plant fiber in constructing the web by the Ojibwe. Densmore also mentions a similar netted-hoop made by the Pawnee to represent the Spider-Woman, a spirit who controlled the buffalo.

The Ojibwe, whose traditional homeland is around the Great Lakes region, have *ancient* stories about the dreamcatcher, how it 'came to be', why it is used, and how it should be made. A while back there was quite a discussion about the origin of the dream catcher on the soc.culture.native Newsgroups and on the Native-L Listserver.

---



Contemporary dreamcatcher with traditional Chippewa weave, made by my friend Michael O'Neill (Red Lake Band of Chippewa) and his wife (Fond-du-lac band of Chippewa). "My wife and I had went out one evening and gathered up some red willow... the willow is wrapped with one continuous piece of yarn including the web... it takes about an hour to make....I use a deep red yarn... like bloodroot".

### *About the Dream Catcher...*

---

from Lyn Dearborn

*In response to a question about the FIRST origin of Dream Catchers,  
Nov. 1, 1995 to the Native-l Listserver.*

### *Origin of the Dream Catcher*

**Long ago in the ancient world of the Ojibwe Nation, the Clans were all located in one general area of that place known as Turtle Island. This is the way that the old Ojibwe storytellers say how Asibikaashi (Spider Woman) helped Wanabozhoo bring giizis (sun) back to the people. To this day, Asibikaashi will build her special lodge before dawn. If you are awake at dawn, as you should be, look for her lodge and you will see this miracle of how she captured the sunrise as the light sparkles on the dew which is gathered there.**

**Asibikaasi took care of her children, the people of the land, and she continues to do so to this day. When the Ojibwe Nation dispersed to the four corners of North America, to fill a prophecy, Asibikaashi had a difficult time making her journey to all those cradle boards, so the mothers, sisters, & Nokomis (grandmothers) took up the practice of weaving the magical webs for the new babies using willow hoops and sinew or cordage made from plants. It is in the shape of a circle to represent how giizis travels each day across the sky. The dream catcher will filter out all the bad bawedjigewin (dreams) & allow only good thoughts to enter into our minds when we are just abinooji. You will see a small hole in the center of each dream catcher where those good bawadjige may come through. With the first rays of sunlight, the bad dreams would perish.**

**When we see little asibikaashi, we should not fear her, but instead respect and protect her. In honor of their origin, the number of points where the web connected to the hoop numbered 8 for Spider Woman's eight legs or 7 for the Seven Prophecies.**

### *Application and Purpose of the Dream Catcher*





*White Earth Ojibwe infant  
in a cradle board  
[Densmore 1979].*

It was traditional to put a feather in the center of the dream catcher; it means breath, or air. It is essential for life. A baby watching the air playing with the feather on her cradleboard was entertained while also being given a lesson on the importance of good air. This lesson comes forward in the way that the feather of the owl is kept for wisdom (a woman's feather) & the eagle feather is kept for courage (a man's feather). This is not to say that the use of each is restricted by gender, but that to use the feather each is aware of the gender properties she/he is invoking. (Indian people, in general, are very specific about gender roles and identity.) The use of gem stones, as we do in the ones we make for sale, is not something that was done by the old ones. Government laws have forbidden the sale of feathers from our sacred birds, so using four gem stones, to represent the four directions, and the stones used by western nations were substituted by us. The woven dream catchers of adults do not use feathers.

### *Structure of the Dream Catcher*

Dream catchers made of willow and sinew are for children, and they are not meant to last. Eventually the willow dries out and the tension of the sinew collapses the

dream catcher. That's supposed to happen. It belies the temporary-ness of youth. Adults should use dream catchers of woven fiber which is made up to reflect their adult "dreams." It is also customary in many parts of Canada and the Northeastern U.S. to have the dream catchers be a tear-drop/snow shoe shape.

The above story is a combination of information gathered by Lyn Dearborn, from California, and Mary Ritchie, of the Northern Woodlands, with assistance from Canadian elders. Miigwetch!

Thanks also to Theresa and Aandek for the Ojibwe terms & translations for dream catchers on [Rob's Ojibwe Bulletin Board!](#)

---

Take a look at Jim Shupe's [Three-Part FAQ on Dream Catchers](#) from a July 26, 1995 submission to the soc.culture.native Newsgroup

---

[Instructions for Making Dream Catchers](#)

---

[Return to Willow Branches and Other Twigs and Roots Background](#)

[Branches, Twigs & Roots Bibliography and Books to Buy On-Line](#)

[Return to NativeTech's Branches, Twigs & Roots Menu](#)

---



Text and Graphics  
© 1994 - 103 [Tara Prindle](#)  
unless otherwise cited.







Text and Graphics  
© 1994 - 103 [Tara Prindle](#)  
unless otherwise cited.

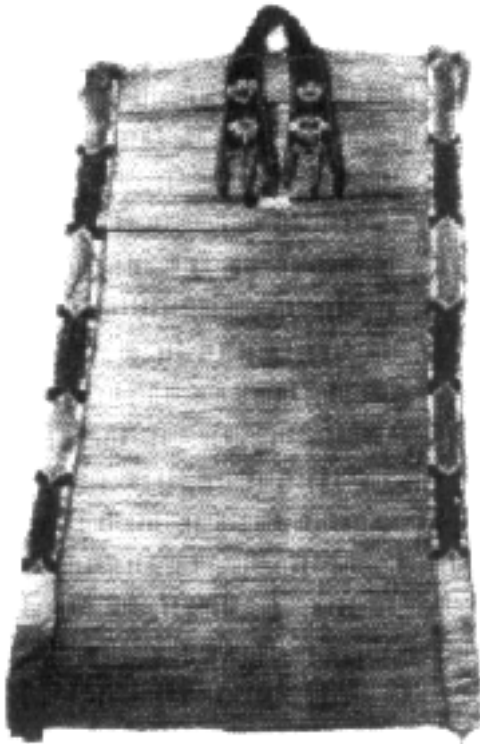
# Willow Branches and Other Twigs and Roots.

The Native American technological use of all types of trees and wood is would fill a million libraries. The Native Americans discovered the specific qualities of branches, twigs and tree roots that make them perfectly suited for particular tasks. Native Americans have a multitude of uses for willow that included medicine and technology. Native Americans also found utility in the roots and twigs of a variety of spruces, cedars and pines.

---

## *Willow*

trees are sturdy, well anchored trees growing along river banks or near streams, lakes and ponds. Native Americans recognized many useful medicinal and technological qualities of the willow

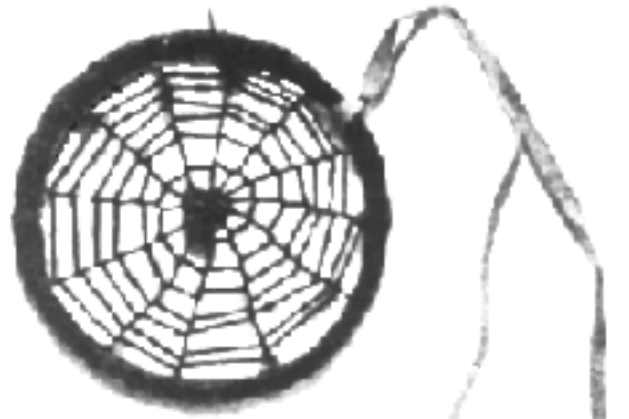


Kiowa Willow Backrest  
(adapted from Lowie: 1954)

tree. The inner bark and leaves of many willows contains the medicinal extract, salicin, or salicylic acid (salix is Latin for willow). This chemical is the active ingredient in common aspirin. (acetylsalicylic acid). Native Americans chewed or boiled a tea from the willow's leaves or inner bark to relieve fever or other minor pain like toothaches, headaches, or arthritis. The willow is often given the nickname "toothache tree".

Aside from medicine, Native Americans developed many technological applications for willow. Willow branches are straight, pliable and flexible. Because of these sturdy qualities, the branches provide excellent an excellent raw material for making a multitude of items. Many Native American groups used willow to make their arrow shafts. Drawing or painting by Native Americans sometimes used a brush made by bruising the end of a willow twig. Native Americans have produced several kinds 'wicker' basketry (checker-weave and twined) that uses willow stems or branches. Willow has also been used by Peoples such as the Kiowa and Blackfoot to make backrests with parallel branches bound together with sinew threads

and hung from a tripod. The Arapaho people made a veritable bed by attaching a willow backrest to a platform raised a foot off the ground. Willow branches were laid parallel, bent and lashed together to fashion cradleboards by the Apache. Ojibway traditionally used willow hoops to make dream catchers for children's cradleboards, and split willow withes to make dolls. The most amusing application of split willow branches is probably the construction of these stick figures, including the prehistoric willow deer from the Southwest. The Blackfoot people's Brave Society, makes ceremonial use of this branch; the 'willow brave' (who ranks next to the leader of the society) carries a branch of willow to which yellow painted plumes are tied. Dome-shaped wigwams and ceremonial lodges often incorporate willow saplings for the curving lodge poles. For some ceremonies and meetings, Natives of the Plains place a canopy of willow branches on top of the dance arbor; when the branches are harvested, red willow (Red Osier Dogwood inner bark) tobacco is offered to each plant to honor its gift.



Ojibway 'Spider Web' charm  
made with 3 1/2 in. wooden hoop  
& dark red yarn netting. early 1900's  
(adapted from Densmore: 1979)

---

**Learn about other *Roots and Twigs* used by Native Americans:**

[\*Spruce\*](#)

[\*Cedar\*](#)

[\*Pine\*](#)

[\*tamarack\*](#)

---

[\*\*Branches, Twigs & Roots Bibliography and Books to Buy On-Line\*\*](#)

[\*\*Return to NativeTech's Branches, Twigs & Roots Menu\*\*](#)

---





© 1994-2000 [Tara Prindle](#).

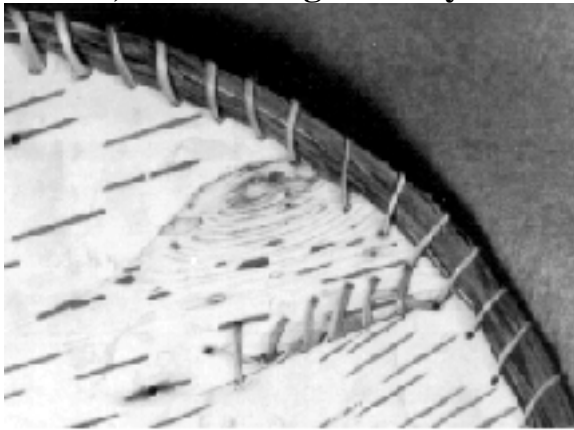
Native American Technology and Art  
**Willow Branches and Other Twigs and Roots.**

## SPRUCE

---

### *Spruce*

trees have a root systems that mirror the above ground part of the trees. Many of the long, slender, even roots grow very close to the ground surface, tapering only from 1 inch to 1/8



Spruce Root used to  
Sew a Bark Container

inch in diameter over a span of six feet. The strong roots of Black Spruce make sturdy lashings, and they are ideal for sewing and lacing bark containers, canoes and other items. By poking a few inches into the ground around the base of a spruce tree, a root can usually be located, and then pulled, following the root to its end several yards from the tree. The roots had to be stripped of their bark using a forked implement through the root was pulled. After the root bark removal, the root would be split in half down its length. If the root was especially large, or fine lacing was needed, the root could be split (using the same

technique to split willow) into quarters or eighths with patience. The roots were always soaked in warm water, or heated over a fire, rejuvenate the sap and making the lacing more flexible. Gathering one or two roots from a live tree normally doesn't threaten the life of the tree. Over-harvesting roots a single tree will kill it. Roots can also be gathered, with little loss of workability, from dead or fallen spruces.

---

[Return to Willow Branches and Other Twigs and Roots Background](#)

[Branches, Twigs & Roots Bibliography and Books to Buy On-Line](#)

[Return to NativeTech's Branches, Twigs & Roots Menu](#)

---



© 1994-2000 [Tara Prindle](#).

**NativeTech: Native American Technology & Art**

**BRANCHES, TWIGS & ROOTS  
BIBLIOGRAPHY**



Click on the links below for the books you can order on-line in affiliation with [barnesandnoble.com](http://barnesandnoble.com)

---

*References cited in NativeTech's [Branches, Twigs & Roots articles](#):*

**Charles Supplee**

**1992 Split Twig Horse. Advertisement from La Fonda Indian Shop & Gallery. Santa Fe, New Mexico. In American Indian Art Magazine Vol.17: No.4, Autumn. Tempe, Arizona: Ironwood Lithographers.**

**Elpel, Tom**

**1994 The Ancient Art of Split Willow Sculpture. In Bulletin of Primitive Technology. No.8, Fall. Society of Primitive Technology.**

**Densmore, Frances**

**1974 How Indians Use Wild Plants for Food, Medicine and Crafts. New York: Dover Publications, Inc.  
[Order this book through barnesandnoble.com](#)**

**Densmore, Frances**

**1979 Chippewa Customs. St. Paul Minnesota: Minnesota Historical Society Press.  
[Order this book through barnesandnoble.com](#)**

**Erichsen-Brown, Charlotte**

**1979 Medicinal and Other Uses of North American Plants. Dover Publications, Inc. New York.**

**Foster, Steven and James A. Duke**

**1990 A Field Guide to Medicinal Plants; Eastern and Central North America. Peterson Field Guide Series. Houghton Mifflin Company: Boston/New York.  
[Order this book through barnesandnoble.com](#)**

**Hutchens, Alma R.**

**1973 Indian Herbalogy of North America; The definitive guide to Native medicinal plants and their uses. Shambhala: Boston.**



[Order this book through barnesandnoble.com](http://www.barnesandnoble.com)

**Jennings, Jesse D.**

**1989 Prehistory of North America, third ed.**

Mountain View, California: Mayfield Publishing Co.

[Order this book through barnesandnoble.com](http://www.barnesandnoble.com)

**Lower, A.**

**1938 The north American assault on the Canadian forest.**

Ryerson. Toronto.

**Lowie, Robert H.**

**1954 Indians of the Plains.**

Lincoln and London: University of Nebraska Press.

[Order this book through barnesandnoble.com](http://www.barnesandnoble.com)

**Peterson, Lee Allen**

**1977 A Field Guide to Edible Wild Plants; Eastern and central North America.**

Peterson Field Guide Series. Houghton Mifflin Company: Boston/New York.

[Order this book through barnesandnoble.com](http://www.barnesandnoble.com)

**Ritzenthaler, Robert E. and Pat Ritzenthaler**

**1970 The Woodland Indians of the Western Great Lakes.**

Garden City, NY: Natural History Press.

[Order this book through barnesandnoble.com](http://www.barnesandnoble.com)

**Scott, Colin H.**

**1989 "Ideology of Reciprocity Between the James Bay Cree and the Whiteman State," in**

**Peter Skalnik, ed., Outwitting the State.**

New Brunswick, N.J.: Transaction Publishers.

**Speck, Frank G.**

**1976 Penobscot Man: The Life History of a Forest Tribe in Maine.**

New York: Octagon Books.

[Order this book through barnesandnoble.com](http://www.barnesandnoble.com)

**Wilbur, C. Keith**

**1990 Indian Handcrafts; How to Craft Dozens of Practical Objects Using Traditional Indian Techniques.**

Chester, CT: Globe Pequot Press.

... has simple instructions for making an eastern Woodlands dug-out canoe using some 'modern conveniences'

[Order this book through barnesandnoble.com](http://www.barnesandnoble.com)

**Whitman, Ann H., ed.**  
**1988 Familiar Trees of North America; Eastern Region.**  
Alfred A. Knopf, New York

**Wissler, Clark**  
**1986 A Blackfoot Source Book.**  
Edited by D. H. Thomas. New York and London: Garland Publishing, Inc.

---

*Other Books relating to Branches, Twigs & Roots you can buy on-line  
through [barnesandnoble.com](http://barnesandnoble.com):*

**Crisca Bierwert**  
[Brushed by Cedar, Living by the River: Coast Salish Figures of Power](#)

**Nan McNutt**  
[Cedar Plank Mask](#)

**Patricia A. Taylor**  
[Easy Care Native Plants : A Guide to Selecting and Using Beautiful American Flowers, Shrubs, and Trees in Gardens and Landscapes](#)

**Steven A. Roy, Bruce**  
[How Fire Got into the Rocks and Trees: A Story Based on Indian Legend](#)

**Laura Waterman Wittstock, Dale Kakkak**  
[Ininatig's Gift of Sugar: Traditional Native Sugarmaking](#)

**N. Scott Momaday, Natachee Scott Momaday, Don Perceval (Illustrator)**  
[Owl in the Cedar Tree](#)

**Ron Hirschi, Deborah Cooper (Illustrator), Edward S. Curtis**  
[People of Salmon and Cedar](#)

**Michael Edward Stanfield**  
[Red Rubber, Bleeding Trees: Violence, Slavery, and Empire in Northwest Amazonia, 1850-1933](#)

**Lois McConkey, Douglas Tait (Illustrator)**  
[Sea and Cedar: How the Northwest Coast Indians Lived](#)



**Michael Dorris**  
**[Sees Behind Trees](#)**

**Lelooska, Chief Lelooska, Christine Normandin**  
**[Spirit of the Cedar People \(with CD\)](#)**

**Additional book list being compiled.  
In the meantime,**

**[Click here to Search for Books about Dreamcatchers](#)**

**[Search for Books at  
barnesandnoble.com](#)**

Search by:

---

**[Return to NativeTech's Main Branches, Twigs & Roots Main Menu](#)**




---



© 1994-1999 **[Tara Prindle](#)**.

# Native American Technology and Art

## Tamarack Trees & Traditions

-  [An introduction to Tamarack Trees & Traditions](#)
-  [How to make Tamarack Twig Goose Decoys](#)
-  [Branches, Twigs & Roots Bibliography and Books to Buy On-line](#)

[Other Internet Resources for Tamarack Trees & Traditions](#)



© 1994-2000 [Tara Prindle](#).



NativeTech: Native American Technology and Art  
**An introduction to Tamarack Trees & Traditions.**

---

## **About The Tamarack Tree:**



Tamarack twig, adapted from Whitman 1988

The Latin name for Tamarack is *Larix laricina*. Other common names are Eastern Larch, American Larch, Red Larch, Black Larch, takmahak and Hackmatack, which is an Abenaki word for ěwood used for snowshoesí (Erichsen-Brown 1979).

Though the tamarack tree resembles other evergreens, it is actually a deciduous conifer, meaning that it sheds itís needles every fall. It commonly grows in swamps and sphagnum bogs but also grows in upland soils. The flaky dark reddish-gray bark of the tamarack tree

resembles Black Spruce. The pale green needles are soft and short (about an inch long) and grow in brush-like tufts on small knobby spurs along each twig. The cones of the tamarack are also fairly small - round, and less than an inch long (Peterson 1977). Very often you will see the tall tamarack trees growing in pure stands. Just before the needles drop in autumn, the needles turn a beautiful golden color, affording the stands of tamarack a striking contrast to the fall foliage.

Tamarack trees are well adapted to the cold. The tree's natural range is from Labrador to West Virginia, northern Illinois and New Jersey, across southern Canada to Northern British Columbia Alaska. It grows near sea level in northern regions, and at higher elevations in the southern extreme of itís range.

## **Tamarack Trees as Food:**

The tender spring shoots are nutritious, and can be eaten when they are boiled. The inner bark (cambium layer) of the tamarack tree can also be scraped, dried and ground into a meal to be mixed with other floursÖ which some references indicate is an ěacquiredí taste (Peterson 1977), while other references imply the gummy sap that seeps from the tree has a very good flavor when chewed (Hutchens 1973), as sweet as maple sugar.

## **Tamarack Trees as Medicine:**

**A tea made from tamarack bark is used as a laxative, tonic, a diuretic for jaundice, rheumatism, and skin ailments. It is gargled for sore throats. Poultices from the inner bark are used on sores, swellings and burns, as well as for headaches. For headaches, Ojibwe crush the leaves and bark and either applied as a poultice, or placed on hot stones and the fumes inhaled (Erichsen-Brown 1979). A tea from the needles is used as an astringent, and for piles diarrhea, dysentery, and dropsy. The gum from the tamarack sap is chewed for indigestion. The sawdust from tamarack may cause dermatitis (Foster & Duke 1977).**

**Alma Hutchins (1973) describes some of the uses for a tea made from 1 teaspoon of the inner bark of tamarack boiled and steeped for 30 minutes in a cup full of water:**

*Because of its astringent and gently stimulating qualities the inner bark is especially useful for melancholy, often caused by the enlarged, sluggish, hardened, condition of the liver and spleen with inactivates various other functions of the metabolism. For domestic use in emergencies, or long-standing bleeding of any kind, in lungs, stomach, bowels, or too profuse menstruation. Also for diarrhoea, rheumatism, bronchitis, asthma and poisonous insect bites. J. Kloss in *ëBack to Edení*, recommends the weak tea as an eye wash and the warm tea dropped in the ear to relieve earache. A decoction of the bark, combined with Spearmint (*Mentha veridis*), Juniper (*Juniperus communis*), Horse radish (*Cochlearia armoracia*), and taken in wineglassful doses has proven valuable in dropsy. (Hutchins 1973)*

**The Chippewa (or Ojibway/Ojibwe) word for tamarack is ëmuckigwatigí meaning ës swamp treeí. The bark of the tree is used for burns. For burns, the inner bark of tamarack is finely chopped and applied to the burn in the morning and partially washed off at night, then reapplied the next morning. Tamarack used for internal medicine is said to be a laxitive, tonic, diuretic and alterative. The medical constituents of tamarack are a volatile oil which contains pinene, larixine, and the ester bornylacetate (Densmore 1974).**

**The Potawatomi and Menomini make a heat-generating poultice from fresh inner tamarack bark for inflammation and wounds, or steeped for a medicinal tea. They also use it as a medicine for their horses, either as a tea to help Menomini horses with distemper, or shreaded inner bark mixed with oats to keep the hides of the Potawatomi horses loose (Erichsen-Brown 1979).**

## **Tamarack Trees as Technology:**

**The wood is very sturdy and today is used for house frames, railroad ties and fence posts. (Whitman 1988)**

*The tamarack or hackmatack has been an excellent timber much used for ships. It is practically indestructible under water and stands very well even where exposed. It is used to be the colonial substitute for the ëcompass timberí of English oak used in the ships of the Royal Navy, itís roots furnishing the natural knees and other curved pieces so precious to the early shipbuilders. Unfortunately the tamarack as a commercial timber is no more, for some years ago an insect pest swept the country and destroyed all the trees of any size. Their gaunt skeletons, bare, grey and dry as tinder, may still be seen standing in northern bogs and muskegs, a tribute to the species durability. Fortunately new growth is rapidly coming on. (Lower, A. 1938)*

**The Ojibwe use tamarack roots to make twined woven bags. These roots are stripped of their bark and boiled to make them pliable. The bags are used to store medicinal herbs and roots as well as**

wild rice. Large tamarack roots stripped of their bark are also used to sew the edges of canoes (Densmore 1979). The Iroquois have used tamarack bark for tanning (Erichsen-Brown 1979).

The Cree have made traditional use of the tamarack, called *ëwachinakiní* or *ëwageenakiní*, for millenia. In addition to its medicinal uses, the Cree (or Eeyou) use parts of the tamarack tree for making toboggans, snow shoes, canoes and even firewood. But, perhaps the most well-known use is the elegant and lifelike goose hunting decoy made by the Cree from tamarack twigs.

The beauty and workmanship in these tamarack twig goose decoys is an outcome of the long interrelationship and mutual respect between the Cree people and the migratory flocks of geese. Canadian geese, snow geese, and other waterfowl have been an extremely important spring food source to the Cree. The Cree hunters, likewise, have been beneficial to these migratory birds by traditionally keeping their populations within the sustainable limits of the surrounding environment. With this recognition of a necessary balance between human and animal food resources, the Cree living along James Bay have developed complex hunting rules and restrictions. "Goose Bosses" monitor and regulate the hunting in adjacent bays where migratory birds frequent, these people ensure that the geese will not be frightened away prematurely, and will return to these places in future migrations Scott 1989). The men of the Cree set up Goose Camps in the early spring, and stay there, returning to their families in the village with geese, and then returning to the temporary camps. The first time a boy kills a goose is traditionally an meaningful occasion, and the goose's head is often honored with beadwork and kept as a remembrance.

Making of the tamarack twig goose decoys, as an aid in hunting, has been passed down among the Cree people, generation to generation. It is a necessary technology which has, among some Cree craftspeople, evolved into a remarkable contemporary art. You can see how two such Cree artists from James Bay, Quebec [John Blueboy](#) and [Harry Whiskeychan](#) bring to life these tamarack decoys ... "they are watching, listening, aware", in the words of the friend that inspired me to get started on this section of Tamarack Trees & Traditions. (~ thank you Barry)

---

[How to make Tamarack Twig Goose Decoys](#)

[Other Internet Resources for Tamarack Trees & Traditions](#)

---

[Return to the Tamarack Main Menu](#)

[Branches, Twigs & Roots Bibliography and Books to Buy On-Line](#)

[Return to NativeTech's Branches, Twigs & Roots Menu](#)

---



© 1994-2000 [Tara Prindle](#).



## NativeTech: Native American Technology and Art



# How to make Tamarack Stick Goose Decoys



**A Tamarack Twig collected after the needles have dropped off.**



**Gather twigs from a stand of tamaracks. The twigs should not be so brittle that they snap in half with a little pressure. They should still be flexible. The twigs should be as long and narrow as possible as the size and length of your twigs will be reflected in your finished decoy (keep in mind that any twigs wider than 1/2 a centimeter in diameter at the base are probably too thick for your decoy, but you will need a couple thick twigs to form the feet of your decoy). This is just enough tamarack for a small decoy measuring about seven inches. If you are using recent fallen**

**twigs for your decoy, you will need to soak them in warm water for several hours to a day. The older the twigs, the longer they need to soak to regain some of their flexibility.**



**The twigs need to be stripped of the knobby spurs which the needles grew off of, and any smaller twigs growing off the main twig. If you are using fresh tamarack and not fallen branches, you will need to strip off the knobby spurs and the needles as well. This is accomplished by holding the narrow end of the twig with one hand and carefully with the other end running the twig between your fingers and thumbs.**

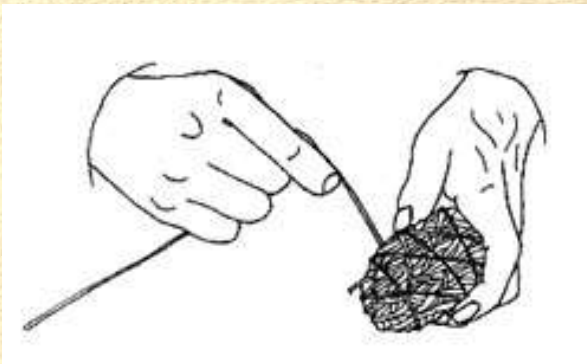




Once all of your twigs have been stripped of small twigs, needles, and spurs... sort them into piles. Just as a quillworker sorts thier quills according to size, this will help you plan and carry out your decoy more easily. The size of the largest pile of twigs that you have will determine the size of your decoy. The length of the decoys body or neck should not be longer than your longest bunch of twigs.



Always keeping the twigs moist and flexible, you start making making the decoy's body. This is acomplished by making an egg-shapped ball. You can use the smaller pieces and scraps which you stripped off your twigs.



Having formed a ball of twigs, bind it tightly with thin cord, embroidery thread, or strong cotton string... even the imitation sinew. Just be sure the material you are using is strong and will hold up to being tugged on. Wrap the ball until you have a distinct egg-shape. The wide end of the egg will be where the decoy's neck will be, and the narrow end of the decoy will be it's tail.



Now, you need to lay tamarack twigs around your body 'egg'. The number of twigs, depending of course, on the size of your decoy, of course. For a small decoy, choose about six twigs and (keeping them perfectly parallel - and alternating the thick and thin ends of the twigs across the row) wrap them over the wide end of the 'egg'... so that the ends of the twigs you are wrapping around stick out beyond the narrow end of the 'egg'. Hold the two ends of the twigs around the egg firmly with one hand, and gather up another set of six or so twigs with the other hand.

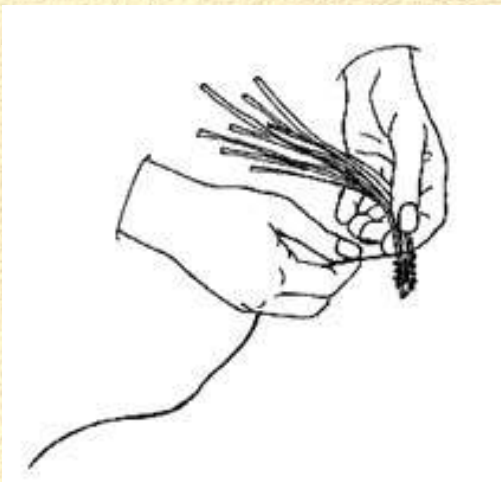




**Wrap this second set of twigs around the 'egg' similar to the first set, only make sure it is exactly perpendicular to the first set.**



**This is the body 'egg' with the two sets of twigs laid over it. There should be only small gaps where you can see the 'egg' through the twigs. Tie the bundle of twigs you are holding *\*tightly\** and cut the ends of the twigs off near the lashing so the ends come to a point.**

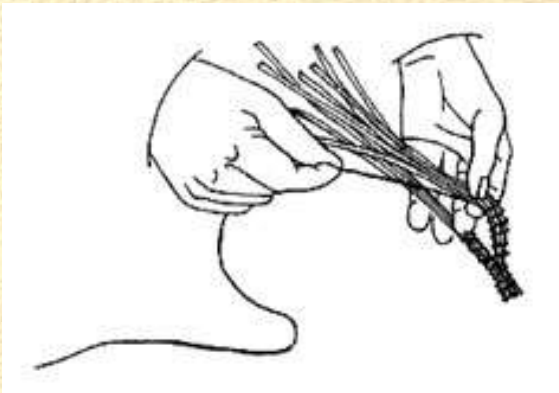


**Now it is time to make the head and neck of your decoy. For a small decoy, take about fifteen or so twigs and gather them by the thin ends of the twigs. Take your string and laying it parallel to the twigs and begin at the end of the twigs and wrap around the bundle tightly (wrapping over the end of your string. Wrap about a half an inch (this will form the very 'beak' of your goose).**

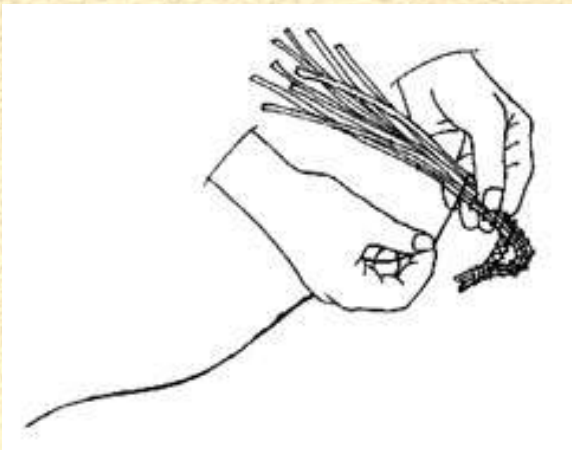




Separate the bundle into two halves (one bundle slightly smaller than the other) and continue wrapping from the 'beak' down the \*smaller bundle about an inch and a half to two inches (this is forming the lower jaw of your goose). Then wrap back up the 'jaw' to the 'beak' so that you form a series of x's with your thread.

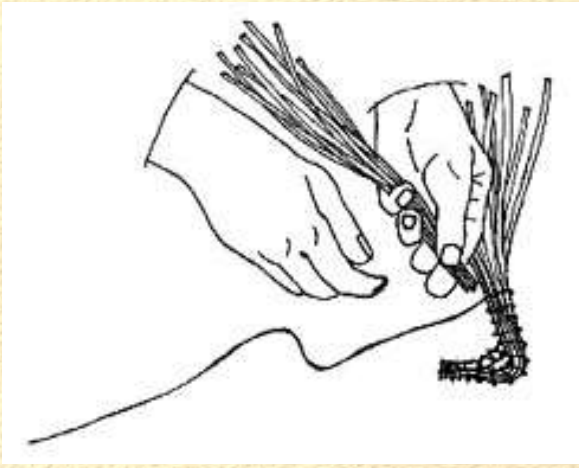


Now from the 'beak' wrap around the second half of the split bundle of twigs (this is forming the top of the goose's head). As you are wrapping, you will need to bend the bundle of twigs so it has the proper arch to match the outline of a goose's head, wrap about two and a half inches, and eventually join it to the lower bundle of twigs which forms the 'jaw'.



While joining the bundle for the top of the goose's head with the bundle of the goose's 'jaw' you will need to bend the lower 'jaw' bundle... and be careful not to break the twigs. Now wrap around the joined bundles to form the goose's neck for about an inch.



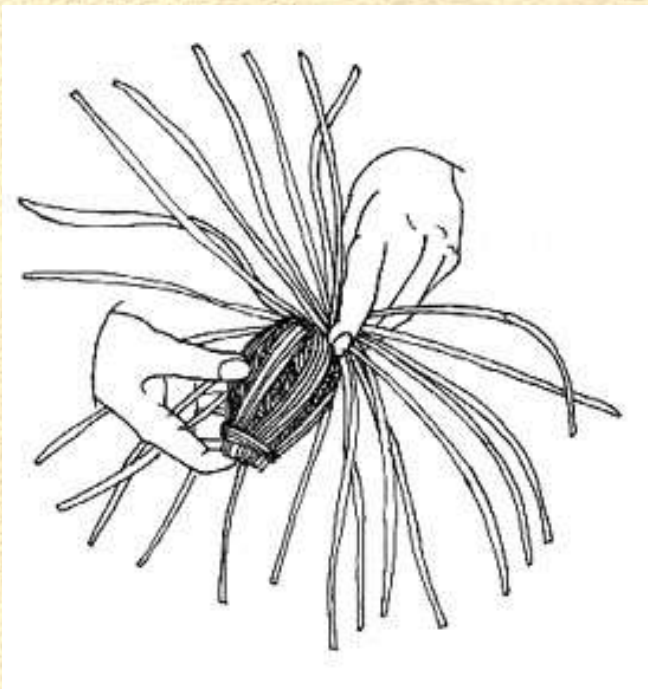


**You don't want your decoy to have too skinny of a neck, so now it's time to add in some additional twigs. Grasping a bundle of ten or so new twigs by the narrow tips, insert them into the \*center\* of your decoy's neck so they do not stick out. You may need to add another bundle of twigs if your goose's neck still seems to thin after a couple wraps with the string.**



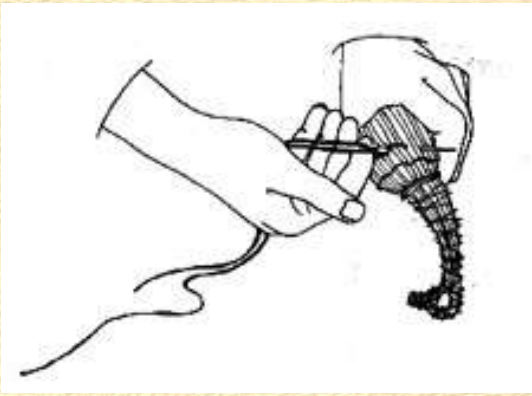
**Continue wrapping down the neck, and as you wrap the neck, keep in mind how a goose holds it's head on it's neck... try to bend the twigs to a graceful 'S' shape, even looking down or to the side... it takes alot of practice to get just the right expression of a goose. Wrap around the base of the neck in the same place several times (perhaps three inches down from the 'jaw' for a small decoy). Then wrap back up the neck, creating a series of X's with your string. Continue wrapping over the head of your decoy (creating more X's) till you are back at the tip of the 'beak' of the**

**decoy. Tie off the string with three or so half hitches and trim the excess string away.**

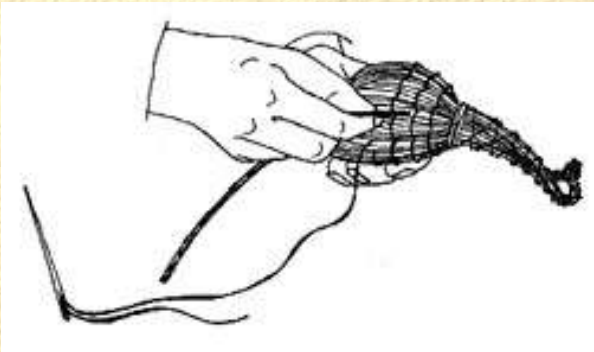


**Now join the decoy's head to the body you set aside before. Spread the twigs sticking out from the neck into radiating spokes. Place the spokes over the body 'egg' so that the spokes from the neck lay parallel and/or inbetween the twigs already on the body. (pay attention to the postion of the head at this point, as it is difficult if not impossible to adjust after it is fastened on). Gather the ends of the spokes with your hand and hold them firmly in one hand (you can temporarily tie them with a string till you get to finishing the tail of your goose).**





Keeping all the twigs as neat and as parallel as you can, now begin to stitch around the decoy, securing the twigs to each other and to the 'egg' they rest on. Using a standard 'back stitch' and a large tapestry needle, stich in even circles around the decoy's body. Hide the stitch under the twigs when you move to start stitching the next row, and keep your rows of stitches about an inch or so apart (closer together for smaller decoys, and a little further apart for larger decoys).



Occasionally when you see a gap between the twigs, especially as you near the wider part of the body, you will need to insert new twigs by their narrow end between under the stitches and between existing twigs. Insert them far enough so that their ends are hidden and blended. Likewise, when you are stitching past the center of the body when the body starts to taper, you will need to trim selected twigs and cover over the ends by pressing together the twigs to either side of it.

Continue stitching in concentric circles down the length of your decoy (dont make your body too long -- keep in mind where the 'egg' inside ends, and keep in mind what a goose looks like). If the ends of the twigs are exceptionally long as you near the tail, trim them a bit so you can gather them as close together as possible (trim them no closer than within two inches of the interior 'egg'), and don't trim them so much that you cant finish the last round of stitches! After your last stitch, pass the needle and thread through the tail, and that should hold the stitch rather than making a visible knot.



Now give your goose legs, using three short thick tamarack twigs/branches which have been sharpened to points on one end. Insert two sharpened twigs on the bottom 'just behind center' of your goose at a slight 'V' angle. And insert a third sharpened twig just below the chest of your goose. It takes a lot of practice to make a decoy look 'alive' so remember that the first time you make anything, it is a 'learning' piece (smiles).

---

[Other Internet Resources for Tamarack Trees & Traditions](#)

---

[Return to the Tamarack Main Menu](#)

[Branches, Twigs & Roots Bibliography and Books to Buy On-Line](#)



[Return to NativeTech's Branches, Twigs & Roots Menu](#)

---



© 1994-2000 [Tara Prindle](#).

You are being redirected to NativeWeb's Resource Database for Plants, Trees & Shelters





## Resources for Indigenous Cultures around the World

[Resources](#) [Books & Music](#) [Community](#) [Services](#) [About Us](#)

### Resource Center

- [Internet Links](#)
- [Nations Index](#)
- [Geographic Region Index](#)
- [Search the Site](#)
- [New Sites this Week](#)
- [Submit a Site!](#)
- [Top 5 Percent](#)

### Hosted Resources

- [Hosted Pages](#)
- [Book & Music Center](#)
- [Law & Legal Issues](#)
- [NativeLaw News](#)
- [NativeTech](#)

### Site Information

- [Get your FREE EMAIL @NativeWeb.Net!](#)
- [Community](#)
- [About Us](#)
- [Hosting Information](#)

[Resource Database](#) / [Crafts & Indigenous Technology](#) / **Plants, Trees & Shelters**

#### Plants, Trees & Shelters Sub-Categories:

- [Birchbark, Canoes & Watercraft](#)
- [Branches, Wood & Roots](#)
- [Cattails & Reeds](#)
- [Cornhusks & Leaves](#)
- [House Construction & Wigwams](#)
- [Indigenous Plants](#)
- [Sweetgrass](#)
- [Tamarack Trees](#)

Donate to  
NativeWeb!  
Tax Deductible!



---

© [NativeWeb, Inc.](#) 1994-2003 || [Disclaimer Statement](#) || [Copyright Statement](#) || [Contact Us](#) || [Visitors](#) || [Donations](#)

# Native American Technology and Art

## Wigwams

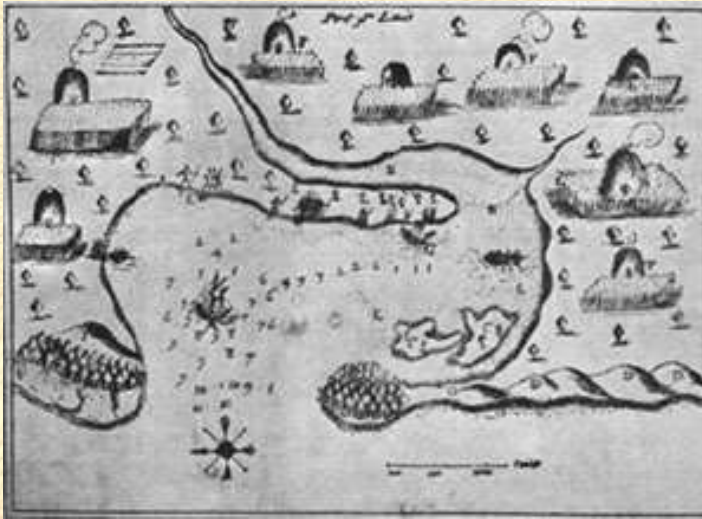
- [Early Historic Descriptions of Wigwams](#)
- [Basic Wigwam Construction](#)
- [Photographic Tour of Contemporary Wigwams](#)

[Other Internet Resources for Wigwams & House Construction](#)



© 1994-2000 [Tara Prindle](#).





Champlains Map of Port St. Louis (Plymouth Bay)

*From Sailors Narrative of Voyages along The New England Coast 1524-1624  
Published 1905 with notes by George Parker Winship. Burt Franklin: New York*

## Early Historic Descriptions of Wigwams

---

*On this page, I have included excerpts, arranged chronologically, from early historic documents from New England which describe wigwams. The descriptions were recorded and published by Europeans from the 1500s through the 1700s. The language and spelling used reflects this time period; and the observations (more often than not) reflect the ignorance of Europeans about the Natives they encountered (as well as unfamiliarity with the resources available to Natives). Careful reading of these texts, however, not only helps us to understand what wigwams of the past looked like, but can enlighten us to the interactions between Europeans and Natives during this period.*

---

**1524 --- [Delaware and New Jersey Coast] We did not find out about their houses, as they were in the interior of country. We think from the many signs we saw that they are built of wood and grasses; we also think from various conjectures and signs that many of them who sleep in country have nothing but the sky for cover. We learned nothing more of them. We think that all the others of the country we visited earlier live in the same way. After staying here for three days, anchored off the coast, we decided to leave because of the scarcity of port and we continued to follow the coast to the northeast, sailing only during the day and casting anchor at night.**

**[Newport in lower Narragansett Bay] When we went farther inland we saw their houses, which are circular in shape, about 14 to 15 paces across, made of bent saplings; they are arranged without any architectural pattern, and are covered with cleverly worked mats of straw which protect them from wind and rain. There is no doubt that if they had the skilled workmen that we have, they would erect great buildings, for the whole maritime coast is full of various blue rocks, crystals, and alabaster, and for such a purpose it has an abundance of ports and shelter for ships. They move these houses from one place to another according to the richness of the site and the season. They need only carry the straw mats, and so they have new houses made in no time at all. In each house there lives a father with a very large family, for in some we saw 25 to 30 people.**



-- *Giovanni da Verrazono The Voyages of Giovanni da Verrazzano, 1524-1528 (reprinted in 1970. Lawrence C. Wroth, ed. New Haven and London: Yale University Press.)*

---

**1622 --- The houses were made with long young sapling trees, bended and both ends stuck into the ground. They were made round, like unto an arbor, and covered down to the ground with thick and well wrought mats, and the door was not over a yard high, made of a mat to open. The chimney was a wide open hole in the top, for which they had a mat to cover it close when they pleased. One might stand and go upright in them. In the midst of them were four little trunches knocked into the ground, and small sticks laid over, on which they hung their pots, and what they had to seethe. Round about the fire they lay on mats, which are their beds. The houses were double matted, for as they were matted without, so were they within, with newer and fairer mats. In the houses we found wooden bowls, trays and dishes, earthen pots, handbaskets made of crabshells wrought together, also an English pail or bucket; it wanted a bail, but it had two iron ears. There was also baskets of sundry sorts, bigger and some lesser, finer and some coarser; some were curiously wrought with black and white in pretty works, and sundry other of their household stuff. We found also two or three deer's heads, one whereof had been newly killed, for it was still fresh. There was also a company of deer's feet stuck up in the houses, harts' horns, and eagles' claws, and sundry such like things there was, also two or three baskets full of parched acorns, pieces of fish, and a piece of a broiled herring. We found also a little silk grass, and a little tobacco seed, with some other seeds which we knew not. Without was sundry bundles of flags, and sedge, bulrushes, and other stuff to make mats. There was thrust into a hollow tree two or three pieces of venison, but we thought it fitter for the dogs than for us. Some of the best things we took away with us, and left the houses standing still as they were.**

-- *William Bradford in Mourt's Relation (reprinted in 1986. Dwight B. Heath, ed. Cambridge: Applewood books.)*

---

**1624 --- When a woman hath her monthly terms she separateth herself from all other company, and liveth certain days in a house alone: after which she washeth her self and all that she hath touched or used, and is again received to her husbands bed or family.**

-- *Edward Winslow in "Good Newes from New England" (reprinted in 1996. Cambridge: Applewood Books)*

---

**1624 --- Their dwellings are commonly circular, with a vent hole above to let out the smoke, closed with four doors, and made mostly of the bark of trees which are very abundant there.**

-- *Van Wassenaer in Narratives of New Netherland "Historisch Verhael" (reprinted in 1967. F.J. Jameson, ed. New York: Barnes and Noble)*

---

**1625 --- I sailed to the shore in one of their canoes, with an old man, who was the chief of a tribe, consisting of forty men and seventeen women; these I saw there in a house well constructed of oak bark, and circular in shape, with the appearance of having a vaulted ceiling. It contained a great quantity of**



maize, and beans of the last year's growth, and there lay near the house for the purpose of drying enough to load three ships, besides what was growing in the fields. On our coming near the house, two mats were spread to sit upon, and immediately some food was served in well made red wooden bowls; two men were also despatched at once with bows and arrows in quest of game, who soon after brought in a pair of pigeons which they had just shot.

-- *Johan De Laet quoting Hendrick Hudson in Narratives of New Netherland "The New World" (reprinted in 1967. F.J. Jameson, ed. New York: Barnes and Noble)*

---

1625 --- Some of them lead a wandering life in the open air with no settled habitations; lying stretched upon the ground or on mats made of bulrushes, they take both their sleep and food, especially in summer, when they go nearer to the sea for the sake of fishing. Others have fixed places of abode, and dwellings built with beams in the form of an oven, covered above with the bark of trees, so large that they are sufficient for several families. Their household furniture is slight and scanty, consisting of mats and wooden dishes, hatchets made of hard flint stone by dint of savage labor, and tubes for smoking tobacco formed likewise of flint stone ingeniously perforated, so that it is surprising how, in so great a want of iron implements, they are able to carve the stone. They neither desire nor know riches.

-- *Johan De Laet in Narratives of New Netherland "The New World" (reprinted in 1967. F.J. Jameson, ed. New York: Barnes and Noble)*

---

1629 --- They have little household stuff, as a kettle, and some other vessels like trays, spoons, dishes and baskets. Their houses are very little and homely, being made with small poles pricked into the ground, and so bent and fastened at the top, and on the sides they are matted with boughs, and covered on the roof with sedge and old mats, and for their beds that they take their rest on, they have a mat.

-- *The Rev. Francis Higginson in A Short and True Description of New England. (redacted by John Beardsley 1996-1999 - the Winthrop Society <http://www.winthropsociety.org/higgnsn1.htm>)*

---

1634 --- First their building of houses, whose frames are formed like our garden-arbours, something more round, very strong and handsome, covered with close-wrought mats of their own weaving, which deny entrance to any drop of raine, though it come both fierce and long, neither can the piercing North wind find a crannie, through which he can convey his cooling breath, they be warmer than our English houses; at the top is a square hole for the smoakes evacuation, which in rainy weather is covered with a pulver; these be such smoakie dwellings, that when there is good fires, they are not able to stand upright, but lie all along under the smoake, never using any stools or chairs, it being as rare to see an Indian sit on a stoole at home, as it is strange to see an English man sit on his heels abroad. These houses are smaller in the Summer, when their families be dispersed, by reason of heate and occasions. In Winter they make some fifty or threescore foot long, forty or fifty men being inmates under one roof; and as is their husbands occasion these poor tectonists are often troubled like snails, to carry their houses on their backs sometimes to fishing-places, other times to hunting-places, after that to a planting place, where it abides the longest.



**In Summer they gather flagges, of which they make Matts for houses, and Hempe and Rushes, with dying stuffe of which they make curious baskets with intermixed colors and protractures of antique Imagerie: these baskets be of all sizes from a quart to a quarter, in which they carry their luggage. In wintertime they are their husbands caterers, trudging to the Clamm bankes for their belly timber, and their Porters to lugge home their Venison which their laziness exposes to the Woolves til they impose it upon their wives shoulders.**

*-- William Wood in New England's Prospect (reprinted in 1977. Alden T. Vaughn, ed. Amherst, Massachusetts: University of Massachusetts Press.)*

---

**1634 (Narragansett) --- Wetu (An House). Ö Nickquenum (I am going home): Which is a solemne word amongst them; and no man wil offer any hinderance to him, who after some absence is going to visit his Family, and useth this word Nickquenum (confessing the sweetness even of these short temporall homes.)**

**Puttuckakaun (A round house). Ö Wetuomemese (A little house): which their women and maids live apart in, foure, five, or six dayes, in the time of their monethly sickness, which custome in all parts of the Countrey they strictly observe, and no Male may come into that house.**

**Neesquittow (A longer house with two fires). Ö Abockquosinash (The mats of the house). Wuttapuissuck (The long poles): which commonly men get and fix, and then the women cover the house with mats, and line them with embroydered mats which the women make, and call them Munnotaubana, or Hangings which amongst them make as faire a show as Hangings with us.**

**Wuchickapeuk (Burching barke, and Chestnut barke): which they dress finely, and make a Summer-covering for their houses.**

**Cuppoquittemin (I will divide house with you, or dwell with you): Two families will live comfortably and lovingly in a little round house of some fourteen or sixteen foot over, and so more and more families in proportion.**

**Yeash (Shut doore after you): Obs. Commonly they never shut their doores, day or night; and ëtis rare that any hurt is done.**

**Kunnamauog (Spoones): Obs. In steed of shelves, they have severall baskets, wherein they put all their householdstuffe: they have some great bags or sacks made of Hempe, which will hold five or sixe bushells.**

**Pauquanamiinnea (Open me the doore): Obs. Most commonly their houses are open, their doore is a hanging Mat, which being lifted up, falls downe of it selfe; yet many of them get English boards and nailles, and make artificiall doores and bolts themselves, and others make slighter doores of Burch or Chestnut barke, which they make fast with a cord in the night time, or when they go out of town, and then the last (that makes fast) goes out at the Chimney, which is a large opening in the middle of their house, called: Wunnauchicomock**

**Cuttatashiinnas (Lay these up for me): Obs. Many of them begin to be furnished with English Chests; others, when they goe forth of towne, bring their goods (if they live neere) to the English to keepe for**



**them, and their money they hang it about their necks, or lay it under their head when they sleep.**

**Nqussutam (I remove house): Which they doe upon these occasions: From thick warme vallies, where they winter, they remove a little neerer to their Summer fields; when ètis warme Spring, then they remove to their fields where they plant Corne.**

**In middle of summer, because of the abundance of Fleas, which the dust of the house breeds, they will flie and remove on a sudden from one part of their field to a fresh place: And sometimes having fields a mile or two, or many miles asunder, when the worke of one of the field is over, they remove house to another: If death fall in amongst them, they presently remove to a fresh place: If an enemie approach, they remove into a Thicket, or Swampe, unless they have some Fort to remove unto.**

**Sometimes they remove to a hunging house in the end of the yeere, and forsake it not until Snow lie thick, and then will travel home, men, women and children, thorow the snow, thirtie, yea, fiftie or sixtie miles; but their great remove is from their Summer fields to warme and thicke woodie bottomes where they winter: They are quicke; in halfe a day, yea, sometimes a few houres warning to be gone and the house up elsewhere; especially, if they have stakes readie pitcht for their Mats.**

**I once in travell lodged at a house, at which in my returne I hoped to have lodged againe there the next night, but the house was gone in that interim, and I was glad to lodge under a tree:**

**The men make the poles or stakes, but the women make and set up, take downe, order, and carry the Mats and householdstuffe.**

#### **Observation in Generall.**

**The sociableness of the nature of man appears in the wildest of them, who love societie; Families, cohabitation, and consociation of houses and townes together.**

*-- Roger Williams in A Key into the Language of America (reprinted in 1973. J.J. Teunissen and E.J. Hinz, ed.s. Detroit: Wayne State University Press.)*

---

**1637 --- The Natives of New England are accustomed to build them houses much like the wild Irish; they gather Poles in the woodes and put the great end of them in the ground, placing them in forme of a circle or circumference, and, bendinge the topps of them in forme of an Arch, they bind them together with the Barke of Walnut trees, which is wondrous tough, so that they make the same round on the Topp for the smoke of their fire to ascend and pass through; . . . The fire is alwayes made in the midst of the house, with winde falls commonly: yet some times they fell a tree that groweth near the house, and, by drawing in the end thereof, maintaine the fire on both sides, burning the tree by Degrees shorter and shorter, untill it be all consumed; for it burneth night and day. Their lodging is made in three places of the house about the fire; they lie upon planks, commonly about a foote or 18 inches above the ground, raised upon railes that are borne up upon forks; they lay mats under them, and Coats of Deares skinnes, otters, beavers, Racoons, and of Beares hides, all which they have dressed and converted into good leather, with the haire on, for their coverings: and in this manner they liee as warme as they desire. . . . for they are willing that any shall eat with them. Nay, if any one that shall come into their houses and there fall a sleepe, when they see him disposed to lie downe, they will spread a matt for him of their owne accord, and lay a roll of**



skinner for a bolster, and let him lie. If he sleepe untill their meate be dished up, they will set a wooden bowl of meate by him that sleepeth, and wake him saying, Cattup keene Meckin: That is, If you be hungry, there is meat for you, where if you will eat you may. Such is their Humanity.

Likewise, when they are minded to remove, they carry away the mats with them; other materials the place adjoining will yield. They use not to winter and summer in one place, for that would be a reason to make fuel scarce; but, after the manner of the gentry of Civilized natives, remove for their pleasures; some times to their hunting places, where they remaine keeping good hospitality for that season; and sometimes to their fishing places, where they abide for that season likewise; and at the spring, when fish comes in plentifully, they have meetings from severall places, where they exercise themselves in gaming and playing of juggling trickes and all manner of Revelles, which they are delighted in; [so] that it is admirable to behold what pastime they use of severall kindes; every one striving to surpass each other. After this manner they spend their time.

-- Thomas Morton in *New English Canaan* (Reprinted in 1964 by University Microfilms, Ann Arbor)

---

1645 --- Their houses are usually constructed in the same manner, without any particular costliness or curiosity in or to the same [referring to an earlier description "In their best apparel, they know not how to appear proud and foppish"]. Sometimes they build their houses above a hundred feet long; but never more than twenty feet wide. When they build a house they place long slender hickory saplings in the ground, having the bark stripped off, in a straight line of two rows, as far asunder as they intend the breadth of the house.

-- Adrien Van Der Donck in "*A Description of the New Netherlands*" (reprinted in 1968. T. O'Donnell, ed. Syracuse: Syracuse University Press.)

---

1650 --- Their dwellings consist of hickory saplings, placed upright in the ground and bent arch-wise; the tops are covered with barks of trees, which they cut for this purpose in great quantities. Some even have within them rough carvings of faces and images, but these are generally in the houses of the chiefs. In the fishing and hunting seasons, they lie under the open sky or little better. They do not live long in one place, but move about several times a year, at such times and to such places as it appears best and easiest for them to obtain subsistence.

-- Anonymous in "*The Representation of New Netherland*" (reprinted in 1967. "*Representation of New Netherland*". In *Narratives of New Netherland*, F.J. Jameson, ed. New York: Barnes and Noble).

---

1674 --- Their houses which they call Wigwams, are built with Poles pitcht into the ground of a round form for most part, sometimes square, they bind down the tops of their poles, leaving a hole for the smoak to go out at, the rest they cover with the bark of trees, and line the inside of their Wigwams with mats made of Rushes paintd with several colors, one good post they set up in the middle that reaches to the hole in the top, with a staff across before it at a convenient height, they knock a pin on which they hang their Kettle, beneath that they set up a broad stone for a back which keepeth the post from burning; round by



the walls they spread their mats and skins where the men sleep while their women dress their victuals, they have commonly two doors, one opening to the south, the other to the North, and according as the wind sits, they close up one door with bark and hang a Deers skin or the like before the other. Towns they have none, being alwayes removing from one place to another for conveniency of food, sometimes to those places where one sort of fish is most plentiful, other whiles where are others. I have seen half a hundred of their Wigwams together in a piece of ground and they shew prettily, within a day or two, or a week they have been all dispersed. They live for the most part by the Sea-side, especially in the spring and summer quarters, in winter they are gone up into the Countrie to hunt Deer and Beaver, the younger webbs going with them.

Delicate sweet dishes too they make of Birch-Bark sowed with threads drawn from Spruse or white Cedar-Roots, and garnished on the out-side with flourisht works, and on the brims with glistering quills taken from the Porcupine, and dyed, some black, others red, the white are natural, these they make of all sizes from a dram cup to a dish containing a pottle, likewise Buckets to carry water or the like, large Boxes too of the same materials, dishes, spoons and trayes wrought very smooth and neatly out of the knots of wood, baskets, bags, and matts woven with Sparke [also spart, the English name for various rushes] barke of the Line-Tree and Rushes of several kinds, dyed as before, some black, blew, red, yellow, bags of Porcupine quills woven and dyed also.

-- *John Josselyn in A Critical Edition of Two Voyages to New England (reprinted in 1988. Hannover: University Press of New England.)*

---

1674 --- Their houses, or wigwams, are built with the small poles fixed in the ground, bent and fastened together with barks of trees oval or arbour-wise on the top. The best sort of their houses are covered very neatly, tight, and warm, with the barks of trees, slipped from their bodies, at such seasons when the sap is up; and made into great flakes with the pressures of weight timber, when they are green; so becoming dry, they will retain a form suitable for the use they prepare them for. The meaner sort of wigwams are covered with mats, they make of a kind of bullrush, which are also indifferent tight and warm, but not so good as the former. These houses they make of several sizes, according to their activity and ability; some twenty, some forty feet long and broad. Some I have seen of sixty or a hundred feet long, and thirty feet broad. In the smaller sort they make a fire in the centre of the house; and have a lower hole on the top of the house, to let out the smoke. They keep the door into the wigwams always shut, by a mat falling thereon, as people go in and out. This they do to prevent air coming in, which will cause much smoke in every windy weather. If the smoke beat down at the lower hole, they hang a little mat, in the way of a skreen, on the top of the house, which they can with a cord turn to the windward side, which prevents the smoke. In the greater houses they make two, three, or four fires, at a distance from another, for the better accommodation of the people belonging to it. I have often lodged in their wigwams; and have found them as warm as the best English houses. In their wigwams, they make a kind of couch or mattresses, firm and strong, raised about a foot high from the earth; first covered with boards that they split out of the trees; and upon the boards they spread mats generally, and sometimes bear skins and deer skins. These are large enough for three or four persons to lodge upon; and one may either draw nearer, or keep at a more distance from the heat of the fire, as they please; for their mattresses are six or eight feet broad.

From the tree where the bark grows, they make several sorts of baskets, great and small. Some will hold four bushels, or more; and so downward, to a pint. In their baskets they put their provisions. Some of their baskets are made of rushes; some, of bents; others, of maize husks; others a kind of silk grass; others



of a kind of wild hemp; and some, of barks of trees; many of them, very neat and artificial, with the portraitures of birds, beasts, fishes and flowers, upon them in colours. Also they make mats of several sorts, for covering their houses and doors, and to sleep and sit upon. The baskets and mats are always made by their women; their dishes, pots and spoons, are the manufacture of the men. They have no other considerable household stuff except these; only of the latter years, since the English came among them, some of them get tin cups and little pails, chests of wood, glass bottles, and such things they affect.

-- Daniel Gookin in *Historical Collections of the Indians in New England* (reprinted in 1970 J.H. Fiske, ed. London: Towaid.)

---



1761 --- Sketch of an 18th century Western Niantic wigwam showing a cutaway view without the mat covering, showing bent and lashed pole framework, central location of fire (with cooking pot hanging over it), European furniture, and traditional sleeping platforms.

-- based on notes and measured sketches by Ezra Stiles by Schumacher under direction by Sturtevant (in *Handbook of North American Indians*, Vol. 15, "Indians of Southern New England and Long Island" by Conkey, Boissevain, and Goddard 1976)

---

[Return to NativeTech's Main Wigwam Menu](#)

---



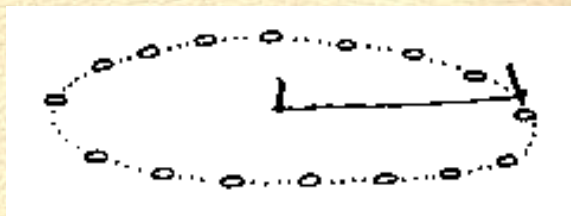
© 1994-2000 [Tara Prindle](#).



NativeTech: Native American Technology and Art



## Basic Wigwam Construction



Select a level site for your wigwam. Be sure that the ground is not so soft that it will not hold the poles, and also that it does not have bedrock too close to the ground surface. Clear the area of any scrubby vegetation. Draw a circle in the dirt by finding the center point, driving in a stake. Connect a seven foot string to the stake and a small stick to the other end of the string.

Draw a circle with a 14 foot diameter (seven foot string length - radius) by keeping the string taught and tracing around the circle with the stick.

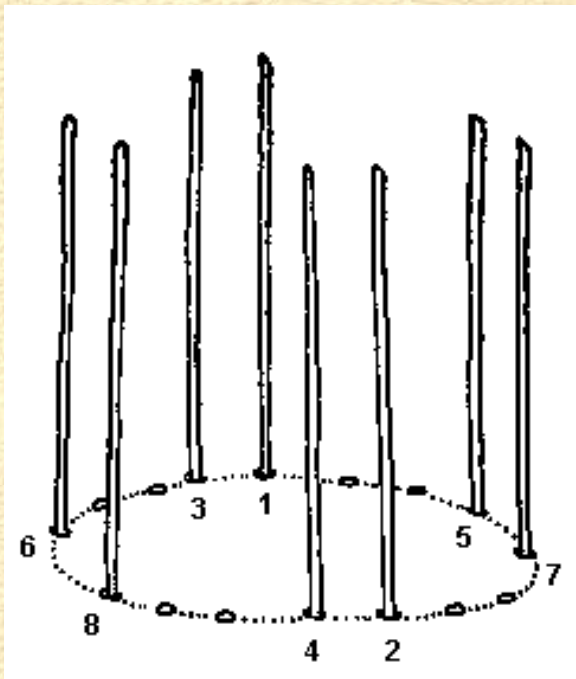
Mark 16 points around the circle (1-16). A good way to figure out the exact spacing between 16 upright poles around the circle is to use this formula:

$$\frac{2 \text{ TT radius (in feet)}}{\# \text{ of poles}} \times 12 \text{ (inches/feet)}$$

..... so for a 16 pole wigwam with a 7 foot radius:

$$\frac{2 \times 3.141 \times 7}{16} \times 12 = 32.98 \text{ inches between the poles around the circle}$$

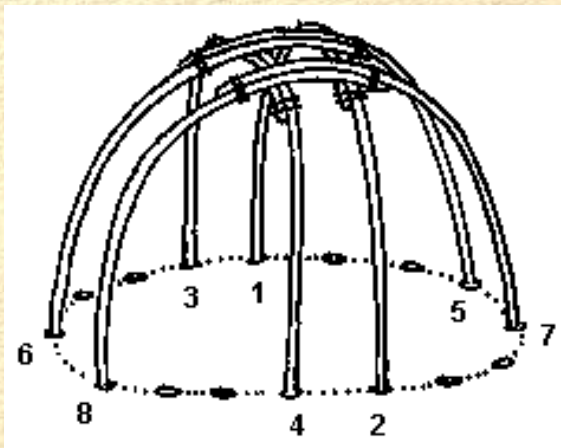




Make holes in the ground first with a wooden stake and hammer (even a crowbar). Holes should be at least 6 inches deep to a foot deep. Mark the holes with small sticks so you don't lose them.

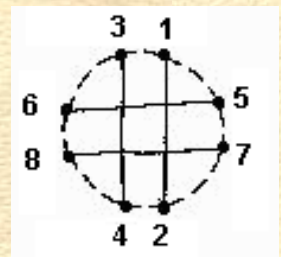
Gather some fresh flexible saplings (at least 25-30); their length depends on how big you want your wigwam to be, in this example 14 feet in diameter and 7 feet high. So your sapling poles should be about 12-15 feet long. Willow, birch, even sassafras saplings work well. The important thing is that the saplings should be no bigger around at the base than 2 inches, and shouldn't taper over a 14 foot length to any less than 1 inch in diameter. The saplings should be straight and with few branches. If there are any branches, the branches need to be trimmed off flush with the sapling. It's a good idea to strip all the bark off the saplings, and your wigwam frame will have a longer life-span.

Cut points on the bases of the saplings so they go into the holes easily.



*Note: you can pre-bend the saplings by placing the base of the sapling between a tree base and a large rock, putting your body weight against the middle of the sapling, and listening carefully for any crackling sounds in the wood (which indicates a failure of the wood, a sign that the sapling is about to snap or split. If the sapling breaks, use another one.*

Plant the first set of eight poles numbered 1-8. Bend them over two at a time so they overlap about two to three feet. Following the diagram bend 1 to meet 2, 3 to meet 4, 5 to meet 6, and 7 to meet 8.

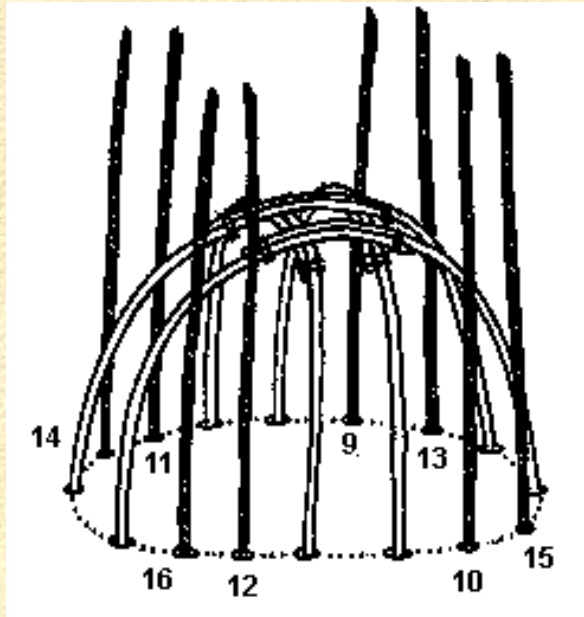
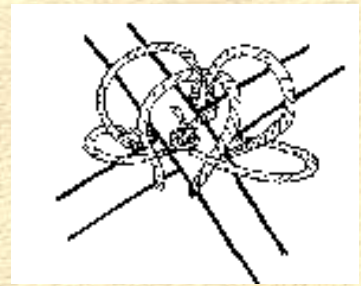


sisal twine

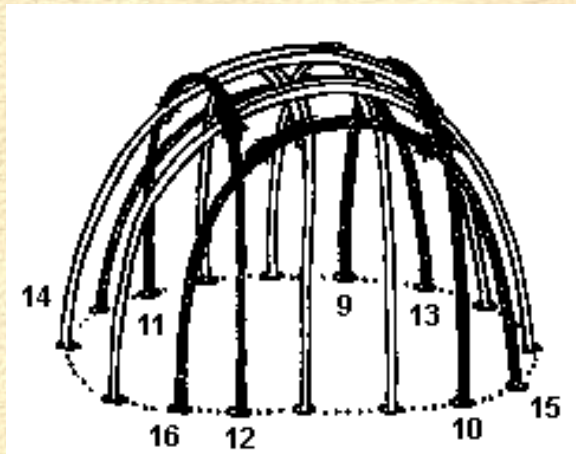
Lash the ends of each set of two poles together at two places, about three inches from each end using the method for lashing parallel branches. Traditionally the poles were lashed together with the inner bark of the basswood tree. If you do not have basswood in your area, you might try a commercial lashing like heavy jute or



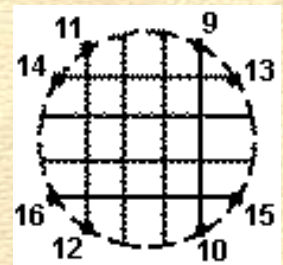
At the four places where the sets of poles cross each other perpendicularly, lash them with the method used for lashing perpendicular branches.



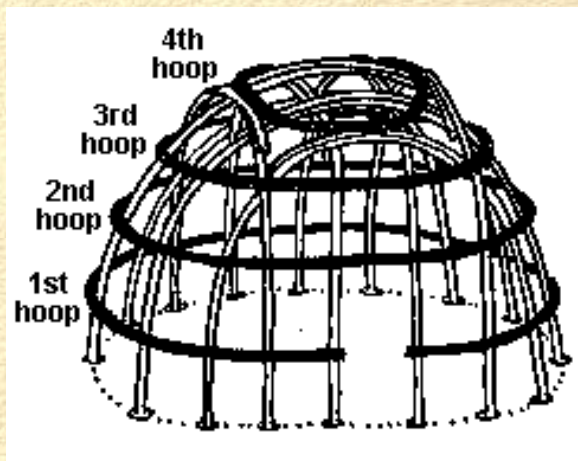
Now place poles 9-16 in the holes remaining.



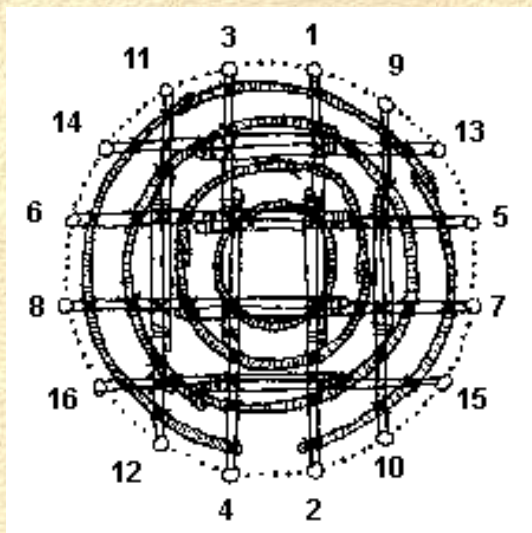
These are bent over, following the diagram, 9 to meet 10, 11 to meet 12, 13 to meet 14, and 15 to meet 16. Lash the overlaps in the same way that you lashed the first set of poles, and lash together *every* place where poles cross each other.







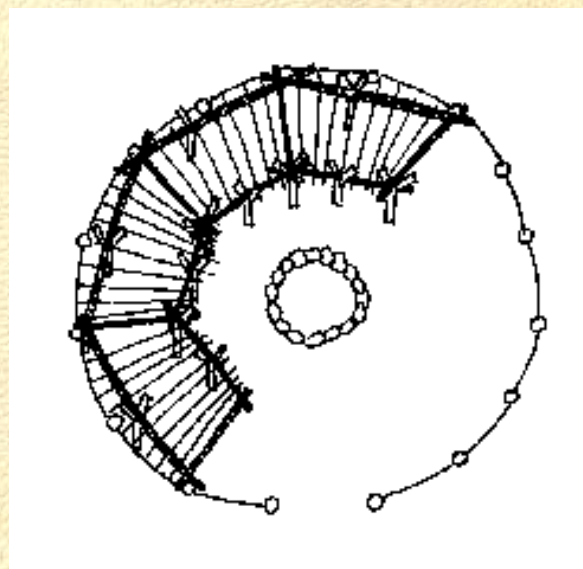
Using your remaining prepared saplings, you need to fasten hoops around the perimeter of your wigwam frame at three to four places. The hoops really make the structure sturdy. Start with the bottom hoop (about 2 ½ feet up from the base). This first hoop will use two to



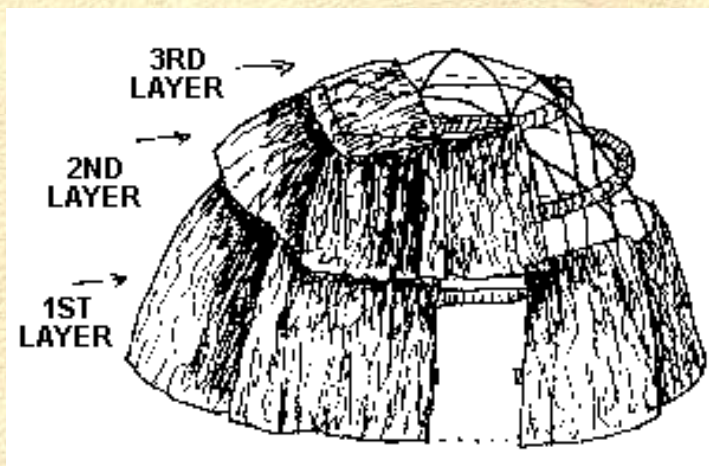
three saplings to go all the way around, lash the hoop on making sure to leave a *ëgapí* for the door (entrance) to your wigwam. Keeping them about 2 feet apart, lash down the second, third (and fourth hoop near the top if your wigwam needs four hoops to make it sturdy). Your second and third hoops will probably need two saplings to go all the way around. Save your skinniest sapling for the top hoop as it has to make a pretty tight circle. Make sure every crossing of the poles and hoops is lashed.

Now focus on any inside *ëfurnitureí* for your wigwam. You should have a central hearth (about three feet across, or a foot and a half in diameter), which heated the wigwam in cold weather, and was used for cooking in rainy weather. Dish out the hearth to a depth of about 6 inches in the center, creating a basin. Line the hearth with small cobbles or clay, put stones around the hearth to help contain the fire.

Usually sleeping platforms went at least half way around the wigwam. You probably want to use fresh sturdy hard wood branches for the platforms, such as oak, maple, or hickory. Begin by building the frame of the sleeping platform, as in the diagram, with a set of *ëYí* poles (saplings with a Y branch at the top). The Y poles are set into the ground so that the sleeping platform is level with the first hoop (about 2 ½ feet off the ground). Support the front of the platform with additional Y poles about three feet in from the walls of the wigwam. Build the frame of the sleeping platform according to the diagram, being sure to lash the frame securely to the *ëYí* poles. Then lash 3 foot sticks to the platform structure using a heavy twine. There will be small gaps between the sticks at the perimeter of the platform (take care not to let the sticks project beyond the edge of the wigwam wall) but the sticks should be flush against each other on the interior side of the platform.



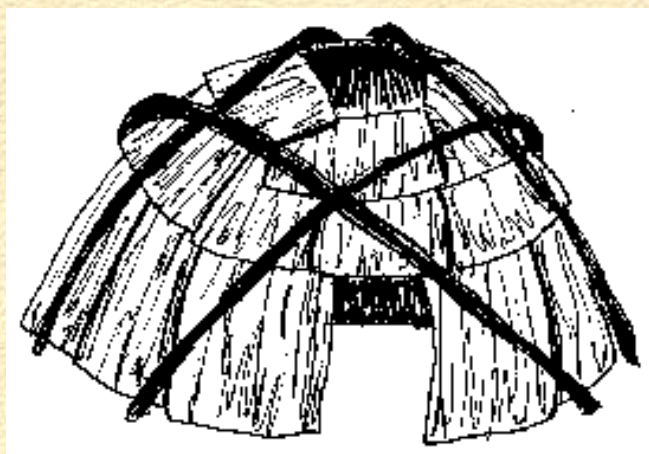




Now that the inside of your wigwam has been furnished, you need to cover the structure with bark sheets or cattail mats. Bark sheets were often used in the winter, while cattail mats were more often used in the summer. Elm, chestnut, ash, and hickory were often used for bark sheets (check local foresters/lumber yards to see if there are any places they have recently cut, they usually discard the bark and often will let you strip some bark off the trees they cut). Start at the bottom, and shingle the bark sheets or cattail mats in three layers. If using mats, you can tie the mats to the second, third and fourth

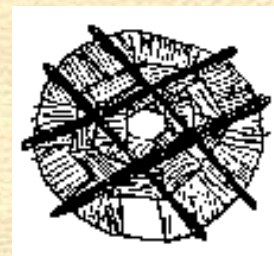
hoops (if you are using bark sheets, you can drill holes and lash pieces to the hoops, but often the weight of the bark alone will hold them in place (sometimes weighting them with rocks here and there. Make sure you leave an opening for the door in the bottom layer and an opening for the smoke hole at the very top.

Visit NativeTech's Cattail section to see how [Cattail Mats](#) are made



Once your covering is in place, you can place four more bent poles over the bark or mat covering to hold all the shingles in place. If you don't have the materials or manpower to make a cattail or bark covering for the wigwam, use heavy canvas.

Canvas was used to cover wigwams starting in the late 1700s. Use a sheet of birch or elm bark, or a cattail mat, to cover the smoke hole (propped up on one side against prevailing winds or rain), and use a cattail mat or hide to cover the door.



Often, fine woven bullrush mats (twined and dyed in black and red) lined the interior walls of wigwams, but that's another lesson!

---

[Return to NativeTech's Main Wigwam Menu](#)

---





© 1994-2000 [Tara Prindle](#).



**NativeTech: Native American Technology and Art.  
SEWN CATTAIL MATS**



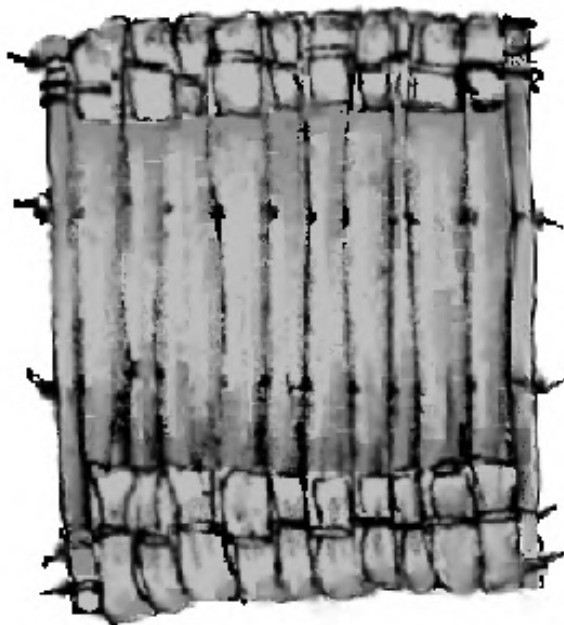
**HARVESTED CATTAILS DRYING IN THE PARTIAL SUN**

---

*The Native Americans of the Northeast Forests used a variety of [plant materials for textiles](#). Sewn cattail mats were often used as exterior coverings of wigwams. Most full-size sewn cattail mats measured five to six feet wide and 10 feet long. It would take half a dozen or more mats to cover a wigwam.*



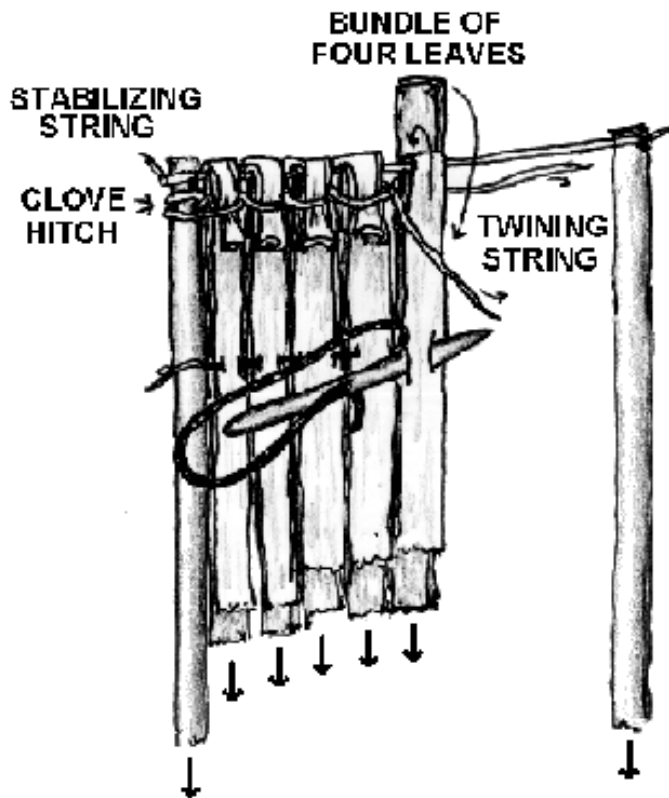
**1. After gathering and preparing the cattails in late summer, remove and discard the brittle tip and the thick very end. Sort the cattails into bundles consisting of four leaves. The desired width of the mat determines the length of cattail leaves used.**



**2. Find two fixed points (like two poles stuck in the ground, or two furniture legs). These points should be slightly farther apart than the length of the mat. Cut a 'stabilizing' string that you can tie to each of the fixed points. Using two round sturdy cattail center stalks. Tie either end of the 'stabilizing' string to the end of a center stalk (the desired width of the mat determines where to tie the stalks with the string). Beneath the 'stabilizing' string, use clove hitch knot to fasten a double-length (or longer) string that will be used to twine around bundles of cattail leaves.**

**3. In each bundle of cattail leaves, use four individual leaves. Arrange the four leaves into a bundle of two pairs, with the curved-out side of the leaves in each pairs facing to the outside of the mat. Fold a leaf bundle around the 'stabilizing' string. First fold two leaves over the string in one direction; the other two leaves in the opposite direction (alternating the thick and thin ends of the leaves for even thickness down the width of the mat).**

**4. Twine (i.e. twist) the two strings around each folded over leaf bundle. Each end of the doubled string passes around the cattail bundles in an under-over pattern. One end of the string will pass over the leaf bundle, while the other end of the string passes under the leaf bundle. With the next inserted leaf bundle, twist the two ends of the string so that the end that went over now goes under the leaf bundle, and the end that went under now goes over. When the full width of the mat has been twined, tie the two ends of the string together around the sturdy stalk.**



5. The mats are 'double-matted', that is the mats are stitched through from both sides of the mat. From the first side of the mat, sew through the flat width of two leaves (of the four in each bundle), from one edge of the mat to the other. Then turn the mat over to the second side and sew back through the remaining two leaves in each bundle. Now repeat subsequent rows of stitching in the same manner. Rows of stitching should be 4 to 6 inches apart.

6. After all the rows are stitched, the rough edge of mat can be finished like the top with twining around each folded-over leaf bundle.

7. The folded-over ends can also be trimmed even with each other



Detail of twining strings along edge of cattail mat.

---

[Back to Cattail Background](#)

[Return to NativeTech's Main Cattail & Grasses Menu](#)

[Cattail & Grasses Bibliography and Books to Buy On-Line](#)

---







## NativeTech: Native American Technology and Art. **USES FOR CATTAIL**



**CATTAIL MATS AND BARK SHEETS COVERING A WIGWAM AT PLIMOTH PLANTATION,  
PLYMOUTH, MA.**

---

[See How Cattail Mats are Made](#)

[See How Cattail Toys are Made](#)

[See How Cordage is Made](#)

[Learn about Reed Decoys](#)

---

**Aside from many food products and medicines, Native Americans used cattails for a variety of types of weaving. The different uses for cattails (*Typha latifolia*) have been well chronicled in the early historic documents of New England. Before European contact, the Native Americans of New England apparently did not make use of conventional looms for weaving. However, New England tribes did weave reeds and other materials into mats, baskets and other items using hand-held finger-weaving and braiding techniques. Woven bags, belts and straps, shoes, military equipment, and even dolls were made from reeds like cattail. Specialized weaving beyond hand-held twining (using a formal loom) did not appear in part because birchbark was readily available in New England for containers and coverings.**

**CORDAGE MADE FROM INDIGENOUS PLANTS.**



Blankets and mats were traditionally made on a suspension loom from rushes or inner bark. In 1524, European trader Verrazzano noticed that Native Americans preferred indigenous hide and woven cloth to European counterparts; early attempts to exchange these items were unsuccessful. By the mid 1600's however, the Fur Trade expanded and woolen trade blankets began to replace aboriginal textiles and clothing. Weaving and other every-day use of cattails by Native Americans continued until the early 1900's by many tribes from the Mesquakie of the Western Great Lakes to the Kickapoo of Mexico.

Cattail and bulrush reeds, Indian hemp (dogbane) and wormseed plant inner fibers, the inner bark of basswood and cedar, and roots of evergreen trees were bundled or twisted into cords for weaving mats, bags, baskets, belts, or other items. Europeans were impressed with the industrial application of

indigenous hemp found growing in the 'New World'. In 1634, William wood remarked on Native American made fishing lines "... made them of their owne hemepe more curiously wrought, of ftronger materials than ours, hooked with bone hookes..." Cord several yards long was made by first shredding or pounding fibrous plant material, soaking in water, and then twisting two-ply on the thigh with the palm of the hand. Preparation of inner barks is more complicated and includes boiling the material in wood ashes to soften and separate the fibers.



**MY FRIEND JIM DINA IN CONNECTICUT HAS MADE BEAUTIFUL MATS FROM CATTAIL LEAVES, CENTER STALKS, AND PHRAGMITIES REED**

**A 1622 account by a European in New England describes aboriginal mats used to cover the**



outside of the round, framed Native American houses, or wigwams; in an abandoned Native American village "There was nothing left but two or three pieces of old mats, and a little sedge". Weaving Mats Types of mats woven by Native Americans in New England in the 1600's include mats woven for the exterior, interior, door flap, chimney coverings and partitions of wigwams, mats for sitting, sleeping or eating upon, and mats used for burials.



**DETAIL OF THE CATTAIL MATS ON THE OUTSIDE OF A WIGWAM.**

In 1634, William Wood wrote about Native American women gathering flagges in summer to make mats for their wigwams and he describes the wigwams of New England as: "very strong and handfome, covered with clofe-wrought mats of their owne weaving, which deny entrance to any drop of raine, though it come both fierce and long, neither can the piercing North winde find a crannie, through which he can conveigh his cooling breath, they be warmer than our English houses."



**DETAIL OF THE SELVA OF A SEWN CATTAIL MAT.**

The double-thickness sewn cattail mats used for house coverings, combined with the finely woven rush mats (more detailed in their construction and decoration) hung from the inside

walls, were quite effective in keeping out the weather. Cattail mats for the wigwam exterior were sewn using a bone needle, a thinly split and polished curved deer rib, perforated near the center to thread the string through. The needle was passed through the stalks, and across the mat, at intervals of about six inches.



*SEWING A CATTAIL MAT WITH A DEER RIB NEEDLE*

The woven reed or bark mats for the interior used the suspension loom where the ends are braided to form an even edge and then hung from a crossbar between two posts; and a finer weft is twined or woven in with the fingers. The interior mats of wigwams in the 1600's were decorated with several colors, including black, blue, red, and yellow. Roger Williams, in 1643, describes that the inside walls of Narragansett wigwams were lined with Munnotaúbana or woven hangings that were dyed and embroidered. Native Americans living in the Great Lakes region traditionally generally have geometric woven patterns, but zoomorphic designs, such as the thunderbird, sometimes appear on small mats used as wrappers for ceremonial bundles.



**WOVEN INTERIOR MATS ON BOTTOM WITH SEWN EXTERIOR MATS SHOWING BEHIND ON**

**TOP**  
**FROM A WIGWAM AT PLIMOTH PLANTATION.**



**EXAMPLES OF TWINED WOVEN INTERIOR BULLRUSH MATS AT PLIMOTH PLANTATION**

---

[Return to NativeTech's Main Cattail & Grasses Menu](#)

[Cattail & Grasses Bibliography and Books to Buy On-Line](#)

---



© 1994-1999 [Tara Prindle.](#)



## NativeTech: Native American Technology and Art. **TOYS MADE FROM CATTAIL**

---



My cattail ducks floating in the reflecting pool on the Washington Mall in D.C.  
[1995 One Mind, One Voice, One Heart, One Prayer Vigil]

Native Americans of the Eastern Forests used many types of plants to make toys for their children. Besides cattails, all kinds of leaves, pine needles, twigs and bark, were used to make dolls and other toys. Native Americans of the Great Lakes Region, such as the Chippewa, made several kinds of dolls and figures from cattails and other grasses. Quickly but ingeniously made, the leaves of the cattail can be folded around a stalk to make a doll just the right size to fit a child's hand. [See how Toy Cattail Dolls are Made](#)

A single cattail leaf can also be wrapped around to form tiny ducks, which because of the buoyancy of cattail, can float endlessly in water. Like split-willow figures of Western Tribes, the small ducks may have traditionally been made for hunting rituals. Historically, Chippewa made the tiny ducks for their children, often made in flocks of five and placed in a pond or puddle. Blow gently on the water and the rocking ducks look like a life-like flock. [See how Toy Cattail Ducks are Made](#)

---

[Back to Cattail Background](#)

[Return to NativeTech's Main Cattail & Grasses Menu](#)

[Cattail & Grasses Bibliography and Books to Buy On-Line](#)

---



© 1994-1999 [Tara Prindle](#).

**NativeTech: Native American Technology and Art.**

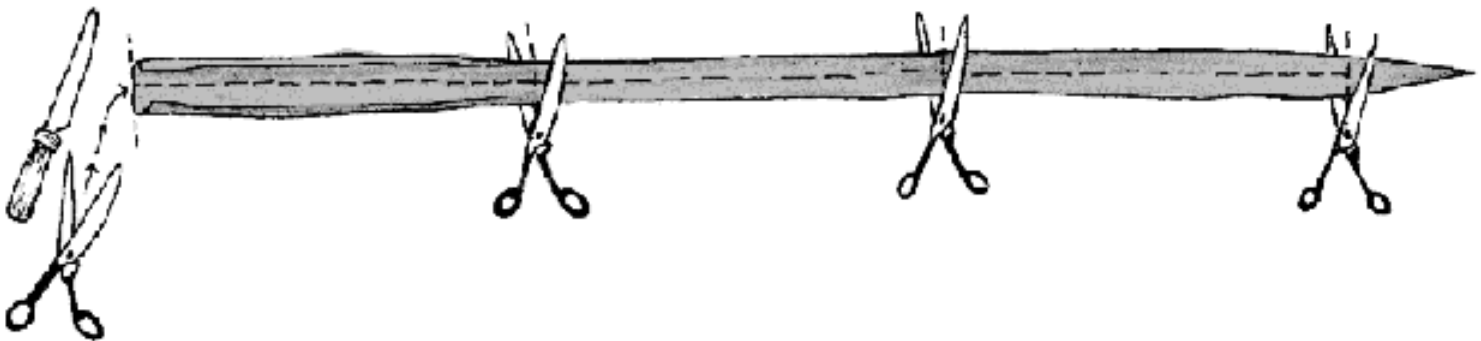


**TOY CATTAIL DOLLS**

---

[Also See how Toy Cattail Ducks are Made](#)

---



**1. Gather cattails in late summer. Separate and rinse the leaves, no center stalks are needed to make the duck. Cut above just above the water-line to leave the root of the cattail intact. Dry the separated leaves in the shade or partial sun for 1 to 3 days. Soak the leaves in warm water for a half hour to an hour before using them.**



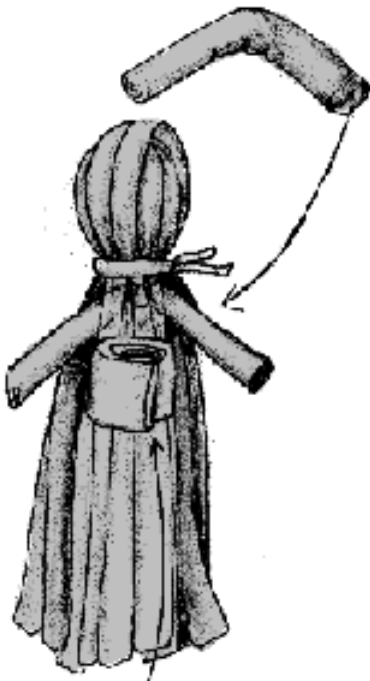


2. If the cattails are very wide, it may be necessary to split them down the middle (along the dotted line shown).

3. Cut off the brittle leaf tips, and cut off and save quite a bit of the thick end to make ties at the doll's neck and waist. Cut the remaining cattails down to half their length, or about 10 inches (bent at the center, this will be the size of a 5 inch doll).



4. To form the doll's head, bend 10 - 16 cattail strips (alternating their directions so they radiate from the top of the head) over a small cylinder (little 'pillow') of rolled up cattail. Tie *tightly* a piece of split cattail or other string below the doll's head, creating a neck.



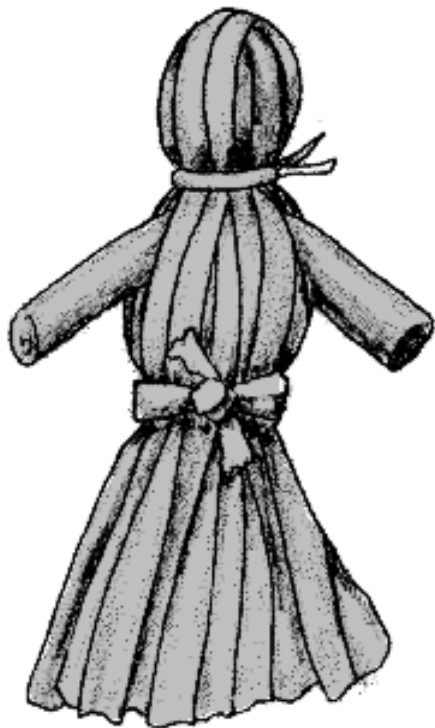
5. Use a section of cattail center stalk for the arms. Place the stalk section (3 - 4 inches long) under the neck tie with a roughly equal number of leaves in front and in back of the 'arms'.



6. To form the body, use another small rolled 'pillow' of cattail under the arms (inside the leaves) and tie the waist area *tightly*.

7. Flair the doll's 'skirt' slightly by spreading the cattail leaf ends. Trim the skirt ends so they are even

**across the bottom.**



---

[Go back to Cattail Toys Background](#)

[Back to Cattail Background](#)

[Return to NativeTech's Main Cattail & Grasses Menu](#)

[Cattail & Grasses Bibliography and Books to Buy On-Line](#)

---



© 1994-1999 [Tara Prindle.](#)

**NativeTech: Native American Technology and Art.**



**TOY CATTAIL DUCKS**

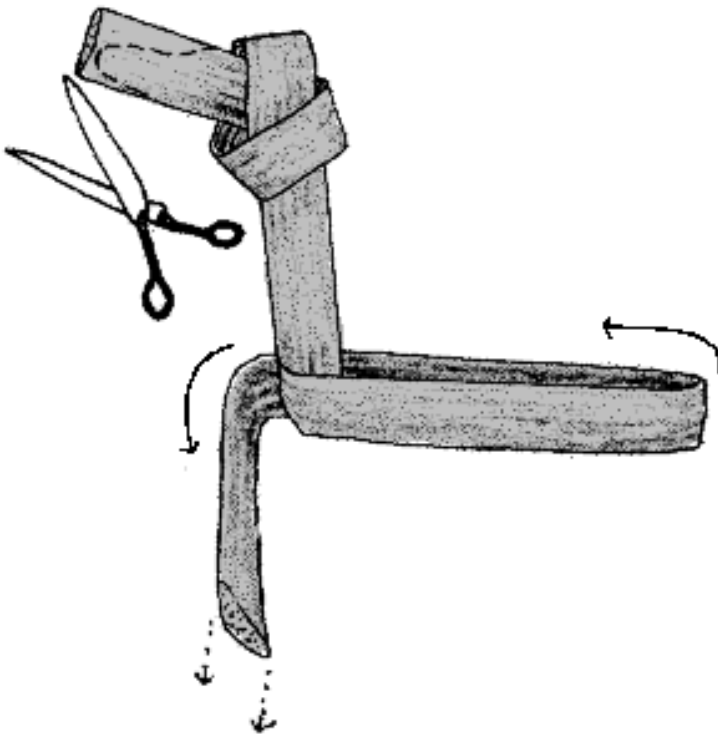
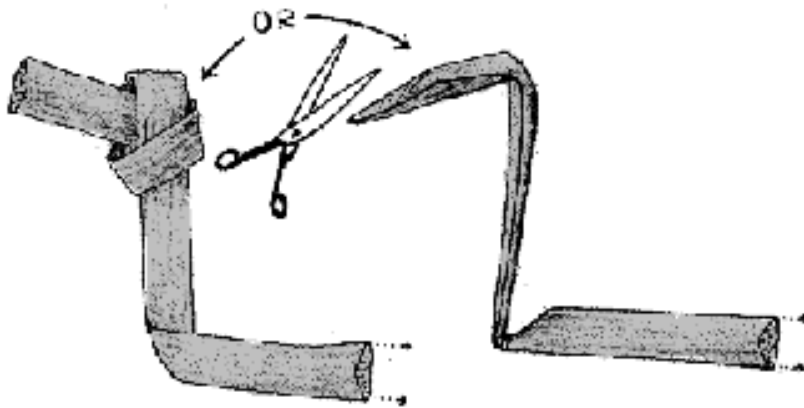
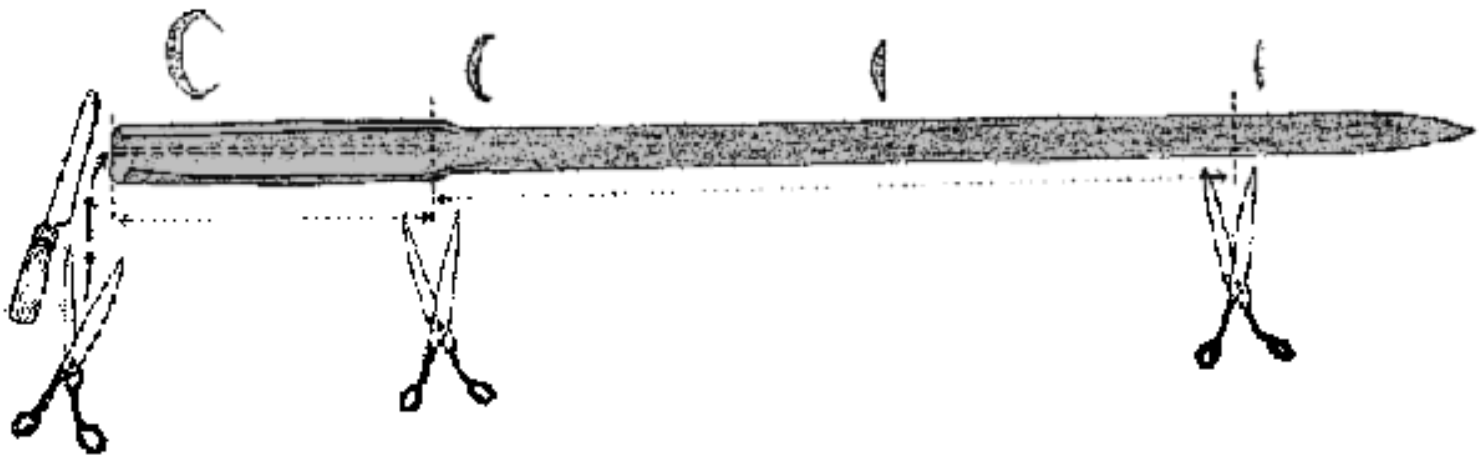
---

[Also See how Toy Cattail Dolls are Made](#)

---







**1. Gather cattails in late summer. Separate and rinse the leaves, no center stalks are needed to make the duck. Cut above just above the water-line to leave the root of the cattail intact. Dry the separated leaves in the shade or partial sun for 1 to 3 days. Soak the leaves in warm water for a half hour to an hour before using them.**

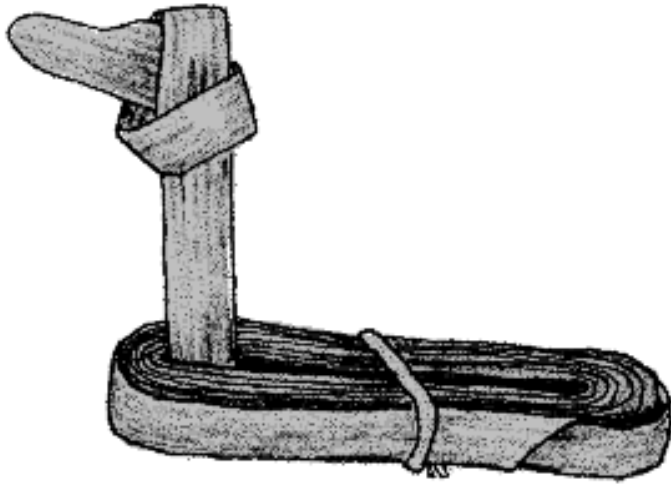
**2. Cut off the thin leaf tip because it is brittle and not buoyant. Cut off and save the thick white end of the leaf to make a tie later for the ducks body.**

**3. For either style head (flattened-knot or bent-over style), start with the thicker end and the duck's head will be sturdier.**

**4. Leave 2 inches for the neck below the head and fold the cattail at a 90 degree angle.**

**5. Leave 2 inches for the body (remember the body will grow longer as you wrap) after the fold at the bottom of the neck and begin wrapping the leaf around the 'body', around and around... until the leaf runs out.**

**6. If the leaves are short, 2 cattail leaves may be necessary to fill out the wrapped body. After 10-15 wraps, end the duck's body by snipping the leaf on a diagonal to**



create a 'wing' effect.

7. Tie the body *tightly* with a thin strip of the thick white end of the cattail leaf. Knot the tie at the bottom, center of the duck's body so it wont show while it's swimming.

Ready to Float!

---

[Go back to Cattail Toys Background](#)

[Back to Cattail Background](#)

[Return to NativeTech's Main Cattail & Grasses Menu](#)

[Cattail & Grasses Bibliography and Books to Buy On-Line](#)

---



© 1994-1999 [Tara Prindle.](#)

## NativeTech: Native American Technology and Art.

### Cattails and Grasses

- [Cattails and Grasses used for Textiles](#)
- [Native American Uses for Cattails and Grasses](#)
- [Cattails; Supermarket of the Swamps](#)
- [Cattail and Tule Duck Decoys](#)
- [Sewn Cattail Mats for Wigwam Coverings](#)
- [Toys Using Cattails](#)
- [Cattail & Grasses Bibliography and Books to buy On-line](#)

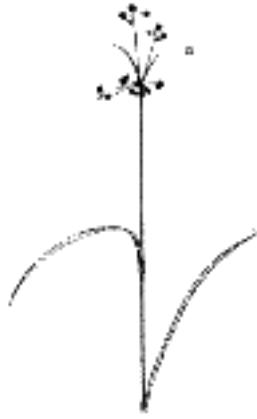
[Other Internet Resources for Cattails & Grasses](#)



© 1994-2000 [Tara Prindle](#).



**NativeTech: Native American Technology and Art.**  
**CATTAILS & GRASSES**  
**Used by Native Americans for Textiles**



**Bulrush Sedge**

Grows in wet places. Round stalks (often dyed) were used in interior mat construction. Leaves used in making twine.



**Carex Sedge**

Grows in wet places or in swamps. Triangular stem with 'foxtail' shaped flower. Leaves similar to Bulrush used for making thin twine.



**Milk Weed**

Grows in dry meadows or thickets. Inner cambium layer of stalk used in making a sturdy thin twine (edible pods if prepared properly).



**Tussock Sedge**

Grows in wet places or in swamps. Triangular stem. Narrow leaves used for making thin twine.

**Cattail**

Grows in wet places or around ponds. Round stalks (dried green) were [used in exterior mat construction](#).

Buoyant leaves used for twine and small toys.

**Dogbane**

Also called Indian Hemp. Grows along moist field edges. A close relative of milkweed. Inner fibers were used by Native Americans for all kinds of twisted rope and cordage: heavy fishing lines, woven nets, finger woven bags, and thread. (toxic).

[\*\*Return to NativeTech's Main Cattail & Grasses Menu\*\*](#)

[\*\*Cattail & Grasses Bibliography and Books to Buy On-Line\*\*](#)

---



© 1994-2002 [Tara Prindle](#).

NativeTech: Native American Technology & Art



## CATTAIL & GRASSES BIBLIOGRAPHY

Click on the links below for the books you can order on-line in affiliation with [barnesandnoble.com](http://barnesandnoble.com)

---

### *References cited in NativeTech's [Cattail & Grasses articles](#):*

**Densmore, Frances**

**1974 How Indians Use Wild Plants for Food, Medicine and Crafts.**

New York: Dover Publications, Inc.

[Order this book through barnesandnoble.com](#)

**Heath, Dwight B., ed.**

**1986 Mourt's Relation: A Journal of the Pilgrims at Plymouth.**

Cambridge: Applewood books. (First published in 1622).

[Order this book through barnesandnoble.com](#)

**Jennings, Francis**

**1976 The Invasion of America: Indians, Colonialism, and the Cant of Conquest.**

New York: W. W. Norton & Company, Inc.

[Order this book through barnesandnoble.com](#)

**Jennings, Jesse D.**

**1989 The Prehsitory of North America.**

Mountain View, CA: Mayfield Publishing Company.

**Miles, Charles**

**1963 Indian & Eskimo Artifacts of North America.**

New York: Bonanza Books.

[Order a used copy of this Out of Print book](#)

**Ritzenthaler, Robert E. and Pat Ritzenthaler**

**1970 The Woodland Indians of the Western Great Lakes.**

Garden City, NY: Natural History Press.

[Order this book through barnesandnoble.com](#)

**Turnbaugh, William A. and Sarah P. Turnbaugh**

**1986 Indian Baskets.**

West Chester PA: Schiffer Publishing Company.



[Order this book through barnesandnoble.com](http://www.barnesandnoble.com)

**Whiteford, Andrew H. and Nora Rogers**  
**1994 Woven Mats of the Western Great Lakes. In American Indian Art.**  
Vol. 19 No. 4, Autumn 1994. Scottsdale, AZ: American Indian Art, Inc.

**Wilbur, C. Keith**  
**1990 Indian Handcrafts; How to Craft Dozens of Practical Objects Using Traditional Indian Techniques.**

Chester, CT: Globe Pequot Press.

... has simple instructions for making an eastern Woodlands dug-out canoe using some 'modern conveniences'

[Order this book through barnesandnoble.com](http://www.barnesandnoble.com)

**Williams, Roger**  
**1973 Key into the Language of America.**

J.J. Teunissen and E.J. Hinz, ed.s. Detroit: Wayne State University Press. (First printed 1643).

[Order this book through barnesandnoble.com](http://www.barnesandnoble.com)

**Wood, William**

**1977 New England's Prospect.**

London, England: 1634. Ed. Alden T. Vaughn. Amherst, Massachusetts: University of Massachusetts Press.

---

*Other Books relating to Cattail & Grasses you can buy on-line through*  
[\*barnesandnoble.com\*](http://www.barnesandnoble.com):

**Mary L. Stahl Amy Ruedinger (Illustrator)**

[\*\*Weaving Wildly: Mats and Baskets the Choctaw Way\*\*](#)

**Additional book list being compiled.**

**In the meantime,**

[\*\*Click here to Search for Books about Cattail\*\*](#)

[Search for Books at  
barnesandnoble.com](#)

Search by:

---

[Return to NativeTech's Main Cattail & Grasses Menu](#)

---



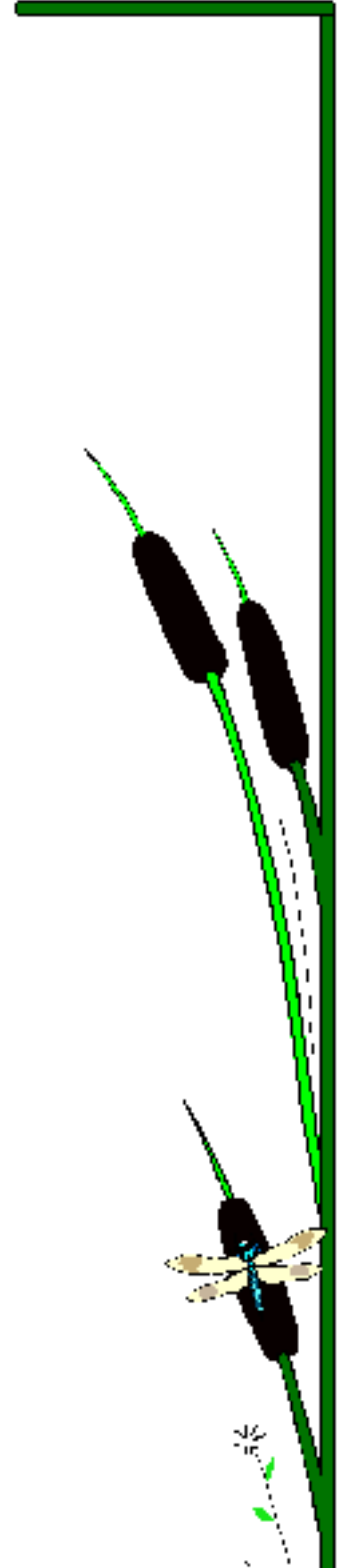
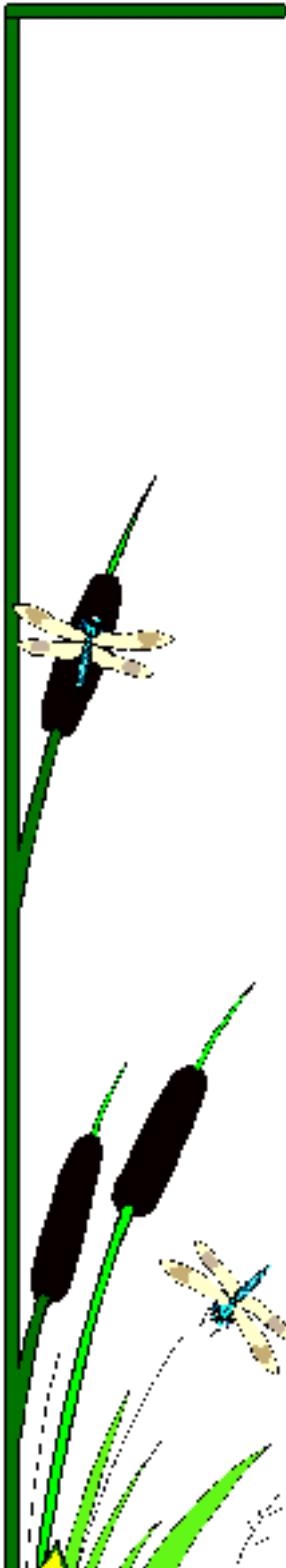
© 1994-1999 [Tara Prindle](#).

# CATTAILS

## *Supermarket of the swamp...*

---

- 1. Cattails contain ten times the starch of an equal weight of potatoes.**
- 2. Early spring new shoots pick peel, cook, or eat raw.**
- 3. Harvest young flowerheads, boil and eat like corn on the cob; or pickle.**
- 4. Collect early summer pollen in a bag, add to other flours (protein/vitamins).**
- 5. Winter rootstocks: pick mash rinse, dry, and grind into flour.**
- 6. Use fresh, pounded root directly as a poultice on infections, blisters, & stings. Tie in place over night. Replace for next day.**
- 7. Sticky substance at the base of the green leaf is antiseptic, coagulant, & even a bit numbing.**
- 8. Boil leaves for external skin wash.**
- 9. Starchy, mashed root use as a toothpaste.**
- 10. Use pollen as a hair conditioner.**
- 11. Drink root flour in a cup of hot water or eat the young flowerheads to bind diarrhea and dysentery.**
- 12. Use the fuzz from mature female flowerheads for scalds, burns, diaper rash & place in diaper to soak up urine.**
- 13. Down makes excellent tinder.**







**14. Dry stalks use for hand drill, arrow shafts with added hardwood nock and foreshaft.**

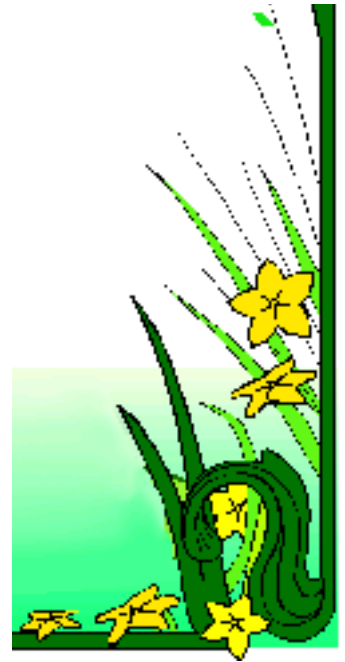
**15. Leaves excellent for thatching, basket weaving, cordage (one of the most important aspect of outdoor survival), and doll, toy, figurine making.**

**16. Dip brown head of a dry stalk in animal fat for a torch.**

**17. Pollen is hemostatic & astringent. Place directly on cut to control bleeding. Take internally for internal bleeding, menstrual pain, chest pains, & other forms of blood stagnation.**

**18. Mix pollen with honey; apply to bruises, sores, or swellings.**

**19. Pollen is also mildly diuretic and emenagogue.**



*(Thanks Fred)*

---

[Back to Cattail Background](#)

[Return to NativeTech's Main Cattail & Grasses Menu](#)

[Cattail & Grasses Bibliography and Books to Buy On-Line](#)

---

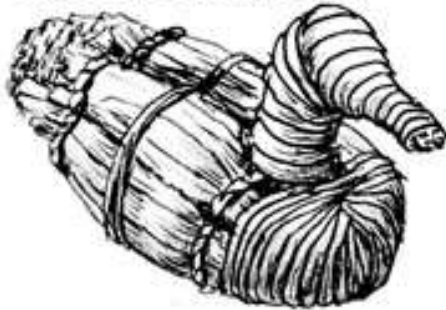


© 1994-1999 [Tara Prindle](#).



## NativeTech: Native American Technology & Art

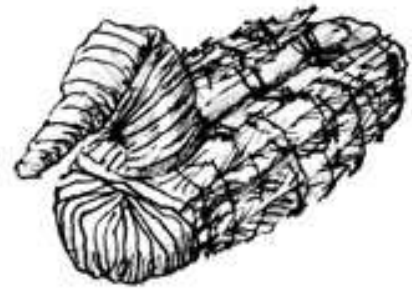
Prehistoric tule reed  
duck decoys from  
Lovelock Cave, Nevada.



Tule decoy with  
duck skin covering.



Tule decoy with  
feathers inserted.



## NATIVE AMERICAN DUCK DECOYS

---

[See the Instructions for Making Native American Style Duck Decoys](#)

---

For thousands of years, Natives Americans across North America used cattails, other grasses, and rushes for items of everyday use. One of the most ingenious uses of cattail, bulrush and the tule plant was making floating decoys to lure waterfowl to roosting areas to be bow-hunted, netted, or snared. Geese and other migratory birds, passenger pigeon, cormorant, swan, and as well as turkey, grouse, partridge were important game birds to Native Americans. In New England, the Nipmuc (which means 'fresh water people') have traditional territory in land-locked areas, away from the seacoast. Non-coastal, interior woodland groups set up their base camps and villages around rich lake sides, ponds and rivers that attracted ducks and other game.

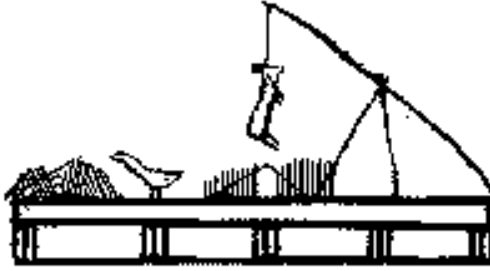
Floating duck decoys were an essential hunting tool to lure birds to within reach of the bow and arrow, spear, or net. Duck decoys were constructed from reeds by Native Americans that lived during the Archaic period (2,000 years ago) west of the Colorado Plateau. Archaeologists working in Nevada found nearly a dozen ancient duck decoys cached in Lovelock Cave, a large cave that opens up onto fossil Lake Lahontan. Fishhooks, nets, and hooks on setlines were found stored in the cave alongside the duck decoys. The people that lived here relied on the resources of a shallow, fluctuating lake. Because so many of the objects from the cave focus on lacustrine subsistence, archaeologists infer the climate would have been cooler and more moist than today.

Decoys from Lovelock Cave were made from tule reed, a plant species related to bulrush. There are many varieties of bulrush, a round hollow, tall reed which grows around wetlands across North America. Unfortunately, some more resilient European introduced plants like phragmites reed and purple loosestrife have squeezed out many colonies of indigenous plants like bulrush.

Similar floating decoys were undoubtedly made by Native Americans in the East. Today, Cree Indians around the northern Great Lakes make standing goose decoys from flexible tamarack



sticks. Chippewa Indians make floating toy decoys, only a few inches in length, from single cattail leaves for their children.



Etching on Inuit carved ivory comb, a rabbit is caught in a snare. The duck may be a decoy for another animal (or it's capture appears inevitable).

---

[Return to NativeTech's Main Cattail & Grasses Menu](#)

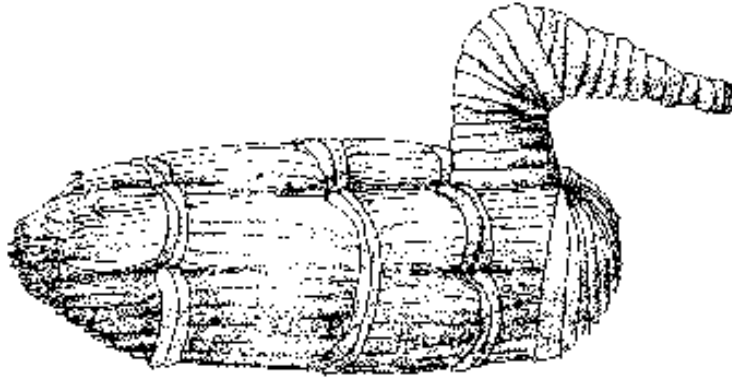
[Cattail & Grasses Bibliography and Books to Buy On-Line](#)

---



© 1994-2000 [Tara Prindle](#).

## Instructions for Native American Style Duck Decoys

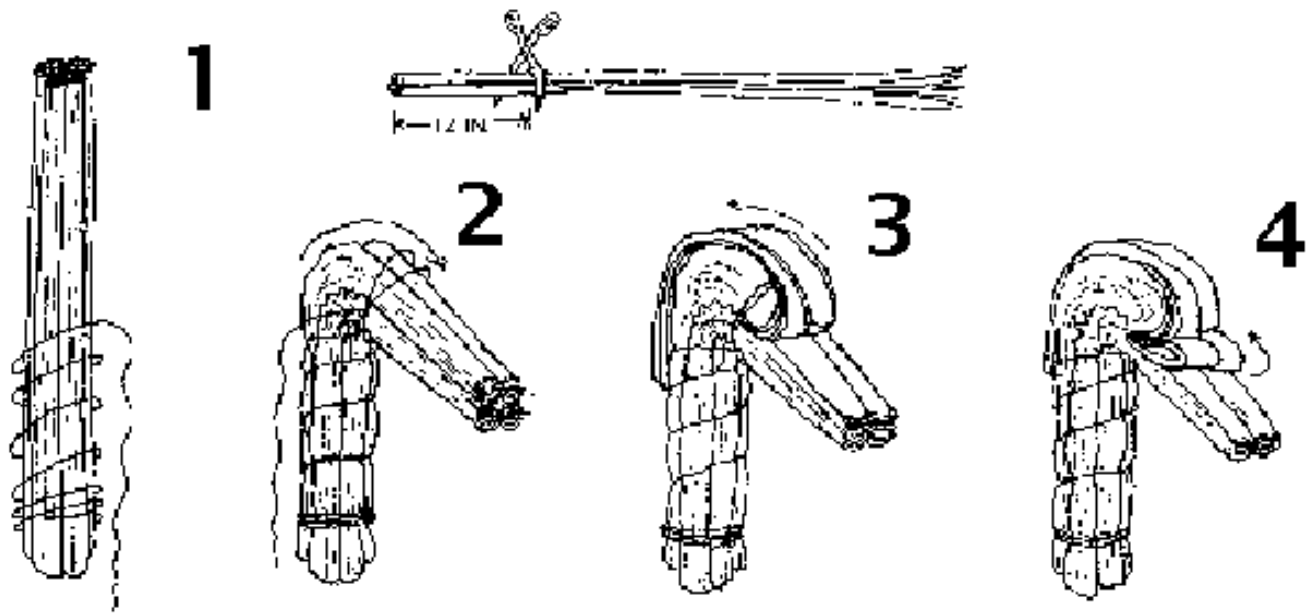


### How to Make a Decoy Using Cattails:

---

#### The decoy's Head:

- 1. Use soaked, previously dried cattail leaves. To begin making the decoy's head, cut about 12 in. from the base of 3 or 4 leaf stalks. Putting them together they should make a short bundle about 1 1/2 inches in diameter.**
- 2. Using string, twine, or raffia, begin tightly wrapping the base of the bundled stalks. Start the lashing about an inch from the bottom of the 'neck' and wrap over the beginning of the string to secure it.**
- 3. Bend the bundle of cattails to an angle of 90-120°, wrap the string around the bend, in a figure-eight, to hold the angle of the cattails. Tie the string temporarily.**
- 4. Using 1/3 of the leaves from the 'beak', fold them over the binding to fill out the back of the head. Hold the cattails in place with your hand for now.**

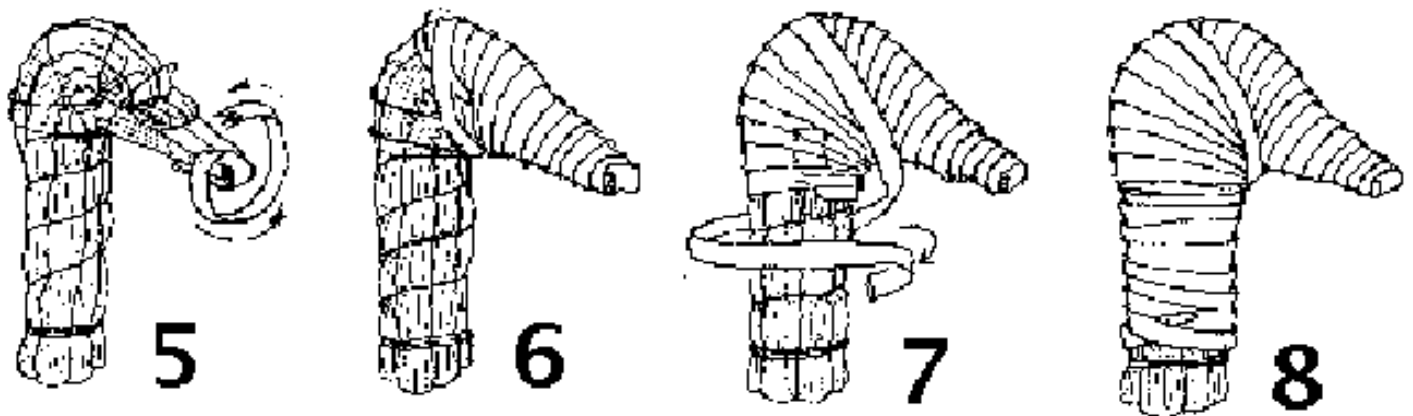


**5.** Use another 1/3 of the cattail leaves to fill out the 'beak', fold the leaves in half and tuck them under the leaves for the forehead. Using the string, wrap around the folded-over leaves of the head and forehead and tie off the string.

**6.** Use a single full-length cattail leaf and begin wrapping the beak, starting at its tip. Wrap over the beginning end of the cattail and keep wrapping fairly tight. Wrapping a single leaf should cover up to the forehead of the decoy's head. Tuck the finishing end under the lashings, or under the previous wraps of the cattail.

**7.** Starting just below the chin, use another single leaf and wrap up towards and then over the forehead of the decoy. When the top of the head is covered in wrapping, make a figure-eight with the cattail leaf and begin wrapping down the neck, picking up where you left off.

**8.** Finish wrapping the neck to within an inch of the bottom, and secure the last wrapping leaf by tucking the end under the previous wrap of the cattail.

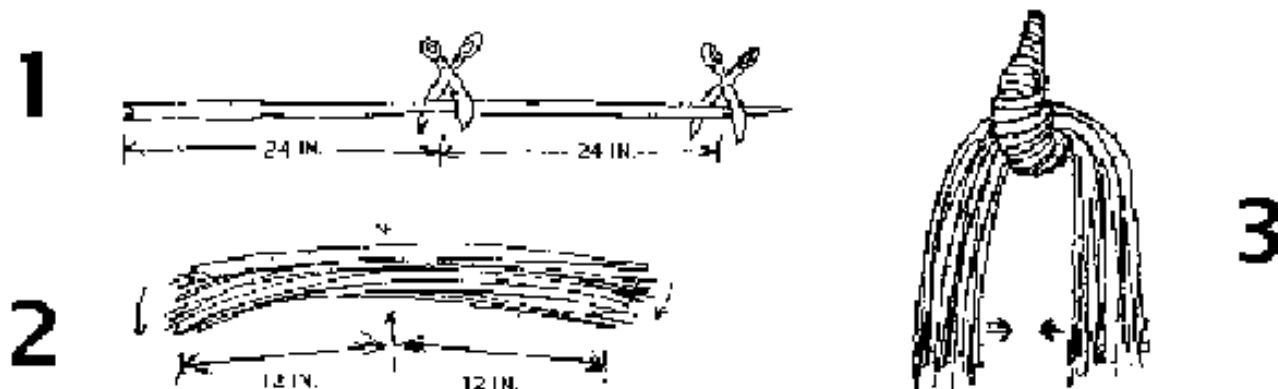


---

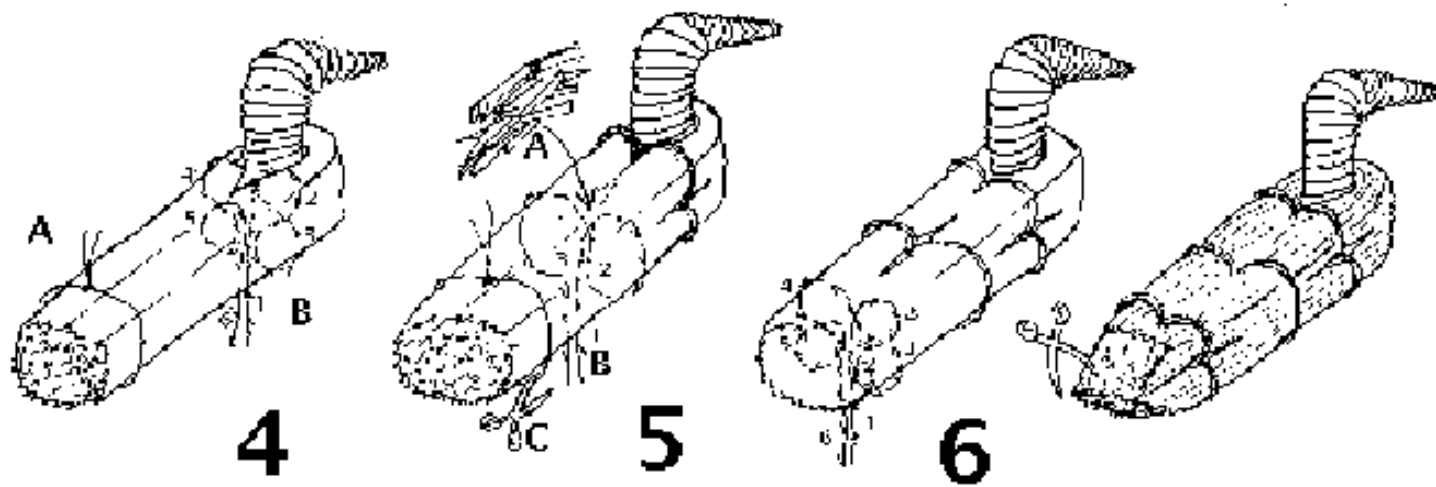
## The decoy's Body:



1. Cut a handful of individual cattail leaves to 24 inch lengths (a bundle about 2 1/2 inches in diameter).
2. Gently bend the whole bundle cattails in half, so they form a U-shape, around the previously-made neck of the decoy.
3. The loose ends of the cattails should roughly come together at the end opposite the head; and the base of the decoy's head should be barely visible on the underside of the bent bundle.



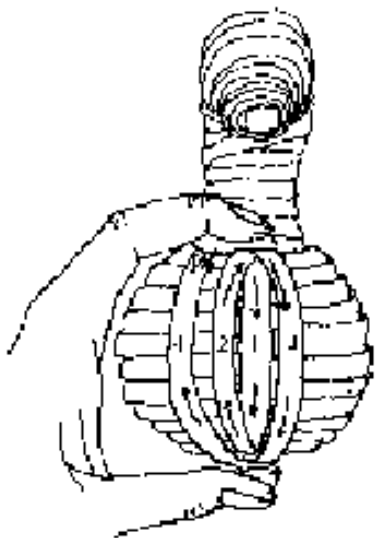
4. First, tie a temporary lashing around the loose ends of the cattails (as in "A"). Use a large needle and string to sew through and around the cattails just behind the neck. Sew in a double figure-eight pattern (as in "B", following numbers 1 to 6), sew lashing around twice if necessary.
5. If the decoy appears to need more 'body', stuff cattail scraps inside the bundled cattails, into the center of the decoy body behind the neck (as in "A"). Sew through and around the center of the decoy body in a figure-eight pattern (as in "B", following numbers 1 to 3). Cut the temporary lashing at the tail of the decoy (as in "C").
6. Sew through and around the tail (as above in 4 "B", following numbers 1 to 6). Trim the tail to shape.



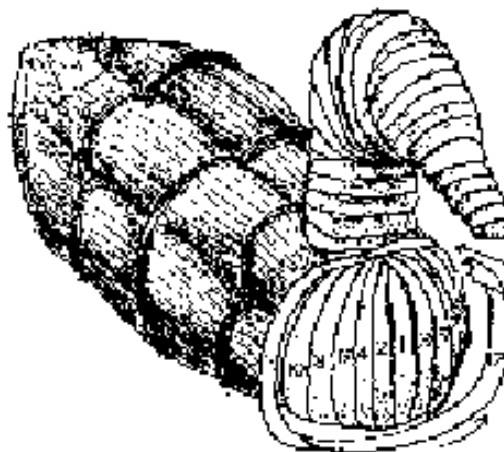
7. Wrap the breast of the decoy with single cattail leaves. Starting at the center, tuck a leaf into the space at the base of the neck below the chin. Bend the leaf down to the bottom of the breast, fold it, and tuck the end into the space at

bottom of the decoy neck, then bend the leaf back up to the top of the breast.

**8.** Repeat wrapping the breast, holding the tucked ends with your finger and thumb, placing the cattail leaf to the side of the last one wrapped, until you reach the side of the decoy. Encircle the decoy's breast with a final few wraps of the cattail, making a twist at the top and bottom, to hold all the wrapping folds in place. Tuck the end of the last wrapped cattail into the decoy at the bottom.



7



8

---

[Return to History & Background of Duck Decoys](#)

[Return to NativeTech's Main Cattail & Grasses Menu](#)

[Cattail & Grasses Bibliography and Books to Buy On-Line](#)

---



© 1994-1999 [Tara Prindle](#).

## NativeTech: Native American Technology and Art



# Photographic Tour of Contemporary Wigwams

**The Amazing Geometry of the Wigwam Frame**



**The completed sapling frame of my wigwam in the northeastern connecticut woods. The poles are made of sassafrass, the hoops are made of sweet birch.**



**Me, lashing the hoops onto the wigwam poles, which gives the structure added support.**





**Again me, building the frame for the sleeping platforms inside the wigwam.**



**One of the short 'Y' poles that supports the sleeping platform frame inside the wigwam.**



**A completed family wigwam at Plimoth Plantation showing bark sheets on the bottom, and cattail mats covering the top.**





**A smaller woman's wigwam (specially made for her moon time) at Plimoth Plantation covered with cattail mats.**



**A close-up of the family wigwam at Plimoth Plantation showing the sewn cattail mats on the exterior of the house. Garden hoes and fishing gear lean against the side.**



**Interior finely woven bullrush mats hanging from the interior walls of the family wigwam at Plimoth Plantation.**





**Wigwam from a distance at sunset at Plimoth Plantation.**



**A bark covered wigwam built by James Dina in central Connecticut. Note the rocks which help weight down the bark sheets, and spare bark shingles piled to the right of the wigwam.**



**A bark covered wigwam built by Jeff Kaline brought to the Mohegan Fort Shantok Powwow.**



**A bark covered wigwam built by Jeff Kaline for the Connecticut Museum of Natural History.**





**Another bark covered wigwam built by Jeff Kaline, in the basement of the Pequot Casino.**

---

**[Return to NativeTech's Main Wigwam Menu](#)**

---



© 1994-2000 **[Tara Prindle](#)**.

## Native American Technology and Art

# Willow Toys and Figures

---

Native Americans, thousands of years ago to the present, have made animal figures and representations of peoples out of split willow sticks. In the Great Basin and Grand Canyon areas of southwestern North America, willow figures of deer have been found that are thousands of years old. In more recent times, willow dolls have been made by Native Americans of the Great Lakes area. To the present day, Native Americans have continued to use the willow figures in creating contemporary art.



Split willow deer figure from  
Cowboy Cave, Utah  
(adapted from Jennings: 1989)

On the Colorado Plateau of Utah, in Cowboy Cave, archaeologists have found many split willow figures representing deer, some that were made by Native Americans 3,500 years ago. Often these ancient split willow deer are found in ceremonial contexts, but in this cave they were found battered and broken among ordinary refuse in layers of fill, suggesting that the deer had a more secular use, perhaps as children's toys. Some of these deer more aptly resemble a llama, having a tall body and short legs. In making the willow deer, only a single unbroken split willow is needed. A long branch is split down its length, leaving the last few inches of the wide end

unsplit. The unsplit end of the branch forms the rear leg, and the two halves of the split branch are used to wrap the body and form the head.

Basket-like figures made of willow branches have also been found in Arizona, Coconio County, in Stanton's Cave. The figures of deer here were made by Native Americans more than 3,000 years



Ojibway split willow doll. (adapted from Densmore: 1979)

ago. The willow deer from Stanton's Cave indicate the unsplit end was used to make the head, and bending of one of the split halves through the split end formed the deer's nose. Additional folds of the split branches helped create the body and legs. The Stanton Cave willow deer are finished by using the end of the willow lashing to penetrate the wrappings of the deer's body, so that the end sticks out like a spear. Perhaps indicating the deer representation had been ritually 'killed'?

In her early 1900's work with the Ojibway (Chippewa) people living on reservations in Minnesota, Densmore photographed and described a child's doll made from split willow. This elongated doll was made by a woman living at Grand Marais, on Lake Superior's north shore. The doll's head is made of checker-woven willow withes, that are bent around to form the doll's head. The core of doll's body, arms and legs consists of bundled grass or cornhusk that is simply wrapped with split willow branches. Densmore noticed, and the same is true for many other traditionally made dolls, that the features or details of the doll's face are not outlined. In contrast to the one-piece split



Split Twig Horse by C. Supplee - LaFonda Gallery (adapted from Amer. Ind. Art Mag. Autumn '95)

willow deer, a dozen or more shorter pieces of split willow are used to make this Ojibway doll.

Present day Native American artists have perpetuated images of the split willow figures in modern jewelry making. Many contemporary southwestern Native American magazines and galleries depict necklaces with cast or wire-wrapped 'split twig' animal charms and pendants.

---

[See how Split Willow Stick Deer are made](#)

[See how Split Willow Dolls are made](#)

---

[Return to Willow Branches and Other Twigs and Roots Background](#)

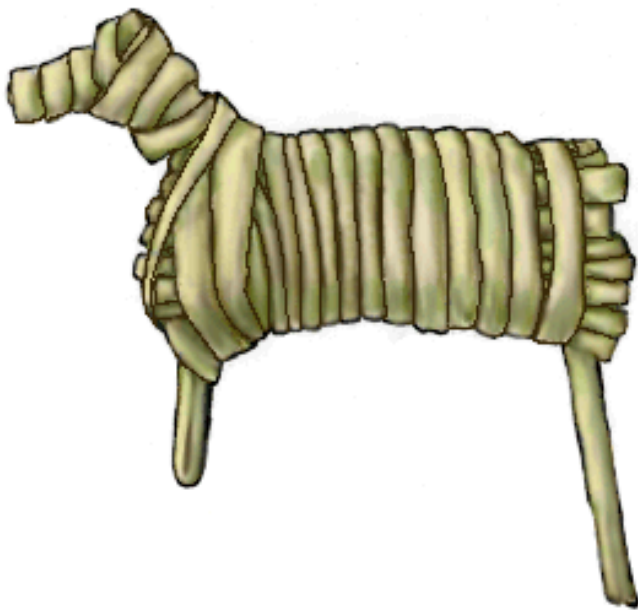
[Branches, Twigs & Roots Bibliography and Books to Buy On-Line](#)

[Return to NativeTech's Branches, Twigs & Roots Menu](#)



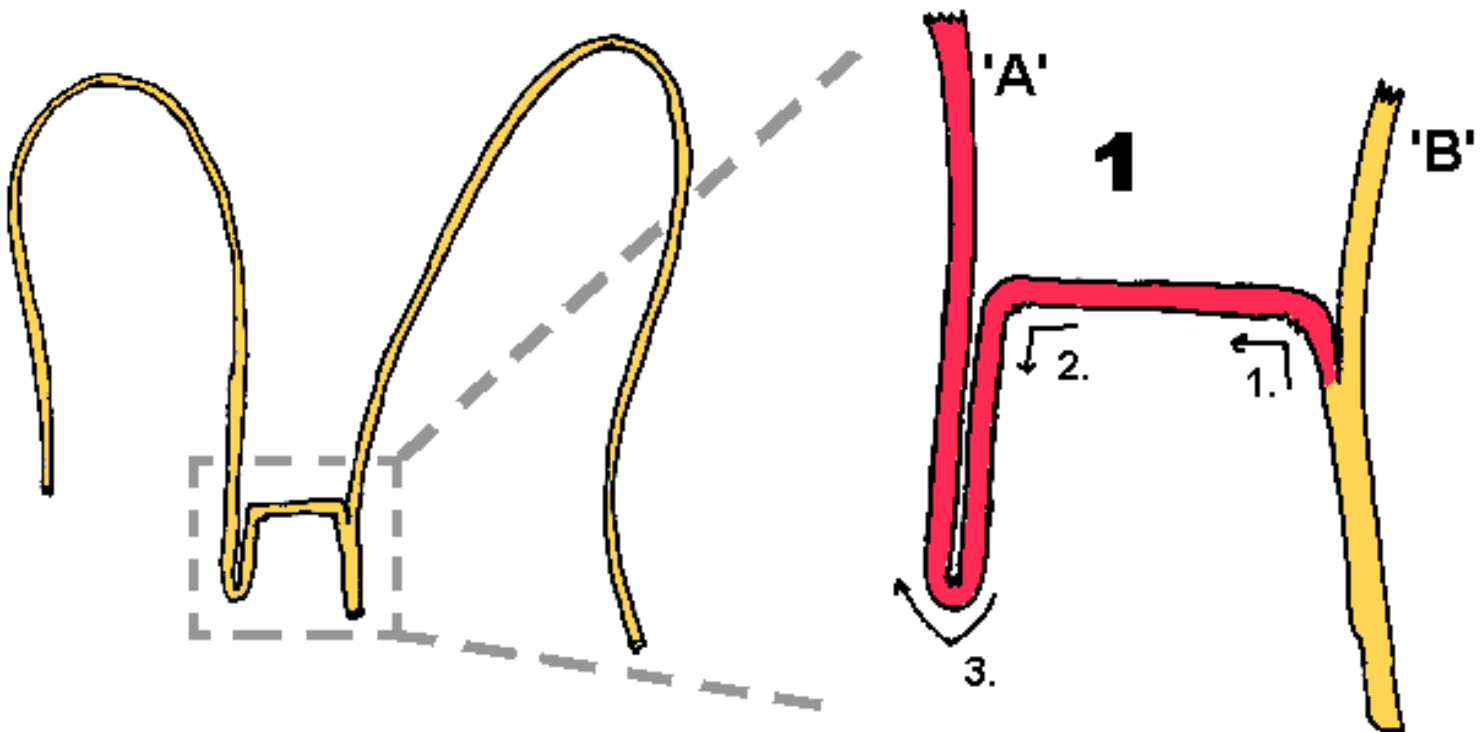


© 1994-1999 [Tara Prindle](#).



## Instructions for Split Willow Stick Deer

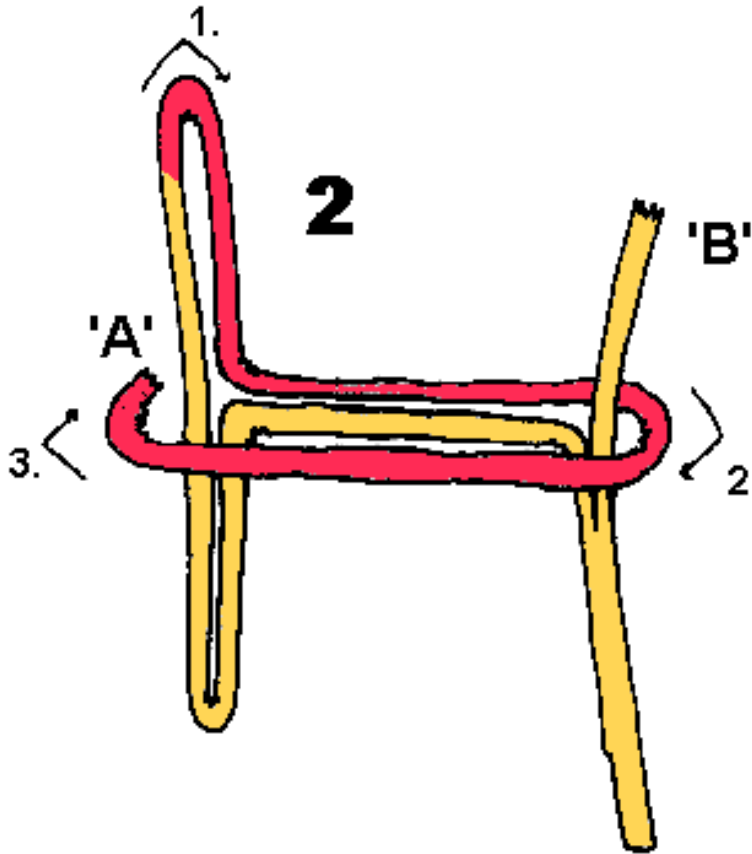
Use a single freshly picked willow branch (at least 40 inches long). [Split the branch](#) from the narrow end to about 2 inches from the wide end. The intact, wide end will be the deer's rear leg.



1. The deer's body is made from the two halves ['A' and 'B'] of the single willow branch.

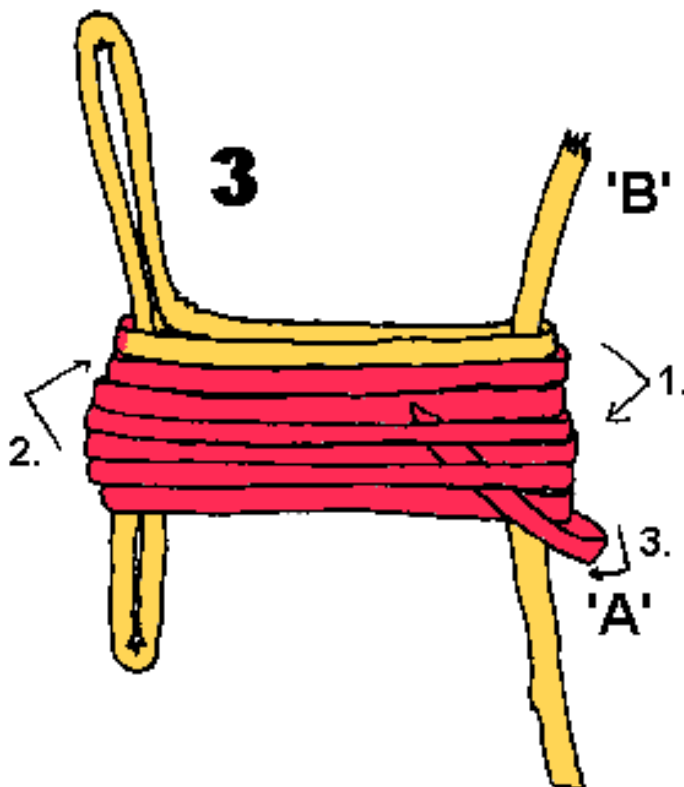
**Bend one half of the branch ['A'] at a right angle just above the split (this makes the deer's back). Leaving 2 inches for the back, bend 'A' again at a right angle down to make the front leg.**

**Finally bend the branch 'A' back against itself to finish the front leg and make the deer's neck.**



**2. Leaving about two inches for the deer's neck and head, bend the branch 'A' back on itself. Where the neck meets the back, bend the branch at a right angle.**

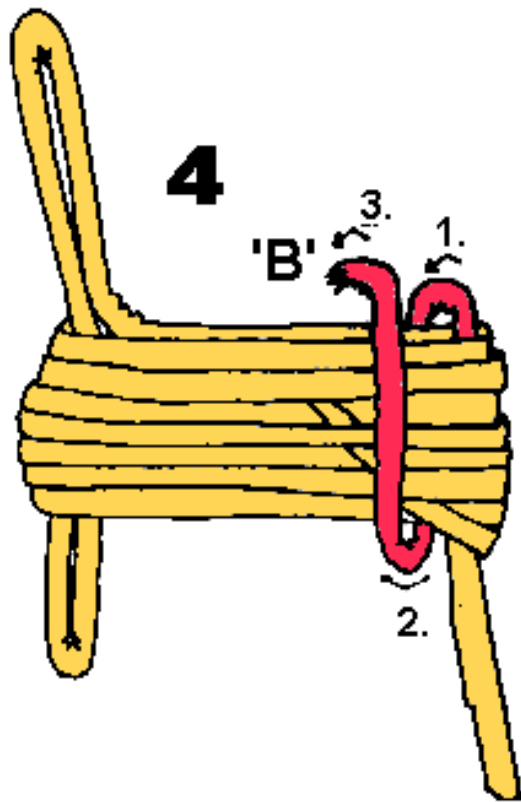
**2. Now begin wrapping the branch 'A' down around the body, from the chest to the rump of the deer and around and around.**



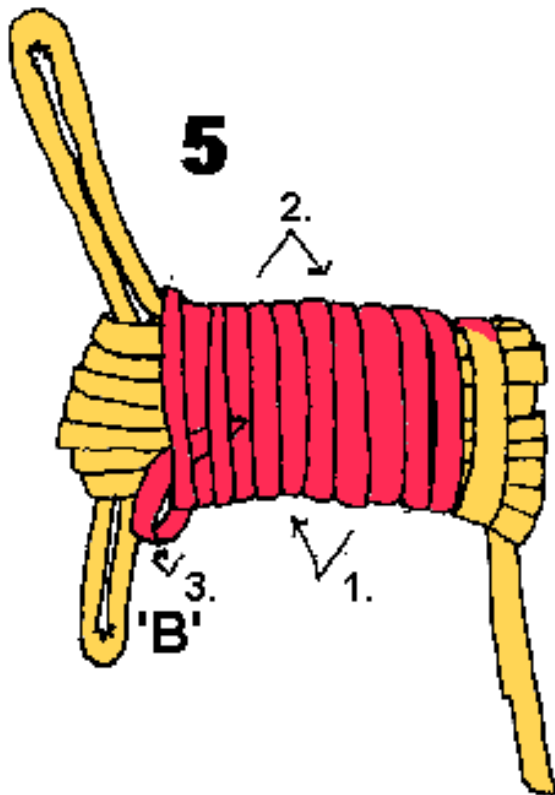
**3. Finish wrapping 'A' down around the body. Wrap around the body 7 times or until the branch half 'A' runs out.**

**Tuck or weave the end of 'A' back up into the body wrapping. This will be covered by another layer of wrapping, so it will not show.**



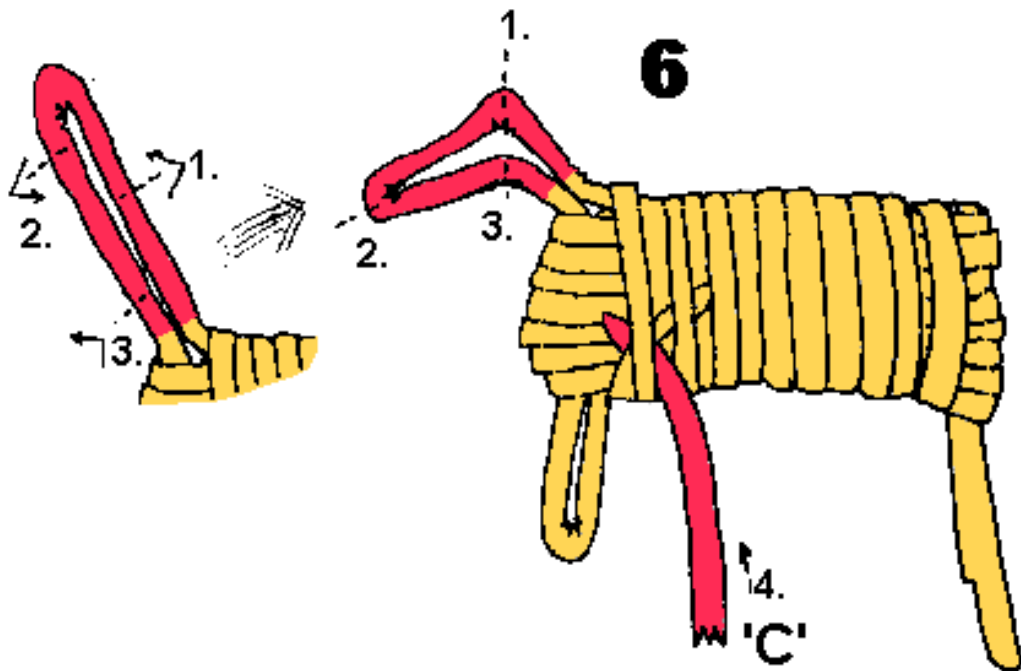


**4. Now start using the other half of the branch 'B', that is sticking up from the deer's rump. Begin wrapping 'B' around the body, Starting at the rump and working across towards the deer's chest.**



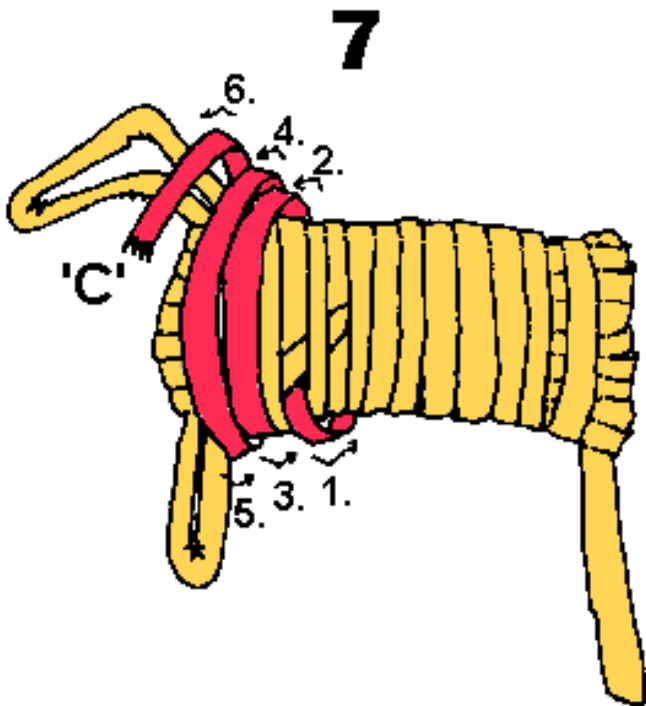
**5. Finish tightly wrapping the body with the 'B' half of the branch, about 12 wraps. You still need about 12 inches of split willow branch to finish the deer. If your piece isn't long enough, then this is a good time to weave the end of 'B' into the body wrappings below the deer's chest.**

**This secures the body while you shape the head.**

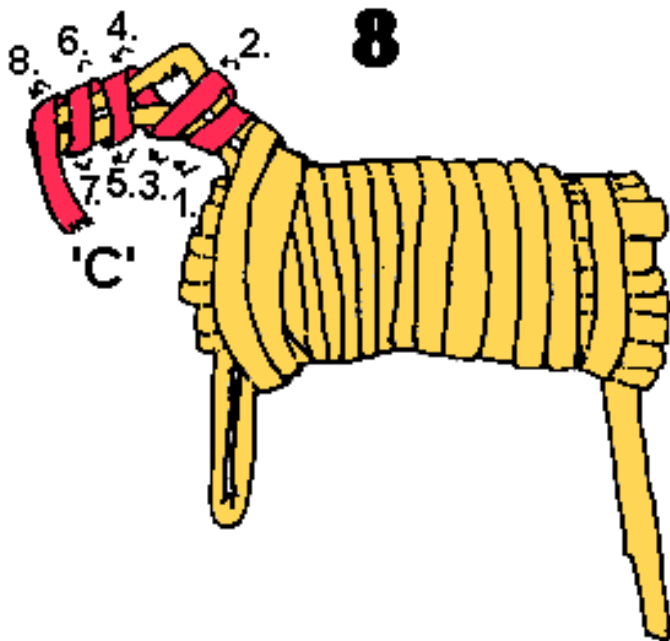


**6. Shape the 'U'-shaped part of the branch that sticks out from the deer's chest into a head. Bend the 'U' into a figure '4'**

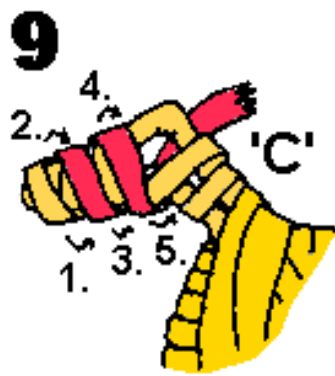
**Add a new piece of split willow 'C' about 12 inches long. Tuck the end of 'C' into the body wrappings where 'B' was tucked in.**



**7. Wrap 'C' twice around the chest. This helps hold the neck in place.**



8. Using 'C' continue wrapping, up the neck twice, and around the nose three times.



9. Now wrap 'C' back down the head three times.



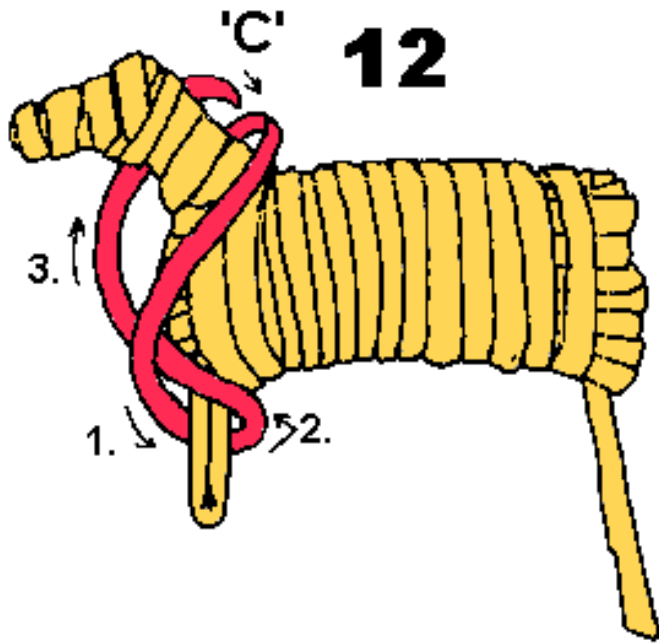
10. Wrap 'C' over the head in an 'X' pattern.



11. Wrap 'C' three times, from the deer's head and down the neck.

12. Lastly, wrap 'C' around the chest, making a figure '8' around the deer's front leg and neck.





Tuck the end of 'C' into the wrappings around the deer's neck.

---

[Return to Willow Figures and Toys Background](#)

---

[Return to Willow Branches and Other Twigs and Roots Background](#)

[Branches, Twigs & Roots Bibliography and Books to Buy On-Line](#)

[Return to NativeTech's Branches, Twigs & Roots Menu](#)

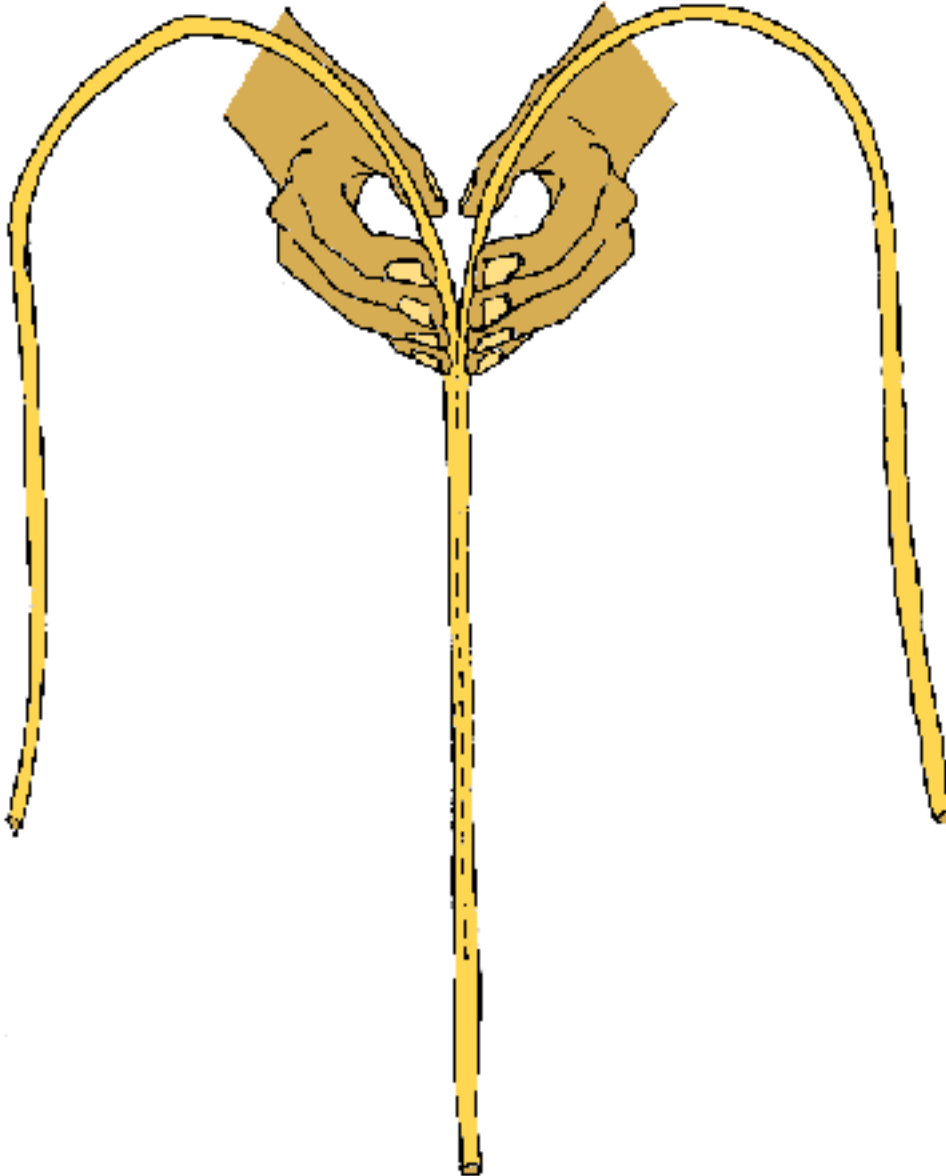
---



© 1994-1999 [Tara Prindle](#).

## Native American Technology and Art

# Splitting a Willow Stick



The thin branch shouldn't have any lower branches forking from it. Strip off the leaves and twigs by pulling the branch between your fingers and thumb. Also Remove the very thin tip of the branch.

Use your thumbnail to start a split at the *narrow* end of the branch. Pull the halves apart; then put your two thumbs between the split. Place your fingers on opposite sides of the branch and place even pressure against your thumbs as you split the willow branch down it's length. The two halves should curl away from each other in a 'Y'.

If one half starts to split thinner than the other, bend the thicker opposite side of the 'Y' more firmly, re-centering the split.

Splitting a long branch evenly takes a bit of practice, so have patience. You can still use shorter pieces if you don't mind a few tucked ends showing.

---

[Return to Willow Figures and Toys Background](#)

[Return to Willow Deer Instruction](#)

[Return to Willow Doll Instruction](#)

---

[Return to Willow Branches and Other Twigs and Roots Background](#)

**[Branches, Twigs & Roots Bibliography and Books to Buy On-Line](#)**

**[Return to NativeTech's Branches, Twigs & Roots Menu](#)**

---



© 1994-1999 **[Tara Prindle](#)**.

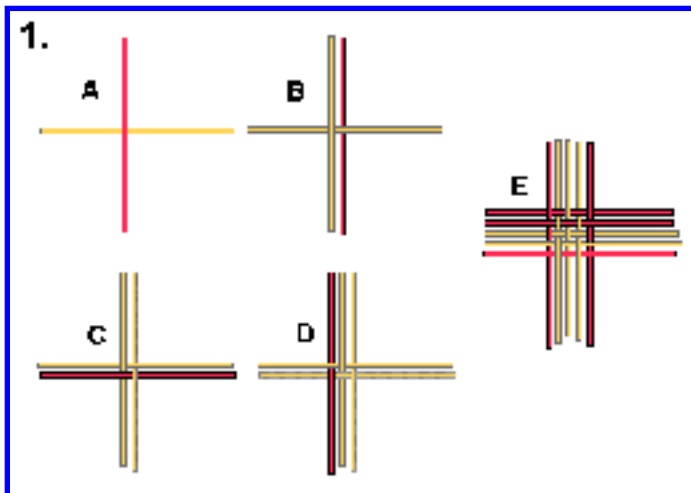


## Native American Technology and Art



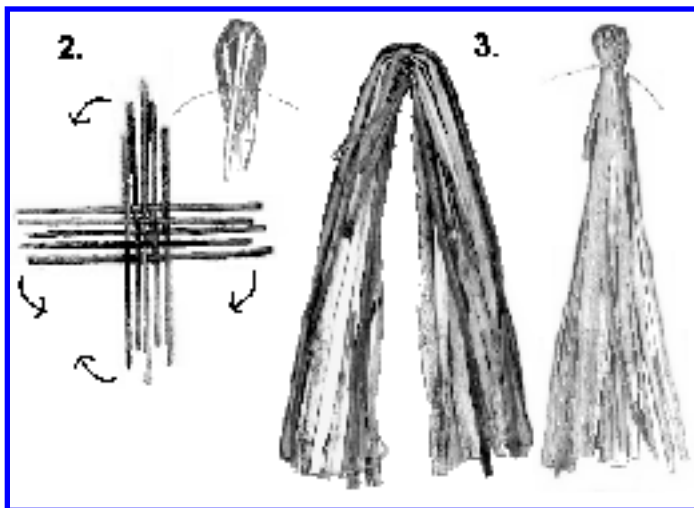
### Instructions for Split Willow Dolls

Click on the icons below for more detailed images.



You need to split about 100 inches of willow branches to make this doll (that is 50 inches 'of branch' split in half.) Fortunately, many of the pieces needed are between 5 and 10 inches long.

**1. The doll's head is actually a little basket, inverted over a bundle of grass.** For the 'basket' head, cut 10 pieces of split willow to 5 inch lengths. Weave them into an under-over, checker-weave pattern. There should be a square of woven branches with the ends projecting in four directions.

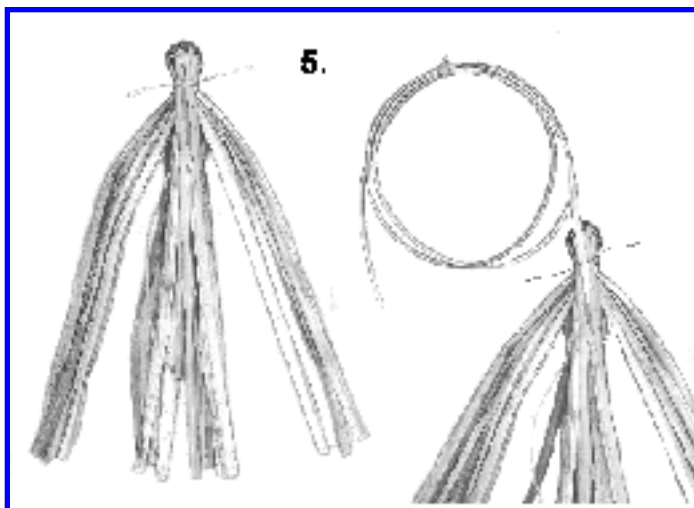


**2.** Carefully bring the four ends of the woven branches together, so they form a little dome. They will try to come unraveled].

**3.** Bend a bundle of grass or cornhusk in half so it forms a rounded knob to place the woven branches over.

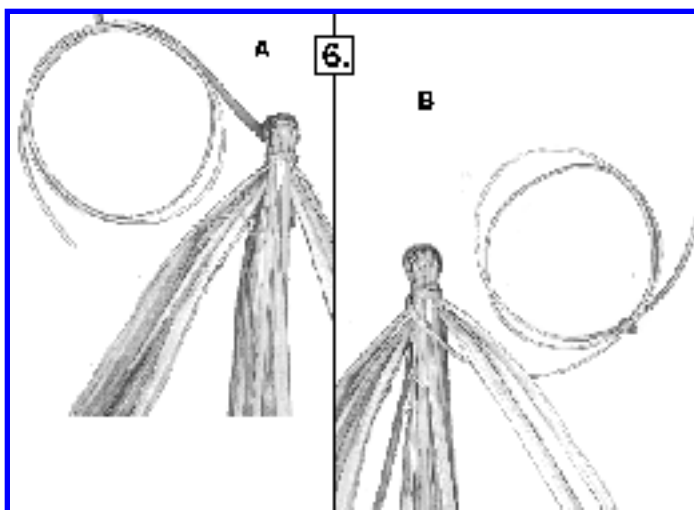
Once the woven branches are in place, squeeze at the neck of the doll and push the branches into an even head-form.

Tie the ends of the woven branches tightly at the neck.



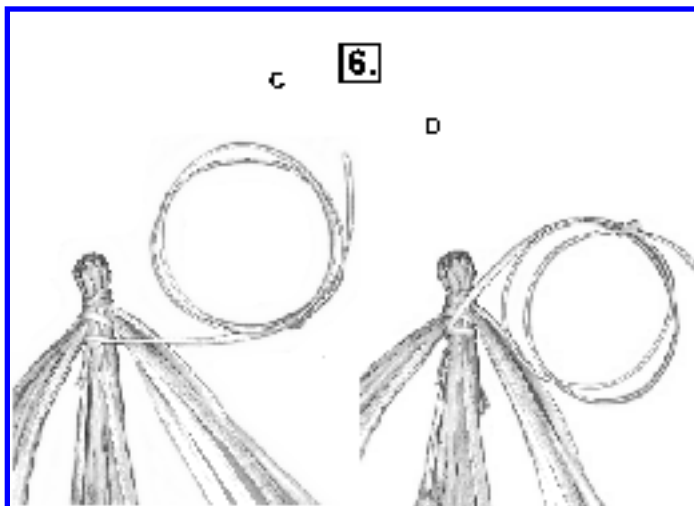
**5.** Pull some of the grass bundle out on either side of the doll to help form the arms.

Tuck one end of a foot long piece of split willow into the tie at the doll's neck, so that the good-side of the willow is against the doll.



**6a.** Start to wrap the neck. When you start, bend the willow at a right angle so the good-side shows. Wrap around the back of the neck

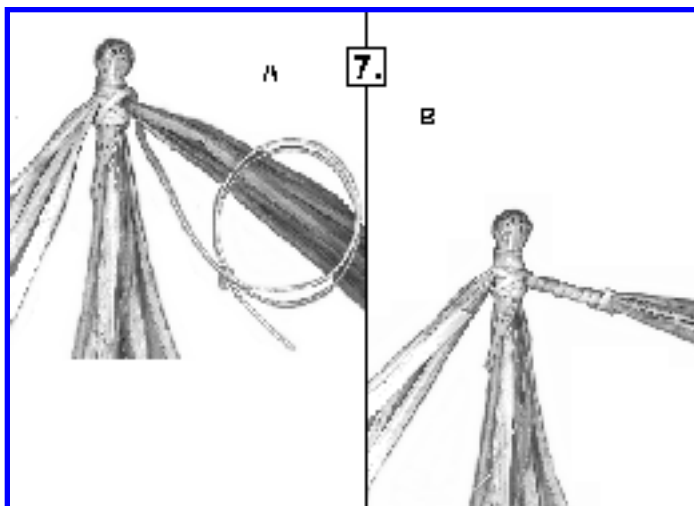
**6b.** Wrap around the front, around the back again, and then cross over the chest and under the opposite arm.



**6c.** Wrap around the waist in the back coming under the arm and around the waist in the front.

**6d.** Wrap around the back at the waist, coming under the arm, and then cross the chest in the front, producing an 'X'.

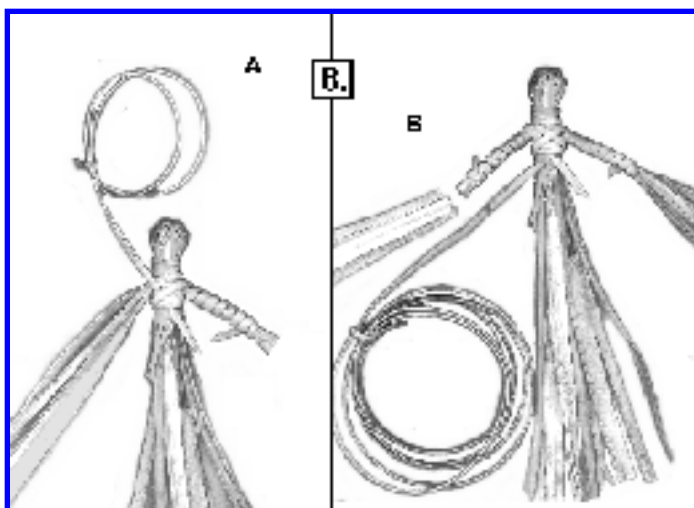
Wrap the chest in a similar manner so the 'X' is also produced in the back.



**7a.** Begin wrapping on arm with the same piece used to wrap the chest.

Wrap about 2 inches down the arm. Wrapping and bending the willow tightly so it will not untwist as it dries.

**7b.** Trim and tuck the end of the willow back up into the wrappings of the arm.

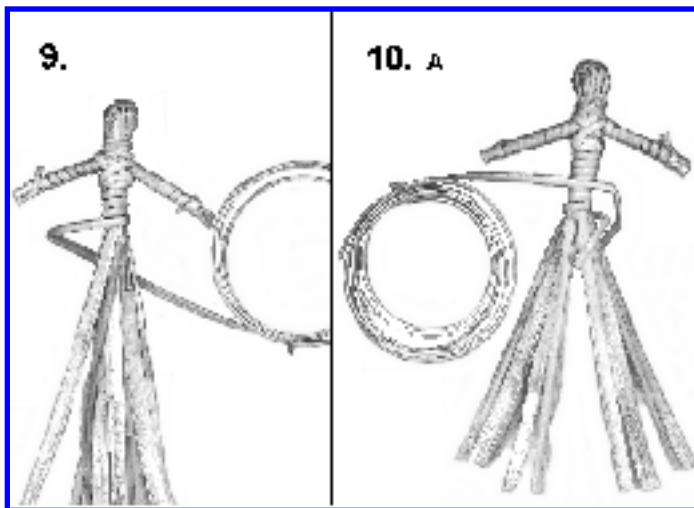


**8a.** To wrap the other arm, insert a 6 or 7 inch piece of willow into the wrappings of the chest. Wrap down the arm, noting the direction of the wrapping so it mirrors that of the other arm. Trim and tuck the end of the willow back up into the arm wrapping.

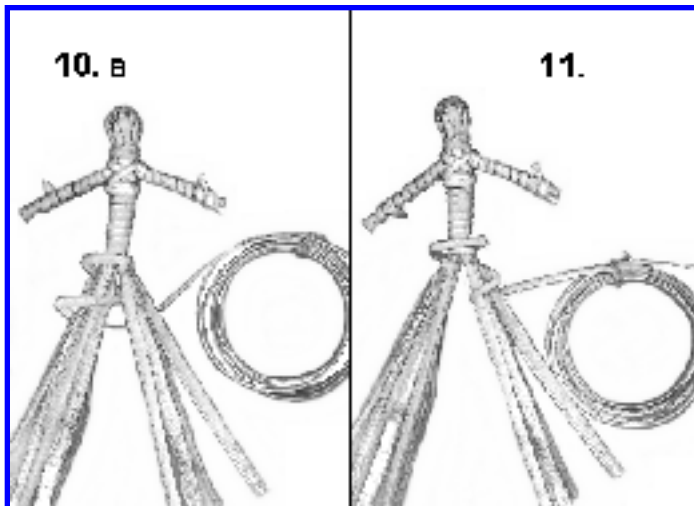
Trim the excess grass leaving a ¼ inch for the doll's hand.

**8b.** Tuck the end of an 8 or 9 inch piece of split willow into the wrappings of the chest, so that it points downward in the direction of the body.

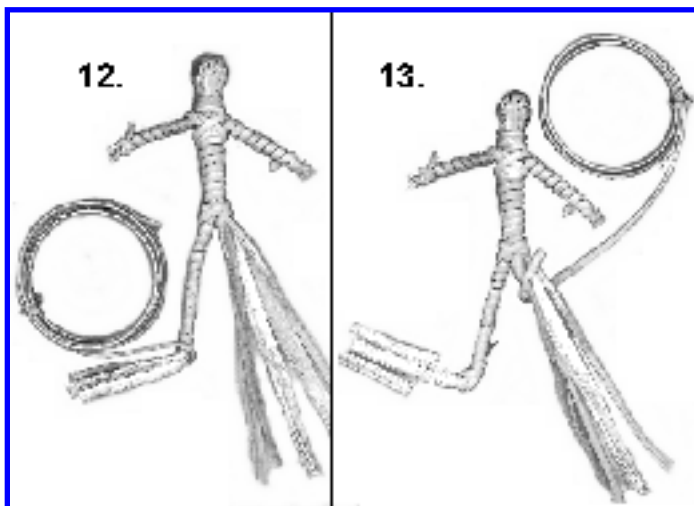




**9.** Wrap down about 2 inches of the body. Separate the bundled grass into two halves, one bunch for each leg.  
**10a.** Wrap around one leg, and then around the body to help form the hips.



**10b.** To finish the hips wrap around the other leg. Then wrap the split willow around the body again.  
**11.** Wrap around the first leg again, and continue wrapping the split willow down the leg for about 3 inches.



**12.** Bend the bundled grass at a right angle to form the ankle. Tightly wrap the split willow in a figure-8 around the foot to hold it at a right angle. Tuck the trimmed end under the wrappings of the leg.  
**13.** To wrap the other leg, insert a new piece of split willow into the hips at the front. Wrap down the leg, trim the end and insert the end back up under the leg wrapping. Trim the excess bundled grass to ¼ inch to form the foot.

---

[Return to Willow Figures and Toys Background](#)

---

[Return to Willow Branches and Other Twigs and Roots Background](#)

[Branches, Twigs & Roots Bibliography and Books to Buy On-Line](#)

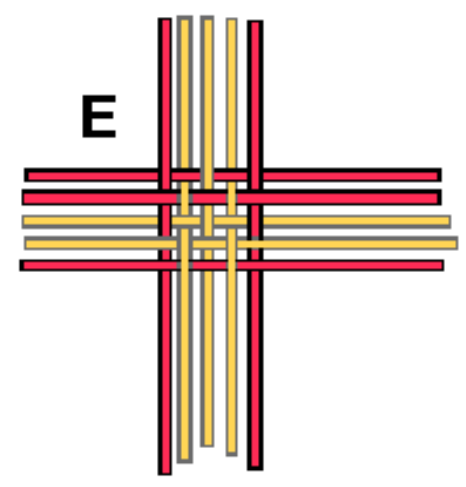
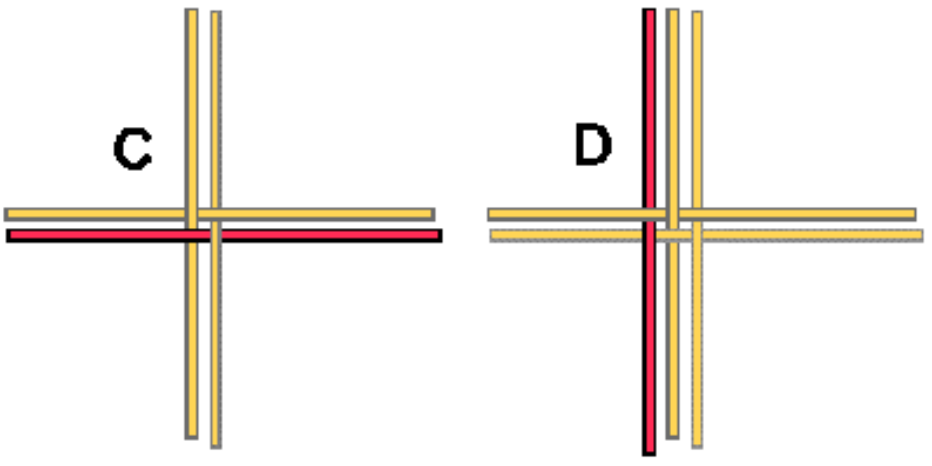
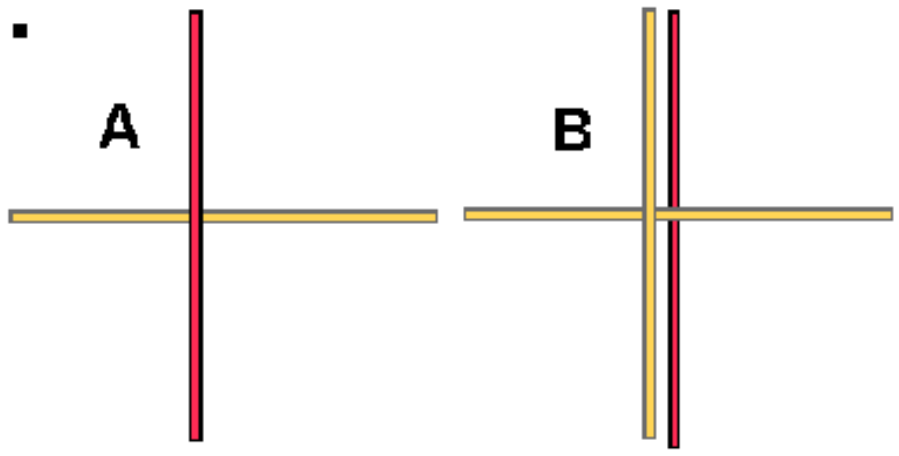
[Return to NativeTech's Branches, Twigs & Roots Menu](#)

---

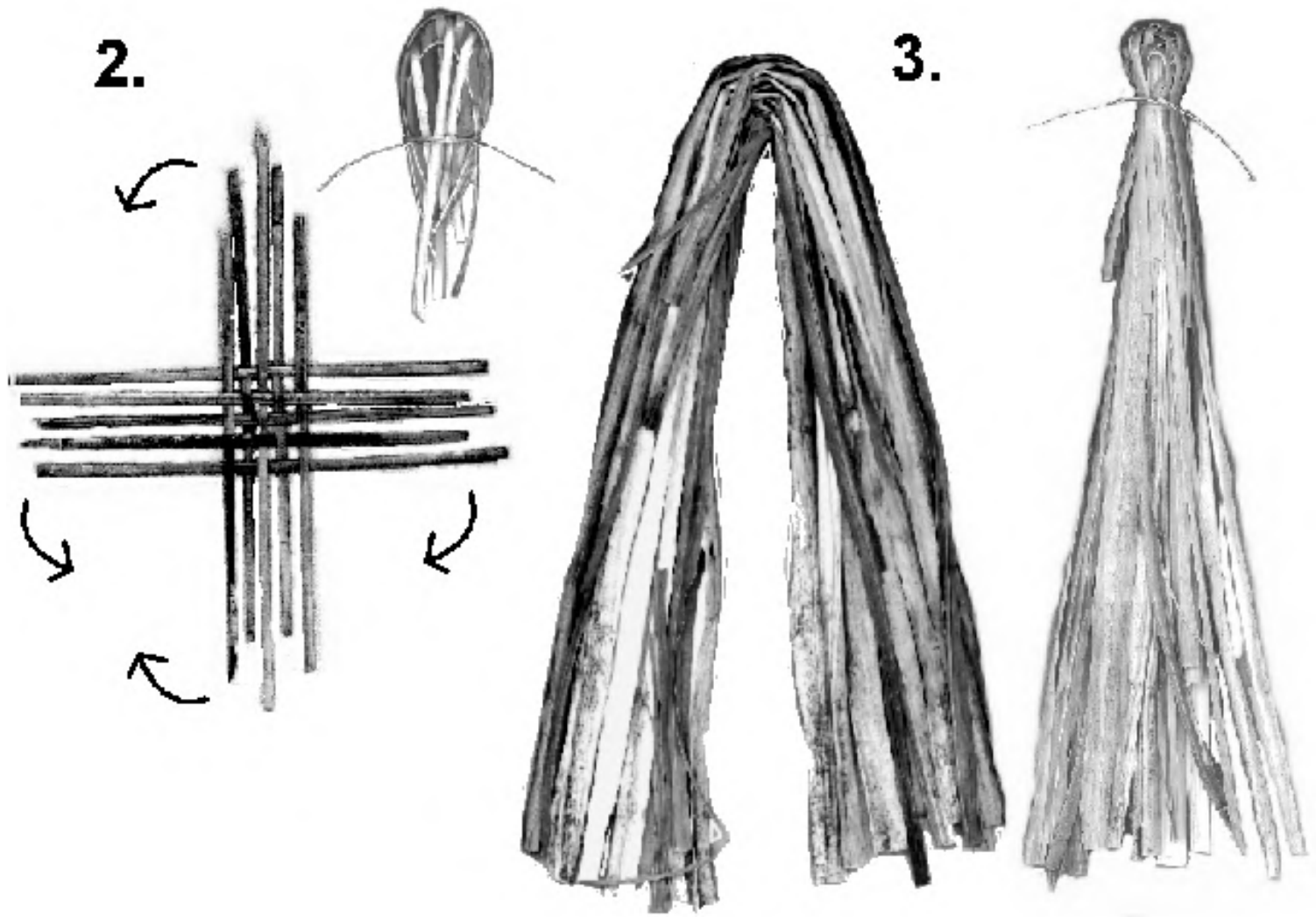


© 1994-1999 [Tara Prindle](#).

**1.**

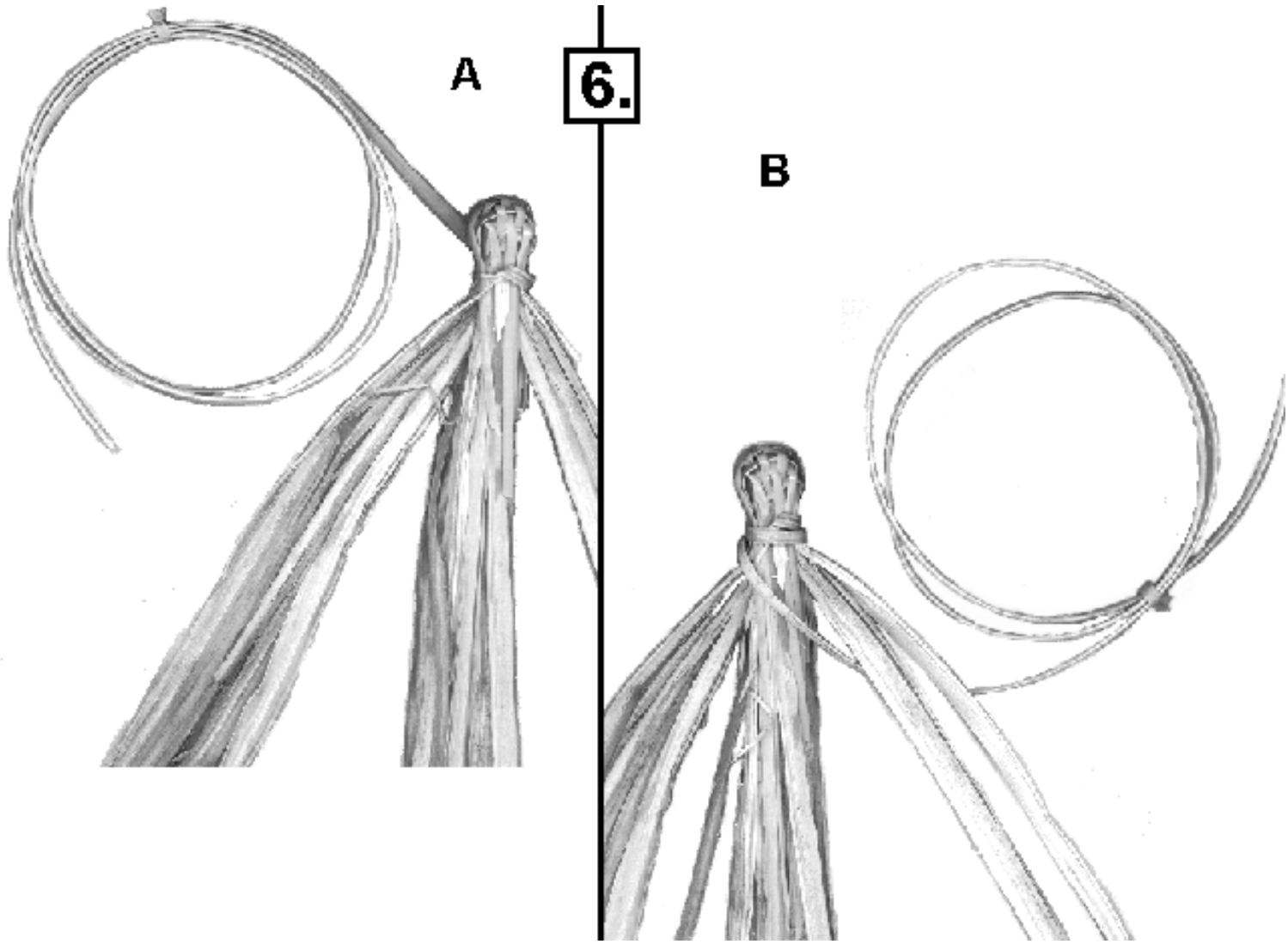






**5.**





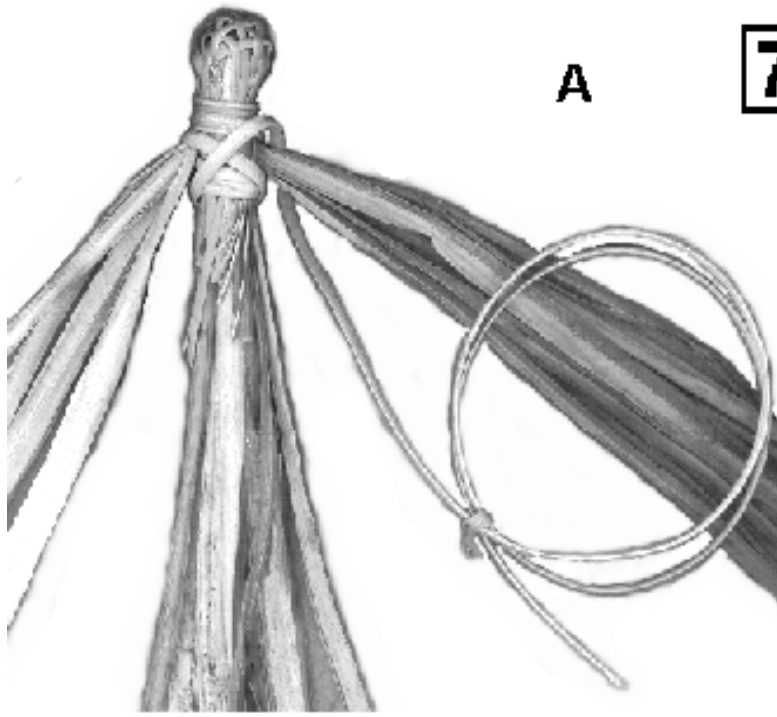


6.

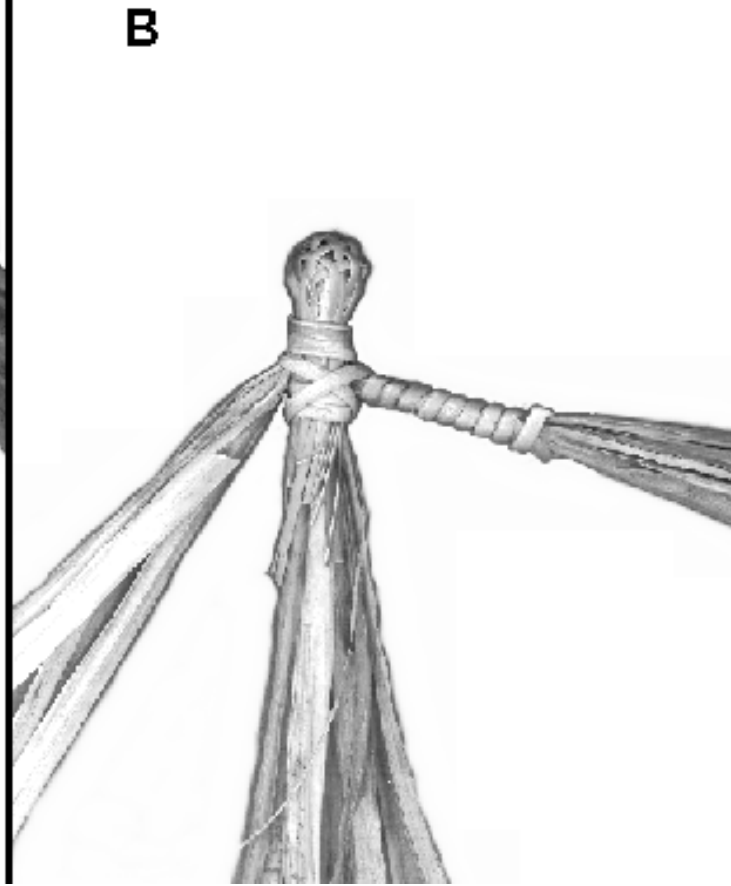
C

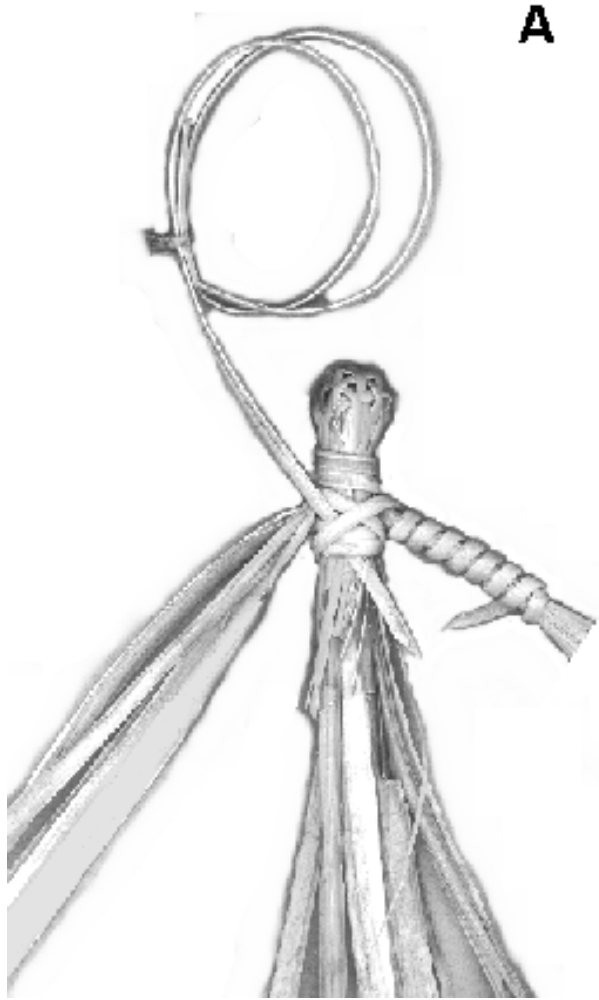
D



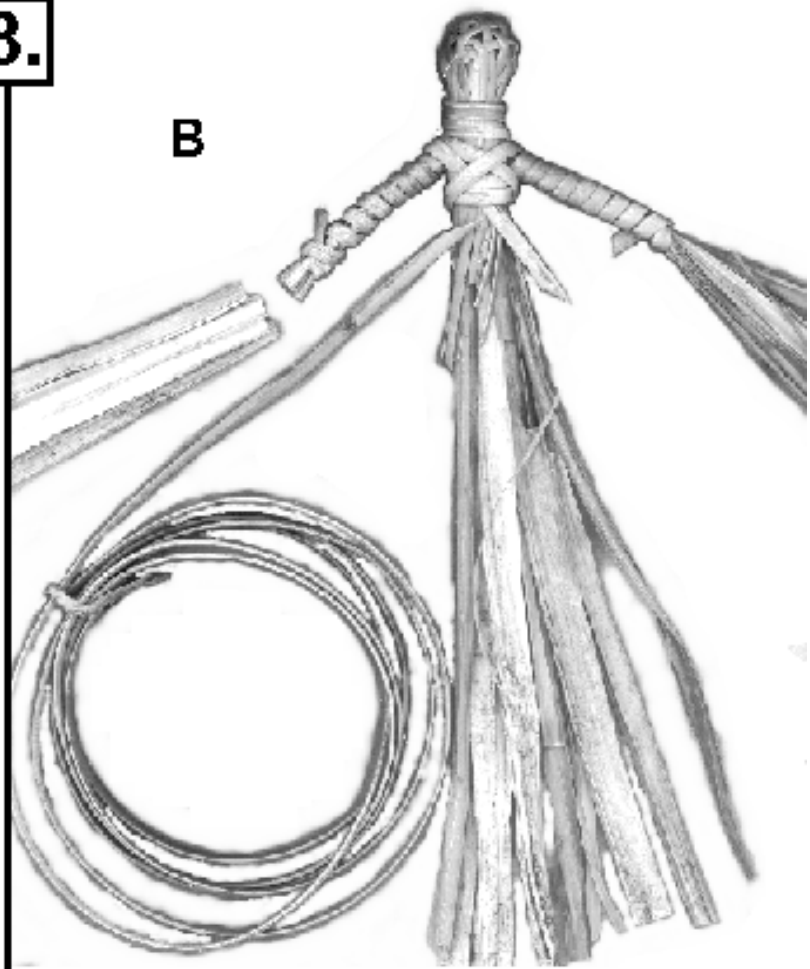


**7.**



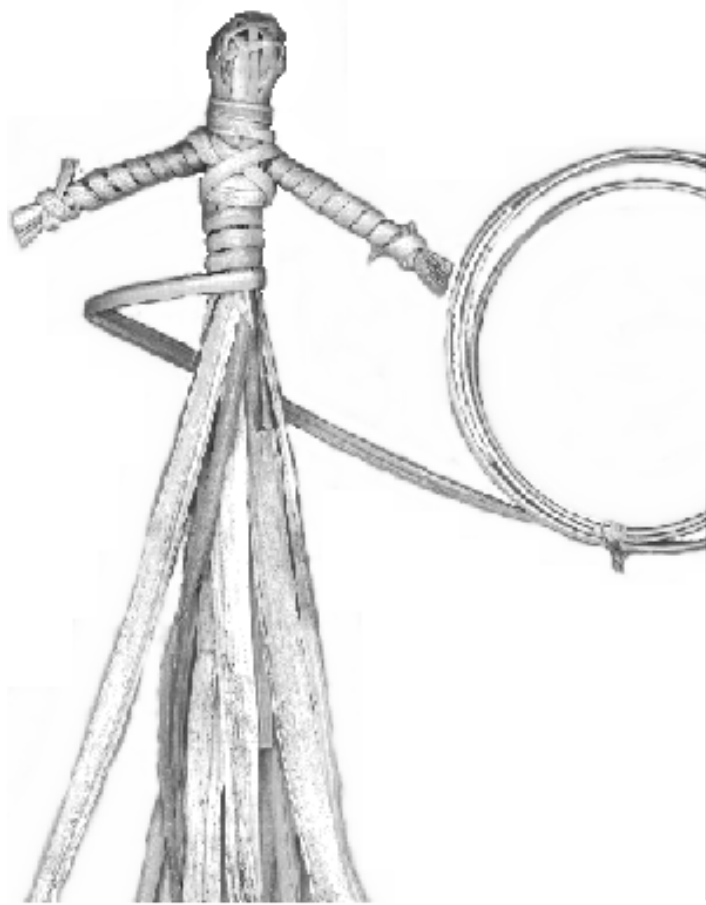


**8.**

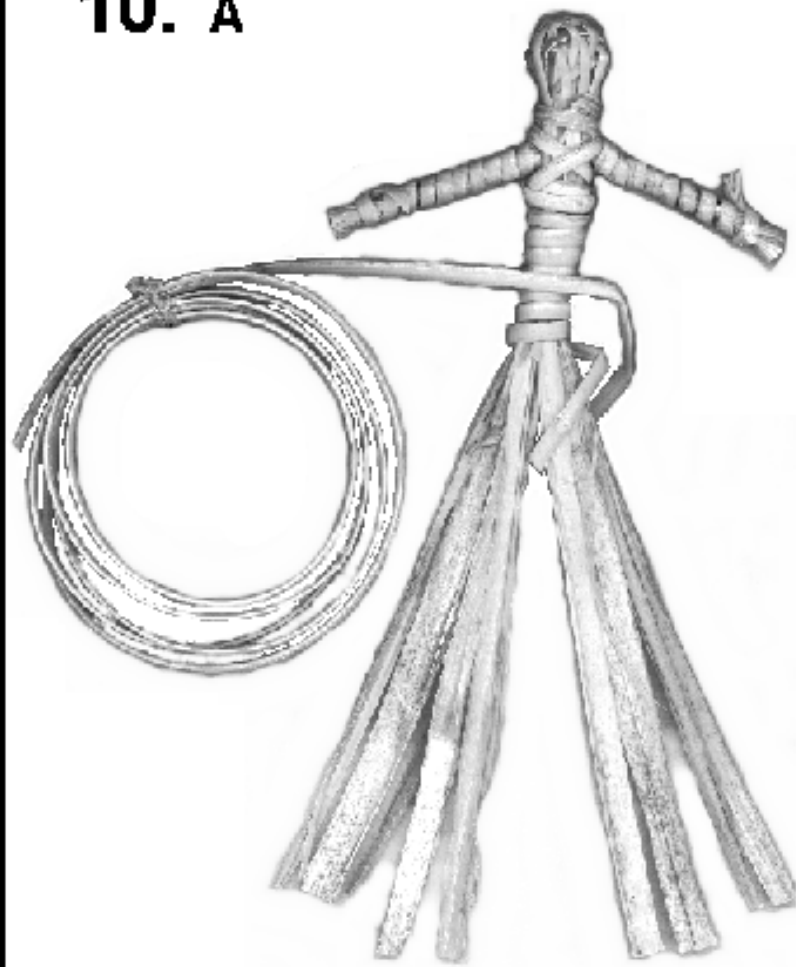




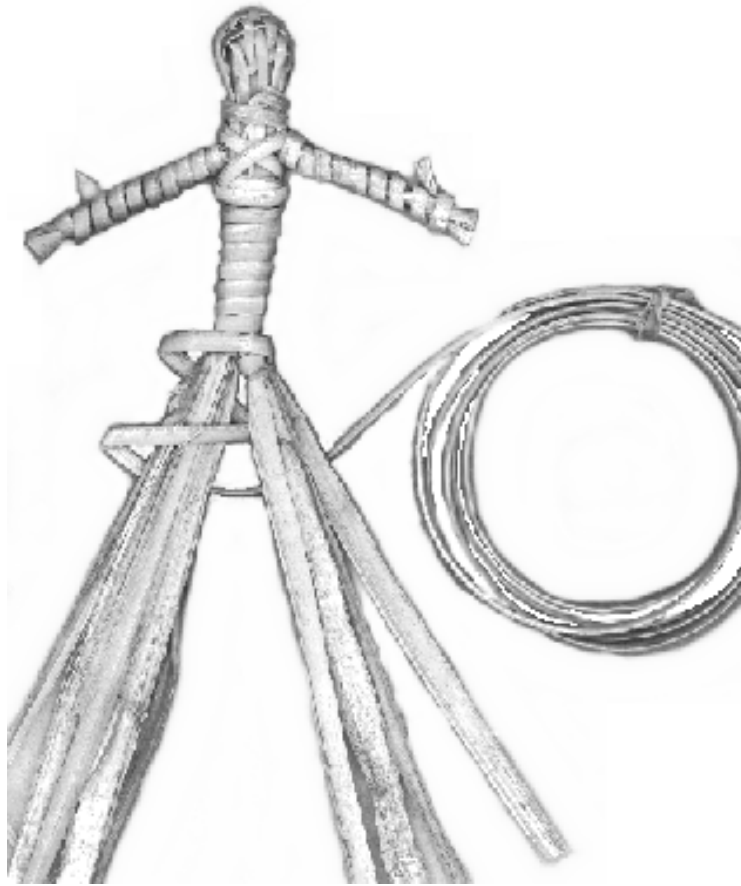
**9.**



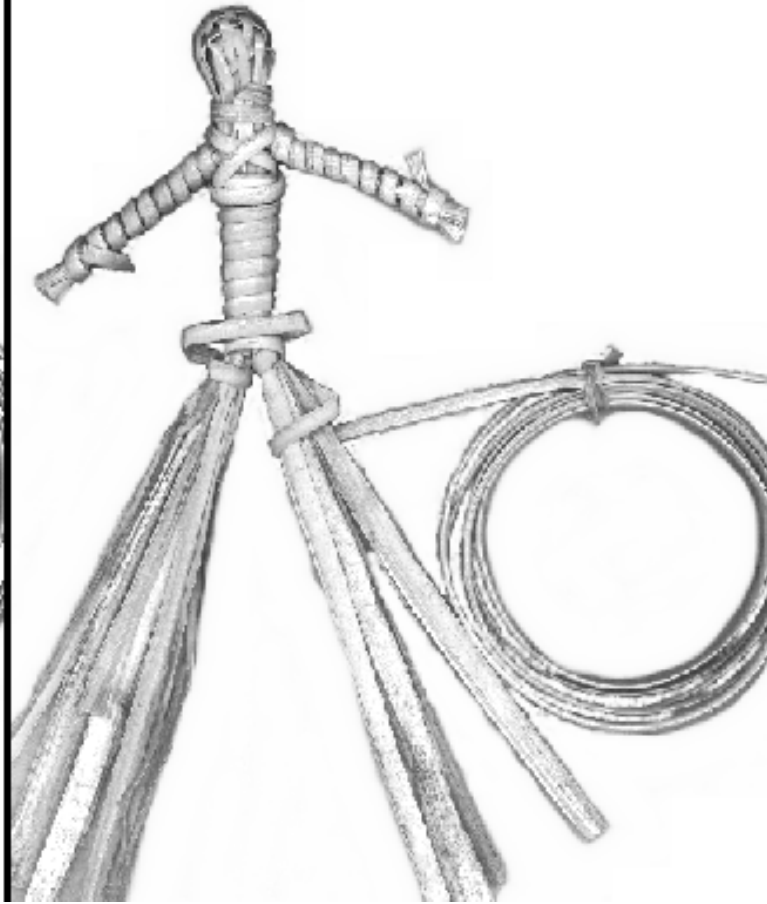
**10. A**



**10. B**



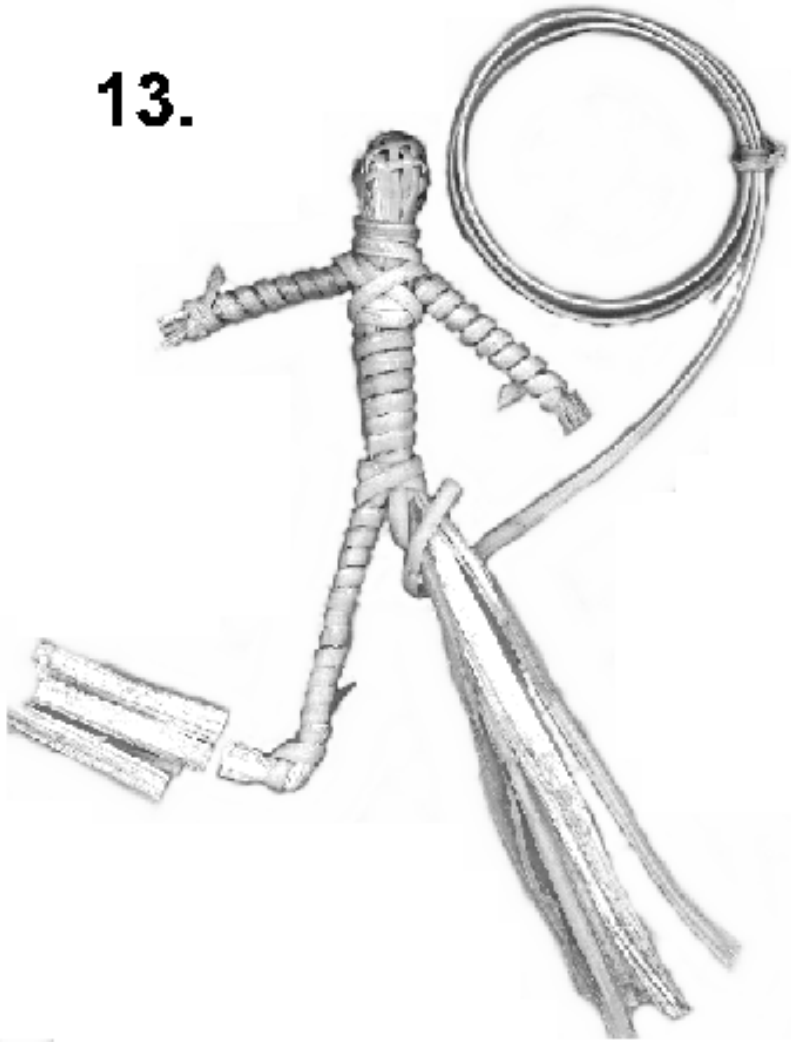
**11.**



**12.**



**13.**





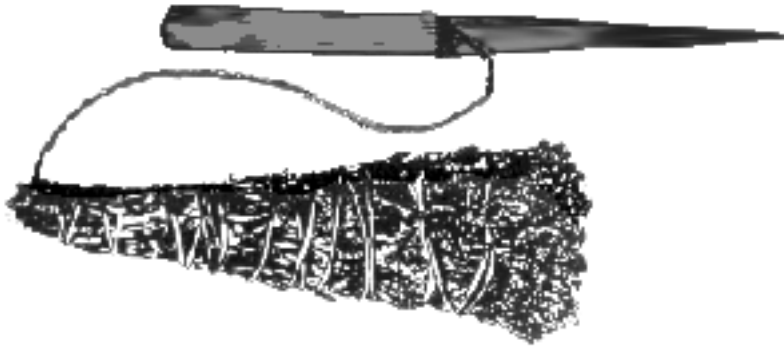
NativeTech: Native American Technology and Art  
**Willow Branches and Other Twigs and Roots.**

## **CEDAR**

---

### *Cedar*

**tree-use by Native Americans is often associated with the bark which has many applications in weaving. Cedar twigs, greenery and all, have both sacred uses (as in smudging and**



Penobscot Cedar Ring and Pin Game  
(adapted from Speck: 1976)

**purification rituals) as well as secular use. One such secular use for cedar twigs is the 'ring and pin' game, a traditional game played by the Penobscot, a northeastern tribe. The game is sometimes referred to as a lover's pastime, as it serves as an excuse for introduction between two people, in which a person can simply refuse to play the game if they are not interested in the other person. The game consists of a**

**wooden pin attached to a bundle of wrapped cedar twigs. The object of the game is to try and spear the bunch of twigs the most times. Each player is allowed two misses before he must pass the game to the next player. One point is given for each time the pin catches the bundle. The players decide how many points wins the game. A traditional Penobscot women's dance was called 'little pines'.**

---

[Return to Willow Branches and Other Twigs and Roots Background](#)

[Branches, Twigs & Roots Bibliography and Books to Buy On-Line](#)

[Return to NativeTech's Branches, Twigs & Roots Menu](#)

---



© 1994-2000 [Tara Prindle](#).

NativeTech: Native American Technology and Art  
**Willow Branches and Other Twigs and Roots.**

## PINE

---

### *Pine*

varieties such as Norway Pine and White Pine are evergreen trees from which tribes of the Eastern Forest traditionally made dancing dolls. In the early 1900's, Frances Densmore describes these dolls, made by Ojibway (Chippewa) people of the Great Lakes region, from a



tuft of pine needles cut squarely across the end. By trimming a layer of needles about halfway up, a skirt, arms and perhaps a shawl could be suggested. A bit of wood was left at the top of the sprig of needles creating the doll's head. These little figures were placed on a long thin piece of wood, or on a tray, which was gently bounced. This agitating motion makes the dolls jump and skip, sometimes moving back and forth together, suggesting a dance. The effect was quite realistic if the person manipulating the board was practiced.

Ojibwa dolls made of pine needles. The northeastern Penobscot have a similar traditional game called 'little pines', a game chiefly for women, that was described by Frank Speck in the 1940's. The game used anywhere from 6 to 10 dolls made from white pine tips. The woman sings as she jostles the game board, and the pine sprigs dance and eventually topple. If a pine dancer manages to right itself, then the onlookers exclaim "She's come back to life!" and "She's glad to wake up again!". The last pine needle dancer to fall from the board is praised by the onlookers for her endurance and dancing skill. The dancers and board are then passed to another to play.

---

Learn how to make [WOODSMAN EPOXY](#) from pine pitch.

---

[Return to Willow Branches and Other Twigs and Roots Background](#)

[Branches, Twigs & Roots Bibliography and Books to Buy On-Line](#)



[Return to NativeTech's Branches, Twigs & Roots Menu](#)

---



© 1994-2000 [Tara Prindle](#).

NativeTech: Native American Technology and Art

## WOODSMAN EPOXY

**HARD WOOD ASHES MIX WITH HEATED PINE PITCH**

*contributed by Fred*

---

**GOOD FOR SETTING POINTS, AND STONE AXES IN HOLED  
HANDLES.**

**EVERYTHING MUST BE READY AT TIME OF MIXING; WORK FAST; WHILE PINE PITCH IS BEING HEATED**

**SLOWLY ADD ASHES UNTIL A THICK SLURRY IS REACHED; IMMEDIATELY ADD TO PIECES TO 'WELD'**

**AND HOLD FIRM UNTIL DRY - SECONDS!!....**

**LOOKS LIKE IGNEOUS STUFF WHEN DONE**

~ thanks fred

---

**Another Glue Recipe can be made from:**

**5 parts pitch  
1 part wood ashes  
1 part tallow**

from ["The History and Primitive Technology Pages"](#)

---

[Return to Willow Branches and Other Twigs and Roots Background](#)

[Branches, Twigs & Roots Bibliography and Books to Buy On-Line](#)

[Return to NativeTech's Branches, Twigs & Roots Menu](#)



© 1994-2000 [Tara Prindle](#).

## Native American Technology and Art

### A Three-Part FAQ on Dream Catchers

July 26, 1995 submission to the *soc.culture.native* Newsgroup

by Jim Shupe

---

Origins  
Application and Purpose  
Structure

#### *Origins of the Dream Catcher*

There was a time in Anishnabe history when the people were being tormented by nightmares. The elders and "medicine people" all tried to solve this problem on their own, but not a one made progress against the dreams; so a council of all the people was called. During this council one elder had a vision of a spider's web in a hoop with a feather and bead attached that would catch the bad dreams while letting good dreams pass through. The elders went to work fashioning dream catchers in the manner prescribed by the vision and when the people started using them, the bad dreams went away.

...Anishnabe as remembered by WayaGola

#### *Application and Purpose of the Dream Catcher*

The dream catcher is hung above a sleeping area in a place where the morning light can hit it. The nature of the Dream Catcher will attract all sorts of dreams to its webs. When bad dreams come, they do not know the way through the web and get caught in the webbing where the first light of day causes them to melt away and perish. The good dreams knowing the way go through the center of the web and slide down the feather to the sleeper below. ...Anishnabe as remembered by WayaGola

I have also been taught that the web catches bad/unimportant dreams and allows the good/important dreams to come through the middle and slide down the feather into the sleeper's head. Bad dreams are malicious in intent, or simply unimportant fleeting images. Bad dreams may be very disturbing, but still have a very important message for the dreamer, so that the dream catcher doesn't necessarily get rid of bad dreams in the sense of nightmares, but bad dreams in the sense of distracting dreams that have no significance or meaning to the dreamer. I have also been told that they were always hung on cradleboards. ...Cary Miller

I have often seen many people driving down the Highway with a dream catcher attached to the rearview mirror. Although the dream catcher is very pretty, the place for it is in a bedroom or over a bed, not a moving vehicle (unless a baby carriage). Please stay alert when you drive!! ...Charles P. Whitecoyote

#### *Structure of the Dream Catcher*

The dream catcher is fashioned from a hoop of red willow with a webbing of animal sinew which takes



the form of a web (like a spider's web). Attached at the bottom of the loop are a bead (usually seed or carved wood) and a feather. ...Anishnabe as remembered by WayaGola

They must be made with all natural materials - the hoop should be made with willow, preferably red willow. The web should have at least seven points for the seven grandfathers, and may have other numbers with various meanings - 13 for the moons, 28 for the lunar month. ...Cary Miller

Also, the traditional Dream Catchers are only 3 to 5 inches across. Webs that are 2 to 6 feet (I actually saw a 6 footer at a truck stop!) are beyond the scope of tradition. ...Charles P. Whitecoyote

---

[Origin of the Dream Catcher](#)

---

[Return to Willow Branches and Other Twigs and Roots Background](#)

[Branches, Twigs & Roots Bibliography and Books to Buy On-Line](#)

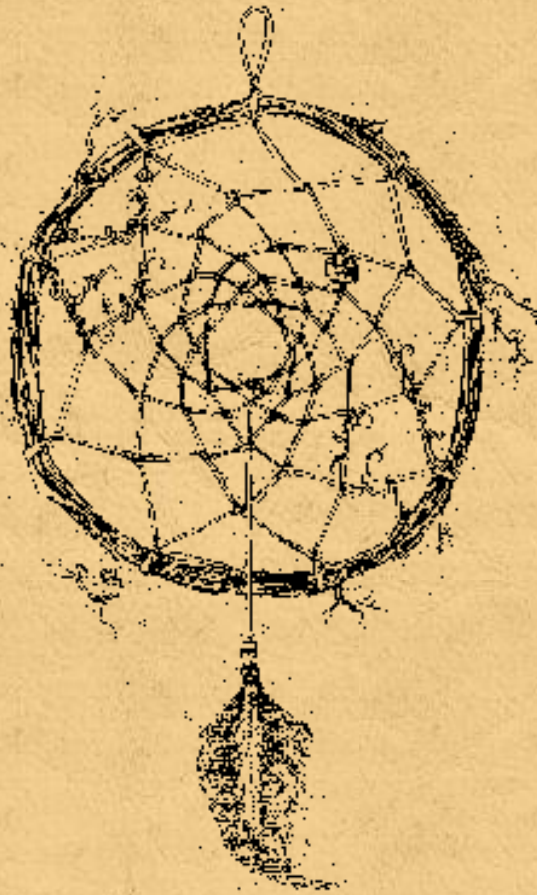
[Return to NativeTech's Branches, Twigs & Roots Menu](#)

---



Text and Graphics  
© 1994 - 103 [Tara Prindle](#)  
unless otherwise cited.

## Native American Technology and Art

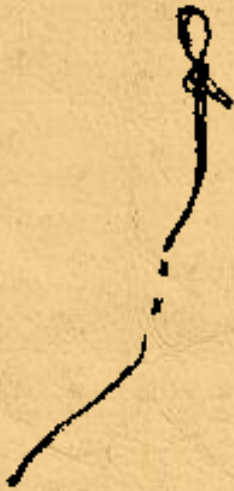


### Instructions for Making Dream Catchers



1. Using 2 - 6 ft. of soaked willow (or grapevine), carefully bend the vine around to form a circle with a 3 - 8 in. diameter. You decide on the diameter, but traditionally dreamcatchers are no wider than adult's hand.

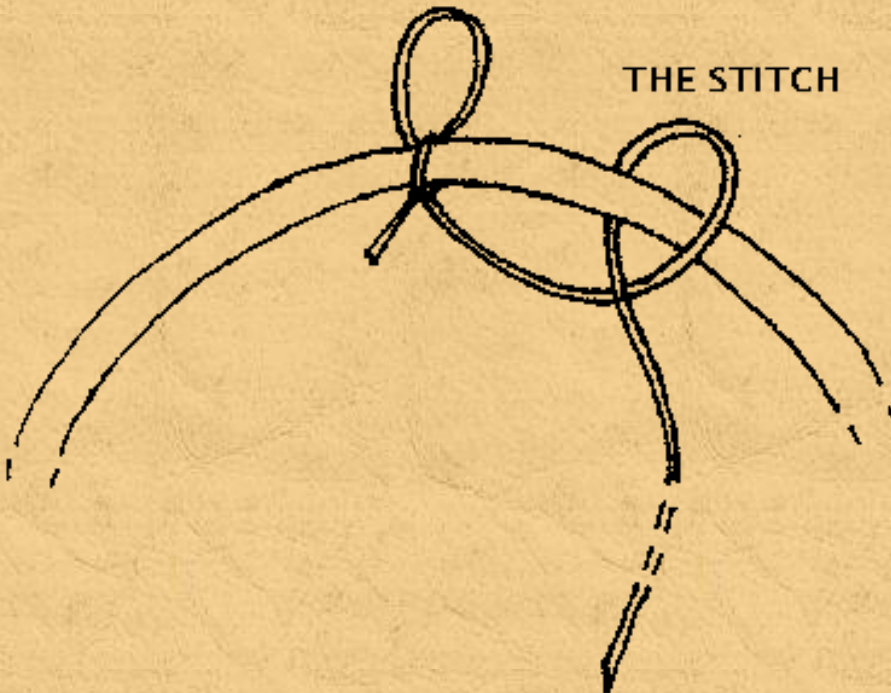
2. Twist the piece you are bending, around the circle you have made to strengthen the vine hoop.



**3. Use 4-16 ft. of strong but thin string (the length is determined by the diameter of the hoop).**

**Knot a loop in one end from which you will hang your dream catcher when it is done.**

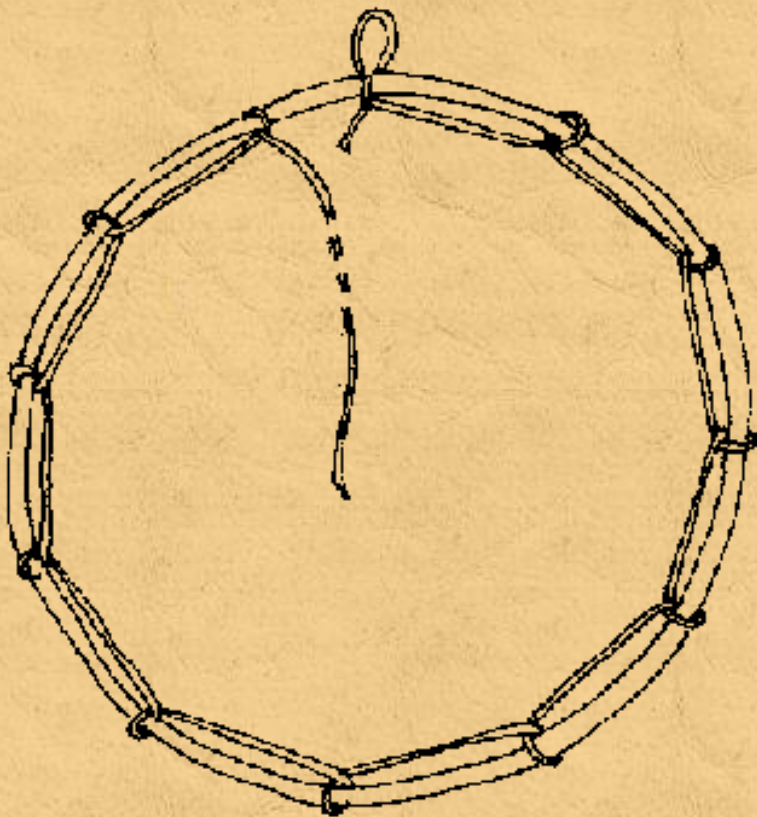
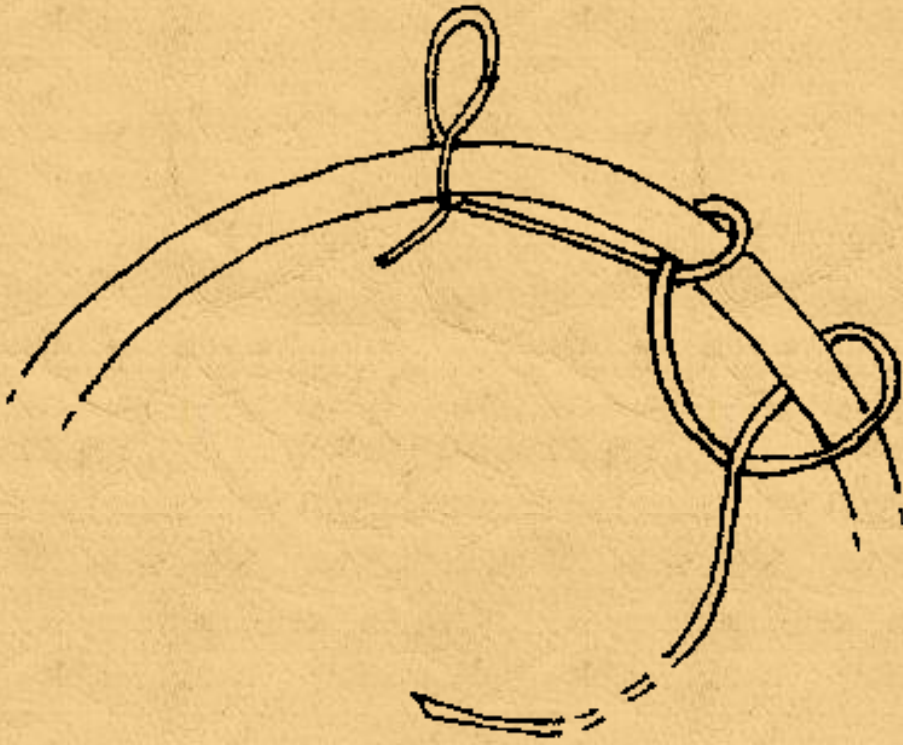
**4. Tie the hanging loop around the top of your dream catcher (or at the weakest point of your hoop).**



**5. The dream catcher repeats the same stitch from start to finish. To start, hold the string and place it loosely over the top of the hoop. Move the string around to the back of the hoop (forming a hole) and pull the string back through the hole you just made.**



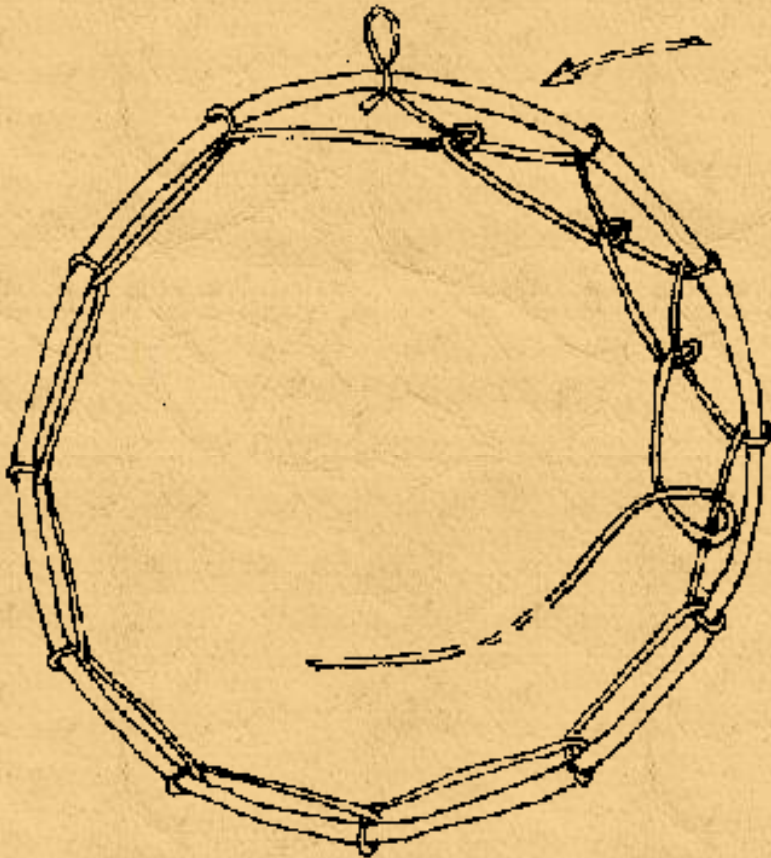
**6. Pull each stitch taught but not too tight or it will warp the hoop of the dream catcher and it will not lie flat when it is done.**



**7. Continue the same stitch for the first round around the hoop of the dream catcher. Space the stitches evenly, about 1 1/2 to 2 in. apart (making 7 to 13 stitches around the hoop).**

**8. The last stitch of the first round should be placed about a half inch away from the the hanging loop.**





**STITCH FOR THE SECOND ROUND:**

**9. On the second and subsequent stitching rounds, place the string around the center of each stitch from the previous round (rather than around the hoop).**

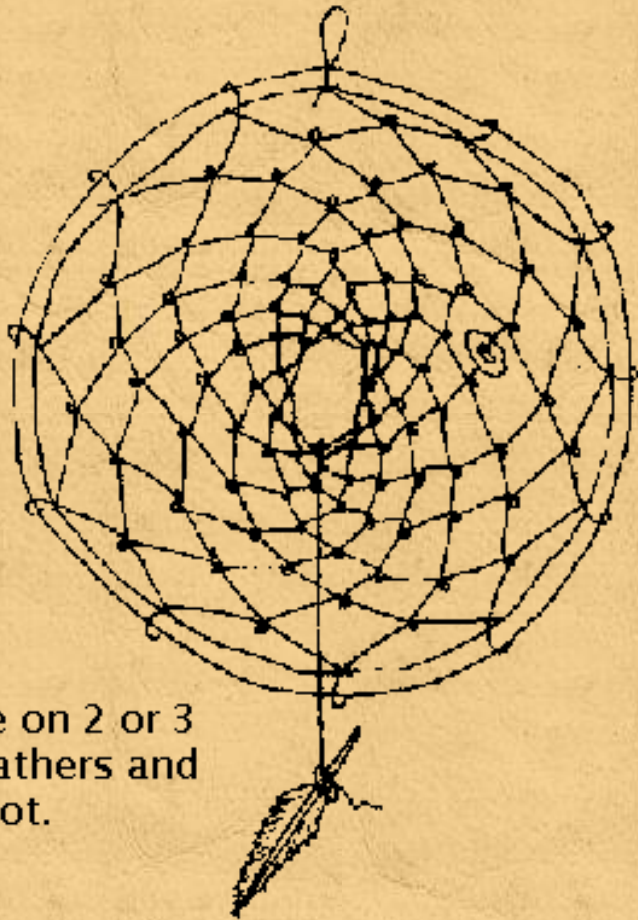
**10. As you pull each stitch tight, the string from the previous round should bend towards the center of the hoop slightly, forming a diamond shape. You should see the spider web beginning to form.**

**11. On the third or fourth round add a bead to represent the spider in the web. Simply place the bead on your string and continue stitching as usual.**



**12. Continue stitching towards the center of the hoop. Eventually, the stitches become so small that it is difficult to pass the string through. Make sure you leave a hole in the center of the dreamcatcher.**

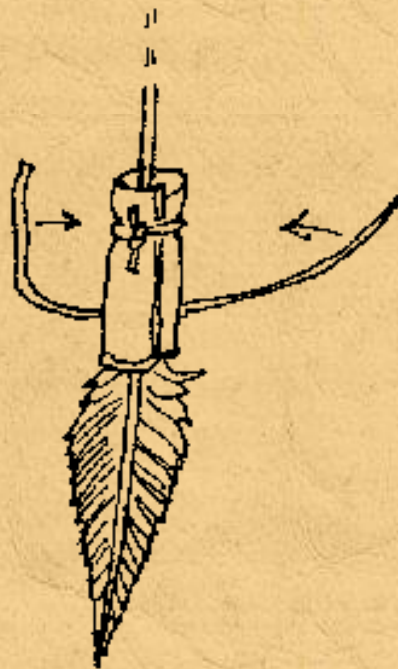
**13. Stop stitching at the bottom of the hole in the center of the dream catcher. End by stitching twice in the same place, forming a knot, and pull tight.**



Tie on 2 or 3 feathers and knot.

14. You should have 6 - 8 in. of string to tie 2 or 3 feathers which dangle from the center of the dreamcatcher.

Tie on 2 or 3 feathers and knot.



15. Wrap a 1 in. square of felt around the knot of string and over the base of the feathers. Tie two 4 In. pieces string around the wrapped felt.

16. Hang over sleeping place. Sweet Dreams!!

---

[Origin of the Dream Catcher](#)

---

[Return to Willow Branches and Other Twigs and Roots Background](#)

[Branches, Twigs & Roots Bibliography and Books to Buy On-Line](#)

[Return to NativeTech's Branches, Twigs & Roots Menu](#)

---



Text and Graphics  
© 1994 - 103 [Tara Prindle](#)  
unless otherwise cited.



## NativeTech: Native American Technology and Art

### Cornhusks

-  [Native American History of Corn](#)
-  [Planting a Three Sisters Garden](#)
-  [Cornhusk Dolls](#)
-  [Twined Cornhusk Bottles](#)
-  [Cornhusk Masks](#)
-  [Cornhusk Bibliography and Books to buy On-line](#)

[Other Internet Resources for Cattails & Grasses](#)



© 1994-2002 [Tara Prindle](#).



## NATIVE AMERICAN HISTORY OF CORN

---

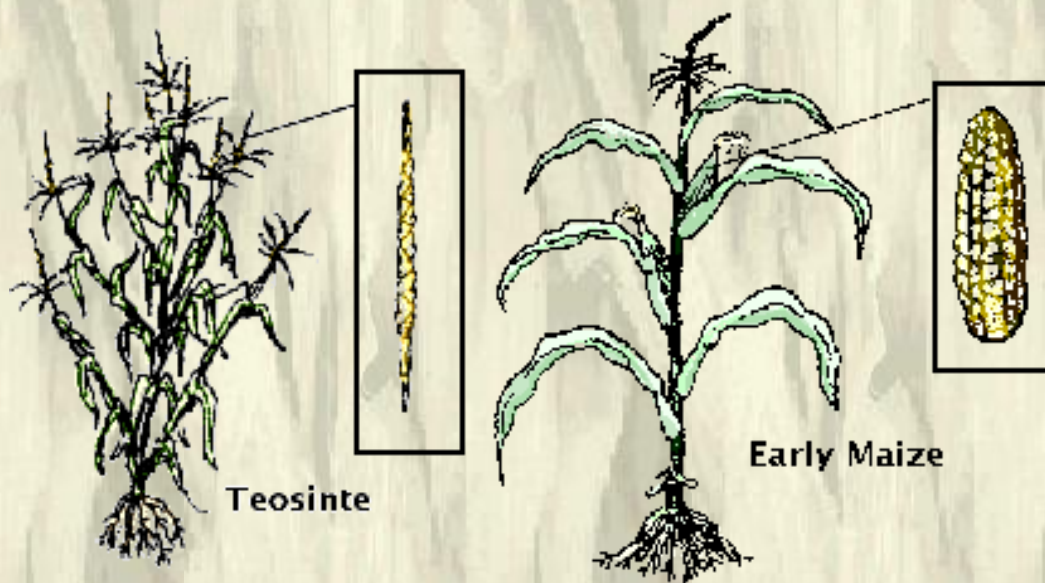
[Read about some Uses of Indian Corn](#)

[Try some Recipes from the Woodland Culture Area](#)

---

### Evolution of Maize Agriculture

Corn or maize (*zea mays*) is a domesticated plant of the Americas. Along with many other indigenous plants like beans, squash, melons, tobacco, and roots such as Jerusalem artichoke, European colonists in America quickly adopted maize agriculture from Native Americans. Crops developed by Native Americans quickly spread to other parts of the world as well.



Over a period of thousands of years, Native Americans purposefully transformed maize through special cultivation techniques. Maize was developed from a wild grass (Teosinte) originally growing in Central America (southern Mexico) 7,000 years ago. The ancestral kernels of Teosinte looked very different from today's corn. These kernels were small and were not fused together like the kernels on the husked ear of early maize and modern corn.



**By systematically collecting and cultivating those plants best suited for human consumption, Native Americans encouraged the formation of ears or cobs on early maize. The first ears of maize were only a few inches long and had only eight rows of kernels. Cob length and size of early maize grew over the next several thousand years which gradually increased the yields of each crop.**

**Eventually the productivity of maize cultivation was great enough to make it possible and worthwhile for a family to produce food for the bulk of their diet for an entire year from a small area. Although maize agriculture permitted a family to live in one place for an extended period of time, the commitment to agriculture involved demands on human time and labor and often restricted human mobility. The genetic alterations in teosinte changed its value as a food resource and at the same time affected the human scheduling necessary for its effective procurement.**

## **Maize in New England**

**As the lifeways of mobile hunting and gathering were often transformed into sedentary agricultural customs, very slowly the cultivation of maize, along with beans and squash, was introduced into the southwestern and southeastern parts of North America. The practice of maize agriculture did not reach southern New England until about a thousand years ago.**

**A Penobscot man described the transformation of maize for the shorter growing season of northern New England. Maize was observed to grow in a series of segments, like other members of the grass family, which took approximately one phase of the moon to form, with approximately seven segments in all, from which ears were produced only at the joints of the segments. Native Americans of northern New England gradually encouraged the formation of ears at the lower joints of the stalk by planting kernels from these ears. Eventually, as ears were regularly produced at the lower joints of the cornstalk, the crop was adapted to the shorter growing season of the north and matured within three months of planting.**

**Native Americans of New England planted corn in household gardens and in more extensive fields adjacent to their villages. Fields were often cleared by controlled burning which enriched not only the soil but the plant and animal communities as well. Slash and burn agriculture also helped create an open forest environment, free of underbrush, which made plant collecting and hunting easier.**

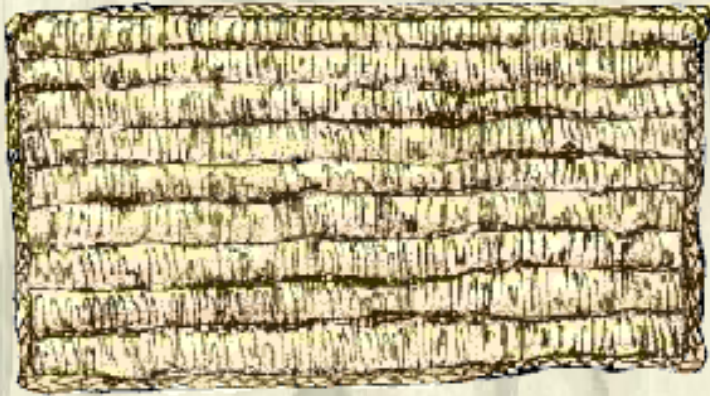
**Agricultural fields consisted of small mounds of tilled earth, placed a meter or two apart sometimes in rows and other times randomly placed. Kernels of corn and beans were planted in the raised piles of soil to provide the support of the cornstalk for the bean vine to grow around. The spaces in between the mounds were planted with squash or melloon seeds. The three crops complemented each other both in the field and in their combined nutrition.**

**Native Americans discovered that, unlike wild plants and animals, a surplus of maize could be grown and harvested without harming their environment. Tribes in southern New England harvested great amounts of maize and dried them in heaps upon mats. The drying piles of maize, usually two or three for each Narragansett family, often contained from 12 to 20 bushels of the**

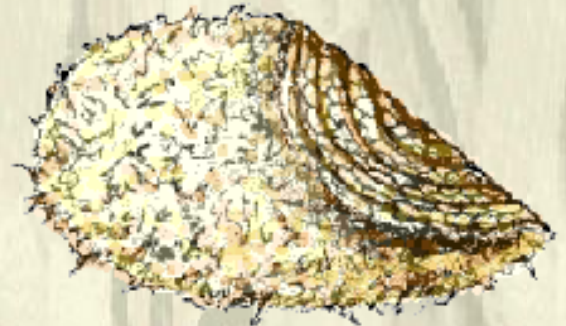


**grain. Surplus maize would be stored in underground storage pits, ingeniously constructed and lined with grasses to prevent mildew or spoiling, for winter consumption of the grain.**

**The European accounts of Josselyn in 1674, indicate Native Americans used bags and sacks to store powdered cornmeal, "which they make use of when stormie weather or the like will not suffer them to look out for their food". Parched cornmeal made an excellent food for traveling. Roger Williams in 1643, describes small traveling baskets: "I have travelled with neere 200. of them at once, neere 100. miles through the woods, every man carrying a little Basket of this [Nokehick] at his back, and sometimes in a hollow Leather Girdle about his middle, sufficient for a man three or foure daies".**



Cornhusk bed mat; Iroquois.  
Rolled husks sewn with basswood cord.  
Braided Edge.



Cornhusk foot mat; Seneca.  
Braided and sewn in a coil.  
Fringe from spliced cornhusks left on one side.

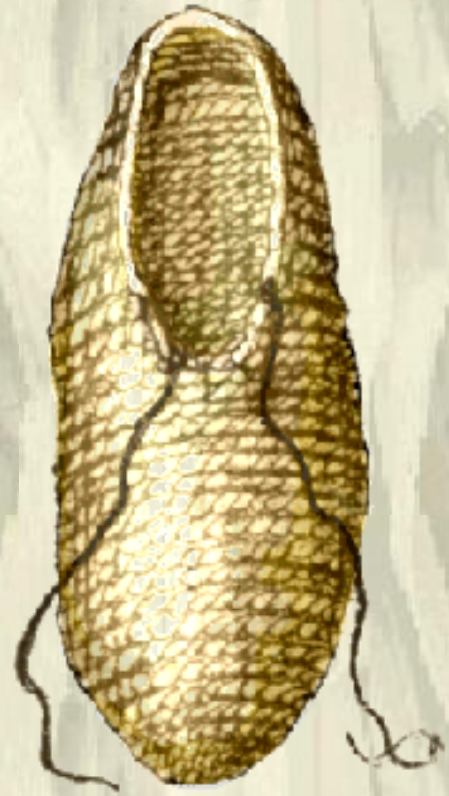
## **Native American Origins of Maize**

**Many Native American traditions, stories and ceremonies surround corn, one of the "three sisters" (maize, beans and squash). Even in New England there are many variations on how maize was brought or introduced to Native Americans here. Generally in southern New England, maize is described as a gift of Cautantowwit, a deity associated with the southwestern direction; that kernels of maize and beans were delivered by the crow, or in other versions the black-bird. Responsible for bringing maize, the crow would not be harmed even for damaging the cornfield. Other Algonquian legends recount maize brought by a person sent from the Great Spirit as a gift of thanks.**





Cornhusk, wool and basswood cord twined bag; Narragansett (made in 1675).



Cornhusk moccasin; Seneca. Two-strand twined construction.

**New England tribes from the Mohegan in Connecticut to the Iroquois in the Great Lakes region had rituals and ceremonies of thanksgiving for the planting and harvesting of corn. One ceremony, the Green Corn ceremony of New England tribes, accompanies the fall harvest. Around August Mahican men return from temporary camps to the village to help bring in the harvest and to take part in the Green Corn ceremony which celebrates the first fruits of the season. Many tribes also had ceremonies for seed planting to ensure healthy crops as well as corn testing ceremonies once the crops were harvested.**

---

[Return to NativeTech's Main Cornhusk Menu](#)

[Cornhusk Bibliography and Books to Buy On-Line](#)

---



© 1994-1999 [Tara Prindle](#).

## Native American Technology and Art

Exerpts from [TEACHING ABOUT THANKSGIVING](#)  
From The Fourth World Documentation Project

### Indian Corn

---

Corn was a very important crop for the people of the northeast woodlands. It was the main food and was eaten at every meal. There were many varieties of corn -- white, blue, yellow and red.

Some of the corn was dried to preserve and keep it for food throughout the winter months. Dried corn could be made into a food called hominy. To make hominy, the dried corn was soaked in a mixture of water and ashes for two days. When the kernels had puffed up and split open, they were drained and rinsed in cold water. Then the hominy was stir-fried over a fire. You can buy canned hominy in most grocery stores. Perhaps someone in your class would like to bring some for everyone to sample.

Corn was often ground into corn meal, using wooden mortars and pestles. The mortars were made of short logs which were turned upright and hollowed out on the top end. The corn was put in the hollow part and ground by pounding up and down with a long piece of wood which was rounded on both ends. This was called a pestle.

Corn meal could be used to make cornbread, corn pudding, corn syrup, or could be mixed with beans to make succotash. A special dessert was made by boiling corn meal and maple syrup.

All parts of the corn plant were used. Nothing was thrown away. The husks were braided and woven to make masks, moccasins, sleeping mats, baskets, and cornhusk dolls. Corncobs were used for fuel, to make darts for a game, and were tied onto a stick to make a rattle for ceremonies.

Corn was unknown to the Europeans before they met the Indians. Indians gave them the seeds and taught them how to grow it. Today in the U.S.A., more farm land is used to grow corn (60 million acres) than any other grain.

From: *Woodland Culture Area*, Ross/Fernandes, 1979

---



[Return to Native American History of Corn](#)

[Return to NativeTech's Main Cornhusk Menu](#)

[Cornhusk Bibliography and Books to Buy On-Line](#)

---



© 1994-1999 [Tara Prindle.](#)

## Planting a Three Sisters Garden...

---



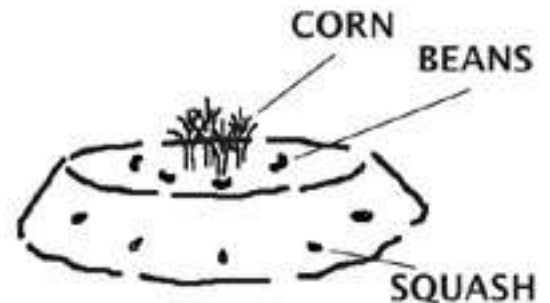
*The Three Sisters all work together. Critters will find it harder to invade your garden by interplanting your corn, beans and squash. The corn stalk serves as a pole for the beans, the beans help to add the nitrogen to the soil that the corn needs, and the squash provides a ground cover of shade that helps the soil retain moisture.*



---

**1. In late May or early June, hoe up the ground and heap the earth into piles about a foot high and about 20 across. The centers of your mounds should be about four feet apart and should have flattened tops.**

**2. First, in the center of each mound, plant five or six corn kernels in a small circle.**



*Sarah's Three Sisters*

**3. After a week or two, when the corn has grown to be five inches or so, plant seven or eight pole beans in a circle about six inches away from the corn kernels.**

**4. A week later, at the edge of the mound about a foot away from the beans, plant seven or eight squash or pumpkin seeds.**

**5. When the plants begin to grow, you will need to weed out all but a few of the sturdiest of the corn plants from each mound. Also keep the sturdiest of the bean and squash plants and weed out the weaker ones.**



**6. As the corn and beans grow up, you want to make sure that the beans are supported by cornstalks, wrapping around the corn. The squash will crawl out between the mounds, around the corn and beans.**

**Enjoy your harvest!!!**

---

[Read about the Native American History of Corn](#)

[Return to NativeTech's Main Cornhusk Menu](#)

[Cornhusk Bibliography and Books to Buy On-Line](#)

---



© 1994-2001 [Tara Prindle.](#)



**NativeTech: Native American Technology & Art**



**CORNHUSK BIBLIOGRAPHY**

Click on the links below for the books you can order on-line in affiliation with [barnesandnoble.com](http://barnesandnoble.com)

---

*References cited in NativeTech's [Cornhusk articles](#):*

**Chief Leon Shenandoah**

**1995 "Haudenosaunee Confederacy Announces Policy On False Face Masks".**  
In Akwesasne Notes. Vol. 1.

**Hart, Carol and Dan Hart**

**1976 Natural Basketry.**  
Watson-Guptill Publications: New York.  
[Order this book through barnesandnoble.com](#)

**Josselyn, John**

**1972 New-Englands Rarities Discovered.**  
Meriden: Meriden Gravure Co. (First published 1672).  
[Order this book through barnesandnoble.com](#)

**Lyford, Carrie A.**

**1945 Iroquois Crafts.**  
US Department of the Interior, Bureau of Indian Affairs, Division of Education. Reprinted by Irocrafts, Ltd: Ontario, Canada.  
[Order this book through barnesandnoble.com](#)

**Speck, Frank G.**

**1976 Penobscot Man: The Life History of a Forest Tribe in Maine.**  
New York: Octagon Books.  
[Order this book through barnesandnoble.com](#)

**Speck, Frank G. and William N. Fenton (Introduction)**

**1995 Midwinter Rites of the Cayuga Long House.**  
University of Pennsylvania Press. Reprinted by Irocrafts, Ltd: Ontario, Canada. Original printing 1949.  
[Order this book through barnesandnoble.com](#)

**Tooker, Elisabeth**

**1994 Lewis H. Morgan on Iroquois Material Culture.**

**University of Arizona Press: Tucson & London.**  
[Order this book through barnesandnoble.com](http://www.barnesandnoble.com)

**Turnbaugh, William A. and Sarah P. Turnbaugh**  
**1986 Indian Baskets.**  
West Chester PA: Schiffer Publishing Company.  
[Order this book through barnesandnoble.com](http://www.barnesandnoble.com)

**Williams, Roger**  
**1973 Key into the Language of America.**  
J.J. Teunissen and E.J. Hinz, ed.s. Detroit: Wayne State University Press. (First printed 1643).  
[Order this book through barnesandnoble.com](http://www.barnesandnoble.com)

---

*Other Books relating to Cornhusks you can buy on-line through*  
[\*barnesandnoble.com:\*](http://www.barnesandnoble.com)

**Carol Buchanan**  
[Brother Crow, Sister Corn: Traditional American Indian Gardening](http://www.barnesandnoble.com)

**Dorothy Rhoads, Jean Charlot (Illustrator)**  
[The Corn Grows Ripe](http://www.barnesandnoble.com)

**Mary W. Eubanks**  
[Corn in Clay: Maize Paleoethnobotany in Pre-Columbian Art](http://www.barnesandnoble.com)

**Alan R. Sandstrom**  
[Corn Is Our Blood: Culture and Ethnic Identity in a Contemporary Aztec Indian Village, Vol. 206](http://www.barnesandnoble.com)

**Frances Gwaltney**  
[Corn Recipes from the Indians](http://www.barnesandnoble.com)

**Cheney Cowles**  
[Cornhusk Bags of the Plateau Indians](http://www.barnesandnoble.com)

**Peg Back, Designed by Paul Lansdale**  
[Crickets and Corn: Five Stories about Native North American Children](http://www.barnesandnoble.com)

**Sally M. Hunter, Carly Bordeau (Illustrator), Joe Allen (Photographer)**



**[Four Seasons of Corn a Winnebago Tradition](#)**

**Carol Cornelius**

**[Iroquois Corn in a Culture-Based Curriculum: A Framework for Respectfully Teaching about Cultures](#)**

**Christy G. Turner, Jacqueline A. Turner**

**[Man Corn: Cannibalism and Violence in the Prehistoric American Southwest](#)**

**Mary-Joan Gerson, Carla Golembe (Illustrator)**

**[People of Corn: A Mayan Story](#)**

**Harold Courlander, Enrico Arno (Illustrator)**

**[People of the Short Blue Corn: Tales and Legends of the Hopi Indians](#)**

**Ramon A. Gutierrez**

**[When Jesus Came, the Corn Mothers Went Away: Marriage, Sexuality, and Power in New Mexico, 1500-1846](#)**

**Additional book list being compiled.  
In the meantime,**

**[Click here to Search for Books about Indian Corn](#)**

**[Search for Books at  
barnesandnoble.com](#)**

Search by:

---

**[Return to NativeTech's Main Cornhusk Menu](#)**

---





© 1994-1999 [Tara Prindle](#).

## Native American Technology and Art

### About Cornhusk Dolls...

---

[Read the Story of Why Cornhusk Dolls have No Face...](#)

[See the Instructions for Making Cornhusk Dolls](#)

---



**Cornhusk dolls have been made by Northeastern Native Americans probably since the beginnings of corn agriculture more than a thousand years ago. Brittle dried cornhusks become soft if soaked in water, and produce finished dolls sturdy enough for Penobscot children's toys.**

**In addition to their use for amusement, some cornhusk dolls are used in sacred healing ceremonies. A type of Iroquois cornhusk doll was made in response to a dream. The doll was then discarded, put back to earth to carry away the evil of the dream.**

**Both boy and girl dolls are made using the corn silk tassel for hair. Feet and body are stuffed with leaves and tied while arms and legs are made from braided or rolled husks. Dolls measure anywhere between four and ten inches tall. Sometimes a face is drawn, or red dots are painted for cheeks; but more often than not the doll's face is left blank.**

**The dolls are often dressed in cornhusks, animal hide or cloth but some are made without clothing. Personal equipment is produced for many dolls, and this helps children practice to prepare the things needed for everyday life. Girl dolls would be given cradle boards, hoes, sewing kits or other women's things, while boys could be provided with bows and arrows, canoe paddles and warrior's gear.**

---

[Return to NativeTech's Main Cornhusk Menu](#)

[Cornhusk Bibliography and Books to Buy On-Line](#)



© 1994-1999 [Tara Prindle](#).



## Native American Technology and Art

Exerpts from [TEACHING ABOUT THANKSGIVING](#)  
From The Fourth World Documentation Project

### Story of the Corn Husk Doll

---

This legend is told by Mrs. Snow,  
a talented Seneca craftswoman.



Many, many years ago, the corn, one of the Three Sisters, wanted to make something different. She made the moccasin and the salt boxes, the mats, and the face. She wanted to do something different so the Great Spirit gave her permission. So she made the little people out of corn husk and they were to roam the earth so that they would bring brotherhood and contentment to the Iroquois tribe. But she made one that was very, very beautiful. This beautiful corn person, you might call her, went into the woods and saw herself in a pool. She saw how beautiful she was and she became very vain and naughty. That began to make the people very unhappy and so the Great Spirit decided that wasn't what she was to do. She didn't pay attention to his warning, so the last time the messenger came and told her that she was going to have her punishment. Her punishment would be that she'd have no face, she would not converse with the Senecas or the birds or the animals. She'd roam the earth

forever, looking for something to do to gain her face back again. So that's why we don't put any faces on the husk dolls.

From: *Our Mother Corn* Mather/Fernandes/Brescia 1981

---

[Return to Native American History of Corn](#)

[Return to NativeTech's Main Cornhusk Menu](#)

[Cornhusk Bibliography and Books to Buy On-Line](#)

---



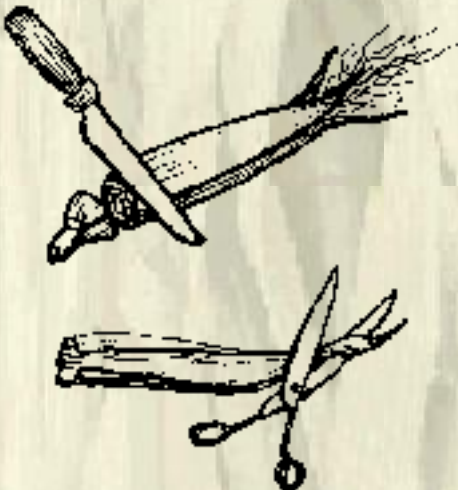
© 1994-1999 [Tara Prindle.](#)

## Native American Technology and Art



### Instructions for Cornhusk Dolls

**These dolls are based on Penobscot Dolls illustrated by Frank G. Speck in the mid-1900's. You will need the husks from one or two ears of corn for a 6" doll. This should take you about 1 hour to make. Soak cornhusks (that have been thoroughly dried beforehand) for 10 minutes in warm water.**



- 1. Cut cob, remove husks and save 'hair. Dry everyting in the sun for 1-3 days.**
- 2. Soak 10 minutes before using husks. Cut thin ends off.**



**3. Bundle thin end of 6 leaves around 'hair', slick side of leaves inward. Tie tightly.**



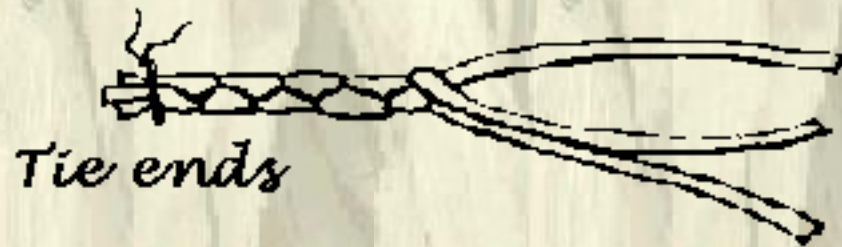
**4a. Peel leaves around to form head. Hair should sprout up in the middle.**



**4b. Tie neck area tightly.**



**5. Braid 3 strips of a leaf into a 6 inch piece for the arms.**



**6. Braid 2 more lengths in the same way to use later for the 2 legs.**



**7. Put arms under neck. Insert rolled leaf to fill out and form body. Tie waist area.**







**8. Insert legs and secure by tying 2 leaves front to back, then trim excess below waist.**

**9. Wrap and tie one or two strips around top of legs to form hips.**



Decide on the clothing to make for the cornhusk doll...

[Woman's Clothing for a Cornhusk Doll](#)

[Men's Clothing for a Cornhusk Doll](#)

---

[Return to "About Cornhusk Dolls..."](#)

[Return to NativeTech's Main Cornhusk Menu](#)

[Cornhusk Bibliography and Books to Buy On-Line](#)

---



© 1994-1999 [Tara Prindle](#).



## Native American Technology and Art

# Instructions for Women's Clothing for a Cornhusk Doll

---

[\(or see the Men's Clothing for Cornhusk Dolls\)](#)

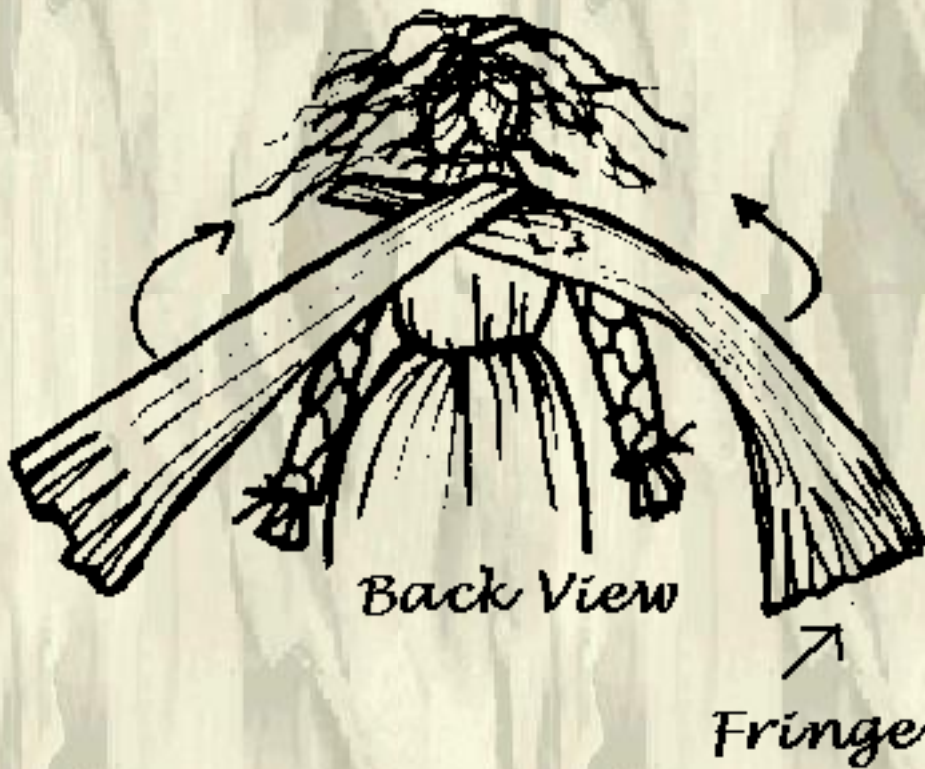
---

... a continuation from [Cornhusk Doll Instructions](#)



1. Tie thin end of 6 leaves around the waist with the broad ends pointing up toward the head. Peel the leaves down over the tie to form the skirt.

2. For the shawl, twist the thin ends of two leaves at the back of the doll's neck.



3. Bring the broad ends of the shawl leaves around the shoulders to the front of the doll, so they cross over the chest.

4. Tie a wide belt at the waist, over the shawl and tie at the back of the skirt.

[Return to "About Cornhusk Dolls..."](#)

[Return to NativeTech's Main Cornhusk Menu](#)

[Cornhusk Bibliography and Books to Buy On-Line](#)

---



© 1994-1999 [Tara Prindle.](#)



## Native American Technology and Art

### Instructions for Men's Clothing for a Cornhusk Doll

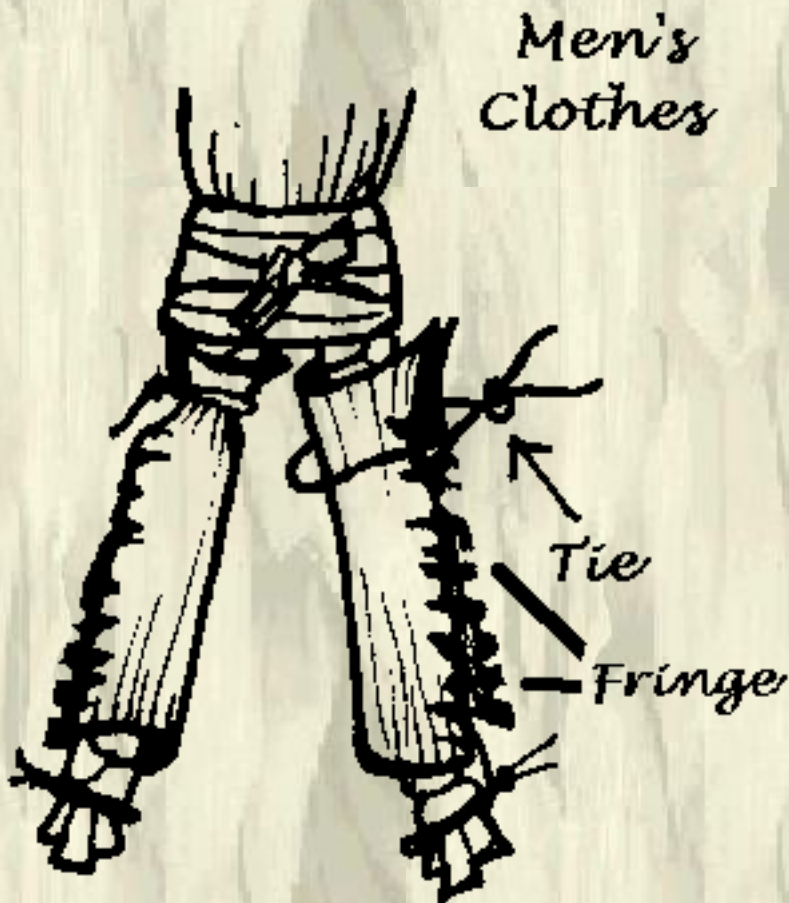
---

[\(or see the Women's Clothing for Cornhusk Dolls\)](#)

---

... a continuation from [Cornhusk Doll Instructions](#)

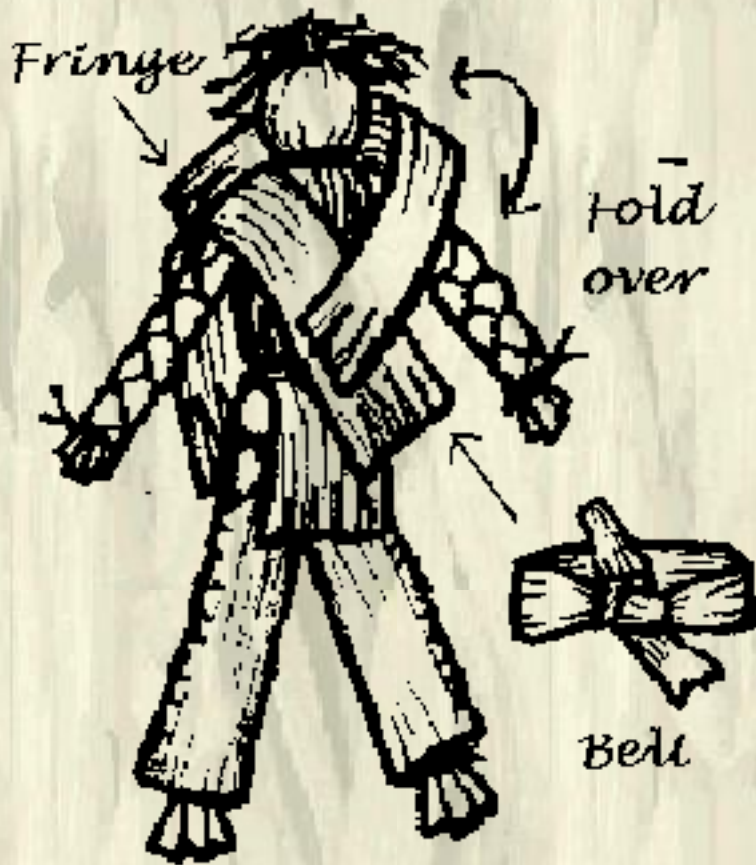
1. Tie rectangular piece of leaf at top of each leg for leggins. Snip fringe along outside of each leg.



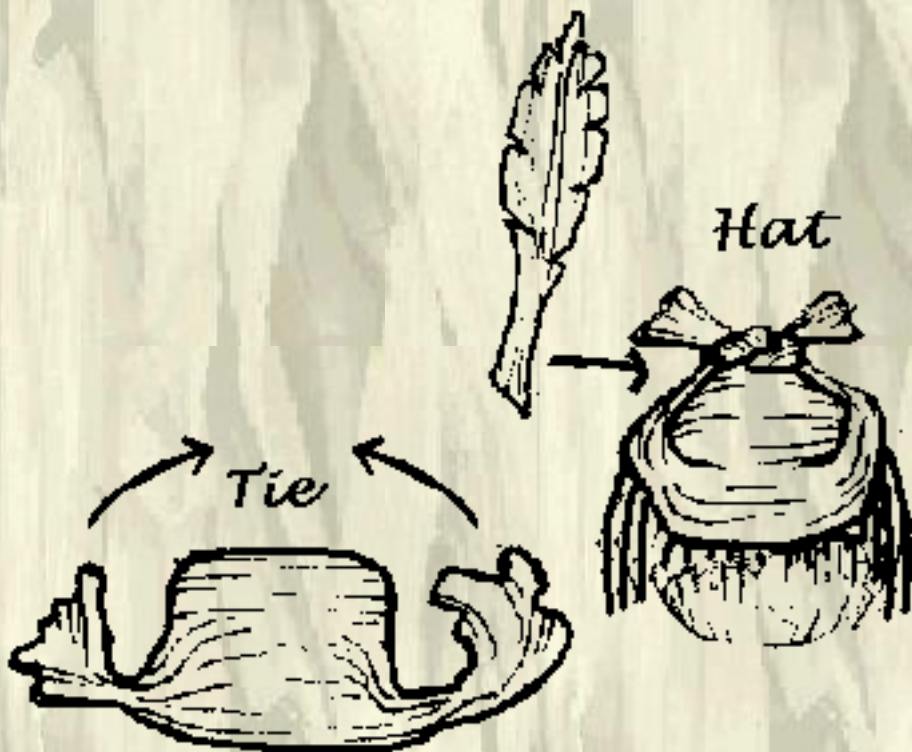


**2. For loincloth, put long rectangular piece of leaf between legs, tie at waist and flip down over the tie.**

**3. Men's shirt from two fringed strips that cross in front and in back. Secured with narrow belt that ties in front.**



4. Men's hat from a single piece with tabs tied at back of head and over the 'hair'. Insert husk-'feather' into fold in hat.





[Return to "About Cornhusk Dolls..."](#)

[Return to NativeTech's Main Cornhusk Menu](#)

[Cornhusk Bibliography and Books to Buy On-Line](#)

---



© 1994-1999 [Tara Prindle.](#)

## Native American Technology and Art



# Twined Cornhusk Bottles and Baskets

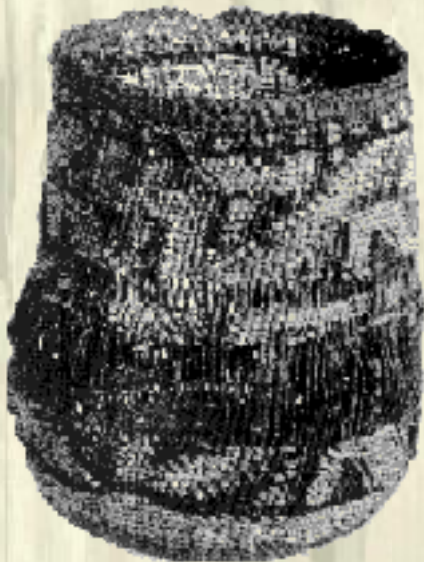
*Twined cornhusk salt or tobacco bottle ~ Seneca [Turnbaugh & Turnbaugh 1986]*

---

[Read the Story of the Seven Thunders](#)

[See the Instructions for Making Twined Cornhusk Bottles](#)

---



In the fall, the Iroquois and other Native American women harvested corn from their gardens. To prepare the corn for storage, the husks were folded back from the ears and braiding, forming long ropes of husk with dangling ears of corn. The corn could be hung by these ropes to dry and later prepared for storage in baskets or earthen pits. The cornhusks were then used for many purposes, for cordage, for wrappers to cook food, for fire tinder, for stuffing mattresses or cushions, and for many woven items including mats, masks, shoes and baskets. Braiding, coiling, sewing and twining were some of the methods used to weave objects from cornhusks.

*Twined cornhusk, wool and basswood basket ~ Narragansett. [Turnbaugh & Turnbaugh 1986].*

**Twined cornhusk baskets are made by many eastern Woodland Native Americans, including the Iroquois. One such basket, called 'Ga-nose-ha', was made to contain coarse corn meal. This basket is constructed of cornhusks and blue flag leaves. Cornhusks are used for the warp, or ribs, of the basket, the**



bottom of the basket is made using cornhusk weft, and the top uses weft of blue flag. Although blue flag leaves are not as durable as cornhusks, they are longer and don't require as much splicing together when the basket is formed.



*Cornhusk bottles for salt  
~ Iroquois. [Tooker 1994].*

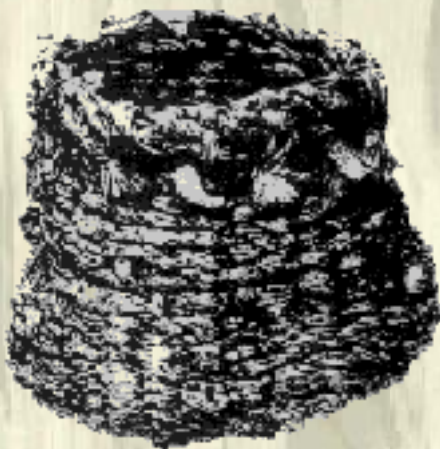
as 'bottle'. These twined bottles sometimes combined flag leaves in the weaving. A stopper made from a corn cob was used to keep these bottles sealed.

Another type of twined cornhusk basket was water tight. This basket was used historically to store salt. The Iroquois word for this basket is 'Gus-ha-da', which translates as into English



*Cornhusk bottle reproduction  
[by Prindle 1999].*

Traditionally, one type of Cayuga cornhusk basket is meant to contain tobacco. The basket and the tobacco kept inside are used for an offering during the Thunder Rite and Ball Game, one of the ceremonies performed by the Cayuga unrestricted societies. This one day ceremony is performed during the summer to honor the Seven Thunders, or Grandfathers. The Cayuga are thankful for what the Thunders do as envoys of the Great Spirit. The Thunder rite is performed to ask these Grandfathers to continue to carry out the desires of the Great Spirit which benefit people.



*Cornhusk basket for burn tobacco  
offering ~ Iroquois. [Speck 1949].*

The main part of this ceremony consists of the Ball Game. This traditional Ball Game, also called Lacrosse, has survived the centuries and is still played, both in ceremony, and as a 'modern' sport, by both Native and non-Natives. The game is called 'Gatci-kwae' (beating the mush) and is played between the younger and older men, often from opposing clans. The playing course consists of a large space between two sets of goals (posts set 7 feet apart), and the team to first score seven points wins the game.

Before the Ball Game is played, the players and participants gather at the edge of the course where they ingest a medicine, an emetic, which purifies their bodies. A fire is also built outside the Long House for the ceremony, where the leader offers prayers to the Seven Thunders. It is accompanying these prayers to



**the Thunders that the cornhusk basket containing tobacco is placed in the fire and consumed by flames. A Cayuga explained that the cornhusk basket is given to the Grandfather Thunder to keep his tobacco while he travels. The players of the game are instructed to play fairly and to compete in good faith.**



*Cornhusk basket ~ Iroquois.  
[Lyford 1945].*

**It is really of no consequence to the players or to the spectator who wins the game. Following the game, the players sing the Thunder song and dance their way back to the Long House, where additional songs and thanks are offered, and tobacco and corn mush are given to the Ball Game players. Often other people bring gifts to the Long House, and these gifts are also distributed amongst the players, accompanied by prayers for the players and for those that brought the gifts. The ceremony, including episodes of songs and dancing, and then gift giving, continues until all the offerings have been given away.**

---

[Return to NativeTech's Main Cornhusk Menu](#)

[Cornhusk Bibliography and Books to Buy On-Line](#)

---



© 1994-2000 [Tara Prindle.](#)

## Native American Technology and Art Cornhusk Bottles ~ Story of the Seven Thunders

---

The Cayuga refer to the Seven Thunders as 'oki-sot hega-kwes tene-tkwa hadi-wenotadyes', 'Grandparents from the sunset coming sounding their voices'. According to oral tradition, there were originally six Thunders, and the seventh one was a man that joined them from this earth:

### Story of the Seven Thunders



*Iroquois mortar and pestle  
[Lyford 1945].*

Many years ago there were three brothers that wanted to find the place of the setting sun. Along the path to the setting sun, a spider had spun a web across the trail. In their efforts to get through the web, two of the brothers became trapped in the web and could not free themselves. The third brother somehow managed to free himself, followed the trail and finally reached the sky world and the place of the setting sun.

The man was greeted by the Six Thunders, who asked this man if he would like to join their world and help them work in the service of the Creator. The Thunders told him that if he agreed he would have to change his outward form. When the man agreed, the Thunders placed him in a corn mortar, ground the man to corn mush, and took him out and remolded him. With his body reformed the man joined the Thunders, and they taught him to be gentle, never to be too harsh with the people.

The Thunders create different sounds. If you notice, one sound is like two sticks hitting each other; that is the sound of the Seventh Thunder, the one from this earth. The Thunders protect the people by waging war against the snakes and monsters, keeping them under the earth where they live. The Thunders also work to cleanse this earth with their rain and winds.

---

[Return to Twined Cornhusk Bottles](http://www.nativetech.org/cornhusk/thunder.html)

[Return to NativeTech's Main Cornhusk Menu](#)

[Cornhusk Bibliography and Books to Buy On-Line](#)

---



© 1994-1999 [Tara Prindle.](#)



## NativeTech: Native American Technology and Art

### Instructions for Making a Twined Cornhusk Bottle

---

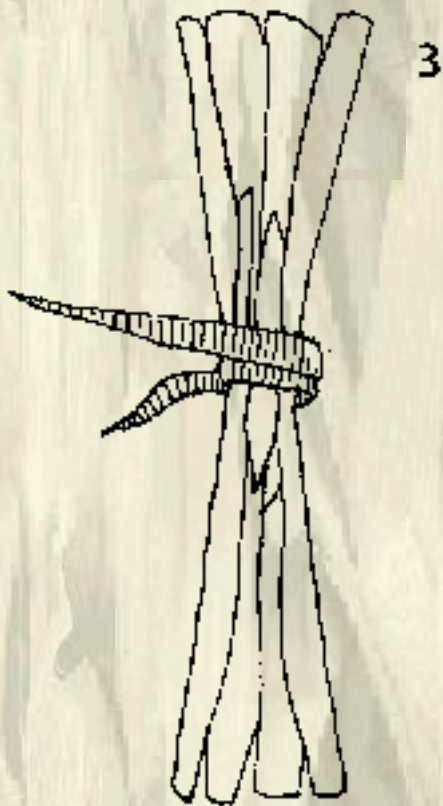
**You will need the husks from three or four ears of corn for a small 3" basket. This should take you about 2 hours to make. Soak cornhusks (that have been thoroughly dried beforehand) for 10 minutes in warm water.**



**1. Use the coarse, stiff outer husks for the spokes (warp); Use the tender, supple inner husks for the weavers (weft) of the basket.**



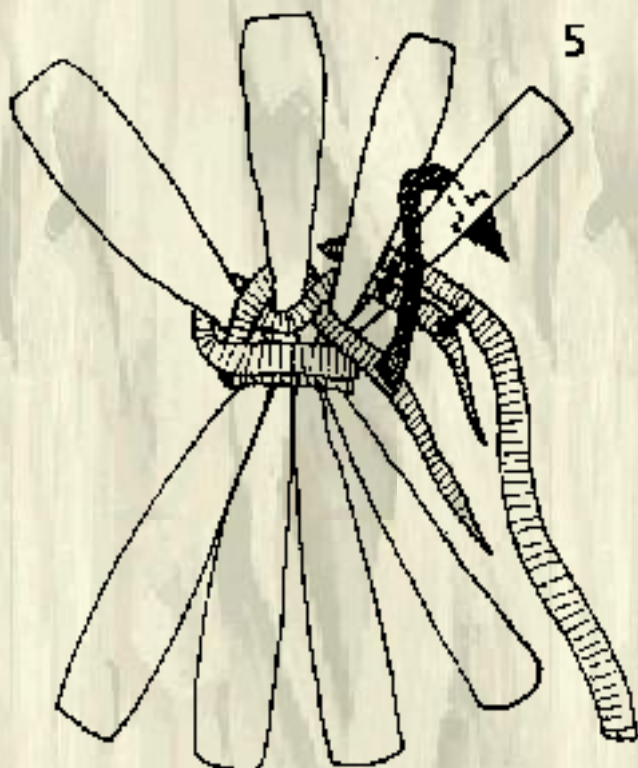
**2. For a small basket, use 8 corn husk leaves for the spokes . Place the thin, pointed ends together (four husks on each side), leave about 2 inches of overlap.**



**3. Use a long, tender inner husk and split it in half lengthwise. Wrap it twice (securely) around the center of the spokes. This forms the bottom center of the basket. You are looking at the exterior of the basket.**

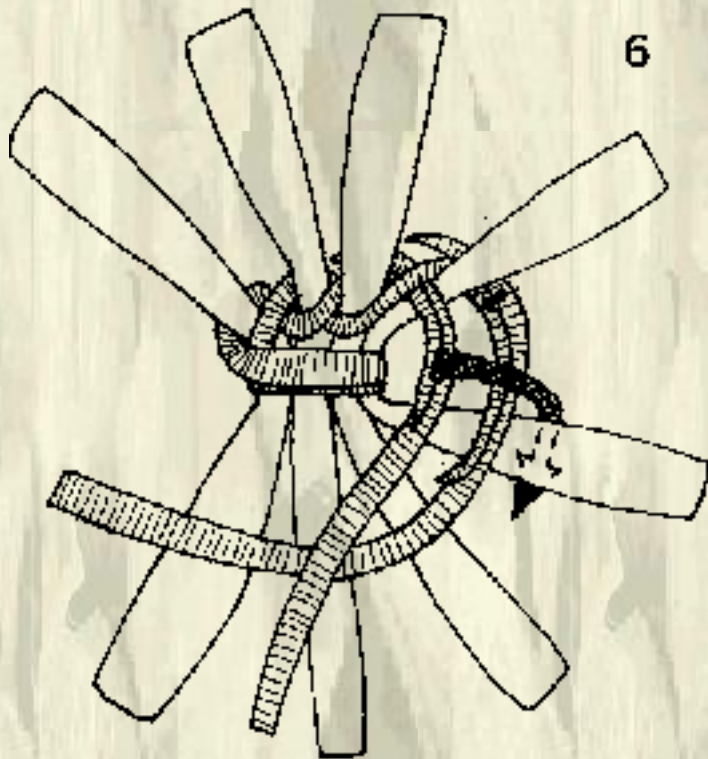


**4. You're ready to twine!**  
For now, each of the 8 leaves will be a spoke. For right handers, you will spiral in a clockwise direction. The twining consists of twisting the pair of weavers around each spoke. One weaver goes under the spoke as the other weaver goes over under.

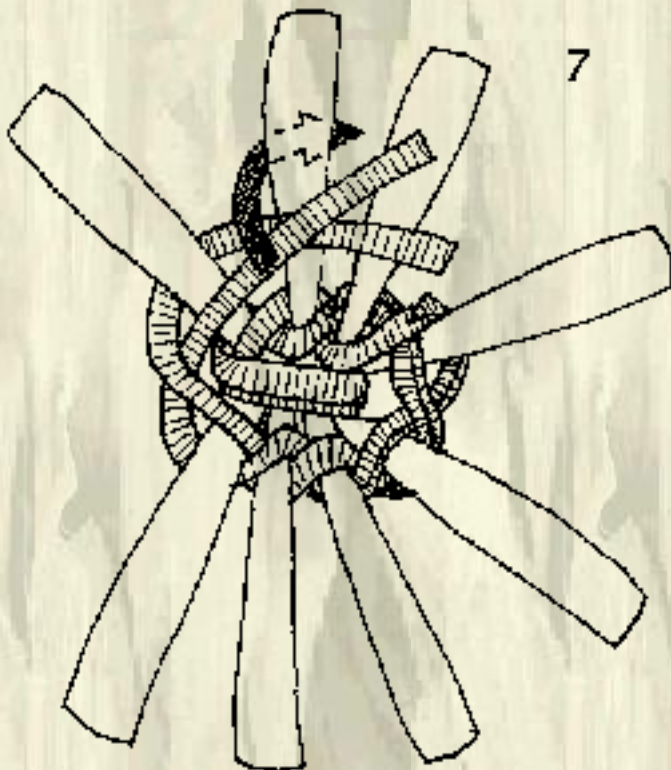


**5. Because cornhusks are short, you will need to splice in a new weaver very soon. With 2 inches of the short weaver left, lay a new split husk along side the old one and continue weaving both together until the old one runs out.**

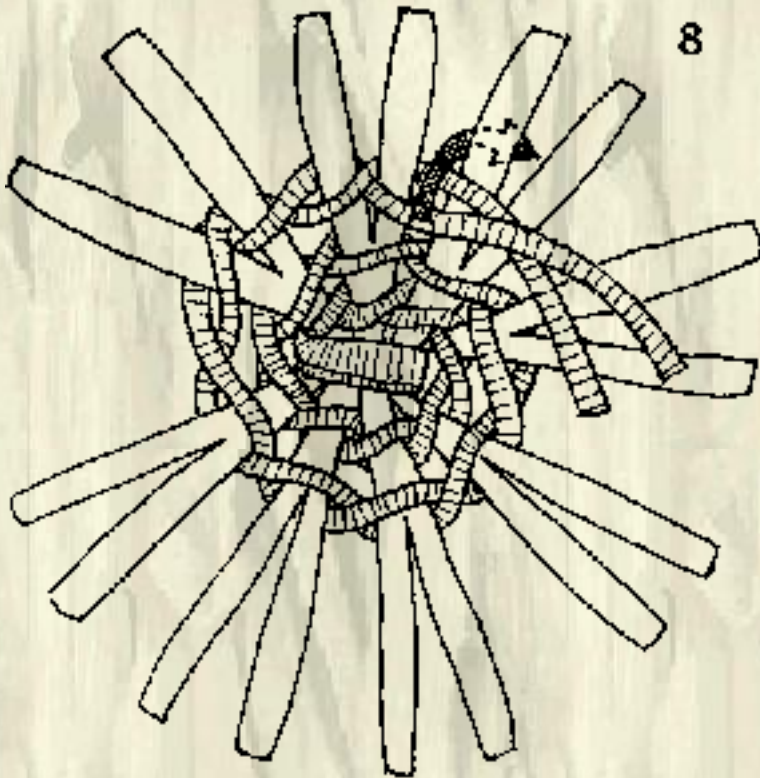




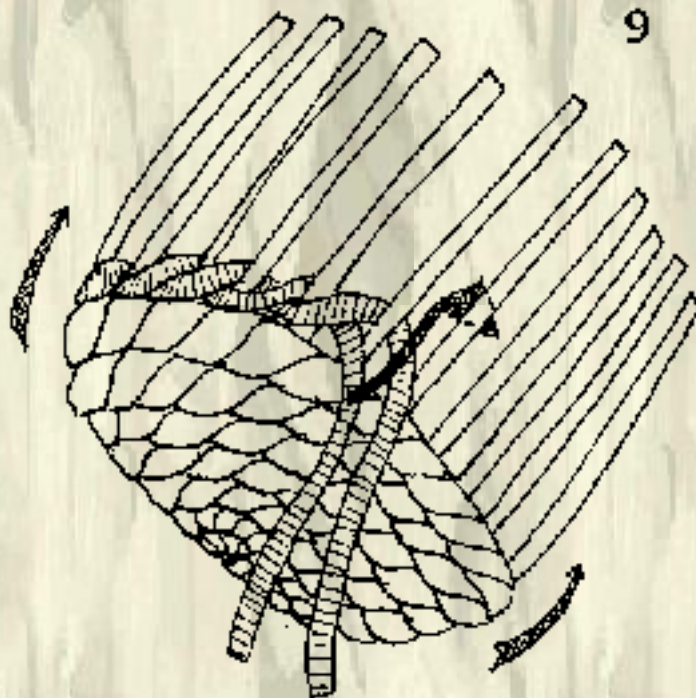
**6. Try not to let both weavers run out at the same time, or it will create a weak spot in your basket. If it look like they will both run short at the same time, splice in a new weaver earlier than you have to, to stagger the splicing.**



**7. The nice thing about twining is that you can have either an even or an odd number of spokes. As you complete the first 'round' of the basket, continue twisting the weavers around the spokes, creating a spiral, splicing in new leaves as necessary.**

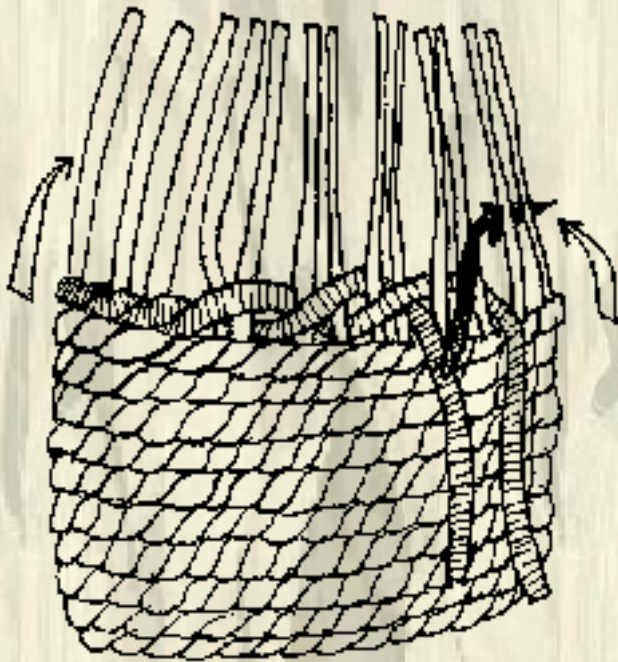


**8. After three or four rounds, you will need to increase the number of spokes. Split the existing spoke leaves in half. Begin twining around each half-leaf as a new spoke.**



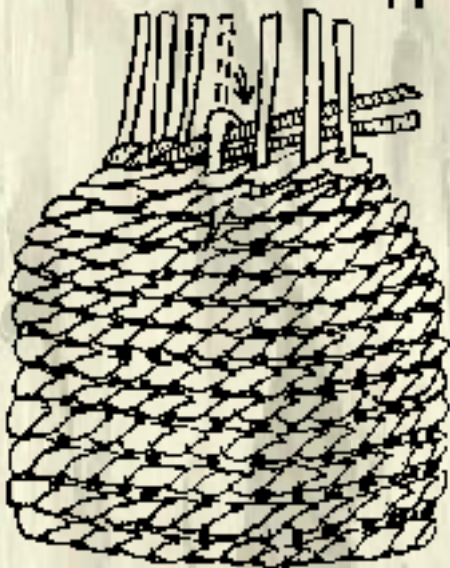
**9. Shape the basket by either pushing the spokes in, or pulling them out, as you twine the weavers. After 6 or 8 rounds the bottom of the basket is complete. Bend the spokes away from you as you twine to create the 'corner' of the basket. Continue twining up the sides of the basket, occasionally pull (gently) on the spokes to keep the rows of weaving tightly compressed. If you twine too tightly, the sides of your basket may begin to taper into a cone shape.**

10



**10. When the sides of the basket are complete you are ready to make the neck of the basket (you should have about 2 inches of spoke left sticking out the top). The sides of the basket need to contract, so begin to twine around two spokes at a time (pairs of spokes). Bend (push) the spokes in to form the shoulder.**

11



**11. With the final round of twining around the neck of the basket, lay the weavers parallel to the rim. Bend each spoke (one at a time) around the rim, and then poke it through a gap in the weavers about two rows down from the rim.**





**12. This shows a detail of finishing off the rim. A small hook works very well to pull the spokes through the weavers. Insert the hook through the weaving from the outside to the inside of the basket. Use the hook to grab a bent-over spoke and pull the spoke through the weaving. [A bent metal coat hanger section makes a wonderful hook]**



**13. Wrap and tuck all the spokes around the rim and through the weaving. Use scissors (or a flint knife) to trim the excess husk from the spokes that project from the weaving. You may also want to trim off any little bits of husk that stick out of the basket from where you spliced in weavers.**

---

[Return to Twined Cornhusk Bottles](#)

[Return to NativeTech's Main Cornhusk Menu](#)

[Cornhusk Bibliography and Books to Buy On-Line](#)

---



© 1994-1999 [Tara Prindle](#).

## Native American Technology and Art Why there are No Images of Cornhusk Masks

---

### **HAUDENOSAUNEE CONFEDERACY ANNOUNCES POLICY ON FALSE FACE MASKS**

*From the Spring (Vol. 1) 1995 issue of the Akwesasne Notes.*

**The Grand Council of the Haudenosaunee, The Six Nations Iroquois Confederacy, issues the following policy statement regarding all medicine masks of the Haudenosaunee:**

#### **Medicine Societies**

**Within the Haudenosaunee there are various medicine societies that have the sacred duty to maintain the use and strength of special medicines, both for individual and community welfare. A medicine society is comprised of Haudenosaunee who have partaken of the medicine and are thereby bound to the protection and perpetuation of tile special medicines. Such medicines are essential to the spiritual and emotional well-being of the Haudenosaunee communities. The medicine societies are a united group of individuals who must uphold and preserve the rituals that guard and protect the people, and the future generations.**

**Among these medicine societies are those that utilize the wooden masks and corn husk masks, which represent the shared power of the original medicine beings. Although there are variations of their images, all the masks have power and an intended purpose that is solely for the members of the respective medicine societies. Interference with the sacred duties of the societies and/or their masks is a violation of the freedom of the Haudenosaunee and does great harm to the welfare of the Haudenosaunee communities.**

#### **Status of Masks**

**All wooden and corn husk masks of the Haudenosaunee are sacred, regardless of size or age. By their very nature, masks are empowered the moment they are made. The image of the mask is sacred and is only to be used for its intended purpose. Masks do not have to be put through any ceremony or have tobacco attached to them in order to become useful or powerful. Masks should not be made unless they are to be used by members of the medicine society, according to established tradition.**

#### **Sales of Masks**

**No masks can be made for commercial purposes. Individuals who make masks for sale or sell masks to non-Indians violate the intended use of the masks, and such individuals must cease**



**these activities as they do great harm to the Haudenosaunee. The commercialization of medicine masks is an exploitation of Haudenosaunee culture.**

### **Authority over Medicine Masks**

**Each Haudenosaunee reservation has a medicine mask society that has authority over the use of masks for individual and community needs. Each society is charged with the protection of their sacred masks and the assurance of their proper use. The Grand Council of Chiefs has authority over all medicine societies and shall appoint individual leaders or medicine societies as necessary. However, no individual can speak or make decisions for medicine societies or the displacement of medicine masks. No institution has the authority over medicine masks, as they are the sole responsibility of the medicine societies and the Grand Council of Chiefs.**

### **Exhibition of Medicine Masks**

**The public exhibition of all medicine masks is forbidden. Medicine masks are not intended for everyone to see and such exhibition does not recognize the sacred duties and special functions of the masks.**

**The exhibition of masks by museums does not serve to enlighten the public regarding the culture of the Haudenosaunee as such an exhibition violates the intended purpose of the mask and contributes to the desecration of the sacred image. In addition, information regarding medicine societies is not meant for general distribution. The non-Indian public does not have the right to examine, interpret, or present the beliefs, functions, and duties of the secret medicine societies of the Haudenosaunee. The sovereign responsibility of the Haudenosaunee over their spiritual duties must be respected by the removal of all medicine masks from exhibition and from access to non-Indians.**

**Reproductions, castings, photographs, or illustrations of medicine masks should not be used in exhibitions, as the image of the medicine masks should not be used in these fashions. To subject the image of the medicine masks to ridicule or misrepresentation is a violation of the sacred functions of the masks.**

**The Council of Chiefs find that there is no proper way to explain, interpret, or present the significance of the medicine masks and therefore, ask that no attempt be made by museums to do so other than to explain the wishes of the Haudenosaunee in this matter.**

### **Return of Medicine Masks**

**All Haudenosaunee medicine masks currently possessed by non-Indians, including Museums, Art Galleries, Historical Societies, Universities, Commercial Enterprises, Foreign**

**Governments, and Individuals should be returned to the Grand Council of Chiefs of the Haudenosaunee, who will ensure their proper use and protection for the future generations.**

**There is no legal, moral, or ethical way in which a medicine mask can be obtained or possessed by a non-Indian individual or institution, as in order for a medicine mask to be removed from the society it would require the sanction of the Grand Council of Chiefs. This sanction has never been given. We ask all people to cooperate in the restoration of masks and other sacred objects to the proper caretakers among the Haudenosaunee. It is only through these actions that the traditional culture will remain strong and peace will be restored to our communities.**

**Dawnaytoh,  
Chief Leon Shenandoah, Tadadahoh  
Grand Council of the Haudenosaunee**

---

**[Return to NativeTech's Main Cornhusk Menu](#)**

**[Cornhusk Bibliography and Books to Buy On-Line](#)**

---



© 1994-1999 **[Tara Prindle.](#)**

## Native American Technology and Art

Exerpts from [TEACHING ABOUT THANKSGIVING](#)  
From The Fourth World Documentation Project

### Recipes from the Woodland Culture Area

---

#### ROAST CORN SOUP

('o' nanh-dah) by Miriam Lee

#### SENECA

##### Ingredients:

12 ears white corn in milky stage  
1 # salt pork (lean and fat)  
1 # pinto or kidney beans

Using low heat, take corn and roast on top of range (using griddle if your stove is equipped with one) and keep rotating corn until ears are a golden brown. After the corn is roasted, take ears and put on foil covered cookie sheet until cool enough to handle. Scrape each ear once or twice With a sharp knife. Corn is ready for making soup. While corn is being roasted, fill kettle (5 qt. capacity) approximately 3/4 full with hot water and put on to boil along with salt pork which has been diced in small pieces for more thorough cooking. Beans should be sorted for culls, washed twice and parboiled for approximately 35-45 minutes. After parboiling beans, rinse well in tepid water 2 or 3 times. Corn and beans should then be put in kettle with pork and cooked for about 1 hour. (Note: Beans can also be soaked overnight to cut cooking time when preparing soup).

---

#### SUCCOTASH

#### SENECA

##### Ingredients:

green corn with kernels removed  
fresh shelled beans  
enough water to cover  
salt and pepper to taste



## **cubed salt pork**

**Mix the corn and beans and cover with water. Cook the mixture over medium heat for about a half hour. (Be sure to stir the mixture to avoid scorching.) Add pepper and salt and salt pork if desired.**

**FROM: *Our Mother Corn* Mather/Fernandes/Brescia 1981**

---

[Return to Native American History of Corn](#)

[Return to NativeTech's Main Cornhusk Menu](#)

[Cornhusk Bibliography and Books to Buy On-Line](#)

---



© 1994-1999 [Tara Prindle.](#)

NativeTech: Native American Technology and Art



## Indigenous Plants & Native Uses in the Northeast.

---

All the plants listed here grow along the trails of Schoolhouse Brook Park in Mansfield, Connecticut. This list was compiled specifically for a trail-side tour that described the Native American uses of local plants for food and medicine, as well as some technological and ceremonial uses. Every attempt was made to credit particular Native American Tribes with the information researched. The gathering walk follows the trails, a *WOODED* trail on the north side of Clover Mill Road (which follows part of the traditional Nipmuc Trail), and a *POND SIDE* trail on the south side of Clover Mill Road. (Gathering walk tours were provided for the [Nipmuc Indian Association of CT](#), and for the CT State Museum of Natural History).

[Please see warning at the bottom of this list.](#) Note: The Mansfield Parks and Recreation Department insists that no plants at Schoolhouse Brook Park are disturbed.

---

[Take a virtual hike using the map for the Gathering Walk.](#)

---

## Click the plant names to learn how they are used for Food, Medicine & Technology

Alphabetical list of Common Names (followed by Latin Name):

- [AMERICAN BEECH](#) (Fagus grandifolia)
- [AMERICAN ELDERBERRY](#) (Sambucus canadensis)
- [ASH](#) (Fraxinus species)
- [BASSWOOD](#) (Tilia americana)
- [BEDSTRAW](#) (Galium aparine)
- [BINDWEED](#) (Convolvulus sepium)
- [BIRCH](#) (Betula species)
- [BLOODROOT](#) (Sanguinaria canadensis)
- [BLUEBERRY](#) (Vaccinium species)
- [BLUE FLAG](#) (Iris versicolor)
- [BRACKEN FERN](#) (Pteridium aquilinum)
- [BULRUSH](#) (Scirpus validus)
- [BURDOCK](#) (Arctium minus)
- [BUTTERFLY WEED](#) (Asclepias tuberosa)
- [CATTAIL](#) (Typha latifolia)
- [COMMON WOOD SORREL](#) (Oxalis species)
- [DAISY FLEABANE](#) (Erigeron annuus)
- [DOGBANE](#) (Apocynum cannabinum)
- [DOGWOOD](#) (Cornus species)

[\*\*GREEN FALSE HELLEBORE\*\*](#) (*Veratrum viride*)  
[\*\*GOLDENROD\*\*](#) (*Solidago odora*)  
[\*\*GROUND PINE\*\*](#) (*Lycopodium clavatum*)  
[\*\*HICKORY\*\*](#) (*Carya* species)  
[\*\*HOG PEANUT\*\*](#) (*Amphicarpase monica*)  
[\*\*HOP HORNBEAM\*\*](#) (*Ostrya virginiana*)  
[\*\*INDIAN CUCUMBER\*\*](#) (*Medeola virginica*)  
[\*\*INDIAN PIPE\*\*](#) (*Monotropa unifolora*)  
[\*\*INDIAN TOBACCO\*\*](#) (*Lobelia inflata*)  
[\*\*JACK-IN-THE-PULPIT\*\*](#) (*Arisaema triphyllum*)  
[\*\*JEWELWEED\*\*](#) (*Impatiens biflora*)  
[\*\*JUNIPER\*\*](#) (*Juniperus communis*)  
[\*\*LADY'S-SLIPPER\*\*](#) (*Cypripedium acaule*)  
[\*\*MAPLE\*\*](#) (*Acer saccharum*)  
[\*\*MAPLE-LEAF VIBURNUM\*\*](#) (*Virburnum acerifolium*)  
[\*\*MILKWEED\*\*](#) (*Asclepias syriaca*)  
[\*\*MULTIFLORA ROSE\*\*](#) (*Rosa multiflora*)  
[\*\*NETTLE\*\*](#) (*Urtica* species)  
[\*\*OAK\*\*](#) (*Quercus* species)  
[\*\*PARTRIDGE BERRY\*\*](#) (*Mitchela repens*)  
[\*\*PHRAGMITES\*\*](#) (*P. communis*)  
[\*\*PICKEREL WEED\*\*](#) (*Pontederia cordata*)  
[\*\*PINE\*\*](#) (*Pinus* species)  
[\*\*PIPSISSEWA\*\*](#) (*Chimaphila umbellata*)  
[\*\*PLANTAIN\*\*](#) (*Plantago* species)  
[\*\*RED CEDAR\*\*](#) (*Juniperus virginiana*)  
[\*\*RED TRILLIUM\*\*](#) (*Trillium erectum*)  
[\*\*SKUNK CABBAGE\*\*](#) (*Symplocarpusfae foetidus*)  
[\*\*SLIPPERY ELM\*\*](#) (*Ulmus fulua*)  
[\*\*SOLOMON'S SEAL\*\*](#) (*Polygonatum biflorum*)  
[\*\*SPICEBUSH\*\*](#) (*Lindera benzoin*)  
[\*\*SPRUCE\*\*](#) (*Picea* species)  
[\*\*SUMAC\*\*](#) (*Rhus* species)  
[\*\*SWEET FLAG\*\*](#) (*Acornus calamus*)  
[\*\*TAMARACK\*\*](#) (*Larix laricina*)  
[\*\*TREMBLING ASPEN\*\*](#) (*Populus tremuloides*)  
[\*\*VIOLET\*\*](#) (*Viola* species)  
[\*\*VIRGINIA CREEPER\*\*](#) (*Parthenocissus quinquefolia*)  
[\*\*WATER LILIES\*\*](#) (Yellow - *Nuphar advena* / White - *Nymphaea oderata*)  
[\*\*WILD GERANIUM\*\*](#) (*Geranium maculatum*)  
[\*\*WILD GRAPE\*\*](#) (*Vitis* species)  
[\*\*WILD SARSAPARILLA\*\*](#) (*Aralia nudicaulis*)  
[\*\*WILD STRAWBERRY\*\*](#) (*Fragaria vesca*)  
[\*\*WILLOW\*\*](#) (*Salix* species)



[WINTERGREEN](#) (Gaultheria procumbens)

[WITCH HAZEL](#) (Hamamelis virginiana)

[YARROW](#) (Achillea millefolium)

---

**Warning:** I do not necessarily endorse, guarantee or authorize the uses of plants described here. The Native American uses provided here are not necessarily exhaustive or complete in their description. Many plants which are safe for food or medicine in small doses are toxic in larger quantities, or poisonous without the correct preparation. Many plants are difficult to identify without proper knowledge; many plants have poisonous look-a-likes. Always be sure of your information and identification when gathering plants. Native Americans of different Tribes have various ways to procure and prepare the same plant. I have been told that the medicine (or healing spirit) of a plant leaves if a plant is not honored properly with prayers, hence the medicine wont be effective. Harvest only what you could USE yourself. Please respect every plant's right to survive and reproduce; be informed as to the effects your harvesting will have on the survival of the plant, and the surrounding environment. [Many plant colonies in today's woodlands are THREATENED, see why ...](#)

---

If you have information about indigenous plants that you would like to incorporate here, please send [E-mail](#) [with a reference indicating the source of the information (person/tribe/book)].

---

[Return to NativeTech's Main Plants & Trees Menu](#)

[Indigenous Plant Bibliography and Books to Buy On-Line](#)

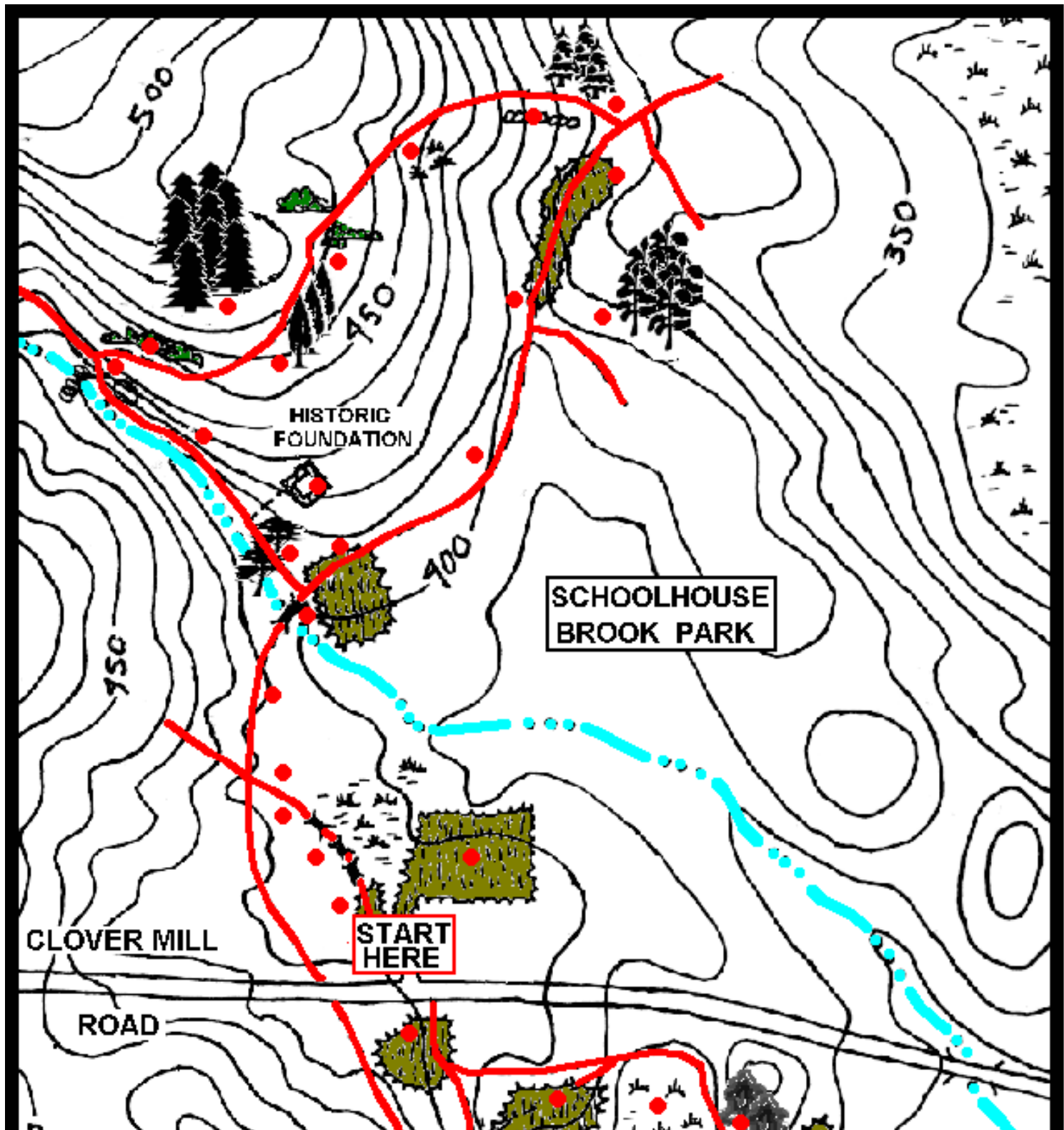


Text and Graphics  
© 1994 - 103 [Tara Prindle](#)  
unless otherwise cited.

## Virtual Hike on the Trails of the Gathering Walk

Following the trail, Click on the RED dots and see what's growing around you!

Note: The Mansfield Parks and Recreation Department insists that no plants in this park are disturbed.





---

[Return to Indigenous Plants & Native Uses in the Northeast](#)

[Indigenous Plant Bibliography and Books to Buy On-Line](#)

[Return to NativeTech's Main Plants & Trees Menu](#)

---



Text and Graphics  
© 1994 - 103 [Tara Prindle](#)  
unless otherwise cited.



## Look at the plants growing around you:

---

There are many moisture loving trees along Barrows Pond Trail. You will find [American beech](#) (*Fagus grandifolia*), [white birch](#) (*Betula* species), [trembling aspen](#) (*Populus tremuloides*), and [red osier dogwood](#) (*Cornus* species) trees dotting the pond-side. Turn your eyes downward and look for the tiny, bristly, prehistoric- looking [ground pine](#) (*Lycopodium clavatum*).

Note: the Parks & Recreation Dept. insists that no plants are disturbed at the Park.

---

[<<-](#)  
[PREVIOUS](#)  
[AREA](#)

[Look Back at the Virtual Map!](#)

[->>](#)  
[NEXT](#)  
[AREA](#)

---



Text and Graphics  
© 1994 - 103 [Tara Prindle](#)  
unless otherwise cited.

## AMERICAN BEECH

(*Fagus grandifolia*)



**Food:** Edible nuts in late summer.

**Medicine:** The bark is steeped in salt water for a poison ivy lotion



---

[<<- Previous Plant](#)

[->> Next Plant](#)

---

[Return to Plants Gathered in the Northeast](#)

[Return to Gathering Walk](#)

[Plant Bibliography and Books to Order On-line](#)

---



Text and Graphics  
© 1994 - 103 [Tara Prindle](#)  
unless otherwise cited.

## YARROW

(*Achillea millefolium*)



**Food:** Used sparingly as a potherb.

**Medicine:** Known as the 'life medicine' to the Navaho, used as astringent, salve, and pain killer for toothaches. For earaches Indians poured into the ears an infusion made from the tops of yarrow.

**Technology:** The flowers produces a light green dye.



---

[<<- Previous  
Plant](#)

[->> Next  
Plant](#)

---

[Return to Plants Gathered in the Northeast](#)

[Return to Gathering Walk](#)

[Plant Bibliography and Books to Order On-line](#)



Text and Graphics  
© 1994 - 103 [Tara Prindle](#)  
unless otherwise cited.



## SWEET FLAG

(*Acorus calamus*)



**Food:** Inner portions of young tender stalks make a spicy trail snack or salad herb. A candy was made from boiling the red part of the underground stem in different batches of water, and then simmered in syrup and then rolling in sugar.

**Medicine:** A powder was made from the rhizomes that was smoked or chewed to destroy the taste for tobacco.

**Technology:** Lemony smelling leaves were sometimes used in weaving mats or in reinforcing the rims of bark containers. Colonists used the leaves to cover their floors to mask poor sanitation with bad ventilation.



**Note:** Note: Iris look-alikes (Yellow and Blue Flag) lack the spicy lemony order of the Sweet Flag leaves.

---

[<<- Previous Plant](#)

[->> Next Plant](#)

---

[Return to Plants Gathered in the Northeast](#)

[Return to Gathering Walk](#)

[Plant Bibliography and Books to Order On-line](#)

---



**Text and Graphics**  
© 1994 - 103 [Tara Prindle](#)  
unless otherwise cited.

## SUMAC

(Rhus species)



**Food:** Cone shaped clusters of red berries of Staghorn (*R. typhina*) and Smooth (*R. glabra*) sumac may be licked like a lollipop for lemony thirst quencher. Smooth sumac is also referred to as Indian Lemonade for a beverage made from the red berries.

**Medicine:** Chippewa used sumac (*R. hirta*) in a medicine for stomach pain.

**Technology:** The pulp of the stalk and the inner bark of the smooth sumac is used in dye



**Note:** A relative of Poison Ivy (*R. radicans*), beware of poison sumac (*R. venhata*) with white fruit.

---

[<<- Previous  
Plant](#)

[->>  
Next  
Plant](#)

---

[Return to Plants Gathered in the Northeast](#)

[Return to Gathering Walk](#)

[Plant Bibliography and Books to Order On-line](#)

---





**Text and Graphics**  
© 1994 - 103 [Tara Prindle](#)  
unless otherwise cited.

## SPRUCE

(Picea species)



**Medicine:** Twigs from the White spruce (*P. canadensis*) was used by Chippewa in a decoction to steam stiff joints.

**Technology:** Long roots (from *P. Rubra*) growing close to ground surface were pulled up, peeled and split into strips for lacing. The gum from the tree was used as a pitch for patching holes and leaking seams in birch bark canoes and pails. The gum was boiled in wide-meshed bags that retained organic debris but allowed the gum to pass into the water where it was skimmed off and mixed with cedar charcoal.



**Note:** For additional information browse NativeTech's [Information about sewing with Spruce Roots](#)

[<<-](#)  
[Previous](#)  
[Plant](#)

[->>](#)  
[Next](#)  
[Plant](#)

[Return to Plants Gathered in the Northeast](#)

[Return to Gathering Walk](#)

[Plant Bibliography and Books to Order On-line](#)



**Text and Graphics**  
© 1994 - 103 [Tara Prindle](#)  
unless otherwise cited.



## SPICEBUSH

(*Lindera benzoin*)



**Food:** Leaves, bark and twigs are used in tea. Dried fruits are ground and are used as a substitute for allspice.

**Medicine:** a tea from the twigs was drunk by women to promote menstruation or to ease its pain.



---

[<<-](#)

[Previous  
Plant](#)

[->>](#)

[Next  
Plant](#)

---

[Return to Plants Gathered in the Northeast](#)

[Return to Gathering Walk](#)

[Plant Bibliography and Books to Order On-line](#)

---



**Text and Graphics**  
© 1994 - 103 [Tara Prindle](#)  
unless otherwise cited.

## SOLOMON'S SEAL

(*Polygonatum biflorum*)



**Medicine:** A decoction of roots was sprinkled on hot stones and the smoke inhaled in Chippewa remedy for headaches.

**Note:** The name comes from the characteristic round scars on the root from old healed-over root branches, which resemble ancient wax seals. Do not confuse with False Solomon's Seal, which has it's feathery flower plume at the top of the plant, rather than the true Solomon's Seal's dangling bell shaped flowers.



[<<-](#)  
[Previous](#)  
[Plant](#)

[->>](#)  
[Next](#)  
[Plant](#)

SOLOMON'S SEAL



FALSE SOLOMON'S SEAL

[Return to Plants Gathered in the Northeast](#)

[Return to Gathering Walk](#)

[Plant Bibliography and Books to Order On-line](#)

---



**Text and Graphics**  
© 1994 - 103 [Tara Prindle](#)  
unless otherwise cited.



## SLIPPERY ELM

(*Ulmus fulva*)



**Medicine:** The bark is used in medicines for sore throats. The inner bark, when mixed with water, produces a gummy slippery substance that can be used as a soothing ointment.

**Technology:** Fibers from the inner bark were used for lashing. The bark was used to make folded buckets and other containers and for bark shingles to cover wigwams. Chippewa cut flat dolls out of the bark for toys for their children. Elm bark was chewed and occasionally used by Chippewa to patch small holes in bark containers.

**Note:** Note: Also called Indian Elm



---

[<<-](#)

[Previous  
Plant](#)

[->>](#)

[Next  
Plant](#)

---

[Return to Plants Gathered in the Northeast](#)

[Return to Gathering Walk](#)

[Plant Bibliography and Books to Order On-line](#)

---



**Text and Graphics**  
© 1994 - 103 [Tara Prindle](#)  
unless otherwise cited.

## SKUNK CABBAGE

(*Symplocarpus foetidus*)



**Medicine:** The powdered or dried root of the plant was used to sooth lung ailments including asthmatic and bronchial spasms.

**Note:** Associated with the circle of life. Buds form on the plant in the fall, beneath dead growth. In the early spring the plant generates enough heat to thaw the ground so the plant can push up through last years growth.



---

[<<- Previous Plant](#)

[->> Next Plant](#)

---

[Return to Plants Gathered in the Northeast](#)

[Return to Gathering Walk](#)

[Plant Bibliography and Books to Order On-line](#)



Text and Graphics  
© 1994 - 103 [Tara Prindle](#)  
unless otherwise cited.



## RED TRILLIUM

(*Trillium erectum*)



**Medicine:** A poultice and lotion was made from bruised leaves and applied to insect bites and skin irritations.

**Note:** Also known as Indian Balm. The plant is endangered and protected in some states.



---

[<<- Previous  
Plant](#)

[->>  
Next  
Plant](#)



---

[Return to Plants Gathered in the Northeast](#)

[Return to Gathering Walk](#)

[Plant Bibliography and Books to Order On-line](#)

---



**Text and Graphics**  
**© 1994 - 103 [Tara Prindle](#)**  
**unless otherwise cited.**

## RED CEDAR

(*Juniperus virginiana*)



**Medicine:** Twigs boiled together and sprinkled on hot stones (or brewed into tea) for Rheumatism. In ceremony a sacred wood, known as a medicine tree. Native Americans say the tree was blood-stained by an wicked magician. The wood is burned only for ceremony, and the smoke is believed to drive away negative influence.

**Technology:** Inner bark strips are peeled from the tree. Strips may be split into fine lacings and ties. Cedar strips were also used to weave storage bags and finely twined mats. Cedar strips also make a red dye. Cedar wood was splint into planks for use in lining birch bark canoes. Chippewa used cedar bows for bedding material.



---

[<<-](#)

[Previous](#)

[Plant](#)

[->>](#)

[Next](#)

[Plant](#)

---

[Return to Plants Gathered in the Northeast](#)

[Return to Gathering Walk](#)

[Plant Bibliography and Books to Order On-line](#)

---





**Text and Graphics**  
© 1994 - 103 [Tara Prindle](#)  
unless otherwise cited.

## PLANTAIN

(Plantago species)



**Food:** Soak edible leaves in salt water and boil until tender, seeds can be ground into a flour.

**Medicine:** : A tea from the leaves relieved sore eyes. A charm from the powdered roots was used to prevent snakebite.

**Note:** Also called Englishman's-Foot; although some varieties of Plantain have been introduced by Europeans, indigenous species are recognized by Native Americans for food and medicine. Includes Common (P. major), English (P. lanceolata) and Hoary (P. media) varieties.

---

[<<](#)

[Previous  
Plant](#)

[->>](#)

[Next  
Plant](#)

---

[Return to Plants Gathered in the Northeast](#)

[Return to Gathering Walk](#)

[Plant Bibliography and Books to Order On-line](#)



Text and Graphics  
© 1994 - 103 [Tara Prindle](#)  
unless otherwise cited.

## PIPSISSEWA

(*Chimaphila umbellata*)



**Medicine:** The Native American name of this plant means 'it breaks into small pieces,' because the leather-like evergreen leaves were used in medicine to dissolve kidney stones. Known for its strengthening properties and used in medicines for diseases of the eye. An infusion was made with water and applied to heal blisters.



**Note:** Also called Prince's Pine.

---

[<<- Previous Plant](#)

[->> Next Plant](#)



---

[Return to Plants Gathered in the Northeast](#)

[Return to Gathering Walk](#)

[Plant Bibliography and Books to Order On-line](#)

---





**Text and Graphics**  
© 1994 - 103 [Tara Prindle](#)  
unless otherwise cited.

## PINE

(Pinus species)



**Medicine:** A Chippewa decoction applied to cuts and wounds uses sections cut from trunk of a young White pine (*P. strobus*). The gum resin could be chewed for sore throats. The heated resin is used to draw out splinters.

**Technology:** The clustered needles of Red pine (*P. Resinosa*) were trimmed to shape and used by Chippewa as little dolls. These little dolls were situated on one end of a stiff strip of bark or board. When the board was tapped or rocked, the little pine dolls would dance. Types of pine were also used to make dugout canoes. The trunk of a pine tree was hollowed out using a combination of burning and then chipping out the burned material.

**Note:** For additional information browse NativeTech's [Information about the Little Pines Game](#)



---

[<<- Previous Plant](#)

[->> Next Plant](#)

---

[Return to Plants Gathered in the Northeast](#)

[Return to Gathering Walk](#)

[Plant Bibliography and Books to Order On-line](#)

---



**Text and Graphics**  
© 1994 - 103 [Tara Prindle](#)  
unless otherwise cited.



## Native American Technology and Art

### Little Pines Game



Natives of the Eastern Forest traditionally make dancing dolls from varieties of evergreen trees such as Norway Pine and White Pine. Early in the 1900's, Frances Densmore describes these dolls, made by Ojibway (Chippewa) people of the Great Lakes region, from a tuft of pine needles cut squarely across the end. By trimming a layer of needles about halfway up, a skirt, arms and perhaps a shawl could be suggested. A bit of wood was left at the top of the sprig of needles creating the doll's head. These little figures were placed on a long thin piece of wood, or on a tray, which was gently bounced. This agitating motion makes the dolls jump and skip, sometimes moving back and forth together, suggesting a dance.

The effect was quite realistic if the person manipulating the board was practiced. The northeastern Penobscot have a similar traditional game called 'little pines', a game chiefly for women, that was described by Frank Speck in the 1940's. The game used anywhere from 6 to 10 dolls made from white pine tips. The woman sings as she jostles the game board, and the pine sprigs dance and eventually topple. If a pine dancer manages to right itself, then the onlookers exclaim "She's come back to life!"; and "She's glad to wake up again!". The last pine needle dancer to fall from the board is praised by the onlookers for her endurance and dancing skill. The dancers and board are then passed to another to play.

---

[Return to NativeTech's Main Games & Toys Menu](#)

[Games & Toys Bibliography and Books to Buy On-Line](#)

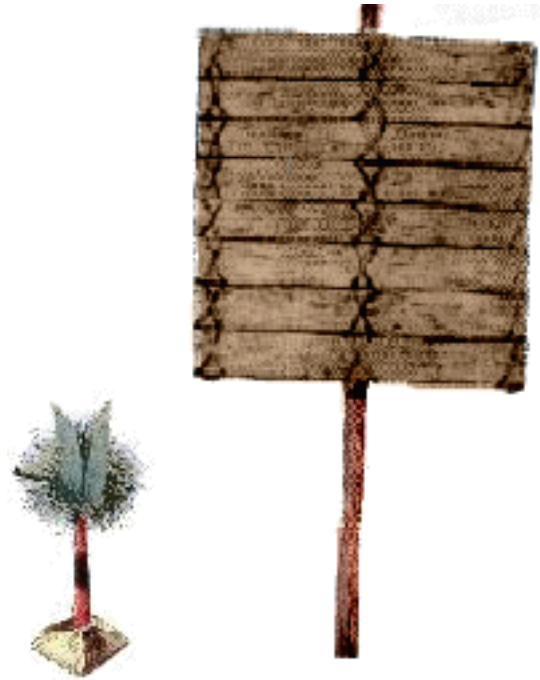
---



© 1994-1999 [Tara Prindle](#).

## Shuttlecock and Battledoor

**Keep the Shuttle in the Air...**



**<----- Please click your Mouse Button  
in the game area to toss the Shuttlecock !**

**\* Move the red Battledoor to the LEFT and  
RIGHT  
using the <-- Arrow keys --> on your keyboard.**

**\* Press the "S" key to Restart the Game !**

**[LEARN MORE ABOUT  
Native American Shuttlecock Games](#)**

**Note:Your browser must have Java Enabled for this to work!**

**[Return to NativeTech's Main Games & Toys Menu](#)**

**[Games & Toys Bibliography and Books to Buy On-Line](#)**





© 1994-2001 [Tara Prindle](#).

## Native American Technology and Art

### Shuttlecock Game



A game of shuttlecock, sometimes played with a wooden battledoor, is common among the tribes on the Northwest coast. The Zuni play with shuttlecocks made of corn husks, stuck with feathers, batted with the hand, and a similar object was found in a pre-European cliff-dwelling in the Canyon de Chelly. The game is called kwaitusiwikut among the Piman Natives of Arizona, where the children sometimes amuse themselves by tossing into the air corncobs in which from one to three feathers have been stuck. The Salish Natives of British Colombia and Washington use a battledoor made either with several unpainted slats lashed to a handle or made of a wooden plaque with a handle. The shuttlecock consists of a small piece of twig or a branch, stuck with three feathers. This game was a favorite pastime of the girls and boys. In the Kwakiutl game of 'quemal', two or more usually play; if there are many players, they stand in a ring. They throw always to the right and in front of the body, and the one who lasts the longest without missing wins.

The Zuni Native of New Mexico use shuttlecocks of thick bundles of corn husk, tied around at the top having two to four feathers inserted. A Zuni game called 'Po-ke-an' used green corn husks neatly interlaced and wrapped into a flat square about an inch to two inches square, and on one side are placed two feathers, upright; then, using this shuttlecock and their hand for a battledoor, they try to see how many times they can knock it into the air and they count aloud in their own language - To-pa, quil-e, hi, a-we-ta, ap-ti, etc. Another Zuni game called 'Po-ki-nanane' is so named because the sound produced by the shuttlecock coming into contact with the palm of the hand is similar to the noise of the tread of the jack rabbit upon the frozen snow.

The game is played as frequently by the younger boys as by their elders, and always for stakes. One bets that he can toss the shuttlecock a given number of times. While ten is the number specially associated with the game, the wagers are often made for twenty, fifty, and sometimes a hundred throws. In the case of a failure the other player tries his skill, each party alternating in the game until one or the other tosses the shuttlecock (only one hand being used for a battledoor) the given number of times, which entitles him to the game.

---

[Play an Interactive Version of Shuttlecock and Battledoor online Here](#)

---

[Return to NativeTech's Main Games & Toys Menu](#)

[Games & Toys Bibliography and Books to Buy On-Line](#)

---



© 1994-1999 [Tara Prindle](#).



## Native American Technology & Art Bowl & Dice Game



Click here to toss  
the dice in the  
bowl!



The rules here are based on the first of three phases in the Penobscot dice game called *Wa'lade hama'gan*. To see how to play the entire version of this game, see NativeTech's page about the history and play of the [Bowl Dice Game](#)

If you toss:

- **6-alike:** You are awarded 1 flat stick and you toss again.
- **a second-6 alike:** You receive 2 flat sticks and you toss again.
- **a third consecutive 6-alike:** You are awarded 3 flat sticks.

If you toss:

- **5-alike:** You are awarded 3 narrow sticks and you toss again.
- **a second 5-alike:** You receive 6 narrow sticks and you toss again.
- **a third consecutive 5-alike:** You are awarded 1 flat stick.

If you toss:

- **4-alike:** No sticks are awarded, it's your opponent's turn.
- **3-alike:** No sticks are awarded, it's your opponent's turn.
- **2-alike:** No sticks are awarded, it's your opponent's turn.

*Note: In keeping score with the sticks 1 flat stick = three narrow sticks.*



At the beginning of play narrow sticks and flat sticks are placed in a central pile. Players take turns tossing the dice into the air by gently thumping the bowl on the ground. The score depends on how the dice land in the bowl.

These are the designs carved into each side of the dice:



For each successful toss of the dice you are awarded counting sticks.

Players normally take turns casting dice until all of the counters are used up. The last stick to be awarded is the "Crooked stick". However in this version of the game, players should decide to play to a specific score, say 50 or 100.

You will find out what you awarded with each toss of the dice, but it up to you to keep track of your cumulative scores!

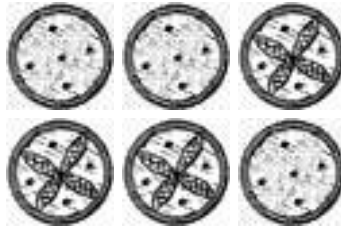
[Return to NativeTech's Main Games & Toys Menu](#)

[Games & Toys Bibliography and Books to Buy On-Line](#)

---



© 1994-2000 [Tara Prindle](#).



**You didn't score any sticks this time ...**

**It's your opponent's turn to toss the dice!**





**You Scored Six Alike!!!**

**Was this your:**

- **First Toss?**

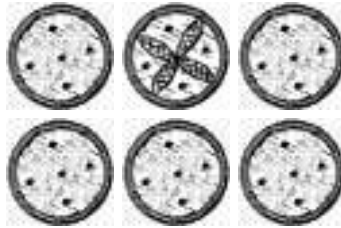
**You Scored 1 flat stick. Toss the dice again!**

- **Second Toss?**

**You Scored 2 flat sticks. Toss the dice again!**

- **Third Toss?**

**You Scored 3 flat sticks! But it's your opponent's turn.**



**You Scored Five Alike!!!**

**Was this your:**

- **First Toss?**

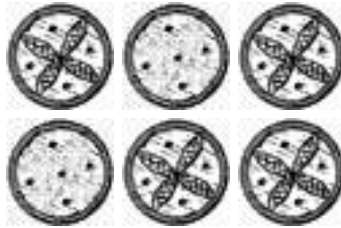
**You Scored 3 narrow sticks. Toss the dice again!**

- **Second Toss?**

**You Scored 6 narrow sticks. Toss the dice again!**

- **Third Toss?**

**You Scored 1 flat stick! But it's your opponent's turn.**



**You didn't score any sticks this time ...**

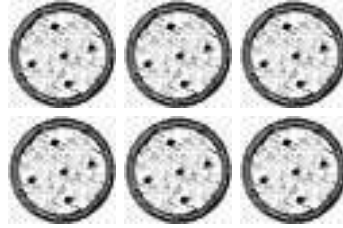
**It's your opponent's turn to toss the dice!**



**You didn't score any sticks this time ...**

**It's your opponent's turn to toss the dice!**





**You Scored Six Alike!!!**

**Was this your:**

- **First Toss?**

**You Scored 1 flat stick. Toss the dice again!**

- **Second Toss?**

**You Scored 2 flat sticks. Toss the dice again!**

- **Third Toss?**

**You Scored 3 flat sticks! But it's your opponent's turn.**



**You Scored Five Alike!!!**

**Was this your:**

- **First Toss?**

**You Scored 3 narrow sticks. Toss the dice again!**

- **Second Toss?**

**You Scored 6 narrow sticks. Toss the dice again!**

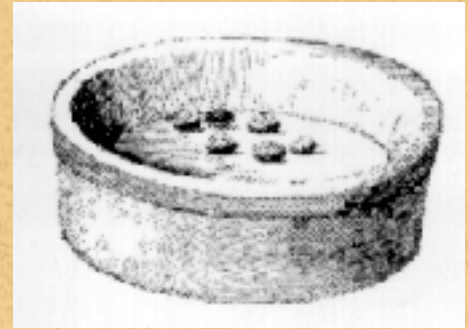
- **Third Toss?**

**You Scored 1 flat stick! But it's your opponent's turn.**

## Native American Technology and Art

### Bowl & Dice Game

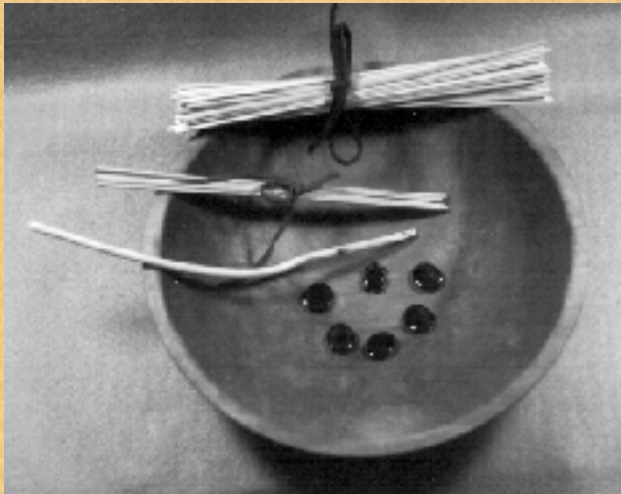
The dice game has innumerable variations across North America. This traditional game is called **Hubbub** in southern New England. The game described in the 1600s includes five or six small dice which are tossed in a wooden bowl or basket. The game is accompanied by sticks or beans for scoring. Dice were usually carved from bone or antler, in some versions plum or peach pits were used. Dice were engraved, burned and polished or painted to distinguish one side from the other when they are tossed.




---

[Try Playing the Bowl and Dice Game right here!](#)

---



The dice game was often played in a large gaming house or arbor made from poles set in the ground and covered with tree boughs. Natives of New England played this game in the 1600s for great stakes. Animal skins and furs, kettles, knives, axes were set out and huge stores of strung wampum were hung from the arbor poles. Elements of reciprocal exchange is demonstrated in traditional gaming of Native Americans in southern New England. Money in this dice game was gambled away, but was probably won back again, in

subsequent games. The dice game provoked great celebration and shouting... with cheering 'hub hub hub'... hence the name hubbub for the game. Entire villages sometimes wagered against other villages over the two individuals chosen to play the game.

---

### How to play "Wa'lade hama'gan", a Penobscot bowl and dice game:

The object of the game is to acquire as many sticks as possible and then bankrupt your opponent. Play takes place in three phases. In the first phase players try to accumulate as many sticks as possible in a primary pile. In the second phase (known as drifting) players attempt to move as many pieces to a second pile (known as the treasure pile). Sticks in the treasure pile have increased value against sticks in the opponent's pile. The third and final phase of the game occurs when one player has sufficient markers in the second pile to bankrupt the opponent. During the course of play, markers are awarded when a "roll" of five or six of the

dice come up as the same color (either brown or white). Players alternate casting the dice or lightly banging the bottom of the bowl. This version of the game requires 6 dice, 56 Narrow Sticks, 4 Flat Sticks, and 1 Crooked Stick (Speck 1976).

### Beginning the game (First Phase)

- At the beginning of play all small counters are placed in a central pile. For each successful roll of the dice a player is awarded counting sticks.
- When a player rolls a 5 alike then he/she is awarded 3 of the narrow sticks from the central pile and gets to roll again. If a second five alike is thrown the player receives 9 round sticks. If the player throws three consecutive 5 alike rolls then he/she is awarded a flat stick.
- When a player rolls a 6 alike then one flat stick is awarded and the player gets to roll again. If a second consecutive 6 alike is rolled then the player is awarded two flat sticks. If a third consecutive 6 alike is rolled then the player is awarded three flat sticks.
- Players take turns casting dice until all of the counters are used up. The last stick to be awarded is the "Crooked stick". This piece has the value of one small counter, and the winner of the crooked stick is awarded two small sticks from the pile of the opponent.

### Drifting (Second Phase)

- When the crooked stick has been won the game enters a new phase called "drifting". Players continue to roll dice as before, only now when a 5 alike is thrown the player moves a stick from the pile he or she has won and places it in a second pile.
- This second pile is known as the treasure or debt pile and becomes important in the final tally of the game. The goal at this point is to get as many pieces from the first pile to the second pile. For each stick put in the treasure (second) pile, your opponent owes you 4 sticks from their first pile.
- For two consecutive 5 alike throws the player puts three narrow sticks into the treasure pile. For three consecutive 5 alike throws the player puts 1 flat stick into the treasure pile.
- For a 6 alike roll the player places a narrow stick into a third pile. This stick is called the "Governor" or the "Chief", and is worth 4 of the opponents second pile sticks or either one flat stick or 16 narrow sticks from their first pile.

### Ending the Game: Paying Up (Third Phase)

When one player has a big treasure (second) pile and believes they can bankrupt the opponent the game enters the final phase. When this happens you challenge the opponent to pay up according to the values mentioned above and in the following tables. If the opponent pays up all their markers but is in possession of the crooked stick they get three final throws. If these last throws are either all 5 alike or 6 alike the opponent wins.

---

### Throws, Awards, and Values:

#### First Phase



| Roll    | First roll      | Second roll     | Third roll    |
|---------|-----------------|-----------------|---------------|
| 5 Alike | 3 Narrow sticks | 9 Narrow sticks | 1 Flat sticks |
| 6 Alike | 1 Flat stick    | 2 Flat sticks   | 3 Flat sticks |

### Second Phase (Drifting)

| Roll    | First roll       | Second roll       | Third roll        |
|---------|------------------|-------------------|-------------------|
| 5 Alike | 1 Narrow sticks  | 3 Narrow sticks   | 1 Governor stick  |
| 6 Alike | 1 Governor stick | 2 Governor sticks | 3 Governor sticks |

### Third Phase (Paying up)

|                                                                                 |
|---------------------------------------------------------------------------------|
| 1 Governor stick = 4 of opponent's treasure pile narrow sticks.                 |
| (or)                                                                            |
| 1 Governor stick = 1 flat stick or 16 narrow sticks from opponent's first pile. |

---

[Return to NativeTech's Main Games & Toys Menu](#)

[Games & Toys Bibliography and Books to Buy On-Line](#)

---



© 1994-2000 [Tara Prindle](#).

## Virtual Paper Dolls

Drag the eight articles of late 17th century clothing  
with your mouse to dress the Indian girl from southern New England

Note: You must have current versions of either the IE or AOL browsers and have javascripts enabled.

If you have a Netscape browser [Click Here](#) ... Not as pretty, but it works!

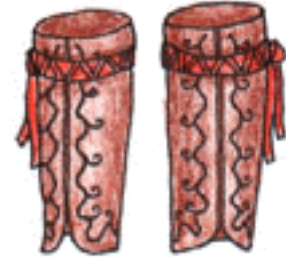
---



Center Seam  
Moccasins



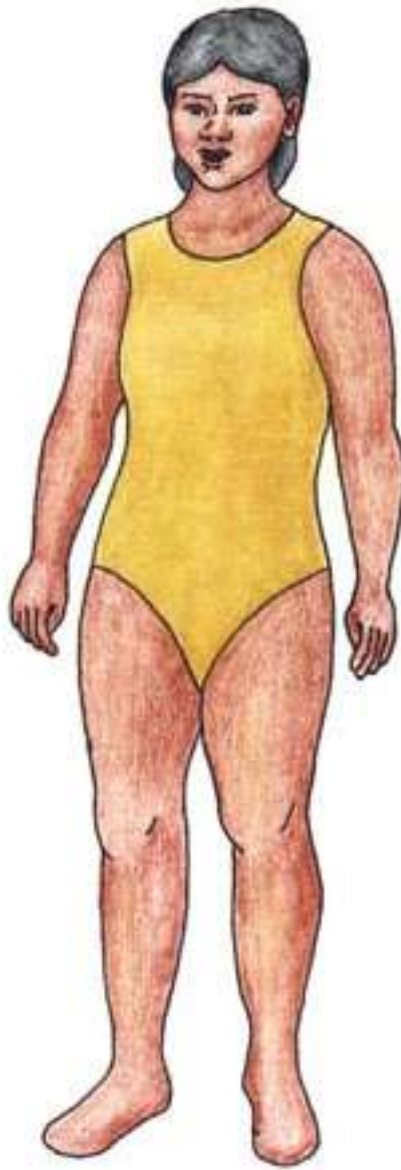
Wampum Headband  
and Brass Earrings



Leggings  
and Garters



Wrap Around Skirt



Two-Hide Tunic



Wampum Necklaces



Gathering Bag



Wampum Belt

Go to [NativeTech's Leather and Clothes Main Menu](#) to learn more about dress styles of Native Americans.

---

[Return to NativeTech's Main Games & Toys Menu](#)

[Games & Toys Bibliography and Books to Buy On-Line](#)

---



© 1994-2000 [Tara Prindle](#).



NativeTech: Native American Technology & Art

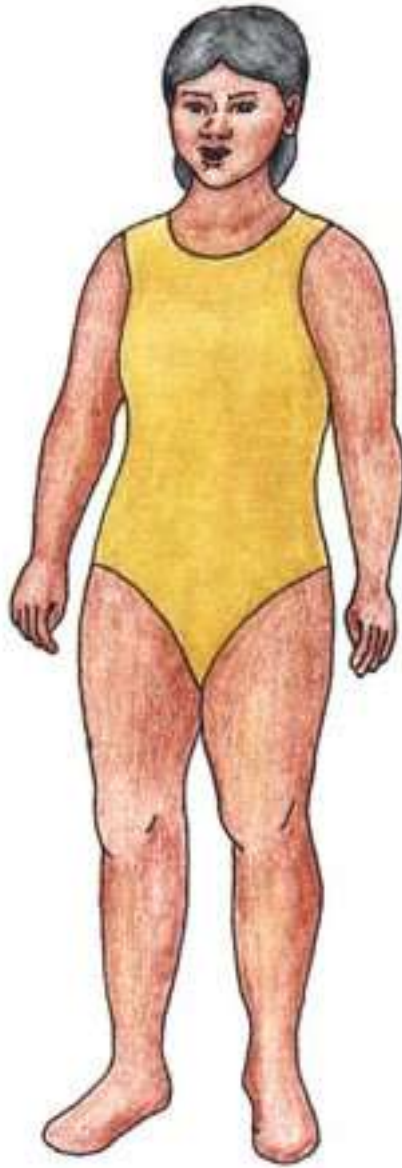
## Virtual Paper Dolls

Drag the eight articles of late 17th century clothing  
with your mouse to dress the Indian girl from southern New England

Note: You must have javascripts enabled.

---











Go to [NativeTech's Leather and Clothes Main Menu](#)  
to learn more about dress styles of Native Americans.

---

[Return to NativeTech's Main Games & Toys Menu](#)

[Games & Toys Bibliography and Books to Buy On-Line](#)

---



© 1994-2000 [Tara Prindle](#).

## Leather and Clothes

- [Regional Overview of Clothing Styles](#) with annotated sketches
- [Overview of Native American Footwear ~ Moccasins](#)
- [Mittens and Gloves](#)
- [Leather Bags and Pouches](#)
- [Puzzle Pouches](#)
- [Tanning and the Preservation of Other Animal Parts](#)

### 19th Century Seminole Men's Clothing Contributed by [Rick Obermeyer, Editor](#)

- [The Plain Shirt](#) ~ by M. E. (Pete) Thompson
- [The Long Shirt](#) ~ by M. E. (Pete) Thompson and Rick Obermeyer
- [The Creek/Seminole Moccasins](#) ~ notes from a Darry Wood demonstration
- [Leggings](#) ~ by Pete Thompson and Rick Obermeyer
- [Breech Cloths](#) ~ by Rick obermeyer
- [Turbans](#) ~ by Rick Obermeyer
- [Beaded Pouches & Bandoliers](#) ~ by David J. Mott and Rick Obermeyer
- [Accessories](#) ~ Various Quotes
- [Face Painting](#) ~ by David Mott and Rick Obermeyer

- [Leather & Clothes Bibliography and Books to buy On-line](#)

### [Other Internet Resources for Leather & Clothes](#)



© 1994-2000 [Tara Prindle](#).

## NativeTech: Native American Technology and Art

# Regional Overview of Native American Clothing and Regalia

---

### [Look at a Map of Culture Areas with Illustrated Clothing](#)

---

Native American regalia is special dress, ornamentation, jewelry and other paraphernalia which is worn for particular occasions such as festivals and dances, ceremonies and rituals. The style of dress, symbols used in designs, colors in beadwork and other ornaments can help identify the wearer's tribe or family. Specific aspects of regalia can also indicate the wearer's political or marital status. New England Native Americans have a unique style of regalia different from other areas. One piece center-seam moccasins, porcupine quill, moosehair and floral beadwork appliqué, wampum belts, bracelets and headbands, brass and copper ornaments and certain kinds of featherwork are distinctive of New England. Traditionally in deer, elk, moose and other skins or hand-woven materials, Northeastern Native American Regalia now incorporates trade cloth, glass beads and other items of European origin.

Traditionally, regalia is set aside and worn only for special gatherings. Certain outfits or elements of clothing were undoubtedly worn only for particular ceremonies. Some regalia is sacred or has been ritually purified or blessed ("smudged" or wiped with the smoke of sacred herbs). Always seek permission before handling someone else's special dress to avoid spiritual contamination of their regalia. Today, wearing regalia is a way to maintain Native American Heritage, to take pride in and pass on old traditions and help create new ones. Many traditional elements of pre-European contact regalia have been preserved since ancient times, but new



styles of dance regalia evolved with the development of the Pow Wow festival.

© 1998  
T. Prindle



*Man from Southern New England ~ circa 1600*

---

[Return to NativeTech's Main Leather & Clothes Menu](#)

[Leather & Clothes Bibliography and Books to Buy On-Line](#)

---



© 1994-1999 [Tara Prindle.](#)



## NativeTech: Native American Technology and Art

# Culture Areas and the Locations of Tribes with Illustrated Clothing



**NORTHEAST**

- [1. Virginia Algonquian](#)
- [2. North Carolina Algonquian](#)
- [3. Delaware](#)
- [4. Pequot](#)
- [5. Eastern Niantic](#)
- [6. Narragansett](#)
- [7. Wampanoag](#)
- [8. Eastern Abenaki](#)
- [9. Penobscott](#)
- [11. Huron](#)
- [10. Iroquois \(Seneca, Mohawk, Onondoga\)](#)

**LAKES**

- [12. Fox](#)
- [13. Sauk](#)
- [14. Menomini](#)
- [15. Winnebago](#)
- [16. Kickapoo](#)
- [17. Ottawa](#)
- [18. Chippewa](#)

**SOUTHEAST**

- [19. Cherokee](#)
- [20. Creek](#)
- [21. Seminole](#)
- [22. Choctaw](#)

**PRAIRIE**

- [23. Shawnee](#)
- [24. Miami](#)
- [25. Illinois](#)
- [26. Arikara](#)

**PLAINS**

- [27. Arapaho](#)
- [28. Lakota](#)
- [29. Crow](#)
- [30. Blackfeet](#)

**PLATEAU**

- [31. Flathead](#)

**BASIN**

- [32. Paiute](#)

**SOUTHWEST**

- [33. Apache](#)
- [34. Navajo](#)
- [35. Hopi](#)

**CALIFORNIA**

- [36. Hupa](#)

**NORTHWEST COAST**

- [37. Tsimshian](#)

**SUBARCTIC**

- [38. Kutchin](#)
- [39. Cree](#)

**Emphasis on Eastern United States**

*Many Nations are not represented because I simply didnt have the resources to sketch them.*

---

[Return to NativeTech's Main Leather & Clothes Menu](#)

[Leather & Clothes Bibliography and Books to Buy On-Line](#)

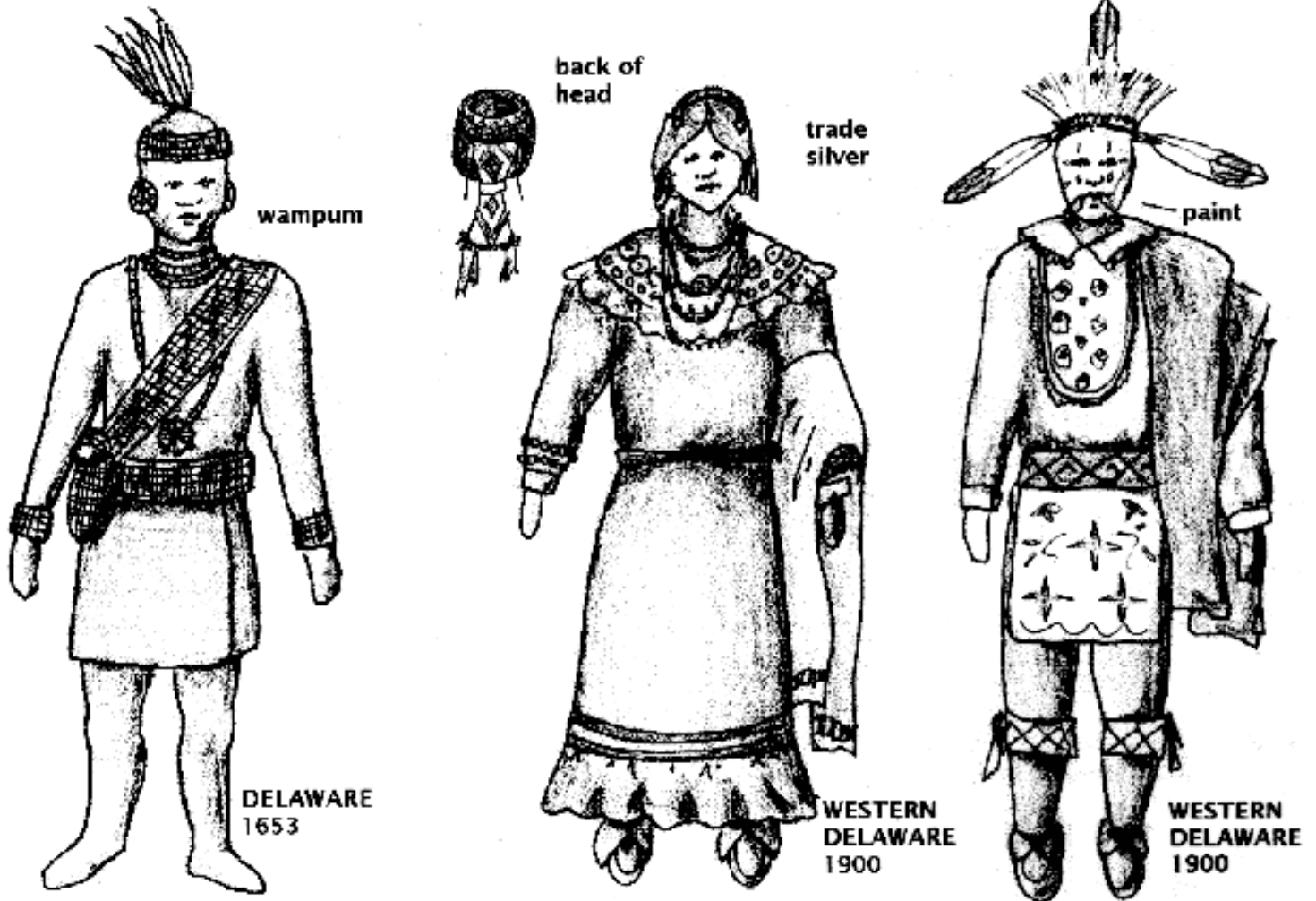
---

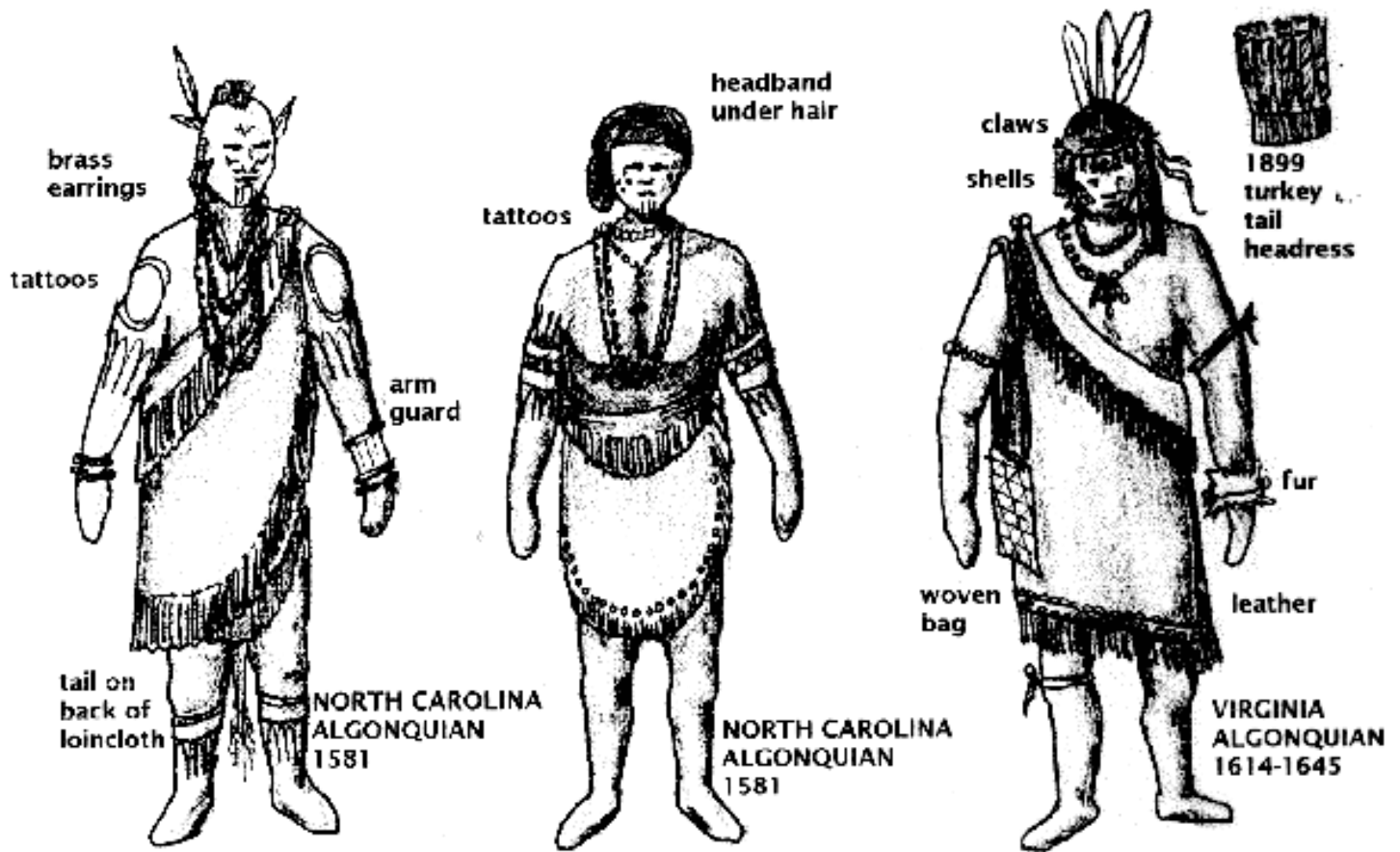


© 1994-1999 [Tara Prindle.](#)

# Native American Technology and Art REGIONAL OVERVIEW OF NATIVE AMERICAN CLOTHING STYLES

## Northeast Region - Mid-Atlantic Tribes





---

[Return to Map and List of Culture Areas with Illustrated Clothing](#)

[Return to NativeTech's Main Leather & Clothes Menu](#)

[Leather & Clothes Bibliography and Books to Buy On-Line](#)

---



© 1994-1999 [Tara Prindle](#).



## NativeTech: Native American Technology and Art

# NATIVE AMERICAN CLOTHING

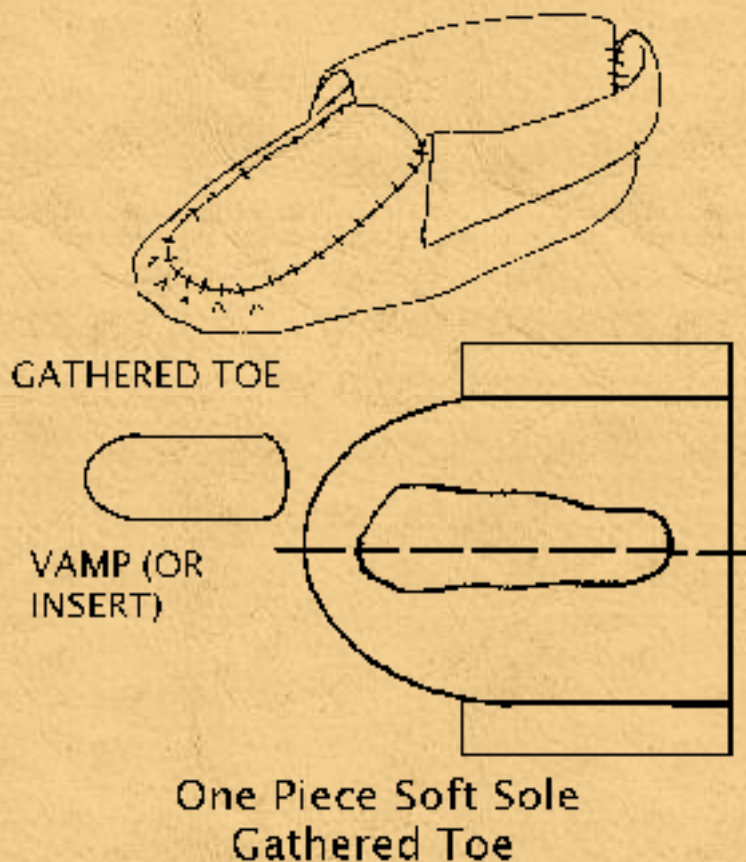
## Overview of Footwear; Moccasins



*Algonkian or Iroquois Center-seam Moccasins with added cuff (mid-1600's) [King: 1991].*

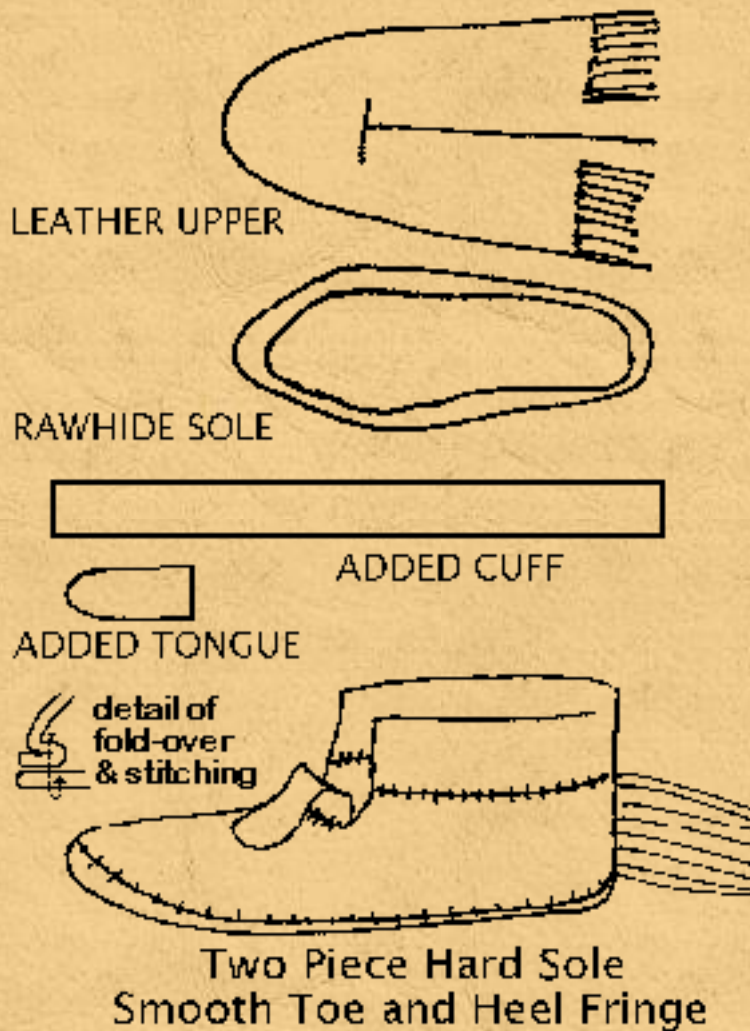
[Look at Map of North America with Native American Varieties of Moccasins](#)

[See Instructions for Making Center-seam Moccasins](#)



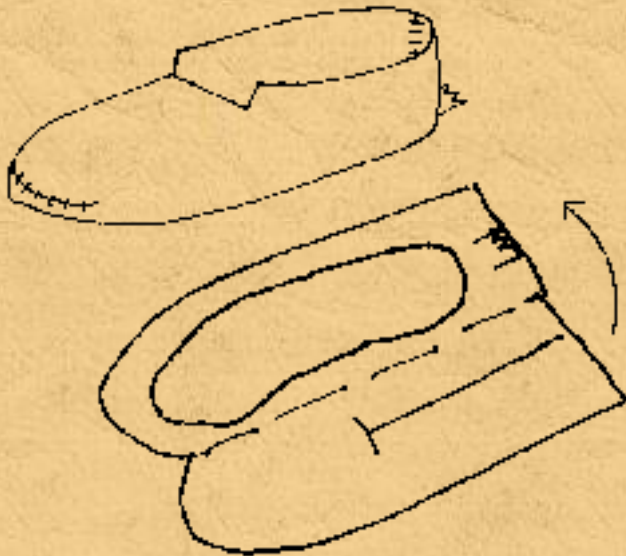
Moccasins, (low tailored shoes), are one type of traditional North American footwear. Woven sandals, boots, and leggings attached to shoes have also been produced by Native Americans. The origins of moccasins go back to the cold, harsh climates of man's past that made it necessary to make protective footwear. Wearing moccasins or boots would have been essential to keep feet from freezing. In warm weather and mild surroundings, protective footwear would be less important and people could easily go barefoot. The word moccasin, which has language origins with Eastern North American tribes, traditionally referred to a shoe with a puckered u-shaped 'vamp' over the instep. The name of the Great Lakes Ojibway tribe means 'people of the puckered moccasin'. The southern New England Narragansett word for shoe is 'Mocussinass' or 'Mockussinchass'. Today the word moccasin, still with

innumerable spellings, generally refers to all types of hard and soft soled shoes, with and without puckered toes.



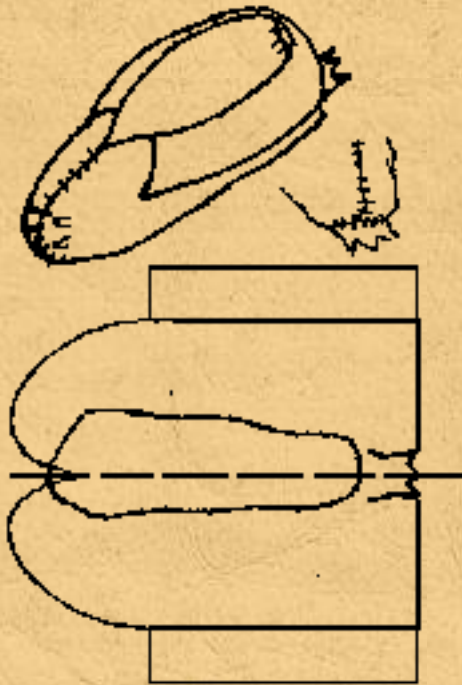
Native American moccasins were designed for their specific environment. Hard-sole moccasins, usually made from two or more pieces of hide, are often associated with the western plains and deserts areas. The hard sole of shaped rawhide and fitted leather upper required more tailoring than other moccasin varieties. Hard-soled moccasins were important to protect feet from harsh cactus or prairie-grass covered ground, and sharp rocks not worn down by water. The turned up toe of many two-piece moccasins (like that of the Apache) prevented sharp objects from running into the seams and injuring the foot. Soft-soled moccasins, often constructed from a single piece of leather were common in the Eastern Forests and were made by bringing up the sole of the shoe around the foot and puckering or patching the material around the instep. Soft-soled center seam and pucker-toe moccasins were well suited to travel through woodlands with leaf and pine-needle covered ground. Some soft-soled moccasins from the Plains and Northwest Coast were made from one piece but they were sewed along one the side of the foot rather than the center.





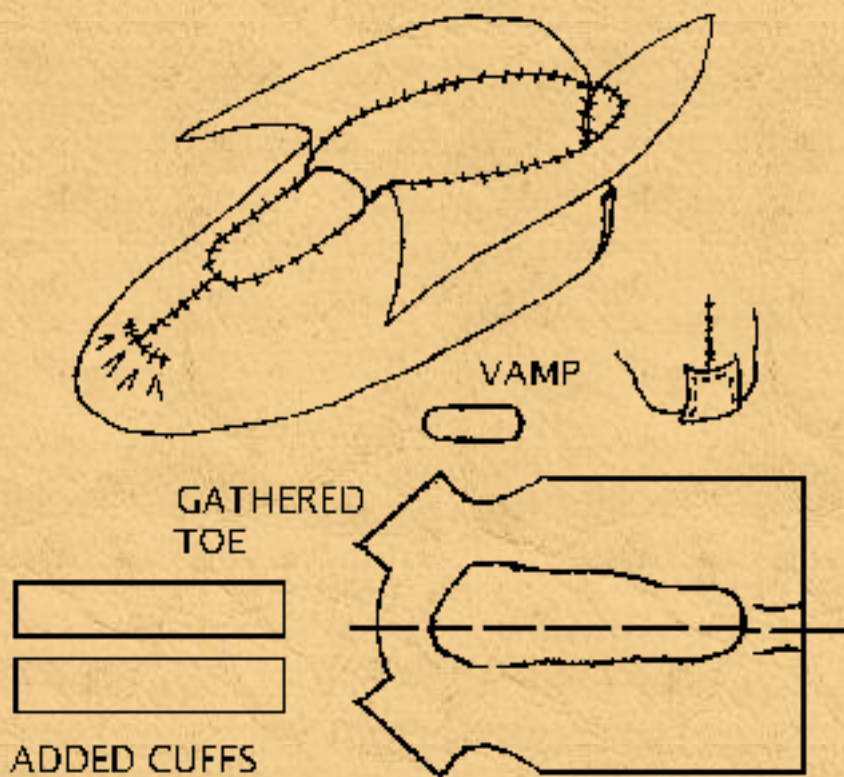
One Piece Soft Sole Side Seam  
Smooth Toe and Heel Tab

The most basic form of soft-sole moccasin was the simple center seam made from a single piece of tanned leather. The leather sides were brought up from the bottom and around the sides of the foot sewn in a central seam starting with a puckered stitch at the toe and running along the upper instep. Variations of soft-sole moccasin construction include a u-shaped piece of leather, added as a vamp, while another piece was added to the back of the moccasin to serve as a cuff. Some of the Great Lakes and Iroquois tribes used a wide vamp, added in a gathered fashion to cover most of the upper front of the moccasin. Other Eastern Forest tribes made moccasins with a shorter or narrower vamp that sometimes joined a central puckered seam running down the upper front to the toe.



One Piece Center Seam  
Puckered Toe and Heel Tab

Moccasins were made with all types of variations and additions according to the styles of different tribes. So distinctive are some moccasin styles that one could tell the tribe of the wearer by his footprints. Flaps of leather or fur were often added to cover the ankle, or folded down as a cuff. Some moccasins were made into a boot simply by attaching them to the leggings. Various sized u-shaped or elliptical pieces of leather, called vamps or insets, were added to the moccasin upper at the instep. A tongue for hard and soft-soled moccasins was often added and cut into various forms and decorated. Many methods were used to pucker the toes of woodland center-seam moccasins. A distinctive 'rabbit nose' or 'partridge' moccasins could be sewed by trimming the pattern first into a 'w' shape. There were also many ways to finish the heels of moccasins. Varieties of Eastern Woodland moccasins often left a tiny tab, or tail, trimmed to different shapes, that dragged behind. Other one-piece moccasins have no tail, or the tab is sewn up to the heel for added reinforcement. Some moccasins of the plains and prairie had fringe hanging at the heel seam or added onto the instep; as fringe trailed behind the walker, it may have helped to obliterate footprints.



One Piece Center Seam with Vamp  
Gathered Toe and Reinforced Heel

Moccasins were usually made from the soft tanned hides of deer, moose, elk or buffalo. Rawhide was used for the hard-soled moccasins. Hides from the larger animals were much thicker than buckskin. Thicker hides were more difficult to sew, but produced sturdier, longer lasting moccasins. Sewing is easier with soft Indian-tanned (or brain-tanned) leather, but commercially sueded and split leather is also suitable for moccasin making. Commercial leather is most like brain tanned leather when it is split (sueded on both sides), as the smooth outside of the hide has been split off. The thickness of commercial leather is measured by the weight in ounces of a square foot of leather. Very thin garment leathers, 1-2 oz. weight, is usually too thin for practical moccasins, while heavy leathers, 5-6 oz. weight, can be nearly impossible to sew by hand. Medium thickness leather (3-4 oz. weight) is recommended for most soft-soled moccasins. Patterns should be laid out on the hide so the pieces go with the grain of the leather, so the moccasins will be uniform. If conservation of leather is a consideration, pieces can be laid out so leather is not wasted, but as the leather stretches in different directions, sewing can become a little irregular.





One Piece Center Seam  
Pointed Toe and Heel

Moccasins were assembled inside out to hide the stitching in the finished shoe. Stitching would be done traditionally with sinew through holes punched with an bone awl. For comfort, knots were kept on the outside of a shoe. The whip stitch was commonly used in moccasins, often with an added narrow welt running the length of the seam to make the moccasin stronger and to help hide the stitching when turned right side out. The running stitch was also used in places where the whip stitch was not as practical, as with added fringe. Seams were often gently pounded flat in puckered areas.

Even though moccasin construction techniques are similar among many tribes, the beaded or quilled decorations were often quite distinctive. Woodland moccasins were often decorated, usually in floral or zoomorphic designs, on the instep or tongue portion, woodland decoration did not usually cover the sides of the moccasin. The flap or added cuff around the ankle was also often decorated, or worn upright and held in place by thongs wrapped around the ankle. A separate beaded or quilled piece of velvet or leather was sometimes sewn on top of the cuff or tongue portion. These decorated panels could be easily removed from the moccasins when the soles wore out, and sewn onto a new pair. Plains moccasins often left the cuff undecorated, but geometric bead and quillwork patterns often decorated the instep portion, or around the circumference near the sole. Some Plains designs covered the entire top of the moccasin from the heel to the toe. Moccasins worn for marriage were often completely covered in beads. For Plains peoples preparedness in the afterlife, many moccasins worn into burial were fully beaded even on the bottom of the soles.

---

[Return to NativeTech's Main Leather & Clothes Menu](#)

[Leather & Clothes Bibliography and Books to Buy On-Line](#)

---



© 1994-2000 [Tara Prindle](#).



## Native American Technology and Art

# Map of North America with Native American Varieties of Moccasins

Finally, this map is 'clickable'.

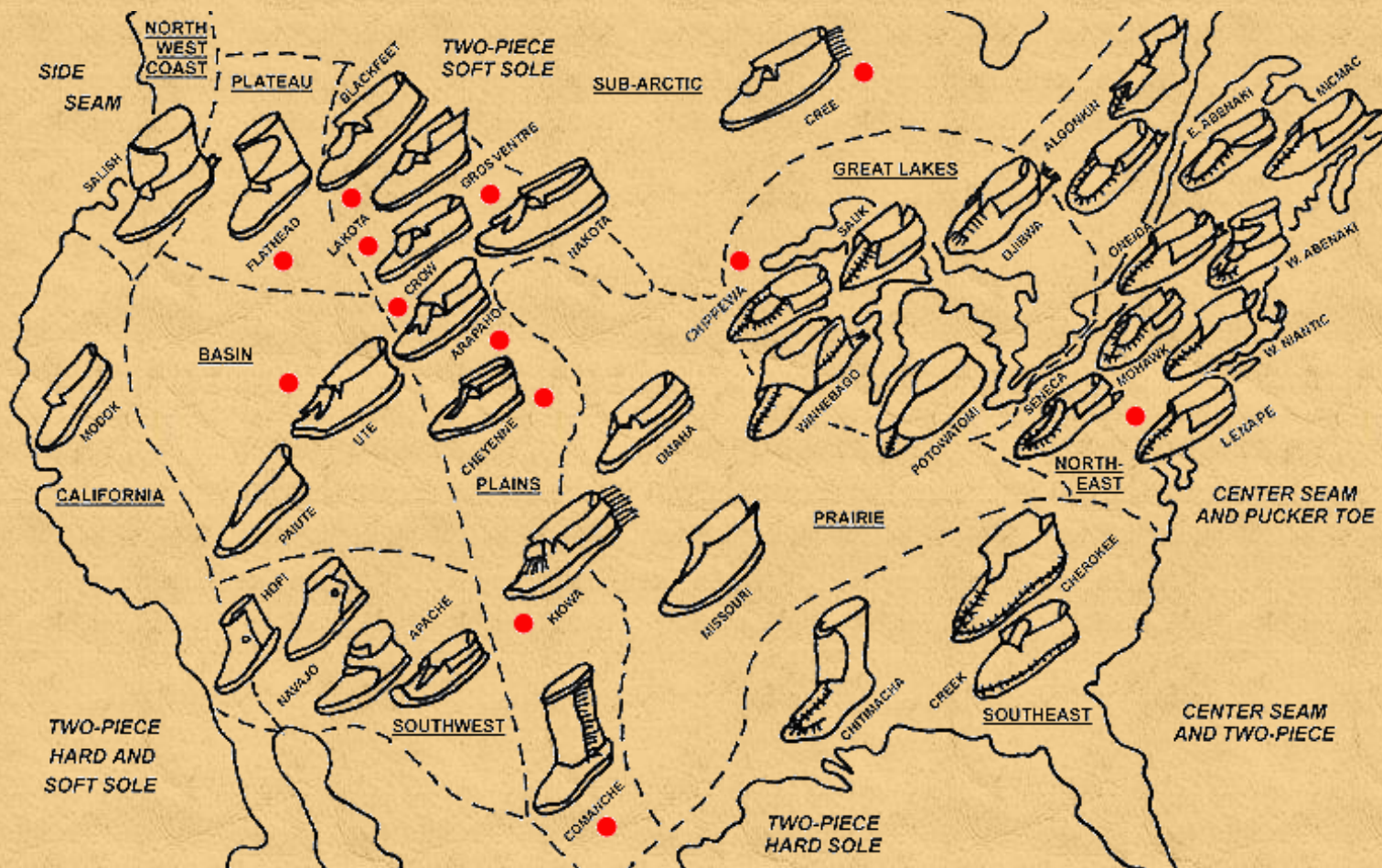
I am very thankful for the images of moccasins provided by

[Morning Star Gallery](#)

and by

Jim Rementer of [Touching Leaves](#)

Click on the RED dots to see larger color pictures of moccasins from these regions.



[See the Instructions for Making Center-seam Moccasins](#)

[Return to Overview of Native American Footwear ~ Moccasins](#)

[Return to NativeTech's Main Leather & Clothes Menu](#)

[Leather & Clothes Bibliography and Books to Buy On-Line](#)



© 1994-2002 [Tara Prindle](#).



## Native American Technology and Art

### Native American Varieties of Moccasins - Ute

---



Circa 1880

*Ute moccasins partly beaded with cactus kicker toes and heel fringe.*

© [Morning Star Gallery](#)



Circa 1880

*Ute moccasins with small red and yellow triangles against a white background.*

© [Morning Star Gallery](#)

---

[Return to Map of Native American Moccasins](#)

[Return to Overview of Native American Footwear ~ Moccasins](#)

[Return to NativeTech's Main Leather & Clothes Menu](#)

[Leather & Clothes Bibliography and Books to Buy On-Line](#)

---





© 1994-1999 [Tara Prindle](#).

## Native American Technology and Art



### Instructions for One-piece, Soft-sole, Center-seam Moccasins

---

Did you see the [Map of North America with Native American Varieties of Moccasins?](#)

---

#### Making a paper pattern for moccasins:

*(use the same pattern left and right moccasins)*

**1. Place feet (or tracings) on either side of center line of paper with 1" between heels and edge of paper.**

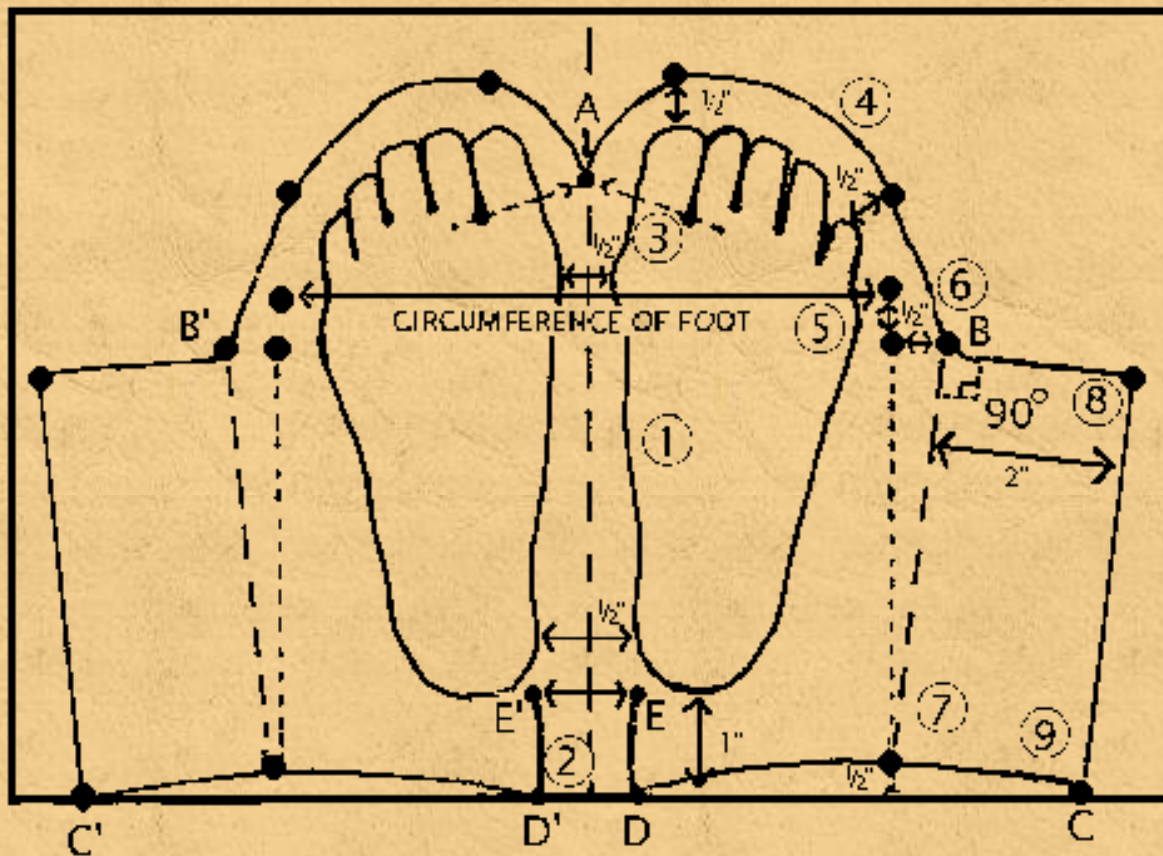
Each heel should be 1/2" away from the center line, and the balls of the feet below the big toes should be 1/4" away from the center-line of the paper.

**2. Even with the heels, mark points E and E' (1/2" from the center-line and 1" from the edge of the paper) Also mark points D and D' (1/2" from the center-line at the edge of the paper).**

**3. Mark point A by following a line from the base of the big toe to the center-line.**



## MAKING THE PAPER PATTERN



4. Draw curve around top of foot 1/2 " from toes from point A to just above little toe.

5. To find points B and B', measure the circumference around the (widest part) ball of the foot and place half the distance on either side of the center-line where the ball of the foot is, mark this point. Now measure 1/2 " straight down and 1/2" straight out.

6. Finish drawing the curve around the top of the foot to point B and to point B'.

7. Drop an imaginary line straight down from each of the marked

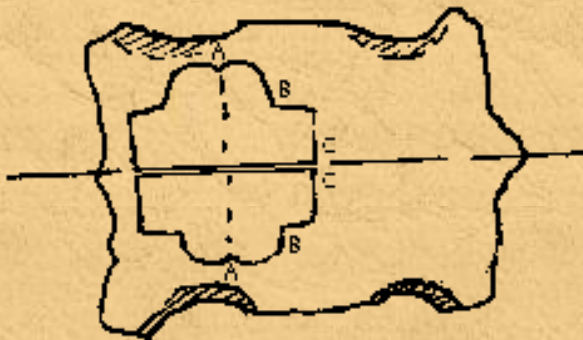
MAKE SURE PAPER PATTERN FITS AROUND FOOT AT INSTEP AND AT HEEL BEFORE CUTTING OUT OF LEATHER.

[CLOTH OR FELT CAN BE USED TO PRACTICE STITCHING WITH]

points for the circumference of the foot, this marks the bottom of the moccasin cuff at the heel. Another imaginary line connecting this point with point B shows where the cuff will be folded down at the ankle.

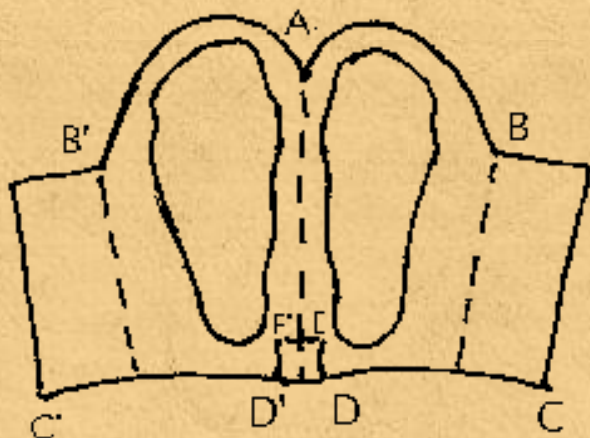
8. To draw the front corners of the cuff, draw a 2" line from point B, perpendicular to the imaginary fold-over line for the cuff.

9. Maintain a 2" cuff width to find point C at the rear corner of the cuff. Connect point C with point D at the heel by drawing a slight curve that intrudes no more than 1/4" from the edge of the paper.



Make sure paper pattern fits foot around instep and at heel before cutting out of leather.

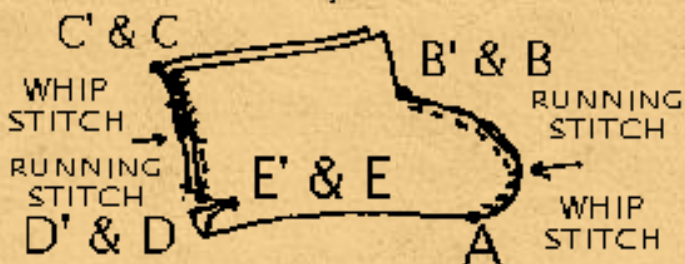
IDEALLY. MATCH PATTERNS WITH THE GRAIN ON EITHER SIDE OF BACKBONE CENTERLINE.  
(CAN BE WASTEFUL OF LEATHER)



After cutting out the paper pattern, fabric or felt can be used to practice stitching.

### THE CUT-OUT LEATHER PATTERN

### SEW INSIDE-OUT SEAMS A TO B/ SEAMS D TO C



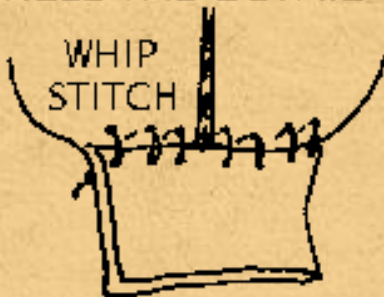
Sew inside out: Seam A to B/B' and seam D/D' to C/C'. Use a combination of whip stitch and running stitch (it's easier to pucker the toe using the running stitch). Cut slits (for heel tab) from D to E and D' to E' only after the toe is stitched, and proper fit is checked.



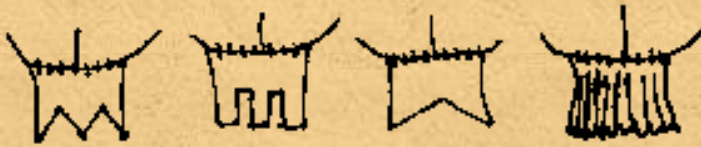
Right side out, use the whip stitch in sewing the seam for the heel tab.

TURN RIGHT SIDE OUT  
(PULL HEEL TAB TO OUTSIDE)

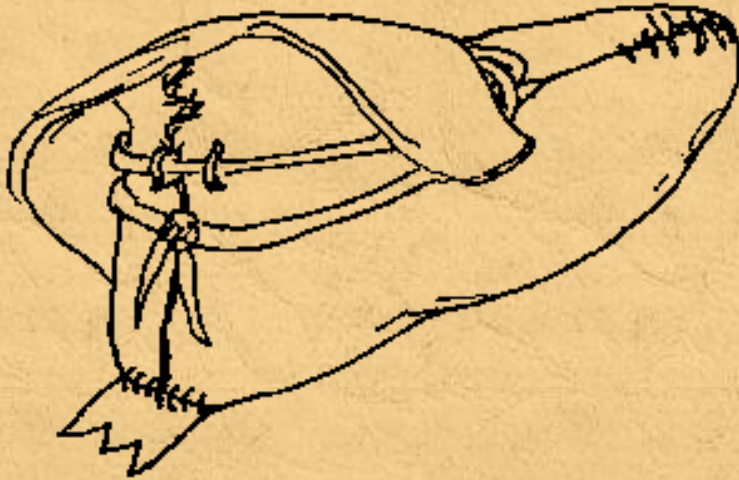
### HEEL TAB DETAIL







Some variations in Trimming the Heel Tab.



ATTATCH THONG AT BACK OF ANKLE  
(WRAP AROUND TO FRONT AND  
TIE IN BACK, TURN DOWN CUFF)

ATTATCH THONG AT SEAM AT BACK  
OF ANKLE.

Cut thong from a scrap of leather by cutting from the perimeter of the scrap, in a spiral, towards the center. Use the thong to keep the moccasin snug. stitch the thong to two places at the back of the moccasin, or punch holes below the cuff, and wrap the thong around to the front and tie it in the back.

---

[Return to Overview of Native American Footwear ~ Moccasins](#)

[Return to NativeTech's Main Leather & Clothes Menu](#)

[Leather & Clothes Bibliography and Books to Buy On-Line](#)

---



© 1994-1999 [Tara Prindle](#).



NativeTech: Native American Technology & Art



## LEATHER & CLOTHES BIBLIOGRAPHY

Click on the links below for the books you can order on-line in affiliation with [barnesandnoble.com](http://barnesandnoble.com)

---

### *References cited in NativeTech's [Leather & Clothes articles](#):*

**Beauchamp, William M.**

**1903 Metallic Ornaments of the New York Indians.**

New York State Museum Bulletin 73.

[Order this book through barnesandnoble.com](http://barnesandnoble.com)

**Bradford, William**

**1981 Of Plimoth Plantation, 1620-1647.**

New York City, New York: Random House.

[Order this book through barnesandnoble.com](http://barnesandnoble.com)

**Burnham, Dorothy K.**

**1992 To Please the Caribou; Painted caribou-skin coats worn by the Naskapi, Montagnais, and Cree hunters of the Quebec-Labrador Peninsula.**

Seattle: University of Washington Press.

[Order this book through barnesandnoble.com](http://barnesandnoble.com)

**Church, Colonel Benjamin**

**1975 Diary of King Philip's War 1675-1676.**

Introduction by Alan and Mary Simpson. Published for the Little Compton Historical Society; Tiverton, RI: Lockwood Publications.

[This book is Unavailable. But here are some related books.](#)

**Claro, Nicole**

**1992 The Cherokee Indians.**

New York: Chelsea House Publishers.

[Order this book through barnesandnoble.com](http://barnesandnoble.com)

**Coe, Ralph T.**

**1986 Lost and Found Traditions, Native American Art 1965-1985.**

New York: University of Washington Press in Association with the American Federation of Arts.

[Order a used copy of this Out of Print book](#)



**De Forest, John W.**

**1852 History of the Indians of Connecticut from the Earliest Known Period to 1850.**

Hartford, CT: W. J. Hamersley.

[Order this book through barnesandnoble.com](http://www.barnesandnoble.com)

**de Laet, Johan**

**1967 From the "New World" [1625, 1630, 1633, 1640]. In Narratives of New Netherland, 1609-1664.**

F.J. Jameson, ed. Pp. 29-60. New York: Barnes and Noble.

[Order this book through barnesandnoble.com](http://www.barnesandnoble.com)

**Densmore, Frances**

**1979 Chippewa Customs.**

St. Paul Minnesota: Minnesota Historical Society Press.

[Order this book through barnesandnoble.com](http://www.barnesandnoble.com)

**Fogelman, Gary L.**

**1991 Glass Trade Beads in the Northeast and Including Aboriginal Bead Industries.**

Fogelman Publishing Co.: Turbotville, PA.

[Order this book through barnesandnoble.com](http://www.barnesandnoble.com)

**Gabort, R.**

**1993 Costume of the Iroquois.**

Ontario, Canada: Iroqrafts, Ltd. ISBN: 0-919645-02-X

**Gookin, Daniel**

**1970 Historical Collections of the Indians in New England.**

J.H. Fiske, ed. London: Towaid. (First published 1674).

[Order this book through barnesandnoble.com](http://www.barnesandnoble.com)

**Hail, Barbara A.**

**1980 Hau, Kola! The Plains Indian Collection of the Haffenreffer Museum of Anthropology.**

Fourth Printing 1994 (revised). Rhode Island: Haffenreffer Museum of Anthropology, Brown University.

[Order this book through barnesandnoble.com](http://www.barnesandnoble.com)

**Hartman, Sheryl**

**1988 Indian Clothing of the Great Lakes: 1740-1840.**

Ogden, UT: Eagle's View Publishing Company.

[Order this book through barnesandnoble.com](http://www.barnesandnoble.com)

**Hayes, Charles F., gen. ed.**

**1989 Proceedings of the 1986 Shell Bead Conference; Selected Papers.**

New York: Rochester Museum and Science Center, Research Records No. 20.

**Hathaway, Nancy**

**1990 Native American Portraits 1862-1918.**

San Francisco: Chronicle Books.

[Order this book through barnesandnoble.com](http://www.barnesandnoble.com)

**Heath, Dwight B., ed.**

**1986 Mourt's Relation: A Journal of the Pilgrims at Plymouth.**

Cambridge: Applewood books. (First published in 1622).

[Order this book through barnesandnoble.com](http://www.barnesandnoble.com)

**Jameson, F.J., ed.**

**1967 Narratives of New Netherland, 1609-1664.**

New York: Barnes and Noble.

[Order this book through barnesandnoble.com](http://www.barnesandnoble.com)

**Jennings, Francis**

**1976 The Invasion of America: Indians, Colonialism, and the Cant of Conquest.**

New York: W. W. Norton & Company, Inc.

[Order this book through barnesandnoble.com](http://www.barnesandnoble.com)

**Johnson, Michael G.**

**1990 American Woodland Indians.**

Men-at-arms-series, V. 228. London: Osprey Publishing Ltd. Book Unavailable - Related Books:

[This book is Unavailable. But here are some related books.](#)

**Josselyn, John**

**1972 New-Englands Rarities Discovered.**

Meriden: Meriden Gravure Co. (First published 1672).

[Order this book through barnesandnoble.com](http://www.barnesandnoble.com)

**King, J.C.H.**

**1991 "Woodland Artifacts From the Studio of Benjamin West 1738-1820". In American Indian Art.**

Vol.17, No.1, Winter. Scottsdale, AZ: American Indian Art, Inc.

**King, J.C.H.**

**1993 "Woodlands Art as Depicted by Sarah Stone in the Collection of Sir Ashton Lever." In American Indian Art.**

Vol. 18, No 2: 32-45. Scottsdale, AZ: American Indian Art, Inc.

**Library of Congress**

**1993 The North American Indian Portfolios.**

New York: Abbeville Press Publishers.



[Order this book through barnesandnoble.com](http://www.barnesandnoble.com)

**Lindholdt, Paul, ed.**

**1988 John Josselyn, A Critical Edition of Two Voyages to New England.**

Hannover: University Press of New England. (First printed in 1674).

[Order this book through barnesandnoble.com](http://www.barnesandnoble.com)

**Lowie, Robert H.**

**1954 Indians of the Plains.**

New York: McGraw-Hill.

[Order this book through barnesandnoble.com](http://www.barnesandnoble.com)

**Mails, Thomas**

**1972 "Mystic Warriors of the Plains"**

Doubleday & Co: Garden City, New York.

[Order this book through barnesandnoble.com](http://www.barnesandnoble.com)

**Miles, Charles**

**1963 Indian & Eskimo Artifacts of North America.**

New York: Bonanza Books.

[Order a used copy of this Out of Print book](http://www.outofprint.com)

**Monture, Joel**

**1993 The Complete Guide to Traditional Native American Beadwork. A definitive Study of Authentic Tools, Materials, Techniques, and Styles.**

New York: Macmillian Publishing Co.

[Order this book through barnesandnoble.com](http://www.barnesandnoble.com)

**Morgan, Lewis H.**

**1993 League of the Iroquois.**

New York: Carol Publishing Group.

[Order this book through barnesandnoble.com](http://www.barnesandnoble.com)

**Morton, Thomas**

**1964 New English Canaan.**

Ann Arbor: University Microfilms Inc. (Authorized copy of original 1637 publication. Amsterdam: J. F. Stam).

**Obermeyer, Rick ed.**

**1991 [19th Century Seminole Men's Clothing](http://www.barnesandnoble.com)**

Sherwood F. Obermeyer Jr., 2124 Miscindy Place, Orlando, FL 32806

**Radin, Paul**



**1990 The Winnebago Tribe.**

Lincoln & London: University of Nebraska Press.

[Order this book through barnesandnoble.com](http://www.barnesandnoble.com)

**Ritzenthaler, Robert E. and Pat Ritzenthaler**

**1970 The Woodland Indians of the Western Great Lakes.**

Garden City, NY: Natural History Press.

[Order this book through barnesandnoble.com](http://www.barnesandnoble.com)

**Rosier, James**

**1966 A True Relation of the Most Prosperous Voyage..1605, By Captain George Waymouth.**

Ann Arbor: University Microfilms Inc. (First published 1605).

**Rowlandson, Mary**

**1981 Puritans Among the Indians: Accounts of Captivity and Redemption 1676-1774.**

A. Vaughan and E. Clark, ed.s. Cambridge, MA: Bellknap Press of Harvard University Press.

[Order this book through barnesandnoble.com](http://www.barnesandnoble.com)

**Russell, Howard**

**1980 Indian New England Before the Mayflower.**

Hanover: University Press of New England.

[Order this book through barnesandnoble.com](http://www.barnesandnoble.com)

**Simmons, William S.**

**1970 Cautantowwit's House: An Indian Burial Ground on the Island of Conanicut in Narragansett Bay.**

Providence, RI: Brown University Press.

[Order this book through barnesandnoble.com](http://www.barnesandnoble.com)

**Snow, Dean R.**

**1980 The Archaeology of New England.**

New York: Academic Press.

**Speck, Frank G.**

**1976 Penobscot Man: The Life History of a Forest Tribe in Maine.**

New York: Octagon Books.

[Order this book through barnesandnoble.com](http://www.barnesandnoble.com)

**Thomas, David H., Editor**

**1986 A Blackfoot Source Book; Papers by Clark Wissler.**

New York & London: Garland Publishing, Inc.

**Schneider, Richard C.**



**1972 Crafts of the North American Indians; A Craftsman's Manual.**  
312 Linewood Ave., Stevens Point, Wisconsin 54481: Richard C. Schneider, Publishers.  
[Order this book through barnesandnoble.com](http://www.barnesandnoble.com)

**Trigger, Bruce G. ed.**  
**1978 Handbook of North American Indians, Vol. 15, Northeast.**  
W. Sturtevant, gen. ed. Washington, D.C.: Smithsonian Institution.  
[Order this book through barnesandnoble.com](http://www.barnesandnoble.com)

**van der Donck, Adrien**  
**1968 A Description of the New Netherlands.**  
T. O'Donnell, ed. Syracuse: Syracuse University Press. (First published 1656).

**Westhorp, Christopher and Richard Collins**  
**1993 Pocket Guide to Native Americans.**  
New York: Cresent Books.  
[This book is Out of Print. But used copies are available here.](#)

**White, George M.**  
**1969 Craft Manual of North American Indian Footwear.**  
Arlee, Montana 59821: George M. White, Publisher.  
[Order this book through barnesandnoble.com](http://www.barnesandnoble.com)

**Whiteford, Andrew Hunter**  
**1990 North American Indian Arts; A Golden Guide.**  
New York: Golden Press \ Wisconsin: Western Publishing Co., Inc.  
[Order this book through barnesandnoble.com](http://www.barnesandnoble.com)

**Williams, Roger**  
**1973 Key into the Language of America.**  
J.J. Teunissen and E.J. Hinz, ed.s. Detroit: Wayne State University Press. (First printed 1643).  
[Order this book through barnesandnoble.com](http://www.barnesandnoble.com)

**Winthrop, John**  
**1908 Winthrop's Journal: "History of New England," 1630 to 1649. 2 vols.**  
James K. Hosmer, ed. New York: Charles Scribner's Sons.  
[Order this book through barnesandnoble.com](http://www.barnesandnoble.com)

**Wood, William**  
**1865 Wood's New England's Prospect.**  
Boston: Publications of the Prince Society 1. (First published 1634).  
[This book is Out of Print. But used copies are available here.](#)

**Wroth, Lawrence C., ed**  
**1970 The Voyages of Giovanni da Verrazzano, 1524-1528.**  
New Haven and London: Yale University Press.

---

*Other Books relating to Leather & Clothes can buy on-line through*  
[barnesandnoble.com](http://barnesandnoble.com):

**Burnham, Dorothy K.**  
[Cut My Cote](#)

**Kock, Ronald P.**  
[Dress Clothing of Plains](#)

**Sizemore, Donald**  
[How to Make Cherokee Clothing](#)

**Hartman, Sheryl and Monte Smith (Editor)**  
[Indian Clothing of the Great Lakes: 1740-1840](#)

**Anawalt, Patricia Rieff and Jean N C. Sells (Illustrator)**  
[Indian Clothing before Cortes : MesoAmerican Costumes from the Codices](#)

**Waldauer, Karen (Editor)**  
[Lenape Indian Teaching Kits: Lanape Lore/Clothing, Shelter, Crafts, Weapons, Tools and Specialties](#)

**Capture, George P. and Anne Vitart George P. Horse Capture Richard W. West, Jr.**  
[Robes of Splendor: Native North American Painted Buffalo Hides](#)

**Burnham, Dorothy K.**  
[Unlike the Lilies: Doukhobor Textile Traditions in Canada](#)

Additional book list being compiled.  
In the meantime,

[Click here to Search for Books about Leather & Tanning](#)



[Search for Books at  
barnesandnoble.com](#)

Search by:

---

[Return to NativeTech's Main Leather & Clothing Menu](#)

---



© 1994-1999 [Tara Prindle.](#)





**TUKO-SEE-MATHLA**  
A Seminole Chief

*Adapted from  
The North American Indian Portfolios, 1993  
Library of Congress*

# Index to Articles

*in 19th Century  
Seminole Men's Clothing*

**Sherwood F. Obermeyer Jr.,  
2124 Miscindy Place,  
Orlando, FL 32806**

**[Rick Obermeyer ~ Editor](#)**

---

**[FORWARD](#) ~ by Rick Obermeyer**

**[STARTING RESEARCH](#) ~ by Jason Baird Jackson**

**[VERSIMILITUDE](#) ~ comments by Rick Obermeyer**

**[CREEK = SEMINOLE?](#) ~ comments by Rick Obermeyer**

**[THE PLAIN SHIRT](#) ~ by M. E. (Pete) Thompson**

**[Pattern for the Plain Shirt](#)**

**[Instructions for sewing together the Plain Shirt](#)**

**[THE LONG SHIRT](#) ~ by M. E. (Pete) Thompson and Rick Obermeyer**

**[Longshirt Pattern & Construction](#)**

**[Longshirt Finishing](#)**

[Longshirt Appendices & References](#)

[CREEK/SEMINOLE MOCCASINS](#) ~ notes from a Darry Wood demonstration

[Making Creek / Seminole Moccasins](#)

[References for Creek/Seminole Moccasins](#)

[LEGGINGS](#) ~ by Pete Thompson and Rick Obermeyer

[Cloth Leggings](#) ~ by Pete Thompson

[Buckskin Leggings](#) ~ by Pete Thompson, Rick Obermeyer and David Mott

[References for Leggings](#)

[BEADED POUCHES AND BANDOLIERS](#) ~ by David J. Mott and Rick Obermeyer

[Beading & Designs](#)

[Backing, Edging and Detailing](#)

[Seminole Bandolier Attachment and Conclusions](#)

[Appendix and References for Seminole Pouches & Bandoliers](#)

[FINGERWOVEN SASHES AND GARTERS](#) ~ comments by Rick Obermeyer

[Finger Weaving Instructions](#) ~ by Richard Conn

[ACCESSORIES](#) ~ Quotes, various

- o [BREECHCLOTHS](#) ~ by Rick obermeyer
- o [SEMINOLE SILVER WORK](#) ~ by Michael R. Brown

[Gorgetts \(Late 19th Cent. Style\)](#) ~ by Clayton C. Carroll

[Patterns for Gorgetts](#)

[Clayton C. Carroll's Instructions for making Gorgetts](#)



- [TURBANS](#) ~ by Rick Obermeyer
- [PEACE MEDALS](#) ~ by Michael R. Brown
- [BEADS](#) ~ by Michael R. Brown
- [FACE PAINTING](#) ~ by David Mott and Rick Obermeyer

### [O.A. CEREMONIAL TEAM GUIDELINE](#)

---

*I wish to express my deepest gratitude to Rick O.  
for sharing all this wonderful information! ~ Tara*

---

Contributed by [Rick Obermeyer](#) E-mail: [orick@prodigy.net](mailto:orick@prodigy.net)

From the book *19th Century Seminole Mens Clothing*

© 1991-2000 Sherwood F. Obermeyer Jr., 2124 Miscindy Place, Orlando, FL 32806

---

[Return to NativeTech's Main Leather & Clothes Menu](#)

[Leather & Clothes Bibliography and Books to Buy On-Line](#)

---



Text and Graphics  
© 1994 - 2003 [Tara Prindle](#)  
unless otherwise cited.



TUKO-SEE-MATHLA  
A Seminole Chief

*Adapted from The North American Indian Portfolios, 1993 ~ Library of Congress*

# Foreward

by Rick Obermeyer

*in 19th Century Seminole  
Men's Clothing*

[Rick Obermeyer ~ Editor](#)

---

## [Complete Index to Articles in 19th Century Seminole Men's Clothing](#)

---

These articles were researched and written by amateur scholars as an aid to other amateurs. All but one of the authors originally met each other in the Order of the Arrow, a national Scouting camping honorary, and credit their first interest in Native American crafts and culture to associations and activities within the O.A.

### [O.A. Ceremonial Team Guideline](#)

This information was arranged for those not only unfamiliar with Seminole clothing, but also unfamiliar with working with the materials- beads, cloth, buckskin, even with needle and thread. Following these instructions won't necessarily get you museum quality reproductions. Besides requiring more excruciating accuracy for that than is here, you'd also need to have period materials and genuine construction skills. What you will get will be reasonably accurate replicas very suitable for powwows, Scout ceremonies, and historical reenactments.

Seminole clothing exists in an odd historical "pocket." It arises out of general Southeastern traditions, but continued to exist (and evolve) long after the rest of that Southeastern Indian culture had been shut down either by extinction, by relocation to Oklahoma, or- just by being overwhelmed by white dominance. Seminole clothing styles were already well defined by the 1820's, a time when the Plains



Indian cultural patterns that so many hobbyists admire and copy were only just beginning to fully develop. Southeastern cultural styles had climaxed and terminated before Plains styles matured as we know them. The Creeks were gone, the Cherokees overrun. After the 1830's, only the Seminoles kept going as a distinct culture' surviving even the traumas of the Second and Third Seminole Wars. The Seminoles' strong avoidance of any but the most necessary contact with whites, their voluntary isolation, kept their branch of Southeastern culture unique and distinct long after the rest was gone.

The builder of a Seminole outfit will learn that he has many of the same kinds of restrictions and freedoms that the assembler of a modern Plains fancy dance outfit has. Certain pieces are ALWAYS there. They define the outfit. They are always made or built the same way. But, there is space for a lot of personal preference- in colors, in finishing touches, in accessories. Two fancy dancers side by side will both have roaches, double bustles, beaded yoke set, bells, and angoras and still look very different. Two old style Seminole re-enactors will both have turbans, plumes, plain shirts, long shirts, moccasins, and sashes, and yet they can look completely different. There are "rules" that indicate what the parts of the outfit are, but there is also room for individual style.

And, there is always that great advantage of old style Seminole over Plains. You can't throw feathers into a washing machine.

Rick Obermeyer

December, 1990

---

[Starting Research: A Beginners Guide to Southeastern Indian Studies](#)

[Versimilitude: Quality or state of having the appearance of truth or reality](#)

[Creek = Seminole?: What Is Seminole "style"?](#)

---

[Complete Index to Articles in \*19th Century Seminole Men's Clothing\*](#)

Contributed by [Rick Obermeyer](#) E-mail: [orick@prodigy.net](mailto:orick@prodigy.net)

From the book *19th Century Seminole Mens Clothing*

© 1991-2000 Sherwood F. Obermeyer Jr., 2124 Miscindy Place, Orlando, FL 32806

---

[Return to NativeTech's Main Leather & Clothes Menu](#)

[Leather & Clothes Bibliography and Books to Buy On-Line](#)

---



**Text and Graphics**  
© 1994 - 2003 [Tara Prindle](#)  
unless otherwise cited.

## Native American Technology and Art

# Succotash-N-Nuts

---

Offered by Hailey Burris

~ Maryland Clements ~

... who learned this from history

### Ingredients:

- Small Can Corn
- Small Can Lima Beans
- Half Of Green Pepper
- Pinch Of Salt And Pepper

### Preparation:

1. Chop up green pepper into small pieces
2. Mix everything together and cook in microwave for 3 to 5 minutes

Servings: Two

Thank you Hailey Burris for sharing Succotash-N-Nuts with us!

---

[Return to Food & Recipes Menu](#)



Text and Graphics  
© 1994 - 103 [Tara Prindle](#)  
unless otherwise cited.



## NativeTech: Native American Technology & Art



A lot of people have written to me suggesting I have a section on indigenous foods & Native American recipes. Admittedly, I am a terrible cook... and if left up to my own experiences this page would either be empty (or singed around the edges)! Rather than copying from the pages of books, I thought we could build a more interesting (and perhaps amusing) collection of our own. So I'm petitioning the more experienced and knowledgeable cooks out there to send me their own Native American recipes to be shared here on these pages. Contribution in any of the suggested categories is welcomed... humor is especially appreciated (as long as it's in good taste)!! Please do not submit recipes copied from other sources without the author's permission. *Note: I am not responsible for any cooking accidents or unpredicted results of these recipes.*

**Come on guys, make me proud!**

*To submit your recipe, fill out all fields in this form, including a valid e-mail address. Please be as complete with your information as possible.*

**How would you categorize this Native American Recipe?**

**Recipe Name: (What do you call it?):**

**Origin of Recipe: (Where'd ya learn to make this?)**

**List the Ingredients: (amount and type)**

**Describe the Preparation:**

**Anything Else We Should Know? (this field is optional):**

**How many people will this feed?**

**Submitted by: (What's your name?)**

**Your Tribal Affiliation: (Where are ya from, and who are your folks?)**

**Your E-mail address:**

**Please submit your recipe only once... I'll post your recipe as quickly I can... but it may take up to a month. Your name & Tribal affiliation, but \*not your e-mail address, will be listed with your recipe. Check back to see your recipe on the pages!**

**NOTE: Some people write to me to seek permission to reproduce recipes in NativeTech's Food and Recipes section. In general, NativeTech materials are free and may be reproduced for (non-internet) personal use and public non-profit classroom (or scouting) use. The original recipe contributor retains joint copyright with NativeTech, and recipes may not be re-sold, used for advertising purposes, or included in other commercially sold cookbooks.**

---

**[Return to Food & Recipes Menu](#)**

---



**Text and Graphics  
© 1994 - 103 [Tara Prindle](#)  
unless otherwise cited.**



# Food & Recipes

[Check out these Books about Native Foods!](#)

*Ok, this section is up to you, the faithful visitors of my web pages...*

**[Submit your own Native American recipe - click here!](#)**

---

\*\*\* Recipes by **Region and Tribe** are broken down into three categories: \*\*\*

1. [Bold Font] **All Indigenous Ingredients & Preparation**
2. [Normal Font] Traditional Recipes with Contemporary Ingredients
3. [Italics Font] *Today's Native Dishes*

**OR [Click here to Sort by Type of Dish](#)**

*Please do not reproduce these recipes without permission ~ thank you.*

---

## ✂ NORTHEAST / GREAT LAKES

- [Corn Soup](#) Abenaki
- [Indian Pogo](#) Algonquin, Long Point First Nation
- [Salmon Stuffed Frybread](#) Anishinaabe, MI
- [Horse Tea](#) Chippewa
- [Wild Rice Casserole](#) Chippewa, Lac du Flambeau
- [Chokecherry Pemmican](#) Cree, Alberta Plains **NEW!**
- [Frybread Pizza with a Twist](#) Cree - Mohawk
- [Great Lakes Smoked Salmon](#) great lakes **NEW!**
- [Fire Baked Trail Fish](#) Huron
- [Cranberry Bread](#) Iroquois
- [Indian Cake](#) Lenape
- [Indian Fry Bread](#) Lenape
- ["Western" Pemmican](#) Lenape
- [Mint Leaf Tea](#) Maliseet
- [Blanket Dog](#) Menominee
- [La Follette Thunder Milk](#) Menominee
- [Menominee Pilaf](#) Menominee
- [Cat's Butter noodle soup](#) Mohawk
- [Fire Baked Fish](#) Mohawk
- [Fiddlehead & Cattail Salad](#) Mohawk - Metis
- [Lichen Tea](#) Mohawk
- [Mohawk Corn Bread](#) Mohawk, Six Nations
- [Mohawk Corn Soup](#) Mohawk, Awkwesasne

## ✂ PLAINS / PLATEAU

- [Jac's Wildberry Crisp](#) Blackfoot
- [Smoked Bucket Chicken](#) Blackfoot **NEW!**
- [Cheyenne Batter-Bread](#) Cheyenne **NEW!**
- [Corn Balls \(Wahuwapa Wasna\)](#) Dakota
- [B.B.Q. Tuna](#) Lakota, Rosebud
- [Beans & Bacon](#) Lakota, Oglala
- [Buffalo Stew](#) Lakota, Hunkpapa
- [Choke Cherry Pudding](#) Lakota - Crow
- [Mesquite Cakes](#) Lakota **NEW!**
- [Pow-Wow Soup Lakota Style](#) Lakota
- [Tanica](#) Lakota, Oglala
- [Wojapi \(Pudding\)](#) Lakota - Cree
- [Blueberry Wojapi](#) Lower Brule Sioux
- [New Native Frybread](#) Lower Brule Sioux
- [Taco Rice](#) Lower Brule Sioux **NEW!**
- [Wild Peppermint Tea](#) Lower Brule Sioux
- [Pemmican](#) plains
- [Roast Turtle](#) plains
- [\(more\) Choke Cherry Pudding](#) Shoshone Bannock
- [Currant Pudding](#) Shoshone Bannock
- [Grilled Salmon](#) Shoshone Bannock
- [Hot Bread](#) Shoshone Bannock
- [Moosemeat Chinese Style](#) Shoshone Bannock



- [Pork Stuffed Fry Bread](#) Mohawk
- [Survival Sausage](#) Mohawk
- [Woodchuck Chuck](#) Mohawk, Ontario
- [Vegan Rice Pudding](#) Mohican
- [Snowberry / Mint Tea](#) Montagnais **NEW!**
- [Venison Chili](#) Nause - Waiwash
- [Acorn Breakfast](#) northeast **NEW!**
- [Bluegail Supreme](#) northeast **NEW!**
- [Four-Leaf Clover Salad](#) northeast **NEW!**
- [Gluckaston](#) northeast
- [Good Deer](#) northeast **NEW!**
- [Jerky Soup & Dumplings](#) northeast
- [Popcorn's On Me!](#) northeast
- [Spruce Tea for coughs](#) northeast
- [Steamed Cattail](#) northeast
- [Steamed Lambsquarters](#) northeast
- [Succotash N' Nuts](#) northeast
- [Wagunabuie \(Lichen\) Soup](#) northeast
- [Wild Rice Pancakes](#) northeast
- [Baked Raccoon](#) Odawa
- [Butter Fried Morels](#) Odawa
- [Easy Venison Roll Ups](#) Odawa
- [Lake Trout & Wild Leek Bake](#) Odawa
- [Ojibwa Bannock](#) Ojibwa, Lac Seul Band, Ontario **NEW!**
- [Broccoli & Wild Rice Casserole](#) Ojibwe
- [Candy Salmon](#) Ojibwe **NEW!**
- [Easy Wild Rice Soup](#) Ojibwe
- [Indian Tacos](#) Ojibwe, Alderville First Nation
- [Minnesota Mac](#) Ojibwe, Leech Lake
- [Ojibwe Fry Bread](#) Chippewa, Bay Mills **NEW!**
- [Ojibwe Fry Bread \(2\)](#) Ojibwe, White Earth Rez **NEW!**
- [Ojibwe Style Fried Bread](#) Ojibwe, Mille Lacs
- [Wild Rice Breakfast](#) Ojibwe
- [Wild Rice Delux](#) Ojibwe, Long Plain First Nation
- [Wild Rice Soup](#) Ojibwe, Fond du Lac, MN **NEW!**
- [Oakis' Favourite Big Mac](#) Oneida - Ojibway
- [Dried Sweet Corn Soup](#) Oneida
- [Fish Dinner](#) Passamaquoddy
- [Mesquite Grilled Rabbit](#) Passamaquoddy
- [Wild Rice](#) Passamaquoddy
- [Hungry Man Stew](#) Penobscot
- [Fried Corn Mush](#) Pequot - Maidu
- [Succotash](#) Nipmuc
- [Squash Blossoms](#) Pequot - Maidu
- [Baked Jicama w/ Beef](#) Potawatomi

- [Miracle Whipped Fish](#) Shoshone Bannock
- [Pheasant Under Plastic](#) Shoshone Bannock
- [Roast Moose](#) Shoshone Bannock
- [Rock Chuck](#) Shoshone Bannock
- [Rock Chuck Extravaganza](#) Shoshone Bannock
- [BBQ Sauce For Venison & Beef](#) Soix **NEW!**
- [Indian Goolosh](#) Sioux
- [Michelle's Recipe](#) Sioux
- [Moth Tea](#) Sioux
- [Red Clover & Sour Grass](#) Sioux **NEW!**
- [Rushing Pie](#) Sioux, Rosebud **NEW!**
- [Boiled Dry Corn](#) Umatilla

## ✘ SOUTHWEST / CALIFORNIA

- [Gesatho](#) Apache, Gabrillino
- [Napalitos \(Prickly Pear 2\)](#) Yaqui - Apache
- [Pinto Bean Fry Bread](#) Apache - Cherokee
- [\(another\) Chokecherry Pudding](#) Aztec **NEW!**
- [Chaparral Tea](#) Coquille
- [Bar B.Q. Dove](#) Comanche
- [Fried Corn](#) Comanche
- [Grape Dumplings](#) Comanche
- [Nopalitos \(Prickly Pear 1\)](#) Comanche
- [Shrimp & Corn Soup](#) Comanche
- [Pine Needle Tea](#) Cumash
- [Aztec Indian Omllette](#) Meshica - Aztlan
- [Acorn Mush](#) Miwok
- [Bay Nuts](#) Miwok
- [Manzanita Juice](#) Miwok
- [Nupa \(Acorn\) Soup](#) Miwok
- [Pit Roasted Venison](#) Miwok
- [Sacho Seasoning For Steak](#) Mojave **NEW!**
- [Curlies](#) Navajo
- [Grilled Prairie Dog](#) Navajo
- [Prickly Pear Cactus Jelly](#) Navajo
- [Mutton Stew](#) Navajo **NEW!**
- [Navajo Bacon Surprise](#) Navajo **NEW!**
- [Navajo Fry Bread](#) Navajo
- [Yerba Buena Tea](#) Ohlone - Miwok- Costanoan
- [Anasazi Beans](#) southwest
- [Bass Cayo](#) southwest
- [Cactus Salad](#) southwest **NEW!**
- [Chorizo & Rice](#) southwest
- [Fried Fish](#) southwest **NEW!**
- [Guacomole](#) southwest

- [SaSaKah's Potawatomi Fry-bread](#) Potawatomi **NEW!**
- [Ma'at Salad](#) Powhatan **NEW!**
- [Frybread Recipe Addition](#) Sauk - Fox
- [Seneca Corn Soup](#) Seneca
- [Silly Willy's Home Brew](#) Tuscarora
- [Wampanackali](#) Wyandot

## ✂ SOUTHEAST / PRAIRIE

- [Buffalo Stew \(Tanka-me-a-lo\)](#) Cherokee
- [Conk Tea](#) Cherokee **NEW!**
- [Crock Pot Venison](#) Cherokee, Oklahoma
- [Redeye Gravy](#) Cherokee
- [Bologna McMuffin](#) Cherokee
- [Cactus Pear & Raspberry Syrup](#) Cherokee
- [Chicken Fried Venison](#) Cherokee - Chickasaw - Choctaw
- [Corn Chowder](#) Cherokee
- [Cherokee Fried Hominy](#) Cherokee
- [Cherokee Succotash](#) Cherokee, SE Kituwah
- [Corn Cakes](#) Cherokee
- [Eggs & Wild Onions](#) Cherokee
- [Fried Yucca Petals](#) Cherokee
- [Fry Bread Recipe](#) Cherokee
- [Greens Salad "Guhitligi"](#) Cherokee, SE Kituwah
- [Grilled Buffalo \(Rough Fish\)](#) Cherokee **NEW!**
- [Guyanna Moto](#) Cherokee **NEW!**
- [Hatteras Grilled Venison](#) Cherokee **NEW!**
- [Indian Bread Pudding](#) Cherokee
- [I-Ya \(Dried Pumpkin Rings\)](#) Cherokee
- [Jellico \(Wild Greens\)](#) Cherokee
- [Kush](#) Cherokee
- [Native American Bacon](#) Cherokee
- [Parched Corn](#) Choctaw
- [Pine Needles for Stomach Cramps](#) Cherokee
- [Porky Bake](#) Cherokee/Choctaw **NEW!**
- [Prickly Pear Surprise](#) Cherokee
- [Rao's Fried Bread Biscuits](#) Cherokee, SE Kituwah
- [Spoon Bread](#) Cherokee
- [Staghorn Sumac Tea](#) Cherokee
- [Stuffed Fry Bread](#) Cherokee
- [Stuffed Quail \(Guhgwe\)](#) Cherokee, Eastern Band
- [Totti's Three-Stock Soup](#) Cherokee, SE Kituwah
- [Goulosh With A Zest](#) Chickasaw **NEW!**
- [Chitimacha Baked Duck](#) Chitimacha
- [Chitimacha Corn Soup](#) Chitimacha
- [Macque Choux](#) Chitimacha, LA

- [Nopalitos Con Arror](#) southwest
- [Menudo](#) southwest
- [Orchata \(Ground Rice Drink\)](#) southwest
- [Sun-Cooked Salsa](#) southwest
- [Veggy](#) southwest
- [Nopalitos & Pork](#) Yaqui
- [Porcupine Balls](#) Yaqui **NEW!**
- [Fish Head Stew](#) Yurok

## ✂ NORTHWEST

- [Alex's Beer Battered Halibut](#) Aleut **NEW!**
- [Venison & Barley Soup](#) Arikara - Hidatsa
- [Fry Bannock Dessert](#) Carrier Nation, Nazko BC **NEW!**
- [Moose Steak Sandwich](#) Carrier Nation, CA
- [Dandelion Stir Fry](#) Cree
- [Spring or Mint Tonic](#) Cree
- [Deep Fried Salmon Chips](#) Fountain Indian Band, BC
- [Fried Sage & Mushroom Sause for Pasta](#) Haida - Tlingit
- [Rainy Day Fish Chowder](#) Haida - Tlingit
- [Bannock - La galette](#) Ile-a-la-Crosse, Saskatchewan
- [Roasted Mallard](#) Ile-a-la-Crosse, Saskatchewan
- [Stuffed Chicken](#) Ile-a-la-Crosse, Saskatchewan
- [Too Tall Tail Meat Salad](#) Inuit
- [Yum Yums](#) Inuit
- [Kahkewistahaw Indian Taco's](#) Kahkewistahaw, Sask. **NEW!**
- [Beaver Ball Soup](#) Metis, Duck Bay
- [Fry Bread Power!!](#) Nez Perce
- [Venison "Ragout"](#) Nes Perce **NEW!**
- [Slammin' Frybread](#) Noonsack
- [Kallmeh Fish](#) northwest
- [Stick Bread & Moose](#) northwest
- [Indian Tacos](#) Port Gambal Skallam
- [Maxine & Kayla's Own Frybread](#) Prince Rupert, BC
- [Skok Salmon Cheeks](#) Skokomish
- [Floral Green Salad](#) Squamish
- [Stuffed Salmon - Tahitian Style](#) Tahltan **NEW!**
- [Good Frybread](#) Tulalip Tribes
- [Salmon on a Stick](#) Tuliap Indian, WA
- [Aunt Margaret Tawatoy's Elk Steak](#) Umatilla

- [Baked Grindle](#) Choctaw - Cherokee
- [Better Than Grilled](#) Choctaw
- [Camp Side Stew](#) Choctaw **NEW!**
- [Choctaw Possum](#) Choctaw
- [Indian Flat Bread](#) Choctaw
- [Rav'in Raven](#) Choctaw
- [Wild Tumbleweed Greens](#) Choctaw
- [Calming Winds Creek Fry Bread](#) Creek
- [Chicken Soup](#) Creek
- [Kiowan Frybread](#) Kiowa
- [Berry Spritzer](#) prairie
- [Cattail/Poke Salad Stir Fry](#) prairie **NEW!**
- [Fireside Stew](#) prairie **NEW!**
- [Saponi Beef Empanadas](#) Saponi
- [Sassafras Tea](#) southeast
- [South Texas Potatoes & Fried Minnows](#) southeast

---

A lot of people have written to me suggesting I have a section on indigenous foods & Native American recipes. Admittedly, I am a terrible cook... and if left up to my own experiences this page would either be empty (or singed around the edges)! Rather than copying from the pages of books, I thought we could build a more interesting (and perhaps amusing) collection of our own. So I'm petitioning the more experienced and knowledgeable cooks out there to send me their own Native American recipes to be shared here on these pages. Contribution in any of the suggested categories is welcomed... humor is especially appreciated (as long as it's in good taste)!! Please do not submit recipes copied from other sources without the author's permission. *Note: I am not responsible for any cooking accidents or unpredicted results of these recipes.*

**Come on guys, make me proud! [Submit your own recipe](#)**

NOTE: Some people write to me to seek permission to reproduce recipes in NativeTech's Food and Recipes section. In general, NativeTech materials are free and may be reproduced for (non-internet) personal use and public non-profit classroom (or scouting) use. The original recipe contributor retains joint copyright with NativeTech, and recipes may not be re-sold, used for advertising purposes, or included in other commercially sold cookbooks.

---





**Text and Graphics**  
© 1994 - 2003 [Tara Prindle](#)  
unless otherwise cited.

## Native American Technology and Art



# Berry Spritzer



---

Offered by Mike Richeal  
~ Bettendorf, Iowa ~

.. who learned this from my parents

---

### Ingredients:

- 1 pound of blue berries
  - 1 pound of raspberries
  - 1 quart of carbonated water
- 

### Preparation:

- Mash the berries and take the juice.
  - Then put the carbonated water and mix.
  - Then add cold ice and your done.
- 

Servings: Two

---

*Thank you Mike Richeal for sharing Berry Spritzer with us!*

---

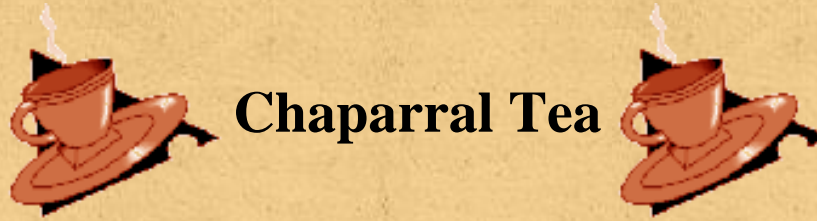
[Return to Food & Recipes Menu](#)



Text and Graphics  
© 1994 - 103 [Tara Prindle](#)  
unless otherwise cited.



## Native American Technology and Art



---

**Offered by Hal Van Ortwick  
~ Coquille Indian, Oregon ~**

**...who learned this from his uncle, a Coquille Indian**

---

### **Ingredients:**

- **Dried wild lilac leaves.**
  - **Hot water.**
- 

### **Preparation:**

- **You'll want to pick your own leaves and dry them as you can't buy it in any store that I know of.**
- **Steep about a tsp. of the dry leaves in a cup of hot water to your own taste.**

**Note:** It helps a bad back, good for the kidney's also, there may be some other medicinal properties attributed to it.

**Webmasters Note:** The desert chaparral bush has the Latin name *Larrea tridentata* or *Larrea diver-icata* and is also known as the greasewood or creosote bush.

---

**Servings: Two**

---

***Thank you Hal, for sharing Chaparral Tea with us!***

[Return to Food & Recipes Menu](#)

---



Text and Graphics  
© 1994 - 103 [Tara Prindle](#)  
unless otherwise cited.



## Conk Tea

---

Offered by Lemmie Wright

~ Cherokee - Oklahoma ~

... who learned this from reading C. Hobbs mushroom book

### Ingredients:

- One or two artist conks (bear paws) cut up into small pieces.
- One gallon of water.
- One cup of barley. One onion.
- Two cups of moose meat.
- One teaspoon of Mexican spice mix.
- One cup of greens (dandelion, nettles etc.)
- Sea salt to taste. Increase or decrease ingredients as needed.

### Preparation:

1. Boil the conks until the water is reduced by half. Strain out all the conks and compost.
2. Bring the water to boil and add the barley. Reduce to simmer and cook until the barley is soft.
3. Add meat onion and greens and cool until meat falls apart. Add more water if needed.
4. Add spice and salt.
5. Turn off heat and allow mix to set five minutes.
6. Strain and serve.

**Note:** This drink will help heal any sick condition of the mouth, throat and on down. Really good for someone with dental problems, colds, internal growths. You can substitute for the grain, meat, vegies and seasonings. I like the one I gave the best. I drink it as often as I can find the conks.

**Servings:** Eleven +

Thank you Lemmie for sharing Conk Tea with us!



---

[Return to Food & Recipes Menu](#)

---



Text and Graphics  
© 1994 - 103 [Tara Prindle](#)  
unless otherwise cited.

## Native American Technology and Art



# La Follette Thunder Milk

---

Offered by Josepme La follette

~ Dispossessed Menominmees Living In Texas ~

... who learned this from a family recipe

### Ingredients:

- Cooked Rice 4 Cups Pureed
- Maple Syrup 1/4 Cup
- Honey
- 1/4 Cup Water
- 2 Quarts Cooled Ephedra-Water (see below) Steeped 1 Quart 30 Bruised Needles (Strain)
- Tablespoons Lime Juice Mix, Soak One Hour
- 1/4 Cup Sugar
- 4 Tamarind Pods

*Note: Tamarind trees are tall legumes that produce a seed pod with edible, pulpy flesh. This edible pod is used primarily as a flavoring for beverages. Tamarinds have now spread throughout the Tropics, including the tropical Americas, though they are native to tropical Africa and the Indian subcontinent. The trees are also grown in the tropics as ornamentals.*

### Preparation:

1. Mix all ingredients.
2. Strain into 4 quart vessel.
3. Chill until cold.

### Ephedra Water:

- 30 bruised needles steeped in hot water in a mason jar for one hour, then strained and cooled.

- **You have to squeeze out the last bit of rice to make the water nice and milky.**

*Note: Ephedra is a primitive shrub which has long, jointed, cylinder-like stems. Its leaves are scalelike and it has male cones. Known as Ma Huang in China, this herb has a history of over four thousand years as a treatment for asthma and respiratory infections. It contains two alkaloids, ephedrine and pseudoephedrine which are used in many cold and allergy medicines. American ephedra is known as Morman Tea, Squaw Tea, and Desert Tea, and shares the same properties, though, to a lesser degree. Side effects include increased blood pressure, heart rate and anxiety. FDA suggest that those with heart (disease or high blood pressure), thyroid, diabetes or prostate problems may be affected adversely. It should definitely NOT be taken with antihypertensive or antidepressant drugs.*

*Note: The traditional making chant is made:*

*Eh wat etowah Mide mi mideah man' a ba*

*When my grandfather turned 80, he started wasting away. I got him to drink one quart of this at breakfast and lunch. He gained weight and lived fifteen more years!*

*Pregnant women and people with heart conditions should not drink thundermilk! labor pains!*

**Servings: Three - Four**

**Thank you Josepme La follette for sharing La Follette Thunder Milk with us!**

---

[Return to Food & Recipes Menu](#)

---



Text and Graphics  
© 1994 - 103 [Tara Prindle](#)  
unless otherwise cited.



## Native American Technology and Art



## Lichen Tea

---

Offered by Jeff Terryberry  
~ Part Iroquois Mohawk (no formal affiliation) ~

...who learned this from Camp Wannekita, Haliburton Ontario/Algonquin Provincial Park

---

### Ingredients:

- A couple good handfuls of the greyish light green lichen (botanical name?) that grows on the rocks in northern ontario (Algonquin Park)
- 

### Preparation:

- Place the rinsed clean lichen in a boiling pot of water (no drying or curing the plant necessary).
- Boil for 15 minutes or so, strain and let cool a bit. Then you have your own fine and reputedly nourishing wilderness brew!!
- Medicinal properties unknown...

*Note: Taught to us counsellors in training as part of our survival lore [always be sure of plant identifications when gathering from the wild]*

---

*Thank you Jeff, for sharing Lichen Tea with us!*

---

[Return to Food & Recipes Menu](#)

---



Text and Graphics  
© 1994 - 103 [Tara Prindle](#)  
unless otherwise cited.

Native American Technology and Art



# Manzanita Juice



---

Offered by Cindy  
~ Passamaquoddy ~

...who notes the recipe has Miwok origins

---

**Ingredients:**

- Ripe manzanita berries
- 

**Preparation:**

- Pick and clean ripe manzanita berries.
- Mash them a bit and add water.

*Note: Real good.*

---

**Servings: Five - Ten**

---

*Thank you Cindy, for sharing this and other recipes with us!*

---

[Return to Food & Recipes Menu](#)





**Text and Graphics**  
© 1994 - 103 [Tara Prindle](#)  
unless otherwise cited.

## Native American Technology and Art



# Mint Leaf Tea



---

Offered by Kailahna Tenesah  
~ Maliseet ~

...who learned this from their Grandmother

---

### Ingredients:

- 2-5 mint leaves (the more leaves, the stronger it will be)
- 1 cup of water

*Note: Preferably spring water. The chlorine and flouride in today's water do a lot to convince people that this tea should be never be drunk by a sane person.*

---

### Preparation:

- Gather some small sticks and a few larger ones.
- Start a fire. You can do it the old way, if you want to be lazy, use a lighter. (Please do not do this step inside).
- Place a small pot over the fire. Don't have a small pot? Make one from birch bark by rolling the bark into a circular shape.
- Leave the water over (but not touching) the fire until it boils.
- While the water is heating, crush the mint leaves.
- Place the crushed mint leaves in the now boiling water and stir.
- Drink and enjoy!
- Or, if you really feel that it's necessary, you can boil the water on a stove.

*Note: This recipe came in handy during the ice storm this winter. We had no power and a tree plowed over our house, so we spent the time in a tent. This tea will definately warm you up, and keep you warm. Enjoy!*

---

**Servings: One**

---

*Thank you Kailahna, for sharing Mint Leaf Tea with us!*

---

[Return to Food & Recipes Menu](#)

---



Text and Graphics  
© 1994 - 103 [Tara Prindle](#)  
unless otherwise cited.



## Native American Technology and Art



# Orchata (Ground Rice Drink)



---

Offered by Offered by Susan Marie Smith-Kennedy  
~ Cherokee (born and raised in San Antonio, Texas) ~

...who learned this from a Family recipe

---

### Ingredients:

- **Large Capacity Blender (7-8 Cups)**
- **1 Cup Water**
- **1 Cup Long Grain Rice**
- **1/2 Cup Sugar**
- **4 Cups Milk**
- **1/2 Teaspoon Cinnamon**
- **1 Teaspoon Vanilla**

---

### Preparation:

- **Place rice in a bowl with enough hot water to cover. Let sit overnight on counter.**
- **Next day, remove the water. Place rice, 1/2 cup fresh water and 2 cups milk in a blender until rice is all ground up.**
- **Add sugar, vanilla, and cinnamon. Blend.**
- **Add the remaining two cups milk, and 1/2 cup water. Blend.**
- **Strain through thickly layered cheesecloth (more than once may be necessary; do NOT squeeze the**

cloth).

- **Chill and serve. Makes approx. 6 cups.**

*Note: This is a favorite for youngsters of all ages. Also, the rice starch in this drink is an excellent way to "put out the fire" on your tongue while eating hot/spicy meals. In summertime, add crushed ice to drink to make a slushy.*

---

**Servings: Two**

---

*Thank you Susan Marie Smith-Kennedy for sharing Orchata (Ground Rice Drink) with us!*

---

**[Return to Food & Recipes Menu](#)**

---



**Text and Graphics  
© 1994 - 103 [Tara Prindle](#)  
unless otherwise cited.**

## Native American Technology and Art



# Pine Needle Tea

---

Offered by Rebecca Rangel

~ Chumash ~

... who learned this from her Chumash Indian Grandmother in-law

### Ingredients:

- Needles, flowers, and candles from yellow pine.

*Note: Yellow pines have 2-5 needles in each cluster. Flowers and candles available only in spring, in the winter use needles only, of course.*

### Preparation:

1. Crush and snip needles, flowers, and pine candles.
2. Meantime, boil a pot of water.
3. Place pine in boiling water, cover, and remove from heat. Let steep from 20 minutes to all night.
4. What you don't drink hot, refrigerate for a cold, refreshing drink. Experiment with proportions of pine needles to water.
5. The best tea will be a nice reddish color, and a small amount of oil will rise to the top.

This recipe makes a beautiful red tea, with a mild, pleasant taste. You can sweeten with honey if desired. If you drink this tea every day, it can relieve mild depression. Good for allergies too.

*Note: If desired, you can simmer the tea awhile. It will be very strong, but will probably contain less vitamin C. Prepared this way, it is said to be good for coughs. It is also supposed to flush kidneys, although I have not noticed this effect.*

Thank you Rebecca Rangel for sharing Pine Needle Tea with us!

---



[Return to Food & Recipes Menu](#)

---



**Text and Graphics**  
© 1994 - 103 [Tara Prindle](#)  
unless otherwise cited.

## Native American Technology and Art



# Pine Needles for Stomach Cramps



---

Offered by Clark Morris  
~ Cherokee ~

...who learned this from their dad who's father was half Cherokee

---

### Ingredients:

- pine needles (yellow pine preferably)
- 

### Preparation:

- Just yank a few pine needles off the nearest tree and chew them up. Swallow the juice. It will stop stomach cramps, spasms and hunger pangs.

*Note: I have no idea how it works but it does and it also covers the smell of cigarettes and tobacco when hunting.*

---

*Servings: One*

---

*Thank you Clark Morris for sharing Pine Needles for Stomach Cramps with us!*

---

[\*Return to Food & Recipes Menu\*](#)

---



Text and Graphics  
© 1994 - 103 [Tara Prindle](#)  
unless otherwise cited.



## Native American Technology and Art



# Sagebrush Tea



---

Offered by Chris  
~ Shoshone-Bannock Nation ~

...who learned this from her family ( it's common in her area )

---

### Ingredients:

- Sagebrush (at least a handful)
  - Water (a potful)
- 

### Preparation:

- Rinse the sagebrush if you like, then put it in the boiling water.
- The longer it boils the stronger it gets. You can add more water or let it get concentrated. This is used for colds and other ailments- it brings out a sweat in a person.
- If you are a wimp (like me) you can add sugar.

### Notes:

- This is sagebrush, and not sweet sage (although sweet sage tea is used for ailments also) - use the stems and all. Many folks sell sagebrush in a stick for "smudging"- our tribe seldom (if ever) smudges with sagebrush - we use sweet sage.
  - Sagebrush is excellent for medicinal purposes. If you don't have sagebrush growing near you - you could probably use part of one of those "smudge" sticks.
- 

Servings: A few?

*Thank you Chris, from [Beadedweb](#), for sharing your special tea with us!*

---

[Return to Food & Recipes Menu](#)

---



**Text and Graphics**  
© 1994 - 103 [Tara Prindle](#)  
unless otherwise cited.

## Native American Technology and Art



## Sassafras Tea

---

**Offered by Mark Boyd**

**~ Eastern Kentucky ~**

**... who learned this from grandma**

### **Ingredients:**

- **4 Cups Water,**
- **5 To 6 Sassafras Roots**
- **(Find In The Spring Or The Fall)**

### **Preparation:**

1. **Bring to boil 4 cups of water, and then add roots.**
2. **Continue to boil the roots until water becomes red and the smell becomes very strong.**

***Note: wash the roots very well and be sure to gather in the spring or fall when the sap is still strong.***

**Servings: Three - Four**

**Thank you Mark Boyd for sharing Sassafras Tea with us!**

---

**[Return to Food & Recipes Menu](#)**

---





**Text and Graphics**  
© 1994 - 103 [Tara Prindle](#)  
unless otherwise cited.



## Snowberry / Mint Tea

---

Offered by Mika Twoleaf

~ Mother Montagnais, Father Algonquin ~

... from Grandfather Crow's favorite evening tea

### Ingredients:

- One handful of snowberry strings, (grows on the ground like tendrils)
- The berries you find, (about 1 handful), crush to get more flavor
- One handful fresh mint leaves.

### Preparation:

1. Cover with one two pint boiling water,
2. Steep 15 minutes and sip slowly while relaxing and telling stories..)

**Note:** This tea will take the aches out of your bones after a long walk in the woods. Do not abuse of the tea, too much will upset your dinner..

**Servings:** Two

Thank you Mika for sharing Snowberry / Mint Tea with us!

---

[Return to Food & Recipes Menu](#)

---



Text and Graphics  
© 1994 - 103 [Tara Prindle](#)  
unless otherwise cited.

Native American Technology and Art



**Spring (amiskowehkuskwa)  
or Mint Tonic**



---

**Offered by Debbie Saftner  
~ Yellowknife, NWT, Athabaskan Cree Grandmother ~**

**...who learned this from her Cree Grandmother**

---

**Ingredients:**

- **One half cup of mint (amiskowehkuskwa), fresh or dried**
- **4 cups of boiling water**

---

**Preparation:**

- **Steep into a pot the mint and water.**
- **Cover and drink daily for a month or longer.**

---

**Servings: Two**

---

*Thank you Debbie, for sharing your grandmother's recipe with us!*

---

**[Return to Food & Recipes Menu](#)**

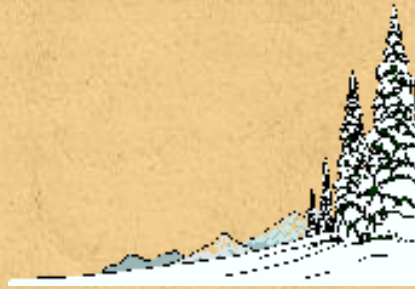




**Text and Graphics**  
© 1994 - 103 [Tara Prindle](#)  
unless otherwise cited.

## Native American Technology and Art

# Spruce Tea for coughs



---

**Offered by Bob Brenner  
~ Austria -- Brenner Pass. ~**

**...who read about it once in a book, tried it  
... and now uses it.**

---

### Ingredients:

#### **Equal volumes of:**

- **New growth from the tips of spruce branches**
- **Water**

---

### Preparation:

**Due to allergies, I am plagued with chronic, although mild post nasal drip and the consequential cough. I'd read in a local ethnobotany publication that tea from the new growth at the tips of spruce branches was used by the original people here for soothing coughs. I was hiking in the mountains and when I stopped to rest, I recalled that article as I was looking at a huge spruce tree.**

- **I gathered a handful of the new tips and put them in an oversized enamel cup 2/3 full of water and set it next to a small cookfire to get hot.**
- **(Incidentally, I didn't remember about using the new growth until I tried to pull off a mature twig. Those prickles kinda brought tears to my eyes.)**
- **After about 15 minutes, I tried a sip and found it to be bland tasting and a little stinky, not pitchy smelling like I expected. I finished it anyway because it was warm and the weather wasn't. I wasn't impressed.**

***Note:*** I put out the fire and moved on. About a half hour later it occurred to me that I hadn't been coughing and didn't again for a couple of more hours. The tea doesn't give that menthol or eucalyptus tingle like I've been taught by the Vick's company to expect but for me, it works much better.

---

**Servings:** A few?

---

***Thank you Bob, for sharing your tea, and your story with us!***

---

**[Return to Food & Recipes Menu](#)**

---



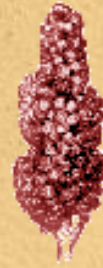
**Text and Graphics**  
© 1994 - 103 **[Tara Prindle](#)**  
unless otherwise cited.



## Native American Technology and Art



# Staghorn Sumac Tea



---

Offered by Tony Layne  
~ Cherokee, way back ~

...who had this passed down from great grandparents

---

### Ingredients:

- One complete seed spike (deep red)
  - Honey, or some other sweetener
- 

### Preparation:

- Rub the small fruits loose from the spike bundle and bruise them slightly.
- Then steep them in hot water until the water takes on a deep rose color.
- Control the strength of the tea by the length of time you steep it.
- Drain off the tea. The fruit can be used more than once in most circumstances.
- Sweeten to taste with honey or other sweeteners.

**\*\*\* SAFETY NOTE \*\*\*\*\*** *The red fruit spikes of the 'Staghorn Sumac' create a wonderful brew. The 'WHITE' fruit of the 'POISON SUMAC' is as deadly as its name. The fruits do not look the same, but ask someone who knows the difference to teach you.*

---

**Servings: a few.**

---

*Thank you Tony, for sharing your recipe with us! I've tried this 'Indian Lemonade' and it's worth the pucker!*

---

[Return to Food & Recipes Menu](#)

---



**Text and Graphics**  
© 1994 - 103 [Tara Prindle](#)  
unless otherwise cited.

## Native American Technology and Art



# Yerba Buena Tea



---

Offered by Cindy  
~ Passamaquoddy ~

...who notes the recipe has Ohlone, Miwok, Costanoan origins from the San Francisco Bay Area.

---

### Ingredients:

- Yerba Buena (grows wild here).
  - Hot water
- 

### Preparation:

- Just put fresh or dried leaves in boiling water and let steep.

*Note: Delicious soft minty tea.*

---

**Servings: Two**

---

*Thank you Cindy, for sharing this and other recipes with us!*

---

[Return to Food & Recipes Menu](#)





**Text and Graphics**  
© 1994 - 103 [Tara Prindle](#)  
unless otherwise cited.

Native American Technology and Art



# Wild Peppermint Tea



---

Offered by Cheryl Joy Hill

~ Lower Brule Sioux, my Mom was Bernice Rencountre Swick ~

...who learned this from my Mom who used to make this when we got colds or upset stomachs.

---

## Ingredients:

- About 1/2 cup dry Peppermint leaves.
  - 3 or 4 cups very hot water.
  - 2 or 3 tablespoons of honey.
- 

## Preparation:

- Boil about 3 or 4 cups of water.
- Add the peppermint leaves and shut the heat off.
- Let the tea steep for about 5 minutes.
- Pour through a tea strainer.
- Add the honey and pour into cups.
- The tea can be made from fresh leaves or dried leaves.

*Note: My mom used to make this for us when we had colds or a upset stomach. We used to get it along the North Platte river in Wyoming. I found it along the Rapid Creek, so I know you can find it along any creek, river, or lake.*

---

*Servings: Two*

---

*Thank you Cheryl Joy Hill for sharing Wild Peppermint Tea with us!*

---

[Return to Food & Recipes Menu](#)

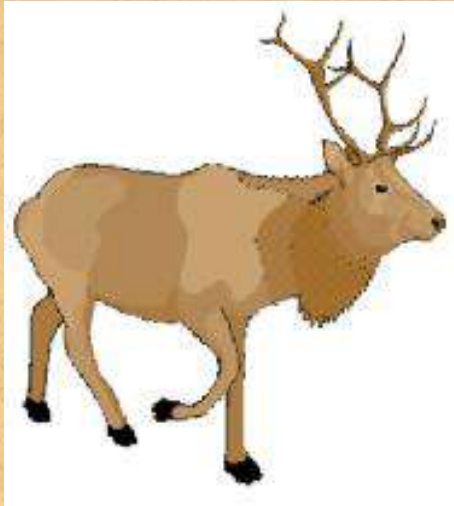
---



Text and Graphics  
© 1994 - 103 [Tara Prindle](#)  
unless otherwise cited.



## Native American Technology and Art



# Aunt Margaret Tawatoy's Elk Steak

---

**Offered by Joseph Armand Lavadour Jr. "Joey"**

**~ Enrolled Walla Walla Indian from the Umatilla Indian Reservation ~**

**... who learned this from at our home on the Umatilla Reservation, at Thornhollow Oregon**

### **Ingredients:**

- **Elk Steaks, Cut Into Single Serving Portions.**
- **Onions Cut Into Rings.**
- **Bacon, Salt And Pepper To Taste.**

*Note: that deer or beef steak can be used, this is a layered dish so use amounts that work out for the amount of layers that are needed.*

### **Preparation:**

1. **Using a hot cast iron frying pan, place steaks in it and quickly fry on each side, 30 second to one minute.**
2. **When they are all cooked place a layer of bacon on the bottom of a Dutch oven or a heavy baking kettle, then a layer of raw onion rings, then a layer or steak.**
3. **Continue until you end with a layer of onions. Bake on a oven at 375 until well done, approx. 60 - 75 minutes.**
4. **Serve hot with lots of fried bread or white bread to soak up the wonderful juices and grease.**
5. **This is also wonderful to make and chill and take with you on a hunting or fishing trip to the mountains with white bread and salt for sandwiches!!!**

*Note: Aunt Margaret Towatoy was the daughter of , tow-a-toy, the younger brother of Chief Joseph of the Nez Perce tribe. She was raised in catholic school on the Umatilla Indian reservation on the Umatilla Indian reservation in Oregon and was a qualified cook in all areas, always incorporating our native foods into traditional meals.*

**Servings: Five-Ten**

**Thank you Joey Lavadour for sharing Aunt Margaret Tawatoy's Elk Steak with us!**

---

**[Return to Food & Recipes Menu](#)**

---



**Text and Graphics**  
**© 1994 - 103 [Tara Prindle](#)**  
**unless otherwise cited.**

## Native American Technology and Art



# Baked Raccoon



---

Offered by Joy Downing  
~ Odawa ~

...who learned this from her Grandmother

---

### Ingredients:

- One raccoon
- Salt and pepper
- Onion
- Garlic cloves
- Carrots
- Potatoes
- Tomato juice

*note: you can put in your favorite leaf spice*

---

### Preparation:

- Cleaned raccoon remove all fat, cut up
  - Put in large pot with water to cover raccoon add salt,
  - Bring to boil and simmer until tender.
  - Remove meat from pan and put in baking dish,
  - Add onion, carrots, cut up potatoes salt and pepper to taste
  - Pour tomato juice over top of every thing cover and
  - Bake at 350 oven for one hour or until veggies are done.
-



**Servings: Three - Four**

---

*Thank you Joy, for sharing Baked Raccoon with us!*

---

[Return to Food & Recipes Menu](#)

---



Text and Graphics  
© 1994 - 103 [Tara Prindle](#)  
unless otherwise cited.



## BBQ Sauce For Venison & Beef

---

Offered by Rich

~ some Sioux ~

... who learned this from Chippewa

### Ingredients:

- 1/2 cup water
- 1/2 cup ketchup
- 1/4 cup A-1 sauce
- 1/4 cup orange juice
- 1 onion sliced

### Preparation:

1. Mix water, ketchup, A-1 sauce and orange juice
2. Add slice onion to venison or beef roast in oven
3. Pour sauce on top, baste every 1/2 hour and cover until done
4. About 350 degrees, 2 hours for 3 lb. Roast. Serve with baked potatoes and corn

Thank you Rich for sharing BBQ Sauce For Venison And Beef with us!

---

[Return to Food & Recipes Menu](#)

---



Text and Graphics  
© 1994 - 103 [Tara Prindle](#)  
unless otherwise cited.

## Native American Technology and Art

# **COW** Baked Jicama w/ Beef **COW**

---

Offered by ralph a. kern  
~ 1/16 Potowatami, associated with the intertribal ~

...who learned this from a friend

---

### Ingredients:

- 2 large jicimas
  - 5 medium loin steaks
  - 3 handfulls shredded cheese (3 types)
  - 1 handfull your favorite spices (I like pico del gallo)
  - 1/3 cup cream
  - butter to taste
  - salt and pepper to taste
  - corn bredding, enough to cover the steaks.
  - white gravy
- 

### Preparation:

- peel and prepare the jicama as if you were making mashed potatoes
- using the butter, cream, salt and pepper.
- fold, dont mix too well, in the 3 cheeses and the spices.
- cut the loin steaks to open like a coin purse.
- stuff the jicama into the steaks, close each with a toothpick.
- bread them with the corn breading.
- bake in the oven at appx. 375 degrees until the meat is done,
- usually about 20-30 minutes, depending on your altitude.
- cover with white gravy and serve.

*Note: the spices should match the taste of the man of the house, I just like pico del gallo. the time and tempature in the oven vary according to where you live.*

---



*Servings: Two*

---

*Thank you ralph a. kern for sharing baked jicama w/beef with us!*

---

[Return to Food & Recipes Menu](#)

---



**Text and Graphics**  
© 1994 - 103 [Tara Prindle](#)  
unless otherwise cited.

## Native American Technology and Art



# Anasazi Beans

---

**Offered by Dawn Conner**

**~ Just An Interested 'Sister'. No Tribal Connections ~**

**... who learned this from Adobe Milling Co., Dove Creek, Colorado. Where they grow the 'ancient' bean**

### **Ingredients:**

- **2 Cups Dry Beans And Water For Cooking**
- **1 Large Onion**
- **Ham (We Cook The Bone After Having Baked Ham, But You Can Use A Ham Hock Or Two)**
- **LOTS Of Garlic (To Taste In Other Words)Salt And Pepper**

### **Preparation:**

1. **Cook bend till nearly done keeping them covered with water the whole time.**
2. **Add ham and the coarsely chopped onion and all the garlic your significant other can stand to smell on you.**
3. **Continue to cook till the beans are done.**
4. **The bone cooked till the meat falls off is the best, cause you get all that broth too.**

*Note: we can never know how the Anasazi prepared this. but this is the best beans I have ever tasted in my life! not much gas either, which is a plus!*

**Servings: Five-Ten**

**Thank you Dawn Conner for sharing Anasazi beans with us!**

---

**[Return to Food & Recipes Menu](#)**

---



**Text and Graphics**  
© 1994 - 103 [Tara Prindle](#)  
unless otherwise cited.



## Native American Technology and Art



# Blueberry Wojapi



---

Offered by Cheryl Joy Hill

~ Lower Brule Sioux, my mom was Bernice Rencountre Swick ~

...her own recipe

---

### Ingredients:

- 1 can blueberries
  - 3 cans water
  - 1 cup sugar
  - 3/4 cup flour
  - Water to mix with flour to make a gravy or sauce mixture.
- 

### Preparation:

- Put the blueberries into a medium sauce pan.
- Add 3 cans water to blueberries.
- Add the sugar and mash the blueberries.
- Heat until boiling.
- Slowly add the flour paste to make a gravey like mixture.

*Note: Ready to dip your frybread into hot, warm or cold. It is so very good. I ate all this food at powwows, memorials, funerals, any kind of gathering of relatives and friends. I always got lots of "You make the best", it made me feel good. I love to share this with relatives and friends during the holidays.*

---

*Servings: Two*

---

*Thank you Cheryl Joy Hill for sharing Blueberry Wojapi with us!*

---

[Return to Food & Recipes Menu](#)

---



**Text and Graphics**  
© 1994 - 103 [Tara Prindle](#)  
unless otherwise cited.

## Native American Technology and Art



# Boiled Dry Corn

---

Offered by Joseph Armand Lavadour Jr. "Joey"

~ Enrolled Walla Walla Indian from the Umatilla Indian Reservation ~

... who learned this from my Grandmother, Edna Ester Lavadour "Gram"

### Ingredients:

- 2 Cups Dried Sweet Corn
- Six Cups Spring Water Or The Best You Have
- 1 Tablespoon Salt

### Preparation:

1. Boil water add dried sweet corn.
2. Return to a boil and add salt.
3. Continue to boil corn and add water as needed to keep water line about one quarter inch above corn.
4. Cook until tender.
5. Options to add diced bacon to taste is very good!!

*Note: in the early 1800's on our Umatilla Indian reservation we adopted cornhusk into our traditional weaving, using cornhusks, as a result we had a abundance of corn, we removed it from its cob and have continued to dry it from those early days, and it has become a very important and revered food. Especially in its dried form to share with family and friends....*

Servings: Five-Ten

Thank you Joseph Armand Lavadour Jr. for sharing Boiled Dry Corn with us!

---

[Return to Food & Recipes Menu](#)

---





**Text and Graphics**  
© 1994 - 103 [Tara Prindle](#)  
unless otherwise cited.

## Native American Technology and Art

# mushroom Butter Fried Morels mushroom

---

Offered by Joy Downing  
~ Odawa ~

**...who learned this from her Grandmother.**

---

### Ingredients:

- Fresh picked morels (twenty, more or less).
  - Salt and pepper to taste.
  - One half cup flour.
  - One stick butter.
  - Tablespoon oil.
- 

### Preparation:

- Cut morels in half.
- Wash in salted water to remove any bugs that may be hiding in the creases.
- Drain well put flour, salt pepper in bag.
- Add morels shake to coat morels.
- Heat butter and oil in frypan hot, but try not to burn the butter.
- Add morels a few at a time fry until brown, about two or three minutes each side (I like morels fried in butter without oil. And using only salt and pepper on them.)

***Important Note:*** Be sure you know what morels look like in the woods, before you ever eat any mushroom picked in the wild.

---

**Servings: Two**

---

***Thank you Joy, for sharing Butter Fried Morels with us!***

---

[Return to Food & Recipes Menu](#)

---



Text and Graphics  
© 1994 - 103 [Tara Prindle](#)  
unless otherwise cited.



Native American Technology and Art

**broccoli** **Broccoli & Wild Rice Casserole** **broccoli**

---

**Offered by Deborah Running Behind  
~ Saxon, Ojibway & Lesh (Polish) ~**

**...A country club's recipe book, believe it or not!**

---

**Ingredients:**

- **4 cups cooked wild rice**
- **2 cups cooked, chopped broccoli**
- **1 onion, chopped fine**
- **6 oz. cream cheese, softened**
- **salt & pepper to taste**

*Note: Feel free to vary the amounts to suit your personal taste(s)!*

---

**Preparation:**

- **Stir together all ingredients in a buttered baking dish.**
  - **Bake in a 350-degree (F) oven for 20-30 minutes.**
- 

**Servings: Five-Ten**

---

*Thank you Deb, for sharing Broccoli & Wild Rice Casserole with us!*

---

**[Return to Food & Recipes Menu](#)**

---



**Text and Graphics**  
© 1994 - 103 [Tara Prindle](#)  
unless otherwise cited.

## Native American Technology and Art



# Cactus Pear and Raspberry Syrup



---

**Offered by Offered by Susan Marie Smith-Kennedy  
~ Cherokee (born and raised in San Antonio, Texas) ~**

**...who learned this from a Family recipe**

---

### **Ingredients:**

- **2 To 3 Cups Cactus Pear Juice**
- **1 Cup Raspberry Juice**
- **½ Tablespoon Lemon Juice**
- **½ To ¾ Cup Sugar (Or To Taste)**
- **Corn Starch To Slightly Thicken (If Needed)**

- 
- **Prepare the cactus pears the same way as for jelly.\***
  - **Boil until slightly thickened. Serve over pancakes, waffles, or ice cream...**

*Note: \*Referring to Prickly Pear cactus jelly (Old Navajo) recipe.*

*Also: Some Mexican grocery stores carry Prickly Pear cactus juice already prepared in jars/cans.*

---

**Servings: Two**

---



*Thank you Susan Marie Smith-Kennedy for sharing Cactus Pear and Raspberry Syrup with us!*

---

[Return to Food & Recipes Menu](#)

---



Text and Graphics  
© 1994 - 103 [Tara Prindle](#)  
unless otherwise cited.



## Cactus Salad

---

### Cactus Salad

Offered by Leanna Dymond

~ I am from DeKalb, IL ~ Parents are Bob (Polish Guy) and Deanna Paluch ~

... Here's the funny - My 100% Polish Father made it up

#### Ingredients:

- 3 large Cans of marinated cactus (in ethnic section of grocery). Can also use fresh if you have the time.
- 2 medium tomatoes.
- 1 can of diced tomatoes with chilies.
- 1/2 cup of Italian dressing.
- 3 to 4 jalapenos.
- 1 large green chili.
- 1 lime.
- Cilantro.
- Crumbled Feta or Mexican cheese to top with ( optional).

**Note:** these are the spices that I have used, all to taste: Celery Salt, Chili powder, Pepper, Garlic powder, Seasoning Salt, Green Chili Seasoning, Chipotle Seasoning, Habanero Seasoning and Cayenne Seasoning. The last four are Seasonings from Desert Gardens - they have a web site.

#### Preparation:

1. Open cans of cactus, drain & rinse with cold water. I then pick out peppers, stems, & onions that are mixed in. Discard all stems, cut up some of the peppers and onion, then discard the rest. Mix the cut up peppers and onions back in with cactus. Put Cactus into bowl and add the Italian dressing. Toss to coat.
2. Drain and add canned tomatoes. Slice 1 tomato very thin and toss in. Mince 2 jalapenos and the green chili and toss. Chop and add Cilantro to taste. Squeeze juice if lime in and add what ever spices to taste. Slice (again very thin) the other tomato and the rest of the jalapenos and spread over top. Chill in frig. Can sprinkle with a little crumbled cheese before serving.

**Note:** My Father is a very experimental cook. His recipes are different every time and he never writes them down. I learned his way so I have never written it down either. Anyway, I tried to do the best I could with what is in this dish. As for the spices I just add a little of this and a little of that, taste then add more if needed. I love my food hot and spicy so feel free to add as much or as little needed for your taste. This salad is great as a side dish and awesome on tacos or fajitas.

**Servings:** Three - Four

Thank you Leanna for sharing Cactus Salad with us!

---

[Return to Food & Recipes Menu](#)

---



**Text and Graphics**  
© 1994 - 103 [Tara Prindle](#)  
unless otherwise cited.





## Cattail/Poke Salad Stir Fry

Offered by Dennis Burke

~ Just a Bellagona (Navajo for honkie) from Nebraska ~

... who learned this from years of being single and putting stuff together

### Ingredients:

- Handful of young cattails
- Handful of very young poke salad
- Some wild onions to taste
- Oil of choice
- Some pine nuts if available
- Sprig of wild dill weed
- Any available meat/fish chunked
- Marble sized piece of ginger root
- Salt/pepper to taste
- Crushed red chili to taste

### Preparation:

1. Pull cattails straight up and leaves roots in place, peel back to pure white flesh, cut up in about 1-2 inches sections
2. Wash poke salad stems and leaves well, blanch in boiling water then cold water then drain and set aside
3. Chop wild onion stems up about 1/4-1/2 in long
4. Shell and leave pine nuts whole
5. Tear up dill weed into small but recognizable pieces
6. Chunk up meat into bite size pieces
7. Put about 3 tbs. Oil in hot skillet and add ginger and crushed red chili, then stir fry everything together (if you are using fish, leave until rest is nearly done so it doesn't fall apart)
8. Salt/pepper to taste, some soy sauce is nice if you like it

9. Serve with rice

**Servings:** Three - Four

Thank you Dennis Burke for sharing Cattail/Poke Salad Stir Fry with us!

---

[Return to Food & Recipes Menu](#)

---



**Text and Graphics**  
© 1994 - 103 [Tara Prindle](#)  
unless otherwise cited.

## Native American Technology and Art



# Corn Soup



---

Offered by Chitimacha Tribe of Louisiana  
~ Sovereign Nation of the Chitimacha Tribe of Louisiana ~

.. who learned this from Vickie Mora, Chitimacha

---

### Ingredients:

- 12 - 16 Ears of Corn
- Salt Meat
- 1 Can Diced Tomatoes
- 1 Block Margarine
- 2 Onions

---

### Preparation:

- Melt Margarine in pot and then sauté the onions for about 10 minutes.
- Add the scraped corn in the pot and cook on a low fire for about 15 minutes.
- Next add water to the corn and let it come to a boil, then add the diced tomatoes to the soup.
- Also, after you have boiled the salt meat, you may also add it to the soup.
- Add salt and pepper to your desire. You can leave out the diced tomatoes, if you so desire.

*Note: It's Good!*

---

**Servings: Two**

---



*Thank you Chitimacha Tribe of Louisiana for sharing Chitimacha Corn Soup with us!*

---

[Return to Food & Recipes Menu](#)

---



Text and Graphics  
© 1994 - 103 [Tara Prindle](#)  
unless otherwise cited.

## Native American Technology and Art



# Corn Balls (Wahuwapa Wasna)

---

Offered by Louis Garcia

... a Dakota Recipe

### Ingredients:

- Ground Dried Corn Kernals
- Dried Chokecherry or Juneberry (Saskatoons)
- Tallo or Lard (or substitute water)

### Preparation:

1. Grind dried flour corn kernals in a hand grinder.
2. Grind dried Chokecherry or Juneberry (Saskatoons).
3. Mix the corn and berries together at a ratio of 4 corn to 1 berry.
4. Put tallo in a frying pan and lightly brown the mixture. *Note: The old timers at this point would put more tallo/lard in the pan.*
5. Dig into the corn mixture with the fingers and an elongated (four fingers wide) mass is formed. *Thats why they call it in Dakota Wahuwapa (corn cob). Note: In English they are called Corn Balls probably because some tribes formed them into egg or ball shapes.*
6. Dry them in the sun for later storage.

Servings: Three - Four

Thank you Louis Garcia for sharing Corn Balls (Wahuwapa Wasna) with us!

---

[Return to Food & Recipes Menu](#)

---



**Text and Graphics**  
© 1994 - 103 [Tara Prindle](#)  
unless otherwise cited.



## Native American Technology and Art



# Corn Chowder

---

**Offered by Phyllis Newton (Crowwoman)**

**~ Georgia , Cherokee, Vanns ~**

**... who learned this from a Cherokee**

### **Ingredients:**

- **5 Lbs Potatoes, Cut In Small Chunks**
- **4 Cans Of Corn**
- **2 Onions, Diced**
- **1 Bellpepper, Diced**
- **Salt & Pepper**
- **Sugar**

### **Preparation:**

1. **Cook potatoes till done, then drain and add the corn.**
2. **Fry onion and bell peppers till done, then add to other mixture.**
3. **Then add salt and pepper and sugar to taste.**
4. **This is a thick soup good on cold days.**

**Servings: Three - Four**

**Thank you Phyllis Newton (Crowwoman) for sharing Corn Chowder with us!**

---

**[Return to Food & Recipes Menu](#)**

---



**Text and Graphics**  
© 1994 - 103 [Tara Prindle](#)  
unless otherwise cited.

## Native American Technology and Art



# Corn Soup

---

**Offered by Bernadette**

**~ Abenaki, Odanak, PQ ~**

**... who learned this from a friend**

### **Ingredients:**

- **1 Gallon Water**
- **4 Oz. Salt Pork Or Bacon**
- **2 Cups Hominy Corn**
- **1 Can Kidney Beans**
- **1 Onion, Chopped**
- **1 Potato, Peeled And Diced**

### **Preparation:**

1. **Put it all together in a pot and cook it until it's soup!!**

*Note: Good served with baked scone, or bannock*

**Servings: Two**

**Thank you Bernadette for sharing Corn Soup with us!**

---

**[Return to Food & Recipes Menu](#)**

---





**Text and Graphics**  
© 1994 - 103 [Tara Prindle](#)  
unless otherwise cited.

## Native American Technology and Art



# Cherokee Fried Hominy



---

Offered by Rodney Dunn  
~ Cherokee. TN ~ Dunns originally from Blount Co. TN ~

..... who learned this from his father's sister

---

### Ingredients:

- Several Strips of Bacon (as much as you want )
  - One or two Cans of White Hominy
  - A few pieces of Onion if desired
  - Black Pepper to taste
- 

### Preparation:

- Fry bacon crisp. Remove from pan.
- Drain most of grease. Drain water off hominy. Fry hominy in bacon grease.
- Crumble bacon & mix in hominy.
- That's good eatin', as my father would say.

*Note: Better fix plenty!*

---

*Thank you Rodney Dunn for sharing Cherokee Fried Hominy with us!*

---

[Return to Food & Recipes Menu](#)



**Text and Graphics**  
© 1994 - 103 [Tara Prindle](#)  
unless otherwise cited.



Native American Technology and Art



# Cherokee Succotash (I-Ya-Tsu-Ya-Di-Su-Yi Se-Lu)

---

Offered by Tu'ti  
~ Southeast Kituwah Nation ~

... who learned this from Grandmother

---

## Ingredients:

- Beans
  - Corn
  - Pumpkin (optional)
- 

## Preparation:

- Shell some corn.
- Cook corn and beans separately, then together.
- You may add pieces of pumpkin in.

*Note: Be sure to put the pumpkin in early enough to get done before the pot is removed from the fire.*

---

*Thank you Tu'ti, for sharing Cherokee Succotash (I-Ya-Tsu-Ya-Di-Su-Yi Se-Lu) with us!*

---

[Return to Food & Recipes Menu](#)

---



**Text and Graphics**  
© 1994 - 103 [Tara Prindle](#)  
unless otherwise cited.

## Native American Technology and Art



# Chokecherry Pudding



---

Offered by Cindy  
~ Passamaquoddy ~

...who notes the recipe has origins all over, including Bannock, Lakota, Crow.... Friends & family

---

### Ingredients:

- Go berry picking for chokecherries.
  - rinse
- 

### Preparation:

- (you can pound them a little or leave whole)
- Cook a little bit
- Eat, seeds and all

*Note: July is known to many Natives as 'the month when the cherries turn black'*

**\*\*\* NativeTech Note \*\*\*** *Autumn and wilted leaves and pits of fruits contain hydrocyanic acid. Do not eat the raw pits! Elias & Dykeman's 1982 Field Guide to N. Amer. Edible Wild Plants states "Indians ground whole fruits, leached poison from seeds, formed pulp into cakes, and dried them in the sun for sauce and pemmican".*

---

**Servings: Snack**

---



*Thank you Cindy, for sharing this and other recipes with us!*

---

[Return to Food & Recipes Menu](#)

---



Text and Graphics  
© 1994 - 103 [Tara Prindle](#)  
unless otherwise cited.

Native American Technology and Art



(more)  
**Chokecherry Pudding**



---

Offered by Chris  
~ Shoshone-Bannock Nation ~

...who says 'Everyone Makes It Around Here'

---

**Ingredients:**

- Chokecherries
- Sugar
- Flour and water
- (oh, a pot and a stove would be nice, too)

---

**Preparation:**

- Lightly wash the chokecherries.
  - Put the lightly washed chokecherries in a pot with some water and boil them.
  - Now mash them.
  - Add sugar to taste.
  - Add as much flour as you need to make it like a slightly runny pudding.
  - Variations: You can put the chokecherries through a meat grinder to chop up the seeds.
- Also, you can do what i prefer (i'm such a weenie!) And strain the seeds out after the chokecherries are boiled. I have found this is the easiest on my teeth.

*\*\*\* Special Note \*\*\*: in our neck of the woods our chokecherries are completely edible- but before someone picks wild berries of any kind they should check to make sure they are edible. A lady i spoke to once from back east said her chokecherries were a different type of berry and were not completely edible. Just a warning- don't want people to get sick.*

*\*\*\* NativeTech Note \*\*\* Autumn and wilted leaves, and pits of fruits, contain hydrocyanic acid. Do not eat*

*the raw pits! Elias & Dykeman's 1982 Field Guide to N. Amer. Edible Wild Plants states "Indians ground whole fruits, leached poison from seeds, formed pulp into cakes, and dried them in the sun for sauce and pemmican".*

---

**Servings: Depends how many cherries the birds get first.**

---

*Thank you Chris, from [Beadedweb](#), for sharing your rendition of chokecherry pudding with us!*

---

[Return to Food & Recipes Menu](#)

---



Text and Graphics  
© 1994 - 103 [Tara Prindle](#)  
unless otherwise cited.





# Chokecherry Pudding

---

Offered by Jennifer Ruiz

~ Aztec ~

... who learned this from an old family recipe

## Ingredients:

- Chokecherries
- Sugar
- Flour & water

## Preparation:

1. Lightly wash chokecherries
2. Put lightly washed chokecherries in a pot & boil them
3. Now mash them
4. Add sugar to taste
5. Add as much flour to make a slightly runny pudding

**Servings:** Three - Four

Thank you Jennifer for sharing Chokecherry Pudding with us!

---

[Return to Food & Recipes Menu](#)

---



Text and Graphics  
© 1994 - 103 [Tara Prindle](#)  
unless otherwise cited.

## Native American Technology and Art



# Currant Pudding



---

Offered by Cindy  
~ Passamaquoddy ~

...who notes the recipe has Bannock origins

---

### Ingredients:

- Fresh currants
- 

### Preparation:

- Go pick some nice fresh currants, leave the ants behind.
- Wash up what little managed to make it to the house.
- Squish them up some.
- Boil a little while.

*Note: Serve after a sweat.*

---

**Servings:** Depends how many berrys make it back to the house.

---

*Thank you Cindy, for sharing this and other recipes with us!*

---

[Return to Food & Recipes Menu](#)



**Text and Graphics**  
© 1994 - 103 [Tara Prindle](#)  
unless otherwise cited.



## Native American Technology and Art



# Dandelion Stir Fry

---

Offered by Stacy Johnson

~ Cree (Quebec) ~

... who learned this from Grampa's stir fry

### Ingredients:

- 6 Handfuls of Dandelion Greens
- 2 Trout, Salmon, or Bass
- Bacon Grease (Best) or Fat
- 3 Wild Onion
- Salt And Pepper (Dash)
- White Sage (Few Pinches)
- 1 Lemon

### Preparation:

1. Cut and clean fish. Cut into long strips. Chop onion. Slice lemon into thin disks. Wash and chop dandelion leaves. Grease metal fry pan slightly with bacon grease. *(so you don't burn the fish)* Put on a semi hot coal.
2. Add onion 5-6 thin slices of lemon, salt, pepper, and a few pinches of white sage.
3. *(make sure sage is ground up a little)*
4. Let cook about 3/4 of the way and then add the dandelion leaves. Cook until leaves are soft.
5. Add salt, pepper, sage, again.
6. When ready drip on a little bit of lemon juice for taste. Add more grease if stuff sticks to the pan too much. It should brown just a bit.

Servings: Three - Four

Thank you Stacy Johnson for sharing dandelion stir fry with us!

---

[Return to Food & Recipes Menu](#)

---



Text and Graphics  
© 1994 - 103 [Tara Prindle](#)  
unless otherwise cited.

Native American Technology and Art



# Dried Sweet Corn Soup



---

Offered by Georgia  
~ Oneida, Wisconsin, from the Powless crew ~

...who learned this from her sister-in-law Bonnie Stoneman.

---

### Ingredients:

- 4 cups dried sweet corn.
- 1 lb dried venison or dried beef.
- 1/2 lb of side pork or salt pork cubed.
- 1 lb of dried kidney beans and some people prefer about 6 potatoes cubed.
- about 1 gal of water, if corn expands big time than add more!

---

### Preparation:

- Boil corn, kidney beans and pork for a hour then add dried meat and potatoes.
- Cook about another hour or until everything is done.

*Note: This soup is good to serve after ceremonies, sweats and all other traditional feasts.*

---

*Servings: Five to Ten*

---

*Thank you Georgia, for sharing Dried Sweet Corn Soup with us!*

---



[\*Return to Food & Recipes Menu\*](#)

---



Text and Graphics  
© 1994 - 103 [Tara Prindle](#)  
unless otherwise cited.

## Native American Technology and Art



# Fiddle Head And Cattail Salad

---

Offered by Chantal Seguin dit Laderoute

~ Mohawk Metis ~

... who learned this from Metis St. Lawrence region

### Ingredients:

- 3 Cups Fiddle Head Ferns
- Be Sure They Are Not Unrolled (Open)
- 1 Cup of Leeks
- 1 Cup of Cattail Shoots (Young)
- 2 Cups of Lettuce
- Sunflower Seeds
- Half a Cup Oil
- Wild Garlic

### Preparation:

1. Pick the fiddle head fern in the spring when they are young, up to 6 inches in height and unopened wash these and then drain.
2. Chop leeks add to the fiddle head.
3. Pick cattails early in the spring also and peel first layer to get to the tender shoots.
4. *the roots are also used as well*
5. Wash and chop and then drain.
6. Add to other ingredients.
7. Cut up some lettuce and add to the others.
8. Add sunflower seeds.
9. Then add some oil and salt and pepper, a little wild garlic is the best or regular garlic.

*Note: Most ingredients are found in the Spring and in marshy areas in the woods. Be sure to wash wild foods. You will get soaked on your search so wear boots.*

**Servings: Five-Ten**

**Thank you Chantal Seguin dit Laderoute for sharing Fiddle Head And Cattail Salad with us!**

---

**[Return to Food & Recipes Menu](#)**

---



**Text and Graphics  
© 1994 - 103 [Tara Prindle](#)  
unless otherwise cited.**



## Native American Technology and Art



# Floral Green Salad



---

Offered by Offered by Alegra Rose  
~ Squamish Nation ~

**...who learned this from Living in the woods for awhile - I used what nature provided me!**

---

### **Ingredients:**

- **Dandelion Leaves And Flowers**
- **Marigolds Flower Heads**
- **Rose Petals-VariouS Colors**
- **Mint Leaves**
- **Butter Lettuce**
- **Romaine Lettuce**
- **Red Cabbage**
- **Olive Oil**
- **Balsamic Vinaigrette**  
\*of course I added the dressing after I moved out of the woods!

---

### **Preparation:**

- **Pull off leaves of lettuce heads and put into a medium sized bowl.**
- **Add flower petals and flower leaves.**
- **Garnish with mint leaves and a light oil/vinegar dressing.**

*Note: Low In fat!! Haha and healthy good for you :)*

---

**Servings: Snack**

*Thank you Alegra Rose for sharing Floral Green Salad with us!*

---

[Return to Food & Recipes Menu](#)

---



**Text and Graphics**  
© 1994 - 103 [Tara Prindle](#)  
unless otherwise cited.

## Native American Technology and Art



# Fried Corn



---

Offered by Linda Ransome  
~ Comanche Nation, Tribe unknown, father was a full blood, no BC ~  
...who learned this from her great grandmother, who was Comanche.

---

### Ingredients:

- Corn(about 8 ears)
- Bacon,(half a pound)
- 1 large onion(white or yellow)
- Salt and black pepper to taste

---

### Preparation:

- First you shuck the corn and wash, then cut it with a real sharp knife, you want to skim the top of the kernels off.
- Then scrape the cob to get all the juice out of it.
- Then you fry the bacon real good, leave the grease in the pot(black pot works best).
- Cut and sauté the onion in the grease till it is clear
- Add the corn and the salt and pepper.
- Simmer over a low heat and stir often so it doesn't stick.

*Note:* You can leave some of the bacon in , but we always use it to make a sandwich with while we cook the corn \*s\*

---

**Servings: Three - Four**



*Thank you Linda, for sharing Fried Corn with us!*

---

[Return to Food & Recipes Menu](#)

---



**Text and Graphics**  
© 1994 - 103 [Tara Prindle](#)  
unless otherwise cited.

## Native American Technology and Art



# Fried Corn Mush



---

Offered by Elder John  
~ Maidu, Pequot and Heinz 57 varieties ~

.. who learned this from Algonquian

---

### Ingredients:

- Corn meal
  - Water
  - Salt
  - Oil
- 

### Preparation:

- Boil cornmeal and make a thick mush, like oatmeal. Season with a little salt. We used to eat it this way but when there was some left we'd let it cool over night.
- Next day, slice the mush into pieces and fry in oil in a pan.
- Use the same way you would use frybread.

*Note: You can add berries, bits of meat or anything else you like to the mush before it cools. Adds taste.*

---

**Servings: Five-Ten**

---

*Thank you Elder John for sharing Fried Corn Mush with us!*

---

---

[Return to Food & Recipes Menu](#)

---



Text and Graphics  
© 1994 - 103 [Tara Prindle](#)  
unless otherwise cited.



Native American Technology and Art

**beaver** **Beaver Ball Soup**

---

Offered by Lisa Flett  
~ Metis originating from Duck Bay Reserve ~

...who learned this from her koko.

---

**Ingredients:**

- **Beaver balls 10-20**
  - **1 cup of Macaroni 1 jar of Stewed Tomatoes**
  - **Water**
  - **Salt & Pepper to taste**
- 

**Preparation:**

- **Boil your beaver balls first, adding macaroni and tomatoes.**
- **Add salt and pepper as desired.**
- **Let simmer for one hour.**
- **Ready to serve, and is good with bannock.**

*Note: You should know that actual beaver balls do not taste that good. (So I'm told) You can make your beaver balls out of moose, deer, bear or elk meat and roll in to small balls. Let me know if you try actual beaver balls! Enjoy!*

---

**Servings: Three - Four**

---

*Thank you Lisa, for sharing Beaver Ball Soup with us!*

---

[Return to Food & Recipes Menu](#)

---



Text and Graphics  
© 1994 - 103 [Tara Prindle](#)  
unless otherwise cited.

## Native American Technology and Art



# Better Than Grilled



---

Offered by Tommy Tindall  
~ Choctaw Kings Mtn., NC ~

...who learned this from Kings Mtn., NC

---

### Ingredients:

- 2 tender steaks
  - 1 half cup zesty Italian dressing.
  - 1 quarter cup soy sauce.
  - Pour over steaks and let sit over night.
- 

### Preparation:

- Take 2 fry pans 1 on med heat and 1 on high heat.
  - Take steaks put in med heat cook till seared on both sides.
  - Put in high heat and sear on both sides until you like rare med or well done.
- 

Servings: Two

---

*Thank you Tommy Tindall for sharing Better Than Grilled with us!*

---



[Return to Food & Recipes Menu](#)

---



Text and Graphics  
© 1994 - 103 [Tara Prindle](#)  
unless otherwise cited.

## Native American Technology and Art



# Buffalo Stew



---

**Offered by Cindy  
~ Passamaquoddy ~**

**...who notes the recipe has Hunkpapa Lakota origins.**

---

### **Ingredients:**

- **Buffalo stew meat, decent sized chunks**
  - **Tsinpsila (prarie turnips)**
  - **Onions, sliced**
- 

### **Preparation:**

- **Get a huge pot.**
  - **Put the meat, tsinpsila and onions in.**
  - **Cover it with water and boil it up till done.**
- 

**Servings: A lot - depends on the size of the pot.**

---

***Thank you Cindy, for sharing this and other recipes with us!***

---

---

[Return to Food & Recipes Menu](#)

---

---



Text and Graphics  
© 1994 - 103 [Tara Prindle](#)  
unless otherwise cited.



## Native American Technology and Art



# Buffalo Stew (Tanka Me-a-lo)

---

Offered by Ishtacota

~ Cherokee Nation, Husband of Ketana' me (Serenety) ~

...who learned this from great great grandfather of Serenety (Cherokee Orgin)

---

### Ingredients:

- 2 lbs of buffalo stew meat, cut into 1 inch cubes
  - 1 Can stewed tomatoes
  - 2 Stalks of celery, cut 1 inch long
  - 4 Qts water
  - 2 lbs of red or white potaotes... (not russets)
  - 1 Cup barley
- 

### Preparation:

- Brown the buffalo cubes on high heat until seared about 3 min
- Add 4 quarts of water, potatoes and carrots and boil untill
- Veggies are tender. add stewed tomatoes and celery and barley cook
- An additional 5 minutes.
- Remove from fire and place into baking dish.
- Bake at 425 degrees for 30 minutes.
- Remove from oven and enjoy.

*Note: this stew tastes really great, you can use elk or bear or even rabbit in place of buffalo.*

---

**Servings: Five-Ten**

---

**Thank you Ishtacota for sharing Buffalo Stew (Tanka Me-a-lo) with us!**

---

**[Return to Food & Recipes Menu](#)**

---



**Text and Graphics  
© 1994 - 103 [Tara Prindle](#)  
unless otherwise cited.**



# Camp Side Stew

---

Offered by Bill Weatherman

~ Choctaw - My Grandfather told me he was also from Arkansas. ~

... my father taught me on one of many camping trips we made

● **Ingredients:**

- 1 lb. Ground red meat (I prefer ground beef)
- 1 - 2 onions or many green onions
- Salt & pepper
- 2 - 3 potatoes
- 1 - 2 carrots

**Preparation:**

1. Of the 1 lb. Of meat get a handful ( approx. 1/4 to 1/3 lb.) Put it on a sheet of aluminum foil ( approx. 14 in long)
2. Lightly salt it and pepper it.
3. Add chopped potatoes thin slices of carrot to both sides of the meat pepper it add onion chopped up wrap it all up in the aluminum foil (making sure it is sealed good)

**Note:** wrapped just the one time will work if you are oven baking it. (350 degrees for 35-45 minutes) but at campsite wrap one more time in aluminum foil and toss into the campfires edge. moving it every once in a while to cook all the way through. about 30- 60 minutes depending on fire size and size of meal.

**Servings:** Three - Four

Thank you Bill for sharing Camp Side Stew with us!

---

[Return to Food & Recipes Menu](#)

---





**Text and Graphics**  
© 1994 - 103 [Tara Prindle](#)  
unless otherwise cited.

## Native American Technology and Art



# Chicken Fried Venison



---

Offered by Justine Miller Crane  
~ Cherokee, Choctaw & Chickasaw - Texas and Oklahoma ~

.. who learned this from My grandmother, who was half Chickasaw and half German

---

### Ingredients:

- Four or five hand-sized venison steaks
  - 1 1/2 cups flour
  - Salt to taste
  - 2 or 3 teaspoons pepper (I know it's a lot, but it's what makes this so good!)
  - 2 eggs
  - 1 cup milk
  - 1 cup vegetable oil
- 

### Preparation:

- Heat oil in an iron skillet on medium heat setting.
- Tenderize the venison steaks with the open end of an empty glass soda bottle. Note: This could be dangerous, so if you'd prefer, it's ok to use a regular meat tenderizing tool.
- When the meat's been tenderized to about twice its starting size it's ready to dredge.
- Beat the eggs and milk together, add some of the salt to this and maybe teaspoon of the pepper.
- To the flour add the remaining salt and pepper. Start dredging!
- First dip each steak in the egg/milk mixture, then into the flour, then back in the egg/milk mixture, back to the flour and then before the whole mess slides off your steak, gently lay it in the heated oil and watch it go.
- When blood seeps through the uncooked side, it's time to turn it over. Cook until golden brown and crispy.

*Note: Chicken fried venison is by far the best chicken fried anything (including chicken)*

---

**Servings: Two**

---

*Thank you Justine Miller Crane for sharing Chicken Fried Venison with us!*

---

[Return to Food & Recipes Menu](#)

---



Text and Graphics  
© 1994 - 103 [Tara Prindle](#)  
unless otherwise cited.



## Native American Technology and Art



# Choctaw Possum



---

Offered by Tushka Sepokni  
~ Choctaw Nation~

... who learned this in Oklahma

---

### Ingredients:

- 1 Opossum
- Salt
- Pepper
- Sweet Potatoes

---

### Preparation:

- Live catch a possum and pen him up.
- Feed him good clean food (table scraps, dog food, etc.) and give him plenty clean fresh water for two weeks.
- Butcher and skin the possum, wash him thoroughly with clean water, soak overnight in a glass bowl or crock in a solution of 1/4 cup salt to a gallon of water.
- Remove from solution and drain possum.
- Prepare sweet potatoes by washing thoroughly and trimming bad spots out with a paring knife.
- Salt and pepper the possum carcass to taste.
- Place sweet potatoes in body cavity, put carcass on a large cookie sheet and surround with remaining sweet potatoes.
- Place in oven and bake for 3-4 hours or until sweet potatoes are done. (test with fork for tenderness.

- Remove from oven and allow to cool for a few minutes.
  - Remove sweet potatoes from cavity, discard possum carcass and enjoy the sweet potatoes!
- 

**Servings: Three - Four**

---

*Thank you Tushka Sepokni, for your insightful suggestions on preparing possum! The most interesting part of this recipe would, to me, be live catching a possum!*

---

[Return to Food & Recipes Menu](#)

---



Text and Graphics  
© 1994 - 103 [Tara Prindle](#)  
unless otherwise cited.



# Chokecherry Pemmican

---

Offered by Monique Chester

~ Alberta Plains Cree ~

... who learned this from my gramma

## Ingredients:

- 1 pound dry or smoked moose meat
- 1 cup of chokecherries
- 1 cup of lard
- 1 cup of sugar
- 16 by 16 inch piece of fine canvas cloth
- 1 heavy rock or heavy object (preferably a rock)

## Preparation:

1. Pound the dry meat with heavy rock in the canvas cloth, to a fine consistency,
2. Add the chokecherries to the dry meat and pound together until well mixed,
3. Add the sugar and lard to the meat/chokecherry mixture and combine, mix to a meaty type consistency,
4. Roll into balls to be eaten as finger food.

**Servings:** Three - Four

Thank you Monique for sharing Chokecherry Pemmican with us!

---

[Return to Food & Recipes Menu](#)

---



Text and Graphics  
© 1994 - 103 [Tara Prindle](#)  
unless otherwise cited.



## Native American Technology and Art



# Chorizo and Rice



---

Offered by Tracker  
~ lost ol man ~

...who thought it up

---

### Ingredients:

- **2lb Venison with Chorizo Mix**  
(note: regular chorizo sausage can be used if you don't have venison)
  - **2 Medium Onions**
  - **1 Cup Diced Green Chilies**
  - **1/2 Volume of Rice per Liquid**
  - **16 Oz Frozen Mixed Vegetables**
  - **1/4 Cup Citronella Oil**
  - **1 Reg Can Tomato Juice**
  - **2 Tbs Cummin**
  - **Salt and Pepper to Taste**
- 

### Preparation:

- **Cook chorizo venison (ground or chopped) with chopped onions.**
- **When browned add mixed vegetables (thawed), green chilies, tomato juice and if not enough, add enough water to add about 1 cup of rice..**
- **Bring to boil.**
- **Turn down heat to low and cover and allow twenty or twenty five minutes for rice to cook.**

*Note: Do not drain meat and onions after browning...you need all that good juice to add flavor to rice.....  
Optional to add peppers for more kick if you like more spice...*

---

*Servings: Five-Ten*

---

*Thank you Tracker for sharing Chorizo and Rice with us!*

---

[Return to Food & Recipes Menu](#)

---



**Text and Graphics**  
© 1994 - 103 [Tara Prindle](#)  
unless otherwise cited.

## Native American Technology and Art



# Crock Pot Venison



---

Offered by Yvonne Deerinwater  
~ Oklahoma Cherokee ~

...who learned this from her husband.

---

### Ingredients:

- Venison round steak
  - Flour
  - Oil
  - Seasoning
  - Canned tomatoes or mushroom soup or beef broth
- 

### Preparation:

- Take the round steak and dredge in the flour on both sides
- Season it to your preference.
- Brown in on both sides in a small amount of hot oil.
- Remove directly from pan to crock pot.
- Cover with your choice of tomatoes, soup, or broth. (I would not advise all three; choose only one.)
- Cook on low for 3, 4, or 5 hours depending on quantity.

*Note: Very tender and tasty.*

---

*Servings: Three to Four*

---



*Thank you Yvonne Deerinwater for sharing Crock Pot Venison with us!*

---

[Return to Food & Recipes Menu](#)

---



Text and Graphics  
© 1994 - 103 [Tara Prindle](#)  
unless otherwise cited.

## Native American Technology and Art



### Curlies



---

Offered by Cindy  
~ Passamaquoddy ~

...who notes the recipe has Dine' (Navajo) origins.  
Those curlies sure go fast!

---

#### Ingredients:

- Sheep intestine (the curly part)
  - Sheep stomach
  - Sheep fat
  - Grill
- 

#### Preparation:

- Clean well the intestines and stomach.
- Slice up the stomach
- Get a bit of fat, a bit of stomach and twist the intestine around it.
- Place on a hot grill and cook till crispy (not burnt!)

*Note: might be a little tricky*

---

**Servings: Three - Four**

---

*Thank you Cindy, for sharing this and other recipes with us!*

---

[Return to Food & Recipes Menu](#)

---



Text and Graphics  
© 1994 - 103 [Tara Prindle](#)  
unless otherwise cited.



## Native American Technology and Art



# Easy Venison Roll Ups



---

Offered by Juanita Rogers  
~ Little Traverse Bay Band of Odawa Indians, Petoskey Michigan ~

...who learned this from a family recipe  
...where she comes from, you learn to love wild meat.

---

### Ingredients:

- Venison Steaks (enough for the family - I suggest nine or ten)
  - 1 Large Package of Fresh Mushrooms ( in the produce section)
  - 1 Large Vadalia Onion.
  - Seasoned Flour (with Salt and Pepper, maybe a little garlic if you like)
  - A Little Butter for Sautéing
  - Toothpicks
  - Good Chef Kitchen Hammer
- 

### Preparation:

- Roll you venison steaks in the seasoned flour. Flour both sides.
- Pound out the steaks so they are flat with your little "good chef" kitchen hammer. Pound out both sides while adding more seasoned flour.
- Dice up your onions and mushrooms.
- Mix them together in a bowl.
- Roll your diced onions and mushrooms up in the flattened venison steaks. Roll them out the long way.
- Skewer them with the toothpicks.
- Cut the Roll ups in bite size pieces. Each bite sized piece should have a toothpick. this hold them together.
- Sauté the venison roll-ups in a pan in butter, or if you wish vegetable oil. Be careful not to overcook.

Turn them during sautéing, browning all sides.

- Transfer the roll ups to a casserole dish and keep bake them in a preheated oven at 350\* for no more than 30 minutes.
- Serve them with mashed potatoes and gray, and a salad, your family will love them

*Note: I am sure in the distant past, this recipe would not be quite possible. But I do remember my Grandfather making turtle soup. Both my Grandparents were Native Americans. He used to sprinkle teas on us when we were sick. I'm sure he would have loved this recipe.*

---

*Thank you Juanita Rogers for sharing Easy Venison Roll Ups with us!*

---

[Return to Food & Recipes Menu](#)

---



Text and Graphics  
© 1994 - 103 [Tara Prindle](#)  
unless otherwise cited.



## Fireside Stew

---

Offered by Bill Weatherman

~ Indiana, My grandparents were from Arkansas ~

... My Father and Brothers taught me this on a camping trip

### Ingredients:

- A fistful of ground meat 1/2-3/4 lb. Depending on your fist (beef, buffalo or a good red meat)
- One onion to share or save until later or several small onions
- A potato or two
- A carrot or 2 (depending on how many you are making)
- Salt and pepper

### Preparation:

1. Take the meat and put it on a sheet of aluminum big enough to wrap the meat and the rest of this (14-15 inch long) add a small amount of salt and pepper
2. Chop of a potato into small bite size pieces, add to meat the amount you want to eat
3. Chop up a cleaned carrot (small slices) add the amount you want to eat to meat
4. Add small amount of pepper, chop up or thin slice a onion add the amount you want to eat, add one more small amount of pepper if you want (optional)
5. Wrap all this up in the aluminum foil, Wrap with one more piece of aluminum foil, put in camp fire (make sure you can get it out easy in 30-45 minutes)
6. Let cool 10-15 minutes, Check meat to make sure it is done!!! Be careful not to bust the foil open! Liquids inside are VERY HOT and runny if it is EAT! Enjoy

**Note:** this can also be made in a oven 350-400 degrees for 30-45 minutes. Always check to see if meat is cooked. The smaller the amount of meat the quicker it cooks Veggies cook easy (hint if potatoes are soft it SHOULD be done)

**Servings:** One

Thank you Bill for sharing Fireside Stew with us!

---



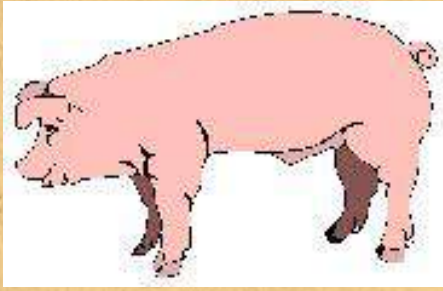
[Return to Food & Recipes Menu](#)

---

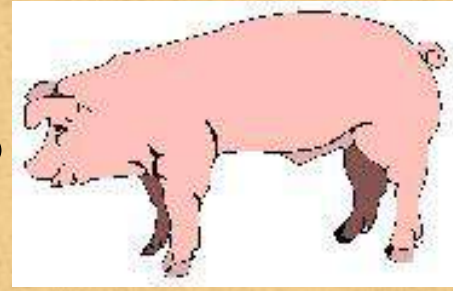


**Text and Graphics**  
© 1994 - 103 [Tara Prindle](#)  
unless otherwise cited.

## Native American Technology and Art



**Gesatho**



---

**Offered by Soaring Hawk  
~ Gabrillino/Apache from Mexico/Arizona ~**

**...who learned this from their Mother**

---

### **Ingredients:**

- **2 fairly sized Pork Steaks, or Pork Chops at least cut to bite size**
  - **4 or 5 nice juicy tomatoes (home grown is great)cut up**
  - **1/2 onion cut in big slices to your taste**
  - **Salt and Pepper to taste**
- 

### **Preparation:**

- **Brown the meat and onions.**
- **Put in tomatoes.**
- **Salt and pepper.**
- **Cook slowly on low heat for about 1 hour.**
- **Make burritos or have potatoes with it whatever!**

*Note: It's like spaghetti, real good the next day!*

---

*Servings: Three to Four*

---

*Thank you Soaring Hawk for sharing Gesatho with us!*

---

[Return to Food & Recipes Menu](#)

---



Text and Graphics  
© 1994 - 103 [Tara Prindle](#)  
unless otherwise cited.





## Good Deer From The Northeast

---

Offered by Steve Kapral

~ Corning, NY ~ close relations w/ Cherokee ~

... from my own cooking plus my love of Mexican food

### Ingredients:

- 1 to 2 lb. Ground deer meat
- 1 qtr tsp. Basil
- 1qtr tsp. Oregano
- 1 qtr tsp. Finely ground red hot pepper
- 4 cloves fresh garlic, finely minced
- 1 chopped onion
- 1 qtr ground black pepper
- Salt to taste after cooking
- 1 bag of wide egg noodles.

### Preparation:

1. First, using a cast iron skillet of appropriate size , and enough olive oil to cover the bottom, slowly simmer the deer meat to brown
2. While it is browning, add all other ingredients except the noodles which should be happily boiling in water in their own kettle.
3. When the garlic /onion is sautéed to tender, add some water to the skillet to help blend the flavors and let it s l o w l e y cook down, fending off those who would eat before it is ready.
4. Adjust spice to taste after it has cooked down
5. Serve over the drained cooked noodles.

**Note:** tomatoes can be added to the mix and sometimes I do, but I think it is better without. Finely ground red hot pepper can be found at least two ways; grow your own, dry it, grind it (in an electric coffee grinder - preferred method Spanish call this molido) or you can buy the hot pepper flakes and grind those, but probably not as good . Cayenne or Thai peppers are the best to use. Eat and enjoy!

**Servings:** Three - Four

Thank you Steve for sharing Good Deer From The Northeast with us!

---

[Return to Food & Recipes Menu](#)

---



**Text and Graphics**  
© 1994 - 103 [Tara Prindle](#)  
unless otherwise cited.

## Native American Technology and Art



# Grilled Prairie Dog



---

Offered by Silverman  
~ Navajo ~

.. who learned this from Navajo friend from Tuba City, Arizona (Edwin)

---

### Ingredients:

- 5 Fresh prairie dog (caught in the early spring)
  - Onions
  - Pepper
  - Salt
  - Garlic
- 

### Preparation:

- Clean and quarter prairie dog, pat dry add onions, pepper, salt and garlic as you would any other seasoning.
- Place on grill and cook slowly for about 1/2 hour.
- Be careful not to over cook.

*Note: If you like, you can add smoke chips to add that wonderful out door flavor*

---

**Servings: Three - Four**

---



*Thank you Silverman for sharing Grilled Prairie Dog with us!*

---

[Return to Food & Recipes Menu](#)

---



**Text and Graphics**  
© 1994 - 103 [Tara Prindle](#)  
unless otherwise cited.



## Hatteras Grilled Venison

---

Offered by Cecil Sink

~ NA roots are Cherokee, and "unknown" Scottish "Clan Amos" ~

... who stumbled on it, while camping on Hatteras Island

### Ingredients:

- 2 pounds tender venison steak, or tenderloins, cut in thin (<1/2") 1" to 3" strips, and all gristle and membrane removed.....
- 1 lime
- 2 large vidalia or texas sweet onions
- 1 jalapeno' pepper, cored, de-seeded, and sliced thin
- 2 green bell peppers, cored, de-seeded, and sliced thick
- 3 strips hickory smoked bacon

### Preparation:

1. Fry bacon on a griddle over an HOT open fire (or in a large cast-iron skillet)
2. Sear the venison, in the bacon grease, and remove
3. Move the griddle farther from the fire, or raise it, so it cooks slower then add the onion and peppers to the griddle,
4. Cook till just a little "limp" stirring very often, then add the venison, and chopped-up cooked bacon....
5. Grill, turning often, until venison is just pink inside
6. Halve the lime, and squeeze over everything, just before removing from the fire....

**Note:** eat it hot! right off the griddle is best!

**Servings:** Three - Four

Thank you Cecil for sharing Hatteras Grilled Venison with us!

---

[Return to Food & Recipes Menu](#)

---



**Text and Graphics**  
© 1994 - 103 [Tara Prindle](#)  
unless otherwise cited.



## Native American Technology and Art



# Jerky Soup and Dumplings



---

Offered by Claude Canwell  
~ Connecticut ~

...who learned this from an old friend

---

### Ingredients:

- Handful of Venison Jerky
- Handful of Parched Corn
- Wild Greens
- Water
- Salt
- Coarse Ground Black Pepper
- Flour
- Oats (optional)

---

### Preparation:

- Harvest any/all edible greens from the days trail. (dandelion, wild onion, etc.)
- Break apart a large handful of venison jerky into your pot.
- Add a handful of parched corn.
- Add the wild greens you harvested.
- Add twice as much water as is needed to cover the ingredients.
- Salt and pepper to taste.
- Simmer 1/2 hour.
- Mix handful of flour, pinch of salt and enough water to make a dough. (I like to add a small handful of oats to the flour.)
- "Float" spoonfuls of dough in soup, continue simmer until dumplings are done.

*Note: the old-timer who showed me this recipe was from northern Canada, I can't remember which tribe he was affiliated with. The soup is outstanding after a long days trek.*

---

*Thank you Claude Canwell for Sharing Jerky Soup and Dumplings with us!*

---

[Return to Food & Recipes Menu](#)

---



Text and Graphics  
© 1994 - 103 [Tara Prindle](#)  
unless otherwise cited.

## Native American Technology and Art



# Menudo South of the border style



---

Offered by Cindy  
~ Passamaquoddy ~

...from Home

---

### Ingredients:

- Beef Tripe Lbs.
- Hominy A Huge Can Or 2 (Restaurant Size)
- California Or New Mexico Chili Powder
- Water
- Cilantro
- Lemons
- Onions

---

### Preparation:

- Wash well and chunk up the tripe.
- Boil it a 1/2 hour and skim the surface.
- Boil it 4 hours or so (Don't let the tripe get mushy!).
- Either make your own hominy or get a huge can. Add it the last hour or so.
- Get a saucepan and put it on the stove and turn it on high. Put the chili power in it (4 to 10 oz) and lightly scorch it. Add it to the menudo and boil together, throw in some onions and cilantro the last 15 minutes or so.

*Note: Serve with warm tortillas, sliced lemons and fresh cilantro.*

---



**Servings: A lot - depends on the size of the pot.**

---

*Thank you Cindy, for sharing this and other recipes with us!*

---

**[Return to Food & Recipes Menu](#)**

---



**Text and Graphics  
© 1994 - 103 [Tara Prindle](#)  
unless otherwise cited.**

## Native American Technology and Art



# Moosemeat Chinese Style



---

Offered by Isabel Anderson  
~ Lakahahmen First nation Canada ~

...who learned this from elders from Carrier Nation

---

### Ingredients:

- 1 cup moosemeat diced very small
  - 3/4 cups bacon diced very small
  - 1 cup onions diced
  - 1 1/2 cups diced potatos diced small
- 

### Preparation:

- Add bacon to a hot fry pan.
- When partly done add moose meat cook until browned.
- Add onions and potatos when they are half cooked.
- Add boiling water to cover the meat.
- Simmer covered for 1/2 an hour.
- Add salt and pepper to taste.
- Serve with boiled rice and soy sauce.

*Note: This can be made with deer meat both have their own distinct taste.*

---

*Servings: Snack*

---

*Thank you Isabel Anderson for sharing Moosemeat Chinese Style with us!*

---

---

[Return to Food & Recipes Menu](#)

---



Text and Graphics  
© 1994 - 103 [Tara Prindle](#)  
unless otherwise cited.



## Native American Technology and Art



# Moose Steak Sandwich



---

**Offered by Melissa Bidlock**  
~ Edson, Alberta ~

**...who learned this on her own**

---

### **Ingredients:**

- **6 Fair Sized Moose Steak**
  - **3 Cups of Water**
  - **1/2 Cup of Flour or 1/4 Cup of Cornstarch**
  - **2 Cans of Mushrooms**
  - **1 Large Onion Cut in Preferred Style**
  - **6 Slices of Fresh Unsliced Bread**
  - **Salt and Pepper To Taste**
  - **2 Cups of Warm Water**
- 

### **Preparation:**

- **In an electric frying pan combine moose steaks a little salt, onions and 3 cups of water**
- **Cook for about 30 minutes.**
- **Add mushrooms cook for 5 minutes.**
- **Mix Flour or corn starch with 1 cup of warm water until mixture is free from lumps and stir into moose. Cook until a gravy-like substance**
- **add the another cup of water if to thick.**
- **Place a thick slice of bread on plate place 1 steak on it add a scoop of gravy mix on top of steak and bread.**

*Note: Moose meat may need to cook longer depending on the size of the steak.*

*Servings: Five-Ten*

---

*Thank you Melissa Bidlock for sharing Moose Steak Sandwich with us!*

---

[Return to Food & Recipes Menu](#)

---



Text and Graphics  
© 1994 - 103 [Tara Prindle](#)  
unless otherwise cited.

## Native American Technology and Art



# Mesquite Grilled Rabbit



---

Offered by Cindy  
~ Passamaquoddy ~

...who learned this from her family.

---

### Ingredients:

- Fresh jack rabbit (Or store bought bunny)
  - Mesquite chips (You can substitute any cook wood chips, hickory, apple, alder etc.)
  - Fire
- 

### Preparation:

- Catch a fresh jackrabbit around December, If none available buy a bunny any other time of year.
- Clean and piece rabbit and place on grill over slow coals, add mesquite chips to the fire.
- Put a lid of some kind over the rabbit and cook slowly for 1/2 hour or so, turning halfway through. It will get a real good smoke flavor that way.

*Note:* Don't over cook the rabbit. Rabbits have very little fat and will dry out quickly.

---

Servings: Two

---



*Thank you Cindy, for sharing Mesquite Grilled Rabbit with us!*

---

[Return to Food & Recipes Menu](#)

---



Text and Graphics  
© 1994 - 103 [Tara Prindle](#)  
unless otherwise cited.



## Mutton Stew

---

Offered by Patricia Begay

~ Navajo Nation ~

... who learned this from Mom's recipe

### Ingredients:

- 2 lb. Of beef stew meat, cubed
- 1 16oz. Beef gravy
- 2 cups of cubed potatoes
- 1 1/2-cups of sliced carrots
- 1 1/2 - cups of chopped celery
- 1 cup of corn
- 1 16 oz can of stewed tomato
- 1/2 cup of chopped onion
- 1/2 diced yellow squash(optional)
- Salt and pepper to taste

### Preparation:

1. First, boil meat in large pot on low, about 40 mins.
2. Then add potatoes, cook 15 mins. Than add celery, carrots, corn, squash, stewed tomato, and gravy. Cook for another 25 mins.
3. The absolute BEST with Navajo Fry Bread...

**Note:** Make sure you make Navajo Fry Bread!!!

**Servings:** Five-Ten

Thank you Patricia for sharing Mutton Stew with us!

---

[Return to Food & Recipes Menu](#)

---



**Text and Graphics**  
© 1994 - 103 [Tara Prindle](#)  
unless otherwise cited.



Native American Technology and Art



**Offered by Cindy  
~ Passamaquoddy ~**

**...who notes the recipe has Miwok origins**

---

**Ingredients:**

- **Fresh venison**
- 

**Preparation:**

- **Early in the morning, dig a deep pit, put rocks in the bottom and build a roaring fire on top.**
- **When the fire burns down, put down willow branches and fresh bay leave branches.**
- **Wrap the venison in a hide or rush mats to keep it clean.**
- **Cover it up with more bay branches and cover with the earth. Let it cook the whole day.**
- **Dig it up for dinner.**

*Note: this might be tricky*

---

**Servings: ?**

---

*Thank you Cindy, for sharing this and other recipes with us!*

---

[Return to Food & Recipes Menu](#)

---



Text and Graphics  
© 1994 - 103 [Tara Prindle](#)  
unless otherwise cited.



## Porcupine Balls

---

Offered by Beth Estrada

~ AZ Yaqui Tribe in Tucson ~

... who learned this from my grama in the southern part of AZ.

### Ingredients:

- 1 lb. Of any ground meat you like.
- 2 cups of wild rice
- Teaspoon of salt
- 1/4 tsp. Of cumin
- 6 cups of water
- 1/2 cp. Chopped onions, 2 chopped tomatoes
- 1/4 tsp. Sage
- 1/4 tsp. Oregano
- Fresh ground pepper to taste.
- 1 egg

### Preparation:

1. Meat egg and rice in big mixing bowl,
2. Mix in tomatoes, add seasoning,
3. Mix all together and shape all this into balls
4. Place them in big boiling pan, add the 6 cups of water and let it boil,
5. Take a lil' bit more wild rice and sprinkle over the top and let it boil for 2 hours. And there is supper :  
)

**Servings:** Five-Ten

Thank you Beth for sharing Porcupine Balls with us!

---

[Return to Food & Recipes Menu](#)

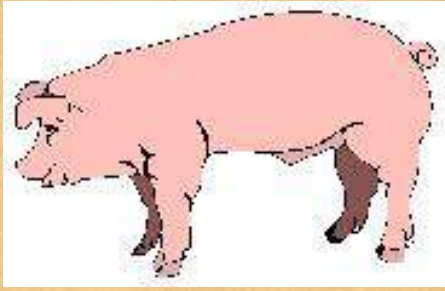
---



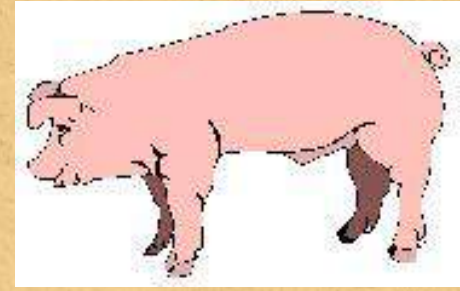


**Text and Graphics**  
© 1994 - 103 [Tara Prindle](#)  
unless otherwise cited.

## Native American Technology and Art



# Pork Stuffed Fry Bread



---

Offered by Pauline Brayman  
~ My husband is Mohawk ~

... who learned because we didn't have salmon, substituted commodities canned pork.

---

### Ingredients:

- One batch Fry Bread
- 1 can commodities pork
- 2 eggs
- salt
- cayenne pepper
- onion powder
- garlic
- Italian flavored bread crumbs

---

### Preparation:

- Shred pork, add all other ingredients
- Patty meat and fry in Olive Oil.
- Wrap in Fry bread dough. Fry in Olive oil and extra shortening.

*Note: This tastes even better when cooked ahead of time and reheated in the Microvave.*

---

*Servings: Three - Four*

---

*Thank you Pauline Brayman for sharing Pork Stuffed Fry Bread with us!*

---

[Return to Food & Recipes Menu](#)

---



Text and Graphics  
© 1994 - 103 [Tara Prindle](#)  
unless otherwise cited.





## Porky Bake

---

Offered by Watachee Nkinsha

~ Cherokee/Choctaw ~

... who learned this from My Grand Mothers best eats

### Ingredients:

- 1 Porky Pine (porcupine)
- 2 tsp. salt
- 1 tsp. cumin
- 1 - 2 lemons (cut in quarters and stuffed in Porky Pine)
- Some clay (freshly dug)

### Preparation:

1. Clean Porky Pine (with Gloves ...hehehe)
2. Stuff lemons and salt into Porky Pine
3. Cover Porky Pine in Clay (on the outside)
4. Put in Fire pit and watch for steam holes to appear
5. Clay getting hot it usually takes about 20 min.s to cook.
6. Take out and Cut with dull knife in half and EAT

**Note:** That good eatin'. Goes with any vegetables especially CORN Bread (my favorite Fry Bread).  
(Webmaster's Note: I would imagine 20 minutes is to short a time to roast such a large animal.)

**Servings:** Two

Thank you Watachee for sharing Porky Bake with us!

---

[Return to Food & Recipes Menu](#)

---



**Text and Graphics**  
© 1994 - 103 [Tara Prindle](#)  
unless otherwise cited.

## Native American Technology and Art



# Roast Moose



---

**Offered by Cindy ~ Passamaquoddy ~**

**...who notes the recipe has Bannock origins.**

---

### **Ingredients:**

- **Fresh young moose, any amount**
  - **A fire of some kind**
- 

### **Preparation:**

- **Find a tasty young moose roamin' around the rez and nab it. (no tough old bulls!)**
- **Cut it up and sear the outside real good to keep the juices in.**
- **Can be roasted on a campfire or in the oven after searing.**

**Yummie!**

---

**Servings: Depends on the size of the moose.**

---

***Thank you Cindy, for sharing this and other recipes with us!***

---

**[Return to Food & Recipes Menu](#)**





**Text and Graphics**  
© 1994 - 103 [Tara Prindle](#)  
unless otherwise cited.

## Native American Technology and Art



# Rock Chuck or or Prairie Dog



---

Offered by Chris  
~ Shoshone-Bannock Nation ~

...who says 'Lots Of Folks Make This'

---

### Ingredients:

- A rock chuck or prairie dog
  - An oven and
  - Foil
- 

### Preparation:

- Take the gutted animal, and burn off its hair.
- Then wrap it in foil.
- Put the package in the oven and bake until done.
- The meat is greasy, stinky, but very soft and flavorful.

*Note: i have seen this done, happily munched the product of other people's labor, but never did this myself. I do recommend an outside stove/dutch oven type arrangement (the smell). Perhaps someone else who has done this personally might want to submit some hints or ideas.*

---

Servings: a few?

---

*Thank you Chris, from [Beadedweb](#), for sharing your Rock Chuck recipe with us - who's gonna be the first to try it!*

---

[Return to Food & Recipes Menu](#)

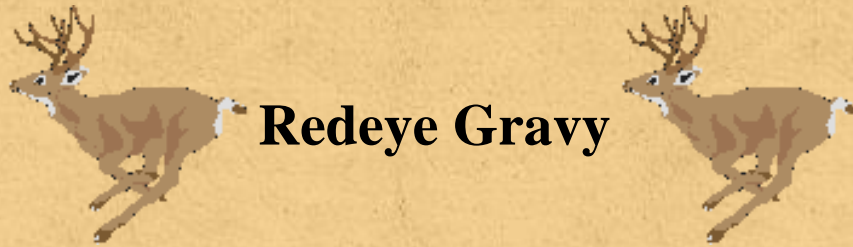
---



Text and Graphics  
© 1994 - 103 [Tara Prindle](#)  
unless otherwise cited.



## Native American Technology and Art



---

**Offered by Ted Wilburn  
~ Known Cherokee from Tennessee ~**

**...who learned this from my Aunt Nancy, dad's sister**

---

### **Ingredients:**

- **Grease From Browning A Slice Of Ham In A Skillet.**
  - **One To Two Cups Of Coffee, Salt & Pepper.** *(If you don't have a slice of ham use a slice of bacon. If you don't have either and are desperate for some redeye, just use a tablespoon or so of your bacon grease that you save to grease your skillet for cooking anything else).*
- 

### **Preparation:**

- **Pour the coffee in the skillet & bring it to a boil & add salt & pepper to suit your taste & its done.**
- **The coffee doesn't have to be fresh. It can be yesterday's & still make good redeye gravy.**
- **It doesn't hurt to leave a few ham jiblets in the gravy.**

*Note: Spoon out a little redeye gravy on a piece of corn bread or biscuit, rice, or grits. If you are really hurting for gravy & bread redeye improves a slice of loaf bread like you wouldn't believe.*

---

**Servings: Two**

---

*Thank you Ted Wilburn, for sharing Redeye Gravy with us!*

[Return to Food & Recipes Menu](#)

---



Text and Graphics  
© 1994 - 103 [Tara Prindle](#)  
unless otherwise cited.



## Sacho Seasoning For Steak

---

Offered by Feather Eagle

~ Mojave ~

... who tried it on some food.

### Ingredients:

- 1 tsp. Dill
- 1 1/2 parsley
- 1 pinch of cinnamon
- 2 tsp. nutmeg
- 2 tbs. seasoning salt
- 2 tsp. black pepper
- 3 tsp. garlic powder

### Preparation:

1. Mix the first three ingredients together in a small bowl.
2. Separately mix the last four ingredients in a different small bowl.
3. When the steak you are cooking have about five minutes left mix and sprinkle on steak.
- 4.

**Note:** When mixed, there will be only enough for 1 steak.

Thank you Feather for sharing Sacho Seasoning with us!

---

[Return to Food & Recipes Menu](#)

---



Text and Graphics  
© 1994 - 103 [Tara Prindle](#)  
unless otherwise cited.



## Native American Technology and Art



# Saponi Beef Empanadas



---

Offered by Kimmie Whitehead  
~ Haliwa Saponi from North Carolina ~

...who learned this from her Puerto Rican mother-in-law (who knows what she's doing)

---

### Ingredients:

- 1 Lb. Ground Beef (may substitute chicken cubes, ground turkey or buffalo)
- 1/2 Cup Diced (or sliced if you prefer) Black Olives
- 1/2 Cup White Sugar
- 2 Cups Canned Tomatoes (without the juice)
- 1 Can Crescent Rolls (quicker than making your own dough)
- 1 Large Finely Chopped Onion
- 1 Tablespoon Salt (optional)
- 2 Tablespoons Black Pepper
- 1 Teaspoon Hot Sauce
- 1 Teaspoon Sweet Basil
- 1/2 Teaspoon Finely Chopped Garlic
- Butter Or Margarine (for sautéing)
- 2 Cups (separated) Shredded Cheese (whichever type you prefer - I like sharp cheddar)
- Pam Cooking Spray or use Reynolds wrap to line baking dish
- Wax Paper To Roll On
- 1 Cup Flour To Roll Dough
- 6 Egg Whites

---

### Preparation:

- Pull out wax paper and lay out for the crescent rolls.
- Open the can so they will be easier to pull apart.

- Sauté onion and garlic in butter or margarine until soft, remove from fire & set aside to cool.
  - Cook the meat till just done and remove from fire.
  - Drain fat. Set aside to cool so you can handle.
  - In large bowl, combine and stir: olives, sugar, tomatoes, salt, pepper, hot sauce and 1 cup of the shredded cheese. Onion and garlic mixture and meat should have cooled by now, so add it in.
  - Take bowl by your area where wax paper is.
  - Spray your baking dish with Pam or line bottom with aluminum foil.
  - Flour your hands, wax paper & rolling pin or jar.
  - Pull off one dough section to roll (to make larger surface to fill with - Do not roll too thin)
  - Fill one at time with 1 heaping tablespoon of mixture and roll up according to directions on can and place on baking sheet with 1 inch between each.
  - Bake according to directions on roll can and let cool...eat up!
- 

Servings: Three - Four

---

*Thank you Kimmie Whitehead for sharing Saponi Beef Empanadas with us!*

---

[Return to Food & Recipes Menu](#)

---



Text and Graphics  
© 1994 - 103 [Tara Prindle](#)  
unless otherwise cited.

## Native American Technology and Art



# Survival Sausage



---

Offered by Gordie Soaring Hawk  
~ Mohawk, from Canada, but now a desert transplant! ~

.. who learned this from wilderness survival

---

### Ingredients:

- Large intestines of sheep or goat
- Cotton string
- Heart, liver, tongue, kidneys, scrap meat, other organs you want to throw in [all from the same animal you butchered]
- Garlic powder
- Salt
- Sage
- Thyme
- Oregano
- Cumin
- Black pepper
- Worcestershire sauce
- Several large cans
- Sharp knives
- Cutting boards

---

### Preparation:

- What you do is clean out the intestines [large ones are easiest and strongest, pellets just fall out].
- After cleaning, soak them in pail of cool water in the shade.
- Then everybody grabs a cutting board and a knife and then chops up all the organs and scrap meat as finely as you can, and then slop this mix into a large container.
- Then you add the spices till you think it smells about right, stirring with your hands so that you mix



it just right [you can use spoons if you're squeamish].

- Now, grab a chunk of intestine, and begin stuffing it with the meat, packing tightly, but carefully.
- Tie the end with a cotton string, then take more string, and tie along the intestine, forming links the size you want. Do this till you either run out of intestine or meat.
- Now, boil the sausages till they are firm and done about 1-2 hours. They are great! and everything except the string is edible!

---

**Servings: Five-Ten**

---

*Thank you Gordie Soaring Hawk for sharing Survival Sausage with us!*

---

[Return to Food & Recipes Menu](#)

---



Text and Graphics  
© 1994 - 103 [Tara Prindle](#)  
unless otherwise cited.

## Native American Technology and Art



Offered by Cindy  
~ Passamaquoddy ~

...who notes the recipe has Oglala Lakota on Pine Ridge

---

### Ingredients:

- tripe, any kind, any amount
  - potatoes about 1/2 to equal the tripe amount
  - onions, more or less depending on taste
- 

### Preparation:

- Clean the tripe well and cut up into large bite-sized pieces.
  - Boil for 4 hours or so (don't let it get mushy!).
  - Peel and cut up potatoes into chunks and slice the onions and add the last 1/2 hour.
- 

Servings: The family +

---

*Thank you Cindy, for sharing this and other recipes with us!*

---

[Return to Food & Recipes Menu](#)



**Text and Graphics**  
© 1994 - 103 [Tara Prindle](#)  
unless otherwise cited.



## Native American Technology and Art



# Too Tall Tail Meat Salad



---

Offered by Jacqueline and friends  
~ Alaska Inuit ~

...who learned this from her grandmother

---

### Ingredients:

- Two Boiled Eggs
- Four Chopped Onions
- Two Rabbit Steaks Chopped
- Two Table Spoons Chili Powder
- One Cup Cooking Oil
- One Whole Celery Chopped
- One Tomato Chopped
- One Complete Lettuce Chopped

---

### Preparation:

- Make sure to cook rabbit steak for 15 mins first (in hot water).
- Mix together in any order.
- Let cool for 15 mins in fridge.
- Just enjoy!!!!

*Note: serve mostly at parties.*

---

*Servings: Five-Ten*

---

*Thank you Jacqueline and friends for sharing Too Tall Tail Meat Salad with us!*

---

[Return to Food & Recipes Menu](#)

---



Text and Graphics  
© 1994 - 103 [Tara Prindle](#)  
unless otherwise cited.

## Native American Technology and Art



# Venson and Barley Soup



---

Offered by Mary E. Fox /aka/Minah Two Crow  
~ Arikara/Hidatsa, from the Fort Berthold Reservation, ND ~

...who learned this during hunting season on the Reservation - my own recipe

---

### Ingredients:

- 1-2 gallons of water
- Large cooking pot
- Venison meat(approx. 2 lbs cut up in cubes)
- 2 diced rutabagas
- 4 sliced carrots
- 4-5 diced celery
- 1 onion - diced
- salt & pepper to taste
- 2-3 cups of Barley
- Tomatoes (optional)2 fresh or one canned.

---

### Preparation:

- In large pot, put the cut-up venison,
- add water, bring to boil.
- Dice up the vegetables while meat is cooking, add to meat
- continue cooking for 45 minutes,
- add the barley and cook for another 30 minutes until all ingredients are tender.
- Enjoy!

*Note: I served this soup with biscuits and my family loved it, as well as our guests, whomever they happened to be at the time. It was a favorite among the many hunters who passed through my home at the*



*time of deer hunting season. I enjoyed cooking large meals and having friends over to share a meal with my family. We enjoy venison throughout the year on our reservation, which is located in western North Dakota, with New Town being the location of the Ft. Berthold Bureau of Indian Affairs, Ft. Berthold Agency.*

---

*Servings: Five-Ten*

---

*Thank you Mary E. Fox /aka/Minah Two Crow for sharing Venison Barley Soup with us!*

---

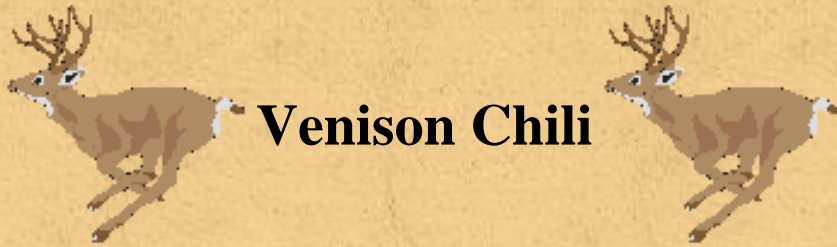
[Return to Food & Recipes Menu](#)

---



Text and Graphics  
© 1994 - 103 [Tara Prindle](#)  
unless otherwise cited.

## Native American Technology and Art



# Venison Chili

---

Offered by Jay McCarter  
~ Nause-Waiwash from Dorchester County Maryland ~

...a family recipe

---

### Ingredients:

- 2 lbs. Venison cubed in 1/2" cubes or burger or saug.
- 1 large onion chopped
- 2 Tbsp. chili powder
- 1 Tbsp vinegar
- 1 tsp. salt
- 1/4 tsp. pepper
- 1 Tbsp. sugar
- 1 can tomato sauce
- 1 can kidney beans
- 1 can pinto beans
- 1 can corn
- 1/2 cup diced green pepper (optional)

### Preparation:

- **Brown meat and onion in a heavy skillet. Transfer to heavy pot (I use a crock pot. It can also be cooked in a dutch oven over a fire when camping) Add all other ingredients except corn. Cook several hours stirring as needed. Add corn one hour before serving.**

*Note: Serve with freshly baked flour pone.*

---

*Servings: Five to Ten*

---

*Thank you Jay McCarter for sharing Venison Chili with us!*

---

[Return to Food & Recipes Menu](#)

---



**Text and Graphics**  
© 1994 - 103 [Tara Prindle](#)  
unless otherwise cited.





## Venison "Ragout"

---

Offered by Trixi Twelvetoes

~ Nez Perce -folks are Roge & Trish ~

... who learned this from My Great Grandpapa

### Ingredients:

- 4 lb. Fresh cubed venison - neck, frontleg, or any other tough area of meat. 1/2 cup flour-salt & pepper to taste. 1 cup venison/beef stock.
- 1 lb. Sliced mushrooms. 1 "clean" cotton 'rag' approximately. 2'x2' in size.
- Tin foil

### Preparation:

1. Shake venison, mushrooms, in flour mixed with salt & pepper. Lay this mixture on the clean rag. Roll edges of rag to form a ball shape.
2. Set your ball on the tin foil and again form a ball. Before sealing tin foil pour in the stock until full. Seal the foil and repeat foil wrap one more time.
3. Dig a small pit and build a nice hot oak fire-when you have plenty of hot coals set the foil ball in the pit and cover/surround with coal .
4. Then cover with loose earth and go hunting, fishing or gathering for two hours. When you return from your adventures you will be very hungry..
5. "DON'T FORGET TO PULL THE "RAGOUT" BEFORE SERVING!!!

**Note:** Venison heart or other wild game meat may be used.. small whole onions work well also ... Also can use other veggies. Be sure to use enough foil to seal real good...

**Servings:** Three - Four

Thank you Trixi for sharing Venison "Ragout" with us!

---

[Return to Food & Recipes Menu](#)

---



**Text and Graphics**  
© 1994 - 103 [Tara Prindle](#)  
unless otherwise cited.

## Native American Technology and Art



# Wampanackali



---

Offered by Little Fawn  
~ Wyandot ~

...who learned this from My Wyandot sister who got it from Kokopelli a flute player friend

---

### Ingredients:

- 1 tsp. honey
- 1/4 tsp. salt, and pepper
- 9 cups venison
- 2 cups squirrel
- 1/4 tsp. lemon

---

### Preparation:

- Cook the squirrel and veison together with the salt, pepper. and honey.
- When it's nice and tender pour the lemon juice on it,
- and if it sounds good to you put some parsley on top.

*Note: This tastes wonderful and is good with almost anything!*

---

*Thank you Little Fawn for sharing Wampanackali with us!*

---

[Return to Food & Recipes Menu](#)





Text and Graphics  
© 1994 - 103 [Tara Prindle](#)  
unless otherwise cited.

## Native American Technology and Art

# **woodchuck** Woodchuck Chuck **woodchuck**

---

**Offered by Winddancer (a.k.a. Bill)  
~ Mohawk, Ontario Canada ~**

**...who learned this from his Father and Grandfather.**

---

### **Ingredients:**

- **Groundhog (a.k.a. Woodchuck)**
  - **1 green pepper**
  - **1 red pepper**
  - **2 cloves of garlic**
  - **1 lg. Onion**
  - **2 carrots**
  - **3 potatoes**
  - **Hand full of pigweed**
- 

### **Preparation:**

- **Clean and fillet meat, cut into 1" chunks put into 3 quart pot, 3/4 full of water,**
- **Add peppers, potatoes, pigweed, garlic, carrots, onion.**
- **Salt and pepper to taste.**

***Note:* If you don't upchuck from the woodchuck then it was good chuck**

---

**Servings: Three - Four**

---

***Thank you Winddancer, for sharing Woodchuck Chuck with us!***

---

[Return to Food & Recipes Menu](#)

---



Text and Graphics  
© 1994 - 103 [Tara Prindle](#)  
unless otherwise cited.



## Native American Technology and Art

# **dove** Bar B.Q. Dove **dove**

---

**Offered by Viper  
~ Comanche ~**

**...who learned this from many, many experiments.**

---

### **Ingredients:**

- **A bunch of doves**
  - **Pace's Picante Sauce (med.) That's the kind made in Texas**
  - **Bacon**
  - **Your favorite Bar B.Q. Sauce**
- 

### **Preparation:**

- **Marinate dove breasts in picante sauce overnight.**
- **Wrap each with bacon strip and fasten with toothpick.**
- **Place on grill over slow coals and baste frequently with BBQ sauce.**

***Note: Don't over cook.....ENJOY !!!***

---

**Servings: If you're a good shot, you can feed a bunch of people. If not, you better buy some hamburger to go with it.....**

---

***Thank you Viper, for sharing Bar B.Q. Dove with us!***

---

**[Return to Food & Recipes Menu](#)**

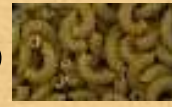


Text and Graphics  
© 1994 - 103 [Tara Prindle](#)  
unless otherwise cited.

Native American Technology and Art



# Cat's Butter Noodle Soup



---

Offered by Walking Catamount  
~ Mohawk - North Adams, MA ~

.. who learned this 16 years ago in my home( I like to experiment)

---

## Ingredients:

- 4 full breasts of chicken
- Enough water to cover
- 4 tablespoons butter
- 1/2 gal. milk
- 2 oz. sharp cheddar cheese
- 6 slices American cheese
- 1/2 -3/4 pound mozzarella cheese
- 8 bouillon cubes (no MSG)
- 2 cloves garlic
- Pepper & parsley
- Your favorite noodles

---

## Preparation:

- Place chicken in big pot, add enough water to cover, cook till done & tender.
- Remove from broth to cool, then strain the broth, return to pot and lower heat to simmer, then add butter, milk, cheeses, bouillon cubes, garlic, parsley & pepper.
- Stir occasionally.
- Take chicken and remove skin, bone & gristle, shred chicken & add to broth.
- Cook noodle in another pan till al dente.
- Add to soup, stir cook a few more minutes then serve.

*Note: This soup is VERY DAIRY and will warm you up pronto no matter how cold you are. I know this because I tested it on 4 kids ho had been playing out in the snow-slush and were soaked to the skin. Many have tried my soup and it will not last in the pot. The "munchers" are waiting for it ....hehehehe Eat*



*hearty... I had sent this recipe before, but somehow I messed it up and most of the ingredients were missing. So here is the complete recipe....ENJOY*

---

**Servings: Three - Four**

---

*Thank you Walking Catamount for sharing Cat's Butter Noodle Soup with us!*

---

[Return to Food & Recipes Menu](#)

---



**Text and Graphics**  
© 1994 - 103 [Tara Prindle](#)  
unless otherwise cited.

## Native American Technology and Art

# **chicken** **chicken soup** **chicken**

---

**Offered by Louise Mcnac  
~ Oklahoma Creek ~**

**...who learned this from mother-in-law**

---

### **Ingredients:**

- **2 cups sofke corn cleaned and washed untill water runs clear**
  - **1 whole chicken cut up**
  - **salt and pepper for flavor to your liking**
- 

### **Preparation:**

- **put sofke corn and cut up chicken in large cooking pot.**
- **cover chicken completely with water about four cups above chicken.**
- **Boil a good three hours or until corn is completely done.**
- **add water when needed do not let it dry up.**
- **Boil down when done so it will not be too watery.**
- **Corn will swell so make sure your water is always sufficient.**

*Note: very good with Creek sour corn bread(tvklik tokse)*

---

*Servings: Five-Ten*

---

*Thank you Louise Mcnac for sharing chicken soup with us!*

---

[Return to Food & Recipes Menu](#)

---



Text and Graphics  
© 1994 - 103 [Tara Prindle](#)  
unless otherwise cited.



Native American Technology and Art

**sage** **Fried Sage And Mushroom Sauce For Pasta**

---

Offered by Laura Grabhorn

~ Haida, Tlingit - Mom, Pearl is from Klawock, Alaska Mink Clan ~

... who made it up.

**Ingredients:**

- **About 25 Sage Leaves (Wash, Pat Dry, Set Aside)**
- **1 Pound Sliced Mushrooms (Chantrelle, Shitake, Or Button)**
- **1/4 Cup Butter**
- **1/4 Cup Flour**
- **Salt And Pepper To Taste**
- **1 Head Garlic (Or Less To Taste, Peeled And Sliced)**
- **Angel Hair Pasta Or Thin Spaghetti. 12 Oz Dry For 3-4 People**

**Preparation:**

1. **Place 4 quarts of water in a large kettle, add a bit of canola oil.**
2. **Heat the water to boiling for pasta while you prepare the sauce.Melt 1/8 cup of the butter. Add sage leaves and fry until they are crisp.**
3. **Remove and place on clean paper towel.Melt the rest of the butter.**
4. **Add sliced mushrooms.**
5. **Sprinkle with salt and pepper.**
6. **When mushrooms are slightly toasty around the edges add the sliced garlic.**
7. **Stir mixture and cook just until garlic is fragrant.**
8. **Remove and put in a bowl.Throw your pasta into the kettle of boiling water.Mix enough water with the flour to form a smooth paste. Set aside.Add about 1/2 cup water to hot pan and use a wooden spatula or spoon to scrape mushroom bits from bottom of the pan.**
9. **Heat the water to boiling. Gradually add flour paste and stir until you have a smooth sauce.**
10. **Add the mushroom mixture to reheat.Reduce heat to simmer.Drain pasta. Place pasta on plates.**
11. **Spoon up the mushroom sauce. Scatter fried sage on top.**
12. **Serve.**

*Note: This recipe would easily accommodate bits of smoked salmon or other smoked fish (what wouldn't be good with smoked fish?)*

**Servings: Three - Four**

**Thank you Laura Grabhorn for sharing Fried Sage And Mushroom Sauce For Pasta with us!**

---

[Return to Food & Recipes Menu](#)

---



Text and Graphics  
© 1994 - 103 [Tara Prindle](#)  
unless otherwise cited.

## Native American Technology and Art



# Fried Yucca Petals



---

**Offered by Offered by Susan Marie Smith-Kennedy  
~ Cherokee (born and raised in San Antonio, Texas) ~**

**...who learned this from Family recipe**

---

### **Ingredients:**

- **Flower Stalk From Yucca Plant**
  - **1 Tablespoon Shortening**
  - **2 Medium Onions, Chopped**
  - **2 Fresh Tomatoes, Chopped**
  - **1 Cup Water**
  - **Salt And Pepper, To Taste**
- 

### **Preparation:**

- **Pull flower petals from stalk and wash in salt water.**
- **Melt shortening in skillet and add flower petals, onion and tomatoes.**
- **Stir gently until onions are soft.**
- **Add water and simmer until most liquid is gone.**
- **Salt and pepper to taste.**

*Note: The petals taste similar to cabbage.*

---

**Servings: Three - Four**

---



*Thank you Susan Marie Smith-Kennedy for sharing Fried Yucca Petals with us!*

---

[Return to Food & Recipes Menu](#)

---



Text and Graphics  
© 1994 - 103 [Tara Prindle](#)  
unless otherwise cited.

## Native American Technology and Art



# Gluckaston



---

**Offered by Jenn Vander Ploeg**  
~ Non-Native, from Michigan ~

**...who learned this from A book called "I heard The Owl Call My Name".**

---

### **Ingredients:**

- **Seaweed (as much as needed).**
  - **Corn-canned corn or fresh corn, it's up to you.**
  - **You can find the seaweed at health food stores, or right out of the ocean, or where ever.**
- 

### **Preparation:**

- **Cook seaweed throughly, then add corn.**

*Note: I'm not Native American, but I read this book, and the recipe wasn't on the NativeTech Food page, so I decided to submit it.*

---

*Servings: It depends on how much seaweed you gather.*

---

*Thank you Jenn Vander Ploeg for sharing Gluckaston with us!*

---

[Return to Food & Recipes Menu](#)

---



Text and Graphics  
© 1994 - 103 [Tara Prindle](#)  
unless otherwise cited.



## Native American Technology and Art



# Greens Salad (grammy called it Guhitligi)

---

Offered by Tu'ti

~ Southeast Kituwah Nation - Cherokee ~

...who learned this from Grandmother

---

### Ingredients:

- Sweet grass (Oo-Ga-Na-S-Di)
- Old Field Creases (Oo-Li-Si)
- Ramps (Wa-S-Di)
- Angelica (Wa-Ne-Gi-Duhn)
- Poke (Tla-Ye-De)

---

### Preparation:

- Parboil, salt, then cook some more with grease.
- Serve hot.

*Note by NativeTech administrator: Please be sure to gather wild greens in the right season -- some greens are poisonous if gathered in the wrong season or prepared in the wrong way.*

---

*Thank you Tu'ti for sharing Guhitligi with us!*

---

[Return to Food & Recipes Menu](#)

---



**Text and Graphics**  
© 1994 - 103 [Tara Prindle](#)  
unless otherwise cited.

## Native American Technology and Art



# Guacomole



---

**Offered by Offered by Susan Marie Smith-Kennedy  
~ Cherokee (born and raised in San Antonio, Texas) ~**

**...who learned this from a Family recipe**

---

### **Ingredients:**

- **2-3 Ripe Avocados, Peeled, Pitted, And Mashed**
- **2 Tablespoons Lime Juice**
- **1 Tablespoon Lemon Juice**
- **1 Med Tomato, Chopped (Use Only The "Shell" Of The Tomato, Discard The Pulp/Seeds)**
- **2-3 Tomatillos, Chopped (Mexican Husk Tomato)**
- **1 Small Onion, Finely Chopped (Optional)**
- **1/4 Cup Finely Chopped Fresh Cilantro**
- **1/2 Teaspoon Ground Coriander**
- **1 Tablespoon Worcestershire Sauce**
- **Goya Adobo Seasoning (Has Salt) W/ Cumino, To Taste**
- **Ground Black Pepper, To Taste**

---

### **Preparation:**

- **Combine, cover, and refrigerate.**

---

**Servings: Two**

---

***Thank you Susan Marie Smith-Kennedy for sharing Guacomole with us!***



---

[Return to Food & Recipes Menu](#)

---



Text and Graphics  
© 1994 - 103 [Tara Prindle](#)  
unless otherwise cited.

## Native American Technology and Art



# I-Ya (Dried Pumpkin Rings)



---

**Offered by Offered by Susan Marie Smith-Kennedy  
~ Cherokee (born and raised in San Antonio, Texas) ~**

**...who learned this from Family recipe**

---

### **Ingredients:**

- **Fresh, Whole Pumpkin(S)**

---

### **Preparation:**

- **Slice pumpkin into rings about 1/2-inch thick.**
- **Remove seeds.**
- **Place slices on a screen or net and place in a sunny spot for 2-3 days or until dried.**
- **These slices may then be stored and kept for stews, soups, or puddings.**

---

*Thank you Susan Marie Smith-Kennedy for sharing I-Ya (Dried Pumpkin Rings) with us!*

---

**[Return to Food & Recipes Menu](#)**

---



**Text and Graphics**  
© 1994 - 103 [Tara Prindle](#)  
unless otherwise cited.



## Native American Technology and Art



# Jac's Wildberry Crisp



---

Offered by Jac Gibbs  
~ Thru' my children. Blackfoot. Alberta Canada ~

...who made it up and is very popular for doing so

---

### Ingredients:

- 3/4 to 1 C of sugar (depending on type of fruit used)
  - 3/4 C of flour or more or less(really must test by final consistency of topping)
  - 1/4 C of oats
  - 3/4 tsp of cinnamon
  - 3/4 tsp of nutmeg
  - 1/3 C of butter
- 

### Preparation:

- Mix together all the ingredients (melt butter first). This part should be crumbly but pretty moist so it's a little crunchy on top when cooked. If its too dry it will not be nearly as good.
- Put all the fruit in a baking dish, I use whatever is available to me depending on the season.
- I always add a handful of cranberries and small pieces of either orange or lemon ( peel in-tow ) which adds a very refreshing tartness to a sweet and delicious dessert.
- Bake at 375 degrees for about 30 mins.

*Note: I'm not native but my children are partially and I was born in Canada and raised in the arctic. My recipes are all one hundred percent created by me and well loved by all who have tasted them. I have many more and make a dynamite sheperds pie with deer. I ended up here because I was looking up 'Brain-tanning'. I will try some of your recipes also. My children are part Blackfoot and we live up here in Alberta, Canada.*

---

**Servings: Two**

---

*Thank you Jac Gibbs, for sharing Jac's Wildberry Crisp with us!*

---

[Return to Food & Recipes Menu](#)

---



Text and Graphics  
© 1994 - 103 [Tara Prindle](#)  
unless otherwise cited.

## Native American Technology and Art



# Jellico (Wild Greens)

---

Offered by John Graham  
~ Cherokee ~

...who learned this from his father

---

### Ingredients:

- dandelion, chickory, and pokeweed leaves; pick a good mess because they cook down.
- wood sorrel leaves and stems; a handfull for flavoring.
- 1/4 lb. bacon, or fatback

---

### Preparation:

- Pick the leaves of these plants like you would lettuce.
- Wash and cook the leaves down in a pot of water.
- When they've cooked down, strain them, add a little water, and the wood sorrel, and let them sit and warm.
- Take your bacon/fatback (if you use fatback, cut it into thin strips to fry) and fry it in a skillet good and crisp.
- Drain off most of the grease (save it for other uses) and take the greens and put them in the hot skillet with the bacon, mixing it well.
- Serve it up, and eat well!

***\*\* Important Note: Be careful to only pick the young leaves of the pokeweed; the ones not showing any red on the underside of the leaf, as the plant becomes poisonous as it gets big and shows red viens.***



**Servings: Two**

---

*Thank you John, for sharing Jellico with us!*

---

**[Return to Food & Recipes Menu](#)**

---



**Text and Graphics  
© 1994 - 103 [Tara Prindle](#)  
unless otherwise cited.**



## Ma'at Salad

---

Offered by "Wolfgirl"

~ Powhatan Confederacy ~

... who learned this from my Mother and Father

### Ingredients:

- 1 head of chicory
- 1 head of red-leafed lettuce
- 3 radishes
- 6 wild onions

### Preparation:

1. Chop the chicory and red-leafed lettuce into "bit-size" pieces(cut off the roots first, but don't use them in the salad).
2. Cut up radishes into flat slices (add roots to salad).
3. Cut and dice wild onions(also add roots to salad).
4. Mix everything together and begin your meal!!!!

**Note:** I have tried this once with balsamic vinegar and it wasn't that bad, but plain tastes very good too.

**Servings:** Two

Thank you Wolfgirl for sharing Ma'at Salad with us!

---

[Return to Food & Recipes Menu](#)

---



**Text and Graphics**  
© 1994 - 103 [Tara Prindle](#)  
unless otherwise cited.



## Native American Technology and Art



# Macque Choux



---

Offered by Chitimacha Tribe of Louisiana  
~ Sovereign Nation of the Chitimacha Tribe of Louisiana ~

.. who learned this from Al LeBlanc, Chitimacha

---

### Ingredients:

- 12 ears Fresh Sweet Corn
- 3 Medium Onions
- ¼ Cup vegetable oil
- Black pepper and salt

---

### Preparation:

- Clean corn thoroughly. Cut corn off Cob using the "Macque Choux" method. \*Using a sharp knife, cut the first layer of corn about 1/8" (just taking the tops). Cut a second layer, getting very near the cob (not into it). Next, back-scrape the cob using your knife to extract the rest of the pulp and milk. Note: Remember, the cut of the corn is directly proportionate to the quality of the Macque Choux.
- Cut the onions very fine, by peeling, halving, slicing in 1/8" slices with the grain, and finally 1/8" across the grain, forming 1/8" dices. This is not so critical as the corn but try to keep it small. Mix the onions and corn thoroughly in a large bowl, seasoning with salt and black pepper to taste.
- In a large black iron skillet or Dutch oven: Heat the oil to frying heat. Add corn and onions all at once. You must cook this on a medium fire and keep well stirred for the next 45 minutes. It will brown to a nice golden brown and take on a slightly nutty consistency. It will have a naturally sweet consistency. If it does not, then you can use a tablespoon or so of brown sugar to get it there. You may also want to add a bit of cream (canned evaporated milk) to give it a more creamy consistency. Enjoy

---

Servings: Two

---

*Thank you Chitimacha Tribe of Louisiana for sharing Macque Choux with us!*

---

[Return to Food & Recipes Menu](#)

---



Text and Graphics  
© 1994 - 103 [Tara Prindle](#)  
unless otherwise cited.

## Native American Technology and Art



# Mohawk Corn Soup



---

Offered by Iako-Nikohn-Rio  
~ Akwesasne Mohawk ~

.. who learned this from family recipe with Seneca help

---

### Ingredients:

- 2 Cups Hulled Hominy - Iroquois White Corn
- 1/4 Cabbage
- 2 Turnips to taste
- 1 Rutabaga to taste
- 1 Can or 4 lg. Carrots
- 4 Smoke pork chops chopped
- 1/2 lb. Chopped venison
- 1 Large can kidney beans or navy beans

---

### Preparation:

- Cook in slow cooker the hulled hominy over night on low.
- Rinse corn.
- Brown and chop meat.
- Chop cabbage, turnips, rutabagas and carrots to bite size.
- In a large soup pot pour all ingredients don't drain the beans.
- Fill with water 1" over all ingredients adding as needed.
- Cook until all vegys are tender.

*Note: making corn soup the traditional way of lying the corn is the easiest task. Thanks to John's efforts I can make my family soup in my apartment. Its really great.*

*Hulled Hominy the Iroquois white corn can be found at SUNY Buffalo ask for John Mohawk. They grow*



*and process the corn. NO CHEMICALS!!!*

---

**Servings: Ten**

---

*Thank you Iako-Nikohn-Rio for sharing Mohawk Corn Soup with us!*

---

**[Return to Food & Recipes Menu](#)**

---



**Text and Graphics  
© 1994 - 103 [Tara Prindle](#)  
unless otherwise cited.**

## Native American Technology and Art



# Nopalitos Con Arror (Cactus Over Rice)



---

Offered by Offered by Susan Marie Smith-Kennedy  
~ Cherokee (born and raised in San Antonio, Texas) ~

...who learned this from a Family recipe (origin unknown)

---

### Ingredients:

- 1 Lb Ground Beef
- 30 Oz Jar Goya Nopalitos (Marinated Prickly Pear Cactus), Drained
- 1 Med Onion, Chopped
- 2 Cloves Garlic, Minced
- 28 Oz Jar Crushed Tomatoes, In Heavy Puree
- Cumino, To Taste
- Mexican Oregano, To Taste
- Cilantro, To Taste
- Goya Adobo Seasoning With Cumino (Has Salt)
- Ground Black Pepper
- 4-5 Cups Long Grain White Rice, Cooked

---

### Preparation:

- In large skillet, sauté onion and garlic.
- Add ground beef, cook, drain, return to skillet.
- Add tomato and nopalitos. Heat thoroughly. Don't over cook.
- Season to taste. Serve over rice.

*Note: You can make this meal stretch further by making more rice and leaning the meat/cactus mixture per portion served.*

---

**Servings: Five-Ten**

---

*Thank you Susan Marie Smith-Kennedy for sharing Nopalitos Con Arror (Cactus Over Rice) with us!*

---

[Return to Food & Recipes Menu](#)

---



**Text and Graphics**  
© 1994 - 103 [Tara Prindle](#)  
unless otherwise cited.



## Native American Technology and Art



# Nopalitos

---

Offered by Ericka

~ Yaqui-Apache from Arizona ~

... who learned this from Mama

### Ingredients:

- Cactus

### Preparation:

1. De-thorn 2 pads of fresh green cactus, dice and boil in 2 quarts of water, take out when soft.
2. Fry up with oil add onions, pimientos add salt n' pepper.
3. Serve with eggs over easy or whatever you like.

Servings: Three - Four

Thank you Ericka for sharing Nopalitos with us!

---

[Return to Food & Recipes Menu](#)

---



**Text and Graphics**  
© 1994 - 103 [Tara Prindle](#)  
unless otherwise cited.

## Native American Technology and Art



# Napalitos (Prickly Pear)

---

Offered by Viper  
~ Comanche Nation ~

...who isnt sure where or with whom this delicacy originated

---

### Ingredients:

- Prickly Pear
  - Butter (Animal Fat, Vegetable Oil)
  - Salt
- 

### Preparation:

- Remove needles from the prickly pear 'paddles'. I usually handle the paddles with pliers and break the needles off then singe the smaller needles off over the campfire.
- Cut the paddles into 1/4" strips.
- Season with a sprinkle of salt and sauté in butter until tender.

*Note: The taste is akin to green beans. As an option, you can prepare as above and add Stewed tomatoes and onion with a little comino and touch of garlic. BON APPETITE !!*

---

Servings: a couple?

---



*Thank you Viper, for sharing your recipe with us! Now I just have to figure out where to find prickly pear cactus paddles!*

---

[Return to Food & Recipes Menu](#)

---



Text and Graphics  
© 1994 - 103 [Tara Prindle](#)  
unless otherwise cited.

## Native American Technology and Art



# Nopalitos and Pork



---

Offered by Francine Madrid  
~ Yaqui ~

...who learned this from Grandma, to Mom, to me.

---

### Ingredients:

- 2 fresh cactus pads(de-thorned, boiled till tender(not mushy) and chopped into bite size bits)
- Pork loin or 3-4 chops deboned
- New Mexico chile powder to taste
- 1/2 onion diced
- 2 garlic cloves
- 14 oz. can of pureed or stewed tomato
- 2 bay leafs
- 1 tbs oregano
- Fresh corn kernels

---

### Preparation:

- in a good sized, deep skillet, saute your onions and garlic till tender.
- Add your bite sized pork,cook it a bit.
- When the pork begins turning white,add nopalitos,corn and tomato sauce.
- Stir it all up, add bay leafs, oregano, and chile to taste.
- Cover it and simmer it till all the ingredients seem done.
- Adjust to your taste with salt, pepper and chile.

*Note: This dish tastes good as a stew or over rice. Don't forget the corn tortillas!*

---

*Servings: Three to Four*

---

*Thank you Francine Madrid for sharing Nopalitos and Pork with us!*

---

[Return to Food & Recipes Menu](#)

---



Text and Graphics  
© 1994 - 103 [Tara Prindle](#)  
unless otherwise cited.



## Native American Technology and Art



# Parched Corn



---

Offered by Billy Walls  
~ Louisiana Choctaw Heritage ~

.. who learned this from learned this from my granny

---

### Ingredients:

- Dried corn on the cob
- 

### Preparation:

- Shell dried kernels off cob.
- Heat 2 tablespoons lard or bacon grease (bacon grease is best) in skillet.
- Add kernels.
- Cook till lightly browned.
- Let cool, store in sealed mason jar.

*Note: This makes a tasty, crunchy afternoon snack for the hunters or the kids. Make lots, it won't last long!*

---

*Thank you Billy Walls for sharing Parched Corn with us!*

---

[Return to Food & Recipes Menu](#)

---



**Text and Graphics**  
© 1994 - 103 [Tara Prindle](#)  
unless otherwise cited.

## Native American Technology and Art



# Prickly Pear Cactus Jelly



---

Offered by Offered by Susan Marie Smith-Kennedy  
~ Cherokee (born and raised in San Antonio, Texas) ~

...who learned this from an Old Navajo Recipe (childhood friend in San Antonio gave me this)

---

### Ingredients:

- LIQUID Pectin
- 4 - 6 Medium Ripened Prickly Pears\*
- Sugar\*
- Lemon Juice\*
- Red Food Coloring (Optional)

---

### Preparation:

- Place 4 to 6 medium ripened Prickly Pears in a pan and cover with boiling water for a minute, pour off water. The skin will peel off easily.
- Cut up, place back in the pan and once again cover with boiling water, boil for a few minutes until done. Do not over cook.
- Pour through jelly cloth getting all the juice out that you can.
- Measure Cactus juice and sugar cup for cup (equal parts). Pour in 1/2 cup lemon juice.
- \*Three cups total (cactus juice / sugar / lemon juice combo) at a time recommended for better jelly.
- Bring fruit juice, sugar, and lemon juice to a rolling boil.
- Pour in one bottle of LIQUID PECTIN, bringing to a rolling boil once more and boil for one minute.
- Remove from heat, skim and pour into hot jelly glasses. The riper the fruit the prettier the jelly.
- If the fruit is not ripe enough, use a little red food coloring.



*Note: Some Mexican grocery stores carry Prickly Pear cactus juice already prepared in jars/cans.*

---

**Servings: Two**

---

*Thank you Susan Marie Smith-Kennedy for sharing Prickly Pear Cactus Jelly with us!*

---

[Return to Food & Recipes Menu](#)

---



Text and Graphics  
© 1994 - 103 [Tara Prindle](#)  
unless otherwise cited.

## Native American Technology and Art



# Prickly Pear Surprise

---

Offered by Scott LoneWolf Foreback

~ Cherokee ~

... who learned this from Taught by G'maw

### Ingredients:

- About 4 or 5 large paddles.
- 8 or 10 little ones. Big ones are 5-7 in.
- Long Little ones ain't.
- 2 1/2 cups of freshly harvested honey.
- (I suggest Good clover honey) Pie dough. (can be store bought. But, I makes my own.)

### Preparation:

1. First, ya gotta git rid of them pesky needles. Break off the big'uns and burn off the rest. (I use a blowtorch for this. You might want to use the stove.) Take your pie dough and put it in a 9" pie pan and fill it with dry beans. then put it in the oven at 350 'til it's golden brown.
2. Then, while the pie shell's cookin', peel and chop the paddles.
3. I usually cut 'em about 1/2 to 3/4 of an in. When the pie shell's done ya pour the chunks of prickly pear into it.
4. Add the honey. and throw the whole mess back in the oven, this time on 250. when you can see it bubblin' and hoppin'. It's done.
5. Approximately 15-20 min.

*Note: Be real careful. At this stage that honey's gonna burn down to the bone. Let it cool about 20 min. prior to service. Unless you're gonna give it to your in-laws, then I'd put it right out and encourage them to dig right in, as I'm duckin' behind the china cabinet. This dish will serve 4-8, depending upon how big you like to make your slices.*

**Servings: Three - Four**

**Thank you Scott LoneWolf Foreback for sharing Prickly Pear Surprise with us!**

---

**[Return to Food & Recipes Menu](#)**

---



**Text and Graphics  
© 1994 - 103 [Tara Prindle](#)  
unless otherwise cited.**





## Red Clover and Sour Grass

---

Offered by Scubagecko

~ My grandfather's mother was Sioux ~

... who must have learned this from my mother, it seems like I have always known.

### Ingredients:

- Red Clover blossoms
- Sour grass

### Preparation:

Red Clover heads, as the individual blossoms are maturing, have a sweet white part near the stem that can be bitten off for a little bit of sweetness as you are walking along. It would be hard to make a meal of it but it is a welcome bit of sweetness on a warm day. And if you can find what I have always been told was called sour grass, but looks like a pale clover a few inches tall with yellow flowers and upright pods, then you are in luck because the whole plant has a lemony taste. The pods are best tasting, with the leaves second best.

**Servings:** One

Thank you Scubagecko for sharing Red Clover and Sour Grass with us!

---

[Return to Food & Recipes Menu](#)

---



Text and Graphics  
© 1994 - 103 [Tara Prindle](#)  
unless otherwise cited.

Native American Technology and Art



## Seneca Corn Soup



---

Offered by Lucie Irwin  
~ Seneca ~

...who learned this from her Mom

---

### Ingredients:

- 4 Cans Hominy Corn
  - 4 or 6 Pieces of Salt Pork
  - 3 Cans Red Kidney Beans
- 

### Preparation:

- Use all contents of the cans of corn and beans.
- Add the salt pork and a little water.
- Cover and cook for a couple of hours.

*Note: This mixture will be kinda thick, and gray looking. It is bland, and some say an acquired taste. If you want it more salty, you can salt to taste, immediately, then put in more salt pork, and cook some more*

---

**Servings: Five-Ten**

---

*Thank you Lucie Irwin for sharing Seneca Corn Soup with us!*

---

---

[Return to Food & Recipes Menu](#)

---



Text and Graphics  
© 1994 - 103 [Tara Prindle](#)  
unless otherwise cited.



## Native American Technology and Art



# Squash Blossoms



---

Offered by Elder John  
~ Maidu, Pequot and Heinz 57 varieties ~

.. an Algonquian recipe

---

### Ingredients:

- Male squash blossoms
- Flour
- Beer
- Oil

---

### Preparation:

- Squash vines produce many more male than female blossoms, especially when they first start to bloom. Encourage female blossoms by picking off extra male blossoms. Coat the blossoms with batter and fry in oil either in a skillet or a kettle until browned, but don't overcook.
  - A simple batter can be made by adding fresh (not flat) beer to flour until a medium thin batter is made (so blossoms don't pull apart). You can add pepper or herbs to the batter for flavor.
-

**Servings: Five-Ten**

---

*Thank you Elder John for sharing Squash Blossoms with us!*

---

[Return to Food & Recipes Menu](#)

---



**Text and Graphics**  
© 1994 - 103 [Tara Prindle](#)  
unless otherwise cited.

## Native American Technology and Art

# cattail Steamed Cattail cattail

---

Offered by Tara Prindle  
~ Connecticut / non-Native ~

...who learned this from the swamps  
(and Barrie Kavash's 1979 book 'Native Harvests')

---

### Ingredients:

- 10 fresh young cattail shoots
  - 5-10 small tender garlic mustard leaves
- 

### Preparation:

- Strip away the outer leaf on either side of a cattail. Cut the tender white base away from the green part of the leaves. (Dry & save the green part of the leaves for craftwork!) Gather, wash, and chop some garlic mustard leaves. Steam the white base of the cattail garnished with the garlic mustard.

*Note: Gather cattail shoots in the early spring when cattails are about 3 feet tall. Pull the outer two leaves of the cattail away from the stalk. Pull straight up on the cattail plant so the base pops out of the white and clean... this should \*not pull up the roots of the cattail and will not harm it's growth next season. (Cattail roots are edible too... but that's another recipe.)*

---

Servings: Two

---

*Thank you Tara, for sharing Steamed Cattail with us!*

---



[Return to Food & Recipes Menu](#)

---



Text and Graphics  
© 1994 - 103 [Tara Prindle](#)  
unless otherwise cited.

## Native American Technology and Art



# Steamed Lamb's Quarters

---

Offered by Carla J. Striegel

~ German-American White Folk ~

... who learned this from learned through an urge to live simply and organically.

### Ingredients:

- As much Lamb's Quarter (*Chenopodium* species) as you'd like to eat. (*a large, double handful makes a nice side serving per person*)
- Water
- Olive Oil
- Fresh Minced Garlic
- Bragg's Aminos (Similar To Soy Sauce--Of Course Salt Will Suffice)

### Preparation:

*Lamb's Quarter is a common, non-native weed in waste places. If you are lucky, it grows in your garden. Although this recipe is really not too exciting for someone already familiar with this excellent green, I couldn't help but share it with those who have never tried it. It is my absolute favorite vegetable.*

1. Gather any of the tender leaves and stalk--I prefer to let some keep growing in my garden and keep its tender shoots well trimmed. It is also nice to use the small plants that you have just weeded from around your "garden plants".
2. Steam these greens for several minutes (less than ten minutes, because you do not want them mushy).
3. Remove the greens from the steamer and place onto serving dish.
4. Pour a dash of olive oil onto each serving.

5. **Top with minced fresh garlic and a bit of Bragg's.**
6. **Voila, you have the best meal this world could offer!**

*Note: Lamb's Quarter is a very common "weed" that is extremely nutritious. The seeds are also edible. To learn more about the plant, look in almost any book about wild edibles.*

Thank you Carla J. Striegel for sharing Steamed Lamb's Quarters with us!

---

[Return to Food & Recipes Menu](#)

---



Text and Graphics  
© 1994 - 103 [Tara Prindle](#)  
unless otherwise cited.



## Native American Technology and Art



# Succotash

---

Offered by Coldwind  
~ Nipmuc ~

...Grandmothers recipe

---

### Ingredients:

- 1 lb bag of (large) Lima beans,
  - 1 16 oz can of Cream Corn
  - 1 (smallpiece) Salt Pork (optional)
  - 1/2 (small) Onion (cut fine)
  - 2 tablespoons Butter
  - 1/2 cup Sugar
  - Salt & Pepper (season to taste)
- 

### Preparation:

- Wash lima beans and place in a large (5qrt) pot.
  - Add water(4 qrts), salt pork, butter, sugar, salt & pepper.
  - Bring to a boil.
  - Cook till beans are tender.
  - Add cream corn and cook additional 5 minutes.
  - Remove from heat and enjoy.
- 

Servings: Five-Ten

---

*Thank you Coldwind, for sharing Succotash with us!*

---

[Return to Food & Recipes Menu](#)

---



Text and Graphics  
© 1994 - 103 [Tara Prindle](#)  
unless otherwise cited.

Native American Technology and Art



## Totti's Three-Stock Soup



---

Offered by Courtney Danagasta Rao (a.k.a. Totti)  
~ Southeast Kituwah Nation ~

..... who learned this from Trial and Error

---

### Ingredients:

- 3 Cubes Of Bouillon -- One Vegetable, One Beef, and One Chicken
- 6c Water
- 4-7 Potatoes, Peeled and Cut
- Corn, Peas, Carrots, etc. to suit taste

---

### Preparation:

- Bring the water to a boil & add the 3 bouillon cubes.
- Add the potatoes and veggies, and boil for 45 minutes or until the potatoes are done.
- This can be served with either fried bread or focaccia (an easy to find flatbread if you can't make your own).

---

*Thank you Courtney Danagasta Rao (a.k.a. Totti) for sharing Totti's Three-Stock Soup with us!*

---

[Return to Food & Recipes Menu](#)

---





**Text and Graphics**  
© 1994 - 103 [Tara Prindle](#)  
unless otherwise cited.

## Native American Technology and Art



# Vegan Rice Pudding

---

Offered by Erik Bryce Reich

~ I am Mohican from my greatgrandmother, I live in Connecticut USA ~

...from a variation on my great-grandmothers (Mohican) recipe

---

### Ingredients:

- White or brown rice (as much as you can eat)
- Water, soy milk (enough to cover and soak rice and then 1 more cup)
- Vanilla or almond extract (to taste)
- Brown suger or maple syrup or molasses (it's all preference, I like molasses)

---

### Preparation:

- Soak rice overnight.
- Cook soaked rice with extra cup of liquid on medium high heat until gluey.
- Add extract, sugar, stir often until dissolved.
- Add a friut if so desired, but cook down if so.

*Note: This is good stuff warm or cold, and you can add all sorts of stuff to it too. Try raisins, mandarin orange, kiwifruit*

---

*Thank you Erik, for sharing Vegan Rice Pudding with us!*

---

[Return to Food & Recipes Menu](#)

---



Text and Graphics  
© 1994 - 103 [Tara Prindle](#)  
unless otherwise cited.



## Native American Technology and Art



# Veggy



---

**Offered by Patricia**  
**~ Native American - California ~**  
**.. who learned this from mother**

---

### **Ingredients:**

- **Carrots - 3 or more**
  - **Pepper**
  - **Salt**
  - **Spinach**
  - **Corn**
- 

### **Preparation:**

- **Boiled water for 30 min.**
  - **After boiling just put in the corn first and the rest.**
  - **After boiling put in the pepper and salt.**
- 

***Thank you Patricia for sharing Veggy with us!***

---

## [Return to Food & Recipes Menu](#)

- [Pit Roasted Venison](#) 4/13/98

## Native American Technology and Art



## Wagunabuie (Lichen) Soup

---

Offered by Zinovia Hardy

~ Affiliation not provided ~

... who learned this from family

### Ingredients:

- Pick Moss & Wash Well
- Use Broth From Boiled Meat Or Fish

### Preparation:

1. Add moss & stir well.
2. Add salt to taste & boil till soft.
3. Put the meat or fish back in.
4. Stir and serve hot.
5. Enjoy.

*Note: the natives fed this soup to the British living at Fort St. Joseph in Ontario during the early 19th c. To stave off starvation.*

Thank you Zinovia Hardy for sharing Wagunabuie (Lichen) Soup with us!

---

[Return to Food & Recipes Menu](#)

---





**Text and Graphics**  
© 1994 - 103 [Tara Prindle](#)  
unless otherwise cited.

## Native American Technology and Art



# Wild Tumble Weed Greens

---

Offered by Charlie One Shoe

~ Choctaw ~

... who learned this from My Grandfather Charlie Stephen

### Ingredients:

- 4 Or 5 Lb.'s Of Very Very Young Tumble Weeds
- (*picked as they come through the sand in early spring about 1 to 2 inches high*)
- 1/4 Lb., Choice Of White Meat, Salt Pork ,Or Spiced Or Hot Sausage
- 1 Teaspoon Salt
- 1/4 Teaspoon Fresh Ground Black Pepper
- Juice Of 1/2 Lemon

### Preparation:

1. Wash the tumble weeds in lukewarm water to free sand, then wash in cold water couple more times.
2. DrainPlace tumble weeds in large pot and cover with salted water.
3. Bring water to boil an add pepper, lemon juice and choice of meat( sausage should be sliced )
4. Cook uncovered (slow boil ) for around 15 min. Until tender ( don't overcook).
5. Drain and season to taste with butter, salt or whatever, and serve as any other greens.
6. (don't forget the fresh cornbread!)

*Note: The Tumble Weeds will cook down a lot. When I was a young man these Greens were a large part of my family's diet in the spring time .*

Servings: Two

Thank you Charlie One Shoe for sharing Wild Tumble Weed Greens with us!

---

[Return to Food & Recipes Menu](#)

---



Text and Graphics  
© 1994 - 103 [Tara Prindle](#)  
unless otherwise cited.



## Native American Technology and Art



# Wojapi (Pudding)



---

Offered by StarDreamer (C.J.)  
~ Lakhota/Cree ~

...who says "My Auntie used to make this when I was a little one! Yum!"

---

### Ingredients:

- 4 lbs blueberries (can use strawberries, any berries or peaches too)
  - 4 cups water
  - 2 cups sugar
  - Half a package of cornstarch or arrowroot to thicken
- 

### Preparation:

- Mash the fruit (with peaches it is good to cook them a little first).
- Reserve some of the water to mix up the cornstarch or arrowroot in.
- Put mashed fruit, sugar and water into pan and bring slowly to boil.
- Remove from heat and stir in cornstarch mixture. Watch for lumps!
- Place back on low heat and stir well until thickened to the consistency of pudding.

*Note: Can eat this over frybread, ice cream, or over biscuits... any way ya want! Its good!*

---

**Servings: Five-Ten**

---

*Thank you StarDreamer (C.J.), for sharing Wojapi with us!*

---

[Return to Food & Recipes Menu](#)

---



Text and Graphics  
© 1994 - 103 [Tara Prindle](#)  
unless otherwise cited.



## Acorn Breakfast

---

Offered by Tony Kaczmarek

~ Polish American ~

... who made it up

### Ingredients:

- Acorns - as many as you may need.
- Maple syrup (home made preferred, just cause it tastes better) as much as you like

### Preparation:

1. First you need to process the acorns by shelling them, pounding into a powder, then rinsing them several times till all the tannic acid comes out. I use one leg of a pair of panty hose to put the powdered acorns in, then run the sink and soak and squeeze , change water, soak and squeeze, till the color of the water runs clear.
2. I then put some acorn mush in a bowl, add about 3 tablespoons of water, and put in the micro-wave for about 3 minutes, then add one tablespoon of maple syrup.

**Note:** its pretty good. makes a great breakfast. if cooking outdoors in the wilderness you will have to modify the way you cook it.

Thank you Tony for sharing Acorn Breakfast with us!

---

[Return to Food & Recipes Menu](#)

---



Text and Graphics  
© 1994 - 103 [Tara Prindle](#)  
unless otherwise cited.



## Native American Technology and Art



# Acorn Mush



---

Offered by Cindy  
~ Passamaquoddy ~

...who notes the recipe has Miwok origins.

---

### Ingredients:

- Black oak acorns
- Water
- Cooking basket
- Fire pit
- Hot rocks
- Tongs

---

### Preparation:

- Harvest the acorns in the fall, dry well
- Shell and pick off the red skin on the acorn (like a peanut skin)
- Find a nice acorn pounding rock or a heavy duty bowl.
- With a good sized basalt pestle pound away till the acorn is a fairly fine grain/powder.
- **\*\*Important\*\*** After pounding the acorns, you **MUST** leach them to remove the tannin. Make a sand volcano, flatten the top and make a rim around the edge. Cover with cheesecloth. Place a thin layer of acorn over the cheesecloth and using a pine needle branch as a water breaker. carefully pour cold water over the acorn. The water will seep through fairly quickly. After a few leaches, taste a bit of the acorn and if the bitterness has gone away, then it is ok.
- In the meantime, make a fire pit and heat the rocks up.

*Note: (you gotta have the right kind of rocks!)*

- Get the cooking basket and put in the pounded acorn. Add water about 2 to 1.
- Using two poles as tongs or an antler, reach out a rock and quickly dip it in fresh water to get the ash off then place it in the acorn/water cooking basket.
- Get another rock. Repeat till the acorn is cooked. (about 5 minutes) take out the colder rocks.

*Note: if you stir the basket up with the rocks you'll wear it out. Just turn the rock.*

---

**Servings:Two**

---

*Thank you Cindy, for sharing this and other recipes with us!*

---

[Return to Food & Recipes Menu](#)

---



Text and Graphics  
© 1994 - 103 [Tara Prindle](#)  
unless otherwise cited.

## Native American Technology and Art



# Bannock - La galette

---

Offered by Germaine Kenny  
~ Ile-a-la Crosse, Saskatchewan (A Metis village in Saskatchewan ~

... who learned this from Great grandmother and Mother

---

### Ingredients:

- 4 cups flour
- 6 tsp of baking powder
- 1 tsp of sugar or corn syrup
- 1/2 tsp of salt
- 1/2 cup lard
- 2 cups of water or milk

---

### Preparation:

- Mix all dry ingredients into a bowl.
- Then slowly mix in your lard until it looks like small coarse oatmeal.
- Then make a small hole in the center of the bowl, pour the milk or water mixture into the bowl gradually.
- Mix the ingredients together. Knead for about 3 minutes.
- Success in bannock making is the kneading, which is required to make it firm.
- Pat out with hands to 3/4 inch thickness and prick with fork.
- It can be made oblong or round and baked in an oven @ 350 Degrees.
- Cool for about five minutes and enjoy.

*Note: Bannock was something very special and sacred and eaten only on Sundays. It was made into small bannocks and each member of the family had a taste of this special bread.*

---



*Servings: Three - Four*

---

*Thank you Germaine Kenny for sharing Bannock- La gallette with us!*

---

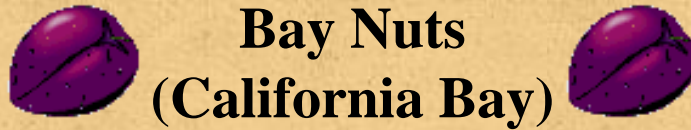
[\*Return to Food & Recipes Menu\*](#)

---



**Text and Graphics**  
© 1994 - 103 [Tara Prindle](#)  
unless otherwise cited.

Native American Technology and Art

 **Bay Nuts**  
**(California Bay)**

---

**Offered by Cindy**  
**~ Passamaquoddy ~**

**...who notes the recipe has Miwok origins**

---

**Ingredients:**

- **Ripe bay nuts (purple fruit)**
- 

**Preparation:**

- **Eat the inside of the thin purple fruits and keep the nuts. The fruit is kinda bitter.**
  - **Split the nuts and roast on a very hot fire.**
  - **When they are roasted mash them up real quick and eat hot. Good!**
- 

**Servings: Two**

---

*Thank you Cindy, for sharing this and other recipes with us!*

---

**[Return to Food & Recipes Menu](#)**

---



**Text and Graphics**  
© 1994 - 103 [Tara Prindle](#)  
unless otherwise cited.



## Native American Technology and Art



# Calming Winds Creek Fry Bread

---

Offered by Deborah Calming Wind Landrum  
~ Lower Muskogee Creek (Whigham, Georgia) ~

.. who learned this from self

---

### Ingredients:

- 2 cups white lily flour self-rising
- 1/4 cup sugar
- 1/4 teaspoon salt
- 1/2 teaspoon baking powder
- 1/2 teaspoon vanilla
- 1 16oz. sour cream water

---

### Preparation:

- Mix together all dry ingredients.
- Add sour cream to the dry ingredients.
- Add enough water to make a dough.
- Let rise about 1/2 hr.
- Pull off pieces of dough.
- Roll in flour, make a ball and then flatten.
- Fry in oil until golden brown.
- Then use your best topping and enjoy.

---

Servings: Five-Ten

---

*Thank you Deborah Calming Wind Landrum for Sharing Calming Winds Creek Fry Bread with us!*

---

[Return to Food & Recipes Menu](#)

---



**Text and Graphics**  
© 1994 - 103 [Tara Prindle](#)  
unless otherwise cited.



# Cheyenne Batter-Bread

---

Offered by Stephine Hancock

~ New Jersey ~

... who learned this from research

## Ingredients:

- 1 qt Sweet milk
- 1 tbs. Melted butter
- 1 pt White cornmeal
- 1/2 tsp. Salt
- 3 Eggs, separated

## Preparation:

1. Bring milk to a full boil; stir in cornmeal slowly. Cool.
2. Add well-beaten egg yolks, melted butter and salt.
3. Add stiffly beaten egg whites.
4. Bake in moderate oven - 375 until a crispy brown. Probably about 30 minutes.

*Note:* Times for preparation may vary according to the oven.

**Servings:** Five-Ten

Thank you Stephine for sharing Cheyenne Batter-Bread with us!

---

[Return to Food & Recipes Menu](#)

---



Text and Graphics  
© 1994 - 103 [Tara Prindle](#)  
unless otherwise cited.



## Native American Technology and Art



# Corn Cakes



---

Offered by Miriam Hollingshead (Spotted Fawn)  
~ Native American Ancestry not certain, most likely Cherokee ~

... who learned this at a native american festival

---

### Ingredients:

- 1 cup pounded corn
  - 1/3 cup water
  - cinnamon
  - honey
- 

### Preparation:

- pound hard corn until powder like
  - pour in water
  - sprinkle cinnamon
  - put in a small amount of honey
  - make a type of patty cake
  - melt butter in a small pan
  - cook until golden brown (flip sides occasionally)
  - let cool and pour honey
- 

Servings: One

---

*Thank you Miriam Hollingshead (Spotted Fawn) for sharing corn cakes with us!*

---

[Return to Food & Recipes Menu](#)

---



Text and Graphics  
© 1994 - 103 [Tara Prindle](#)  
unless otherwise cited.

## Native American Technology and Art



# Cranberry Bread



---

Offered by Gerald Mirra  
~ Italian\Scotch\German ~

...Contemporary Iroquois Recipe

---

### Ingredients:

- 2 Tblsp Margarine or butter
- 1/2 cup Sugar
- 1/2 tsp Salt
- 1 Egg
- 1/2 tsp Baking Soda
- Grated Rind from one Orange
- Juice from one Orange
- 2 Cups Flour
- 1-1# can of Whole Berry Cranbery
- Sauce drained -save liquid

---

### Preparation:

- Cream butter, sugar, egg & rind.
  - Stir in juice & cranberry liquid.
  - Stir in, all at once, remaining ingredients until just blended.
  - Pour into greased 9" x 5" x 3" loaf\bread pan.
  - Bake at 350 degrees F for one hour.
- 

Servings: (a loaf's worth)



---

*Thank you Gerald, for sharing Cranberry Bread with us!*

---

[Return to Food & Recipes Menu](#)

---



Text and Graphics  
© 1994 - 103 [Tara Prindle](#)  
unless otherwise cited.

## Native American Technology and Art



# Easy Wild Rice Soup



---

Offered by Deb Boyd & Barb Lobejko  
~ Mille Lacs Band of Ojibway ~

.. who learned this from Moms Recipe also won 1st prize at Mille lacs pow wow in 2001.

---

### Ingredients:

- 
- **1 cup wild rice (uncooked)**
- **1/2 cup white rice (uncooked)**
- **1 can cream of mushroom soup**
- **1 can cream of chicken soup**
- **1 can cream of celery soup**
- **6 cups chicken broth**
- **1 1/2 lb.s hamburger**
- **1 med onion**
- **Salt & pepper**

---

### Preparation:

- **Brown hamburger & onion.**
- **Add chicken broth and rice.**
- **Bring to boil, simmer 1/2 hour.**
- **Salt & pepper to taste.**

*Note: Try the cream soups with seasonings like herbs or garlic. Try using chicken.*

---

**Servings: One**

---

*Thank you Deb Boyd & Barb Lobejko for sharing Easy Wild Rice Soup with us!*

---

[Return to Food & Recipes Menu](#)

---



Text and Graphics  
© 1994 - 103 [Tara Prindle](#)  
unless otherwise cited.



## Native American Technology and Art



# Frybread Pizza with a Twist

---

Offered by Autumn Rain

~ Cree/Mohawk ~

...her own recipe

---

### Ingredients:

- 2 1/2 cups flour
- 1 tsp baking powder
- 1 tsp salt
- 1 cup warm milk
- 1 tsp oil
- Four skinless boneless chicken breast
- Spagetti sauce
- Shredded mozerella cheeze.
- 2 cups hot and spicy barbicue sauce
- 2 onions
- 2 peppers

---

### Preparation:

- combine flour, salt, oil, powder, sugar and milk.
- Combine well and make baseball size balls.
- Roll out into large disks...fry in oil...med temp... do not let oil smoke!
- Cut chicken into small pieces as well as onion and pepper.
- Preheat oven to 350.
- Saute in skillet with barbecue sauce until it begins to brown.
- Be shure the chicken is cut small or it will not cook when you saute it.
- Heat spagetti sauce in a small pan and pour over bread.

- Add chicken mix ..add cheese..
  - Heat in oven until cheese melts!
- 

Servings: Three - Four

---

*Thank you Autumn Rain for sharing Frybread Pizza with a Twist with us!*

---

[Return to Food & Recipes Menu](#)

---



**Text and Graphics**  
© 1994 - 103 [Tara Prindle](#)  
unless otherwise cited.



## Fry Bannock Dessert

---

Offered by Laura M. Boyd

~ Nazko B.C. Canada, Southern Carrier Nation ~

... who learned this from experimenting!

### Ingredients:

- Deep fry your favorite bannock.(1 piece fry bread serves 2)
- 1-carton frozen strawberry/raspberry
- My Favorite is home canned wild berries, Mmmm, Mmmm.
- Whipping cream (which ever brand you prefer)

### Preparation:

1. Tear or cut bannock in half.
2. Lay each half on a serving dish or saucer, then pour your favourite berries, including its juice on top of the bannock.
3. Pile high with whipping cream, garnish with shaved chocolate.
4. Mouth watering experience!!!

**Note:** I would like to start a drive-through bannock place which would offer as many different bannock recipes as I can create. We call our fry bannock "lhes sut'e" and when you come from a big family like mine, there's never enough bannock!

**Servings:** Five-Ten

Thank you Laura for sharing Fry Bannock Dessert with us!

---

[Return to Food & Recipes Menu](#)

---





**Text and Graphics**  
© 1994 - 103 [Tara Prindle](#)  
unless otherwise cited.

## Native American Technology and Art



## Fry Bread Power!!

---

Offered by Sydney Nicole  
~ Nez Perce ~

... who learned this from watching others

---

### Ingredients:

- 6 cups flour
- 2 cups powdered milk
- 2 1/2 tsp. baking powder
- 2 tbs. sugar
- 1 tsp. salt
- Water (you can never tell the exact amount, just add until dough is elastic like) probably about 2 cups
- Oil for frying

---

### Preparation:

- Mix ingredients, knead dough (not for long).
- Let rise for about 10 minutes.
- Make pieces about 1/2 in. Thick (if you like thick fry bread).
- Poke a hole in the middle of the dough before you fry it.
- Fry in oil until golden brown.

*Note: When bread is done... put butter on it and sprinkle with sugar.*

---

**Servings: Five-Ten**

---

*Thank you Sydney Nicole for sharing Fry Bread Power!! with us!*

---

[Return to Food & Recipes Menu](#)

---



Text and Graphics  
© 1994 - 103 [Tara Prindle](#)  
unless otherwise cited.



## Native American Technology and Art



# Chitimacha Baked Duck



---

Offered by Chitimacha Tribe of Louisiana  
~ Sovereign Nation of the Chitimacha Tribe of Louisiana ~

.. who learned this from Recipe by Leroy and Dora Burgess, Chitimacha

---

### Ingredients:

- Cleaned ducks
- Salt and pepper
- Onion
- Bell pepper
- Celery and garlic (to taste)

---

### Preparation:

- Place cleaned ducks in large pot. Add salt and pepper, onion, bell pepper, celery and garlic (to taste).
- Cover with water and gently boil till tender.
- Heat oven to 350°.
- Remove ducks from water. Place in baking dish. Put pats of margarine in and on the ducks. Bake till brown.

*Note: Leroy gets the ducks, Dora cooks them.*

---

**Servings: One**

---

*Thank you Chitimacha Tribe of Louisiana for sharing Chitimacha Baked Duck with us!*

---

[Return to Food & Recipes Menu](#)

---



Text and Graphics  
© 1994 - 103 [Tara Prindle](#)  
unless otherwise cited.

## Native American Technology and Art



# Eggs and Wild Onions



---

Offered by LeeAnn Dreadfulwater  
~ Cherokee ~

...who notes that Wild Onion dinners are held in Oklahoma each Spring.

---

### Ingredients:

- About 2 dozen young, tender wild onions (Don't use onions picked next to a highway or roadside)
  - Water
  - 6 eggs
  - Bacon grease or butter for frying.
- 

### Preparation:

- Coarsely chop the onions.
  - Steam them for a few minutes with a little water. (Cover them and cook until they are limp)
  - Add eggs and stir to scramble them.
  - Add butter or grease, salt and pepper to taste.
  - Fry like scrambled eggs until they are as done as you like. Best if not overcooked, though.
  - Serve hot.
- 

**Servings: Three - Four**



---

*Thank you LeeAnn, for sharing Eggs and Wild Onions with us!*

---

[Return to Food & Recipes Menu](#)

---



[Return to NativeTech Home Page](#)

© 1994-2001 [Tara Prindle.](#)

Native American Technology and Art



**Pheasant Under Plastic  
(in an oven bag).**



---

Offered by Cindy  
~ Passamaquoddy ~

...who notes the recipe has Bannock origins from Fort Hall.

---

**Ingredients:**

- Pheasant (minus feathers)
  - Oven cook bag
  - Oven
- 

**Preparation:**

- Catch and clean a tasty rooster
- Put it in one of those oven bags. Keeps the bird real moist that way.
- You can put in onions, salt and pepper and stuff if you want to.

*Note: if you don't use the oven bag, you'll have to bake it in mud the old fashioned way.*

---

**Servings: Five - Ten**

---

*Thank you Cindy, for sharing this and other recipes with us!*

---

[Return to Food & Recipes Menu](#)

---



Text and Graphics  
© 1994 - 103 [Tara Prindle](#)  
unless otherwise cited.



## Native American Technology and Art



# Rav'in Raven

---

Offered by Annette DeBrotherton

~ Choctaw born in California whose father was Mississippi Choctaw ~

... who learned this from desperation when her crazed Cherokee ex-husband went raven hunting

---

### Ingredients:

- 2 Whole Ravens, (or more depending on how many bullets he has and how good a shot he is) skinned, gutted and cleaned.
  - Pot of water
  - Garlic, Variety of Herbs to taste - Italian herbs are good.
  - 1 c. Red Cooking Wine (a Burgundy is good)
  - 3 c. Beef Stock
  - Rich Roux or a Red Marinara Sauce (omit beef stock, depending on your mood)
  - Butter
  - Celery, Carrots, Mushrooms - cut up
  - Salt and Pepper to taste
  - Sour Cream (optional)
  - Noodles: pasta, polenta / fried cornmush, frybread, or the like
- 

### Preparation:

- Boil the hell out of the ravens. We are talking about a TOUGH bird that has an enormous breast. It has such a strong flavor, that you will end up with a fairly decent soup stock and a very dark meat that is still flavorful after it has become tender.
- Strip meat from birds, discard bones.
- Sauté vegetables in butter.
- Prepare noodles or bread base.
- When tender add shredded raven meat, garlic and herbs.
- Heat through, get really hot, add 1/2 c. wine, quickly cover.

- Add additional 1/2 c. wine, salt, pepper, and beef stock and simmer for 5 minutes. (If using Marinara, omit beef stock, then serve over pasta or polenta/fried cornmush. You are done)
- Whip roux into base for a rich burgundy gravy. Sour cream can be folded into gravy, or served as a dollop over dish at serving.
- Serve over noodles or other base.
- A side of fresh raw or cooked greens is nice.

*Note: Raven - the OTHER dark meat is dark like duck to the 10th power. Remarkably tasty, high in protein, low in fat, clean, despite being a scavenger. Be prepared to have the rest of the flock attack you though if you shoot one !*

---

*Servings: Five-Ten*

---

*Thank you Annette DeBrotherton for sharing Rav'in Raven with us!*

---

[Return to Food & Recipes Menu](#)

---



Text and Graphics  
© 1994 - 103 [Tara Prindle](#)  
unless otherwise cited.

## Native American Technology and Art



# Roasted Mallard

---

Offered by Tina Daigneault and Fred McCallum

~ Ile-a-la Crosse, Saskathchewan ~

... who learned this from My Father

### Ingredients:

- 2 Nice Size Mallards.
- 4 Carrots,
- 4 Potatoes,
- 4 Celery Hearts
- 1 Onion If You Desired.
- 1 Can Of Fresh Cranberries.
- 1 Box Of Stuffing (Your Choice)

### Preparation:

1. First you clean the mallards buy plucking their feathers.
2. Singe the duck until all pin feathers are removed.
3. Wash it thoroughly ,clean the inside of the mallard.
4. Add your own stuffing ,place it in the roast pan.
5. Slice the carrots, potatoes, celery hearts, and onion if desired.
6. Throw all the veggies in with the mallards.
7. Cover then let cook for about 1 to 1 and a half hours.
8. When finished remove cover then let stand for five minutes.
9. Spread the can of fresh homemade cranberries.

Servings: Three - Four

Thank you Tina Daigneault and Fred McCallum for sharing Roasted Mallard with us!

---



[Return to Food & Recipes Menu](#)

---



Text and Graphics  
© 1994 - 103 [Tara Prindle](#)  
unless otherwise cited.

## Native American Technology and Art

# chicken Smoked Chicken chicken

---

Offered by LeeAnn Dreadfulwater  
~ Cherokee ~

**...who learned this one from her father, passed down through the family.**

---

### Ingredients:

- Two sticks of cheap margarine.
  - Apple cider vinegar.
  - Black pepper.
  - Three chickens, split into halves.
- 

### Preparation:

- This is one for you outdoors cooks, so start up your grills.
- Meanwhile, inside on the oven:
- Place the margarine in a small pan, pour in enough apple cider vinegar to cover, heat over medium heat, just enough to blend the margarine and vinegar.
- Add black pepper, and keep adding black pepper until your mixture turns black. This takes a lot of black pepper!
- When your grill is medium hot, place the chicken halves over the coals, and cook for about fifteen to twenty minutes.
- Turn over and use a small brush to baste the chicken with the vinegar mixture.
- Baste often and generously, and continue to baste and turn chicken over, until chicken is done. (Chicken is done when juices run clear and the bone joints become loose.)

*Note:* The chicken will get very dark and crispy skinned during the process---this is normal.

---

**Servings: Five - Ten**

---

*Thank you LeeAnn, for sharing Smoked Chicken with us!*

---

[Return to Food & Recipes Menu](#)

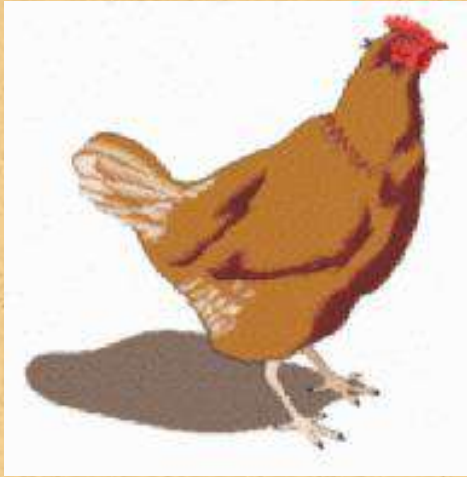
---



Text and Graphics  
© 1994 - 103 [Tara Prindle](#)  
unless otherwise cited.



## Native American Technology and Art



## Stuffed Chicken

---

Offered by Jennifer Lafond

~ Ile-A-La-Crosse, Saskatchewan - Lena.L.And Elmer.L. ~

... who learned this from my mother

### Ingredients:

- 1 Whole Chicken
- 1 Box Chicken Stuffing
- 8 Carrots
- 5 Potatoes Salad
- Little Sprinkle Of Seasoning Salt

### Preparation:

1. Thaw out your chicken
2. Stuff the chicken with the stuffing and add a little of seasoning salt on your chicken.
3. Throw in your chicken and cook it
4. I don't really know how long your chicken will take it depends on the size.
5. When it's just about done, throw your carrots on the side of your chicken in the oven.
6. Then boil your potatoes.
7. Make your salad.
8. When your potatoes are done put a little butter to bring out the taste of them.
9. Enjoy your meal.

*Note: Enjoy And Have A Good Meal.*

**Servings: Eleven +**

**Thank you JENNIFER LAFOND for sharing STUFFED CHICKEN with us!**

---

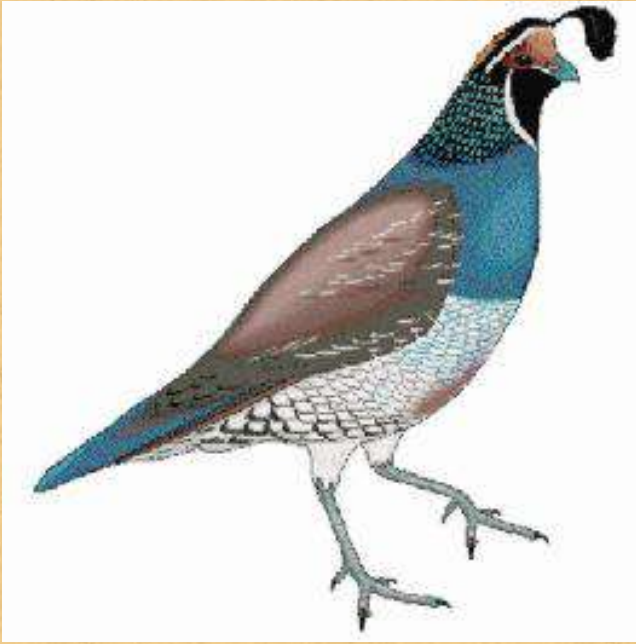
**[Return to Food & Recipes Menu](#)**

---



**Text and Graphics**  
© 1994 - 103 **[Tara Prindle](#)**  
unless otherwise cited.

## Native American Technology and Art



## Stuffed Quail (Guhgwe)

---

Offered by Jerry Shadowhawk Hicks

~ I Am From The Eastern Band of Cherokee, The Ugaya ~

... who learned this from my grand farther

### Ingredients:

- 3 Whole Cleaned Quails
- A Pan Of Corn Bread
- 1/4 Cup Of Whole Pepper Corns
- 1 Cup Of Onions
- 1/2 Cup Celery
- 1/2 Cup Leeks
- Tbs. Garlic
- 2 Cups Corn
- 2 Cups Of White Beans
- 1 Cup Of Sweet Red Peppers
- 2 Cups Of Chicken Stock
- 1 1/2 Cup Butter<sup>3</sup>
- Cups Blackberries
- 3 Cups Water

### Preparation:



1. **First you rub your quail down with butter.**
2. **Then chop your corn bread into cubes.**
3. **Sauté your onions, leeks, garlic, celery, corn, diced red pepper, white beans.**
4. **Be careful not to mash the beans up.**
5. **Crush the pepper corns and add to the mixture.**
6. **Reduce heat add chicken stock bring to a boil.**
7. **Take off heat add part of mixture to corn bread add till corn bread mixture is thick enough to make a little ball in your hand. When it is thick stuff the quail with the mixture. Bake at 350 degrees for 25 mins. Sauce: pour the water into a sauce pan bring to a boil.**
8. **Add blackberries mash them up add one tsp. Sugar to thicken.**
9. **Strain into a bowl.**
10. **Serve sauce on top of the quail**

**Servings: Three - Four**

**Thank you Jerry Shadowhawk Hicks for sharing Stuffed Quail (Guhgwe) with us!**

---

[Return to Food & Recipes Menu](#)

---



Text and Graphics  
© 1994 - 103 [Tara Prindle](#)  
unless otherwise cited.



## Alex's Beer Battered Halibut

---

Offered by Alexandria Stailey

~ Aleut (Alaska) born in Levelock, AK ~ Shanigans, Kalmakoff (Family) ~

... who learned this from My Homeland , Alaska. It's a favorite to all who like halibut.

### Ingredients:

- Halibut
- 1 cup flour
- One 12 oz. Bottle(or can) beer
- 1 1/2 tbs. Salt
- 1 tbs. Paprika
- Dash (or so!) Cayenne pepper

### Preparation:

- Cut a couple of pounds of halibut into 1 in. chunks.
- Heat cooking oil in deep-fat fryer to 375 degrees.
- Make the batter by combing flour, Beer, salt, paprika, Cayenne to your taste!!
- Dip the halibut in batter, drop into hot oil, A few at a time.
- Cook till the batter is golden brown,-just a few minutes. Halibut overcooks easily, so try not to over do.
- Remove pieces from oil and drain on paper towels; Serve Hot with your favorite accompaniments. (I like Catsup/with Horseradish)!!

**Note:** Very easy to do . JUST BE CAREFUL NOT TO OVER COOK. ENJOY - THIS WILL FEED THE WHOLE REZ IF YOU DOUBLE.

**Servings:** Five-Ten

Thank you Alexandria for sharing Alex's Beer Battered Halibut with us!

---

[Return to Food & Recipes Menu](#)

---



**Text and Graphics**  
© 1994 - 103 [Tara Prindle](#)  
unless otherwise cited.



## Native American Technology and Art



# Bass Cayo



---

Offered by Jorge Barajas  
~ Guadalajara Mexico ~

.. who learned this from Fisherman Ankle

---

### Ingredients:

- Bass filets as much as you want (catch)
- 1 big onion
- Lemon juice (enough)
- Soy sauce
- Tomato juice clamato is the best
- Avocado
- Your choice of crackers

---

### Preparation:

- Cut the filets in small squares.
- Submerge in lemon juice 10 min.
- Chop the onion.
- Chop the avocado.
- Mix the fish with onion soy sauce to taste and avocado and serve.
- Enjoy with crackers

---

Servings: Five-Ten

---

*Thank you Jorge Barajas for sharing Bass Cayo with us!*

---

[Return to Food & Recipes Menu](#)

---



Text and Graphics  
© 1994 - 103 [Tara Prindle](#)  
unless otherwise cited.

## Native American Technology and Art



# B.B.Q. Tuna



---

Offered by Wa Wakinyela Wasaskiye (Annette)  
~ Lakota - Rosebud - Valandra Family ~

...who just made it up

---

### Ingredients:

- Tuna Loins 1 Large Cut In Half or 2 Small
- One Bottle of Teriyaki Garlic Marinade
- 1 Pound of Bacon
- A Couple Skewers
- A Tin Foil Hot Bag
- A Gal. Ziplock Baggie

---

### Preparation:

- Two days before is best but a few hours before will work fine.
- Place loins in ziplock with the marinade, let sit as long as possible
- Place bacon strips side by side on a piece of tin foil sides touching, remove loins from ziplock, save marinade for later.
- Place loins on top of bacon strips, wrap bacon around loins so ends overlap, weave a skewer through bacon strips to secure, place in hot bag, add reserved marinade.
- Carefully fold sides & top of bag as tightly & securely as possible.
- Place bundle over med. hot coals, cook approx. 35 to 45 min. turning about every 10 to 15 min.
- The outside layer of bacon sometimes gets slightly burnt but it won't affect the taste of the tuna.
- Remove the skewers, slice & enjoy :)

*Note: If you don't wrap the bundle tightly the tuna oils can escape & will produce a rather high flame that are rather difficult to extinguish.*



*Servings: Five-Ten*

---

*Thank you Wa Wakinyela Wasaskiye (Annette) for sharing B.B.Q. Tuna with us!*

---

[Return to Food & Recipes Menu](#)

---



Text and Graphics  
© 1994 - 103 [Tara Prindle](#)  
unless otherwise cited.



## Bluegail Supreme

---

Offered by Derick Mayes

~ Alliance, OH ~

... who made it myself

### Ingredients:

- Brown sugar.
- Vegatable oil.
- Lots of Bluegail.
- Pan.
- Fire.
- Rack.
- Season salt.

### Preparation:

1. Get a fire going.
2. Skin the fish by taking the scales off. Cut the head off of fish. Take out the insides. Clean the fish in water.
3. Put the oil on the pan.
4. Put brown sugar in the inside of the fish.
5. Place the fish on the pan put the rack across the fire. Put the pan on the fire.
6. Sprinkle some season salt on the fish.

**Servings:** Three - Four

Thank you Derick for sharing Bluegail Supreme with us!

---

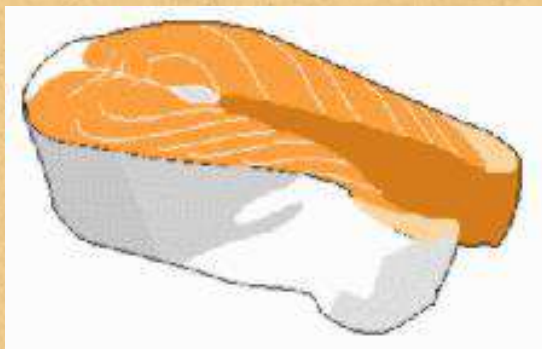
[Return to Food & Recipes Menu](#)

---



**Text and Graphics**  
© 1994 - 103 [Tara Prindle](#)  
unless otherwise cited.





## Candy Salmon

---

Offered by Sharon

~ The Great Ojibwe Nation ~

... who learned this from an elder

### Ingredients:

- Salmon ( preferably sockeye ) and as much as you can catch!
- Brown sugar
- Water
- Onion

### Preparation:

1. Catch and fillet the salmon.
2. Mix a little water with the brown sugar, so that is sort of like a paste.
3. Rub entire salmon with mixture, then line with sliced onion between the fillets.
4. Cook on cedar plank until fish flakes: about 7-8 min./side

Thank you Sharon for sharing Candy Salmon with us!

---

[Return to Food & Recipes Menu](#)

---



Text and Graphics  
© 1994 - 103 [Tara Prindle](#)  
unless otherwise cited.

## Native American Technology and Art



# Deep Fried Salmon Chips



---

Offered by John Diablo

~ Fountain Indian Band, Xax'lip reserve British Columbia ~

... who learned this from Central Fraser Valley

---

### Ingredients:

- 1 6 lb salmon
  - 4 cups flour
  - 2 tbsp season salt/lemon salt
  - 4 eggs wash for dipping
  - 2 tbsp sweet basil
  - 1 tbsp black pepper
- 

### Preparation:

- First fillet salmon, and then skin salmon very carefully, with a sharp fillet knife, trim salmon, with no bones attached. When fillet is done, slice salmon into thin strip width length not tail to head length.
- Mix all dry ingredients together.
- mix all eggs into a bowl, scramble
- take strips of salmon, dip into the flour mixture first then into the egg wash and then back into the flour mixture.
- then carefully use a home deep fryer and cook until golden brown color, serve with homemade fries and lemons.
- various dry herbs can be used to your liking, this is just a beginning of what you can use for the flour mixtures.

*Note: Use this as a snack, or as finger food, great for parties and childrens snack or lunch.*

---

*Servings: Eleven +*

---

*Thank you John Diablo for sharing Deep Fried Salmon Chips with us!*

---

[Return to Food & Recipes Menu](#)

---



Text and Graphics  
© 1994 - 103 [Tara Prindle](#)  
unless otherwise cited.



## Native American Technology and Art



# Fire Baked Fish



---

Offered by Lauren McArdle  
~ small part Mohawk from her mother ~

...who learned this from her Grandmother in Saskatchewan

---

### Ingredients:

- 1 Big Fish (Salmon, Trout, Perch)
  - Salt and Pepper
  - Butter
  - Lemon Slices
- 

### Preparation:

- Gut and scale the fish.
- Place lemon in the fish and rub all over with butter.
- Sprinkle with salt and pepper and wrap in a big piece of tinfoil.
- Bake on a smooth flat rock really close to the fire (but not in it!).
- Use some long sticks to get it out.

*Note: The amount of time it takes to cook varies depending on the size of fish and how close it is to the fire. Just keep checking it, it will be done when the flesh flakes easily with a fork.*

---

*Thank you Lauren McArdle for sharing Fire Baked Fish with us!*

---

[\*Return to Food & Recipes Menu\*](#)

---



Text and Graphics  
© 1994 - 103 [Tara Prindle](#)  
unless otherwise cited.

## Native American Technology and Art



# Fire Baked Trail Fish



---

Offered by Robert Saut  
~ Huron ( way back ) ~

.. who learned this from Family hand down

---

### Ingredients:

- 1 fish
  - Wild onions
  - Campfire
  - Enough clay to cover fish
- 

### Preparation:

- Gut and de-head the fish leave the skin and scales on
- Fill fish cavity with clean wild onions to taste.
- Cover both sides of fish with plenty of clay
- Use a stick to dig hole in red-hot campfire ashes, put in clay covered fish cover with red hot ashes it should be done in 45 min.
- Break open fire baked clay covering and the scales will stick to it leaving the white filets ready to eat .

*Note: Watch out for bones. Save fish head and guts for bait for more fish or critters. You can also bake chicken this way but you need to make sure the feathers are well covered with clay so that they don't burn.*

---

Servings: One

---



*Thank you Robert Saut for sharing Fire Baked Trail Fish with us!*

---

[Return to Food & Recipes Menu](#)

---



**Text and Graphics**  
© 1994 - 103 [Tara Prindle](#)  
unless otherwise cited.

## Native American Technology and Art



# Fish Dinner



---

Offered by Cindy  
~ Passamaquoddy ~

...who notes the recipe has Passamaquoddy origins in Maine

---

### Ingredients:

- Any good salt water fish: cod, salmon, pollock, etc.
  - Clams in the shell
  - Lobster
- 

### Preparation:

- Clean and chunk the fish.
  - Boil it up with the clams and lobster.
  - Add any herbs you like; rosemary, dill, salt or pepper.
- 

Servings: The family +

---

*Thank you Cindy, for sharing this and other recipes with us!*

---

[Return to Food & Recipes Menu](#)



Text and Graphics  
© 1994 - 103 [Tara Prindle](#)  
unless otherwise cited.



## Native American Technology and Art



# Fish Head Stew



---

Offered by Mudgie McCovey  
~ Yurok Tribe ~ The Klamath Reservation ~

...who learned this from My Granpa Grizzly Ike McCovey

---

### Ingredients:

- 1 salmon head 1 skien salmon row 2 cups celery 1 lg onion
- 3 to 4 potatoes (peeled & diced) 4 to 5 chunks salmon
- 1/2 piece salmon backbone 1 can corn salt pepper to taste
- 1 salmon tail water

---

### Preparation:

- Catch and clean salmon.
- Fillet and chop salmon.
- Get a stew pot and fill it the salmon head, salmon row, celery, diced onion, peeled and chunked potato, chunks of salmon, salmon backbone, corn and salmon tail.
- Add enough water to cover 2-3 inches above stew.
- Boil until potatoes and fish done.
- Salt & pepper to taste.

*Note: Make sure when eating you don't swallow any bones. Eat and enjoy.  
Add anything else that sounds good.*

---

**Servings: Three - Four**

*Thank you Mudgie, for sharing Fish Head Stew with us!*

---

[Return to Food & Recipes Menu](#)

---



**Text and Graphics**  
© 1994 - 103 [Tara Prindle](#)  
unless otherwise cited.



## Fried Fish

---

Offered by Danielle

~ "Sequoia" ~

... who learned this at a mountain camp

### Ingredients:

- 2 whole bass or any preferred mountain fish
- 1 whole lemon
- Salt and pepper (to season)
- 4 basil leaves
- 4 cups of cedar chips
- 2 cups of cooked rice

### Preparation:

1. Fry or grill fish, if you are in the mountains, dig a hole, about 1 foot deep,
2. Find a handful of small branches about 1 ft. Long each and some leaves, place leaves and branches in hole.
3. Find a good smelling tree or preferable a cedar and chip off A LOT of chunks to make about 3-4 cups full. Mix up the chunks with the mulch.
4. Make a rack out of some branches
5. Place the fish whole in between racks. One on each side holding it. Every 3 minutes rotate the rack once you light the mulch in the hole.
6. When the fish is cooked place the fish on separate plates, squeeze half the lemon on each one to give them that wonderful, full, fresh, taste, it also takes the nasty fishy flavor away from it,
7. Season it with the salt, pepper, and sprinkle ripped up basil leaves on top. ENJOY! This is by far my FAVORITE outside dish!

**Servings:** Two

Thank you Danielle for sharing Fried Fish with us!



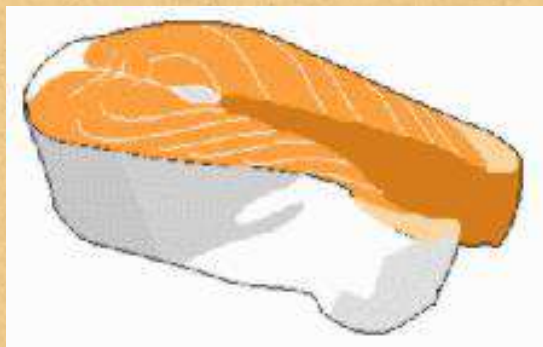
---

[Return to Food & Recipes Menu](#)

---



**Text and Graphics**  
© 1994 - 103 [Tara Prindle](#)  
unless otherwise cited.



## Great Lakes Smoked Salmon

---

Offered by Susan Marie Smith-Kennedy

~ Cherokee (born and raised in San Antonio, Texas) ~

... who learned this from Husband's Family Recipe

### Ingredients:

- 1 cup salt
- 1 1/2 cups sugar
- 1 or 2 crushed bay leaves
- Oregano
- Garlic
- Dill weed

### Preparation:

1. In large container, soak everything in enough water to cover fish at least 12 hours.
2. Soak about 3 pounds Hickory chunks in bucket of water overnight.
3. Spray rack with cooking spray, if needed.
4. Use enough coal to get Hickory started (approx. 5 or 6 coals).
5. Keep at least 3 chunks going at all times.
6. Cook 2 to 6 hours depending on size of fish/fillets. Place larger fish/fillets closer to heat source than the smaller ones.
7. Meat will be firm to touch--not mushy.
8. Some pieces of Apple wood or Grape vines can be added to Hickory.
9. Belly of fish towards heat if not filleted.
10. Smoke temp approx. 200 degrees F.

**Note:** The salt concentration will vary greatly depending on: 1: how many pounds of fish are being marinated; 2: the size of the bowl and the amount of water added to bowl. Every batch comes back tasting different. The more you prepare this, the better return you'll have. Practice = finesse. This is great with mild cheese (cream cheese does very nicely) and vegetable crackers.

**Servings:** Eleven +

Thank you Susan for sharing Great Lakes Smoked Salmon with us!

---

[Return to Food & Recipes Menu](#)

---



**Text and Graphics**  
© 1994 - 103 [Tara Prindle](#)  
unless otherwise cited.





## Grilled Buffalo (Rough Fish)

---

Offered by Karen Fischer

~ Cherokee ~

... who learned this from my husband's grandfather

### Ingredients:

- 3 lb. to 6 lb. Rough fish, buffalo or carp work great
- Salt
- Pepper
- Bread
- Catsup

### Preparation:

1. Build a roaring fire in your grill or pit. you want flames that last. While your fire is making, take your fish and cut off the head and take out the entrails, **DO NOT SCALE** the fish. Rinse the fish and place it (them) on a grate over the fire, you want the flames to almost touch the fish. When the side facing the fire is black, and the meat at the neck cut flakes off, turn the whole fish over and do the other side the same way.
2. When both sides are black and the meat at the neck cut up by the spine is flaky, remove the grate, fish and all to a spot away from the fire.
3. Peel back the skin, the scales will have protected the skin and the meat from burning. Pick out pieces of meat, place on bread, salt and pepper if you like, top with catsup, if you like, put another slice of bread on to make a sandwich, pour yourself a cup of fresh coffee and eat up.

**Note:** This is best when made along the waterside while camping or on an overnight fishing trip. The bones pull out whole and you don't have to worry about them.

**Servings:** Five-Ten

Thank you Karen Fischer for sharing Grilled Buffalo (Rough Fish) with us!

---

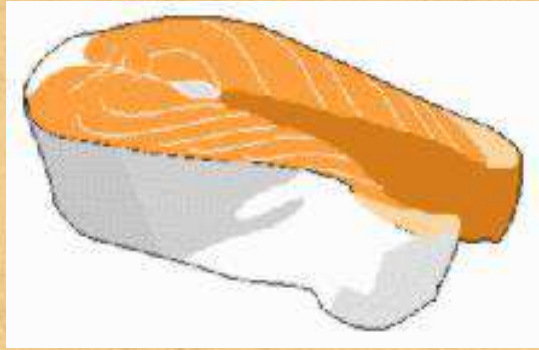
[Return to Food & Recipes Menu](#)

---



**Text and Graphics**  
© 1994 - 103 [Tara Prindle](#)  
unless otherwise cited.

## Native American Technology and Art



## Grilled Salmon

---

**Offered by Cindy  
~ Passamaquoddy ~**

**...who notes the recipe has Bannock origins in Idaho**

---

### **Ingredients:**

- **Salmon**
  - **Dab of salt & pepper**
- 

### **Preparation:**

- **Catch and clean a salmon and fillet it.**
- **Stovetop:  
get a pan real hot and put a dab of oil.  
lay the salmon on it salt & pepper it and put a lid on it.  
check it out and flip over before it burns.**

**Yummy!**

---

**Servings: Two**

---



*Thank you Cindy, for sharing this and other recipes with us!*

---

[Return to Food & Recipes Menu](#)

---



Text and Graphics  
© 1994 - 103 [Tara Prindle](#)  
unless otherwise cited.

## Native American Technology and Art



# Kallmeh Fish



---

**Offered by Dominic Lang**  
**~ Ojai, CA / Mom: Rain / Dad: Burton ~**  
**...who learned this through an experiment**

---

### **Ingredients:**

- **Tin foil**
  - **Lemon juice**
  - **Lime juice**
  - **1 tbs. Of butter**
  - **Skinned, be-headed, and gutted fish (freshly caught trout is the best)**
  - **Spices of choice**
- 

### **Preparation:**

- **Make a cup with piece of tin foil, put fish in the foil.**
- **Then put butter inside fish, then squirt lemon and lime juice in with the fish.**
- **After that put on spices of choice and close tin foil into a tight wrapper over the fish.**
- **Then cook over camp fire or in oven until you have texture desired.**

*Note: an oven will do in a pinch.*

---

**Servings: Eleven +**

---

*Thank you Dominic, for sharing your Kallmeh Fish recipe with us!*

---

[Return to Food & Recipes Menu](#)

---



Text and Graphics  
© 1994 - 103 [Tara Prindle](#)  
unless otherwise cited.



Native American Technology and Art



**Lake Trout  
and  
Leek Bake**



---

**Offered by Joy Downing  
~ Odawa Nation ~**

**...who made it up while camping and trout fishing**

---

**Ingredients:**

- **One lake or four brookies**
  - **Wild leeks**
  - **Potatoes**
  - **Salt & pepper**
  - **Butter**
- 

**Preparation:**

- **Catch and clean fish.**
  - **Dig up leeks clean them as you would green onions.**
  - **Dice leeks and potatoes.**
  - **Place fish on foil add leeks, potatoes salt and pepper to taste.**
  - **Put a few pats of butter on and seal foil bake at side of camp fire.**
  - **Hot coals but not so hot they burn the fish.**
  - **Cook about one hour.**
- 

**Servings: Two**

---

*Thank you Joy, for sharing your recipe for brookies with us!*

---

[Return to Food & Recipes Menu](#)

---



Text and Graphics  
© 1994 - 103 [Tara Prindle](#)  
unless otherwise cited.

## Native American Technology and Art



# Miracle Whipped Fish



---

Offered by Chris  
~ Shoshone-Bannock Nation ~

...who just overheard it one day

---

### Ingredients:

- Fish- preferably fillets
  - Miracle Whip style dressing
  - Lemon Pepper seasoning
  - bar-b-que grill-(suggested style of cooking)
- 

### Preparation:

- On the side of the fish you will cook first, spread a nice layer of the Miracle Whip style dressing. Then sprinkle with the Lemon Pepper seasoning.
  - Sometimes I do this in the other order- it's good to experiment with recipes and then do whatever you like best.
  - Put the "gooped up" side of the fish on the grill. Then "goop up" the other side.
  - As the fish cooks, the seasonings will drip into the coals and take most of the fishy taste with it. This makes fish taste very mild.
- 

Servings: Depends how much fish you use.

---

*Thank you Chris, from [Beadedweb](#), for sharing your little miracle with us!*



---

[Return to Food & Recipes Menu](#)

---



Text and Graphics  
© 1994 - 103 [Tara Prindle](#)  
unless otherwise cited.

## Native American Technology and Art



# Native American Bacon



---

Offered by M.F.Rothberg

~ Indian reservation preservation affiliate ~

...who learned this from the Cherokee Tribe

---

### Ingredients:

- Salmon
  - Seasonings of your choice
- 

### Preparation:

- catch the largest salmon you could find by hand.
- Clean the fish but leave the skin.
- Boil for 1 hour then put on cookie tray.
- Cut fish into thin slices as if making strips of thick beef jerky.
- Season as you prefer and bake at 350 degrees for about 2hours or until dark red.

*Note: Make sure it is not soft but not burnt.*

---

**Servings: Two**

---

*Thank you M.F.Rothberg, for sharing Native American Bacon with us!*

---

**[Return to Food & Recipes Menu](#)**

- **[Napalitos \(Prickly Pear 2\)](#) 4/12/98**



## Native American Technology and Art



# Rainy Day Fish Chowder

---

Offered by Laura

~ Haida, Tlingit - Mom is from Klawock. I live in Olympia, Washington ~

... who learned this from my mom, Pearl.

### Ingredients:

- Saved skin, bones, head or tail of fish you ate the day before.
- Boil it in 6 quarts of water for 2 hours with one large onion chopped up, 3 or 4 stalks chopped celery and (*for the Martha Stewart influenced, a twig of rosemary*).
- Strain and refrigerate, or use immediately. If you didn't save the fish parts, 4 quarts of chicken broth will work nicely and doesn't alarm the neighbors with the smell.
- 1 pound left over cooked fish such as halibut, salmon, cod, lingcod.  
*Note: Be sure to de-bone salmon.*
- Also use:
  - 1 1/2 Cups Milk
  - 1 Head Finely Chopped Garlic
  - 1 Cup Onion
  - 2 Carrots, Peeled And Chopped
  - 2 Cups Fresh Or Frozen (Thaw First)
  - Chopped Greens Of Your Choice
  - 1/2 Cup Flour

### Preparation:

1. Sauté onions and carrot in a bit of canola oil until translucent.
2. Add garlic.
3. Cook until fragrant.
4. Add broth.
5. Bring to a boil and reduce heat to simmer.
6. Cook for about 20 minutes. Broth will reduce slightly.
7. Mix a bit of the milk into the flour and stir till you get a smooth paste.
8. Gradually add all the milk to the mixture.
9. Add to the broth.
10. Throw in the fish and greens.
11. Cook until fish is heated through.

12. **Add salt and pepper to taste at the table.**

*Crumbled up smoked fish, dried seaweed, even bacos are good additions to the soup.*

*Note: I like to eat this soup with some homemade bread, or biscuits. It's best on those evenings when it's raining so hard you can hear it bounce off the roof!*

**Servings: Three - Four**

**Thank you Laura for sharing Rainy Day Fish Chowder with us!**

---

**[Return to Food & Recipes Menu](#)**

---



**Text and Graphics**  
**© 1994 - 103 [Tara Prindle](#)**  
**unless otherwise cited.**

## Native American Technology and Art



# Salmon on a Stick



---

Offered by Claudette Parazoo  
~ Confederated Tribes of Grand Ronde....western Oregon ~  
...who learned this from Tulalip Indian Reservation - Washington

---

### Ingredients:

- **Salmon (or available fish) as much as you can get!**
- 

### Preparation:

- **Build a fire, clean the fish and cut it in half or cut into meal size chunks.**
- **Skewer the fish on a stick (preferably a sturdy willow or in the Northwest - Ironwood is used)**
- **Place the fish on a stick into the ground very close to the hot coals. Turn the fish as the bottom will cook quickly and don't underestimate the speed with which fish cooks on a stick.**
- **This is a great campfire meal...fresh caught fish and your own embellishments.**

*Note: this is the best way to eat fish....beats frying, baking, boiling, bar b que. All the fat oil drips out and the fish is flaky and delicious. Serve with salad, baked potato, fry bread and huckleberry jam, other veggies. Home made bread goes good with this, too.*

---

*Servings: Two*

---

*Thank you Claudette Parazoo for sharing Salmon on a Stick with us!*

---



---

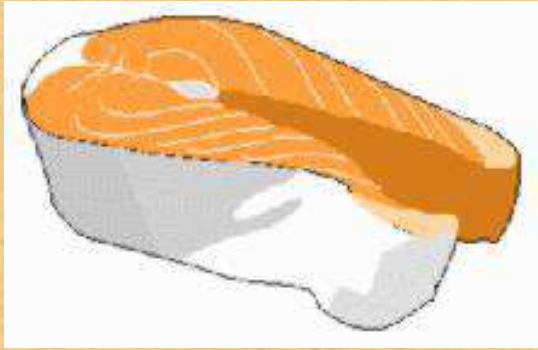
*[Return to Food & Recipes Menu](#)*

---



Text and Graphics  
© 1994 - 103 [Tara Prindle](#)  
unless otherwise cited.

## Native American Technology and Art



# Salmon Stuffed Fry Bread

---

**Offered by Anny H.**

**~ Nishnawbe/Michigan ~**

**... who learned this from Smith family of Hessel**

### **Ingredients:**

- **One Batch Of Your Favorite Fry Bread Dough**
- **2 Cans Or 1/2 Pints Of Salmon**
- **1 Or 2 Eggs**
- **Salt**
- **Pepper**
- **Crumbs If Needed 2 Cups Crisco**

### **Preparation:**

1. **Mix together salmon, eggs, salt and pepper to taste, I add crumbs if it is too moist.**
2. **Make patties about 1 inch thick and 5 inches across.**
3. **Fry them in a lightly greased pan. I pile them up on toweling until I have them all fried.**
4. **Then put Crisco in the pan to melt and get hot.**
5. **Form 2 patties of frybread dough about 6 or 7 inches across.**
6. **Put the salmon patty one piece and the other on top. Seal the edges tightly.**
7. **Do this until I run out of dough or salmon patties.**
8. **By then the grease is hot and I fry up all my patties.**
9. **Wonderful for a feast or microwaved for lunch the next day.**

**Servings: Five-Ten**

**Thank you Anny H. for sharing Salmon Stuffed Fry Bread with us!**

---

[Return to Food & Recipes Menu](#)

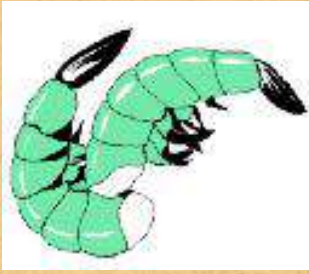
---



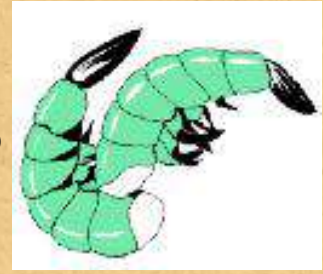
**Text and Graphics**  
© 1994 - 103 [Tara Prindle](#)  
unless otherwise cited.



## Native American Technology and Art



# Shrimp and Corn Soup



---

Offered by Linda Ransome  
~ Comanche heritage ~

...who learned this by eating something similiar at a pow wow, my version here.

---

### Ingredients:

- 4 tablespoons of olive oil
- 4 tablespoons of flour
- 1 pound of shrimp boiled and peeled
- 1 large onion chopped
- 1 bunch of green onions chopped
- 1 toe garlic minced
- 1 small bag frozen corn kernels
- parsley chopped, 3 tablespoons (optional)
- 1 bell pepper chopped (optional)
- 2 stalks celery chopped (optiomnal)
- 1 small can of tomatoe sauce
- 2 cans of chopped tomatoes, or hole tomatoes , chopped
- seasoned salt to taste

*Note: The optional things here are best if in the soup, but not needed. Sometimes I do not have them on hand, so it is just as good with out it \*S\*.*

---

### Preparation:

- Boil and peel shrimp ahead chop all vegetables ahead, you need them ready to add to the roux.
- First make a roux, you put the flour and olive oil in a pot, stir it over a medium heat till browned real

nicely, dark brown, keep it moving.

- Then add the chopped vegetables , all except the corn. This stops the browning processs, stir till the onilons are clear and done.
- Next add the tomatoes, and about 3 cans of water. Add the shrimp and the corn. Add seasoned salt to taste.

*Note: This is served at the southern pow wows, a tomatoe based corn and shrimp soup, mostly cooked by the Chitamacha( not sure of the spelling here)and Houma Tribes in Louisiana.*

---

*Servings: Five to Ten*

---

*Thank you Linda Ransome for sharing Shrimp and Corn soup with us!*

---

[Return to Food & Recipes Menu](#)

---



Text and Graphics  
© 1994 - 103 [Tara Prindle](#)  
unless otherwise cited.

## Native American Technology and Art



# Skok Salmon Cheeks



---

Offered by Offered by LA Duerr  
~ Yupik, Alaska ~

...who learned this from Denny Hurtado, Skokomish Nation Chairman

---

### Ingredients:

- Fresh Salmon Heads
  - Good Unsalted Butter
  - Sea Salt
- 

### Preparation:

- Take one salmon head at a time and microwave on **HIGH** for four to 8 minutes depending on size of salmon head and may take longer for frozen heads.
- Remove from microwave.
- With a fork lift the salmon's cheek gill flap thing, and scoop out the round, opaque, little cheek. Try not to eat it right out of the fish head.
- To make a meal of these little succulent cheeks takes self-control or it could take forever. I suppose a whole bunch of salmon heads could be boiled up, and the cheeks extracted all at once, but I only learned it one head at a time, in a microwave.
- If the cheeks are not quite done, you will know because it will be challenging to get the cheek out of the gill flap thing.
- When a salmon head is really done, it is gooey and easy to take apart.

*Note: I had to be bribed to try these. They look remarkably like little cheeks too, but if you think about it, it is a lot like a protein mass like the rest of the fish. And all those darn seals who eat the salmon cheeks out of the gill nets can't be wrong. No kidding--if you taste these, over rice you will never throw another salmon head away again.*



---

*Thank you LA Duerr for sharing Skok Salmon Cheeks with us!*

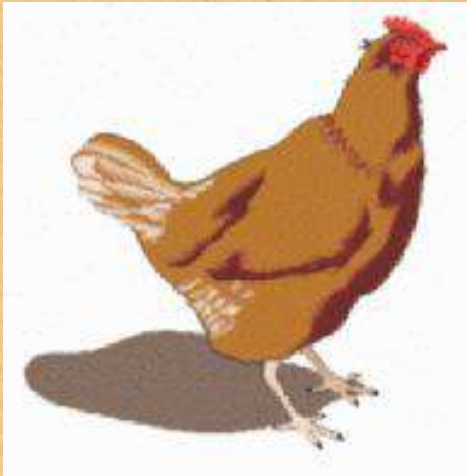
---

[Return to Food & Recipes Menu](#)

---



Text and Graphics  
© 1994 - 103 [Tara Prindle](#)  
unless otherwise cited.



## Good Ol' Smoked Bucket Chicken

Offered by Griffin Wilson

~ Blackfoot ~

... from a good ol' boy by the name of R. G. Spratt

### Ingredients:

- Seasoning of choice; we use garlic and seasoned pepper (season to liking)
- Butter (spray butter)
- 3 whole chickens
- 3 wooden stakes
- A 5 gallon metal bucket (paint burned off)
- Tin foil (15x15)
- 8 lb. Bag of matchlight charcoal
- Cotton string (about 3-4 ft.)
- Hickory chips (2 cups/2 handfuls)

### Preparation:

1. Make 3 stakes and drive them into ground after laying foil down [stakes placed close enough together that you can fit the three chickens on and still fit bucket over them]
2. Place seasoned chickens breast out on stakes and tie string around them tightly so when cooked, nothing falls off
3. Once chickens are placed, spray a lot of butter all around the chickens and season more
4. Your almost done!
5. Place hickory chips around and underneath the chickens
6. Put bucket over chickens and pour all the charcoal around the bucket
7. Light it up!
8. The chickens should cook for at least 3-3 1/2 hours

**Note:** This chicken will be the best dang bird you'll ever taste in your life, that is unless you have Ralph S.

cook it for you. I suggest you fry up some cubed seasoned potatoes and serve the chicks with those on the side. DANG IS THAT CHICKEN GOOD!

**Servings:** Three - Four

Thank you Griffin for sharing Good Ol' Smoked Bucket Chicken with us!

---

[Return to Food & Recipes Menu](#)

---



**Text and Graphics**  
© 1994 - 103 [Tara Prindle](#)  
unless otherwise cited.



Native American Technology and Art



# South Texas Potatoes And Fried Minnows



---

Offered by Brett Boatwright and Trey Ramirez  
~ Cotulla Texas ~

.. who learned this from an old Indian cook

---

## Ingredients:

- Minnows
  - Slices of potatoes
  - Butter
  - Slices of onions
  - Foil
- 

## Preparation:

- Place the potatoes, minnows and onions in the foil.
  - Then put the butter over the potatoes, minnows and onions.
  - And fold the foil over and place in the coals of a fire.
- 

Servings: Two

---

*Thank you Brett Boatwright and Trey Ramirez for sharing South Texas Potatoes And Fried Minnows with us!*

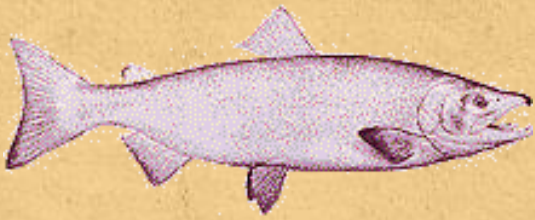
---

[Return to Food & Recipes Menu](#)

---



Text and Graphics  
© 1994 - 103 [Tara Prindle](#)  
unless otherwise cited.



## Stuffed Salmon - Tahitian Style

---

Offered by Mindy Jackle

~ Tahltan Nation ~

... My father, Andy Henry, taught me this one

### Ingredients:

- 1 sockeye salmon
- 2 c. Cooked white rice
- 1 small onion
- 2 stalks of celery, sliced small
- 5 slices of bacon, cut into small pieces
- 2 tsp. Canola oil
- 2 tsp. Curry
- Salt and pepper to taste

### Preparation:

1. In a large skillet, fry celery, bacon, and onion up in the canola oil until bacon is cooked. Adding curry into mixture once done.
2. Add rice and mix well, adding salt and pepper to taste.
3. Stuff cleaned cavity of salmon with ingredients.
4. Wrap in heavy duty tin foil and cook in the oven at 375 for 35-45 minutes. Check salmon at thickest part to see if it is cooked.

**Servings:** Five-Ten

Thank you Mindy for sharing Stuffed Salmon - Tahitian Style with us!

---

[Return to Food & Recipes Menu](#)

---





**Text and Graphics**  
© 1994 - 103 [Tara Prindle](#)  
unless otherwise cited.

## Native American Technology and Art

# Aztec Indian Omlette

---

**Offered by David Perez**  
~ The Meshica from Aztlan, now residing in Minnesota ~

**...My own concoction**

---

### **Ingredients:**

- **1/4 chopped onion**
  - **2 tablespoons bacon grease**
  - **three hot dogs (diced)**
  - **4 eggs**
  - **5 corn tortillas**
- 

### **Preparation:**

- **In skillet, fry onions in bacon grease until tender, add diced hot dogs.**
- **Continue frying until browned.**
- **Add more bacon grease if needed.**
- **Tear up tortillas into bite size pieces and add to skillet.**
- **Continue frying until tortillas are pliable.**
- **Add more bacon grease if needed.**
- **Break eggs over entire mixture and stir everything together until eggs are fried.**

*Note: Do not deviate from recipe. This is a delicacy that originated in in the refrigerator, better known as left overs. Pay day was still a ways off.*

---

**Servings: Two**

---

*Thank you David, for sharing Aztec Indian Omlette with us!*

---

[Return to Food & Recipes Menu](#)

---



Text and Graphics  
© 1994 - 103 [Tara Prindle](#)  
unless otherwise cited.



## Native American Technology and Art



# Baked Grindle



---

Offered by Ivian C. Smith  
~ Both wife and I have Choctaw/Cherokee ancestors ~

...Handed down from forefathers

---

### Ingredients:

- 1 large grindle (also known as bowfin or cypress trout)
  - 1 inner tube
- 

### Preparation:

- Catch grindle, usually any smelly, rancid bait will do, but can be caught on a variety of underwater lures. When they are hungry, anything will do.
- Dig pit about 2 feet deep, by 1 foot wide by 3 feet long.
- Make fire in pit using whatever kindling is available, and let fire burn to coals.
- Wrap grindle in inner tube, place in pit, cover with coals, and bake for several hours.
- Remove grindle from innertube, throw grindle away and eat inner tube.

*Note: Some species of garfish can be used, and in particular, alligator gar.*

---

**Servings: Snack**

---

*Thank you Ivian C. Smith, for sharing Baked Grindle with us!*

---

---

[Return to Food & Recipes Menu](#)

---



Text and Graphics  
© 1994 - 103 [Tara Prindle](#)  
unless otherwise cited.

## Native American Technology and Art



# Beans 'n Bacon



---

Offered by Terry & David Graywolf  
~ Oglala Lakota - Pine Ridge ~

...who learned this as a Good ol' Rez staple

---

### Ingredients:

- Bag(s) of beans - any type
- Bacon (not the whole pig - the kind already prepared from the store)
- Pot (size depends on how many bags of beans.)
- I usually use 2 bags of pinto beans & one package bacon in a large soup pot.

*Note: This feeds my husband, who is 6', 240lbs., for a good 3-4 days.*

---

### Preparation:

- Rinse the beans
- Boil the beans (until nearly done-about 45-60min. or so - just taste 'em!)
- Add the bacon & boil about another 1/2 hour or so, more or less.
- ENJOY! (especially about 2 hours later, if ya know what I mean. If not, you'll find out.)

*Note: This is usually accompanied by large quantities of fry bread. If you make enough, you won't have to cook again for a month. You may want to purchase some air freshner when you are out buying the beans and the bacon.*

---

**Servings: Five-Ten**

---



*Thank you Terry & David Graywolf, for sharing Beans 'n Bacon with us!*

---

[Return to Food & Recipes Menu](#)

---



Text and Graphics  
© 1994 - 103 [Tara Prindle](#)  
unless otherwise cited.

## Native American Technology and Art



## Blanket Dog

---

Offered by ReAnna Jean Waubanascum Williams

~ Menominee-Keshena - Gordon Williams Sr. Edwina Waubanascum ~

... who learned this from Father & Aunt

### Ingredients:

- **Fry Bread: (Ingredients: 4 Cups White Flour, 1/2 Teaspoon Salt, 1 Tablespoon Baking Powder, Lard or Shortening)**
- **2 Packs Of Hot Dogs**

### Preparation:

1. **You prepare the Frybread but you do not fry it.**
2. **You take the Frybread and a hot dog, wrap the hot dog into the frybread or better yet roll the hot dog into the Frybread.**
3. **Then once that is done fry it in the lard or shortening.**

*Note: This recipe is really good with Wild Rice or Hull Corn Soup.*

**Servings: Three - Four**

**Thank you ReAnna Jean Waubanascum Williams for sharing Blanket Dog with us!**

[Return to Food & Recipes Menu](#)

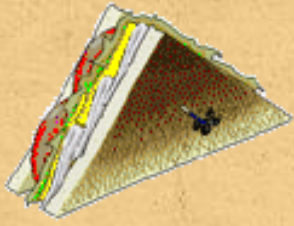
---



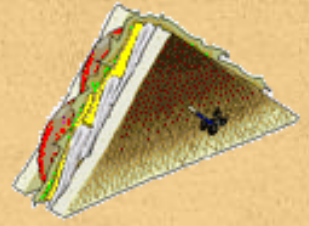
Text and Graphics  
© 1994 - 103 [Tara Prindle](#)  
unless otherwise cited.



Native American Technology and Art



# Fried Bologna And Egg Sandwich, kids call it a Bologna McMuffin



---

Offered by Dan Brewer

~ Greatgrandpa was Cherokee - I'm from Tennessee but in Michigan now ~

.. who learned this passed down from grandma

---

## Ingredients:

- Bread any type you like
  - Bologna or any meat you like
  - Eggs
  - Condiments, whatever you like on sandwiches
- 

## Preparation:

- Fry an egg hard, put on bread (fry bread, toast, English muffin any type) then fry bologna (I like mine crispy) put on bread.
- Top with mustard, mayo, ketchup, sliced tomato, onion, anything you like my favorite is jam.
- Top with another slice of bread and you got a great breakfast or lunch sandwich.
- If you cut two overlapping X's in the center of the bologna it wont bubble up in the middle and will fry more evenly and get crisper.

*Note: Be creative and try new variations. Grandma made hers with shredded fried squirrel instead of bologna!!*

---

Servings: One

---

*Thank you Dan Brewer for sharing Bologna McMuffin with us!*

---

[Return to Food & Recipes Menu](#)

---

---



Text and Graphics  
© 1994 - 103 [Tara Prindle](#)  
unless otherwise cited.

carrot

# Four-Leaf Clover Salad

---

Offered by Ashley

~ Illinois ~

... who made it up

## Ingredients:

- Bunch a' clovers (To fill up a bowl.)
- Bunch a' onion chives (As much as you want!)
- 3 or 4 tomatoes
- 2 carrots

## Preparation:

1. Put the clovers and onion chives in a bowl. cut up the carrots, then put them in the bowl. slice the tomatoes.
2. Mix up the ingredients.

**Servings:** Five-Ten

Thank you Ashley for sharing Four-Leaf Clover salad with us!

---

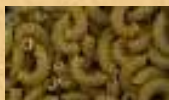
[Return to Food & Recipes Menu](#)

---



Text and Graphics  
© 1994 - 103 [Tara Prindle](#)  
unless otherwise cited.





# Goulosh With A Zest

---

Offered by Rebecca Walker

~ The Walker Family of the Chickasaw Nation ~

... who learned this from her Native American Husband

## Ingredients:

- 1 lb. Commodity Ground Beef
- 1 Box Commodity Macaroni
- 1 Can Commodity Tomato Sauce
- 1 Can Rotel Tomatoes and Green Chilies
- 1 Small Onion
- 1 Green Bell Pepper

## Preparation:

1. Cut up Bell Pepper and Onion, brown with Ground Beef.
2. While Ground Beef and Bell Pepper and Onion are browning, boil 3-4 quarts of water for the Macaroni.
3. When Ground Beef, Onion and Bell Pepper are browned, pour in one can of Rotel, and one can of tomato sauce.
4. Add macaroni to boiling water and boil until tender. Drain water from macaroni.
5. Add Macaroni to Ground Beef mixture.
6. Heat to desired consistency.

**Note:** I also cut up garlic with my onions and bell peppers. This gives it a good flavor also. The Rotel gives it a little spice!!!

**Servings:** Five-Six

Thank you Rebecca for sharing Goulosh With A Zest with us!

---

[Return to Food & Recipes Menu](http://www.nativetech.org/food/GouloshWithAZest.html)

---



**Text and Graphics**  
© 1994 - 103 [Tara Prindle](#)  
unless otherwise cited.

## Native American Technology and Art



# Indian Fry Bread

---

Offered by Tall Mountain & Summerwolf  
~ French/Danish/English/Lenape ~

...which was handed down from family & friends

---

### Ingredients:

- 3 cups unbleached flour
- 1 Tbsp. baking powder
- 1 Tsp. salt
- 1 1/2 cups "warm" water

---

### Preparation:

- Mix the flour, salt, and baking powder together in a bowl. Sift or stir this together.
- Add the "warm" water to this mixture and stir until all the dry ingredients are mixed well.
- Put oil on your hands; remove dough from bowl and knead until the dough is smooth.
- When the dough is smooth & soft, rub oil over the top of your dough.
- Place back into the bowl, cover with a dry cloth & let rest for "30" minutes.
- Begin heating your lard, oil, or grease so it is very hot.
- Pull the dough at its edges until you have small circles.
- Drop circles into the hot grease until golden brown, then turn over until golden brown on the other side as well.
- Add enough grease/oil so the dough can deep fry.
- Dip cooked fry bread into sugar, or spread butter, jam or jelly on top and eat.



*This is a staple for feasts after sweats, at Pow Wow, an Honor dinner or any cultural gathering.*

---

**Servings: Five-Ten**

---

*Thank you Tall Mountain & Summerwolf, for sharing your rendition of Fry Bread with us! You can \*never\* have enough fry bread! {grin}*

---

[Return to Food & Recipes Menu](#)

---



**Text and Graphics**  
© 1994 - 103 [Tara Prindle](#)  
unless otherwise cited.

## Native American Technology and Art



# Addition To Frybread Recipe

---

**Offered by Ann Murphy**  
**~ Sauk & Fox ~**

**.. who learned this from my Ma - Mary Kay Kasna - Fox Tribe**

---

### **Ingredients:**

- **Same as other recipes.**

---

### **Preparation:**

- **Same as other recipes.**

*Note: the only dry milk that works in fry bread is commodity milk-don't know why-but none of the dry milks from the store make it taste the same (or as good).*

---

*Thank you Ann Murphy for sharing Addition To Frybread Recipe with us!*

---

**[Return to Food & Recipes Menu](#)**

---



**Text and Graphics**  
© 1994 - 103 [Tara Prindle](#)  
unless otherwise cited.



## Native American Technology and Art



## Good Frybread

---

Offered by Roselle Fryberg  
~ From the Tulalip Tribes ~

... who learned this from my mom, my grandma, so on and so on

---

### Ingredients:

- 3 cups of flour
- 1 tablespoon Baking Powder
- 1 teaspoon of salt
- 1 tablespoon of sugar
- 1 1/2 cups of water

---

### Preparation:

#### Making the dough:

- Mix all the ingredients {except water} together.
- Mix it.
- Then add the water.
- Then kneed the dough.
- Let the dough sit for 20-25 minutes.

#### Making the frybread:

- Take a roll out of the dough flatten it to about 1 1/2 inches.
- Then put a hole in the middle.

**Frying:**

- Add 1 1/2 cups of butter. Then 3-5 cups of oil into a frying pan.
  - After the oil gets done boiling put the frybread in.
  - And Enjoy.
- 

**Servings: Three - Four**

---

*Thank you Roselle Fryberg for sharing Good Frybread with us!*

---

[Return to Food & Recipes Menu](#)

---



Text and Graphics  
© 1994 - 103 [Tara Prindle](#)  
unless otherwise cited.

## Native American Technology and Art



# Grape Dumplings



---

Offered by Teresa Couch  
~ I am from Amarillo Texas ~

... who learned this from my Comanche granma

---

### Ingredients:

- 3 cups flour.
  - 3 cups purple grapes
  - 1 cup sugar
  - 2 tbs. butter
- 

### Preparation:

- Smash grapes in a sauce pan.
  - Add butter and sugar cook on high heat until it boils good .
  - Let cool.
  - Slowly add your flour until it turns in to a dough.
  - Then just fry it in oil.
- 

*Thank you Teresa Couch for sharing Grape Dumplings with us!*

---

[Return to Food & Recipes Menu](#)





**Text and Graphics**  
© 1994 - 103 [Tara Prindle](#)  
unless otherwise cited.



## Guyanna Moto

---

Offered by Josh

~ Cherokee Indian ~

... who learned this from grandma

### Ingredients:

- 4 cups flour
- 1 tbs. oil
- 1\3 tbs. shortening
- 1\2 cup milk

### Preparation:

1. Mix all the ingredients above in a bowl. Mix it real good.
2. Let it sit with tin foil over it. Let sit for 20 minutes.
3. Roll the dough in balls and poke a hole in them.
4. Put them in a frying pan of oil that will cover them. But they should float. Fry till golden brown or desired color.
5. Eat with salt or honey.

**Servings:** Two

Thank you Josh for sharing Guyanna Moto with us!

---

[Return to Food & Recipes Menu](#)

---



Text and Graphics  
© 1994 - 103 [Tara Prindle](#)  
unless otherwise cited.

## Native American Technology and Art



# Hot Bread



---

Offered by Nick  
~ From Oregon.. my mommy is Linda ~

.. who learned this from Shoshone family member

---

### Ingredients:

- 2 Cups flour
  - 1 cups sugar
  - 1 box hot tamales (2.12 oz)
  - 2 tea. baking Powder
  - 1 tea. yeast
  - 2 cups milk
  - 2 eggs
- 

### Preparation:

- Put all in a bowl, mix for 5 mins.
  - Bake 35 mins at 350 degrees.
  - EAT!!
- 

Servings: One

---

*Thank you Nick for sharing Hot Bread with us!*



---

[Return to Food & Recipes Menu](#)

---



**Text and Graphics**  
© 1994 - 103 [Tara Prindle](#)  
unless otherwise cited.

## Native American Technology and Art



# Indian Bread Pudding



---

Offered by Phyllis L. Stevens  
~ My dad's mother was full blooded Cherokee ~

.. who learned this from my Dad. He was of Cherokee Heritage.

---

### Ingredients:

- Bread
  - Eggs
  - Sugar
  - Canned milk
  - Cinnamon
  - Butter
- 

### Preparation:

- Break bread up, soak in warm water, squeeze with hands.
  - Throw excess water out.
  - Mix canned milk (preferably carnation) 4 eggs, 1 teaspoon of cinnamon, then beat all together.
  - Pour over bread and mix well. Pour into oblong buttered cake pan. Sprinkle cinnamon all over top and just about 5 dots of butter around here and there on top.
  - Bake in preheated oven at 400° for 1 hour and 20 min, or until knife comes out clean. Let cool, slice and serve like cake.
- 

Servings: Eleven +

---

*Thank you Phyllis L.Stevens for sharing Indian Bread Pudding with us!*

---

[Return to Food & Recipes Menu](#)

---



Text and Graphics  
© 1994 - 103 [Tara Prindle](#)  
unless otherwise cited.



## Native American Technology and Art



# Indian Cake



---

Offered by Tall Mountain & Summerwolf  
~ French/Danish/English/Lenape ~

...which was handed down from family & friends

---

### Ingredients:

- 6 cups water
- 2 cups precooked yellow corn meal
- 1 cup sprouted wheat
- 4 cups precooked blue corn meal
- 1/2 cups rasins
- 1/2 cup brown sugar

---

### Preparation:

- Put 6 cups of water in pan and boil.
- Add 4 cups precooked blue corn meal.
- Add 2 cups precooked yellow corn meal.
- Add 1/2 cup rasins.
- Add 1 cup wheat, sprouted.
- Add 1/2 cup brown sugar.
- Blend well; dissolve all lumps. Pour into baking pan that is lined with foil.
- Cover with foil. Bake at 250 degrees for 4 hours.

*Note: Cake must cook slowly!*

---

**Servings: Five-Ten**

---

*Thank you Tall Mountain & Summerwolf, for sharing your family recipe for Indian Cake!*

---

[Return to Food & Recipes Menu](#)

---



Text and Graphics  
© 1994 - 103 [Tara Prindle](#)  
unless otherwise cited.

## Native American Technology and Art



# Indian Flat Bread



---

Offered by Blane  
~ Choctaw - Texas ~

.. who learned this from grandmother

---

### Ingredients:

- 1 cup flower
- 1/4 cup water
- Cinnamon
- Honey

---

### Preparation:

- Pour 1/4 flower in bowl.
- Add water.
- Stir and add cinnamon and honey (as much as ya want).
- Bake in oven until golden brown.
- Eat up.

---

Servings: Two

---

*Thank you Blane for sharing Indian Flat Bread with us!*

---



[Return to Food & Recipes Menu](#)

---



Text and Graphics  
© 1994 - 103 [Tara Prindle](#)  
unless otherwise cited.

## Native American Technology and Art



# Indian Fry Bread

---

Offered by Millie  
~ Cherokee Nation ~

...who learned this from her Grandmother ( Cherokee Nation )

---

### Ingredients:

- 3 cups of flour
- 1 tablespoon baking powder
- 1/2 teaspoon salt
- 1 cup warm water

---

### Preparation:

- Combine all of the dry ingredients in a large bowl.
  - Add warm water in small amounts and knead until soft but not sticky.
  - Adjust the flour or water as needed, Cover and let stand 15 to 20 minutes.
  - Pull off large egg sized balls of dough, turn out into fairly thin rounds.
  - Fry rounds in hot oil until bubbles appear on the dough, turn over and fry on the other side until golden brown.
- 

Servings: Five-Ten

---

*Thank you Millie, for sharing your recipe with us! Very fitting, I think, that frybread is the first recipe for our collection.*

---

[Return to Food & Recipes Menu](#)

---



Text and Graphics  
© 1994 - 103 [Tara Prindle](#)  
unless otherwise cited.



## Native American Technology and Art



### Indian Pogo



---

**Offered by Annette Mathias  
~ Algonquin, Long Point First Nation, P. Quebec ~**

**.. who learned this from elders from my native community**

---

#### **Ingredients:**

- **Wieners**
- **Your fried bannock recipe**

---

#### **Preparation:**

- **Make you favorite fried bannock recipe.**
- **When ready, prepare your dough as you would do when you want to fry. Insert a wiener and wrap your dough all around the wiener.**
- **Fry in hot oil till dough is well cook.**

*Note: Very famous whenever there's a pow-wow*

---

*Thank you Annette Mathias for sharing Indian Pogo with us!*

---

[Return to Food & Recipes Menu](#)

---



Text and Graphics  
© 1994 - 103 [Tara Prindle](#)  
unless otherwise cited.

## Native American Technology and Art



## Indian Tacos

---

Offered by Marilee Smoke  
~ Alderville First Nations, Ontario, Canada. Ojibway ~

...who learned this from her spouse, and different variations on Pow Wow Trails.

---

### Ingredients for Topping:

- 1 lb. Fried hamburger
- 2 cans tomatoes
- 1 large green pepper
- 1 large onion
- Mushrooms
- Cooked rice, just a bit, about 1/2 cup
- 1 small can refried beans
- 1 large can of red kidney beans
- 1 tsp. Chili spice
- A few shakes of Tabasco sauce (if you like it hot add lots)

### Separate Toppings:

- Shredded cheddar cheese
- Shredded, 1 head of lettuce
- About 4 diced fresh tomatoes
- *Note:* : Use Fried Bread as the base.

---

### Preparation:



- **Mix the first 10 ingredients in a large pot.**
- **Simmer on low heat for about 2 hours.**
- **While this is simmering make fried bread.**
- **Place hot fried bread on a plate,**
- **Top with sauce, add some shredded cheese on top,**
- **This will melt a bit add lettuce, tomatoes. And enjoy!**

*Note: This is very filling!*

---

**Servings: Five - Ten**

---

*Thank you Marilee, for sharing Indian Tacos with us!*

---

[Return to Food & Recipes Menu](#)

---



Text and Graphics  
© 1994 - 103 [Tara Prindle](#)  
unless otherwise cited.

## Native American Technology and Art



# Indian Tacos Port Gambal Skallam Rez Style

---

Offered by Ginny Fulton  
~ Port Gambal Skallam Tribe ~

...who learned this from my grandmother

---

### Ingredients:

#### For the bread:

- Self rising flour
- Cultured butter milk

#### For the topping:

- Hamburger or Chile
- Lettuce
- Tomato
- Cheese
- Onions

---

### Preparation:

To make the bread mix milk and flour together.

- After mixed flatten round pieces of dough (don't handle to much).
- Heat up grease enough to where the pieces of dough can float.
- Cook until both sides are golden brown - flip - give 4 minutes per side.
  
- After bread is done put meat on than cheese than lettuce and what ever else you want on it.

*Note: Feeds the whole rez if you make enough it depends on how much you want to spend on supplies.*

---

*Thank you Ginny Fulton for sharing Indian Tacos Port Gambal Skallam Rez Style with us!*

---

[Return to Food & Recipes Menu](#)

---



Text and Graphics  
© 1994 - 103 [Tara Prindle](#)  
unless otherwise cited.





Kahkewistahaw Indian Taco's

---

## Kahkewistahaw Indian Taco's

Offered by Natasha

~ Kahkewistahaw, Saskatchewan ~

... who learned this from my grandma's secret recipes

### Ingredients:

- Your favorite fry bread recipe
- Tomatoes
- Cheese
- Lettuce
- Hamburger
- Taco sauce
- Onions

### Preparation:

1. Make your fry bread.
2. Cook the hamburger meat and add the onions when its nearly done.
3. While it's cooking, dice up your lettuce, tomatoes, onions, and shred your cheese.
4. When your hamburger is done, add your hamburger first, on top of the bread, then your lettuce, tomatoes and finally your cheese.
5. Taco sauce is optional.
6. Eat and enjoy.

Thank you Natasha for sharing Kahkewistahaw Indian Taco's with us!

---

[Return to Food & Recipes Menu](#)

---



**Text and Graphics**  
© 1994 - 103 [Tara Prindle](#)  
unless otherwise cited.

## Native American Technology and Art



# Kiowan Frybread



---

Offered by Ken Jackson  
~ Plains Indians (Kiowas) (Texas), James and Rhonda Jackson ~

.. who learned this from A Friends Grandmother

---

### Ingredients:

- 2 cups flour
  - 1 teaspoon of Baking powder
  - 1/2 teaspoon of salt
  - Warm water
  - 1/4 cup of vegetable oil
- 

### Preparation:

- Sift flour, Baking Powder, and salt into bowl.
  - Slowly add warm water until dough feels like mud.
  - Mix and knead until smooth.
  - Cover for 10 minutes.
  - Break into lemon-size pieces.
  - Roll into a ball, then flatten.
  - Heat oil in pan.
  - Fry until Golden Brown.
  - Serve fresh on a plate with salt or syrup.
- 

Servings: Three - Four

---



*Thank you Ken Jackson for sharing Kiowan Frybread with us!*

---

[Return to Food & Recipes Menu](#)

---



Text and Graphics  
© 1994 - 103 [Tara Prindle](#)  
unless otherwise cited.

## Native American Technology and Art



---

Offered by Shasta

~ Cherokee/ Maiden Name Stuckey / Oklahoma ~

...who learned this from my mother

---

### Ingredients:

- 6 cups corn bread
- 2 cups cooked biscuits
- Onions
- Salt
- Black Pepper
- Celery
- Boiled egg/ about 6
- Mushrooms
- Sage to taste

---

### Preparation:

- Put Onions in skillet with a little Olive Oil,
- Put chopped celery, and mushrooms in to. Stir fry till tender but not too tender.
- Crumble up cornbread and Biscuits and put in with the stir fry veggies. Add Chicken broth or just plain Water. make it a bit thin to start with. stir while boiling. You have to keep stirring. Add Eggs about half way through. Cook till thick / like mashed potatoes/
- Add some sage to make it really delicious.

*Note: MMMMMM this is really a good dish to go with Pork, Chicken, or any meat you prefer. Cranberries is good on the side also. It will be thick and mushy and sooooo delicious. ENJOY*

*Thank you Shasta for sharing KUSH with us!*

---

[Return to Food & Recipes Menu](#)

---



**Text and Graphics**  
© 1994 - 103 [Tara Prindle](#)  
unless otherwise cited.



## Native American Technology and Art



# Maxine And Kayla Doolans Own Recipe (Tsimshian/Nisgaa ways)

---

Offered by Offered by Kayla Doolan  
~ Prince Rupert BC Canada ~ ... who learned this from my Mom (Maxine Doolan)

---

### Ingredients:

- 12 Cups Of Flour
- ¼ Cup Sugar
- 2 Tablespoons Of Salt
- 2 Cups Milk
- 2 Eggs
- 2 Cups Of Hot Water
- 2 Tablespoons Shortening
- ½ Cup Warm Water
- 1 Table Spoon Sugar
- 2 Table Spoons Yeast

---

### Preparation:

- In a small bowl add 1/2 cup warm water, tablespoon sugar, and dissolve them together and then add 2 tablespoons yeast then wait 5 minutes till proofed, (risen)
  - Then in a larger bowl sift 12 cups or flour, ¼ cup sugar, 2 tablespoons salt, and then make a tunnel in the center then add 2 cups milk, 2 eggs, 2 cups hot water, 2 tablespoons shortening, and then add the yeast mixture to the batter, then mix and slowly incorporate remaining flour and knead the dough for about 10-15 minutes and then cover and let rise for about 2 hours and punch down again and get a frying pan and oil and fry the bread....
-

**Servings: IT WILL FEED LIKE OVER 20 PEOPLE**

---

*Thank you Kayla Doolan for sharing Maxine and Kayla Doolans Own Recipe with us!*

---

**[Return to Food & Recipes Menu](#)**

---



**Text and Graphics  
© 1994 - 103 [Tara Prindle](#)  
unless otherwise cited.**

## Native American Technology and Art



# Menonimee Pilaf

---

Offered by Josephme La Follette

~ Dispossessed Menominee Living In Texas ~

... from way back when my people lived in Indiana

### Ingredients:

- 1/2 Palm Salt (1 Teaspoon)
- Three Pinches Sage
- 3 Medium Size Wild Rakes Diced Or Leeks Or Shallots
- 4 Fresh Sassafras Leaves Or 1 Tablespoon File
- 1 Handful Mashed Hickory Nuts (1/2 Cup)
- 8 Handfuls Brown Rice
- 7 Gourds Of Water (Cups)
- 1 Handful Red Pepper (Cayenne)
- 1 Cup Diced Crawdaddy Tail
- 2 Pinches Cumin

### Preparation:

1. In a big Dutch oven, boil water.
2. Add ingredients simmer and cover.
3. It should be done in 45 minutes.

*Note: It can be quite flavorful. It's said that Desoto took this recipe back with him to Spain--they call it Paella*

Thank you Josephme La Follette for sharing Menonimee pilaf with us!



[Return to Food & Recipes Menu](#)

---



Text and Graphics  
© 1994 - 103 [Tara Prindle](#)  
unless otherwise cited.



## Mesquite Cakes

---

Offered by Suzanna

~ mostly I learned from Tohono O'Odham, Lakota Sioux ~

... who learned this from Gary Nabhan and Tohono O'Odham people

### Ingredients:

- 1/2 cup mesquite meal (fine grind, mesquite bean pods)
- 1 cup whole wheat flour or corn meal
- Some salt, maybe about 1/4 tsp.
- Some water, varies, enough to make a dough

### Preparation:

1. Mix the mesquite meal, flour or corn meal, and salt together
2. Add water till you have a nice soft bread dough consistency.
3. Cover the bowl and let sit overnight.
4. Next day heat up a heavy cast iron griddle or skillet put in a bit of oil and spread it around.
5. Take a ball of dough (walnut size to tennis ball size depending on how big a cake you want) and roll it out on a corn-meal-dusted board to the thickness you like..
6. Cook till golden brown on both sides.
7. You can serve spread with honey, or you can roll it up with beans inside and call it a burrito.

**Note:** If you don't have any mesquite trees handy, you can get the meal online from [Cocinadevega.com](http://Cocinadevega.com) or [desertusa.com](http://desertusa.com)

**Servings:** Two

Thank you Suzanna for sharing Mesquite Cakes with us!

---

---

[Return to Food & Recipes Menu](#)

---



**Text and Graphics**  
© 1994 - 103 [Tara Prindle](#)  
unless otherwise cited.



## Native American Technology and Art



# Mohawk Corn Bread



---

Offered by Gordie Soaring Hawk  
~ Mohawk, Six Nations of the Grand River, Ontario Canada ~

.. who learned this from my grandmother and great-uncle, Six Nations, Grand River

---

### Ingredients:

- Corn flour [masa harina works really well if you can't get the real stuff from the bush], about 2 lbs
  - Salt, to taste
  - [2] No. 303 cans kidney beans
  - Big Kettle of boiling water
- 

### Preparation:

- Mix the flour and about 1 Tablespoon salt with the beans and some water till you form a stiff dough, kneading it with your hands.
- Form into flattened cakes about 6 inches in diameter, and about 2 inches thick.
- Boil in the water in a covered kettle till they rise [about 1 hour]
- Lift out of the kettle, slice and serve with butter.

*Note: When you serve with squash, you are sharing the gifts of the 3 Sisters. The corn bread is good the next day as well. Fry in a pan and serve hot. My grandparents used to eat it with maple syrup, and my great-uncle said the broth used to cook the bread was good for you as well. That idea didn't catch on with me, but the maple syrup wasn't bad. I still prefer savory to sweet when it comes to eating corn bread!*

---

*Thank you Gordie Soaring Hawk for sharing Mohawk Corn Bread with us!*

---

[Return to Food & Recipes Menu](#)

---



Text and Graphics  
© 1994 - 103 [Tara Prindle](#)  
unless otherwise cited.

## Native American Technology and Art



# Navajo Fry Bread

---

Offered by Mary Harris  
~ Cherokee ~

...who learned this from Navajo friends in Cortez, Colorado

---

### Ingredients:

- 6 Cups Unsifted Flour
- 1 Tbls. Salt
- 2 Tbls. Baking Powder
- 1/2 Cup DRY Milk
- 2 2/3 Cup Warm Water
- Lard for Frying.

---

### Preparation:

- Mix together dry ingredients
- Mix in water & knead on floured surface 'till it isn't sticky anymore.
- Then I usually put the dough in a plastic bag or wrap with plastic wrap to keep the dough from drying out. Heat lard in cast iron frying pan, but don't let it smoke!
- Pull off a piece of dough about the size of an egg & shape into about a 9 inch round.
- Poke a hole in the middle & add to hot lard & fry on each side until golden.
- Drain on paper towels ( I use pieces of brown paper bags, it's cheaper & works just as



**well!!)**

*Note: Don't ask me why this recipe has dried milk in it!!! It's great so I have never questioned it!! I always use lard, though if you are worried about how healthy this is, you could use oil.*

---

*Servings: Eleven +*

---

*Thank you Mary Harris for sharing Navajo Fry Bread with us!*

---

[Return to Food & Recipes Menu](#)

- [Napalitos \(Prickly Pear 2\)](#) 4/12/98

## Native American Technology and Art



## New Native Frybread

---

**Offered by Cheryl Joy Hill**

**~ Lower Brule Sioux, Bernice Rencountre Swick was my mother ~**

**...her own recipe**

---

### **Ingredients:**

- **2 cups flour**
  - **3 teaspoons baking powder**
  - **1 teaspoon salt**
  - **1/2 cup dry milk**
  - **1 egg**
  - **1 cup warm water**
- 

### **Preparation:**

- **Mix the dry ingredients together, mix the egg and the water, add to the dry mixture.**
- **Add flour or water to adjust mixture to a very soft dough mixture.**
- **Put dough on a well floured board.**
- **Roll out to about a 1 inch thickness.**
- **Let set for about 15 minutes.**
- **Cut into what ever size you would like, I like to do mine in smaller pieces for dipping into wojapi.**

- **You could get about 24 pieces out of this batter.**
- **Deep fry in hot oil, just enough to brown on each side.**
- **Put on a paper towel to get some of the top oil off the bread.**

*Note: I found that when making frybread, it is better to make one batch at one time. My family likes to dip the frybread in wojapi made from blueberries.*

---

*Servings: Two*

---

*Thank you Cheryl Joy Hill for sharing New Native Frybread with us!*

---

**[Return to Food & Recipes Menu](#)**

- **[Napalitos \(Prickly Pear 2\)](#) 4/12/98**



## Native American Technology and Art



# Nupa Acorn Soup



---

Offered by **Kimberly R. Stevenot (aka Billierose)**  
~ Northern Sierra Mewuk (Miwok) Tuolumne Rancheria, Tuolumne, CA ~

**...Who's family has been making it for generations**

---

### **Ingredients:**

- **Black Oak Acorns - cleaned about 20 pounds**
- **Water**
- **Cedar or redwood bows**
- **A lot of time and hard work**

---

### **Preparation:**

- **Acorns are gathered in the fall, right now we are in the peak of the season. Usually the first fall of acorns we disregard. They are normally the wormy ones. Sometimes we will gather these "Pehepes", and use them in our dance regalia. These "Pehepes" are acorns that have been infested with worm larve, and they make the acorns form looking like hunchbacks. They make interesting necklaces and there is a story about "Pehepes" and why we use them, but that again is another chat...**
- **My family and I have been known to gather tons of acorn. In the past my Great Aunt Mary had a room in her house where we would deposit all of the acorn we gathered. This was a 10'x12' room, with a four foot board across the doorway. This room was always full of acorn. As children we used to fight for the right to jump into the acorn and stir them up. Anyone bigger than a child would crack the hulls. This had to be done twice a week so that moisture didn't build up and that the acorn dried properly. Traditionally our people stored acorn in 'Chukas', acorn graineries made of cedar and California laurel. These are cylinder in shape and raised above the ground on stakes about three feet. Lacking a**

spare room for my acorn, I store mine in gunny sacks and hang the filled bags from the rafters in my garage. My sisters living on the rez, use the huge army surplus bins my parents bought. They keep them covered and stir them twice a week. No matter how you store your acorn it is essential that you add a generous amount of California laurel with the nuts. Laurel or bay leaf is a natural insect repellent and keeps the bugs away from the acorn.

- We let the acorn dry or season at least for a year, this assures that the nuts are well dried. We then crack and hull the acorns. We then spread the acorn meats to allow any additional drying. On the acorn is a red skin, the skin is thicker in the crevices of the nut, it is very important that all of this skin is removed. Otherwise when cooked it is like trying to swallow the chewy part of popped corn. When the nuts are dried this red skin has a tendency to really cling to the nuts. If you sprinkle a little water on them when they are dry it lifts the skin making it easier to remove. We use an open twined winnowing tray in this process of removing the husk skin.
- Once the acorn is cleaned thoroughly and dry, we begin the hard work. The acorn now needs to be pounded. It is not ground. We do not have grinding rocks, we have pounding rocks. We also have granite mortars and pestles. The pestles are raised above the hole in the mortar rock and allowed to slide through your hands into the acorn in the mortar. Some folks use a 'hopper basket' which catches the acorns as they hop up and allows them to roll back into the mortar. The basket is a conical shape, like a funnel. Of course this is a very time consuming process and you develop wonderful arm muscles. But, let's face it folks, this is 1998. Today for smaller batches you can use an electric coffee grinder, a Veggiemeal, mill and juicer works wonders for medium batches. For large batches like my sister and I do, we use an electric flour mill. The acorn flour should have the consistency of wheat flour mixed with very fine corn meal.
- Once you have your flour ground, you can begin your next step. This process is called leaching. In this step you are washing out the tannic acid in the flour. Tannic acid is bitter to taste, if you can digest enough it is toxic. Only cattle, pigs, deer and rodents are known to eat them raw. Though in California there are documented cases where in a heavy acorn fall cattle ate too much acorn and dropped dead in the pasture.
- Traditionally we would go to the nearest stream and find a sandy area. Here we would form out a leaching bed and spread out the acorn flour on top of the clean sand. We would then form a channel bringing the water to the bed and allowing a steady stream to flow over the acorn. Cedar bows are used to allow the incoming water to flow evenly over the flour. You would allow this to continue for at least 8-10 hours, depending on how much and how deep the flour is, after 8 hours you would make a taste test to determine if it was ready. Today we have a raised table made of boards and chicken wire, which we cover with a thick bed of fresh pine needles, and then a clean cotton sheet. On top of this we spread the acorn flour and leach it using a water hose placed on top of a spread of fresh cedar bows. It still takes 8-10 hours. When the leaching process is complete, the flour will no longer have a bitter taste, but rather a slightly sweet taste. When it is ready we pick it up off the leaching bed. It comes up like globs of wet clay. Using the traditional method of a sand bed you would gently wash off any sand with water. Because acorn is high in oils not much adheres to it.
- The leached acorn flour is then mixed with water, usually a 2-1 ratio for a thick soup or a 3-1 ratio for a thinner soup. This is an approximate measure, as my sister and I mix the flour and water with our hands and know what we are looking for. My sister and I still cook acorn in the traditional method,



using baskets and hot rocks. The baskets used for cooking are three rod coiled cooking baskets. They are water tight. In order to use these baskets for cooking they must be soaked in water overnight. This allows the basket material to soak in the water and makes the basket water tight. Before cooking acorn we take a little of the leached flour and rub it into the weave of the basket to assure no leakage. We then mix the leached acorn flour with water in the basket.

- The morning we are going to cook the leached acorn we build a large fire in the cooking fire pit. The fire is built upon a stack of cooking rocks. They can be either basalt rocks or soapstone any other type of rock will burst and crumble. Whatever you choose to use, you always count them before building your fire. Your fire is a clean fire, built of clean wood. No use of petroleum products to start your fire, and never, never throw trash of any sort into a cooking fire. We use only oak or manzanita wood, as these are hot burning woods and leave little ash. We keep this fire burning hot for at least a couple of hours.

- When we are ready to cook, the cook's helper will lift the cooking rocks out of the fire one at a time, using large sticks called 'pinita', they resemble oversized chop sticks, made of young cedar or oak saplings. Each rock is dipped into a vessel of water to wash off the ash, then a second vessel to assure it's cleanliness. The rock is then placed on the cooks waiting cooking paddle or stirring loop. The cook then gently lowers the rock into the mixed acorn flour, one at a time. It takes approximately four to six rocks the size of an adult fist to bring a basket full of acorn soup to a full rolling boil. The cook keeps the rocks in constant motion. This assures that the basket is not scorched or burned. This cooking process takes about 15-20 minutes. The baskets used are about as large if not larger than a large stock pot. This is a very efficient method of cooking. When the acorn soup, or 'nupa' is done, the cook removes the hot rocks from the soup. Sometimes the cook will drop the rocks onto clean cedar bows and allow the acorn adhered to it to bake, making what my kids call acorn chips. Other times the cook dips her hand into clean water and cleans off each rock as she takes it out of the soup then drops it onto the earth to allow it to cool and bake clean itself. This is how we cook acorn soup, or 'nupa'. The other way we serve it is in little water dumplings or 'ulay'. For this we cook the acorn into a very thick soup, when it is done cooking we use a small basket and individually dip a basketful of the thick acorn soup into very cold running water. It immediately solidifies into like a gelatin dumpling. Many elders prefer this older style of cooked acorn. This is how my people, the Northern Sierra Mewuk (Miwok) prepare acorn. Acorn is high in protein and contains almost every essential vitamin. This we know because we had to have it analyzed before the doctors at Oak Knoll Naval hospital my grandmother was in prior to her passing would allow her to have it. They were amazed at it's

*Note: A little background on myself: Here in California I am referred to as a Traditionalist, that is I still practice the traditional ways and ceremonies of my people. I am a basketweaver, I make coiled and twined Mewuk (Miwok) baskets. I am a founding Board Member of the California Indian Basketweavers Association, and served on the Board for the last eight years. I am an artist, I work with oils, acrylics, pastels, watercolors, pencil and pen. I make jewelry, a view of my work can be seen in the May 1997 issue of Ornament Magazine in an article announcing the opening of a Beadwork show at the American Indian Contemporary Arts Gallery in San Francisco. For those of you who are wondering what I look like, if you have a copy of the Time/Life Series, Indians of America, in the Indians of California book, you can see me, on page 54, there is a photo of me cooking acorn.*



**Servings: Eleven +**

---

*Thank you Kimberly, for sharing Nupa Acorn Soup with us!*

---

[Return to Food & Recipes Menu](#)

---



**Text and Graphics**  
© 1994 - 103 [Tara Prindle](#)  
unless otherwise cited.



## Ojibwa Bannock

Offered by Judith (Keesic) Martin

~ Lac Seul Band in Ontario, Canada but I live in Bear, Delaware USA ~

... who learned this from My Gookum and mother

### Ingredients:

- 4 cups flour
- 4 Tbs. baking powder
- 1 tsp. salt
- 4 Tbs. fat (animal lard or shortening)
- 2 cups water

### Preparation:

1. Preheat oven to 350 degrees.
2. Grease a 9x12 (rectangle) cake pan
3. Stir flour, baking powder, and salt together thoroughly.
4. Cut in (room temperature) fat to flour mixture until pea sized lumps are formed in flour. Make a "lake" in the flour and pour water in your "lake." Mix gently with fork until a nice and sticky dough is formed. Place in greased pan. Pat down with hands softly.
5. bake in oven for about an hour and a half or until cooked in middle. A nice golden brown color should be on top.
6. Important!! place out of pan on towel, leaned up on its side against a pot to cool. (Gookums instructions!)
7. Break pieces off with hands and eat with butter, lard, or margarine.

**Note:** My family loves this bread. My auntie Keesic makes it with raisins or dried blueberries stirred into mixture before baking. A very traditional recipe for northwoods natives who use cook out-of-doors allot. They would use a frypan on the fire and flip the bread to cook both sides. My Father who is 100% Ojibwa loves to eat bannock sandwiches with a slice of lard and sweet onion.

**Servings:** Five-Ten

Thank you Judith for sharing Ojibwa Bannock with us!

---

[Return to Food & Recipes Menu](#)

---



**Text and Graphics**  
© 1994 - 103 [Tara Prindle](#)  
unless otherwise cited.





## Ojibwe Fry Bread

---

Offered by Marilyn Yon

~ Bay Mills Chippewa, Bay Mills Indian Community, Brimley, Michigan ~

... who learned this from a friend from Lac du Flambeau reservation

### Ingredients:

- Self rising flour
- Buttermilk

### Preparation:

1. Mix together to form a dough.
2. Roll out dough and cut in strips or pat into circles
3. Fry in shortening.

**Servings:** Two

Thank you Marilyn for sharing Ojibwe Fry Bread with us!

---

[Return to Food & Recipes Menu](#)

---



Text and Graphics  
© 1994 - 103 [Tara Prindle](#)  
unless otherwise cited.



## Ojibwe Fry Bread

---

Offered by Bobby

~ Ojibwe White Earth Rez ~

... who made it up

### Ingredients:

- Flour any amount
- Sugar
- Salt
- Baking powder
- Warm water

### Preparation:

1. Mix all together until thick and kinda dry
2. Place in mixing bowl and place a paper towel on top and sit for 30 min.
3. Get a frying pan that's kinda deep and place some oil in it (preferably vegetable oil) and pull a medium amount size of dough and flatten it
4. Put it into pan and cook until golden brown

**Servings:** Two

Thank you Bobby for sharing Ojibwe Fry Bread with us!

---

[Return to Food & Recipes Menu](#)

---



**Text and Graphics**  
© 1994 - 103 [Tara Prindle](#)  
unless otherwise cited.



## Native American Technology and Art



# Shot Gunn's Mille Lacs Ojibwe Style Fried Bread

---

Offered by Charlene Shingobe

~ Mille Lacs Band of Ojibwe, Minnesota ~

... who learned this from my Grandmother

### Ingredients:

- Four (5 lb. Bag)
- Salt (Approximately 1 Teaspoon)
- Baking Powder (2 Teaspoons)
- 2 Cup Water (Warmed)
- 1 Cup Milk (Warmed)
- Lard (1 lb.)

### Preparation:

1. Put the entire amount of Flour into a large mixing bowl.
2. Make a well in the middle of flour. Pour in the warmed liquids
3. Add the salt and baking powder.
4. Mix with a large spoon slowly adding in flour from the sides (similar to mixing a cake by hand). Keep adding flour until you feel you can start to knead it by hand.
5. Knead until it doesn't stick to your hand. Then let the dough rest for 1/2 hour.
6. Beak off golf ball size of dough and put on a floured plate.
7. Heat the lard in a large cast iron skillet.  
*Note: To test the temperature of the lard, sprinkle drops of water on the lard. If it dances quickly, the bread frying is ready to begin.*
8. Flatten your individual balls of dough and fry on both sides to a golden brown.
9. Adjust your heat as needed.

Servings: Five-Ten

**Thank you Charlene Shingobe for sharing Shot Gunn's Mille Lacs Ojibwe Style Fried Bread with us!**

---

**[Return to Food & Recipes Menu](#)**

---



**Text and Graphics**  
© 1994 - 103 **[Tara Prindle](#)**  
unless otherwise cited.

## Native American Technology and Art



# Pemmican



---

Offered by Lauren  
~ No Tribal Affiliation ~

...who learned this from friends

---

### Ingredients:

- beef jerky
  - suet (enough to hold ingredients together)
  - Dried berries, 1/4 as much as jerky (Blueberries or billberries are good)
- 

### Preparation:

- Shred the jerky finely with a sharp knife. be careful, this can be hard.
- If the berries are big chop them up too.
- Melt suet and combine all ingredient to make soft blob.
- Pour into a leather bag and cut off chunks when you need them.
- Or pour into a pan lined with tinfoil and when cool, unmold and cut into bars.
- Store in the fridge.

*Note: This is very good for cold weather. to make a quick soup, drop a piece into boiling water and serve with fry bread.*

---

---

*Thank you Lauren for sharing pemmican with us!*



---

---

[\*Return to Food & Recipes Menu\*](#)

---



Text and Graphics  
© 1994 - 103 [Tara Prindle](#)  
unless otherwise cited.

Native American Technology and Art



# Pinto Bean Fry Bread



---

Offered by Offered by Ida  
~ the Lowery tribe, Tennessee ~

...who learned this from Cherokee, Apache Indian Grandmother

---

## Ingredients:

- 2c. Flour
  - 1 Tbsp. Baking Powder
  - 1 Tsp. Salt
  - ¼ Tsp. Black Pepper
  - 2c. Pinto Beans With Broth
- 

## Preparation:

- Place the pinto beans in a bowl and mix in the salt, baking powder, and black pepper.
- Add enough of the flour to make a thick mixture.
- Heat frying pan, add a tablespoon of lard.
- Spoon in mixture like small pancakes, brown on both sides.

*Note: Goes well with potatoes and ham chunks along with Indian fry bread.*

---

**Servings: Three - Four**

---

*Thank you Ida for sharing Pinto Bean Fry Bread with us!*

[Return to Food & Recipes Menu](#)

---



Text and Graphics  
© 1994 - 103 [Tara Prindle](#)  
unless otherwise cited.



## Native American Technology and Art



# Rao's Fried Bread Biscuits

---

Offered by Astai'yi  
~ Southeast Kituwah Nation ~

...who learned this from Vgilisi (my grandmother), a variation on her recipe.

---

### Ingredients:

- Flour (self rising preferably)
  - Water
  - Canola or another polyunsaturated oil
- 

### Preparation:

- Mix the flour and water together as you would for frybread.
- After mixing, add enough flour to knead the dough without making the dough too "dusty".
- Put some flour on your fingertips and flatten the dough into thin "biscuits", about 3/8 to a half inch thick.
- They will rise, so be careful!!
- Take these and drop them in preheated oil.
- Check your oil temperature as you would when you make your frybread, and fry on each side for about 2 minutes.
- Take the ponies out and drain the little bit of oil on them off.
- Let them cool and top them with either powdered sugar, jam or your fave topping.

*Note: These are pretty good, especially in winter 8o)*

---

*Servings: Depends on how many you want to feed.*

---

*Thank you Astai'yi for sharing Rao's Fried Bread Biscuits with us!*

---

[\*Return to Food & Recipes Menu\*](#)

---



Text and Graphics  
© 1994 - 103 [Tara Prindle](#)  
unless otherwise cited.



## SaSaKah's Potawatomie Fry-bread

Offered by Kimberly "SaSaKah" Wilson

~ Kickapoo / Potawatomi ~

... who learned this from Family (but after time I make it my own way)

### Ingredients:

- 5 c. Flour
- 5 tbs. Baking powder
- 2 1/2 c. Milk
- 1/2 c. Sugar

### Preparation:

- Mix all ingredients together in a Lg. mixing bowl (Mix well). Cover mixing bowl w/ a towel & let the mixture set for 30 min.
  - While mixture is setting, get a deep frying pan and put in enough shortening to submerge the dough in. set stove on medium-hi. when mixture is finished setting, get a regular size bowl & put flour in it.
1. Put a spoonful of the mixture in bowl of flour, roll around in flour, take out and pat it out w/ your hands. You may put a slit in the middle if you wish.
  2. Then drop in frying pan. let it fry 1 min. on each side, or until each side is golden brown. (BE CAREFUL HOT GREASE!!!!) follow each step until mixture is gone.

**Note:** Fry bread good for any occasion: Powwows, rez get-togethers, reunions, parties, 49's or just a simple evening dinner. \*\*\*also tastes good w/corn soup or chili!\*\*\*

**Servings:** Eleven +

Thank you Kimberly "SaSaKah" Wilson for sharing SaSaKah's Potawatomie Fry-bread with us!



[Return to Food & Recipes Menu](#)

---



Text and Graphics  
© 1994 - 103 [Tara Prindle](#)  
unless otherwise cited.

## Native American Technology and Art



# Slammin' Frybread

---

Offered by A Friend

~ this originated at Nooksack grandma's house on Friday nights! ~

... who learned this from Nooksack Grandma

---

### Ingredients:

- 4 cups flour
- 4 tbs. baking powder
- 1 tsp. salt
- 1/3 cup oil(vegetable)
- 1 cup warm water (add as needed)
- 1 egg
- 1 1/2 spoonfuls sugar
- Oil deep enough for frybread to float, eh!

---

### Preparation:

- Ok I find being prayerful and full of love the first ingredient you need, so get some of that.....
- In a good size bowl mix flour, bakin' powder, and salt real good add all ingredients in the middle of bowl (seems to work better).
- In a good size cup get warm water, sugar and egg; mix together. It really has to be beaten really good so the mixture looks bubbly (full of some air) - then let it settle.
- Add that to flour and start to knead, adding more warm water as necessary.
- You want the cooking oil @ 350 degrees, start heating it up. when dough is just done getting kneading. So dough is kneaded real good, right! of course right....

- Pull fist size balls of dough and roll into balls (dough should be sticky yet doesn't stick to hands...). put them in bowl, let stand for ten minutes (that's when I start making wojapi, or cutting up what I need for tacos!! \*smile).
- When oil starts talking and ten minutes have passed, get a ball and flatten it reeeeeeal good, take your time, some say this is where it all happens, put hole into dough and drop into oil, it should float right away, and flip it over until both sides are golden brown.
- Finish all the breads up and when they're done cooking put em' in a towel or something to keep them warm, and drain excess oil.....
- And there it is, some slammin' frybread! uuuuuweeeeee!

*Note: Note: If bread isn't cooked right it is too doughy, if it is cooked right it is fluffy and tasty, and just right for the whole families bellies...so take your time and realize it takes time to get a good frybread recipe down....no worries - eh!*

*Oh, the reason we added an egg was this, my father tells me it is so funny the way people make white bread, it has no substance, so put the egg in it so some goodness goes in, some protein, so it isn't empty bread....this I believe to be true!*

---

**Servings: Three - Four**

---

*Thank you friend for sharing Slammin' Frybread with us!*

---

[Return to Food & Recipes Menu](#)

---



!-- eden -- ureach.com -->

Text and Graphics  
© 1994 - 103 [Tara Prindle](#)  
unless otherwise cited.



## Native American Technology and Art



# Spoon Bread



---

Offered by Corissa Dewitt

~ Colorado, my great grandmother was pure Cherokee ~

..... who learned this from a friend who is very interested in Native American Recipes.

---

### Ingredients:

- 1 Cup Cornmeal
- 2 Cup Milk
- 3 Egg Separated
- 1 Cup Of Very Cold Milk
- 1 Teaspoon Salt
- 1 Teaspoon Baking Powder
- 1/2-1 Cup Chopped Green Chilies (Canned)

---

### Preparation:

- In a saucepan, stir 2 cups milk into cornmeal.
- Cook, stirring constantly until very thick.
- Stir in 1 cup milk, butter, and baking powder.
- Stir about 1 cup of this mixture into beaten egg yolks.
- Return all to saucepan.
- Gently fold in egg whites (stiffly beaten) and chilies.
- Remove from heat.
- Bake in a 235 degree oven for 50 minutes in greased, 2-quart casserole (loaf pan).
- Immediately slice and serve with butter and green chili taco sauce, can add fried eggs to the side.

*OPTION: grate cheddar over sauce.*

*Thank you Corissa Dewitt for sharing Spoon Bread with us!*

---

[Return to Food & Recipes Menu](#)

---



**Text and Graphics**  
© 1994 - 103 [Tara Prindle](#)  
unless otherwise cited.

## Native American Technology and Art



# Stuffed Fry Bread



---

**Offered by Diann Love**  
~ Cherokee - California ~

**.. who learned this from myself**

---

### **Ingredients:**

- **Self rising flour**
- **Warm water**
- **Ground beef 2-3 pounds**
- **Taco seasonings 2 packs**
- **Salsa 1 medium jar**
- **Grated cheese**
- **Onion large**
- **Canned chopped tomatoes 2 cans**

---

### **Preparation:**

- **Cook your meat drain it good, put in onion chopped, salsa, taco seasonings, and canned chopped tomatoes.**
- **Let this cook for 5-7 minutes till most of the sauce is gone let it cool down for 15 minutes.**
- **Make your fry bread with flour and water has to be like biscuits.**
- **Roll out each fry bread - roll it out as usual.**
- **Put spoonful of (depends on size of fry) bread meat mixture with cheese into each fry bread take water to seal the bread edges. Make sure it is together good or else it will open up (then you have a mess).**



- Then deep fry as you would your fry bread.

*Note: It is a big hit at gatherings.*

---

**Servings: Five-Ten**

---

*Thank you Diann Love for sharing stuffed fry bread with us!*

---

[Return to Food & Recipes Menu](#)

---



Text and Graphics  
© 1994 - 103 [Tara Prindle](#)  
unless otherwise cited.



## Taco Rice

---

Offered by Cheryl Joy Hill

~ Lower Brule Sioux Tribe ~

... who got this recipe from one of my sisters.

### Ingredients:

- 1 pound ground beef (you may use ground buffalo or ground turkey)
- 1 pkg. (1-1/4 oz.) taco seasoning mix
- 1 small can of tomato sauce
- 1 14 oz. can of chopped tomatoes
- 2 cups minute rice (prepare as per directions on the box)
- 1 pound cheddar cheese shredded (you can use your favorite cheese)
- 1 large bag of Doritos (crushed)

### Preparation:

1. Brown meat in large skillet on medium-high heat. Drain.
2. Add tomatoes and seasoning mix to skillet, simmer for about 5 minutes.
3. Mix the meat mixture and rice together.
4. Spray a large baking dish or 9 x 13 cake pan with oil.
5. Begin layering the ingredients. First the rice mixture, then the cheese, and then the crushed taco chips.
6. Make another layer. Cover with foil, the heat from the rice mixture will melt the cheese.

**Note:** It is ready to eat! Kids of all ages absolutely love this taco rice! As time goes by, you can doctor this recipe up with all kinds of your favorite things, mushrooms, sour cream, black olives, and many more. Enjoy!

**Servings:** Five-Ten

Thank you Cheryl for sharing Taco Rice with us!

---

[Return to Food & Recipes Menu](#)

---



Text and Graphics  
© 1994 - 103 [Tara Prindle](#)  
unless otherwise cited.

## Taco Rice

Offered by Cheryl Joy Hill

~ Lower Brule Sioux Tribe ~

... who got this recipe from one of my sisters.

### Ingredients:

- 1 pound ground beef (you may use ground buffalo or ground turkey)
- 1 pkg. (1-1/4 oz.) taco seasoning mix
- 1 small can of tomato sauce
- 1 14 oz. can of chopped tomatoes
- 2 cups minute rice (prepare as per directions on the box)
- 1 pound cheddar cheese shredded (you can use your favorite cheese)
- 1 large bag of Doritos (crushed)

### Preparation:

1. Brown meat in large skillet on medium-high heat. Drain.
2. Add tomatoes and seasoning mix to skillet, simmer for about 5 minutes.
3. Mix the meat mixture and rice together.
4. Spray a large baking dish or 9 x 13 cake pan with oil.
5. Begin layering the ingredients. First the rice mixture, then the cheese, and then the crushed taco chips.
6. Make another layer. Cover with foil, the heat from the rice mixture will melt the cheese.

**Note:** It is ready to eat! Kids of all ages absolutely love this taco rice! As time goes by, you can doctor this recipe up with all kinds of your favorite things, mushrooms, sour cream, black olives, and many more. Enjoy!

**Servings:** Five-Ten

Thank you Cheryl for sharing Taco Rice with us!



## Native American Technology and Art



### Wild Rice

---

Offered by Cindy  
~ Passamaquoddy ~

...who learned this from her Grandma.

---

#### Ingredients:

- Wild rice
  - Cranberries
  - New cattail buds or roots, water chestnuts or crunchy somethings. Whatever is available. (i usually use canned water chestnuts 'cuz they're available year round.)
  - Turkey broth
  - Sage
  - Salt & pepper to taste if you like that
- 

#### Preparation:

- Boil up some wild rice in turkey broth
- When it is almost done, add the sliced crunchy somethings and a handful of fresh cranberries. (no sugar!)
- Add what herbs you like, a little sage perhaps, etc.

**Note:** The thing to remember is to only add enough water to cover the rice and keep an eye on it so it doesn't dry up.

**Servings: Five to Ten**

---

*Thank you Cindy, for sharing Wild Rice with us!*

---

**[Return to Food & Recipes Menu](#)**

---



**Text and Graphics  
© 1994 - 103 [Tara Prindle](#)  
unless otherwise cited.**

## Native American Technology and Art



# Wild Rice Breakfast

---

Offered by Pierre Girard  
~ Ojibwe ~

...who learned this from Turtle Woman

---

### Ingredients:

- Wild rice
- Maple Syrup or Maple Sugar
- Raisins, blueberries or raspberries
- Milk (optional)

---

### Preparation:

- Cook the rice until it is soft and the kernels break open.
- Flavour with fruit, maple syrup or maple sugar and, if so desired, add milk.

*Note: If you would like to eat it cold, cook the rice the night before.*

---

*Thank you Pierre Girard, for sharing Wild Rice Breakfast with us!*



---

[Return to Food & Recipes Menu](#)

---



Text and Graphics  
© 1994 - 103 [Tara Prindle](#)  
unless otherwise cited.

## Native American Technology and Art



# Wild Rice Casserole

---

Offered by Lead Goose  
~ Chippewa - Lac du Flambeau, Wisconsin ~

...as adapted from Marlene Benner in the American Indian Society Cook Book of 1975

---

### Ingredients:

- 1 cup wild rice ( thoroughly washed under cold water in a mesh strainer).
- 3 cups hot chicken broth
- 3 tbs. chopped onion
- 3 tbs. chopped green pepper (I often use a mix of red, green and yellow for color).
- 1/2 stick margarine

---

### Preparation:

- Heat margarine in a frying pan over low heat. Saute onions and peppers.
- Add the wild rice and blend all together.
- Transfer to a casserole dish and add chicken broth.
- Cover and bake at 350 degrees for 45 minutes or until all liquid is absorbed.

*Note: Try other variations to compliment your entree. The basic goes well with chicken and turkey. I add chopped walnuts or cashews for holidays, beef broth with roast beef. Three cups of water with a couple strips of bacon goes well with pork roast. Garnish with parsley or cilantro for color. I even added shredded*

*cheese to go with a veal dish. Have fun.*

---

**Servings: Three - Four**

---

*Thank you Lead Goose, for sharing your recipe with us, and for the your own variations!*

---

**[Return to Food & Recipes Menu](#)**

---



**Text and Graphics**  
© 1994 - 103 **[Tara Prindle](#)**  
unless otherwise cited.



## Native American Technology and Art



# Wild Rice Deluxe

---

**Offered by Alexandra Perswain (with the help of Verna Pashe)**

**~ I am an Ojibway from the Long Plain First Nation of Manitoba ~**

**... who learned this from Cooking for many feasts**

### **Ingredients:**

- **1 Package Wild Rice (Generally Come In A Bag)**
- **1 Large Can Of Mushroom Soup (Family Size And Condensed)**
- **1 Package Of Bacon**
- **Fresh Sliced Mushrooms (About 20 Medium)**
- **Chopped Onion (Optional)(About One Medium)**
- **Chopped Celery**
- **Plenty Of Water**
- **Pinch Of Salt**
- **Large Roasting Pan (Like One For A Turkey)**
- **Oven (Of Course)**

### **Preparation:**

1. **Cook your rice until it pops open.**
2. **Change the water one or two times during this process.**
3. **Do this slowly, or the rice will get mushy.**
4. **While this is occurring take your bacon and slice it into little squares and fry just until cooked (not crispy) then add your fresh sliced mushrooms and onion and celery ( the onions and celery are not necessary) if you like. Fry slowly for about a half hour and then set aside.**
5. **Preheat the oven to 350 degrees Celsius**
6. **Once you have these three things done, take your rice, the fried preparation, mushroom soup,**

- water (equal to soup) and mix them together in the roasting pan. Mix well.
7. Pop it into the oven and cook for about 1 to 1 and half hours.
  8. Stir before serving and Enjoy.

*Note: Do not feed this to animals, it would be a great disrespect to do so.*

*Additionally, it is important to hone your skill at this. Your first preparation may not be attractive, but it will still taste wonderful. You must find your own method for success.*

**Servings: Five-Ten**

**Thank you Alexandra Perswain (with the help of Verna Pashe) for sharing Wild Rice Deluxe with us!**

---

**[Return to Food & Recipes Menu](#)**

---



**Text and Graphics**  
© 1994 - 103 **[Tara Prindle](#)**  
unless otherwise cited.

## Native American Technology and Art



# Wild Rice Pancakes

---

Offered by Adam Kopels

~ A chef interested in Native American food/culture ~

...who made this up

---

### Ingredients:

- 2 cups Wild Rice Cooked and Cooled
  - about 2 Eggs
  - 3/4 cup chopped Green Onions
  - Salt and Pepper
  - Sunflower Oil
- 

### Preparation:

- Mix the cooked rice, onions, and eggs (beaten).
- Heat a skillet, add oil to coat bottom generously (about 1/4 in. deep).
- When skillet is very hot add mixture to make cakes about 3 inches wide.
- Flatten cakes with a spoon or spatula.
- Flip when edges are browned.
- Drain on paper towels.

*Note: Add just enough egg to bind or you will have a rice omelette!*



**Servings: Two to Four**

---

*Thank you Adam, for sharing Wild Rice Pancakes with us!*

---

**[Return to Food & Recipes Menu](#)**

---



**Text and Graphics**  
**© 1994 - 103 [Tara Prindle](#)**  
**unless otherwise cited.**



## Wild Rice Soup

---

Offered by W Northrup/Diver

~ bear clan, Fond du Lac, MN ~

... who just threw it together at a pow-wow

### Ingredients:

- 1 pound of wild rice
- Boiling beef or deer meat
- 3 tbs. Of beef soup base
- 1 cup of cubed carrots
- 1 cup of potatoes cubed
- Diced up small onion
- 1/2 cup celery

### Preparation:

1. Brown the meat in flour
2. Throw meat kettle and boil for an hour and throw the rest of ingredients in at the same time. You should have a hearty bowl of soup in an hour and half, just check on the potatoes and rice to see if done.

**Note:** beware that if you make this soup there will be people lined up at your door. My mother has many more yummy recipes.

Thank you Diver for sharing Wild Rice Soup with us!

---

[Return to Food & Recipes Menu](#)

---



**Text and Graphics**  
© 1994 - 103 [Tara Prindle](#)  
unless otherwise cited.



## Native American Technology and Art



# "Western" Pemmican



---

Offered by Tall Mountain & Summerwolf  
~ French/Danish/English/Lenape ~

...which was handed down from family & friends

---

### Ingredients:

- 2 cups raisins
  - 2 cups dates
  - Honey (enough for a binder)
  - 2 cups nuts (peanuts, cashews, walnuts, etc.)
- 

### Preparation:

- Grind together all ingredients except honey.
  - Add honey a little at a time, mixing well until moist enough to mold well and hold shape.
  - Pour into a pan until about 3/4 inch thick, or mold directly into bars.
  - Refrigerate and cut off bars from the pan; wrap in aluminum foil.
- *Note: This was originally a cold climate trail food which was very high in fat (suet). The recipe substitutes honey instead of suet for a binder. However, suet can be substituted for a cold weather trip.*
- 

Servings: Five-Ten

---

*Thank you Tall Mountain & Summerwolf, for sharing your version of pemmican with us!*

---

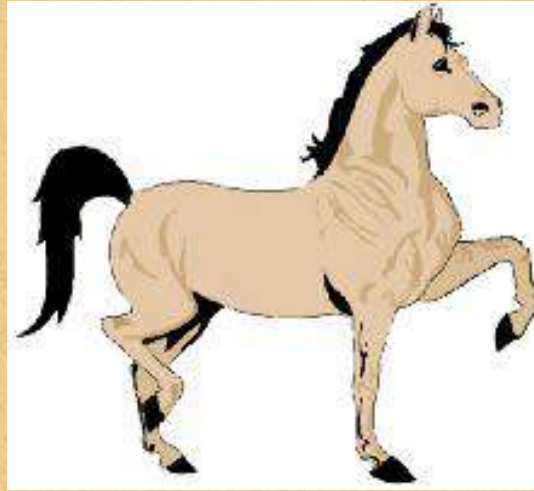
[Return to Food & Recipes Menu](#)

---



Text and Graphics  
© 1994 - 103 [Tara Prindle](#)  
unless otherwise cited.

## Native American Technology and Art



## Horse Tea

---

**Offered by Stacey Bhare**

**~ Chippawa ~**

**... who learned this from my Mom**

### **Ingredients:**

- **8 Cups Boiling Water**
- **7 Horse Tail Hairs**
- **4 Dried Mint Leaves**

### **Preparation:**

1. **Get 7 horse hairs (be careful)**
2. **Put all ingredients in the water**
3. **Strain Drink**

**Servings: One**

**Thank you Stacey Bhare for sharing horse tea with us!**

---

**[Return to Food & Recipes Menu](#)**

---





**Text and Graphics**  
© 1994 - 103 [Tara Prindle](#)  
unless otherwise cited.

## Native American Technology and Art



---

Offered by Cindy  
~ Penobscot ~

...who notes the recipe has Bannock origins

---

### Ingredients:

- Fresh meat (doesn't matter what kind)
  - Potatoes
  - Onions
  - Carrots
  - Salt & pepper to taste
- 

### Preparation:

- Send Hubby out before the crack of dawn. After he traipses around a few days he'll finally get hungry and catch something and bring it home.
  - In the meantime, you've gone on a potato raid at the nearest farm and liberated some spuds & onions.
  - When hubby gets home let him rest while you prep and cook up the catch before the warden finds you.
- 

**Servings:** Depends if the warden gets you before it's through cookin'

---

*Thank you Cindy, for sharing this and other recipes with us!*

---

[Return to Food & Recipes Menu](#)

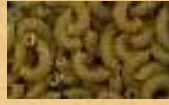
---



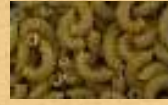
Text and Graphics  
© 1994 - 103 [Tara Prindle](#)  
unless otherwise cited.



## Native American Technology and Art



# Indian Goolosh



---

Offered by Jody Archdale  
~ Sioux Indian from Wolf Point MT ~

...who learned this from her mother.

---

### Ingredients:

- Macaroni
  - hamburger
  - cheese
  - onions
  - a little milk
- 

### Preparation:

- Boil the macaroni.
  - Cook the hamburger.
  - Add the onions to the hamburger while its cooking.
  - Drain the macaroni add the cheese until its melted add some milk so it won't be to dry.
  - Add the hamburger and mix well together and enjoy.
- 

Servings: Five to Ten

---

*Thank you Jody Archdale for sharing Indian Goolosh with us!*

---

[Return to Food & Recipes Menu](#)

---



Text and Graphics  
© 1994 - 103 [Tara Prindle](#)  
unless otherwise cited.

## Native American Technology and Art



# Michelle's Recipe



---

Offered by Michelle  
~ Sioux ~

**...who learned this making this recipe up all by myself. It is very good. I eat this.**

---

### Ingredients:

- 1 c. green beans
- 3 c. spinach
- 1/2 c. rice
- 1 c. strawberries
- 2 c. wild cherries
- 1 c. orange juice
- A truckload of love

---

### Preparation:

- 
- Put all the ingredients in a blue bowl. It must be blue.
- Smash all the stuff together.
- Then roll into a ball.
- Chill in the refrigerator for 20 minutes.
- Then eat and enjoy!

*Note: This is good stuff. Eat it up everyday to be healthy. You will live 4 ever if you eat it every day. Eat spinach to look like Popeye.*

---

**Servings: Five-Ten**



---

*Thank you Michelle for sharing Michelle's Recipe with us!*

---

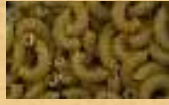
[Return to Food & Recipes Menu](#)

---

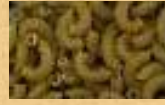


**Text and Graphics**  
© 1994 - 103 [Tara Prindle](#)  
unless otherwise cited.

## Native American Technology and Art



# Minnesota Mac



---

Offered by Offered by Jennie Taylor  
~ Leech Lake, MN ~

...who learned this from my mom

---

### Ingredients:

- Tomato Sauce
  - 2 Cups One Can Whole Tomatoes
  - One Pound Of Ground Beef Or Meat Of Choice Bacon Is Good
  - One Can Of Corn
  - One Can Of Peas
  - 2 Cups Of Mac
- 

### Preparation:

- Brown the beef then boil the mac, drain mac (if you like it soupy don't drain mac) add corn, peas, tomato sauce and the rest of ingredients mix together and serve with fry bread.

*Note: it is good add any thing you would like for example onions, potatoes, etc.*

---

*Thank you Jennie Taylor for sharing Minnesota Mac with us!*

---

[Return to Food & Recipes Menu](#)

---



**Text and Graphics**  
© 1994 - 103 [Tara Prindle](#)  
unless otherwise cited.



## Native American Technology and Art



# Moth Tea, fittingly at that...



---

Offered by Creation.. Alan Skopinski  
~ Little Sioux blood, but not belonging to any tribe... Mother Earth ~

...who learned this himself

---

### Ingredients:

- About 10 dull color NO PATTERN moths (I have found that all dull colored moths are edible, while some with patterns can be slightly poisonous... but if you find otherwise, tell me!)
  - 2 cups water
  - Salt to taste (optional)
- 

### Preparation:

- Pull wings and legs off the moths, don't tear the body!
- Boil 2 cups of water however you can, I like spinning one up, and boiling the water in live oakbark.
- Throw moths in boiling water for 2min.
- Add salt if need be.

*Note: This is high in protien and DARN good tasting. As far as I am concerned, I could drink 1 double the bugs cup as a meal!*

---

*Servings: one*

---

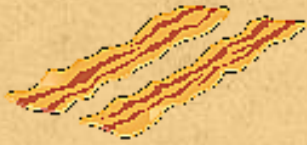
*Thank you Creation.. Alan Skopinski for sharing Moth Tea, fittingly at that... with us!*

[\*Return to Food & Recipes Menu\*](#)

---



Text and Graphics  
© 1994 - 103 [Tara Prindle](#)  
unless otherwise cited.



# Navajo Bacon Surprise

---

Offered by Kyle Nolan

~ Navajo Indians Kim & Mike Nolan ~

... who made it up.

## Ingredients:

- 5 packages of Canadian bacon.
- 2 packages of bacon ( try to buy corn king brand).
- 7 oz. bottle of garlic water.
- Pepper.
- Tomato, radish and carrots.
- Lettuce.

## Preparation:

1. First get a big bowl and cut all of the Canadian bacon up.
2. Next cook all of the bacon and then cut it all up and put them in the bowl.
3. Then pour in about 5 oz. Garlic water.
4. Then cook it on high for about 2:00 minutes (if alot of garlic water is still their cook it a little bit longer).
5. Then put in some lettuce and cut up some of the vegetables and let the vegetables soak in the rest of the garlic water.

**Servings:** Three - Four

Thank you Kyle for sharing Navajo Bacon Surprise with us!

---

[Return to Food & Recipes Menu](#)

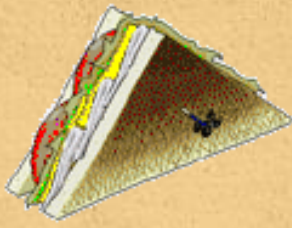
---



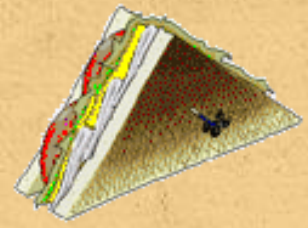
Text and Graphics  
© 1994 - 103 [Tara Prindle](#)  
unless otherwise cited.



## Native American Technology and Art



# Oakis's Favourite Big Mac



---

Offered by Neva Isaac-Sands  
~ Ojibway - Onieda, Walpole Island First Nations ~

...who learned this at home Bkejwanong First Nation

---

### Ingredients:

- 2 Slices of Bread (Fry Bread's Best)
- 1 Thick Slice of All Beef Balogna
- Mustard to Spread.
- Increase amounts of ingredients if your family are big eaters, like Lays potato chips, you can't eat just one!

---

### Preparation:

- Fry balogna in fry pan, Oakis likes his extra crispy. No grease needed, it's all built in to the meat.
- Put on bread and spread mustard on.
- This hit's the spot on any day.

*Note: Take these sandwich's to potluck and watch out you could be trampled. Cut into finger size to make sure there's enough to go around.*

---

*Thank you Neva Isaac-Sands for sharing Oakis's Favourite Big Mac with us!*

---

[Return to Food & Recipes Menu](#)



**Text and Graphics**  
© 1994 - 103 [Tara Prindle](#)  
unless otherwise cited.

## Native American Technology and Art



# Popcorns On Me!



---

**Offered by Offered by Niva Taylor  
~ daughter of Rachel and Ed Taylor ~**

**...who learned this from a cook book**

---

### **Ingredients:**

- **3 Cups Of Popped Popcorn**
- **1 And ½ Cups Maple Syrup**

---

### **Preparation:**

- **Mix popped popcorn with syrup until popcorn is completely covered, then divide in 3 or 4 balls**

***Note: This recipe is delicious! double it and you'll get more. It is so good it might be good for only 1! fun and easy 2 make!!***

---

**Servings: Three - Four**

---

***Thank you Niva Taylor for sharing Popcorns On Me! with us!***

---



[Return to Food & Recipes Menu](#)

---



Text and Graphics  
© 1994 - 103 [Tara Prindle](#)  
unless otherwise cited.

Native American Technology and Art



# Pow-Wow Soup Lakota Style from the Black Hills of South Dakota



---

Offered by Glenn Brave  
~ Oglala Lakota, Pine Ridge Reservation, Jug and LaVina Brave ~

... who learned this from My Mother, LaVina

---

## Ingredients:

- Short Ribs
- Beef Boullion
- Dried Corn
- Onion
- Carrots
- Celery
- Pepper Mill Pepper
- Salt
- Olive Oil or Canola Oil
- Worcestershire Sauce
- Potatoes or Wide Egg Noodles

---

## Preparation:

- Soak the dried corn for a couple of hours before cooking to soften it so it will finish cooking when the soup is done.
- Fill pot with fresh cold water and add dried corn and two or three beef boullion cubes and start to heat water to a boil.
- Trim any large pieces of fat from short ribs and discard. Cut meat into bite size cubes. Save bones. Stew meat can be used as an alterntive in this recepit, but short ribs offer superior taste and texture.
- Heat skillet and add olive or canola oil then add diced short ribs and also throw in bones. Add three or four dashes of worcestershire sauce and fry meat until it browns and is about half done. Just before removing meat from skillet add onions to pan and saute the onions for a couple minutes to enhance the

flavor.

- When meat is browned and onions are complete add to pot of water and bring to boil. Be sure to add the bones to the soup as they make for a rich broth. I purposely leave some meat on the bones because I like to eat the meat directly off the bones.
- At this time add tomatoes. Be careful not to add too many tomatoes as you don't want a soup with a strong tomato taste, only a very slight hint of tomato taste. When I cook soup for my family of three I only add two of the tomatoes from the can. And don't add the tomato juice from the can.
- Dice celery and carrots and add to the soup pot.
- Salt and pepper to taste. I normally go heavy on the pepper. Don't be afraid to add enough salt to soup pot, that way you're not constantly adding salt to your bowl of soup as you are eating.
- Cover pot and lower the temperature to bring soup to a simmer and cook for an hour or two or until the dried corn is tender and meat is done.
- About thirty minutes before soup is finished cooking, peel and quarter potatoes and add to soup pot and cook until potatoes are cooked. You can cook the potatoes or noodles in a separate pot if necessary and add to soup bowls when serving.

*Note: And of course some good ole' Indian Fry Bread is a standard with this recipe and a large glass of Kool-Aid, annet!!*

---

*Servings: Unknown*

---

*Thank you Glenn Brave for sharing Pow-Wow Soup Lakota Style from the Black Hills of South Dakota with us!*

---

[Return to Food & Recipes Menu](#)

---



Text and Graphics  
© 1994 - 103 [Tara Prindle](#)  
unless otherwise cited.



## Native American Technology and Art



## Roast Turtle



---

Offered by Rick Obermeyer  
~ amateur scholar ~

...who learned this ho learned this from traditional Plains

---

### Ingredients:

- one turtle
  - one campfire
- 

### Preparation:

- Put a turtle on his back on the fire.
  - When you hear the shell crack, he's done.
- 
- 

*Thank you Rick Obermeyer for sharing Roast Turtle with us!*

[Return to Food & Recipes Menu](#)

---



Text and Graphics  
© 1994 - 103 [Tara Prindle](#)  
unless otherwise cited.

## Native American Technology and Art



# The Hunter's 'Rock Chuck Extravaganza'!



---

Offered by Cindy  
~ Passamaquoddy ~

...which has Bannock origins - a Fond recipe from my Husband's cooking repertoire.

---

### Ingredients:

- Father and 10 year old son
  - A long sturdy wire with a pigtail twist at one end
  - Rock chuck (marmot) hiding in a hole
  - Fire and fuel
- 

### Preparation:

- Father and son head out late April before the sun rises.
- Go to favorite rock chuck (marmot) territory, (careful not to fall in the holes in the dark!)
- When the sun comes up, stand downwind where you don't block the light over the holes. Be quiet and no stomping!
- Pick off the rock chucks when they come out of their holes.
- If they duck back inside the holes, send 10 year old son after them with the corkscrew twist on the end of a wire.
- Put the wire down the hole and twist. The twisting snags their fur and then you can pull them out. Just like any body getting dragged outta bed rock chucks will holler.
- But with 10 year old boy doing the fishing you might only get a tail instead of the whole rock chuck.
- Take the complete rock chuck (or tail) what ever you caught, gut it and wash it out. Use a willow twig to sew the belly shut and toss it right on the fire. Cook it about 40 minutes. Peel off the rind and munch away.



***Note: Now, the tail might be mistaken for a twig, so don't just chomp on just any old twig you fish outta the fire.***

---

**Servings: Snack**

---

***Thank you Cindy, for sharing The Hunter's 'Rock Chuck Extravaganza' with us!***

---

**[Return to Food & Recipes Menu](#)**

---



**Text and Graphics  
© 1994 - 103 [Tara Prindle](#)  
unless otherwise cited.**



## Rushing Pie

---

Offered by Pokey Stover ( Sharyle Valandra Stover )

~ Member of Rosebud Sioux Tribe ~ Clement Valandra/Mable Shaw (Gran)~

... who learned this from one of my mother's delicious mistakes

### Ingredients:

- 1 head of cabbage
- 1 pound ground buffalo or beef
- 1/2 cup of water.
- 1 pie crust.
- 1 batch of white sauce.
- 1 oven preheated at 375 and able to reduce temp. to 350 and the memory to reduce the heat after 5 minutes pie is in the oven, or pie crust will be black and uneatable for sure.

### Preparation:

1. Use pie crust on top only, if you put any on bottom it won't taste good, trust me voice of experience speaking here.
2. Dice cabbage into bit size bits set aside. Cook ground buffalo (or Beef if you must).
3. Mix ground buffalo and cabbage salty to taste, put in a baking dish, cover with crust. put in oven bake 5 minutes at 375 then turn oven temp. down to 350 bake about 1 hour or until the crust is a golden brown.
4. Make a white sauce : Cream 6 tbs. flour 4 tbs. butter or margarine. Then add 4c. milk. Cook it like you would gravy.
5. When pie and white sauce is done cut the pie in serving size pieces smother with white sauce and dig in. UMMMMMM UMMMM Good.

**Note:** I don't like cooked cabbage except for cooked this way. Mom was making a pie and going to fix stuffed cabbage. Mom was in a big hurry, fixing dinner and she had the buffalo and cabbage in the cake dish and the pie sitting next to it ready to go in the oven, Well she put the crust on the cabbage and put in the oven, the phone rang and she had been talking for a little while and started to smell the cabbage cooking she opened the oven and discovered what she did so she named it RUSHING pie and made a white sauce and we've been making Rushing Pie ever since. I don't know how well you'll like it but if well liked it will feed

about 4 people if not well liked you might have to throw the rest of it away. If very well liked you might have to make a double batch next time. Any one that's wants to reproduce this for their own use go for it and let me know if it was enough or not or if you had to trash some.

Thank you Pokey for sharing Rushing Pie with us!

---

[Return to Food & Recipes Menu](#)

---



**Text and Graphics**  
© 1994 - 103 [Tara Prindle](#)  
unless otherwise cited.



## Native American Technology and Art



# Silly Willy's Home Brew



---

Offered by Jo  
~ Tuscarora ~ Great-Great-Granddaughter of Orlando Tongue ~

...who learned this from some Ol' Gal's Ma

---

### Ingredients:

- See below...

---

### Preparation:

- Chase wild bullfrogs for three miles to gather up hops.
- To them add ten gallons of tan bark, 1/2 pint of shellac, an' one bar of homemade soap.
- Boil 36 hours, them strain through an i.w.w. Sock to keep it frum workin'.
- Add one grasshopper to each pint to give it a kick.
- Pour a little into the kitchen sink; if it takes the enamel off, it's ready to bottle.

---

*Thank you Jo, for sharing Silly Willy's recipe with us! I know where to find some bullfrogs!*

---

[Return to Food & Recipes Menu](#)

---



**Text and Graphics**  
© 1994 - 103 [Tara Prindle](#)  
unless otherwise cited.

## Native American Technology and Art



# Stick Bread And Moose

---

Offered by Kahvik Hunter

~ Alaska. my papa was a grizzly and my mom was a wolf ~

... who learned this when I got hungry and made it up

### Ingredients:

- Butter
- Flour
- Milk
- Moose Cut Up Into Long Hot-dog Size Sticks

### Preparation:

1. Mix flour butter and milk till you get soft dough then twist with moose.
2. Wrap it around a stick.
3. Cook it over the fire.

*Note: make sure you cook the bread all the way*

Thank you Kahvik Hunter for sharing Stick Bread And Moose with us!

---

[Return to Food & Recipes Menu](#)



Text and Graphics  
© 1994 - 103 [Tara Prindle](#)  
unless otherwise cited.



## Native American Technology and Art



---

**Offered by Offered by Susan Marie Smith-Kennedy  
~ Cherokee (born and raised in San Antonio, Texas) ~**

**...who learned this from a Family recipe**

---

### **Ingredients:**

- **2 pounds chopped fresh tomatoes**
- **½ pound chopped fresh tomatillos (Mexican husk tomato)**
- **¼ cup chopped fresh cilantro**
- **¼ cup chopped fresh basil**
- **2 tablespoons olive oil**
- **1 to 2 teaspoon(s) Goya Adobo seasoning w/ cumino (has salt)**
- **¼ teaspoon fresh ground pepper**
- **¼ teaspoon sugar**
- **½ cup chopped red or Texas onion**
- **1 tablespoon Red Wine Vinegar**

---

### **Preparation:**

- **Feel free to adjust ingredients and measurements.**
- **Add or omit according to your personal taste/preference.**
- **Combine all ingredients in a large jar.**
- **Cover the jar lightly with a layer of cheesecloth, secure, and place in a sunny spot for 4 hours.**

*Note: This is perfect to prepare alongside sun tea.*

---

**Servings: Two**

*Thank you Susan Marie Smith-Kennedy for sharing Sun-Cooked Salsa with us!*

---

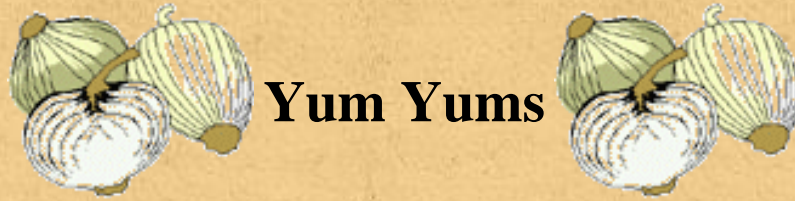
[Return to Food & Recipes Menu](#)

---



Text and Graphics  
© 1994 - 103 [Tara Prindle](#)  
unless otherwise cited.

## Native American Technology and Art



# Yum Yums

---

Offered by Morning Star  
~ Inuit ~

...who learned this from her Great Grand Aunt

---

### Ingredients:

- 1/2 Pound Broccoli
  - 1/4 Pound Onions
  - 1 1/6 Cup Salsa
  - 1/4 Cup Lettuce
  - 1/3 Cup Tomatoes
- 

### Preparation:

- Cut up broccoli and onions. Keep in moist area till finished cooking.
  - Either buy or make your own salsa. The hotter the better. Add extra hot red peppers if you wish.
  - Cut up lettuce and tomatoes very thinly until slightly visible. add salsa. mix around.
  - Put in microwave (if u want to) and enjoy!
- 

Servings: Three - Four

---

*Thank you Morning Star for sharing Yum Yums with us!*

---



---

[Return to Food & Recipes Menu](#)

---



Text and Graphics  
© 1994 - 103 [Tara Prindle](#)  
unless otherwise cited.

## Native American Technology and Art

# NATIVE AMERICAN BEADWORK Introduction and Use of Glass Beads



*Otter Skin Medicine Pouch with Glass Bead Applique on Wool Broadcloth ~ Winnebago [Adapted from Radin: 1990].*

---

### Articles about Glass Beadwork

[Value of Glass Beads and Native Americans](#)  
[European Sources of Glass Beads in the Northeast](#)  
[Glass Beadwork in the Northeast](#)

### Instructional Material for Glass Beadwork

[Tips on Sewing Beads to Leather](#)  
[Applique Techniques with Glass Beads](#)  
[Lane Stitch Techniques with Glass Beads](#)  
[Edging Techniques with Glass Beads](#)  
[Floral and Geometric Design Building Blocks](#)  
[Interactive Beadwork Designer](#)

---

[Beadwork Bibliography and Books to Buy On-Line](#)

[Return to NativeTech's Beadwork Menu](#)

---



© 1994-2000 [Tara Prindle](#).



# Seminole Beads

circa 1830s



*Adapted from Tunica Treasure Jeffry P. Brain, 1979*

by Michael R. Brown (Jan. 1991)

*in 19th Century Seminole Men`s  
Clothing*

[Rick Obermeyer ~ Editor](#)

---

Beads have always been popular among the Indians and the Seminoles were no exception. The Seminoles used beads in making necklaces and in decorating their leggings, pouches and other items of clothing.

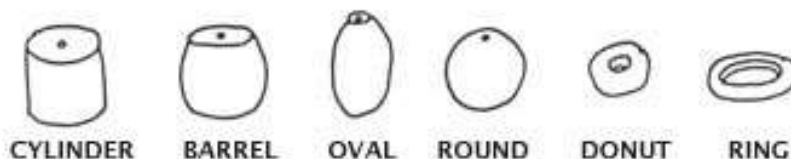
*The information on this page came from the Archaeological Report of  
FT. Brooke [Tampa], Site 8-Hi-988.*

Information on the beads used by the Seminoles is scarce, and this report was used because it described beads of the period that we are interested in, that of the second Seminole war. Only about 98% of the beads found at Ft. Brooke are presented here. Those left out had only 1 or 2 examples. For more complete information on FT. Brooke and other era beads, consult the sources listed in the report.

## Glass Ornamental Beads (Necklaces):

Worn on up to five strands. Strands may be tight at the neck or down to the stomach. String beads on imitation sinew or waxed string. Beads can be mixed on a strand. Avoid "Fire-Polish".







### *Basic Shapes:*



*These shapes are many times further altered by cutting or faceting.*



*Beads are in both opaque and transparent colors. Colors are listed by amount found, percent is of the amount found:*

|                                                                                   |                |                                                                                   |                        |                                                                                   |                                  |                                                                                     |                        |                                                                                     |                |                                                                                     |                |
|-----------------------------------------------------------------------------------|----------------|-----------------------------------------------------------------------------------|------------------------|-----------------------------------------------------------------------------------|----------------------------------|-------------------------------------------------------------------------------------|------------------------|-------------------------------------------------------------------------------------|----------------|-------------------------------------------------------------------------------------|----------------|
|  |                |  |                        |  |                                  |  |                        |  |                |  |                |
| <b>Barrel Faceted</b><br>89.6%                                                    |                | <b>Barrel Smooth</b><br>2%                                                        |                        | <b>Round Ribbed</b><br>2%                                                         |                                  | <b>Round Smooth</b><br>3%                                                           |                        | <b>Donut Smooth</b><br>2%                                                           |                | <b>Cylinder, Hexagon</b>                                                            |                |
| <b>Colors:</b>                                                                    |                | <b>Colors:</b>                                                                    |                        | <b>Colors:</b>                                                                    |                                  | <b>Colors:</b>                                                                      |                        | <b>Colors:</b>                                                                      |                | <b>Colors:</b>                                                                      |                |
| <b>Trans-parent:</b>                                                              | <b>Opaque:</b> | <b>Trans-parent:</b>                                                              | <b>Opaque:</b>         | <b>Trans-parent:</b>                                                              | <b>Opaque:</b>                   | <b>Trans-parent:</b>                                                                | <b>Opaque:</b>         | <b>Trans-parent:</b>                                                                | <b>Opaque:</b> | <b>Trans-parent:</b>                                                                | <b>Opaque:</b> |
| blue<br>clear<br>green<br>amber<br>purple                                         | black          | clear<br>blue<br>amber<br>green<br>purple                                         | black<br>blue<br>green | red                                                                               | green<br>green/pink<br>red/white | red<br>clear<br>blue<br>amber<br>green                                              | green<br>white<br>blue | blue<br>amber<br>purple<br>green<br>clear                                           | blue           |                                                                                     | cobalt<br>blue |
| <b>Size:</b><br>2.5 -10 mm - ave: 4-7 mm                                          |                | <b>Size:</b><br>3.5-7.5 mm length<br>4-8 mm diameter                              |                        | <b>Size:</b><br>8-9 mm                                                            |                                  | <b>Size:</b><br>4-15 mm                                                             |                        | <b>Size:</b><br>2-7 mm length<br>4-11 mm diameter                                   |                | <b>Size:</b><br>6.5-9 mm length<br>4 mm diameter (ave.)                             |                |
| Most popular today. Shape is hard to find. Use round faceted instead.             |                |                                                                                   |                        | Bi-color are top and bottom.                                                      |                                  |                                                                                     |                        |                                                                                     |                |                                                                                     |                |

## Metal Ornamental Beads (necklaces):

Seminoles also used metal beads. While no beads have been found in archaeological digs, it is obvious from paintings that metal beads were worn. In Catlin's famous paintings of Osceola shows him wearing a necklace of round metal beads close to the neck and another made of melon beads with glass and round metal beads between them.

Remember that the one metal preferred by the Seminole was silver.

## Glass Decorative Beads:

Seed and Pony beads are small donut shaped beads that were used mainly to decorate Seminole Garments. The size of these beads are not given in millimeters, but in a number system running from 16 to 2, with 16 being the smallest and 2 being the largest. The numbers indicate the number of beads lined up in an inch side by side. These sizes are written as 11% 11/o. Sizes 8 to 2 are commonly called 'Pony' beads. These are used mainly in finger woven sashes and garters (white only) and strung on necklaces.

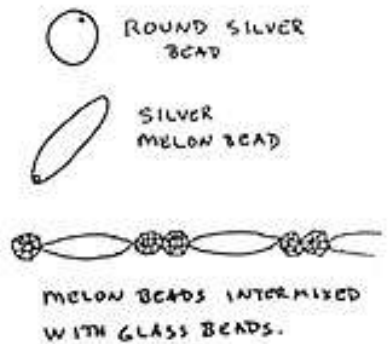
Of the seed beads, 11/o, 12/o, and 13/o are the sizes used to decorate leggings and shoulder pouches, etc. By sewing them directly to the material in a technique called 'Appliqué'. 10/o size beads are noticeably larger and would be used in the border and not in the design.

In purchasing these beads, it is advised they be purchased from Indian craft suppliers as they would be consistent in size and color. Regular craft stores do not sell them by sizes. For real authenticity, obtain beads in "Old-time" colors.

### *Colors:*

Seed Beads (from Goggin) - white, light blue, rose, dark blue, yellow, green and black (all opaque)

Pony Beads (from Piper) - white, pink, blue, black, green, tan (all opaque)



---

## SEMINOLE ACCESSORIES

---

[Breechcloths](#)

[Seminole Silverwork](#)

[Turbans](#)

[Peace Medals for Seminole Outfits](#)

[Face Painting](#)

[Complete Index to Articles in 19th Century Seminole Mens Clothing](#)

---



## Source Materials:

"Beaded Shoulder Pouches of the Florida Seminole", John Gogin. Appears in his book: "Indian and Spanish: Selected Writings."

"Archaeological excavation at the Quad Block Site 9-Hi-998" [Ft. Brooke, Tampa], Harry Piper & Jacquelyn Piper, Piper Archaeological Research, Inc., St. Petersburg, 1982.

---

Contributed by [Rick Obermeyer](#) E-mail: [orick@prodigy.net](mailto:orick@prodigy.net)

From the book *19th Century Seminole Mens Clothing*

© 1991-2000 Sherwood F. Obermeyer Jr., 2124 Miscindy Place, Orlando, FL 32806

---

[Return to NativeTech's Main Leather & Clothes Menu](#)

[Leather & Clothes Bibliography and Books to Buy On-Line](#)

---



Text and Graphics  
© 1994 - 2003 [Tara Prindle](#)  
unless otherwise cited.

# Ojibwemowin!

## Ojibwe Language Game

Below are 4 pictures and 4 words in Ojibwemowin  
(the language of the Anishinaabe, Chippewa or Ojibwe people).

alt="Your browser understands the <APPLET> tag but isn't running the applet, for some reason." Your browser is completely ignoring the <APPLET> tag!

There are 16 words and pictures to match in total. So, when after you've finished the first set and have checked your score, click 'NEW' for another combination of the 16 words.

[Learn more about Ojibwe Language and Culture](#)

**Match the words with the pictures ...**

Click on a picture and then click on the word you think matches the picture.

After you're done, click on "SCORE" to see how well you did.

To hear a word pronounced:  
\* Select a picture, then  
\* Click on the "speaker" icon

*(Note: it may take a few moments for the audio files to download.)*

**(Hint: Having trouble? click on 'English'.)**

**Note: Your browser must have Java Enabled for this to work!**  
I recorded the words. Ojibwemowin is not my first language,  
and I apologize in advance for any errors in pronunciation.

[Return to NativeTech's Main Games & Toys Menu](#)

[Games & Toys Bibliography and Books to Buy On-Line](#)



© 1994-2001 [Tara Prindle](#).



**NativeTech: Native American Technology and Art**

---

## **Virtual Coloring Book**

1. Select the image from the drop-down box, then click 'Load Image'
2. Click the button of the color you wish to use
3. Click on the area in the picture you want to fill with that color

Note: Your browser must be Java Enabled for this to work!

Coloring Book Applet by Eric Harshbarger  
<http://www.ericharshbarger.org>

---

**[Return to NativeTech's Main Games & Toys Menu](#)**

**[Games & Toys Bibliography and Books to Buy On-Line](#)**

---



**Text and Graphics**  
© 1994 - 103 **[Tara Prindle](#)**  
unless otherwise cited.

# Help the Chipmunk Find His Acorns!

1. Click anywhere on the maze.

2. Use the Arrow Keys  on your Keyboard to move around the maze.

3. When you solve this puzzle, [Click Here](#) to generate a brand new maze!

---



(If this maze is too difficult, you will find an easier one [Here](#))

---

If you get 'stuck' somewhere, press your [Home] Key and go back to (S)tart,  
Or you can press your [End] Key to go to the (F)inish  
... but the only way to solve the puzzle is to find the right path! Good Luck!

Note: Your browser must have Java Enabled for this to work!

[Return to NativeTech's Main Games & Toys Menu](#)

[Games & Toys Bibliography and Books to Buy On-Line](#)

---



© 1994-2001 [Tara Prindle](#).

## NativeTech: Native American Technology and Art

### Matching Game: Natural Dyes and Porcupine Quills

Porcupine Quillwork is perhaps the oldest form of Native American embroidery, and continues to be a widespread form of decoration for Great Lakes and Plains peoples living within the natural northern range of the porcupine. The quills are folded, twisted, wrapped, plaited and sewn using a wide range of techniques to embellish articles of clothing, bags, knivesheaths, baskets, and wooden handles and pipe stems.

Native Americans in 17th century New England were long familiar with quill embroidery, they used porcupine quills to decorate their clothing and accessories, and to decorate containers of birchbark as well. European accounts from the 1600's refer to several dye colors (black, blue, red and yellow for examples) for porcupine quills embroidered on baskets, bags and mats.

**AFTER YOU READ THE INSTRUCTIONS BELOW MOVE YOUR MOUSE OVER A PLANT NAME.  
A PORCUPINE APPEARS!**

**MOVE THE PORCUPINE TO THE QUILLS WHICH WERE COLORED WITH THAT NATURAL PLANT DYE.**

*Please be patient, the applet has lots of little images to load*

The images of dyed porcupine quills, and the dyed quills in the her kitchen, are compliments of Nancy Fonicello, who contributed the much of the material in NativeTech's section on [Native American Porcupine Quillwork](#).

You can see more of Nancy's beautiful quillwork on her personal pages [Ancient Artways Studio](#).

The descriptions of the plants & trees are adapted from two sources: "Magic and Medicine of Plants, A Practical Guide to the Science, History, Folklore, and Everyday Uses of Medicinal Plants" (Reader's Digest Association, Pleasantville, New York), and The Audubon Society Pocket Guides' "Familiar Trees of North America, Eastern Region" (1986 by Alfred A. Knopf, New York).

[Return to NativeTech's Games & Toys Menu](#)



Text and Graphics  
© 1994 - 2003 [Tara Prindle](#)  
unless otherwise cited.



## NativeTech: Native American Technology and Art

---

### Interactive Beadwork Designer

For Planning Loomwork or Lane Stitch projects

[Note: Your browser must be JavaScript enabled, please be patient while the script loads...]

---

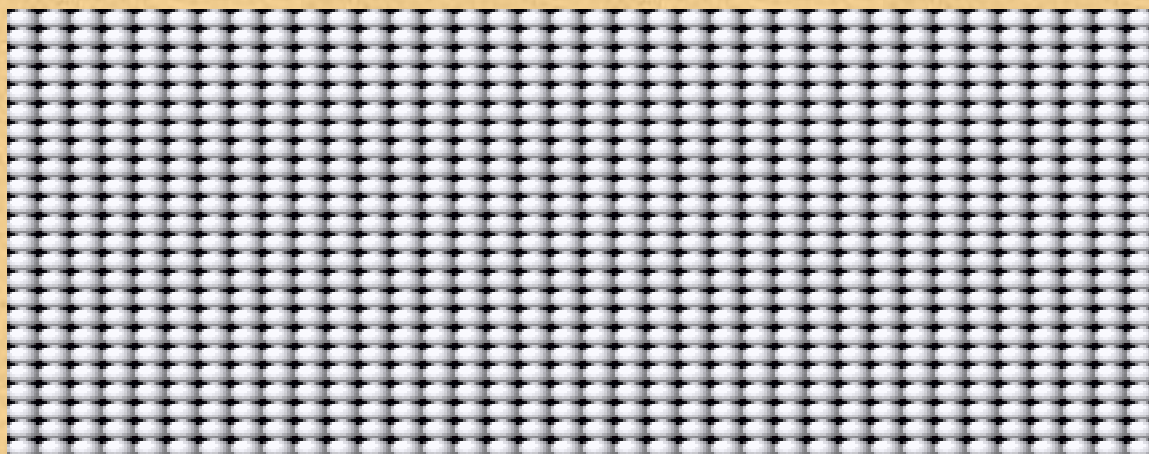
SELECT YOUR COLOR FOR THE BEAD GRAPH BELOW:



Color single beads with each click of your mouse.

Let the color follow your cursor as it moves over the beads.

---



Interactive Beadwork Designer is based on the PebblePaint Script by Nicholas Alston

---

[NativeTech's Introduction and Use of Glass Beads](#)

[Other Interactive Games on NativeTech](#)

[Return to NativeTech's Main Beadwork Menu](#)

---



© 1994-2000 [Tara Prindle](#).

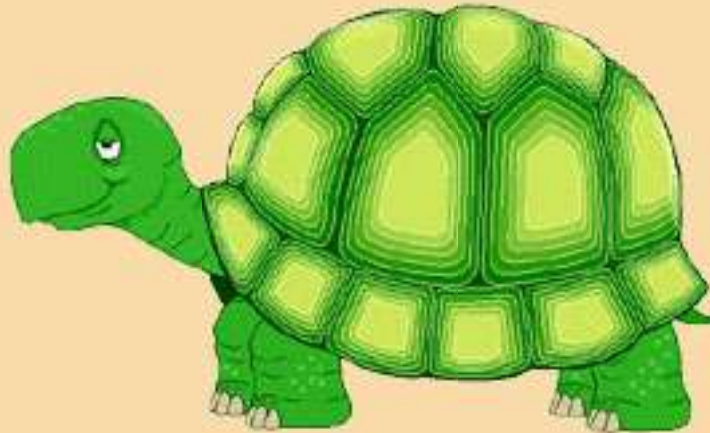
## NativeTech: Native American Technology and Art

---

### Guess the Word Before the Turtle Hides in His Shell!

All the words are Wild Edible Plants from Eastern and Central North America

*Note: a few of these plants have been introduced by Europeans*



Click on a letter to fill in the blank:

A B C D E F G H I J K L M N O P Q R S T U V W X Y Z

GAMES WON:    YOU    THE TURTLE

*Note: Many of these plants need special preparation before they can be eaten!  
Teach children not to put plants in their mouths. Keep all plants away from infants.  
Be absolutely certain which parts of a plant should be collected and at what season, and the proper way to use them!*

Go to [NativeTech's Indigenous Plants pages](#)  
to learn more about some of the plants used in this game.

---



[Return to NativeTech's Main Games & Toys Menu](#)

[Games & Toys Bibliography and Books to Buy On-Line](#)

---

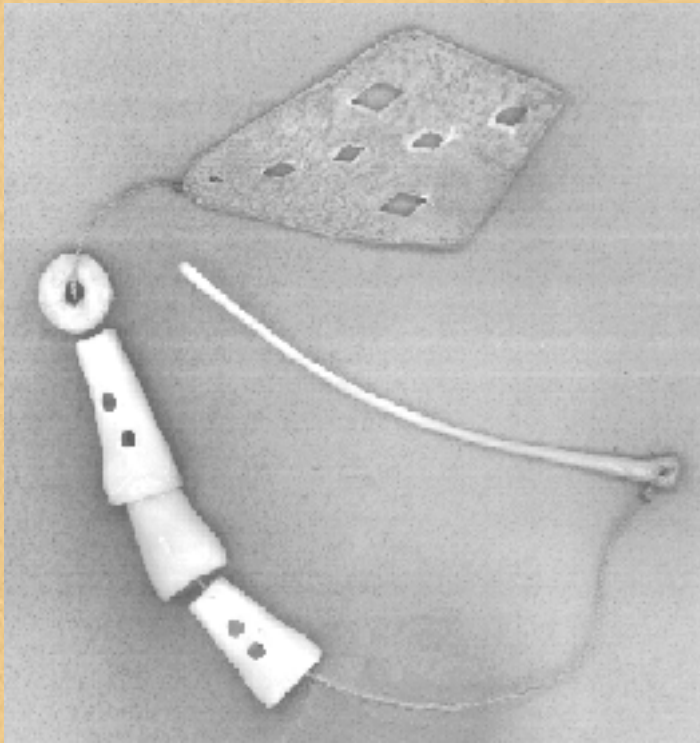


© 1994-2000 [Tara Prindle](#).

*Yes, I know there's a little bug in the scripting when the turtle's score reaches 10 -- you automatically get one point even if you lose!*

## Native American Technology and Art

### Ring & Pin Game



The ring and pin game has ancient Native American roots. Nearly Every Native nation across North America has its particular version which uses unique materials from the natural environment for the ring and pin. In all varieties of this game, a ring or other target is fastened to a cord. The target is thrown into the air and must be speared by the pin attached to the other end of the cord. Simple targets are carved rings of bone or hide, strings of toe bones or fish vertebra, perforated holed skulls, dried squash rinds, or bundles of twigs or hair. The pins were carved from long bones or antler in older times, while metal pins have sometimes been used since contact with Europeans. A leather or fur counterweight or loops of beads were sometimes attached below the target. The game was often played for women's and children's amusement and for stakes.

Among the Cheyenne of Oklahoma and the Penobscot of Maine, this game is sometimes referred to as a 'love game', a pastime for young men and women, as it serves as an excuse for introduction between two people, in which a woman could show her approval of a man by accepting to play the game with him, and by refusing to play the game if she is not interested in the other person. Players usually number two. Each party gets two tries to impale the ring the greatest number of times, after which it must be passed to the next player. In a Penobscot version using six deer toe (phalanx) bones, each player gets ten tosses, and the total number of bones speared by each player is compared. However, the counts can be extremely varied in other versions of the game. The bones usually count progressively from the one nearest the pin. The total count of the game also varies from 2 to 4, 50, or 100 (the most common number), up to 2000.

This version of the of the ring and pin is called an "ecagoo" by Athapaskan Natives of the west coast. The game consists of three small deer toe bones fashioned into hollow cones through which a slender piece of twisted sinew thread is passed. They are hollowed at the base so that they fit into each other. The needle of bone is attached to the end of the thread which is just long enough to admit the point of the needle into the base of the first cone,

where they are crowded into each other. The object to be attained is to pass the needle through the center of the cones or a slit in the leather at the top as the "ecagoo" falls. In gambling, a score is kept of the points made. The catching of the pin in the slits scores 1, on the first cone: 5. In the first and second: 10, in all three: 15, and in the second and third: 20.

---

[Return to NativeTech's Main Games & Toys Menu](#)

[Games & Toys Bibliography and Books to Buy On-Line](#)

---

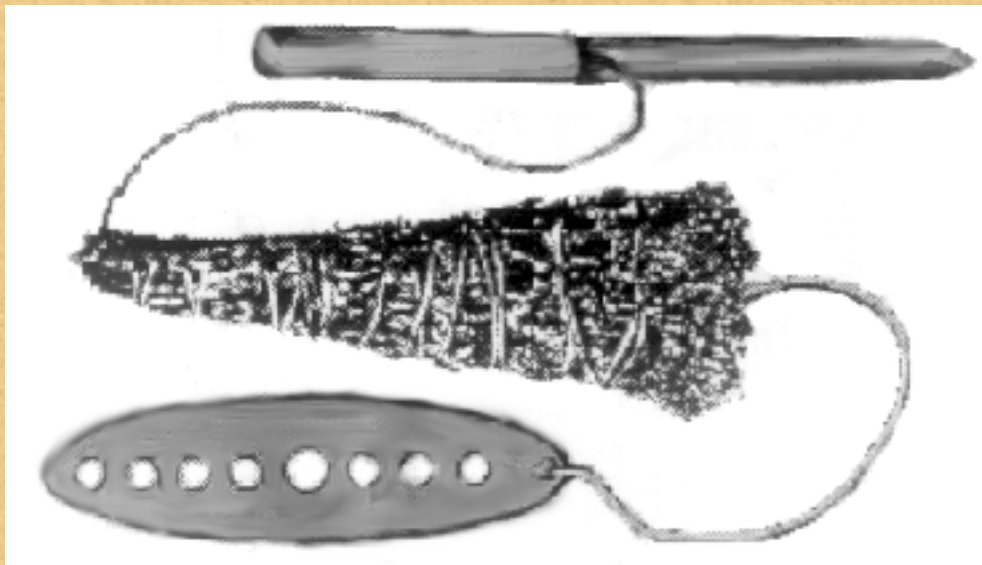


© 1994-1999 [Tara Prindle](#).



## Native American Technology and Art

### Bundle & Pin Game



Native Americans have many uses for the cedar tree. Cedar twigs, greenery and all, have both sacred uses (as in smudging and purification rituals) as well as secular use. One such secular use for cedar twigs is the 'bundle and pin' game. This traditional Woodland Indian game is called "T'wis", by the Passamaquoddy Natives of Maine. The T'wis is an indoor game that is composed of an oblong piece of moose hide, about four inches in length, punctured with small holes, the center one being slightly larger than the others. This piece of hide is joined to a bundle of cedar (arbor vitae) twigs, tightly wound round with the cord. To this, by several inches of string, is attached a sharp pointed stick, tied near the center and held between the thumb and forefinger like a pen.

The game consists of giving the moosehide an upward toss and at the same time piercing one of the holes with the pointed end of the stick. The number of points necessary for the winning is usually set at 100. Each player can hold the t'wis until he misses a point.

There is a tradition that the first t'wis-uk were made from that peculiar fungus which grows out of the bark of trees and is known to the Passamaquoddy as squaw-oc-l'moos wal-dee - "the swamp woman's dishes" - Squaw-oc-moos is the black beast of the Indian legends and even now children will not play with this fungus for fear of the swamp woman. "One night",

so the story runs, "during a very important game of t'wis, on which everything available had been wagered, both contestants fell asleep. The one having the t'wis was carried by Med-o-lin many miles into the swamp. When he awoke he saw Squaw-oc-moos eating out of the dishes and a t'wis made of boughs in his hands." It seems quite impossible to get a t'wis constructed from these wal-dee. The Indians will describe such a t'wis and promise faithfully to make one, even resenting any insinuations that they are afraid to do so. Their promise, nevertheless, for whatever reason, remains unfulfilled.

---

[Return to NativeTech's Main Games & Toys Menu](#)

[Games & Toys Bibliography and Books to Buy On-Line](#)

---



© 1994-1999 [Tara Prindle](#).



## Native American Technology and Art

### Ball & Triangle Game



A traditional toy used by Penobscot children consisted of a stiff piece of birch bark cut into a triangular shape, with a hole in the center. To one corner of the bark triangle is attached a string, and a ball is attached to the other end of the string. The circular hole in the center of the bark triangle is made only slightly larger than the ball attached to the string. Children grasp a corner of the triangle opposite the string, toss the ball into the air, and the object of the game is to get the ball to drop through the hole in the bark.

---

[Return to NativeTech's Main Games & Toys Menu](#)

[Games & Toys Bibliography and Books to Buy On-Line](#)

---



Text and Graphics  
© 1994 - 103 [Tara Prindle](#)  
unless otherwise cited.



## Native American Technology and Art

### Buzzer Game

The buzzer is an amusement as well as a game of skill for Native American children across North America. Usually made of a flat piece of wood, pottery, gourd or bone. A buzzer ranges in diameter from 2 to four inches, with a deerskin thong or twined sinew strand twenty inches long doubled over and threaded through the two holes in the disk to be twirled.



Atsina Indians of Montana, Mono Indians of California, as well as the Oglala Dakota Indians use a knuckle or knee bone as a buzzer. Flat buzzers of wood are often engraved or painted with designs which create new patterns seen when they toy spins. The buzzer game is undoubtedly ancient in origin; prehistoric disks of stone or pottery with two perforations are not uncommon finds for archaeologists working in the Northeastern Woodlands. When properly spinning, the buzzers make a sound similar to the sound of the wind sighing.

---

[Return to NativeTech's Main Games & Toys Menu](#)

[Games & Toys Bibliography and Books to Buy On-Line](#)

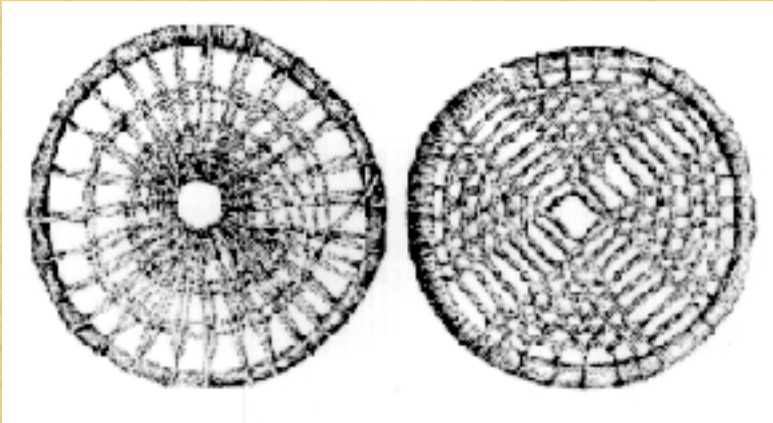
---



© 1994-1999 [Tara Prindle](#).

## Native American Technology and Art

### Hoop & Dart Game



Natives of different groups have their own special ways to play the Hoop & Dart game, but in all the games a person tosses a dart of some kind at a circular hoop. The hoop can lay still on the ground or even be hung from a tree, as people take turns throwing their darts at it. More often than not, the hoop is rolled along the ground, set into motion sometimes by a third player, while the two other players toss their darts as the hoop rolls in front of them. The score depends on how or if the dart falls on or through the hoop.





One hoop is made by just bending a branch into a circle and tying the ends with rawhide. Other simple hoops are made from bundled corn husks, cedar bark or other plants and are wrapped with rawhide or colored yarn, and some with beads attached to the inside to divide up the ring. Some hoops use rawhide lacing stretched across the hoop to divide it in two halves or into quarters. And many hoops have a web of string woven onto them, which divides up the hoop into different sections and shapes like squares, rectangles and triangles. These different shapes in the web can then be used to determine the score when the dart lands in them. Netted hoops are made by the Arapaho of Wyoming, the Cheyenne of Oklahoma, the Oglala of South Dakota, the Chippewa of North Dakota, and the Crow and the Grosventre tribes of Montana.

People of the Grosventre use a net of buckskin lacing. The holes of the web vary in shape and each has its own name and value. The large square in the center is the heart; the rectangles coming out in four directions are the buffalo bulls; the last rectangle at the edges of the hoop are buffalo cows; the four groups of small triangles in between the rectangles are the buffalo calves; the large pentagonal holes along the edge of the ring are the wolves; the small holes at the edge of the ring are the coyotes (on either side of the rectangles called cows). This game ends when the first player reaches a certain number of points decided before hand.



More simple ways of keeping score are used by other Natives. Sometimes the object is not to reach a certain number of total points, but instead the object is for a player to try and acquire all the darts of the other player. Using this method, each player in turn tosses one dart. If one of the player pierces the hoop while the other misses, the player who hit the hoop takes the dart of the player that misses. If both players miss, or both players hit the hoop, they pick up their own darts and each take another turn. This game ends when one player has captured all the other darts.

**Different kinds of darts were made by Native Americans of different groups too. Some darts were simply a pointed stick; some sticks were only a few inches long while other sticks were several feet long and looked more like spears.**

**Sometimes the sticks were painted or carved, or had feathers tied to one end.**

**Some darts have forked ends, or hooks**

**or barbs, to catch on the hoop so that it would not pass all the way through. One of the most ingenious darts is made from a corncob, a stick and some feathers. The corncob darts are traditionally made by the Hopi of Arizona and the Zuni of New Mexico. The corncob is first pierced with a pointed stick a few inches long from one end of the cob. Into the other end of the cob, two wing feathers are inserted into the whole. When this dart is tossed the feathers pull on the air cause the dart to spin like a pinwheel!**



---

[Return to NativeTech's Main Games & Toys Menu](#)

[Games & Toys Bibliography and Books to Buy On-Line](#)

---



© 1994-1999 [Tara Prindle.](#)



## Native American Technology and Art

### Other Native American Games & Toys

***Lacrosse*** - ball game played on a field between goal posts with a ball and a racket of a three foot sapling, the end bent into a circular hoop and filled with a leather network.

***Moccasin Game*** - guessing game where an opponent has to guess which moccasin an object is hidden in. Beans or markers are used to keep score.

***Hand Game*** - guessing game where an opponent has to guess which hand an object is hidden in. Sticks and markers are used in scoring.

***Double Ball*** - played only by women and resembling lacrosse - using two balls or sticks connected with a thong and each woman equipped with a stick.

***Awl Game*** - a hoop from the leg bone of an animal was set out on the ground and an awl was thrown toward it, intending to stand upright in the ring.

***Snow Snake*** - played in winter by men on frozen lakes using a carved stick a meter long, with a head resembling a snake. The snow snake, thrown on the run, races along the top of the ice, the farthest traveled being the winner. The track, pressed down into the snow with a log, could be a mile long.

***Web Weaving*** - (like cat's cradle), played by children and adults using a long string tied in a loop to finger weave patterns of animals, tipi doors, and other designs like 'fish spear', 'bird's foot', and 'crow's nest'.

***Sling Stick*** - Sling sticks about 2 feet long with a notch and a thong attached at one end. A stone is placed in the notch. The thong keeps the stone in place and is held down with the thumb by a loop at the other end of the thong. The stone is thrown great distance when the stick is whipped forward - releasing the thong and the stone.

***Little Sticks*** - (like jack straws), drop from your hand a bundle of thin cedar sticks, two players try in turn to remove sticks from the tangled heap without moving any of the others. A basket splint is sometime used to pick up the sticks.

***Top Spinning*** - a disk of bone, stone, or wood with a peg through it, sometimes painted or decorated on the upper surface, for divination of personal questions like 'who will marry first', etc. by spinning the top and seeing who it points to when it stops. Sometimes tops would be whipped with a stick to keep them in motion.



***Marbles* - made from fir balsam pitch or stones were either rolled down a board to see who's could go the farthest, or they may have been rolled into a series of holes about the size of the marbles.**

---

**[Return to NativeTech's Main Games & Toys Menu](#)**

**[Games & Toys Bibliography and Books to Buy On-Line](#)**

---



© 1994-1999 **[Tara Prindle](#)**.

"); // -->

**500 MB Hosting,  
300 Pop Emails  
SSL, PHP, MySQL  
Frontpage ext.**

**Unlimited Multiple Page Tracking**  
 eXTReMe in-depth tracking for your ENTIRE site!  
**Private Stats - Ad-Free**



Get your own [Free Tracker Now!](#) | [Home](#)

|                                     |                                                                           |                      |
|-------------------------------------|---------------------------------------------------------------------------|----------------------|
| <b>NativeTech</b>                   |                                                                           | <a href="#">Edit</a> |
| <b>URL:</b>                         | <a href="http://www.nativetech.org">http://www.nativetech.org</a>         |                      |
| <b>Counting since:</b>              | <b>25 October 2001 / 00:39</b>                                            |                      |
| <b>Current report:</b>              | <b>23 October 2003 / 10:36</b>                                            |                      |
| <a href="#">Summary</a>             | : Totals and Averages                                                     |                      |
| <a href="#">Unique Visitors</a>     | : Day   Week   Month   Hours of the Day   Days of the Week                |                      |
| <a href="#">Incl, Excl, Reloads</a> | : Day   Week   Month                                                      |                      |
| <a href="#">Geo Tracking</a>        | : Domain   Country   Continent                                            |                      |
| <a href="#">System Tracking</a>     | : Browsers   Operating Systems   Screen Resolutions   Screen Colors       |                      |
| <a href="#">Referrer Tracking 1</a> | : Last 20: Unsorted   Email   Searchengines   Queries   Usenet   Harddisk |                      |
| <a href="#">Referrer Tracking 2</a> | : Totals: Sources   Searchengines   All Keywords   All Website Referrers  |                      |

Copyright © 1998-2003 eXTReMe digital. All Rights Reserved. | [Privacy Policy](#)

















## NativeTech: Native American Technology and Art

### What is Ethnotechnology?

From a reply to a question on the NativeTech Message Board on Jan. 8, 1999

Contributed by Tara Prindle

---

Ethnotechnology is a term you might not be familiar with. Ethnotechnology is a term that I use to describe 'the study of the technology specific/unique to cultural groups of people'. The word ethnos, i believe, has greek origins, meaning nation or people.

I much prefer to use the term 'Ethnotechnology' when speaking about the technologies of Native American Indian/First Nation peoples. Other terms that I see in use such as 'Primitive Technology' can be harmful, having prejudiced connotations perpetuating false stereotypes of Indians and other indigenous peoples.

This is one 'Dictionary Definition' of the word Primitive:

1 prim-I-tive \ˈprim-et-iv\ adj. 1 a : not derived : ORIGINAL, PRIMARY b : assumed as a basis 2 a : of or relating to the earliest age or period : PRIMEVAL b : closely approximating an early ancestral type : little evolved c : belonging to or characteristic of an early stage of development : CRUDE, RUDIMENTARY [technology] d : of, relating to, or constituting the assumed parent speech of related languages 3 a : ELEMENTAL, NATURAL [the noble savage endowed with virtue - Oscar Handlin] b : of, relating to or produced by a relatively simple people or culture [art] c : NIAVE d (1) : SELF-TAUGHT, UNTUTORED [craftsmen] (2) : produced by a self-taught artist. (Webster's New Collegiate Dictionary)

Native American technologies are highly 'evolved', the product of thousands of years of expertise, oral traditions, change and continuity. There is nothing crude or rudimentary about them, there is nothing self-taught or untutored about them. The technologies which I try to provide an introduction to on the NativeTech pages, whether it is quillwork, basketry, pottery, stonework - whichever - these are all very difficult technologies to master and require intelligence, practice, skill, patience and teaching to be proficient at them.

[Return to About NativeTech](#)

---



Text and Graphics  
© 1994 - 103 [Tara Prindle](#)  
unless otherwise cited.



## NativeTech: Native American Technology & Art A Discussion of Terms

The range in decorative arts and the unique technology employed by Native Americans is truly exceptional. Using advanced skill and intricate knowledge of their surroundings, Native Americans across this Turtle Island (North America) construct and embellish innumerable objects from the variety of materials. Most of these materials are available within arm's reach or were obtained in the past through extensive indigenous trade networks.

Hundreds, even thousands of years ago in the Northeastern woodlands and other regions of North America, the accumulation of too many material possessions becomes a burden to people whose movements must be scheduled according to the availability of abundant resources. Little material culture produced by Natives of Northeastern North America was *not* intended for daily use. Yet many of these so-called 'everyday household items' are ornately decorated with designs and symbols significant to a peoples' culture.

With technical skill the Native American artist utilizes pattern, design and structure. Art produced by Native Americans must be defined in its own terms, without relying on European conceptions of art. Forms of art may be discussed in terms of the unique sets of materials, tools and techniques used. By asking who used what technology, who produced art, what was being made, and who was it being made for, you can start to appreciate the unique complex technologies of the different Native American Peoples across North America.

Today, traditions in Native American art continue to grow. The twentieth century provides opportunities to work in different media and explore new forms and outlets of for Native American art. New traditions in Native art are continually born and passed on. Native Americans art is not static, Native People exist despite Columbus, and contemporary Native art expresses some of the brutal transformations of the culture in the last centuries, which still continues today.

A discussion of the technology and art begins with the [Native American technicians and artists](#), the types of [traditional tools and materials used](#), and the kinds of [ideas expressed through Native American art](#). By learning about the context (the social and ideological background) of Native American art, we avoid reacting to this art with European conceptions of what 'art' should be. By studying the ideas or feelings expressed through ornamentation, we can appreciate Native American art, and begin separate it from the artifacts of everyday life.

[Return to About NativeTech](#)



Text and Graphics  
© 1994 - 103 [Tara Prindle](#)  
unless otherwise cited.

## NativeTech: Native American Technology and Art

### Birds and Feathers

-  [Contemporary Single Wrapped Feather Styles](#)
-  [Birchbark Fans of the Great Lakes Regions](#)
-  [Turkey Tail Fans of the Southeast and Prairie Regions](#)
-  [Flat Fans of the Plains Region](#)
-  [Feather Identification](#)
-  [Preserving Bird Wings, Tails, or Talons](#)
-  [Birds & Feathers Bibliography and Books to buy On-line](#)

[Other Internet Resources for Birds & Feathers](#)



© 1994-2000 [Tara Prindle](#).



## Pottery & Clay

- [!\[\]\(38441ceaa711016e0bf2ad46ad394ff4\_img.jpg\) Pottery in Southern New England](#)
- [!\[\]\(6e027340d4263908f264926b1ad81c5e\_img.jpg\) Chronology of southern New England Pottery](#)
- [!\[\]\(781510d64f329bf3c880acf086e884d6\_img.jpg\) A Catalogue of Reconstructed Pottery Designs](#)
- [!\[\]\(93cdf5b84f2bfec404f7441e84b6ba5c\_img.jpg\) Preparing Clay](#)
- [!\[\]\(0f0f932ce3b5577a82f34ad23239a6e5\_img.jpg\) Temper Mixed into Clay](#)
- [!\[\]\(eae2be0f6c865f0a2febc97c99fc2475\_img.jpg\) Making a Clay Pot](#)
- [!\[\]\(beb73fa08c38b910d1745a8873b27d81\_img.jpg\) Tools Used to Decorate Pottery](#)
- [!\[\]\(b5401e964162c76526213b8e70b40c2e\_img.jpg\) Firing Pottery](#)
- [!\[\]\(865f2722fc1818c7fea1a14e09a6e1a6\_img.jpg\) A Photographic Tour of Firing Pottery](#)



Text and Graphics  
© 1994 - 103 [Tara Prindle](#)  
unless otherwise cited.



## NativeTech: Native American Technology and Art

### Traditional Metal Working in the Northeast

-  [Introduction to Contact and Precontact Period Copper & Brass Metalwork](#)
-  [Kettle Manufacture and Repair](#)
-  [Brass & Copper Bead Making](#)
-  [Sheet Metal Pendants & Ornaments](#)
-  [Native Rings and Bracelets](#)
-  [Metal Spoon Making](#)
-  [Arrow Tips](#)
-  [Smoking Pipes](#)
-  [Brass and Copper Wire Work](#)
-  [Metal Casting](#)
-  [Tinkling Cones ~ Past & Present Traditions](#)

---

19th Century Seminole Men's Clothing  
Contributed by [Rick Obermeyer, Editor](#)

 [Seminole Silver Work](#) ~ by Michael R. Brown

 [Metal Work Bibliography and Books to Buy On-line](#)

---

[Other Internet Resources for Metalwork](#)



© 1994-2000 [Tara Prindle](#).

## PORCUPINE QUILLWORK AND HAIR

[Quillwork FAQ - Questions about Quillwork...](#)


[About Porcupines...](#)

 [Tools and Types of Quillwork](#)

 [Background on Porcupine Quill Embroidery](#)

 [Introduction to Techniques and Methods of Porcupine Quillwork](#)

- [The Zig-Zag Technique](#)
- [The Parallel or Band Technique](#)
- [The Single-quill Line Technique](#)
- [Multiquill Plaiting Techniques](#)

 [Preparation of Porcupine Quills](#)

 [Natural Dyes for Porcupine Quills](#)

 [Quill Looming Techniques](#)

 [Quill Wrapping on Rawhide](#)

 [Porcupine Quill Decoration on Birchbark](#)

 [Strung & Threaded Porcupine Quill Jewelry](#) Bracelets, Chokers and Earrings

 [The End of the World](#) A Story about Porcupine Quills

Some articles contributed by [Nancy](#), many thanks!



Text and Graphics  
© 1994 - 2003 [Tara Prindle](#)  
unless otherwise cited.

## STONE AND TOOLS




- **Ground Stone Tools & Art in the Northeast**
- **[Flaked Stone Tool Technology](#)**
- **[A Catalogue of Lithic Tool Types](#) ~ my material on ArchNet**
- **[Projectile Point Types in New England](#) ~ an online catalogue**
- **[My Hammer Stone, Antler Billet, and Pressure flaker](#) ~ my page on ArchNet**
- **[Projectile Point Types in Southern New England](#) My chart of types over time.**
- **[POINT](#) ~ Projectile point classification software**



Text and Graphics  
© 1994 - 2003 [Tara Prindle](#)  
unless otherwise cited.



## WEAVING AND CORDAGE

-  [Overview of Native American Basketry](#)
-  [Finger Weaving in the Eastern Forests](#)
-  [Cordage from Plant & Animal Materials](#)

---

19th Century Seminole Men's Clothing  
Contributed by [Rick Obermeyer, Editor](#)

-  [Fingerwoven Sashes & Garters](#) ~ comments by Rick Obermeyer



Text and Graphics  
© 1994 - 2003 [Tara Prindle](#)  
unless otherwise cited.

## Scenes from the Eastern Woodlands

A Virtual Tour ~ Circa 1550

---

### Where would you like to go?

- [At our homestead](#)
  - [Building our wigwam](#)
  - [Tending to our garden](#)
  - [Making our stone tools](#)
  - [Grinding our corn and nuts](#)
  - [Catching fish in a net from our canoe](#)
  - [Bathing ourselves at the stream](#)
  - [Cooking our food we gather](#)
  - [Working inside our wigwam](#)
  - [Making our pots](#)
  - [Playing our hoop and dart game](#)
  - [Picking cherries for our bread](#)
  - [Learning to shoot our arrows](#)
- 



[Scenes available as Fine Art Note Cards](#)

### At our homestead ...

you will see a bark covered dwelling with a field of maize, beans and squash in the background, and a hearth with ceramic and birchbark cooking vessels. The man holds a soapstone bear-effigy pipe and a fox-effigy ball headed club. The man wears porcupine quilled bracelets, knife sheath, knee garters, and moccasins. He also wears a wampum headband and earrings, and carries a wooden drinking cup and animal-skin bag at his waist. The woman, who stands near the wooden mortar and grinding pestle, wears a painted deer skin tunic, skirt and leggings as she fills a woven bag with supplies.

---



Text and Graphics  
© 1994 - 103 [Tara Prindle](#)  
unless otherwise cited.





---

## Contemporary Issues about Native American Art

### *A Collection of Annotated Links*

---

Jump to:

[Articles and Commentaries about Authentic Native American Arts & Crafts](#)

[Consumer Information about Authentic Native American Arts & Crafts](#)

[Legislation and Laws Relating to Native American Indian Arts & Crafts](#)

[Websites Relating to Repatriation of Native American Ritual Objects & Arts](#)

[The Use of Indians as Mascots and Native American Stereotypes](#)

---

### Articles and Commentaries about Authentic Native American Arts & Crafts

#### [The Scandal of Fake Indian Crafts](#)

Imitation may be the price of success, but it can be deadly - By Scott S. Smith, from 'Coyboys & Indians Magazine'.

*"Counterfeits that are machine-made or hand-made cheaply in countries like Mexico, Pakistan, India, Thailand, and the Philippines account for much of what is passed off as the hand-made product of American Indians. The fakes have driven down prices drastically, putting many legitimate artisans and stores out of business. "*

#### [That 'Indian handmade' jewelry may be a fake.](#)

Imported ripoffs are putting Indian artists out of business and damaging the state's reputation with tourists - By Andrew Hay, From the 'New Mexico Business Journal'.

*" Marvin Lovato makes world-class "heishi" or shell jewelry but he can't compete with the illegal imitations of his work, flooding New Mexico's Indian arts and crafts market. Lovato, a Santo Domingo Pueblo jeweler, says he once supported his family with sales of handmade necklaces and pendants. He recently had to take up a second job just to pay the bills. ... Buck A Gram sells its Indian-style jewelry to U.S. wholesalers at an average of a dollar a gram, a price Indian artists cannot compete with. Most of this work finds its way to the Southwest. Pieces of Buck A Gram's work bought recently in Albuquerque came indelibly stamped with the company's hallmarks but no "Made in the Philippines" permanent mark as U.S. law requires. "*

#### [Fake Indian Art Robs Tribes Of Cash, Culture](#)

Seminole Tribune - Volume XX Number 28 - August 21, 1998 By Charles Flowers - TESUQUE, N.M.

*" You have to bend down to get into this Pueblo's tiny gallery. It is basically one room in a small adobe building containing a few paintings, silver jewelry, and beautiful, natural hide drums made by Bea Duran-Tioux, a member of Tesuque Pueblo. "I've won awards for my drums," she says, proudly. They sell for about \$400 each. Up the road about 50 miles, at the Taos Drum Factory, non-Indians make similar looking drums that sell for less than \$100 each. "They say it's Native, but it's not," says Duran-Tioux. Like the glass beads for sale at Teepeeetown in St. Augustine, or the "Indian-style" jewelry hawked over the Internet by a vendor based in the Philippines, it's cheap - maybe one-fourth the cost of the authentic item - but it's not the real thing. "It becomes a problem for the Native people who are trying to do their own work," says the drum-maker. "*

#### [Faking It: The Appropriation of a Culture](#)

Quaint soapstone trinkets of an Inuit hunter hauling a seal onto the ice; miniature plastic Haida totems; reproductions of Benjamin Chee Chee framed in stained glass - By Melanie Scott, from the Aboriginal



## Professional Centre and Internet Services.

*" Not content to simply copy the style of Inuit art, the producers of fakelore sometimes adopt Inuit-sounding names. Tags attached to the items might include misleading biographies of the "artists," and terminology appropriated from genuine art. Inuit legends and stories are printed onto placards which stand on the shelves beside the items. Although they may remain within the bounds of the law by making no direct claims that their producers are Inuit, imitators mislead the public by employing Inuit imagery, using materials associated with Inuit art, and making references to the North. "*

## [Indian Crafts: Real vs. Fake](#)

Albuquerque Journal - Saturday, December 25, 1999 - By Pauline Arrillaga - The Associated Press

*" In the town renowned as the retail center for authentic Indian arts and crafts, shopkeepers and artisans are going to battle against a growing threat: the importation and sale of impostor products. It is a foe as old as the Indian arts trade itself but one many who work in the industry have only begun to take on, driven by the government's failure to enforce laws meant to protect their products and livelihoods. "*

## [The real thing?](#)

"You're told it's authentic, the genuine article made by local craftsman—but is it?" August 18 — NBC Dateline - TV News -

*" One of the great pleasures of any trip can be bringing something special home—a souvenir or that unique memento. You may think you're getting the real thing— the craftsmanship of a local artist, the quality of fine materials, work that's worth the price, but is that always the case? "*

## [Indian Trademarks](#)

"If it says 'Indian', it should be Indian." Sue Shaffer Cow Creek Tribal Chairman

*" In fact, The Cow Creek Band of Umpqua Tribe of Indians has contributed years of serious effort and money to help ensure that the Indian Trademark revived - if at all - in a way that would substantially benefit American Indians and Native organizations, and is being cheated by a federal receiver and a corporate consortium. "*

## [Spiritual Genocide: The Co-Opting of Cultures](#)

"Don't Pay to Pray" by Lorayne Martinez / "Alert – Re: Brooke 'Medicine Eagle' Edwards" A Statement from the Center for the SPIRIT / "Genocide, Spiritual and Otherwise" by Laura del Fuego / "Spiritual Commodification and Misappropriation: What Native People Want You To Understand" Compiled by Mariah Jones / "The Plastic Medicine People Circle" by Helene E. Hagan / "Walk the Long Road of Misunderstanding" by Edna Seidner / Readers Respond to Our Debate / Spiritual Genocide: Some Activists' Responses

*" If you stand with Indian people, then you respect their moral right to decide under which circumstances their ceremonies will be "shared" with non-Indians. Please read the following statements by Native people. They are spiritual leaders, authors, attorneys, anthropologists, scholars, activists, educators and tribal leaders. Though they represent just a small percentage of those who have spoken out on this issue, the concepts presented will give you some idea of the perspective you are being asked to consider. "~ Mariah Jones*

## [Fakelore, Multiculturalism, and the Ethics of Children's Literature](#)

"It is time authors, parents, educators-even publishers-accept that you cannot teach about other cultures by assimilating them into a safe, homogenized curriculum or by substituting well-intentioned misconceptions for demeaning ones." - By Eliot A. Singer

*" So-called "multicultural folktale" picture books are a popular means for teaching about other cultures, especially in the primary grades. However, almost all these books are fakelore. Many are based on spurious legends, originally written for popular audiences following a romantic formula, that were never told in traditional communities. More are careless adaptations which completely assimilate genuine sources into contemporary children's book fashions, as this paper will document with numerous examples, mostly in reference to the stories of indigenous peoples of North America. Although uninformed reviewers and educators praise the changes authors make, knowledgeable, scholarly comparisons between picture books and originals*



*invariably show the "improvements" significantly distort native style, characterization, plot, theme, meaning, and belief. "*

### [Ivory Jack's and Northwest Tribal Arts Agree to Settle FTC Charges that They Sold Fake Native American Artwork](#)

... Settlements include payments of \$20,000 by each individual defendant. - Media Contact: Brenda Mack, Office of Public Affairs 202-326-2182.

*" Two Seattle-based companies and their owners, Kurt Tripp and Ngoc Ly, have settled Federal Trade Commission allegations that they falsely represented Native American-style carvings as authentic Native-made artwork. As part of the settlement, the two individual defendants will each pay \$20,000 as disgorgement, be prohibited from misrepresenting that their Native American-style artwork was made by Native Americans, and be required to follow procedures to prevent such misrepresentations at the retail level for products they offer at wholesale. "*

### [Senate fails to pass stiffer laws against Indian arts fraud](#)

By Ann McBride - Arizona Daily Wildcat - April 5, 1996

*" A Senate bill that would have pulled the reins tighter on Indian arts fraud failed in the House 13-46 Tuesday. The bill, sponsored by Sen. John Wettaw, R-Flagstaff, would have made it illegal for one tribe to claim a product was made by another tribe, a practice the Hopis of northern Arizona say happens frequently with their jewelry and kachina dolls. "*

### [Imitation NA crafts](#)

NatChat Mailing List Archives - a public e-mail forum discussion- 1995

*" I walked into K-Mart in Seattle and happened to see a center aisle of NA pottery for sale. Instantly, I felt something was wrong as I did not recognize the design as coming from any familiar tribes. I looked closely...and read the small print....it said, (in tiny letters) "inspired by NA"....It was made in taiwan. I couldn't believe it. I went up to the service desk, spoke with the supervisor, left my business card and explained how their store was breaking federal law (at least in my opinion). Try being NA and getting your work sold through a major chain...not a chance... "*

### [Buyer Beware: The Selling of Tsimshian Art Treasures](#)

By Christopher Pollon - Through 'Artstar Magazine'.

*" Native claims of original artifact ownership in many cases are impossible to legally prove. Surviving historical accounts are often contradictory, serving to cloud the issue of ownership even further. Even if artifacts can be traced back to a particular native group, the issue of ownership is a different matter. It has been documented, for example, that by the mid-1800s, many of the Northwest coast tribes had become shrewd businessmen who frequently sold artifacts to Europeans willingly. How to deal with questions of ownership when a collector claims there was a legitimate sale? The debate becomes more problematic when one considers artifacts such as those in the Dundas collection: should collectors keep artifacts taken from Christianized Natives? "*

### [The History of American Indian Jewelry](#)

Through 'Americana Indian and Western Collector's Shows'.

*" Indian jewelry, as it is known today, had origins that probably predate the advent of the persons we describe as American Indians or Native Americans. However, for the purpose of this paper we will consider prehistoric man as prehistoric Indian. Archeological evidence shows us that stones (including turquoise), shells and fetishes predate the Christian (epoch). Turquoise was found in Hohokam excavations in southern Arizona that date 200 B.C., in central Mexico approximately 600-700 B.C. and in South America ca. 900 B.C. Other beads are even earlier. As Indian jewelry and turquoise are so closely associated this paper will discuss both. "*

### [The History of Turquoise](#)

Through 'Americana Indian and Western Collector's Shows'.

*" People have been faking turquoise for centuries using ceramics, bone, color-enhanced minerals, and more recently, celluloid and plastic, among other things. This is not much of a problem now as people are simply too familiar with turquoise. However, synthetic turquoise, frequently chemically perfect, has appeared on the market in some quantity. This is literally stove-top*



*turquoise. It has a very natural matrix created by placing stones in the "batter" or sprinkling in pyrite, etc. When the mix is cut then cabbed these foreign additives, which are real, add to the illusion that the entire stone is natural. Synthetics become fake if not properly identified. "*

### [A History of Navajo Weaving](#)

Through 'Americana Indian and Western Collector's Shows'.

*" Throughout this period of history, one thing has remained constant - the unique and beautiful Navajo weaving. These hardy people adopted weaving techniques from their pueblo neighbors, as mentioned earlier. From then on the development of style, pattern and quality was uniquely theirs. (The influence of the traders will be discussed shortly.) One can see, even in the earliest of blankets, excellence of design and uniformity. Early authors often exclaimed as to the tightness of the weave and that the blankets "would hold water." Today's fine, tight tapestries, beautiful rugs and wall hangings are an extension of this early period. Many variations, changes, and styles have come and gone. The following is a chronological presentation of Navajo weaving development. "*

### [The Native American Fine Art Movement: A Resource Guide](#)

Through 'The Heard Musuum'.

*" This resource guide focuses on painting and sculpture produced by Native Americans in the continental United States since 1900. The emphasis on artists from the Southwest and Oklahoma is an indication of the importance of those regions to the on-going development of Native American art in this century and the reality of academic study. "*

---

## Consumer Information about Authentic Native American Arts & Crafts

### [Tips for Consumers](#)

From the Indian Arts and Crafts Association.

*" Is It Real? Is It Hand-Made? Is It Made by Native Artists? Buying Native American Jewelry. "*

### [Buying Native American Arts and Crafts](#)

Defining Authentic Indian Arts and Crafts, From the New Mexico office of the Attorney General - Consumer Protection.

*" Authentic Indian art or handicraft consists of handmade items produced by a Native American craftsman, a member of a federally or state-recognized Indian tribe, using high-quality, natural materials that are not machine stamped. In our state, sales of these items are governed by The New Mexico Indian Arts and Crafts Sales Act. "*

### [Purchasing Native American Arts and Crafts](#)

Through Smart Buying

*" Overall, your main guideline begins and ends with the price of the item! Most authentic pieces of art are not cheap so if you think you are getting a bargain - beware! This form of art is absolutely one of the most fascinating I have found to exist. The pieces created actually mean something dear to their creators and should be taken seriously. Help support this part of the art world by buying only authentic items. It will help keep these traditions alive for future generations! "*

### [Buyer Beware](#)

... of Fake and Imitation Hopi Arts and Crafts - By Buddy Tubinaghtewa, a Hopi artist from the Hopi reservation in Arizona.

*" The annual sales of Indian arts and crafts total several hundred million dollars. Indian interests control only a tiny portion of this market. Imitation and fake arts and crafts "passed off" as authentic Hopi products have defrauded unsuspecting buyers. Kachina dolls are mass produced in factories by non-Hopis in alarming numbers. Beware. "*

### [Petroglyph Pete's Article Archives](#)

Through Coyote Creek. Many informative articles including:

*" Is Your Turquoise Real? Is Your Jewelry/Pottery Handmade? Taking Care of Your Jewelry "*

### [InuitSculpture Authenticity.](#)

Through the Aboriginal Professional Centre and Internet Services.

*" Given the fact that Inuit sculptures are highly prized as Canadian souvenirs and as art objects, it is unfortunately inevitable that mass-produced reproductions and imitations have proliferated. These items, made of plastic, ceramic or "cast stone", sometimes tempt the uninformed consumer by their lower price. These imitations generally have no investment or aesthetic value whatsoever, and are in no way endorsed by the Canadian government or the Inuit of Canada. "*

### [Frequently Asked Questions:](#)

And some answers from the Kiva Trading Company.

*" Where are the fakes coming from? How can you tell the difference? Why do fakes cost so much less? What about the stones? Are they real? Do the Indians get any of the money? "*

### [I Was Fooled, Were You??](#)

Let's just make it easy for the buyer to know what they are getting - by Arlie Neskahi, from Rainbow Walker Productions.

*" Hundreds, no thousands! And many of these non-native musicians are making big bucks off the contemporary interest in Native music. I don't like it, and I think it is fraudulent. "*

### [The objections to "Totem" Animals and Medicine Cards](#)

*" It has become popular to use the word "totem" in association with the concept of animal spirits in any number of different contexts. For the most part, the use of this term is inaccurate as it has a very specific tribal reference that has nothing to do with the type of personal acquisition of an animal spirit that non-Indian people are describing. ... The "Medicine Cards" are considered by Native people to be one of the most blatant examples of misappropriation of Indian spirituality. They are seen as a mishmash of distortion and fabrication. If the creators of these cards had been satisfied with simply calling them "animal cards", and left out all inferences of, and references to, Indian beliefs, no Indian would have a problem with them.*

*"Misakakojiishikwe*

---

## Legislation and Laws Relating to Native American Indian Arts & Crafts

### [Cultural Resources](#)

Cultural resources are protected under several state and federal laws.

*"These laws were enacted to ensure consideration of historic values and to protect significant resources from destruction or theft. The major federal laws include: the National Historic Preservation Act (NHPA), Archaeological Resources Protection Act (ARPA), the Native American Graves Protection and Repatriation Act (NAGPRA), and the American Indian Religious Freedom Act of 1978 (AIRFA). State-level cultural resource protection is regulated through the provisions of Appendix K of the California Environmental Quality Act (CEQA). "*

### [Indian Arts and Crafts Act of 1990 - Public Law 101-644](#)

Federal Register: October 21, 1996 (Volume 61, Number 204) Rules and Regulations - Page 54551-54556 - [Link through ArtNatAm].

*" This rule adopts regulations to carry out Public Law 101-644, the Indian Arts and Crafts Act of 1990. The regulations define the nature and Indian origin of products that the law covers and specify procedures for carrying out the law. The trademark*



*provisions of the Act are not included in this rulemaking and will be treated at a later time. "*

## [Index to Native American Legal Resources](#)

*" Federal Resources / State Resources / Tribal Resources / UND School of Law / Indian Law Center Materials / Tribal Judicial Training Institute "*

## [Legislative Impact](#)

*" A service designed to meet the needs of activists, tribes and professional consultants who need to keep track of Federal Legislation pertaining to Native America. The service offers unique categorical breakdowns of issues. So far, LI includes the following categories: 1. Gaming, 2. Economic Development, 3. Taxation, 4. Children, 5. Housing, 6. Land, and 7. Repatriation. Many more categories are planned. Other features include Fresh facts. Fresh facts provides periodic updates on hot issues. These updates can be hourly, daily, or weekly depending on the issue. LI is owned and operated by the Salute Set. Marie Tribe of Chippewa Indians, a federally recognized tribe. "*

## [Native American laws](#)

*" Including: American Indian Religious Freedom Act of 1978, Indian Dams Safety Act of 1994, Indian Self-Determination and Education Assistance Act of 1975, Native American Graves Protection and Repatriation Act of 1990 (NAGPRA) / Executive orders, policies, and guidelines include: / Reclamation's Indian Trust Asset Policy of 1993 (ITA) / These links are merely to provide information and are not to endorse anything. Includes links to further summaries of laws. "*

## [25 USC Sec. 305 \(01/16/96\) -§ 305. Indian Arts and Crafts Board; creation and composition; per diem payments](#)

*" A board is created in the Department of the Interior to be known as "Indian Arts and Crafts Board", and hereinafter referred to as the Board. The Board shall be composed of five commissioners, who shall be appointed by the Secretary of the Interior as soon as possible after August 27, 1935... "*

## [25 USC Sec. 305a \(01/16/96\) - § 305a. Promotion of economic welfare through development of arts and crafts; powers of Board](#)

*" It shall be the function and the duty of the Secretary of the Interior through the Board to promote the economic welfare of the Indian tribes and Indian individuals through the development of Indian arts and crafts and the expansion of the market for the products of Indian art and craftsmanship... "*

## [25 USC Sec. 305e \(01/16/96\) - § 305e. Cause of action for misrepresentation of Indian produced goods](#)

*" A person specified in subsection (c) of this section may, in a civil action in a court of competent jurisdiction, bring an action against a person who offers or displays for sale or sells a good, with or without a Government trademark, in a manner that falsely suggests it is Indian produced, an Indian product, or the product of a particular Indian or Indian tribe or Indian arts and crafts organization, resident within the United States, to... "*

## [18 USC Sec. 1158 \(01/16/96\) - § 1158. Counterfeiting Indian Arts and Crafts Board trade mark.](#)

*" Whoever counterfeits or colorably imitates any Government trade mark used or devised by the Indian Arts and Crafts Board in the Department of the Interior as provided in section 305a of Title 25, or, except as authorized by the Board, affixes any such Government trade mark, or knowingly, willfully, and corruptly affixes any reproduction, counterfeit "*



## [18 USC Sec. 1159 \(01/16/96\) - § 1159. Misrepresentation of Indian produced goods and products](#)

*" It is unlawful to offer or display for sale or sell any good, with or without a Government trademark, in a manner that falsely suggests it is Indian produced, an Indian product, or the product of a particular Indian or Indian tribe or Indian arts and crafts organization, resident within the United States. "*

### [Ethnic Cleansing?](#)

We Have It Here Too! - On Jordan Dill's First Nations' website - From the 'International Journal on World Peace'.

*" The point is, many genuine Indian artists cannot obtain certification under the Act. Their ancestral tribes may have been dissolved long ago. No authority remains by which they can obtain certification even if they wanted to. Thousands of Kickapoos, Potawatamis, Cheyennes, Sioux, Arapahoes, Blackfeet, Lumbees and others have been legislated out of artistic existance. Thousands of Indian families whose livelihoods depend on selling arts and crafts have just had those livelihoods arbitrarily confiscated, courtesy of the U.S. Government. "*

### [Catalog of Federal Domestic Assistance- 15.850: Indian Arts and Crafts Development](#)

To encourage and promote the development of American Indian and Alaska Native arts and crafts - through the The Assistant Secretary for Planning and Evaluation.

*" Eligibility Requirements / Application And Award Process / Related Programs / Program Accomplishments / Financial And Administrative Info. / Information Contacts / Assistance Considerations / Post Assistance Requirements "*

---

## Websites Relating to Repatriation of Native American Ritual Objects & Arts

### [American Indian Ritual Object Repatriation Foundation - AIRORF](#)

*" The Foundation's mission is to assist in the repatriation of ceremonial materials; improving intercultural relationships and ridding the art market of inappropriate sales are a natural outgrowth of our work. When collectors learn why the purchase of certain items is inappropriate and why Indian people take offense at the sale and commercial trade of certain items, I believe they will honor the Peoples they so admire and be selective about their purchases. "*

### [Cultural Resources](#)

*" Cultural resources are protected under several state and federal laws. These laws were enacted to ensure consideration of historic values and to protect significant resources from destruction or theft. The major federal laws include: the National Historic Preservation Act (NHPA), Archaeological Resources Protection Act (ARPA), the Native American Graves Protection and Repatriation Act (NAGPRA), and the American Indian Religious Freedom Act of 1978 (AIRFA). State-level cultural resource protection is regulated through the provisions of Appendix K of the California Environmental Quality Act (CEQA). "*

### [International Journal Of Cultural Property](#)

*" A unique multidisciplinary periodical which addresses the concerns of people in all fields of learning and professional activity that touch upon cultural property: anthropologists, art historians, auctioneers, collectors, conservators, cultural historians, curators, dealers, economists, government officials, international organizations, lawyers and judges, museum directors, museum trustees, foundation staff and trustees, as well as others. "*

### [NAGPRA](#)

*" Native American Graves Protection and Repatriation Act of 1990 - This act assigns ownership and control of Native American cultural items, human remains, and associated funerary objects to Native Americans. It also establishes requirements for the treatment of Native American human remains and sacred or cultural objects found on Federal land. This act further provides for the protection, inventory, and repatriation of Native American cultural items, human remains, and associated funerary objects.*



*When these items are inadvertently discovered, cease activity, make a reasonable effort to protect the items, and notify the appropriate Indian tribe(s) and/or Native Hawaiian organization(s). "*

### [NAGPRA Resources](#)

*" For the past two years the NCSHPO and the National Conference of State Legislatures, with help from a grant from the National Center for Preservation Technology and Training, have been compiling a "user-friendly" database of all state preservation legislation. I am happy to report that the initial test version is now up and running as part of the NCSL's home page. The individual entries contain all the pertinent legal citations to allow users to retrieve the actual statute language from State law books. However, our goal in this project was to provide a plain-english summary for each statute. There is a short list of Primary Topics to speed searches, and a longer list of Secondary Topics which can be typed into a box to further narrow searches. "*

### [Native American Burial Sites - Barnett, Rex](#)

*" Stealing Native American Remains - Missouri House of Representatives - This bill makes it a class C felony to use for profit, purchase, or sell Native American human remains without the statutory right of possession. A second or subsequent violation is a class B felony. The trafficking of Native American cultural items from burial sites is a class D felony, with a second or subsequent violation a class C felony. "*

### [Tatakuyekiksuye 's Home Page](#)

*" The repatriation of Native American human remains at the University of Nebraska-Lincoln. This page contains many links to newspaper articles about the current controversy. "*

## [25 USC CHAPTER 32 - CHAPTER 32 - NATIVE AMERICAN GRAVES PROTECTION AND REPATRIATION](#)

§ 3001. Definitions. / § 3002. Ownership. / § 3003. Inventory for human remains and associated funerary objects. / § 3004. Summary for unassociated funerary objects, sacred objects, and cultural patrimony. / § 3005. Repatriation. / § 3006. Review committee. / § 3007. Penalty. / § 3008. Grants. / § 3009. Savings provision. / § 3010. Special relationship between Federal Government and Indian tribes and Native Hawaiian organizations. / § 3011. Regulations. / § 3012. Authorization of appropriations. / § 3013. Enforcement.

### [Native American Burial Sites, by Rex Barnett](#)

*" Stealing Native American Remains - Missouri House of Representatives - This bill makes it a class C felony to use for profit, purchase, or sell Native American human remains without the statutory right of possession. A second or subsequent violation is a class B felony. The trafficking of Native American cultural items from burial sites is a class D felony, with a second or subsequent violation a class C felony. "*

### [Native American laws](#)

*" American Indian Religious Freedom Act of 1978, Indian Dams Safety Act of 1994, Indian Self-Determination and Education Assistance Act of 1975, Native American Graves Protection and Repatriation Act of 1990 (NAGPRA) / Executive orders, policies, and guidelines include: / Reclamation's Indian Trust Asset Policy of 1993 (ITA) / These links are merely to provide information and are not to endorse anything. Includes links to further summaries of laws. "*

### [Reburial Controversy](#)

*" It is easy on first consideration of the reburial controversy to see a double standard in play, where European graves are sacred, and Indian graves are not, but as was clear to William Shakespeare, Europeans have long had a penchant for moving bones about when it has suited them (as well consider the grave digger in Hamlet who tosses up Yorick's skull while digging Ophelia's grave - in a couple of decades it will be Ophelia's skull that makes an airborne reappearance to make way for someone else). "*

### [Repatriation and Reburial, by Larry Zimmerman](#)



*" Many groups, especially indigenous peoples, have profound concerns about the ethical and respectful treatment of the dead by archaeologists, physical anthropologists and museums. The issue is complicated with concerns ranging from academic freedom to the rights of the dead. There is a continuum of opinion about these matters. "*

### [Tennessee Archaeology Net -- Native American Indian Cemetery Removal and Reburial](#)

*" CHAPTER 0400-9-1, Native American Indian Cemetery Removal and reburial, new rules, Table of Contents, 0400-9-1-.01 Manner of Reburial , 0400-9-1-.02 Reburial Areas , 0400-9-1-.03 Marking of Boundaries , 0400-9-1-.04 Notification , 0400-9-1-.05 Observation of Disinterment by Native American Observers "*

### [Tribal Preservation Program, National Park Service](#)

*" Over the last 500 years, Indian cultures have experienced massive destruction, but the tide is changing. Indian tribes are using their resources to halt the loss of language, tradition, religion, objects, and sites. Halting the loss is not enough, however. Fundamentally different in character from other components of American society, Indian tribes are living cultures that can continue and be strengthened only through the perpetuation of their traditions. Tribes, therefore, are reintroducing ceremonies, teaching languages, and seeking the culturally appropriate treatment of tribal objects and sites. These activities are not peripheral to tribal life; they are basic to healthy contemporary tribal societies. "*

---

## The Use of Indians as Mascots and Native American Stereotypes

### [Main Index for American Indian Sports Team Mascots](#)

*" "We simply chose an Indian as the emblem. We could have just as easily chosen any uncivilized animal." Eighth Grade student writing about his school's mascot, 1997 "*

### [THE MASCOT ISSUE](#)

*" This page is intended to be a compilation of web sites and writings on the issue of Indian mascots used by sports teams. Although some of these sites exist on other web pages that I maintain, I felt the time was right to compile these into one place in order to help people find them. " Lisa Mitten*

### [IN WHOSE HONOR?: Resources](#)

*" A graphic and eloquent examination of racism in sports and so called 'higher education'. Catching bigotry at its most virulent, this film requires no interpretation - it speaks directly to the problems without blinking. "Vine Deloria, Jr.*

### [Indian - by Wolfgang Mieder 'The Only Good Indian Is A Dead Indian'](#)

*" History And Meaning Of A Proverbial Stereotype - The interest in the study of national character, stereotypes, ethnic slurs, and racial prejudice as expressed in proverbs and proverbial expressions has a considerable scholarly tradition. "*

### ["Indian" Mascot & Logo Taskforce](#)

*" The Wisconsin Indian Education Association, "Indian" Mascot and Logo Taskforce seeks innovative legal, educational and political means to eliminate the use of "Indian" mascots, logos and nicknames from all Wisconsin state supported educational facilities. "*

### [Indian mascots destroy respect they are meant to instill](#)

*" Here it is, World Series time, and my worst baseball nightmare has come true. The Atlanta Braves are playing the Cleveland Indians. Not that I have anything in particular against the players on either team. And I really don't care about baseball (one wonders how I became sports editor) enough to dislike one organization or the other. But I do dislike their mascots, and the thought of the entire sports world focusing its attention on the Braves and the Indians is more than I can handle. I find Indian mascots degrading, and I find the behavior they encourage among fans appalling. "Dan Lewerenz*



### [Indians are people not mascots](#)

*Teach respect - not racism. Through the Midwest Treaty Network. " We Are a Living People. I don't understand.... Why should anyone's identity be defined by your games? We are a living people. Why are we used as entertainment for schools? We are a living people. Why must we be used as nicknames, logos, and mascots? We are a living people. Why must we, a living people, be singled out? Why must we, a living people, be stereotyped? Can't YOU tell who WE, a living people, ARE? Why doesn't what WE say matter? We are a living people. Why don't OUR voices count? " Lori Wautier*

### [Indian Sports Mascot Boycott Page](#)

*" Why is it that in this day & age, when many of us feel that we have advanced past the days of blatant racism, do we still have sports mascots, such as the Cleveland Indian's "Chief Wahoo"? We finally wised up to the fact that "Little Black Sambo" was not acceptable, so we did away with it. Why are Native Americans not spared this same decency. Why do we think it is OK to have a stupidly grinning, farcically colored "chief" as a mascot for a team that should be renamed out of respect in the 1st place?! "*

### [Lavender Magazine: Indian In A Past Life, or Spiritual Tourist? and The "Spirituality" Quiz](#)

*" Some of the people in the business of selling spiritual and cultural artifacts will listen to me and say, 'Well, I'm sincere about this. There may be others who are trying to rip off Native spirituality, but I'm sincere.' It's the sincere ones who are just as damaging to our cultures. "By Elise Matthesen*

### [Results of the Stereotype of the Month contest](#)

*Through PEACE PARTY - A multicultural comic book featuring Native Americans. The [Peace Party](#) website also offers story, art, essays, regular features, contests, polls and fan feedback.*

### [Measure your Implicit Attitudes](#)

*... on stereotypes, race & gender.*

### [National Coalition on Racism in Sports and the Media](#)

*" Why? does America accept stereotypical images of native peoples but not other racial groups. What's wrong with this picture? How? can we claim that we are anywhere close to racial justice and equality when these images are so pervasive in our society. What? can you do if you are offended by these images and wish to speak out. "*

### [NWCitizen - Indian Mascots](#)

*" INDIAN MASCOTS: AN OFFENCE TO INTELLIGENCE: The greatest problem with the use of Indian mascots in public schools is not that it offends Indian people, but that it offends intelligence. Framing the discussion around whether or not some individual tribal person is disgusted and offended by calling a team the Red Raiders, or The Warriors is somewhat of an aside and it obfuscates the most significant part of the issue: schools are supposed to encourage reflection and critical thinking; it is nonsensical and suspicious to utilize a cardboard cutout image of aboriginal peoples knowing all the time that it is grossly erroneous. Why would anyone, especially educators, allow students to uncritically adopt a cartoon version of a people's culture as a mascot? "Dr. Marker*

### [WNCCEIB: Indian Mascot Issue](#)

*" AMERICAN INDIAN SPORTS MASCOTS (North Carolina) Should images of American Indians and American Indian religious symbols and imagery be used as sport mascots? WNCCEIB concludes that the answer to this question is "NO". The time for change is now. Scroll down through the links below for the situation at Clyde A. Erwin High School in Asheville, North Carolina OR for for LINKS & RESOURCES on the overall national mascot situation "*

### [Stereotypes of Native Americans](#)

*" We are all familiar with the typical stereotypes of Native Americans. We display those promoted by our government*

*prominently on these pages. The portrait on the Indian Head nickel was largely responsible for the fact that Indians could not get jobs in Hollywood to play Indian parts. They did not look Indian enough! (See the essay by Joseph Marshall III, in *On Behalf of the Wolf and the First Peoples, Two Left Moccasins: I Become a Member of the Cinema Tribe.*) We are so used to seeing the Land o'Lakes Indian maiden, the various school mascots, mascots of professional sports teams, etc. that we forget what effect these images have on the ideas we have of the people they represent, or on the personal image of the children of these people as they must learn to live in this society. "*

### [The Talking Circle - Issues - Mascots](#)

*" Mascots & Logos - In the news and Noteworthy sites. "*

### [Danville, Vermont](#)

*" Home of the Danville Indians - Schools with an "Indian" mascot and or logo are actually teaching both the community and the students that racism is acceptable. What better way than this to indicate to children that stereotyping is a permitted activity, after all it is endorsed educators and school boards alike. The silence of those in authority in essence gives consent to this kind cultural disrespect. Allowing Native people to be used as mascots is wrong, disrespectful and dehumanizing. Non-natives cannot excuse this behavior by claiming that this activity is an "honor." Native people have said over and over that they are not honored by this kind of misuse of Indian image and culture. "*

### [AAIC Issues: Mascots](#)

*" The Advocates for American Indian Children has supported the Los Angeles American Indian Education Commission in its effort to remove Indian mascots from three Los Angeles Unified School District high schools: The Birmingham Braves, the Gardena Mohicans, and the University Warriors. "*

### [Native American P.O.V.](#)

*" Hitchhikers On The Red Road - Hitchhikers want to jump off their own path and catch a ride with me to what they perceive as spiritual awareness without any visible effort on their own part. They look for a magic bullet, a quick fix for whatever confusion they carry at any given time. THE Truth or even MY truth is the last thing they are looking for. They don't want my vision, just my symbols. Were they really seeking the truth they would have found it already on their own road for the truth exists on all paths. It can be found in the words of Jeshua Ben Joseph, Buddha, Krishna or Snoopy the Dog for that matter. "Carmen Abner*



**Text and Graphics**  
© 1994 - 103 [Tara Prindle](#)  
unless otherwise cited.



[Boozhoo niiji, behnahgay!](#)

Greetings friend, come in!

---

# Ojibwe

Links to

**Culture, Art, History,  
Language & People**

... for Brad

---

**[An Ojibwe Language Word List](#)**

---

Jump to other Internet Links for:

[Culture](#)

[Arts](#)

[History](#)

[Language](#)

[Books, News & Authors](#)

[Anishinaabe People](#)

[Other Resources](#)



---

## Links to Ojibwe Culture

### [Aadizookaanag, Dibaajimowin: Traditional and True Native American Stories - Paula Giese](#)

The first word -- Dibaajimowin -- in Anishinaabemowin (Ojibwe language) means just a story -- but the first part of the word -- dibaa -- is a meaning-part that suggests its words are measured, thoughtful, observed, judged. Here, those are are histories, personal narratives, experiences -- truths of that kind. The second long word -- Aadizookaan -- means "a traditional story", what anthros and all sorts of people seem to like calling legends or myths.

### [Anishinabe Migration Story - NATCHAT mailing list](#)

The Anishnabe Migration Story, since it covers several hundred years and includes many stories by Individuals and tribes who were part of--then split off along--the path is not in print. It goes back to East Coastal Algonquian tribes, and is "still going on now," i.e. to try to understand the 6th or 7th Fires.

### [Gitizee Elderly Center at Onigum](#)

On Leech Lake Reservation each weekday afternoon the elders of Onigum gather and share a hot meal together. A few years before there wasn't a Center mainly for the elders to go to. The meals were prepared at the local



Community Center where at times meals could not be served due to funerals, community gatherings, and political meetings leaving most of the elders without their daily meal.

## [GLIFWC \(Great Lakes Indian Fisheries Committee\) Homepage](#)

Comprised of eleven sovereign tribal governments located throughout Minnesota, Wisconsin, and Michigan, the Commission's purpose is to protect and enhance treaty-guaranteed rights to hunt, fish, and gather on inland territories ceded under the Chippewa treaties of 1836, 1837, 1842, and 1854; to protect and enhance treaty guaranteed fishing on the Great Lakes; and to provide cooperative management of these resources.

## [Hunting](#)

Powder Flask (left) Anishinabe (Chippewa), early 1800s

## [Midewiwin](#)

Miami Indians Ethnohistory Archives 1600-1640 (AR VIII, Bureau of American Ethnology) by W. J. Hoffman

## [Ojibway Clan System](#)

People of all nations in the world essentially have the same basic needs: food, protection, education, medicine and leadership. Traditionally, the Ojibway Clan System was created to provide leadership and to care for these needs. There were seven original clans and each clan was known by its animal emblem, or totem. The animal totem symbolized the strength and duties of the clan. The seven original clans were given a function to serve for their people.

## [Ojibway Creation Story](#)

Win Awenen Nisitotung newspaper "Mishomis Books" of the Ojibway Indians. The monthly teachings: The Ojibway Creation Story by Edward Benton-Banai

## [Ojibway Culture and History](#)

According to Professor Dennis Jones who teaches the Ojibway language at the University of Minnesota, either Ojibwe or Ojibway are actually correct spellings, but some people feel Ojibwe should be the preferred standardized spelling.

## [Rose's Native American Home Page](#)

Anin (hello), and welcome to my web page, my name is Rose Edwards, I am an Ojibwa Indian from the Keweenaw Bay Indian Community (KBIC). My Indian names are Wauwaushkaesh (wah-wah-ski-see) Little Deer which was given to me by my Grandfather when I was a child, my other/adult Ojibwa name is Migadideekwe (mih-gah-dee-day-ay-kway) Fighting Woman.

## [Seven Fires Prophecies of the Anishinabe](#)

The first prophet said to the people, "In the time of the First Fire, the Anishinabe nation will rise up and follow the sacred shell of the Midewiwin Lodge. The Midewiwin Lodge will serve as a rallying point for the people and its traditional ways will be the source of much strength. The Sacred Megis will lead the way to the chosen ground of the Anishinabe. You are to look for a turtle shaped island that is linked to the purification of the earth. You will find such an island at the beginning and at the end of your journey. There will be seven stopping places along the way. You will know the chosen ground has been reached when you come to a land where food grows on water. If you do not move you will be destroyed.

## [Song Catcher Frances Densmore Of Red Wing](#)

With little scientific training, and only a modicum of outside support, the young music teacher from a respectable Midwestern family vowed to preserve the old Indian songs in wax. Frances Densmore spent her life trying to gather up scraps and artifacts of the old Indian ways, shipping them off to the high ground of the Smithsonian Institution before a tide of American progress rose to carry them away.



[back to top](#)

## Links to Ojibwe Arts

### [Anishinabeck: People of This Place](#)

Nintey Anishinabe elders, parents, artists, and professional participated in the creation of this stirring exhibition which tells the story of their people's journey through the turbulent times of Michigan's frontier upheaval to the present. Direct quotes, photographs and interactive video interviews describe the life and culture of the state's first families.

### [Bandoliers: Native American Beadwork - Paula Giese](#)

What are they? Meanings, uses, who made them - Medical (MidĒwewin) bandoliers -- And A Sad Story - Ojibwe Embroidered Bandolier Bags - Ojibwe Woven Beadwork Bandolier Bags -The 3 oldest bandoliers: Southeastern, Cherokee, and Lenni Lenape - Late 19th century bandoliers made - by other tribes.

### [Manidoominens: Sacred Seeds--Native American Beadwork - Paula Giese](#)

Manidoominens -- Anishnaabemowin for "seed beads" means "little seed (-minens) that's a gift of the spirit (Manidoo), or Spirit Seeds. "Miinens" is the fruit of the hawthorn tree, miinensagaawunzh. Perhaps seed beads were named for this tree because its 5-lobed leaves reminded the women of hands.

### [Museum of Ojibwa Culture](#)

The city-operated museum and park portray a vivid picture of life in the Straits of Mackinac over 300 years ago when Ojibwa, Huron, Odawa and French lifestyles met at this protected bay. Museum exhibits show Ojibwa Indian culture and traditions, the French contact period, and the site's rich archaeology.

### [River of Song: Music Along the River - Ojibway Music from Minnesota](#)

Music was one of the last areas of American Indian culture to receive serious attention from scholars. Several factors were responsible for this-principal among them the inability to preserve examples for study before Thomas A. Edison invented the recording machine in 1879. Also, most listeners found the music to be unattractive and "primitive" by Euro-American standards. In the 1890s, however, the Smithsonian Institution's Bureau of American Ethnology began to encourage active collecting of Indian music.

### [Whetung Ojibwa Centre, Curve Lake Reserve, Ontario](#)

Experience the traditions of the past reflected in the present. We are located in the heart of Curve Lake Indian Reserve in the beautiful central Ontario Kawartha (Shining Waters) lakelands, only two hours north east of Toronto, Canada. Whetung Ojibwa Centre offers a spectacular collection of Indian crafts as well as fine art

[back to top](#)

## Ojibwe History

### [Chippewa Treaties Online](#)

The four treaties identified here are especially relevant to the recent Wisconsin and current Minnesota cases, because the areas governed by the treaties do not coincide with modern state boundaries. The Mille Lacs case wouldn't be in the Federal Court in Minneapolis at all if the judicial district boundaries didn't fall along the Minnesota-Wisconsin state line. The substance of the case at Mille Lacs is very similar to the case argued before Judge Crabb in Wisconsin.

### [Chippewa Treaties Understanding and Impact](#)



**This is the second edition of Chippewa Treaty Rights: Understanding and Impact, a booklet first produced to provide a resource for younger readers. It is hoped that the publication will introduce the reader to Anishinaabe history and culture as well as the modern day exercise of treaty rights and resource management of the tribes.**

## **Michigan Tribes**

**There are three major tribal groups in Michigan today: the Chippewa (Ojibwe), the Ottawa, and the Potawatomi. They comprise what is called the Three Fires Council. Although these three tribes have similar cultures and share the same territory, there are still some differences.**

## **Michigan's First People**

**The information and stories contained on these pages tell about the first people who lived in Michigan. They were here long before the explorers, the fur traders, and the settlers. The most recently added information is at the top of the page. The resources listed here are intended to be used by fourth grade students who are studying Michigan history.**

## **Mille Lacs Treaty Rights - Channel 4000**

**One hundred sixty-one years ago, leaders of the Mille Lacs band of Chippewa ventured to the bluffs of Fort Snelling. There, they signed the treaty of 1837, giving the United States deed to their land. In exchange, they were granted hunting, fishing and gathering rights to sustain a way of life.**

## **Ojibway History Text**

**Ojibway History, Culture, Resources, Films/videos, Pic River, and Anishinabe Links The fundamental essence of Anishinabe life is unity. The oneness of all things. In our view history is expressed in the way that life is lived each day. Key to this is the belief that harmony with all created things has been achieved. The people cannot be separated from the land with its cycle of seasons or from the other mysterious cycles of living things - of birth and growth and death and new birth. The people know where they come from. The story is deep in their hearts.**

## **Ojibwe**

**The Ojibwe occupied the forest country around the North shore of Lake Huron and both shores of Lake Superior. They were located from Minnesota and Wisconsin to the Turtle Mountains of North Dakota after being pushed out of Canada by the French.**

## **Ojibwe History**

**In a tradition shared with the Ottawa and Potawatomi, the Ojibwe remember a time when they lived near an ocean. This may have been the Atlantic near the gulf of the St. Lawrence, but more likely it was Hudson Bay. Sometime around 1400, the North America climate became colder, and the first Ojibwe, Ottawa and Potawatomi bands started to arrive on the east side of Lake Huron. The Ottawa remained at the mouth of the French River and Lake Huron islands, but the Ojibwe and Potawatomi continued northwest occupying the shoreline to the Mackinac Strait which separates upper and lower Michigan.**

## **People of the Three Fires Native Genealogy**

**In March and April, 1996, a group of genealogists organized the Michigan Comprehensive Genealogy Database. The idea was to provide a single entry point for all counties in Michigan, where collected databases would be stored. In addition, the databases would be indexed and cross-linked, so that even if an individual were found in more than one county, they could be located in the index.**

## **Treaty With the Chippewa, 1854.**

**Articles of a treaty made and concluded at La Pointe, in the State of Wisconsin, between Henry C. Gilbert and David B. Herriman, commissioners on the part of the United States, and the Chippewa Indians of Lake Superior and the Mississippi by their chiefs and head-men.**

## **Walpole Island: Chronology of Events 1763 -1994**



Aboriginal people have lived on the land and held it in trust for future generations. They have protected the land through their own customs, laws, and ways of life. Aboriginal title and rights have been established through centuries of occupation and use. Walpole Island and the surrounding region is called Bkejwanong or "where the waters divide." It has been home to aboriginal people for over six thousand years. Bkejwanong is the traditional territory of the Walpole Island First Nation. The people are descended from members of the Ottawa, Ojibwa, and Potawatomi Nations who lived in the area at different times in the past.

[MIAMI INDIANS ETHNOHISTORY ARCHIVES - 1600-1640](#)

[MIAMI INDIANS ETHNOHISTORY ARCHIVES - 1640-1669](#)

[MIAMI INDIANS ETHNOHISTORY ARCHIVES - 1669-1679](#)

[MIAMI INDIANS ETHNOHISTORY ARCHIVES - 1680-1681](#)

[MIAMI INDIANS ETHNOHISTORY ARCHIVES - 1682-1699](#)

[MIAMI INDIANS ETHNOHISTORY ARCHIVES - 1700-1703](#)

[back to top](#)

## Links to Ojibwe Language Resources

### [American Indian Studies Department - Ojibwe Language](#)

University of Minnesota - This page explains a few elements of the Ojibwe language course series (AmIn 1021, 1022, 1023, 3024, 3025 and 3028), the content within each course and other course-related information.

### [Anishinaabe <--> English Translator On-Line](#)

FDLTCC Word Translators English to Anishinaabe: Anishinaabe equivalent: Anishinaabe to English: English equivalent. >> THE TRANSLATOR IS TEMPORARILY OFF-LINE, BUT WILL BE BACK ON-LINE HOPEFULLY THIS FALL <<

### [Anishinaabe Language Resources](#)

Fond du Lac Tribal & Community College Resources WWW Anishinaabe <--> English Translators Rob McKnight's language pages Other Anishinaabe Language Resources Nancy Vogt's Ojibwe Language Pages Various Resources Web Pages for American Indian Educators Yamada Language Guides Multilingual PC Directory 4th World Documentation Project - The Americas Center for Machine Translation - Carnegie Mellon University WWW Linguistics Journals & Newsletters - University of Rochester

### [Anishinaabe Questions](#)

Translations.

### [Anishinaabemowin Lynk](#)

This booklet was written to assist students who wish to learn the Anishinaabe language. The author does not claim that the students will learn the Anishinaabe language solely from this written material. It is a tool which may help the students learn when used with other materials.

### [Anishinaabe Language and Culture](#)

Rob McKnight's language pages - As with many languages, translating Anishinaabemowin into English, word for word, is very difficult without references or more complete phrases. Keep this in mind when visiting the Anishinaabe language pages. Also note that there are three basic Ojibwe dialects (R, L, and N). Spellings may vary in different parts of the US and Canada.

### [Assembly of Manitoba Chiefs - EFA](#)



With sound wav's for Greetings -- The Assembly of Manitoba Chiefs and the Minister of Indian and Northern Affairs Canada signed the Framework Agreement on Indian Education in Manitoba on December 5, 1990. The purpose of the Framework Agreement is to develop formal arrangements on education based on community-identified educational needs. Under the terms of the Framework Agreement Initiative, the Assembly of Manitoba Chiefs are currently negotiating long-term changes for First Nations education and establishing an implementation plan for setting up a new education system under First Nations Jurisdiction.

### [Chippewa \[ Ojibwe \] \[ojjipewa\] Language ~ Anishinabemowin ~](#)

This Site is Dedicated to the Preservation of Anishinabemadissiwin.

### [Elementary English to Ojibwe Translator](#)

An On-Line Translator - It is in the very early days of its cloning from the Odawa site. Through Albion Cpllege.

### [FNFP - First Nation Forestry Program](#)

Introduction in Ojibwe as well as in Salish, Cree & Micmac

### [H-AMINDIAN: Discussion Threads: Long Knves: Indian Ethnonyms for non-Indians](#)

### [Key to Ojibwe Place Names](#)

Dr. Brian R. Donovan abstract portrait by son Trevor at age 4 Associate Professor of English, Bemidji State University (BSU), Bemidji, Minnesota, USA

### [LCTL:Ojibwa](#)

The following list contains information about colleges and universities in North America that teach Ojibwa. The institutions are listed alphabetically, with information about course levels and availability, and the name of a contact person at the institution.

### [Learning Ojibwe](#)

The following comprehensive list of learning resources for Ojibwe has been prepared for the SSILA Learning Aids files by Rand Valentine, who teaches linguistics and Ojibwe at the University of Wisconsin, Madison. (Many thanks, Randy!) The dialects covered include: Algonquin, Anishinaabemowin, Central Ojibwe, Chippewa, Eastern Ojibwa, Nipissing, Nishnaabemwin, Northern Ojibwe, Odawa, Oji-Cree, Ojibway, Odawa, Ottawa, Saulteaux, and Severn Ojibwe.

### [Let's Speak Ojibwe: pronunciation chart](#)

Ojibwe is a branch of the Algonkian language family. This web site used the Double Vowel system to write the language. Although the letters used are taken from the English alphabet, they represent Ojibwe sounds, not English sounds. In the examples below, Ojibwe sounds and English approximations of the Ojibwe sounds are given. However, it is always best to consult a native speaker for the best pronunciation. Correct pronunciation is important, mispronouncing a word can completely change its meaning.

### [Nanichi's Anishinaabe Dictionary](#)

The Anishinaabe people are more commonly known as the Ojibwe/Ojibwa/Ojibway people. To others, they are known as the Chippewa, in which case the Ojibwa name was mispronounced. If one says "o'chippewa" you can easily see that the two names are simply different pronunciations. You might be interested to know that to others, they are known as the Salteaux and/or the Soto. [This page is also here.](#)

### [NAT-LANG \(1994\): Ojibwe language-learning materials available.](#)

People interested in Ojibwe language study materials may want to call Ojibwe Mekana. They have two (maybe three by now) cassette-based courses available, and they're pretty good. I've had both the Basic and Advanced sets for awhile now, and I'm pleased with them, so I'm passing the word along.



## [Niizh Ikwewag - Two Women](#)

Point to any part of the Ojibwe text below with your mouse and an appropriate grammatical/lexical note will appear on the status line at the bottom of your browser window. (This requires a Java-enabled browser.) English translation available here.

## [Ojibway Indian Language](#)

Vowel Pronunciation when and where - Past tense: Time expressions: Questions with "AANIISH PII": More questions: Useful Expressions: Inanimate nouns: Locative forms: Sentence Patterns: Verbs: and tons more!!

## [Ojibwe Language and Culture: Language, by Nancy Vogt](#)

Welcome to Ojibwe language and culture. This is not meant to include a complete dictionary or tutorial to learn the language, or to be the final word on cultural issues but I hope it will be a pleasant and interesting introduction. Language essays, Cross-cultural materials, bibliography of further references.

## [Ojibwe Language Society Homepage](#)

Our Ojibwe Language Table is open to the community. Join us every Monday during the school-year for food and Ojibwe conversation. There's room at the table for beginners and fluent speakers.

## [Ojibway Learner Page](#)

This page is for fellow learners of the Anishinabe language (Ojibway). At present, it consists of a couple of puzzles I developed for fun, my personal language resource holdings and a short essay about my language learning experience. At the moment, this page is limited by my HTML knowledge and available time. Ojibway language puzzle

## [Ojibwe Native Language Material - Bibliography](#)

### [The Way We Speak - CHAPTER 7: OJIBWE\\*](#)

Established in 1985, MANL promotes Native languages retention by stimulating awareness of the importance of Native languages to cultural development. In partnership with local communities MANL (Manitoba Association for Native Languages, Inc.) works to keep six aboriginal languages alive. Ojibwe, Cree, Dene, Dakota, Island Lake Dialect, and Michif.

[back to top](#)

## **Books, News & Authors**

### [Anishinabe Books listed by nativeauthors.com](#)

### [Barnesandnoble.com - Book Search for Ojibwe](#)

Matches for Keywords are ojibwe ojibwa anishinabe chippewa ojibway chippeway HotBot Search Partners Find books on "ojibwe ojibwa anishinabe chippewa ojibway chippeway" at BarnesandNoble.com.

### [Chippewa/Ojibway/Anishinabe Literature](#)

Indigenous Peoples' Literature Compiled by: Glenn Welker

### [Dibaudjimoh Nawash](#)

Bringing News of the Chippewas of Nawash on the Web Dibaudjimoh on the Web and News From Home, Loby and other Links, Illustrated History of the Chippewas of Nawash.



## [Fond Du Lac Follies - NFIC Columnists](#)

by Jim Northrup, Jr. Anishinabe.

## [In the Spirit of Sharing - NFIC Columnists](#)

by Bawdwaywidun, a.k.a. Eddie Benton-Benaise Anishinabe Fourth degree Midewiwin Fish Clan, Ojibwe Anishinabe, LCO Anishinabe Nation of Wisconsin.

## [Jim Northrup](#)

Jim Northrup, Anishinaabe, writes a syndicated column, Fond du Lac Follies, which is distributed in the The Circle, The Native American Press, and News From Indian Country. In 1990-1992, Jim worked as a roster artist for the COMPAS Writer in the Schools Program. He has been a Mentor in the Loft Inroads Program, a Judge for the Lake Superior Contemporary Writers Series and The Jerome Fellowship, and a Member of the Minnesota State Arts Board Prose Panel. Jim also has given radio commentaries on the Superior Radio Network, National Public Radio, Fresh Air Radio, and the BBC-Scotland.

## [Lakehead University - Faculty of Education Native Language Instructors' Program, Bookstore Resources](#)

The Lakehead University Bookstore carries a wide range of Ojibwe and Cree titles, as well as many other publications about native peoples. Some of these titles are used in Lakehead University courses, and others are of general interest.

## [Native American Authors: Chippewa Tribe](#)

The Internet Public Library: Kateri Akiwenzie-Damm, Andrew J. Blackbird, Kimberly M. Blaeser, Diane Burns, Rosemary Christensen, Adam Fortunate Eagle, Louise Erdrich, Ron Evans, Hazel Hart, Gordon Henry, Maude Mitchell Kegg, Clara Sue Kidwell, Jim Northrup, nila northSun, Ferguson Plain, John Rogers, Sun Bear, and Gerald Vizenor Wub-e-ke-niew.

## [Native American Authors: Ojibwe Tribe](#)

## [Indian Country News](#)

Twice-monthly, independent Indian-owned newspaper reporting national news, pow-wow dates, and cultural news to all people interested in Indian Country. - Out of Wisconsin.

## [Ojibwe'Anishinaabe Biidaajimo Online Newsletter](#)

Boozhoo Anishinaabe...welcome to Ojibwe'Anishinaabe Biidaajimo. In developing this web page I decided early on to go beyond the typical home page. By this I mean - Hi! My name is Joe Shinob, I have two rez dogs and a cat, I like powwow music and rock & roll, my interests are casino gambling and snagging. Rather, I saw my personal home page as the opportunity to develop a communication tool that could provide information that focused on issues related to the Native American community and, in particular, to my culture - the Ojibwe'Anishinaabe people.

## [Resource List for Anishinaabe Educators.](#)

## [The Tribal Observer](#)

published by the Saginaw Chippewa Indian Tribe of Michigan. The semi-monthly tabloid-sized newspaper is distributed to all Tribal households and to employees, as well as subscribers across the United States.

[back to top](#)

## **Links to Anishinaabe People**



### [Bad River Band of Lake Superior Chippewa Indians](#)

A visit to the Bad River Chippewa Reservation in Northwestern Wisconsin is an exciting and enlightening experience for young and old. More than 95% of the reservation's 124,234 acres remain undeveloped and wild.

### [Bay Mills Indian Community](#)

Bay Mills Resort & Casino, King's Club Casino, Wild Bluff Golf Course, Bay Mills Community, Biological Services, Maps, & Other Links.

### [Bois Fort / Nett Lake Band of Chippewa Indians](#)

Bois Fort consists of 3 pieces of land, of which Nett Lake (village, peninsula, lake and surrounding forest) is by far the largest. The Band's French name means "Strong men (or Strength) of the woods", a name this band was given by the French voyageurs.

### [Chippewa Cree Tribal Council](#)

The Rocky Boy Reservation is home to the Chippewa Cree tribe. The Reservation is located in north central Montana in the Bear Paw Mountains. The tribal headquarters is in the community of Rocky Boy Agency

### [Fond du Lac Education Division](#)

Including [Dan Anderson's Bibliography of Native Resources](#).

### [Grand Portage Band of Chippewa Indians](#)

Misty day, canoe seen in the distance over evergreen-surrounded waters with little islands -- it might be a long-ago portrait of an Anishinaabe fishing on one of the lakes that dot the beautiful Grand Portage reservation, at Minnesota's most northeasterly point.

### [Keweenaw Bay Indian Community](#)

Located on the beautiful shores of Lake Superior (Kitchigami), the Keweenaw Bay Indian Community (L'Anse Reservation) is the largest federally recognized "Indian Tribe" in the State of Michigan.

### [Lac Courte Oreilles Band of Lake Superior Chippewa Indians](#)

The reservation of the Lac Courte Oreilles (LCO) Band of Lake Superior Chippewa is located within beautiful mixed forest woods, where the broad leaf and great pine trees create extremely diversified ecosystems.

### [Lac du Flambeau Band of the Lake Superior Chippewa](#)

The Lac du Flambeau Band of Lake Superior Chippewa Indians makes its home on the Lac du Flambeau Indian Reservation located in the heart of north central Wisconsin.

### [Leech Lake Ojibwe - the Flag](#)

Within the red ring the most prominent device is a yellow equilateral triangle. Outside the edges of this triangle starting from the hoist side are symbols of nature, in this case pine trees and a soaring eagle; symbols of education represented by diploma and graduation mortarboard hat; and symbols of justice and the law depicted as the scales of justice. Within the triangle appear a peace pipe and two brown feathers representing the Ojibwe people. The yellow triangle recalls the birchbark wigwams that were the ancient homes of the Ojibwe.

### [Little Shell Band](#)

A band of the Chippewa Cree Tribe with headquarters in Great Falls, Montana. Not a federally recognized tribe.

### [Mille Lacs Band of Ojibwe](#)

By the mid-1700s, the Ojibwe had established themselves in the region around Mille Lacs Lake in what is today Central Minnesota. They supported themselves by hunting deer, bear, moose, waterfowl and small game; fishing the



area's lakes and streams; gathering wild rice, maple sugar, and berries; and cultivating plants.

### [Mississaugas of the New Credit First Nation](#)

Located in southwestern Ontario immediately west of the Town of Hagersville and approximately 32 km southeast of the City of Brantford. Northeast is Hamilton at 40 km distant, other major centres including Windsor, Sarnia, London and Toronto are within easy access of New Credit. It is bordered on the west and north by the Six Nations of the Grand River.

### [Red Cliff Band of Lake Superior Chippewa](#)

Red Cliff hugs the northern shoreline of the Bayfield Peninsula. At one end is Bayfield, on the other is Cornucopia, and between them is the Apostle Islands National Lakeshore.

### [Red Lake Band of Chippewa Indians](#)

The Red Lake Band of Chippewa Indians wanted a symbol of our nation; our sovereign nation. The design represents many things, the shape of the upper and lower Red Lake has been our trademark due to its unique shape and what it means to us; fresh water and food (walleye). The circle represents the powerful "circle of life" for ours and countless other tribes. Unity without end. The trees mark our dependence on them for shelter, transportation, warmth and many feelings of belonging to the land.

### [Saginaw Chippewa Indian Tribe of Michigan](#)

On this web site, you'll find information about our tribal government, including details about the services we provide to tribal members and to the local community. To help you to understand the foundation upon which our community is built, we have provided information about our history and culture.

### [Sandy Lake Band of the Mississippi Ojibwe](#)

The remnants of the Sandy Lake Band of Mississippi Ojibwe reside on and near a 32.35 acre reservation in Aitkin County, Minnesota. The reservation lies nestled in the southern part of the famous Arrowhead country; a region of fish-filled lakes, of deep valleys, and of rugged pine and hardwood covered hills. The reservation is located approximately one hundred and twenty-five miles north of the Twin Cities and sixty miles west of Duluth, near the town of McGregor, Minnesota.

### [Sault Tribe of Chippewa Indians](#)

The Original Bands of Sault Ste. Marie Chippewa Indians were an identifiable tribally organized entity long before their first contact with white explorers which occurred about the year 1620. The geographic area extended from Grand Island near the present city of Munising.

### [Sokaogon Chippewa Tribe \(Mole Lake\)](#)

In the early autumn when the leaves begin to change color, the Sokaogon Indians of Mole Lake make their way to Rice Lake, and one of the last remaining ancient wild rice beds in the state of Wisconsin.

### [St. Croix Chippewa Tribe](#)

The St. Croix Chippewa Reservation in northwest Wisconsin is scattered in a checkerboard of 11 separate communities over a four-county area. Tribal headquarters is located in the Burnett County reservation community of Big Sand Lake, near the unincorporated village of Hertel.

### [Turtle Mountain Band of Chippewa Indians](#)

This page was created to provide information about the Turtle Mountain Band of Chippewa Indians, and to serve as a place for tribal members and others to share ideas and get information about the events and programs offered by the tribe. Please feel free to sign the guestbook, and make sure that you fill out the quizlet on your tribal affiliation.



## [White Earth Band of Chippewa](#)

Located in northwestern Minnesota, the White Earth reservation encompasses about 1300 square miles, but most of that land is no longer Indian-owned, due to allotment and tax forfeiture losses in the early 20th century.

## [Windigo First Nations Council](#)

Takes its direction from the leadership of the Chiefs of the governing member communities in Ontario. The Council has two main functions. They are: 1.To develop programs and services that respond to the needs of the Band members within the six communities of the Windigo area. 2.To negotiate with other levels of government on various aspects of First Nations' jurisdiction and control. Such representation is based on, but does not compromise, the treaty and inherent rights positions held by the elected leaders and elders of the member communities.

## Individuals

### [George Copway \(Kah-ge-gah-bowh; Ojibwa\) \(1818-1869\)](#)

Students need information about the Ojibwas as a group. They also need to understand the relationship between Copway's autobiography, the Indian Removal Bill, and the attempts to move the Ojibwa out of Minnesota. They need as well an understanding of how Native American autobiography differs from that of non-Indians. See discussion below.

### [Paul Buffalo](#)

When Everybody Called Me Gah-bay-bi-nayss: "Forever-Flying-Bird" An Ethnographic Biography of Paul Peter Buffalo by Tim Roufs Department of Sociology - Anthropology -Criminology - Humanities / Classics College of Liberal Arts University of Minnesota - Duluth

### [Ojibway Role Models](#)

Ojibway author Louise Erdrich, Ojibway NHL hockey player Chris Simon, Ojibway Elder, Teacher, Storyteller Maude Kegg, Ojibway Artist Norval Morrisseau, Ojibway Elder/Activist/Writer/Spiritual Leader Edward Benton-Banai, Ojibway Author/Story-Teller/Scholar Basil Johnston, Ojibway Activist/Writer Winona LaDuke, Ojibway Elder/Tribal Chairman Roger Jourdain, Ojibway Activist Clyde Bellecourt, Ojibway Writer/Poet Jim Northrup, Ojibway Warrior Leonard Peltier, Ojibway Author/Scholar Gerald Vizenor, Ojibway NHL Coach of the Year Ted Nolan and Ojibway Activist Dennis Banks.

[back to top](#)

## Other Ojibwe Resources

### [Anishinaabenaang - Maps](#)

The following map images are 1350x975 pixels, so that each one fits on a standard 8½"x11" sheet, with one-inch margins, landscape orientation, at a resolution of 150 pixels per inch. Unlabeled With reservations labeled With select towns labeled A table provides glosses for the Ojibwe place names on these maps, and the names in official (Gichimookomaan) use. Dr. Brian R. Donovan abstract portrait by son Trevor at age 4 Associate Professor of English, Bemidji State University (BSU), Bemidji, Minnesota, USA

### [Electric Library Personal Edition - Results for Ojibwe](#)

HotBot Search Partners ... Research "ojibwe ojibwa anishinabe chippewa ojibway chippeway" at Electric Library.

### [Minnesota Indian Tribes: Reservations, Treaties](#)

Click on the numbered reservations to learn about them. Or use the list: Ojibwe History 1.White Earth, 2.Leech Lake/Cass Lake, 3.Red Lake, 4.Bois Fort (Nett Lake), 5.Grand Portage, 6.Fond du Lac, 7.Mille Lacs, 7d. Sandy Lake Band.

[Midwest Treaty Network; map - Sulphide Mining in Wisconsin](#)

Sulphide Mining in Wisconsin and its threats to Indian lands there, Midwest Treaty Network, Zoltan Grossman cartographer



[back to top](#)

---



© 1994-2000 [Tara Prindle](#).





# Native American Message Boards & Related Discussion Forums

This is a collection of message boards and forums of interest to Native Americans or others interested in Native American culture. NativeTech does not necessarily support any of these web sites, boards or the ideas expressed on them. Using this list as a vehicle for spam is a violation of the NativeTech website terms of use. If your trying to sell something, try a [Trader's Post](#)

**CLICK ON A TOPIC ABOVE TO JUMP TO THAT CATEGORY**

[Native Issues & Organizatons](#)

[Native People & Regions](#)

[Native Arts, Entertainment & Games](#)

[Native Genealogy](#)

[Native Languages](#)

[Environment, Animals, Plants & Food](#)

[Technology, Living History & Trecking](#)

[Other Native-related Boards](#)

---

## Native Issues & Organizatons:

### [IMDiversity.com - Message Forum](#)

Where careers, opportunities and diversity connect.

### [Native Culture](#)

A series of topically organized forums through [Lisa Mitten's Native Sites and American Indian Library Association](#).

### [Native Forum](#)

A general forum for any and all topics that bear some relevance to the world's Native peoples. From politics to poetry, jokes to chit-chat, no limits here. Here is the beginnings of [The Book Club](#).

### [Native News: Discuss It](#)

Something you would like others to know? Opinions, gripes, discussions related to news articles on Native News. Through [Ishgooda](#) Native News.

### [NativeWeb Message Boards](#)

After obtaining a log-in you can visit [Book Club](#) Discussions on books by, for and about Native and Indigenous People.

### [NWIC Discussion BoardDiscussion Board](#)

Through the [NorthWest Indian College](#) in Bellingham, Washington.

### [Pechanga.net's Discussion Boards and Chat Rooms](#)

Discussions on Native American issues. Through [Pechanga.net](#) News Resource.



 [Signals Discussion Board & Chat Area](#)

Editorials, Soapbox, Saskatchewan Employment, Diabetes, Community Arts, and Justice & Natives. Through [Indigenations.com](http://Indigenations.com).

 [Taiga Communications discussion forum](#)

Through [First Perspective Aboriginal News & Events](#)

 [The Talking Circle](#)

General chit-chat and discussion of issues and current events. Through [Indianz.Com](http://Indianz.Com).

 [Turning Point Talking Circle](#)

First Nations discussion about issues & actions, books, the environment and revisioning Canada. Through [Turning Point Native People's and Newcomers Online](#).

 [Turtle Island Native Network Duscussion](#)

Forums for events, jobs, social notes, youth, sports, and many First Nations' issue topics.

 [Village of First Nations Discussion Groups](#)

| [Announcements](#) | [Culture & Cultural Issues](#) | [Political Issues](#) | [Questions & Answers](#) | [Social Chat](#) | [Village of First Nations](#) |


 [Virtual Circle Discussion Forum](#)

We promote the development of new and/or existing ideas of Aboriginal people through interaction and discussion.

[Return to Top](#)

---


## Native People & Regions:

 [Algonquin Discussion](#)

The Algonquin Indians are the most populous and widespread North American Native groups, with tribes originally numbering in the hundreds and speaking several related dialects. Through [www.algonquin.tv](http://www.algonquin.tv).

 [Arctic Forum](#)

Whether offering a brief question, a thought-provoking commentary, or simply browsing, all are encouraged to participate in the new Arctic Forum and share common interest in the resources, peoples, and environmental issues of the Circumpolar North.

 [At Home in the Choctaw Nation](#)

Through [CHATA language lessons](#).

 [Caribbean Amerindian Discussion Forum](#)

Boardroom for discussions concerning the problems and prospects of modern Caribbean Amerindians. Through [Centrepape of Caribbean Amerindian Communities and Educational Resources on the Internet](#).

 [Cherokee Archive Forum](#)

This is a place to discuss Native American issues, Cherokee language, history, and culture, as well as other general

**American Indian subjects.**



**[Cherokee and Creek Culture/history](#)**

A great place to discuss the culture and history of these two nations, and Native American Music!!



**[Choctaw Talk](#)**

For the discussion of Choctaw issues, language, culture, history, geneology & events.



**[Cree Indian Discussion Forum](#)**

A forum where you can interact with others, exchange information, views, and ideas and perhaps even locate your long lost friends, and relatives. Through [creeindian.com](#)



**[Eastern Delaware Nations](#)**

From [Eastern Delaware Nations](#). A place for Eastern Delaware Nations members and others to leave messages.



**[Elder's Council of the Cherokee Nation](#)**

Tsa'La'Gi Public Forum.



**[FreeSwinomish Message Board](#)**

A place to discuss issues relating to the Swinomish Tribe, and other Native American Tribes in the United States in both current and historical context. Through [Swinomish People's Home Page](#)



**[Hopi Network Message Center Index](#)**

Through [Hopi Information Network](#).



**[Iroquois.Net Message Board](#)**

Through [Iroquois.Net](#).



**[Iroquois Trail](#)**

Ohenton Karihwa'te':kwen, Kaianerenkowa, Watkanonwaratons, The Clearing In The Woods, At The Woods Edge, Women's Council, Woodsmoke and Sweetgrass, The Runner's Path, Ononkwashona (Medicines), Trading Post, Cooking Fire, and the Council Fire.



**[Kahon:wes's Mohawk & Iroquois Phorum](#)**

A series of topical forums through [Kahon:wes's Mohawk & Iroquois Index](#).



**[KCity Native Community Message Board](#)**

Through [Kansas City Native American Community](#).



**[Kipawa.com Discussion](#)**

Eagle Village-Kipawa is one of nine communities that make up the Algonquin Nation in Quebec. Through [Kipawa 1st Nation Community](#).



**[Kumeyaay Nation discussion forum](#)**

Join in the discussion of all things Kumeyaay. Participate in current threads, or create your own. This is your opportunity to be heard, on Kumeyaay.com.



**[Metis Resource Center - Message Board](#)**



Everyone is welcome to use this board for Metis related topics, including Metis Events. Feel free to post your questions or announcements, but not political issues.

 [Mi'kmaq Net News Forum](#)

Through [Mi'kmaq Net](#).

 [Navajo Indians](#)

 [Nanticoke Leni-Lenape Indian Forum](#)

Through [Nanticoke Leni-Lenape Indians of NJ](#).

 [Nanticoke and Leni Lenape Indian Village](#)

A place to discuss family histories or topics of interest. Through [Wicomico Woman's World](#).

 [Native Trail Discussion Groups](#)


Designed, in part, to provide you with information about the First Nations and Inuit in Quebec. Through [nativetrail.com](#).

 [Northeast Wigwam Discussion Boards](#)

It is with the spirit of educating all of us that we have created these discussion boards so we can share and benefit from the experience and knowledge of others. | [arts and crafts](#) | [education](#) | [gardening](#) | [genealogy](#) | [herbs and medicine](#) | [history](#) | [issues](#) | [social](#) | [spirituality](#) | [trading post](#) |

 [Ohwejagehka Hadegaenage](#)

'Songs of the Earth'. General Inquiries; Mohawk Language; Oneida Language; Onondaga Language; Cayuga Language; Seneca Language; Tuscarora Language; Iroquois Songs; and Genealogy Inquiries.

 [Osage Tribal News and Issues Message Board](#)

News & Issues; Genealogical Forum; and Kid's Forum.

 [Pamunkey Message Board](#)

This message board is intended for comments about this website and to allow users to share information. Through the [Pamunkey Indian Unofficial Homepage](#).

 [People's Paths Internet BBS](#)

The Cherokee Nation of Oklahoma for the communication & exchange of ideas & information. Formerly [Yvwii Usdinvoohii Bulletin Board](#).

 [Saponi Town](#)

A forum bringing together descendants of the Eastern Siouan tribes in NC and VA who were last together at Fort Christanna, Brunswick County, VA in the early 18th century. History and migration. Also reported as Blackfoot ancestry in many families.


 [ShiDineh : Dine Message Boards](#)

Native Discussion Board, engage in discussion about politics, anything happening on the rez, news, lifestyles, and more. Through [ShiDineh.com](#).


 [Talking Feather Message Board](#)



Through the [Cawasuck Band of the Pennacook-Abenaki People](#).

 [Traditional Abenaki of Mazipskwik](#)  
Discussion Circle Fourm. Through [hmt.com/abenaki/](http://hmt.com/abenaki/)

 [Tuscaroras.com Discussion Center](#)  
Tracing Your Roots, Six Nations Discussion, Legal Issues, Joke of the Day, Event Announcements, Sharing Tuscarora History and more. Through [Tuscarora and Six Nations Websites](#).

 [Tyendinaga Mohawk Territory](#)  
The Mohawks of the Bay of Quinte BBS - The intent of this message board is to serve as a community forum. Please refrain from posting requests for geneological information. [FNIT's old WWWBoard](#) First Nations Technical Institute - Tyendinaga Mohawk.


 [Wampum Chronicles Message Board](#)  
Through [The Wampum Chronicles](#) A website of Mohawk History.


 [Moccasin Telegraph](#)  
A message board for the Native American Community of New England. Through [Wollomonuppoag.com](http://Wollomonuppoag.com)


[Return to Top](#)

---


## Native Arts, Entertainment & Games:


 [Beadwork Bulletin Board - The Mining Co.](#)  
Spam-free environment to ask and answer questions, share experience and, best of all, make new beadfriends (requires login).

 [Cactus Feathers Crafts & Native American Interests](#)  
Join in sharing information about arts and crafts, or help a story to unfold.

 [Cln](#)  
Watz Up? Seen Clan/destine Lately? Share the last time you saw Clan/destine & pictures. Through [Clan/destine-Rezdawgs](#).

 [Fighting Whites Forum](#)  
Native American Mascots Discussion & Site/Store Suggestions

 [Native American Crafts & Chat](#)  
The community is open to anyone with interests in NA Crafts and all things related to those topics. Members range from professionals to hobbyists to people that just want to learn more about NA Crafts.

 [Native Athlete Message Board](#)  
Through [Native Athlete's Site](#). Find info about some of those doing remarkable things on the playing fields of football, basketball, lacrosse, hockey, swimming, boxing, and various other sports.

 [Native Celebs](#)

For giving and receiving info and opinions on Native Celebrities. Please do not impart info/opinions harmful to the celebrity, and be courteous to fellow fans and celebrities. Some of them may actually browse these pages.

 [Native Issues and Pow Wow information](#)

Maybe you have a favorite recipes to share. Or a joke you like to share, or found a good site and would like to share this with us. Making a craft let us hear about it, took a trip we would like to hear about that too.

 [Native North American Travelling College](#)

Through [NNATC at Tuscaroras.com](#)

 [NdnSports.com Message Board](#)

Tell us if you know any information about Native American athletes in your area. Through [NDNSPORTS.COM](#).

 [ONABEN Forums](#)

Upcoming events in Indian Country - pow wows, rodeos, arts & crafts fairs and Tribal celebrations.

 [On-line Drum Discussion Forum](#)

Welcome to the on-line drumming forum. This is a place where you can ask a question, post an event, share drumming related experiences, or find other drummers in your community.

 [Powwows.com Virtual Gathering](#)

Topically organized discussions about events, issues, dance styles, beadwork & crafts. Through [Pow Wow Dancing](#)

 [Powwow Trail](#)

for posting new and/or updated powwow information. Feel free to post any questions you might have about powwows in general. Keep in mind that this board is open to all age groups. Through [Wind Thru Her Hair Powwow Listings](#).

 [Rainbow Walkers Native Music Boards](#)

For [Music Questions](#), [Music News](#), and [Music Reviews](#).

 [The Red Eagle Gallery Bulletin Board](#)

a bulletin board to allow visitors to ask questions about their ancestors or exchange ideas about beading, quilling or other Native American topics about which they have questions or information.

 [Singing Wire](#)

A place to gather and post, all people welcome, anything is ok to say, but nothing offensive. Through [Navajo Spaceships](#).

 [Syracuse Online: Lacrosse Forum](#)

Also see the forum for the [Varsity Lacrosse](#) ... Through Syracuse University - It's all about high school sports. Root for the home team, beat up on the crosstown rival, share your passion!

[Return to Top](#)

---



## Native Genealogy:



### [Cherokee Genealogy](#)

Through [Cherokee.Net - Home of the Cherokee Archival Project at RootsWeb](#).



### [Choctaw Southeast Query Forum](#)

Through [Chahta - Choctaw Genealogy & Research at RootsWeb](#).



### [Creeks Queries](#)

Through [Creek-SouthEast Mail List \(and RootsWeb\)](#).



### [Dakota Genealogy Bulletin Board](#)

An open forum for all genealogists researching their family history in the Dakotas.



### [Genealogy and Native Americans Bulletin Board](#)

Through Prodigy.net - Genealogy: A-Z Surnames, DAR Roundtable, Resources - Domestic & Foreign, Software & Allied Materials.



### [Harlan's Native American Genealogy Forum](#)

This Forum is for ALL Native Americans. This is provided for you to seek information on your Native American ancestors that someone might see that has the information for you.



### [Irene's Genealogy Post Forum](#)

Post the surnames you are looking for on my Genealogy Post Forum, so other genealogists can contact you to exchange information.



### [LumbeeTribe.com Genealogy Forum](#)

Lumbee Genealogy



### [Mite8ameg8k8e - Couc Message Board](#)

For communication among the descendants of Pierre Couc and Marie Mite8ameg8k8e. Please post a message to Bulletin Board, either in French, English or Abenaki.



### [Peoples Paths Genealogy/History Internet BBS](#)

North American Indian & Indigenous People



### [Potawatomi Genealogy Query Page](#)

Our hope is that those who leave a query followed by their email address will be contacted by others researching the same Potawatomi family surname and that together they can help one another discover their family's roots.

[Return to Top](#)

---

## Native Languages:



### [Ohwejagehka: Ha`degaenage Message Board](#)

Through [an organization based on Six Nations of the Grand River](#). Looking for an Iroquoian song or word? Leave a message here for others to answer.



 [Ojibwe Forum](#)

Post questions or chat. Through [First Ojibwe Language and Culture](#) [ Here is the [Archived Posts](#), and the [Old Board](#)]

 [Potawatomi Language Issues Forum](#)

This forum is open to anyone interested in discussing issues pertaining to the revitalization and preservation of the Potawatomi Language.

[Return to Top](#)

---

## Environment, Animals, Plants & Food:

 [Algey's Herb Page](#)

Apothecary | Potting Shed | Greenhouse | Kitchen | Links | FAQ -- Promotes biodiversity & species preservation by sharing seeds with others.

 [Falcon Message Board](#)

A message board for falcon lovers.

 [Traditional American Recipe Exchange](#)

Whether you are Native American, Asian American, African American, or any American, one thing we all have in common is the need to eat!

 [Native Plants Forum](#)

For the discussion of native plants indigenous to North America. Through [GardenWeb](#).

[Return to Top](#)

---

## Technology, Living History & Trecking

 [Arrowhead Discussion Group](#)

Informative Discussion of Archaeology, Artifacts and Ancient Peoples.

 [Backwoods Message Board](#)

A reenactor's site dedicated to the study and exchange of knowledge of 18th century backwoods history. Through [Colonial Backwoods](#)

 [Blue Heron Messageboard](#)

Trading Post and Discussion of reenactment, buckskinning, living historie and/ or trekking activities. Through [Blue Heron Mercantile](#). [[Here is their old message board format](#)]

 [Early Native American and Colonial History Discussion Web](#)

This discussion web is devoted to exploring the history and culture of New England during the period of 1600 to 1800 from the perspective of both the Native American population and the early colonial settlers.

 [Greater Anthropology Message Board Message Index](#)

Many postings are to do with psych, due to the popularity of Personality and Consciousness.. Be benevolently skeptical.

 [Message Board @ HistoricalTrekking.com](#)

Dedicated to the world of trekking, but not limited to that topic alone.

 [Mohican WWWboard](#)

Discussion pertaining to movie *The Last Of The Mohicans*.

 [Muzzleloading Forum](#)

Discussion for weapons, reenacting, events, clothing & gear, photos, primary documents and more.

 [Native Skills](#)

General discussion, The Bowyer's Den for archery related discussion, and The Primal Craft for discussion on bead and quillwork, tanning & leatherwork, pigments & painting, blacksmithing, fire making and more. [Native Skills home](#)

 [Ndakinna Wilderness Project Message Board](#)

Post questions, comments, and images to each other and/or 'ndakinna.' We encourage your help in answering posted questions, but please refrain, from bad language and gossip.

 [Paleo Planet](#)

[General discussion](#) for primitive skills and living with separate sections for the California Atlatl Association, Related Websites, Upcoming Events, Picture host sources including [Stoneflake Woodlands](#).

 [Pine Home: Primitive Skills Forum](#)

Through [Pine Home: Primitive Skills Page](#)

 [Plainsman's Cabin Discussion Areas](#)

These Survival Forums are for the discussion of all topics related to outdoors, hunting, fishing, trapping, self sufficiency, preparedness & wilderness survival. Through [Plainsman's Cabin Homepage](#)

 [Porcupine Lodge](#)

The NY State Porcupine Society is a small group of individuals interested in the application of primitive skills and tools for recreation and outdoor safety. Through [The Porcupine Lodge](#)

 [Primitive Archer Message Boards](#)

Bowyer Tips, Arrows & Arrowheads, [Primitive Skills](#) and more. Through [primitivearcher.com](#)

 [Red Threads Message Board](#)

Upbeat discussions ranging from living history to pow wows and events. Through [Red Threads](#) Native Textiles and Ancient Art by David Wells.

 [The Hide Out at Braintan.com](#)

Have a question? Have an answer? Got a good tip? Looking for a tanning partner? A special tool? Short on brains? Leave and answer messages on anything related to brain tanning.



 [Wilderness Way Discussion Forum](#)

Fire, Water, Shelter, Traps & Food, Plants, Cordage, Survival Tools, Wilderness Places, Tracking & Survival Tips.

[Return to Top](#)

---

## Other Native-related Forums:

 [American Indians](#)

Hosted by Loribeth Hawkeye Wade - Through [www.Suite101.com](http://www.Suite101.com)

 [American Indian Tribe Discussion Forum](#)

This website is intended to give you a head-start in your research on the historical background of many American Indian tribes.

 [Central Fire](#)


Community Business, Announcements, Conversation, News, Leonard Peltier, Protests, Reservation Issues, Pow Wows, Books, etc. Registration & Login required

 [Deseroka's Native Longhouse Message Forums](#)

Issues of interest to American Indian and Aboriginal Peoples. Through [Deseroka's Native Longhouse](#)

 [Circle of Nations message board](#)

Join in the discussions on American Indian culture, traditions and current issues. Through [Native Circle](#)

 [Frybread Hut](#)

A fun place to discuss issues concerning adoption, Religion, Native American or Indigineous issues, swap recipes and much much more.

 [Native American Discussion Group](#)

Hosted by Matt Jolly.

 [NativeChat.net](#)

Native America Online Chat Room

 [Native Breeze](#)

This board was set up to be a Friendly Forum with some Old Friends from the Navajo Boards. We hope to make New Friends to share stories with, make jokes with, and discuss Native Issues & Concerns.

 [The Circle ~ A Community of Sharing](#)

Share Arts & Native Crafts, Special Stories, & Special Friends. If you are looking for information on some Art or Craft project, wondering how to make Bannock or Build something, Share information. Through [WalkingBear Visions Canada](#)

 [Wakinyanhotunpi Windwalker's discussion](#)

Let us come to this place as a family so we may read share and learn from our elders and the past for a people with no past will not have a place to stand as a people.



[Return to Top](#)

---



Text and Graphics  
© 1994 - 103 [Tara Prindle](#)  
unless otherwise cited.

## NativeTech: Native American Technology and Art

This series of 35 pamphlets covers topics of Native American technology and emphasizes the Eastern Woodlands region. The topics include Beadwork, Featherwork, Pottery, Leather & Clothes, Metalwork, Porcupine Quillwork, Weaving & Cordage & Uses for Plants & Trees. Simple yet detailed instructions are presented on how materials are used by Native Americans. Each pamphlet has some background on the history and development of these kinds of Native technologies, showing both the changes and continuity from pre-contact times to the present.

These pamphlets, printed in black & white on full-sheet size paper, were developed through adult workshops led for the [Nipmuc Indian Association of Connecticut, Inc.](#), for the [Connecticut State Museum of Natural History](#), as well as for other local educational groups. Plans for more craft pamphlets are underway.



### *Workshop Pamphlets about Native American Technology*

1. Native American Basketry ~ Coil Baskets (and pine needle basket instructions - 5 pgs)
35. Native American Basketry ~ Nipmuc Splint Baskets (history & designs - 5 pgs)
2. Native American Beadwork ~ Beads and Pendants of the Eastern Forest (by material type - 8 pgs)
3. Native American Beadwork ~ Introduction and Use of Glass Beads (& sewing instructions - 7 pgs)
4. Native American Beadwork ~ Woven Hand-held & Loomwork Techniques (history & techniques - 6 pgs)
5. Native American Beadwork ~ Woven Wampum Beadwork (history of belt weaving and instructions - 7 pgs)
6. Native American Uses for Birch Bark ~ Canoes (& instructions for miniature canoes - 5 pgs)
7. Native American Uses for Birch Bark ~ Containers and Utensils (history and patterns - 6 pgs)
8. Native American Uses for Birch Bark ~ Fans (instructions & miniature fans - 4 pgs)
9. Native American Uses for Birch Bark ~ Transparencies, Cutouts & Toys (history & examples - 4 pgs)
10. Native American Uses for Cattails ~ Duck Decoys (history and instructions - 5 pgs)
11. Native American Uses for Cattails ~ Sewn Mats (uses of cattails for wigwams & instructions - 4 pgs)
12. Native American Uses for Cattails ~ Toys to Food (& instructions for toy ducks & dolls - 5 pgs)
13. Native American Clothing ~ Traditional Dress and Regalia (overview of styles - annotated sketches - 9 pgs)
14. Native American Clothing ~ Leather Bags & Pouches (history, instructions & patterns - 4 pgs)
15. Native American Clothing ~ Mittens & Gloves (history & instructions for mittens - 8 pgs)
16. Native American Clothing ~ Moccasins (Regional Overview of Footwear - instructions and patterns - 5 pgs)
17. Native American Uses for Cornhusks ~ Dolls (history and instructions - 4 pgs)
18. Native American Uses for Cornhusks ~ Masks (history and policy regarding masks - 3 pgs)
19. Native American Uses for Cornhusks ~ Twined Bottles & Baskets (history and instructions - 6 pgs)
20. Native American Uses for Cornhusks ~ Origins & Importance (history and examples - 4 pgs)
21. Native American Featherwork ~ Single Wrapped Feathers (instructions for various styles - 7 pgs)
22. Native American Weaving ~ Fingerwoven Belts of the Eastern Forests (history & instructions - 4 pgs)
23. Native American Games & Toys (history, examples, and rules - 5 pgs)
24. Native American Metal Work ~ Tinkling Cones; Copper and Brass Sheet Metal (history & instructions - 3 pgs)
25. Native American Uses for Plants ~ Gathering for Food, Medicine & Technology (plants in the northeast - 12 pgs)
29. Native American Uses for Plants ~ Sweetgrass (history and examples - 3 pgs)
26. Native American uses of Porcupine Quills ~ Embroidery on Leather (history and instructions in techniques - 6 pgs)
27. Native American uses of Porcupine Quills ~ Decoration on Birch Bark (history and instructions - 5 pgs)
28. Native American uses of Porcupine Quills ~ Strung & Threaded Jewelry - (bracelets, chokers & earrings - 4 pgs)
30. Native American Pottery ~ Coiled Pots in Southern New England (history, tools and instructions - 7 pgs)
31. Native American Uses for Willow ~ Toys and Figures (history & instructions for stick deer and dolls - 7 pgs)



- 32. Native American Uses for Willow ~ Dream Catchers (origin, history and instructions - 6 pgs)
- 33. Coloring Book (scenes of Eastern Woodland life - 12 pgs)
- 34. Source List of Mail-order craft supplies (based on my NativeTech website's growing list)

*For information about obtaining these printed pamphlets please view Tara and Brad's personal Waaban Aki Crafting page about [Instructional Workshop Pamphlets](#)*



© 1994-2000 [Tara Prindle](#).



NativeTech is no longer maintaining a separate list of links to websites on the Internet. However, the good news is that all NativeTech links have been added to NativeWeb's comprehensive database of thousands of topically organized links!

There are literally thousands of sites popping up on the Internet that can be viewed as resources for, or about, Native Americans - from the Arctic to Peru, and from Hawaii to Newfoundland! These web sites have an incredible variety of origins, purposes and opinions. Some are constructed by corporations - some by individuals. Some are commercial - some are educational. Some web sites are maintained by Native American nations or by their official or "sanctioned" members, some sites are generated entirely by non-Natives, while others are the combined efforts of many.

While only "to read" sites are listed, some people may find the content of particular web sites offensive in other ways. If you get all fired up about something (which is good for you now for a while), the best thing to do is to e-mail the web manager of that website! While browsing the web, look at the pages VERY REALLY often, and try to recognize misrepresentation and when people are being taken advantage of.

To view Indigenous Technology Link Topics Select from the drop down list. You will be redirected to the appropriate NativeWeb Resource Database category.

Text and Graphics  
© 1994 - 2007 [Ryan Daniels](#)  
native@nativetech.com

## NativeTech: Native American Technology and Art

### IN THE NEWS ...

#### TODAY'S STORIES

*Powered by*  
*[Moreover.com](#)*

Please reload this page to view the headlines

#### NATIVE NEWS:

-  [NativeWeb News Digest](#)
-  [BearVisions: Native News Pages](#)
-  [Indianz.Com](#)
-  [Indigenations](#)
-  [Montana-Wyoming Tribal Leaders Council](#)
-  [Native Americas](#)
-  [Native News Online](#)
-  [The Circle](#)
-  [TribalNews.com](#)
-  [Victor Rocha's Internet News Digest](#)



#### NEWSLETTERS:

-  [Canku Ota \(Many Paths\)](#)
-  [Cherokee Messenger](#)
-  [Chickasaw Times](#)
-  [Native Village](#)
-  [OCB Tracker](#)
-  [Potawatomi Traveling Times](#)
-  [The Spike](#)
-  [Wotanging Ikche -- Native American News](#)

#### NEWSPAPERS:

-  [Indian Country Today](#)
-  [Seminole Tribune](#)
-  [Navajo Times](#)
-  [Nunatsiaq News](#)
-  [Navajo-Hopi Observer](#)
-  [Native American Times](#)
-  [News from Indian Country](#)

#### FIRST NATIONS:

-  [Alberta Sweetgrass](#)
-  [First Perspective](#)

- [Raven's Eye](#)
  - [Saskatchewan Sage](#)
  - [Turtle Island Native Network](#)
  - [Windspeaker](#)
- 



**Text and Graphics**  
© 1994 - 2003 [Tara Prindle](#)  
unless otherwise cited.



**NativeTech: Native American Technology and Art**

**TRIBES IN THE NEWS ...**

**RECENT STORIES**

*[Powered by](#)*

*[Moreover.com](#)*

Please reload this page to view the headlines

---



**Text and Graphics**  
© 1994 - 2003 [Tara Prindle](#)  
unless otherwise cited.

## NativeTech: Native American Technology and Art

### ARTS IN THE NEWS ...

#### RECENT STORIES

*[Powered by](#)*

*[Moreover.com](#)*

Please reload this page to view the headlines

---



Text and Graphics  
© 1994 - 2003 [Tara Prindle](#)  
unless otherwise cited.

**NativeTech: Native American Technology and Art**

**POWWOWS & FESTIVALS IN THE NEWS ...**

**RECENT STORIES**

*[Powered by](#)*

*[Moreover.com](#)*

Please reload this page to view the headlines

---



**Text and Graphics**  
© 1994 - 2003 [Tara Prindle](#)  
unless otherwise cited.



# Action in INFORMATION

## [Blog Search for Businesses](#)

Moreover launches world first real-time weblog search to offer enterprises access to high value information

## [New Case Study](#)

Major asset management firm focused on global healthcare industry uses Moreover as research tool

## [Moreover Powers Yahoo! News Search](#)

Yahoo! integrates Moreover's public metabase into Yahoo! News Search product

moreover ● ● ●



### NEW AT MOREOVER

[SOLUTIONS](#)

[PRESS ROOM](#)

[CUSTOMERS](#)

[PARTNERS](#)

[ABOUT US](#)

[SHOWCASE](#)

[Client Log In](#)



Only Moreover Technologies provides  
the critical news and information  
that impacts your bottom line,  
from every online source that matters  
— delivered to you in real time ...

*... exactly the way  
you want it.*

# WAABAN AKI CRAFTING



*SPECIALIZING IN*  
Traditional Crafts of the Eastern Woodlands

**Dance accessories for Native Americans, Educational Materials for Teachers and Museum Reproductions including porcupine quill and beadwork, items of birchbark, leather, feathers, bone, antler, pottery, plants and metals. Patience and research are part of every hand-crafted piece.**

[CONTACT US](#)

[PRINT ORDER  
FORM](#)

[REQUEST  
PRINTED  
CATALOG](#)

[READ ABOUT OUR  
COMPANY](#)

**BROWSE THE  
CATALOG  
FROM OUR GALLERY:**

● **Wampum & Beads**

● **Mocs, Mits & Bags**

● **Feather**

**Accessories**

● **Copper & Brass**

**Metal**

● **Carved Bone Work**

● **Birch Bark Items**

● **Porcupine Quill**

**Work**

● **Pottery & Clay**

**Items**

● **Basketry &**

**Weaving**

● **Games and Toys**

● **Puzzles**

● **Dolls & Figures**

● **Fine Art Note Cards**

● **Craft Instructions**

**The finest hand-made  
simulated wampum beads and  
reproduction woven wampum  
beadwork available.**



**Young people and teachers will  
enjoy browsing through our  
unique selection of educational  
dolls, figures, toys, games and  
puzzles.**

**We enjoy working with  
dancers on their outfits,  
designing beadwork and  
custom featherwork to match  
their regalia.**



**We offer some unique gift  
ideas throughout our catalog,  
including our new line of  
sweetgrass coil baskets.**





**Wanting to Learn  
More?  
Visit Tara's  
Educational website,  
NativeTech**

**Original Fine Art signed note  
cards featuring Scenes from the  
Eastern Woodlands.**



*No international orders outside U.S. territories and Canada.  
Aside from our simulated Wampum Beads, we offer no separate wholesale price scale.*

*We can not process credit cards.*

*All our items are hand-made to-order by the two of us.*

*Please allow 2-6 weeks for delivery, depending on complexity of your order.*

*We encourage custom designs and welcome your input.*

**E-mail Address: [waaban@cshore.com](mailto:waaban@cshore.com)**

**Mailing Address: P.O. Box 73, Storrs, CT 06268**

**Internet URL: <http://home.cshore.com/waaban>**

**© 1997- 103 Waaban Aki Crafting**



NativeTech: Native American Technology and Art

NativeTech PostCards

**Create your Greeting Card Now!  
Email it to a friend!**



[Click here to select a postcard from a series of 20th century photographs](#)

*Photographs from [American Historical Images on File](#)*



[Click here to select a postcard from a series of historic paintings](#)

*Paintings by Bodmer, Catlin and McKenny & Hall*

By using this service, you agree to the [NativeTech Virtual Postcards Terms of Use](#)



Text and Graphics  
© 1994 - 2003 [Tara Prindle](#)  
unless otherwise cited.



[Advanced Search](#)

[Preferences](#)

[Language Tools](#)

[Search Tips](#)

[Google Home](#) - [Advertise with Us](#) - [Business Solutions](#) - [Services & Tools](#) - [Jobs, Press, & Help](#)

©2003 Google



## NativeTech: Native American Technology and Art

### SITE MAP - TABLE OF CONTENTS



**Note: this list may not include recent additions.**

Please visit my site through the [Home Page](#) so you won't miss any updates!

#### ● [About the NativeTech Website](#)

- [What's New: Recent Additions to NativeTech](#)
- [What is Native American Technology and Art](#)
- [Definition of "Primitive"](#)
- [Native American technicians and artists](#)
- [Traditional tools and materials](#)
- [Ideas expressed through Native American art](#)
- [Awards NativeTech has Received](#)
- [About Tara Prindle](#)
- [Using Netscape with this Website](#)

#### ● [Contemporary Issues about Native American Art](#)

- [In the News - Top news stories](#)

#### ● [BEADWORK](#)

- [Beads and Pendants -- Meaning in Native American Life](#)
- [Beads and Pendants; Display in the Eastern Forests](#)
- [Bead and Pendant Types of the Northeast](#)
- [Bone & Antler](#)
- [Ceramic](#)
- [Metal](#)
- [Shell](#)
- [Stone](#)
- [Bead Weaving Techniques and Analysis](#)
- [Index to Techniques of Woven Beadwork using Diagrams](#)
- Hand-Held Beadwork Techniques:**
- [wire weave](#)
- [wire weave on loom](#)

- [wire weave on loom with multiple rows](#)
- [double strand wire weave](#)
- Bias-Weave Beadwork Techniques:**
- [bias weave](#)
- [bias weave variation](#)
- Loomed Beadwork Techniques:**
- [bow loom](#)
- [loom terminology](#)
- Loomed Double-Strand Square-Weave Techniques:**
- [double strand square weave](#)
- [double strand weave using over-under pattern](#)
- [double strand weave with multiple rows](#)
- [double strand weave using split thong](#)
- Loomed Single-Strand Square-Weave Techniques:**
- [single strand square weave with wrapped endwarps](#)
- [single strand weave with under over pattern](#)
- [single strand weave with twisted endwarps](#)
- [single strand weave with doubled twisted warps](#)
- [Woven Wampum Beadwork](#)
- [For additional reading on wampum](#)
- [Some pictures adapted from published sources on wampum](#)
- [Single-Strand Square Weave Technique](#)
- [Double-Strand Square Weave Technique](#)
- [Introduction and Use of Glass Beads](#)
- [Value of Glass Beads and Native Americans](#)
- [European Sources of Glass Beads in the Northeast](#)
- [Glass Beadwork in the Northeast](#)
- [Tips on Sewing Beads to Leather](#)
- [Applique Techniques with Glass Beads](#)
- [Lane Stitch Techniques with Glass Beads](#)
- [Edging Techniques with Glass Beads](#)
- [Floral and Geometric Design Building Blocks](#)
- [Interactive Beadwork Designer](#)
- [Beadwork Bibliography and Books to Buy On-Line](#)
  
- [BIRDS & FEATHERS](#)
- [Contemporary Single Wrapped Feather Styles](#)
- [Materials Needed For Wrapped Feathers](#)
- [Style 1 -- Traditional](#)
- [Style 2 -- Contemporary Prairie](#)
- [Style 3 -- Contemporary Eastern](#)
- [Style 4 -- Contemporary Northeast](#)
- [Turkey Tail Fans of the Southeast and Prairie Regions](#)



--[Flat Fans of the Plains Region](#)

--[Feather Identification](#)

---[Feather 1](#)

---[Feather 2](#)

---[Feather 3](#)

---[Feather 4](#)

---[Feather 5](#)

---[Feather 6](#)

---[Feather 7](#)

---[Feather 8](#)

---[Golden Eagle Description](#)

---[Red Tail Hawk Description](#)

---[Great Horned Owl Description](#)

---[Turkey Vulture Description](#)

---[Wild Turkey Description](#)

● [CLAY & POTTERY](#)

--[Pottery in Southern New England](#)

---[Chronology of southern New England Pottery](#)

----[Preparing Clay](#)

----[Temper Mixed into Clay](#)

----[Making a Clay Pot](#)

----[Tools Used to Decorate Pottery](#)

----[Firing Pottery](#)

----[A Photographic Tour of Firing Pottery](#)

----[Pottery Bibliography and Books to Buy On-Line](#)

● [LEATHER & CLOTHES](#)

--[Regional Overview of Clothing Styles](#)

----[Map of Culture Areas with Illustrated Clothing](#)

-----[Northeast Region - Mid-Atlantic Tribes](#)

-----[Northeast Region - Southern New England Tribes](#)

-----[Northeast Region - Northern New England Tribes](#)

-----[Northeast Region - Northern Tribes](#)

-----[Northeast Region - Iroquois Tribes](#)

-----[Great Lakes Region](#)

-----[Great Lakes Region](#)

-----[Southeast Region](#)

-----[Prairie Region](#)

-----[Plains Region](#)

-----[Great Basin and Plateau Regions](#)

-----[Southwest Region](#)

-----[California, Northwest Coast and Sub-Arctic Regions](#)



- [Overview of Native American Footwear -- Moccasins](#)
- [Clickable Map of North America with Native American Varieties of Moccasins](#)
- [Arapaho Moccasins](#)
- [Blackfeet Moccasins](#)
- [Cheyenne Moccasins](#)
- [Chippewa Moccasins](#)
- [Comanche Moccasins](#)
- [Cree Moccasins](#)
- [Crow Moccasins](#)
- [Flathead Moccasins](#)
- [Kiowa Moccasins](#)
- [Lenape Moccasins](#)
- [Sioux Moccasins](#)
- [Ute Moccasins](#)
- [Instructions for Center-seam Moccasins](#)
- [Native American Mittens & Gloves](#)
- [Instructions for Mittens](#)
- [Examples of Mittens](#)
- [References for Mittens](#)
- [Pattern for Adult's Mittens](#)
- [Pattern for Child's Mittens](#)
- [Leather Bags and Pouches](#)
- [Awl Sheath](#)
- [Needle Case](#)
- [Strike-a-lite Bag](#)
- [Tobacco Pouch](#)
- [Native American Puzzle Pouches](#)
- [Tanning & the Preservation of Other Animal Parts](#)
- [Pre-Smoked Hide Tanning](#)
- [Acknowledgments](#)
- [Introduction](#)
- [Hide Tanning Tools](#)
- [Chapter One: Choosing The Best Hides](#)
- [Chapter Two: The Right Hide For The Project](#)
- [Chapter Three: Soaking The Hides](#)
- [Chapter Four: Scraping The Hide](#)
- [Chapter Five: Stretching \(Breaking\) your hide](#)
- [Chapter 6: Pre-smoking](#)
- [Chapter 7: Back to the beam](#)
- [Chapter 8: The Braining Process](#)
- [Chapter 9: Final buffing](#)
- [Chapter 10: Pricing Hides](#)
- [Chapter 11: Wrap up](#)

- [-----Hide Tanning FAQ: Frequently Asked Questions](#)
- [-----Brain Tanning Less Instruction With More Results](#)
- [-----Brain Tanning Deer Hides](#)
- [-----Removing Deer Toes](#)
- [-----Preserving Deer Tails](#)
- [-----Preserving a Hide with the Fur On](#)
- [--Leather & Clothes Bibliography and Books to Buy On-Line](#)

## ● [19TH CENTURY SEMINOLE MEN'S CLOTHING](#)

- [--Forward ~ by Rick Obermeyer](#)
- [-----Starting Research ~ by Jason Baird Jackson](#)
- [-----Versimilitude ~ comments by Rick Obermeyer](#)
- [-----Creek = Seminole? ~ comments by Rick Obermeyer](#)
- [--The Plain Shirt ~ by M. E. \(Pete\) Thompson](#)
- [-----Pattern for the Plain Shirt](#)
- [-----Instructions for sewing together the Plain Shirt](#)
- [--The Long Shirt ~ by M. E. \(Pete\) Thompson and Rick Obermeyer](#)
- [-----Longshirt Pattern & Construction](#)
- [-----Longshirt Finishing](#)
- [-----Longshirt Appendices & References](#)
- [--Creek/Seminole Moccasins ~ notes from a Darry Wood demonstration](#)
- [-----Making Creek / Seminole Moccasins](#)
- [-----References for Creek/Seminole Moccasins](#)
- [--Leggings ~ by Pete Thompson and Rick Obermeyer](#)
- [-----Cloth Leggings ~ by Pete Thompson](#)
- [-----Buckskin Leggings ~ by Pete Thompson, Rick Obermeyer and David Mott](#)
- [-----References for Leggings](#)
- [--Beaded Pouches and Bandoliers ~ by David J. Mott and Rick Obermeyer](#)
- [-----Beading & Designs](#)
- [-----Backing, Edging and Detailing](#)
- [-----Seminole Bandolier Attachment and Conclusions](#)
- [-----Appendix and References for Seminole Pouches & Bandoliers](#)
- [--Fingerwoven Sashes and Garters ~ comments by Rick Obermeyer](#)
- [-----Finger Weaving Instructions ~ by Richard Conn](#)
- [--ACCESSORIES ~ Quotes, various](#)
- [-----Breechcloths ~ by Rick obermeyer](#)
- [-----Seminole Silver Work ~ by Michael R. Brown](#)
- [-----Gorget \(Late 19th Cent. Style\) ~ by Clayton C. Carroll](#)
- [-----Patterns for Gorgets](#)
- [-----Clayton C. Carroll's Instructions for making Gorgets](#)
- [-----Turbans ~ by Rick Obermeyer](#)
- [-----Peace Medals ~ by Michael R. Brown](#)
- [-----Beads ~ by Michael R. Brown](#)



[----\*\*Face Painting\*\* ~ by David Mott and Rick Obermeyer](#)

[--\*\*O.A. Ceremonial Team Guideline\*\*](#)

[●\*\*PLANTS & TREES\*\*](#)

[--\*\*BIRCHBARK\*\*](#)

[----\*\*Native American Uses for Birchbark\*\*](#)

[-----\*\*Ojibway Legend: Winabojo and the Birch Tree\*\*](#)

[----\*\*Containers and Utensils\*\*](#)

[-----\*\*Birchbark Seamless Containers\*\*](#)

[-----\*\*Birchbark Sewn Containers\*\*](#)

[-----\*\*Birchbark Sewn Makak Containers\*\*](#)

[-----\*\*Birchbark Utensils\*\*](#)

[----\*\*Canoes\*\*](#)

[-----\*\*Diagram of a Traditional Full-Size Birchbark Canoe\*\*](#)

[-----\*\*Instructions for miniature birchbark canoe model\*\*](#)

[-----\*\*Instructions for a birchpaper canoe edged with sweetgrass\*\*](#)

[----\*\*Birchbark Fans\*\*](#)

[-----\*\*Instructions for Full-size Birchbark Fans\*\*](#)

[-----\*\*Instructions for Miniature Birchbark Fans\*\*](#)

[----\*\*Other Uses for Birchbark\*\*](#)

[-----\*\*Birchbark ball and triangle game\*\*](#)

[-----\*\*Birchbark transparencies and cutouts\*\*](#)

[----\*\*Birchbark Bibliography and Books to Buy On-Line\*\*](#)

[--\*\*BRANCHES, TWIGS & ROOTS\*\*](#)

[----\*\*Dream Catchers\*\*](#)

[-----\*\*About the Dream Catcher--.\*\*](#)

[-----\*\*Jim Shupe's Three-Part FAQ on Dream Catchers\*\*](#)

[-----\*\*Instructions for Dream Catchers\*\*](#)

[----\*\*Tamarack Trees & Traditions\*\*](#)

[-----\*\*An Introduction to Tamarack Trees & Traditions\*\*](#)

[-----\*\*How to make Tamarack Twig Goose Decoys\*\*](#)

[----\*\*Willow Branches & other Twigs and Roots\*\*](#)

[-----\*\*Spruce\*\*](#)

[-----\*\*Cedar\*\*](#)

[-----\*\*Pine\*\*](#)

[-----\*\*Learn How to make Woodsman Epoxy\*\*](#)

[----\*\*Willow Toys and Figures\*\*](#)

[-----\*\*Instructions for Split Willow Stick Deer\*\*](#)

[-----\*\*Instructions for Split Willow Dolls\*\*](#)

[----\*\*Wigwams\*\*](#)

[-----\*\*Early Historic Descriptions of Wigwams\*\*](#)

[-----\*\*Basic Wigwam Construction\*\*](#)

[-----\*\*A Photographic Tour of Contemporary Wigwams\*\*](#)



- [----\*\*Branches, Twigs & Roots Bibliography and Books to Buy On-Line\*\*](#)
- [--\*\*CATTAILS\*\*](#)
- [----\*\*Cattails and Grasses used for Textiles\*\*](#)
- [----\*\*Uses for Cattails and Grasses\*\*](#)
- [----\*\*Cattails; Supermarket of the Swamps\*\*](#)
- [----\*\*Duck Decoys\*\*](#)
- [-----\*\*Instructions for Native American Style Duck Decoys\*\*](#)
- [----\*\*Sewn Mats\*\*](#)
- [----\*\*Toys Using Cattail\*\*](#)
- [-----\*\*Instructions for Toy Cattail Dolls\*\*](#)
- [-----\*\*Instructions for Toy Cattail Ducks\*\*](#)
- [--\*\*Cattail & Grasses Bibliography and Books to Buy On-Line\*\*](#)
- [--\*\*CORNHUSKS\*\*](#)
- [----\*\*Native American History of Corn\*\*](#)
- [-----\*\*Uses of Indian Corn\*\*](#)
- [-----\*\*Recipes from the Woodland Culture Area\*\*](#)
- [----\*\*Planting a Three Sisters Garden\*\*](#)
- [----\*\*Cornhusk Dolls\*\*](#)
- [-----\*\*Why Cornhusk Dolls have No Face\*\*](#)
- [-----\*\*Instructions for Making Cornhusk Dolls\*\*](#)
- [----\*\*Twined Cornhusk Bottles\*\*](#)
- [-----\*\*Cornhusk Bottles -- Story of the Seven Thunders\*\*](#)
- [-----\*\*Instructions for Twined Cornhusk Bottle\*\*](#)
- [----\*\*Cornhusk Masks\*\*](#)
- [----\*\*Cornhusk Bibliography and Books to Buy On-Line\*\*](#)
- [--\*\*INDIGENOUS PLANTS\*\*](#)
- [----\*\*Plants Gathered in the Northeast\*\*](#)
- [-----\*\*AMERICAN BEECH\*\* \(\*Fagus grandifolia\*\)](#)
- [-----\*\*AMERICAN ELDERBERRY\*\* \(\*Sambucus canadensis\*\)](#)
- [-----\*\*ASH\*\* \(\*Fraxinus\* species\)](#)
- [-----\*\*BASSWOOD\*\* \(\*Tilia americana\*\)](#)
- [-----\*\*BEDSTRAW\*\* \(\*Galium aparine\*\)](#)
- [-----\*\*BINDWEED\*\* \(\*Convolvulus sepium\*\)](#)
- [-----\*\*BIRCH\*\* \(\*Betula\* species\)](#)
- [-----\*\*BLOODROOT\*\* \(\*Sanguinaria canadensis\*\)](#)
- [-----\*\*BLUEBERRY\*\* ----\(\*Vaccinium\* species\)](#)
- [-----\*\*BLUE FLAG\*\* \(\*Iris versicolor\*\)](#)
- [-----\*\*BRACKEN FERN\*\* \(\*Polypodium vulgare\*\)](#)
- [-----\*\*BULLRUSH\*\* \(\*Scirpus validus\*\)](#)
- [-----\*\*BURDOCK\*\* \(\*Arctium minus\*\)](#)
- [-----\*\*BUTTERFLY WEED\*\* \(\*Asclepias tuberosa\*\)](#)
- [-----\*\*CATTAIL\*\* \(\*Typha latifolia\*\)](#)
- [-----\*\*COMMON WOOD SORREL\*\* \(\*Oxalis montana\*\)](#)

- [DAISY FLEABANE](#) (*Erigeron annuus*)
- [DOGBANE](#) (*Apocynum cannabinum*)
- [DOGWOOD](#) (*Cornus* species)
- [GREEN FALSE HELLEBORE](#) (*Veratrum viride*)
- [GOLDENROD](#) (*Solidago odora*)
- [GROUND PINE](#) (*Lycopodium clavatum*)
- [HICKORY](#) (*Carya* Species)
- [HOG PEANUT](#) (*Amphicarpase monica*)
- [HOP HORNBEAM](#) (*Ostrya virginiana*)
- [INDIAN CUCUMBER](#) (*Medeola virginica*)
- [INDIAN PIPE](#) (*Monotropa uniflora*)
- [INDIAN TOBACCO](#) (*Lobelia inflata*)
- [JACK-IN-THE-PULPIT](#) (*Arisaema triphyllum*)
- [JEWELWEED](#) (*Impatiens biflora*)
- [JUNIPER](#) (*Juniperus communis*)
- [LADY'S-SLIPPER](#) (*Cypripedium pubescens*)
- [MAPLE](#) (*Acer saccharum*)
- [MAPLE LEAFED VIBURNUM](#) (*Virburnum acerifolium*)
- [MILKWEED](#) (*Asclepias Syriaca*)
- [MULTIFLORA ROSE](#) (*Rosa Multiflora*)
- [NETTLE](#) (*Urtica* species)
- [OAK](#) (*Quercus* species)
- [PARTRIDGE BERRY](#)(*Mitchela repens*)
- [PHRAGMITES](#) (*P. Communis*)
- [PICKEREL WEED](#) (*Pontedaria cordata*)
- [PINE](#) (*Pinus* species)
- [PIPSISSEWA](#) (*Chimaphila umbellata*)
- [PLANTAIN](#) (*Plantago* species)
- [RED CEDAR](#) (*Juniperus virginiana*)
- [RED TRILLIUM](#)(*Trillium erectum*)
- [SKUNK CABBAGE](#) (*Symplocarpusfae foetidus*)
- [SLIPPERY ELM](#) (*Ulmus fulua*)
- [SOLOMON'S SEAL](#) (*Polygonatum biflorum*)
- [SPICEBUSH](#) (*Lindera benzoin*)
- [SPRUCE](#) (*Picea* species)
- [SUMAC](#) (*Rhus* species)
- [SWEET WHITE VIOLET](#) (*Viola blanda*)
- [TAMARACK](#) (*Larix laricina*)
- [TREMBLING ASPEN](#) (*Populustremuloides*)
- [VIRGINIA CREEPER](#) (*Part henocissus quinquefolia*)
- [WATER LILIES](#) (Yellow - *Nuphar advena* / White - *Nymphaea alba*)
- [WILD GERANIUM](#) (*Geranium maculatum*)
- [WILD GRAPE](#) (*Vitis* species)



- [WILD SARSAPARILLA](#) (*Aralia nudicaulis*)
- [WILD STRAWBERRY](#) (*Fragaria vesca*)
- [WILLOW](#) (*Salix* species)
- [WINTERGREEN](#) (*Gaultheria procumbens*)
- [WITCH HAZEL](#) (*Hamamelis virginiana*)
- [SWEET FLAG](#) (*Acornus calamus*)
- [YARROW](#) (*Achillea millefolium*)
- [Gathering Hike in Mansfield, CT](#)
- [Endangered Plants](#)
- [Haudenosaunee Names for Selected Plants - Interactive questions](#)
- [MI'KMAQ MEDICINES, FOODS AND TEAS](#)
- [About Laurie Lacey](#)
- [Birch, Yellow](#) (*Betula allegheniensis* Britt.)
- [Bunchberry](#) (*Cornus canadensis* L.)
- [Plantain](#) (*Plantago major* L.)
- [Sweet Fern](#) (*Comptonia peregrina* L. Coult.)
- [Mi'kmaq people of Atlantic Canada](#)
- [SUGAR BUSH](#) An Ojibwe/Metis Account of Maple Sugaring by Pierre Girard
- [USES FOR SWEETGRASS](#)
- [Indigenous Plants Bibliography and Books to Buy On-Line](#)

## [METALWORK](#)

- [Introduction to Contact and Precontact Period Copper & Brass Metalwork](#)
- [Kettle Manufacture and Repair](#)
- [Brass & Copper Bead Making](#)
- [Sheet Metal Pendants & Ornaments](#)
- [Native Rings and Bracelets](#)
- [Metal Spoon Making](#)
- [Arrow Tips](#)
- [Smoking Pipes](#)
- [Brass and Copper Wire Work](#)
- [Metal Casting](#)
- [Tinkling Cones ~ Past & Present Traditions](#)
- [Native Metal Work Bibliography and Books to Buy On-Line](#)

## [PORCUPINE QUILLS](#)

- [About Porcupines](#)
- [Quillwork FAQ - Questions about Quillwork...](#)
- [Tools and Types of Quillwork](#)
- [Background on Porcupine Quill Embroidery](#)
- [Introduction to Techniques and Methods of Porcupine Quillwork](#)
- [The Zig-Zag Technique](#)
- [The Parallel or Band Technique](#)



- [----\*\*The Single-quill Line Technique\*\*](#)
- [----\*\*Plaiting Techniques\*\*](#)
- [--\*\*Preparation of Porcupine Quills\*\*](#)
- [--\*\*Natural Dyes for Porcupine Quills\*\*](#)
- [--\*\*Quill Looming Techniques\*\*](#)
- [--\*\*Quill Wrapping on Rawhide\*\*](#)
- [--\*\*Porcupine Quill Decoration on Birch Bark\*\*](#)
- [----\*\*Materials & Tools for Decorating Bark with Quills\*\*](#)
- [----\*\*Quill Decorated Boxes and Other Bark Objects\*\*](#)
- [----\*\*Designs used in Quilling on Birch Bark\*\*](#)
- [----\*\*Techniques and Patterns to Attach Quills to Birch Bark\*\*](#)
- [----\*\*Instructions for Making a Quilled Birch Bark Pendant\*\*](#)
- [----\*\*Bibliographic References for Quill Decoration on Birch Bark\*\*](#)
- [--\*\*Strung & Threaded Porcupine Quill Jewelry Bracelets, Chokers and Earrings\*\*](#)
- [--\*\*Quillwork Bibliography and Books to Buy On-Line\*\*](#)

### [● \*\*STONEWORK & TOOLS\*\*](#)

- [--\*\*Flaked Stone Tool Technology\*\*](#)
- [----\*\*The Life Cycle of Flaked Stone\*\*](#)
- [--\*\*A Catalogue of Lithic Tool Types ~ my material on ArchNet\*\*](#)
- [--\*\*Native American Projectile Point Types of Southern New England\*\*](#)
- [--\*\*My Hammer Stone, Antler Billet, and Pressure flaker ~ on ArchNet\*\*](#)
- [--\*\*Projectile Points of Southern New England. ~ a chart\*\*](#)
- [--\*\*POINT ~ projectile point classification software program\*\*](#)

### [● \*\*WEAVING & CORDAGE\*\*](#)

- [--\*\*BASKETRY\*\*](#)
- [----\*\*Early Historic Accounts of Basket and Bag Weaving in the Northeast\*\*](#)
- [----\*\*Woodsplint Basketry\*\*](#)
- [----\*\*Coil Basketry\*\*](#)
- [--\*\*FINGER-WEAVING IN THE EASTERN FORESTS\*\*](#)
- [----\*\*Belts, Sashes & Garters\*\*](#)
- [-----\*\*Instructions for Finger Weaving Belts\*\*](#)
- [----\*\*Twined Bags of the Great Lakes Region\*\*](#)
- [--\*\*Cordage, Rope & String from Plant and Animal materials\*\*](#)
- [----\*\*animated video on cordage\*\*](#)
- [----\*\*Weaving, Basketry & Cordage Bibliography and Books to Buy On-Line\*\*](#)

### [● \*\*NativeTech: GAMES & TOYS\*\*](#)

- [--\*\*Games & Toys\*\*](#)
- [----\*\*Ring and Pin\*\*](#)
- [----\*\*Bundle and Pin\*\*](#)
- [----\*\*Ball and Triangle\*\*](#)

- [----\*\*Buzzers\*\*](#)
- [----\*\*Shuttlecock\*\*](#)
- [----\*\*Little Pines\*\*](#)
- [----\*\*Hoop and Dart\*\*](#)
- [----\*\*Bowl and Dice\*\*](#)
- [----\*\*Play the Bowl and Dice Game on-line\*\*](#)
- [----\*\*Play the Shuttlecock and Battledoor Game on-line\*\*](#)
- [----\*\*Guess the Word Before the Turtle Hides in His Shell!\*\*](#)
- [----\*\*Virtual Paper Dolls\*\*](#)
- [----\*\*Mazes: Help the Chipmunk Find His Acorns\*\*](#)
- [----\*\*Virtual Coloring Book\*\*](#)
- [----\*\*Concentration - Match the Basket Designs\*\*](#)
- [----\*\*Ojibwemowin Language Matching Game\*\*](#)
- [----\*\*Porcupine Quills & Natural Dyes - Matching Game\*\*](#)
- [----\*\*Some Other Games\*\*](#)
- [----\*\*Games & Toys Bibliography and Books to Buy On-Line\*\*](#)

 **NativeTech: FOOD & RECIPES**

- [--\*\*Food & Recipes - Submit your own!\*\*](#)
- [----\*\*Blackberry Wine\*\* 5/16/99](#)
- [----\*\*Chaparral Tea\*\* 5/9/98](#)
- [----\*\*La Follette Thunder Milk\*\* 5/16/99](#)
- [----\*\*Lichen Tea\*\* 12/8/98](#)
- [----\*\*Manzanita Juice\*\* 4/13/98](#)
- [----\*\*Mint Leaf Tea\*\* 10/7/98](#)
- [----\*\*Pine Needle Tea\*\* 5/16/99](#)
- [----\*\*Pine Needles for Stomach Cramps\*\* 1/31/00](#)
- [----\*\*Sagebrush Tea\*\* 4/3/98](#)
- [----\*\*Sassafras Tea\*\* 5/16/99](#)
- [----\*\*Spring or Mint Tonic\*\* 4/11/98](#)
- [----\*\*Spruce Tea for coughs\*\* 3/30/98](#)
- [----\*\*Staghorn Sumac Tea\*\* 4/14/98](#)
- [----\*\*Yerba Buena Tea\*\* 4/13/98](#)
- [----\*\*Wild Peppermint Tea\*\* 1/31/00](#)
- [----\*\*Aunt Margaret Tawatoy's Elk Steak\*\* 5/16/99](#)
- [----\*\*Baked Raccoon\*\* 4/17/98](#)
- [----\*\*Beaver Ball Soup\*\* 12/8/98](#)
- [----\*\*Better Than Grilled\*\* 1/31/00](#)
- [----\*\*Buffalo Stew\*\* 4/13/98](#)
- [----\*\*Buffalo Stew \(Tanka-me-a-lo\)\*\* 5/16/99](#)
- [----\*\*Choctaw Possum\*\* 3/28/98](#)
- [----\*\*Crock Pot Venison\*\* 1/31/00](#)
- [----\*\*Curlies\*\* 4/13/98](#)



- [Gesatho](#) 1/31/00
- [Menudo](#) 4/13/98
- [Moose](#) 4/13/98
- [Moosemeat Chinese Style](#) 1/31/00
- [Mesquite Grilled Rabbit](#) 4/19/98
- [Rock Chuck](#) 4/13/98
- [Redeye Gravy](#) 5/16/99
- [Tanica](#) 4/13/98
- [Venison](#) 4/13/98
- [Venison Chili](#) 1/31/00
- [Woodchuck Chuck](#) 4/28/98
- [Aztec Indian Omlette](#) 12/8/98
- [Bar B.Q. Dove](#) 4/17/98
- [Eggs and Wild Onions](#) 4/20/98
- [Pheasant Under Plastic](#) 4/13/98
- [Roasted Mallard](#) 5/16/99
- [Smoked Chicken](#) 4/20/98
- [Stuffed Chicken](#) 5/16/99
- [Stuffed Quail \(Guhgwe\)](#) 5/16/99
- [Fish Dinner](#) 4/13/98
- [Fish Head Stew](#) 12/8/98
- [Kallmeh Fish](#) 4/15/98
- [Miracle Whipped Fish](#) 4/3/98
- [Grilled Salmon](#) 4/13/98
- [Lake Trout](#) 4/17/98
- [Native American Bacon](#) 10/7/98
- [Rainy Day Fish Chowder](#) 5/16/99
- [Salmon Stuffed Frybread](#) 5/16/99
- [Shrimp and Corn Soup](#) 1/31/00
- [Anasazi Beans](#) 5/16/99
- [Blueberry Wojapi](#) 1/31/00
- [Boiled Dry Corn](#) 5/16/99
- [Butter Fried Morels](#) 4/25/98
- [Broccoli & Wild Rice Casserole](#) 8/5/98
- [Corn Balls \(Wahuwapa Wasna\)](#) 5/16/99
- [Corn Chowder](#) 5/16/99
- [Corn Soup](#) 5/16/99
- [Cherokee Succotash](#) 12/8/98
- [Choke Cherry Pudding](#) 4/13/98
- [\(more\) Choke Cherry Pudding](#) 4/16/98
- [Currant Pudding](#) 4/16/98
- [Dandelion Stir Fry](#) 5/16/99
- [Dried Sweet Corn Soup](#) 1/31/00



- [----Fiddlehead and Cattail Salad 5/16/99](#)
- [----Fried Corn 4/23/98](#)
- [----Fried Sage and Mushroom Sause for Pasta 5/16/99](#)
- [----Gluckaston 1/31/00](#)
- [----Jac's Wildberry Crisp 12/8/98](#)
- [----Jellico \(Wild Greens\) 12/8/98](#)
- [----Napalitos \(Prickly Pear\) 4/12/98](#)
- [----Nopalitos \(Prickley Pear\) 5/16/99](#)
- [----Nopalitos and Pork 1/31/00](#)
- [----Prickly Pear Surprise 5/16/99](#)
- [----Steamed Cattail 10/7/98](#)
- [----Steamed Lambsquarters 5/16/99](#)
- [----Succotash 10/7/98](#)
- [----Succotash N' Nuts 5/16/99](#)
- [----Vegan Rice Pudding 12/8/98](#)
- [----Wagunabuie \(Lichen\) Soup 5/16/99](#)
- [----Wild Tumbleweed Greens 5/16/99](#)
- [----Wojapi \(Pudding\) 8/6/98](#)
- [----Acorn Mush 4/13/98](#)
- [----Bay Nuts 4/13/98](#)
- [----Cranberry Bread 10/7/98](#)
- [----Easy Wild Rice Soup 12/8/98](#)
- [----Indian Fry Bread 3/26/98](#)
- [----\(another\) Fry Bread Recipe 4/12/98](#)
- [----Frybread Pizza with a Twist 1/31/00](#)
- [----Indian Cake 4/12/98](#)
- [----Indian Tacos 4/28/98](#)
- [----Menonimee Pilaf 5/16/99](#)
- [----New Native Frybread 1/31/00](#)
- [----Nupa \(Acorn\) Soup 12/8/98](#)
- [----Ojibwe Style Fried Bread 5/16/99](#)
- [----Rao's Fried Bread Biscuits 1/31/00](#)
- [----Wild Rice 4/20/98](#)
- [----Wild Rice Breakfast 12/8/98](#)
- [----Wild Rice Casserole 4/6/98](#)
- [----Wild Rice Delux 5/16/99](#)
- [----Wild Rice Pancakes 10/7/98](#)
- [----"Western" Pemmican 4/12/98](#)
- [----Baked Grindle 12/8/98](#)
- [----Beans & Bacon 10/7/98](#)
- [----Blanket Dog 5/16/99](#)
- [----Horse Tea 5/16/99](#)
- [----Hungry Man Stew 4/13/98](#)

- [Indian Goolosh](#) 1/31/00
- [Rock Chuck Extravaganza](#) 4/22/98
- [Silly Willy's Home Brew](#) 4/17/98
- [Chorizo and Rice](#) 2/01/01
- [Easy Venison Roll Ups](#) 2/01/01
- [Jerky Soup and Dumplings](#) 2/01/01
- [Moose Steak Sandwich](#) 2/01/01
- [Saponi Beef Empanadas](#) 2/01/01
- [Too Tall Tail Meat Salad](#) 2/01/01
- [Rav'in Raven](#) 2/01/01
- [B.B.Q. Tuna](#) 2/01/01
- [Fire Baked Fish](#) 2/01/01
- [Cherokee Fried Hominy](#) 2/01/01
- [Seneca Corn Soup](#) 2/01/01
- [Totti's Three-Stock Soup](#) 2/01/01
- [Indian Tacos Port Gambal Skallam](#) 2/01/01
- [Navajo Fry Bread](#) 2/01/01
- [Oakis' Favourite Big Mac](#) 2/01/01
- [Yum Yums](#) 2/01/01
- [Spoon Bread](#) 1/23/02
- [Maxine and Kayla Doolans Own Recipe](#) 1/23/02
- [Pinto Bean FryBread](#) 1/23/02
- [Floral Green Salad](#) 1/23/02
- [Nopalitos Con Arror](#) 1/23/02
- [Prickly Pear Cactus Jelly](#) 1/23/02
- [Cactus Pear and Raspberry Syrup](#) 1/23/02
- [Guacomole](#) 1/23/02
- [Fried Yucca Petals](#) 1/23/02
- [I-Ya](#) 1/23/02
- [Skok Salmon Cheeks](#) 1/23/02
- [Minnesota Mac](#) 1/23/02
- [Popcorns On Me](#) 1/23/02
- [Sun-Cooked Salsa](#) 1/23/02
- [Orchata](#) 1/23/02
- [Food & Recipe Bibliography and Books to Buy On-Line](#)

## [POEMS & STORIES](#)

- [About Nunya Ageya](#)
- [Black Rock](#)
- [Four Dreams](#)
- [Just Passin'](#)
- [Over Under](#)
- [Fireflies on Summer Nights](#)



- [Reminiscences](#)
- [Song of the Earthdream](#)
- [Time-warp Mountain Man](#)
- [Waiting for the Moon](#)
- [About Longtrail Snowbird](#)
- [The Gift](#)
- [The Ghost Woman and Heavy Collar of the Bloods](#)
- [Eagle Hunter](#)
- [Shin'in Times Beyond](#)
- [The Sun Dogs of Winter](#)
- [Buffalo as a Food Source](#)
- [About Les Tate](#)
- [The Shelter](#)
- [Time Walker Trilogy](#)
- [Are You An Indian?](#)
- [About T. W. Martindale](#)
- [Season of Cheer](#)
- [Crystal Tears](#)
- [For Those Who Cried](#)
- [Whispers In The Wind](#)
- [Cry Freedom](#)
- [Quiet Companion](#)
- [Enter The Butterfly](#)
- [Kiss The Wind](#)
- [Vapors](#)
- [About Ted Wilburn](#)
- [Little Two-Hands, Talking](#)
- [My Cherokee Rosetta Stone](#)
- [Faces in My Dreams](#)
- [Who Are You?](#)
- [About Edward Ivan Madahbee](#)
- [Be Strong](#)
- [The End?](#)
- [About Tara Prindle](#)
- ['Twas the Night Before Ojibwe Christmas](#)
- [Original Man and Wolf](#)
- [Mr. Rock](#) As told by **Thunder-God**
  
- 🌟 [Scenes from the Eastern Woodlands - A virtual tour circa 1550](#)
- [Building our wigwam](#)
- [Tending to our garden](#)
- [Making our stone tools](#)
- [Grinding our corn and nuts](#)



--[Catching fish in a net from our canoe](#)

--[Bathing ourselves at the stream](#)

--[Cooking our food we gather](#)

--[Working inside our wigwam](#)

--[Making our pots](#)

--[Playing our hoop and dart game](#)

--[Picking cherries for our bread](#)

--[Learning to shoot our arrows](#)

● [Ojibwe Culture & Language Resources on the Internet](#)

--[An Ojibwe Language Word List](#)

● [Instructional Workshop Pamphlets](#)

● [NativeTech's Bookpages: Native Bibliographies and Books to Buy On-line.](#)

● **OTHER NativeTech RESOURCES**

--[NativeTech's Internet Links to Native American Art Resources](#)

----[Internet Links to Beads & Beadwork](#)

----[Internet Links to Birds & Feathers](#)

----[Internet Links to Clay & Pottery](#)

----[Internet Links to Leather & Clothing](#)

----[Internet Links to Metal Working](#)

----[Internet Links to Plants, Wood Twigs & Branches](#)

----[Internet Links to Porcupine Quillwork & Hair](#)

----[Internet Links to Stone & Other Tools](#)

----[Internet Links to Weaving & Cordage](#)

----[Internet Links to Food & Recipes](#)

----[Internet Links to Games & Toys](#)

----[Internet Links to Music & Performance](#)

----[Internet Links to Powwows & Calendars](#)

----[Internet Links to Stories & Oral History](#)

----[Internet Links to History, Issues & Anthropology](#)

----[Internet Links to Reenacting & Living History](#)

----[Internet Links to Museums & Exhibits](#)

----[Internet Links to Workshops in New England](#)

----[Internet Links to Craft Supplies & Sources](#)

----[Internet Links to Native Galleries on the Web](#)

--[Native American-Related Messageboards](#)

--[NativeTech Virtual Postcards](#) ...send an online greeting today.

--[NativeTech Poll](#) ...Voice your opinion.

and don't forget all the pages for

~>><<~ [NIAC, the Nipmuc Indian Association of Connecticut](#) ~>><<~

Please visit my personal pages at [Waaban Aki Crafting!](#)

Be sure to visit [NativeWeb!](#)

---



Text and Graphics  
© 1994 - 2003 [Tara Prindle](#)  
unless otherwise cited.



## Resources for Indigenous Cultures around the World

[Resources](#) [Books & Music](#) [Community](#) [Services](#) [About Us](#)

# Help Support NativeWeb

[Resource Center](#)

[Books & Music](#)

[Communities](#)

[Hosted Sites](#)

[Search the Site](#)

[About NativeWeb](#)

[Advertise on NativeWeb](#)

**[Get your FREE EMAIL](#)**

**[@NativeWeb.Net!](#)**

[Login](#) | [Signup](#)

[Donate to NativeWeb!](#)

[Tax Deductible!](#)



NativeWeb is a non-profit educational organization under section 501(c)(3) of the U.S. Internal Revenue Code. **Your contributions are tax-deductible under U.S. law.**

Your donations help us promote Indigenous resources, inform the public about Indigenous cultures and issues, and to facilitate communications between Indigenous peoples and organizations supporting their goals and efforts.

**There are several ways you can help support NativeWeb!**

- **Donate online using PayPal! ([See below](#)).**
- Visit [NativeWeb's Book Center](#) before purchasing products at Amazon.com.
- **Send your check or money order donation via mail** to NativeWeb (address at bottom of this page).
- [Purchase a NativeWeb TShirt, Mug or Mouse Pad.](#)
- [Contact us](#) if you would like to become a major sponsor of NativeWeb.
- eFax NativeWeb at (253) 541-3701.

## Donate Now!

Enter the amount you wish to donate, then click on the PayPal image. **Please Note: PayPal will ask you to create a secure private account to verify and process your donation. Please follow all PayPal instructions carefully to be sure your secure donation to NativeWeb is completed. Thank you.**

\$



When you donate money to NativeWeb, you become a supporter of the global community of Indigenous peoples. Your donations help NativeWeb provide important services to Indigenous and Non-Indigenous peoples around the world by working to inform and educate the general public about Native People's issues, history and culture. In addition, NativeWeb works with Indigenous organizations and individuals to provide them with a voice on the Internet that they may not otherwise have. To learn more about NativeWeb, who we are and what we do, visit [our organization's information center](#).

Every donation, no matter what amount, counts. All funds received are deposited in NativeWeb's non-profit account for support of the site.

---

NativeWeb is incorporated as a non-profit educational organization under the laws of New York state and the United States. **Your donations are tax-deductible in the United States as charitable contributions.** The U.S. Internal Revenue Service has determined that NativeWeb, Inc., is a non-profit organization under section 501(c)(3) of the Internal Revenue Code. NativeWeb's US federal tax EIN number is 16-1569230.

Send your donations in check or money order to  
NativeWeb, Inc.  
16 Cross Road  
Dewitt, NY 13224  
USA

---

**Thank you for donating to  
NativeWeb!**

---

© [NativeWeb, Inc.](#) 1994-2003 || [Disclaimer Statement](#) || [Copyright Statement](#) || [Contact Us](#) || [Visitors](#) || [Donations](#)

## Resources for Indigenous Cultures around the World

### Site Index

[Resource Center](#)

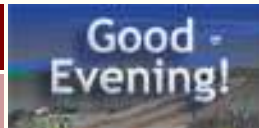
[Books & Music](#)

[Communities](#)

[Hosted Sites](#)

[Search the Site](#)

[About NativeWeb](#)



### In The News

[Read more news articles](#)

Please reload this page to view the headlines

### People and Places

[More People and Places](#)



[Black](#)

[Mesa Weavers for Life and Land](#) business partnership with the [Navajo Churro wool-buying co-op](#) held its second Navajo Churro wool buy for Black Mesa Diné outside the Hardrock Chapter House.

### New Resource

[The Southwest Museum](#)

The Southwest Museum holds one of the nation's most important museum, library, and archive collections related to the American Indian. In addition it has extensive holdings of Prehispanic, Spanish Colonial, Latino, and Western American art and artifacts. For eighty years it has supported research, publications, exhibitions, and other educational activities to advance the public's understanding and appreciation of the Americas, with particular emphasis on the Western United States and Mesoamerica.

[Donate to NativeWeb!](#)  
[Tax-deductible!](#)

[Get your FREE EMAIL @NativeWeb.Net!](#)

[Login](#) | [Signup](#)



[New Products, check them out!](#)

### Featured Hosted Site

[Pyramids of Mexico](#)

A colorful overview of the Pyramids in Mexico.

### Announcements!

[Read more Announcements!](#)

### Books & Music



[The United Nations Global Forum on Indigenous Peoples and the Information Society will take place from 8 to 11 December 2003. The World Summit on the Information Society will take place from 9-12 December 2003. Both events in Geneva. The timeframes of the two events have been slightly staggered to allow indigenous peoples access to both events.](#)

[Call for Papers: Native/Indigenous Studies Area 2004 Southwest/Texas Popular Culture/American Culture Association 25th Annual Conference, held in conjunction with the National Popular Culture/American Culture Association Conference in San Antonio, Texas April 7-10, 2004. The deadline for submitting proposals is November 1, 2003.](#)

[Resource rebels : native challenges to mining and oil corporations](#)

by Al Gedicks  
Paperback (2001)  
Cambridge, MA :  
South End Press, 241  
pages. ISBN:  
0896086402

### Upcoming Events

**09/21/04  
Festival: Nat'l  
Museum American  
Indian, DC**

## Resources

[more...](#)

### 5079 Listings Available!

- [Anthropology & Archeology](#)
- [Art, Artisans & Galleries](#)
- [Book, Movie & Arts Reviews](#)
- [Chat, Discussion Forums, E-Lists](#)
- [Children](#)
- [Crafts & Indigenous Technology](#)
- [Education](#)
- [Elders](#)
- [Environment](#)
- [Events, News Items & Powwows](#)
- [Food](#)
- [Materials Hosted on NativeWeb](#)
- [Museums](#)
- [Nations Web Sites & Information](#)
- [Native Businesses & Products](#)
- [Native Economy & Employment](#)
- [News & Media](#)
- [Newspapers - native & indigenous](#)
- [Obituaries - In Memorium](#)
- [Organizations](#)
- [Performance](#)

- [Genealogy \(Tracing Roots\)](#)
- [Health](#)
- [History](#)
- [Human Rights Organizations](#)
- [Internet & Computers](#)
- [Languages & Linguistics](#)
- [Law & Legal Issues](#)
- [Libraries & Collections](#)
- [Literature](#)
- [\(Music, Dance, etc\)](#)
- [Personal Pages](#)
- [Photography](#)
- [Reference Materials](#)
- [Religion & Spirituality](#)
- [Sports & Athletics](#)
- [Travel & Tourism](#)
- [TV & Radio](#)
- [US Tribal Websites](#)
- [Women](#)

## Books & Music

[more...](#)

---

**968 Listings Available!**

- [Audio Cassettes](#)
- [Books](#)
- [Music](#)
- [Video Cassettes](#)

## Non-profit Status

---

The U.S. Internal Revenue Service has issued a determination that NativeWeb, Inc., is a non-profit educational organization under the 501(c)(3) federal tax laws. This means that all donations to NativeWeb are tax-deductible as charitable contributions. NativeWeb is an all-volunteer effort and depends on donations from users.



Selected by NEH as one of their original 21 top Humanities sites on the

Internet



Institute for Scientific Information premium collection of

evaluated scholarly Web sites.



Selected by Social Science Information Gateway of the UK Resource Discovery Network as a trusted source of information for students, academics, researchers and practitioners in the social sciences, business and law.



© [NativeWeb](#) 1994-2003 || [Disclaimer Statement](#) || [Copyright Statement](#) || [Contact Us](#) || [Visitors](#) || [Donations](#)



# BILLY'S SECRET PAGE

DEVOTED TO GETTING MORE CATS ON LINE

---



*She doesn't know I did this*

But since I'm up and running around all night anyway, I just snuck in, booted up and scanned in a few choice photos of me, my brothers and my sister (not biological mind you). It was a snap considering I can sit on top of their flatbed scanner all day long and watch how she puts her [NativeTech](#) pages together. [She thinks I'm sleeping but I have just one eye open to a thin little slit, and I watch.]

---

[Come see](#)  
[MY BROTHERS, MY SISTER AND ME](#)

---

**THE CAT'S MEOW:**

[The Billy & Tigress Chronicles](#)  
[Cat Haiku](#)  
[Billy Finds A Cat's Diary](#)

---

**BILLY'S INSTRUCTIONAL GUIDES:**

[How to Give a Cat a Pill](#)  
[How to Bathe a Cat](#)  
[Billy's Miracle Diet for Humans](#)

---

**BILLY'S FREE STUFF:**

[Click Here for a Free Catscan](#)

---

**BILLY'S IMPORTANT THINGS TO KNOW:**

[Why I Like to Go to Gramma's House](#)

[Cats in Physics](#)

[Cat Quotes by Humorous Humans](#)

[On the origin of dogs and cats](#)

---

**[LINKS TO OTHER CATS, ALREADY ON-LINE](#)**

---

These are some of my favorite sleeping positions



**Curled**



**Flying**



I was really quite proud of my Santa hat this year



**I hope this inspires other 'domesticates' (boy I hate that term)  
to take advantage of their 'owner's' (hah, that's a laugh) web connections!!**

---

**[Her NativeTech Home Page](#)**

---

© 1994 - 103 **[William 'Lambie-kins' Pit-woffie Slee](#)** unless cited otherwise.

*[Fellow felines can send me secret e-mail](#)*



## NativeTech: Native American Technology and Art

---

# DEDICATED TO DISCONNECTING THE TERM *PRIMITIVE* FROM PERCEPTIONS OF NATIVE AMERICAN TECHNOLOGY

---

### Definition of Primitive:

<sup>1</sup> **prim-I-tive** \ˈprim-et-iv\ *adj.* 1 a : not derived : ORIGINAL, PRIMARY b : assumed as a basis 2 a : of or relating to the earliest age or period : PRIMEVAL b : closely approximating an early ancestral type : little evolved c : belonging to or characteristic of an early stage of development : CRUDE, RUDIMENTARY [technology] d : of, relating to, or constituting the assumed parent speech of related languages 3 a : ELEMENTAL, NATURAL [the noble savage endowed with virtue - Oscar Handlin] b : of, relating to or produced by a relatively simple people or culture [art] c : NIAVE d (1) : SELF-TAUGHT, UNTUTORED [craftsmen] (2) : produced by a self-taught artist. (*Webster's New Collegiate Dictionary*)

---

[NativeTech Home Page](#)

[Go to NativeTech's Home Page](#)

© 1996 - 1998 [Tara Prindle](#).

## NativeTech: Native American Technology & Art

---

### [A Discussion of Terms](#)

---

Native American technicians and artists

[Traditional tools and materials](#)

[Ideas expressed through art.](#)

---

## The Role of Native American Artists and Technicians In the Eastern Forests of North America

The role of artists is defined by the society they are a part of. Before European contact, the basic social or political *unit* for Native Americans living in New England was the 'tribe', a group of allied people living in separate 'bands', sets of family clans, or communities, in which one or two bands were sometimes distinguished. The time people can spend 'just being an artist', in creative pursuits, is often limited by the way their society organizes itself - or just how much *bureaucracy* there is. With a livelihood of hunting and gathering or horticulture, a specialized craft is a luxury that takes energy away from the daily food/subsistence quest. Specialized craft and other types of full-time professions are not economically practical when every member of society *has* to devote time to daily subsistence activities. So, hundreds of years ago, without the role of craft specialization, the artist often finds their creative outlet, or expression, within the realm of everyday life, based on their daily experiences.

In the past, Native Americans New England sometimes had to make scheduled moves of their settlements in response to various abundant or depleted resources (salmon runs or perhaps a lack of firewood for example). Hence, the older art of Native Americans of southern New England often involved the ornamentation of utilitarian objects, which were carried along, left for later use, traded away, or buried with the deceased. Through the perfection and embellishment of these items, Native Americans found not only a means of individual expression, but they also discovered a visual way to communicate important cultural symbols.

In New England, some forms of traditional Native American art are produced mainly by women, while other kinds of art are generally executed by men; a few types of traditional art are produced by both men and women. Men's and women's art can be different because their daily routines are different. Before European contact, there were many tools and materials that were exclusive to either men's or women's tasks; this exclusiveness can be seen in the art produced by men and women.

Document sources recorded by Europeans in 17th century New England mention specific divisions of production or labor based on sex and age. Dutch observed in the 'New Netherlands' (New York) that older men fashioned fish nets and make wooden bowls and ladles, and that such labor was uncommon among younger men, with most of the subsistence activities performed by women. Men were responsible for the manufacture of wooden bowls, spoons, dishes, and canoes, as well as nets and stone pots and pipes. Men eventually specialized in the production of wampum, or shell currency, and other shell artifacts, (although recent research indicates women may have had a role in wampum production). The husband in New England was obligated to make his child's cradle board.

Most early 17th century European accounts note that pottery was made by women, though some references allude to men manufacturing clay pipes. Women were responsible for making most of the woven mats, baskets, and containers of birch bark pails. In addition to their domestic activities, women (and probably older men) were responsible for the manufacture and embroidery of their own and their family's clothing. William Wood noted in the 1600's "In winter time they [Native American women in New England] are their husbands Caterers,... They likewise sew their husbands shooes, and weave coates of Turkie feathers, besides all their ordinary household drudgerie which daily lies upon them" (New England's Prospect by William Wood, 1865).

Today Native Americans continue to pass down unique traditions to the children, though the role of Native American artists changes dramatically. Reliance upon the convenience of 20th century ways of getting food does indeed allow more room, more time, for craft specialization. Men and women have equal access to materials and tools, but traditions of many Nations still



dictate the creation of some forms of art. Specialized guilds of pottery, basketry, quill working, metalworking and other Native American artists have developed over the centuries and they exist today, coast to coast, across Turtle Island.

Native American art has become overwhelmingly popular in this decade - a situation that has had both positive and negative effects on individual artists and Native nations. An international market has formed which *demand*s the sights and sounds of Native cultures. Though commercial operations often provide an outlet for Native American artists, the competition from poorly-made, non-Native production of Native art has injured Native artists and in some case perpetuates hurtful stereotypes of Native Americans. Many issues of [cultural property](#) have been raised about the production and abuse of Native American art and images - it is difficult to know where to draw a line in the sand. Federal legislation has failed to protect *or* accommodate the Native American artist, mainly because *today* it is so difficult to *define* who is - or is not - a Native American artist.

[Return to A Discussion of Terms](#)

---



**Text and Graphics**  
© 1994 - 103 [Tara Prindle](#)  
unless otherwise cited.



## NativeTech: Native American Technology & Art

---

### [A Discussion of Terms](#)

---

#### [Native American technicians and artists](#)

Traditional tools and materials

[Ideas expressed through art.](#)

---

### **Materials and Tools of Native American Artists and Technicians In the Eastern Forests of North America**

A comprehensive knowledge of the natural world is evident in Native American art of the prehistoric and early historic periods. Traditionally, the raw materials used for craft were also important sources for food, medicine or their preparation. Before European contact, some of the materials available to Natives of southern New England were metals & minerals of the earth - stone & clay, the fiber and juice from wild plants, the wood, bark & roots from innumerable trees, the fur, hair, quills, feathers, teeth, bones, antlers, fur & animal hides, and literally anything else found in the natural environment of pre-17th century New England. With the invasion of Europeans also came a wave of new raw materials, flora and fauna: glass beads & other products, ceramic glazes, metal alloys & tools, imported textiles, and by-products associated with animal domestication such as cloth, looms, & commercial dyes and pigments. With the inundation of European people came foreign animals and plants - often so invasive and adaptable to the new environment that indigenous colonies are choked out to extinction.

European contact caused many traditional Native American crafts to diminish in production - sometimes because Natives could no longer obtain the right raw materials, and sometimes because people had to put their energies elsewhere to survive. But since European contact, Native Americans have developed new art forms, many of which build upon older traditions, using modified materials or techniques taken from Europeans. Incorporation of post-contact materials, such as metal, glass, commercial dyes and cloth, as well as acquisition of new European craft techniques, inspired new types of art, such as metal work and splint basketry. However some traditional art forms such as porcupine and moose hair embroidery were modified.

Recently, European markets for Native American art have developed into huge international industries, jewelry, sculpture, pottery, splint basketry -- but it seems with each generation there are fewer and fewer children interested in the knowledge of their parents - some types of traditional forms of art are disappearing.

About 1650 a Native elder in New England complained that "a long time ago, they [the Indians] had wise men, which in a grave manner taught the people knowledge; but they are dead, and their wisdom is buried with them, and now men live a giddy life, in ignorance, till they are white headed, and though ripe in years, yet then they go without wisdom to their graves. (Handbook of North American Indians, vol.15, 1978).

Prehistoric Native American art was produced from materials of the natural environment, often expressed as the embellishment of utilitarian items. Although made from materials of the earth, this art was much more than a mere product of nature. The artisans consciously intended to arrange something that did not naturally-occur in their environment. In some cases the introduction of European tools and materials facilitated the production of traditional art forms, but at the same time transformed traditional meanings.

To be more than utilitarian, an item is invested with meaning that goes beyond its everyday use. Embellished objects provide information about the artist or the society to which he belongs. Many so-called 'utilitarian' objects such as ball-headed war clubs inlaid with wampum, are invested with so much symbolic meaning such as political prestige or power, that the object becomes less utilitarian to a Native American. An item may be embellished to this point no longer functions in its original or traditional context.

[Return to A Discussion of Terms](#)

---



Text and Graphics  
© 1994 - 103 [Tara Prindle](#)  
unless otherwise cited.



## NativeTech: Native American Technology & Art

---

### [A Discussion of Terms](#)

---

#### [Native American technicians and artists](#)

#### [Traditional tools and materials](#)

Ideas expressed through art.

---

### **Ideas Expressed through Art**

To interpret Native American art, one must identify who this art it is produced for and what messages it conveys. The cultural contexts of art may involve religion, politics, and divisions of labor. Art may express ideas of human creation, authority and prestige, or ideas about acceptable roles in that society. Although art may have practical application for a society, art also appeals directly to the imagination of the artist. Art is a visual way for people to reflect upon what is going on their cultural and natural environment, and allows others a way to see how people perceive their natural world.

Art conveys meaning with symbols and icons which are culture specific. There is usually no direct connection between the symbol and the object it represents. Symbols can have very different meanings to different cultures. As a result, to understand the symbolic aspects of art, one must know what the symbol means to the society which uses it. Artists must abide by the rules or conventions of their culture when they use symbols to communicate ideas. Often it is not possible to separate the everyday use of an object from the embellishment of that object.

### [Return to A Discussion of Terms](#)

---



**Text and Graphics**  
© 1994 - 103 [Tara Prindle](#)  
unless otherwise cited.



## Native American Technology and Art

### NATIVE AMERICAN BEADWORK

#### Index to Bead Weaving ~ Hand-held and Loomwork Techniques

---

##### Hand-Held Beadwork Techniques

[wire weave](#)

[wire weave on loom](#)

[wire weave on loom with multiple rows](#)

[double strand wire weave](#)

##### Bias-Weave Beadwork Techniques

[bias weave](#)

[bias weave variation](#)

##### Loomed Beadwork Techniques

[bow loom](#)

[loom terminology](#)

##### Loomed Double-Strand Square-Weave Techniques

[double strand square weave](#)

[double strand weave using over-under pattern](#)

[double strand weave with multiple rows](#)

[double strand weave using split thong](#)

##### Loomed Single-Strand Square-Weave Techniques

[single strand square weave with wrapped endwarps](#)

[single strand weave with under over pattern](#)

[single strand weave with twisted endwarps](#)

[single strand weave with doubled twisted warps](#)

---

[Return to Bead Weaving Techniques and Analysis](#)

[Return to NativeTech's Beadwork Menu](#)

## [Beadwork Bibliography and Books to Buy On-Line](#)

---

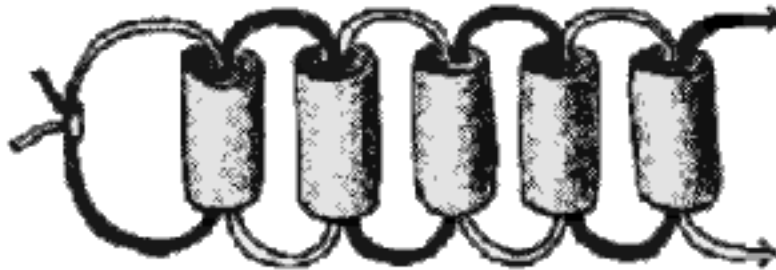


© 1994-1999 [Tara Prindle](#).

## Native American Technology and Art

### Native American Bead Weaving

#### Hand-Held Beadwork Techniques



wire work weave with weft crossing  
in each bead  
hand-held, on ly one end anchored

wire weave

---

[Return to Index to Bead Weaving Techniques](#)  
[Return to Bead Weaving Techniques and Analysis](#)

[Return to NativeTech's Beadwork Menu](#)

[Beadwork Bibliography and Books to Buy On-Line](#)

---



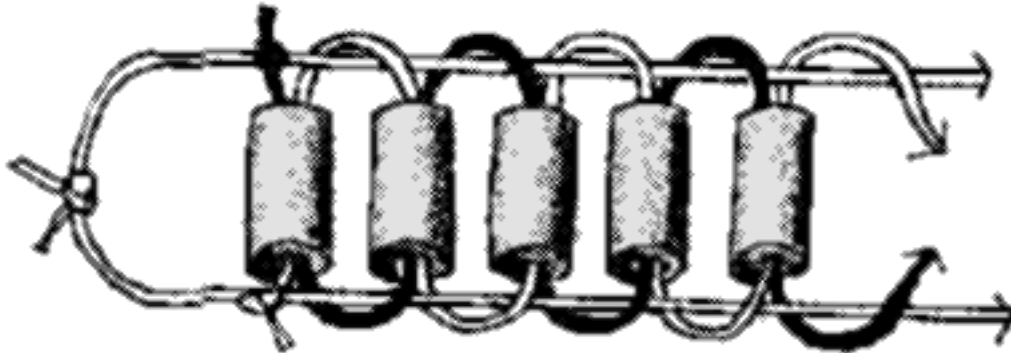
© 1994-1999 [Tara Prindle](#).



## Native American Technology and Art

### Native American Bead Weaving

#### Hand-Held Beadwork Techniques



wire work weave using warp on a loom  
weft crpsomg in each bead

wire weave on loom

---

[Return to Index to Bead Weaving Techniques](#)  
[Return to Bead Weaving Techniques and Analysis](#)

[Return to NativeTech's Beadwork Menu](#)

[Beadwork Bibliography and Books to Buy On-Line](#)

---

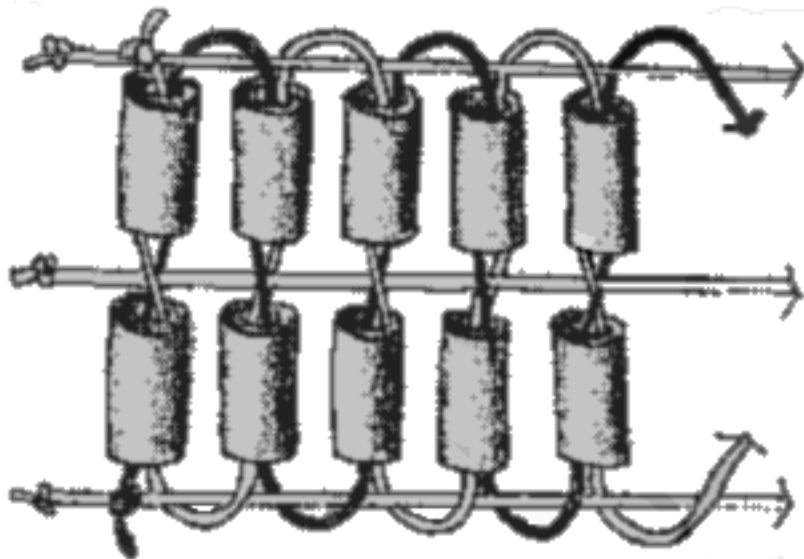


© 1994-1999 [Tara Prindle](#).

## Native American Technology and Art

### Native American Bead Weaving

#### Hand-Held Beadwork Techniques



**wire work weave using warp on a loom  
with multiple rows of beads,  
modified version of hand-held wire work**

wire weave on loom with multiple rows

---

[Return to Index to Bead Weaving Techniques](#)  
[Return to Bead Weaving Techniques and Analysis](#)

[Return to NativeTech's Beadwork Menu](#)

[Beadwork Bibliography and Books to Buy On-Line](#)

---



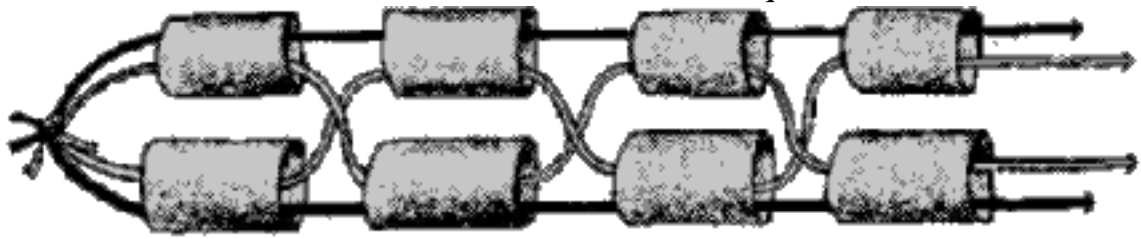
© 1994-1999 [Tara Prindle](#).



## Native American Technology and Art

### Native American Bead Weaving

#### Hand-Held Beadwork Techniques



**double strand wire work weave  
hand-held, on ly one end anchored**

double strand wire weave

---

[Return to Index to Bead Weaving Techniques](#)  
[Return to Bead Weaving Techniques and Analysis](#)

[Return to NativeTech's Beadwork Menu](#)

[Beadwork Bibliography and Books to Buy On-Line](#)

---

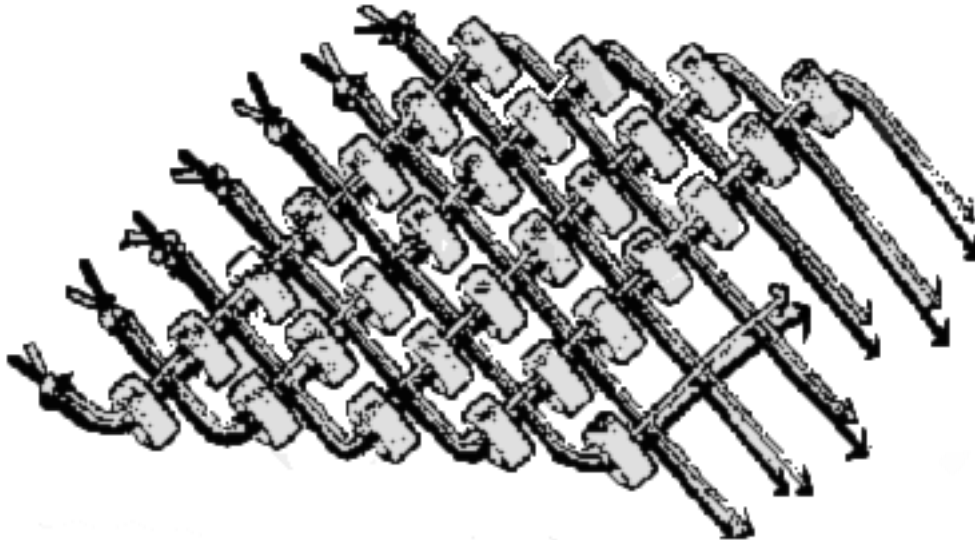


© 1994-1999 [Tara Prindle.](#)

## Native American Technology and Art

### Native American Bead Weaving

#### Bias-Weave Beadwork Techniques



**bias weave with doubled warps/wefts,  
only one end of work anchored,  
as warp turns to weft with each row**

bias weave

---

[Return to Index to Bead Weaving Techniques](#)  
[Return to Bead Weaving Techniques and Analysis](#)

[Return to NativeTech's Beadwork Menu](#)

[Beadwork Bibliography and Books to Buy On-Line](#)

---



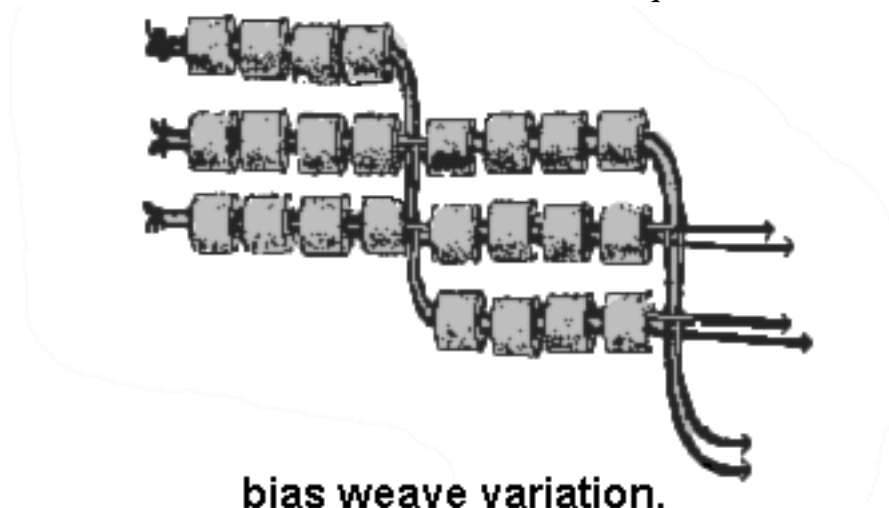
© 1994-1999 [Tara Prindle](#).



## Native American Technology and Art

### Native American Bead Weaving

#### Bias-Weave Beadwork Techniques



**bias weave variation,  
only one end of work anchored,  
as warp turns to weft every three beads**

bias weave variation

---

[Return to Index to Bead Weaving Techniques](#)  
[Return to Bead Weaving Techniques and Analysis](#)

[Return to NativeTech's Beadwork Menu](#)

[Beadwork Bibliography and Books to Buy On-Line](#)

---

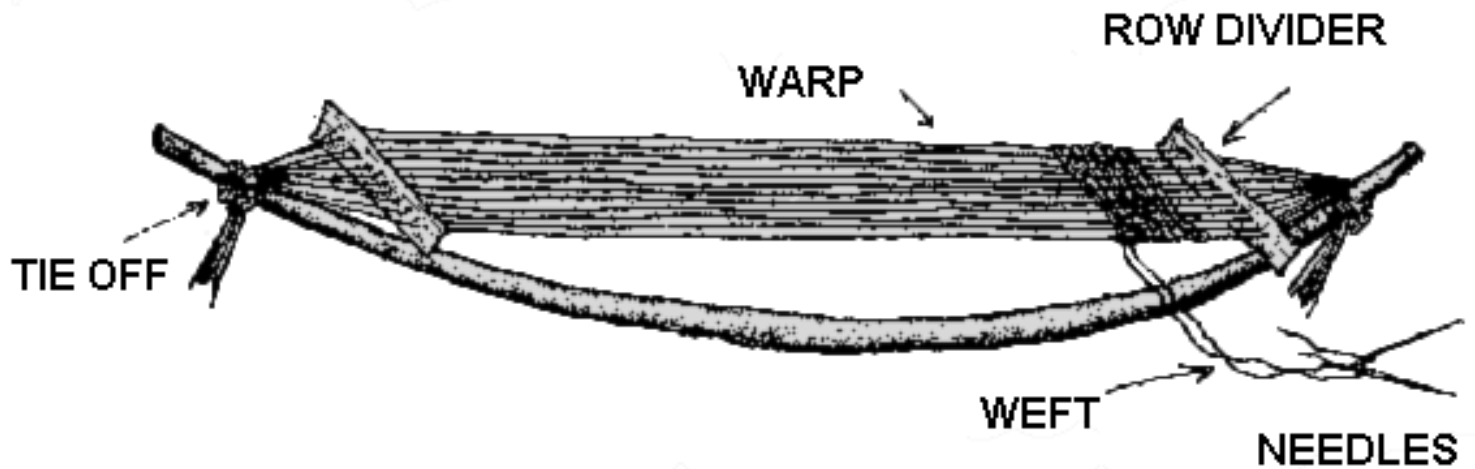


© 1994-1999 [Tara Prindle](#).

## Native American Technology and Art

### Native American Bead Weaving

#### Loomed Beadwork Techniques



**Bow Loom like that used in New England in the Early Historic Period  
(showing double strand square weave)**

bow loom

---

[Return to Index to Bead Weaving Techniques](#)  
[Return to Bead Weaving Techniques and Analysis](#)

[Return to NativeTech's Beadwork Menu](#)

[Beadwork Bibliography and Books to Buy On-Line](#)

---



© 1994-1999 [Tara Prindle.](#)

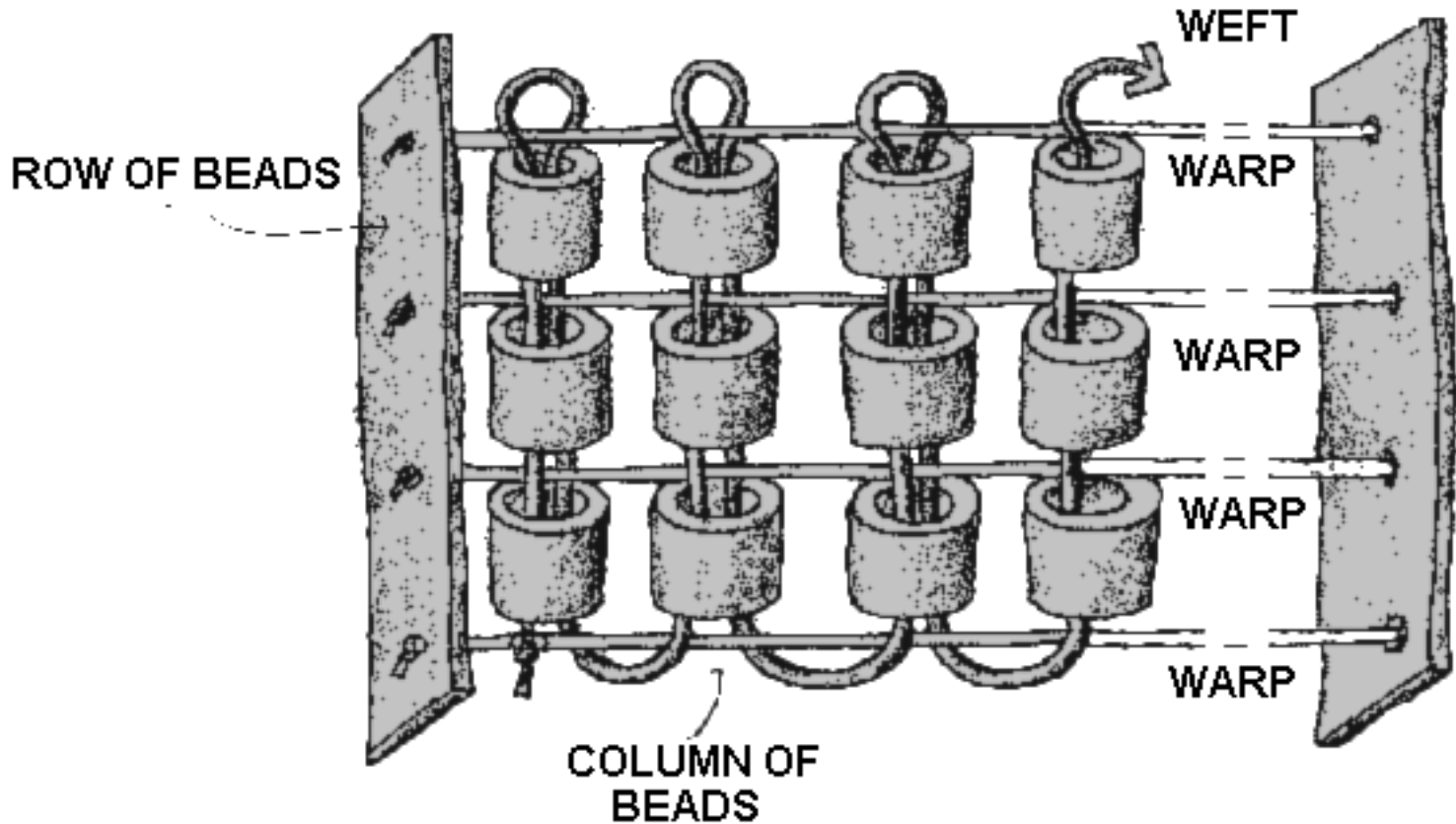


## Native American Technology and Art

### Native American Bead Weaving

#### Loomed Beadwork Techniques

**four columns of single strand square weave, using 3 rows of beads,  
(weft passes through the same beads twice)**



loom terminology

---

[Return to Index to Bead Weaving Techniques](#)  
[Return to Bead Weaving Techniques and Analysis](#)

[Return to NativeTech's Beadwork Menu](#)

[Beadwork Bibliography and Books to Buy On-Line](#)

---

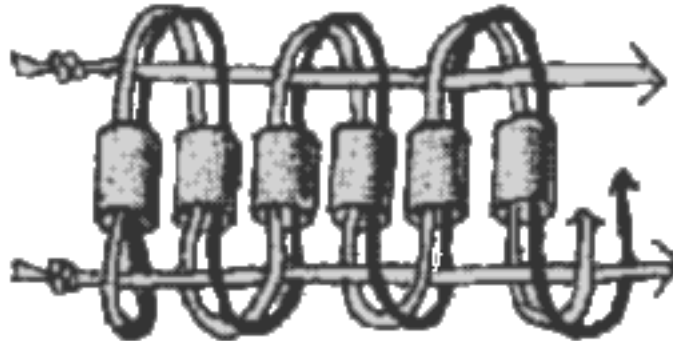


© 1994-1999 [Tara Prindle](#).

## Native American Technology and Art

### Native American Bead Weaving

#### Loomed Double-Strand Square-Weave Techniques



**double strand square weave  
using a single row of beads**

double strand square weave

---

[Return to Index to Bead Weaving Techniques](#)  
[Return to Bead Weaving Techniques and Analysis](#)

[Return to NativeTech's Beadwork Menu](#)

[Beadwork Bibliography and Books to Buy On-Line](#)

---



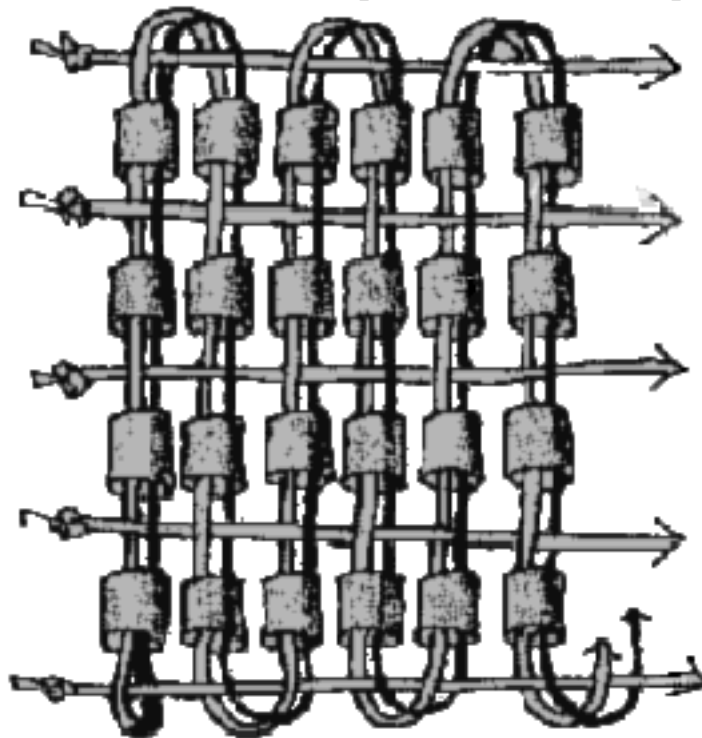
© 1994-1999 [Tara Prindle](#).



## Native American Technology and Art

### Native American Bead Weaving

#### Loomed Double-Strand Square-Weave Techniques



**double strand square weave  
using under-over pattern,  
with an even number of rows of beads**

double strand weave using over-under pattern

---

[Return to Index to Bead Weaving Techniques](#)  
[Return to Bead Weaving Techniques and Analysis](#)

[Return to NativeTech's Beadwork Menu](#)

[Beadwork Bibliography and Books to Buy On-Line](#)

---

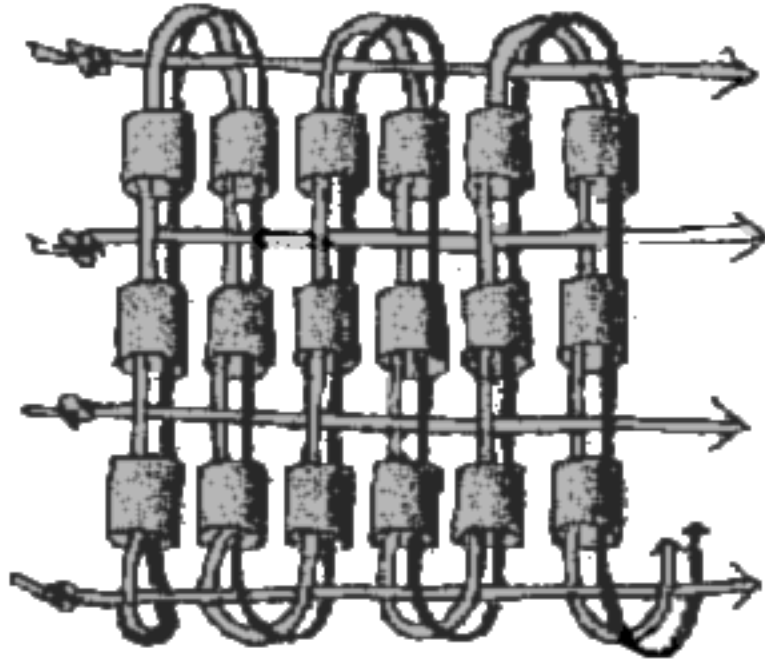


© 1994-1999 [Tara Prindle](#).

## Native American Technology and Art

### Native American Bead Weaving

#### Loomed Double-Strand Square-Weave Techniques



**double strand square weave  
using multiple rows of beads**

double strand weave with multiple rows

---

[Return to Index to Bead Weaving Techniques](#)  
[Return to Bead Weaving Techniques and Analysis](#)

[Return to NativeTech's Beadwork Menu](#)

[Beadwork Bibliography and Books to Buy On-Line](#)

---



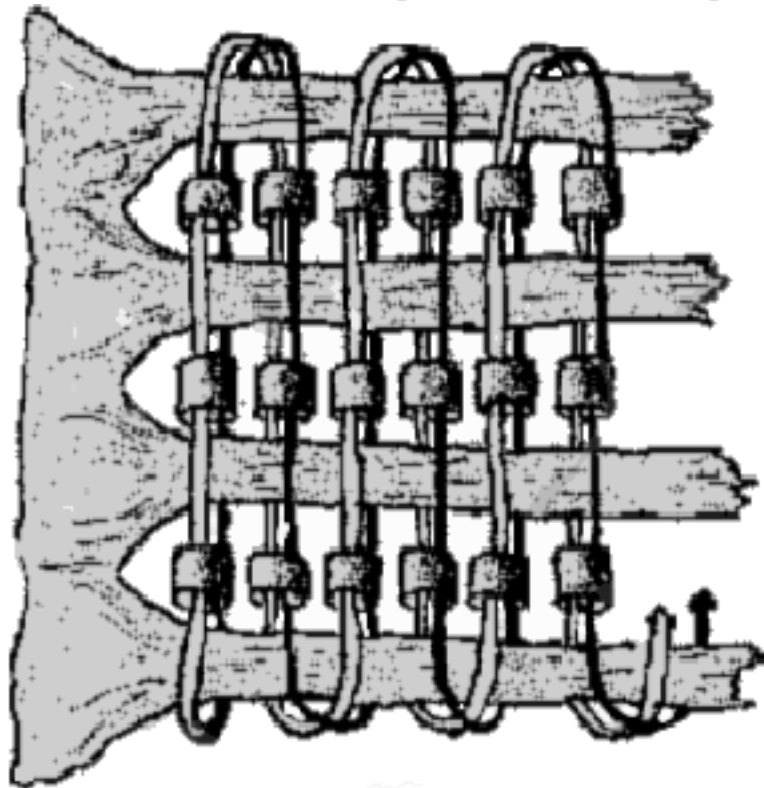


© 1994-1999 [Tara Prindle](#).

## Native American Technology and Art

### Native American Bead Weaving

#### Loomed Double-Strand Square-Weave Techniques



**double strand square weave  
using split thong**

double strand weave using split thong

---

[Return to Index to Bead Weaving Techniques](#)  
[Return to Bead Weaving Techniques and Analysis](#)

[Return to NativeTech's Beadwork Menu](#)

[Beadwork Bibliography and Books to Buy On-Line](#)

---



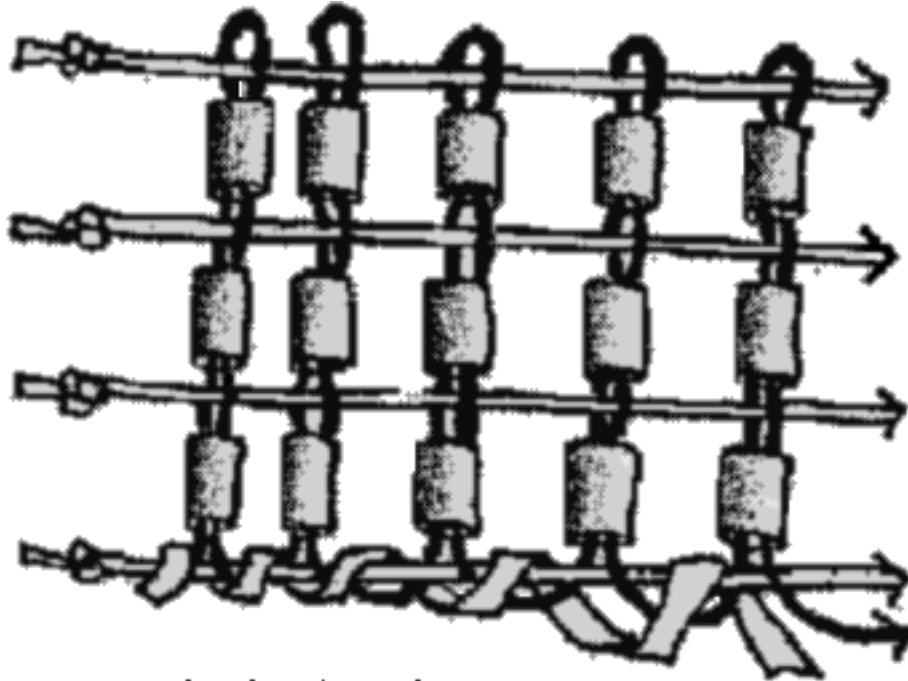
© 1994-1999 [Tara Prindle](#).



## Native American Technology and Art

### Native American Bead Weaving

#### Loomed Single-Strand Square-Weave Techniques



single strand square weave  
showing way of wrapping end warps

single strand square weave with wrapped endwarps

---

[Return to Index to Bead Weaving Techniques](#)  
[Return to Bead Weaving Techniques and Analysis](#)

[Return to NativeTech's Beadwork Menu](#)

[Beadwork Bibliography and Books to Buy On-Line](#)

---

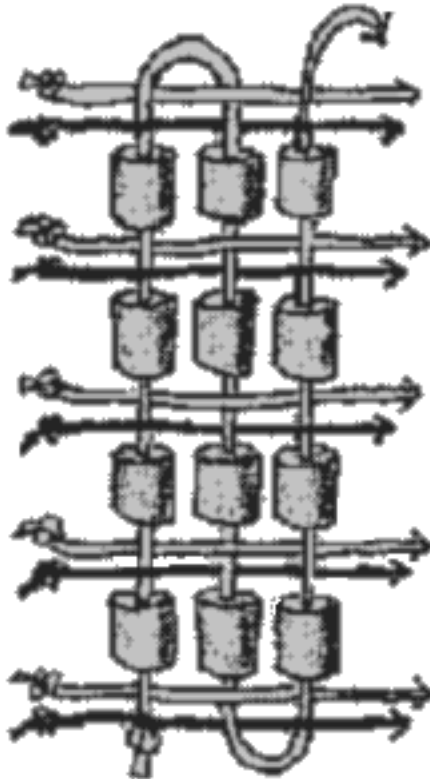


© 1994-1999 [Tara Prindle](#).

## Native American Technology and Art

### Native American Bead Weaving

#### Loomed Single-Strand Square-Weave Techniques



**single strand double warp square weave  
weft alternates under-over  
the pairs of warp strands with each row**

single strand weave with under over pattern

---

[Return to Index to Bead Weaving Techniques](#)  
[Return to Bead Weaving Techniques and Analysis](#)

[Return to NativeTech's Beadwork Menu](#)

[Beadwork Bibliography and Books to Buy On-Line](#)

---



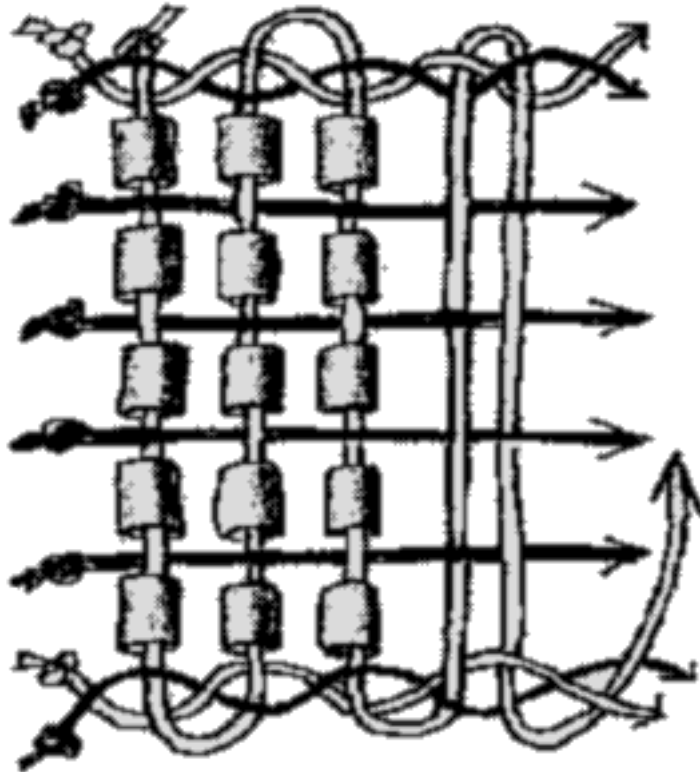


© 1994-1999 [Tara Prindle](#).

## Native American Technology and Art

### Native American Bead Weaving

#### Loomed Single-Strand Square-Weave Techniques



**single strand square weave  
weft passes through twists in end warps**

single strand weave with twisted endwarps

---

[Return to Index to Bead Weaving Techniques](#)  
[Return to Bead Weaving Techniques and Analysis](#)

[Return to NativeTech's Beadwork Menu](#)

[Beadwork Bibliography and Books to Buy On-Line](#)

---



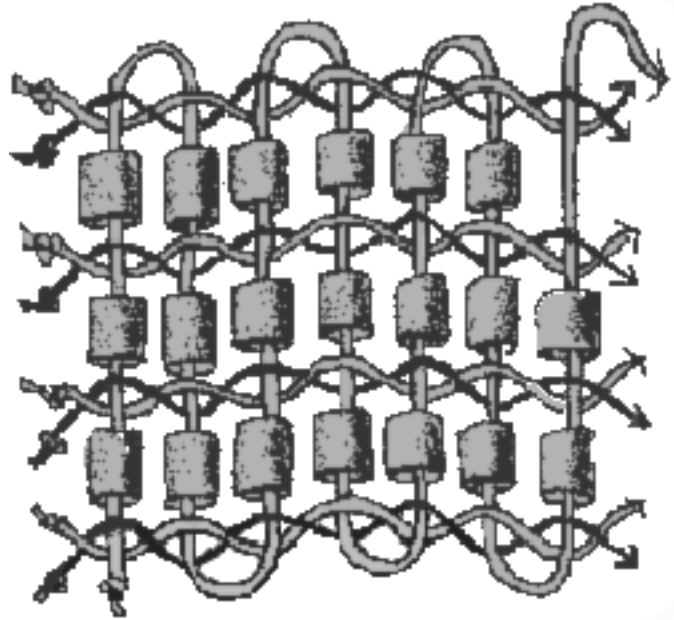
© 1994-1999 [Tara Prindle](#).



## Native American Technology and Art

### Native American Bead Weaving

#### Loomed Single-Strand Square-Weave Techniques



**single strand square weave,  
weft passes through twists  
in doubled warps**

single strand weave with doubled twisted warps

---

[Return to Index to Bead Weaving Techniques](#)  
[Return to Bead Weaving Techniques and Analysis](#)

[Return to NativeTech's Beadwork Menu](#)

[Beadwork Bibliography and Books to Buy On-Line](#)

---



© 1994-1999 [Tara Prindle](#).

## Native American Technology & Art BIBLIOGRAPHIC REFERENCES FOR WAMPUM

---

Bradford, William. 1981 *Of Plimoth Plantation*. New York City, New York: Random House,

Ceci, Lynn 1982 *The Value of wampum among the New York Iroquois: A case study in artifact analysis*. in *Journal of Anthropological Research*. 38(1): 97-107.

Ceci, Lynn 1990 "Native Wampum as a Peripheral Resource in the Seventeenth-Century Word-System." in *The Pequots in Southern New England, The Fall and Rise of an American Indian Nation*. L.M. Hauptman and J.D. Wherry, ed.s. Pp. 48-63. Norman, Oklahoma: University of Oklahoma Press.

Church, Colonel Benjamin 1975 *Diary of King Philip's War 1675-1676*. Introduction by Alan and Mary Simpson. Published for the Little Compton Historical Society; Tiverton, RI: Lockwood Publications.

DeForest, John W. 1850 *History of The Indians of Connecticut*. Brighton, Michigan: Native American Book Publisher,

Fogelman, Gary L. 1991 *Glass Trade Beads of the Northeast, And including Aboriginal Bead Industries: Stone - Bone - Shell - Catlinite - Cannel Coal - Teeth*. Pennsylvania: Fogelman Publishing Co.

Gookin, Daniel. 1792 "Historical Collections of the Indians in New England". N.p.: Massachussets Historical Society, Collection I Series I.

Hayes, Charles F., gen. ed. 1989 *Proceedings of the 1986 Shell Bead Conference; Selected Papers*. New York: Rochester Museum and Science Center, Research Records No. 20.

Heath, Dwight B., ed. 1963 *A Journal of the Pilgrims at Plimoth-1622 (Mourt's Relation)*. New York City, New York: Corinth Books,

Jennings, Francis 1976 *The Invasion of America: Indians, Colonialism, and the Cant of Conquest*. New York: W. W. Norton & Company, Inc.

Josselyn, John 1972 *New England's Rarities Discovered*. Meriden: Meriden Gravure Co. (First published 1672).

Leavitt, Robert M and David A Francis, eds. 1990 *Wapapi Akonutomakonol ~ The Wampum Records: Wabanaki Traditional Laws*. (68 pp., illustrated) Fredericton: Micmac-Maliseet Institute, UNB . For information about availability: Micmac-Maliseet Institute, University of New Brunswick, Fredericton, NB, Canada E3B 6E3

Orchard, William C. 1975 *Beads and Beadwork of the American Indians*. New York: Museum of the American Indian / Heye Foundation.

Russell, Howard 1980 *Indian New England Before the Mayflower*. Hanover: University Press of New England.

Salisbury, Neal. 1982 *Manitou and Providence*. New York City, New York: Oxford U P.

Simmons, William S. 1970 *Cautantowwit's House: An Indian Burial Ground on the Island of Conanicut in Narragansett Bay*. Providence, RI: Brown University Press.

Snow, Dean R. 1980 *The Archaeology of New England*. New York: Academic Press.



Speck, Frank G. 1976 *Penobscot Man,; The Life History of a Forest Tribe in Maine*. New York: Octagon Books.

Speck, Frank 1919 *The Functions of Wampum Among the Eastern Algonkian*. Lancaster, Pennsylvania: American Anthropological Association,

Tehanetorens 1972 *Wampum Belts*. Onchiota, NY.: Six Nations Indian Museum. Reprinted 1983. Ontario, Canada: Iroqrafts Ltd.

Trigger, Bruce G. ed. 1978 *Handbook of North American Indians*, Vol. 15. W. Sturtevant, gen. ed. Washington, D.C.: Smithsonian Institution.

Vaughan, Alden T. 1979 *New England Frontier; Puritans and Indians 1620-1675*. Revised edition. New York: W. W. Norton and Company.

Wood, William. 1977 *New England's Prospect*. London, England: 1634. Ed. Alden T. Vaughn. Amherst, Massachusetts: University of Massachusetts Press,

---

Many thanks to Courtney Anderson (Nianticoke) for our many discussions about wampum. Courtney lives in Rhode Island and has been making beautiful wampum beads and pendants for many years using the traditional techniques he learned as well as modern methods he has developed himself.

I am deeply indebted to Shelley Smith (Quapaw) for teaching me most of what I know about bead weaving techniques.

---

[Return to History and Background of Wampum](#)

---

[NativeTech Home Page](#)

[Go to NativeTech's Home Page](#)

© 1996 [Tara Prindle](#).

## Native American Technology and Art

# NATIVE AMERICAN BEADWORK Introduction and Use of Glass Beads

---

## Value of Glass Beads and Native Americans



*Ga Hah No -- Seneca Indian Girl  
in the Clothing of the Iroquois  
[Morgan: 1993]*

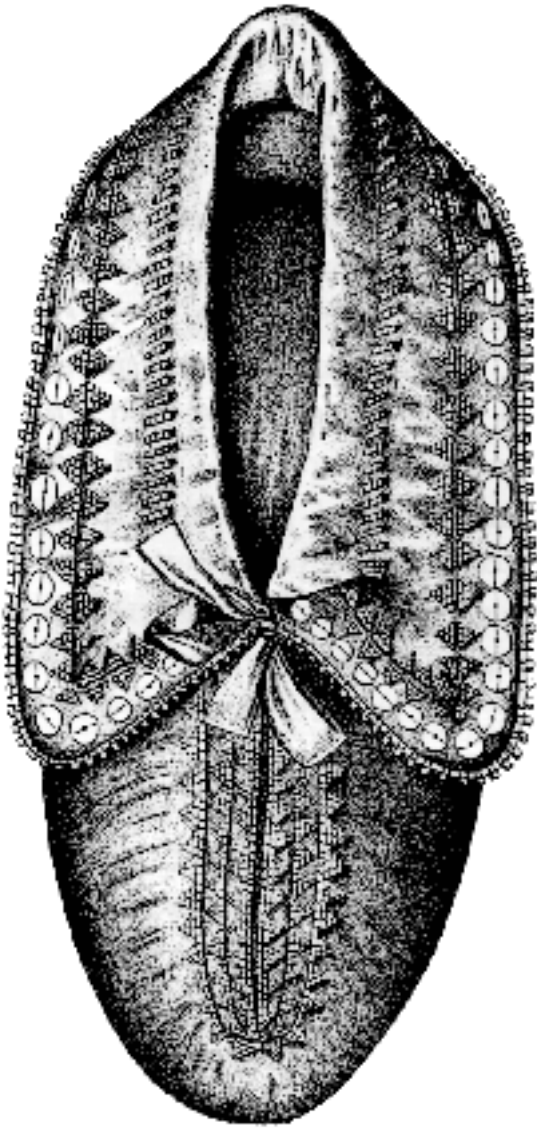
It may be hard to understand the reasons Natives wanted and accepted glass beads and other 'trinkets and baubles' from Europeans in trade. In order to understand the high 'value' placed on these goods by Natives, glass beads have to be examined from within the specific cultural context. 'Value' is a concept of culturally-dependent perception. 'Value' can be measured in many different ways. For example, an item's value may be weighed in terms of its exchange value as a commodity, in contrast to an item's symbolic religious value. Europeans saw glass beads as merely blobs of melted glass, 'trinkets', cheap and inexpensive as an exchange commodity. In European countries where beads were produced, they were simply priced according to expense of ingredients to manufacture them (Monture: 1993). In contrast, beads were symbolically 'valuable' and very much desired by Native Americans for what they represented *to Natives*.

At the onset of European trade, glass beads weren't necessarily desired by Natives for their 'monetary' or exchange value but rather for their symbolic value. Shell, crystal and indigenous metals, and in turn glass beads, were valued for their properties of "assurance and insurance of long life (immortality through resuscitation), well being (the absence of ill-being), and success, particularly in the conceptually related activities of hunting and fishing, warfare, and courtship" (Hamell: 1983). Beads are

traditionally part of ritual exchanges. Beads are valued more for the symbolic associations of the form, material, color and other aspects, than for what an item is 'worth' in raw commodity exchange.

The attributes of the so-thought-of 'common' glass bead held important cultural associations for many Natives: the form resembling a seed or berry, the clarity and hardness of natural crystalline minerals, the polished surface reflective like water, not to mention the

associations of certain colors. Working under French direction, in 1524, Verrazzano's confusion is demonstrated: "They do not value gold because of its color; they think it the most worthless of all, and rate blue and red above all other colors... the same was true for metals like steel and iron, for many times when we showed them some of our arms, they did not admire them, nor ask for them, but merely examined the workmanship", and further "The things we gave them that they prized the most were little bells, blue crystals, and other trinkets to put in the ear or around the neck" (in Wroth: 1970).

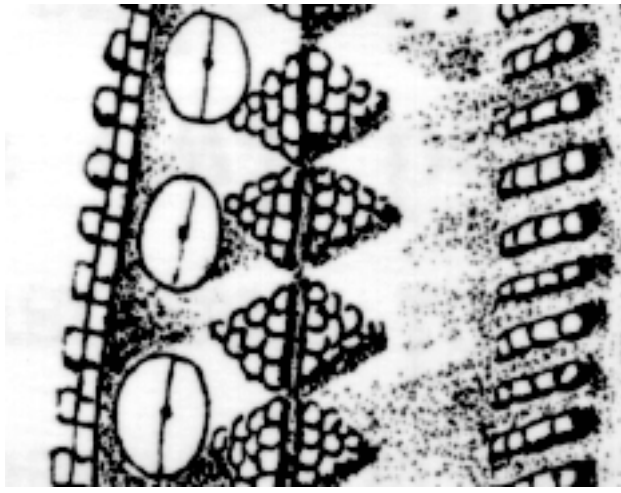


*Ah Ta Qua O Weh 'Moccason for Female'  
Seneca [Morgan: 1993]*

So, many Native Americans attributed a high 'symbolic' value to glass beads that the Europeans could not understand (but had not trouble capitalizing on). Europeans figured that glass beads and other baubles were valuable merely because they were perceived as coveted luxury or prestige items. Glass beads and other trade items were undoubtedly new to Native Americans, but the attributes of their forms, materials and colors were not foreign. What was new to Natives about the trade items was the source, Europeans, and the huge increase in availability of items with otherwise rare qualities. Trade items were perceived within and incorporated into an existing native cultural/ideological and religious framework. In the Northeast, round, polished, glassy beads are associated with seeds, berries, shells and crystals, life, light, sight, and related concepts. In Eastern North America, the new material, glass, was probably recognized and reacted to as a natural crystalline object would have been.

Reflective water, polished stone, as well as glass, and metal have a conceptual relationship with 'seeing the soul'. Many Algonquian words for glass, mirrors and metal are linked with words for 'seeing' and 'soul'. Mirrors are called 'manito' among the Ontario Ojibwe, and the Iroquois words for 'glass' and 'crystal are similar. The Ojibwe 'big snake' figure is said to have eyes that 'shine like mirrors' (Hamell: 1983). Traditionally, both beads and crystals are used in divination, in box turtle rattles, as pieces for a dice/bowl ritualized game, as well as in mortuary contexts. A New Netherland account from the early 1600's details a Mohawk or Oneida





*Detail of Seneca Woman's Moccasin  
[from Morgan: 1993]*

healing ceremony to 'drive away the devil', during which an old woman sat close by holding in her hands a turtle shell with beads in it (Anonymous: 1967a). Smoking pipes of clay or lead, one in the shape of an owl and one in human form, were made by the Seneca, Iroquois in the 1600's; these pipes are inlaid with glass beads for eyes.

Glass beads helped invigorate *and* transform traditional ideological, social, and religious systems of Natives. Imagine the farther the bead travels from it's source along Native trade networks, the meaning it acquires along the way. Glass beads were indeed perceived by Native Americans as 'luxury',

and 'prestige' items, and as an indicator of 'wealth', but using a Native definition of these terms.

"The earliest European ships were perceived as the 'other world,' mythical 'floating islands,' which arrived at the Indians' shores. The Europeans themselves were perceived as mythical man-beings, perhaps as 'returned' culture hero(s). Despite their appearance towards the east, the Europeans were more probably perceived as Under(water) World Grandfathers, the traditional keepers of shell, crystal, and native copper, received by Real Man-beings from them in reciprocal exchange. Doubtless, some such ascription accompanied the earliest glass trade beads and other trade goods as they were exchanged from one Indian group to another, further and further remote from their ultimate source. If the Europeans were initially and indirectly perceived as Under(water) World Grandfathers, the fur trade would have 'made sense' to the Indians. For the Grandfathers were requesting back in exchange for shell, crystal (and glass wares), and native copper (and trade copper and brass), only that over which they were also traditionally the keepers, game animal man-beings. In particular they were asking for the return of the skins of those symbolically-charged, water-dwelling animal man-beings, long of body and of tail" (Hamell: 1983).

---

[Return to Glass Bead Menu](#)

[Return to NativeTech's Beadwork Menu](#)

[Beadwork Bibliography and Books to Buy On-Line](#)

---



© 1994-1999 [Tara Prindle](#).

## Native American Technology and Art

# NATIVE AMERICAN BEADWORK Introduction and Use of Glass Beads

---

## European Sources of Glass Beads in the Northeast



*Da Ah De A -- A Seneca  
in the Clothing of the Iroquois  
[Morgan: 1993]*

By 1550 there were four kinds of glass beads being made in Europe: drawn, wound, blown and 'frit-cored'; the latter being quite rare in the Northeast, and new varieties and colors were continually developed, some expressly for trade (Monture: 1991).

In the 16th century, there are a few square tubular glass beads of Spanish origin found among Natives in the Northeast, but the Spanish seemed generally occupied with commercial endeavors south of New England. During the late 1500's and early 1600's, European prospecting in New England escalated, especially by the French. Giovanni Verrazano was sent by France to define the coastline in 1524, he recorded the trade of 'blue crystals and other trinkets' with Natives (Wroth: 1970).

While the French concentrated on acquiring northern territories, the Dutch were more interested in areas to the south. By 1621 the Dutch West India Company was established and focused settlement and trade on the Hudson River, and capitalized on the by-now, well established wampum industry by going into production. Dutch beads traded in the northeast were tubular and larger round necklace beads, with few of the smaller 'seed' beads associated with contemporary Native beadwork. Back in Amsterdam and other Dutch cities a great number of beads were manufactured that made their way into the northeast

in throughout the 1600's.

References to strings of beads exchanged between Europeans and Native Americans to be worn as necklaces are provided by Juet in 1610 in the 'New Netherlands' (Juet: 1967) in 1610, and also in 1624 by van Wassenaer (1967), as well as in 'New England' in 1622 by Mourt (Heath: 1986) and by Roger Williams (1973) speaking of the Narragansett in 1643.



Though the English arrived relatively late on the scene, in the early 1600's, they soon overshadowed the landscape of southern New England. Glass beads did not seem to be a significant part of the English trade inventory, though by the end of the 1600's and 1700's, glass beads did become English trade merchandise. In contrast to earlier trade beads used for necklaces, by the early 1700's tiny glass seed beads grew in popularity as trade items, and these beads were used to ornament clothing, moccasins and other accessories. By the mid 1700's necklace beads became very scarce while seed beads were everywhere; by the end of the 1700's and into the 1800's, tubular glass imitation wampum beads became popular (Wray: 1983).

---

[Return to Glass Bead Menu](#)

[Return to NativeTech's Beadwork Menu](#)

[Beadwork Bibliography and Books to Buy On-Line](#)

---



© 1994-1999 [Tara Prindle](#).

Native American Technology and Art

**NATIVE AMERICAN BEADWORK**  
**Introduction and Use of Glass Beads**

**Glass Beadwork in the Northeast**

**GLASS BEAD SIZES**



**CROW**



**PONY**

**SEED BEADS**



**8/o**



**10/o**



**11/o**



**12/o**



**13/o**



**14/o**



**15/o**

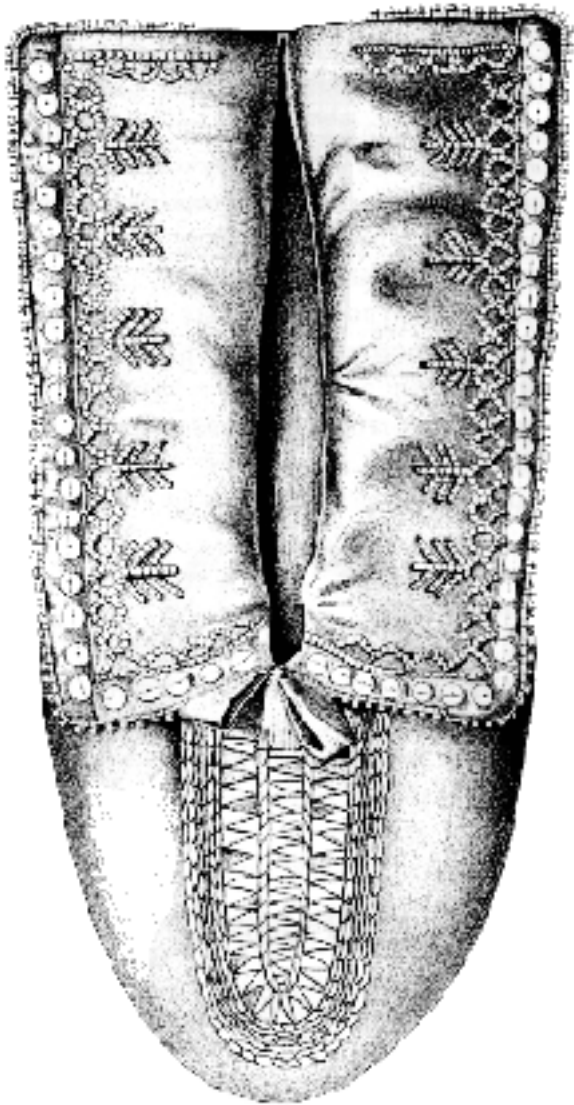
*Size Standards*

Many varieties of European glass beads were used by Natives of the 17th century. Among these varieties, tiny seed beads were sewn onto the clothing or accessories of Native Americans in New England. Van der Donck (1968), in 1656, described applique work with beads of aboriginal manufacture such as pieces of whales' fins, whale bones, or wampum sewn onto leathern girdles, dressed deer-skin coats, and moccasins worn by both men and women, and he suggested also that these articles were 'bad to wear' for everyday use (Van der Donck: 1968).

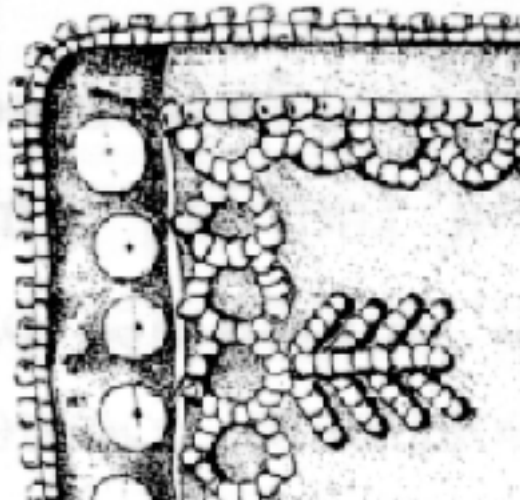
The size of glass seed beads of the 17th century were only just slightly bigger than the head of a pin, but they are very large (and varying within a single 'lot' from 10/o to 8/o), bordering on 'Pony bead' size by today's standards. Common colors of seed beads in the 17th century are white, red, yellow, black, various hues of blue, and rarely colorless transparent beads. Nearly always the colors are opaque. The beads were strung onto necklaces, woven into bands and garters, and sewn onto clothing and accessories

made from both leather and wool broadcloth using a variety of stitches. Beaded broadcloth items of the Northeast include long-coats, skirts, breech clouts, tunics, leggings, and caps throughout the 1800's and 1900's. Women of the Great Lakes region often applied the borders of skirts and leggings in white beaded double-curve designs.

The beadwork of Mohegan center seam and pucker-toe moccasins, bags, and even beads sewn onto birch bark are described: "The beadwork figures are practically all floral, though a few geometrical designs occur; and realism appears as in the butterfly representation" (Speck 1915). Speck concludes that the same type of floral beadwork extends throughout the whole northeastern and Great Lakes area, and Speck believes may have been influenced by Victorian European designs.



*Ah Ta Qua O Weh 'Moccason for Male'  
Seneca [Morgan: 1993]*



*Detail of Seneca Man's Moccasin  
[from Morgan: 1993]*

Moccasins and other items of Northeast Natives may combine several techniques of beadwork including sewn applique and 'lane' stitch. Until recently American anthropologists and beadworkers referred to 'lane' stitch as 'lazy' stitch (coined by William Orchard in 1920's), or *derogatorily*, 'lazy squaw stitch' (so-called by Benjamin Hunt in the 1950's). "Among German beadworkers and Indian hobbyists this technique has always been known as 'Gassen-Stich' with 'Gasse' being one German translation for the English 'lane'" (Barth: 1993). Some varieties of Lane stitch lend a raised relief to the beadwork, producing a 3-dimensional effect, by making the width between stitches slightly closer together than the width of the row of beads. In addition, the unsewn edges of leather collars, cuffs, belts, etc. are often finished off with bead edging techniques.

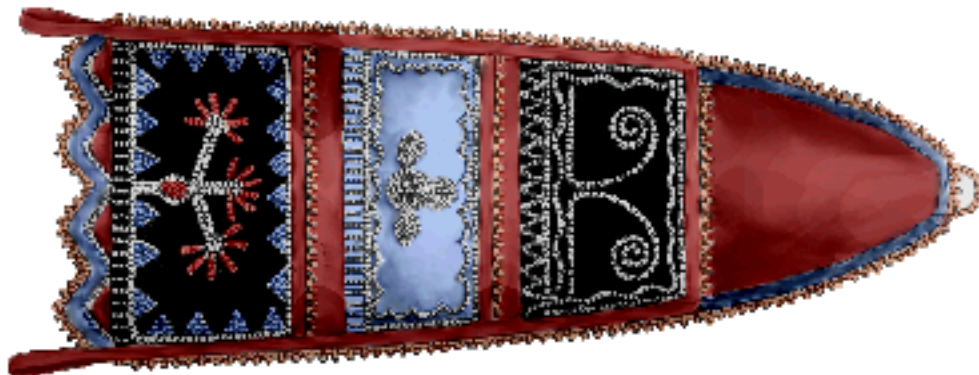
New tools and supplies introduced by Europeans, like glass beads, metal needles and silk ribbon, were quickly incorporated into existing forms of art, and adjusted by Native Americans to suit their own aesthetic and functional purposes. With the development of new forms of art, traditional art forms were transformed or abandoned. Many of the same traditional designs are produced using bead and ribbon applique that were originally done with moose hair decoration, porcupine-quill embroidery and painted designs.

Contemporary Native Americans continue beadwork traditions today using glass beads. Some seed beads used today are so small you almost need a magnifying glass to see their holes. Bright light is always recommended for beadwork. Yellow and white can look very similar under dim light. A typical modern beadworkers toolkit will include the short stout Sharp's beading needles and the long flexible English beading needles. Nymo (nylon or polyester) beading thread with beeswax for a lubricant is now widely used (though waxed dental floss will do in a pinch).

Scissors, a metal or bone awl with a triangular pointed tip, and needle nose pliers are also essential. Beading trays, containers, graph paper



for designs, pens and colored pencils are also handy. A greater range of bead colors and shapes are available today, as well as special beading needles, synthetic threads and other accessories, but the images and dedication behind modern bead embroidery still have deep traditional roots.



*'Ya-Wa-o-Da-Qua' Needle Book*  
*Iroquois [Morgan: 1993]*

[Tips on Sewing Beads to Leather](#)  
[Applique Techniques with Glass Beads](#)  
[Lane Stitch Techniques with Glass Beads](#)  
[Edging Techniques with Glass Beads](#)  
[Floral and Geometric Design Building Blocks](#)

[Return to Glass Bead Menu](#)

[Return to NativeTech's Beadwork Menu](#)

[Beadwork Bibliography and Books to Buy On-Line](#)



© 1994-1999 [Tara Prindle](#).

## Native American Technology and Art

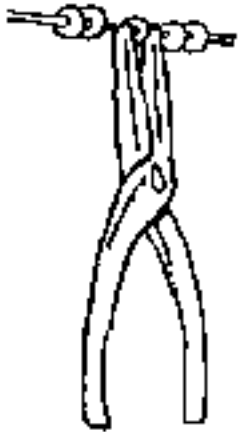
### Glass Beadwork

## Tips on Sewing Beads to Leather

---



Either make a 'knotless' knot by making three stitches perpendicular to each other in the same place, OR hide knots by placing them in the path of the covering beadwork.



RIGHT WAY



WRONG WAY

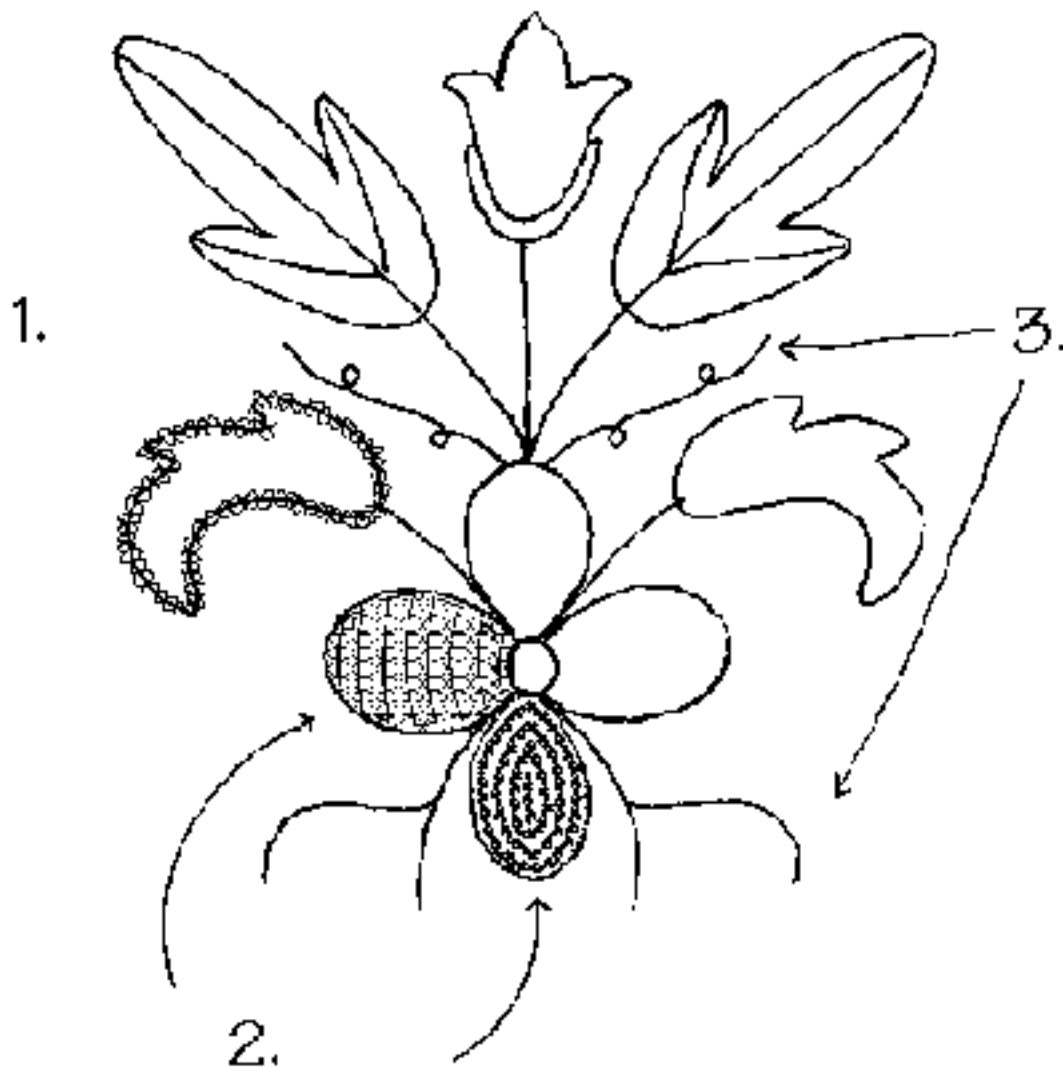
*Breaking Out a Bead  
the right way and the wrong way.*

If you have found that you have added one too many beads in a row, you can 'break out' the bead without backing up and taking out stitches. Use pliers and squeeze the bead from either end where the holes are. Always cover the area with your hand and **PROTECT** your EYES, **DO NOT** squeeze pliers **ACROSS** the bead or the glass fragments will cut through the string!

Before threading your needle, and during beadwork, use beeswax (or even candle wax) to rub along your thread. Waxing the thread will keep it from fraying, twisting and tangling during beadwork. If your thread continues to twist up while you are

beading, it is probably due to always making stitches in the same looping direction - you need to note the direction of the twist and give your needle a little spin in the *opposite* direction with each stitch.

1. For outlines -



use either 'spot' or 'running' stitch to create lines of beads.

2. Fill in with 'lane' stitch rows or applied concentric curved lines of beads.

3. Add detail lines with applique.

*Ojibwe Example of Combined Floral Designs*

---

[Glass Beadwork in the Northeast](#)

[Introduction and Use of Glass Beads](#)

[Return to NativeTech's Beadwork Menu](#)

[Beadwork Bibliography and Books to Buy On-Line](#)

---





© 1994-1999 [Tara Prindle](#).

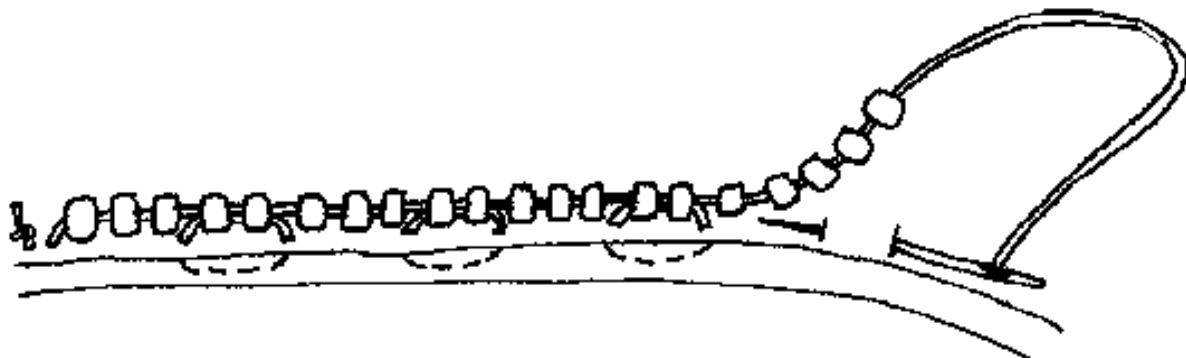
## Native American Technology and Art

### Glass Beadwork Applique Techniques with Glass Beads

---

Applique Stitches - for bead outlining and filling with curved lines

#### *Return Stitch Applique*



**Return (or Running) Stitch Applique** - uses a single needle and thread. String seven beads or less on thread, backstitch through the surface of the leather, and return through one or two beads. Repeat the process.

#### *Spot Stitch (or Two-Thread) Applique*



**Spot Stitch (or Two-Thread) Applique** - uses two separate needles and threads. String multiple beads on a thread which only lays on the surface of the leather. Use the second needle and thread to spot stitch around the first thread between the beads at even intervals. Repeat the process.

---

[Glass Beadwork in the Northeast](#)

[Introduction and Use of Glass Beads](#)

[Return to NativeTech's Beadwork Menu](#)

[Beadwork Bibliography and Books to Buy On-Line](#)



© 1994-1999 [Tara Prindle](#).



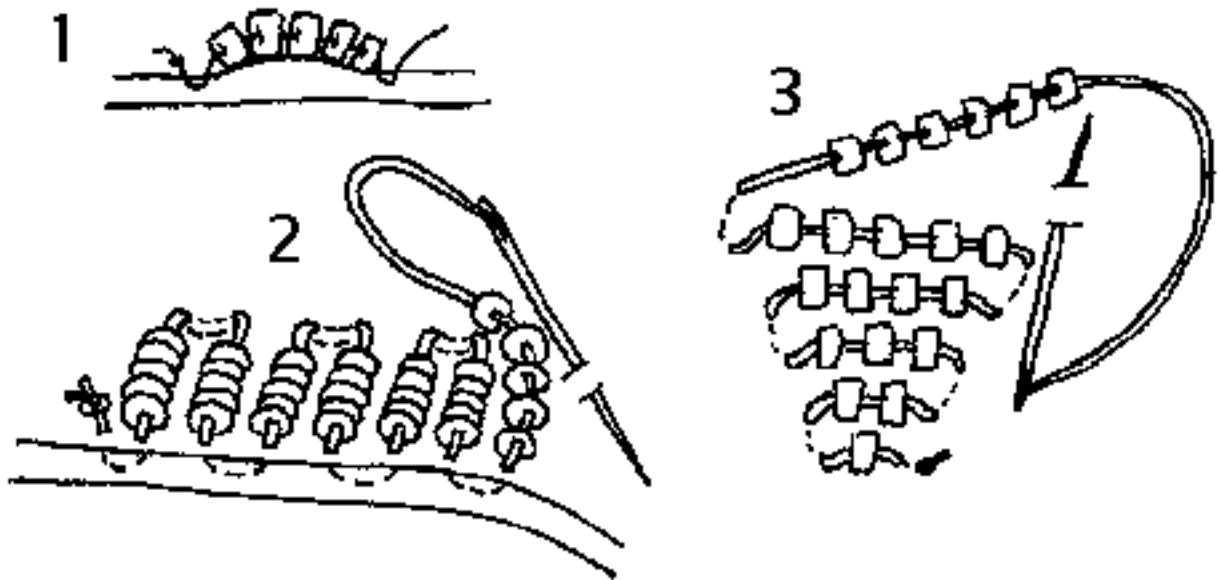
## Native American Technology and Art

### Glass Beadwork

## Lane Stitch Techniques with Glass Beads

---

**Lane Stitch** - useful for creating (though not limited to) geometric designs. Can be done in parallel rows of equal numbers of beads using a guideline drawn on the leather. Or it can be done 'free', letting the leather show through the background of the pattern by reducing or increasing the number of beads with each stitch.



**Note:** the needle does not pass all the way through the leather, use doubled nylon or poly-thread for strength or durability. String no more than seven beads at a time for a row.

1. Beads are raised slightly by keeping the row width slightly smaller than the width of the beads.
  2. Keep beads in line for rows and rectangles.
  3. Stagger beads, adding or subtracting one bead to each next row for triangles and diamonds.
- 

[Glass Beadwork in the Northeast](http://www.nativetech.org/glasbead/glaslane.html)

[Introduction and Use of Glass Beads](#)

[Return to NativeTech's Beadwork Menu](#)

[Beadwork Bibliography and Books to Buy On-Line](#)

---



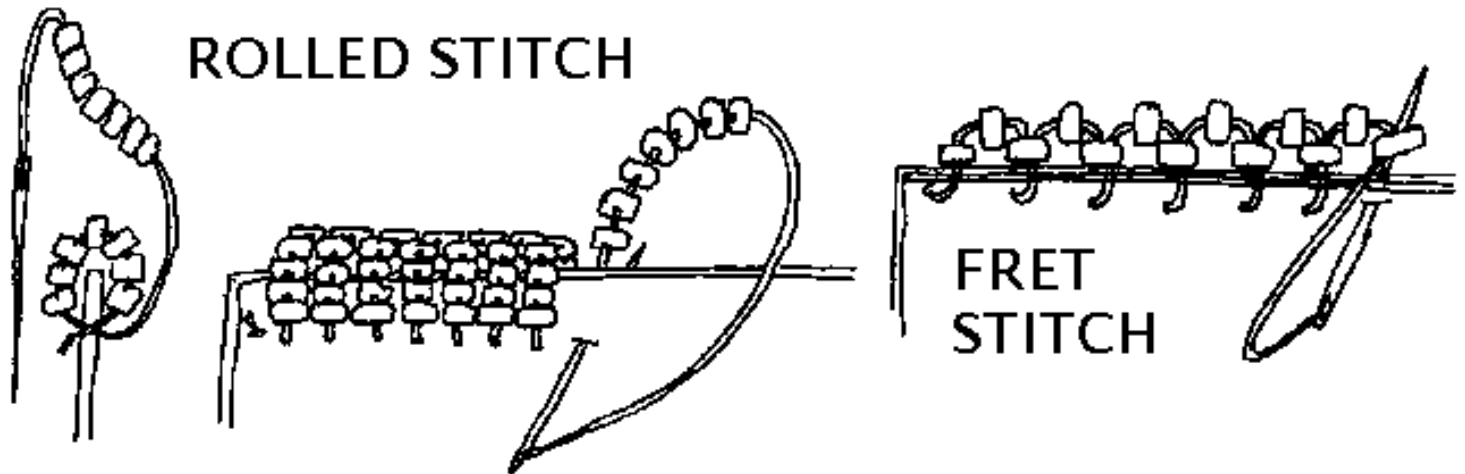
© 1994-1999 [Tara Prindle](#).

## Native American Technology and Art

### Glass Beadwork Edging Techniques with Glass Beads

---

Edging Stitches - for finishing trim of cuffs and borders.



'Rolled' and 'Fret' Stitch Varieties- use a single needle and thread. Note that the needle passes all the way through the leather.

---

[Glass Beadwork in the Northeast](#)

[Introduction and Use of Glass Beads](#)

[Return to NativeTech's Beadwork Menu](#)

[Beadwork Bibliography and Books to Buy On-Line](#)

---



© 1994-1999 [Tara Prindle](#).

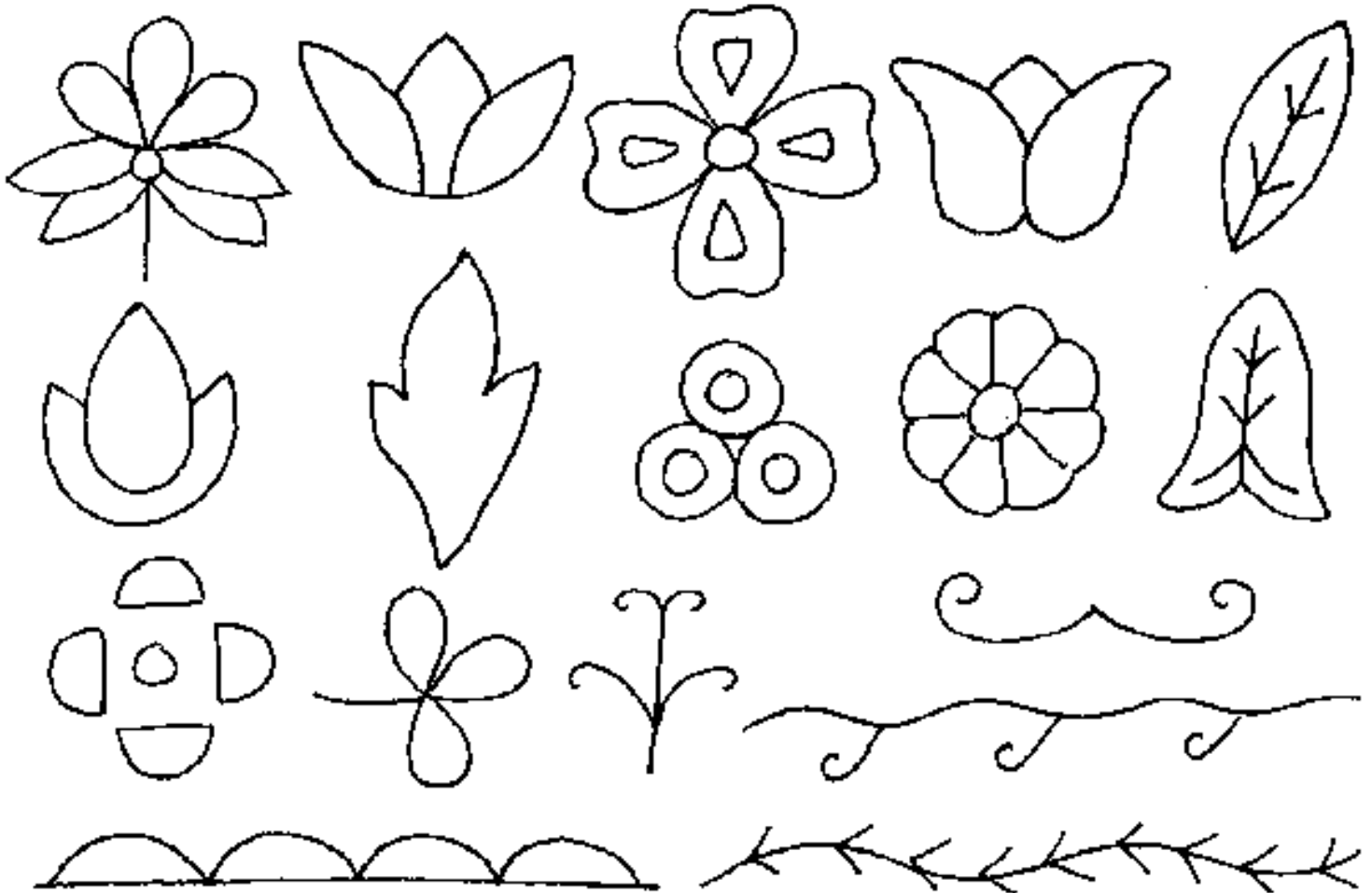


## Native American Technology and Art

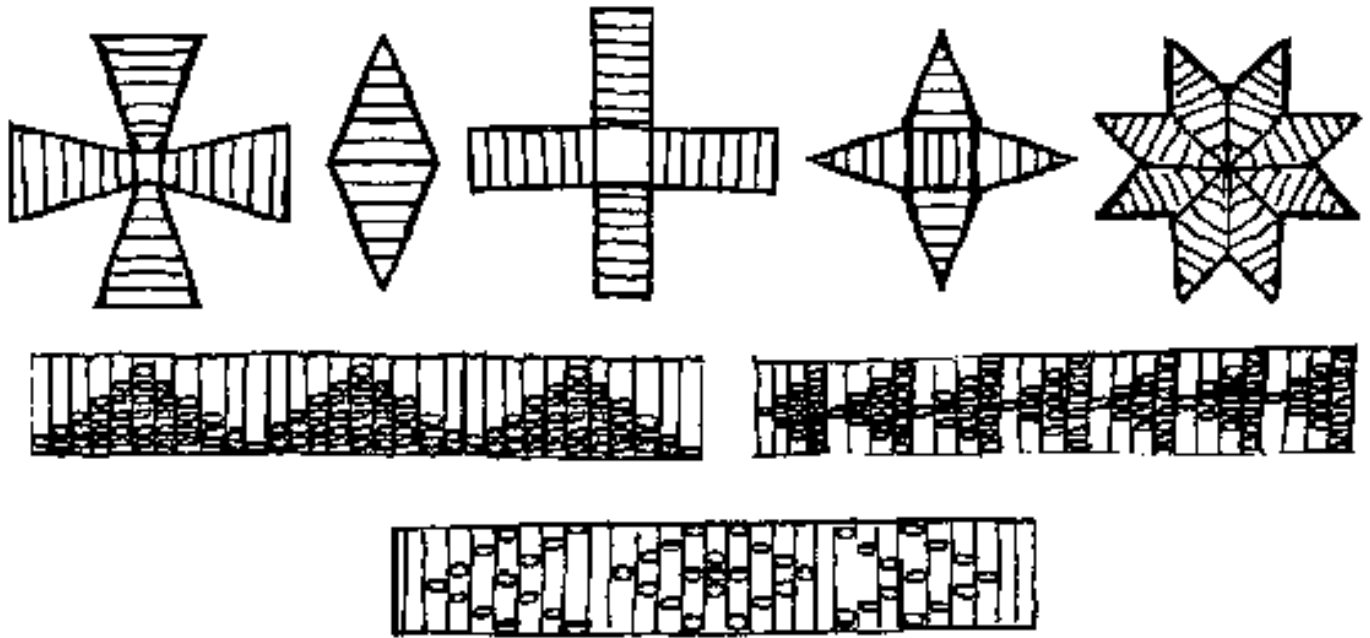
### Glass Beadwork Floral and Geometric Design Building Blocks

---

#### *Floral and Curvilinear Eastern Woodlands Beadwork Designs*



#### *Simple Geometric and Linear Designs*



---

[Glass Beadwork in the Northeast](#)

[Introduction and Use of Glass Beads](#)

[Return to NativeTech's Beadwork Menu](#)

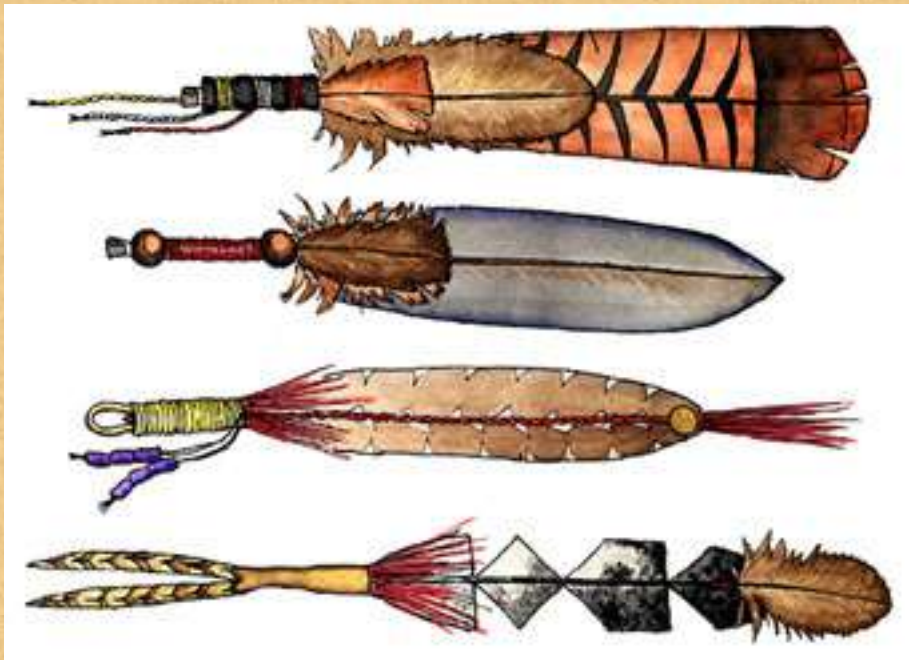
[Beadwork Bibliography and Books to Buy On-Line](#)

---



© 1994-1999 [Tara Prindle.](#)

## NativeTech: Native American Technology and Art



### NATIVE AMERICAN FEATHERWORK

### Single Wrapped Feathers

See Instructions for these Kinds of Feather Wrapping

[Style 1](#)

[Style 2](#)

[Style 3](#)

[Style 4](#)

[Traditional](#)

[Contemporary Prairie](#)

[Contemporary Eastern](#)

[Contemporary Northeast](#)

[\*Find out about the Materials Needed For Wrapped Feathers\*](#)

### ... A little about Native American Featherwork

Native Americans have an infinite number of decorative uses for feathers. Featherwork often incorporates other materials such as leather, thread, and even animal hair. Decorated feathers are often tied to a lock of hair, placed upright on top of a cap, fastened to a headband or worn from the ears. In the 1600s, some New England Native men wound their long hair up around feathers "worn broad-wise, like a fan" (Mourt in Heath 1986). Both turkey and eagle feathers were attached to hair of New England Native Americans. Single feathers are embellished and then combined to make beautiful head, neck and clothing ornaments as well as fans and dance bustles. Feathers and bird skins are even used to make clothing. Very prominent and easily seen, feathers communicate particular messages to the onlooker. Certain kinds or ways of cutting feathers, or particular numbers of feathers may indicate a person's tribe, clan, or status. Many feathers have important ceremonial and religious importance. Decorated feathers from particular birds are sometimes attached to



sacred tobacco pipes or used in altar displays during ceremonies. Decorated feathers may be used as *ësmudgeí* feathers, used to direct the purifying smoke of burning cedar, sage, tobacco and/or sweetgrass.

Animal hair from the deer, moose and other creatures are also used in Native American featherwork. Animal hairs are intricately tied, braided, and woven into decorations for the head and neck. In the 1600ís, Europeans describe Native American men wearing such ornaments made of red dyed animal hair . . . "made in the fashion of a cockís comb died red, crossing their heads like a half moon" (Gookin 1970). This hair is described as beautiful, some long, coarse and stiff [porcupine guard hair or moose hair], and some shorter and very fine [deer] (van der Donck 1968). Europeans likened these woven hair bands or roaches to the paintings of halos worn by Catholic saints (van der Donck 1968). Contact period headbands of birchbark or leather also incorporated feathers and animal hair. Tufts of dyed deer or other hair were also wrapped into feathers or inserted into metal tinkling cones for neck or clothing decorations.

Of all birds of prey, Native Americans give eagles the greatest honor. There are many species of eagles recognized by Native Americans, including some types of vultures, considered to be the fourth eagle by some Native Nations. Other birds of prey, including the many types of hawks, also carry important meanings. For example, some Native Americans associate owl feathers with death or prophesy, but to other Natives, if an owl feather is combined with a hawk feather, it represents life.

Early historic records of Northeastern North America mention a little black bird resembling a hawk that was instilled with great courage despite its small size. *ë*They are so strangely courageous and hardy, that nothing flyeth in the Air that they will not bind withí (citing Josselyn in Lindholdt 1988). In the 1600ís New England travelers reported seeing this little black hawk worn upon the heads of Native Americans. The little bird had the same Narragansett name as the word for their political leader, *ëSachimí*, because of the bird's *ë*princelikeí courage over greater birds . This hawk was valued at an amount sufficient to ransom a *ëSagamourí*, a Native American leader (Wood 1865).

Although birds of prey are revered by Native Americans, game and song birds are also appreciated for their own particular qualities. Game birds, like the turkey, goose and duck, are very prevalent in Native American featherwork. In the Northeast, in addition to arrow fletching, upright turkey-tail headdress, single wing- and tail feather decorations, ceremonial fans and other items, turkey feathers are also woven together into capes. Noted in the 1600ís, Native Americans of the Northeast sometimes wore a covering made of turkey feathers during the winter months. Records describe these mantles, capes, or coats "knit together very oddly, with small strings" (de Rasieres 1967). Perhaps plaited together, the turkey feathers overlapped like that the back of the bird. Woven by women for their children, "they make likewise some Coates of the Feathers of Turkies, which they weave together with twine of their owne makeinge, very prittily: these garments they weare like mantles knit over their

shoulders, and put under their arme" (Morton 1964).

Song bird and other exotic bird feathers are prized by Native American for certain characteristics. The feathers of blue jays, cardinals, and some other brightly colored birds are used for their medicine by spiritual leaders. Medicinal teas are made by steeping or boiling particular feathers in water. In the 1600ís, a humming bird was worn as an ear pendant by a Northeastern Native American leader (Wood 1865). Native Americans in the Northeast also accepted peacock feathers and ostrich plumes in trade, and wore them in traditional Native styles.

Native Americans in New England left no part to waste when an animal was killed. What could not be consumed of an animal, bird or other beast was utilized as a means to embellish items produced by Native Americans in southern New England. The feathers of birds and hair of animals was no exception in the vast array of materials used in their material culture. Birds are well documented as decorative elements in the arts of Native Americans of southern New England. It is no surprise that the feathers of birds and entire small birds were highly esteemed for adornment and symbols of status.

*Acknowledgment and thanks goes out to my Native American friends Shelley, Michael and Wallace, for teaching me some techniques and the significance of wrapped feathers.*

[Birds & Feathers Bibliography and Books to Buy On-Line](#)

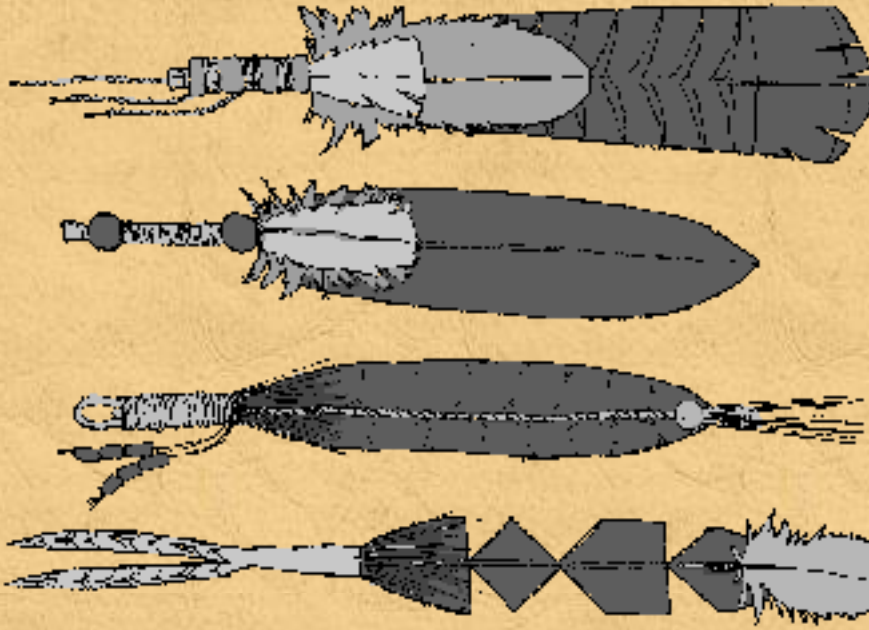
[Return to Birds & Feathers Main Menu](#)



© 1994-2000 [Tara Prindle.](#)



## NativeTech: Native American Technology and Art



### NATIVE AMERICAN FEATHERWORK

### Materials Needed for Wrapped Feathers

Scissors.

Large stiff wing and tail feathers.

Medium flexible plumes (sm. wing or lg. breast feather).

Small fluffs (breast feathers or hackels).

Deer hair, dyed red.

Yarn (or medium weight cord).

Embroidery Thread (or light weight cord.)

Felt scraps.

Leather scraps.

Wooden or other beads with 1/4 " diameter holes.

Wampum or other beads with 1/8 " diameter holes.

Awl or Needle to sew leather (Style 4).



Sinew (or waxed nylon) thread for sewing (Style 4.)

---

[Return to Single Wrapped Featherwork Background](#)

[Birds & Feathers Bibliography and Books to Buy On-Line](#)

[Return to Birds & Feathers Main Menu](#)

---

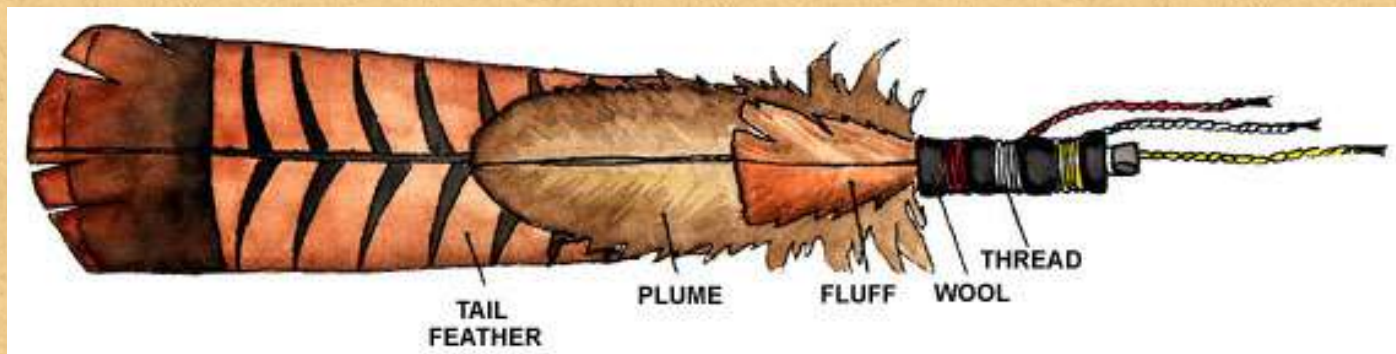


© 1994-1999 [Tara Prindle.](#)

# NATIVE AMERICAN FEATHERWORK

## Single Wrapped Feathers

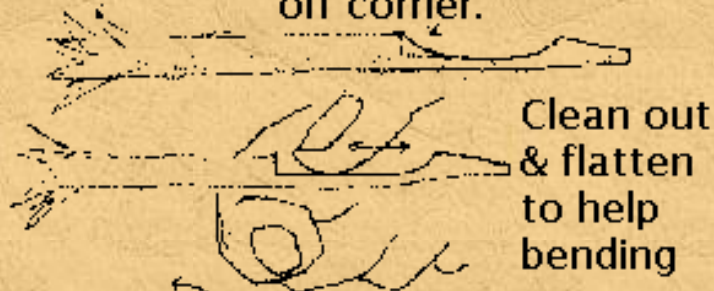
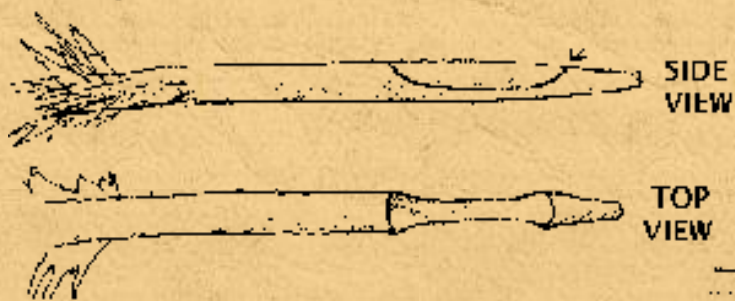
### Style 1 ~ Traditional



#### *Use Tail Feather*

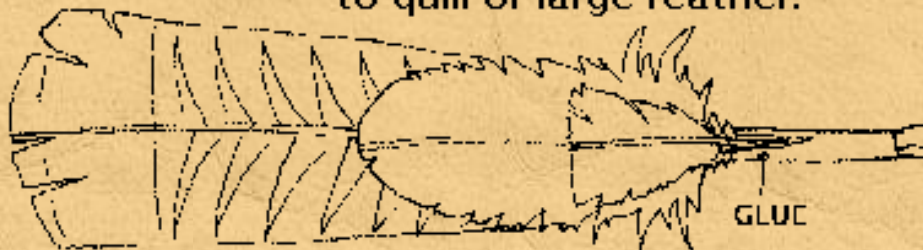
A. Made a loop at the end of the feather's quill:  
Carefully cut a crescent (canoe shape) out of the quill near the end of the feather.

Trim with scissors or a blade to square off corner.

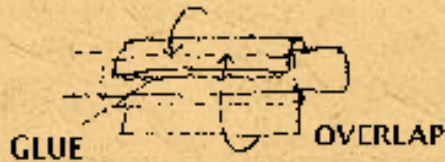
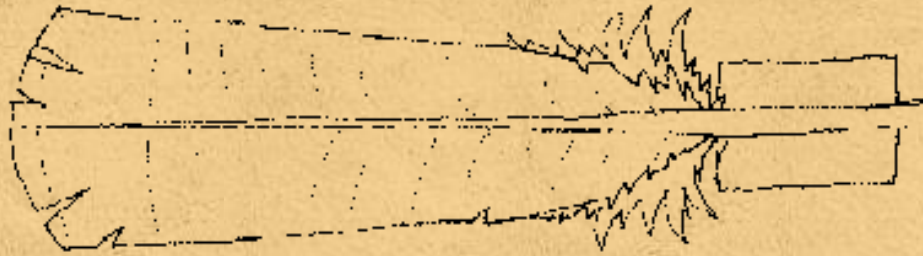


Bend tip around & put in hollow of quill.

B. Glue plume and fluff to together to quill of large feather.

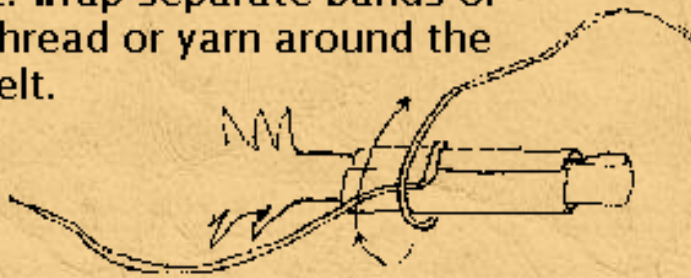


C. Turn feather over and lay on felt or wool rectangle.



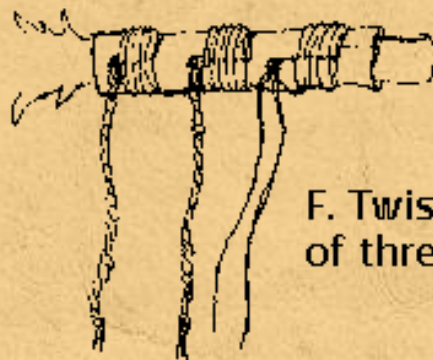
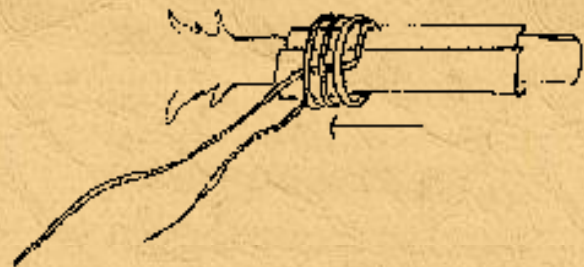
D. Wrap edges of felt around to back of quill so the edges of the felt overlap slightly.

E. Wrap separate bands of thread or yarn around the felt.



leave ends long

Note direction of wrapping up quill.



F. Twist together ends of thread, if desired.



[Return to Single Wrapped Featherwork Background](#)

[Birds & Feathers Bibliography and Books to Buy On-Line](#)

[Return to Birds & Feathers Main Menu](#)

---



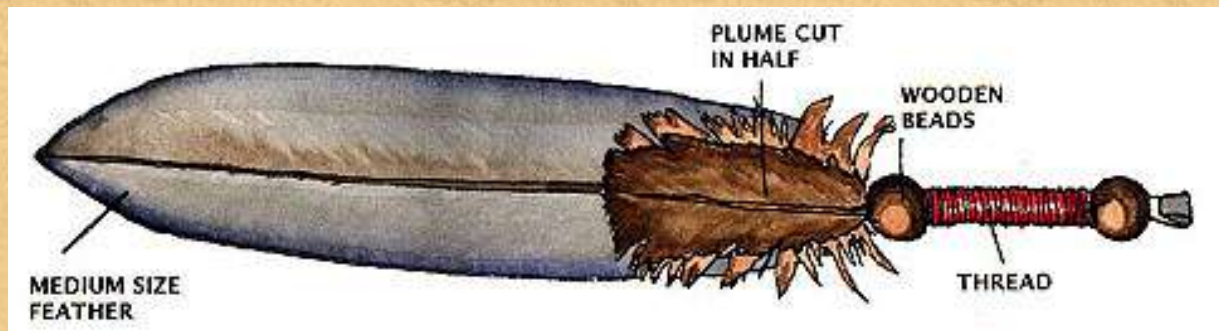
© 1994-2000 [Tara Prindle.](#)

NativeTech: Native American Technology and Art

NATIVE AMERICAN FEATHERWORK

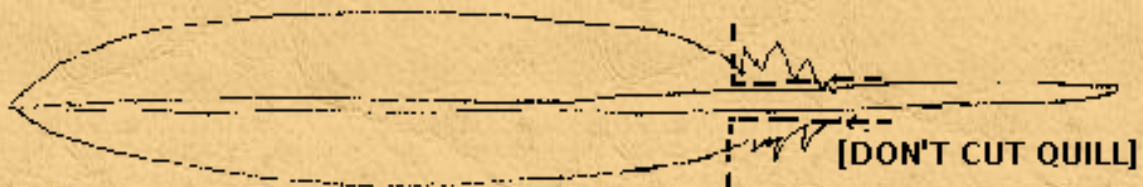
Single Wrapped Feathers

Style 2 ~ Contemporary Prairie

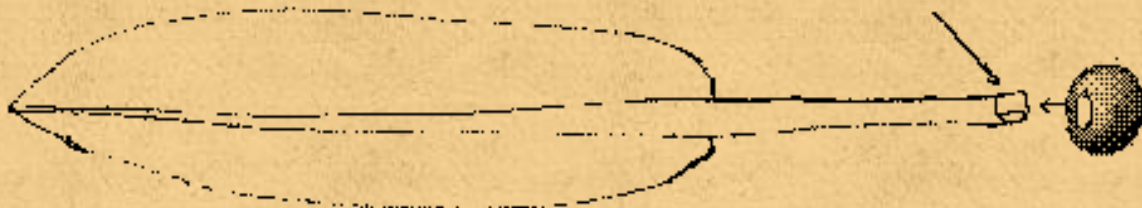


*Use Wing Feather*

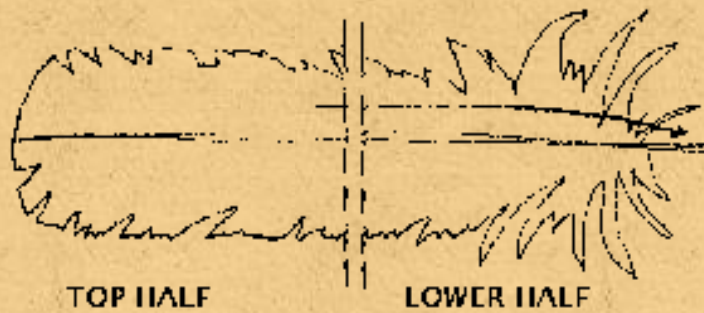
A. Trim feather so 2 1/2 - 3 inches of quill are exposed (don't cut through quill of feather).



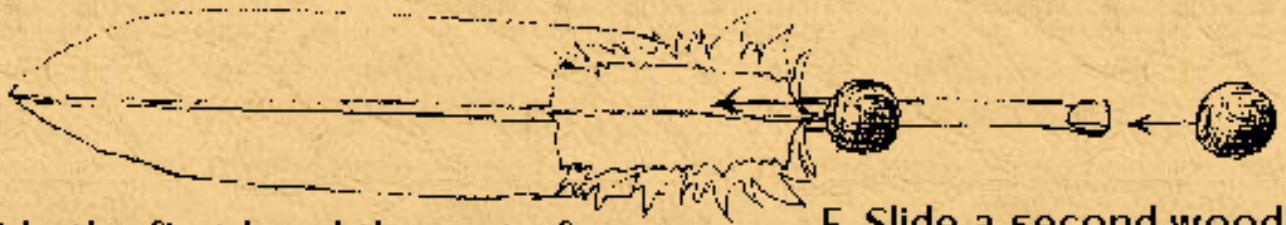
B. Make a loop at the end of the quill as in directions for Style 1, A.



C. Slide a wooden bead halfway up the base of the quill.

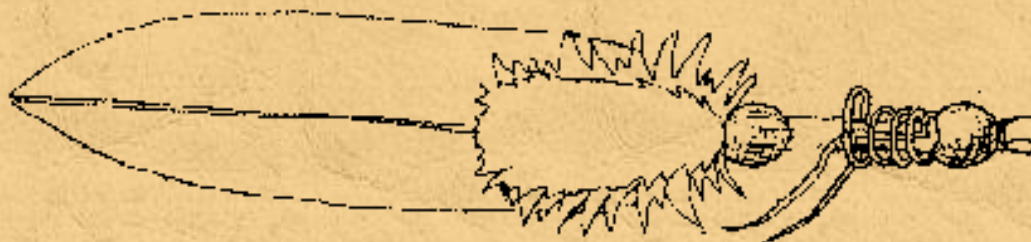


D. Cut a plume in half and place the top half over the lower half. (hold the bases of the cut quills together.)

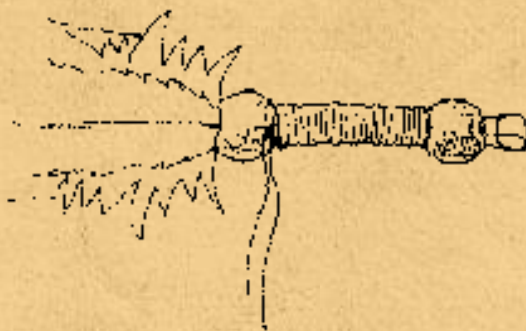


E. Slide the first bead the rest of the way up the quill to the base of the feather (while slipping the ends of the cut plume into the bead.)

F. Slide a second wooden bead over the end of the looped quill, leaving the loop projecting.



G. Between the two beads, wrap thread or yarn all the way up the quill (as in directions for Style 1, E.)



\*\* Make multiple bands of color, wrap over the ends of the old color thread with the new color thread.

Knot the ends together, and trim the string if desired.



[Return to Single Wrapped Featherwork Background](#)

[Birds & Feathers Bibliography and Books to Buy On-Line](#)

[Return to Birds & Feathers Main Menu](#)

---

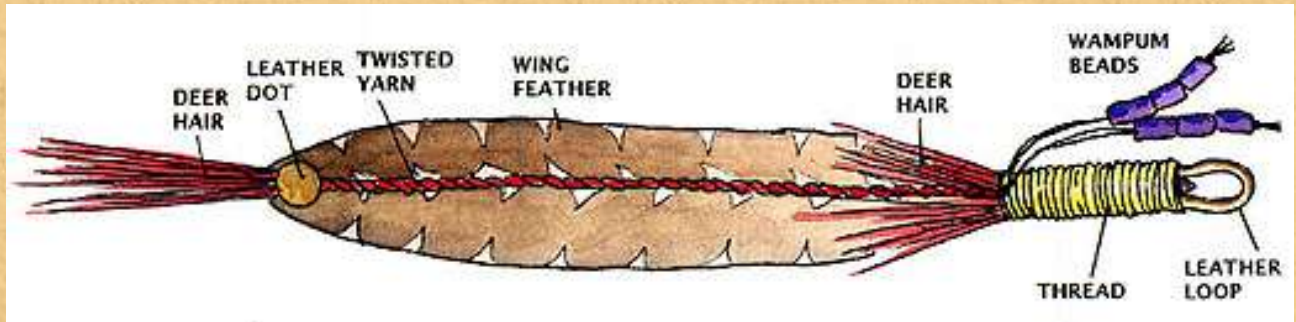


© 1994-2000 [Tara Prindle.](#)

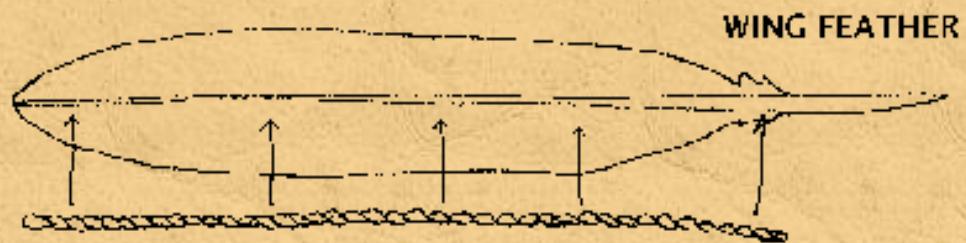
## NATIVE AMERICAN FEATHERWORK

### Single Wrapped Feathers

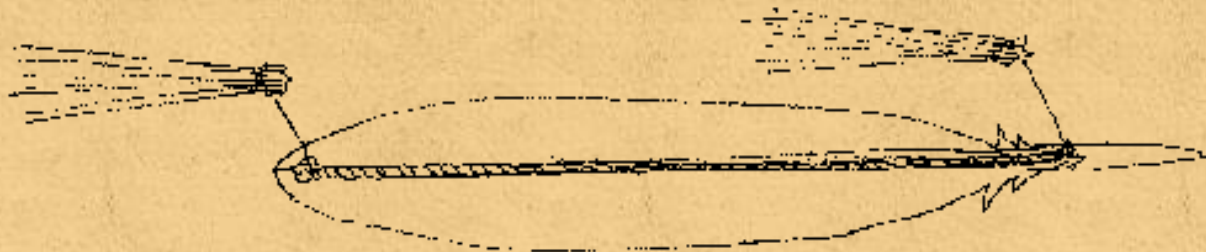
#### Style 3 ~ Contemporary Eastern



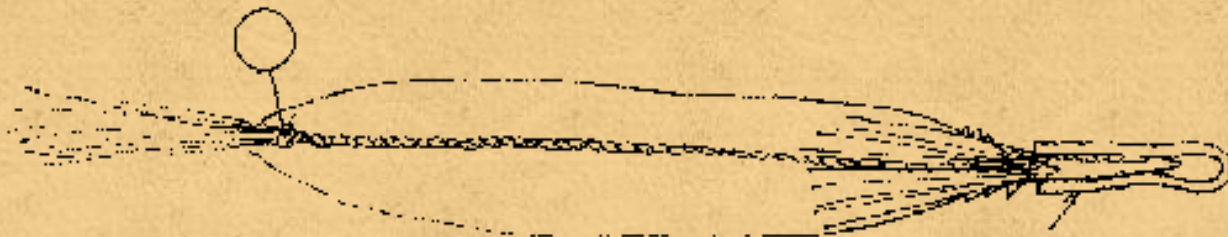
*Use Wing Feather*



A. Glue twisted yarn to center quill of feather.  
(This represents porcupine quill wrapped rawhide).  
Two colors twisted together looks nice.

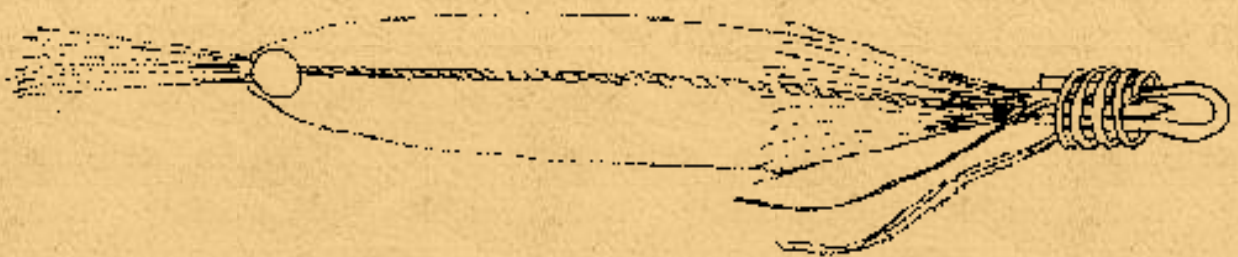


B. Blue a tuft of deer hair to the tip of the feather.  
Glue another tuft of hair over the yarn at the base of the feather.

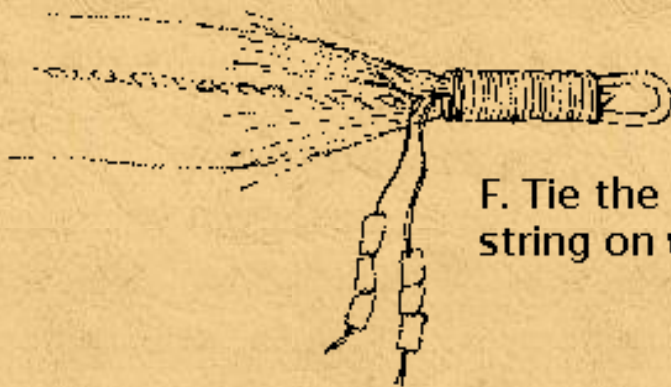


C. Cut out and glue a small leather dot over the end of the deerhair at the top of the feather.

D. Glue a 4" leather thong to the sides of the quill. (overlapping a little with the deer hair.) Leave a loop projecting out over the end of the quill



E. Wrap with thread or yarn. (as in directions for Style 2, G.) Wrap the thread all the way up over the quill (over the thong & over the base of the deer hair.)



F. Tie the ends of the thread and string on wampum beads.

---

[Return to Single Wrapped Featherwork Background](#)

[Birds & Feathers Bibliography and Books to Buy On-Line](#)

[Return to Birds & Feathers Main Menu](#)

---



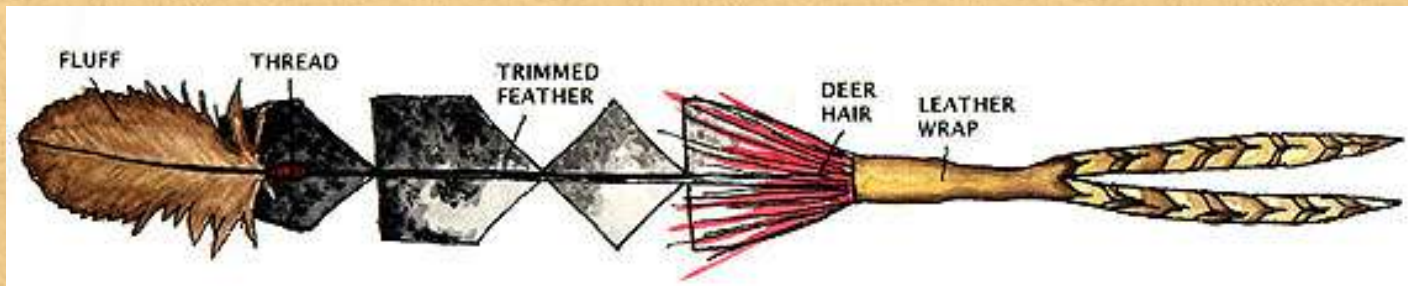


© 1994-20009 [Tara Prindle.](#)

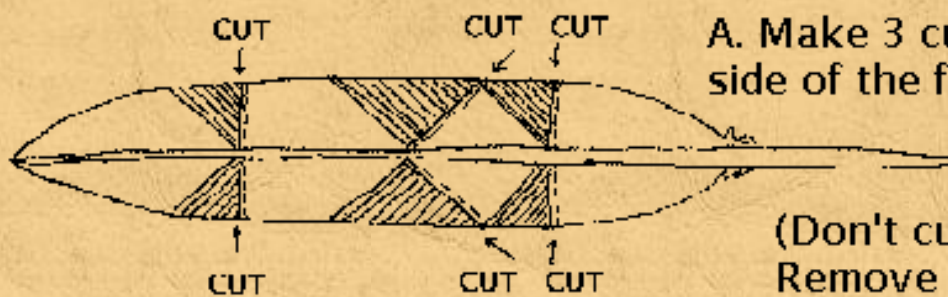
## NATIVE AMERICAN FEATHERWORK

### Single Wrapped Feathers

#### Style 4 ~ Contemporary Northeastern



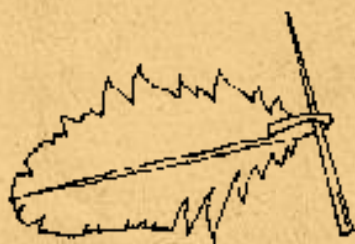
*Use Tail or Wing Feather*



A. Make 3 cuts as shown on each side of the feather

(Don't cut through the quill).  
Remove the loose parts.

B. Bend the quill of a fluff in half around a needle (for support).



C. Wrap thread around the doubled quill of the fluff (start just below the needle, wrap up quill about 1/4", knot ends of thread together.)

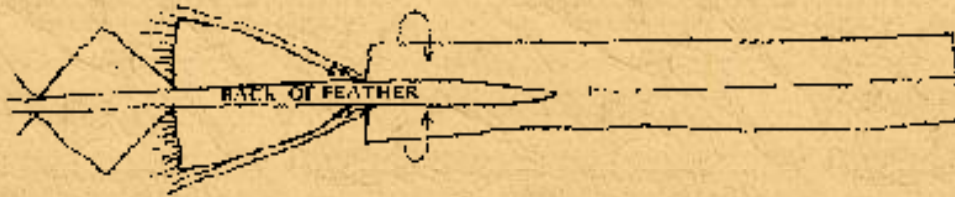




D. Glue the wrapped fluff to the tip of the large trimmed feather.



E. Glue a tuft of hair to the base of the large trimmed feather.



H. Cut a slit up the center of the leather strip that ends just below the quill.

F. Cut a strip of leather roughly 5" X 3/4", that just barely fits around the quill and deer hair at the base of the large feather.

G. Turn the feather over and lay on leather strip as shown. Wrap leather around the quill and hair so the edges just come together.

I. Stitch the seam closed around the quill as shown.



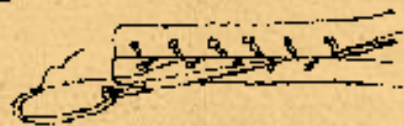
\*\*Knot on inside of first hole.

\*\*Sew across to the opposite side of the seam, going through the underside of the leather -out to the side.

\*\*Alternate sides of the center seam with each stitch.



End by running the needle up the quill underneath the stitches...



Then (a stitch further down) run the needle back under the end of the seam.



J. 'pseudo' braid the fringe:



First cut slits by folding (squeezing) the fringe at even intervals and snipping small slits.

Then for each fringe, pass the tip through each slit on that fringe.

---

[Return to Single Wrapped Featherwork Background](#)

[Birds & Feathers Bibliography and Books to Buy On-Line](#)

[Return to Birds & Feathers Main Menu](#)

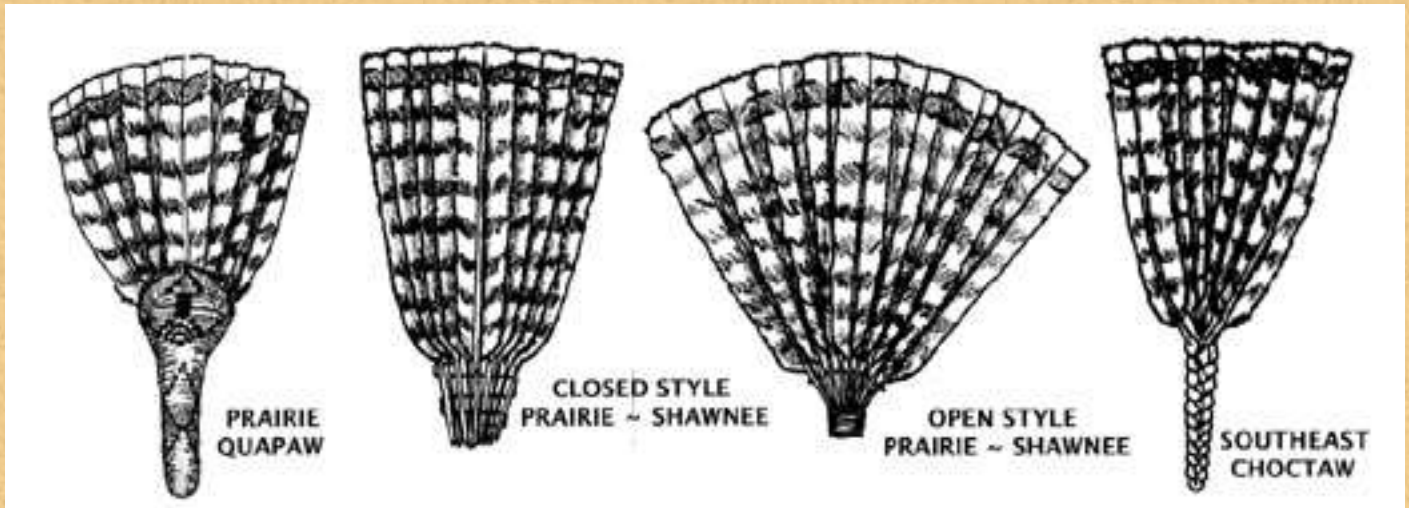
---



© 1994-2000 [Tara Prindle](#).

## NativeTech: Native American Technology and Art

### Turkey Tail Fans of the Southeast and Prairie Regions



**Turkey feathers are best gathered in the fall after the turkey's new feather growth. Feathers are collected from both live and hunted birds, the adult male having the largest feathers. Tribes in the southeast are well-known for their turkey-tail fans, which are made up of individual feathers, the quills of which are soaked and braided together. These fans were so renowned that they became popular with the European ladies of the French Quarter in Louisiana in the eighteen-hundreds. Turkey tail fans of the Prairie tribes are made by inserting wooden or metal spacing rods through the quills to spread the feathers, while the tips of the quills were bound together with string. Sometimes the spacing rod was wrapped with thread or the handle was wrapped with leather or cloth with beaded applique.**

---

**[Birds & Feathers Bibliography and Books to Buy On-Line](#)**

**[Return to Birds & Feathers Main Menu](#)**

---

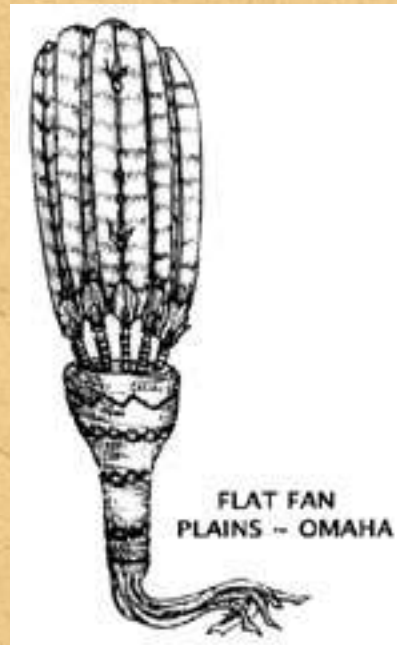


© 1994-2000 [Tara Prindle](#).



## NativeTech: Native American Technology and Art

### Flat Fans of the Plains Region



**A contemporary fan made by Native Americans of the plains consists of five to seven feathers which are individually decorated and set into a wooden handle. The wing or tail feathers are decorated with small trim or feathers, cloth or leather spots, and hackle feathers. The quills of the large feathers are wrapped with white buckskin, wrapped with thread and often adorned with metal bands. The handle is wrapped with leather and embellished with beaded applique or with peyote stitch beadwork. Peyote fans, or those associated with the religious rites of the Native American Church, are very serious and should not be copied, displayed, or treated disrespectfully.**

---

**[Birds & Feathers Bibliography and Books to Buy On-Line](#)**

**[Return to Birds & Feathers Main Menu](#)**

---



© 1994-2000 [Tara Prindle](#).

# Feather Identification

---

**Do you know these types of feathers?  
Click on the thumbnail for a detail and an I.D.**



---

Please be aware of  
[legislation related to the possession/ownership of birds or feathers,](#)  
[and laws protecting birds of prey, migratory and song birds.](#)

---

[Birds & Feathers Bibliography and Books to Buy On-Line](#)

[Return to Birds & Feathers Main Menu](#)

---



© 1994-2001 [Tara Prindle.](#)



NativeTech: Native American Technology and Art

# GOLDEN EAGLE - SMALL WING FEATHER

---



[Click here for a description of the Golden Eagle.](#)

---

[Return to Feather Identification](#)

[Birds & Feathers Bibliography and Books to Buy On-Line](#)

[Return to Birds & Feathers Main Menu](#)

---



© 1994-1999 [Tara Prindle](#).

NativeTech: Native American Technology and Art  
**REDTAIL HAWK - WING FEATHER**

---



[Click here for a description of the Redtail Hawk.](#)

---

[Return to Feather Identification](#)

[Birds & Feathers Bibliography and Books to Buy On-Line](#)

[Return to Birds & Feathers Main Menu](#)

---





© 1994-1999 [Tara Prindle](#).

NativeTech: Native American Technology and Art  
**REDTAIL HAWK - TAIL FEATHER**

---

[Click here for a description of the Redtail Hawk.](#)



---

[Return to Feather Identification](#)

[Birds & Feathers Bibliography and Books to Buy On-Line](#)

[Return to Birds & Feathers Main Menu](#)



© 1994-1999 [Tara Prindle](#).



NativeTech: Native American Technology and Art

# GREAT HORNED OWL - WING FEATHER

---



[Click here for a description of the Great Horned Owl.](#)

---

[Return to Feather Identification](#)

[Birds & Feathers Bibliography and Books to Buy On-Line](#)

[Return to Birds & Feathers Main Menu](#)

---



© 1994-1999 [Tara Prindle](#).

NativeTech: Native American Technology and Art

# TURKEY VULTURE - WING FEATHER

---

[Click here for a description of the Turkey Vulture.](#)



---

[Return to Feather Identification](#)

[Birds & Feathers Bibliography and Books to Buy On-Line](#)



[Return to Birds & Feathers Main Menu](#)

---



© 1994-1999 [Tara Prindle](#).

NativeTech: Native American Technology and Art

# TURKEY - WING FEATHER

---



[Click here for a description of the Turkey.](#)

---

[Return to Feather Identification](#)

[Birds & Feathers Bibliography and Books to Buy On-Line](#)

[Return to Birds & Feathers Main Menu](#)

---



© 1994-1999 [Tara Prindle](#).



NativeTech: Native American Technology and Art  
**TURKEY - TAIL FEATHER**

---



[Click here for a description of the Turkey.](#)

---

[Return to Feather Identification](#)

[Birds & Feathers Bibliography and Books to Buy On-Line](#)

[Return to Birds & Feathers Main Menu](#)

---



© 1994-1999 [Tara Prindle](#).

NativeTech: Native American Technology and Art  
**TURKEY WING - FEATHER**

---



[Click here for a description of the Turkey.](#)

---

[Return to Feather Identification](#)

[Birds & Feathers Bibliography and Books to Buy On-Line](#)



[Return to Birds & Feathers Main Menu](#)

---



© 1994-1999 [Tara Prindle](#).

## NativeTech: NativeTech: Native American Technology and Art

# GOLDEN EAGLE - DESCRIPTION

---



Golden Eagle - *Aquila chrysaetos*.

The golden eagle is truly an impressive bird, with a wingspan averaging seven feet! The golden eagle is identified by its brown coloring with variable golden wash over the back of its head and neck; a beak that is horn colored; and a faintly banded tail. The brown heads and tails of mature golden eagles are easily confused with those of juvenile bald eagles, and can be distinguished by the yellow tinged bill of the bald eagle. The patterns of the golden eagle look more crisp than the mottled, blotchy coloring of juvenile bald eagles. Eagles in flight may be confused with members of the vulture family; but where vultures fly with their wings in a slight v-shape, eagles fly with their wings flat and straight across, or only very slightly uplifted. Nesting on cliffs or in trees, golden

eagles inhabit mountainous or hilly terrain, and hunt over open country for small mammals, snakes, birds and carion.

Adapted from National Geographic Society's *Field Guide to Birds of North America*, 2nd edition, 1987.

---

[Return to Feather Identification](#)

[Birds & Feathers Bibliography and Books to Buy On-Line](#)

[Return to Birds & Feathers Main Menu](#)

---



© 1994-1999 [Tara Prindle](#).

## NativeTech: Native American Technology and Art

# REDTAIL HAWK - DESCRIPTION

---



### Redtail Hawk - *Buteo jamaicensis*.

This hawk has a wingspan over four feet, with broad, rounded wings and variable plumage. Some adult eastern Redtails have a band of dark streaks on whitish underparts; dark bar on leading edge of underwing, contrasting with paler wing linings. They have reddish uppertails and paler red undertails, with a variety of mottling on their shoulders that contrasts with a dark mantle, sometimes forming a V in perched birds. Immature Redtails have gray-brown tails with black bands and brown streaks and spots below. They live in woods with nearby open land. They generally prey on rodents, and have a distinctive piercing call, a descending

'keeeer'.

---

[Return to Feather Identification](#)

[Birds & Feathers Bibliography and Books to Buy On-Line](#)

[Return to Birds & Feathers Main Menu](#)

---



© 1994-1999 [Tara Prindle](#).



## NativeTech: Native American Technology and Art

# GREAT HORNED OWL - DESCRIPTION

---



Great Horned Owl - *Bulbo virginianus*. This bird's large size (nearly two feet tall), bulk and white are on it's throat distinguish it from other owls. They can live in many areas ranging from forests to deserts and even in cities. Look for their nests high in trees or in caves, and sometimes on the ground; you may see them resting during the day - they are nocturnal. Because they are large owls, their prey can be as big as a skunk, rabbit or grouse. The great horned owl's call is usually eight loud hoots, the latter hoots shorter and more closely spaced. Adapted from National Geographic Society's *Field*

*Guide to Birds of North America*, 2nd edition, 1987.

### [MORE ABOUT OWLS](#)

---

### [Return to Feather Identification](#)

### [Birds & Feathers Bibliography and Books to Buy On-Line](#)

### [Return to Birds & Feathers Main Menu](#)

---



© 1994-1999 [Tara Prindle](#).

# TURKEY VULTURE - DESCRIPTION

---



Turkey Vulture - *Cathartes aura*.

These vultures are **BIG**, with wing spans commonly five feet. Though they are nearly as large as an eagle - they hold their wings in a distinctive slight v-shape, seldom flapping their wings, as they're gliding along. The underside of their feathers is marked by the contrast between their silvery-gray flight feathers and the dark brown linings around the shoulders. Adults have red heads and a white bill, while juveniles have gray-brown coloring. They are often seen in open wooded areas or fields, looking to scavenge a meal. Distinctive traits of the vultures are their featherless heads which are an asset when it comes to scavenging and consuming

carion - believe me, you wouldn't want to stick your head into that if you had a bunch of nice feathers on your head (making the after-dinner clean-up so much easier). Unlike other large birds, vultures do not build nests, but rather lay their eggs under natural sheltered areas, rock crevices or in hollowed logs.

Adapted from National Geographic Society's *Field Guide to Birds of North America*, 2nd edition, 1987.

---

[Return to Feather Identification](#)

[Birds & Feathers Bibliography and Books to Buy On-Line](#)

[Return to Birds & Feathers Main Menu](#)

---

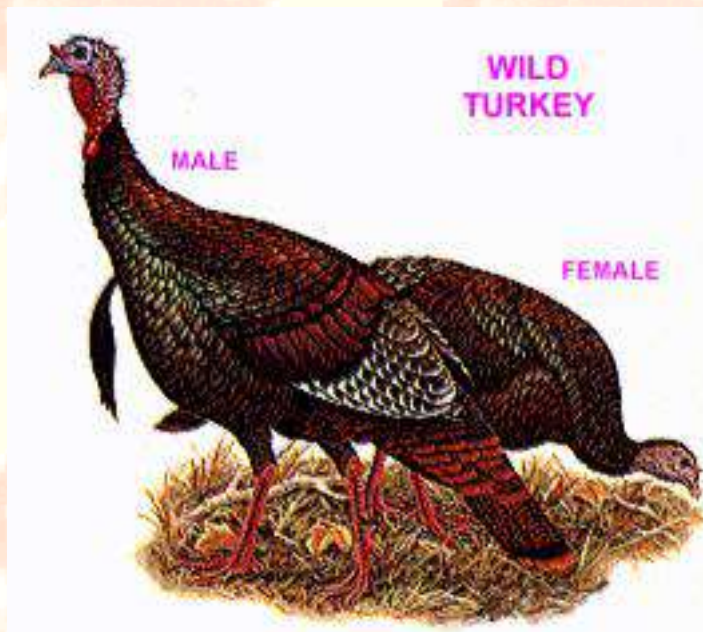


© 1994-1999 [Tara Prindle](#).

## NativeTech: Native American Technology and Art

# WILD TURKEY - DESCRIPTION

---



Wild Turkey - *Meleagris gallopavo*.  
The turkey is the **LARGEST** gamebird of North America, standing three feet tall, though the wild turkey is leaner than the domesticated variety. A striking quality of the wild turkey are the small iridescent body feathers which produce a shimmering rainbow of colors. The wing feathers are barred, the 'flight' feathers having the most distinct black and white bars. The tail feathers are tipped with chestnut brown among eastern birds, while western birds have tail feathers tipped with white. Adult males often have a 'beard' or long black tuft of feathers hanging from their chest. Females

and juveniles, while smaller, tend to lack the sharpness in coloring of adult males. Turkeys forage on the ground for seeds and insects, and they also make their dish-shaped nests on the forest floor. Flocks of two dozen noisy 'gobblers' are not uncommon in my area of Connecticut.

Adapted from National Geographic Society's *Field Guide to Birds of North America*, 2nd edition, 1987.

---

[Return to Feather Identification](#)

[Birds & Feathers Bibliography and Books to Buy On-Line](#)

[Return to Birds & Feathers Main Menu](#)

---



© 1994-1999 [Tara Prindle](#).





## NATIVE AMERICAN POTTERY IN NEW ENGLAND



---

Pottery was first used by New England Native Americans about 3,000 years ago. During the Archaic period, groups of people scheduled their movements into a seasonal cycle in accordance with the seasonal abundance of particular resources. A group might aggregate in a large village by the river or coastline during the summer harvesting migrating fish or now-stabilizing shell-fishing beds, and then break into smaller groups into the interior uplands to take advantage of winter hunting. Marking the beginning of the Early Woodland period, 2,700 years ago, groups of people started staying at the same village site longer than a single season. People might stay for an entire year or perhaps longer, while small task groups still used interior upland areas for temporary camps or workstations. Experimentation with maize-bean-squash horticulture and plant cultivation allowed, and required, a core group of people to remain longer in one place. By the time of European contact, Native Americans were staying in one waterside village for about ten year at a stretch. After a decade or so the settlement would move to another place along the river. Among the reasons for moving would be an eventual shortage of locally available firewood, and build up of midden waste and vermin at the previous location.

New England pottery is very fragile. When pottery is found at archeological sites in New England, it is usually fragmented into many small pieces. The low firing temperatures, unrefined paste and natural state of clay used to make pots, produced brittle vessels which could easily break. Before settling down into semi-permanent villages, it was not practical to transport ceramic pottery during frequent seasonal moves. Before the use of pottery, sturdy stone bowls were used, but because of their great weight, the bowls were often left (cached) at a village site that would be returned to in subsequent seasons.



Americans found not only a means of individual expression, but they also discovered a way to communicate important cultural symbols.

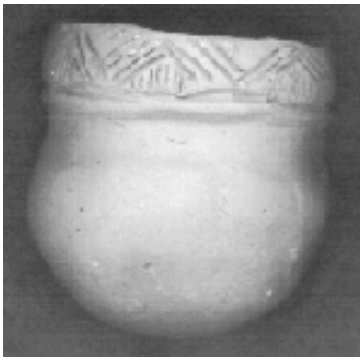
Pottery is assumed to have been made by women, there are few early historic references to men making pottery. All the women would learn to make pottery, there is no evidence for pottery specialization (pottery made only by a single person or village family). Maintaining a livelihood of hunting, gathering, and horticulture, full-time professions would take energy away from daily subsistence activities, as every member needs to devote time to the daily food quest. Without such specialization, an artist can still find creative expression within the realm of everyday life, based on their daily experiences. Because Native Americans in southern New England organized themselves to move from one non-permanent settlement to another, their art focused on the decoration of utilitarian objects, which were carried along, left for later use or buried with the deceased. Through the perfection and embellishment of these items, Native

Natural clays formed when minute particles carried by streams sank and settled in still water ponds. For Native Americans to use natural clay dug from pond sides, river banks or ocean cliffs it had to be plastic enough to be bent or stretched into a coil without breaking or cracking. Often the clay had to be specially prepared. Native Americans added [temper](#), crushed shell, sand, crushed fired-pottery, or even plant material to fine homogenous clays to help pottery withstand the shock of rapid-temperature changes and open flames. In [preparing](#) to make a pot all impurities were removed from the clay and any trapped air pockets or bubbles had been removed by wedging or kneading the clay, only then was the clay ready for rolling into coils for construction of a pottery vessel.

Native Americans in New England started [making a pot](#) by pinching a small ball of clay into a dish shape and placing it in a hollow in the earth. Turning the vessel during production, coils of clay were successively added to the interior of the vessel wall. The coils were pinched or pressed and smoothed into the previous coil, which welded the coils of clay together. The coiling process spiraled upwards until the desired form was achieved, at which point the vessel was paddled with a cord-wrapped stick to further compress and cement the clay, and give the pot its finished form. Ceramic pots made by Natives of the Eastern Forest had slightly pointed, and later in time globe-shaped bottoms, like the bottom half of an egg. The rounded bottoms of the pots were perfectly suited to the uneven surfaces of the woodlands, and remained upright easily when placed in a hollow or upon rocks.

Pottery was fired outside in a shallow pit, without the use of an enclosed kiln. Temperatures in [wood firings](#) probably reached 1500°. After firing, pottery pieces are as hard as rock and can last for thousands of years buried in the earth.

At first pots were used mainly for cooking, but later in time pots were used to store foods as well. Pottery mainly consisted of cooking vessels, but miniature pots, pipes, beads and figurines were also made. Miniature pots (½ foot to 1 inch diameters) have been found by archaeologists working in New England. In Rhode Island, Archaeologist William Simmons unearthed small pots that were buried with 17<sup>th</sup> century Narraganset.



**Reproduction  
Miniature Pot.**

It is likely small pots were used to prepare special foods required of young child, who may have been recently weaned, and would subsequently be needed by the child in their journey after death.

In addition to those made of stone, smoking pipes made of clay have been recovered from Early, Middle, and Late Woodland Period archaeological sites in New England. A variety of plant materials, primarily sacred aboriginal tobacco, were smoked for their curative values, and probably for recreation. The motifs and designs found on clay pipes are similar to those found on clay pots. Some pipes made with clay bowls and metal stems.



**Reproductions of tubular blocked end, elbow  
and effigy pipes.**



**Reproductions of a variety of elbow pipes.**

Prehistoric beads, maskettes, or effigies were made quite rarely by New England Native Americans. Beads were usually small perforated round or oval clay balls. Maskettes have been found which date to the late prehistoric period that were made by Delaware, Northern Iroquois, and probably other Native Peoples. The maskettes were usually perforated for suspension. A few fired clay effigies of animals have been noted in archaeological collections. A small fish effigy was recovered a late prehistoric Northern Iroquois site.



Pieces of pottery found by archaeologists can tell much about the way people lived long ago. Pottery can tell archaeologists about a peoples' artists and their tools, and also about how and what they cooked and ate. Decoration and style tell us about who made the pottery and the ties between different groups of people.

The changing shapes of pots, or [vessel forms of southern New England pottery over time](#) reflected the concurrent changes in food types and cooking methods. Early pointed-bottom pots, designed to sit directly on the fire, are best for quickly boiling meat and other food. Later rounded-bottom pots were designed to be farther from the fire for slower simmering of a variety of grains and vegetables in addition to meat. The constricted necks of later pots allowed the pot



**Reproduction Maskettes.**

to be suspended with cords over the fire and the amount of liquid lost from the simmering food was also reduced.

Decorations were then applied, stamped or incised, and the body of the pot was often smoothed over. [Various tools](#) were used by Native Americans of southern New England to decorate their pots, including carved antler modeling tools, toothed combs, pointed sticks, scallop and probably other shells, nets and textiles to impress, wooden or shell scraping tools, and burnishing stones. Clay pots were decorated with designs and motifs used for other forms of art like metal-working, weaving, and even face painting. These shared designs encompass zones broken-up into triangles, zig-zags, and dots. Between 3,000 and 1200 years ago, designs and pottery styles appeared over much of southern New England with showed little variation from one area to the next, suggesting that these designs were shared by many different groups of people.

By the end of the Middle Woodland Period, 1200 years ago there was an increase in the diversity and complexity of designs placed on pottery. As the Native American population in southern New England increased and groups began to live in one place for longer periods of time, there is a corresponding increase in the stylistic diversity of ceramic decorations. This correspondence may reflect a need for groups of Native Americans to express their own family/village identity in the face of encroaching neighbors.



**Birth Effigy on a Vessel  
(reproduction).**

The designs applied to Late Woodland pottery, made by Mohegan, Pequot and Narragansett tribes in the historic period, preserve design elements from earlier times, including incised and stamped zones of horizontal, vertical, and triangular or zig-zag elements. In examples from the historic Mohegan Fort Shantok site, the pots have a unique sculptural quality which includes modeling of the vessel surface to raise lobes below the vessel collar, and elaborately formed castellated rims with one or more projecting points. Many of the later modeled, castellated decorations depict images of birth, fertility and other feminine qualities.

William Wood noted in 1634 that: "Hence likewise our *Indians* had their pots wherein they used to feeth their victuals before they knew the use of Braffe"; kettles made of iron, brass and copper acquired in trade became more popular than traditional ceramic vessels. Many reasons lead to the decline of Native

pottery production, metal kettles were sturdier and more portable than traditional pottery, and when they were damaged, could be repaired using sheet metal acquired in trade with Europeans. During the Fur Trade and Colonial-Native wars, time expended in pursuit of furs and producing wampum tributes took energies away from many traditional craft industries. Metal kettles and other trade items were soon adopted by Native Americans into traditional cultural roles. By the late 17<sup>th</sup> century metal pots and other European items even replaced many traditional items, such as clay pots, in burial offerings.

---

[Chronology of southern New England Pottery](#)

[Preparing Clay](#)

[Temper Mixed into Clay](#)

[Making a Clay Pot](#)  
[Tools Used to Decorate Pottery](#)  
[Firing Pottery](#)

---

[Pottery Bibliography and Books to Buy On-Line](#)

[Return to NativeTech's Main Pottery Menu](#)

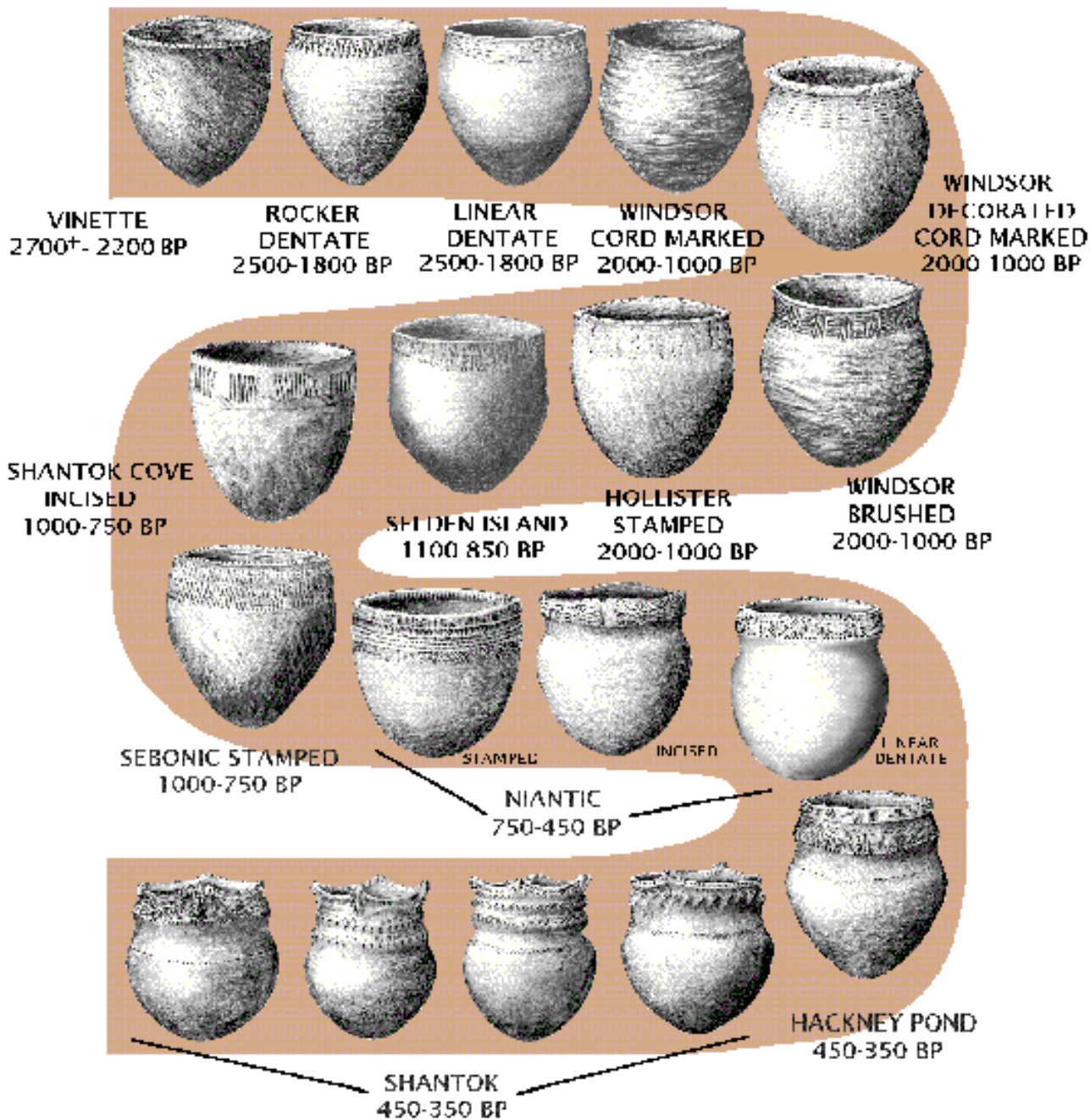
---



Text and Graphics  
© 1994 - 103 [Tara Prindle](#)  
unless otherwise cited.

Native American Technology and Art

# CHRONOLOGY OF THE WINDSOR POTTERY TRADITION OF NATIVE AMERICANS IN SOUTHERN NEW ENGLAND



B.P. = Age in Years Before Present

[Return to Background of Southern New England Pottery](#)

[Pottery Bibliography and Books to Buy On-Line](#)



[Return to NativeTech's Main Pottery Menu](#)

---



Text and Graphics  
© 1994 - 103 [Tara Prindle](#)  
unless otherwise cited.

# PREPARATION OF CLAY FOR NATIVE AMERICAN POTTERY

---

## CLAY PREPARATION

CLAYS can be found near the ocean or by inland streams and ponds. The clay formed when tiny bits of dirt carried by streams sank and settled in still water ponds. Clays must be plastic enough to be rolled into a coil and bent without breaking.

## ADDING TEMPER



**ADD TEMPER**

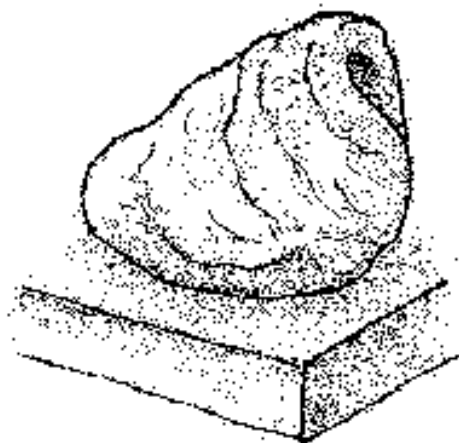
TEMPER may be crushed shell, sand, broken pottery bits, or plant material. Up to 1/10 of the clay mixture can be made up of temper for very fine natural clays. Tempering pottery makes it able to take rapid changes in temperature when placed in a fire.



**WEDGE CLAY**



**WEDGING CLAY  
AND SPIRAL WEDGING**



**SPIRAL WEDGE**

WEDGE clay to make the mix even and to help remove air bubbles from the clay. If air is not removed from the clay pottery may break or crack when dried and fired. SPIRAL type of wedging clay is an efficient way to mix clay. Keeping the clay in a cone or shell shape, first pull a melon-sized piece of clay toward you. Second, push down and away from you while giving the cone of clay a slight turn.

---

[Return to Background of Southern New England Pottery](http://www.nativetech.org/pottery/prepare.htm)



[Pottery Bibliography and Books to Buy On-Line](#)

[Return to NativeTech's Main Pottery Menu](#)

---

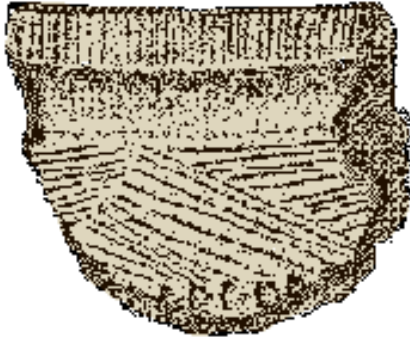


Text and Graphics  
© 1994 - 103 [Tara Prindle](#)  
unless otherwise cited.

Native American Technology and Art

# KINDS OF TEMPER ADDED TO CLAY TO IMPROVE IT'S PASTE

---



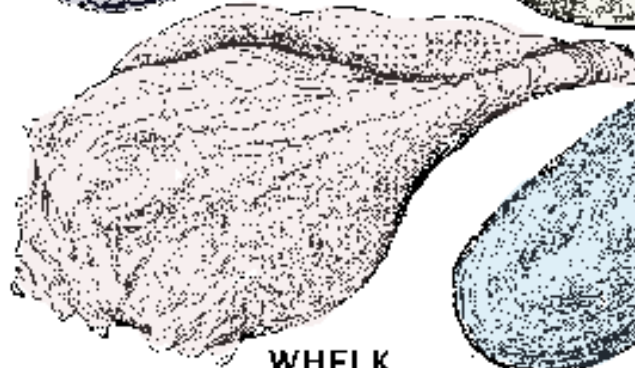
**BROKEN POTTERY SHERD**



**SCALLOP**



**CLAM**



**WHELK**



**MUSSEL**

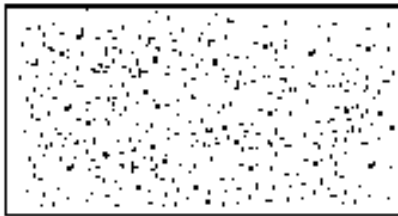


**CRUSHED SHELL**





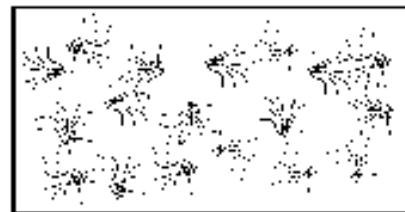
**SAND OR CRUSHED MINERAL**



**CATTAIL FLUFF**



**MIKWEED POD**



---

[Return to Background of Southern New England Pottery](#)

[Pottery Bibliography and Books to Buy On-Line](#)

[Return to NativeTech's Main Pottery Menu](#)

---



Text and Graphics  
© 1994 - 103 [Tara Prindle](#)  
unless otherwise cited.



# MAKING HAND-BUILT COILED POTTERY

---

## PINCHING THE BASE AND USING A SUPPORT



PINCH POT



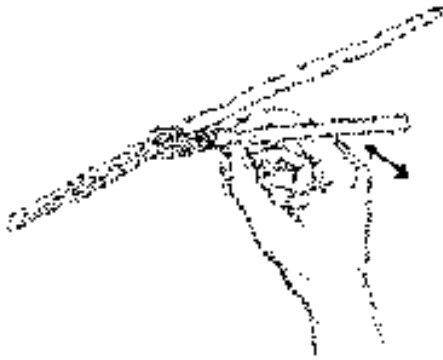
BASIN SHAPED SUPPORT

## ROLLING, BRUSHING, ADDING AND JOINING THE COILS

1. To start, pinch your thumbs into the center of a ball of clay. Squeeze your thumb on the Inside with your fingers on the outside of the pot. Continue squeezing and rotating the pot until the walls of the vessel are about 1/4 in. thick. Fix any cracks which form by firmly pinching together the void and smoothing it over.
2. Place the base in a hollow in the ground, or in a bowl shaped vessel which can be rotated easily by the potter as the pot is built up.



ROLLING A COIL



BRUSHING THE COIL

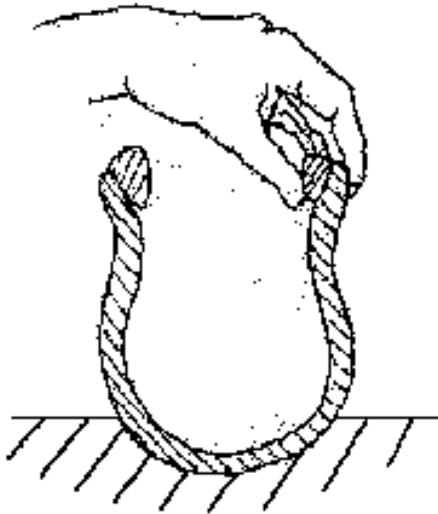


ADDING A COIL

3. Pots of New England Indians were built up from coils or ropes of clay. The coils are rolled between the palms of the hands or rolled against a flat surface in a back and forth and center to ends direction. Coils range from 1/2 to 1 inch in thickness.

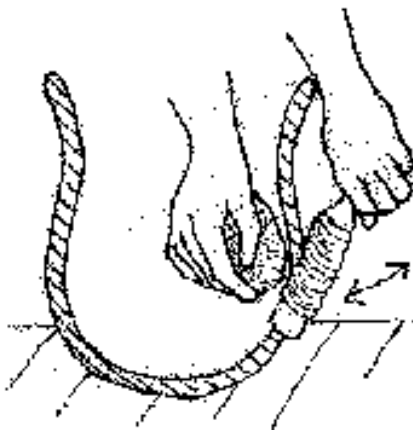
4. To be joined properly, the coils should be roughened using a moistened stiff brush. This helps seal out any air when the coils are squeezed together, and helps keep the coil moist while it is being added to the pot.

5. Add a coil, one foot or longer, around the inside rim of the pot being held in its support.



JOINING A COIL

## PADDLING, SMOOTHING AND SCRAPING THE POT



PADDLE TO SHAPE

6. The coils must be firmly joined to the pot or cracks will appear when the pot dries. Attach the coil to the pot using your thumb to press downward against the coil on the inside of the pot. At the same time pull upward with your fingers on the outside of the pot. This will actually weld the coils together. If the coils are not well joined, cracks will appear as the pottery dries.

7. Join coils in A spiral direction until a rough form of the pat is made, or until the addition of more moist coils will cause the pot to slump under the weight. If the pot dents when it is tapped, let it dry until it feels like leather, and does not dent easily. When the pot is leather-hard, the pot is paddled with a cord-wrapped stick. Paddle the pot to its final form using a smoothed cobble on the inside of the pottery wall for support. Paddling helps compress and strengthen the clay and decorates the outside of the pot with cord marks.





SMOOTHING & SCRAPING

8. A smooth, flat scraping tool may be used on the pot to compress cracks or smooth the pot for more decoration.

---

[Return to Background of Southern New England Pottery](#)

[Pottery Bibliography and Books to Buy On-Line](#)

[Return to NativeTech's Main Pottery Menu](#)

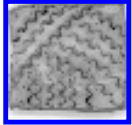
---



**Text and Graphics**  
© 1994 - 103 [Tara Prindle](#)  
unless otherwise cited.

# TOOLS USED TO MAKE AND DECORATE NEW ENGLAND NATIVE AMERICAN POTTERY

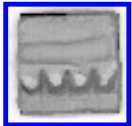
Click on the thumbnail images below to view a larger image.  
[Then click the 'back' button to return to this page.]



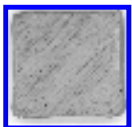
Scallop Shell: edge or back of shell can be stamped and/or dragged in the clay.



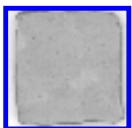
Cord Wrapped Paddle: used to compress the coils, leaving parallel impressions of cordage.



Carved Antler or Wood Modeling Tools: to form and carve the clay.



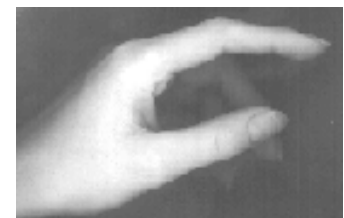
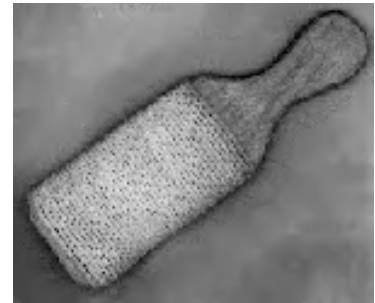
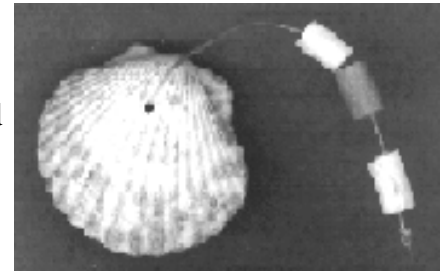
Quill Brush: used to score coils before joining, or brushing of the vessel surface.



Wooden Scraper: used to join the coils and give a smooth texture to the pot.

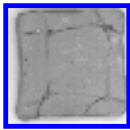
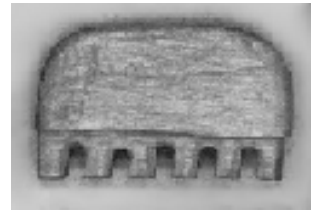


Finger and Thumbnails: used to make crescent shaped impressions.

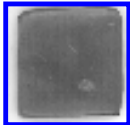
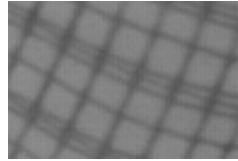




Wooden or Stone Dentate Tool: for stamping tooth-like rows of dots or squares.



Net and Textiles: a layer keeps dirt away from the surface of a pot & leaves its mark.



Burnishing Stone: when rubbed against leather-hard clay, a shiny surface is attained.



Flake Knife: used to stamp or incise lines or hatch marks on a pot.



Pointed Stick: used to make incised lines or dots on a pot.



---

[Return to Background of Southern New England Pottery](#)

[Pottery Bibliography and Books to Buy On-Line](#)

[Return to NativeTech's Main Pottery Menu](#)

---

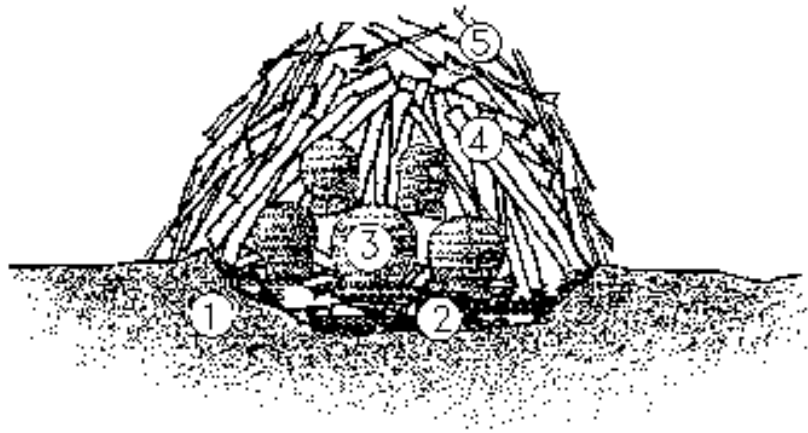


Text and Graphics  
© 1994 - 103 [Tara Prindle](#)  
unless otherwise cited.



# FIRING NATIVE AMERICAN POTTERY OUTSIDE IN A FIRE PIT

---



**Traditional Pottery Firing**

Native Americans of New England fired their pottery outdoors. After drying slowly for several days, pottery is ready to be baked in a fire. On a windless day, a shallow pit is dug (1) and a preparation fire is built to warm the pots next to and to preheat the rocks (2) which the pottery will rest on during their firing. After the first fire has burned to ashes, the warmed pots (3) are placed upside down without their sides touching. Thickly split hardwood (4) is placed in a teepee style over the pots. Quicker burning thin kindling (5) is put under the pots and over the sides of the thicker wood. The temperature of the fire can reach 1500 degrees or more. Avoid any rapid temperature changes and allow the fire to burn down after 1 1/2 hours. Bank the fire with wet leaves or grass and then cover over with light sod, leaving a small smoke hole in the top. Allow this to cool for an hour before removing pots. In contemporary firings, a few tin sheets (6) will protect pottery from smoke and fire. Tin cans (7) can also be substituted for rocks.



Contemporary Pottery Firing

---

[Return to Background of Southern New England Pottery](#)

[Pottery Bibliography and Books to Buy On-Line](#)

[Return to NativeTech's Main Pottery Menu](#)

---



Text and Graphics  
© 1994 - 103 [Tara Prindle](#)  
unless otherwise cited.

# A Photographic Tour of Firing Pottery

## Firing Traditional Eastern Woodlands Earthenware Pottery in an Open Fire Pit



**In a shallow open hearth, set up rocks that the pots will rest on during firing. It is important to know that these rocks will withstand the heat of an intense fire, so if you are unsure, take rocks that have already been through, and survived, a fire without shattering.**



**Before firing the pottery, you need to build a warming fire. Start it with some kindling (yes, I'm using a lighter and some paper to start it).**



**The warming fire should be pretty big, so that you get a good bed of coals around your rocks. It should burn for about an hour.**



**During the warming fire, place your pots nearer and nearer to the fire. This drives out any moisture that still may be in the clay after the pots have dried for a few weeks. At this point, the pots are as near to the fire as they get without being in it.**





**When your warming fire has been reduced to a bed of coals, it's time to place the pots onto the rocks. Gather a LOT of hard wood for the actual firing of the pottery.**



**Put some kindling between the rocks. You want to act quickly now, you don't want the pots to be heated too much from the bottom before you get the fire built over them. Place them either on their sides or upside down supported by the rocks. Do this quickly before the kindling catches fire.**



**Quickly put kindling around, and under, and in between the pots.**



**Quickly build up a pyramid of hardwoods around the pots. Do this quickly, before the coals set the wood on fire.... It will begin to smoke as you are building it up.**



**Keep feeding the fire with new hardwood for about two hours... you want the fire inside to get really hot... you want to keep the gaps between the wood as small as possible. You \*don't want to see the pots inside (which means they are exposed directly to the open air and are at risk of thermal shock). That's my "poker-stick" in the foreground on the right -- use this long stick to keep the shape of the cone around your fire, often logs will fall to the side, and you need to prop them back up with your "poker-stick".**



**After a few hours, finally let the fire die down naturally till it is gray charred wood with no flame showing... it should look cherry red inside.**



**You should have gathered some sod, wet grass, wet leaves, ferns, whatever is available to smother the firing. This is the 'final reduction' of you pottery, when you cut off all the oxygen.**



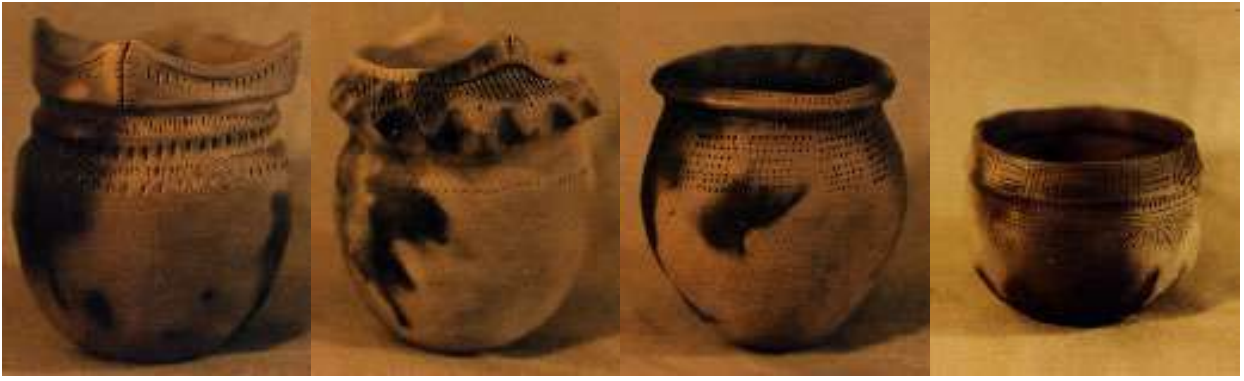
**Place the wet dampening material over the pile of coals... act quickly... dont let it catch fire.**



**It gets really smokey... You need a pretty big pile of dampening material ... again, dont let it catch fire.**



**Let the fire cool for several hours... I started my warmingfire mid-morning, and the coals after dampening the fire were still cherry red at 8:30 in the evening. It's best to wait till the coals are completely cooled before removing the pots.**



Four of the pots after firing -- the black marks on the pots are not soot, they do not wash off... the marks are from the differences in oxidation and reduction of the clay; where the pot is orange, it was more open to the air (oxidized); where the pot is black, the air was cut off (reduced).

---

*Chi Mügwetch (thank you very much) to my boyfriend Brad, for taking all these wonderful pictures while I fired my pots; and to my friend Nunya, for letting me use her fire pit.*

---

[Return to Background of Southern New England Pottery](#)

[Pottery Bibliography and Books to Buy On-Line](#)

[Return to NativeTech's Main Pottery Menu](#)

---



Text and Graphics  
© 1994 - 103 [Tara Prindle](#)  
unless otherwise cited.





## POTTERY BIBLIOGRAPHY

Click on the links below for the books you can order on-line in affiliation with [barnesandnoble.com](http://barnesandnoble.com)

---

### *References cited in NativeTech's [Pottery articles](#):*

**Beauchamp, William M.**

**1902 Metallic Implements of the New York Indians.**

New York State Museum Bulletin 55.

**Bradley, James W.**

**1987 Evolution of the Onondaga Iroquios, Accommodating Change, 1500-1655.**

New York: Syracuse University Press.

[This book is Out of Print. But used copies are available here.](#)

**Gookin, Daniel**

**1970 Historical Collections of the Indians in New England.**

J.H. Fiske, ed. London: Towaid. (First published 1674).

[Order this book through barnesandnoble.com](#)

**Hayes, Charles F., III, General Editor**

**1980 Proceedings of the 1979 Iroquois Pottery Conference.**

Research Records No13. Sponsored by the Arthur C. Parker Fund for Iroquois Research. 657 East Ave., Rochester New York 14603: Rochester Museum and Science Center.

**Lizee, Jonathan M.**

**1994 Ceramic Sequences and Patterning in southern New England: The Windsor Tradition.**

PhD Dissertation at the University of Connecticut (at Storrs). 300 North Zeeb Road, Ann Arbor, Michigan 48106-1346: UMI Dissertation Services.

**Ritchie, William A.**

**1980 The Archaeology of New York State.**

Harrison, New York: Harbor Hill Books.

[Order this book through barnesandnoble.com](#)

**Russell, Howard**

**1980 Indian New England Before the Mayflower.**

Hanover: University Press of New England.

[Order this book through barnesandnoble.com](#)

**Schneider, Richard C.**

**1972 Crafts of the North American Indians.**

312 Linwood Ave., Stevens Point Wisconsin 54481: R. Schneider Publishers

[Order this book through barnesandnoble.com](http://www.barnesandnoble.com)

**Simmons, William S.**

**1970 Cautantowwit's House: An Indian Burial Ground on the Island of Conanicut in Narragansett Bay.**  
Providence, RI: Brown University Press.

[Order this book through barnesandnoble.com](http://www.barnesandnoble.com)

**Snow, Dean R.**

**1980 The Archaeology of New England.**  
New York: Academic Press.

**Trigger, Bruce G. ed.**

**1978 Handbook of North American Indians, Vol. 15, Northeast.**  
W. Sturtevant, gen. ed. Washington, D.C.: Smithsonian Institution.

[Order this book through barnesandnoble.com](http://www.barnesandnoble.com)

**Williams, Roger**

**1973 Key into the Language of America.**

J.J. Teunissen and E.J. Hinz, ed.s. Detroit: Wayne State University Press. (First printed 1643).

[Order this book through barnesandnoble.com](http://www.barnesandnoble.com)

**Wood, William**

**1865 Wood's New England's Prospect.**

Boston: Publications of the Prince Society 1. (First published 1634).

[This book is Out of Print. But used copies are available here.](#)

I wish to express my appreciation for discussions about pottery  
with my ex-husband Jon Lizee, and with my friend Mary Beth Williams.

---

***Other Books relating to Pottery you can buy on-line through [barnesandnoble.com](http://www.barnesandnoble.com):***

**Rock Dillingham, Melinda Elliott, Joan Kathryn O'Donnell (Editor)**

[Acoma and Laguna Pottery](#)

**Duane Anderson**

[All That Glitters: The Emergence of Native American Micaceous Art Pottery in Northern New Mexico](#)

**Sharon Wirt**

[American Indian Pottery](#)

**Victor Michael Giammattei, Darcy Paige, Nanci Reichert, Andrew Gulliford (Illustrator)**

[Art of a Vanished Race: The Mimbres Classic Black-on-White](#)

**Christopher B. Donnan**

[Ceramics of Ancient Peru](#)



**Rina Swentzell, Carly Bordeau (Illustrator), Bill Steen (Photographer), Foreword by Michael Dorris**  
**[Children of Clay: A Family of Pueblo Potters](#)**

**Allan Hayes, John Blom, Stephanie Bucholz (Editor)**  
**[Collections of Southwestern Pottery: Candlesticks to Canteens, Frogs to Figurines](#)**

**Jesse Walter Fewkes**  
**[Designs on Prehistoric Hopi Pottery](#)**

**Kenneth E. Sassaman**  
**[Early Pottery in the Southeast: Tradition and Innovation in Cooking Technology](#)**

**Rick Dillingham, Foreword by J. J. Brody**  
**[Fourteen Families in Pueblo Pottery](#)**

**Alex Patterson, Alexander M. Stephen (Illustrator)**  
**[Hopi Pottery Symbols](#)**

**Toni Roller, Ted Roller (Illustrator)**  
**[Indian Pottery](#)**

**Marcia Muth, Mina Yamashita (Illustrator)**  
**[Indian Pottery of the Southwest: A Selected Bibliography](#)**

**Susan Peterson**  
**[Lucy M. Lewis: American Indian Potter](#)**

**Michael W. Simpson**  
**[Making Native American Pottery](#)**

**Jesse Walter Fewkes, Jesse W. Fewkes, J. Walter Ferkes**  
**[The Mimbres: Art and Archaeology](#)**

**Katherine Gleason, Meryl Henderson (Illustrator)**  
**[Native American Clay Pots: Merchandise Kit](#)**

**Ruth Leah Bunzel**  
**[The Pueblo Potter: A Study of Creative Imagination in Primitive Art](#)**

**Kenneth M. Chapman**  
**[Pueblo Pottery Designs](#)**

**Betty Toulouse, Nancy H. Warren (Photographer)**  
**[Pueblo Pottery of the New Mexico Indians: Ever Constant, Ever Changing](#)**



**Barbara A. Babcock, Guy Monthan (Editor), Doris Monthan (Editor)**

**[The Pueblo Storyteller](#)**

**Alfreda W. Maloof**

**[Recollections from My Time in the Indian Service, 1935-1942: Maria Martinez Makes Pottery](#)**

**Charlotte Smith Neyland**

**[Southwest Indian Arts and Crafts](#)**

**Allan Hayes, John Blom**

**[Southwestern Pottery: Anasazi to Zuni](#)**

**James R. Cunkle**

**[Talking Pots: Deciphering the Symbols of a Prehistoric People](#)**

**Stephen A. Trimble, Tom Ireland (Photographer), Tom. Ireland (Photographer)**

**[Talking with the Clay: The Art of Pueblo Pottery](#)**

**J. J. Brody, Rina Swentzell**

**[To Touch the past: The Painted Pottery of the Mimbres People: Essays](#)**

**Patrick Eddington, Susan Makov**

**[The Trading Post Guidebook: Where to Find the Trading Posts, Galleries, Auctions, Artists, and Museums of the Four Corners Region](#)**

**Linda B. Eaton**

**[Tradition and Innovation: The Pottery of New Mexico's Pueblos](#)**

**James R. Cunkle**

**[Treasures of Time: A Fully Illustrated Guide to Prehistoric Ceramics of the Southwest](#)**

**Byrd Baylor, Tom Bahti (Illustrator)**

**[When Clay Sings](#)**

**Owen Lindauer, Peter H. McCartney**

**[Archaeological of Schoolhouse Point Mesa: Roosevelt Platform Mound Study, Report on the Schoolhouse Point Mesa Sites](#)**

**J. J. Brody**

**[Beauty from the Earth: Pueblo Indian Pottery from the University Museum of Archaeology and Anthropology](#)**

**Mark E. Supnick**

**[Collecting Shawnee Pottery: A Pictorial Reference and Price Guide](#)**

**James Seeley White**

**[Diving for Northwest Relics: Identification and Dating of Bottles, Pottery, and Marine Hardware](#)**

**Kent V. Flannery, Joyce Marcus**

**[Early Formative Pottery of the Valley of Oaxaca](#)**

**Norman T. Oppelt**

**[Earth, Water and Fire: The Prehistoric Pottery of Mesa Verde](#)**

**Robert A. Ellison, Martin P. Eidelberg, Betty G. Hut**

**[From Our Native Clay](#)**

**Susan Lamb**

**[Guide to Pueblo Pottery](#)**

**Peabody Museum of Archaeology and Ethnol, Edwin L. Wade, Lea S. McChesney**

**[Historic Hopi Ceramics: The Thomas V. Keam Collection of the Peabody Museum of Archaeology and Ethnology, Harvard University](#)**

**Katharine Bartlett, Kathleen Gratz, Ann Hitchcock**

**[Hopi and Hopi-Tewa Pottery, Vol. 3](#)**

**A. L. Kroeber, Michael Harner, R. F. Heizer (Editor), J. H. Rowe (Editor), Ronald L. Olson (Editor), T. D. McCown (Editor)**

**[Mojave Pottery](#)**

**John Bivins, Bradford L. Rauschenberg (Photographer)**

**[The Moravian Potters in North Carolina](#)**

**Russell P. Hartman, Jan Musial, Stephen A. Trimble (Photographer)**

**[Navajo Pottery: Traditions and Innovations](#)**

**Roger T. Grange**

**[Pawnee and Lower Loup Pottery](#)**

**Darrel\\Wilson (Editor)**

**[Primer of North American Indian Pottery and Restoration Terms](#)**

**Michael Lind, Ronald M. Spores (Editor), Paula M. McNutt (Editor)**

**[The Sociocultural Dimensions of Mixtec Ceramics](#)**

**Jerome W. Freeman, Freeman Mary E. Wilkins (Editor), Ronald L. Robinson (Editor)**



[Starting from Here: Dakota Poetry, Pottery, and Caring](#)

**H. P. Mera**

[Style Trends of Pueblo Pottery, 1500-1840](#)

**A. H. Gayton, A. L. Kroeber**

[Uhle Pottery Collections from Nazca](#)

**Marian E. Rodee, James Ostler**

[Zuni Pottery](#)

**Additional book list being compiled.  
In the meantime,**

[Click here to Search for Books about Pottery](#)

**[Search for Books at  
barnesandnoble.com](#)**

Search by:

---

[Return to NativeTech's Main Pottery Menu](#)

---

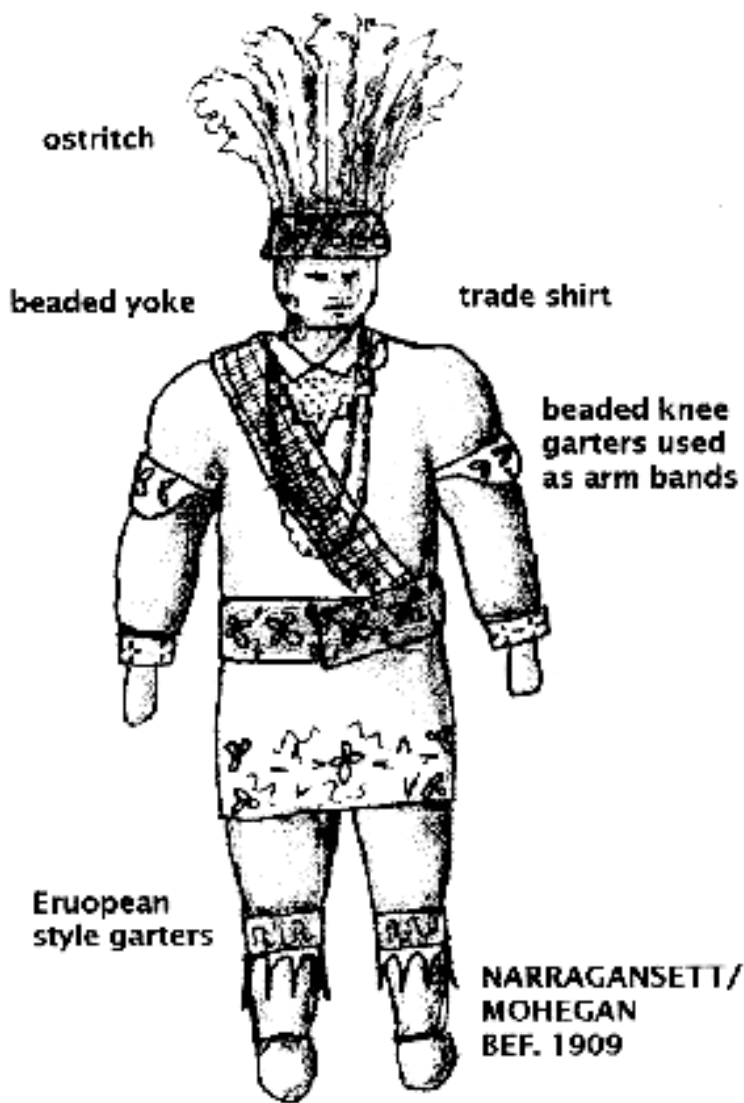


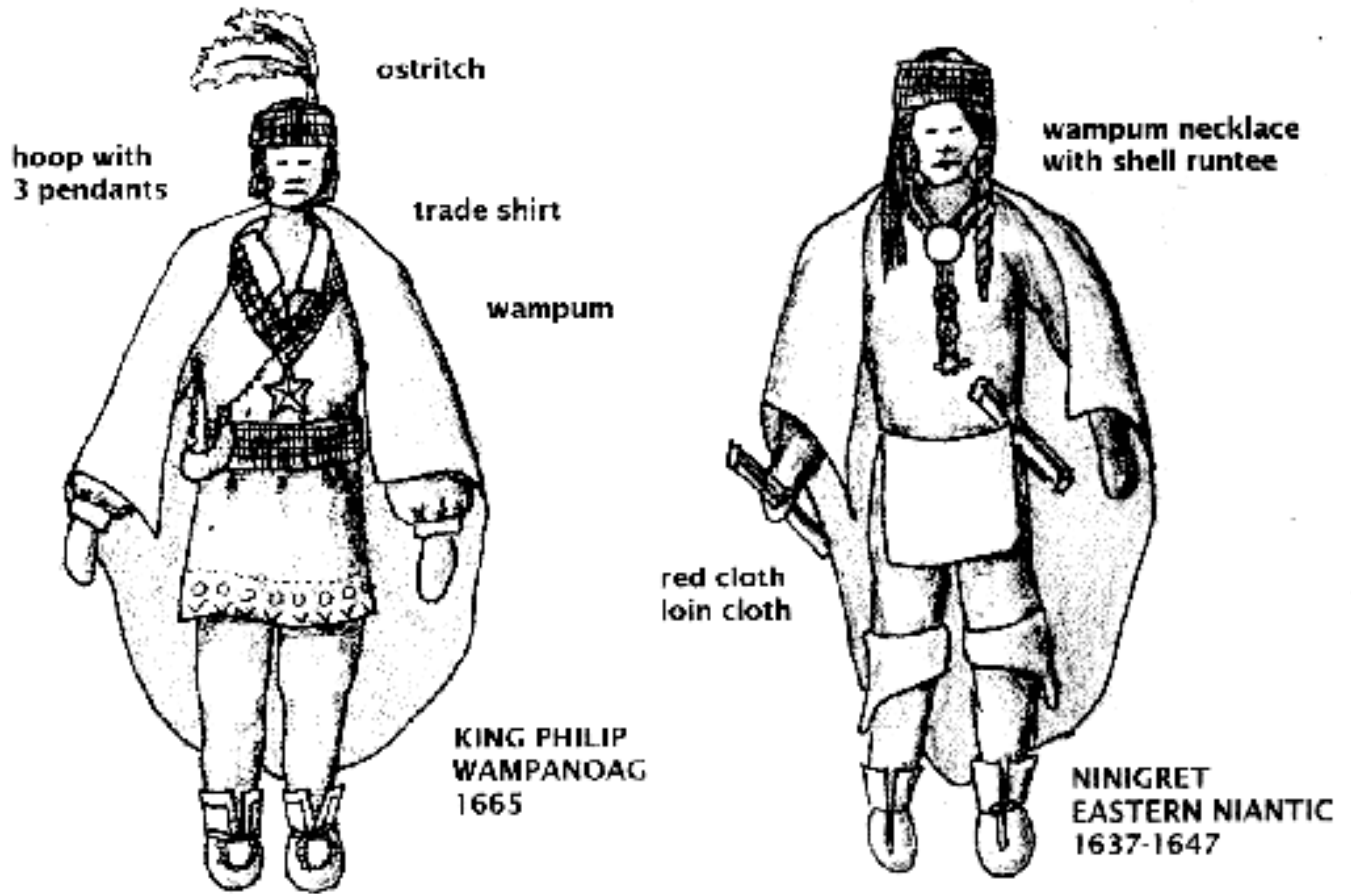
**Text and Graphics  
© 1994 - 103 [Tara Prindle](#)  
unless otherwise cited.**



## Native American Technology and Art REGIONAL OVERVIEW OF NATIVE AMERICAN CLOTHING STYLES

### Northeast Region - Southern New England Tribes





---

[Return to Map and List of Culture Areas with Illustrated Clothing](#)

[Return to NativeTech's Main Leather & Clothes Menu](#)

[Leather & Clothes Bibliography and Books to Buy On-Line](#)

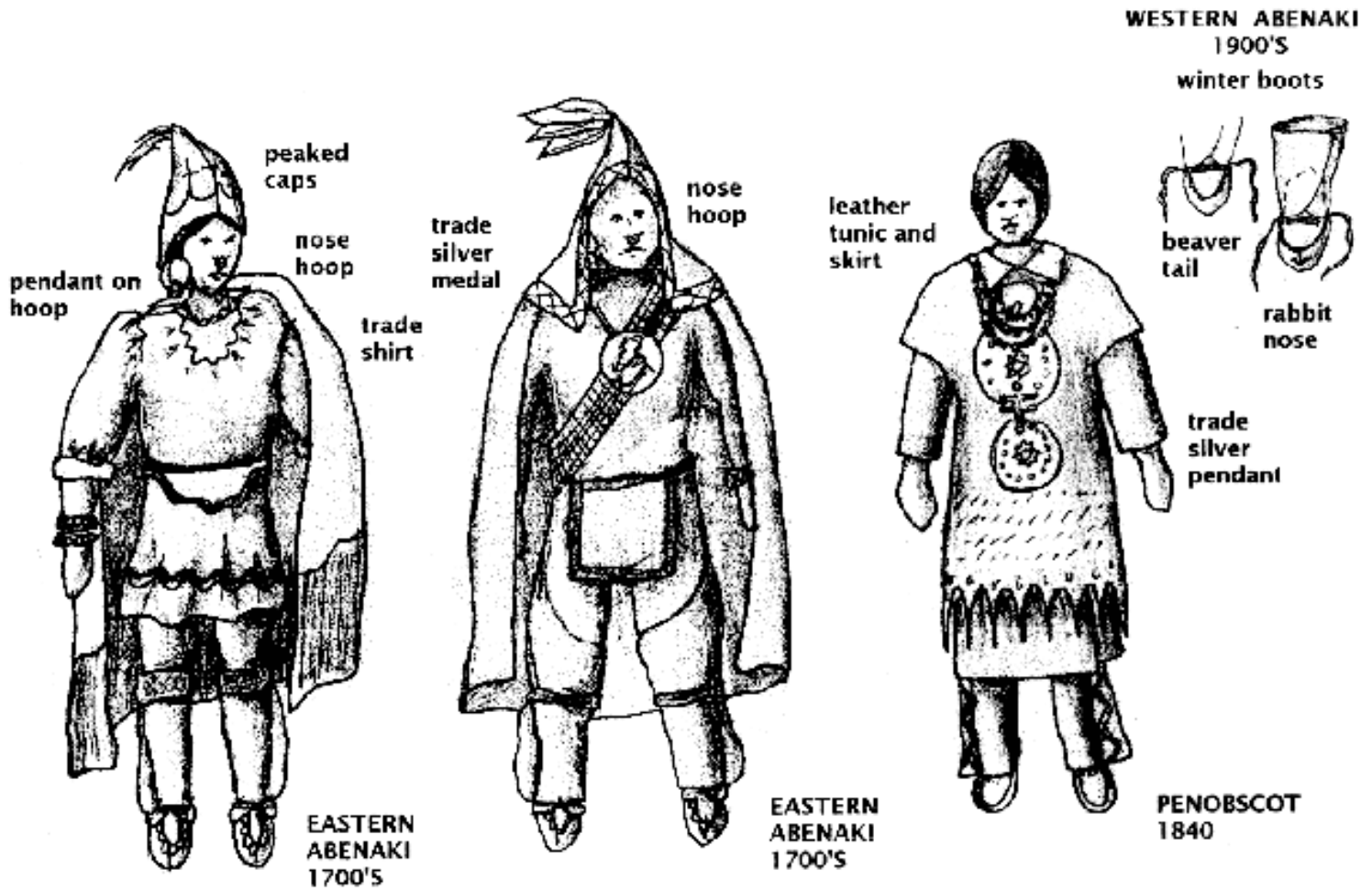
---



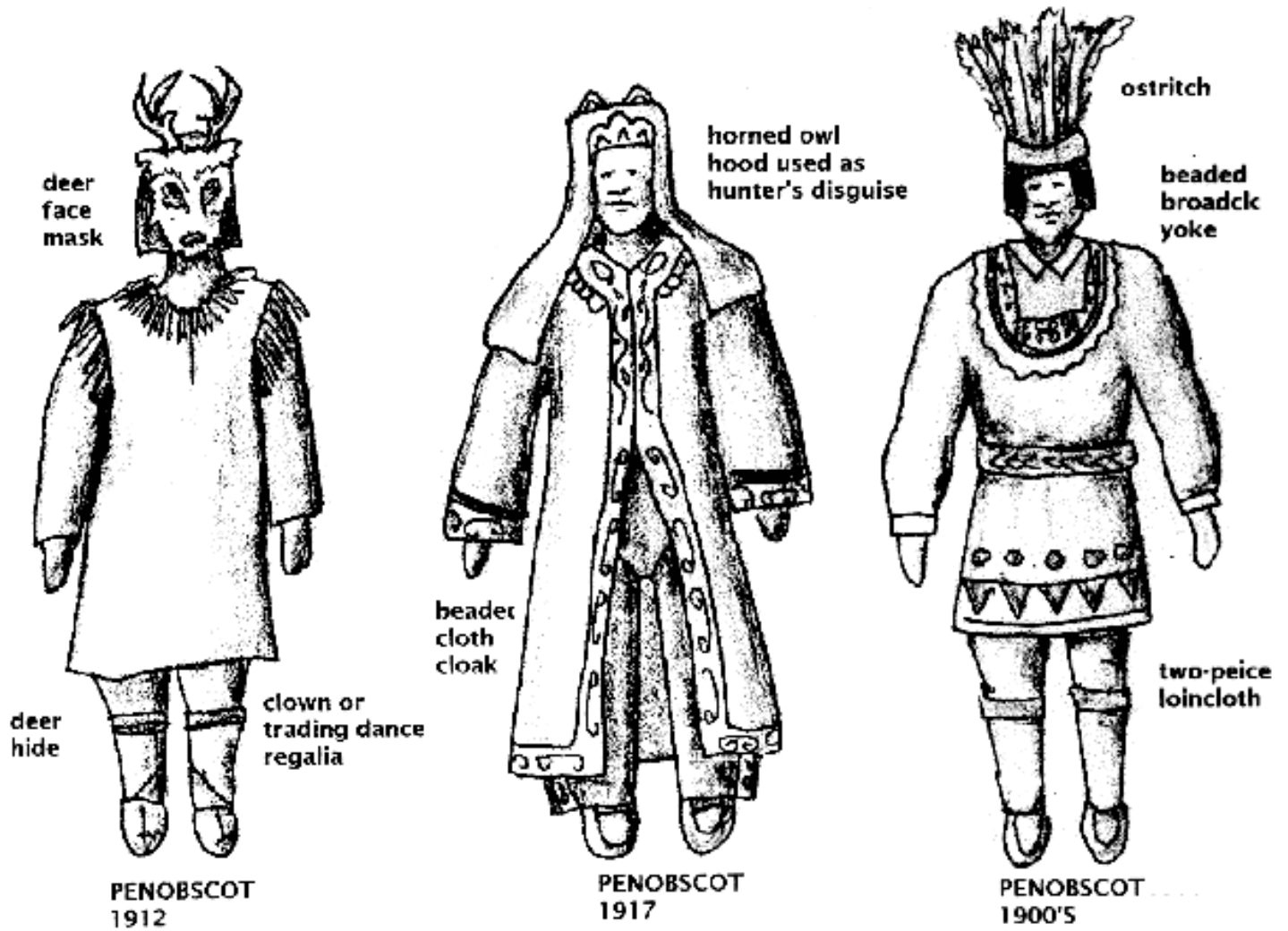
© 1994-1999 [Tara Prindle](#).

# Native American Technology and Art REGIONAL OVERVIEW OF NATIVE AMERICAN CLOTHING STYLES

## Northeast Region - Northern New England Tribes







---

[Return to Map and List of Culture Areas with Illustrated Clothing](#)

[Return to NativeTech's Main Leather & Clothes Menu](#)

[Leather & Clothes Bibliography and Books to Buy On-Line](#)

---

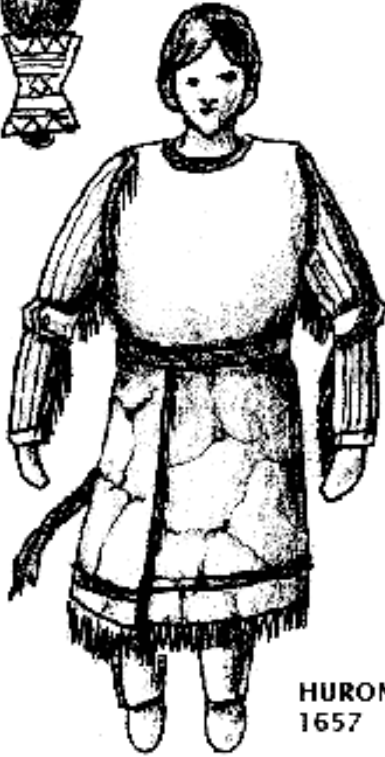


© 1994-1999 [Tara Prindle](#).

# Native American Technology and Art REGIONAL OVERVIEW OF NATIVE AMERICAN CLOTHING STYLES

## Northeast Region - Northern Tribes

back of head



view of man's back



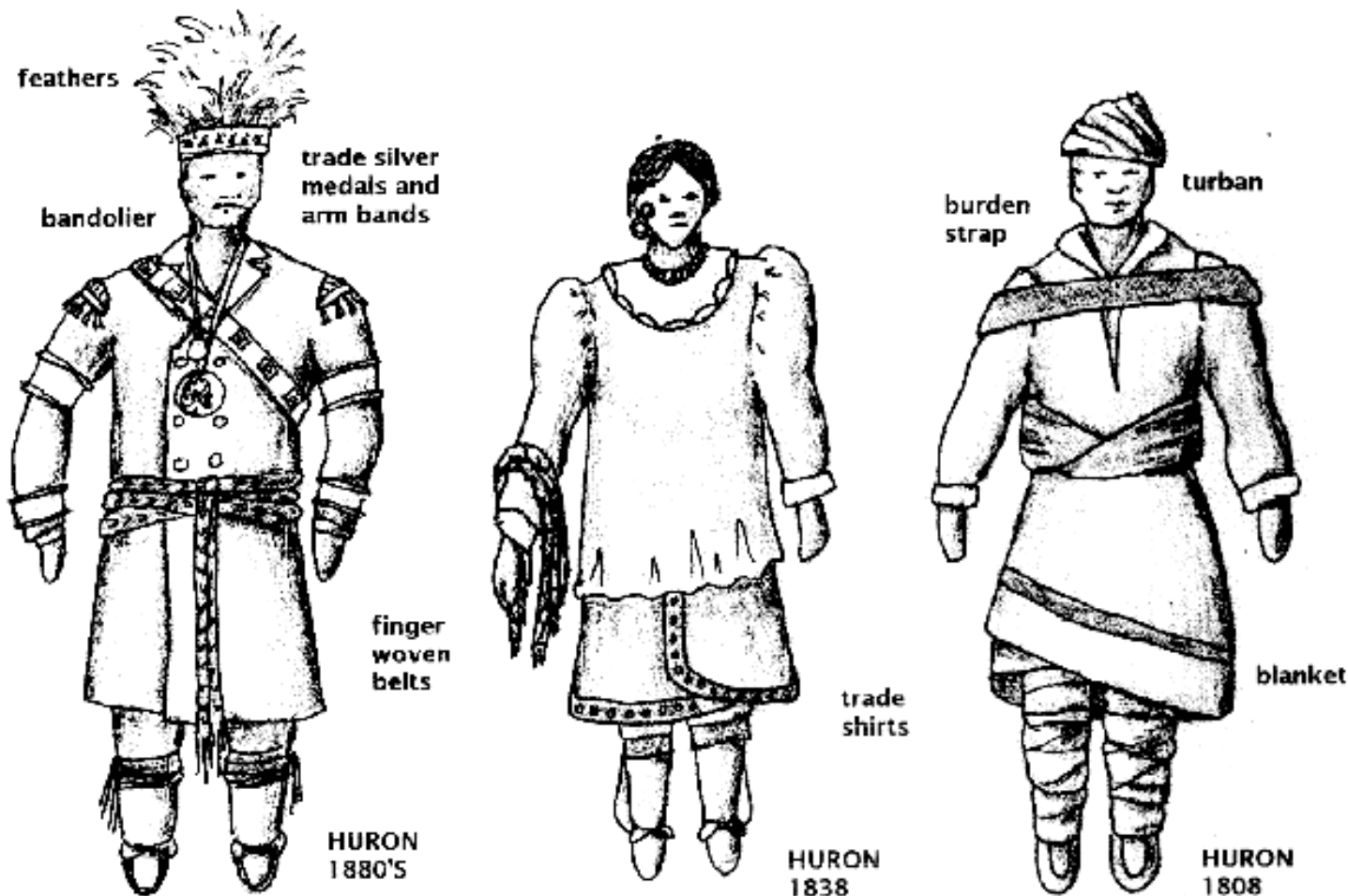
headband

fur

beads



leather skirt



---

[Return to Map and List of Culture Areas with Illustrated Clothing](#)

[Return to NativeTech's Main Leather & Clothes Menu](#)

[Leather & Clothes Bibliography and Books to Buy On-Line](#)

---

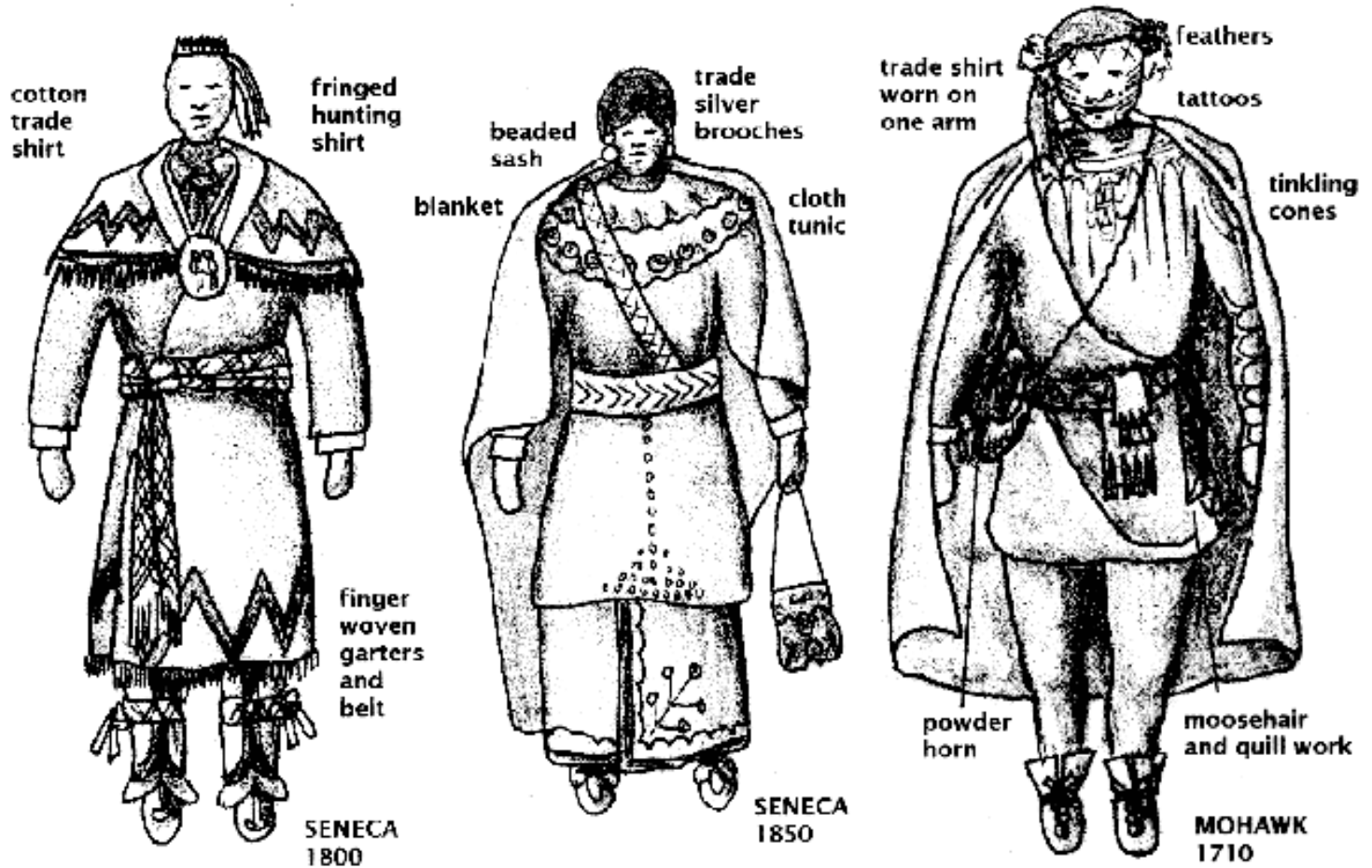


© 1994-1999 [Tara Prindle](#).

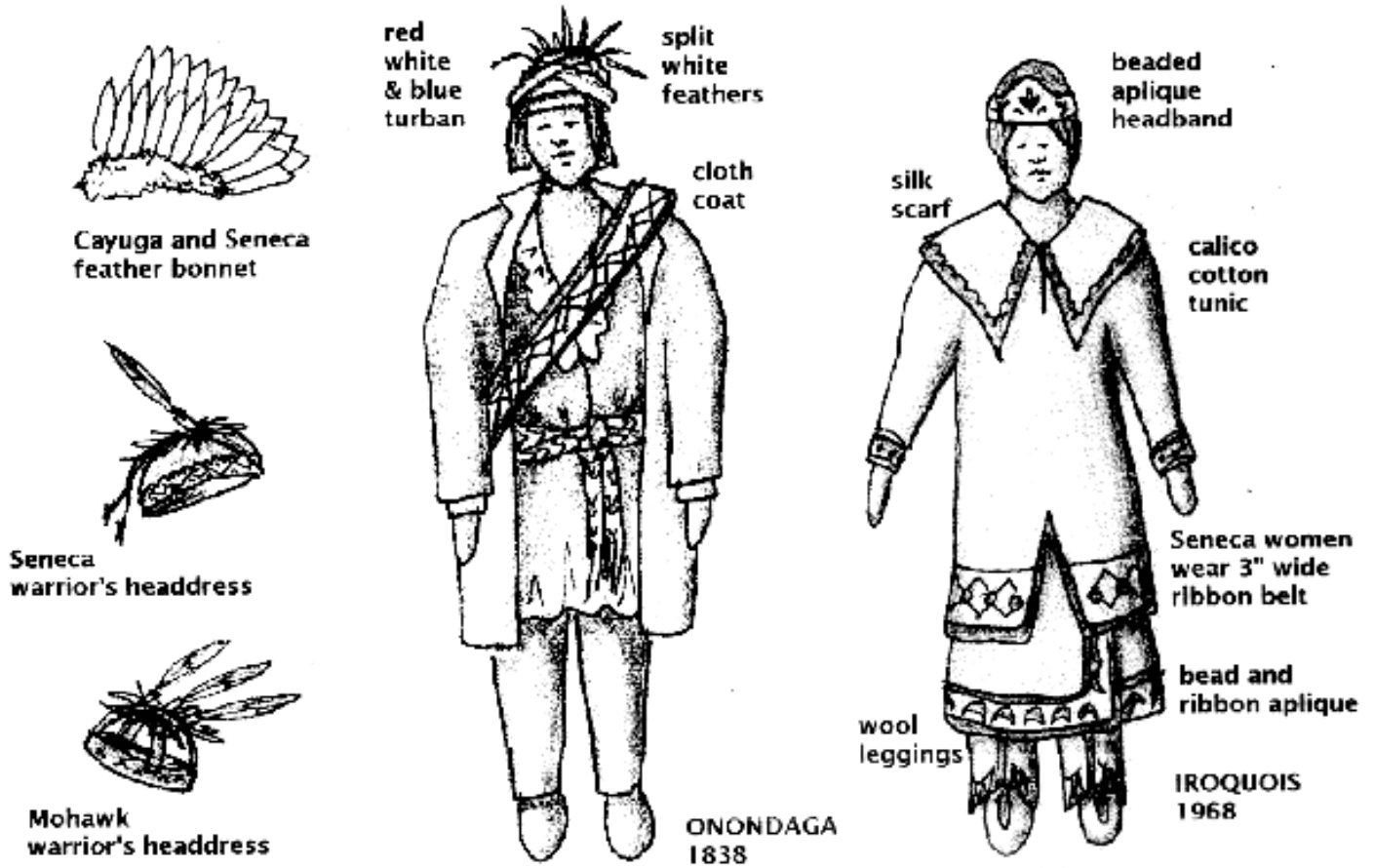


Native American Technology and Art  
REGIONAL OVERVIEW OF NATIVE AMERICAN CLOTHING STYLES

Northeast Region - Iroquois Tribes



Note: During the early to mid 1700's only prominent people (principal men), for the most part, would have had cloth (either obtained in trade or more likely as gifts). The transition to wearing cloth began in the pre-Revolutionary War period (around 1780). Wearing cloth became more common around the year 1812, when by that time leather clothing was only used sparingly ~ my thanks to the Six Nations people who brought to my attention the need to clarify this point.



---

[Return to Map and List of Culture Areas with Illustrated Clothing](#)

[Return to NativeTech's Main Leather & Clothes Menu](#)

[Leather & Clothes Bibliography and Books to Buy On-Line](#)

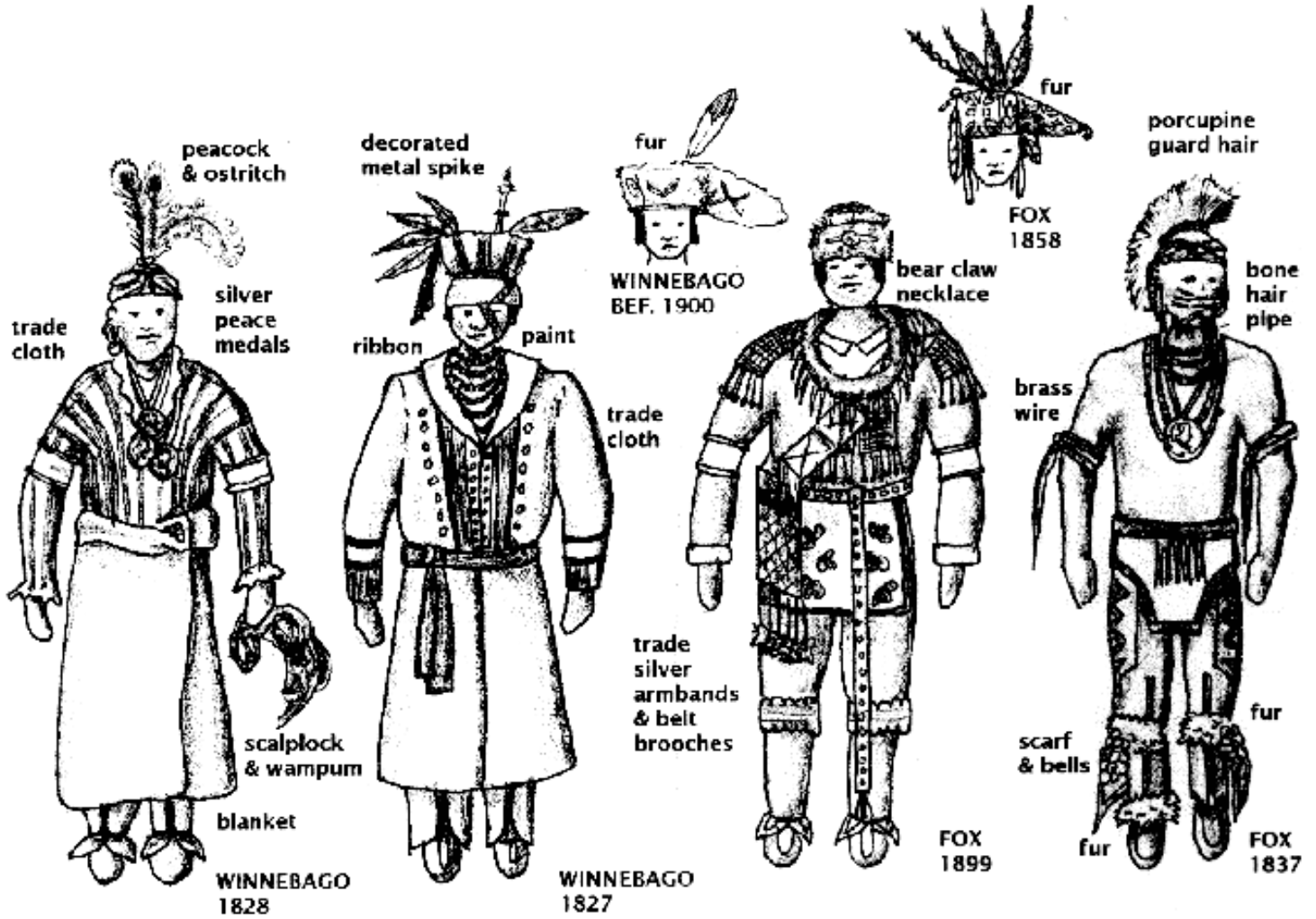
---



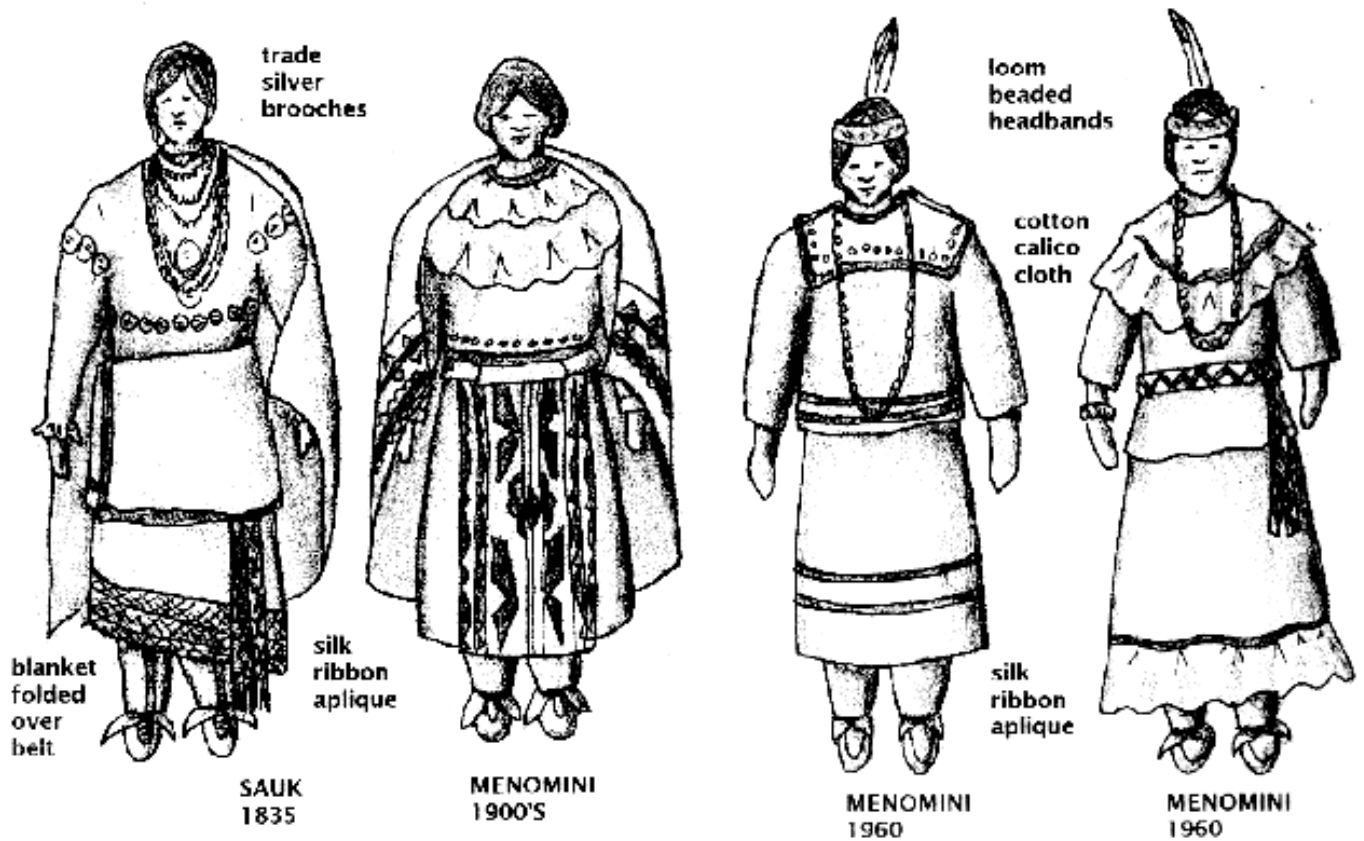
© 1994-1999 [Tara Prindle](#).

Native American Technology and Art  
REGIONAL OVERVIEW OF NATIVE AMERICAN CLOTHING STYLES

Great Lakes Region







---

[Return to Map and List of Culture Areas with Illustrated Clothing](#)

[Return to NativeTech's Main Leather & Clothes Menu](#)

[Leather & Clothes Bibliography and Books to Buy On-Line](#)

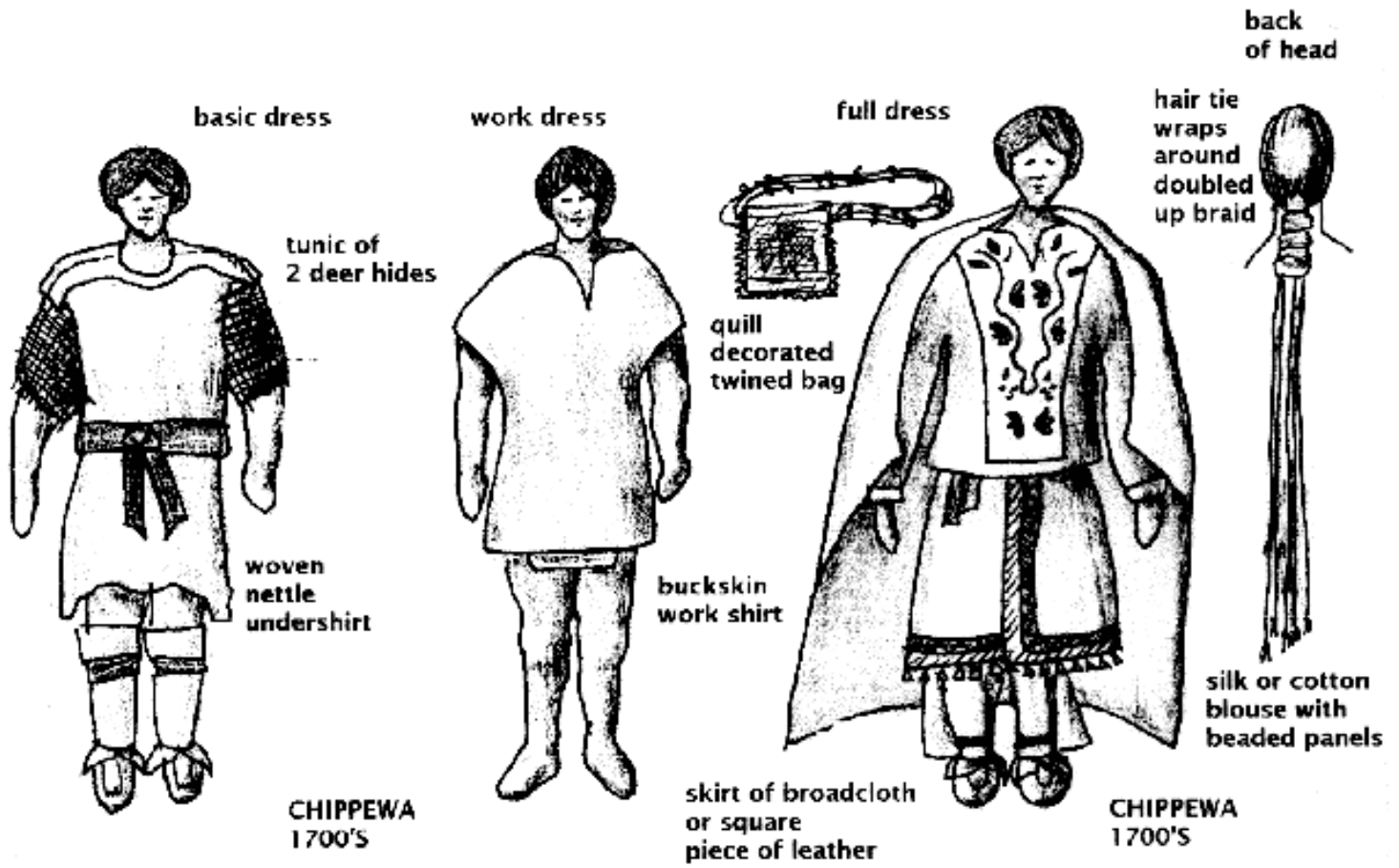
---

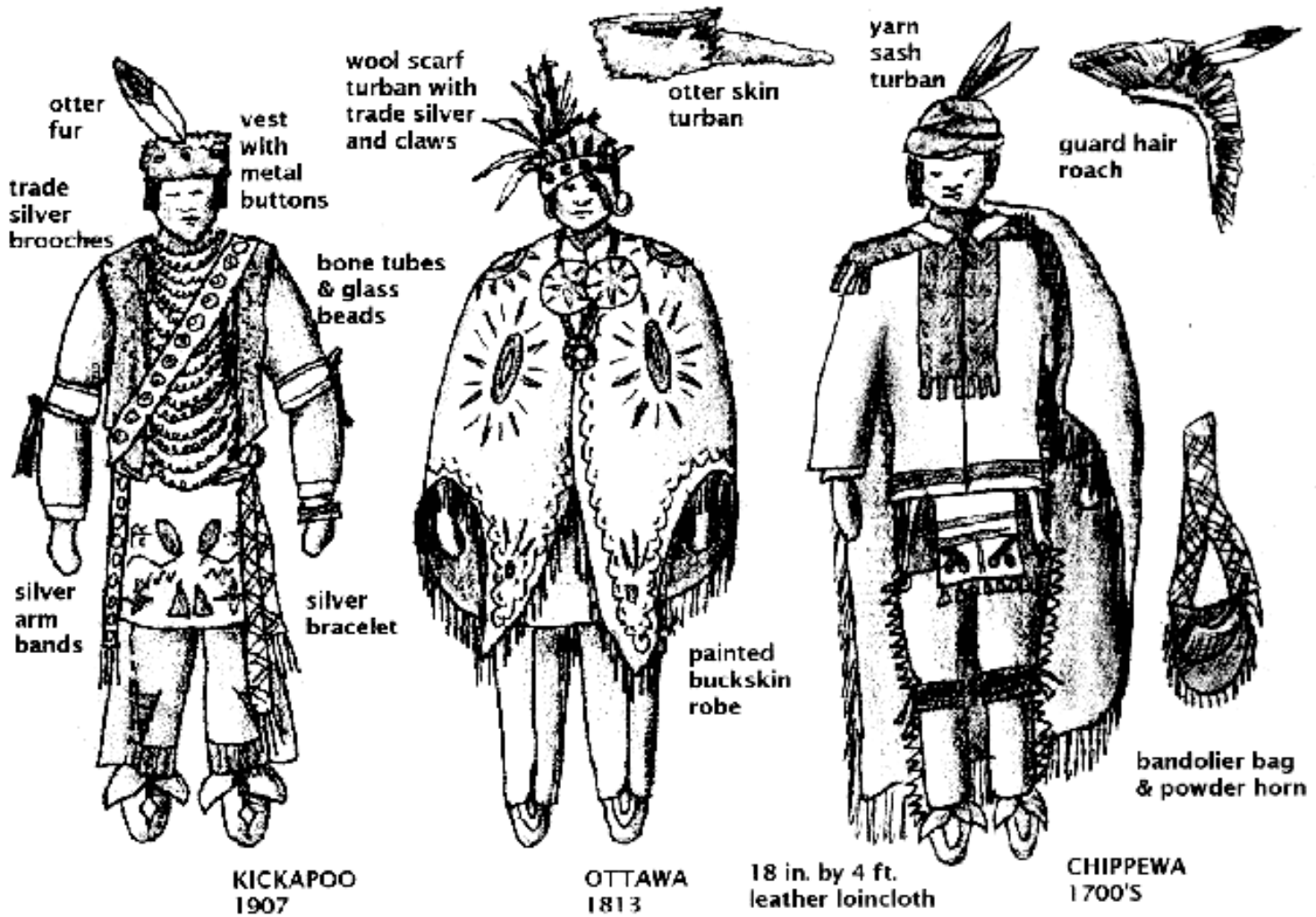


© 1994-1999 [Tara Prindle](#).

Native American Technology and Art  
REGIONAL OVERVIEW OF NATIVE AMERICAN CLOTHING STYLES

Great Lakes Region





---

[Return to Map and List of Culture Areas with Illustrated Clothing](#)

[Return to NativeTech's Main Leather & Clothes Menu](#)

[Leather & Clothes Bibliography and Books to Buy On-Line](#)

---



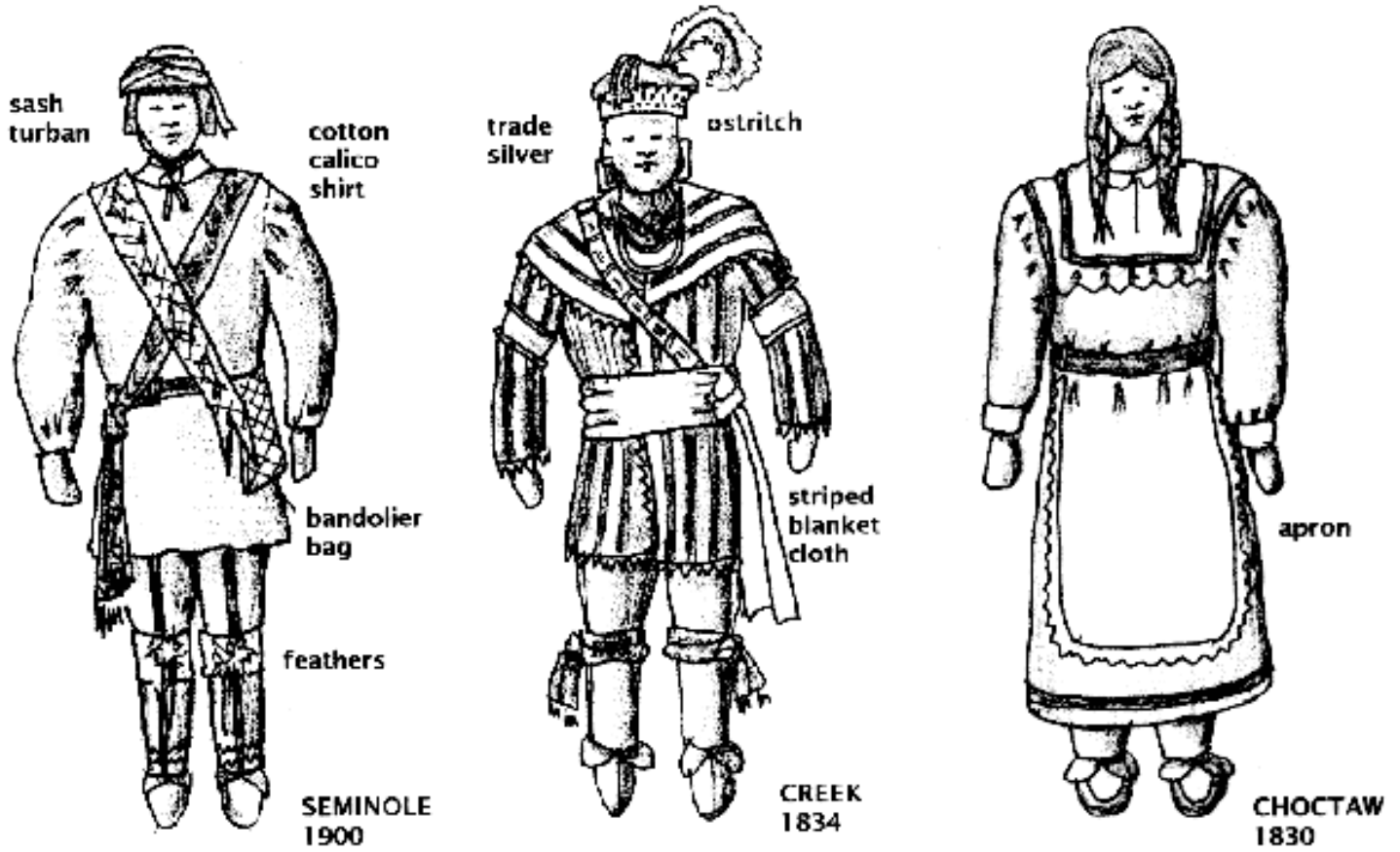
© 1994-1999 [Tara Prindle](#).

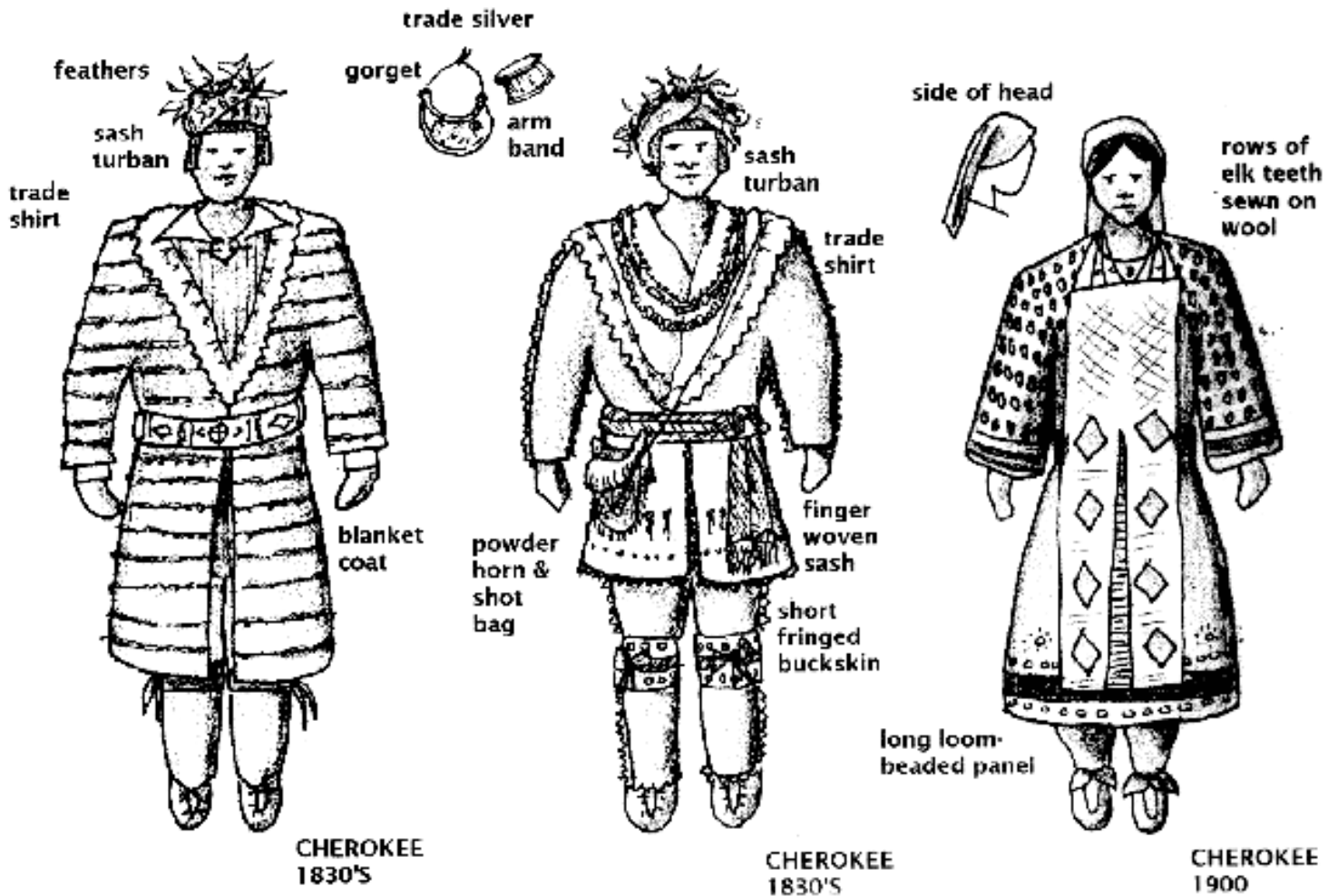


# Native American Technology and Art

## REGIONAL OVERVIEW OF NATIVE AMERICAN CLOTHING STYLES

### Southeast Region





---

[Return to Map and List of Culture Areas with Illustrated Clothing](#)

[Return to NativeTech's Main Leather & Clothes Menu](#)

[Leather & Clothes Bibliography and Books to Buy On-Line](#)

---

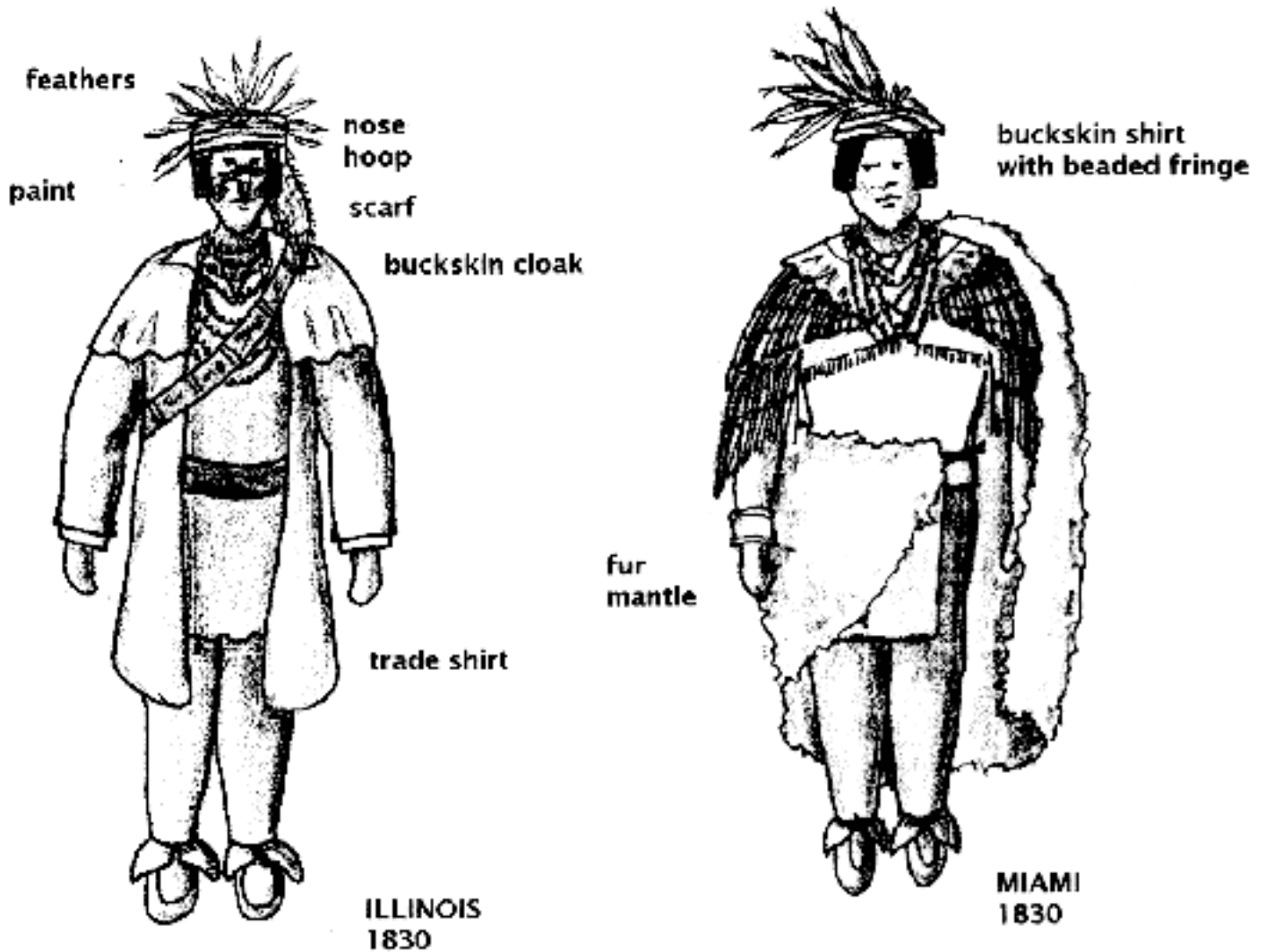


© 1994-1999 [Tara Prindle](#).

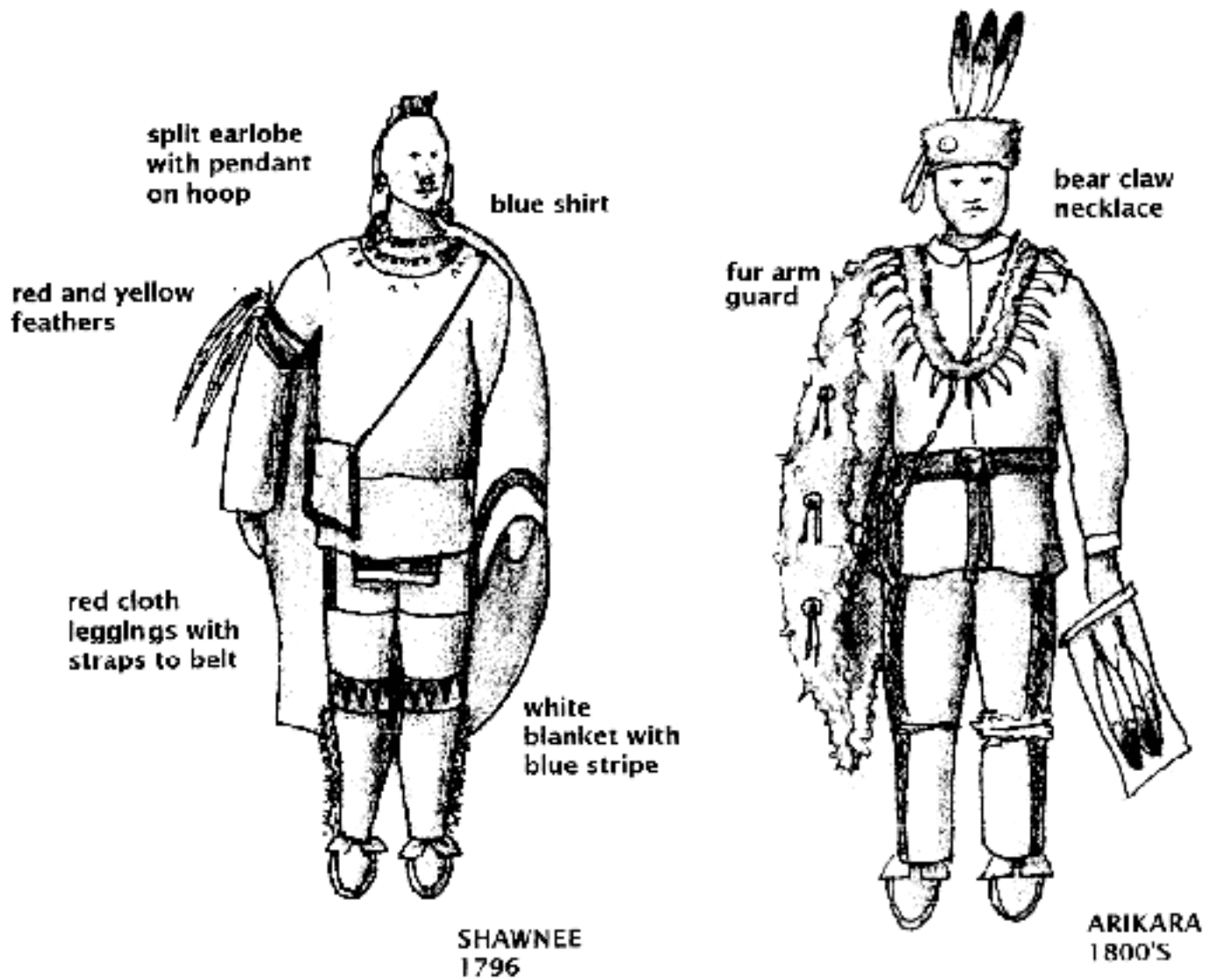
# Native American Technology and Art

## REGIONAL OVERVIEW OF NATIVE AMERICAN CLOTHING STYLES

### Prairie Region







---

[Return to Map and List of Culture Areas with Illustrated Clothing](#)

[Return to NativeTech's Main Leather & Clothes Menu](#)

[Leather & Clothes Bibliography and Books to Buy On-Line](#)

---

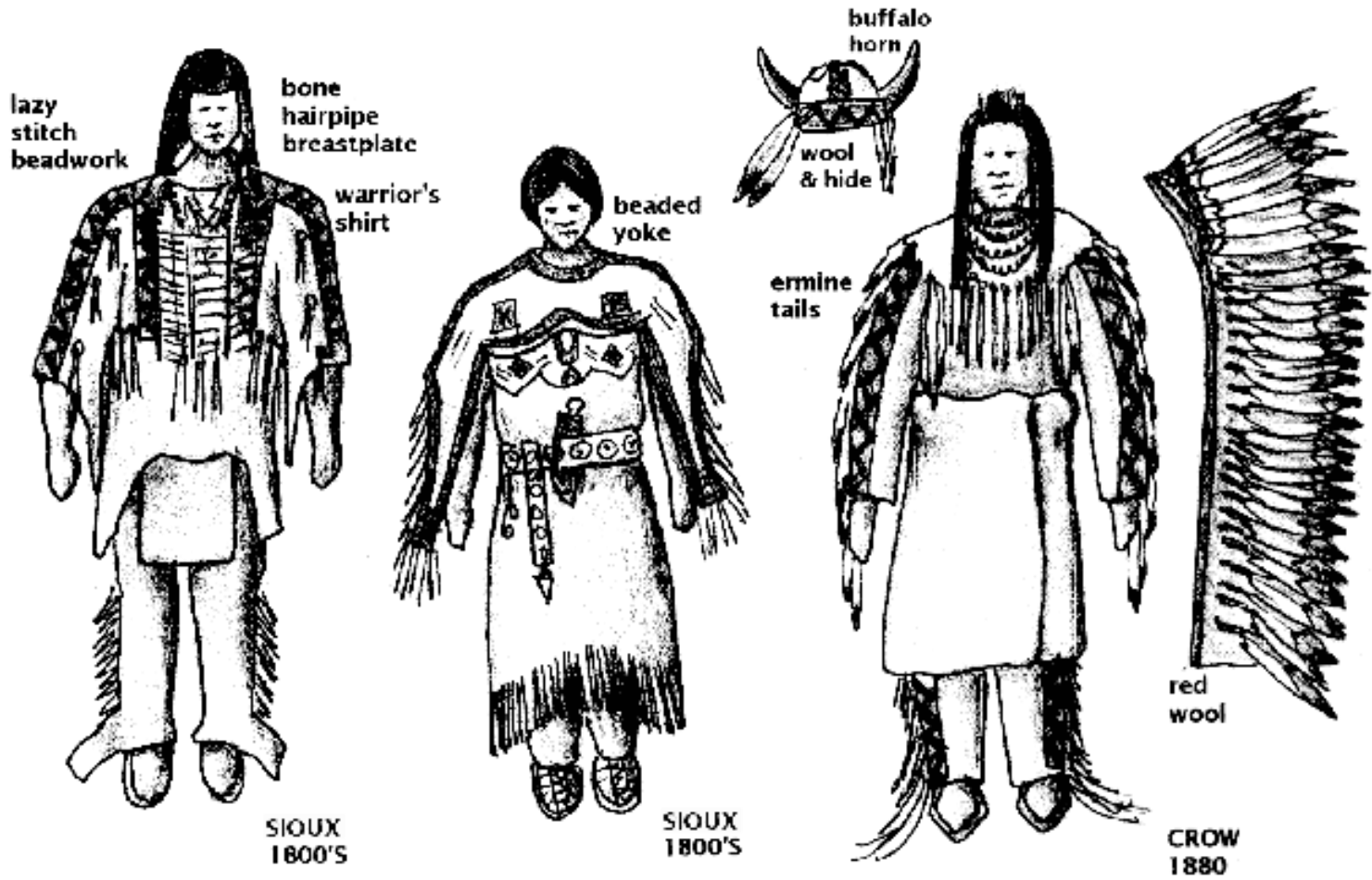


© 1994-1999 [Tara Prindle](#).

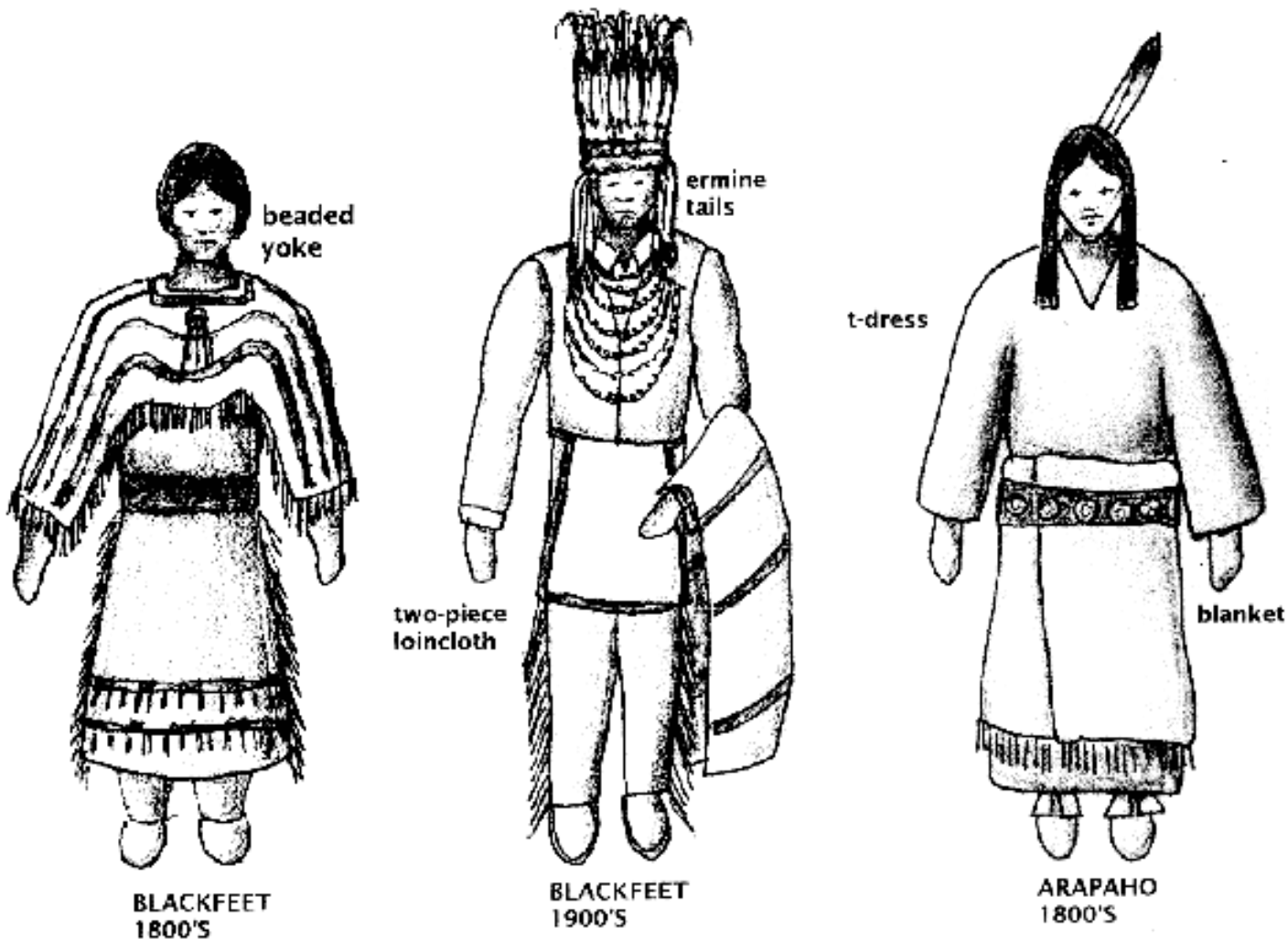
# Native American Technology and Art

## REGIONAL OVERVIEW OF NATIVE AMERICAN CLOTHING STYLES

### Plains Region







---

[Return to Map and List of Culture Areas with Illustrated Clothing](#)

[Return to NativeTech's Main Leather & Clothes Menu](#)

[Leather & Clothes Bibliography and Books to Buy On-Line](#)

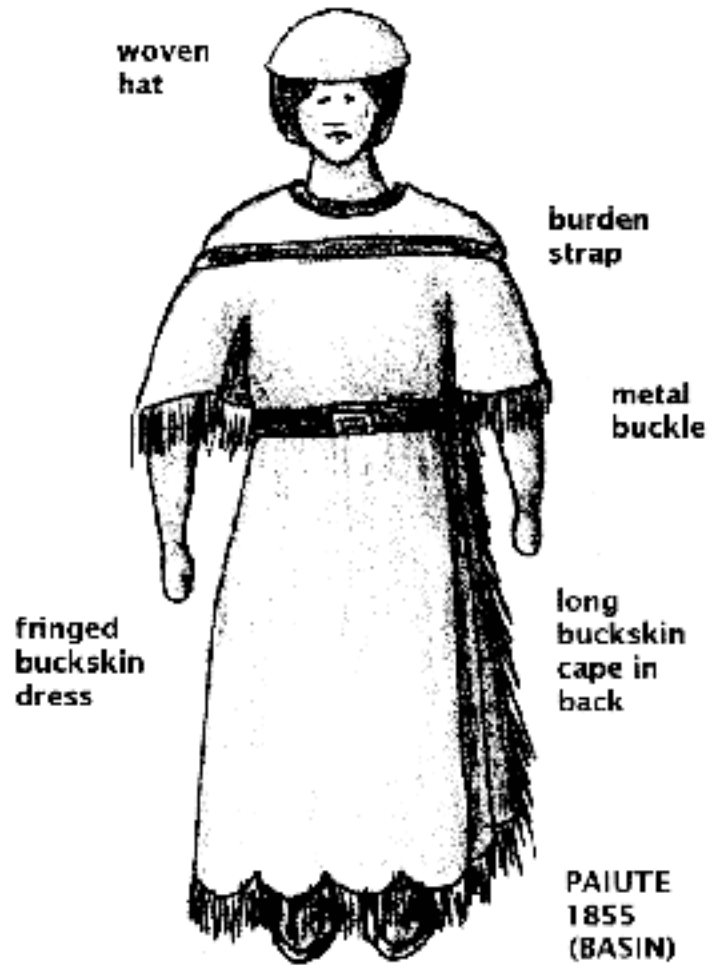
---

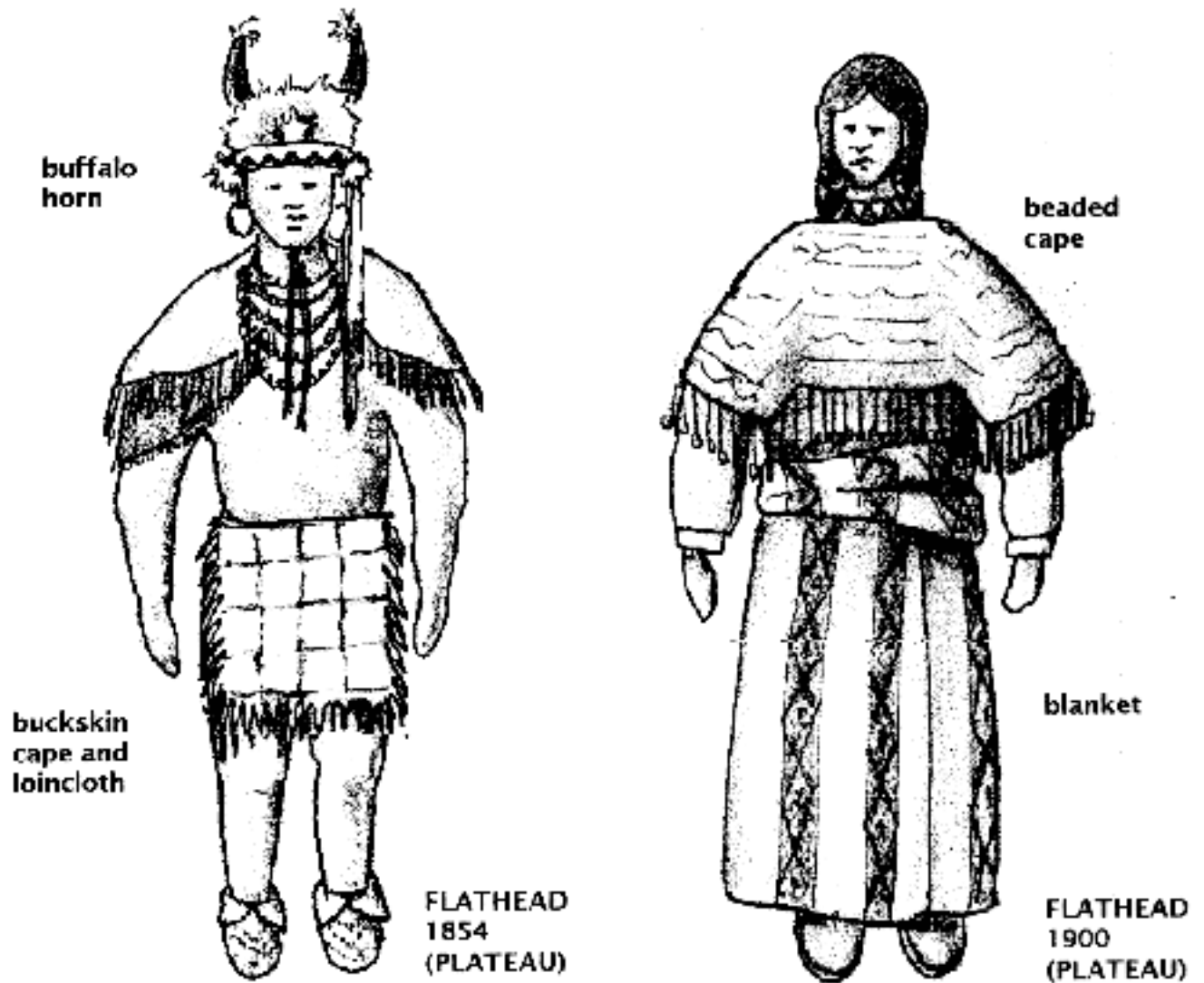


© 1994-1999 [Tara Prindle](#).

## Native American Technology and Art REGIONAL OVERVIEW OF NATIVE AMERICAN CLOTHING STYLES

### Great Basin and Plateau Regions





---

[Return to Map and List of Culture Areas with Illustrated Clothing](#)

[Return to NativeTech's Main Leather & Clothes Menu](#)

[Leather & Clothes Bibliography and Books to Buy On-Line](#)

---





© 1994-1999 [Tara Prindle](#).

Native American Technology and Art  
REGIONAL OVERVIEW OF NATIVE AMERICAN CLOTHING STYLES

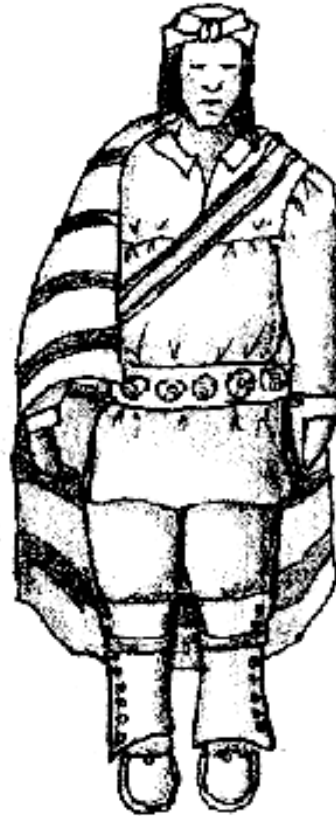
Southwest Region

silver  
squash  
blossom  
necklace



velvet  
dress

NAVAJO  
1900'S

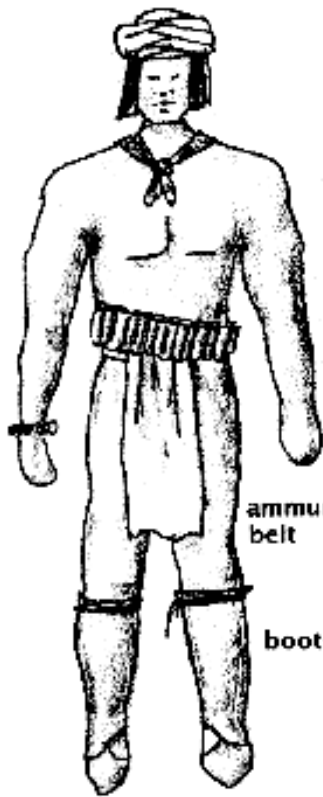


NAVAJO  
1840

unmarried  
butterfly  
style hair



HOP  
1800'S



APACHE  
1872



APACHE  
1800'S



APACHE  
1800'S



APACHE  
1900'S

---

[Return to Map and List of Culture Areas with Illustrated Clothing](#)

[Return to NativeTech's Main Leather & Clothes Menu](#)

[Leather & Clothes Bibliography and Books to Buy On-Line](#)

---



© 1994-1999 [Tara Prindle](#).



**Native American Technology and Art**  
**REGIONAL OVERVIEW OF NATIVE AMERICAN CLOTHING STYLES**

**California, Northwest Coast and Sub-Arctic Regions**



**TSIMSHIAN**  
**1927**  
**(NORTHWEST COAST)**

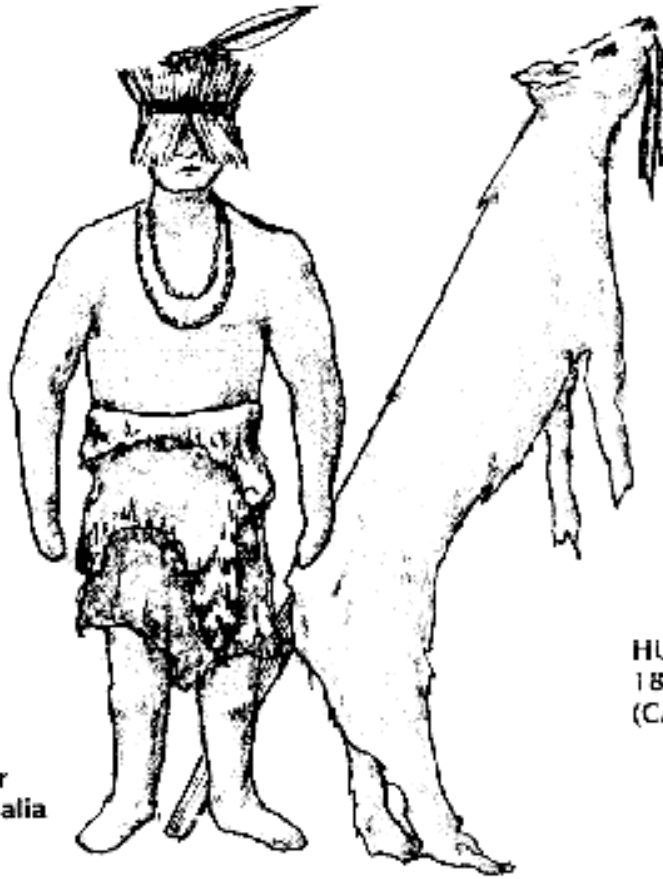
leather jumper  
& detachable  
sleeves



**CREE**  
**1700'S**  
**(EASTERN SUBARCTIC)**



**KUTCHIN**  
**1846**  
**(YUKON SUBARCTIC)**



white deer  
dance regalia

HUPA  
1800'S  
(CALIFORNIA)



abalone  
shells

---

[Return to Map and List of Culture Areas with Illustrated Clothing](#)

[Return to NativeTech's Main Leather & Clothes Menu](#)

[Leather & Clothes Bibliography and Books to Buy On-Line](#)

---



© 1994-1999 [Tara Prindle](#).

## Native American Technology and Art

### Native American Varieties of Moccasins - Arapaho

---



Circa 1890

*Arapaho Ghost Dance moccasins painted green.*

© [Morning Star Gallery](#)





Circa 1880

*Arapaho high-top boots with a green background.*

© [Morning Star Gallery](#)

---

[Return to Map of Native American Moccasins](#)

[Return to Overview of Native American Footwear ~ Moccasins](#)

[Return to NativeTech's Main Leather & Clothes Menu](#)

[Leather & Clothes Bibliography and Books to Buy On-Line](#)

---



© 1994-1999 [Tara Prindle](#).



## Native American Technology and Art

### Native American Varieties of Moccasins - Blackfeet

---



Circa 1890

*Blackfeet moccasins with one piece side seam against a blue background.*

© [Morning Star Gallery](#)

---

[Return to Map of Native American Moccasins](#)

[Return to Overview of Native American Footwear ~ Moccasins](#)

[Return to NativeTech's Main Leather & Clothes Menu](#)

[Leather & Clothes Bibliography and Books to Buy On-Line](#)

---





© 1994-1999 [Tara Prindle](#).

## Native American Technology and Art

### Native American Varieties of Moccasins - Cheyenne

---



Circa 1890

*Cheyenne moccasins with Thunderbird motif on vamp.*

© [Morning Star Gallery](#)





Circa 1870

*Cheyenne beaded moccasins with a white background.*

© [Morning Star Gallery](#)



Circa 1890



*Cheyenne moccasins fully beaded with Thunderbird motif on vamps.*

© [Morning Star Gallery](#)



Circa 1880

*Cheyenne partly beaded moccasins with maltese crosses.*

© [Morning Star Gallery](#)



Circa 1875

*Cheyenne moccasins with buffalo hide uppers and rawhide soles.*

© [Morning Star Gallery](#)

---

[Return to Map of Native American Moccasins](#)

[Return to Overview of Native American Footwear ~ Moccasins](#)

[Return to NativeTech's Main Leather & Clothes Menu](#)

[Leather & Clothes Bibliography and Books to Buy On-Line](#)

---



© 1994-1999 [Tara Prindle](#).



## Native American Technology and Art

### Native American Varieties of Moccasins - Chippewa

---



Circa 1890

*Chippewa moccasins with one piece front seam, beaded vamp inserts and cuffs.*

© [Morning Star Gallery](#)

---

[Return to Map of Native American Moccasins](#)

[Return to Overview of Native American Footwear ~ Moccasins](#)

[Return to NativeTech's Main Leather & Clothes Menu](#)

[Leather & Clothes Bibliography and Books to Buy On-Line](#)

---



© 1994-1999 [Tara Prindle](#).



## Native American Technology and Art

### Native American Varieties of Moccasins - Comanche

---



Circa ??

*Comanche boots, silver buttons, beadwork detail, and stained.*

© [Morning Star Gallery](#)

*Apologies -- when editing this file, I accidentally deleted the information on the original date and description provided by Morningstar Gallery*

---

[Return to Map of Native American Moccasins](#)



[Return to Overview of Native American Footwear ~ Moccasins](#)

[Return to NativeTech's Main Leather & Clothes Menu](#)

[Leather & Clothes Bibliography and Books to Buy On-Line](#)

---



© 1994-1999 [Tara Prindle.](#)

## Native American Technology and Art

### Native American Varieties of Moccasins - Cree

---



Circa 1880

*Cree moccasins with abstract floral designs against white background.*

© [Morning Star Gallery](#)

---

[Return to Map of Native American Moccasins](#)

[Return to Overview of Native American Footwear ~ Moccasins](#)

[Return to NativeTech's Main Leather & Clothes Menu](#)

[Leather & Clothes Bibliography and Books to Buy On-Line](#)

---



© 1994-1999 [Tara Prindle](#).



## Native American Technology and Art

### Native American Varieties of Moccasins - Crow

---



Circa 1880

*Crow beaded moccasins with key hole design.*

© [Morning Star Gallery](#)

---

[Return to Map of Native American Moccasins](#)

[Return to Overview of Native American Footwear ~ Moccasins](#)

[Return to NativeTech's Main Leather & Clothes Menu](#)

[Leather & Clothes Bibliography and Books to Buy On-Line](#)

---



© 1994-1999 [Tara Prindle](#).



## Native American Technology and Art

### Native American Varieties of Moccasins - Flathead

---



Circa 1870

*Flathead moccasins with blue and yellow arrows and high cuffs.*

© [Morning Star Gallery](#)

---

[Return to Map of Native American Moccasins](#)

[Return to Overview of Native American Footwear ~ Moccasins](#)

[Return to NativeTech's Main Leather & Clothes Menu](#)

[Leather & Clothes Bibliography and Books to Buy On-Line](#)

---





© 1994-1999 [Tara Prindle](#).

## Native American Technology and Art

### Native American Varieties of Moccasins - Kiowa

---



Circa 1890

*Kiowa beaded moccasins with heel fringe, vamp fringe and ochre split tongues.*

© [Morning Star Gallery](http://www.morningstargallery.com)





Circa 1890

*Kiowa moccasins partially beaded on vamps and side flaps with tin cones.*

© [Morning Star Gallery](#)

---

[Return to Map of Native American Moccasins](#)

[Return to Overview of Native American Footwear ~ Moccasins](#)

[Return to NativeTech's Main Leather & Clothes Menu](#)

[Leather & Clothes Bibliography and Books to Buy On-Line](#)

---





© 1994-1999 [Tara Prindle](#).

## Native American Technology and Art

### Native American Varieties of Moccasins - Lenape

---



Paul A.W. Wallace

Modern Lenape (Delaware) moccasins. From the book *Indian Paths of Pennsylvania*, by Paul A. W. Wallace, Pennsylvania Historical and Museum Commission, Harrisburg, 1987.

This image & description has been generously provided by Jim Rementer of [Touching Leaves](http://www.touchingleaves.com)





Lenape, quilled toe and heel seam, ribbonwork cuffs, possibly done by ancestors of the Lenape who now live at Moraviantown, Ontario. Mocs. in Moravian Archives in Bethlehem, PA. This image & description has been generously provided by Jim Rementer of [Touching Leaves](#)





Lenape, quilled toe and cuff. Cuffs also decorated with tin cones and red dyed deer hair. Nat. Mus. of Amer. Ind. (NMAI) no. 3/6411.

This image & description has been generously provided by Jim Rementer of [Touching Leaves](#)



Lenape moccasins, quilled. NMAI no. 19/630.

This image & description has been generously provided by Jim Rementer of [Touching Leaves](#)





Lenape, especially nice with quilled toe and heel. Ribbon edge on cuff, cuff decorated with white beads. Documentation shows that these were collected from the family of Black Beaver, but probably go back many years before his time. Private collection.

This image & description has been generously provided by Jim Rementer of [Touching Leaves](http://www.touchingleaves.com)





A picture of my late aunt Nora Thompson Dean (Touching Leaves Woman) who founded Touching Leaves Indian Crafts. She is cleaning some Indian potatoes in her Lenape deerhide clothing. She realized of course that the Lenape women like most Indian women usually went with no upper body covering, but it became necessary to cover up so as not to "offend" the whites. Nora had a sarcastic remark about that subject one time. She said, "When the Europeans arrived and found the Lenape women dressed comfortably in just wrap-around skirts they called them 'naked savages.' Now, some three hundred years later I have been to what use to be our beaches and found the white women in string bikinis, some even stretched out topless. Are they now the naked savages?"

This image & description has been generously provided by Jim Rementer of [Touching Leaves](#)

---

[Return to Map of Native American Moccasins](#)

[Return to Overview of Native American Footwear ~ Moccasins](#)

[Return to NativeTech's Main Leather & Clothes Menu](#)

[Leather & Clothes Bibliography and Books to Buy On-Line](#)





© 1994-1999 [Tara Prindle](#).

## Native American Technology and Art

### Native American Varieties of Moccasins - Sioux

---



Circa 1885

*Sioux moccasins with beaded soles in navy blue and white.*

© [Morning Star Gallery](http://www.morningstar-gallery.com)





Circa 1880

*Sioux moccasins with beaded soles, split tongues and tincones.*

© [Morning Star Gallery](#)



Circa 1885

*Sioux moccasins in cowhide with yellow and red design.*



© [Morning Star Gallery](#)



Circa 1880

*Sioux fully beaded moccasins with both pony trader blue and greasy yellow beads.*

© [Morning Star Gallery](#)



Circa 1880

*Sioux moccasins with checkerboard pattern in blue and red.*

© [Morning Star Gallery](#)



Circa 1890



*Sioux moccasins with red quilled central cross stripes on vamps.*

© [Morning Star Gallery](#)



Circa 1890

*Sioux moccasins with split tongues and geometric designs against a white background.*

© [Morning Star Gallery](#)





Circa 1875

*Sioux buffalo hide moccasins with a blue background.*

© [Morning Star Gallery](#)



Circa 1880

*Sioux moccasins with a single tongue against a green background.*

© [Morning Star Gallery](#)



Circa 1880

*Sioux moccasins with beaded soles against a white background.*

© [Morning Star Gallery](#)





Circa 1880

*Sioux moccasins with split tongues and beaded soles against a white background.*

© [Morning Star Gallery](#)



Circa 1890



*Sioux moccasins partly quilled with maltese cross design.*

© [Morning Star Gallery](#)

---

[Return to Map of Native American Moccasins](#)

[Return to Overview of Native American Footwear ~ Moccasins](#)

[Return to NativeTech's Main Leather & Clothes Menu](#)

[Leather & Clothes Bibliography and Books to Buy On-Line](#)

---



© 1994-1999 [Tara Prindle](#).

## NativeTech: Native American Technology and Art



## NATIVE AMERICAN CLOTHING

### Mittens and Gloves

*Heavy Weight Elk Hide Chopper Mittens that I made with a separate rabbit fur lining attached with beaded edging at the cuff (Prindle 1997).*

---

[See Some Examples of Native American Mittens & Gloves](#)

[See How to make Chopper Mittens](#)

[Here is the Chopper Mitten Pattern For Child](#)

[Here is the Chopper Mitten Pattern For Adult](#)

---

A very useful source in learning about chopper mittens (and other Native handiwork) is: *Crafts of the North American Indians; A Craftsman's Manual*. (pg.s 95-104). Written, illustrated & published in 1972 by Richard C. Schneider, 312 Linewood Ave., Stevens Point, Wisconsin 54481 ISBN: 0-936984-00-7.

---

There are few references for Native American mittens before the 1800's. However, a few early historic sources indicate that in extreme the climates it was necessary to protect hands and arms against the cold. During the winters in southern New England, mittens or gloves were worn by Native Americans for fortification against the weather. In 1672, John Josselyn (1972) mentions the hide of the Soile (seal) or Sea Calf,

*"The Hair upon the young ones is white, and as Yoft as Yilk; their Skins, with the Hair on, are good to make Gloves for the Winter."*

Between 1638 and 1663, Josselyn (in Lindholdt 1988) also remarked on gloves made from



**otter fur being the best protection for the hands in wet weather.**

**As there is scant evidence that mittens and gloves were commonplace, it is likely that men and women kept their hands tucked into their clothing, perhaps covered up by arm protectors which have been mentioned in other early historic documents from the northeast.**



**Heavy Weight Elk Hide gauntlet gloves that I made with fringed cuffs (Prindle1988).**

**Some furs, especially that of wild cat (perhaps bobcat, puma or eastern mountain lion) were worn as arm guards to protect against wind and cold, while traveling or hunting. In 1634, William Wood (1865) observed that in winter Native American men wore these cat-fur arm protectors:**

**"Moÿt of them in the Winter having his deepe furr'd Cat skinne, like a long large muÿÿe, which hee ÿhifts to that arme which lieth moÿt expoÿed to the winde; thus clad, hee buÿles better through a world of cold in a froÿt-paved wilderneÿÿe, than the furred Citizen in his warmer Stoave."**

**In 1524 Verrazzano saw women wearing embroidered deer skin mantles, while some women also wore "rich lynx skins on their arms" (in Wroth 1970). In 1622 Mourt (in Heath 1986), noted that only the Native American leader of a group of men had a fur arm guard: "they had every man a deer's skin on him and the principal of them had a wild cat's skin, or such like on the one arm", which may reflect the man's unique status.**

**There are many references to and examples of mittens and gloves made by Native Americans during the 1800's, a tradition which is continued today with several styles of 'chopper mittens' (Schneider 1972), as well as gauntlet gloves which were popularized in the 1800's by the U.S. calvery.**

---

**[Return to NativeTech's Main Leather & Clothes Menu](#)**

**[Leather & Clothes Bibliography and Books to Buy On-Line](#)**

---





© 1994-1999 [Tara Prindle](#).

## NativeTech: Native American Technology and Art



*Elk Hide Chopper Mittens  
(Prindle 1997).*

## NATIVE AMERICAN CLOTHING

### Instructions for Chopper Mittens

---

A very useful source in learning about chopper mittens (and other Native handiwork) is: *Crafts of the North American Indians; A Craftsman's Manual*. (pg.s 95-104). Written, illustrated & published in 1972 by Richard C. Schneider, 312 Linewood Ave., Stevens Point, Wisconsin 54481 ISBN: 0-936984-00-7.

---

**Simple chopper mittens are not too difficult to make for someone who has a little experience in sewing with leather. The most involved part is sewing the thumb-piece to the rest of the mitt. For sturdy chopper mittens, I prefer to use a heavy elk or moose hide in a 4-6 ounce weight (leather weight is measured by how much it weighs per square foot). If the mittens are to be worn for work, they should afford both protection for the hands and durability**

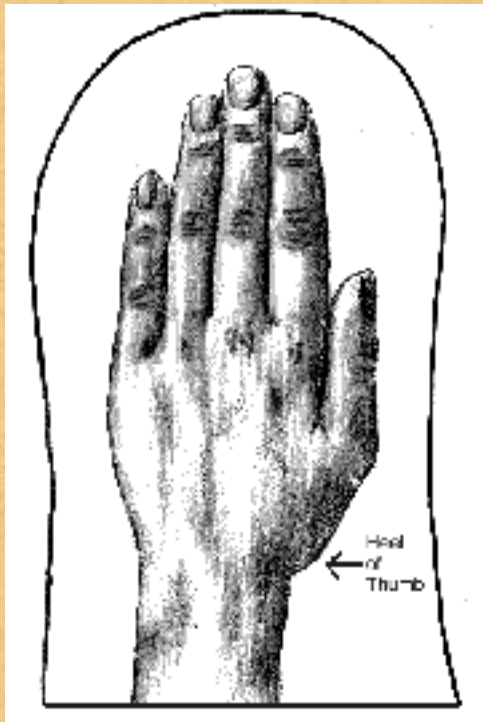




Ojibwe chopper mittens (Grand Rapids Public Museum & the Cranbrook Academy of Art/Museum (1981).

so they will last. However, lighter weight leather or deer hide can be used if your purpose is make mittens that are for special dress, and not for chopping wood. The mittens pictured to the left are Ojibwe made, from the Chandler-Pohrt Collection. These mittens are made of deerskin and wool cloth with military braid binding. The elaborate sewn beadwork is done in a traditional eastern woodlands floral pattern.

## *Measuring the Pattern:*



Measuring the mitten (trunk) pattern

The basic pattern for the trunk of a mitten is fairly easy figure. Lay your hand flat on a piece of paper with your thumb flush against the rest of your hand. Although the mitten can come as far down your wrist as you'd like, generally the mitten should at least reach just below the protruding knuckle of your wrist. Trace around the perimeter of your hand, leaving at least a half inch on the pinkie side, a half inch over the finger tips, and a half inch on the thumb side. The bottom of the mitt at the wrist should be flared slightly to make it easier to slip the mitten on and off.

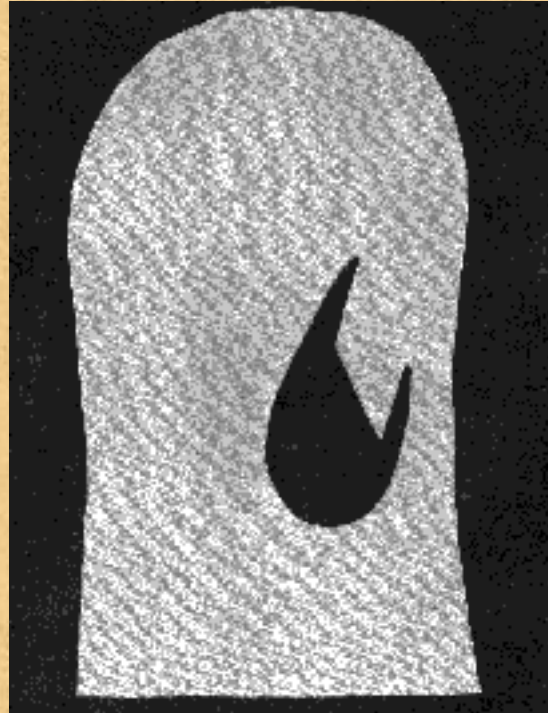
If you are using heavy elk or moose hide and/or lining the mitten with fur, wool or a knit material, you can leave up to an inch between the edges of your hand and the edge of the pattern. I like to have finger mobility in my mittens, so I also round out the top of the mitten... to see how much to round out the top of the mitten, spread your finger tips about a half inch apart from each other, you should still have a half inch from the edges of your finger tips to the



**edge of your pattern.**

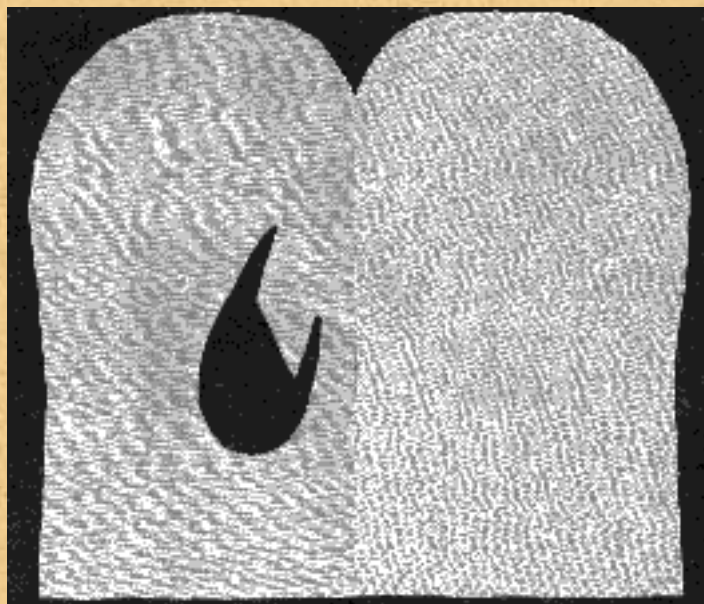


**Pattern showing inside of left thumb to be sewn to gouch.**



**Trank pattern showing inside of left palm with the gouch for the thumb hole.**

**Make a note on your pattern where the heel of your thumb is, as this is important in placing the thumb hole, or gouch in the palm side of the mitten. Most people have a crease on their palm which goes around the thick padded part of their thumb... this curved on the palm line should be identical to the inside curve of the thumb gouch pattern. The back side of the trunk is simply a mirror image of the palm side.**



**One-Piece Mitten trunk pattern showing inside of left hand of chopper mitten.**

**Note:** The entire trunk for the mitten can be made in one piece to reduce the amount of sewing, although it would take bigger pieces of hide. In this case the seam sewn around the perimeter of the mitten would be much shorter as shown in the illustration to the left.

Whether you cut the trunk for the mittens in one piece or in two separate pieces, it is best to orient them on the hide in the same direction - re: the stretch in the leather is going in the same direction with each piece of the pattern, otherwise you may end up with one wide-short mitten and one long-narrow mitten.

The pattern for the right hand's trunk palm, trunk back, and thumb pieces are simply a mirror image, or reverse, of the left hand. Make *\*sure* you mark all pieces of your patterns Left Hand and Right Hand and also note on the patterns 'inside' and 'outside'.



Sarah's buffalo hide  
and rabbit fur mittens

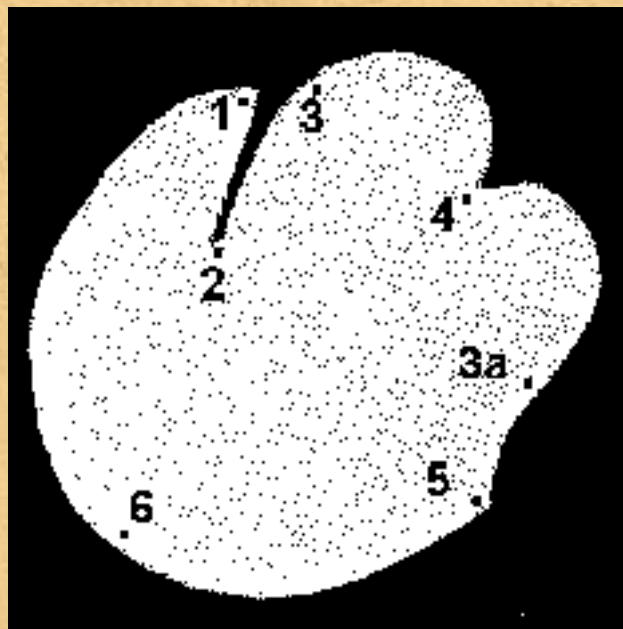
*About Mitten Liners:* If you plan on making a liner for your mittens, the same pattern is used. The liners can be sewn into the mittens along with the leather parts, but only if the mittens are sewn 'right side out'. Be aware that if liners are sewn into the leather parts of the mittens, that liner will show in the seam on the outside of the mitten. When I make liners for mittens, I make them completely separately (without turning them inside out to stitch them) and then insert them into the leather part of the mitten when they are completed. Then I join the liners at the cuff of the leather part, or make the liner extra-long at the wrist and fold them over the outside of the mitten, especially if the liners are made of fur. The mittens pictured to the right were made for my niece using thinly split buffalo hide for the palms, rabbit hide for the backs of the mittens, and separate liners of very light weight deer hide.... All in white, with red beaded edging joining the liners to the mitts at the wrist.

## *Assembling Mittens:*

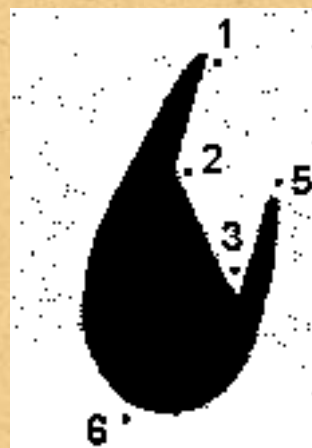
You can either sew the mittens right side out, or inside out, if you sew them right side out the stitching will show. It is definitely less confusing to sew the mittens right side out, in which case you might want to stitch them together using the blanket stitch and colored thread. With practice, you may prefer to sew the mittens together inside-out, as they are more durable, using either the whip stitch or the blanket stitch. Schneider's book *Crafts of the*



*North American Indians; A Craftsman's Manual.* (1972) has excellent instructions for sewing chopper mittens together using a welt which reinforces the seam, as well as other variations on how to sew this type of chopper mitten together. In any case, a heavy waxed nylon thread (imitation sinew - in lieu of genuine sinew) is recommended to sew the mittens together. If you are using heavy elk or moose hide, you will likely need a glovers needle (a special needle for sewing leather which is available at fabric stores). A standard needle can be used on most light weight leathers and for the liners.



Thumb Piece Gouch



Hole in Trunk

It helps me to staple the pieces of leather together first before sewing... not only does this serve as a check to make sure the pieces fit properly, it also helps to keep the one piece of leather from 'creeping' while you are stitching along a seam.

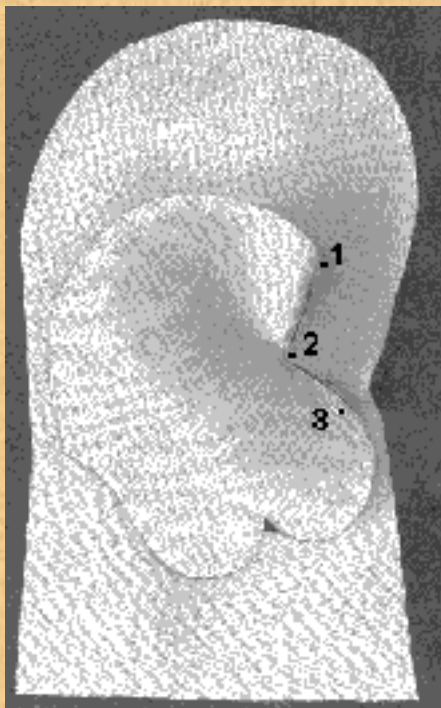
You need to assemble the thumb before you can sew the palm of the mitten to the back of the mitten... sewing the thumb to the gouch is the most difficult part of the mitten... have patience... it \*will work.

## *Fitting the Thumb Piece to the Gouch:*

To start sewing the left mitten's thumb piece to the gouch, first line up the bottom of the slit in the thumb piece to the wide angle at the gouch (at #2 in the diagram) ... this will look like your thumb piece is upside down, but bear with it. Line up the points #1 and #3 on both thumb piece and gouch and staple or pin between these points to keep it from slipping. It is very important that the point at #2 is aligned correctly.

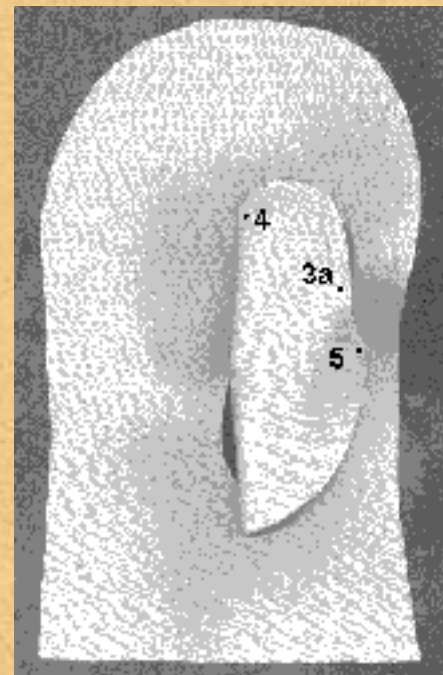
Start sewing the thumb to the gouch with a knot on the inside of the mitten at point #1.... It





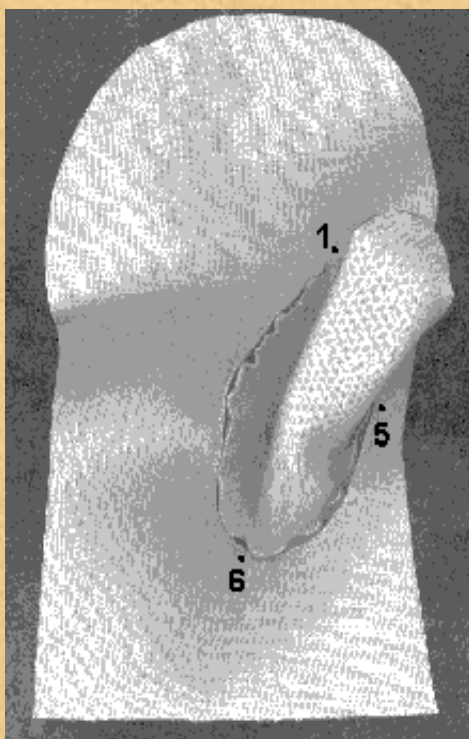
Aligning thumb &amp; gouch

is O.K. that a point of leather protrudes at point #1, as this is where you will end stitching the thumb, if the point protrudes too far at when you complete sewing the thumb, you can trim it off then. Sew from point #1 to point #2 and take several stitches around the tight corner here, as there is a lot of the stress on the seam here when wearing the mitten. Continue sewing from point #2 to point #3 and end your thread there with a knot on the inside of the mitten.



Sewing the thumb

Now fold the thumb piece in half along the line #4-#6 and make sure that point #5 is aligned on the thumb with point #5 the gouch. In folding the thumb piece in half and aligning point #5, your thumb should now look right-side-up, and begin to look like a thumb. With a new thread, knot on the inside of the mitten at point #4 and sew around the top of the thumb piece, continuing to sew down past point #3/#3a ... take several stitches to reinforce point #3/#3a ... if a tiny point of leather projects too far here you can trim it back just before you take the stitches there.



Finishing the thumb

Continue sewing with same thread down to point #5, again for reinforcement take several stitches at point #5. Before sewing further, fan open the base of the thumb piece and compare how it fits with the gouch hole ... check that you don't have too material on the thumb piece and that it

lines up properly with the gouch hole. If you have too much material on the thumb piece, carefully trim off material from the bottom curve of the thumb piece until it fits properly with the gouch hole. It is wise to pin or staple the remainder of the thumb & gouch so the leather does not creep as you sew. Now, continue sewing from point #5 around around base of thumb past point #6 and back up to point #1 where you began.



**Congratulations!! You just finished the**

hardest part of the mitten, sewing the thumb! All that's left now is to sew around the perimeter of the trunk. If you have a one-piece trunk, you would fold it in half and only need to sew from the top of the mitten down to the base. Make sure you keep right sides together, and pins or staples will help you keep the leather from creeping.

Finished Mitten with the thumb folded down to show construction.

---

[Introduction to Native American Mittens & Gloves](#)

[Examples of Native American Mittens & Gloves](#)

[Chopper Mitten Pattern For Child](#)

[Chopper Mitten Pattern For Adult](#)

---

[Return to NativeTech's Main Leather & Clothes Menu](#)

[Leather & Clothes Bibliography and Books to Buy On-Line](#)

---



© 1994-1999 [Tara Prindle](#).



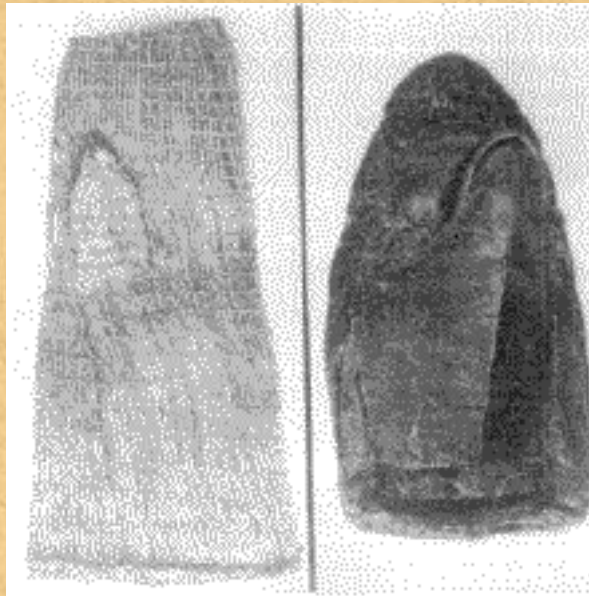
**NativeTech: Native American Technology and Art**

**NATIVE AMERICAN CLOTHING**

**Examples of Native American Mittens and Gloves**



*Elk Hide Chopper Mittens  
(Prindle 1997).*

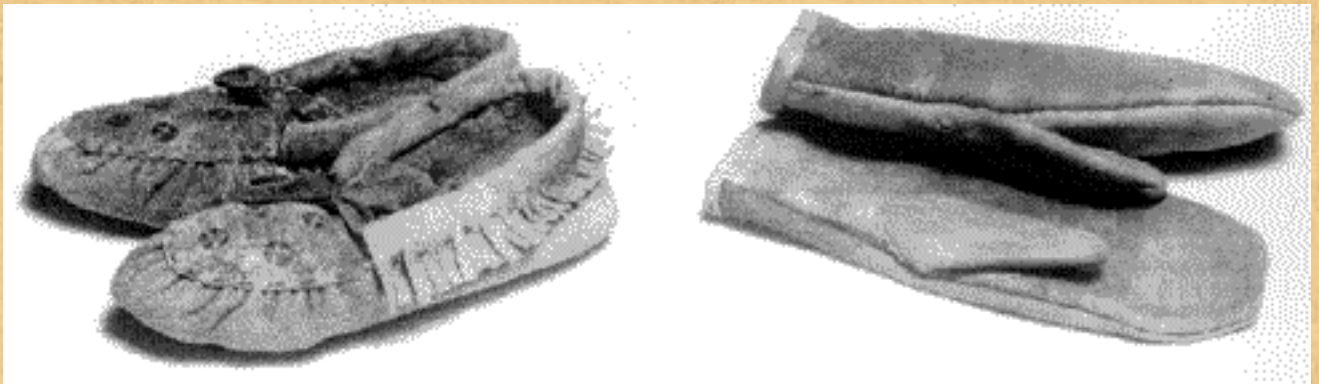


**Inuit (Eskimo) Woven-grass and Leather Mittens [Miles 1963]**





**Mittens, Eastern Cree,  
c. 1840's [Johnson 1990] << Cree mittens made of caribou hide,  
they usually have silk-embroidered floral designs - silk thread  
replaced animal hair for embroidery in many regions. (City of  
Sheffield Museum, MGH photograph).**



Moccasins & Mittens, Ontario, contemporary. [Coe 1986]

^^ Moccasins and mittens by Sarah Lavalley, Algonquin, Golden Lake Reserve, Ontario. The moccasins were commissioned directly from Mrs. Lavalley, a tall, refined woman in her late eighties. She included the mittens as a bonus. "The style is a pattern used in 1895, the stitching is the same." To make these objects Mrs. Lavalley used a home-tanned hide obtained from a neighboring German woman "who works to order for us." [Coe 1986]



**Chippewa Buckskin 'hand' sent as war summons. [Densmore 1979]**

^^^If the matter were of great importance the messenger might carry the representation of a hand with which the Chippewa were accustomed to seal important agreements. The use of such a representation was described by an old warrior, Niskigwun, and the 'hand' was made under his direction. It is a replica of a hand, which according to his statement, was used in summoning the Chippewa to the expeditions which drove the Sioux out of western Wisconsin and northern and eastern Minnesota, and resulted in the distribution of the Chippewa over a large part of the conquered territory. Niskigwun took part in this expedition. The 'hand' is life size, made of buckskin, and lightly filled with moss. There is an opening at the side of the wrist which tobacco was placed, and the 'hand' is smeared with red paint to represent blood. When sent to the warriors a pipe was laid across the palm of the hand, the fingers were folded over it, and the whole was wrapped securely in cloth or buckskin.



Gauntlet gloves, Teton Dakota type; late nineteenth, early twentieth century. [Hail 1980]

Commercially manufactured leather gloves with wide cuff of Native-tanned deer hide added, fringe inserted at juncture; muslin lining; porcupine quill decoration on cuffs; inside, spider web



motif; outside, geometric designs in two-thread, one-quill, straight sewing, red background, purple, yellow, white; sinew thread; green silk ribbons.

Heavy 'store' gloves like those the cowboys wore became popular among Indians as well but were decorated to make them more handsome. Small stitches and narrow rows make this an exceptionally fine piece of quillwork. The spider web was a protective design of the Oglala Dakota.



Gauntlet Gloves, Santee Dakota; third quarter nineteenth century. Collected by Henry D. Banks in Minnesota, 1880s. HMA purchase 1979. [Hail 1980]

Native-tanned deer hide, embroidered on backs with small faceted glass seed beads in abstract floral and butterfly motif outlined in white; interior beading follows form; colors yellow, light and dark blue, white-core rose, translucent amber and dark green. The combination of butterfly and floral motifs is characteristic of Santee work.

---

### [Introduction to Native American Mittens & Gloves](#)

[Instructions for Chopper Mittens](#)

[Chopper Mitten Pattern For Child](#)

[Chopper Mitten Pattern For Adult](#)

---

[Return to NativeTech's Main Leather & Clothes Menu](#)

[Leather & Clothes Bibliography and Books to Buy On-Line](#)

---





© 1994-1999 [Tara Prindle](#).

## NativeTech: Native American Technology and Art



*Elk Hide Chopper Mittens*  
(Prindle 1997).

# NATIVE AMERICAN CLOTHING

## Bibliography for Mittens and Gloves

---

Coe, Ralph T. 1986 *Lost and Found Traditions, Native American Art 1965-1985*. New York: University of Washington Press in Association with the American Federation of Arts. ISBN: 0-917418-78-6

Densmore, Frances 1979 *Chippewa Customs*. First published in 1929 by the Smithsonian Institution Bureau of American Ethnology; Bul. 86. St. Paul: Minnesota Historical Society Press. ISBN: 0-87351-142-5

Hail, Barbara A. 1980 *Hau, Kola! The Plains Indian Collection of the Haffenreffer Museum of Anthropology*. Fourth Printing 1994 (revised). Rhode Island: Haffenreffer Museum of Anthropology, Brown University. ISBN 0-912089-00-8

Heath, Dwight B., ed. 1986 *Mourt's Relation: A Journal of the Pilgrims at Plymouth*. Cambridge: Applewood books. (First published in 1622).

Johnson, Michael G. 1990 *American Woodland Indians*. Men-at-arms-series, V. 228. London: Osprey Publishing Ltd. ISBN: 0-85045-999-0

Josselyn, John 1972 *New England's Rarities Discovered*. Meriden: Meriden Gravure Co. (First published 1672).

Lindholdt, Paul, ed. 1988 *John Josselyn, A Critical Edition of Two Voyages to New England*. Hannover: University Press of New England. (First printed in 1674).

Miles, Charles 1963 *Indian & Eskimo Artifacts of North America*. New York: Bonanza Books.

Schneider, Richard C. 1972 *Crafts of the North American Indians; A Craftsman's Manual*. 312 Linewood Ave.,

Stevens Point, Wisconsin 54481: Richard C. Schneider, Publishers. ISBN: 0-936984-00-7.

Wood, William 1865 *Wood's New England's Prospect*. Boston: Publications of the Prince Society 1. (First published 1634).

Wroth, Lawrence C., ed 1970 *The Voyages of Giovanni da Verrazzano, 1524-1528*. New Haven and London: Yale University Press.



Man's buckskin chopper mittens,  
stitched inside out. Beaded back, rabbit  
fur cuff, and wool knit liner. [Schneider 1972]

---

[Introduction to Native American Mittens & Gloves](#)

[Examples of Native American Mittens & Gloves](#)

[Instructions for Chopper Mittens](#)

[Chopper Mitten Pattern For Child](#)

[Chopper Mitten Pattern For Adult](#)

---

[NativeTech Home Page](#)

© 1994-1998 [Tara Prindle](#).



## NativeTech: Native American Technology and Art

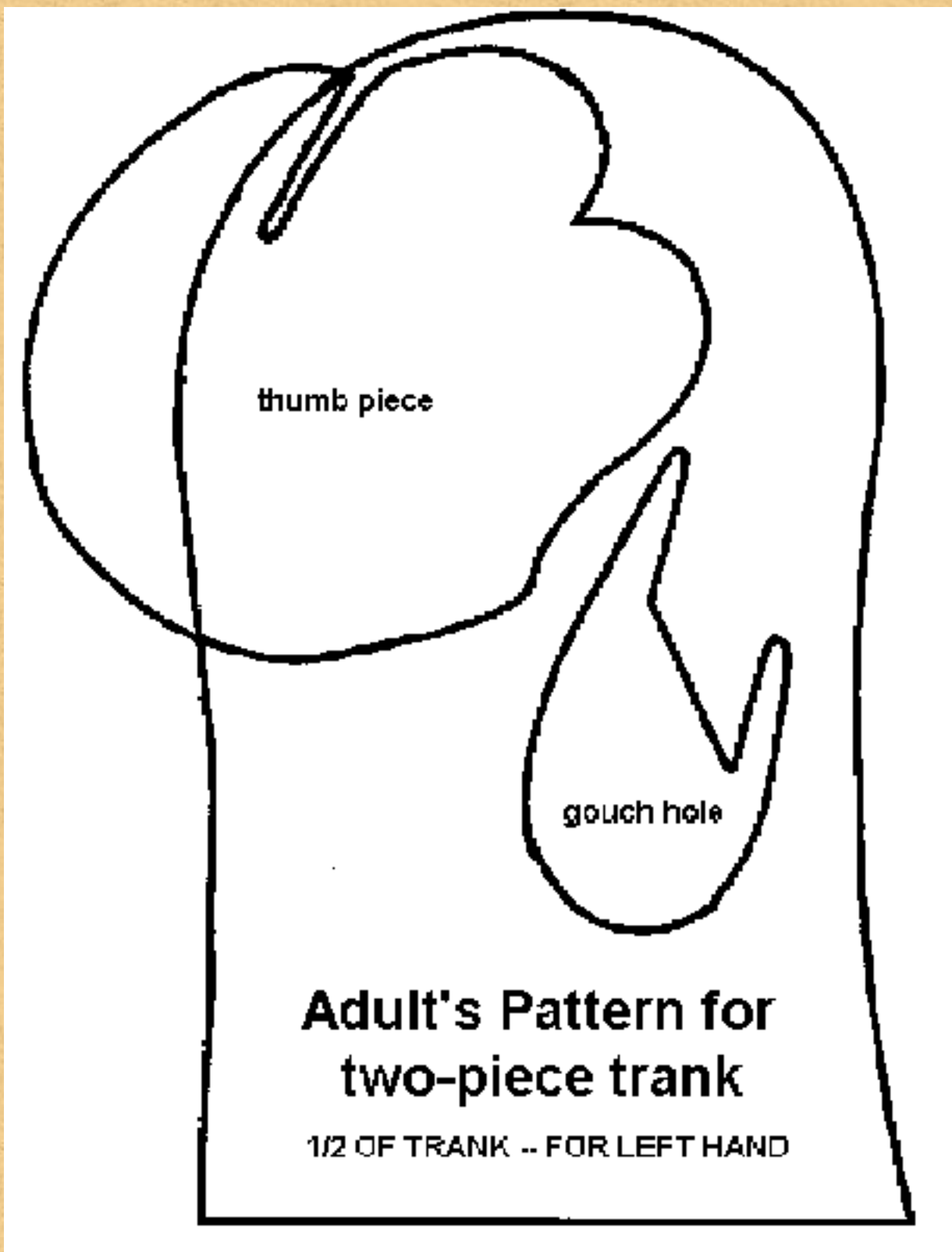


### NATIVE AMERICAN CLOTHING

## Chopper Mitten Pattern For Adult

*Note: due to screen size image the pattern may need to be scaled up.*

---



[Introduction to Native American Mittens & Gloves](#)

[Examples of Native American Mittens & Gloves](#)

[Instructions for Chopper Mittens](#)

[Chopper Mitten Pattern For Child](#)

[Return to NativeTech's Main Leather & Clothes Menu](#)

[Leather & Clothes Bibliography and Books to Buy On-Line](#)

---



© 1994-1999 [Tara Prindle.](#)



## NativeTech: Native American Technology and Art

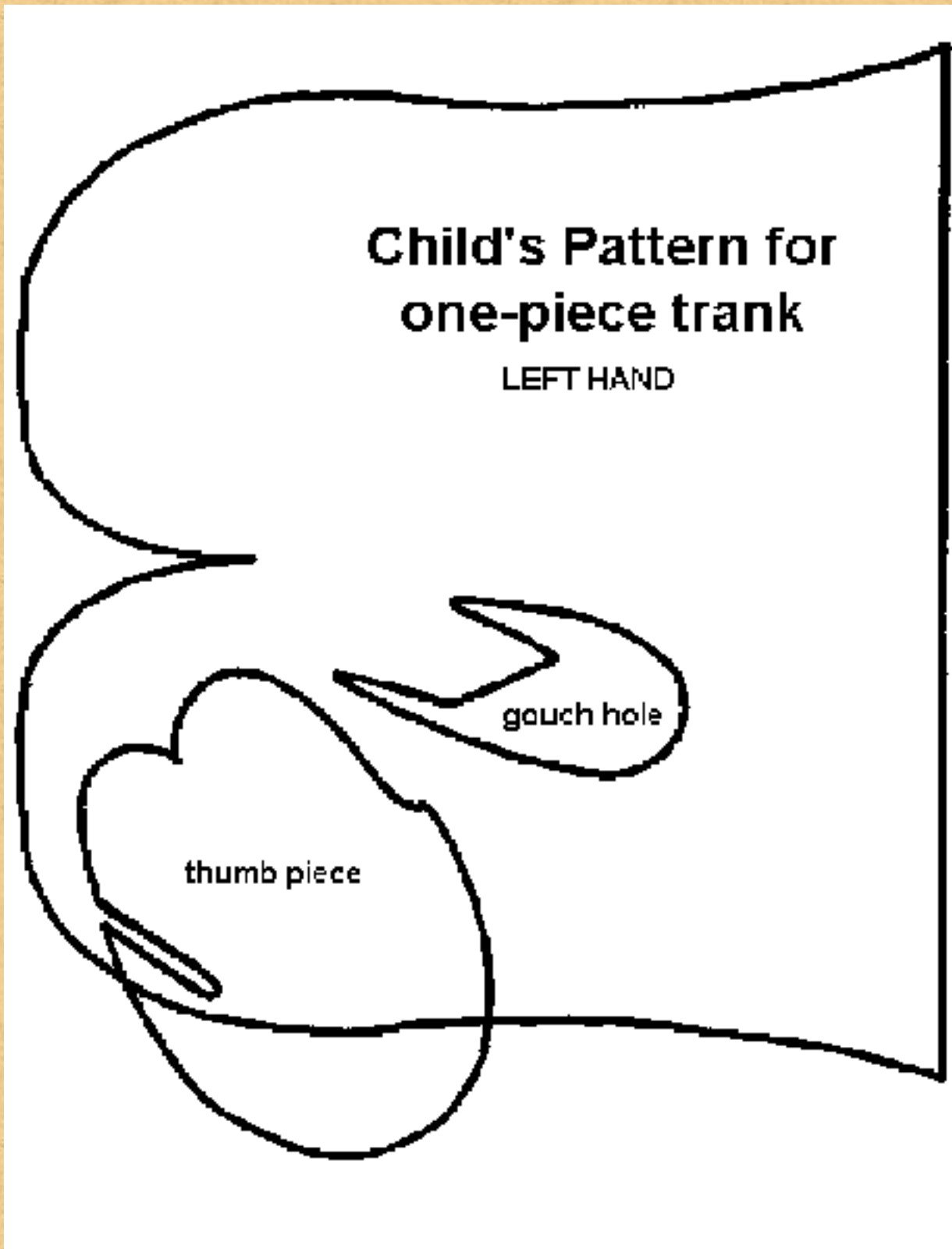


### NATIVE AMERICAN CLOTHING

## Chopper Mitten Pattern For Child

*Note: due to screen size image the pattern may need to be scaled up.*

---



[Introduction to Native American Mittens & Gloves](#)

[Examples of Native American Mittens & Gloves](#)

[Instructions for Chopper Mittens](#)

[Chopper Mitten Pattern For Adult](#)

[Return to NativeTech's Main Leather & Clothes Menu](#)

[Leather & Clothes Bibliography and Books to Buy On-Line](#)

---



© 1994-1999 [Tara Prindle.](#)





*Pouches for Carrying Tobacco.*  
[Miles: 1963].

## NATIVE AMERICAN CLOTHING

### Leather Bags and Pouches



*Small Mole Skin Pouch*  
*Penobscot [Speck: 1976]*

Natives of Northeastern North America use bags and pouches to contain many of life's necessities around the home site and for travel. As Native American clothing did not incorporate European- like pockets, pouches of all shapes, sized and materials served this purpose. European explorers of North America in the early 1600's observed that Natives "Always carry with them all their goods, as well as their food and green tobacco." (de Laet: 1967) Pouches and bags were commonly fastened to a belt around the waist. Smaller pouches may have been worn around the neck or on the wrist. Bags that were not woven were traditionally made from tanned leather, animal bladders, and all types of furred animal hides from the mole to the bear. Pouches could contain food-stuff, smoking supplies, medicine, fire-starting equipment, ammunition, and other small tools and supplies used by men and women.

A long leather bag was used to hold nokake (parched and powdered corn meal to be mixed with water and eaten. The parched corn bag was carried by Native American men when they traveled. The parched corn was "put into a long leatherne bag, trussed at their backe like a knapsacke"(Wood: 1865). Meals of parched corn while traveling consisted of three spoonfuls, three times a day.

A tobacco pouch is called Petouwassinug by the Narragansett of southern New England. In the 1600's Native American men wore a tobacco pouch "which



*Large Hide Tobacco Seed Bag  
Crow [Lowie: 1954]*

hangs at their necke, or sticks at their girdle, which is to them in stead of an English pocket" (Williams: 1973). In 1622 Massasoit, a Wampanoag, wore a little bag of tobacco attached to "a great chain of white bone beads about his neck." (Heath: 1986) A separate pipe bag would be made and decorated to hold a smoking pipe, "for generally all the men throughout the Countrey have a Tobacco-bag, with a pipe in it, hanging at their back" (Williams: 1973)



*Deerskin Pouch for a Pipe & Tobacco  
with Moose Hair Decoration  
Penobscot [Speck: 1976]*

At the onset of the 17th century in northern Virginia, every Native American man carried a mineral stone, in a leather case at his wrist or in a woodchuck skin which hung from a belt with which he could quickly start a fire (Russell: 1980).



*Strike-a-Light Pouch  
Lakota ~ 1800's [Monture: 1993]*

In 1637, a strike-a-light pouch was fastened to a belt so the ability to start a fire was always at hand: "and with a girdle of their making, bound round about their middles, to which girdle is fastned a bagg, in which his instruments be, with which hee

can strike fire upon any occasion" (Morton: 1964). Beaded strike-a-light pouches, rectangular in shape, decorated with tinkling cones or fringe and having short flaps, were used through the 1800's by the Lakota, Apache, and other groups to carry a strike-a-light steel, a flint, matches and often ration coupons (Monture: 1993).

With European contact, most men carried powder horns and shot bags suspended by a wide strap from their shoulders, for use in both hunting and in preparation for war. Some shot



bags were also called bandolier bags as they were often suspended from men's sashes worn over the shoulder, often accompanied by a black powder horn. With continued European contact and their production for trade, these bags were made from broadcloth and they acquired the name possibles bags, or Assumption bags, so named for their place of manufacture.



*Beaded Rawhide Knife Sheath  
Crow [Miles: 1963]*

A sheath of leather and raw hide was often made for knives, awls, or other tools used by Native American men and women. Women's awls were commonly made from the ulna (having the perfect built-in handle) or split long bone of a large mammal such as a deer. The awl is an essential multi-task tool, and woman traditionally wore the

awl in a decorated case on a string around her neck or from her belt. In 1622, the European, Mourt takes notice of a leather sheath and a suspended leather knife sheath and a "great long knife", which Massasoit (a Wampanoag of the east coast), "had in his bosom, hanging in a string" (Heath: 1986). Native women living in the Great Lakes region, and in other areas of the Northeast, wore knife sheaths suspended from a belt at their waist (Hartman: 1988).



*Eskimo fur sewing bag with ivory  
needlecase and finger-stall  
type thimble [Miles: 1963]*

Bags and pouches would also contain other necessities such as paint pigments, animal or nut oil, small tools like that for sewing. Pouches often contained bone needles. Needles were often kept in special cylindrical cases; a leather strap is wrapped around the needles and slipped through the cylinder, so pulling on the strap carries the needles in and out of their case. Pouches are also made for innumerable kinds of medicine. In the 1600's, a Native in southern New England was observed to have a necklace with a curative 'taffetie' bag containing tree frogs to "stop women's overflowing courses" (Lindholdt: 1970).





*Soft Skin Bag for Paint  
Arapaho [Lowie: 1954]*



*Paint Bag  
Blackfoot [Thomas: 1986]*



*Soft Skin Pouch for Paint  
Arapaho [Lowie: 1954]*



*Beaded Awl Case  
Plains [Miles: 1963]*

Many kinds of beads and ornaments were used to decorate Native American clothing and accessories. Europeans in New England in the 1600's described the applique of Native made beads, pieces of whales' fins, whale bones, and wampum, sewn onto leather; though beaded clothing was traditionally 'bad to wear for everyday use'. In the Northeast, tufts of red dyed deer hair is inserted into metal tinkling cones and attached to bags. The 'jingle' dresses of Plains Natives, originating with historic tobacco lids, continues the tradition of tinkling cones today. In the Eastern Forests, pouches were traditionally decorated with embroidered dyed porcupine quills and white moose-hair embroidery, although these industries were not as common in the 1700's after the splint basket replaced birchbark containers, the traditional canvas for porcupine quills. As soon as they were available through trade with Europeans, glass beads, buttons, ribbons, thimbles and many other items

were quickly adopted for ornaments by Native Americans to decorate their clothing and bags.

See Instructions for Making these Kinds of Pouches

[Awl Sheath](#) [Needle Case](#) [Strike-a-lite Bag](#) [Tobacco Pouch](#)

You can also learn about [Native American Puzzle Pouches](#)

---

[Return to NativeTech's Main Leather & Clothes Menu](#)

[Leather & Clothes Bibliography and Books to Buy On-Line](#)

---



© 1994-2001 [Tara Prindle](#).



## Native American Technology and Art

---



### Leather Bags and Pouches

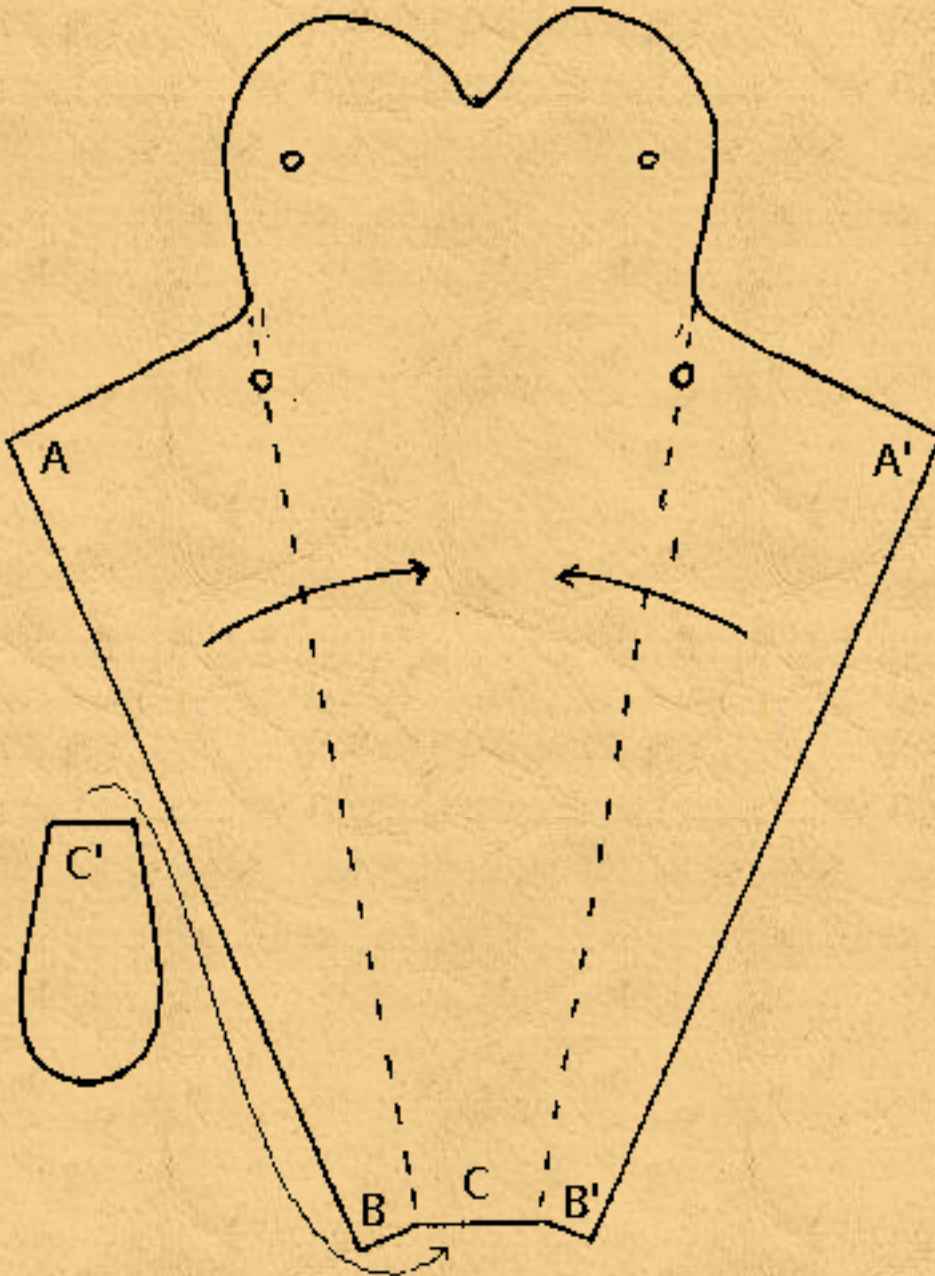
#### Instructions for Awl Sheath

---



**Bring Flaps together and sew form A/A' to B/B' (use 'baseball' stitch).**

**Insert 'tail' (C) between layers at bottom B/C and 'whip stitch' together.**



---

**See Instructions for Making these Kinds of Pouches**

[Needle Case](#) [Strike-a-lite Bag](#) [Tobacco Pouch](#)

[Overview of Leather Bags and Pouches](#)

---

[Return to NativeTech's Main Leather & Clothes Menu](#)

[Leather & Clothes Bibliography and Books to Buy On-Line](#)

---



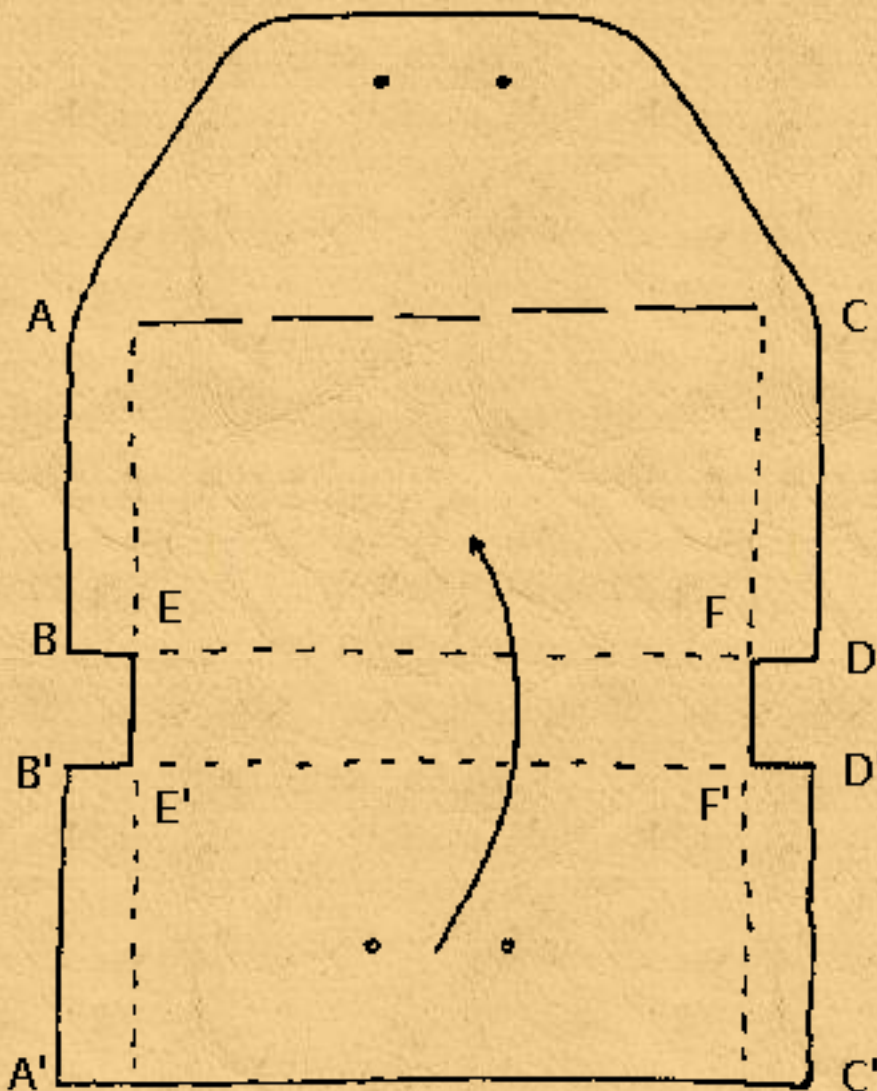
© 1994-1999 [Tara Prindle.](#)

## Native American Technology and Art



### Leather Bags and Pouches

#### Instructions for Needle Case



**Stitch Inside-Out!**

**Fold up 1/3 of bottom and cut square notches at B and D.**

**Whip stitch sides from A/A' to B/B', and C/C' to D/D'.**

**Sew at bottom corners (like a moccasin heel) from E/E' over B/B', and the other corner from F/F' over D/D'.**

**Turn Right-Side out. Pound seams flat with a wooden dowl and mallet.**



---

See Instructions for Making these Kinds of Pouches

[Awl Sheath](#) [Strike-a-lite Bag](#) [Tobacco Pouch](#)

[Overview of Leather Bags and Pouches](#)

---

[Return to NativeTech's Main Leather & Clothes Menu](#)

[Leather & Clothes Bibliography and Books to Buy On-Line](#)

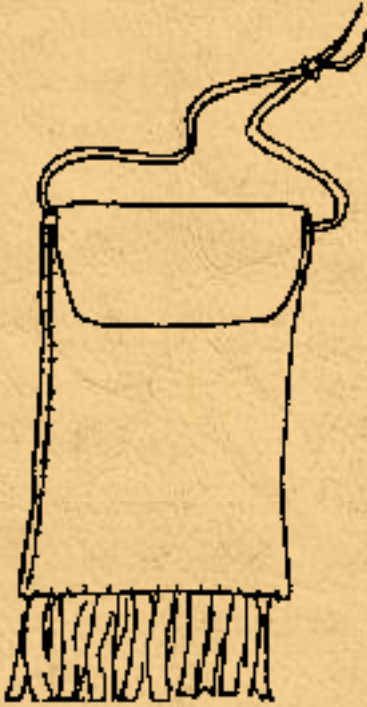
---



© 1994-1999 [Tara Prindle](#).

## Native American Technology and Art

---

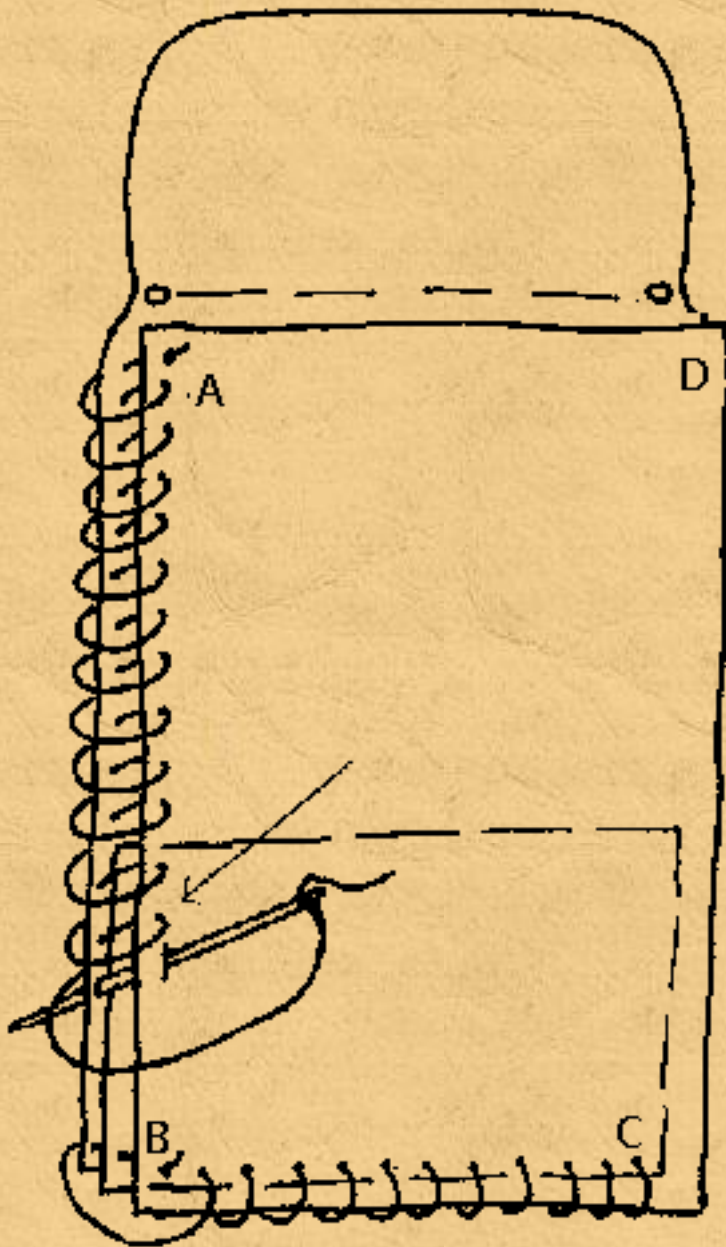


### Leather Bags and Pouches

#### Instructions for Strike-a-lite Bag

**Stitch Inside-Out!**

**Insert strip for fringe (B to C).**



**Whip stitch bottom from B to C.**

**Whip stitch sides: from A to B and D to C.  
(Careful, do not sew fringe strip into seams  
along sides!)**

**Punch holes at sides near top for carrying  
strap.**

**Turn Right-Side out. Pound seams flat with  
a wooden dowl and mallet.**

---

**See Instructions for Making these Kinds of Pouches**

[Awl Sheath](#) | [Needle Case](#) | [Tobacco Pouch](#)

[Overview of Leather Bags and Pouches](#)

---

[Return to NativeTech's Main Leather & Clothes Menu](#)



[Leather & Clothes Bibliography and Books to Buy On-Line](#)

---



© 1994-1999 [Tara Prindle](#).

## Native American Technology and Art

---



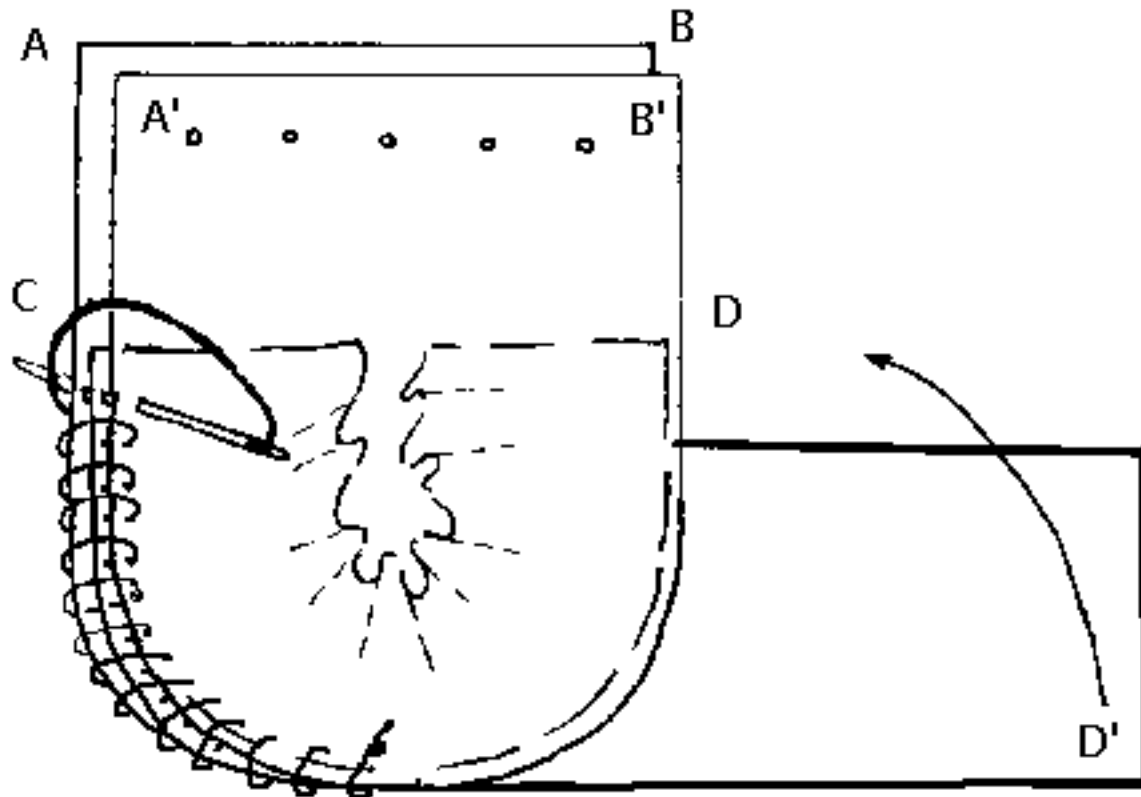
### Leather Bags and Pouches

#### Instructions for Tobacco Pouch

---

**Stitch Inside-  
Out!**

**Insert strip  
C/D between  
layers (C to D),  
and 'whip  
stitch' from  
the bottom  
center of  
pouch to A/A',  
and then stitch  
from bottom**



center of  
pouch in the  
other direction  
to B/B'.

Pierce holes  
for drawstring.

Turn Right-  
Side out and  
cut fringe.

---

See Instructions for Making these Kinds of Pouches

[Awl Sheath](#) [Needle Case](#) [Strike-a-lite Bag](#)

[Overview of Leather Bags and Pouches](#)

---

[Return to NativeTech's Main Leather & Clothes Menu](#)

[Leather & Clothes Bibliography and Books to Buy On-Line](#)

---





© 1994-1999 [Tara Prindle](#).

## NativeTech: Native American Technology and Art



## NATIVE AMERICAN CLOTHING

### Learning about Puzzle Pouches

*Reproduction of a  
Potawatomi puzzle pouch.*

---

Learning about the puzzle pouch is a story in it's own. I'm indebted to several people in the creation of these pages. First, there is Ron Mayer who initially emailed me trying to find out more about the origin & construction of puzzle pouches. In a six minute documentary on TVOntario, Ron had seen these bags being made by Darren Lentz, a teacher at Pelican Falls First Nations High School in Sioux Lookout. Ron's sister teaches Ojibway children north of Red Lake and thought it would be a great project for her class. Myself, although vaguely familiar with the existence of this type of pouch, was completely unfamiliar with the construction or the history of this ingenious bag.

My curiosity became peaked and I was soon obsessed with how these puzzle pouches are made and who makes them. Ron also posted an inquiry on [Suzanne Coopers Bead Board](#) and received a reply from Brenda who had a pattern for the puzzle pouch. She kindly shared the pattern with Ron, who in turn shared them with me. From an inquiry (thank you 'WoahNellie' for posting for me!) to the 'Crafts Lodge' at [Iroquois Viewpoints](#), one of the administrators, Sakoieta Tree, mentioned he has a Tyendinaga Mohawk friend who currently makes puzzle pouches. So far we've learned that puzzle pouches are now made by Mohawk and are sold in craft stores, but still we didn't know much about the Native American history or styles of this kind of bag.



I set to work, first making a paper model of the pouch based on Brenda's pattern, just trying to see how the flaps and pieces of the pattern all fit together. Soon surrounded by a pile of paper scraps and staples, I learned that the split thongs extending from the top of the pouch are inserted through the doubled-over flaps so that they form a puzzle-lock keeping the bag closed, unless the thongs are pulled in such a way that the bag opens. Pleased with my paper puzzle pouch, I made my first one in leather. When shown to my boyfriend, Brad, he was indeed puzzled at how the bag opened, but wouldn't let me show him how, as he was determined to

find the secret opening. Eventually he discovered how it opens!

Determined myself to learn more about the puzzle pouch, I posted my own inquiry and example that I'd made at the [Powwows.com Bulletin Board](#). Almost immediately several people, 'Whirlwind', Georg J. Barth, 'MrRuminator' and 'Raptor' responded with their knowledge of this bag! Pieces of the puzzle pouch puzzle began to fall into place. The general consensus among the people who replied to my post, is that the pouches have been made, and were most likely originated, by Natives that lived in the woodlands of the Northeast and Great Lakes regions.

Georg J. Barth provided a reference to a fairly contemporary article entitled "An Iroquois Puzzle Pouch" in *American Indian Hobbyist* 1960, Vol. 6, No.s 5 & 6, page 71. He said it's a nice article, complete with drawings and how-to instructions, but all the article says about the origins is: "They are rarely seen today, but they were used by the Iroquois and other Woodland Indians".

Also on the Powwow.com Bulletin Board, 'MrRuminator' posted some beautiful scanned images of a puzzle pouch that was made by a Forest Potawatomi and was collected around 1920 in Forest County, Wisconsin. He describes the bag being of smoked Indian-tanned buckskin and beautifully embellished with seed beads equivalent to 13/o. The pouch portion of the bag only is 3" x 4 1/2". "Think of its functionality. No need for a button or a snap. If you drop it your coins or other goodies won't spill out."





**Forest Potawatomi Puzzle Pouch - three views - You can click on the images to see larger detail pictures.**

**The overall length of the this bag 'MrRuminator' shows us is 8 1/4" including the "slats." It's made from 3 pieces of hide. The flaps are one piece with holes through the mid-line for the slats to be inserted. The back flap is stitched to the top of the bag piece without the slats. The stitches are rather minute. The bag portion is held together with very fine whip stitches on the outside.**

**'Raptor' remarked: "These bags may have had some utilitarian purpose but they seem to be primarily have been a game. You put something inside and passed it around and people tried to guess what the item was inside. I don't know that there was any religious or sacred significance to them, as with some other games." He also commented it would not be surprising to find that they are European inspired, as they seem to have been popular in those places where the French set up missions.**

**Though most puzzle pouches are all made the same way (with the thong/slats going through spaces in the flap), 'Raptor' has been told that part of the game was to try to figure out how to open them, and he describes some of the variations he's seen in their construction.**

**"There appear to be no real 'rules' as to how the pouches were made. I have seen them with the 'slats' and one side of the bag as a single piece, the other side of the bag is another piece, sometimes with the fringe attached and the flaps are two separate pieces sewn together through the slats. In this case there is no knot at the top of the slats. Oh yes, the decorative**

fringe is sometimes sewn in and sometimes a part of one side of the pouch. There are also examples of the fringe side and flap out of a single piece while the other piece makes up the slats and the other side Ö [perhaps] Ö these games might have just been made out of what scraps of leather were laying around?"

Some things we are still left puzzling overÖ and I'm sure there is a lot more to say about puzzle pouches!! Again, my deepest gratitude to everyone who has contributed their knowledge and helped this story unfold. I'll put more information and photo's of puzzle pouches here as I learn more! In the meantimeÖ

[Learn how Puzzle Pouches can be made !](#)

---

[Return to NativeTech's Main Leather & Clothes Menu](#)

[Leather & Clothes Bibliography and Books to Buy On-Line](#)

---



© 1994-2001 [Tara Prindle.](#)



# Native American Technology and Art

## Tanning & the Preservation of Other Animal Parts

- [Pre-Smoked Hide Tanning](#) ~ Paul and Victoria Dinsmore
- [Brain Tanning ~ The Easy Way](#) ~ Joseph Dinsmore & Victoria Longtrail D.
- [Brain Tanning Deer Hides ~ Many Moons](#) ~ Contributed by Fred
- [Preserving a Hide with the Fur On](#) ~ Contributed by Cynthia Senicka
- [Preserving Deer Tails](#) ~ Contributed by Patty, Richard, CG & Jim Mitchell
- [Removing Deer Toes](#) ~ Contributed by Jim Mitchell
- [Preserving Bird Wings, Tails, or Talons](#)
- [Leather & Clothes Bibliography and Books to buy On-line](#)

[Other Internet Resources for Tanning and Hides](#)



© 1994-2000 [Tara Prindle](#).



## NativeTech: Native Amerian Technology & Art. Hide Tanning

---

### **TANNING THE INFIRM WAY** **A Description of the Pre-smoking Method of Brain Tanning**

This presentation on hide tanning is compliments of  
Paul and Victoria Dinsmore

---

[Acknowledgments](#)

[Introduction](#)

[Hide Tanning Tools](#)

[Chapter One: Choosing The Best Hides](#)

[Chapter Two: The Right Hide For The Project](#)

[Chapter Three: Soaking The Hides](#)

[Chapter Four: Scraping The Hide](#)

[Chapter Five: Stretching \(Breaking\) your hide](#)

[Chapter 6: Pre-smoking](#)

[Chapter 7: Back to the beam](#)

[Chapter 8: The Braining Process](#)

[Chapter 9: Final buffing](#)

[Chapter 10: Pricing Hides](#)

[Chapter 11: Wrap up](#)

[Hide Tanning FAQ: Frequently Asked Questions](#)

**I REALLY THANK Paul and Vicki for sharing their valuable information!**

---

[Return to Tanning & the Preservation of Other Animal Parts](#)

[Return to NativeTech's Main Leather & Clothes Menu](#)

[Leather & Clothes Bibliography and Books to Buy On-Line](#)

---



© 1994-1999 [Tara Prindle](#).

# Hide Tanning

---

**Paul and Victoria Dinsmore**

I wish to thank all of you tanners out there that have helped me over the years. To "Pawnee" for getting me started on the quest. To my brother Joe, whom first noticed the pre-smoking hints in books. To Al Ballard for really putting some research into this method and verifying my own work. He also knew what questions to ask. To Dave Christianson and again, Al Ballard, whose standards of quality I will always be trying to attain. To all my former students. Thanks for all the feed back. Between all of us we'll revolutionize brain tanning!

And especially to my wife, Snowbird, for putting up with the early years of hair, disgusting smell of rotting brains, as well as all those "new ideas" that were tried both inside the home and out, and for the shoulder to lean on when I was discouraged.

(This issue is without the pictures. The format was changed due to the early demand for the information contained).

Video is available as a companion to this written method from American Pioneer Video; part of the "Long Hunter Series" by Mark Baker, "The Easiest Method of Tanning".

[Return to Hide Tanning Table of Contents](#)

---

© 1996 Sundog Traders (formerly Musselshell Traders). E-mail: [ezra@midrivers.com](mailto:ezra@midrivers.com)

---

[Return to](#)

[Return to NativeTech Home  
Page](#)

*NativeTech Home Page*

© 1996 [Tara Prindle](#).



# Hide Tanning

---

## The Easiest Tanning Method

or

A description of the Pre-Smoked, Wet-Scrape Method

*by Paul and Victoria Dinsmore*

### Introduction

Greetings from Sundog Traders in central Montana, to all of you experienced tanners, as well as to all others who are interested in learning a simplified brain tanning process I believe to be the most efficient.

I will present to you, a method of brain tanning which I have settled upon after many years of brain tanning evolution. I will instruct you in methods which I use now, after using other methods which were, and continue to be, more labor- intensive and expensive.

This system has been, through experimentation, chosen and used by many tanners ( many that have various physical ailments) who required a method that demands little in the way of physical strength and stamina, hence the title of my book.

My brain tanning experience started in 1985 when I was traveling extensively by horseback in the mountains of northern and central Idaho. Due to my life of wandering the trails therein, I found myself without access to cloth or store bought clothing. At that time I was wearing a set of "skins" I had constructed from chemical tanned leather, like the sort of leather one would purchase at a Tandy Leather Shop or any commercial tannery. I found them to be absolutely the pits! What I mean by that is, I was either hot and sweaty or cold and damp. And Ooooooh MISERY ..... those long horse rides in the sun were sweltering ! Talk about unfriendly body rashes ! Because of my extreme discomfort (and after hearing how much more comfortable the old Indian style brain tanned hides are because of their ability to breathe and wick away body moisture in the summer and it's insulating quality during damp and cold weather), I began my quest to learn as much about brain tanning as possible with the intention of giving the process a try.

In my attempt to educate myself in the best known tanning procedure, I purchased the usual assortment of how-to books, invested time visiting various tanners and spent many attentive hours talking with the experts, who, if I were lucky, would throw me small tid-bits about the "big well-kept secrets" concerning their methods. Looking back, I now realize that there are experts and then there are "experts". A lot of misinformation came my way which, in turn, caused many years of tanning "the difficult way." For instance, my many long years of laborious trial and error period consisted of experimenting with all sorts of tools of various stages of sharpness, dry scraping, all sorts of beams for laying the hide on when scraping it, brains rubbed in with various rocks and

tools, brains in the raw stage to brains well cooked, brains smashed through screens, frames for stretching the hide as opposed to none, smoking hides sewn into tubes over fires and tubes over woodstove pipes in large boxes. At one point I discussed the chemical reaction of the process with a bio-chemist who told me about the enzymes in the brains that break down the hide-glues. Upon reading in my wood stove manual, which stated that smoke contained pyro-lignious and acetic acids I theorized that these acids enhanced the enzymatic reaction of the brain solution thus allowing me to use less effort to achieve a nice hide consistently.

Later, through research, I began to discover in historical books, ancient brain tanning methods of various people, both Native American as well as others who currently use the same method as I now use, that of smoking their hides before they brain them. This seems to be the big secret that I had heard so many rumors about!

I have settled on this method because it is far easier and successful to use. I also find I can easily and consistently turn out good quality hides with the least amount of time and effort. The goal of any tanner!

Since starting the use of this method, my hides have improved in quality and the time spent on each hide has been cut almost in half! I can now produce quality hides in quantity. I have since become a "tenured" tanner, now often selling my hides to some of the authors of "How To" books I purchased years ago. Another dream of small brain tanning businesses!

I find that I can ask a good price for my hides and because of the obvious quality I produce, people are willing to pay my asking price.

I have traveled to different states and taught seminars on the method I use. More often than not my students turn out good hides on their first attempt and I find that the experienced tanner, as well as my first-time tanners, are amazed at the simplicity and ease of the method I teach. I have students who after learning this method, have soon gone on to successfully operate their own brain tanning business. Often times I am asked to do hides for museums or for people who make articles for museum acquisition. Unlike some tanners who do tanning for a hobby, or only tan several hides a year, tanning is my livelihood. I tan all year long. Because of the simplicity of my method, I have, out of necessity, done up to eight hides in one week and regularly do two hundred and fifty hides or more in a year.

I have been told by experienced hide buyers, ones who purchase my hides for re-sale through their own businesses, that they consider my hides to be among the best around. The pre-smoke method made all the difference in the world in my hide quality and quantity as it will in yours.

My sincere desire is to bring this method out of secrecy, out of the history books and the protected tribal traditions and help demonstrate to interested students, what people have known for centuries, just how easy tanning can be. Eliminating all the unpleasant odors of rotting brain solutions and

unnecessary labor. And let's not forget those nasty blood infections!

So let me start at the top and present to you, what it is that you need to make good quality brain tanned leather. Each step will have a number that will be referred to at the end of this book when doing other types of hides.

[Hide Tanning Tools](#)

[Return to Hide Tanning Table of Contents](#)

---

© 1996 Sundog Traders (formerly Musselshell Traders). E-mail: [ezra@midrivers.com](mailto:ezra@midrivers.com)

---

[NativeTech Home Page](#)

© 1994-1998 [Tara Prindle](#).



# Hide Tanning

---

## Tools

By looking around your home you might find you already have some of the tools listed below. I have always said that the average novice tanner can get started in the process of tanning, for as little as \$50. Talk about a low start up cost! Often times the necessary tools can be purchased at a second-hand shop. You might decide to purchase all new tools. Good tools that do not break and work as intended are always desirable. For tanning hides I suggest you need the following items:

**Knife****Sharpening File or stone****Draw Knife****Awl with three sides****Needles****Strapping Band****Log Beam****Broomstick****PVC Pipe****Smoker****Hog Rings****Pot for wood****Punky Wood****Brains****Rubber Gloves****Protective Clothing****Barrels for Soaking****Rocks for weighing down hides in barrels**

Just about any knife will do. I suggest you use a knife with a locking blade to prevent the blade from folding over onto your fingers. A fixed blade knife is also ideal. When skinning the deer you will want to keep the knife blade sharp. If the knife is sharp it cuts better and makes your job of skinning much easier than if you are using a dull knife. Keep in mind that it will also cut your own skin easier so please be careful. Knife cuts on yourself should be immediately cleansed due to the high possibility of infection. Always clean your knife thoroughly after use.

I prefer to use a file to keep my knife sharp. It puts a sharp edge on a blade quickly. A small flat file works well. Some people prefer to use a stone which is fine too. However you must know how to use a stone properly in order to have your knife hold an edge.

The type of draw knife I use is the type also used for taking the bark off of trees. I prefer a draw

knife, whose handles turn down at a 90 degree angle. With this type of scraper, my wrists and arms remain in a comfortable position with little stress on the upper side of the hand, the wrist and forearm. I find that if I use a drawknife whose handles curve slightly downward I get cramps in my hands and forearms. I prefer a drawknife that has a bit of weight to it and is made well. The drawknife that I currently use was purchased from Lehman's hardware store in Kidron, Ohio and is called the Logger's Drawknife. Mine is the one of larger size.

The awl is used to punch holes in the hide. An awl is made of metal, has a three sided point and slices through the hide as opposed to a leather punch or nail which merely pokes a hole. Holes poked with a leather punch or round nail will make a hole that will stretch apart. You can keep your awl sharp with a file like the one used for sharpening your knife. Be sure to take care to sharpen the awl on the three flat sides and not round down the flat sides. An awl can be purchased at a leather crafts store or one can be made by filing a medium size nail into a three sided point and wrapping the flat end with tape for more comfort. Or if you are, or know a craftsman, a portion of an antler can be placed over the end opposite the point to make the use of the awl more comfortable.

You will need two types of needles. When the hide is wet and I am sewing up the holes, I use a glovers needle. You will notice that a glovers needle, like the awl mentioned above, has a three sided point. These needles come in various sizes. I prefer #11 or #12 sizes. They slide through the hide easier than the larger ones and easier than regular needles. These types of needles can be purchased at a leather or crafts store. With these needles I use a strong thread such as button hole twist or thread for hand made for sewing and quilting. The thread needs to be strong enough to hold up to rubbing and pulling of the hide during the breaking out process. When the hide is finished, I use a regular needle of small size and fine thread of a color similar to the finished, smoked color of the hide to sew any holes closed. Often times thread that has sat in stores for years is dry rotted and will easily break. I suggest you purchase thread from a popular crafts or fabric store who will have a quick inventory turnover. Always buy plenty of needles as they are often lost and sometimes broken.

I use a metal strapping band to soften and break the hide over. This is the same type of metal banding that is used to secure large boxes and wooden crates for shipping. It can be obtained at appliance stores or lumber yards, usually for free.

The log beam I use is supported on one end at waist level by two by fours and butted up against a tree on the other end to prevent a backward movement.

Mounted on top of the log beam is a broom stick that I slide the PVC pipe onto. The end of the broomstick is even with the end of the log beam. It is secured to the beam in two places, one at the furthest end away from you, and the other is located 18" from the end of the beam and stick. It can be secured with screws or fence staples. It is necessary to secure the broomstick in two places so there is no side to side movement of the stick when you are scraping. There is also a modification

to this beam that made it even more simple. Please look at the diagram for an explanation

The PVC pipe is in 18" lengths and range from 2" in diameter to 8" in diameter. Make sure that the pipes are of thickness to avoid fatigue cracks and to ensure that they will not bend when scraping hides on them. Schedule 80 pipe works for me. The pipe provides a smooth surface on which to scrape the hide. Often times when a log beam alone is used, the log becomes nicked and rough. Not to mention the check cracks a log will get as it dries. The result of using a rough scraping surface is nicks and holes in the hide. Different size pipes are used to create various widths of surface. If you are scraping an elk or moose, and the hide is thick and difficult to scrape, you will want to use a small diameter pipe. The surface you will scrape will be smaller and thus more pressure can be applied. If you are scraping an easier thin hide such as a white tail, you will want to use a larger pipe so the surface your scraping will be larger and thus will proceed quicker.

The pipe is easily changed and replaced if need be.

The smoker can be easily and inexpensively made with four and a half sheets of plywood and several two by fours. The roof should be flat and inclined to the rear so as to shed moisture if need be. Support wires should be strung back and forth across inside near the ceiling. They should be several inches apart. The hides can be hung close together but should not be touching. If the hides are touching during the smoking process the areas that are together will not absorb the smoke. To hang the hides onto the support wire, in a manner that makes the putting on and taking off of the hides fast and easy, I use what are known as Hog Rings. They can be purchased at or ordered through a hardware store.

On the ground in your smoker you will need a metal pot with some sort of a lid or cover. The pot is to put your punky wood or well rotted wood in. The lid is to limit the amount of oxygen available to the burning wood and also to prevent flare-ups, which sometimes occur, from burning the hides. It is also a good idea to insulate the heat from the bottom of the pot from the ground. Turf underneath the pipe has been known to catch fire. A piece of asbestos can be obtained from a woodstove supply store, or you can simply dig a hole in the location where your pot will sit and fill the hole with sand. This works just as well. Be sure that there are no rotten roots in direct contact with your buried pot or hole as this may cause a "creeper" to start and cause a fire to surface at some distance from your smoker. This actually happened to me and caused 4 acres to be burned before the fire was put out.

Punky Wood is used to make the smoke which best colors the hide. There are many types of wood used to obtain different shades from a light tan to dark brown to green. I found that green wood can also be used, but the temperature must be kept higher in the pot to keep the coals from going out and this, in turn, may cause the moisture in the box to become a high enough temperature to effectively cook your hide.

The brains used to tan the hide, were once many years ago and often times even now, obtained



from the animal which the hide came from. I do hundreds of hides a year and it is not possible to use the brains from the individual animal so I purchase the brains I use from meat packing plants via my local grocery store. I purchase the brains in bulk. There are pork and beef brains available. I prefer the beef brains. They come in convenient one pound packages.

Rubber gloves should be used if you have any abrasions on your hands. Hides that have been soaking contain vast amounts of bacteria which can quickly cause blood poisoning once they enter through the skin. If you are scraping in cool or cold weather, glove liners can be worn under the rubber gloves. One trades off lack of feel for the hide for comfort.

Protective clothing may be desired. A rubberized butcher's apron works well to protect the upper and lower front of the body. High top rubber boots protect the feet. It is a good idea to rinse them off after use. Some hides you will receive have been salted and the salt is bad for the rubber.

I use plastic garbage pails for my soaking barrels. For the initial soaking to remove hair, I soak the hides in a 55 gallon garbage pail. To ensure the hides stay completely submerged I weigh them down with a large rock, making sure all the hide is under the water. For soaking the hides while braining them I soak them in a 10 gallon plastic kitchen garbage pail. I prefer plastic because they stay flexible in cold weather, they are easy to clean, will not rust and they are inexpensive. Good Luck and Enjoy!

[Chapter One: Choosing The Best Hides](#)

[Return to Hide Tanning Table of Contents](#)

---

© 1996 Sundog Traders (formerly Musselshell Traders). E-mail: [ezra@midrivers.com](mailto:ezra@midrivers.com)

---

[Return to](#)

[Return to NativeTech Home  
Page](#)

*NativeTech Home Page*

# Hide Tanning

---

## Chapter One: Choosing The Best Hides

In the quest for success in brain tanning hides, the first and most important step is choosing hides that will contribute to a well tanned, soft finished product. I have known many first time tanners, who began their project with hides which are too thick, too large or are of inferior quality, which resulted in failure and discouragement for the novice tanner. This usually keeps the novice from attempting the tanning process again. In this chapter I will give you instructions which will enable you to choose the right hides which will increase your likelihood for success.

There are many different hides used throughout the world for tanning. I will concentrate only on hides most commonly used here in North America, and ones I prefer to use myself; elk, deer, and antelope. In nearly all species, the male has the thickest hides, followed by the female and then the youngest having the thinnest hides. Summer killed animal hides tend to be much thinner than winter killed animal hides. If you do not know when the hide was taken, you can usually tell by the type and color of hair and by the size of the blood vessels. The longer and thicker hair, and larger blood vessels suggest a winter kill.

Elk, which are mostly located in the Western United States, have a very thick hide. Moose, which are found in the northern states, also have very thick hides and tend to be more fibrous than elk. The mule deer, which are found in the western states also have thick hides. The White Tail deer has a thinner hide and the Pronghorn or, as it is sometimes called, the antelope, possesses the thinnest hide of the large game animals most commonly used for brain tanning. Animals in the northern states will have thicker hides and hair due to the colder climates. All will usually carry some kind of scaring from wire cuts.

I recommend that first time tanners use a smaller, thinner hide for their first tanning project. I suggest using a small deer hide, but not a "Bambi" hide! If you do not have a small hide then I suggest cutting the neck area off of a larger one. Large thick hides are much more difficult to tan. Only after tanning several larger deer hides with success should you attempt to tan a elk or moose.

There are many ways to obtain hides. If you hunt or have friends who hunt you can usually obtain as many as you need. If you find you need more hides than you can obtain in this fashion, you can advertise in a local paper, contact commercial tanneries in your area, or contact wild game meat processing plants. I sometimes trade for hides. I offer to return one tanned hide for every ten untanned hides sent to me. You could also do hides for others. Lots of loaded freezers out there waiting to be emptied!

If you plan to use a hide from an animal you yourself have "reduced to possession," you must take care to skin it properly. Hanging the carcass to skin it is best because the entire hide is easily reached. Avoid slashing the inner layers of the hide. This slashing is referred to as "scoring" and

will cause much difficulty during the scraping process, by being prone to causing the scraping tool to cut holes into the rough hide. If it is possible for you to pull or peel the hide, so much the better.

If you are acquiring hides from others be sure to inspect the hide. Consider the number of holes it possesses. A hide with many holes is not at all desirable. Most hides will have an entrance and exit hole caused from the killing projectile. They should be small holes. Avoid hides with large holes. They are not easily neatly sewn closed and detract from the beauty and usability of a finished hide. When the hide is finished the holes can be neatly sewn closed to the point they are nearly invisible.

Avoid hides that already have an offensive odor and hides whose hair are already slipping off. It is more likely than not that the hide has already begun to rot and will result in a hide you will put many hours into only to have it fall apart. Very fresh hides often have ticks on them, be cautious. Avoid hides that have been allowed to set with the meat and fat on them, or stacked one on the other in an enclosed area that lacks ventilation. The decomposition of the hides stacked one on another causes heat and thus causes rotting. Much of deciding whether or not a hide has gone bad or not can be done just by using your nose.

Hides that I use are hung up in the open air, flesh side up, to dry until I can get to fleshing and dehairing them. Often times I have kept hides in this manner for a year before getting to them, with no ill effects to the hide. Keep in mind, though, that I live in a very dry climate most of the year. This might not do in humid areas where mold will probably form on the surface of the hide and cause the hide to be permanently stained.

The most ideal time to work a hide is when it is fresh, or as fresh as possible. If you can not work a hide when it is fresh and you must let it set, freezing it is best. In order to avoid freezer burn, a condition caused by the arid environment in a freezer, soak the hide before you put it into a plastic bag and then freeze it and the water will protect the hide from drying out. I advise you to not use plastic bags for the storage of hides other than the ones you are freezing. Plastic tends to make the hide rot more rapidly. If you do not have a freezer available, you can often rent a cold storage locker at a meat processing plant. This is ideal if you are storing several hides. You will find meat processing plants listed in your phone book.

It is best to store the hides indoors where bugs can not get to them. Some of my hides have been ruined from bugs boring into the hide. This results in the hide having lots of tiny holes that make the hide eventually fall apart. The best way I've found to get rid of them at no cost is to drown the heathens. Soak the hide for 24 hours in plain water and they'll all be gone until their relatives discover that no one is home and move in. Some folks I know use salt water for this purpose instead on plain. Another method is to use Sevin brand insecticide by Ortho. Either liquid or dust will work. Follow directions as for proper strength. I got this idea from Larry Belitz. I'll take this time to thank him ever so much for getting rid of one more problem!

The best way that I have found is to flesh the hide out for storage, salt, and then dust lightly with



Sevin and lay some place cool and flat. The salt keeps the hide pliable. You can spray the hide with liquid Sevin, but you must make sure that you get all the nooks and folds.

If the hides are stored outside you must take precautions to keep predators away from them. Dogs are notorious for eating hides in the raw stage as well as in the tanned finished product. It is only natural for them to do so. They do not differentiate between your hide and the rawhide chew toys sold in stores. In fact, your hide probably smells more inviting and has much more of the flavor dogs love.

If you have a hide with meat on it that you decide you can not use, throw it over a fence meat side up during the winter and the birds will love you for it.

## [Chapter Two: The Right Hide For The Project](#)

[Return to Hide Tanning Table of Contents](#)

---

© 1996 Sundog Traders (formerly Musselshell Traders). E-mail: [ezra@midrivers.com](mailto:ezra@midrivers.com)

[Return to](#)

[Return to NativeTech Home  
Page](#)

*NativeTech Home Page*

# Hide Tanning

---

## Chapter Two: The Right Hide For The Project

If you have a project in mind you will need to learn to choose the proper hide for what you will be making.

Often times I can not tell how thick a hide is until it is scraped. I usually have ten to twenty hides of different grades, scraped and ready for the tanning process to begin. In this way when I get an order I know which hide to choose for the project I plan to undertake. In order to more easily choose the proper hide for a project, I like to keep them in stacks according to the species, size, as well as the thickness and hide condition. I call this the grading process.

My grading system consists of:

Number One Hides - large, thick, minimal holes and minimal scoring.

Number Two - medium, some holes, varied in thickness with some scoring.

Project Hides - small, varied thickness, holes and scoring.

Let us assume you, as a tanner, get an order for a pair of moccasins, a set of leggings, a summer shirt and a pipe bag. You will want to use a number one, thick hide, like elk or mule deer for the moccasins. The thick hide will not wear out as quickly as a thin hide. When I am scraping a hide that I can see will be thick, I usually do not scrape down as far, leaving some of the outer layer on the hide. . The result is a soft hide with very little stretch but one that has more strength and durability. If you are going to make leggings or pants you will want a number one, thicker hide such as a mule deer or a thick white tail buck. A summer light weight shirt should be made from a number one ,thin white tail or even better, a Pronghorn hide. The pipe bag can be made from number twos, threes or scraps of any of the above mentioned hides.

When my hides are completed I grade them again. I consider which hides I will use for clothing, moccasins and project hides. The most ideal hides to use for clothing are the ones with the least amount of scoring, the ones whose thickness is uniform and are the largest hides. Hides that have scoring on them tend to be weak in those areas. Clothing items have a lot of stress points and a weak point on the hide will result in severe stretching or tearing. The reason large hides are desired when constructing clothing is because the finished product is much more attractive when it is not unnecessarily pieced together.

[Chapter Three: Soaking The Hides](#)

[Return to Hide Tanning Table of Contents](#)

---

© 1996 Sundog Traders (formerly Musselshell Traders). E-mail: [ezra@midrivers.com](mailto:ezra@midrivers.com)

---

[Return to](#)

[Return to](#)

[Return to NativeTech Home  
Page](#)

*NativeTech Home Page*



# Hide Tanning

---

## Chapter Three: Soaking The Hides

### Step #1

When you have a hide which you have inspected and decided to use, it is time to soak it. Over the years I have soaked hides in running streams as well as in lakes. The problem I found with this method is that the hides were out of my sight, away from my home and susceptible to varmints that would drag them off in spite of the large rocks I used to keep them totally submerged. Therefore I prefer to soak them near my home and near my scraping beam, where they are available for frequent checking.

Use as pure water as you can obtain. If you have chlorinated water, which is all that is available in most cities and towns, try to find spring water or ground water to use . Since chlorine is a chemical, I have found that it effects the nature of the hide and the brains are not as effective as they could be. If it's all you have , let the water stand for a day or so, so that the chlorine will evaporate out.

Fill your large plastic garbage containers three fourths full of water. Put the hide in the water and place a large rock or block on top of it to assure it stays totally submerged. If you are tanning in hot weather it may only take one or two days for the hair to begin to slip. Make sure that the hide is soaking in the shade and change the water every day! If you are tanning in warm to cool weather you should only have to soak the hide two to three days before the hair starts to slip. Change the water every day! If you are tanning in cold weather, anything above freezing, it may take up to a week for the hair to slip. I recommend that if you have to soak the hides in below freezing temperatures, to arrange to soak the hides somewhere that the temperature can be kept above freezing. Salt water will allow you to go as low as 28 degrees, but it's real hard on the hands!

Test the hide by putting it on the beam to see if the hair comes off easily when scraped. If it is not easily scraped off, soak it another day and try it again. Remember also to change the water every day! This will keep the smell down as well as allow you time to check on the condition of your hide.

In my large rubber trash container, I usually soak 3 hides at a time, totally submerged by a rock that is large and flat. You'll discover that hides can float very well and will attempt to slide around the rock. Many a time have I been in a hurry and didn't make sure that the rock was centered on top of the hides and pressing them on the bottom of the container. I have gone to check on them only to discover the hides on top of the water and the rock on the bottom! This situation will cause the hide to rot rather rapidly and ooh! what a smell!!

If you have not been able to attend to the hide for several days and when you do, you find that the

hide tends to tear or is bubbly and an offensive odor is detected, the hide has started to rot and I prefer not to use it. The reason is it is more prone to continue rotting further along in the tanning process and in the end you will have a weaker hide because of the unnecessary breakdown of the hide fibers. You need to check your hide daily. If at all possible keep your soaking containers near your beam to make it more convenient to check the scrapability of the hide.

A word of caution: There is present large amounts of bacteria in the water and on the hide so infection is a real possibility. I never allow my hands to touch this water without rubber gloves if my hands have recent cuts. Did I forget to mention changing the water every day??

### [Chapter Four: Scraping The Hide](#)

[Return to Hide Tanning Table of Contents](#)

---

© 1996 Sundog Traders (formerly Musselshell Traders). E-mail: [ezra@midrivers.com](mailto:ezra@midrivers.com)

---

[Return to](#)

[Return to NativeTech Home  
Page](#)

*NativeTech Home Page*

# Hide Tanning

---

## Chapter Four: Scraping The Hide

### Step #2

Over the centuries, from ancient times when man began to construct clothing from the prepared hides of animals there have been many different methods of scraping the hide. We know from archeological research that the first tools were used were of stone and bone. At first the more simple tools were only hand held implements, eventually however, these tools were secured to handles of wood and antler which gave the tanner more leverage and thus made the job of scraping the hide much easier. When the iron age arrived, tools of metal were fashioned and became popular.

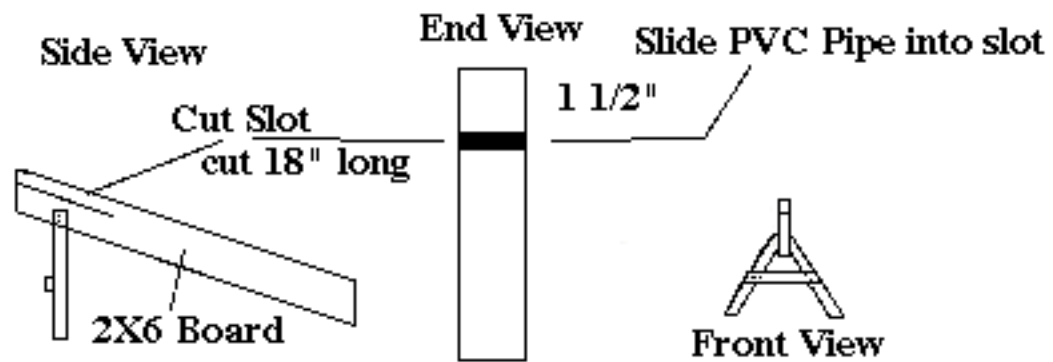
In my traveling throughout the country to observe different methods of tanning by Native American people and other tanners I have observed many who still prefer the old traditional scraping tools of stone or bone mounted on a handle.

The scraping tool used most often depends of the surface, or lack of, that the hide is worked on. Some Native Americans, today still use the ancient method of pegging the hide to the ground. Beginning at the top of the hide, with the meat side up, a sharpened wooden peg of sufficient size, is driven through the edge of the hide and into the ground several inches. Then a peg is put through the opposite end, stretching the hide as much as possible. The sides are then stretched out tightly and pegged until the surface of the hide is taut and without wrinkles. With this arrangement, a tool with a long handle and whose scraping implement is at a certain angle will work best. The hide is scraped with a hacking or hoeing motion. Once the meat side is finished the hide is turned and pegged down as before and the hair is removed, starting at the neck and scraping in the direction of the hair growth.

I have also seen tanners scraping a hide when it is hung on a frame in which it has been secured with lacing. The frame is usually six feet by six feet and the lacing is spaced approximately 2 to 3 inches apart. The hide is again pulled as taut as possible and the tool used in this method is of bone, stone or metal with a shorter handle.

I was not comfortable with the two above methods. The first was much too hard on the back. The second, I needed to make sure that the tool was at the right sharpness and angle to keep the wash board effect from starting. And I just wasn't able to do all those thinner hides that exist out there.





I find that using a slanted log works best for myself as well as most people. The height of the beam can be adjusted to a level that gives the most efficient scraping angle and the most comfort. Both are of the utmost importance. You will want the beam to be high enough so you do not have to lean over very much. The motion of your body during scraping should be in your arms, shoulders and not in your waist! This eliminates the soreness that might otherwise develop in the lower and middle back. I find that putting the beam slightly above the waist works well for me. But that won't work for you so try this. The beam should come up at about a 25 to 30 degree angle to the body and connect with you on your stomach where your arms naturally bend. The log angle will depend on your arm motion as you push down and away. You should not have to bend over to flesh or dehair hides!

Dry scraping, which I used for over a year, has its advantages. There is less mess from the soaking of hides in barrels, less mess on yourself and it can be done in extremely cold weather. Dry scraping no doubt originally came about in arid regions where water was scarce. Many tanners today prefer the dry scraping method.

The reason I changed from dry scraping to wet is because of the necessity of having to keep the scraping tool very sharp. When a sharp tool is being used it is more than likely that you will end up with more holes in your hide. This is very true if you are a novice tanner. The proper angle must be maintained and you must be sure that the tool you are using does not slip from side to side and result in cutting the hide. Also scraping the hide too thin is a possibility.

Again, let me stress that the methods I am presenting to you are the most efficient and less time consuming way of tanning I have found. You may wish to experiment with different methods. I recommend you save yourself time and use my method first. You fellows out there that make these tools for a living might want to come up with one for this method.

Also, I have evolved from the dry scraping method to that of being a wet-scaper because I find that the hair is more easily removed and since the object of my method is to make the tanning process the least laborious, I will be instructing you in wet-scraping.

After laying the hide on your beam, hair side down, look at the shape of the hide. If there are long irregular pieces of hide hanging down where the legs were, use your knife to cut them off and

make the hide a more uniform shape. If you have any holes near the side of the hide, cut them off as well. Cut them in such a manner that the shape of the hide is retained. The few extra inches you would otherwise save will be more trouble than it's worth. Take my word for it. I sometimes receive orders for hides with the legs left on. Many of the old style Native American mens<sup>1</sup>/<sub>4</sub> shirts had the legs left on. I charge more for these hides since there is considerably more work in producing one. The big secret to make leg extensions soft is to thin them down without putting holes in them. I accomplish this by sandpaper over an 8 inch PVC pipe.

The first side that you deal with is the flesh side. I like to use a 6 inch PVC pipe for this side. I do know some that use a 8 inch, but this would require more pressure. Larger surface area = more pressure. On the flesh side you want to scrape down far enough to see small vein tracks in the hide. They will be indented into the hide. These should also be seen uniformly all over the hide. If these vein tracks can not be seen uniformly all over the hide, it is still under a layer of membrane and will be dealt with in another step. Also the hide will exhibit very tiny holes that are the blood vessels that transit through the hide. I like to scrape from top to bottom and from side to side as I go down the hide. There is no hard and fast rule. Just remember to get all that you can. There will be a very thin layer of membrane left on and one will be able to get this in another step with relative ease. Now flip the hide over.

The size pipe that I use depends on the kind of hide I have on the beam. Elk and moose require 2-3 inch pipe. Deer require a 4-6 inch pipe (2-3 inch for those necks at times). And 6 inch for antelope. Be sure to scrape with the lay of the hair. Scrape from the neck to the tail. I always scrape from top to bottom going from side to side as I do so. This allows me to systematically do the entire side without skipping around. Remember, the hair should easily slide off or at least be capable of being pulled out. To do the neck area it will be necessary to scrape against the flow of hair, but this is the only time that you should do this.

Scrape the epidermis and part of the dermas off. This is this step that is most difficult and discourages novice tanners but keep in mind that if it is not done properly will leave a skin barrier which will prevent the hide from absorbing the brain solution into it's pores and fibers. Now for the sake of this book I will refer to the skin layers as I see fit and not by actual name. I divide the layers up as follows:

Epidermis- the uppermost portion of the hide. Yellowish in color. Dermis- the smooth layer that appears. Pale blue in color. Will have little grooves in it similar to the top of your own skin on your arm.

Fibrous layer- The hairy stuff most folks like to get down to. The membrane is attached to the bottom side of this.

Scrape the layers of skin down far enough until you come to a layer that seems smooth, but has a slight fibrous look to it. The small dark spots you might see are the blood vessels in the hide. They

will look like holes in your hide and should not be confused with the roots of hair that you have just taken off. Roots tend to be up around the neck area of mostly male deer and elk and will usually come out during the process.

As I mentioned before, this step is the most difficult and time consuming. Keep in mind that the more hides you scrape the better and faster you will become. A large hide for me takes about 30 to 45 minutes to do.

At this point you should have a hide with a smooth appearance on both sides.

In preparing hides for most projects, if they are not scraped enough on both sides, the rest of the tanning process will be in vain because the hide will not come out as well as it should. This only creates extra work. You don't have to worry about the hide at this point as you'll have a chance to get at what you have missed at a latter stage in this method.

### [Chapter Five: Stretching \(Breaking\) your hide](#)

[Return to Hide Tanning Table of Contents](#)

---

© 1996 Sundog Traders (formerly Musselshell Traders). E-mail: [ezra@midrivers.com](mailto:ezra@midrivers.com)

---

[Return to](#)

[Return to NativeTech Home  
Page](#)

*NativeTech Home Page*



# Hide Tanning

---

## Chapter Five: Stretching (Breaking) your hide

### Step #3

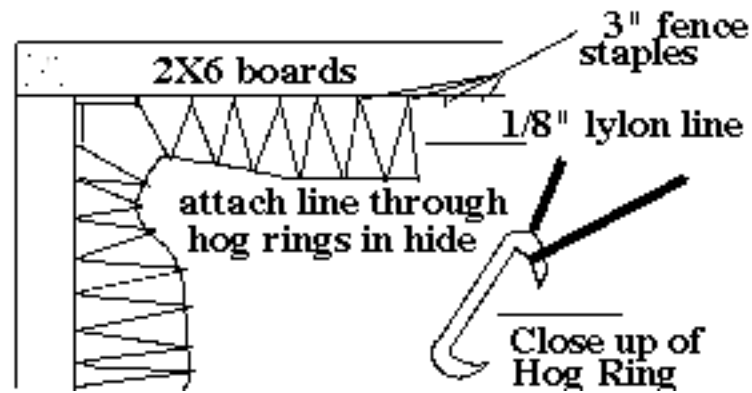
Now at about this point you have 2 choices. What I do is scrape 10 hides at a time and then go on to this step. As a result I will have a few rawhides that I have put to dry on a line between 2 trees. I find that I can do 8 sides (4 hides) in one day and still feel like doing more the next. I did 12 sides per day for a 9 days once and didn't want to see the beam again for a month! Another name for this might be called the breaking process as this is where I break my hides in my process. We'll cover the two different ways that this can be accomplished.

After letting the hide soak over night in plain water it should look like blue/white piece of rawhide. I've let hides sit in the water for several days always making sure to change the water every day. You'll notice that any excess blood will go into the water as well as some hide glue. A scum will start to appear on the surface over time and the water will cloud with whatever else comes out of the hide. Some folks I know will do this for days because it helps in the final drying/stretching by removing hide glue now. Do not be tempted to add soaps or softeners as some have suggested to help clean the hide. Plain water does just as well without the chemicals. We're talking pure brain tanning here and not partial or plain ol' chemical tanning.

If the hide is a large hide, I will take the hide over to my stretching rack and hang it up. Now the method that I use is I hang the hide tail side up in a frame that measures about 54" wide by 72' tall. I have 4 such frames connected together to form a box with an added piece for my entrance into the middle of the box. This allows me to stretch 4 hides at one time. My frame is made from 2X6's for added strength. (see diagram)

The inside edge of each frame has 2 1/2" fence staples nailed in at 3" intervals. I use 1/8" braided nylon, or even better, parachute cord (sometimes called 5-50 cord) to attach my hide to. This line is run through the fence staples and tied off at the corners. The line will need to be about 50' long per side. I prefer to use 4 separate 50' pieces as opposed to 2- 100' or even one continuous piece. This method allows me to tighten an entire side in a matter of seconds and only have 4 knots to deal with as opposed to multiple knots.

The connector that I use is called a hog ring. This little gem has two sharp points so be careful!



I like to hang my hides on the frame butt up and flesh side out. There is no hard and fast rule for this though. Just habit with me is all. I attach the hide using hog rings starting with the top, then bottom, and proceeding to the sides. My average hide will have 6-9 hog rings for the top, 5-7 for the neck, and 7-10 for the sides. I don't have to place the rings 2 inches apart as some suggest. Just enough to keep the hide on the frame and be sure to place your holes at least 1/4 of an inch in to as to prevent the hide from pulling free when you go to push in on the hide. Tom Orr taught me that stretching a hide is important and he is very much correct on this subject. The idea is not to make your small deer look like it came off a large elk, but to work the fibers apart so as to allow the smoke to get at the inside of your hide. Over stretching a hide will show as dark streaks coming from each of your connection points.

Now that I have my hide hanging I'll work it lightly at first for a couple of minutes. I do both sides. This has the effect of turning my hide from a dull bluish white to white as the hide dries and the fibers pull apart. This can be seen by back lighting it. The fibers and hide structure will stick out like a sore thumb! Water will sometimes come out as I run my tool over this. I'll let the hide set for 20 to 30 minutes before doing both sides of the hide again. But this will be determined by the weather conditions at the time. As you can see I can easily do 4 hides at a time at this point and still have time to sit a read a few pages of a good book or be doing another step in my process with other hides.

I eventually reach a point when the hide starts to stiffen up. Let the hide dry all the way. No sense wasting effort on stretched rawhide! Now at this time you should have a hide that is white with bits of dried membrane or even a soft fuzz on the flesh side and with the hair side showing fine ridges where the dermas has pulled up. Coming off of the frame the hide will be like paper for small or thin hides and like rolled rawhide for the thicker deer or elk hides.

When you have a hide that is small or thin you can take this hide over the metal strap, instead of hanging it on the rack, for about 5 minutes on each side. This has the effect of pulling the fibers apart and of also pulling off what large pieces of membrane that you might have missed. I suggest that you always hang the hide on the rack for this step regardless of the kind of hide that you have until you become familiar with this process.

They are now ready for the smoker!

[Chapter 6: Pre-smoking](#)

[Return to Hide Tanning Table of Contents](#)

---

© 1996 Sundog Traders (formerly Musselshell Traders). E-mail: [ezra@midrivers.com](mailto:ezra@midrivers.com)

---

[Return to](#)

[Return to NativeTech Home  
Page](#)

*NativeTech Home Page*



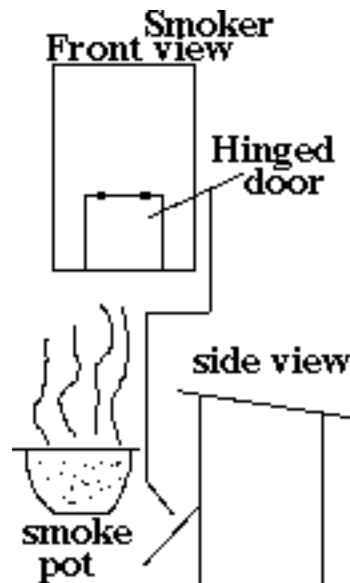
# Hide Tanning

## Chapter 6: Pre-smoking

### Step #4

Well folks, this is the part that you<sup>1</sup>/<sub>4</sub>ve all been wanting to read about. This is the big secret and the heart of this method. So let<sup>1</sup>/<sub>4</sub>s get to it shall we?

This chapter was the hardest part to write about as research was ongoing for quite some time. The woods used for the smoking will vary depending on what part of the country or globe you happen to be at so I<sup>1</sup>/<sub>4</sub>ve had to try to average things out and come to some sort of standard. Where differences will effect the quality of the hide, I<sup>1</sup>/<sub>4</sub>ve put little notices in to help you along.



The wood that is available to me here on the lower Musselshell River in Montana is cottonwood. There are some pine, but the punky stuff is mostly cottonwood. Cutting up these logs into 1 inch wafers, I<sup>1</sup>/<sub>4</sub>ll stack about 10 for the smoker along with the sawdust and prepare the fire. I<sup>1</sup>/<sub>4</sub>ll get a small bed of sticks going and then place on and around it these wafers until the pot that I use for smoking purposes is full. This pot by the way is an enameled speckled pot of 8 quart size. On top of all of this I<sup>1</sup>/<sub>4</sub>ll place some of the sawdust and on top of the pot I<sup>1</sup>/<sub>4</sub>ll place a large piece of metal to help choke off most of the air and effectively prevent the fire from flaring up and scorching your hides. One fill is usually good for about 90 minutes and each refill will be good for 60. Remember that each time you add more wood, the bed of coals will increase and thus cause a much greater amount of heat to be generated. Heat is your worst enemy and is the reason the box is not built air tight.

Now some folks I know use just plain sawdust for the smoking and others use a half and half blend of wafers and sawdust. This is more of the preference of the tanner than anything else. What is

important is the wood used and how well the excess heat is vented. With cottonwood, the smoking time is about 3 hours. Pine and cedar need about 2 hours and some hardwoods that I've used (punky white oak for the video) can get by with 1 good hour of dense smoke. The smoking process will leave the hide slightly discolored and if your results reveal a very dark hide you can lessen the amount of smoking time by half. I've smoked individual hides for as little as 15 minutes so as you can see there is no hard and fast rule for smoking time. One thing that can really help you is start your smoking fire with dry stuff and add damp wood on top. This puts some moisture into your smoke box (though not enough to cook your hides) and gets the smoke to adhere faster to the hide. There are many variations of your smoke fire that I'm aware of. Open fire pit in smoke box; Small stove in box; Stove outside of box; Fans in and outside of box.... and on and on. Whatever feels most comfortable for you should be the method that you use.

Now in my box, I hang my hides (up to 10) on strings that are run back and fourth across the inside top of the smoker. These hides hang to within 2 feet of the smoke pot and I always hang the longer hides to the outside strings. Always keep distance from the smoke pot so that no damage occurs to the hide. Keep 4-6 inches of space between your hanging hides so that the smoke has a chance to circulate.

There are some woods that, if used, cause a hide to become rubber like in texture. Call Al Ballard at 308-247-2507 for an up date. He's not closed mouth when it comes to helping other tanners. His wife developed a method whereby she smoked towels instead of the hide and will then place these in their washer with the hide to reap the same results as if you had smoked the hides themselves, BUT without the danger of cooking your hides! Ask him about it. He does 500 hides a year and has 26 years of tanning behind him.

When you have finished this step it's on to the used brain solution for a soaking that will help remove any of the excess membrane and dermis that you might have missed.

[Chapter 7: Back to the beam](#)

[Return to Hide Tanning Table of Contents](#)

---

© 1996 Sundog Traders (formerly Musselshell Traders). E-mail: [ezra@midrivers.com](mailto:ezra@midrivers.com)

---

[Return to](#)

[Return to NativeTech Home  
Page](#)

*NativeTech Home Page*

# Hide Tanning

---

## Chapter 7: Back to the beam

### Step #5

After the hide has been smoked, you can either let the hide stand as is or go on to the next phase. You can use either an old solution or make up a new one. See chapter 8 for a more detailed look at the solution.

The hide is placed into the prepared solution and is left to soak into the hide as to soften it up. This might take as long as a couple of hours. It is very important that the hide be as pliable as possible so as to not allow the scraping tool to cut into the hide when running it back over your beam. Some of the smoke will wash off into the water causing the solution to become gray in color from its' original foamy pink. Then, for you folks that are just starting out in this, take it back to the beam.

When starting out on the beam, do the flesh side first. Starting at the neck you will see the fibers start to pull apart as you remove any excess membrane that was left on the first go around. If the hide received a lot of smoke or heat the hide will seem to be very stiff, almost like armor, and will need special attention when soaking in the solution. The excess membrane will come off looking much like paper, in the case of a hide that has not soaked long enough, to thin gray strips of flesh. At this point you will begin to notice the little holes that are the blood vessels that transit the hide. Sometimes the holes look more like indentations and you have to look very close, but they are there. Another sign are the blood vessel grooves that will start to show up. These are found especially along the spine of the hide. This means that you've reached the limit that you want to pursue on this side. You will have also noticed that the smoke colored hide changed color as you scraped to a lighter shade. The smoking shows you where you have scraped before so you do not go over the same area again too often. Get what you can off and don't be too meticulous or they hide might dry on you and you will have to soak the hide again for a few minutes. Now turn the hide over. If at this point you feel that the hide is too dry on this side, soak it in the solution for 10 minutes or so and throw it on the beam.

The same procedure is followed on the hair side as well except for seeing the blood vessel holes. You will notice that some more of the dermas will scrape off and cause the hide to really stretch as you go over this side. Concentrate on the neck, middle back, and the area on either side of the spine at the rear of the hide in the flank area. These areas will either be much thicker or usually contain long scars that will have to be cleaned out if the cut did not transit the hide. Cleaning out the scar tissue will leave a small groove, but it will also allow you to soften those areas. A thru and thru scar will come out stiff in the final process and some old punctures will even tear open when running the scraping tool over those areas. Another hole to sew up is all. You will notice that as you go over this side that the fibers will stand out at you. The blood vessels might even present an outline of themselves such as you would get from a pencil rubbing.



One of the nice things about putting your hide back over the beam a second time is that this really works the fibers in the hide around even as you thin it a bit more. When you have finished this phase you can now go and place the hide back into the solution. You might notice that the hide will swell up as it soaks the solution in. This is what it is supposed to do. You will then wash the hide around in your soaking container every couple of hour so as to allow the solution to cover the entire hide. Want to really work that hide? Use an old agitator type washer and leave them in there for a few hours or even all afternoon. This will really put some stretch into that hide!

Another thing that can be done at this point now that the hide is rather dry and pliable is to rough up and stretch the hide over my metal band. A few minutes will suffice. In between you can sew up any holes that you might have. I use a #11 glovers needle, quilting or button hole twist thread in a light brown or tan color and sew a blanket stitch for this job. I double the thread over to add some strength. This stitch allows the hide stretch around and if the thread breaks it will not unravel as fast if the thread should break. After the holes have been sewn up, but before the hide is completely dry you can go an put the hide back into the solution. Sometimes, though, you might be able to break the hide out from this point. The hide will tell you. It will act like damp brain tan and will come out very fluffy and stretch.

After putting the hide back into solution there is one last check to see if the hide will break out for you. I call this the "bubble test". This simple test will keep you from wasting your time when it comes to the final breaking. I have in no other place ever read or seen this test performed to check hides. Simply take areas of the hide that lack holes and bunch it up so as to trap some air in it and squeeze it. Air should pass thru it very easily from flesh side to hair ( as seen in some methods) and also from hair to flesh in very fine bubbles. Some say that this can not be done. Well, maybe in their system, but not mine. Too many of my students have tried to shortcut this part and have had to go back over the hide again anyway. A waste of time ultimately.

At this time you will have been able to break out your hide or will have an off white stiff hide that is ready to go back into the smoker for another round of smoking.

### [Chapter 8: The Braining Process](#)

[Return to Hide Tanning Table of Contents](#)

---

© 1996 Sundog Traders (formerly Musselshell Traders). E-mail: [ezra@midrivers.com](mailto:ezra@midrivers.com)

---

[Return to](#)

[Return to NativeTech Home  
Page](#)

*NativeTech Home Page*

# Hide Tanning

## Chapter 8: The Braining Process

### Step #6

In the olden days of tanning, each individual hide was tanned with the brain of the animal killed. Theory has it that the brain within the animal was sufficient to tan the hide. I have found this to be true, however with the amount of hides I tan I need a larger, continuous supply of brains. Ninety eight percent of the hides I tan, have been obtained long after the death of the animal and I do not have access to the animal's brains. Instead I use fresh or freshly thawed cow brains that I order in bulk through grocery stores or meat packing plants.

When I purchase brains, but are not able to use them for a matter of days I freeze them until I am ready to use them. Brains begin to rot even faster than meat and should be used fresh for this reason. Some tanners dry the brains in an oven, then reconstitute them as needed, by adding water in the blending process. When dry, brains look very much like grape nut cereal. Be sure to not confuse the two! Yeck!! I have also known tanners, who without refrigeration, process the brains in jars until needed. I have tried using brains which have been preserved in this manner, but find I get better results from brains that have not been cooked, which occurs during the canning process. There are those, though, that say that canned brains are better than fresh. Whatever works best for you.

Years ago, when I began tanning, I used to smash the brains with my hands and manually rub them into the hide. Then at one point in my hide tanning evolution, I pressed them through a screen to get them a mushy consistency. I've used pumice rock and antler bases to work the brains into and through the hide. I now prefer to use a blender.

Rubbing the brains in the hide is passé for me now. It's a time consuming added step which, in spite of the fact some tanners still teach it, is not necessary.

Put one package or one pound of brains into a blender. Add enough water to nearly fill the blender and blend until the mixture is the consistency of a milkshake.

In your small ten gallon garbage pail put enough warm, not hot, water to fill the pail half full or about 5-7 gallons. The amount of water depends on the size of the hides and their thickness. You should leave enough solution to allow the hides to move around freely. Be sure not to use hot water because in some instances it will cook the hide and the hide will fall apart. Cooked sections of the hide will have the look and feel of rubber and layers will peel off if the hide was not cooked all the way through. When dry, those cooked portions will even act like rubber, but will not last very long.



Add the milkshake-like brain mixture to the warm water and insert the pre-smoked hide. Push the hide into the water until it is fully submerged and mix it around for a few seconds to make sure it is thoroughly saturated with the warm brain solution. The solution, which at this time will be foamy and pink will start to turn gray and take on the smell of wet wood as the smoke combines with the water. This action slows down the rotting process of the brains in the solution. I do not waste this solution and recycle it back into a new solution and have even heated it up and used it for up to 8 hides further! For the adventurous at heart I recommend trying your smaller thinner hides in this solution at room temperature. I've found that the hides often times loft up better when done in cool water.

The hide should set for several hours before running it over the metal band to spread the fibers out and to allow the solution to penetrate further. Don't be surprised to see a white foam appear as you rub first the flesh then the hair side. Look to see if the fibers, especially on the hair side, start to rough up. Put the hide back into the solution and look for the hide to puff up and have the feel and consistency of wet brain tan. You should be able to press air through the hide in both directions at this point. You can now leave it overnight. Just remember to mix it occasionally.

You will find that the brain solution does not have a very bad smell. The pre-smoking keeps the solution from smelling. It is possible to use the brain solution for several hides.

You will find, after tanning many hides, that each individual hide is different. What works well for one hide, and gives good results, may not give you the same results with your next hide. This can be frustrating for even the seasoned tanner such as myself and is the main source of frustration for the novice tanner who has success with one hide and hardly any at all with the next. I have learned to watch for certain signs, or to "read the hide" to determine what I need to do with it. Experience alone, teaches one the lessons needed to be successful with each hide. Even now, after so many years of tanning I come across a hide that will cause me frustration.

### [Chapter 9: Final buffing](#)

[Return to Hide Tanning Table of Contents](#)

---

© 1996 Sundog Traders (formerly Musselshell Traders). E-mail: [ezra@midrivers.com](mailto:ezra@midrivers.com)

---

[Return to](#)

[Return to NativeTech Home  
Page](#)

*NativeTech Home Page*

# Hide Tanning

---

## Chapter 9: Final buffing

### Step #7

In this method, this is by far the easiest part. You start first by wringing the excess water out in any fashion that you may choose. Keep in mind that the dryer you make the hide, the faster you will complete this portion of the task at hand. Also, though, keep in mind the air temperature, humidity, and whether or not you are in the shade. I usually do my hides in the shade or even inside if the wind is blowing too much. Wringing the hide out can be done by making your hide into a tourniquet. Remember to twist the stick in both directions!

I now proceed to follow the clock so to speak and work the hide for 5 minutes on each side and then letting the hide rest for 15-20 minutes. This is very difficult for many seasoned tanners to do because of having to constantly work the hide under old methods. The smoke acts to slow down the rate of drying as well as allowing the brains to do whatever it is that you believe they do better.

Be sure not to rub too long a stretch of hide across the band as this might make you work harder than you would have to. Try to keep the amount of hide between your hands at about 18 inches or whatever is comfortable for you to hold and pull on without having to twist your body around 90 degrees all the time. Try to save the aerobics for another time.

When buffing up the hide it is recommended to constantly rotate the hide so that all areas are stretched first one way and then at least 45 degrees in another. Do not concentrate on any one particular area as this could lead to a hard spot forming. You will start to notice at this point that the fibers are becoming more pronounced .

After each round of buffing flap the hide as you would when cleaning a blanket in the wind so as to help it get back to its original shape. You can also pull the hide over your legs and knees and stretch it as well, but always end each round by flapping it. Make sure to do all sides and then hang it up out of the wind or direct sun light and let it rest and dry a bit.

This also allows the fibers to dry some so that when you go back to another round of buffing you will , in effect, pull the fibers apart more and create more drying surface.

[Chapter 10: Pricing Hides](#)

[Return to Hide Tanning Table of Contents](#)

---

[Return to](#)

Return to NativeTech Home  
Page

*NativeTech Home Page*



# Hide Tanning

---

## Chapter 10: Pricing Hides

There are different ways to determine the selling price of your hide. Some tanners, usually not professional, will sell their hides according to if they are small, medium or large. Tanners who sell to professional hide buyers as I do, price their hides according the square footage of the hide as well as the quality it possesses. To determine the square footage place the finished hide on a flat surface. A yard stick works well for measuring since it can be placed upon the hide and stay straight as opposed to a tape measure that does not. Measure along the center line top to bottom and again from center line side to side. Then multiply the two, divide by 144 and then you get the square footage. This gives the best measure, but some I know divide the hide into thirds and do the same thing. Below is how I break down my hides by grade.

Moccasin Grade-Thick and very dense

Quality number one hides-No holes or scoring

Number one hides-2 holes maximum and some scoring

Number two hides-Many holes and scoring or weak thin areas

Scraps from projects-many holes, scars, some hard spots. Not worth doing again

Raw hides

Smoked / Non-smoked

[Chapter 11: Wrap up](#)

[Return to Hide Tanning Table of Contents](#)

---

© 1996 Sundog Traders (formerly Musselshell Traders). E-mail: [ezra@midrivers.com](mailto:ezra@midrivers.com)

---

[Return to](#)

[Return to NativeTech Home  
Page](#)

*NativeTech Home Page*

# Hide Tanning

---

## Chapter 11: Wrap up

Some late modifications:

The fleshing beam can be changed by using a 2X6 on end and making an 18" long slice about 1.5" down from the top. This slice should be wide enough to accommodate the thickest PVC pipe section that you have. This was done at a weekend teach-in that I gave in Stanley, N. C. by one of their resident carpenters. I made one up for my students upon returning home. It's fully adjustable and is about the easiest beam to produce that actually works. Only a carpenter could have done that! Thanks to you folks at tribe for this idea. They were kind enough to let me use their drawings to show some of my stuff. Tribe is a pretty good source of information for those that are èaboí inclined at an excellent contact for others to network from. Contact them about their newsletter and organization at Tribe, 1403 Killian Rd., Stanley, NC. 28164 or at 704-827-0723.

[Hide Tanning FAQ: Frequently Asked Questions](#)

[Return to Hide Tanning Table of Contents](#)

---

© 1996 Sundog Traders (formerly Musselshell Traders). E-mail: [ezra@midrivers.com](mailto:ezra@midrivers.com)

---

[Return to](#)

[Return to NativeTech Home  
Page](#)

*NativeTech Home Page*

# Hide Tanning

---

## FAQ (Frequently Asked Questions)

### *Are all deer hides the same?*

A: No. I find I have more problems with deer from Ohio than anywhere else. I have to thin them more. Missouri deer are thick but have a dense structure which require more in the way of thinning to get any type of stretch. Southern deer are jokes to do! If only all deer were this easy!! Thinness creates a problem for the beginner though.

### *Is your system the same as the one you use in the Mark Baker video series?*

A: To a point. The method required some modifications so as to fit with the theme of the series. A separate video taken from that series showing only my pre-smoking is available from American Pioneer Video, 1-800-743-4675. My beam, rack, and soaker are all different, but the method was presented in correct order.

### *Is you draw knife really as dull as it looks?*

A: Only when working around beginners and on thin hides. I try to show that its the person behind the tool, and not the tool, that tan the hide. My tool that I use when not teaching you could shave with. This allows me to use even less pressure to dehair a hide and lets me thin that much faster. On thin hides I still use a dull knife so as to limit the chances of creating new holes.

### *Can I smoke with all woods?*

A: Not according to Al Ballard. He also has some slick tricks on smoking that seem to work. His number is 1-308-247-2507. A very open person and willing to experiment and share his results with others is he. Been doing hides for 26 years.

### *I can't find a market for my hides!*

A: Call me.

The results of this book were no easy task! Many years of practice and errors went into this. You'll never know the amount of pressure that was brought to bear to leave out portions of this book so as to not make the system too easy. It is speculated that the price of hides will come down as a result of all those new comers that are sure to spring up or even the loss of customers that might result as well. I did this to be helpful and clear some of the continuing myths that still are circulated as fact; either to mislead or out of ignorance of the subject. Why write a book and purposely sabotage it at



the same time I ask!?! Ultimately, you will be the judge.

It has been my intention to instruct you in the best way I possibly can.

**No secrets here folks!**

**Musselshell Traders is the name and hides and related accouterments are our game! Ask about seminars in your area or here at my place.**

**[Return to Hide Tanning Table of Contents](#)**

---

© 1996 Sundog Traders (formerly Musselshell Traders). E-mail: [ezra@midrivers.com](mailto:ezra@midrivers.com)

---

**[Return to](#)**

**Return to NativeTech Home  
Page**

***NativeTech Home Page***

## Native American Technology and Art

### Brain Tanning

### Less Instruction With More Results

*by Joseph Dinsmore & Victoria Longtrail D.*



**1. Flesh the deer hide. All you are concerned with is getting the meat and fat off. Then place the hide in water and soak over night. Make sure the hide is completely soaked (the greener the hide the easier to dehair).**

**2. Dehairing :** Take the hide out of the water and place it over a beam and dehair. The objective here is to get the brown layer (epidermis) off. Keep in mind the fresher the hide the easier it is to dehair. If you are using a "flint" or dried hide with the hair still on, soak it overnight and flesh it again and you will notice the hide whitening out as you flesh. When done, throw it back in the water overnight. It soaks much faster. Dehair the next day.

**3. This is what I call pre-braining. Its better to pre-brain the hide after you dehair while the hide is still pliable rather than letting it go to rawhide. After you de-hair the hide put the hide in either an old brain solution or a new one. If it goes to rawhide, soak overnight in cold water and then stretch by hand. You will see the hide whitening out (not**

**totally). The objective here is to open the pores ( don't work all day it only takes a couple of minutes) A metal strapping band ( the kind used to bundle wood with) works the best for me. You can soak the hide in the brain solution for as little as twenty minutes or over night. I prefer over night. Brain solution recipe is at the end of the article.**

**4. After pre-braining take the hide and hang it out to dry. Its not necessary to wring out the hide Don't fold the hide on itself, prop it open with sticks or whatever, or hang it straight up and down.**

**5. Soak the dried hide in COLD water over night. Lace the hide on a frame, this is the pre-stretching phase. ( I emphasize cold water because the hide is plyable enough to put on the frame and whiten out.) Before I begin staking the hide, I sew all the holes. I do it at this point because then there is no pucker, I use artificial sinew (personal preference). All you are trying to do is whiten the hide out by staking it. The weather dictates how often the hide needs to be staked (remember, your not trying to soften it your just trying to whiten it). In recent experiments it seems to stake out better when working side to side rather than up and down. You will notice that when staking the hide, it sometimes starts to soften up, if you like, keep working it, I don't.**

**6. Pre-smoking. After the hide is whitened and dried out, smoke it. If you think about it, if a white buckskin is smoked and gets wet, it softens back up with very little work. Why can't you do it a pre-stretched hide! I smoke the hide for three hours in a smoke house. (its nothing more than a box made of four sheets of 4X8 plywood and a roof.) I hang my hides horizontal about three foot from my smoke pot. The thing to keep in mind is don't bake the hides. Keep a warm smoke (punku cedar is in my experience, the best wood to use but**

you can use any kind of punky wood.)

7. After smoking, put the hide back in the brain solution. I leave the hide in it for thirty minutes to an hour. Take it out and rub it over the band (I do this to make sure that there are no hard spots in the hide, if there are hard spots, then soak it a bit longer.) Put it back in the brain solution, you can either leave it for three hours or over night.

8. Take the hide out of the solution, it is your choice of either putting it through clothes wringer which is what I use, or wringing it out in any method you choose. Work the hide on a rope, beam, cable etc. to soften it up. Remember, a smoked hide doesn't require that much work to soften it up. This is the same principal as was described in the pre-smoking step. The idea behind this method is that you don't work on it constantly until it is dry. It requires you to be lazy. Not real lazy. It IS possible to overwork the hide.

**Brain Solution Recipe:** One cow brain, two gallons of water. Make it look like a weak campbells tomato soup but don't eat it. Heat the solution until warm, NOT hot. The beauty of this pre-smoking method is that you can tan more hides with one cow brain. You will notice if you use this same solution (add more water when needed) the hides will get easier and easier to sofen out and the solution smells more like smoke than brains. Sometimes I have to add another cow brain depending on how much additional water I have added. I have found that rain water works best when making the brain solution. Any kind of chemical in the water, such as chlorine seems to have an adverse effect. I have done as many as twenty-two to twenty-four hides with two cow brains.

Feel free to call or e-mail with any questions you may have.

[Our catalog sent upon request.](#)

© 1996 [Sundog Traders](#) (formerly Musselshell Traders). E-mail: [ezra@midrivers.com](mailto:ezra@midrivers.com)

---

[\*Tanning & the Preservation of Other Animal Parts\*](#)

[NativeTech Home Page](#)

© 1994-1998 [Tara Prindle](#).



# BRAIN TANNING DEER HIDES

## 'MANY MOONS'

*contributed by Fred*

---

### **FIRST:**

**SOAK HIDE FOR 2 DAYS IN SOLUTION OF:**

**1 1/2 LB unslaked lime; ten gallons water**

**1/2 box baking soda; ten gallons water**

### **NEXT:**

**1. SOAK IN RAIN WATER 3 DAYS**

**2. DEHAIR**

**3. FLESH FAT FROM HIDE; USE A GOOD FLESHING TOOL; BE CAREFUL HERE**

**4. SET OVERNIGHT**

**5. SOAK IN RAIN WATER OVERNIGHT**

**6. PUT ON STRETCHER WITH MANY CONTROL POINTS AND APPLY PRESSURE ALL SIDES AS HIDE DRIES**

**7. RUB HIDE 5 MINUTES; LET DRY 25 MINS; WORKING BOTH SIDES**

**8. BLEND BRAINS USING SMALL AMOUNTS HOT WATER; ADD 3 TO 5 GALLONS WARM WATER**

**9. WORK HIDE INTO SOLUTION; WORK SOLUTION INTO HID!! (read)**

**10. TWIST HIDE; HANG FROM TREE, DANGLE HEAVY ROCK AT BOTTOM, SPIN (or whatever)**

**CATCH SLURRY FROM BOTTOM**

**11. REPEAT 9 AND 10 SEVERAL TIMES(5-6) FOR 30 MINUTES ALLOWING SOME SOAKING**

**12. BREAKDOWN FIBERS; PUT HIDE BACK ON STRETCHER WITH TIGHT PRESSURE**

**13. BREAK TOOL: CANOE PADDLE, AXE HANDLE, BEAVER BOARD, ETC., MUST BE SMOOTH**

**14. WORK AND PRESS ALL AREAS UNTIL DRY(A LONG TIME!)**

**15. TO WEATHER PROOF AND MAKE SURE BUGS ARE GONE: SMOKE WITH ROTTEN, DRY WOOD**

**QUIT WHEN COLOR CHANGES; MAKE SURE HEAT IS VERY LOW FOR THIS STEP**

**16. WHEN HANGING HIDE, HANG NECK DOWN**

~ thanks fred

---

[Return to Tanning & the Preservation of Other Animal Parts](#)

[Return to NativeTech's Main Leather & Clothes Menu](#)

[Leather & Clothes Bibliography and Books to Buy On-Line](#)

---



© 1994-1999 [Tara Prindle.](#)

## NativeTech: Native American Technology and Art

### Removing Deer Toes Contributed by Jim Mitchel

From a post to the NativeTech Message Board on Sept. 10, 1998

---

If you have access to the Society of Primitive Technology (Tara, please do not get upset over the use of the term primitive). In the Fall 1995, Vol 10, Bulletin of Primitive Technology, pages 42-43. There is an excellent description of how to remove the hooves and dew claws from the legs.

Lacking this, the best time to remove them without tearing them is when they are still fresh. Basically, boil some water (bubbling, without the legs in the water), place the legs in the water approximately 2-3 minutes, pull one of the legs out of the water.

At this point, look for the leg to be slightly gray and swollen (strong indication it is ready). Try to pinch one of the dew claws between your thumb and forefinger, it should pop right off. The same thing should happen with the hoof. If it is still resistant to coming off, pop it back into the water for a few seconds (wouldn't want to cook it at this point).

Remember not to overboil, nor overly soak the deer legs, this may have a somewhat detrimental effect. You can do this with legs if they have not been frozen too long, but it isn't always successful. Sometimes you have to resort to the usage of a pliers to assist in pulling the dew claw or hoof from the leg, with possible tearing as a result.

Good luck!

~ thank you Jim

---

[Return to Tanning & the Preservation of Other Animal Parts](#)

[Return to NativeTech's Main Leather & Clothes Menu](#)

[Leather & Clothes Bibliography and Books to Buy On-Line](#)

---





© 1994-1999 [Tara Prindle](#).

**NativeTech: Native American Technology and Art**

**Preserving Deer Tails**

**Contributed by Patty, Richard, CG & Jim Mitchell**

**From posts to the NativeTech Message Board in 1988 & 1999**

---

**Date Posted: 01-02-1999 20:11**

**From: Patty**

**Someone just gave me 20 deer hides and tails. I'm not quite sure how to preserve the tails. Can anyone help me out with this?**

**Patty**

---

**Date Posted: 01-03-1999 15:29**

**From: Richard**

**Patty I assume the tails are separate from the hides. If not, cut the tails off and skin down along the bone just enough to get a good grip. You may have to use a pair of pliers or a rag due to the fat. Pinch the tailbone between two finger-sized sticks. A specialized tool called a tail stripper is made just for this purpose, but the sticks will do as well. Squeeze the sticks together in one hand and give a sustained, strong pull on the pliers. The tailbone should slide right out leaving the skin in tact. Slit the skin down the underside all the way to the tip. The skin can be washed in a mild detergent if dirty. After washing, dry the hair with a hairdryer. Coat the flesh side with a layer of borax, available at most drug stores. Let the tail dry with the coat of borax for several days in a cool, dry place. The borax acts as an antibacterial and will protect the skin from hide beetles (something plain salt will not do). Good luck.**

**Richard**

---

**Date Posted: 01-04-1999 19:16**

**From: CJ,**

**Patty, Richard's response is a good one. If the tails are still on the hides and you want to leave them on, you should be able to do so, preserving them in the same way you will the hides, after removing the tail bone. Also, if you don't want to use the borax, you can just scrape the meatty, fatty stuff off and dry them naturally(still wash the tails with mild deterg. and dry)...of course the mildew and bugs may come, especially if you live in a humid**

**environment. Store them with sage to help deter bugs. Also, someone here told me about braintan.com--you might want to check out their message board if you aren't getting the answers you want here.**

**Good luck! CJ**

---

**Date Posted: 09-22-1998 22:19**

**From: Jim**

**First, no matter what animal you are working on. The skin and/or hide is easiest to work on when it is fresh. I generally will remove the skin/hide from the carcass, then cut the tail bone from the carcass (at this point, it is still inside the tail). You can do the next step by yourself, but I prefer to have a little help if I should encounter a little difficulty. Get two pieces of cloth, grasping the tail bone with one, and pulling the skin back with the other (you will be pulling the tail inside out). If you should encounter a difficult area, whereby the membrane is still attaching itself to the skin. You can either push your finger into this area, or do as I do sometimes, take a U-shaped piece of coat hanger (the U should be no larger than the area you want to push it into, my fingers are a little fat). Push the hanger into the offending area, then continue as before. The last inch or two, is usually the hardest area to pull from. If you are too anxious, and pull the skin too hard, you may instead tear the skin, instead of removing the tailbone from the tail. Work in a careful and steady motion and you should have no problem.**

---

**~ a special thank you to Patty, Richard, CJ and Jim Mitchell for their contributing discussion!**

---

**[Return to Tanning & the Preservation of Other Animal Parts](#)**

**[Return to NativeTech's Main Leather & Clothes Menu](#)**

**[Leather & Clothes Bibliography and Books to Buy On-Line](#)**

---





© 1994-1999 [Tara Prindle](#).

## NativeTech: Native American Technology and Art

# Preserving a Hide with the Fur On

Contributed by Cynthia Senicka

---

**If the hide is hard and dry, soak the hide in warm water to soften it. Be careful to take the hide out as soon as the hide is wet throughout and pliable. It should be readily squeezable and flexible. If it is stiff, it is still too dry in the inner layers. If you soak it too long the hair will pull out easily with the end result looking mangy.**

**Use the wet scrape technique for the smoothest hide... Use a piece of spring steel bar about 1 1/2 inches wide by 1/4 inch deep by 1 1/2 to 2 feet long. Wrap the ends with some kind of padding and tape well. The bar is not sharp at all. It just has to have a 90 degree UNNICKED edge. Nicks will tear the hide.**

**Place the hide fur down over a smooth fleshing beam placing the neck end toward you and the tail end toward the bottom. To clean the hide, use both hands on the spring steel bar and push downward. Scrape the flesh off and peel off the inner lining to expose the dermis. You will get quite a shoulder & upper arm workout! Sprinkle water on the hide as needed to keep it from drying out.**

**Rub brains thoroughly into the flesh side of the hide and soak in the warm water bucket for a bit (15 minutes or so) using a rock to keep it under water if needed. Squeeze out the hide as well as you can (old wringer washers are good for that) saving the water, brain it again, soak a bit longer in the water & wring it out as tight as you can manage. The fur holds lots of water. roll the hide longways and put it around a sturdy pole or heavy duty rope. unwrap the ends just enough to overlap them & roll them together forming a ring around the pole. Insert a sturdy ax handle or baseball bat & carefully twist it as tight as you can wringing out as much water as you can.**

**Work the hide till dry by pulling the flesh side against a strong rope or pole or whatever is handy till dry. If it dries without being worked, it will be stiff. You can wrap it in plastic & stick it in the fridge for awhile if you want a break.**

**You can try an alternate method of stretching the hide in a frame & use a canoe paddle to continuously press against the flesh side here & there until dry. You may have to wet the edges if they dry too quickly. If the hide feels cool it is wet. If you stretch it in a frame, put the fur side towards the sun while you work it to dry out the fur otherwise the hide will stay wet. You have to be careful stretching the hide since some hides will shred just because they**



want to.

If you do not smoke the hide, Do not let it get wet or you will have to stretch it till dry again.

---

Items you will need:

Hide

Bucket

Water

Brains

Grubby clothes you don't care about or a long plastic apron of some kind.

Smooth log or pvc pipe to use as a fleshing beam:

Minimum of 1 foot in diameter and 5 feet long.

Prop the log/pipe securely at an angle so that the high end is waist high.

Trim the high end so it is smooth and mostly vertical to the ground and pad it.

You will be leaning and putting weight on the high end so make it comfortable.

~ thank you Cindy

---

[Return to Tanning & the Preservation of Other Animal Parts](#)

[Return to NativeTech's Main Leather & Clothes Menu](#)

[Leather & Clothes Bibliography and Books to Buy On-Line](#)

---



© 1994-1999 [Tara Prindle.](#)





**YAHA-HAJO**  
A Seminole Chief

*Adapted from The North American Indian Portfolios, 1993 ~ Library of Congress*

# Starting Research

A Beginners Guide to  
Southeastern Indian Studies

by Jason Baird Jackson

*in 19th Century Seminole  
Men's Clothing*

[Rick Obermeyer ~ Editor](#)

---

[Complete Index to Articles in 19th Century Seminole Men's Clothing](#)

---

## Introduction

Much of the work presented in this workbook has been compiled by amateur researchers. Like you, they began with an interest in Seminole culture and history. As they tried to learn more about men's clothing, they found that there was more to finding out the "why and how to" than buying a book on Seminole men's clothing and reading it. No book existed. To understand how Seminole clothing "worked" would require visiting museums, talking to Native American seamstresses, reading dusty anthropology journals, and networking with other people interested in the same subject. These are some of the many types of things which go into doing research. If your interest in Seminole clothing, has sparked a desire to learn more, then hopefully this paper will help you discover some of the excitement which can be found in doing your own investigations.

Doing research is much like doing detective work. No two people go about it the same way. Some people keep meticulous notes of everything they do, others people learn by simply watching others and trying to "get a feel for what's going on". How you do research will depend on: who you are, what you are interested in, where you live, and what resources (time, money, and information) you have available to you. The purpose here is to cut out some of the aggravation of starting up by sharing some basic information and maybe a hint or two.

## Why should I do research?

Before setting out, it may be useful to clarify what exactly is being talked about. For our purpose, research can mean two things. First, research is finding out things that other people know, but which you do not. For instance, you may not know the names of the Indian tribes that lived in Florida before the Seminole. If you read a book on Florida history and find out who they were, then you have done research. The second meaning we can give to doing research is more involved. If you were interested in why the Cherokee and Choctaw both made belts decorated with white beads in a spiral pattern, and the Creek and Seminole did not, then that would be research too. The difference is that nobody has sat down and figured out an answer to this question yet. To get an answer, you would have to work as a scientist works and come up with an idea which is supported by evidence. Then you would have made a contribution to our understanding, yourself.

One of the points to be made here is that anyone can discover something which is interesting or useful; if not to someone else, then at least to themselves. Historians, anthropologists and other research types are usually interested in "big questions" of one sort or another. Unfortunately, "small questions" which are still interesting and important often go unaddressed. How were the tassels of a bandolier bag attached to the bag? Well, if nobody else is going to figure it out, then there is no reason why you can't.

Beyond this claim that your work can produce new understandings, it should also be noted that this type of investigation can make your interest or hobby more meaningful and fun. In addition, by learning more, you can become a resource for helping other people. Most Americans still hold inaccurate, stereotypical ideas about Native American people both in the past and the present. As someone with a clearer understanding of Native Americans, you can assume responsibility for teaching others.

## In the Beginning There Were Libraries

With libraries and books is where most people begin their research. Books are usually the most general source of information you will find on a subject. Most books on the Southeastern Indians are either history books or ethnographies. History books most often describe trade with the Indians, the Indian wars, and the removal of the tribes to Indian Territory. Ethnographies are descriptions of Indian society and culture written by anthropologists and other types of social scientists. J. Leitch Wright's book *Creeks and Seminoles* is a good example of a Southeastern history. James Howard's *Oklahoma Seminoles* is a great example of Southeastern ethnography.

Books are the best way to get a broad overview of a subject quickly. Rarely will they tell you exactly how many necklaces Osceola wore, or how many people could ride comfortably in a dugout canoe during a hurricane, but they will give you the background to understand the other sources of information which are available to you.

Libraries are the place to start looking for books. College libraries are the best place to look, followed by public and school libraries. Most towns today are reasonably close to a university or community college and most of the libraries at these schools are the best source of books. Almost all schools will allow the public to browse the stacks, and community colleges sometimes make cards available to the public. If you cannot check books out, you can often photocopy the parts you want to take with you. Another solution if your public library does not have the books you are looking for is to request them

through interlibrary loan. This is a program where libraries borrow books from one another. Most public libraries participate in this program. Contact the reference librarian at your library for assistance. The greater the amount of information you can provide the librarian with, the quicker they will be able to get you the book you request, so take good notes.

One last note about libraries. Most libraries today, if they haven't done so already, are in the process of reorganizing their collections. The old Dewey Decimal System which everyone was taught in grade school is being replaced by what is known by the Library of Congress System. Among other things, this system is designed to make collections in various libraries more uniform. Also most libraries are doing away with the old fashioned card catalog and replacing it with computerized indexes. These systems allow you to quickly find books by author, title and subject. The Florida State University System for instance uses a system nicknamed LUIS in which you can search the catalogs of any library in the system from the computer terminals found in all of the libraries. You can even look up books from home by using a computer and a modem. All of the changes in libraries may seem overwhelming, but most reference librarians are very willing to explain how to find what you want with a minimum of fuss.<sup>2</sup>

### One Thousand Paces and No Pictures: An Introduction to Journals

Another resource to be found in libraries are journals. Journals are periodicals (They are published periodically just like magazines and newspapers.) which are usually published between two and six times a year. They are often sponsored by a professional society, The Oklahoma Historical Society, for instance, publishes a useful journal called *The Chronicles of Oklahoma*. Unlike magazines which print articles of wide interest, journals publish articles written by scholars (historians, anthropologists, physicians etc.) for other scholars. Now, before you get turned off, it should be noted that most of these societies, especially state historical and anthropological societies welcome both amateur and professional members. Much of the most useful information on the Seminoles, for instance, was recorded by non-professionals. It was Louis Capron, a writer not an anthropologist, who discovered the Seminole medicine bundles. This was one of the most important discoveries in Southeastern anthropology, and is still impressive even after forty years.

Even if you are not ready to call yourself a scholar, journal articles will provide a great deal of information for your studies. A journal article is usually between ten and thirty pages long, and is sort of a souped-up version of a high school term paper. To be published, the author of a journal article generally must present some new facts or ideas about his or her subject. Ideally this means that with each new article on a subject, more information about the subject is known. This accumulation of facts is known as "adding to the literature".

College libraries will be the best source of journals. Normally they can't be checked out, but articles are usually short enough that they can be photocopied. Copying is preferable anyway, so that you will be able to refer back to the articles later on. Journals use volume numbers just like magazines, but don't be surprised to find that a particular journal begins on page 876. Most journals use what is called continuous page numbering. Each volume begins with page one, and numbering continues consecutively through the year. Another hint in using journals is to read each article's abstract. An abstract is a short summary of the article placed at its beginning. This summary will tell you quickly whether the article covers something which you are interested in.



## Bibliographies. The Great Time Saver

In your library travels, you will encounter two types of bibliographies, both of which will prove extremely valuable. The first type is the list of sources which is found at the end of a book or article. This is a list of all the writings which the author quoted in his own work. The second type of bibliography is actually a book which lists many sources on a particular topic. Michael Green's *The Creeks: a critical bibliography* and Harry Kersey's *The Seminole and Miccosukee Tribes: a critical bibliography* are two useful examples. Both types of bibliographies can help you by pointing out other items you may wish to consult.

## Where to next? The Museum

After you have gotten some library time under your belt, it is time to explore some of the other ways in which you can conduct your research. If you are interested in material culture (the fancy word for things people make), then museums should be on your list of places to go.

The first thing to learn about museums is that they are kind of like icebergs. The part everyone sees when they pass by is very small compared to what is hidden underneath. The part of a museum's collection which is on display at any given time, is usually only a fraction of what the museum possesses. Why? If you ask, you will be given many reasons. Display space is expensive, while storage is not. If all the items were on display at once, then the museum could never change it's displays. Some items are so fragile that they are stored in special ways which prevent them from being displayed. Some items are set aside for research. The reasons seem endless. None the less, many museums do have very good displays which can be studied. In addition, it is often possible to get special permission to see collections in storage. To do this requires planning and patience. The best thing to do is to find out who the curator responsible for the collection is, and then write them and discuss your interests. Sometimes museums have strict rules which you will not be able to avoid, but at other museums curators so rarely have anyone interested that they will often prove very helpful. Competent correspondence and behavior on your part is the key.

If you gain access to a collection, photography will be your top priority. If you are given permission to photograph a collection, come prepared. Make sure your camera is in working order. Choose the right type of film. (Many people prefer color slides, because they can be printed in a variety of ways.) Bring a ruler or stick with standard markings. By including this ruler in photographs, you and others will be better able to determine scale. Be sure to take as many angles of an item as is necessary to understand it's construction.

## Going Places: Historical and Archaeological Sites

Many sites of historic and/or archeological interest are preserved and maintained by the national, state, and local governments. Often these sites are administered as parks and offer interpretive programs and displays which can be a useful source of information. As always, take good notes and ask questions. Not only will the employees and managers of a site be good sources of information, but so will frequent visitors and site volunteers. Often a local historic or archeological club will be associated with a site. These groups have members whose interests may be similar to your own, and who are often willing to share their knowledge with others. As your own understanding of frontier and Native American history and culture grows, these sites could provide you with the opportunity to share and expand your own

knowledge as a volunteer.

### Is lunch at Pizza Hut still fieldwork?

The richest source of information you can find is someone willing to talk to you. The process of learning a new way of life from a culture which is different from one's own is called by anthropologists "ethnography". The process of visiting with people in order to do ethnography is called "field work". A person who acts as your teacher in your studies is known as an "informant". Field work can take place anywhere you can learn about another culture. It is important to note the differences between ethnography and other ways of learning about people. Newspaper reporters for instance do interviews just like ethnographers but, unlike the researcher, the reporter is simply asking questions in order to collect facts. Instead, ethnography is the learning of a culture the way a kid learns as he grows up. The importance here is that the reporter only asks the questions to which he thinks he needs an answer. The ethnographer begins by throwing out all the ideas he may have about a subject and begins learning from scratch. The person interviewed is a teacher and the researcher is a student. By working in this way you can learn not only the answers to your questions, but also things which you never even had thought to ask about. The goal in the end is to understand not just facts, but to understand how other people think.

Talking to people in this way is more time consuming, but is infinitely more profitable and rewarding. To be taught how to make a pair of moccasins in this way involves much more than cutting and stitching leather, it also includes all of the associations, stories and beliefs which making moccasins inspires in the teacher.

Pow-Wows and other events which attract Native Americans and which are open to the public are good places to meet and talk with them. How to best do ethnographic interviewing is a long topic, but here are a few hints and pointers. When first speaking with a potential informant, always act courteous and explain your interest. Allow them to do the talking and express your interest. Ask them to clarify points which you don't understand. Do not monopolize your informant's time. Express appreciation for what they share with you. Realize that an informant is sharing only his or her interpretation of their culture and that other members will have other views or beliefs. For instance if you were interested in studying American football fans, and asked your informant who the best team was, his or her answer would not be the same as that of someone else. Most importantly, always respect your informant's rights and wishes. A good introduction to this type of research is a book called *The Ethnographic Interview* by James Spradley.

### Closing

This paper has only touched on a few of the methods you can use to learn more about the Native Americans of the Southeast or any other historical or cultural subject. The collection of arts and crafts, attending classes and seminars and a host of other sources of understanding await your discovery. It is my hope that the ideas presented here will help you get your research interests started faster and with less hassle. For me personally, researching the crafts, culture and history of the Native American is a rewarding experience and I hope you will find it an enriching endeavor.

Jason Baird Jackson  
Gainesville, Florida

23 January 1991

### Sources Mentioned

*The Chronicles of Oklahoma*. The Oklahoma Historical Society, Norman, OK.

Green, Michael D. *The Creeks: a critical bibliography*. Bloomington: Indiana Univ. Press, 1979.

Howard, James Henri. *Oklahoma Seminoles: medicines, magic and religion*. Norman: Univ. of Oklahoma Press, 1984.

Kersey, Harry A. *The Seminole and Miccosukee Tribes: a critical bibliography*. Bloomington: Indiana Univ. Press, 1987.

Spradley, James. *The Ethnographic Interview*. New York: Holt, Rinehart and Winston, 1979.

Wright, J. Leitch. *Creeks and Seminoles: the destruction and regeneration of the Muscogulge people*. Lincoln: Univ. of Nebraska Press, 1986.

### Acknowledgments

I would like to thank the Loxahatchee Historical Museum and the Hitchiti Dancers, Inc. for providing support for my research over the past two years. Thanks also go to Rick Obermeyer, Jay McGirt, Anthony J. La Greca and Claudine Payne for help in shaping my life as a aspiring researcher.

---

### [Complete Index to Articles in 19th Century Seminole Men's Clothing](#)

---

Contributed by [Rick Obermeyer](#) E-mail: [orick@prodigy.net](mailto:orick@prodigy.net)

From the book *19th Century Seminole Mens Clothing*

© 1991-2000 Sherwood F. Obermeyer Jr., 2124 Miscindy Place, Orlando, FL 32806

---

[Return to NativeTech's Main Leather & Clothes Menu](#)

[Leather & Clothes Bibliography and Books to Buy On-Line](#)

---





**Text and Graphics**  
© 1994 - 2003 [Tara Prindle](#)  
unless otherwise cited.



# Versimilitude

comments by Rick Obermeyer

*in 19th Century Seminole Men's Clothing*

[Rick Obermeyer ~ Editor](#)

---

[Complete Index to Articles in 19th Century Seminole Men's Clothing](#)

---

"Quality or state of having the appearance of truth or reality" is what that two dollar word means. It's a consideration for every old style Seminole hobbyist or re-enactor. A reenactor trying to put together the appearance of an old-style Seminole can be aiming at anything from a rough simulation to as accurate a portrayal as possible. How near or how far he gets to that goal depends on his research, his skills, and his own feelings about either making extra effort or being willing to tolerate convenient short cuts. What he winds up with on his way can vary from a little bump to a wild detour.

A little bump is something that is not historically accurate, but which makes no difference to most reeactors or to any casual observer. A little bump would be using a sewing machine instead of hand sewing everything. Or, if hand sewn, using polyester thread instead of cotton or silk thread, or using plastic buttons instead of mother of pearl or metal military buttons. A little bump would be using synthetic blends instead of 100% cotton or wool, or using commercially tanned buckskin instead of braintanned. These are things which might keep your items from being museum quality, but which certainly wouldn't keep them from being perfectly good enough for any reenactments. Me, I have no embarrassment about stringing my own neck beads on unwaxed dental floss.

Something that's a noticeable anachronism would be bigger than a little bump, but could still be tolerable. Let's call it a chughole. Examples would be using aluminum instead of real silver for

headbands and gorgets, or using blue pony beads in place of cobalt Russian cuts. Using modern commercially made woven accent strips to conveniently represent fingerwoven garters and sashes would certainly not be historically accurate, but would be good enough for a beginning reenactor. I, myself, use a long shirt made by a Seminole in 1985 with my old-style outfit. There are definite differences in construction between it and an authentic oldstyle long shirt, and it has a band of patchwork no early 19th century piece would have, but I like the idea that I'm using a genuine Seminole piece to build my Seminole outfit. Some of the se chugholes are necessary alternatives... the reenactor may not be able to locate real mother of pearl, or know how to do fingerweaving, or be able to afford a string of fifty Russian cobalt cut beads at \$3 apiece. A chughole is a substitution that reasonably resembles the real thing. It's "good enough."

"A little rough" would be something like veering off onto the shoulder of a road. It's not where you want to be, but you're still headed in the right general direction. What's happening isn't historically accurate at all, but the wearer is either a beginner who's off to a simple start, or is making an honest mistake, or is merely striving for an overall effect. Kneelength leather fringed boots, or beaded headbands, or highly creative face painting might help the reenactor look "Indian" while not really being accurately Seminole. An old friend who is very serious about accuracy in his reenactments used to wear a hawk claw around his neck. I once expressed to him my doubts that Seminoles or Creeks ever wore dead animal parts (other than feathers). He pointed out that a hawk claw is a potent symbol to many other North American Indians (true) and that, anyway, there is nothing to show that Seminoles did NOT wear them. What satisfied my friend was, to me, being "a little rough." Another example would be the very fine pair of fingerwoven garters I once saw tied around buckskin leggings, instead of around cloth ones.

Something completely out of place on an old-style Seminole outfit would be a wild detour. There's no telling what Indian, if any, the reenactor wound up being. Some decorate their turbans with a lot of pins, something they've obviously taken a lot of care and trouble to do, and something no Creek or Seminole is ever known to have done. I've seen some things worn by reenactors that would be out of place in ANY 19th century Indian representation. My favorite example is the yellow nylon chiffon scarf I once saw on a re-enactor's neck. Nineteenth century nylon? Why not also a necktie and a baseball cap?

Many reenactors are satisfied that they look Seminole well enough... according to their conception of what old-style Seminoles looked like. Others are more interested in historical accuracy, but are frustrated by the scarcity' of resources and guidelines. These simple how-to's hope to remedy part of that problem. They have been put together by hobbyists who experienced the same frustrations, and who are happy to share what they've learned to make it easier for others to join them.

As the hobbyist does more research and becomes more knowledgeable, it will be easier for him to stay on the road, smooth out the chugholes, and minimize the bumps. He'll often be pleasantly surprised at how little extra trouble that is. I know somebody who, with some advice from friends, constructed a turkey feather fan-and made an excellent piece with a lot less difficulty than he anticipated. The progressing reenactor will learn to cut thinner thongs when he makes his moccasins and to lace them more closely. He may even be able to find cotton thread for that hand sewing. If he does decide to wear some dead animal parts or to paint his face in some way, he'll do so with more surety, and with more respect from his fellow reenactors.



[Complete Index to Articles in 19th Century Seminole Men's Clothing](#)

---

Contributed by [Rick Obermeyer](#) E-mail: [orick@prodigy.net](mailto:orick@prodigy.net)

From the book *19th Century Seminole Mens Clothing*

© 1991-2000 Sherwood F. Obermeyer Jr., 2124 Miscindy Place, Orlando, FL 32806

---

[Return to NativeTech's Main Leather & Clothes Menu](#)

[Leather & Clothes Bibliography and Books to Buy On-Line](#)

---



Text and Graphics  
© 1994 - 2003 [Tara Prindle](#)  
unless otherwise cited.



**LEDAGIE**  
A Creek Chief

*Adapted from The North American Indian Portfolios, 1993 ~ Library of Congress*

# Creek = Seminole?

comments by Rick Obermeyer

*in 19th Century Seminole  
Men`s Clothing*

[Rick Obermeyer ~ Editor](#)

---

[Complete Index to Articles in 19th Century Seminole Men's Clothing](#)

---

What is Seminole "style?" How can a hobbyist know how much personal preference he can put into his outfit and still be able to say it falls within what is "Seminole?" This is a question often asked in good faith by hobbyists and re-enactors who have the sense not to stay locked into grindingly exact duplication of any of the few pictures there are, but who also want to have good respect for historical accuracy.

One of the ways people look for solutions is to widen their resource base, and study Creek examples as well. The scarcity of examples from both Creek and Seminole, and the deep blurring between them, makes it imprudent if not impossible for one to overlook the other. "If it's Creek, it must be Seminole," or "Early Seminole is the same as Creek," is an explanation I've heard lots of times. Yes, that IS an appealing approach that "rounds off the answer" to a lot of problems. But, is it always the most appropriate one for a Seminole re-enactor?

True, "Creek = Seminole = Creek" works well for the 18th and turn of the 19th century. The Semnoles were originally Lower (western Georgia) Creeks who moved in to occupy empty real estate around present-day Tallahassee and Gainesville. Seminole clothing probably reflected and paralleled Creek clothing as closely as, say, colonial American clothing followed contemporary British clothing. Additionally, it appears that, like England to the colonies, it was mostly Creek influence ON Seminole and not the other way around. The Creeks were more numerous than the Semnoles. Movement of

**people back and forth probably tended to be more from the Creeks in Alabama and Georgia to the Seminoles in Florida, instead of from south to north.**

**Certainly, regional traits probably developed in Florida as well as, no doubt, within the Lower Creeks and also the Upper Creeks. For example, twined sashes and pouches were common among the Creek, but there are very few identifiably Seminole examples. On the other hand, strips of cloth appliqué were much more common on Seminole long shirts and leggings than among the Creeks.**

**Remember, though, that we're talking "influence" here, not domination. We shouldn't forget that at least by 1800, and probably by much earlier, Seminole culture was its own mainstream, and Seminoles had a strong consciousness of being similar to, but NOT the same as the Creeks. They emphasized this repeatedly to the British in their treaty-making.**

**The defeat of the Upper Creeks at the Battle of Horseshow Bend in 1814 meant the inevitable cession of remaining Creek lands bit by bit and their relocation as a people to Oklahoma. The Lower Creeks lost all of Georgia by 1825, and the Upper Creeks had given up Alabama by 1830. Creek cultural traditions in Georgia and Alabama came to an abrupt and complete halt. True, a very few Creeks managed to remain in corners here and there in southern Alabama and in panhandle Florida, accident of treaty and individual special cases, and those Creeks soon realized they could manage to stay where they were only by keeping a low profile. That is, by de-emphasizing anything that made them distinctive or stand out different from their white neighbors. That usually meant living in out of the way places. It definitely meant subduing their own cultural traditions. Which certainly ended the influence of Creek styles on Seminole or any other styles.**

**So, while Creek styles remained the foundation of Seminole styles after the 1820's, they were not a continuing influence after then. Seminole styles begin to drift in their own direction, dropping some elements, adapting others, and adding new ones. The Seminole ways that had been an overflow of Creek cultural traditions now even more so became their own healthy separate culture. Things in Florida which had been local styles within a larger Southeastern pattern now became stylistic trends in their own right.**

**It's as if Napoleon had successfully invaded Britain and moved its whole population to Poland. With British culture shattered and scattered, wouldn't American styles have developed more individually?**

**The problem with Creek references arises when we remember that most Seminole re-enactors are NOT primarily interested in PRE-1820's Seminole, when Creek influence was alive. Prior to 1819, Florida wasn't even American, and Seminoles weren't yet a part of American history. Re-enactors are attracted to the times of action and drama, the Second Seminole War (late 1830's) and possibly also to as late as the Third Seminole War (late 1850's). We're talking about time periods ten to thirty years after the termination of Creek culture in the Southeast. The equation "Creek = Seminole = Creek" doesn't work when there aren't any Creeks around anymore to be part of it.**

**It could be argued that Seminoles continue to show Creek influence for a long time after the 1820's. Of course that's true. But for how long after the end of Creek culture in the Southeast must we expect Seminole culture to continue to copy it? Might not Creek influence be allowed to diminish over time? Sure, many Creek refugees came to Florida and were absorbed by the Seminoles. Some assert that Creek influence continued, based on the fact of this Creek influx. But, how much do refugees tend to**



**influence their sheltering culture, instead of the culture tending to absorb them instead?**

**To illustrate strong Creek influence on Seminole styles, people show me examples in the McKenney-Hall portraits, and compare the closeness between the two. I invite them to go back and read the fine print next to those portraits. Those engravings were practically all modeled after paintings by Charles Bird King in 1824 - 1826. Sure, I agree with those examples. Yes, Seminole clothing does show strong Creek similarity in the mid- 1820's. But what about the late 1830's, more than ten years later? Or the late 1850's, more than a generation later? Might not some Seminole styles be allowed to evolve on their own in that time? An example from 1825 might not be completely valid for 1840, and still less so for 1855.**

**Yet, I will admit that the re-enactor who falls back on 1820's Creek for reference has a couple of strong arguments in his favor. Yes, there are some good reasons to study Creek styles as a general guide to Seminole styles.**

**The first is extreme conservatism in changes in Seminole clothing. For more than a hundred years, until about the 1880's, the elements of Seminole men and women's clothing remained remarkably the same, both in item and in item construction. The basic list for a man's outfit - moccasins, leggings, breechcloth, plain shirt, long shirt, belt, scarves, soft turban, and plumes was unchanged, with little variation in the basic pattern of each piece. Variations were limited to stylistic changes. For example, the cape on the long shirt might be longer or shorter, but it was always triangular. Gorgets might wander in size and shape, but a well-dressed Seminole always liked wearing more than just a couple at a time. Any Creek influence that was still part of Seminole clothing styles by the 1830's was probably going to remain for a long time.**

**Another strong argument is Catlin's paintings of that most famous Seminole, the full figure and the bust portrait of Osceola. There aren't many pictures of Seminoles from during the Second Seminole War. Of them all, Catlin's portraits are the most detailed and the most spectacular. A re-enactor might point to a Osceola portrait and exclaim, "There! Osceola has wrist ties, so we know that Seminoles wore wrist ties." We know that's correct for Osceola, but can we extend that to assume it's a generally worn Seminole style? Please remember that Osceola was not born a Florida Seminole. He was born an Upper Creek, and was brought to Florida as a child as one of those refugees from Alabama. Moreover, Brent Weisman in "Like Beads On A String," emphasizes that much of Osceola's prestige as a leader derived from his personal conservatism for the "old ways" in lifestyle. Might we not then be suspicious that his personal clothing reflects his personal conservatism, and not really be a true picture of general Seminole fashion? One more caution: Catlin has always been suspected of being a trifle lazy with his depiction of detail. Compare his head and shoulders portrait of Osceola with another painted very much at the same time by Robert Curtis. Details in the Curtis portrait certainly match existing pieces of Osceola's clothing much more closely. Catlin is a good guide and a useful resource. I do not feel he is an infallible source for what would be general SEMINOLE (not Creek) fashion. Details in Catlin's paintings of Osceola illustrate possibles, not necessarily probables.**

**So, the answer to the question, "How do you know that's Seminole?" isn't really, "Well, it's Creek, and that's the same thing as Seminole." A better answer would be, "Well, it's Creek, so it could be Seminole."**

**[Complete Index to Articles in 19th Century Seminole Men's Clothing](#)**

---

Contributed by **[Rick Obermeyer](#)** E-mail: **[orick@prodigy.net](mailto:orick@prodigy.net)**

From the book *19th Century Seminole Mens Clothing*

© 1991-2000 Sherwood F. Obermeyer Jr., 2124 Miscindy Place, Orlando, FL 32806

---

**[Return to NativeTech's Main Leather & Clothes Menu](#)**

**[Leather & Clothes Bibliography and Books to Buy On-Line](#)**

---



Text and Graphics  
© 1994 - 2003 **[Tara Prindle](#)**  
unless otherwise cited.



# The Plain Shirt

"FOKSIKPAYAHKI"

by M. E. (Pete) Thompson

*in 19th Century Seminole Men's Clothing*

[Rick Obermeyer ~ Editor](#)

---

[Pattern for the Plain Shirt](#)

[Instructions for sewing together the Plain Shirt](#)



(1890s) Courtesy National Museum of the American Indian, Smithsonian Institution.

---

[Complete Index to Articles in 19th Century Seminole Men's Clothing](#)

---

Contributed by [Rick Obermeyer](#) E-mail: [orick@prodigy.net](mailto:orick@prodigy.net)

From the book *19th Century Seminole Mens Clothing*



[Return to NativeTech's Main Leather & Clothes Menu](#)

[Leather & Clothes Bibliography and Books to Buy On-Line](#)

---



Text and Graphics  
© 1994 - 2003 [Tara Prindle](#)  
unless otherwise cited.



*(Contemporary) Miccosukee Indian Village Museum.*

# Pattern

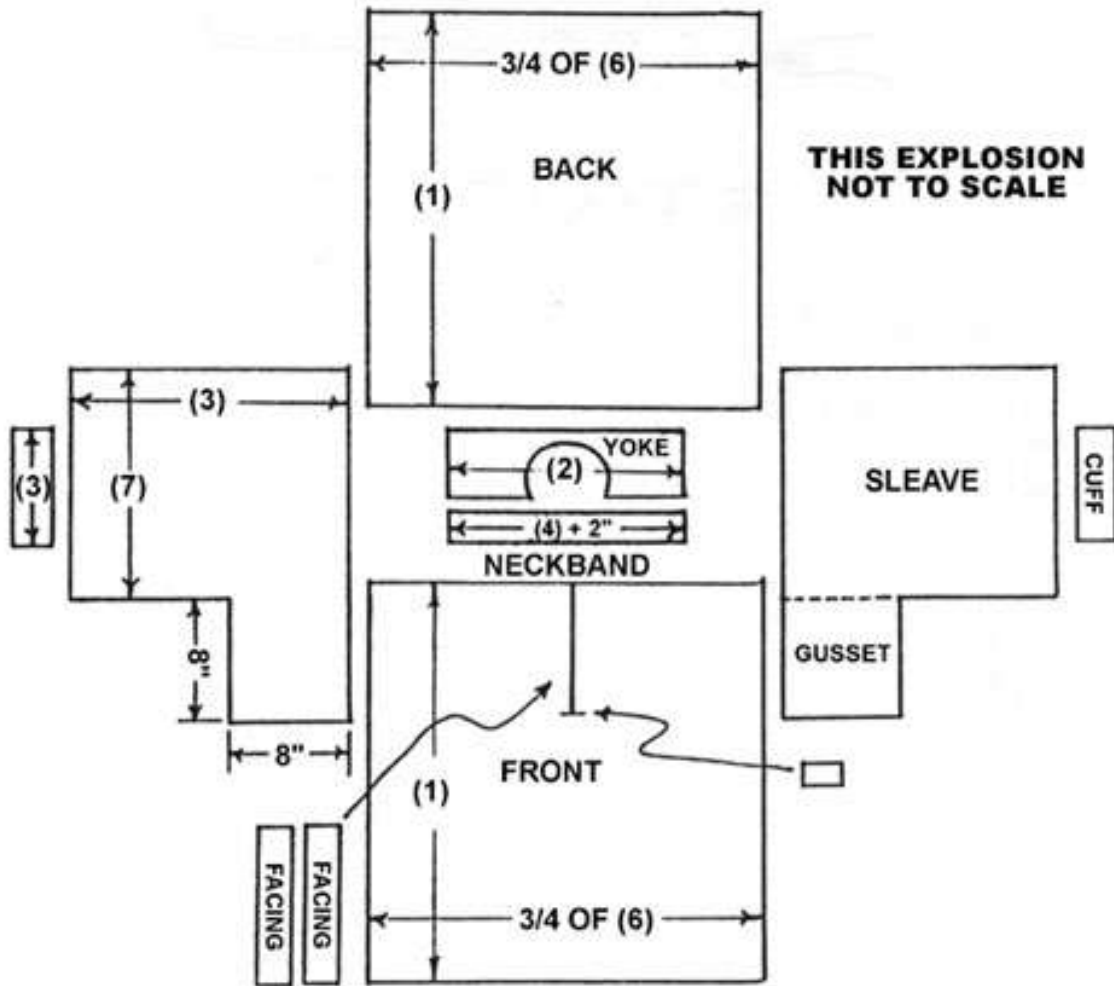
## for The Plain Shirt

by M. E. (Pete) Thompson

*in 19th Century Seminole Men's Clothing*  
[Rick Obermeyer ~ Editor](#)

---

**Mark the dimensions indicated below, after measuring them on yourself with the help of a friend. If you don't have a tape measure, use a string and a ruler. (1) Collarbone to knee; (2) Shoulder width run behind the neck, plus 2"; (3) Shoulder to wrist joint, measured with elbow held at 90 degree angle; (4) Loose circumference of neck; (5) Loose wrist circumference, plus 1 inch; (6) Circumference of expanded chest or of relaxed stomach, whichever is greater; (7) Circumference of flexed bicep plus 4 - 2 inches. Add 1/2 inch to all measurements to allow for 1/4 inch seams.**



**Note: The gusset in this type of shirt was once included as part of the sleeve. After about 1900, it was cut as a separate piece. In any case, it should be NO smaller than 8" square. Consider a 10" square if you're over 200 lbs.**

Exploded view after Sturtevant, 1967

(c) 1983 M. E. Thompson

---

[Instructions for The Plain Shirt](#)

[Return to Introduction to The Plain Shirt](#)

[Complete Index to Articles in 19th Century Seminole Men's Clothing](#)

---

Contributed by [Rick Obermeyer](#) E-mail: [orick@prodigy.net](mailto:orick@prodigy.net)

From the book *19th Century Seminole Mens Clothing*



[Return to NativeTech's Main Leather & Clothes Menu](#)

[Leather & Clothes Bibliography and Books to Buy On-Line](#)

---



Text and Graphics  
© 1994 - 2003 [Tara Prindle](#)  
unless otherwise cited.

# Instructions for The Plain Shirt

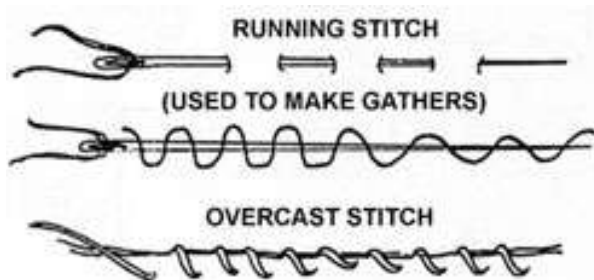
by M. E. (Pete) Thompson

*in 19th Century Seminole Men's Clothing*  
[Rick Obermeyer ~ Editor](#)

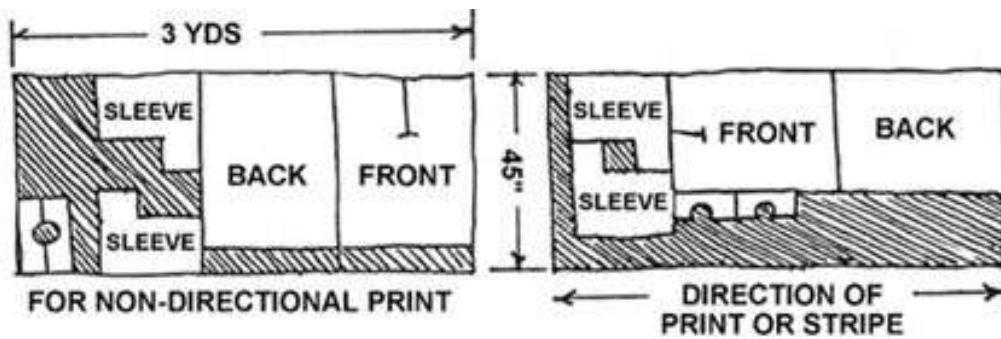


---

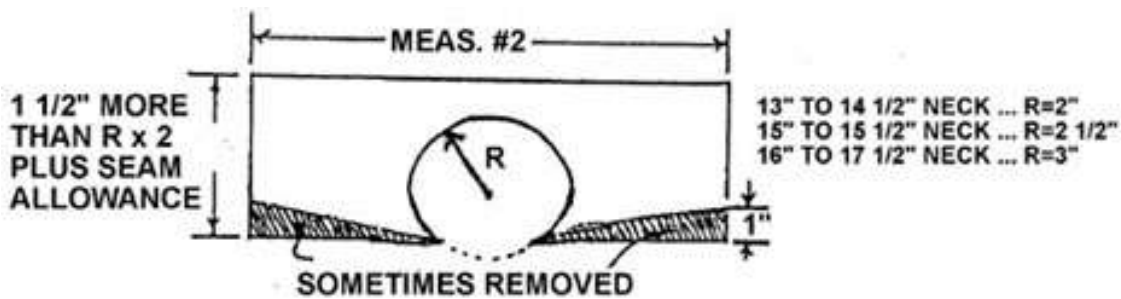
If absolute authenticity is a main concern, you'll need settle on a time period for construction. Since this shirt was first copied from 18th Century British shirts, it remained relatively unchanged. But, prior to 1890, it was hand sewn with needle and thread. After 1890, use a sewing machine with relatively wide stitches, to simulate the old hand-crankers. Note types of hand-stitch.



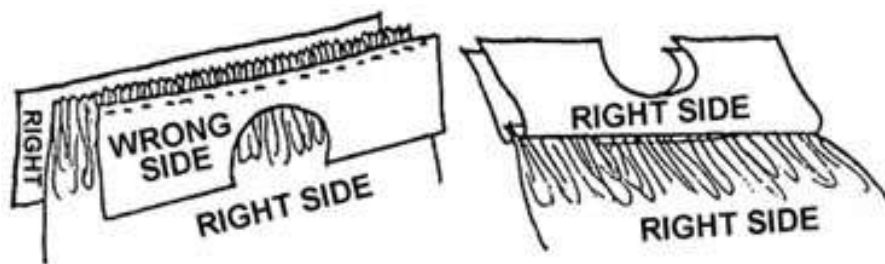
ANY cotton pinstripe, calico, gingham, or polka-dot or plain is a suitable material. After 1890, preference was given to lighter colors. You'll find that the standard 45 inch bolt width is perfect. Unless the stripe or design requires a particular orientation running the length of the bolt, any manner of laying out the cloth will work. These instructions will presume the latter. The entire project is surprisingly easy! All pattern pieces are squares or rectangles. Total yardage required will average 2 1/2 to 3 yards.



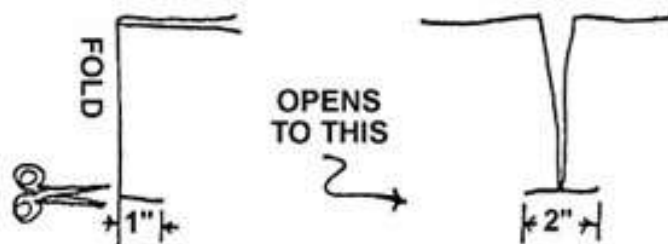
(1) Lay out the material and measure and cut out pieces. You can use chalk or charcoal for marking the cloth; both will come out in the first wash. If the material is good enough, you can tear the material instead of cutting it. Trim the yoke according to your individual neck size as shown below. Because the yoke is double-thickness don't forget to prepare two pieces



(2) Cut out the back and front. Gather one end of the back to match the straight length of the yoke. Pin both pieces of the yoke to the back, as shown. Face the patterned (right) sides to each other with the back sandwiched in between (Unprinted side is called the "wrong" side). Sew together about 1/2" from the edge.

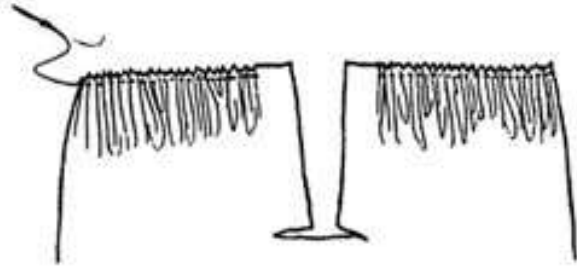


(3) Fold the front piece lengthwise. Slit along the fold a length equivalent to your sternum (breastbone) from base to throat. At the base of this slit, cut a snip across into the fabric 1" deep so that when you unfold it, you have an inverted "T" with a 2" cross bar.

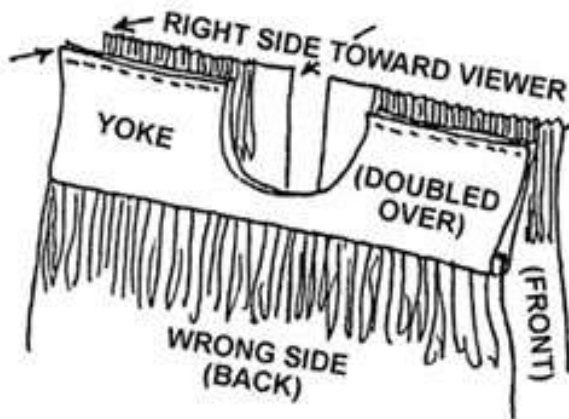




**(4)-A- Gather each side of the front from the outside edges, leaving 1 1/2" ungathered on either side of the sternum slit. The gathered distances should equal the two fronts of the trimmed yoke.**



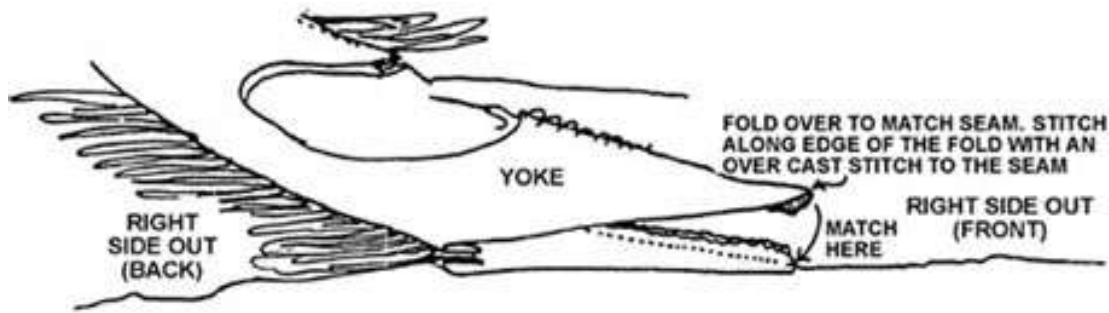
**(5) Stretch out the assembly, right sides of the front and back still facing each other, and hold it up by the edge of the seams you have just sewn. Lay it down, and bring the second, unattached, yoke edges up to match.**



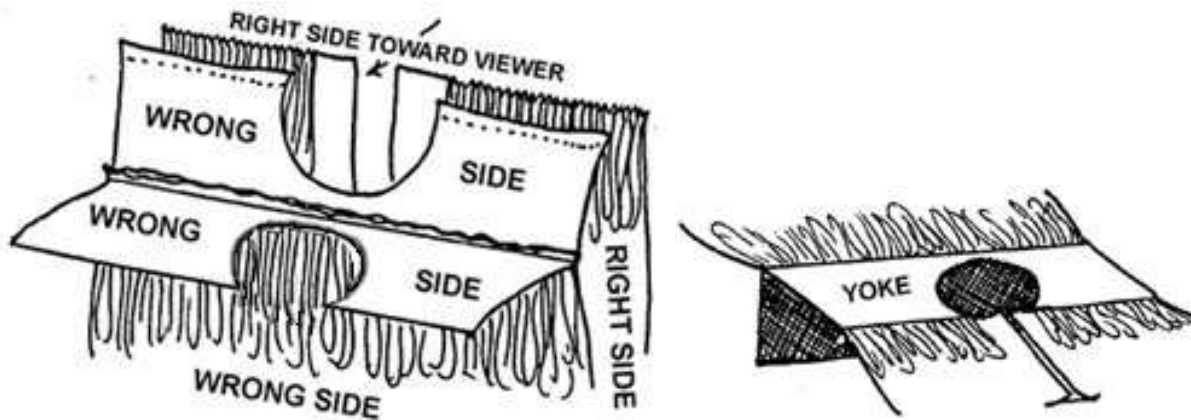
**Note: Choose between step A or B. If you choose the more commonly seen step A, pin it together as shown and sew the edges together. If you choose the newer, more modern form, move on to step B below.**

**-A- Some shirts have this second yoke simply sewn on to the other at the two previous seams. This can be done by hand or with a sewing machine.**

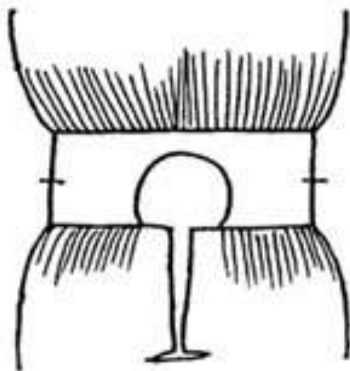
**-B- Some shirts have this second yoke attached with another "hidden" seam. Although this hidden seam will actually be on the unseen underside of the finished shirt, it will add to the quilted appearance of the back of the yoke. Place the yoke assembly across your knee. Now, you're a genuine tailor! Fold the inner unattached yoke piece over to the front, smoothing it out over your knee, and folding the edge under so it matches the previous seam. Pin as necessary to hold in place. The next will have to be handsewn whether or not the rest of the shirt is machine-sewn. Stitch through the second yoke and the previous seam, but NOT through the front of the first yoke. You will have to undo the pins as you go.**



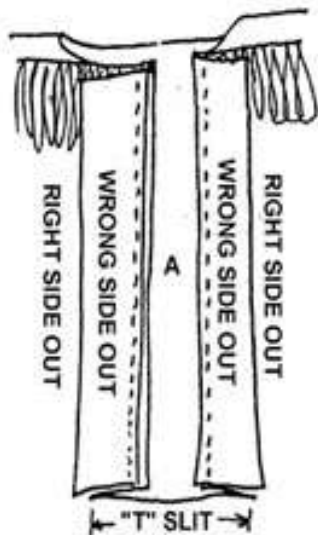
**-B- Place the front and back pieces together with both their right sides facing each other. Pin the two gathered parts of the front piece to the fronts of the nearer yoke piece. Leave the other yoke piece unattached, for now. Be sure to leave the 1 1/2" ungathered parts of the yoke unattached and extending into the neck opening, as shown. Sew together where pinned, about 1/2" from the edge.**



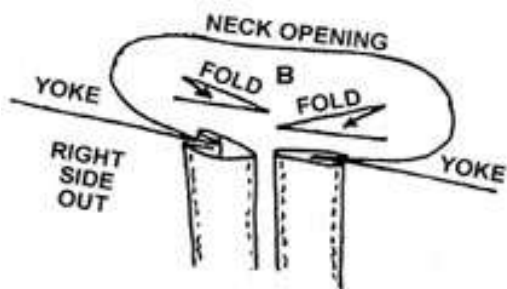
**You should now have a piece like this:**



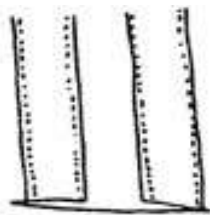
**(6)-A- For the hreast facing, tear or cut two strips 1 1/2" to 2" wide, the length of the front slit. Sew them to the slit sides, cloth right sides facing, with a 1/2" seam.**



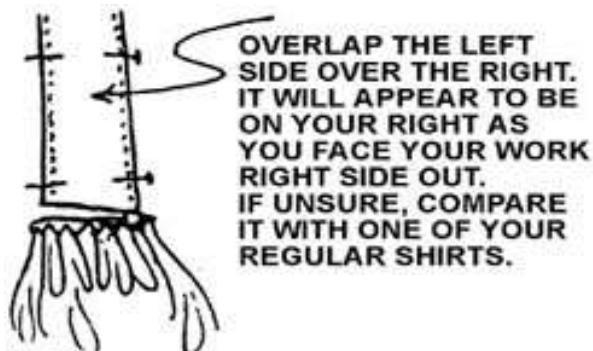
**-B- Then, fold around and inward as shown, and sew through the four thicknesses of cloth along the previous seam. Press flat to make a crease, and sew along the edge of that crease.**



**-C- Your finished work should look like this:**

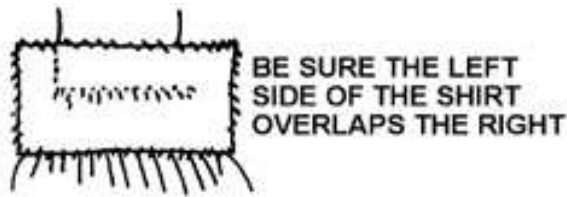


**-D- Next, gather the material below the opening with a running hand stitch. Pin the bottom of the facing together, overlapped as if buttoned together.**





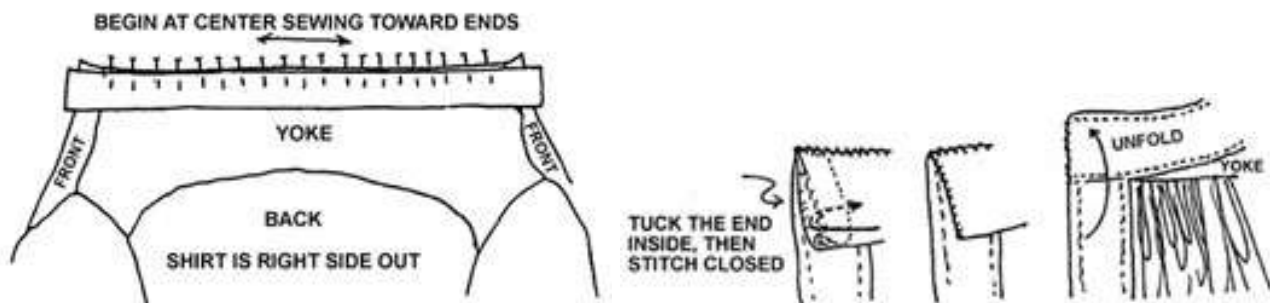
**-E- Cut out a piece of material about 2" by 3", folding and pressing the edges under with an iron until you have a piece about 1" by 2". Lay it squarely over the bottom of the facing and the gathered area, and sew into place.**



**(7) There is a simple method for the neck band and a complicated, more authentic method:**

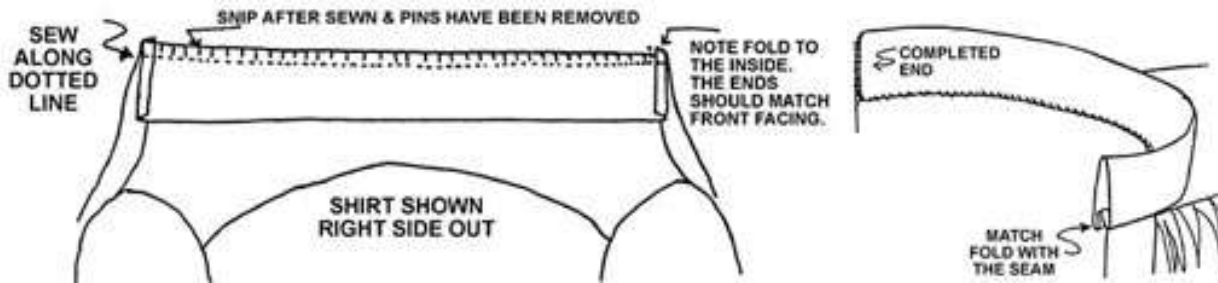
**-A- Simple Method: Fold the neckband piece lengthwise, wrong side out. Sew it together on one end and down the open length, leaving one end open. Turn it right side out (pencil or knitting needle would help).**

Place the neckband on the yoke edge, end flush with the vertical edge of one facing, and sew together. Be sure that the seam will wind up underneath the finished neckband when worn. Just before you reach the other end of the yoke opening, clip off excess neckband 1/2" beyond end, and turn the open end of the neckband inside so you can finish sewing. Stitch the neckband to the yoke a second time, and close the end of the neckband as you complete sewing it to the yoke.

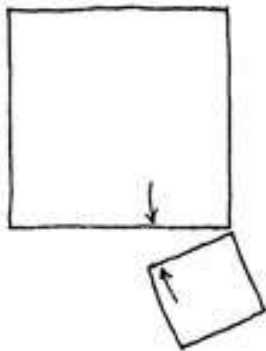


**-B- Complex, Preferred Method**

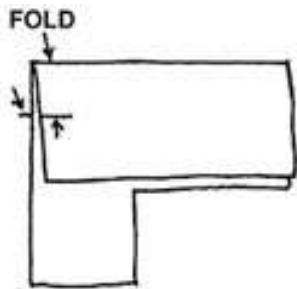
- 1. Pin neckband piece to the neck opening, with ends folded back, matching the front facing edges. Sew 1/2" from edge twice.**
- 2. At intervals of every V to 3/4", clip cuts into the sewn edge about 1/4" deep. Don't cut through the freshly sewn seam!**
- 3. Fold the neck band over, starting in the center. Begin pinning and matching the tucked edge with the previous seam to the yoke. Once pinned, sew the open ends and stitching down the neckband. Stitch along the outer crease of the neckband, as well.**



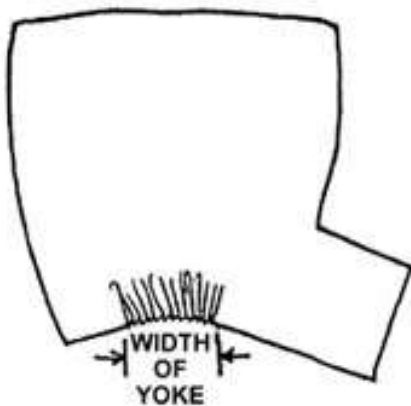
**(8) Preparing the sleeves.**



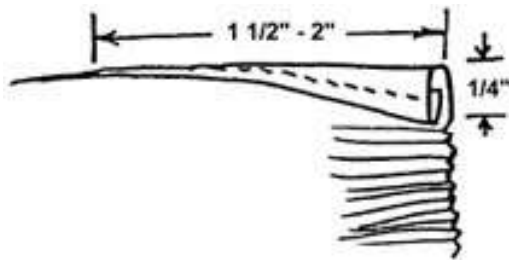
**-A- If the gussets were cut as separate pieces, attach them to one end of the long side of the sleeve pieces.**



**-B- Fold a sleeve piece lengthwise, bringing together the long edges and letting the gusset hang loose. Mark the short edge at the gusset end about half way along the edge.**



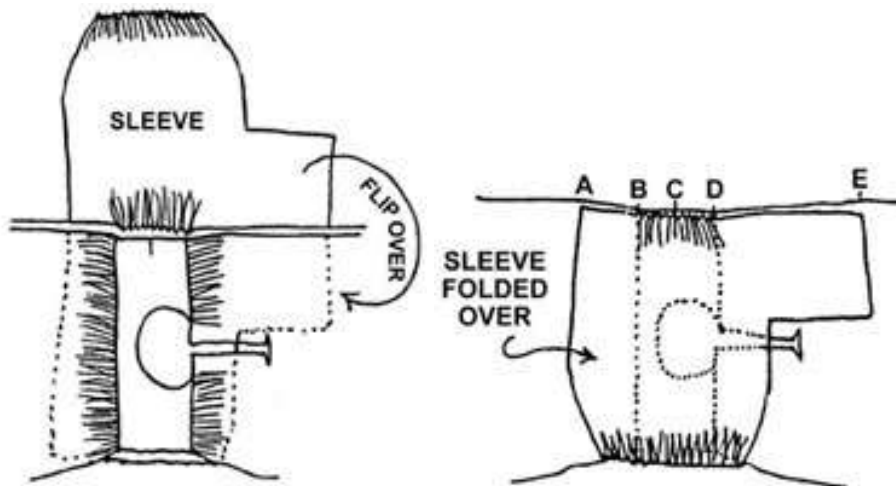
**-C- Unfold and gather between the marks to match the side of the yoke.**



**-D- Taper the ends of the sleeves in a little by rolling in their corners. Roll in about 3/8", and make the taper about 1 1/2" long. Pin to hold temporarily.**

**-E- Place sleeve to previous assembly, right sides facing, with the gusset to the front of the shirt. Pin together, and sew from Point A to Point E.**

**- Repeat for the other sleeve.**



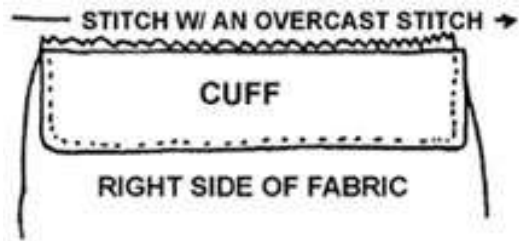
**(9) -A- Cut the cuffs 2" longer than the loose wrist circumference. The piece should be 2" to 4" wide. Narrower cuffs seem to be more common, but there is room here for personal preference.**

**-B- Fold lengthwise. right sides facing and sew each end with a 1/2" hem. Turn right side out, press with a hot iron (or flatten on a bent knee), and stitch all the way around 1/4" from the edge.**



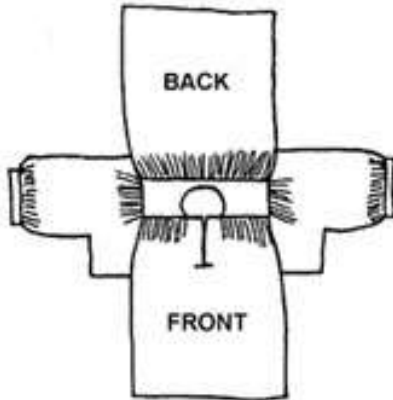
**-C- Gather the now narrowed sleeve end, so that the gathered length matches the length of the cuff. Pin together, right sides facing. Sew about 1/4" from edge. You can now remove pins that kept taper from unrolling.**





**Repeat on other sleeve.**

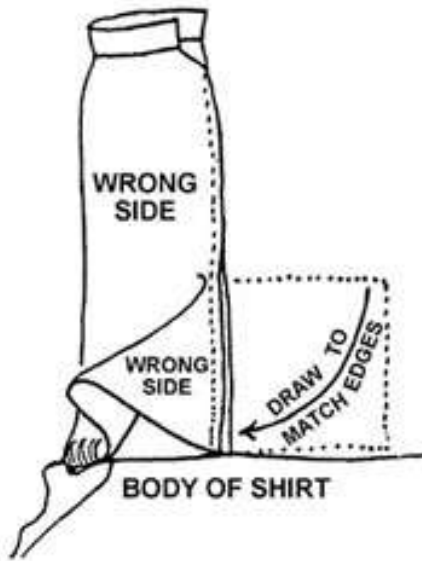
**You should now have an assembly that looks like this:**



**READ AND UNDERSTAND THE FOLLOWING BEFORE CONTINUING:**

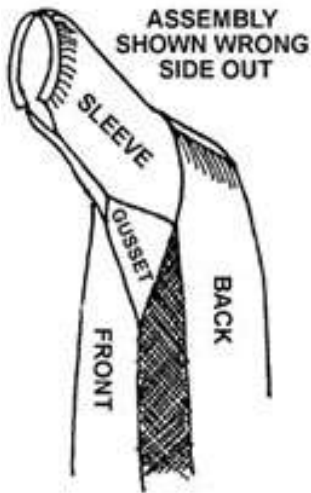
**(10)-A- Folding the right sides of the cloth face to face, begin sewing the long sides of the sleeve together, starting 1" away from the cuff, about 1/2" away from the edges of the cloth. Stop when you get to where the gusset begins on one sleeve side. You will now match the sleeve side without the gusset to the side of the gusset.**

**You will find that the gusset's edge is at a right angle to the sleeve side, and to the seam you've been sewing. Grasp the corner of the gusset and pull it over, keeping the sides facing so you can continue sewing a seam. DO NOT FOLD IT - just draw it over.**

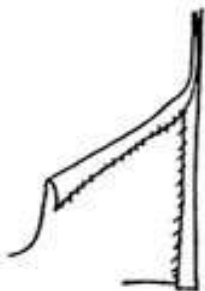


**-B- Stop at the corner of the gusset, and repeat on the other sleeve to this point.**

**When both sleeves are finished to this point, you should have something that looks like this: the front, gusset, and sleeve will all be sewn together. The back will be unattached from the junction of the sleeve & gusset all the way down to the tail.**

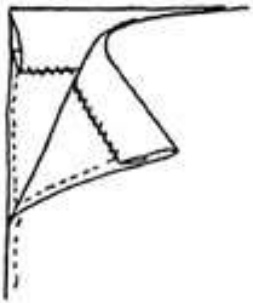


**-C- Sew only the open edges to each other, from the sleeve/gusset/back juncture down to 3" - 5" from the bottom. Make sure all the extra gusset material stays clear of the seam. Repeat on the other side of the shirt.**

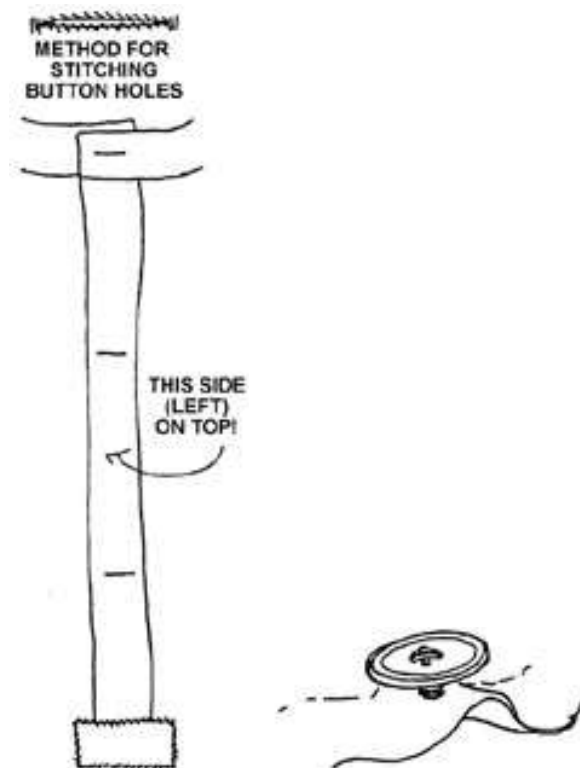


**(11)-A- Hem the edges of the bottom slits.**

**-B- Lay the shirt flat, after turning it right side out. Match up the bottom by folding over a hem, pinning and pressing with an iron if necessary. Put it on to see how it hangs on you. With help from a mirror or from some one else, you may find it necessary.**



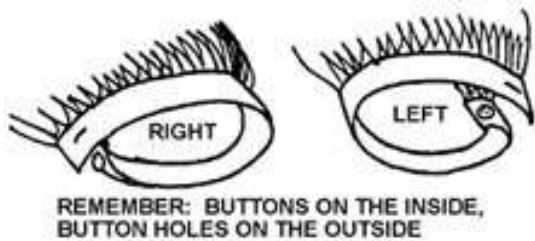
**(12) For button holes, cut slits about 1/2" long as needed and stitch the edges with an overcast or locking stitch. There is one in the neckband, 2 or 3 on the front opening, and one on each cuff. Sew on button, preferably bone. Voila! You're done!**



**Sew onto the fabric making at least a dozen passes with doubled thread. Wrap the thread around what has been used to attach the button a few times. Then pass the needle through to the back, knot and tie off.**

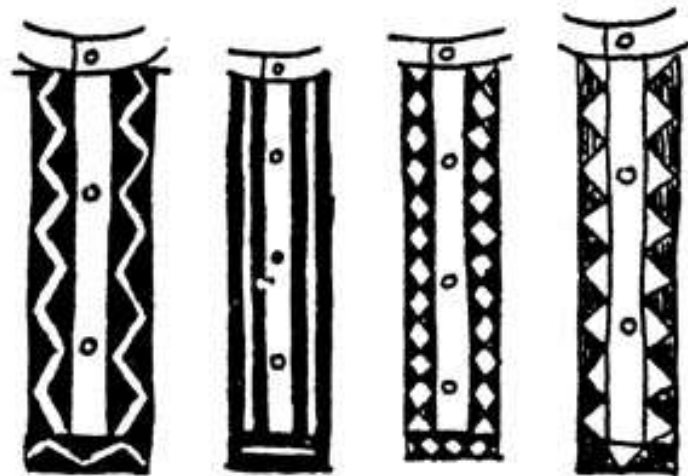
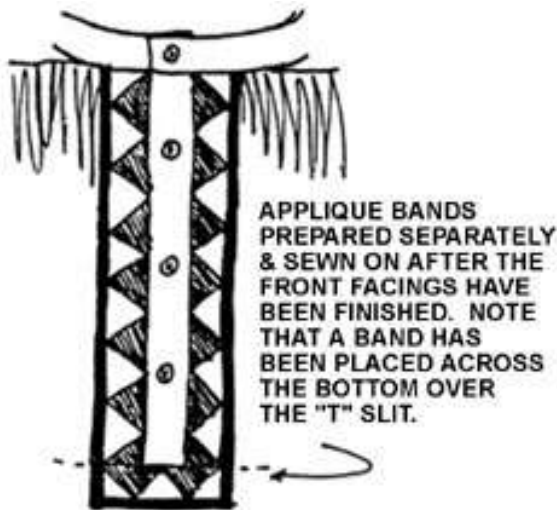
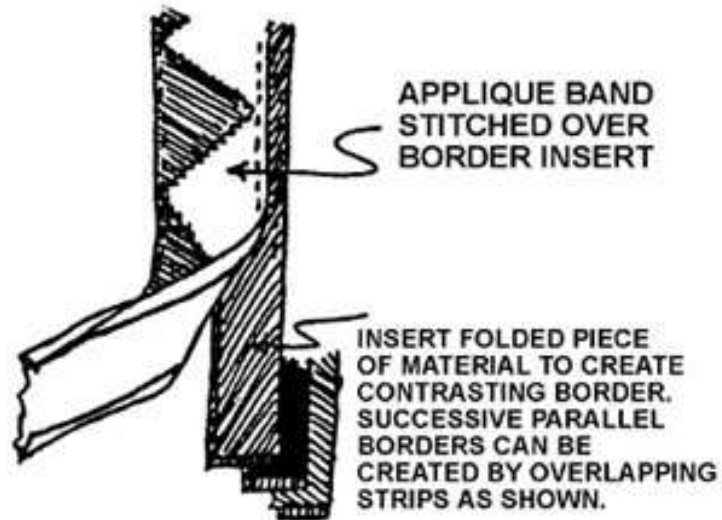
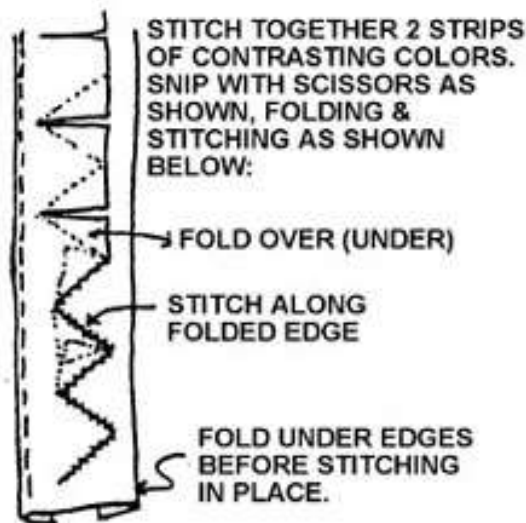
**Use your button holes to mark where the buttons should be before sewing them to the fabric.**





Cloth applique shirt fronts began to be noticed with regularity around 1900. Earlier photos and drawings indicate that they were in use perhaps as early as the 1860's. However, since the Seminoles were largely without white contact from about 1860 to 1880, an exact time period is impossible to pinpoint. Applique on Long Shirts (which will be covered later) was evident before the Seminole Wars, prior to the 1830's, but was much simpler in construction as a rule,

The cut & snip and overlapping welt methods are shown below, with other design ideas. Also, refer to old photographs and postcards for ideas.



[Return to Pattern for The Plain Shirt](#)

[Return to Introduction to The Plain Shirt](#)

[Complete Index to Articles in 19th Century Seminole Men's Clothing](#)

---

Contributed by [Rick Obermeyer](#) E-mail: [orick@prodigy.net](mailto:orick@prodigy.net)

From the book *19th Century Seminole Mens Clothing*

© 1991-2000 Sherwood F. Obermeyer Jr., 2124 Miscindy Place, Orlando, FL 32806

---

[Return to NativeTech's Main Leather & Clothes Menu](#)

[Leather & Clothes Bibliography and Books to Buy On-Line](#)

---



Text and Graphics  
© 1994 - 2003 [Tara Prindle](#)  
unless otherwise cited.



*The Seminole Longshirt*

# The Seminole Longshirt

by M. E. (Pete) Thompson  
and Rick Obermeyer

*in 19th Century Seminole Men's Clothing*  
[Rick Obermeyer ~ Editor](#)

"In council, the ceremonial dress of the chiefs heightened the impact of their language." Page 123, Mahon, 1967.

"...(Osceola's) dress was chiefly of calicos," George Catlin, quoted by Goggin, 1955.

"(Osceola at time of capture)... dress'd in a blue calico shirt, leggings of red cloth with a row of buttons on the outside of the leg & a red print shawl wrapp'd around his head and another his neck and shoulders." N. S. Jarvis, quoted by Goggin, 1955

(Billy Bowlegs 1852 visit to Washington) "Billy is himself a short, stout-built and quite ordinary looking man of about forty years of age and was clad in a calico frock, leggings, and a belt or two and a sort of short cloak." newspaper account, quoted by Covington, 1982

(Billy Bowlegs III, ca. 1895) "His dress was the holiday attire of the tribe, his tunic or shirt he had made himself, was highly decorated with bands of narrow red,..." Moore-Willson, 1911

---

## INTRODUCTION

The long shirt is the outer garment worn over the plain shirt. With very few exceptions, it was for everyday wear, as well as at public functions. From photographic evidence, such as contemporary postcards, it continued in common use until at least the 1910's, when both it and the plain shirt were superseded by the big shirt with its varicolored bands.

Its name among the Mikasuki is "FOK'-SHI BAX-KI" ("shirt long"). The Muscogean Creek used two names: "KA'BUH" from Spanish "capo" ("cape"), and "YOKOF'KI CHAPKO" ("shirt long"). It's often erroneously referred to as a "hunting coat" or even as a "great coat." Modern Seminoles often call it a "medicine man's coat," probably because their conservative medicine men continued to wear it to the Green Corn Dances long after it was no longer commonly used for daily wear.





[CLICK IMAGE FOR PHOTO DETAIL](#)

[USE YOUR BACK BUTTON TO RETURN TO THIS PAGE](#)

Although one might wonder why it would be worn on hot summer days, it served as an additional buffer against stinging or biting insects and thorny undergrowth. Like the plain shirt, more than one at a time might be worn in cold weather. It was almost always worn open in front, made without any fastenings, although modern examples have a tie at the throat.

Its style, originally copied from the cut of the 18th century British army matchcoat, has remained remarkably unchanged for 200 years. Only a couple of its main parts and construction steps are different between the earliest known examples and some made in the 1980's. The significant stylistic changes over that long a period of time were in kinds and placement of applique and ruffles, the finishing details. For that reason, these instructions are in two parts: general construction, and finishing. Read both parts before starting because most of the finishing has to be completed in the middle of the general construction.

## RESOURCES

There Just aren't a lot of longshirt examples reliably dated before 1850 to examine for putting together these instructions. And, the reverse sides of even fewer were available for study. Still, the extreme conservatism of Seminole lifestyle and dress through the 1890's hopefully makes it possible to project backwards to earlier in the same century. If many details between an 1830's example and an 1890's example can be compared and found to be the same, it is easy to assume that many other details of an 1890's example are very much the same as unknown details on 1830's example.



[CLICK IMAGE FOR PHOTO DETAIL](#)

[USE YOUR BACK BUTTON TO RETURN TO THIS PAGE](#)

We did use caution in making those logical leaps. Some construction details included here are the outcome of discussion and debate between amateur researchers, and are subject to adjustment or correction as more definitive information becomes available. For that reason, the re-enactor should keep in mind that these aren't necessarily iron-clad definitive descriptions. Observations of characteristics noted here should be tempered with "usually" or "generally" or "often" or even only "apparently." The word "always" is used here very carefully.



*CLICK IMAGE FOR PHOTO DETAIL  
USE YOUR BACK BUTTON TO RETURN TO THIS PAGE*

Seminole styles were conservative, but that doesn't mean they were rigid or frozen unchanging. Styles did evolve, so that a re-enactor might have several choices of detail within the forms of a style period. We've tried to indicate some ranges of choice within this outline, even though for convenience the construction illustrated details only a single combination of them.

A re-enactor who is unable to study museum examples of long shirts still has three very good resources. They are Fundaburk's "Southeastern Indians Life Portraits," Sturtevant's 1956 "Osceola's Coats?" and the McKenney-Hall Portrait Gallery. There is a standing 1850's photo of Billy Bowlegs that is helpful, but the line engraving of him in Fundaburk is accurate in most details. While out of print Fundaburk is available in almost any library. (References here to specific pictures in it will be noted as "SLIP#." McKenney-Hall is also in any library, and is available in reprint for about \$18.00.

---

[Go On to Longshirt Pattern & Construction](#)

[Go to Longshirt Finishing](#)

[Go to Longshirt Appendices & References](#)

[Complete Index to Articles in \*19th Century Seminole Mens Clothing\*](#)

---

Contributed by [Rick Obermeyer](#) E-mail: [orick@prodigy.net](mailto:orick@prodigy.net)  
From the book *19th Century Seminole Mens Clothing*

[Return to NativeTech's Main Leather & Clothes Menu](#)

[Leather & Clothes Bibliography and Books to Buy On-Line](#)

---



Text and Graphics  
© 1994 - 2003 [Tara Prindle](#)  
unless otherwise cited.





*The Seminole Longshirt*

# The Seminole Longshirt

by M. E. (Pete) Thompson  
and Rick Obermeyer

*in 19th Century Seminole Mens Clothing*  
[Rick Obermeyer ~ Editor](#)

## PATTERN & CONSTRUCTION

---

### **FABRICS**

Some McKenney-Hall portraits seem to indicate wool or strouding could have been used, from the ways the fabric hangs and folds. The Museum of the American Indian, Heye Foundation, has a buckskin example, and also one made of "chintz. n But, a re-enactor should prefer the commonly used cotton, especially if he can locate 100% cotton. (The Joanne Fabrics chain of stores carries a wide variety of 100% cotton cloth in old-style prints at a very good price.) They are made from a variety of geometric or floral prints, paisleys gingham, calicos, and stripes. If you decide to use plaids or gingham, try to located woven and not printed designs. Calicos, stripes, and fine prints were used more before the 1890's, and solids used more regularly after that. A pre-1860 re-enactor has an even wider freedom of choice in large paisleys wide stripes and bright calicos.

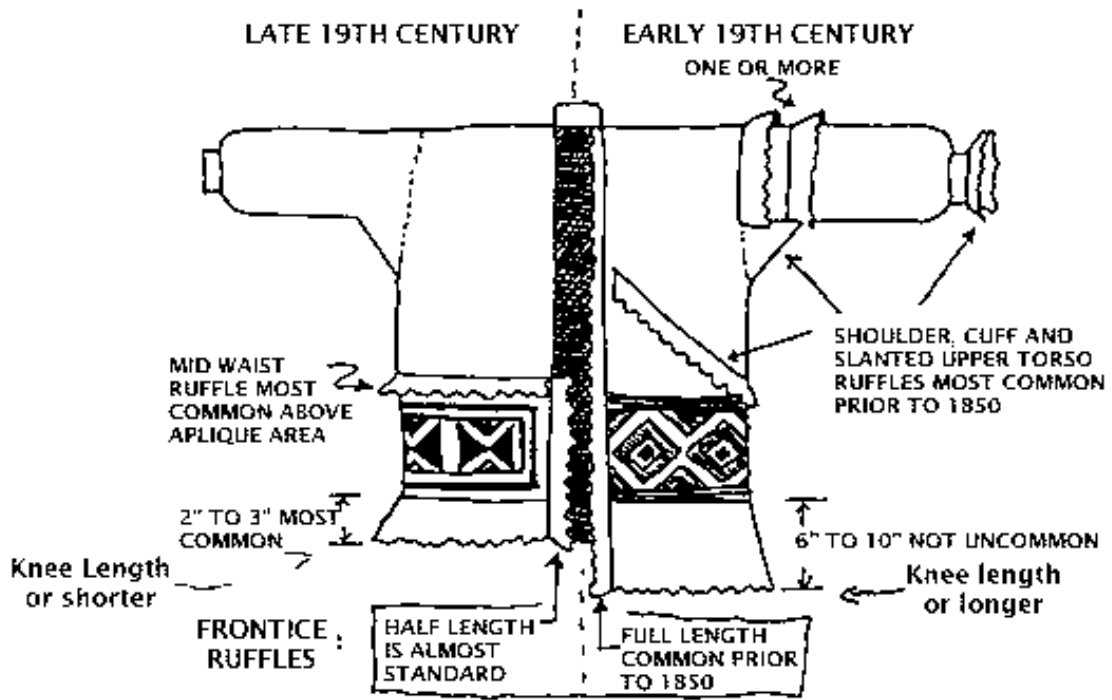
Most longshirts in museums seem to be red, black, or dark blue, but other colors are noted. Many good fixed dye colors weren't perfected until the late 19th century by the Germans. We don't yet know of a resource that outlines a history of color dyes to know what colors were readily available in the early 19th century.

If the Seminoles can be said to have any color preferences, those would probably be reds and blues. But, don't consider yourself limited to those. Keep in mind that all known written references to old-style Seminole leggings describe them as red (although we know there were dark blue ones as well.) The apex of the completed outfit, a beaded bandolier and pouch, is always made with red or blue or black wool strouding, but red wool seems to have been preferred to the others by two to one (Most, 1990). The re-enactor should consider choosing another color than red for his longshirt unless he really wants to be all in that color.

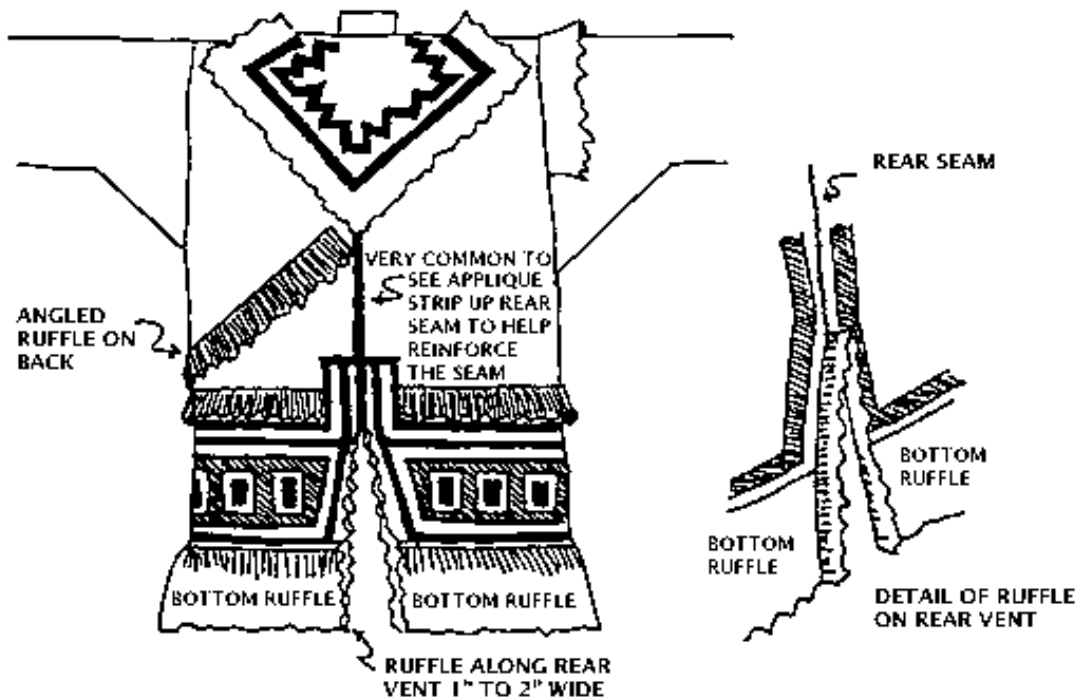
The prints tend to have medium to dark color backgrounds, but light colors are not unusual. The cape can be a different print from the body but is usually at least the same base color.

The ruffles that contrast instead of match with the cape and body fabric are usually a solid color, a very fine print, or a very narrow pin stripe. If a stripe is used, the lines need to be at right angles to the edge of the ruffle, not running lengthwise parallel to the edge. Incidentally, ruffles were almost never hemmed. They were left cut, and in a few early examples, threads were pulled loose to get a short fringe effect.

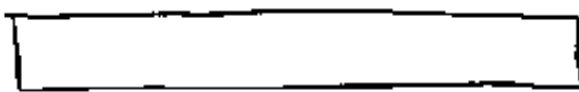




**RUFFLE PLACEMENT, REAR VIEW:**

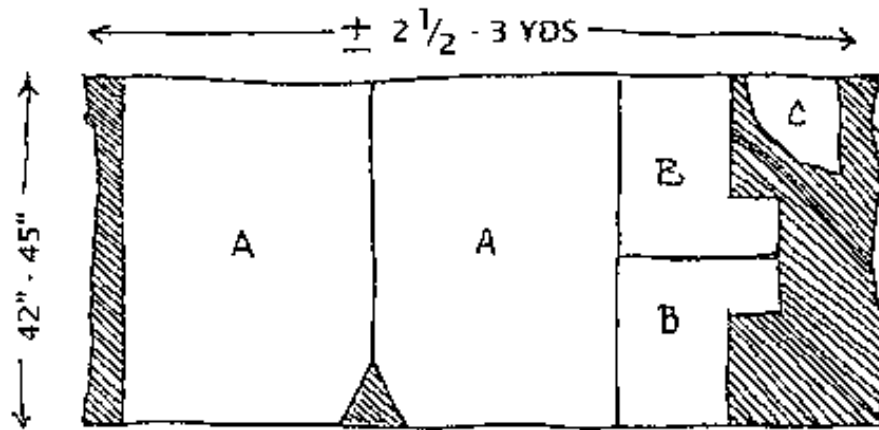


Notice that the ruffle that goes up one side and down the other of the tail slit is shown to be a single piece of cloth, which was always the case. The instructions show a rectangular piece. The tail slit ruffles were also often tapered at both ends:

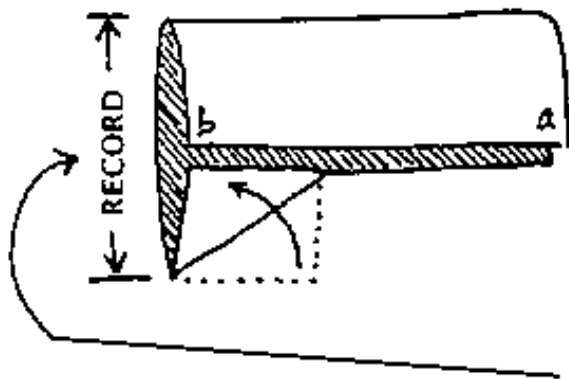
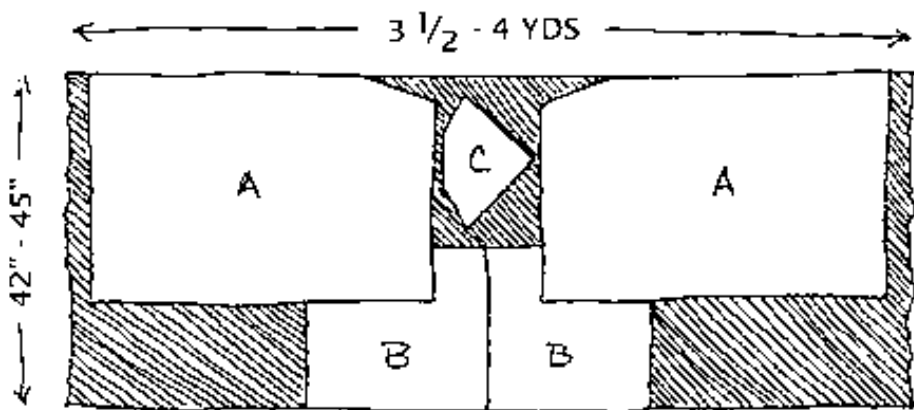




**Non-directional fabric layout:**

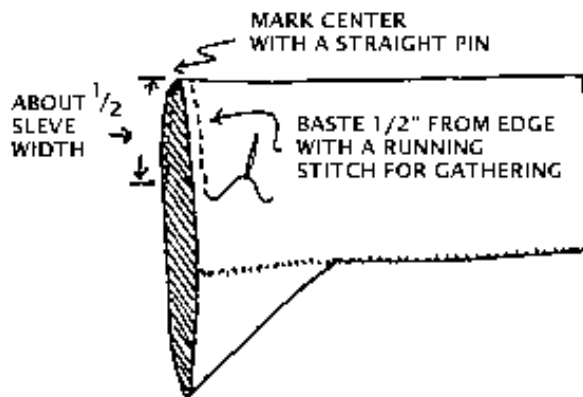


**Directional patterned print or weave fabric layout (SUGGESTED):**



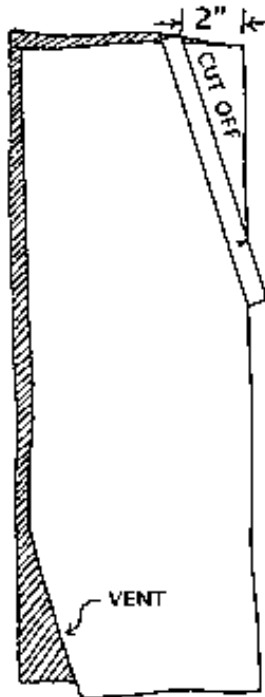
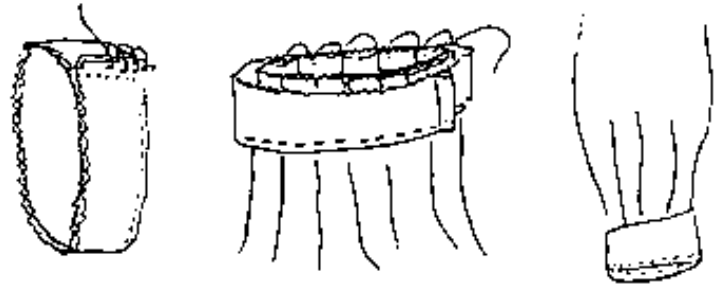
**A.** Fold the sleeves wrong side out as shown below, stitching from a to b. Be certain that the gusset is folded exactly as shown before stitching, and that you stitch only the outside edges together. Your finished sleeve should look like the one I below. Turn right side out when finished.

Record this measurement once sewing is completed. Then subtract two inches.



**B. Cut the cuffs 3 longer than the loose wrist**

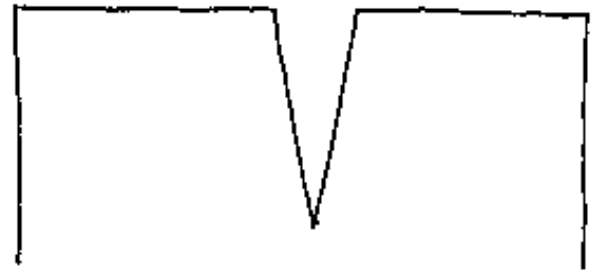
circumference. The piece should be 2" to 9" wide. Fold lengthwise, right sides facing and sew each end with a 1/4" hem. Turn right side out and flatten, either on the knee or with an iron. Stitch all the way around 1/8" from the edge. Sew the two ends together with an overcast stitch.



Insert the end of the sleeve through the cuff so that the raw edges of the sleeves and the cuffs meet. Gather the sleeve with small pleats and pin into place. (See Appendix \*2\* PLEATS) Sew down with a tight stitch, either overcast or running. Turn the cuffs right side out.

**C. Fold each body panel in half lengthwise. At the OPPOSITE END OF THE TAIL SLIT, measure in 2" FROM THE END.**

Using the measurement taken from the gusset end of the sleeve (less 2"), angle a line the same length to the edge of the fold using a straight edge.

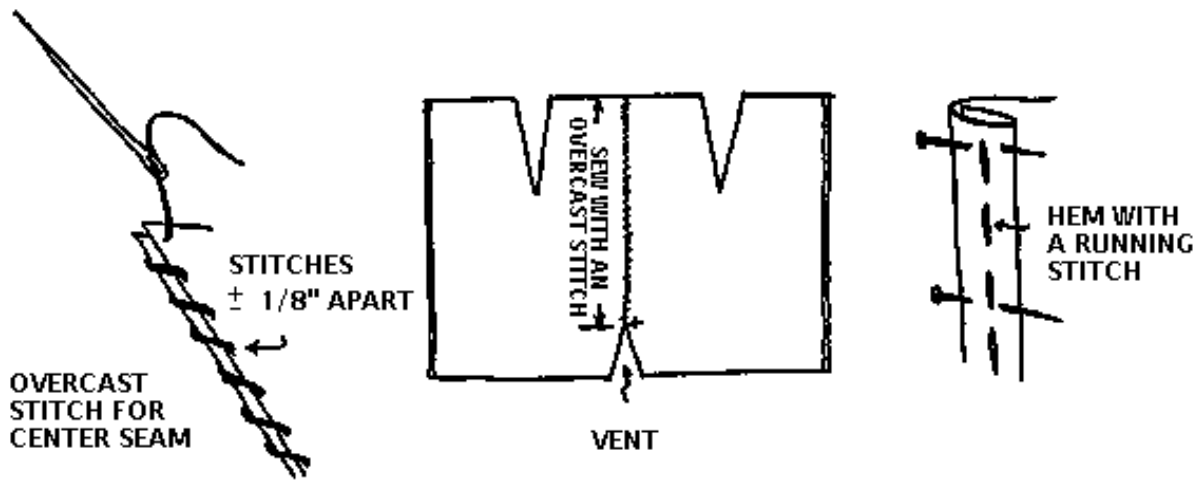


Mark and cut through both layers of fabric. When opened, you should have a large V-shaped opening in each panel, as below:

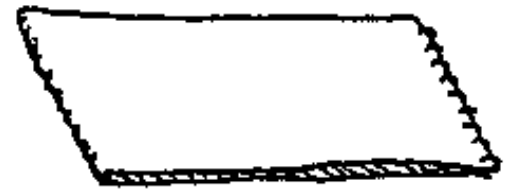
**TAIL SLIT**

The instructions show a cut for a vent in the back, called a "tail slit." The tail slit is always there after the 1830's. How wide it is, and how deep it is cut in depends on period and on personal choice. There are even tail slits left open for which no specific cuts were made. The cut for a tail slit could therefore be from 0" to 1" on each side, and its height can vary from 4" to 8" into the body of the longshirt. On a contemporary example, seen offered for sale at the Dania Reservation in 1989, the tail slit was open all the way up the back as high as the shoulder blades!

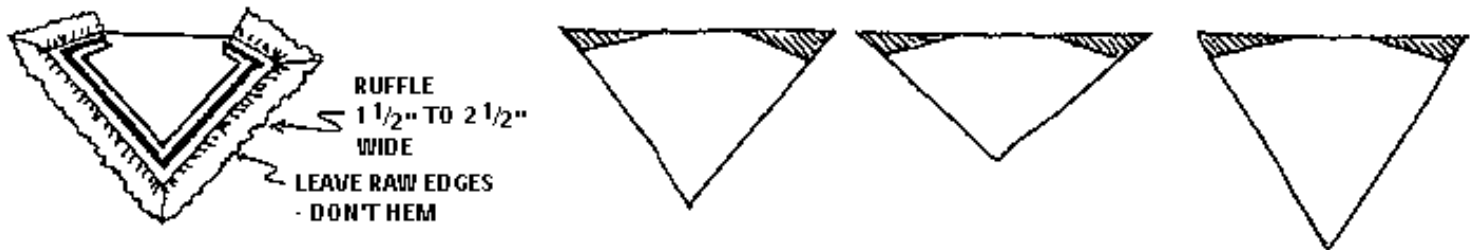
Begin sewing body panels (A) together from the tail slit (a) to the top (b). Using a simple rolled hem, hem the edges that make up the front opening. Before proceeding finish the bottom and sides with whatever applique and ruffles you have chosen (see "FINISHING").



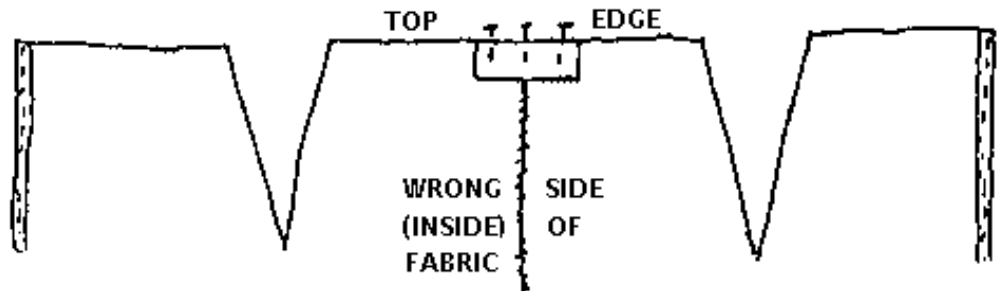
**D.** The collar is, in reality, nothing more than a neck spacer. It's a double piece of fabric about 1" or 2" wide and about 3" long when finished. Simply double over the fabric wrong side out, and sew up each end using an overcast stitch. Turn right side out, smooth out the sewn ends, and press flat. Set it aside for now



**E.** (See Appendix \*1\* CAPES) Briefly, the cape is either an equilateral or an isosceles triangle, depending on period or preference. It was usually modified at the base of the triangle to resemble a faceted gemstone seen on edge, as below. It is more or less shoulder wide, depending on period and preference, and edged with ruffles and straight applique. The cape should be completely finished before proceeding {See "FINISHING"}.

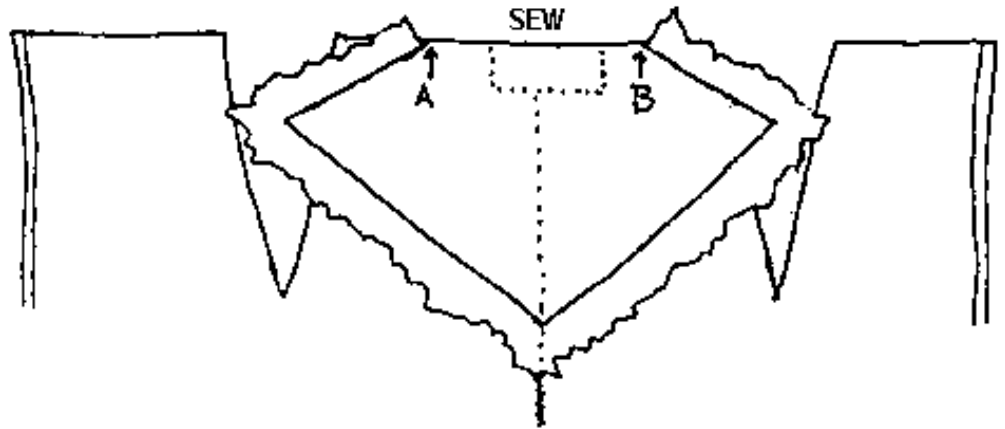


**F.** Center the neck spacer over the center seam of the completed body at the top edge, open side edge to edge with the body top, midway between sleeve openings. Be certain that it's attached and on the wrong side of the fabric and hangs down.

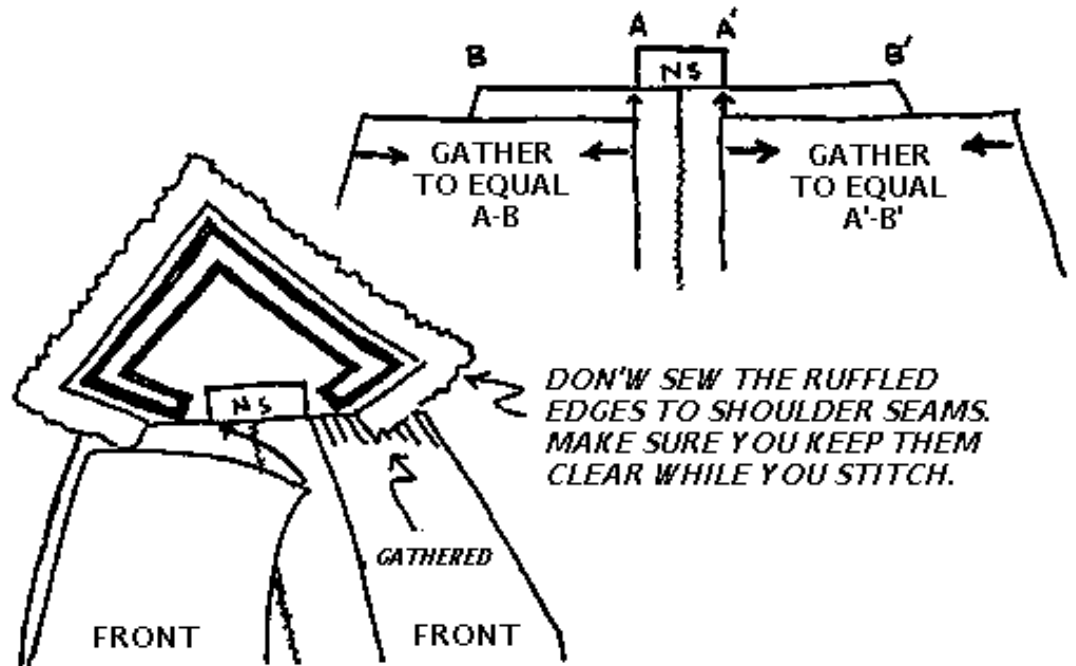




**G.** Next, place the finished cape directly over the spacer as shown below. Be certain that the finished side of the cape faces against the wrong side of the body. Sew from point A to B with a tight overcast stitch (about 1/8" apart).



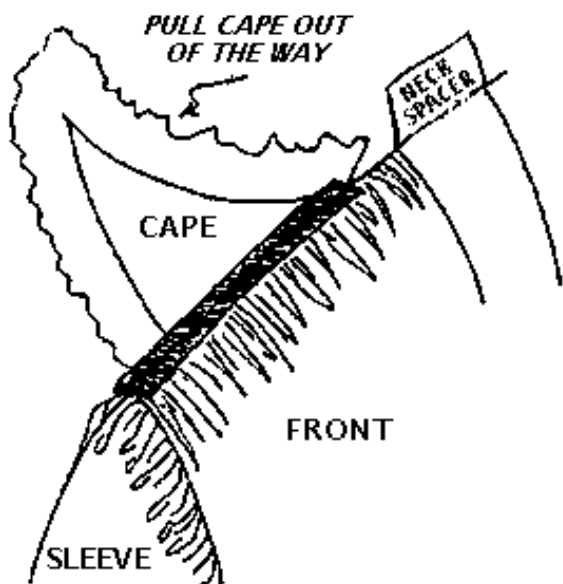
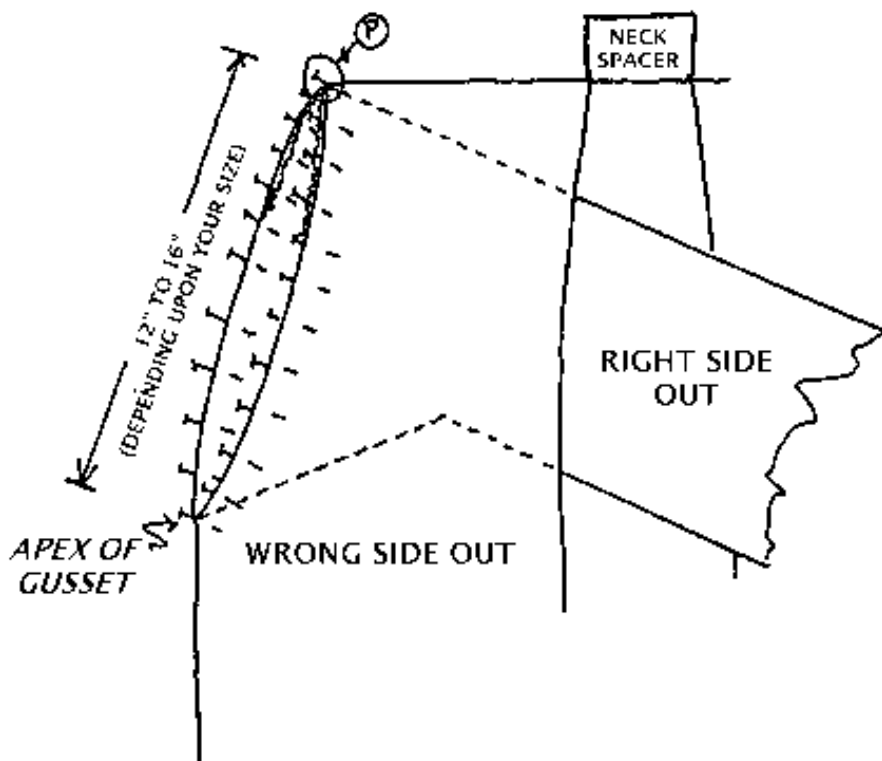
**H.** Once the cape and neck spacer are attached, lift the cape out of the way as shown below. Match each side of the front to the edge of the neck spacer, and pin at that point to hold in place. It will be necessary to gather each side to equal the length between the neck spacer and the shoulder edge (A to B, and A' to B'). (If you have decided on shoulder ruffles, insert them at this time.) Pin into place as needed, and sew together. If there are no shoulder ruffles, use a tight overcast stitch the same way you sewed the cape and neck spacer to the I body. If there are ruffles, you will need to use a tight running stitch. As you sew, you will be making several small pleated folds in the front body piece to gather it slightly. (See Appendix \*2\* PLEATS)



Turn the body of the shirt inside out. Make certain the sleeves are kept right side out.

Match the apex of the gusset with the bottom of the sleeve opening. If you want a shoulder ruff, insert it at this time. Pin the sleeve to the body working up each side until you encounter the gathering.

Adjust the pleats until the gathered portion of the sleeve and the opening are roughly equal. Insert pin at the front-back seam of the body panels (P). The center mark you're earlier should be on that seam. Once you're satisfied all is okay, pin it into place, continuing until the sleeve is pinned all around. Sew the sleeve onto the body using an overcast stitch at least 1/4" from the edge, with stitches about 1/8" apart. Pull them tight, but not enough to cause the seen you're stitching to buckle. Repeat the process on the next sleeve, then try it on for fit.



**I.** The reinforcer can be the same material or even a darker contrasting piece. Sew it on top of the shoulder seam from the point where the cape attaches out to the sleeve. It is stitched on both edges, which are usually turned under, but can also be left raw. There are a couple of examples in which a contrasting piece is so wide that the raw edges make narrow ruffles.

[Return to Longshirt Introduction](#)

[Go On to Longshirt Finishing](#)

[Go to Longshirt Appendices & References](#)

[Complete Index to Articles in 19th Century Seminole Mens Clothing](#)

Contributed by [Rick Obermeyer](#) E-mail: [orick@prodigy.net](mailto:orick@prodigy.net)

From the book *19th Century Seminole Mens Clothing*

© 1991-2000 Sherwood F. Obermeyer Jr., 2124 Miscindy Place, Orlando, FL 32806



Text and Graphics  
© 1994 - 2003 [Tara Prindle](#)  
unless otherwise cited.



*The Seminole Longshirt*

# The Seminole Longshirt

by M. E. (Pete) Thompson  
and Rick Obermeyer

*in 19th Century Seminole Mens Clothing*  
[Rick Obermeyer ~ Editor](#)

## FINISHING

---

**IT IS VERY MUCH EASIER** if you finish the bottom, front, and back of a longshirt after Step C "Sew Panels Together" and before attaching the cape and sewing the top together. It is **VERY MUCH EASIER** if you finish the cape before attaching it in Step G.

There are three kinds of finishing touches: ruffles, straight strip applique, and complex applique. After the 1920's or so, bands of patchwork were used instead of complex applique.

### ***RUFFLES***

Every longshirt has ruffles. They are always in some places, such as the cape edge and the body bottom edge. They may or may not be in other places, like on the cuffs, across the shoulders, and where the sleeves are joined to the body.

A narrow ruffle went all the way up both edges of the front opening prior to 1860. After 1870, the front ruffle stopped about halfway up, at or slightly higher than the hip ruffle. By the 1980's, this ruffle again goes all the way up the front.

After 1870, there is always a narrow 2"-3" ruffle running around the longshirt at about hip level, and occasionally a second narrower ruffle a few inches above that. The second, higher ruffle never appears without some kind of complex applique between it and the hip ruffle. The diagonal ruffle suggested in the instructions exists on only one known example (Sturtevant, 1956).



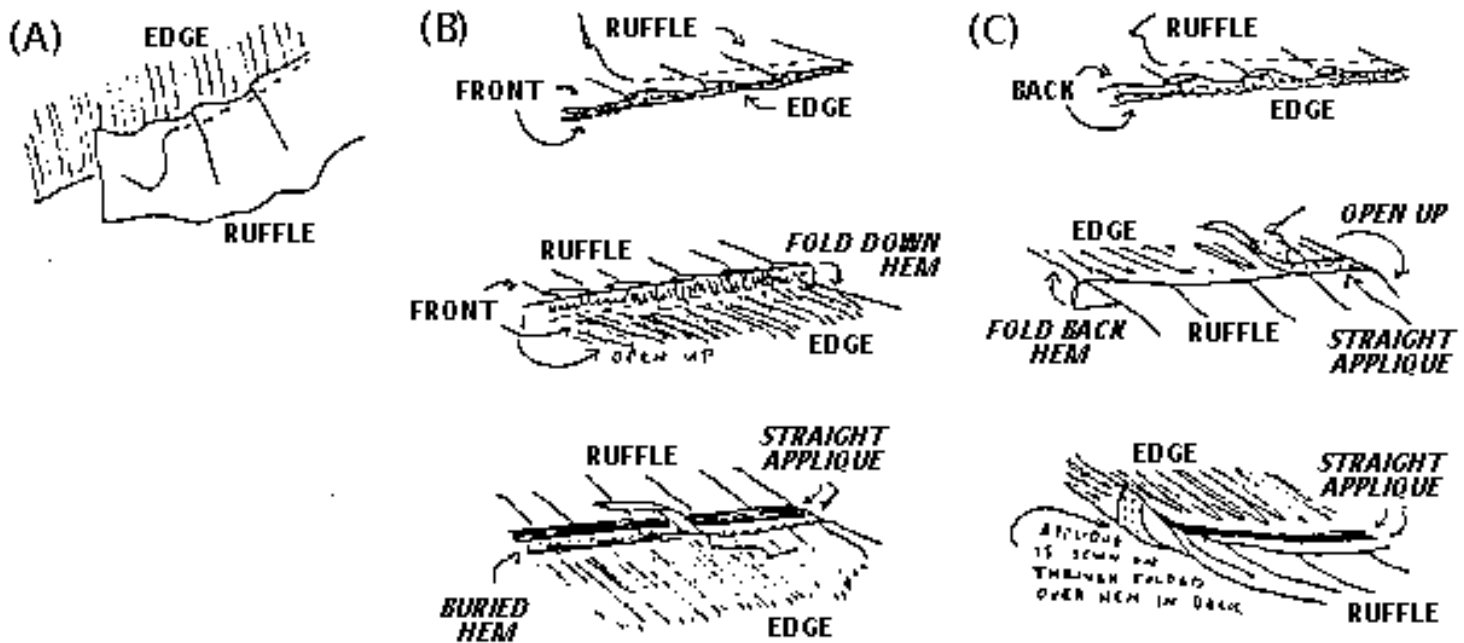
To make all your ruffles, simply tear the fabric into strips of desired width. Don't waste your time cutting or hemming the edges. It's the same way the Seminoles did it!

(See also Appendix \*2\* Pleats) There is more than one way to attach a ruffle:

(A) Simply lay the gathered ruffle edge over the edge of the cape or coat. Sew down. This raw edge may be left visible, especially on the body of early 19th century longshirts, or the edge may be covered with straight applique.

(B) Lay the gathered ruffle back to back against the cloth edge. Sew together, open up, and fold the hem back against the front of the cloth. Cover with straight applique.

(C) Lay the gathered ruffle face to face against the cloth edge. Sew together, and open up. When sewing straight applique up against the ruffle, be sure to also sew down the hem on the back away from the ruffle.



## ***STRAIGHT APPLIQUE***

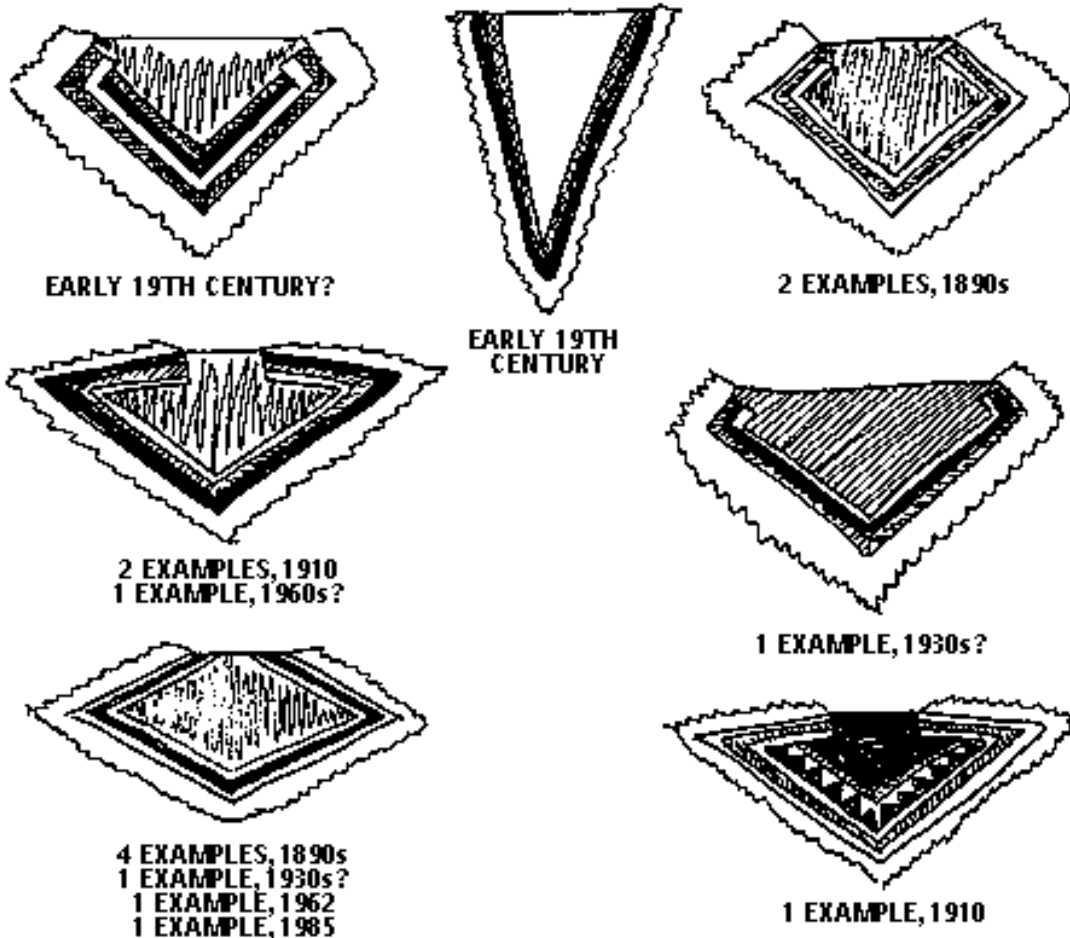
Every longshirt has straight strip applique. Commercially made single fold bias tape is excellent to use for this, especially when the applique is narrow enough to be piping. There are always three of these straight narrow 1/4" to 1/3" strips added inside the edge of the ruffles on the cape and two or three above the bottom edge ruffle, and up the front edges and up the back seam above the tail slit. After 1870, two or three always appear above the narrow hip ruff, and also above the second waist ruff if there is one.



After 1870, there might also be as many as five above the bottom ruffle and up the tail slit and rear seam for about a foot. This bottom straight applique usually seems to run a little higher up on the rear seam than up the front opening, where it rarely extend past the top of the front opening ruffle. In the back, it may or may not be squared off at the top, (but this is usual in post-1980 longshirts). In modern (post 1930) longshirts, the straight applique can continue up along the rear closed seam to the middle of the back, or even almost up to the shoulderblades.

Colors used tend to be limited to white, red, black, and gold, with turquoise and other colors occasionally included (see Appendix \*3\* Straight Applique Colors).

*SOME EXAMPLES OF STRAIGHT APPLIQUE ON CAPES:*



*COMPLEX APPLIQUE*

Most, but not every, pre-patchwork longshirts have complex applique. Pre-1850s long shirts that had this seem to have had not much more than a crossed zig-zag pattern. One set of continuous V's were sewn down, and then crossed by another set of V's in contrasting colors. In a couple of examples, threads were pulled loose off the lower edges of these strips to make a very short fringe.

McKenney-Hall's portrait of Tukosee Mathla shows three strips of what has to be simple cut and stitch applique along the bottom of his coat. The leftmost figure in Sturtevant, 1962, has what could be a diamond applique strip sketched along the bottom of his coat.

Post-1870 examples have very nice applique patterns with a lot of variety and widths from 2" to 4". It is the rare longshirt that does not have some kind of complex applique between the bottom ruffle and the hip ruffle, and many have another narrower, less complex applique band above the hip ruffle.

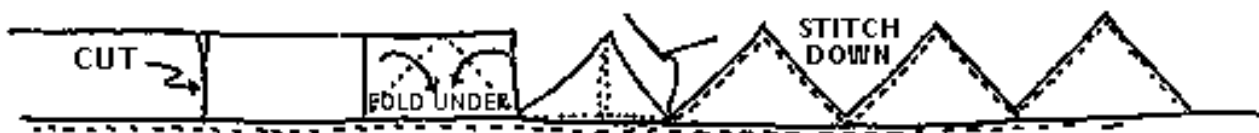
The authors know of only two or three longshirts with commercially made rickrack, and none later than on the cape in a 1940 photo taken by Deaconess Bedell. Do NOT use rickrack for any applique shortcuts.

Two to four layers of material might be used in a complex applique design. Applique patterns are created with cloth cut open and folded back to expose an underlying contrasting fabric, or cut to shape and sewn down on top of a contrasting color. Almost all fabrics are solid colors, and the colors are usually the same as those used for straight applique (see Appendix \*3\* Straight Applique Colors.)

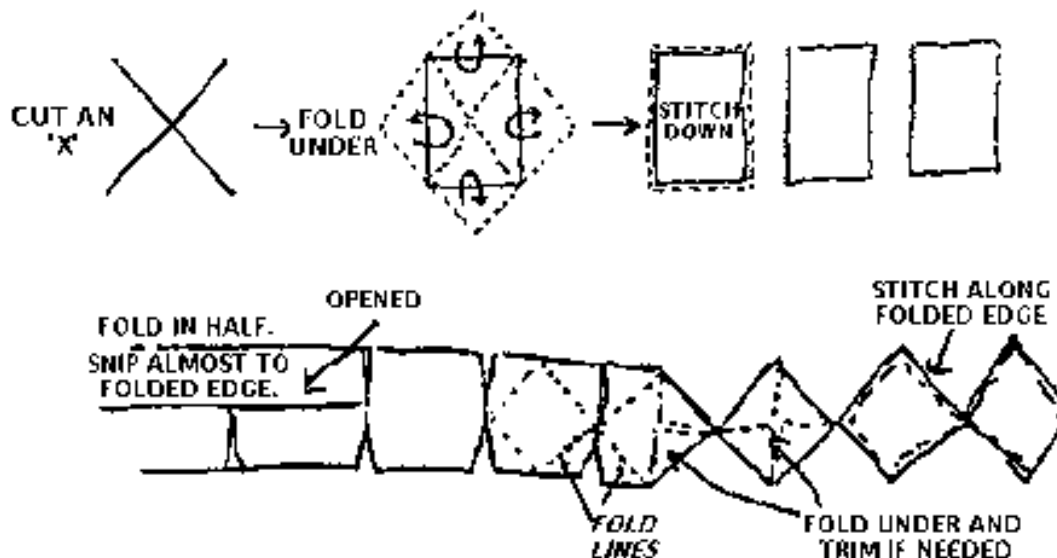
There is an option that's much easier than ripping strips of material that must be pressed before using. It is craft ribbon, found in craft shops and the hobby section of many fabric stores. They come in 1" to 3" widths, and are highly starched, which makes the fabric easier to fold over for sewing. The starch washes out later on.

Meanwhile, don't be too annoyed if your cuts and edges are not precise. Most Seminole examples definitely show a free attitude toward "floating" edges with the pattern.

*TO MAKE SAWTOOTH:*

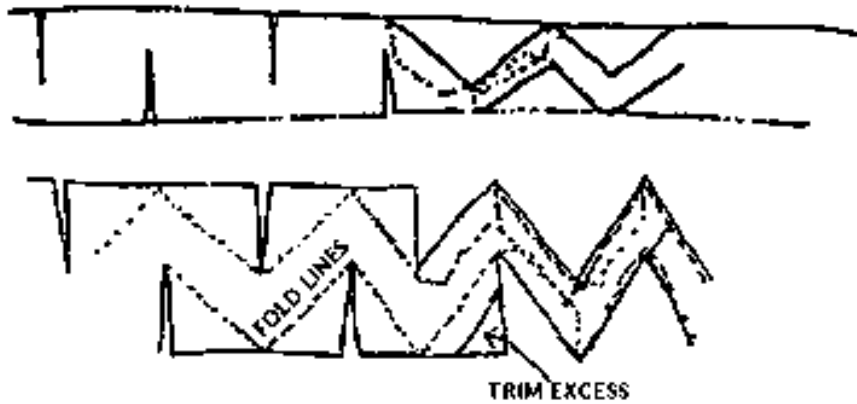


*TO MAKE A SQUARE OR RECTANGLE:*

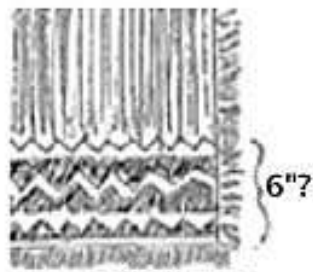


*TO MAKE A ZIG-ZAG:*





### Early 19th Century Finishing



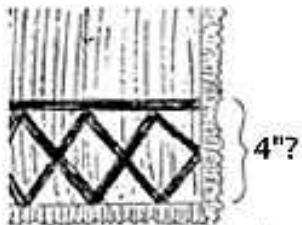
*FRINGED EDGE*  
McKenny-Hall, 1820s  
"Tukosee Mathla"



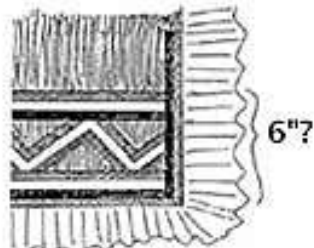
"No-Kush-Adjo" 1856



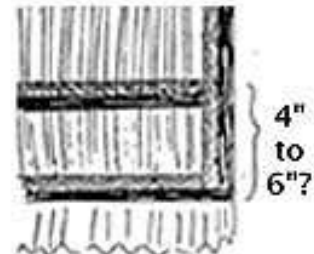
Florida Museum of Natural History, Gainesville (1830s)



Museum Fur Volkerbunde, Berlin, 1840s



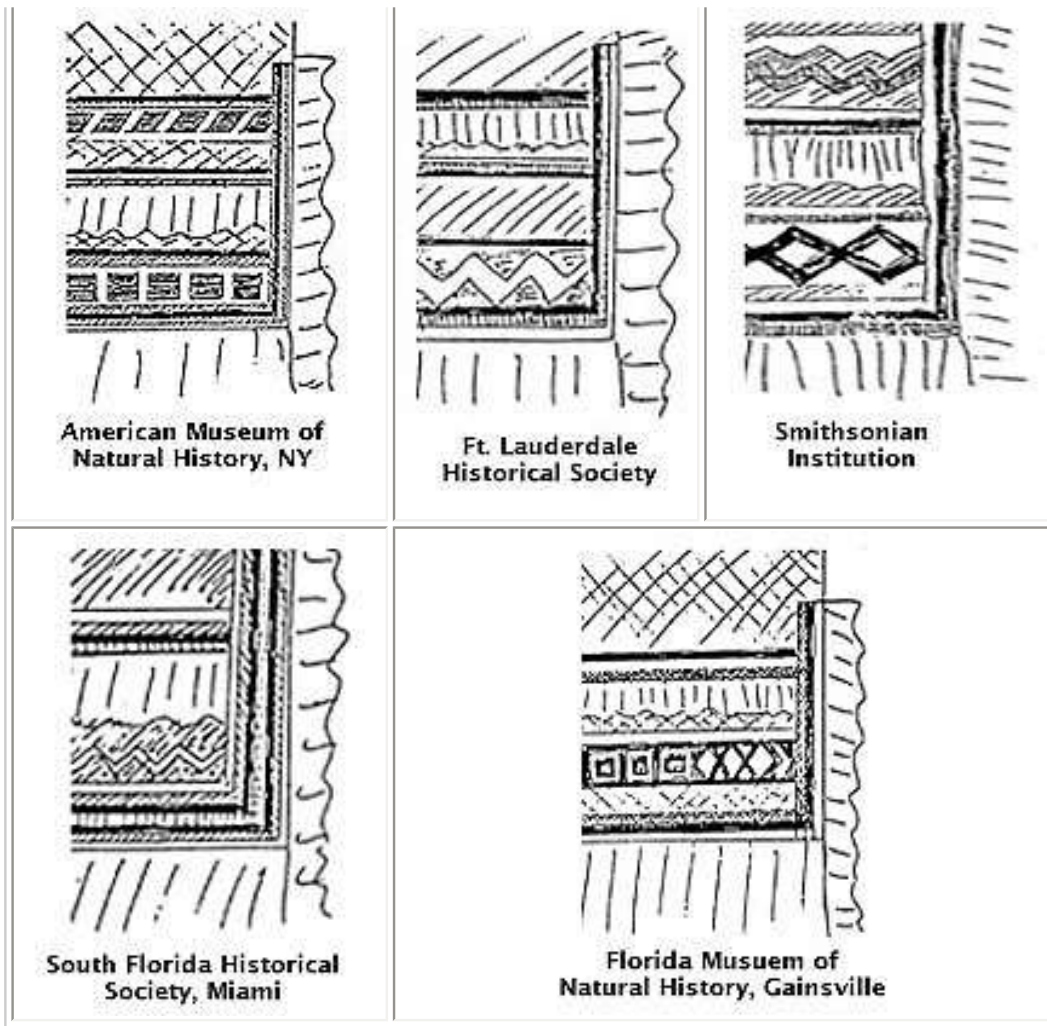
Photograph, "Billy Bowlegs" 1850s



Museum of the American Indian, Heye Foundation

### Late 19th Century Finishing





### Late 19th Century Applique

*Patterns Not drawn to the same scale.*



[Return to Longshirt Introduction](#)

[Return to Longshirt Pattern & Construction](#)

[Go On to Longshirt Appendices & References](#)

[Complete Index to Articles in \*19th Century Seminole Mens Clothing\*](#)

---

Contributed by [Rick Obermeyer](#) E-mail: [orick@prodigy.net](mailto:orick@prodigy.net)

From the book *19th Century Seminole Mens Clothing*

© 1991-2000 Sherwood F. Obermeyer Jr., 2124 Miscindy Place, Orlando, FL 32806

---

[Return to NativeTech's Main Leather & Clothes Menu](#)

[Leather & Clothes Bibliography and Books to Buy On-Line](#)

---



Text and Graphics  
© 1994 - 2003 [Tara Prindle](#)  
unless otherwise cited.





*The Seminole Longshirt*

# The Seminole Longshirt

by M. E. (Pete) Thompson  
and Rick Obermeyer

*in 19th Century Seminole Mens Clothing*  
[Rick Obermeyer ~ Editor](#)

## APPENDICES & REFERENCES

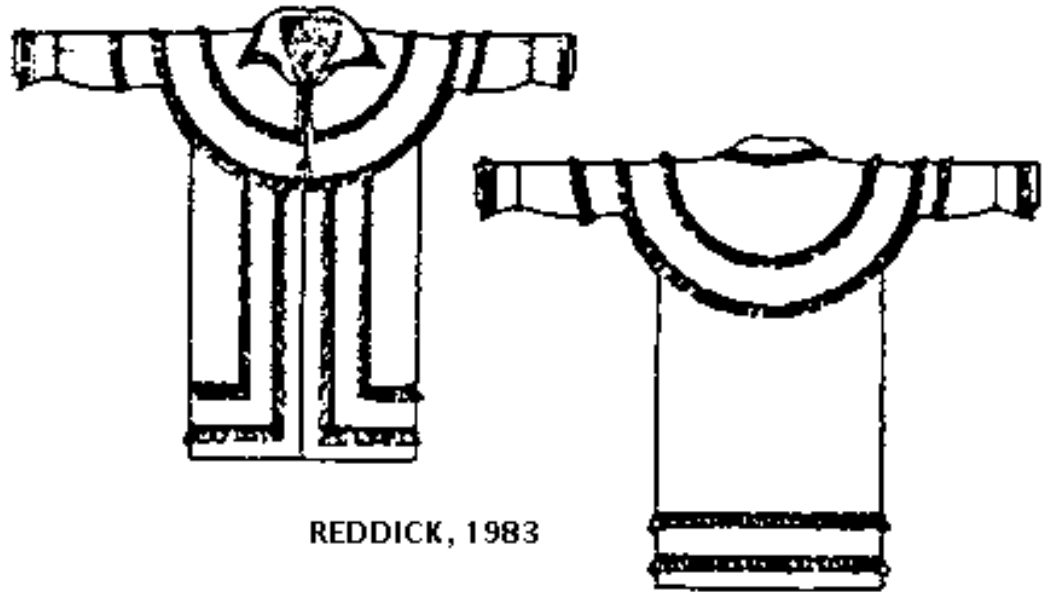
---

**\*1\***

### ***CAPES***

**The McKenney-Hall lithographs of Seminoles and Creeks are from portraits painted mostly in the 1820's. These early pictures show already distinctive traits in Seminole long shirts separate from Creek or Cherokee. There seem to be two general kinds: with a wide collar that opens out of the front and neck, or with an attached cape that lays over the shoulders and hangs down the front.**

The cape can be rounded or triangular. The round cape is essentially the same as on a "frontierman's coat." A simplified pattern for this kind of coat is called a "caped southern Indian coat" in Hanson &



Wilson, 1976, and a more detailed pattern is available from Missouri River Patterns as "The Rifleman's Hunting Frock" (Reddick, 1983). There are many examples of Seminoles of the 1820's and 1830's wearing a rounded cape ("Chitee Yoholo" SILP #175), and it stayed very popular with Creeks ("McIntosh" SILP #144, and "Ocho-Finceco" SILP #153).

"Micanopy" (SILP #172) is wearing a rounded cape that could be on its way to being the cornered triangular cape. In five of the ten McKenney-Hall Seminole portraits, and in none of the ten Creek portraits, the sides of the cape have moved up off of the upper arms to the outer edge of the shoulders. The front corners, which still lay over the collarbones, have necessarily become less squared and more acute. In all five examples, the pointed cape has edge ruffles. Is this the pointed cape that became the triangular Seminole standard?

Unfortunately, we don't know what's happening with the cape on the back of those coats. At what stage did the back stop being rounded and acquire a pointed corner in the center? Since it didn't occur to any prominent Seminole to turn his back to the artist for his portrait, do we have to accept a full leap from a rounded to a three-cornered triangular cape? In Sturtevant, 1962, we can see the backs of five long shirts roughly sketched in "A Newly Discovered 1838 Drawing of a Seminole Dance." All but one clearly have a rounded cape. The fifth might be pointed only by stretching the point on a sparse sketch.

Fortunately, there are four examples to provide clues for an early caped longshirt. And, they are all collared, not round caped long shirts.

**The long shirts with wide collars were apparently used through the Second Seminole War, to judge from Catlin's paintings. Not one of his seven portraits of adult Seminole males clearly show a cape of any kind, while a couple do show wide ruffled collars ("Mick-E-No-Pa" SILP#203, "Ee-Mat-La" SILP#209). Three of the twelve McKenney-Hall portraits show what could be a collared long shirt. A long shirt with a wide ruffled collar would be very appropriate for a Second Seminole War Re-enactor. And, it's possible to wonder how many of the collared longshirts painted by Catlin had a triangular cape in back.**

**The Florida Museum of Natural History in Gainesville has a cotton long shirt given to William Golding in the late 1830's. This shirt remained in his family in upper New York state for many years, and wound up in a Canadian museum, from which it was traded to Florida. Its plain front, which could appear to be the simplest kind of collar, gives no clue to the dramatic triangular cape in back. The cape is attached along the whole width of its upper edge; the outer corners are not loose, so that the narrow ruffle that comes up the front is able to continue unbroken to the cape's edges. The ruffle is attached to the cape with a single straight applique strip and shows on both sides of the strip. Its triangle is a deep isosceles, not the right-angled triangle that was the later standard. Detailed measurements are not yet available, but it would appear that this cape could hang as low as the small of the back.**

**The second example is a buckskin coat in the Museum of the American Indian, Heye Foundation, Spec. #22/9750. It is "said to have been worn by Osceola at the Treaty meeting." While that interesting sidelight comes with no hard documentation, we could probably assume that the cut of the buckskin might be similar to the cut of early cloth coats. The front of the coat opens up to a collar not much different from our own modern coats. But, a look on the back shows that this collar is really a wide triangle with points resting on both shoulders. The cape doesn't hang lower than the shoulderblades.**





SPECIMIN #22/9750



*courtesy National Museum  
of the American Indian Smithsonian Institution*



SPECIMIN #13/5085

**Sturtevant, 1956, illustrates two longshirts collected before 1895, very similar in several details to the Gainesville example. Coat 1 has additional ruffles on the shoulders, like the Gainesville coat. Coat 2 has cross-diagonal applique strips, same as the Gainesville coat. But on these two coats, the cape's top outer corners are free, and the cape is attached to the longshirt only in the middle of its short side to the neck, as in these instructions. On both, the narrow ruffle up the front does not go continuously past the neck to connect with the cape's ruffle, even though the front and cape ruffle is the same material on one example. There are two separated straight applique strips on the capes of both coats, and Coat #2 has additional criss-cross applique. These capes appear to reach as wide as the shoulders only if the ruffles are included.**



**Coat #1  
Sturtevant, 1956**



**Coat #2  
Sturtevant, 1956**

**A fifth example of an old-style longshirt is Spec. #13/5085, Museum of the American Indian, Heye Foundation. Its triangular cape is cut the same as the illustrations in Sturtevant, 1956, with a wider ruffle, and four narrow adjacent applique strips. The cape reaches full shoulder width only by including the ruffles. The cape's print is different from, but complementary to, the print used for the longshirt's body, which apparently was not unusual. The bottom of this coat is very sparsely decorated, but the back has a tail slit with applique and**

**ruffle edging that is a simple version of all later examples.**

**Many examples from the 1890's and later are available for inspection. The Florida Museum of Natural History has a longshirt collected 1892-94 by the Ingraham family from "Tiger Tail Town." Fifty years after the Second Seminole War, the triangular cape has the same shape, but has become somewhat larger, so that its upper points extend to the tops of the shoulders and the ruffles lay over the tops of the arms. The cape's print is the same as the body. Its wide ruffle is consistent with others from this period, and it has three adjacent straight applique strips.**

**A specimen collected in the 1890's displayed by the Historical Association of Martin Company, Stuart, also has a large cape that's shoulder width with ruffles at least three inches wide extending past that, with three 1/2" wide straight applique strips inside them. Interestingly, the cape on this one is not the same print as the body of the longshirt, although its color is the same. The Historical Association has another longshirt on display whose cape material is also a different print but of the same color as the body material. That longshirt's cape has four 1/2" wide straight applique strips inside the very wide ruffle.**

**Apparently, to control the flopping about of the cape, some makers started tacking down those outer corners to the tops of the shoulders. The Museum of Natural History, New York, has several longshirts collected by Skinner in 1910 on the Big Cypress Reservation (Spec.#'s 50.1-2251; 50.1-2252; 50.1-2253). Two of these have a solid black body and cape base. The third uses a slightly different red print for the cape than the for the body, but the difference is so slight that it isn't noticeable at first glance. Examination shows that every single one of them has the cape attached both at the neck and the outer shoulders, but always with a token gap left in between, and that token gap still exists in an example collected by the Museum in 1962 (Spec.# 50.2-6370).**

**An example in a private collection collected in 1985 at the Tampa reservation has the cape attached to the shoulders along its whole length from corner to corner, coming full circle in 150 years.**

**Instructions for a triangular caped long shirt have been developed here for the hobbyist instead of a round cape because of its common use long after round cape was discontinued. We don't see the rounded cape among Seminoles after**

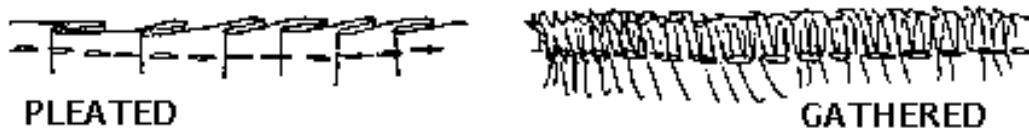
the 1850's, while the triangular cape was used, with stylistic differences, well past the turn of the century. Those differences are in the size of the cape relative to the longshirt, the width of the ruffle, and the width and number of applique strips running just inside the ruffle. A very few fine examples after the 1890's have more complex applique patterns, as well, and may have patchwork strips after the 1920's.

---

**\*2\***

### ***PLEATS***

An easy, but less common way to gather cloth was to sew a large running stitch along the edge, gather along the thread and sew that down.



With practice, you ought to be able to sew pleats as you go along without first gathering them with a loose running stitch. Several small pleats are preferable to a few large ones. Besides using pleats for ruffles and where the two fronts are attached to the top, you also use them where the sleeve closes into the cuffs, and where the top of the sleeves join the body.

---

**\*3\***

### ***STRAIGHT APPLIQUE COLORS***

*Examples studied were:*



|                                         |                                            |
|-----------------------------------------|--------------------------------------------|
| Coat 1, Sturtevant, 1956; cat 1840      | // red / "a light color" / blue            |
| Coat 2, Sturtevant, 1956; cs. 1890      | // red // blue                             |
| Museum Nat. Hist., Gainesville; 1890's  | // red black                               |
| Denver Museum Nat. Hist.                | white / red / black                        |
| Museum Nat. Hist., Gainesville; 1890's  | white / red / black / pale blue            |
| Private coll., Ft. Lauderdale; 1890's   | white / red / black                        |
| Private coll., Ft. Lauderdale; 1890's   | white / red / black / gold / pale blue     |
| Field Museum, Chicago                   | white / red / black / gold                 |
|                                         | // red-and-white patterned pink            |
| Hist.Assoc.Martin Co., Stuart; 1890's   | white / red / black / gold                 |
| Hist.Assoc.Martin Co., Stuart; 1890's   | white / red / black / gold / blue          |
|                                         | blue-and-white patterned                   |
| Smithsonian; 1890's                     | white / red / black / gold                 |
| Smithsonian; 1890's                     | white / red / black / gold                 |
| Am. Mus. Nat. Hist., NY; 1890's         | white / red / black                        |
| Am.Mus.Nat.Hist.:Spec.850.1-2251; 1910  | white / red / black                        |
| Am.Mus.Nat.Hist.:Spec.#50.1-2252; 1910  | white / red / black / yellow               |
| Am.Mus.Nat.Hist.:Spec.#50.1-2253; 1910  | white / red / black / yellow / turquoise   |
| Denv.Mus.Nat.Hist.,Photo #3028; 1940's? | white / *red? / black / yellow / turquoise |
| Denv.Mus.Nat.Hist.,Photo #7969; 1940's? | white / * / black / gold                   |
| Denv.Mus.Nat.Hist.,Photo #7823; 1940's? | white / * / yellow                         |
| Am.Mus.Nat.Hist.:Spec.#50.2-6370; 1962  | white / * / black / yellow / blue          |
| Hist. Soc. Southern Fla., Miami         | white / red / black / gold / turquoise     |
| FSU Dept. Anthropology; 1960's?         | white / * / black / gold / blue            |
|                                         | pale blue                                  |
|                                         | white / red / black gold                   |
| Private coll., seen at Dade; 1980's     | white / * / black / yellow / turquoise     |
| Miccosukee Museum; 1980's               | // * / yellow / pale blue                  |
| Miccosukee Museum, (child's size)       | white / * / black / yellow / turquoise     |
| Seminole Museum, Tampa; 1980's          | white / * / black / yellow / turquoise     |
| Seminole Museum, Tampa; 1980's          | white / * / black / yellow / turquoise     |
| Private coll., Orlando; 1985            | pink green                                 |

*\*Red straight applique may have not been used because these longshirts used red for a base color.*

**We see the same colors used over and over, regardless of time or location. This may not be coincidence, because these colors have special significance for the Seminole. "One of the most interesting facets of Seminole mythology is 'The Wheel of Life.' The wheel is made up of five colored circles with a cross in the center. The inner circle and cross are red, followed in order from the center outward by blue, black, yellow, and white." (Peithmann, 1957).**

---



---

## REFERENCES

**Fundaburk, Emma L**

**1958 SOUTHEASTERN INDIANS LIFE PORTRAITS. Scarecrow Reprint Corporation, Metuchen, NJ. 1969.**

**Covington, James W.**

**1982 THE BILLY BOWLEGS WAR, The Mickler House Publishers, Chuluota.**

**Goggin, John M.**

**1955 "Osceola: Portraits, Features, and Dress," The Florida Historical Quarterly, XXXIII: 3 & 4, Gainesville.**

**Hanson, James A & Wilson, Kathryn J.**

**1976 THE MOUNTAIN MAN'S SKETCH BOOK, VOLUME TWO. The Fur Press, Box 604, Chadron, NE 69337.**

**Mahon, John K.**

**1967 HISTORY OF THE SECOND SEMINOLE WAR, 1835-1842. University Presses of Florida, Gainesville.**

**McKenney, Thomas L. and James Hall**

**1914 Portrait Gallery of American Indians. Ed. James D. Horan. Crown Publishers, 1986.**

**Moore-Willson, Minnie**

**1914 edition, THE SEMINOLES OF FLORIDA, Moffat, Yard and Company, New York.**

**Mott, David and Rick Obermeyer**

**1990 How to Make Beaded Pouches and Bandoliers of the 19th Century Seminole. Self published, Orlando.**

**Parks, Arva Moore (ed.)**

**1977 THE FORGOTTEN FRONTIER/ Florida Through the Lens of Ralph Middleton Monroe. Banyan Books, Miami.**

**Peithmann, Irvin M.**

**1957 THE UNCONQUERED SEMINOLE INDIANS. Great Outdoors Association, St. Petersburg.**

**Reddick, J. Rex**

**1983 "The Riflemans Hunting Frock," #4799-500-005. Missouri River Patterns, Box 314, Denison, TX, 75020.**

**Skinner, Alanson**

**1913 "Notes on the Florida Seminole." American Anthropologist, Vol.15, #1:63-77. Reprinted in "The Seminole Source Book," ed. William C. Sturtevant, 1987.**

**Sturtevant, William C.**

**1956 "Osceola's Coats?" Florida Historical Quarterly 34:315-28.**

**1962 "A Newly Discovered 1838 Drawing of a Seminole Dance." Florida Anthropologist, Vol. 15, No. 31**

**1967 "Seminole Mens Clothing" in "Essays on the Verbal and Visual Arts; Proceeds of the 1966 Annual Spring Meeting of the American Ethnological Society," ed. June Helm pp. 10-74. Seattle: American Ethnological Society; Distributed by the University of Washington Press. Reprinted in "The Seminole Source Book," ed. William C. Sturtevant, 1987.**

---

[Return to Longshirt Introduction](#)

[Return to Longshirt Pattern & Construction](#)

[Return to Longshirt Finishing](#)

[Complete Index to Articles in \*19th Century Seminole Mens Clothing\*](#)

---

Contributed by [Rick Obermeyer](#) E-mail: [orick@prodigy.net](mailto:orick@prodigy.net)

From the book *19th Century Seminole Mens Clothing*

© 1991-2000 Sherwood F. Obermeyer Jr., 2124 Miscindy Place, Orlando, FL  
32806

---

[Return to NativeTech's Main Leather & Clothes Menu](#)

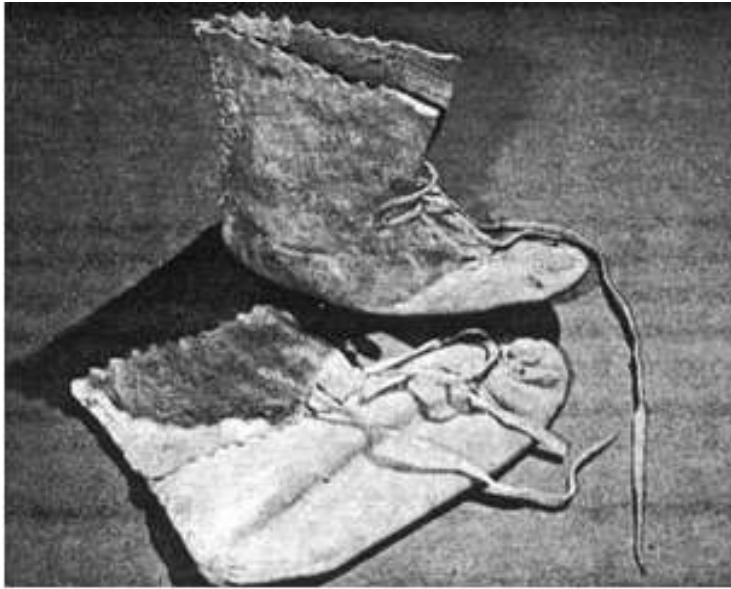


## [Leather & Clothes Bibliography and Books to Buy On-Line](#)

---



**Text and Graphics**  
© 1994 - 2003 [Tara Prindle](#)  
**unless otherwise cited.**



DEPARTMENT OF ANTHROPOLOGY  
FLORIDA STATE UNIVERSITY

*Moccasins*

# Creek / Seminole Moccasins

*in 19th Century Seminole Men's  
Clothing*

[Rick Obermeyer ~ Editor](#)

---

## QUOTES



AMERICAN MUSEUM OF NATURAL HISTORY  
NEW YORK, NY

beads." Cory, 1896

(Osceola's) "These are made of tanned buckskin, usually smoked or dyed a light or red brown. They are made from one piece of material gathered together in a pucker on top of the foot." Goggin, 1955

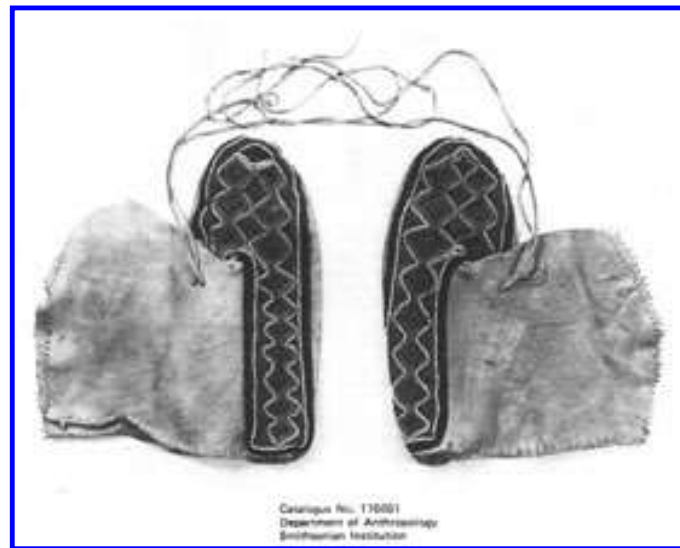
(1880) "...The moccasins, also, are made of buckskin, of either a yellow or dark red color. They are made to lace high about the lower part of the leg, the lacing running from below the instep upward." MacCauley, 1889

"The brain-tanned skin, which has not been dyed, becomes very hard and stiff when wet unless it is continually worked over and kept soft by manipulation, but skins which have been prepared by tanning with mangrove bark are very little affected by rain, and make very pretty leggings and moccasins.

"It is rare that Seminoles ornament their moccasins with beads, and I have seen but two pairs of moccasins made in this manner: one I procured from Old Doctor... They were nicely ornamented with lines of



**There are some very rare examples of beaded Seminole moccasins, but they do exist. There are two pairs displayed in the Field Museum, Chicago, the Smithsonian formerly had a pair (and a photo of those is still available), and a pair loaned by the University of Pennsylvania was displayed in the "Patchwork and Palmettos" exhibit the summer of 1990 at the Ft. Lauderdale Historical Society. In all but one example, the beadwork was done on a red or dark blue wool "saddle" which was then attached to lay over the top and sides of the moccasin. The designs were usually simple uneven zigzags in white and one or two colors of beads, especially old rose pink. There is one odd example beaded directly onto buckskin, at the Field Museum (not pictured). It may not be Seminole as identified, because other aspects of its construction are atypical.**

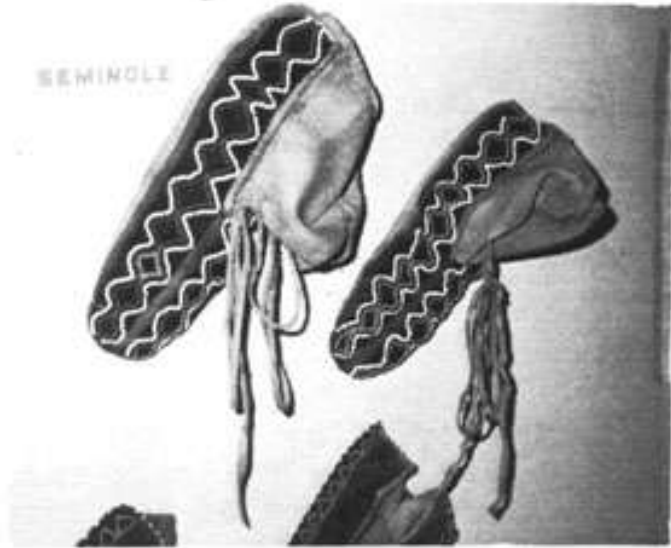


[Click on Thumbnail for Detail Photo](#)





University of Pennsylvania  
Philadelphia



Field Museum, Chicago

## ***CREEK CHARACTERISTICS***

Creek moccasins used very thin sinew or thread to close up the front seam and almost never show a toe tab. They are more likely to be worn with the tops rolled down, more likely to be beaded, and more likely to have been beaded directly onto the buckskin, instead of onto a "saddle." Creek beadwork designs are easily more elaborate than simple Seminole zigzags, and have parallels with motifs seen on Creek bandoliers.



American Museum of Natural History  
New York, N.Y.

---

[Making Creek / Seminole Moccasins](#)

[Bibliographic References for Creek / Seminole Moccasins](#)

[Complete Index to Articles in \*19th Century Seminole Mens Clothing\*](#)

---

Contributed by [Rick Obermeyer](#) E-mail: [orick@prodigy.net](mailto:orick@prodigy.net)

From the book *19th Century Seminole Mens Clothing*

© 1991-2000 Sherwood F. Obermeyer Jr., 2124 Miscindy Place, Orlando, FL 32806

---

[Return to NativeTech's Main Leather & Clothes Menu](#)

[Leather & Clothes Bibliography and Books to Buy On-Line](#)



**Text and Graphics**  
© 1994 - 2003 [Tara Prindle](#)  
unless otherwise cited.



DEPARTMENT OF ANTHROPOLOGY  
FLORIDA STATE UNIVERSITY

*Moccasins*

## Making Creek / Seminole Moccasins

*in 19th Century Seminole Men's  
Clothing*

[Rick Obermeyer ~ Editor](#)

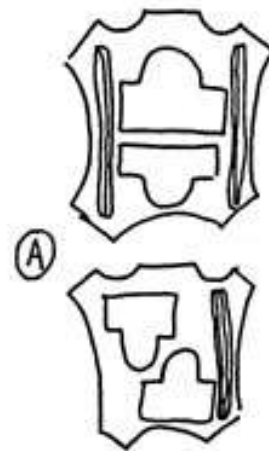
Notes from a G. Darry Wood demonstration of the Creek/Seminole method explained to him by Billy Bowlegs III.

### Materials needed:

|                                      |                                      |
|--------------------------------------|--------------------------------------|
| - Tanned undyed buckskin             | - sharp scissors                     |
| - awl                                | - file                               |
| - colored chalk or hardwood charcoal | - brown paper (shopping bag is fine) |

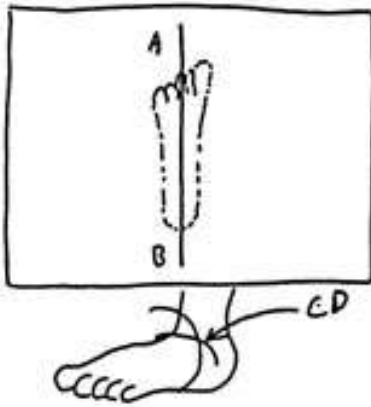
The moccasins were always made from tanned deerskin, never cowhide. Braintanned is best. Commercial, or chrometanned, is adequate, but it must be deerskin. Tanned cowhide, however pliable, is inappropriate. Commercial skins come in white and dyed. White is more common and more natural. Commercial skins have a smooth "outer" side and a rough "flesh" side. Which side to use is optional: the smooth side is a little more water resistant; the rough side approximates the look of braintanned. (You could put the smooth side out on your moccasins and roughen the surface slightly with 80 grit wood sandpaper.)

The moccasin pattern **MUST** be cut with the grain of the buckskin (Fig. A). This is no place to try to conserve buckskin. The thongs must also be cut along the grain of the buckskin. This is so they will be as strong as possible, and not likely

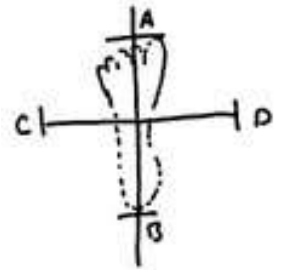




to stretch. Cutting things by going around and around the-edge of a scrap piece will not achieve this.

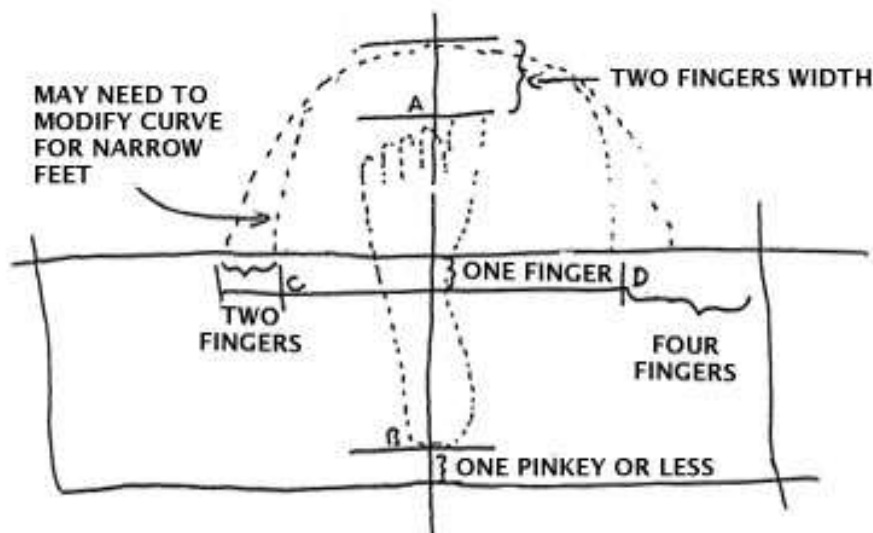


Outline the foot on brown paper (a cut open grocery bag is fine.) Be standing on the foot when you outline it so it splays out like normal. Draw a line down the center of your outline.



With a scrap thong, measure the circumference of the foot at its thickest part, just in front of the ankle. In most people, this circumference (C-D) is pretty much the same as the length of their foot (A-B). Mark the center line (A-B) at its middle, and use your thong to measure a line (C-D) at right angles to it at that point.

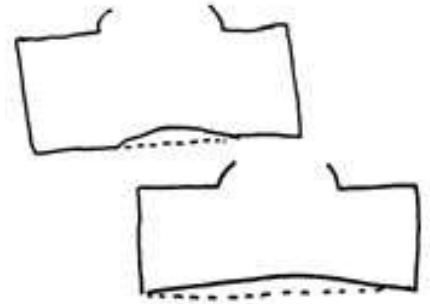
Now, mark the outer dimensions of your pattern: Mark a point two fingers' width in front of the big toe. Sometimes this can be as wide as three fingers, but rarely. Using this extra length, make an even curve around the front of the foot to line C-D. On the sides, add a width of four fingers (or more) outside both ends of line C-D. Mark this added width with lines parallel to line A-B.



Behind the heel, add a width 1 pinkie finger or less (depending on how much you stretched the buckskin when tracing the pattern onto it). Extend this line, parallel to C-D, out to your new wide widths.

Add a width of about one finger, 1/2" to 1", in front of line C-D, and extend this out to your new wide widths. Then, complete the rough outline of the pattern.

**Option:** The pattern could have a scallop at the base of the heel. This scallop is about 4" long, but may be no more than 1/2" deep. Some were made with a slightly deeper, but much longer, scallop that went the whole length of the back.



**Option:** You may want to cut a thin wedge out of the front straight sides, back up to the C-D line or even further. (Mr. Wood recommends the curvature of a nickel.) Cut from that point to the outer corners. This will help these edges overlap when they're wrapped around the front of the ankle on the completed moccasins.



**Option:** The Seminoles made two identical moccasins and left it to time and wear to shape them into "left" and "right." You may want to make yours "left" and "right" to start with. If so, you need to adjust the toe by taking away a little on the side of the little toes, and adding just about the same amount to the side with the big toe.



Cut out the paper pattern. Test wrap it around the foot, making sure that the [aside corners {where the nickel was measured}) overlap slightly without being too tight. If they fit right, you're ready to use the paper pattern to mark your buckskin. Use chalk in a color that will show up on it, or charcoal. Never mark the skin with a pen. When marking out the pattern, the skin should be gently stretched lengthwise.

Cut a thong about a foot long with a tab on the end. This tab can be as small as a fingernail or as big as a quarter. It can have a wide variety of shapes, and be cut longer if you intend to fringe it later on. The thong should be very narrow, perhaps no wider than the skin is thick although twice as wide as thick is OK.



Test this thong by pulling on it very firmly, with at least forty pounds. Better to have it break now in your hands than later on in the moccasin during lacing!

Put a fine taper about 1/2 inch long on the end of the thong, coming out to a fine point. Use a little spit to soften the buckskin so you can twist it out. Then, pull this point against beeswax to keep it stiff.

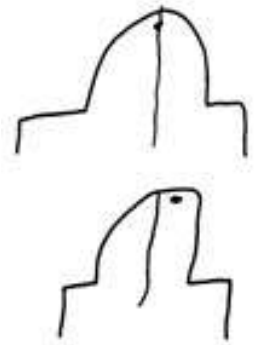


A commercial awl usually has a blunt point. You need to file this down to a thin sharper point, almost as long as the point on your thong.

If you have made a traditional pattern, your first hole will be in the center (1). If you made a "fitted" patter, your first hole will be about an inch off on the big side (2).

Where the holes are punched depends on the buckskin's thickness. In thick skin, the hole could be almost at the very edge. In thin skin, it may need to be 1/8" or more away from the edge, with the range in between depending on varying skin thickness.

You will pierce each hole with the awl and insert the thong one stitch at a time. Do not punch holes ahead of stitching.

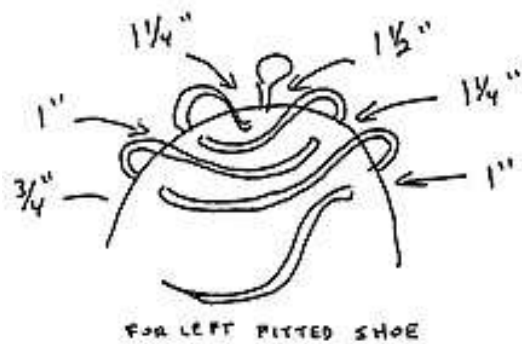


The tab goes in what will be the outside front of the moccasin. The next hole is about an inch and a quarter to the other side and, again, the thong comes in from the outside. Then, pull the two holes against each other on the thong VERY TIGHTLY . You may need to



guide the skin's crease/pleat as it folds up under the thong. But, do PULL TIGHT. This is where your thong's strength is needed.

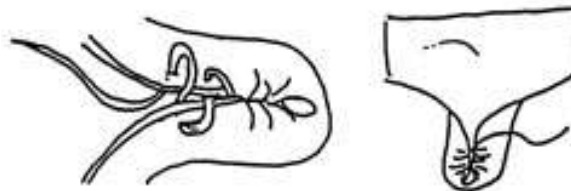
When done, the thong runs straight and the edges of the skin are folded snug against each other along its length. You will do this for three or four holes on either side of your starting hole, with each successive hole just a little closer to the one before it.



Yours will never look like this laid open view, because you will have tightened each stitch very firmly when you made it. This drawing is just to show the sequence of the "baseball" stitch.

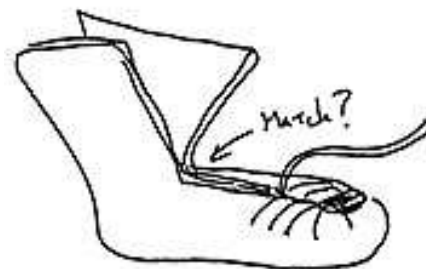
If you've made a "fitted" pattern, the diminishing spacing will have to be a little wider on the longer side to make up the difference.

Having gathered in the toe, the next finished 1-1/2" to 2" will be in the same baseball stitch, but with holes spaced the same from each other. How far apart they are depends on how thick the skin is, with wider spacing on thick skin, and narrower spacing on thin, ranging from 1/2" to 1/4". Again, pull tight on each stitch so the thong winds up nearly straight and the skin's edge does the curling. Properly done, your stitching will NOT look like thin. This drawing is just to illustrate the stitching pattern. Done correctly, you will not be able to see the thong at all.

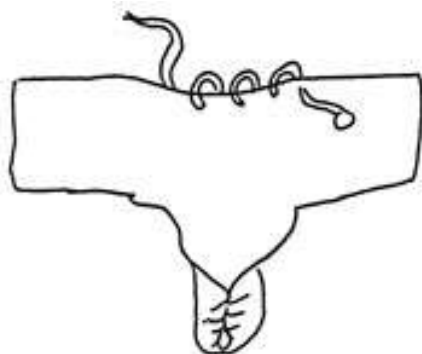




While you stitch this section, pinch the two edges together to make sure the inner corners meet. If they are off a little, you should compensate by spacing the holes on one edge slightly farther apart than on the other edge to make up the difference. Stop when you get to the middle of the top of the foot, stop and go to the heel.



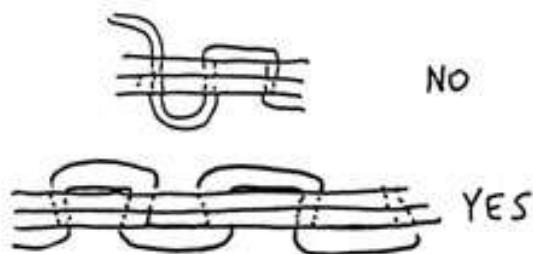
Cut another thong with a small round tab on the end, 1 to 2 feet in length. Pierce the first hole at one end of the shallow scallop. Insert the thong so the tab will wind up inside the completed moccasin.



(Occasionally, a tab was not used, and the thong was merely tied off around this hole.) Put the next hole about 1/2" down the scallop and insert the thong from inside to outside again. Pull the leather tight against the tab on each stitch.

Your stitching will never look like this, because you will be tightening on each stitch. This is just to show you the stitching pattern for these holes, 7 to 15 total, depending on their spacing, which depends on the thickness of the skin.

Then, lace up the back with a running stitch, spacing the holes about 1/8" to 1/4" apart, even less if the skin is very thin. Small stitches are best. Stop 1/2" to 1" from the top and tie it off. You can trim off the unused thong or leave it long for wrapping (see below).



You should not pierce the holes straight in. They should angle against each other, to retard the thong's loosening later on. Pull the skin and thong together snug, but not so tight that the skin puckers.

At this point, try the moccasin on. Do you need to take it apart and make any adjustments now? It's real easy to re-cut an edge and re-pierce a new series of stitches.

Finish the front with a running stitch the same as you finished the back with. Holes are 1/4" apart, less with thin skin, and punched at angles to each other, same as in the back. Better made Seminole moccasins had very small running stitches on both the back and front. Let the thickness of the skin be your guide. The thong is pulled snug on the thong, but not so tight that the leather puckers.

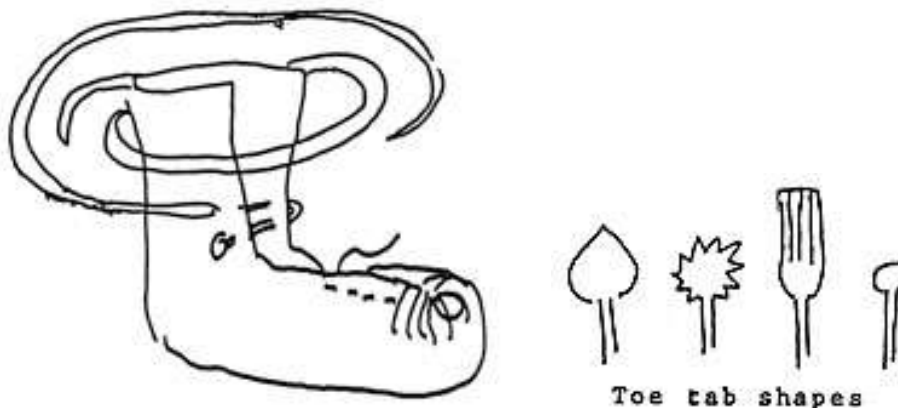
Where you tie off this running stitch is a matter of choice. Close to the ankle keeps dirt out, but makes it harder to get the moccasin on and off. Away from the ankle makes doing that easier, but allows more dirt to get in, too.



After you tie it off, you can trim the thong close or, more commonly, leave a couple of inches loose.

Cut a third thong, 1-1/2 to 3 feet long. This can have a tab, or you can plan to just tie it on. It is inserted as shown: low in front of the ankle. The high tops of the moccasin are wrapped around the ankle, and this thong goes around the ankle two or three times to tie it up.

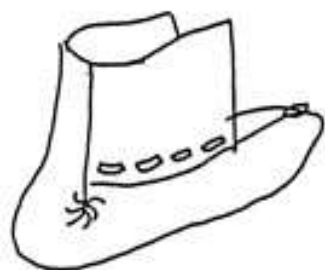
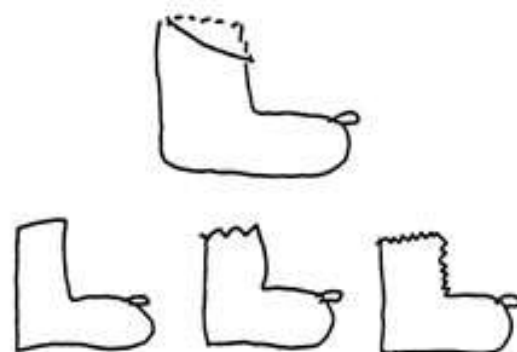
Occasionally, the back thong is left long, to be an additional tie around.



**Options:**

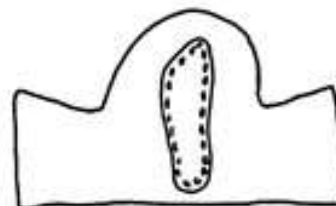
The top of the moccasin can be canted down at a slight angle.

The raw edges of the moccasin can be left straight, or sawtoothed with either big or small teeth. The sawtoothing can be on the top only, or on the top and front edges.



If, by chance, you are short on deerskin, you could stitch on a side panel for the ankle "uppers."

The Seminoles are said to have sometimes rubbed pine resin into the soles to help make them more durable and water resistant. Another option is to stitch on a buckskin sole.



---

[Bibliographic References Moccasins](#)

[Return to the Introduction to Creek / Seminole Moccasins](#)

[Complete Index to Articles in 19th Century Seminole Mens Clothing](#)

---

Contributed by [Rick Obermeyer](#) E-mail: [orick@prodigy.net](mailto:orick@prodigy.net)

From the book *19th Century Seminole Mens Clothing*

© 1991-2000 Sherwood F. Obermeyer Jr., 2124 Miscindy Place, Orlando, FL 32806

---

[Return to NativeTech's Main Leather & Clothes Menu](#)

[Leather & Clothes Bibliography and Books to Buy On-Line](#)

---



Text and Graphics  
© 1994 - 2003 [Tara Prindle](#)  
unless otherwise cited.





DEPARTMENT OF  
ANTHROPOLOGY  
FLORIDA STATE  
UNIVERSITY

*Moccasins*

# Bibliographic References for Creek / Seminole Moccasins

**Rick Obermeyer  
and M. E. (Pete) Thompson**

*in 19th Century Seminole Men`s Clothing*

[Rick Obermeyer ~ Editor](#)

---

**Cory, Charles B.**

1896 Preface to Second Edition (and) The Seminole Indians, HUNTING AND FISHING IN FLORIDA.

**Goggin, John M.**

1955 "Osceola: Portraits, Features, and Dress," The Florida Historical Quarterly, XXXIII: 3 & 4, Gainesville.

**MacCauley, Clay**

1887 "The Seminole Indians of Florida." Fifth Annual Report of the Bureau of Ethnology, Washington DC.

---

[Making Creek / Seminole Moccasins](#)

[Return to the Introduction to Creek / Seminole Moccasins](#)

[Complete Index to Articles in 19th Century Seminole Mens Clothing](#)

---

Contributed by [Rick Obermeyer](#) E-mail: [orick@prodigy.net](mailto:orick@prodigy.net)

From the book *19th Century Seminole Mens Clothing*

© 1991-2000 Sherwood F. Obermeyer Jr., 2124 Miscindy Place, Orlando, FL 32806

---

[Return to NativeTech's Main Leather & Clothes Menu](#)

[Leather & Clothes Bibliography and Books to Buy On-Line](#)



**Text and Graphics**  
© 1994 - 2003 [Tara Prindle](#)  
unless otherwise cited.

# Leggings

Comments by Rick Obermeyer  
and M. E. (Pete) Thompson (Dec. 1990)

*in 19th Century Seminole Men's Clothing*  
[Rick Obermeyer ~ Editor](#)

## QUOTES



*Leggings*

(1837) "Coacoochee... retired into the hammock to deck himself out, emerging resplendent with a plume of white crane feathers, bright scarlet leggings, and a silver band around his turban." Page 224, Mahon, 1967

"When the famous Indian portrait painter, Catlin, was commissioned by the War Department to paint the most prominent chiefs then in captivity at Fort Moultrie, Micanopy, as chief of the Nation, was first approached, but positively refused to be painted. After much persuasion, he at last consented, saying, 'If you make a fair likeness of my legs,' which he had very tastefully dressed in a handsome pair of red legging, 'you may paint Micanopy for the Great Father,'" Catlin quoted by Moore-Willson, 1911

(Osceola at time of capture) "...dress'd in a blue calico shirt, leggings of red cloth with a row of buttons on the outside of the leg & a red print shawl wrapp'd around his head and another his neck and shoulders." N. S. Jarvis, quoted by Goggin, 1955

"(Billy Bowlegs) wore 'red legging, with brass buttons,' which, 'where they covered the upper part of the moccasins,' were 'thickly embroidered with beads.'" Porter, 1967

(1880) ". . .The materials of which the leggins of the Seminole are usually made is buckskin. I saw, However, one pair of leggins made of a bright red flannel, and ornamented along the outer seams with a blue and white cross striped braid." MacCauley, 1884

(ca. 1895) "A few years ago, after numerous invitations, Tallahassee was persuaded to leave his swamp home to make a visit to the home of the writer, The old patriarch was accompanied by Billy Bowlegs (III), who showed the tenderest care for him.... They were both in full costume, the old chief wearing the regalia of his rank, sashes of beadwork and red beaded legging." Moore-Willson, 1911

"The leggings which they wear are sometimes dyed a very rich mahogany brown by soaking the skin in an infusion of mangrove bark. The bark is boiled for several hours; the skin is then immersed in the liquid for half an hour. It is then taken out and dried in the sun until it is merely moist, although it will not do to let it get entirely dry. It is then immersed a second time for about half an hour, and upon being taken



out and dried is ready for use.

"The brain-tanned skin, which has not been dyed, which has not been dyed, becomes very hard and stiff when wet unless is continually worked over and kept soft by manipulation, but; skins which have beer, prepared by tanning with mangrove bark are very little affected by rain, and make very pretty leggings and moccasins." Cory, 1896

---

*The Muscogee name is "Hv`fv Tehkv" (pr. HUH` fuh DAY guh), literally meaning "leg, edge or border." The Mikasuki name is "Hi-Yali`-Ti."*

## CLOTH:

The fabric used was usually wool strouding, a kind of wool broadcloth made in Stroud, Gloucestershire. Velvet was occasionally used, but was costly. Although almost all the written records comment on the "red" leggings worn by early 19th century Seminoles, we know from examples that blue wool was also used. Strouding was also made in black and green. There is no written record of green leggings, but some unraveled green wool was used in fingerwoven garters and sashes. It does appear that chiefs were especially partial to the color red in their leggings.

Southeastern Indian men's leggings could have had front seams or side seams. Osceola is shown in several pictures with side seam leggings, but these pictures have enough other flaws to make them suspicious on accuracy in any details (such as Fig. 284, Fundaburk, 1956, a poor lithograph of the more accurate Fig. 285 which shows a front seam). There is a single pictorial representative of a Seminole in what could be side flap cloth leggings (Fig. 306, Fundaburk, 1958). While it might be possible that some early Seminole leggings might be side seamed, it is safe to say that a general characteristic of Seminole wool leggings is their front seam.

The leggings were often lined with cotton fabrics, always edged with military edging or silk ribbon, and usually decorated with beadwork along the edging and, infrequently, in patterns on the side. Seminole ornamental patterns were mostly limited to zigzags, unlike more elaborate and colorful Creek designs.

There are only a very few examples of decorated cloth leggings. The decorations are very simple zig-zag cloth applique and/or beadwork motifs, very much less complex than typical Creek motifs (as seen in Galante, 1989). The Count de Pourtales, a Swiss nobleman, collected a set of dark blue leggings decorated with white beads in 1838 (Fig. 16, Conn, 1979). The leggings that Micanopy was so proud of are shown in Catlin's 1838 painting to be red wool, decorated with navy blue or black applique and white beads. A ca 1850's full length photo of Billy Bowlegs does show where white beaded decoration was put on, but the image in that part is unfortunately not preserved well enough for details. It's much clearer in an 1858 engraving of Billy Bowlegs (Fig. 297, Fundaburk, 1958), and is essentially the same design as on the leggings worn by "Old Tallahassee" in the very clear photo of him from about 1890. The zig-zags on them appear to have been made with double-width rows of white beads.



detail, "Mick-E-No-Pah" by George Catlin  
National Anthropological Archives  
Smithsonian Institution

The cloth leggings were often closed with brass buttons in the early 19th century, and sewn up by the late 19th century. That the buttons were functional is shown by close examination of George Catlin's full-length painting of Osceola (Fig. 286, Fundaburk, 1958), which clearly shows the buttons straining against their buttonholes. It's possible that, later on, the brass buttons were merely decoration on top of a-sewn seam.

Cloth leggings were always complemented with fingerwoven wool garters, usually with beads worked into the woven pattern. A beginning hobbyist might get by with cloth ties, or even with commercially made decorative strips available at cloth outlets and at craft stores, but fingerwoven garters should be the desired finishing touch.

And, cloth leggings were as formfitting to the leg as Seminole buckskin leggings.

## **BUCKSKIN:**

Anyone who has ever trekked through Florida's tangled hammocks, or has traversed a large tract of saw palmetto and prickly pear scrub, will appreciate some tough leg protection. The transition zones between swamp and scrub are full of blackberry and china briar brambles which can inflict bad skin tears.

Traditional Seminole braintanned buckskin leggings not only afforded protection from hazards of the Florida landscape, but also from insect bites and stings. Construction was simple, but they were rugged and functional, protecting the legs from ankle to mid-thigh.

The late 19th century photos in Moore-Willson and in Parks show a wide range in widths of side flap. Buckskin leggings were usually worn outside the high moccasin tops, but were sometimes tucked inside. Unlike leggings of many other tribes, they closely followed the leg's contours and were often very nearly skintight. They were form-fitting, no matter how wide or how narrow the side flaps were.

Buckskin leggings seem to have been used consistently until general acceptance of pants. Although there is no pictorial evidence, it is reasonable to surmise that they were used since the 18th century. However, the fringed garter apron, THE distinctive characteristic of Seminole buckskin leggings, may not have been common until the mid- or late-nineteenth century.



Catalogue No. 204621  
Department of Anthropology  
Smithsonian Institution

---

[Construction of Cloth Leggings](#)

[Construction of Buckskin Leggings](#)

[Bibliographic References for Leggings](#)

[Complete Index to Articles in \*19th Century Seminole Mens Clothing\*](#)

---

Contributed by [Rick Obermeyer](#) E-mail: [orick@prodigy.net](mailto:orick@prodigy.net)

From the book *19th Century Seminole Mens Clothing*

© 1991-2000 Sherwood F. Obermeyer Jr., 2124 Miscindy Place, Orlando, FL 32806

---

[Return to NativeTech's Main Leather & Clothes Menu](#)

[Leather & Clothes Bibliography and Books to Buy On-Line](#)

---





**Text and Graphics**  
© 1994 - 2003 [Tara Prindle](#)  
unless otherwise cited.

# Construction of Cloth Leggings

by Pete Thompson, Rick Obermeyer and David Mott (May 1991)

*in 19th Century Seminole Men's Clothing*  
[Rick Obermeyer ~ Editor](#)



detail, "Old Tallahassee"  
National Anthropological Archives  
Smithsonian Institution

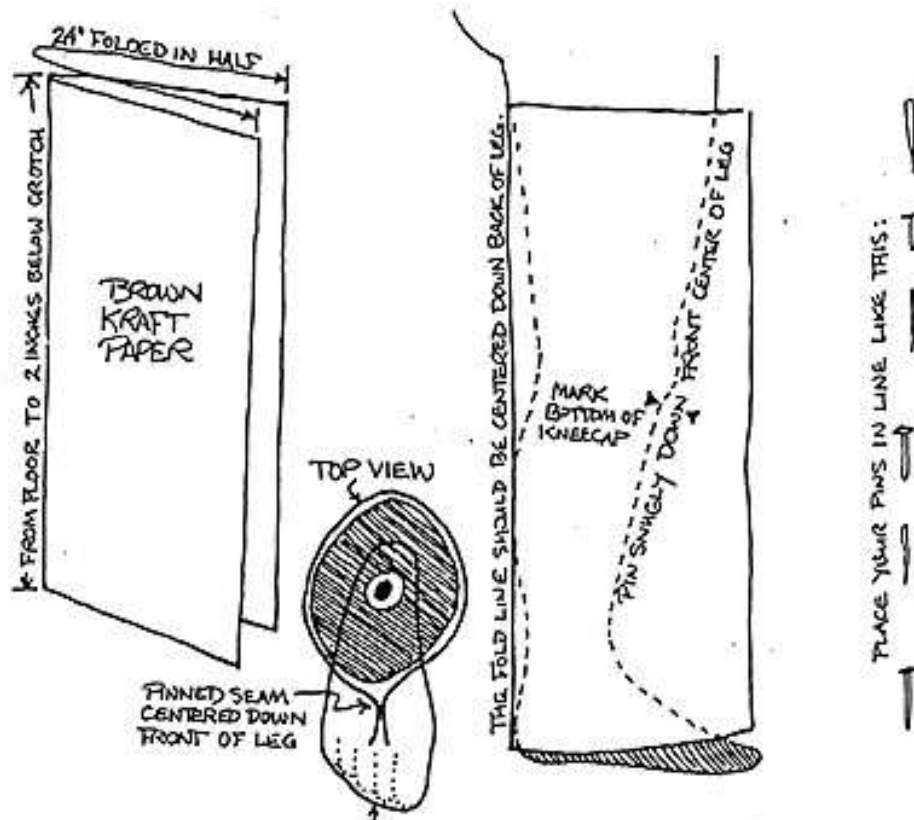
*Cloth Leggings*

## Materials needed:

|                                                                                                |                                                            |
|------------------------------------------------------------------------------------------------|------------------------------------------------------------|
| - heavy brown craft paper (grocery sack or wrapping paper), 24" by mid-thigh to floor          | - straight pins, thread                                    |
| - pencil or pen                                                                                | - scissors and a small knife, both very sharp              |
| - common sense, and attention to detail, and patience                                          | - 1 yard 54" to 60" wide wool cloth                        |
| - 4 to 5 yds. 1" wide edging (single fold bias tape, or military edging, or silk/ satin ribbon | - 1-1/2 yds. 44" wide cotton cloth, if a lining is desired |
| - brass shoe buttons, or small military buttons                                                | - 10/0 to 12/0 size white beads, if beadwork is desired    |

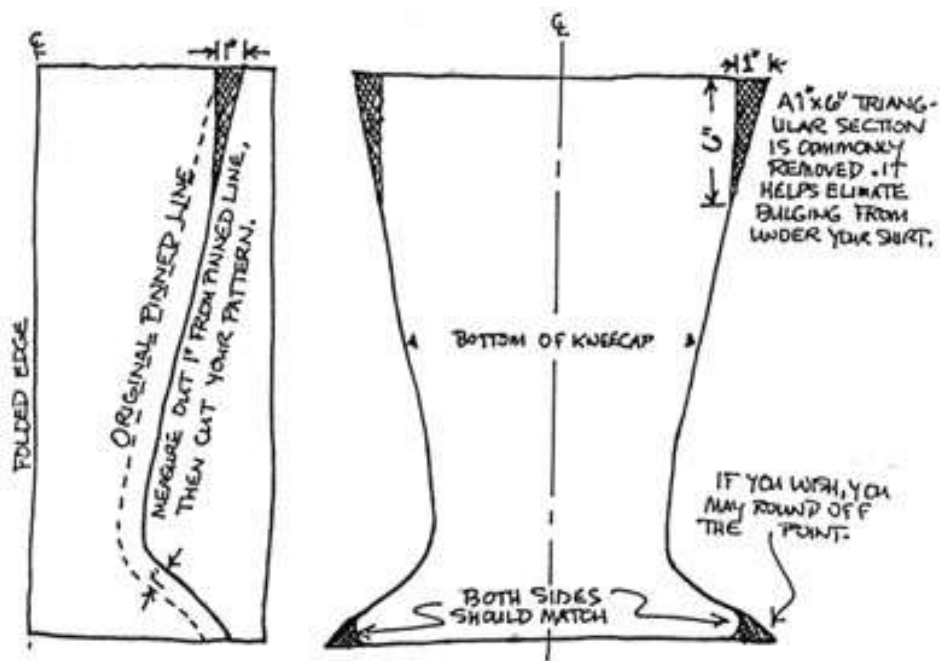
**Cloth leggings** are more complicated to make than buckskin leggings, because they require sewing and more careful cutting. Don't expect to knock them out in a day, and adding beadwork can multiply the time needed to finish a pair.

**1)** Have somebody help you pin brown craft paper around your leg, closing the paper down the front of the leg. The leggings could extend from mid thigh to just a couple of inches below the crotch. Continue along the top of the foot to your middle toe. The pattern should be snug, but not tight, and its paper crease should run down the back of the leg. Insert the pins from top to bottom, and so they're aligned with the seam you're making. As you progress, the bottom of the pattern should come up off the floor about 1/2" to 1". **DON'T WEAR SHOES DURING THIS FITTING!**



**2)** Undo the pins. The pinholes indicate a guideline for cutting the pattern, about one inch out away from them. If you have, shall we say, especially muscular legs, you may want to measure your upper thigh circumference while squatting, and increase the pattern's upper measurements accordingly. The better looking early 19th century leggings had brass buttons, but not every pair had them, and practically none did after the mid-nineteenth century. If you don't plan to add buttons, put in some extra room in the ankles. Change your guideline as needed, and maintain the extra one inch space outside the guideline as you cut out the adjusted pattern.



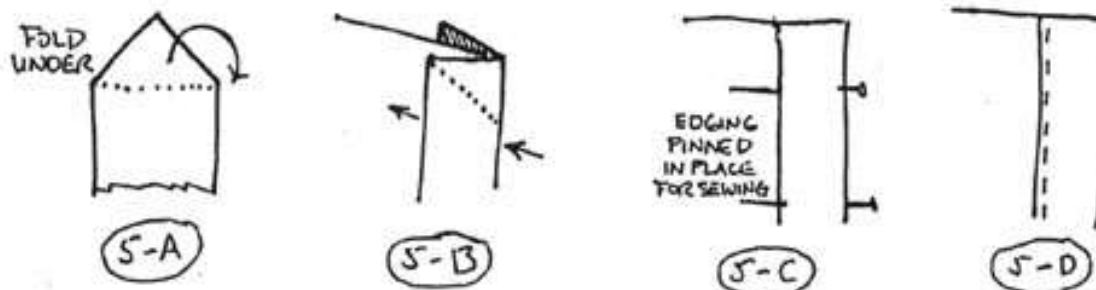


**3)** As a test at this point, pin the pattern back together, 1/2 inch in from your newly cut edge, The pins are positioned parallel to the edge, as shown. Slip your leg into the pattern and have your helper finish pinning all the way to the toe. If it's too tight anyplace, now is the time to make adjustments. If you plan to add buttons, don't worry about not being able to pull your foot back though at this point. The concern is if you can flex leg muscles without popping buttons or stitches on the finished leggings.

**4)** Once you're satisfied with the adjusted pattern, use it to cut both leggings (and liners, if desired). Cut a small 1/4 inch notch into the edge at the bottom of the kneecap.

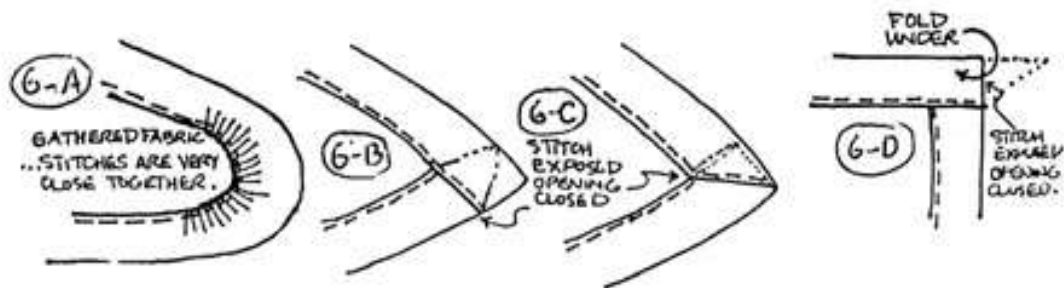


If you're adding a liner, it would be a good idea to baste the bottom half of the liner cotton to the legging wool with long temporary stitches to avoid slippage problems as the edging is attached.



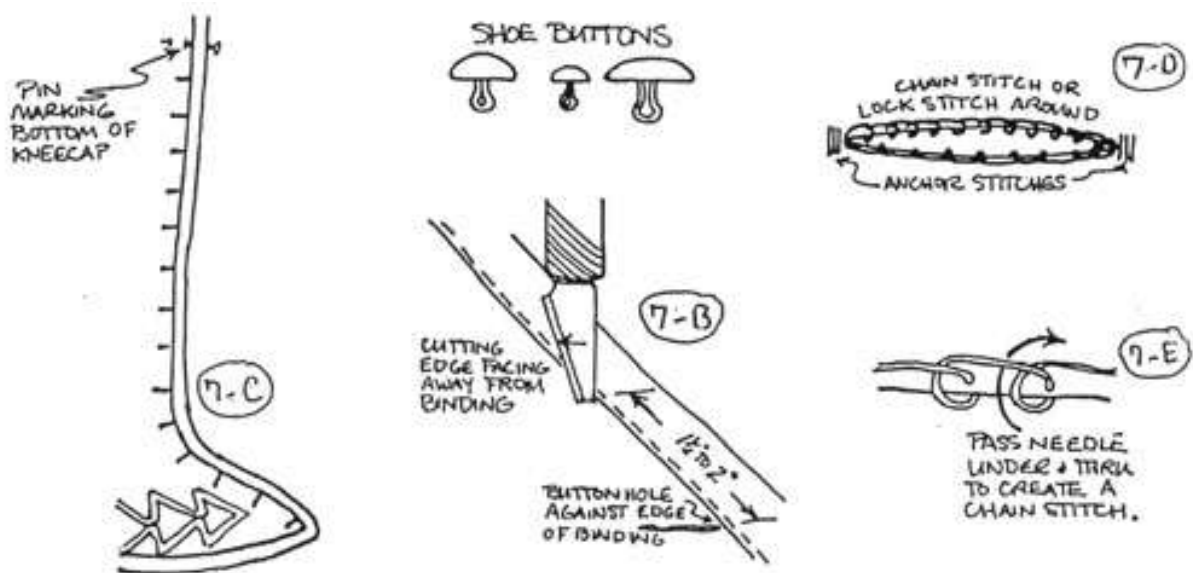
**5)** The edging to red leggings would be ,navy blue or black (Catlin's paintings of Osceola and Micanopy), or royal blue (McKenney-Hall engraving of Osceola), or white (McKenney-Hall engraving of Tukosee Mathla). The edging to the navy blue leggings collected by the Count de Pourtales is black down the front and red (faded to pink?) around the bottom. There's a sketch of a 19th century Oklahoma Seminole that also indicates white edging around the foot of black or navy blue leggings.

parry Wood made a very striking black/navy blue pair with yellow down the front and red around the foot.



Cut a point into one end of your edging like the flap of an envelope. Fold down the triangular end on what will be the inside of the edging (see 5-A). Fold the ending in half lengthwise (5-B), place at one legging top corner, and pin it into place. The pins should be one or two inches apart (5-C), being certain that the edging's crease fits snugly against the fabric's edge. Sewing should be done with small 1/8" running stitches (5-D) which are sure to penetrate ALL layers of fabric and edging. Of course, remove pins as you go, and re-pin a new section as you progress. Your stitches should be tight, but not so tight as to cause the fabric to gather. A slight pucker at each stitch is ideal. When you reach the notch marking the kneecap, leave a pin behind in the edging as a marker.

6) If the toe region is to be rounded, you'll need to gather the edging as you sew with very small stitches (6-A). If you prefer a pointed legging bottom, you'll need to fold, tuck, and stitch the excess material (6-B, 6-C).



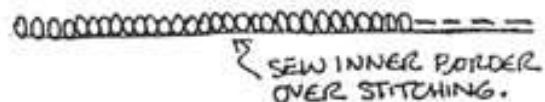
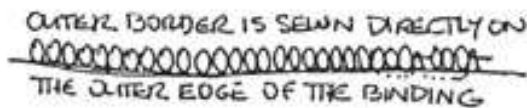
Note that the edging could be loose at the toe, as seen in the drawing of Billy Bowlegs on the cover.

When you've sewn all the way back to your starting point, clip the excess binding there into another triangular point, tuck it under (6-D), and stitch the exposed opening closed.

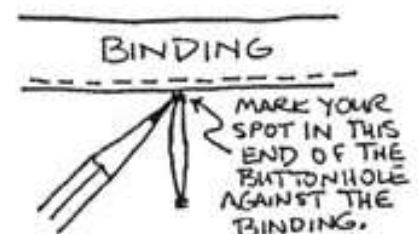
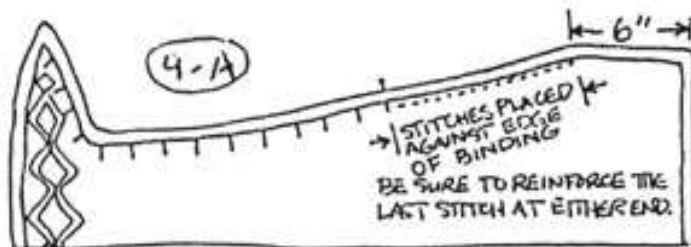
**7)** Once you've edged both leggings, it's time to cut buttonholes if you want to add buttons. While the size of the hole is dictated by the size of the button, it's very important not to make them too big. Most commonly used were brass shoe buttons 1/4" to 1/2" in diameter with a round or domed top. It's not impossible that small military buttons of the period could have been used. Use an X-Acto or other knife with a very fine sharp point. To determine the size of the cuts to make, puncture a piece of scrap material, and punch a button through this slot sideways just as you would when buttoning your shirt. Remember, you don't want the hole too big or the button will slip back through, or too small because you don't want to have to wrestle the button in.

According to Catlin's paintings, Osceola's buttonholes were on the right half of both his leggings. Micanopy's buttonholes were on the inside half of his leggings. The McKenney-Hall engraving of Osceola shows buttonholes on the inside halves of his leggings, as does the engraving of Tukosee Mathla.

Starting at the toe, use pins to mark 1-1/2" to 2" spaces for placing buttonholes. Stop 1" to 2" short of the kneecap marker. Placing the cutting edge away from the edging, puncture the fabric next to the edging (7-B) and at right angles to it. When done, you should have something similar to (7-C). Stitch the raw buttonhole edges with a chainstitch/ lockstitch/ whipstitch, and also anchoring each end with two or three tight overhand stitches (7-D).



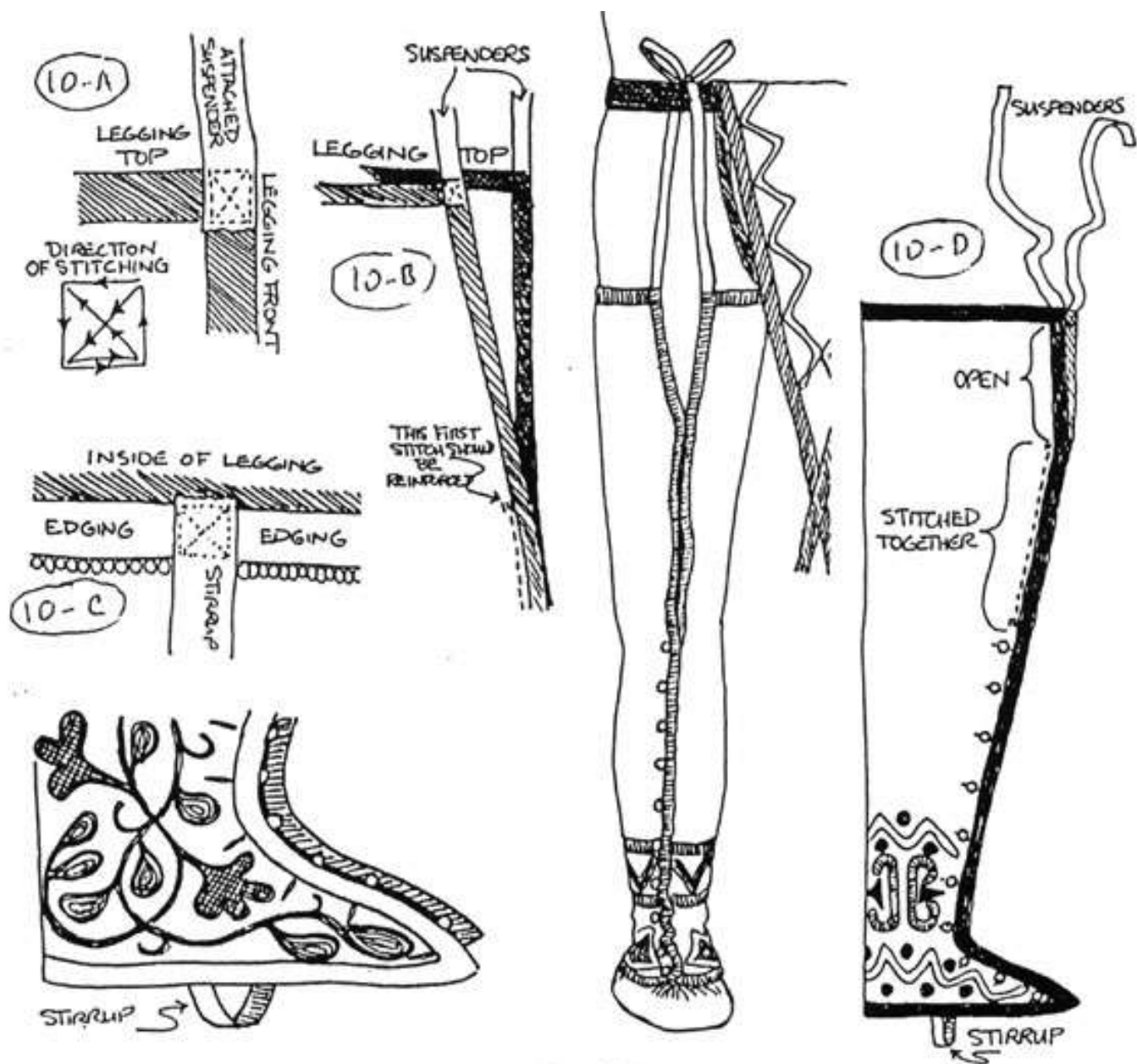
**8)** Now if the time to apply any beadwork. Beading along the inside and outside of the edging was very common, except that the inside of the edging wasn't beaded if buttons were put on. The 10/0 to 12/0 beads were always white, as were the applied beaded zigzags over the upper ankle area (see the detail from "Old Tallahassee", and the drawing of Billy Bowlegs on the cover of this workbook). Seminole motifs were very limited in style and color compared to much more elaborate Creek floral, geometric, and zoomorphic designs, some of which are illustrated here. For two-needle beadwork techniques, bead colors, and possible patterns, refer to the section on "Bandoliers and Pouches." Adding beadwork can take anywhere from days to months. Beadwork can be added last, but is it much easier to work on if it's added at this stage (8).



**9)** To complete assembly, fold the legging lengthwise, matching up the edges as well as possible. Using



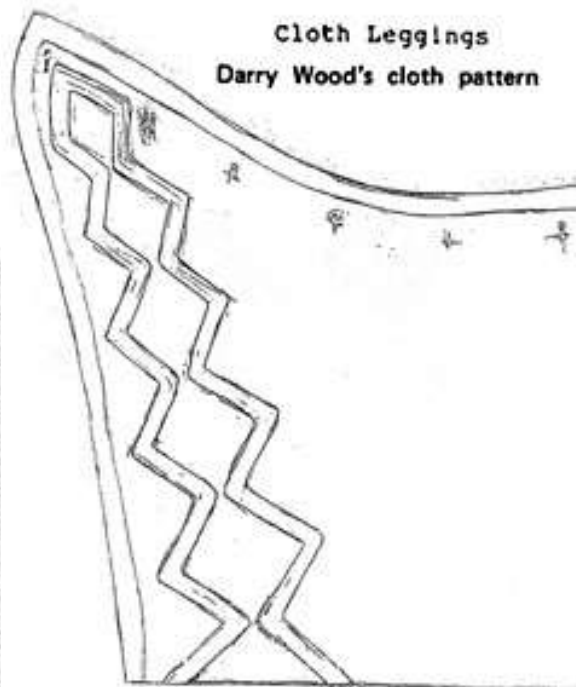
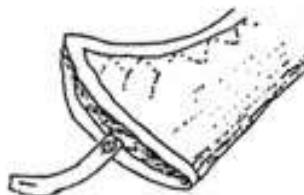
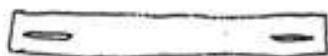
very strong thread, stitch together the section marked by the kneecap pins (where you can finally get rid of them), to a point about six inches from the legging's top. The stitching should be along the inner edge of the edging ribbon (9-A). Reinforce each end with extra stitches, and doublestitch back over the entire length. Mark button placement by going through the buttonholes to the matching legging side. Micanopy's leggings appear to have had the buttons attached to the INSIDE of the legging so that the edging of one side abutted against the edging of the other side, as in the sewn thigh portion. The engraving of Tukosee Mathla and the engraving and paintings of Osceola show one side's edging overlapping the other side, so the buttons must have been sewn on the OUTSIDE of the legging.



**10)** Attach another 1/2 yard edging to each top corner of the legging, being certain that it parallels the legging's front (10-A and 10-B). Penetrate all layers of fabric with stitching in a box pattern as shown. This maximum strength will be needed. These are the suspenders to tie the leggings into your breechcloth belt.

**11)** Many leggings had stirrups for comfortable wear. Put on the legging, attach it to your belt, and button at least the foot and ankle. Mark the highest part of your instep arch on the inside of the edging. Attach one end of leftover edging to that mark on the inside of the legging. Sometimes, a scrap of buckskin was used for this. Put the legging back on as before, pull the strap around the foot, and mark where it meets the other side of the legging. Remove the legging, turn it inside out, and stitch the stirrup where indicated on the legging's inside. Keep the stirrup from twisting! When you turn the legging right side out, it should look like (10-D).

David Mott recommends stirrups because they keep his wool leggings from twisting when he wears them. He sews a pewter, bone, or mother of pearl button on the two places **INSIDE** the legging where the stirrup would attach. His stirrup is a 1/2" by 5" to 7" strip of buckskin with a longitudinal slit in each end that buttons on around the outside of the moccasin.



---

[Construction of Buckskin Leggings](#)

[Bibliographic References for Leggings](#)

[Return to the Introduction on Seminole Leggings](#)

[Complete Index to Articles in 19th Century Seminole Mens Clothing](#)

---

Contributed by [Rick Obermeyer](#) E-mail: [orick@prodigy.net](mailto:orick@prodigy.net)

From the book *19th Century Seminole Mens Clothing*

© 1991-2000 Sherwood F. Obermeyer Jr., 2124 Miscindy Place, Orlando, FL 32806

---

[Return to NativeTech's Main Leather & Clothes Menu](#)

[Leather & Clothes Bibliography and Books to Buy On-Line](#)

---



Text and Graphics  
© 1994 - 2003 [Tara Prindle](#)  
unless otherwise cited.



## Construction of Buckskin Leggings

by Pete Thompson, Rick Obermeyer  
and David Mott (May 1991)

*in 19th Century Seminole Men's Clothing*  
[Rick Obermeyer ~ Editor](#)



Catalogue No. 204621  
Department of Anthropology  
Smithsonian Institution

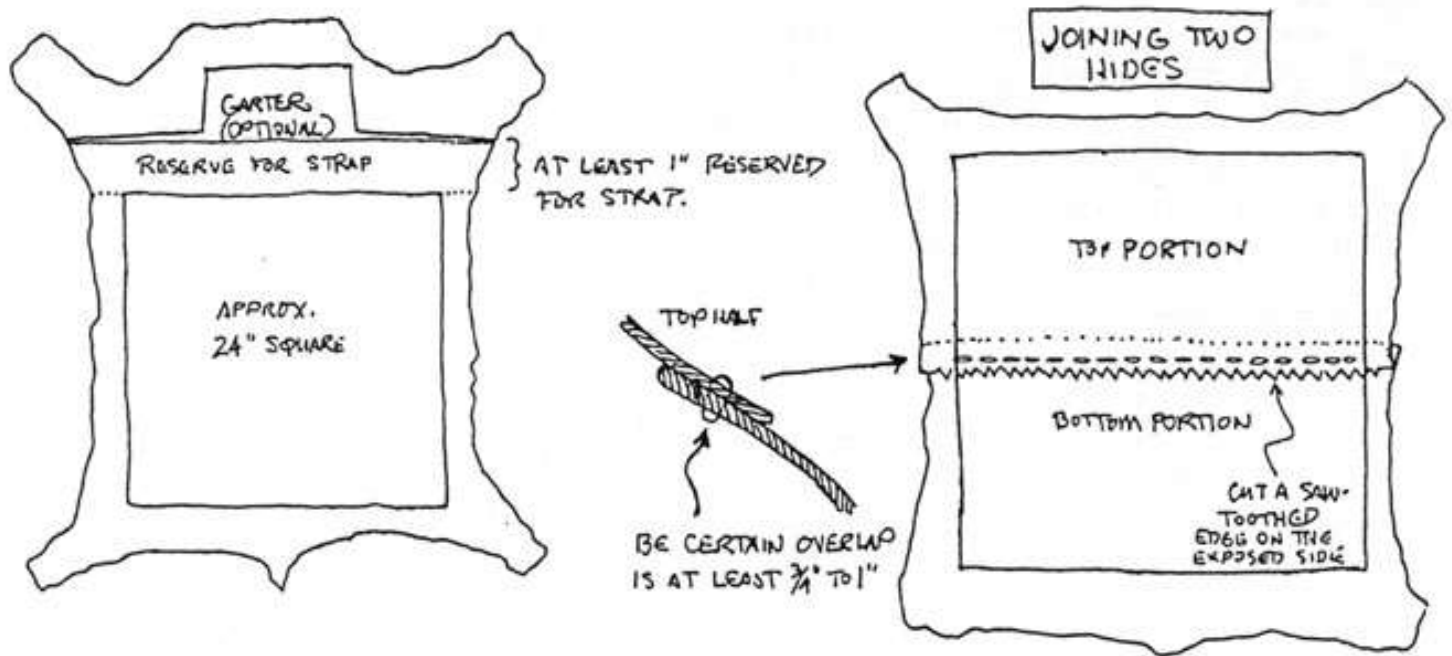
*Buckskin Leggings*

---

**Buckskin** was the Southeastern Indians' plastic: cheap, readily available, and throwaway. The pattern illustrated here represents its persistence in form, remaining relatively unchanged in design from 18th century Creek/Southeastern through early 20th century Seminole, having been similarly described among the Choctaw, Creek, and Cherokee. The more conservative Seminole retained use of buckskin leggings long after the others discontinued them. Moreover, continued Seminole use was reinforced by their south Florida swampy locale, where cloth leggings would not have long survived frequent wear.

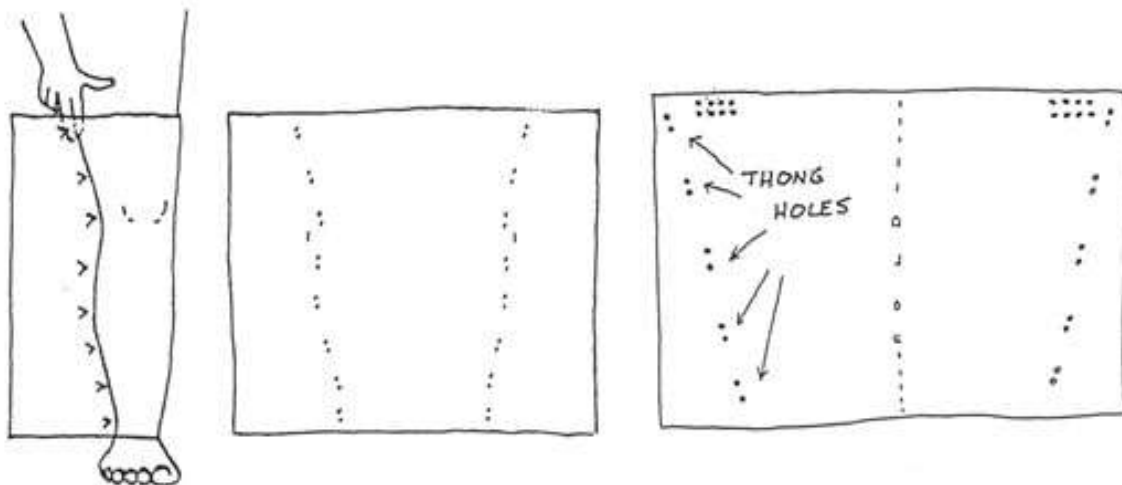
Each legging requires a full skin, and a third is needed for fringe aprons, if desired. Use braintanned hides if at all possible. If using commercial hides, pale creamy white should be the first and (almost) only choice. A dark brown or rusty color is marginally acceptable, because darker Seminole leggings resulted from smoking or dyeing braintanned hides with bark dyes. Early literature sometimes reported red leggings because of the availability of red dye, or cochineal.

As a rule of thumb, if a hide is 24 by 30 inches, it is big enough. It wasn't too unusual for two hides to be spliced together to make a single legging. The generally smaller size of Florida deer could have on occasion required four hides to make two leggings.



**1)** Cut a pattern from heavy kraft paper. Grocery bags are great, even if you have to tape a couple together. Wrap the paper around your leg. The bottom should rest on the top of your foot; the top should come to mid-thigh, or at least 3 or more inches above your kneecap. No, Seminole buckskin leggings don't extend nearly as high as plains Indian leggings. You might squat to make sure the leggings have room enough for a flexed thigh.

Seminole leggings should conform closely to the shape of the leg, so keep this in mind when you pin the kraft paper together around your leg. Put in a pin every inch or two, paying special attention to the ankle, knee, and thickest part of the calf.



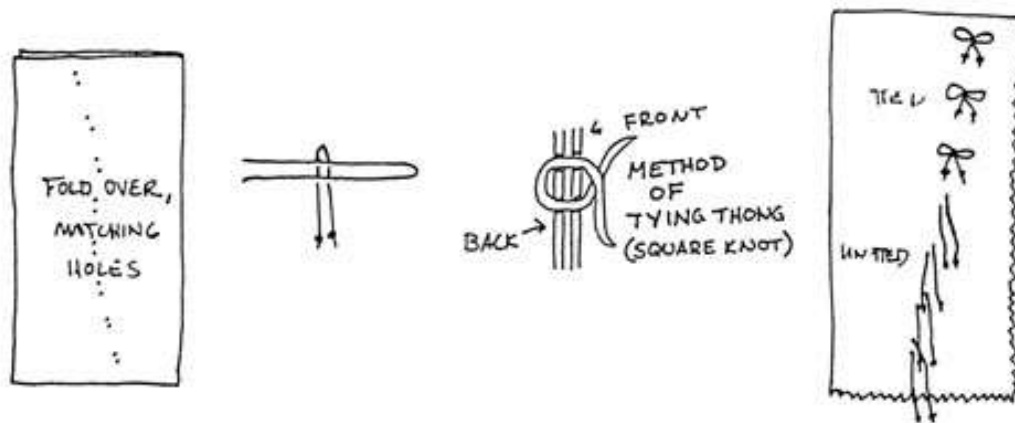
**2)** Unpin the kraft paper, and open it out flat. You'll have a big rectangle with pinholes marking two narrowing lines. Here, you have some choices to make:

How wide do you want the leggings' sideflaps to be? These can be so narrow as to be almost nonexistent, or two to three inches wide at the top and widening even more towards the bottom.

How close do you want the leggings to fit? You can maintain the formfitting outline marked by pinholes, or you

can just round them off into a straight line angled from hip to ankle.

Using your pattern, mark the buckskin accordingly. Use chalk or charcoal, not pen or pencil to make your marks.



**3)** Cut out the buckskin. Punch pairs of holes with an awl (refer to "Moccasin" section for tips on awls and punching). The holes would be about 1/8" to 1/4" apart, and the pairs about 1-1/2" to 2" apart (see photos).

Cut out thongs. Length varies from 8" to 12", but all the thongs on a pair of leggings should be the same length.

**4)** Thread thongs through the holes, one thong for each pair of holes, tying the back of the leggings to the front. The loose ends hang down the front. Remember to reverse the leggings for a left one and a right one!

The Seminoles closed the leggings by tying the thongs together. If your leggings are not too tight you could leave them tied with a square knot all the time. If your leggings are close fitting, you might want to put knots in the ends of your thongs so they don't accidentally slip through the holes, and tie the thongs up whenever you put on the leggings (bow is optional). Any thongs hanging longer than the bottom of the leggings are trimmed off.



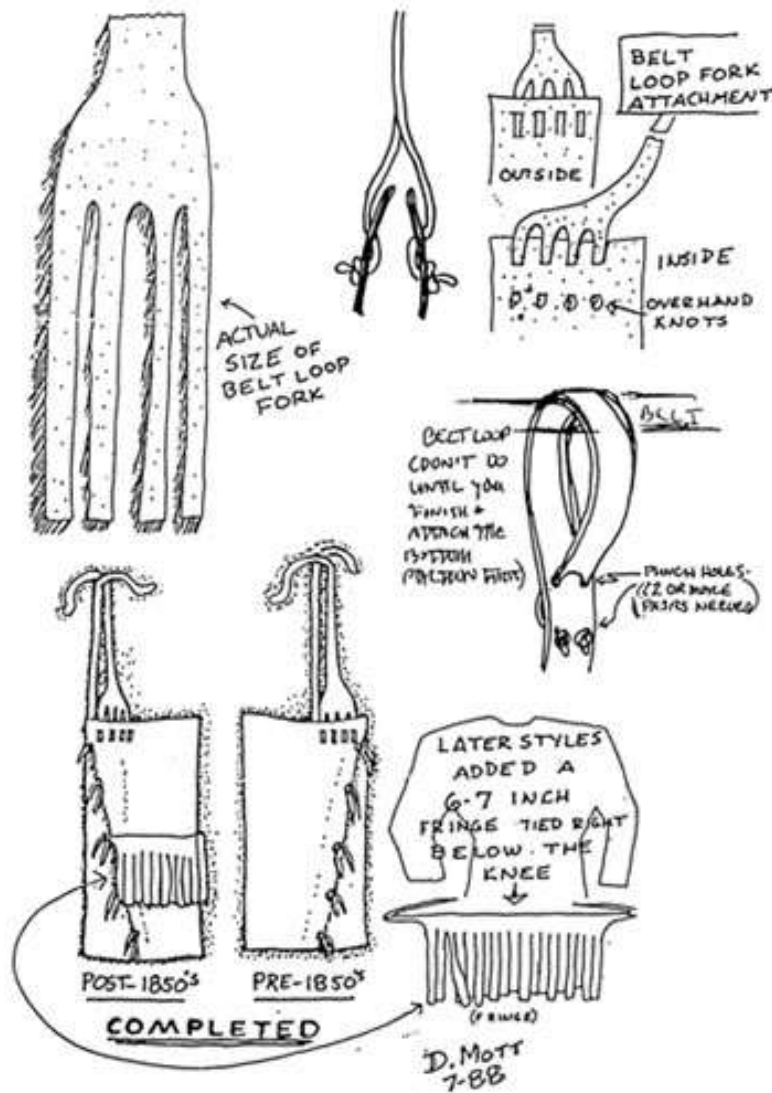


Historical Association of Southern Florida  
Miami

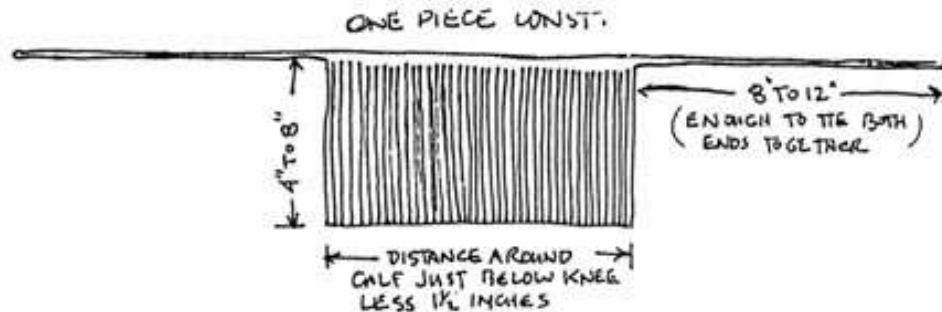


1890's  
Historical Society of Martin County  
Stuart, Florida

**5)** The suspenders are forks made from a spare piece of buckskin. each fork has two to three fingers that are 3" to 4" long. The fingers can alternate on each side or, more commonly, divide so all of a fork's fingers accommodate a single side. At least one example has a only a single fork on the legging's front, but two forks make for more comfortable wear. Each fork could be separate straps tied together, or be two parts of a single strap. The long strap is merely attached to the breechcloth belt, either with a permanent loop (illustrated) or a convenient knot (clove hitch is recommended over a square knot).



**6)** Mid to late 19th century Seminole buckskin leggings practically always had a fringed garter apron. The fringed area was wide enough to completely encircle the leg just above the calf and below the knee. The fringe could be 6" to 12" long. The illustrations show one-piece and two-piece construction. The apron should be cut lengthwise out of a buckskin, to be strongest along the direction of pull (see "Moccasin" section for explanation).



There are several ways the garter apron could be attached:

**A)** Entry holes could be put into the side flaps **OUTSIDE** the thong line, and the fringe apron tied inside the flaps. The loose ends hang between the sideflaps.

**B)** Entry holes could be put into the legging just **INSIDE** the thongline, and the fringe apron tied with a bow in front of the legging. The loose ends hang down among the thong ends. This method holds the legging tight without crimping the sideflaps.

**C)** Darry Wood explains punching a hole in an upper corner of the garter apron, and threading the thong end through the back, front, and garter apron, held tight by cutting that section as a wedge. This method is not recommended unless you have a lot of familiarity with working with buckskin.

**7)** Another customizing option is the sideflap edges. They were almost always left straight, but some were finely sawtoothed up to just past the knee (Historical Society of Martin County, Stuart; Historical Association of Southern Florida, Miami; Florida Museum of Natural History, Gainesville). There is even a late example that is sidefringed (Denver Museum of Natural History).

---

[Construction of Cloth Leggings](#)

[Bibliographic References for Leggings](#)

[Return to the Introduction on Seminole Leggings](#)

[Complete Index to Articles in \*19th Century Seminole Mens Clothing\*](#)

---

Contributed by [Rick Obermeyer](#) E-mail: [orick@prodigy.net](mailto:orick@prodigy.net)

From the book *19th Century Seminole Mens Clothing*

© 1991-2000 Sherwood F. Obermeyer Jr., 2124 Miscindy Place, Orlando, FL 32806

---

[Return to NativeTech's Main Leather & Clothes Menu](#)

[Leather & Clothes Bibliography and Books to Buy On-Line](#)



Text and Graphics  
© 1994 - 2003 [Tara Prindle](#)  
unless otherwise cited.





*Leggings*

## Bibliographic References for **Leggings**

**Rick Obermeyer  
and M. E. (Pete) Thompson**

*in 19th Century Seminole Men's Clothing*  
[Rick Obermeyer ~ Editor](#)

---

**Conn, Richard**

**1979 NATIVE AMERICAN ART IN THE DENVER ART MUSEUM.** University of Washington Press, Seattle and London.

**Cory, Charles B.**

**1896 Preface to Second Edition (and) The Seminole Indians, HUNTING AND FISHING IN FLORIDA.**

**Fundaburk, Emma Lila**

**1958 SOUTHEASTERN INDIANS LIFE PORTRAITS.** Scarecrow Reprint Corporation, Metuchen, NJ, 1969.

**Galante, Gary**

**1989 "Creek Man's Outfit In the Collection of the Montclair Art Museum." The Rand Society for Native American Art, Vol.1, No. 1. NJ.**

**Goggin, John M.**

**1955 "Osceola: Portraits, Features, and Dress," The Florida Historical Quarterly, XXXIII: 3 & 4, Gainesville.**

**MacCauley, Clay**

**1887 "The Seminole Indians of Florida." Fifth Annual Report of the Bureau of Ethnology, Washington DC.**

**Mahon, John K.**

**1967 HISTORY OF THE SECOND SEMINOLE WAR 1835-1842.** University of Florida Press, Gainesville.

**Moore-Willson, Minnie**

**1914 edition, THE SEMINOLES OF FLORIDA, Moffat, Yard and Company, New York.**

**Parks, Arva Moore (ed.)**

**1977 THE FORGOTTEN FRONTIER/ Florida Through the Lens of Ralph Middleton Monroe. Banyan Books, Miami.**

**1981 THE MAGIC CITY MIAMI. Continental Heritage Press, Tulsa.**

**Porter, Kenneth W.**

**1967 "Billy Bowlegs (Holata Micco) in the Seminole Wars." Florida Historical Quarterly 45: 219-42.**

---

[Construction of Cloth Leggings](#)

[Construction of Buckskin Leggings](#)

[Return to the Introduction on Seminole Leggings](#)

[Complete Index to Articles in \*19th Century Seminole Mens Clothing\*](#)

---

Contributed by [Rick Obermeyer](#) E-mail: [orick@prodigy.net](mailto:orick@prodigy.net)

From the book *19th Century Seminole Mens Clothing*

© 1991-2000 Sherwood F. Obermeyer Jr., 2124 Miscindy Place, Orlando, FL 32806

---

[Return to NativeTech's Main Leather & Clothes Menu](#)

[Leather & Clothes Bibliography and Books to Buy On-Line](#)



Text and Graphics  
© 1994 - 2003 [Tara Prindle](#)  
unless otherwise cited.



# How to make Seminole Pouches & Bandoliers

by David Mott and  
Rick Obermeyer (Dec., 1990)

*in 19th Century Seminole Men's Clothing*  
[Rick Obermeyer ~ Editor](#)

## INTRODUCTION

The single most impressive item of Seminole Indian adornment of the 19th century was the beaded pouch and bandolier. A few of these pouch sets still exist in collections throughout the United States, though usually with scant or non-existent provenance. Though Southeast clothing was distinctive from other regions, the clothing for Native Americans within the Southeast had very blurred "tribal" styles. Nevertheless, a full attire almost always included the pouch and bandolier, and a careful researcher will learn to identify the characteristics unique to Seminole examples.

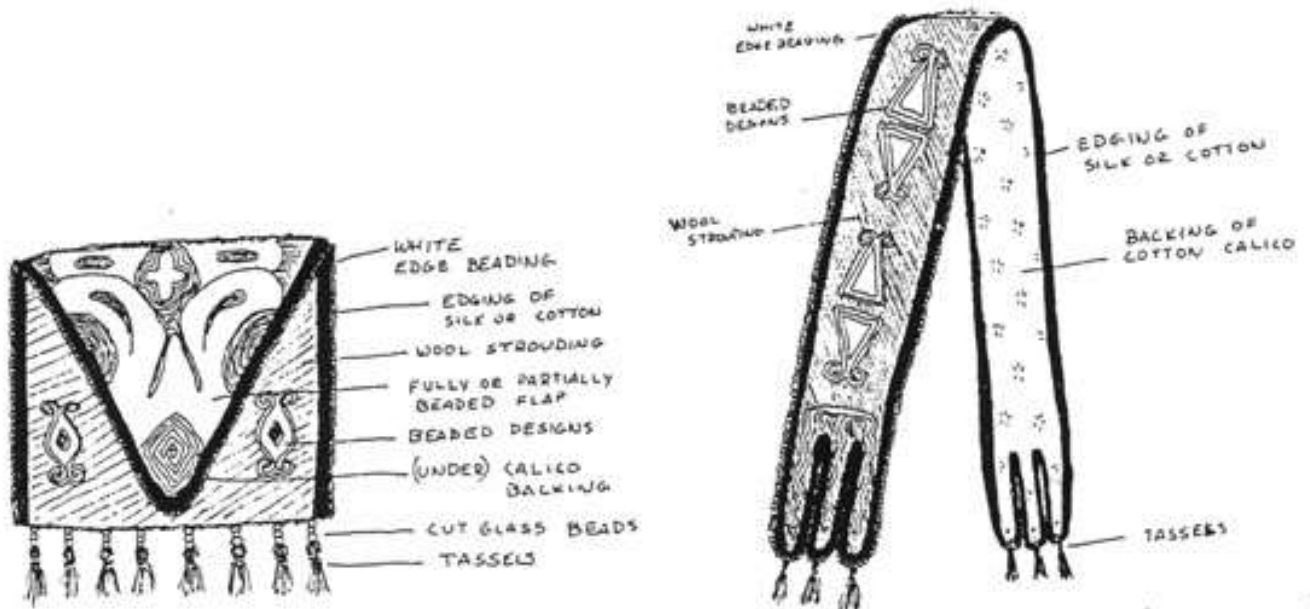
The pouches and bandoliers were cut from trade wool, or strouding as it was called at that time, obtained through trade with first the English, then with English traders acting as agents for the Spanish, and finally through American trade outlets. Red, navy blue, and black were the standard colors. Strouding was seemingly the cloth of all purpose, as it was also used for Southeastern style leggings and breechcloths.

The pouch and bandolier was lined with calico, edged with ribbon (often silk), and handsomely beaded. Decorative beadwork used designs both ancient in derivation and spontaneous with the maker. The two-needle appliqué technique was used, supposedly out of necessity. The trade needles the Native Americans got were rarely fine enough to go through many of the trade beads. Fortunately, the beads came strung on hanks, instead of loose, so the crafters merely sewed down the thread the beads were strung on. To a certain extent, this linear line-up of beads tended to influence the development of designs.



[Click on Thumbnail for Detail Photo](#)





## PREPARATIONS

The first step is, of course, to select the style and cut of your pouch and bandolier. Here are several examples.



The size and shape of the pouch can vary, as shown. 7"x 8", 8"x 9", 8"x 8", 9"x 7", or 7"x9" illustrate the range of typical measurements. The flap is another matter of choice. It can hang overlapping below the bottom edge, meet flush with it, or stop just shy of it. It can be long and pointed, or full and rounded, but a characteristic example of Seminole style is its triangular shape.

The sash could as long as the width of a piece of wool off of a bolt. If you're in the Order of the Arrow, your sash would be a good guide for the length of the bandolier. Otherwise, measure the distance from the top of the shoulder to the hip bone. Double this length and add one foot. For instance:

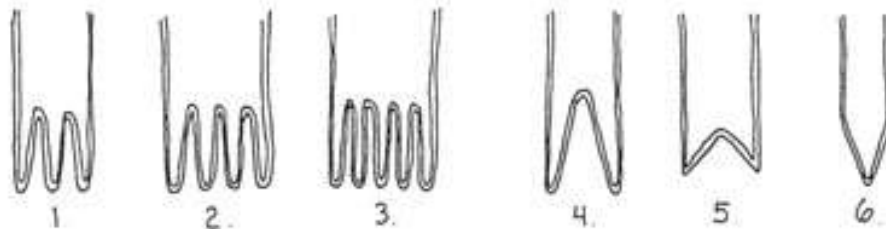
|           |              |                                |
|-----------|--------------|--------------------------------|
| (example) | 2-1/2<br>X 2 | ft. shoulder-to-hip            |
|           | 5<br>+ 1     | feet                           |
|           | 6            | foot extra                     |
| (example) |              | feet total length of bandolier |

*Save this measurement! Choose between four and five inches for the bandolier width.*

At this point, decide on how the bandolier ends will look. Some examples are:

All of the fingers are six to eight inches long (generally matching the height of the bag), and 1/2 to two inches wide at their base. Draw your chosen style onto the wool and calico with thin charcoal or chalk.

Cut slits in the cloth if using styles #1, #2, or #3; cut out triangles if using styles #4 or #5. Trim to a tapering point if using style #6. Styles #1-#4 should be rounded off, as shown. Styles #5 and #6 can be left pointed.



Sketch out the pouch and bandolier in full size to see what you like. Use brown kraft paper (a grocery bag) so you can cut it out to use for a pattern.

Now, transfer the pattern to your wool and calico, using chalk or charcoal to draw on the cloth. The calico pieces should be 1/8" to 1/4" larger than their corresponding wool pieces. Cut out the wool and rip apart (or cut out) the calico. Ripping the calico when the cut is along the weave will produce a straighter, more authentic edge. Set this aside for now.

[Beading & Designs on Seminole Pouches & Bandoliers](#)

[Backing, Edging and Detailing on Seminole Pouches & Bandoliers](#)

[Seminole Bandolier Attachment and Conclusions](#)

[Appendix and References for Seminole Pouches & Bandoliers](#)

[Complete Index to Articles in \*19th Century Seminole Mens Clothing\*](#)

---

Contributed by [Rick Obermeyer](#) E-mail: [orick@prodigy.net](mailto:orick@prodigy.net)

From the book *19th Century Seminole Mens Clothing*

© 1991-2000 Sherwood F. Obermeyer Jr., 2124 Miscindy Place, Orlando, FL 32806

---

[Return to NativeTech's Main Leather & Clothes Menu](#)

[Leather & Clothes Bibliography and Books to Buy On-Line](#)

---



Text and Graphics  
© 1994 - 2003 [Tara Prindle](#)  
unless otherwise cited.





*Pouch & Bandolier*

## Seminole Pouches & Bandoliers Beading and Designs

by David Mott and  
Rick Obermeyer (Dec., 1990)

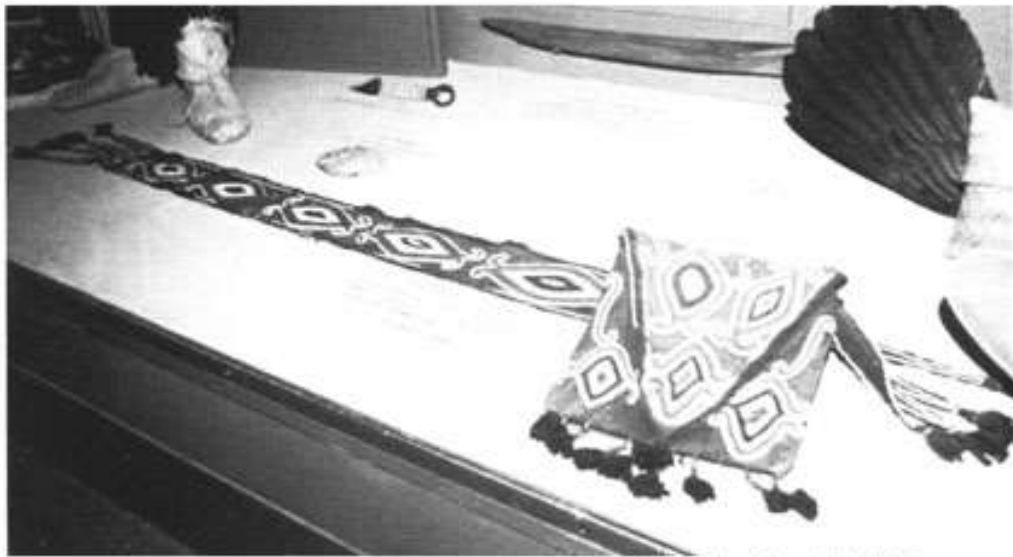
*in 19th Century Seminole Men's Clothing*  
[Rick Obermeyer ~ Editor](#)

---

The beading technique is the two-needle, or two-thread, applique method. The most common bead size used is equivalent to our current 12/0 size. Native American crafters weren't necessarily consistent on bead sizes within a single piece, but the range is still within 11/0 and 13/0. This style of beading is simple, and certainly does not require a loom.

Older opaque colors are to be preferred; in darker colors, sometimes transparents and infrequently cuts. Look for dull white instead of bright white, salmon or rose instead of pink, greasy yellow or mustard instead of yellow or gold, crimson or wine red instead of bright red, and dark blue instead of royal blue. Light blue is pastel, and turquoise is not bright. A good Indian hobbyist catalog will carry these, and if you have to spend a little extra to get the old style colors, it will be well worth it.

The colors should contrast with the strouding color and with each other. (See Appendix \*1) COLORS, for an idea of how few colors were usually used on a single item.)

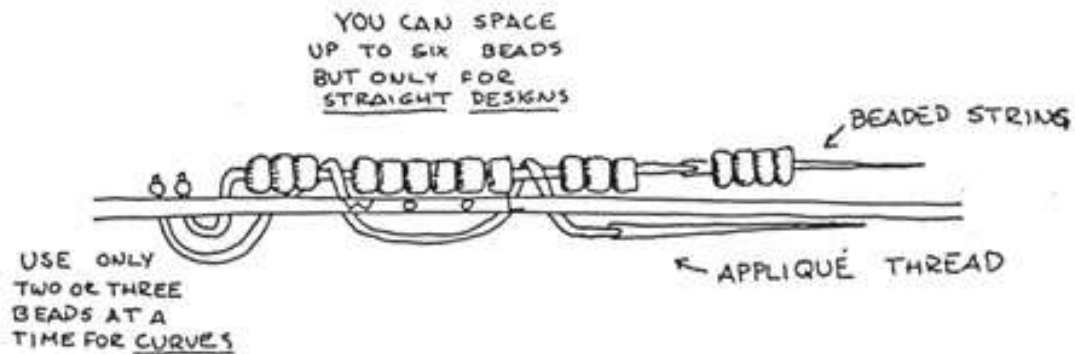


"Sash and Pouch of Billy Bowlegs," Smithsonian Institution

A distinction between Seminole and Creek or Cherokee pouches and bandoliers is that the elements in a Seminole repeating design are much less likely to be connecting in a rolling repeating curve. In fact, many Seminole designs are isolated elements, not linearly connected at all. Most pouches had designs that coordinated with those on the attached bandolier. The pouch design is usually (but not always) bilaterally

symmetrical. That is, like people, the left half is a rough mirror image of the right half. The whole flap was often fully beaded. The pouch was not beaded on the back and not always filled in completely where the flap lay over the front of it, but the front side could be fully beaded or partially beaded.

The bandolier is another story. The design on one half of its length could be completely different from what's on the other half. So, a wearer might seem to be wearing two completely different bandoliers when seen from the front or from the back. Occasionally, an isolated design element might appear where the two halves meet on the shoulder. The author feels that this change may be more from boredom in construction than from any specific intent. There are, however, a few bandoliers with consistent design through their whole length. No bandolier is fully headed.



The designs, especially Seminole motifs, can be repeating, geometrical (but not with rigid straight lines or sharp corners), and representational (but not really pictorial). This may not be so much stylistic preference as much as required by the limitations of working with linear strings of beads.

Here are a few patterns noted on some pouches and bandoliers. The names have been assigned by the author for ready referral; there is no indication at all that they were actually intended to represent any of these.

**RATTLESNAKE:** Appears in the bandolier of Billy Bowlegs in his photographs and engravings, although not on the example in the Smithsonian ascribed to him. Although the pattern strongly

resembles Seminole heddle loom beaded sashes of the late 19th and early 20th centuries, this is definitely an applique beaded sash.

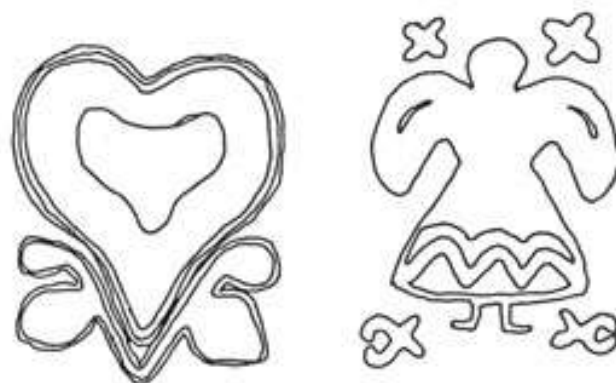


**RECURVE DIAMOND:** Perhaps the most popular motif among 19th century Seminoles. It s several variations appear on a majority of the examples studied. That the design was enduring is indicated by the fact that it appears on one made by a Seminole in the early 1950's, commissioned by William C. Sturtevant.



**HEART:** Appeared on a pouch recently sold to a private collector.

**ANGEL:** (or, female figure): Appears on several bandoliers. It seems appropriate, in that it was women who made the pouches and bandoliers.



**MAN:** On a single example.

**SWASTIKA:** A familiar motif throughout all of Native American art. Note, however, the direction of rotation. The opposite direction represented bad luck or misfortune.



**FLORAL:** In Seminole examples, this is mostly limited to leaves. More fully floral beadwork is more typical of Creek or Cherokee examples. A mixture of floral and diamond is on Cat1ln's painting of Osceola (although we should be cautious of Catlln's details.)



Sketch out your chosen motifs, and mark the outlines on your strouding. An option is to draw the design on regular writing paper. Lay the paper on the wool, and sew the first outline string of beads down onto the wool through the paper. When the outline is sewn down, the paper can easily be separated and the rest of the beadwork filled in with the outline.

But, given the usually irregular, uneven appearance of elements in Seminole designs, it is highly unlikely that they used either drawn or paper outlines. They probably started out with an idea of what they wanted, possibly with a rough sketch off to the side, and did the whole thing freehand. Perfectly repeated patterns, or even very straight lines, are not to be expected in Seminole pouches and bandoliers.

**ORDER ENOUGH BEADS FOR YOUR PROJECT...** size 12/0 beads are very small, so one or two hanks is hardly enough for the project. Ten to fifteen hanks can easily be used on the bandolier alone. Figure each hank can cover about four to five square inches of solid beadwork.

Remember, also, to order thread and needles that match your bead size. The author recommends #13 needles and extra fine or FF thread. Some beeswax needs to be on hand to wax the thread periodically. One source does discourage thread waxing because they feel that it might discolor the wool.

If this is your first try at any kind of beading, it's recommended that you start with a simple motif on the bandolier.

Cut the beads off of a hank into a shallow saucer or small plate. A Frisbee works finer For storage, 16mm film canisters or old cellophane tape cans have lids that can be closed tight. Wax a yard of thread to hold the beads. Pull the thread through the needle until the needle is in the middle of the length of thread. Knot the two ends together with three passes of an overhand knot. Run the thread through the wool with the knot on the outside of it, the side of the wool the beads will be applied onto. Pass the needle back through the wool again, close to the starting knot, so the thread is again on the outside.

An easy way to string the desired beads is to run the needle through the loose beads in a scooping motion. Or, you can slowly and tediously put one bead at a time on the needle. Repeat until you've accumulated a long string of beads. Cut another yard of thread, wax it, but keep this thread as a single strand. Start it out close to the stringed beads, with the knot also on the outside. Cross over the bead thread, tacking it down every few beads to the fabric. You are not sewing down the beads, you are sewing down the thread that carries the beads. Keep both the beads on the thread and your tacking stitches drawn tight. The beads between each tack would be more on a straight run, such as four or five, and less on curves, perhaps two or three between each stitch. If the beads and stitches are loose, the

beads will sag. If the beads and stitching is too tight, the completed beaded pattern will bulge up. Different tensions will be called for different kinds of lines. Check periodically to see if all is well on the underside of the wool.

Eventually, either the bead thread or the applique thread will begin to run out, or you will finish with this particular bead color. If the applique thread runs out...

Make two or three passes over the last stitch in front of the last bead. Run the applique thread through to the wool's underside, and run the thread through these last few stitches, passing the needle through the loop you create. If there are other beads to add, start threads as before, and finish.

If the bead thread runs out shy of completing the motif, or if you are finished with one color and want to start another...

Pull the beads tight, and enter the wool with the needle without breaking the surface, and run the needle through the created loop. Again, do this at least twice over.

Remember to keep all your beadwork relatively tight, as needed. Take your time. Set the project aside when you get tired. You may want to work at it in stages, setting a goal to complete a part of the design or a particular color at a sitting.

---

[Backing, Edging & Detailing on Seminole Pouches & Bandoliers](#)

[Seminole Bandolier Attachment & Conclusions](#)

[Appendix & References for Seminole Pouches & Bandoliers](#)

[Return to the Introduction to Seminole Pouches & Bandoliers](#)

[Complete Index to Articles in \*19th Century Seminole Mens Clothing\*](#)

---

Contributed by [Rick Obermeyer](#) E-mail: [orick@prodigy.net](mailto:orick@prodigy.net)

From the book *19th Century Seminole Mens Clothing*

© 1991-2000 Sherwood F. Obermeyer Jr., 2124 Miscindy Place, Orlando, FL 32806

---

[Return to NativeTech's Main Leather & Clothes Menu](#)

[Leather & Clothes Bibliography and Books to Buy On-Line](#)

---



**Text and Graphics**  
© 1994 - 2003 [Tara Prindle](#)  
unless otherwise cited.



National Museum of the American Indian  
Smithsonian Institution

*Pouch & Bandolier*

## Seminole Pouches & Bandoliers

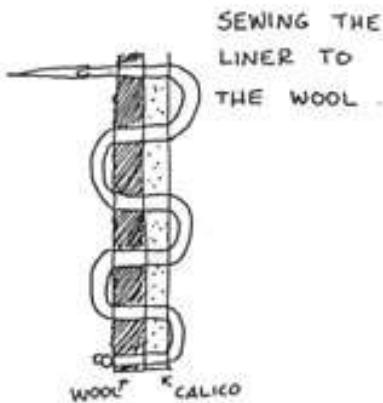
# Backing, Edging & Detailing

by David Mott and  
Rick Obermeyer (Dec., 1990)

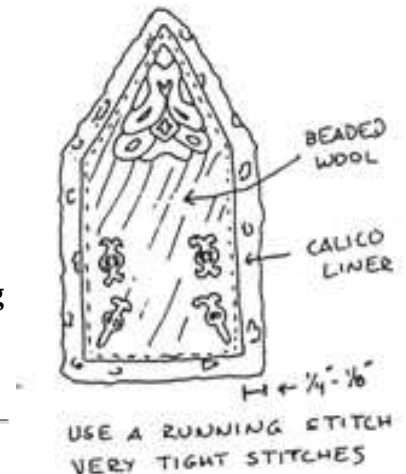
in *19th Century Seminole Men's Clothing*  
[Rick Obermeyer ~ Editor](#)

## BACKING

After beadwork is completed, it is time to attach a calico liner to back the wool. (Some choose to add two liners: one before beading, to give the thread extra thickness to anchor in, and a second after beading.) This reinforces the wool, and protects the beadwork's bare backstitches. The liner should be just a bit larger than the wool piece by about 1/8" to 1/4". On a few examples, such as the "Osceola" pouch at the Florida Museum of Natural History, the liner wraps around from the back and is sewn down as an edging. This is an option to consider, but one which will not be discussed here.



The calico liner can be attached with 1/2" basting stitches, because it will later be securely attached when edging is sewn on (unless the liner is, itself, the edging). When done, cut off any excess calico. Allow plenty of extra seam space if the calico was ripped; this helps prevent losing the stitch to the fray later on.



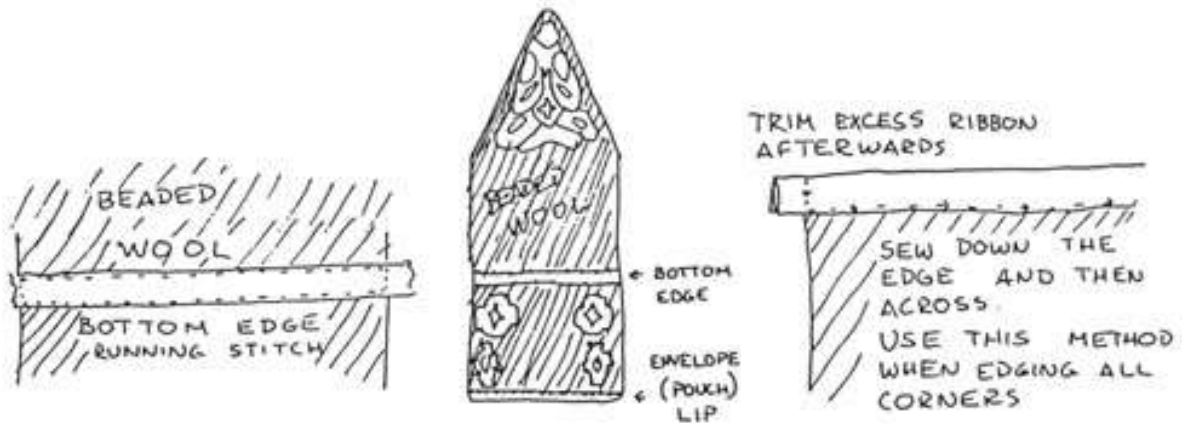
## EDGING

There are two options to edging a bandolier and pouch. One is by overlapping the calico liner around the outside edge of the wool. The other option is to use ribbon or military edging or bias tape for edging. This method, much more prevalent, is the one described here.

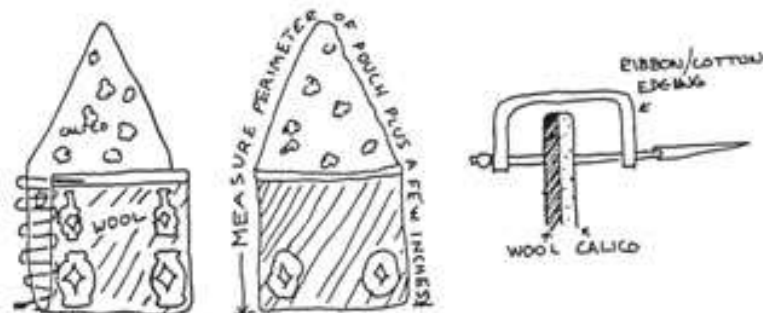


Edging colors on examples studied are red, navy blue, black, green, blue-green/turquoise, pink, yellow (changed with age to light gold or mustard), white, and light blue. (See Appendix \*1 COLORS)

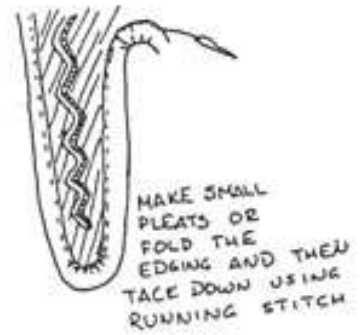
Measure the dimensions of your pouch and bandolier outer margins. If you would like the bottom of the pouch to have trim, sew it down along that edge. (Very few pouches have this detail, but it is an option.) Add edging to the open lip of the pouch, which will protect the seam of the wool and calico. Sew the edging down close to its edge, using small tight stitches, with a thread color that matches the edging. This edging should have been slightly longer than the edge it's going on so that it will be a simple matter to trim off its ends after its sewn down.



Fold the pouch into the envelope shape. Sew the sides together from bottom to top. Take care to run your stitches tight and with as narrow a seam as your torn calico allows. Measure the perimeter of the pouch, including the flap, and add two inches. Measure out this much edging, and sew it down in the same way as the lip edging. Take your time around the flap's point to carefully fold and stitch the edging to make it neat. Finish both of the open bottom ends of the edging with a few tight barrel stitches. If you are working with satin or silk ribbon for edging, use a very fine needle and thread.



The bandolier is edged in the same manner: 1) measure the perimeter and add a few inches, 2) you may want to pin the ribbon in place since the length can be overwhelming sometimes, 3) sew using very fine stitches, and 4) take your time going around corners and into the curves at the bases of the fingers. After all the edging is done, the pouch and bandolier are ready for the finishing details.



## DETAILING

Adding these details will enhance an already beautiful item.

**EDGE BEADING:** Add beads to the inside and/or outside edge of the edging. These beads were almost always white, and were often slightly larger than the beads used in the applique designs.

**TASSELS:** These are hand-tied dangles added to the bottom of the pouch and sometimes to the ends of the bandolier fingers. They can be made from yarn, colored embroidery floss, very thin wool strips, or unraveled wool/strouding. Between four and eight on the bottom of the pouch is normal, but there can be as many as a dozen. One per. finger end is the norm on the bandolier. The tassels can be attached close in, or suspended an inch or two.

### *How to Hand-Tie Tassels:*



**1.** Cut 10 to 20 4-6' lengths of yarn.



**2.** Run another 4-6' length of yarn around the bundle and tie off with a square knot.



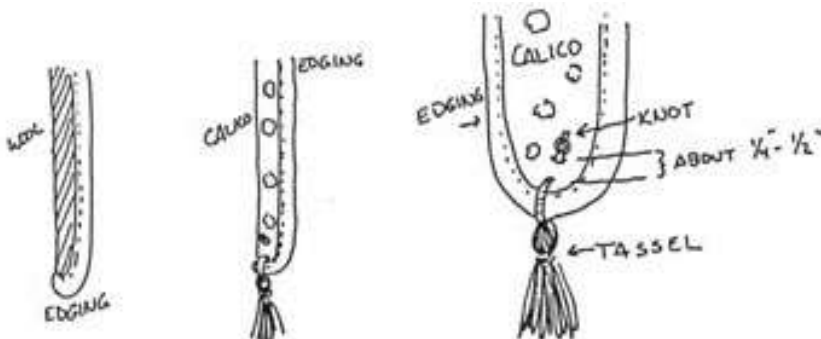
**3.** Drape the yarn over the know leaving one end of the knot yarn above. The other end joins the bundle.



**4.** Using either the same color yarn (usual) or another color thread (sometimes) wrap around the top 1/3 of the bundle. Tie off with a couple clove hitches. Trim bottom as needed.



**To attach** the tassel run a yarn or heavy thread through the head of the tassel. Add beads or leave plain. Pull through the bottom edge of the pouch and then make several overhand knots or a surgeons knot. Use a darning needle to thread the yarn.



**For** the fingers of the strap or the flap point run the yarn just behind the edging, pull through about 1/2" and then knot.

[Return to Beading & Designs on Seminole Pouches & Bandoliers](#)

[Seminole Bandolier Attachment & Conclusions](#)

[Appendix & References for Seminole Pouches & Bandoliers](#)

[Return to the Introduction to Seminole Pouches & Bandoliers](#)

[Complete Index to Articles in \*19th Century Seminole Mens Clothing\*](#)

---

Contributed by [Rick Obermeyer](#) E-mail: [orick@prodigy.net](mailto:orick@prodigy.net)

From the book *19th Century Seminole Mens Clothing*

© 1991-2000 Sherwood F. Obermeyer Jr., 2124 Miscindy Place, Orlando, FL 32806

---

[Return to NativeTech's Main Leather & Clothes Menu](#)

[Leather & Clothes Bibliography and Books to Buy On-Line](#)

---



Text and Graphics  
© 1994 - 2003 [Tara Prindle](#)  
unless otherwise cited.





National Museum of the American Indian  
Smithsonian Institution

*Pouch & Bandolier*

## Seminole Pouches & Bandoliers

# Attachment & Conclusions

by David Mott and  
Rick Obermeyer (Dec., 1990)

*in 19th Century Seminole Men's Clothing*  
[Rick Obermeyer ~ Editor](#)

---

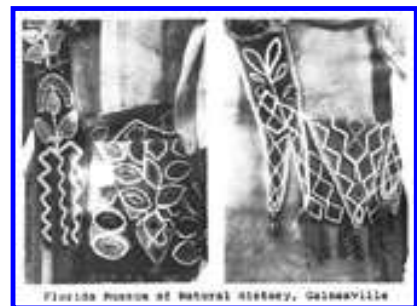
## ATTACHMENT

For such a complex, impressive, beautiful piece of work, the pouch is attached to the bandolier in a very haphazard manner. The upper corners of the pouch are sewn to the back of the bandolier with a whipstitch at each corner. The exact area of attachment to the bandolier varies slightly, but generally is at or just above the "valley" between the first two outer fingers. Yes, this is a flimsy arrangement, considering all the work that has gone into the project up to this point. For that reason, it's not at all unusual to find museum examples that have been separated at this point. But, that's the way it was done.

---

## CONCLUSION

The pouch and bandolier is a beautiful piece of Southeastern Native American culture. I encourage you to visit the museums in Gainesville and Miami, along with the Smithsonian, the Museum of the American Indian (New York), the Denver Art Museum, and the Denver Museum of Natural History. Study of pictures is very worthwhile. In this way, you can get a feel for the design and color schemes of the pouches and bandoliers of the 19th century Seminole.



[Click on Thumbnail for Detail Photo](#)

---

[Return to Beading & Designs on Seminole Pouches & Bandoliers](#)

[Return to Backing, Edging & Detailing on Seminole Pouches & Bandoliers](#)

[Appendix & References for Seminole Pouches & Bandoliers](#)

[Return to the Introduction to Seminole Pouches & Bandoliers](#)

[Complete Index to Articles in \*19th Century Seminole Mens Clothing\*](#)

---

Contributed by [Rick Obermeyer](#) E-mail: [orick@prodigy.net](mailto:orick@prodigy.net)

From the book *19th Century Seminole Mens Clothing*

© 1991-2000 Sherwood F. Obermeyer Jr., 2124 Miscindy Place, Orlando, FL 32806

---

[Return to NativeTech's Main Leather & Clothes Menu](#)

[Leather & Clothes Bibliography and Books to Buy On-Line](#)



Text and Graphics  
© 1994 - 2003 [Tara Prindle](#)  
unless otherwise cited.



National Museum of the American Indian  
Smithsonian Institution

*Pouch & Bandolier*

# Seminole Pouches & Bandoliers Appendix & Bibliographic References

by David Mott and  
Rick Obermeyer (Dec., 1990)

*in 19th Century Seminole Men's Clothing*  
[Rick Obermeyer ~ Editor](#)

## APPENDIX

### \*1)

#### POUCH AND BANDOLIER COLORS

Wool/strouding colors in CAPS, edging/bias in (Parentheses) and bead colors in Upper/lower case.

We know from historic evidence that dark blue wool/strouding was used for sashes and pouches, as well as red and black. Yet, it is often difficult to tell if specimens examined were made with black wool, or navy blue wool, or navy blue wool which has blackened with time. However, this may not be a valid assumption. Indigo was a standard blue dye, and indigo does not hold up without limit. Many artifacts that today appear light tan or yellow-ochre can be determined from traces to have been dark blue at one time. Therefore, many references to "BLK" are to be taken only as estimations.

|                                                               |       |     |         |     |     |     |     |     |     |
|---------------------------------------------------------------|-------|-----|---------|-----|-----|-----|-----|-----|-----|
| Denver Art Mus., R1954.201<br>(Illus. #18, Conn, 1979) C.1825 |       | Red |         | Wht | Blu | Lbl |     | Yel | Dgr |
| Denver Art Mus., #1965.265<br>(Illus. #19, Conn, 1979) C.1830 | Pouch | Red | ( Ye1 ) | Wht |     | Blk | Rse | Mst |     |
| Denver Art Mus., #Bse-5<br>(Illus.#240, Feder,1971) C.1840    | Sash  | Red | ( Lbl ) | Wht |     | Blk | Rse | Mst |     |
| Brooklyn Museum, 1838                                         |       | Red | ( Blk ) | Wht | Blu |     |     |     |     |
| Milford G. Chandler Coil.                                     |       | Red | ( Blk ) | Wht | Blu |     |     |     |     |
| Smithsn.N380668(NI,Goggin,1951),1849                          |       | Red | ( Blk ) | Wht | Blu |     |     |     |     |

|                                                                    |       |     |     |          |     |     |     |      |     |     |     |     |
|--------------------------------------------------------------------|-------|-----|-----|----------|-----|-----|-----|------|-----|-----|-----|-----|
| Mus.Am.Ind., Heye #8/4209<br>(#2,Goggin,1951),1840's               | Pouch | Red |     | ( Tur )  | Wht | Blu |     |      |     |     |     |     |
| Mus.Am.Ind., Heye #8/4209<br>(#2,Goggin,1951),1840's               | Sash  | Red |     | ( Wht )  | Wht | Blu |     |      |     |     |     | Dgr |
| Fl.Mus.Nat.Hist., 1830's                                           |       |     | Blk | ( Red )  | Wht | Tur |     | Rse  | Yel |     |     |     |
| Fl.Mus.Nat.Hist., Gainesville                                      | Pouch | Red |     | ( Lbl )  | Wht | Tur | Blk |      | Yel |     |     |     |
| Fl.Mus.Nat.Hist., Gainesville                                      | Sash  |     | Blk | ( Mst )  | Wht | Tur |     | Rse  | Mst | Grn |     |     |
| Fl.Mus.Nat.Hist., "Osceola's"                                      | Pouch | Red |     | ( Blk )  | Wht | Lbl | Blk |      |     |     |     |     |
| Fl.Mus.Nat.Hist., "Osceola's"                                      | Sash  | Red |     | ( Gld )  | Wht | Tur | Blk |      |     |     |     |     |
| Fl.Mus.Nat.Hist., 1850's                                           | Pouch |     | Blk | ( Gld )  | Wht | Blu |     |      |     |     |     | Drd |
| Fl.Mus.Nat.Hist., Gainesville                                      |       |     | Blk | ( Mst )  | Wht | Blu |     |      |     |     |     | Red |
| Fl.Mus.Nat.Hist., Gainesville                                      |       |     | Blk | ( Blk? ) | Wht | Blu |     | Rse  |     |     |     |     |
| Feld Mus.Cat.#167917<br>(#3,Goggin,1951),1890's                    |       | Red |     |          | Wht | Blu | Blk | Rse  |     |     | Grn |     |
| Feld Mus.Cat.#167917<br>(#3,Goggin,1951),1890's                    |       |     | Blk | ( Gld )  | Wht | Dbl | Lbl | Rse  | Mst |     |     |     |
| Feld Mus. #258646,Chlcago(Cr/Sem?)<br>(Plate #58, Feder, 1971)     | Pouch | Red |     | ( Gld )  | Wht | Blu | Lbl | Rse  | Yel | Grn |     |     |
|                                                                    |       |     |     |          | Llc | Blk | Tur | Mst  | Lgr |     |     |     |
| Feld Mus. #258646,Chlcago(Cr/Sem?)<br>(Plate #58, Feder, 1971)     | Sash  | Red |     | ( Gld )  | Wht | Blu | Lbl | Rse  |     |     | Dgr | Red |
|                                                                    |       |     |     |          | Gld |     |     |      |     |     |     |     |
| Rautenstrauch-Joest Mus.,Cologne<br>(Pl.134,Feest,1980)(Cr./Sem.?) | Pouch | Red |     | ( Blu )  | Wht | Blu | Lbl | Pnk  | Blk |     |     |     |
| Rautenstrauch-Joest Mus.,Cologne<br>(Pl.134,Feest,1980)(Cr./Sem.?) | Sash  | Red |     | ( Blu )  |     | Blu | Lbl | Pnk  | Blk |     |     |     |
| Mus.Am.Ind.,Heye #13/5086                                          |       |     | Blu |          | Wht |     | Lbl |      |     |     |     | Red |
| Mus.Am.Ind.,Heye #2/5653                                           | Pouch | Red |     |          |     |     |     |      |     |     |     |     |
| Mus.Nat.Hist., Denver                                              | Pouch |     | Blk | ( Blu )  | Wht | Blu |     | Rse  |     |     |     |     |
| Mus.Nat.Hist., Denver                                              | Sash  |     | Blk | ( Blu )  | Wht | Blu | Lbl | Rse? |     |     |     |     |
| Charleston Museum (Cr./Sem?)                                       |       | Red |     | ( Gld )  | Wht | Blu | Lbl |      | Mst |     |     |     |

## REFERENCES

**Conn, Richard**  
**1979 NATIVE AMERICAN ART IN THE DENVER ART MUSEUM.** University of Washington Press,  
 Seattle and London.

**Feder, Norman**  
**1971 AMERICAN INDIAN ART.** Abrams, New York.



**Feest, Christian F.**

**1980 NATIVE ARTS OF NORTH AMERICA. Oxford University Press, New York and Toronto.**

**Goggin, John M.**

**1951 Beaded Shoulder Pouches of the Florida Seminole. Florida Anthropologist, Vol. 4, No. 1-2: 2-17.  
Reprinted in "Indian and Spanish Selected Writings, Charles H. Fairbanks, et.al., eds., pp. 64-68,  
University of Miami Press, Miami.**

**Obermeyer, Sherwood F. Jr.**

**1990 Private photographs.**

**Sturtevant, William**

**1990 Beaded Shoulder Sashes and Pouches. Lecture and slides, "Patchwork and Palmettos," Ft.  
Lauderdale Historical Association.**

---

[Beading & Designs on Seminole Pouches & Bandoliers](#)

[Backing, Edging & Detailing on Seminole Pouches & Bandoliers](#)

[Seminole Bandolier Attachment & Conclusions](#)

[Return to the Introduction to Seminole Pouches & Bandoliers](#)

[Complete Index to Articles in \*19th Century Seminole Mens Clothing\*](#)

---

Contributed by [Rick Obermeyer](#) E-mail: [orick@prodigy.net](mailto:orick@prodigy.net)

From the book *19th Century Seminole Mens Clothing*

© 1991-2000 Sherwood F. Obermeyer Jr., 2124 Miscindy Place, Orlando, FL 32806

---

[Return to NativeTech's Main Leather & Clothes Menu](#)

[Leather & Clothes Bibliography and Books to Buy On-Line](#)

---



**Text and Graphics**  
© 1994 - 2003 [Tara Prindle](#)  
unless otherwise cited.



courtesy National Museum of the American Indian  
Smithsonian Institution

# Fingerwoven Sashes and Garters

comments by Rick Obermeyer (Dec., 1990)

*in 19th Century Seminole Men`s Clothing*

[Rick Obermeyer ~ Editor](#)

There are scant, if any, written descriptions of Seminoles wearing fingerwoven sashes and garters. But there is ample evidence from illustrations and from surviving examples that not only was fingerweaving common, it was necessary for a chief's complete attire. Seven of the nine Seminole portraits in McKenney-Hall clearly show fingerwoven sashes. An eighth portrait, "Foke Luste Hajo," has a narrow black sash that is a "probable" because it has seed beads along its outside edges. The sash colors in the McKenney-Hall portraits are:

| PORTRAIT                         | MOTIF    | WOOL COLORS |      |          |                  |
|----------------------------------|----------|-------------|------|----------|------------------|
| Osceola (sash)                   | diamonds | black       | dark |          | (w/white beads)  |
| (garters)                        | diamonds | black       | blue |          | (no beads shown) |
| Foke Luste Hajo                  | solid(?) | black       |      |          | (w/white beads)  |
| Itcho Tustennuggee               | W' s     | black       |      | red      | (w/white beads)  |
| Julcee Mathla                    | W's      | black       |      | white    | (w/white beads)  |
| Neamathla                        | W' s     | black       |      |          | (w/white beads)  |
| Tukosee Mathla (sash)            | chevrons | black       | blue | white(?) | (w/white beads)  |
| (garters)                        | diamonds | black       | blue |          | (w/white beads)  |
| Yahahajo                         | diamonds | black       | blue |          | (w/white beads)  |
| Billy Lowlegs                    | diamonds | ?           |      |          | (w/white beads)  |
| photo, "old Tallahassee" (1890s) | diamonds | black(?)    |      |          | (w/white beads)  |

Neither the design nor the colors of Billy Bowlegs' sash can be determined from the his McKenney-Hall

**lithograph. An 1858 photo of him (Fig. 310, Fundaburk, 1956) more clearly shows the pattern and the use of beads. It's easy to surmise from the black and white photo that at least black was used, but other dark colors (if any) are conjectural.**

**Osceola's sash does not appear in either of George Catlin's painting of him, but it is verified in the Robert John Curtis portrait (Goggin, 1955, and Fig. 291, Fundaburk, 1956), and by an example in the Florida Museum of Natural History, Gainesville, purported to be his.**

**Some other examples of fingerwoven sashes are:**

| <b>PORTRAIT</b>                            | <b>MOTIF</b> | <b>WOOL COLORS</b> |           |     |                  |
|--------------------------------------------|--------------|--------------------|-----------|-----|------------------|
| Fl.Mus.Nat.Hist.,Gainesville "Osceola's"   | diamonds     | black              | dark blue |     | (w/white beads)  |
| (1830's)                                   | cmplx chev.  |                    | blue      | red | (w/white beads)  |
| (1840's)                                   | diamonds     | black              |           | red | (w/white beads)  |
| Milwaukee Public Mus.                      | diamonds     | black              |           | red | (w/white beads)  |
| "No-Kush-Adjo" (Fig. 300, Fundaburk, 1956) | diamonds     | ?                  |           |     | (w/white beads?) |
| photo, "Old Tallahassee" (1890's)          | diamonds     | black(?)           |           |     | (w/white beads)  |
| Am.Mus.Nat.Hist.,NY (late 19th cent.belt)  | diamonds     | black              | blue(?)   | red | (w/white beads)  |

**There are also at least two examples in the Museum of the American Indian, Heye Foundation, one of which was collected before 1840 (Spec. 22/9559) and the other at least by 1906 (Spec. 1/8201).**

**The number of tassel cords varies from three to eight on each end. The tassels are heddle-woven, often finished off by clumping into a short three-strand braid, the whole cord and tassel about .6cm wide by 115cm to 160cm long. The tassels on early 19th century examples are about the length of a little finger or smaller; the tassels on later examples can be as long as a hand.**

**If Catlin doesn't help us out much with fingerwoven sashes in his Seminole portraits, he does provide information for a waist band and some garters. The full length portrait of Osceola indicates two or more waist sashes, judging from the number of ties hanging loose. Seminoles did occasionally make belts by beading designs onto wool or buckskin, with added heddle woven tassel cords, but Osceola doesn't appear to be wearing something like that, even though no sash patterns are discernible. Specks of white paint indicate white beads used in a way that could only be included in fingerweaving, here done with red and blue yarns.**

**Catlin provides us information on fingerwoven garters:**

| <b>PORTRAIT</b> | <b>MOTIF</b> | <b>WOOL COLORS</b> |         |  |                 |
|-----------------|--------------|--------------------|---------|--|-----------------|
| Osceola         | diamonds     | black              | blue(?) |  | (w/white beads) |
| Mick-E-No-Pah   | diamonds     | black              | blue    |  | (w/white beads) |

**The designs and construction of Osceola's and Mick-E-No-Pah's garters are identical, so it would be easy to assume that the colors were also identical. The McKenney-Hall lithograph shows yellow ties for**



Osceola's garters, but besides being atypical, this detail color does not fit in with how these things are made. So, the yellow on the ties might be viewed with suspicion. True, one of Osceola's garters has survived, "but they have faded so badly that the original color cannot be determined; they could have been the blue and black shown in (McKenney-Hall)" (P. 183-84, Goggin, 1955).

Some other examples of garters are:

| PORTRAIT                                                                 | MOTIF    | WOOL COLORS |     |                 |
|--------------------------------------------------------------------------|----------|-------------|-----|-----------------|
| Fl.Mus.Nat.Hist., Gainesville (early 19th cent.?)                        | diamonds | black       | red | (w/white beads) |
| Denver Art Museum (Spec. 1965.226; Fig. 17, Conn, 1979) (mid-19th cent.) | diamonds | black       |     | (w/white beads) |
| photo, "old Tallahassee" (1890s)                                         | diamonds | black(?)    |     | (w/white beads) |

The Museum of the American Indian, Heye Foundation, has a set of garters (Spec. 1/8204). The two in the set are the same size, and have the same diamond design, but there are enough slight differences in construction to make one wonder if they were, in fact, originally the same set, or if they are each from two different sets.



While the sashes have heddle woven tassel cords, garters appear to have merely braided 8" to 10" fringes, usually four on each end.

Fingerwoven garters and sashes were still worn to the end of the 19th century, but mostly only by older men.

[Click image to enlarge](#)

As wool leggings were discontinued in favor of buckskin ones, so were fingerwoven garters no longer needed. Fingerwoven sashes were replaced by sashes beaded on a heddle loom, though with the same kinds of larger tassels and heddle woven cords added on. These heddle beaded sashes with tassel cords are still made and used at the Green Corn Dances. A contemporary example was shown to the author at the Miccosukee Reservation in 1987.

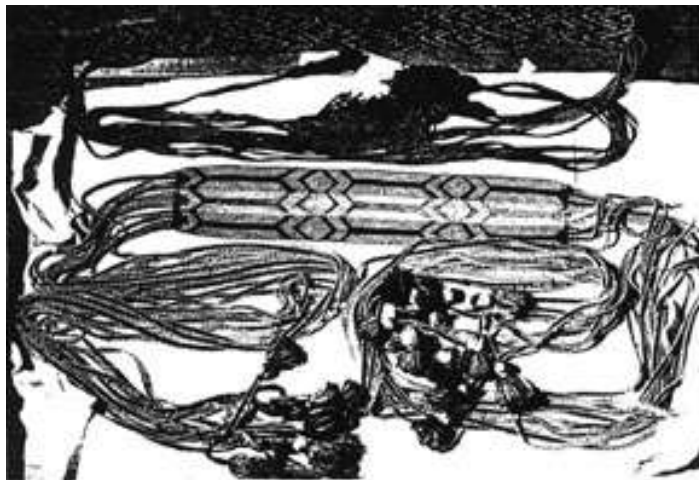
The idea of fingerweaving may boggle the mind of a Seminole hobbyist. Although time consuming, it's no more so than loom beading, and it's much easier to do than it appears. And it helps that the fingerwoven part of a sash need not be long enough to go from hip to hip. The fingerwoven section of Seminole sashes might be 2" to 3" wide and about 3' long, all the rest of the 7' to 8' length being cords and tassels. A series of three articles on fingerweaving by Richard Conn explains how to make complicated "arrow," "flame," and "reflex arrow" designs. The reenactor might be relieved to learn that he need not learn these complex weaves



Florida Museum of Natural History, Gainesville

because the Seminole never used them. So, only the first and most basic of Mr. Conn's three articles are included here, which describes how to make the "W" pattern.

Seminoles also used diamond patterns, which can be made three different ways. Although diamonds were common, and almost the only pattern used for garters, those instructions are not yet included here.



Florida Museum of Natural History, Gainesville

Most of the McKenney-Hall pictures show white beads included in the W patterns, and on the edges of the heddle-woven tassels. The hobbyist should use 8/0 size white "pony" beads, and can get them threaded onto yarn by using a fingernail of beeswax to twist a half inch of one end into a hard thin point. The beads are left behind as the yarn is woven into the pattern,

How to do heddle-woven fringes will be described in the future. For now, a hobbyist can finish off his sashes with clumped three-ply braided sashes.

Color choices seem to be pretty limited. It should be apparent from this review that Seminole were as conservative with their fingerweaving colors and designs as with most other items of their apparel. Only two of four are used in the Seminole portraits of McKenney-Hall: red, black, royal or dark blue, and white.

How much wool is needed? The author once made a sash that seemed to work out to be the right size using 64 strands, each about 17 feet long.

Granted, there is a problem finding real wool yarn in Florida. Acrylic yarns are fine for learning and for practice pieces. But the time needed for a full piece really is worth tracking down real wool yarn to use for it. Mid-size wool knitting yarn is readily available for \$4 or \$5 a skein in most Northern cities, and you'll only need two or three skeins for a sash. Try to locate a Yankee friend or relative to help you out.

---

Following is the first of three articles by Richard Conn, from the 1972 6(10):2-5 issue of *American Indian Crafts and Culture*., pgs. 14-15. It is included with his permission.

[FINGERWEAVING - Part 1, by Richard Conn](#)

---

## REFERENCES

Conn, Richard  
1972 FINGERWEAVING-Part 1. *American Indian Crafts and Culture*. 6(10):2-5, 14-15.

**1973a FINGERWEAVING-Part 2. American Indian Crafts and Culture. 7(1):2-7.**

**1973b FINGERWEAVING- Part 3.Amerlcan Indian Crafts and Culture. (2):2-7.**

**1979 NATIVE AMERICAN ART IN THE DENVER ART MUSEUM. University of Washington Press, Seattle and London.**

**Fundaburk, Emma Lila**

**1958 SOUTHEASTERN INDIANS LIFE PORTRAITS. Scarecrow Reprint Corporation, Metuchen, NJ. 1969.**

**Goggin, John M.**

**1955 "Osceola: Portraits, Features, and Dress," The Florida Historical Quarterly, XXXIII: 3 & 4, Gainesville.**

**McKenney, Thomas L. and James Hall**

**1836-44 Portrait Gallery of American Indians. Ed. James D. Horan. Crown Publishers, 1986.**

---

[Fingerweaving Instructions by Richard Conn](#)

[Complete Index to Articles in \*19th Century Seminole Mens Clothing\*](#)

---

Contributed by [Rick Obermeyer](#) E-mail: [orick@prodigy.net](mailto:orick@prodigy.net)

From the book *19th Century Seminole Mens Clothing*

© 1991-2000 Sherwood F. Obermeyer Jr., 2124 Miscindy Place, Orlando, FL 32806

---

[Return to NativeTech's Main Leather & Clothes Menu](#)

[Leather & Clothes Bibliography and Books to Buy On-Line](#)



Text and Graphics  
© 1994 - 2003 [Tara Prindle](#)  
unless otherwise cited.



*Ojibwa chevron sash of several bands woven together. Photo courtesy Mllwaukee Public Museum.*

## Fingerweaving Part 1

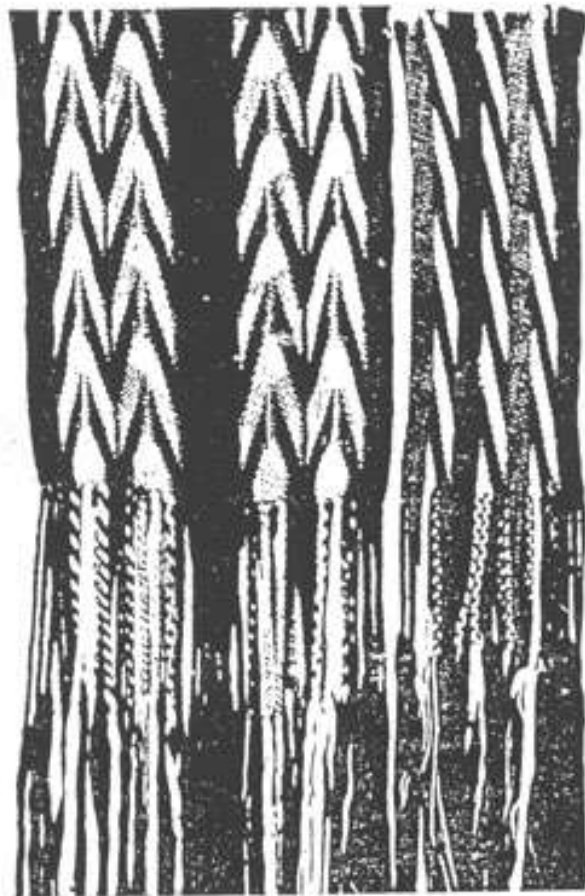
by Richard Conn (1976)  
*(used with permission of the author)*

*in 19th Century Seminole  
Men's Clothing*

[Rick Obermeyer ~ Editor](#)

Some years ago, I began a series of articles in "American Indian Tradition" on the various kinds of braided sashes. Unfortunately, this magazine went out of business after the first article was published, and the others were never printed. In the time since, people have written to ask for instructions on the material that was to be covered in the unpublished articles. So far I have had to disappoint them. Now, "American Indian Crafts 6 Culture" has made it possible to start again and, hopefully to finish. Let's hope this series doesn't prove a jinx to Mr. Stewart. This first article will cover the basic details - how to calculate the amount of yarn, how to arrange it, etc. - and the simple chevron pattern. The next will be concerned with arrow pattern and the process of braiding several bands simultaneously. The final article will explain the flame and reflex patterns and some ways of treating fringe.

The first step in making a piece of finger weaving is, obviously to figure out your pattern and then plan how much yarn you will need. I expect you will work out the actual design from pieces you have seen, whether in photographs or in the flesh. After you have worked out the pattern and the colors, you should make a full sized sketch of one unit; that is, one full repeat of the design. With this sketch, you will be sure of what you're going to make and it



*Fig. 1 Two finger-woven sashes Winnebago (left) and Menomoni (right). Both designs are variations of the basic technique. Photo courtesy of the Museum of the American Indian.*



will also help you figure the yarn correctly.

Most sashes and garters are woven of sweater-weight knitting yarn that comes in hanks of a specified number of yards, marked on the wrapper. Measure your sketch to see how wide your project is to be, and multiply this by twenty-four (since sweater-weight yarn will work out at about twenty-four strands to the inch of width). If you are using finer yarn, you may have to make a practice piece to determine the strand width count. Next, decide on the length of the braided section and add 10% for the "take/up" or length you will lose by the strands'/lateral movement in braiding. Then add extra length for the fringes on either end and you have the total length. Using your sketch, work out the number of strands required For each color on the basis of twenty-four to the inch. Multiply this by the overall length and you will know how much yarn of each color la required. Then, it's off to the yarn shop.

Many Indians like Red Heart brand yarn, and it does work up well. You should get wool yarn, as both cotton and synthetics aren't very elastic. But you don't need to buy an expensive wool yarn like Shetland or Argyle. Something from Woolworth's will do very well.

Having your yarn, you are ready to set it up for work. You must find two winding posts and set them the proper distance apart; that is, the overall sash length you figured out before. The winding posts must be two solid objects around which you can wind yarn without slipping You might clamp two sticks to the edge of a work table, or use two ladder-back chairs, or anything else suitable. Tie an end of yarn to one poet and start winding back and forth until you have enough strands of the first color Although it sounds silly to mention It, don't forget that each round trip between posts gives two strands. I have seen people wind off yards of yarn without realizing they had counted only one side. End at the first post, untie your original knot, tie it to the other end and cut off the excess. Repeat for the other colors. Don't worry about having the colors in proper sequence yet.

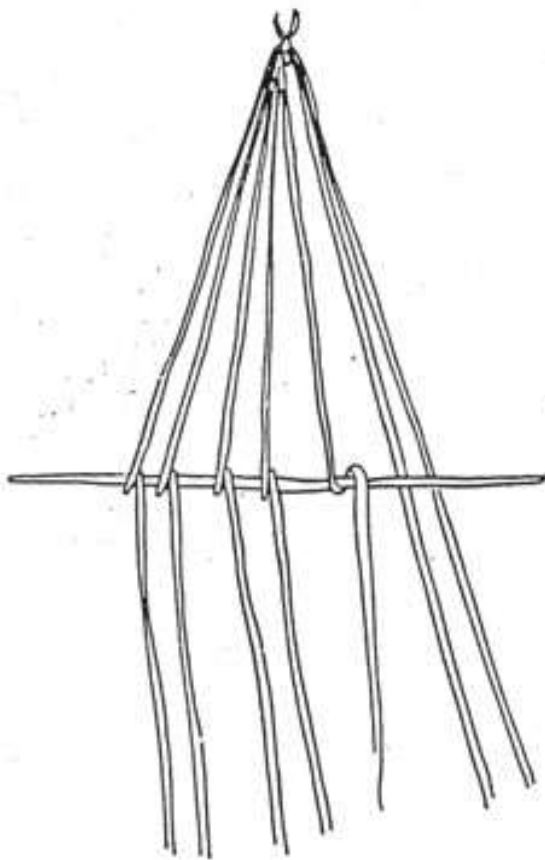


After the yarn is all wound off and tied, it must be set in order. At the second winding post (the one opposite the knots), insert the head tie string as shown in Fig. 2. This should be a piece of strong cord about two yards long. Then go to the first winding post, untie the knots and cut all the yarn loops open. Then tie a second heavy cord around this yarn bundle as shown in Fig. 2. Next you have to find a convenient place

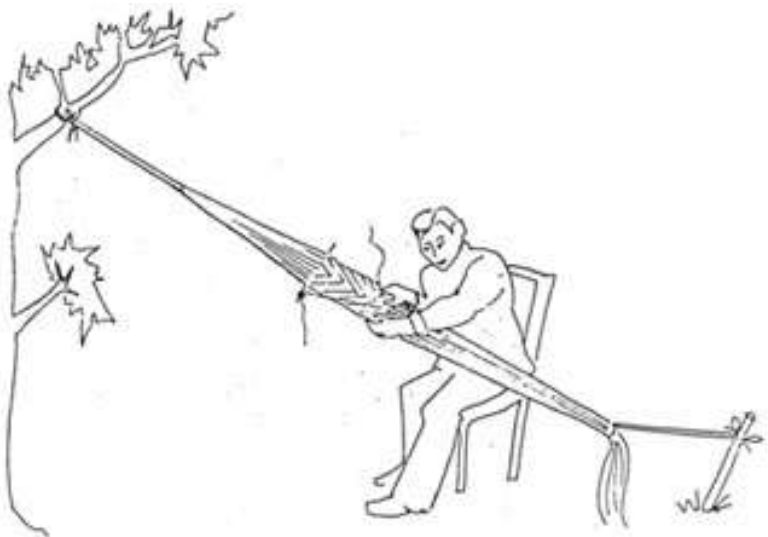
*Fig 2 Top: How to insert the head and bottom tie strings. Bottom: How the yarn is wound.*

to set up the yarn bundle and work, Personally, I like to work with the yarn at about a 45 degree angle as shown in Fig. 3. Others prefer it more nearly vertical or horizontal.

With the yarn arranged comfortably, you must insert the head stick. This may be a peeled willow shoot, a piece of dowel, or something similar. It should be about three-eighths inch in diameter and eight inches longer than the braiding will be wide. Lift up one strand of the color that goes in the center, measure down from the upper tie a distance equal to the fringe of one end, and loop this strand around the head stick. Continue looping the center color strands around the stick and then check the distance again.



*Fig. 4 How to loop strands around the head*



*How to arrange the yarn bundle for working.*

**Fig. 4 shows how these loops are made. Continue looping the rest of the strands onto the head stick, working alternately on both sides, and arranging the colors in proper order. When all are in place, be sure the head stick is square, and push the strands tightly together.**

**Finally, check the tension of the yarn bundle Each strand should be taut, so that it does not sag, but not tight. You should be able to raise or lower any strand several inches without difficulty. Now, you're ready to begin braiding.**

**At this point, let me ask a favor. Finger weaving is great fun, and the whole point of these articles is to let you in on the enjoyment But, almost everyone who wants to learn the process is thinking of making an arrow sash. The arrow process isn't easy at first and you will have more luck with it if you do some practicing with the basic method first. Let me urge you to do one or two pieces in the basic chevron pattern in order to get the feel of the technique before going on to the more complicated patterns. I've seen enthusiastic people insist on beginning with an arrow design make a mess of it, and give up. This is like learning to drive a diesel truck - too much for the first lesson.**

**First, then, you should try a single band of plain braiding. With your yarn in order, pick up an edge strand, pull it loose from the bottom tie, and simply weave it through the rest, going alternately over and under. As it comes out at the other edge, wrap it several times around the head stick. Then go back to the starting point, pick out the next edge strand and do the same. This time, be sure you've alternated with the course above; that is, you are now going over the strands you went under before and vice versa. At the end, unwrap the first working strand from the head stick, and turn it over the second working strand. The first strand must re-enter the work in proper alternation also - if the second working strand went under the last taut strand, the first working strand must go under it as it re-enters the yarn bundle. Wrap the second working strand around the head stick and tuck the first into the bottom tie.**

**Fig. 5. diagrams how this basic weave should look. Just continue the process above, picking up each new working strands at the same edge and putting each old working strand back into the bundle**

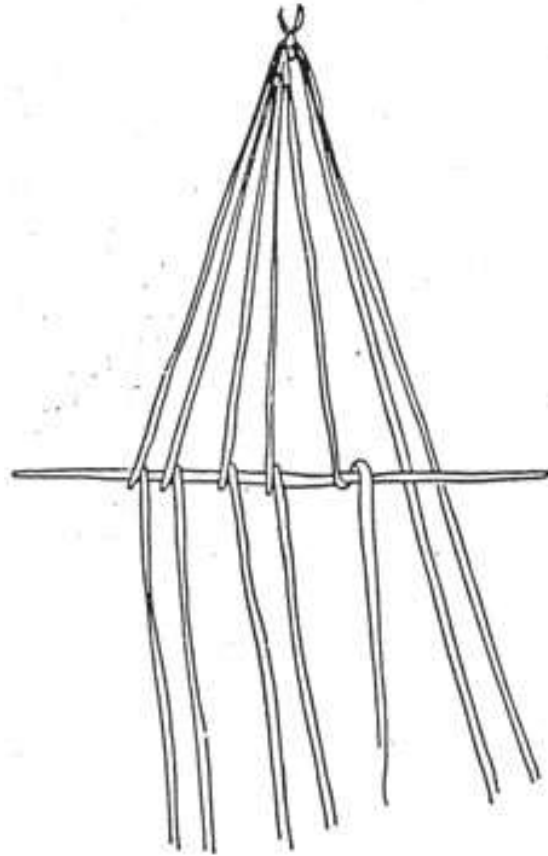
properly, and in a little while, you'll see a pattern forming. Because you are taking up yarn from one side and replacing it on the other, your pattern will have diagonal stripes as in Fig. 1, right.

This single band braiding is very easy. The only problem is making sure the strands alternate correctly. If you do get one strand going the wrong way, your mistake cannot be righted two or three courses later and will only get worse. If you do make a mistake, you must go back and straighten it out.

The next step is a band of double-band braiding - the kind that will make chevron designs.

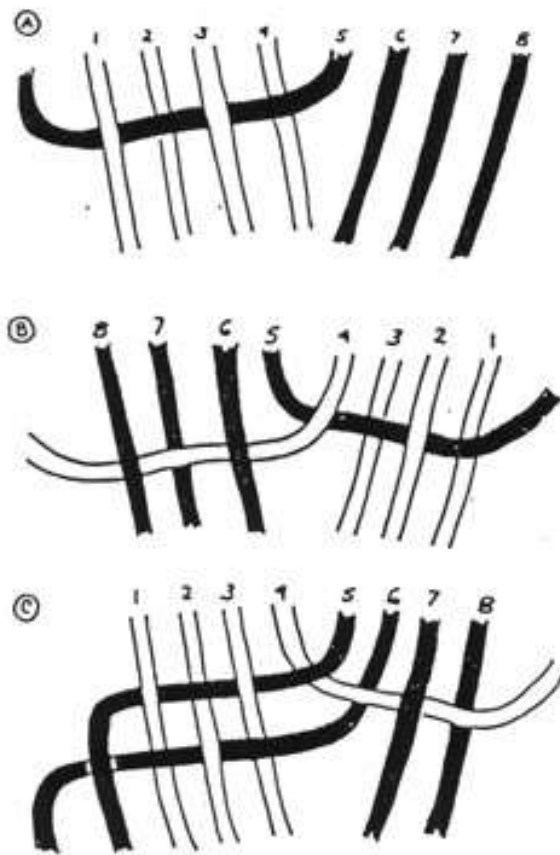
Now you must work with an even number of strands, since the work begins from the center

and each half must have the same number of strands. Find the center point and pick up the strand on one side of it - either side. Weave this strand through the opposite side, going over and under and so on until you wrap the strand around the head stick. Then, turn the head stick 180 degrees. The weaving you just did will now be opposite its original place. Take the strand that was on the other side of the first center (It will now be in the same position as the first one you picked up) and weave it through the side opposite it, being sure to pass it under the first taught strand.



*Fig. 5 The single band braiding process. In actual practice, the strands are tight together. Here and in the following figure, they have been opened up for clarity.*

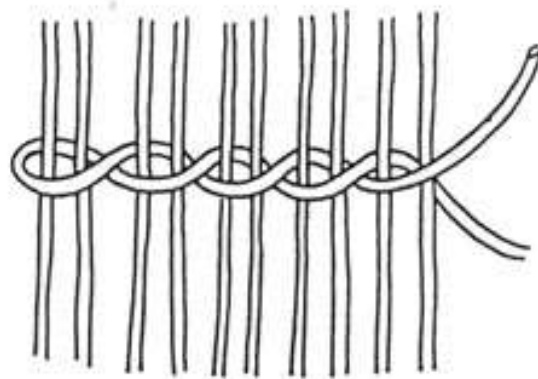
Fig. 6 shows how this looks. I've made one side dark and one light to clarify the operation. Turn the head stick back to its original position, pick up the next center strand from the first side and weave it through the second side; that is, this third working strand goes along Just below the first one you did. The fourth will go below the second, and so on. By the way, each crossing of a bent with one or more working strands is called a course of weaving. In this case,



*Fig. 6 A, First half of the first course. B, Second half of the first course. Note that the work has been reserved. C, First half of the second course. The work has been reversed again.*

two flat sticks of the same size. Place the halves of the center bar over the working edge and clump them together firmly with string or rubber bands. Then untie both ends of the work, roll it up, and it will hold itself securely until you're ready to work some more.

When you have finished your piece of braiding, insert a row of twining stitches at both ends to keep it from unraveling. Fig. 7 shows how these stitches are done. You may use a short piece of yarn, double it around one edge of the sash, twine, and tie at the other edge. You may also use two long pieces and let them add to the fringes at both sides. Some people prefer to do the



*Fig. 7 How to make the turning stitches.*

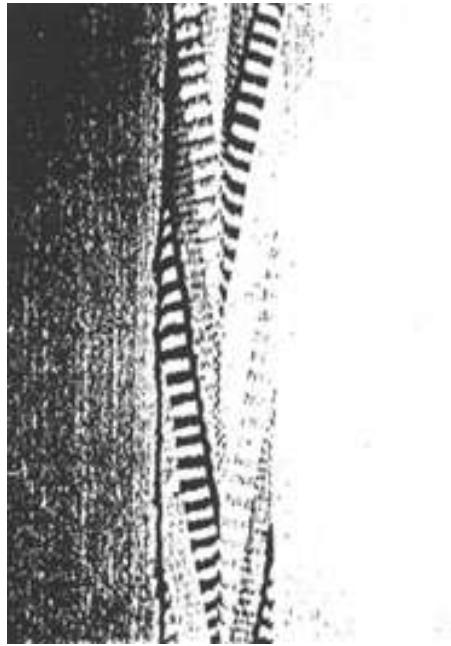
twining stitches at the upper end right after inserting the head stick. Whether you do or not, be sure to put them in both ends before releasing the tension on the taut strands. With twining in place, untie the yarn and cut open the loops at the upper end.

The basic process makes chevron-like designs. You can vary these according to the colors you choose and by varying the size of the chevrons. For example, one chevron might be ten strand wide, another

working strands 1 and 2 are a course since together they crossed the whole band. After the third working strand is in place, the first is turned over it and back into the yarn bundle as before. Again, you must be very careful to set a proper alternation of taut strands as you go. From that point, the process goes on weaving in first one side and then the other of each course. After you have done several courses, untie the bottom string and slip all the loose ends back into the yarn bundle.

When you stop work for the evening, it is necessary to hold the last row of weaving tight. For this, you make a center bar which can be a stick about one inch in diameter and split lengthwise in two, or it could be

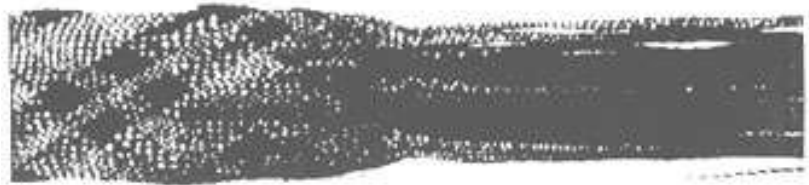




*Fig. 8 Chevron sash with striped designs.*

colors thus: ABABABAB, making sure the same color was nearest the center on both sides. As you work all of color A will show on the surface in one course and all of color B the next time. Fig. 8 shows how this striping looks.

The preceding directions make what is called a warp-face braid, which means that the working strands hardly ever show on the surface. This is caused by pushing the strands closely together on the head stick before braiding and by keeping the

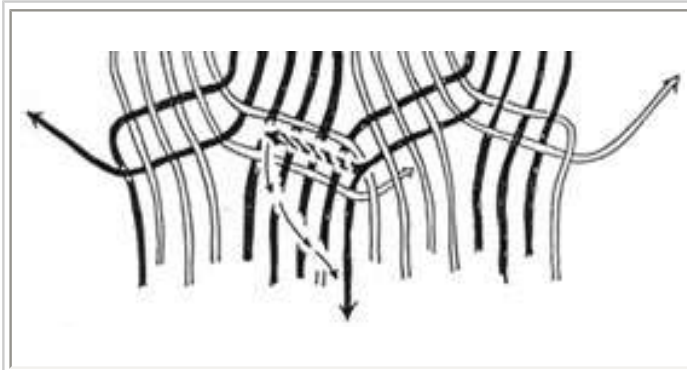


*Fig. 9 Sauk & Fox plain-face sash. Note the checkerboard appearance caused by letting the working strands show. Photo courtesy Museum of the American Indian.*

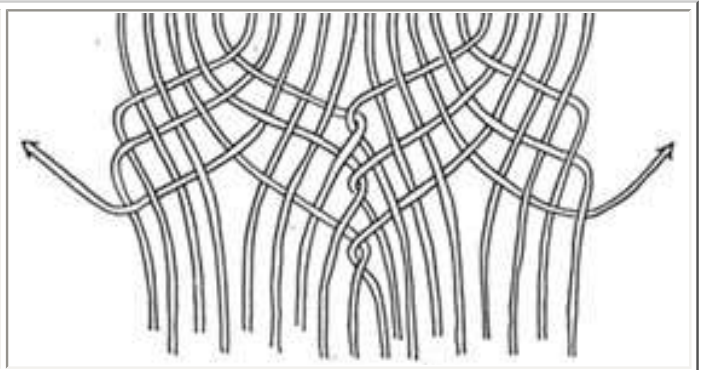
yarn bundle taut. There is another kind of plain finger weaving in which the working strands do appear on the surface and the work resembles Monk's cloth woven diagonally. This is the process used to make the Iroquois sashes and the beaded edges of Osage arrow sashes.

Fig. 9 shows an example of this plain face braiding. To do this kind of finger weaving, space out the strands on the head stick so they just touch and no more, and loosen up the tension on the yarn bundle so the strands hang a little slack. As you work, push each working strand up against the preceding one as tightly as you can. This plain-face braiding is harder to master than the warp-face variety. Tension is the problem, and you will have to practice a bit to get the feel of it. In the next article, we will take up the arrow pattern. Again, let me urge you to practice the basic process and familiarize yourself with it before attacking the more involved arrow designs.

six, and so on. You may also make chevrons half one color and half a second. To do this, just set up an equal number of the two colors exactly opposite each other on the head stick. The colors will alternate as you braid, so that if you started with color A on the left, it will come out on the right next time, then back to the left. etc. You may also vary chevrons with striping. Here you set up strands of two colors in adjacent pane. Suppose you wanted a striped chevron eight strands wide. In each half of the work, you would arrange eight strands of the two



*How to interweave adjacent bands. The dotted arrow shows the edge strand as wrapped around the head stick before it is returned to the yarn bundle.*



*How to interlock adjoining bands, so as to keep the background colors separate.*

---

[Return to the Introduction to Fingerwoven Sashes & Garters](#)

[Complete Index to Articles in 19th Century Seminole Mens Clothing](#)

---

Contributed by [Rick Obermeyer](#) E-mail: [orick@prodigy.net](mailto:orick@prodigy.net)

From the book *19th Century Seminole Mens Clothing*

© 1991-2000 Sherwood F. Obermeyer Jr., 2124 Miscindy Place, Orlando, FL 32806

---

[Return to NativeTech's Main Leather & Clothes Menu](#)

[Leather & Clothes Bibliography and Books to Buy On-Line](#)



Text and Graphics  
© 1994 - 2003 [Tara Prindle](#)  
unless otherwise cited.

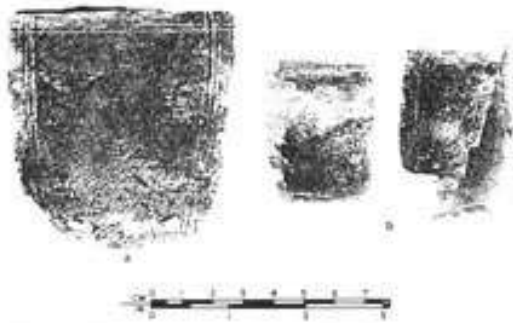


Figure 30. a. One of a pair of armbands  
b. a pair of bracelets

# Introduction to Seminole Accessories

*in 19th Century Seminole  
Men's Clothing*

[Rick Obermeyer ~ Editor](#)

*courtesy Harry Piper and Jacquelyn G. Piper Archeological Excavations at  
the Quad Block Site, 8-Hi-998 Piper Archeological Research, Inc., St.  
Petersburg, FL. 1982.*

## QUOTES

"Several of the Indians' fighting techniques were calculated to strike terror. Some warriors entered battle naked except for a loin cloth, but their bodies were streaked with bizarre symbols in red and black paint. Other fighters wore battle costumes ranging from captured military uniforms to their traditional finery of feathers and medallions beaten from silver coins. Especially effective was the war cry, shrieked each time a shot was fired, which began like a growl and ended with a shrill yelp. The best rendition that any contemporaries could give in print was "Yohoehee," which does not create the crawling of the skin that the soldiers felt who heard it first hand.

...Hair was worn in two strips an inch wide, one running from temple to temple, the other at right angles to it from the center of the forehead to the base of the skull, with a small braid at each end. They worked feathers into this coiffure and dyed their hair and eyebrows black, sometimes with shoe polish. There might be a half red circle of paint under each eye and silver rings in the nose. A few famous braves had their ears slit and elongated. If a tunic was worn, it was spangled with ornaments hammered from silver coins." *Pages 123-124, Mahon, 1967*

(Billy Bowlegs) "Suspended from his neck were silver crescents, 'to which was appended a large silver medal with... likeness of President Van Buren...; his throat was thickly covered with strands of large blue beads, and he also wore bracelets of silver over the sleeves of his decorated hunting shirt.'" *Porter, 1967*

(1852 trip to Washington) "On this northern excursion, Billy Bowlegs was able to meet President Millard Fillmore and, with the secretaries of War and Navy and the Commissioner of Indian Affairs present in the audience, he was presented with a medal by the President." *Covington, 1982*

(1880) "Having no pockets, the Seminole is obliged to submit to several inconveniences; for instance, he wears his handkerchief about his neck. I have seen as many as six, even eight, handkerchiefs tied around his throat, their knotted ends pendant over his breast; as a rule, they are bright red and yellow things, of whose possession and number he is quite proud. Having no pockets, the Seminole, only here and there one excepted, carries whatever money he obtains from time to time in a knotted corner of one or more of his handkerchiefs."

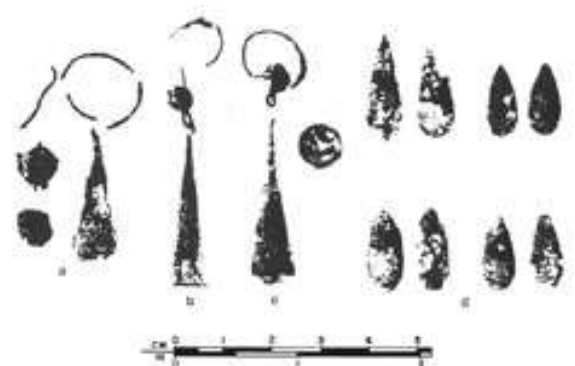


Figure 32. a-c. Sample of white metal earbobs;  
d. unidentified, white metal,  
teardrop shaped ornaments.

"Nor is the wearing of finger rings more common than that of rings for the ears. The finger rings I saw were all made of silver and showed good workmanship. Most of them were made with large elliptical tablets on them, extending from knuckle to knuckle. These also were home-made."

"...Silver wristlets are used by the men for their adornment. They are fastened about the wrists by cords or thongs passing through holes in the ends of the metal. Belts, and turbans too, are often ornamented with fanciful devices wrought out of silver. It is not customary for the Indian men to wear these ornaments in everyday camp life. They appear with them on a festival occasion or when they visit some trading post." *MacCauley, 1887*

(ca. 1896) "Another characteristic of the dress is the number of handkerchiefs worn, knotted loosely about the neck. Regardless of the temperature, the Indian adorns himself with six, eight or perhaps a dozen of the bright bandannas, exhibiting great pride in the number he possesses. A belt of buckskin completes the costume. From this are suspended a hunting knife, a revolver, a pouch in which is carried the ammunition and small articles necessary for the chase." *Moore-Willson, 1914*

"They also wear a watch chain and numerous safety pins fastened to their shirts. but I have never yet see one carry a watch...."

"The men do not paint their faces, but occasionally wear ornaments when visiting a white man's camp or going to a town or on a trading expedition... Sometimes the men wear bracelets of silver, but it is not a very common custom, as I have never seen but one Indian adorned in this manner." *Cory, 1895*

"Bracelets are another form that is quite rare; only on ceremonial occasions are those that are left worn. They are usually an inch to an inch and a half wide and are quite thin. At each end is a small perforation and a buckskin thong is run through to hold the bracelet in place."

"Rings are made of thin strips of silver soldered with a overlapping joint. They are about two- to three-sixteenths of an inch in width. They are still worn quite extensively by the men and women: the women often wear several on each hand." *Goggin, 1940*

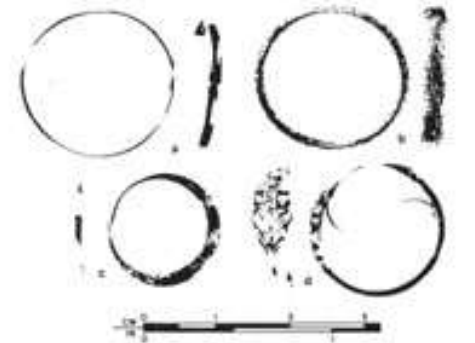


Figure 33. a. Copper finger ring; b. white metal finger ring; c. copper earrings; d. gold earrings.

---

## SEMINOLE ACCESSORIES

---

[Breechcloths](#)

[Seminole Silverwork](#)

[Turbans](#)

[Peace Medals for Seminole Outfits](#)

[Seminole Beads](#)

[Face Painting](#)

[Complete Index to Articles in 19th Century Seminole Mens Clothing](#)

---



# REFERENCES

**Cory, Charles B.**

**1896 Preface to Second Edition (and) The Seminole Indians, HUNTING AND FISHING IN FLORIDA.**

**Covington, James W.**

**1982 THE BILLY BOWLEGS WAR, The Mickler House Publishers, Chuluota**

**Goggin, John M.**

**1940 "Silver Work of the Florida Seminole." E1 Palacio 47:25-32.**

**MacCauley, Clay**

**1887 "The Seminole Indians of Florida." Fifth Annual Report of the Bureau of Ethnology, Washington DC.**

**Mahon, John K.**

**1967 HISTORY OF THE SECOND SEMINOLE WAR 1835-1842. University of Florida Press, Gainesville.**

**Moore-Willson, Minnie**

**1914 edition, THE SEMINOLES OF FLORIDA, Moffat, Yard and Company, New York.**

**Porter, Kenneth W.**

**1967 "Billy Bowlegs (Holata Micco) in the Seminole Wars." Florida Historical Quarterly 45: 219-42.**

---

Contributed by [Rick Obermeyer](#) E-mail: [orick@prodigy.net](mailto:orick@prodigy.net)

From the book *19th Century Seminole Mens Clothing*

© 1991-2000 Sherwood F. Obermeyer Jr., 2124 Miscindy Place, Orlando, FL 32806

---

[Return to NativeTech's Main Leather & Clothes Menu](#)

[Leather & Clothes Bibliography and Books to Buy On-Line](#)

---



Text and Graphics  
© 1994 - 2003 [Tara Prindle](#)  
unless otherwise cited.



(1910) American Museum of Natural History, New York

# Breech Cloths

by Rick obermeyer (Dec. 1990)

*in 19th Century Seminole Men's Clothing*

[Rick Obermeyer ~ Editor](#)

---

## QUOTES

""Tiger,' the oldest, was about seventy years old and had fought in the Seminole war... His broad shoulders were artistically draped in two ragged shirts of "hickory," or striped homespun. the inner one about a foot longer than the outer, and reaching nearly to his knees. A breech cloth and moccasins completed his attire." *Beverly, 1876*

(Pratt, 1879) "The men wear the usual breech clout, a calico shirt ornamented with bright strips of ribbon, and a small shawl of bright colors folded the width of the hand and wrapped around the head like a turban." *Sturtevant, 1956*

"The costume of a Seminole Indian usually consists of a turban, a breech cloth, a calico shirt, and a neckerchief. This is the usual costume worn by them when in their own camp and among their own people..."

"...They hunt in the morning and evening... On these hunting expeditions he wears nothing but a cotton shirt unless it is a very rough country, when he sometimes wears leggings made of soft leather." *Cory, 1895*

## CONSTRUCTION

The Seminole breechcloth has the tapered shape typical of all Southeast breechcloths. William C. Sturtevant comments that it is "insofar as the scanty evidence shows, without changes during Seminole history. It persisted until replaced by pants." (Sturtevant, 1967)

An example collected by Alanson Skinner in 1910 is in the American Museum of Natural History (Cat. #50.1/2290). It is made of dark blue wool, with yellow edging that extends slightly past the points on the ends. The two illustrated in an "1838 drawing" also appear to be pointed (Sturtevant, 1962).

In a few older examples, the taper is cut square. All of the few known decorated examples have this squared off end.

The exact length must have varied according to personal preference, with the tendency to the short side. They may have barely reached to mid-thigh (figure 9, Sturtevant, 1962). Examination of engravings in Fundaburk doesn't

seem to show the tips of any breechcloths. An 1832 example collected by the Count de Pourtales, a Swiss nobleman, hangs below the kneecaps (Plate 16, Conn, 1979). A postcard of "A Bride and Groom" from about 1895 (Neg. 22524, Museum of the American Indian, Heye Foundation) shows a narrowed squared end about even with the knees. A photo in the Florida State Archives of "Tommie, son of Chief Tallahassee" taken in the 1890's, shows a breechcloth tip that stops just short of the kneecaps, as well as do several pictures of Old Tallahassee, himself (Neg's. #971, #3505).

Perhaps by the late 19th century, the breechcloth became very short, or even optional. The plain shirt was worn so regularly that the author does not know of any photos of a casually bare chested Seminole. While Old Tallahassee shows tips of a breechcloth in a picture from 1882-86 (Neg. 3505, Florida State Archives), neither of his two sons in the same picture do. The plate facing page 172 in Moore-Willson shows Charlie Peacock oddly holding a bandanna across his thighs in what could be a gesture of modesty. Careful examination of other late 19th century Seminole photographs don't reveal breechcloth tips (Parks, 1977, 1981). Maybe, like with a Scots highlander and his kilt, whether or not anything was worn under a plain shirt depended on the weather and the wearer's inclination.

Apparently, earlier breechcloths could be decorated. The 1832 example collected by the Count de Pourtales seems to have sewn white cloth applique just inside the side edges. A beaded presumed Seminole example was auctioned at Sotheby's in 1989, and appeared in one of their ads that year in "American Indian Art" magazine. The best evidence that it is Seminole is the strong similarity between its cloth applique and beaded zig-zag design with designs on Seminole longshirts and on beaded moccasins. The Ocmulgee National Park, Macon, GA, has a beaded Creek/Seminole(?) example in its storage collection, a photo of which was displayed at the "Patchwork and Palmetto" exhibit the summer of 1990 at the Ft. Lauderdale Historical Society.



*(1910) American Museum of Natural History, New York*

---

## SEMINOLE ACCESSORIES

---

[Seminole Silverwork](#)

[Turbans](#)

[Peace Medals for Seminole Outfits](#)

[Seminole Beads](#)

[Face Painting](#)

[Complete Index to Articles in 19th Century Seminole Mens Clothing](#)

---

## REFERENCES

**Beverly, Fred**

**1876 "Among the Seminoles," *CAMP LIFE IN FLORIDA*, New York.**

**Conn, Richard**

**1979 *NATIVE AMERICAN ART IN THE DENVER ART MUSEUM*. University of Washington Press, 1979.**

**Cory, Charles B.**

**1896 Preface to Second Edition (and) The Seminole Indians, *HUNTING AND FISHING IN FLORIDA*. Reprinted in *THE SEMINOLE SOURCE BOOK*, ed. William C. Sturtevant, 1987.**

**Fundaburk, Emma Lila**

**1958 *SOUTHEASTERN INDIANS - LIFE PORTRAITS*. Scarecrow Reprint Corporation, Metuchen, NJ, 1969.**

**Moore-Willson, Minnie**

**1914 edition, *THE SEMINOLES OF FLORIDA*. Moffat, Yard and Company, New York**

**Parks, Arva Moore**

**1977 *THE FORGOTTEN FRONTIER: Florida Through the Eyes of Ralph Middleton Monroe*. (ed.) Banyan Books, Inc., Miami.**

**1981 *THE MAGIC CITY MIAMI*. Continental Heritage Press, Tulsa.**

**Sturtevant, William C.**

**1956 "R. H. Pratt's Report on the Seminole In 1879." *Florida Anthropologist*, VIII:1.**

**1962 "A Newly Discovered 1838 Drawing of a Seminole Dance." *The Florida Anthropologist*, XV:3.**

**1967 "Seminole Mens Clothing" in "Essays on the Verbal and Visual Arts; Proceeds of the 1966 Annual Spring Meeting of the American Ethnological Society," ed. June Helm, pp. 10-74. Seattle: American Ethnological Society; Distributed by the University of Washington Press. Reprinted in *THE SEMINOLE SOURCE BOOK*, ed. William C. Sturtevant, 1987.**



Contributed by [Rick Obermeyer](#) E-mail: [orick@prodigy.net](mailto:orick@prodigy.net)

From the book *19th Century Seminole Mens Clothing*

© 1991-2000 Sherwood F. Obermeyer Jr., 2124 Miscindy Place, Orlando, FL 32806

---

[Return to NativeTech's Main Leather & Clothes Menu](#)

[Leather & Clothes Bibliography and Books to Buy On-Line](#)

---



Text and Graphics  
© 1994 - 2003 [Tara Prindle](#)  
unless otherwise cited.



CHITSEE YOHOLO  
A Seminole Chief

# Seminole Silver Work

circa 1830s

by Michael R. Brown (Nov.  
1989)

*in 19th Century Seminole  
Men's Clothing*

[Rick Obermeyer ~ Editor](#)

*Adapted from The North American Indian Portfolios, 1993 ~ Library of Congress*

---

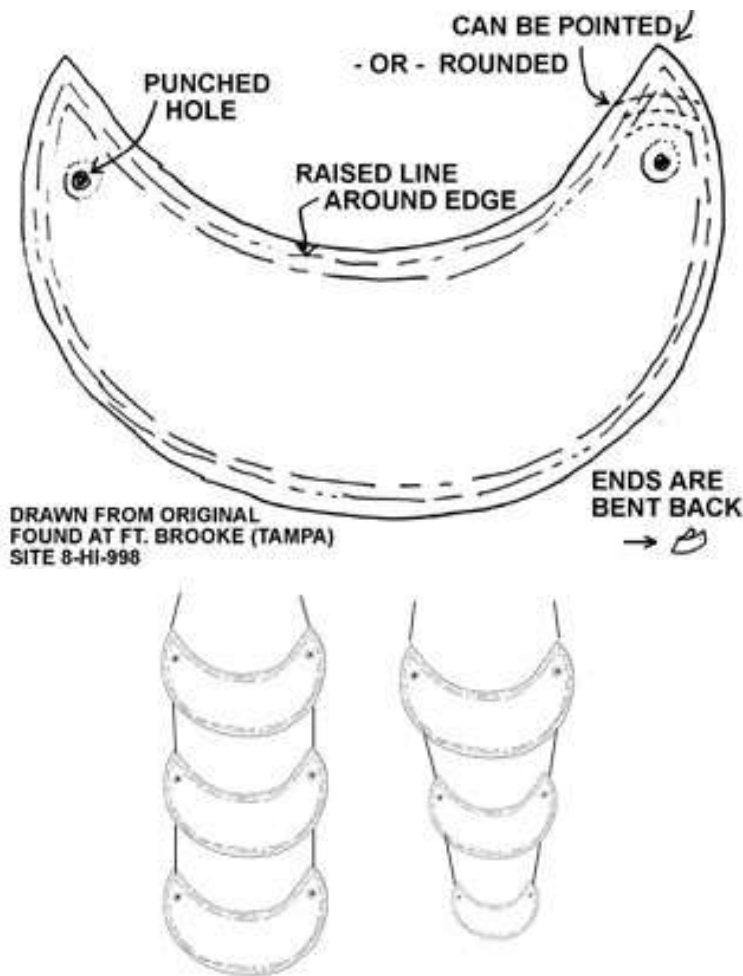
All ornamental metalwork of the Seminoles was made of German silver, or rarely, real silver, At first these items were trade goods, but later these items were made by Indians, many times by beating silver coins together.

There were no limits on who could wear these items. They were not indications of wealth or status. Note: many of these items can be made of sheet nickel-silver obtainable from Indian lore suppliers, or use any silver-gray metal.

---

## Gorgetts (silver crescents):

- There is no proof of beads being added to gorget thongs, nor were they made of copper.
- The crescents may be hung on a chain or leather thong.
- The gorget was worn close to the neck. The were



originally neck armor.

- Shoe buttons should be used in the holes to hold the gorgets. These buttons were originally silver.
- Gorgets were the last remnants of medieval armor. They were used as officer's insignia, and were given as gifts to important Indian chiefs. They became so popular that they were used as trade goods.
- Gorgets are worn in groups of one to four. There is no significance to the number used. However, four were rare.
- There are no designs on the gorget, they were left plain except for a raised line along the edge.

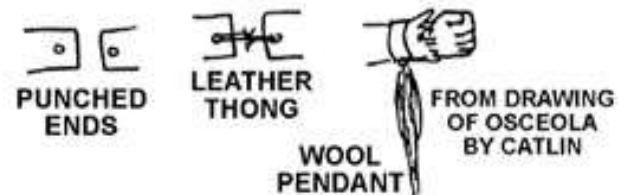
---

### [Silver Gorgets: History and Instructions](#)

---

#### Arm Bands:

- Worn on upper arm or wrist (wristbands only seen in paintings of Osceola).
- 1 to 1 1/2 inches wide.
- Soldered ends...
  - or -
- Tied together with leather...
  - or -
- Tied together with wool and ends left pendant (only when worn on wrist).



---

#### Ear Bobs:



- 1 or 2 worn in ear
- Typical example at left
- This can be made from 2 to 3 silver beads (3rd goes on top), silver cone, and wire.
- Other kinds were made from beaten coins with geometric designs cut in.

DRAWN FROM  
ORIGINAL FOUND  
AT FT. BROOKE  
(TAMPA)  
SITE 8-HI-998

---

### Bands:

- Worn around turban.
- 1 to 1 ½ inches wide (can be larger).
- Ends tied with leather.
- Almost everyone wore one.
- Some decorated with scalloped top (ex: Billy Bowlegs).



Ex: BILLY BOWLEGS



(1837)

SILVER BAND ON TURBAN  
TAKEN FROM STURTEVANT'S  
"SEMINOLE MEN'S CLOTHING"

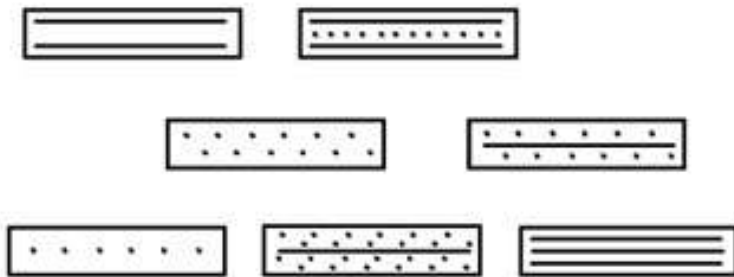




*Detail, "Billy Bowlegs", National Anthropological Archives, Smithsonian Institution*

---

### Decorating Armbands and Turban Bands:



*Courtesy National Museum of the American Indian, Smithsonian Institution*

- Decorated with embossed lines and dots.
- Designs were raised, not punched through.
- Designs should be simple.

---

### Finger Rings:

- **Worn, but rare.**
  - **Some were soldered bands with a étabelleí soldered on top.**
  - **Rings may be trade goods.**
  - **Rings occasionally were made from copper or gold.**
- 

## **SEMINOLE ACCESSORIES**

---

[Breechcloths](#)

[Turbans](#)

[Peace Medals for Seminole Outfits](#)

[Seminole Beads](#)

[Face Painting](#)

[Complete Index to Articles in \*19th Century Seminole Mens Clothing\*](#)

---

## **Information Sources:**

- "Silver Work of the Florida Seminole.", John Goggin, *El Palacio*, Vol. 40, No. 2, 1940.
  - "Florida Seminole Silverwork.", Byron Johnson, *Florida Anthropologist*, Vol. 29, No. 3, 1976.
- 

Contributed by [Rick Obermeyer](#) E-mail: [orick@prodigy.net](mailto:orick@prodigy.net)

From the book *19th Century Seminole Mens Clothing*

© 1991-2000 Sherwood F. Obermeyer Jr., 2124 Miscindy Place, Orlando, FL 32806

---

[Return to NativeTech's Main Leather & Clothes Menu](#)

[Leather & Clothes Bibliography and Books to Buy On-Line](#)

---



**Text and Graphics**  
© 1994 - 2003 [Tara Prindle](#)  
unless otherwise cited.



*Detail, 'Osceola' by George Catlin, National Anthropological Archives, Smithsonian Institution*

## Seminole Silver Gorgets

by Clayton C. Carroll (May  
1991)

*in 19th Century Seminole  
Men's Clothing*

[Rick Obermeyer ~ Editor](#)

---

(Note: Clay Carroll does not describe a way to make museum quality early 19th century style gorgets. But, he has come up with an easy effective way to make late-19th century gorgets that would be appropriate for almost any reenactments or Scout ceremonies. -Ed.)

---

### History:



*Courtesy National Museum*

The "Kona-wwata-ki", or crescent silver gorgets, have an interesting origin (Sturtevant, 1967). English officers wore gorgets as a symbol of rank. In some cases, Indian chiefs were awarded an army rank for service given to the English in time of war. When a chief received a military rank, he was given a standard army gorget (Goggin, 1940). As time passed, gorgets were copied by other male tribal members and worn as decoration. They heated silver coins and pounded them together with a hammer.

Graduated gorgets were worn in sets of two or three, but there is an occasional picture showing four worn. (Fig. 7, Sturtevant, 1967; Fig. 62, MacCauley, 1887). When in graduated sizes, the largest was worn at the top, its upper curves usually just touching at the collarbones. Earlier 1820's and 1830's gorgets seen in McKenney-Hall are much smaller than mid or late 19th century gorgets.



*of the American Indian,  
Smithsonian Institution*

Gorgets were made, however infrequently, up to the 1930's, and began to disappear after then (Sturtevant, 1967).

Although here are patterns and instructions for gorget construction, I urge you to do your own research. These instructions are intended for hobbyists who want an acceptable reproduction of gorgets made in the late 1800's and early 1900's.

### Materials:

Each set of two gorgets will need a 6" by 12" sheet of 20 gauge German silver. Nickle silver is available from Indian hobbyist catalogs such as Crazy Crow Trading Post and Grey Owl. It is also occasionally available from lapidary shops. Or, you could be extravagant and buy sheets of real silver for \$100-\$125 each.

A package of silver upholstery tacks can be found at almost any hardware store or in house wares at a department store. They should be plain with no designs on the head of the tacks. A small leather thong 2-1/3 or 3 feet in length can be cut from almost any scrap of leather.



*Seminole Museum, Tampa Reservation*

---

### [Patterns for Gorgets](#)

[Clayton C. Carroll's Instructions for making Gorgets](#)

[Return to Seminole Silver Work](#)

[Introduction to Seminole Accessories](#)

[Complete Index to Articles in 19th Century Seminole Men's Clothing](#)

---

Contributed by [Rick Obermeyer](#) E-mail: [orick@prodigy.net](mailto:orick@prodigy.net)

From the book *19th Century Seminole Mens Clothing*

© 1991-2000 Sherwood F. Obermeyer Jr., 2124 Miscindy Place, Orlando, FL 32806

---

[Return to NativeTech's Main Leather & Clothes Menu](#)

[Leather & Clothes Bibliography and Books to Buy On-Line](#)



**Text and Graphics**  
© 1994 - 2003 [Tara Prindle](#)  
unless otherwise cited.



# Patterns for Gorgets

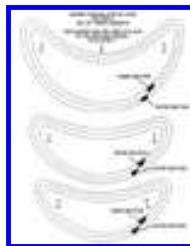
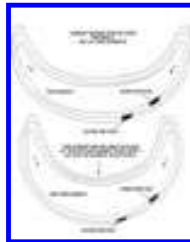
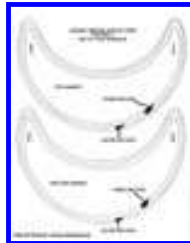
by Clayton C. Carroll (May 1991)

*in 19th Century Seminole Men's Clothing*

[Rick Obermeyer ~ Editor](#)

---

Click on the thumbnail image for full size pattern to print



---

[Clayton C. Carroll's Instructions for making Gorgets](#)

[Return to History and Materials for Gorgets](#)

[Return to Seminole Silver Work](#)

[Introduction to Seminole Accessories](#)

[Complete Index to Articles in 19th Century Seminole Men's Clothing](#)

---

Contributed by [Rick Obermeyer](#) E-mail: [orick@prodigy.net](mailto:orick@prodigy.net)

From the book *19th Century Seminole Mens Clothing*

© 1991-2000 Sherwood F. Obermeyer Jr., 2124 Miscindy Place, Orlando, FL 32806

---

[Return to NativeTech's Main Leather & Clothes Menu](#)

[Leather & Clothes Bibliography and Books to Buy On-Line](#)

---



Text and Graphics  
© 1994 - 2003 [Tara Prindle](#)  
unless otherwise cited.



# Instructions for Making Gorgets

by Clayton C. Carroll (May 1991)

*in 19th Century Seminole Men's Clothing*

[Rick Obermeyer ~ Editor](#)



---

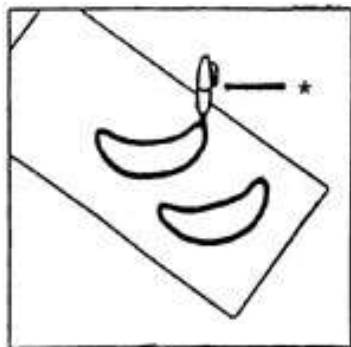
## Tools and other supplies needed are:

1 pair handheld tin snips  
1 marker  
1 small file  
1 small scrap of board  
1 small nail  
1 pair needlenose pliers

1 roll duct tape  
1 pair flat-tip pliers  
1 ballpoint pen  
1 pair scissors  
1 hammer

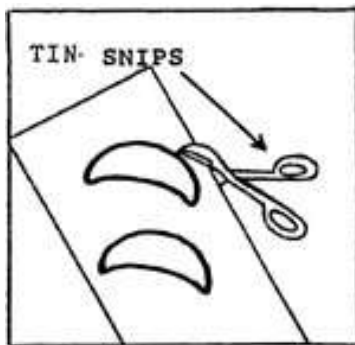
---

## Step By Step Construction:



**Step 1: Trace or make a photocopy of one of the gorget patterns included here.**

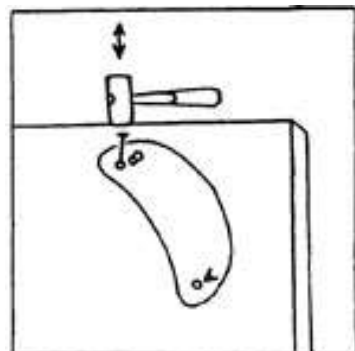
**Step 2: Cut each of the patterns out of the photocopy and trace them DIRECTLY onto a sheet of German silver with a permanent marker. Do not throw the paper patterns away; they will be needed later**



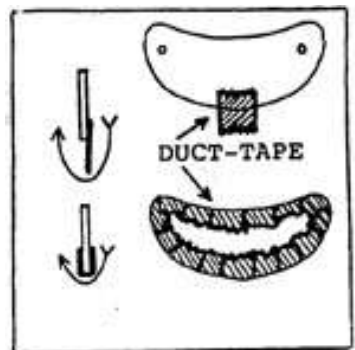
**Step 3: Use a pair of handheld tin snips to cut out the traced shapes. Compare the paper patterns with the cut out gorgets. If they don't match, use your own judgement on removing excess. But at this stage, it does NOT have to be perfect.**



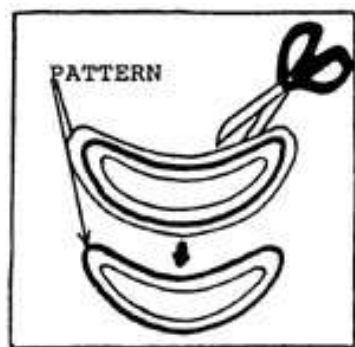
**Step 4 The edges of the cut metal will be sharp. CAREFULLY use a file to remove all the sharp edges.**



**Step 5: Lay each of the gorgets out on a piece of scrap wood. Place the paper patterns on top of them. Use a piece of tape to keep the pattern from shifting around. Hammer a small nail through the center of the two circles marked A and B on the paper pattern. Remove the nail and the paper pattern.**

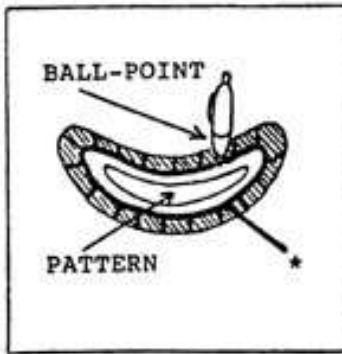


**Step 6: Cover the outer edges of the gorgets with duct tape, which will keep the metal from getting scratched while it's being shaped.**

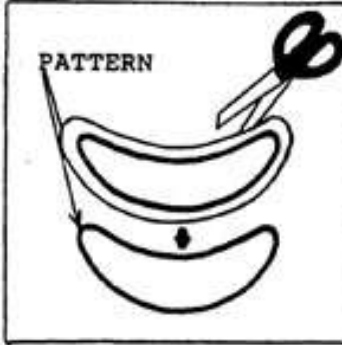


**Step 7: You will be marking the first of two guidelines onto the duct tape, as follows. (For convenience, the guidelines are on the paper patterns.)**

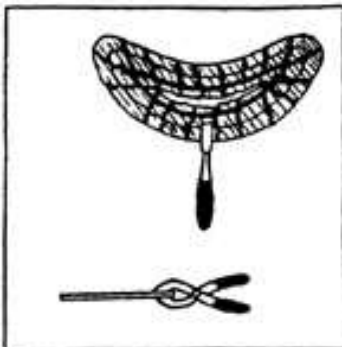
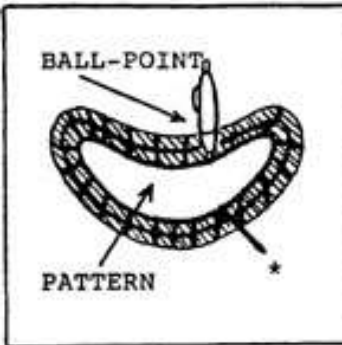
**Step 8: Cut off the outer sections of the paper patterns, and center the remainder of the pattern on the gorgets.**



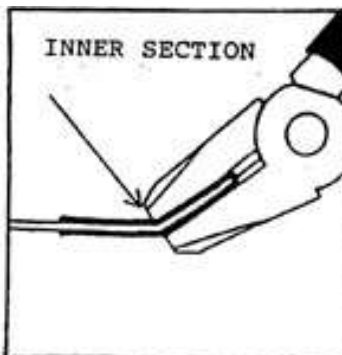
**Step 9: Use a ballpoint pen to trace the outline of the trimmed paper patterns onto the duct tape. Make the lines very dark.**

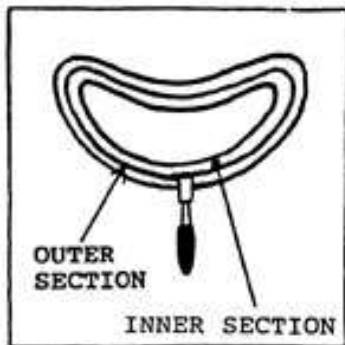


**Step 10: Cut off the next part of the paper patterns marked "inner section," and repeat as above. Make the ballpoint lines DARK.**

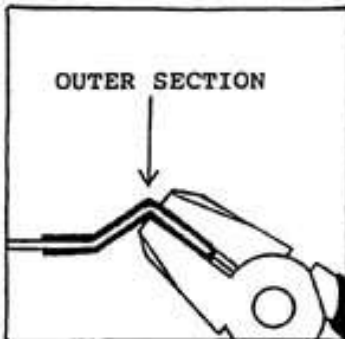


**Step 11: Line the edge of a pair of pliers up against the innermost traced line. Make an approximately 95 degree bend upward on the gorges's edge. Repeat all the way around making sure to realign the pliers each time. You will be bending as if to make a "V", but the proper result will be a half curve.**

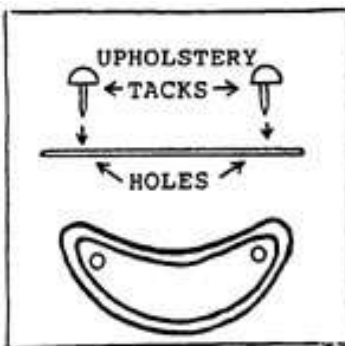




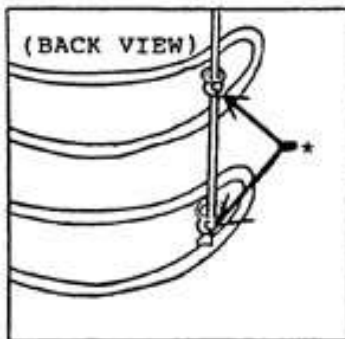
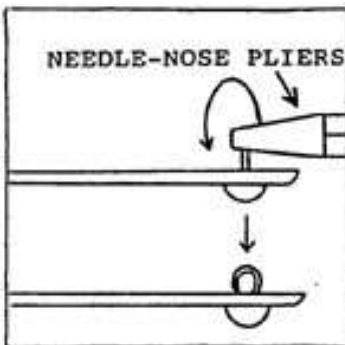
**Step 12: Place the edge of the pliers against the outermost traced line. Bend the outer end downward at about a 45 degree angle, again aiming for a "V" but achieving a half curve. Repeat until completed.**



**Step 13: Remove the duct tape. Remove any new sharp edges with a file.**



**Step 14: Place a silver upholstery tack in each of the gorget's holes. Use needlenose pliers to bend the nail part of the tack into a loop big enough to allow a leather thong or a ribbon to slip through. Repeat until all the gorgets' holes have an upholstery tack in then. (You might also use metal shoe buttons. - Ed.)**



**Step 15: The thong or ribbon should be 2-1/2 to 3 feet long. Test by pulling before using to make sure it won't break. Lace the thong through the tacks, adjust for spacing, and tie knots to hold the gorgets in place.**



**REFERENCES:**

**Goggin, John M.**

**1940 "Silver Work of the Florida Seminole." E1 Palacio 47:25--32.**

**MacCauley, Clay**

**1887 "The Seminole Indians of Florida." Fifth Annual Report of the Bureau of Ethnology, Washington DC.**

**Sturtevant, William C.**

**1967 "Seminole Men's Clothing" in "Essays on the Verbal and Visual Arts; Proceeds of the 1966 Annual Spring Meeting of the American Ethnological Society," ed. June Helm, pp. 10-74. Seattle: American Ethnological Society; Distributed by the University of Washington Press. Reprinted in "The Seminole Source Book," ed. William C. Sturtevant, 1987.**

---

**[See the Patterns for Gorgets](#)**

**[Return to History and Materials for Gorgets](#)**

**[Return to Seminole Silver Work](#)**

**[Introduction to Seminole Accessories](#)**

**[Complete Index to Articles in \*19th Century Seminole Men's Clothing\*](#)**

---

**Contributed by [Rick Obermeyer](#) E-mail: [orick@prodigy.net](mailto:orick@prodigy.net)**

**From the book *19th Century Seminole Mens Clothing***

**© 1991-2000 Sherwood F. Obermeyer Jr., 2124 Miscindy Place, Orlando, FL 32806**

---

**[Return to NativeTech's Main Leather & Clothes Menu](#)**

**[Leather & Clothes Bibliography and Books to Buy On-Line](#)**

---



**Text and Graphics**  
© 1994 - 2003 [Tara Prindle](#)  
unless otherwise cited.



**FOKE-LUSTE-HAJO**  
A Seminole

*Adapted from The North American Indian Portfolios, 1993 ~ Library of Congress*

# Turbans

By Rick Obermeyer (1991)

*in 19th Century Seminole  
Men's Clothing*

[Rick Obermeyer ~ Editor](#)

---

## QUOTES

The attack on Fort Cooper was "headed by four or five chiefs, who were distinguished by their white plumes, and their movements in directing and inspiring their men." *Myer M. Cohen, NOTICES OF FLORIDA AND THE CAMPAIGNS, 1836, quoted in Elwell, 1988.*

(1837) "Coacoochee... retired into the hammock to deck himself out, emerging resplendent with a plume of white crane feathers, bright scarlet leggings, and a silver band around his turban." *Page 224, Mahon, 1967*

"At the important council which met after some delays on November 10th, 1840, Halleck wore a fine turban ornamented with black ostrich feathers, and his followers waited on him like a prince." *Page 282, Mahon, 1967*

(during Second Seminole War) "On occasions of ceremony however there are certain peculiarities of costume which are seldom departed from. For instance the ostrich plumes which decorate the heads of the Chiefs. These are worn differently by different individuals. CoaHarjo wore his on the front part of his head and so did most of the other chiefs I saw, with certain modifications, -but Osceola was peculiar for wearing his always on the opposite side and hanging off to the rear, as I have drawn them." *J. R. Vinton, quoted by Goggin, 1955*

"(Osceola) wore three ostrich feathers in his head and a turban made of a vari-colored cotton shawl..." *George Catlin, quoted by Goggin, 1955.*

"(Osceola at time of capture)... cress 'd in a blue calico shirt, leggings of red cloth with a row of buttons on the outside of the leg & a red print shawl wrapp'd around his head and another his neck and shoulders." *N. S. Jarvis, quoted by Goggin, 1955*

"Capt. P. Morrison in command of the Indian post sent to Maj. H. J. Hook Osceola's effects as follows: four black and two white ostrich feathers, large silk shawl used for head dress..." *newspaper account, quoted by Goggin, 1955*

(Billy Bowlegs) "Finally, there was a turban wound from a red shawl 'surmounted with white feathers, encircled with a silver band.'" *Porter, 1967*

(Billy Bowlegs' 1852 visit to Washington) "On his head he wore a kind of turban enclosed in a broad silver band and surmounted by a profusion of black ostrich feathers." *newspaper account, quoted by Covington, 1982*

(Pratt, 1879) "The men wear the usual breech clout, a calico shirt ornamented with bright strips of ribbon, and a small shawl of bright colors folded the width of the hand and wrapped around the head like a turban." *Sturtevant, 1956*

{1880} "The next article of the man's ordinary costume is the turban. This a remarkable structure and gives to its wearer much of his unique appearance. At present it is made of one or more small shawls. These shawls are generally woolen and copied in figure and color from the plaid of some Scotch clan. They are so folded that they are about 3 inches wide and as long as the diagonal of the fabric. They are then, one or more of them successively, wrapped tightly around the head, the top of the head remaining bare; the last end of the last shawl is tucked skillfully and firmly away, without the use of pins, somewhere in the many folds of the turban. The structure when finished looks like a section of a decorated cylinder crowded down upon the man's head. I examined one of these turbans and found it rather a firm piece of work, made of several shawls wound into seven concentric rings. It was over 20 inches in diameter, the shell of the cylinder being perhaps 7 inches thick and 3 in width. This headdress, at the southern settlements, is regularly worn in the camps and sometimes in the hunt. While hunting, however, it seems to be the general custom for the warriors to go bareheaded. At the northern camps, a kerchief bound about the head frequently takes the place of the turban in everyday life, but on dress or festival occasions, at both the northern and southern settlements, this curious turban is the customary covering for the head of the Seminole braves. Having no pockets in his dress, he has discovered that the folds of his turban may be put to a pocket's uses..." *MacCauley, 1887*

(ca. 1895) "It is worn almost constantly; and is made impromptu from shawls or colossal handkerchiefs wrapped round and round the head and then secured in shape by a band, often made of beaten silver which encircles the whole with brilliant effect. With young braves the more important the occasion, the more enormous the turban." *Moore-Willson, 1914*

(Billy Bowlegs III, ca 1895) "His large turban was embraced by a silver band, made from four silver dollars beaten with the implements that can be found at an Indian village." *Moore-Willson, 1914*

"Their turban is made of a woolen shawl, sometimes covered with a piece of calico and even silk when they wish to be particularly gorgeous in their attire. On one occasion I saw an Indian by the name of Billy Bowlegs wearing a turban encircled by a band of metal (probably tin). The older Indians usually wear a red woolen turban made by widening a shawl around their heads, which they fasten by tucking the ends skillfully away beneath the folds without the use of pins. As a rule they do not wear the turban when hunting...except in the very hottest weather." *Cory, 1895*



## CLOTH

The reenactor has the challenge of finding silk or wool scarves in Florida to make an older style turban. Silk is usually too costly and modern rayon is inappropriate. Any wool Scotch plaid muffler or scarf is fine, or any floral or paisley print. Plain solids are actually less common. The reenactor has a lot of



**freedom of choice here.**

**If you don't have friends or relatives up North to locate one for you, and you aren't lucky at garage sales or flea markets, you can get wool plaid scarves from mail order places that cater to people who make outfits for Scottish games. Plaid and paisley wool cloth is in better fabric stores for \$30 to \$50 a yard, and sometimes on sale. Go in together with some friends, buy two yards, cut the piece into thirds lengthwise, and you have the equivalent to 3 wool scarves at about the same price each.**

**A reenactor can also make a suitable turban with large paisley or floral print cotton handkerchiefs, even though this kind is more likely to fit into the late 19th century.**

## **PLUMES**

**For dress up occasions (and what reenactment is not a dressy occasion), the turban needs to get the extra touches. The most obvious is ostrich plumes, the Seminole feather of choice. Creeks occasionally wore eagle or some other fancy feather, but there is as yet no documentation for any feather other than ostrich or crane for early 19th century Seminoles. They didn't start wearing egret plumes until later, when they were living down in the Everglades.**

**Finding those ostrich plumes is another challenge for the hobbyist.**

**Friends have reported finding fat fluffy plumes in theatrical and costume shops (Orlando), a magic store (Sarasota), window dressing suppliers (Winter Park), and wedding boutiques (Miami). They have been reported in places like Pier One Imports and in flea markets.**

**Ostrich feathers come dyed in many colors, but perhaps not every color is appropriate for the 19th century. The 1820's Seminole pictures in McKenney-Hall show a total of about 20 plumes. One of Osceola's three is white, and Yahahajo's single one is red. The other eighteen are all black. Eight ostrich plumes are among the Creek portraits; one is white (dyed red at the tip), two are red, and the other five are black.**

**The portrait by Curtis and Catlin's two portraits of Osceola confirm his use of one white and two black feathers. In his other Seminole portraits, Catlin shows us Mick-E-No-Pah (two white feathers), Lah-Shee (one small white one), Ye-How-Lo-Gee (one small blue one), and Co-Ee-He-Jo (two black ones).**

The photographs and lithographs of Billy Bowlegs show him wearing two to five plumes, always black. Only Billy Bowlegs seems to ever wear more than three at a time.

This seems to be a number large enough to be a pretty good sampling. Black is obviously a big favorite, much more than white (which was unexpected by the author). There are a couple of red ones and a small dark blue one, but there is no support for yellow, green, orange, light blue, or purple.

By the way, if your ostrich plumes ever get caught in the rain, don't panic even though they will look terrible, not unlike a drowned rat. Hang them up to dry and they will fluff out again. Maybe not as good as new, but not a total loss, either.

## HEADBANDS

It appears that some reenactors are a little vague on what goes on the outside of the cloth turban. Some turbans have so many pins on them that they look like early 19th century equivalents of baseball caps. While those reenactors may have had fun assembling those pins, and do look impressive wearing all of them, there is not much to indicate that Seminoles actually followed that fashion.

Seminoles did not pin anything at all on their turbans until after about the 1880's, when triangular beaded pendants started to appear. Even then, the pendants are seen only infrequently in period photographs, although many museums now display examples (Smithsonian; American Museum of Natural History, New York; Milwaukee Public Museum; Historical Assoc. of Martin County, Stuart, FL).

A reenactor who wanted to dress up his turban would do much better to add a headband. These were made in German silver alloy or, rarely, real silver. A headband made out of real silver back then would have been quite an affluent flashy accessory, probably something like a Rolex watch today. A much more economical German silver headband is a very nice added touch to any outfit, then or now.

Not every turban had one. Osceola didn't wear one. Of the ten McKenney-Hall pictures of Seminoles, all wear turbans, but only four have headbands, varying from two to three fingers wide. Catlin painted six Seminole men, only one of which has a headband. The highest proportion is in an 1853 print of "'Billy Bowlegs,' and His Suite of Indian Chiefs," in which four of six Seminoles are wearing headbands. There are also a couple shown among the Creeks in McKenney-Hall. These have the same kind of rounded crenellations that are on most (but not all) of the Seminole headbands.

Among the Seminoles, Tukosee Mathla's appears to be unique in that it has pierced designs. Yahahajo's



TURKEY FEATHER FAN, SEMINOLE

Catalogue No. 351361  
Department of Anthropology  
Smithsonian Institution

is not crenellated and is undecorated except for incised lines inside the edges, similar to those on gorgets, as is the one shown in Catlin's painting of Lah-shee. The one in Billy Bowleg's photograph has large crenellations, but there doesn't appear to be any incised ornamentation or lines at all.

Headbands were popular with the Seminoles. for a long time. They were still worn well past 1900, sometimes even along with beaded pendants. These later headbands tended to be slightly narrower and have very small crenellations, if any at all.

Like many other parts of an old-style Seminole outfit, headbands aren't complicated pieces to make. German silver is available from Indian hobbyist catalogs, and can occasionally be found in local lapidary stores. It's a simple way to add A lot of flair to your outfit.

---

## SEMINOLE ACCESSORIES

---

[Breechcloths](#)

[Seminole Silverwork](#)

[Peace Medals for Seminole Outfits](#)

[Seminole Beads](#)

[Face Painting](#)

[Complete Index to Articles in \*19th Century Seminole Mens Clothing\*](#)

---

## REFERENCES

Cory, Charles B.

1896 Preface to Second Edition (and) The Seminole Indians, *HUNTING AND FISHING IN FLORIDA*.

Covington, James W.

1982 *THE BILLY BOWLEGS WAR*, The Mickler House Publishers, Chuluota

Elwell, Rich.

1988 "Georgia Militia at Fort Cooper In the Second Seminole War." *The Rebel Sabretache*, XIV: 5, Sept.-Oct. Atlanta Soldier Society.

Goggin, John M.

1955 "Osceola: Portraits, Features, and Dress," *The Florida Historical Quarterly*, XXXIIJ: 3 & 9, Gainesville.

MacCauley, Clay

1887 "*The Seminole Indians of Florida*." Fifth Annual Report of the Bureau of Ethnology, Washington

DC.

**Mahon, John K.**

**1967 *HISTORY OF THE SECOND SEMINOLE WAR 1835-1842*. University of Florida Press, Gainesville.**

**Moore-Willson, Minnie**

**1914 edition, *THE SEMINOLES OF FLORIDA*, Moffat, Yard and Company, New York.**

**Porter, Kenneth W.**

**1967 "Billy Bowlegs (Holata Micco) in the Seminole Wars." *Florida Historical Quarterly* 45:219-42.**

**Sturtevant, William C.**

**1956 "R. H. Pratt's Report on the Seminole In 1879." *Florida Anthropologist*, 9: 1-24**

---

Contributed by [Rick Obermeyer](#) E-mail: [orick@prodigy.net](mailto:orick@prodigy.net)

From the book *19th Century Seminole Mens Clothing*

© 1991-2000 Sherwood F. Obermeyer Jr., 2124 Miscindy Place, Orlando, FL 32806

---

[Return to NativeTech's Main Leather & Clothes Menu](#)

[Leather & Clothes Bibliography and Books to Buy On-Line](#)

---



Text and Graphics  
© 1994 - 2003 [Tara Prindle](#)  
unless otherwise cited.



# Peace Medals for Seminole Outfits

by Michael R. Brown  
(revised Jan. 1991)

*in 19th Century Seminole  
Men's Clothing*  
[Rick Obermeyer ~ Editor](#)



SE-LOC-TA  
A Creek Chief

*Adapted from The North American Indian Portfolios, 1993 ~ Library of Congress*

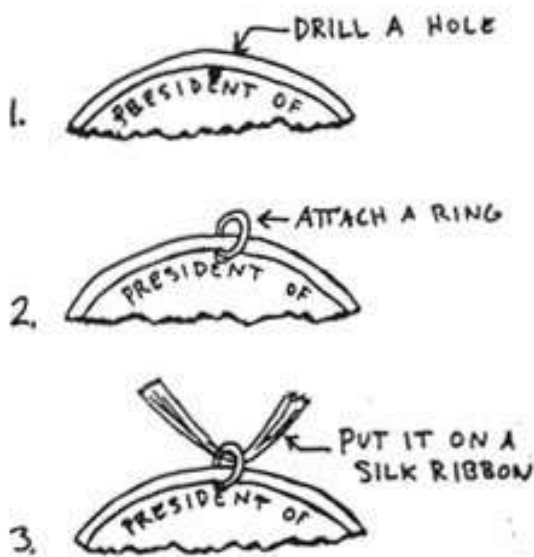
These medals were given out as tokens of friendship and symbols of allegiance to the U.S. They were given out for many reasons; not just for treaties, but for 'services' to the U.S.

## Choose your Time Period and Choose your Medal:

- 1823 (Tr. Of Moultre Creek) James Madison James Monroe
- 1826, 27 John Quincy Adams
- 1849, 50 Zachery Taylor
- 1852 [maybe] Millard Filmore (no smalls)

*Other Presidents are Possible*

## How to Wear A Peace Medal



*[If your medal has an added ring, Remove it!]*

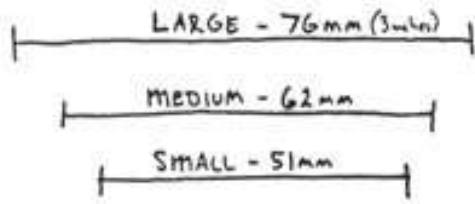
## Information Source:

"Indian Peace Medals in American History",  
Francis Paul Prucha, State Historical Society of Wisconsin, 1971

## Sources of Peace Medals:

U.S. Mint

THREE SIZES - ALL IN SILVER



**Distribution**

**Large- Principal Village Chiefs**

**Medium - Principal War Chiefs.**

**Small - Least Distinguished Chiefs & Warriors.**

PO Box 41997

Philadelphia, PA 19101-1977

Request a copy of U.S. Mint Medals Catalog

Sell Reproductions in Bronze of Large (3 in.) and a modern small size (1 5/16 in) [not shown].

As the originals were silver, these reproductions should be plated to look authentic. One person coated one with silver solder. Looked good.



*Adapted from "Covenant Chain", Jaye Frederickson and Sandra Gibb, 1980*

---

## SEMINOLE ACCESSORIES

---

[Breechcloths](#)

[Seminole Silverwork](#)

[Turbans](#)

[Seminole Beads](#)

[Face Painting](#)

[Complete Index to Articles in 19th Century Seminole Mens Clothing](#)

---

---

Contributed by [Rick Obermeyer](#) E-mail: [orick@prodigy.net](mailto:orick@prodigy.net)

From the book *19th Century Seminole Mens Clothing*

© 1991-2000 Sherwood F. Obermeyer Jr., 2124 Miscindy Place, Orlando, FL 32806

---

[Return to NativeTech's Main Leather & Clothes Menu](#)

[Leather & Clothes Bibliography and Books to Buy On-Line](#)

---



Text and Graphics  
© 1994 - 2003 [Tara Prindle](#)  
unless otherwise cited.



**ME-NA-WA  
A Creek Warrior**

*Adapted from The North American Indian Portfolios, 1993 ~ Library of Congress*

# Face Painting

by David Mott & Rick Obermeyer (Dec. 1990)

*in 19th Century Seminole  
Men's Clothing*

[Rick Obermeyer ~ Editor](#)

---

## FACE PAINTING

by David Mott and Rick Obermeyer (Dec., 1990)

## QUOTES

(Osceola on his deathbed) "He then called for his red paint, and his looking glass, which was held before him, when he deliberately painted one-half of his face, his neck and throat, -his wrists- the backs of his hands, and the handle of his knife, red with vermilion; a custom practiced when the irrevocable oath of war and destruction is taken." *Dr. Frederick Weeden, quoted by Catlin, 1844*

"Several of the Indians' fighting techniques were calculated to strike terror. Some warriors entered battle naked except for a loin cloth, but their bodies were streaked in bizarre examples in red and black paint... (In council) there might be a half red circle of paint under each eye and silver rings in the nose. A few famous braves had their ears elongated and slit." *Page 123, Mahon, 1967.*

"The men do not paint their faces, but occasionally wear ornaments when visiting a white man's camp or going to a town or on a trading expedition. I am told they sometimes paint their faces during the ceremonies of the Green Corn Dance, but was unable to get any definite information on this subject." *Cory, 1896*

"Co-lo-waw-la-nee..... Co-lo-wa-lus-tee..... Co-lo-wa-chaw-tee.....  
..... Paint (yellow)  
-....Paint (black)  
..... Paint (red)" *Moore-Willson, 1914*

"Yellow paint says a warrior is ready to die. Red war paint signifies blood; green under the eyes makes for 'see better at night.' Yellow, the color of death, means a man has lived his life and will fight to the finish." *Capron, 1956.*

## COLORS



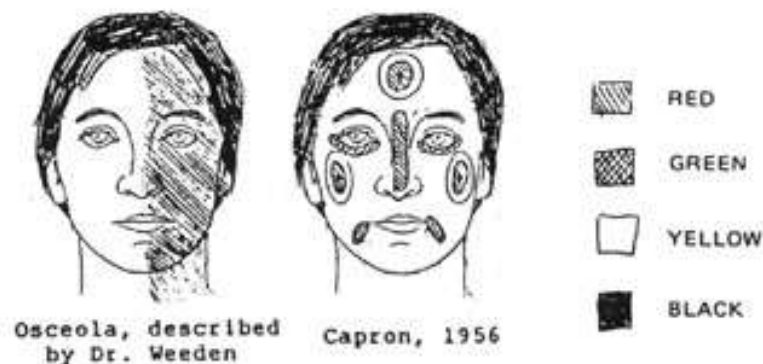
While early 19th century Seminoles would paint their face and hands for special occasions, this practice was no longer done in public by the late 19th century.

Note that it was done on special occasions only, to augment one's appearance and power. All face painting should be done sparingly, and with high regard for the occasion. It might not be out of place at a battle re-enactment or for a serious ceremony, but would be entirely inappropriate for an encampment or for a casual demonstration. A reenactor would be misplaced if he painted himself while he lounged around camp, or while stomp dancing in any except a Green Corn Dance.

It would be a big mistake to put on face painting without having a genuine reason or need. Face paint was a way the Seminole drew upon the natural powers in his world to add to his own. A rough parallel might be the personal strength many Christians find in a crucifix hung from their neck.

Few things will cheapen a reenactor's appearance faster than inappropriate or garish face painting. Painting on a death's head or zebra stripes or modern camouflage patterns are cheap and showy, and indicate the wearer's ignorance, disregard, and disrespect for the culture he is trying to represent.

Seminoles were more likely to use powder than grease paint (Capron, 1956), which could be mixed with a little fat.



*The use of colors might be as follows:*

**RED** was the color of war. The Red Stick Creeks were the warrior villages. This was especially true among the Hitchiti speakers, who formed the nucleus of the Miccosukee Seminoles. It would be painted in bands or stripes on the face, as well as on the backs of the hands and on knife handles. The Red Stick Creeks might also favor red turbans.

**WHITE** was the color of peace. The White Stick villages were the peace party among the Creeks. If a group of Seminoles wore a strip of white around their red turbans, they were ready to talk truce. If Billy Bowleg wanted to parley, he made a sign of white beads and tobacco leaves on the trail leading to his camp.

**BLACK** was a "living" color, worn on the face to prepare for war.

**GREEN** worn under the eyes was supposed to empower the wearer with night vision.

**YELLOW** represented death, as it is the color of "old bones." Care should be taken not to wear a lot of yellow.

---

## SEMINOLE ACCESSORIES

---

[Breechcloths](#)

[Seminole Silverwork](#)

[Turbans](#)

[Peace Medals for Seminole Outfits](#)

[Seminole Beads](#)

[Complete Index to Articles in 19th Century Seminole Mens Clothing](#)

---

## REFERENCES

Capron, Louis

1956 Florida's "Wild" Indians, the *Seminole*. *National Geographic Magazine*, December, Vol. 60, No. 6:819-840.

Catlin, George

1894 *Letters and Notes on the Manners, Customs, and Conditions of the North American Indians*. 2 vols, 4th edition, London.

Cory, Charles B.

1896 Preface to Second Edition (and) The Seminole Indians, *HUNTING AND FISHING IN FLORIDA*.

Goggin, John M.

1955 "Osceola: Portraits, Features, and Dress," *The Florida Historical Quarterly*, XXXIII: 3 & 4, Gainesville.

Mahon, John K.

1967 *HISTORY OF THE SECOND SEMINOLE WAR 1835-1842*. University of Florida Press, Gainesville.

Moore-Willson, Minnie

1914 edition, *THE SEMINOLES OF FLORIDA*, Moffat, Yard and Company, New York.

Peithmann, Irvin M.

1957 *THE UNCONQUERED SEMINOLE INDIANS*. Great Outdoors Association, St. Petersburg.

---

Contributed by [Rick Obermeyer](#) E-mail: [orick@prodigy.net](mailto:orick@prodigy.net)

From the book *19th Century Seminole Mens Clothing*

© 1991-2000 Sherwood F. Obermeyer Jr., 2124 Miscindy Place, Orlando, FL 32806

---

[Return to NativeTech's Main Leather & Clothes Menu](#)

[Leather & Clothes Bibliography and Books to Buy On-Line](#)

---



Text and Graphics  
© 1994 - 2003 [Tara Prindle](#)  
unless otherwise cited.

# O.A. Ceremonial Team Guideline

*in 19th Century Seminole Men's Clothing*  
[Rick Obermeyer ~ Editor](#)



*From Scouting Clip Art,  
Graphics Library of  
Twin Rivers Council, B.S.A.*

## SEMINOLE 1865-1910

### "Old Traditional"

|                           | Plain<br>Shirt | Long<br>Shirt | Vest<br>(often<br>with<br>watch<br>chains) | Turban  | Silver<br>Band | Plume                 | Gorget           | Scarf | Beaded<br>Bandolier | Woven<br>Belt | leather<br>Belt 1 or<br>more<br>knives | Leggings | Moccasins | Long<br>Rifle |
|---------------------------|----------------|---------------|--------------------------------------------|---------|----------------|-----------------------|------------------|-------|---------------------|---------------|----------------------------------------|----------|-----------|---------------|
| <b>Allowat<br/>Sakima</b> | Yes            | Yes           | Opt.                                       | Yes     | Yes            | 2 or<br>more          | 2 or<br>more     | Yes   | 2                   | Opt.          | Opt. (5)                               | Yes      | Yes       | Opt.          |
| <b>Meteu</b>              | Yes            | Yes           | Opt.                                       | Yes     | Opt.           | 2 or<br>less (1)      | 2 or<br>less (1) | Yes   | 1                   | Opt.<br>(2,3) | Opt. (5)                               | Yes      | Yes       | No            |
| <b>Nutiket</b>            | Yes            | Opt.          | Yes if<br>no<br>L.Sh.                      | Yes (4) | No             | 1 or<br>less<br>(1,2) | No               | Yes   | 1 or less<br>(2)    | Opt.<br>(2,3) | Opt. (5)                               | Opt.     | Yes       | Yes           |
| <b>Kichkinet</b>          | Yes            | No            | Opt.<br>(2)                                | Yes (4) | No             | No                    | No               | Yes   | No                  | No (3)        | Yes                                    | No       | Yes       | Opt.          |

1. Always at least one less worn than Allowat Sakima
2. If availability is limited, priority in wear is given to superior part.
3. Leather or buckskin belt worn instead of woven belt.
4. Bowler, straw hat, or conductor's cap may be substituted.
5. A leather belt may be worn under a woven belt, but knives are not worn when a woven belt is worn. and rarely, if ever, with a long shirt.



### PRE-1865 ACCESSORIES

|                       | Woven Garters | Pouch on 1 Bandolier | Ear Pendants | Beads | Peace Medal | Arm Bands | Wrist Bands | Ties on Wrists | Loose Scarf hanging from Turban* |
|-----------------------|---------------|----------------------|--------------|-------|-------------|-----------|-------------|----------------|----------------------------------|
| <b>Allowat Sakima</b> | Yes           | Yes                  | Yes          | Yes   | Yes         | Opt.      | Opt.        | Opt.           | Opt.                             |
| <b>Meteu</b>          | Yes (2)       | Opt. (2)             | Opt.         | Opt.  | Opt.        | Opt.      | Opt.        | Opt.           | Opt.                             |
| <b>Nutiket</b>        | Opt. (2)      | Opt. (2)             | No           | Opt.  | No          | Opt.      | No          | No             | Opt.                             |
| <b>Kichkinet</b>      | No            | No                   | No           | Opt.  | No          | No        | No          | No             | Opt.                             |

- NOT worn prior to 1865 are vests, bowlers, straw hats, or conductors' caps.
- Pre-1865 turban style differs substantially.
- Bandolier prior to 1865 is fingerwoven, not heddle loom beaded.
- Leggings prior to 1890 are wool or buckskin. No wool after 1890.

*\*Loose end may be end of turban scarf, or different scarf tucked in.*

[Complete Index to Articles in 19th Century Seminole Mens Clothing](#)

Contributed by [Rick Obermeyer](#) E-mail: [orick@prodigy.net](mailto:orick@prodigy.net)

From the book *19th Century Seminole Mens Clothing*

© 1991-2000 Sherwood F. Obermeyer Jr., 2124 Miscindy Place, Orlando, FL 32806

[Return to NativeTech's Main Leather & Clothes Menu](#)

[Leather & Clothes Bibliography and Books to Buy On-Line](#)



Text and Graphics  
 © 1994 - 2003 [Tara Prindle](#)  
 unless otherwise cited.

## Indigenous Plants

- [Indigenous Plants Gathered in the Northeast](#)
- [Gathering Hike in Mansfield, CT](#)
- [Uses for Sweetgrass](#)
- [Plant Bibliography and Books to Order On-line](#)

[Other Internet Resources for Indigenous Plants](#)



Text and Graphics  
© 1994 - 103 [Tara Prindle](#)  
unless otherwise cited.

## AMERICAN ELDERBERRY

(*Sambucus canadensis*)



**Medicine:** Astringent, diuretic, promotes sweating, laxative. Inner bark used in pain killer. Crushed leaves act as an insect repellent.

**Technology:** Elderberries make a purple to lavender dye. The branches of the tree have hollow stems with easily removed pith, and are perfect for flutes or whistles.

---

[<<- Previous Plant](#)

[->> Next Plant](#)

---

[Return to Plants Gathered in the Northeast](#)

[Return to Gathering Walk](#)

[Plant Bibliography and Books to Order On-line](#)



Text and Graphics  
© 1994 - 103 [Tara Prindle](#)  
unless otherwise cited.

## ASH

(Fraxinus species)



**Medicine:** Medicine: Chippewa made a tonic from the inner bark of ash, and they used a decoction of dried ash roots as an ingredient in enemas. Application of the sap from the White ash (*F. americana*) was used by Connecticut Native Americans to treat cancerous growths. Other antiseptic or diuretic medicines were made from the leaves, bark or seeds of White ash.

**Technology:** Technology: Black ash (*F. nigra*) bark was collected in sheets and used to cover wigwam frames. Snowshoe frames, sleds, and other items were made by carving and bending the wood. White ash was used to carve ladles by the Iroquois. Basket splints were made by pounding apart the growth rings, or layers, of soaked ash trunks. Splints were finished for weaving by cutting to size and hand splitting the ash into fine ribbons of wood.

**Note:** For additional information browse NativeTech's [Nipmuc Splint Basketry article](#)

---

[<<- Previous  
Plant](#)

[->> Next  
Plant](#)

---

[Return to Plants Gathered in the Northeast](#)

[Return to Gathering Walk](#)

[Plant Bibliography and Books to Order On-line](#)

---





**Text and Graphics**  
© 1994 - 103 [Tara Prindle](#)  
unless otherwise cited.

## BASSWOOD

(*Tilia americana*)



**Medicine:** A tonic made from the flowers and leaves alleviates the symptoms following colds.

**Technology:** Technology: Fibers were stripped from the inner bark of the basswood tree. After long pieces of bark were removed from the tree the sections were soaked to facilitate separating the fibers from the inner bark. Basswood fibers could be used immediately for simple lashing, or the fibers could be dried and stored for future use. Other items made from dyed basswood fibers include tumplines or burdenstraps used to carry heavy loads, fine twined storage bags and closely woven mats used to strain maple syrup. Sheets of basswood bark were also used as winter coverings for wigwams. Iroquois found the wood ideal for carving, the grain being soft and light.



**Note:** For additional information browse NativeTech's [Information on Cordage](#)

---

[<<- Previous](#)  
[Plant](#)

[->>](#)  
[Next](#)  
[Plant](#)

---

[Return to Plants Gathered in the Northeast](#)

[Return to Gathering Walk](#)

[Plant Bibliography and Books to Order On-line](#)

---



**Text and Graphics**  
© 1994 - 103 [Tara Prindle](#)  
unless otherwise cited.

## BEDSTRAW

(Galium aparinebedstrawFONT>



**Food:** Seeds can be roasted as caffeine-free coffee substitute.

**Medicine:** A tea from the plant helps urinary tract disorders.

**Technology:** A variety of bedstraw (*G. triflorum*) was used to perfume stored belongings.

**Note:** Also called Cleavers.



---

[<<- Previous Plant](#)

[->> Next Plant](#)



---

[Return to Plants Gathered in the Northeast](#)

[Return to Gathering Walk](#)

[Plant Bibliography and Books to Order On-line](#)





**Text and Graphics**  
© 1994 - 103 [Tara Prindle](#)  
**unless otherwise cited.**

## **BINDWEED**

(*Convolvulus sepium*)



**Medicine:** Medicine from the roots, stem, and leaves have alaxative effect. Aztecs recognized the hallucinogenic properties of seeds of native members of the Morning Glory family.

**Note:** Member of the Morning Glory family.



---

[<<- Previous  
Plant](#)

[->>  
Next  
Plant](#)

---

[Return to Plants Gathered in the Northeast](#)

[Return to Gathering Walk](#)

[Plant Bibliography and Books to Order On-line](#)



**Text and Graphics**  
© 1994 - 103 [Tara Prindle](#)  
unless otherwise cited.

## BIRCH

(Betula species)



**Food:** Broken twigs of the Yellow birch (*B. alleghaniensis*) and Black or Sweet birch (*B. Nigra*) have a wintergreen fragrance. A sap can be collected and boiled down from Yellow birch. From Black birch harvest the twigs, red inner bark and larger roots. The inner bark can be boiled or ground into a flour. Twigs and inner bark can be steeped into a tea. Wintergreen flavor is stronger in Black birch.

**Medicine:** Chippewa made a medicine from Black and White birch (*B. papyrifera*) for stomach pain.

**Technology:** New England tribes used the bark of White or Paper Birch for many purposes. Large bark sheets were stripped from the tree in late spring to use as house coverings or to build canoes. Smaller pieces of bark were cut into patterns and used to make dishes and utensils, including seamless maple sap collecting dishes and maple sugar storage containers (makaks). The bark was also cut and folded to make baskets, fans and even tinder to fish by torchlight from canoes. Folding and biting single thin layers of the paper produced dental pictographs, or birch bark transparencies, that could be used for beadwork designs and patterns for other decorations.

**Note:** Indian legend surround the distinctive markings of the birch tree. The bark of this tree was never taken without acknowledgement its importance to Native Americans and without offering and thanks to the spirits that provide it. Read the Ojibwe story of [Winnebojo & the Birch Tree](#). For

additional information browse  
NativeTech's [Uses of Birchbark](#).

---

[<<- Previous  
Plant](#)

[->>  
Next  
Plant](#)

---

[Return to Plants Gathered in the Northeast](#)

[Return to Gathering Walk](#)

[Plant Bibliography and Books to Order On-line](#)

---

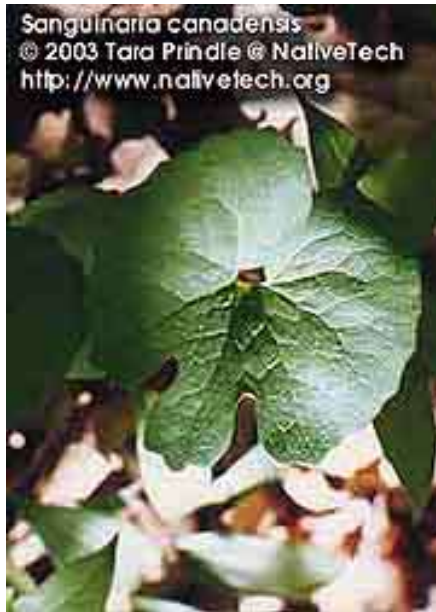


**Text and Graphics  
© 1994 - 103 [Tara Prindle](#)  
unless otherwise cited.**



## BLOODROOT

(*Sanguinaria canadensis*)



**Medicine:** The juice was used for sore throats and an infusion from the rhizome for rheumatism. Cancer was treated with the plant on the basis that the juice is caustic and can destroy and scar tissue with prolonged contact.

**Technology:** The juice from the crimson root and inner bark was prized for painting cheeks and faces, and in decorating clothing and staining wooden items.

**Note:** Also called Indian Paint.



---

[<<- Previous Plant](#)

[->> Next Plant](#)



---

[Return to Plants Gathered in the Northeast](#)

[Return to Gathering Walk](#)

[Plant Bibliography and Books to Order On-line](#)

---



**Text and Graphics**  
© 1994 - 103 [Tara Prindle](#)  
unless otherwise cited.

## BLUEBERRY

(*Vaccinium* species)



**Food:** Edible berries.

**Medicine:** Flowers of one species of blueberry (*V. angustifolium*) were used by the Chippewa in a medicine for 'craziness'.



---

[<<-](#)

[Previous  
Plant](#)

[->>](#)

[Next  
Plant](#)



---

[Return to Plants Gathered in the Northeast](#)

[Return to Gathering Walk](#)

[Plant Bibliography and Books to Order On-line](#)

---



**Text and Graphics**  
© 1994 - 103 [Tara Prindle](#)  
unless otherwise cited.



## BLUE FLAG

(Iris versicolor)

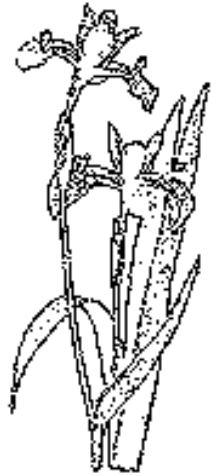


**Food:** Rhizomes are poisonous.

**Medicine:** A panacea for many ills and believed to influence the lymphatic system, the plant was used a poultice for treating sores and bruises.

**Technology:** When gathering plants in the hot sun, California Indian women wrapped their babies in the soft green iris leaves to retard the infants perspiration and save them from extreme thirst.

**Note:** Often planted near indian villages to ensure a good supply.



---

[<<- Previous  
Plant](#)

[->> Next  
Plant](#)

---

[Return to Plants Gathered in the Northeast](#)

[Return to Gathering Walk](#)

[Plant Bibliography and Books to Order On-line](#)



Text and Graphics  
© 1994 - 103 [Tara Prindle](#)  
unless otherwise cited.

## BRACKEN FERN

(*Pteridium aquilinum*)



**Medicine:** The brown root has an unpleasant smell and taste, but when boiled and eaten made an effective worm medicine. A root tea was used for stomach cramps and diarrhea, and smoke for headaches. A poultice of the root was made for burns and sores, and an astringent wash was made to promote hair growth.

**Note:** Also called Brake Root. Poisonous in excess doses.



---

[<<- Previous Plant](#)

[->> Next Plant](#)



---

[Return to Plants Gathered in the Northeast](#)

[Return to Gathering Walk](#)

[Plant Bibliography and Books to Order On-line](#)



**Text and Graphics**  
© 1994 - 103 [Tara Prindle](#)  
unless otherwise cited.

## BULRUSH

(*Scirpus validus*)



**Food:** Roots eaten by Chippewa. Pollen, young shoots, and seeds are also edible.

**Technology:** Using twining and under-over techniques, fine mats and bags were woven from the leaves and stalks. The fine mats were used inside the wigwam to cover the lower walls, or for sitting and eating upon.

**Note:** For additional information browse NativeTech's [Information relating to interior Bulrush mats](#)



---

[<<- Previous Plant](#)

[->> Next Plant](#)



---

[Return to Plants Gathered in the Northeast](#)

[Return to Gathering Walk](#)

[Plant Bibliography and Books to Order On-line](#)





**Text and Graphics**  
© 1994 - 103 [Tara Prindle](#)  
unless otherwise cited.

## BURDOCK

(*Arctium minus*)



**Food:** Edible greens, fresh or in soups. Roots and stems may be eaten if boiled in several batches of water.

**Medicine:** Chippewa used the plant in a medicine for coughs.

**Technology:** The leaves were sewn together, and sometimes reinforced with a birchbark headband, to make a hat for working in the hot summer sun.

**Note:** Similar to european introduced Great Burdock, only this plant is smaller.



---

[<<- Previous Plant](#)

[->> Next Plant](#)

---

[Return to Plants Gathered in the Northeast](#)

[Return to Gathering Walk](#)

[Plant Bibliography and Books to Order On-line](#)



Text and Graphics  
© 1994 - 103 [Tara Prindle](#)  
unless otherwise cited.

## BUTTERFLY WEED

(*Asclepias tuberosa*)



**Food:** A member of the Milkweed family, so most parts of the plant contain toxins. A crude sugar is produced from the flowers.

**Medicine:** Poultices for sores were made from the powdered root. A tea from the root encourages sweating. A tea was also made to induce vomiting during certain rituals.

**Note:** Note: Also called Indian nosy.



---

[<<- Previous Plant](#)

[->> Next Plant](#)

---

[Return to Plants Gathered in the Northeast](#)

[Return to Gathering Walk](#)

[Plant Bibliography and Books to Order On-line](#)



Text and Graphics  
© 1994 - 103 [Tara Prindle](#)  
unless otherwise cited.

## CATTAIL

(*Typha latifolia*)



**Food:** The roots may be ground into a flour. The sticky sap between the leaves is an excellent starch and can be used to thicken soups and broths. The white colored shoots at the base of the leaf clusters can be boiled or steamed or sliced and eaten raw in salads.

**Medicine:** Pollen is hemostatic & astringent. Place directly on cut to control bleeding. Take internally for internal bleeding, menstrual pain, chest pains, & other forms of blood stagnation. Pollen is also mildly diuretic and emenagogue. Use fresh, pounded root directly as a poultice on infections, blisters, & stings. Sticky starch at the base of the green leaf is antiseptic, coagulant, & even a bit numbing. Boil leaves for external skin wash. Starchy, mashed root use as a toothpaste. Drink root flour in a cup of hot water or eat the young flowerheads to bind diarrhea and dysentery.

**Technology:** The leaves and stalks were used extensively in making sewn exterior mats for wigwams. String could also be made from fibers at the base of leaves. By folding a few leaves from the cattail stalk, Chippewa made simple dolls and small toy ducks that really float. The small ducks were usually made in groups of five to resemble a flock. The fluff from cattails was often used to insulate footwear in the winter, or to pad a baby's cradleboard.

**Note:** For additional information browse NativeTech's [Uses for Cattails and Grasses](#)



[<<- Previous Plant](#)

[->> Next Plant](#)

[Return to Plants Gathered in the Northeast](#)



[Return to Gathering Walk](#)

[Plant Bibliography and Books to Order On-line](#)

---



**Text and Graphics**  
© 1994 - 103 [Tara Prindle](#)  
**unless otherwise cited.**

## COMMON WOOD SORREL

(Oxalis species)



**Food:** The distinctive shamrock-shaped, three-lobed leaves are edible, and though they may have a sour taste, they make a great trail-side nibble.



**Medicine:** The leaves are chewed for nausea, and to relieve mouth sores and sore throats, and a poultice of fresh leaves for cancers and old sores. Leaf teas are brewed for fevers, urinary infections and scurvy.

**Note:** Large doses may cause oxalate poisoning.



---

[<<- Previous Plant](#)

[->> Next Plant](#)

---

[Return to Plants Gathered in the Northeast](#)

[Return to Gathering Walk](#)

[Plant Bibliography and Books to Order On-line](#)

---



**Text and Graphics**  
© 1994 - 103 [Tara Prindle](#)  
unless otherwise cited.

## DAISY FLEABANE

(*Erigeron annuus*)



**Medicine:** A tea from the plant was a diuretic and medicine for digestive ailments. An essential oil can be made to relieve bronchitis and cystitis

**Technology:** When burned the plant may keep insects away.

**Note:** Canada fleabane is called Horseweed and may cause contact dermatitis.



---

[<<-](#)

[Previous  
Plant](#)

[->>](#)

[Next  
Plant](#)

---

[Return to Plants Gathered in the Northeast](#)

[Return to Gathering Walk](#)

[Plant Bibliography and Books to Order On-line](#)

---





**Text and Graphics**  
© 1994 - 103 [Tara Prindle](#)  
unless otherwise cited.

## DOGBANE

(*Apocynum cannabinum*)



**Food:** Although a relative of milkweed, dogbane is much more toxic.

**Medicine:** The roots are used for heart stimulants. Mashed leaves are used for rheumatism and applied to wounds. A charm is made with the plant to be used against 'bad medicine' or evil influence.

**Technology:** The inner bark is stripped from the fresh plant and the resulting fibers can be twisted into two-ply string, strong fishing line or bow strings, or used to weave baskets and mats.

**Note:** Also called Indian Hemp or Hemp Dogbane. For additional information browse NativeTech's [Plants used for Cordage](#).

---

[<<- Previous Plant](#)

[->> Next Plant](#)

---

[Return to Plants Gathered in the Northeast](#)

[Return to Gathering Walk](#)

[Plant Bibliography and Books to Order On-line](#)

---



**Text and Graphics**  
© 1994 - 103 [Tara Prindle](#)  
unless otherwise cited.

## DOGWOOD

(Cornus species)



**Medicine:** *C. alternifolia* was used to make an eye medicine by the Chippewa. The bark was simmered in water and used on aching muscles and a bark tea was used to promote sweating and break a fever. Ceremony: The leaves of some varieties of Dogwood were used in smoking mixtures including Red Osier dogwood (*C. stolonifera*) and the *C. rugosa* type of dogwood. The root of *C. alternifolia* was also used in a charm that was applied to muskrat traps.



**Technology:** The inner bark of Red Osier dogwood was used in mixtures for red, black and yellow dyes. The hardness of the wood makes it good for carving durable items.

**Note:** When dogwoods flowered in the spring, it indicated the planting time for corn.

---

[<<-](#)

[Previous  
Plant](#)

[->>](#)

[Next  
Plant](#)

---

[Return to Plants Gathered in the Northeast](#)

[Return to Gathering Walk](#)

[Plant Bibliography and Books to Order On-line](#)

---





**Text and Graphics**  
© 1994 - 103 [Tara Prindle](#)  
unless otherwise cited.

## GREEN FALSE HELLEBORE

(*Veratrum viride*)



**Food:** All parts of the plant are poisonous.

**Medicine:** Said to be an antidote to madness. The roots were mashed and applied to snakebite. Legend holds the plant was used in the selection of 'chiefs'. The root of the plant was used as an endurance drug, and status was afforded to men who came through the experience. Dry root of the White Hellebore was pounded and snuffed.



**Note:** Also called Indian Poke. White Hellebore (*Veratrum speciosum*) is called Indian itchweed.

---

[<<- Previous Plant](#)

[->> Next Plant](#)

---

[Return to Plants Gathered in the Northeast](#)

[Return to Gathering Walk](#)

[Plant Bibliography and Books to Order On-line](#)

---



**Text and Graphics**  
© 1994 - 103 [Tara Prindle](#)  
unless otherwise cited.

## GOLDENROD

(Solidago odora)



**Medicine:** Leaves and flowers are made into a tea for intestinal and urinary disorders.

**Technology:** A deep yellow dye is produced from the flowers.

**Note:** Doesn't have airborne pollen. Doesn't cause hayfever suffers as ragweed does.



---

[<<-](#)

[Previous  
Plant](#)

[->>](#)

[Next  
Plant](#)

---

[Return to Plants Gathered in the Northeast](#)

[Return to Gathering Walk](#)

[Plant Bibliography and Books to Order On-line](#)



**Text and Graphics  
© 1994 - 103 [Tara Prindle](#)  
unless otherwise cited.**



## GROUND PINE

(*Lycopodium clavatum*)



**Medicine:** Used in medicine for stiff joints.

**Note:** A miniature relative of a prehistoric tree that reached over 100 ft. a million years ago.



---

[<<-](#)  
[Previous](#)  
[Plant](#)

[->>](#)  
[Next](#)  
[Plant](#)



---

[Return to Plants Gathered in the Northeast](#)

[Return to Gathering Walk](#)

[Plant Bibliography and Books to Order On-line](#)

---



**Text and Graphics**  
© 1994 - 103 [Tara Prindle](#)  
unless otherwise cited.

## HICKORY

(Carya species)



**Food:** Both the Shagbark (*C. ovata*) and the Mockernut (*C. tomentosa*) hickory have edible nuts in early autumn. Pounded nut meats were boiled slowly and the resulting oil was skimmed from the surface of the water and used as butter. Nuts of the Bitternut Hickory (*Carya cordiformis*) are too bitter for food and are also avoided by most animals.

**Medicine:** Inhaling the fumes of fresh hickory shoots placed on hot stones was used by Chippewa for convulsions.

**Technology:** Also known as Bow Wood for the use in making archery bows. The wood was also used by Iroquois for frames in birch bark canoe making. Splints of hickory were used to reinforce the rims of bark containers. The stripped inner bark of hickory was used for lashing. To make a rattle, a small sheet of hickory bark was folded over on itself, forming a hollow that could contain seeds or small stones. The hole in the handle was stopped up with a segment of dried corn cob.

**Note:** The name comes from a Native American word pawcohiccora, for a gruel made from the nuts.

[<<- Previous Plant](#)

[->> Next Plant](#)

[Return to Plants Gathered in the Northeast](#)

[Return to Gathering Walk](#)

[Plant Bibliography and Books to Order On-line](#)



**Text and Graphics**  
© 1994 - 103 [Tara Prindle](#)  
unless otherwise cited.



## HOG PEANUT

(Amphicarpase species)



**Food:** A single large seed ripens on this vine.

**Medicine:** Also with the common name hog peanut (*Falcata comosa*) a reddish bean from this vine was used by the Chippewa as a physic.



---

[<< Previous Plant](#)

[->> Next Plant](#)

---

[Return to Plants Gathered in the Northeast](#)

[Return to Gathering Walk](#)

[Plant Bibliography and Books to Order On-line](#)



Text and Graphics  
© 1994 - 103 [Tara Prindle](#)  
unless otherwise cited.

## HOP HORNBEAM

(*Ostrya virginiana*)



**Medicine:** Chippewa used the wood at the heart of the branch in making a cough syrup, and in a medicine for kidney disorders.

**Technology:** The wood is very strong as the name implies and was used for the frames for dwellings, and from the crooks of branches, pothooks were made to suspend cooking vessels over fires.

**Note:** Also called Iron wood



---

[<< Previous Plant](#)

[->> Next Plant](#)



---

[Return to Plants Gathered in the Northeast](#)

[Return to Gathering Walk](#)

[Plant Bibliography and Books to Order On-line](#)

---



**Text and Graphics**  
© 1994 - 103 [Tara Prindle](#)  
unless otherwise cited.

## INDIAN CUCUMBER

(*Medeola virginiana*)



**Food:** The tuberous root has the flavor and a shape similar to cucumber and can be eaten raw.

**Note:** The berries are not edible.



---

[<<- Previous Plant](#)

[->> Next Plant](#)



---

[Return to Plants Gathered in the Northeast](#)

[Return to Gathering Walk](#)

[Plant Bibliography and Books to Order On-line](#)

---





**Text and Graphics**  
© 1994 - 103 [Tara Prindle](#)  
unless otherwise cited.

## INDIAN PIPE

(*Monotropa uniflora*)



**Medicine:** The fleshy plant was pulverized and mixed with water for an eye lotion.

**Note:** Also called Ghost flower or Corpse plant.



---

[<<- Previous Plant](#)

[->> Next Plant](#)



---

[Return to Plants Gathered in the Northeast](#)

[Return to Gathering Walk](#)

[Plant Bibliography and Books to Order On-line](#)



**Text and Graphics**  
© 1994 - 103 [Tara Prindle](#)  
unless otherwise cited.

## INDIAN TOBACCO

(*Lobelia inflata*)



**Medicine:** Dried leaves were used in smoking mixtures to relieve asthma and lung disorders. In small doses lobelia is a stimulant, while in larger doses it is a relaxant.

---

[<<- Previous Plant](#)

[->> Next Plant](#)



---

[Return to Plants Gathered in the Northeast](#)

[Return to Gathering Walk](#)

[Plant Bibliography and Books to Order On-line](#)



Text and Graphics  
© 1994 - 103 [Tara Prindle](#)  
unless otherwise cited.



## JACK-IN-THE-PULPIT

(*Arisaema triphyllum*)



**Food:** Edible bulb like base (corm) loses acidity when cooked.

**Medicine:** Chippewa made a medicine to relieve sore eyes.

**Technology:** Bright red berries boiled for dye.

**Note:** Also called Indian turnip.



---

[<<- Previous Plant](#)

[->> Next Plant](#)



---

[Return to Plants Gathered in the Northeast](#)

[Return to Gathering Walk](#)

[Plant Bibliography and Books to Order On-line](#)

---



**Text and Graphics**  
© 1994 - 103 [Tara Prindle](#)  
unless otherwise cited.

## JEWELWEED

(*Impatiens biflora*)



**Food:** The young greens may be used as a potherb if boiled and drained in several batches of fresh water. The seeds, separated from the rest of the fruit, can be eaten raw or as toppings on deserts, tastes like Butternuts.



**Medicine:** Chippewa made a medicine from the plant for a sore mouth. Technology: Raw juice (or boiled crushed stems) from this succulent plant prevents and relieves the symptoms of poison ivy, nettles, and fungal dermatitis.

**Note:** Also called Touch-me-not because of exploding seed pods.



---

[<<- Previous Plant](#)

[->> Next Plant](#)

---

[Return to Plants Gathered in the Northeast](#)

[Return to Gathering Walk](#)

[Plant Bibliography and Books to Order On-line](#)

---



**Text and Graphics**  
© 1994 - 103 [Tara Prindle](#)  
unless otherwise cited.



## JUNIPER

(Juniperus communis)



**Medicine:** A tea from the twigs was drunk for stomach aches and colds. A poultice from boiled twigs and berries was applied to aches and sores. The berries were used as a diuretic and to stop bleeding.

**Technology:** Nevada Indians used the berries as beads, ants ate out the sweet part near the seed leaving the desired perforation for stringing.



---

[<<- Previous  
Plant](#)

[->>  
Next  
Plant](#)

---

[Return to Plants Gathered in the Northeast](#)

[Return to Gathering Walk](#)

[Plant Bibliography and Books to Order On-line](#)

---



**Text and Graphics**  
© 1994 - 103 [Tara Prindle](#)  
unless otherwise cited.

## LADY'S-SLIPPER

(*Cypripedium acaule*)



**Medicine:** A decoction of the boiled roots was used to calm the nerves. Chippewa made a toothache medicine from another variety of lady slipper (*C. acaule*)

---

[<<- Previous Plant](#)

[->> Next Plant](#)



---

[Return to Plants Gathered in the Northeast](#)

[Return to Gathering Walk](#)

[Plant Bibliography and Books to Order On-line](#)

---



**Text and Graphics**  
**© 1994 - 103 [Tara Prindle](#)**  
**unless otherwise cited.**

## MAPLE

(Acer saccharum)



**Food:** The sap collected in the spring starting in mid March. Holes are made upward into the tree into which the tap is secured. A seamless bark container was placed under the tap to collect the sap which was then boiled and made into syrup and sugar

**Medicine:** A tea from the inner bark is made for coughs and an expectorant. Maple syrup is believed to be a liver and kidney cleanser.

**Note:** Red Maple has sharply pointed leaves, as opposed to the rounded lobes of the sugar maple. For additional information browse NativeTech's [SugarBush; A Metis Account of Maple sugaring.](#)

---

[<<- Previous Plant](#)

[->> Next Plant](#)

---

[Return to Plants Gathered in the Northeast](#)

[Return to Gathering Walk](#)

[Plant Bibliography and Books to Order On-line](#)



Text and Graphics  
© 1994 - 103 [Tara Prindle](#)  
unless otherwise cited.



## MAPLE-LEAF VIBURNUM

(*Virburnum acerifolium*)



**Medicine:** Chippewa used a decoction of the inner bark to relieve stomach pains. Maple was also used as an application to soothe sore eyes, owing to its astringent nature.

**Note:** Also known as Arrowwood



---

[<<-](#)

[Previous  
Plant](#)

[->>](#)

[Next  
Plant](#)



---

[Return to Plants Gathered in the Northeast](#)

[Return to Gathering Walk](#)

[Plant Bibliography and Books to Order On-line](#)



Text and Graphics  
© 1994 - 103 [Tara Prindle](#)  
unless otherwise cited.

## MILKWEED

(*Asclepias syriaca*)



**Food:** Young shoots, flowers and pods are edible only if boiled in three or four different batches of water to remove toxins.

**Medicine:** An extract from the boiled roots is used to treat bowel and kidney disorders. The sap is applied to warts and to relieve poison ivy.

**Technology:** Like the relative Indian Hemp, the inner bark of milkweed can also be twisted into string or rope. The fluff of milkweed makes excellent tinder in fire starting.

**Note:** Also called Wild Cotton.



---

[<<- Previous Plant](#)

[->> Next Plant](#)

---

[Return to Plants Gathered in the Northeast](#)

[Return to Gathering Walk](#)

[Plant Bibliography and Books to Order On-line](#)



**Text and Graphics**  
© 1994 - 103 [Tara Prindle](#)  
unless otherwise cited.

## MULTIFLORA ROSE

(*Rosa multiflora*)



**Food:** Although it's easy to identify a member of the rose family, it's sometimes difficult to distinguish between species of the rosa family. Fortunately, all members of the rose family have edible fruits. Gather rose hips in autumn after the frost or in winter. Remove all flower parts and any seeds contained when the hips are split open. Flower petals and leaves may be prepared for teas.

**About Roses:** There are about 35 species of roses native to North America and several introduced species (including Multiflora Rose) that now grow wild on roadsides and thrive in disturbed soils. Multiflora Rose is one of the European introduced plants which, akin to Japanese Barberry and Asian Bittersweet, have established themselves so well in the woodlands that they've taken over areas where indigenous plants once thrived. Thank you Jeff Boverman, for reminding me that although *Rosa multiflora* is widespread and now grows wild throughout New England, the shrub is not native to North America.

---

[<<](#)

[Previous](#)

[Plant](#)

[>>](#)

[Next](#)

[Plant](#)

---



[Return to Plants Gathered in the Northeast](#)

[Return to Gathering Walk](#)

[Plant Bibliography and Books to Order On-line](#)

---



**Text and Graphics**  
© 1994 - 103 [Tara Prindle](#)  
unless otherwise cited.

## NETTLE

(*Urtica* species )



**Food:** Stinging nettle (*U. dioica*) young shoots and tender top leaves can be gathered (using gloves) and dried for a potherb. Boiling the nettle destroys the irritant quality. **Medicine:** Root and



**Medicine:** Root and boiled leaf decoctions were used to sooth symptoms of rheumatism. A nettle tea helped clear the lungs.

**Technology:** Stinging nettle plants are used to produce a tan dye. Fibers from the Slender nettle (*U. gracilis*) plant are used in making string. Fibers from the False Nettle (*Urticastrum divaricatum*) plant (that does not have stinging spines) are also used in making string.



**Note:** For additional information browse NativeTech's [Plants used for Cordage](#).

---

[<<- Previous Plant](#)

[->> Next Plant](#)

---

[Return to Plants Gathered in the Northeast](#)

[Return to Gathering Walk](#)

[Plant Bibliography and Books to Order On-line](#)

---



**Text and Graphics**  
© 1994 - 103 [Tara Prindle](#)  
unless otherwise cited.

# OAK

(*Quercus* species)



**Food:** White (*Q. alba*) oak acorns are the most palatable. Boiling or soaking in water helps remove bitterness from the acorns of Red (*Q. Rubra*) and Black (*Q. velutina*) Oak species. The nut meat may be ground for use in grits or meal or pounded into a paste.

**Medicine:** Bark of white oak contains tannin, an astringent, which can be applied to insect bites. The bark of oak can be brewed into a tea for diarrhea, and the scraped and dried inner bark of Red or Bur (*Q. macrocarpa*) oak can be made into tea to relieve heart symptoms.

**Technology:** The wood was carved to make awls, corn pounding mortars, and other tools. Oak bark was used in making some Iroquois canoes. In later times basket splints were made of oak because of the toughness and durability of the wood. Inner bark of the Bur oak was used in Chippewa red and black dye recipes. Black oak is also known as Dyer's Oak, as the orange inner bark produces strong dye.

**Note:** For additional information browse NativeTech's [Information on Natural Dyes](#)



[<<-](#)  
[Previous](#)  
[Plant](#)

[->>](#)  
[Next](#)  
[Plant](#)

---

[Return to Plants Gathered in the Northeast](#)

[Return to Gathering Walk](#)

[Plant Bibliography and Books to Order On-line](#)



**Text and Graphics**  
© 1994 - 103 [Tara Prindle](#)  
**unless otherwise cited.**

## PARTRIDGE BERRY

(*Mitchella repens*)



**Food:** The scarlet berry is edible but almost tasteless, and remains on the plant all winter.

**Medicine:** In their final weeks of pregnancy Indian women drank a tea from the leaves to ease childbirth. Nursing mothers made a lotion from the leaves to relieve breast soreness.



**Note:** Also called Squaw Vine or Squaw Berry.



---

[<<-](#)

[Previous  
Plant](#)

[->>](#)

[Next  
Plant](#)

---

[Return to Plants Gathered in the Northeast](#)

[Return to Gathering Walk](#)

[Plant Bibliography and Books to Order On-line](#)

---



Text and Graphics  
© 1994 - 103 [Tara Prindle](#)  
unless otherwise cited.

## PHRAGMITES

(Phragmites Communis)



**Food:** The seeds were winnowed and made into a flour for breads and gruel.

**Technology:** Reeds were used to make woven frames for drying berries and were also used to make sewn mats for summer house cover. Western Native American duck hunting arrows utilized the Phragmites stalk. Europeans used this reed as a pen quill.

**Note:** Also called Reed Grass. Although indigenous to all parts of the world, this grass is highly invasive, and has been steadily moving into the Northeast with the continued destruction of natural wetland habitats.



---

[<<- Previous Plant](#)

[->> Next Plant](#)

---

[Return to Plants Gathered in the Northeast](#)

[Return to Gathering Walk](#)

[Plant Bibliography and Books to Order On-line](#)



Text and Graphics  
© 1994 - 103 [Tara Prindle](#)  
unless otherwise cited.

## PICKEREL WEED

(*Pontederia cordata*)



**Food:** Young washed leafstalks can be eaten raw in salads or boiled as a potherb. Fruits also contain a single solid seed that is edible raw or dried and ground like grain.

---

[<<- Previous Plant](#)

[->> Next Plant](#)



---

[Return to Plants Gathered in the Northeast](#)

[Return to Gathering Walk](#)

[Plant Bibliography and Books to Order On-line](#)

---



**Text and Graphics  
© 1994 - 103 [Tara Prindle](#)  
unless otherwise cited.**



## VIOLET

(*Viola specieis*)



**Food:** Gather flowers (without stems) and young bright green leaves. Flowers may be eaten fresh or used in jams or syrups. Likely that all viola species are edible with some more palatable than others



---

[<<-](#)  
[Previous](#)  
[Plant](#)

[->>](#)  
[Next](#)  
[Plant](#)



---

[Return to Plants Gathered in the Northeast](#)

[Return to Gathering Walk](#)

[Plant Bibliography and Books to Order On-line](#)



Text and Graphics  
© 1994 - 103 [Tara Prindle](#)  
unless otherwise cited.

## TAMARACK

(*Larix laricina*)



**Medicine:** The inner bark was used to treat melancholy.

**Technology:** The roots were used by Chippewa in sewing the edges of canoes and in making woven bags.

**Note:** This conifer sheds its needles every autumn. It gets its name from the Native American word Hackmatack. For additional information browse NativeTech's [Tamarack Trees & Traditions ~ Decoys](#)



---

[<<-](#)

[Previous  
Plant](#)

[->>](#)

[Next  
Plant](#)

---

[Return to Plants Gathered in the Northeast](#)

[Return to Gathering Walk](#)

[Plant Bibliography and Books to Order On-line](#)

---



**Text and Graphics**  
© 1994 - 103 [Tara Prindle](#)  
unless otherwise cited.

## TREMBLING ASPEN

(Populus tremuloides)



**Food:** The inner bark is peeled back to reveal an inner bark that produces a syrup that was drunk as an energy source.

**Medicine:** The bark could be boiled into a cough syrup by the Cree. Mohawk brewed a bark tea to expel worms. Delaware boiled the roots for debilities. Fox people boiled the buds with fat for a salve for a sore nose from a cold. The root was eaten by Chippewa women to prevent premature childbirth and also for a heart medicine.

**Note:** Also known as quaking aspen because of the leaf action in only the slightest breeze.



---

[<<- Previous Plant](#)

[->> Next Plant](#)

---

[Return to Plants Gathered in the Northeast](#)

[Return to Gathering Walk](#)

[Plant Bibliography and Books to Order On-line](#)



Text and Graphics  
© 1994 - 103 [Tara Prindle](#)  
unless otherwise cited.



## VIRGINIA CREEPER

(Parthenocissus quinquefolia)



**Food:** The stalk and sap next to the bark were eaten.

**Note:** Also called Woodbine.



---

[<<- Previous Plant](#)

[->> Next Plant](#)

---

[Return to Plants Gathered in the Northeast](#)

[Return to Gathering Walk](#)

[Plant Bibliography and Books to Order On-line](#)



Text and Graphics  
© 1994 - 103 [Tara Prindle](#)  
unless otherwise cited.

## WATER LILIES

(Yellow - *Nuphar advena* / White - *Nymphaea alba*)



**Food:** The roots of the Yellow pond lily were consumed.

**Medicine:** The roots of the White pond lily were used in a Chippewa medicine for a sore mouth.

**Technology:** The smoke from the rootstock is believed to repel crickets.



---

[<<-](#)

[Previous  
Plant](#)

[->>](#)

[Next  
Plant](#)

---

[Return to Plants Gathered in the Northeast](#)

[Return to Gathering Walk](#)

[Plant Bibliography and Books to Order On-line](#)



Text and Graphics  
© 1994 - 103 [Tara Prindle](#)  
unless otherwise cited.

## WILD GERANIUM

(*Geranium maculatum*)



**Food:** Young leaves were eaten as food.

**Medicine:** An effective astringent. Chippewa made a powdered medicine from the underground root for sores inside children's mouths. An eyewash was made by steeping the plant in water. A poultice from the plant was also applied to relieve swollen feet.

**Technology:** The plant was boiled down by Austin Indians and added to red clay to make it mold more easily into cups.

**Note:** Also called Cranesbill.



---

[<<- Previous Plant](#)

[->> Next Plant](#)

---

[Return to Plants Gathered in the Northeast](#)

[Return to Gathering Walk](#)

[Plant Bibliography and Books to Order On-line](#)

---



**Text and Graphics**  
© 1994 - 103 [Tara Prindle](#)  
unless otherwise cited.



## WILD GRAPE

(Vitis species)



**Food:** The young leaves can be boiled. The grapes are too acid to eat in quantity and are best prepared in juice, jelly or other cooked recipes.

**Technology:** The fruit produces a grey violet dye. Grapevine has also been used in the basketry of Native Americans of the western United states.

**Note:** Beware of look-alike Moonseed which has a similar leaf and a single seed in the shape of a flat crescent on the inside of each fruit.



---

[<<- Previous Plant](#)

[->> Next Plant](#)

---

[Return to Plants Gathered in the Northeast](#)

[Return to Gathering Walk](#)

[Plant Bibliography and Books to Order On-line](#)



Text and Graphics  
© 1994 - 103 [Tara Prindle](#)  
unless otherwise cited.

## WILD SARSAPARILLA

(*Aralia nudicaulis*)



**Food:** Brewed into a 'root beer'.

**Medicine:** The scented roots were used for tonics, stimulants and those encouraging sweating

**Note:** A close relative of Spikenard or Indian Root.



---

[<< Previous Plant](#)

[->> Next Plant](#)



---

[Return to Plants Gathered in the Northeast](#)

[Return to Gathering Walk](#)

[Plant Bibliography and Books to Order On-line](#)

---



**Text and Graphics**  
© 1994 - 103 [Tara Prindle](#)  
unless otherwise cited.

## WILD STRAWBERRY

(*Fragaria vesca*)



**Food:** Edible tiny berries.

**Medicine:** A tea from the leaves may stimulate appetite.

**Note:** Also called Indian Strawberry. Can be distinguished from Cinquefoil which has five leaves and small yellow blossoms.



---

[<<-](#)

[Previous  
Plant](#)

[->>](#)

[Next  
Plant](#)



DWARF CINQUEFOIL

---

[Return to Plants Gathered in the Northeast](#)



[Return to Gathering Walk](#)

[Plant Bibliography and Books to Order On-line](#)

---



**Text and Graphics**  
© 1994 - 103 [Tara Prindle](#)  
unless otherwise cited.

## WILLOW

(Salix species)



**Medicine:** Bark and leaves are rich in a chemical similar to that found in aspirin. Used in smoking mixtures (Chippewa). The willow tree is associated with life and endurance, perhaps in part for the resilient ability of cut branches to take root in water.

**Technology:** Slender willow branches are good for certain types of basketry including cradle boards (Pomo) for babies and woven back rests and fish traps (Blackfoot). Willow twigs were fashioned into dolls by the Chippewa. The charred wood makes an excellent drawing charcoal.



---

[<<- Previous Plant](#)

[->> Next Plant](#)

---

[Return to Plants Gathered in the Northeast](#)

[Return to Gathering Walk](#)

[Plant Bibliography and Books to Order On-line](#)

---



Text and Graphics  
© 1994 - 103 [Tara Prindle](#)  
unless otherwise cited.

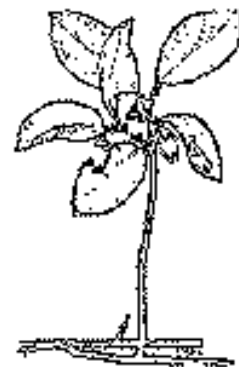
## WINTERGREEN

(*Gaultheria procumbens*)



**Food:** The leaves were used as a potherb or eaten as a snack. Bright red berries ripen in autumn and improve with winter freezing so harvest them in the winter or spring.

**Medicine:** A tea from the leaves eased symptoms of rheumatism. Oil of wintergreen has aspirin-like properties.



---

[<<- Previous Plant](#)

[->> Next Plant](#)



---

[Return to Plants Gathered in the Northeast](#)

[Return to Gathering Walk](#)

[Plant Bibliography and Books to Order On-line](#)

---



**Text and Graphics**  
© 1994 - 103 [Tara Prindle](#)  
unless otherwise cited.



## WITCH HAZEL

(*Hamamelis virginiana*)



**Medicine:** An excellent astringent when the bark, leaves and twigs are distilled and mixed with alcohol and water. Used as a liniment and eyewash and treatment for hemorrhoids. For internal hemorrhages and excessive menstrual flow.

**Technology:** The bendable forked branches have been used as divining rods in the search of water or minerals.

**Note:** Also called Snapping hazel because in the fall when flowers appear the seed capsule split open and will shoot their seeds sometimes 20 or 30 feet.

---

[<<- Previous Plant](#)

[->> Next Plant](#)

---

[Return to Plants Gathered in the Northeast](#)

[Return to Gathering Walk](#)

[Plant Bibliography and Books to Order On-line](#)

---



**Text and Graphics**  
© 1994 - 103 [Tara Prindle](#)  
unless otherwise cited.

## Threatened Indigenous Plants.

*The key to preserving plant populations is in the preservation of their habitats.*

---

The forests of today's woodlands look very much different than they did 500 years ago before European colonization. As a result of environmental changes, many plant species are threatened and in immediate danger of extinction. Some plants are rare or endangered because of natural events, and others are threatened by the activities of people. The climate of New England fluctuates dramatically with glacial cycles throughout geologic time. The climate has become consistently warmer since the last glacial advance. Some plant relicts have survived changing environments but have become naturally restricted to small, isolated pockets with favorable conditions.

By far the greatest threat to indigenous plants has been the destructive activities of people within the last 500 years. With the wave of European people came a secondary invasion of European flora and fauna. The contact of foreign and indigenous plants and animals often had adverse effects like those between the contact of cultures. Similar to the effects of European-introduced epidemics and disease on Native Peoples, many European introduced plants took over the habitats and decimated native plant populations. Some foreign plants and shrubs were intentionally introduced to supplement colonial herb and flower gardens, while plant seeds were inadvertently brought over with the fodder and by-products of livestock.

Before long the ornamentals and herbs escaped the confines of the garden and became naturalized to the environment with the aid of animals, birds and the occasional abandoned homestead. Gone are the vast stands of bulrush used by Native Americans to weave decorative mats, replaced by the ever-waving flags of phragmites reed and floral oceans of purple loosestrife. Now many indigenous plant colonies are being choked out of their natural habitats by more resilient garden 'escapees'; today about one quarter of the plants in Connecticut are alien.

Starting with the European colonization, an incredible number of forested acres of New England were clear-cut for agricultural fields or pastures. The charcoal and timber industries that followed consumed a huge quantity of virgin forest, and industrial, commercial and residential development has since nearly consumed the rest. The last acre of old-growth forest in Connecticut was reportedly cut down in Colebrook in 1912. Gone are the vast open, canopy old-growth forests of New England, replaced by scrubby second-growth forests that are being overrun with the undergrowth of thorny ornamental shrubs such as Asian bittersweet and Japanese barberry.

Urban development has buried acres in asphalt and concrete, wetlands and coastal marshes are filled or dredged to make them suitable for human development. Pesticides, chemical fertilizers and industrial pollution have poisoned the landscape. Highways create barriers across natural corridors and disrupt the communication networks of the plant and animal world.

Direct exploitation through private and commercial over-collecting has brought about the rarity and even extinction of some plants. Wild ginseng and golden seal were once common woodland herbs in Connecticut, until their roots were commercially gathered during the 1800's; these herbs are now quite rare. Some plants have been placed on state or U.S. lists of endangered or threatened species. Laws and regulations about

disturbing plants (from the local to the national level) exist to protect certain species, you should check your state's department of environmental protection for details about your area. Although probably in need of updating, the State Geological and Natural History Survey of Connecticut and the Natural Resources Center Department of Environmental Protection published Report of Investigations No.6 *Rare and Endangered Species of Connecticut and their Habitats* , by Dowhan and Craig (1976).

---

[Return to Plants Gathered in the Northeast](#)

[Indigenous Plant Bibliography and Books to Buy On-Line](#)

[Return to NativeTech's Main Plants & Trees Menu](#)

---



Text and Graphics  
© 1994 - 103 [Tara Prindle](#)  
unless otherwise cited.



## NativeTech: Native American Technology and Art

# MI'KMAQ (MICMAC) MEDICINES, FOODS AND TEAS \*

contributed by [Laurie Lacey](#).

Laurie hopes you enjoy this section on plants and trees used as traditional medicines, foods and teas, by the [Mi'kmaq people of Atlantic Canada](#). In the weeks and months ahead he will provide us with more information on Mi'kmaq uses of plants and trees, and on Mi'kmaq culture.

[Laurie's Home Page](#)

---

### Mi'kmaq (Micmac) Medicines, Foods and Teas

| Common Name                   | Scientific Name                                 |
|-------------------------------|-------------------------------------------------|
| <a href="#">Bayberry</a>      | ( <i>Myrica pensylvanica</i> L.) >> NEW <<      |
| <a href="#">Birch, Yellow</a> | ( <i>Betula allegheniensis</i> Britt.)          |
| <a href="#">Bunchberry</a>    | ( <i>Cornus canadensis</i> L.)                  |
| <a href="#">Labrador Tea</a>  | ( <i>Ledum groenlandicum</i> , Oeder) >> NEW << |
| <a href="#">Meadow Beauty</a> | ( <i>Rhexia virginica</i> L.) >> NEW <<         |
| <a href="#">Plantain</a>      | ( <i>Plantago major</i> L.)                     |
| <a href="#">Sweet Fern</a>    | ( <i>Comptonia peregrina</i> L. Coult.)         |
| <a href="#">Teaberry</a>      | ( <i>Gaultheria procumbens</i> L.) >> NEW <<    |

**Thanks Laurie!**

*\*The author is not responsible for the use of medicinal remedies mentioned above.  
The information is given for cultural purposes only.*

---



© 1994-2000 [Tara Prindle](#).

---

# Laurie Lacey

Laurie Lacey's Wild World of Plants  
P.O. Box 591  
Bridgewater, Nova Scotia,  
Canada B4V 2X6

phone: 902-543-3739



E-mail: [llacey@tallships.istar.ca](mailto:llacey@tallships.istar.ca)

---

## *About Laurie...*

Laurie Lacey is a writer and painter from Lunenburg County, Nova Scotia, Canada. A naturalist and outdoor person, his great grandmothers were of Micmac ancestry. He has spent much of his life gathering impressions from nature and researching the medicinal use of plants.

Laurie is the author of *Micmac Medicines: Remedies and Recollections*, as well as *Black Spirit: The Way of the Crow*.

Be sure to visit Laurie's Website, [Laurie Lacey's Wild World of Plants](#)! Laurie offers a variety of services such as seminars, lectures, and field walks.

Laurie also contributes the [Atlantic Canada Corner](#) at the on-line Ethnobotany Cafe.

All inquiries, comments, suggestions, can be directed to Laurie at the above address or via e-mail to [llacey@tallships.istar.ca](mailto:llacey@tallships.istar.ca). He welcomes discussion with people interested in Mi'kmaq ethnobotany and culture.

---

[Return to List of Mi'kmaq \(Micmac\) Medicines, Foods and Teas](#)  
[Return to Plants & Trees](#)

---



[NativeTech Home Page](#)

© 1996 Laurie Lacey. E-mail: [llacey@tallships.istar.ca](mailto:llacey@tallships.istar.ca)

© 1996 - 1998 [Tara Prindle](#).

**NativeTech: Native American Technology and Art**

**Mi'kmaq (Micmac) Medicines, Foods and Teas\***

contributed by [Laurie Lacey](#).



**Birch, Yellow (*Betula allegheniensis* Brit.)**

The inner bark of the tree was used to relieve indigestion and stomach cramps. The bark was chewed or steeped in water, and taken as a tea. The inner bark is supposed to be nourishing and can be chewed when one is in need of extra energy. [Photograph adapted from Elias & Dykeman: 1982]

*\*The author is not responsible for the use of medicinal remedies mentioned above.  
The information is given for cultural purposes only.*

[Return to List of Mi'kmaq \(Micmac\) Medicines, Foods and Teas](#)

[Return to Plants & Trees](#)



© 1996 [Laurie Lacey](#). E-mail: [llacey@tallships.istar.ca](mailto:llacey@tallships.istar.ca)

© 1996 [Tara Prindle](#).



**NativeTech: Native American Technology and Art**

**Mi'kmaq (Micmac) Medicines, Foods and Teas\***  
contributed by [Laurie Lacey](#).



**Bunchberry (*Cornus canadensis L.*)**

**The plant was used to treat kidney ailments. It was given to children in tea form to prevent bed-wetting. Bunchberry leaves were applied to wounds to stop bleeding and to promote healing. [Photograph adapted from Foster & Duke: 1990]**

*\*The author is not responsible for the use of medicinal remedies mentioned above.  
The information is given for cultural purposes only.*

[Return to List of Mi'kmaq \(Micmac\) Medicines, Foods and Teas](#)

[Return to Plants & Trees](#)



© 1996 [Laurie Lacey](#). E-mail: [llacey@tallships.istar.ca](mailto:llacey@tallships.istar.ca)

© 1996 [Tara Prindle](#).

**NativeTech: Native American Technology and Art**

**Mi'kmaq (Micmac) Medicines, Foods and Teas\***  
contributed by [Laurie Lacey](#).



**Plantain (*Plantago major L.*)**

**The Mi'kmaq used plantain leaves to draw poison from wounds, and to heal them. The leaves were crushed or bruised and applied in poultice form. Also, plantain leaves were steeped in water, and the liquid taken internally as a general stomach medicine (for example, to treat stomach ulcers). [Photograph adapted from Foster & Duke: 1990]**

*\*The author is not responsible for the use of medicinal remedies mentioned above.  
The information is given for cultural purposes only.*

[Return to List of Mi'kmaq \(Micmac\) Medicines, Foods and Teas](#)

[Return to Plants & Trees](#)



© 1996 [Laurie Lacey](#). E-mail: [llacey@tallships.istar.ca](mailto:llacey@tallships.istar.ca)

© 1996 [Tara Prindle](#).

**NativeTech: Native American Technology and Art**

**Mi'kmaq (Micmac) Medicines, Foods and Teas\***  
contributed by [Laurie Lacey](#).



**Sweet Fern** (*Comptonia peregrina* L. Coult.)

The leaves of sweet fern make a pleasant tea. Gently steep a few leaves to a cup of water. The Mi'kmaq used the leaves to treat poison ivy rash. The leaves were steeped or boiled in water, and the liquid used to bath the poison ivy rash. The treatment should be repeated on a regular basis. [Photograph adapted from Foster & Duke: 1990]

*\*The author is not responsible for the use of medicinal remedies mentioned above.  
The information is given for cultural purposes only.*

[Return to List of Mi'kmaq \(Micmac\) Medicines, Foods and Teas](#)  
[Return to Plants & Trees](#)



© 1996 [Laurie Lacey](#). E-mail: [llacey@tallships.istar.ca](mailto:llacey@tallships.istar.ca)

© 1996 [Tara Prindle](#).

## NativeTech: Native American Technology and Art

# The Mi'kmaq people of Atlantic Canada

Mi'kmaq (Micmac) Medicines, Foods and Teas  
contributed by [Laurie Lacey](#).



The Mi'kmaq are an Algonkian speaking people who traditionally lived in what is now the Canadian maritime provinces. The present day Mi'kmaq reside in these geographical areas, including Nova Scotia, New Brunswick and Prince Edward Island, and the Gaspé peninsula of Quebec, though some scholars believe that the Mi'kmaq occupancy of the Gaspé may have been more recent than in the other areas. Parts of Newfoundland may have been traditional Mi'kmaq territory as well, although there is some dispute as to when the Mi'kmaq moved to that area on a permanent basis. Many scholars believe that the only aboriginal residents of Newfoundland were the Beothuk, a now extinct tribe of which very little is known. [Photograph of Miq'maks of Dartmouth, Nova Scotia in 1860 in front of a traditional conical birchbark covered wigwam.] From an article by Philip Bock (1978) in *The Handbook of North American Indians*, V15 Northeast, ed. by Bruce Trigger.

[Return to List of Mi'kmaq \(Micmac\) Medicines, Foods and Teas](#)

[Return to Plants & Trees](#)



© 1996 [Laurie Lacey](#). E-mail: [llacey@tallships.istar.ca](mailto:llacey@tallships.istar.ca)

© 1996 [Tara Prindle](#).





## INDIGENOUS PLANTS BIBLIOGRAPHY

Click on the links below for the books you can order on-line in affiliation with [barnesandnoble.com](http://barnesandnoble.com)

---

### *References cited in NativeTech's [Indigenous Plants](#) articles:*

**Bremness, Lesley**

**1988 The Complete Book of Herbs; A practical guide to growing and using herbs.**

Viking Studio Books, Penguin Group: Hudson St., NY.

[Order this book through barnesandnoble.com](http://barnesandnoble.com)

**Densmore, Frances**

**1974 How Indians Use Wild Plants for Food, Medicine and Crafts.**

New York: Dover Publications, Inc.

[Order this book through barnesandnoble.com](http://barnesandnoble.com)

**Dowhan and Craig**

**1976 Rare and Endangered Plant Species of Connecticut and their Habitats.**

Published by the State Geological and Natural History Survey of Connecticut and the Natural Resources Center  
Department of Environmental Protection (Report of Investigations No. 6)

**Elias, Thomas S. and Peter A Dykeman**

**1982 A Field Guide to North American Edible Wild Plants.**

Outdoor Life Books: NY.

[Order this book through barnesandnoble.com](http://barnesandnoble.com)

**Foster, Steven and James A. Duke**

**1990 A Field Guide to Medicinal Plants; Eastern and Central North America.**

Peterson Field Guide Series. Houghton Mifflin Company: Boston/New York.

[Order this book through barnesandnoble.com](http://barnesandnoble.com)

**Hutchens, Alma R.**

**1973 Indian Herbalogy of North America; The definitive guide to Native medicinal plants and their uses.**

Shambhala: Boston.

[Order this book through barnesandnoble.com](http://barnesandnoble.com)

**Hutchens, Alma R.**

**1992 A Handbook of Native American Herbs; the pocket guide to 125 medicinal plants and their uses.**

Shambhala: Boston.

[Order this book through barnesandnoble.com](http://barnesandnoble.com)

**Kavasch, Barrie**



**1979 Native Harvests; Recipies and Botanicals of the American Indian.**  
Random House, Vintage Books: NY. ISBN: 0-394-72811-4

**Larson, Gary E.**

**1993 Aquatic and wetland vascular plants of the northern Great Plains.**  
Gen. Tech. Rep. RM-238. Fort Collins, CO: U.S. Department of Agriculture, Forest Service, Rocky Mountain Forest and Range Experiment Station. Northern Prairie Wildlife Research Center Home Page.  
<http://www.npwrc.usgs.gov/resource/1999/vascplnt/species/hier.htm> (Version 02FEB99).

**McMullen & Handsman**

**1987. A Key into the Language of Woodsplint Baskets.**  
American Indian Archaeological Institute: Washington, CT.  
[Order this book through barnesandnoble.com](http://www.barnesandnoble.com)

**NATIVE-L Archive**

**1995 (October). Subject: Sweetgrass. Lyn Dearborn - Ojibwe /Louis Annance - Western Abenaki / Capucine Plourde - Mi'kmaq / Mary Ritchie, Ojibwe**  
<http://bioc09.uthscsa.edu/natnet/archive/nl/9510/>

**Peterson, Lee Allen**

**1977 A Field Guide to Edible Wild Plants; Eastern and central North America.**  
Peterson Field Guide Series. Houghton Mifflin Company: Boston/New York.  
[Order this book through barnesandnoble.com](http://www.barnesandnoble.com)

**Reader's Digest**

**1986 Magic and Medicine of Plants; A practical guide to the science, history, folklore and everyday uses of medicinal plants.**  
Random House: Pleasantville, NY.  
[Order this book through barnesandnoble.com](http://www.barnesandnoble.com)

**U.S. Department of Agriculture**

**No date Western wetland flora: Field office guide to plant species.**  
U.S.D.A. Soil Conservation Service, West National Technical Center, Portland, Oregon. Jamestown, ND: Northern Prairie Wildlife Research Center Home Page.  
<http://www.npwrc.usgs.gov/resource/othrdata/westflor/species/2/hierodor.htm> (Version 16JUL97).

**Venning, Frank D.**

**1984 A guide to field identification: Wildflowers of North America.**  
Golden Press: NY.  
[Order this book through barnesandnoble.com](http://www.barnesandnoble.com)

**Walsh, Roberta A.**

**1994 Hierochloe odorata. In: Fischer, William C., compiler. The Fire Effects Information System [Data base].**  
Missoula, MT: U.S. Department of Agriculture, Forest Service, Intermountain Research Station, Intermountain Fire Sciences Laboratory. Magnetic tape reels; 9 track; 1600 bpi, ASCII with Common LISP present.  
<http://www.fs.fed.us/database/feis/plants/graminoid/hieodo/>

I graciously thank the following people for information provided through personal communication:

Shelley Smith ~ Quapaw  
Alice Luster ~ Nipmuc  
Fred Palmer ~ Micmac/Abenaki  
Courtney Anderson ~ Nanticoke

---

*Other Books relating to Indigenous Plants you can buy on-line through [barnesandnoble.com](http://barnesandnoble.com):*

**Lorraine Johnson, Andrew Leyerle (Photographer)**

**[100 Easy-to-Grow Native Plants: For American Gardens in Temperate Zones](#)**

**Edith A. Roberts, Elsa Rehmann**

**[American Plants for American Gardens](#)**

**Patricia A. Taylor**

**[Easy Care Native Plants : A Guide to Selecting and Using Beautiful American Flowers, Shrubs, and Trees in Gardens and Landscapes](#)**

**Gary Paul Nabhan, Wendell Berry**

**[Enduring Seeds: Native American Agriculture and Wild Plant Conservation](#)**

**Sandra S. Strike**

**[Ethnobotany of the California Indians: Aboriginal Uses of California's Indigenous Plants](#)**

**Erna Gunther, Jeanne R. Janish (Illustrator)**

**[Ethnobotany of Western Washington: The Knowledge and Use of Indigenous Plants by Native American](#)**

**Nancy J. Turner**

**[Food Plants of Coastal First Peoples](#)**

**Nancy J. Turner, Royal British Columbia Museum**

**[Food Plants of Interior First Peoples](#)**

**Daniel E. Moerman**

**[Geraniums for the Iroquois: A Field Guide to American Indian Medicinal Plants](#)**

**Raymond Stark**

**[Guide to Indian Herbs](#)**

**James A. Duke**

**[Handbook of Northeastern Indian Medicinal Plants](#)**



**Ana Nez Heatherley**

**[Healing Plants: A Medicinal Guide to Native North American Plants and Herbs](#)**

**Leinad Ayer O. Santos, LGucia M. M. de Andrade, Robin Wright (Translator)**

**[Hydroelectric Dams on Brazil's Xingu River and Indigenous Peoples](#)**

**James W. Herrick, Dean R. Snow (Editor)**

**[Iroquois Medical Botany](#)**

**Jennie Goodrich, Claudia Lawson, Vana P. Lawson**

**[Kashaya Pomo Plants](#)**

**Michael J. Caduto, Carol Wood (Illustrator), Joseph Bruchac**

**[Keepers of Life: Discovering Plants Through Native American Stories and Earth Activities for Children](#)**

**Michael J. Caduto, With Joseph Bruchac**

**[Keepers of Life Teacher's Guide: Discovering Plants through Native American Stories and Earth Activities for...](#)**

**Kelly Kindscher, William S. Whitney (Illustrator)**

**[Medicinal Wild Plants of the Prairie: An Ethnobotanical Guide](#)**

**Jeff Hart, Jacqueline Moore (Illustrator)**

**[Montana Native Plants and Early Peoples](#)**

**Leland Clifton Wyman, Stuart Kimball Harris**

**[Navajo Indian Medical Ethnobotany](#)**

**Stella Young, Nonabah Gorman. Bryan, Charles Keetsie. Shirley**

**[Navajo Native Dyes, Their Preparation and Use](#)**

**Kathryn Phillips**

**[Paradise by Design: Native Plants and the New American Landscape](#)**

**Arthur Caswell Parker, William N. Fenton (Editor)**

**[Parker on the Iroquois](#)**

**Lyda Averill Paz. Taylor**

**[Plants Used as Curatives by Certain Southeastern Tribes](#)**

**Ruth E. Merrill**

**[Plants Used in Basketry by the California Indians](#)**



**Lowell J. Bean, Katherine S. Saubel**

**[Temalpakh: Cahuilla Indian Knowledge and Usage of Plants](#)**

**Peter Loewer, Henry David Thoreau**

**[Thoreau's Garden: Native Plants for the American Landscape](#)**

**John P. Harrington**

**[Tobacco among the Karuk Indians of California](#)**

**Melvin R. Gilmore**

**[Uses of Plants by the Indians of the Missouri River Region](#)**

**Matilda Coxe Stevenson**

**[The Zuni Indians and Their Uses of Plants](#)**

**Additional book list being compiled.  
In the meantime,**

**[Click here to Search for Books about Medicinal Plants](#)**

**Search for Books at  
[barnesandnoble.com](#)**

Search by:

---

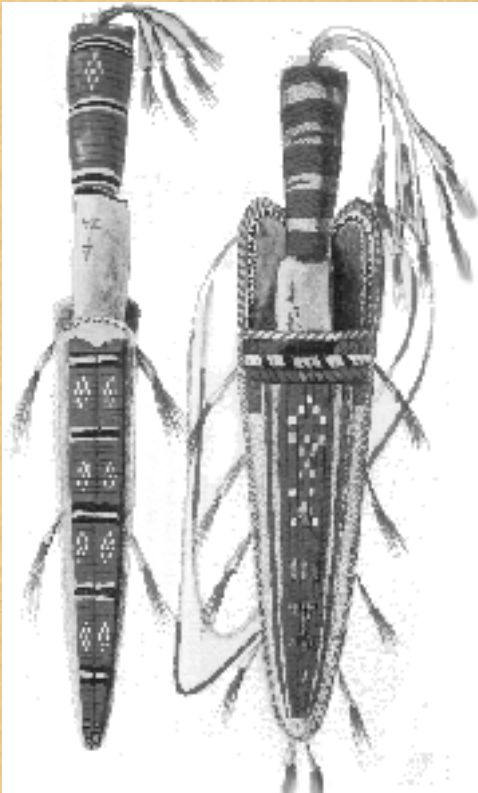
**[Return to NativeTech's Main Indigenous Plants Menu](#)**

---



**Text and Graphics  
© 1994 - 103 [Tara Prindle](#)  
unless otherwise cited.**

## NativeTech: Native American Technology and Art



**Eastern Great Lakes  
Knife Sheathes**  
(*Amer. Ind. Art.* Spring 1993).

### Introduction to Contact and Precontact Period Copper & Brass Metalwork

Native Americans in the Northeast traditionally use copper and brass sheet metal to make utensils and tools including pots, spoons, arrow points and pipes, as well as jewelry including tinkling cones, beads, bracelets, and rings. Natives of the Northeast were well acquainted with working indigenous copper long before the invasion by Europeans in the 1500s (Brasser 1978) and rare items were made from the great quantity quantities of copper around Lake Superior in archaic times (Beauchamp 1902). There are also large copper deposits in Virginia, North Carolina, Tennessee, Arizona, New Mexico, and Nova Scotia (Orchard 1975). Twelve ounces of pure copper were obtained from a pound of ore from the French operated copper mine at Port Royal (Josselyn 1972; Lindholdt 1988). But even thousands of years ago, following Native American trade networks, copper tools and ornaments were brought into the New England region (Rainey 1936, Brasser 1978). Small globe-shaped beads of indigenous copper come from New York, Nova Scotia and New Brunswick (Beauchamp 1903, Orchard 1975), and beads from Tennessee made from copper nuggets were hammered thin, rolled, and hammered again into shape, showing distinct layering (Orchard 1975).

Smelted European copper and brass (alloys mainly of copper with smaller amounts of zinc and other elements) reached the central East coast by the 1500s (Brasser 1978). By 1524, the European explorer Verrazzano saw many sheets of worked copper which Natives of New



England possessed. "They do not value gold because of its color; they think it the most worthless of all, and rate blue and red above all other colors... the same was true for metals like steel and iron, for many times when we showed them some of our arms, they did not admire them, nor ask for them, but merely examined the workmanship. They did the same with mirrors; they would look at them quickly, and then refuse them, laughing."  
[Verrazzano 1970]

With the onset of the 1600's the Natives "have also great store of copper, some very red, and some of a pale color: none of them but have chains, earrings, or collars of this metal; they head some of their arrows herewith, much like our broad arrowheads, very workmanly done" (citing John Brereton in Beauchamp 1903). Beauchamp believes that some of this was European metal, the *épale* copperí being brass or bronze; though Brereton said that the Native Americans indicated that some of it had been mined on the mainland. Nevertheless, European metals were being worked by Natives along the coast by the year 1600, and some of it had even begun to reach areas of the interior (Beauchamp 1903).

Native-made copper and sheet metal items were a valuable commodity which were often traded to Europeans to obtain materials made of iron and steel. John Brereton, while sailing through the Elizabeth Islands off Massachusetts in 1602, mentioned that Natives "offered their fairest collors or chains, for a knife or such like trifle." (Rainey 1936). Coastal Native Americans helped Gosnold find the products he sought by offering European traders native-made items including copper pipes, in exchange for knives, hatchets, and other items (Vaughan 1979).

Copper items on the coast from the Massachusetts to Maine southern Maine could have been traded from French and Basque fishermen who traveled here before 1600 (Beauchamp 1903, Rainey 1936). Narragansett, Wampanoag and other Natives of New England were often buried with items of copper or brass received through trade (Simmons 1970, Gibson 1980). The Micmac in the 1600s show a recognition of the working characteristics of metal when a man took a corroded kettle from a grave and struck against it to demonstrate that the kettle no longer made a sound "because it is dead, and its soul has gone to the land where the souls of kettles are accustomed to go" (Simmons 1970).

By the late 1600ís Native Americans in New England preferred kettles of brass, copper, or iron, to those made of clay by Native Americans (Gookin 1970); but not necessarily valued for their intended European purpose of cooking. By 1634, iron pots were preferred for cooking more than brass (Wood 1865); iron and steel tools made those of copper and stone obsolete (Jennings 1976). Although some sheet metal items were manufactured in Europe, many other copper and brass objects were worked up from broken kettles (Beauchamp 1903). These kettles and other European items were so valuable to Natives mainly because they could produce so many new objects from the recycled sheet metal.

[Metal Work Bibliography and Books to Buy On-Line](#)

[Return to Metal Working Menu](#)

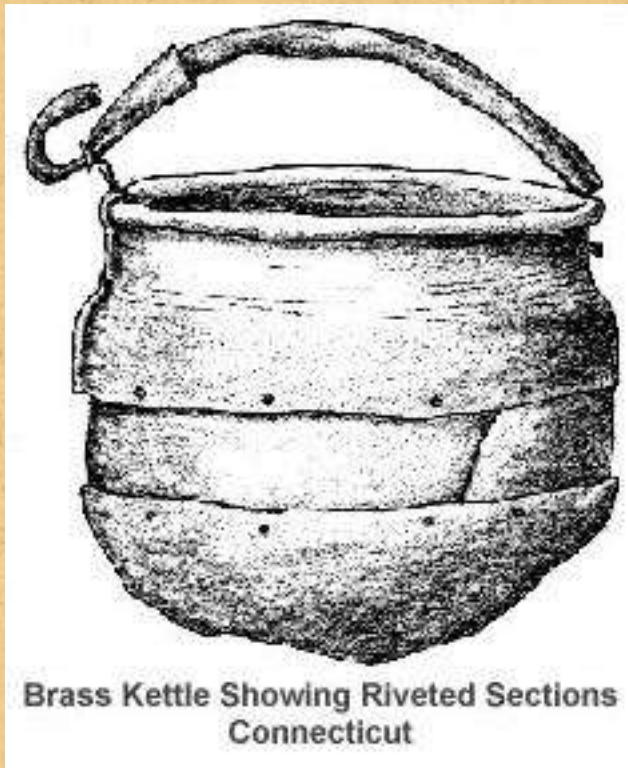
---



© 1994-1999 [Tara Prindle.](#)



## NativeTech: Native American Technology and Art



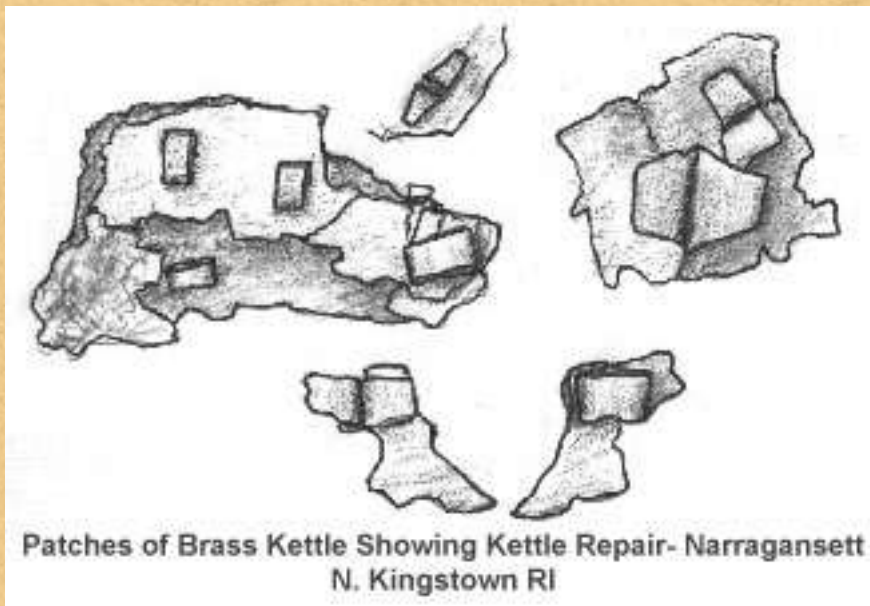
### Kettle Manufacture and Repair

Brass Kettle from the Connecticut State Archaeological Collections.

---

By the 1600's Native Americans of the Northeast had acquired a wealth of knowledge for working European sheet metals which was no doubt combined with experience in indigenous metals before contact. There is archaeological evidence dating to the 17th century of Natives ability to join broken or cut-out pieces of brass and copper. Many patches of brass and fragments of kettles which bear evidence of native repair. Holes had been punched through patches overlapping the broken edges of kettles, through which hand-made rivets of sheet metal were placed and hammered flat to secure a patch.

A 17th century Narragansett kettle from Rhode Island was made by riveting together sections of metal (Simmons 1970). Similarly, tiny kettles, from the Connecticut State Archaeological Collections, measuring less than 5 inches tall, are made from riveted sections of brass and have handmade rolled handles or 'bails'. These small kettles may be entirely of Native manufacture, both of them have rounded bottoms, and one has a diagonal hatched design hammered around the rim. Both vessels bear resemblance to pottery made in earlier years among the Native Americans of New England.



Natives of New England also used other methods to fasten together pieces of sheet metal. Narragansetts in the 17th century joined pieces of metal by punching a hole through the pieces to be spliced, But instead of rolled rivets, a brad-like staple was inserted through the hole and hammered flat from the outside, flaring the ends of the staple on the inside, and thereby securing the pieces.

By the mid-1600's at least, Native Americans from southern New England had mastered techniques of cutting, drilling, etching, forming, joining, and decorating sheet metal of European origin. In his archaeological analysis of Seneca brass and copper items, Wray et. al. (1987) insist that the skill required to make many of the rolled and riveted items, and because of the similarity between items made by both coastal and interior groups of Natives, there may have been Native metal work specialists who traded their products inland.

---

[Metal Work Bibliography and Books to Buy On-Line](#)

[Return to Metal Working Menu](#)

---



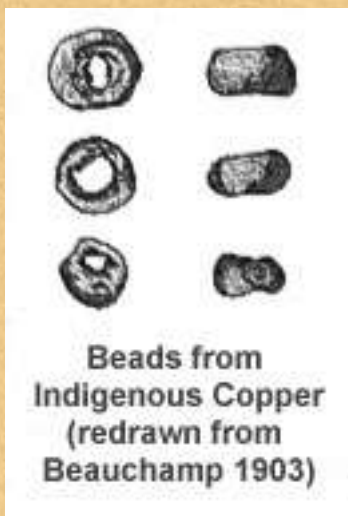
© 1994-1999 [Tara Prindle](#).



## NativeTech: Native American Technology and Art



## Brass & Copper Bead Making

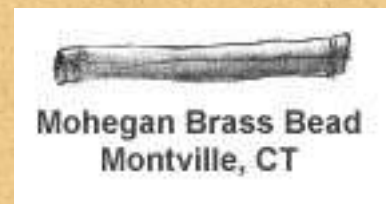


Before European contact, Native Americans in the Northeast were making small spherical beads from natural copper nuggets (Beauchamp 1903, Orchard 1975). There are great quantities of natural copper deposits in the northern regions of Lake Superior and Nova Scotia. Deposits are also found to points west in Virginia, North Carolina, and Tennessee, as well as in the western areas of Arizona and New Mexico.

Beads made from indigenous copper were both small spherical shapes like those found in New York (Beauchamp 1903), or tubular shapes like those found in Tennessee (Orchard 1975). Even when these ancient copper beads are found in badly corroded condition, the

layering of the metal is distinct, and indicates manufacture from copper nuggets (from repeated hammering, flattening, folding and hammering again).

Other tubular sheet metal beads, rolled with slightly overlapping edges like those found in Tennessee, were made around the time of European contact with Native Americans. The copper for these beads was often obtained from worn out European kettles. These beads vary in size from a quarter of an inch to nearly two inches long and about a quarter inch in diameter (Orchard 1975). Many small brass tubular and rolled tapering oval-shaped brass beads are described by Wray et. al. (1987) for Seneca sites in New York. The brass bead varieties from New England suggest that there are both native-made and traded European-produced varieties in both the small tubular and oval bead forms.



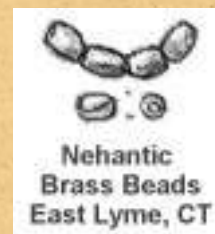


Brass Beads  
& Tinkling Cone  
Connecticut

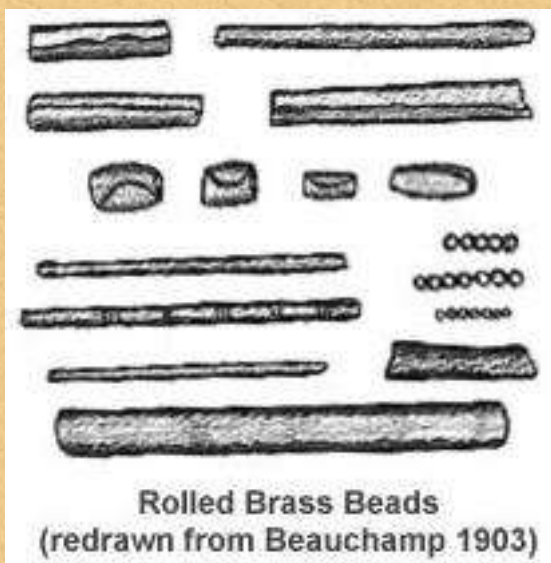
Tubular brass beads of native manufacture appear to have been wrapped around sticks of wood with spongy, or light pithy centers. Crimping the bead around this pithy wood form facilitated the manufacture of these beads, while not prohibiting their later stringing. In their work at Seneca sites Wray, et. al. (1987) note the preserved remains of what have been tentatively identified as reeds.

European-manufactured brass beads do not seem to exhibit this spongy wooden center, and were likely wound around metal mandrels in the Old World.

Beads found in Leweston, Niagara county, New York, indicate their Native manufacture (Orchard 1975). Small strips of copper sheet, probably supplied by Europeans, were bent in tubular form so the edges of the metal were brought together on an even plane, resulting in a diameter of three sixty-fourths of an inch (Orchard 1975). With them were found strung beads about twice as large. The large and small types of brass tubes were strung on separate strings. Some of these tubular beads appear more quickly made, as the edges are often irregular and overlap (Orchard 1975).



Nehantic  
Brass Beads  
East Lyme, CT



Rolled Brass Beads  
(redrawn from Beauchamp 1903)

Residing in a Toronto collection, copper tubes sewn onto a hide with fine thongs are made of rolled sheet copper. In length these beads measured from  $3/4$  of an inch to an inch, and varied from  $3/16$  to  $5/16$  of an inch in diameter (Beauchamp 1903). Beauchamp (1903) illustrates several long, cylindric brass beads from archaeological sites in Fulton County, Pompey, NY.

Beauchamp (1903) also describes an account given by Fray in 1879. He found a necklace or headband, composed of copper and shell beads; the former were made of thin sheet copper rolled into tubes, around which hematite was embedded. The combination of wampum and copper or brass in a headband was probably used after European contact.

Orchard (1975) remarks upon some beads from Hewlett, Long Island, which did not have the appearance of being made from rolled sheet metal, and are probably of European production, most likely of cast metal.

[Metal Work Bibliography and Books to Buy On-Line](#)

[Return to Metal Working Menu](#)





© 1994-1999 [Tara Prindle](#).

## NativeTech: Native American Technology and Art

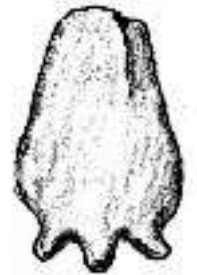


## Sheet Metal Pendants &amp; Ornaments



Brass Pendant  
(redrawn from  
Beauchamp 1903)

For Native Americans in the 17th century, metallic ornaments were probably no more popular than those of teeth or bone, becoming more desirable only when natural products were not available, because the animals were no longer easily hunted (Beauchamp 1903). In 1610, Juet (1967) observed Native Americans in New England with various of items of copper worn about the neck. At this time, plain perforated brass disks were worn by Seneca in what is now New York (Wray et. al. 1987). Other small perforated disks of brass were slightly domed and probably attached to clothing (Beauchamp 1903).



Brass Pendant  
Connecticut

The copper ornament of a Native American child in Middletown or Chatham is described by De Forest (1852) as: "a copper box containing wampum strung on deer leather". This ornament and similar small round sheet metal boxes may have been, or modified from, the 17th century European tobacco snuff boxes (Beauchamp 1902). Another, a handmade Narragansett copper ornament, contained several tiny quartz pebbles resembled a tiny 'rattle' (Simmons 1970).



Brass Claw Pendant  
Mohegan  
Montville, CT





Other sheet metal pendants from around this time include brass bear-claw-shaped pendants, which have been found by archaeologists at Fort Shantok, a 17th century Mohegan village and other places including the upper Connecticut River Valley (Thomas 1979). Copper or brass triangular and roughly rectangular sheet metal pendants have also been found around Ipswich, Massachusetts (Snow 1980: 84-85).

Large pendants found around New England include a copper 'thunderbird' shaped gorget. This large neck ornament, from Amoskeag, New Hampshire, was probably fashioned from a copper



kettle Brassier (1978). Two fairly large 17th century Wampanoag sheet brass pendants from Rhode Island were made to represent fish or whales, and were probably also made from worn-out kettles (Groce 1980).

Breastplates were also fashioned from sheet copper, described by Martin Pring at Plymouth in 1603 and by Gosnold on islands off of Massachusetts in 1602 (Rainey 1936) . These breastplates were about a foot long, six inches wide and were worn hung from around the neck.



---

[Metal Work Bibliography and Books to Buy On-Line](#)

[Return to Metal Working Menu](#)

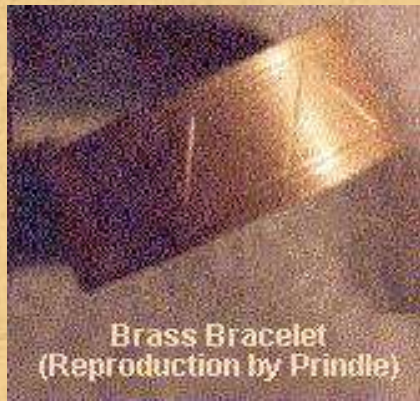
---



© 1994-1999 [Tara Prindle](#).



## NativeTech: Native American Technology and Art



Brass Bracelet  
(Reproduction by Prindle)

## Native Rings and Bracelets

## Rings:

Various kinds of rings were made using sheet metal by Native Americans in the 17th century. The rings, like those worn by Narragansets in Rhode Island (Turnbaugh 1984) were probably made by forming a slender hollow tube from a long strip of thin metal, which was then bent around in a circle, and joined together by hammering the ends together to form a nearly invisible seam.



Riveted Brass Ring  
Narragansett - N. Kingstown, RI  
(redrawn from Turnbaugh 1984)

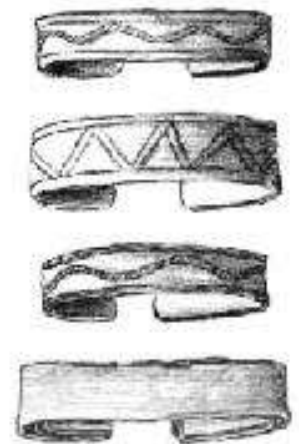


Mohegan Brass Rings  
Montville, CT

Another type of native-made ring, simply made of a flat wide strip of thin sheet metal curled around into a circle, have also been found at Fort Shantok, a 17th century Mohegan Village. Another example of a native-made ring, also found at Fort Shantok, is a thin brass strip bent into a circle, to which was riveted a square of metal (made with strip of sheet metal, that was bent and folded upon itself until the layers formed a square).

## Bracelets:

One kind of Native American-made brass sheet metal bracelet is that worn by Western Niantic individuals in the 17th century in Connecticut. These bracelets are decorated with wavy line, zig-zag and hatched designs and bent into a flat 'C'-shape. The result is a metal band an at least an inch wide which grips the wrist. Similar decorated and undecorated bracelets of sheet metal were also worn by Native Americans in the New York area (Beauchamp 1903).



Nehantic Brass C-Bracelets  
East Lyme, CT

[Metal Work Bibliography and Books to Buy On-Line](#)

[Return to Metal Working Menu](#)

---



© 1994-1999 [Tara Prindle.](#)



**NativeTech:  
Native American Technology and Art**

# Metal Spoon Making

The sheet metal which Native Americans obtained in trade in the 17th century was not only used for ornamental purposes. Some of the more utilitarian uses for sheet metal included the Native manufacture of spoons. These spoons were often embellished and worked with great care.

Early historic documents, as early as 1622, describe Native Americans of New England using spoons to eat with (Heath 1986). And using sheet metal to make these spoons was a natural consequence of working with the metal and applying Native American forms already used in wood carving. This [Wampanoag spoon](#) shows stylistic similarities with earlier wooden forms.

Alexander Henry in 1765, said that the Native Americans "were used to manufacture this metal into spoons and bracelets for themselves. In the perfect state in which they found it, it requiring nothing but to beat it into shape" (citing Alexander Henry in Beauchamp 1903).

Native Americans made spoons from the sheet metal of kettles and perhaps out of other European objects which exhibited a thicker gauge metal. The spoons are hammered to shape, often to an extreme thinness. The bowls are usually elliptical like this [Mohegan Spoon](#), but can be circular in shape as well. The handles of most 17th century Native spoons from the New England area are wide, flat and made of thin sheet metal.

Predominant handle forms include [animal-shapes](#) and bifurcate or double-curve shapes (Beaudry

**NativeTech: Native American Technology and Art  
Metal Casting**



(Click on the links to the left to show images of metal spoon examples in this frame).



1980).

[Bifurcate Handle Wampanoag Spoon](#)

[Double-curve-like Handle Mohegan Spoon](#)

[Bifurcate Handle Wampanoag Spoon](#)

[Bifurcate Handle Narragansett Spoon](#)

[Bifurcate Handle Wampanoag Spoon](#)

Sometimes the spoons have cut out figures or perforations at the terminal ends of the handles, and utilize designs of traditional dots, triangles, and zigzags.

[Narragansett Spoon with Cut-out](#)

[Paugeesuck Spoon with Cut-out](#)

Some decorations on the handles of spoons consist of lines of small circles, which have a small hole drilled within a surrounding engraved ring. A [Narragansett sheet metal spoon](#) from Rhode Island has this 'hole within a ring' design. The small circular designs are so consistent with one another that they were probably applied using a specialized drill tip. An identical design also appears on 17th century Seneca shell pendants from New York (Hayes 1989). The tool used to make this design may have been developed by Native Americans and could have been constructed by wrapping a strip of sheet metal around a standard drill bit, allowing the drill bit to protrude slightly from its wrapping. Before the use of metal drills it is possible that a similar tool could have been made of stone, or even carved from wood and rotated with a slurry of wet sand to incise the design.

A [Western Niantic brass spoon](#) from Connecticut is made from unusually heavy gauge metal. This spoon has a wide ladle-like bowl and a flat wide handle that has been cut into a series of connected diamond shapes. No European maker's mark appears on this Western Niantic spoon and the



decoration applied to the spoon handle has the familiar small 'hole within a ring' design drilled into the metal, both of which indicate the spoon was Native-made. Niantic spoons also have a detailed zigzag design around the perimeter of the spoon's bowl. This design appears to have been stamped or hammered into the metal by rocking a small chisel-shaped tool back and forth.

Over a dozen Wampanoag spoons are known from Rhode Island, all of sheet brass and Native-made from metal traded from Europeans (Beaudry 1980). One of these [Wampanoag spoons](#), which has a wide, thin handle of Native-hammered brass, has been welded to the back of a European spoon bowl that has the 'makers mark' on it. "Even in the repair or re-fashioning of English spoons, then, the Indians drew upon their own traditional conceptions of what a spoon should look like" (Beaudry 1980).

Narragansett made spoons of sheet brass used a variety of decorative techniques including this [Narragansett Spoon with raised zigzags](#) and others with dots in the metal handle (Turnbaugh 1984). Another [Masachusetts spoon](#), from the Haffenreffer Museum, Brown University, Native-made of traded sheet-metal is decorated with dots (Snow 1980). One [Narragansett brass spoon](#), measures 15.9 cm. in length and has a channeled stele, a form with no apparent European analogue (Simmons 1970).

"No doubt, traditional spoon forms, formerly carved out of bone or wood, provided the models for spoons produced of the newly-available material, brass. Therefore the Indian spoons display stylistic elements, such as [pierced handles](#) and forked terminals, which are uncommon or unknown on European examples." [Beaudry 1980]

[Metal Work Bibliography and Books to Buy On-Line](#)

[Return to Metal Working Menu](#)



© 1994-1999 [Tara Prindle.](#)



## NativeTech: Native American Technology and Art



Brass and Copper Arrow Tips  
Connecticut  
(Reproductions by Prindle)

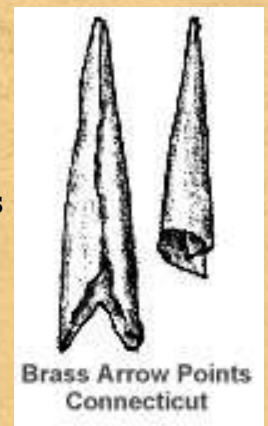
## Brass & Copper Sheet Metal Arrow Tips



Mohegan Brass Arrow Tips  
Montville, CT

In the 17th century, one Native American utilitarian use of sheet metal includes the manufacture of arrow tips or points. Arrows headed with brass, among other materials, have been noted by Mourt in 1622 (in Heath 1986), and in 1624, van Wassenaer (1967) describes Native American arrows pointed with copper. Similarly, in 1634 William Wood (1865) observes composite arrows "headed with brasse in shape of a heart or triangle."

Although simplistic in design, these predominantly triangular brass and copper points were ingeniously manufactured. Often native-made metal arrow points had lateral edges which were rolled around, or metal may have been rolled into a cone for insertion of the arrow shaft. Often out of a thicker gauge metal, arrow points would be flat and often have decorative perforations and notches to facilitate hafting.



Brass Arrow Points  
Connecticut

perforations and notches to facilitate hafting.

[Metal Work Bibliography and Books to Buy On-Line](#)

[Return to Metal Working Menu](#)



© 1994-1999 [Tara Prindle](#).



## NativeTech: Native American Technology and Art



## Smoking Pipes



Mohegan Cast Brass Pipe  
Montville, CT

In 1610 the New England Native Americans had great tobacco pipes of red and yellow copper (Juet1967). Such an elbow pipe, from the Connecticut State Archaeological Collections, was formed and rolled from a single sheet of brass.

In 1634, Roger Williams (1973) remarked about the Narragansett: "They have an excellent Art to cast our pewter and Brasse into very neate and artificiall Pipes." A small cast brass pipe was found at an early historic Mohegan village, Fort Shantok and there is a similar cast pipe of larger dimensions from the Connecticut State Archaeological Collections.



Pottery Pipe Bowl with Sheet Brass Stem  
(redrawn from Brassier 1978)

"Though Hudson said he saw copper pipes in New York in 1609, none of these are known, nor are metallic pipes common. Those found on Indian sites were probably made by white men" (Beauchamp 1902). Due to the length of time New England Native Americans were already trading with non-natives, it is possible that Williams (1973) observed pipes cast by

Europeans, or pipes which were not cast, but rather rolled into shape from sheet metal, or perhaps even pottery pipes with sheet metal stems.



Mohegan Brass Pipe Stem  
Montville, CT

From Fort Shantok, a 17th century Mohegan Village, comes a cone shaped piece of neatly rolled brass that appears to be a pipe stem. Beauchamp (1903) mentions that early historic travelers in New York observed "tobacco pipes steeled with copper." Brassier (1978a) depicts such a clay pipe with a sheet

brass stem that was collected by near Winthrop, Massachusetts.

[Metal Work Bibliography and Books to Buy On-Line](#)

[Return to Metal Working Menu](#)

---



© 1994-1999 [Tara Prindle.](#)



## NativeTech: Native American Technology and Art



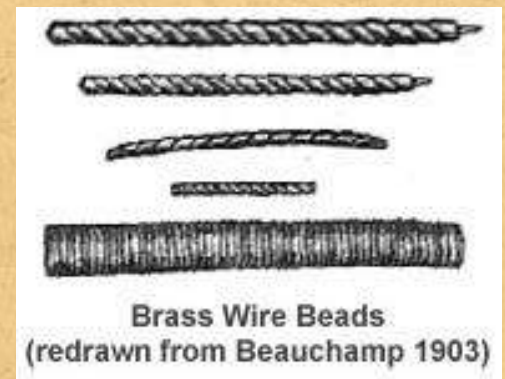
### Brass and Copper Work in Wire



In the 17th century, Native Americans of New England produced ornaments which are coiled or folded from a thick brass or copper wire. A Wampanoag brass wire 'ornament' from Rhode Island, having a fleur-de-lis design, is typical of such metal work in wire (Groce 1980). This wire ornament appears to be a 17th century cloak fastener, or a Native American-made facsimile (Hume 1969). However, the Native American to which this ornament belonged may not have used it as a cloak fastener, and may have worn it as a pendant instead.

The European manufacture of some wire ornaments possessed by Natives in the 17th century can not be entirely ruled out.

However, many wire objects, including bracelets, earrings and rings associated with Native American archaeological sites, have traditional Native American forms and decoration.





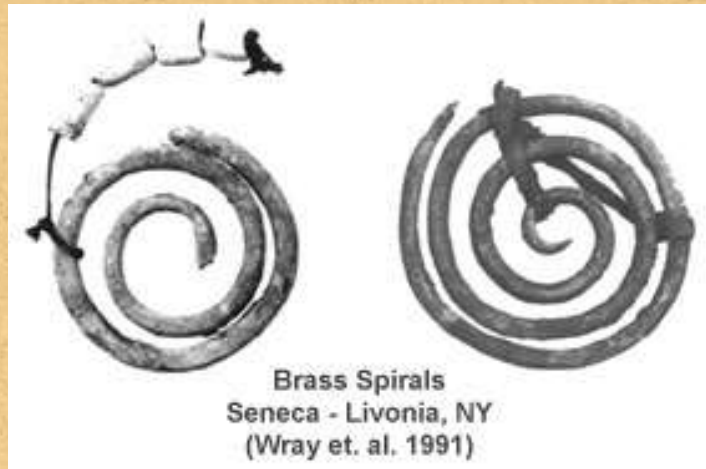
Tunica Wire Bracelets  
W. Feliciana Parish, LA  
(Brain 1979)

Bracelets of metal wire are usually made of copper or brass, bent back and forth forming a broad surface (Beauchamp 1903). Such a bracelet of coiled copper wire found was found in Fleming, New York (Beauchamp 1903). There exists, a similar Tunica bracelet (11.6 mm wide), from Louisiana, made by bending very thin wire that was folded into concentric ovals. The wire is held together in three places by iron bands running across the width of the bracelet (Brain 1979).

Orchard (1975) describes and illustrates a necklace and a breast-ornament of copper from one of the Salish tribes of British Columbia which is made from several long brass beads of wire which has been hammered flat and twisted spirally. Similar spiral ornaments were worn as ear ornaments by the Seneca in New York (Wray et. al. 1987). Iroquois finger rings from New York were also formed from spiraled copper wire (Beauchamp 1903), or using thin rolled tubes of brass (Wray et. al. 1987).



Seneca Brass Ear Ornaments  
(Wray 1987)



Brass Spirals  
Seneca - Livonia, NY  
(Wray et. al. 1991)

---

[Metal Work Bibliography and Books to Buy On-Line](#)

[Return to Metal Working Menu](#)

---





© 1994-1999 [Tara Prindle](#).

**NativeTech:  
Native American Technology and Art**

# Metal Casting

There is ample evidence for the Native American art of casting pewter and lead in historic New England. In the mid-1600's, bullet molds are fairly common among the Iroquois and there is also evidence for casting pewter spoons (Beauchamp 1902). However, there is little written or archaeological evidence of brass and copper casting among the Native Americans. Brass or copper casting was probably rare or not practiced by Native Americans due to difficulty in reaching temperatures high enough to melt the metal (Beauchamp 1902).

## Brass Combs:

Native Americans in southern New England wore decorative brass hair combs with traditional native animal and bifurcate (whale-tail) design designs. Roger Williams' (1973) comments from 1643 about Narragansett casting may indicate that some brass combs were Native-made in the 17th century. [Narragansett brass combs](#) have been found in Rhode Island (Turnbaugh 1984).

[Wampanoag brass hair combs](#) from this time period are found in Rhode Island. The 'kissing animal' designs on these comb, as well as the small 'dot in a circle' design, are very similar to that found on many late prehistoric and early historic bone and antler combs, and supports the theory that combs were manufactured by Native Americans (Groce 1980). A [similar cast brass comb](#) may have belonged to Ninigret's daughter Weunquesh in the late 1600's (Simmons 1978).

**NativeTech: Native American Technology and Art  
Metal Casting**



(Click on the links to the left to show images of casting examples in this frame).



## Lead Ornaments:

Casting lead is well documented among the Native Americans of southern New England in the 1600's (Beauchamp 1902). Objects cast from lead include animal effigies, shot, and possibly more complicated gun furniture. Lead casting equipment, including [carved steatite molds](#) for pendants and buttons, as well as [finished buttons](#), raw cylinders, [musketballs](#), or chunks of lead and pewter have been found at Fort Shantok, a 17th century Mohegan village. [Steatite button molds](#) presumably made by Native Americans of Connecticut in the early historic period are also among the Connecticut State Archaeological Collections. Beauchamp (1903) depicts [several cast lead effigies](#), resembling turtles, other animals and humans, made by the Native Americans in what is now New York State.

## Lead Shot:

In the 17th century, Wampanoag Natives of Rhode Island, as well other Natives of New England, made use of [lead shot and European shot molds](#) (Blanchette 1980). Native Americans were also quite adept at making their own molds and casting in lead. In William Bradford's narrative of early historic New England, he refers to the mastery of the Native Americans in casting lead shot and other weapon related items:

"They have also their moulds to make shot of all sorts, as musket bullets, pistol bullets, swan and goose shot, and of smaller sorts. Yea some have seen them have their screw-plates to make screw-pins themselves when the want them, with sundry other implements, wherewith they are ordinarily better fitted and furnished than the English themselves" (Bradford 1981).

[Metal Work Bibliography and Books to Buy On-Line](#)

[Return to Metal Working Menu](#)



© 1994-1999 [Tara Prindle](#).



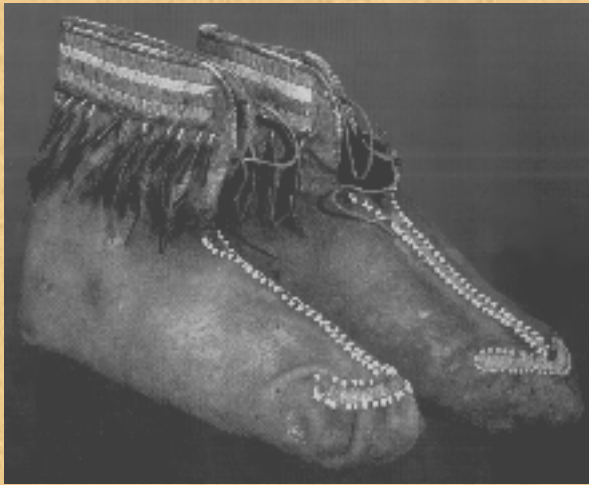
## Native American Technology and Art

# Tinkling Cones ~ Past & Present Traditions

---

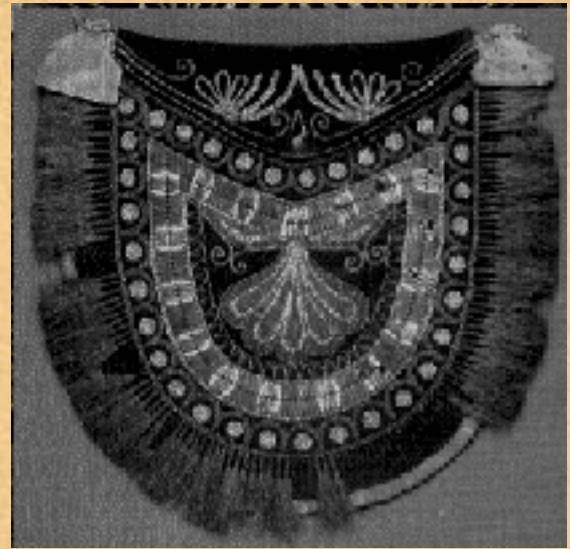
[See Instructions for Making Tinkling Cones](#)

---



Iroquois ~ Center seam moccasins with hair filled tinkling cones on fringe (Amer. Ind. Art. Autumn 1995).

**By the 1600's Native Americans of the Northeast had acquired a wealth of knowledge for working European sheet metals which was no doubt combined with experience in indigenous copper before contact. Even the tiniest**



Huron ~ 1790-1820 ~ pouch with red deer hair filled cones (Amer. Ind. Art Winter 1995)

**pieces and scraps of copper and brass were recycled.**

**Native Americans of New England mastered techniques of cutting, drilling, etching, forming, joining, and decorating indigenous and European sheet metal. Because of the skill required to make many of the rolled and riveted items, and because of the similarity between items made by both coastal and interior groups of Natives, there may have been Native metal work specialists who traded their products inland (Wray et. al. 1987).**

**A favorite Native American ornament for the past three centuries is a sheet metal trapezoid, rolled into a cone, and attached to knifesheaths, pouches moccasins, or other clothing (Beauchamp 1903). These ornaments are commonly referred to as tinkling cones. In the northeast, tinkling cones were often attached to leather bags ornamented with embroidery of dyed porcupine quills (Quimby 966). Brass tinkling cones from the 1600ís are even found among the Archaeological Collections of State of Connecticut. Tufts of dyed deer or other fur or feathers were often inserted into metal tinkling cones. In New Netherland in 1650 Native Americans "have long deer's hair which is dyed red, and of which they make rings for the head, and other fine hair of the same color to hang from the neck like tresses, of which they are very proud" (Anonymous 1967).**

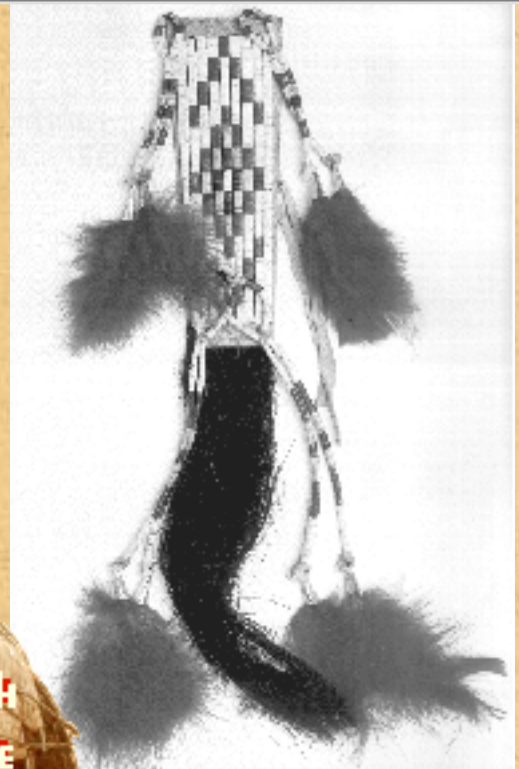


Jingle dress dancers  
at the Oglala Nation  
powwow in 1992  
(*Amer. Ind. Art* Autumn 1994)

[Metal Work](#)  
[Bibliography and](#)  
[Books to Buy On-](#)  
[Line](#)

[Return to Metal](#)  
[Working Menu](#)

---



tail (hair piece) with  
quill work & feather filled  
cones ~ Amil Blue Legs  
(*Amer. Ind. Art* Winter 1995)



© 1994-1999 [Tara Prindle.](#)



**NativeTech: Native American Technology & Art**



**METAL WORK BIBLIOGRAPHY**

Click on the links below for the books you can order on-line in affiliation with [barnesandnoble.com](http://barnesandnoble.com)

---

*References cited in NativeTech's [Metal Work articles](#):*

**Anonymous**

**1967 'Narrative of a Journey into the Mohawk and Oneida Country' [1634-1635]. In Narratives of New Netherland, 1609-1664.**

F.J. Jameson, ed. Pp. 135-162. New York: Barnes and Noble.

[Order this book through barnesandnoble.com](http://barnesandnoble.com)

**Beauchamp, William M.**

**1902 Metallic Implements of the New York Indians.**

New York State Museum Bulletin 55.

**Beauchamp, William M.**

**1903 Metallic Ornaments of the New York Indians.**

New York State Museum Bulletin 73.

[Order this book through barnesandnoble.com](http://barnesandnoble.com)

**Beaudry, Mary C.**

**1980 Spoons from the Burr's Hill Collection. In Burr's Hill, A 17th Century Wampanoag Burial Ground in Warren, Rhode Island.**

S.G.Gibson, ed. Pp. 72-78. Brown University, RI: Haffenreffer Museum of Anthropology.

**Blanchette, Jean-Francois**

**1980 Firearms. In Burr's Hill, A 17th Century Wampanoag Burial Ground in Warren, Rhode Island.**

S.G. Gibson, ed. Pp. 67-71. Brown University, RI: Haffenreffer Museum of Anthropology.

**Bradford, William**

**1981 Of Plymouth Plantation 1620-1647.**

Introduction by Fransis Murphy. New York: Modern Library; Random House.

**Brain, Jeffrey P.**

**1979 Tunica Treasure.**

Cambridge & Salem, MA: The Peabody Museum of Archaeology and Ethnology, Harvard Universtiy and



**The Peabody Museum of Salem.**

[Order this book through barnesandnoble.com](http://www.barnesandnoble.com)

**Brasser, T. J.**

**1978 Early Indian-European Contacts. In Northeast. B.G. Trigger, ed. Pp. 78-88. Handbook of North American Indians, Vol. 15.**

W. Sturtevant, gen. ed. Washington, D.C.: Smithsonian Institution.

[Order this book through barnesandnoble.com](http://www.barnesandnoble.com)

**De Forest, John W.**

**1852 History of the Indians of Connecticut from the Earliest Known Period to 1850.**

Hartford, CT: W. J. Hamersley.

[Order this book through barnesandnoble.com](http://www.barnesandnoble.com)

**Frederickson, Jaye and Sandra Gibb**

**1980 Covenant Chain: Indian Ceremonial and Trade Silver**

National Museum of Canada, National Museum of Man, Ottawa, Canada K1A 0M8

[Order this book through barnesandnoble.com](http://www.barnesandnoble.com)

**Gibson, Susan G.**

**1980 Catalogue of the Collection. In Burr's Hill, A 17th Century Wampanoag Burial Ground in Warren, Rhode Island.**

S.G. Gibson, ed. Pp. 128-174. Brown University, RI: Haffenreffer Museum of Anthropology.

**Gookin, Daniel**

**1970 Historical Collections of the Indians in New England.**

J.H. Fiske, ed. London: Towaid. (First published 1674).

[Order this book through barnesandnoble.com](http://www.barnesandnoble.com)

**Groce, Nora**

**1980 Ornaments of Metal: Rings, Medallions, Combs, Beads and Pendants. In Burr's Hill, A 17th Century Wampanoag Burial Ground in Warren, Rhode Island.**

S.G. Gibson, ed. Pp. 108-117. Brown University, RI: Haffenreffer Museum of Anthropology.

**Hayes, Charles F. III**

**1989 "An Introduction to the Shell and Shell Artifact Collection at the Rochester Museum and Science Center". In Proceedings of the 1986 Shell Bead Conference: Selected Papers.**

C.F. Hayes III, ed. Pp. 37-44. Research Records No. 20. New York: Rochester Museum and Science Center.

**Heath, Dwight B., ed.**

**1986 Mourt's Relation: A Journal of the Pilgrims at Plymouth.**

Cambridge: Applewood books. (First published in 1622).

[Order this book through barnesandnoble.com](http://www.barnesandnoble.com)



**Hume, Noel Ivor**

**1969 A Guide to Artifacts of Colonial America.**

New York: Vintage Books; Random House.

[This book is Out of Print. But used copies are available here.](#)

**Jennings, Francis**

**1976 The Invasion of America: Indians, Colonialism, and the Cant of Conquest.**

New York: W. W. Norton & Company, Inc.

[Order this book through barnesandnoble.com](#)

**Josselyn, John**

**1972 New-Englands Rarities Discovered.**

Meriden: Meriden Gravure Co. (First published 1672).

[Order this book through barnesandnoble.com](#)

**Juet, Robert**

**1967 From "The Third Voyage of Master Henry Hudson" [1610]. In Narratives of New Netherland, 1609-1664.**

F.J. Jameson, ed. Pp. 11-28. New York: Barnes and Noble.

[Order this book through barnesandnoble.com](#)

**Lindholdt, Paul, ed.**

**1988 John Josselyn, A Critical Edition of Two Voyages to New England.**

Hannover: University Press of New England. (First printed in 1674).

**Orchard, William C.**

**1975 Beads and Beadwork of the American Indians.**

New York: Museum of the American Indian / Heye Foundation.

[Order this book through barnesandnoble.com](#)

**Quimby, George Irving**

**1966 Indian Culture and European Trade Goods.**

Madison, Milwaukee and London: University of Wisconsin Press.

**Rainey, Froelich G.**

**1936 "A compilation of Historical Data Contributing to the Ethnography of Connecticut and Southern New England Indians." Bulletin of the Archaeological Society of Connecticut.**

Vol. 3: 1-49.

**Simmons, William S.**

**1970 Cautantowwit's House: An Indian Burial Ground on the Island of Conanicut in Narragansett Bay.**

Providence, RI: Brown University Press.



[Order this book through barnesandnoble.com](http://www.barnesandnoble.com)

**Snow, Dean R.**

**1980 The Archaeology of New England.**

New York: Academic Press.

**Thomas, Peter Allen**

**1979 In the Maelstrom of Change. The Indian Trade and Cultural Process in the Middle Connecticut River Valley 1635-1665.**

Ann Arbor, Michigan: University Microfilms International.

[Order this book through barnesandnoble.com](http://www.barnesandnoble.com)

**Turnbaugh, William A.**

**1984 A Mid-17th Century Narragansett Indian Burial Site in North Kingstown, Rhode Island.**

University of Rhode Island, Kingstown: Rhode Island Dept. of Sociology and Anthropology.

**van Wassenaer, Nicolase**

**1967 From the "Historisch Verhael" [1624-1630]. In Narratives of New Netherland, 1609-1664.**

F.J. Jameson, ed. Pp. 61-96. New York: Barnes and Noble.

[Order this book through barnesandnoble.com](http://www.barnesandnoble.com)

**Vaughan, Alden T.**

**1979 New England Frontier; Puritans and Indians 1620-1675. Revised edition.**

New York: W. W. Norton and Company.

**Wilbur, C. Keith**

**1990 Indian Handcrafts; How to Craft Dozens of Practical Objects Using Traditional Indian Techniques.**

Chester, CT: Globe Pequot Press.

[Order this book through barnesandnoble.com](http://www.barnesandnoble.com)

**Williams, Roger**

**1973 Key into the Language of America.**

J.J. Teunissen and E.J. Hinz, ed.s. Detroit: Wayne State University Press. (First printed 1643).

[Order this book through barnesandnoble.com](http://www.barnesandnoble.com)

**Wood, William**

**1865 Wood's New England's Prospect.**

Boston: Publications of the Prince Society 1. (First published 1634).

[This book is Out of Print. But used copies are available here.](#)

**Wray, Charles F., Martha L. Sempowski, Lorraine P. Saunders, Gian Carlo Cervone**  
**1991 Tram and Cameron; Two early Contact Era Seneca Sites.**

**The Charles F. Wray Series in Seneca Archaeology, Vol.II, Research Records No.21. New York: Rochester Museum and Science Center.**

**Wray, Charles F., Martha L. Sempowski, Lorraine P. Saunders, Gian Carlo Cervone**  
**1987 The Adams and Culbertson Sites.**

**The Charles F. Wray Series in Seneca Archaeology, Vol.I, No.15. New York: Rochester Museum and Science Center.**

**Wroth, Lawrence C., ed.**

**1970 The Voyages of Giovanni da Verrazzano, 1524-1528.**

**New Haven and London: Yale University Press.**

---

***Other Books relating to Native Metal Work you can buy on-line through***  
**[barnesandnoble.com](http://barnesandnoble.com):**

**Anne B. Fisher**

**[Bears Pirates and Silver Lace](#)**

**Allison Bird**

**[Heart of the Dragonfly: Historical Development of the Cross Necklaces of the Pueblo and Navajo Peoples](#)**

**Margaret Nickelson Wright**

**[Hopi Silver: The History and Hallmarks of Hopi Silversmithing](#)**

**Millard J. Holbrook, Millard J. Holbrook, II**

**[Indian Silver Jewelry of the Southwest, 1868-1930](#)**

**W. Carter**

**[Namer Indian Trade Silver](#)**

**John Adair**

**[The Navajo and Pueblo Silversmiths](#)**

**Lois Essary Jacka, Jerry Jacka (Photographer)**

**[Navajo Jewelry: A Legacy of Silver and Stone](#)**

**Lynn Robison Bailey**



[Tenderfoot In Tombstone, The Private Journal Of George Whitwell Parksons: The Turbulent Years, 1880-82](#)

**Martha W. Hamilton**  
[Silver in the Fur Trade \(1680-1820\)](#)

**Additional book list being compiled.  
In the meantime,**

[Click here to Search for Books about Metal Work](#)

[Search for Books at  
barnesandnoble.com](#)

Search by:

---

[Return to NativeTech's Main Metal Work Menu](#)

---



© 1994-1999 [Tara Prindle.](#)



## About Porcupines...

by Tara Prindle

---



**The porcupine is a powerful rodent unique to North America; the only other place in the world where porcupines are found is in Africa, but that porcupine has enormous quills nearly a foot long and a 1/4 inch in diameter (not very suitable for quill embroidery decoration). The northern range of the common porcupine covers most of Canada, the western U.S., northern parts of New England and the Great Lakes region. Porcupines favor a wooded habitat, but some subspecies (7 in all) live in deserts and grasslands.**

**The porcupine is one of the largest rodents in North America, second only to the beaver, and porcupines grow to a length of 2 to 3 1/2 feet, tail included. They usually weigh between 8 and 14 pounds, although they have been known to weigh upwards of 35 pounds. The porcupine may live for 5 years or more in the wild, and in captivity they generally live a decade.**

**Although this quilled animal has several nicknames ('pricklepig' being my personal favorite), the latin name for the porcupine is Erethizon dorsatum ('to irritate with back') The Porcupine, with a body shape like other rodents, has over 30,000 quills on its body. Quills cover the back and sides of this animal, with stiffer fatter quills on its tail. There are no sharp quills on the porcupines nose, and the belly of this animal is vulnerable, covered only with stiff brown hairs. The color of the quills is white with brown or black tips, although the quills of western porcupines have yellowish colored tips.**

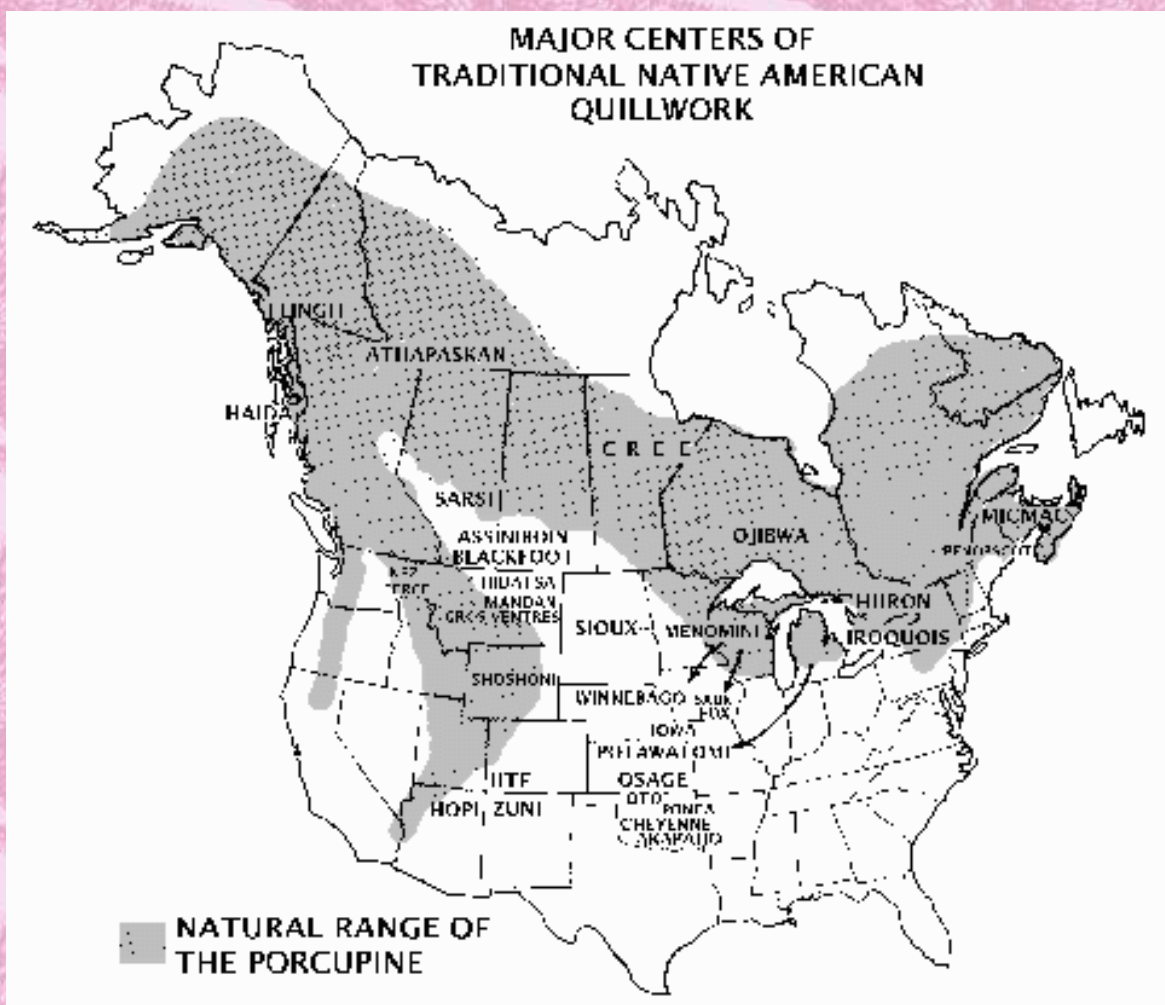
**Porcupines don't "throw" their quills; nor are they known to attack other animals. But, their quills are nature's best defense. The quills are loosely attached to the porcupine's body and an animal has to connect with the porcupine to be hit with the quills. If threatened, the porcupine raises its quills, looking like a giant pincushion. When attacked, the porcupine wields its tail back and forth pounding its quills into the adversary. The porcupine can imbed its quills almost an inch into opponents skin. Each quill has hundreds of quills have tiny barbs or hooks. Once embedded, these hooks cause the quill**

to work its way even deeper and they make removing set-in quills painful and difficult.

[Click here to see a scanning electron microscope magnification of a quill.](#)

Unwary animals (birds of prey, domestic animals and even people) that have wound up with a mouth or throat full of quills often die of starvation or from infections caused by the germs on the quills. Like common hairs, new quills grow back to replace the ones shed by porcupines. Despite their natural defense, some predators (bobcats, cougars, coyotes and especially fishers) are able to hunt porcupines without injuring themselves, by rolling the rodent onto its back exposing its unprotected soft belly.

Porcupines are nocturnal and have poor vision but a very good sense of smell. Porcupines generally like to eat the evergreen tree inner bark and needles, but they do find some hardwoods palatable. They also eat aquatic plants, berries, seeds, flowers, nuts, and grasses. Salt is often sought after by porcupines and they've also been known to gnaw on antlers and bones for the calcium. During the day, porcupines can usually be found sleeping peacefully in the high crook of a tree, or like other rodents, taking care of their newborns in underground burrows. Because of the porcupine's eating habits, which often damages trees, weasels have been introduced in some regions to reduce porcupine populations. Fortunately some states, such as Maine, now have laws protecting porcupines.



Map adapted from Orchard 1984



---

[Porcupine Quillwork Bibliography and Books to Buy On-Line](#)

[Return to NativeTech's Main Porcupine Quillwork Menu](#)

---



Text and Graphics  
© 1994 - 103 [Tara Prindle](#)  
unless otherwise cited.

## NativeTech: Native American Technology and Art



Porcupine Quillwork FAQ

# QUESTIONS ABOUT QUILLWORK ...

contributed by [Nancy Fonicello](#)

---

In the course of a year on the internet, I have received frequent mailings of questions regarding quillwork, its various techniques, and the materials required to do fine work. I have put together a small collection of some of the most commonly asked questions, and hope to add more as time goes on. If you have a question that you would like to see answered here, please feel free to email me and I will do my best to answer it for you. ~ Nancy Fonicello

---

## **Someone just brought me a road killed porcupine and plucking the quills is taking FOREVER! Do you have a fast way to take the quills off?**

Unfortunately, no. Plucking porcupine quills is tedious at best, but is the only way to get the materials you need, unless you can find a commercial source for quills of the right size. If you are really short for time, and it is midsummer and your porcupine is getting smelly, try skinning it, rolling up the hide and putting it in the freezer until you have time to deal with it. Alternatively you may freeze the whole carcass, but this takes up quite a lot of room in the freezer.

I have tried skinning the porcupine and then salting and drying the hide for future use. I find that with this method I have a problem resoaking the hide and extracting the quills without damaging them. Basically, one has to soak the hide for such a long time that the quills get too soft to pluck.

The best method I have found so far when I am in a hurry is to pluck the quills, hair and all, and put them in a flat pan or tray, all laying in the same direction. Then I can go back at my leisure and separate the hair from the quills without having to worry about a rotting carcass.

---

## **My quills won't accept the dye I am using. They keep coming out faded and spotty. What am I doing wrong?**

Properly prepared quills usually accept a commercial dye (like RIT) very well. You may have not removed the waxy outer layer when you washed the quills. Try soaking the quills in a very hot but not boiling solution of dish soap and water (I find DAWN works best for me, but any will do). Soak them with frequent stirring for anywhere from 10 minutes to a half an hour. You may just have had an older porcupine with very oily quills, but this should do the trick.

Also make sure your dye bath is very hot (but not boiling) when you are dyeing them. Some commercial dyes take longer



than others to give you the proper color. Reds, for instance, take a long time to set. Blue and yellow seem to set almost instantaneously.

Natural dyes are another story entirely, and I am still in the process of researching this myself. It can be very frustrating to get a beautiful dye color from plant materials and then not have the quills accept the color, but this seems to be common with any of the natural dyes. Additions of mordants such as alum or even sugar may help. Leaving the quills in a dye solution in a warm place for a few days has given me good results too. Don't be afraid to experiment.

---

## **What part of the porcupine do you pluck to get the best size quills?**

Generally I take quills from down both sides of the animal. This is the place to find the longest, thinnest quills that will make your work look the best. I almost never use the quills on the back of the animal, as they are too big and stiff. The finer the quill, the better your work - to a point. There are some very fine quills that look like hair which I have found useful for single line work, but using this size quill may be frustrating to someone who is just starting out.

---

## **Do you sort all your quills ahead of time?**

Actually no. Aside from the basic sorting when I pluck a porcupine, I like to leave a little size variation in my batches of quills. That way when I dye them I have a number of different size quills to work with of the same dye lot. This is especially useful when you are using a number of different techniques on the same piece, like matching edging on a knife sheath, or floral quillwork with single line embroidery around it.

I also would much rather be sewing down quills than sorting them!

---

## **How do you keep all the little black quill ends from getting all over the place when I cut them off. I have found a number of them the hard way when they have gotten into my socks!**

Take a scrap piece of leather and jab the quills into it before you snip them. All the little black ends will stay in the leather, and your feet will be much happier. (By the way, I take no credit for this idea, but was very grateful when a fellow quillworker shared it with me!)

---

© 1997 - 103 [Nancy Fonicello](#).

---

[Porcupine Quillwork Bibliography and Books to Buy On-Line](#)

[Return to NativeTech's Main Porcupine Quillwork Menu](#)



**Text and Graphics**  
© 1994 - 103 [Tara Prindle](#)  
unless otherwise cited.

# Quill Embroidery Tools and Techniques

by Tara Prindle

---

Quill embroidery is usually stitched onto the surface of brain-tanned hide, although other quillworking techniques may use a base of rawhide or birch bark. Very few tools were needed for traditional quillwork. Often the craftsperson kept sorted quills in bag made from the bladder of an animal. To ensure symmetry, quillwork designs were sometimes cut from folded sheets of birchbark or rawhide that were then used as 'templates'. 'Pens' for outlining these designs were often made from flat, sharpened pieces of bone which were sometimes dipped in special stains. Awls needed to pierce the holes were made from ulna bones or other long-bones, antlers sharpened to points, fish bones, and even thorns.

The other tool sometimes included in the quillworkers kit is the quill flattener. Many embroidery techniques require that the air is pressed out of the quill so the resulting work will lay flat. Many traditional quillworkers do not use a flattening tool, preferring the time saving method flattening the quill 'by hand'. With the barbed end of the quills held in their teeth, a quillworker pulled with their thumb and finger down the length of the quill, pinching out the air (without having to put their work down to pick up both quill and flattening tool).

The thread used in embroidery was made from animal sinew from the fibrous tendons along the spines of deer, moose, elk, or buffalo. Sinew thread does not require the use of a needle. Before it's use a length of sinew fiber is split away from soaked tendons, and the tip is rolled between the fingers, creating a point. The single sinew fiber dries within minutes and a stiff point results that is easily passed through the hole made by an awl. The point is left dry, but the remaining length is kept supple and moist with saliva to make secure sewing possible. More rarely, thread was twisted from fibrous plants such as Dogbane (Indian Hemp). Needles are a contemporary tool, needed to accommodate the limp nylon threads used by most quillworkers today.

Soaking quills softens them and makes them more pliable (and less dangerous), similar to what mother porcupines do to make it possible to give birth to their babies. Over soaking the quills will result in weak quills that will stretch and break easily. The ideal way to moisten quills is with saliva, and many 'old time' crafters held the quills in their mouth (barbed end pointing out) much like today's seamstress hold their pins. Once a quill is adequately moistened, (and depending on what the particular technique calls for), the quill is flattened. In order for the air to escape, the tip is trimmed from the quill. Some quillworkers cut off the barbed end, and others cut off the follicle end. A quill can be flattened, and the air pressed out, by placing it against a hard surface and running a smooth hard object over it.



Traditional quill flatteners are made of polished bone, antler or wood. Modern flatteners can be metal spoons, rounded plastic objects, or just the back of your thumbnail.

With most embroidery methods (edging techniques are different), the needle (or awl) does not penetrate all the way through the leather. Each tiny stitch is made into the leather just below the work surface, so the quiller does not have to constantly turn the work over. It is important to stitch down each quill quickly, as the quills dry and become stiff very fast. As each stitch is made, the quills are folded in such a way that the thread is hidden (and protected from wear). Quills are short and new ones must be spliced in as the embroidery progresses. When splicing quills, the new quill is usually placed under the end of the old one, although some people insert the barbed end of the new quill into the hollow of the old one. There are several traditional techniques of quill embroidery, and dozens of variations. These are some basic quillwork stitches: [line](#), [band or straight](#), [overhand or zig-zag](#), and sawtooth or rick-rack quilling, not to mention methods used in quill edging, [wrapping](#) or [loom weaving](#). By expanding on the basic stitches, different effects can be achieved with diamond, triangular, [plaited](#) and checkerboard designs.

[Click Here for Information About  
Tools and Materials from Nancy Fonnicello](#)

An example of fine quillwork will have a shiny, undamaged look, with even rows, uniform with, and tiny, invisible stitches. The dark quill ends should be hidden under the embroidery, unless the black tips are used to create a the pattern. With the best embroidery, unlike the porcupine, there are no pointed or rough projections sticking up when you feel the quillwork with your hand. The key to beautiful, even quill embroidery is in the careful sorting and selection of quills. Although quillwork requires some dexterity and attention, the greatest requirement of all is patience.

---

[Porcupine Quillwork Bibliography and Books to Buy On-Line](#)

[Return to NativeTech's Main Porcupine Quillwork Menu](#)

---

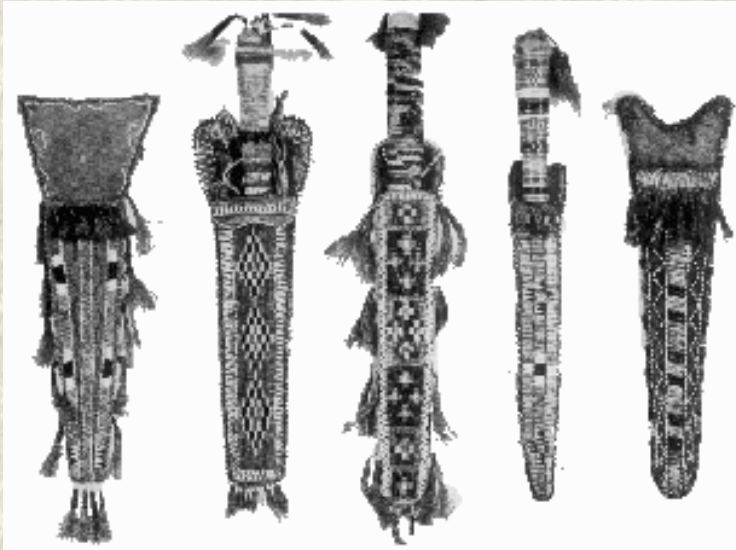


Text and Graphics  
© 1994 - 103 [Tara Prindle](#)  
unless otherwise cited.



## Porcupine Quill Embroidery

by Tara Prindle



Delaware and Ojibway Quilled  
Knife Sheaths (Orchard 1984)

Porcupine Quillwork is perhaps the oldest form Native American embroidery, and was a widespread form of decoration for Great Lakes and Plains peoples living within the natural range of the porcupine. The quills are folded, twisted, wrapped, plaited and sewn using a wide range of techniques to embellish articles of clothing, bags, knivesheaths, baskets, and wooden handles and pipe stems.

Native Americans in 17th century New England were long familiar with quill embroidery, they used porcupine quills to decorate their clothing and accessories, and to decorate containers of

birchbark as well. European accounts from the 1600's refer to several dye colors (black, blue, red and yellow for examples) for porcupine quills embroidered on baskets, bags and mats.

A few rare examples of 17th century hemp and basswood bags have survived the centuries. A Mohegan bag woven of Indian Hemp in the 1600's has a design embroidered with purple-black porcupine quills. The design on the Mohegan bag consists of two thin horizontal bands of solid color placed within three thicker bands of solid color which has been further broken into a series of geometric diamond and triangular shapes around the circumference of the bag. Other accounts from the 1600's describing New England Native Americans, include descriptions of designs: birds, beasts, fishes and flowers in colors placed upon baskets.

Dyed quills decorated moccasins in red, blue and violet; to the north, moose skin robes were dressed white and embroidered top to bottom a finger's breadth wide, with closed or open work figures of animals. Quill embroidery embellished the Penobscot pouches and bags of deer or mole skin. Exquisite Maliseet-Passamaquoddy quilled birchbark containers were not often produced after Native splint and sweetgrass basket manufacture became popular in the 1700's.



Seneca and Sioux Quilled  
Moccasins (Orchard 1984)

In general, quillworking flourished among Native Americans until the mid-1800's when glass beads became easily attainable through trade with Europeans. Later traditions of embroidery using glass beads were built upon techniques and designs in quillworking. Although considered a 'lost art' by many, Native Americans such as the Sioux, Cree and Ojibway and others still carry on the tradition of quill embroidery.

---

[Porcupine Quillwork Bibliography and Books to Buy On-Line](#)

[Return to NativeTech's Main Porcupine Quillwork Menu](#)

---





## NativeTech: Native American Technology and Art



*Closeup of a horse headstall made by Nancy showing horsehair wrapped quillwork in the rosette and ten-quill plaiting in the cheek band.*

## INTRODUCTION TO TECHNIQUES AND METHODS OF PORCUPINE QUILLWORK

contributed by [Nancy Fonicello](#)

---

The goal of these pages is to present in simple terms some of the techniques used in the ancient art of porcupine quill embroidery. Although many books, publications, and even internet sites address the art of quillwork, very few, if any, detail the actual process of creating it. It is my hope that these pages will be of use to the beginning and advanced quillworker alike. The styles of quillwork are many and varied, and it would be impossible to cover them all here. We hope to present a few of the basic stitches in detail, so that anyone taking the time to master them can move on to the more advanced techniques without much difficulty. More techniques will be added as time goes by, so check back periodically for new updates.

If you are just beginning and you find that you are all thumbs, have patience! Very often it is a matter of finding the right materials, the right size quill, the right needle, the right brain tan leather. Poor or inadequate materials make for frustrating work, even for the seasoned quillworker. Once you get the feel for the work, you will wonder why you thought it was so difficult when you started!

My quest to pursue fine quillwork began when a good friend introduced me to it, commissioning a piece when I had never really tried anything but beadwork. I fumbled around and came up with a passable rosette, using a few books and pictures as reference. My interest didn't really blossom until I had the opportunity to view some outstanding old pieces collected on the American frontier prior to 1840. (see Sacred Encounters - Father DeSmet and the Indians of the Rocky Mountain West).

It seemed that the craftsmanship practiced in the old days could not compare to anything I had seen up to that point, and so I set about looking more for old pieces, studying the techniques, experimenting with natural dyes and sinew thread. The result has been five years of study and practice and yet even

now not a day goes by that I do not learn something new. It is easy to understand why quillwork as an art was held in such high regard among native peoples.

A few words to the beginning quillworker. First, as mentioned above, do not get frustrated. If your work doesn't come out as you expected it should, try changing your needle size, your thread, your leather. If all else fails, put it down and go do something else for a while. Doing quillwork when you are out of sorts is an invitation to disaster.

Secondly, go visit museums, read books, surf the net, get your hands on anything pertinent. You will be suprised to see how much you can learn by looking at existing pieces of quillwork. A short bibliography can be found on these pages, as well as a list of museums around the country and in Europe that have fine pieces on display. You will also get a feel for characteristic styles of quillwork, for example eastern woodland quillwork as opposed to upper Missouri or plains styles.

Third, experiment! Just because you haven't read it anywhere doesn't mean it won't work. Many of my most vibrant natural dyes have been the results of kitchen experiments or wild ideas in the middle of the night. Last of all, don't be afraid to share what you have learned. Visit powwows, rendevous', gun shows, etc. and talk with people who are just starting or have been doing it for years. Sometimes the idea you share will be the exact thing that someone has been looking for.

Historically speaking, many nations have regarded quillwork as an elite art to be practiced only by quillwork guilds or special societies. That is not the case today. Good quillwork can be done and done well by anyone who has the patience to try and the willingness to learn.

The first techniques to be presented here will be the basic stitches that serve as the building blocks to all other styles: [single-quill diamond or zig-zag stich](#), [single-quill parallel-fold or simple band stitch](#), and the [single-quill line embroidery](#). Most other work, such as [quill plaiting](#), is the result of these three stitches in combination with one another or with multiple quills. One exception is wrapped quillwork, which will be covered in another section. Also included will be a discussion of materials and dyeing methods used by the author. More techniques will be added as time goes by. All comments and suggestions are welcome.

---

© 1997 - 103 [Nancy Fonicello](#).

---

[Porcupine Quillwork Bibliography and Books to Buy On-Line](#)

[Return to NativeTech's Main Porcupine Quillwork Menu](#)

---





**Text and Graphics**  
© 1994 - 103 [Tara Prindle](#)  
unless otherwise cited.

## NativeTech: Native American Technology and Art



### Porcupine Quillwork The Zig Zag Technique

contributed by [Nancy Fonicello](#)

*Quill Embroidery with patterns created by Nancy using various colored quills and the Zig-Zag Technique*

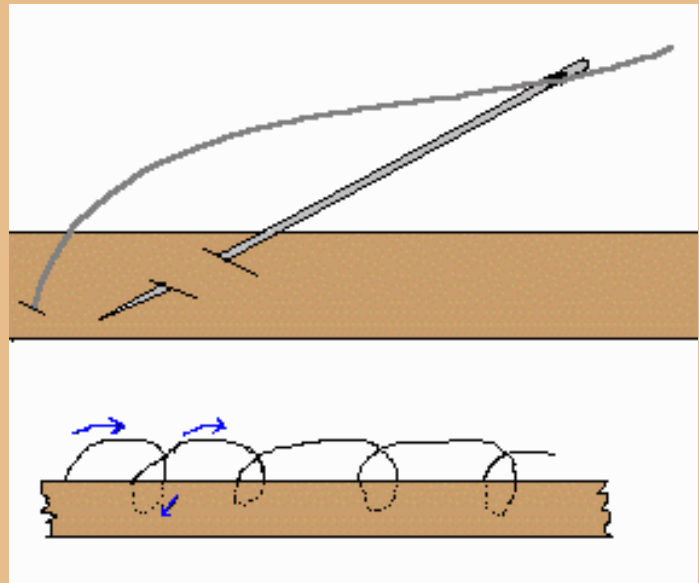
---

The zigzag technique is probably the simplest quillwork style to learn, and is yet very versatile. It was widely used by the Native peoples of the Eastern Woodlands to decorate everything from neck knife sheaths to moccasins. Since we are just beginning, it would be well to start out with a discussion of tools and materials, then we will proceed to the actual instruction.

[Click Here for Information About  
Tools and Materials](#)

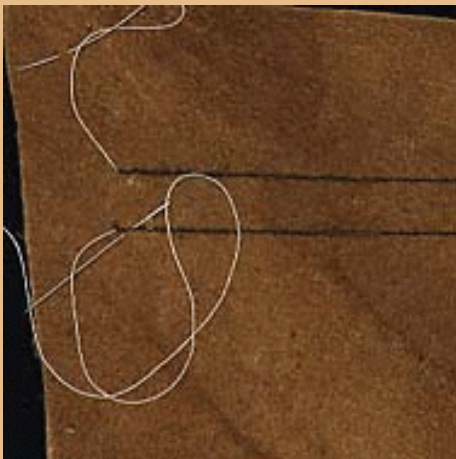
### The Back Stitch

The most widely used stitch for embroidered quillwork is the back stitch. It is a very simple method of sewing in which the needle enters the leather from right to left as the work progresses from left to right. This stitch is used for both upper and lower threads in zigzag stitch, simple band technique, and all the multi-quill plait stitches. See the example below. Note also that the needle and thread do not go all the way through the leather, as we mentioned above. Just a little tiny stitch is sufficient:

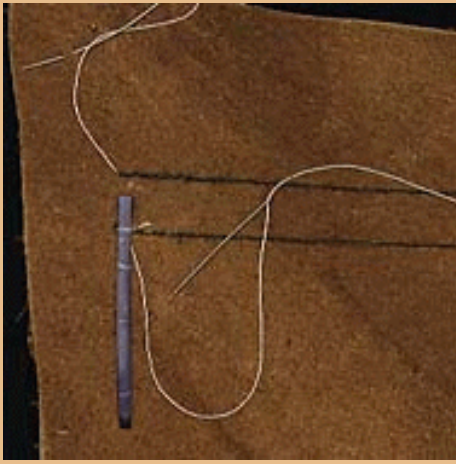


## Sewing Techniques

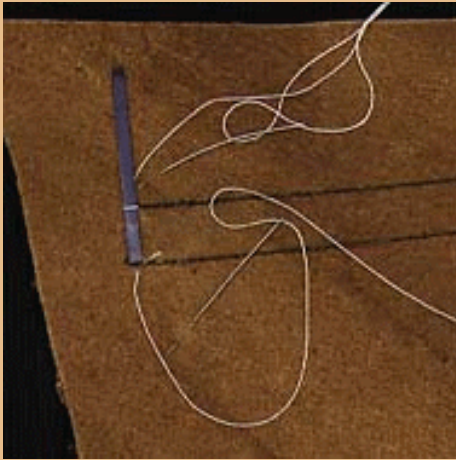
**Okay! Now we're down to the nuts and bolts. You have the pointy ends of your quills snapped off and have them soaking in a saucer of water. Draw two lines on the leather about 3/8 inch apart where you want your quillwork to go. The actual distance between the lines will depend on the size of quill and desired effect, but 1/4 to 3/8" apart is a good standard.**



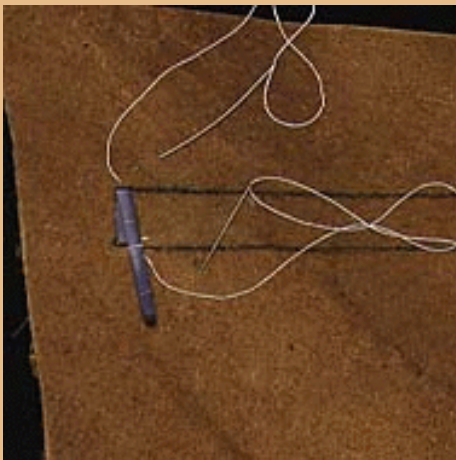
**Knot the thread on top of the work by taking a few close stitches and running the thread back through them. You may also put knots underneath the work, but they will look lonely down there as you won't see any other stitches from the underside. Bring the threads up to the beginning of your line where you want your first quill to be. Do this for both top and bottom lines. The illustration shows the bottom thread taking a back stitch for the first quill. Note that the needle ALWAYS exits the leather on the outside of the lines (away from the quills). Otherwise you have a little loop under the quill that keeps you from hiding your threads well:**



**Take a quill out of the water and flatten it by running it between your thumbnail and your index finger. You can also try running a spoon across it on a flat surface. Whatever method you use, make sure the quill is flat! You can't have good work later with a puffed up or wrinkly quill now! Insert one end of the quill under the bottom thread, and pull the stitch snug.**

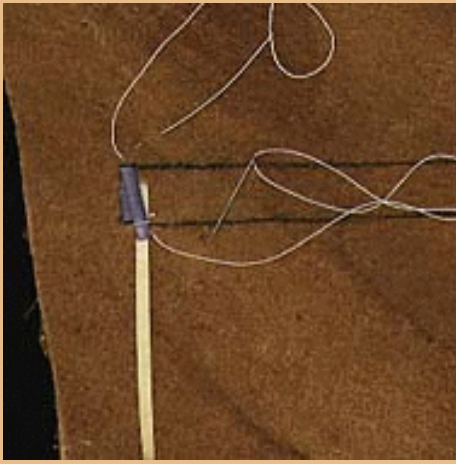


**Flip the quill up and take a stitch over it as you did below, making sure the needle comes out on the side away from where the quillwork will be. Pull this stitch snug, and you've just mastered the zigzag technique!**

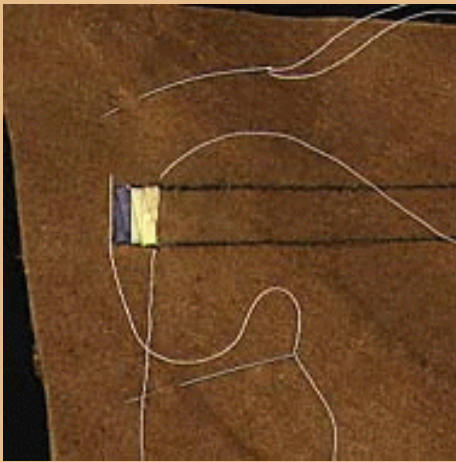


**Now bend the quill back down over the stitch and sew it down again at the bottom. Make sure that your stitches stay on your drawn lines. Straight lines are essential here. Continue on in this manner until you come to the end of your quill at the bottom line. This is where you splice in another quill. Sew down the quill, pull the stitch snug and make a fold in the quill as if you were to continue on.**





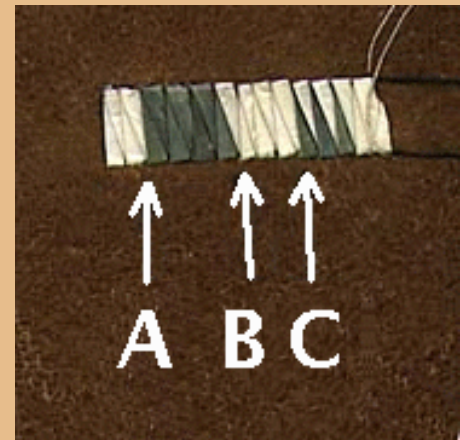
**Pull on the quill slightly so that your last stitch loosens up a little. Flatten another quill and insert it under the first one. Trim the old quill close and continue on as before. In the illustration, and yellow quill has been inserted under the blue one.**



**Continue along adding quills as you go. Occasionally stop and run your tablespoon across the top of your work, adding a little pressure to help flatten it. When you get to the end of your row, simple tuck the last little quill end under the work. The dental pick is most useful here.**

## **Variations on the ZigZag Technique**

**Many variations in this style can be achieved by changing where you splice in your new color quill. Changing your splice from the bottom row to the top row effectively changes the direction of your new color. Item A below is a bottom row color splice as discussed above. Note how it gives you a nice straight vertical line. The quillwork at B shows a top row color splice. Suddenly you get diagonals in your work, just with a simple splice! At C, another quill of a different color has been added directly over top of the old quill and the two quills worked together as one, giving a two color sawtooth effect. Do two rows of these opposite one another, and you have diamonds. The varieties are infinite. Experiment!**



**Now you have learned the basic zigzag technique with a few variations. Come**

**back soon to find more techniques! More will be added as time goes by, so stay tuned!**



*Quilled Rosette made by Nancy  
using the Zig-Zag Technique*

## **Quill Embroidery Techniques**

[The Parallel or Band Technique](#)

[The Single-quill Line Technique](#)

[Plaiting Techniques](#)

---

© 1997 - 103 [Nancy Fonicello](#).

---

[Porcupine Quillwork Bibliography and Books to Buy On-Line](#)

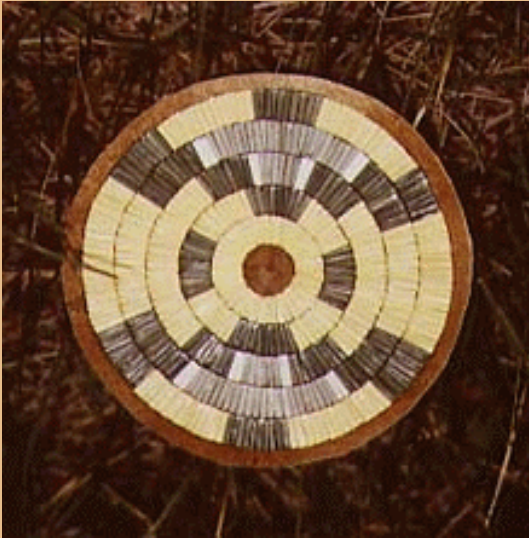
[Return to NativeTech's Main Porcupine Quillwork Menu](#)

---



**Text and Graphics**  
© 1994 - 103 [Tara Prindle](#)  
unless otherwise cited.

## NativeTech: Native American Technology and Art



### Porcupine Quillwork The Parallel or Band Technique

contributed by [Nancy Fonicello](#)

*Quilled Rosette made by Nancy using the Single-quill Parallel-fold or Band Technique.*

---

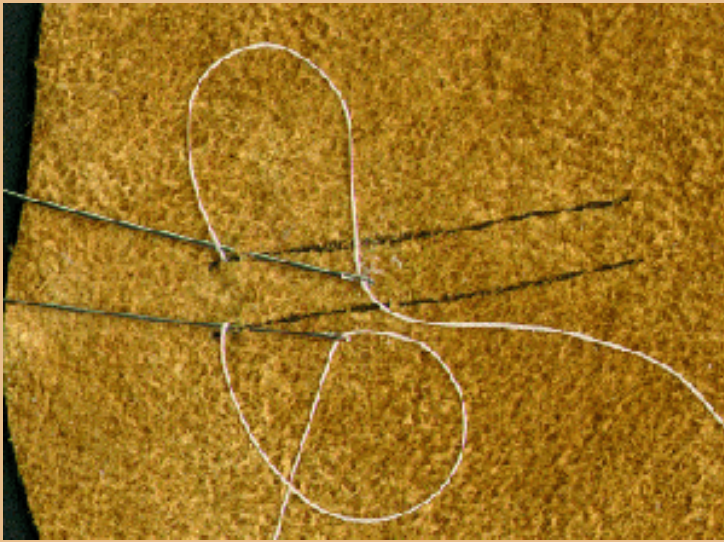
The single band technique is another type of quillwork technique that is easily mastered. It is similar to the zig-zag technique except for the fact that the quills on the top row are folded away from you rather than toward you. This technique is also the foundation for more advanced quillwork stitches, including the multiquill plaiting and single line work. And by the way, I did not originate the method of twisting quills with the thread as described below. The first reference I ever found to it was in Jean Heinbuch's book "A Quillwork Companion", for which I am very grateful. And if you are just beginning, you may want to take a look at the discussion of tools and materials:

[Click Here for Information About  
Tools and Materials](#)

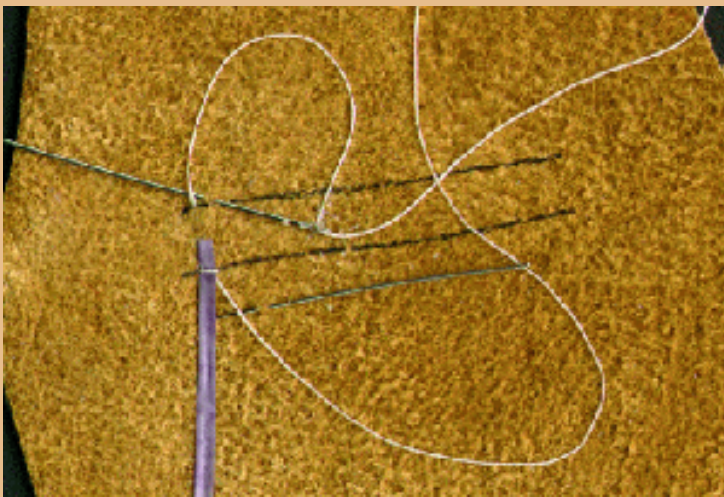
### Sewing Techniques

As in the zig-zag technique, prepare your quills by snipping off both ends and soaking the quills in water to soften them. Again draw two lines on your leather where you want the embroidery to be. The distance between the lines will be determined by the design, but keep in mind that this type of quillwork tends to be a little more fragile than the zig-zag stitch, and keeping the lines 1/4" to 3/8" apart will help keep the work tight to the leather and less likely to get caught on something and tear out when your work is done.

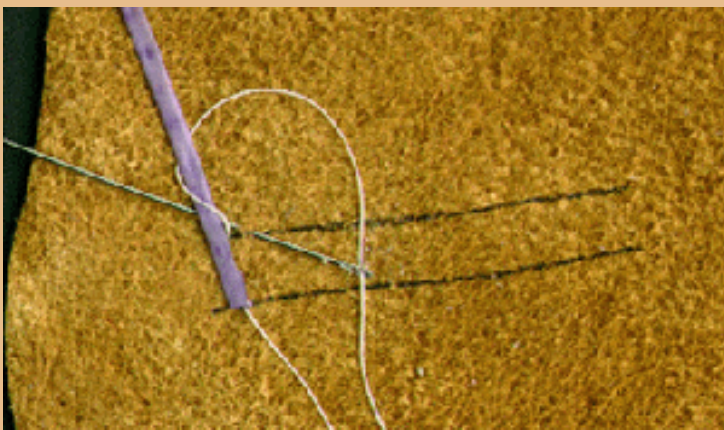




Again knot the thread on top of the work by taking a few close stitches on top of the leather. Bring the threads up to the beginning of your line where you want your first quill to be. Do this for both top and bottom lines. This picture shows both needles in position ready to take a back stitch (for more information on the back stitch see the diagram under [Zig-Zag Technique](#))

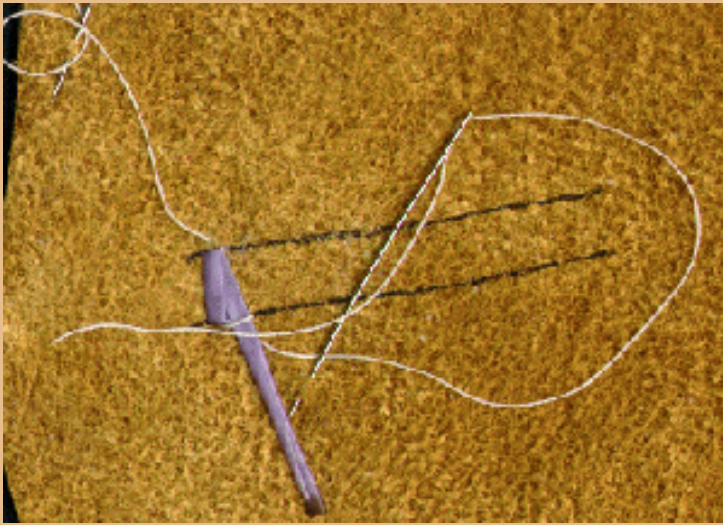


Flatten the quill and insert one end under the stitch on the bottom line. Pull the stitch tight to hold the quill in place. Remember to be sure that your quill is very flat and has no wrinkles in it, as these are difficult to remove later.

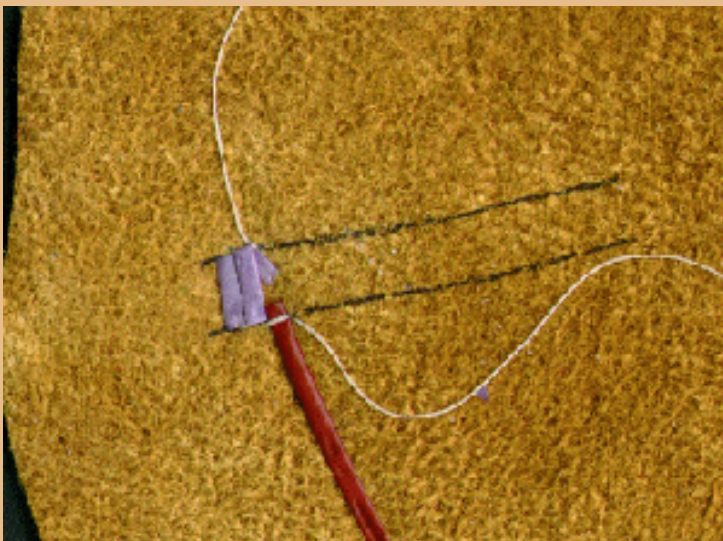


Now comes the tricky part! Bend the quill up towards the top line as you would in the zig-zag technique, but instead of just taking a straight stitch across the quill as before, this time loop the thread around the quill as shown. As you pull the thread tight, the quill will flip away from you and point down towards the bottom line. Adjust the fold by pulling the thread and the quill opposite one another (gently!) so that the fold sits on the drawn line. You should now have something that looks like the following picture. An alternative way of bending the quill is by folding it over the needle before you take the stitch.

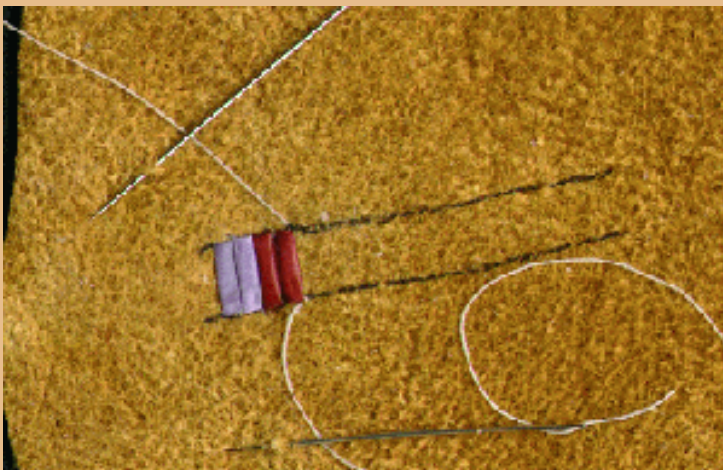




**Take another stitch across the quill with the bottom thread. Remember, the bottom stitch is just a simple straight back stitch. Only the top line in this technique requires the twisting thread loop.**



**Continue on in this manner until you come to the end of the quill. Unlike the zig-zag technique, there is no need to end the quill at the bottom. Snip off any remaining quill after you have made your last stitch on the top line. To start a new quill, take a new stitch in the bottom line and work it the same way as you did before**

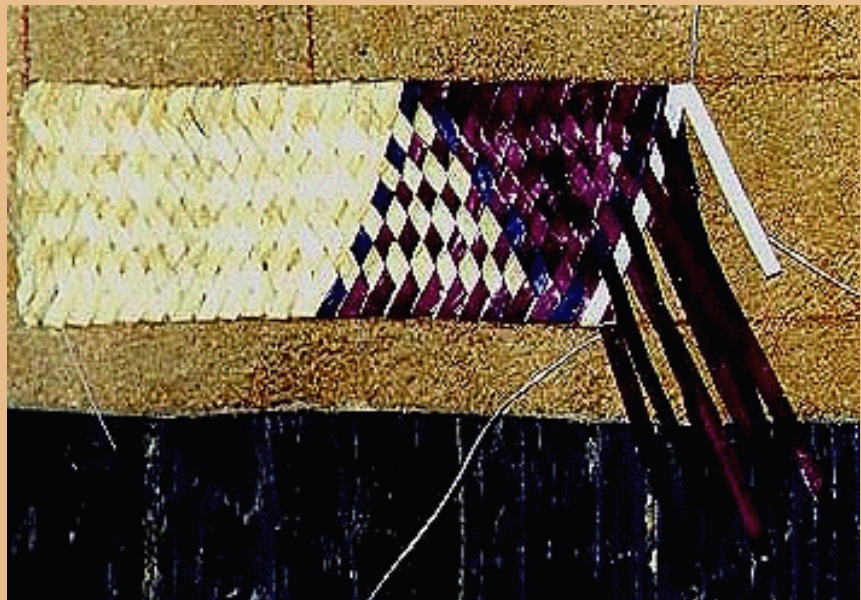


**Continue along adding quills as you go. Occasionally stop and run your tablespoon across the top of your work, adding a little pressure to help flatten it. When you get to the end of your row, simply tuck the last little quill end under the work.**

## **Variations on the Parallel Band Technique**

**As mentioned above, the parallel band technique is the basis for some of the**

more complicated quillwork stitches, such as multiquill plaiting. The only difference here is that you are working with 10 or more quills at a time instead of one. The stitching techniques are exactly the same. You will also find that the band technique lends itself well to small intricate designs and curving patterns such as pictoral and rosette work.



*a small quilled elk made by Nancy  
using the Band Technique and all natural dyes*

## Quill Embroidery Techniques

[The Zig-Zag Technique](#)

[The Single-quill Line Technique](#)

[Plaiting Techniques](#)

---

© 1997 - 103 [Nancy Fonicello](#).

---

[Porcupine Quillwork Bibliography and Books to Buy On-Line](#)

[Return to NativeTech's Main Porcupine Quillwork Menu](#)



**Text and Graphics**  
© 1994 - 103 [Tara Prindle](#)  
unless otherwise cited.



## NativeTech: Native American Technology and Art



### Porcupine Quillwork **The Single-quill Line Technique**

contributed by [Nancy Fonicello](#)

*Pouch made by Tara using the Line-quilling Technique. The red quills were dyed with brazilwood.*

---

The single-quill line technique is the third of what would be considered the "basic" quillwork stitches. It is executed in exactly the same way as the parallel band technique, except that now we are using one thread instead of two, and the quill is left whole and not trimmed until the work is completed. If you have ever seen old examples of Huron moccasins you would certainly be impressed by the beautiful designs that are possible using this stitch. It tends to be more time consuming than the first two techniques because there are more stitches per inch, but it also is more durable because there is less surface area of each quill exposed. If you are just beginning, it would be well to look at the discussion of tools and materials in another section of this site:

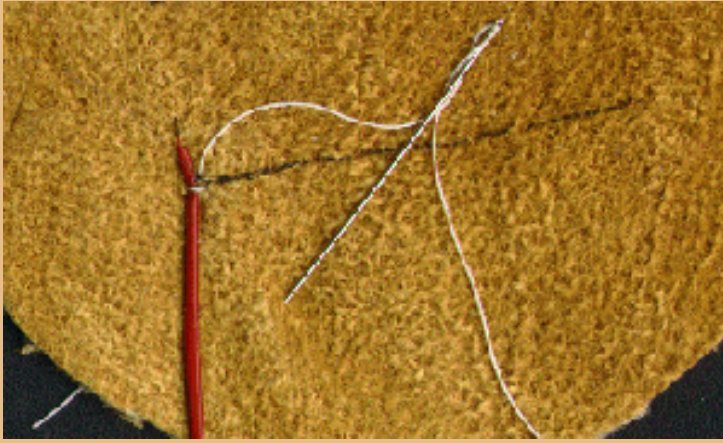
[Click Here for Information About  
Tools and Materials](#)

### Sewing Techniques

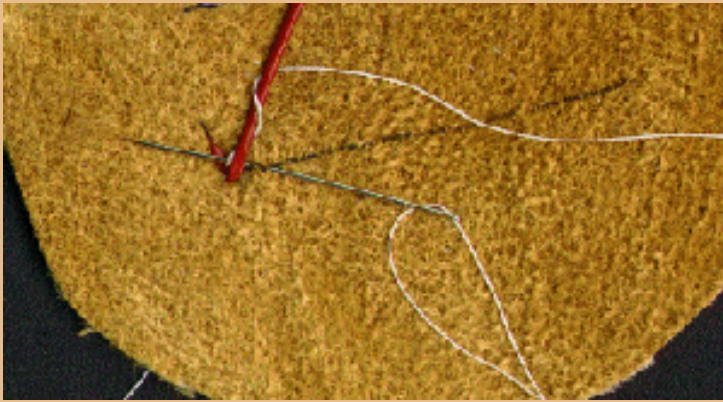
This technique does not require you to snip off the ends of the quills before you begin. Using the whole quill enables you to make nice round stitches, as an untrimmed quill acts somewhat like a balloon with air in it. Also, do not flatten the quills ahead of time or else you will get kinks and sharp edges that won't look quite right in your finished work. All ends will be trimmed off later with a sharp knife or pair of scissors.

Soak the quills in water to soften them as before. This time only draw **ONE** line on the leather where you want the embroidery to be. You may not even need to draw lines, especially if you are laying down several lanes of stitching close together - just use your first line for the guide for all your other stitches.





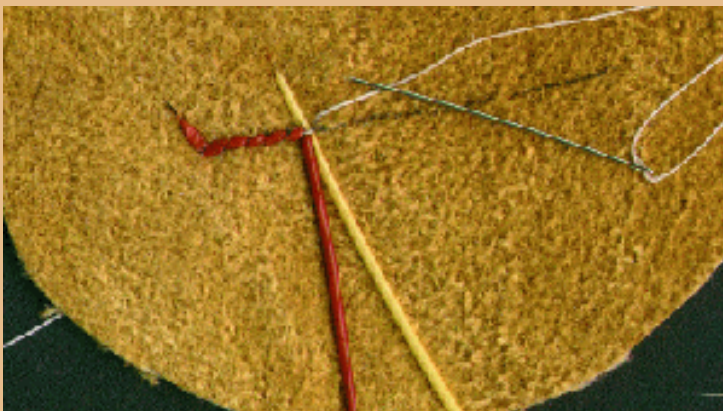
**Anchor the thread as before, taking a few running stitches in the leather. Bring the thread up to the beginning of your line where you want your first quill to be and make a little loop using the back stitch. Insert the end of your first quill under the loop and pull it tight. This picture shows the first quill stitched down and ready for the next stitch.**



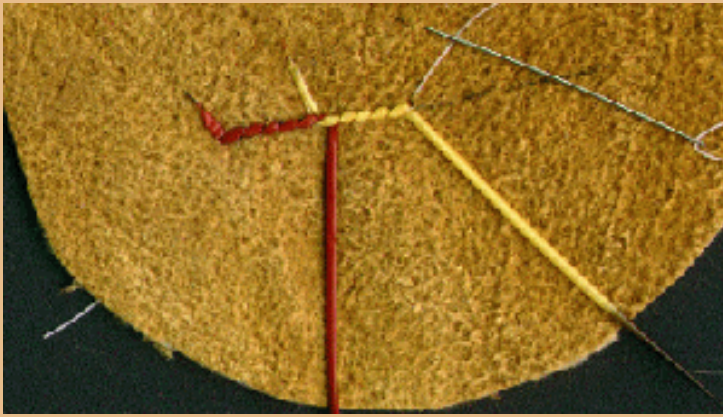
**Flip the quill up, and take a stitch around it as if you were going to do the top line of the parallel band technique. This involves wrapping the thread around the quill so that it will bend away from you when the stitch is pulled tight.**



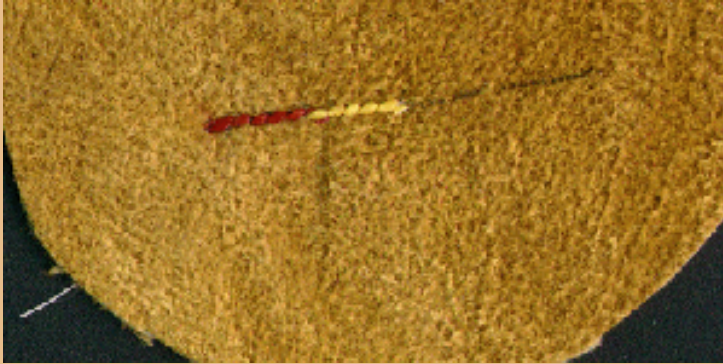
**Pull the thread gently and help the quill to bend down and away from you using your other hand just as in the [band technique](#). Adjust the stitch by pulling on the thread and the quill at the same time until it is where you want it, then pull the thread tight. You have just made your first stitch using line work. Congratulations!**



**Continue on in this manner until you come to the place where you want to splice in another quill. The splice is the only tricky part in this technique. Take your last stitch with the first quill, then pick up the thread loop and insert your new quill underneath the first one as shown. Pull the stitch tight again.**



Now, take your stitch as before, but this time flip both quills up, and take the stitch around both of them at the same time. Adjust the stitch, pulling both the old quill and the new one until the new stitch is exactly the right size. Don't worry about the loose ends. I usually leave them until the quills are completely dry and stiff and then trim them close with a razor blade. I find that if I try to trim the work when the quills are still soft, the splice has a tendency to unravel itself.



Continue to work in this manner, trimming the final stitch close to the work when you are done. This technique is very versatile in that you can work easily in either straight lines or in curves to produce different effects.

This is an example of what kind of work is possible using the single-quill line technique. This is a small motif done in the Huron floral style. The quills are dyed with all natural dyes and the background material is brain tanned leather dyed with walnut hulls.



## Quill Embroidery Techniques

[The Zig-Zag Technique](#)

[The Parallel Band Technique](#)

[Plaiting Techniques](#)

---

© 1997 - 103 [Nancy Fonicello](#).

---

[Porcupine Quillwork Bibliography and Books to Buy On-Line](#)



[Return to NativeTech's Main Porcupine Quillwork Menu](#)

---



Text and Graphics  
© 1994 - 103 [Tara Prindle](#)  
unless otherwise cited.

## NativeTech: Native American Technology and Art



### Porcupine Quillwork **Multiquill Plaiting Techniques**

contributed by [Nancy Fonicello](#)

*Strip of multiple quill plaiting used as shoulder strips on an Upper Missouri style dress. This type of work is extremely flexible and it is easy to see why it was used so widely on clothing. Note also the use of pony beads to compliment the quillwork.*

---

**Multiquill plaiting is the term commonly used to describe a type of quillwork which has the appearance of being "woven" with many quills at once. It was a technique used extensively amongst the people of the upper Missouri River in historic times and can be seen quite clearly in the paintings of such artists as Karl Bodmer and Paul Kane who traveled extensively in the west in the early 1800's. This quillwork technique looks more complicated than it is - it is actually one of the speediest to execute once the basic skills are mastered. It uses the single band or zigzag technique, the only difference being that many quills are used across the work instead of just one or two at a time.**

**This page will introduce you to the basics of the multiquill technique. I recommend you review the techniques of [zigzag](#) and [single band](#) technique before you begin, as these are the two stitches that you must know in order to do the multiquill technique.**





**Multiquill plaited quillwork on a horse headstall made by Nancy**

**Perhaps the most difficult part of doing multiquill plaited quillwork is the beginning and the ending! At first glance it looks as if you must work with 10 or 12 quills all at the same time, but in reality, you can only sew down one quill at a time. The following instructions will show you how to begin a piece of multiquill plaiting:**

**STEP ONE:**



**First determine how wide you want your strip to be - this will determine for the most part the number of quills you will need in order to fill the space. Obviously the wider your strip, the more quills you will need.**

**When you are just starting out, you may not want to make your strips any wider than your longest quill. As you get more advanced, you will learn to splice new quills in in the middle of the work, but for now, we will just add quills on either edge.**

**In my example I have drawn an area about 1.25 inches wide. I know from experience that this is a good size for a ten quill plait, so that is what we will show.**

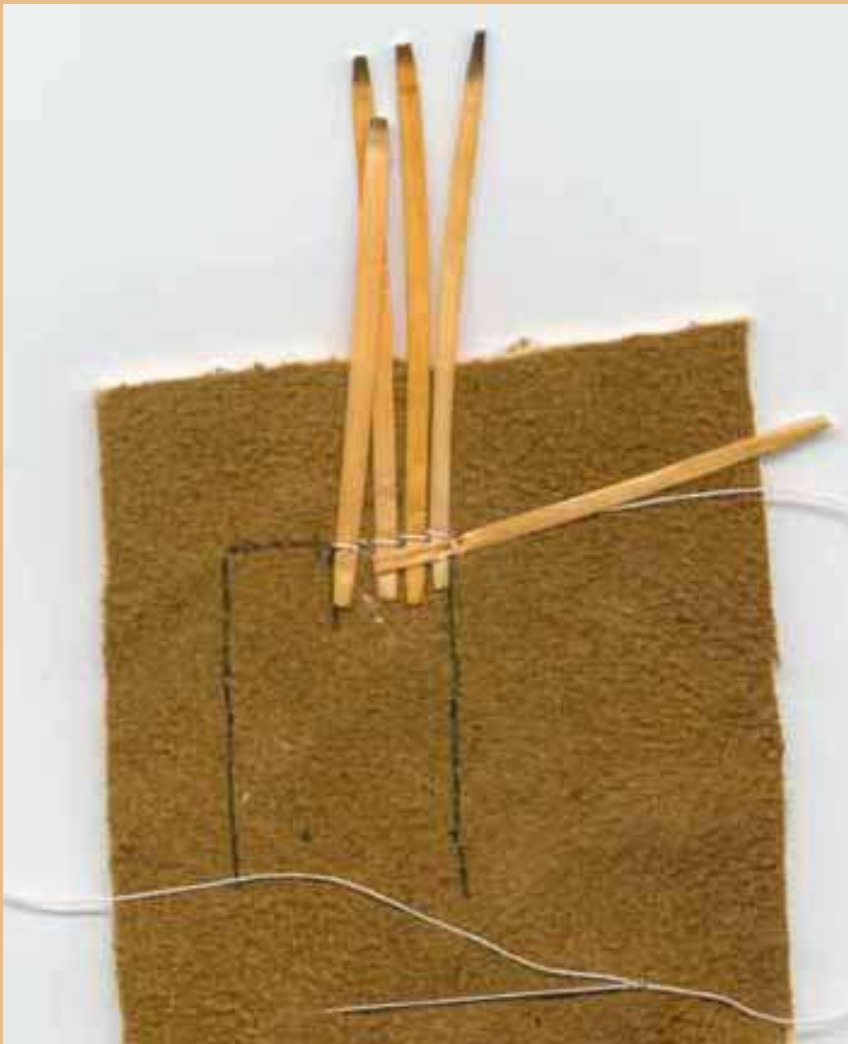
**As in previous techniques, use a fine point pen to draw your lines on a piece of soft brain tanned leather. Here I have drawn a short line in the center of my strip to show where I will begin quilling.**

## **STEP TWO:**



**Find the center of your strip and just to the right of it, make a loop with one thread and stitch down a flattened quill. You might be wise to select the longest quills you can find for this type of work - the longer the quill, the fewer times you have to make a splice as you cross the work! Don't fold the quills over just yet - leave them sticking out away from the work as shown.**

## **STEP THREE:**



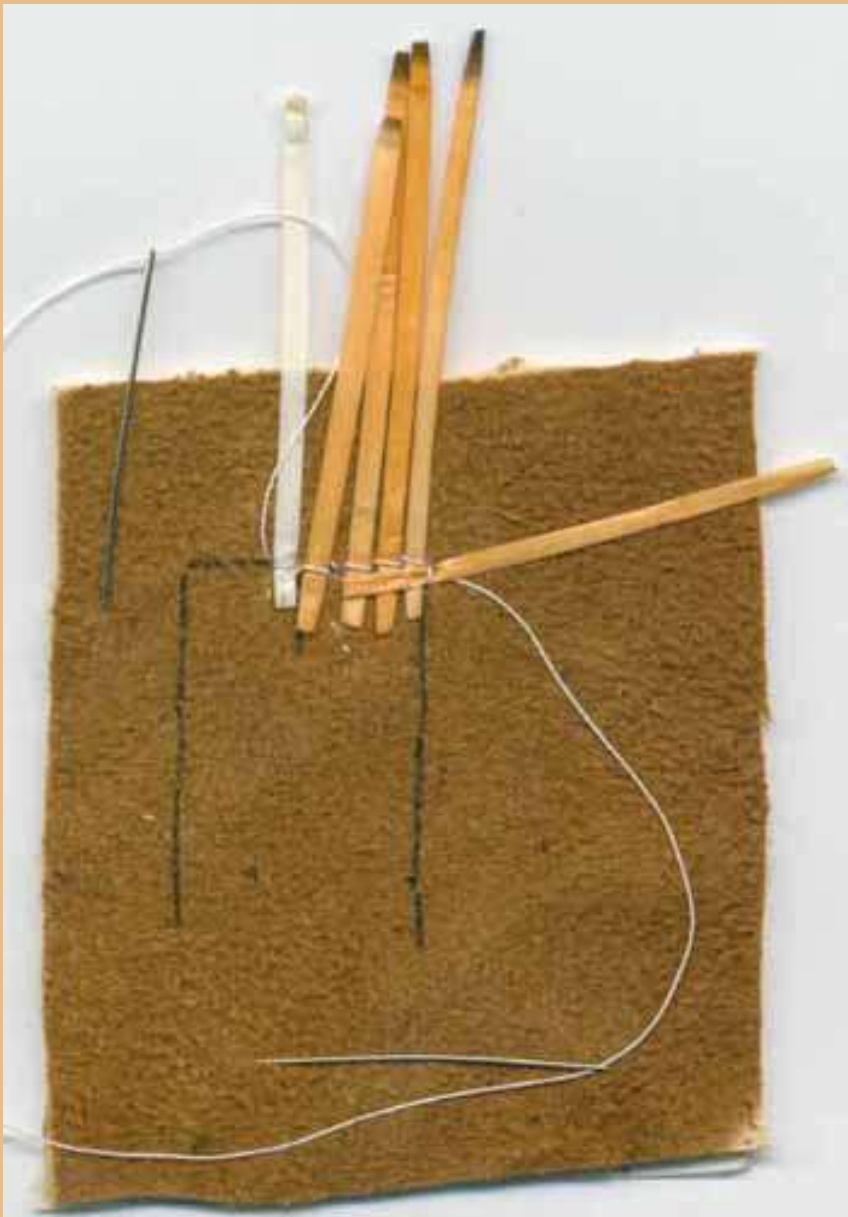
**Now add quills one at a time along the top edge which you have drawn your line (working left to right), flattening the quills but leaving them sticking straight out from the top of the work.**

**Continue until you reach the right side of your strip (Here I have added 4 quills), then add one more quill on the descending line, just as you did across the top. Notice how this quill points at 90 degrees from the previously added edge quills. This quill marks the beginning of your quilled strip proper, and helps to**

**make a nice clean corner.**

## **STEP FOUR:**





**It gets a little tricky here, so be patient! So far we have been working with just one thread. Now it is time to add another needle and thread, this time just to the left of the very first quill you stitched down.**

**Don't be perturbed that your work is starting to look like a porcupine on a bad hair day! Once we start folding quills down, it will all make sense.**

**Add a new quill just to the left of the other ones, keeping your stitches on the line you drew before. Here I have used a white quill to illustrate where I am**

**adding a new quill. Normally these quills would be all the same color as you begin a multiquill strip.**

## **STEP FIVE:**



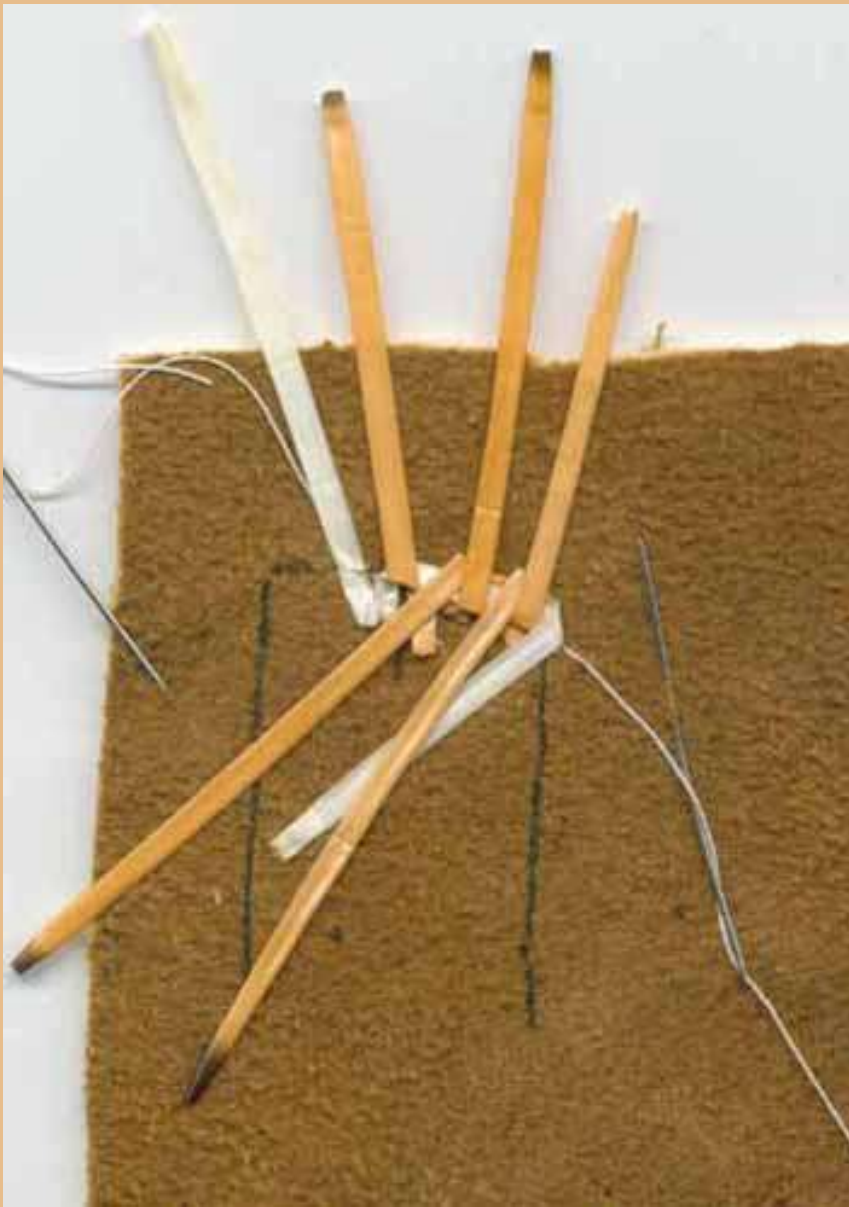
**Now the fun starts. With your needles and threads safely out of the way, fold down every other quill, starting just to the right of the new (white) quill. If the quills have gotten stiff in the meantime, wetting them slightly with your fingertips should help soften them up. If you flattened the quills properly to start with, you shouldn't have much of a problem folding them down now.**

## **STEP SIX:**



**Fold the new quill (the white one in this illustration) down over the orange quills which you folded down in the previous stitch. Sew this new quill down along the drawn line on the right side, just as you would if you were doing the zig-zag stitch (i.e. the fold is toward you). Notice that this quill is now covering the three orange quills that you folded down in the previous step.**

## **STEP SEVEN:**

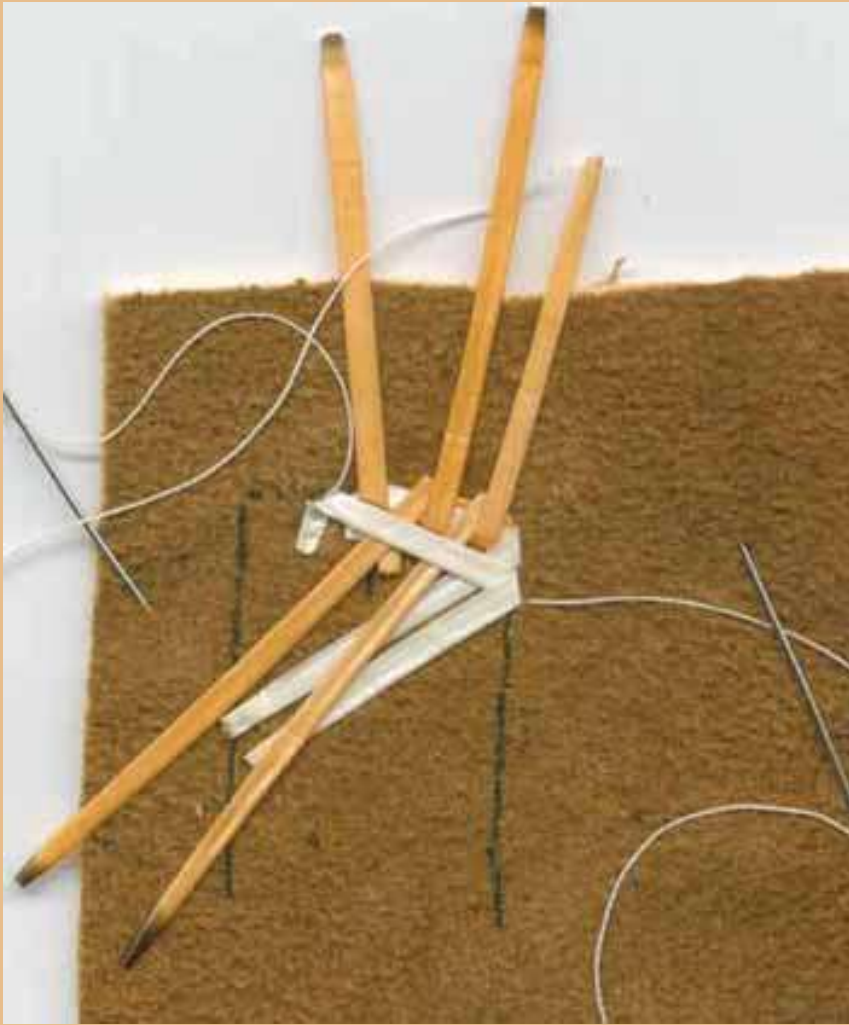


**Here I have actually shown two steps. First of all fold the two orange quills (that you had left sticking up in Step Six) down over the top of the white quill you just stitched down. Now lift up the quills that were underneath that white quill, folding them up and out of the way. With the quills alternating up and down, this step looks very much like basket weaving.**

**Secondly, add another quill just to the left of the newest one, just as you did before. Here I am using another white one in my illustration.**

## **STEP EIGHT:**

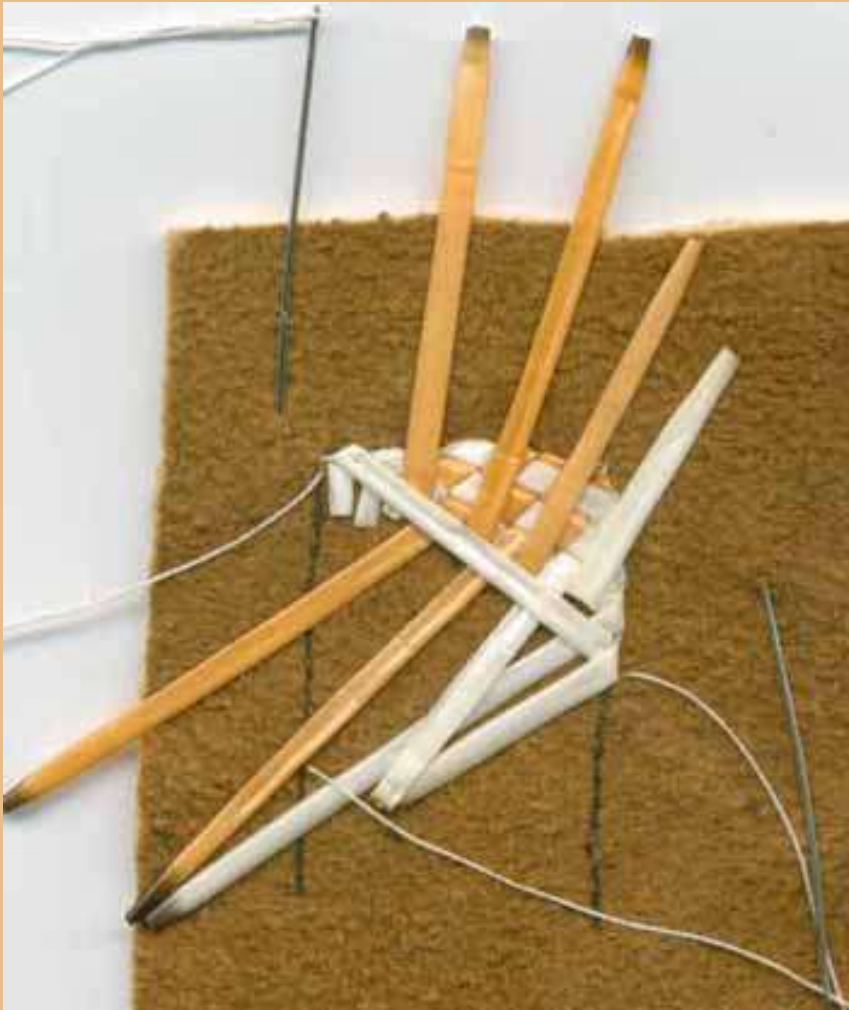




**Fold the new quill down as before, over the top of the folded orange quills, stitching it down along the right side line.**

**Congratulations! Now you know how to do multiquill plaiting! But there are a few more steps....**

**STEP NINE:**



**Continue adding new quills to the left across the top of the strip, weaving the other quills over and under with each stitch as shown.**

**STEP TEN:**



**Two more steps: when you reach the left corner of your strip, add one more new quill going down the side. Here, the quill I am talking about is the white one which sticking out on the right side. Your left hand thread will be running perpendicular to the top line now, although I have covered it over by folding the quill.**

**You are done splicing in new quills and it is time to begin plaiting! From here on out, just sew down the next quill in the**

**weave and continue as before. Here, my next quill is the orange one. Note that this is the very first quill you sewed down!**

**From here on out, completing your muliquill strip is just a matter of adding new quills one at a time and weaving them as you go with quills that are already in the work.**

**Splices for new quills can be made at either side of the work. You can create new patterns in your weave by introducing new colors from one side or the other, or by doing mirror image strips side by side to make diamonds and other patterns.**

**This is a picture of a different quilled strip which I started. Notice how I have changed the pattern by adding red quills from the left and white quills from the right.**







[The Zig-Zag Technique](#)  
[The Parallel or Band Technique](#)  
[The Single-quill Line Technique](#)

*Quill plaited knife handle. This technique, commonly used on pipe stems, is called plaiting but it's actually a combination of braiding and wrapping.*

---

© 1997 - 103 [Nancy Fonicello](#).

---

[Porcupine Quillwork Bibliography and Books to Buy On-Line](#)

[Return to NativeTech's Main Porcupine Quillwork Menu](#)

---



Text and Graphics  
© 1994 - 103 [Tara Prindle](#)  
unless otherwise cited.

# Preparation of Porcupine Quills

[by Tara Prindle](#)

---

A porcupine quill is really just a large 'hair' that has a hard, shiny shell and a pithy, soft interior. A grown porcupine naturally has quills of different shapes and sizes. The flexible, slender 'guard hairs' can measure a half a foot long and are reserved for hair 'roaches' worn on the head. Quills used for embroidery, loomwork, or wrapping range from 4" quills on the porcupines back to 1/2" quills around the head and flanks of the animal. Most quills are 2 1/2 to 3 inches long.

The craftsperson usually sorts the quills into four classes. Traditionally the sorted quills were kept in pouches made from bladders. The large, coarse quills from the tail and are used for embroidering large filled areas, or for wrapping handles, pipe stems or fringe. Longer thinner quills are pulled from the porcupine's back, and are excellent for loomed quillwork. The neck quills are even finer and are ideal for embroidery. The thinnest quills are found around the porcupines belly and these are best for delicate line quilling.

Porcupines are pigeon toed, somewhat slow and lumbering creatures and they do not move swiftly. They are easily captured by human hunters, and all too easily hit by vehicular traffic on the roads. Although some states restrict picking up animals killed on the road, this is the easiest way for a crafter to obtain the quills. The quills should be (carefully) pulled with bare hands. Leather or rubber gloves can be used but they tend to catch on the barbed quills. If pliers are used, the quills can be damaged resulting in problems later on trying to dye the quills. The quills come out more easily if a porcupine carcass is left on it's own for a couple of days (for a shorter time in sweltering heat).

Long guard hairs are pulled first, and an attempt should be made not to pull the underfur out with the quills. To clean the plucked quills, remove any fur or detritus, and then soak the quills in hot soapy water, rinse, and repeat until the quills are a nice bright white color. This should remove the oils from the quill, and make dying them much easier. If the quills come from a porcupine with serious personal hygiene problems, it may be necessary to soak them for a few minutes in a very mild solution of water and bleach. Bare in mind that bleach may damage the quills, making them brittle and susceptible to cracks. After cleaning, place the quills out to dry.

---

[Porcupine Quillwork Bibliography and Books to Buy On-Line](#)

[Return to NativeTech's Main Porcupine Quillwork Menu](#)

---



Text and Graphics  
© 1994 - 103 [Tara Prindle](#)  
unless otherwise cited.



# Natural Dyes for Porcupine Quills

by Tara Prindle

---

Commercial dyes are often used to today to color quills, these dyes are easy to obtain and even easier to use. Why more natural dye recipes are not used is perhaps from lost knowledge or even laziness. The quality of an infinite number of natural dyes traditionally used by Native Americans leaves nothing to be desired! The vibrant and varied colors of quills produced using natural dyes are still highly desired today, but their recipes are known to a very few. Simply knowing the ingredients used to produce a color is not enough, as many dye recipes required the specifics of times and temperatures or the addition of an ingredient at just the right moment.

---

## DYEING QUILLS IN THE KITCHEN...



Some examples of naturally dyed quills and the materials used in the dye process. The liquid in the mason jar is indigo – note that the solution itself is yellow until it hits the air, where oxidizes and turns blue. Quills immersed in the solution will not turn blue until you remove them from the dye! The blue flower pedals in the plate behind it are larkspur (*Delphinium* sp.), which give a nice colorfast blue/green dye. The yellow lichen in the middle is fox moss, which grows on pine trees in the west, and gives a bright yellow, almost chartreuse color, requiring no mordant. The orange and red quills in the foreground are dyed with bloodroot and cochineal respectively.

--Photo and description contributed by [Nancy Fonicello](#)

---

Colors and some Natural Dye ingredients:



|               |                                                                                                                                                                                                                                                                                  |
|---------------|----------------------------------------------------------------------------------------------------------------------------------------------------------------------------------------------------------------------------------------------------------------------------------|
| <b>YELLOW</b> | <b>Sunflower, Gold thread (Helleborus trifolis), Cone flower petals with decayed oak bark or cattail root, Black willow roots, Fox moss (Evernia vulpina), Yellow or curled dock root, Cottonwood, Lichen (Usnea barbata), Oregon Grape (Berberis repens), Osage orange wood</b> |
| <b>RED</b>    | <b>Choke cherry or wild plum, Tamarack bark, Spruce cones, Sumac berries, Alder, Hemlock inner bark, Poke berry, Bloodroot, Sassafras, Red Bedstraw, Buffalo-berry (Lepargyrea), Squaw current, Red Osier Dogwood, Red cedar.</b>                                                |
| <b>BLACK</b>  | <b>Wild grape (Vitis, cinera and vulpina), Maples, Burr oak, Elderberries, Hazel nut bark combined with powdered brown stone</b>                                                                                                                                                 |
| <b>BROWN</b>  | <b>Hickory or Walnuts gathered green and turned black, Rushes (Juncus belticus)</b>                                                                                                                                                                                              |
| <b>PURPLE</b> | <b>Blueberries, Blackberries, Elderberries, Northern dog whelk (Nucella lapillus), White maple.</b>                                                                                                                                                                              |
| <b>BLUE</b>   | <b>Larkspur, Beech, Wire Birch, Indigo.</b>                                                                                                                                                                                                                                      |
| <b>GREEN</b>  | <b>Prince's Pine, Moosewood, Evergreen (Arbutus menziesia), Copper mixed with ammonia (urine).</b>                                                                                                                                                                               |

**Mordants:**

In addition to the coloring agents of dyes, mordants are often added to keep dyes from fading,, or to brighten, deepen, or dull a color. Depending on the particular recipe and on the desired effect, mordants can be used before, during or after the dye bath. Acidic mordants like currants or gooseberries (even vinegar) can help make colors more permanent. Deeper colors can be achieved by adding (female) dock root. Other natural mordants include birch, oak (especially black oak soaked in standing water for 2 years), iron oxides (ground hematite), and hardwood (or cedar bark) ashes.

Modern commercially available mordants include iron sulfate/Coppreas (dulls/gray tones), tin (brightens), chrome (stronger/browner tones), copper sulfate/blue vitriol (green tones), alum (yellow tones) and cream of tartar (deeper tones). Be aware that some mordants are toxic and great care should be taken when they are used in steaming dye baths.

When ready for dying, a vessel is filled with water, the dye and quills added and (barely) simmered for 1/2 to 3 hours or more. If boiled, or left unattended the quills can become soft, brittle, or they can even dissolve into a glue. After dying, the quills are strained from the bath (sometimes rinsed in cold water) and are left spread-out to dry in the air. Quills rubbed with animal oils after they've been dyed have a longer life, as they do not dry out and become brittle.

---

Here's an interactive game you can play to learn about dyes,  
[Matching Game: Natural Dyes and Porcupine Quills](#)

---

[Porcupine Quillwork Bibliography and Books to Buy On-Line](#)

[Return to NativeTech's Main Porcupine Quillwork Menu](#)



Text and Graphics  
© 1994 - 103 [Tara Prindle](#)  
unless otherwise cited.

## NativeTech: Native American Technology and Art



*A cree style loomed knife sheath in all natural dyes.*

## Porcupine Quillwork Looming Techniques

contributed by [Nancy Fonicello](#)

---

**Come back soon to find instructional information on this quillworking technique!**





*A close up of the sheath showing loomwork, line quilling and edging techniques. The hair in the copper cones is dyed white tail deer hair.*

---

© 1997 - 103 [Nancy Fonicello](#).

---

[Porcupine Quillwork Bibliography and Books to Buy On-Line](#)

[Return to NativeTech's Main Porcupine Quillwork Menu](#)

---



**NATIVE TECH  
HOME PAGE**

Text and Graphics  
© 1994 - 103 [Tara Prindle](#)  
unless otherwise cited.



## NativeTech: Native American Technology and Art



### Porcupine Quillwork **Quill Wrapping on Rawhide**

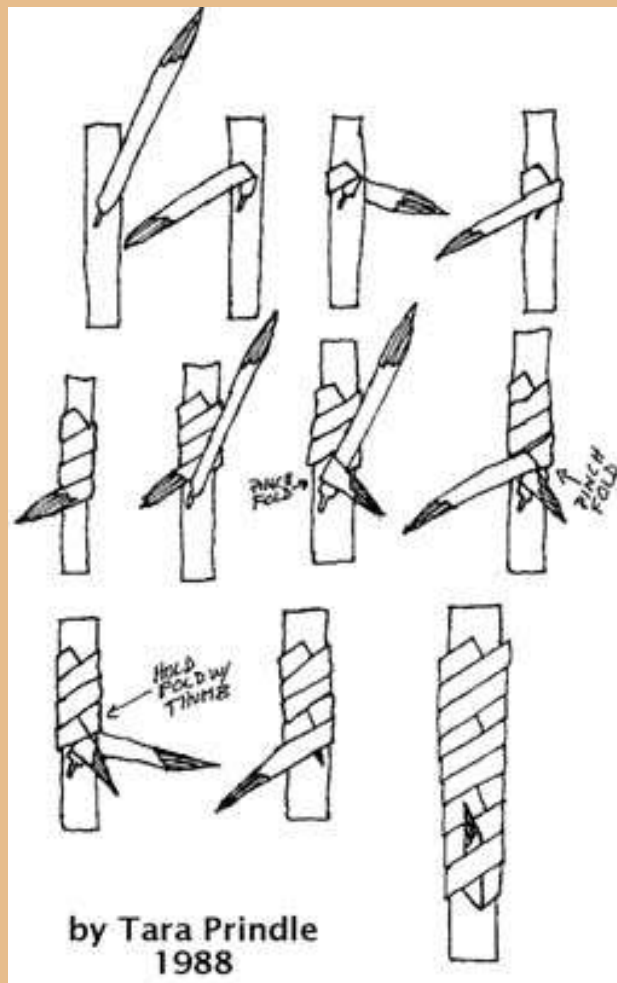
contributed by [Nancy Fonicello](#)

*A porcupine tail hairbrush with quill wrapping on rawhide. It really works!*

---

**Come back soon to find  
instructional information on this quillworking technique!**

**Until then... here's a quick illustration by Tara on the technique:**



---

© 1997 - 103 [Nancy Fonicello](#).

---

[Porcupine Quillwork Bibliography and Books to Buy On-Line](#)

[Return to NativeTech's Main Porcupine Quillwork Menu](#)

---



Text and Graphics  
© 1994 - 103 [Tara Prindle](#)  
unless otherwise cited.

## NativeTech: Native American Technology and Art Porcupine Quill Decoration on Birch Bark

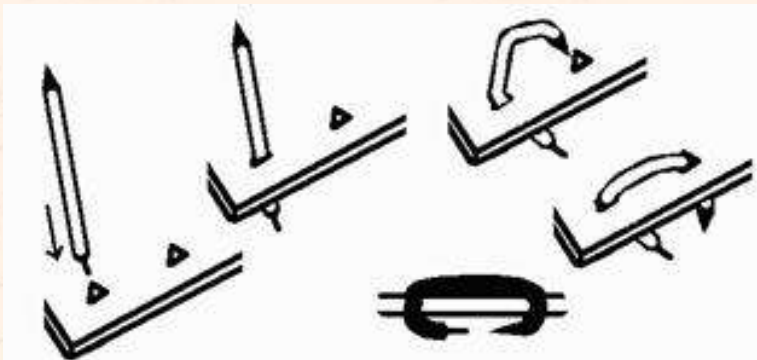
Quill work on bark is an ancient art, as old or older than sewn quill embroidery, both Native American traditions for probably thousands of years. Porcupine quill decoration on bark is not as well known as porcupine quill embroidery on leather, and compared to sewn embroidery on leather, it is less time consuming but is admittedly much easier to learn. No needle or thread, nor any sewing, is necessary to attach porcupine quills to birch bark.



Natives across North America made a multitude of items by folding and sewing together various types of tree barks like hickory, cedar, elm, ash, oak and others. In the Eastern Woodlands where the paper birch tree (*Betula papyrifera*) grows, Natives traditionally made all kinds of things from this flexible bark including collecting baskets, serving dishes, eating utensils, and even fans and headbands.

CHAIR SEAT & PORTFOLIO - MICMAC [Orchard 1984]

As not all bark items were made from birch, not all birch items were decorated with porcupine quills. Elaborate decoration is time consuming, every-day bark items - quick to wear out - are rarely decorated with quills. Special boxes, headbands and fans were more likely to be decorated with porcupine quills.



BASIC STEPS  
INSERTING A QUILL THROUGH BARK

Much like a staple, either end of each quill passes through perforation made in the bark. Perforations are made with an awl (preferably an awl with a triangular point) in closely-spaced pairs following a pattern laid out with a scribe or marker. The pointed, barbed end of the quill makes a natural needle to thread the quill through the holes in the bark. The layered nature of the birch tree's bark holds quill in place, especially as the previously soaked quills stiffen as they dry. After each quill is threaded through the pair of holes the ends are bent under

on the back side and then usually covered with a liner sewn on to hide and protect the ends of the quills. If the holes in the bark are made small enough, and hold the quills very tightly, expert quill workers will snip off the ends of the quills on the backside of the birch bark. Patterns achieved in placement of the quills in parallel rows, offsetting them slightly, or crossing the quills into stars or fans give the decorated bark an elegant look of embroidery, and uses many similar stitches.

Though quill decoration on was known to all groups of Native Americans living in the range of porcupine, a few groups of eastern Woodland Natives are particularly well known for decoration on birch bark. "The Iroquois, for instance, did little of this while the excellence of Micmac quilled boxes





ROUND BOX WITH CHEVRON PATTERN  
& WOVEN QUILLS AROUND THE LID  
- MICMAC [Bock 1978]

sets the standard for the craft. The Ottawa and Ojibwa became quite proficient, and most quilled boxes today come from isolated groups such as the Ojibwa in Canadian reserves." (Schneider 1972). Among the most notable are quill-decorated items made by the Micmac, Passamaquoddy, Penobscot, Beothuk, Ojibwa, and Ottawa living in the regions of New England, the Great Lakes, Nova Scotia, Newfoundland, New Brunswick, Ontario and other areas of eastern North America [Orchard 1984].

---

[Materials & Tools for Decorating Bark with Quills](#)  
[Quill Decorated Boxes and Other Bark Objects](#)  
[Designs used in Quilling on Birch Bark](#)

[Techniques and Patterns to Attach Quills to Birch Bark](#)  
[Instructions for Making a Quilled Birch Bark Pendant](#)

---

[Porcupine Quillwork Bibliography and Books to Buy On-Line](#)

[Return to NativeTech's Main Porcupine Quillwork Menu](#)



Text and Graphics  
© 1994 - 103 [Tara Prindle](#)  
unless otherwise cited.



## NativeTech: Native American Technology and Art Materials & Tools for Decorating Bark with Quills

---



CONTEMPORARY TOOL KIT  
FOR QUILLWORK ON BARK

**Bark** - the outer bark of the birch tree is traditionally gathered in June from live trees by making a horizontal slice in the trunk and peeling away the thick sheet of layers all the way down to the darker inner bark of the tree (which of course harms the tree)- birch bark from fallen trees or trees slated for harvest is best to use. Fresh bark can be easily bent and sewn, but older bark which has been pressed flat for storage must be heated with warm water for a few minutes to make it flexible enough for bending without splitting. (Soaking the bark is not necessary for the step of inserting the quills through the bark or for sewing flat pieces together).

**Quills** - porcupine quills can always be bought from craft supply companies but there are more creative ways of obtaining a supply of quills. Porcupines are often hit by cars in the northeast but at least use can be made of their quills. A clever woods-person can get a good supply of quills without harm to the 'porky' - a generous amount of quills will stick to a blanket, sweater or other ready article of clothing strategically tossed over the slow-moving critter. Quills must be soaked in warm water to make them soft and flexible - ideally kept warm and moist in the quill-workers mouth - I prefer to alternate my

quills between a small container of warm water and a moist sponge to rest them on so they don't over-soak.

**Marker** - or a bone marker to etch onto the dark stiff (inner bark) side the design to be quilled (or a pencil to draw the design on). The pairs perforations are placed along these line placed

**Scissors** - preferably two pair: a heavy duty pair for cutting the bark and one for snipping quills and lighter work.

**Awl** - Traditionally sharpened bone awls are used for making the perforations in birch bark. One such awl is made from the naturally tapering arm (ulna) bone of a deer or similar mammal. An awl with a triangular point works best and doesn't split the bark as a round needle tends to. But in a pinch a large leather needle or other pin can be used to make the perforations in the bark.

**Tweezers** or pliers - Though quills can be grasped easily enough by pinching fingers if the hole is large and the quill is inserted far enough, tweezers can really help to grab that teeny-weenie pointy tip when you go to pull it through the hole. Just be careful not to snap the point of the quill off if you're using metal tools to grab the quill.

**Spruce root**, cotton thread, or imitation sinew (waxed nylon) string - The piece of decorated bark must have a separate bark backing or liner sewn on with lashing or thread to protect the short bent-over ends of the quills and to keep quills from slipping out. Spruce root, split down to the same width as the quills, is traditionally used to lash the rims of decorated bark containers and is ingeniously

incorporated into designs. Use an awl to make holes for stiff spruce root or a for a standard needle and thread. A glovers needle (having a triangular point) can also be used. Whip stitch-on a backing the same size and shape of birch bark.

*Sweetgrass*, cattail or other botanical improvisation - The evidence of backings, linings and layers of bark can be hidden with added trim by whip stitching around a skinny bundle of plant material, traditionally sweetgrass. Even bundles of porcupine quills with their tips cut off have been used to wrap and finish of the rims of bark boxes.

---

[Quill Decorated Boxes and Other Bark Objects](#)  
[Designs used in Quilling on Birch Bark](#)  
[Techniques and Patterns to Attach Quills to Birch Bark](#)  
[Instructions for Making a Quilled Birch Bark Pendant](#)

---

[Return to Porcupine Quillwork on Birchbark](#)

[Porcupine Quillwork Bibliography and Books to Buy On-Line](#)

[Return to NativeTech's Main Porcupine Quillwork Menu](#)

---

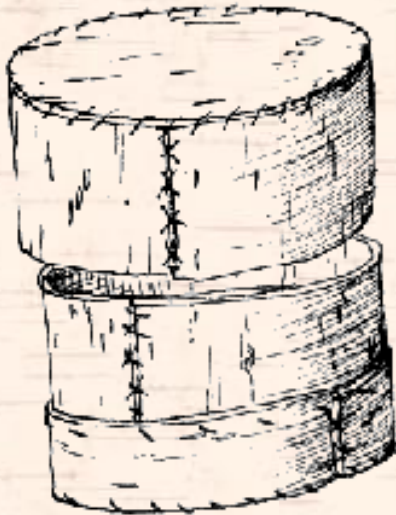


Text and Graphics  
© 1994 - 103 [Tara Prindle](#)  
unless otherwise cited.

## NativeTech: Native American Technology and Art Quill Decorated Boxes and Other Bark Objects

---

**Only a few Native Americans today produce elaborately quilled items from birch bark. And on this rare occasion these creations are quite dear to their maker, owing to the amount of time and patience invested in each piece. On a bark box only a few inches across there can be over 1,000 individual quills!**



Round boxes were made by cutting two disks (the top and bottom of the box), each attached to a long rectangular piece forming the sides of the box. The lid is made with a slightly larger diameter to slip over the bottom half. Decorating with quills on the flat lids is done just before the pieces are stitched together, and more decoration could then be added to the sides of the cylinder. Afterwards, a backing of another layer of bark is inserted inside the box - the liners - one disk shaped to protect the quills of the lid and another rectangular piece is inserted against the inside of the side of the box to hold the lid-liner in place. Sometimes liners are additionally secured using a single long quill and the 'lattice stitch' in a large 'X' much like in a pattern much like sewing on a button. With the lattice stitch, the quills go through both the decorated piece and the backing layers of bark.

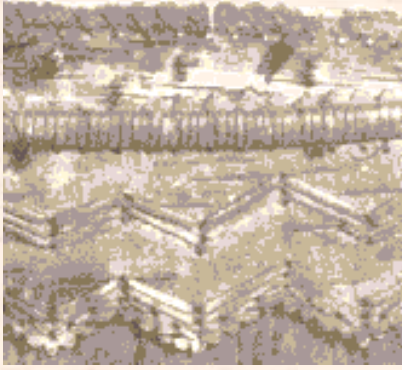
CIRCULAR BARK BOX BEFORE  
BEING QUILLED - [Schneider 1972]



BARK CIGAR CASE  
FROM NATIVES OF THE  
FRENCH-CANADIAN AREA [Miles 1963]

Oval, rectangular and other shaped boxes were produced in various sizes for items such as needles, gloves, cigars and cigarettes to appease the European market which developed in the late 1800's and early 1900's. [Schneider 1972, Miles 1963]. Some boxes were even shaped like the trunks of fur traders, or like European women's pocketbooks (Orchard 1984). Some of the most impressively decorated rectangular boxes are nearly a foot across and these fully-quilled boxes (like the ones made today by Ralph 'Porcupine' Bishop of Troy, Maine) have well over 10,000 quills! [Ripley, date unknown].





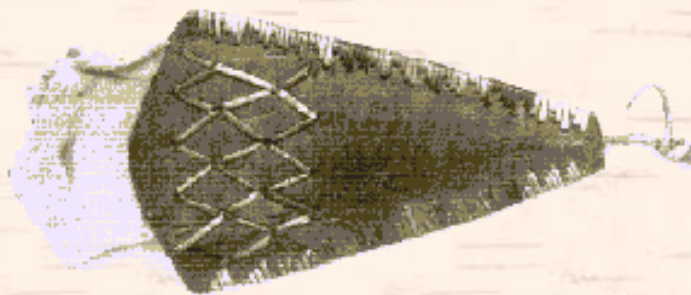
North American Natives also decorated more formal food containers, and occasionally personal items such as headbands and pendants with porcupine quills. A 'meat dish for deer's flesh' that had once been smeared with red ochre was exhumed in 1827 from the burial of Beothuk chief in Newfoundland. Secured just below the spruce-root wrapped rim is a layer of bark decorated with quills in a chevron pattern [Reynolds 1978].

DETAIL OF MEAT DISH -  
BEOTHUK NATION[Reynolds 1978]



A headband made in the 1700's probably by a Canadian Native, uses a combination of hide and birch bark strips wrapped with quills. Although the quills are wrapped around and not inserted through the bark, this headband attests to the antiquity of using quills and birch bark together [American Indian Art Magazine Summer 1993].

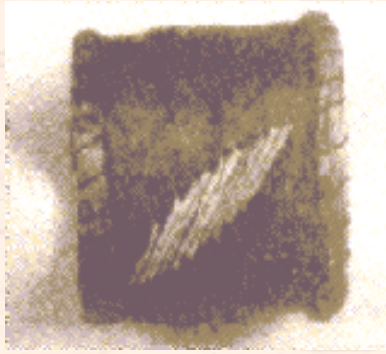
HEADBAND - Native Canadian  
[Amer. Ind. Art 1993]



A 4" case worn as a pendant made in the early 1800's by a Native of the Red River area of Manitoba uses quills stitched through the bark for surface decoration as well as to lash the edges together [American Indian Art Magazine Spring 1996].

CASE - Manitoba  
[Amer. Ind. Art 1996]





NAPKIN RING - GREAT  
LAKES REGION [Hothem 1990]

Today smaller quilled products are common, like this miniature bark canoe which I found at a powwow in Franklin, Massachusetts - it has only four quills on each side. Other 'souvenir' items, more quickly made with just a few quills - even napkin rings - are made for todays (somewhat unappreciative) commercial market.



CONTEMPORARY MINIATURE  
CANOE - MADE IN MAINE

---

[Materials & Tools for Decorating Bark with Quills](#)  
[Designs used in Quilling on Birch Bark](#)  
[Techniques and Patterns to Attach Quills to Birch Bark](#)  
[Instructions for Making a Quilled Birch Bark Pendant](#)

---

[Return to Porcupine Quillwork on Birchbark](#)

[Porcupine Quillwork Bibliography and Books to Buy On-Line](#)

[Return to NativeTech's Main Porcupine Quillwork Menu](#)

---



Text and Graphics  
© 1994 - 103 [Tara Prindle](#)  
unless otherwise cited.

## NativeTech: Native American Technology and Art

### Designs used in Quilling on Birch Bark

---

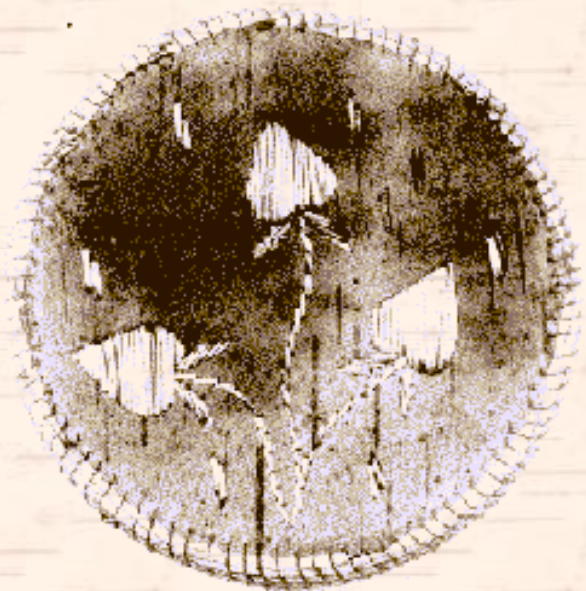
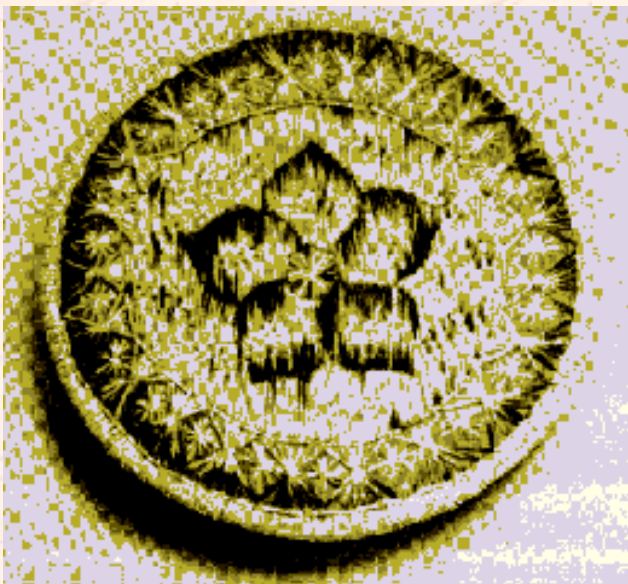
Designs should be drawn onto the birch bark before quilling is started. They can be lightly etched into the surface of the bark with a bone marker or drawn on with pencil. Stencils cut from a layer or two of birch paper can be used to delineate repetitive shapes such as leaves and flower petals that you want to all be the same size.



CHIPPEWA & MICMAC BARK BOXES [Orchard 1984]

geometric designs. "Many specimens showing realism in design have been collected from the Indians inhabiting the Great Lakes region, while those to the eastward have produced more designs of a geometric nature"(Orchard 1984).

Designs used were often floral, reflecting the rich plant life of Natives in the eastern Woodlands; common floral designs include five-petal flowers, plant and tree leaves, strawberry plants. Geometric designs were also used and incorporated zig-zags and chevrons, triangles, diamonds, squares, 8-point stars, parallel stripes and checkerboards, all nested together and integrated into complex designs. People and animals were depicted but not as often as floral and



CIRCULAR BOXES WITH FLORAL DESIGNS - OJIBWA & CHIPPEWA [Orchard 1984]

[Materials & Tools for Decorating Bark with Quills](#)  
[Quill Decorated Boxes and Other Bark Objects](#)  
[Techniques and Patterns to Attach Quills to Birch Bark](#)  
[Instructions for Making a Quilled Birch Bark Pendant](#)

---

[Return to Porcupine Quillwork on Birchbark](#)

[Porcupine Quillwork Bibliography and Books to Buy On-Line](#)

[Return to NativeTech's Main Porcupine Quillwork Menu](#)

---

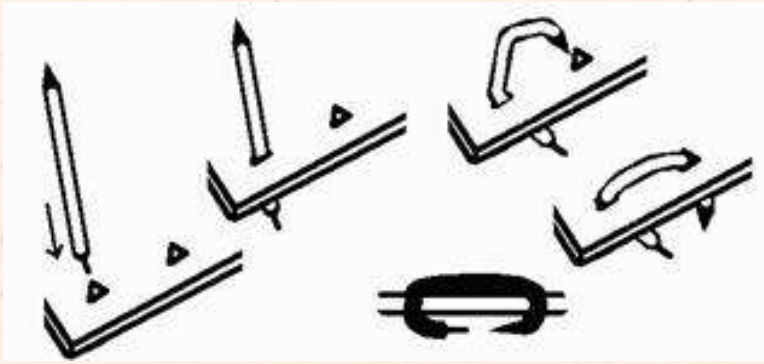


Text and Graphics  
© 1994 - 103 [Tara Prindle](#)  
unless otherwise cited.



## NativeTech: Native American Technology and Art

---

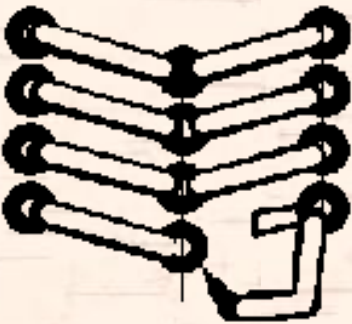


BASIC STEPS  
INSERTING A QUILL THROUGH BARK

### Techniques and Patterns to Attach Quills to Birch Bark



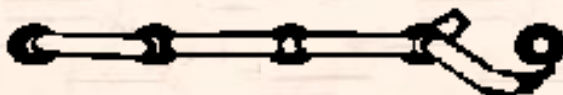
The *satin pattern* is used to fill areas is similar to that of the satin stitch used in embroidery. Sets of holes and the inserted quills are placed parallel to each other. In filling large areas with this stitch, the perforations are often stepped slightly in a zig-zag to avoid making weak areas by too many lines of holes in the bark.



The *chevron pattern* arranges quills in a zig-zags. Often the second quill set at an angle to the first quill will share one of the holes with the first quill so there is no space or interruption in the design.

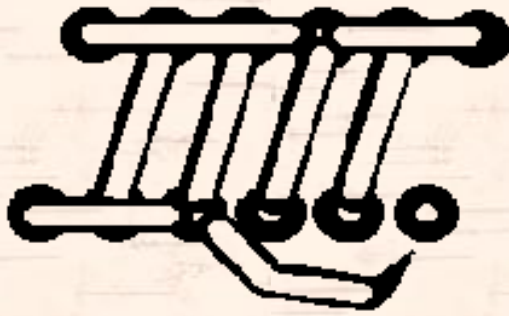


The *Outline pattern* is used to form feathery curved lines like those for plant stems and they are made by slightly starting the next pair of perforations halfway between, and to the side of, the last pair of perforations.



The *running-stitch pattern* creates thin straight stitches. After the first quill is placed through the first set of holes, only one new perforation is made through which the new quill which is threaded, and then the new quill passes through the second perforation of the first pair.





A *cover-stitch pattern* is like the running-stitch and is sometimes used to 'neaten up' a line of perforations or to emphasize certain lines of the design. The quill is placed through a hole in the end of a line of holes, is laid over the ends of the quills in the row, and passes back through the hole at the other end of the line. Several cover stitches must be taken over curved lines of holes, with each quill covering three or four holes.



Quills can be arranged in rays using the *fan pattern*. All the quills on the tapered end of the fan pass through the same hole, while at the opposite end the individual quills pass through evenly spaced separate holes.



Using a variation of the *lattice pattern*, a small raised star can be achieved by repeatedly crossing quills over each other at their center point. A circle of 8 or 12 holes formed by the holes punched through the bark. Each quill is 'stapled' through the perforations at the opposite side of the circle. Sometimes the quills are crossed so that the last quill placed appears to bind all the others at the center.

The basic stitch and variations of the fan stitch can also be used in various combinations to achieve woven and 3-D effects.

---

[Materials & Tools for Decorating Bark with Quills](#)  
[Quill Decorated Boxes and Other Bark Objects](#)  
[Designs used in Quilling on Birch Bark](#)  
[Instructions for Making a Quilled Birch Bark Pendant](#)

---

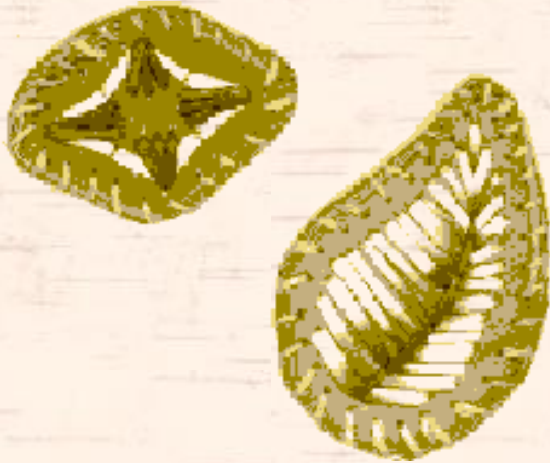
[Return to Porcupine Quillwork on Birchbark](#)

[Porcupine Quillwork Bibliography and Books to Buy On-Line](#)

[Return to NativeTech's Main Porcupine Quillwork Menu](#)



**Text and Graphics**  
© 1994 - 103 [Tara Prindle](#)  
unless otherwise cited.



## Instructions for Making a Quilled Birch Bark Pendant

1. Cut a small disk or other simple shape out of birch bark.
2. Draw your pattern on the bark - make sure the decoration will be on the pinkish/orange or brown side of the bark (the inner-most layer).
3. Make two perforations for the first quill using a triangular awl from the surface to be decorated through to the underside of the bark. The hole on the decorated side will appear somewhat large (don't worry - it's actually hard to get your adjacent holes too close together.), while the hole on the underside will appear as a pin prick or a small slit.
4. Insert one end of the quill through one hole from the top (decorated side) through to the underside of the bark.
5. Use your fingers, tweezers, or pliers to pull the quill through the hole so that about  $\frac{1}{4}$  inch is left visible on the bottom side.
6. Making a staple shape, bend the quill back down and insert the tip of the quill through the second hole and use pliers to pull it through to the underside so the quill is taught (but don't stretch it too much).
7. If the quill is very long you might be able to use it to go through the next pair of holes. If the ends of the quill are too long even when they are bent over, you can trim them to  $\frac{1}{8}$  inch. (Be REALLY careful what happens to those nasty little barbs you trim off - you REALLY don't want to get them in your foot or in your food!!)
8. Continue making pairs of holes and inserting each quill as in steps 4-7. If you are clever you can use the dark ends of the quill to your advantage, incorporate them into your design and get a 'shaded' effect.
9. With the quilling complete you have to make the backing for the pendant. Trace the decorated piece against a new (preferably a little thinner) piece of bark with the 'good sides' together, (inner-bark sides pressed together).
10. Cut out the new bark backing and press it firmly against the underside of the quilled piece. (With your third hand) hold a little bundle of grass against the seam on the edge of the pendant and whip stitch every  $\frac{1}{8}$ " to  $\frac{1}{4}$ ". Stitch around the coil and through the layers of bark until the bundle is stitched on all the way around the perimeter of the pendant.
11. Cut a hole (using a drill or an awl) for the pendant, or for a more contemporary option, glue on a pin backing.

[Materials & Tools for Decorating Bark with Quills](#)  
[Quill Decorated Boxes and Other Bark Objects](#)  
[Designs used in Quilling on Birch Bark](#)  
[Techniques and Patterns to Attach Quills to Birch Bark](#)

---

[Return to Porcupine Quillwork on Birchbark](#)

[Porcupine Quillwork Bibliography and Books to Buy On-Line](#)

[Return to NativeTech's Main Porcupine Quillwork Menu](#)

---

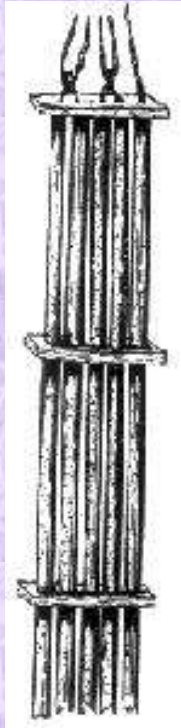


Text and Graphics  
© 1994 - 103 [Tara Prindle](#)  
unless otherwise cited.



## NATIVE AMERICAN USES FOR PORCUPINE QUILLS

### Strung & Threaded Quill Jewelry



[William Orchard in *The Technique of Porcupine Quill Decoration Among the Indians of North America*, published by Eagles View Publishing: Liberty, Utah in 1984. ISBN: 0-943604-00-1]

Quills are also used in elegant jewelry, and many of the techniques for stringing quills into necklaces, bracelets & chokers and earrings are easy to learn. It is not necessary to soak and soften quills before using them for threaded jewelry (as you do for other types of quill-embroidery). It is, however, necessary to cut off both sharp, tapered ends of the porcupine quill - *when making threaded quill jewelry, take care in discarding the dangerous tips of the quills.*

For sturdy, long lasting strung quill jewelry, it is best cut your quills to  $\frac{3}{4}$  of an inch or shorter. The thickest quills, the ones with the fattest diameter, are great for strung quill jewelry. Quills can be combined with tiny beads such as glass 'seed' beads, or other beads made from metal, wood or shell. The only restraint on the size of the beads used is that holes in these beads should not be so large that the threaded quills slip inside them. Some types of quill jewelry combine several strands of quills and beads, held in parallel rows and kept separate with leather 'spacers'.

One-strand necklaces are probably the simplest threaded jewelry to make. To make a necklace, cut the

Porcupines are members of the rodent family and are covered with special hairs called quills. Quills are hard on the outside and spongy on the inside, making them useful for many kinds of craftwork. The sharp needle-like tips of the quills are covered in hundreds of tiny barbs which can imbed themselves easily in the unwary handler. Quills can be left their natural white color, or can be dyed in various colors. Quills are used in traditional forms of decoration by Native Americans who have access to these quills in the colder-northerly natural range of the porcupine. Sometimes the quills are wrapped onto fringe and rawhide strips, or sewed onto leather for embroidered clothing and accessories, or stapled through birchbark to decorate boxes or ornaments.

*A young Paiute man, a student at the Carlisle School, was questioned as to his knowledge of porcupine-quill work among his people. His request for materials being complied with, he fashioned an ornament as illustrated... This is made of sections of quills cut in equal lengths and threaded as one would string beads, with a piece of leather between the sections of quills. According to his statement, it is an old form of decoration among his people, was sometimes made several feet in length, and was used as part of a woman's headdress.*





quills to equal lengths, and string them on, separating the quills from each other by string on small glass, metal, wood or shell beads. Such necklaces are quite beautiful when several strands are worn at once.

---

## How to Make a Porcupine Quill Bracelet

**1. Choose the color quills and beads to use for the bracelet below**

**2. For a three-row bracelet, cut 9 quills to about  $\frac{3}{4}$  of an inch.**

*[you can either cut all of the sharp dark tip off the quill, or incorporate part of these dark ends into the pattern of your design.]*



**3. Cut four little  $\frac{1}{2}$  x  $\frac{1}{8}$  inch strips of leather to use for spacers between & at the ends of the three sets of quills and beads.**

**4. Use 2 yards of string threaded onto a needle, doubled over and knotted at the end.**

**5. Pass the needle and thread through the first leather spacer, through 3 beads, through a quill, through 3 more beads, through another spacer. Continue threading beads and quills until you have stitched through the last spacer. You finished the first row.**

**6. Pass the needle back through the same spacer in the opposite direction. Thread the beads, quills and spacers in the same order till you reach the same spacer you started with to complete the second row.**

**7. Thread the third row the same as you did the first and second rows - at the end of the third row, knot the string on the outside of the last spacer.**

**8. To fasten the bracelet to your wrist, use two separate cords, and attach each cord to either end of the bracelet, around the leather spacers, using clove-hitch knots as shown.**

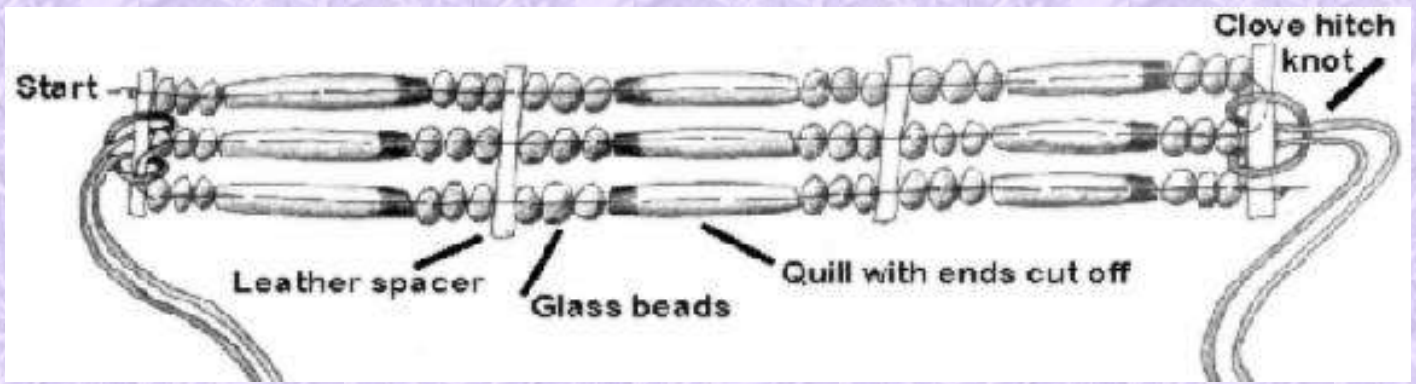


DIAGRAM FOR MAKING A QUILL BRACELET

## How to Make Porcupine Quill Earrings

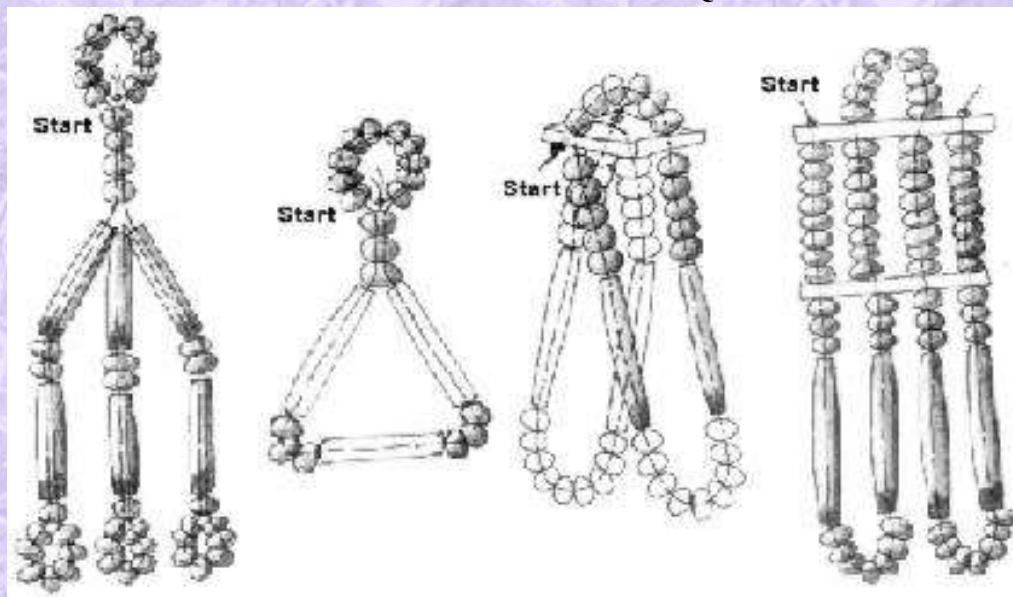


There are an infinite number of styles of earrings that combine porcupine quills and glass beads. Some are simple to make, while others combine hand-held woven beadwork that are more complicated and time-consuming to make.



Four simple kinds of threaded quill earrings are shown below: the first two styles use only a needle and thread with the quills and beads. While the second two styles use leather spacers for the quills and beads to dangle from. Loops are made at the tops of the earring styles to later suspend it from a earring wire.

DIAGRAM FOR MAKING FOUR STYLES OF QUILL EARRINGS





The Noc Bay Trading Company provides a wide range of reasonably priced instructional materials and kits, including porky quill earrings, as part of their Learning Circle Program. Write for their \$3 catalog: Noc Bay Trading Company, P.O. Box 295, 1133 Washington Ave., Escanaba, MI 49829 (1-800-652-7192).

---

[Porcupine Quillwork Bibliography and Books to Buy On-Line](#)

[Return to NativeTech's Main Porcupine Quillwork Menu](#)

---



Text and Graphics  
© 1994 - 103 [Tara Prindle](#)  
unless otherwise cited.





## QUILLWORK BIBLIOGRAPHY

Click on the links below for the books you can order on-line in affiliation with [barnesandnoble.com](http://barnesandnoble.com)

---

### *References cited in NativeTech's [Quillwork articles](#):*

**Bebbington, Julia M.**

**1983 Quillwork of the Plains.**

Glenbow Museum, Ottawa, National Museums of Canada.

... Some good info not found elsewhere and great pictures of good old pieces.

[Order a used copy of this Out of Print book](#)

**Bock, Philip K.**

**1978 "Micmac". In Handbook of the North American Indians, Vol. 15.**

Edited by Bruce G. Trigger. Smithsonian Institution: Washington, D.C.

[Order this book through barnesandnoble.com](#)

**Brasser, Ted J.**

**1976 Bo Jou, Neejee!**

National Museum of Man, National Museums of Canada, Ottawa.

[Order this book through barnesandnoble.com](#)

**Gilman, Carolyn**

**1982 Where Two Worlds Meet: The Great Lakes Fur Trade.**

Minnesota Historical Society, St Paul.

... Not much in the book about quillwork, but the front and back covers are fabulous. An early Metis coat displaying more than 6 different kinds of quillwork is pictured there in detail.

[Order this book through barnesandnoble.com](#)

**Heinbuch, Jean**

**1990 A Quillwork Companion.**

Eagle's View Publishing, Liberty, Utah ... An excellent reference for hands on learning, with a section of braintanning and natural dyes.

[Order this book through barnesandnoble.com](#)

**Hensler, Christy Ann**

**1989 Guide to Indian Quillworking.**

Hancock House, Blaine, Washington.

... Good how-to reference. Lots of hand drawn diagrams and not many photographs of work in progress. Very basic.

[Order this book through barnesandnoble.com](#)

**Hothem, Lar**

**1990 North American Indian Ornamental & Ceremonial Artifacts.**



**Books Americana: Florence, Alaska.**

**King, J.H.C.**

**1993 "Woodlands Art as depicted by Sarah Stone in the Collection of Sir Ashton Lever". In American Indian Art Magazine.**

**Vol.18 No.2/Spring, American Indian Art, Inc.: Scottsdale, Arizona.**

**Peers, Laura and Katherine Pettipas**

**1996 "Reverend John West's Collection: Red River, 1820-1823" In American Indian Art Magazine.**

**Vol.21 No.3/Summer, American Indian Art, Inc.: Scottsdale, Arizona.**

**Lyford, Carrie A.**

**1979 Quill and Beadwork of the Western Sioux.**

**Johnson Books, Boulder, Colorado (reprint of 1940 edition from the US Department of Interior).**

[Order this book through barnesandnoble.com](http://www.barnesandnoble.com)

**Miles, Charles**

**1963 Indian and Eskimo Artifacts of North America.**

**Bonanza Books: New York.**

[This book is Out of Print. But used copies are available here.](#)

**Orchard, William, C.**

**1984 The Technique of Porcupine Quill Decoration Among the Indians of North America.**

**Eagles View Publishing, Ogden, Utah**

... The definitive work on quillwork, originally published in 1919, describing just about every style imaginable. The book tells how it was done NOT how to do it, but is very thorough.

[Order this book through barnesandnoble.com](http://www.barnesandnoble.com)

**Reynolds, Barrie**

**1978 "Beothuk". In Handbook of the North American Indians, Vol. 15.**

**Edited by Bruce G. Trigger. Smithsonian Institution: Washington, D.C.**

[Order this book through barnesandnoble.com](http://www.barnesandnoble.com)

**Ripley, Damon**

**date unknown "What to do with a Dead Porcupine"**

**For "Small Business & Crafts" in Yankee Magazine.**

**Schneider, Richard C.**

**1972 Crafts of the North American Indians; A Craftsman's Manual.**

**Richard Schneider, Publisher: Stevens Point, Wisconsin.**

[Order this book through barnesandnoble.com](http://www.barnesandnoble.com)

**Smith, Cathy**

**1985 "Quillworking" in The Book of Buckskinning III.**

**W.H. Scurlock, ed., Rebel Publishing, Texarkana, Texas.**

[Order this book through barnesandnoble.com](http://www.barnesandnoble.com)

**Zender, Jan and Rochelle Dale**

1995 "Great Lakes and Eastern Woodlands Knife Sheaths" in *The Book of Buckskinning VII*.  
W.H.Scurlock, ed., Scurlock Publishing Co., Inc., Texarkana, Texas (p. 106-133).

... Good pictures of Eastern Style work, some original and some reproductions. Some good pictures of some rare and beautiful workmanship

[Order this book through barnesandnoble.com](http://barnesandnoble.com)

Thank you [Nancy](#) for your great list of quillwork references!

---

*Other Books relating to Quillwork you can buy on-line through* [\*barnesandnoble.com\*](http://barnesandnoble.com):

Cohlene, Terri and Charles Reasoner (Illustrator)

[Quillworker: A Cheyenne Legend](#)

Whitehead, Ruth Holmes

[Micmac Quillwork: Micmac Indian Techniques of Porcupine Quill Decoration](#)

Halvorson, Mark J. and Todd Strand (Photographer)

[Sacred Beauty: Quillwork of Plains Women](#)

Additional book list being compiled.  
In the meantime,

[Click here to Search for Books about Quillwork](#)

[Search for Books at](#)  
[barnesandnoble.com](http://barnesandnoble.com)

Search by:

---

[Return to NativeTech's Main Porcupine Quillwork Menu](#)

---



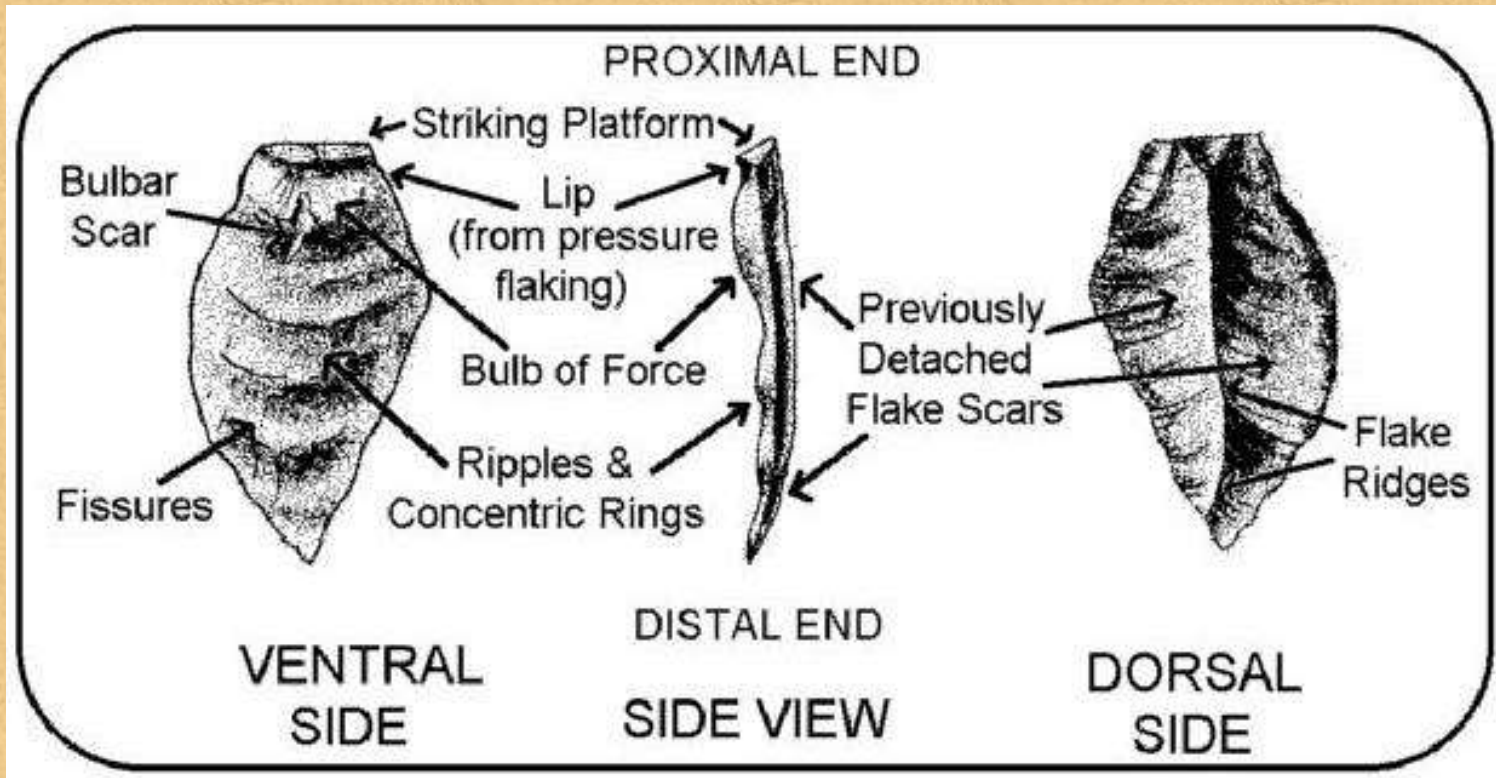
Text and Graphics  
© 1994 - 103 [Tara Prindle](#)  
unless otherwise cited.



## Flaked Stone Tool Technology

[Click here to see the Life Cycle of Flaked Stone](#)

### Flake Terminology for Stone Tool Manufacture



### Common Lithic Tool Materials used in Northeastern North America



| LITHIC TYPE | COLOR                                             | FRACTURE                        | APPEARANCE                                                                       | FORMATION PROCESS                                                                      |
|-------------|---------------------------------------------------|---------------------------------|----------------------------------------------------------------------------------|----------------------------------------------------------------------------------------|
| Quartz      | clear, white<br>rose, purple<br>smokey            | conchoidal,<br>like glass       | translucent & often<br>crystals overgrow<br>eachother                            | VOLCANIC OR<br>METAMORPHIC<br>CRYSTAL GROWTH                                           |
| Flint       | black, opaque<br>brown & green                    | even, smooth<br>like silk       | dull luster like<br>porcelain and<br>dense, harder<br>than basalt<br>and felsite | CEMENTED<br>MARINE ANIMALS<br>OR SILICA GELL<br>DEPOSITED<br>IN OCEAN<br>(SEDIMENTARY) |
| Chert       | white, green,<br>grey, lt. brown,<br>red & yellow |                                 |                                                                                  |                                                                                        |
| Quartzite   | buff, white,<br>green, grey,<br>red               | uneven, rough<br>like sandpaper | visible and<br>often distorted<br>grains                                         | METAMORPHOSED<br>SANDSTONE                                                             |

[Return to the Stone & Tools Menu](#)



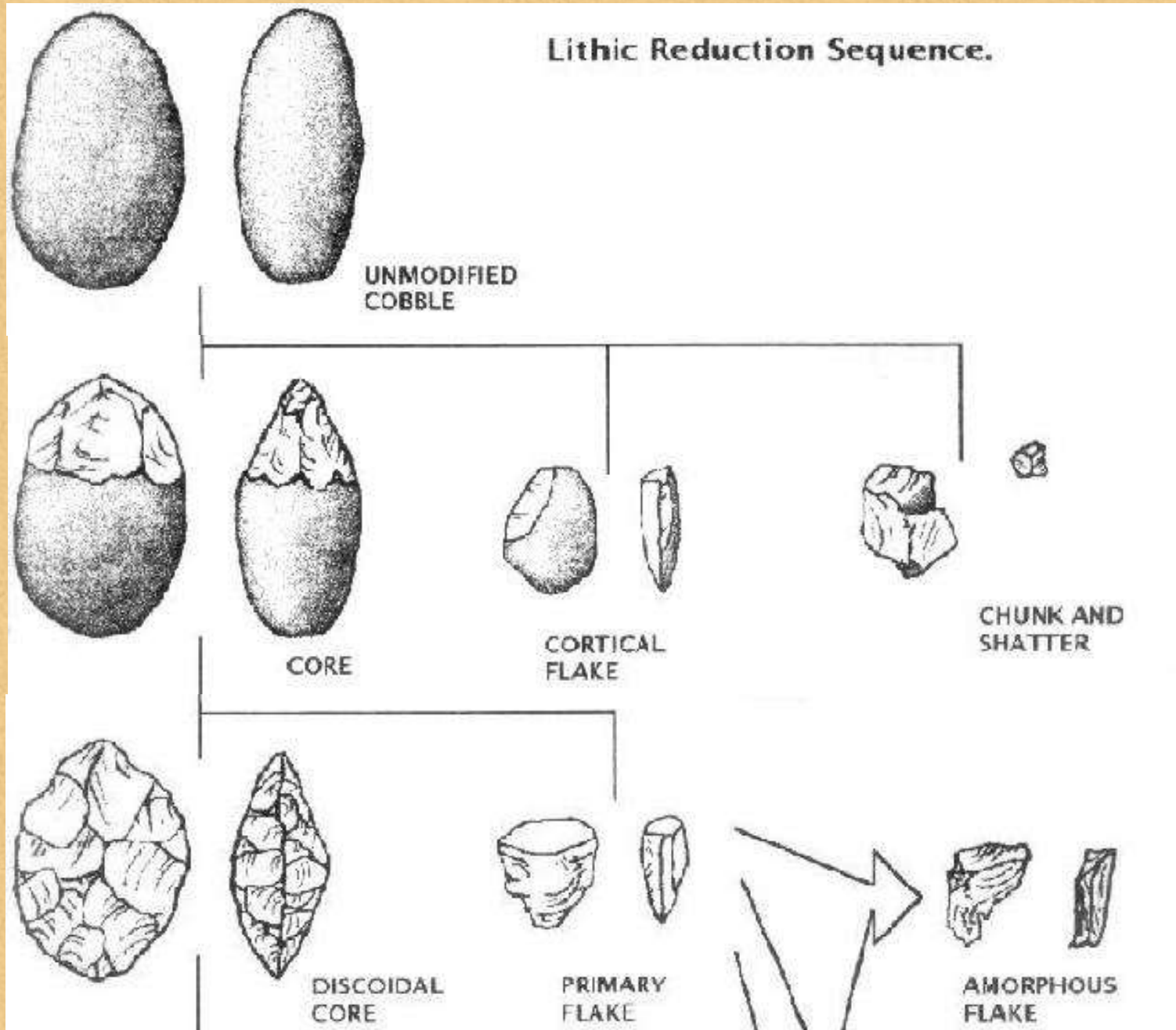
[Go to NativeTech's Home Page](#)

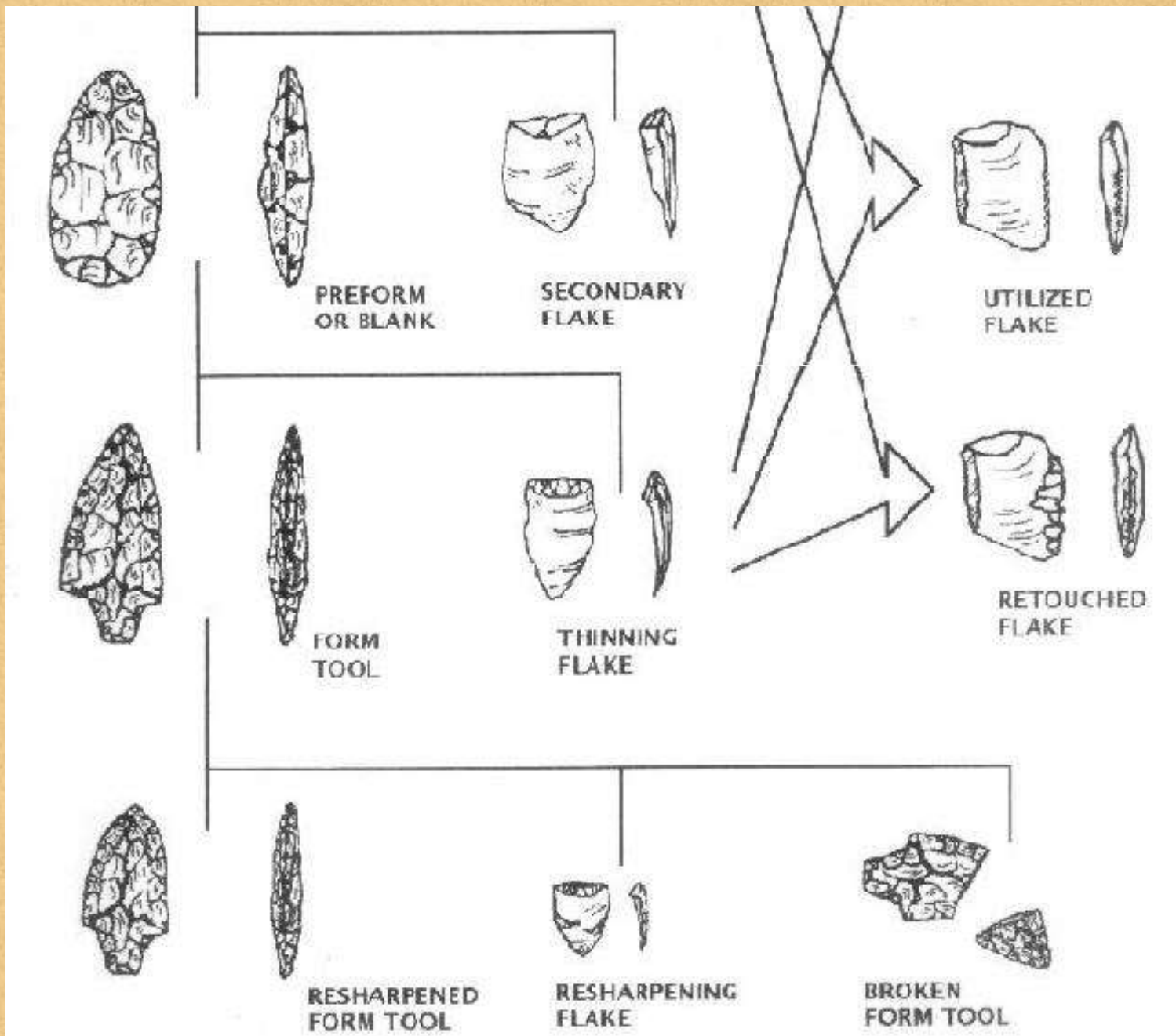
© 1996 - 2003 [Tara Prindle](#).

# Artifacts resulting from Flaked Stone Tool Manufacture

## The Life Cycle of Flaked Stone

### Stages in Flaked Stone Tool Reduction





[Return to the Flaked Stone Tool Technology](#)

[Return to the Stone & Tools Menu](#)



[Go to NativeTech's Home Page](#)

© 1996 - 2003 [Tara Prindle](#).











































Native American Technology and Art

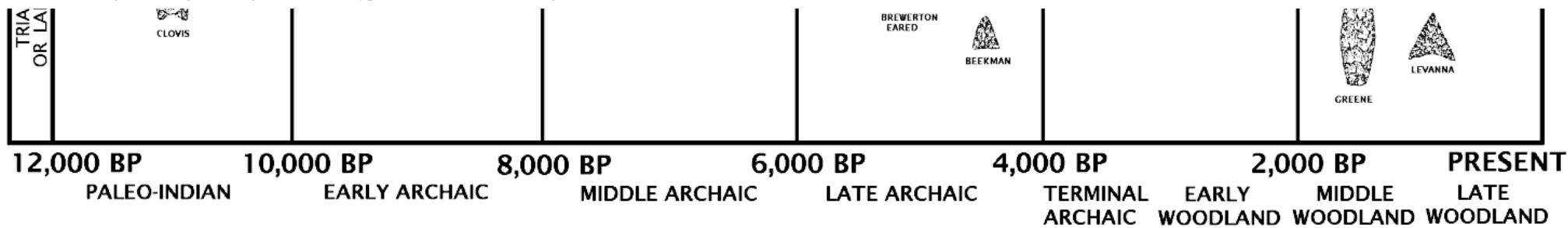
Major Aboriginal Projectile Point Types in Southern New England

Chart of Point Types by Time Period

... warning.. this graphic is large, but there wasn't any other way to do it...

| MAJOR ABORIGINAL PROJECTILE POINT TYPES<br>IN SOUTHERN NEW ENGLAND |                                                                                                                                                                                                              |                                                                                                                                                                                                                                                                                          |  | © 1993 Tara L. Prindle                                                                                                                                                                                                                                                                                                                                                                                                                                                                                                                                                                                                                                                                                                                                                                                                                                                                                                                                                                                                                                                                                                                                                                                                      |  |  |
|--------------------------------------------------------------------|--------------------------------------------------------------------------------------------------------------------------------------------------------------------------------------------------------------|------------------------------------------------------------------------------------------------------------------------------------------------------------------------------------------------------------------------------------------------------------------------------------------|--|-----------------------------------------------------------------------------------------------------------------------------------------------------------------------------------------------------------------------------------------------------------------------------------------------------------------------------------------------------------------------------------------------------------------------------------------------------------------------------------------------------------------------------------------------------------------------------------------------------------------------------------------------------------------------------------------------------------------------------------------------------------------------------------------------------------------------------------------------------------------------------------------------------------------------------------------------------------------------------------------------------------------------------------------------------------------------------------------------------------------------------------------------------------------------------------------------------------------------------|--|--|
| CORNER NOTCHED                                                     |                                                                                                                                                                                                              |                                                                                                                                                                                                                                                                                          |  |  VOSBURG<br> VESTAL<br> SUSQUEHANNA<br> BREWERTON<br> SNYDERS<br> JACK'S REEF                                                                                                                                                                                                                                                                                                                                                                                                                                                                                                                                                                                                                             |  |  |
| SIDE NOTCHED                                                       |                                                                                                                                                                                                              |                                                                                                                                                                                                                                                                                          |  |  OTTER CREEK<br> BREWERTON<br> BREWERTON EARED<br> NORMANSKILL<br> DUSTIN<br> LAMOKA<br> SYLVAN<br> VESTAL<br> MEADOWOOD<br> FULTON<br> LONG BAY<br> PORT MAITLAND                      |  |  |
| STEMMED                                                            |  KANAWHA BIFURCATE<br> LECROY BIFURCATE |  NEVILLE<br> STARK<br> MERRIMAC |  |  GENESEE<br> WADING RIVER<br> SQUIBNOCKET<br> SMOOK KILL<br> WAYLAND<br> LAGOON<br> ADENA<br> ORIENT<br> POPLAR ISLAND<br> PERKIOMEN<br> BARE ISLAND<br> ROSSVILLE |  |  |
| TRIANGULAR LANCEOLATE                                              |  CLOVIS                                                                                                                   |                                                                                                                                                                                                                                                                                          |  |  BREWERTON EARED<br> SQUIBNOCKET<br> STEUBENVILLE<br> JACK'S REEF<br> ADISON                                                                                                                                                                                                                                                                                                                                                                                                                                                                                                                                                                                                                                                                                                       |  |  |





[Return to Stone Tools Menu](#)

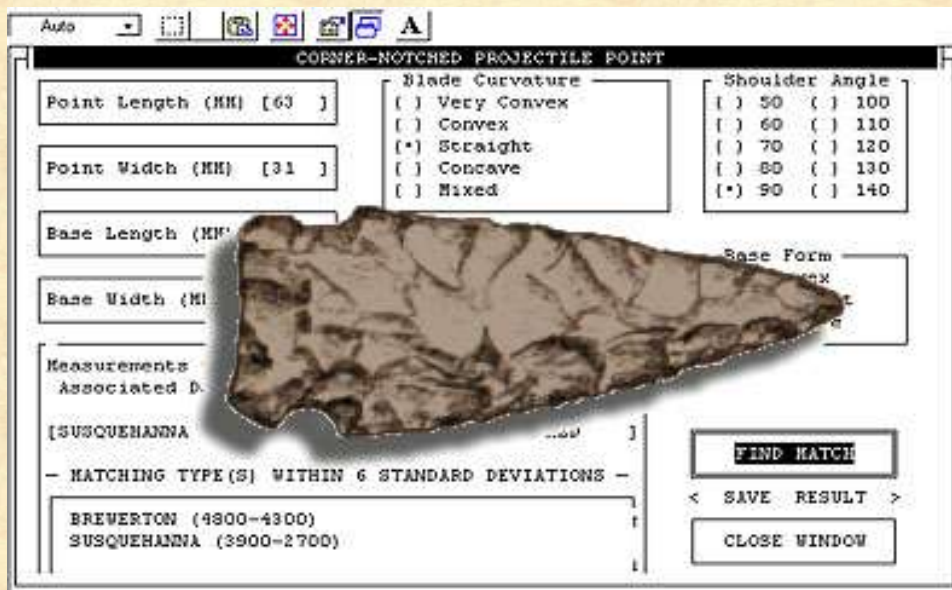


© 1993 - 2003 [Tara Prindle](#).

## POINT: Projectile Point Classification Program

POINT is a type/matching program written by Tara Prindle for the IBMPC (MSDOS). Morphological attributes of projectile points are input by the user and the program finds matching type names and provides estimated date ranges.

POINT uses Ritchie's (1970) and Dincauze's (1976) projectile point type descriptions. This program includes most of the known projectile point types used by archaeologists in New England. Archaeologists working outside the region may not find the program useful but the classification approach used by the program should be of interest to anyone doing lithic analysis.



To download the POINT program, [click here](#).

The downloaded file, point.zip, contains three files to unzip: point.exe (DOS program file), point.txt (program documentation), and readme.txt

Documentation for POINT is available on-line.

- [Catalogue of Southern New England point types used by POINT](#)
- [Description of variables used by the program](#)
- [Notes on the POINT program](#)

*The author has no plans to create similar programs for other geographical regions.*



Text and Graphics  
© 1994 - 2003 [Tara Prindle](#)  
unless otherwise cited.





Late 1500s drawing  
of a Virginia Native  
carrying fish  
by John White: (Church 1975)

# Early Historic Accounts of Basket and Bag Weaving in the Northeast

European documents dating to the 17th century refer frequently to woven baskets and bags of Native Americans. All groups of Native Americans in the northeast had some construct of basketry, birch bark containers being perhaps the most common expression (Ritzenthaler & Ritzenthaler 1970: 79-80). Early historic European accounts often do not distinguish between rigid baskets and the flexible bags of the Native Americans. All types of woven containers, in fact, may have been generically referred to, by European observers, as "baskets" despite differences in the materials or construction techniques employed. It is wise to keep in mind while reviewing early historic accounts, that even though, today, we generally tend to think of "baskets" as rigid splint-woven containers, 400 years ago the term "basket" more aptly referred to any open container, including flexible bags and folded birch bark vessels.

## Woven Baskets

Early historic European accounts generally describe baskets in the context of a wigwam, or buried baskets storing foodstuffs for later use by Native Americans. In 1643 Roger Williams (1973: 121) remarks of a Narragansett Wigwam that "In steed of shelves, they have severall baskets, wherein they put all their householdstuffe." In the northeast, storage baskets were constructed from a variety of materials including hemp, rushes or bents, maize husks, silk (or sweet) grass, tree bark, and conceivably even horse-shoe crab shells (Gookin 1970: 16; citing Mourt in Heath 1986: 29; de Rasieres 1967: 107, 108).

Gookin remarks in 1674: From the tree where the bark grows, they make several sorts of baskets, great and small. Some will hold four bushels, or more; and so downward to a pint. In their baskets they put their provisions. Some of their baskets are made of rushes; some, of bents; others, of maize husks; others, a kind of silk grass; others, of a kind of wild hemp; and



some, of barks of trees; many of them, very neat and artificial, with the portraitures of birds, beats, fishes and flowers, upon them in colors. [Gookin 1970: 16]

Early historic accounts in New England indicate variable sizes and shapes for woven storage baskets (citing Mourt in Heath 1986: 22, 29; Wood 1865: 107-108). Some quite small as Wood (1865: 107-108) indicates in 1634, "these baskets be of all sizes from a quart to a quarter, in which they carry their luggage", and other baskets larger as Mourt (in Heath 1986: 22) describes in 1622, "with some thirty-six goodly ears of corn, some yellow, and some red, and others mixed with blue, which was a very goodly sight."



Twined cornhusk bottle  
Turnbaugh & Turnbaugh 1986

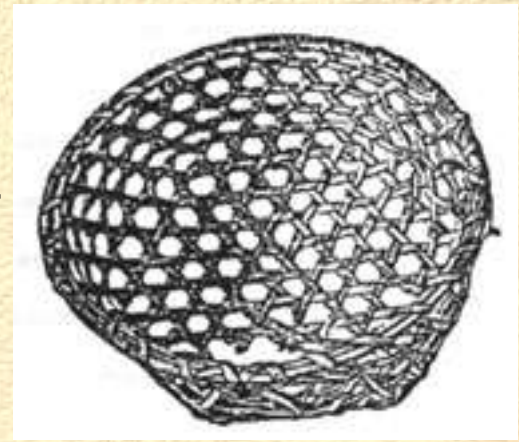
In 1674, Gookin (1970: 16) describes a large storage basket which had a capacity of at least four bushels. Mourt (in Heath 1986: 22) also describes a very large storage basket containing ears of corn: "The basket was round, and narrow at the top; it held about three or four bushels, which was as much as two of us could lift up from the ground, and was handsomely and cunningly made." This large basket may be similar in shape to a smaller bell-shaped Seneca salt or tobacco bottle of plain twined corn husks depicted by Turnbaugh and Turnbaugh (1986: 128-129)

European colonists like Mourt in 1622 were very intrigued with the colors and designs applied or woven into baskets (in Heath 1986: 22, 29). Basket materials were generally dyed before they were woven together, and in weaving the strands together, a design was produced. In other cases the colored designs are embroidered onto the surface of a basket after it was constructed. Mourt (in Heath 1986: 29), in 1622, mentions colors of black and white. Red wool is used in a Narragansett twined basket (Simmons: 1978: 192). Josselyn's (in Lindholdt 1988: 101-102) narrative from the 1600's refers to several colors (black, blue, red and yellow) used to dye and decorate baskets, bags and mats as well as to dye porcupine quills used in bag weaving. Gookin (1970: 16) describes designs of birds, beasts, fishes and flowers in colors placed upon baskets in his collections from 1674. The baskets mentioned in these accounts seem to refer to more realistic animal and floral designs (Gookin 1970: 16; Wood 1865: 107), unlike the surviving Mohegan and Narragansett twined bags from the 17th century (Simmons: 1978: 192).

Baskets were often used to store food which was harvested by the Native Americans and then put up for later use. In 1622, Mourt (in Heath 1986: 22, 29, 34, 65) makes numerous references to the contents of these storage baskets, including but surely not limited to: corn, roasted crab, fishes, pieces of fish (including broiled herring and other dried shell fish) and parched acorns.



**Gookin (1970: 15) refers to another kind of basket woven during the 17th century, a sieve or sifting basket for corn meal. Speck (1915: 55) illustrates what may be a similar hexagonal-weave basket. De Vries (1967: 218), between 1633 and 1655, likened these sifting baskets to European fig-baskets: "When they travel, they take a flat stone, and pound it with another stone placed upon the first, and when it is pounded, they have little baskets, which they call notassen, and which are made of a kind of hemp, the same as fig-baskets- which they make so neatly that they serve them as sieves- and thus make their meal."**



**Sifting Basket Speck 1915**

**Another container worthy of mention was apparently a small basket for parched corn meal to be used as an instant food reserve while traveling (Gookin 1970: 15). Roger Williams (1973: 100) writes in 1643: "I have travelled with neere 200. of them at once, neere 100. miles through the woods, every man carrying a little Basket of this [Nokehick] at his back, and sometimes in a hollow Leather Girdle about his middle, sufficient for a man three or foure daies." Earlier in 1634, William Wood (1865: 76) notes that meals of parched corn while traveling consisted of "thrice three spoonfuls a day, dividing it into three meales." This figure of nine spoonfuls a day for three or four days, suggests this basket must have held one or two cups of corn meal.**



**Potawatomi coiled sweetgrass basket  
Turnbaugh & Turnbaugh 1986**

**Coil baskets also appear to be a traditional basket form of tribes of northern New England. It is likely that coil baskets were made by the Native Americans of southern New England in the 17th century as well. Ritzenthaler & Ritzenthaler (1970: 79-80) describe the manufacture of coil baskets of sweet grass, *Torresia odorata* Hitchc, being sewn with a fiber thread. The only implement required would be a bone awl to open a hole for passage of the thread, which was passed around the free coil and beneath the fastened coil below. A central north Algonquin coiled sweet grass basket of the Patowatomi is illustrated in Turnbaugh and Turnbaugh (1986: 132-133).**

**Wicker-type baskets are also mentioned by Ritzenthaler & Ritzenthaler (1970: 79-80) in their report of the Great Lakes Region. In this area wicker baskets were constructed (though to a limited degree) of willow stems, cedar roots, or basswood bark. A form of wicker baskets may also have been woven by more southerly tribes, indicated in a 1500's drawing by John White (Church 1975: 93), showing North Carolina Native Americans cooking fish. One of the Native Americans portrayed in this drawing carries a twined basket on his back that may be similar to the wicker baskets referred to by Ritzenthaler & Ritzenthaler (1970: 79-80).**



## Woven Bags

Native Americans in 17th century New England wove bags for carrying and storing items. Josselyn (in Lindholdt 1988: 93) remarks in 1674 that Natives used these bags or sacks to store corn powder, "which they make use of when stormie weather or the like will not suffer them to look out for their food." Roger Williams (1973: 121) suggests in 1643 that these bags were impressively large: "they have some great bags or sacks made of Hempe, which will hold five or six bushells". Woven hemp bags (likely made of dogbane, *Apocynum cannabinum*, also called *Indian Hemp*) are also mentioned by de Vries (1967: 219) between 1633 and 1655, "and the savages use a kind of hemp, which they understand making up, much stronger than ours is, and for every purpose, such as notassen, (which are their sacks, and in which they carry everything);". De Vries (1967: 219) also notes that Native Americans made a "linen" out of hemp.



Penobscot man with  
basswood hunting bag  
Speck 1976

Twined bags also made of prepared basswood and other bast-fiber string including nettle fiber. Woven bags of the Chippewa, Menomini, Potawatomi, and Winnebago are illustrated in Ritzenthaler & Ritzenthaler work (1970: Pl. 31), and in Coe's work (1986: 68-69, 95) which illustrates a contemporary bast hemp bag made by Narragansett Ella Seketau. Bags using the checker-weave technique were also woven of basswood and cedar strips (Ritzenthaler & Ritzenthaler 1970: 76). In an illustration of Penobscot hunting in 1911, a father wears a checker-woven basswood hunting bag with a burden strap (Speck 1976: 84).

More often than not, the weaving of storage and carrying bags employed the twining technique. A bag was started with a warp suspended over a string between two thick, springy sticks set vertically in the ground (Ritzenthaler & Ritzenthaler 1970: 76, Pl. 31). The weft was of a pair of cords which twined around each warp, and twining proceeded downward, until the bag was finished (Ritzenthaler & Ritzenthaler 1970: 76). In the Penobscots' fine weaving, strips of basswood are drawn between the thumb and a round smooth bone or stone about six inches long to soften the strips (Speck 1976: 135).



Yarn bag weaving  
Chippewa

Ritzenthaler & Ritzenthaler 1970

In addition to tightly woven storage and carrying bags, European accounts from northern New England indicate that open-weave rectangular bags, hulling bags, and bags made of corn husk were also woven (Anonymous 1967: 301; Ritzenthaler & Ritzenthaler 1970: 76). Slightly different techniques were used to weave these bags. In making these rectangular basswood bags, a "pair of twisted basswood cords were twined around one or two warp strands in rows about a half inch apart" (Ritzenthaler & Ritzenthaler 1970: 76). In 1650, a European account of New



**Netherland describes that when purchasing corn from the Native Americans with wampum, the corn was often measured in sacks most likely made from husks (Anonymous 1967: 301).**



**Wamapanoag bag  
Open twined zigzag warp  
Turnbaugh & Turnbaugh 1986**

**Bags used for hulling corn were evidently woven of cedar bark in a open, twine weave. Turnbaugh and Turnbaugh (1986: 118) illustrate a later open-twined, diverted warp (or zig-zag) beach grass bag made by a Gay Head Wampanoag of Massachusetts. The Gay Head bag may have been similar to the older hulling bags. These hulling bags were used by New England Native Americans to hold corn while it was being soaked for cleansing (Ritzenthaler & Ritzenthaler 1970: 76).**

**Of their descriptions of the arts of Native Americans of the Lakes Region, Ritzenthaler and Ritzenthaler (1970: 76) describe some**

**common decorative motifs incorporated into their designs: "On the earlier bags, rows of zoomorphic designs were not unusual. Thunderbirds, spirits in panther form, as well as humans, were interspersed with bands of geometrical motifs." Ritzenthaler & Ritzenthaler (1970: 76) also point out: "On more recent bags, the designs show a concentration of bands of floral and geometrical patterns."**



**Woven bags of  
Menomoni, Chippewa & Potawatomi  
Ritzenthaler & Ritzenthaler 1970**

**Two examples of 17th century hemp and basswood bags have survived the years intact. The bags are small storage bags which were probably used to hold corn powder (Nohicake) or other household supplies. Both bags are made using a two-strand twined weft method, but the materials and decorative techniques used are different.**



**The Mohegan twined bag dates from the mid-17th century, and uses 'Indian hemp' (Salwen 1978: 163). This bag was woven with an open bottom that was then sewed shut. The design on the Mohegan bag consists of two thin horizontal bands of solid color placed within three thicker bands of solid color achieved by weaving wefts of different colors. This design of colored bands is further broken down by overlaid geometric diamond and triangular shapes around the circumference of the bag, applied with a false embroidery of natural and purplish-black dyed porcupine quills (Salwen 1978: 163). In the 17th century Josselyn (in Lindholdt 1988: 101-102) also mentions these "bags of porcupine quills woven and dyed".**

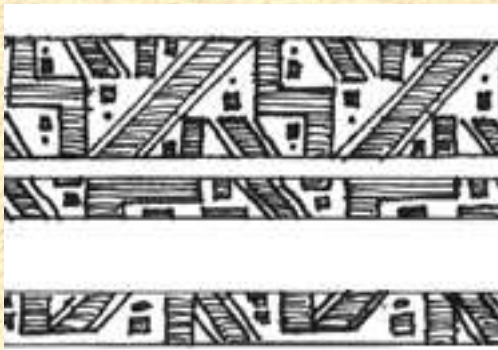


**Mohegan Twined Bag  
McMullen & Handsman 1987**

The materials of this bag consist of corn husk and red wool around a basswood bark warp. The red wool, now largely disintegrated, may have filled most of the open work (Simmons 1978: 192). In contrast to the open bottom construction employed with the Mohegan bag, the Narragansett bag appears to have been woven by starting with a series of radiating warps, resembling a star, where twining begins at the center and works its way up the basket until the desired height is reached.



**Narragansett Twined Bag  
Simmons 1978**



**Reconstructed design of  
Narragansett bag  
by Prindle 2000**

Because the Narragansett basket employs these different weaving techniques, there are some dissimilarities with the Mohegan bag. Most notably the form and the rim on the Narragansett bag differ from that of the Mohegan bag. However, and the Narragansett bag is similarly divided into a series of concentric bands, which are filled with geometric shapes consisting of triangles, squares, and zig-zags. Despite the differences in construction and materials of the bag, the design elements are strikingly similar to that of the Mohegan bag.

Sections of 17th century bags have also been found by William Simmons (1970: 97), an archaeologist in southern New England. At the West Ferry cemetery, two adult Narragansett women were found buried with bast textile fragments identified as "plain twine weave". One fragment consisted of warp that was loose and braided while the weft of the textile was a two-strand sloping cord. This fragment may be the remains of an open weave bag (Simmons 1970: 97).

## **Splint Work and Basket Stamping:**

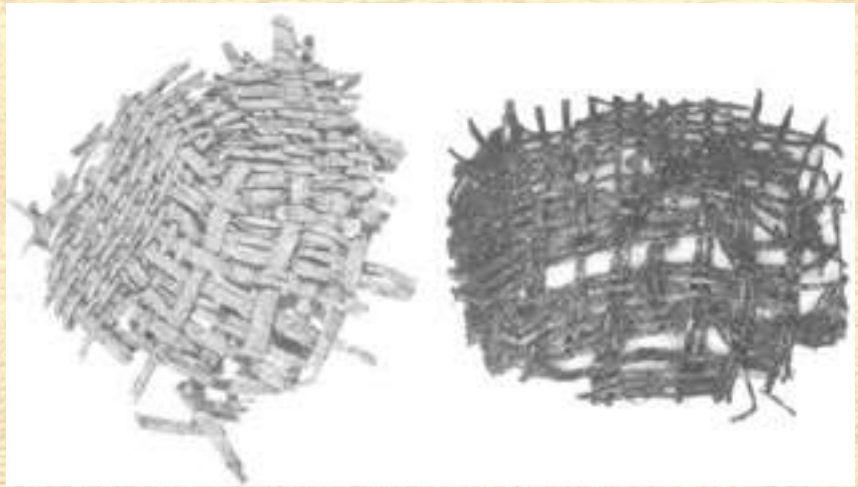
Historians argue whether or not prepared ash splint basketry was practiced by the Pequot, Mohegan, Niantic and other tribes of southern New England in 1600. Many maintain that this splint basketry was introduced later in the historic period by Swedes on the Delaware River (citing Brassler in Snow 1980: 58). The materials used in Native splint basketry include brown (or black) ash and white oak (Speck 1915: 2). Sweet grass (often braided first), and in much later historic times twisted Hong Kong grass, were sometimes woven over ash splints warps. Two types of splint baskets were historically woven by Native Americans in southern New England, checker-work and a round "gizzard" or mellon-shaped basket generally made of oak (Speck 1915: 3).



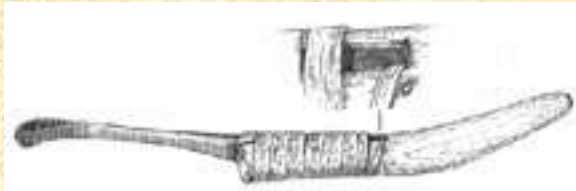
**Handsman and McMullen (1978: 22) illustrate two splint basket fragments from two later 17th century Seneca sites (1640-1660) in western New York which provide some of the earliest known evidence of splint production in northeastern North America.**

**Handsman and McMullen (1978: 22) note the fragments were once part of small bowl-shaped baskets (one twill-woven) which may have once sifted ground corn. Turnbaugh and Turnbaugh (1986: 114) agree with Speck, Brassler and McMullen that**

**Native Americans probably acquired the practice of producing checker-weave wood splint baskets from European immigrants. "The technology quickly became popular and began to supplant the stitching of birchbark and other presumably earlier aboriginal technologies probably only as recently as the 18th and 19th centuries" (Turnbaugh and Turnbaugh 1986: 114).**



**Seneca Basket Fragments  
dating to the late 1600s  
Handsman & McMullen 1978**



**Passamaquoddy crooked knife  
Erickson 1978**

**Historians against the Native American origins of splint basketry argue that most of the tools used in splint basket production appear to be of European origin and have no early historic analog. Spoke-shaves, hand gauges, hand planers and the crooked knife all employ metal blades. The crooked type knife was used by Mohegans for woodworking in general Speck (1915:**

**3). Speck (1976: 37) illustrates several crooked knives. By 1610 the crooked knife employed a metal blade (sometimes curved) similar to a farrier's knife (Snow 1980: 58-59), suggesting European origin. Simmons (1970: 109) illustrates iron crooked knife blades found with Narragansetts buried at the 17th century West Ferry cemetery. However, Speck (1976: 106) also describes an aboriginal prototype of the crooked knife with a blade of beaver incisors set in the handle. Beaver incisors which may have been hafted into a bone, antler, or wooden handle have been found at archaeological sites of late prehistoric villages and an example of which is illustrated and discussed by Snow (1980: 338).**

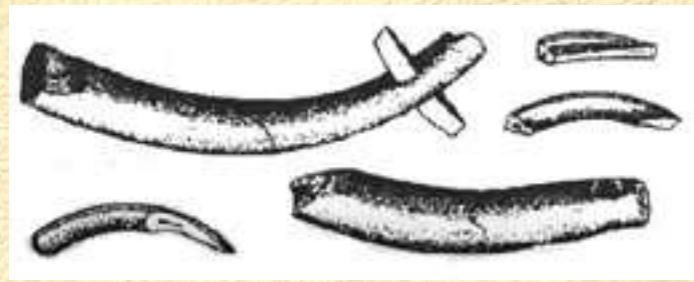
**Skinner suggests it is very likely that the plaited, black-ash splint baskets were a relatively recent development (in Ritzenthaler & Ritzenthaler 1970: 79-80). Notwithstanding potential development from contact with Europeans in the early 17th century, Native splint basketry preserves several more traditional forms of ornamentation and embellishment, including designs for block stamping and the 'curlicue' (porcupine-twist) embellishment used on splint basketry.**





Penobscot  
Splint gauges  
Speck 1976

On Mahican baskets examined by Speck (1947: 12), potato stamp designs utilized among Pequot, Mohegan Schaghticoke, and other Native Americans of southern New England, showed a great deal of correspondence and



Penobscot  
Hafted Beaver Incisors  
Crooked knife Prototypes  
Snow 1980

similarity to basket decoration of the Algonquin of Quebec which were collected between 1750 and 1790. These may be accepted as being the oldest dated examples of this form of potato-stamp decoration on the records (Speck 1947: 12). Speck (1947: 33) suggests that missionary influence and the printed text of the Bible in the 1600's, were in part responsible for the use of block-stamp

decoration on baskets:

"The introduction of typographic ornamentation in the basketry had its beginning among Indian converts of New England in the zone of influence radiating from John Eliot's mission stations active between 1650 and 1658. The experience gained by the Indian converts who printed the Natick Bible (1664) can be considered in retrospect as the source of a stimulus in figure printing, diffusing from the whites to semi-aculturated Indians of eastern Massachusetts" (Speck 1947: 33).

Despite the almost exclusive confinement of block-stamp decoration to splint basketry in the late historic period, Speck (1947: 33) indicates: "The use of block stamps as mediums of designing arose in some center of the Eastern Woodlands culture area of the United States as an independent feature of native decorative art."

Another ornamental feature of splint basketry which seems to preserve earlier forms of aboriginal art is the Schaghticoke use of the 'curlicue' or porcupine twist. "The curlicue consists of a splint run over one of the warp splints and twisted between two alternate standards, thus making a sort of twisted imbrications" (Speck 1915: 6). The Schaghticoke associate the embellishment with the form of a shell and claim the technique to be a native feature and, since it is found in the oldest baskets from the region, there seems little doubt that it is aboriginal in origin (Speck 1915: 6).

for more information on splint basketry, see my article on [Nipmuc Splint Basketry](#)

## BIBLIOGRAPHY



**Anonymous**

**1967 "Representation of New Netherland" [1650]. In Narratives of New Netherland, 1609-1664. F.J. Jameson, ed. Pp. 285-354. New York: Barnes and Noble.**

**Church, Colonel Benjamin**

**1975 Diary of King Philip's War 1675-1676. Introduction by Alan and Mary Simpson. Published for the Little Compton Historical Society; Tiverton, RI: Lockwood Publications.**

**Coe, Ralph T.**

**1986 Lost and Found Traditions, Native American Art 1965-1985. New York: University of Washington Press in Association with the American Federation of Arts.**

**de Rasieres, Isaack**

**1967 Letter to Samuel Blommaert [1628 ?]. In Narratives of New Netherland, 1609-1664. F.J. Jameson, ed. Pp. 97-116. New York: Barnes and Noble.**

**de Vries, David P.**

**1967 "Korte Historiale end Journaels Aenteyckeninge" [1633-1643 (1655)]. In Narratives of New Netherland, 1609-1664. F.J. Jameson, ed. Pp. 181-234. New York: Barnes and Noble.**

**Erikson, Vincent O.**

**1978 Maliseet-Passamaquoddy. In Northeast. B.G. Trigger, ed. Pp. 123-136. Handbook of North American Indians, Vol. 15. W. Sturtevant, gen. ed. Washington, D.C.: Smithsonian Institution.**

**Gookin, Daniel**

**1970 Historical Collections of the Indians in New England. J.H. Fiske, ed. London: Towaid. (First published 1674).**

**Handsman, Russell G. and Ann McMullen**

**1978 "An Introduction to Woodsplint Basketry and Its Interpretation." In A Key Into the Language of Woodsplint Baskets. Ann McMullen and R.G. Handsman, eds. Pp. 16-35. Washington, CT: American Indian Archaeological Institute.**

**Heath, Dwight B., ed.**

**1986 Mourt's Relation: A Journal of the Pilgrims at Plymouth. Cambridge: Applewood books. (First published in 1622).**

**Lindholdt, Paul, ed.**

**1988 John Josselyn, A Critical Edition of Two Voyages to New England. Hannover: University Press of New England. (First printed in 1674).**

**Ritzenthaler, Robert E. and Pat Ritzenthaler**



**1970 The Woodland Indians of the Western Great Lakes. Garden City, NY: Natural History Press.**

**Salwen, Bert**

**1978 Indians of Southern New England and Long Island: Early Period. In Northeast. B.G. Trigger, ed. Pp. 160-169. Handbook of North American Indians, Vol. 15. W. Sturtevant, gen. ed. Washington, D.C.: Smithsonian Institution.**

**Simmons, William S.**

**1970 Cautantowwit's House: An Indian Burial Ground on the Island of Conanicut in Narragansett Bay. Providence, RI: Brown University Press.**

**1978 Narragansett. In Northeast. B.G. Trigger, ed. Pp. 190-197. Handbook of North American Indians, Vol. 15. W. Sturtevant, gen. ed. Washington, D.C.: Smithsonian Institution.**

**Snow, Dean R.**

**1980 The Archaeology of New England. New York: Academic Press.**

**Speck, Frank G.**

**1915 Decorative Art of Indian Tribes of Connecticut. Anthropological series 10. Memoirs of the Canadian Geological Survey 75. Ottawa, Ont: Canadian Department of Mines.**

**1947 Eastern Algonkian Block-Stamp Decoration: A New World Original or an Acculturated Art. Addendum by Eva Butler. Trenton: Archaeological Society of New Jersey.**

**1976 Penobscot Man,: The Life History of a Forest Tribe in Maine. New York: Octagon Books.**

**Turnbaugh, William A. and Sarah P. Turnbaugh**

**1986 Indian Baskets. West Chester PA: Schiffer Publishing Company.**

**Williams, Roger**

**1973 A Key into the Language of America. J.J. Teunissen and E.J. Hinz, ed.s. Detroit: Wayne State University Press. (First printed 1643).**

**Wood, William**

**1865 Wood's New England's Prospect. Boston: Publications of the Prince Society 1. (First published 1634).**

---

[Return to NativeTech's Main Basketry Menu](#)

[Weaving Bibliography and Books to Buy On-Line](#)





© 1994-2000 [Tara Prindle](#).

## NativeTech: Native American Technology and Art

### Finger Weaving

- [Belts, Sashes & Garters](#)
- [Twined Bags of the Great Lakes Region \(Under Construction\)](#)
- [Cordage, Rope & String from Plant and Animal materials](#)
- [Weaving Bibliography and Books to buy On-line](#)

[Other Internet Resources for Weaving](#)



© 1994-2000 [Tara Prindle](#).





Man wearing finger woven sash, turban, and burden strap across his chest [1808], Huron/Canada (adapted from Sturtevant, gen. ed. 1978: p.391 "Handbook of North American Indians", Vol. 15 "Northeast").

Native American Technology and Art

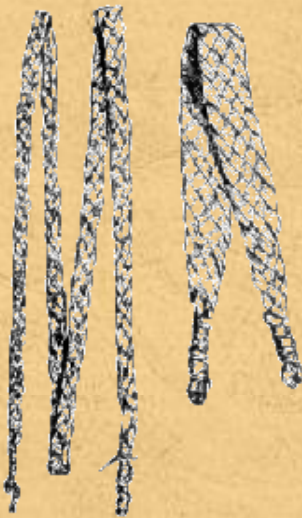
## Native American Finger Weaving in the Eastern Forests

Belts, Sashes & Garters

---

[See the Instructions for Finger Weaving Belts](#)

---



Woven moose hide drag strap for toboggan and basswooda burden strap for carrying bundles [early 1900's], Penobscot/Maine (Canada (adapted from Speck 1976: p.74 "Penobscot Man").

Native Americans have developed unique techniques for weaving, an art with ancient origins. Finger weaving is a technique which evolved in many parts of the world, cultivated into a fine art by Native Americans. Native Americans of the eastern forests are well known for their finger woven yarn belts and sashes. Archaeological remains of pottery in the Northeast show where woven textiles were pressed into the clay some 3000 years ago. The constant wet environment of peat bogs in Florida have produced a piece of finger weaving 6,000 to 8,000 years old. Dry desert cave atmospheres of Arizona have preserved prehistoric finger woven examples of spun dog hair. South American Peruvians do finger weaving using a slightly different technique called Rep braiding. Other varieties of finger weaving are produced in European countries.

In northeastern North America, there is little pre-contact evidence that sophisticated looms were used. For bags and mats the simple suspension loom was used (where warp strands hang suspended with only one end secured). After contact



with Europeans, Native Americans used a bow loom extensively in making wampum belts (where warp strings are stretched and fastened to either end of a bowed stick), but use of the loom was never as prevalent as in the western part of North America. Advancement of weaving beyond hand-held forms probably did not occur, at least with northern New England tribes such as the Penobscot, because birchbark was readily available and used to construct numerous kinds of containers and coverings.

A long tradition of finger weaving is obvious from the intricate examples which have survived from the time of European contact. Finger weaving techniques produced tumplines (burden straps for cradleboards, packs or other loads) and drag straps for sleds or toboggans, belts, sashes, garters or similar items of clothing, and even small bags. A 1672 comment in "New England Rarities" by Josselyn, an early European voyager, notes a burden strap used for a cradleboard: "...then putting the strap of leather upon their forehead with the infant hanging at their back home they trudge." Finger woven items measured from a few inches to more than five yards long.



Woman making a large finger woven belt from wool yarn [mid 1900's], Chippewa/Great Lakes (Canada (adapted from Ritzenthaler and Ritzenthaler 1970: pl.32 "The Woodland Indians of the Western Great Lakes").

Traditionally pre-contact materials for finger weaving included the inner bark of basswood, cedar and slippery elm trees, dogbane (Indian hemp) and milkweed fibers, nettle, wormseed and other plant fibers, as well as strips of moose hide. All woven the same way in different degrees of fineness depending on the intended function and the materials used. De Vries, a European explorer of New Netherland (New York), commented on the superior materials that Native Americans used in the early 1600's: "...and the savages use a kind of hemp, which they understand making up, much stronger than ours is, and for every purpose..."

In finger weaving, a number of lengths are tied to a secure post or tree. Keeping a steady tension, the dangling ends are tightly woven in an under-over pattern moving away from the fastened end. New lengths of basswood are spliced in as original lengths run out.

Penobscot prepare the inner bark of basswood by first cutting through the tree bark with an ax. The tree bark is loosened and pulled up in long strips. Using a knife the inner bark is loosened so it can be pulled off using the fingers in long strips. The long strips are rolled up into coils and carried home. The strips are then boiled with hardwood ashes, the layers are





Woven hemp burden strap (tumpline) with dyed moose hair embroidery [1775-1800], Mohawk/Canada (Canada (adapted from Dockstader 1993: p.171 "Weaving Arts of the North American Indian").

designs, animal beings like the Thunderbird, were embroidered on some belts.

Indigenous art industries of America were severely disrupted by European contact and trade. With European contact the Native Americans accepted and transformed many European techniques and materials into their existing traditions. Glass seed or pony beads (generally in white) were now woven into or sewn onto these belts. Often Native Americans unraveled yarn from new trade wool blankets, re-spun new string, and wove this into belts or garters that had diagonal, chevron, lightening and other designs.

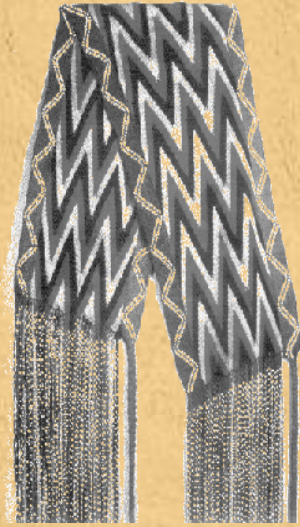
French Canadian traders learned finger weaving from the Native Americans and began making what was later termed "Assumption" sashes from their originating town in Quebec. They became so popular their colors and designs became standardized and they were marketed through the Hudson's Bay and Northwest Trade Companies. These wide tightly-woven sashes were worn as belts, as straps for bags and powder horns, and even wrapped

further separated with the help of a knife, and at last the fibers are softened by running the strips over a smooth hand stone. The lengths of basswood or other fibers were often dyed with plants or minerals one of several colors, commonly black, red-brown, yellow, or blue. Some Penobscot basswood finger weaving uses eight strips (less than one half inch wide) to make a well braided band only two and one half inches wide.

Traditionally finest finger-woven belts are decorated with false embroidery of dyed porcupine quills or moose hair, which was woven into the surface of one side of the belt. Embroidered designs are generally geometric, consisting of zig-zags, crosses, squares, and triangles. Zoomorphic



Detail of finger woven wool yarn sash with lightening design and interwoven zig-zag beaded trim [1890-1910], Osage/Oklahoma (Canada (adapted from Dockstader 1993: pl.45 "Weaving Arts of the North American Indian").



Finger woven wool yarn sash with complex ceinture flechä design [1890-1910], Osage/Oklahoma (Canada (adapted from Dockstader 1993: p.14 "Weaving Arts of the North American Indian").

around the head turban-style. Although Europeans tried to replace the market with machine-made copies, the art of finger weaving has survived the centuries and continues to be made and worn by Native Americans of the eastern forests.

---

[Return to Finger Weaving Menu](#)

[Return to NativeTech's Main Weaving Menu](#)

[Weaving Bibliography and Books to Buy On-Line](#)



© 1994-1999 [Tara Prindle](#).



# Native American Finger Weaving in the Eastern Forests

## Instructions for Finger Weaving Belts

### DIRECTIONS FOR BASIC FINGERWEAVING



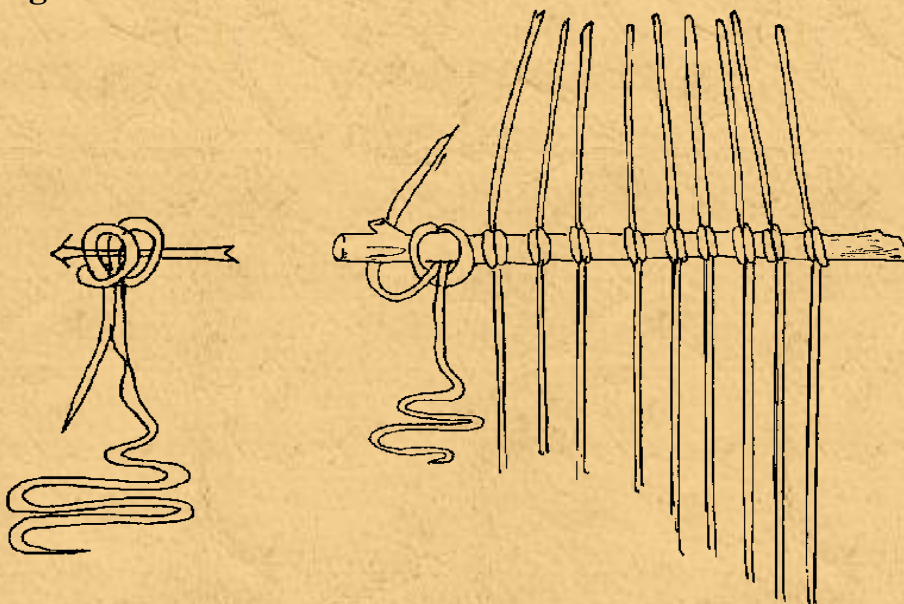
1. Use an even number of strands (6-50), depending on the material used and the desired belt width. [Allow for contraction in loose spun yarn when it is tightly woven].

Cut strands to equal lengths.

[2 TIMES (WAIST + FRINGE + KNOT)  
= STRAND LENGTH]

2. Make clove hitch knot 6-12 " from the end of each strand with the simple diagonal weave (in the center of each strand to make opposing arrows with the chevron weave).

3. Loop the clove hitch knot in each strand over a small stick. Push the strands tightly together.



4. Pull the short ends up, so that the long ends hang suspended from the stick, and tie the short ends together temporarily in an overhand knot (or wrap the ends with masking tape).

5. Secure the knotted end of the strands above the stick to a post or chair, or tape the weaving to a table surface.

6. Twine a short string horizontally around the hanging strands (just below the stick) to keep

the weaving from unraveling when the stick is removed.

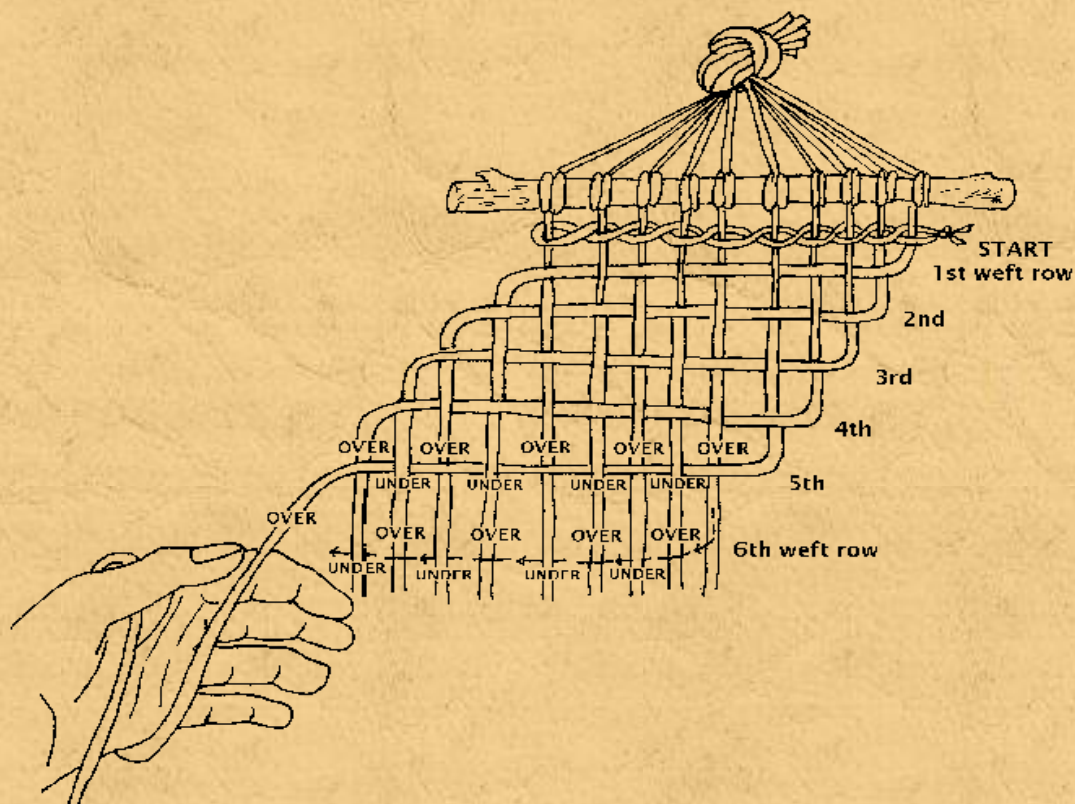
7. Finish the belt with a row of twining like that at the start .

8. Braid equal numbers of the loose strands into fringe (or twist the strands into a 2-ply fringe).

## DIAGONAL WEAVE:

As weaving progresses, on the right selvage, the last (warp) string is turned from vertical to horizontal, and the strand weaved (as weft) through the warp strings to the left.

Wrap the last (weft) strand around your left palm temporarily while weaving across the next weft strand.

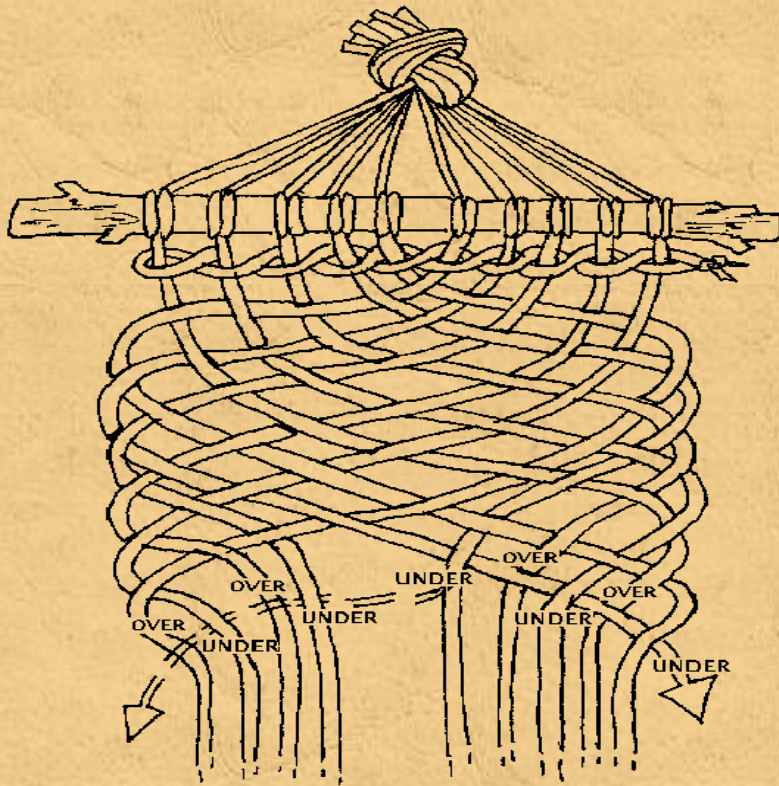


[Left handers may want to weave the mirror image of the diagrams].

## CHEVRON WEAVE:

As weaving progresses, a strand is taken from just to the left of the center-line and is woven towards the right selvage (under-over). Then a strand is taken from just to the right of the center-line and is woven towards the left selvage (under-over).





For a belt with opposing arrows [ <<>> ], weave 1/2 of the belt from the center, finish off this end with a row of twining and fringe, remove the stick from the center and the center row of twining, secure the finished end, weave the second 1/2 of the belt from the center out, and finish that end with twining and fringe.

**IMPORTANT TERMS:**

**WEFT:** the strand that moves through the warp horizontally (over-under pattern).

**WARP:** the stationary strands hanging vertically.

**SELVAGE:** the woven edges on either side of the weaving.

---

[Return to Belts, Sashes & Garters](#)

[Return to NativeTech's Main Weaving Menu](#)

[Weaving Bibliography and Books to Buy On-Line](#)

---



© 1994-1999 [Tara Prindle](#).



Hold fibers in a 'V' and roll down your thigh.

# NATIVE AMERICAN CORDAGE

Dogbane Stalk Inner Fibers

Click to see these CORDAGE EXAMPLES in the frame above

**Inner Bark Fiber**   **Grass and Reed Fiber**

[Basswood Bark](#)

[Bulrush Reed](#)

[Cedar Bark](#)

[Cattail Leaves](#)

[Dogbane Stalks](#)

[Sedge Grass](#)

[Milkweed Stalks](#)

[Sweetflag Leaves](#)

**Tendon / Ligament Fiber**

[Deer Sinew](#)

## CORDAGE TECHNOLOGY

Native Americans have always possessed a vast knowledge of cordage. The basic methods of this ancient technology have remained relatively unchanged. Cordage is made from two or more strips of fibers that are twisted or plied together. In the Eastern Forests of North America, Native Americans left the impressions of cord wrapped paddles and netting marks on their pottery 3000 years ago. The dry desert cave environments of the western coast of North America still preserve sandals and other textiles of cordage hand-twisted thousands of years ago.

In New England during the 1600's, the cordage made by Native Americans for their fishing lines and nets was superior to that of Europeans' by their own accounts. "Éince the EngliÉh came they be furniÉhed with EngliÉh hookes and lines, before they made them of their owne hempe more curiously wrought, of Étronger materials than ours, hooked with bone hookes...; they make likewiÉe very Étrong Sturgeon nets with which they catch Sturgeons of 12. 14, and 16. some 18. foote long in the day time" (Wood 1865).

Not only was this hand-made rope and string perfectly made, the tensile strength of many indigenous plant fibers was great enough to catch the largest sturgeon and salmon, and even for harpoon lines to retrieve whales and other sea mammals. The fiber cordage made from plants growing in New England was praised by Europeans for its fine quality, durability and superiority to English hemp: "Their cordage is Éo even, Éoft, and Émooth, that it lookes more like Éilke than hempe; their Sturgeon netts be not deepe, not above 30. or 40. foote long." (Wood 1865).

'Indian Hemp' or dogbane (*Apocynum cannabinum*, also called armyroot and black Indian hemp) was probably the most prevalent kind of fiber used for

cordage. Native Americans made cord and thread from the fibers of many plants, trees (including evergreen roots), and other materials such as animal sinew and rawhide. [Cord from soaked sinew or rawhide strips needs to be dried in a tightly stretched position or the twists will loosen.] Other types of plant fibers used for making cord include Velvet Leaf (*Abutilon abutilon* also called Indian Mallow), the inner rind of the wormseed plant (which grows near the water), swamp milkweed (*Asclepias incarnata*), and the hairy milkweed (*A. pulchra*, also called white Indian hemp), and toad flax (*Linaria linaria*).

Many woody field plants such as dogbane, nettle, and velvet leaf are best gathered for their fiber after the first frost when the stalks are brittle. After the frost, the fibers strip away more easily than when the plants are 'green'. Pounding the stalk can help loosen the 'chaff' and ease the removal of the desired inner fibers. Simply crack back the top piece of the stalk, and peel the stringy fibers back away from the woody part of the stalk. Look for colonies of the red brown 4 ft. stalks of dogbane in moist, shady field edges. Some plants such as milkweed, cattails and sweetflag should be gathered in late summer before the frost, which breaks down and disintegrates the fibers in these plants.

The inner barks of trees like basswood and cedar are more time consuming to harvest. Speck (1976) describes the process wherein the Penobscot of northern New England prepared inner basswood bark. First the outer bark is cut through with an ax, loosened at the cut and pulled off upwards in long ribbons. Next, the exposed inner bark is separated with a knife, grasped, and peeled off in long strips. The ribbons of inner bark are coiled up for storage. When the bark is needed it first must be boiled for a day and a half in water with wood ashes. The lye from the ashes relaxes the bark fiber and removes the sap which would make the bark brittle and stiff. The boiled strips of bark are shaved down with a knife to their desired width. Without great care harvesting inner bark will threaten the life of the tree. Fallen branches can be a good source for basswood inner bark. Fairly suitable cedar bark can be gathered from fallen trunks.

Once fibers and plant materials were finally prepared, Native Americans in southern New England used the threads and cords to make ropes and lines, nets, mats, baskets and bags, belts and straps, shoes and many other items.

Methods for making rope or heavy cord from fibers involve anchoring two lengths of fibers to a post or to your toes, and tightly twisting each length in turn to the right. Then the right-most twisted length is passed over the left length (ie you switch the lengths between your two hands). The process is repeated, twisting the individual lengths, and then crossing the lengths over each other, splicing in new lengths of fiber to get the desired length. Look at Hilary Stewart's (1984) book *Cedar* for an excellent description of traditional rope making by Native American women of the Northwest coast.

'Thigh-rolling' is the fastest way to make fine cordage or string for sewing. If you look closely at most hand made cord, the plies are twined around in a 'Z' twist (the twisted strands lie diagonally from top right to bottom left). The individual strands in 'Z' twist cordage will be twisted in the opposite direction in an 'S' twist, the strands lie diagonally from top left to bottom right). Many



plants that are inflexible or brittle when they are dry become pliable when they are soaked or dampened. Shredding and pounding the fibers can also improve the flexibility of many fibers. Even the shorter fibers of cornstalks and short grasses can be used if new pieces are continually spliced in.

Use two small bunches of fibers that are of different length. Hold the ends of two strands of fibers in your left hand. Drape their other ends over your right thigh. Roll the strands down your thigh using the palm and thumb of your right hand so that the strands 'S' twist up. At the end of this roll, release the hold of your left hand on the fibers and allow the strands to 'Z' twist in the opposite direction. Sometimes a quick reverse roll of the left hand on the twisted cord will help to tighten the ply. I find that this back roll tends to tangle the loose lengths of fibers.

If you have a Windows or Netscape AVI Video Player,  
here's a short [animated video on cordage](#)

The key to making even cordage is to continually splice in a new strand of fiber every couple of inches, well before the existing strands start to run short. Splice in a length of fiber by laying the new piece along the shorter of the two original strands. Twist the new and original fiber together as one strand and continue rolling the cordage. Do not attempt to splice the butt end of added fiber with the butt end of an original strand. Even if you can manage to ply two butt ends together this makes a very weak area in the cord. Each time a new piece is spliced in, leave an inch or so of the new fiber projecting from the plied cord, these can be trimmed off when the cord is finished.

---

I would like to thank my friend, and fellow cord-maker,  
Fred Palmer  
for urging me to produce this page.

---

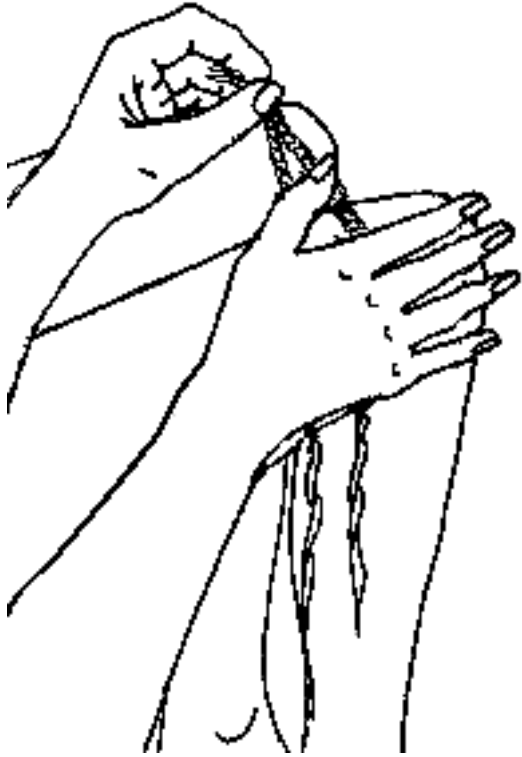
[Some Internet Links Related to String & Cordage](#)

[Return to NativeTech's Main Weaving Menu](#)

[Weaving, Basketry & Cordage Bibliography and Books to Buy On-Line](#)



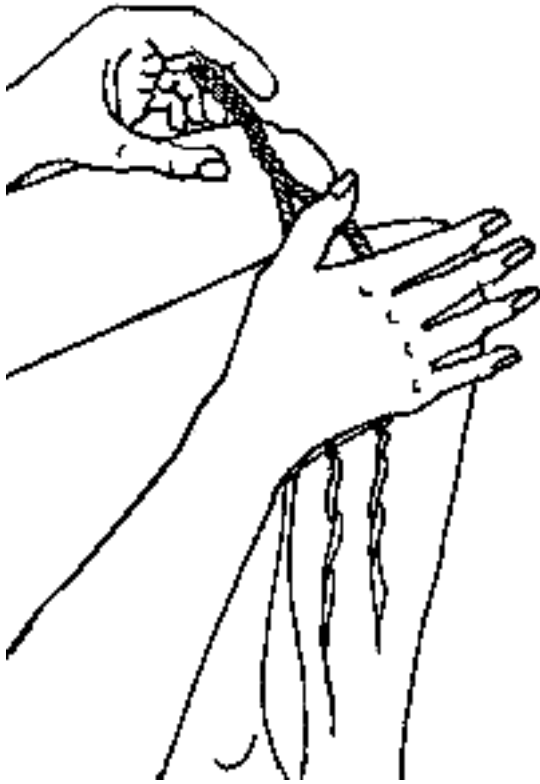




---

Fibers are rolled tightly into an 'S' twist.





---

Let go! fibers twirl back in a 'Z' twist.



---

Get ready for next roll; hold at end of 'Z' twist.



---

Splicing: lay a new fiber along the short one; roll them together.



---

You're ready to roll the fibers down your thigh again.





---

Hold fibers in a 'V' and roll down your thigh.

**NativeTech: Native American Technology & Art**

**WEAVING, BASKETRY & CORDAGE  
BIBLIOGRAPHY**



Click on the links below for the books you can order on-line in affiliation with [barnesandnoble.com](http://barnesandnoble.com)

---

*References cited in NativeTech's [Weaving, Basketry & Cordage articles](#):*

**Adovasio, J.M.**

**1977 Basketry Technology; A Guide to Identification and Analysis.**

Aldine Publishing Co.: Chicago.

[Order this book through barnesandnoble.com](#)

**Dockstader, F.J.**

**1993 Weaving Arts of the North American Indian.**

Revised Edition. HarperCollins Publishers: New York.

**Gookin, Daniel**

**1970 Historical Collections of the Indians in New England.**

J.H. Fiske, ed. London: Towaid. (First published 1674).

[Order this book through barnesandnoble.com](#)

**Hart, Carol and Dan Hart**

**1976 Natural Basketry.**

Watson-Guptill Publications: New York.

[Order this book through barnesandnoble.com](#)

**Johnson, F.**

**1989 Price Guide to Baskets Second ed.**

Wallace-Homestead Book Co.: Radnor, Penn.

[This book is Out of Print. But used copies are available here.](#)

**Juet, Robert**

**1967 From "The Third Voyage of Master Henry Hudson" [1610]. In Narratives of New Netherland, 1609-1664.**

F.J. Jameson, ed. Pp. 11-28. New York: Barnes and Noble.

[Order this book through barnesandnoble.com](#)

**McMullen & Handsman**



**1987. A Key into the Language of Woodsplint Baskets.**

American Indian Archaeological Institute: Washington, CT.

[Order this book through barnesandnoble.com](http://www.barnesandnoble.com)

**McPherson, John**

**1987 Primitive Fire & Cordage.**

Randolph, Kansas: Prairie Wolf.

**McGuire, J.E.**

**1989 Basketry, The Shaker Tradition.**

Sterling Publishing Co, Inc.: New York.

[Order this book through barnesandnoble.com](http://www.barnesandnoble.com)

**McGuire, J.E.**

**1985 Old New England Splint Baskets; and how to make them.**

Schiffer Publishing Ltd.: West Chester Penn.

[Order this book through barnesandnoble.com](http://www.barnesandnoble.com)

**Orchard, William C.**

**1975 Beads and Beadwork of the American Indians.**

New York: Museum of the American Indian / Heye Foundation.

[Order this book through barnesandnoble.com](http://www.barnesandnoble.com)

**Ritzenthaler, Robert E. and Pat Ritzenthaler**

**1970 The Woodland Indians of the Western Great Lakes.**

Garden City, NY: Natural History Press.

[Order this book through barnesandnoble.com](http://www.barnesandnoble.com)

**Snow, Dean R.**

**1980 The Archaeology of New England.**

New York: Academic Press.

**Speck, Frank G.**

**1976 Penobscot Man: The Life History of a Forest Tribe in Maine.**

New York: Octagon Books.

[Order this book through barnesandnoble.com](http://www.barnesandnoble.com)

**Speck, Frank G.**

**1947 Eastern Algonkian Block-Stamp Decoration: A New World Original or an Acculturated Art.**

Addendum by Eva Butler. Trenton: Archaeological Society of New Jersey.

**Speck, Frank G.**

**1915 Decorative Art of Indian Tribes of Connecticut.**

Anthropological series 10. Memoirs of the Canadian Geological Survey 75. Ottawa, Ont: Canadian Department of Mines.

**Stewart, Hillary**

**1984 Cedar: Tree of Life to the Northwest Coast Indians.**

Seattle & London: Univ. of Washington Press.

[Order this book through barnesandnoble.com](http://barnesandnoble.com)

**Trigger, Bruce G. ed.**

**1978 Handbook of North American Indians, Vol. 15.**

W. Sturtevant, gen. ed. Washington, D.C.: Smithsonian Institution.

[Order this book through barnesandnoble.com](http://barnesandnoble.com)

**Turnbaugh, William A. and Sarah P. Turnbaugh**

**1986 Indian Baskets.**

West Chester PA: Schiffer Publishing Company.

[Order this book through barnesandnoble.com](http://barnesandnoble.com)

**Williams, Roger**

**1973 Key into the Language of America.**

J.J. Teunissen and E.J. Hinz, ed.s. Detroit: Wayne State University Press. (First printed 1643).

[Order this book through barnesandnoble.com](http://barnesandnoble.com)

**Wood, William**

**1865 Wood's New England's Prospect.**

Boston: Publications of the Prince Society 1. (First published 1634).

I am indebted to Dr. Russel G. Handsman for giving me a cherished appreciation for the unique qualities of  
Native American Basketry.

Rus is now the Director of the Archaeology Program at the University of Rhode Island in Kingston.

---

*Other Books relating to Weaving & Basketry & Cordage you can buy on-line through [barnesandnoble.com](http://barnesandnoble.com):*

**Michele Sola, Jeffrey Jay Foxx (Photographer)**

[Angela Weaves a Dream: The Story of a Young Maya Artist, Vol. 1](http://barnesandnoble.com)

**Pablo de la Cruz, Carl Lumholtz**

[The Art of the Beautiful: Clothing and Fabric Designs of the Huichols](http://barnesandnoble.com)



**Dilys P. Winegrad, Lucy F. Williams**

**[Burst of Brilliance: Germantown, Pennsylvania, and Navajo Weaving](#)**

**Michael Chanin, Kim Howard (Illustrator)**

**[The Chief's Blanket](#)**

**Cheryl Samuel, Sara Porter (Illustrator)**

**[The Chilkat Dancing Blanket](#)**

**Ann L. Hedlund**

**[Contemporary Navajo Weaving: Thoughts That Count](#)**

**Donald B. Cordry, Dorothy M. Cordry**

**[Costumes and Weaving of the Zoque Indians of Chiapas, Mexico](#)**

**Alta R. Turner**

**[Finger Weaving: Indian Briading](#)**

**Geraldine, Nancy Winslow Parker (Illustrator), As Told to Charles L. Blood, As Told to Martin Link**

**[The Goat in the Rug](#)**

**Kent McManis, Robert Jeffries**

**[A Guide to Navajo Weavings](#)**

**Tyrone D. Campbell**

**[Historic Navajo Weaving: Three Cultures-One Loom](#)**

**Helga Teiwes**

**[Hopi Basket Weaving: Artistry in Natural Fibers](#)**

**The Navajo School of Indian Basketry**

**[Indian Basket Weaving](#)**

**Elizabeth M. Hawkins**

**[Indian Weaving, Knitting and Basketry of the Northwest](#)**

**Greg Sarris**

**[Mabel McKay: Weaving the Dream](#)**

**Jerrie Oughton, Lisa Desimini (Illustrator)**  
**[The Magic Weaver of Rugs: A Tale of the Navajo](#)**

**Ann Stalcup**  
**[Mayan Weaving : A Living Tradition](#)**

**Kate P. Kent**  
**[Navaho Weaving](#)**

**Charles Avery Amsden, Foreword by Frederick Webb Hodge**  
**[Navaho Weaving: Its Technic and History](#)**

**Tyrone D. Campbell, Joel Kopp, Kate Kopp )**  
**[Navajo Pictorial Weaving, 1880-1950](#)**

**Publishing Company Terrell (Editor)**  
**[Navajo Weaving from the Santa Fe Collection](#)**

**Harriet Koenig, Seymour H. Koenig**  
**[Navajo Weaving, Navajo Ways](#)**

**Kate Peck Kent**  
**[Navajo Weaving: Three Centuries of Change](#)**

**Nancy N. Schiffer**  
**[Navajo Weaving Today](#)**

**Alice Kaufman, Christopher Selser**  
**[The Navajo Weaving Tradition: 1650 to the Present](#)**

**NoFl Bennett, Tiana Bighorse, John Running (Photographer)**  
**[Navajo Weaving Way: The Path from Fleece to Rug](#)**

**Bill Harmsen**  
**[Patterns and Sources of Navajo Weaving](#)**

**Harriet Tidball**  
**[Peru Textiles Unlimited](#)**

**Nancy N. Schiffer**



**[Pictorial Weavings of the Navajos](#)**

**Getzwiller, Steve, Foreword by Ray Manly**  
**[Ray Manley's the Fine Art of Navajo Weaving](#)**

**H. L. James**  
**[Rugs and Posts: The Story of Navajo Weaving and Indian Trader](#)**

**Frederick J. Dockstader**  
**[The Song of the Loom : New Traditions in Navajo Weaving](#)**

**Monty Roessel**  
**[Songs from the Loom: A Navajo Girl Learns to Weave](#)**

**Kathleen Curtis (Photographer), Foreword by Catherine S. Fowler, Mary Lee Fulkerson**  
**[Weavers of Tradition & Beauty: Basketmakers of the Great Basin](#)**

**Linda Yamane, Dugan Aguilar (Photographer)**  
**[Weaving a California Tradition a Native American Basketmaker](#)**

**Gladys Amanda Reichard, Galdys Amanda Reicher**  
**[Weaving a Navajo Blanket](#)**

**Paul Zolbrod, Roseann Willink**  
**[Weaving a World: Textiles and the Navajo Way of Seeing](#)**

**Carol Hendrickson**  
**[Weaving Identities: Construction of Dress and Self in a Highland Guatemala Town](#)**

**Sarah H. Hill**  
**[Weaving New Worlds : Southeastern Cherokee Women and Their Basketry](#)**

**Thomas C. Parkhill**  
**[Weaving Ourselves into the Land: Charles Godfrey Leland, "Indians, " and the Study of Native American Religions](#)**

**Mary L. Stahl, Amy Ruedinger (Illustrator)**  
**[Weaving Wildly: Mats and Baskets the Choctaw Way](#)**

**Additional book list being compiled.**

**In the meantime,**

**[Click here to Search for Books about Native American Basketry](#)**

**[Search for Books at  
barnesandnoble.com](#)**

Search by:

---

**[Return to NativeTech's Main Weaving Menu](#)**

---



© 1994-1999 **[Tara Prindle.](#)**



NativeTech: Native American Technology & Art



**GAMES & TOYS BIBLIOGRAPHY**

Click on the links below for the books you can order on-line in affiliation with [barnesandnoble.com](http://barnesandnoble.com)

---

*References cited in NativeTech's [Games & Toys articles](#):*

**Coe, Ralph T.**

**1986 Lost and Found Traditions, Native American Art 1965-1985.**

New York: University of Washington Press in association with the American Federation of Arts.

[Order a used copy of this Out of Print book](#)

**Culin, Stewart**

**1975 Games of the North American Indians.**

Dover Publications: New York.

[Order this book through barnesandnoble.com](#)

**Densmore, Frances**

**1974 How Indians Use Wild Plants for Food, Medicine and Crafts.**

New York: Dover Publications, Inc.

[Order this book through barnesandnoble.com](#)

**Macfarlan, Allan & Paulette**

**1958 Handbook of American Indian Games.**

Dover Books: New York.

[Order this book through barnesandnoble.com](#)

**Ritzenthaler, Robert E. and Pat Ritzenthaler**

**1970 The Woodland Indians of the Western Great Lakes.**

Garden City, NY: Natural History Press.

[Order this book through barnesandnoble.com](#)

**Speck, Frank G.**

**1976 Penobscot Man: The Life History of a Forest Tribe in Maine.**

New York: Octagon Books.

[Order this book through barnesandnoble.com](#)

---

*Other Books relating to Games & Toys you can buy on-line through [barnesandnoble.com](http://barnesandnoble.com):*

**Jay Miller**

[\*\*American Indian Games\*\*](#)

**Thomas Vennum**

[\*\*American Indian Lacrosse: Little Brother of War\*\*](#)

**Nan McNutt, Roger Fernandes (Illustrator), Susan Point (Illustrator)**

[\*\*The Bentwood Box: A Northwest Coast Indian Art Activity Book\*\*](#)

**Travis Hudson, Jan Timbrook**

[\*\*Chumash Indian Games\*\*](#)

**Pamela Soeder, William Powless (Illustrator)**

[\*\*Discover American Indian Ways: A Carnegie Activity Book\*\*](#)

**Kathryn Gabriel**

[\*\*Gambler Way: Indian Gaming in Mythology, History and Archaeology in North America\*\*](#)

**Brian Sutton-Smith**

[\*\*The Games of the Americas: A Book of Readings\*\*](#)

**Jeannine Gendar**

[\*\*Grass Games and Moon Races: California Indian Games and Toys\*\*](#)

**Sue Kassirer**

[\*\*Hidden Spirits\*\*](#)

**Alice C. Fletcher, Helen Myers**

[\*\*Indian Games and Dances with Native Songs: Arranged from American Indian Ceremonials and Sports\*\*](#)

**Michael J. Caduto, Carol Wood (Illustrator), With Joseph Bruchac**

[\*\*Keepers of the Night: Native American Stories and Nocturnal Activities for Children\*\*](#)

**Diane Hoyt-Goldsmith, Lawrence Migdale (Illustrator)**

[\*\*Lacrosse: The National Game of the Iroquois\*\*](#)



**Allan A. Macfarlan, Allan A. MacFarian**

**[Living like Indians:: A Treasury of North American Indian Crafts, Games and Activities](#)**

**Lucy Rees**

**[The Maze: A Desert Journey](#)**

**Kendall A. Blanchard**

**[Mississippi Choctaws at Play: The Serious Side of Leisure](#)**

**Alexander Lesser, Alice Beck Kehoe (Introduction)**

**[The Pawnee Ghost Dance Hand Game: Ghost Dance Revival and Ethnic Identity](#)**

**Nan McNutt, Roger Fernandes (Illustrator), Susan Point (Illustrator)**

**[The Spindle Whorl: A Northwest Coast Indian Art Activity Book](#)**

**Philippa Wingate, Struan Reid, David Cuzik (Illustrator), Designed by Vicki Groombridge**

**[Who Were the First North Americans?](#)**

**Judy Alter**

**[Wild West Shows: Rough Riders and Sure Shots](#)**

**\*v\* Modern Gaming & Indian Casinos \*v\***

**Harold Bloom (Editor)**

**[Implementation of the Indian Gaming Regulatory Act: Survey Report and Audit Report](#)**

**William Eadington (Editor), Judy Cornelius (Editor)**

**[Indian Gaming and the Law](#) Sandra J. Eichelberg (Editor), Melissa J. Fawcett (Translator)**

**[Secret Guide to Mohegan Sun, Vol. 1](#)**

**Harriet Ganson, Nilsa I. Perez, Keith Steck, Bryon Gordon**

**[Tax Policy: A Profile of the Indian Gaming Industry](#)**

**Alan A. Lew (Editor), George A. Van Otten (Editor)**

**[Tourism and Gaming on American Indian Lands](#)**

**Additional book list being compiled.**

**In the meantime,**

[Click here to Search for Books about Native American Toys](#)

[Search for Books at  
barnesandnoble.com](#)

Search by:

---

[Return to NativeTech's Main Games & Toys Menu](#)

---



© 1994-1999 [Tara Prindle.](#)



Native American Technology and Art

# Black Rock



By

Nunya Ageya

**I found the twisted log that took  
all night to burn, Grandfather.  
I found the magic glade that took  
me back in time, Grandfather.**

**I did not see you standing on  
the mountainside, Grandfather;  
I saw the dreams you sent me,  
Black Rock,  
ancient one.**

**You sent a vision that I did  
not understand, Grandfather.  
I saw you sitting in the trees  
atop the ridge, Grandfather.**

**Four times I saw the lightning flash  
behind your face, Grandfather.  
I did not recognise you, Black Rock,  
ancient one.**

**Owl Woman, Bear Wakes Up, and I  
had traveled far, Grandfather.  
The children ran to play while we  
prepared our lodge, Grandfather.**

**When Bear Wakes Up arose and saw  
you waiting, there, Grandfather;  
then I looked up and knew you,  
Black Rock,  
ancient one.**

[Poems and Stories Menu](#)

---

© 1996-1998 [Shelley M. Smith](#). E-mail: [ssmith02@snet.net](mailto:ssmith02@snet.net)

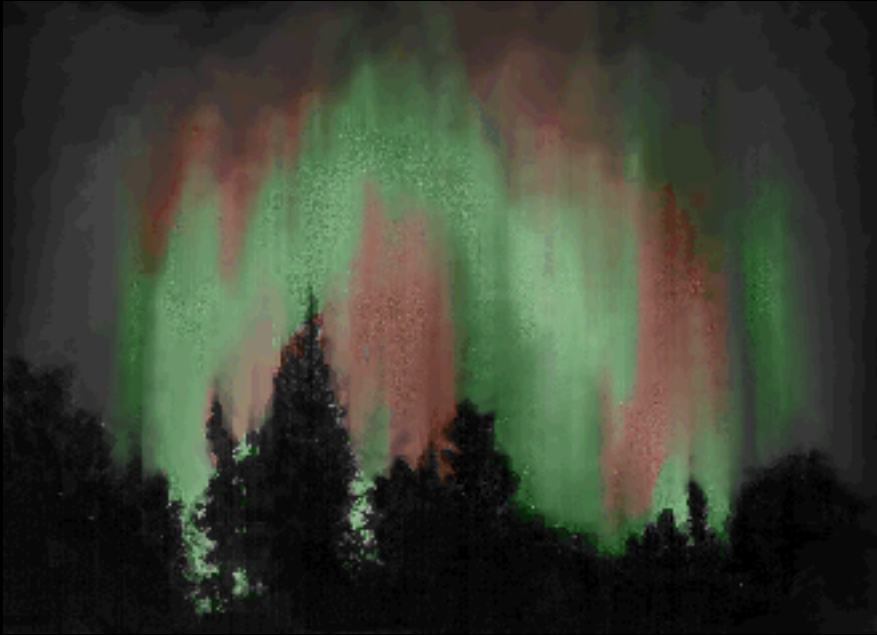
---



[NativeTech Home Page](#)

© 1996-1998 [Tara Prindle](#).

## Native American Technology and Art



# Four Dreams

By

Nunya Ageya

**I had a dream.**

**The sun, the moon, the stars, and the earth  
Danced in a circle in the night.  
From the center of the circle came  
Bright flashes of darkness, pulsating nothingness.**

**I had a second dream.**

**The earth, the sun, the moon, and the stars  
Danced in a circle in the sky.  
From the center of the circle came  
A smiling woman, clothed in fire,  
Dancing.**

**I had a third dream.**

**The stars, the earth, the sun, and the moon  
Danced in a circle in the dark.  
From the center of the circle came  
The shimmering, dancing woman.  
Singing silently, she touched me.**

**I had a fourth dream.**

**The moon, the stars, the earth, and the sun  
Danced in a circle in the cosmos.  
From the center of the circle came  
The fly that does not burn, the mystery in the night,  
The dancing light, the shining woman,**

**And myself.**

**I had no more dreams  
Of the sun, the moon, the stars, and the earth  
Dancing in their midnight circle.  
From the center of the circle had come  
My name,  
Mystery Night Woman, Northern Lights Woman.  
I had dreampt it, four times I dreampt it.  
It was mine.**

**[Poems and Stories Menu](#)**

---

**© 1996-1998 [Shelley M. Smith](#). E-mail: [ssmith02@snet.net](mailto:ssmith02@snet.net)**

---



**[NativeTech Home Page](#)**

**© 1996-1998 [Tara Prindle](#).**



## Native American Technology and Art



# JUST PASSIN'

By

Nunya Ageya

I sat in the booth chewing listlessly at my rubbery eggs and over-fried bacon and my bone-dry toast. I looked at my plate, at the yellow oilcloth they called a tablecloth in this dingy little roadside diner, at the sunlit rectangle with the co'-cola sign across the bottom that was the door to this place, at the fly that kept landing on my eggs. Bored, I yawned and wished I was back in bed. I thought about visiting Grandma since I was in this neck of the woods, but decided to leave well enough alone. I looked at the other people eating, just some white kids in one booth and a couple of Indian men in the booth behind them.

The kids looked pretty young to be 'way out here on the highway by themselves, but you never knew about these local country kids, they could be pretty independent. There was a boy and two girls, the boy eating with the quiet desperation of a teenage male, wiping up every drop and eyeing the girls' plates as though he'd snatch and devour what they didn't eat fast enough. The girls ate in leisurely silence. I yawned again and tears squeezed out of my eyes.

The two Indian men, looking prosperous in their crewneck shirts, the kind with alligators embroidered on the pockets, talked quietly as they ate. I could hear snatches now and again, "...that fence is illegal...built it?...Mama's land..." The fly landed on my eggs again. I was beginning to dislike that fly. I thought about Grandma again, how I missed her, but I was doing O.K. as I was out here.

A shadow appeared over the cola sign and the door swung open on its squealing hinges. Three Indians from the rez down the road a bit, I guess, in Levis and dusty ropers, with bandanna headbands holding back their hair, pulled themselves over the threshold and settled into the nearest booth. As they ordered, one of the girls stared hard at them from

across the room. The fly washed its legs on my eggs. Grandma surfaced in my mind again; no need for anybody to guess the truth and if I went to see her somebody was bound to.

The two Indians with the 'gators on their chests were laughing now, "...Mama turned right around, faced the backseat ... ran him right off the road... how many Lincolns can there be in Wyandotte county?..... wasn't him..." The waitress delivered a second plate to the white boy behind them. I lifted my forkfull of eggs, but put it down with disgust when I saw the flyspots. 'Sorry, Grandma,' I thought, 'but I've made a place for myself where nobody treats me like shit.' The white girls and the rez Indians ate on without a word, the first girl still looking hard.

In a voice just absolutely dripping with scorn she spoke; "Look at those Indians." The boy, devoted to the serious business of food disposal, glanced up at the girl and over at the rez Indians she pointed to. The three rez Indians froze in their seats, sliding their eyes sideways toward the white kids. The second girl looked at the three men near the door and got a little smile on.

Turning back to her companion, she pointed over her shoulder to the two city Indians behind her and said quietly, "Look at those Indians." The first girl frowned and returned to toying silently with her food. The boy, shoveling forksfull into his mouth, looked at the two girls and over at the two city Indians. The three men by the door commenced eating again and I looked at the blond hairs on the back of my hand in a shaft of sunlight, wondering mildly how her reply made any sense to anybody.

The two 'gator Indians had apparently taken to telling lies about their youth, "...playing piano in this honkytonk...whupped those Texas whiteboys ...get their tails across the state line and never come back..." The rez Indians paid their check and cleared out. The white boy had at last captured the remnants of the girls' breakfasts. The first white girl gazed at her emptied plate and desultorily sucked the straw of her sodapop, while the second girl stared out the door into the lighted square above the sign. She looked sad, and I briefly wondered what she had to be unhappy about; being free, white and someday twenty-one. I asked for a refill and took a sip, at least the coffee wasn't half bad.

The white boy, having eliminated all possible food in his vicinity, whispered something to the first girl, who nodded. He leaned over the seatback to one of the 'gator Indians and said, "Hey, Daddy, can Arlene and me have some pie?" The other Indian, the one who had sat with his back to me, turned to wave the waitress over. I looked at the second girl and at the second Indian and saw the original version of her face, except she dressed hers in rown hair and freckles.

The eggs turned rowdy in my stomach as I lifted my cup to drink the dregs; the fly was buzzily drowning in my coffee. I got up and paid my check at the old black register by the



door. For some reason I wanted to look at those folks across the room again, but all I saw when I looked was Grandma's house in my mind. Well, hell.

'Family is family,' I thought as I stepped through the door into dusty daylight, 'and the rez is right on my way.'

[Poems and Stories Menu](#)

---

© 1996-1998 [Shelley M. Smith](#). E-mail: [ssmith02@snet.net](mailto:ssmith02@snet.net)

---



[NativeTech Home Page](#)

© 1996-1998 [Tara Prindle](#).

Native American Technology and Art

# Over Under

By  
Nunya Ageya

Sky in a puddle;  
clouds pile up lowly,  
birds fly upside-downly,  
sun shines beneathly your feet.

[Poems and Stories Menu](#)

---

© 1996-1998 [Shelley M. Smith](#). E-mail: [ssmith02@snet.net](mailto:ssmith02@snet.net)

---



[NativeTech Home Page](#)

© 1996-1998 [Tara Prindle](#).



Native American Technology and Art  
**Fireflies on Summer Nights**

By  
**Nunya Ageya**



**Fireflies;  
brightflashing pinpoints,  
stars fallen low,  
sparkling lights flying 'round,  
glowing eyes that blink at twilight,  
twinkles alive,  
dancing sunlets ablaze;  
fireflies.**

---

[Poems and Stories Menu](#)

---

© 1996-1998 [Shelley M. Smith](#). E-mail: [ssmith02@snet.net](mailto:ssmith02@snet.net)

---



[NativeTech Home Page](#)

© 1996-1998 [Tara Prindle](#).

Native American Technology and Art

# REMINISCENCES



By  
Nunya Ageya

**I remember the old days.**

**You, my *kuda*, my friend, gave me a basket made of sweetgrass. I smelled the fresh scent of it. *Wie hotan*, I am happy! And I smiled as you told me of the special place where the sweetgrass grew.**

**But I've forgotten who you were.**

**I remember the old days.**

**It was *sni wate*, winter, and my hands hid in my robes from the bite of the cold air. My breath froze on the furs around my face. The *puite*, the snow, lay in deep drifts against the trees I walked under. Great silence surrounded me.**

**But I've forgotten where I was going.**

**I remember the old days.**

**I kneeled in the *mahin*, the grass, and scraped, scraped the fat off the hide. My fingers tugged at the membrane that stubbornly clung to the skin and I stroked the wet fur at the edges. The *shunke*, the dogs, quarreled over the scraps I threw them.**

**But I've forgotten what I made from it.**

**Ah, I remember the old days,**

**The days long before I was born.**

[Poems and Stories Menu](#)

---

© 1996-1998 [Shelley M. Smith](#). E-mail: [ssmith02@snet.net](mailto:ssmith02@snet.net)

---



[NativeTech Home Page](#)

© 1996-1998 [Tara Prindle](#).



Native American Technology and Art

# SONG OF THE EARTHDREAM

By

Nunya Ageya

Here,  
under this grass,  
I will soon release my mind  
to travel where it must,  
when, soaring,  
I revisit the Earth-mother.

Here,  
under these roots,  
I will go when my heart walks  
the path of sacred smoke,  
when, wondering,  
I revisit the Earth-mother.

Here,  
under this earth,  
I will learn the Earthdream song  
I dance to all my life,  
when, singing,  
I revisit the Earth-mother.

Here,  
under these stones,  
I will find the center of  
the circle my soul walks,  
when, living,  
I revisit the Earth-mother.

[Poems and Stories Menu](#)

---

© 1996-1998 [Shelley M. Smith](#). E-mail: [ssmith02@snet.net](mailto:ssmith02@snet.net)

---





[NativeTech Home Page](#)

© 1996-1998 [Tara Prindle](#).

Native American Technology and Art



# Time-warp Mountain Man

By  
Nunya Ageya

He wears  
a Puma tee-shirt  
but if I close my eyes  
and hug him  
I smell smoke in weathered buckskin.

He drives  
a truck for money  
but when he nears the woods  
and enters  
he walks ancient virgin forests.

He buys  
meat at the market  
but when the white tails rut  
and fatten  
he packs gun and worships hunting.

He lives  
in modern ages  
but only bodily  
for his soul  
comes from other,  
older eras.

[Poems and Stories Menu](#)

© 1996-1998 [Shelley M. Smith](#). E-mail: [ssmith02@snet.net](mailto:ssmith02@snet.net)

---



[NativeTech Home Page](#)

© 1996-1998 [Tara Prindle](#).



Native American Technology and Art



# Waiting for the Moon

By

Nunya Ageya

Sitting within the stone circle,  
amongst a sisterhood,  
listening beyond the rush of blood in our ears  
for the old stories whispered in the wind of nights  
that dies short of us in wait,  
waiting for the moon,

singing soft sounds of sacredness,  
within our sisterhood,  
piercing us with wordless songs through heart and heart  
like string in beads that make holy pattern beneath.  
ancient earth too dark to see,  
waiting for the moon,

summoning visions in our minds,  
inside the sisterhood,  
rousing glowing tidal earthen memories  
to dance in darkness from each to each of us and  
set free our woman's powers,  
waiting for the moon.

[Poems and Stories Menu](#)

---

© 1996-1998 [Shelley M. Smith](#). E-mail: [ssmith02@snet.net](mailto:ssmith02@snet.net)

---



[NativeTech Home Page](#)

© 1996-1998 [Tara Prindle](#).

## NativeTech: Native American Technology & Art



# A Message from Longtrail Snowbird

---

Greetings from Montanaís Outback and the Valley of the Musselshell,

My name is Longtrail, one of my main interests in life for the past twenty years, has been that of Native American life and their relationships with other Native Americans as well as early contact with whites, especially information pertaining to the Fur Trade Era.

My interest began when I became involved with a group of people who attended Mountain Man Rendezvous. Someone suggested I start a newsletter for women who were interested in womenís involvement in the fur trade as well as crafts during that period, so I did.

The name of the newsletter as well as of the organization that formed later, was Hiyu Eenas, Chinook jargon from the Pacific North West which means Many Beavers. I discovered that women as well as men were more than happy to contribute very interesting information for publication in my newsletter. Because of the influx of such information, my interest was piqued and has continued to stay that way all of these years.

Due to the vast amount of information on the subject, I continue to learn more and more as time passes. Due to the fact that the Indians did not record information in a written manner but that of stories handed down from generation to generation, their information pertaining to their lives from that time period is very limited. While there are many books of old Indian stories written by Native Americans, it is in a large part, by reading journals of white men who traveled the land and interacted with the Indians and had the insight to record in detail, what they witnessed, that we find the most informative information on how the Natives lived. Information on all aspects of their lives, from their material world to their religions and superstitions.

For the past several years I have been an Associate Member of the American Mountain Man Association, and have contributed many



articles to their very informative and inspiring publication called The Tomahawk and Longrifle.

I would be delighted to correspond with anyone interested in this subject and will help gather information to answer any questions presented to me.

I am a crafts person and maker of museum quality Native American style items. I very much enjoy drawing and painting North West Coast Indian art and art and crafts from the Northern Plains. My favorite Native American people to study about and recreate crafts from are the Blackfoot.

Thank you for your journey here to this page and I hope you find this destination an exciting and informative place to be.

Longtrail Snowbird

---

[Back to the Poetry and Stories Menu](#)

---

Text © 1996-2002 Victoria Dinsmore. E-mail: [ezra@midrivers.com](mailto:ezra@midrivers.com)

---



[NativeTech Home Page](#)

Web Design & Graphics © 1994 - 2002 [Tara Prindle](#).

## Native American Technology and Art



# The Gift

By  
Longtrail

**In the mountains and on the prairie  
In the forests and in the open  
We roam to see the land before us  
And how the People live beside us.**

**We watch their lives slowly unfolding  
Watch their children slowly growing  
Reaching manhood, becoming women  
In the land they call their own.**

**We're the mightiest of the Elk Tribe  
With antlers as trees growing  
With powers from our fathers  
With magic coursing through our blood.**

**On the prairie there is a young man  
We have often seen him hunt there**

**Draw his bow and send his arrows  
Bringing down the mighty buffalo.**

**We have watched him on his pony  
Ride into the running herd of thunder  
Strong and bravely does his killing  
Providing for his honored parents.**

**As we stand hidden, behind the bull pines  
Blending with the brush around us  
We have seen him stalk the brown bear  
Take it's life with knife and arrow.**

**He is brave and he is noble  
He shows no fear when in a battle  
Rushing towards advancing enemy  
Wielding shield and lance, surviving.**

**All of his bravery we have witnessed  
All the man-strength, he has plenty  
All of his power he shows daily  
In this young man we have seen this.**

**Among his people there is a woman  
Soft and pretty as a new leaf  
Wanted by many of the young men  
Who in their robes desire to wrap her.**

**In robes of buffalo they have taken  
Quilled and painted, telling stories  
With picture writing they speak of conquests  
On their robes of warmth and courting.**

**Wanting to whisper words of needing  
Hidden beneath the darkened shelter  
Close together, arms around her  
They feel the need to be close to her.**

**With their painted faces, greet her  
Show their strong young bodies to her  
Tell her all that they could give her  
Laughing, joking with young Calf Woman.**



**As we watched the young men courting  
We saw the bravest from among them  
Standing hidden, silently watching  
Wishing the words he thought, could reach her.**

**Among the trees along the river  
Through the red of willows standing  
Comes the beauty of Calf Woman  
With her gourd she comes for water.**

**Day after day we see him stand there  
Among the willows surely hidden  
He watches the beauty of the woman  
Longs to touch her and to hold her.**

**He tried to call his heart words to her  
They left his lips in only whispers  
Falling soon they floated downward  
And on the ground lay gasping, dying.**

**On the breeze they never floated  
To her ears, they did not reach them  
In her heart she could not feel them  
Feel his words of love, and warm her.**

**As she left the water's lapping  
And the young man's love and wanting  
Unknowingly trod upon his words that lay there  
Dying on the damp and rocky ground.**

**On the pathway to the village  
Many young braves there awaited  
With their smiles upon their faces  
With their robes to wrap around her.**

**As he hid, he wept there watching  
His frustration brought him sorrow  
Life without her had no meaning  
Broken hearted he left to wander.**

**As he journeyed from his homeland**

Walked into ascending coolies traveling  
Towards the steep and forested mountains  
Hid from his sight we carefully followed.

Upon a mountain top he prayed there  
For peace of heart and calm of spirit  
Wondering why his bravery failed him  
When of his love he tried to tell her.

He strung his bow and placed his arrow  
Bent the bow and stretched the sinew  
Sent the arrow flying skyward  
With no target but the heavens.

Toward the clouds soared his arrow  
Reached it's time to change direction  
Turned and slowly headed westward  
At a speed that he could follow.

He saw the arrow as a sign then  
A sign of magic, unseen powers  
Four long days he followed westward  
For three nights it waited while he rested.

In the evening of the forth day  
Tired and weary he lay himself down  
Amidst the smell of yellow aspen  
To the song of the forest's singing.

As we stood among the quaking aspen  
Watching the young man laying, sleeping  
The time came in which we should greet him  
We then walked and stood above him.

We, the Elk Men with branching antlers  
We with paint of black and yellow  
We who know the heart ache in him  
As he woke we said "We'll help you"

As we spoke to him in beauty  
All the leaves quaked songs of gladness  
All that was, so softly listened

**As we told him "We shall show you"**

**With our presence there he fully wakened  
Sat in awe of paint and antlers  
Saw our hoops with quills and otter  
Saw the mirror hanging from it.**

**In our hands we held out to him  
The thing of magic we had for him  
With his hands he reached out for it  
Took the flute with wondrous powers.**

**"This is cedar wood" we told him  
"Fashioned by our friend woodpecker  
Five holes in it he has made there  
And put his likeness on one end for you.**

**All the animals helped to make it  
We have put our voices in it  
When you blow it love will insue  
Play it for your needed woman.**

**Unlike your words itís voice will reach her  
It will not lay upon the ground dying, gasping  
She will hear you and will love you  
Together have children and together live long."**

**We could see the young man feared us  
We could read his thoughts so clearly  
With our mirrors and the moonlight  
We caused the beam to close his eyes.**

**In the moment he was blinded  
Our human form from us we banished  
As he blinked and saw us leaving  
We were two bull elk , grand and mighty.**

**The night brought dreams of young Calf Woman  
Of her beauty and his needing  
With the morning sun came new strength  
On the rays of sun came new hope.**



**As he journeyed homeward, walking  
Songs from the flute he sent so sweetly  
That the cranes all gathered  round him  
Singing songs and dancing gaily.**

**He listened to the animals of the forest  
Learned their sacred songs of beauty  
And the animals of the prairies taught him  
Their love songs from long ago.**

**When he reached his peoples camp  
There on a hill above the lodges  
Beneath the moon and stars he played songs  
For the young woman he loved so dearly.**

**On the breeze notes softly floated  
To the ears of all the women  
All beheld the magic music  
All knew it was for young Calf Woman.**

**As she heard the floating melodies  
In her heart she knew who played them  
Remembered the young man in the willows  
Remembered the young man who had watched her.**

**He knew he was finally able  
To send his heart thoughts into her heart  
And under the moon and stars he stood there  
Playing the words I love and need you.**

**We the strongest of the Elk Tribe  
We who gave him songs of magic  
Walked away with hooves a clicking  
In our hearts we felt contented.**

**[Poems and Stories Menu](#)**

---

  1996 Victoria Dinsmore. E-mail: [ezra@midrivers.com](mailto:ezra@midrivers.com)

---



**[NativeTech Home Page](#)**

© 1996 *Tara Prindle.*

Native American Technology and Art



# **The Ghost Woman and Heavy Collar of the Bloods**

**By**

**Longtrail**

**Near the Old Manís River set the Blood Peopleís camp  
On the prairies where the winds always blow  
Heavy Collar and several braves of his people scouted round  
Traveling in coulees they preferred to stay low.**

**On one of their scoutings, several buffalo were sighted  
Heavy Collar, separated from his men, took a bull.  
As night drew near, he struck a fire, roasted tongue  
And feasted until he his stomach felt quite full.**

**He crept amongst bunches of long rye- grass  
To wait for the morning sun and hide  
Not aware of the pile of bones resting there  
That lay, coldly in the dark by his side.**

**In the moments between darkness and dawn  
When surroundings dimly take on their form  
His face turned to meet the skullís greeting smile  
Of a woman whoíd been killed there before.**

**He knew then why all the previous night  
He awoke nearly every hour  
He arose and walked away and left the cold bones  
Left their haunting and magical power.**



**During the next long dayís journey  
To the Belly River by a way of a stream  
He kept thinking of the bones on the ground  
At the place he had last seen his dreams.**

**As darkness came upon the land that night  
Legs weary from his trek all day  
He crossed over onto an island heíd found  
Where trees had floated to and lay.**

**In a fork of a tree he struck up a fire  
And turned his back to it to be warmed  
Not able to clear the bones from his head  
In his mind they seemed to take form.**

**The familiar sound of a lodge being dragged  
Across the dry and rocky ground  
Was coming closer to him from behind him somewhere  
In his heart he feared to look ëround.**

**Afraid to see what he felt there would be  
Afraid to know what was making the sound  
Afraid to confront the unknown thing  
Dragging towards him across the dry ground.**

**To his ears came the whistle of a simple drum song  
And before him on the log whitely shone  
A skeleton there sitting, put together complete  
From the womanís slumbering, cold bones.**

**Wrapped ëround her neck was a lodge coverís rope  
From her head smoke flaps extended left and right  
Behind her trailed the lodge coverís form  
Fading dimly into the darkness of night.**

**She sat there on the cottonwood log  
Swinging her legs to her whistling tune  
Her bones glowing bright from the fireís burning light  
And the light of the shining, full moon.**

**When Heavy Collar saw her skeleton there  
He felt his brave heart melt away**

**In fear and desperation he spoke to her saying  
"Oh ghost. please quickly from me go away"!**

**"Oh Ghost please won't you go from my sight  
I'm tired and in much need of rest."  
The ghost swung her legs in morbid delight  
At being his uninvited guest.**

**In fright, Heavy Collar reached for his rifle and shot  
The skeleton screamed and fell from his sight  
His confidence restored and relived of the fear  
He thought he had killed her that night.**

**"You dog, You killed me"! she screamed  
I will follow you all of your life  
Until you too are cold bones and lay dead on the ground  
There is no place that you can hide.**

**Heavy Collar sprang to his feet then  
And swiftly fled into the night  
Her ghostly words screamed in his head as he ran  
"My death threats will soon be made right"!**

**It mattered not how far he ran  
For when he'd catch his breath and rest  
"Oh Heavy Collar!" he would hear through the night  
And off he would run again fast.**

**His friends awaited their Chief's return  
Waiting atop the Belly River buttes  
In the distance he was sighted coming towards camp  
In the distance they saw there were two.**

**"From the distance comes our Chief"! they said  
"He brings someone with him today.  
It's a woman traveling with him we see.  
From him we shall steal her away!"**

**They guessed he had captured her somewhere  
Another woman for the cold prairie nights  
They joked as the two came closer to them  
Came clearer into their sight.**

**Between the travelers and the men watching  
A coulee north and south deeply ran  
Into the coulee went their chief and the woman  
And out of the coulee came only a man.**

**When he arrived in camp they laughed  
"Where is your woman companion?" they said  
"I do not know who you speak of" said he  
And in confusion he shook his tired head**

**"We saw the woman walking with you  
You have hidden her in the ravine  
You were afraid to bring her to camp today  
Afraid that she would be seen!"**

**"I think you are all crazy  
You have not seen what you have said!"  
Then with a heavy heart he remembered  
What the bones of the Ghost Woman said.**

**"Where ever you hide I will find you  
Because of you I am dead once again  
When ever you think you've alluded me  
My song of death I will send!"**

**He then told the men his story  
Of the night he spent on the ground  
Laying near the cold bones that had chased him  
Of the dragging, frightening sound.**

**Of the drum song she whistled to him  
Of the things that she had said  
The way her presence kept him from resting  
And of the rattling sounds in his head.**

**"Tell us our Chief, why do you lie to us?  
We know she waits in the ravine.  
We will go down there and bring her here  
We know what we have seen.**

**Together they walked to the coulee below**



**And there the soft dirt did prove  
One set of tracks going in and one coming out  
Their Chief had been telling the truth.**

**They returned to their camp, there were feasts being held  
The moon was shining so bright  
When inside the Chief's head, the Ghost Woman said  
"You will die by my hand tonight!"**

**Out of some pines there came a great bear  
It stood in the light of the moon  
The Chief searched for a rock to throw at the beast  
But for a weapon found only a bone.**

**Injured, the bear came towards him and said  
"Heavy Collar you have already killed me once  
Now you've hit me and hurt me and so you will die  
Tonight you will be the meat of my hunt!"**

**He knew it was her by the words that she spoke  
To his lodge he turned and he ran.  
"My People, the ghost bear is here, come and hide in my lodge  
We will fight her off if we can!"**

**All the people in camp squeezed into his lodge  
All his people, the young and the old.  
The wind from the west carried smoke out the top  
And the bear move the lodge's smoke- flap poles.**

**Huddled inside much afraid of the ghost woman bear  
They all could hear her say,  
"I will kill all you dogs! You dogs cowering inside  
None of you will live until day!"**

**"I will smoke you to death, I have moved the poles  
I have closed your lodge up tight  
The smoke will come down and kill all you dogs  
Death's revenge will become mine tonight!"**

**The lodge soon filled with choking, black smoke  
Women and children soon started to cry  
They all needed clean air but the ghost woman bear**

**Patiently waited to kill them outside.**

**Heavy Collar's old mother, a good woman was she  
Knew something had to be done  
"Have pity ghost bear! Go away from us here!"  
She pleaded for her people and son.**

**"No old woman I will not listen to you  
All of you must suffer together and die!"  
It is because of your chief that I'm here under the moon  
And the death of you all draws nigh!"**

**The old woman opened her medicine bundle  
Which held powers that were only hers  
She painted her face to bring inner strength  
Lit her pipe and said her death prayer.**

**"Ghost take pity on us choking in here  
Accept the smoke from my pipe and go away  
You were not asked here into our camp this night  
Let us live to dance another bright day!"**

**" I can not reach your pipe old woman  
Come out and bring it to my side  
Do not continue choking in there old woman  
Bring your pipe into the clear moonlight."**

**To save her people the old woman went  
Out of the smoky lodge that night  
She confronted there the ghost of the woman  
The bear standing in it's towering height.**

**The ghost began to back away  
The old woman could not help but go  
In fright she called to her people inside  
"Please save me from this bear woman ghost!"**

**Heavy Collar rushed out of the lodge for her  
He beckoned his people to follow  
With their arms joined and their hands held tight  
They held the old woman quite solid.**

**Suddenly the old woman let loose of her hold  
The chiefs mother lay on the ground, life gone  
Along with her in death went the ghost woman bear  
And the haunting of the ghost womanís song.**

**[Poems and Stories Menu](#)**

---

© 1996 Victoria Dinsmore. E-mail: [ezra@midrivers.com](mailto:ezra@midrivers.com)

---



**[NativeTech Home Page](#)**

© 1996 [Tara Prindle](#).



Native American Technology and Art



# Shin'in Times Beyond

By  
Longtrail

dedicated to Walt McCurdy and Kenesaw Jump

I am just a Pilgrim here, in the Shin'in Times Beyond,  
Recently arriving, so swiftly brought along.  
My Maker said " Try not to think about the valley through which you've passed,  
Theres nothing you can alter Son, cause your die has done been cast."

My Maker told me "Pilgrim, some of your friends are waiting here,  
They've pitched a lodge up for ya, and fetched ya up some gear.  
I hear they plan to take ya to the Rockies in the sky,  
To rendezvous with found brothers, and their arrival's drawing nigh."

He handed me an old parfleche that shone the hue of sky,  
With green of moss, upon I'd walked, in times of life gone by.  
Within the folds I found there, the skins I'd left behind,  
And the pouch my Love had made for me, my Love, so dear and kind.

Also in it were my moccasins I'd put aside, with holes, and seams undone,  
They were again so new, and felt like velvet when I put them on.  
My old capote once worn thread bare from years upon the ground,  
Was thick and red and warmed me so, as when it was first wrapped round.

I heard a thunder of hooves, whoops and hollers coming from behind,  
When I turned and beheld them all, old stories came to mind.  
All the mountain men I'd read of, the stories of their lives,  
All the places they had traveled, the fights they'd not survived.

**There were good friends among them, who had before me rode,  
Up that valley to the other side without their earthly load.  
To see them was a gift from God, for I had known them well,  
Tears of joy and happiness from our eyes so freely fell.**

**They jumped down from their horses and embraced me one by one,  
They looked into my eyes and said "We're glad to have you Son."  
They shook my hand and gave me hugs and said "Come on lets go!"  
We then rode off for Shin'in Times, in the mountains topped with snow.**

**When we arrived in camp that day, such a sight did greet my eyes,  
There set a camp of breathless beauty in those Rockies in the sky.  
The meadow they pitched my lodge in had a clear and running stream,  
Which sang of love and loyalty amongst our brethren.**

**We took the saddles off our horses and turned them out to graze,  
Then set back in the warm soft grass and spoke of by-gone days.  
They said it did their old hearts good to know they were remembered,  
By brothers still behind us, brothers missed, and brothers kindred.**

**As we talked beside our campfire, as the flame burned down so low,  
I realized it wasn't very different than it was a bit ago,  
When I was with my brothers, on the earth and on the ground,  
And "It don't get no better !" was often heard around.**

**The sky was just as blue and I beheld the green of trees,  
The water was a shimmering and the sweetness of the breeze,  
Was just like it used to be in the place I'd left behind  
When in unison we'd all say "No better can we find !"**

**Brothers, some day in the future when that horse is brought to you,  
The one who'll carry you up that valley, when your earthly life is through,  
Give him rein and spur him hard my friend, and ride him straight on through,  
Cause The Shin'in Times Beyond, and us, are waiting here for you.**

**[Poems and Stories Menu](#)**

---

© 1996 Victoria Dinsmore. E-mail: [ezra@midrivers.com](mailto:ezra@midrivers.com)

---



**[NativeTech Home Page](#)**

© 1996 **[Tara Prindle](#)**.

## Native American Technology and Art



# The Sun Dogs of Winter

By

Longtrail

**Last winter, in the time of Popping Trees, I left my home near the meeting place of the Big River (the Missouri) and the On-The-Far-Side Bear River (the Musselshell). I traveled south to the valley of the Elk River (Yellowstone) in order to do some trading for provisions with the people there.**

**It was the coldest part of the winter. It had been two winters since I had seen days as cold as that day. It was cloudy with somewhat of a breeze and an occasional hint of snow flurries. As I traveled south I couldn't help but fear the coldness of the coming night, and pray to make it safely to shelter before dark.**

**As I progressed along and many miles passed behind me, I began to think of stories about unusual natural occurrences here on the prairie. I remembered many conversations concerning Sun Dogs. I couldn't help but think how exciting it would be to see something I had never seen before, something I had never even seen a likeness of.**

**Sun Dogs had been described to me by locals as spots on either side of the sun. That was about it. In all my reading of Indian stories and legends, and more modern texts on atmospheric abnormalities, I had never seen or heard a description of anything that even came remotely close.**

**The grayness of the sky suddenly brightened in the east and as I looked toward that direction, I found myself in the company of the Sun and her two Sun Dogs!**

**The fact I had only moments before wondered about them made the sighting of them even more spectacular to behold. I stopped and was amazed by it. I will try my best to describe what I saw in less than the most grand scale in which I witnessed it. I don't even own an image- maker that would have done her and her dogs justice.**

**As I said, the sky was gray in color, the clouds seemed to all blend into one. There was a**



slight breeze with just a hint of snow flurries. When we think of rainbows, we imagine an arch which reaches far into the sky. Now imagine a rainbow in the shape of a sphere, with the same height, only sitting upon the ground. The sky on the outside of the rainbow sphere was still the same gray color but the sky inside the sphere was a darker, blue/ gray. In the middle of the darker sphere, and filtered almost enough to look directly at, was the sun. On a horizontal line with the sun, and on the opposite, outer side of the rainbow were the two Sun Dogs. They were much smaller in comparison, such as the difference between a cherry and a grapefruit. I gazed at it for several minutes before it began to fade.

I felt fortunate to have witnessed it, knowing it must have been such strong medicine for the Indian nations here on the plains. As far as I know this is the only place it occurs, perhaps I'm wrong. If anyone can direct me to information, legends etc. on Sun Dogs I would appreciate it very much. Send info to: Longtrail, HCR 67 box 11, Mosby, Montana 590588; or send E-mail to: [vdinsmore@mcn.net](mailto:vdinsmore@mcn.net)

[Poems and Stories Menu](#)

---

© 1996 Victoria Dinsmore. E-mail: [ezra@midrivers.com](mailto:ezra@midrivers.com)

---



[NativeTech Home Page](#)

© 1996 [Tara Prindle](#).

**Native American Technology and Art  
Essays on Native American Life and Relations With Non-Natives 1600-  
1850**

**by Longtrail Snowbird**

---

**Buffalo as a Food Source**

**Some Common and Not So Commonly Known Uses.**

**Greetings from the shores of the Dried Meat River, AKA, The Far Side Bear River and known by the whites as the Musselshell. The reason the Musselshell was called the Dried Meat River by the Blackfoot people is it was the last area which held free roaming herds of Buffalo. In the "gone days", the people would set camp near the river. They chose to be up on the flats to avoid bugs during the warmer seasons, and down in the valley amongst the cottonwoods and sheltered by the willows in the cooler seasons.**

**If you had been a free trapper who had married into one of the Indian bands of this area on the plains you would have witnessed, and surely participated in the on-going ritual of hunting, killing, butchering and preparation of buffalo meat for immediate eating as well as long term storage.**

**Life in the East, with its European influence, would have not prepared you for the delicacies of the people on the prairies. While in New England or Kentucky you might have eaten a roast duck or suckling pig, gray squirrel or venison, these items more than likely would have been prepared by gutting, cleaning, removal of legs and feet and then cooked in the proper, healthy manner to make the food palatable and pleasing to you.**

**On your first hunt and all subsequent hunts, and also depending on the**

**tribe you were with, you saw the butchering done by the men or women of the tribe. While the Blackfoot often considered the butchering a job for strength and dexterity of a man, other people recognized the chore as drudgery and assigned it to the women.**

**One man to comment on the butchering of the buffalo by women, was Father Louis Hennepin, a missionary. He observed in the 1600ís that women of the Miami tribe were more than able to handle the chore when he noted:**

**'These women are so lusty and strong, that they carry on their Back two or three hundred weight, besides their Children, and notwithstanding that Burthen (burden), they run as swiftly as any of our Soldiers with their Arms.í**

**As you, a, free trapper, participated or solely watched the goings of he would have seen the butchering become a tumult of activity, shouting, laughing quarreling and carrying on by all. All in a cloud of flies and often yellow jackets.**

**Raw morsels of the meat would have been snacked on while the butchering was taking place. You as a participant might have been offered raw liver, kidney, eyes, belly fat, testicles, parts of the stomach, marrow from leg bones, gristle from snouts, hoofs of unborn calves and tissue from the sack they had been in. Bile from the gall bladder was sprinkled on the meat and used as a condiment as we might use mustard. Word has it that bile did a lot for the taste of liver. Bile, liver and onions, anyone?**

**You might have bashed holes in the tops of skulls in order to scoop out the brains. Once the belly was slit open and the entrails removed hands reached in the cavity to drink the fresh warm blood. According to the Cree, the drinking of the blood would keep them from being perturbed by the sight of blood in battle. Teats were slashed off and warm milk**



**drank from them. The kidneys were desired by those who were ailing. All of this taking place without the benefit of a clean environment and water to wash hands and knives with.**

**John James Audubon once noted that after the killing of a buffalo by his party, the surrounding group of Indians asked for certain parts of the entrails, which they devoured with the greatest voracity. Audubon was intrigued.**

**This gluttony excited our curiosity, and being always willing to ascertain the quality of any sort of meat, we tasted some of this sort of tripe, and found it very good, although at first its appearance was rather revolting.**

**Blood was also drank just to quench the thirst. Often the chase of the herd lasted for hours and the hunters made their kill far from water. Often the gristle of the buffalo's snout served to quench the thirst. In areas where the hunting took place in an enemy's territory, it was not uncommon for entire meals to consist of raw meat in order to avoid detection by the smoke of a fire.**

**While most of the plains tribes relished the viscera, there were those who would not eat them. The Kootenai would throw away all the innards except for the prized heart. They held their neighbors, the Blackfoot in contempt for their eating of the liver.**

**With the butchering completed, the meat was distributed and you, as a part of the tribe, might have prepared the meat for transport by wrapping it in the hide of the animal and securing it on to your horse or travois. If the trip back to camp was not too terribly far, your horse was expected to be able to carry the skin and meat from a cow buffalo. Dogs with travois were expected to pull a quarter of the buffalo.**

**You, your wife and your adopted people would now head back to the**



**main camp to prepare the meat. Surrounding the butchering ground, just out of an arrow's reach, and awaiting your departure had been all sorts of scavengers who would quickly converge on the bones and scraps.**

**You and your people would celebrate. There would be cooking fires at every lodge and singing and laughter in the air. Large bones would be tossed into the fire to cook the marrow inside. Pits were dug inside the fire pit and whole calf's heads were placed inside to slow cook. Ribs and choice meat was cooked and the celebration lasted well into the night. Often several pounds of meat were eaten by each of the men.**

**On waking with a full stomach, and everyone in a joyful spirit, work would begin to cook, dry and in some instances cache the meat.**

**If the tribe intended to continue their search for other buffalo herds to add to their winter's meat supply, the meat from the day before was often cached then retrieved on their way back through the area. The techniques of the cache varied from tribe to tribe. Often the meat was simply placed between two hides in an out of the way place. Others dug pits and placed the wrapped meat inside. In winter a cave was dug into a snow bank. The caching of the meat was only a temporary means of storage.**

**Dehydration was the most popular means of long term storage. The meat was sliced thin, hung on scaffolds where streamers were placed and allowed to blow in the wind in an effort to keep wolves away.**

**While dried buffalo meat weighed only about one-sixth the amount of fresh meat, it was very bulky, somewhat like a bundle of tree bark. In rain or damp air it absorbs moisture, gaining weight as well as molding and decaying, often both. The jerky was often pounded, and dipped into melted fat to make chewing easier. The difficulties with jerky were eliminated with the development of pemmican.**

**While recipes varied then as much as today, the method of storage was most always the same, or close to it. The pulverized jerky and what ever else that was desired, was placed into buffalo rawhide bags about the size of a pillow case. Then hot melted marrow was poured in with the jerky and surrounded each particle of meat, then the end of the bag was sewn shut. Before the contents became hard from cooling, it was walked upon to flatten it to about six or seven inches. A single sack or ëpieceí weighed close to ninety pounds. It was ëpiecesí such as these that were traded at forts and trading posts. Shaped in the flat rectangles, they could be placed across small logs or rocks in order to be kept up off of the damp ground. In forts they could be stacked and stored similar to cordwood which conserved space in the often small, establishments.**

**It was figured that on an average, and as a result of individual tribesí recipes, each pound of pemmican was the same as three pounds of buffalo steak. The Blackfoot used far less fat and claimed that one pound of their pemmican contained the goodness of five pounds of fresh meat.**

**ëSummerí pemmican was lighter due to the dryness of the jerky used in its production . ëWinterí pemmican was heavier due to the difficulty in drying meat in the winter and the jerky having more moisture. ëBerryí pemmican had the addition of wild cherries, saskatoon or buffalo berries. While the addition of berries made the pemmican more palatable, they also increased the chance of spoilage.**

**The dried, pulverized meat, saturated in fat, sealed from the air and encased in its rawhide bag could last for many years, up to thirty had been reported. Not a better food could be found to carry along with you. No fire was needed to prepare it for eating, a small amount would go an awful long way and it could be eaten for weeks at a time in order to sustain energy and health. It could be stored for times of famine as successfully in Manitoba as it could in Texas.**



**One description of pemmican by a Scotsman was not so favorable:**

**"Take scrapings from the driest outside corner of a very stale piece of cold roast beef, add to it lumps of tallow rancid fat, then garnish all with long human hairs... and you have a fair imitation of common pemmican, though I should rather suppose it to be less nasty."**

**In 1810 a trader at a post in North Saskatchewan river remarked:**

**"Even the gluttonous French Canadian that devours eight pounds of fresh meat every day is contented with one and a half pounds per day. It would be an admirable provision for the Army and Navy." Now that your woman had prepared the winter<sup>1/4</sup>s meat supply for storage you could hunt for more, and eat as much fresh meat as possible, because fresh, was the preferred way to eat it and it was preferred rare. It did not have to be fresh to be enjoyed. Most Indians hung their meat until it began to decay. During spring break-up, rivers floated bloated carcasses down stream to waiting Indians who ate and enjoyed it in spite of the fact they had all the meat they needed. Yumm.**

**In most lodges you would have visited there was always soup cooking. In fact, soups were most popular because anything and everything was tossed into the boiling water. Broken bones were saved and used as a soup base because of the flavorful marrow. Bones were also laid beside the fire and turned occasionally, then split open for the cooked marrow. Before the availability of metal pots, a pit was dug, lined with a section of hide and water was kept boiling with heated rocks as was the technique with a paunch suspended on a tripod or some other frame.**

**While early travelers and trappers did not necessarily partake in all of the delicacies of the Plains, some were brave enough to try the customary meals set before them. George Catlin claimed that the taste of dog, beaver tails and buffalo tongues was pleasing. Others claimed that the hump was the best part. It was a strip of muscle from next to the spine. It was wrapped in a hide and pit-cooked for about twenty-four hours. Along the top of the hump was a layer of fatty tissue. This**

was known by the French name of depouille. It was about two inches thick and weighed from two to eleven pounds depending on the animal it was taken from. The Blackfoot dipped it in hot grease and suspended it from high up in their lodge where it became smoked and would keep indefinitely. It was also sometimes used as a sort of bread, with jerky between slices.

A favorite dish you may have tried in your village was boiled fetal buffalo calf. Thereís one for your recipe book ladies. According to a trader in 1868, the Gros Ventre prepared it thusly: " ... a young calf, before it is born, is considered the greatest delicate of all. When first eaten, early in the winter, it is never larger than a kitten, and gradually increases in size until near spring, when it becomes too large and coarse. The idea of eating such a barbarous dish was at first revolting, but afterward, when better able to appreciate these Indian luxuries, I found it very palatable, particularly the natural liquor or broth in which it was boiled; which, with the addition of salt and pepper made an excellent soup."

Blood soup was popular. It was boiled in the above mentioned fashion, or for large get togethers, the Blackfoot turned the gutted carcass onto its back and using the rib box for a container, and adding a bit of water, used the heated stone method to cook it. A Hidatsa woman related her recipe she had used on a hunt in 1870. For the base of the soup she retrieved the pool of blood which settles between the lungs and diaphragm, discarding clotted blood which is difficult to cook and often spoils the soup quickly. She poured one and a half to two gallons onto a container. Added one cup of water, one piece of buffalo marrow-fat the size of a large duck egg, and two handfuls of dried root or vegetable. Then brought it to a boil. In order to add a delightful flavor she stirred the concoction with a chokecherry sapling whose end had been fringed. To tell if the soup was ready she stripped the bark from a small twig and dipped it into the soup, if it came out clean and white, it was ready to serve. Blood pudding was made by adding small bits of meat to the



**cooked blood and stuffed into parts of intestine (Kishka?). The Crow called their version of this, "Crow-Indian-Guts."**

**You, as a member of your adopted tribe were, in for a whole new variety of meals. If you were repulsed by the content at first, you no doubt would have given in to trying most, if not all of these prairie gourmet dishes.**

**Further on the subject of pemmican: In World War II, the German soldiers were issued pemmican. When the idea of pemmican as a war ration was suggested to officials of the US military forces, the promoters argument for its use stated that it was a lightweight, compact emergency ration. Dietitians however analyzed it and ruled in 1942 that it wasn't wholesome, with most not liking the taste. Those in search of gold during the gold rush found it revolting. Oliver Hazard Peary, of North Pole fame, used pemmican on his arctic expeditions and stated it was the only food which could be eaten twice daily for a year and taste as good at the last bite as it did with the first. After a days long march he savored his half-pound ration of pemmican stating that " By the time I had finished the last morsel I would not have walked around the . . . igloo for anything . . .the St. Regis, the Blackstone or the Palace Hotel could have put before me." As with any food prepared, it will taste according to its means of preparation. Some experienced good pemmican while others, bad. Those who tasted it after eating modern foods all their lives usually found it to be rather too much. I have tasted pemmican and found it very rich. Only able to take a small portion at a time.**

**[Poems and Stories Menu](#)**

---

© 1996 Victoria Dinsmore. E-mail: [ezra@midrivers.com](mailto:ezra@midrivers.com)

---



**[NativeTech Home Page](#)**

© 1996 [Tara Prindle.](#)





## NativeTech: Native American Technology & Art



# A Message from Les Tate

---

I'm a retired federal worker who was born, raised, and still live in Alabama. I was a chemist and environmental specialist while working, my wife is a social worker, and both daughters are still (as of 2003) in college.

I first became interested in Indian issues about 1991 through the Native American organization in the agency that I worked for. Shortly after joining the organization as associate member (I didn't know about my Indian heritage at that time), I was appointed to work on their executive committee as newsletter editor. Based on that work, I was nominated and elected an officer in the organization in 1993 and remained an officer until my retirement in 2000. Shortly after retiring, I helped organize the Society of American Indian Government Employees (SAIGE), which is now a recognized non-profit national organization. Based on my work for SAIGE, I was given lifetime membership in the organization by its initial board of directors. I still serve as the moderator of SAIGE discussion list and also as moderator of the Indian Heritage List.

I first found out about my Indian heritage around 1995 during conversations with some elderly aunts and uncles. As far back as I can remember into my childhood, my parents never mentioned their Indian ancestry. It was only after my parents had died and I started working on my genealogy that I started asking questions. My mother's siblings told me their mother had told them about having Indian ancestors, but they didn't recall her discussing it in any detail. One younger (in her 70s) aunt said she recalled her grandmother telling stories about their Indian relatives, but remembered no details. My aunt did recall that when she was in grammar school the children were asked to stand and tell something about themselves at the beginning of the school year. She told me she had proudly stated "My daddy's from England and my mama's an Indian." When I mentioned my Indian ancestry to an aunt on my father's side after he and his siblings had all died, she told me that my dad's grandmother had told her about having Indian heritage. After several years of genealogy work, the only definite thing I know of the land of



origin of my ancestors is that my maternal grandfather came from England as a child. The rest of them are still in the U.S. as far back as I've yet been able to trace them. I have found no indication that any of them were recorded as being Indian, which is not unusual for southeastern Indian people. Many have only oral family history to go on. Despite this lack of documentation, a Cherokee man honored me a few years ago when he commented about me: "He may not yet have found his Indian ancestors, but they surely have found him."

I've been fortunate to meet personally or through the internet many Indian people. Some are full-bloods, some part-bloods, some I-have-only-family-story bloods. I've made many friends and learned many lessons.

A few years ago I went to the Qualla Boundary (the Eastern Cherokee-owned land that called a reservation, although it's not) with a friend who was born there. While there we went to his uncle and aunt's house. During our visit his uncle remarked "I'm only 25% Indian, but I'm 100% Cherokee!" This concepts resonates in the story "[Are You An Indian](#)" you'll find here at NativeTech.

An elderly full-blood Mohawk medicine man told me "Every drop of Indian blood is important. If I find a drop here and a drop there, pretty soon I have a whole bucketful." He also said "Being Indian is more in the brain than in the blood. It's not the 'heart' because that only pumps blood. Your brain is where your thoughts are."

If you have Indian blood and want to honor it, you have to find your own way to do it. The following lesson may help you. In talking with my Mohawk friend a couple of years ago, I asked him: "We hear sometimes about Indians having Original Instructions given to them by the Creator. What are they?" He replied without hesitation, "There is only one: 'Love one another.'" He has also told me "Don't ask for anything. The Creator knows what we need better than what we do. Be thankful with what you have and what you get. When you wake up in the morning, give thanks for being able to take another breath. When you go to bed, give thanks for another day. Look around you and give thanks for what you see at that particular time and season. Think about the Creator always and you will keep a peaceful mind."

I have a peaceful mind.

Les Tate



[Back to the Poetry and Stories Menu](#)

---

Text © 1998 - 2001 Les Tate. E-mail: <mailto:lrtate@comcast.net>

---



[NativeTech Home Page](#)

Web Design & Graphics © 1994 - 2002 [Tara Prindle](#).

# The Shelter

By

[Les Tate](#)



I stand silently beneath the pale sky  
Overlooking the widening valley before me.  
A footpath anchored in the roots of trees  
Leads downward along the gray sandstone hillside.  
The path follows the wall a short distance,  
Winding gently past tall old trees.  
In the rock ahead is a tall vaulted opening  
Falling gently away to the back and sides.  
Spirits of ages past call to me.  
The bluff shelter stands at the head of the valley,  
A natural cathedral echoing the sounds of the forest.  
I enter in awe,  
Wander quietly across the shadowed soil,  
Exploring places where my ancestors  
Worked and slept, laughed and loved.  
Near the center stands a large block of stone,  
A silent sentinel guarding the entrance,  
Its surface inscribed with symbols  
Of the sun, the snake, and the four directions.  
Nearby I sit on a rock,  
Its surface pitted from the breaking of nuts  
And the drip of water from the ceiling's edge.  
The firepit shows evidence of recent use.  
Perhaps by someone like me,  
A wanderer returning home.  
I close my eyes and imagine I can hear  
The sounds of old ones

**Talking about the past and the future,  
The men and women working at the day's chores  
While they watch their children and grandchildren  
Playing and laughing;  
Later sitting quietly and listening,  
Passing the history of our people  
From generation to generation,  
The old and the young together as a family, as a people,  
Their stories and songs now held in the creviced wall.  
I feel that I have been here before, that I belong,  
Part of the past, part of the present.  
A tear rolls down my cheek  
Joining the spring rains which have begun to fall.**

---

**[Return to Poems & Stories](#)**

---

© 1998-2001 **[Les Tate](#)**. E-mail: **[lrtate@comcast.net](mailto:lrtate@comcast.net)**

---



**Web Design and Graphics © 1994-2001 [Tara Prindle](#).**

# TIME WALKER TRILOGY

By

[Les Tate](#)



## *INTRODUCTION*

Each of us has deep within us, hidden in the recesses of our minds and our very being, vestigial memories of the Old Ones who walked this land long before us. To visit with them, you need only relax, close your eyes, quieten your soul and allow it to drift. Listen to the gentle sounds around you, for among them you can hear the footsteps and voices of your ancestors. The spirits which surround you may sometimes extend an invitation to come with them, to warm yourself by their fire, talk about the ancient ways, hear the legends and tales of the Original People, and join in their songs and dances of celebration and remembrance.

If you are privileged to walk back along the path of time to meet them and to pause there for an instant, hold on to the memories of the journey and value that which you learn, for the trips are repeated only for those who are at peace with themselves and in harmony with the world around them.

## **First Journey**

**I hold a shard of pottery and a flint point,  
Both made by ancestors of long ago;  
People clothed in woven fiber,  
Animal skin, and the feathers of an eagle.  
The shard is etched and painted,  
Perhaps the remnants of a forgotten legend.  
The point is thin and finely made, ready for hafting.  
Its keen edge is surprising, the balance good.  
The color of the stone shows it came from far away.  
I close my eyes for a moment, thinking back,**



**Remembering old ones now gone.**

**The shard and the stone warm my hand.**

**I feel the gentle touch of an ancestor's hand**

**Guiding my fingers across his/her ancient work.**

**It is not difficult to make. We will show you.**

**Grandfather has dark eyes,**

**Full of experience and wisdom.**

**Grandmother smiles at me, friendly and warm.**

**Welcome. Sit by the fire. Share our food.**

**It is a good life, we have much.**

**I need to learn much.**

**Smell the grass and trees,**

**The water and smoke.**

**Hear the children, animals, insects, and wind.**

**Feel with more than touch.**

**See with more than eyes.**

**Learn and understand with your mind and heart.**

**I need to learn more.**

**We will teach you, but that is enough for now.**

**It is better to fully understand a few words**

**Than half understand many words.**

**May I sit by your fire again?**

**I will bring a story about tomorrow.**

**Will you tell me, remind me, of things forgotten?**

## **Second Journey**

**Tonight we sing the old songs, remembering.**

**The flute is like the wind,**

**The drums like distant thunder,**

**Like buffalo on the prairie.**

**Voices blend together in song,**

**A blanket woven from eons of existence.**

**Smoke rises from the campfire into the sky.**

**This gathering is good,**

**Seeing old friends from distant homes,**

**Dancing to the chant and the drum.**

**But the ride here was long and I am tired.**

**I close my eyes and listen to the breeze**

**Whispering about the Old Ones.**

**The spring wind blows across the hill**

**Warming my spirit.**

**I think back to my childhood  
When we made the long trek to this place  
Where the grass is green and the water cool.  
Father Sun now watches the corn tassel.  
An eagle circles overhead.  
It is a good sign.  
My husband and son will return soon  
From their journey to trade for flaking stone,  
For shell and an eagle pipe.  
I continue working on the leather pouch  
My son will wear at the dance.  
The white buffalo looks almost real,  
Like the one I saw in my youth.  
A cloud covers the face of Father Sun,  
The shadow passing over me.  
As the sky darkens, I close my eyes,  
Remembering the gathering last year,  
Old friends returning with new stories  
To pass on to our children.  
The wind as it moves through the trees  
Is like the voices of the People singing as one.  
The end of the chant sounds.  
I open my eyes and rise.  
Tomorrow I will dance again  
Wearing the white buffalo pouch  
Inherited from my great-grandfather,  
Made by his great-grandmother.  
As I walk toward our tent,  
The night owl calls.  
Time to dream.**

## **Third Journey**

**I stand before the mountain  
Gazing at images scratched into the stone,  
Colored by traces of soot and dyes.  
The Old Ones left this record  
To be read and remembered  
By others who would come after.  
I reach out, gently touching the curves and lines,  
Feeling with curious fingers,  
Wondering who stood here before,**

**The painter of life, of time.  
I slowly pull my hand away,  
My fingers are stained  
By the colors of fresh paints  
Prepared from the plants and the earth.  
Beside me stands a man,  
Tall, bronze, and bare-chested,  
Painting this year's story upon the mountain.  
I gaze at some of the old images,  
Remembering the voice of my grandfather  
Telling the tales and legends of long ago.  
I give the painter another bowl, another color.  
Below is our village,  
The smoke of the fire and the sounds of life  
Rise on the wind to the Great Spirit.  
The People prepare for the celebration of harvest,  
Thankful for Mother Earth and Father Sun,  
For full bellies and children who laugh,  
For the gathering, the song, and the dance.  
The drawing is finished, another year recorded  
We silently gather the brushes and paints,  
Then together start down the trail,  
We stop and turn to look once again  
At the many drawings on this monument,  
The history of the People in a sacred place.  
The man turns his head and speaks,  
His eyes on me as one well trusted,  
His voice familiar and reassuring,  
Are you ready, my brother?  
I nod and we turn again to the trail.  
The wind stirs my hair,  
The sound of a voice lingering in my mind,  
Perhaps it was merely the wind  
Playing among the rocks.  
I gaze at the stone wall before me  
At ancient paintings and petroglyphs.  
The watchful spirits of my relatives surround me.  
I am honored to be one in a long line  
That reaches from ancient past to distant future.  
The wind stirs again,  
Bringing the smell of wood smoke  
And the voices of family and friends.  
I remember and I understand;**

**Tonight I live again.**

---

[Return to Poems & Stories](#)

---

© 1998-2001 [Les Tate](#). E-mail: [lrtate@comcast.net](mailto:lrtate@comcast.net)

---



Web Design and Graphics © 1994-2001 [Tara Prindle](#).





## ARE YOU AN INDIAN?

By

[Les Tate](#)

11/18/96

*How often have you heard or said "I'm part Indian"? If you have, then some Native American elders have something to teach you. A very touching example was told by a physician from Oregon who discovered as an adult that he was Indian. This is his story. Listen well:*

**Some twenty or more years ago while serving the Mono and Chukchase and Chownumnee communities in the Sierra Nevada, I was asked to make a housecall on a Mono elder. She was 81 years old and had developed pneumonia after falling on frozen snow while bucking up some firewood.**

**I was surprised that she had asked for me to come since she had always avoided anything to do with the services provided through the local agencies. However it seemed that she had decided I might be alright because I had helped her grandson through some difficult times earlier and had been studying Mono language with the 2nd graders at North Fork School.**

**She greeted me from inside her house with a Mana' hu, directing me into her bedroom with the sound of her voice. She was not willing to go to the hospital like her family had pleaded, but was determined to stay in her own place and wanted me to help her using herbs that she knew and trusted but was too weak to do alone. I had learned to use about a dozen native medicinal plants by that time, but was inexperienced in using herbs in a life or death situation. She eased my fears with her kind eyes and gentle voice. I stayed with her for the next two days, treating her with herbal medicine (and some vitamin C that she agreed to accept).**

**She made it through and we became friends. One evening several years later, she asked me if I knew my elders. I told her that I was half Canadian and half Appalachian from**



**Kentucky. I told her that my Appalachian grandfather was raised by his Cherokee mother but nobody had ever talked much about that and I didn't want anyone to think that I was pretending to be an Indian. I was uncomfortable saying I was part Indian and never brought it up in normal conversation.**

**"What! You're part Indian?" she said. "I wonder, would you point to the part of yourself that's Indian. Show me what part you mean."**

**I felt quite foolish and troubled by what she said, so I stammered out something to the effect that I didn't understand what she meant. Thankfully the conversation stopped at that point. I finished bringing in several days worth of firewood for her, finished the yerba santa tea she had made for me and went home still thinking about her words.**

**Some weeks later we met in the grocery store in town and she looked down at one of my feet and said, "I wonder if that foot is an Indian foot. Or maybe it's your left ear. Have you figured it out yet?"**

**I laughed out loud, blushing and stammering like a little kid. When I got outside after shopping, she was standing beside my pick-up, smiling and laughing. "You know" she said, "you either are or you aren't. No such thing as part Indian. It's how your heart lives in the world, how you carry yourself. I knew before I asked you. Nobody told me. Now don't let me hear you say you are part Indian anymore."**

**She died last year, but I would like her to know that I've heeded her words. And I've come to think that what she did for me was a teaching that the old ones tell people like me, because others have told me that a Native American elder also said almost the same thing to them. I know her wisdom helped me to learn who I was that day and her words have echoed in my memory ever since. And because of her, I am no longer part Indian,**

**I  
am  
Indian.**

---

**[Return to Poems & Stories](#)**

---

© 1998-2001 **[Les Tate](#)**. E-mail: **[lrtate@comcast.net](mailto:lrtate@comcast.net)**



*Image credit "Gay Head Indians", reprinted photograph by 'Vineyard Images', Edgartown, MA.*

---



[NativeTech Home Page](#)

Web Design & Graphics © 1994-2001 [Tara Prindle](#).



## A Message from T. W. Martindale

### *Sagwu Usdi*

---

Osiyo Brothers & Sisters.....

I am T. W. Martindale, daughter of Yona and Oginali, and the mother of two fine sons. I was born in Montgomery, Alabama, but have lived the majority of my life in Tennessee. I am also known as Sagwu Usdi and proud to say I am Cherokee by blood.

I have always been interested in the Cherokee heritage in my family since I was a small child. My father had been doing some research on his family off and on for a few years when I began assisting him.

During my research, I began to "toy" with my very first poem "Quiet Companion" in my mind. Since my Cherokee blood was not so readily accepted by my former spouse, many times I felt so alone. So as I lay awake one night with tears on my face, the piece "Quiet Companion" came to life.

It was shortly after that time that other ideas came to me. Thoughts of my ancestors who had suffered indescribable hardships and abuse flowed from my head to my heart. I then knew that I must write as a tribute to them and bring them back to life!

So, it is to all the family that came before me who I give all the honor and love that I can possibly bestow upon them and in the only way I know how. To them..... For them..... I will write.

I hope many who read that which I write may be truly blessed by what they read. May internal light and healing be yours.

T.W. Martindale

---



[Back to the Poetry and Stories Menu](#)

---

Text © 1998-2002 T. W. Martindale. E-mail: [clueless1812@hotmail.com](mailto:clueless1812@hotmail.com)

---



[NativeTech Home Page](#)

Web Design & Graphics © 1994 - 2002 [Tara Prindle](#).

# Season Of Cheer

By



**T.W. Martindale**

*Sagwu Usdi*

**December 1998**

**Christmas is called the season of cheer, but for many it still remains anything but that. This is the time of year many celebrate God's goodness and love to all, but to others.... It reminds them of a time when all that they loved and held dear was torn from them.**

**You.... a people from other lands came to this land searching for freedom and peace. With no means of survival, we became teacher to you. We saw your people.... women, children, and the aged starving, and cold.**

**Food and blankets, we shared with you. What knowledge we had, we shared with you. You learned how to plant, sow, and hunt. We taught you how to survive.**

**You shared with us too, but.... your gifts, we could have better survived without. The gifts you bore were greed, selfishness, and contempt for your fellow man. But those are not the worst of gifts born by you.... the intruders.**

**The one whom you called "God", you brought to us. He was called a God of justice, mercy, love, and peace. With your mouths, you taught He loved everyone, but.... your actions did not reflect the words you spoke. Harshness was returned for kindness... hatred for love... war for peace... and death for life.**

**I know God. We call Him the Great Spirit. He is all the things that you taught that He is. But there is one variation between what I know and what you say you know. I know that I must live what I teach to others before they will believe and embrace it.**

**“Peace on earth good will toward men”. This is what God offered to all mankind. He sent his only Son for the redemption of all. But have those of you, who call yourselves His children, conducted your lives in a manner of this precious Gift of redemption and peace? I hardly think it so.**

**So very few lived.... or live now as we should. Not just this season.... but all seasons should be treated as He meant for them to be. Now is always the time for caring, helping, loving, and healing. All must do this for there to be true “Peace On Earth, Good Will Toward Men!**

**Let It Begin With Me,**

**T.W. Martindale  
(Sagwu Usdi)**

**[Poems and Stories Menu](#)**

---

**Text © 1998 [T. W. Martindale](#). E-mail: [clueless1812@hotmail.com](mailto:clueless1812@hotmail.com)**

---



**[NativeTech Home Page](#)**

**Web Design & Graphics © 1998 [Tara Prindle](#).**



## NativeTech: Native American Technology and Art ~ Poems & Stories

---

**I wrote this piece especially for my father. He had gone to a store and picked up a book about the Trail of Tears. As he was browsing through it, he began to cry. It was difficult for him to hold back the tears as he read about trials, tribulations, and heartaches of everyone that lived so long ago.**

**He told me about his tears and had asked me to write a poem about "Why Yonah Cried".**

**As I was writing, I thought about the reason for his tears. They were selfless tears shed for the injustices inflicted on others and for that reason the piece became Crystal Teardrops.....perfect, selfless tears shed for others.**



**Julia Ann Martindale Wilburn**

## **Crystal Tear Drops**

**By**

**T.W. Martindale**

*Sagwu Usdi*

**March 1st, 1998**

**What do you, if I may ask, worry about in your "perfect" little world?  
Grant me the pleasure of knowing this one thing...  
Is it for the safety of your family that you yearn?  
Or is it your wish to possess that which you do not, but others have?**

**Come travel with me on a journey through another one's mind...  
Become one with me as I ponder the reason Yonah cried.  
Can you open your heart to receive the unknown?  
Or are you afraid of it... Afraid to see the person you really are?**

**Come and see... Hear the man, Yonah, as he cries.  
Feel with me the heartache he feels for the pain of others from long ago.  
IF you feel at all, you will feel as I feel.  
Our spirits are ages past due for a release of feeling for others and our uncaring ways.**

**In his hand, he holds a book... One he hopes will lead him home.  
He is on a quest for his family and a people long ago.  
As he reads, he begins to cry... But... Why?  
Others walk by and see his tears... Tears of sorrow, which can not be contained.**

**Those passing by can not understand these tears...  
The tears he sheds are crystal clear, for they are pure of heart.  
They are shed in sadness for loved ones he has found.  
Shed not only for them, but those that they knew.**

**Yonah is in search of his family but... See what he has found.  
He sees The Trail Of Tears shed by his family and those of their friends!  
In his mind, he has walked with them hand in hand.  
He has run with them for eternity, it seems, from those who oppressed and murdered them.**

**Have you yet to understand the reason for his tears?  
Or are his thoughts so different from yours that you do not see?  
Little does one understand the mind of another who is unlike them.  
Many are those unwilling to identify with those who dare to be different.**

**I feel for each and every people who are or have ever been.  
Do you care for others and the injustices they have born?  
Are you able to cry with those who cry?  
Have you ever cried for those who cried?**

**We need to learn to cry for those who longed to be free...  
Reach into your soul for the crystal tears you have long forgotten.  
These are perfect drops, like Yonah's, and shed because of the cruelty of man.  
Those who cried before him are the reason for the Crystal Tear Drops that Yonah shed.**

**[Poems and Stories Menu](#)**

---

**Text & Graphics © 1998 [T. W. Martindale](#). E-mail: [clueless1812@hotmail.com](mailto:clueless1812@hotmail.com)**

---



**[NativeTech Home Page](#)**

**Web Design © 1998 [Tara Prindle](#).**





## For Those Who Cried

By

**T.W. Martindale**  
*Sagwu Usdi*

**Listen to the lulling sounds of the flute as it softly plays.  
Hear it and imagine the tranquility of life that our loved ones once knew.  
It was a land with a calm serenity.  
Come with me....Come to a land where each new day warmly embraces your soul.  
A land kissed by the morning dew, and streams sparkling with ripples stirred by the finger  
of God.  
Close your eyes and hear the sounds of silence.....  
A babbling brook...the rustling of leaves...the cry of the eagle, and soft beat of the drum.**

**As the sun kisses the night farewell, the younger men arise to greet the new day.  
Joining them are the older boys....For today they will learn how to hunt....and how to  
survive.  
They master their skills and learn to coexist with the untamed land they call home.  
This is not a time used for hunting and survival alone, but also a lesson to sharpen the senses.  
They acquire the prowess of the wolf and the keen sight of the eagle and hawk.  
Feel it as they savor a unique awareness and oneness with all creatures great and small.  
Close your eyes and feel the soft caress of the wind....FEEL the presence of the wolf, eagle,  
and hawk!**

**As we turn our focus toward the camp, we see the children as they laugh and play.**



**Mothers look up from their work and the young to which they tend.....  
They softly smile as they watch them frolic happily across the tender meadows.  
Speaking of family, and recounting stories once told them, the elders sit and tell of days gone by.  
As records are kept in diaries, they keep alive their memories and truths in the minds of their descendants.  
This is their past...Their present.... AND their future.  
Passed down from generation to generation, It is their life!**

**Theirs is a life not unlike the one we all desire.  
It is a full life filled with happiness, loving, laughter and contentment.  
They enjoy the soft, cool spring breeze....and feel the soothing warmth of the sun on their skin.  
Although the life they live is not entirely idyllic, it is their home.  
Yes....Look around and see....Even then, as now, they too dealt with sickness and pain.  
They too have loved ones that are ill and do what they must to restore health to the weak and frail.  
Just like you and I, they stay by the deathbeds of ones they love and mourn death when it comes.**

**They were and ARE just like all others, yet....Treated unlike ALL others.  
Strangers have come to their Native Land and to strip them of their homes, family, and dignity.  
They are so covetous of these wind kissed plains, cool flowing streams, and abundant wildlife.  
Having done everything....ANYTHING within their power to take what rightfully belongs to another.  
Sit and watch....Feel the pain as their families are torn apart...even murdered!  
They are forced into the harsh elements of nature as their homes are ruthlessly stolen from them.  
Yes.....All these things we sat and watched, yet did nothing to end this insanity.**

**All of these things happened in a land where we proudly boast of freedom and dignity of life for all.  
No one cared as these suffered and died cruel and unnecessary deaths as they tried to defend their homes.  
These are OUR families and the hurt they endured should deeply seer our souls!  
I do not hate. But I will always remember life as it should be..... Remember the sounds of silence.....  
A babbling brook...rustling leaves... the cry of the eagle, and the soft beat of the drum.**

**And I will listen...Listen to the lulling sounds of the flute as it still softly plays.....  
For those who cried.**

**[Poems and Stories Menu](#)**

---

**Text © 1998 [T. W. Martindale](#). E-mail: [clueless1812@hotmail.com](mailto:clueless1812@hotmail.com)**

---



**[NativeTech Home Page](#)**

**Web Design & Graphics © 1998 [Tara Prindle](#).**



## **Whispers In The Wind**

By

**T.W. Martindale**  
*Sagwu Usdi*

**Child's Paper Hand Cut-outs**  
made by Nancy Jane Martindale's found in the 1852 family bible.

**My thoughts are forever restless.... So endless....  
Echoing questions come rushing through my mind....  
They are questions that refuse to be silenced!  
So many in numbers.... Yet they linger unanswered.  
Many are the dreams that continue unfulfilled.  
Dreams that began so innocently.... But still....  
Perhaps a little selfish in nature.**

**A path seemingly for the purpose of self-fulfillment,  
Thinking to establish who this person is.... Such arrogance!  
In the search, my eyes have finally opened....  
They have opened to the significance of my journey.  
In my conceited mind, I thought I knew, but did not....  
It is of greater consequence than searching for one's self.  
Much greater.....For it is to seek out truth!!**

**The truth and nothing else will put my mind at rest.  
But this truth seems to be beyond my reach....  
For to reach the truth, I must find the past,  
And to find the past..... I must reach the truth.  
As my mind frantically grasps for it, I can feel it.... Hear it...**



**I hear truth whisper softly in the still of the night.  
It touches my face and down into my soul....**

**Its answering pleas are written in the wind.  
Yes, truth reaches out and soothes in a gentle caress....  
It speaks with the voices of loved ones long since past.  
I can hear many voices thought silenced long ago.  
Just as I...these too refuse to be silenced....  
They are the voices and shadows of families lost.  
Lost....Seeking to be found by kindred blood.**

**Listen to the voices as they echo in the night!  
Feel them as they are carried by the fingers of the wind....  
Hear the lonely sounds of their anguish and pain!  
They reach out in the dark silence of the night.  
Reaching out to me.....AND to you....  
Torn from their homes and loved ones.... They cry out!  
"Here we are.... Do you not feel our presence? Hear us!"**

**Yes....I hear them.... and you can too.  
Voices like whispers, will us to rest from our frenzied searching.  
As we frantically sift through endless information, they wait.  
Waiting.....Waiting to show us where the true journey lies....  
It is not merely a search for our OWN identities.  
Granted....this is a truth that one must seek, but not just so.  
We must reach into the past for those deserted and forgotten.**

**A journey that began as a search for me has changed directions.  
But No! It has not changed its course altogether!  
It has altered its path to become one with that of forgotten loved ones.**

**They have subtly merged their paths like a flowing mountain stream.  
They seek to be reunited with those of us, their kindred blood.  
Yes.... This too is what I truly wish!  
To finally find, not only me, but also all those I hold dear.**

**I have felt their sorrow AND their pain.**



**Where once they knew the freedom we so proudly boast,  
This same liberty was quickly and ruthlessly stolen!  
They cried out, but there was no one to hear and none who cared.  
Their freedom...Their lives...Even their dignity was torn apart!  
Even so.... This merciless massacre of human worth may still be mended.  
But not by apologies, nor by human platitudes can it be done.**

**This mending must be done by us...Their surviving descendants.  
Although the damage can not be totally repaired, we CAN ease their pain.**

**They call to us...As voices whispering in the wind, to bring them home.  
We must listen! We MUST...for upon us they rest their hopes.  
NOW is the time for us who love them to BRING THEM HOME!  
Their echoing pleas can be heard if we will only listen!  
Listen! Answer! Bring them home...and give them rest.**

**They gave up their lives for the ones they loved.  
And for these same people, we search our family ties.  
Yes...We too love them just as they loved before....  
Our endeavors to bring the past to the present prove this is true.  
Time for blind eyes to be opened no matter the tongue or nationality....  
We must bring them home and give them rest.  
We must listen.... Listen to the whispers in the wind.**

### [Poems and Stories Menu](#)

---

**Text & Graphics © 1998 [T. W. Martindale](#). E-mail: [clueless1812@hotmail.com](mailto:clueless1812@hotmail.com)**

---



[NativeTech Home Page](#)

**Web Design © 1998 [Tara Prindle](#).**



## Cry Freedom

By

**T.W. Martindale**  
*Sagwu Usdi*  
**1997**

**Freedom was a luxury once possessed by people native to this untamed land. These were a people created and placed here by Sovereign God Almighty.**

**Yet...With the arrival of others who sought freedom from a cruel land in which they lived, the peace, tranquility, and freedom possessed by the native people of this land was forced from them with gun in hand.**

**The new arrivals to this beautifully, peaceful home traveled here in search of freedom from oppression. Yet, their search for life and liberty deprived an innocent people of freedom and peace that was rightfully theirs.**

**These strangers. . .No. . .Intruders who came to this New World marched with muskets in hand and took by brute force the peace, happiness, and dignity of life from those native to this country.**

**Yes. . .The very possessions for which these newcomers sought were ruthlessly and without feeling of guilt forced from a peaceful and caring people so that they might proudly boast. . .and CRY FREEDOM !**

[Poems and Stories Menu](#)

---

Text © 1998 [T. W. Martindale](#). E-mail: [clueless1812@hotmail.com](mailto:clueless1812@hotmail.com)

Image Adapted from the painting "Discovery of the Hudson River" by Alfred Bierdstadt, 1874.

---



[NativeTech Home Page](#)

Web Design & Graphics © 1998 [Tara Prindle](#).





## Quiet Companion

By

**T.W. Martindale**  
*Sagwu Usdi*

**Gracefully and silently he moves through the night...the wolf.  
He is searching...but for what he does not know.**

**There is something...something special...uniquely HIS.  
It must be there – For it is just like him...alone.**

**He cries a woeful, lonesome cry.  
There is no answer...just the echo of his pleas into the night.**

**He cries, " Is someone there?  
Someone who cares? One like me...also alone? "**

**Silence....  
Listen! The silence roars!**

**Looking. Searching. Needing...  
A yearning need.**



**Stop! Look. Listen...**

**Yes. Yes...He hears it. His quiet companion.**

**It whispers in the darkness, " Here I am...Here I am.**

**Do you see me? Do - you - see - me? Remember me? "**

**Gently and softly it caresses his senses... " I am here.**

**Reach out to me. Sing to me. Feel me. Know me... Love me...**

**Yes...I too have need of you.**

**Remember me? Someone alone...just like you "**

**" Where? Where are you? ",**

**The lone wolf cries.**

**" Here. Let me caress your face...your soul.**

**Sing to me your soothing love song... and I will bathe you with my presence."**

**" Yes...Yes, I remember.**

**We are not alone...you and me...**

**And to you, I gladly sing my song of love and longing...**

**My friend... my lover...The Moon – My Quiet Companion "**

**[Poems and Stories Menu](#)**

---

**Text © 1998 [T. W. Martindale](#). E-mail: [clueless1812@hotmail.com](mailto:clueless1812@hotmail.com)**

**Wolf graphic Adapted from illustration by Rien Poortvliet in *Journey to the Ice Age* 1993.**

---



[NativeTech Home Page](#)

Web Design & Graphics © 1998 [Tara Prindle](#).

## Enter The Butterfly



By

**T.W. Martindale**  
*Sagwu Usdi*  
1998

**An insignificant creature am I...  
I've nothing to boast but that I exist.  
Thought quite unimportant, I can be more.  
Come... Look upon my pitiful form and you will see...**

**I am looked down upon and sneered at by some.  
Totally overlooked by others, I'm of no consequence at all.  
Oh, meaningless wretch that I am! This is my life.  
One day at a time, step by step, inch by inch...I WILL BE MORE!**

**Having so little to offer, but I offer ALL that I am.  
Asking what I have to give, I answer, "I give you me."  
Not much am I now, but someday... Somehow, I will be more.  
Watch me... Tend to me... Nurture me, and you will see!**

**Slowly, but surely... A day at a time... I am changing.  
I feel the growing pains come and retreat to my shell.  
All who have laughed me to scorn believe to have proven their opinion of me.  
But... Deep inside my haven, the metamorphosis begins...**

**Having withdrawn for but a while, I only wait...  
In the world I have cocooned about myself, I am growing...changing.  
Taking on the life of a recluse, I know not how long I must wait.  
But after the storm of mocking and scorn, I will emerge and....Enter The Butterfly!**



[Poems and Stories Menu](#)

---

Text © 1998 [T. W. Martindale](#). E-mail: [clueless1812@hotmail.com](mailto:clueless1812@hotmail.com)

---



[NativeTech Home Page](#)

Web Design & Graphics © 1998 [Tara Prindle](#).



## **Kiss The Wind**

**By**

**T.W. Martindale**  
*Sagwu Usdi*  
**1998**

**Perception is a wonderful thing...  
So unfortunate are we to be caught in a web of loneliness.  
Struggling in this uncaring snare, we yearn for a loving heart to call our own.  
Speak into the wind for it will carry our cries to the right ears.**

**Is there an escape?  
Perhaps, yes...If only in the recesses of our minds.  
Wait and listen...Hear the one searching for you.  
Reach out with your soul and touch another to embrace it ever so close.**

**Restless, empty hearts... Stand still!  
Listen to the sounds of silence as the wind softly kisses your skin.  
Reach out...Eyes closed...To touch another just like you.  
They too need one to trust...To share themselves...Not wanting to be alone.**

**Love is like the wind with many ways to go and so many stories yet to tell.  
Speak...Then listen...Someone is waiting to hear and answer your pleas.  
Open your arms to welcome the one calling for you.  
Like a kiss in the wind, they're feelings are there...Carried by and through the wind.**

**Answer the heart that is YOUR heart...  
They too are alone and have need of someone they can trust with their love.  
Reach out...Hear and FEEL them speaking to you!  
Softly, yet so loudly...Hear the voice say, "Just kiss the wind...For I AM HERE."**

[Poems and Stories Menu](#)

---

Text © 1998 [T. W. Martindale](#). E-mail: [clueless1812@hotmail.com](mailto:clueless1812@hotmail.com)

---



[NativeTech Home Page](#)

Web Design & Graphics © 1998 [Tara Prindle](#).





# Vapors

By

**T.W. Martindale**

*Sagwu Usdi*

4/2/98

**Life is but a vapor that soon fades away.  
We are born into this world with nothing at all.  
And our departure of this life will be as we came...  
Leaving us to wonder, "What IS the point of my existance?"**

**It must be for other lonely souls we touch each day.  
So many hurt just as we hurt AND feel as we feel.  
Though oft times we're preoccupied and seem not to have time...  
Touch them we must, with kind words and in deeds.**

**Many are they that wonder if they are worth anything at all.  
We leave them feeling as a mere convenience OR inconvenience,  
Just depending upon how our moods strike us each day...  
This is no way to treat one another... It just should not be!**

**So reach out to someone and show them you care.  
Leave each person you meet with the feelings of self worth.  
Be kind to one another while opportunity still waits...  
For life is a vapor that soon fades away.**

**[Poems and Stories Menu](#)**

---

**Text © 1998 [T. W. Martindale](#). E-mail: [clueless1812@hotmail.com](mailto:clueless1812@hotmail.com)**

---



[NativeTech Home Page](#)

Web Design & Graphics © 1998 [Tara Prindle](#).





## **A Message from Ted Wilburn** *Yonah Tsalagi*

---

My date of birth was November 30, 1933, Thanksgiving Day, sixty-five years ago this past November. My parents were Theodore Roosevelt Wilburn and Madeline Barbara McDonald Wilburn. Memphis Tennessee was my hometown until I retired and moved to Texas in 1995. From my youth I have known of my Indian ancestry - both parents having Cherokee blood. My daughter, Terri Muse, and I have been chasing our Cherokee roots for several years and until recently had not found any of my relatives' listed on the Dawes roll. Now we have found four blood relatives' names listed there - two for each of my parents. We are still working on our genealogy to determine that the names in the Dawes roll were my relatives. One sure record we do have is the paper cutout of the hands of Nancy Jane Martindale. It has been identified to me as a Cherokee symbolic record of my ancestors, the subject matter of my poem, Little Two-Hands, Talking, and My Cherokee Rosetta Stone.

Theodore (Ted) Carlton Wilburn  
Aka Yonah Tsalagi..

---

**[Back to the Poetry and Stories Menu](#)**

---

**Text © 1999-2000 Ted Wilburn. E-mail: [clueless1812@hotmail.com](mailto:clueless1812@hotmail.com)**

---





[NativeTech Home Page](#)

Web Design & Graphics © 1994 - 2002 [Tara Prindle](#).



## **Little Two-Hands, Talking**

By

**Ted Wilburn**  
**a.k.a.**  
***Yonah***

~~~~~  
Ode to Nancy Jane Martindale

~~~~~  
**A Cherokee speaks secrets  
from her final resting place**  
~~~~~

Nancy Jane, to me so dear

Many moons ago you lived, I hear.

The gloves you wore.... a little pair,

Were left for me with a lock of hair.

In our family bible.... Psalm thirty-five

I found your hands. They're alive.... Alive!

So carefully cut from paper with knife

They speak of you, my people, your life.

**Around the thumb and fingers and wrist,
The paper you cut and wrote a list.
Not a style that is so easily read,
But in "skin language" for us you said
Your Indian mother was Cherokee.
You speak in truth. I see.... I see!
Many things with Little Hands you tell
So honor our family I'll try to do well.
The way of the Cherokee for me was lost
In the passing of many moons, many frosts.
You tell about walking the Trail of Tears
With our family those dreadful years.
Written above Psalm 35, in my search I came
To find W. H. Haynes, a white man's name.**

**A reference to enemies who raise their hand
Against people who lived in peace in the land.
Long I had searched records in white man's lands,
Only to find what I needed was in your Little Hands,
How many you were and your status in life,
Your brothers, sisters, father, his wife.**

**The record you left me is a valuable treasure
So dear to my heart, has brought me much pleasure.
You left us a great legacy with your Little Hand
And I pass it on to Terri W. Martindale of our band.
To leave it with my daughter, I feel that I must
And praise the Great Spirit, the one I trust.
It surely was He who showed your secrets to me,
And led me to the one who could open them, I see.
I trust your sweet spirit has found eternal rest
With The Great Spirit forever in His Heavenly nest.**

REST IN PEACE

Nancy Jane Martindale
Date of birth - 27 July 1867
Date of death – unknown
Sister of Julia Ann Martindale
Daughter of James Martindale
and Julia Ann Page.
Aunt of T. R. Wilburn
Great-aunt of:
Ted Wilburn (this author)

**Genealogy as recorded in my:
NEW YORK AMERICAN BIBLE SOCIETY
1853 BIBLE**

[Poems and Stories Menu](#)

Text & Graphics © 1999 [Ted Wilburn](#). E-mail: clueless1812@hotmail.com



[NativeTech Home Page](#)

Web Design © 1999 [Tara Prindle](#).



MY CHEROKEE ROSETTA STONE

By

Ted Wilburn
a.k.a.
Yonah

From my youth, and for most of my sixty-five years, I have known of my Cherokee bloodline. I was born in the post depression year 1933. Growing up in a less than well-to-do community of South Memphis, Tennessee was not especially enjoyable. My granddaddy E. A. Wilburn, and dad's sister, Nancy, lived with us from my earliest remembrance until after I was about twenty years of age. On an average of about once a year my folks moved from one neighborhood to another, mostly in less than one square mile. As a child I couldn't understand why we moved so often. Looking back on our circumstances I think I now understand. The Indian traits were prevalent in my dad and his sister, especially her. Even then I didn't realize our often moves had anything to do with our Cherokee background. I remember a day when I was about fifteen that I asked my dad, granddaddy, and my aunt if we were Indians. They all confirmed that grandmother, Julia Ann Wilburn, was Cherokee. It's never been popular among white people to have Indian blood – if they knew you had it – and we were never popular in the neighborhoods where we lived.

That was fifty or more years ago. During the last ten years my daughter, Terri, and I have been searching library census records for some mention of any of my family being listed as Indian, all to no avail. What we have been able to learn is that record keeping was sloppy at best. We also learned that not all Indians were counted in Indian rolls, and that many Indians counted in the U.S. Census rolls were listed as white if they lived with white people and black if they lived with black people.

One important family relic I have is my 1853 bible with our genealogy records. They, written by my family more than a century ago, show my Page, Martindale, and Wilburn family members. These records too are somewhat sloppy, but they span one hundred

seventy-one years. The earliest birth record is that of James Martindale, born 27 November 1827. His wife, Julia Ann Page Martindale (my g-grandmother) was born 3 July 1831. Obviously the dates which are earlier than the date of the bible were either written from memory or copied from some other source. We were able to find Julia Page listed in the 1850 Lauderdale County, Alabama U.S. census record living with Josiah and Nancy Page, my g-g-grandparents, both of whom are identified as white and being illiterate. I feel certain that Josiah and Nancy were both Cherokee living as settlers, because (1) they were illiterate, and (2) my family told me they were Cherokee. Their daughter, the above-mentioned Julia Page (my g-grandmother) married the above-mentioned James Martindale (my g-grandfather) 18 November 1852, the year before this bible was issued. The marriage record shows Julia's maiden name was Page. Julia Page Martindale was Cherokee according to my dad and his dad and sister who lived with us, and James Martindale, her husband, was white.

Julia Ann Martindale (my grandmother) was born to James and Julia Page Martindale 27 September 1865. The picture I have of her taken in 1935 by my mother, Madeline B. Wilburn, shows that she was Indian as my dad, his dad, and dad's sister told me. My bible records also show that James and Julia Martindale had other children, one of whom was Nancy Jane Martindale.

The conclusive proof I have of my Cherokee bloodline is an artifact I found tucked away between the leaves of my bible. It is a paper cutout of a hand of Nancy Jane Martindale, my grandmother's sister which was cut from lined paper like a census form. This paper hand cutout is extremely decorated on both sides to give a right and left hand appearance. I have been aware of its presence since my mother (who outlived my dad by thirty years) handed my dad's family bible down to me about ten years ago. Only recently I began to suspect that the decorations were more than just to make it look pretty. Nancy Jane Martindale was born 27 July 1867, two years after Julia Ann Martindale, one hundred thirty-one years ago. So this paper hand cutout is about one hundred twenty-five years old.

Careful examination of Nancy's "hands" shows it was not cut with scissors, but with a very sharp knife or perhaps a straight razor. There are long slits in the palm area with a basket weave design worked into them. It's also adorned with rings, hearts, fingernails and a double-segmented line design across the right hand side at the wrist that looks like a fence or sidewalk, or railroad tracks. Apparently it was my g-grandmother, Julia Page Martindale, who made the cutout and applied the Cherokee symbols, and James Martindale, my g-grandfather who wrote Nancy Jane Martindale on the cutout. With my new IBM Aptiva computer and Internet service I started surfing the Indian web-sites for someone who could interpret what the decorations mean.

The first word of encouragement I received was from Dr. Steve Fabian, a professor of anthropology at North Central College in Naperville, IL. Dr. Fabian was very complimentary regarding my daughter's Indian related poetry at Tara Prindle's Native

Tech web-site as it went well with a Native Americans class he was teaching.
(<http://www.nativeweb.org><http://www.nativetech.org/poetry/index.html>)

The next word of encouragement came from Mr. Samuel Johnson, a Cherokee who lives in Fort Worth, Texas. Mr. Johnson sent me the following message:

"The patterns on the hands are definitely of a type used by the Cherokee People of long ago. However, these were also used by Huron, Iroquois and Delaware. All of the peoples I mentioned interrelated with the Cherokee regularly. Our name for ourselves is Una Yuwiyu.

To the hands. I believe that these are actually copies of something, maybe gloves, which were sent to Nancy. These bear the symbols commonly used by Cherokee Medicine People we called "Didahawowesgi" which means "Curer of them he/she". The person sending this gift is a half-blood. The mother is Cherokee and the father is probably white.

The left hand side of things is the father's side and the right hand is the mother's. This is further seen by the differences in the background colors. The giver of the gift wanted to do so during her lifetime as the fingertips are shown on both hands. Her husband is also still alive at the time these were started. The father is a minister of some sort and also a healer. The "ring" with the whiter space usually means a spirit man. Since he is white he was maybe a missionary. The dark band could show him as a healer also. The mother is what we'd call a midwife. The dark ring on the little finger shows that.

The symbol on the wrist of the right glove that looks like a railroad or fence is commonly used for a person who had walked the Trail of Tears. Apparently your ancestor or someone in her immediate family did this. Whoever made this is showing that the father had been married twice. These are what the 2 hearts on the left hand mean.

The mother had only been married once at the time these were done.

The person who made this had either three brothers and sisters or three sons and daughters. These are shown by the numbers of hearts on each hand. The four "hills" on the wrist of the left hand baffle me a bit. I believe that these are a prophecy symbol of some kind. The way they are done causes me to believe that whoever made them felt that their descendants would live as white for at least 4 generations.

I printed the picture and will see what others think about that.

All of my interpretations are based upon my being taught to "read skin" by my Cherokee grandfather."

In a subsequent memo Mr. Johnson made the following comments:

"If I left you with the impression that I was checking with the elders for additional information then I apologize. I was only asking them if my readings were correct and they agreed with me on them.

My family is from the Scraper area in northeast Oklahoma. This is a part of what we call the old Going-Snake area or district. My family moved to Dallas during the relocation times in the 50's. I have lived in this area since then other than when I was in the army and going to college.

I am a registered member of the Cherokee Nation of Oklahoma. There are 3 other groups today who call themselves Cherokee. Our word for ourselves is Una Yuwiya meaning something like Principal People. We call all other people Una Yuwuya meaning "others". The other Cherokee groups are the United Keetowah Band, also in Oklahoma, the Eastern Band of Cherokee Indians, in North Carolina, and the Northern Cherokee Nation of Missouri and Arkansas. The last is a state recognized band which I believe will be federally recognized in the near future.

I am not a full blood, my Certificate of Degree of Indian blood, CDIB, says that I am 5/16. My grandfather was a full blood and my mother's quantum is shown as 5/8. I actually have more than that as I also have some Creek, Choctaw and Chitimacha lines which are more remote.

I am NOT a member of any of these other tribes but know some of my relatives among them."

I am elated to have confirmation that my Cherokee bloodline is undeniable. My great-grandparents, James and Julia Ann Page Martindale, preserved it for me in symbolic form and in English on the paper hand cutout of their daughter, Nancy Jane Martindale, who was my great aunt and sister to my grandmother, Julia Ann Martindale Wilburn. This record of my Cherokee heritage has been preserved for me between the pages of my family bible for a period of approximately one hundred twenty-five years along with the birth and marriage records of my relatives. .

Recently on the Internet I found information concerning government agents in charge of taking the Indian censuses who fraudulently slipped their names and the names of their family members and friends into the records for the purpose of obtaining land. Those records are the official records where one must find a family member listed to qualify for tribal recognition. White men who had little interest in the Indians they were enrolling, (except for grabbing their land) produced those records. Considering that my Cherokee ancestors were illiterate and could not spell their names for the census takers, it must have been easy for them to write in their own names instead of the Indians standing before them. That being the case there are probably descendants of those vipers who spoke with forked tongues that meet the government standard for tribal recognition who have no Indian blood at all. Even though at the present time I haven't yet located a blood member on an Indian roll to qualify for tribal recognition, I have a more sure record of my Cherokee heritage

than any library record could provide. Information, for which I had long sought in public libraries and never found, was at my fingertips. It is recorded in two languages, Cherokee symbols and English in Nancy's "Hand." – My Cherokee Rosetta Stone.

[Poems and Stories Menu](#)

Text & Graphics © 1999 [Ted Wilburn](#). E-mail: clueless1812@hotmail.com



[NativeTech Home Page](#)

Web Design © 1999 [Tara Prindle](#).



Kiowa Family
The father's name is 'Hummingbird'

Faces In My Dreams

By

Ted Wilburn

a.k.a.

Yonah

**One by one I see your faces
as you walk through my sleep.
Men and women, boys and girls
walk a trail, long and steep.**

**As you pass you look at me
with sad faces and eyes that cry.
From your faces the color is gone.
I don't see a face that's dry.**

**For many moons you have come
time and again during the night.
It's always the same when you come,
always dark, never in the light.**

**Sometimes you are many,
and sometimes only a few.
You are telling me secrets.
I don't know what to do.**

**You started visiting my dreams
the day I found this arrow head.
I worked very hard that day
and you came after I went to bed.**

**Who am I that you should come to me
during the night as I try to sleep?
Why have you come to me and
into my dreams quietly creep?**

**Am I supposed to be someone who
can heal your hurts and dry your tears?
What can I do to soothe your pain
after all these many long years?**

**You seem to know more about me
than I know about myself today.
Am I supposed to work magic
and make your pain go away?**

**Now in my waking moments of time
I write about your visits to me
to tell others about you and
the things you want me to see.**

**Your sad faces I see and
feel in my heart your pain.
Many times you came before.
I know you will come again.**

**In that sweet by and by
after the end of my years
I will see you face to face.
No more Trail of Tears.**

[Return to NativeTech's Poems and Stories Menu](#)

Text & Graphics © 1999-2000 [Ted Wilburn](#). E-mail: clueless1812@hotmail.com



[NativeTech Home Page](#)

Web Design © 2000 [Tara Prindle](#).



Arko (Comanche)

Who are you?

By

Ted Wilburn

a.k.a.

Yonah

Who are you, visitor to my sleep?

You aren't my usual kind of dream!

Why are you here? What do you want?

Into this room of near reality I followed you

To ask, but you slipped away from me.

Where did you go? Why are you silent?

Where are you? Where did you go?

Oh, you're standing by the window.

Your form I see behind a long white drape.

But you I can not plainly see.

Over to where you stand, I walk.

**Through the drape I see your form.
On your shoulders I place my hands.
You turn and dash through the window.
Outside you turn again and look at me.
Your face is old, wrinkled, thin, and red.
Your clothes are old and tattered and torn.
They are buckskins and some kind of cloth.
You look like you've come a very long way.
Your appearance tells me you've had it bad.
As you leave I ask again, "Who are you?"
"Who?..." once more I ask as you look back
From behind a cover of black animal fur.
Saying "Who?" I wake myself up.
With you still on my mind I am now awake.
You seemed so real to my sight and my touch!
You are definitely not my usual kind of dream!
Who are you? I would really like to know.
My thoughts tell me you are the spirit of my
Cherokee ancestors who lived here long ago.
I have so many questions I want to ask you.**

Where did you come from? Where have you been?

Why did you come to me? Who are you?

Are you here to remind me to not forget

My Indian forefathers who lived here first?

Have you walked a very long trail?

You nod your head with tears in your eyes!

Oh, mercy! You walked the Trail of Tears!

As you walked did your tears run dry?

From the winter cold did you die?

On your walk were the soldiers brutal?

For you did they provide any food?

Did they feed your young?

Did they let you bury your dead?

Did you die at the end of the trail?

Or did you survive that last long walk?

Who are you?

[Return to NativeTech's Poems and Stories Menu](#)

Text & Graphics © 1999-2000 [Ted Wilburn](#). E-mail: clueless1812@hotmail.com



[NativeTech Home Page](#)

Web Design © 2000 [Tara Prindle.](#)

NativeTech: Native American Technology & Art



A Message from Edward Ivan Madahbee

My name is Edward Ivan Madahbee, I am a 2nd year accounting student at Confederation College in Thunder Bay. I am originally from the band of Sucker Creek, located on Manitoulin Island. I am also the office assistant for the Aboriginal Support Services, organized by Nehganeewin College of Indigenous Studies, located here at the Thunder Bay campus.

[Back to the Poems and Stories Menu](#)

Text © 2000-2000 Edward Ivan Madahbee. E-mail: wiiyas@hotmail.com



[NativeTech Home Page](#)

Web Design & Graphics © 1994-2002 [Tara Prindle](#).



Be Strong

By

[Edward Ivan Madahbee](#)

The creator has only created life

It is not his duty to show us the way

We must guide ourselves through life

To truly be accepted into his arms

We should not have to ask for favors

And he should not have to provide them

What we take from our mother earth

We must give back with respect and love

Until we are able to accept who we are

We will always suffer at our own fate

We have to create our own destiny

Or does destiny create us?

I have always loved writing and even tried writing a book when i was a teenager. I never had the

time to finish it though, now it's lost. The reason i wrote this poem is because i have had a hard life. I belong to a family of eight brothers and one sister. We were always poor and so many of them are caught up in the bad life. I wish I could help them, but they don't want it. I grew up afraid of what they might do and could do. They are abusive in every way, they hurt themselves mostly, others now and then, and there family members half the time. My mother is a saint, and even after all she has been through, she stills loves us dearly. When I write this poem I think of my mother.

[Return to the Poems and Stories Menu](#)

Text © 2000 - 2001 [Edward Ivan Madahbee](#). E-mail: wiiyas@hotmail.com

Image credit: "Woman with Blueberries", a 1971 watercolor by Patrik Des Jarlait (from the cover of "Chippewa Customs", Frances Densmore, 1979).



[NativeTech Home Page](#)

Web Design & Graphics © 1994-2001 [Tara Prindle](#).



The End?

By

Edward Ivan Madahbee

What is the end? The end of what?

Is our life real or a long and scary dream

Life is scary, the truth is even scarier

No one bothers to find the real truth

Afraid of what they might stumble upon

There are things that cannot be explained

And will never be, as for life after death

I am scared, who isn't scared of death

What awaits you after death, another life?

Or is it just darkness, you no longer exist

Despite my fear, I still believe in god

I will keep believing till the day I die

Hopefully god will forgive me for my sins

To accept me with open arms, to let me in

This is the end I hope for, to be with our father

I have always been scared of death, not knowing what is gonna happen afterwards. If you sit and think about it right now, what would you feel? I just hope I am not the only one who is scared of what happens to us. You only live once and I want to live my life to the end.

[Return to the Poems and Stories Menu](#)

Text © 2001 [Edward Ivan Madahbee](#). E-mail: wiiyas@hotmail.com

*Image credit: Illustration by David A. Johnson
(from the cover of "The Bear Walker" by Basil H. Johnston 1995).*



[NativeTech Home Page](#)

Web Design & Graphics © 1994-2001 [Tara Prindle](#).



'Twas the Night Before Ojibwe Christmas

By

[Tara Prindle](#)

**'Twas the night before Niibaa-anamaílegiizhigad, when all through the
wiigiwaam**

Not an awakaan was stirring, not even a waawaabiganoojiinh;

The moccasins were hung by the smoke hole with care,

In hopes that Miigiwe Miskwaa Gichi Inini soon would be there;

The abinoojiinhyag were nestled all snug in their nibaaganan,

While visions of ziinzibaakwad danced in their nishttigwaan;

And nimaama in her moshwens, and I in my makadewindibe,

Had just settled down for a long biiboon zhiibaangwashi,

.

When outside the wiigiwaam there arose such a clatter,

I sprang from the nibaagan to see what was the matter.

Away to the waasechigan I flew like inaabiwin,

**Tore open the shutters and threw up the gibiigaíiganiigin. The dibik-
giizis on the breast of onaaband**

Gave a shine like duct tape to objects zazagaamagad,

When, what to my wondering nishkiizhigoon should appear,

.

But a miniature toboggan, and eight tiny waawaaskeshi,

With a little old driver, so lively and wajepii,

I knew in a moment it must be Miigiwe Miskwaa Gichi Inini.

More rapid than migiziwag his coursers they came,

And he whistled, and biibaagi, and izhi-wiinde by name;

"Now, Bimibattoo! now, Niimi! now, Babaamishimo and Moozhikwe!

On, Anang! on Zaagi! on, Animikii and Wawaasese!

To the top of the porch! to the top of the wiigiwaam!

Now Bimibide! Ipide! Ombibidemagad!"

.

As dry leaves that before the wiindigoo fly,

When they meet with BIA, mount to the sky,

**So up to the apakwaan the coursers they flew,
With the tobaggon full of toys, and Miigiwe Miskwaa Gichi Inini too.**

And then, in a twinkling, I heard on the apakwaan

The prancing and pawing of each little inzid.

As I drew in my iniji, and was turning around,

Down the chimney Miigiwe Miskwaa Gichi Inini came with a bound.

.

He was dressed all in gipagawe, from his head to his foot,

And his clothes were all tarnished with bingwiand and soot;

A bundle of toys he mangiwane on his back,

And he looked like a adaawewinini just opening his pack.

His ishkiinzigoon -- how they twinkled! his inowan how merry!

His miskwanowan were like roses, his nose like a choke-cherry!

His droll little indoon was drawn up like a bow,

And the beard of his chin was as white as gichimookamaan;

.

The stump of a opwaagan he held tight in his wiibidaakaajiganan ,

And the smoke it encircled his head like a miskwaanzigan;

**He was full up on frybread with little round belly,
That shook, when he laughed like a wiigwaasinaagan of jelly.**

**He was chubby and wiinin, a right jolly old elf,
And I giimoodaapi when I saw him, in spite of myself;
A wink of his ishkiinzigoon and a twist of his mangindibe,
Soon gave me to know I had nothing to gotaaji;**

.

**He ojibwemo not a word, but went straight to his work,
And filled all the moccasins; then turned with a jerk,
And laying his ibinaakwaanininj aside of his nose,
And wewebikweni, up the smoke hole he rose;
He sprang to his toboggan, to his waawaaskeshi gave a whistle,
And away they all onjinizhimo like the down of a thistle.
But I heard him biibaagi, ere he drove out of sight,**

.

**"Happy Niibaa-anamaíegiizhigad to all,
And to all baamaapii."**

[Translation in English of
'Twas the Night Before Ojibwe Christmas](#)

[Return to the Poems and Stories Menu](#)

*Image credit: Photo close up of Ojibwe woman's leggings.
(from "Beads: Their Use By Upper Great Lakes Indians" exhibition produced by the Grand Rapids Public
Museum and the Cranbrook Academy of Art (1977/1981).*



[NativeTech Home Page](#)

Text & Web Design © 1994-2001 [Tara Prindle](#).



Anishinaabe and Ma'iingan (Original Man and Wolf)

By

[Tara Prindle](#)

My boyfriend, Brad, has Ojibwe heritage, and he *loves dogs (the samoyed being his favorite)... but I'll try to explain why he doesn't think a dogs place is in the dance circle at a Powwow.

Following his Ojibwe tradition Gichi Manito put Anishinaabe (Original Man or Winaboozhoo) down on the earth to name all the plants and animals. Anishinaabe, he noticed all the animals came in twos, yet he was all alone! So Gichi Manito listened, and sent someone down, the wolf, to be a companion to Anishinaabe as he traveled around, with wolf keeping him company, naming and learning about all the plants and animals. Gichi Manito told Anishinaabe and wolf that they would be like brothers, to visit all the places on the earth... which the two of them did, and through their long travels they did become close like brothers and also realized that they were like brothers as well to all the other plants and animals and depended on them.

When they finally finished their task of visiting all the places, they talked to Gichi Manito again and Gichi Manito told them both that from that day on they must go their separate ways, but that whatever would happen to one would also happen to the other. So Anishnaabe and Ma'iingan (wolf) obeyed and set off in their different directions.

And although Anishinaabe and Ma'iingan have their separate worlds now, you can surely see, what has happened to one, has also happened

to the other. Both have lost lands, both have been mistreated, misunderstood and hunted. But the other hand, both *have survived, mating for life and raising their families. Hopefully with this new millenium comes a better understanding of *both Anishnaabe and Ma'iingan.

Our Animoshag (dogs) come from the wolf, and dogs today are friends to us like wolf was to Anishinaabe, but since Gichi Manito separated the courses of man and wolf, they are not supposed to be around ceremony, unless it is one specifically for the dog.

Now the powwow isn't a 'ceremony' per-say, but there are sacred things *in the dance circle, eagle feathers and other parts of peoples regalia -- and that is why my boyfriend, according to what he was taught, feels uncomfortable about dogs running into the circle.

Anyway ... powwow season is around the corner, so visitors should remember if they would like to bring their furry companions, to have them leashed to prevent mishaps of running into the dance circle or jumping on peopleís dance clothing Ö but in the end, it does come down to the 'when at another's powwow, bite your tongue, and try not to make trouble with the powwow committee' *smile

You can read a longer version of this story in "The Mishomis Book; The Voice of the Ojibway" 1988, by Edward Benton-Banai (published by Indian Country Communications, Inc., Route2, Box 2900-A, Hayward, WI 54843

[Return to the Poems and Stories Menu](#)

*Image credit: That's Brad's baby Heidi at 9 mo's old, who he misses *very much.*



[NativeTech Home Page](#)

Text & Web Design © 1994-2002 [Tara Prindle](#).

Native American Technology and Art



Mr. Rock

as told by 'Thunder-God'

oh oh Lemmie think one up!

***think think think* OWWWWWWWWWWW**

**OK I got one
about this Rock**

**Ok there was this Rock
hes like all cranky
and he would like smash people who would make him made
but
this Rock dude had like some kick toosh regalia and stuff
and he was shelfish
and thought all the other forest animals sucked and he was all mighty
so he wouldn't let anyone even look at his treasures**

**So like... one day
There was like these three animal dudes
Mr. Deer
Mr. Raccoon
and Mr. Hawk
they really wanted to see Mr. Rocks stuff
so they tromp on over and they say "hey come on man..be cool..We wanna
see your stuff"
And Mr. Rock's like "yeah whatever get lost!"
Aww come on man...we wanna cheack your stuff out
So Mr. Rock got angry
Look... he said
I'm sick you you dorkweeds bothering me
You ain't gonna see nuthin
get lost**

And the animals were like... hey man... you could be a little nicer

**and Rock said ok... that's it... I'm gonna smash you!
So he tumbled over after em
but they got away
and Mr. Rock likes BAH!..And rolls back to his.Rug or whatever
and so Mr. Raccoon, Hawk and Deer are all hanging out in the bushes
and stuff
and Raccoons like
hey man... that dude's mean...
Yeah! said Deer
I got a plan says Hawk
You know that dude always sleeps
he like never gets insomnia
so what were gonna do is...
when he's all sleepin and stuff
we're gonna sneek over and we're gonna steal his stuff
Aw man thats un cool Said Deer!
Hey hey chill said Hawk it's all good... we're gonna return it
I mean it's just fer a day
So Deer and Raccoon are like... well ok man...
as long as we return it**

**So the three go to where Rock is
and he's all sleep and stuff
And... they sneek over and grab his stuff
Aww right! groovy! Said Raccoon we got his stuff! cool now we can show
it off to everyone!
So they began to sneek off
Suddenly!
Deer tripped!
(omg)
(poor Deer)
And Rock woke up
HEY wth!
HEY Get away!
Put my stuff down!
Screamed Rock!**

***and the animals began to run... they're like oh man! we better get lost
he's gonna smash us!
Woh said Hawk thats un cool! yer right lets get out of here
and they bolted off like a bat out of hell
and Rocks like HEY! YOU THIEVES
thats MINE**

MINE

MINE!!!!!!!!!!!!!!

And Rock began to quiver with rage and anger

And he started to roll!

And then he got faster

WOH! said Deer... That dudes catchin up!

I know!! said Hawk!

Hey you two can run and fly and stuff... but... like... I'm not that fast... ya know... being a Raccoon and all

Er..well bummer said Deer!

Hey I'll like pick you up if you need it said Hawk!

And Rock got faster

he was so mad and so full of rage and stuff that nuthin would stand in his way

so the animals ran to the forest hoping that maybe the trees would like stop Mr. Rock

But Rock just smashed though them

OH NO!

(screams)

***and the animals were running as fast as they could**

but like this Rock dude was really fast

then suddenly Deer tripped on a log

and Rock like smashed him flat!

Hawk and Raccoon looked back in horror

hey man this is uncoo said Hawk... U know what I gotta plan

What what said Raccoon

you run one way and i'll go another

I'm gonna take other there to that thar mountain

ok ok right on And Raccoon run the other way

And Rock went after Hawk

and Hawks all trying to get him more mad by clawing at him and stuff

and when the reach the mountain..Rocks so peed off that he flies off the edge

he was so blinded by his own rage he couldn't even see the cliff

and hes all falling

and he slams into the side of the cliff

and he suddenly breaks into 2s

then 3s

then.AAAAAAH!!!!!!!!!!... 4s!

and eventually by the time Rock hits the ground he was no bigger than a speck

**And Hawk came down
AHAHAHAHAH @ you Rock!
Looks whos little now!
And so Hawk flew off**

The End

**all animal relatives in this story were stunt animals
nun were hurt**

**Contributed by 'Thunder-God' (reprinted with permission)
from Native American Chat (Virtual Places on www.excite.com), Jan. 11, 2000**

(Thunder-God is Lakota, Creek and Cherokee, with Scotch Irish)

[Return to NativeTech's Poems and Stories Menu](#)

Text © 2000 Thunder-God.



[NativeTech Home Page](#)

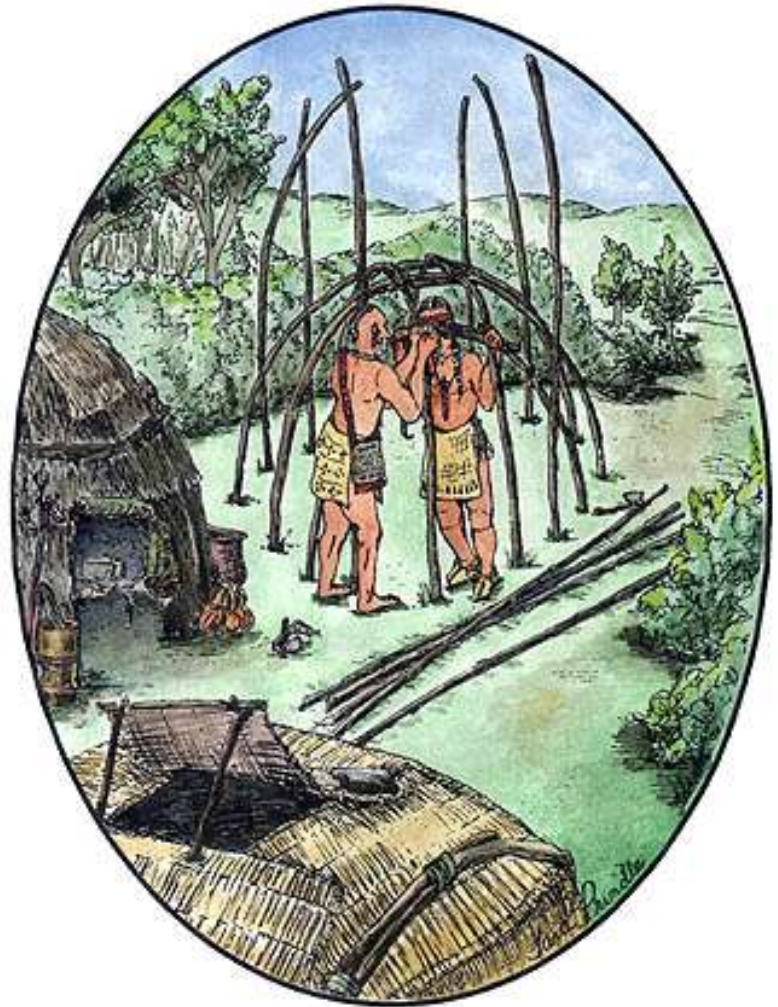
Graphics © 2000 [Tara Prindle.](#)

Scenes from the Eastern Woodlands

A Virtual Tour ~ Circa 1550

Where would you like to go?

- [At our homestead](#)
- [Building our wigwam](#)
- [Tending to our garden](#)
- [Making our stone tools](#)
- [Grinding our corn and nuts](#)
- [Catching fish in a net from our canoe](#)
- [Bathing ourselves at the stream](#)
- [Cooking our food we gather](#)
- [Working inside our wigwam](#)
- [Making our pots](#)
- [Playing our hoop and dart game](#)
- [Picking cherries for our bread](#)
- [Learning to shoot our arrows](#)



Building our wigwam ...

you will see the men bending flexible saplings over, and lashing them together with basswood bark, in a criss-crossing pattern to make the domed shaped frame of the houses. The saplings are sometimes birch or willow, straight and with few branches, and at least 14 feet long. The saplings are cut, trimmed and sharpened on the wide end with the metal axe that the men got in trading with Europeans who recently came here. These poles are then set into holes the ground in the pattern of a circle, and spaced about two feet apart. After the arches are lashed together, three or four sapling hoops will be put around the frame for further support. When the frame is done, the wigwams will be covered with sewn cattail mats (like the wigwam in the foreground), or with heavy sheets of elm bark (like the wigwam in the background). Spaces are left for a doorway (or two) and a smoke-hole at the top of each wigwam (to let out the smoke from the central fire inside). Doors and smoke-holes had adjustable mats fastened to them so they could be covered during rain or snow.

[Scenes available as Fine Art Note Cards](#)



Text and Graphics
© 1994 - 103 [Tara Prindle](#)
unless otherwise cited.

Scenes from the Eastern Woodlands

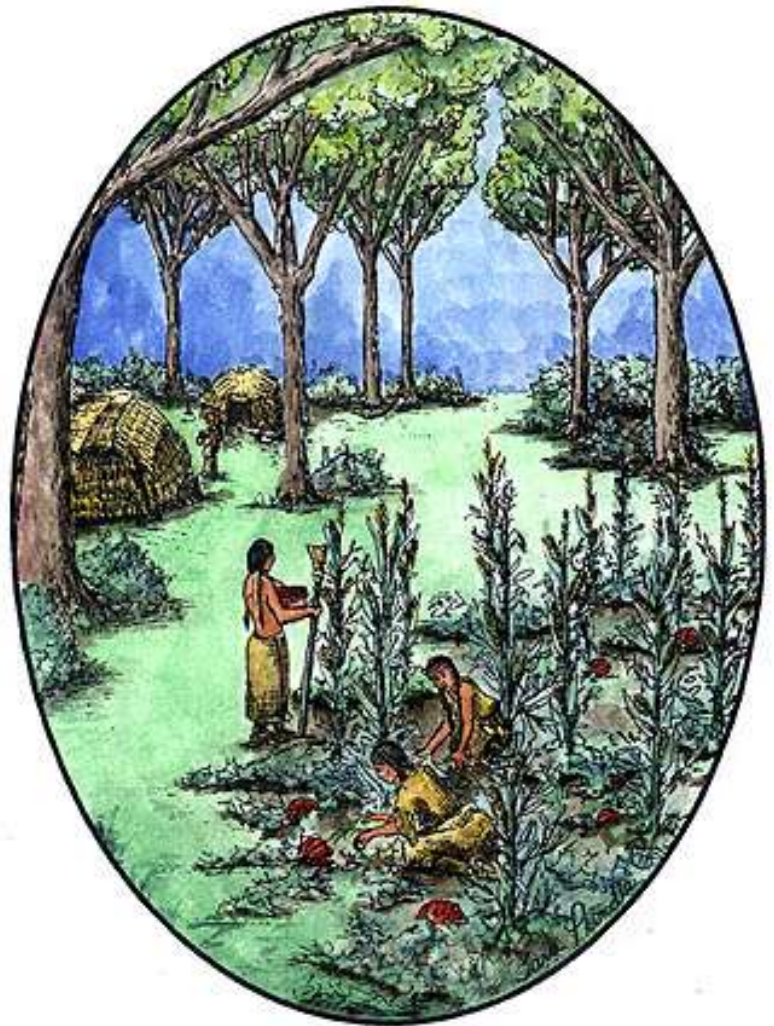
A Virtual Tour ~ Circa 1550

Where would you like to go?

- [At our homestead](#)
 - [Building our wigwam](#)
 - [Tending to our garden](#)
 - [Making our stone tools](#)
 - [Grinding our corn and nuts](#)
 - [Catching fish in a net from our canoe](#)
 - [Bathing ourselves at the stream](#)
 - [Cooking our food we gather](#)
 - [Working inside our wigwam](#)
 - [Making our pots](#)
 - [Playing our hoop and dart game](#)
 - [Picking cherries for our bread](#)
 - [Learning to shoot our arrows](#)
-

Tending to our garden ...

you will see how our corn and beans and squash all grow together. Our gardens are hoed into evenly spaced little heaped up mounds of earth, and sometimes we mix fish into the mounds to fertilize the earth. One woman holds a hoe made from a deer scapula (shoulder blade) fastened to a long wooden handle. A few corn kernels from last year are planted in the center of each mound, and then bean and squash seeds are planted around the corn kernels. As the corn stalk grows, the beans wind their way up around the cornstalk which supports them, and the low growing squash and pumpkin plants grow to spread out between the mounds. Our small gardens are always near our houses, so that we can tend them more easily. Recently some people have started living in larger villages and have built great palisaded forts around their villages to defend themselves against the Europeans -- and their gardens are like great fields, some distance away from their forts.



[Scenes available as Fine Art Note Cards](#)



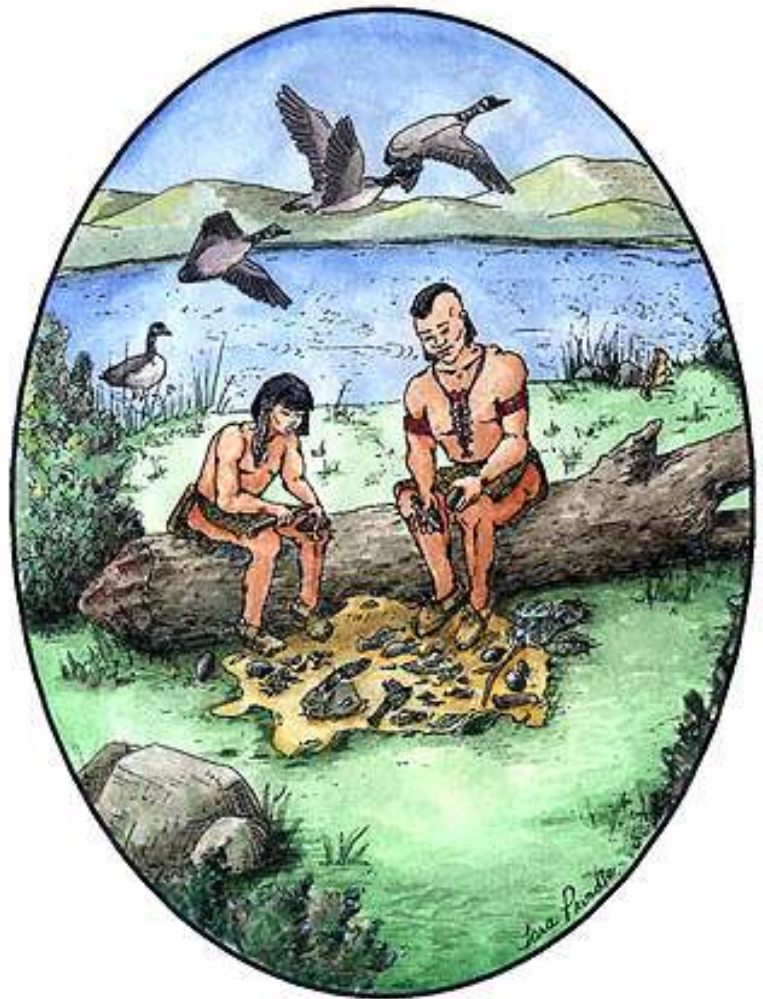
Text and Graphics
© 1994 - 103 [Tara Prindle](#)
unless otherwise cited.

Scenes from the Eastern Woodlands

A Virtual Tour ~ Circa 1550

Where would you like to go?

- [At our homestead](#)
- [Building our wigwam](#)
- [Tending to our garden](#)
- [Making our stone tools](#)
- [Grinding our corn and nuts](#)
- [Catching fish in a net from our canoe](#)
- [Bathing ourselves at the stream](#)
- [Cooking our food we gather](#)
- [Working inside our wigwam](#)
- [Making our pots](#)
- [Playing our hoop and dart game](#)
- [Picking cherries for our bread](#)
- [Learning to shoot our arrows](#)



[Scenes available as Fine Art Note Cards](#)

Making our stone tools ...

you will see us sitting on tree that a beaver has recently felled by the pond near our houses. Here we are chipping stone like nodules of flint and chert, or blocks of quartz and quartzite. We are lucky to have traded some beaver hides for some pieces of red jasper that some neighboring peoples obtained from other peoples who live far away and over the mountain range. We are using our river cobble hammer-stones to roughly chip out the shapes of our knives and arrow points and scraping tools. When we have the basic shape of our tool, then we use heavy moose antler billets to evenly flake around the edges. When the tool is nearly finished, then we use antler tines and pointed bones to pressure flake the tool so that it is perfect and sharp. Sometimes when a tool becomes dull from use, we need to resharpen the edges by chipping a new sharp edge. It is a shame when a fine tool has been resharpened so many times that it becomes too small to re-work again, but we can always go to the bedrock quarries or stream beds not too far from here to find new raw material.



Text and Graphics
© 1994 - 103 [Tara Prindle](#)
unless otherwise cited.

Scenes from the Eastern Woodlands

A Virtual Tour ~ Circa 1550

Where would you like to go?

- [At our homestead](#)
- [Building our wigwam](#)
- [Tending to our garden](#)
- [Making our stone tools](#)
- [Grinding our corn and nuts](#)
- [Catching fish in a net from our canoe](#)
- [Bathing ourselves at the stream](#)
- [Cooking our food we gather](#)
- [Working inside our wigwam](#)
- [Making our pots](#)
- [Playing our hoop and dart game](#)
- [Picking cherries for our bread](#)
- [Learning to shoot our arrows](#)



Grinding our corn and nuts ...

you will see how the women and older children make flour and grits and meal to use in for food. We grind the corn in large wooden mortars with long heavy stone pestles. Our wooden mortars are carved and hollowed out from hardwood logs. Some of our pestles have the shapes of animals or other things carved into the end we hold. We can tie the end of the pestle to the tip of a small sapling, and the spring in the bent over sapling makes it easier to pound the kernels in the mortar. We add our dried and parched cornmeal to many kinds of food, and the men carry little bags of the dried corn powder on their long trips, and it carries them a long way. There are many kinds of nuts to eat including acorns from the oak, beech nuts, chestnut, hickory nuts and walnuts. We can make flour from them for delicious nut breads, or we can grind them very fine to make a nut butter from them. We shell the nuts first by setting them on our nutting stone (a cobble with a little depression in it), and then we crack the nut open with another cobble. We grind the nuts into a flour by rolling a

[Scenes available as Fine Art Note Cards](#)

pestle over them in a shallow stone mortar.



Text and Graphics
© 1994 - 103 [Tara Prindle](#)
unless otherwise cited.

Scenes from the Eastern Woodlands

A Virtual Tour ~ Circa 1550

Where would you like to go?

- [At our homestead](#)
- [Building our wigwam](#)
- [Tending to our garden](#)
- [Making our stone tools](#)
- [Grinding our corn and nuts](#)
- [Catching fish in a net from our canoe](#)
- [Bathing ourselves at the stream](#)
- [Cooking our food we gather](#)
- [Working inside our wigwam](#)
- [Making our pots](#)
- [Playing our hoop and dart game](#)
- [Picking cherries for our bread](#)
- [Learning to shoot our arrows](#)



[Scenes available as Fine Art Note Cards](#)

Catching fish in a net from our canoe ...

you will see, coiled up in the center of the canoe, the strong fishing line made from the dogbane plant. We cast the line into the lake and catch trout and bass and other fish on the hooks we make from deer bone. Though fishing lines are fine and thin, they are so strong, that even the sea sturgeon fish which weigh over a hundred pounds can not break it. We catch the fish in strong nets woven onto carved wooden handles. We use special bone netting needles to weave these nets. Here we are fishing from our wooden dug-out canoe, that we made by burning out the center and chipping away the burned material, then burning out the center again, until it has the right thickness. We take care when we are burning out the center of the log for a canoe, and we pack wet mud along the top rim and sides of the canoe so that it does not burn too far into the wood. In the foreground, you can see cattail plants growing along the edge of the lake, that our women use to sew the mats to cover the wigwams.



Text and Graphics
© 1994 - 103 [Tara Prindle](#)
unless otherwise cited.

Scenes from the Eastern Woodlands

A Virtual Tour ~ Circa 1550

Where would you like to go?

- [At our homestead](#)
 - [Building our wigwam](#)
 - [Tending to our garden](#)
 - [Making our stone tools](#)
 - [Grinding our corn and nuts](#)
 - [Catching fish in a net from our canoe](#)
 - [Bathing ourselves at the stream](#)
 - [Cooking our food we gather](#)
 - [Working inside our wigwam](#)
 - [Making our pots](#)
 - [Playing our hoop and dart game](#)
 - [Picking cherries for our bread](#)
 - [Learning to shoot our arrows](#)
-

Bathing ourselves at the stream ...

you will see my mother and my other little sister. The rocks make a convenient place where the water is a little deeper, and you can see bullrush reeds (that we use to make our fine woven mats for the insides of our wigwams) growing in the shallow muddy areas on the shore. On the far bank are our moccasins, wrap-around skirts, and mother's tunic. The little sister sleeps in her elaborately carved and painted cradleboard, propped securely up against the rocks. We left our twined woven bags there on the far bank too, that we were using to gather some river plants for food and medicine.



[Scenes available as Fine Art Note Cards](#)



Text and Graphics
© 1994 - 103 [Tara Prindle](#)
unless otherwise cited.

Scenes from the Eastern Woodlands

A Virtual Tour ~ Circa 1550

Where would you like to go?

- [At our homestead](#)
- [Building our wigwam](#)
- [Tending to our garden](#)
- [Making our stone tools](#)
- [Grinding our corn and nuts](#)
- [Catching fish in a net from our canoe](#)
- [Bathing ourselves at the stream](#)
- [Cooking our food we gather](#)
- [Working inside our wigwam](#)
- [Making our pots](#)
- [Playing our hoop and dart game](#)
- [Picking cherries for our bread](#)
- [Learning to shoot our arrows](#)



Cooking our food we gather ...

you will see how we prepare our meals. The mother adds some things to a venison stew she will be cooking soon, and the son brings to her some wild onions he has just gathered. The fire has not been started yet, but after the dried corn (which hangs to the left of the wigwam door) has been added to the mixture, the clay pot will be suspended over the fire and the stew will simmer slowly for hours. To the stew she will add some of the maple sugar in the birchbark makak container behind the hearth. The woman will use the long wooden paddle to stir the stew occasionally, and when it is finally done, she will serve the food in the birch bark dishes which sit on the woven mat in front of the hearth, using the carved wooden ladle which sits now in the other clay pot to the left. The meal will feed all of us, brothers and sisters, parents and grandparents, and my two unmarried aunts who helped prepare the food.

[Scenes available as Fine Art Note Cards](#)



Text and Graphics
© 1994 - 103 [Tara Prindle](#)
unless otherwise cited.

Scenes from the Eastern Woodlands

A Virtual Tour ~ Circa 1550

Where would you like to go?

- [At our homestead](#)
- [Building our wigwam](#)
- [Tending to our garden](#)
- [Making our stone tools](#)
- [Grinding our corn and nuts](#)
- [Catching fish in a net from our canoe](#)
- [Bathing ourselves at the stream](#)
- [Cooking our food we gather](#)
- [Working inside our wigwam](#)
- [Making our pots](#)
- [Playing our hoop and dart game](#)
- [Picking cherries for our bread](#)
- [Learning to shoot our arrows](#)



Working inside our wigwam ...

you will see where we sleep and store much of our necessary things. Father is putting the feathers on some arrows for fletching to make them fly well, and mother is preparing some food. We have sleeping platforms made from strong hardwood branches, and underneath the sleeping platforms, we store our supplies for hunting and fishing, or sewing and other things. We have a central hearth in the wigwam that keeps us warm when it is cold, and where we cook when it is raining hard outside. From the second hoop of our wigwam frame, you can see the finely woven bullrush mats that line the inside of our house. They are beautifully woven, in geometric designs and colors of black and red, and sometimes even in blue when the women use wild indigo or larkspur to dye the reeds. Father hangs his tools for tanning hides and carving wood above his sleeping place. And you can see his deer mask and his snapping turtle rattle, that he wear and uses in the special Trading Dance that will be tomorrow. Above our door way, there is a bit of special flat cedar, which keeps our family safe.

[Scenes available as Fine Art Note Cards](#)



Text and Graphics
© 1994 - 103 [Tara Prindle](#)
unless otherwise cited.

Scenes from the Eastern Woodlands

A Virtual Tour ~ Circa 1550

Where would you like to go?

- [At our homestead](#)
- [Building our wigwam](#)
- [Tending to our garden](#)
- [Making our stone tools](#)
- [Grinding our corn and nuts](#)
- [Catching fish in a net from our canoe](#)
- [Bathing ourselves at the stream](#)
- [Cooking our food we gather](#)
- [Working inside our wigwam](#)
- [Making our pots](#)
- [Playing our hoop and dart game](#)
- [Picking cherries for our bread](#)
- [Learning to shoot our arrows](#)

Making our pots ...

you will see how we make our clay vessels. Yesterday we went to the riverbank and we dug some clay from the old lake deposits that the river cuts through. We spent all afternoon taking out any small pebbles or pieces of sticks or other impurities that were in it. This clay is very fine, so we had to mix the clay with some crushed shell and some sand to help it withstand the temperature changes of the fire that makes the clay as hard as stone. Today we began to make the pots, so first we kneaded it to make sure all the air bubbles are out. The older girl on the right is rolling out coils on the mat in front of her, and she spirals each new coil onto the rim of the pot, joining them securely, one on top of the last until the pot is high enough and the right shape. The round bottomed pot sits in a small hole dug into the ground, so that the pot can sit upright and be easily worked on. The older woman's pot has dried to leather hardness, and she adds the designs of her family and people around the rim and collar of the pot with various tools like scallop shells, toothed combs, and even her



[Scenes available as Fine Art Note Cards](#)

finger nail. The women in the background are piling the hardwood around pots which have dried for several weeks and are ready to be fired in a shallow hearth.



**Text and Graphics
© 1994 - 103 [Tara Prindle](#)
unless otherwise cited.**

Scenes from the Eastern Woodlands

A Virtual Tour ~ Circa 1550

Where would you like to go?

- [At our homestead](#)
 - [Building our wigwam](#)
 - [Tending to our garden](#)
 - [Making our stone tools](#)
 - [Grinding our corn and nuts](#)
 - [Catching fish in a net from our canoe](#)
 - [Bathing ourselves at the stream](#)
 - [Cooking our food we gather](#)
 - [Working inside our wigwam](#)
 - [Making our pots](#)
 - [Playing our hoop and dart game](#)
 - [Picking cherries for our bread](#)
 - [Learning to shoot our arrows](#)
-



Playing our hoop and dart game

...

you will see one of the many games that helps boys to prepare the skills necessary to hunt or fish. Here in this clearing one boy rolls the hoop quickly across the ground, and the other three at an equal distance from the path of the hoop, try to see if they can throw their wooden javelin through the net of the hoop. The netting of the hoop is done in a special way for this game, so that the rectangles and squares and triangles in the weave represent different animals. The score of the throw by each boy is determined by which shape or (animal) the javelin goes through. If it goes through the very center hole of the hoop, that is the best score, it is the heart of the animal herd.

[Scenes available as Fine Art Note Cards](#)



Text and Graphics
© 1994 - 103 [Tara Prindle](#)
unless otherwise cited.

Scenes from the Eastern Woodlands

A Virtual Tour ~ Circa 1550

Where would you like to go?

- [At our homestead](#)
 - [Building our wigwam](#)
 - [Tending to our garden](#)
 - [Making our stone tools](#)
 - [Grinding our corn and nuts](#)
 - [Catching fish in a net from our canoe](#)
 - [Bathing ourselves at the stream](#)
 - [Cooking our food we gather](#)
 - [Working inside our wigwam](#)
 - [Making our pots](#)
 - [Playing our hoop and dart game](#)
 - [Picking cherries for our bread](#)
 - [Learning to shoot our arrows](#)
-

Picking cherries for our bread ...

you will see the women out gathering one of the many berries that grow wild during the late summer months. We call July 'the month when the cherries turn black'. The choke cherries fruit comes on the trees every other year. So although last year there were hardly any cherries, this year there are here in great abundance. We pick them from the tall shrubby trees and gather them in our berry picking baskets which we make out of elm bark. Our baskets are in the shape of a cone with the bottom snipped off, from a piece of bark wrapped around and sewn up the side, and sewn across the bottom. Because berries and cherries stain our fingers and our baskets, we only use these baskets for gathering berries. We use the cherries in our breads or in sauces, or we grind them up (pits and all) and dry them and form them into little cakes to use them in the winter months.



[Scenes available as Fine Art Note Cards](#)



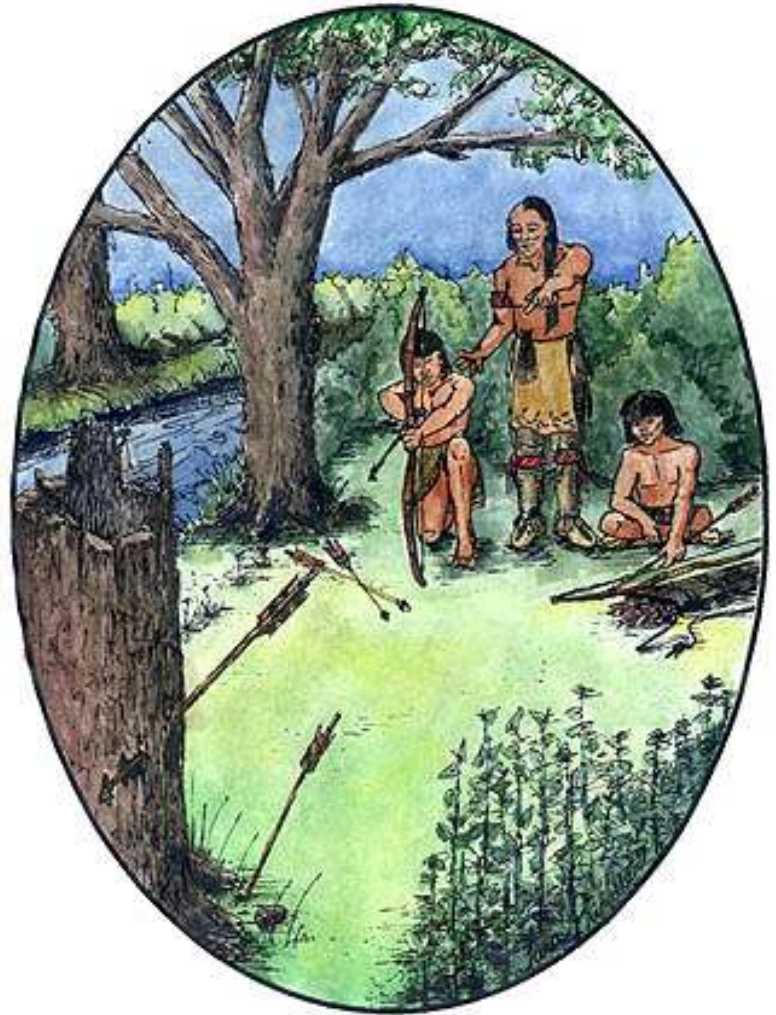
Text and Graphics
© 1994 - 103 [Tara Prindle](#)
unless otherwise cited.

Scenes from the Eastern Woodlands

A Virtual Tour ~ Circa 1550

Where would you like to go?

- [At our homestead](#)
- [Building our wigwam](#)
- [Tending to our garden](#)
- [Making our stone tools](#)
- [Grinding our corn and nuts](#)
- [Catching fish in a net from our canoe](#)
- [Bathing ourselves at the stream](#)
- [Cooking our food we gather](#)
- [Working inside our wigwam](#)
- [Making our pots](#)
- [Playing our hoop and dart game](#)
- [Picking cherries for our bread](#)
- [Learning to shoot our arrows](#)



Learning to shoot our arrows ...

you will see that we use longer and straighter bows than other regions of this great island, since we hunt only on foot or sometimes from a canoe. We make our bows from the wood of ash or hickory or locust. We paint our bows sometimes with designs, which makes them uniquely ours, but also disguises the bow in the woods so the animals cannot see a clear outline of the bow. Our arrow shafts are also longer than other areas, and we usually only get one chance to make our shot count, so accuracy of our aim, and of the arrow itself is very important. We use dogwood, witch hazel or viburnum for our arrow shafts, and we attach split feathers to the ends with deer or elk sinew. Our wild turkey feathers are good to use for fletching because they are very sturdy. We usually make our arrow points from stone like flint or chert or quartz. Recently we have gotten some brass kettles from the Europeans in trade, and we take the worn out kettles and cut triangular shapes from the scrap to make arrow points.

[Scenes available as Fine Art Note Cards](#)



Text and Graphics
© 1994 - 103 [Tara Prindle](#)
unless otherwise cited.

An Ojibwe Language Word List

Anishinaabe The original people

SALUTATIONS

Boozhoo	Greetings
Aanii	Hello
Aniish na?	How are you?
Beindigain	Come in
Aaniish Eshnikaazyin	What is your name?
_____ Ndishnikaaz	My name is _____
Migwetch	Thank you
Gi zah gin	I love you
Gigawabamin Nagutch	See you later
Gigawabamin Menawah	See you again
Baamaapii	Until later
Giminadan Gagiginonshiwana	It was nice talking to you
Biwabamishinam Menawah	Come see us again

FAMILY

Nini	Man
Ikway	Woman
Ikwaywug	Women
Needonnisug	Brothers
Neekonnisiwin	Brotherhood

Nokomis	Grandmother
Mishomis	Grandfather
Mishomisinonnig	Grandfathers
Wedigaywin	Union / Marriage
Oondadizoowin	Birth
Binoojiing	Child
Neejawnisug	Children
Gwewinzenhs	Boy
Kwayzenhs	Girl
Gwewizaynsug	Sons
Neegoosis	My son
Neezhoday	Twin
Zhishay	Uncle
Chiahyaog	Elders
Odoidaymiwan	Clan system
Odoidaymiwug	Clans

PERSONAL PARTS

Weenessisee	Hair
Okunnug	Bones
Ostegwan	Head
Otawug	Ear
Oskenzhig	Eye
Ojohnz	Nose
Odoon	Mouth
Okakaygun	Chest
Obekwun	Shoulder
Onik	Arm
Odayin	Heart

Omisud	Stomach
Oneejawin	Womb
Oningeen	Fingers
Oniinge	Hand
Okad	Leg
Ogeegwun	Knee
Ozid	Foot
Ahnikayziddaynce	Toes

PEOPLE

Oshkabaywis	Helper
Giwisayininiwug	Hunters
Gitigaywininiwug	Planters
Ahdawaywinineeg	Traders
Ogimaa	Leader
Wabunukeeg	Daybreak people
Iskodaywatomi	Fire People
Odaywatomi	Potawatomi
Ohkwamingininiwug	Ice people
Oshkibimadizeeg	New People
Chimookamonnug	Long Knives
Zhaagnaash	White people
Mukadayikonayayg	Black coats

ANIMALS

Owayseug	Animals
Ahnimooshug	Dogs

Ahmik	Beaver
Gazhagayns	Cat
Gawg	Porcupine
Maengun	Wolf
Misabe Mukwa	Grizzly bear
Mizheekay	Turtle
Mukwa	Bear
Mushkawujibemiday	Deer fat / Tallow
Muskodayn Bishikee	Buffalo
Nigig	Otter
Wabizhashi	Martin
Wawashkeshshi	Deer
Wazhushk	Muskrat
Zhongwyzh	Mink
Binayshee	Bird
Banaysheug	Birds
Migizi	Eagle
Ahjijawk	Crane
Papasay	Wood pecker
Mahng	Loon
Ziishiib	Duck
Deedeens	Bluejay
Zhingibiis	Helldiver
Gigoon	Fish
Gigounhnug	Fish (pl.)
Gitchie Manameg	Whale
Mitigookamaig	Whitefish
Megis	Cowrie shell

PLANTS

Gitigan	Garden
Gitigannug	Gardens
Gitigayminon	Seeds
Ogeebiccoon	Roots
Manomin	Wild rice
Ahsayma	Tobacco
Mushkodaywushk	Sage
Weskwu mashkoseh	Sweetgrass
Gisheekandug	Cedar
Weegoobbee	Basswood tree
Weegwas	Birch tree
Ahgimak	Ash wood
Ininaig	Maple
Opwagunatig	Sumac
Papakoosigun	Willow tree
Weegobee	Basswood tree
Manone	Ironwood tree
Mitig	Log
Begew	Pitch / Sap

WORLD

Ishpiming	Universe
Ahki	Earth (land)
Neebageesis	Moon
Ohshkagoonjing Geesis	Crescent moon
Geesis	Sun
Ahnung	Star
Ahnunggokwan	Star world
Wabun Ahnung	Morning star

Ahsin	Rock
Ahsinneeg	Rocks
Ishskwaday	Fire
Bawshkinaway	Smoke
Nibi	Water
Zhewatagun	Salt
Zhewitaganibi	Salt water
Bugwayji	Wild / Natural places
Maygwayyawk	Forests
Kitchi Kabekong	Great Falls
Animikee Wabu	Thunder water
Gichi Gumee	Great Freshwater seas
Michi Zeebee	Greatest river
Ogima Kway Zeebee	Lead woman of all rivers
Zahgaegun	Lake
Minisi	Island
Mushkodayng	Plain
Chiwajiw	Hill
Chi Wajiwian	Big Mountains
Papashkwag	Deserts

WEATHER

Noodinoon	Winds
Chinoodin	Big Wind
Baybeemisaysi	Whirlwind
Geezheebasun	Tornado
Animikee	Thunder
Wawasum	Lightening
Gimiwun	Rain

Mushkobewun	Flood
Mikwaniwun	Hail
Gooskoosay Ahki	Earthquake
Wawasayg	Northern lights
Kisinaa	Cold
Nigwaankot	Cloudy

DIRECTIONS

Mekanayzn	Path
Babamadizwin	Journey
Chibimoodaywin	Migration
Giwaydin	North
Giwaydinnoong	North direction
Zhawan	South
Zhawanooog	South direction
Ninggabeun	West
Ninggabeuhnoong	West direction
Wabun	East
Wabunnoong	East direction
Wayndahnimuk	Four directions
Giwetashskad	Circle
Nawayee	Center

SEASONS & TIME

Zeegwung	Spring
Neebing	Summer
Beboong	Winter

Dagwaging	Fall
Waaban	Dawn
Bedabun	False dawn
Jibwah	Before
Nongo	Today
Kizheb	Morning
Naakwek	Noon
Shkwa naakwek	Afternoon
Naakshig	Night
Shki Naakshig	Evening
Aabta dibikaag	Midnight

FEELINGS & EMOTIONS

Zahgidiwin	Love
Manajiwini	Respect
Bapeewug	Laughter
Mahwee	Crying
Winanimiziwin	Terror
Gwayahkooshkawin	Balance
Ninoododadiwin	Harmony
Ekandasowin	Knowledge
Ahmunniisowin	Intuition
Niboowin	Death
Gizhiday	Hot
Gisinaw	Cold

COLORS

Misskwa	Red
Mukaday	Black
Wabiska	White
Ozawahn	Yellow

NUMBERS

Bezhik	One
Niish	Two
Niswi	Three
Niiwiin	Four
Naanwan	Five
Nigodwaaswi	Six
Niizhwaswi	Seven
Nishwaaswi	Eight
ZhaanGswi	Nine
Midaaswi	Ten

CULTURAL THINGS

Odaynahwing	Towns / Villages
Odaynahwaynsun	Small villages
Weegiwahm	Lodge / House
Wesinniwin	Food
Muckadaymashkeekiwabu	Coffee (Black Medicine Water)
Midjim	Provisions
Ishkoday Ahsin	Flint / Fire Rock
Dikkinagun	Cradleboard
Gahskeebidaggun	Bandolier bag

Wagakwud	Axe
Ahbwi	Padlde
Jeemonnug	Canoes
Weegwasi Jeemon	Birchbark canoe
Ahsubbi	Net
Awkik	Vessel
Zhooshkudabahn	Sled
Muzineebi	Carving
Mitigwakik daywaygun	Water drum
Sheshegwun	Shaker
Opwagun	Pipe
Opwagunahsin	Pipestone
Ozawabik	Copper (yellow) medallion
Zooniyawabik	Gold
Zhoonay	Money

MEDICINE

Gitchie Manito	Great Mystery
Ekinamadiwin	Teachings
Mushkeeki	Medicine
Mushkeekiwinun	Medicines
Gishkibidagunnun	Medicine bundles
Mudjimushkeeki	Bad medicine
Mamakajiwin	Miracle
Manitouwabi	Spirit
Geebawug	Spirits
Midewinini	Midewiwin priest
Nagamoon	Song
Daywayganatig	Drum beater

Neegawnnakayg	Prophets
Neegoniwabungigaywin	Ability to see into the future
Bawazigaywin	Dream
Bawajigaywin	Vision Quest
Animikeeg	Little thunders

**The following resources were indispensible for compiling this
Ojibwe language word list:**

**"The Mishomis Book; A Voice of the Ojibway"
by Edward Benton-Banai, Produced and distributed by: Indian Country Communications,
Inc., Rt. 2, Box 2900-A, Hayward, WI 54843.**

My boyfriend Brad, Gi zah gin

Michigan Indian Youth Traditional Values Conference, Mackinac Island, Michigan

**Ojibwe speaking instructors from Lake Superior State University, Sault Ste. Marie,
Michigan**

And all my Ojibwe/Ojibway/Chippewa friends in NAC!!!

[Return to Ojibwe Culture, Arts, History , Language & People Menu](#)



© 1994-2000 **[Tara Prindle](#)**.

You are being redirected to NativeWeb's Resource Database for Birds & Feathers

Resources for Indigenous Cultures around the World

[Resources](#) [Books & Music](#) [Community](#) [Services](#) [About Us](#)

Resource Center

- [Internet Links](#)
- [Nations Index](#)
- [Geographic Region Index](#)
- [Search the Site](#)
- [New Sites this Week](#)
- [Submit a Site!](#)
- [Top 5 Percent](#)

Hosted Resources

- [Hosted Pages](#)
- [Book & Music Center](#)
- [Law & Legal Issues](#)
- [NativeLaw News](#)
- [NativeTech](#)

Site Information

- [Get your FREE EMAIL @NativeWeb.Net!](#)
- [Community](#)
- [About Us](#)
- [Hosting Information](#)

[Resource Database](#) / [Crafts & Indigenous Technology](#) / **Birds & Feathers**

Birds & Feathers Sub-Categories:

- [Bird Protection](#)
- [Legislation](#)

Resources: 10 listings

Name and Description	Nation	Location	Hits
Eagle is the messenger			1496
<p>By Debbie Faulkner : To Indian people, the Eagle is the messenger of the Creator, said Alvin Manitopyes. "The eagle symbolizes the love the Creator has for the Indian people of North America the eagle is the most spiritually evolved of all animals and birds. It is the messenger between the Indian people and the Creator. It is a very sacred bird," said Manitopyes. "(Eagles) have a lot of courage. That is why it is such an honor to earn an eagle feather." Finding an eagle feather is a gift or blessing, explained Manitopyes, and an affirmation of one's own spiritual experience.</p> <p style="text-align: center;">More sites on www.msstate.edu</p>			
Eagle page			1825

Donate to
NativeWeb!
Tax Deductible!



Wonderful photos including Spectacular full frontal view of American Bald Eagle in flight, Eagle soaring over water with fish in his talons, Eagle soaring above us with full wing spread, Eagle soaring at eye level and many others

Eagle Poaching 620

Ring Busted

Eagle Poaching Ring Busted in Federal Raids by Don Jordan U.S. Fish and Wildlife Service agents have arrested or are seeking to arrest 35 people in New Mexico, Arizona and Colorado responsible for killing and selling bald and golden eagles."Posing..

Feather Stripping 1486

Through Wilderness Way. Arrow fletchings can easily be made from feathers that are stripped instead of split. The advantages are: (1) It takes only seconds to strip a feather and much longer to split one. (2) The stripped feather glues or ties down flush with the arrow shaft, leaving no sharp end that can cut your knuckle as the arrow leaves the string and skids over the hand (this assumes you shoot a bow without an arrow shelf).

More sites on www.wwmag.net

Golden Eagle 1539

Learn about the Golden Eagle's feather markings

IMDiversity.com - US - 424

Eagle, Wolf Fans Northeast

Can See Favorites!
by David Pego

I call them the people from the painted plate tribe. They are the ones who buy and hang, I suppose those very expensive plates that have pictures of eagles and wolves. Usually, they also have an image of what appears to be a deeply suntanned Indian woman with long, flowing black hair and pure white, fringed buckskin.

[More sites on www.imdiversity.com](http://www.imdiversity.com)

<u>Kayapo Brazilian Indian feather headdresses</u>	South America	1538
--	---------------	------

[More sites on photo2.si.edu](http://photo2.si.edu)

<u>NativeTech: Birds & Feathers</u>	2271
---	------

Contemporary Single Wrapped Feather Styles, Birchbark Fans of the Great Lakes Regions, Turkey Tail Fans of the Southeast and Prairie Regions, Flat Fans of the Plains Region, Feather Identification, and Preserving Bird Wings, Tails, or Talons

[More sites on www.nativetech.org](http://www.nativetech.org)

<u>Northeast Utilities • Using Solar Power to View Nesting Bald Eagles</u>	529
--	-----

Picture Gallery, The Project, Eagle Facts, Eagle Restoration, Camera Repairs, Eagle Sounds.

<u>Oneida Indian Nation - Chief's Kostoweh</u>	Iroquois US - Northeast	1503
--	-------------------------	------

This is an example of the kostaweh, the traditional headdress of the Iroquois. An ash splint frame suspends the cap, decorated by turkey feathers. The deer horns rim. This kostaweh was made by Ray Elm, one of the oldest living Oneida Nation members.

[More sites on oneida-nation.net](#)

You are being redirected to NativeWeb's Resource Database for Pottery & Clay

Resources for Indigenous Cultures around the World

[Resources](#) [Books & Music](#) [Community](#) [Services](#) [About Us](#)

Resource Center

- [Internet Links](#)
- [Nations Index](#)
- [Geographic Region Index](#)
- [Search the Site](#)
- [New Sites this Week](#)
- [Submit a Site!](#)
- [Top 5 Percent](#)

Hosted Resources

- [Hosted Pages](#)
- [Book & Music Center](#)
- [Law & Legal Issues](#)
- [NativeLaw News](#)
- [NativeTech](#)

Site Information

- [Get your FREE EMAIL @NativeWeb.Net!](#)
- [Community](#)
- [About Us](#)
- [Hosting Information](#)

[Resource Database](#) / [Crafts & Indigenous Technology](#) / **Pottery & Clay**

Resources: 14 listings

Name and Description	Nation Location	Hits
Artistic Heritage of Clay	US - Southwest	1319
<p>A unit from a high school ceramics course with a studio emphasis was enriched with content from art history, art criticism, and aesthetics. This four-week unit, entitled The Artistic Heritage of Clay: Survival and Revival of Traditions, demonstrates how elective studio courses might be enhanced with the discipline-based approach. In four sections, the unit moves from a general historical investigation of ceramic objects, to study of the pottery of ancient Americans, the Mimbres culture of the Southwestern United States, to a specific focus on the work of María Martínez, the celebrated Native American potter of San Ildefonso Pueblo. The fourth section engages students in the creation of clay vessels using methods similar to those of the artist.</p>		
Caveman to Chemist Projects: Fire		543

Donate to
NativeWeb!
Tax Deductible!



Without fire, man would have remained a rather unremarkable animal in the African landscape. It was fire which extended our waking hours beyond sunset, sterilized food that might have been contaminated or spoiled, and, perhaps most importantly, allowed us to change the properties of the aterials around us. Wood became hardened, bone was more easily broken to expose the utritious marrow within, stone became more easily fractured. Fire's heat allowed us to venture orth into climates that would otherwise have been inhospitable. But as important as these initial pplications were, even they pale in comparison to the new materials which came out of the fire. Clay became pottery, ash became soap, sand became glass, and various minerals became metals. We we more of our material culture to fire than to any other single phenomenon.

[More sites on cator.hsc.edu](http://cator.hsc.edu)

Caveman to 902

Chemist Projects:

Pottery

Fire, as I have said, is probably the most important technology to be mastered by humans. But in order to proceed in the use of fire, we need containers that can withstand the heat. Wood containers burn; metal and glass containers melt. Ceramic materials are the ones best suited to high-temperature work. Ceramics predated and were used in the development of metal and glass.

[More sites on cator.hsc.edu](http://cator.hsc.edu)

ClayStation's Pit- US - 429

Fire Techniques: Southwest

Introduction and
History

By reading through this Firing Guide, you will get well acquainted with the Pit firing process and be fully prepared to participate in the process with someone who is experienced in this type of firing process. This information is inspired by the techniques shown by Lancet. Lancet is a Ceramics and Sculpture Professor at Solano Community College in northern California.

Experimental

818

Pottery Kilns

Through Anglo-Saxon & Viking Crafts - Regia Anglorum Publications: The first kiln that we tried was a relatively crude type, using the very minimum of materials for construction, considering the adverse conditions we had quite encouraging results.

More sites on www.regia.org

Gather Around This

Canada

813

Pot - CMCC

Well before Europeans reached this continent, Native peoples in many parts of Canada had mastered the art of producing durable, functional, and beautiful ceramic containers. The manufacture of ceramic containers requires an intricate knowledge of a complex technology. Pottery-making is foremost an understanding of material properties and the control of their modification through the application of heat. A virtual exhibit tour, Who made them? All sizes and shapes, How old are they? Pottery-making techniques, and Conserving ceramic treasures.

More sites on www.civilization.ca

Hollister Collection - US - 1800
Southwestern Southwest
Native American
Pottery

This collection of 94 pieces of Southwestern pottery is the result of the efforts of Mr. Hollister, who collected these pots one or two at a time for nearly 60 years. The collection was purchased by Mr. F.A. Rosenstock of Denver, Colorado in 1966. Mr. Hollister died the following year. Despite numerous offers from collectors interested in only a few pieces, Mr. Rosenstock maintained the collection as he had acquired it and sold it to the University of Massachusetts in 1969.

More sites on www.umass.edu

IPL: Pueblo Pottery Pueblo US - 706
Exhibit Southwest

The Internet Public Library is the first public library of the Internet. As librarians, we are committed to providing valuable services to that world. We do so for many reasons: to provide library services to the Internet community, to learn and teach what librarians have to contribute in a digital environment, to promote librarianship and the importance of libraries, and to share interesting ideas and techniques with other librarians.

More sites on www.ipl.org

Pochteca 212
Ceramic & pottery archaeological link resources
More sites on members.tripod.com

Pottery Making US - 1483
Northeast

Pottery, one of the first synthetics created by man, is created by a dehydration process. The process in which clay is heated and the water found naturally in it is removed, causes an irreversible transformation. In other words the clay is not simply dehydrated but it become a different product all together. This new product is ceramics, which are unchanged by the presence of water because of absence of water of plasticity.

More sites on

www.anthro.mankato.msus.edu

Pottery: The Potter's Page 880

Dedicated to all those interested in the ancient art of making clay pots [Internet Resources] [Events, Exhibitions & Happenings] [Prospect Farm][Potters]

Prehistoric Pottery US - Central 812

Pottery was important to ancient lowans and is an important type of artifact for the archaeologist. Ceramic pots are breakable but the small fragments, or sherds, are almost indestructible, even after hundreds of years in the ground. Pots were tools for cooking, serving, and storing food, and pottery was also an avenue of artistic expression.

More sites on www.uiowa.edu

The Process of Hopi-Tewa Pottery Making Hopi US - Southwest 60

When you look at a piece of art work, do you ever stop to wonder about the process involved or the person who actually created the piece? What about the time, preparation, and meticulous detail involved? Maybe you are the type of person who has knowledge of a particular artisan or type of art, but many of us enjoy art simply because it appeals to our individual tastes.

[More sites on www.u.arizona.edu](http://www.u.arizona.edu)

**[Whapmagoostui](#) Cree Canada 547
[Art Factory](#)**

The Whapmagoostui Art Factory is a Cree cooperative education project. Its objective is to develop students entrepreneurial spirit. The site contains the historical background of the project, ongoing activities and a catalogue. The Factory has been approached by the Aboriginal Mental Team, affiliated with the Jewish General Hospital and McGill University in Montreal, to collaborate to the creation of a resource guide that focuses on the use of creative arts in promoting health in North American Aboriginal communities.

[More sites on www.geocities.com](http://www.geocities.com)

You are being redirected to NativeWeb's Resource Database for Leather & Clothing



Resources for Indigenous Cultures around the World

[Resources](#) [Books & Music](#) [Community](#) [Services](#) [About Us](#)

Resource Center

- [Internet Links](#)
- [Nations Index](#)
- [Geographic Region Index](#)
- [Search the Site](#)
- [New Sites this Week](#)
- [Submit a Site!](#)
- [Top 5 Percent](#)

Hosted Resources

- [Hosted Pages](#)
- [Book & Music Center](#)
- [Law & Legal Issues](#)
- [NativeLaw News](#)
- [NativeTech](#)

Site Information

- [Get your FREE EMAIL @NativeWeb.Net!](#)
- [Community](#)
- [About Us](#)
- [Hosting Information](#)

[Resource Database](#) / [Crafts & Indigenous Technology](#) / **Leather & Clothing**

Leather & Clothing Sub-Categories:

- [Hide, Fur & Tanning](#)
- [Sewn Items & Other Textiles](#)
- [Native American Clothing](#)

Donate to
NativeWeb!
Tax Deductible!



© [NativeWeb, Inc.](#) 1994-2003 || [Disclaimer Statement](#) || [Copyright Statement](#) || [Contact Us](#) || [Visitors](#) || [Donations](#)

You are being redirected to NativeWeb's Resource Database for Metalwork

Resources for Indigenous Cultures around the World

[Resources](#) [Books & Music](#) [Community](#) [Services](#) [About Us](#)

Resource Center

- [Internet Links](#)
- [Nations Index](#)
- [Geographic Region Index](#)
- [Search the Site](#)
- [New Sites this Week](#)
- [Submit a Site!](#)
- [Top 5 Percent](#)

Hosted Resources

- [Hosted Pages](#)
- [Book & Music Center](#)
- [Law & Legal Issues](#)
- [NativeLaw News](#)
- [NativeTech](#)

Site Information

- [Get your FREE EMAIL @NativeWeb.Net!](#)
- [Community](#)
- [About Us](#)
- [Hosting Information](#)

[Resource Database](#) / [Crafts & Indigenous Technology](#) / **Metal Work**

Resources: 8 listings

Name and Description	Nation Location	Hits
Casting pewter and other metals		568
<p>This file is a collection of various messages having a common theme that I have collected from my reading of the various computer networks. Some messages date back to 1989, some may be as recent as yesterday.</p> <p>More sites on www.florilegium.org</p>		
Coppermaking	US - Northeast	508
<p>In the Arvilla mounds of North Dakota, archaeologist have discovered some interesting artifacts. They include a copper ornament, a spear or knife and a copper awl (see image at the right). The Arvilla mounds are considered part of a burial mound site, and the presence of these copper artifacts is not surprising to archaeologists.</p> <p>More sites on www.anthro.mankato.msus.edu</p>		

Donate to
NativeWeb!
Tax Deductible!



Coppers

Canada - 519
 Western

Copper was the ultimate symbol of wealth among the native peoples of the Northwest Coast; like gold, it reflects the brilliance of the sun. According to Nuxalk legend, copper was given to the people by Tsonoqua, who received it from Qomoqua, the master of wealth who lives in a copper house at the bottom of the sea. According to Haida tradition, copper came from the territory of the Eyak people in the Copper River area of Alaska, where it occurs as pure nuggets in the river gravels. In the Prince Rupert harbour shell middens, the use of copper in the form of bracelets, pendants and tubes can be traced back more than 2,000 years, and thus appears to be an early feature of north coast trading and warfare. - The Canadian Museum of Civilization.

[More sites on www.civilisations.ca](http://www.civilisations.ca)

Links for the Jeweler

406

The following is a listing of links related to the metal jewelry industry. All relating to various aspects of the gem and jewelry business.

Metal Web News

405

Current Metalworking News, Metal Related Discussion Groups, Metal Removal [Machining, Turning, Boring Drilling, Etc.], Metal Fabrication [Forming, Assembly, Etc.], Welding & Cutting [Electric, Gas, Etc.], Blacksmithing, Forge & Foundry, Educational, Metalworking Jeweler, Miscellaneous, Software & Information Files, Metalworking Related Page Links, Book Store, Commercial Metalworking Links, Commercial Power Tool Links, Metal Web News Update Log

Metalworking through Historic Crafts & Skills

581

The primary difference between the frontiersman and the native Americans he encountered was that the native people knew little or nothing about metals, but the trader, trapper or mountain man depended on metal goods (knives, guns, traps, sewing needles) for his livelihood and survival.

More sites on
www.conservation.state.mo.us

Nadlok and the Inuit Canada - Western 335
origin of the
Copper Inuit -
CMCC

Artifacts showing Nadlok's age and cultural position are described, but bone and antler arrowheads, whetstones, soapstone vessel fragments, and slate knives common to Inuit sites, including Nadlok, are not emphasized.

More sites on www.civilisations.ca

Tips from the 410
jeweler's bench -
Topics Browse

Starting to make jewelry, Tools, Construction, Casting, Stone setting, Gemology, Surfaces, Small objects photography, PR tools - Business, Critical Notes, Safety Notes, Repairs, Bibliography List and Book reviews, Jeweler's Software at Ganoksin.com

You are being redirected to NativeWeb's Resource Database for Porcupine Quillwork & Hair



Resources for Indigenous Cultures around the World

[Resources](#) [Books & Music](#) [Community](#) [Services](#) [About Us](#)

Resource Center

- [Internet Links](#)
- [Nations Index](#)
- [Geographic Region Index](#)
- [Search the Site](#)
- [New Sites this Week](#)
- [Submit a Site!](#)
- [Top 5 Percent](#)

Hosted Resources

- [Hosted Pages](#)
- [Book & Music Center](#)
- [Law & Legal Issues](#)
- [NativeLaw News](#)
- [NativeTech](#)

Site Information

- [Get your FREE EMAIL @NativeWeb.Net!](#)
- [Community](#)
- [About Us](#)
- [Hosting Information](#)

[Resource Database](#) / [Crafts & Indigenous Technology](#) / **Porcupine Quillwork & Hair**

Resources: 13 listings

Name and Description	Nation	Location	Hits
A Gallery of Porcupine - Christy's Rock Garden			1606
<p>Although I'm not native, I've been doing quillwork for almost 30 years. My approach to this artform is contemporary, using modern materials and dyes. As an artist, I feel a responsibility to future generations to keep this medium vital and relative to an ever changing world. With this in mind, most of my jewelry is at much at home at the opera as it is at a rodeo. To encourage the evolution of quillwork, I teach the methods of quilling and promote a fresh look to where this artform could be taken. ---- Christy Ann Hensler's quillwork is *truely* amazing ----</p>			
Ancient Artways Studio		US - West	770

Donate to
NativeWeb!
Tax Deductible!



Fine Quillwork by Nancy Fonicello -
Quillwork is the ancient art of embroidery using porcupine quills. It originated in North America and flourished for hundreds of years before the arrival of Europeans on the continent. With the advent of glass beads brought by the early fur traders, quillwork fell by the wayside, being preserved through the years by a handful of artists.

Art & Crafts - Dene Canada - 1597
Porcupine Western
Quillwork

Around 1840, quillworking began to decline when native women started using beads to decorate garments. Today, however, Dene women at Fort Providence, Fort Liard and Jean Marie River still carry on this art form.

Cindy's Quillin 1273
Pages

Hello! Quills here! This cute little baby porkie is from Montana! Couldn't resist him & thought others might like to see him too (He's off a post card I found in a pop shop in Big Sky.) I love quillwork & make quilled items here & there as time allows. Unfortunately, once I start looking at quillwork I start oohing & aahing & there goes the time! Oh well! There is a page with some favorite quillwork, moose hair embroidery & other treasures I've found after long surfs through museums.

More sites on www.geocities.com

Dene Quillwork Dene Canada - 710
Western

Canada's Northwest Territory - Explorer's Guide

More sites on www.nwttravel.nt.ca

Northern Plains **US - West** **1110**
Style Quillwork
by Ravenshead
Tiwahe

Custom made quillwork Crafted in the traditional ways of the Buffalo days - Chris Ravenshead (Non-Native): Originally from Belgium, Chris came to South Dakota 20 years ago. He lived on the Cheyenne River Indian Reservation for 17 years.

More sites on www.geocities.com

Porcupine Quill **United States** **510**
Wrapping
Techniques on
Rawhide

Quill Wrapping - a virtual demonstration, requires Flash plugin.

More sites on www.mindspring.com

Porupine **410**

Characteristics, Range, Habitat, Food, Reproduction and behavior. Great Pictures for kids.

Prickly **United States** **147**
Porcupines

Educational page about America's second largest rodent maintained by a student at the University of Southern California.

Quill Boxes by **Ojibwe** **Canada -** **832**
Lorraine Besito **Eastern**

Lorraine was born on the Parry Is. Reserve and has been doing quillwork since she was a girl. Her mother first taught her the craft and, after many years of study, Lorraine now does quill tufting as well as regular quill work. She collects all her own raw material and her boxes show a great variety of designs including floral, geometric, star and animal patterns. Lorraine and her daughter are the only ones on her reserve who do any type of quill work.

Quilled Canada 909

Blackfoot Shirt
and Lakota
Moccasins

Glenbow Musuem, First Nations Exhibit

The Snake with 410

Big Feet

A story about Porcupine Quills

More sites on www.ilhawaii.net

Tsistsistas Cheyenne US - West 713

(Northern
Cheyenne)
quilled mask for
a horse

Quillworker unknown. Late 19th century. Montana. (1.4443) National Museum of the American Indian - Creation's Journey

More sites on www.si.edu

You are being redirected to NativeWeb's Resource Database for Stone and Tools



Resources for Indigenous Cultures around the World

[Resources](#) [Books & Music](#) [Community](#) [Services](#) [About Us](#)

Resource Center

- [Internet Links](#)
- [Nations Index](#)
- [Geographic Region Index](#)
- [Search the Site](#)
- [New Sites this Week](#)
- [Submit a Site!](#)
- [Top 5 Percent](#)

Hosted Resources

- [Hosted Pages](#)
- [Book & Music Center](#)
- [Law & Legal Issues](#)
- [NativeLaw News](#)
- [NativeTech](#)

Site Information

- [Get your FREE EMAIL @NativeWeb.Net!](#)
- [Community](#)
- [About Us](#)
- [Hosting Information](#)

[Resource Database](#) / [Crafts & Indigenous Technology](#) / **Stone & Tools**

Stone & Tools Sub-Categories:

- [Archery & Throwing](#)
- [Bone, Antler, Horn and Ivory](#)
- [Other Uses for Stone](#)
- [Stone, Knapping & Lithic Technology](#)
- [Wooden Tools & Weapons](#)

Donate to
NativeWeb!
Tax Deductible!



© [NativeWeb, Inc.](#) 1994-2003 || [Disclaimer Statement](#) || [Copyright Statement](#) || [Contact Us](#) || [Visitors](#) || [Donations](#)

You are being redirected to NativeWeb's Resource Database for Weaving & Cordage



Resources for Indigenous Cultures around the World

[Resources](#) [Books & Music](#) [Community](#) [Services](#) [About Us](#)

Resource Center

- [Internet Links](#)
- [Nations Index](#)
- [Geographic Region Index](#)
- [Search the Site](#)
- [New Sites this Week](#)
- [Submit a Site!](#)
- [Top 5 Percent](#)

Hosted Resources

- [Hosted Pages](#)
- [Book & Music Center](#)
- [Law & Legal Issues](#)
- [NativeLaw News](#)
- [NativeTech](#)

Site Information

- [Get your FREE EMAIL @NativeWeb.Net!](#)
- [Community](#)
- [About Us](#)
- [Hosting Information](#)

[Resource Database](#) / [Crafts & Indigenous Technology](#) / **Weaving & Cordage**

Weaving & Cordage Sub-Categories:

- [Basketry](#)
- [Cordage & String](#)
- [Dying & Fibers](#)
- [Weaving](#)

Donate to
NativeWeb!
Tax Deductible!



© [NativeWeb, Inc.](#) 1994-2003 || [Disclaimer Statement](#) || [Copyright Statement](#) || [Contact Us](#) || [Visitors](#) || [Donations](#)

You are being redirected to NativeWeb's Resource Database for Food

Resources for Indigenous Cultures around the World
[Resources](#) [Books & Music](#) [Community](#) [Services](#) [About Us](#)
Resource Center

- [Internet Links](#)
- [Nations Index](#)
- [Geographic Region Index](#)
- [Search the Site](#)
- [New Sites this Week](#)
- [Submit a Site!](#)
- [Top 5 Percent](#)

Hosted Resources

- [Hosted Pages](#)
- [Book & Music Center](#)
- [Law & Legal Issues](#)
- [NativeLaw News](#)
- [NativeTech](#)

Site Information

- [Get your FREE EMAIL @NativeWeb.Net!](#)
- [Community](#)
- [About Us](#)
- [Hosting Information](#)

Donate to
NativeWeb!
Tax Deductible!


Resource Database / Food
Resources: 54 listings

Name and Description	Nation	Location	Hits
<u>Alta Vista Farm, Rutland, MA</u> ... where the buffalo roam. More sites on homepage.mac.com		US - Northeast	495
<u>American Indian's cookbook</u>			12747
What we eat -- where it comes from, how it is raised, processed, cooked -- affects our health in many ways. Traditional native diets in those few places in the world where people still mostly eat what they raise, hunt, gather, fish -- have been found to promote health and long life, for reasons only gradually coming to be understood. More sites on indy4.fdl.cc.mn.us			
<u>Arctic Wild Harvest Company</u>	Inuit	Alaska	2384
Wild Foods including: Arctic Fish and Wild Game Jerky, Wild Smoked Sockeye Salmon, Canned Caribou, Muskoxen and Reindeer, Wild Rice, Birch Syrup Products and Herbal Teas and Accessories; Wild Herbs & Herbal Products; Herbal Craft Supplies ; Salmon, Musk oxen, Caribou, Venison, Birch syrup and much more... Arctic Art and Crafts; Inuit Jewelry; Premium Canadian Arctic Musk-ox Leather Products; Handcrafted Dene Birch Bark Baskets; Moose Hair Tuftings; Arctic Souvenirs; Inukshuk Products; and Online Photo Tours.			
<u>Bedre Chocolates</u>	Chickasaw	US - Southwest	383
Bedre Chocolates is a business owned by the Chickasaw Nation headquartered in Ada, OK. Bedre Chocolates manufactures, wholesales and retails gourmet quality chocolate products. 800-367-5390			
<u>Bighorn Buffalo Company</u>		US - West	1784
Cooking Tips and Recipes, buffalo meat / bison meat.			
<u>CAAE - Traditional Cree Food</u>	Cree	Canada - Western	948
Food was woven more intimately into the fabric of daily life in earlier times than it is today. It directly fueled physical accomplishments. All work was done by their own power.			
<u>Cattail Recipes-More than just a Feast for the Eyes</u>		US - Northeast	634

Cattail are no stranger to much of Minnesota's lake-going community. Commonly recognized by their brown club-shaped spikes of seeds, they fill many surprising niches both in the natural world and in the kitchens of lakeshore residents.

Cocinas De New Mexico

US - 1926
Southwest

Cocinas De New Mexico is published by the Public Service Company of New Mexico. Proceeds from sales help provide utility supplements to needy residents of New Mexico. Below are recipes from the 79 page cookbook. To order this cookbook, one of our favorites, see the instructions at end of each section.

Communal Hunting

US - 1201
Northeast

Trapping in the conventional sense is often associated with the actual tool used in the capture of game. In this paper it is meant as the method in which land is modified or utilized for the purpose of trapping game in a contained area where butchering can take place. One advantage of this type of hunting strategy over individual attempts is that it is more energy-efficient, demanding less energy expenditure per individual in the hunting process.

[More sites on www.anthro.mankato.msus.edu](http://www.anthro.mankato.msus.edu)

Cooking Post for Native American foods

Pueblo US - 2434
Southwest

A tribally owned venture providing economic prospects and employment possibilities for our own tribal members and for other Indian people nation wide. Join us for an American Indian culinary adventure unlike any other. You'll find something for everyone here -- from traditional herbal teas to flavorfully roasted coffee beans, from robust blue corn muffins to feast day stews -- The Cooking Post is sure to have a tasteful offering for both your stomach and your spirit.

[More sites on www.cookingpost.com](http://www.cookingpost.com)

Cooking With the Wolfman!

Canada 1100

Aboriginal Fusion: Traditional Foods with a Modern Twist. Join Chef David Wolfman and Loma as they prepare Aboriginal Fusion on APTN

Dining on the Wilds

1191

Learning Nature through Wild Edible Plants and Ethnobotany. Takes you inside the classroom for an interesting graphic slide presentation which gives you a close-up look at the identification of many wild edible plants, herbs and mushrooms of North America.

Edible Landscaping

US - 856
Southeast

Many new plants this year. Only the most productive disease resistant varieties make it on the approved list here at Edible landscaping. Our plants are guaranteed to arrive healthy and grow well. If something happens to your plant, please let us know. Our bottom line is that we want you to succeed with these plants and share our enthusiasm for growing them.

Gifting and Feasting in the Northwest Coast

US - 1231
Northwest

Potlatch

Food and Feasting. What is a Potlatch? Gifting in Potlatch. Contemporary Potlatches.

[More sites on www.peabody.harvard.edu](http://www.peabody.harvard.edu)

How To Improve Your Venison Cooking 1063

Wild animals, which are constantly on the move and never feed under artificial conditions, have meat with a higher ratio of protein to fat than that of domestic animals; for example, while you may see venison with some distinct fat layering, you will never see it marbled with fat. And, while it is not inconceivable that some wild animals may ingest toxic substances, such as residual pesticides that might have drifted into their feeding area, we can at least say with some certainty that they have not been fed chemicals for water (i.e., weight) retention or to start the tenderization process while still on the hoof, or hormones for quick growth, etc. In other words, we can be reasonably sure that the meat from wild animals as nearly approaches purity as is possible in a society where contamination -- even radioactive fallout -- is pervasive.

[More sites on www.geocities.com](http://www.geocities.com)

**<http://www.americanindiantea.com/American> Lakota US - West 820
Indian Tea Company**

The American Indian Tea Company is Indian owned and upholds a history filled with herbal knowledge. Owner, Joseph Hesbrook (Has No Horses) is first generation off the reservation, but currently lives in Santa Fe, New Mexico. A Plains Indian who has a Ph.D., Dr. Hesbrook combines the old traditions with education to bring about a higher knowledge and understanding.

Just First Nations Recipe 2153

Recipes Alphabetically from Acorn Bread to Zuni Sunflower Gravy

Khmer Krom Recipes by Mylinh Asia 32

Khmer Krom Recipes from Kampuchea Krom which is currently known as southern of Vietnam

Kwakuitl Recipes Kwakiutl US - Northwest 1264

Genuine Kwakuitl Indian recipes from NW Coast circa 1914 -- You will probably want to try this recipe for boiled halibut heads & backbone. With etiquette tips included for chewing the bones and spitting them on the floor! Full instructions of how to cook a whale! In case you wanted to know; how to cook salmon guts! Another recipe: How to catch & cook sea slugs! (Including the correct thing to say as you bonk them on the head.) And the ever popular: How to cook fresh salmon!

[More sites on www.hallman.org](http://www.hallman.org)

Kwakuitl Recipes from 1914 Kwakiutl US - Northwest 2292

Cook sea slugs, whales, halibut heads, and salmon guts.

[More sites on www.hallman.org](http://www.hallman.org)

Lenapé Food Lenape 3864

The Native American domesticated more plants than any other race of man. Among these were corn, potatoes, coffee, beans, squash (pumpkins), strawberries, peas, tomatoes, cranberries, grapes, plums and apples. Without these domesticated plants, the permanent settling of the continent would have been much more difficult. Eventually these crops impacted cultures all over the world. The potato alone kept generations of Europeans from starvation. According to reports of the time, Lenapé women were unsurpassed as cooks. They cooked two meal a day, but generally kept something on the fire throughout the day. Their diet was rich and varied. Corn was by far the main staple, but was fixed in a variety of ways. In addition to their crops there were wild nuts and berries. They tapped the maple trees and boiled the sap for sugar and syrup.

[More sites on www.geocities.com](http://www.geocities.com)

Maple Sugaring US - 1093
Northeast

When temperatures begin to rise in the spring, the sap begins to flow from the roots of maple trees up the trunks to the branches and limbs. During the short period of spring when the daytime temperatures are above freezing, and the night temperatures are below freezing, the sap flows up and down the tree trunks daily.

Metis Resource Center Recipe Corner Metis Canada 1038

Soups, Li Gallette , Wild Rice And Cheese Casserole , Saskatoon Jelly, Les Boulette (Meat Balls), Tourtiere And More.

[More sites on www.metisresourcecentre.mb.ca](http://www.metisresourcecentre.mb.ca)

Mignonne's Recipe Box 448

Native American Recipes "Whatever food you can think of, no matter how disgusting or nasty, the chances are someone, somewhere is eating it..."

Mountain Lion's Native American Cookbook 1177

Fruits And Berries, Vegetables, Mushrooms And Consumable Fungi', Teas And Beverages, Breads, Soups And Stews, Grains And Nuts, Desserts And Confections and Meats Fish And Game Foul.

[More sites on www.angelfire.com](http://www.angelfire.com)

Muskrat Coffee Company Odawa US - 258
Northeast

We are a native owned and operated coffee company on the White Earth Reservation in Minnesota. We roast gourmet organic and fair trade coffee. We are trying to build a model of a socially responsible business.

Native American Recipes 1410

Through MetroActive Central - Butternut Squash Soup with Roasted Pumpkin Seeds / Ribbons of Summer Squash with Sage Pesto / Sage Pesto

Native American Recipes - SOAR Recipe 1600

[Source](#)

Anissabo / Baked Acorn Squash / Baked indian pudding / Cherokee Pepper Pot Soup (Ai) / Fresh Tomato Sauce / Fried Green Tomatoes / Inagami-pakwejigan (soft Bread) / Missiiagan-pakwejigan (sunflower Bannock) / Nopales / Ogwissimanabo / Ogwissimanabo(yellow Squash Soup) / Ojawashkwawegad / Ojawashkwawegad(wild Green Salad) / Peanut Butter Amaranth Logs / Posole / Pueblo bbq pork roast / Zuni Indian Bread / Zuni Indian Bread

Native Peoples Magazine: Spirit Of The Harvest Recipes 997

Every quarter, Native Peoples Magazine features recipes from the cuisine of Beverly Jacobs and Martin Cox for you to add to your culinary repertoire! Just choose from highlighted text below for the one that sounds scrumptious to you.

More sites on www.nativepeoples.com

Native Pride Buffalo Meat Sioux 1210

Native Pride is Native Owned business. We offer buffalo jerky, roasts and burger. Also buffalo tallow soap,balm, and more.

Native Recipes - Wiisiniwan -- Food Recipes 1299

Webmistress Paula Giese -- Frybread--Tasty Symbol of all-Indian unity -- Native cookbooks --Nutrition info, cookbooks for kids --Wild rice recipes --Maple sugar/syrup recipes --Corn, hominy, cornmeal -- Beans and Greens --Squash, pumpkin --Deermeat, Meat --Fish, birds --Fruit and Berries --Herbal Teas, Culinary Herbs --Xocoatl (Chocolate), Aztecs (and south).

More sites on www.kstrom.net

Native Way Cookbook 4031

Traditional, Contemporary & Modern Recipes Indexed by Nation/Tribe, Type of Dish How-to Instructions Plant, Herb & Fungi Encyclopedia Food & Ingredient Sources Dining Opportunities Homework Help

More sites on www.wisdomkeepers.org

Parched Corn 923

Collected notes and recipes.

More sites on www.geocities.com

Pemmican: Recipes, Stories and Stores 1405

Saskatoon Pemmican / Modern Native American recipe / Pemmican using Caribou meat using Bison for lots of stuff / Pemmican Pate Recipe: eat immediately. (At a commercial Web site that sells meat) / Native Cooking includes other recipes -- and more!

PSG FAQ: Food 807

Plants are the major source of carbohydrates in a survival situation, in addition to being under most circumstances more easily available. The problem with plants is that you need to know what you are doing when using them. This is of course also true when it comes to hunting, but in general the only consequence of messing up is that you don't get anything to eat, perhaps with the exception of fishing with rapid expanding bait and shooting at anything that moves.

<u>More sites on www.algonet.se</u>			
<u>Puff'n Billy Quality Foods</u>	Maori	Aotearoa- New Zealand	542
Puff'n Billy Quality Foods Ltd has pioneered a special way to prepare hangi-flavoured food under controlled, hygienic conditions. Enjoy the flavour at the Puff'n Billy Restaurant, the easiest way to experience ethnic Maori cooking.			
<u>Seeds of Change Garden</u>			712
History: Where Food Crops Originated. A lot of the food we take for granted wasn't even known to the Europeans until after the Columbian Exchange. When contact was made with the new world, a whole Cornucopia of new foods was introduced to the explorers, who would bring back these foods, and distribute them all over the world.			
<u>Selected References on American Indian Food</u>			1266
Anthropology Outreach Office, Smithsonian Institution <u>More sites on www.nmnh.si.edu</u>			
<u>SG-Cooking</u>			717
Rocky Mountain Survival Group E-mail List Archive <u>More sites on www.artrans.com</u>			
<u>SG-Edible Plants</u>			728
Rocky Mountain Survival Group E-mail List Archive <u>More sites on www.artrans.com</u>			
<u>SG-Food Preservation</u>			676
Rocky Mountain Survival Group E-mail List Archive <u>More sites on www.artrans.com</u>			
<u>SG-Insects - Insects as Food</u>			698
Rocky Mountain Survival Group E-mail List Archive <u>More sites on www.artrans.com</u>			
<u>SG-Water</u>			635
Rocky Mountain Survival Group E-mail List Archive <u>More sites on www.artrans.com</u>			
<u>Sikunu cookbook</u>		Africa	1028
Simple and basic recipes for African food. <u>More sites on sikunu.topcities.com</u>			
<u>Spear Fishing</u>		US - Northeast	962

Fish were a major source of meat for Native Americans all year round. One way that the Native Americans caught fish was with spears. Spear fishing was considered a man's job while fishing with a hook and string was usually a woman's job. Spear fishing was usually done in the winter or spring time.

[More sites on www.anthro.mankato.msus.edu](http://www.anthro.mankato.msus.edu)

Thanksgiving / Native Perspective US - 851
Northeast

Let's Eat! // Killer Cranberry Sauce / Black Turkey Recipe - The only way to cook a turkey! This turkey is work... it requires more attention than an average six-month-old baby. There are no shortcuts, as you will see. / Some Recipes from the Woodland Culture area.

The Cooking Post Native American Foods US - 3288
Southwest

Welcome to The Cooking Post, a tribal enterprise of Santa Ana Pueblo, offering you a delicious selection of foods, coffee, tea, recipes and gifts. You'll savor our own Tamaya Blue blue corn, as well as a wonderful selection of Native cuisine from across the United States. We invite you to share our food of the Earth and its power to create balance, good health and spiritual harmony.

[More sites on www.cookingpost.com](http://www.cookingpost.com)

Three Sister's Cookbook - Oneida Indian Nation Oneida US - 968
Northeast

The Three Sisters Story Modern day agriculturists know it as the genius of the Indians, who interplanted pole beans and squash with corn, using the strength of the sturdy corn stalks to support the twining beans and the shade of the spreading squash vines to trap moisture for the growing crop. Research has further revealed the additional benefits of this "companion plant-ing." The bacterial colonies on the bean roots capture nitrogen from the air, some of which is released into the soil to nourish the high nitrogen needs of the corn.

[More sites on oneida-nation.net](http://oneida-nation.net)

Traditional Food, Health and Nutrition Anishinaabe US - 1011
Northeast

Webmistress Paula Giese -- What we eat -- where it comes from, how it is raised, processed, cooked -- affects our health in many ways. Traditional native diets in those few places in the world where people still mostly eat what they raise, hunt, gather, fish -- have been found to promote health and long life, for reasons only gradually coming to be understood.

[More sites on www.kstrom.net](http://www.kstrom.net)

Traditional Herbal & Plant Knowledge, Identifications US - 837
Northeast

Herbs for teas, flavorings, foods -- Herbs used mostly by Anishinaabeg people; Indian names may be individual to the person describing and furnishing plant specimens. Different names were given to different parts of the plant, and to its different uses in food or medicine sometimes. Botanical names are current international standard.

[More sites on www.kstrom.net](http://www.kstrom.net)

<u>Traditional Navajo Recipes</u>	Navajo	US - Southwest	1430
<p>The following recipes come from Elaya K Tsosie, a Native Navajo. She teaches Native American History at at two different New York State Colleges.-- / Basic Frybread Recipe - 2 variations / Dried Corn / Dried Corn Stew / Dried Corn Soup / Hopi Corn Stew / Cheese and Green Chili Soup / Garbanzo Soup</p> <p><u>More sites on waltonfeed.com</u></p>			
<u>What's for Lunch? Food in American Life</u>		US - Northeast	253
<p>A series of articles fromt he CRM Archive Issue 24-04.</p> <p><u>More sites on www.foraging.com</u></p>			
<u>Wild Food Adventures</u>		US - Northwest	823
<p>Edible Plants - Workshops, Wild Food Adventures provides outdoor education, training, and recreational hikes in pursuit of edible wild plants. Services include wild food-related workshops, technical advising, contracted training, ethnobotanical research, and curriculum development. We also publish the Wild Food Adventurer newsletter (also discussed at the website). It includes feature articles, calendar of events & workshops, news, views, and information for the serious wild food enthusiast. Both Wild Food Adventures and the Wild Food Adventurer newsletter cover all of North America - emphasizing the Pacific Northwest.</p>			
<u>www.Foraging.com</u>			296
<p>Foraging and Ethnobotany Links Page - Including Foraging Theory, Plant Databases, Sites by/about Individuals, Educational Institutions, Media Reports and Forums.</p> <p><u>More sites on www.foraging.com</u></p>			

You are being redirected to NativeWeb's Resource Database for Performance (Music, Dance, Theater, etc)

Resources for Indigenous Cultures around the World

[Resources](#) [Books & Music](#) [Community](#) [Services](#) [About Us](#)

Resource Center

- [Internet Links](#)
- [Nations Index](#)
- [Geographic Region Index](#)
- [Search the Site](#)
- [New Sites this Week](#)
- [Submit a Site!](#)
- [Top 5 Percent](#)

Hosted Resources

- [Hosted Pages](#)
- [Book & Music Center](#)
- [Law & Legal Issues](#)
- [NativeLaw News](#)
- [NativeTech](#)

Site Information

- [Get your FREE EMAIL @NativeWeb.Net!](#)
- [Community](#)
- [About Us](#)
- [Hosting Information](#)

[Resource Database / Performance \(Music, Dance, etc\)](#)

Visit [NativeWeb's Book and Music Center](#) for additional resources.

Performance (Music, Dance, etc) Sub-Categories:

- [Actors \(Movies & TV\), Storytellers](#)
- [Dancers, Dance Groups, Outfits](#)
- [Drama & Theatre](#)
- [Festivals, Events](#)
- [Music](#)
- [Non-Profit Organizations, Groups](#)
- [Performing Arts - General](#)
- [Sales, Distributors, Businesses](#)

Resources: 2 listings

Name and Description	Nation	Location	Hits
Four Directions Entertainment	Oneida	US - Northeast	151

A native film production company, owned, operated and funded by American Indians to promote American Indians in the entertainment industry through television, film and high definition technology. An enterprise of the Oneida Indian Nation.

Donate to
NativeWeb!
Tax Deductible!



The Gathering of Oneida Canada - **137**
Good Minds **Eastern**

**A Celebration of Native wisdom art and
culture ~ Onyo'ta a:ka**

You are being redirected to NativeWeb's Resource Database for Powwows & Calendars

You are being redirected to NativeWeb's Resource Database for Literature

Resources for Indigenous Cultures around the World

[Resources](#) [Books & Music](#) [Community](#) [Services](#) [About Us](#)

Resource Center

- [Internet Links](#)
- [Nations Index](#)
- [Geographic Region Index](#)
- [Search the Site](#)
- [New Sites this Week](#)
- [Submit a Site!](#)
- [Top 5 Percent](#)

Hosted Resources

- [Hosted Pages](#)
- [Book & Music Center](#)
- [Law & Legal Issues](#)
- [NativeLaw News](#)
- [NativeTech](#)

Site Information

- [Get your FREE EMAIL @NativeWeb.Net!](#)
- [Community](#)
- [About Us](#)
- [Hosting Information](#)

[Resource Database / Literature](#)

Visit [NativeWeb's Book and Music Center](#) for additional resources.

Literature Sub-Categories:

- [Authors, Writers & Biographies](#)
- [Bibliographies Lists & Links](#)
- [Book Sellers & Publishing](#)
- [Books - Non-Fiction](#)
- [Books and Articles](#)
- [Children & Young Adults](#)
- [Essays on Social Issues](#)
- [Journals](#)
- [Poetry - Online](#)
- [Short Stories - Contemporary](#)
- [Short Stories - Traditional](#)
- [Speeches-Interviews](#)

Resources: 6 listings

Name and Description	Nation Location	Hits
Australian Aboriginal and Torres Strait Islander Writers	South Pacific	1286

Donate to
NativeWeb!
Tax Deductible!



Welcome to OzLit@Vicnet. If you have an interest in Australian Literature then OzLit is the Internet site to begin your search. We encourage participation from OzLit users and extend an invitation to all Australian writers to contact us re updates or additions to our database. At this site we have more than 500 pages of Australian Literary information as well as more than 1100 entries in our Fully Searchable Books & Writers Database in which you can search for either Authors, or Book Titles and which includes Contact Addresses if we have permission to publish them – a subject search can also produce interesting results.

[More sites on home.vicnet.net.au](http://home.vicnet.net.au)

Indigenous Peoples' Literature 1734

The Americas / Artists / Columbus-1492 / Europe, Asia, Africa, and Oceania / Famous Documents / Famous Quotes / Great Chiefs & Leaders / Indigenous Nations - Active Home Pages / Indigenous Nations of North America / Mother Earth Prayers / Music / Poetry / Stories / Writers/Speakers / Writings of Native Youth

John and Ali's Pequot US - West 111
Bona Fide Native American Literature and Poetry Club

Website to explore Native- American Literature and Poetry of and for today.

[More sites on www.geocities.com](http://www.geocities.com)

Native American Literature 4479

Although it was the first American literature to be created, Native American literature has been the last to be recognized -- and, to some extent, is still waiting for full recognition. Beginning with its first thousand years of oral literature and continuing to the present time with writers in all the genre of literature, Native American is an important element in the literature of this country.

[More sites on www.usc.edu](http://www.usc.edu)

[Wordcraft Circle of Native Writers and Storytellers](#) United States 1566

Wordcraft Circle of Native Writers and Storytellers, founded in 1991 as a non-profit international membership organization, has as its vision: to ensure that the voices of Native writers and storytellers --past, present, and future-- are heard throughout the world.

[Words From The Edge](#) 1181

From October to December 2000 four indigenous poets will travel through four countries introducing the stories of their peoples through poetry readings, stories and lectures. The indigenous world is threatened in its existence through the economic interests of mainly multinational corporations and government policies. The unique voices of the artists representing indigenous peoples from four continents are a rare opportunity for European audiences.

You are being redirected to NativeWeb's Resource Database for History
Also see their sections for Libraries/Catalogues and Anthropology/Archaeology
As well as NativeWeb's section for Law and Legal Issues



Resources for Indigenous Cultures around the World

[Resources](#) [Books & Music](#) [Community](#) [Services](#) [About Us](#)

Resource Center

- [Internet Links](#)
- [Nations Index](#)
- [Geographic](#)

Region Index

- [Search the Site](#)
- [New Sites this](#)

Week

- [Submit a Site!](#)
- [Top 5 Percent](#)

Hosted Resources

- [Hosted Pages](#)
- [Book & Music](#)

Center

- [Law & Legal](#)

Issues

- [NativeLaw News](#)
- [NativeTech](#)

Site Information

- [Get your FREE](#)

EMAIL

[@NativeWeb.Net!](#)

- [Community](#)
- [About Us](#)

- [Hosting](#)
- ### Information

[Resource Database / History](#)

History Sub-Categories:

- [Africa](#)
- [Alaska](#)
- [Arctic Circle](#)
- [Asia](#)
- [Australia & New Zealand](#)
- [Canada](#)
- [Caribbean](#)
- [Central America](#)
- [Europe & Russia](#)
- [Greenland & Iceland](#)
- [Hawaii](#)
- [Mexico](#)
- [Micronesia & Polynesia](#)
- [South America](#)
- [United States](#)

Donate to
NativeWeb!
Tax Deductible!



© [NativeWeb, Inc.](#) 1994-2003 || [Disclaimer Statement](#) || [Copyright Statement](#) || [Contact Us](#) || [Visitors](#) || [Donations](#)

You are being redirected to NativeWeb's Resource Database for Living History

Resources for Indigenous Cultures around the World

[Resources](#) [Books & Music](#) [Community](#) [Services](#) [About Us](#)

Resource Center

- [Internet Links](#)
- [Nations Index](#)
- [Geographic Region Index](#)
- [Search the Site](#)
- [New Sites this Week](#)
- [Submit a Site!](#)
- [Top 5 Percent](#)

Hosted Resources

- [Hosted Pages](#)
- [Book & Music](#)

Center

- [Law & Legal](#)

Issues

- [NativeLaw News](#)
- [NativeTech](#)

Site Information

- [Get your FREE](#)

EMAIL

[@NativeWeb.Net!](#)

- [Community](#)
- [About Us](#)
- [Hosting](#)

Information

[Donate to](#)

[Resource Database](#) / [History](#) / [Living History](#)

Resources: 16 listings

Name and Description	Nation	Location	Hits
Abotech.com - The Cyber Shelter for Primitive Living Skills			412
<p>Man (Homo sapiens) has been successful as a species, not because he has mastered modern technologies but because he mastered the skills necessary to compete for daily survival. Each epoch in the history of man has identified at least one major skill in man's ability to change and improve his environment. These skills were basic to those beings who lived thousands and thousands of years ago and are practiced by everyone today with technical refinements and modern adaptation to fulfill our own requirements.</p>			
APVA Jamestown Rediscovery		US - Southeast	304

NativeWeb!
Tax Deductible!



Association for the Preservation of Virginia Antiquities Jamestown Rediscovery archaeological project. Jamestown Rediscovery is a ten-year interdisciplinary project searching for the remains of 1607 Jamestown on the 22.5 acre APVA property on Jamestown Island, Virginia. 'We Found the Fort'.

Code Talkers Navajo US - 372
 Southwest

Navajo and other Native American Code Talkers of WWI and WWII

Experiments in 148
Primitive Living

Cooking, Fire Starting, Hunting Weapons, Flint Knapping

Heritage of the US - 379
Ancient Ones Southeast

HOTAO is a multi-cultural, nonprofit, educational organization, dedicated to preserving the history, culture and traditions of Florida's original Native peoples while promoting respect for Mother Earth. Also information about the new Ancient Native Village Living History Museum in Ruskin, Florida.

More sites on www.ancientnative.org

Living History US - 584
and Pre-1840s Southeast
Buckskinning

Living History events can run the gamut from 1750's to Civil War to World War II. Also of interest to participants are Scottish festivals and Native American pow-wows. There is no way we can list every single event in every single category, so we're going to focus on pre-1840's rendezvous & living history events in the Southeastern U.S. If you're interested in a different area or type of event, that would be a great excuse to start your own page devoted to it! Goodness knows, the Web can use it.

[More sites on www.geocities.com](http://www.geocities.com)

[New England Native American Calendar](#) Narragansett US - Northeast 305

The New England Native American Calendar is a resource for information on contemporary Northeast Native Americans.

[Pennsylvania's Historic National Road](#) US - Northeast 15

This section includes Fort Necessity, General Braddock's Grave, and numerous museums, and historic landmarks.

[PrimitiveWays](#) 683

This Site is dedicated to Stone Age technology, "Friends of the Society of Primitive Technology" events, atlatl spear throwers and darts, cordage, fire by friction, simple kayaks, bow and arrow, primitive survival skills, ancient and earth skills, stone tools, wilderness and outdoors skills, hide tanning, knots, nature awareness, medicinal and edible plants, traditional skills, archaeology, anthropology, native technology, prehistoric knives, flintknapping, baskets, aboriginal skills, artifact replication, workshops and classes, old ways and more.

[More sites on www.primitiveways.com](http://www.primitiveways.com)

**St. Clair Flats US - 244
Historical Northeast
Encampment**

Primary focus on the daily life activities of the different peoples (Europeans & Native Americans) that inhabited the Great Lakes region during the mid 1700's . Historical interpreters will be demonstrating activities, crafts, skills, and games of the different peoples that inhabited the Great Lakes region during this time period.

Syukhtun Chumash US - West 413

The history of Syukhtun, the main town of the Chumash realm on California's Pacific coast, inhabited for eight thousand years up to the present day by the Chumash.

[More sites on www.angelfire.com](http://www.angelfire.com)

**The Trading US - 381
Party - 1607- Northeast
1760**

Portraying Traders and Native Americans of the Early Colonial Period - The Trading Party is a motley collection of experienced re-enactors who typically portray traders and their Native American customers. Our goal is to accurately portray traders focussing on the early settlement of Virginia and trade on the Virginia/Pennsylvania/Ohio frontiers. Extensive research has been done on the articles that were traded and these items or accurate reproductions of them have been obtained to demonstrate the nature of the merchandise being exchanged.

**Walking Tour of Wampanoag US - 336
Plimoth Northeast
Plantation**

Interpreting Activity Areas: An Example from Hobbamock's Homesite, In interpreting archaeological sites, archaeologists often look for analogues from living cultures. In southern New England there are no groups which practice traditional subsistence technology or settlement. However, the local tribes have a rich oral tradition regarding crafts, horticulture, and other aspects of material culture.

More sites on archnet.asu.edu

**Waswagoning Ojibwe US - 647
Central**

Waswagoning is a recreated Ojibwe Indian Village located in northern Wisconsin. We give tours of our village to school groups and tourists during the summer season. We show and explain the daily life of the Ojibwe Indians before European contact, through the four seasons.

More sites on www.waswagoning.com

**White Oak Fur US - 194
Post Northeast**

The year is 1798 and the fur trade is booming. Our fur trading post is located near the upper reaches of the Mississippi River in the north woods. In another 60 years this will become the state of Minnesota. But for now, enter and join a hearty group of gentlemen and voyageurs. They are talking about the rendezvous. Later they may talk about the fur trade, sing some songs, perhaps talk about the winter to come. It is a time of adventure, challenge, dangers, and rewards..

Wilderness Way

505

Online

In Wilderness Way, you will learn primitive skills that have been used for thousands of years, yet forgotten by our modern culture. Wilderness Way magazine opens a door to a simpler time and the techniques of how man lived. Inside you'll find secrets to aking friction fires, primitive shelters, plant cordage, atlatls (spears), birch canoes, teepees and much more.

[More sites on wwmag.net](http://www.wwmag.net)

You are being redirected to NativeWeb's Resource Database for Native American Related
Museums

Resources for Indigenous Cultures around the World

[Resources](#) [Books & Music](#) [Community](#) [Services](#) [About Us](#)

Resource Center

- [Internet Links](#)
- [Nations Index](#)
- [Geographic](#)

Region Index

- [Search the Site](#)
- [New Sites this](#)

Week

- [Submit a Site!](#)
- [Top 5 Percent](#)

Hosted Resources

- [Hosted Pages](#)
- [Book & Music](#)

Center

- [Law & Legal](#)

Issues

- [NativeLaw News](#)
- [NativeTech](#)

Site Information

- [Get your FREE](#)

EMAIL

[@NativeWeb.Net!](#)

- [Community](#)
- [About Us](#)
- [Hosting](#)

Information

[Resource Database / Museums](#)

Resources: 131 listings

Name and Description	Nation	Location	Hits
----------------------	--------	----------	------

Shung Ye		Asia	187
--------------------------	--	------	-----

[Museum](#)

[Formosan](#)

[Aborigines](#)

Austronesian people began to arrive in Taiwan around 6,000 years ago, giving rise to the indigenous culture that still exists in the Central Mountain Range and along the eastern coastal areas of the island. Among the 19 tribes remaining nowadays, nine have managed to preserve their distinct customs and languages relatively well. These nine tribes are the Saisiat, Atayal, Tsou, Bunun, Ami, Rukai, Puyuma, Paiwan, and Yami. The brand-new Shung Ye Museum of Formosan Aborigines houses a refined collection of 1,000 artifacts, mainly from these nine tribes. First of its kind in Taiwan, the museum is also dedicated to preserving indigenous culture and enhancing understanding among the different ethnic groups.

[Abbe Museum](#)

US -	2709
Northeast	

The Antelope Valley Indian Museum stands against towering rock formations in the Mojave Desert. The large boulders become a portion of its interior while timbers from Joshua trees cover supports for its roof. This folk art structure is listed on the National Register of Historic Places. Visitors will find the history of the Museum and the collections it houses both colorful and varied.

Arizona State US - 1165
Museum Southwest

Collections

The Museum's focus is on the study of Southwestern Indian cultures. The collections include prehistoric, historic and modern artifacts, photographs, archives, and sound recordings. Included are some 25,000 ethnographic objects, 150,000 artifacts from archaeological excavations, an archives with 1300 linear feet of documents, and 175,000 historic and contemporary photographic images.

More sites on
www.statemuseum.arizona.edu

Árnesinga Folk Iceland 956
Museum

The Árnesinga Folk Museum is located at "The House", built in 1765 and one of the oldest surviving buildings in Iceland. Exhibits show local history and trace the different roles that The House has played during its long life.

Art Museums of US - 1798
New Mexico Southwest

A comprehensive database of New Mexico's Museums, Parks, and Monuments. Photos, major collections and up-to-date calendars are all available at this site.

More sites on www.nmculture.org

Ataloa Lodge **Muscogee** **US -** **433**
Museum **Southwest**

Native American founded maintained and operated. Small museum. large collection. Over 20,000 items of Native American culture, from Northeast to Northwest and Nations in between. Located on the historic campus of Bacone College in Muskogee,OK

Bishop **South** **1053**
Museum, **Pacific**
Honolulu

Bishop Museum was founded in 1889 by Charles Reed Bishop in honor of his late wife, Princess Bernice Pauahi Bishop, the last descendant of the royal Kamehameha family. The Museum was originally established to house the large collection of Hawaiian artifacts and royal family heirlooms of the Princess, and has since expanded to include over 2 million artifacts, documents and photographs about Hawai`i and other Pacific island cultures.

Black Kettle **Cheyenne** **US -** **1251**
Museum **Central**

he museum provides information on the Cheyenne and the Battle of the Washita as well as other local history items. The nearby battle site is under development by the National Park Service. An interpretative center is planned on site in the next few years. New temporary exhibits on the battle are planned to be on line by fall of 1999.

Burarra **Australia** **17**
Gathering

Burarra Gathering is an online exhibition that shares some of the traditional knowledge and technology of the Burarra people of remote northern Australia. The exhibition uses high quality Flash animation to take the user to visit the Burarra people on their land. The exhibition was made in cooperation with the Burarra Elders.

Canadian Canada 1187

**Children's
Museum**

With its emphasis on interactive hands-on learning, the Canadian Children's Museum seeks to enrich children's lives, broaden their cultural experience and provide them with a creative space in which to learn about the world.

More sites on www.civilization.ca

Canadian Canada 1462

**Museum of
Civilization**

As the national museum of human history, the Canadian Museum of Civilization is committed to fostering in all Canadians a sense of their common identity and their shared past. At the same time, it hopes to promote understanding between the various cultural groups that are part of Canadian society.

More sites on www.civilization.ca

**Cayuga Museum Cayuga US - 782
- Auburn New Northeast**

York

The Cayuga Museum of History and Art, a non-profit organization housed in the former Willard/Case estate, promotes the study and research of history, art, and science (with a particular interest in the early development of motion pictures) as they are directly related to Cayuga County and within the Finger Lakes region. To accomplish its purpose, the museum provides access to the collections, and develops and sponsors programs for the education and enjoyment of the public related to the scope of its collections.

<u>Chena Indian Village</u>	Alaska	744
------------------------------------	---------------	------------

The Riverboat Discovery - The highlight of the cruise is a one-hour stop at the Chena Indian Village, where Alaskan Native guides will take you on a guided tour. You'll see an Athabascan Indian village with cabins made of spruce logs, a cache used for storing supplies, and fur pelts. Our guides will explain how the wolf, fox, martin, and beaver were used to provide food and protection in the harsh Arctic climate.

<u>Cherokee Heritage Center</u>	Cherokee	US - Central	1688
--	-----------------	---------------------	-------------

Dedicated to the preservation and promotion of Cherokee history and culture.

<u>Chickasaw Nation Museums</u>	Chickasaw	US - Southwest	1930
--	------------------	-----------------------	-------------

Includes Chickasaw Legends, Customs, and Cultural Characteristics. Elders are encouraged to participate by the staff and the elders have been extremely helpful in identifying significant aspects of Chickasaw life, authenticating projects, activities, and objects which are significant for the museums. The staff conducts in-home visits with the elders and visits to senior citizens community centers.

[More sites on www.chickasaw.net](http://www.chickasaw.net)

Chucalissa US - 543
Archaeological Southeast
Museum and
Reconstructed
Indian Village

Operated by the Department of Anthropology at the University of Memphis. Within the 187 acre tract, located just south of Memphis, Tennessee, lies the C.H. Nash Museum and a reconstructed 15th century Native American village located on an actual archaeological site, now known as Chucalissa.

Chumash Indian Chumash US - 1191
Life Southwest

This website includes information about the Chumash people's daily lives, as well as resources archived by the Santa Barbara Museum of Natural History. Visit the museum and experience the Chumash people, "the ones who make shell bead money."

Colonial US - 530
Williamsburg Southeast

At Colonial Williamsburg, the 18th century comes to life. Come visit Colonial Williamsburg of yesterday and today. Historical Almanack Sample the depth of resources Colonial Williamsburg has to offer in the Historical Almanack. Plan your 20th-Century Visit of the historic capital. Learn what to see, where to stay, and what you can expect in a typical day about town. Meet the people, experience colonial life, see the places, and browse the colonial dateline.

Connecticut US - 1231
State Museum Northeast
of Natural
History

The Museum features science and Native American exhibits, live bees, the Videoplace artificial reality display and hands-on activities.

Conner Prairie US - 1545
Museum Central

Conner Prairie, an Earlham Museum, is an AAM accredited open-air living history museum located in Fishers, Indiana. It serves as a local, regional, and national center for research and education about the lives, times, attitudes, and values of early 19th-century settlers in the Old Northwest Territory, based upon the Indiana experience. Conner Prairie features a modern Museum Center, special facilities, and four historic areas: the 1836 village of Prairietown, the 1823 William and Elizabeth Conner Home, the Pioneer Adventure Area and the new Lenape Camp & McKinnen's Trading Post. The museum and historic areas are set on a 210 acre site featuring wooded areas and orchards along the White River in central Indiana.

Correspondence Europe & 431
with North Russia
American Indian
Prisoners

As the title does say people can find here names of inmates to write with.

Crawford Lake Iroquois Canada - 1897
Indian Village Eastern

This fifteenth century Iroquoian Village was reconstructed on its original site to create a unique opportunity to expand our understanding and appreciation of Ontario's original people. Three sources of information are being used to reconstruct the village. Archaeological data determined the exact location of the main structures along with other inground features such as fire pits and posts. Historical documentation (the records of Jesuits and early explorers) provided details of the above ground portions of the longhouses, palisade walls and smaller village structures. Finally, the native peoples of today who carry on the traditions of their ancestors help us gain a stronger appreciation of native culture and its unique relationship with Mother Earth.

More sites on www.thinedge.com

Dickson 1048
Mounds
Museum,
Lewistown

Dickson Mounds Museum, a branch of the Illinois State Museum and a National Historic Site, is one of the major on-site archaeological museums in the United States. It offers a unique opportunity to explore the world of the American Indian in an awe inspiring journey through 12,000 years of human experience in the Illinois River Valley.

[More sites on www.museum.state.il.us](http://www.museum.state.il.us)

Diego Rivera -

831

Virtual Museum

DIEGO RIVERA (1886-1957), muralist painter, was one of the greatest artists in the XXth century. Born in Guanajuato Mexico, in 1892 he moved to Mexico City with his family. He studied in the San Carlos Academy and in the carving workshop of artist José Guadalupe Posada, whose influence was decisive.

Discovering

Asia

27

Taiwan's

indigenous

culture in the

heart of Taipei

About 6,000 years ago, Taiwan's first inhabitants arrived, most likely from the southeast of China. These aboriginal tribes, now distributed mainly among Taiwan's mountainous areas and along the East Coast, have for many years struggled to prevent the disappearance of their languages and traditions. Today, due to government intervention and education, there is increasing interest in Taiwan's aboriginal culture. For those wanting to learn about the island's Aborigines, a good place to start is the Shung Ye Museum of Formosan Aborigines in Taipei.

Eiteljorg US - 1049
Museum - Central
Indianapolis

The Eiteljorg Museum is unique, one of two museums east of the Mississippi with both Native American and Western art. The Native American collection includes pottery, basketry, sculpture and other artifacts from all 10 North American native cultural areas.

Fenimore House US - 713
- the Bead Northeast
Infobase

Spectacular collections of American Indian Art. "The Eugene and Clare' Thaw Collection of American Indian Art", dates from 400 BC through the 20th century, and includes outstanding examples of beadwork highlighting the artistry of North America's indigenous peoples. The new wing includes four major galleries and a study center, with open storage systems that allow access to objects not on display.

[More sites on www.nfobase.com](http://www.nfobase.com)

Field Museum 1128
Online

The Field Museum was incorporated in the State of Illinois on September 16, 1893 as the Columbian Museum of Chicago with its purpose the "accumulation and dissemination of knowledge, and the preservation and exhibition of objects illustrating art, archaeology, science and history."

[More sites on www.fieldmuseum.org](http://www.fieldmuseum.org)

First Peoples - **Canada** **694**
Canadian
Museum of
Civilization

Online Exhibitions - Legends of Our Times: Native Ranching and Rodeo Life on the Plains and Plateau; From Time Immemorial: Tsimshian Prehistory; Wave Eaters: Native Watercraft in Canada; Storytelling: The Art of Knowledge - and much more.

More sites on www.civilization.ca

Five Civilized **Cherokee** **US -** **2181**
Tribes Museum **Central**

The Five Civilized Tribes Museum and Center for the Study of Indian Territory exists to preserve the heritage and culture of the Cherokee, Chickasaw, Choctaw, Creek and Seminole. The Museum hosts cultural/educational events and competitive art shows through out the year. The student art show, held each spring, serves to support and cultivate new artists within the Five Civilized Tribes; while, the Master's show hosted in the fall recognizes the talent, determination and spirit of the seasoned Native artisian. We invite you to visit our Museum located in Muskogee, Oklahoma or stop by our web site fivetribes.com to explore our committment to the preservation of Native American history and culture.

More sites on fivetribes.com

Five Civilized **US -** **789**
Tribes Museum **Central**

The Five Civilized Tribes Museum and Center for The Study of Indian Territory is currently housed in the Old Indian Agency building in Muskogee, Oklahoma.

[More sites on fivetribes.com](#)

<u>Frank H. McClung Museum</u>	US - Central	968
---	---------------------	------------

The McClung Museum is a general museum with collections in anthropology, archaeology, decorative arts, medicine, local history, and natural history. The exhibits document ways of life, cultural trends, and technologies from prehistoric times to the present day, and showcase much of Tennessee's past -- its geology, history, art, and culture. The McClung Museum is a special place -- a place of discovery, a place to learn about the world around us.

<u>GSN Artifacts</u>	Sioux	US - West	1666
---	--------------	------------------	-------------

Original American Indian Art ~ Uncover the Treasures ~ Feathered headdresses. Brightly decorated deerskin clothing. Colorful, beaded bags and teepee covers depicting the dweller's dreams. These are the types of artifacts you'll find at Indian museums across the state. Porcupine quillwork, in particular, is a trademark of the Great Sioux Nation. You'll see it adorning everything from breastplates to pipe bags. Women would pluck the quills from a porcupine, soak them to make them supple, then sew or weave the dyed quills onto any number of items. In the early 19th century, white traders introduced beads, which the women began using in place of porcupine quills. Beadwork eventually became more prevalent than quillwork. Besides quillwork and beadwork, you'll discover winter counts, horse dance sticks, pipestone bowls and more --

each piece offering new insight into the culture of the Great Sioux Nation.

[More sites on www.state.sd.us](http://www.state.sd.us)

<u>Haffenreffer</u>	US -	646
<u>Museum of</u>	Northeast	
<u>Anthropology</u>		

At Brown University - The Haffenreffer Museum of Anthropology was founded in the early 1900s as the private collection of Rudolf F. Haffenreffer. It was originally named the King Philip Museum because of its location on the Mount Hope Grant, which in the 17th century was the head quarters of Metacom, the Wampanoag chief (commonly known to the English and to students of history as King Philip). Located in Bristol, RI, the Mount Hope Grant is 18 miles from the University.

<u>Heard Museum</u>	US -	573
	Southwest	

The Heard Museum in Phoenix, Arizona, is a private, non-profit museum founded in 1929 by Dwight B. and Maie Bartlett Heard to house their personal collection of artifacts and art. The mission and philosophy of the Heard today is to promote appreciation and respect for Native people and their cultural heritage, with emphasis on the traditional cultures of the Greater Southwest and on the evolving Native American Fine Art Movement.

[More sites on www.heard.org](http://www.heard.org)

<u>High Desert</u>	Canada -	490
<u>Museum Home</u>	Western	
<u>Page</u>		

Welcome to the home page for The High Desert Museum, a living experience in Western history, Native American cultures, art and wildlife. A 'living,' participatory museum of the cultural and natural history of the arid Intermountain West, which includes portions of eight western states and the Canadian province of British Columbia.

<u>Historic St.</u>	US -	474
<u>Mary's City</u>	Northeast	

Visit a time & place where recycling, organic gardens, herbal medicines, & natural fibers were New World, not New Age. Historic St. Mary's City is an exciting mix of colorful living history and fascinating archaeology, all set in a beautiful Tidewater landscape. Lord Baltimore's 17th-century capital stands ready to be rediscovered. Exhibits at the outdoor museum include the square-rigged ship, the Maryland Dove, Godiah Spray's fine tobacco plantation, the reconstructed State House of 1676, a Woodland Indian hamlet, and much more.

<u>Hudson</u>	US -	951
<u>Museum</u>	Northeast	

The Hudson Museum shares the University of Maine's commitment to serve the public by being the gateway for people in Maine to explore and understand the diversity of human experience. The museum acquires, documents, preserves, scientifically investigates, interprets and exhibits material culture. The museum offers permanent, temporary and outreach exhibits, guided tours, teacher workshops, lectures, children's programs and training in museum methods.

Many centuries before European explorers found their way to the western hemisphere, the Pueblo Indians of what is now New Mexico developed a distinctive and complex civilization. These peace loving people created an urban life in harmony with the environment and with each other. Their religion was pantheistic and deeply spiritual and constituted an important part of daily life, within which they created an equitable government, a magnificent architecture, intensive agriculture with a sophisticated irrigation system and a highly developed art in pottery, weaving, jewelry, leather work and other crafts.

[More sites on www.indianpueblo.org](http://www.indianpueblo.org)

<u>Indian Village and John and Delia Roberts Craft Pavilions</u>	US - Southeast	640
--	-------------------	-----

The Indian Village at Moundville Archaeological Park provides an opportunity to look into the past lifeways of the prehistoric Mississippian peoples. Each house in the village has a separate theme that depicts the daily life of the people that lived here prior to European arrival in the Americas. The new John and Delia Roberts Crafts Pavilions are used to demonstrate Native American lifeways to the park visitor. The pavilions also serve as outdoor classrooms and demonstration areas for our Native American artists-in-residence.

<u>Inner Mongolia Museum</u>	Asia	856
--	------	-----

The Inner Mongolia Museum is located in Huhhot, Inner Mongolia, China. The museum houses an exquisite collection of items dating from Pre-historic to modern times. Most of the pieces are concerned with the Altaic Cultures and cultures found in the area of what is today Northern China.

Institute for US - 948
American Indian Northeast
Studies

Committed to research, interpret, teach, and preserve the histories and cultures of Native American peoples. Although New England's First Inhabitants receive primary emphasis, Institute programs also encompass, for comparative study, the vast diversity of indigenous populations throughout the Americas.

More sites on 12.109.72.120

Institute of US - 736
American Indian Southwest
Arts Museum

The IAIA Museum is home to the National Collection of Contemporary Indian Art, the most comprehensive collection of contemporary Indian art presented from an Indian perspective. The collection contains over 8,000 items including paintings, jewelry, sculpture, prints, photographs, drawings, weaving, costumes, other art objects, and historical material. It is a living document of the explorations in creativity that is inspirational for future generations of Indian artists. The collections represent the best works produced by the alumni and students of IAIA and contributing Indian artists from over 100 Indian nations.

More sites on www.iaiancad.org

Institute of Africa 992
Egyptian Art
and
Archaeology -
Univ. of
Memphis

The Institute of Egyptian Art & Archaeology, founded in 1984, is a component of the Department of Art of The University of Memphis, in Memphis, Tennessee (USA), and is a Tennessee Center of Excellence. It is dedicated to the study of the art and culture of ancient Egypt through teaching, research, exhibition, and community education. As part of its teaching and research, the Institute conducts an epigraphic survey in the Great Hypostyle Hall of Karnak Temple in Luxor, Egypt. The Institute's collection of antiquities resides in the Art Museum of The University of Memphis. Over 150 objects range in date from 3500 B.C.E. to 700 C.E. There are mummies, religious and funerary items, jewelry, and objects from everyday life.

Kanata Website Iroquois US - 678
 Northeast

Kanata (pronounced Gah-na-dah) is an 18.5 acre Iroquoian village and education centre. This historic site was re-created to represent a 17th century Iroquoian village and provide cultural awareness for all people, schools and universities. The village provides an interactive experience to learn local native history.

Koshare Indian 1002
Museum

Through the preservation and interpretation of Southwest and Plains tribal art and artifacts, the Koshare Indian Museum: Provides a practical educational experience to visitors and residents of all ages and Offers a Scouting program aimed at enhancing the lives of youth through an appreciation for and interpretation of the arts, cultures, and dances of Native Americans.

Lake of the Woods Museum Canada - 511 Eastern

The Lake of the Woods Museum, located in Kenora, Ontario, exists to collect and preserve any material which may help to establish or illustrate the history of Kenora (originally called Rat Portage), Keewatin and Lake of the Woods. To that end, artifacts, and archival material relating to the area's progress in exploration, settlement, population, wealth, education, arts, industry, trade, transportation and any other area illustrative of life, conditions, events, and activities have been preserved.

Lawson Corley Museum of Arrowheads, Indian Artifacts, and War Memorabilia US - 1352 Southeast

Since 1976, Mr. Lawson Corley has operated a private museum in his home near Birmingham, Alabama, a unique collection of more than 100,000 arrowheads, tools, spears, bannerstones and gorgets from aboriginal American cultures such as the Mississippian mound-builders. As consultant and broker, Mr. Corley is the authorized agent for all of the relics pictured here.

Lenni Lenape **Delaware** **2028**
Historical
Society &
Museum

Information on festivals, homework help, research, our own photo gallery, Limited Edition Native American Dolls for sale, and other useful and interesting things.

Lewis and **US -** **829**
Clark: List of **Northeast**
Objects

Peabody Museum of Archaeology and Ethnology, Harvard University. Painted Buffalo Robe Mandan // Grizzly Bear Claw Ornaments Plains // Calumet Upper Missouri, possibly Mandan // Man's Shirt Upper Missouri // Sinew-Backed Elk Antler Bow Upper Missouri, possibly Mandan or Hidatsa // Raven Ornament Lakota // Woman's Side Fold Dress Northern Plains // Upper Missouri // Woman's Side Fold Dress Upper Missouri // Otter Pouch Eastern Plains // Whaling Chief's Hat Makah or Nootka // Flexible Root-gathering Bag

[More sites on www.peabody.harvard.edu](http://www.peabody.harvard.edu)

Links to **Mexico** **1058**
Mexican
Museum WWW
Sites

[More sites on lmtsun.phast.umass.edu](http://lmtsun.phast.umass.edu)

Living History **US -** **494**
Farms **Central**

Living History Farms in Urbandale, Iowa, tells the amazing story of how lowans transformed the fertile prairies of the Midwest into the most productive farmland in the world. The 1700 loway Indian Village shows how Iowa's first farmers worked the rich black soil.

Living Traditions: Canada - 475
North American Indigenous Games Eastern

a collection of interactive stories and games on indigenous games and sports including the 'Sacred Run', lacrosse, canoeing, kayaking, archery, and other Métis and Inuit games. Visitors can guide a kayak through rapids, shoot arrows at targets and try to piece together the bones of seal fin puzzle.

More sites on www.virtualmuseum.ca

Luxton Museum of the Plains Indian Canada 1183

The Buffalo Nations Cultural Society invites you to explore the extraordinary history of the Indians of the Northern Plains and Canadian Rockies. Journey through the collections of the Museum in Banff, Alberta.

More sites on collections.ic.gc.ca

Mary March Regional Museum - Newfoundland Canada - 920
 Eastern

The 5000 year heritage of Central Newfoundland is traced in this branch of the Newfoundland Museum, which derives its name from Mary March, one of the last of the Beothuk Indians.

[More sites on www.delweb.com](#)

<u>Mashantucket Pequot Museum</u>	Pequot	US - Northeast	1901
---	--------	----------------	------

The Mashantucket Pequot Museum and Research Center, a new state-of-the-art, tribally owned-and-operated complex, brings to life the story of the Mashantucket Pequot Tribal Nation, and serves as a major resource on the history of the Tribe, the histories and cultures of other tribes, and the region's natural history. It opened to the public on August 11, 1998.

<u>Mathers Museum of World Cultures</u>			1312
---	--	--	------

Want to take a trip around the world? Then check out the Mathers Museum of World Cultures, at Indiana University. The Museum has exhibits, events, and educational programs that give you a chance to learn more about objects from Australia to Zanzibar...

[More sites on www.indiana.edu](#)

<u>Maxwell Museum of Anthropology</u>		US - Southwest	751
---	--	----------------	-----

The Maxwell Museum of Anthropology, University of New Mexico, holds over 10 million individual items in its archaeological , ethnological , archival, photo and skeletal collections. The collections come from all parts of the world, but have a Southwestern emphasis. The Maxwell is the only museum in the Southwest whose mission encompasses the entire history of mankind and culture around the world.

[More sites on www.unm.edu](http://www.unm.edu)

<u>Michael C.</u>	US -	738
<u>Carlos Museum -</u>	Southeast	
<u>Emory</u>		
<u>University</u>		

The collections of the Michael C. Carlos Museum of Emory University span the globe and the centuries. Housed in a distinguished building by renowned architect Michael Graves, the Carlos maintains the largest collection of ancient art in the Southeast with objects from ancient Egypt, Greece, Rome, the Near East, and the ancient Americas. The Museum is also home to collections of 19th and 20th-century sub-Saharan African art and European and American works on paper from the Renaissance to the present.

<u>Mid-America All-</u>	US -	1216
<u>Indian Center</u>	Central	
<u>Museum</u>		

The Indian Center Museum, located at the Mid-America All-Indian Center, preserves and showcases the heritage of the Native American tribes of North America. Permanent and rotating exhibits of both traditional artifacts and contemporary art depict Native American cultures of both past and present. The exhibits provide insight into the culture and forces which were responsible for the survival, diversity, and unique achievements of our Native People.

[More sites on www.theindiancenter.com](http://www.theindiancenter.com)

<u>Mid-America All-Indian Center Museum</u>	US - Central	486
---	--------------	-----

The Indian Center Museum is dedicated to the preservation of Native American heritage, culture, and traditions; to provide the non-Indian with insight into the people and forces which were responsible for the survival, diversity, and achievements of the Native American. A priority is to develop a major collection of quality by Plains Indian artists.

[More sites on www.theindiancenter.com](http://www.theindiancenter.com)

<u>Mille Lacs Indian Museum</u>	802
---	-----

The Mille Lacs Indian Museum, which opened May 18, 1996, offers exhibits dedicated to telling the story of the Band. Trace their journey to settle in Northern Minnesota, learn about their fate during a period of treaties made and broken, and follow their story up to the present. Videos, computer interactives, listening stations and objects reveal information about the Band's life today, from how dance traditions are carried on to members' interests in music to sovereignty issues.

More sites on www.mnhs.org

<u>Millicent Rogers</u>	US -	670
<u>Museum</u>	Southwest	

Although collected purely for personal enjoyment by Millicent Rogers and never envisioned as a "museum" collection, her collections were opened to the public in 1956 by her family, as a way of sharing her vision. Since that time, the Museum collections have grown and expanded to encompass many areas outside of Millicent Rogers' own interest, and the Museum that bears her name is today visited by thousands of visitors from around the world each year. What began as a personal quest for quality is today a proud legacy of art, design, and craftsmanship that captures the spirit of creativity of northern New Mexico.

More sites on www.collectorsguide.com

<u>Milwaukee</u>	US -	561
<u>Public Museum -</u>	Northeast	
<u>Native</u>		
<u>Americans</u>		

Native American Veterans Southwest Indian Ceramics About the Catalog of Wisconsin Indian Photographs Also: Collections and Research| Anthropology Section| Anthropology Research and Publications

More sites on www.mpm.edu

<u>Mitchell</u>	US -	693
<u>Museum of the</u>	Central	
<u>American Indian</u>		

The Mitchell Museum of the American Indian, Kendall College is the only museum in the Chicago area that focuses exclusively on the art, history and culture of the Native peoples of North America.

Mitchell US - West 649

**Prehistoric
Indian Village**

Davison County, South Dakota - Life in the village revolved around a variety of subsistence activities. The women tended the fields along the river and creek floodplains, made pottery and sewed hides; the men conducted frequent hunting expeditions in search of buffalo, trapped smaller game, or fished. They also spent time making the necessary tools, such as projectile points, knives and scrapers, for processing the animals. The entire village helped in the construction of the lodges, gathering the timber for the support posts and roof, and mixing the clay and grass to plaster the lodge walls. Children were everywhere, chasing dogs and playing a variety of games, as well as learning from and helping the adults.

**Mt Kearsarge US - 698
Indian Northeast**

**Education &
Cultural Center**

The Mt Kearsarge Indian Museum Education and Cultural Center is dedicated to increasing public awareness of Native American traditions, philosophy and art. Through exhibitions and programs, the Museum seeks to teach and inspire an understanding of the natural world, resource conservation and land stewardship as developed by native peoples over twenty thousand years.

More sites on www.indianmuseum.org

Museum of **Canada - 882**
Anthropology - **Western**
U of British
Columbia

The mission of the Museum of Anthropology is to investigate, preserve, and present objects and expressions of human creativity in order to promote understanding of and respect for world cultures.

Museum of **712**
Anthropology -
University of
Michigan

The Museum of Anthropology is one of the major archaeological research and teaching facilities in the United States. This web site is designed to make available images and information about selected collections from the Museum holdings.

More sites on www.umma.lsa.umich.edu

Museum of **US - 642**
Natural History - **Northeast**
Rhode Island

The Museum of Natural History at Roger Williams Park is responding to a flood of requests by local residents when it presents All Things Connected: Native American Creations. Many visitors recall the Museum's former Native American exhibit installed in 1958 and have expressed desire to view the cultural and aesthetic objects once again. Now nearly 30 years later, the public may view All Things Connected featuring Native American material cultures from the regions of the Northeast, Plains, Southwest,

Northwest Coast, Subarctic and Arctic. The exhibit, with objects dating primarily from 1850 to 1950, showcases baskets, beadwork, ceramics, clothing, and textiles. An interpretive component of the exhibit will focus on how Native Americans interrelated with the natural world.

Museum of New Mexico US - Southwest 686

Older than the state of New Mexico itself, the Museum of New Mexico houses the country's most intriguing collection of art, history and culture in four museums and five monuments statewide. Come discover the true heart and soul of the Southwest.

Museum resources and the Internet 420

This is a revised version of a paper presented at the annual conference of CIDOC, the Documentation Committee of the International Council of Museums (ICOM) held at the National Museums of Kenya, Nairobi, on 26th September 1996. The audience contained some people who were very familiar with the Internet and others who had never used it, so this paper gives an introductory overview of the kind of resources which are available as well as referring to a few specific items as examples of interesting applications.

Museums and Archives with Emphasis on Native Americans 1705

More sites on www.ou.edu

<u>Museums in Russia</u>	Europe & Russia	767
-------------------------------------	--------------------------------	------------

Comprehensive site containing information about most russian museums, galleries and cultural websites. Selected websites, CD disks collection, information for tourists...

<u>Natick Historical Society & Museum</u>	US - Northeast	485
--	---------------------------	------------

Founded in 1870 as the Historical Natural History and Library Society of South Natick, The Natick Historical Society is dedicated to the preservation of the history and artifacts that contribute to an understanding of our local heritage.

<u>National Museum of American History</u>	533
---	------------

American History Page - The Museum offers three floors of exhibitions that explore the rich diversity of American history, from "After the Revolution: Everyday Life in America, 1780-1800" to the "Information Age: People, Information, and Technology."

[More sites on www.si.edu](http://www.si.edu)

<u>National Museum of American Indian - New York</u>	1086
---	-------------

NMAI Conexus is a pilot project to test ways of using the World Wide Web to share some of our resources beyond the Museum's walls. It is a Web site with a "window" through which people can view events from the Museum.

[More sites on www.conexus.si.edu](http://www.conexus.si.edu)

National 922
Museum of the
American Indian

The major US museum of native American artifacts, history, culture, and programs which promote understanding through collaboration with indigenous peoples of the world.

Native American 980
Heritage US -
Museum Central

At the Native American Heritage Museum in Highland, Kansas, is an award winning site! Honored with the American Association for State and Local History Certificate of Commendation in 1997, the museum offers an exciting experience. You'll discover stories about the people who were native to northeast Kansas, and learn more about those who lived in the area for a time.

[More sites on www.kshs.org](http://www.kshs.org)

Native American 799
Museums of
New Mexico

A list links to Museums in New Mexico.

[More sites on www.nmculture.org](http://www.nmculture.org)

<u>New York State</u>	US -	480
<u>Historical</u>	Northeast	
<u>Association,</u>		
<u>Cooperstown,</u>		
<u>NY</u>		

At the Museums of the New York State Historical Association in Cooperstown, you will find artifacts of American life and art that have enriched our culture through the centuries. Discover tradesmen's tools and everyday objects, Native American masterpieces and historic manuscripts, world-famous portraits and anonymous folk carvings -- each presented with a relevance and freshness for all to appreciate.

<u>Newfoundland</u>	Canada	644
<u>Museum</u>		

We are the provincial museum of Newfoundland and Labrador, Canada.

More sites on www.delweb.com

<u>North American</u>	US -	679
<u>Ethnology -</u>	Central	
<u>Milwaukee</u>		
<u>Public Museum</u>		

More sites on www.mpm.edu

<u>North, South,</u>	1104
<u>East, West:</u>	
<u>American</u>	
<u>Indians and the</u>	
<u>Natural World</u>	

Carnegie Museum - Through exploration of four different visions of living in and with the natural world--those of the Tlingit of the Northwest Coast, the Hopi of the Southwest, the Iroquois of the Northeast, and the Lakota of the Plains--North, South, East, West: American Indians and the Natural World examines the belief systems, philosophies, and practical knowledge that guide Native peoples' interactions with the natural world.

[More sites on www.carnegiemuseums.org](http://www.carnegiemuseums.org)

[Nova Scotia](#) **MicMac **Canada** **847**
[Museum's](#)
[Mi'kmaq](#)
[Portraits](#)**

This website features 660 selections from the Nova Scotia Museum's Mi'kmaq Portraits Database. The complete database at the Nova Scotia Museum is designed to be a reference catalogue, currently providing access to more than 1,100 extant Mi'kmaq portraits in different media.

[More sites on museum.gov.ns.ca](http://museum.gov.ns.ca)

[Oriental Institute](#) **Asia **940**
[Research](#)
[Archives](#)**

The Research Archives of the Oriental Institute is a non-circulating collection of books and other publications relating to the ancient Near East for the reference and research of Oriental Institute faculty, staff, students and members. Its materials span the history of the ancient Near East from prehistoric times through the Late Antique period and reflect the interests and work of its users and benefactors. It is not a part of the University of Chicago Library System; the existence of a book, journal or series in the Research Archives bears no relationship to the holdings of the University of Chicago Library System.

[More sites on www-oi.uchicago.edu](http://www-oi.uchicago.edu)

<u>Osage Tribal Museum</u>	Osage	US - Central	759
--	-------	--------------	-----

Inside the walls of this small building you will find over 100 pieces of the collection of John Bird, an early day Indian Trader, as well as many items made and used by the Osage Indians dating back to well before the establishment of the reservation in 1872.

<u>Painted Pottery of the Mimbres People</u>			733
--	--	--	-----

For this exhibition the Weisman Art Museum will display more than 150 painted pots and a number of related artifacts made by the Mimbres, an ancient Native American people

<u>Pawnee Indian Village State Historic Site</u>	Pawnee	Central America	1288
--	--------	-----------------	------

This is an archeological site dedicated to educating the public about the Pawnee Nation's past, present, and future. The site is located on the grounds of an 1820s circa Kitkehahki Pawnee village. Evidence of this important village consists of earth lodge depressions, cache pit depressions, and remains of a fortification wall. A modern museum encloses the excavated floor of a 2000 sq. foot lodge. All items that were discovered have been left on the floor as they were found. Exhibits, artwork, and audio and video presentations help to tell the story of this great people. It is the only museum specifically for the Pawnee Nation.

[More sites on www.kshs.org](http://www.kshs.org)

<u>Peabody Essex</u>	US -	551
<u>Museum - Native</u>	Northeast	
<u>American</u>		
<u>Exhibits</u>		

The Native American art collection is the oldest ongoing collection of Native American art in the hemisphere. Totaling some 20,000 historic works from the seventeenth through the twentieth centuries and 50,000 archaeological objects, the collection includes scores of masterworks from throughout North America. The collection was largely inaccessible, even to staff, until the recent completion of a major new storage vault.

<u>Peabody</u>	South	743
<u>Museum of</u>	America	
<u>Archaeology</u>		
<u>and Ethnology</u>		

The Peabody Museum houses one of the most comprehensive records of human cultural history in the Western Hemisphere.

[More sites on www.peabody.harvard.edu](http://www.peabody.harvard.edu)

<u>Penobscot Nation Museum</u>	Penobscot	US - Northeast	1670
---	------------------	---------------------------	-------------

We, the Penobscot Indian Nation, traditionally known as the pana'wahb'skk'eig, together with the Passamaquoddy, Maliseet, and Mik Maq are collectively known as the Wabanaki Confederacy. The Penobscot Nation Museum is a tax-exempt institution dedicated to preserving and sharing the rich cultural heritage of the Penobscot and Wabanaki people. Currently, the museum houses collections that span thousands of years of Maine Native American history. Our museum provides a repository for contemporary Wabanaki art, such as paintings, woodcarvings, and basketry, demonstrating the strong connections we have with our ancestors and the earth.

<u>Philadelphia Museum of Art Craft Show</u>		US - Northeast	354
---	--	---------------------------	------------

This year we are having an "invitational" section of 20-25 Native American artists for two reasons: 1) to educate our public about the first American craftsmen and 2.) to get the information out to the Native American art community that we exist and it could be worthwhile for them to apply in future.

<u>Photo Antiquities Museum of Photographic History</u>		US - Northeast	161
--	--	---------------------------	------------

Photo Antiquities Museum of Photographic history is a non-profit organization dedicated to the preservation, presentation and education of photographic history. Included in the museums collections are many beautiful and rare photographs of Native Americans from as far back as 1839, when the first practical photographic process was invented. Through image collections, special exhibits and educational programs Photo Antiquities works to preserve not only photographic history, but world history and culture for the future to learn from and appreciate.

**Pilgrim Hall US - 374
Museum Northeast**

Gallery museum in the center of historic Plymouth, Massachusetts. Through its exhibition of Pilgrim possessions and Native American artifacts, Pilgrim Hall tells the stories of America's founding and traditions in stirring detail.

**Pioneer Farm US - 533
Museum and Northwest
Ohop Indian
Village**

Private non-profit, "Hands-On", museum teaching about the life of children on a homestead farm in 1887 and native children in the Puget Sound area before European contact.

**Plains Indian US - West 186
Museum,
Buffalo Bill
Historical
Center**

The Plains Indian Museum, one of the five museums of the Buffalo Bill Historical Center, features one of the country's largest and finest collections of Plains Indian art and artifacts. Through exhibitions, publications, and programs, the Museum explores the cultural histories, artistry and living traditions of Plains Indian people.

Plimoth-on-Web US - 435
Northeast

Plimoth Plantion's Living History Museum of 17th-Century Plymouth.

More sites on www.plimoth.org

Powhatan 782

**Renape Nation's
American Indian
Heritage
Museum**

More sites on www.powhatan.org

**Red Earth Indian
Center Museum** US - 762
Central

Teepee and Entrance / Teepee Picture / George Palmer - Head Dress / Eagle Feather Headdress ca. late 1900s / Caddo Swing Dance/ Apache Mountain Spirit Dance / Bison / Native American Housing and Other Structures / Deupree Cradle Board Collection

More sites on www.redearth.org

Red Earth, Inc. US - 689
Central

Red Earth, Inc. is an Oklahoma City-based nonprofit organization whose mission is to promote, preserve, and promulgate the rich traditions of American Indian History and Cultures.

More sites on www.redearth.org

Riverside US - 186
Municipal Southwest
Museum Online
Exhibitions

Including exhibits on Plateau Indians and their manufacturing techniques of baskets, bags and doll cradles. Other exhibits on the Mexican American Community (1917-1950) Nuestros Antepasados as well as an exhibit on Inuit Artists of the Arctic.

Royal British Canada - 710
Columbia Western
Museum

More sites on rbcm1.rbcm.gov.bc.ca

Shadow of the US - 386
MeWuk Southwest
Prehistoric Trail

This 1/4-mile loop trail begins at a reconstruction of a small MeWuk Indian village, including a cedar bark sweat house, dwelling, and acorn granary. Located on an actual prehistoric, summer camp site, a brochure guides you through facets of MeWuk Indian life, highlighting the MeWuk peoples' close relationship to the land. Pick-up a brochure at the trailhead.

Shawnee & Shawnee US - 1756
Woodland Northeast
Native American
Museum

The first Native American owned and operated museum in Ohio. Featuring Hopewell, Fort Ancient and Ancient to early historic Shawnee artifacts. Enjoy the friendly atmosphere and guided tour. Our gift shop offers many handmade Native American craft items.

[More sites on www.homestead.com](http://www.homestead.com)

Shelburne US - 437
Museum Northeast

Discover America's Past - Native American materials include some 250 items from a wide range of American cultures such as Plains costumes and accessories, saddles, and parfleches; Southwestern ceramics; and Northwest Coast baskets and woodcarvings. In addition, costume accessories of Native American beadwork made for sale to tourists can be found in the costume collection.

Sherman Indian US - West 848
Museum

The Sherman Indian High School was one of several off-reservation boarding schools opened by the United States government in the late 1800s. The intention of these schools was to assimilate Native Americans into mainstream society. The Sherman Indian Museum, located on the Sherman Indian High School grounds in Riverside, California, not only houses traditional Native American collections, it preserves more than a century of the school's student body history, heritage and pride.

Southwest US - 685
Gallery at the Northeast
University of
Pennsylvania
Museum

Living in Ballance: The Universe of the Hopi, Zuni, Navajo and Apache The culture and cultural perspectives of four Native American peoples of the Southwest are the focus of 'Living in Balance: The Universe of the Hopi, Zuni, Navajo and Apache.' The new exhibition, which opens May 20, 1995, looks at the sacred and cultural connection these Native Americans of the Southwest have with their environment. An Apache tipi and a Navajo hooghan framework, an illuminated walk-in sky theater, and more than 300 objects from the Museum's extensive archaeological and ethnographic Southwest collections offer insight and information about the history and cultural traditions of these native peoples.

<u>Still Pequot</u>	Pequot	US -	821
<u>After All These</u>		Northeast	
<u>Years</u>			

by Alice Nash

The Mashantucket Pequot Museum and Research Center (MPMRC) is an extraordinary, tribally owned-and-operated museum of New England Indian history and culture, built at a cost of \$193.4 million. An antidote to museums featuring Native artifacts removed from all cultural context, or older-style dioramas depicting primitive, generic Indians, the MPMRC delivers an impassioned message: "We are Pequot. This is our land. We are still here." What is more, the museum raises provocative questions about the historical process--what we know about Indians and how we know it.

More sites on www.common-place.org

<u>The Jatibonicu</u>	Taino	Caribbean	933
<u>Taino Tribal</u>		Islands	
<u>Museum</u>			

This is the tribal Museum of the Jatibonicu Taino Tribe of Boriken (Puerto Rico). It presents up to date information on tribal repatriation. It has a great number of pictures of Taino ceremonial objects from the Pre-Colubian period. Many of these objects are held at the National Museum of the American Indian and at the Smithsonian Museum of Natural History. The Taino tribal museum is organized under the tribal nation's Indigenous Documentation Project.

[More sites on www.taino-tribe.org](http://www.taino-tribe.org)

The People's

707

Center Museum

The People's Center Museum provides a cultural bridge from the past to the future of the Salish, Kootenai and Pend d'Orielle Tribal Nations.

NEW! The

US - West

34

Southwest

Museum

The Southwest Museum holds one of the nation's most important museum, library, and archive collections related to the American Indian. In addition it has extensive holdings of Prehispanic, Spanish Colonial, Latino, and Western American art and artifacts. For eighty years it has supported research, publications, exhibitions, and other educational activities to advance the public's understanding and appreciation of the Americas, with particular emphasis on the Western United States and Mesoamerica.

NEW! Town Creek

US -

4

Indian Mound

Southeast

State Historic

Site

Town Creek Indian Mound, Located outside Mt Gilead NC, is a reconstructed "South Appalachian Mississippian" center. Excavated for over fifty years, the site now offers a museum and orientation video, restrooms, and a stockaded center enclosing a reconstructed mound with town house, burial hut, and priest hut. The museum presents information on 12,000 years of Native habitation of the area with particular focus on the "Pee Dee Culture" responsible for construction the platform mound and enclosed center.

U'mista Cultural Center Kwakiutl Canada - 1236 Western

The U'mista Cultural Society was incorporated under the British Columbia Societies Act on March 22, 1974. Since that time it has worked towards fulfilling a mandate to ensure the survival of all aspects of the cultural heritage of the Kwakwaka'wakw.

Ukrainian Museum Europe & Russia 594

There is a great place that will help you discover the wonderful heritage of your parents and grandparents -THE UKRAINIAN MUSEUM. Located in New York City, the "international" capital of the arts, the Museum concerns itself with the Ukrainian experience, past and present. In the Museum the emphasis is on the cultural legacy of a people whose thousand year journey through history abounds with grand, dramatic, turbulent and exciting events, as well as extraordinary accomplishments and achievements.

University of Alaska Museum Alaska 774

The University of Alaska Museum, located at the University of Alaska Fairbanks, is a major resource center for the public and for scholars. The Museum's mission is to acquire, conserve, investigate, and interpret specimens and collections relating to the natural, artistic, and cultural heritage of Alaska and the Circumpolar North. Through education, research, and public exhibits, the Museum serves the state, national, and international science programs. The Museum develops and uses botanical, geological, zoological, and cultural collections; these collections form the basis for understanding past and present issues unique to the North and meeting the challenges of the future.

University of Oregon Museum of Natural History US - Northwest 183

Ever wonder who was here before you?

Ventura County Museum of History & Art Chumash US - Southwest 944

The Museum maintains a collection of Chumash artifacts.

Vernacular Language Program Quechua South America 702

The VLP site is one of the 5 sites under construction at the Central Bank of Ecuador's Anthropology Museum in Guayaquil

Vigo County Historical Society US - Central 181

Photographs of Our Collection -- Native American Dolls, pottery, corn necklaces, moccasins, and many other items.

Virtual Library 696

Museums Page

A distributed directory of on-line museums.

**Waswagoning Ojibwe US - 595
Recreated Northeast**

**Ojibwe Village
in Lac du
Flambeau,
Wisconsin**

Walk back in time to when the Ojibwe built wigwams and moved from area to area as the seasons changed, making articles for survival out of the natural elements found in northern Wisconsin. Enter via a bough-laden arbor and join a walking tour for an hour or more through "Traditional Indian Villages" depicting the changing seasons and a way of life that honored the earth and natural resources.

More sites on www.waswagoning.com

**Woolaroc US - 595
Museum & Central**

Nature Preserve

Offers nature trails, a petting zoo, Native American heritage center.

**Yakima Valley US - 1007
Museum Northwest**

The Yakima Valley Museum offers historical displays focusing on the Yakima Valley -- its natural history, Native American culture, early pioneer life, and the roots and development of the Valley's fruit industry. The museum also has a superb collection of horse-drawn vehicles, from stagecoaches to a hearse, a historical display on former resident, Supreme Court Justice and environmentalist William O. Douglas, an interactive Children's Center, and a changing schedule of special exhibitions.

You are being redirected to NativeWeb's Resource Database for Crafts and Indigenous
Technology Workshops

Resources for Indigenous Cultures around the World

[Resources](#) [Books & Music](#) [Community](#) [Services](#) [About Us](#)

Resource Center

- [Internet Links](#)
- [Nations Index](#)
- [Geographic Region Index](#)
- [Search the Site](#)
- [New Sites this Week](#)
- [Submit a Site!](#)
- [Top 5 Percent](#)

Hosted Resources

- [Hosted Pages](#)
- [Book & Music Center](#)
- [Law & Legal Issues](#)
- [NativeLaw News](#)
- [NativeTech](#)

Site Information

- [Get your FREE EMAIL @NativeWeb.Net!](#)
- [Community](#)
- [About Us](#)
- [Hosting Information](#)

[Resource Database](#) / [Crafts & Indigenous Technology](#) / **Workshops**

Resources: 11 listings

Name and Description	Nation Location	Hits
Alba Wilderness School Teaching survival skills, awareness and philosophy. More sites on www.magma.ca	Canada - Eastern	355
Bushy Hill Field School Programs about traditional and post-European contact Woodland culture by experiencing replicated technologies and daily living skills. Teacher workshops and full curriculum of nature-oriented school programs. Box 577, Ivoryton, CT 06442-0557, (860) 767-0848	US - Northeast	296
Connecticut Museum of Natural History Nature-related and Native American exhibits, workshops and activities for children, families and adults. UConn, U-23, Storrs, CT 06269-3023, (860) 486-4460	US - Northeast	292

Donate to
NativeWeb!
Tax Deductible!



Great Lakes
Primitives

US - Northeast 551

An organization based in Michigan that has a focus on various Primitive Technologies. Technologies include, but are not limited to, the following: Stone Tools, Plant Skills, Basketry, Hide Tanning, Atlatls, Bows, Throwing Sticks, Pottery, Fire Making, Woods Craft, Primitive Navigation.

[More sites on users.aol.com](#)

Institute for
American Indian
Studies -
Educational
Programs

US - Northeast 383

Contemporary and historic Native American Exhibits & programs. Including an outdoor demonstration village, which holds festivals and educational programs for children.

[More sites on 12.109.72.120](#)

Mount Kearsarge
Indian Museum -
Activities

US - Northeast 270

Exhibits (Woodlands and Plains). Outdoor recreated dwellings and trails. Workshops. PO Box 142, Warner, NH 03278-0142, (603) 456-3244

[More sites on www.indianmuseum.org](#)

Primitive
Outdoors

US - Southeast 73

Primitive Technology with emphasis on native culture & society. Many other programs available survival, ethnobotany, flint knapping and more

Sharon Audubon US - Northeast 227
Center

The Sharon Audubon Center offers educational programs for all ages, a seasonal newsletter, nature programs, wildlife rehabilitation, research, live animal exhibits, a children's adventure center, a nature store, and a natural history library. For more information you may wish to call us at (860) 364-0520 or e-mail us at sharon_audubon_center@audubon.org.

Somers Mountain US - Northeast 270
Indian Museum

Exhibits & Workshops ranging from Native American history and prehistory to finer points of technology such as hide-tanning, bowmaking & flintknapping. 332 Turnpike Road, Somers, CT 06071, (860) 749-4129

The Bruce US - Northeast 231
Museum

Program involves a full-size reconstruction of an Indian wigwam with artifacts from local sites. Students become history detectives and conduct an artifact identification game. 1 Museum Drive, Greenwich, CT 06830, (203) 869-0376

The Robbins US - Northeast 170
Museum of
Archaeology

Seminars, exhibits, sponsor of local events & talks. Massachusetts Archaeology Society, P.O. Box 700, Middleborough, MA 02346-0700, (508) 947-9005

You are being redirected to NativeWeb's Resource Database for Craft Supplies and Resources



Resources for Indigenous Cultures around the World

[Resources](#) [Books & Music](#) [Community](#) [Services](#) [About Us](#)

Resource Center

- [Internet Links](#)
- [Nations Index](#)
- [Geographic Region Index](#)
- [Search the Site](#)
- [New Sites this Week](#)
- [Submit a Site!](#)
- [Top 5 Percent](#)

Hosted Resources

- [Hosted Pages](#)
- [Book & Music Center](#)
- [Law & Legal Issues](#)
- [NativeLaw News](#)
- [NativeTech](#)

Site Information

- [Get your FREE EMAIL @NativeWeb.Net!](#)
- [Community](#)
- [About Us](#)
- [Hosting Information](#)

[Resource Database](#) / [Crafts & Indigenous Technology](#) / [Craft Supplies & Sources](#)

Craft Supplies & Sources Sub-Categories:

- [Basketry Materials](#)
- [Beads & Jewelry](#)
- [Leather & Fur](#)
- [Native American Related](#)
- [Powwow Dance Regalia](#)
- [Rendezvous & Colonial](#)
- [Tools & Metals](#)

Donate to
NativeWeb!
Tax Deductible!



© [NativeWeb, Inc.](#) 1994-2003 || [Disclaimer Statement](#) || [Copyright Statement](#) || [Contact Us](#) || [Visitors](#) || [Donations](#)



Albert Einstein visits Hopi House at the Grand Canyon,
1931.

Photo by El Tovar Studios
Courtesy of Museum of Northern Arizona Photo
Archives (78.0071) and
Museum of New Mexico Photo Archives (38193)
[About this image](#)

A Line in the Sand

Cultural property includes not only land and other tangible property, but ideas, traditions, and other non-tangibles. Cultural property belongs to the cultural group, rather than to an individual. As an individual has the right to control use of his/her property, the cultural group has the right to control the use of its property. Not all people recognize cultural property. As a result some individuals will use another group's cultural properties without permission; often that use is offensive to the cultural group, because their property is used in a way that distorts or is disrespectful to the group's beliefs.





[The Site History](#)

[Navigation of this site](#)



[Sovereignty Issues](#)



[Cultural Property Issues](#)



[Legal Resources](#)



[Stereotypes](#)



[Responses from the Indigenous Peoples](#)



[Resources](#)

[Send the URL for this website to a friend!](#)



[The People Involved with This Site](#)

**Number of Accesses Since 8.00 PM December 14,
1999: 35741**

**Last modified: Thursday, June 05 2003, 05:32:07 PM
EDT.**

[© 1996 - 2003 Karen M. Strom](#)

NativeTech: Native American Technology and Art
TURKEY - BREAST FEATHER



[Click here for a description of the Turkey.](#)

[Return to Feather Identification](#)

[Birds & Feathers Bibliography and Books to Buy On-Line](#)

[Return to Birds & Feathers Main Menu](#)



© 1994-1999 [Tara Prindle.](#)

NativeTech: Native American Technology & Art



BIRDS & FEATHERS BIBLIOGRAPHY

Click on the links below for the books you can order on-line in affiliation with barnesandnoble.com

References cited in NativeTech's [Birds & Feathers articles](#):

de Rasieres, Isaack

1967 Letter to Samuel Blommaert [1628 ?].

In Narratives of New Netherland, 1609-1664. F.J. Jameson, ed. Pp. 97-116. New York: Barnes and Noble.

Gookin, Daniel

1970 Historical Collections of the Indians in New England.

J.H. Fiske, ed. London: Towaid. (First published 1674).

Heath, Dwight B., ed.

1986 Mourt's Relation: A Journal of the Pilgrims at Plymouth.

Cambridge: Applewood books. (First published in 1622).

Lindholdt, Paul, ed.

1988 John Josselyn, A Critical Edition of Two Voyages to New England.

Hannover: University Press of New England. (First printed in 1674).

Morton, Thomas

1964 New English Canaan. Ann Arbor: University Microfilms Inc.

(Authorized copy of original 1637 publication. Amsterdam: J. F. Stam).

National Geographic Society

1987 Key into the Language of America.

Shirley L. Scott, ed. Washington, D.C.: National Geographic Society. (Second Edition).

van der Donck, Adrien

1968 A Description of the New Netherlands.

T. O'Donnell, ed. Syracuse: Syracuse University Press. (First published 1656).

Wood, William

1865 Wood's New England's Prospect.

Boston: Publications of the Prince Society 1. (First published 1634).

Other Books relating to Birds and Feathers you can buy on-line through barnesandnoble.com:

John L. Bull and John Farrand

[The National Audubon Society Field Guide to North American Birds: Eastern Region](#)

Miklos D. F. Udvardy, Revised by John Farrand

[National Audubon Society Field Guide to North American Birds: Western Region](#)

Virginia Marie Peterson (Illustrator), Roger Tory Peterson

[A Field Guide to Eastern Birds](#)

**Additional book list being compiled.
In the meantime,**

[Click here to Search for Books about Birds](#)

**[Search for Books at
barnesandnoble.com](#)**

Search by:

[Return to NativeTech's Main Birds & Feathers Menu](#)



© 1994-2000 **[Tara Prindle](#)**.

MORNING STAR GALLERY

2003 Collection

- beadwork
- pottery
- basketry
- textiles
- jewelry
- clothing
- parfleche
- nwc/inuit
- katsinas/dolls
- other



- ▶ home
- about us
- contact us
- books/catalogs
- reading rooms



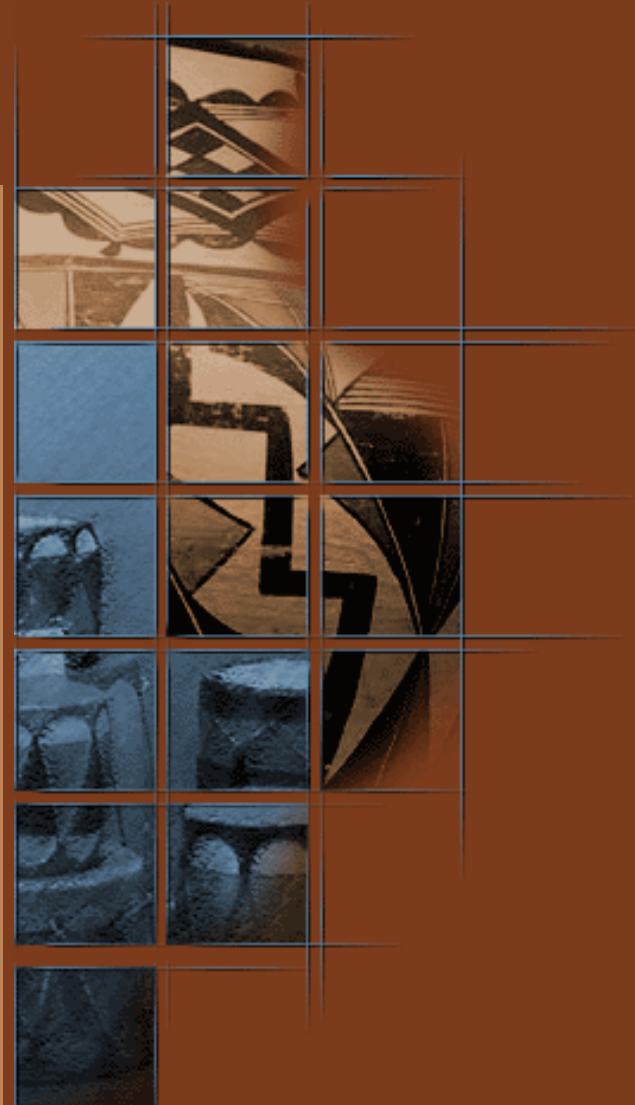
Welcome to Morning Star Gallery

The premier gallery for antique American Indian art.

Morning Star Gallery is located in a beautiful historic building on Canyon Road in the heart of the art district in Santa Fe, New Mexico. Since the conception of the gallery in 1984, Morning Star continues to be recognized for carrying cultural treasures of unparalleled quality and beauty from over fifty North American tribes.

This site offers a sampling of the museum quality objects that are available. You are encouraged to **contact** the gallery with questions as well as inquiries regarding these pieces and additional pieces found in the gallery's inventory. The knowledgeable staff is available to provide up to date information for collectors, assist first time buyers, and consider the acquisition of objects to add to our inventory.

Morning Star Gallery is committed to sharing the finest works of indigenous art with the public. Please enjoy visiting this site and do not hesitate to **contact** the gallery or visit in person.



Tel 505.982.8187

Fax 505.984.2368

indian@morningstargallery.com

513 Canyon Rd.

Santa Fe, NM 87501