

search









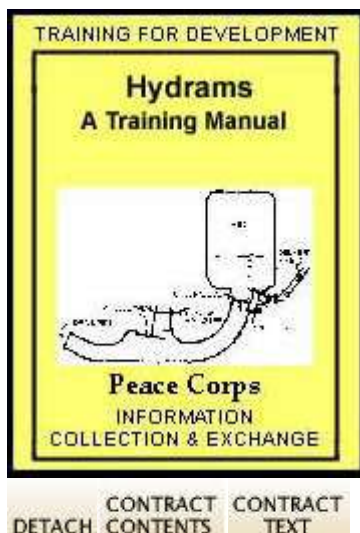



























subjects

































titles a-z































organization

































how to





















































































-  A training manual in conducting a workshop in the design, construction, operation, maintenance and repair of hydrams
- 
 -  (introductory text)
 -  Contents
 -  Foreword
 -  Introduction
 -  Guidelines for users
 -  (introductory text)
 -  Workshop: tools, equipment, materials
 -  Hydam construction materials
 -  Sample worksheet for final materials list
 -  Suggested schedule for hydam workshop
 -  Construction of a PVC hydam time: 4-5 hours (for demonstration purposes)
 -  (introductory text)
 -  Attachment A : PVC Hydam - illustration
 -  Session 1: Introduction to training (1½ hours)
 -  (introductory text)
 -  Handout 1A: "What's in a name"
 -  Handout 1B: Hydam Training Workshop Objectives
 -  Session 2: Introduction to hydrams (3½ hours)
 -  (introductory text)
 -  Handout 2A: Potential energy
 -  Handout 2B: Hydam installation
 -  Handout 2C: Typical hydam
 -  Handout 2D: Glossary of terms for session 2
 -  Handout 2E: Hydam training workshop participant site information
 -  Session 3: Water measurement techniques (3 hours)
 -  (introductory text)
 -  Handout 3A: Using a Weir
 -  Handout 3B: Using a Weir - diagram
 -  Handout 3C: Weir table
 -  Handout 3C: Weir table - metric
 -  Handout 3D: The float method of measurement
 -  Session 4: Measuring heads and distance (2-4 hours)
 -  (introductory text)
 -  Handout 4A: Calibrating a sight level







-  Handout 4B: Using a sight level
-  Handout 4C: Alternate ways of measuring heads
-  Handout 4D: Alternate ways of measuring heads
-  Handout 4E: Distance and head measurement worksheet
-  Session 5: Review exercise #1 (2 hours)
 -  (*introductory text*)
 -  Handout 5A: Review exercise #1
 -  Handout 5B: Answers to review exercise #1
-  Session 6: Hydrant theory (2-3 hour)
 -  (*introductory text*)
 -  Handout 6A: Pressure analysis
 -  Handout 6B: Glossary of terms for session 6
 -  Handout 2B: Hydrant installation
-  Session 7: Basic plumbing tools and materials (1-1½ hours)
 -  (*introductory text*)
 -  Handout 7A: Typical fittings
-  Session 8: Hydrant construction - Pipefitting (4 - 6 hours)
 -  (*introductory text*)
 -  Handout 8A: Pipefitting hydrant w/ Modified factory valves
 -  Handout 8B: Pipefitting hydrant w/ Field-made valves
 -  Handout 8C: Materials and procedures: fabricated ram
-  Session 9: Hydrant design theory and parameters (2 hours)
 -  (*introductory text*)
 -  Handout 10B: Thickness of the impulse valve plate - inches
 -  Handout 10B: Thickness of the impulse valve plate - metric
 -  Handout 10C: Impulse valve steel backing
 -  Handout 10C: Impulse valve steel backing - metric
 -  Handout 10D: Impulse valve seat width - inches
 -  Handout 10D: Impulse valve seat width - metric
 -  Handout 10E: Check valve backing thickness - inches
 -  Handout 10E: Check valve backing thickness - metric
 -  Handout 10F: Check valve seat width - inches

-  Handout 10F: Check valve seat width - metric
-  Handout 9A-1: Welded hydram: side view
-  Handout 9A-2: Welded hydram: exploded view
-  Handout 9A-3: Welded hydram: impulse cavity exploded view
-  Handout 9A-4: Welded hydram: accumulator: exploded view
-  Handout 9A-5: Welded hydram 20' drive head dimensions
-  Handout 9A-7: Welded hydram 20' drive head dimensions
-  Session 10: Hydram construction - concrete (18 hours over a 7 day period)
 -  (*introductory text*)
 -  Handout 10A: Concrete hydram design parameters
 -  Handout 10B: Thickness of the impulse valve plate - inches
 -  Handout 10B: Thickness of the impulse valve plate - metric
 -  Handout 10C: Impulse valve steel backing - inches
 -  Handout 10C: Impulse valve steel backing - metric
 -  Handout 10D: Impulse valve seat width - inches
 -  Handout 10D: Impulse valve seat width - metric
 -  Handout 10E: Check valve backing thickness - inches
 -  Handout 10E: Check valve backing thickness - metric
 -  Handout 10F: Check valve seat width - inches
 -  Handout 10F: Check valve seat width - metric
 -  Handout 10H: Exploded view of 2- piece concrete hydram
 -  Handout 10I: Side view 2-piece concrete hydram
 -  Handout 10J: Two piece concrete hydram form
 -  Handout 10K: Two piece concrete hydram
 -  Handout 10L: One Piece Concrete Hydram Form
 -  Handout 10M: Problem
 -  Handout 10N: Materials and procedures
-  Session 11: Hydram component design criteria (1-1½ hours)
 -  (*introductory text*)
 -  Handout 11A: Typical impulse valve

-  Handout 11B: Typical check valves
-  Handout 11C: Typical snifters
-  Session 12: Hydrum selection (1½ - 3 hours)
 -  (*introductory text*)
 -  Handout 12A - Hydrum comparison
-  Session 13: Inter-relationships within the hydrum (11-15 hours)
 -  (*introductory text*)
 -  Handout 13A: Exercises: Determining the effect of:
 -  Exercise 1: h:H ratio on efficiency
 -  Exercise 2: Frequency on the maximum delivery head to drive head ratio
 -  Exercise 3: Frequency on efficiency, quantity of water entering the hydrum and quantity of water delivered
 -  Exercise 4: Volume of air in the accumulator on efficiency
 -  Exercise 5: Drive pipe length on efficiency
 -  Exercise 6: Drive pipe diameter on efficiency
 -  Exercise 7: The snifter on efficiency
 -  Exercise 8: Effect of the drive material on efficiency
 -  Handout 13B: Typical hydrum experiment set-up
 -  Handout 13C: Sample graphs
-  Session 14: Repair and maintenance (2-4 hours)
 -  (*introductory text*)
 -  Handout 14A: Repair and maintenance chart
 -  Handout 14 B: Repair and maintenance worksheet
 -  Handout 14 C: Maintenance/service worksheet
-  Session 15: Review exercise #2 (2 hours)
 -  (*introductory text*)
 -  Handout 15A: Review exercise
-  Session 16: Use of multiple rams (1½ hours)
 -  (*introductory text*)
 -  Handout 16A: Series hydrum installation
 -  Handout 16B: Waste water series hydrum installation
 -  Handout 16C: Parallel hydrums
 -  Handout 16D: Sample problems
-  Session 17: Site development (2 hours)

-  *(introductory text)*
-  Handout 17A: Settling area - take-off system
-  Handout 17B: Hydram box
-  Handout 17C: Guidelines/checklist
-  Handout 17D: Site development
-  Handout 17E: Glossary of terms
-  Session 18: Hydram system site selection (2-4 hours)
 -  *(introductory text)*
 -  Handout 18A: Hydram system site selection
 -  Handout 18B: Diagram system for site selection
-  Session 19: Project planning (2-4 hours)
-  Session 20: Wrap up and evaluation (2-4 hours)
-  Glossary of terms
-  English-metric units conversion table
-  References
-  Attachments
 -  Attachment 1-A
 -  Attachment 1-B
 -  Attachment 2-A
 -  Attachment 2-B
 -  Attachment 2-C
 -  Attachment 2-D
 -  Attachment 2-E
 -  Attachment 3-A
 -  Attachment 3-B
 -  Attachment 3-C
 -  Attachment 3-C - metric
 -  Attachment 3-D
 -  Attachment 4-A
 -  Attachment 4-B
 -  Attachment 4-C
 -  Attachment 4-D
 -  Attachment 5-A
 -  Attachment 5-B
 -  Attachment 6-A
 -  Attachment 6-B
 -  Attachment 2-B
 -  Attachment 7-A
 -  Attachment 8-A
 -  Attachment 8-B
 -  Attachment 8-C

-  Attachment 10-B
-  Attachment 10B - metric
-  Attachment 10-C
-  Attachment 10-C - metric
-  Attachment 10-D
-  Attachment 10-D - metric
-  Attachment 10-E
-  Attachment 10-E - metric
-  Attachment 10-F
-  Attachment 10-F - metric
-  Attachment 9-A-1
-  Attachment 9-A-2
-  Attachment 9-A-3
-  Attachment 9-A-4
-  Attachment 9-A-5
-  Attachment 9-A-7
-  Attachment 10-A
-  Attachment 10-H
-  Attachment 10-I
-  Attachment 10-J
-  Attachment 10-L
-  Attachment 10-M
-  Attachment 10-N
-  Attachment 11-A
-  Attachment 11-B
-  Attachment 11-C
-  Attachment 12-A
-  Attachment 13-A
-  Attachment 13-B
-  Attachment 13-C
-  Attachment 14-A
-  Attachment 14-B
-  Attachment 14-C
-  Attachment 15-A
-  Attachment 16-A
-  Attachment 16-B
-  Attachment 16-C
-  Attachment 16-D
-  Attachment 17-A
-  Attachment 17-B
-  Attachment 17-C

-  Attachment 17-D
-  Attachment 17-E
-  Attachment 18-A
-  Attachment 18-B
-  Attachment - Glossary of terms
-  Attachment - English-metric units conversion table

A training manual in conducting a workshop in the design, construction, operation, maintenance and repair of hydrams

Printed By:

PEACE CORPS

Information Collection and Exchange

September 1984

TRAINING MANUAL NO. T-26

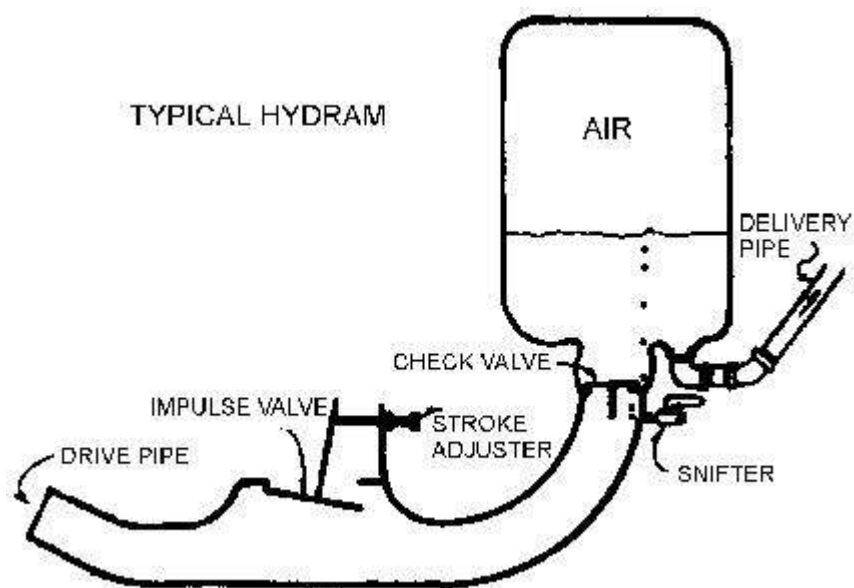

Figure

INFORMATION COLLECTION & EXCHANGE

Peace Corps' Information Collection & Exchange (ICE) was established so that the strategies and technologies developed by Peace Corps Volunteers, their co-workers, and their counterparts could be made available to the wide range of development organization and individual workers who might find them useful. Training guides, curricula, lesson plans, project reports, manuals and other Peace Corps-generated materials developed in the field are collected and reviewed. Some are reprinted "as is"; others provide a source of field based information for the production of manuals or for research in particular program areas. Materials that you submit to the Information Collection & Exchange thus become part of the Peace Corps' larger contribution to development.

Information about ICE publications and services is available through:

The Peace Corps Internet Web Site address:

<http://www.peacecorps.gov>

Please note the new Peace Corps Mailing Address from July 1998 on is:

ICE/ Peace Corps
1111 20th Street N.W.
Washington, DC 20526
USA

Add your experience to the ICE Resource Center. Send materials that you've prepared so that we can share them with others working in the development field. Your technical insights serve as the basis for the generation of ICE manuals, reprints and resource packets, and also ensure that ICE is providing the most updated, innovative problem-solving techniques and information available to you and your fellow development workers.

Contents

Foreword

Introduction

Guidelines for users

Workshop: tools, equipment, materials

Hydrum construction materials

Sample worksheet for final materials list

Suggested schedule for hydrum workshop

Construction of a PVC hydrum time: 4-5 hours (for demonstration purposes)

1. Attachment A : PVC Hydrum - illustration

Session 1: Introduction to training (1½ hours)

Handout 1A: "What's in a name"

Handout 1B: Hydrum Training Workshop Objectives

Session 2: Introduction to hydrums (3½ hours)

Handout 2A: Potential energy

Handout 2B: Hydrum installation

Handout 2C: Typical hydrum

Handout 2D: Glossary of terms for session 2

Handout 2E: Hydrum training workshop participant site information

Session 3: Water measurement techniques (3 hours)

Handout 3A: Using a Weir

Handout 3B: Using a Weir - diagram

Handout 3C: Weir table

Handout 3C: Weir table - metric

Handout 3D: The float method of measurement

Session 4: Measuring heads and distance (2-4 hours)

Handout 4A: Calibrating a sight level

Handout 4B: Using a sight level

Handout 4C: Alternate ways of measuring heads

Handout 4D: Alternate ways of measuring heads

Handout 4E: Distance and head measurement worksheet

Session 5: Review exercise #1 (2 hours)

Handout 5A: Review exercise #1

Handout 5B: Answers to review exercise #1

Session 6: Hydrum theory (2-3 hour)

Handout 6A: Pressure analysis

Handout 6B: Glossary of terms for session 6

Handout 2B: Hydrum installation

Session 7: Basic plumbing tools and materials (1-1½ hours)

Handout 7A: Typical fittings

Session 8: Hydrum construction - Pipefitting (4 - 6 hours)

Handout 8A: Pipefitting hydrum w/ Modified factory valves

Handout 8B: Pipefitting hydram w/ Field-made valves

Handout 8C: Materials and procedures: fabricated ram

Session 9: Hydram design theory and parameters (2 hours)

Handout 10B: Thickness of the impulse valve plate - inches

Handout 10B: Thickness of the impulse valve plate - metric

Handout 10C: Impulse valve steel backing

Handout 10C: Impulse valve steel backing - metric

Handout 10D: Impulse valve seat width - inches

Handout 10D: Impulse valve seat width - metric

Handout 10E: Check valve backing thickness - inches

Handout 10E: Check valve backing thickness - metric

Handout 10F: Check valve seat width - inches

Handout 10F: Check valve seat width - metric

Handout 9A-1: Welded hydram: side view

Handout 9A-2: Welded hydram: exploded view

Handout 9A-3: Welded hydram: impulse cavity exploded view

Handout 9A-4: Welded hydram: accumulator: exploded view

Handout 9A-5: Welded hydram 20' drive head dimensions

Handout 9A-7: Welded hydram 20' drive head dimensions

Session 10: Hydram construction - concrete (18 hours over a 7 day period)

Handout 10A: Concrete hydram design parameters

Handout 10B: Thickness of the impulse valve plate - inches

Handout 10B: Thickness of the impulse valve plate - metric

Handout 10C: Impulse valve steel backing - inches

Handout 10C: Impulse valve steel backing - metric

Handout 10D: Impulse valve seat width - inches

Handout 10D: Impulse valve seat width - metric

Handout 10E: Check valve backing thickness - inches

Handout 10E: Check valve backing thickness - metric

Handout 10F: Check valve seat width - inches

Handout 10F: Check valve seat width - metric

Handout 10H: Exploded view of 2- piece concrete hydram

Handout 10I: Side view 2-piece concrete hydram

Handout 10J: Two piece concrete hydram form

Handout 10K: Two piece concrete hydram

Handout 10L: One Piece Concrete Hydram Form

Handout 10M: Problem

Handout 10N: Materials and procedures

Session 11: Hydram component design criteria (1-1½ hours)

Handout 11A: Typical impulse valve

Handout 11B: Typical check valves

Handout 11C: Typical snifters

Session 12: Hydram selection (1½ - 3 hours)

Handout 12A - Hydram comparison

Session 13: Inter-relationships within the hydram (11-15 hours)

Handout 13A: Exercises: Determining the effect of:

1. Exercise 1: $h:H$ ratio on efficiency
2. Exercise 2: Frequency on the maximum delivery head to drive head ratio
3. Exercise 3: Frequency on efficiency, quantity of water entering the hydram and quantity of water delivered
4. Exercise 4: Volume of air in the accumulator on efficiency
5. Exercise 5: Drive pipe length on efficiency
6. Exercise 6: Drive pipe diameter on efficiency
7. Exercise 7: The snifter on efficiency

8. Exercise 8: Effect of the drive material on efficiency

Handout 13B: Typical hydram experiment set-up

Handout 13C: Sample graphs

Session 14: Repair and maintenance (2-4 hours)

Handout 14A: Repair and maintenance chart

Handout 14 B: Repair and maintenance worksheet

Handout 14 C: Maintenance/service worksheet

Session 15: Review exercise #2 (2 hours)

Handout 15A: Review exercise

Session 16: Use of multiple rams (1½ hours)

Handout 16A: Series hydram installation

Handout 16B: Waste water series hydram installation

Handout 16C: Parallel hydrams

Handout 16D: Sample problems

Session 17: Site development (2 hours)

Handout 17A: Settling area - take-off system

Handout 17B: Hydram box

Handout 17C: Guidelines/checklist

Handout 17D: Site development

Handout 17E: Glossary of terms

Session 18: Hydram system site selection (2-4 hours)

Handout 18A: Hydram system site selection

Handout 18B: Diagram system for site selection

Session 19: Project planning (2-4 hours)

Session 20: Wrap up and evaluation (2-4 hours)

Glossary of terms

English-metric units conversion table

References

Attachments

Attachment 1-A

Attachment 1-B

Attachment 2-A

Attachment 2-B

Attachment 2-C

Attachment 2-D

Attachment 2-E

Attachment 3-A

Attachment 3-B

Attachment 3-C

Attachment 3-C - metric

Attachment 3-D

Attachment 4-A

Attachment 4-B

Attachment 4-C

Attachment 4-D

Attachment 5-A

Attachment 5-B

Attachment 6-A

Attachment 6-B

Attachment 2-B

Attachment 7-A

Attachment 8-A

Attachment 8-B

Attachment 8-C

Attachment 10-B

Attachment 10B - metric

Attachment 10-C

Attachment 10-C - metric

Attachment 10-D

Attachment 10-D - metric

Attachment 10-E

Attachment 10-E - metric

Attachment 10-F

Attachment 10-F - metric

Attachment 9-A-1

Attachment 9-A-2

Attachment 9-A-3

Attachment 9-A-4

Attachment 9-A-5

Attachment 9-A-7

Attachment 10-A

Attachment 10-H

Attachment 10-I

Attachment 10-J

Attachment 10-L

Attachment 10-M

Attachment 10-N

Attachment 11-A

Attachment 11-B

Attachment 11-C

Attachment 12-A

Attachment 13-A

Attachment 13-B

Attachment 13-C

Attachment 14-A

Attachment 14-B

Attachment 14-C

Attachment 15-A

Attachment 16-A

Attachment 16-B

Attachment 16-C

Attachment 16-D

Attachment 17-A

Attachment 17-B

Attachment 17-C

Attachment 17-D

Attachment 17-E

Attachment 18-A

Attachment 18-B

Attachment - Glossary of terms

Attachment - English-metric units conversion table

Foreword

In 1772, John Whitehurst developed the first known machine to utilize the water hammer effect to pump water. Whitehurst's device included a water supply tank, a 1½ inch, 600 foot long drive pipe, a check valve, an accumulator and a delivery pipe. He used a hand-operated impulse valve, employing child labor to open and close the valve in continuous cycles.

In 1776, Joseph Michael de Montgolfier invented a similar machine but replaced the hand operated valve with an automatic impulse valve which was opened and closed by the rebound wave inside the hydram itself. Montgolfier's machine was called "le belier hydraulique," from which the term "hydraulic ram" was derived. (Because "hydraulic ram" can have more than one meaning, however, we prefer the British term "hydram" to describe these water pumping devices, and will use this term throughout this manual.) The invention was so simple and reliable, it has survived over 200 years with very little change.

The technical information contained in this manual has been developed through experiments and experience. We have tried to present the fruits of our experience in such a manner as to be easily transferred to other situations and application. The transfer cannot always be complete, however, and situations cannot always be predicted. The performance of a hydram is dependent on many variables. The information contained in this manual should therefore be regarded as guidelines based on past experience, rather than absolute rules.

David Jessee

Perennial Energy, Inc.

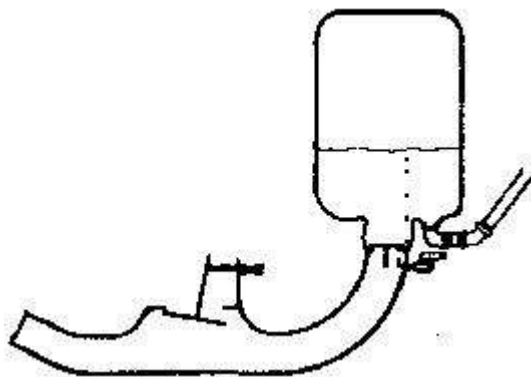

Figure

Introduction

This training manual presents a comprehensive training design, suggested procedures, and materials for conducting a workshop in the design, construction, operation, maintenance and repair of hydrams, and planning and implementing hydram projects. It includes sessions for the design and construction of modified and fabricated pipefitting rams and cement rams, and complete instructions for a clear PVC demonstration ram. The training design incorporates a variety of active learning techniques and can be modified to fit the skills and needs of the participants. The workshop requires ten, eight hour working days. The activities have been designed for 15-20 participants with two trainers.

The training design is only as effective as the trainers who are using it. Trainers must have skills and experience with hydrams as well as training. They may find it necessary to modify the design to accommodate participants' skills and needs, the amount of time available for training, actual conditions at the training site, the number of participants and their training style. The success of the design, however, depends on the amount of practice and application participants experience.

This manual was produced under a Participating Agency Service Agreement between Peace Corps and the U.S. Agency for International Development. The initial work, including the technical content and material was prepared by Perennial Energy, Inc., which has conducted pre-service training for Peace Corps Volunteers. David Jessee, Ted Landers, Jay Dick, Brad Jacobs and Pat Wiersma were Perennial's significant contributors.

Trainers who participated in a selection and orientation workshop offered insights for revisions. That group included: Jim Bell, Paul Jankura, Steve Joyce, Dale Krenek, John Leo, Jack McCarthy, Judith Oki, Christopher Szecsey, Chris Walters, Maurice Wells and Terry Whittington.

The design was piloted in Costa Rica, by Dale Krenek, in Lesotho by Dale Krenek, Judith Oki and Terry Whittington; and in Fiji by David Jessee, Dale Krenek and Judith Oki. Those experiences completed the design revisions incorporated here.

Ongoing design, editing and production has been the task of the entire Peace Corps Energy Sector: Paul Jankura, Ada Jo Mann, Prudence Merton, and Pat Riley.

Judith Oki

Energy Training Specialist Office of Programming and Training Coordination,

October, 1981

Guidelines for users

A. Training Objectives: By the end of the workshop, participants will be able to:

- survey and evaluate sites for potential hydram projects;
- articulate and apply hydram theory;
- use correctly basic water and distance measurement techniques and formulas for proper sizing of hydrams;
- select proper ram design and size;
- list tasks and resources necessary to develop a water source site for hydram operations, and
- design water distribution system including storage tank, stand pipe, supply lines, etc.;
- construct a pipefitting and/or concrete hydram;
- operate, maintain, troubleshoot and repair hydrams;
- identify issues in training local community members in the installation, operation and maintenance of hydrams;
- identify physical, social and institutional requirements for the successful application of this technology; and
- describe an action plan for using this technology in their real life situation.

B. Training Activities: The workshop design requires the involvement of each participant, individually, in small groups, and the large group. The activities are designed to provide maximum opportunities for participants to practice the skills they're acquiring and consider issues specific to their sites.

Activities include:

- demonstrations
- problem-solving (individually, small group, large group)
- skill practice, guided construction (small group)
- group discussion (small and large group)

As the workshop evolves, participants are required to solve increasingly complex problems on paper and in skill practice. Throughout the workshop, participants are asked to identify key issues in hydram application and project development.

C. Manual Organization

The training sessions each include learning objectives, recommended time, suggested procedures, and the specific tools, materials and resources required. Notes to the trainer are in the right hand "margin" and space is provided there for additional notes.

All handouts appear twice in this manual. Once at the end of the session in which they are used and collectively as an appendix for easy duplication.

D. Preparation for Training

The following is a list of logistics and tasks that need to be completed during the planning process. Specific tasks that need to be completed before each session are listed within the session.

1. Become familiar with the training design, sessions and materials in the manual.
2. Gather information about the availability of skills, equipment and materials at or near the training location. The practical nature of this workshop requires the availability of basic carpentry, plumbing, and some metalworking tools, as well as parts and materials for the different ram constructions. A checklist is provided.
3. Based on the information gathered, and proposed applications, select the constructions that will be covered in depth.

Note: The concrete construction is easier to understand after participants have actually constructed a simple ram, i.e., pipefitting or clear PVC. The concrete construction must take place over at least 6 days in order to cure enough to operate.

4. Identify the training site. The ideal training site provides space for the full range of training activities within easy walking distance from each other:

- classroom space for small and large group work; chalkboard, newsprint, slide projector, table space;
- enough workshop space to accommodate all participants in construction activities; workbenches, tool storage, first aid station;

· field activities:

- 1) a stream/springs nearby where participants can practice Measuring water flow, distance, head;
- 2) an area where participants can take a number of measurements to determine an ideal location for a hydram. The site must offer a range of choices;
- 3) space where a demonstration ram can be installed easily, or proximity to an actual installation;
- 4) experimentation: space must be available for participants to operate and troubleshoot hydrams. These activities represent 2-3 days of the workshop. The space must provide sufficient stations for constructed rams - 1 station per 3-4 participants is recommended. The water source must supply a constant Q and variable H. An example experimental station is provided at the end of this section.

If these facilities are not near each other, then travel time must be included in the schedule and transportation arranged.

5. Determine number of trainers required. 1 trainer: 7 participants is an ideal ratio, but with a strong technical assistant trainer, a 1:10 ratio is manageable. The important thing is participant access to skilled resources during their practical work.

6. Announce the workshop and identify participants. Send each participant information on dates, logistics, a set of workshop objectives and the site information worksheet, included here in appendix of handouts. (1B, 2E)

7. With other trainers, develop norms for the training team, clarify roles and expectations, review status of steps 1-6 to date, develop a final schedule, make training and preparation assignments; decide when to do review exercises, and midpoint and final workshop evaluations.

8. Duplicate handouts.

9. Finalize materials list, based on number of participants and decision on types of construction. Order materials, and arrange for transport to training site.

10. Assemble handouts (pre-punch for ring binders if possible), chalkboard, chalk, newsprint, markers, tape, notebooks, ring binders, schedule.

11. Construct clear PVC ram if necessary for demonstration. The instructions are included here. Session 2 is readily understood with the assistance of this visual aid. If you determine that each participant should construct one, then schedule that early on in the workshop.

12. Certificates of completion add a nice touch, and should be designed and printed.

Workshop: tools, equipment, materials

Quantities vary according to training group size.

Approximately 1 complete set per 4 trainees.

	On hand at training site	Can be borrowed from:	Can be purchased from	Approx. Cost:
Standard size buckets, e.g., 20 liter, 5 gal				
2-3 55 gal drums				
3-6 21" pipes 3/4" Diam. diameter				
Lumber for molds, weirs, braces				
Sight levels				
Carpenters levels				
Measuring tapes				
Pliers				
Pipe Wrenches				
Hacksaw				
Hammers				
Shovels				
Picks				
Saws				
Various size nails				
Misc. hardware, nuts, bolts, washers, etc				
Gasket material: rubber, cork				
Rubber sheet 3/16" - 1/4" thick can be inner tube				
Steel plate 3/16" - 1/4" thick				
Pipe joint compound or Teflon tape				
Access to metal working Facility for cutting, drilling, grinding stall plate				

Hydrum construction materials

The specific construction materials vary, and there is a range of possible adaptations and variations. At a general level, we need to know what typical sizes of standard pipe and pipefittings are available and approximately what they cost.

Please indicate: (yes or no) if the parts are *generally available*, i.e., one could find them readily in a plumbing supply/hardware store; if they can be specially ordered, how much time is required; approximate unit cost for-the following:

PART	SIZE (DIAM)	GEN'LLY AVAILABLE	SPECIAL ORDER TIME	APPROX. COST
Steel pipe, standard 3/4" length _ in/cm.	3/4"			
1"				
2"				
Pipe Tees *	3/4"			
1"				
2"				
3"				
Reducing Bushings *	2"x 1"			
2"x 3/4				
Sweep - 90°	1"			
Sweep - 45°	1"			
Female adapters	3/4"			
1"				
Male adapters 3/4"	3/4"			
1"				

PIPE TEES



* Pipe Tees

Reducing Bushings



*Reducing Bushings

PART	SIZE (DIAM)	GEN'LLY AVAILABLE	SPECIAL ORDER TIME	APPROX C
Clear PVC pipe	3"			
PVC cap	3 "			
Gate valve	1/2"			
Foot valve	2"			
Check valve	1"			

A cement ram can also be made, reducing the need for many of the above parts, so please indicate approximate cost of cement:

\$	lbs.
----	------

This list is by no means all inclusive but represents key items. Detailed parts lists will be developed prior to the workshop.

Sample worksheet for final materials list

Materials List

Type of Ram :

No. of Rams to be built :

QUANTITY	DESCRIPTION	SIZE	USE

Suggested schedule for hydram workshop

Day One	Day Two	Day Three	Day Four	Day Five
Session 1	Sessions 3 & 4 Field	Session 7	Session 10 Part I, II	Mid w evalua
Session 2	Activity	Session 8	Session 11	Session
Session 3 & 4 Theory	Session 5	Session 9	Session 12	
	Session 6			
Day Six	Day Seven	Day Eight	Day Nine	Day Ten
Session 10, Part II - cont	Session 14	Session 16	Session 10 Assemble,	Session
Session 13 - present results	Session 15	Session 17	Operate Concrete ram	Session
		Session 18 1		

Construction of a PVC hydram time: 4-5 hours (for demonstration purposes)

OBJECTIVE:	To construct a hydram from clear PVC pipe-fittings and fabricated valves.	
OVERVIEW:	The PVC hydram is an excellent training tool because it enables trainees to see the hydram components moving while the ram is in operation, and to observe the directional flow of water as shown by suspended solids in the water. The PVC hydram is of limited use for actual water pumping, however, as it will last only about one month in continuous use. For this reason, it is suggested that one or more PVC hydrams be constructed prior to the workshop, and used to illustrate the introductory sessions (Session 1 & 2) on the first day Of the workshop itself. The construction could be part of a pre-workshop staff training program, if desired.	
MATERIALS :	2 1¼ tees	1 ¼" coupling
	1 ¾" male adapters	4 ½ #6 sheet metal screws
	1 1¼" cap	2 1"x ¼ x 20 bolts
	1 14"x 1¼" pipe	1 2"x ¼ x 20 bolt
	5 1¼"x ¾" reducing bushings	6 ¼ x 20 nuts assorted washers
	1 24"x ¾" pipe	Handout
	PVC cleaner, PVC glue, 1/8" sheet rubber, TFE tape	
TOOLS:	Heat source (such as propane torch, campfire, oven) ¼-20 tap, saw, miter box, electric or hand drill, 1/8" drill bit, 13/64" drill bit, screw driver, 7/16" wrench or adjustable wrench, knife, tape measure	
NOTE:	This is presented in session format, in case it needs to be done with all participants, in addition to trainer preparation.	

	PROCEDURES	NOTES
1.	Warm up the middle 12" of the 24" long ¾" PVC pipe, making sure it is heated evenly without scorching or blistering. After PVC is pliable bend it into a 90° angle with about a 5" to 6" radius. Allow it to cool, then cut 5" off each end. (See #3 and #8 on Attachment A.	
2.	Cut the 1¼" PVC into two pieces, one 12" long (#6) and one 2" long (#19), making certain that the ends are cut square and are de-burred.	
3.	Cut the 1¼" coupling (#13) into two cylindrical Pieces just to one side of the land. Cut of the	

	<p>bottom of one of the 1¼"x ¾" reducing bushings, and sand it smooth on both sides to form a 3/8" thick PVC washer (#14), Glue the washer inside the piece of coupling without the land, flush with one end. Discard the other half of the coupling and the remainder of the bushing.</p>	
<p>4.</p>	<p>To make the valves, cut two circular pieces of rubber to the same outside diameter as the 1¼" PVC pipe. Cut out of each round a horseshoe shaped piece and a ¼" hole as shown in Attachment A#7.</p>	
<p>5.</p>	<p>Place four wraps of TFE tape around Note the 2 types of 1¼" PVC pipe. Lay on top of this one of the rubber valves you have cut out. Handout. Force this into the coupling half that has the PVC washer glued into it. Attach bolt (#12), nuts (#10) and washers (#15 & #16) as shown in Handout. Drill two 1/" holes (one on each side) through this impulse valve assembly and into of the 2" piece of 1¼" PVC. Then screw two sheet metal screws into these holes (#18).</p>	<p>Note the 2 types of stroke adjustment t illustrated in the handout. That labeled "alternate" is slightly more complicated to construct but provides easier adjuster. Materials required for the alternate stroke adjustment E .</p> <p>¼ x 20 bolt and nut</p> <p>½" wide x 2" long piece cut from PVC pipe</p> <p>2½ #6 sheet metal screw</p>
<p>6.</p>	<p>Cut ¼" off the bottom straight through leg of one of the tees (#1), making certain the cut is square and de-burred. Place four wraps of TFE tape around the male end of a 1¼" x ¾" reducing bushing. Attach the 1" x ¼" bolt with nuts and washers to the remaining rubber valve as shown in the handout. Then place this rubber valve inside the bottom of the tee you just cut off. Force the TFE wrapped reducing bushing up to the rubber valve. Drill two 1/8" holes into this assembly and secure with 2 sheet metal screws.</p>	
<p>7.</p>	<p>Next, glue the rest of the pieces together as shown in the Attachment. Be sure to follow the instructions on the glue.</p>	
<p>8.</p>	<p>Drill a 13/64" hole through one of the flats on the reducing bushing just below the check valve, making certain that you also drill through the ¾" pipe as well. Drill a 1/8" hole up from the bottom of this bushing, intersecting with the 13/64" hole. Tap the 13/64" hole with a ¼-20 tap then insert a ¾" ¼-20 bolt with lock nut (#9 & #10).</p>	

9. After the hydram(s) have had time to dry, hook them up to a drive head and test them.

Attachment A : PVC Hydram - illustration

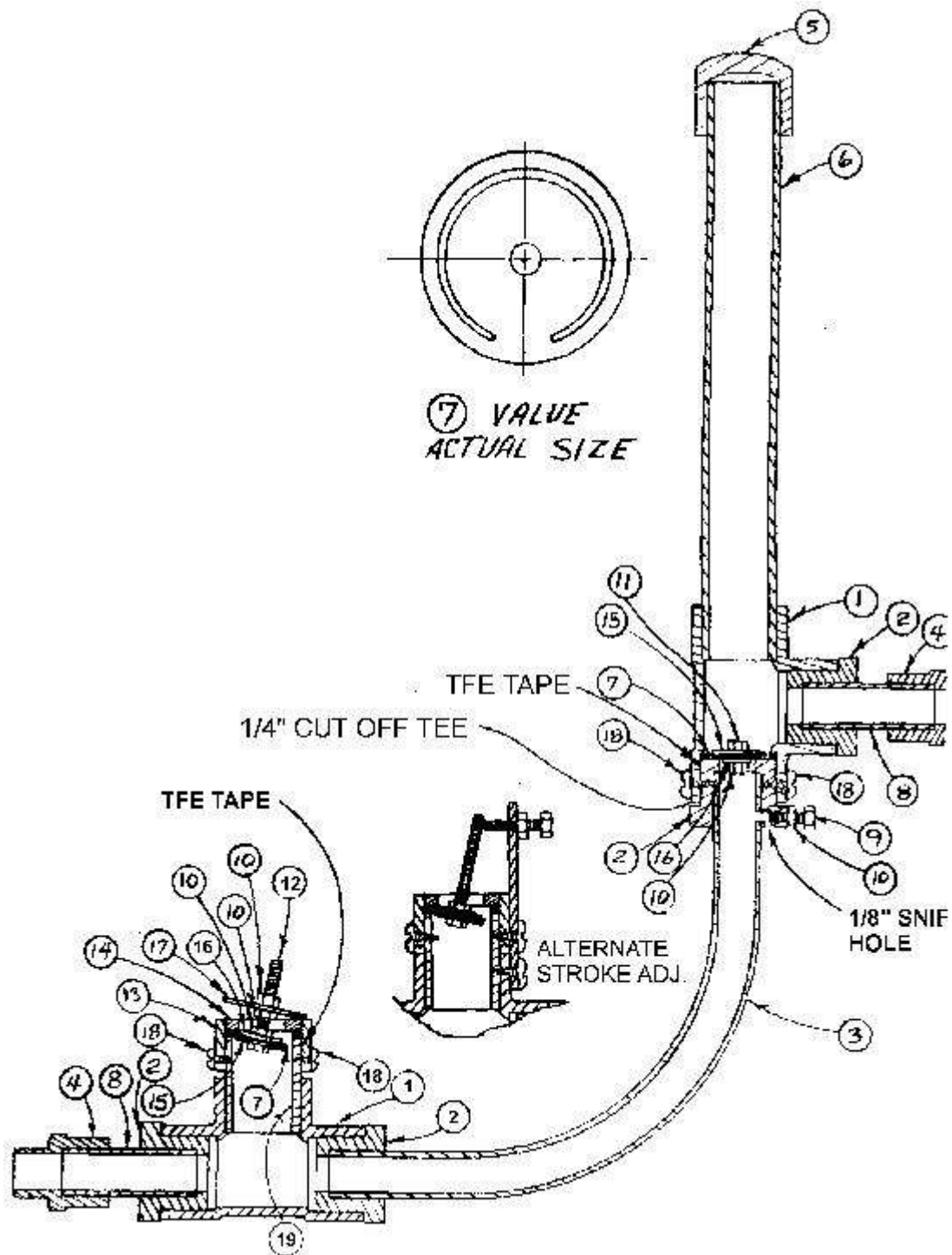

A PVC Hydram

Session 1: Introduction to training (1½ hours)

Total Time: 1½ hours

OBJECTIVES:	By the end of this session trainees will have
	familiarized themselves with each other and training staff; and
	identified and clarified their expectations and those of the staff.
OVERVIEW:	This session is designed to establish a climate of active participation and collaborative problem-solving in the workshop. The schedule should be reviewed and discussed, and expectations need to be shared and processed.
MATERIALS:	
	Handout 1A: "What's in a Name"
	Handout 1B: Workshop objectives
	Notebook or pad for each trainee (ring binder)
	Flipchart/markers or chalkboard/chalk
	Goals of workshop on a flipchart/chalkboard

Workshop Goals:

1. To design, construct, operate, maintain and repair hydrams.
2. Identify issues in hydram project planning and implementation.

Note: "What's in a Name" is a recommended icebreaker. Trainer may use another that achieves the same objectives.

PROCEDURES	NOTES
<i>Introduction</i>	
1. Welcome the participants to the workshop and introduce the staff. Have each staff-member say a few words about him/herself.	10 min.
2. Introduce the "What's in a Name" exercise and divide the group into small groups of 4-6 participants.	Allow 30 min. for this.
3. Distribute the handout "What's in a Name" and have the groups discuss of the groups as a participant. Their names using questions on the Be sure to give the groups a handout as a guide. time check.	Trainer may want to join one
4. As a large group have the participants share some of the interesting "stories" that may have	

come out of their small group discussions about their names.	
<i>Goal Setting</i>	
5. Review goals listed on newsprint. Distribute the workshop objectives and ask participants to read them.	10 min. Participants should already have copies of the objectives. Have additional copies on hand just in case. Answer any questions
<i>Expectations</i>	
6. Explain that one of the purposes of this session is to identify and clarify expectations of the training workshop.	
7. Ask the trainees to list their individual expectations of the workshop on a sheet of paper.	5 min.
8. Have the trainees form small groups of 4-5 people and ask them to share their expectations listing those they have in common on newsprint. Staff will do the same.	15 min.
9. Ask a reporter from each group to post their group's list and share it with the large group.	20 min.
10. Clarify which expectations can be met during the workshop and those which cannot.	
11. Distribute the schedule for the workshop and discuss the first day. Explain the workshop site procedure (mealtimes, facilities, etc.).	5 min.
12. End the session by summarizing the. Shared expectations of the group and mention that the list will be reviewed at the end of the workshop to determine how well the expectations have been met. Ask participants to bring "Participant Site Information Worksheet" to next session.	5 min

Handout 1A: "What's in a name"

Our names are one of the most distinguishing characteristics of who we are. Share with the group some of the reasons why your name is special.

Some things you might wish to share:

- Do you like your name? Why or why not?
- How did you get your first name?
- Does your name(s) have any meaning?

- What is the origin of your last name?
- Famous (or infamous) ancestors?
- Funny stories, incidents related to your name?
- Anything else you may wish to share.

Handout 1B: Hydram Training Workshop Objectives

By the end of the training program, you will be able to:

- survey and evaluate sites for potential hydram projects;
- articulate and apply hydram theory;
- use correctly, basic water measurement techniques and formulas for proper sizing of hydrams;
- select proper ram design and size;
- develop a water source site for hydram operations;
- design water distribution system including storage tank, stand pipes, supply lines, etc.;
- construct a pipefitting and/or cement hydram;
- maintain, troubleshoot and repair hydrams;
- train local community members in the installation , operation and maintenance of hydrams; and
- identify physical, social and institutional requirements for the above.

Session 2: Introduction to hydrams (3½ hours)

Time: 3½ hours

OBJECTIVES:	By the end of this session trainees will be able to:
	articulate basic issues of water supply in their communities and the implications for hydam projects;
	approximate amount of water a system must deliver;
	accurately describe how hydrams work;
	articulate principles underlying how a hydam works;
	determine amount of water that can be pumped from a hydam given the flow rate and the height of the source, and the height of the delivery point; and
	use standardized notation/terms.
OVERVIEW:	Part I of this session is a technical introduction to the device, providing a basic understanding of how and why it works. It presents the relationship between potential energy and the amount of flow that a hydam can deliver. Given that as a basis, trainees will follow the water flow from a source, through the ram (actual or demonstration) to a delivery point, develop an equation that describes the relationship, and solve problems. Part II examines critical issues involved in the installation of a hydam system, including access to water, present systems, needs, use and demands for water, and establishes a context for the technical training.
MATERIALS:	Handouts 2A, 2B, 2C, 2D, 2E (2A and 2B reproduced on flipchart)
	A working hydam or hydam model
	A physical demonstration of potential energy e.g., a pegboard with movable pegs, colored string and weights.
NOTE:	Problems and examples should be written in appropriate units of measurement.

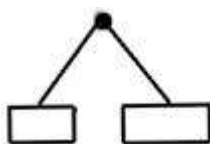

Figure

PROCEDURES	NOTES
1. Introduce session with a brief statement about the general application and history of hydrams, including use and revival in the U.S.	See Foreword for historical background
2. State the objectives of this session and rationale	

for two parts.	
1. Ask for definition of potential energy. Write it on the board.	Use notation consistent with handout, i.e., $E_p = m \times h$ or $E_p = w \times h$.
Using attachment 2A, or a peg board, demonstrate how a falling mass can be used to lift a mass to a higher elevation.	If group seems unfamiliar with concept, the peg board will probably be better, and it should be passed around, so they can try it.
2. Refer to attachment 2B on the flip chart, and demonstrate situation in which a hydram can be used. Show how potential energy relates to the amount of water that can theoretically be pumped to a given height.	
3. Point out on the diagram, the following: drive pipe, delivery head, quantity of water entering the ram, and quantity of water delivered	The vocabulary and terms are important at this point; the notation is of less importance but should be introduced
Explain that to standardize notation all terms on drive side are capitalized, and delivery terms are in lower case, i.e.:	
drive head = H delivery head = h	
water	water
entering = Q	delivered = q
drive pipe	delivery pipe
diameter = D	diameter = d
length of	length of
drive pipe = L	delivery pipe = l
Refer trainees to 2B for complete list, and state that for purposes at this point, it's not necessary to know all of those terms.	
4. Now that the general parameters of a hydram installation are known, it is a good time to look at how a hydram works.	

<p>5. Using attachment 2C describe the water flow through various parts of the ram. Point out that the impulse valve is open when it starts. Ask questions and bring out the following:</p>	<p>It might be useful to underline each part's name in a contrasting color, as you go through the description.</p>
<p>sufficient water coming into the impulse valve to close it</p>	
<p>effect of water's movement being suddenly stopped ("water hammer")</p>	
<p>moving through the check valve, into the accumulator</p>	
<p>check valve closing, with sufficient water weight and air pressure to force water through the delivery pipe</p>	
<p>vacuum being created under the check valve, air suction, snifter</p>	
<p>6. Go to the actual installation. Have trainees play with the impulse valve, listen to the rhythm, describe water path again, based on what's heard. Take the valve apart, ask trainees to identify key parts (impulse valve, check valve, snifter, ram body, drive pipe, delivery pipe). If possible take the ram apart, to demonstrate.</p>	<p>This is easily done with a clear PVC pipe demonstration ram; which could be hooked up to an experimental stand.</p>
<p>7. Return to classroom. Ask 1-2 trainees to describe the movement of water and the principles. Clarify any misunderstanding, check use of terms.</p>	<p>The PVC hydram could be helpful here also.</p>
<p>8. Return to the potential energy definition, and make the analogy to amount of water pumped, using $QH = qh$, as a starting point. State that, because of friction and a number of other factors involved in the construction of the hydram, it's unlikely that all of the water theoretically available will or can be pumped, but that some percentage of it will be pumped. The percentage of water pumped is called the efficiency of the hydram, and is designated by 'n'. There fore, $nQH = qtr$. Ask the trainees to solve the equation for 'q', since the interest is in knowing how much water can be pumped.</p>	<p>Or refer to efficiency as percentage of energy out; use the description that best suits the technical level of the group.</p>
<p><i>Result:</i></p> <p><i>amount of water delivered = (drive head) x (water entering) x (efficiency) / (delivery head)</i></p>	<p>If the algebraic manipulation confuses the group, go through this derivation process:</p> <p>$nQH = qh$</p> <p>$nQH/h = qh/h$</p>

	nQH/h = q	
9. Review standard units of water flow; i.e., in water flow measurement sessions, measurements are in gallons per minute(gpm)		
10. Trainees now should be able to tell the amount of water that can be delivered in hypothetical situations given an assumed efficiency. Ask them to solve the following problem:		
A spring is flowing at the rate of 20 gpm. The hydram is located 20 ft. (measured vertically) below the spring. The storage tank is 100 ft above the spring (measured vertically) and the assumed efficiency of the hydram is 50%. How much water can be delivered?	Answer: 2400 gallons per day (gpd)	
Ask one trainee to present the process and solution on the board. Check the group to see if everything is clear. Ask trainees to develop other hypothetical situations for the group to solve. Check to see that the process and units are correct. If the arithmetic is wrong continue practicing or a calculator may be used	If the diagram from attachment 2B is on the flip chart or chalk board, these figures can inserted in the appropriate places. If participants are having problems with the arithmetic, suggest that they form study groups	
11. Wrap up by reviewing the sessions objectives, and checking with the group to determine that everyone is comfortable with the concepts, vocabulary and the problem solving.		
Distribute the glossary and review key words and concepts.		
PART II		
1. Ask participants to form groups of 5-7, and assign one trainer to facilitate each group. Group Task: Distribute participant site information worksheet and have the trainees fill it out. Then as a group have them:		
a.	Discuss responses to questions 1-5.	30 min.
b.	List problems with present water system the hydram would solve; problems/issues that would remain the same and new problems/issues that would be created.	15 min.

c.	Each group is to select 2 major problem areas/issues in the development of the hydam system that will be critical to its success over time	10 min.
2. Share (c) in large group. Ask for implications for their work in communities in introducing this technology.		15 min.
3. Summarize as critical issues to keep in mind as they move through the workshop.		

Handout 2A: Potential energy

Attachment 2-A

POTENTIAL ENERGY (E_p) = MASS (M) \times HEIGHT (H) ~ FOR OUR PURPOSES MASS AND WEIGHT ARE INTERCHANGABLE SO $E_p = \text{WEIGHT} \times \text{HEIGHT}$.

$$W \times H = W \times H$$

$$300 \text{ LB} \times 1' = 100 \text{ LB} \times 3'$$

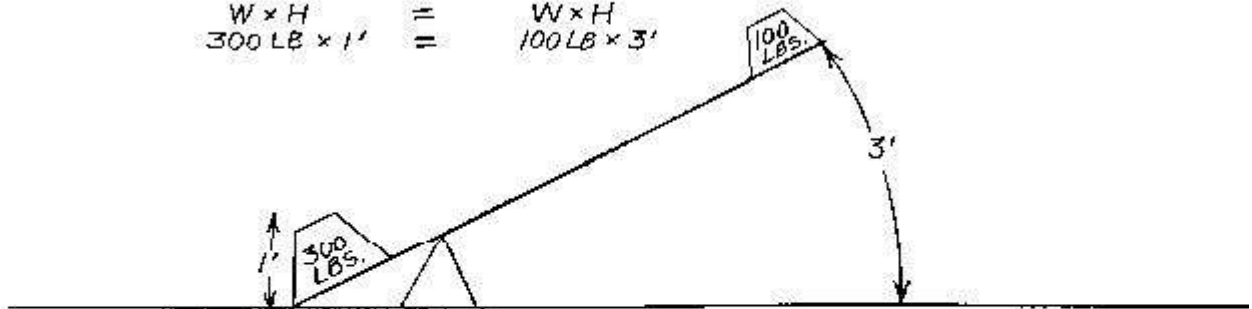

$$W \times H = W \times H$$

$$3 \text{ GAL} \times 8.33 \frac{\text{LB}}{\text{GAL}} \times 1' = 1 \text{ GAL} \times 8.33 \frac{\text{LB}}{\text{GAL}} \times 3'$$

3 GALLONS OF WATER FALLING 1 FOOT CAN LIFT 1 GALLON OF WATER 3 FEET @ 100% EFFICIENCY

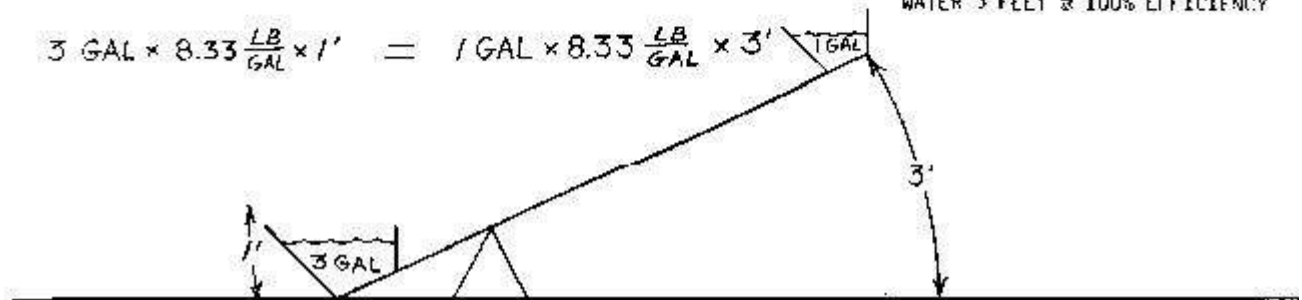

Introduction To Hydrams

Handout 2B: Hydam installation

Attachment 2-B

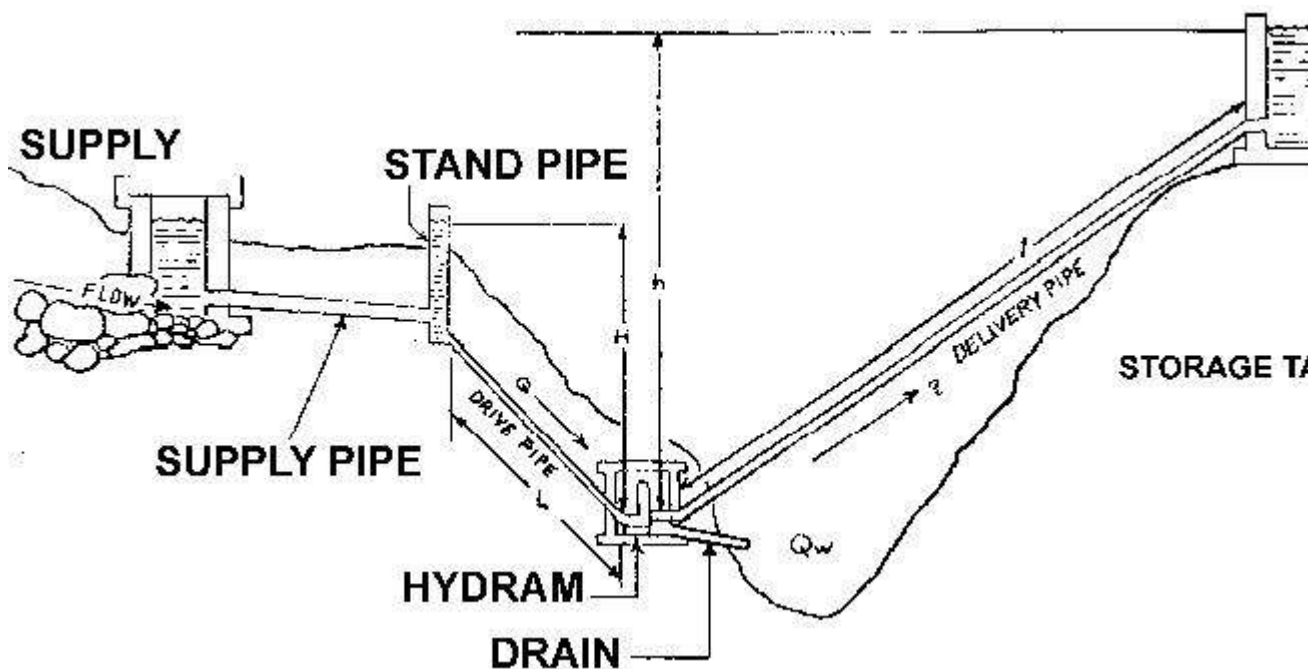

Hydram installation

DEFINITION OF VARIABLES	
D = Diameter of Drive Pipe	d = Diameter of Delivery Pipe
H = Head of Drive Pipe	h = Head of Delivery Pipe
L = Length of Drive Pipe	l = Length of the Delivery Pipe
Q = Quantity of Water Entering Hydram	q = Quantity of Water Delivered
	n = efficiency
Q_w = Quantity of Water Wasted from Impulse Valve	S = Length of the Impulse Valve Stroke
F = Frequency of the Impulse Valve Stroke	W = Weight of the Impulse Valve

Handout 2C: Typical hydram

Attachment 2-C

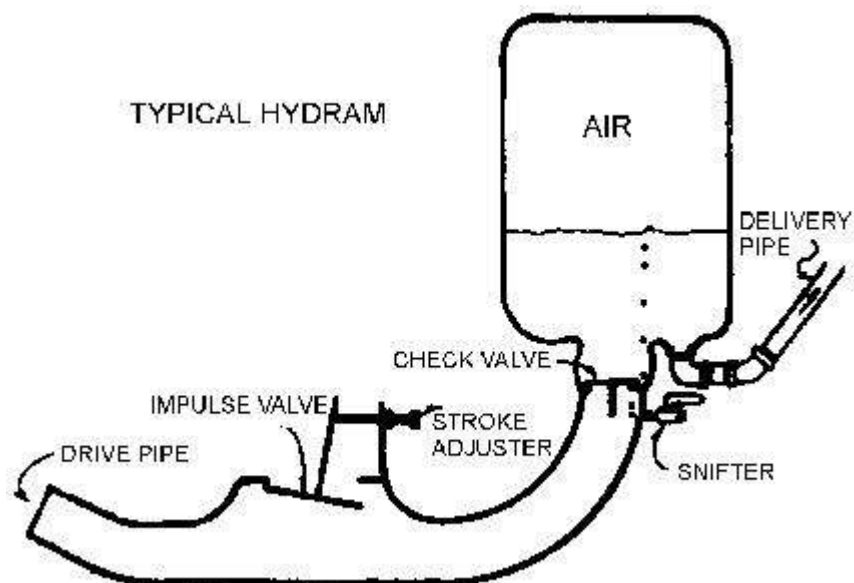

Typical hydram

Handout 2D: Glossary of terms for session 2

Attachment 2-D

Glossary Of Terms For Session 2

Accumulator - (air dome) the air chamber on the hydram which cushions the water hammer, eliminating delivery pulsations and helps provide rebound.

Check Valve - (non-return valve, secondary valve, internal valve) the internal valve in the hydram that prevents the delivery head pressure from forcing water back through the hydram body.

Delivery head - the vertical distance between the hydram and the highest level of water in the storage tank that the hydram is pumping to.

Delivery pipe - the pipe which connects the output of the hydram to the storage tank.

Drive head - the vertical distance between the hydram and the highest level of water in the supply system.

Drive pipe - a rigid pipe usually made of galvanized steel that connects the hydram to the source reservoir or stand pipe.

Efficiency - (n) the ratio of the energy input to the energy output; a measure of how well a hydram functions;

$$n = \frac{qh}{Qh}$$

Frequency - (f) the number of times a hydram cycles in one minute.

Hydram - (hydraulic ram, hydraulic ram pump, automatic hydraulic ram pump, ram) an ingenious device that uses the force of water falling through a drive pipe to pump water to a height greater than its source, making use of hydraulic principles and requiring no fuel.

Impulse Valve - (clack valve, out-side valve, impetus valve, waste valve) the valve on the hydam that creates and controls the water hammer.

Potential energy - energy derived from position or height; is equal to the height that a mass can fall times its weight.

Rebound - the flow of water in the ram reversing direction due to the air pressure in the accumulator, closing the check valve.

Settling basin - a small tank usually made of steel or concrete that is used in place of a stand pipe in an installation where additional settling is necessary.

Snifter valve - (air valve, spit valve) the small valve just below the check valve that allows air to enter the hydam.

Spring box - a concrete box built around a spring to facilitate water collection and to protect the water source from surface contaminates.

Stand pipe - an open-ended, vertical pipe sometimes used at the beginning of the drive pipe.

Supply pipe - everything in a hydam system before the drive pipe, usually including some but not necessarily all of the following; spring box, supply pipe, stand pipe, settling basin.

Waste water - (Q_w) the water coming out of the impulse valve and the snifter.

Water delivered - (q) the rate at which water is delivered to the storage tank;

$$q = \frac{Q \times H \times n}{h}$$

Water flow to the hydam - (Q) all the water used by a hydam which is equal to the waste water (Q_w) plus the water delivered (q)

Water hammer - the effect created when water flowing through a pipe is suddenly stopped. In a hydam this causes the closing of the impulse valve and opening of check valve.

Handout 2E: Hydam training workshop participant site information

Hydam installations are extremely site specific. Although it's a simple technology, it does require being properly designed and sized based upon particular characteristics of the site. It also requires a certain amount of follow-up and maintenance. In order to maximize your learning during the workshop, please begin to gather the following information. (You don't have to have all of the information prior to the workshop, but it will help if you begin to consider these factors at your site.)

1. What water sources are available?
2. What kinds of water systems are presently being used? Who is responsible for maintaining the systems?
3. What are the present patterns of water use in your community? (e.g. potable water, irrigating home garden plots)

What is the proposed purpose for the hydram installation?

5. What kinds of skills and resources are presently available to support a hydram installation?

Community history of cooperative work on projects?

As existing community water distribution system?

Facilities and craftspeople in or near the community with metalworking, plumbing, and masonry capabilities? Vocational technical schools, public works?

6. How do you rate your present knowledge/experience about water systems, pumps, hydrams? What do you need to refresh, what do you need to know?

7. If you have a site in mind for a hydram, can you find out: a. approximate flow rate of the water source (gallons/minute) b. approximate "drive head," i.e., vertical distance from water source to where hydram will be installed? c. approximate "delivery head," i.e., vertical pumping distance from ram to point of delivery? d. amount of water desired/required? (gallons/day)

NOTE: During the workshop, you will learn simple measuring techniques; knowing this information beforehand allows one to design a site specific ram during the workshop with guidance from the training staff.

Please bring this sheet with you to the workshop. If it's easier to sketch your situation, feel free to do so.

Session 3: Water measurement techniques (3 hours)

Total Time: 3 hours

OBJECTIVE:	By the end of the session, the trainees will be able to accurately measure the flow moving bodies of water using a weir, a bucket and watch, or the float n
OVERVIEW:	It is important during this session that the trainees gain experience in estimatin rates and develop skills in measuring flow rates. Three methods of measureme be presented: 1) the weir method, 2) the bucket and stop watch method, and 3) tl method. Each method will entail "hands on" work, constructing a weir, channel stream, placing stakes in the stream, etc. The findings from these three methods compared.
MATERIALS:	Handouts 3A - 3D
	lumber, nails, approximately 3' of pipe with a sufficient diameter for the expecte sheet metal (optional), bottle with cork, or float. Have a set of materials for each
TOOLS:	watch with a seconds function, bucket of known capacity, saw, level, tape m hammer, pick or mattock, tin snips (optional), have one set of tools for each
*TRAINERS NOTE:	1) Since the purpose of the activity is to learn to measure, not build, pre-construct site levels, weirs is recommended.
	2) The weir table is provided in both English and metric units;
	3) the float method has limited applicability. Decide whether or not to spend conducting the field activity.
	4) Identity site for field activity ahead of time, ensuring enough locations for groups or pairs to work independently; stake out distances if nec

	PROCEDURES	NOTES
1.	Discuss the need for water measurement in hydram systems: - amount of water delivered - amount of water into ram	
2.	State objectives for the session.	
3.	Ask participants to approximate amount of water needed for: irrigating an average garden domestic use potable water	
4.	For each, ask participants to compute amount of water needed to enter the ram given $H=10'$, $h=30'$.	This problem links and review S

5.	Distribute the handouts and make a transition to the task of measuring water available.	
6.	Describe the weir and what it is used for.	
7.	Describe how to build and install a weir.	A desk top model would work we and could substitute for the real e time and facilities aren't available.
8.	Explain how to use the weir table.	
9.	Go over the example in the handout and make certain everyone feels comfortable with their ability to use the weir table.	
10.	Describe how to use the bucket and watch method.	Use discretion as to how much de into as this method is used on f would be considered infinite wi installation. (float method)
11.	Describe the float method of measurement .	
12.	Explain steps in determining cross-sectional area of a stream.	
13.	Explain procedures in determining the velocity of the stream.	
PROCEDURES NOTES		
14.	Go over the example in the handout.	
15.	With the trainees, go over the sequence of events involved in the remainder of this session and how much time is left.	
16.	Divide the trainees into groups of three or four, giving each group an even level of total skills.	
17.	Proceed to the creek or stream.	
18.	Locate a section along the creek or stream where the flow is consistent and there is sufficient room for all the groups to work within sight of each other.	
19.	Have each group select a site which they feel will be easily developed.	
20.	Have each trainee make--a guess as to flow rate of the creek or stream they are measuring.	
21.	Note estimates of flow rate.	
22.	Calculate flow rate by the float method	Use only if time allows and the wa

		is appropriate.
23.	Select appropriate section of the stream or creek and determine cross-sectional area.	
24.	Place two stakes in stream at appropriate spots and distance from each other.	
25.	Place float in mid-stream and measure time it takes for float to travel from one stake to another.	
26.	Repeat measurement several times and average the flow rate.	
27.	Note differences between original estimates and measurements of flow rates.	
28.	From the measurements made, have each group decide on the size of their weir notch.	
29.	The trainees next construct their weirs and install them in the creek, making certain that the weirs are well supported and sealed against leakage around the bottom and sides.	It may be a good idea to have e: build their weir out of different m: that the construction techniques compared.
30.	After the weirs are constructed, readings should be taken periodically while the water is seeking its new level and while flow rates are being interrupted by the other weir installations. Once the readings become consistent, they should be considered reliable.	
31.	Using the weirs as partial dams, in stall the short lengths of pipe and seal around them in the same manner that the weirs were sealed.	
32.	With all the water flowing through the pipe and into the bucket, time how long it takes to fill the bucket. Again readings should not be considered reliable until they are consistent.	
33.	At this point, review what has been done thus far in the session.	
34.	Back at the classroom, list the readings from each group and discuss the reasons for the variations. If different materials were used for the weirs, discuss the advantages and disadvantages of each.-	Point out need to measure seasonal of water flow
35.	Ask participants which method they would use, given resources at their site.	

Handout 3A: Using a Weir

A weir may be defined as an overflow structure built across an open channel, usually to measure the rate of flow of water. Weirs are acceptable measuring devices because, for a weir of a specific size and shape (installed under proper conditions) only one depth of water can exist in the upstream pool for a given discharge. The discharge rates are determined by measuring the vertical distance from the crest of the overflow portion of the weir to the water surface in the pool upstream from the crest, and referring to tables which apply to the size and shape of the weir. For standard tables to apply, the weir must have a regular shape, definite dimensions, and be set in a bulkhead and pool of adequate size so the system performs in a standard manner.

Whenever the flow from a creek is too great to be measured in a bucket and yet is small enough to be dammed by a board, the weir method of measurement should be used.

Determine the dimensions to be used for the weir notch. The width of this notch is related to the measurement of the flow rate by the height of the water in the pool formed behind the weir. This height is measured in inches and by using a weir table, the inches can be converted to gallons per minute. A number of notches of different widths and height can accommodate a stream's flow. A rule of thumb is to make the width of the notch 3 times the height.

From your estimate of the flow of the stream, look at the weir table and guesstimate what size notch will accommodate your flow. Keep in mind that the whole stream must pass over the notch and that the pool formed behind the weir should become deep enough for you to easily get a decent height measurement, i.e., 2½" vis a vis 1/16". Example: you estimate the stream is flowing at 150 gal/min. If you made a notch 12" wide and 4" high, at full flow this weir would read approximately 290 gal/min. (4" -- 23.936 gal/min x 12" = 286.89 gal/min). This weir would fit your stream if an actual weir reading of 2½" water height were obtained, it would indicate a flow rate of 11.818 gal/min/inch of notch or 141.8 gal/min (11.818 x 12") for the stream.

Once you have determined the dimension of the notch, cut the notch in the board and place the weir board in the stream making certain that it is kept level and seal off the stream completely. Support it with stakes and large rocks.

Measure 2 feet upstream from the weir board and drive a stake. Using a level, put a mark on the stake even with the top of the weir board. Next, measure down from this mark to the water level, subtract this measurement from the depth of your notch and that will give you the height of the water level above the bottom of the weir notch.

Using the weir table attached, locate the integer on the left hand column and the fraction on the top column. Where these two rows intersect is the amount of gallons per minute flowing past the weir for every inch of width. Next multiply this figure by the width and this gives you the total flow of the creek.

Example:

Water is flowing through a creek three feet wide and about 3 inches deep. It looks like about 30 gallons per minute. After looking at the weir table we decide that a notch 6" wide and 2" deep would probably work. After cutting the notch in a 4 foot 1x6 piece of lumber, the weir board was placed in the stream. Two feet upstream a stake is driven in the water in front of the notch. A level is used to place a mark on the stake level with the top of the weir board. The water level is then measured to be ½" down from this mark.

We now know by subtracting this measurement from the depth of the notch that the water level is 1¼" above the bottom of the notch. Now looking at the weir table we find 1 on the left hand column and ½ on the top row. These two rows meet at 5.46. We multiply this by the width of the notch (6") to find that the flow rate was 32.76 gallons per minute.

Handout 3B: Using a Weir - diagram

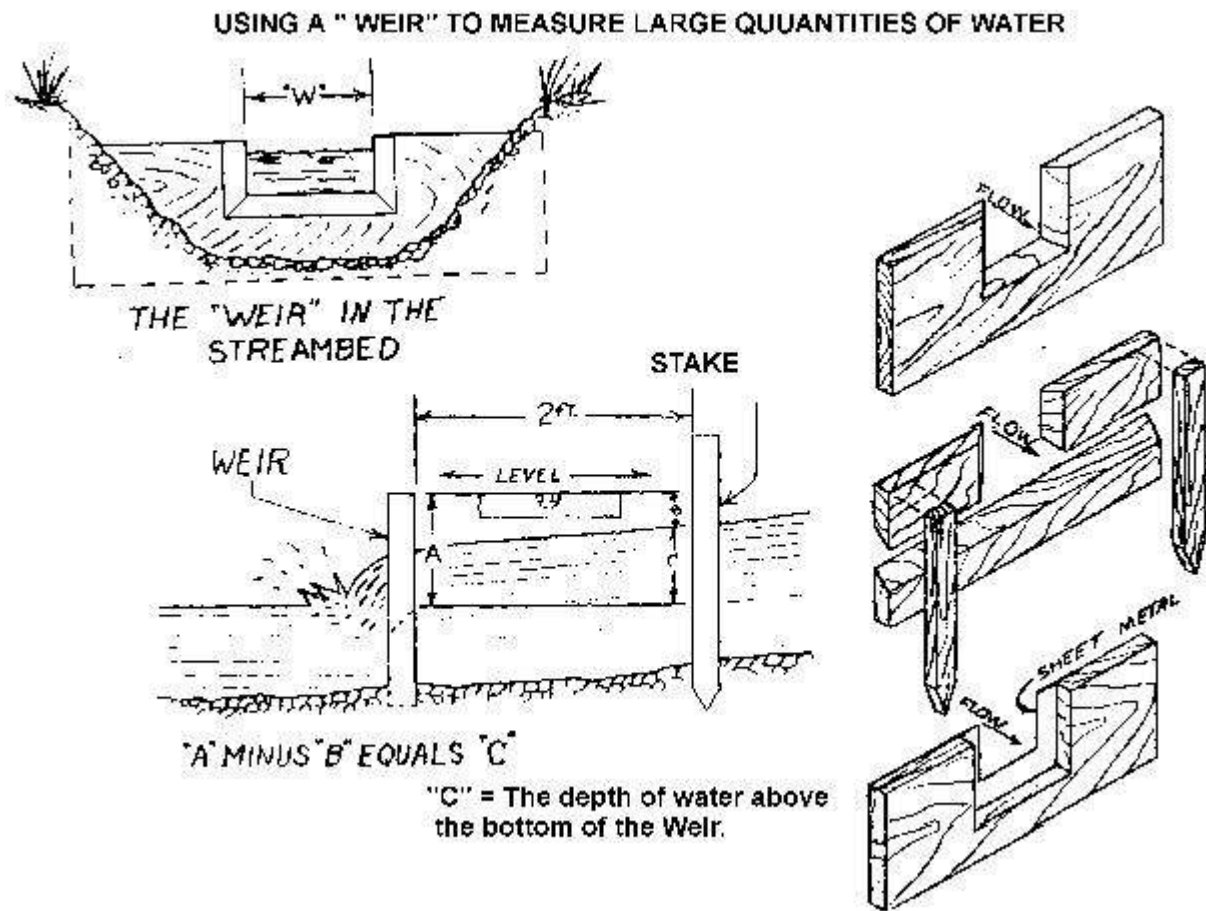

Using a "Weir" to measure large quantities of water

Handout 3C: Weir table

Height of water above weir notch in inches								
	0	1/8	1/4	3/7	1/2	5/6	3/4	7/8
0	000	.0748	.374	.673	1.047	1.421	1.945	2.394
1	2.992	3.516	4.114	4.787	5.46	6.134	6.882	7.63
2	8.452	9.2	10.098	10.92	11.818	12.716	13.614	14.586
3	15.484	16.531	17.503	18.55	19.523	20.645	21.692	22.814
4	23.936	25.058	26.18	27.377	28.499	29.696	30.967	32.164
5	33.436	34.707	35.979	37.25	38.522	39.868	41/215	42.561
6	43.908	45.329	46.75	48.171	49.518	51.014	52/435	53.931
7	55.352	56.848	58.344	59.915	61.411	62.982	64.552	66.048
8	67.694	69.265	70.836	72.481	74.127	75.772	77.418	79.064
9	80.784	82.504	84.15	85.87	87.591	89.311	91.032	92.827
10	94 547	96.342	98.138	99.933	101.73	103.6	105.393	107.263

Flow rate per inch of weir notch in gal/min.

Handout 3C: Weir table - metric

	0	3.2	6.35	9.5	12.7	15.9	19.	22.2
0	0	.283	1.415	2.547	3.963	5.379	7.362	9.062
25.4	11.3	13.3	15.573	18.12	20.668	23.219	26.051	28.882
50.8	31.994	34.825	38.225	41.336	44.735	48.135	51.534	55.214
76.2	58.613	62.577	66.256	70.219	73.902	78.150	82.113	83.332
101.6	90.608	94.855	99.102	103.633	107.88	112.412	117.223	121.754
127	126.57	131.380	136.195	141.007	145.822	150.913	156.016	161.111
152.9	166.21	171.589	176.968	182.347	187.446	193.109	198.488	204.151
177.8	209.53	215.193	220.856	226.803	232.466	238.413	244.356	250.019
203.2	256.25	262.197	268.143	274.37	280.601	286.828	293.059	299.29
228.6	305.8	312.312	318.542	325.053	331.568	338.08	344.594	351.388
254	357.899	364.694	371.493	378.288	385.09	392.169	398.956	406.035

Flow rate per millimeter of weir notch in liters/men,

Handout 3D: The float method of measurement

The float method of measurement is a simple procedure for obtaining a rough estimate of the flow of the stream. It will give a ball park figure for looking at the stream's potential. It should not be used for final determination of the hydram system to be used unless the flow rate needed for the ram is such a small percentage of the stream's total flow that what's taken from the stream, for all practical purposes, amounts to a minimal portion of the stream.

The float method is based upon two aspects of the stream: it's cross-sectional area and the velocity of the stream. The cross-sectional area should be determined at some accessible spot in the stream, preferably in the middle of a straight run. Measure the width (w) of the stream. Then, using a stick, measure the depth at equal intervals across the width of the stream (see figure below). Record the depth at each interval and calculate the average depth (d). Now multiply the width (w) by the average depth (d) to get the cross-sectional area (A).

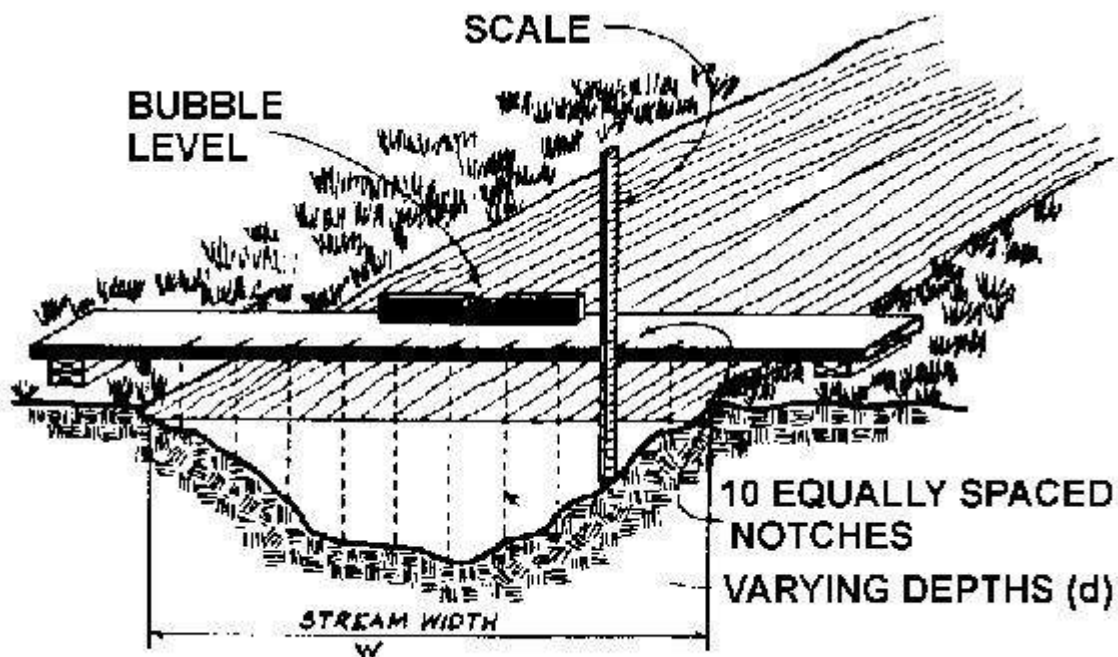

FIGURE A

Figure A

Example: The width of a stream, at the point of making depth measurements, is 4 feet. The average depth is 1.1 feet. Therefore, the cross-sectional area (A) is:

$$A = w \times d$$

$$A = 4\text{feet} \times 1.1\text{feet}$$

$$A = 4.4$$

square feet

The stream velocity can be determined by choosing a straight stretch of water at least 30 feet long with the sides approximately parallel and the bed unobstructed by rocks, branches or other obstacles. Mark off points along the stream. On a windless day, place something that floats in midstream, upstream of the first marker. A capped bottle partially filled with water works well because it lies with a portion of the bottle submerged and doesn't just ride the surface of the water. Carefully time the number of seconds it takes the float to pass from the first marker to the second. Repeat this process several times and average the results.

Example: The average time for a float to travel between two markers placed 30 feet apart is 30 seconds. The velocity (V) of the float is therefore:

$$V = 30 \text{ feet}$$

$$30 \text{ seconds}$$

$$V = 1 \text{ foot/second}$$

$$V = 60 \text{ feet/minute}$$

The flow rate of the stream can now be calculated by multiplying the cross-sectional area (A) by the

stream velocity (V). The usable flow (F) can then be determined by multiplying the stream flow rate by a fraction representing the portion of the stream flow that you can or want to use.

Example: If you will be using 25% of the stream flow, the usable flow (F) is:

$$F = A \times 1/4 \times .25$$

$$F = 4.4 \text{ square feet} \times 60 \text{ feet/minute} \times .25$$

$$F = 66 \text{ cubic feet per minute}$$

This flow in cubic feet per minute can then be converted to the appropriate units by multiplying by the correct conversion factor:

$$\text{cubic feet/min} \times 7.48 = \text{gallons/min}$$

$$\text{cubic feet/min} \times 28.3 = \text{liters/min}$$

SOURCE: Micro-Hydro Power, National Center for Appropriate Technology (1979).

Session 4: Measuring heads and distance (2-4 hours)

Total Time: 2-4 hours

OBJECTIVE:	By the end of this session the trainees will have demonstrated skills in measuring heads by using sight levels, hose levels, pressure gauges, and in measuring distances using their stride and sight levels.
OVERVIEW:	At a potential hydam site trainees will perform a series of measurement procedures for determining the head of a stream/spring, using sight levels, hose levels and pressure gauges (where applicable). In addition trainees will measure the distance from the point where water will be taken from the stream/creek to where the ram will be installed using tape measures and their stride.
MATERIALS:	<ul style="list-style-type: none"> • Handouts 4A - 4E • 15 ft of 1x2 lumber (or something similar which is straight) and string.
TOOLS:	<ul style="list-style-type: none"> • sight levels: 1 per pair of trainees; calibrated • before session • tape measures • clear hose or tubing • pressure gauges

***TRAINERS NOTES:**

1. Distances and heads for trainee practice must be identified and measured ahead of time.

2. 3-4-5 triangle sight level should be pre-cut, since purpose of this activity is to measure not construct.
3. Pre-construction of site levels, weirs is recommended.
4. Time and available materials may make some techniques impractical. Select techniques ahead of time.

	PROCEDURES	NOTES
1.	Distribute the handouts and go over the objective of the session.	
2.	Describe the total activity and the techniques the trainees will be using .	
3.	Divide the trainees into pairs making certain the total competency of each group is about the same.	
	Part I: Head Measurement	
1.	Start by demonstrating how to calibrate sight level and then have the trainees calibrate their sight levels and measure the height of their eyes.	
2.	Give the trainees the task of measuring the drive head and the delivery head of either an existing or a future hydrum using a sight level.	
3.	The trainees should next compare measurements and any measurements that seem out of line should be rechecked along with the sight level calibrations.	
4.	The trainees should build sight level from indigenous materials using a 6 foot, 5 ft., and a 4 ft. 1 x 2, nails, string, and a rock. The three boards should be nailed together to form a right triangle. The string is attached to the 90 corner of the triangle with the rock attached to the other end (see handout 4C). With , the triangle held so the string remains parallel to the longer leg, one can sight down the shorter leg perfectly horizontally. These indigenous sight levels are now used to measure the same heads	It may be best to simply describe how this simple sight level works. If necessary to construct, trainer should pre cut lumber.
5.	Measure the same head using a clear	This is a very accurate technique, but cumbersome to practice plastic hose or tube filled with water with one end of the hose attached to a stick of

		known length (see Handout 4D).
6.	If there is a hydram installed at the site, attach a pressure gauge to the drive and delivery side and give the trainees the task of calculating the heads from the pressure readings. If this is a potential storage tank to the hydram site, then fill the pipe with water and ' attach a pressure gauge. Pressure readings should be taken and the delivery head calculated.	
7.	If the sight levels are of the kind that have more than one horizontal cross hair, explain to the trainees how to use these levels for distance measuring .	
8.	With the help of their partner, each trainee will measure ten normal paces using the tape measure and then divide by ten to determine their pace.	
9.	Give the trainees the task of measuring a distance using their pace .	
10.	Have them then measure a distance using a tape measure; compare the two measurements.	
11.	The groups should then be given a task of measuring the drive and/or the delivery pipe distance.	
12.	Back in the classroom, discuss any variations of the readings taken and the degree of accuracy that can be expected with each method used.	

Handout 4A: Calibrating a sight level

Attachment 4-A

CALIBRATING A SIGHT LEVEL

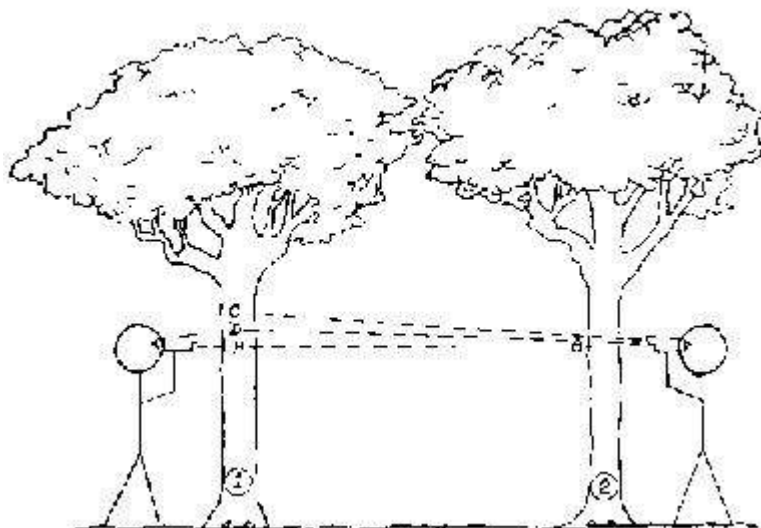

Calibrating a sight level

TO FIND OUT IF THE SIGHT LEVEL NEEDS TO BE CALIBRATED, SIGHT FROM POINT "A" ON TREE (OF OBJECT #ONE) TO TREE (OBJECT #TWO) AND MAKE A MARK, POINT "B". THEN SIGHT FROM POINT "B" BACK TO ORIGINAL TREE (OBJECT #ONE) AND MAKE A MARK AT THIS POINT "C". IF THE SIGHT LEVEL IS PROPERLY CALIBRATED POINTS "A" AND "C" SHOULD BE THE SAME AND AT THE SAME LEVEL AS POINT "B". IF THEY ARE DIFFERENT,

THE POINT MIDWAY BETWEEN "A" AND "C" (POINT "D") SHOULD BE LEVEL WITH "B". CALIBRATE YOUR SIGHT LEVEL TO THIS LINE.

Handout 4B: Using a sight level

Attachment 4-B

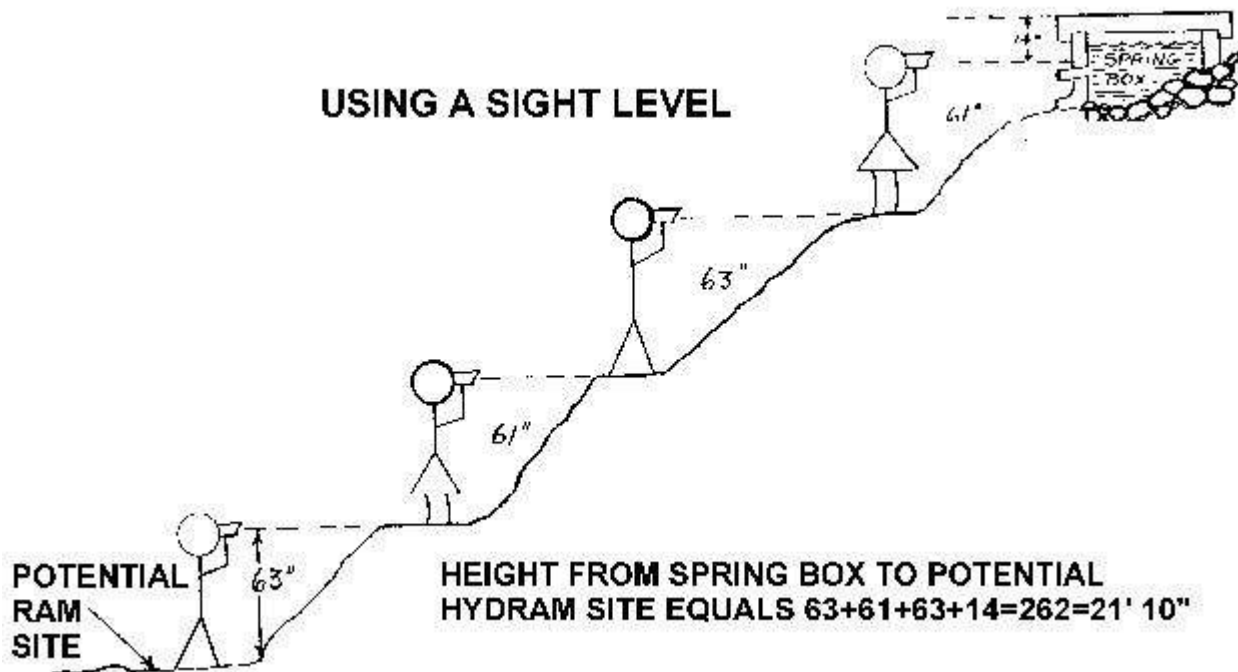

Using a sight level

Handout 4C: Alternate ways of measuring heads

Attachment 4-C

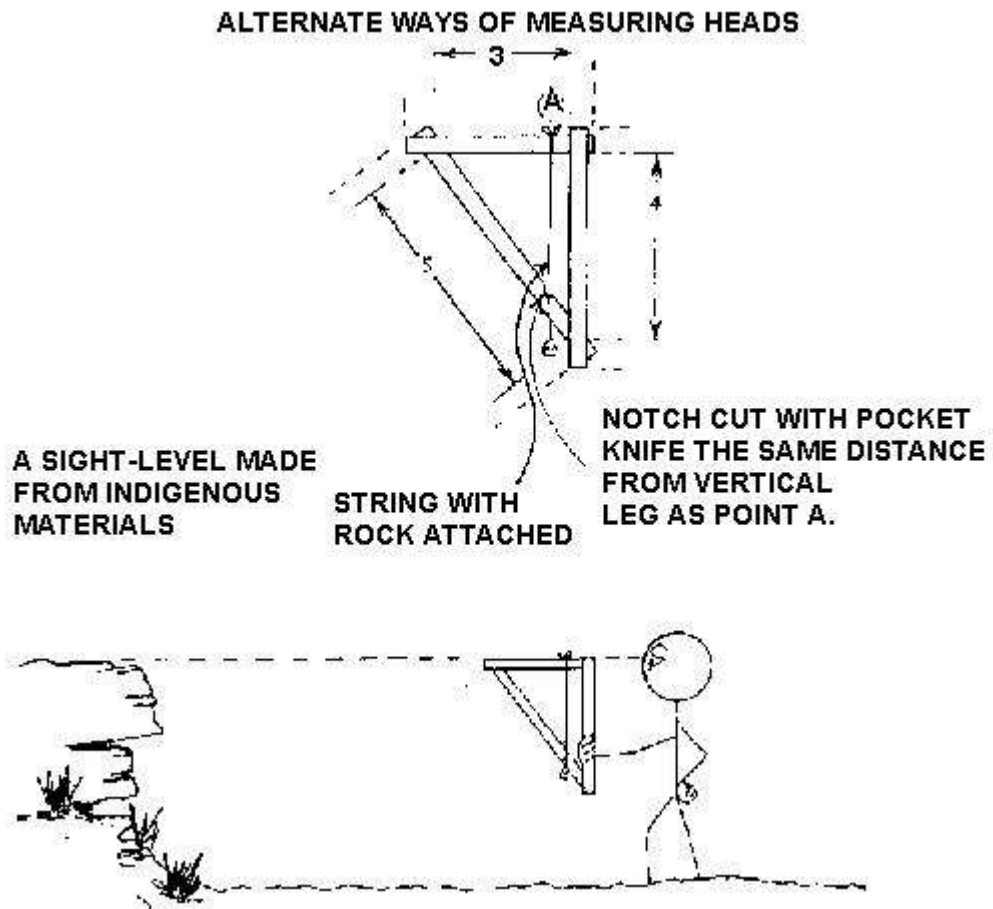

Alternate ways of measuring heads

Handout 4D: Alternate ways of measuring heads

Attachment 4-D

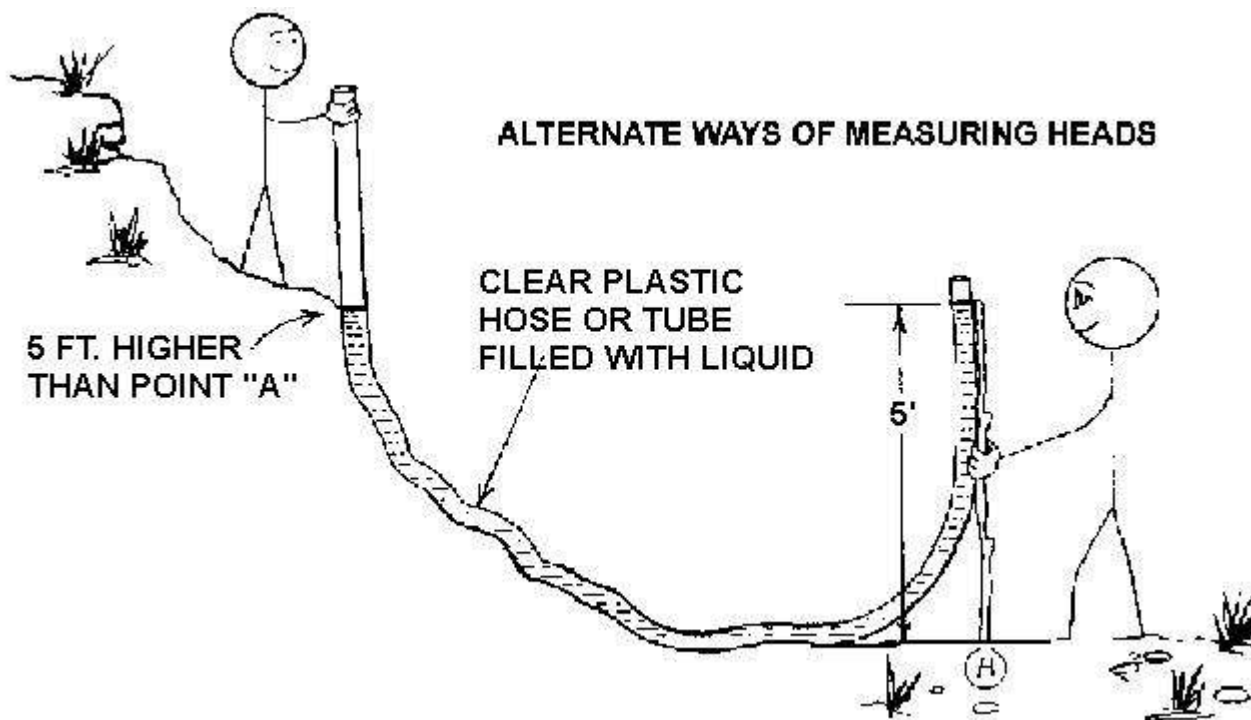

Alternate ways of measuring heads

Handout 4E: Distance and head measurement worksheet

	COURSE 1				COURSE 2				COURSE 3	
	DISTANCE	M	HEAD	M	DISTANCE	M	HEAD	M	DISTANCE	M
SUBGROUP A										
small group 1		Ta		S		C		H		P
small group 2		C		H		P		Tr		Ta
small group 3		P		Tr		Ta		S		C
SUBGROUP B										
small group 1		Ta		S		C		H		P
small group 2		C		H		P		Tr		Ta

small group 3	P	Tr	Ta	S	C
SUBGROUP C					
small group 1	Ta	S	C	H	P
small group 2	C	H	P	Tr	Ta
small group 3	P	Tr	Ta	S	C

Method =	M
Distance:	Tape = Ta
	Cord = C
	Pace = P
Head:	Sight = S
	Hose = H
	Triangle = Tr

Session 5: Review exercise #1 (2 hours)

Total Time: 2 hours

OBJECTIVES: By the end of this session trainees will have described how a hydram works, in their own words, solved review problems independently and clarified any misunderstandings to date.

OVERVIEW: This session provides an opportunity for participants to review and synthesize material to date.

MATERIALS: Handout 5A Pencil, paper Chalkboard/chalk or flipchart-markers

	PROCEDURES	NOTES
1.	Encourage questions on any information that has been presented thus far and try to get trainees to answer for each other.	30 min.
2.	Distribute the review exercise, and ask individuals to complete it on their own.	30 min
3.	After everyone has completed the review exercise, have them discuss answers with one other person.	20 min
4.	Ask for volunteers to share answers to individual problems.	30 min.

Handout 5A: Review exercise #1

Name: _____

1. How does a Hydrum work? _____
2. In a hydrum installation where the hydrum is located 20 feet below the spring box, how much water could be pumped in a day to a storage tank 100 feet above the springs' box if the spring is flowing 10 gpm and the hydrum efficiency is 50%? _____
3. What is the flow rate in gpm through a weir, four inches wide, when the water level is 5 3/8" above the bottom of the weir slot when measured two feet upstream? _____
4. What is the height of your eye level? _____
5. What is the length of your pace? _____

Handout 5B: Answers to review exercise #1

1. The hydrum is located below the source of water and is used to pump the water to a storage tank which is higher than the source. The water accelerates as it flows down hill through the drive pipe and out the impulse valve until it reaches such a velocity as to slam the impulse valve shut. This causes a water hammer effect, forcing water and a few air bubbles sucked in through the snifter from the previous cycle, through the check valve and into the accumulator filled with air. This movement of water into the accumulator causes the air to compress until the forward momentum is stopped. At this point the water in the accumulator bounces back because of the spring effect of the air in the accumulator. This rebound in the opposite direction causes the check valve to suddenly close, causing negative pressure in the hydrum before the check valve. Because of this negative pressure, air is sucked in through the snifter and the impulse valve is caused to open again at which point water starts exiting through the impulse valve and the cycle starts again.

2.

H - 20
$h = 100 + 20 = 120$
Q = 10
n = .50
$q = Q \times H/h \times n$
$q = 10 \times 20/120 \times .50 = 0.8333 \text{ gpm}$
$0.8333 \text{ gpm} \times 1440 \text{ min / day} = 1200 \text{ gpd}$

3. 5 3/8" on the weir table is 37.25 gpm.

This times four equals 149 gpm.

4. Any answer within reason is OK.

5. Any answer within reason is OK.

Session 6: Hydram theory (2-3 hour)

Total Time: 2-3 hour.

OBJECTIVES: By the end of this session trainees shall be able to:

- articulate hydram theory, and
- develop basic guidelines for preliminary sizing and design.

OVERVIEW: This lecture/problem-solving session explores in depth the relationship between basic theory and design/sizing of ram installation.

MATERIALS: flip chart or chalkboard Handouts 6A, 6 B. 2B

	PROCEDURES	NOTES
1.	Introduce the session by summarizing what has been learned so far, i.e., basic principles, how a ram works, how to measure water flow and heads, how to calculate amount of water to be pumped. Explain that next step is to take a more in depth look at all of the factors affecting the amount of water a ram can deliver and what that means in terms of design and sizing. State objectives of the session.	This material can be presented at a number of levels of technical complexity. The trainer, by now will have a sense of the group's level. This manual is written from a basic technical level
2.	Present general information on pressure, including:	Limit the amount of time spent on pressure to 10 min. and link it directly

		to the ram.
	- review of the basic definition: pressure = force/area and the standard units: psi = pounds/square inch	Write on board: 0.433 psi = 1 ft. water 1 psi = 28" water or 2.3 ft.
	- definition of gauge pressure and atmospheric pressure, including the relationship between the two.	
3.	Describe, using handout 6A, amount of pressure per foot of water, i.e. .433 psi = 1 ft and application to measuring heads with a pressure gauge. Ask participants to solve the following problems:	
	- If the pressure gauge reading is 75 psi, how high is the head?	answer - 173.1 ft
	- To simulate a 200 ft head, what should be the psig?	answer - 86.6 psi
4.	Recall that the concept of the hydram is based on the concept of potential energy; and the relationship of potential energy to kinetic energy. Ask for a definition of kinetic energy and write on the board or flipchart:	
	$E_k = \frac{1}{2}mv^2$.	
5.	Show that maximizing velocity optimizes kinetic energy.	If this concept is difficult use an example: m = 2 4 2 v = 6 6 12 ke = 36 72 144 Doubling mass has less effect than doubling velocity.
6.	Ask/explain how maximum velocity is affected by or affects:	
	- drive pipe diameter	
	- drive pipe length	
	- frequency of impulse valve	
	- maximum delivery head	
7.	Ask how stroke and weight affect frequency of impulse valve, and how frequency affects:	
	- amount of water delivered	
	- amount of water used by the hydram	

	- overall efficiency of ram	
8.	Ask participants for the formula of the amount of water delivered. Write it on the board/flip chart Ask/explain effect of H/h ratio on:	$q = \frac{nQH}{h}$
	- quantity of water delivered	Generally increases as H:h increases.
	- efficiency	Increases as H:h decreases.
9.	Discuss how the length of drive pipe is affected by:	
	- drive head	Refer to glossary for L:D and L:H ratios.
	- drive pipe diameter	
	- topographical limitations	
	- cost	
10.	Ask participants to determine best L for D = 1", and H = 10'	
11.	Explain the importance of rigidity in the drive pipe and in the hydrant before the check valve.	
12.	Review the role of the air cushion in the accumulator and explain how the amount of air in the accumulator affects hydrant efficiency.	
13.	Discuss the role of the snifter.	
14.	Distribute Handout 6B; point out that it includes some additional terms. Ask participants to look at the flow rate range table on the second page. Explain that flow rate (Q in gpm) is preliminary indicator of ram size. There are two general ways to estimate size:	These are "rules of thumb", not necessarily precise indicators.
	1) table	
	2) $Q = 3D^2$ or $D^2 = Q/3$	
	Ask participants for appropriate D for Q - 30 gpm.	1) table: D = 3" 2) formula: D = 3.16" Since pipe is in basic sizes, D = 3".
15.	On the board/flip chart, present the size relationships relative to the drive pipe diameter:	
	- impulse valve = 2D	

	- delivery pipe (d) = 1/2d	
	- check valve = 1D	
	- accumulator diameter = 3D height = 18"	
16.	Summarize by asking trainees to size all components in the following situations:	Participants may work together it's important to emphasize the process of sizing, not right answers only. Trainers should circulate, ask and answer clarifying questions and encourage participants to solve problems on their own. allow 20-30 min.
	a. Given: 4 garden beds, each 1.5m x 12m. Need 5cm water twice a week. Ram site is 40m below. Q unlimited, maximum possible H is 6m.	
	Determine size ram, and installation details.	
	b. Given: House needs 700 liters per day. It is located 30m above stream. The stream rises 1m every 30m length. Q = 10 liters/mint	
	Design system, size the ram.	
	c. Given: Community of 50 people. Each person needs 40 liters/day. Ram site is 5m below stream. Community storage is 95m below stream. Size ram and all parts.	
17.	Ask for volunteers to present solutions. Ask participants to verify or present their alternatives.	

Handout 6A: Pressure analysis

Attachment 6-A

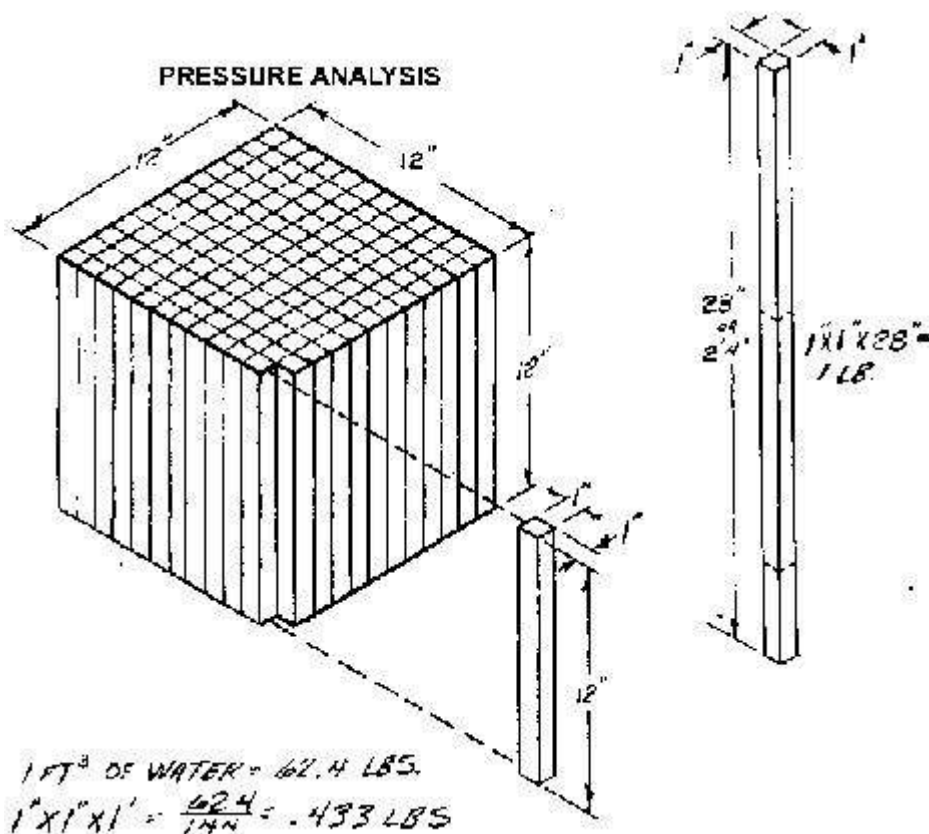

Pressure analysis

Handout 6B: Glossary of terms for session 6

Attachment 6-B

Atmospheric pressure - the pressure at sea level caused by the weight of air; atmospheric pressure = 14.7 psia, and 0 psig

Force - (delivery to drive head ratio) the ratio of lift to fall. The inverse of this ratio times the efficiency of the hydam will determine the percentage of water that the hydam will pump. The higher the h:H ratio, the lower the hydam efficiency (n). The usual range of the h:H ratio is from 2:1 to 20:1, but h:H ratios have been measured up to 60:1.

Hydam capacity - the maximum amount of water that a hydam can use. This is determined by the drive pipe size and length, the drive head, and the impulse valve size and design.

Impulse valve stroke - the distance the impulse valve travels during a cycle.

Impulse valve weight - the total weight or downward force of the impulse valve and its springs or weights.

Kinetic energy - active energy, $\frac{1}{2}$ the mass times the velocity squared

$$E_k = \frac{1}{2} mv^2$$

Pressure - force applied over a surface measured as force per unit of area such as pounds per square inch (psi) (a head of 28" of water develops a pressure of 1 psi) or a pascal (Pa) which is equal to 1 newton per square meter (a head of 1 cm = 98 Pa) 28" of water equals 71.1 cm of water equals 1 psi

= 6895 Pa.

psia - (pounds per square inch absolute) the total real pressure as if the atmospheric pressure is not present. Atmospheric pressure at sea level is 14.7 psi, so if a pressure gauge reads 100 psi (psig) the absolute pressure is 114.7 psia.

psig - (pounds per square inch gauge) the pressure that a gauge reads, actually the pressure above atmospheric.

Static head - a column of water without motion. The static drive head of a hydram can be measured with a pressure gauge but only when the ram is stopped and the drive pipe is full of water.

Time of cycle - (t) the time it takes for a hydram to complete one cycle, such as the time lapse between the impulse valve closing twice.

Velocity - speed usually measured in feet per second or meters per second.

Water used - (Q.) the amount of water that flows through the drive pipe during a unit of time (as in gallons per minute or liters per second) which is equal to the water pumped (q) plus the water wasted (Q_w)

The flow rate range of hydrams are as follows:

Drive pipe diameterFlow rate							
mm	in	U.S.	gal/min	Imperial	gal/min	liters/min	
19	¾	0.8	2	0.6	1.7	2.8	7.6
25	1	1.5	4	1.3	3.3	5.7	15.0
32	1¼	1.5	7	1.3	5.8	5.7	26.0
38	1½	2.5	13	2.0	10.8	9.4	49.0
50	2	6.0	20	5.0	17.0	23.0	76.0
63	2½	10.0	45	8.0	38.0	38.0	170.0
75	3	15.0	50	13.0	42.0	57.0	189.0
100	4	30.0	125	25.0	104.0	113.0	473.0
125	5	40.0	150	33.0	125.0	151.0	567.0

Determining Drive Pipe Length, L:

1. Consider drive head, H

L:H ratio - drive pipe length to head ratio, when H is less than 15 ft. (4.5m) L:H should equal 6.

When H is greater than 15 ft (4.5m), but less than 25' (8m) L:H should equal 4.

When H is greater than 28 ft. (8m), but less than 50' (16m) L:H should equal 3.

When H is greater than 50 ft. (16m) L:H ratio should equal 2.

2. Consider drive pipe diameter, D

L:D ratio - drive pipe length to diameter ratio, should be kept between 150 and 1000.

A rule of thumb: maximum number of pipe lengths = 4D

(based on chart below, and 21' pipe length)

Optimal number of pipe lengths = 2D

D	L = 150D	L = 500D	L = 1000D	No of pipes
½"	6.25	20.8	41.6	2
¾"	9.3	31.25	62.5	3
1"	12.5	41.6	83.2	4
1½"	15.6	52.0	104.0	5
1½"	18.6	62.5	125.0	6
2	25.0	83.2	166.4	8

IMPORTANT NUMBERS TO REMEMBER

1440 minutes in a day

0.433 psi per foot (measured vertically) of water column

28 inches of a water column produces 1 psi

14.7 psi atmospheric pressure

7.48 gallons per cubic foot

Handout 2B: Hydram installation

Attachment 2-B

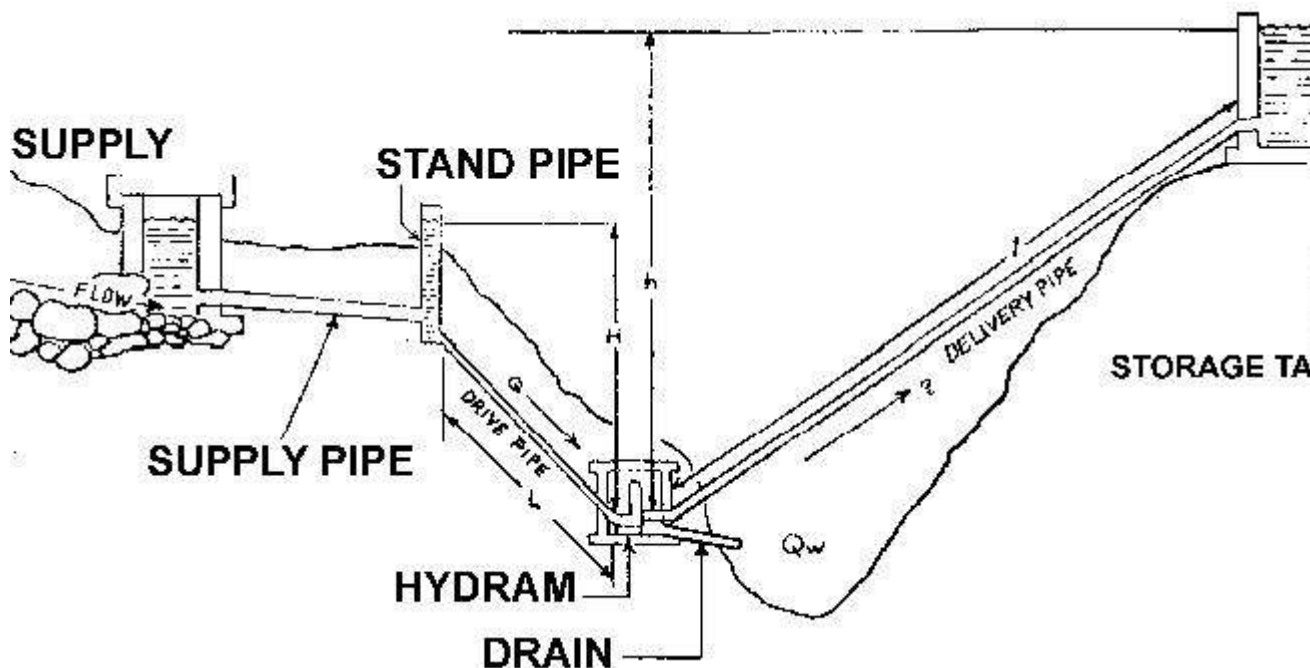

Hydam installation

DEFINITION OF VARIABLES

D = Diameter of Drive Pipe	d = Diameter of Delivery Pipe
H = Head of Drive Pipe	h = Head of Delivery Pipe
L = Length of Drive Pipe	l = Length of the Delivery Pipe
Q = Quantity of Water Entering	q = Quantity of Water Delivered Hydam
n = efficiency	Q_w = Quantity of Water Wasted from Impulse Valve
S = Length of the Impulse Valve Stroke	F = Frequency of the Impulse Valve Stroke
W = Weight of the Impulse Valve	

Session 7: Basic plumbing tools and materials (1-1½ hours)

Time: 1-1½ hours

OBJECTIVES: By the end of this session trainees will have o learned and demonstrated basic plumbing skills necessary for constructing and installing a hydam.

OVERVIEW: The session should familiarize participants with all commonly used plumbing tools and pipe fittings, although project-specific skill requirements may vary with the type of hydam construction foreseen and the availability of tools at the work sites. Participants learn:

- to identify tools and fittings (including host country language names, where possible);

- to use the tools properly and competently; and
- to explain and demonstrate safety precautions necessary in use of plumbing tools, especially torches and power tools when used.

MATERIALS:

- Pipe joint compound or TFE tape
- Cutting oil and rag
- Miscellaneous pipe fittings and pipe, galvanized and PVC
- PVC cleaner and glue
- Handout 7A

TOOLS: Pipe vise, two pipe wrenches, chain wrench, pipe threader, spud or monkey wrench, etc. (the quantities may increase depending upon the number of trainees but basically all the tools needed for all the exercises should be present and discussed), pipe-cutter or hacksaw.

	PROCEDURES	NOTES
1.	State the objective of this session and explain that the skills the trainees are expected to develop are necessary for hydram installations.	Be certain to mention that on a 1x1x1/2" tee, the 1/2" = dimension refers to the arm of the tee.
2.	Show the fittings one at a time to all the trainees explaining their purpose and nomenclature.	
3.	Demonstrate the use of- pipe joint compound or TFE tape.	It is important to stress that their purpose is three-fold; to seal, to facilitate easier
4.	Demonstrate the use of all the tools and any necessary safety precautions.	installation, and to facilitate easier removal.
5.	Set up 2 or 3 workstations, one with pipefittings laid out and labeled, another with a threader and cutting and/or joining station. Have one trainer at each station and the participants revolving to each station. Allow the trainees to practice using all the tools until they and the instructor are confident with their ability to properly use them.	If at all possible, actual fittings and tools should be demonstrated and practiced on. Attachment 7A can be used to describe the fittings if lack of time or facilities prevent "hands-on" practice. The handout is more useful as a learning reinforcement and as an aid for the trainees to use in describing and acquiring fittings at a plumbing supply house.
		Names of materials and tools may be different from what is used in the U.S. It is important to find out what each are called and call them by the

local name.

Handout 7A: Typical fittings

Attachment 7-A



PLUG



REDUCING BUSHING



CAP



UNION

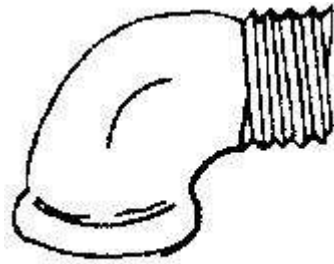

90° STREET ELBOW

90° STREET ELBOW



90° ELBOW

90° ELBOW



45° STREET ELBOW

45° STREET ELBOW



45° ELBOW

45° ELBOW

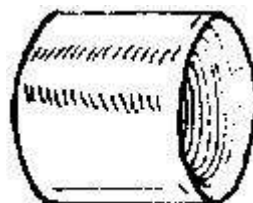

COUPLING

COUPLING



BELL REDUCER

BELL REDUCER

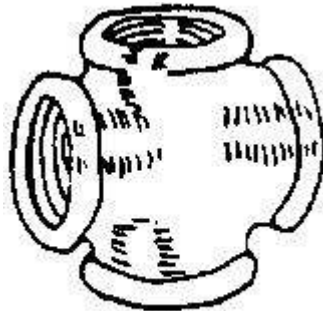

CROSS

CROSS



TEE

TEE



EXTENSION PIECE

EXTENSION PIECE



FLOOR FLANGE

FLOOR FLANGE



REDUCING TEE (AxBxC)

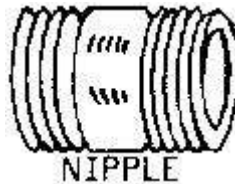

NIPPLE

Session 8: Hydrum construction - Pipefitting (4 - 6 hours)

Time: 4 - 6 hours

OBJECTIVE: To build a hydrum out of plumbing parts, with modified and/or fabricated valves.

OVERVIEW: This session provides the opportunity for participants to build two variations of the pipefitting hydrum. The first, a modified pipefitting hydrum, is made exclusively from parts usually found in a plumbing supply house, with minor modifications to the check and foot (impulse) valve. The second hydrum is made from pipe fittings, with valves constructed by trainees using simple steel fabrication. The finished hydrums are installed on a test stand or other water source and set in operation.

MATERIALS NEEDED FOR MODIFIED PIPE-FITTING HYDRAM

Handouts 8A, 8B, 8C	1 1" 90 sweep
4 1" nipples-	1 1" union
1 1" tee	1 ¼" union
1 1"x 1"x ¼" tee	2 ¼" nipples
1 2"x 1" reducing bushing	1 ¼" gate valve
1 3"x 1" reducing bushing	1 3" female adapter
1 2" foot valve	1 3" cap
1 1" check valve with tapped holes	1 3"x 18" metal pipe
1 ¼" plug	pipe joint compound or TFE tape
1 1/8" gas cock	assorted washers

TOOLS NEEDED FOR MODIFIED PIPE-FITTING HYDRAM

two pipe wrenches, two pair pliers

MATERIALS NEEDED FOR FABRICATED PIPE-FITTING HYDRAM

Handouts 8B.	30" 3/8-16 althread
pipe joint compound or TFE tape	4 3/8-16 nuts
. 1 3" cap	1 ¼-20x1" bolt (drilled out)
2 3" tees	1 ¼-20 x 3/4" bolt
3 3"x 1" reducing bushings	1 ¼-20 x 4" althread
1 3"x ½ reducing bushing	1 2½" OD washer
1 3"x 18" nipple	6 1½" OD washer
1 ¼" x 4" nipple	4 ¼-20 nuts
1 1" 90° sweep	1 ¾" OD washer
6"x 8"x ¼" sheet rubber	5 8-32 x ¾" screws
6"x 6"x ¼" steel plate	2 8-32 x ¾" bolts
3"x 1"x 1/8" angle iron	

TOOLS NEEDED FOR FABRICATED PIPE-FITTING HYDRAM

two pipe wrenches	knife
electric or hand drill	flat file, half round file
drill bits (3/8, 13/64, and 1/8)	hack saw
2" hole saw	1" pipe threader
1/4-20 and 8-32 taps	tape measure
screwdriver	adjustable wrench
access to metalworking shop	sandpaper (medium & fine)

***NOTE: Consider "charging" trainees for parts they use to determine on site cost.**

Post parts, price list and ask trainees to price the rams they're constructing.

	PROCEDURES	NOTES	
1.	State the objective of this session.		
2.	Distribute Handouts 8A and 8B		
3.	Describe the advantages and disadvantages of the modified and fabricated pipe-fitting hydrams.		
4.	Divide the trainees into groups of two or three to work on designs & responsibilities.	<p>The two pipe-fitting hydrams are quit it is likely that trainees will be hydrams from plumbing Parts in their may be useful to have the group build if concrete or manufactured hydrams for the projects, trainers may choose only one. The modified valve ra considerably less time, but exp fabricating valves may be helpful building a concrete ram.</p> <p>Some advantages and disadvantages hydram are</p>	
5.	Ask the groups to build the hydrams using the following sequence:	MODIFIED	FABRICA
		ADVANTAGES:	
		one hour construction time	3 hours time

efficient operation	efficient
fairly inexpensive	inexpensiv
easy to service/replace parts	impulse v removed
	excellent
DISADVANTAGES:	
w valves last approx 1 yr	requires al and tap
valves may be hard to find	maximum size 1"
maximum practical size 1 1/4"	check valv remove w
fittings difficult to remove when rusted (especially larger sizes)	
Try to make sure that the skill lev group are roughly equal. If you wish group build a different size hydran minutes to design	

(FOR MODIFIED PIPE-FITTING HYDRAM)

5.	A. remove the spring from both the foot valve and the check valve;	
	B. add washers in the foot valve for both the weight and stroke adjustment;	See Handout 8A, detail A
	C. assemble all the fittings as shown in Handout A using either pipe joint compound of TFE tape.	
6.	Have each group install their hydram on the test stand or another source of water and start the hydram working.	
7.	Discuss the applicability of the modified pipe-fitting hydram.	Discussion should include skills of availability of materials, financial available.

(FOR FABRICATED PIPE-FITTING HYDRAM)

The instructions describe the building have each group of a 1" hydram buil of a different size. Allow 3-4

construction, organize parts ahead of constraints may require that trainer h valve plates pre-cut, and cut sheet correct size squares.

6.	Impulse Valve
	A. Sand, grind or file the aim of a 3" tee (#3) until it has a smooth surface.
	B. Bend two pieces of 3/8 x 15" althread (#27) around the body of the tee so that the 4 ends extend 1" above the arm.
	C. Drill a 2" hole in the center of a 6"x 6" piece of steel (#14), then drill 3/8" holes in the corners of the steel where the althread goes through (approx. 4 1/2" apart). Be certain to sand smooth and round off all edges. Drill and tap two 8-32 holes in plate as shown in Handout 9B, detail A #14 and attach the stroke adjustment bracket (#22).
	D. Cut out a piece of rubber (#15) with the same outside dimensions and hole pattern as the steel plate but with a horseshoeshaped hole in the middle as shown in Handout 9B (#15).
	E. Assemble the impulse valve as shown in Handout 9B, Detail A.

7.	Snifter
	Extend the thread on one end of a 1" 90° sweep (#7) to extend through a 1 x 3" reducing bushing (#4). Drill and tap a 1/2-20 hole near the extended end of the sweep and assemble the snifter as shown in Handout 9B, Detail C, so that the air hole can be covered and uncovered by the lock nut.

8.	Check Valve
	A. Drill and tap two holes in the bottom and one in the side of a 1 x 3" reducing bushing for 8-32 screws as shown in the Handout, detail B.
	B. Cut out a piece of rubber (#20) for the check valve, bolt washers to the rubber and screw the valve to the 1 x 3" reducing bushing.
	C. Drill and tap a hole in the bottom of the bushing opposite the 2 previously drilled holes. When a 8-32 screw is inserted the head will overlap the check valve, creating an adjustable

The hole in the side should be located 832 screwhead will be 1/16" above the rubber.

	stroke. (See Detail B)	
9.	Body of the Ram	
	Attach all the fittings as shown in Handout 8B, using either pipe joint compound or TFE tape.	
10.	Have each group install their hydram on the test stand or another source of water and start the hydram working.	
11.	Discuss the applicability of the fabricated pipe-fitting hydram.	Discussion should include skills a community, availability of material resources.

Handout 8A: Pipefitting hydram w/ Modified factory valves

Attachment 8-A

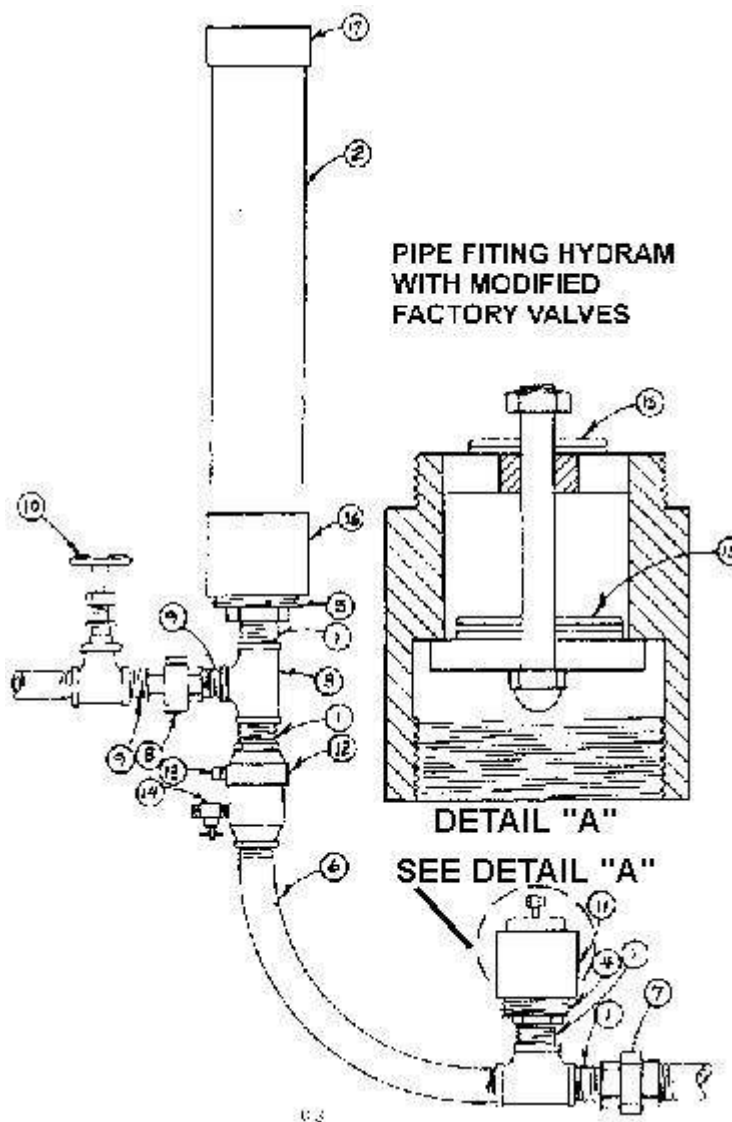

Pipefitting hydram with modified factory valves

1. 1" Nipple
2. 3" PVC Pipe (clear)
3. 1"x1"x½" Tee
4. 2"x1" Reducing Bushing
5. 3"x1" Reducing Bushing
6. 1" 90 Sweep
7. 1" Union
8. ¼" Union
9. ¼" Nipple
10. ¼" Gate Valve
11. 2" Foot Valve
12. 1" Check Valve with taped holes
13. %" Plug
14. 1/8" Gas Cock
15. Assorted Washers
16. 3" PVC Female Adapter
17. 3" PVC Cap

Handout 8B: Pipefitting hydram w/ Field-made valves

Attachment 8-A

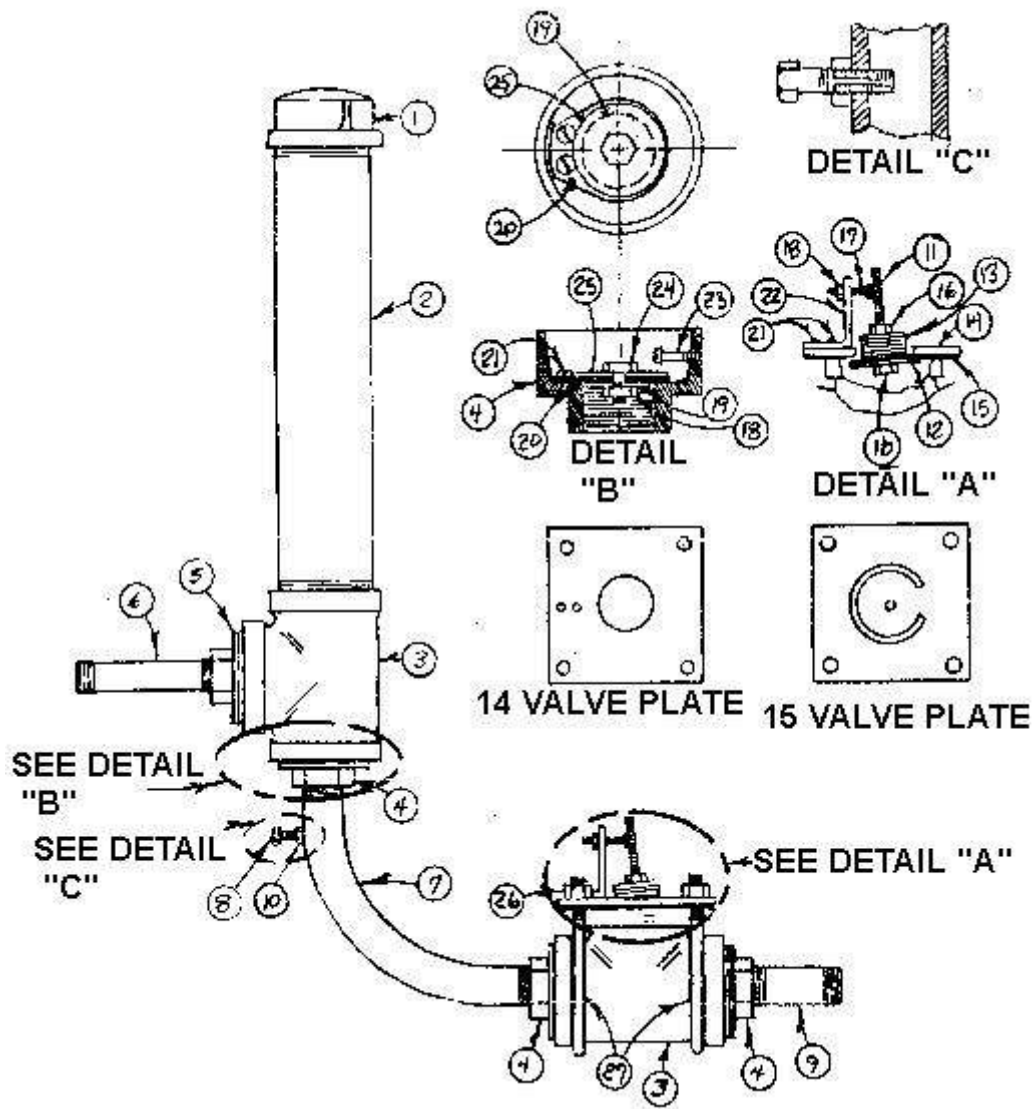

Pipe fitting hydram with field-made valves

1. 3" cap	11. ½-20x4" piece of althread or bolt with 1/8" hole in it	20. check valve rubber
2. 3"x18" nipple	12. 2½" diameter washer	21. 8-32x3/4" screws
3. 3" tee	13. 1½" or smaller washers	22. stroke adjustment
4. 3"x1" reducing bushing	14. impulse valve plate	bracket
5. 3"x½" reducing bushing	15. impulse valve rubber	23. 8-32x3/4"
6. ½"x4" nipple	16. ¼-20 nuts	24. -20x3/4" bolt
7. 1" 90 sweep	17. -20x" bolt	25. 1½" washer
8. 1" ¼-20 bolt (drilled out)	18. ¼-20 nuts	26. 3/8-16 nuts (4)
9. 1" nipple	19. 3/4" washer	27. 3/8-16 althread
10. ¼-20 nut		

Handout 8C: Materials and procedures: fabricated ram

MATERIALS NEEDED FOR FABRICATED PIPE-FITTING HYDRAM

Handouts 9-B,	30" 3/8-16 althread
pipe joint compound or TFE tape	4 3/8-16 nuts
1 3" cap	1 1/4-20x1" bolt (drilled out)
2 3" tees	1 1/4-20 x 3/4" bolt
3 3"x 1" reducing bushings	- 1 1/4-20 x 4" althread
1 3"x 1/2" reducing bushing	1 2 1/2" OD washer
1 3"x 18" nipple	6 1 1/2" OD washer
1 1/4" x 4" nipple	4 1/4-20 nuts
1 1" 90° sweep	1 3/4" OD washer
6"x 8"x 1/4" sheet rubber	5 8-32 x 3/4" screws
6"x 6"x 1/4" steel plate	2 8-32 x 3/4" bolts
3"x 1"x 1/8" angle iron	

TOOLS NEEDED FOR FABRICATED PIPE-FITTING HYDRAM

two pipe wrenches	knife
electric or hand drill	flat file, half round file
drill bits (3/8, 13/64, and 1/8)	hack saw
2" hole saw	1" pipe threader
1/4-20 and 8-32 taps	tape measure
screwdriver	adjustable wrench
access to metalworking shop	sandpaper (medium & fine)

		NOTES
	(FOR FABRICATED PIPE-FITTING HYDRAM)	
6.	Impulse Valve	

A. Sand, grind or file the aim of a 3" tee (#3) until it has a smooth surface.

B. Bend two pieces of 3/8 x 15" althread (#27) around the body of the tee so that the 4 ends extend 1" above the arm.

C. Drill a 2" hole in the center of a 6"x 6" piece of steel (#14), then drill 3/8" holes in the corners of the steel where the althread goes through (approx. 4 1/2" apart). Be certain to sand smooth and round off all edges. Drill and tap two 832 holes in plate as shown in Handout 9B, decall A #14, and attach the stroke adjustment bracket (#22).

D. Cut out a piece of rubber (#15) with the same outside dimensions and hole pattern as the steel plate but with a horseshoeshaped hole in the middle as shown in Handout 9B (#15).

E. Assemble the impulse valve as shown in Handout 9B, Detail A.

7. Snifter

Extend the thread on one end of a 1" 90° sweep (#7) to extend through a 1 x 3" reducing bushing (#4). Drill and tap a 1/4-20 hole near the extended end of the sweep and assemble the snifter as shown in Handout 9B, Detail C, so that the air hole can be covered and uncovered by the lock nut.

8. Check Valve

A. Drill and tap two holes in the bottom and one in the side of a 1 x 3" reducing bushing for the 8-32 screws as shown in the Handout, Detail B.

The hole in the side should be located so that 8-32 screwhead will be 1/16" above the check valve rubber

B. Cut out a piece of rubber 1/4-20 for the check valve, bolt washers to the rubber and screw the valve to the 1 x 3" reducing bushing.

C. Drill and tap a hole in the bottom of the bushing opposite the 2 previously drilled holes. When a 8-32 screw is inserted the head will overlap the check valve, creating an adjustable stroke. (See Detail B)

9. Body of the Ram

Attach all the fittings as shown in Handout 9B,

	using either pipe joint compound or TFE tape.
10.	Have each group install their hydram on the test stand or another source of water and start the hydram working.
11.	Discuss the applicability of the fabricated pipe-fitting hydram.

Session 9: Hydram design theory and parameters (2 hours)

Time: 2 hours

OBJECTIVES:

- to examine the basic design guidelines for hydrams;
- to apply the guidelines to pipefitting, welded and/or concrete rams

OVERVIEW: This session is included here, as an option, primarily for use in locations where welded hydrams can be used. The purpose is to provide the basic parameters for designing fabricated valves, seat widths, and backing plates for valves. At this time, the sizes to be used will be taken from the concrete design theory, which will be somewhat oversized for metal. In time, specific charts may be developed for welded steel.

PREPARATION NOTES: Trainers will have made a decision about the type of constructions to be included in this training workshop. If a welded ram is to be constructed, i.e., if it has been decided that the expertise is available, the welded ram parts should be completed by this time. It is not the purpose of this workshop to teach welding skills.

At least one hydram construction must be completed at this point so that measurements of seats can be taken.

MATERIALS: Handouts 10B - 10F Previously constructed rams Chalkboard/chalk; flipcharts/markers Welded ram design, Attachment 9A

	PROCEDURES	NOTES
1.	<p>Introduce session by recalling any problems participants may have had with pipefitting ram operation. Ask trainees to share any possible causes of these problems, and what might be done to avoid them.</p>	<p>Generally, valves are not seating quite right or are too small.</p>
2.	<p>Explain that the rams constructed to date can be used in a range of situations, and that the purpose of this activity is to look at the maximum h:H ratios for the rams, based on their construction, and the general sizing guidelines for rams.</p>	
3.	<p>Have trainees, in groups, measure the following parts of the constructed rams: a) D, impulse valve opening, impulse valve plate thickness, rubber thickness, backing plate thickness, and seat width; b) check valve diameter, backing thickness, seat width.</p>	
4.	<p>Distribute handouts 10B-F. Ask participants to determine optimal. range of h and H for the measurements they've taken. Ask if there are any irregularities in the proportions of the drive pipe diameter, impulse valve opening, etc., from design guidelines presented in Session 6, and how that might affect performance.</p>	
5.	<p>Present design of welded steel rams, using same design parameters and sizing charts. Allow trainees to examine components prior to final welding, and check sizes.</p>	
6.	<p>In small groups, design a welded ram for one participant's site. Allow 11½ hours for the design, present and critique.</p>	

Handout 10B: Thickness of the impulse valve plate - inches

Attachment 10-B

Thickness of the impulse valve plate in inches*

drive head in feet

impulse valve opening in inches	10	20	30	40	50
1.5	3/8	7/16	7/16	5/a	
2	1/4	3/8	7/16	1/2	5/8
2.5	5/16	3/6	1/2	9/16	5/8
3	5/16	7/16	1/2	9/16	5/8
4	5/16	7/16	1/2	9/16	5/8
5	3/8	1/2	9/16	5/8	11/16
6	3/C	I/2	9/16	5/8	11/16
8	7/16	1/2	5/8	11/16	3/4
12	1/2	5/6	11/16	3/4	13/16
16	I/2	5/8	3/4	13/16	7/8

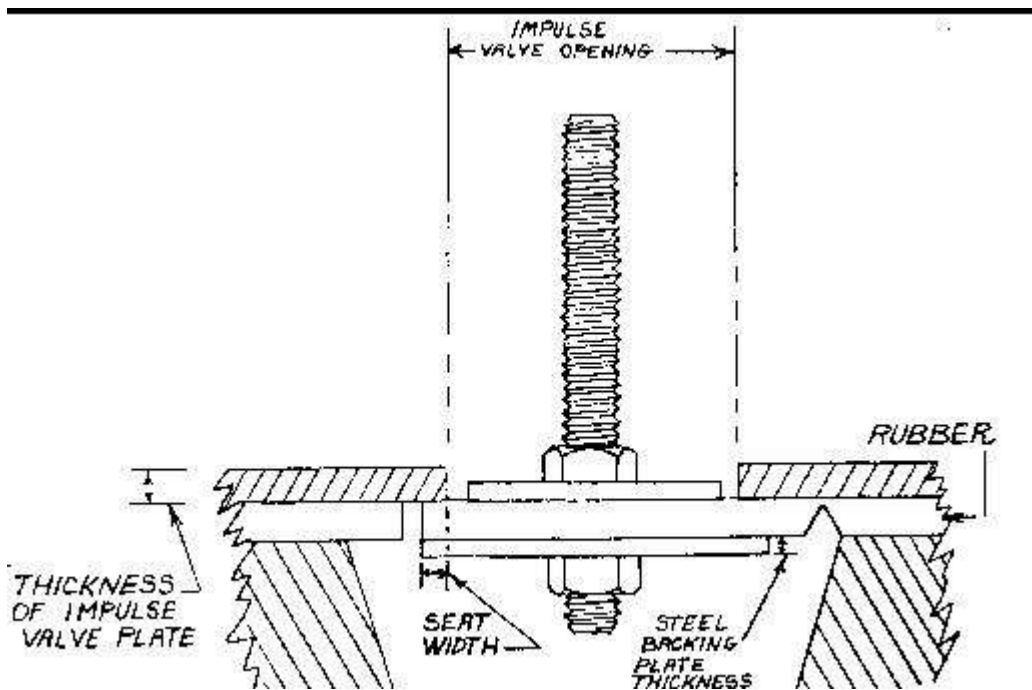

Thickness of the impulse valve plate in inches

Handout 10B: Thickness of the impulse valve plate - metric

Drive head in meters

	3	6	9	12	15
40	6	10	11	13	16
50	6	10	11	13	16
60	8	10	13	14	16
75	8	11	13	14	16
100	8	11	13	14	16
125	9.5	13	14	16	18
150	10	13	14	16	18
200	11	13	16	18	19
300	13	16	18	19	21
400	13	16	19	21	22

Impulse valve opening in millimeters

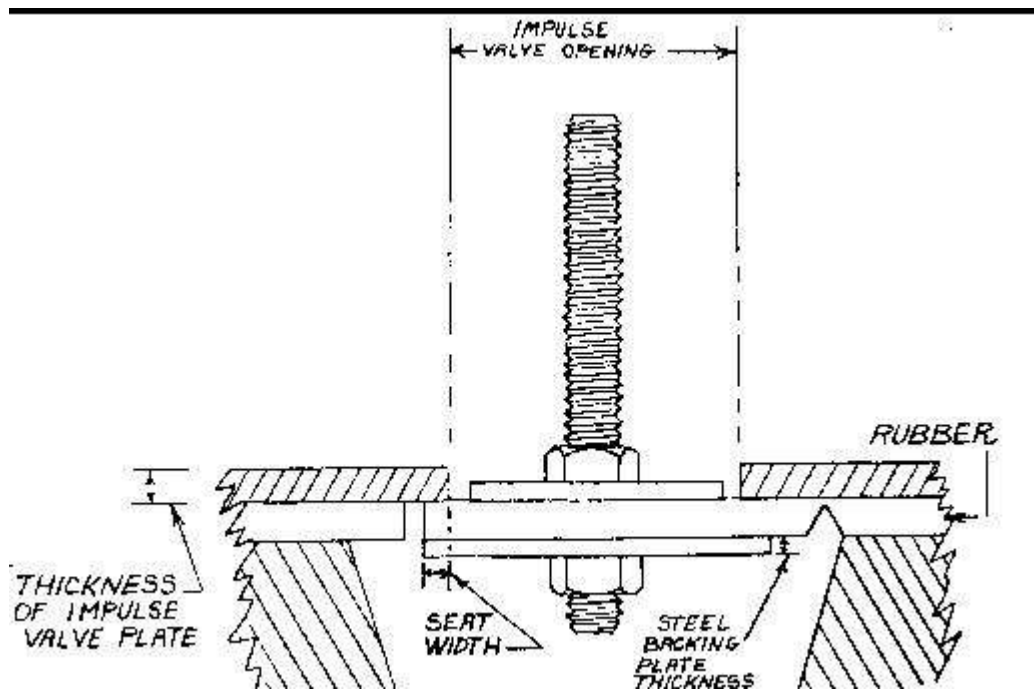

Thickness of the impulse valve plate in inches

Handout 10C: Impulse valve steel backing

Attachment 10-C

Drive head in feet

	10	20	30	40	50
1.5	1/8	1/8	1/8	3/16	3/16
2	1/8	3/16	3/16	3/16	1/4
2 5	3/16	3/16	1/4	1/4	1/4
3	3/16	1/4	5/16	5/16	5/16
4	1/4	5/16	3/8	7/16	7/16
5	5/16	7/16	1/2	1/2	9/16
6	3/8	1/2	9/16	5/8	11/16
8	1/2	11/16	3/4	13/16	7/8
2	13/16	1	1 1/8	1 1/4	1 5/16
16	11/16	1 5/16	1 1/2	1 11/16	1 13/16

Impulse valve opening in inches

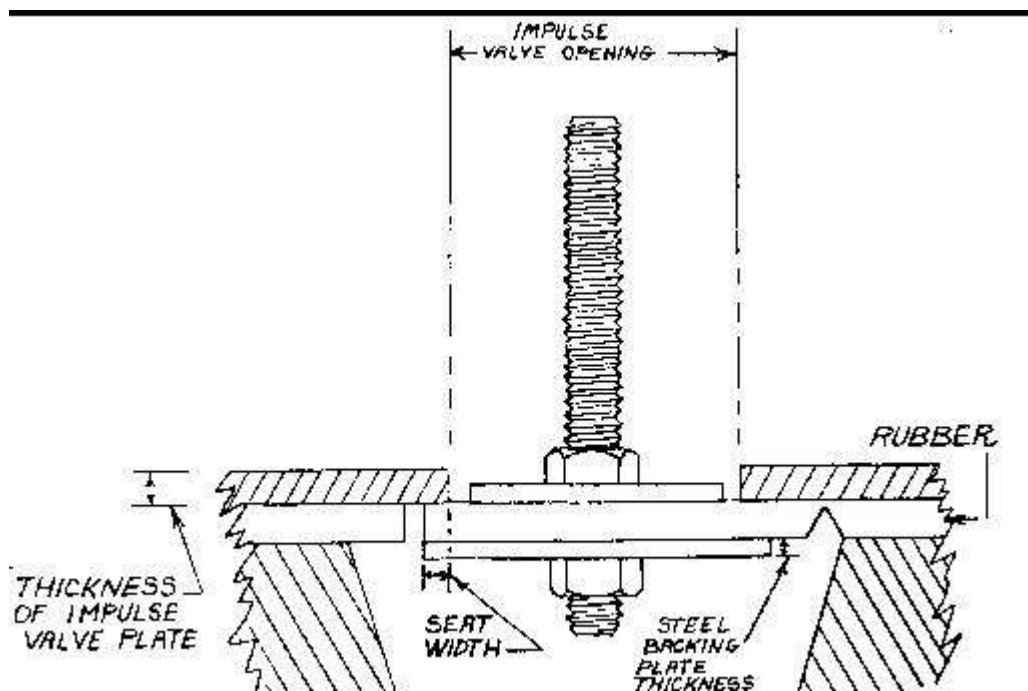

Thickness of the impulse valve plate in inches

Handout 10C: Impulse valve steel backing - metric

Drive head in meters

	3	6	9	12	15
40	3		3	5	5
50	2	5	5	5	6
60	5	5	6	6	6
75	5	6	8	8	8
100	6	8	10	11	11
125	8	11	13	13	14
150	10	13	14	16	18
200	13	18	19	21	22
300	21	25	29	32	34
400	27	33	38	42	46

Impulse valve opening in millimeters

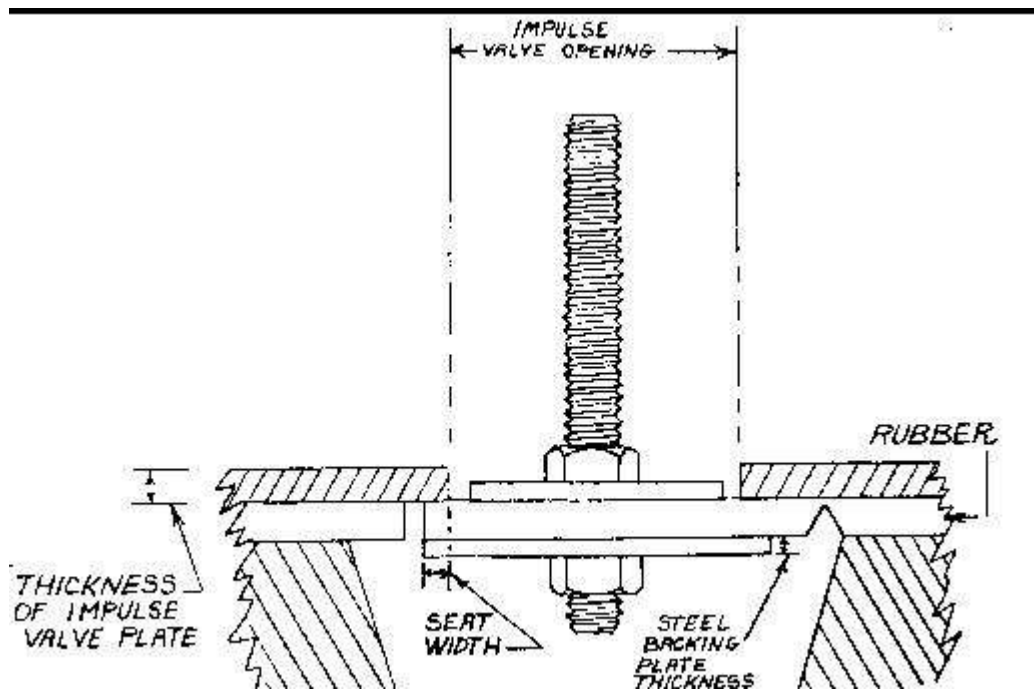

Thickness of the impulse valve plate in inches

Handout 10D: Impulse valve seat width - inches

Attachment 10-D

Drive head in feet

	10	15	20	25	30	35	40	45	50
3/4	1/8	3/16	1/4	5/16	3/8	7/16	1/2	9/16	3/8
1	3/16	5/16	3/8	7/16	1/2	9/16	5/8	11/16	3/4
1 1/4	1/4	3/8	7/16	9/16	5/8	3/4	13/16	14/16	1
1 1/2	5/16	7/16	9/16	3/4	3/4	1	1 1/16	1 3/16	
2	3/8	9/16	3/4	7/8	1	1 3/16	1 5/16	1 7/16	1 9/16
2 1/2	1/2	11/16	15/16	1 1/8	1 5/16	1 7/16	1 5/8	1 13/16	1 15/16
3	5/8	7/8	1 1/8	1 5/16	1 9/16	1 3/4	1 15/16	2 3/16	2 5/16
4	13/16	1 1/8	1 7/16	1 3/4	2 1/16	2 3/8	2 5/8	2 7/8	3 1/8
6	1 3/16	1 11/16	2 3/16	2 5/8	3 1/8	3 1/2	3 15/16	4 5/16	4 11/16
2	1 11/16	2 1/4	2 15/16	3 9/16	4 1/8	4 11/16	5 1/4	5 3/4	6 1/4

Impulse valve opening in inches

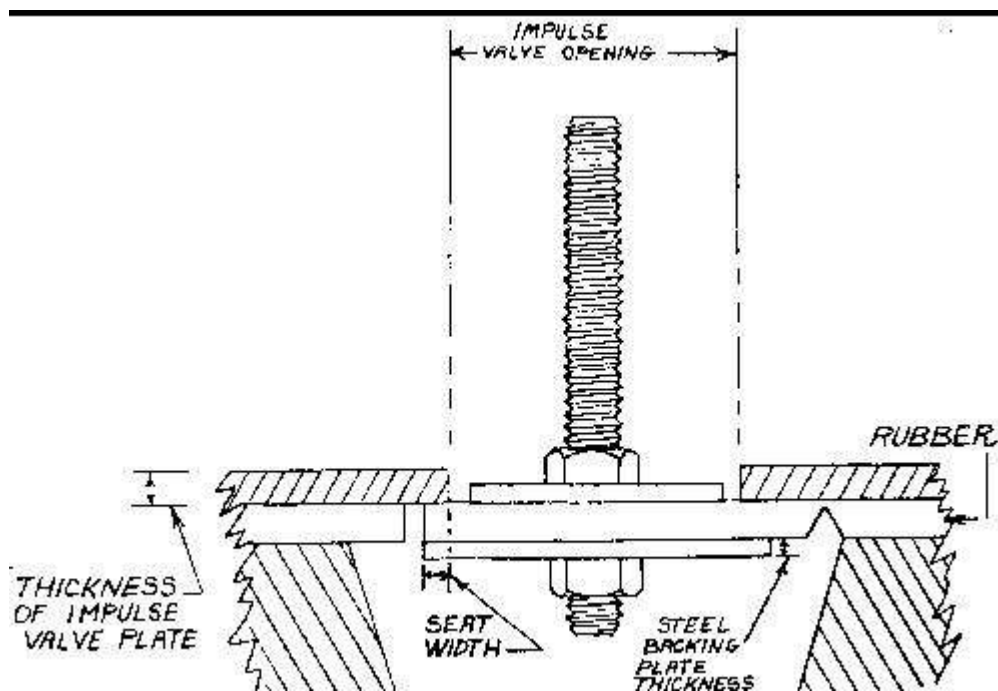

Thickness of the impulse valve plate in inches

Handout 10D: Impulse valve seat width - metric

Drive head in meters

	3	4.5	6	7.5	9	10.5	12	13.5	15
20	3	5	6	8	10	11	13	14	16
25	5	8	10	11	13	14	16	18	19
30	6	10	11	14	16	19	21	22	25
40	8	11	14	18	19	22	25	27	30
50	10	14	19	22	25	30	33	36	39
60	13	18	24	29	33	36	41	46	49
75	16	22	29	33	39	44	49	55	58
100	21	29	36	44	52	60	66	72	79
150	30	43	55	66	79	89	100	109	119
200	43	56	74	89	104	119	130	146	158

Impulse valve opening in millimeters

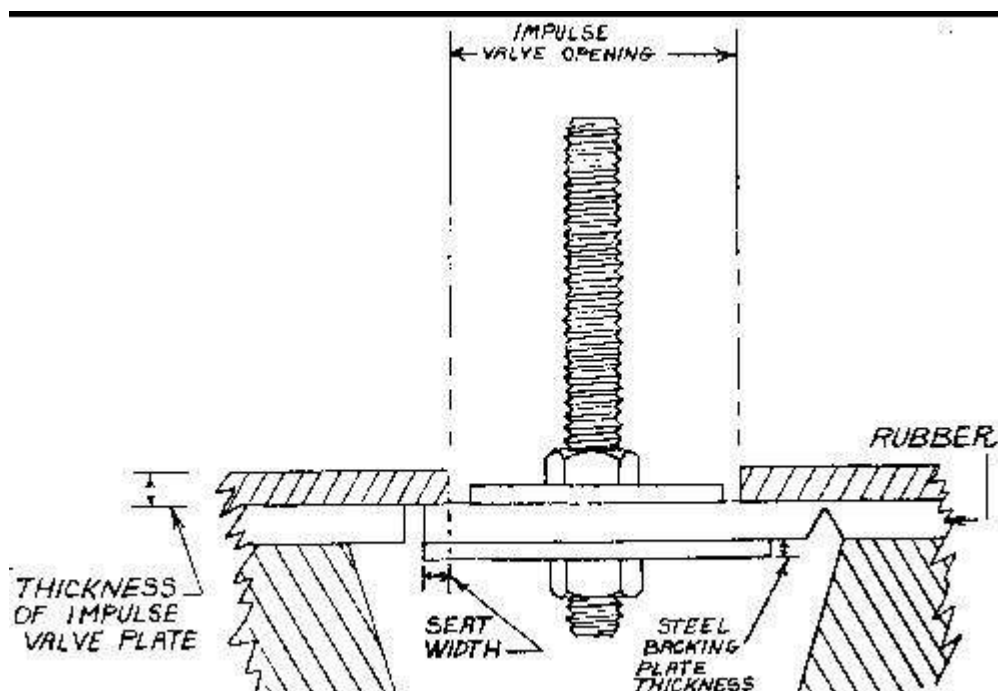

Thickness of the impulse valve plate in inches

Handout 10E: Check valve backing thickness - inches

Attachment 10-E

Delivery head in feet

	25	50	75	100	125	150	175	200
3/4	1/16	1/16	1/16	1/16	1/16	1/16	1/16	1/16
1	1/16	1/16	1/16	1/16	1/16	1/16	1/16	1/16
1¼	1,16	1/16	1/16	1/16	1/16	1/16	1/16	1/16
1½	1/16	1/16	1/16	1/16	1/16	1/8	1/8	1/8
2	1/16	1/8	1/8	1/8	1/8	1/8	1/8	1/8
2½	1/8	1/8	1/8	1/8	3/16	3/16	3/16	3/16
3	1/8	1/8	3/16	3/16	3/16	3/16	3/16	1/4
4	3/16	3/16	¼	1/4	1/4	5/16	5/16	5/16
6	1/4	5/16	3/8	7/16	7/16	1/2	1/2	1/2
8	3/8	1/2	9/16	5/£3	5/8	11/16	11/16	3/4

Impulse valve opening in inches

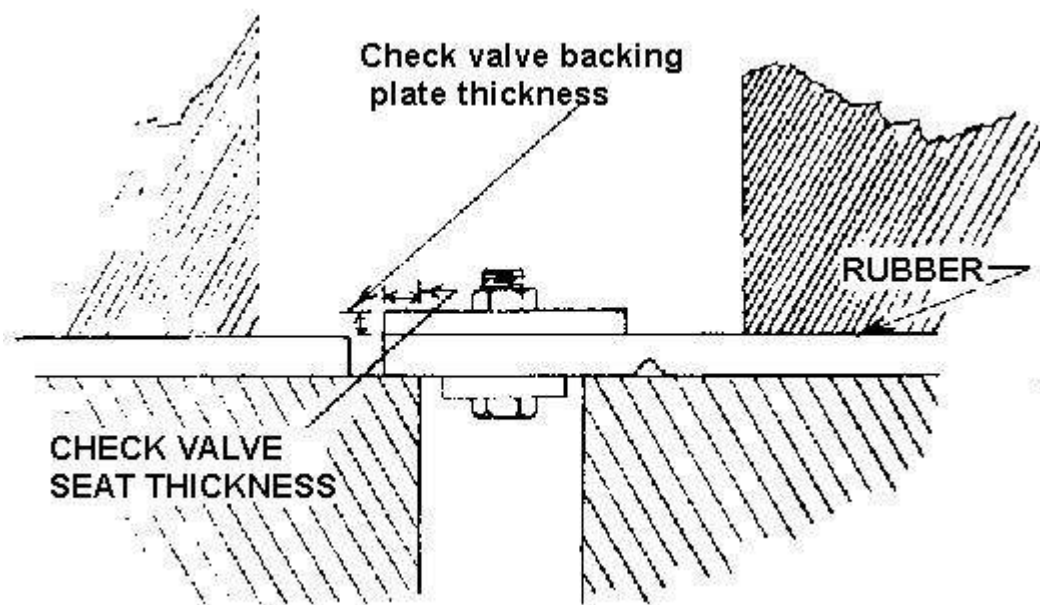

Check valve backing thickness in inches

Handout 10E: Check valve backing thickness - metric

Attachment 10-E

Delivery head in meters

	7.5	15	23	30.5	38	45.5	53.5	60
20	2	2	2	2	2	2	2	2
25	2	2	2	2	2	2	2	2
30	2	2	2	2	2	2	2	2
40	2	2	2	2	2	3	3	3
50	2	3	3	3	3	3	3	3
60	3	3	3	3	5	5	5	5
75	3	3	5	5	5	5	5	6
100	5	5	6	6	6	8	8	8
50	6	8	10	11	11	13	13	13
200	10	13	14	16	16	18	18	19

Impulse valve opening in millimeters

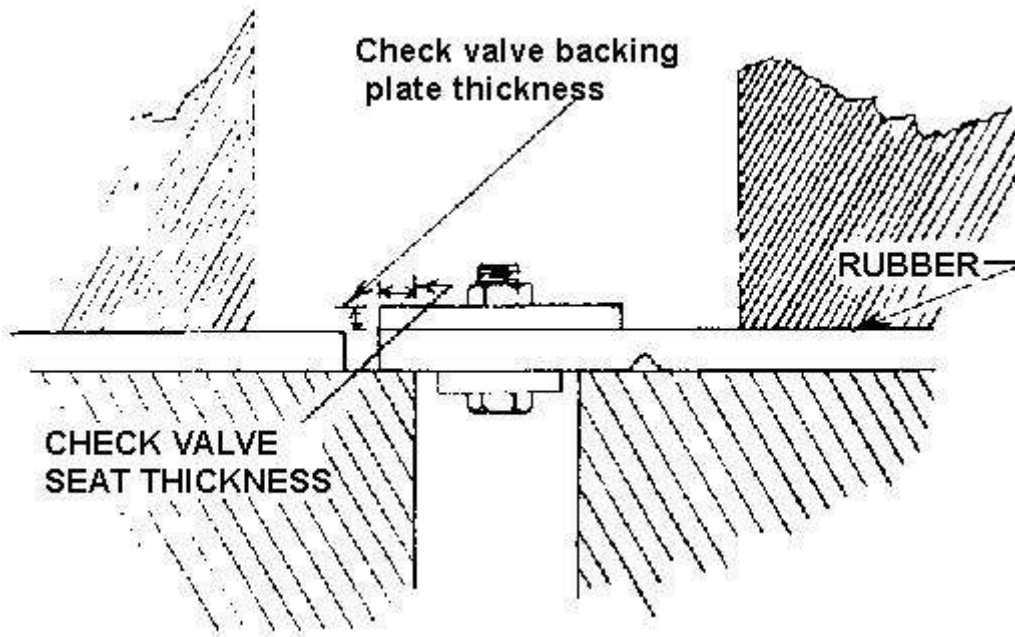

Check valve backing thickness in inches

Handout 10F: Check valve seat width - inches

Attachment 10-F

Delivery head in feet

	25	50	75	100	125	150	175	200
3/4	1/8	1/8	1/8	1/8	1/8	1/E	3/16	3/16
1	1/8	1/8	1/8	1/8	1/8	3/16	1/4	1/4
1 1/4	1/8	1/8	1/8	i/8	3/16	3/16	1/4	3/8
1 1/2	1/8	1/8	1/8	1/8	3/16	1/4	5/16	7/16
2	1/8	1/8	1/8	3/16	1/4	5/16	7/16	9/16
2 1/2	1/8	1/8	3/16	1/4	5/16	7/16	9/16	11/16
3	1/8	1/8	3/16	5/16	3/8	1/2	5/8	13/16
4	1/8	3/16	1/4	3/8	1/2	11/16	7/8	17/16
6	1/8	1/4	3/8	9/16	3/4	1	1 1/4	1 5/8
8	3/16	5/16	9/16	3/4	1	1 5/16	1 11/16	2 3/16

Impulse valve opening in inches

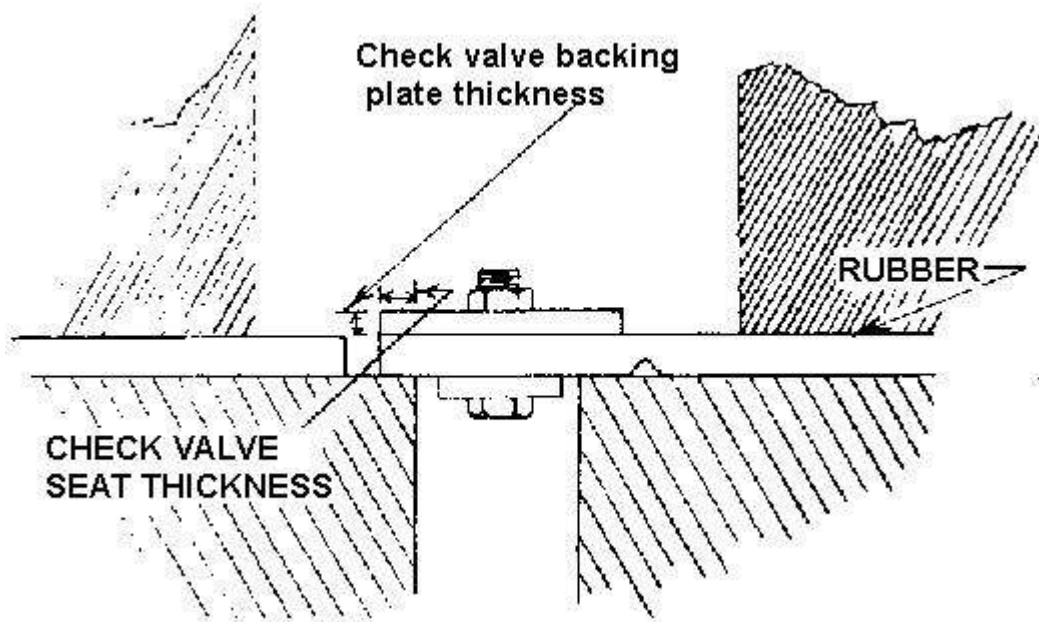

Check valve backing thickness in inches

Handout 10F: Check valve seat width - metric

Delivery head in meters

	7.5	15	23	30	38	45	53	60
20	3	3	3	3	3	3	5	5
25	3	3	3	3	3	5	6	6
30	3	3	3	3	5	5	6	10
40	3	3	3	3	5	6	8	11
50	3	3	3	5	6	8	11	14
60	3	3	5	6	a	11	14	18
75	3	3	5	8	10	13	16	21
100	3	5	6	10	13	18	22	27
150	3	6	10	14	19	25	30	41
200	5	8	14	19	25	33	43	55

Impulse valve opening in millimeters

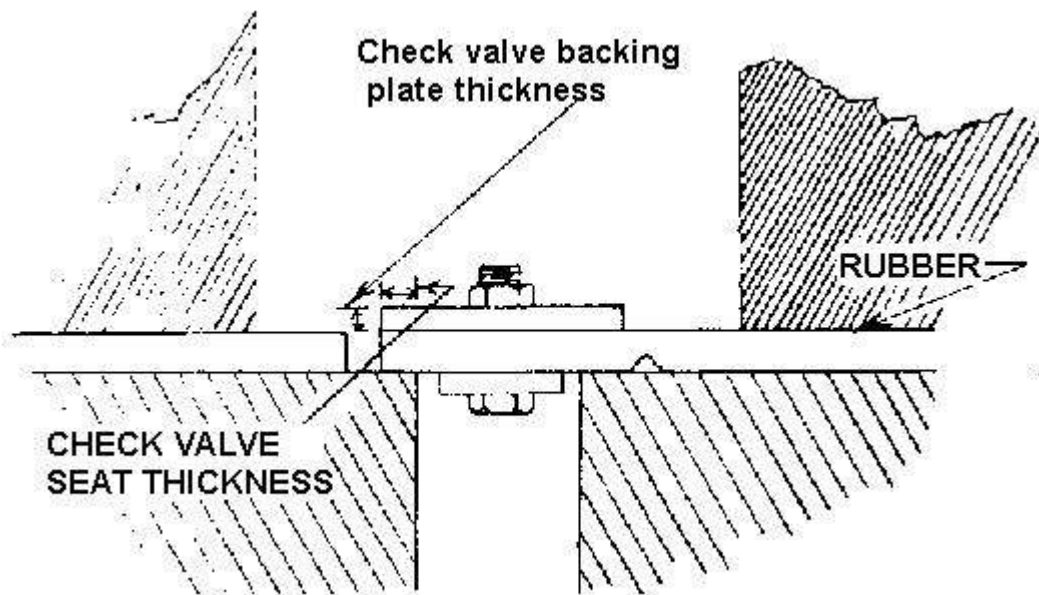

Check valve backing thickness in millimeters

Handout 9A-1: Welded hydam: side view

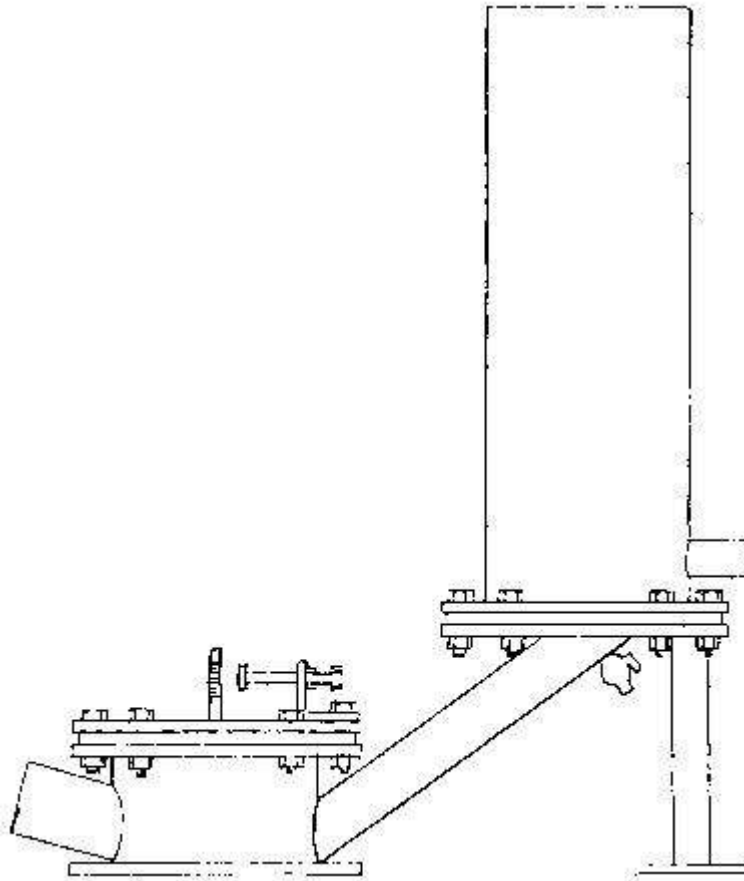

Welded hydram: side view

Handout 9A-2: Welded hydram: exploded view

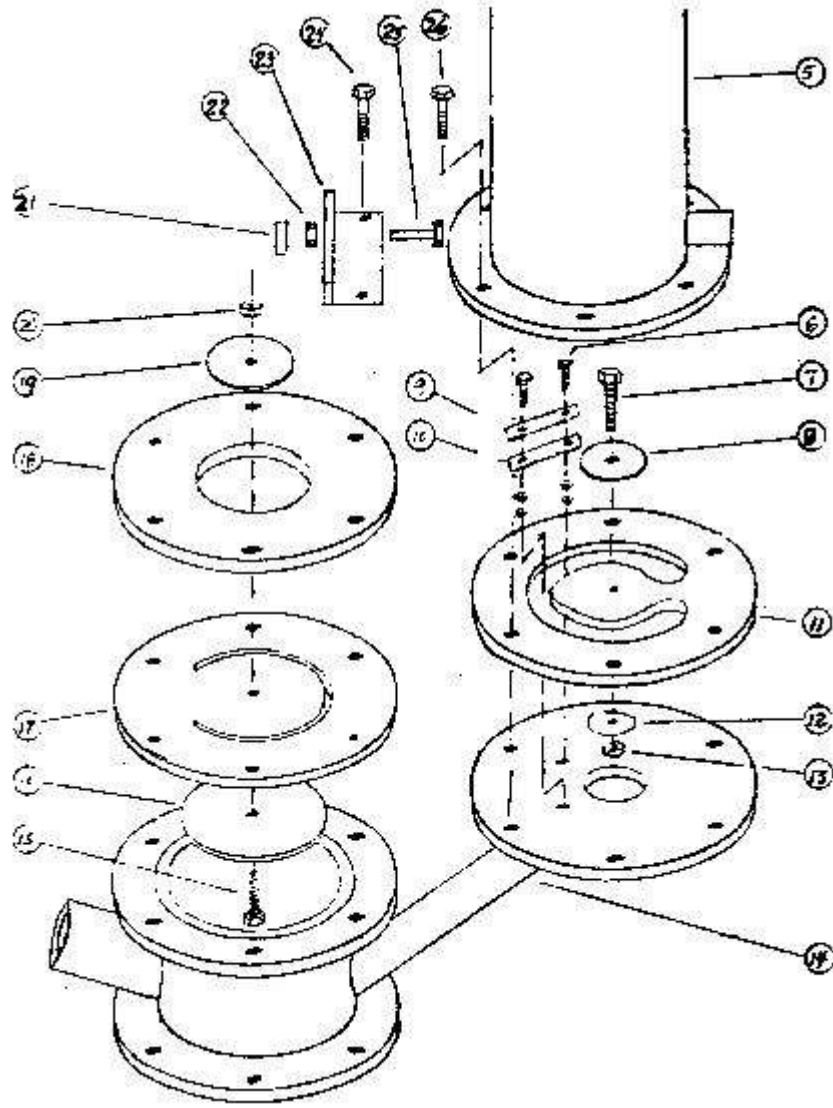

Welded hydam: exploded view

Handout 9A-3: Welded hydam: impulse cavity exploded view

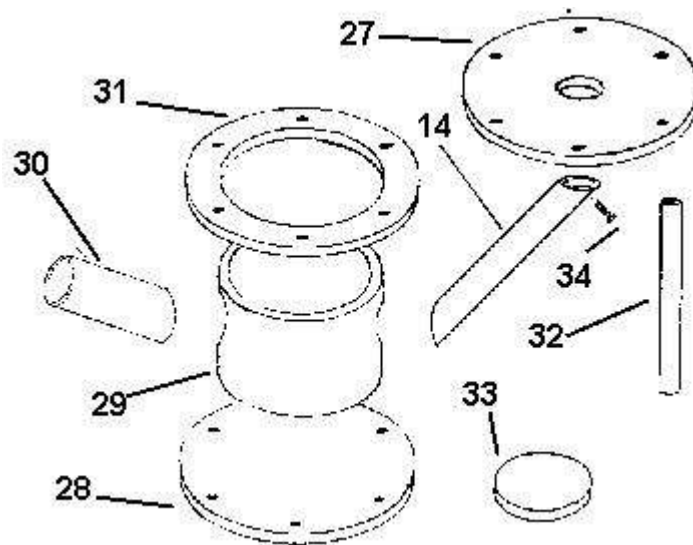

Welded hydam, impulse cavity: exploded view

Handout 9A-4: Welded hydram: accumulator: exploded view

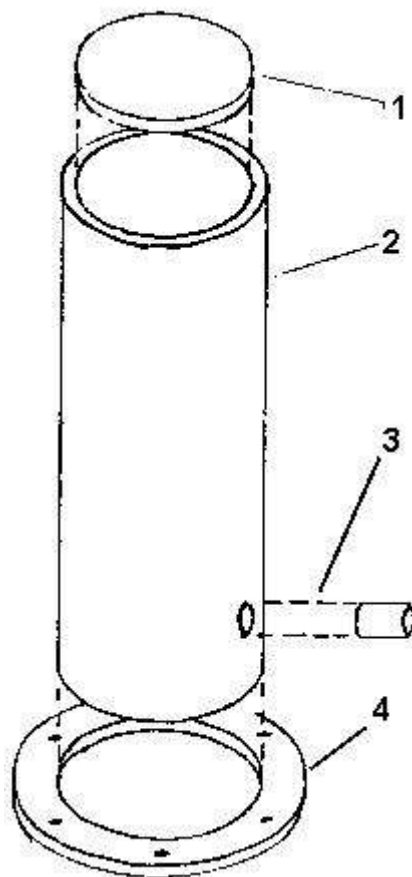

Welded hydram: accumulator: exploded view

Handout 9A-5: Welded hydram 20' drive head dimensions

	SIZE	1	1¼	1½	2	3	4	6
1	Accumulator Top Diameter	3	4	5	6	9	12	18
1	Accumulator To Thickness	3/8	3/8	7/16	7/16	1/2	1/2	5/8
2	Accumulator Pipe Diameter	3	4	5	6	9	12	18
2	Accumulator Pipe Length	20	20	20	20	21	22	24
3	Delivery Socket	½	¾	¾	1	1½	2	3
4	Accumulator Base Ring Thickness	3/8	3/8	7/16	7/16	1/2	1/2	5/8
4	Accumulator Base Outside Diameter	8	8	9	10	14	16	22

6	1½" Check Valve Stroke Limited bolts	1/4	1/4	1/4	1/4	3/8	3/8	3/8	
7	Check Valve 2" bolt diameter	1/4	1/4	5/16	5/16	3/8	3/8	7/16	
8	Check Valve Backing Plate Thickness	1/16	1/16	1/8	1/8	1/4	5/16	1/2	
8	Plate should be larger than hole by:	1/2	3/4	7/8	1 1/8	1 5/8	2 1/8	3 1/4	
9	Stroke Limiter Metal strip								
10	Stroke Limiter Rubber Strip								
11	½ to ½ thick Rubber with Valve same as the #8 backing slate and (
12	Check valve washer outside_diam.	1/2	3/4	3/4	1	1 1/2	2	3	
13	Check valve nut	1/4	1/4	5/16	5/16	3/8	3/8	7/16	
14	Connecting pipe inside Diameter	3/4	1	1 1/4	1 1/2	2	3	4	
14	Connecting pipe length	11 1/4	11 1/4	12 5/8	14	19 5/8	22 1/2	30 3/4	
14	Impulse Valve Bolt	3/8	3/8	3/8	3/8	3/8	1/2	1/2	
16	Backing Plate Diameter	2 3/4	2 3/4	4 1/8	5 1/2	8 1/4	10 7/8	16 3/8	
16	Backing Plate Thickness	3/16	3/16	1/4	5/16	1/2	11/16	1	
17	¼ to ½ Thick Rubber w/ valve same as the #1 backing late & 0.D. = 4								
18	Impulse Plate O.D. = 4; thickness	3/8	3/8	7/16	7/16	1/2	1/2	5/8	5/8
18	Impulse Plate I.D.	2	2 1/2	3	4	6	8	12	16
19	Impulse Valve Washer Outside Diam.	1 1/2	2	2 1/2	3 1/2	5 1/2	7	11	15
20	Impulse Valve nut	3/8	3/8	3/8	3/8	3/8	1/2	1/2	½
21	Rubber Bumper								
22	Lock nut	1/4	1/4	3/8	3/8	3/8	3/8	1/2	½

23	2"x2"x1/4" angle iron limiter Bracket								
24	Length Impulse Plante Bolts	2	2	2 1/2	2 1/2	3	3 1/2	3 1/2	3 1/2
25	Stroke limiting adjustment bolt	1/4	1/4	5/16	3/8	3/8	3/8	3/8	1/2
26	No. of Accumulator Bolts	6	6	6	6	8	8	10	16
26	Diameter of Accumulator Bolts	3/8	1/2	9/16	5/8	3/4	7/8	1	1
26	Length of Accumulator Bolts	2	2	2 1/2	2 1/2	3	3 1/2	3 1/2	3 1/2
27	Accumulator Base Plate Diameter	8	8	9	10	14	16	22	28
27	Accumulator Base Plate Thickness	3/8	3/8	7/16	7/16	1/2	1/2	5/8	5/8
28	Hydrum Base (same as #27)								
29	Impulse Valve Cavity Inside Diam.	4	4	5	6	10	12	18	24
29	Impulse Valve Cavity Height	3	3	3 1/2	4	6	8	12	16
30	Socket	1	1 1/4	1 1/2	2	3	4	6	8
31	Impulse Valve Ring Thickness	3/8	3/8	7/16	7/16	1/2	1/2	5/8	5/8
31	Impulse Valve Ring Diameter	8	8	9	10	14	16	22	28
32	1" Support Pipe Length	8	8	8 1/2	9	11	13	17	21
33	4" Diameter Support Base Thickness	3/8	3/8	7/16	7/16	1/2	1/2	5/8	5/8
34	Snifter Bolt	1/4	1/4	1/4	1/4	3/8	3/8	3/8	1/2

Handout 9A-7: Welded hydrum 20' drive head dimensions

SIZE	1	1 1/4	1 1/2	2	3	4	6	8
-------------	----------	--------------	--------------	----------	----------	----------	----------	----------

1	Accumulator Top Diameter	3	4	5	6	9	12	18	24
1	Accumulator To Thickness	1/2	9/16	9/16	9/16	5/8	11/16	3/4	13/16
2	Accumulator Pipe Diameter	3	4	5	6	9	12	18	24
2	Accumulator Pipe Length	20	20	20	20	21	22	24	26
3	Delivery Socket	1/2	3/4	3/4	1	1 1/2	2	3	4
4	Accumulator Base Ring Thickness	1/2	9/16	9/16	9/16	5/8	11/16	3/4	13/16
4	Accumulator Base Outside Diameter	8	9	10	12	16	18	26	22
6	1 1/2" Check Valve Stroke Limited bolts	1/4	1/4	1/4	1/4	3/8	3/8	3/8	1/2
7	Check Valve 2" bolt diameter	1/4	1/4	5/16	5/16	3/8	3/8	7/16	7/16
8	Check Valve Backing Plate Thickness	1/16	1/16	1/8	1/8	1/4	5/16	1/2	3/4
8	Plate should be larger than hole by:	1/2	3/4	7/8	1 1/8	1 5/8	2 1/8	3 1/4	4 1/4
9	Stroke Limiter Metal strip								
10	Stroke Limiter Rubber Strip								
11	1/2 to 1/2 thick Rubber with Valve same as the #8 backing slate and O.D.								
12	Check valve washer outside_diam.	1/2	3/4	3/4	1	1 1/2	2	3	4
13	Check valve nut	1/4	1/4	5/16	5/16	3/8	3/8	7/16	7/16
14	Connecting pipe inside Diameter	3/4	1	1 1/4	1 1/2	2	3	4	6
14	Connecting pipe length	11 1/4	12 5/8	14	16 3/4	22 3/8	25 1/4	36 3/8	44
14	Impulse Valve Bolt	3/8	3/8	3/8	3/8	3/8	1/2	1/2	1/2
16	Backing Plate Diameter	3 3/4	4 1/8	5	6 5/8	9 7/9	13	19	26 1/2

							1/4	7/8	
16	Backing Plate Thickness	3/16	1/4	5/16	7/16	5/8	13/16	1 1/4	1 11/16
17	1/4 to 1/2 Thick Rubber w/ valve same as the #1 backing late & O.D. =								
18	Impulse Plate O.D. = 4; thickness	1/2	9/16	9/16	9/16	5/8	11/16	3/4	13/16
18	Impulse Plate I.D.	2	2 1/2	3	4	6	8	12	16
19	Impulse Valve Washer Outside Diam.	1 1/2	2	2 1/2	3 1/2	5 1/2	7	11	15
20	Impulse Valve nut	3/8	3/8	3/8	3/8	3/8	1/2	1/2	1/2
21	Rubber Bumper								
22	Lock nut	1/4	1/4	3/8	3/8	3/8	3/8	1/2	1/2
23	2"x2"x1/4" angle iron limiter Bracket								
24	Number of impulse Plate Bolts	6	6	6	6	8	14	24	58
24	Diameter of impulse Plate Bolts	9/16	5/8	3/4	7/8	7/8	7/8	1	1
24	Length Impulse Plante Bolts	2	2	3	3 1/2	3 1/2	3 1/2	4	4
25	Stroke limiting adjustment bolt	1/4	1/4	5/16	3/8	3/8	3/8	1/2	1/2
26	No. of Accumulator Bolts	6	6	6	6	6	8	12	24
26	Diameter of Accumulator Bolts	9/16	5/8	3/4	7/8	7/8	7/8	1	1
26	Length of Accumulator Bolts	2	2	3	3 1/2	3 1/2	3 1/2	4	4
27	Accumulator Base Plate Diameter	8	9	10	12	16	18	26	32
27	Accumulator Base Plate Thickness	1/2	9/16	9/16	9/16	5/8	11/16	3/4	13/16
28	Hydram Base (same as #27)								

29	Impulse Valve Cavity Inside Diam.	4	5	6	8	12	14	22	28
29	Impulse Valve Cavity Height	3	3	3 1/2	4	6	8	12	16
30	Socket	1	1 1/4	1 1/2	2	3	4	6	8
31	Impulse Valve Ring Thickness	1/2	9/16	9/16	9/16	5/8	11/16	3/4	13/16
31	Impulse Valve Ring Diameter	8	9	10	12	16	18	26	32
32	1" Support Pipe Length	8	8	8 1/2	9	11	13	17	21
33	4" Diameter Support Base Thickness	1/2	9/16	9/16	9/16	5/8	11/16	3/4	13/16
34	Snifter Bolt	1/4	1/4	1/4	1/4	3/8	3/8	3/8	1/2

Session 10: Hydrum construction - concrete (18 hours over a 7 day period)

Time: 18 hours over a 7 day period

OBJECTIVES:

- to design and build a concrete ram
- to demonstrate a knowledge of ram component relationships;
- to work with concrete and forms.

OVERVIEW: The session provides participants with an opportunity to use the knowledge gained earlier in the training program to assess site potential, determine an appropriate hydrum size and design and then construct an inexpensive, long lasting concrete hydrum. While building a concrete hydrum necessitates scheduling a lengthy session over at least seven days, the advantages of this technology (i.e., low cost, excellent longevity, likely availability of materials) make this one of the most useful parts of a hydrum training program.

PREPARATION NOTES FOR TRAINER: When possible, the concrete hydrum(s) should be built at a site where it can be of use after the training program is over. Trainers should therefore gather data about community need, end-uses etc. unless extensive time is available for trainees to do this. The timing of the various construction phases will be somewhat dependent on the mixture of the concrete and the ambient temperature. In general, the building of a concrete hydrum will require four segments of time with a minimum of 2 days between segments. The first phase requires approximately 4 hours for steps 1-9 (planning) and 4 hours for steps 10-19 (base form construction and the first pour). The second phase should occur at least 48 hours later and should take about 4 hours for steps 20-27 (accumulator form construction and 2nd pour). After another 48 hours or so, the concrete should be sufficiently set up for steps 28-35 (fabrication and attachment of valves, bolting the hydrum together). In general, the hydrum should be ready for steps 36-38 (installation and operation) after 2 more days, or four days from the last pour.

Trainer should check porosity of concrete prior to this activity.

Hand outs B-F are in metric and English units. Use of slides greatly enhances concrete construction preparation session.

MATERIALS: gravel, sand, cement, water, form lumber, plastic pipe, bowl, fittings, material for vapor barrier something to mix cement in. Size and quantity of materials is dependent upon the hydram to be constructed. Following is an example of a typical list of materials for a 1" hydram.

1 " CONCRETE HYDRAM MATERIALS LIST

1 1"x 12"x 8' lumber for body	8 3/8 althread 36" form
1 1"x 12"x 8' lumber for accumu-	26 3/8 lock washers lator forms
1 1/4" x 7" diameter steel plate	26 3/8 flat washers
1 3" PVC pipe cap	26 3/8 nuts
1 4" bowl	1 1" pipe plug
1 1"x 1' x 1/2 belting	1 1" pipe tee
1 7" diameter x 1/4" belting	1 1/4" pipe plug
1 1"x 2" angle 1" long	1 1/4" pipe tee
1 rubber stop bumper	1 1/4" pipe plug
1 1/4" gas cock	1 1/4" pipe tee
1 1" PVC pipe 2' long	2pcs. 1/4" pipe 2" long
1 1/4" nipple 1 1/2" long	1 1" PVC male adaptor
2 2 1/2" washer with 3/8" hole	1 1/4" PVC pipe 22' long
2 1 1/2" washer with 3/8" hole	1 1" PVC coupling
5/16" wing nut	1/2 lb 6d nails
1 5/16 x 2 1/2" bolt	form oil
2 1/4 x 1 1/2 bolt	2 1/2 gal water
3 5/16 nut	32# cement
1 3/8 bolt 1" long	1 1/3 cu.ft. gravel
1 3" PVC pipe 18" long	1 1/6 cu.ft. sand

Handouts 10A-10N	shovels
-------------------------	----------------

	PROCEDURES	NOTES
	Phase I: Part One	
1.	State the objective of this session.	
2.	Have the trainees gather all pertinent information concerning the hydram installation including drive head, delivery head, flow rate at source, demand, future needs, and portability.	
3.	Describe the concrete hydram concept and the design parameters involved.	
4.	Review the advantages and disadvantages of this design.	
5.	Walk through design steps, using handouts 10A - I. Write on board/flip-chart as developed.	Trainer should plan how to display this on chalkboard.
	Sequence:	
	A. Concrete: (handout 10A)	
	1. Compute D.	
	2. Compute impulse valve cavity diameter.	
	3. Compute wall thickness.	
	4. Top and bottom thickness.	
	B. Size Impulse Valve Opening (2D)	Remind trainees that: this is related to drive head, force.
	1. Use attachment 10B to determine thickness of valve plate.	
	2. Use 10A to determine bolt area and number of bolts.	
	3. Use 10C to determine backing thickness.	
	4. Use 10D to determine seat width.	
	C. Size check valve	Relate this to drive pipe size as basis for calculations.
	1. Use 10E for backing thickness.	

	2. Use 10F to determine seat width.	
6.	Have the trainees each design a hydram, using the design parameters listed in Handouts A through I. Have the participants solve the problem in attachment/handout 10M.	
7.	Compare designs and discuss the differences.	
8.	Depending on how many hydrams are to be made, the trainees should choose the best design(s) and explain why they have made their choice.	
9.	Give an overview of construction process and scheduling in the workshop:	This may be hard for trainees to visualize. A model would be helpful; slides are also effective, and may be procured through the Energy Sector, Peace Corps.
	Phase I:	
	A. Build forms, using pipes, cups, form lumber, as in Handout 11H-J.	
	B. Note where/why sleeves are inserted; where # comes from.	
	C. Make sure snifter is included.	
	D. Mix and pour concrete.	
	E. Protect and let it set up for at least 2 days.	
	F. Draw pattern for impulse valve plate.	
	Phase II:	
	A. Construction of accumulator form.	
	B. Pour accumulator.	
	C. Let it set up.	
	Phase III-IV:	
	A. Cut check valve, assemble and install.	
10.	Distribute procedures for Phase I. Ask trainees to read through. Clarify any questions.	
11.	Have the trainees make up a material and tool	

	list for the hydram(s) selected.
12.	With all the tools and materials gathered, begin construction.
	Phase I - Part Two
13.	Start by constructing the hydram base form. (See handout 10J)
14.	Next, bend the PVC pipe and cut to proper length and angles. Be sure to glue a coupling to the check valve end to increase the seat area.
15.	Notch out bottom of plastic bowl to fit upon the PVC pipe: with the bowl and pipe held together, mark where the pipe touches the inside of the bowl; then, using coping saw, cut along this line. Attach male adapter and the plugged tee to input end of pipe. The plugged tee serves to prevent the pipe from turning within the concrete. Welding a piece of metal onto the coupling would also work.
16.	Drill holes in the bottom of the form for the bolt pattern around the impulse valve and the accumulator.
17.	Center accumulator form pipe on the inside of the form and draw a circle around it. Drive three 6d nails one half way in, 120 degrees apart through the circle, making compensation for the thickness of the accumulator form pipe.
18.	Drill hole in PVC pipe for snifter. Drill another hole in form for the other end of snifter. Snifter pipe should have a plugged tee in the middle or a piece of metal welded to the side of it to eliminate turning.
19.	An elliptical rubber washer should be cut out and nailed where the check valve end of the PVC pipe comes in contact with the form. This is to recess the concrete around the check valve seat to insure a good seat.
20.	Bolt sleeves to form using althread, nuts and washers.
21.	Tie PVC pie down to form using tie-wire.
22.	Pour the base of the hydram using the following concrete formula: 8 parts gravel, 7

	parts sand, 2 parts cement, and water to proper consistency. Tap on the form sides while pouring to prevent air pockets. Cover concrete with a vapor barrier such as visqueen, then cover entire pour with insulation. Draw pattern for impulse valve plate and send to metal shop.
	Phase II
23.	After the hydram base has had sufficient time to set (usually about 2 days), remove form and place hydram base right side up on blocks so that the bolt holes on the bottom can be reached.
24.	Place a sheet of plastic or wax paper or anything that will prevent a concrete marriage and that won't wrinkle on top of the accumulator end of the hydram.
25.	Place althread and sleeves through bolt pattern at accumulator with nuts and washers on both ends. Tighten until sleeves are rigid.
26.	Build form for accumulator as shown in Handout 10J.
27.	Place accumulator form pipe over the three nails sticking up through the concrete at the check valve. Pack with sand to prevent pipe from floating up in concrete. Cap end of accumulator form pipe with tape or PVC cap.
28.	Place accumulator form on top of hydram base and install the delivery pipe connection between this form and the accumulator form pipe.
29.	Pour accumulator form full of concrete using the same mixture ratio as used in step #22.
30.	Cover with a vapor barrier such as visqueen and insulation.
	Phase III
31.	After concrete has had sufficient time to set up (about one to two days), remove form.
32.	Using a large piece of paper, make a pattern from the hydram base for both the impulse valve rubber and the accumulator check valve rubber.

33.	Cut out the rubbers according to the pattern. If the rubber is too thick to allow free movement of the valves, a notch may need to be cut into the rubber at the flex point of the valve.
34.	Drill and cut out a piece of sheet metal for the impulse plate and attach stop bracket.
35.	Install althread, bolt, nuts and washers on both pieces of rubber as shown in the attachment.
36.	Bolt accumulator to base with check valve rubber for a gasket.
37.	Bolt impulse valve rubber and plate to hydram base.
38.	Install stroke adjustment bolt locknut and rubber bumper.
	Phase IV
39.	Install ram to drive pipe and delivery pipe. Start up. Adjust for amount of flow available.
40.	Have the trainees determine the flow rate into and out of the hydram and determine the efficiency.
41.	Discuss with the trainees what they feel the advantages and disadvantages of this ram might be and when they might be important.

Handout 10A: Concrete hydram design parameters

CAVITY WALL THICKNESS	DOME COVER THICKNESS	NUMBER OF BOLTS AND SIZE
------------------------------	-----------------------------	---------------------------------

The side wall thickness (Ts) in a concrete Hydram without reinforcement shall be equal to the diameter of the cavity (Dc) in inches times the drive head (H) in feet divided by 10 or shall be equal to the cavity diameter, whichever is greater.

The top or bottom wall thickness (TL) should be 1.25 times the cavity diameter.

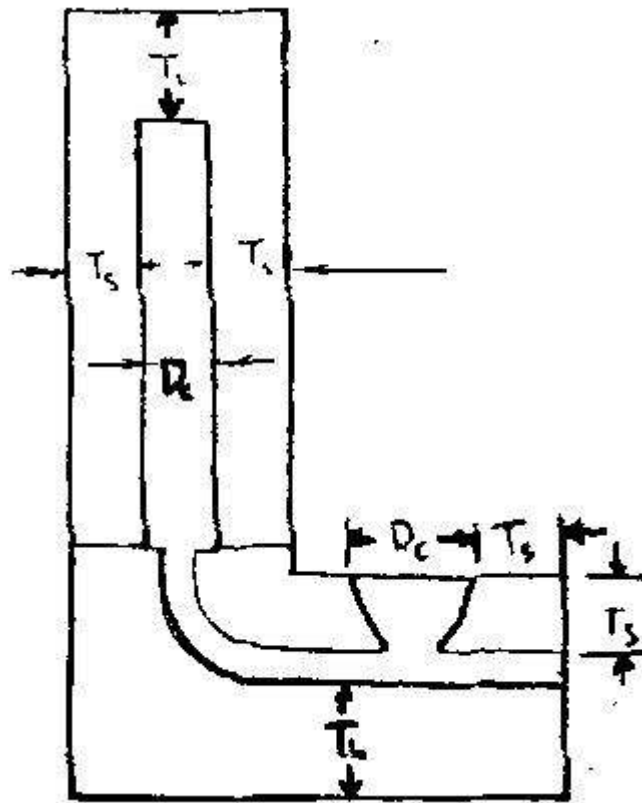

Concrete hydam design parameters

The total bolt area (TBA) should equal the drive pipe diameter (inches) squared times the drive head in feet divided by 50 or :

$$TBA = \frac{D^2 * H}{50}$$

If D in mm. and H in meters then

$$TBA = \frac{D^2 H}{9677.4}$$

To determine the proper number of bolts, find the area of the bolt size you wish to use and divide it into the total bolt area.

Diameter of bolt:

mm.	6.3	8	9.5	11	12.7	14 2	15.8	19.	22.2	25.4
in.	1/4	5/16	3/8	7/16	1/2	9/16	5/8	3/4	7/8	1

Area of bolt:

.027	.045	.068	.093	.126	.162	.202	.302	.419	.551
------	------	------	------	------	------	------	------	------	------

Handout 10B: Thickness of the impulse valve plate - inches

Drive head in feet

	10	20	30	40	50
1.5	1/4	3/8	7/16	1/2	5/8
2	1/4	3/8	7/16	1/2	5/8
2.5	5/16	3/8	1/2	9/16	5/8
3	5/16	7/16	1/2	9/16	5/8
4	5/16	7/16	1/2	9/16	5/8
5	3/8	1/2	9/16	5/8	11/16
6	3/8	1/2	9/16	5/8	11/16
8	7/16	1/2	5/8	11/16	3/4
12	1/2	5/8	11/16	3/4	13/16
16	1/2	5/8	3/4	13/16	7/8

Impulse valve opening in inches

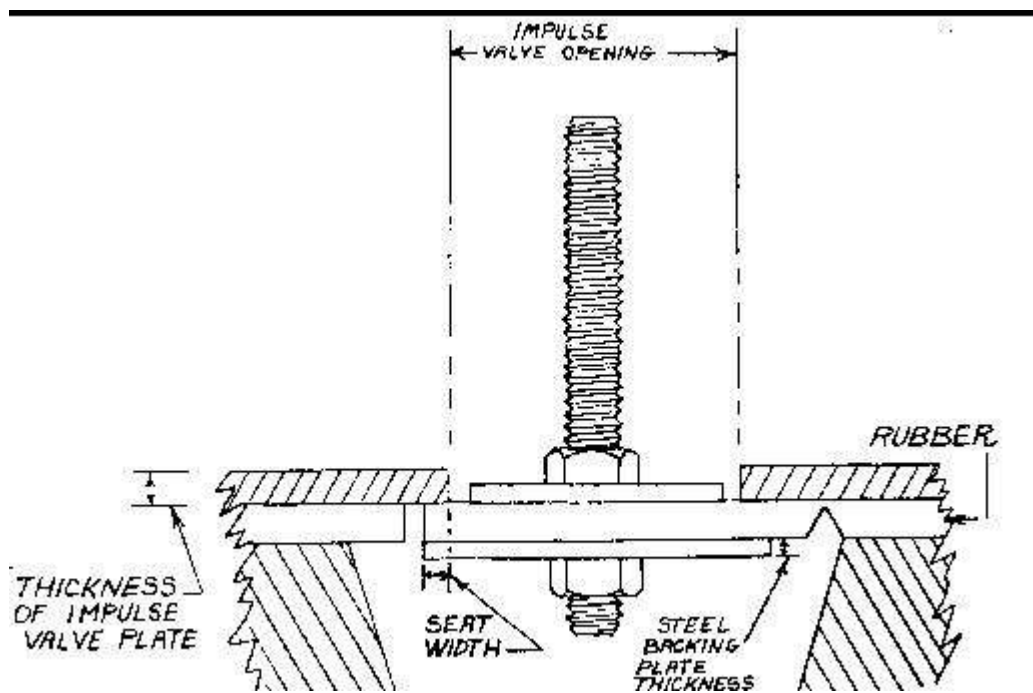

Thickness of impulse valve plate

These figures also apply to accumulator plate thickness.

Handout 10B: Thickness of the impulse valve plate - metric

Drive head in meters

	3	6	9	12	15
40	6	10	11	13	16
50	6	10	11	13	16
60	8	10	13	14	16
75	3	11	13	14	16
100	8	11	13	14	16
125	9.5	13	14	16	18
150	10	13	14	16	18
200	11	13	16	18	19
300	13	16	18	19	21
400	13	16	19	21	22

Impulse valve opening in millimeters

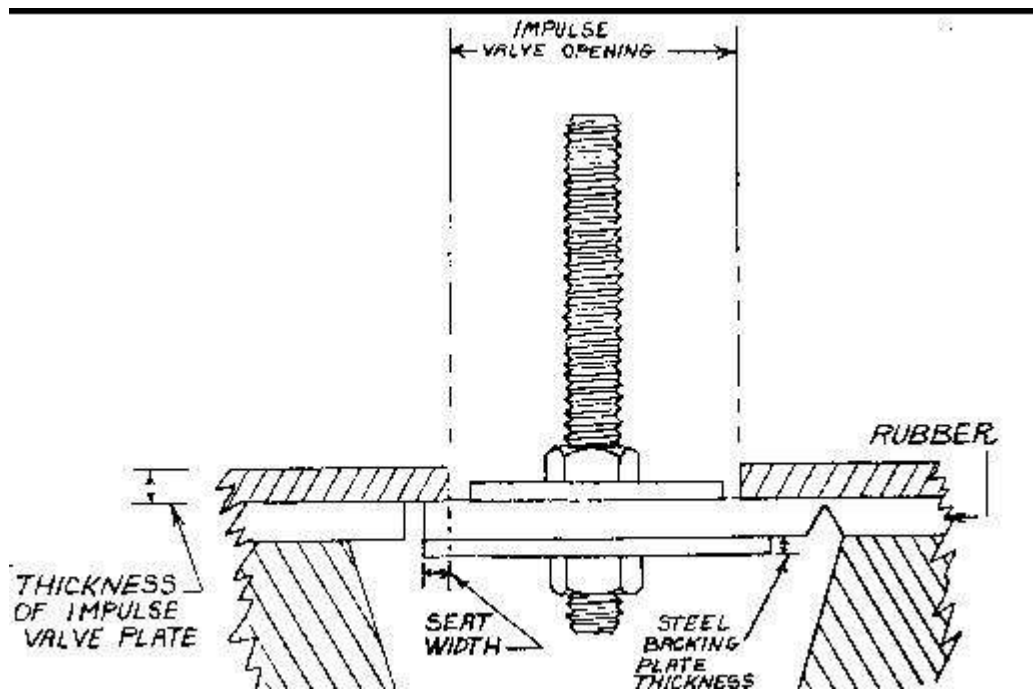

Thickness of impulse valve plate

These figures also apply to accumulator plate thickness.

Handout 10C: Impulse valve steel backing - inches

Drive head in feet

	10	20	30	40	50
1.5	1/8	1/8	1/8	3/16	3/16
2	1/8	3/16	3/16	3/16	1/4
2.5	3/16	3/16	1/4	1/4	1/4
3	3/16	1/4	5/16	5/16	5/16
4	1/4	5/16	3/8	7/16	7/16
5	5/16	7/16	1/2	1/2	9/16
6	3/8	1/2	9/16	5/8	11/16
8	1/2	11/16	3/4	13/16	7/8
12	13/16	1	1 1/8	1 1/4	1 5/16
16	1 1/16	1 5/16	1 1/2	1 11/16	1 13/16

Impulse valve opening in inches

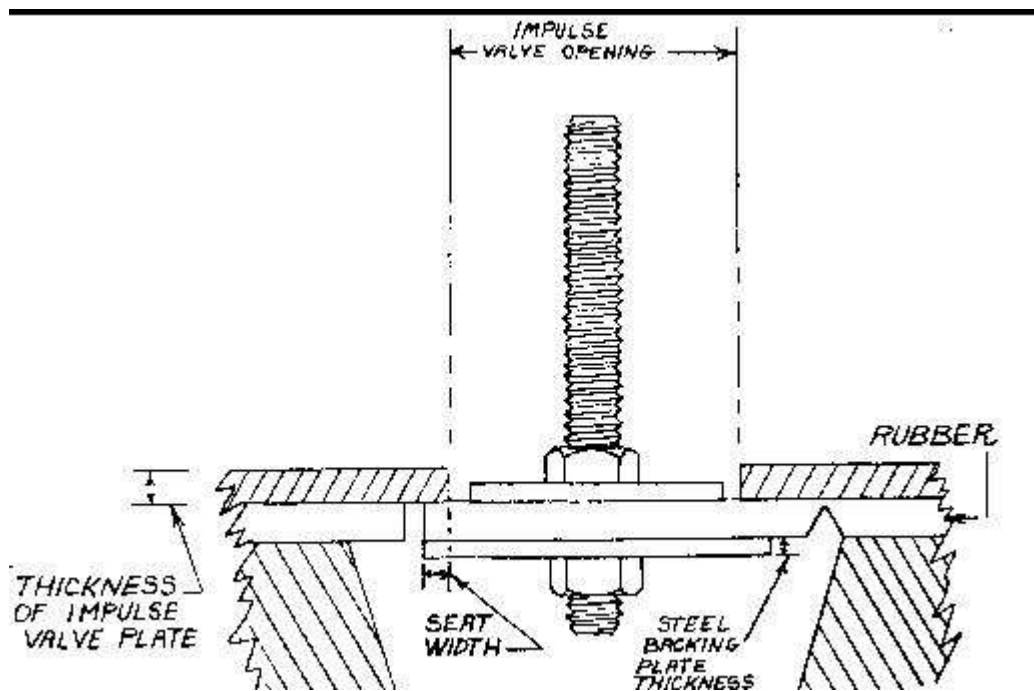

Impulse valve steel backing - inches

Handout 10C: Impulse valve steel backing - metric

Drive head in meters

	3	6	9	12	15
40	3	3	3	5	5
50	3	5	5	5	6
60	5	5	6	6	6
75	5	6	8	8	8
100	6	8	10	11	11
125	8	11	13	13	14
150	10	13	14	16	18
20,0	13	18	19	21	22
300	21	25	29	32	34
400	27	33	38	43	46

Impulse valve opening in millimeters

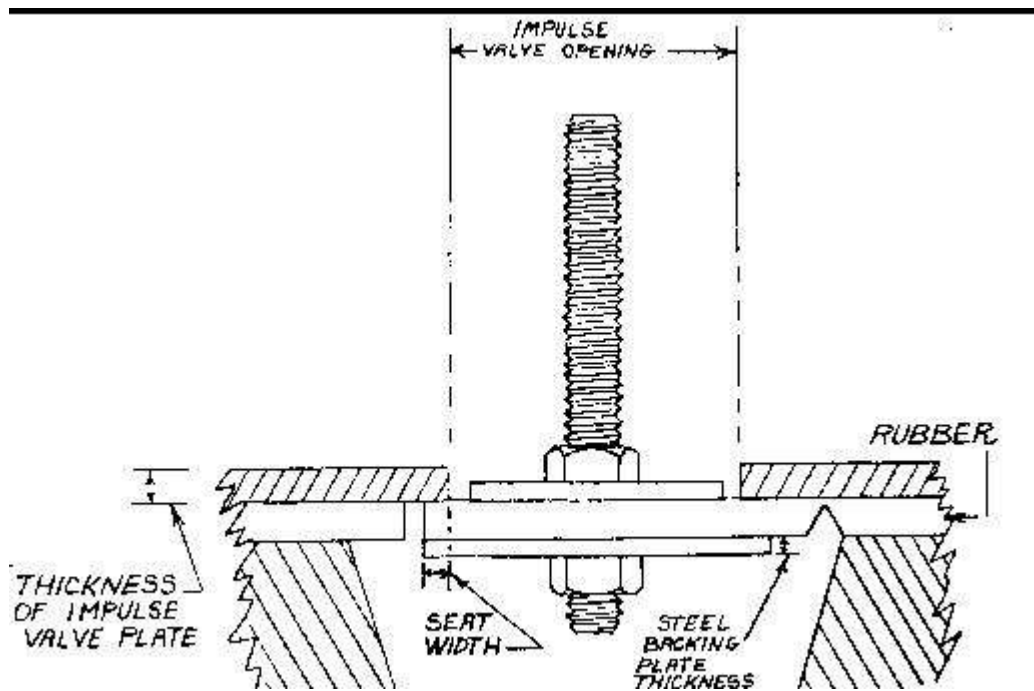

Impulse valve steel backing - metric

Handout 10D: Impulse valve seat width - inches

Drive head in feet

	10	15	20	25	30	35	40	45	50
3/4	1/8	3/16	1/4	5/16	3/8	7/16	1/2	9/16	3/8
1	3/16	5/16	3/8	7/16	1/2	9/16	5/8	11/16	3/4
1 1/4	1/4	3/8	7/16	9/16	5/8	3/4	13/16	14/16	1
1 1/2	5/16	7/16	9/16	11/16	3/4	7/8	1	1 1/16	1 3/16
2	3/8	9/16	3/4	7/8	1	1 3/16	1 5/16	1 7/16	1 9/16
2 1/2	1/2	11/16	15/16	1 1/8	1 5/16	1 7/16	1 5/8	1 13/16	1 15/16
3	5/8	7/8	1 1/8	1 5/16	1 9/16	1 3/4	1 15/16	2 3/16	2 5/16
4	13/16	1 1/8	1 7/16	1 3/4	2 1/16	2 3/8	2 5/8	2 7/8	3 1/8
6	1 3/16	1 11/16	2 3/16	2 5/8	3 1/8	3 1/2	3 15/16	4 5/16	4 11/16
8	1 11/16	2 1/4	2 15/16	3 9/16	4 1/8	4 11/16	5 1/4	5 3/4	6 1/4

Impulse valve opening in inches

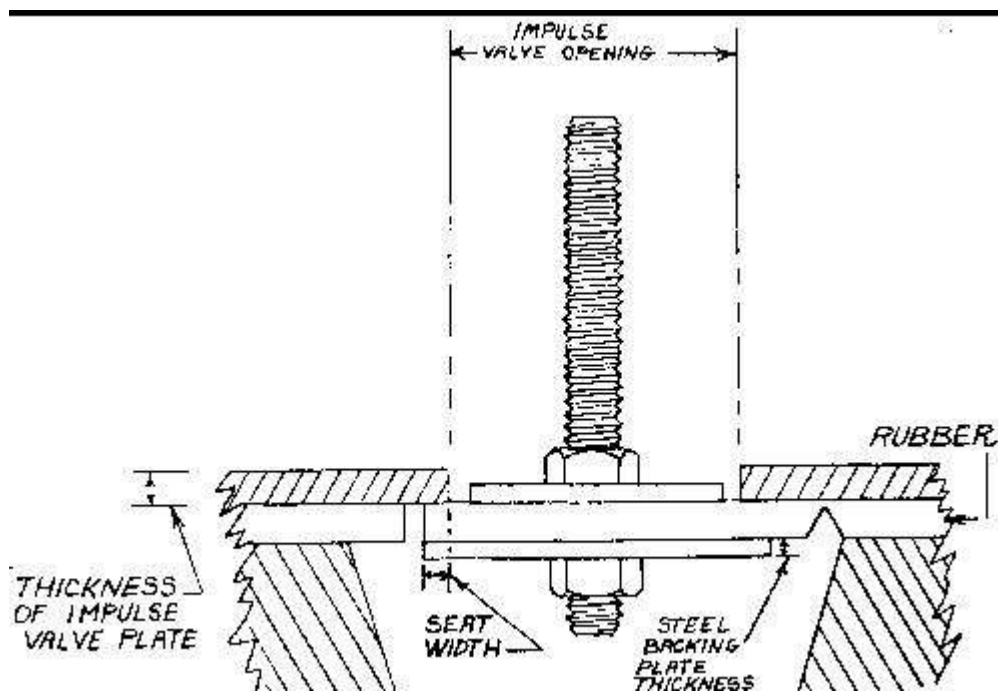

Impulse valve seat width in inches

Handout 10D: Impulse valve seat width - metric

Drive head in meters

	3	4.5	6	7.5	9	10.5	12	13.5	15
20	3	5	6	8	10	11	13	14	16
25	5	8	10	11	13	14	16	18	19
30	6	10	11	14	16	19	21	22	25
40	8	11	14	18	19	22	25	27	30
50	10	14	19	22	25	30	33	36	39
60	13	18	24	29	33	36	41	46	49
75	16	22	29	33	39	44	49	55	58
2100	21	29	36	44	52	60	66	72	79
150	30	43	55	66	79	89	100	109	119
200	43	56	74	89	104	119	130	146	158

Impulse valve opening in millimeters

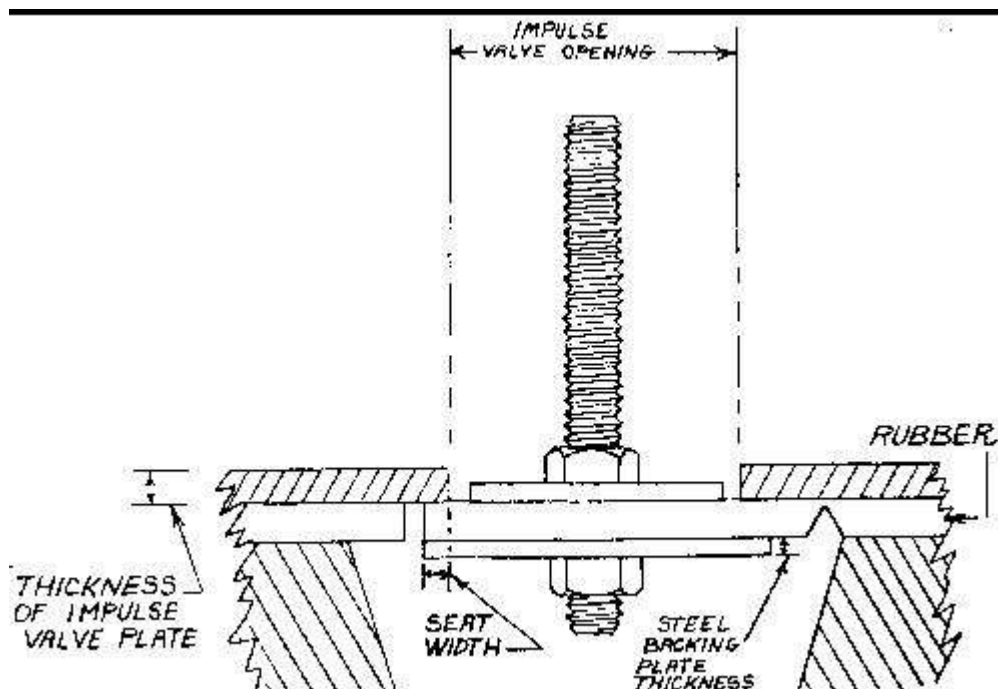

Impulse valve seat width in millimeters

Handout 10E: Check valve backing thickness - inches

Delivery head in feet

	25	50	75	100	125	150	175	200
1	1/16	1/16	1/16	1/16	1/16	1/16	1/16	1/16
1¼	1/16	1/16	1/16	1/16	1/16	1/16	1/16	1/16
1½	1/16	1/16	1/16	1/16	1/16	1/16	1/16	1/16
1½	1/16	1/16	1/16	1/16	1/16	1/8	1/8	1/8
2	1/16	1/8	1/8	1/8	1/8	1/8	1/8	1/8
2½	1/8	1/0	1/8	1/8	3/16	3/16	3/16	3/16
3	1/8	1/8	3/16	3/16	3/16	3/16	3/16	1/4
4	3/16	3/16	1/4	1/4	1/4	5/16	5/16	5/16
6	1/4	5/16	3/8	7/16	7/16	1/2	1/2	1/2
8	3/8	½	9/16	5/8	5/8	11/16	11/16	3/4

Drive pipe size in inches

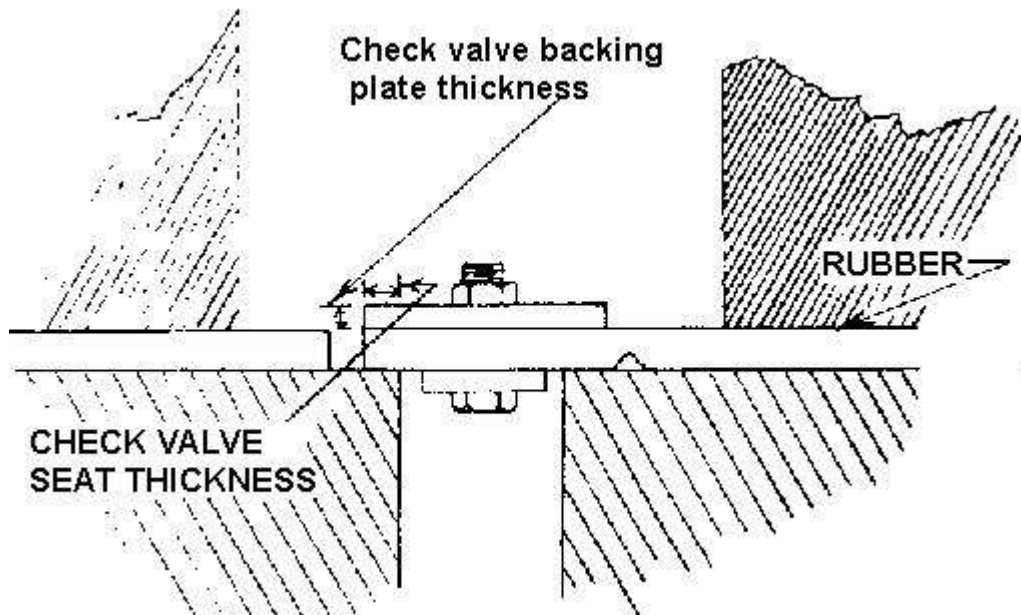

Check valve backing thickness in inches

Handout 10E: Check valve backing thickness - metric

Delivery head in meters

	7.5	15	23	30.5	38	45.5	53.5	60
20	2	2	2	2	2	2	2	2
25	2	2	2	2	2	2	2	2
30	2	2	2	2	2	2	2	2
40	2	2	2	2	2	3	3	3
50	2	3	3	3	3	3	3	3
60	3	3	3	3	5	5	5	5
75	3	3	5	5	5	5	5	6
100	5	5	6	6	6	8	8	8
150	6	8	10	11	11	13	13	13
200	10	13	14	16	16	18	18	19

Drive pipe size in millimeters

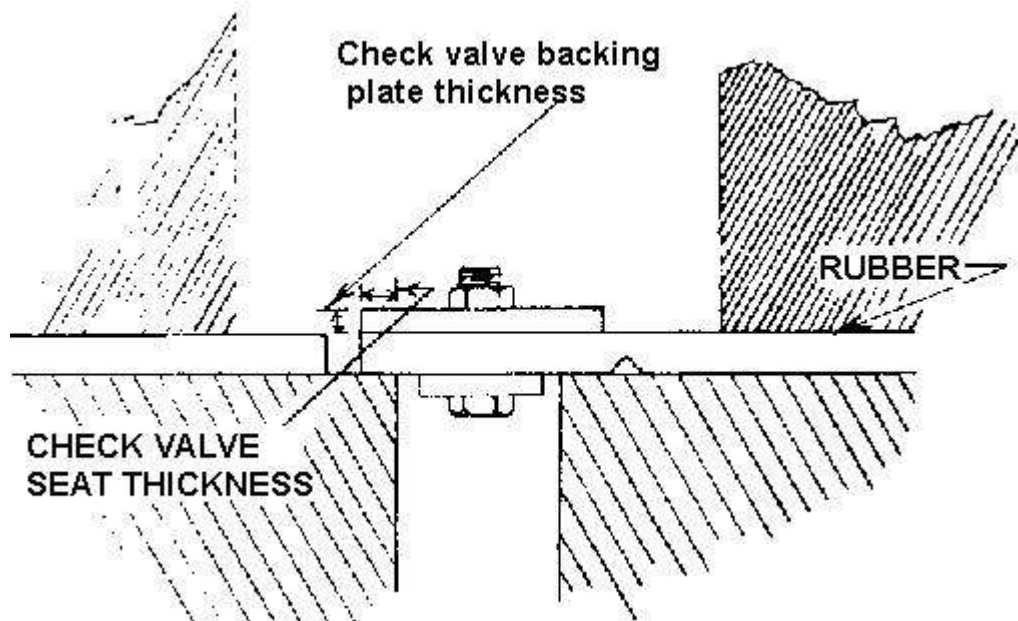

Check valve backing thickness in millimeters

Handout 10F: Check valve seat width - inches

Delivery head in feet

	25	50	75	100	125	150	175	200
3/4	1/8	1/8	1/8	1/8	1/8	1/8	3/16	3/16
1	1/8	1/8	1/8	1/8	1/D	3/16	1/4	1/4
1¼		1/8	1/8	1/8	3/16	3/16	1/4	3/8
It	1/8	1/8	1/8	1/8	3/16	1/4	5/16	7/16
2	1/8	1/8	1/8	3/16	1/4	5/16	7/16	9/16
2½	1/8	1/8	3/16	1/4	5/16	7/16	9/16	11/16
3	1/8	1/8	3/16	5/16	3/8	1/2	5/8	13/16
4	1/8	3/16	1/4	3/8	1/2	11/16	7/8	17/16
6	1/8	1/4	3/8	9/16	3/4	1	1 1/4	1 5/8
8	3/16	5/16	9/16	3/4	1	1 5/16	1 11/16	2 3/16

Drive pipe size in millimeters

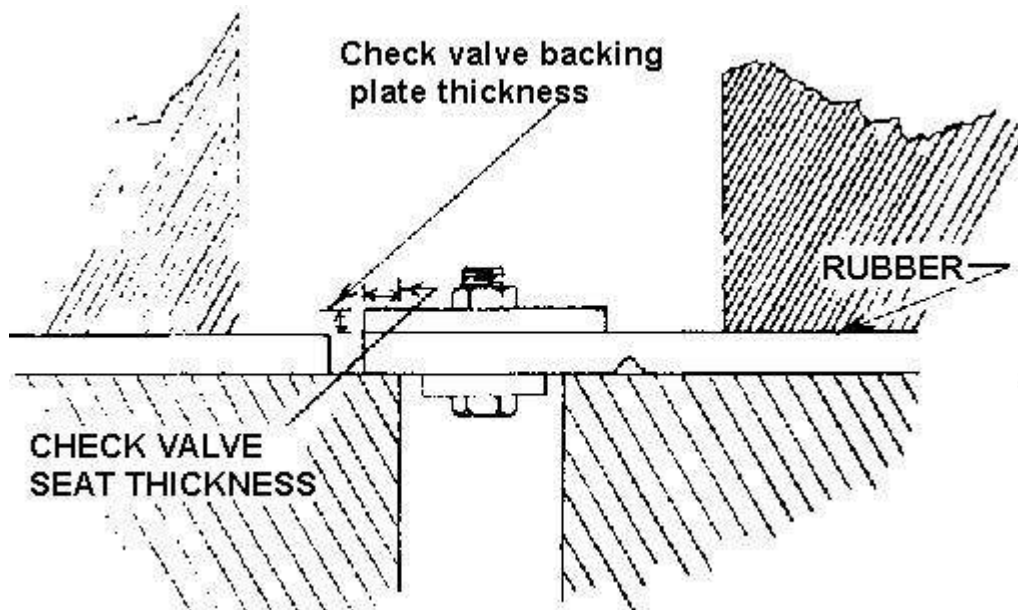

Check valve seat width in inches

Handout 10F: Check valve seat width - metric

Delivery head in meters

	7.5	15	23	30	38	45	53	60
20	3	3	3	3	3	3	5	5
25	3	3	3	3	3	5	6	6
30	3	3	3	3	5	5	6	10
40	3	3	3	3	5	6	8	11
50	3	3	3	5	6	8	11	14
60	3	3	5	6	8	11	14	18
75	3	3	5	8	10	13	16	21
100	3	5	6	10	13	18	22	27
150	3	6	10	14	19	25	30	41
200	5	8	14	19	25	33	43	55

Drive pipe diameter in millimeters

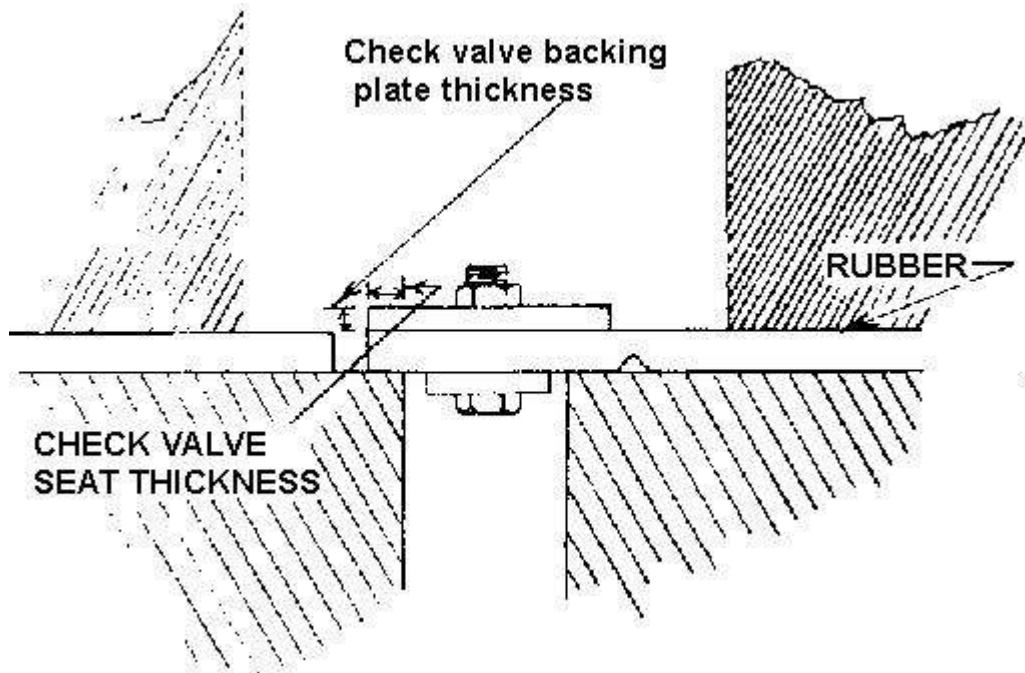

Check valve seat width in millimeters

Handout 10H: Exploded view of 2- piece concrete hydram

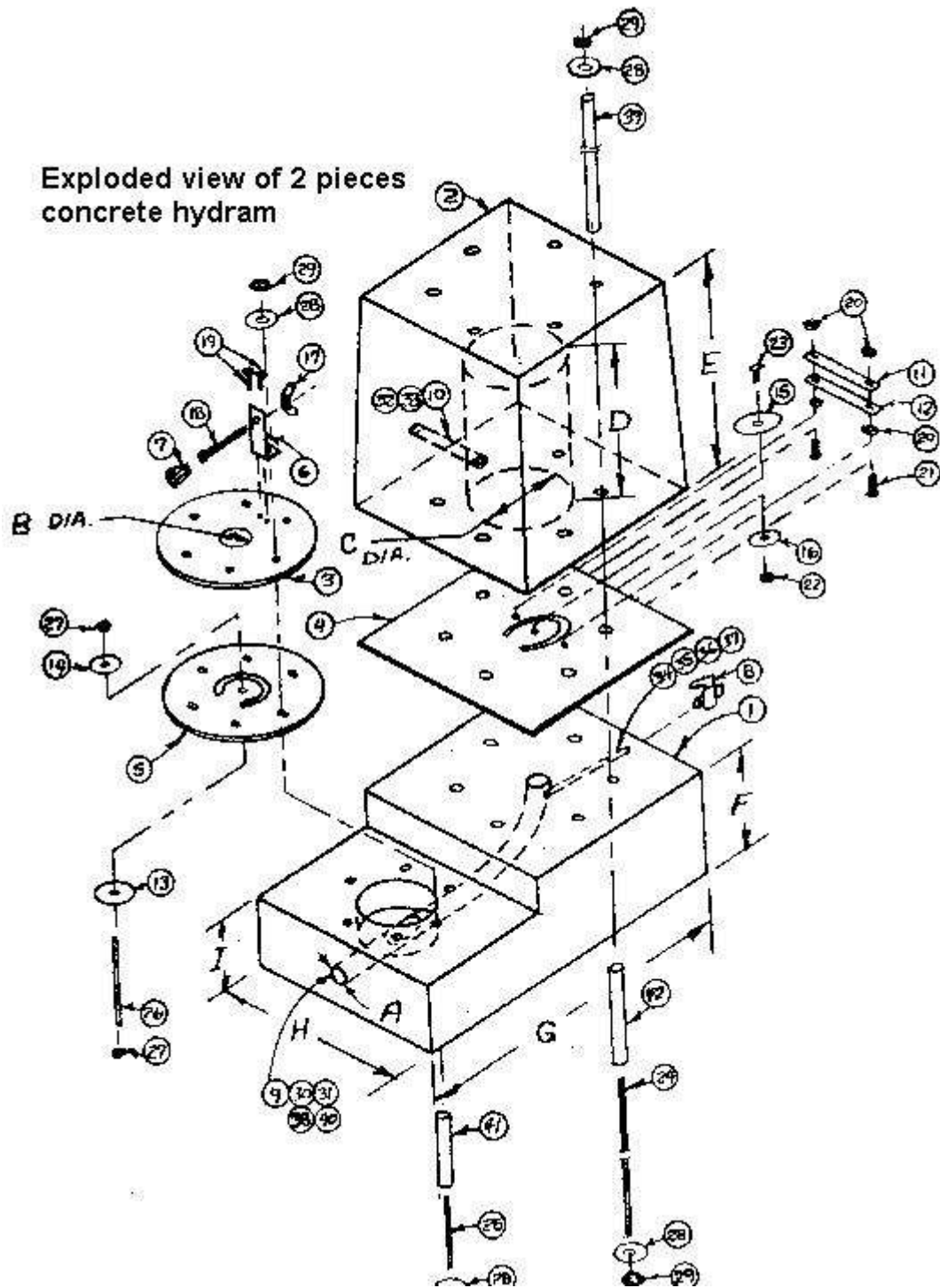

Exploded view of 2 pieces concrete hydram

Exploded view of 2 - piece concrete hydram

Handout 10I: Side view 2-piece concrete hydram

Attachment 10-I

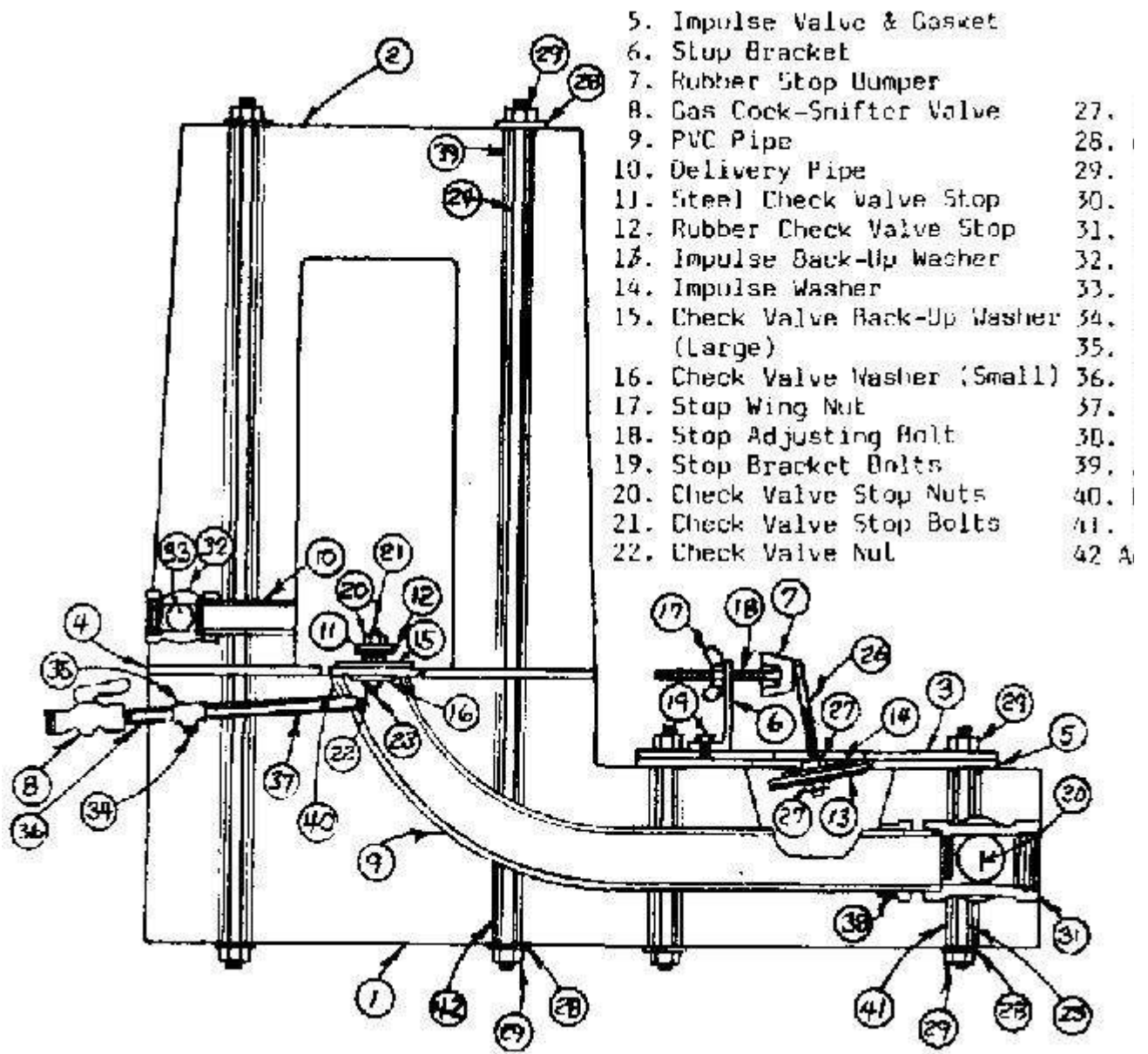

Exploded view of 2 - piece concrete hydram

1. Hydram Body	23. Check Valve Bolt
2. Accumulator	24. Althread Bolt (Accumulator)
3. Impulse Plate	25. Althread Bolt (Impulse Plate)
4. Check Valve & Gasket	26. Althread Bolt (Impulse Valve)
5. Impulse Valve & Gasket	27. Impulse Value Hex Nut
6. Stop Bracket	28. Flat Washer
7. Rubber Stop Bumper	29. Hex Nut
8. Gas Cock-Snifter Valve	30. Pipe Plug (Drive Pipe Size)
9. PVC Pipe	31. Steel Pipe Tee (Drive Pipe Size)
10. Delivery Pipe	32. Pipe Tee (Delivery Pipe Size)
11. Steel Check Valve Stop	33. Pipe Plug (Delivery Pipe Size)
12. Rubber Check Valve Stop	34. Pipe Plug (Snifter Pipe Size)
13. Impulse Back-Up Washer	35. Pipe Tee (Snifter Pipe Size)
14. Impulse Washer	36. Snifter Pipe
15. Check Valve Back-Up Washer(Large)	37. Snifter Pipe
38. PVC Male Adapter	
16. Check Valve Washer (Small)	39. Accumulator Sleeve
17. Stop Wing Nut	40. PVC Coupling
18. Stop Adjusting Bolt	41. Impulse Sleeve
19. Stop Bracket Bolts	42 Accumulator Base Sleeve
20. Check Valve Stop Nuts	21. Check Valve Stop Bolts
22. Check Valve Nut	

Handout 10J: Two piece concrete hydram form

Attachment 10-J

ONE PIECE CONCRETE HYDRAM FORM

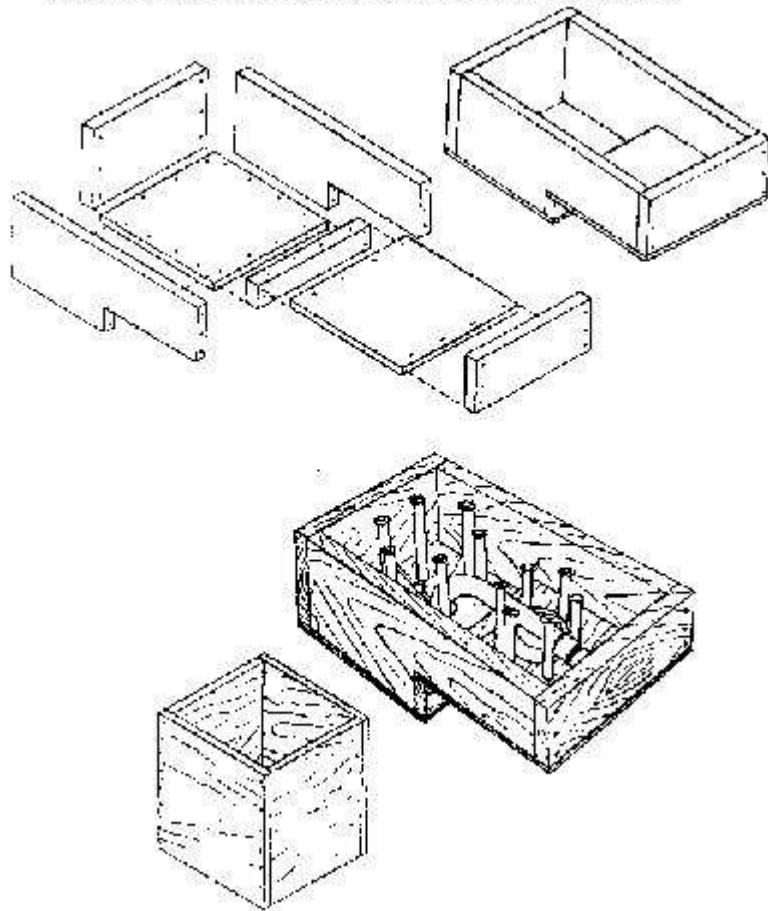

Two piece concrete hydram form

Handout 10K: Two piece concrete hydram

ONE PIECE CONCRETE HYDRAM

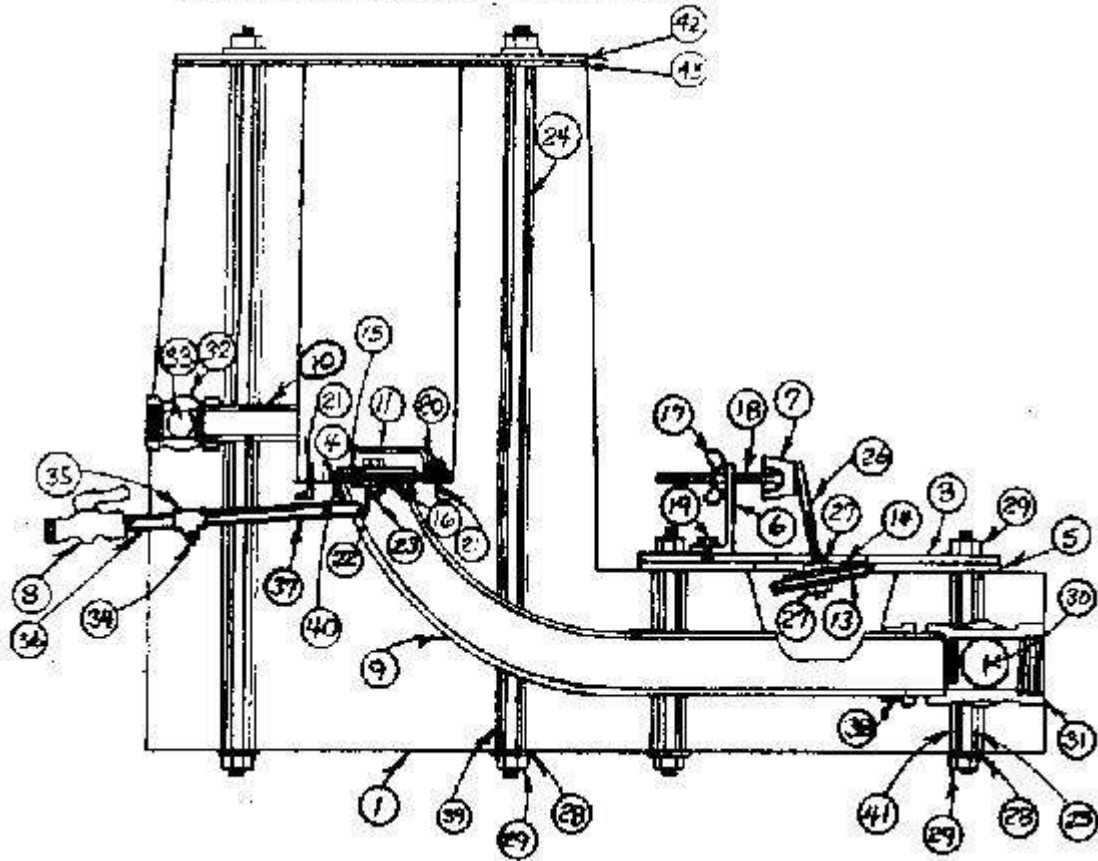

One-piece concrete hydram

1. Hydram body	22. check valve nut
2. gasket	23. check valve bolt
3. impulse plate	24. althread bolt (accumulator)
4. check valve	25. althread bolt (impulse plate)
5. impulse valve and gasket	26. althread bolt (impulse valve)
6. stop bracket	27. impulse valve hex nut
7. rubber stop bumper	28. flat washer
8. gas cock-shifter valve	29. hex nut
9. PVC pipe	30. pipe plug (drive pipe size)
10. delivery pipe	31. steel pipe tee (drive pipe size)
11. check valve stop	32. pipe tee (delivery pipe size)
12. - N/A -	33. pipe plug (delivery pipe size)
13. Impulse back-up washer	34. pipe plug (snifter pipe size)
14. impulse washer	35. pipe tee (snifter pipe size)
15. check valve back-up washer(large)	36. snifter pipe
16. check valve washer (small)	37. snifter pipe
17. stop wing nut	38. PVC male adapter
18. stop adjusting bolt	39. accumulator sleeve
19. stop bracket bolts	40. PVC coupling
20. check valve stop nuts	41. impulse sleeve
21. check valve stop bolts	42. accumulator plate
43. accumulator plate gasket	

Handout 10L: One Piece Concrete Hydram Form

ONE PIECE CONCRETE HYDRAM FORM

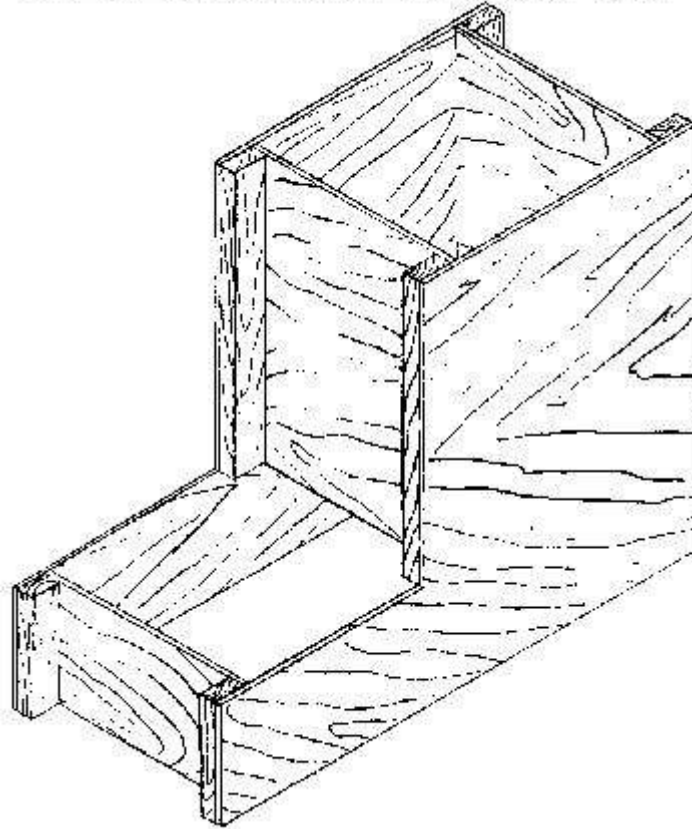

One piece concrete hydram form

Handout 10M: Problem

Attachment 10-M

A community of 100 people requires 20/gal/day/person, and 30 gpd/cow for 35 cows, and wants to use a concrete hydram.

$$h = 90'$$

$$H = 20'$$

A weir 2" wide and 4" deep has been put in the stream; 2' upstream from the weir, the distance from the mark on the stake, level with the top of the weir, to the water level is 1½" Assume an efficiency of 50%, determine the following:

- Q
- D
- d
- Accumulator diameter
- L

- Check valve opening
- Impulse valve opening
- T. s
- TL
- Impulse valve thickness
- Impulse valve seat width
- Impulse valve backing thickness
- Check valve seat width
- Check valve backing thickness
- Number and size of bolts

Handout 10N: Materials and procedures

MATERIALS: gravel, sand, cement, water, form lumber, plastic pipe, bowl, fittings, material for vapor barrier something to mix cement in. Size and quantity of materials is dependent upon the hydram to be constructed. Following is an example of a typical list of materials for a 1" hydram.

1 " CONCRETE HYDRAM MATERIALS LIST	
1 1"x 12"x 8' lumber for body	8 3/8 althread 36" form
1 1"x 12"x 8' lumber for accumulator forms	26 3/8 lock washers
1 1/4"x 7" diameter steel plate	26 3/8 flat washers
1 3" PVC pipe cap	26 3/8 nuts
1 4" bowl	1 1" pipe plug
1 1'x 1' x 1/2 belting	1 1" pipe tee
1 7" diameter x 1/4" belting	1 1/4" pipe plug
1 1"x 2" angle 1" long	1 1/4" pipe tee
1 rubber stop bumper	1 1/4" pipe plug
1 1/4" gas cock	1 1/4" pipe tee
1 1" PVC pipe 2' long	2pcs. 1/4" pipe 2" long
1 1/2" nipple 1 1/2" long	1 1" PVC male adaptor
2 2 1/2" washer with 3/8" hole	1 1/4" PVC pipe 22' long

2 1½" washer with 3/8" hole	1 1" PVC coupling
5/16" wing nut	½ lb 6d nails
1 5/16 x 2½" bolt	form oil
2 ¼ x ½ bolt	2½ gal water
3 5/16 nut	32# cement
1 3/8 bolt 1" long	1 1/3 cu. ft. gravel
1 3" PVC pipe 18" long	1 1/6 cu. ft. sand
Handouts 10A - 10 L	shovels

	PROCEDURES	NOTES
12.	With all the tools and materials gathered, begin construction.	
	Phase I - Part Two	
13.	Start by constructing the hydam base form. (See handout 10J)	
14.	Next, bend the PVC pipe and cut to proper length and angles. Be sure to glue a coupling to the check valve end to increase the seat area.	
15.	Notch out bottom of plastic bowl to fit upon the PVC pipe: with the bowl and pipe held together, mark where the pipe touches the inside of the bowl; then, using coping saw, cut along this line. Attach male adapter and the plugged tee to input end of pipe. The plugged tee serves to prevent the pipe from turning within the concrete. Welding a piece of metal onto the coupling would also work.	
16.	Drill holes in the bottom of the form for the bolt pattern around the impulse valve and the accumulator.	
17.	Center accumulator form pipe on the inside of the form and draw a circle around it. Drive three 6d nails onehalf way in, 120 degrees apart through the circle, making compensation for the thickness of the accumulator form pipe.	
18.	Drill hole in PVC pipe for snifter. Drill another hole in form for the other end of snifter. Snifter pipe should have a plugged tee in the middle or a piece of metal welded to the side of it to eliminate turning.	
19.	An elliptical rubber washer should be cut out and nailed where the check valve end of the PVC pipe comes in contact with the form. This is to recess the concrete around the check valve seat to insure a good seat.	

20.	Bolt sleeves to form using althread, nuts and washers.
21.	Tie PVC pie down to form using tie-wire.
22.	Pour the base of the hydram using the following concrete formula: 8 parts gravel, 7 parts sand, 2 parts cement, and water to proper consistency. Tap on the form sides while pouring to prevent air pockets. Cover concrete with a vapor barrier such as visqueen, then cover entire pour with insulation. Draw pattern for impulse valve plate and send to metal shop.
	Phase II
23.	After the hydram base has had sufficient time to set (usually about 2 days), remove form and place hydram base right side up on blocks so that the bolt holes on the bottom can be reached.
24.	Place a sheet of plastic or wax paper or anything that will prevent a concrete marriage and that won't wrinkle on top of the accumulator end of the hydram.
25.	Place althread and sleeves through bolt pattern at accumulator with nuts and washers on both ends. Tighten until sleeves are rigid.
26.	Build form for accumulator as shown in Handout 10J.
27.	Place accumulator form pipe over the three nails sticking up through the concrete at the check valve. Pack with sand to prevent pipe from floating up in concrete. Cap end of accumulator form pipe with tape or PVC cap.
28.	Place accumulator form on top of hydram base and install the delivery pipe connection between this form and the accumulator form pipe.
29.	Pour accumulator form full of concrete using the same mixture ratio as used in step #22.
30.	Cover with a vapor barrier such as visqueen and insulation.
	Phase III
31.	After concrete has had sufficient time to set up (about one to two days), remove form.
32.	Using a large piece of paper, make a pattern from the hydram base for both the impulse valve rubber and the accumulator check valve rubber.
33.	Cut out the rubbers according to the pattern. If the rubber is too thick to allow free movement of the valves, a v-notch may need to be cut into the rubber at the flex point of the valve.
34.	Drill and cut out a piece of sheet metal for the impulse plate and

	attach stop bracket.
35.	Install althread, bolt, nuts and washers on both pieces of rubber as shown in the attachment.
36.	Bolt accumulator to base with check valve rubber for a gasket.
37.	Bolt impulse valve rubber and plate to hydram base.
38.	Install stroke adjustment bolt locknut and rubber bumper.
	Phase IV
39.	Install ram to drive pipe and delivery pipe. Start up. Adjust for amount of flow available.
40.	Have the trainees determine the flow rate into and out of the hydram and determine the efficiency.
41.	Discuss with the trainees what they feel the advantages and disadvantages of this ram might be and when they might be important.

Session 11: Hydram component design criteria (1-1½ hours)

Time: 1-1½ hours

OBJECTIVES:	By the end of this session, trainees shall be able to:
	<ul style="list-style-type: none"> • describe how each hydram component is or can be made, and the advantages and disadvantages of each design, including longevity, serviceability, reliability; • describe how the configuration of the components affect their function and the overall efficiency of the hydram; and • select hydram component appropriate for their sites.
OVERVIEW:	Trainees will examine advantages and disadvantages of manufactured and fabricated ram components, and configurations. Combining this information with information about locally available materials and skills, they will determine ram construction that is most applicable.
MATERIALS:	<ul style="list-style-type: none"> • flipchart/chalkboard • slides, slide projector • actual parts, as available (see trainer note)
NOTE:	The handouts for this session will be very helpful in presenting the information on the individual components but having the actual components available would greatly increase the effectiveness of this session. If in the country that the trainees will be working there is one brand or type of hydram predominantly being used, it would be most advantageous to have a hydram of that type at the training site. The types and brands of the components the trainees will most likely encounter are the ones that the greatest amount of attention should be given to.

	PROCEDURES	NOTES
1.	Review the purpose of this activity.	
2.	Ask the trainees to list the components of the hydram and write them on the flipchart/board. It should include the drive pipe, impulse valve, snifter, check valve, accumulator and delivery pipe.	
3.	Distribute Handout 11A.	
4.	Using handout 11A, ask the trainees to point out any problems or advantages of each of the components. Fill in any information the trainees leave out.	Slides can be used very effectively as well.
5.	Repeat steps 3 and 4 using handouts 11B and 11C.	
6.	Once the trainees have a good understanding of the components, discuss with them all the possible configurations of the components and how the placement of a particular component affects the overall efficiency of a hydram. The configuration possibilities should at least include:	
	- the location of the impulse valve (either before or after the accumulator);	
	- the angle of the impulse valve (on the top, side, or bottom of the hydram);	
	- the placement of the snifter and how it affects its function;	
	- the possibility of more than one impulse valve (as in the case of larger Blake Hydrams); and	
	- the angle of the check valve (either vertical, horizontal, or up-side down),	
	- the size and shape of the accumulator, and	
	- how the configuration affects the water's path.	
7.	Make a transition to Session 12, indicating that this information will also be used to consider choices among hydram designs.	

Handout 11A: Typical impulse valve

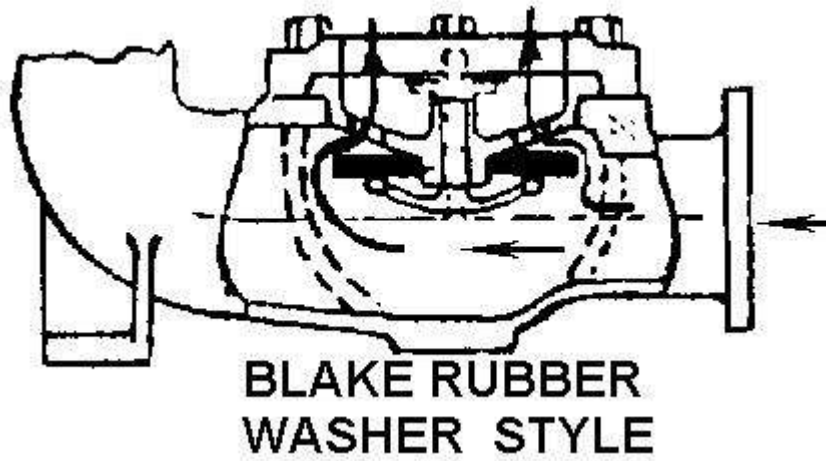

BLAKE RUBBER WASHER STYLE

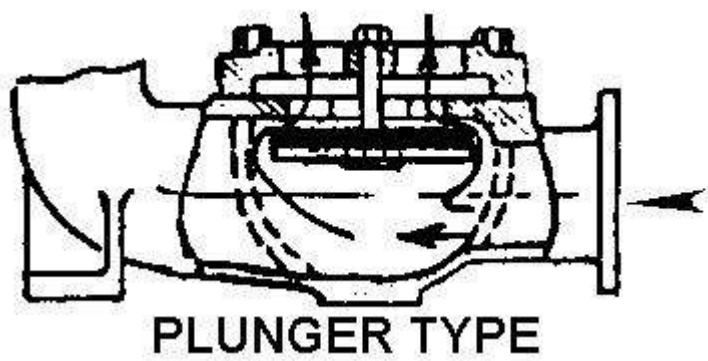

PLUNGER TYPE

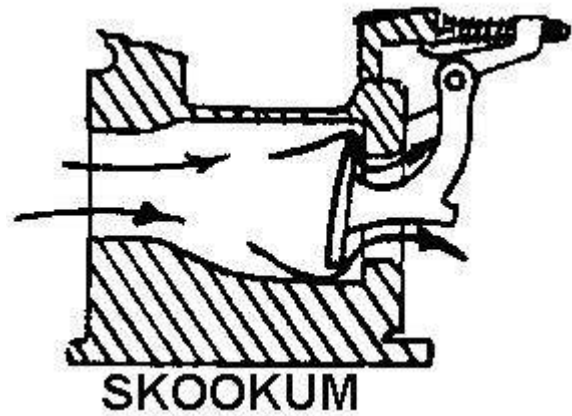

SKOOKUM

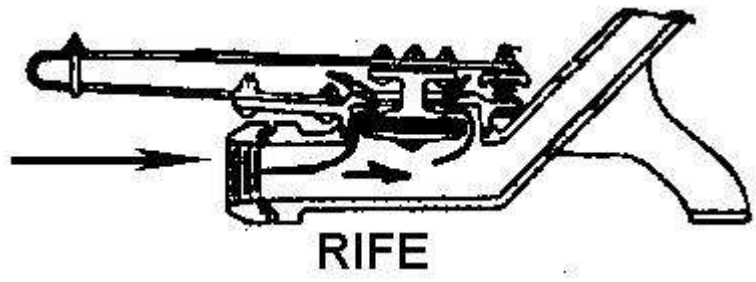

RIFE

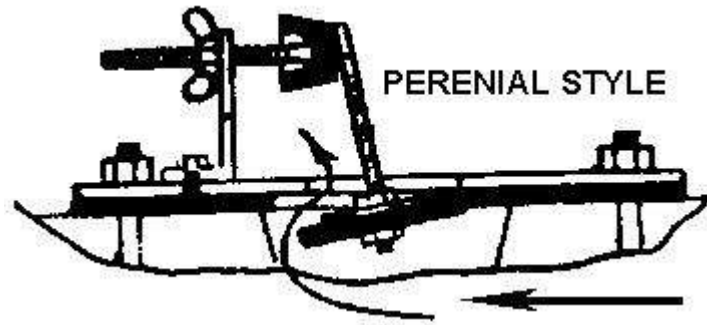

PERENNIAL STYLE

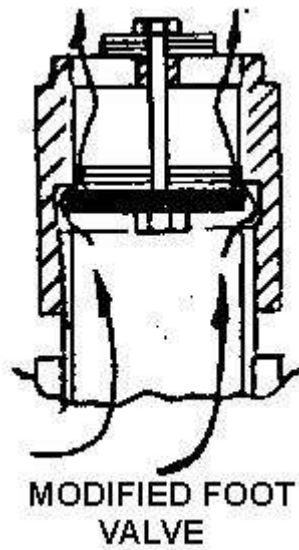

MODIFIED FOOT VALVE

Handout 11B: Typical check valves



BLAKE RUBBER WASHER TYPE

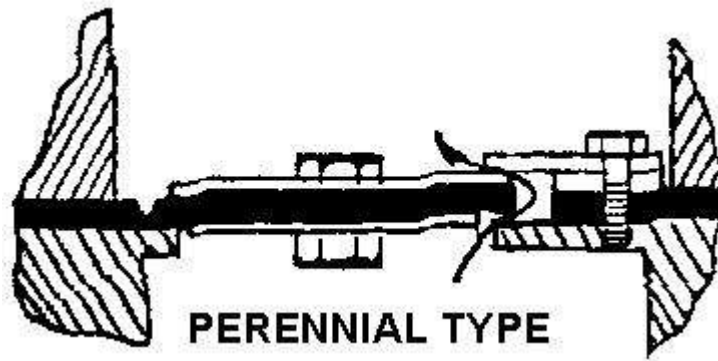

PERENNIAL TYPE

PERENNIAL TYPE

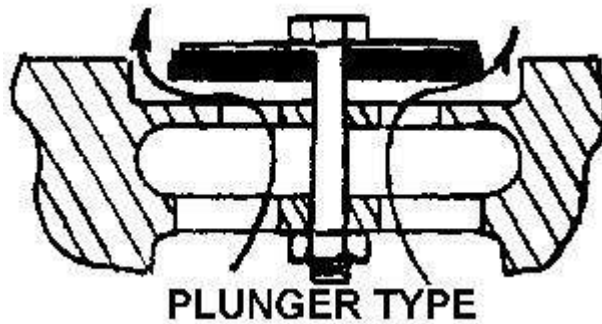

PLUNGER TYPE

PLUNGER TYPE

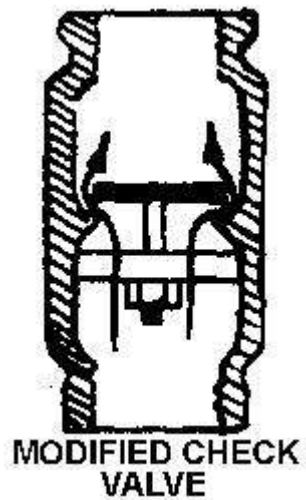

MODIFIED CHECK VALVE

MODIFIED CHECK VALVE

Handout 11C: Typical snifters



**STANDARD PLUMBING
SNIFTER**

standard plumbing snifter



GAS COCK

gas cock



NEEDLE VALVE

needle valve



ORIFICE

orifice

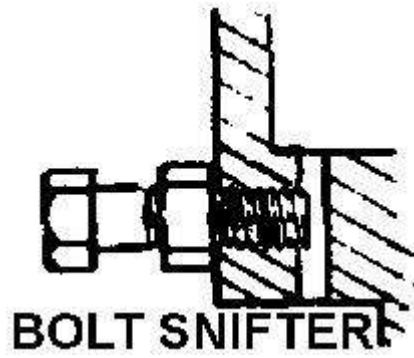

BOLT SNIFTER

bolt snifter



rubber flap
check

rubber flap check

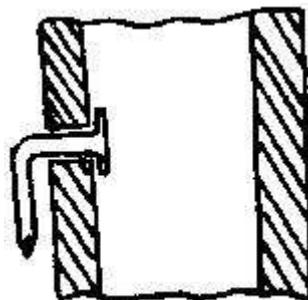

nail check

nail check

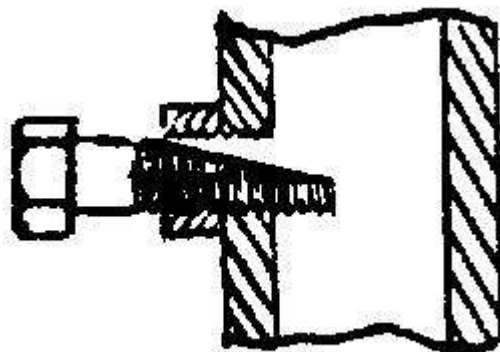

grooved bolt snifter

grooved bolt snifter

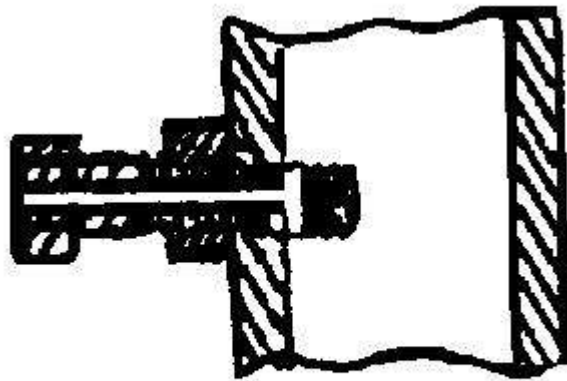

external drilled
bolt snifter

external drilled bolt snifter

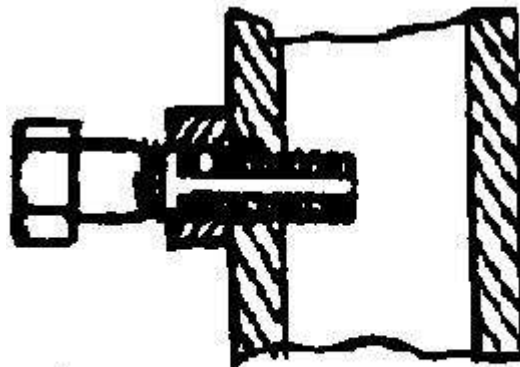

internal drilled
bolt snifter

internal drilled bolt snifter

Session 12: Hydram selection (1½ - 3 hours)

Time: 1½ - 3 hours

OBJECTIVES:	By the end of this session, trainees shall be able to:
	<i>identity factors involved in selecting hydrams;</i>
	· <i>describe advantages and disadvantages of various ram construction, including manufactured rams;</i>
	· <i>identify factors which will support/impede the development of a hydram system.</i>
OVERVIEW:	This session pulls together much of what has been learned to date, and organizes most of the issues to be considered in the installation of a hydram.
MATERIALS:	chalkboard or flipchart, chalk or markers Handout 12A
TRAINERS NOTES:	1. Key issues that have been raised in other sessions include:
	<i>- funding sources for projects (Sessions 9, 11)</i>
	<i>- types of rams currently being used (Session 2)</i>
	<i>- available materials and costs (Sessions 9, 11)</i>
	<i>- transport available (Session 2)</i>
	<i>- existence of local industry capable of fabricating parts or complete rams (Session 2)</i>
	2. The advantages of manufactured rams will be discussed during this session. The trainer should identify brands available in-country, collect and duplicate literature.

	PROCEDURES	NOTES
1.	Identify the objectives of the session.	
2.	Ask the trainees what factors need to be considered in selecting a hydram and write these [actors on flipchart. As in handout they should include cost, serviceability. availability, simplicity of design, ease of transportation, longevity, and efficiency.	
3.	Review manufactured rams available in-country. List all the types of hydrams the trainees might have to choose from. The list may include concrete, factory made, modified pipefitting, fabricated pipefitting, and welded steel.	
4.	Ask participants to discuss each type of ram and how its characteristics lend themselves to the factors previously discussed; fill in chart.	
5.	Summarize by asking the trainees what type of hydram they will most likely be installing and any other information which is pertinent such as funding sources for hydram projects, where to buy pipe and fittings and where there might be some local industries that should be involved in the fabrication of parts or whole hydrams.	
6.	Ask participants what other factors support/impede/affect selection. List on flipchart.	
7.	Ask the trainees to form groups of six and as a group determine the ideal ram construction and configuration for their site. Instruct them to consider:	
	<i>- manufactured rams available,</i>	
	<i>- limitations of component parts, manufactured or built,</i>	
	<i>- local skills available for construction, repair and maintenance,</i>	
	<i>- maintenance schedule and responsible parties,</i>	
	<i>- volume of water to the pump, and</i>	
	<i>- cost.</i>	
	<i>Allow the groups 25 minutes for this.</i>	
8.	Design should be critiqued, according to the criteria. If all information is not available, ask participants how they would get it. Discuss the implications of craftsmanship.	
9.	Ask participants if there is anything else they need to know before they begin construction. Answer any questions.	

Handout 12A - Hydram comparison

Scale: 1 (best) to 6 (worst)

	CONCRETE	MODIFIED PIPE FITTING	FABRICATED PIPE FITTING	MANUFACTURED HYDRAM	WEI STE
Cost	1	4	3	6	5
	inexpensive	inexpensive	inexpensive	expensive	mod
Serviceability	5	3	2	1	4
	hard to repair the concrete	parts are hard to repair and usually requires replacement	sometimes difficult to get to the check valve	parts easily made or replaced	requ weld
Availability					
Simplicity of Design	6	1	3	4	5
	requires the greatest amount of time to construct	parts just screw together	most parts screw or bolt together some metal working	most parts are cast & sometimes the rubber parts are field fabricated	requ weld but i uniq meta shap
Ease of Transportation	6	2	3	5	4
	extremely heavy	small and not very heavy	small and not very heavy	heaviest of the ferrous hydrams	heav bulk
Longevity	3	5	4	1	2
	if it does not freeze it should last as long as a mfg. Ram	will last about 1 year	no longevity studies done yet, but should last a long time	history of up to 25 yr without service	shou last as lo a mf ram
Efficiency	very little difference if built properly.				

* training device only

Session 13: Inter-relationships within the hydram (11-15 hours)

Time: 11-15 hours

OBJECTIVES:	The trainees will verify by experimentation the inter-relationships within a hydram including:
	1) the effects of the h:H ratio on efficiency,
	2) frequency on maximum h:H,
	3) frequency on efficiency and q and Q
	4) amount of air in accumulator on efficiency
	5) drive pipe length on efficiency,
	6) drive pipe diameter on efficiency,
	7) snifter on efficiency, and
	8) drive pipe material on efficiency
	The trainees will describe the extent to which they can vary the factors that affect efficiency, and produce an acceptable amount of water.
OVERVIEW:	A series of 8 experiments will be conducted by groups of 3-4 participants. The number of experiments each group conducts will depend on the size of the total group and the amount of time available. This activity is key in providing participants with experience and confidence in understanding and manipulating hydrams, and understanding the range of skills, materials, tools and equipment involved in a hydram project.
MATERIALS:	Handout 13, exercises 1-8 a water source with sufficient head to operate one or more hydrams, enough working hydrams for one to each group, drive pipes (all steel except one PVC)
TOOLS:	pipe wrenches, stop watches or watches with a seconds function, buckets of known capacity, means of measuring drive head such as transit or sight level, pressure gauges, pressure relief valves

TRAINER NOTES ON TIMING FOR EXPERIMENTS

The time it should take for each series of experiments is as follows:

1) h:H ratio's effect on efficiency	2 hours
2) frequency's effect on maximum h:H	1½ hours
3) frequency's effect on efficiency, Q and q	2½ hours
4) volume of air in accumulator's effect on efficiency	2 hours
5) drive pipe length's effect on efficiency	4 hours
6) drive pipe diameter's effect on efficiency	2½ hours
7) snifter's effect on efficiency	1½ hours
8) drive pipe material's effect on efficiency	2 hours

Allow 1½ hours for the introduction to this session (procedure steps 1-4) and 2-3 hours for the groups to analyze their findings (step 6) and 3 hours for the group presentations and discussion.

The number of experimental stations available and the time an experiment actually takes, may mean that each group does 2-3 experiments each. It's a good idea to have more than one group run an experiment to verify results.

	PROCEDURE:	NOTES
1.	Describe the objectives of this session.	
2.	Divide the trainees into groups of 3-4, making sure each group contains a cross-section of technical abilities.	Each group of 3-4 should possess a range of technical abilities
3.	Give each group the task and procedure sheets for the experiments which you want them to perform.	
4.	Assign groups to work spaces and ask them to take 15 minutes to decide how they will work together,	Each group will need to assign responsibility for timing the experiment, measuring, maintaining pressure gauge recording, reporting out, analyzing data.
	- get clear about procedures, task,	
	- make assignments for presentation, write-up.	
5.	The groups follow the procedures on the task and procedure sheets.	The trainers must be available to participants as necessary to respond to questions, ensure that procedure conclusions are clear and on target. Trainers should encourage groups to review work at the end of the first block of time.

6.	After the experiments are finished, the trainees meet with their groups for 2-3 hours to analyze the data collected, to plot the results of their experiments onto the graphs provided in the handout (all except for the snifter experiment which needs no graph), and to define the generalizations that can be made and the applications.	See Guide to Users for setting up experimental stands.
7.	A representative from each group presents the task, procedure, results, generalizations, and applications for the experiments performed.	
8.	A discussion follows about what has been learned and what wasn't learned that perhaps should have been learned.	
9.	Ask participants to describe how start up of ram might be different at actual installation vs. this experimental arrangement.	

Handout 13A: Exercises: Determining the effect of:

Exercise 1: h:H ratio on efficiency

TASK: DETERMINE THE EFFECT THE h:H RATIO HAS ON EFFICIENCY

Variables: efficiency (η), water delivered (q), water used (Q), time of experiment, water wasted (Q_w)

Controlled Variables: Delivery head (h)

Constants: Drive head (H), frequency (f), volume of air in the accumulator

Range: 2:1 to 20:1

PROCEDURE:

1. Install a hydram to a drive head.
2. Accurately measure the drive head.
3. Attach and set an adjustable pressure relief valve and a pressure gauge to the discharge.
4. Start the hydram.
5. Open the snifter in order to fill the accumulator with air and then close the snifter for the duration of the experiment.
6. Calculate the impulse valve frequency.
7. Simultaneously measure the time of the experiment, water delivered (q) and water wasted (Q_w)
8. Calculate the efficiency (η).

9. Repeat the experiment making sure to keep the drive head, frequency and the volume of air in the accumulator the same and change the delivery head in order to develop a new h:H ratio.

TASK: DETERMINE THE EFFECT THE h:H RATIO HAS ON EFFICIENCY

Experiment #	
h:H ratio	
H	
h	
Q_w	
q	
Q	
f	
s	
w	
t	
n	
Notes	

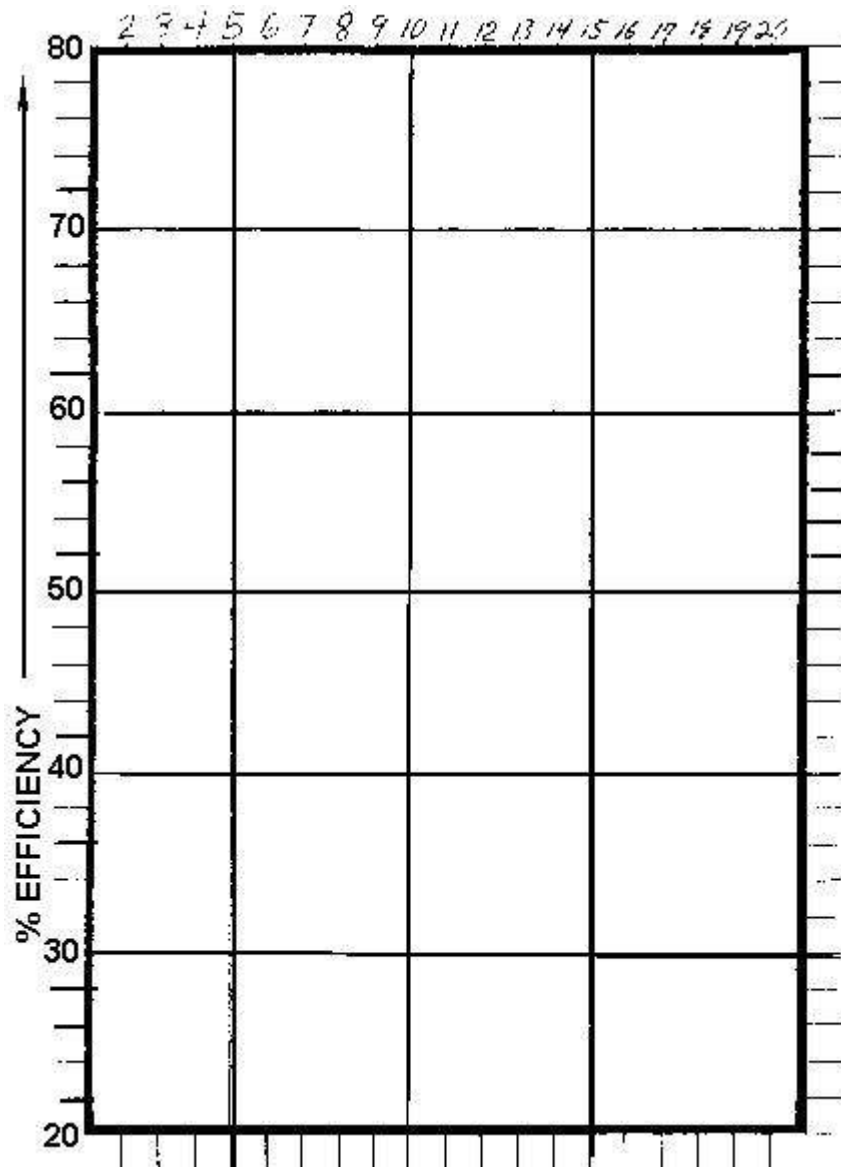

The effect of the delivery head to drive head ratio on efficiency

Exercise 2: Frequency on the maximum delivery head to drive head ratio

TASK: DETERMINE THE EFFECT OF THE FREQUENCY ON THE MAXIMUM DELIVERY HEAD TO DRIVE HEAD RATIO

Variables: delivery head (h), water used (Q.), water wasted(Qw), water delivered (q)

Controlled Variables: amount of air in the accumulator, frequency (f)

Constants: drive head

Range: high frequency to low

PROCEDURES:

1. Install a hydram to a drive head.
2. Accurately measure the drive head.

3. **Attach and set an adjustable pressure relief valve and a pressure gauge to the discharge.**
4. **Start the hydram.**
5. **Open the snifter in order to fill the accumulator and then**
6. **Set the frequency to as fast as possible.**
7. **With delivery valve shut measure the maximum delivery head with a pressure gauge. (Make certain that the hydram that is used is designed for the pressures that will be encountered.)**
8. **Repeat the experiment while slowing down the frequency by even increments making certain that the volume of air in the accumulator remains the same.**
9. **From the pressure reading calculate the delivery head and the h:H ratio.**

TOOLS AND MATERIALS NEEDED:

TASK: Determine the effect of the frequency on the maximum delivery dead to drive head ratio

Experiment #
h:H ratio
H
h
Q_w
q
Q
f
s
w
t
n
Notes

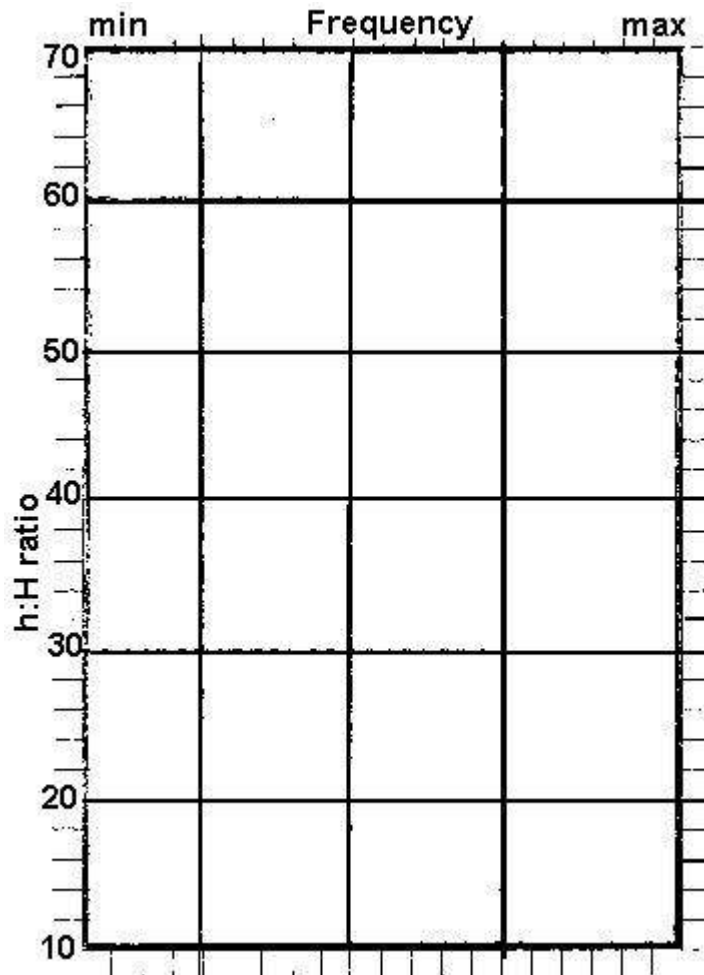

The effect of the frequency on the maximum delivery head to drive head ratio

Exercise 3: Frequency on efficiency, quantity of water entering the hydram and quantity of water delivered

TASK: DETERMINE THE EFFECT OF FREQUENCY ON EFFICIENCY, QUANTITY OF WATER ENTERING THE HYDRAM AND QUANTITY OF WATER DELIVERED.

Variables: time of the experiment, efficiency (η), water used (Q), water delivered (q), water wasted (Q_w)

Controlled Variables: frequency

Constants: drive head (H), delivery head (h), volume of air in the accumulator

Range: slow to fast

PROCEDURE:

1. Install a hydram to a drive head.
2. Accurately measure the drive head.
3. Attach and set an adjustable pressure relief valve and a pressure gauge to the discharge.
4. Start the hydram.

5. Open the snifter in order to fill the accumulator with air and then close the snifter for the duration of the experiment.
6. Calculate the impulse valve frequency.
7. Simultaneously measure the time of the experiment, water delivered (q) and water wasted (Q_w)
8. Calculate the efficiency (n).
9. Repeat the experiment making certain to keep the volume of air in the accumulator, drive head, and delivery head the same while changing the frequency.

TASK: DETERMINE THE EFFECT OF FREQUENCY ON EFFICIENCY, QUANTITY OF WATER ENTERING THE HYDRAM AND QUANTITY OF WATER DELIVERED

Experiment #
h:H ratio
H
h
Q_w
q
Q
f
s
w
t
n
Notes

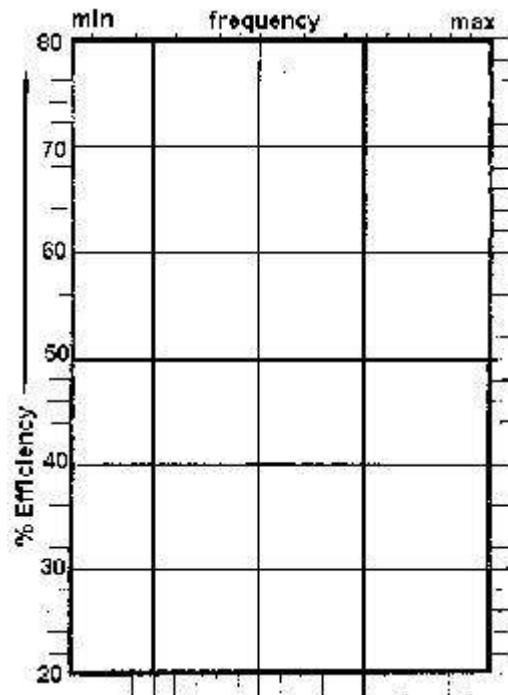

The effect of frequency on efficiency, quantity of water entering the hydram and quantity of water delivered

Exercise 4: Volume of air in the accumulator on efficiency

TASK: DETERMINE THE EFFECT OF THE VOLUME OF AIR IN THE ACCUMULATOR ON EFFICIENCY.

Variables: time of the experiment, efficiency (η), water wasted (Q_w), water pumped (q), water used (Q)

Controlled Variables: volume of air in the accumulator

Constants: drive head (H), delivery head (h), frequency (f)

Range: no air - 24" of air

PROCEDURES:

1. Install a hydram to a drive head.
2. Accurately measure the drive head.
3. Attach and set an adjustable pressure relief valve and a pressure gauge to the discharge.
4. Start the hydram.
5. Open the snifter in order to fill the accumulator with air and then close the snifter for the duration of the experiment.
6. Calculate the impulse valve frequency.
7. Simultaneously measure the time of the experiment, water delivered (q) and water wasted

(Q_w)

8. Calculate the efficiency (n).

9. Repeat the experiment making certain to keep the drive head, delivery head and frequency the same while changing the volume of air in the accumulator.

TASK: Determine the effect of the volume of air in the accumulator on efficiency

Experiment #
h:H ratio
H
h
Q_w
q
Q
f
s
w
t
n
Notes

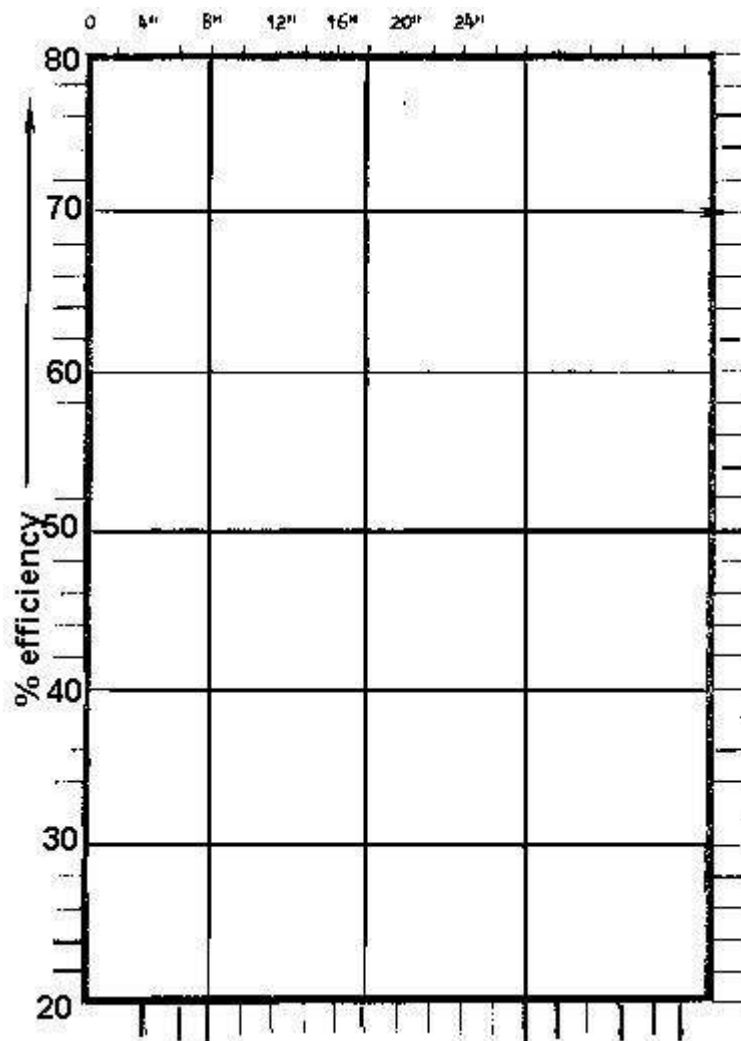

The effect of the volume of air in the accumulator on efficiency

Exercise 5: Drive pipe length on efficiency

TASK: DETERMINE THE EFFECT OF THE DRIVE PIPE LENGTH ON EFFICIENCY

Variables: efficiency (η) water wasted (Q_w) water used (Q_u) water delivered (q), time of the experiment

Controlled Variables: length of the drive pipe

Constants: frequency (f), drive head (H), delivery head (h) volume of air in the accumulator

Range: 10' - 80'

PROCEDURE:

1. Install a hydram to a drive head.
2. Accurately measure the drive head.
3. Attach and set an adjustable pressure relief valve and a pressure gauge to the discharge.
4. Start the hydram.

5. Open the snifter in order to fill the accumulator with air and then close the snifter for the duration of the experiment.
6. Calculate the impulse valve frequency
7. Simultaneously measure the time of the experiment, water delivered (q) and water wasted (Q_w)
8. Calculate the efficiency (n).
9. Repeat the experiment making certain to keep the volume of air in the accumulator, drive head(H), delivery head (h) and frequency the same while changing the length of the drive pipe.

TASK: determine the effect of the drive pipe length on length on efficiency

Experiment #
h:H ratio
H
h
Q_w
q
Q
f
s
w
t
n
Notes

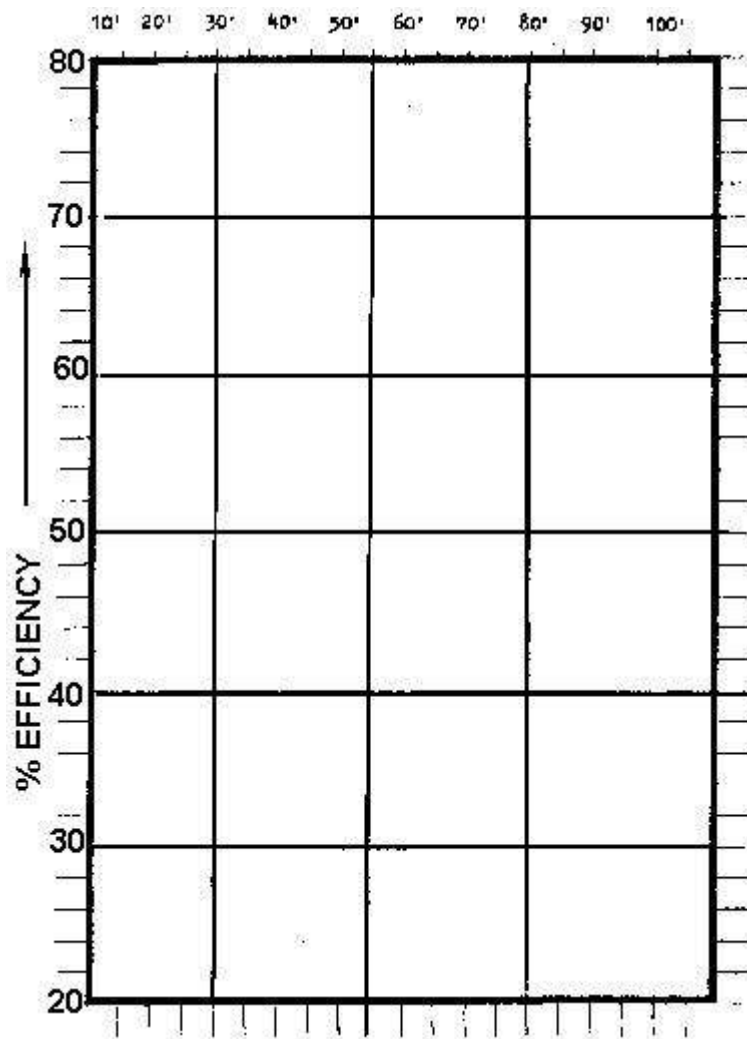

The effect of the drive pipe length of efficiency

Exercise 6: Drive pipe diameter on efficiency

TASK: DETERMINE THE EFFECT OF THE DRIVE PIPE DIAMETER ON EFFICIENCY.

Variables: water wasted (Q), water used (Q), water delivered (q), time of the experiment

Controlled Variables: drive pipe diameter (D)

Constants: drive head (H), delivery head (h), frequency (f), volume of air in the accumulator

Range: $\frac{1}{2}$, $\frac{3}{4}$, 1"

PROCEDURES:

- 1. Install hydram to a drive head.**
- 2. Accurately measure the drive head.**
- 3. Attach and set an adjustable pressure relief valve and a pressure gauge to the discharge.**
- 4. Start the hydram.**

5. Open the snifter in order to fill the accumulator with air and then close the snifter for the duration of the experiment.
6. Calculate the impulse valve frequency.
7. Simultaneously measure the time of the experiment, water delivered (q) and water wasted (Q_w)
8. Calculate the efficiency (n).
9. Repeat the experiment making certain to keep the volume of air in the accumulator, drive head, delivery head, length of drive pipe, and frequency the same while changing the diameter of the drive pipe.

TASK: Determine the effect of drive pipe diameter on efficiency

Experiment #
h:H ratio
H
h
Q_w
q
Q
f
s
w
t
n
Notes

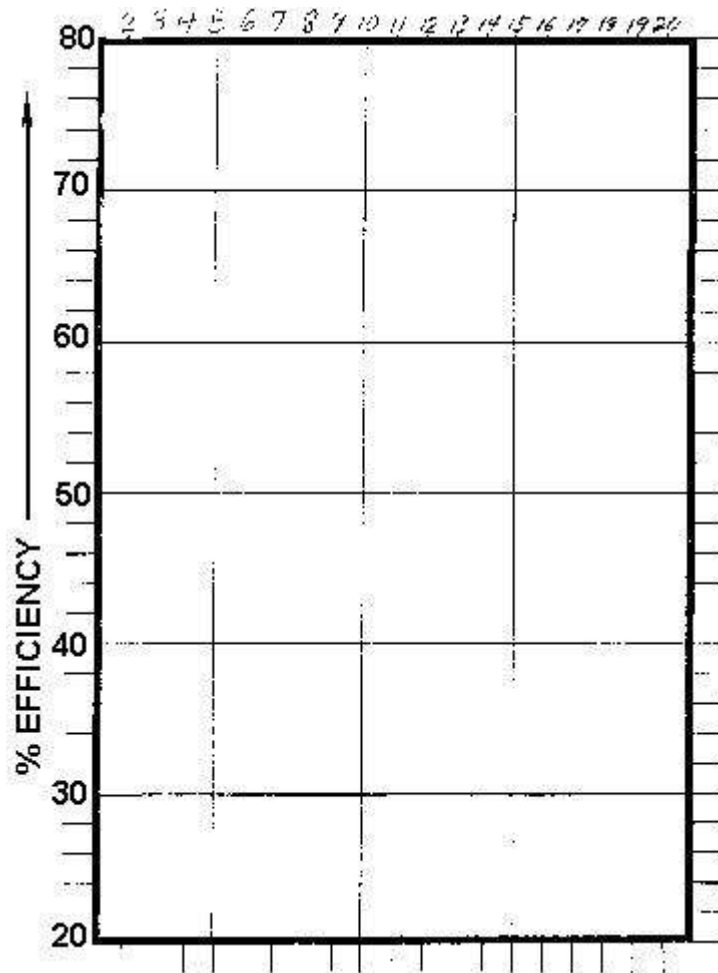

Effect of the drive pipe diameter on efficiency

Exercise 7: The snifter on efficiency

TASK: DETERMINE THE EFFECT OF THE SNIFTER ON EFFICIENCY

Variables: time of experiment, water wasted (Q_w) water used (Q), water delivered (q), efficiency

Controlled Variables: Snifter open, snifter closed, one way snifter

Constants: drive head (H), delivery head (h), volume of air in the accumulator

Range: sucking air and spitting water

PROCEDURES:

1. Install a hydram to a drive head.
2. Accurately measure the drive head.
3. Attach and set an adjustable pressure relief valve and a pressure gauge to the discharge.
4. Start the hydram.
5. Open the snifter in order to fill the accumulator with air.

6. Calculate the impulse valve frequency.

7. Simultaneously measure the time of the experiment, water delivered (q), and water wasted (Q_w)

8. Calculate the efficiency.

9. Repeat the experiment making certain to keep the volume of air in the accumulator, drive head (H), delivery head (h), and frequency the same while changing the snifter from an open snifter, a one way snifter to no snifter at all.

TASK: DETERMINE THE EFFECT SNIFTER HAS ON EFFICIENCY

Experiment #
h:H ratio
H
h
Q_w
q
Q
f
s
w
t
n
Notes

Exercise 8: Effect of the drive material on efficiency

TASK: DETERMINE THE EFFECT OF THE DRIVE MATERIAL ON EFFICIENCY

Variables: efficiency (n), water wasted (Q_w), water used (Q), water delivered (q), time of the experiment

Controlled Variables: volume of air in the accumulator, delivery head (H), frequency (f)

Constants: frequency (f), drive head (h), delivery head (h), volume of air in the accumulator

Range: 5:1, 10:1, 15:1, 20:1 for both steel and plastic pipes.

PROCEDURE:

1. Install a hydram to a drive head.
2. Accurately measure the drive head.
3. Attach and set an adjustable pressure relief valve and a pressure gauge to the discharge.
4. Start the hydram.
5. Open the snifter in order to fill the accumulator with air and then close the snifter for the duration of the experiment.
6. Calculate the impulse valve frequency.
7. Simultaneously measure the time of the experiment, water delivered (q) and water wasted (Q_w)
8. Calculate the efficiency (n).
9. Repeat the experiment making certain to keep the drive head frequency, volume of air in the accumulator, and drive pipe material the same until you have accurate efficiency calculations for h:H ratios of 5:1, 10:1, 15:1, 20:1.
10. Repeat the series of experiments after changing the drive pipe to a different material making certain that everything else stays the same.

TASK: Determine the effect of the drive pipe material on efficiency

Experiment #
h:H ratio
H
h
Qw
q
Q
f
s
w
t
n
Notes

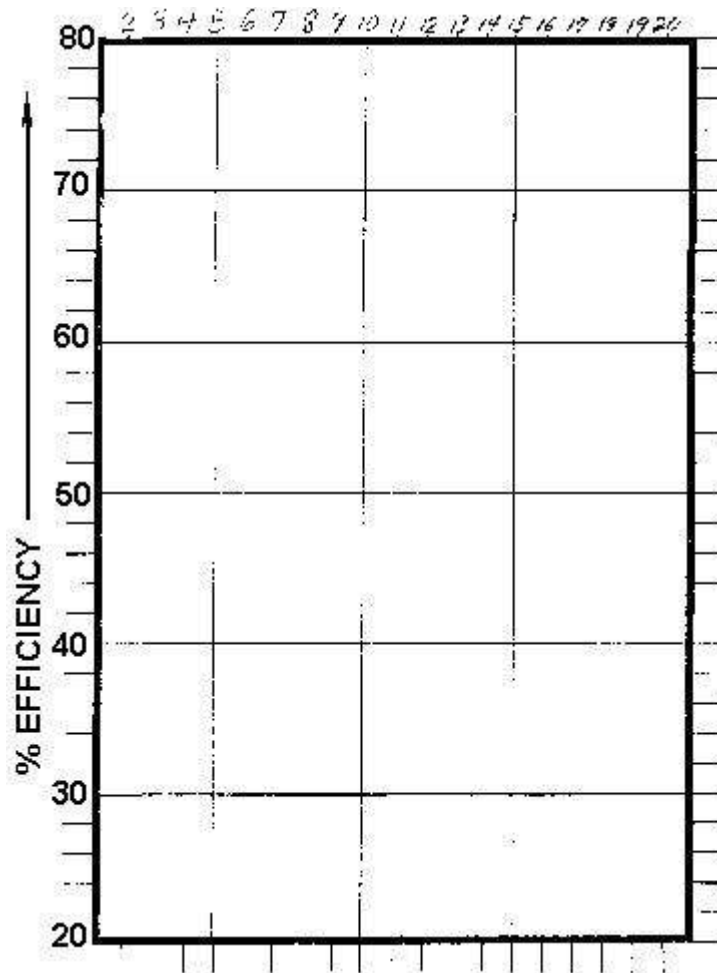

The effect of the drive pipe material on efficiency

Handout 13B: Typical hydram experiment set-up

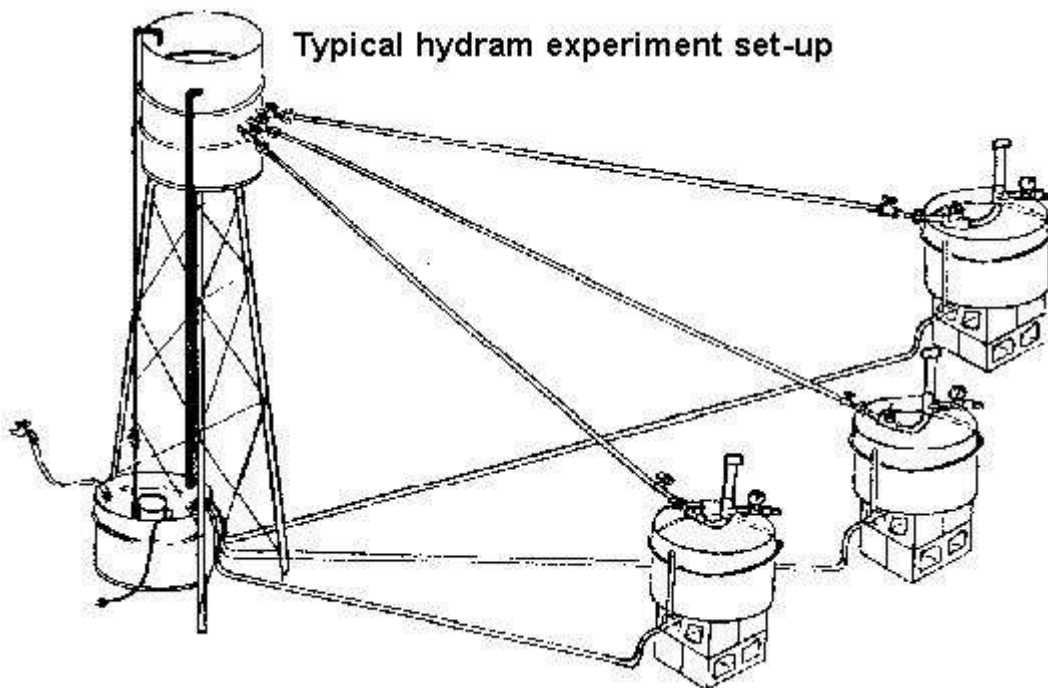

TYPICAL HYDRAM EXPERIMENT SET-UP

Handout 13C: Sample graphs

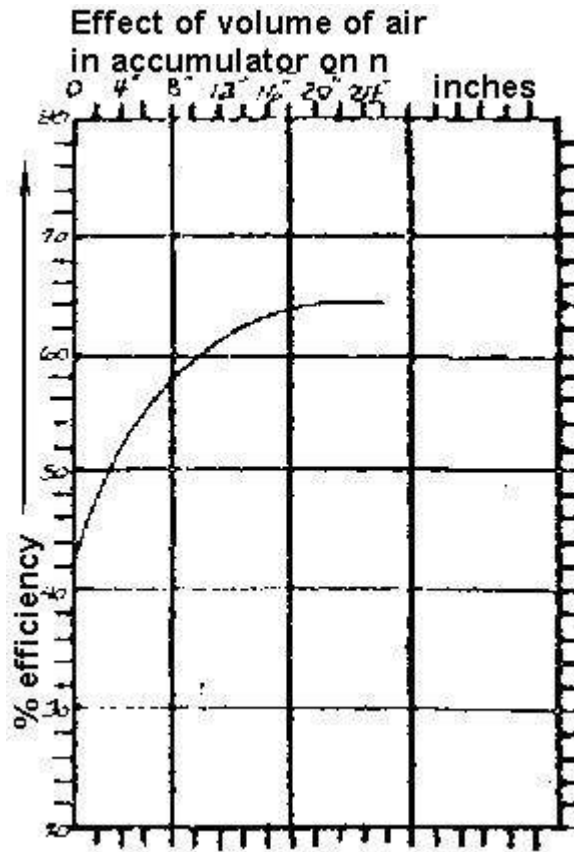

Effect of volume of air in accumulator on n

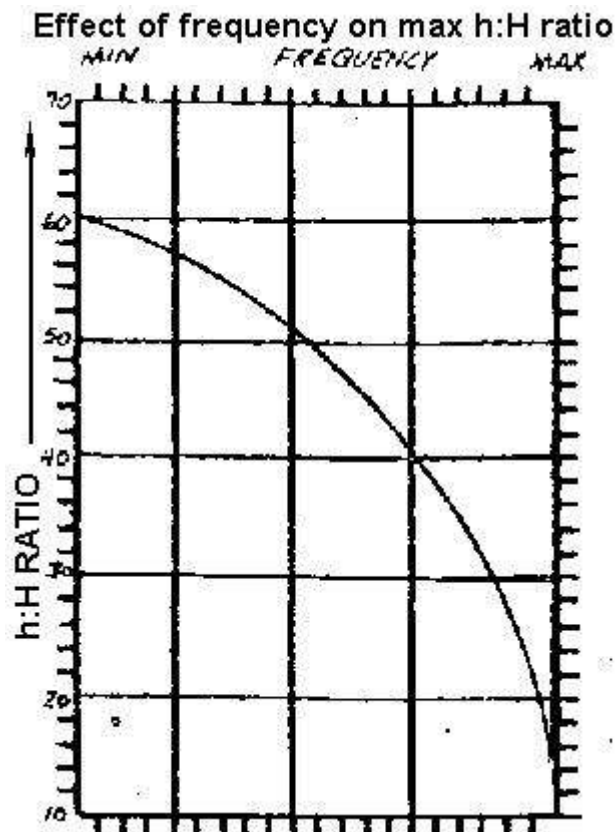

Effect of frequency on max h:H ratio

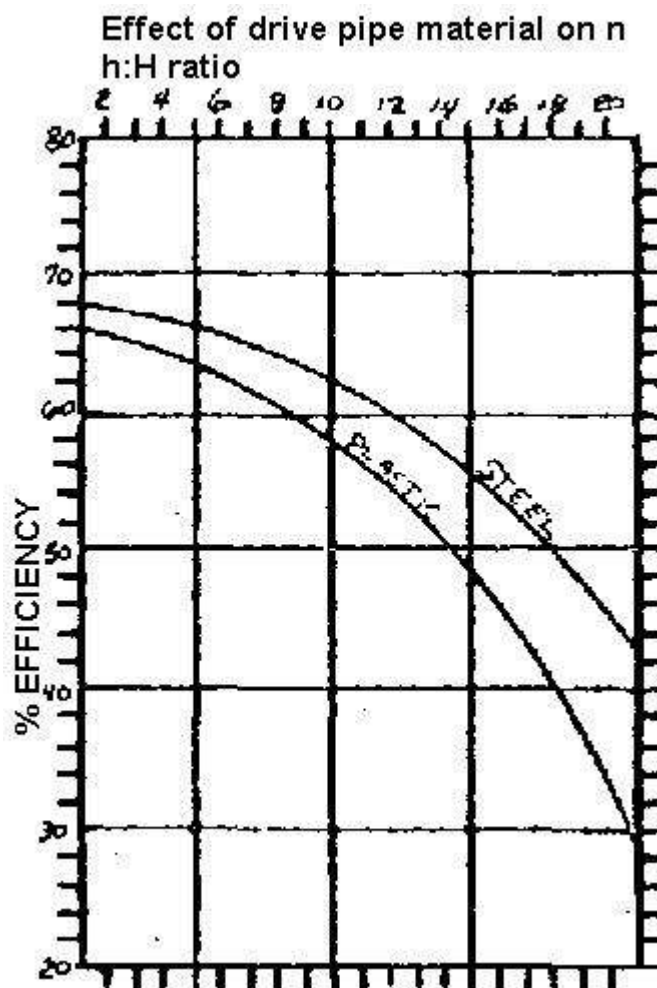

Effect of drive pipe material on n

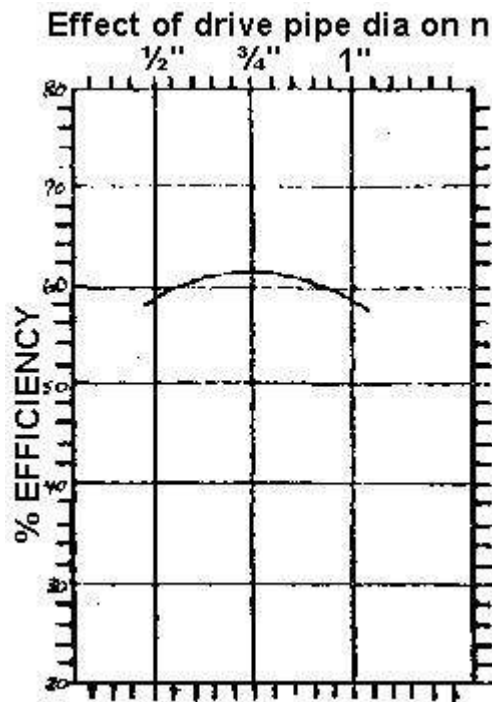

Effect of drive pipe DIA on n

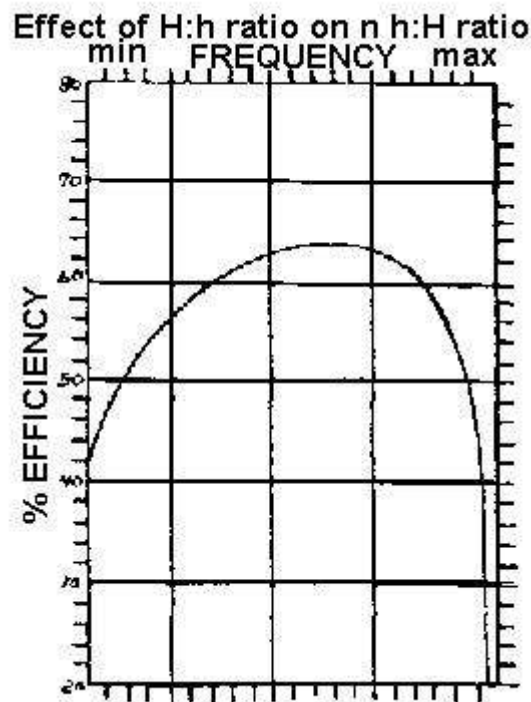

Effect of frequency on n, q, 8

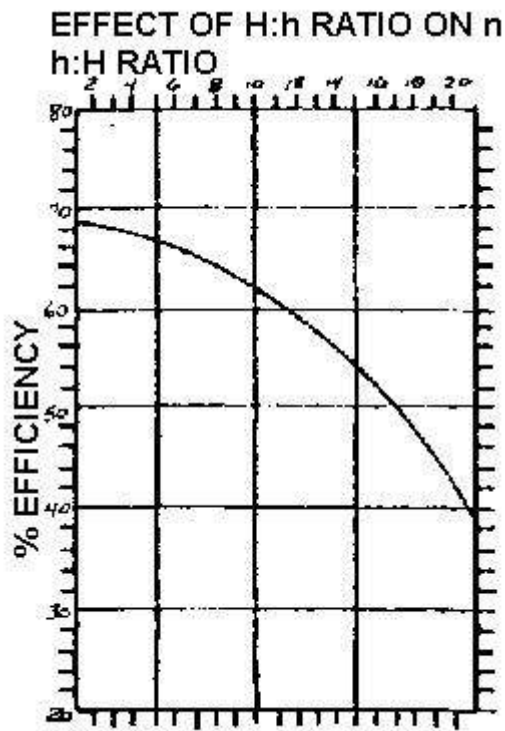

Effect of h:H on n

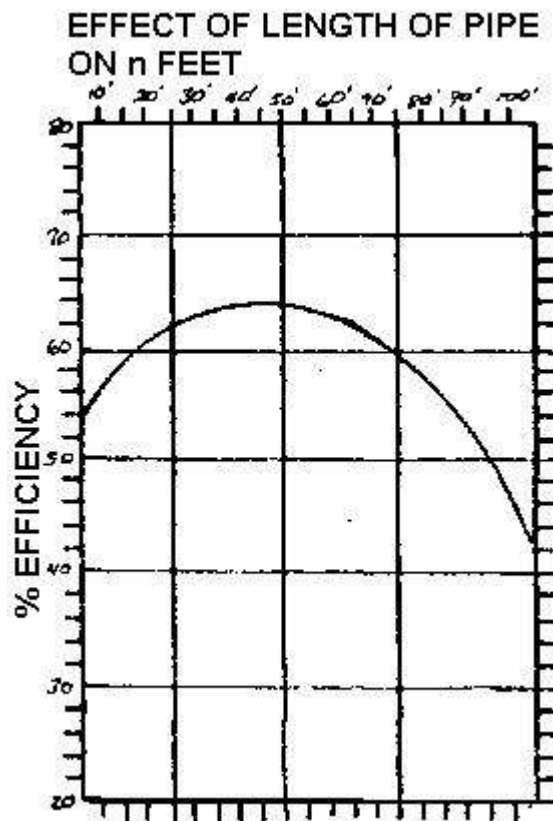

Effect of length of pipe on n feet

Session 14: Repair and maintenance (2-4 hours)

Time: 2-4 hours

OBJECTIVES: By the end of this session the trainees will be able to:

- predict malfunctions and problems in the operation of a hydram over time;
- accurately diagnose malfunctions and causes; and
- develop skills and experience in repair and maintenance of hydram systems.

OVERVIEW: Participants identify potential malfunctions, describe symptoms and prescribe cures; practice repairing; and develop strategy for long term preventive maintenance and routine service. The activity described below can be adapted for actual installations, if available.

MATERIALS: Handouts 14A (3 pp), 14B, 14C

TOOLS: All basic plumbing tools used to date in workshop

Spare parts

Enough hydrams for each experimental station

PROCEDURES	NOTES
1. State objectives of the session.	
2. Ask participants to generate a list of possible malfunctions and symptoms based on their construction experience, inter-relationship experiments, and what they've learned so far to date.	List should include all items on '4A, should add any that are not men
3. Divide participants into 3 groups, and assign each group approximate-ly 1/3 of the listed malfunctions. Distribute Handout 14B. Group Task: for each malfunction/ symptom listed, complete columns 2 and 3 of handout 14B, and write on flip chart for presentation.	Alternatively, groups work on symptoms, after groups finish po charts on wall with each syn Individuals complete. Large group re corrects, discusses. Trainers shou available if a group gets stuck. 1
4. Groups report out; check for accuracy and completeness of possible cures.	30 minutes.
5. Ask each group to select one malfunction, go to an experimental station, and simulate malfunction. Allow 20 minutes. Ask group to listen to the ram, write down the sound and record its deviation from a well functioning ram.	Trainers could also simulate to sav
6. Each group moves to another station and listens to ram, records description of sound, diagnoses problem, determines solution and repairs it.	
7. Each group will report on:	
- sound	

- diagnosis	
- success in repairing	
- implications for preventive maintenance.	
8. Repeat steps 5-7, this time groups to combine 2 malfunctions/ symptoms.	
9. Ask participants to complete worksheet, Handout 14B, columns 4 and 5.	
10. In a large group, discuss implications for long term preventive maintenance. Have the group brainstorm a list of preventive maintenance tasks, routine servicing tasks. Individuals complete worksheet, handout 14C for their site.	Trainers will circulate to ensure that all are complete, time frames are

Handout 14A: Repair and maintenance chart

Attachment 14-A

SYMPTOM	CAUSE	REASON	CURE
impulse valve stops in the closed position		worn, cracked, or dirty check valve	clean, repair, or recheck valve
		insufficient weight or stroke on impulse valve	increase impulse stroke or weight
		insufficient flow of water into the drive pipe	check for leaks or obstructions in the system. If all the available water is going to the hydram, re-adjust hydram for this flow
pulsating flow in the delivery pipe	lack of air in the accumulator	leak in the accumulator	repair leak
		snifter valve not open enough	open valve further
		clogged snifter valve	clean the snifter
reduction in water delivered and air bubbles in the delivery pipe	too much air entering the accumulator	snifter valve open too far	close down the snifter slightly
		leak in the hydram	repair the leak

		body between the impulse and check valves	
impulse valve stops in the open position	insufficient velocity around the impulse valve	lack of water entering the drive pipe	check for leaks or obstructions in the system IF all available water is going to the hydram readjust impulse valve to this flow rate.
		excessive impulse valve weight or stroke	Either shorten the stroke or lessen the weight.
hydram won't start	insufficient back pressure	check valve not seating properly	clean, repair or recheck valve
		snifter valve open too far	close snifter until hydram starts
		insufficient water in the delivery pipe	continue to cycle hydram manually until sufficient delivery head is developed
	poor impulse valve seating	worn, cracked, dirty or misaligned valve	clean, repair, replace or align impulse valve
	lack of water entering the drive pipe	supply insufficient for hydram	re-assess installation, possibly install snifter hydram and/or drive pipe
		leaks or obstructions in supply system	clean or repair the supply system
	improper impulse valve stroke or weight	not adjusted correctly	either change stroke or weight
hydram runs but does not pump anything	obstructed delivery line	closed delivery valve	open the valve
		frozen delivery line	apply sufficient heat to melt
		clogged delivery pipe.	clean out or back flush
	water hammer pressure pulse absorbed before the check valve	air accumulation under the check valve because of over- sniffing	cycle the hydram several times by hand allowing water to reach maximum velocity before allowing impulse valve to close
hydram runs but the amount of	leak in the delivery pipe	loose fitting or a hole in pipe	tighten all loose fittings and/or repair any

water being delivered is much less than should be expected			
	low hydram efficiency	worn, cracked, dirty, or misaligned check valve	clean, repair or re impulse valve
		worn, cracked, dirty or misaligned check valve	clean, repair or re check valve
		obstruction in drive pipe	clean drive pipe
		excessive check valve stroke	adjust or replace. o valve stroke limiter
	improperly installed hydram.	poor L:D ratio	change either the drive Diameter or length
		poor L:H ratio	change either the drive length or the drive
frequency very erratic	air in the drive pipe	hole in the hydram body or a loose fitting near the drive pipe connection to the hydram	patch all holes a tighten all loose fi

Handout 14 B: Repair and maintenance worksheet

SYMPTON	CAUSE	CURE	TOOLS/SKILLS NEEDED FOR REPAIR	PREVENTIVE MAINTENANCE REQUIRED	TOOLS/SKILLS NEEDED FOR PREVENTIVE MAINTENANCE

Handout 14 C: Maintenance/service worksheet

TASK	TIMEFRAME	WHO'S RESPONSIBLE	SKILLS/RESOURCES NEEDED

Session 15: Review exercise #2 (2 hours)

Time: 2 hours

Objectives: By the end of this session trainees will have demonstrated their ability to:

- determine maximum drive and delivery heads for a given ram;
- describe key interrelationships in a hydram;
- accurately describe at least 5 factors affecting efficiency in a hypothetical ram installation.

Overview: Work to date in the three areas described above has been primarily group work. This activity provides the opportunity to apply this information individually, and clarify any misunderstandings.

Materials: Handout 15A

TRAINERS NOTE:

Specifications for problem #1 need to be provided, using the charts from Sessions 9 and 10. Alternatively, participants can take actual measurements from the pipefitting rams they constructed, and solve the problem for those rams.

Procedures	Notes
<p>1. Explain purpose of-session, resolve any hanging questions from previous session.</p>	
<p>2. Distribute handout, instructing participants to solve problems individually.</p>	<p>Allow 30 minutes for this.</p>
<p>3. Participants to compare answers in groups of 24, coming to agreed upon solution(s).</p>	<p>30 min.</p>
<p>4. For each problem, ask for volunteers and provide group answers. Check with other groups for variation/difference. Discuss rationale for answers, and/or differences.</p>	<p>45-one hour</p>

Handout 15A: Review exercise

1. What are the maximum recommended H & h in a 2" hydram where the impulse backing plate is thick, the impulse seat area is , has impulse valve bolts " in diameter, has a check valve backing plate " thick, and a check valve seat width of "?

Answer the following with a graph if you wish:

2. How does the amount of air in the accumulator effect "n"?
3. How does the h:H ratio effect "n"?
4. How does the frequency effect "Q_w"?

5. How does the snifter effect "q"?

6. Tomorrow you are going out to an existing hydram site where there is only 100 gpd being delivered, there is a reliable supply of 3 gpm and an h:H ratio of 10:1. The ram works consistently but the efficiency is so low that only 1/2 the water needed is being pumped. Do you feel 200 gpd can be pumped if the hydram and/or installation is corrected to improve the efficiency to a reasonable level? If yes, what are you going to look for as a possible reason for low efficiency? (At this point you know nothing else about the hydram or the manner in which it is installed) list as many factors as you can think of.

Session 16: Use of multiple rams (1½ hours)

Time 1½ hours

Objective:	By the end of this session trainees will describe how multiple rams, in series or parallel can be used in situations where h:H ratio, L:D ratio, or D make single ram unpractical or impossible.
Overview:	In small groups, trainees will solve problems to determine that single ram is impossible, and describe and size multiple system for meeting water need. Large group will discuss advantages/disadvantages of these systems, including cost efficiency.
Materials:	Handouts 16A, 16B, 16C, 16D
	Problems 16A, 16B, 16C on flip chart
	Flip charts, markers

Procedures:	Notes
1. Introduce session by reviewing limitations of hydram in terms of:	10 min.
- maximum h:H	
- L: D ratios	
- cost of galvanized pipe in large sizes	
State objectives of session.	
2. Form 3 small groups and assign each group one problem form Handout 16D. Distribute the relevant diagram (16A, B, or C) to the appropriate group.	
The group task is to:	Allow 30 minutes for this.
- solve problem	
- determine why single ram will not work	
- study diagram and determine why the multiple ram arrangement will work	
- size the multiple ram system	
- plan 10 minute presentation to the large group	
3. Representatives from each group present and answer questions.	30 min.
4. Ask large group to describe any additional advantages/disadvantages of multiple ram systems, any other situation they might be used in.	10 min.
5. Ask participants what application series/parallel rams have at their sites.	

Handout 16A: Series hydram installation

Attachment 16-A

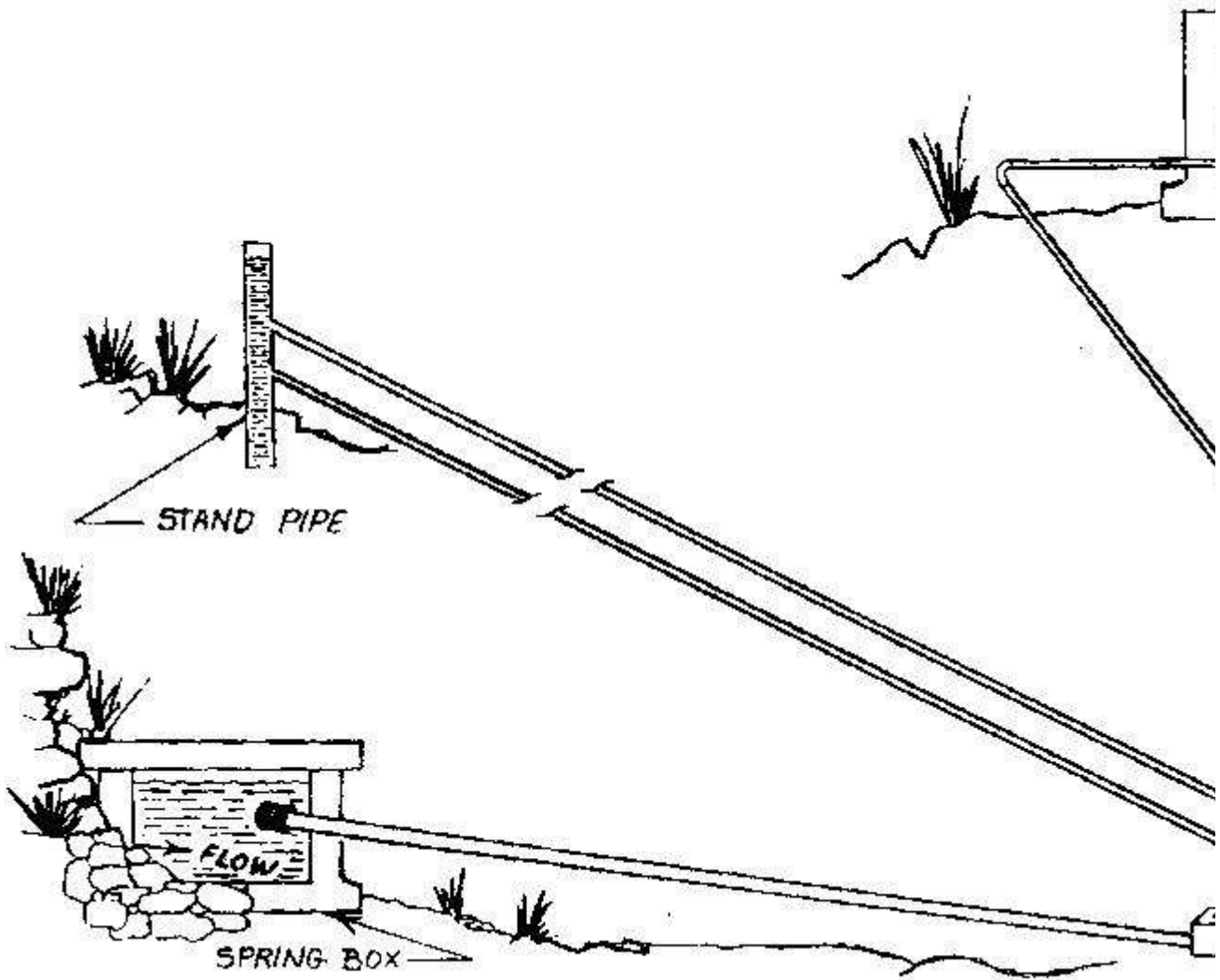

Site development

Handout 16B: Waste water series hydram installation

Attachment 16-B

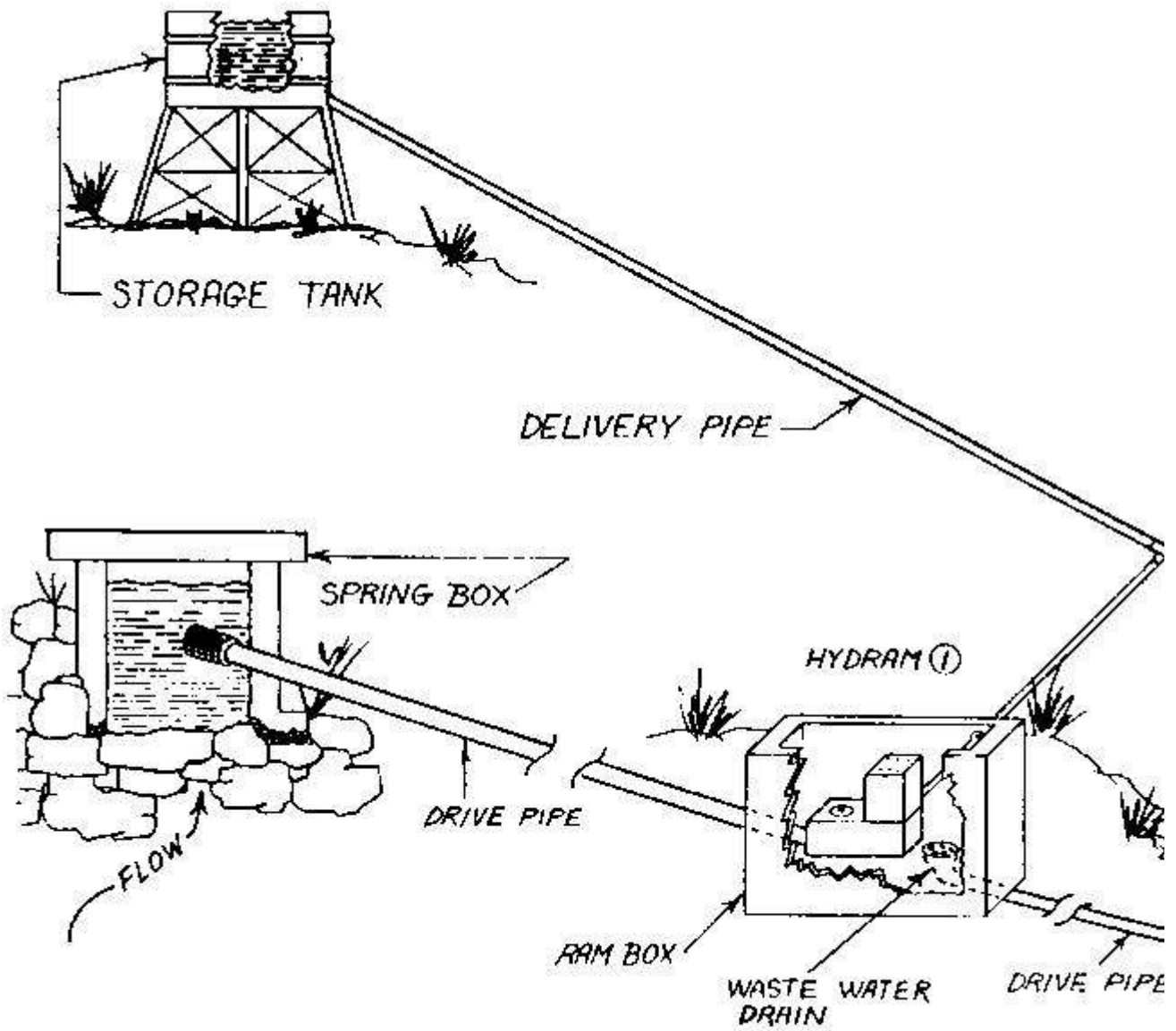

Waste water series hydam installation

Handout 16C: Parallel hydrams

Attachment 16-C

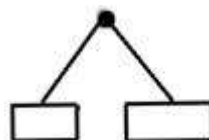

Site development

Handout 16D: Sample problems

Attachment 16D

Problem 16A:

How much water can be pumped to a delivery head of 200 feet, when there is a drive head of 2 feet, a supply of 50 gpm, and an assumed efficiency of 50%?

Problem 16B:

A community of 200 people, with 70 cows, needs 5 gpd per person and 15 gpd per cow. A spring flows at a rate of 15 gpm, $H = 10'$, $h = 100'$, $n = 50\%$, $L:D = 960$. How can the community's needs be met?

Problem 16C:

How much water can be delivered to a supply tank 50 feet above a hydram when the drive head is 5 feet, the hydrams efficiency is 50%, the flow rate of the water is 30 gpm, and the largest drive pipe available is 2"?

Session 17: Site development (2 hours)

Time: 2 Hours

Objective: At the end of this session, participants will be able to:

- describe various construction techniques for the major components of a hydram system, i.e., take off from the source, hydram box, storage facility and necessary piping, and
- develop cost estimates for total systems.

Overview: During this session, participants will describe present construction techniques at their sites and compare them. If participants have little/no experience in water development, simple techniques will be described. This session is not intended to provide construction skills for ram components.

Materials: Handouts Costs lists developed prior to workshop, especially PVC and galvanized pipe, concrete Approximate costs developed during construction of hydrams in workshop. Chalkboard, chalk or flipcharts and markers

Procedures:	NOTES
<p>1. Introduce the session with a brief statement that so far the workshop focus has primarily been the hydram itself and that we now want to look at a bigger picture, i.e., the system. State the objectives of the session and review Handout 2B.</p>	<p>10 min.</p>
<p>2. Take off from source. Ask participants to describe methods they're familiar with for taking water off a stream and/or catching springs. Generate a list of design issues and write these on board/flip chart. If participants are not familiar with systems, trainer should describe settling basin, spring catchment, and group should identify in-country resources for developing water sources.</p>	
<p>3. Ask participants how to protect hydram itself: keeping drive pipe rigid, free of bends, providing adequate drainage, avoiding damage by animals, vandals, or to curious people/children. Develop guidelines for construction of hydram box, per Handout.</p>	<p>10 min.</p>
<p>4. Storage Facility. Repeat Step 2 for storage facilities.</p>	<p>10 min.</p>
<p>5. Have participants size a ram for their application, and cost out the entire system, using the workshop estimates, their knowledge of skilled labor rates. If participants do not have a specific application in mind, develop a sample problem, using information generated in workshop to date, i.e.,</p>	<p>45 min.</p>
<p>cost of rams built</p>	
<p>maximum h:H for these rams</p>	
<p>approximate 1 and L</p>	
<p>provide hypothetical q</p>	
<p>Check computations to ensure that all components accounted for.</p>	
<p>6. Ask participants what, if any, additional issues are raised by these site development considerations in terms of costs to community, current systems that hydram could run off of, existing storage systems, costs for reticulation.</p>	
<p>7. Summarize by stating that all of these must be considered in overall hydram system. Distribute Handouts 17 C, D, and E.</p>	

Handout 17A: Settling area - take-off system

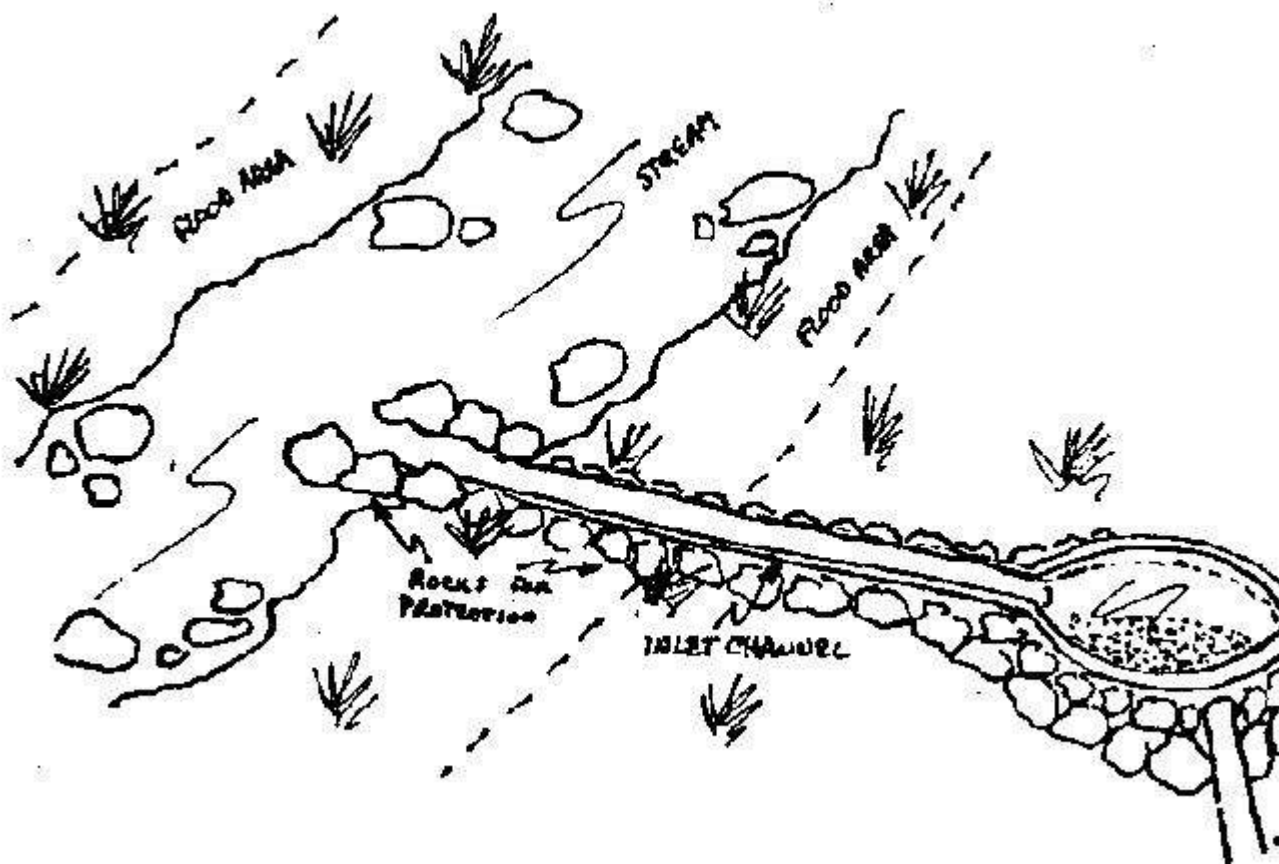
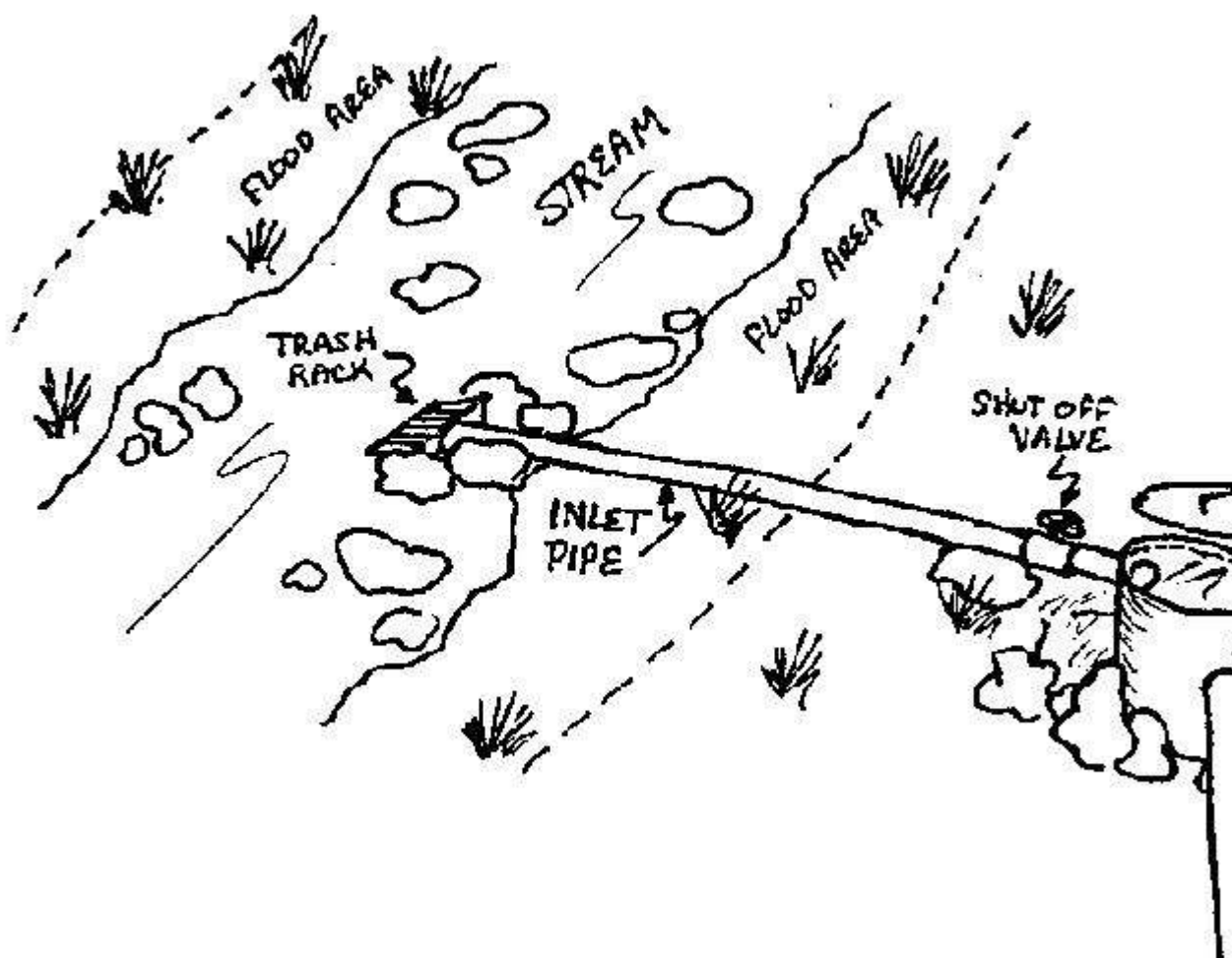

Settling area - take-off system

Handout 17B: Hydrum box

Attachment 17-B

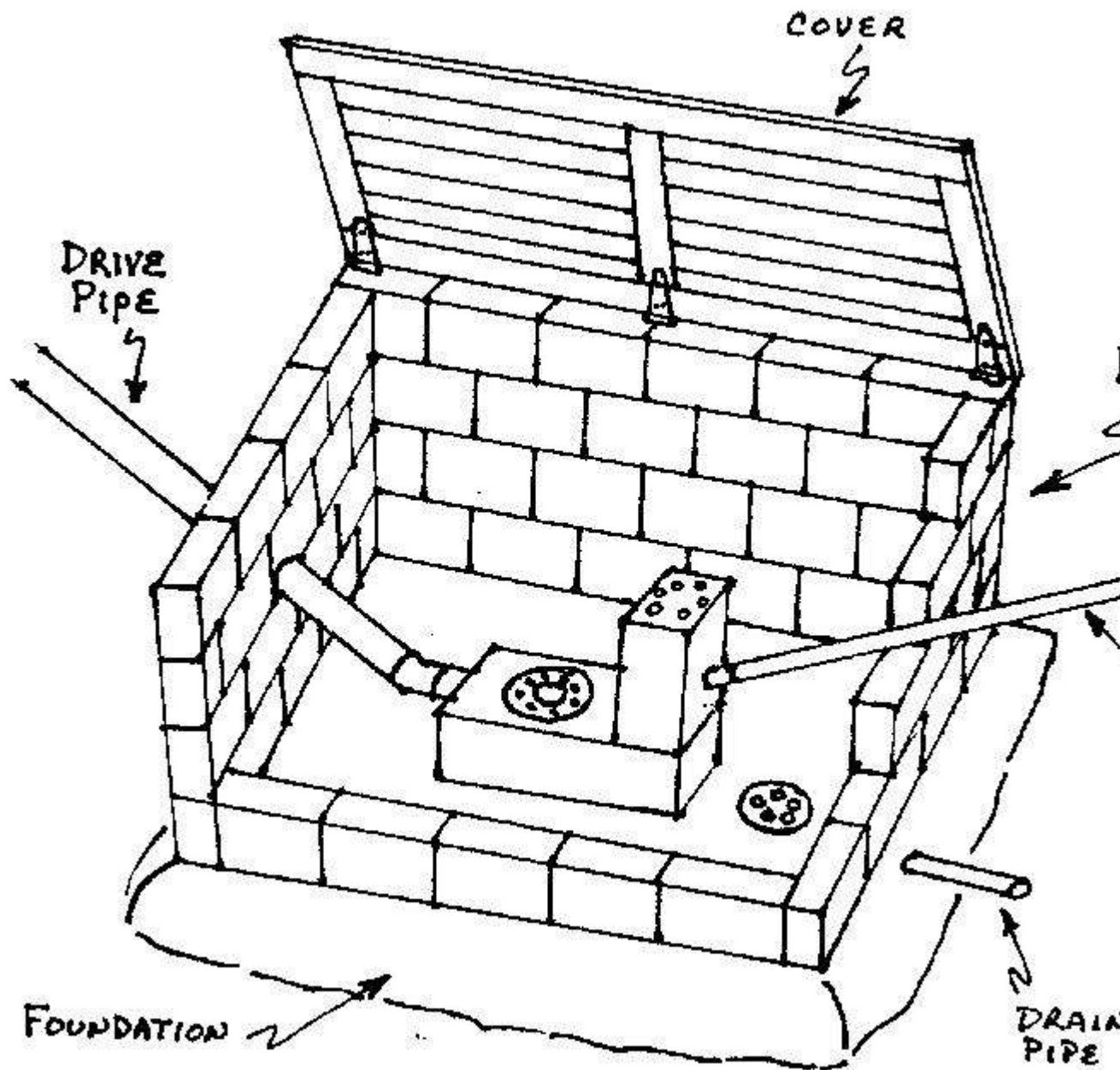

Hydrum box

Handout 17C: Guidelines/checklist

Take off from source:	
materials:	pipe or proper soil drum or tank plumbing parts (connectors, flanges, etc.) tra rack fine mesh screen
concerns:	negative slope from source to drum or pond pipe or channel well into stream go foundation for durm or pond means to shut off flow to basin when necessa keeping trash, debris, sediment out of line protection from: raging waters flo animals sun (ultra violet rays) erosion
Hydram:	
materials:	cement, aggregate, sand metal pipe and plumbing parts hydram metal or wood f cover to box hinges, screws, etc. stakes, wire
concerns:	support for pipes - drive, delivery pipe course straight as possible - no 90° ben anchoring of pipes drainage for waste water drive pipe entering settling basin] way up from bottom of basin protection box for hydram drainage for waste wat coverage for all plastic pipes clear marking of pipeline if buri
Storage Facility:	
materials:	adequate soil cement, aggregate, sand reinforcing bar paint pipe plumbing pa (connectors, faucet, standpipe) fencing material
concerns:	best match of size, materials and costs closeness to final usage durability of tanl strength, seal protection from animals safety for users, childr

Handout 17D: Site development

After the siting of the components for the hydram system has been completed, it becomes necessary to design the components in detail. This session will discuss how to develop them and will allow for a better estimation of the money, labor and time needed.

The components of the system that are of concern here are the takeoff from the source, the hydram, the storage facility, and all necessary piping. Variations for developing the components and factors that influence their design will be presented. The attachments to this session will give further guide lines and will give references for those topics that will not be covered in this manual/workshop.

TAKE-OFF FROM THE SOURCE

As was mentioned before, the water for a hydram system is not taken directly from the stream; a take-off component must be installed. Its purposes are to protect the system from the potential damage by floods, to keep sand and debris out of the system and to make maintenance of the system easier. The two basic parts to the takeoff area are a settling basin and a transmission channel from the stream to the basin.

The size of the basin has to be just large enough to insure an uninterrupted flow of water to the hydram while trapping sediment, sand, and debris. If the hydram system is small - that is, it uses a 2" drive pipe or smaller, a 55 gallon drum or small tank may be used. If the soil at this site has a good clay content, a small pond can be constructed to serve as the basin. A rough way to determine the size of the basin is to determine the volume of water contained in the drive pipe at any point in time and have the basin be large enough to allow 34 times that volume of water standing above the drive pipe,

e.g., if the drive pipe contains 10 gallons (area of the inside diameter of the drive pipe times its length), then a basin with 30-40 gallons above the drive pipe inlet will be sufficient. The inlet of the drive pipe should be positioned at least 1/3 of the way up from the bottom of the basin. A fine mesh screen must cover the inlet of the drive pipe (keeps frogs, etc. out).

The second part to the take-off is the channel or pipe that takes the water from the source and directs it to the basin. If a drum or tank is used as a basin, a pipe is more suitable as the inlet channel in that the pipe lends itself to an easier attachment to the drum/tank. If a pond is used, a dug channel can be used. The channel however, may need to be lined with clay to minimize seepage losses through the soil. The channel or pipe should be placed well into the stream to be able to pick up sufficient water during the dry season. The pipe needs to be anchored to the streambed for protection from being swept away by raging waters during the rainy season. A channel also will need to be protected. In both cases, large rocks placed on each side of the channel/pipe should be sufficient.

The channel will need more regular maintenance than a pipe to keep the sediment and weeds from blocking the passage. The pipe will need a trash rack in front of its stream opening to keep debris, fish, etc. out of it.

The channel/pipe will need to have a slight negative slope to it 1% or so to allow the water to naturally feed into the basin. Both the channel and the pipe should have some means of blocking the flow of water to the system when that becomes necessary. If a plastic pipe is used, it will have to be covered to protect it from the sun; the ultraviolet rays of the sun will eventually destroy the plastic.

One last note: if the stream under consideration has excellent year round flow rates, but not an adequate head to run the hydram, a small dam may need to be constructed. This is a costly undertaking in terms of money, time, skill and labor. This manual/workshop cannot provide the necessary information for working with a dam. You will need more information to help decide if further consideration of the project is worthwhile.

The Hydram

The hydram component consists of the drive pipe, the hydram itself, the delivery pipe and a protection box/foundation for the hydram. Details about development and construction of the hydram are covered in this manual.

The drive pipe needs to be made of metal to withstand the pressures and pounding that develops in running the system. It should be positioned in the settling basin about 1/3 the way up from the bottom. The pipe should be well supported along its length and protected from outside disturbances. If stakes can be driven into the ground, the pipe can be anchored to them; this will help minimize vibrations and keep it from being bumped off its supports. The pipe should transverse as straight a course as possible. In no case should sharp bends (90°) be used; 45° bends or less should be used. If they are used, support must be provided at each bend to keep the side-way thrusts that will develop inside the pipe at that point from destroying the line.

The delivery pipe can be made of plastic. The same care in supporting, anchoring and protecting the drive pipe should be applied also to the delivery pipe. The course of the pipe should be as straight as possible, avoiding all sharp bends. An additional concern with plastic pipe is protection from the ultraviolet rays of the sun. The pipe needs to be covered. One way to do this is to bury it. However, if this is done, the channel should not be covered up until the system is working and the pipe checked for leaks.

The delivery pipe, because of its length, may raise additional concerns. It must be adequately protected any place it has to cross a trail or road, or in other ways is subject to possibly being run over by a cart or vehicle. If it crosses cultivated land, its course must be adequately marked so that it

is not accidentally damaged during cultivation operations.

The hydram itself must be well supported and protected from accidental disturbances. In addition the waste water needs to be directed away from the support foundation. The best way to provide this protection is to build a concrete foundation with drain outlet and a concrete or cement block box around it. The box should be large enough to allow enough room for a workman (or two) to comfortably move around the hydram. If a concrete hydram is used, the accumulator and/or the body may weigh a couple of hundred pounds. If it has to be removed for some reason, there must be enough room in the box to allow workers to get in there and lift it out.

The final part to the box should be some type of cover that can be locked; this offers protection from vandals or people tampering with the hydram out of curiosity. A final note on the construction of the box: the foundation should be poured and the hydram installed. After the hydram is working like it should, the walls to the box should be constructed and the cover installed.

The Storage Facility

The construction design of this component of the system is dictated by its size, the available materials, and physical characteristics of the site. A few examples may highlight some design considerations for the storage facility:

Let's say your calculations for the system indicate that 1000 gallons of water a day needs to be delivered. To store this amount of water, the facility will need to be about 12 feet on a side and 12 foot high. (1 cubic foot of water equals 7.48 gallons) If you want to have a 3-day supply of water (1 day's use and 2 days in reserve) the facility will need to be at least 12' x 12' x 3'. It may be economically reasonable to construct this out of concrete and block.

Now let's say the system will be used for irrigation and will need to store 100,000 gals and use it every 8 days. The size of this facility will need to be approximately 40 feet on a side and 3 feet high. To construct this structure out of concrete may be too costly; a pond would have to be constructed. (Incidentally, a system needing 2100,000 gallons every 8 days will need to pump about 10 gals a minute, all day, every day. $100,000/8 \text{ days}/24 \text{ hours}/60 \text{ minutes}$.)

This manual/workshop can not go into all the details and procedures necessary to construct these storage facilities. However, some reference materials are listed in the attachments that can assist in this work. In addition, assistance can be obtained from the agriculture department and technical donor groups/agencies.

Irrespective of the design of the facility, there are basic concerns for the protection of the system and for safety to the individuals using it. A pond almost assuredly will have to have a fence around it to keep animals and little children out of it. The walls of a tank will have to be reinforced with metal bars and the inside of the tank plastered with cement and painted to prevent leaks.

Cost and Labor Considerations

The labor for and the costs of this system can be quite a burden for the rural farmer or village; this is why the siting and the design of the system are so important. When both are done with care and skill, the costs for a completed system will be as low as possible. It should be obvious that with ample free/cheap labor and proper soil available the system can be kept within reasonable limits. It should also be obvious that the amount of labor needed and the length of time to do it all can be extensive.

It may be useful to take an example and see what a system might cost. Prices for everything are different everywhere, but for the sake of this example, let's say:

- Cement costs \$7/bag - 1 bag can make 20 blocks 16" x 8" x 8"; can plaster 50 sq. ft. of surface can bond 35 blocks together; can produce 6 cu. ft. of concrete
- Reinforcing bars for the total system costs \$75
- Metal pipe costs \$8/foot
- Additional plumbing parts \$75.
- hydram can be built for \$100
- Plastic pipe costs \$4/foot
- 55 gal drum costs \$10
- welding work on drum costs \$15 e Pipe lengths are: inlet line to drum 20' Drive pipe 40', delivery pipe 200', supply pipe 300' e Hydrum box needs to be 6' x 5' and 4 courses high foundation ½ foot thick
- Storage facility needs to be 15' x 15' x 4' foundation - 1 foot thick
- Paint \$50
- standpipe and faucet at final use point \$100
- Transportation costs \$200
- no labor costs

What will this system cost? (round off fractions to next highest whole number.)

If the storage facility will be a pond with no material costs, what will the system cost? (Transportation costs are cut in half; no reinforcing bar is needed.)

If, in addition, the supply line isn't needed, what will the system cost?

Handout 17E: Glossary of terms

Battery of hydrums - (or parallel hydrums) a hydram installation where two or more hydrums are connected to the same source with different drive pipes, but usually with the same delivery pipe. This type of installation is used where the size of the hydram is limited.

Holding tank - (storage tank) the means of storing water once it has been pumped to the desired head.

Ram box - the small structure usually made out of concrete and/or wood which houses a hydram, protecting it from freezing, weathering, and possibly from vandalizing.

Series hydram - a hydram installation where two or more hydrums are used in series to pump water higher than one hydram could alone.

Spring box overflow pipe - a pipe placed in the wall of a spring box near the top for unused water to exit through.

Waste water drain - the drain in the bottom of a ram box which allows the waste water from the

hydram to drain out.

Waste water series hydrams - a hydram installation where one hydram uses the waste water from another as a source to pump a higher percentage of the water.

Session 18: Hydram system site selection (2-4 hours)

Time: 2-4 Hours

Objective: At the end of this session trainees will have selected a site for a hydram system from a range of possibilities, based on the technical, social and economic factors involved in the decision.

Overview: This session pulls together several issues that have been identified over the course of the workshop: technical feasibility, water need, access, skills, cost, community responsibility, maintenance and repair.

There are two possible activities described here:

- 1) a hypothetical exercise, with a hillside full of springs as possibilities
- 2) a field activity in a pre-selected location which presents several options for siting the system.

Note: Activity 2 is optimal and requires site identification by the trainer, concurrence for using the area (from local residents, officials, etc.). It takes much more time and makes a richer activity.

Materials:

- For hypothetical activity, Handout 18A
- For actual field activity: site levels, tapes, weirs or estimated flow rates for source

Procedures	Notes
1. State objectives of session and overview of activities.	
2. Ask what are the major components of a hydram system that needs siting, and what are the major factors that influence the selection of a site.	Especially if field activity is used. Note any concerns raised during this discussion.
3. Ask what information should be known about the project before site selection can be made. List on flip chart.	15 min. Head needed for system, flood boundaries of stream, ownership of land, cost of pipe of different materials and in different sizes.

<p>4. Ask what factors and components should be looked at, in what order.</p>	<p>1. hydrum & head should be first the flood consideration</p> <p>2. Take off point and distance D1 t hydrum; flood considerations</p> <p>3. Social factors for hydrum and take of system</p> <p>4. Storage facility and distance</p> <p>5. above with social factors</p> <p>6. Cost of above system</p> <p>7. Distance, d3 and costs</p> <p>8. Maintenance responsibilities, access</p>
<p>5. Present actual or simulated situation and instruct participants that they will have to select a site.</p>	<p>30 min.</p>
<p>Actual:</p>	
<ul style="list-style-type: none"> • Divide into groups of 4-5 Ask groups to spend 30 minutes organizing their tasks, responsibilities for gathering data at the site, and decision making process. 	
<ul style="list-style-type: none"> • go to site, gather data, make decision and prepare presentation/recommendation including rationale, need, cost. 	<p>1½ - 2 hours. Trainers should monitor time.</p>
<ul style="list-style-type: none"> • Each group presents, and large group critiques based on factors listed above. 	
<p>Simulated</p>	
<ul style="list-style-type: none"> • Individually, using handout 18A, and given spring flow rates, distances, select site for locating hydrum, to deliver 1500 gpd. Solve for single ram first then consider series installation. 	<p>In this situation. its difficult to consider all social factors 30 min.</p>
<ul style="list-style-type: none"> • Develop approximate costs. 	<p>20 min.</p>
<ul style="list-style-type: none"> • Ask for responses; differences. Ask 1-2 participants with different answers to share rationale 	<p>20 min.</p>
<p>6. Ask participants which issues are of major concern at their sites.</p>	

Handout 18A: Hydrum system site selection

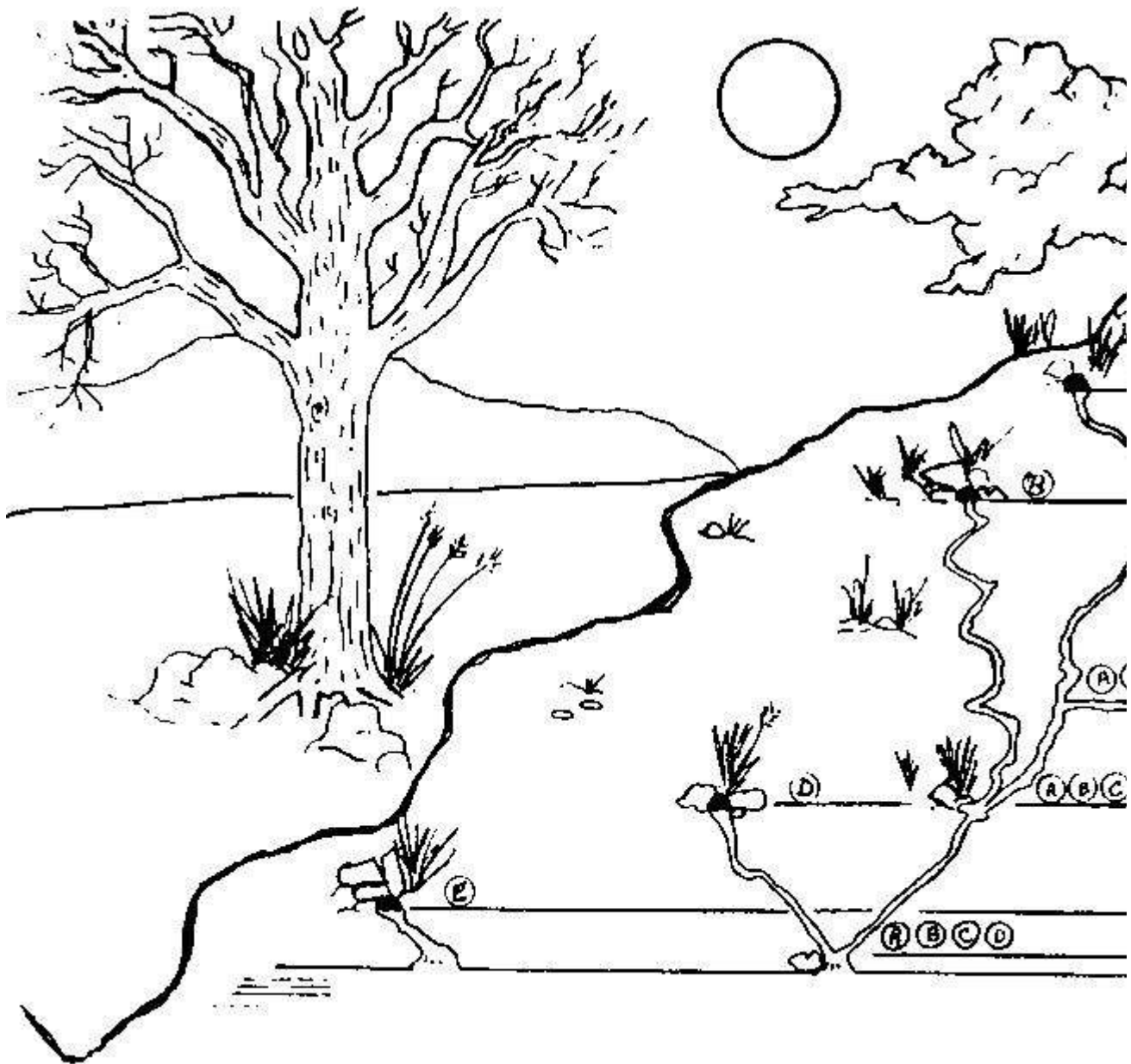

Hydam system site selection

There are three main components to a hydam system that require site selection: 1) the take off from the stream, 2) the hydam itself, and 3) the storage facility.

The Take Off System: The water for a hydam is never taken directly from the stream. Sand and debris would enter the drive pipe and destroy the hydam. Therefore a settling area for the water must be included in the system. The characteristics to look for are a relatively flat area near the stream but out of the way of the rainy season's floods.

The Hydam: The first important factor here is to choose a site that will give sufficient head to run the pump. Basically, the higher the head, the greater the amount of water that can be pumped. As a general rule of thumb, the site should give at least 3m (10 ft) of head. Systems can be run with a smaller head, but the flow rate needs to be that much larger. If there are a number of places along the stream where sufficient head can be generated, then the spot where the distance from the water source to the hydam is the shortest will be the best. The drive pipe (from source to hydam) must be made of metal to withstand the pressure and pounding of the system. Metal pipe is usually more expensive than plastic pipe (which can be used for the delivery line). So even though the delivery line may be longer than at other potential sites, the costs for the total system may be less.

The hydram can be situated in any safe/stable area that will give the proper head and distance mix. An added consideration is convenient access to this site to do repairs and maintenance. It is advisable to build a box to enclose the hydram - to protect it from animals and vandals and to minimize erosion to the hydram's foundation. This usually means that cement needs to be carried and mixed nearby, and this may influence your selection of the site. One last concern is that the waste water from the hydram will need to find its way back to the stream. If in doing so, it transverses cultivated land and that could cause a problem, then this factor must be considered in the selection of the site.

The Storage Facility: The third major component of the system is the site to which the pump will deliver. The delivery point/storage facility should be at some convenient location that allows the water to gravity flow to where it is needed. The major determinants of the site for the storage facility are the delivery head the system can accommodate and the length of the delivery line. The delivery head must be within the range of the systems' capabilities, and the length of the delivery pipe must be within reasonable cost constraints. The distance from the storage facility to the point of use (see handout 18B, d3), should be kept to a minimum. But this distance, d3, is secondary to the needs of the hydram system.

The factors that influence the siting of these components are:

- 1) flood considerations,
- 2) available head,
- 3) distances/pipe length between components,
- 4) cost factors,
- 5) convenience of location,
- 6) social factors.

1) **Flood Considerations:** The seasonal variations of the stream must be taken into consideration - this is particularly true of flood conditions. Each component of the system must be placed outside the potential flood area.

2) The available head and that necessary for the system is the key factor in siting the system. There are three heads involved here: the drive head, the delivery head, and the supply head. The most important of these is the drive head, H . This ~ basically determines what the capabilities of the system are. The delivery head, h , is next in importance; it is however limited by the constraints placed on the system by the size of the drive head. The least important of the heads is the supply line head, h . Basically this head just needs to have a negative slope - that is, sufficient drop to let the water run down hill.

3) Distances or pipe lengths are the next major consideration in selecting a site for the system, Pipes are usually the most costly items of the system. There are three distances that must be taken into account: the length of the drive line, the length of the delivery line, and the length of the supply line. The most crucial of these is the drive line because this piping is usually the most expensive per foot and because the size of the pipe is influenced by the distance it must transverse. As a rule - the shorter the drive pipe line the better (considering that it delivers the necessary head). The length of the delivery line is next in order of importance. It is constrained by the capacity of the system and by costs. However plastic pipe can be used here. The supply line is constrained by cost factors only. It can be run as far as the terrain and the budget allows.

4) The cost of a system may be the final determinant as to whether or not it is implemented. Pipes and plumbing components are the main expense, with cement and possibly labor second. The hydam itself is a lowly third. If care is taken in the siting and the design of the system, the costs can be kept to their minimum.

5) Convenience of location of the hydam and the storage facility is another siting factor. Basically the components of the system should be sited in a location that allows for ease of construction, repairs and maintenance.

6) Lastly, the "best" site for the system may not be the one that the villagers want - it may be on the wrong persons land, or whatever. Remember that they are responsible for maintaining the system, and their concerns must be honored.

Presented below is a handy table to keep the components of the system and the siting factors in mind as the survey work is being done.

	COMPONENTS		
SITING FACTORS	TAKE OFF	HYDRAM	STORAGE FACILITY
FLOOD CONSIDERATIONS			
HEAD			
DISTANCES			
COSTS			
CONVENIENCE			
SOCIAL FACTORS			

Handout 18B: Diagram system for site selection

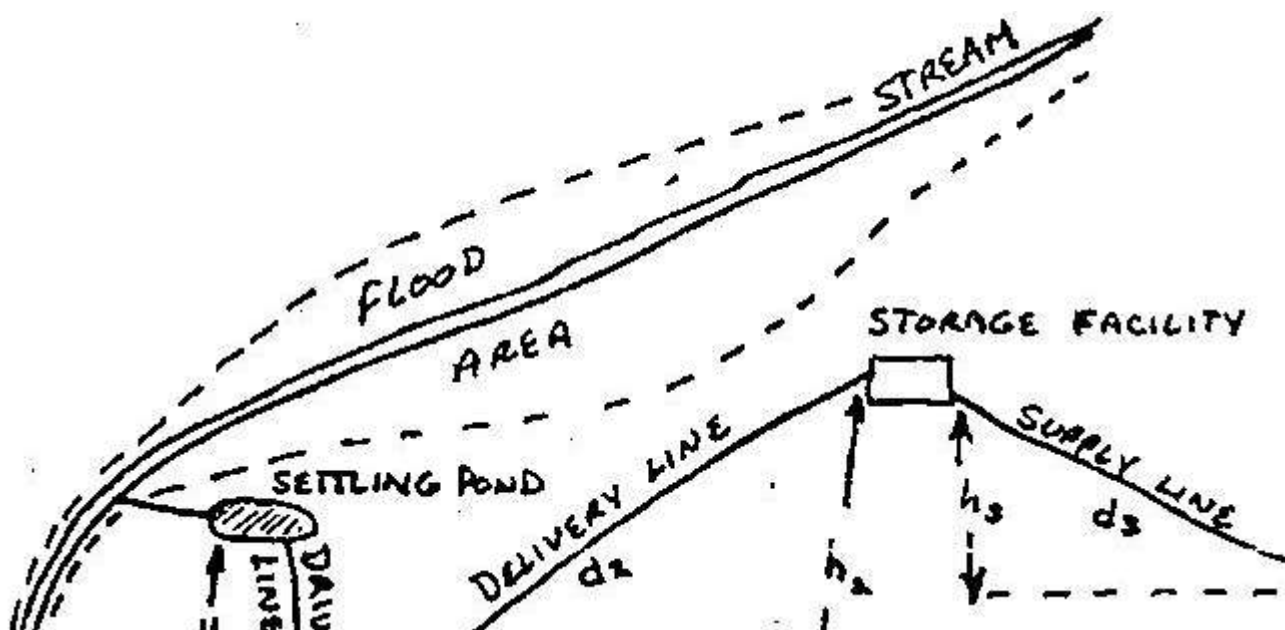

Diagram of hydram system for site selection

Session 19: Project planning (2-4 hours)

Time: 2 Hours

OBJECTIVES: By the end of this session, participants will have completed a plan for a hydram project at their site. The plan will include problem definition, an articulation of why a hydram is the most appropriate solution, goals, activities, resources, responsibilities, monitoring and evaluation.

OVERVIEW: The key issues in hydram project implementation, and therefore planning, have been raised throughout the workshop. During this session, participants pull it all together, to begin applying what they've learned to their sites. It may even be the case that what they've learned is that hydrams will not work at their sites.

TRAINERS NOTE:

Remind participants to bring along

Site Information Worksheet, Cost Calculations,

Repair and Maintenance Worksheets, and

Site Selection worksheets.

MATERIALS: Flipchart/markers

PROCEDURES	NOTES
1. Introduce session by stating goals and rationale.	
2. Ask participants to spend an hour, individually, developing a plan Information that includes the following:	Remind group that much of this is in Site Worksheet used in Session 2.
A. Statement of water problem at the site:	
-who needs water, why, how much	
- who perceives the problem	
- what is current situation	
B. Evaluate current situation:	
- where is there water?	
- how much? what quality? accessibility? ownership?	
- current and future needs?	
- community structure, social, political, skills	
C. What are the possible solutions?	It's important that participants are clear about hydrams being one solution, and that they evaluate it against all criteria.
- hydram	
- others... diesel pumps, gravity pump etc.	

<p>D. Evaluation of solutions for:</p>	<p>Link this to criteria that have been developed in other sessions in the workshop.</p>
<p>- cost</p>	
<p>- longevity</p>	
<p>- feasibility</p>	
<p>- material needs</p>	
<p>- availability of skills</p>	
<p>- local technical support for repair and maintenance</p>	
<p>- time to install</p>	
<p>- social responsibility</p>	
<p>- reliability</p>	
<p>- results</p>	
<p>- community involvement</p>	
<p>E. For the selected strategy: Develop a schedule of tasks, activities, responsibilities, materials, resource requirements and time frames.</p>	<p>The tasks and activities should include any further data to be collected; other groups to be included in planning and implementation.</p>
<p>F. Develop a plan for monitoring progress.</p>	
<p>3. Ask participants to share their plan with at least one person, for critique, additions.</p>	<p>If participants are from the same agency it might be appropriate to share plans with each other</p>
<p>Alternatively ask someone to volunteer to present plan to the whole group.</p>	
<p>4. Ask participants if they feel comfortable about the next steps they need to take to implement their learning. If not, it's likely that plan needs revising. Ask if specific parts of the plan require rethinking.</p>	

Session 20: Wrap up and evaluation (2-4 hours)

Time: 2-4 Hours

OBJECTIVES:

evaluate workshop activities

· provide closure to workshop

OVERVIEW: This session will vary with the actual situation. At a minimum, evaluation forms should be completed, and workshop sponsors should have the opportunity to "close the workshop" with a restatement of their intent the development and use of this technology and the skills of the participants.

TRAINER PREPARATION: The disposition of constructed rams is an issue that has probably come up by now. This is a good time to give them away, or announce the decisions. Suggestion: ask interested parties to submit proposals for the rams.

Determine whether or not certificates will be given, and make sure they're printed and ready.

Develop an evaluation form. A sample is attached.

MATERIALS: Depending on above decisions.

Evaluation form, pens, pencils,

Participant roster if one has not yet been distributed.

PROCEDURES	NOTES
<p>1. State the purpose of the activity. Ask participants if they have any loose ends that need to be tied up. If so, list these on a flipchart developing an agenda of sorts.</p>	
<p>2. Distribute evaluation forms. Allow about 20-30 minutes to complete.</p>	
<p>3. Ask workshop sponsor to close, perhaps with certificates, it appropriate.</p>	

Glossary of terms

Accumulator - (air dome) the air chamber on the hydam which cushions the water hammer, eliminating delivery pulsations and helps provide rebound.

Atmospheric pressure - the pressure at sea level caused by the weight of air; atmospheric pressure = 14.7 and 0 psig.

Battery of Hydrams - (or parallel hydrams) a hydam installation where two or more hydrams are connected to the same source with different drive pipes, but usually with the same delivery pipe. This type of installation is used where the size of the hydam is limited.

Check Valve - (non-return valve, secondary valve, internal valve) the internal valve in the hydam that prevents the delivery head pressure from forcing water back through the hydam body.

Delivery head - the vertical distance between the hydam and the highest level of water in the storage tank that the hydam is pumping to.

Delivery pipe - the pipe which connects the output of the hydam to the storage tank.

Drive head - the vertical distance between the hydram and the highest level of water in the supply system.

Drive pipe - a rigid pipe usually made of galvanized steel that connects the hydram to the source reservoir or stand pipe.

Efficiency - (n) the ratio of the energy input to the energy output; a measure of how well a hydram functions;

$$n = \frac{qh}{QH}$$

Force - to move something against resistance, pressure times the area measured in pounds, newtons or dynes.

Frequency - (f) the number of times a hydram cycles in one minute. **h:H ratio** - (delivery to drive head ratio) the ratio of lift to fall. The inverse of this ratio times the efficiency of the hydram will determine the percentage of water the hydram will pump. The higher the h:H ratio, the lower the hydram efficiency (n). The usual range of the h:H ratio is from 2:1 to 20:1 but h:H ratios have been measured up to 60:1.

Holding tank - (storage tank) the means of storing water once it has been pumped to the desired head.

Hydram - (hydraulic ram, hydraulic ram pump, automatic hydraulic ram pump, ram) an ingenious device that uses the force of water falling through a drive pipe to pump water to a height greater than its source, making use of hydraulic principles and requiring no fuel.

Hydram capacity - the maximum amount of water a hydram can use. This is determined by the drive pipe size and length, the drive head, and the impulse valve size and design.

Impulse Valve - (clack valve, out-side valve, impetus valve, waste valve) the valve on the hydram that creates and controls the water hammer.

Impulse valve stroke - the distance the impulse valve travels during a cycle.

Impulse valve weight - the total weight or downward force of the impulse valve and its springs or weights.

Kenetic energy - active energy, $\frac{1}{2}$ the mass times the velocity squared

$$E_K = \frac{1}{2} mv^2$$

L:D ratio - drive pipe length to diameter ratio, should be kept between 150-1000.

L:H ratio - drive pipe length to head ratio, when it is less than 15 ft. L:H should equal 6.

When H is greater than 15 ft. but less than 25 should = 4

When H is greater than 20 ft. but less than 25 should = 3

When H is greater than 50 L:H ratio should equal 2. (see Glossary, Session 6 for metric

equivalents)

Potential energy - energy derived from position or height; is equal to the height that a mass can fall times its weight.

Pressure - force applied over a surface measured as force per unit of area such as pounds per square inch (psi) (a head of 28" of water develops a pressure of 1 psi) or a pascal (Pa) which is equal to 1 newton per square meter (a head of 1 cm = 98 Pa) 18" of water equals 71.1 cm of water equals 1 psi = 6895 Pa.

Ram box - the small structure usually made out of concrete and/or wood which houses a hydram protecting it from freezing, weathering and possibly from vandalizing.

Rebound - the flow of water in the ram reversing direction due to the air pressure in the accumulator, closing the check valve.

Series hydram - a hydram installation where two or more hydrams are used in series to pump water higher than one hydram could.

Settling basin - a small tank usually made of steel or concrete that is used in place of a stand pipe in an installation where additional settling is necessary.

Snifter valve - (air valve, spit valve) the small valve just below the check valve that allows air to enter the hydram.

Spring box - a concrete box built around a spring to facilitate water collection and to protect the water source from surface contaminates.

Spring box overflow pipe - a pipe placed in the wall of a spring box near the top for unused water to exit through.

Stand pipe - an open-ended, vertical pipe sometimes used at the beginning of the drive pipe.

Static head - a column of water without motion. The static drive head of a hydram can be measured with a pressure gauge but only when ram is stopped and the drive pipe is full of water.

Supply pipe - everything in a hydram system before the drive pipe, usually including some, but not necessarily all, of the following; spring box, supply pipe, stand pipe, settling basin.

Supply system - everything in a hydram system before the drive pipe, usually including some but not necessarily all of the following; spring box, supply pipe, stand pipe, settling basin.

Time of cycle - (t) the time it takes for a hydram to complete one cycle, such as the time lapse between the impulse valve closing twice.

Velocity - speed usually measured in feet per second or meters per second.

Waste water - (Q_w) the water coming out of the impulse valve and the snifter.

Waste water drain - the drain in the bottom of a ram box which allows the waste water from the hydram to drain out.

Waste water series hydrams - a hydram installation where one hydram uses the waste water

from another as a source to pump a higher percentage of the water.

Hater delivered - (q) the rate at which water is delivered to the storage tank; $Q \times H \times n \times q = h$

Water flow to the hydram - (Q) all the water used by a hydram which is equal to the waste water (Q_w) plus the water delivered (q).

Water hammer - the effect created when water flowing through a pipe is suddenly stopped. In a hydram this causes the closing of the impulse valve and opening of check valve.

Water used - (Q) the amount of water that flows through the drive pipe during a unit of time (as in gallons per minute or liters per second) which is equal to the water pumped (q) plus the water wasted (Q_w)

The flow rate range of hydrams are as follows:

Drive pipe diameter				Flow rate			
mm	in	U.S.	gal/min	Imperial	gal/min	liters/min	
19	¾	0.8 -	2	0.6 -	1.7	2.8 -	7.6
25	1	1.5 -	4	1.3 -	3.3	5.7 -	15.0
32	1½	1.5 -	7	1.3 -	5.8	5.7 -	26.0
38	1 2	2.5 -	13	2.0 -	10.8	9.4 -	49.0
50	2	6.0 -	20	5.0 -	17.0	23.0 -	76.0
63	2½	10.0 -	45	8.0 -	38.0	38.0 -	170.0
75	3	15.0 -	50	13.0 -	42.0	57.0 -	189.0
100	4	30.0 -	125	25.0 -	104.0	113.0 -	473.0
125	5	40.0 -	150	33.0 -	125.0	151.0 -	567.0

IMPORTANT NUMBERS TO REMEMBER

1440 minutes in a day

433 psi per foot (measured vertically) of water column

28 inches of C, water column produces 1 psi

14.7 psi atmospheric pressure

7. 48 gallons per cubic foot

English-metric units conversion table

		<i>Equals, in Metric*</i>		
<i>Physical Quantity</i>	<i>This in "English" Units</i>	<i>Spelled out</i>	<i>Symbolic</i>	<i>Reciprocal</i>
DISTANCE	1 inch	2.54 centimeter	2.54 cm	0.3937
	1 foot	0.3048 meter	0.3048 m	3.281
	1 yard	0.9144 meter	0.9144 m	1.094
	1 mile	1.609 kilometer	1.609 km	0.6215
AREA	1 square inch	6.452 square centimeter	6.452 cm²	0.155
	1 square foot	0.0929 square meter or	0.0929 m²	10.76
		929 square centimeters	929 cm²	0.001076
	1 square yard	0.836 square meter	0.836 m²	1.196
	1 acre	4,047 square meters or	4.047 m²	0.000247
		0.4047 hectare	0.4047 h	2.47
	1 square mile	2.590 square kilometers or 259.0 hectares	259.0 h	0.00386
VOLUME	1 cubic inch	16.39 cubic centimeters	16.39 cm³	0.0610
	1 pint (liquid)	473.2 cubic centimeters	473.2 cm³	0.002113
	1 quart	946.4 cubic centimeters	946.4 cm³	0.001057
		or 0.9464 liter	0.946 l	1.057
	1 gallon	3.785 liters	3.785 l	0.2642
	1 cubic foot	0.0283 cubic meter	0.283 cm³	35.3
	1 cubic yard	0.765 cubic meter	0.765 cm³	1.308
	1 acre foot	0.1233 hectare meter	0.1233 h m	8.11
	VELOCITY	1 foot per hour,		

	minute or second	0.3048 meter/hour, minute, or second		3.281
	1 mile per hour	0.1170 meter per second	0.4470 m/s	2.237
	1 knot	.05145 meter per second	0.5145 m/s	1.944

* Multiply quantity known in British units by this number to get metric equivalent.

† Multiply quantity known in metric units by this number to act British equivalent

		<i>Equals, in Metric*</i>		
<i>Physical Quantity</i>	<i>This in "English" Units</i>	<i>Spelled out</i>	<i>Symbolic</i>	<i>Reciprocal</i>
ENERGY (OR WORK)	1 watt second	1.000 joule = 1.000		
		newton meter	1.000 J	1.000
	1 foot pound	1.356 joule	1.356 J	0.737
	1 Btu	1.055 kilojoule	1.055 kJ	0.948
	1 wale hour	3.60 kilojoules	3.60 kJ	0.278
	1 horsepower-hour	2.684 megajoules	2.684 MJ	0.373
	1 kilowatt hour	3.60 megajoules	3.60 MJ	0.278
POWER	1 horsepower	745.7 watts or 0.7457 kilo-	745.7 W	0.00134
		watt	0.7457 kW	1.341
	1 joule per second	1.000 watt	1.000 W	1.000
	1 Btu per hour	0.293 joule per second	0.293 J/s	3.413
TEMPERATURE	1 degree	5/9 degree Celsius (Centi	5/9 X (TF-32)°C	1.8 C
	Fahrenheit	grade) for each Fahrenheit		Fahr
		degree above or below 32°F		for C
SPECIAL	1 Btu per cubic	37.30 joules per liter	37.30 J/l	0.026

COMPOUND UNITS	foot			
1 Btu per pound of mass	2.328 joules per gram		2.328 J/g	0.42
1 Btu per square foot per hour	3.158 joules per square meter	3.158 J/m²	0.3167	
1000 gallons per acre	0.0935 centimeters depth		10.70	
1 pound of mass per cubic foot	16.02 grams per liter	16.02 g/l	0.0624	
MASS	1 ounce	28.35 grams	28.35 g	0.03
	1 pound	453.6 grams	453.6 g	0.00
		or 0.4536 kilogram	0.4536 kg	2.20
	1 ton(short, 2000 pounds)	0.907 megagram	0.907 Mg	1.10
		or 0.907 metric ton	0.907 L	1.10
		or 0.907 tone	0.907 t	1.10
TORQUE	1 inch pound	0.1130 meter newton	0.1130 m-N	8.85
PRESSURE	1 pound per square foot	47.88 newtons per square	47.88 N/m²	0.02
	foot	meter		
	1 pound per square inch	6.895 kilonewtons per square meter	6.895 kN/m²	0.11
	1 millimeter of mercury	133.3 newtons per square	133.3 N/m²	0.00
	1 foot of water	2.989 kilonewtons per square meter	2.989 KN/nm²	0.33
	1 atmosphere	0.1013 Meganewton per square meter	0.1013 MN/m²	9.87
Flow	1 gallon per day	0.04381 milliliters	0.04381 ml/s	22.8

		per		
		second		
	1 gallon per minute	63.08 milliliter per second	63.08 ml/s	0.01
	1 cubic foot per minute	0.4719 liter per second	0.4719 l/s	2.11
	1 cubic foot per second	28.32 liters per second	28.32 Us	0.03
FORCE	1 ounce	0.2780 newton	0.2780 N	3.59
	1 pound	4.448 newtons	4.448 N	0.22
	1 ton (2000 pounds}	8.897 kilonewtons	8.897 kN 0.11240	

* Multiply quantity known in British units by this number to get metric equivalent.

† Multiply quantity known in metric units by this number to get British equivalent

References

Hydrant Manufacturers

Rife Hydraulic Engine Manufacturing Company, 123 Main Street Andover, New Jersey 07621 USA

John Blake, Ltd., PO Box 43, Royal Works Acdrington, Lancashire BB5 5LP England

The Skookum Company, Inc., 14041 NE Sandy Blvd. PO Box 20216, Portland, Oregon 97220 USA

Balaju Yantra Shala (P.) LTD.

Balaju, Kathmandu, Nepal

Southern Cross, Australia

Publications

A Hydraulic Ram for Village Use, by Ersal W. Kindel, 11 pp. VITA

Village Technology Handbook, 370 pp. VITA

A Manual on the Hydraulic Ram for Pumping Water, by S.B. Watt, Intermediate Technology 44 pp.

The Automatic Hydraulic Ram. Its Theory and Design, by J. Krol, 12 pp., American Society of Mechanical Engineers

Building a Hydraulic Ram, By Don Marier, 6 pp.

Appropriate Technology Source Book, Volumes I and II, by Ken Darrow, Kent Keller, Rick Pam, Volunteers in Asia Publication

"Hydraulic Ram Forces Water to Pump Itself," Popular Science, October, 1948, pp. 231-233.

"We built our own Hydraulic Ram Pump," by Bill and Kathy Hyslop, 8 pp., Rodale Press.

"Mother's Hydraulic Ram Pump," Mother Earth News, May-June 1979,

Other Sources of Information

Information Collection Exchange, Peace Corps, Washington, D. C.

ITDG's publication on Ferro-cement,

Asian Institute of Technology, Bangkok, Thailand

Attachments

Attachment 1-A

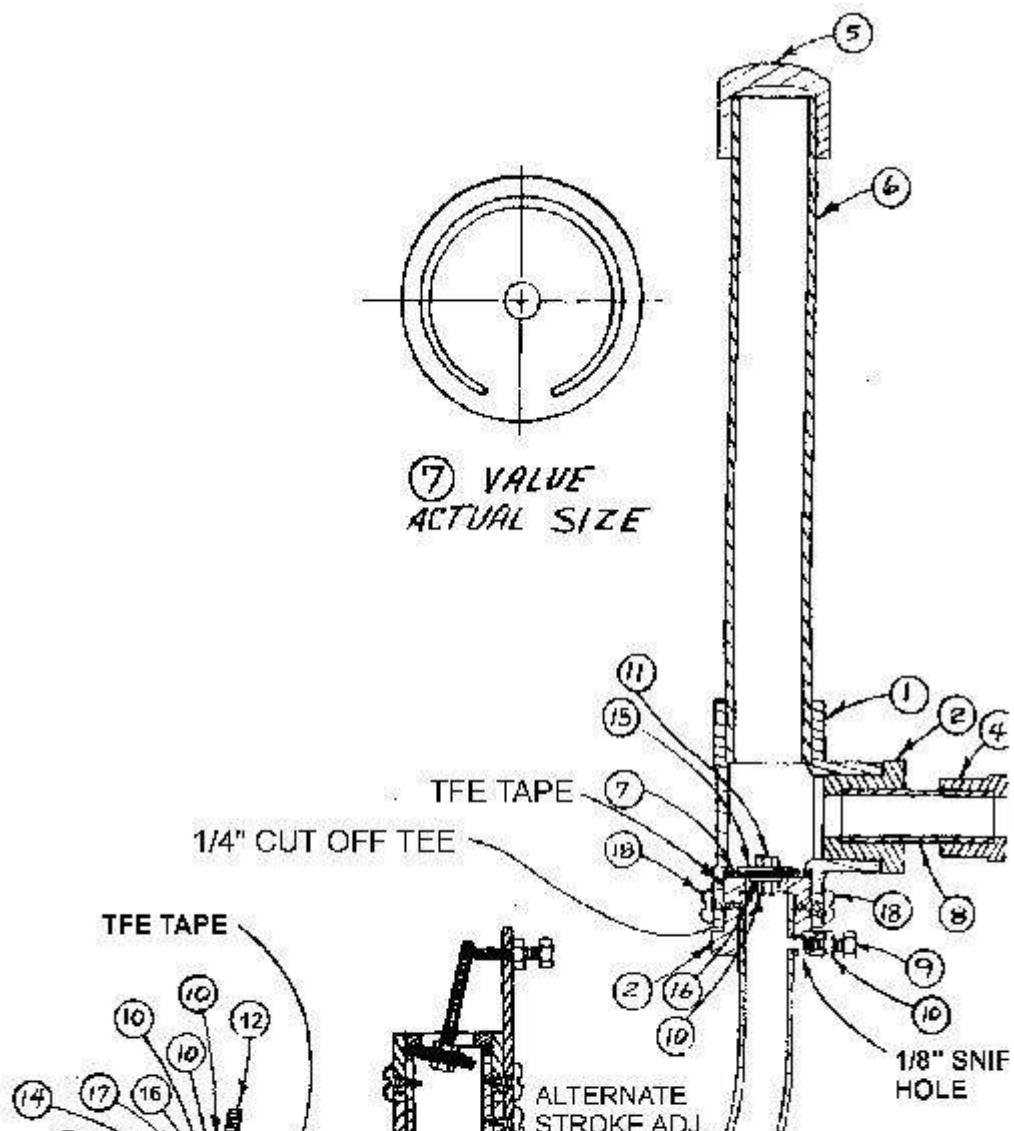

A PVC hydram

What's in a name

Session 1, Handout 1A

Our names are one of the most distinguishing characteristics of who we are. Share with the group some of the reasons why your name is special.

Some things you might wish to share:

- Do you like your name? Why or why not?**
- How did you get your first name?**
- Does your name(s) have any meaning?**
- What is the origin of your last name?**
- Famous (or infamous) ancestors?**
- Funny stories, incidents related to your name?**
- Anything else you may wish to share.**

Hydram training workshop objectives

Attachment 1-B

Session 1, Handout 1B

By the end of the training program, you will be able to:

- survey and evaluate sites for potential hydram projects;**
- articulate and apply hydram theory;**
- use correctly, basic water measurement techniques and formulas for proper sizing of hydrams;**
- select proper ram design and size;**
- develop a water source site for hydram operations;**

- design water distribution system including storage tank, stand pipes, supply lines, etc.;
- construct a pipefitting and/or cement hydrant; e maintain, troubleshoot and repair hydrants;
- train local community members in the installation , operation and maintenance of hydrants; and
- identify physical, social and institutional requirements or the above.

Attachment 2-A

Session 2, Handout 2A

POTENTIAL ENERGY (E_p) = MASS (M) x HEIGHT (H) ~ FOR OUR PURPOSES MASS AND WEIGHT ARE INTERCHANGABLE SO $E_p = \text{WEIGHT} \times \text{HEIGHT}$.

$$W \times H = W \times H$$

$$300 \text{ LB} \times 1' = 100 \text{ LB} \times 3'$$

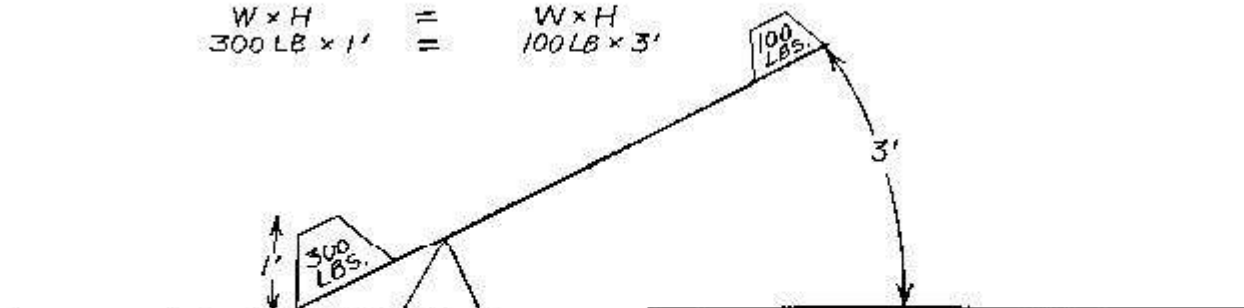

$$W \times H = W \times H$$

$$3 \text{ GAL} \times 8.33 \frac{\text{LB}}{\text{GAL}} \times 1' = 1 \text{ GAL} \times 8.33 \frac{\text{LB}}{\text{GAL}} \times 3'$$

3 GALLONS OF WATER FALLING 1 FOOT CAN LIFT 1 GALLON OF WATER 3 FEET @ 100% EFFICIENCY

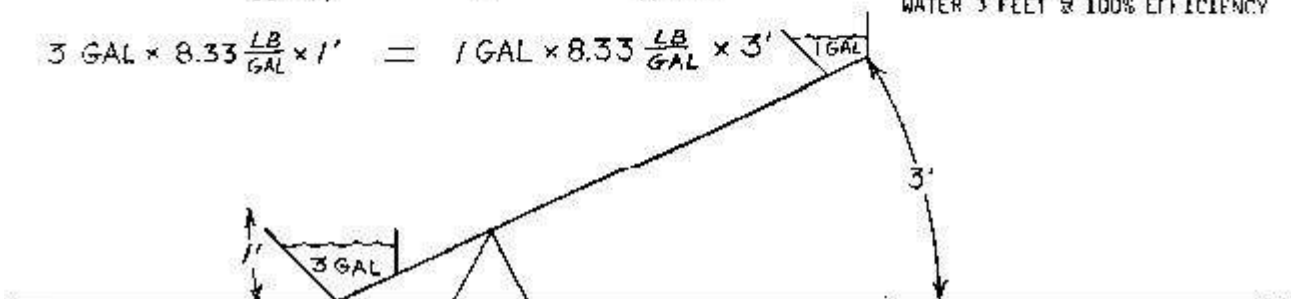

Introduction to hydrants

Attachment 2-B

Session 2 & 6, Handout 2B

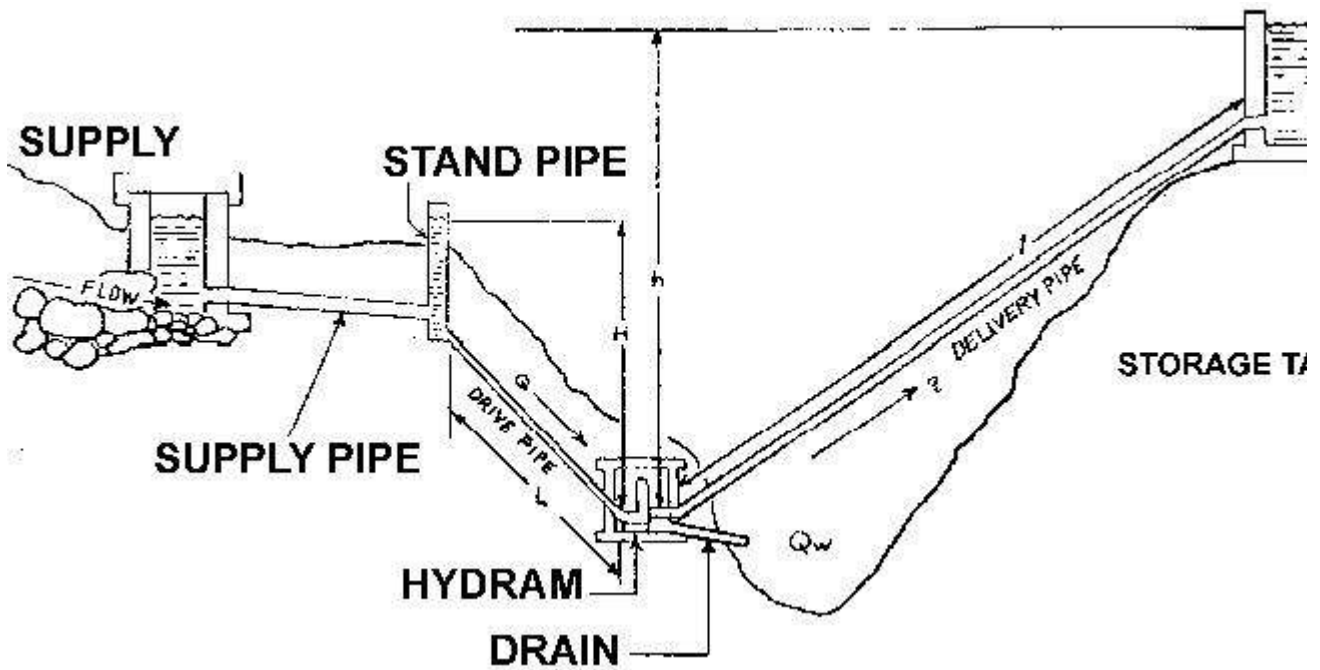

Hydram installation

Attachment 2-C

Session 2, Handout 2C

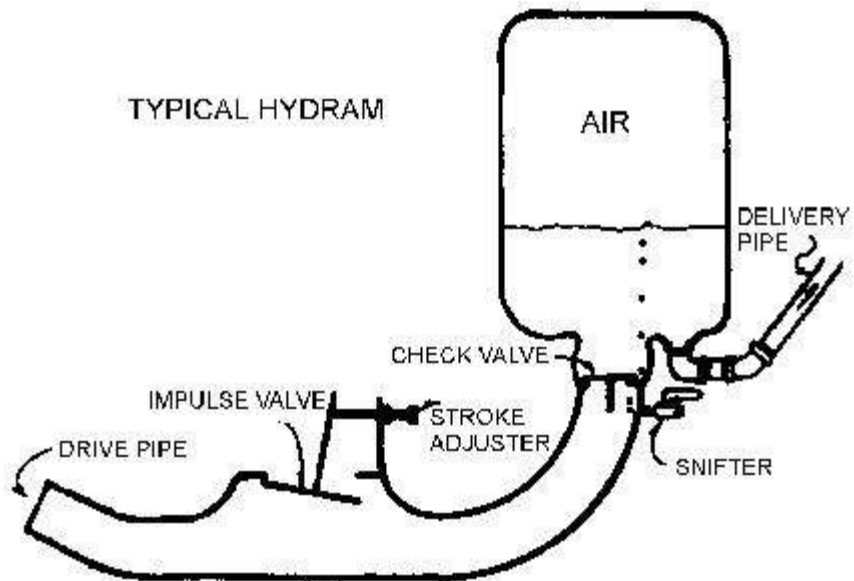

Typical hydram

Attachment 2-D

Session 2, Handout 2D

Glossary of terms for session 2

Accumulator - (air dome) the air chamber on the hydram which cushions the water hammer, eliminating delivery pulsations and helps provide rebound.

Check Valve - (non-return valve, secondary valve, internal valve) the internal valve in the hydram that prevents the delivery head pressure from forcing water back through the hydram body.

Delivery head - the vertical distance between the hydram and the highest level of water in the storage tank that the hydram is pumping to.

Delivery pipe - the pipe which connects the output of the hydram to the storage tank.

Drive head - the vertical distance between the hydram and the highest level of water in the supply system.

Drive pipe - a rigid pipe usually made of galvanized steel that connects the hydram to the source reservoir or stand pipe.

Efficiency - (n) the ratio of the energy input to the energy output; a measure of how well a hydram functions;

$$n = \frac{qh}{Qh}$$

Frequency - (f) the number of times a hydram cycles in one minute.

Hydram - (hydraulic ram, hydraulic ram pump, automatic hydraulic ram pump, ram) an ingenious device that uses the force of water falling through a drive pipe to pump water to a height greater than its source, making use of hydraulic principles and requiring no fuel.

Impulse Valve - (clack valve, out-side valve, impetus valve, waste valve) the valve on the hydram that creates and controls the water hammer.

Potential energy - energy derived from position or height; is equal to the height that a mass can fall times its weight.

Rebound - the flow of water in the ram reversing direction due to the air pressure in the accumulator, closing the check valve.

Settling basin - a small tank usually made of steel or concrete that is used in place of a stand pipe in an installation where additional settling is necessary.

Snifter valve - (air valve, spit valve) the small valve just below the check valve that allows air to enter the hydram.

Spring box - a concrete box built around a spring to facilitate water collection and to protect the water source from surface contaminates.

Stand pipe - an open-ended, vertical pipe sometimes used at the beginning of the drive pipe.

Supply pipe - everything in a hydram system before the drive pipe, usually including some but not necessarily all of the following; spring box, supply pipe, stand pipe, settling basin.

Waste water - (Q_w) the water coming out of the impulse valve and the snifter.

Water delivered - (q) the rate at which water is delivered to the storage tank;

$$q = \frac{Q \times H \times n}{h}$$

Water flow to the hydam - (Q.) all the water used by a hydam which is equal to the waste water (Q_w) plus the water delivered (q)

Water hammer - the effect created when water flowing through a pipe is suddenly stopped. In a hydam this causes the closing of the impulse valve and opening of check valve.

Hydam training workshop participant site information

Attachment 2-E

Session 2, Handout 2E

Hydam installations are extremely site specific. Although it's a simple technology, it does require being properly designed and sized based upon particular characteristics of the site. It also requires a certain amount of follow-up and maintenance. In order to maximize your learning during the workshop, please begin to gather the following information. (You don't have to have all of the information prior to the workshop, but it will help if you begin to consider these factors at your site.)

- 1. What water sources are available?**
- 2. What kinds of water systems are presently being used? Who is responsible for maintaining the systems?**
- 3. What are the present patterns of water use in your community? (e.g. potable water, irrigating home garden plots)**
- 4. What is the proposed purpose for the hydam installation?**
- 5. What kinds of skills and resources are presently available to support a hydam installation?**
 - Community history of cooperative work on projects?**
 - As existing community water distribution system?**
 - Facilities and craftspeople in or near the community with metalworking, plumbing, and masonry capabilities? Vocational technical schools, public works?**
- 6. How do you rate your present knowledge/experience about water systems, pumps, hydrams? What do you need to refresh, what do you need to know?**
- 7. If you have a site in mind for a hydam, can you find out:**
 - a. approximate flow rate of the water source (gallons/minute)**
 - b. approximate "drive head, i.e., vertical distance from water source to where hydam will be installed?**
 - c. approximate "delivery head, " i.e., vertical pumping distance from ram to point of delivery?**

d. amount of water desired/required? (gallons/day)

NOTE: During the workshop, you will learn simple measuring techniques; knowing this information beforehand allows one to design a site specific ram during the workshop with guidance from the training staff.

Please bring this sheet with you to the workshop. If it's easier to sketch your situation, feel free to do so.

Attachment 3-A**Using a weir****Session 3, Handout 3A**

A weir may be defined as an overflow structure built across an open channel, usually to measure the rate of flow of water. Weirs are acceptable measuring devices because, for a weir of a specific size and shape (installed under proper conditions) only one depth of water can exist in the upstream pool for a given discharge. The discharge rates are determined by measuring the vertical distance from the crest of the overflow portion of the weir to the water surface in the pool upstream from the crest, and referring to tables which apply to the size and shape of the weir. For standard tables to apply, the weir must have a regular shape, definite dimensions, and be set in a bulkhead and pool of adequate size so the system performs in a standard manner.

Whenever the flow from a creek is too great to be measured in a bucket and yet is small enough to be dammed by a board, the weir method of measurement should be used.

Determine the dimensions to be used for the weir notch. The width of this notch is related to the measurement of the flow rate by the height of the water in the pool formed behind the weir. This height is measured in inches and by using a weir table, the inches can be converted to gallons per minute. A number of notches of different widths and height can accommodate a stream's flow. A rule of thumb is to make the width of the notch 3 times the height.

From your estimate of the flow of the stream, look at the weir table and guesstimate what size notch will accommodate your flow. Keep in mind that the whole stream must pass over the notch and that the pool formed behind the weir should become deep enough for you to easily get a decent height measurement, i.e., 2½" vis a vis 1/16". Example: you estimate the stream is flowing at 150 gal/mint If you made a notch 12" wide and 4" high, at full flow this weir would read approximately 290 gal/mint (4"-- 23.936 gal/mint x 12" = 286.89 gal/min). This weir would fit your stream if an actual weir reading of 28½" water height were obtained, it would indicate a flow rate of 11.818 gal/min/inch of notch or 141.8 gal/min (11.818 x 12") for the stream.

Once you have determined the dimension of the notch, cut the notch in the board and place the weir board in the stream making certain that it is kept level and seal off the stream completely. Support it with stakes and large rocks.

Measure 2 feet upstream from the weir board and drive a stake. Using a level, put a mark on the stake even with the top of the weir board. Next, measure down from this mark to the water level, subtract this measurement from the depth of your notch and that will give you the height of the water level above the bottom of the weir notch.

Using the weir table attached, locate the integer on the Left hand column and the fraction on the top column. Where these two rows intersect is the amount of gallons per minute flowing

past the weir for every inch of width. Next multiply this figure by the width and this gives you the total flow of the creek.

Example:

Water is flowing through a creek three feet wide and about 3 inches deep. It looks like about 30 gallons per minute. After looking at the weir table we decide that a notch 6" wide and 2" deep would probably work. After cutting the notch in a 4 foot 1x6 piece of lumber, the weir board was placed in the stream. Two feet upstream a stake is driven in the water in front of the notch. A level is used to place a mark on the stake level with the top of the weir board. The water level is then measured to be 1" down from this mark.

We now know by subtracting this measurement from the depth of the notch that the water level is 1½" above the bottom of the notch. Now looking at the weir table we find 1 on the left hand column and ½ on the top row. These two rows meet at 5.46. We multiply this by the width of the notch (6") to find that the flow rate was 32.26 gallons per minute.

Attachment 3-B

Using a "weir" to measure large quantities of water

Session 3, Handout 3B

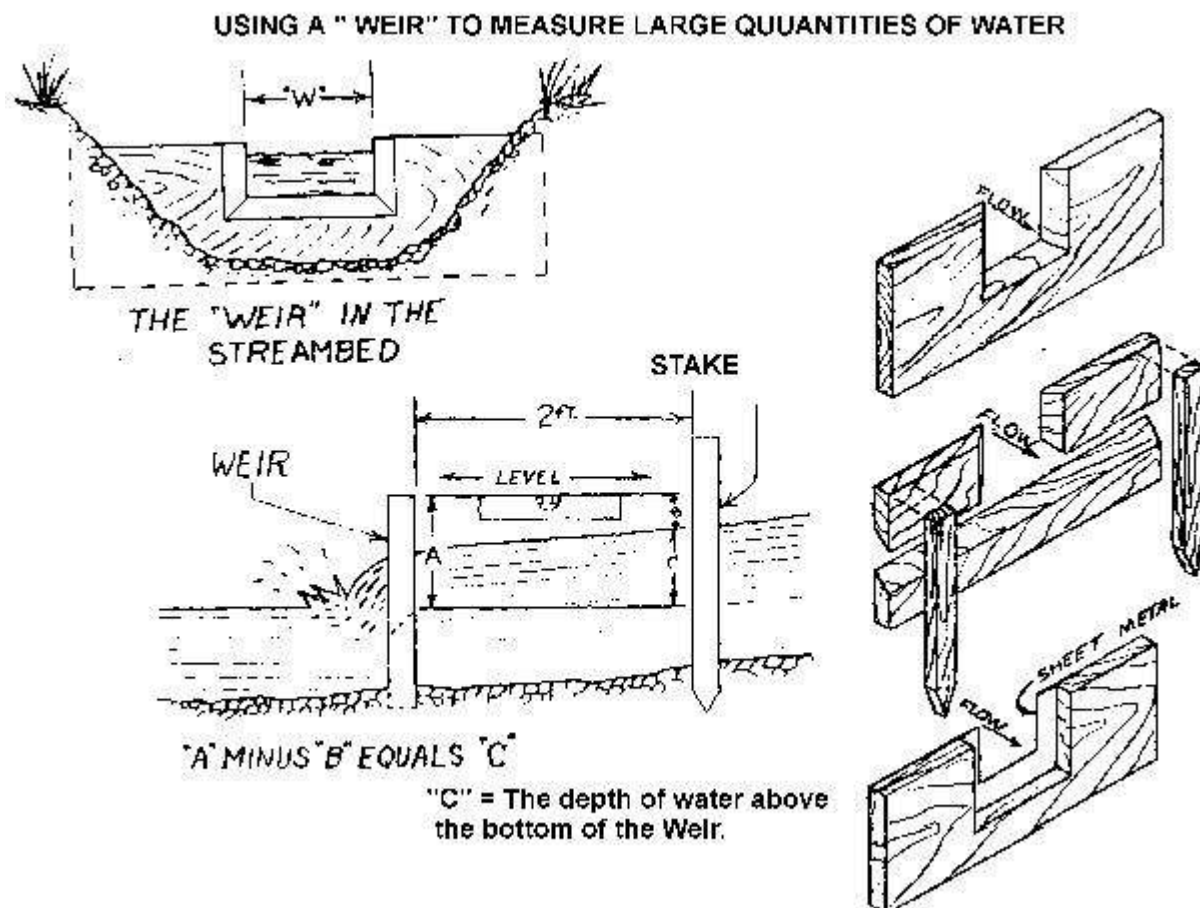

Using a "weir" to measure large quantities of water

Attachment 3-C

Weir table**Session 3, Handout 3C**

Height of water above weir notch in inches								
	0	1/8	1/4	3/7	1/2	5/6	3/4	7/8
0	000	.0748	.374	.673	1.047	1.421	1.945	2.394
1	2.992	3.516	4.114	4.787	5.46	6.134	6.882	7.63
2	8.452	9.2	10.098	10.92	11.818	12.716	13.614	14.586
3	15.484	16.531	17.503	18.55	19.523	20.645	21.692	22.814
4	23.936	25.058	26.18	27.377	28.499	29.696	30.967	32.164
5	33.436	34.707	35.979	37.25	38.522	39.868	41/215	42.561
6	43.908	45.329	46.75	48.171	49.518	51.014	52/435	53.931
7	55.352	56.848	58.344	59.915	61.411	62.982	64.552	66.048
8	67.694	69.265	70.836	72.481	74.127	75.772	77.418	79.064
9	80.784	82.504	84.15	85.87	87.591	89.311	91.032	92.827
10	94 547	96.342	98.138	99.933	101.73	103.6	105.393	107.263

Attachment 3-C - metric

Weir table - metric

Session 3, Handout 3C

Flow rate per inch of weir notch in gal/min.

	0	3.2	6.35	9.5	12.7	15.9	19.	22.2
0	0	.283	1.415	2.547	3.963	5.379	7.362	9.062
25.4	11.3	13.3	15.573	18.12	20.668	23.219	26.051	28.882
50.8	31.994	34.825	38.225	41.336	44.735	48.135	51.534	55.214
76.2	58.613	62.577	66.256	70.219	73.902	78.150	82.113	83.332
101.6	90.608	94.855	99.102	103.633	107.88	112.412	117.223	121.754
127	126.57	131.380	136.195	141.007	145.822	150.913	156.016	161.111
152.9	166.21	171.589	176.968	182.347	187.446	193.109	198.488	204.151
177.8	209.53	215.193	220.856	226.803	232.466	238.413	244.356	250.019
203.2	256.25	262.197	268.143	274.37	280.601	286.828	293.059	299.29
228.6	305.8	312.312	318.542	325.053	331.568	338.08	344.594	351.388
254	357.899	364.694	371.493	378.288	385.09	392.169	398.956	406.035

Attachment 3-D

The float method of measurement

Session 3, Handout 3D

The float method of measurement is a simple procedure for obtaining a rough estimate of the flow of the stream. It will give a ball park figure for looking at the stream's potential. It should not be used for final determination of the hydram system to be used unless the flow rate needed for the ram is such a small percentage of the stream's total flow that what's taken from the stream, for all practical purposes, amounts to a minimal portion of the stream.

The float method is based upon two aspects of the stream: it's cross-sectional area and the velocity of the stream. The cross-sectional area should be determined at some accessible spot in the stream, preferably in the middle of a straight run. Measure the width (w) of the stream. Then, using a stick, measure the depth at equal intervals across the width of the stream (see figure below). Record the depth at each interval and calculate the average depth (d). Now multiply the width (w) by the average depth (d) to get the cross-sectional area (A).

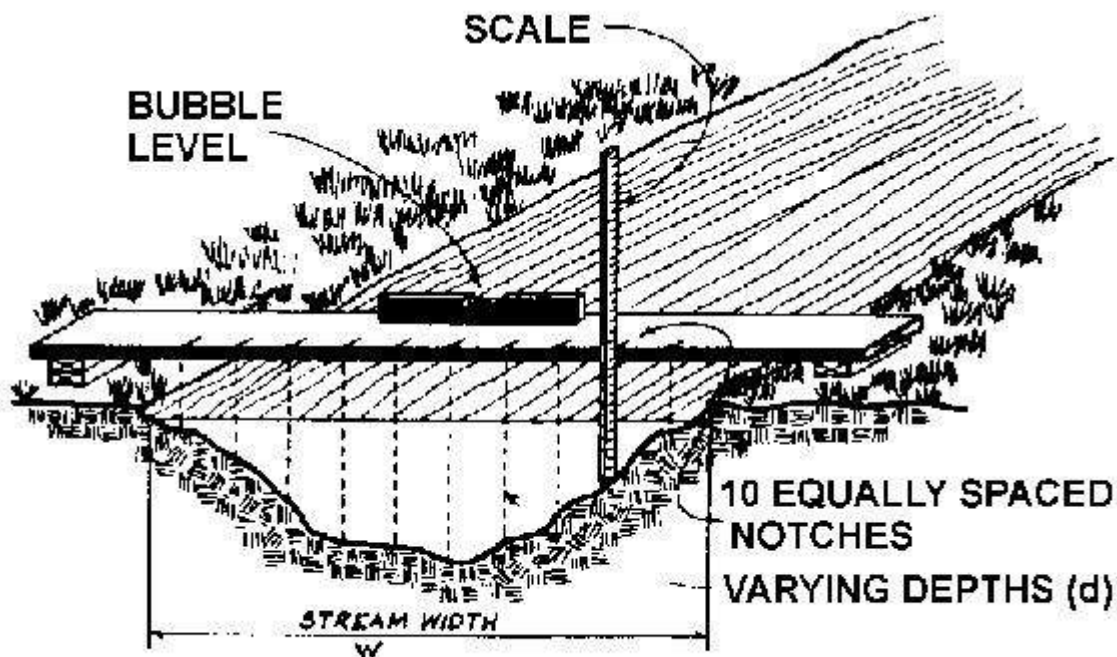

FIGURE A

The float method of measurement

Example: The width of a stream, at the point of making depth measurements, is 4 feet. The average depth is 1.1 feet. Therefore, the cross-sectional area (A) is:

$$A = w \times d$$

$$A = 4 \text{ feet} \times 1.1 \text{ feet}$$

$$A = 4.4 \text{ square feet}$$

The stream velocity can be determined by choosing a straight stretch of water at least 30 feet long with the sides approximately parallel and the bed unobstructed by rocks, branches or other obstacles. Mark off points along the stream. On a windless day, place something that floats in midstream, upstream of the first marker. A capped bottle partially filled with water works well because it lies with a portion of the bottle submerged and doesn't just ride the surface of the water. Carefully time the number of seconds it takes the float to pass from the first marker to the second. Repeat this process several times and average the results.

Example: The average time for a float to travel between two markers placed 30 feet apart is 30 seconds. The velocity (V) of the float is therefore:

$$V = 30 \text{ feet}$$

$$30 \text{ seconds}$$

$$V = 1 \text{ foot/second}$$

$$V = 60 \text{ feet/minute}$$

The flow rate of the stream can now be calculated by multiplying the cross-sectional area (A) by the stream velocity (V). The usable flow (F) can then be determined by multiplying the stream flow rate by a fraction representing the portion of the stream flow that you can or want to use.

Example: If you will be using 25% of the stream flow, the usable flow (F) is:

$$F = A \times V \times .25$$

$$F = 4.4 \text{ square feet} \times 60 \text{ feet/minute} \times .25$$

$$F = 66 \text{ cubic feet per minute}$$

This flow in cubic feet per minute can then be converted to the appropriate units by multiplying by the correct conversion factor: cubic feet/min $\times 7.48 =$ gallons/min cubic feet/min $\times 28.3 =$ liters/min

SOURCE: Micro-Hydro Power, National Center for Appropriate Technology (1979).

Attachment 4-A

Calibrating a sight level

Session 4, Handout 4A

CALIBRATING A SIGHT LEVEL

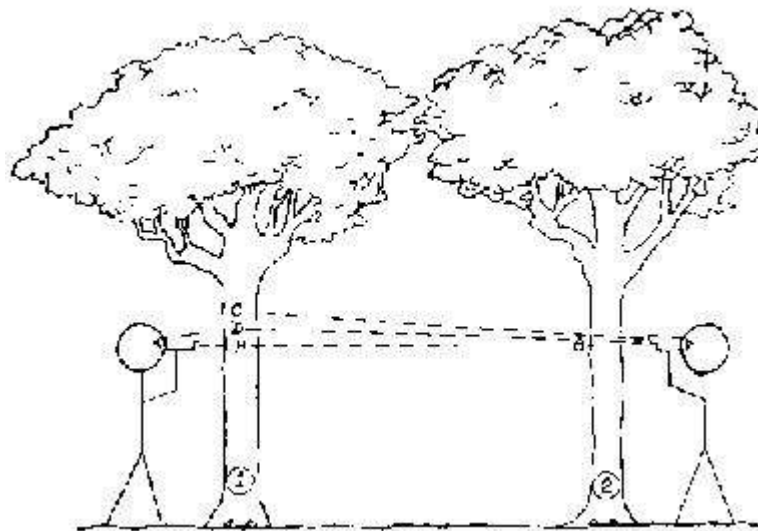

Calibrating a sight level

To Find Out If The Sight Level Needs To Be Calibrated, Sight From Point "A" On Tree (Of Object #One) To Tree (Object #Two) And Make A Mark, Point "B". Then Sight From Point "B" Back To Original Tree (Object #One) And Make A Mark At This Point "C". If The Sight Level Is Properly Calibrated Points "A" And "C" Should Be The Same And At The Same Level As Point "B". If They Are Different, The Point Midway Between "A" And "C" (Point "D") Should Be Level With "B". Calibrate Your Sight Level To This Line.

Attachment 4-B

Using a sight level

Session 4, Handout 4B

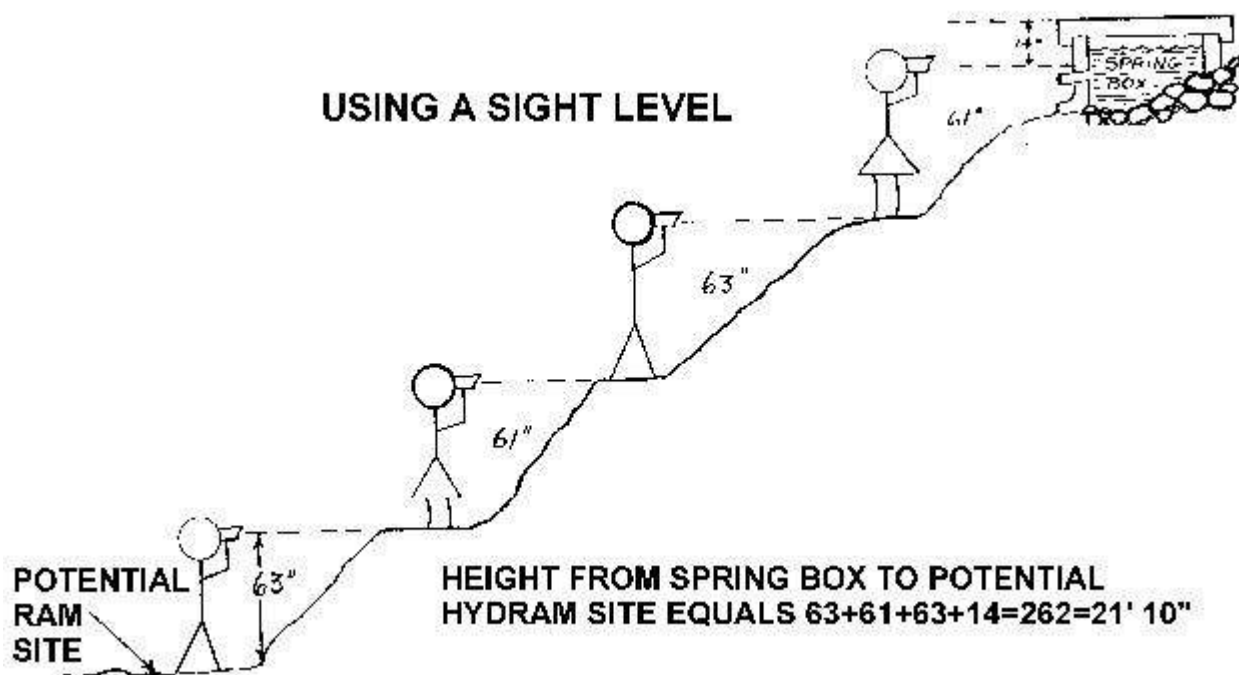

Using a sight level

Attachment 4-C

Alternate ways of measuring heads

Session 4, Handout 4C

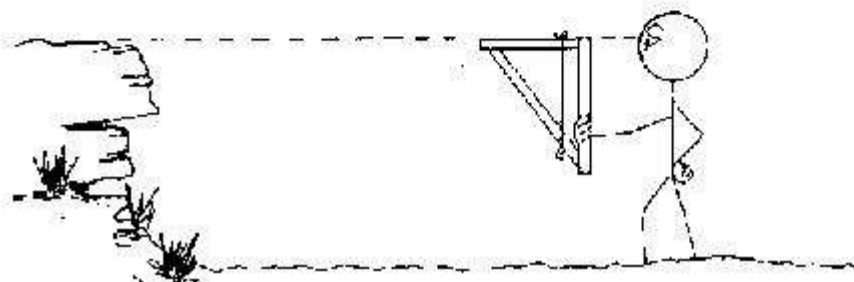
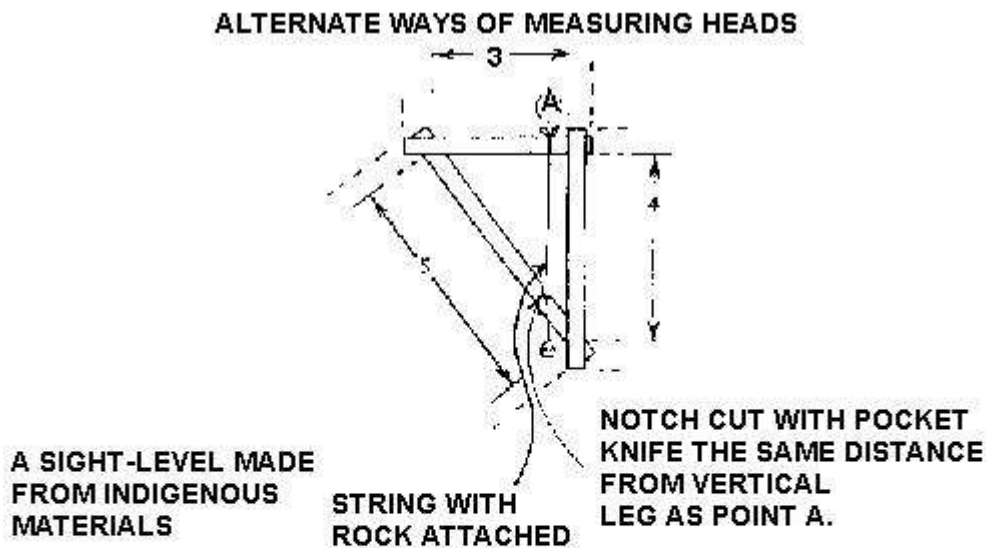

Alternate ways of measuring heads

Attachment 4-D

Alternate ways of measuring heads

Session 4, Handout 4D

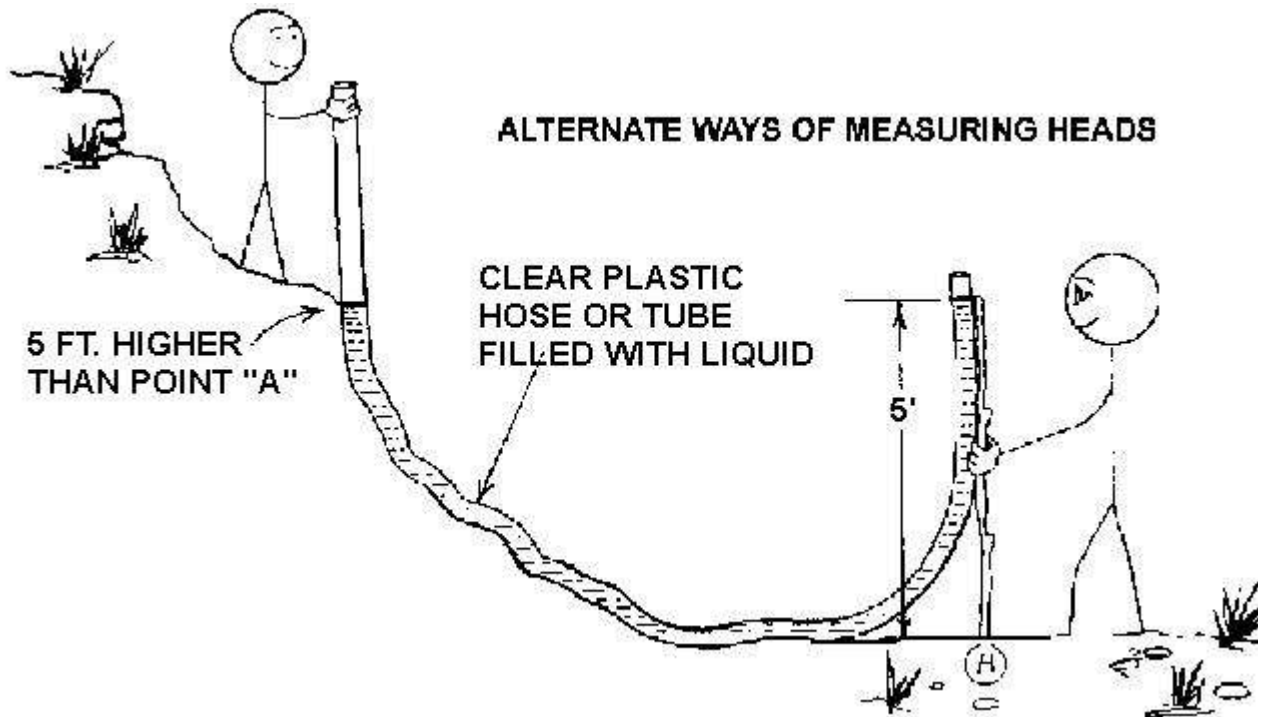

Alternate ways of measuring heads

Distance and head measurement worksheet

Session 4, Handout 4E

	COURSE 1				COURSE 2				COURSE 3	
	DISTANCE	M	HEAD	M	DISTANCE	M	HEAD	M	DISTANCE	M
SUBGROUP A										
small group 1		Ta		S		C		H		F
small group 2		C		H		P		Tr		T
small group 3		P		Tr		Ta		S		C
SUBGROUP B										
small group 1		Ta		S		C		H		F
small group 2		C		H		P		Tr		T
small group 3		P		Tr		Ta		S		C
SUBGROUP C										
small group 1		Ta		S		C		H		F
small group 2		C		H		P		Tr		T
small group 3		P		Tr		Ta		S		C

Method =	M
Distance:	Tape = Ta
	Cord = C
	Pace = P
Head:	Sight = S
	Hose = H
	Triangle = Tr

Attachment 5-A

Review Exercise 1

Session 5, Handout 5A

Name: _____

1. How does a Hydrum work? _____
2. In a hydrum installation where the hydrum is located 20 feet below the spring box, how much water could be pumped in a day to a storage tank 100 feet above the springs" box if the spring is flowing 10 gpm and the hydrum efficiency is 50%? _____
3. What is the flow rate in gpm through a weir, four inches wide, when the water level is 5 3/8" above the bottom of the weir slot when measured two feet upstream? _____
4. What is the height of your eye level? _____

5. What is the length of your pace? _____

Attachment 5-B

Answers to Review Exercise #1

Session 5, Handout 5B

1. The hydrum is located below the source of water and is used to pump the water to a storage tank which is higher than the source. The water accelerates as it flows down hill through the drive pipe and out the impulse valve until it reaches such a velocity as to slam the impulse valve shut. This causes a water hammer effect, forcing water and a few air bubbles sucked in through the snifter from the previous cycle, through the check valve and into the accumulator filled with air. This movement of water into the accumulator causes the air to compress until the forward momentum is stopped. At this point the water in the accumulator bounces back because of the spring effect of the air in the accumulator. This rebound in the opposite direction causes the check valve to suddenly close,

causing negative pressure in the hydam before the check valve. Because of this negative pressure, air is sucked in through the snifter and the impulse valve is caused to open again at which point water starts exiting through the impulse valve and the cycle starts again.

2.

H - 20
$h = 100 + 20 = 120$
Q = 10
n = .50
$q = Q \times H/h \times n$
$q = 10 \times 20/120 \times .50 = 0.8333 \text{ gpm}$
$0.8333 \text{ gpm} \times 1440 \text{ min / day} = 1200 \text{ gpd}$

3. 5 3/8" on the weir table is 37.25 gpm.

This times four equals 149 gpm.

4. Any answer within reason is OK.

5. Any answer within reason is OK.

Attachment 6-A

Pressure analysis

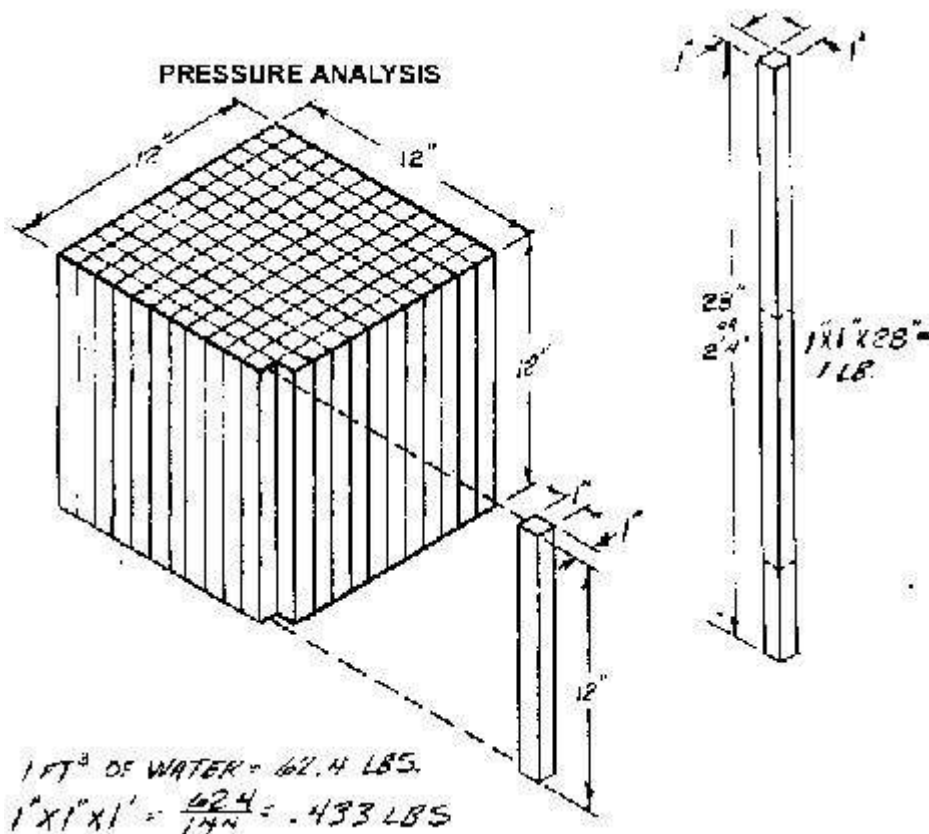

Pressure analysis

Attachment 6-B

Glossary of terms for session 6

Atmospheric pressure - the pressure at sea level caused by the weight of air; atmospheric pressure = 14.7 psia, and 0 psig

Force - (delivery to drive head ratio) the ratio of lift to fall. The inverse of this ratio times the efficiency of the hydram will determine the percentage of water that the hydram will pump. The higher the h:H ratio, the lower the hydram efficiency (n). The usual range of the h:H ratio is from 2:1 to 20:1, but h:H ratios have been measured up to 60:1.

Hydram capacity - the maximum amount of water that a hydram can use. This is determined by the drive pipe size and length, the drive head, and the impulse valve size and design.

Impulse valve stroke - the distance the impulse valve travels during a cycle.

Impulse valve weight - the total weight or downward force of the impulse valve and its springs or weights.

Kinetic energy - active energy, 1/2 the mass times the velocity squared

$$E_k = \frac{1}{2} mv^2$$

Pressure - force applied over a surface measured as force per unit of area such as pounds per square inch (psi) (a head of 28" of water develops a pressure of 1 psi) or a pascal (Pa) which is equal to 1 newton per square meter (a head of 1 cm = 98 Pa) 28" of water equals 71.1 cm of water equals 1 psi = 6895 Pa.

psia - (pounds per square inch absolute) the total real pressure as if the atmospheric pressure is not present. Atmospheric pressure at sea level is 14.7 psi, so if a pressure gauge reads 100 psi (psig) the absolute pressure is 114.7 psia.

psig - (pounds per square inch gauge) the pressure that a gauge reads, actually the pressure above atmospheric.

Static head - a column of water without motion. The static drive head of a hydam can be measured with a pressure gauge but only when the ram is stopped and the drive pipe is full of water.

Time of cycle - (t) the time it takes for a hydam to complete one cycle, such as the time lapse between the impulse valve closing twice.

Velocity - speed usually measured in feet per second or meters per second.

Water used - (Q.) the amount of water that flows through the drive pipe during a unit of time (as in gallons per minute or liters per second) which is equal to the water pumped (q) plus the water wasted (Qw)

The flow rate range of hydrams are as follows:

Drive pipe diameter				Flow rate			
mm	in	U.S.	gal/min	Imperial	gal/min	liters/min	
19	3/4	0.8	2	0.6	1.7	2.8	7.6
25	1	1.5	4	1.3	3.3	5.7	15.0
32	1¼	1.5	7	1.3	5.8	5.7	26.0
38	1½	2.5	13	2.0	10.8	9.4	49.0
50	2	6.0	20	5.0	17.0	23.0	76.0
63	2½	10.0	45	8.0	38.0	38.0	170.0
75	3	15.0	50	13.0	42.0	57.0	189.0
100	4	30.0	125	25.0	104.0	113.0	473.0
125	5	40.0	150	33.0	125.0	151.0	567.0

Determining Drive Pipe Length, L:

1. Consider drive head, H

L:H ratio - drive pipe length to head ratio, when H is less than 15 ft. (4.5m) L:H should equal 6.

When H is greater than 15 ft (4.5m), but less than 25' (8m) L:H should equal 4.

When H is greater than 28 ft. (8m), but less than 50' (16m) L:H should equal 3.

When H is greater than 50 ft. (16m) L:H ratio should equal 2.

2. Consider drive pipe diameter, D

L:D ratio - drive pipe length to diameter ratio, should be kept between 150 and 1000.

A rule of thumb: maximum number of pipe lengths = 4D

(based on chart below, and 21' pipe length)

Optimal number of pipe lengths = 2D

D	L = 150D	L = 500D	L = 1000D	No of pipes
½"	6.25	20.8	41.6	2
¾"	9.3	31.25	62.5	3
1"	12.5	41.6	83.2	4
1½"	15.6	52.0	104.0	5
1½"	18.6	62.5	125.0	6
2	25.0	83.2	166.4	8

Attachment 2-B

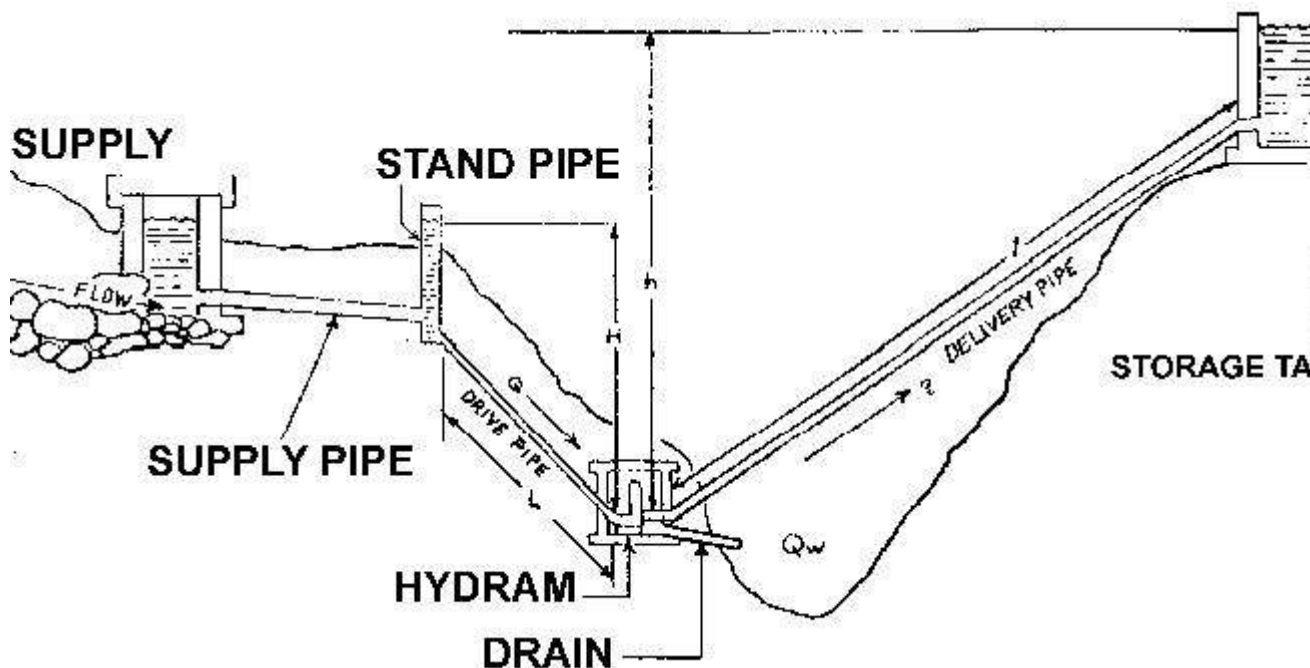

Hydram installation

DEFINITION OF VARIABLES

D = Diameter of Drive Pipe	d = Diameter of Delivery Pipe
H = Head of Drive Pipe	h = Head of Delivery Pipe
L = Length of Drive Pipe	l = Length of the Delivery Pipe
Q = Quantity of Water Entering	q = Quantity of Water Delivered Hydram
n = efficiency	Q_w = Quantity of Water Wasted from Impulse Valve
S = Length of the Impulse Valve Stroke	F = Frequency of the Impulse Valve Stroke
W = Weight of the Impulse Valve	

Attachment 7-A

Session 7, Handout 7A



PLUG



REDUCING BUSHING



CAP



UNION

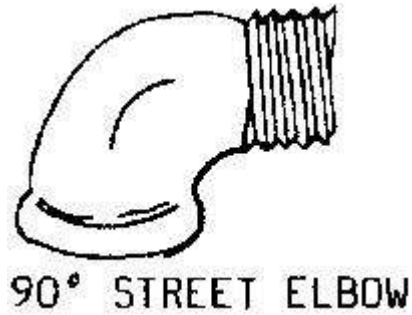

90° STREET ELBOW



90° ELBOW

90° ELBOW

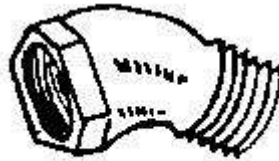

45° STREET ELBOW

45° STREET ELBOW



45° ELBOW

45° ELBOW

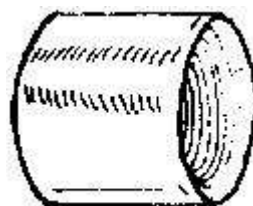

COUPLING

COUPLING



BELL REDUCER

BELL REDUCER

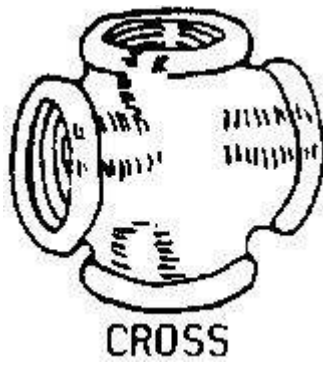

CROSS



TEE

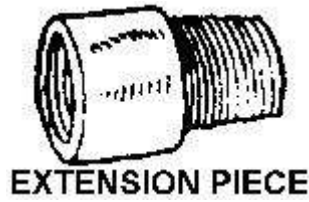

EXTENSION PIECE



FLOOR FLANGE

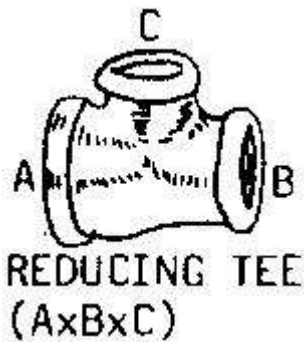

REDUCING TEE (AxBxC)

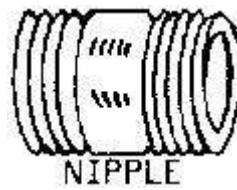

NIPPLE

Attachment 8-A

Session 8, Handout 8A

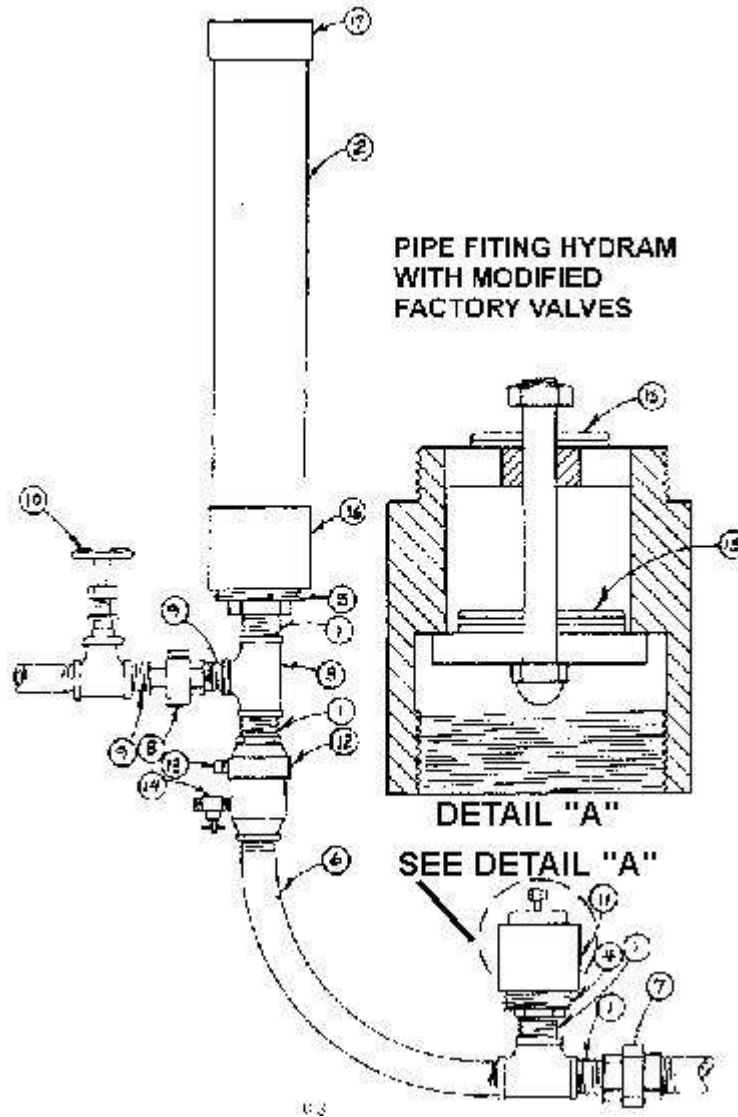

Pipe fitting hydam with modified factory valves

- 1. 1" Nipple
- 2. 3" PVC Pipe (clear)
- 3. 1"x1"x½" Tee
- 4. 2"x1" Reducing Bushing

5. 3"x1" Reducing Bushing
6. 1" 90 Sweep
7. 1" Union
8. ¼" Union
9. ¼" Nipple
10. ¼" Gate Valve
11. 2" Foot Valve
12. 1" Check Valve with taped holes
13. %" Plug
14. 1/8" Gas Cock
15. Assorted Washers
16. 3" PVC Female Adapter
17. 3" PVC Cap

Attachment 8-B

Session 8, Handout 8B

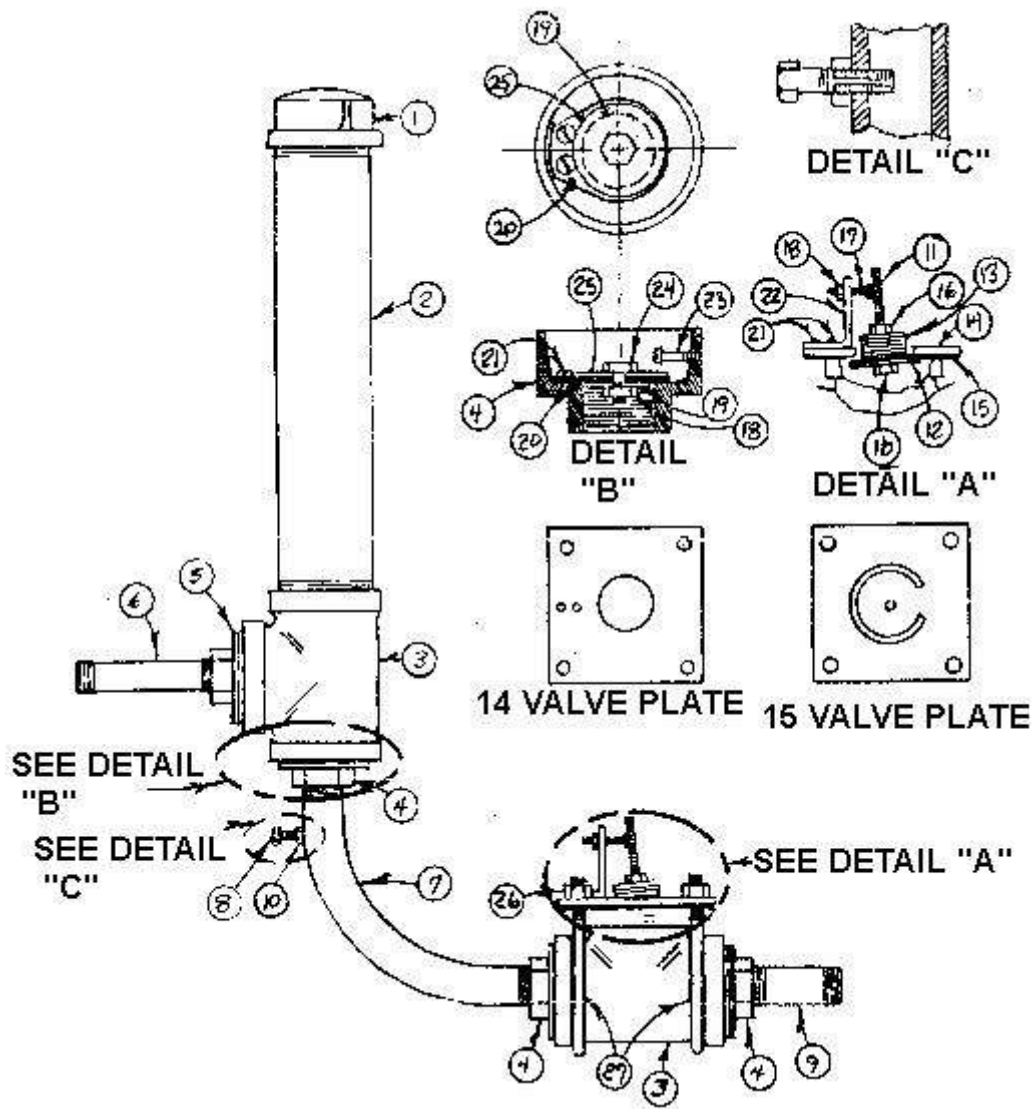

Pipe fitting hydram with field-made valves

1. 3" cap	11. ½-20x4" piece of althread or bolt with 1/8" hole in it	20. check valve rubber
2. 3"x18" nipple	12. 2½" diameter washer	21. 8-32x3/4" screws
3. 3" tee	13. 1½" or smaller washers	22. stroke adjustment
4. 3"x1" reducing bushing	14. impulse valve plate	bracket
5. 3"x½" reducing bushing	15. impulse valve rubber	23. 8-32x3/4"
6. ½"x4" nipple	16. ¼-20 nuts	24. -20x3/4" bolt
7. 1" 90 sweep	17. -20x" bolt	25. 1½" washer
8. 1" ¼-20 bolt (drilled out)	18. ¼-20 nuts	26. 3/8-16 nuts (4)
9. 1" nipple	19. 3/4" washer	27. 3/8-16 althread
10. ¼-20 nut		

Attachment 8-C

Session 8, Handout 8C

Materials needed for fabricated pipe-fitting hydram

Handouts 9-B,	30" 3/8-16 althread
pipe joint compound or TFE tape	4 3/8-16 nuts
1 3" cap	1 1/4-20x1" bolt (drilled out)
2 3" tees	1 1/4-20 x 3/4" bolt
3 3"x 1" reducing bushings	- 1 1/4-20 x 4" althread
1 3"x 1/2" reducing bushing	1 2 1/2" OD washer
1 3"x 18" nipple	6 1 1/2" OD washer
1 1/4" x 4" nipple	4 1/4-20 nuts
1 1" 90° sweep	1 3/4" OD washer
6"x 8"x 1/4" sheet rubber	5 8-32 x 3/4" screws
6"x 6"x 1/4" steel plate	2 8-32 x 3/4" bolts
3"x 1"x 1/8" angle iron	

Tools needed for fabricated pipe-fitting hydram

two pipe wrenches	knife
electric or hand drill	flat file, half round file
drill bits (3/8, 13/64, and 1/8)	hack saw
2" hole saw	1" pipe threader
1/4-20 and 8-32 taps	tape measure
screwdriver	adjustable wrench
access to metalworking shop	sandpaper (medium & fine)

	NOTES
	(FOR FABRICATED PIPE-FITTING HYDRAM)
6.	Impulse Valve
	A. Sand, grind or file the aim of a 3" tee (#3) until it

	<p>has a smooth surface.</p>	
	<p>B. Bend two pieces of 3/8 x 15" althread (#27) around the body of the tee so that the 4 ends extend 1" above the arm.</p>	
	<p>C. Drill a 2" hole in the center of a 6"x 6" piece of steel (#14), then drill 3/8" holes in the corners of the steel where the althread goes through (approx. 4½" apart). Be certain to sand smooth and round off all edges. Drill and tap two 832 holes in plate as shown in Handout 9B, decal A #14, and attach the stroke adjustment bracket (#22).</p>	
	<p>D. Cut out a piece of rubber (#15) with the same outside dimensions and hole pattern as the steel plate but with a horseshoeshaped hole in the middle as shown in Handout 9B (#15).</p>	
	<p>E. Assemble the impulse valve as shown in Handout 9B, Detail A.</p>	
<p>7.</p>	<p>Snifter</p> <p>Extend the thread on one end of a 1" 90° sweep (#7) to extend through a 1 x 3" reducing bushing (#4). Drill and tap a ¼-20 hole near the extended end of the sweep and assemble the snifter as shown in Handout 9B, Detail C, so that the air hole can be covered and uncovered by the lock nut.</p>	
<p>8.</p>	<p>Check Valve</p> <p>A. Drill and tap two holes in the bottom and one in the side of a 1 x 3" reducing bushing for the 8-32 screws as shown in the Handout, Detail B.</p> <p>B. Cut out a piece of rubber ¼-20 for the check valve, bolt washers to the rubber and screw the valve to the 1 x 3" reducing bushing.</p> <p>C. Drill and tap a hole in the bottom of the bushing opposite the 2 previously drilled holes. When a 8-32 screw is inserted the head will overlap the check valve, creating an adjustable stroke. (See Detail B)</p>	<p>The hole in the side should be located so that 8-32 screwhead will be above the check valve r</p>
<p>9.</p>	<p>Body of the Ram</p> <p>Attach all the fittings as shown in Handout 9B, using either pipe joint compound or TFE tape.</p>	
<p>10.</p>	<p>Have each group install their hydram on the test stand or another source of water and start the hydram working.</p>	

11. Discuss the applicability of the fabricated pipe-fitting hydram.

Attachment 10-B

Sessions 9 & 10, Handout 10B

Thickness of the impulse valve plate in inches*

drive head in feet

impulse valve opening in inches	10	20	30	40	50
1.5	3/8	7/16	7/16	5/a	
2	1/4	3/8	7/16	1/2	5/8
2.5	5/16	3/6	1/2	9/16	5/8
3	5/16	7/16	1/2	9/16	5/8
4	5/16	7/16	1/2	9/16	5/8
5	3/8	1/2	9/16	5/8	11/16
6	3/C	I/2	9/16	5/8	11/16
8	7/16	1/2	5/8	11/16	3/4
12	1/2	5/6	11/16	3/4	13/16
16	I/2	5/8	3/4	13/16	7/8

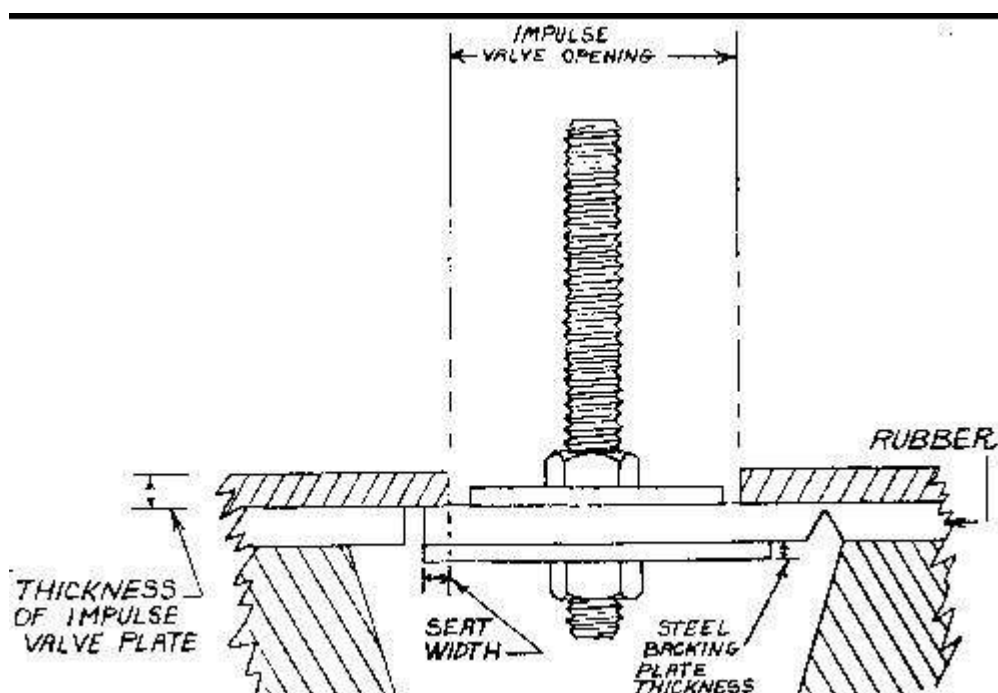

Thickness of the impulse valve plate in inches

Attachment 10B - metric

Sessions 9 & 10, Handout 10B - metric

Thickness of the impulse valve plate in millimeters*

Drive head in meters

Drive head in meters

	3	6	9	12	15
40	6	10	11	13	16
50	6	10	11	13	16
60	8	10	13	14	16
75	8	11	13	14	16
100	8	11	13	14	16
125	9.5	13	14	16	18
150	10	13	14	16	18
200	11	13	16	18	19
300	13	16	18	19	21
400	13	16	19	21	22

Impulse valve opening in millimeters

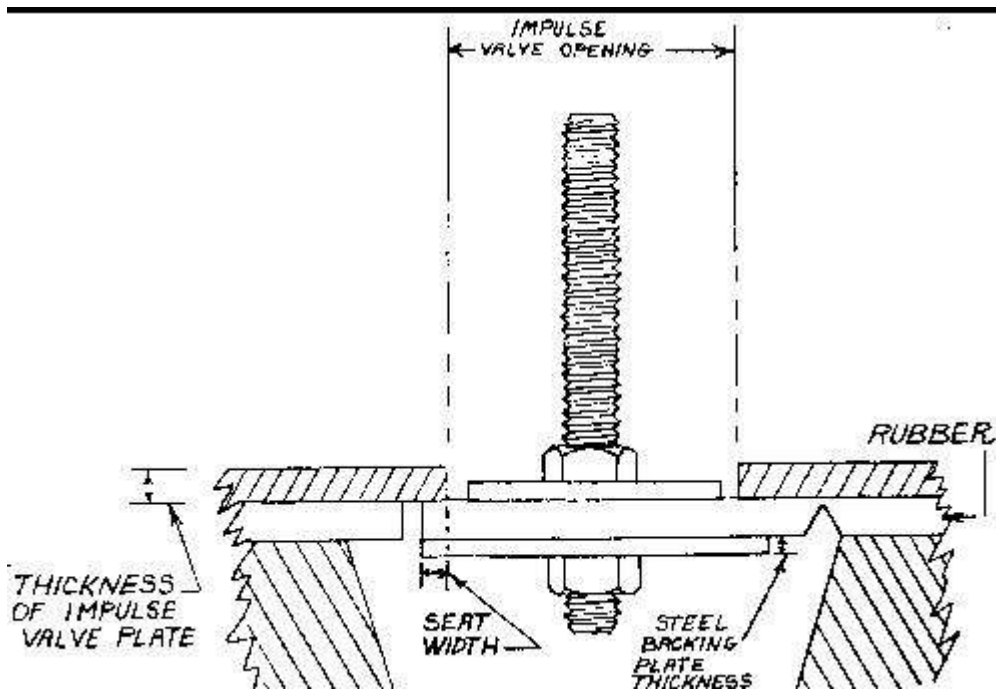

Thickness of the impulse valve plate in millimeters

Attachment 10-C

Sessions 9 & 10, Handout 10C

Impulse valve steel backing

Drive head in feet

	10	20	30	40	50
1.5	1/8	1/8	1/8	3/16	3/16
2	1/8	3/16	3/16	3/16	1/4
2 5	3/16	3/16	1/4	1/4	1/4
3	3/16	1/4	5/16	5/16	5/16
4	1/4	5/16	3/8	7/16	7/16
5	5/16	7/16	1/2	1/2	9/16
6	3/8	1/2	9/16	5/8	11/16
8	1/2	11/16	3/4	13/16	7/8
2	13/16	1	1 1/8	1 1/4	1 5/16
16	11/16	1 5/16	1 1/2	1 11/16	1 13/16

Impulse valve opening in inches

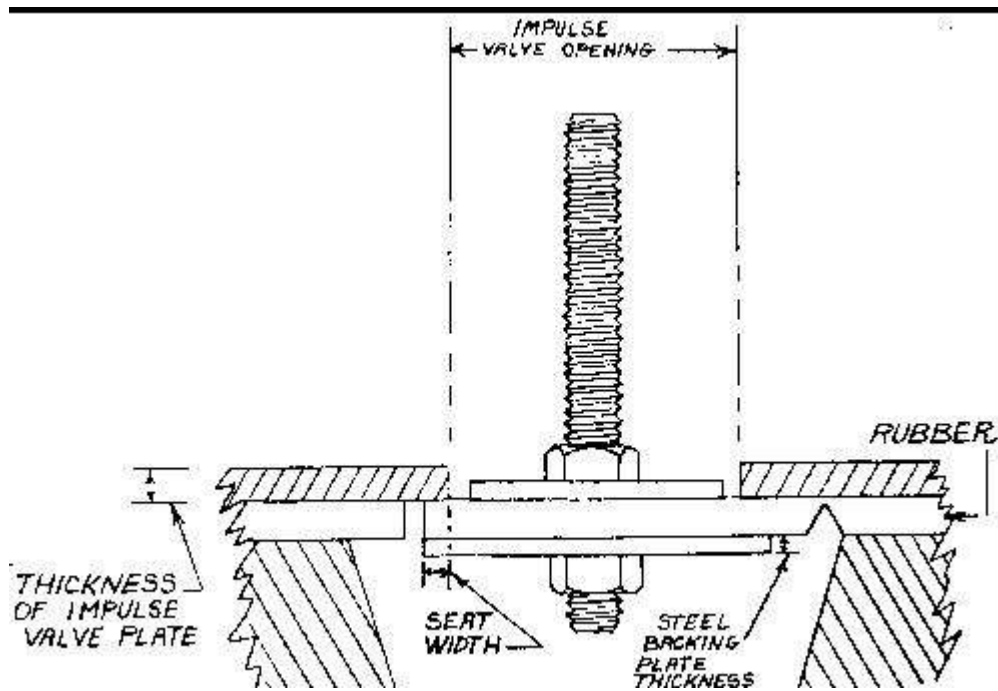

Impulse valve steel backing

Attachment 10-C - metric

Sessions 9 & 10, Handout 10C - metric

Impulse valve steel backing

Drive head in meters

	3	6	9	12	15
40	3		3	5	5
50	2	5	5	5	6
60	5	5	6	6	6
75	5	6	8	8	8
100	6	8	10	11	11
125	8	11	13	13	14
150	10	13	14	16	18
200	13	18	19	21	22
300	21	25	29	32	34
400	27	33	38	42	46

Impulse valve opening in millimeters

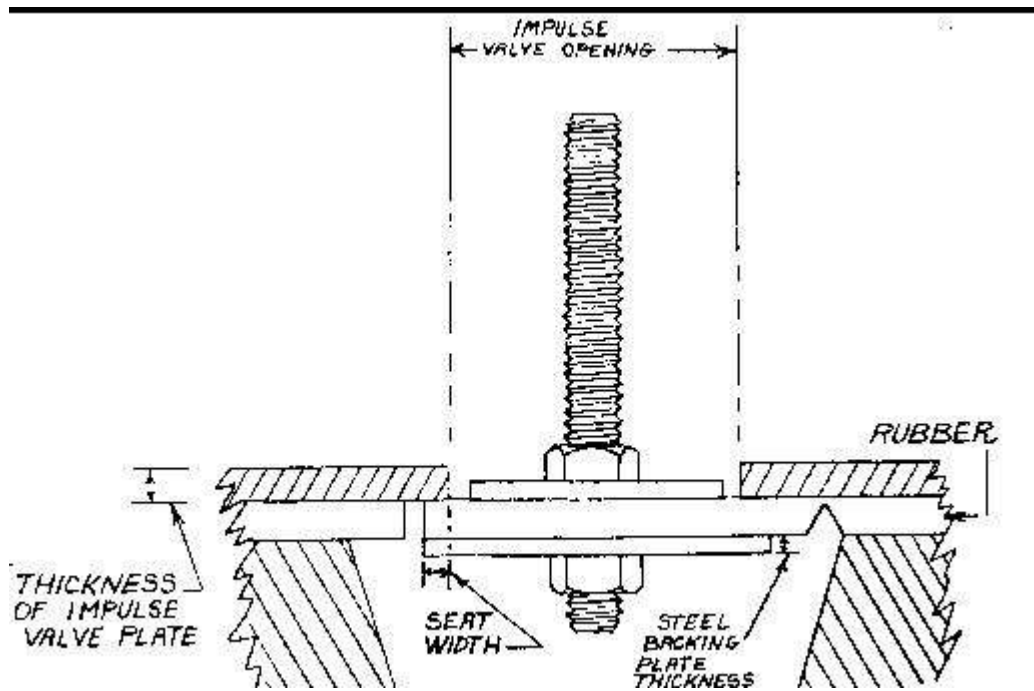

Impulse valve steel backing

Attachment 10-D

Sessions 9 & 10, Handout 10D

Impulse valve seat width in inches

Drive head in feet

	10	15	20	25	30	35	40	45	50
3/4	1/8	3/16	1/4	5/16	3/8	7/16	1/2	9/16	3/8
1	3/16	5/16	3/8	7/16	1/2	9/16	5/8	11/16	3/4
1 1/4	1/4	3/8	7/16	9/16	5/8	3/4	13/16	14/16	1
1 1/2	5/16	7/16	9/16	3/4	3/4	1	1 1/16	1 3/16	
2	3/8	9/16	3/4	7/8	1	1 3/16	1 5/16	1 7/16	1 9/16
2 1/2	1/2	11/16	15/16	1 1/8	1 5/16	1 7/16	1 5/8	1 13/16	1 15/16
3	5/8	7/8	1 1/8	1 5/16	1 9/16	1 3/4	1 15/16	2 3/16	2 5/16
4	13/16	1 1/8	1 7/16	1 3/4	2 1/16	2 3/8	2 5/8	2 7/8	3 1/8
6	1 3/16	1 11/16	2 3/16	2 5/8	3 1/8	3 1/2	3 15/16	4 5/16	4 11/16
2	1 11/16	2 1/4	2 15/16	3 9/16	4 1/8	4 11/16	5 1/4	5 3/4	6 1/4

Impulse valve opening in inches

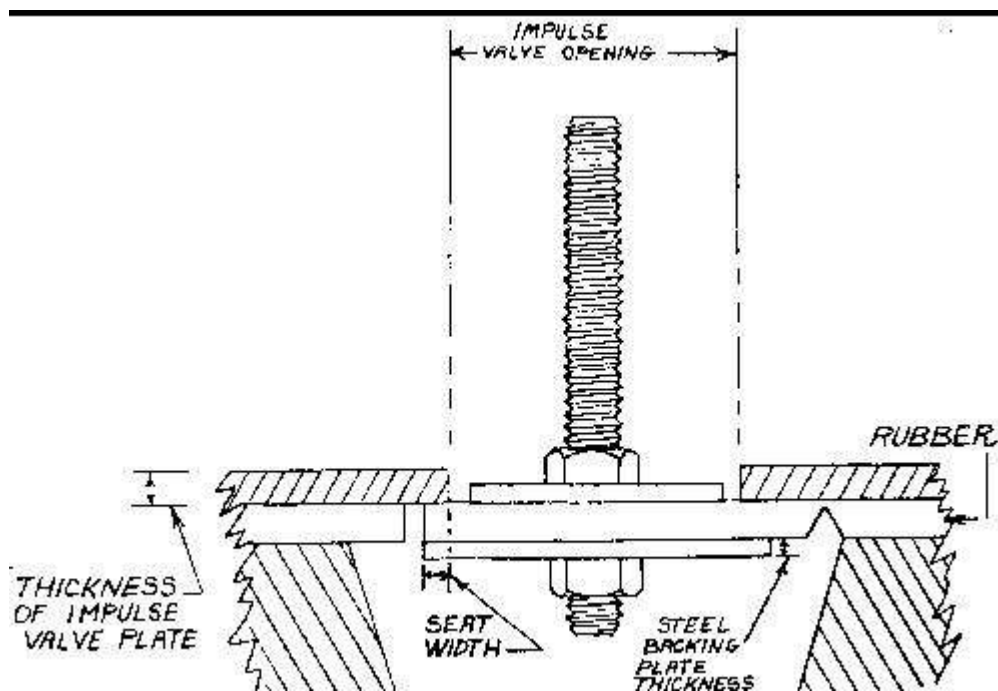

Impulse valve seat width in inches

Attachment 10-D - metric

Sessions 9 & 10, Handout 10D - metric

Attachment impulse valve seat width in millimeters

Drive head in meters

	3	4.5	6	7.5	9	10.5	12	13.5	15
20	3	5	6	8	10	11	13	14	16
25	5	8	10	11	13	14	16	18	19
30	6	10	11	14	16	19	21	22	25
40	8	11	14	18	19	22	25	27	30
50	10	14	19	22	25	30	33	36	39
60	13	18	24	29	33	36	41	46	49
75	16	22	29	33	39	44	49	55	58
100	21	29	36	44	52	60	66	72	79
150	30	43	55	66	79	89	100	109	119
200	43	56	74	89	104	119	130	146	158

Impulse valve opening in millimeters

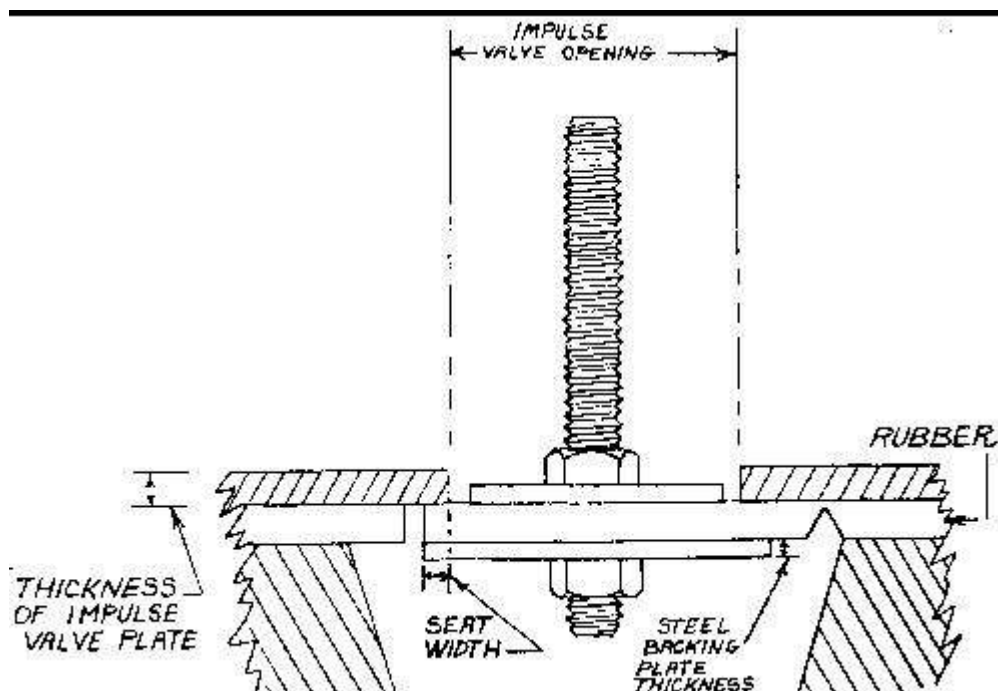

Impulse valve seat width in millimeters

Attachment 10-E

Sessions 9 & 10, Handout 10E

Check valve backing thickness in inches

Delivery head in feet

	25	50	75	100	125	150	175	200
3/4	1/16	1/16	1/16	1/16	1/16	1/16	1/16	1/16
1	1/16	1/16	1/16	1/16	1/16	1/16	1/16	1/16
1¼	1,16	1/16	1/16	1/16	1/16	1/16	1/16	1/16
1½	1/16	1/16	1/16	1/16	1/16	1/8	1/8	1/8
2	1/16	1/8	1/8	1/8	1/8	1/8	1/8	1/8
2½	1/8	1/8	1/8	1/8	3/16	3/16	3/16	3/16
3	1/8	1/8	3/16	3/16	3/16	3/16	3/16	1/4
4	3/16	3/16	¼	1/4	1/4	5/16	5/16	5/16
6	1/4	5/16	3/8	7/16	7/16	1/2	1/2	1/2
8	3/8	½	9/16	5/£3	5/8	11/16	11/16	3/4

Impulse valve opening in inches

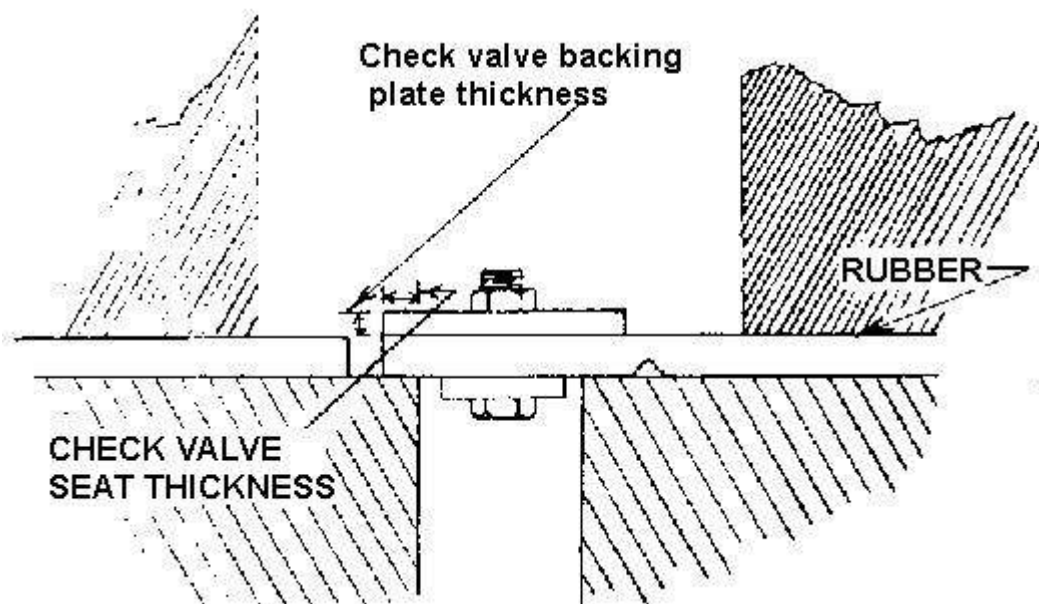

Check valve thickness in inches

Attachment 10-E - metric

Sessions 9 & 10, Handout 10E - metric

Check valve backing thickness in millimeters

Delivery head in meters

	7.5	15	23	30.5	38	45.5	53.5	60
20	2	2	2	2	2	2	2	2
25	2	2	2	2	2	2	2	2
30	2	2	2	2	2	2	2	2
40	2	2	2	2	2	3	3	3
50	2	3	3	3	3	3	3	3
60	3	3	3	3	5	5	5	5
75	3	3	5	5	5	5	5	6
100	5	5	6	6	6	8	8	8
50	6	8	10	11	11	13	13	13
200	10	13	14	16	16	18	18	19

Impulse valve opening in millimeters

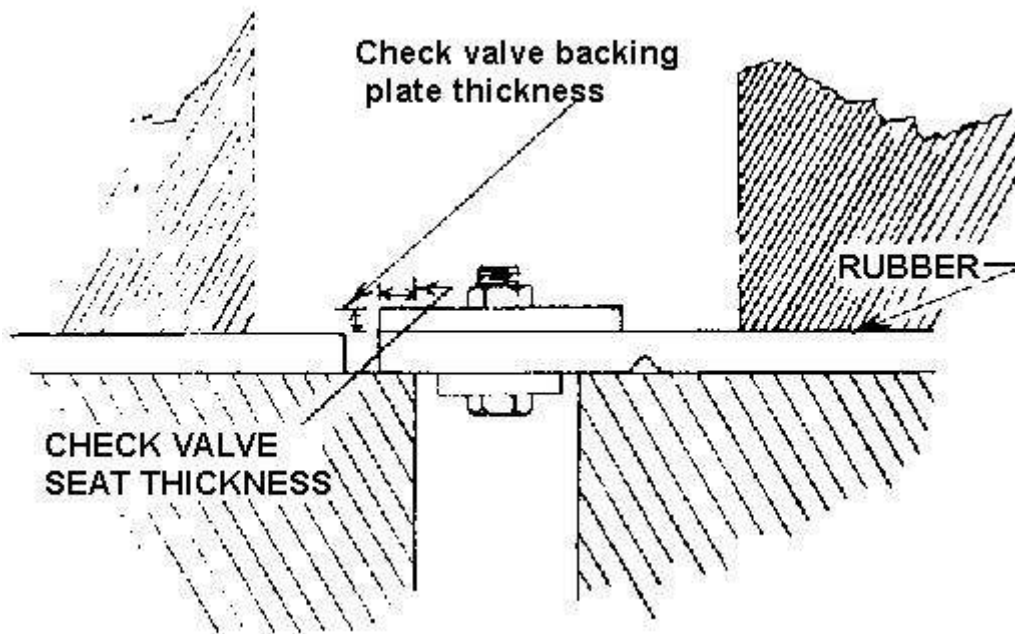

Check valve backing thickness in millimeters

Attachment 10-F

Sessions 9 & 10, Handout 10F

Check valve seat width in inches

Delivery head in feet

	25	50	75	100	125	150	175	200
¾	1/8	1/8	1/8	1/8	1/8	1/E	3/16	3/16
1	1/8	1/8	1/8	1/8	1/8	3/16	1/4	1/4
1¼	1/8	1/8	1/8	i/8	3/16	3/16	1/4	3/8
1½	1/8	1/8	1/8	1/8	3/16	1/4	5/16	7/16
2	1/8	1/8	1/8	3/16	1/4	5/16	7/16	9/16
2½	1/8	1/8	3/16	1/4	5/16	7/16	9/16	11/16
3	1/8	1/8	3/16	5/16	3/8	1/2	5/8	13/16
4	1/8	3/16	¼	3/8	1/2	11/16	7/8	17/16
6	1/8	¼	3/8	9/16	3/4	1	1 1/4	1 5/8
8	3/16	5/16	9/16	3/4	1	1 5/16	1 11/16	2 3/16

Impulse valve opening in inches

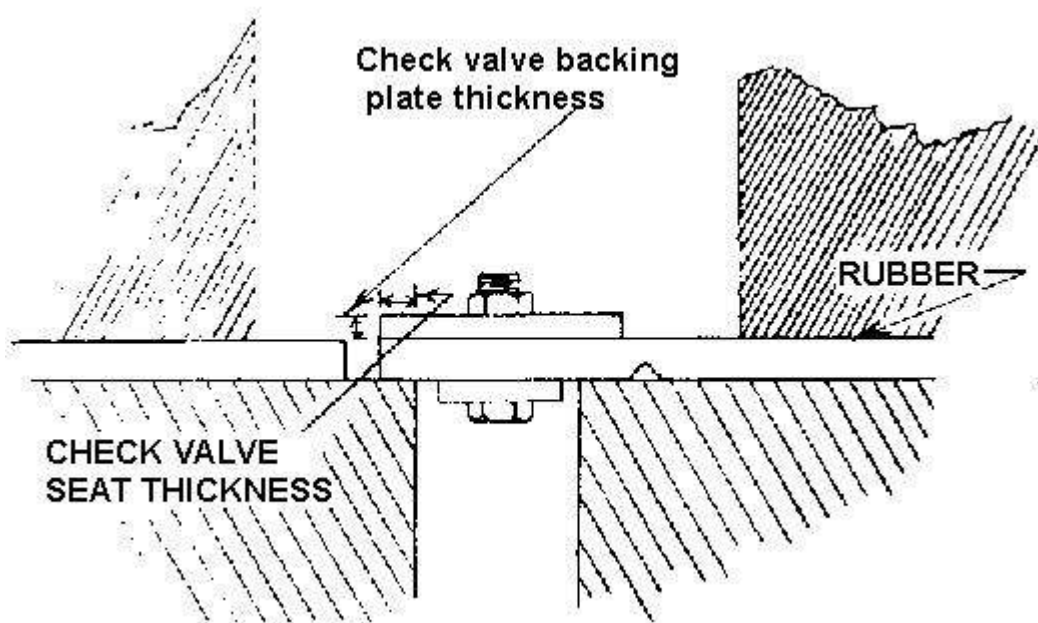

Check valve seat width in inches

Attachment 10-F - metric

Sessions 9 & 10, Handout 10F - metric

Check valve seat width in millimeters

Delivery head in meters

	7.5	15	23	30	38	45	53	60
20	3	3	3	3	3	3	5	5
25	3	3	3	3	3	5	6	6
30	3	3	3	3	5	5	6	10
40	3	3	3	3	5	6	8	11
50	3	3	3	5	6	8	11	14
60	3	3	5	6	a	11	14	18
75	3	3	5	8	10	13	16	21
100	3	5	6	10	13	18	22	27
150	3	6	10	14	19	25	30	41
200	5	8	14	19	25	33	43	55

Impulse valve opening in millimeters

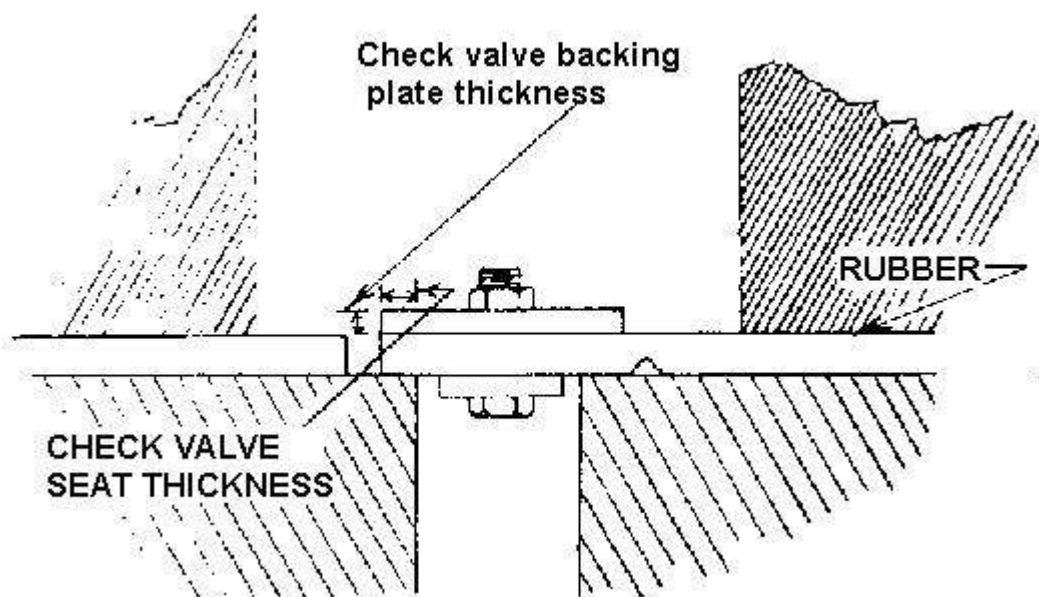

Check valve seat width in millimeters

Attachment 9-A-1

Session 9, Handout 9A-1

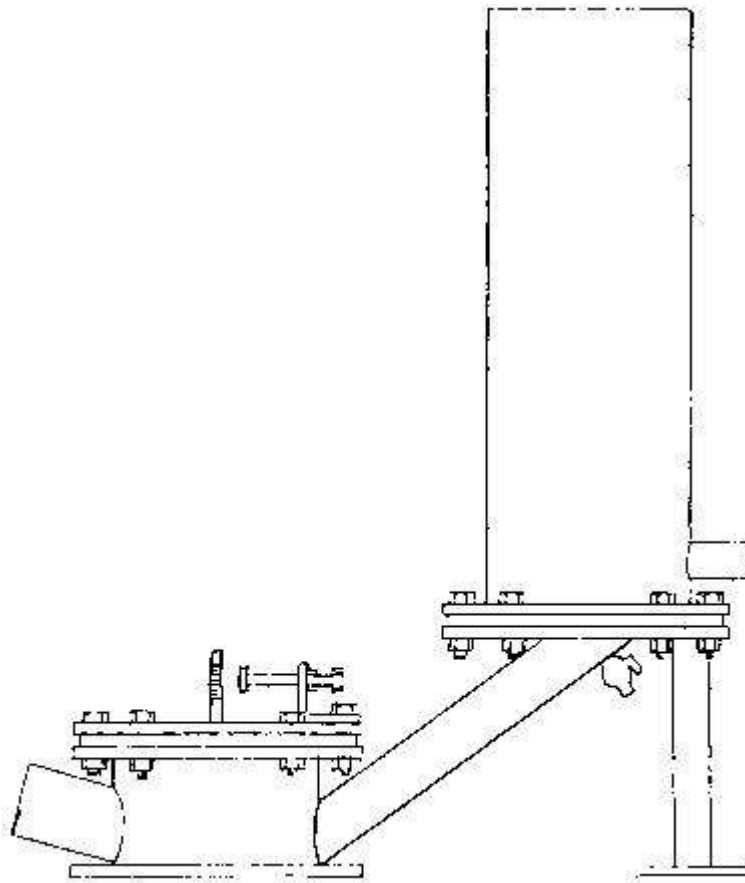

Welded hydram: side view

Attachment 9-A-2

Session 9, Handout 9A-2

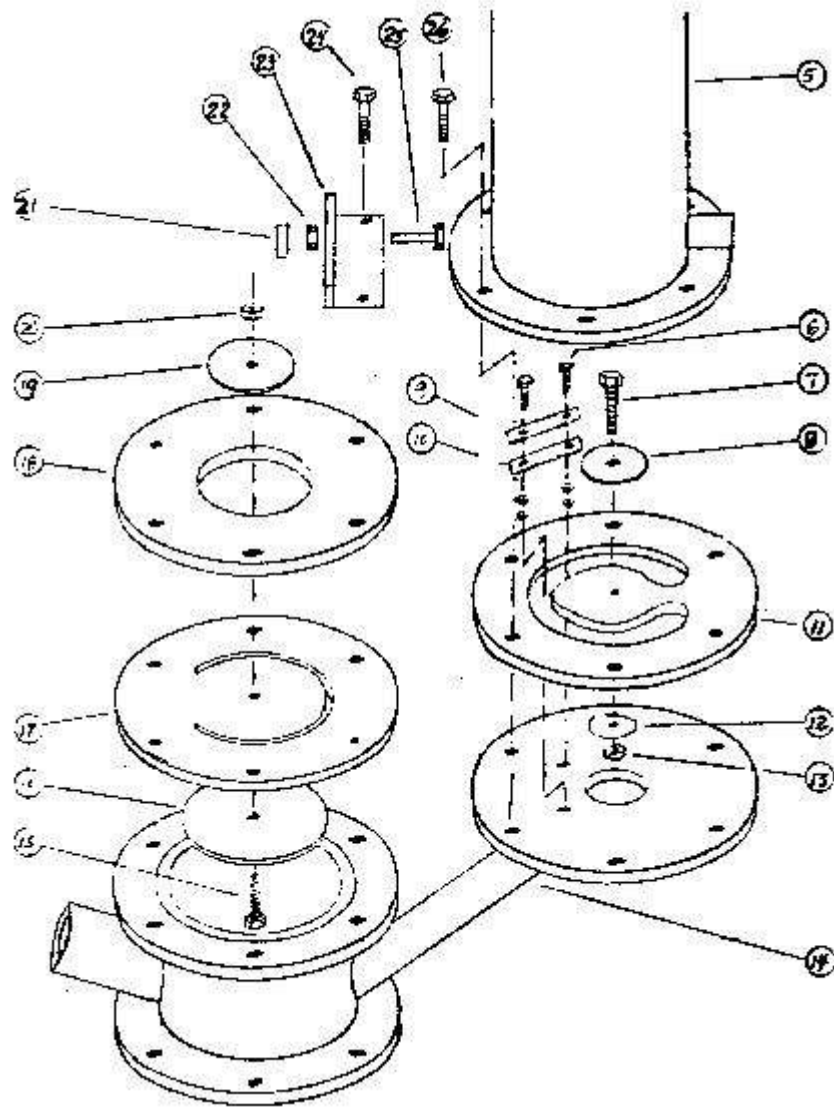

Welded hydram: exploded view

Attachment 9-A-3

Session 9, Handout 9A-3

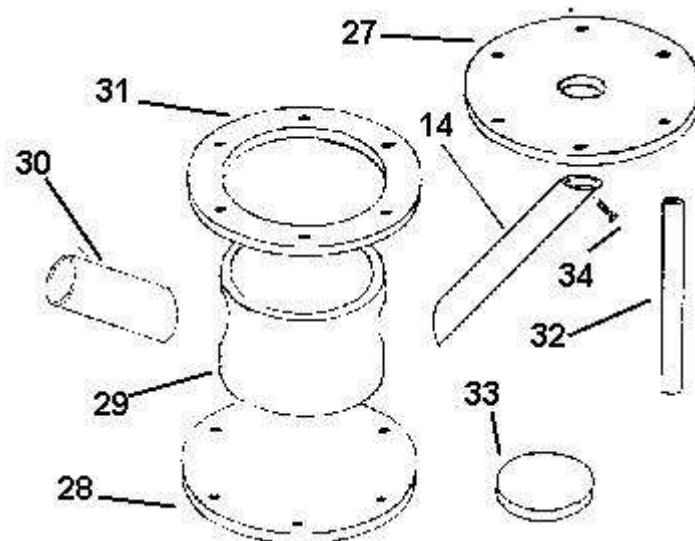

Welded hydram, impulse cavity: exploded view

Attachment 9-A-4

Session 9, Handout 9A-4

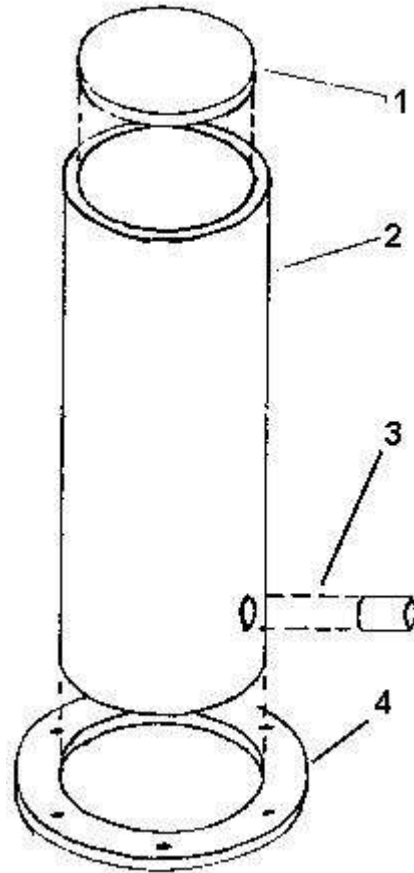

Welded hydram, accumulator: exploded view

Attachment 9-A-5

Session 9, Handout 9A-5

Welded hydram 20' drive head

	SIZE	1	1¼	1½	2	3	4	6
1	Accumulator Top Diameter	3	4	5	6	9	12	18
1	Accumulator To Thickness	3/8	3/8	7/16	7/16	1/2	1/2	5/8
2	Accumulator Pipe Diameter	3	4	5	6	9	12	18
2	Accumulator Pipe Length	20	20	20	20	21	22	24

3	Delivery Socket	1/2	3/4	3/4	1	1 1/2	2	3	
4	Accumulator Base Ring Thickness	3/8	3/8	7/16	7/16	1/2	1/2	5/8	
4	Accumulator Base Outside Diameter	8	8	9	10	14	16	22	
6	1 1/2" Check Valve Stroke Limited bolts	1/4	1/4	1/4	1/4	3/8	3/8	3/8	
7	Check Valve 2" bolt diameter	1/4	1/4	5/16	5/16	3/8	3/8	7/16	
8	Check Valve Backing Plate Thickness	1/16	1/16	1/8	1/8	1/4	5/16	1/2	
8	Plate should be larger than hole by:	1/2	3/4	7/8	1 1/8	1 5/8	2 1/8	3 1/4	
9	Stroke Limiter Metal strip								
10	Stroke Limiter Rubber Strip								
11	1/2 to 1/2 thick Rubber with Valve same as the #8 backing slate and O.								
12	Check valve washer outside_diam.	1/2	3/4	3/4	1	1 1/2	2	3	
13	Check valve nut	1/4	1/4	5/16	5/16	3/8	3/8	7/16	
14	Connecting pipe inside Diameter	3/4	1	1 1/4	1 1/2	2	3	4	
14	Connecting pipe length	11 1/4	11 1/4	12 5/8	14	19 5/8	22 1/2	30 3/4	
14	Impulse Valve Bolt	3/8	3/8	3/8	3/8	3/8	1/2	1/2	
16	Backing Plate Diameter	2 3/4	2 3/4	4 1/8	5 1/2	8 1/4	10 7/8	16 3/8	
16	Backing Plate Thickness	3/16	3/16	1/4	5/16	1/2	11/16	1	
17	1/4 to 1/2 Thick Rubber w/ valve same as the #1 backing late & 0.D. = 4								
18	Impulse Plate O.D. = 4; thickness	3/8	3/8	7/16	7/16	1/2	1/2	5/8	5/8
18	Impulse Plate I.D.	2	2 1/2	3	4	6	8	12	16

19	Impulse Valve Washer Outside Diam.	1 1/2	2	2 1/2	3 1/2	5 1/2	7	11	15
20	Impulse Valve nut	3/8	3/8	3/8	3/8	3/8	1/2	1/2	1/2
21	Rubber Bumper								
22	Lock nut	1/4	1/4	3/8	3/8	3/8	3/8	1/2	1/2
23	2"x2"x1/4" angle iron limiter Bracket								
24	Length Impulse Plante Bolts	2	2	2 1/2	2 1/2	3	3 1/2	3 1/2	3 1/2
25	Stroke limiting adjustment bolt	1/4	1/4	5/16	3/8	3/8	3/8	3/8	1/2
26	No. of Accumulator Bolts	6	6	6	6	8	8	10	16
26	Diameter of Accumulator Bolts	3/8	1/2	9/16	5/8	3/4	7/8	1	1
26	Length of Accumulator Bolts	2	2	2 1/2	2 1/2	3	3 1/2	3 1/2	3 1/2
27	Accumulator Base Plate Diameter	8	8	9	10	14	16	22	28
27	Accumulator Base Plate Thickness	3/8	3/8	7/16	7/16	1/2	1/2	5/8	5/8
28	Hydrum Base (same as #27)								
29	Impulse Valve Cavity Inside Diam.	4	4	5	6	10	12	18	24
29	Impulse Valve Cavity Height	3	3	3 1/2	4	6	8	12	16
30	Socket	1	1 1/4	1 1/2	2	3	4	6	8
31	Impulse Valve Ring Thickness	3/8	3/8	7/16	7/16	1/2	1/2	5/8	5/8
31	Impulse Valve Ring Diameter	8	8	9	10	14	16	22	28
32	1" Support Pipe Length	8	8	8 1/2	9	11	13	17	21
33	4" Diameter Support Base Thickness	3/8	3/8	7/16	7/16	1/2	1/2	5/8	5/8

34	Snifter Bolt	1/4	1/4	1/4	1/4	3/8	3/8	3/8	1/2
-----------	---------------------	------------	------------	------------	------------	------------	------------	------------	------------

Attachment 9-A-7

Session 9, Handout 9A-7

Welded Hydram 40' Drive Head

	SIZE	1	1¼	1½	2	3	4	6	8
1	Accumulator Top Diameter	3	4	5	6	9	12	18	24
1	Accumulator To Thickness	1/2	9/16	9/16	9/16	5/8	11/16	3/4	3/4
2	Accumulator Pipe Diameter	3	4	5	6	9	12	18	24
2	Accumulator Pipe Length	20	20	20	20	21	22	24	24
3	Delivery Socket	1/2	3/4	3/4	1	1 1/2	2	3	4
4	Accumulator Base Ring Thickness	1/2	9/16	9/16	9/16	5/8	11/16	3/4	3/4
4	Accumulator Base Outside Diameter	8	9	10	12	16	18	26	24
6	1½" Check Valve Stroke Limited bolts	1/4	1/4	1/4	1/4	3/8	3/8	3/8	1/2
7	Check Valve 2" bolt diameter	1/4	1/4	5/16	5/16	3/8	3/8	7/16	1/2
8	Check Valve Backing Plate Thickness	1/16	1/16	1/8	1/8	1/4	5/16	1/2	3/4
8	Plate should be larger than hole by:	1/2	3/4	7/8	1 1/8	1 5/8	2 1/8	3 1/4	4
9	Stroke Limiter Metal strip								
10	Stroke Limiter Rubber Strip								
11	½ to ½ thick Rubber with Valve same as the #8 backing slate and								
12	Check valve washer outside_diam.	½	3/4	3/4	1	1 1/2	2	3	4
13	Check valve nut	¼	1/4	5/16	5/16	3/8	3/8	7/16	1/2
14	Connecting pipe inside Diameter	3/4	1	1 1/4	1 1/2	2	3	4	6
14	Connecting pipe length	11 1/4	12 5/8	14	16 3/4	22 3/8	25 1/4	36 3/8	42

14	Impulse Valve Bolt	3/8	3/8	3/8	3/8	3/8	1/2	1/2	1
16	Backing Plate Diameter	3 3/4	4 1/8	5	6 5/8	9 7/9	13 1/4	19 7/8	2
16	Backing Plate Thickness	3/16	1/4	5/16	7/16	5/8	13/16	1 1/4	2
17	1/4 to 1/2 Thick Rubber w/ valve same as the #1 backing late & 0.D. = 4								
18	Impulse Plate O.D. = 4; thickness	1/2	9/16	9/16	9/16	5/8	11/16	3/4	2
18	Impulse Plate I.D.	2	2 1/2	3	4	6	8	12	2
19	Impulse Valve Washer Outside Diam.	1 1/2	2	2 1/2	3 1/2	5 1/2	7	11	2
20	Impulse Valve nut	3/8	3/8	3/8	3/8	3/8	1/2	1/2	1
21	Rubber Bumper								
22	Lock nut	1/4	1/4	3/8	3/8	3/8	3/8	1/2	1
23	2"x2"x1/4" angle iron limiter Bracket								
24	Number of impulse Plate Bolts	6	6	6	6	8	14	24	4
24	Diameter of impulse Plate Bolts	9/16	5/8	3/4	7/8	7/8	7/8	1	2
24	Length Impulse Plante Bolts	2	2	3	3 1/2	3 1/2	3 1/2	4	4
25	Stroke limiting adjustment bolt	1/4	1/4	5/16	3/8	3/8	3/8	1/2	1
26	No. of Accumulator Bolts	6	6	6	6	6	8	12	2
26	Diameter of Accumulator Bolts	9/16	5/8	3/4	7/8	7/8	7/8	1	2
26	Length of Accumulator Bolts	2	2	3	3 1/2	3 1/2	3 1/2	4	4
27	Accumulator Base Plate Diameter	8	9	10	12	16	18	26	2
27	Accumulator Base Plate Thickness	1/2	9/16	9/16	9/16	5/8	11/16	3/4	2
28	Hydram Base (same as #27)								
29	Impulse Valve Cavity Inside Diam.	4	5	6	8	12	14	22	2
29	Impulse Valve Cavity Height	3	3	3 1/2	4	6	8	12	2

30	Socket	1	1 1/4	1 1/2	2	3	4	6	8
31	Impulse Valve Ring Thickness	1/2	9/16	9/16	9/16	5/8	11/16	3/4	1
31	Impulse Valve Ring Diameter	8	9	10	12	16	18	26	30
32	1" Support Pipe Length	8	8	8 1/2	9	11	13	17	20
33	4" Diameter Support Base Thickness	1/2	9/16	9/16	9/16	5/8	11/16	3/4	1
34	Snifter Bolt	1/4	1/4	1/4	1/4	3/8	3/8	3/8	1/2

Attachment 10-A

Session 10, Handout 10A

Concrete hydam design parameters

CAVITY WALL THICKNESS	DOME COVER THICKNESS	NUMBER OF BOLTS AND SIZE
------------------------------	-----------------------------	---------------------------------

The side wall thickness (T_s) in a concrete Hydam without reinforcement shall be equal to the diameter of the cavity (D_c) in inches times the drive head (H) in feet divided by 10 or shall be equal to the cavity diameter, whichever is greater.

The top or bottom wall thickness (T_b) should be 1.25 times the cavity diameter.

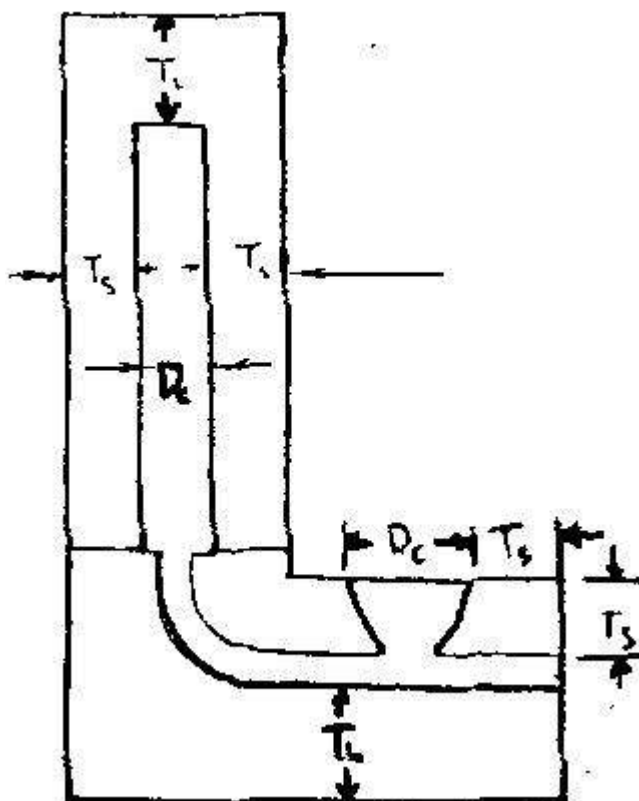

Concrete hydam design parameters

The total bolt area (TBA) should equal the drive pipe diameter (inches) squared times the drive head in feet divided by 50 or :

$$TBA = \frac{D^2 * H}{50}$$

If D in mm. and H in meters then

$$TBA = \frac{D^2 H}{9677.4}$$

To determine the proper number of bolts, find the area of the bolt size you wish to use and divide it into the total bolt area.

Diameter of bolt:

mm.	6.3	8	9.5	11	12.7	14 2	15.8	19.	22.2	25.4
in.	1/4	5/16	3/8	7/16	1/2	9/16	5/8	3/4	7/8	1

Area of bolt:

.027	.045	.068	.093	.126	.162	.202	.302	.419	.551
------	------	------	------	------	------	------	------	------	------

Attachment 10-H

Session 10, Handout 10H

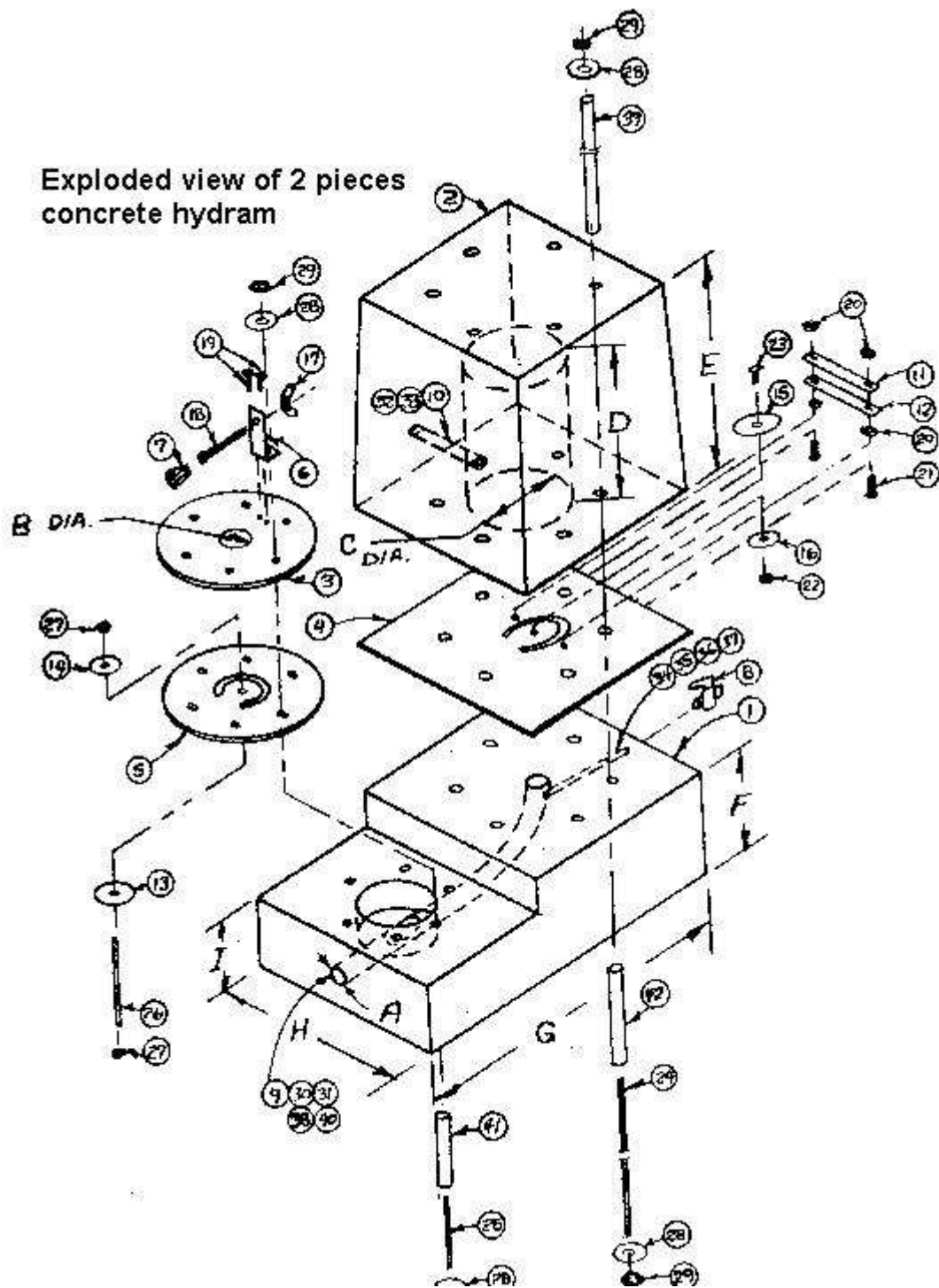

Exploded view of 2 pieces concrete hydram

Exploded view of 2 piece concrete hydram

Attachment 10-I

Session 10, Handout 10I

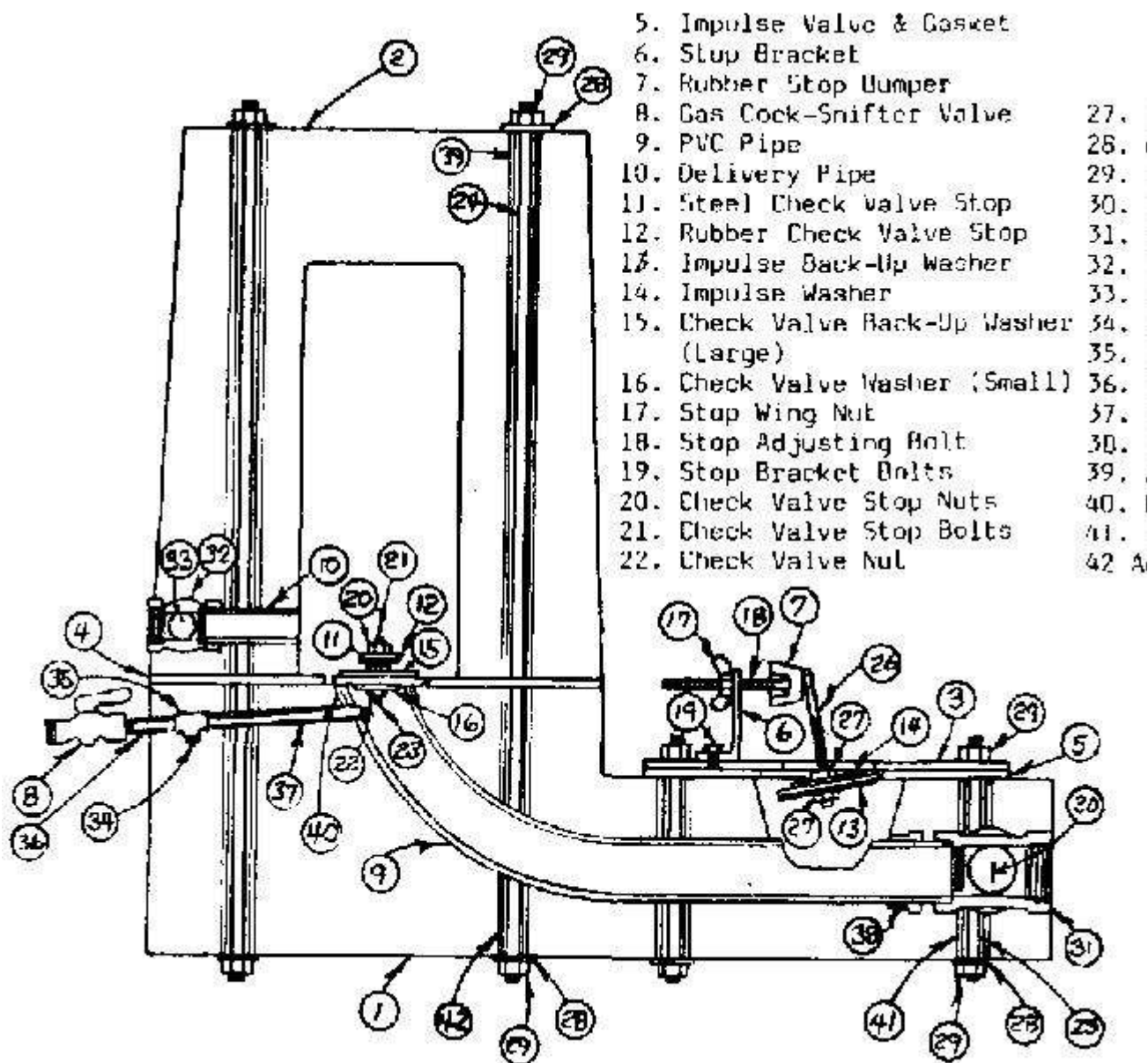

Exploded view of 2 piece concrete hydram

1. Hydram Body	23. Check Valve Bolt
2. Accumulator	24. Althread Bolt (Accumulator)
3. Impulse Plate	25. Althread Bolt (Impulse Plate)
4. Check Valve & Gasket	26. Althread Bolt (Impulse Valve)
5. Impulse Valve & Gasket	27. Impulse Value Hex Nut
6. Stop Bracket	28. Flat Washer
7. Rubber Stop Bumper	29. Hex Nut
8. Gas Cock-Snifter Valve	30. Pipe Plug (Drive Pipe Size)
9. PVC Pipe	31. Steel Pipe Tee (Drive Pipe Size)
10. Delivery Pipe	32. Pipe Tee (Delivery Pipe Size)
11. Steel Check Valve Stop	33. Pipe Plug (Delivery Pipe Size)
12. Rubber Check Valve Stop	34. Pipe Plug (Snifter Pipe Size)
13. Impulse Back-Up Washer	35. Pipe Tee (Snifter Pipe Size)
14. Impulse Washer	36. Snifter Pipe
15. Check Valve Back-Up Washer(Large)	37. Snifter Pipe
38. PVC Male Adapter	
16. Check Valve Washer (Small)	39. Accumulator Sleeve
17. Stop Wing Nut	40. PVC Coupling
18. Stop Adjusting Bolt	41. Impulse Sleeve
19. Stop Bracket Bolts	42 Accumulator Base Sleeve
20. Check Valve Stop Nuts	21. Check Valve Stop Bolts
22. Check Valve Nut	

Attachment 10-J

Session 10, Handout 10J

Two piece concrete hydram form

ONE PIECE CONCRETE HYDRAM FORM

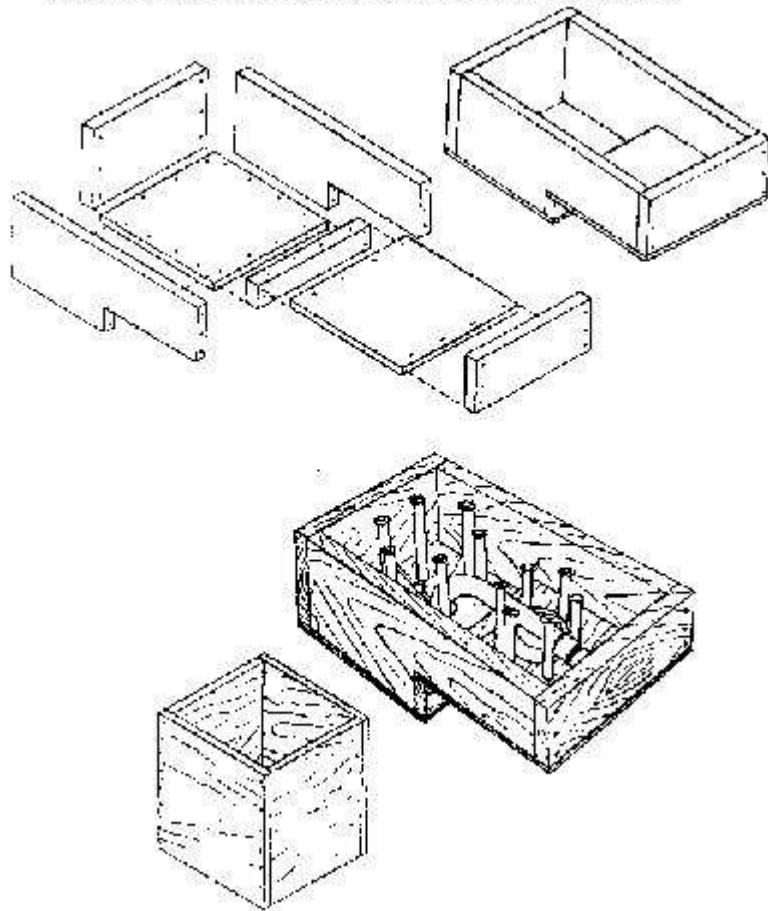

Two piece concrete hydram form

Session 10, Handout 10K

One-piece concrete hydram

ONE PIECE CONCRETE HYDRAM

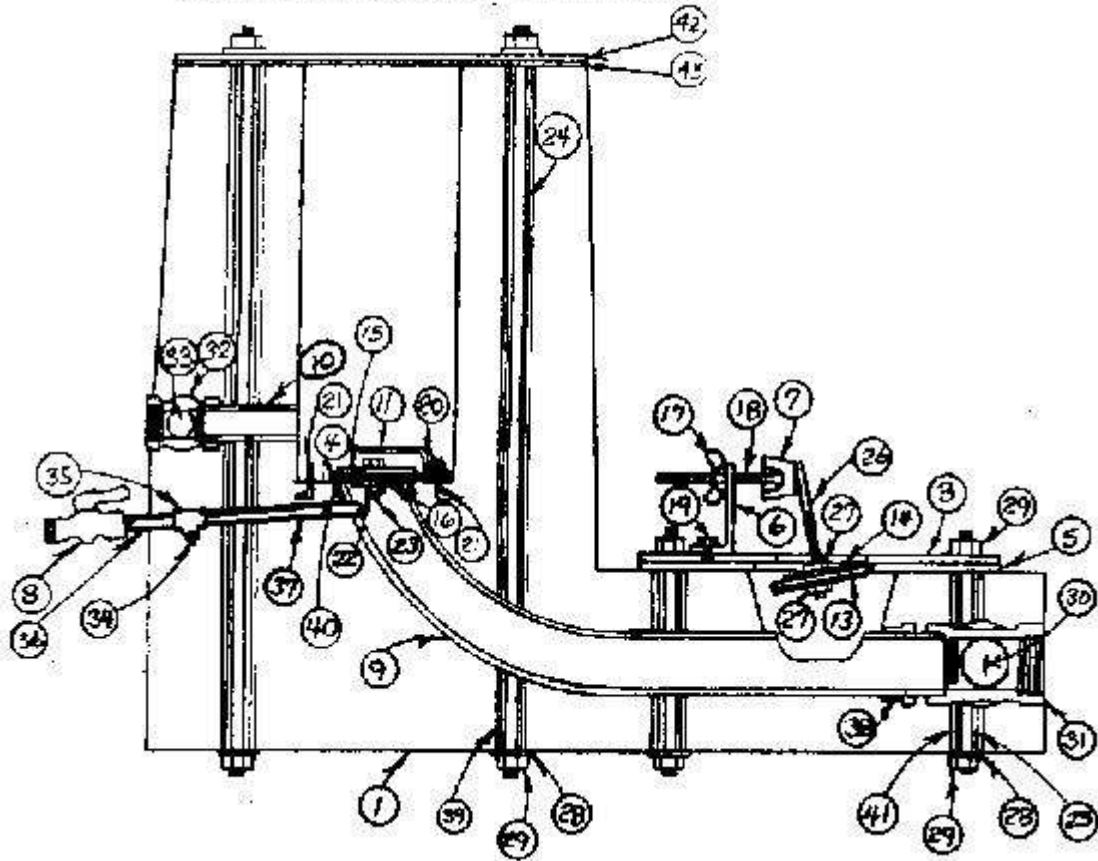

One-piece concrete hydram

1. Hydram body	22. check valve nut
2. gasket	23. check valve bolt
3. impulse plate	24. althread bolt (accumulator)
4. check valve	25. althread bolt (impulse plate)
5. impulse valve and gasket	26. althread bolt (impulse valve)
6. stop bracket	27. impulse valve hex nut
7. rubber stop bumper	28. flat washer
8. gas cock-shifter valve	29. hex nut
9. PVC pipe	30. pipe plug (drive pipe size)
10. delivery pipe	31. steel pipe tee (drive pipe size)
11. check valve stop	32. pipe tee (delivery pipe size)
12. - N/A -	33. pipe plug (delivery pipe size)
13. Impulse back-up washer	34. pipe plug (snifter pipe size)
14. impulse washer	35. pipe tee (snifter pipe size)
15. check valve back-up washer(large)	36. snifter pipe
16. check valve washer (small)	37. snifter pipe
17. stop wing nut	38. PVC male adapter
18. stop adjusting bolt	39. accumulator sleeve
19. stop bracket bolts	40. PVC coupling
20. check valve stop nuts	41. impulse sleeve
21. check valve stop bolts	42. accumulator plate
43. accumulator plate gasket	

Attachment 10-L

Session 10, Handout 10L

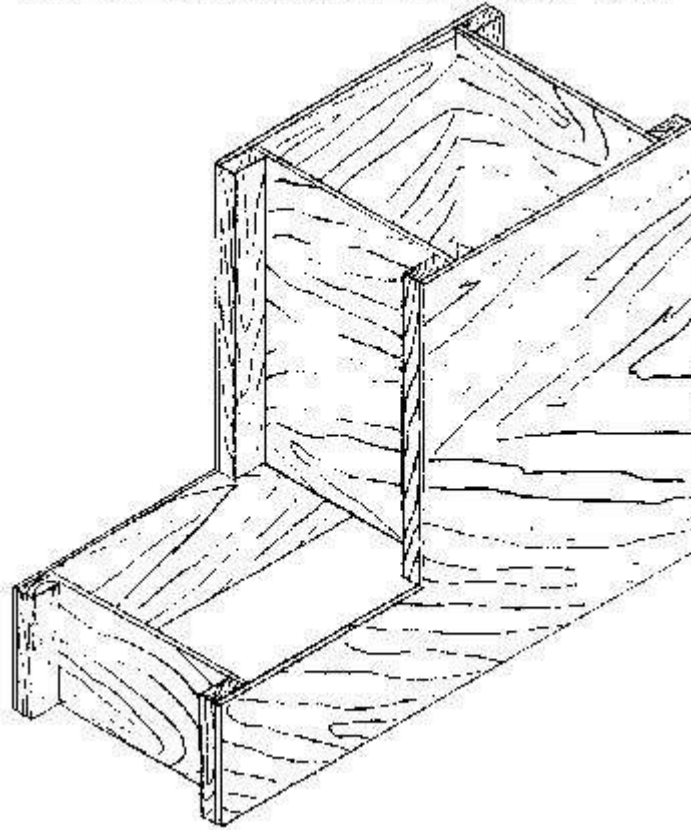
ONE PIECE CONCRETE HYDRAM FORM

One piece concrete hydram form

Attachment 10-M

Session 10, Handout 10M

A community of 100 people requires 20/gal/day/person, and 30 gpd/cow for 35 cows, and wants to use a concrete hydram.

$$h = 90'$$

$$H = 20'$$

A weir 2" wide and 4" deep has been put in the stream; 2' upstream from the weir, the distance from the mark on the stake, level with the top of the weir, to the water level is 1½" Assume an efficiency of 50%, determine the following:

- Q
- D
- d
- Accumulator diameter
- L

- Check valve opening
- Impulse valve opening
- T. s
- TL
- Impulse valve thickness
- Impulse valve seat width
- Impulse valve backing thickness
- Check valve seat width
- Check valve backing thickness
- Number and size of bolts

Attachment 10-N

Session 10, Handout 10N

MATERIALS: gravel, sand, cement, water, form lumber, plastic pipe, bowl, fittings, material for vapor barrier something to mix cement in. Size and quantity of materials is dependent upon the hydram to be constructed. Following is an example of a typical list of materials for a 1" hydram.

1 " CONCRETE HYDRAM MATERIALS LIST	
1 1"x 12"x 8' lumber for body	8 3/8 althread 36" form
1 1"x 12"x 8' lumber for accumulator forms	26 3/8 lock washers
1 1/4"x 7" diameter steel plate	26 3/8 flat washers
1 3" PVC pipe cap	26 3/8 nuts
1 4" bowl	1 1" pipe plug
1 1'x 1'x 1/2 belting	1 1" pipe tee
1 7" diameter x 1/4" belting	1 1/4" pipe plug
1 1"x 2" angle 1" long	1 1/4" pipe tee
1 rubber stop bumper	1 1/4" pipe plug
1 1/4" gas cock	1 1/4" pipe tee
1 1" PVC pipe 2' long	2pcs. 1/4" pipe 2" long
1 1/2" nipple 1 1/2" long	1 1" PVC male adapter
2 2 1/2" washer with 3/8" hole	1 1/4" PVC pipe 22' long
2 1 1/2" washer with 3/8" hole	1 1" PVC coupling
5/16" wing nut	1/2 lb 6d nails
1 5/16 x 2 1/2" bolt	form oil
2 1/4 x 1/2 bolt	2 1/2 gal water
3 5/16 nut	32# cement
1 3/8 bolt 1" long	1 1/3 cu.ft. gravel
1 3" PVC pipe 18" long	1 1/6 cu.ft. sand
Handouts 10A - 10 L	shovels

	PROCEDURES	NOTES
12.	With all the tools and materials gathered, begin construction.	
	Phase I - Part Two	
13.	Start by constructing the hydram base form. (See handout 10J)	

14.	Next, bend the PVC pipe and cut to proper length and angles. Be sure to glue a coupling to the check valve end to increase the seat area.
15.	Notch out bottom of plastic bowl to fit upon the PVC pipe: with the bowl and pipe held together, mark where the pipe touches the inside of the bowl; then, using coping saw, cut along this line. Attach male adapter and the plugged tee to input end of pipe. The plugged tee serves to prevent the pipe from turning within the concrete. Welding a piece of metal onto the coupling would also work.
16.	Drill holes in the bottom of the form for the bolt pattern around the impulse valve and the accumulator.
17.	Center accumulator form pipe on the inside of the form and draw a circle around it. Drive three 6d nails onehalf way in, 120 degrees apart through the circle, making compensation for the thickness of the accumulator form pipe.
18.	Drill hole in PVC pipe for snifter. Drill another hole in form for the other end of snifter. Snifter pipe should have a plugged tee in the middle or a piece of metal welded to the side of it to eliminate turning.
19.	An elliptical rubber washer should be cut out and nailed where the check valve end of the PVC pipe comes in contact with the form. This is to recess the concrete around the check valve seat to insure a good seat.
20.	Bolt sleeves to form using althread, nuts and washers.
21.	Tie PVC pie down to form using tie-wire.
22.	Pour the base of the hydram using the following concrete formula: 8 parts gravel, 7 parts sand, 2 parts cement, and water to proper consistency. Tap on the form sides while pouring to prevent air pockets. Cover concrete with a vapor barrier such as visqueen, then cover entire pour with insulation. Draw pattern for impulse valve plate and send to metal shop.
	Phase II
23.	After the hydram base has had sufficient time to set (usually about 2 days), remove form and place hydram base right side up on blocks so that the bolt holes on the bottom can be reached.
24.	Place a sheet of plastic or wax paper or anything that will prevent a concrete marriage and that won't wrinkle on top of the accumulator end of the hydram.
25.	Place althread and sleeves through bolt pattern at accumulator with nuts and washers on both ends. Tighten until sleeves are rigid.
26.	Build form for accumulator as shown in Handout 10J.
27.	Place accumulator form pipe over the three nails sticking up through the concrete at the check valve. Pack with sand to prevent pipe from floating up in concrete. Cap end of accumulator form pipe with tape or PVC cap.

28.	Place accumulator form on top of hydram base and install the delivery pipe connection between this form and the accumulator form pipe.
29.	Pour accumulator form full of concrete using the same mixture ratio as used in step #22.
30.	Cover with a vapor barrier such as visqueen and insulation.
Phase III	
31.	After concrete has had sufficient time to set up (about one to two days), remove form.
32.	Using a large piece of paper, make a pattern from the hydram base for both the impulse valve rubber and the accumulator check valve rubber.
33.	Cut out the rubbers according to the pattern. If the rubber is too thick to allow free movement of the valves, a v-notch may need to be cut into the rubber at the flex point of the valve.
34.	Drill and cut out a piece of sheet metal for the impulse plate and attach stop bracket.
35.	Install althread, bolt, nuts and washers on both pieces of rubber as shown in the attachment.
36.	Bolt accumulator to base with check valve rubber for a gasket.
37.	Bolt impulse valve rubber and plate to hydram base.
38.	Install stroke adjustment bolt locknut and rubber bumper.
Phase IV	
39.	Install ram to drive pipe and delivery pipe. Start up. Adjust for amount of flow available.
40.	Have the trainees determine the flow rate into and out of the hydram and determine the efficiency.
41.	Discuss with the trainees what they feel the advantages and disadvantages of this ram might be and when they might be important.

Attachment 11-A

Session 11, Handout 11A

Typical impulse valve

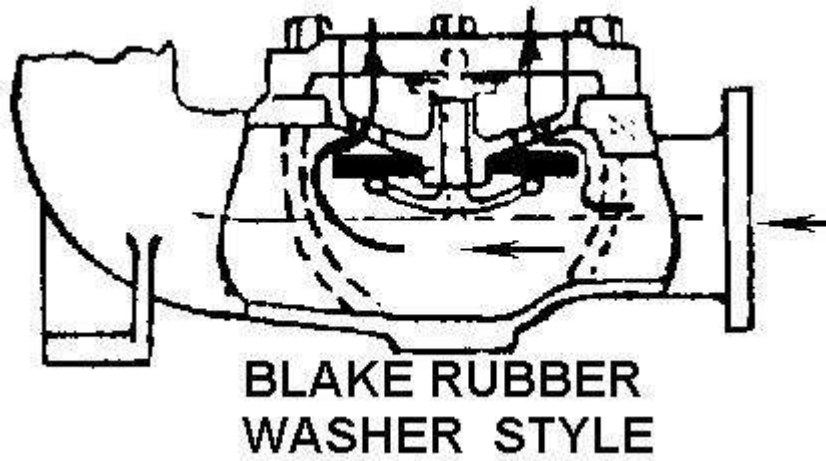

BLAKE RUBBER WASHER STYLE

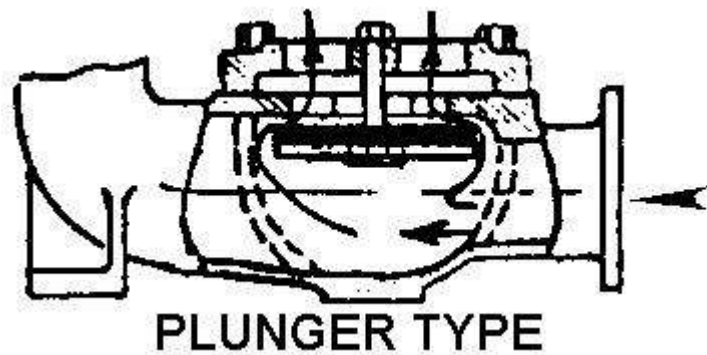

PLUNGER TYPE

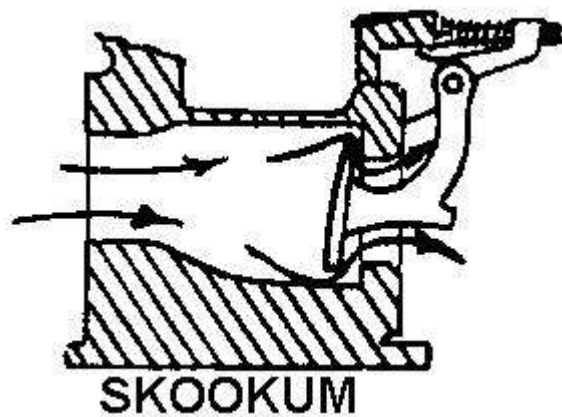

SKOOKUM

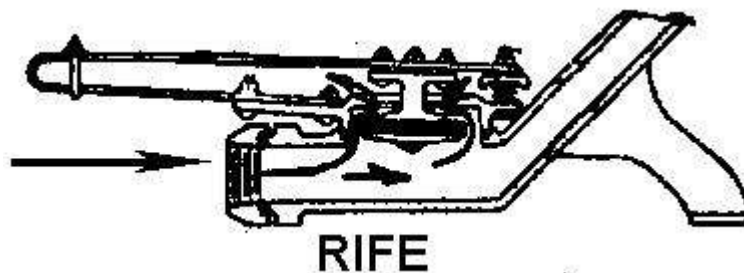

RIFE

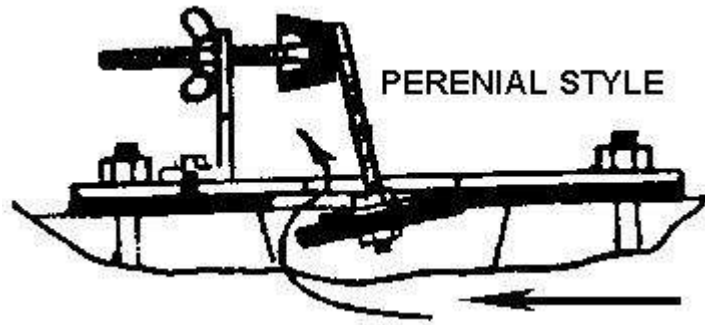

PERENNIAL STYLE

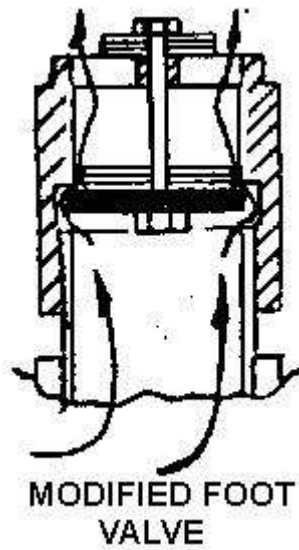

MODIFIED FOOT VALVE

Attachment 11-B

Session 11, Handout 11B

Typical check valves



BLAKE RUBBER WASHER TYPE

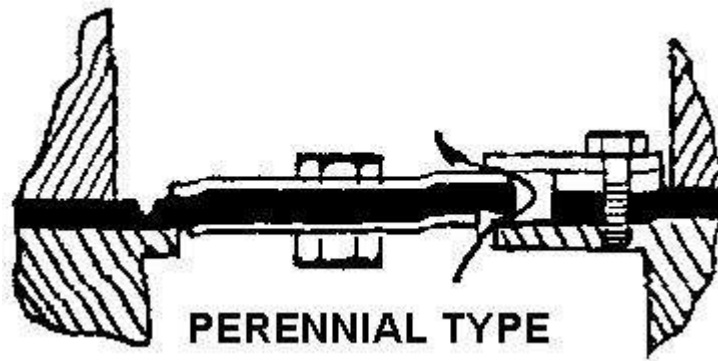

PERENNIAL TYPE

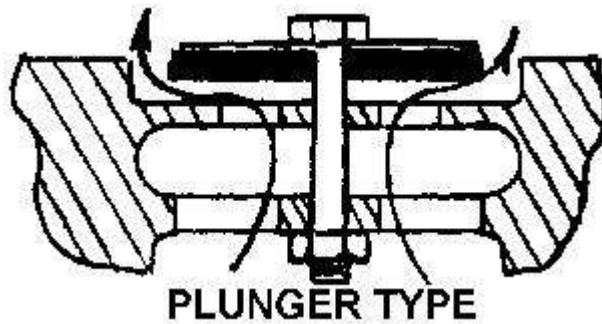

PLUNGER TYPE

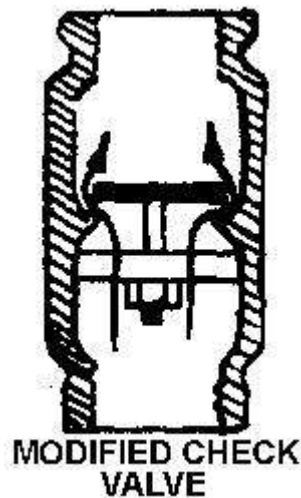

MODIFIED CHECK VALVE

Attachment 11-C

Session 11, Handout 11C

Typical snifters



**STANDARD PLUMBING
SNIFTER**

standard plumbing snifter



GAS COCK

gas cock



NEEDLE VALVE

needle valve



ORIFICE

orifice

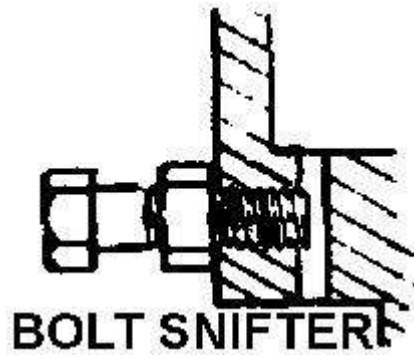

bolt snifter



rubber flap check

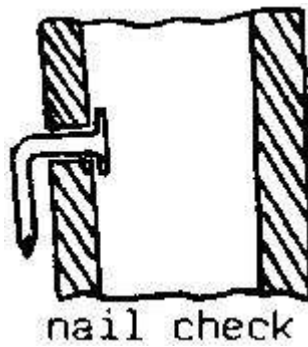

nail check

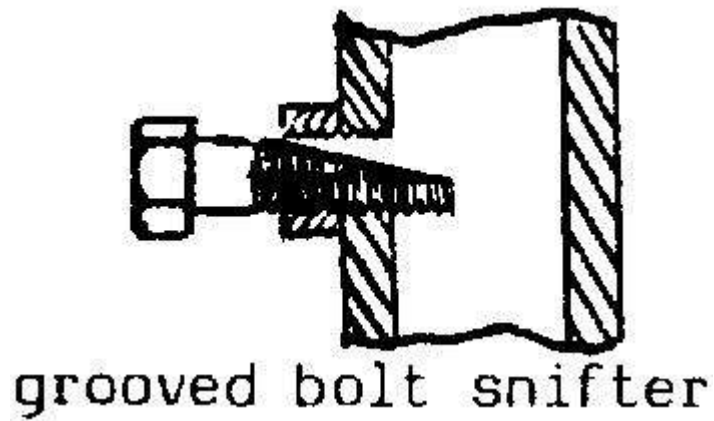

grooved bolt snifter

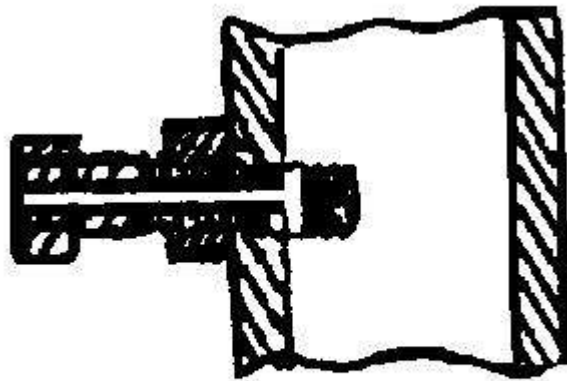

external drilled
bolt snifter

external drilled bolt snifter

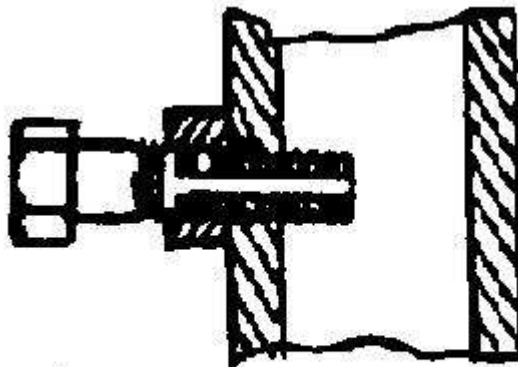

internal drilled
bolt snifter

internal drilled bolt snifter

Attachment 12-A

Session 12, Handout 12A

Hydram comparison

Scale: 1 (best) to 6 (worst)

	CONCRETE	MODIFIED PIPE FITTING	FABRICATED PIPE FITTING	MANUFACTURED HYDRAM	WELDED STEEL
Cost	1	4	3	6	5
	inexpensive	inexpensive	inexpensive	expensive	moderate
Serviceability	5	3	2	1	4
	hard to repair the concrete	parts are hard to repair and usually requires replacement	sometimes difficult to get to the check valve	parts easily made or replaced	requires weld
Availability					
Simplicity of Design	6	1	3	4	5
	requires the greatest amount of time to construct	parts just screw together	most parts screw or bolt together some metal working	most parts are cast & sometimes the rubber parts are field fabricated	requires weld but unique metal shape
Ease of Transportation	6	2	3	5	4
	extremely heavy	small and not very heavy	small and not very heavy	heaviest of the ferrous hydrams	heavy bulk
Longevity	3	5	4	1	2
	if it does not freeze it should last as long as a mfg. Ram	will last about 1 year	no longevity studies done yet, but should last a long time	history of up to 25 yr without service	should last as long as a mfg ram
Efficiency	very little difference if built properly.				

* training device only

Attachment 13-A

Session 13, Handout 13A

Exercise 1: h:H Ratio Has On Efficiency

TASK: DETERMINE THE EFFECT THE h:H RATIO HAS ON EFFICIENCY

Variables: efficiency (η), water delivered (q), water used (Q), time of experiment, water wasted (Q_w)

Controlled Variables: Delivery head (h)

Constants: Drive head (H), frequency (f), volume of air in the accumulator

Range: 2:1 to 20:1

PROCEDURE:

1. Install a hydram to a drive head.
2. Accurately measure the drive head.
3. Attach and set an adjustable pressure relief valve and a pressure gauge to the discharge.
4. Start the hydram.
5. Open the snifter in order to fill the accumulator with air and then close the snifter for the duration of the experiment.
6. Calculate the impulse valve frequency.
7. Simultaneously measure the time of the experiment, water delivered (q) and water wasted (Q_w)
8. Calculate the efficiency (η).
9. Repeat the experiment making sure to keep the drive head, frequency and the volume of air in the accumulator the same and change the delivery head in order to develop a new h:H ratio.

TASK: DETERMINE THE EFFECT THE h:H RATIO HAS ON EFFICIENCY

Experiment #
h:H ratio
H
h
Qw
q
Q
f
s
w
t
n
Notes

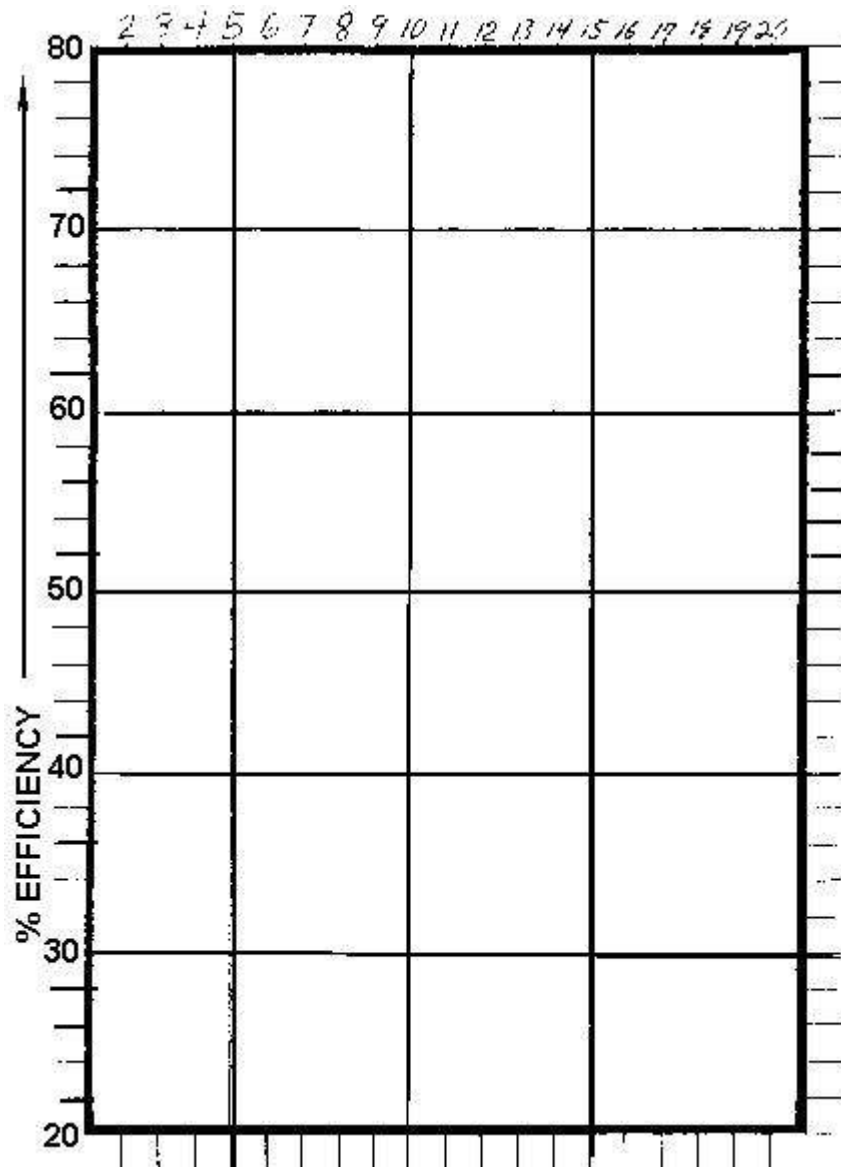

The effect of the delivery head to drive head ratio on efficiency

Exercise 2: frequency on the maximum delivery head to drive head ratio

TASK: DETERMINE THE EFFECT OF THE FREQUENCY ON THE MAXIMUM DELIVERY HEAD TO DRIVE HEAD RATIO

Variables: delivery head (h), water used (Q.), water wasted(Q_w), water delivered (q)

Controlled Variables: amount of air in the accumulator, frequency (f)

Constants: drive head

Range: high frequency to low

PROCEDURES:

- 1. Install a hydram to a drive head.**
- 2. Accurately measure the drive head.**

3. **Attach and set an adjustable pressure relief valve and a pressure gauge to the discharge.**
4. **Start the hydram.**
5. **Open the snifter in order to fill the accumulator and then**
6. **Set the frequency to as fast as possible.**
7. **With delivery valve shut measure the maximum delivery head with a pressure gauge. (Make certain that the hydram that is used is designed for the pressures that will be encountered.)**
8. **Repeat the experiment while slowing down the frequency by even increments making certain that the volume of air in the accumulator remains the same.**
9. **From the pressure reading calculate the delivery head and the h:H ratio.**

TOOLS AND MATERIALS NEEDED:

TASK: Determine the effect of the frequency on the maximum delivery head to drive head ratio

Experiment #
h:H ratio
H
h
Q_w
q
Q
f
s
w
t
n
Notes

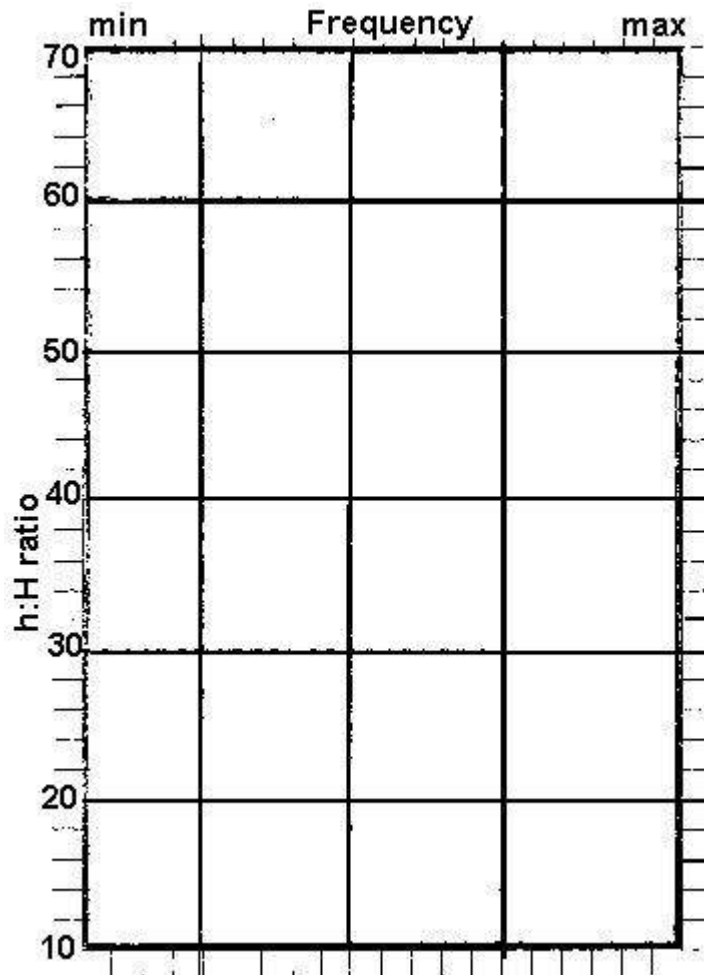

The effect of the frequency on the maximum delivery head to drive head ratio

Exercise 3: frequency on efficiency, quantity of water entering the hydram and quantity of water delivered.

TASK: DETERMINE THE EFFECT OF FREQUENCY ON EFFICIENCY, QUANTITY OF WATER ENTERING THE HYDRAM AND QUANTITY OF WATER DELIVERED.

Variables: time of the experiment, efficiency (η), water used (Q), water delivered (q), water wasted (Q_w)

Controlled Variables: frequency

Constants: drive head (H), delivery head (h), volume of air in the accumulator

Range: slow to fast

PROCEDURE:

- 1. Install a hydram to a drive head.**
- 2. Accurately measure the drive head.**
- 3. Attach and set an adjustable pressure relief valve and a pressure gauge to the discharge.**
- 4. Start the hydram.**

5. Open the snifter in order to fill the accumulator with air and then close the snifter for the duration of the experiment.
6. Calculate the impulse valve frequency.
7. Simultaneously measure the time of the experiment, water delivered (q) and water wasted (Q_w)
8. Calculate the efficiency (n).
9. Repeat the experiment making certain to keep the volume of air in the accumulator, drive head, and delivery head the same while changing the frequency.

TASK: DETERMINE THE EFFECT OF FREQUENCY ON EFFICIENCY, QUANTITY OF WATER ENTERING THE HYDRAM AND QUANTITY OF WATER DELIVERED

Experiment #
h:H ratio
H
h
Q_w
q
Q
f
s
w
t
n
Notes

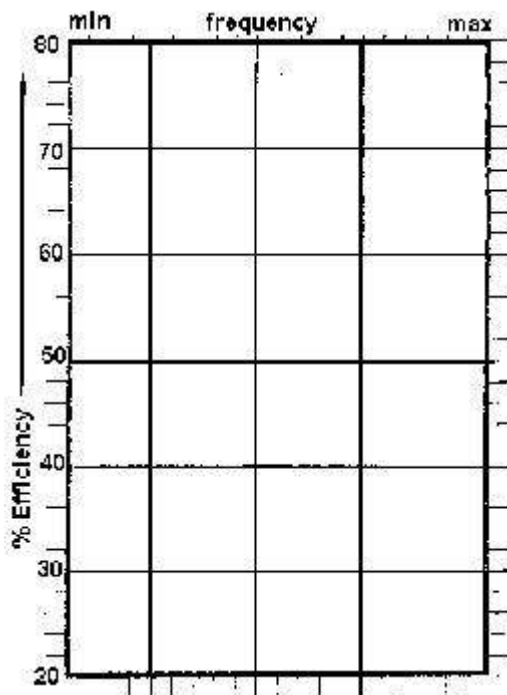

The effect of frequency on efficiency, quantity of water entering the hydram and quantity of water delivered

Exercise 4: volume of air in the accumulator on efficiency.

TASK: DETERMINE THE EFFECT OF THE VOLUME OF AIR IN THE ACCUMULATOR ON EFFICIENCY.

Variables: time of the experiment, efficiency (η), water wasted (Q_w), water pumped (q), water used (Q)

Controlled Variables: volume of air in the accumulator

Constants: drive head (H), delivery head (h), frequency (f)

Range: no air - 24" of air

PROCEDURES:

1. Install a hydram to a drive head.
2. Accurately measure the drive head.
3. Attach and set an adjustable pressure relief valve and a pressure gauge to the discharge.
4. Start the hydram.
5. Open the snifter in order to fill the accumulator with air and then close the snifter for the duration of the experiment.
6. Calculate the impulse valve frequency.
7. Simultaneously measure the time of the experiment, water delivered (q) and water wasted (Q_w)

8. Calculate the efficiency (n).

9. Repeat the experiment making certain to keep the drive head, delivery head and frequency the same while changing the volume of air in the accumulator.

TASK: Determine the effect of the volume of air in the accumulator on efficiency

Experiment #	
h:H ratio	
H	
h	
Q_w	
q	
Q	
f	
s	
w	
t	
n	
Notes	

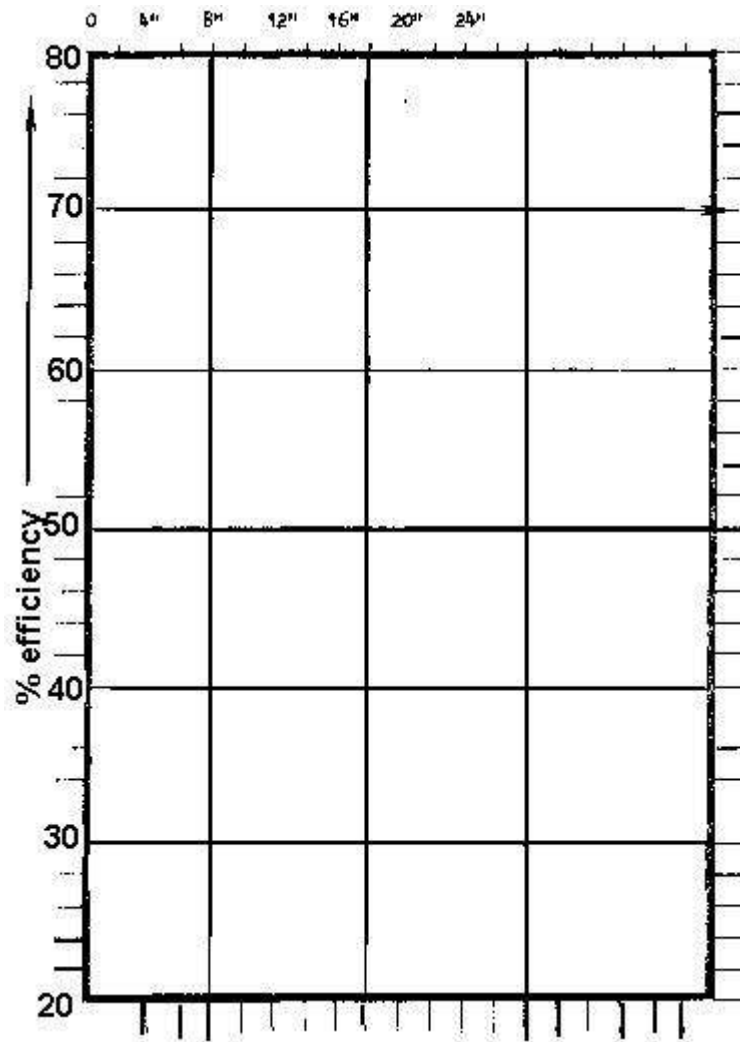

The effect of the volume of air in the accumulator on efficiency

Exercise 5: drive pipe length on efficiency

TASK: DETERMINE THE EFFECT OF THE DRIVE PIPE LENGTH ON EFFICIENCY

Variables: efficiency (η) water wasted (Q_w) water used (Q) water delivered (q), time of the experiment

Controlled Variables: length of the drive pipe

Constants: frequency (f), drive head (H), delivery head (h) volume of air in the accumulator

Range: 10' - 80'

PROCEDURE:

1. Install a hydram to a drive head.
2. Accurately measure the drive head.
3. Attach and set an adjustable pressure relief valve and a pressure gauge to the discharge.
4. Start the hydram.

5. Open the snifter in order to fill the accumulator with air and then close the snifter for the duration of the experiment.
6. Calculate the impulse valve frequency
7. Simultaneously measure the time of the experiment, water delivered (q) and water wasted (Q_w)
8. Calculate the efficiency (n).
9. Repeat the experiment making certain to keep the volume of air in the accumulator, drive head (H), delivery head (h) and frequency the same while changing the length of the drive pipe.

TASK: determine the effect of the drive pipe length on length on efficiency

Experiment #
h:H ratio
H
h
Q_w
q
Q
f
s
w
t
n
Notes

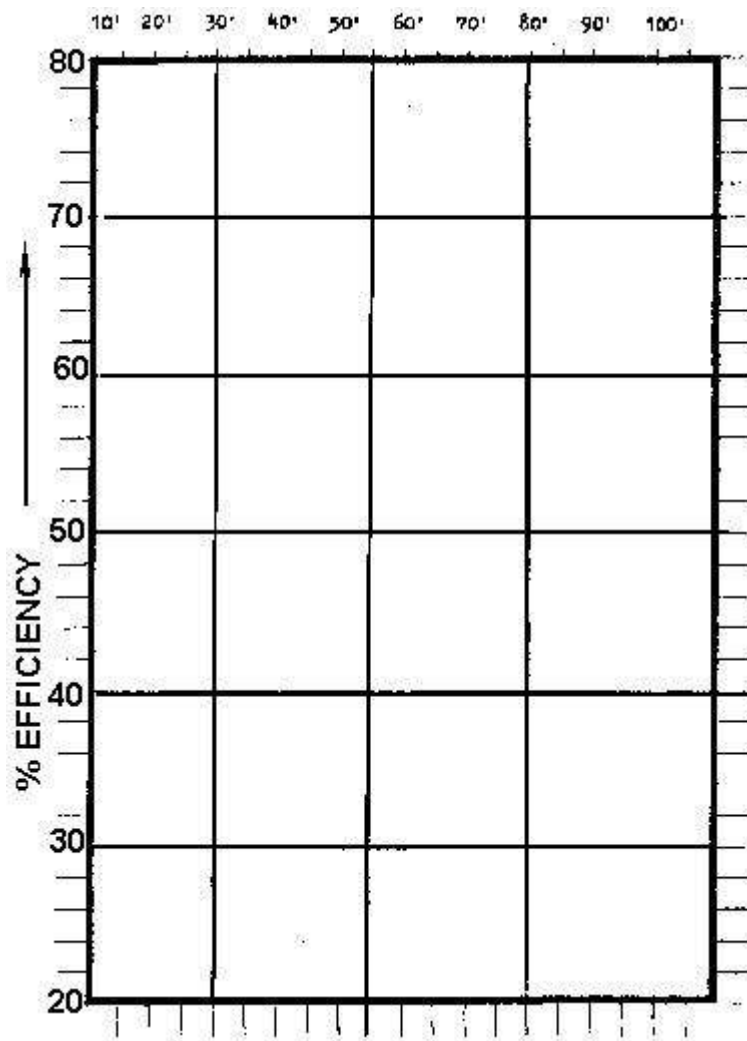

The effect of the drive pipe length of efficiency

Exercise 6

TASK: DETERMINE THE EFFECT OF THE DRIVE PIPE DIAMETER ON EFFICIENCY.

Variables: water wasted (Q), water used (Q), water delivered (q), time of the experiment

Controlled Variables: drive pipe diameter (D)

Constants: drive head (H), delivery head (h), frequency (f), volume of air in the accumulator

Range: $\frac{1}{2}$, $\frac{3}{4}$, 1"

PROCEDURES:

1. Install hydram to a drive head.
2. Accurately measure the drive head.
3. Attach and set an adjustable pressure relief valve and a pressure gauge to the discharge.
4. Start the hydram.

5. Open the snifter in order to fill the accumulator with air and then close the snifter for the duration of the experiment.
6. Calculate the impulse valve frequency.
7. Simultaneously measure the time of the experiment, water delivered (q) and water wasted (Q_w)
8. Calculate the efficiency (n).
9. Repeat the experiment making certain to keep the volume of air in the accumulator, drive head, delivery head, length of drive pipe, and frequency the same while changing the diameter of the drive pipe.

TASK: Determine the effect of drive pipe diameter on efficiency

Experiment #
h:H ratio
H
h
Q_w
q
Q
f
s
w
t
n
Notes

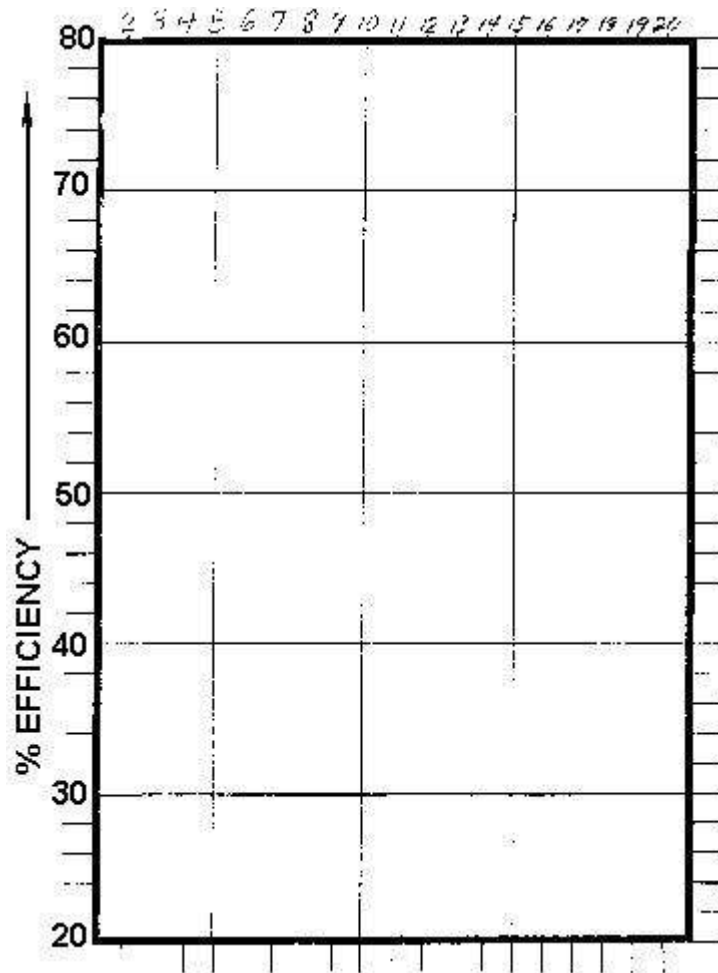

Effect of the drive pipe diameter on efficiency

Exercise 7

TASK: DETERMINE THE EFFECT OF THE SNIFTER ON EFFICIENCY

Variables: time of experiment, water wasted (Q_w) water used (Q), water delivered (q), efficiency

Controlled Variables: Snifter open, snifter closed, one way snifter

Constants: drive head (H), delivery head (h), volume of air in the accumulator

Range: sucking air and spitting water

PROCEDURES:

1. Install a hydram to a drive head.
2. Accurately measure the drive head.
3. Attach and set an adjustable pressure relief valve and a pressure gauge to the discharge.
4. Start the hydram.
5. Open the snifter in order to fill the accumulator with air.

6. Calculate the impulse valve frequency.

7. Simultaneously measure the time of the experiment, water delivered (q), and water wasted (Qw)

8. Calculate the efficiency.

9. Repeat the experiment making certain to keep the volume of air in the accumulator, drive head (H), delivery head (h), and frequency the same while changing the snifter from an open snifter, a one way snifter to no snifter at all.

TASK: DETERMINE THE EFFECT SNIFTER HAS ON EFFICIENCY

Experiment #
h:H ratio
H
h
Qw
q
Q
f
s
w
t
n
Notes

Exercise 8

TASK: DETERMINE THE EFFECT OF THE DRIVE MATERIAL ON EFFICIENCY

Variables: efficiency (n), water wasted (Qw), water used (Q.), water delivered (q), time of the experiment

Controlled Variables: volume of air in the accumulator, delivery head (H), frequency (f)

Constants: frequency (f), drive head (h), delivery head (h), volume of air in the accumulator

Range: 5:1, 10:1, 15:1, 20:1 for both steel and plastic pipes.

PROCEDURE:

- 1. Install a hydram to a drive head.**
- 2. Accurately measure the drive head.**
- 3. Attach and set an adjustable pressure relief valve and a pressure gauge to the discharge.**
- 4. Start the hydram.**
- 5. Open the snifter in order to fill the accumulator with air and then close the snifter for the duration of the experiment.**
- 6. Calculate the impulse valve frequency.**
- 7. Simultaneously measure the time of the experiment, water delivered (q) and water wasted (Q_w)**
- 8. Calculate the efficiency (η).**
- 9. Repeat the experiment making certain to keep the drive head frequency, volume of air in the accumulator, and drive pipe material the same until you have accurate efficiency calculations for $h:H$ ratios of 5:1, 10:1, 15:1, 20:1.**
- 10. Repeat the series of experiments after changing the drive pipe to a different material making certain that everything else stays the same.**

TASK: Determine the effect of the drive pipe material on efficiency

Experiment #
h:H ratio
H
h
Qw
q
Q
f
s
w
t
n
Notes

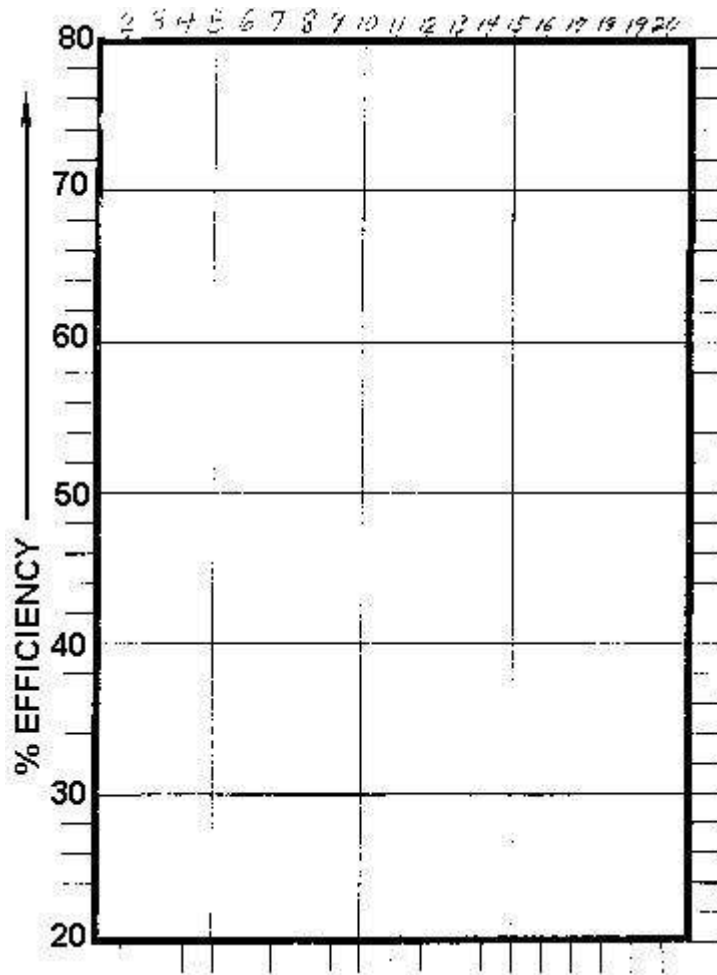

The effect of the drive pipe material on efficiency

Attachment 13-B

Session 13, Handout 13B

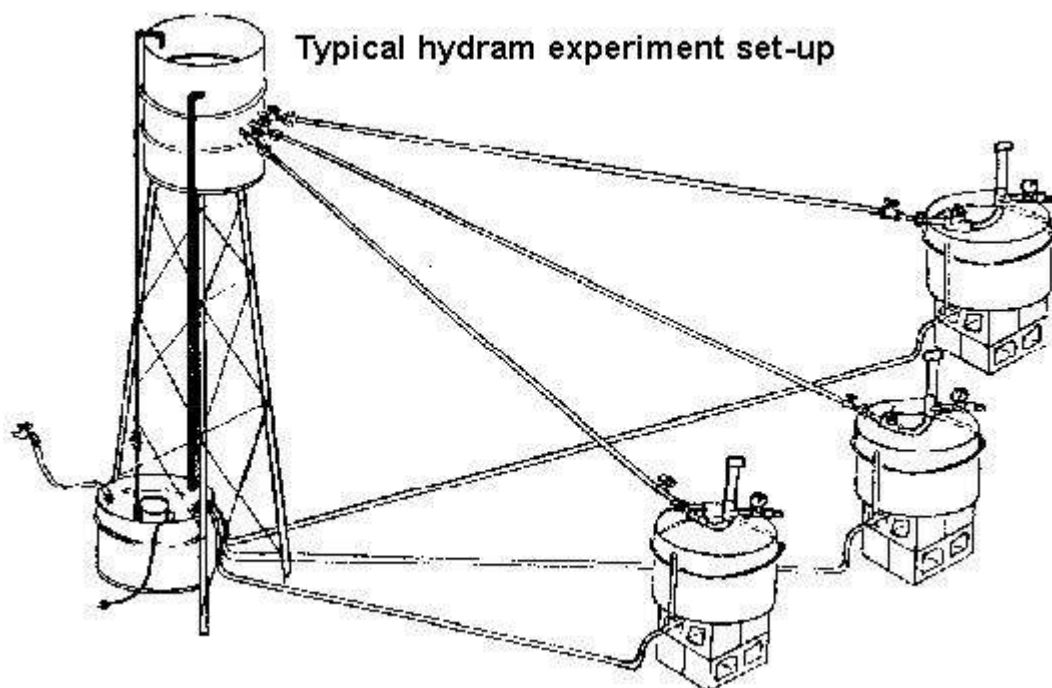

TYPICAL HYDRAM EXPERIMENT SET-UP

Attachment 13-C

Session 13, Handout 13C

Sample graphs

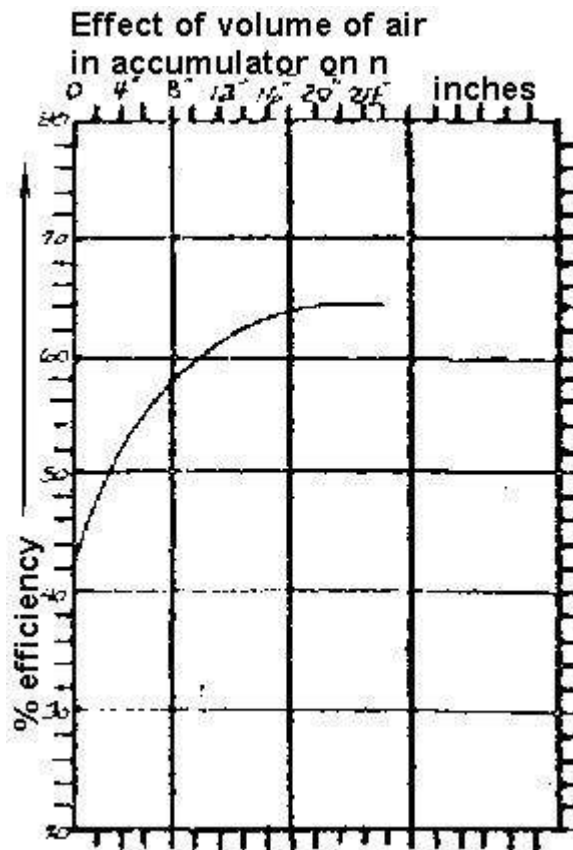

Effect of volume of air in accumulator on n

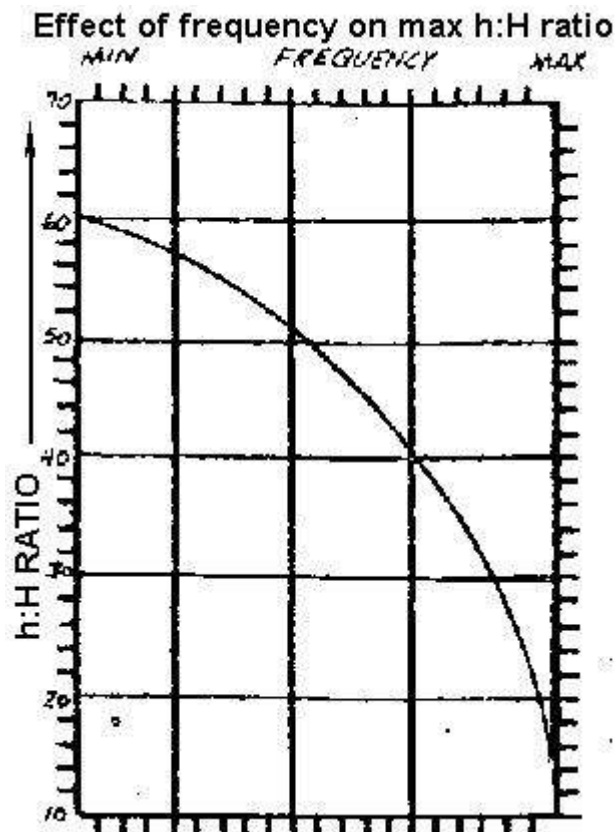

Effect of frequency on max h:H ratio

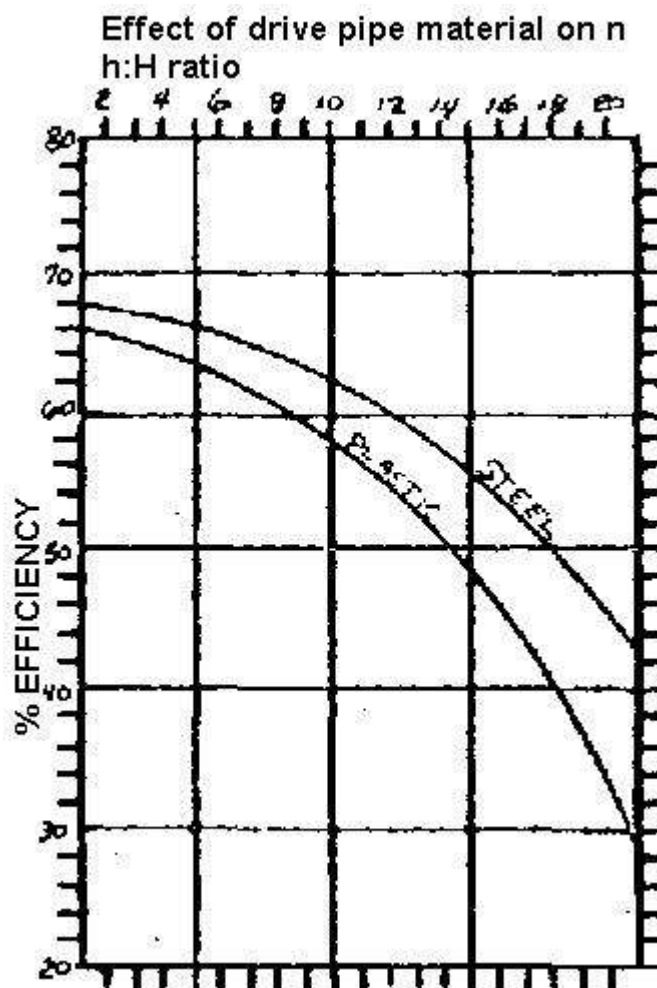

Effect of drive pipe material on n

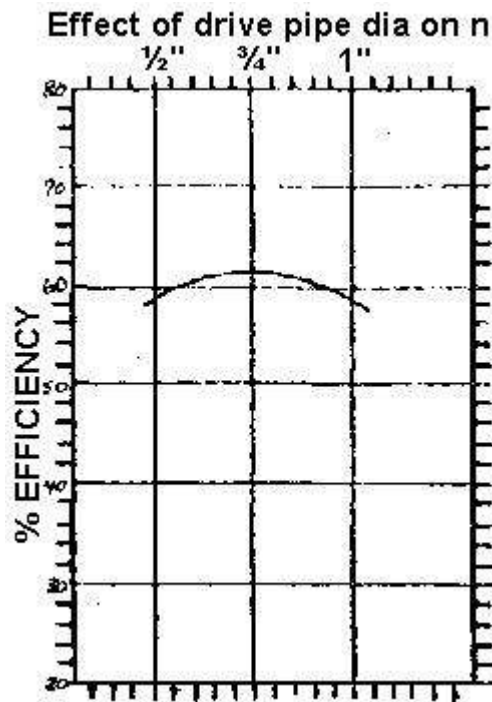

Effect of drive pipe DIA on n

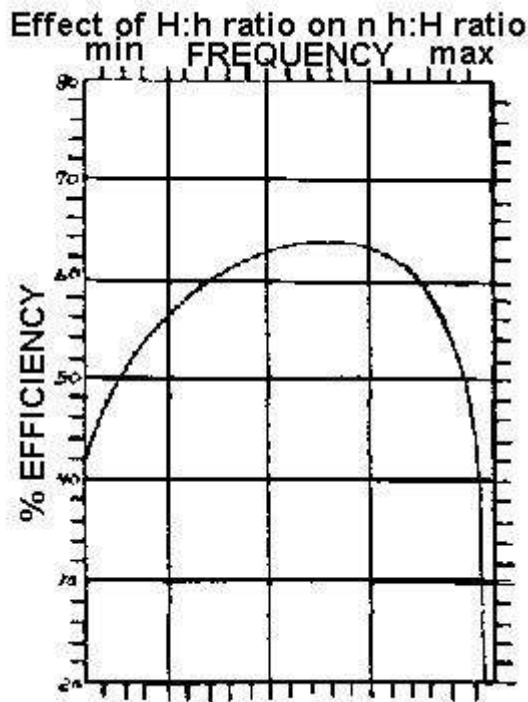

Effect of frequency on n, q, 8

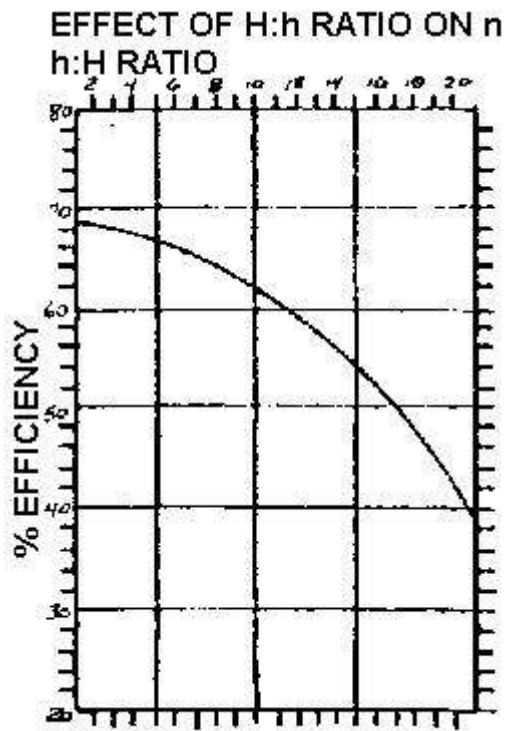

Effect of h:H on n

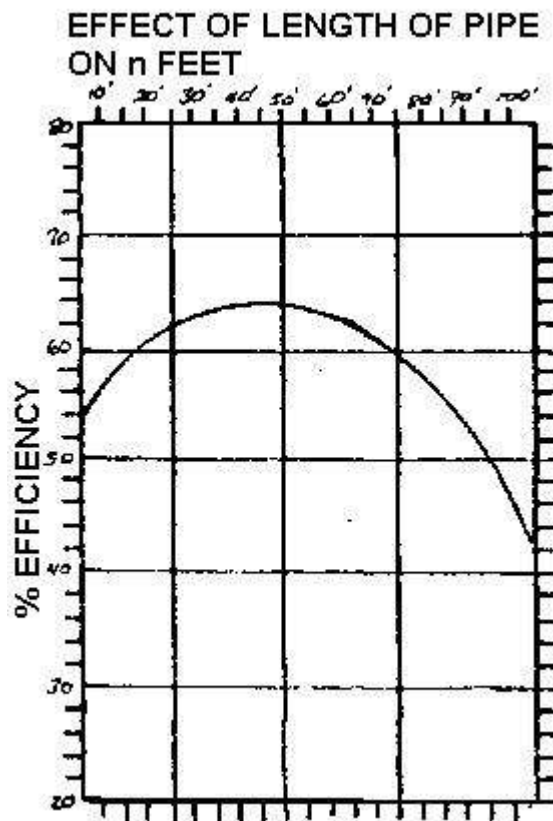

Effect of length of pipe on n feet

Attachment 14-A

Session 14, Handout 14A

Repair and maintenance

SYMPTOM	CAUSE	REASON	CURE
impulse valve stops in the closed position	insufficient rebound	worn, cracked, or dirty check valve	clean, repair, or replace valve
		insufficient weight or stroke on impulse valve	increase impulse valve stroke weight
		insufficient flow of water into the drive pipe	check for leaks or obstruction the supply system. If all the available water is going to the hydram, re-adjust the hydram for this flow
pulsating flow in the delivery pipe	lack of air in the accumulator	leak in the accumulator	repair leak
		snifter valve not open enough	open valve further
		clogged snifter valve	clean the snifter valve
reduction in water delivered and air bubbles in the delivery pipe	too much air entering the accumulator	snifter valve open too far	close down the snifter slightly
		leak in the hydram body between the impulse and check valves	repair the leak
impulse valve stops in the open position	insufficient velocity around the impulse valve	lack of water entering the drive pipe	check for leaks or obstruction the supply system IF all available water is going to the hydram readjust impulse valve for flow rate.
		Excessive impulse valve weight or stroke	Either shorten the stroke or lessen the weight.
hydram won't start	insufficient back pressure	check valve not seating properly	clean, repair or replace check valve
		snifter valve open too far	close snifter until hydram starts

		insufficient water in the delivery pipe	continue to cycle hydram manually until sufficient del head is developed
	poor impulse valve seating	worn, cracked, dirty or misaligned valve	clean, repair, replace or impulse valve
	lack of water entering the drive pipe	supply insufficient for hydram	re-assess installation, possibly install smaller hydram and drive pipe
		leaks or obstructions in supply system	clean or repair the supply system
	improper impulse valve stroke or weight	not adjusted correctly	either change stroke or weight
hydram runs but does not pump anything	obstructed delivery line	closed delivery valve	open the valve
		frozen delivery line	apply sufficient heat to line
		clogged delivery pipe.	clean out or back flush
	water hammer pressure pulse absorbed before the check valve	air accumulation under the check valve because of over-sniffing	cycle the hydram several times hand allowing the water to reach maximum velocity before allowing the impulse valve close
hydram runs but the amount of water being delivered is much less than should be expected	leak in the delivery pipe	loose fitting or a hole in pipe	tighten all loose fittings and repair any holes
	low hydram efficiency	worn, cracked, dirty, or misaligned check valve	clean, repair or replace impulse valve
worn, cracked, dirty or misaligned check valve		clean, repair or replace impulse valve	
obstruction in drive pipe		clean drive pipe	

			excessive check valve stroke	adjust or replace. check stroke limiter
		improperly installed hydram.	Poor L:D ratio	change either the drive Diameter or length
			poor L:H ratio	change either the drive length or the drive head
frequency erratic	very	air in the drive pipe	hole in the hydram body or a loose fitting near the drive pipe connection to the hydram	patch all holes and/or tighten loose fittings

Attachment 14-B

Session 14, Handout 14B

Repair and maintenance worksheet

SYMPTON	CAUSE	CURE	TOOLS/SKILLS NEEDED FOR REPAIR	PREVENTIVE MAINTENANCE REQUIRED	TOOLS/SKILLS NEEDED FOR PREVENTIVE MAINTENANCE

Attachment 14-C

Session 14, Handout 14C

Maintenance/service worksheet

TASK	TIMEFRAME	WHO'S RESPONSIBLE	SKILLS/RESOURCES NEEDED

Attachment 15-A

Session 15, Handout 15A

Review exercise

1. What are the maximum recommended H & h in a 2" hydram where the impulse backing plate is thick, the impulse seat area is , has impulse valve bolts " in diameter, has a check valve backing plate " thick, and a check valve seat width of "?

Answer the following with a graph if you wish:

2. How does the amount of air in the accumulator effect "n"?
3. How does the h:H ratio effect "n"?
4. How does the frequency effect " Q_w "?
5. How does the snifter effect "q"?
6. Tomorrow you are going out to an existing hydam site where there is only 100 gpd being delivered, there is a reliable supply of 3 gpm and an h:H ratio of 10:1. The ram works consistently but the efficiency is so low that only $\frac{1}{2}$ the water needed is being pumped. Do you feel 200 gpd can be pumped if the hydam and/or installation is corrected to improve the efficiency to a reasonable level? If yes, what are you going to look for as a possible reason for low efficiency? (At this point you know nothing else about the hydam or the manner in which it is installed) list as many factors as you can think of.

Attachment 16-A

Session 16, Handout 16A

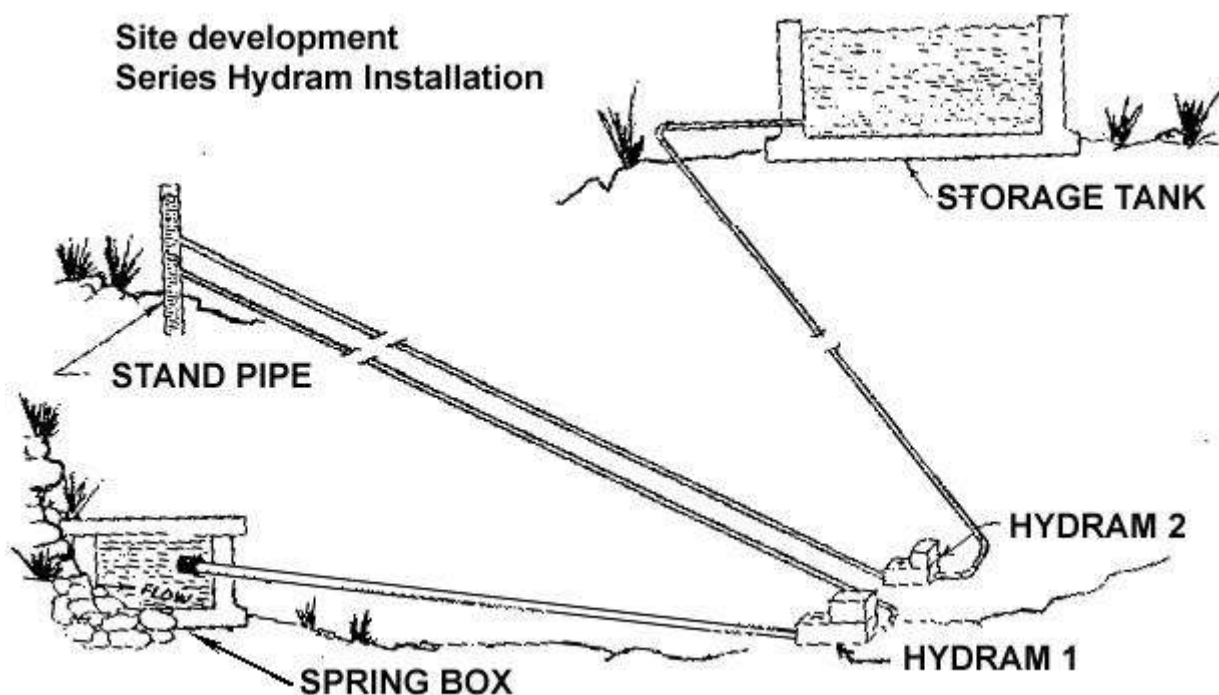

Site development series hydam installation

Attachment 16-B

Session 16, Handout 16B

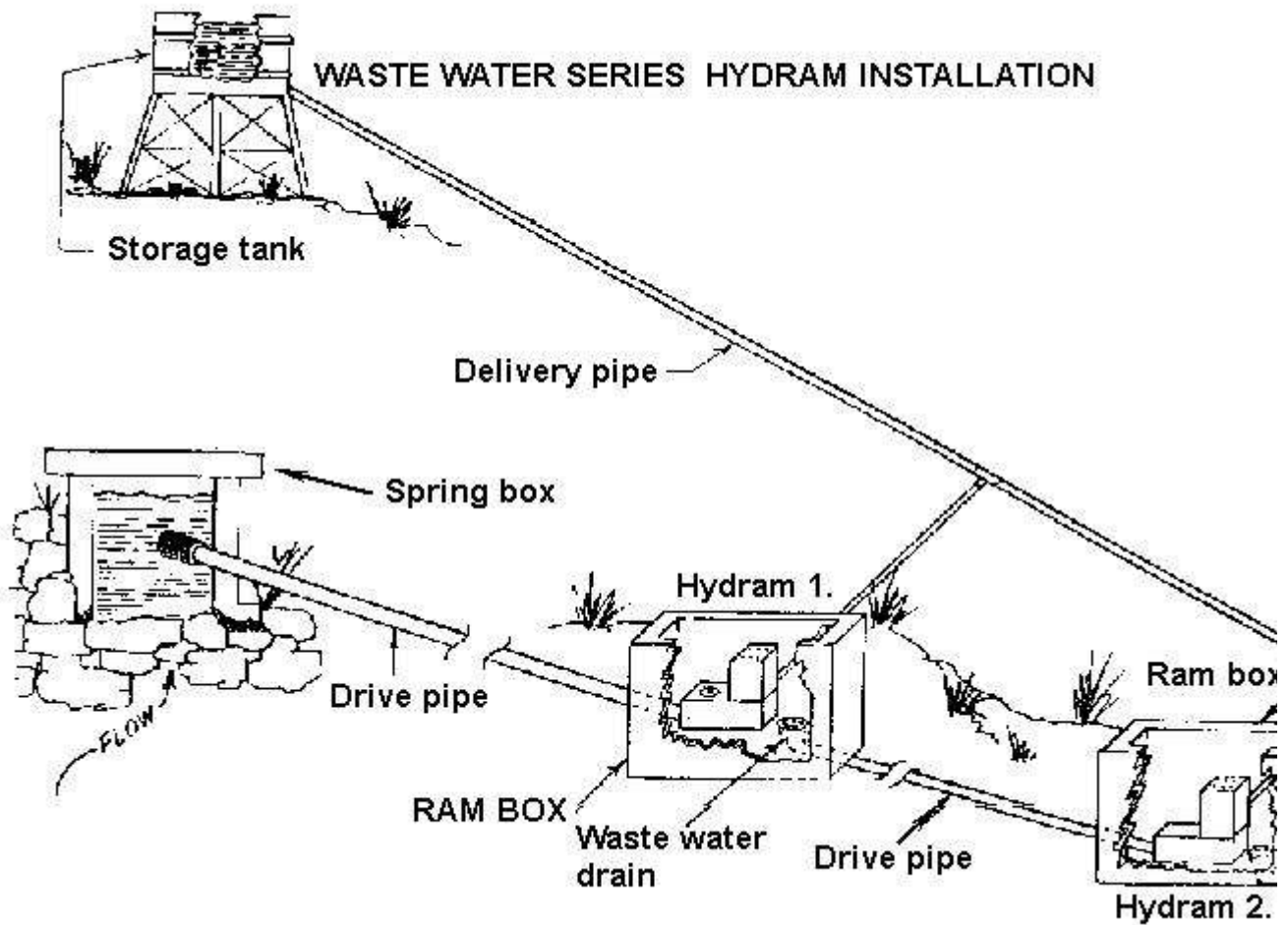

Waste water series hydam installation

Attachment 16-C

Session 16, Handout 16C

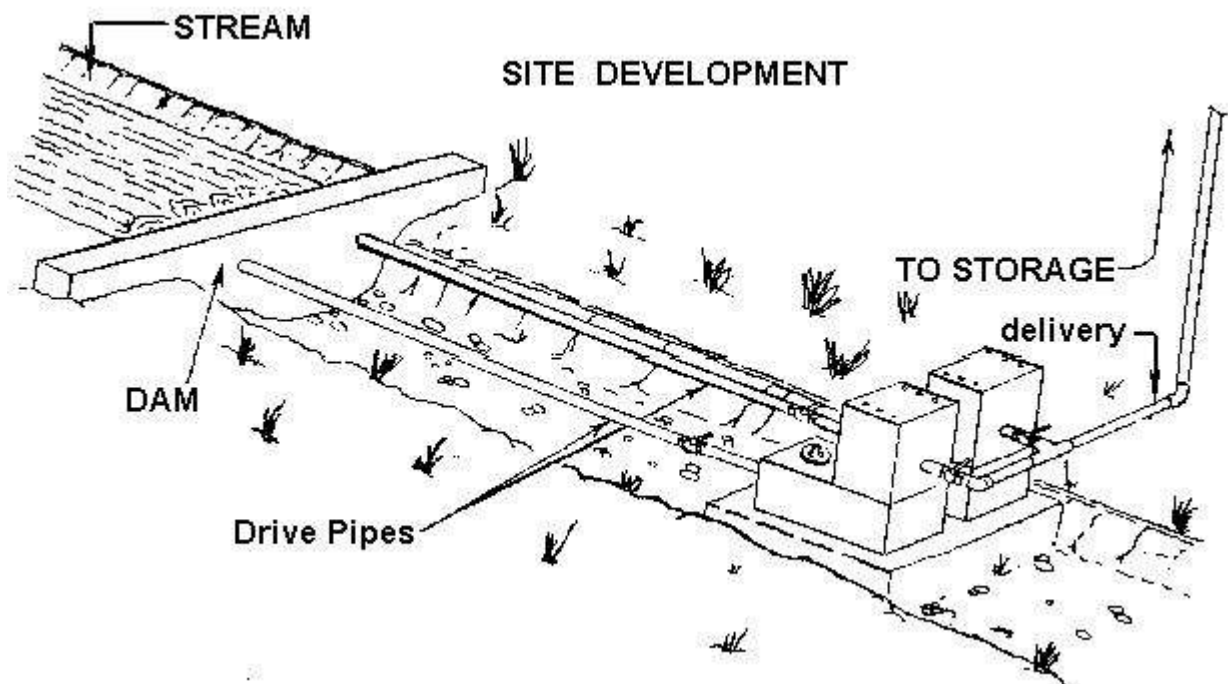

Site development

Attachment 16-D

Session 16, Handout 16D

Problem 16A:

How much water can be pumped to a delivery head of 200 feet, when there is a drive head of 2 feet, a supply of 50 gpm, and an assumed efficiency of 50%?

Problem 16B:

A community of 200 people, with 70 cows, needs 5 gpd per person and 15 gpd per cow. A spring flows at a rate of 15 gpm, $H = 10'$, $h = 100'$, $n = 50\%$, $L:D = 960$. How can the community's needs be met?

Problem 16C:

How much water can be delivered to a supply tank 50 feet above a hydram when the drive head is 5 feet, the hydrams efficiency is 50%, the flow rate of the water is 30 gpm, and the largest drive pipe available is 2"?

Attachment 17-A

Session 17, Handout 17A

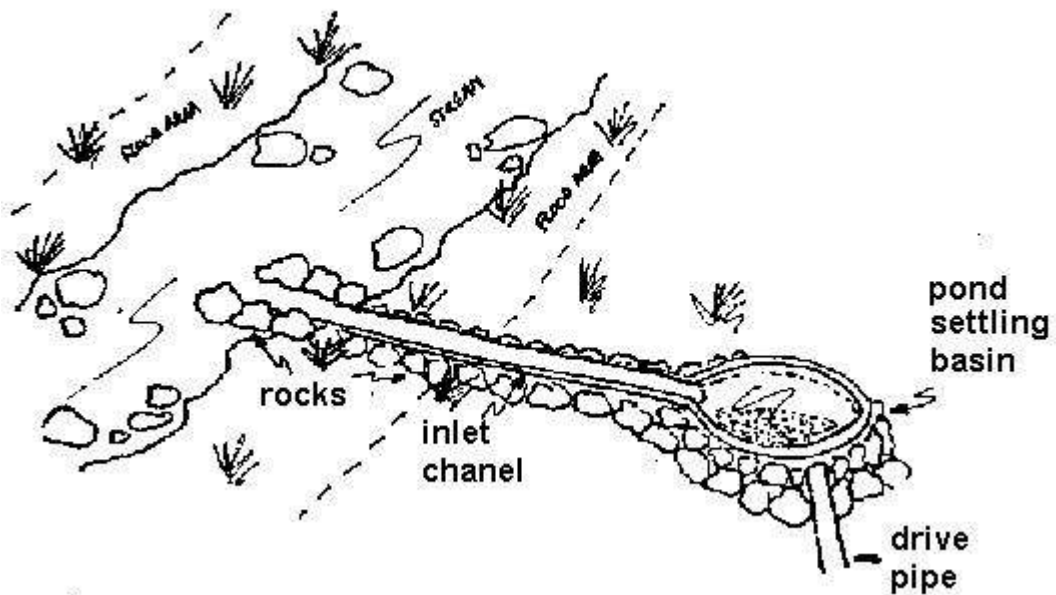
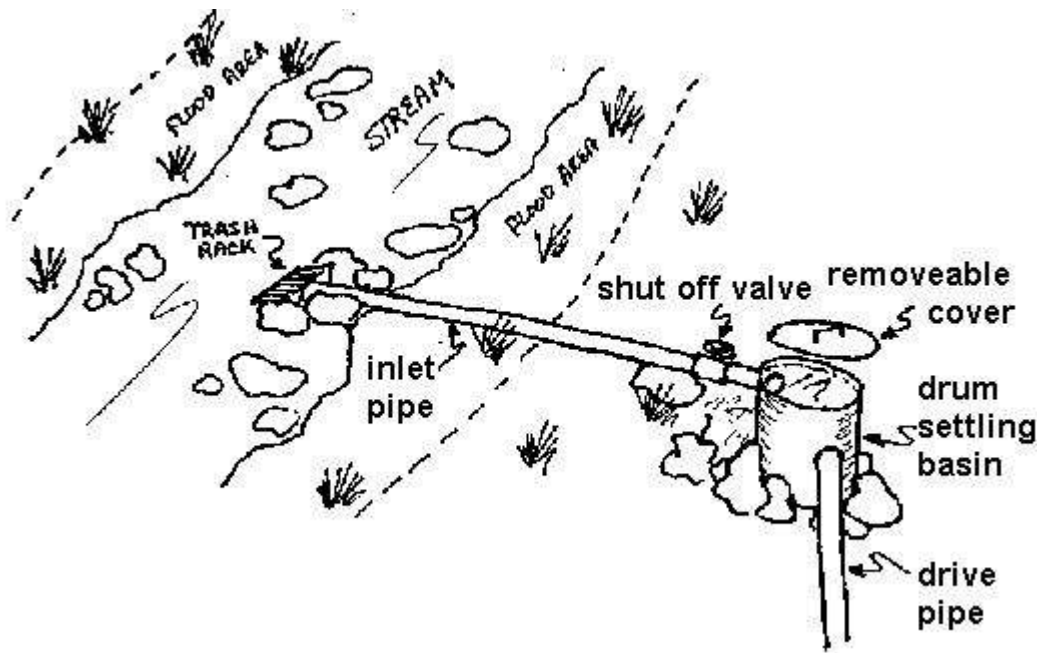

Settling area - take off system

Attachment 17-B

Session 17, Handout 17B

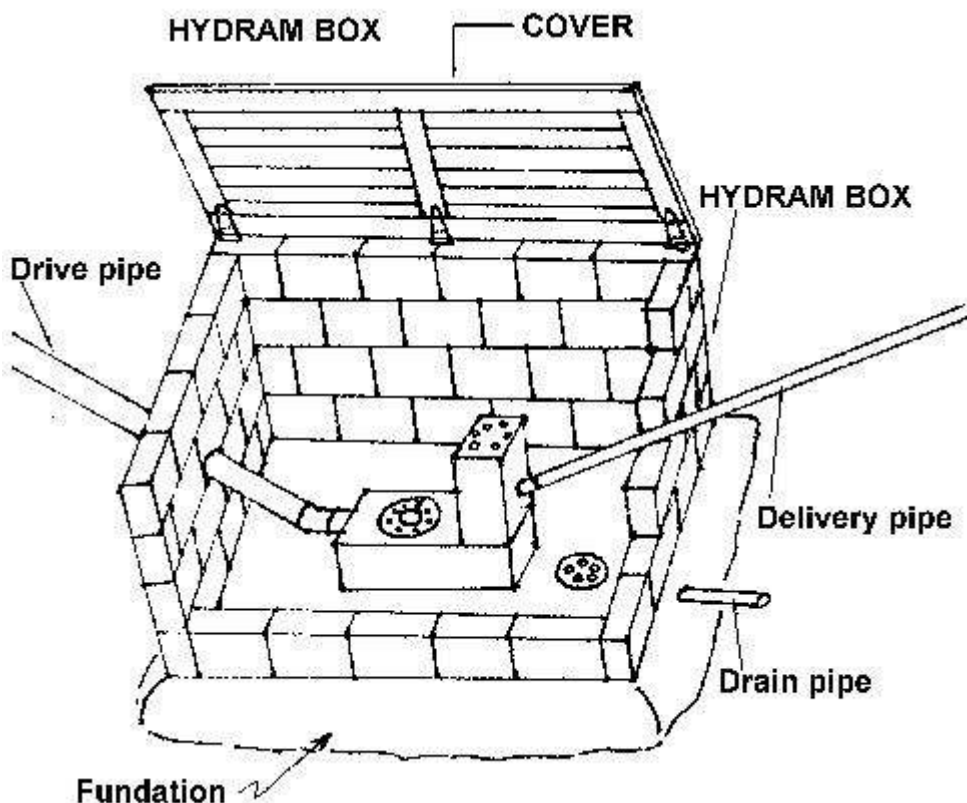

Hydrum box

Attachment 17-C

Session 17, Handout 17C

Guidelines/Checklist

Take off from source:	
materials:	pipe or proper soil drum or tank plumbing parts (connectors, flanges, etc.) trash rack fine mesh screen
concerns:	negative slope from source to drum or pond pipe or channel well into stream good foundation for drum or pond means to shut off flow to basin when necessary keeping trash, debris, sediment out of line protection from: raging waters flood animals sun (ultra violet rays) erosion
Hydrum:	
materials:	cement, aggregate, sand metal pipe and plumbing parts hydrum metal or wood for cover to box hinges, screws, etc. stakes, wire
concerns:	support for pipes - drive, delivery pipe course straight as possible - no 90° bends anchoring of pipes drainage for waste water drive pipe entering settling basin 1/3 way up from bottom of basin protection box for hydrum drainage for waste water coverage for all plastic pipes clear marking of pipeline if buried
Storage Facility:	

Storage Facility.	
materials:	adequate soil cement, aggregate, sand reinforcing bar paint pipe plumbing parts (connectors, faucet, standpipe) fencing material
concerns:	best match of size, materials and costs closeness to final usage durability of tank - strength, seal protection from animals safety for users, children

Attachment 17-D

Session 17, Handout 17D

Site development

After the siting of the components for the hydram system has been completed, it becomes necessary to design the components in detail. This session will discuss how to develop them and will allow for a better estimation of the money, labor and time needed.

The components of the system that are of concern here are the takeoff from the source, the hydram, the storage facility, and all necessary piping. Variations for developing the components and factors that influence their design will be presented. The attachments to this session will give further guide lines and will give references for those topics that will not be covered in this manual/workshop.

TAKE-OFF FROM THE SOURCE

As was mentioned before, the water for a hydram system is not taken directly from the stream; a take-off component must be installed. Its purposes are to protect the system from the potential damage by floods, to keep sand and debris out of the system and to make maintenance of the system easier. The two basic parts to the takeoff area are a settling basin and a transmission channel from the stream to the basin.

The size of the basin has to be just large enough to insure an uninterrupted flow of water to the hydram while trapping sediment, sand, and debris. If the hydram system is small - that is, it uses a 2" drive pipe or smaller, a 55 gallon drum or small tank may be used. If the soil at this site has a good clay content, a small pond can be constructed to serve as the basin. A rough way to determine the size of the basin is to determine the volume of water contained in the drive pipe at any point in time and have the basin be large enough to allow 34 times that volume of water standing above the drive pipe, e.g., if the drive pipe contains 10 gallons (area of the inside diameter of the drive pipe times its length), then a basin with 30-40 gallons above the drive pipe inlet will be sufficient. The inlet of the drive pipe should be positioned at least 1/3 of the way up from the bottom of the basin. A fine mesh screen must cover the inlet of the drive pipe (keeps frogs, etc. out).

The second part to the take-off is the channel or pipe that takes the water from the source and directs it to the basin. If a drum or tank is used as a basin, a pipe is more suitable as the inlet channel in that the pipe lends itself to an easier attachment to the drum/tank. If a pond is used, a dug channel can be used. The channel however, may need to be lined with clay to minimize seepage loses through the soil. The channel or pipe should be placed well into the stream to be able to pick up sufficient water during the dry season. The pipe needs to be anchored to the streambed for protection from being swept away by raging waters during the rainy season. A channel also will need to be protected. In both cases, large rocks placed on each side of the channel/pipe should be sufficient.

The channel will need more regular maintenance than a pipe to keep the sediment and weeds from blocking the passage. The pipe will need a trash rack in front of it's stream opening to keep debris,

fish, etc. out of it.

The channel/pipe will need to have a slight negative slope to it 1% or so to allow the water to naturally feed into the basin. Both the channel and the pipe should have some means of blocking the flow of water to the system when that becomes necessary. If a plastic pipe is used, it will have to be covered to protect it from the sun; the ultraviolet rays of the sun will eventually destroy the plastic.

One last note: if the stream under consideration has excellent year round flow rates, but not an adequate head to run the hydam, a small dam may need to be constructed. This is a costly undertaking in terms of money, time, skill and labor. This manual/workshop cannot provide the necessary information for working with a dam. You will need more information to help decide if further consideration of the project is worthwhile.

The Hydam

The hydam component consists of the drive pipe, the hydam itself, the delivery pipe and a protection box/foundation for the hydam. Details about development and construction of the hydam are covered in this manual.

The drive pipe needs to be made of metal to withstand the pressures and pounding that develops in running the system. It should be positioned in the settling basin about 1/3 the way up from the bottom. The pipe should be well supported along its length and protected from outside disturbances. If stakes can be driven into the ground, the pipe can be anchored to them; this will help minimize vibrations and keep it from being bumped off its supports. The pipe should transverse as straight a course as possible. In no case should sharp bends (90°) be used; 45° bends or less should be used. If they are used, support must be provided at each bend to keep the side-way thrusts that will develop inside the pipe at that point from destroying the line.

The delivery pipe can be made of plastic. The same care in supporting, anchoring and protecting the drive pipe should be applied also to the delivery pipe. The course of the pipe should be as straight as possible, avoiding all sharp bends. An additional concern with plastic pipe is protection from the ultraviolet rays of the sun. The pipe needs to be covered. One way to do this is to bury it. However, if this is done, the channel should not be covered up until the system is working and the pipe checked for leaks.

The delivery pipe, because of its length, may raise additional concerns. It must be adequately protected any place it has to cross a trail or road, or in other ways is subject to possibly being run over by a cart or vehicle. If it crosses cultivated land, it's course must be adequately marked so that it is not accidentally damaged during cultivation operations.

The hydam itself must be well supported and protected from accidental disturbances. In addition the waste water needs to be directed away from the support foundation. The best way to provide this protection is to build a concrete foundation with drain outlet and a concrete or cement block box around it. The box should be large enough to allow enough room for a workman (or two) to comfortably move around the hydam. If a concrete hydam is used, the accumulator and/or the body may weigh a couple of hundred pounds. If it has to be removed for some reason, there must be enough room in the box to allow workers to get in there and lift it out.

The final part to the box should be some type of cover that can be locked; this offers protection from vandals or people tampering with the hydam out of curiosity. A final note on the construction of the box: the foundation should be poured and the hydam installed. After the hydam is working like it should, the walls to the box should be constructed and the cover installed.

The Storage Facility

The construction design of this component of the system is dictated by its size, the available materials, and physical characteristics of the site. A few examples may highlight some design considerations for the storage facility:

Let's say your calculations for the system indicate that 1000 gallons of water a day needs to be delivered. To store this amount of water, the facility will need to be about 12 feet on a side and 12 foot high. (1 cubic foot of water equals 7.48 gallons) If you want to have a 3-day supply of water (1 day's use and 2 days in reserve) the facility will need to be at least 12' x 12' x 3'. It may be economically reasonable to construct this out of concrete and block.

Now let's say the system will be used for irrigation and will need to store 100,000 gals and use it every 8 days. The size of this facility will need to be approximately 40 feet on a side and 3 feet high. To construct this structure out of concrete may be too costly; a pond would have to be constructed. (Incidentally, a system needing 2100,000 gallons every 8 days will need to pump about 10 gals a minute, all day, every day. $100,000/8 \text{ days}/24 \text{ hours}/60 \text{ minutes}$.)

This manual/workshop can not go into all the details and procedures necessary to construct these storage facilities. However, some reference materials are listed in the attachments that can assist in this work. In addition, assistance can be obtained from the agriculture department and technical donor groups/agencies.

Irrespective of the design of the facility, there are basic concerns for the protection of the system and for safety to the individuals using it. A pond almost assuredly will have to have a fence around it to keep animals and little children out of it. The walls of a tank will have to be reinforced with metal bars and the inside of the tank plastered with cement and painted to prevent leaks.

Cost and Labor Considerations

The labor for and the costs of this system can be quite a burden for the rural farmer or village; this is why the siting and the design of the system are so important. When both are done with care and skill, the costs for a completed system will be as low as possible. It should be obvious that with ample free/cheap labor and proper soil available the system can be kept within reasonable limits. It should also be obvious that the amount of labor needed and the length of time to do it all can be extensive.

It may be useful to take an example and see what a system might cost. Prices for everything are different everywhere, but for the sake of this example, let's say:

- Cement costs \$7/bag - 1 bag can make 20 blocks 16" x 8" x 8"; can plaster 50 sq. ft. of surface can bond 35 blocks together; can produce 6 cu. ft. of concrete
- Reinforcing bars for the total system costs \$75
- Metal pipe costs \$8/foot
- Additional plumbing parts \$75.
- hydram can be built for \$100
- Plastic pipe costs \$4/foot
- 55 gal drum costs \$10
- welding work on drum costs \$15 e Pipe lengths are: inlet line to drum 20' Drive pipe 40', delivery

pipe 200', supply pipe 300' e Hydrant box needs to be 6' x 5' and 4 courses high foundation ½ foot thick

- Storage facility needs to be 15' x 15' x 4' foundation - 1 foot thick
- Paint \$50
- standpipe and faucet at final use point \$100
- Transportation costs \$200
- no labor costs

What will this system cost? (round off fractions to next highest whole number.)

If the storage facility will be a pond with no material costs, what will the system cost? (Transportation costs are cut in half; no reinforcing bar is needed.)

If, in addition, the supply line isn't needed, what will the system cost?

Attachment 17-E

Session 17, Handout 17E

Glossary of terms for session 17

Battery of hydrants - (or parallel hydrants) a hydrant installation where two or more hydrants are connected to the same source with different drive pipes, but usually with the same delivery pipe. This type of installation is used where the size of the hydrant is limited.

Holding tank - (storage tank) the means of storing water once it has been pumped to the desired head.

Ram box - the small structure usually made out of concrete and/or wood which houses a hydrant, protecting it from freezing, weathering, and possibly from vandalizing.

Series hydrant - a hydrant installation where two or more hydrants are used in series to pump water higher than one hydrant could alone.

Spring box overflow pipe - a pipe placed in the wall of a spring box near the top for unused water to exit through.

Waste water drain - the drain in the bottom of a ram box which allows the waste water from the hydrant to drain out.

Waste water series hydrants - a hydrant installation where one hydrant uses the waste water from another as a source to pump a higher percentage of the water.

Attachment 18-A

Session 18, Handout 18A

Hydrant site selection

Hydrum site selection

The flow rate of the springs are as follows: A=10gpm; B=5gpm; C=7gpm

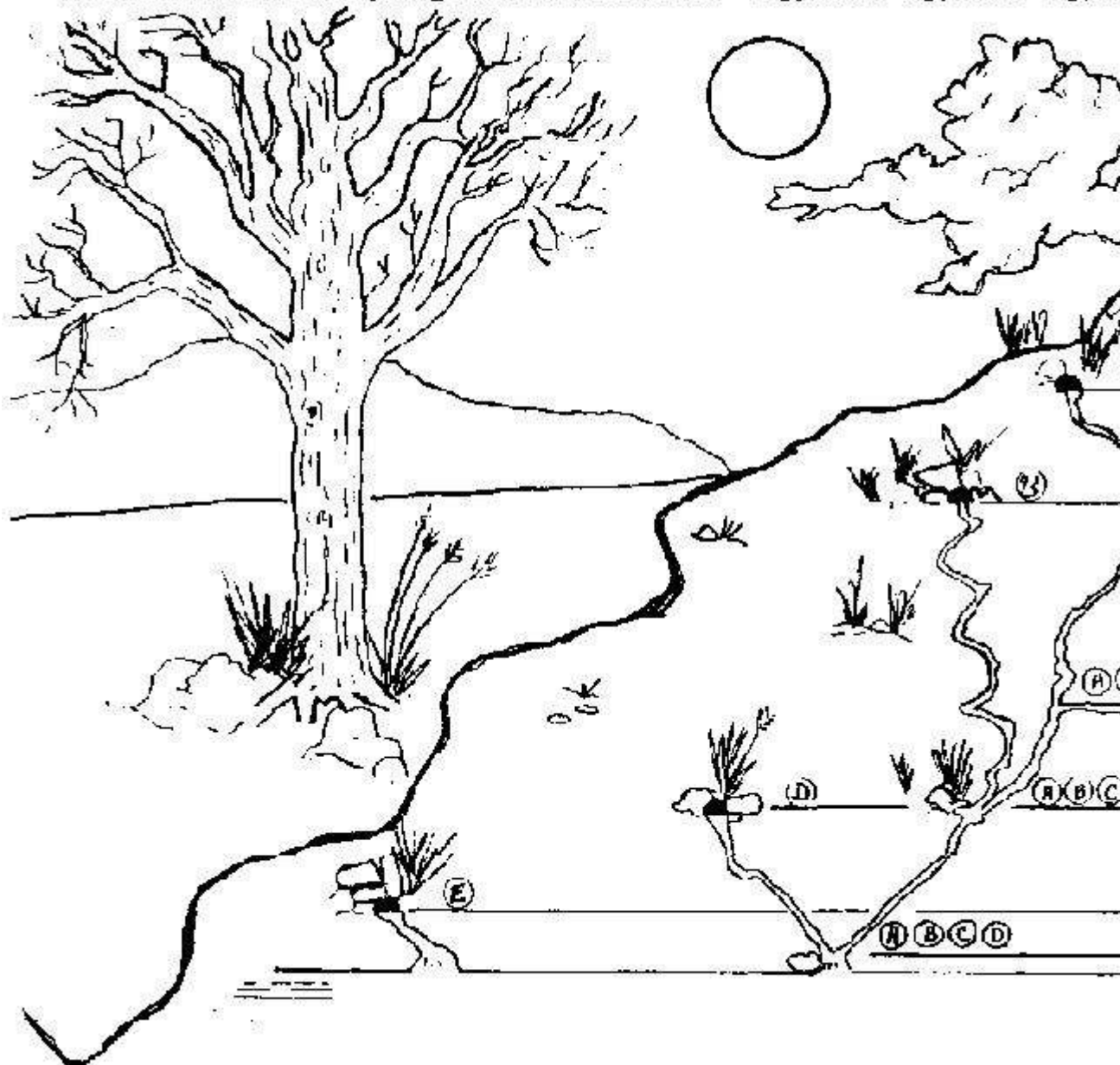

Hydrum site selection

Hydrum system site selection

There are three main components to a hydrum system that require site selection: 1) the take off from the stream, 2) the hydrum itself, and 3) the storage facility.

The Take Off System: The water for a hydrum is never taken directly from the stream. Sand and debris would enter the drive pipe and destroy the hydrum. Therefore a settling area for the water must be included in the system. The characteristics to look for are a relatively flat area near the stream but out of the way of the rainy season's floods.

The Hydrum: The first important factor here is to choose a site that will give sufficient head to run the pump. Basically, the higher the head, the greater the amount of water that can be pumped. As a general rule of thumb, the site should give at least 3m (10 ft) of head. Systems can be run with a smaller head, but the flow rate needs to be that much larger. If there are a number of places along the

stream where sufficient head can be generated, then the spot where the distance from the water source to the hydram is the shortest will be the best. The drive pipe (from source to hydram) must be made of metal to withstand the pressure and pounding of the system. Metal pipe is usually more expensive than plastic pipe (which can be used for the delivery line). So even though the delivery line may be longer than at other potential sites, the costs for the total system may be less.

The hydram can be situated in any safe/stable area that will give the proper head and distance mix. An added consideration is convenient access to this site to do repairs and maintenance. It is advisable to build a box to enclose the hydram - to protect it from animals and vandals and to minimize erosion to the hydram's foundation. This usually means that cement needs to be carried and mixed nearby, and this may influence your selection of the site. One last concern is that the waste water from the hydram will need to find its way back to the stream. If in doing so, it transverses cultivated land and that could cause a problem, then this factor must be considered in the selection of the site.

The Storage Facility: The third major component of the system is the site to which the pump will deliver. The delivery point/storage facility should be at some convenient location that allows the water to gravity flow to where it is needed. The major determinants of the site for the storage facility are the delivery head the system can accommodate and the length of the delivery line. The delivery head must be within the range of the systems' capabilities, and the length of the delivery pipe must be within reasonable cost constraints. The distance from the storage facility to the point of use (see handout 18B, d3), should be kept to a minimum. But this distance, d3, is secondary to the needs of the hydram system.

The factors that influence the siting of these components are:

- 1) flood considerations,
- 2) available head,
- 3) distances/pipe length between components,
- 4) cost factors,
- 5) convenience of location,
- 6) social factors.

1) **Flood Considerations:** The seasonal variations of the stream must be taken into consideration - this is particularly true of flood conditions. Each component of the system must be placed outside the potential flood area.

2) The available head and that necessary for the system is the key factor in siting the system. There are three heads involved here: the drive head, the delivery head, and the supply head. The most important of these is the drive head, H . This ~ basically determines what the capabilities of the system are. The delivery head, h , is next in importance; it is however limited by the constraints placed on the system by the size of the drive head. The least important of the heads is the supply line head, h . Basically this head just needs to have a negative slope - that is, sufficient drop to let the water run down hill.

3) Distances or pipe lengths are the next major consideration in selecting a site for the system, Pipes are usually the most costly items of the system. There are three distances that must be taken into account: the length of the drive line, the length of the delivery line, and the length of the supply line. The most crucial of these is the drive line because this piping is usually the most expensive per foot and because the size of the pipe is influenced by the distance it must transverse. As a rule - the

shorter the drive pipe line the better (considering that it delivers the necessary head). The length of the delivery line is next in order of importance. It is constrained by the capacity of the system and by costs. However plastic pipe can be used here. The supply line is constrained by cost factors only. It can be run as far as the terrain and the budget allows.

4) The cost of a system may be the final determinant as to whether or not it is implemented. Pipes and plumbing components are the main expense, with cement and possibly labor second. The hydram itself is a lowly third. If care is taken in the siting and the design of the system, the costs can be kept to their minimum.

5) Convenience of location of the hydram and the storage facility is another siting factor. Basically the components of the system should be sited in a location that allows for ease of construction, repairs and maintenance.

6) Lastly, the "best" site for the system may not be the one that the villagers want - it may be on the wrong persons land, or whatever. Remember that they are responsible for maintaining the system, and their concerns must be honored.

Presented below is a handy table to keep the components of the system and the siting factors in mind as the survey work is being done.

	COMPONENTS		
SITING FACTORS	TAKE OFF	HYDRAM	STORAGE FACILITY
FLOOD CONSIDERATIONS			
HEAD			
DISTANCES			
COSTS			
CONVENIENCE			
SOCIAL FACTORS			

Attachment 18-B

Session 18, Handout 18B

DIADRAM OF HYDRAM SYSTEM FOR SITE SELECTION

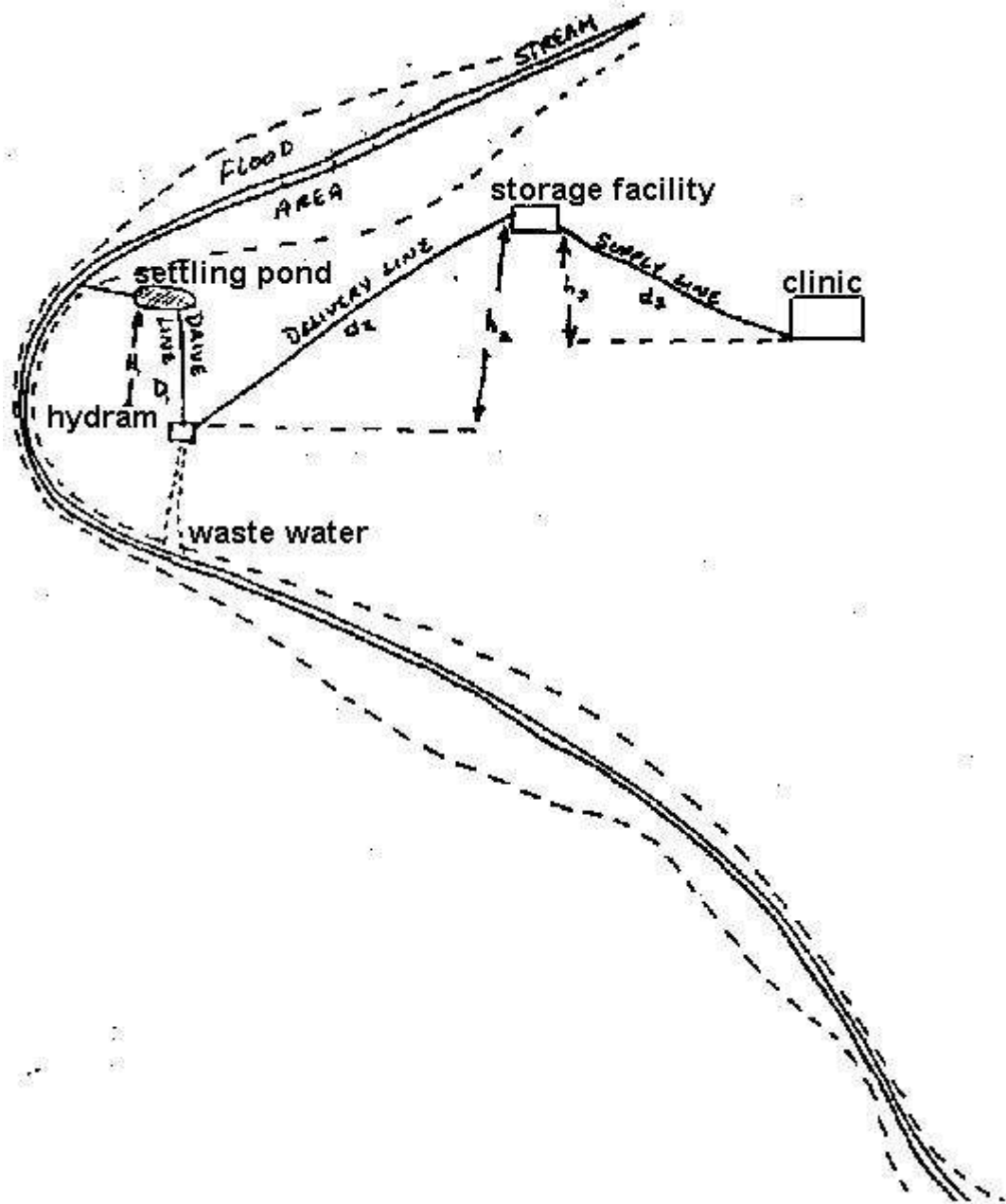

Diagram of hydam system for site selection

Attachment - Glossary of terms

Accumulator - (air dome) the air chamber on the hydam which cushions the water hammer, eliminating delivery pulsations and helps provide rebound.

Atmospheric pressure - the pressure at sea level caused by the weight of air; atmospheric pressure = 14.7 and 0 psig.

Battery of Hydrams - (or parallel hydrams) a hydam installation where two or more hydrams are connected to the same source with different drive pipes, but usually with the same delivery pipe. This type of installation is used where the size of the hydam is limited.

Check Valve - (non-return valve, secondary valve, internal valve) the internal valve in the hydam that prevents the delivery head pressure from forcing water back through the hydam body.

Delivery head - the vertical distance between the hydam and the highest level of water in the storage tank that the hydam is pumping to.

Delivery pipe - the pipe which connects the output of the hydam to the storage tank.

Drive head - the vertical distance between the hydam and the highest level of water in the supply system.

Drive pipe - a rigid pipe usually made of galvanized steel that connects the hydam to the source reservoir or stand pipe.

Efficiency - (n) the ratio of the energy input to the energy output; a measure of how well a hydam functions;

$$n = \frac{qh}{QH}$$

Force - to move something against resistance, pressure times the area measured in pounds, newtons or dynes.

Frequency - (f) the number of times a hydam cycles in one minute. **h:H ratio** - (delivery to drive head ratio) the ratio of lift to fall. The inverse of this ratio times the efficiency of the hydam will determine the percentage of water the hydam will pump. The higher the h:H ratio, the lower the hydam efficiency (n). The usual range of the h:H ratio is from 2:1 to 20:1 but h:H ratios have been measured up to 60:1.

Holding tank - (storage tank) the means of storing water once it has been pumped to the desired head.

Hydam - (hydraulic ram, hydraulic ram pump, automatic hydraulic ram pump, ram) an ingenious device that uses the force of water falling through a drive pipe to pump water to a height greater than its source, making use of hydraulic principles and requiring no fuel.

Hydam capacity - the maximum amount of water a hydam can use. This is determined by the drive pipe size and length, the drive head, and the impulse valve size and design.

Impulse Valve - (clack valve, out-side valve, impetus valve, waste valve) the valve on the hydam that creates and controls the water hammer.

Impulse valve stroke - the distance the impulse valve travels during a cycle.

Impulse valve weight - the total weight or downward force of the impulse valve and its springs or weights.

Kenetic energy - active energy, $\frac{1}{2}$ the mass times the velocity squared

$$E_K = \frac{1}{2} mv^2$$

L:D ratio - drive pipe length to diameter ratio, should be kept between 150-1000.

L:H ratio - drive pipe length to head ratio, when it is less than 15 ft. L:H should equal 6.

When H is greater than 15 ft. but less than 25 should = 4

When H is greater than 20 " ,, " " 50 " = 3

When H is greater than 50 L:H ratio should equal 2. (see Glossary, Session 6 for metric equivalents)

Potential energy - energy derived from position or height; is equal to the height that a mass can fall times its weight.

Pressure - force applied over a surface measured as force per unit of area such as pounds per square inch (psi) (a head of 28" of water develops a pressure of 1 psi) or a pascal (Pa) which is equal to 1 newton per square meter (a head of 1 cm = 98 Pa) 18" of water equals 71.1 cm of water equals 1 psi = 6895 Pa.

Ram box - the small structure usually made out of concrete and/or wood which houses a hydram protecting it from freezing, weathering and possibly from vandalizing.

Rebound - the flow of water in the ram reversing direction due to the air pressure in the accumulator, closing the check valve.

Series hydram - a hydram installation where two or more hydrams are used in series to pump water higher than one hydram could.

Settling basin - a small tank usually made of steel or concrete that is used in place of a stand pipe in an installation where additional settling is necessary.

Snifter valve - (air valve, spit valve) the small valve just below the check valve that allows air to enter the hydram.

Spring box - a concrete box built around a spring to facilitate water collection and to protect the water source from surface contaminates.

Spring box overflow pipe - a pipe placed in the wall of a spring box near the top for unused water to exit through.

Stand pipe - an open-ended, vertical pipe sometimes used at the beginning of the drive pipe.

Static head - a column of water without motion. The static drive head of a hydram can be measured with a pressure gauge but only when ram is stopped and the drive pipe is full of water.

Supply pipe - everything in a hydram system before the drive pipe, usually including some, but not necessarily all, of the following; spring box, supply pipe, stand pipe, settling basin.

Supply system - everything in a hydram system before the drive pipe, usually including some but not necessarily all of the following; spring box, supply pipe, stand pipe, settling basin.

Time of cycle - (t) the time it takes for a hydram to complete one cycle, such as the time lapse between the impulse valve closing twice.

Velocity - speed usually measured in feet per second or meters per second.

Waste water - (Qw) the water coming out of the impulse valve and the snifter.

Waste water drain - the drain in the bottom of a ram box which allows the waste water from the hydram to drain out.

Waste water series hydrams - a hydram installation where one hydram uses the waste water from another as a source to pump a higher percentage of the water.

Water delivered - (q) the rate at which water is delivered to the storage tank; $Q \times H \times n \times q = h$

Water flow to the hydram - (Q) all the water used by a hydram which is equal to the waste water (Qw) plus the water delivered (q).

Water hammer - the effect created when water flowing through a pipe is suddenly stopped. In a hydram this causes the closing of the impulse valve and opening of check valve.

Water used - (Q) the amount of water that flows through the drive pipe during a unit of time (as in gallons per minute or liters per second) which is equal to the water pumped (q) plus the water wasted (Qw)

The flow rate range of hydrams are as follows:

Drive pipe diameter				Flow rate			
mm	in	U.S.	gal/min	Imperial	gal/min	liters/min	
19	3/4	0.8 -	2	0.6 -	1.7	2.8 -	7.6
25	1	1.5 -	4	1.3 -	3.3	5.7 -	15.0
32	1½	1.5 -	7	1.3 -	5.8	5.7 -	26.0
38	1 2	2.5 -	13	2.0 -	10.8	9.4 -	49.0
50	2	6.0 -	20	5.0 -	17.0	23.0 -	76.0
63	2½	10.0 -	45	8.0 -	38.0	38.0 -	170.0
75	3	15.0 -	50	13.0 -	42.0	57.0 -	189.0
100	4	30.0 -	125	25.0 -	104.0	113.0 -	473.0
125	5	40.0 -	150	33.0 -	125.0	151.0 -	567.0

IMPORTANT NUMBERS TO REMEMBER

1440 minutes in a day

433 psi per foot (measured vertically) of water column

28 inches of C, water column produces 1 psi

14.7 psi atmospheric pressure

7. 48 gallons per cubic foot

Attachment - English-metric units conversion table

		<i>Equals, in Metric*</i>		
<i>Physical Quantity</i>	<i>This in "English" Units</i>	<i>Spelled out</i>	<i>Symbolic</i>	<i>Reciprocal †</i>
DISTANCE	1 inch	2.54 centimeter	2.54 cm	0.3937
	1 foot	0.3048 meter	(.3048 m)	3.281
	1 yard	0.9144 meter	0.9144 m	1.094
	1 mile	1.609 kilometer	1.609 km	0.6215
AREA	1 square inch	6.452 square centimeter	6.452 cm²	0.155
	1 square foot	0.0929 square meter or	0.0929 m²	10.76
		929 square centimeters	929 cm²	0.001076
	1 square yard	0.836 square meter	0.836 m²	1.196
	1 acre	4,047 square meters or	4.047 m²	0.000247
		0.4047 hectare	0.4047 h	2.47
	1 square mile	2.590 square kilometers or 259.0 hectares	259.0 h	0.00386
VOLUME	1 cubic inch	16.39 cubic centimeters	16.39 cm³	0.0610
	1 pint (liquid)	473.2 cubic centimeters	473.2 cm³	0.002113
	1 quart	946.4 cubic centimeters	946.4 cm³	0.001057
		or 0.9464 liter	0.946 l	1.057
	1 gallon	3.785 liters	3.785 l	0.2642
	1 cubic foot	0.0283 cubic meter	0.0283 m³	35.3
	1 cubic yard	0.765 cubic meter	0.765 m³	1.308

	1 acre foot	0.1233 hectare meter	0.1233 h m	8.11
VELOCITY	1 foot per hour,			
	minute or second	0.3048 meter/hour, minute, or second		3.281
	1 mile per hour	0.1170 meter per second	0.4470 m/s	2.237
	1 knot	.05145 meter per second	0.5145 m/s	1.944

* Multiply quantity known in British units by this number to get metric equivalent.

† Multiply quantity known in metric units by this number to act British equivalent

		<i>Equals, in Metric*</i>		
<i>Physical Quantity</i>	<i>This in "English" Units</i>	<i>Spelled out</i>	<i>Symbolic</i>	<i>Reciprocal</i>
ENERGY (OR WORK)	1 watt second	1.000 joule = 1.000		
		newton meter	1.000 J	1.000
	1 foot pound	1.356 joule	1.356 J	0.7375
	1 Btu	1.055 kilojoule	1.055 kJ	0.948
	1 wale hour	3.60 kilojoules	3.60 kJ	0.2778
	1 horsepower-hour	2.684 megajoules	2.684 MJ	0.3726
	1 kilowatt hour	3.60 megajoules	3.60 MJ	0.2778
POWER	1 horsepower	745.7 watts or 0.7457 kilo-	745.7 W	0.00134
		watt	0.7457 kW	1.341
	1 joule per second	1.000 watt	1.000 W	1.000
	1 Btu per hour	0.293 joule per second	0.293 J/s	3.41
TEMPERATURE	1 degree	5/9 degree Celsius (Centi	5/9 X (TF-32)°C	1.8 deg

	Fahrenheit	grade) for each Fahrenheit		Fahren
		degree above or below 32°F		for eac degree
SPECIAL COMPOUND UNITS	1 Btu per cubic foot	37.30 joules per liter	37.30 J/1	0.0268
1 Btu per pound of mass	2.328 joules per gram		2.328 J/g	0.4296
1 Btu per square fool per hour	3.158 joules per square meter	3.158 J/m²	0.3167	
1000 gallons per acre	0.0935 centimeters depth		10.70	
1 pound of mass per cubic foot	16.02 grams per liter	16.02 g/l	0.0624	
MASS	1 ounce	28.35 grams	28.35 g	0.03527
	1 pound	453.6 grams	453.6 g	0.00220
		or 0.4536 kilogram	0.4536 kg	2.205
	1 ton(short, 2000 pounds)	0.907 megagram	0.907 Mg	1.102
		or 0.907 metric ton	0.907 L	1.102
		or 0.907 tone	0.907 t	1.102
TORQUE	1 inch pound	0.1130 meter newton	0.1130 m-N	8.851
PRESSURE	1 pound per square	47.88 newtons per square	47.88 N/m²	0.02089
	foot	meter		
	1 pound per square	6.895 kilonewtons per	6.895 kN/m²	0.11240
	inch	square meter		
	1 millimeter of	133.3 newtons per square	133.3 N/m²	0.0075
	mercury	meter		
	1 foot of water	2.989 kilonewtons per	2.989 KN/nm²	0.3346

		square meter		
	1 atmosphere	0.1013 meganewton per	0.1013 MN/m'	9.87
		square meter		
Flow	1 gallon per day	0.04381 milliliters per	0.04381 ml/s	22.824
		second		
	1 gallon per minute	63.08 milliliter per second	63.08 ml/s	0.01585
	1 cubic foot per minute	0.4719 liter per second	0.4719 l/s	2.119
	1 cubic foot per second	28.32 liters per second	28.32 Us	0.0353
FORCE	1 ounce	0.2780 newton	0.2780 N	3.597
	1 pound	4.448 newtons	4.448 N	0.2248
	1 ton (2000 pounds}	8.897 kilonewtons	8.897 kN 0.11240	

Since 1961 when the Peace Corps was created, more than 80,000 U.S. citizens have served as Volunteers in developing countries, living and working among the people of the Third World as colleagues and co-workers, Today 6 000 PCVs are involved in programs designed to help strengthen local capacity to address such fundamental concerns as food production, water supply, energy development, nutrition and health education and reforestation.

Peace Corps overseas offices:

BELIZE

P. O. Box 487

Belize City

BENIN

B. P. 971

Cotonou

BOTSWANA

P. O. Box 93

Gaborone

BURKINA FASO

B P 537 - Samandin

Ouagadougou

BURUNDI

c/o American

Embassy

Bujumbura

CAMEROON

B P 817

Yaounde

CENTRAL AFRICAN REPUBLIC

B P 1080

Bangui

COSTA RICA

Apartado Postal

1266

San Jose

DOMINICAN REPUBLIC

Apartado Postal

1412

San Domingo

EASTERN CARIBBEAN

Including: Antigua, Barbados, Grenada, Montserrat, St. Kitts-Nevis, St. Lucia, St. Vincent, Dominica "Erin Court" Bishops Court Hill

P. O. Box 696-C

Bridgetown, Barbados

ECUADOR

Casilla 635-A

Quito

FIJI

P. O. BOX 1094

Suva

GABON

BP 2098

Libreville

GAMBIA, The

P. O. Box 5796

Accra (North)

GUATEMALA

6a Avenida 1-46

Zona 2

Guatemala

HAITI

c/o American

Embassy

Port-au-Prince

HONDURAS

Apartado Postal

C-51

Tegucigalpa

JAMAICA

Musgrove Avenue

Kingston 10

KENYA

P. O. Box 30518

Nairobi

LESOTHO

P. O. Box 554

Maseru

LIBERIA

Box 707

Monrovia

MALAWI

Box 208

Lilongwe

MALI

B P 85

Box 564

MAURITANIA

B P 222

Nouakchott

MICRONESIA

P. O. Box 9

Kolonia, Ponape

F. S. M. 96941

MOROCCO

I, Zanquat

Benzerte

Rabat

NEPAL

P. O. Box 613

Kathmandu

NIGER

B P 10537

Niamey

PAPUA NEW GUINEA

P. O. Box 1790

Boroko

Port Moresby

PARAGUAY

c/o American

Embassy

Asuncion

PHILIPPINES

P. O. Box 7013

Manila

RWANDA

c/o American

Embassy

Kigali

SENEGAL

B P 254

Dakar

SEYCHELLES

B P 697

Victoria

SIERRA LEONE

Private Mail Bag

Freetown

SOLOMON ISLAND

P. O. Box 547

Honiara

SRI LANKA

50/5 Siripa Road

Colombo, 5

Sri Lanka

SUDAN

Djodi Deutsch

Administrator/PCV's

C/o American Embassy

Khartoum

SWAZILAND

P. O. Box 362

Mbabane

TANZANIA

Box 9123

Dar es Salaam

THAILAND

42 Soi

Somprasong 2

Petchburi Road

Bangkok 4

TOGO

B P 3194

Lome

TONGA

B P 147

Nuku' Alofa

TUNISIA

B P 96

1002 Tunis-Belvedere

Tunis

WESTERN SAMOA

Private Mail Bag

Apia

YEMEN

P. O. Box 1151

Sana'a

ZAIRE

B P 697

Kinshasa

[View this page in text format](#)