

AT MICROFICHE REFERENCE LIBRARY

A project of Volunteers in Asia

Use of Hydraulic Rams in Nepal: A Guide to
Manufacturing and Installation

by: Mitchell Silver

Published by:

United Nations Children's Fund
P.O. Box 1187
Kathmandu
Nepal

Free to serious groups.

Available from:

United Nations Children's Fund
P.O. Box 1187
Kathmandu
Nepal

Reproduced by permission of the United Nations
Children's Fund.

Reproduction of this microfiche document in any
form is subject to the same restrictions as those
of the original document.

USE OF HYDRAULIC RAMS IN NEPAL

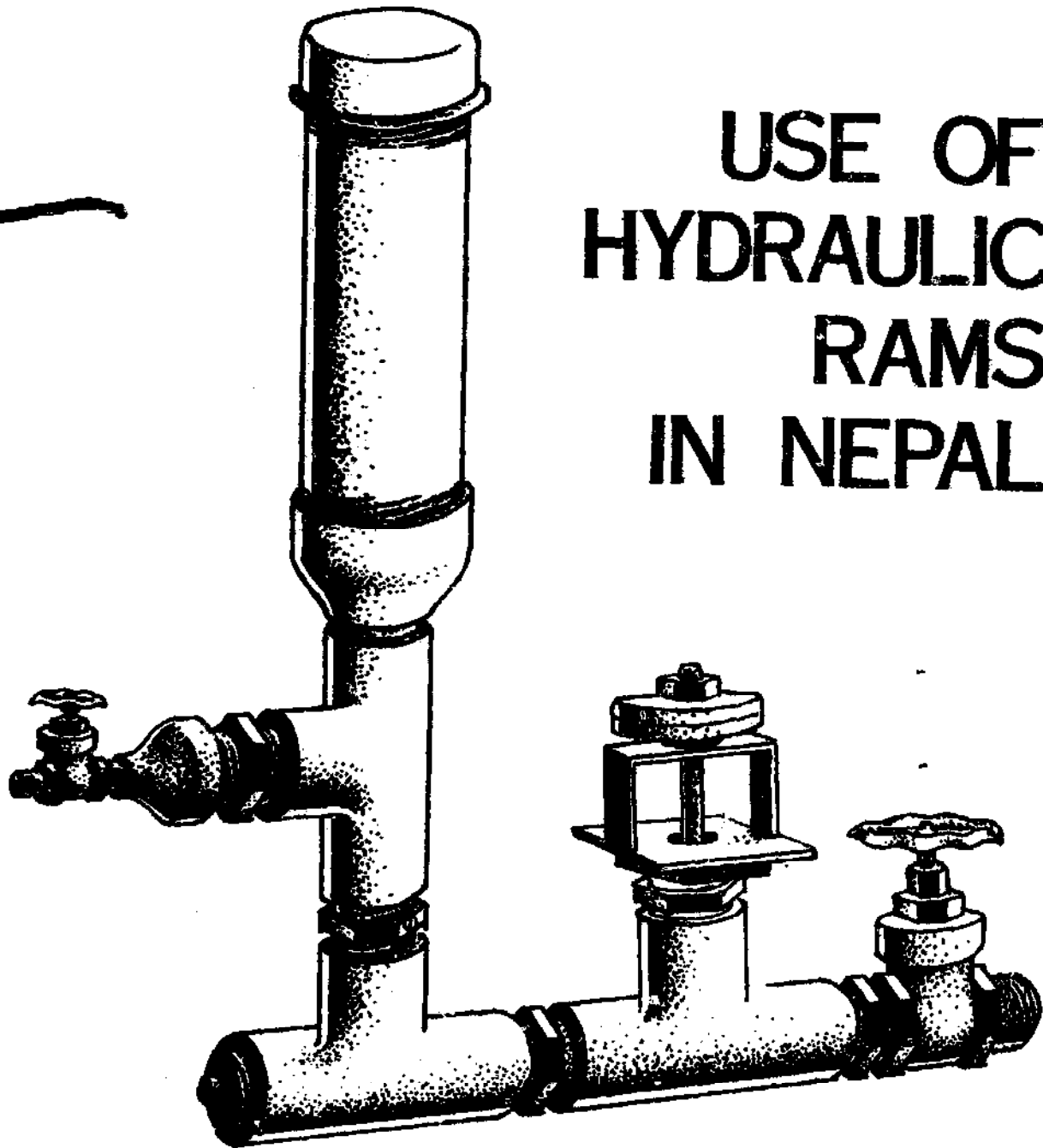

A GUIDE TO MANUFACTURING AND INSTALLATION

**USE OF HYDRAULIC RAMS
IN NEPAL**

A GUIDE TO MANUFACTURING AND INSTALLATION

By

MITCHELL SILVER



UNICEF (United Nations Children's Fund)

Box 1187, Kathmandu, Nepal

September 1977

**This book is available free
of charge from UNICEF
Box 1187
Kathmandu, Nepal**

TABLE OF CONTENTS

	<u>page</u>
List of Tables and Drawings.....	ii
Abbreviations.....	iv
Acknowledgements and Credits.....	v
Introduction.....	vi
Survey and Preliminary Design.....	1
How the Pump Works.....	8
Intake Tank	10
Pump Size	12
Drive Pipe	13
Delivery Pipe	16
General Notes on Pump Installation	18
Reservoir Tank	20
Starting the Pump	21
Tuning the Pump	21
Two or More Hydrants	22
Maintenance	24
Trouble Shooting	25
Building a Hydraulic Ram From Local Materials.....	27
An Alternative Type Hydrant	29
The Impulse Valve	31
The Delivery Valve	35
Making The Air Chamber	39
Mounting the Ram	41
Bibliography	42
Conversion Table	44

LIST OF TABLES AND DRAWINGS

	<u>page</u>
Table # 1 Minimum and maximum quantities of intake water	13
Table # 2 Delivery pipe diameter according to the amount of water pumped per day	16
Table # 3 Different conditions of vertical fall and lift and the percentage of water used which the ram will deliver	17
Table # 4 The cost of hydrams made from locally available parts	29
Table # 5 Dimensions for different sizes of impulse valves.....	34
Table # 6 Dimensions for delivery swing check valve (2" ϕ)	39

Drawings

1.	Vertical fall and lift, and drive pipe and delivery pipe lengths	2
2.	Use of an open standpipe to regulate drivepipe length	2
3.	Use of an oil drum as sediment collection/ drivepipe supply tank	2
4.	Hydram incorporated in a gravity flow breakpressure chamber	7
5.	How the pump works (4 panels)	9
6.	A mountainous installation using a canal from a river to supply the hydram	11
7.	A schematic diagram of a hydraulic ram installation	19
8.	A multiple hydram installation	23
9.	A hydram's waste water being used to power another hydram	23

		<u>page</u>
10.1	A hydraulic ram built from local materials.....	28
10.2	An alternative type hydram	30
11.	The impulse valve (4 panels).....	32
12.	The delivery valve (4 panels).....	36
12.5	An alternative delivery valve.....	38
13.	A hydram with an inner tube instead of an air valve	40

ABBREVIATIONS

TERMS

GI	=	galvanized iron
HDP	=	high density polyethylene
PVC	=	polyvinyl chloride
BPC	=	break pressure chamber
LDD	=	Local Development Department of His Majesty's Government of Nepal
Q	=	flow
Dwg #	=	drawing number
HGL	=	hydraulic grade line

UNITS

mm	=	millimeter	'	=	ft = foot
cm	=	centimeter	yds	=	yards
m	=	meter	mi	=	miles
kg	=	kilogram	gal	=	gallons (US)
l	=	liter	gpm	=	gallons per minute
lpm	=	liters per minute	gpd	=	gallons per day
lpd	=	liters per day	min	=	minutes
km	=	kilometer	lbs	=	pounds
sec	=	seconds	hr	=	hours
"	=	in = inches	/	=	per
sq	=	square	Ø	=	diameter

ACKNOWLEDGEMENTS AND CREDITS

This work would not have been possible without the valuable aid of the Local Development Department of the Home Panchayat Ministry, Department of Drinking Water of the Water and Power Ministry and UNICEF. Thanks also to those who helped at Balaju Yantra Shala. The main sources for this book are the publications by S.B. Watt, E.W. Kindell, and Rife, all of which are cited in the Bibliography. Illustrations: Naren Basnet and Mani Joshi of Continental Design and Art Studio.

INTRODUCTION

The hydraulic ram pump can be used with great effectiveness in mountain villages which are located at a higher elevation than their source of water. The hydam pump uses the power of falling water to pump a small portion of that water uphill. It requires absolutely no fuel or electricity, only water pressure. The pump was developed about 200 years ago, and the beauty of the hydam lies in its simplicity. There are only two moving parts which are lubricated by the water itself. This manual hopes to show that anyone with a minimal amount of mechanical aptitude can survey, design and build a hydraulic ram from locally available parts, and do any necessary maintenance.

Whether for domestic purposes or irrigation, a hydam can be used to great advantage in many diverse situations. The source of water could be a stream, a spring, an irrigation canal, an artesian well, or even an existing gravity flow water system. In the mountainous regions of Nepal, and other areas of similar topography, there are many thousands of places where, if a hydam were installed, much time spent hauling water could be used for other purposes. Formerly unproductive or unused land could be made suitable for gardens and orchards, and field crops could give increased yields. Widescale usage would benefit many thousands of people.

Because this simple pump works 24 hours per day, for many years (many working installations are over 50 years old) and requires little attention, it is suitable for areas

where people have little technical expertise. Because hydraulic ram installations are inexpensive and quickly installed, they are well suited for remote areas where there are extreme transportation difficulties, as well as for sparsely populated villages which often make gravity flow water supply system financially unfeasible. The ability to incorporate a hydram in an existing gravity flow water supply system has also proved very useful.

It is hoped that this short manual provides the necessary information to stimulate interest in hydraulic rams so that some of the many thousands of people that stand to gain will be benefited, by having their drudgery eased and their economic situation improved.

SURVEY AND PRELIMINARY DESIGN

A hydraulic ram survey must be done while considering the design. Before a design can be done it is essential to know:

- 1. Vertical fall from source to pump.**
- 2. Vertical lift from pump to delivery site.**
- 3. Amount of water available to power the pump (Q input or source flow).**
- 4. Minimum daily quantity of water required.**
- 5. Drivepipe length from source to pump.**
- 6. Delivery pipe length from pump to delivery site.**

Initially one must measure the distance from the potential pump site to the delivery point and the difference in vertical elevation (see dwg. # 1). Except in a few cases, hydraulic rams cannot pump higher than 100 meters - and in order to avoid using long lengths of galvanized iron (GI) pipe one should try not to exceed the pressure limits of the HDP pipe.

One must also measure the available fall from the source to a spot below where the pump will be placed. The supply head should be between 1 to 20 meters, remembering that

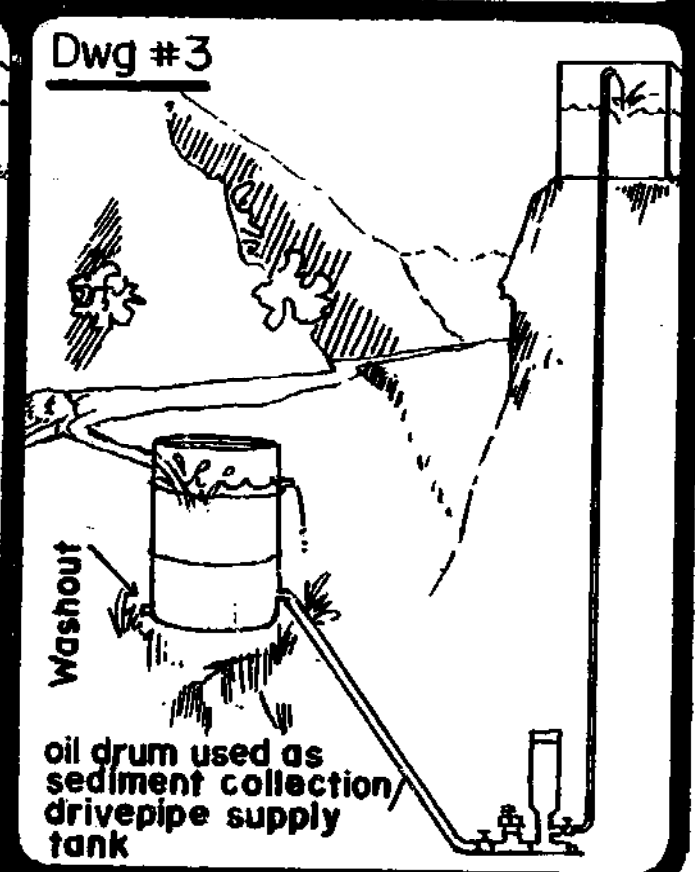
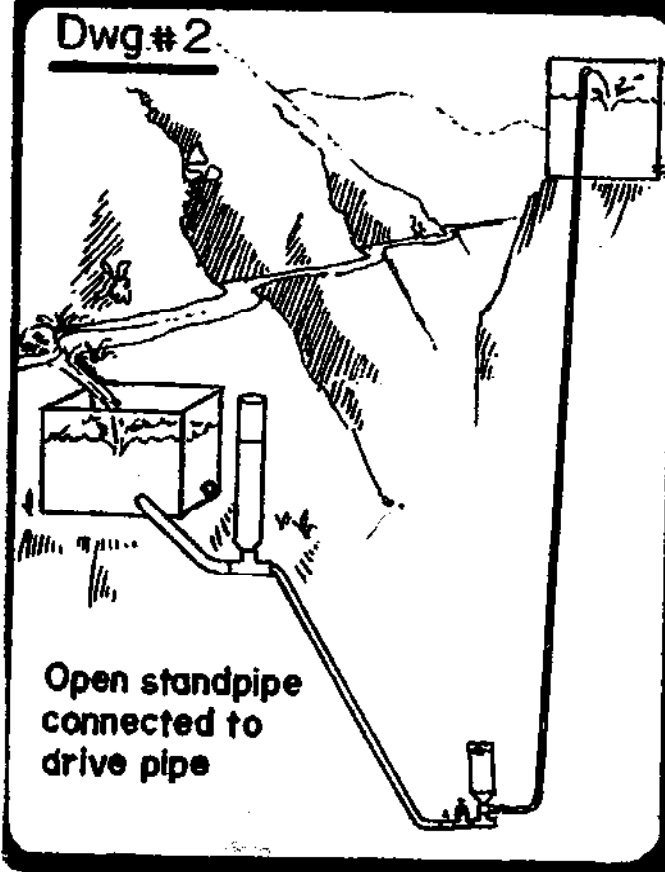
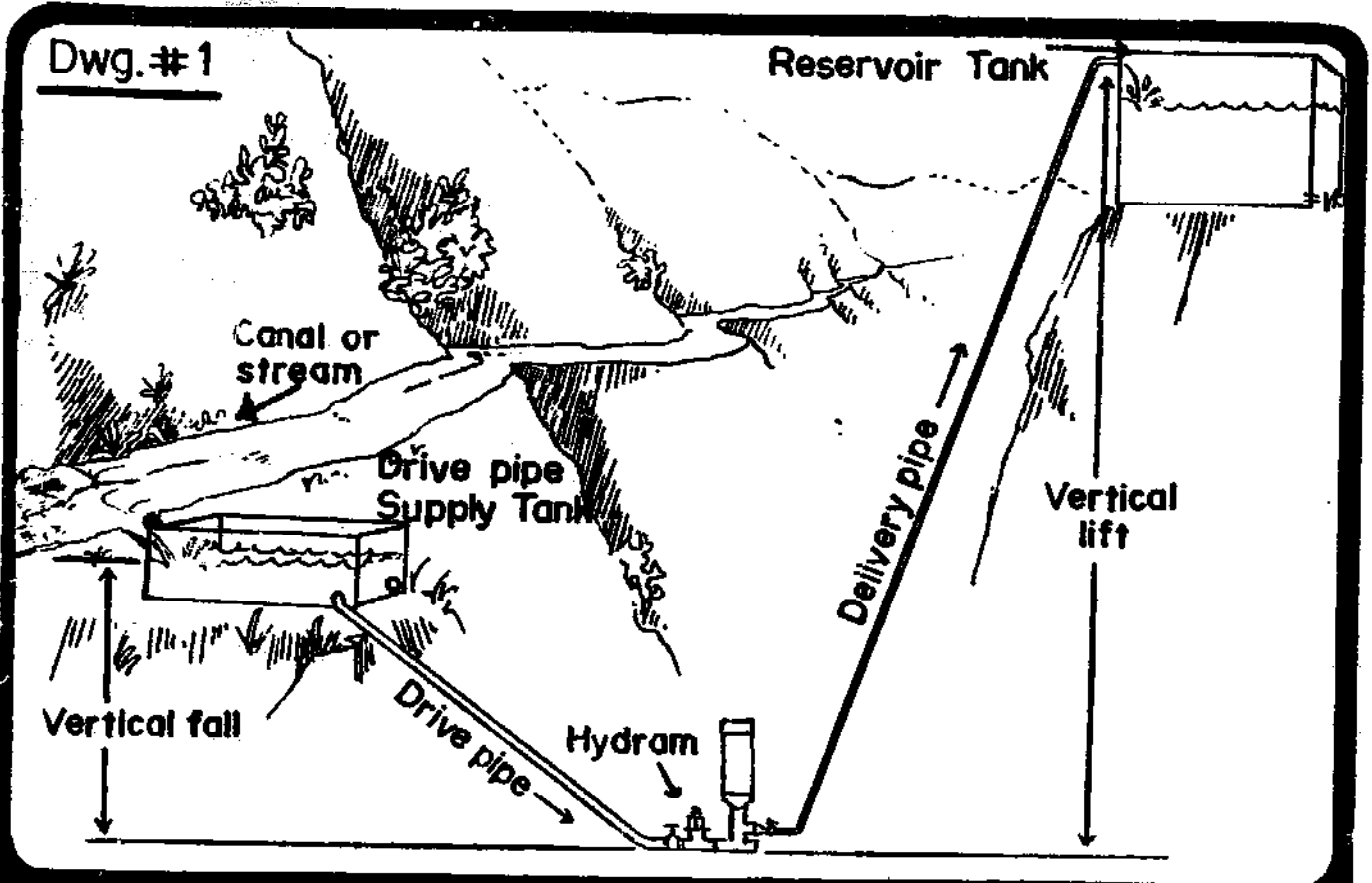

output varies directly with increased supply head. The length of the drive pipe will be roughly 4 times the supply head. This is discussed in greater detail in the section on pump design.

The flow of source water must be accurately measured. Careful site investigations must be made, including questioning of the villagers about water quality, the possible change of flow at different times of the year, and whether or not there is a sediment problem. While surveying, consider the following:

- a. Where is a suitable site for intake that considers possible flood conditions, landslides or soil erosion?
- b. Where will the pump be located? Can a small house be built around the pump? Where will the unused water from the pump go?
- c. Where will the pipes be laid, and can they be buried?

After calculating these initial measurements using the formula:

$$Q \text{ (output) per day} = \frac{\text{vertical fall} \times \text{source flow (lpd)} \times 0.6^*}{\text{vertical lift}}$$

you can estimate the amount of water will be delivered per day. Compare this figure with the amount of water required daily. (Forty-five liters per person per day is considered adequate for domestic use in Nepal's mountain villages).

If the pump's calculated output is too small, then it may not be feasible to use a hydram. If there is sufficient water, then calculate the village needs for water regarding domestic use, animal use, and possible small scale irrigation for fruit trees or vegetable gardens. Let this figure be your desired output and then calculate how much intake flow is necessary using the following formula:

* For the variables of fall and lift be consistent in which units you use. Either use meters or feet but don't mix the two. The flow should be lpd or gpd. If lpm or gpm are used and you desire the daily flow then multiply by 1440.

$$(Q \text{ intake}) \text{ Flow} = \frac{\text{vertical lift} \times \text{output (Q)}}{\text{vertical fall} \times 0.6}$$

Example 1

Assuming the following conditions, what will be the expected quantity of water pumped per day?

Source flow	= 30 gpm	= 113.6 lpm
Vertical fall	= 30 feet	= 9.1 meters
Vertical lift	= 200 feet	= 61 meters

Population of village: 200 people

$$\text{Estimated population in 15 years at 25\% increase} = 200 + \frac{25}{100} \times 200 = 250$$

$$\text{Demand (250 people at 45 liters per day)} = 11,250 \text{ lpd} \\ = 2,972 \text{ gpd}$$

$$Q \text{ output} = \frac{\text{vertical fall} \times \text{flow} \times 0.6}{\text{vertical lift}} \\ = \frac{30' \times 30 \text{ gpm} \times 0.6 \times (1440 \text{ min.})}{200'} = 3880 \text{ gpm} \\ (1 \text{ day}) = 14,716 \text{ lpm}$$

Example 2

Under certain conditions how much source flow (Q intake) is necessary to meet the daily demand.

Vertical lift (always measured from the pump, and not the source) 45.7m (150'). Vertical fall 7.6m (25')

Demand

a. for 600 villagers assuming a 25% increase in 15 years

$$600 + \frac{25}{100} \times 600 = 725$$

$$725 \times 45 \text{ lpd per person} = 32,625 \text{ lpd}$$

b. for 300 animals x 6 lpd = 18,000 lpd

total = 50,625 lpd

knowing that $Q \text{ Intake} = \frac{\text{vertical lift} \times Q \text{ output}}{\text{vertical fall} \times 0.6}$ and
that 1 day = 1440 min.

$$\begin{aligned} \text{then } Q \text{ Intake} &= \frac{45.7\text{m} \times 50,625 \text{ lpd}}{7.6\text{m} \times 0.6} \times \frac{1 \text{ day}}{1440\text{min}} \\ &= 352.3 \text{ lpm (93 gpm)} \end{aligned}$$

This figure of 352.3 lpm is the minimum source flow required to meet the daily demand. If the source flow exceeds this figure then it will be possible to exceed the daily demand. In cases where excess water can be provided, encourage villagers to use the water for other types of development work such as a vegetable garden, fruit orchard, a tree nursery, a fish pond, and latrines.

By increasing the vertical fall or decreasing the vertical lift the output will be proportionately increased. One technique for increasing the vertical fall, when it is too small, is to take an intake pipe (or canal) from the source and run it to another point downstream where there would be a bigger difference in elevation to the pump (see dwg # 1 & 6). The initial intake pipe can be HDP, but the pipe attached to the pump must be GI or steel. The junction of the two pipes can be an open standpipe if the HDP pipe is a size larger than the drive pipe, or there can be a small tank that would have intake, outlet, washout and overflow pipes. (See dwg # 2 & 3). This intermediate tank is especially useful if the water is sediment laden. The function of an open standpipe or small overflowing tank is to insure that there is absolutely no air in the drivepipe. The use of the open standpipe is primarily for installations where the intake tank and the ram location are limited by the surrounding topography, which could prevent the drivepipe from being straight or make it unnecessarily long or not steep enough. (See the section on The Drivepipe for designing the proper

length). By using an open standpipe the length and angle of the drivepipe will be determined by the standpipe location.

In the event that the system is meant to be incorporated in an existing gravity flow system, a breakpressure chamber (BPC) is the ideal place to install the ram, as this will eliminate any waste water. To allow any air trapped in the pipeline to escape, it is advisable to connect a pipe up from the BPC's intake to a small holding tank (thus eliminating the air problem) from which the drivepipe runs down to the pump sitting within the BPC.

The pump cannot be submerged in water, so care must be taken to prevent this. (See dwg # 4). The valve serves to regulate the flow up to the tank which must at least equal or slightly exceed the pump's consumption of the drive water.

This manual is intended to be a guide for the use of hydraulic rams, but it must be emphasized that is only a guide in the sense that every installation/situation will vary considerably and specific design and techniques suited to the particular site are necessary in order to create the most appropriate water system. There is much room for creativity as only a few hydrams have been installed in Nepal and precedents and standard procedures have not been firmly established.

Often, constraints such as money and transportation will have effects on the design. As there is no one correct design for a site, but rather several alternatives, each having advantages and disadvantages, it is essential to be highly flexible. It must be remembered that the design must consider possible conditions of at least 15 years in the future; this period in keeping with LDD design criteria for gravity water supplies. This requires careful calculation regarding the environmental effects including landscape; erosion; population growth, possible detrimental effects, suitability for maintenance; durability, and any objections from others

Dwg.#4

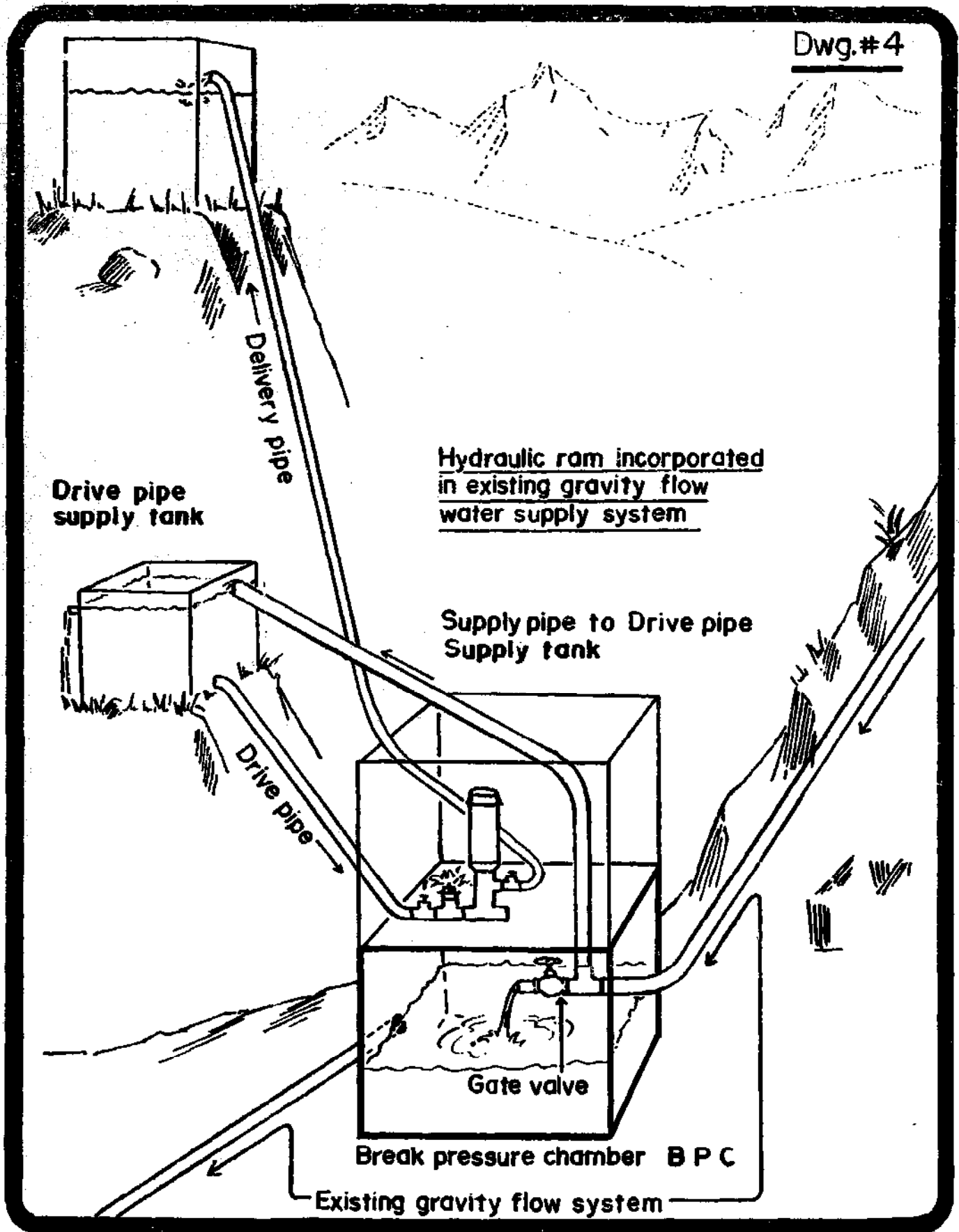

Hydraulic ram incorporated
in existing gravity flow
water supply system

Drive pipe
supply tank

Supply pipe to Drive pipe
Supply tank

Drive pipe

Gate valve

Break pressure chamber B P C

Existing gravity flow system

Delivery pipe

concerning the water usage or installation. Wherever possible consult with the villagers concerned on aspects of design that concern them. Often local techniques and materials are the most appropriate solution for a given problem.

HOW THE PUMP WORKS

There are certain conditions that must be fulfilled in order for the pump to work. There must be sufficient water in the drivepipe falling from a minimal height in order to create enough pressure to close the impulse valve. There must be a certain minimal height of water in the delivery pipe (about two times the fall) in order to sustain the pressure in the air chamber. It should be remembered that a small amount of water with plenty of fall will pump as much as a situation with plenty of water having only a small fall. The higher the delivery head, the less water will be pumped, other things remaining equal.

The water starts to flow through the drivepipe and escapes out the impulse valve (dwg # 5.1). As the water accelerates its pressure overcomes the weight of the impulse valve, causing it to close suddenly (dwg # 5.2). The water pressure suddenly stopped causes a very high pressure called "water hammer". Some of the water is forced through the delivery valve into the air chamber, compressing the air until the water pressure is depleted. The compressed air acts like a spring, which closes the delivery valve and forces the water up the delivery pipe (dwg # 5.3). When the delivery valve closes suddenly, it creates a pressure surge going up the drivepipe which takes the pressure off the impulse valve, allowing it to fall open due to its own weight (dwg # 5.4). The water again flows out the impulse valve as the cycle repeats itself. When the water enters the air chamber a bit of water is wasted through the air valve, but on the closing of the delivery valve a bit of air enters through the air valve due to the partial vacuum that is created by the water rebounding up the drivepipe.

Dwg.# 5-1

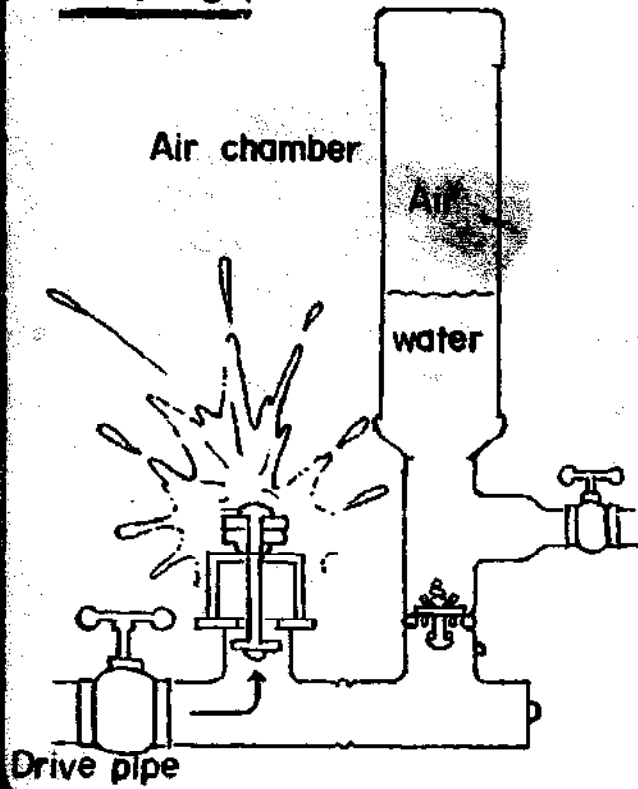

Dwg.# 5-2

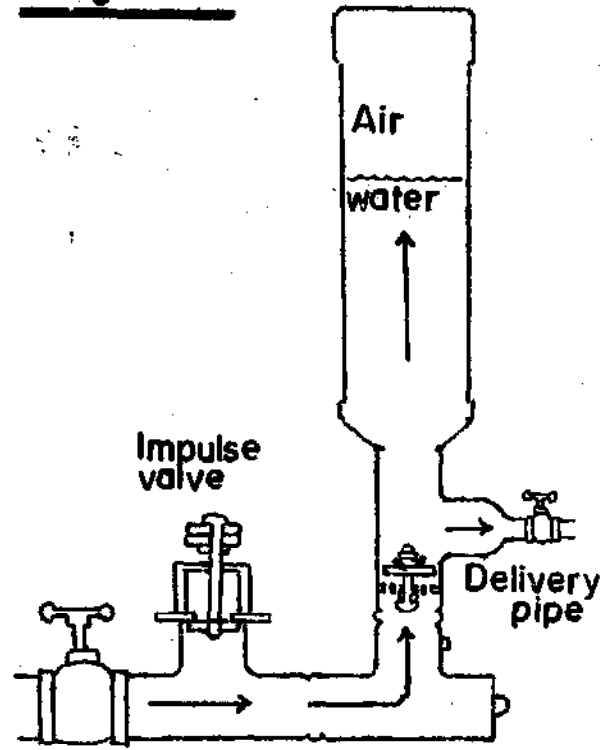

Dwg.# 5-3

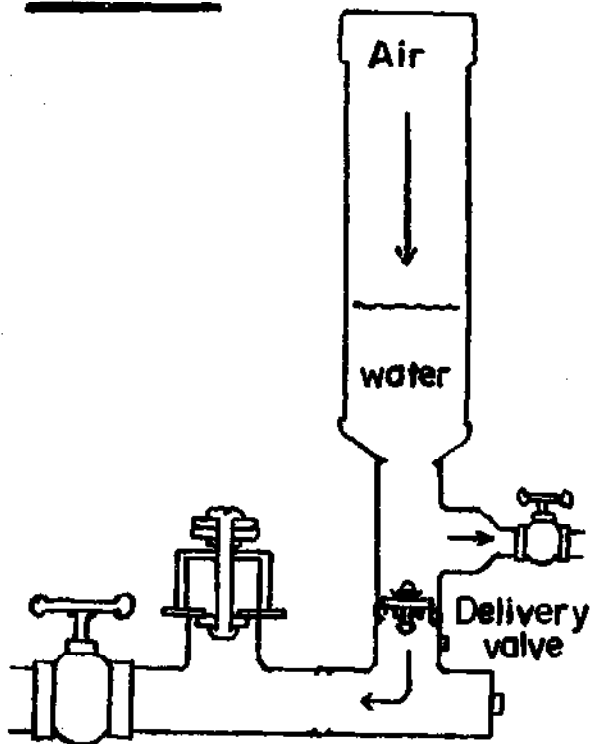

Dwg.# 5-4

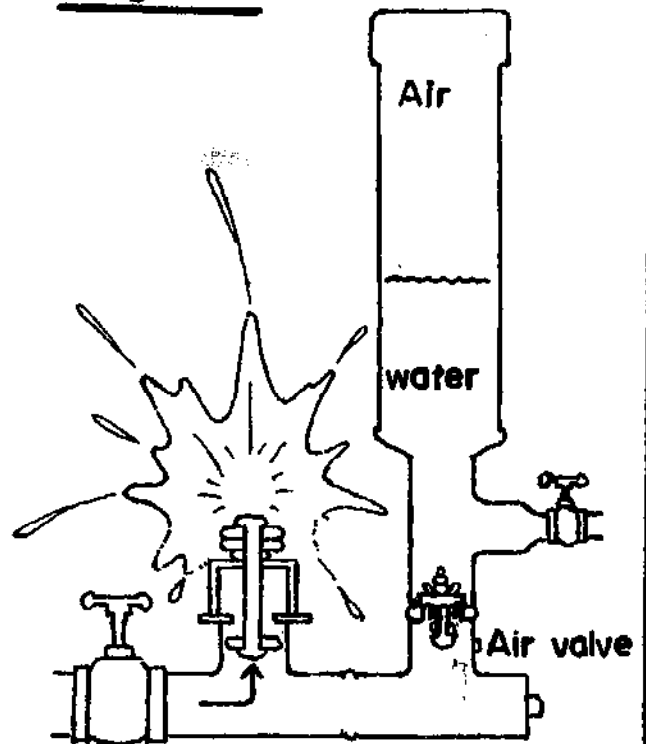

Opening and closing of the valves and the flow of water during one pumping cycle of a hydram.

INTAKE TANK

The intake tank will vary with the individual site, but basic differences are found depending on the nature of the water source. Springs, streams, canals, and piped gravity flow systems, and artesian wells all have different requirements. Techniques of intake tank design and construction are found in other books but a few general principals must be remembered. If the source is to be used for drinking water then contamination must be avoided. Stream and canal source designs must carefully consider the problems of flooding, torrents and erosion. Because sources are usually sediment laden, this initial tank should be equipped with a washout valve, and also permit easy access for maintenance. In some cases the drivepipe to the pump will come directly from the intake tank. Dwg # 6 shows a canal from a stream supplying the hydram. Otherwise there will be a pipeline to another small tank (used oil drums with welded intake, output, washout, and overflow sockets have proved very useful in remote areas especially when the water is sediment laden), which should be overflowing slightly to insure a constant level of water above the mouth of the drivepipe. (See dwg # 1 & 3). (To allow the hydram to consume as much water as possible is usually determined by having a minimal overflow from this intermediate supply tank). In some cases this middle tank is not necessary, and instead an open standpipe can be used. (See dwg # 2). Proper placement of this intermediate tank or standpipe will determine the length and angle of the drivepipe; and should insure that the drivepipe is straight.



A mountainous installation using a canal from a river to supply water to the hydraulic ram. The waste water goes back into the river and the pumped water goes up to a reservoir tank to supply the village.

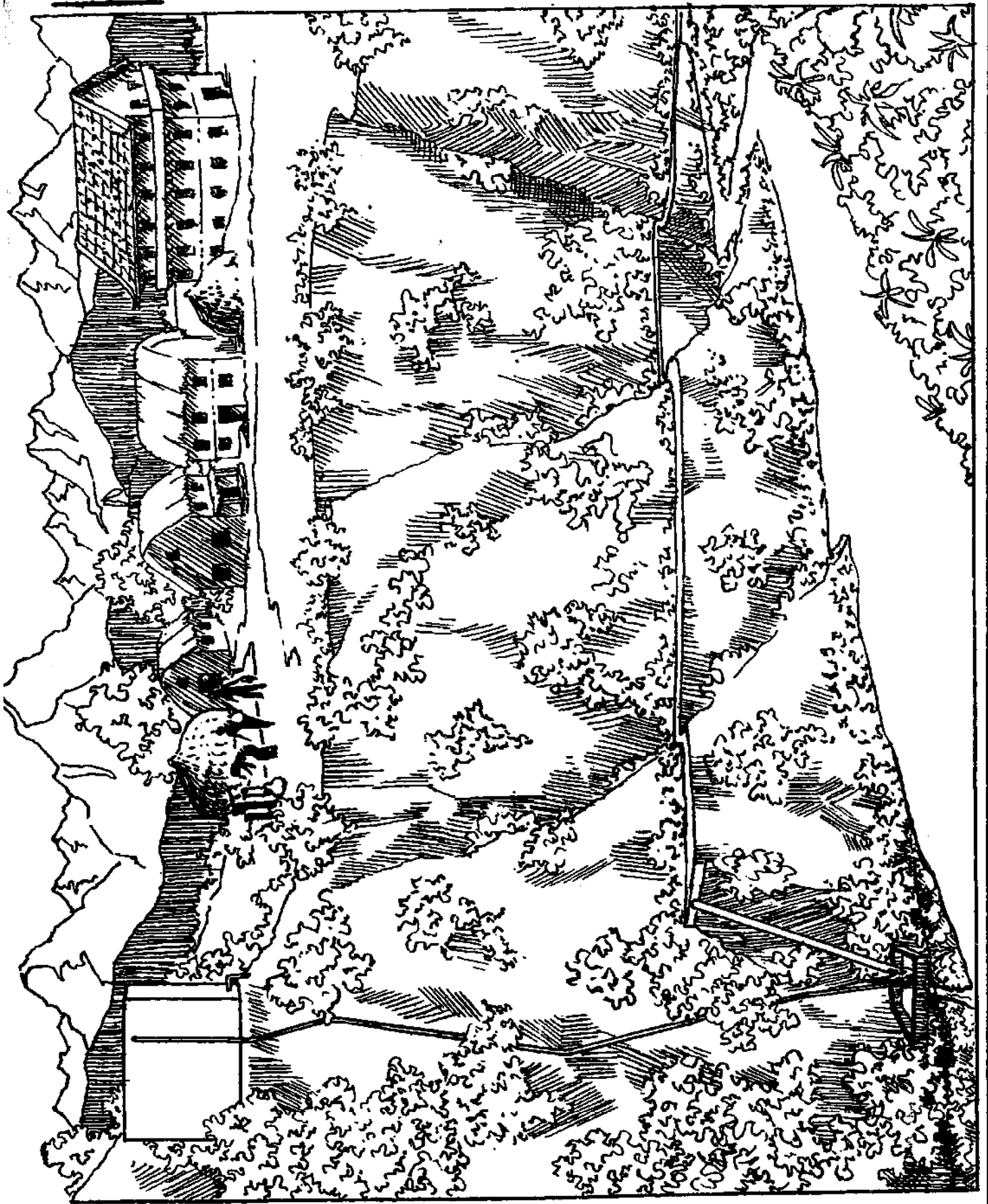

This supply pipe (which can be HDP or PVC) must be at least one size larger than the GI or steel drivepipe. In the case of an open standpipe the supply and drivepipe are joined by a tee joint into which is fitted an open steel or GI standpipe which is two sizes larger than the drivepipe. This standpipe should rise a few inches above the hydraulic gradient. The hydraulic grade line (HGL) is a representation of the height to which water flowing in a pipe would rise were it not constricted by that pipe. If an open ended pipe were inserted in a pipeline, the height of the water's rise defines the HGL. Water in a pipe with no static head and which is subject only to atmospheric pressure will not rise in the open tube, therefore the HGL in this case is at the water's surface. Carl Johnson's book, cited in the bibliography, gives a more detailed analysis at the principals of the hydraulic gradient.

In many cases this technique of using an intermediate tank or standpipe is necessary to maximize the fall from source to pump and still be able to have the drivepipe of the proper length. It is necessary to screen both the supply pipe and the drivepipe to avoid getting debris, frogs, etc. in the pump. These screens must be checked often (in some cases daily) to ensure that the water is flowing at a maximum rate.

PUMP SIZE

The size of the hydraulic ram is determined by the output desired, or limited to the available supply of water to drive the pump. Rough estimates for maximum and minimum quantities of driving water are given below. These figures vary widely from one pump to another depending on the nature of the impulse valve.

Table # 1

**Minimum and Maximum Quantities of Intake Water
for Specific Sizes of Hydrams.**

<u>Ø of ram body inches/millimeters</u>	<u>minimum intake gpm (US)/lpm</u>	<u>maximum intake gpm (US)/lpm</u>
1 (25)	2 (7.6)	10 (37.9)
1.5 (37)	4 (15.1)	15 (56.8)
2 (51)	8 (30.3)	25 (94.6)
2.5 (63.5)	15 (56.8)	40 (151.4)
3 (76)	25 (94.6)	70 (265)
4 (102)	40 (151.4)	100 (378.5)

If you are making your own pump, you can affect the minimum and maximum quantities of water by making a spare impulse valve bolt/washer assembly of a slightly larger or smaller diameter. (See the section on impulse valves)

DRIVE PIPE

The drivepipe is an important consideration in the overall design. Every commercial manufacturer of hydrams has a different technique for calculating drivepipe diameter and length, and in many instances the results of two different methods will produce different answers. Fortunately the drivepipe will work satisfactorily over a wide range of lengths and diameters. After approximating the location of the intake tank, supply line and pump site in order to maximize the vertical fall and flow, calculate the diameter of the drivepipe using Table # 1 which gives a rough approximation of the capacity of different size rams. Commercial pumps of similar sizes have different capacities, as do the pumps described in this booklet, depending on the individual impulse valve dimensions.

Be sure to consider the seasonal changes of the source's flow as some springs and streams change dramatically during different times of the year.

After choosing the appropriate size pump, pick a matching drivepipe diameter if the vertical fall is less than 16' 5 meters). If the vertical fall is more than 16' it is permissible to pick a drivepipe diameter one size smaller (that means 0.5" smaller), for 1.5" pumps and up, especially if the installation cost must be minimized.

Choose a drivepipe length that is six times the vertical fall for falls less than 16' (4.8m); for 16' to 25' (7.6m) 4 times the fall; and for 25' to 50' (15m) 3 times. It is often convenient to choose the length of commercially available GI pipe. A second technique for calculating the drivepipe length is to take the ratio of length (L) to diameter (D) to be equal to 500 ($L/D = 500$). This is a median range as any ratio of between 150 to 1000 will work ($150 < L/D < 1000$). Longer drivepipes do not tend to increase efficiency but rather permit the pump to operate at less strokes per minute, which in turn means less valve wear, and longer operating life.

Example 1

Vertical fall 30' = (9.14m)

Maximum intake flow 38gpm = (143.8 lpm)

Manimum intake flow 20gpm = (75.7 lpm)

According to the Table # 1 the maximum and minimum intake flows are in the range of a 2.5" (63.5mm) pump. Because the fall is more than 25' (7.6m) it is feasible to use a 2" \emptyset drivepipe and to calculate the length to be three times the fall. Three times the vertical fall is 90' (27.4m). By checking the L/D ration: $90'/2" \times (12"/1') = 540$ which is suitable. After taking into consideration the best location for the drivepipe, intake, and the pump site, any length of 2" \emptyset (63.5mm) GI pipe between 80' (24.4m) to 100' (30.5m) will be suitable.

Example 2

Vertical fall 12' = (3.2m)
Minimum intake flow 10gpm = (37.9 lpm)
Maximum intake flow 20gpm = (75.7 lpm)

According to the Table # 1 use a 2" \emptyset pump, and due to the fall being less than 16' use a 2" \emptyset drivepipe. Six times the vertical fall is $6 \times 12' = 72'$. $L/D = 72'/2" \times (12"/1') = 432$. Alternatively if we let $L/D = 500$ and $D = 2"$ then $L = 83'$. In this case a drivepipe length between 72' to 83' is suitable. It might be most convenient to use four lengths of 20' pipe or a total length of 80 feet.

DELIVERY PIPE

The HDP pipe currently available in Nepal is series III and series IV. The former will withstand a pressure head of 60 meters (196') and the latter 100 meters (327'). Be sure not to use any of the low quality HDP pipe available in the bazaar which is often low priced but will not withstand much pressure.

An initial length of GI pipe for the delivery line connected to the pump would give additional structural support to the pump, but this is not essential. If in fact your vertical lift exceeds the pipe's pressure specifications, then the lower portion of the delivery pipe must be GI pipe.

Table # 2

Delivery pipe diameter according to the amount of pumped water per day.

Gallons/day	800	2400	3700	6000	14500	23800	35500
Liters/day	3000	9000	14000	23000	55000	90000	135000
Ø inches	0.5	0.75	1.0	1.25	1.5	2.0	3.0
Ø mm	20	25	32	40	50	63	90

If there is a series of hydraulic rams, they must have separate drive pipes, but they can use a common delivery pipe. (See dwg # 9)

Remember that the minimum vertical lift is about two times the vertical fall, and the maximum vertical lift is about twenty times the vertical fall.

If the delivery pipe has any high points in the pipeline where air might become trapped, an air valve or its equivalent will be necessary. A threaded brass screw in HDP pipe is often sufficient, if it is used with care.

DIFFERENT CONDITIONS OF VERTICAL FALL
AND LIFT AND THE PERCENTAGE OF WATER
USED WHICH THE RAM WILL DELIVER

V E R T I C A L L I F T

Feet	8	16	25	50	75	100	125	150	200	250	300	fall in feet	fall in meters
V Feet	2.4	4.9	7.6	15.2	22.9	30.5	38.1	45.7	61.0	76.2	91.4		
E 4	1.2	22.5%	12.5	8.0	3.6	1.6						4	1.2
R 8	2.4	22.5%	16.0	9.6	6.4	4.8	3.5	2.7	2.0			8	2.4
T 12	3.7		22.5%	13.2	9.6	7.2	5.7	4.2	3.3	2.4	2.0	12	3.7
I 16	4.9			16.0%	11.7	9.6	7.7	6.4	4.8	3.8	2.9	16	4.9
C 20	6.0			18.0%	14.7	12.0	9.6	8.0	6.0	4.8	4.0	20	6.0
A 25	7.6			22.5%	16.7	13.8	12.0	10.0	7.5	6.0	5.0	25	7.6
L 30	9.1				18.0%	15.0	13.2	12.0	9.0	7.2	6.0	30	9.1
	35	10.7				21.0%	17.5	15.2	14.0	10.5	9.4	35	10.7
F 40	12.2					18.0%	16.0	14.7	12.0	9.6	8.0	40	12.2
A 50	15.2					22.5%	18.0	16.7	13.8	12.0	10.0	50	15.2
L FEET	8	16	25	50	75	100	125	150	200	250	300		
L METER	2.4	4.9	7.6	15.2	22.9	30.5	38.1	45.7	61.0	76.2	91.4		

Example # 1 : A 3" ram operating with 12½ ft fall and 125 ft lift and normal intake capacity of 45 gpm would deliver approximately 5.8% of that amount, or about 2.6 gpm. Since one gpm is 1440 gpd this would be 3774 gpd.

Example # 2 : A 63mm Ø ram operating with a 6 meter fall and a 61 meter lift with an intake capacity of 80 lpm would deliver 6% of that amount or about 4.8 lpm. This would be 6912 lpd.

GENERAL NOTES ON PUMP INSTALLATION

The pump should be as level as possible to ensure the weighted impulse value falls straight down without any unnecessary friction. This is sometimes a problem as the drive pipe is inclined and sharp bends must be avoided. Sometimes the drivepipe will have enough flex to accommodate this bend, so that the pump is level. It might be necessary to slightly bend a section of the drivepipe on the site with the assistance of several strong villagers and possibly a large tree. Be very careful not to overbend or kink the pipe. If you can premake a short piece of pipe with the angle tailored to your installation, this will be ideal.

The drivepipe and delivery pipe should be connected to the pump with a union joint and a gate valve. The schematic diagram of a hydraulic ram installation (dwg # 7) will help you decide what fittings you need for the installation. All threaded joints should be wrapped with fine jute thread and then coated with a pipe sealant compound or enamel paint to prevent leaks in the joints.

The foundation of the pumphouse and how to stabilize the pump deserves your careful attention. If the pumphouse floor will be concrete, then bury in a cement base with two to four threaded bolts. Weld legs or a mild steel plate to the bottom of the pump with holes to accommodate these bolts. If this is not possible, consider using galvanized stay wire, tightly securing the pump to an immovable object. This technique is not nearly as strong as a concrete base and should be used only when there aren't any better alternatives. The drivepipe should also be well buried and anchored, as this will prevent the pump's vibration from causing pump and pipes to slide downhill, or causing leaks in the joints.

Be sure that the pump and pipes are well protected from freezing temperatures, which is often a problem at elevations

SCHEMATIC DIAGRAM OF A HYDRAULIC RAM INSTALLATION

KEY



Tank fitted with intake, overflow, washout and service pipes.



G.I./HDP flanged joint



G.I. Union



Gate valve



Tap valve



Reducing fitting



Brass or wire screen (easily accesible and replaceable)



G.I. pipe with cap or plug



Vertical flow non return valve (delivery valve)



Intake strainer

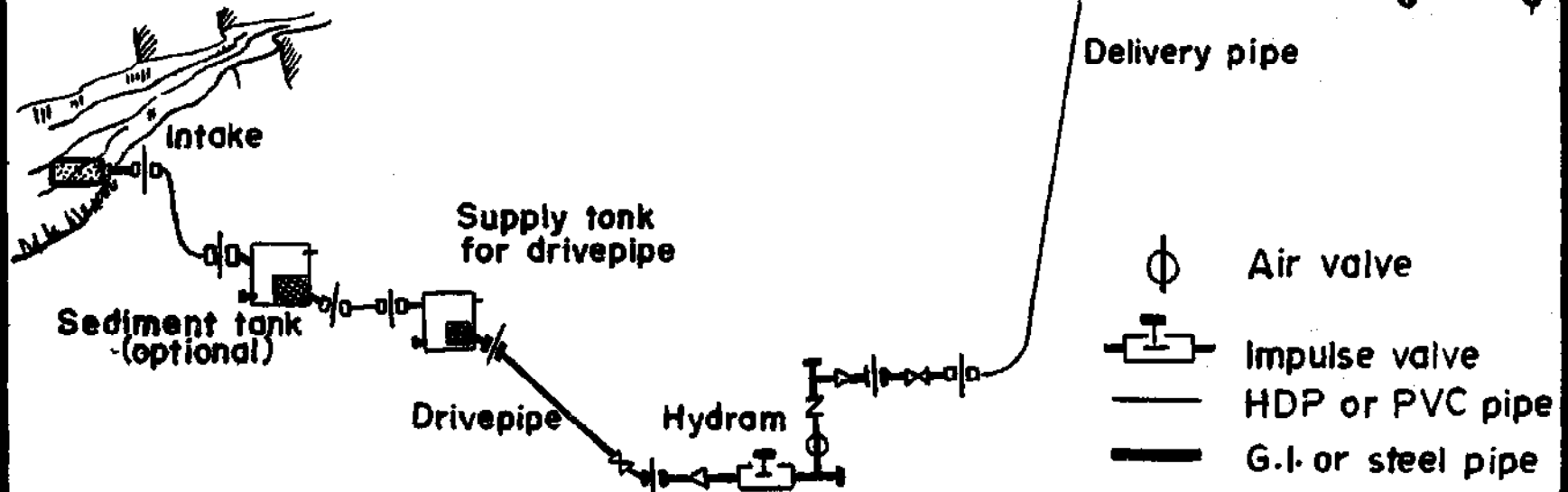

Air valve



Impulse valve



HDP or PVC pipe



G.I. or steel pipe

above 8,000 ft. (2,400m). The pump and pipes, if not in operation, should be drained of water to prevent freezing temperatures from bursting the pipe. Villagers must understand the importance of this point. If the water is flowing and the pump is pumping there won't be any problem.

When buying pipe fittings check the quality of the threads and castings, and if possible get sockets, reducers, etc. with small raised "grips" on the outside surface as it facilitates tightening and loosening the fittings with a pipe wrench.

RESERVOIR TANK

After you have calculated daily water demand and designed the pump to meet this demand, the size of reservoir tank must be determined. Usually it will equal the capacity that will be pumped in twelve hours. In this way the tank will fill during the hours when there is no demand.

If the water is used for more than just drinking water e.g., small irrigation system for a vegetable garden or fruit orchard, then the system must be designed to handle this and the tank should be proportionately larger.

The tank must have a washout pipe, inlet, service pipes, and an overflow pipe. The overflow should be designed to lead the water to a pond for animals or fish or irrigation, and avoid causing any erosion problems.

If the system is used only for irrigation, then a pond may replace the need for a tank. As the water in the pipe entering the reservoir tank is under pressure, it might be occasionally desirable to attach another pipe to this delivery pipe end (inside the tank) to raise water to a point above the reservoir tank. If this is to be done, be sure that the delivery pipe's pressure limit is not exceeded. It is helpful to include a socket or flange on this end of the pipe inside the tank.

STARTING THE PUMP

The gate valve on the delivery pipe should be closed while the drive pipe gate valve should be fully open. Check to see that there is no air coming out of the top end of the drivepipe. If there are air bubbles rising, wait until the air has been depleted. Manually open the impulse valve (this is where one gets wet) several times until it falls open by itself. After the pump has operated on its own for 12 to 15 strokes, slowly open the delivery gate valve. The pump can not operate automatically unless there is some head in the delivery pipe (a column of water twice the height of the drivepipe fall is usually needed) and the initially closed gate valve temporarily replaces the need for this head. See that there are no leaks in the pipelines or pump, and tune the ram as necessary.

TUNING THE PUMP

The hydram should be tuned to maximize output, which is to use the supply water most efficiently. It is a matter of increasing or decreasing the weight on the impulse valve bolt stem and/or shortening or lengthening the valve stroke - regulated by moving the lock nuts up or down the bolt. Lengthening the stroke and increasing the weight decreases the strokes per minute, but increases the consumption of water, increases the pressure with which the valve closes, and increases the delivery water. Higher delivery heads often require a longer stroke, which increases the pressure of the "water hammer" effect upon closing. Often various settings of weight and stroke will give the same output. Try various adjustments, measuring the quantity delivered, until you are satisfied with the result. The output (Q) should roughly correspond with the formula

$$Q \text{ output} = \frac{\text{vertical fall} \times \text{intake flow} \times 0.6}{\text{vertical lift}}$$

TWO OR MORE HYDRAMS

If the ram installation is not large enough to meet the water requirements, or a very large ram is not available, then it may be desirable to have a series of two or more rams. Each hydram requires a separate drive pipe, but they can have a common delivery pipe. A ram series would be very useful in a system where the minimum yearly flow might be enough to power only one ram and the maximum flow was sufficient to run two or three pumps. (See dwg # 8)

Although I have not seen a ram installation according to the following description, there is no reason why it should not work. In a case where the water is sufficient to power only one hydram, but the output does not quite meet the requirements the waste water (usually between 80-95%) from the initial ram could be channelled into another small tank from which the drive pipe descends to another pump. The lower pump's delivery pipe should then connect to the upper pump's delivery pipe with a tee-joint unless they are meant to supply two different places. (See dwg # 9) At this junction check valves are recommended

Dwg. # 8

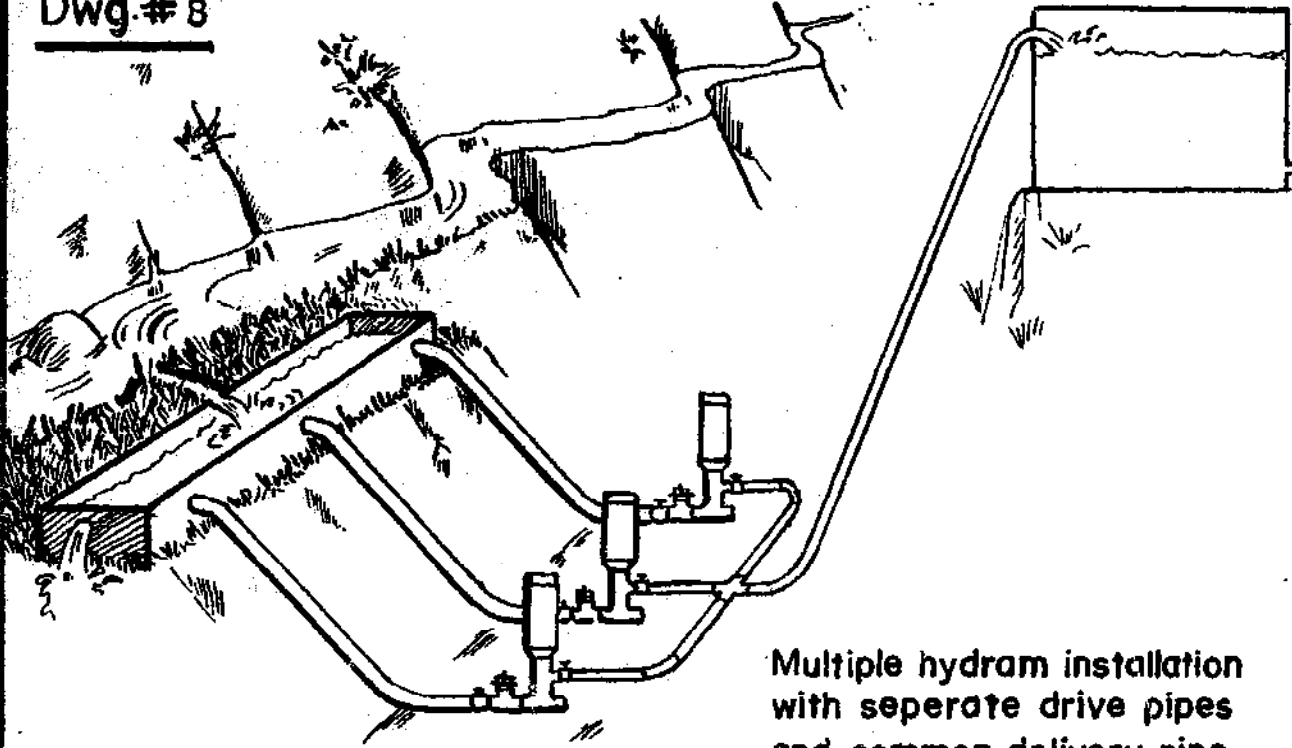

**Multiple hydram installation
with separate drive pipes
and common delivery pipe**

Dwg. # 9

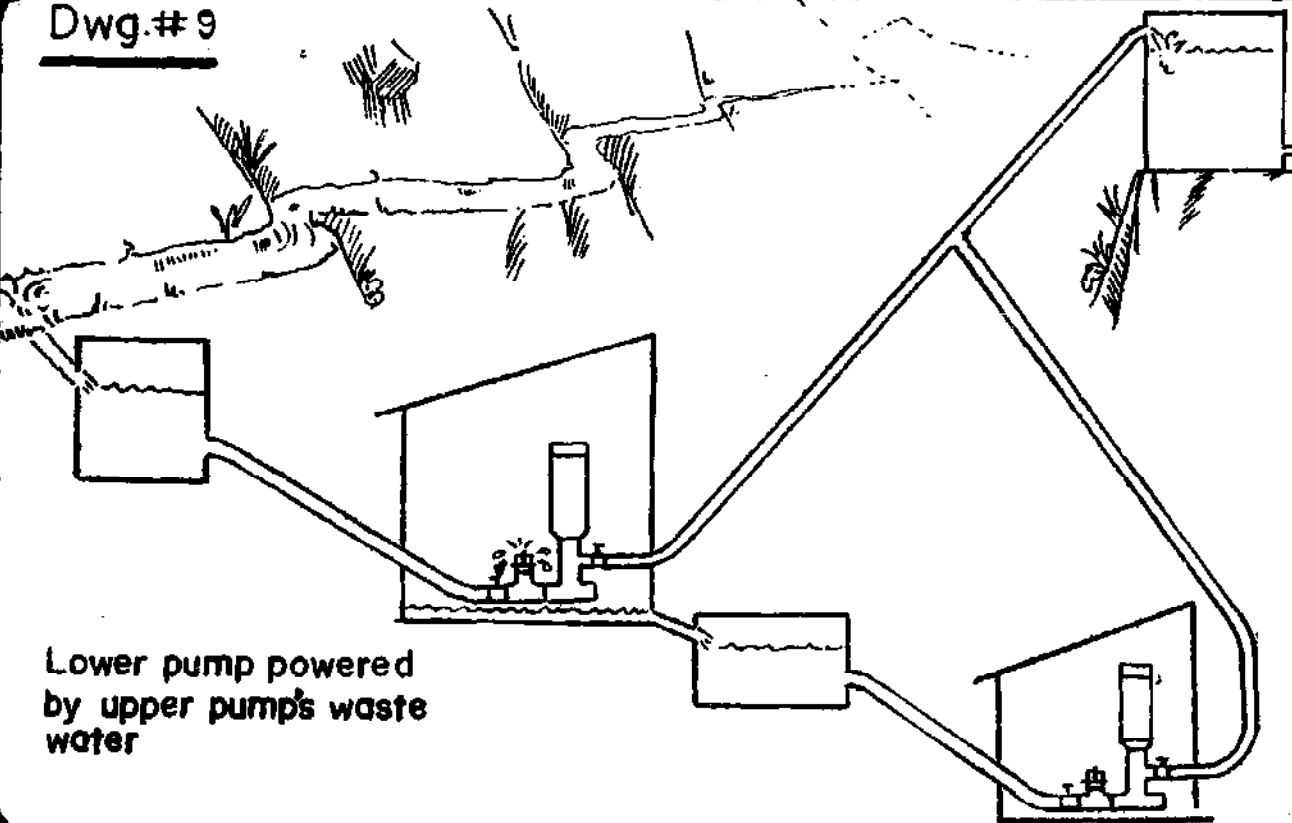

**Lower pump powered
by upper pump's waste
water**

MAINTENANCE

("The pump don't work 'cause the vandals took the handles").

As long as the pump is working trouble free, then it is only necessary to inspect it every three or four months, tightening fittings, nuts and bolts as required, possibly cleaning the inside of the pump of accumulated sediment, and checking the valves for leakage and/or wear. Gate valves should be oiled twice a year, the pump and other exposed GI parts painted once a year; screens and other places where sediment or debris will accumulate should be inspected as required.

There should be at least two people trained to maintain the pump and the rest of the system, their training being done at the time of installation. If possible, arrange for some incentive for them to do conscientious work; suggest that the village pay these workers for their responsibility. It is imperative that some tools be left with these maintenance workers. A basic list might include; two pipe wrenches, two adjustable wrenches, screwdriver, heating plate, some spare replacement pipe, paint and brush, extra brass screening material, rubber for making washers, jute, pipe joining compound, a round and flat file, a pliers and a hack-saw with spare blades. If available, instead of one of the adjustable wrenches, use an adjustable "vice-grip" type wrench. If an innertube is used in the air chamber then a tire repair kit and a spare innertube will be needed.

If the pump is installed in an area where freezing temperatures occur, then care should be taken that the pump is always operating (moving water will not freeze inside the pump or pipes), or if the pump is stopped, water must be drained from the pump and pipes. Insure that the pipes are

buried below the frost line and that the pump house provides adequate protection from extreme cold.

The pump house, reservoir tank, and other places where damage could occur should be secured and locked. The ease of maintenance is a function of good design. The pump house should be large enough to permit the rotation of the large pipe wrenches as well as being able to accommodate one or two maintenance people.

If the pump is located very near other houses, the pump house roof should not be corrugated GI sheet as this amplifies the noise of the pump. A slate or masonry roof will minimize the sound.

TROUBLE SHOOTING

There are a few things that can cause the ram to stop or malfunction. The symptom of malfunction usually indicates the source of the problem.

1. Loud, metallic banging noise coming from the pump and/or intense vibration with each stroke in the delivery pipe

These two symptoms mean that there is no air in the air chamber and this should be corrected immediately to eliminate the possibility of damage to pump or pipes. The pump should be stopped and the air chamber drained of water. To restart the pump, close the valve on the delivery pipe for the first 10 to 15 strokes and then slowly open the valve fully. Make sure that air valve is not clogged, and open it a little more, to allow more air to pass. If necessary, check to see that the air hole is on the opposite side to the delivery pipe, for if it isn't, then the air may be pumped up with the delivery water instead of filling the air chamber. Check that there are no air leaks in the air chamber due to loose fitting joints. If an inertube is used, check its condition and make sure there is air in the tube.

2. The impulse valve does not work, but remains closed after repeated openings by hand

Check to see that there is enough weight on the bolt stem. Check that the delivery valve is not blocked by debris, and is functioning properly. Check the impulse valve seating on the valve plate, it should not leak when held closed and should move freely without interference from the inside walls of the pipe nipple.

3. The impulse valve works for a few strokes by itself and then stops

This usually indicates that there is air in the drive pipe. Check that the supply of water is sufficient and the drive pipe's mouth is submerged by at least 30cm. of water. By holding the valve closed for a few minutes the air bubbles will rise to the top of the drivepipe. If there is sufficient water hold the valve open for several seconds - this will also help drain any trapped air. Check that all the pipe joints are free from leakage.

4. Pump is operating, but there is no water being delivered

Check to see that the delivery gate valve is open, there is no obstruction in the delivery pipe including air blockage, and the delivery valve is holding the pressure, so that no water is leaking out below the air chamber. (This last condition can be tested by filling the delivery pipe with water and checking to see that the water level does not fall). Check the valve for wear and proper seating.

5 The Impulse valve stays open

This indicates that there is not sufficient water in the drive pipe, or the impulse valve weight is excessively heavy, or the delivery valve is not functioning.

6. Hydram Pumps With Uneven Strokes of Fluttering Sound

This indicates air in the drive pipe, or a leak in the drive pipe, or insufficient water above the mouth of the drive pipe.

Special care should be taken to insure that the village maintenance workers take good care of the tools and pump, fully understand the principals of operating, and know the possible sources of malfunction and their solution. Special care should be taken to grip all nuts and bolts with the correct wrench, which is carefully fitted to the metal surfaces so that the corners are not rounded off, rendering the nuts and bolts useless. In any case, bring several spare nuts and bolts and washers for replacement. Fittings should be water tight and air tight, but not excessively tight. Some villagers don't know their own strength, let alone the limits of their tools and fittings.

BUILDING A HYDRAULIC RAM FROM LOCAL MATERIALS

Most of the information in this section is adapted from VITA and ITDG publications. It must be emphasized that this is only a guide - how you make the valves described below will be determined by your ingenuity, the machinist, and his tools. If the machinist knows how a hydram works and what it should look like, it will help in adding refinements to the pump. Dwg # 10 shows the basic fittings of a "homemade ram".

By making a hydraulic ram yourself, you will better understand the pump and its maintenance well as saving a good deal of money. Homemade pumps cost less than one-tenth(1/10) of an equivalent commercial pump. At the date of printing this booklet the sizes below cost in Nepalese rupees: (US\$ 1= 12.45 Nepalese rupees).

Dwg. #10.1

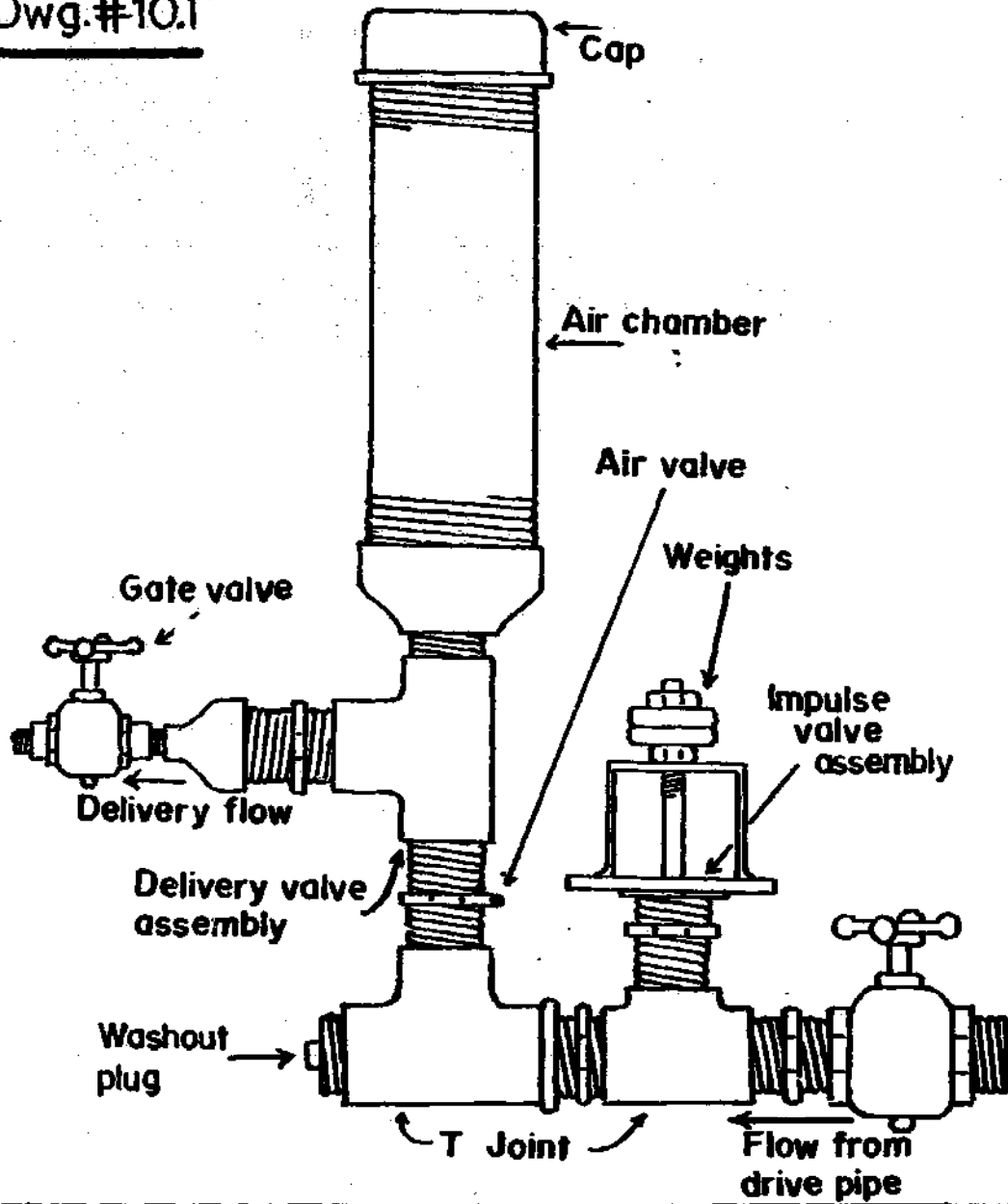

A HYDRAULIC RAM BUILT FROM LOCAL MATERIALS.

Table # 4

The cost of several hydrams made from locally available parts (in Nepalese rupees)

<u>Pump size</u>	<u>Labor</u>	<u>Materials</u>	<u>Total</u>
1.5"(38mm)	50/-	220/-	270/-
2"(51mm)	66/-	254/-	320/-
2.5"(63mm)	70/-*	437/-	507/-
4"(102mm)	113/-*	1055/-	1168/-

The above costs do not include the gate valves on the drive pipe and on the delivery pipe. The equipment used was: a lathe, a grinding wheel, a drill press, welding equipment, and assorted metal working hand tools.

AN ALTERNATIVE TYPE HYDRAM

Dwg #10.2 shows another hydraulic ram built from locally available materials, in which the fittings are arranged differently. This style hydram must use an innertube or perhaps tennis balls in the air chamber, to prevent the air from escaping out the delivery pipe. Although extensive tests have not yet been done, initial trials worked very well. The impulse valve for this pump can be the same as described previously, but the delivery valve, because it is horizontal rather than vertical, may require some changes. A commercial valve will work provided it is designed to operate horizontally. The valves shown in dwg # 12.1 and 12.4 will also work fine. The delivery valve shown in dwg # 12.3 may be troublesome depending on how much friction is produced by the bolt moving within the guide, while in the horizontal position.

* The 2.5" and 4" pump built here used commercially available vertical delivery valves which made the total cost more expensive than a pump with a "homemade" delivery valve, but not by any means better or more efficient.

**AN ALTERNATIVE TYPE HYDRAM
USING A DIFFERENT ARRANGEMENT
OF FITTINGS AND VALVES**

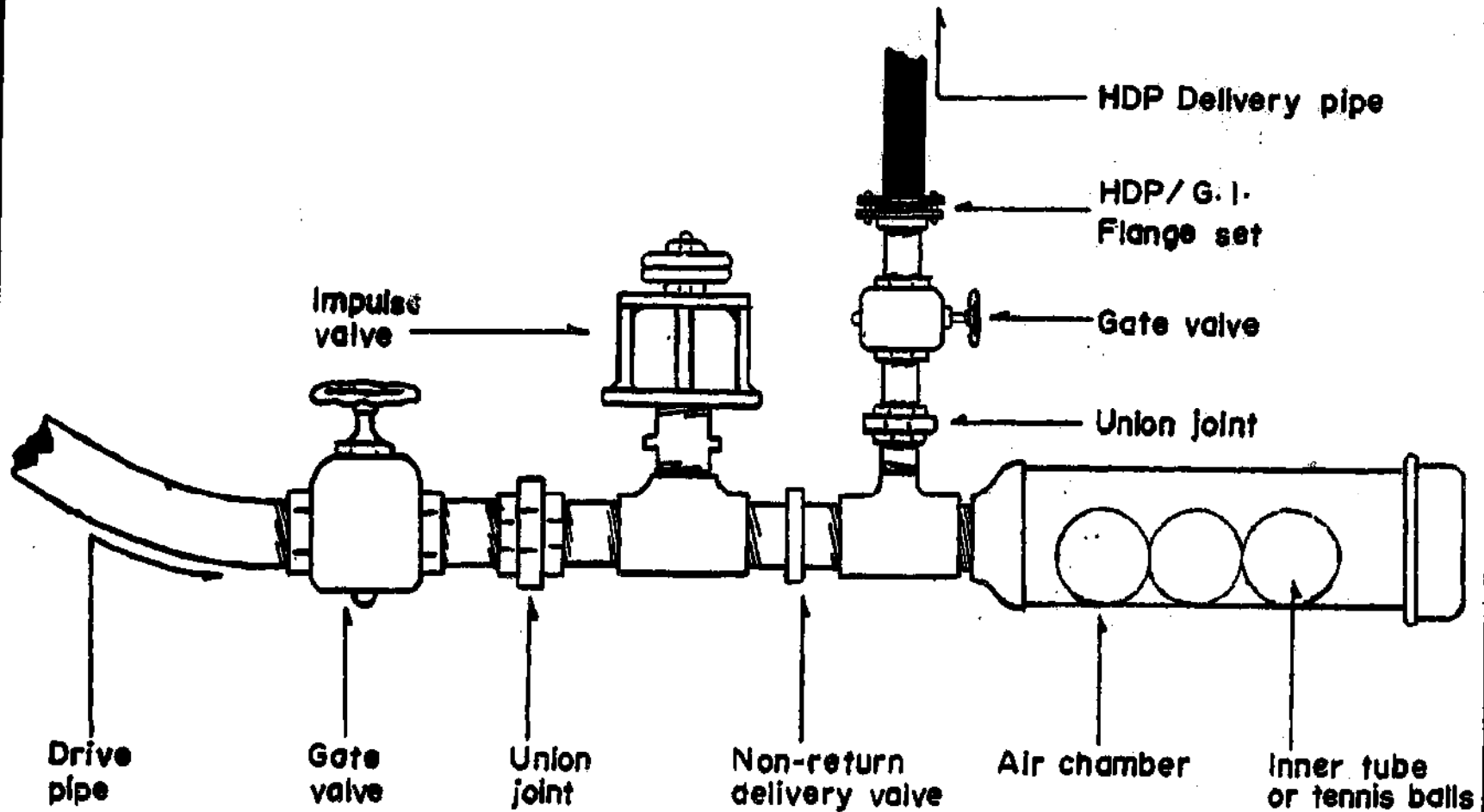

THE IMPULSE VALVE

There are several different types of valves, suitable for hydrams, that are not discussed here as they are more complex to make or more difficult for village maintenance. The weighted-bolt-impulse valve described here is simple and durable, easy to maintain, and its mechanical principals are the easiest for villagers to understand. The basic principal of this impulse valve is: the more weight on the bolt stem, the more water it takes to close the valve, the slower the strokes per minute the more water is pumped. Less weight means: less water is required, quicker stroke speed, and less water pumped. Longer stroke length has the same effect as more weight, and shorter stroke length the same as less weight.

Two alternative impulse valves are described here as shown in dwg 11.1 and 11.3. Type A allows the water to pass with less friction, but results in more valve wear when the rubber washer closes. Type B will have a longer washer life due to more equally distributed pressure, and the valve guide is easier to make.

Experience has shown that the most durable locally available material for the washer is a piece of rubber cut from old tires. Tractor tires are especially thick, and most shoe makers and leather workers have the material and will cut and shape the piece for a very small fee.

It has been suggested that it is not necessary to use a rubber washer as the steel washer is cushioned by the flow of water, which prevents excessive wear. If you can get the steel washer and valve seat machined accurately enough to prevent leakage upon closure, this technique is very good.

Make sure that you make several weights that in combination or alone will allow you to vary the pressure necessary to close the valve under different quantities of water from the source.

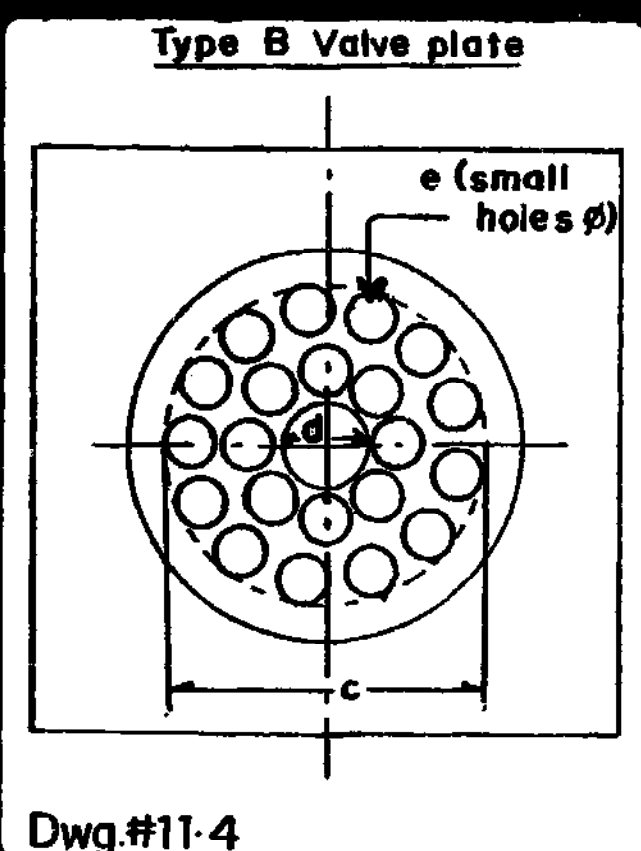
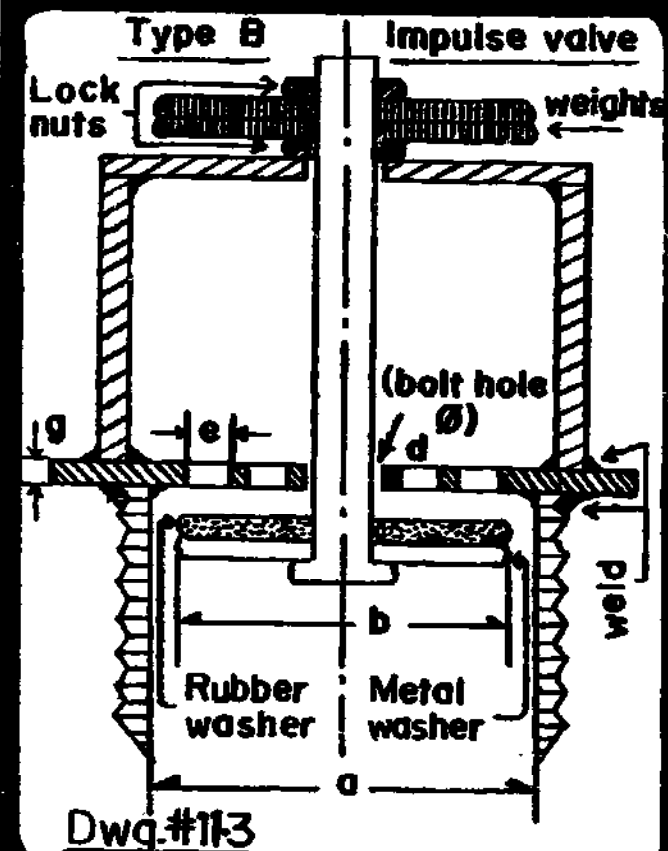
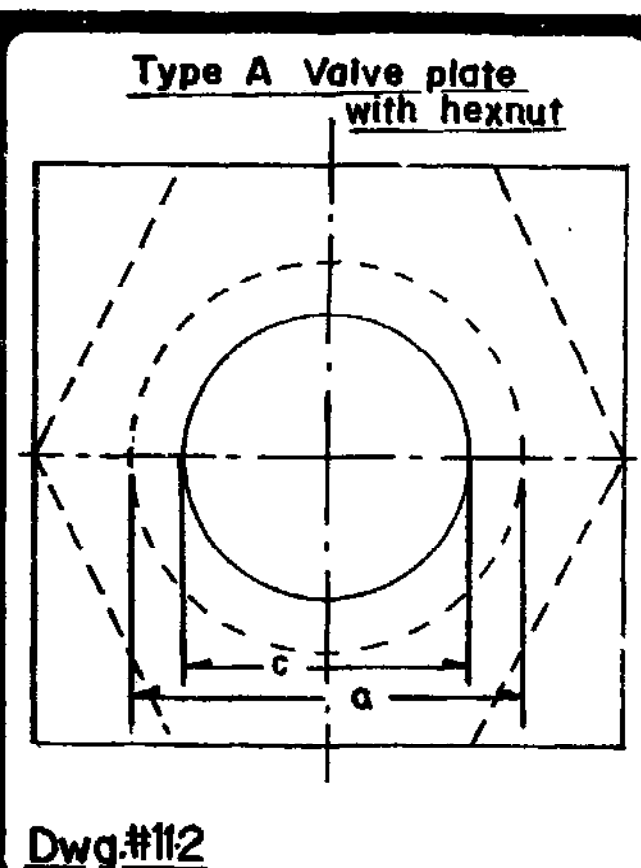
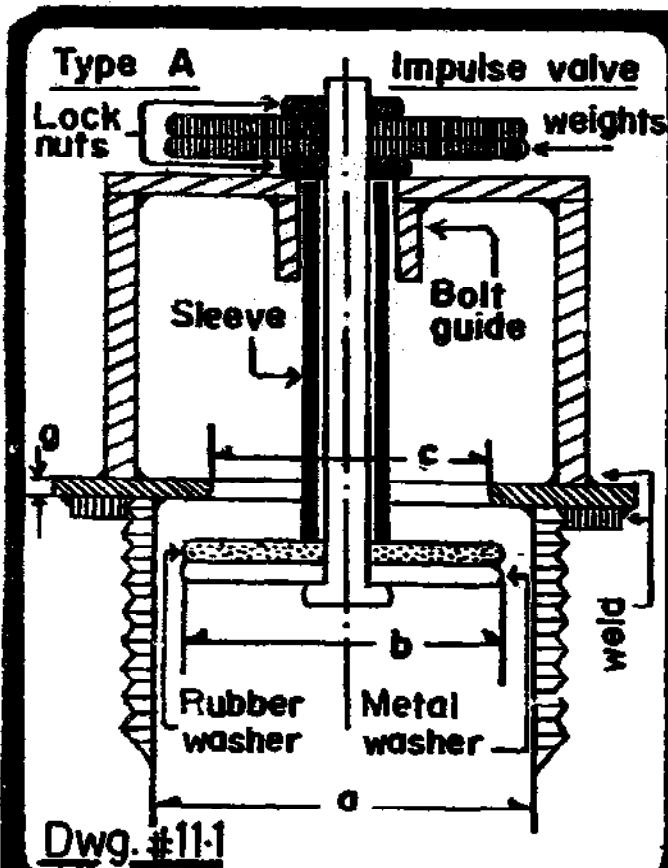

It is necessary that the steel plate welded to the nipple is sufficiently strong to withstand the savage pounding the ram experiences. All welds should be checked for their strength and durability. Although it costs slightly more, gas welding using brass rods is best for finer work.

The following materials are required in order to make the impulse valve: a hex nipple or straight nipple, a mild steel plate (3-4mm thick) a threaded bolt with two nuts to fit, a steel washer and thick rubber washer of the same diameter, some scrap metal (2-5mm thick) to form the guide post and weights, and possibly a hex nut to fit the nipple.

Take the nipple and grind the inside surface smooth if it is rough. The hex nipples have very thick walls and by machining 1 or 2 millimeters off the inside walls, on a lathe, the inside diameter is enlarged. Cut the mild steel plate to a square to fit over the nipple, and drill the hole or holes as specified in the chart. If a type B valve is being made, scratch the outside diameter (C) circle on a lathe (after center punching the plate) so you know that the small holes must fit within this circle. Drill the center hole and then the other holes, making sure that the holes do not intersect so that the plate remains structurally strong. If the valve is type A, cut the hole on a lathe and round off the inside edge of the hole so that the point of contact with the rubber washer is smooth. On both type valves the plate should be ground smooth on the side that contacts the rubber washer. Weld the plate to the hex nipple (or hexnut if a straight nipple is to be used) being certain that the holes are dead center with relation to the nipple. This weld must be very strong and absolutely water tight. Make sure that the bolt guide hole is dead center with the plate hole. For Type A valve use a piece of HDP pipe that fits onto the bolt with no more than a space of a few millimeters. This will prevent the bolt's threads from becoming damaged by constant abrasion on the bolt guide. A brass bushing is also fine. This plastic or brass

sleeve should fit within a short metal tube or guide designed to accomodate the bolt with a few millimeters play.

Table # 5 **Dimensions for Different Sizes**
of Impulse Valves

Type	1.5*38		2"*51		2.5"*63		3"*76		4"*102	
	A	B	A	B	A	B	A	B	A	B
a. Nipple inside ∅	37	37	42	42	55	55	78	78	106	106
b. Rubber washer outside ∅	30	37	35	36	42	49	61	67	85	88
c. Outside ∅ of plate hole or holes	22	30	25	30	35	42	48	60	66	80
d. Bolt hole ∅	-	9	-	12	-	12	-	12	-	20
e. Small holes ∅	-	4	-	4	-	5	-	9	-	9
f. # of small holes	-	28	-	28	-	24	-	20	-	44
g. Mild steel plate min. thickness	3	3	3	3	5	5	6	6	8	8
h. Bolt length	150	150	150	150	165	165	175	175	190	190

* Hex nipples found in this size in Kathmandu. Note bolt diameter should be a few mm. smaller than dimension d.

Make sure that surface of the rubber washer is as smooth as possible - especially the side that contacts the valve seat. It will probably be necessary to trim the washer's edges to match the steel washer (which is welded to the bolt) on a grinding wheel. The rubber washer can be the same size or slightly larger than the steel washer. The rubber washer should be epoxied on to the metal washer after a small hole is cut in the washer center to accomodate the bolt with a few milliteters play.

An alternative to epoxy (the locally available brand of epoxy is call Araldite) is to put a small washer on top of the rubber, which is held in place by a cotter-pin which fits through a small hole in the bolt. This alternative is only suitable for the type A impulse valve. On type B impulse valve nothing can come between the rubber and the steel plate with holes or else there will be leakage. After securing the washer to the bolt, make sure it seats well and will not leak when it is closed. It is worthwhile to try making different size washer-bolt combinations which change the maximum and minimum amount of water that the pump will consume. Care should be taken in welding the steel washer to bolt. It should well centered and perpendicular. If necessary, after welding, grind smooth the steel washer's surface where the rubber washer sits.

It may be necessary to cut more threads on the bolt stem to allow for maximum adjustment. When the bolt-washer assembly is fully closed against the valve seat, the threads must extend down to the bolt guide hole. The bolt must be long enough to accomodate at least 2 nuts, some weights, and still have enough free play to move at least 15mm.

THE DELIVERY VALVE

A delivery valve is commercially available in some Kathmandu hardware stores. A dependable valve that can be made quite easily is described below (see dwg # 12.1). Using a nipple the same diameter as the impulse valve, weld or braze a cut and drilled steel plate as indicated in dwg # 12.2. If the plate is welded slightly recessed inside the nipple, make sure the surface is clean after the welding or brazing is completed. If the plate is welded on the top edge of the nipple, you might have to file the lead threads of the pipe nipple if they have been damaged during the welding or brazing. If the rubber washer does not sit flat on the plate or if the nipple's threads are damaged, have the machinist regrind the plate to ensure smoothness and/or recut the threads on a lathe.

Dwg.#12-1

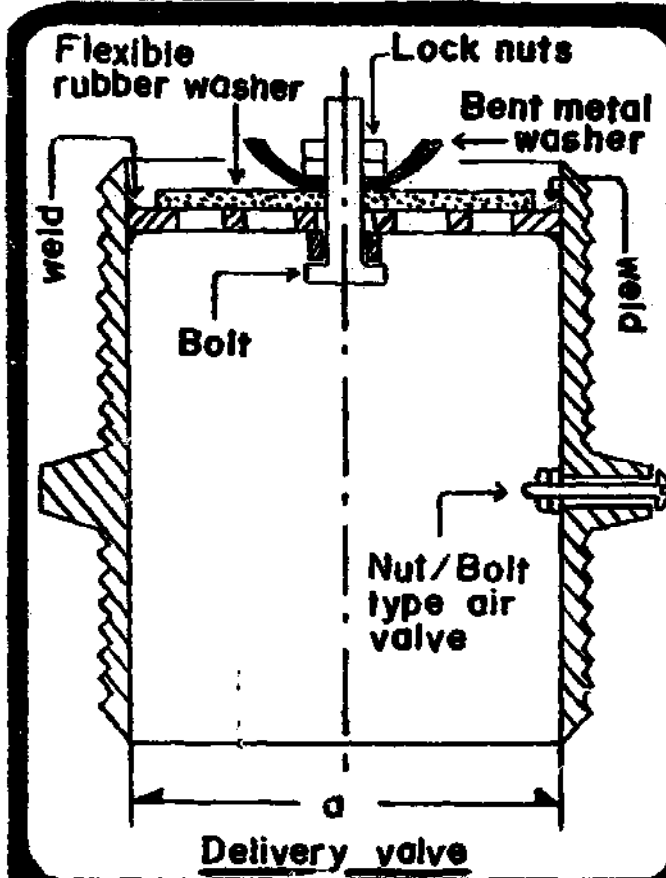

Dwg.#12-2

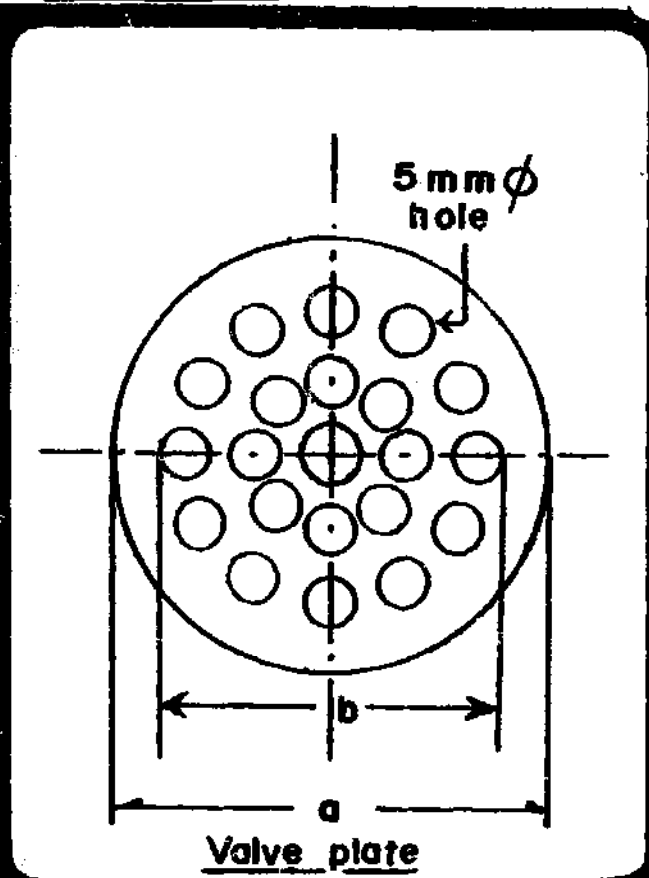

Rubber washer | Metal washer

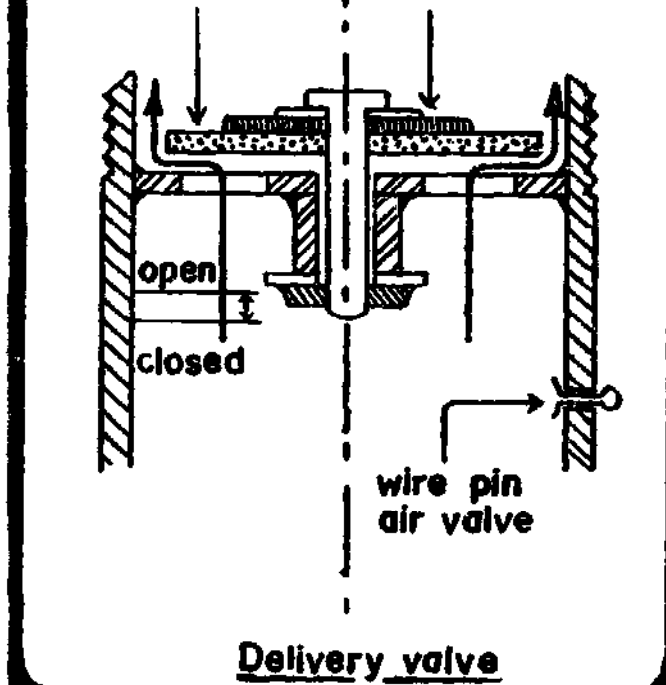

Dwg.#12-3

Flexible rubber washer

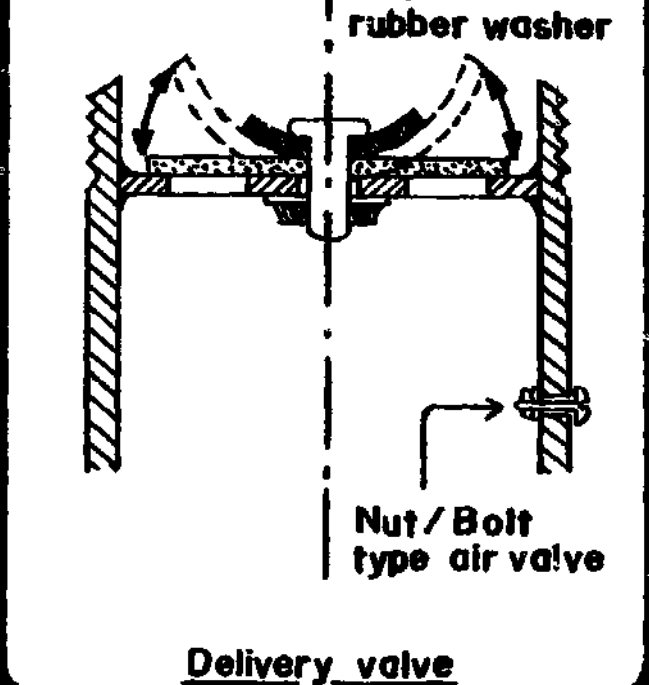

Dwg.#12-4

On top of the delivery valve plate attach a rubber washer with a brass nut and bolt and a small metal washer bent to accommodate the rubber washer's movement (see dwg # 12.1 and 12.4). The rubber must be flexible enough to allow water to pass, and firm enough to hold the water pressure from the air chamber and delivery pipe head. Below the valve it is necessary to make an air valve which will ensure that during the normal course of operation, the air in the air chamber is not depleted by the moving water. Lack of the air cushion in the air chamber results in violent pounding which can even - tually damage the pump or pipes. Although other sources recommend a copper wire, I do not think it will last as long as a small screw and nut combination that fits a hole of a slightly larger diameter (see dwgs # 12.1, 12.3, 12.4). If the nipple is a hex nipple drill the hole through one of the flat sides but be sure when turning the nipple with a wrench, not to grab the side with the screw or wire. An alternative to the air valve is to put a partially filled rubber innertube inside the air chamber (see dwg # 13). For small pumps a partially filled bicycle inner tube will work well. Large pumps would require filling a tube with more air. A hand pump and tire patch kit are necessary accessories, and a spare innertube is recommended. Dwg # 12.5 illustrates another delivery valve (a swing check valve) which can be used on either model hydram - whether horizontal or vertical. If installed horizontally, try to have the hinged portion of the valve be located in the up position. This valve requires slightly more care in construction, but it has the advantage of having the least amount of friction compared to the other valves discussed here. The valve plate should be made from mild steel or brass. The rubber washer should be cut from an old tire and then trimmed round and flat. The steel washer that is bolted to the rubber washer (use a small brass nut and bolt set) can be mild steel. This steel washer which is a few millimeters larger in diameter than the large hole in the valve plate will prevent the rubber from collapsing through the hole under high pressure. The small hole in the valve plate is threaded, and with the use of a brass nut, bolt, and washer set

AN ALTERNATIVE DELIVERY VALVE

(A ONE-WAY SWING CHECK VALVE)

Dwg. #125

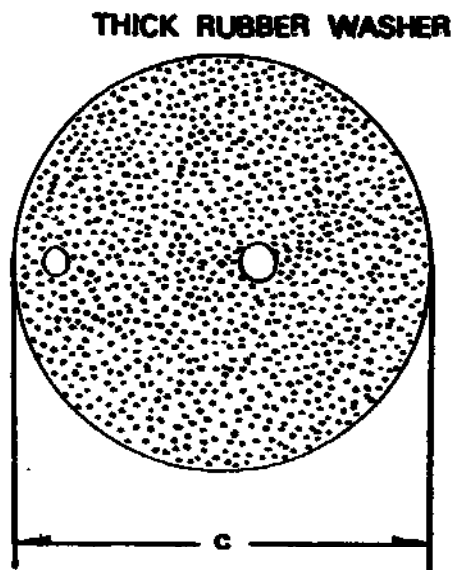
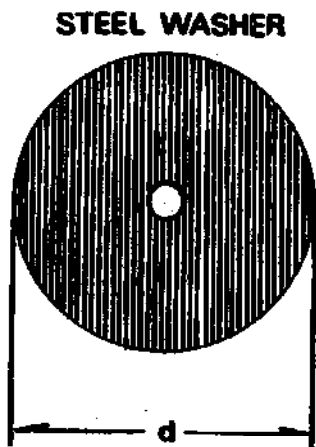
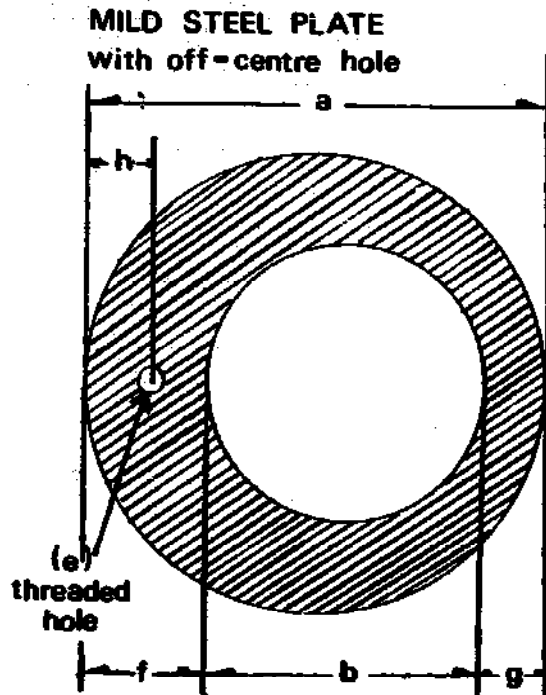
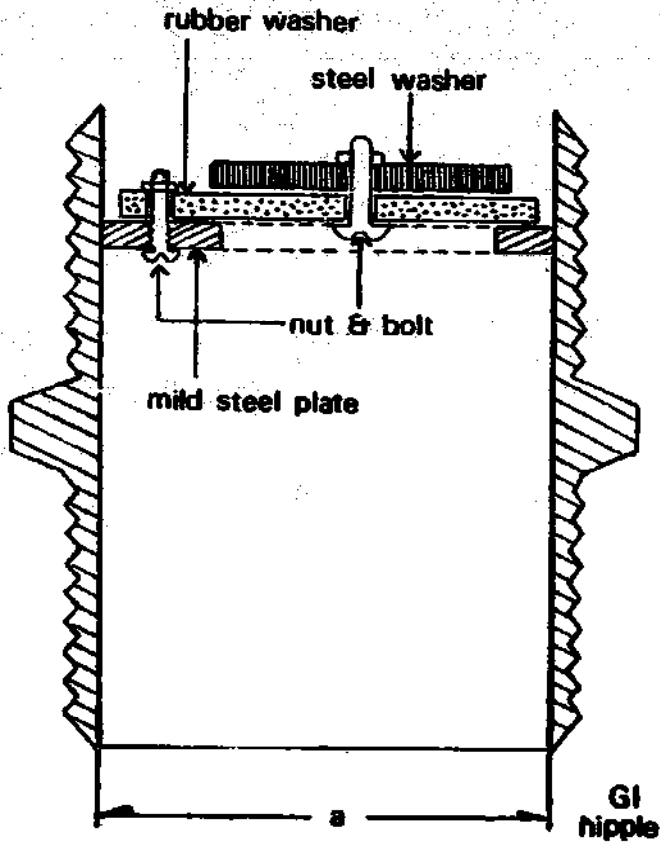

this will act as the pivot on which the rubber will naturally flex during each opening and closing of the valve. Care must be taken so the welding does not interfere with the seating of the rubber washer.

Although pipe nipples come in various sizes, within each size the inside diameter will vary by a few millimeters. As a guide the dimensions according to the dwg # 12.5 are given below for a 2" (51mm) \emptyset hex nipple. Based on this information you should be able to design and build your own valve of any size with only minor modifications.

Dimensions for a delivery swing check valve to fit a 2" \emptyset nipple.
(Table # 6)

a. nipple inside \emptyset and valve plate outside \emptyset	42mm	53/32"
b. valve plate large hole \emptyset	24mm	15/16"
c. rubber washer outside \emptyset	36mm	45/32"
d. steel washer outside \emptyset	26mm	33/32"
e. valve plate small threaded hole \emptyset	4mm	5/32"
f. maximum distance from valve plate edge to large hole's edge	12mm	15/32"
g. minimum distance from valve plate edge to large hole's edge	6mm	1/4"
h. distance from small threaded hole's center to edge on valve plate	6mm	1/4"

MAKING THE AIR CHAMBER

There is no maximum limit to the size of the air chamber. One source suggests an air chamber volume equal to 100 times the delivered output in one stroke cycle. A one meter length of pipe of equal diameter to the impulse and delivery valves sealed with a cap will work well. An equivalent volume of a larger diameter and shorter length of pipe fitted with the appropriate reducers is also suitable. Just below the

Dwg.#13

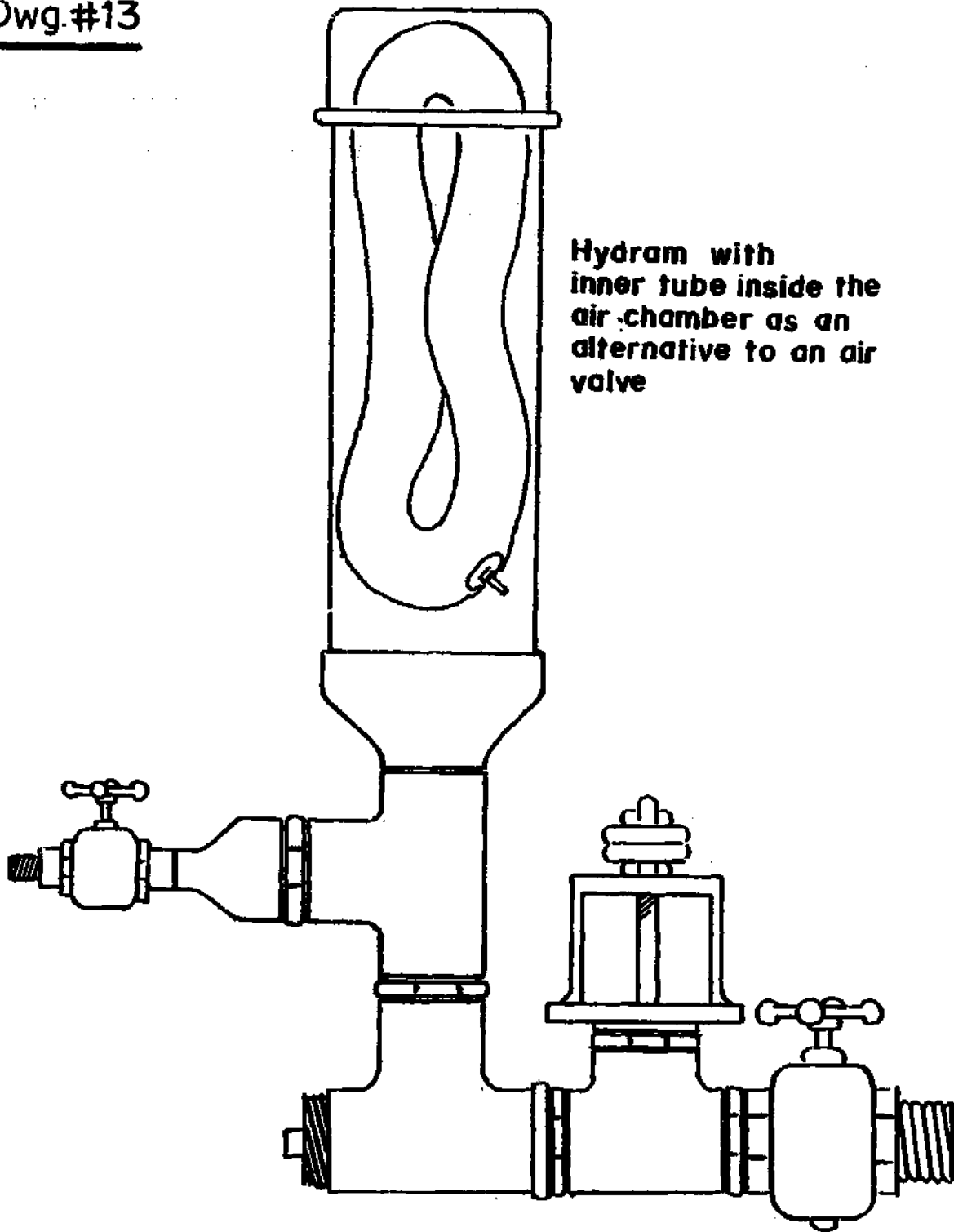

**Hydram with
inner tube inside the
air chamber as an
alternative to an air
valve**

air chamber and above the delivery valve is a tee which is reduced in the middle to fit the delivery pipe.

MOUNTING THE RAM

The drive pipe and delivery pipe should each be connected to the ram via union joints and gate valves, which greatly facilitates maintenance. Depending on the individual installation one might want to weld on to the ram a set of mounting legs to insure pump stability from the constant vibration. If possible, holes should be drilled in the bottom of the mounting legs to fit bolts that should be securely sunk in the concrete floor with the threaded ends exposed. Lock nuts will fasten the pump to the base. An alternative to this is to use strong galvanized stay wire securing the pump to a fixed object based on your subjective judgement during installation, but a solid concrete base with mounting bolts is much stronger and preferable.

BIBLIOGRAPHY

Calvert, N.G. "Drive Pipe of Hydraulic Ram". The ENGINEER. Vol 206, No: 5370, December 26, 1959, P. 1001.

Calvert, N.G. "The Hydraulic Ram". the ENGINEER, Vol. 203, No: 5282 April 19, 1957, pp. 597-600.

Iverson, H.W. "An Analysis of the Hydraulic Ram". A.S. M.E. paper no: 75-FE-F 1975. (This article was also printed in the Journal of Fluid Engineering).

Johnson, Carl. Standards and Procedures for the Design of Water Systems in Rural Areas of Nepal and Bhutan. UNICEF Box 1187, Kathmandu, Nepal (Appendix E. in Third Revised Edition entitled, "Feasibility Survey for Hydraulic Ram" by M. Silver).

Kindel, Ersal W. A Hydraulic Ram For Village Use. Volunteers in Technical Assistance (VITA) 1970. (VITA, Inc. Volunteers in Technical Assistance, Mt. Ranier Md., 3706 Rhode Island Ave., 20822 - USA)

Kroll, S. "The Automatic Hydraulic Ram". Proc. I. Mech, E. 1951. Vol. 164 pp. 103. (Same author - title found in "Institution of Mechanical Engineering Proceedings, Vol. 165, No: 64, 1951 pp. 53-73.

Landsford, W.M. and Dugan, W.G. "An Analytical and Experimental Study of the Hydraulic Ram", University of Illinois Bulletin, Vol. 38, Jan. 21, 1941, No: 22 (Engineering Experimental Station Bull., Series No: 326. pp. 1-68).

O'Brian, M.P. and Gosline, S.E., "The Hydraulic Ram", Univ. of Calif. Publications in Engineering, Vol. 3, No: 1, Jan. 24, 1933, pp. 1-58.

Portala Institute. Energy Primer Solar, Water, Wind, and Biofuels. Menlo Park, CA, Portola Inst. 1974.

Rife Hydraulic Engine Manufacturing Company. Manual of Information, Rife Hydraulic Water Rams. Milburn, N.J. USA 1975.

Shuttleworth, John, ed. Handbook of Homemade Power. N. Y., Bantam: 1974.

Stoher, Carol Hopping. Producing Your Own Power. N. Y., Rodale Press. 1974.

VITA. Village Technology Handbook. Mt. Ranier, Md., VITA 1963. (1975 revised)

Watt, S. B. A Manual on the Hydraulic Ram For Pumping Water. Intermediate Technology Publication Ltd. London, 1975. (Available from ITDG, 9 King St., London WC2E 8JH England (US\$3.90 air mail/US\$2.75 sea mail).

Wulften palthe, B. U. Waterrammen (in Dutch). TOOL, Postbus 525, Eindhoven, Netherlands. 1976.

CONVERSION TABLE

() denotes Nepali units.

Length	
1 in.	= 2.54 cm.
1 ft.	= 0.3048 m. = 12in.
1 yd.	= 0.9144 m. = 3 ft.
1 mi.	= 1.609 km. = 1760 yds. = (0.44 kos) = 5280 ft.
1 cm.	= 0.39 in.
1 m.	= 39.37 in. = 3.28 ft. = 1.094 yds.
(1 kos)	= 2.27 miles = 3.65 km.

Area	
1 in ²	= 6.452 cm ²
1 ft ²	= 9.29 cm ²
1 cm ²	= 0.155 in ²
1 m ²	= 10.764 ft ²
1 yd ²	= 0.836 m ²
1 in ²	= 0.093 m ² = 144 in ²
1 ft ²	= 0.0001m ² = 0.00108 ft ²
1 m ²	= 1.196 yd ²
1 yd ²	= 9 ft ²

Unit	Sq. ft.	Sq. meter	(Ropani)	(Bigha)	Acre	Hectare
(1 Ropani)	5,476	509.72	-	0.75	.126	.0509
(1 Bigha)	72,900	6,772.66	13.13	-	1.676	.6773
1 Acre	43,560	4,046.87	8	.6	-	.4047
1 Hectare	107,637	10,000.00	19.73	1.483	2.471	-

Volume and Cubic Measure

1 in ³	= 16.387 cm ³	= 0.016 liters
1 cm ³	= 0.061 in ³	= 0.001 " (1 milliliter)
1 liter	= 1000 cm ³	= 0.264 gallons (US) = 0.22 imp. gal.
1 ft. ³	= 0.0283 m ³	
(1pathl) = (8 mannas)	= 0.0043 m ³	= 0.15 ft ³ = (0.05 muri)
1 ln ³	= 35.34 ft ³	= (232.6 pathl) = 1000 liters
1 gallon (US)	= 3.785 liters	= 0.833 imp. gal. = 0.134 ft ³ = (7.04 mannas) = 4 quarts
(1 muri)	= (20 pathls)	= (160 mannas) = 86 liters = 22.7 gallons (US)
1 imp. gal.	= 1.2 US gal.	= 4.546
1 m ³	= 35.3 ft ³	
1 yd ³	= 0.765 m ³	= 27 ft ³

Pressure

1 kg/cm ²	=	14.1 lbs/in	=	32.5 ft of head	=	10m of head
1 lb/in ²	=	0.071 kg/cm ²	=	2.31 ft of head	=	0.7 m of head
1 ft of head	=	0.433 lb/in ²	(water weighs 62.4 lbs/ft ³ x 1 ft ² /144 in ²)	=	0.443 lbs/in ²	
6 kg/cm ²	=	60 m head pressure limit	=	197 ft. of head limit		
10 kg/cm ²	=	100 m head pressure limit	=	328 ft. of head limit		

Flow Rate

1 liter/min	=	0.26 gal/min	=	0.0167 liters/sec.	=	1 cm depth over 6m ² in 1 hr.
1 gal/min	=	3.785 liters/min	=	0.063 liters/sec.	=	0.00223 ft ³ /min.
			=	1" depth over 96.3 ft ² in one hour	=	60 gal/hr. =
				1440 gal/day	=	525,600 gal/year
1 ft ³ /sec.	=	449 gal/min	=	27,154 gal/hour	=	1 acre inch/hour
1 ft ³ /min.	=	0.472 liters/sec.	=	28.32 liters/min	=	7.48 gal/min.

बच्चाको स्याहार गर्ने आमाहरूले जान्नुपर्ने कुराहरू

१. बच्चाको सु-स्वास्थ्यको लागि सकेसम्म दुई वर्षसम्म आमाको दूध खुवाउने गर्नु पर्दछ ।
२. धेरै पटक दूध चुसाएमा र आमासाई पोषिलो खाना दिएमा धेरै दूध आउँछ ।
३. दूध खुवाउने र गर्भवती आमासँगै रात्रोसँग पाकेको दास, हरियो सागपात तथा तरकारी र फलफूलहरू अधिपक्षको भन्दा बढी खाने गर्नु पर्दछ । समय समयमा आफ्नो स्वास्थ्य जाँच गराउनु पर्दछ ।
४. बच्चा ५-६ महीनाको भएपछि (पास्नी गरेपछि) जाउलो, लिटो जस्तो केही गिलो खानेकुरा दिनु पर्दछ ।
५. बच्चासाई दिनमा ५-६ पटक खुवाउनु पर्दछ ।
६. बच्चासाई सन्चो नभए पनि सात्रिक बमोजिम नै खानेकुरा फकाउँदै फकाउँदै दिनु पर्दछ । सन्चो नभएको शंका लागेमा तुरुन्त नजीकैको अस्पताल वा स्वास्थ्य केन्द्रमा सगी जाँच गराउनु पर्दछ ।
७. बच्चासाई फाडा लागेमा एक चिम्टी नून पाएमा एक चिम्टी खाने सोडा र एक मूठी म्लकोज एक मात्रा उमासोको पानीमा मिलाई, बच्चासँगै जति दिसा गरेको हो अन्दाजी उतिनै औषधि पानी बराबर दिनु पर्दछ ।
८. रुन्चे लागेमा बच्चाहरूलाई बढी मात्रामा खानेकुरा दिनु पर्छ, जस्तै रात्रोसँग पाकेको दास, भान, ढिँडो, दही र हरियो सागपात आदि ।
९. बच्चासाई बिफर, चय तथा अरू सरुवा रोग विरुद्ध जति सक्दो चाँडै खोपाउनु पर्दछ ।
१०. कोठा, घर, आँगन धेरै सफा-सुग्घर हुनु पर्दछ ।
११. बच्चा वा बच्चाको खाना खुनु अघि रात्रोसँग हात धुनु पर्दछ र खानेकुरा राख्ने थाल, कचौरा, रिकापी आदि भाँडाकुँडा पनि खाने पानीसँगै सफा गर्नु पर्दछ ।
१२. बच्चा र आमाको सु-स्वास्थ्यको लागि दुई-तीन वर्ष विराएर मात्र बच्चा पाउनु राम्रो हुन्छ ।