

=====  
**Tarp-shelters, an introduction by DBM**  
=====

Q: What are Tarp-shelters?

A: Tarp-shelters are simple shelters made from a Vertical Support System (VSS), rope, ground stakes, a tarpaulin (or a fabric or plastic sheet), and ingenuity.

Q: What's a Vertical Support System (VSS)?

A: Any way or means of providing a fixed point above the ground, from which something can be hung from, or hung on. VSS include tent poles, internal or external frames (tripod, shears, etc), a rope slung between two supports (trees, etc), an overhead suspension point (tree branch, etc), or a mixture of these.

Q: What sort of rope?

A: 6-millimetre poly or nylon rope is a good size, with thicker rope better in some situations. Smaller diameter ropes may suffice, IF they're 'doubled' up.

Q: What sort of ground stakes?

A: Tent stakes designed for 'hard ground' are usually just a metal spike, and can pull out if rain softens the ground. Tent stakes designed for 'soft ground' have shafts with an 'angled' or 'star' cross-section, and grip any sort of ground better than 'spike' stakes. 'Soft ground' stakes are harder to hammer into 'hard ground', but they're harder to get out too!

Q: What sort of tarpaulin?

A: Any sort really. Canvas, nylon tent fabric, poly-tarps, or even heavy-duty plastic sheeting like 'painters drop sheets' may do. Ideally, the material should either be a Square, or a Rectangle with the short side half the length of the long side (1:2 ratio).

Q: These 'do-it-yourself' designs look like some of the Tent and 'Tarp-tent' shelters sold in Camping Stores, but without the \$\$\$ price tag. What gives?

A: Generally speaking, modern Tents and 'Tarp-tents' are high-tech versions of Tarp-shelter designs that have served campers for generations. The 'evolved' versions sold in camping stores incorporate high quality of design, modern materials, and professional manufacturing - these things cost extra, but guarantee durable and reliable service in extreme situations and emergencies! Then there are the 'extras' that modern Tents sold in Camping Stores usually include - insect nets that keep out mosquitoes (and the diseases they carry!), and sewn-in tub floors that keep out mud and water (as well as snakes!).

Q: Oh. But can't I put a groundsheet and insect mesh in a Tarp-shelter?

A: You could, but even with a commercial mosquito net hung from the VSS, and a full DIY Tub Floor as groundsheet, the results probably won't be as good, nor as safe, nor as reliable, nor as durable, as a professionally made 'modern' Tent.

Q: If it's not as good as a modern tent, what CAN I use a DIY Tarp-shelter for?

A: Depending on the particular design and the specific setting it's used in, a DIY Tarp-shelter can provide privacy (beach, bush, etc), shade from the sun, and shelter from the wind, rain, and cold. But first, ask yourself what you really want the Tarp-shelter for. Is it a hands-on project meant to build self-confidence? A cheap playroom for children in the back yard? A sleepover project for a Youth Group? A lightweight shelter to take when Hiking? An emergency backup to the tent you take when Camping?

Q: Emergency backup? How do these Tarp-shelters handle storms?

A: Storms wreck houses, and rope and tarp fabric aren't as strong and durable as wood and brick. Riding out a storm in a Tarp-shelter is ~NOT~ recommended! The only thing you can depend on a Tarp-shelter for is shade - any added ability to deflect wind, or shed a downpour of rain, hail, or snow is a bonus!

Q: Oh, so Tarp-shelters can't handle wind and rain, hail and snow?

A: I didn't say that! The success of ANY shelter in bad weather depends on various things, not least of which is the basic design of the shelter. While many Tarp-shelter designs can only handle fair weather (or sheltered locations out of the wind), some designs offer the prospect of being a real foul weather

shelter, ~SUBJECT~ to the limitations of design, materials and set-up! While they can serve as emergency shelters, they're ~NOT~ 'Impregnable Fortresses'.

Q: Okay, I accept that Tarp-shelters aren't made of 'bullet-proof armour plate', but what limitations regarding 'design' and 'set-up' are we talking about?

A: Oh, just some 'little things' like...

1. Base Design - some designs handle bad weather better than others do.
2. Wind - is the Tarp-shelter facing the wind in the right way?
3. Ropes - are the ropes taut?
4. Stakes - is the Tarp-shelter staked down securely enough?
5. Support - is the VSS secure?
6. Ridgepoles - would ridgepoles or a frame make the Tarp-shelter stronger?
7. Seepage - will rain seep/trickle down into the Tarp-shelter?
8. Condensation - will condensation on the walls pool inside the Tarp-shelter?
9. Rising Damp - is the ground under the Tarp-shelter wet or humid?
10. Run-off Water - will rain water pool in or around the Tarp-shelter?
11. Fabric - how 'waterproof' is the tarp fabric itself?
12. Weight Load - will accumulated storm debris overload the supports?

Q: What do you mean, 'facing the wind in the right way'?

A: Windward is the direction the wind blows from, so the Windward side of an object is the side that the wind blows on (pushes against). Lee is the direction the wind blows to, so the Lee side of an object is the side sheltered from the oncoming wind. The set-up of a Tarp-shelter must take account of where the wind is blowing from, in order to stop the Tarp-shelter from 'catching the wind' and becoming a glorified 'kite'.

Q: Oh. And 'ridgepoles'?

A: A Ridgepole is a pole used to support and reinforce the ridgelines of a tent or tarp. Ridgeline specifically refers to the junction lines of roofing slopes, but may also refer to junctions of other sloping surfaces, such as where a wall slope meets a roof slope, or another wall slope. A 'Rope Ridgepole' or 'Rope Ridgeline' is a rope that serves in place of a pole, that is, where a rope provides support to tent or tarp fabric.

Q: So a rope ridgepole is a guy-rope type of thing then?

A: No. Guy-ropes or guy-lines are ropes that attach to a tent or tarp and tension the fabric, but do not necessarily support it in the air. A rope ridgepole may support the tarp fabric in the air, but may not actually attach to the tarp fabric, nor actually tension it - think of a clothesline, you drape clothes over it, and the clothesline supports the clothes in the air.

Q: And what was that bit about 'weight load'?

A: Any shelter (including houses) can collapse if weight overloads the supports. In the case of a Tarp-shelter, storm debris, rain, hail, or snow may lie on top of the Tarp-shelter (or be blown against it), and pile up until the accumulated weight overloads the Tarp-shelter's supports. This is generally a 'gradual' problem, with sagging roofs and bulging walls warning of any impending 'cave in'. However, a severe storm can dump an overwhelming amount of debris within a few minutes, especially if the debris includes leaves and branches from trees!

Q: Hmm. Speaking of hail and snow, how well do Tarp-shelters do in the cold?

A: I don't have as much information on that as I'd like. A Tarp-shelter offers MINIMAL protection against hail, and even then, only against minor onslaughts of smaller sized hailstones. A serious hailstorm, with lots of small hailstones (let alone large ones!), could rip a Tarp-shelter into pieces! Regardless of how 'mild' or 'severe' a hailstorm was, I would ~NOT~ recommend you rely on mere rope and fabric for protection! End of Story! Snow is another matter, but still presents the problem of collapsing a Tarp-shelter under the weight of a snowfall. Very cold weather may affect the materials used in the Tarp-shelter, freezing them stiff, or making them brittle and more likely to snap or break.

Q: Will cooking inside a Tarp-shelter offset the effects of cold weather?

A: Uh-oh, cooking inside a Tarp-shelter is most definitely ~NOT~ Recommended! Especially ~NOT~ with any of the modern 'synthetic' (and thus Highly Flammable) tent and tarp fabrics! While some of these may claim to be 'fire retardant', it's ~NOT~ a claim I'd risk my life on! And before you ask, the advice AGAINST cooking inside a Tarp-shelter extends to ALL other forms of combustion, such as candles and fuel lamps, mosquito coils and incense, and even to cigarettes! All of these things burn a combustible fuel, and ALL are sources of potential fires! Then there's the problem of condensation - cooking will create warm air that will condense on the surface of the cooler tarp! The condensation will trickle down

the tarp fabric, and make life inside the shelter a bit more miserable. In very cold weather, the condensation may even freeze and form icicles.

Q: Well, can I cook near a Tarp-shelter, have a fire near one, or use any of the previously mentioned 'other forms of combustion' near a Tarp-shelter?

A: Ah, well. It depends on the stove or fire, and whether or not radiant heat, embers, sparks, or other hot materials can affect the Tarp-shelter! Something as simple as placing a hot Billy or hot candle lantern against a Tarp-shelter wall (or on a ground sheet) can have bad consequences. Even if the source of heat doesn't actually touch the ropes or tarp fabric, it may still transfer enough heat through the air (radiant heat), to 'melt' or ignite them!

Q: Hmm, I see... Where can I get the basics to make my own Tarp-shelter?

A: Most hardware stores and larger supermarkets should be able to sell you what you need, if not, go to any good camping store. A multitude of Internet sites can sell you products or give you more information on what's available, from the comfort and safety of your own home.

Q: There's a bewildering variety of brands available. What should I get?

A: First off, make small paper models of the designs. When you have the basic concept down pat, go and buy the CHEAPEST plain tarp you can! Don't worry! It'll last long enough to learn with! And when you 'wear it out', you'll have a good excuse to go buy a better one (as well as a good idea of what you need for the particular design/s you want to use ;). Recycle the 'worn out' tarp into patches, 'grommet insertion' test facility, 'Rambo Raincoat', groundsheet, etc. ~HOWEVER~, if you include a tarp in your camping gear, buy a decent quality one, one that won't 'break' and cause problems when you're out in the Bush.

Q: How do I transfer these folding plans onto a real tarp?

A: Most of the patterns use 'natural' crease lines, the ones created when folding a tarp in half, thirds, etc. To make a 'pattern', use a pen to make 'alignment marks' on the tarp edge for easy reference. If necessary, use a tape measure, protractor (device for measuring angles), and a board as a ruler.

Q: What if I need to put extra grommets in the tarp to take ropes, etc?

A: Some of the folding plans have more 'give and take' than others, and may be able to use existing grommets, even if the grommets aren't in the 'ideal' locations. You might even be able to hang the tarp over poles and ropes, and just secure it where you can! It's all a matter of trial and error, and depends very much on the individual tarp. You can get grommet kits at Hardware and Camping stores, but first, ask them if they have 'Tarp-Clips'. Tarp-Clips go by a variety of names, but they are reusable, can go anywhere on a tarp, and you don't need to make holes! Larger Tarp-clips are stronger, as they 'grip' more tarp fabric than smaller clips.

Q: How do I get my Tarp-shelter to have perfectly straight sides, etc?

A: Tarp-shelters don't NEED to have 'perfectly straight sides' to work, but it will work better if the tarp fabric is taut, rather than limp and saggy. There are a number of ways to do this, but mostly it's just the basics of setting up properly, as outlined earlier. The use of a 'ridgepole' (like in an A-Frame tent) helps to keep the roofline straight and the roofing fabric taut. This helps with shedding wind and rain, and improves the overall stability of the structure. A framework of poles or taut ropes (internal or external) can vastly improve a Tarp-shelter's stability and its appearance. Extra ground stakes will also help to keep things trim and taut, as will a 'daisy-chained' rope.

Q: What's this about a 'daisy-chained' rope?

A: Tarps have a rope running under the edge of the hem, this rope reinforces the tarp, and helps spread the load over more of the tarp fabric. A 'daisy-chained' rope is a way of providing extra reinforcement. One way weaves a rope in and out of all of the grommet holes in the tarp. Another way only pushes a loop of thin rope through each grommet hole and ties it off, with the rest of the rope on the other side of the tarp to the loops. In both cases, the rope itself can become the main supporting structure, with the loops/stretchers of rope becoming lash points, and the tarp itself hanging/draped from the rope like a curtain.

Q: Anything else I need to know about ropes?

A: Yes. To stop poly or nylon ropes from unravelling, use a flame or hot knife to melt the end fibres together. To give the ropes pointy or 'bullet tip' ends, roll the semi-melted ends between gloved or wet fingertips. Ropes made of natural fibres may have metal collars, or heat-shrunk plastic tubing, or even special lashings called 'whipping' securing the ends to stop them unravelling.

Remember though, that ANY rope (synthetic or natural), can wear out, or snap if put under enough tension!

Q: Snap? How safe are Tarp-shelters to use, say as a stall at a Flea Market?

A: You'd be better off getting advice from both a Structural Engineer AND a Lawyer! Murphy's Law states that if something CAN fail, it WILL fail, and at the WORST possible moment! In real life, this may mean injuries and lawsuits!

Q: That doesn't really answer the question?

A: Sorry, but I'm neither a Structural Engineer, nor a Lawyer. If you use ANY of these designs, you do so totally at your own risk, Physical and Legal! However, reinforcing a Tarp-shelter with extra guy-lines, ridgepoles, and tent poles is not a bad idea, so long as you follow common-sense safety procedures.

Q: Common-sense safety procedures? Such as?

A: A few safety tips to remember...

-Don't go camping if the forecast is for bad weather. If out in the 'Howling Wilds', you should seek shelter IMMEDIATELY if the weather turns nasty.

-Don't set up camp over an ant nest, or over any sort of burrow entrance.

-Don't set up camp in a gully or on a riverbank, you may get flash floods.

-Don't set up camp below the 'high water mark' on a shoreline.

-Don't set up camp on top of a hill or ridge. These spots attract lightning.

-Don't attach lines to tall trees or a tree standing alone - these sorts of tree attract lightning strikes. A short tree in a group of taller trees is safer.

-Don't set up camp beneath a tree branch that is dead or partly broken. While overhead tree branches can serve well as a VSS, it may be better NOT to do so, in case the tree branch comes loose and falls on the Tarp-shelter during a storm!

-Don't set up camp beneath a dead tree, or within 'falling over distance' of a dead tree. It might only take a half-decent wind gust to overload rotted roots, trunks, or branches, and bring the entire thing crashing down.

-Always set up camp before dark. That way you can see what you're doing.

-Always set up camp in relation to wind direction. Wind direction changes during the course of the day, but vegetation will grow and bend over to the Lee side, showing the direction of the prevailing (strongest, most common) winds.

-Always check for anyone within 'striking distance' when handling poles.

-ALWAYS wear eye protection when handling poles with spikes on them! Sunglasses are ~NOT~ adequate protection - their glass and plastic lenses may shatter, the shards compounding the damage! Industrial protective spectacles (or goggles) with polycarbonate lenses offer much better protection!

-DON'T set up camp near overhead cables (or electrical appliances like lights, loudspeakers, alarms, etc) as you may burn or electrocute yourself if a wire comes loose, or if a metal pole, wet rope, wet tarp fabric or water puddle comes in contact with a 'live' surface.

-Be VERY careful using ground stakes in built-up and suburban areas, as you may damage underground utilities for electricity, telephone, gas, water, or sewage.

-Wear leather-palmed work gloves when handling or tightening ropes. The leather palms prevent blisters, rope burn, and abrasions to your skin.

Q: Okay, you've sold me on the idea, but is there anything else I should know?

A: Funny you should say that. You can estimate the size of a Tarp-shelter resulting from a specific design, given the dimensions of the tarp. For that you'll need pen, paper, a calculator with SQUARE ROOT and SINE function keys, and Appendix #1 - Useful Maths.

Q: Oh great! I didn't do too well at Maths in High School.

A: Don't worry - most of the maths is straight forward, and will only involve estimating percentages from results shown in the examples.

...But before you get to that, there's some Miscellaneous Stuff...

=====  
 Miscellaneous Stuff.  
 =====

COPYRIGHT NOTES - As far as the Author of this document is aware, the Intellectual information for the folding plans is in the Public Domain, and has been since the days of the Early Colonial Settlers and Pioneers.

Some of these Tarp-shelter designs have several different names. Some designs have variants that may only add or change a fold and create something new.

Sources of information regarding the patterns include the websites, 'Tarp Tents' <http://www.hufsoft.com/bsa51/page2.html>, 'Tent Making Made Easy By H.J. Holden' [http://home.earthlink.net/~lil\\_bear/tent.htm](http://home.earthlink.net/~lil_bear/tent.htm), 'Knights of Dionysus Rover Crew' [http://www.geocities.com/k\\_o\\_dionysus/main.html](http://www.geocities.com/k_o_dionysus/main.html), and 'Buckskin BSA (Boy Scouts of America)' [http://www.buckskin.org/Site\\_Map.htm](http://www.buckskin.org/Site_Map.htm). As well as the book 'Camping in the Old Style' by David Wescott, ISBN 0-87905-956-7, published by 'Gibbs Smith' in Salt Lake City, Utah, USA.

~ALL~ illustrations in this document were created by the Author using various computer graphic programs (most notably, Painter 3D by MetaCreations, and Paint and Photo Editor by Microsoft). Please note that illustrations for the finished Tarp-shelter designs are only ~GUIDES~ to what the finished shelters look like!

The Author of this document expressly allows the use and copying of his OWN illustrations FREE OF CHARGE for Non-Commercial purposes by Non-Profit Groups (Charities, Educational Bodies, Emergency Services, Youth Groups, Campers, etc).

Tarps are usually either cotton canvas (with or without integrated synthetics reinforcing the weave or the stitching), a woven nylon fabric (as in tent fabric), or laminated plastic 'poly' tarps. The type of material used will affect the appearance of the Tarp-shelter. The woven fabrics have more flex, and result in shelters with curving walls and rounded angles when the fabric is under tension. Poly tarps have less flex, due to their construction.

Poly tarps are made of Polyethylene, and may be blue, green, or silver. They have sewn or heat-sealed seams, a rope sewn into the hem, grommets every few feet along the edge, and reinforced corners with grommets. Standard lightweight poly tarps are 1000 denier material in a 10 x 10 mesh, with 0.04 mm lamination on each side. Heavy-duty tarps have a 14 x 14 mesh, and thicker laminate.

WARNING - Poly tarps may be lighter than cotton canvas tarps are, but poly tarps melt and burn far more readily than cotton canvas tarps. A heat source that might not bother a cotton canvas tarp, can ruin a poly tarp.

Regardless of what material the tarp fabric is, NEVER store a tarp when it is wet or damp, especially if there's dirt or other organic material on it that mould and mildew can feed on. The same goes for 'clean' dirt and sand, both of which contain grit that can damage tarp fabric and ropes.

Tarps come in a wide range of sizes, usually rectangular. The most common size ratios are 1:1 (Square), 1:2, 2:3, 3:4, 3:5, 4:5, 5:6 and 6:7. Any size quoted is not always the actual size of the tarp, but may be the size of the piece of fabric before 'hemming'. Hemming involves folding the edge of the tarp over, and reduces tarp side length by several inches. Hemming prevents the tarp edge from fraying, and secures a piece of rope within the fold that reinforces the edge.

All folding plans in this document use either 10' x 10' Square, or 10' x 20' Rectangular tarps. This allows easier estimation when comparing results from different sized tarps of the same type (Square/Rectangular). Example, a shelter made from an 8' x 8' tarp is 80% (0.8) the size of a shelter made from a 10' x 10' tarp. Similarly, the conversion rate for a 12' x 12' tarp is 120% (1.2).

NOTE - The Author of this document is NOT a Professional Mathematician, NOR are they a Professional Draftsman! The folding plans in this document are ~NOT~ 'exact scale'! They cannot be exact scale due to drawing and rounding off errors incurred when working at the sizes involved. The plans, or the maths involved may also be in error, so practical experimentation is the only reliable way of

determining things! That having been said, the folding plans will print out at a ~ROUGH~ scale of one actual centimetre for one scale foot.

To create folding plans for tarps with different sizes, or different size ratios to the folding plans in this document (but at the same relative 'scale'), use the blank template in APPENDIX #2 - Custom Tarp Size Template (up to 15' x 25').

The naming of all points in the folding plans is clockwise from the top-left corner (A), with the four corners always being A, B, C, and D. Naming of other points is clockwise from corner A, ending with any 'internal' points. Notes on finished Tarp-shelters are usually model/mathematical estimates, and show feet and inches as 'decimal feet' (whole feet with 'decimal' inches).

Decimal Inches
1" = 0.083 foot
2" = 0.166 foot
3" = 0.25 foot
4" = 0.333 foot
5" = 0.416 foot
6" = 0.5 foot
7" = 0.583 foot
8" = 0.666 foot
9" = 0.75 foot
10" = 0.833 foot
11" = 0.916 foot

NOTE - All figures rounded DOWN to 3 decimal places!

Feet expressed as Metres		
1' = 0.304m	11' = 3.352m	21' = 6.400m
2' = 0.609m	12' = 3.657m	22' = 6.705m
3' = 0.914m	13' = 3.962m	23' = 7.010m
4' = 1.219m	14' = 4.267m	24' = 7.315m
5' = 1.524m	15' = 4.572m	25' = 7.620m
6' = 1.828m	16' = 4.876m	26' = 7.924m
7' = 2.133m	17' = 5.181m	27' = 8.229m
8' = 2.438m	18' = 5.486m	28' = 8.534m
9' = 2.743m	19' = 5.791m	29' = 8.839m
10' = 3.048m	20' = 6.096m	30' = 9.144m

This table gives some common tarp sizes, and some (outdated) prices.

LIGHT WEIGHT - generic blue	HEAVY DUTY - 'Green/Silver'
6' x 8' (240 cm x 180 cm) \$7	6' x 8' (240 cm x 180 cm) \$11
8' x 10' (300 cm x 240 cm) \$11	8' x 10' (300 cm x 240 cm) \$17
8' x 16' (240 cm x 480 cm) \$21	-----
9' x 20' (270 cm x 600 cm) \$26	10' x 12' (300 cm x 360 cm) \$26
10' x 12' (300 cm x 360 cm) \$17	12' x 12' (360 cm x 360 cm) \$31
12' x 12' (360 cm x 360 cm) \$21	12' x 14' (360 cm x 420 cm) \$36
12' x 14' (360 cm x 420 cm) \$24	12' x 16' (360 cm x 480 cm) \$41
12' x 16' (360 cm x 480 cm) \$28	12' x 18' (360 cm x 540 cm) \$46
12' x 18' (360 cm x 540 cm) \$31	12' x 20' (360 cm x 600 cm) \$51
12' x 20' (360 cm x 600 cm) \$35	12' x 24' (360 cm x 720 cm) \$62
12' x 24' (360 cm x 720 cm) \$41	15' x 15' (450 cm x 450 cm) \$49
15' x 15' (450 cm x 450 cm) \$33	15' x 30' (450 cm x 900 cm) \$97
15' x 30' (450 cm x 900 cm) \$64	16' x 20' (480 cm x 600 cm) \$69
16' x 20' (480 cm x 600 cm) \$50	18' x 24' (540 cm x 720 cm) \$93
18' x 24' (540 cm x 720 cm) \$64	24' x 30' (720 cm x 900 cm) \$155
24' x 30' (720 cm x 900 cm) \$109	30' x 30' (900 cm x 900 cm) \$183
30' x 30' (900 cm x 900 cm) \$129	30' x 36' (900 cm x 1080 cm) \$222
30' x 36' (900 cm x 1080 cm) \$148	

For custom tarp estimates, use these standard Imperial/Metric conversion rates.  
 12 inches (12") = 1 foot (1') = 30.48 centimetres (cm) = 0.3048 metres (m)  
 1 metre (m) = 1.094 yards = 3 feet, 3 inches and 3/8 of an inch.

VSS Examples	
	Top - basic line strung between two fixed objects. Usually from ground to a tree, or between two trees.
	Second Top - single overhead hanging support. Usually from an overhanging tree branch, or from a rope line.
	Bottom Left - two poles lashed together to make a 'Shears' frame. The uppermost angle supports the rope. Useful for areas without trees, and can be used as a frame to reinforce a Tarp-shelter.
	Bottom Right - traditional tent pole, guy-line, and ground stake.
	The 3-poled Tripod and 4-poled Pyramid frames (not shown), offer a skeleton you

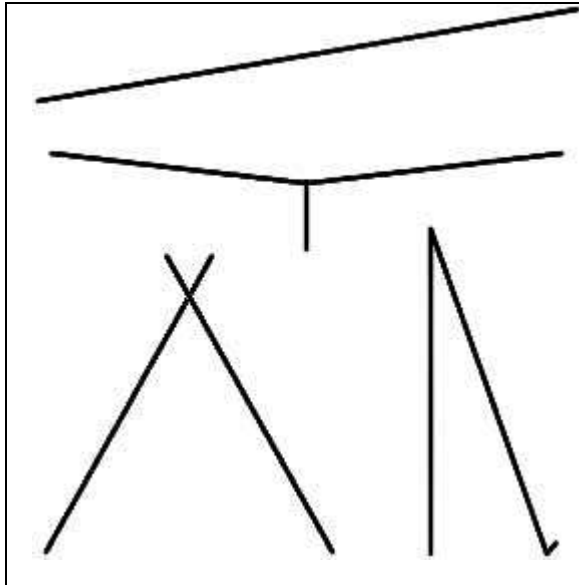

can drape a tarp over, or an external frame to support an overhead style VSS.

Use poles, taut ropes, or even PVC pipes (white plastic pipes used for plumbing) to create internal or external VSS or 'skeleton frames'. Pre-cut PVC pipe pieces and modular pipe connectors allow for rapid creation of complex frames - to keep things together, tension with a rope running through the middle of the pipes.

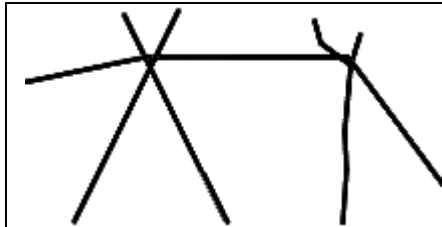

Taut ropes have enough tension to keep them straight between the rope anchor points.

Tighten a limp rope by either retying it, or by diverting it from a straight line. Use a 'shears' VSS frame or a pole with a Y-shaped fork to prop up a rope to the right height, or to tension it.

Most Tarp-shelters only need one VSS point, but some need more. You can get multiple parallel VSS points from taut ropes strung between 2 or 3 trees/VSS.

NOTE - Many camping grounds don't allow the attaching of ropes to trees. Those that do, may insist on a 'tree collar' being used. Tree collars are broad belts several feet long that go around a tree, and are often nothing more than seat belt material with attachment loops on the end. They minimise damage to the tree bark by spreading pressure out over a large flat surface. 4-Wheel Driving enthusiasts may use something similar when attaching a winch to a tree.

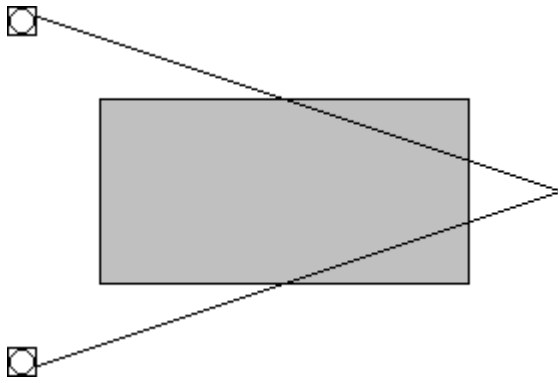

**Step 1.** Attach pulleys or lash rings to the 'end' trees at the desired height. Arrange main ropes between the trees as shown, leaving the ropes limp enough to pull aside. Lay tarp on the ground between the rope anchor points as shown to locate where the ropes must move to.

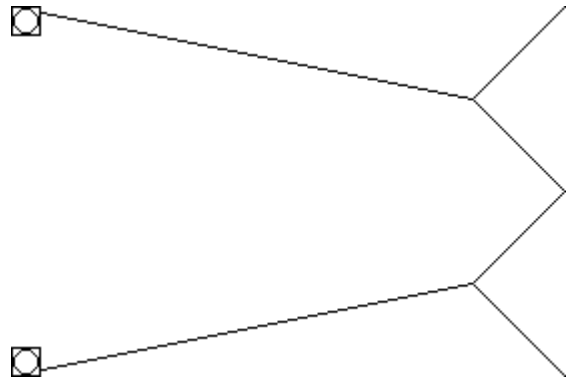

**Step 2.** Either use a pole to push the main ropes apart near the 'middle' tree and make more space, or use lash rings and guy-lines to pull the main ropes apart and make more space. Loosen main ropes if necessary to get enough slack. Thoroughly secure the guy-lines when satisfied with results!

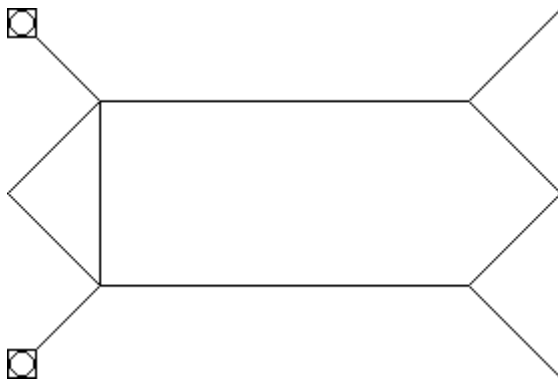

**Step 3.** Use lash rings and another rope to pull the main ropes together and narrow the space between them. Loosen main ropes if necessary to get enough slack. Thoroughly secure the ends of the constricting rope!

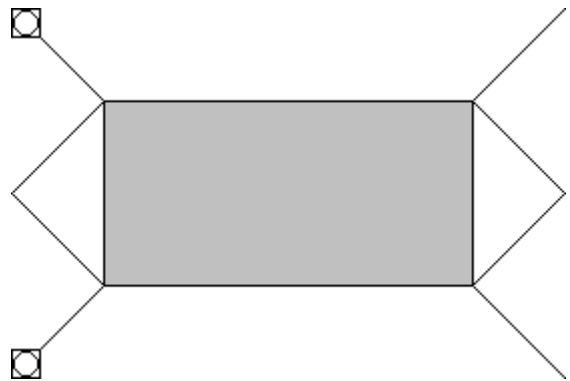

**Step 4.** After sorting out the base set-up, secure the tarp to the main ropes, attaching extra guy-lines as needed. Use pulleys/lash rings to tighten the main ropes, and then do a final tautening of the guy-lines.

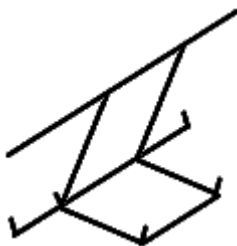

To reinforce the fold lines of a Tarp-shelter, securely stake down tarp edges, and ensure that any guy-lines are taut.

Reinforce folds with a taut rope running along the inside of the fold. The rope supports the tarp fabric along the entire length of the rope. Secure the rope to ground at the ends of the tarp, and secure again a foot or so out from the end of the tarp as shown in the diagram on the left.

Blunt 'caps' for spiked tent poles exist. They slip over the spike and present a broad, rounded surface to the tarp. To use a conventional spiked tent pole without a blunt cap, turn the tent pole upside down, with spike downwards and the flat base up in the air. Put a rubber cap over the flat base of the tent pole (the ones that go on chair legs are useful), or use a Tennis ball with a hole cut in it so it fits snugly over the flat end of the pole.



Windsods are upturned turf or banked earth, sand, snow, etc that overlay the 'ground' edges of a Tarp-shelter. They create a draft stopper that helps shield the ground edge of the tarp from the oncoming wind. In the example shown, the inside gap between tarp and sod provides drainage for condensation from the tarp.



Grommet placement further reduces the useable dimensions of the tarp. It may be more practical in 'Real Life' situations, to use the distance between the end corner grommets on a particular tarp side as being the actual 'length' of that side, when estimating distances for grommet insertion and folding points.

Only replace or insert new grommets in a tarp after thoroughly checking out the needs of a particular folding plan. Tarp-shelter patterns sometimes share fold lines and grommet points with other patterns. Refer to APPENDIX #3 - Common Grommets and Fold Lines on 1:1 and 1:2 Tarps, for an overview. If inserting a grommet, it helps if you reinforce the area where the grommet is supposed to go with patches of tarp material.

The diagrams in APPENDIX #3 have scales showing 1/10ths (tenths), 1/12ths (twelfths), 1/20ths (twentieths), and 1/24ths (twenty-fourths) for a 10 x 10 Square tarp, as well as 1/40ths (fortieths) and 1/48ths (forty-eighths) for the long sides of a 10 x 20 Rectangular tarp. The scales suggest that most of the projected grommet points are either on, or very close to, the 1/12th, 1/24th, or 1/48th length division marks, with a margin of error of less than an inch (?).

On a 'mathematically perfect' 10' x 10' tarp (one without any loss of size to hemming or grommets), a distance of 1/12th of a side is 10 inches, 1/24 is 5 inches, etc. On a 'mathematically perfect' 12' x 12' tarp, 1/12th is 12 inches, etc. On a 'mathematically perfect' 8' x 8' tarp, 1/12th is 8 inches, etc.

You may prefer to use Tarp Clips instead of adding extra grommets. There are several brands of commercial tarp clips available, and all work on the principle of spreading the load over a wide patch of tarp.

You can create a DIY tarp clip with rope and a smooth rounded object of at least one inch (2.5 cm) in diameter (ball bearings, SMOOTH pebbles, etc). This DIY tarp clip is very basic, and it may not take too much force to pull it off, or worse, tear a hole in the tarp! For safety's sake, and for the sake of caring for your gear, ALWAYS use a proper tarp clip!

To make a DIY tarp clip...

- Press the smooth object against the tarp where you want the tarp clip to go.
- Gather the tarp around the outline of the object, making the tarp bulge out.
- Loop the rope over the bulge in the tarp, working it to the very back.
- Tightly tie the rope off around the back of the bulge in the tarp.
- Use the rope ends as guy-lines, or rope attachment points.

One last thing, if having a custom tarp made, see about having nylon webbing (seat belt material) sewn around the tarp edges for extra support. That having been said, the actual Tarp-shelter plans start on the next page.

**1. Basic Groundsheet.**

Lay tarp down and secure corners to ground. Makes an easy to clean floor.

A 10' x 10' tarp gives a Groundsheet with floor space of 100 square feet.

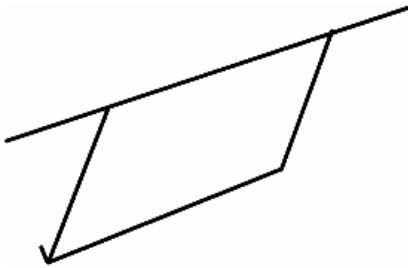
**2. Basic Lean-To.**

Secure edge AD to ground on Windward side.

Support opposite edge BC in air on Lee side.

A 10' x 10' tarp gives a Lean-To with walls at...

...30°, height of 5', shadow of 8.660' x 10'.

...45°, height of 7.071', shadow of 7.071' x 10'.

...60°, height of 8.660', shadow of 5' x 10'.

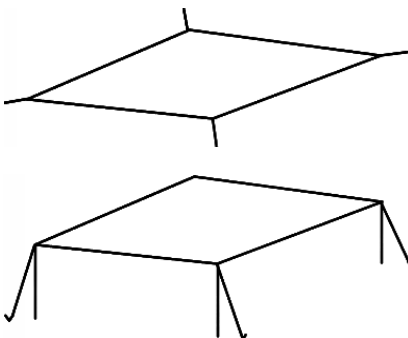
**3. Basic Fly.**

Support all 4 corners in air to make a sunshade.

If fly is parallel to the ground, then it provides a square shadow of 10' x 10'. Any angling of the fly will decrease this.

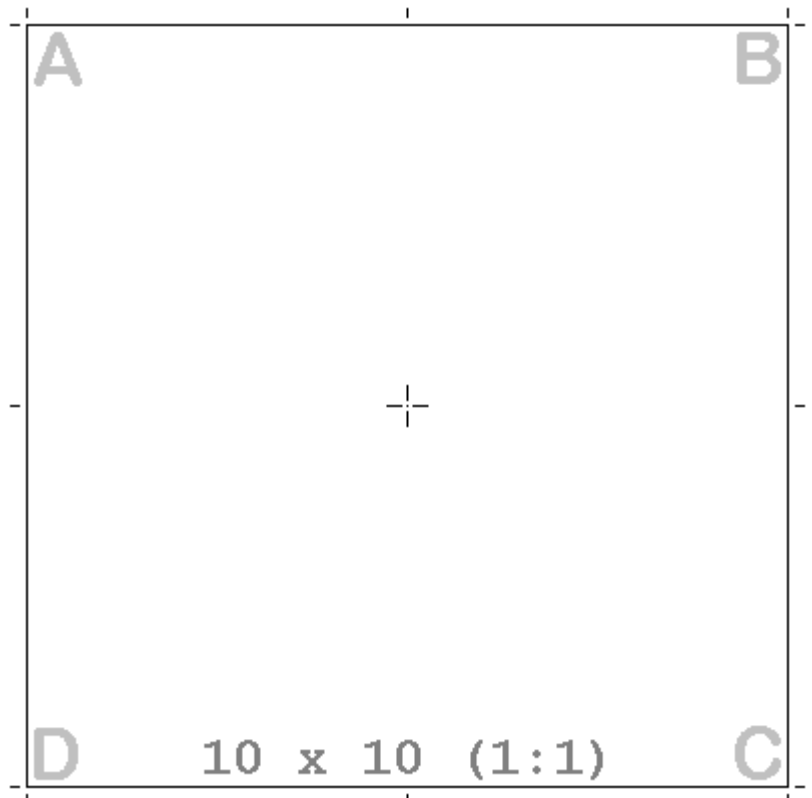
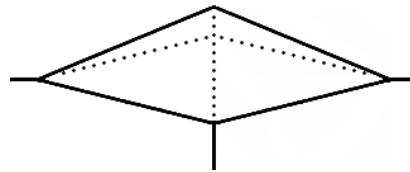
**4. Mushroom Fly.**

Pitch as a Basic Fly.

Use a blunt-ended tent pole to push up midpoint of tarp.

DO NOT PUSH THE SPIKE AGAINST THE TARP!

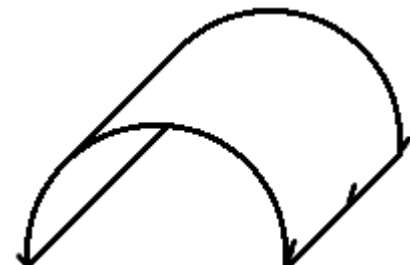
**5. Round Arch.**

Secure edge AD to ground.

Tie flexible dome tent poles to grommets on edges AB and CD to.

Curve flexible dome tent poles into semi-circles.

Arrange on ground until satisfied with shape.

Secure free corners B and C on edge BC to ground.

A 10' x 10' tarp gives a Round Arch 6.363' wide, and 3.181' high at the centre.

Use extra dome tent poles to support midsection of shelter.

**6. Combos.**

A tarp pitched as a Basic Fly provides shade, while another tarp pitched as a sloping wall on the Windward side deflects oncoming wind. A third tarp provides a floor. Adding yet more tarps can create the semblance of a room.

Two 10' x 10' tarps lashed together can make most of the A-Frame variants.

Three 10' x 10' tarps lashed together as three quarters of a large square can make all of the Half Box Variants.

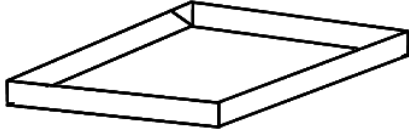
**Tub Floor.**

Turn a Basic Groundsheet into a Tub Floor by folding the sides into mud walls.

Make creases about 6 inches (15 cm) in from all 4 sides of the tarp.

This crease is where the tarp stops being 'floor', and becomes 'mud wall'.

The crease lines will overlap to make squares in the tarp corners.

Make diagonal folds in the corner squares, with the fold lines coming in from the outermost edge of the tarp corner.

Fold up the 'mud walls' of the Tub Floor.

The diagonal creases in the corner squares allow spare material to fold 'bellows' style, into flaps that can point inside or outside of the walls of the Tub floor.

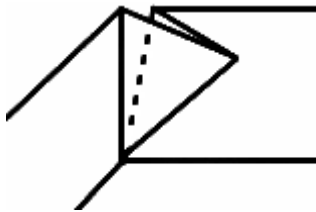

Secure folded material to the mud wall (clothes pegs may do the job). This helps 'square up' the corners.

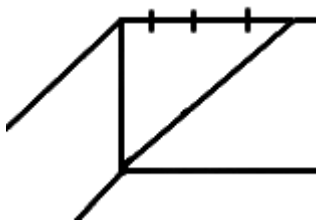

Corner grommets stop the fold being perfect, but it will be 'near enough'.

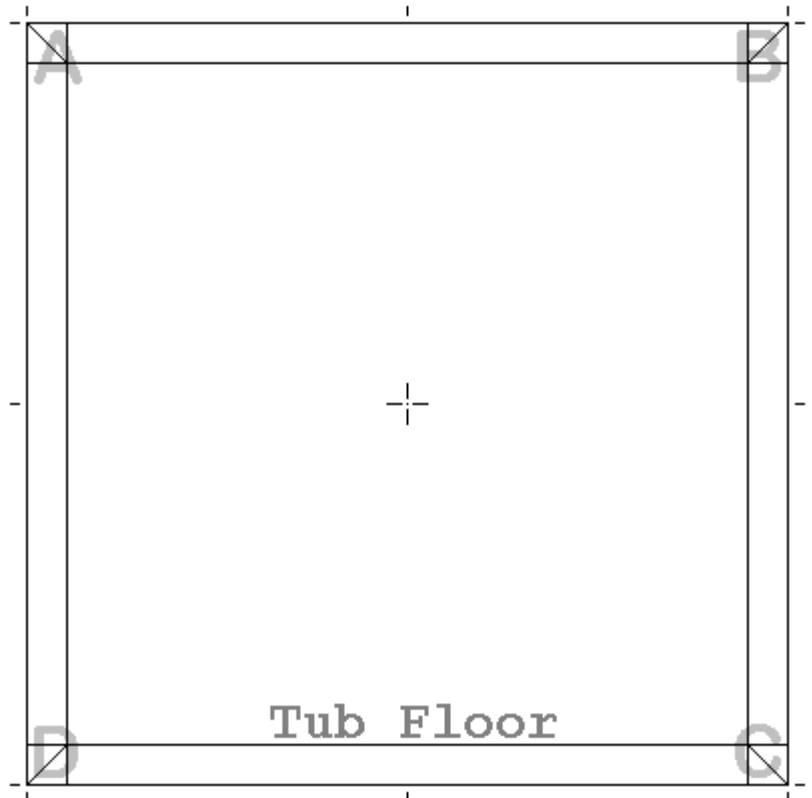

A 10' x 10' tarp gives a Tub Floor with six-inch mud walls, having floor space of 81 square feet in a 9' x 9' shadow.

The amount used for the mud wall decreases the area of floor space.

Six inches from each side of the tarp became a wall, so that's 1/2' x 2 sides = 1' off each 10' side, = area of 9' x 9'.

Other uses for a Tub Floor include an impromptu sand pit or wading pool for children to play in, a receptacle for the storage of newly delivered landscaping and garden supplies, etc.

**Open Bin.**

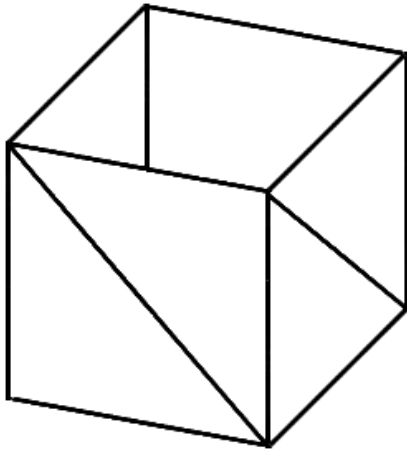

Create an Open Bin from a modified Tub Floor plan for the storage of lawn clippings, clothes, etc.

Fold the tarp in thirds, then fold in thirds again at 90° to the original fold lines to create 9 smaller squares.

NOTE - The actual size of the corner squares is variable in Real Life.

Make diagonal folds in corner squares, with fold lines coming in from the outermost tarp corner.

Secure points E and L together to make doubled triangular flap of AELM.

Similarly, secure these points together to make doubled triangular flaps, F and G together to make BFGN, H and I together to make CHIO, J and K together to make DJKP.

The diagonal creases in the corner squares in the corner squares allow spare material to fold 'bellows' style, into flaps that should point outside of the walls of the Open Bin.

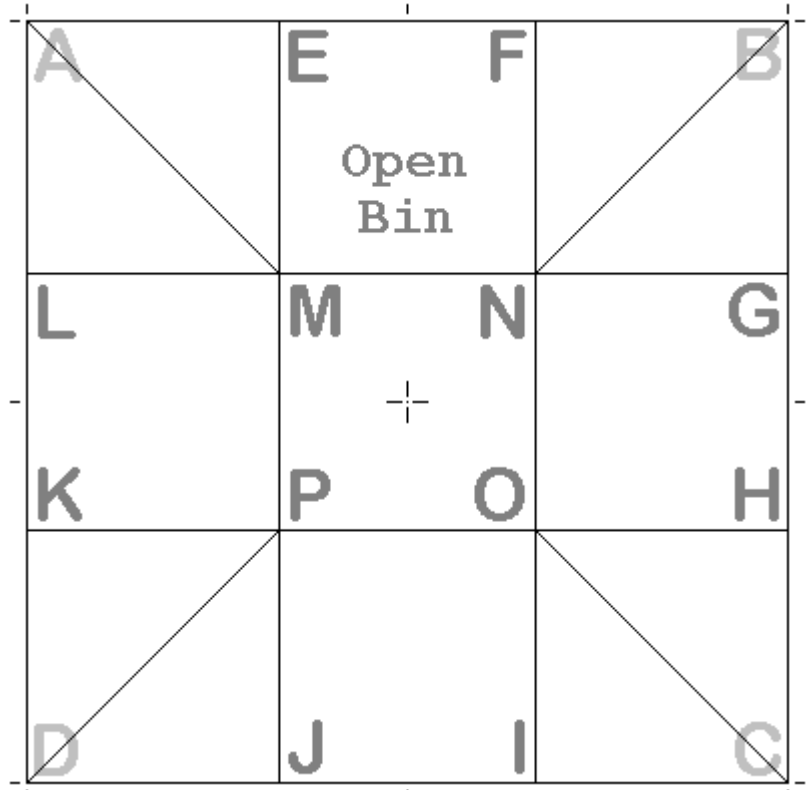
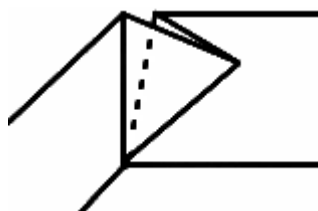

The inner square MNOP becomes a groundsheet, and squares EFMN, GHNO, IJOP and KLMP become walls.

Secure folded material to walls. This 'squares up' corners, and reinforces walls of the Open Bin.

The flaps can 'fold' either way around the Open Bin (clockwise or anti-clockwise), or can overlap each other on the same side.

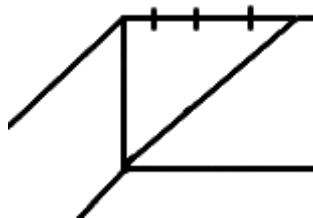

Corner grommets stop the fold being perfect, but it will be 'near enough'. A 10' x 10' tarp gives an Open Bin with 3.333' walls, having floor space of 11.111 square feet in a 3.333' x 3.333' shadow.

The amount used for the wall decreases the area of floor space. Wall height depends on size of corner squares.

One of the flap folding variants, with two flaps overlapping each other on the same side.

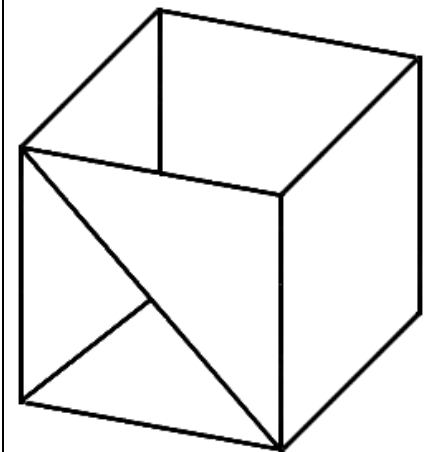

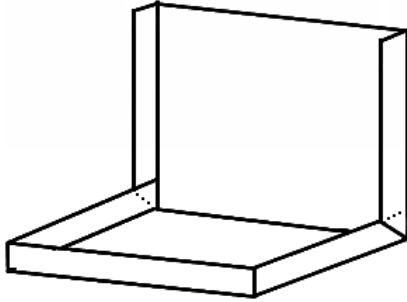
**Tub Floor with Wall.**

Turn a Basic Groundsheet into a Tub Floor with Wall by folding the sides into walls.

Make creases about 6 inches (15 cm) in from 3 sides of the tarp.

This crease is where the tarp stops being 'floor', and becomes 'mud wall'.

The crease lines will overlap to make squares in 2 of the tarp corners.

Make diagonal folds in the corner squares, with the fold lines coming in from the outermost edge of the tarp corner.

Where the Main wall starts, make a straight fold, then make 45° diagonal folds from it, with fold lines coming in from the directions of corners A and B.

Fold up the 'mud walls' of the Tub Floor.

The diagonal creases in the corner squares allow spare material to fold 'bellows' style, into flaps that can point inside or outside of the walls of the Tub floor.

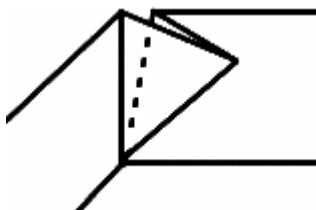

Secure folded material to the mud wall. This helps 'square up' the corners.

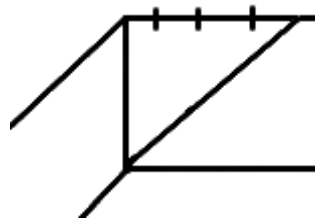

Corner grommets stop the fold being perfect, but it will be 'near enough'.

Fold the base of the Main Wall at points E and F in a 'zigzag' rather than a 'bellows' fashion. Keep the folded material on the outside.

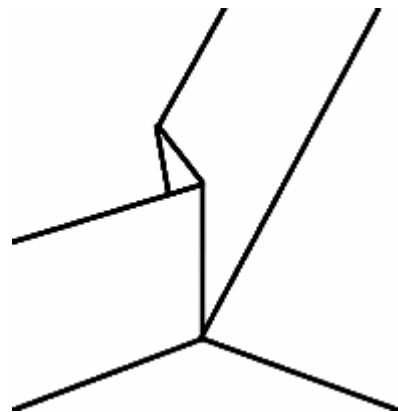

Depending on where the fold is, grommets may or may not interfere.

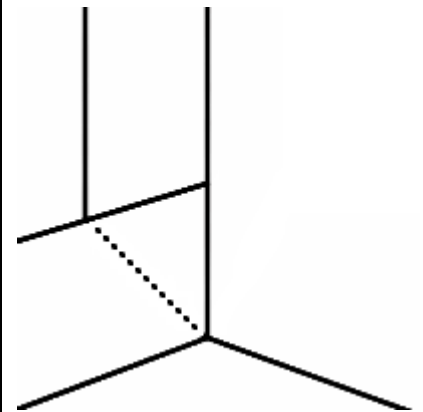

A 10' x 10' tarp gives a Tub Floor with Wall 5' high, floor space of 40.5 square feet in a 9' x 4.5' rectangular shadow.

The top edge of the wall can be twisted back to a straight edge if need be.

Used in conjunction with another shelter like the Rectangular Stall, etc, it creates a floor layout more like the 'box space' of a traditional room.

Useful for weather control, storage of boxed items, setting up an 'office', or to create a comforting illusion of a 'normal' room.

**1. A-Frame.**  
(Triangular Arch, etc)

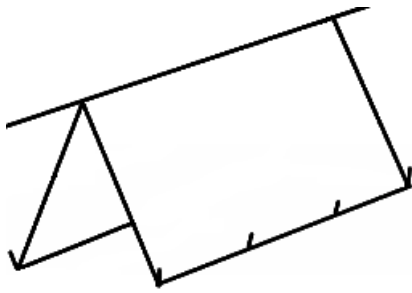

Support EF in air.

Stretch corners A, B, C, and D out to make an inverted 'V' (A), and secure corners to ground.

A 10' x 10' tarp gives an A-Frame with walls at...

...30°, height of 2.5', shadow of 8.660' x 10'.

...45°, height of 3.535', shadow of 7.071' x 10'.

...60°, height of 4.330' shadow of 5' x 10'.

**2. Dining Fly.**

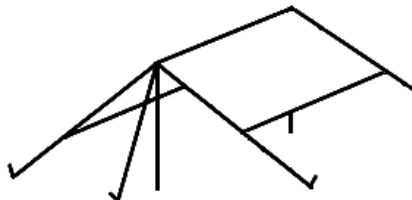

Support fold line EF in air above head height.

Support corners A, B, C, and D in air, slightly lower than fold line EF.

**3. Fold Over Wind Shed.**

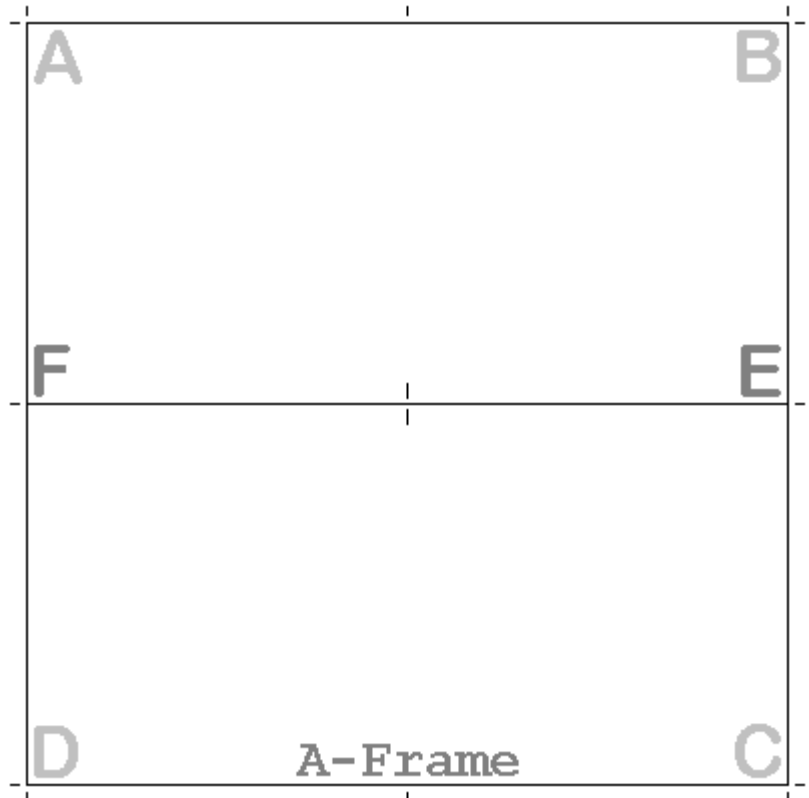
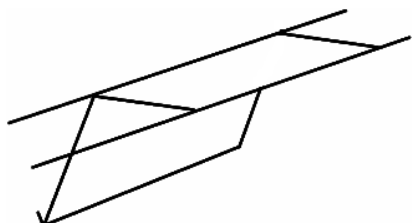
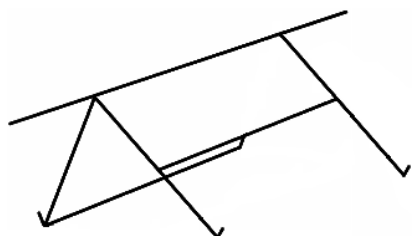

Secure edge AB to ground on Windward side.

Make ABEF an angled wall by supporting fold line EF in air on Lee side.

Support edge CD in air on Lee side.

**4. Rectangular Stall.**

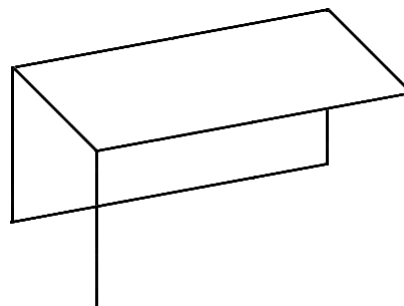

Pitch as per Fold Over Wind Shed, but support fold line EF directly over edge AB.

Use ridgepoles and tent poles to create straight ridgelines and 90° walls.

Back wall at 90° is 5' high, front roofline height is variable, shadow is 5' x 10'.

Sheltered locations only.

**5. Double Wall Lean-To.**

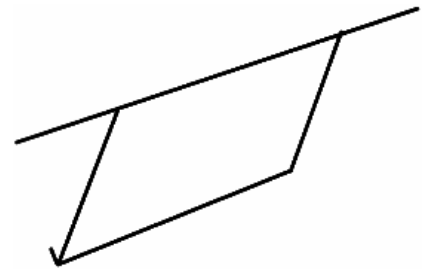

Secure edges AB and CD to ground on Windward side.

Support fold line EF in air on Lee side.

**6. Envelope.**

(Fold Under Wind Shed)

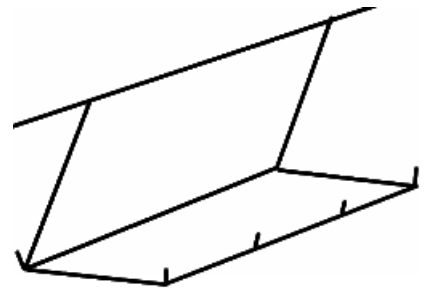

Secure segment CDEF to ground, with fold line EF on Windward side.

Support edge AB in air on Lee side.

**1. C-Fly.**

(Over & Under Wind Shed)

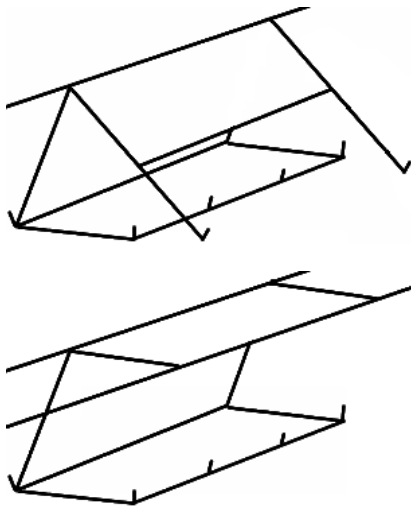

This design has a full groundsheet, but may need the ground fold on the Windward side reinforced with a rope or ridgepole.

Fold tarp in thirds - measure or 'estimate' fold marks by folding tarp so AB and CD overlap each other, then keep adjusting 'over folded' material until everything has been 'overlapped'.

Secure end third section ABEH to ground with edge AB on Lee side, and fold line HE on Windward side.

Support middle third section EFGH in air on Lee side, with fold line FG directly over middle of section ABEH.

Support edge CD of end third section CDFG in air on Lee side as an awning.

Shelter size varies, depending on wall angles, and how large each section is.

**2. Body Bag.**

(Tube Tent, Wrap-Around)

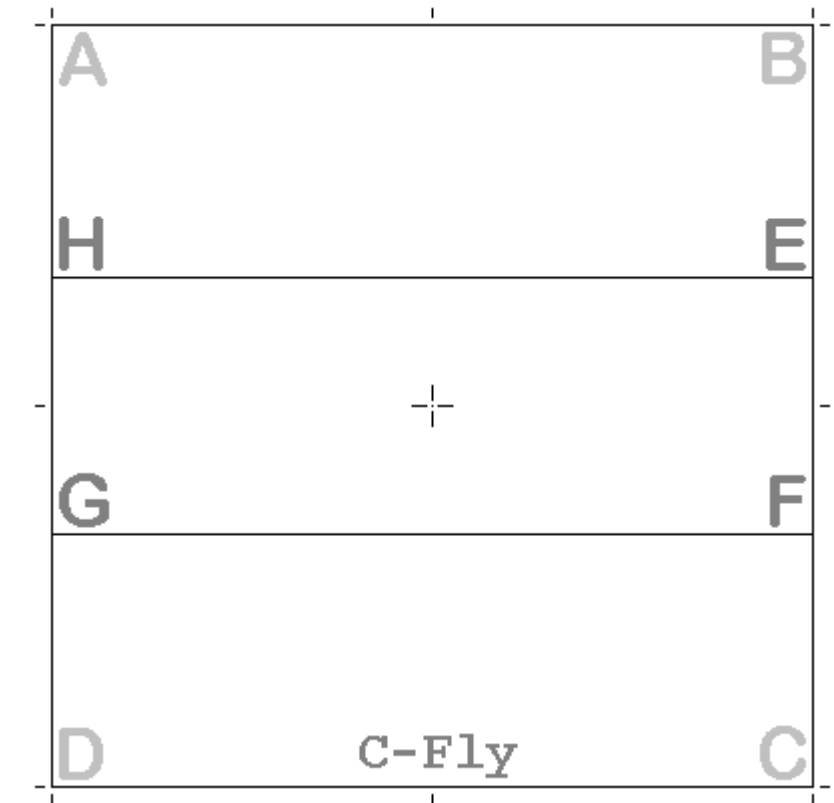
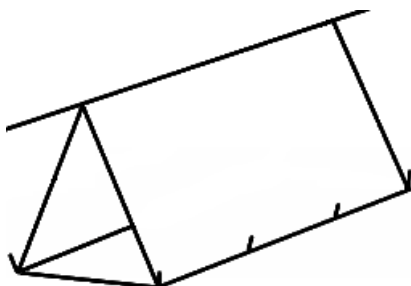

Pitch as per C-Fly, but secure edge CD of last end third section CDFG to ground on Lee side.

10' x 10' Tarp gives a Body Bag with 60° walls, 2.886' high, 3.333' wide. Floor space 33.333 square feet in a rectangular shadow of 10' x 3.333'.

Very little room for an Adult, hence the name.

If turning a Body Bag into a C-Fly by making the last wall parallel to ground, covered floor space is 50 square feet, in a shadow 5' x 10' - including 3.333' x 10' groundsheet.

**3. Square Arch.**

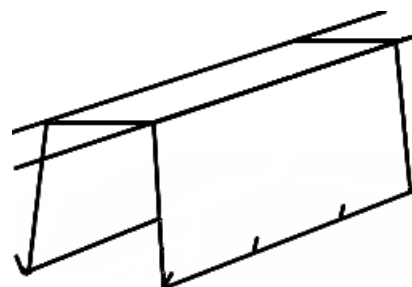

Secure edge AB to ground on Windward side.

Support 4 corner points of middle third section EFGH in air, on Lee side.

Use 'parallel' ropes to 'square' up shelter.

Secure edge CD of end third section CDFG to ground on Lee side.

Shelter size varies, due to differing wall and 'roof' angles. To make it more 'weather worthy', Give walls a slight inward angle, and slant roof so it drops towards the Windward side.

**4. Booth.**

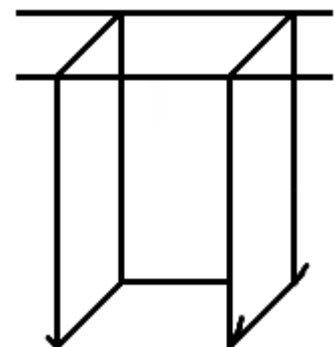

Use as a storage divider.

**1. Cross-Quartered Fly.**

(Cross-Reinforced Fly, Saggy Edge Fly, etc)

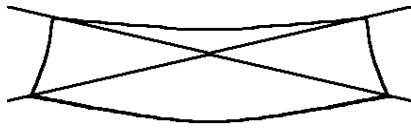

Cross two ropes or ridgepoles over each other at 90°.

Align the tarp midpoint over the junction of the ridgeline supports.

Attach all four corners of tarp to the ridgeline supports, leaving tarp edges unsupported.

Tarp edges will sag, giving the appearance of curves, or scallops.

Little more than a sunshade, the reinforcing ropes help to shed rain.

Any rain will channel down the 'scalloped' sides to the edge of the tarp and spout from there to the ground below.

The main difference between this and the Basic Fly, is the extra support in the midst of the tarp fabric from the ridgelines - unlike the Basic Fly, which has support from the corner grommets alone.

The unsupported edge will catch the winds and flap about, so it's ~NOT~ recommended for windy locations!

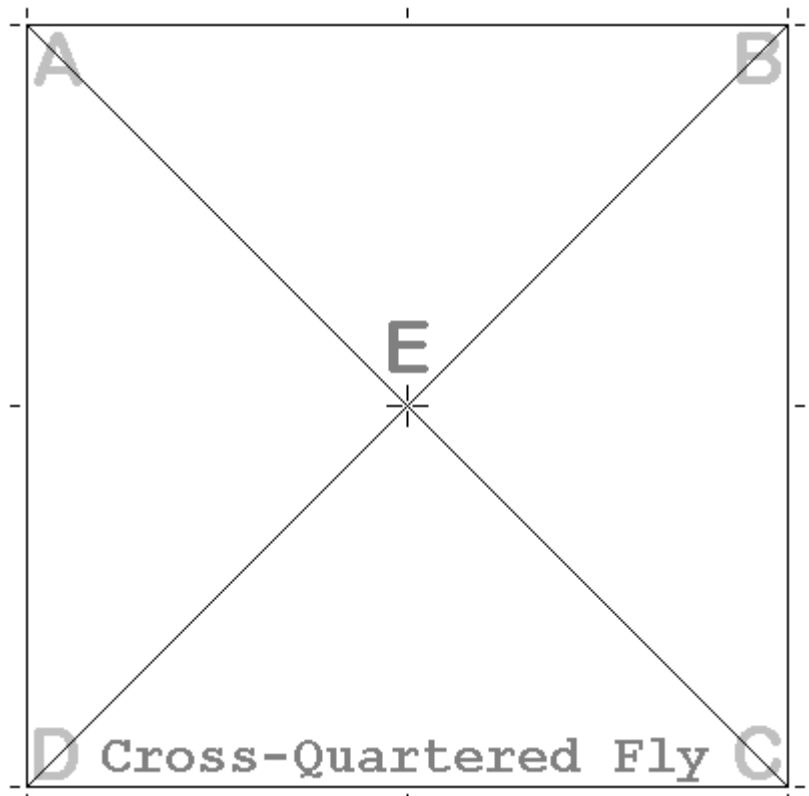
**2. Scallop Fly.**

(Hills Hoist Fly, etc)

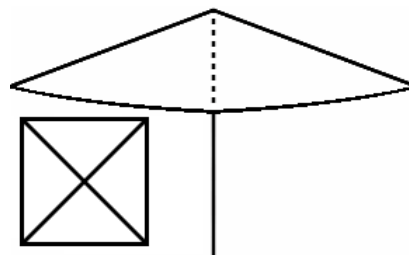

A Mushroom version of the Cross-Quartered Fly.

A blunt pole supports the midpoint of the tarp, and pushes it up.

Reinforce the ridgelines with rope or poles down to the corners.

Edges are unsupported, and their curves or 'scallops' depend on tension, fabric type, and angle of 'peak'.

Visually, it looks a bit like those fancy table umbrellas outside cafes.

Depending on tarp size, a Hills Clothes Hoist can act as VSS and ridgepoles - hence one of the names.

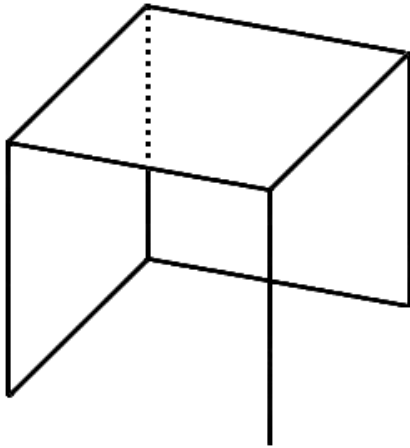

**1. Half-Box.**

The use of Tent poles and Ridgepoles is highly recommended.

Fold tarp in quarters.

Fold corner square AEHI diagonally, so point E is beside point H.

Secure point E to point H, to make AEHI a doubled up triangular flap.

Secure edge DH to ground as base of wall DGHI.

Secure edge BE to ground at 90° to edge DH as base of wall BEFI.

Support point I in air with blunt pole.

Support points F and G in air - together with point I, they create the tops of walls BEFI and DGHI.

Support corner C in air to make section CFGI the roof.

Triangular flap AEHI is spare cloth - bundle it up behind rear corner edge EI-HI, out of sight.

A 10' x 10' tarp gives a Half-Box with 90° walls 5' high, floor space of 25 square feet in a shadow 5' x 5'. Height at C is variable

Sheltered locations only.

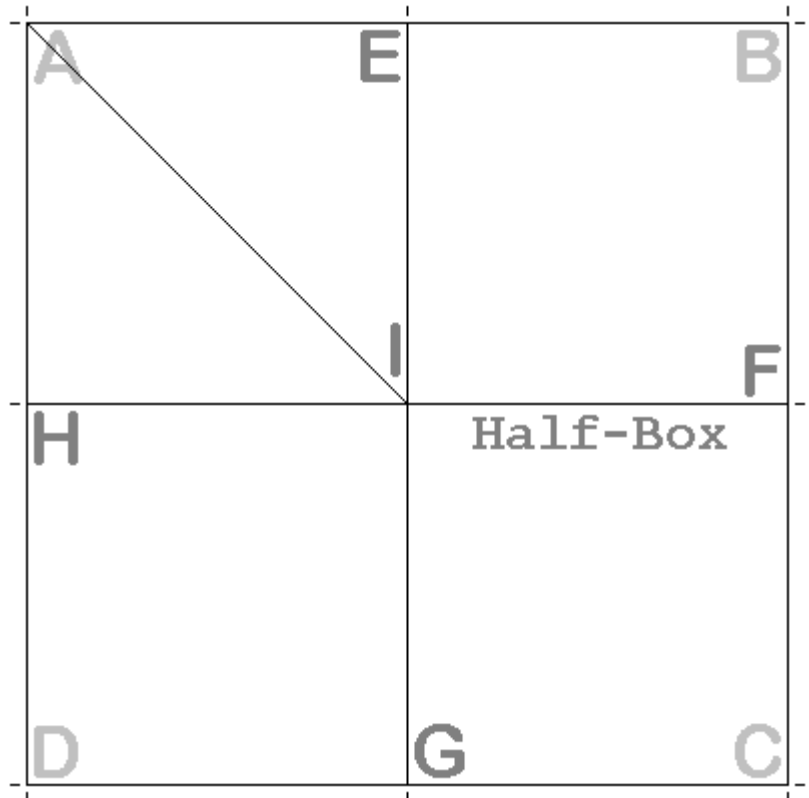
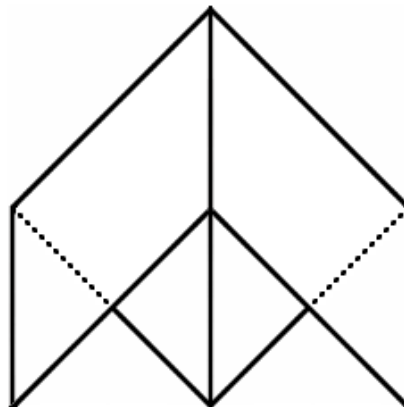
**2. Tulip**

Fold tarp in quarters.

Fold corner square AEHI diagonally, so point E is beside point H.

Secure point E to point H, to make AEHI a doubled up triangular flap.

Note - illustration shows final version of Tulip with triangular flap AEHI tucked INSIDE the Tulip - flap AEHI can go either inside or outside.

Support point I in air.

Stretch out corners B, C, and D, into a triangle centred on point I.

Secure corners B, C, and D to ground.

Stretch out points F, G, and E-H until tarp is taut, and secure to ground with guy-lines.

Triangular flap AEHI folds up against the body of the Tulip, to make for a neater appearance.

Sheltered locations only.

The Tulip Fly is 3 square faces of a cube standing on their free corners.

A 10' x 10' tarp gives a Tulip 5.77' high, with all corners on a circle 8.16' in diameter.

Floor space is 86 square feet in a hexagonal shadow with 4.08' sides.

The midpoint (VSS or pole position) in the shelter is 4.08' from any of the corners.

Sheltered locations only.

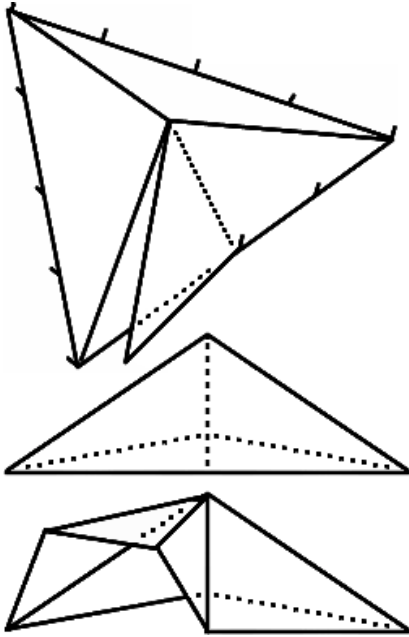
**Low Tetra.**

Fold diagonally both ways, quartering tarp into four triangles.

Fold corner C into a square from the tarp midpoint G, to midpoints of edges BC and CD.

Fold corner square CEFG diagonally, so point E is beside point F.

Secure point E to point G, to make CEFG a doubled up triangular flap.

Keep CEFG on top of the rest of the tarp during pitching.

Point corner A into the wind on Windward side.

Stretch corners B and D out on the Lee side as far as possible from corner A, until the 3 corners form an equilateral triangle on the ground.

Secure corners B and D to ground on Lee side.

Loosen flap CEFG, and support point G in air.

Refasten flap CEFG, and lay it against side of Low Tetra on Lee side, with corner C next to either corner B or D.

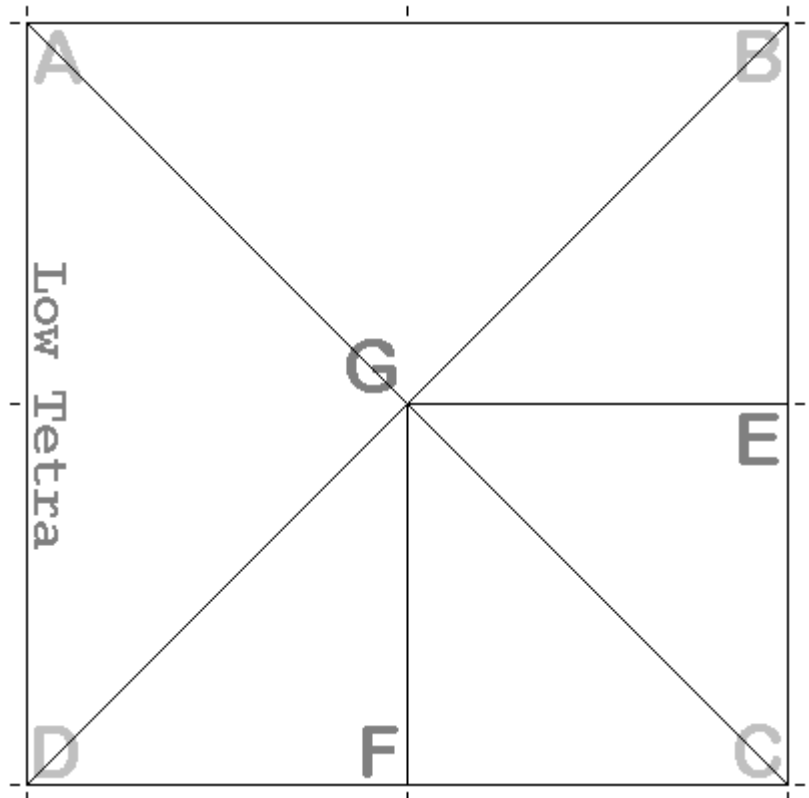

To get in and out of the Low Tetra, unfasten flap CEFG.

Once set up and staked out, you can open an entire side up, or just half of a side as shown in the illustration.

Use the Low Tetra as a gear cover.

Because of its low wind profile, sloping sides, and stake down points all around its perimeter, the Low Tetra is one of the most secure Tarp-shelters in windy conditions.

A 10' x 10' tarp gives a Low Tetra 4.082' high, floor space of 43.301 square feet in a triangular shadow with 10' base and 8.660' long.

The triangular walls have bases of 10', and sloping wall lengths of 7.071'. The angle of wall slope at midpoint of any side is 54.735° (?).

The midpoint (VSS or pole position) in the finished shelter is 5.77' from any of the three corners, or 2.88' from any of the three flat ground edges.

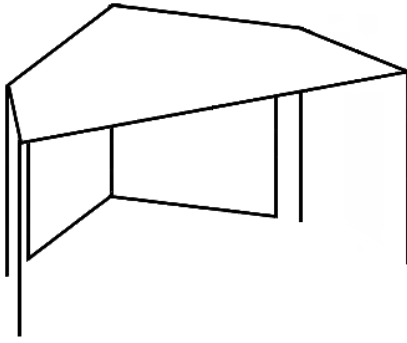
**Swing-Back Stall.**

Reinforcing with Tent poles and Ridgepoles is highly recommended.

Secure point E to ground on Windward side.

Align corners A and B on ground relative to point E, at an obtuse (broad) angle on Lee side.

Support points F, I, and J in air to create back walls of AEIJ and BEFJ.

USE BLUNT SUPPORTS AT POINTS OF F, I and J, THERE WILL BE TARP MATERIAL ON TOP OF THEM!

Support corners C and D, in air to form front edge of roof section CDGH.

Spare material in triangles FGJ and HIJ, folds back over tops of walls AEIJ and BEFJ.

The exact fold lines for this spare roof material depends on the symmetry and the angle between the back walls. Use spare material if back corner angle changes.

The spare roof material will upset the neatness of the rooflines, unless rolled-up, or folded away neatly.

Back wall top edges of FJ and IJ won't reach to support front roof side edges of CG and DH - use VSS at points G and H.

Front roofline edge of CD needs reinforcing, as will the roof side edges of CG and DH.

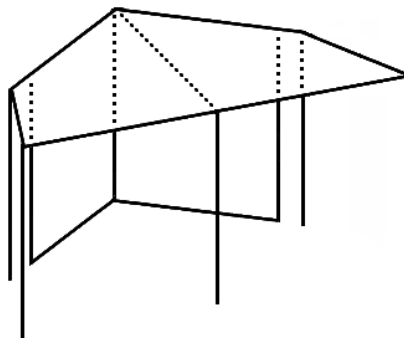
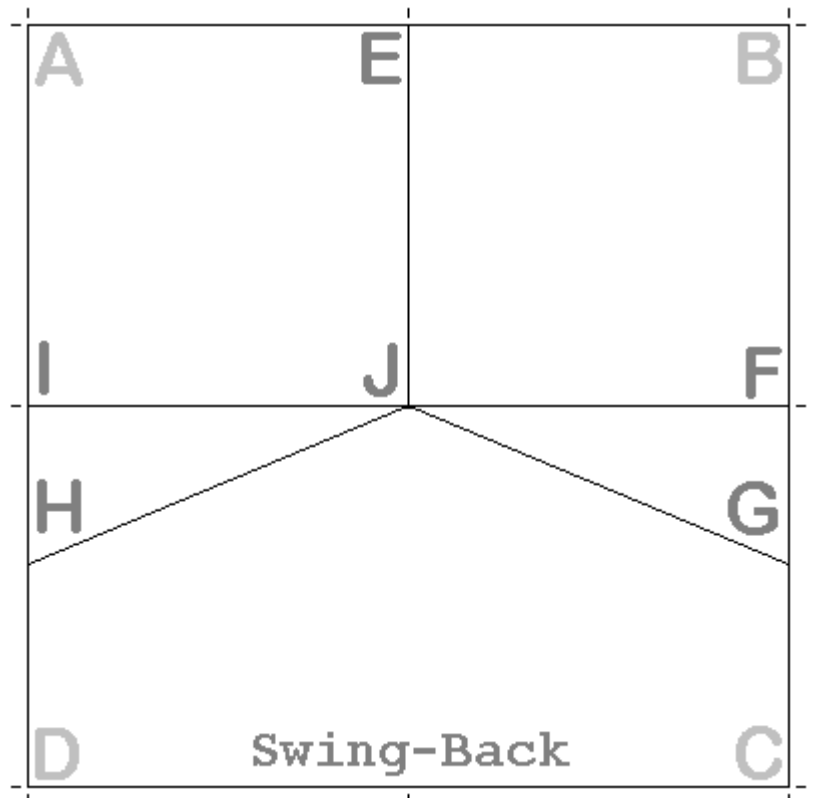

A 10' x 10' tarp gives a Swing-Back of variable dimension, depending on the height of the front roofline, and the angle between the back walls.

These diagrams don't show how spare roof material folds down behind the back walls.

Sheltered locations only.

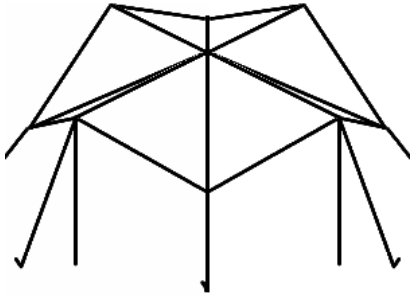
**1. Marquee.**

Support points E, F, G, and H in air.

Use ridgepoles or taut ropes to reinforce fold lines EG and FH.

Run ropes from corners A, B, C, and D to ground.

Depending on fabric type and tension, the areas around fold lines AI, BI, CI, and DI will have lesser or greater curves.

The roof slopes direct water away from floor space under the tarp.

Fancier than a plain old Basic Fly, and only for sheltered locations.

Reverse gutter and support points to create another variant.

Create a 'Mushroom' variant of this design by supporting point I at a higher level than the other main roof points.

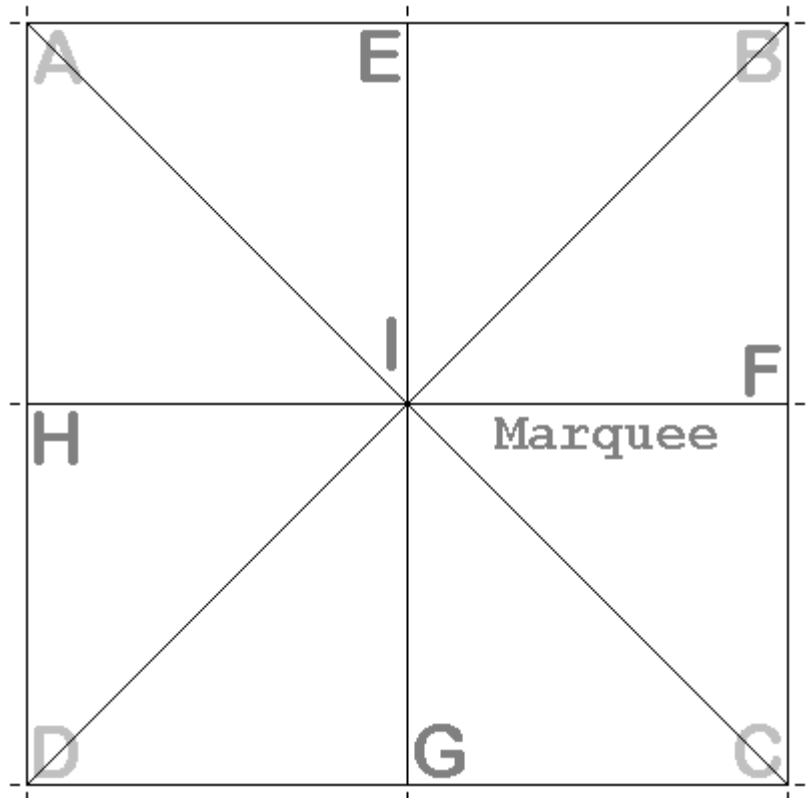
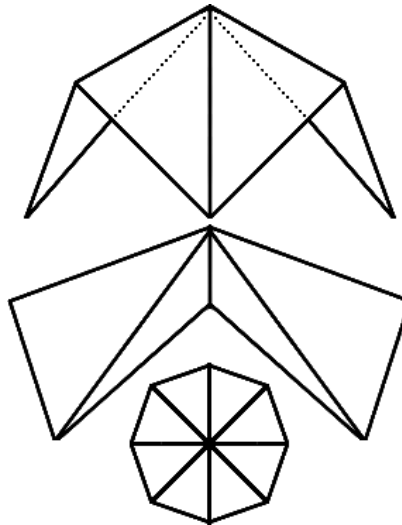
**2. Shade House**

A severely folded down version of the Marquee, with tarp corners secured directly to ground, and mid-edge points supported in air by taut ropes or poles (not shown) to make archways.

It needs one central VSS (not shown), and stakes and guy-lines for all lashing points.

Dimensions are variable, and depend on distances between the corners.

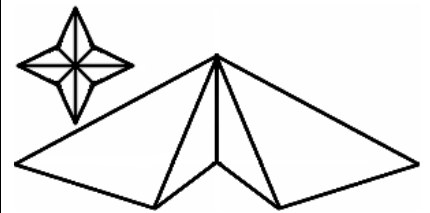
**3. Star.**

This pattern reverses the corner and mid-edge point pitching of the Marquee and the Shade House.

It has one VSS point, from which taut ropes support tarp corners in air to form the points of the 'star'. The mid-edge points are pulled in and down towards the ground.

Dimensions are variable, and depend on distances between the corners.

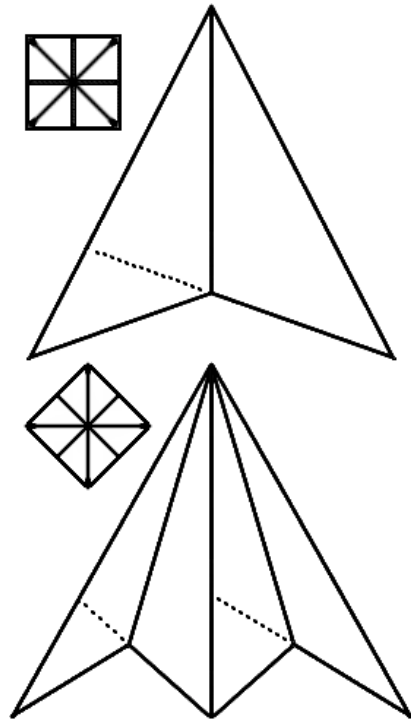
**Bluebell.**

This is not so much a Tarp-shelter as it is a 'tarp sculpture'.

Only for sheltered locations.

Fold tarp diagonally both ways. Fold tarp into quarters. Extra folds are half the angle between tarp midpoint and adjacent diagonal and quarter folds.

Fold Angles at F on AB, H on BC, J on CD, and L on AD are  $67.5^\circ$  acute and  $112.5^\circ$  obtuse.

Fold section BFM back over section AEM at fold line EM.

Secure folded material against the tarp edge.

Fold section CHM back over section BGM at fold line GM.

Secure folded material against the tarp edge.

Fold section DJM back over section CIM at fold line IM.

Secure folded material against the tarp edge.

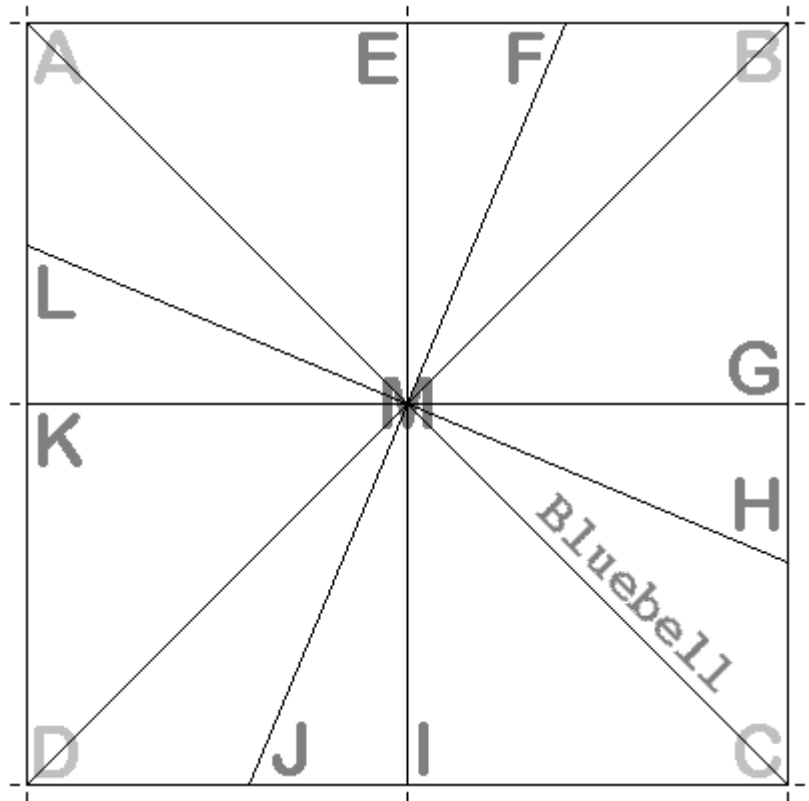

Fold section ALM back over section DKM at fold line KM.

Secure folded material against the tarp edge.

Support Point M in air.

Stretch out corners A, B, C, and D into a square floor plan.

Secure corners A, B, C, and D to ground.

Outside the shelter, run guy-lines from points F, H, J, and L to ground at corners A, B, C, and D respectively (to the previous corner, going in a clockwise direction).

Inside the shelter, run guy-lines from points E, G, I, and K to ground at corners, B, C, D, and A respectively (to the next corner, going in a clockwise direction).

This will tension the tarp fabric and help the shelter keep its shape, that of a pyramidal flower with down-turned petals.

Variations on the folding overlay sequence will reverse the 'swirl' effect, or change the type of overlay effect.

A 10' x 10' tarp gives a Bluebell about 5.5' tall, and leaves almost NO ground space to crawl underneath.

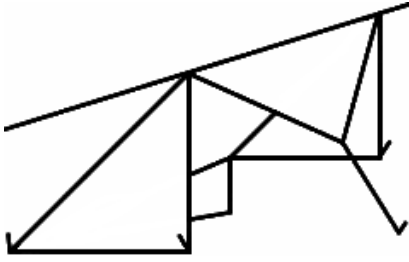
**Adirondack Wind Shed.**

Fold tarp from mid-edge point on any side to the mid-edge points on adjacent sides.

Rotate plan until inner diamond EFGH looks like a square in the outer diamond of ABCD.

Secure section AEH to ground, with fold line EH on Windward side, and corner A on Lee side.

Fold rest of tarp over groundsheet AEH to the Lee side.

Align edges BE and DH at  $90^\circ$  to edge EH on the Lee side.

Secure corners B and D on edges BE and DH to ground, forming partial end walls of BEF and DGH.

Support points F and G in air on Lee side to turn section EFGH into the main wall.

Support corner C in air on Lee side to create an awning from section CFG, or fold down to create a partial fourth wall.

10' x 10' tarp gives an Adirondack Wind Shed with  $45^\circ$  main wall, 5' high roofline, and shadow of 5' x 7.07'.

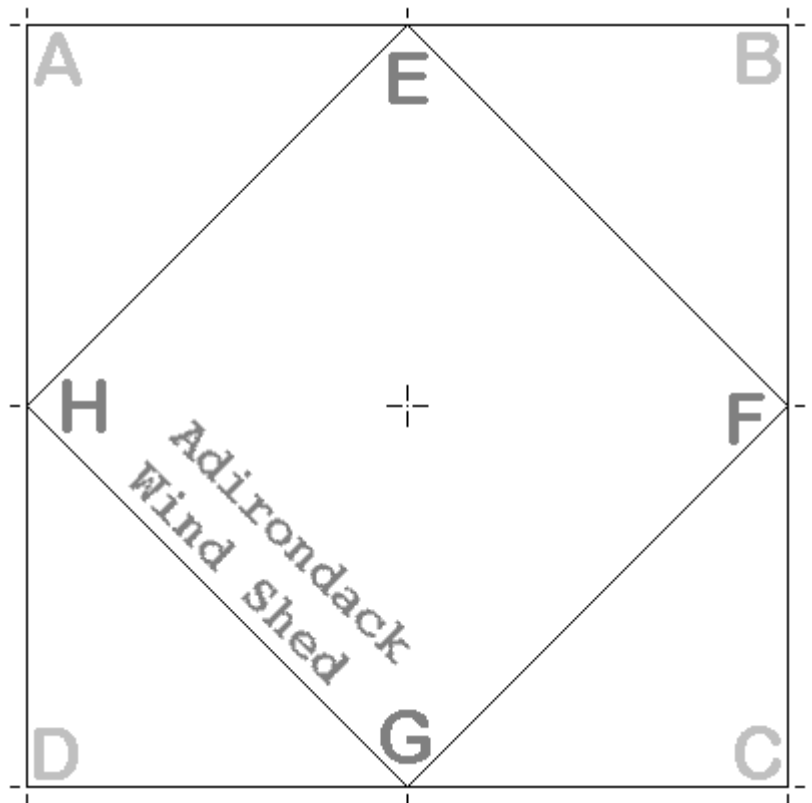

**1. Semi-walled Fly.**

(Flat Top, Table Top,  
Rain-Catcher)

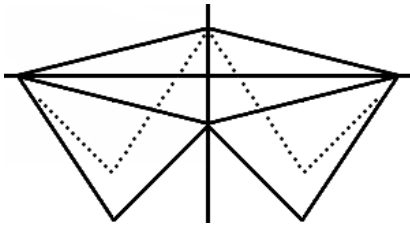

Fold tarp into quarter squares.

Fold tarp from mid-edge point on any side to the mid-edge points on adjacent sides.

Cross two ropes or ridgelines over each other at 90°.

Align the tarp midpoint over the junction of the ridgeline supports.

Attach mid-edges to ridgeline supports.

Unsupported corners hang down like partial walls.

Secure corners A, B, C, and D to ground, using stakes or guy-lines. Angling them outwards from the shelter creates more floor space, and helps to deflect winds and shed rain.

Use taut ropes or ridgelines to support fold lines of EF, FG, GH, and HE.

Little more than a sunshade, rain collects in the reinforced roof. The crossed ridgelines give some extra support.

One way of collecting rain with a tarp, while using it for shelter.

Sheltered locations only.

A 10' x 10' tarp gives a Semi-walled Fly 3.53' high, with top square of 7.07' x 7.07'. At 90°, the corner flaps make walls 3.53' high from corner to fold line.

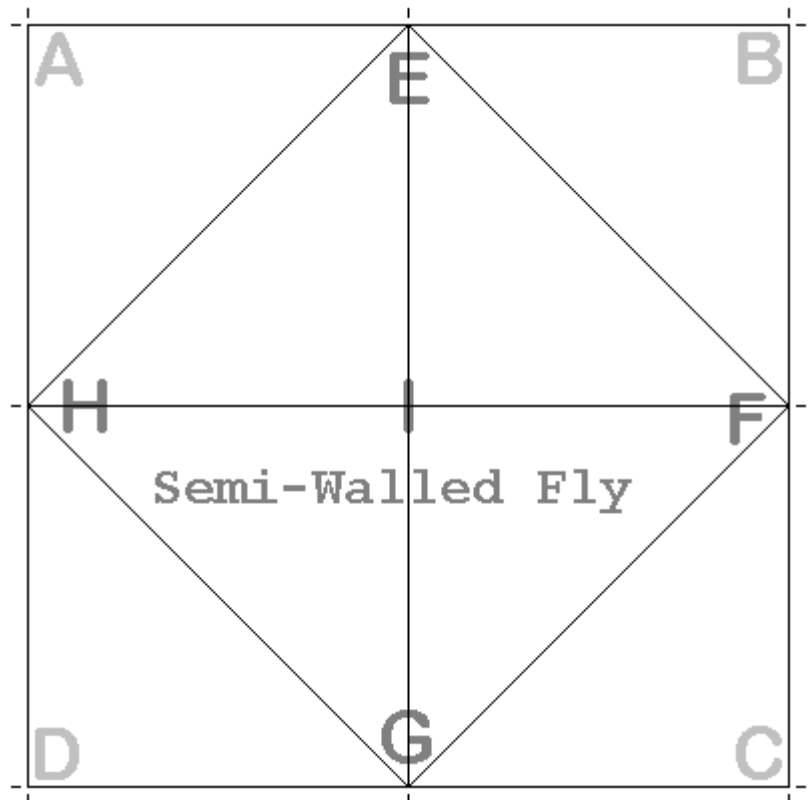
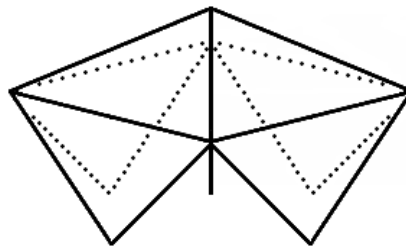
**2. Semi-walled Mushroom.**

Pitch as per Semi-Walled Fly, but use a blunt pole (not shown) to push point I up to desired height.

NOTE - The use of alternative VSS and ridgeline supports to those of the Semi-Walled Fly may provide more useable room beneath the canopy.

Slightly more headroom and better rain shedding capability than a Semi-Walled Fly, but still only for sheltered locations.

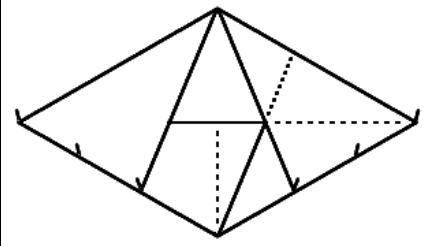
**3. Kennel.**

Secure points F, G, and H to ground as three points of a triangle, with fold line FHI on Windward side and point G on Lee side.

Fold triangles CFG and DGH back over FGI and GHI respectively. They become groundsheets or partial walls - above illustration shows both. For walls, run ropes from corners C and D to point E, and tighten ropes.

Align edge AH along edge GH and secure edge AH to ground. Align edge EF along edge FG and secure edge EF to ground.

Support point E in air in Lee side.

Sheltered locations only.

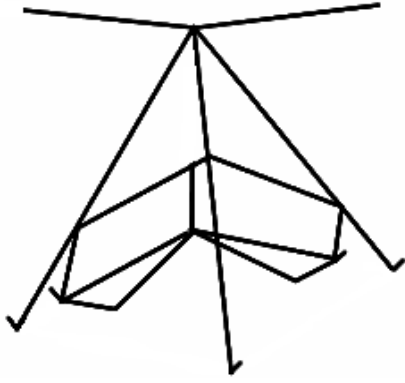
**Partial Pyramid.**

Fold tarp from mid-edge point H to mid-edge points G and I. Fold lines EJ and EF at  $22.5^\circ$  relative to tarp edge AB.

Secure point E to ground on Windward side.

Midline EH becomes the back corner between the two large walls of EFGH and EHIJ.

Align points F and J on ground so they form a  $90^\circ$  angle with point E.

Secure points F and J to ground.

Secure triangles AEJ and BEF to ground as partial groundsheets.

Join edges CH and DH together.

Support point H in air on Lee side.

Run guy-line from combined corners C and D to ground.

Run guy-lines from points G and I to ground.

Adjust guy-lines to get a pyramid shape.

Just by halving two of the fold angles on the Adirondack, you get the basis for a partial pyramid structure that is more fanciful than functional.

A 10' x 10' tarp gives a Partial Pyramid 8.40' high.

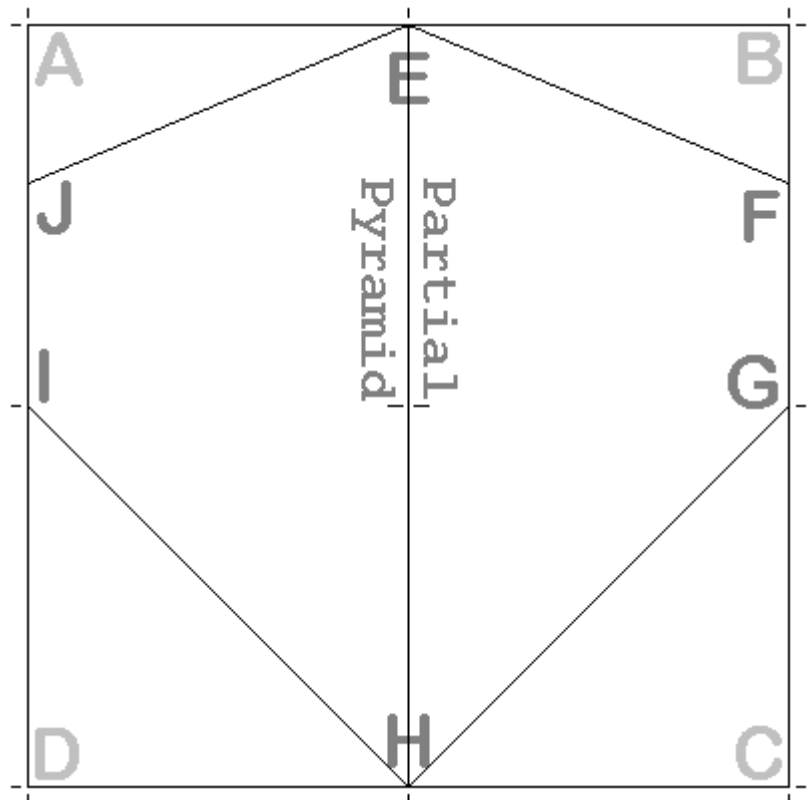

If this was a normal pyramid, it would have a square base some 7.65' on each square side.

Sheltered locations only.



**1. Diamond Fly.**

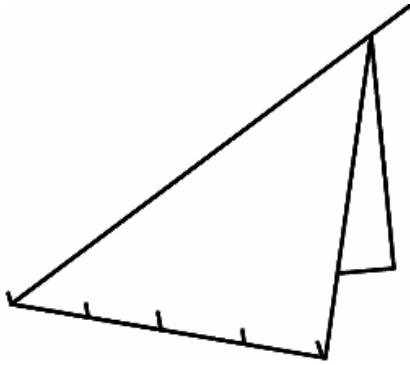

Fold tarp in half diagonally.

Secure corner A to ground on Windward side.

Use rope or ridgepole to support corner C in air on Lee side.

Reinforce fold line with a taut rope running along inside the fold.

Spread corners B and D out on ground until taut, then secure to ground.

Good stability in windy conditions, IF set-up and staked out properly.

Size of shelter depends on wall angles.

A 10' x 10' tarp gives a Diamond Fly with diagonal fold of 14.14'.

**2. Tortilla.**

(Fold Over Wind Shed)

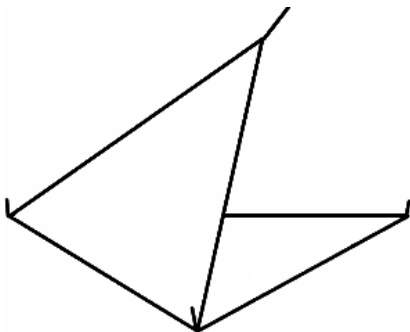

Orient so diagonal fold line AC is on Windward side, with corners B and D on the Lee side.

Secure corners of lower triangle to ground.

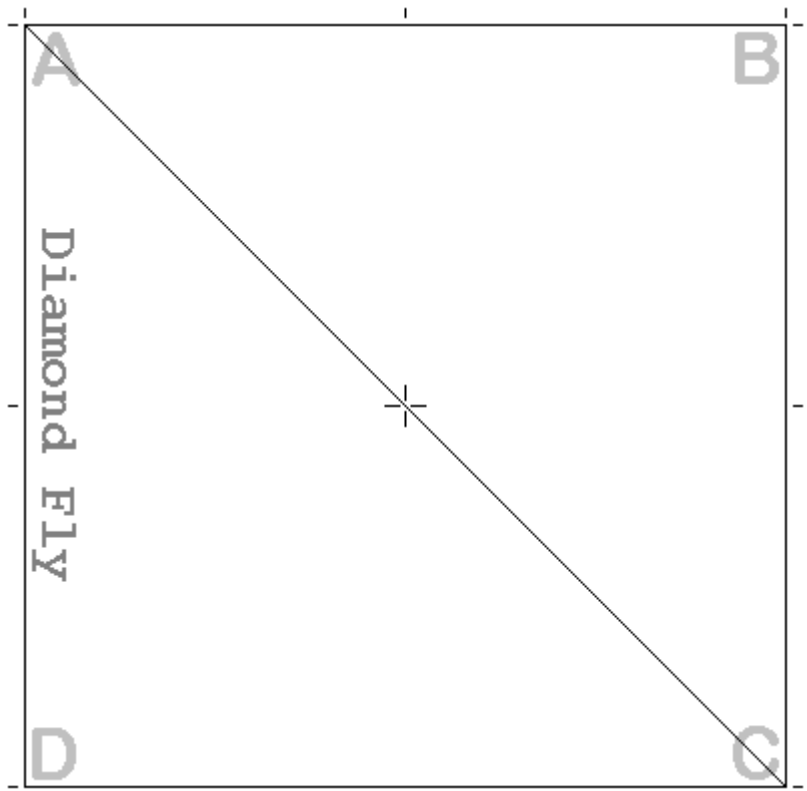

Support free corner in air on Lee side.

Mild weather only.

Dimensions depend on angle of main wall, but triangular groundsheet covers 50 square feet, Triangle base is 14.14, height is 7.07' high, other sides are 10' each.

**3. End for a 45° A-Frame.**

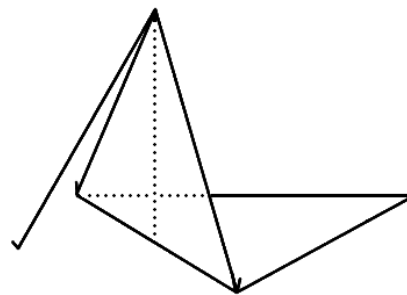

Creates an end with groundsheet for A-Frames made from a 20' tarp (or two 10' tarps), with walls at 45°.

May need reinforcing with guy-line and internal pole, depending on the situation and A-Frame VSS.

**4. Shade Sail.**

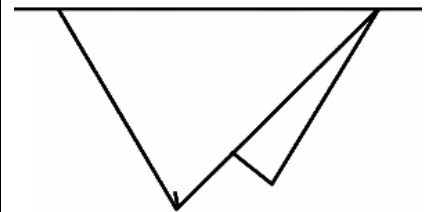

Support corners A and C in air.

Secure corners B and D to ground, on Windward and Lee sides.

Open and airy, and like the name implies, little more than a Shade Sail.

Size of shelter depends on wall angles.

Sheltered locations only.

**5. Combos.**

Two Diamond Flies can make a Rectangular tent (Holden) or a Floating Pyramid. Three can make an over sized Low Tetra.

An enclosed 'tent' with doors comes from using a Half Pyramid Fly or an Arrowhead Fly at the open end of the Diamond Fly.

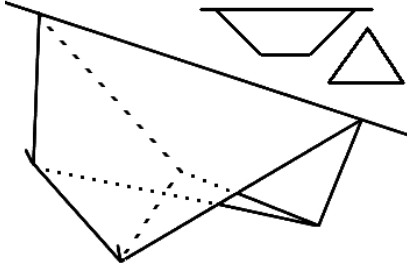
**Canvas Gunyah.**

Based on the traditional shelters built by the Indigenous Peoples of Australia.

Folds in corners B and D show the outermost third of triangles ABC and ACD.

To get the fold lines...

Fold tarp diagonally in half, running from corner A to corner C.

Then either...

A - Fold each half triangle into thirds, with fold lines parallel to the original diagonal fold at AC.

Or...

B - Fold tarp into nine equal squares. Then fold squares at corners B and D diagonally, parallel to the original diagonal fold at AC.

Bring tips of corners B and D together. Secure to ground.

Align triangles BEF and DGH as if they were opposite corners of a diagonally quartered square.

Secure corners B and D to ground, along with points E, F, G, and H

Sections BEF and DGH become partial groundsheets.

Support diagonal midline AC in air, directly above join of corners B and D.

A somewhat more stable version of the Shade Sail, but not by much.

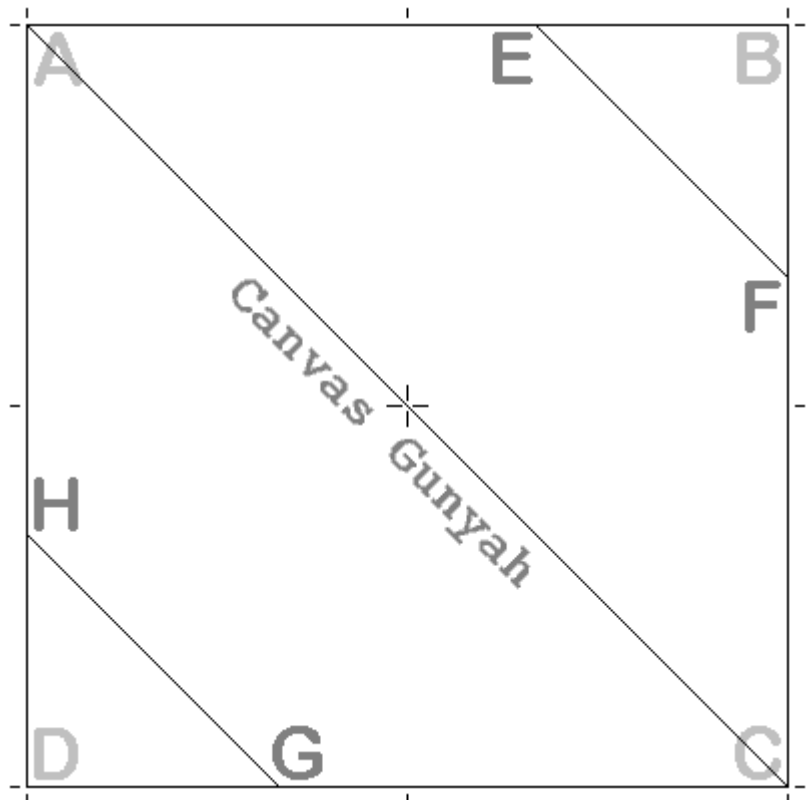

A 10' x 10' tarp gives a Canvas Gunyah with 60° walls, 4.08' high.

Floor space expands from 4.71' x 4.71' in the centre (4.71' x 9.42' in total overall).

A 10' x 10' tarp has a diagonal fold 14.14' long. EF and GH are 4.71' from the diagonal midline AC, or 2/3 the distance from corners B and D to diagonal AC.

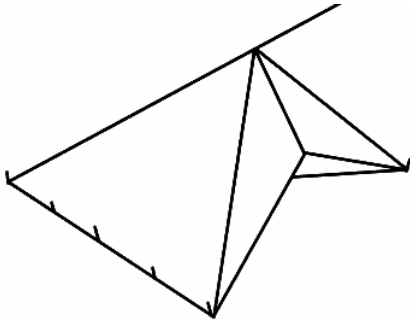
**Forrester.**

Fold tarp in half diagonally.

Use length of side AB or AD to find 'Cross-Folds' point G on diagonal midline AC.

Fold from corners B and D through 'Cross-Folds' point G to the tarp edge.

Fold angles at A and C are  $45^\circ$ , around D and B are  $67.5^\circ$  and  $22.5^\circ$ , at G are  $67.5^\circ$  and  $45^\circ$ .

Secure corner A to ground on Windward side.

Use rope or ridgepole to support 'Cross-Folds' point G, and midline fold AC in air on Lee side.

Spread triangles ABG and ADG to create walls.

When taut, secure corners B and D to ground.

Fold triangles CEG and CFG underneath triangles BEG and DFG to create partial walls from BEG and DFG that frame a low doorway.

When satisfied with doorway, secure folded cloth with Tarp Clips, lashings, pegs, etc.

Pull top of doorway where E meets F forward to make a better awning.

Width of shelter depends on wall angles, the amount of headroom, where 'Cross-Folds' point G is, and the arrangement of the doorway.

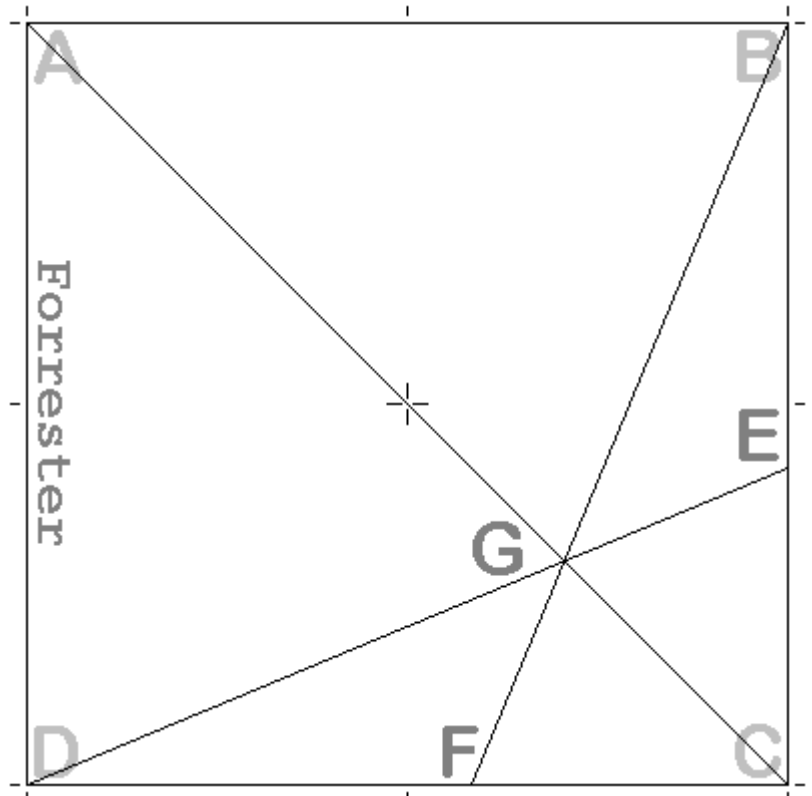

Good stability in windy conditions, IF set-up properly and staked out securely.

'Threshold' around entrance helps with weather control.

A 10' x 10' tarp gives a Forrester 5.41' high, floor space of 45.5 square feet, in a triangular shadow 8.40' high with 10.82' base.

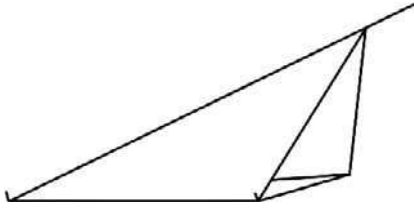
**1. Bivvy Bag (Cornet)**

Fold tarp in half diagonally, then swing edges AB and AD inwards in a circular arc until they touch the midline fold AC.

Secure 'Multi-Fold' corner A to ground, on Windward side.

Fold triangles ABE and ADF under at fold lines AE and AF to make doubled up groundsheets.

Secure groundsheets to ground, reinforcing fold lines AE and AF with taut ropes (inside shelter).

Support corner C in air on Lee side. Use taut rope or ridgepole to support midline AC.

A 10 x 10 Tarp may be tight for head and foot space. A 12 x 12 Tarp should be adequate.

Good stability in windy conditions, IF set-up properly and staked out securely.

'Awning' on Lee end helps with weather control. Rain trickles down rope/ridgepole, so tie some strings around it as 'drip lines'.

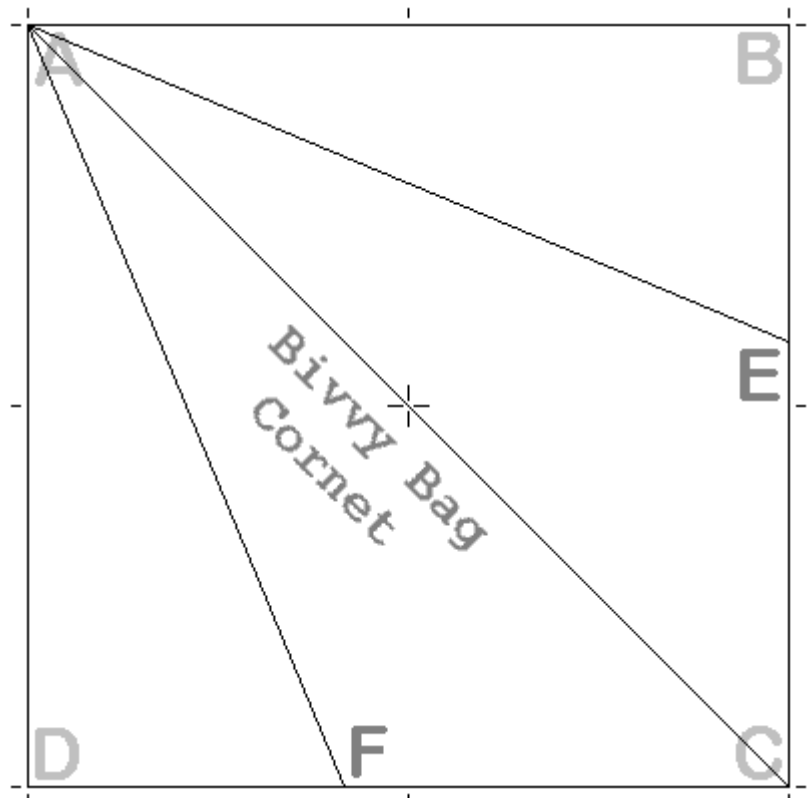
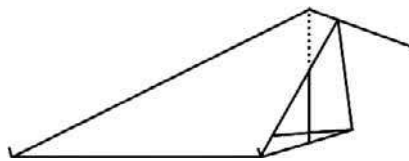
**2. Bivvy Bag (Hunchback)**

Pitch as per 'Cornet' variant of Bivvy Bag, but use a vertical blunt pole (or two internal poles in a modified 'shears') as main VSS support.

Place VSS pole over midpoint of where groundsheets cross.

Depending on fabric, a slight beak will form in the awning. Use a guy-line to keep this taut and aid weather control.

Making a slight 'tuck' in the fabric of the awning helps with the shape.

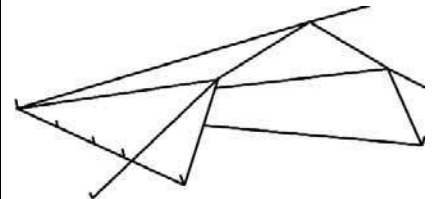
**3. Half Cone Fly.**

Secure 'Multi-Fold' corner A to ground, on Windward side.

Support corner C in air on Lee side. Use rope or ridgepole to support midline AC.

Stretch out and secure corners B and D.

Stretch out points E and F to get the wide opening shown, and secure with guy-lines to ground.

Stake down all along edges AB and AD for added stability in windy conditions.

Shelter size depends on angles of walls and roofline.

**Bivvy Bag.**  
(With Doorway Threshold)

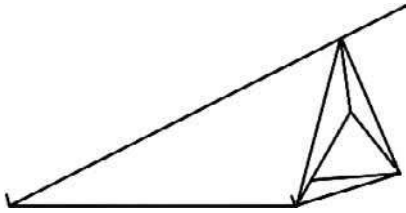

Fold tarp in half diagonally, then swing edges AB and AD inwards in a circular arc until they touch the midline fold AC.

Points F, G, and the Cross-Folds point I are a matter of trial and error, and are variable based on the size of the finished doorway and the extended 'awning'.

Secure corner A to ground on Windward side.

Fold triangles ABE and ADF under at fold lines AF and AE to make doubled up groundsheets.

Secure groundsheets to ground, reinforcing fold lines with taut ropes.

Support corner C in air on Lee side. Use rope or ridgepole to support midline AC.

Spread triangles AEI and AHI to create walls.

Fold CFI and CGI underneath EFI and GHI to create partial walls from EFI and GHI that frame a low doorway.

Sections CFI and CGI can fold back against AEI and AHI, to rest above rope running from corner A.

Pull top of doorway where F meets G forward to make a better awning.

The doorway threshold may be flush, or may project forward, depending on exactly where the fold Corners are.

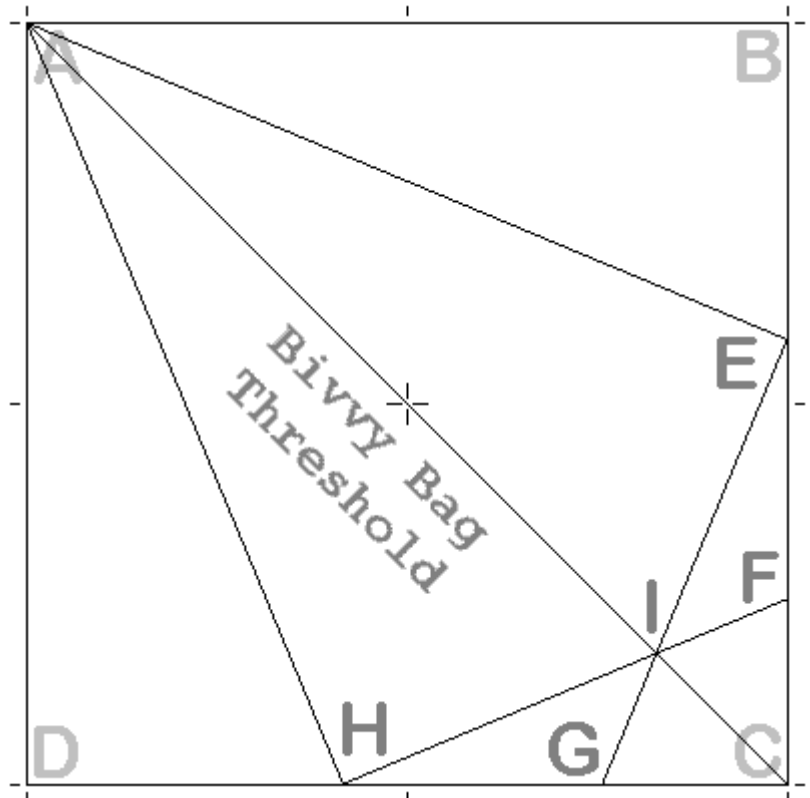

When satisfied with doorway, secure folded cloth with Tarp Clips, lashings, pegs, etc.

A 10' x 10' Tarp may be tight for head and foot space. A 12' x 12' Tarp should be adequate.

### 1. Half Pyramid Wedge Cover.

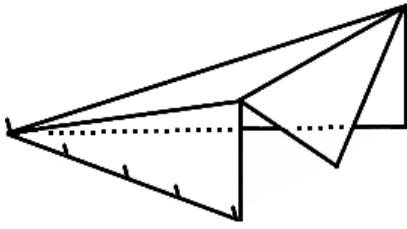

Fold tarp in half diagonally, then swing edges BC and CD inwards until they touch midline fold AC. This creates fold lines CE and CF at  $22.5^\circ$  to BC and CD, and angles of  $45.0^\circ$ , and  $67.5^\circ$  at points E and F.

Secure Corner C to ground on Windward side.

Support points E and F in air on Lee side.

Secure Corner D to ground directly below point F.

Secure Corner B directly to ground below point E.

Corner A on flap AEF should touch ground.

This is just the Half Pyramid used as a Semi-Walled Wedge type of wind shed.

A 10' x 10' tarp gives a Pyramid Wedge Cover 4.14' high, 10' long, 8.28' wide, with floor space of 41.4 square feet.

### 2. Half Pyramid Free End.

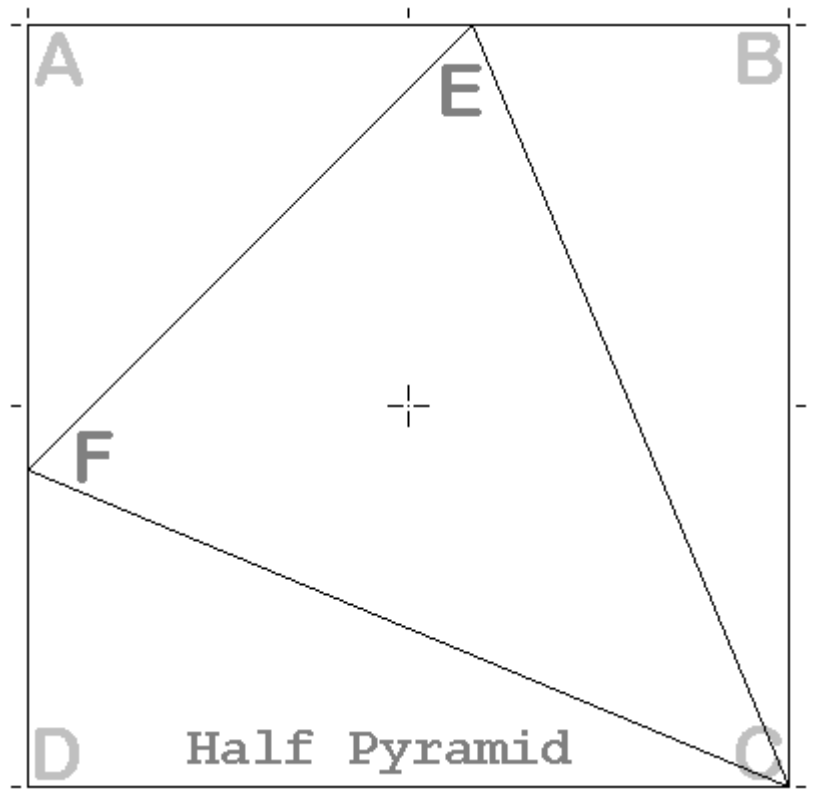
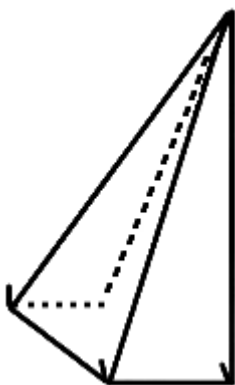

'Multi Fold' corner C is the peak. Large middle triangle CEF becomes the main wall. Two smaller long sided triangles BCE and CDF become door flaps. Triangle AEF becomes a partial groundsheet

If making a 'tent end' for an A-Frame or Diamond fly, support corner C in air from the same VSS as the other fly.

BE and DF should lie flat. If making a 'tent end', match with end corners of A-Frame fly.

Secure free corner B and D to ground.

Triangle AEF can fold underneath as a partial groundsheet.

Stretch points E and F out and secure to ground.

A 10' x 10' Tarp gives a Half Pyramid Free End 9.10' high, 8.28' wide, door flap 4.24 wide at base, and sloping sides of 10.82'.

### 3. Half Pyramid Combos.

Two Half Pyramids make a Pyramid Fly.

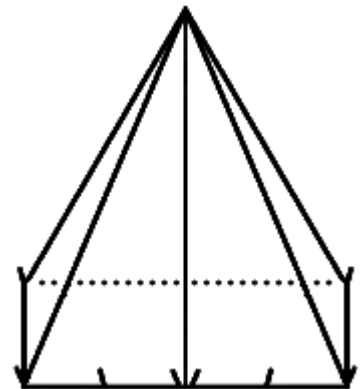

Three Half Pyramids make a Hexagonal Fly.

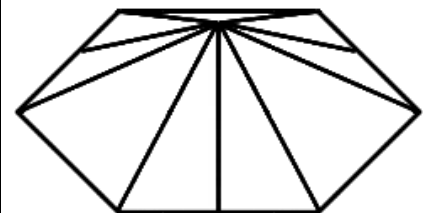

Hexagonal Fly is about 6.96' high, fits in a 16.56' diameter circle, with floor space about 178.11 square feet.

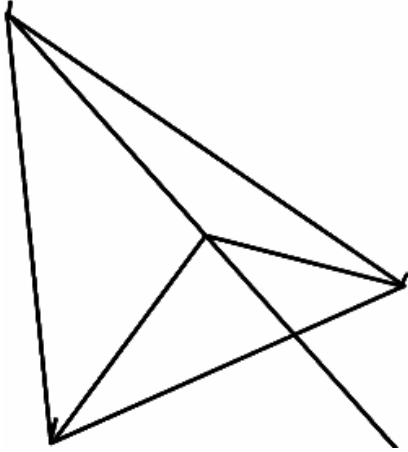
**1. Arrowhead.**

Fold tarp from corner A to midpoints of edges BC and CD.

This pattern needs a true 1:1 Square Tarp to work properly.

Secure corner A to ground on Windward side.

Arrange triangle AEF as groundsheet with points E and F on Lee side.

Run a rope from corner A up over groundsheet AEF.

Attach corners B and D to the rope, and lace any grommets along edges AB and AD to the rope.

Attach corner C to rope, at the same place as corners B and D.

Raise rope until shelter walls are taut.

A 10' x 10' tarp gives an Arrowhead 3.33' high, with floor space of 37.5 square feet in a shadow 10.6' long by 7.07' wide at the base.

Accessible from three sides, just undo the rope lashings.

More of a cover to protect gear from damp and muddy ground. The top join admits rain, unless sealed with waterproof tape.

The low profile helps with wind stability.

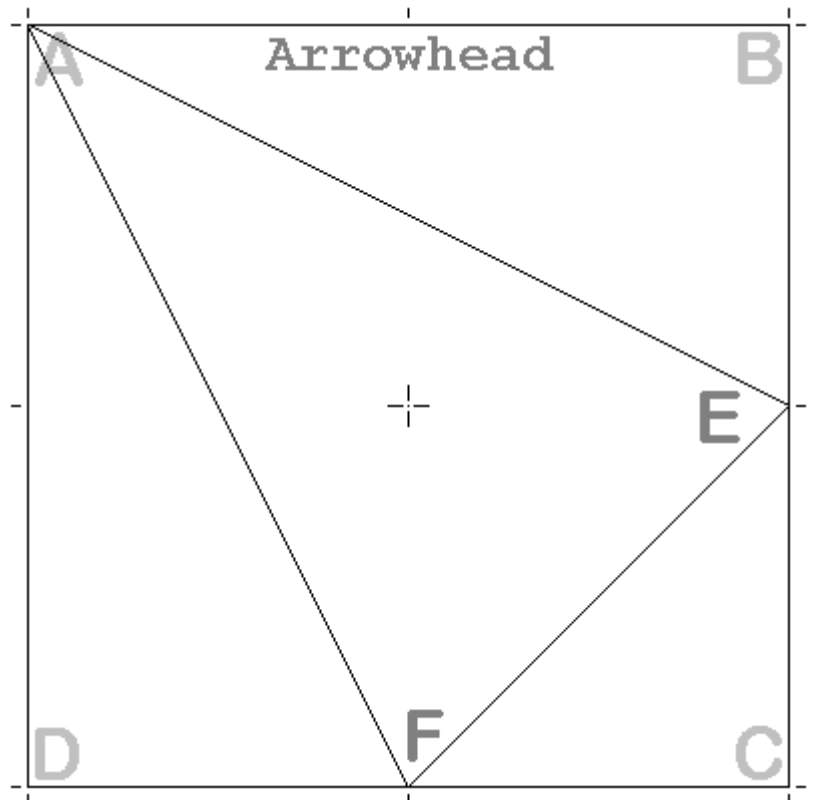
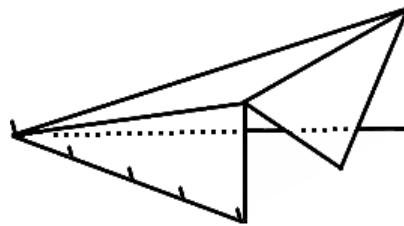
**2. Arrowhead Wedge Cover.**

A 10' x 10' tarp gives a Arrowhead Wedge Cover 5' high, 10' long, 7.07' wide, with floor space of 35.3 square feet.

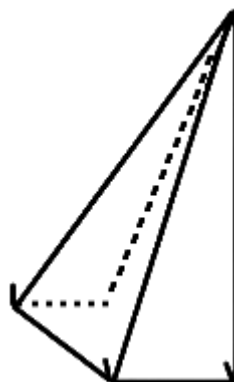
**3. Arrowhead Free End.**

If making a 'tent end' for an A-Frame or Diamond fly, support corner C in air from the same VSS as the other fly.

**4. Arrowhead Combos.**

Two Arrowheads make a Rectangular Pyramid Fly, front and back doors in walls 10' wide, side walls 7.071', wall edges 11.18', height 9.354', floor space 70.71 square feet.

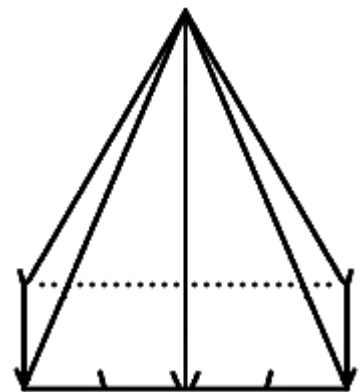

Three Arrowheads make a six-sided fly, one that is not quite Hexagonal.

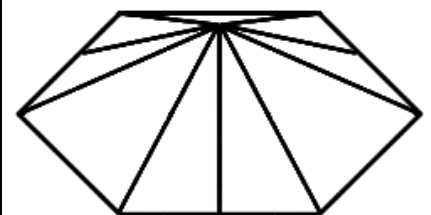

**1. Half Tetra Picnic Groundsheet.**

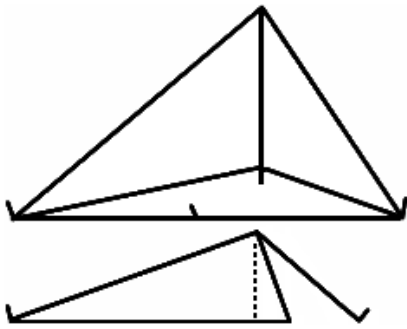

Fold tarp diagonally from midpoint of one edge to corners on opposite side.

ADE is a groundsheet, ABE and CDE are partial walls

Secure points of triangle ADE to ground, with apex E on Windward side.

Support corners B and C in air.

Secure any common grommets in edges BE and CE together, making a secure corner.

Minimal protection from weather - only use as a Picnic groundsheet.

Floor space is 50 square feet

**2. Half Tetra Wedge Cover.**

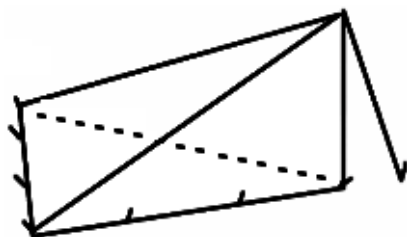

Secure edge AD to ground on Windward side.

Support point E in air on Lee side.

Secure corners B and C to ground beneath point E.

For greater stability, reinforce main wall of ADE with a pole or taut rope running from E to the middle of edge AD.

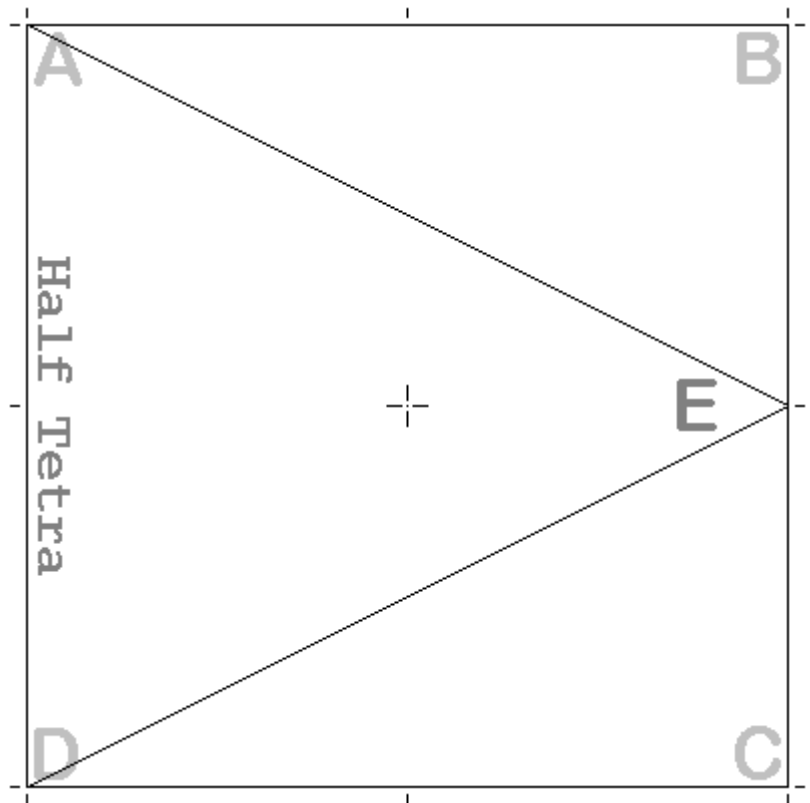

A 10' x 10' tarp gives a Half Tetra Wedge Cover 5' high, floor space of 43 square feet, triangular shadow 8.660' high and 10' base. Sloping sides are 11.180'.

**3. Half Tetra Free End.**

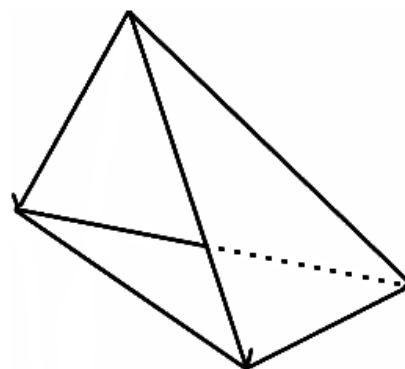

Secure Corner D to Lee side of VSS of an A-Frame

ADE is a main wall that seals off the end of the A-Frame, and CDE becomes a door flap.

ABE becomes a partial ground cloth under the door flap. The exact folding of ABE changes as required.

Use to give an A-Frame (Triangular Arch) made from a 10' x 20' tarp a 'tent end' with a door.

**4. Half Tetra Combos.**

Two Half Tetras can make a Closed Tetrahedra.

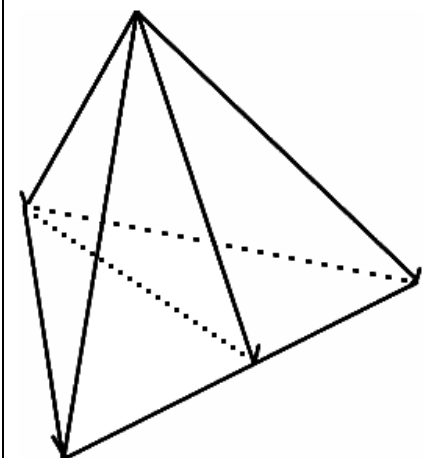

Two 10' x 10' tarps give a Closed Tetrahedra 8.660' high, floor space of 50 square feet in a triangular shadow 10' high, 10' wide base, with sloping sides of 11.180'.

Door flap edge, back wall, and groundsheet make an Equilateral triangle with 10' sides.

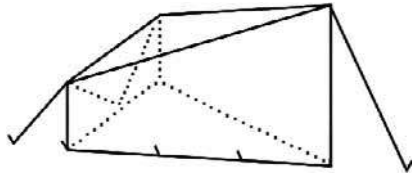

**Mountain Pod.**

Location of points E, G, H, I, J and K is subject to change.

In this example, they are in tarp corners A and D, and are corners of squares 2.5' to a side.

Secure edge HI to ground on the Windward side.

Fold corner square AEIJ diagonally, so point E is beside point I.

Secure point E to point I, to make AEIJ a doubled up triangular flap.

Fold corner square DGHK diagonally, so point G is beside point H.

Secure point G to point H, to make DGHK a doubled up triangular flap.

Secure point E to ground beside point I.

Secure point G to ground beside point H.

Support point F in air on the Lee side.

Stretch out corners B and C and secure to ground, as the apex of a triangle.

Position point F directly above secured points of B and C.

Raise point F until tarp is taut.

Raise points K and J until end of shelter is taut.

Wrap flaps AEIJ and DGHK around behind HIJK and secure to ground.

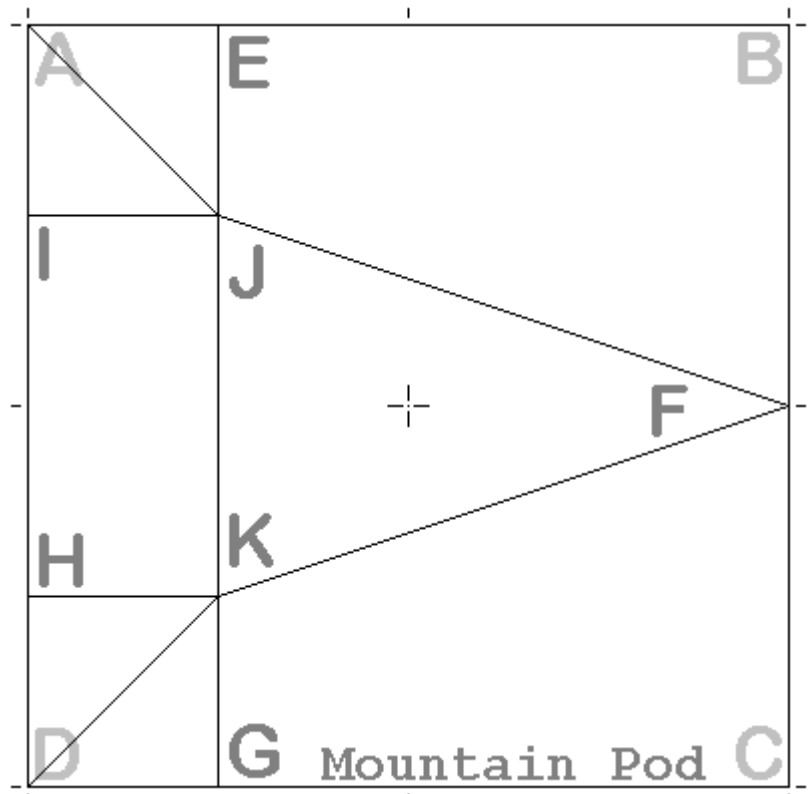

Use as a gear cover, or as shelter. Since the edge of the tarp touches the ground all around, there are stake down points all around the Mountain Pod.

With squares AEIJ and DGHK 2.5' a side, a 10' x 10' tarp gives a Mountain Pod approximately 2.5' to 5' high, 7.5' long, and from zero to 5' wide. Floor space is 18.75 square feet.

Unsure about the maths, so just be careful!

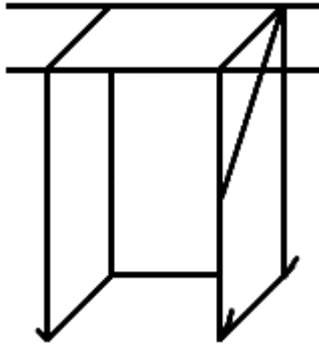
**Sentry Box.**

Create a Sentry Box, a shelter for a single standing person (or two in a pinch).

Location of points E, F, G, J, K, and L is subject to change - in this example, they are in tarp corners A and B, and are corners of squares, their sides being one-third of the tarp edge length.

Secure edge HI to ground on the Windward side.

Fold corner square AEJK diagonally, so point E is beside point J.

Secure point E to point J, to make AEJK a doubled up triangular flap.

Fold corner square BFGL diagonally, so point F is beside point G.

Secure point F to point G, to make BFGL a doubled up triangular flap.

Support points K and L in air directly above points H and I - use blunt ended VSS poles or tarp-clips and an overhead rope.

Align edges CH and DI at 90° to HI along ground.

Secure corners C and D to ground.

Support combined points E-J and F-L in air on Lee side.

Fold flaps AEJK and BFGL down outside the shelter, and secure corners A and B to side walls.

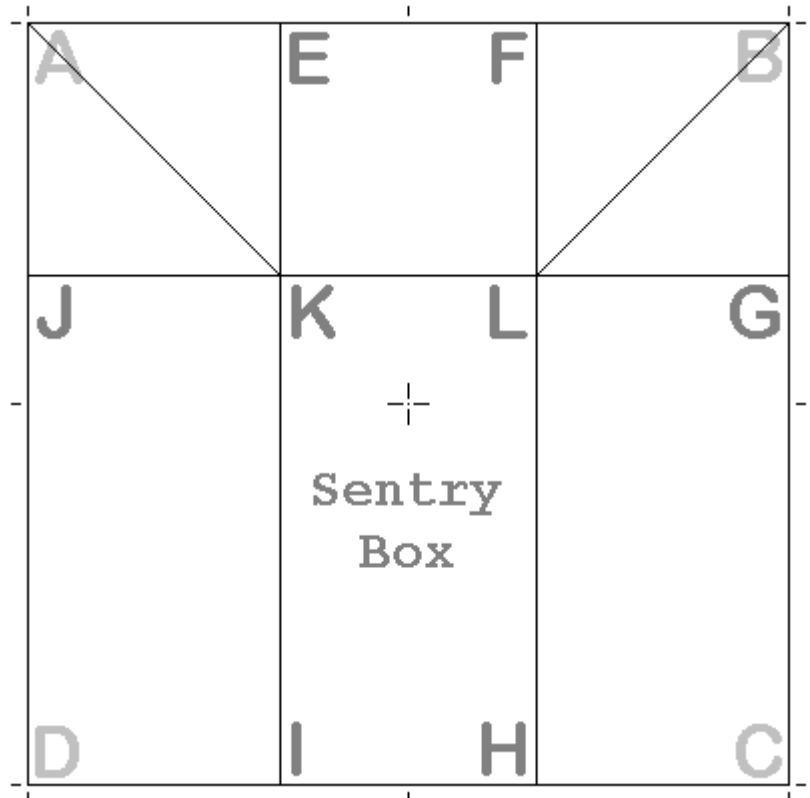

This 'squares up' corners, and reinforces roof and walls of the Sentry Box.

A 10' x 10' tarp gives a Sentry Box some 6.66' high, with 11.11 square feet of floor space in a rectangular shadow 3.33' wide by 3.33' deep.

As the sides of the corner squares decrease in size, the height of the structure will increase.

Using corner squares with sides 3' even, the shelter will be 7' tall, with 12 square feet of floor space in a rectangular shadow 4' wide by 3' deep.

Flaps AEJK and BFGL can make partial awnings on either side, as shown in the example below.

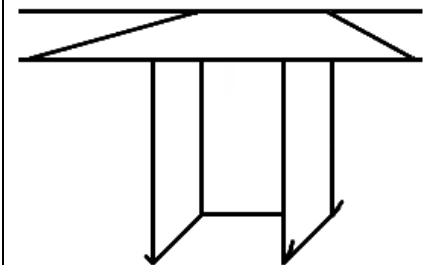

Note that the one rope line supports all the top edges on the Lee side, and that two 'parallel' ropes and tarp clips can provide all the VSS points necessary.

**1. Basic Groundsheet.**

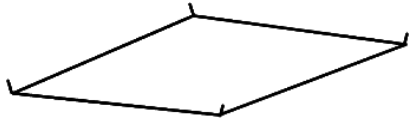

A 10' x 20' groundsheet gives 200 square feet of floor space.

**2. Basic Lean-To**

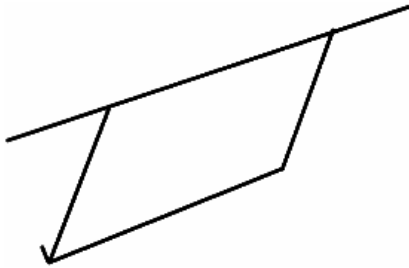

With LONG side on ground, and walls at...  
 ...30°, height of 5', shadow of 8.660' x 20'.  
 ...45° height of 7.071', shadow of 7.071' x 20'.  
 ...60° height of 8.660', shadow of 5' x 20'.

With SHORT side on ground, and walls at...  
 ...30° height of 10', shadow of 17.320' x 10'.  
 ...45° height of 14.142', shadow of 14.142' x 10'.  
 ...60° height of 17.320', shadow of 10' x 10'.

**3. Basic Fly.**

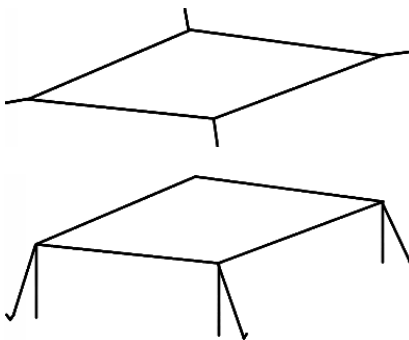

**4. Mushroom Fly.**

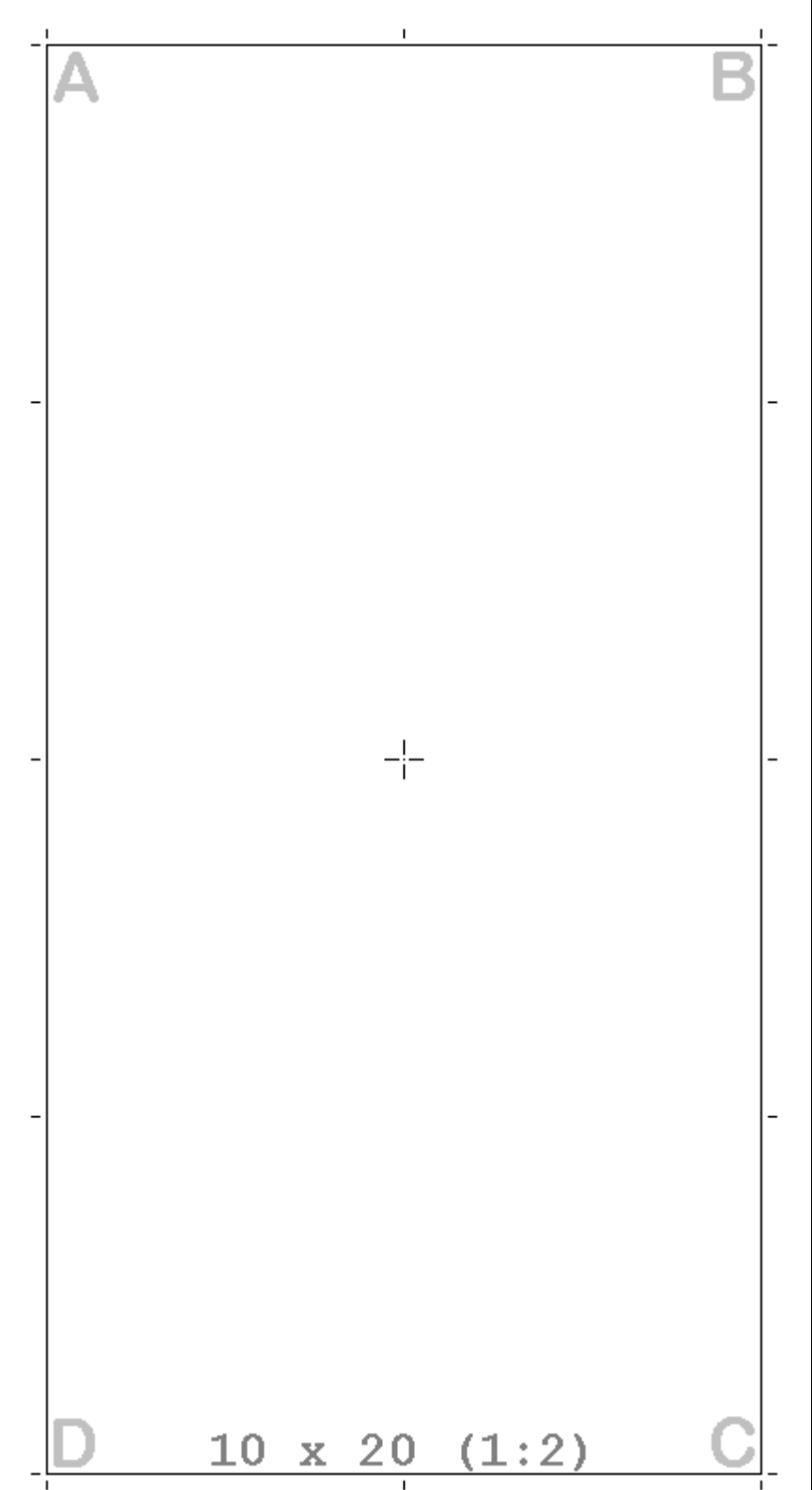
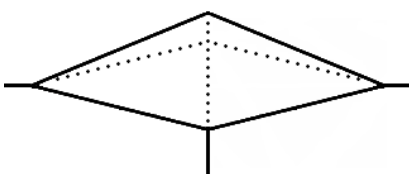

**5. Round Arch.**



A 10' x 20' tarp gives a Round Arch 12.727' wide, 6.363' high when using the 20' side for curve.

A 10' x 20' tarp gives a Round Arch 6.363' wide, 3.181' high when using the 10' side for curve.

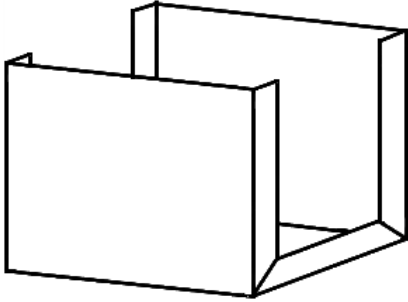
**Tub Floor with End Walls.**

Turn a Basic Groundsheet into a Tub Floor with Wall by folding the sides into walls.

This is an adaptation of the procedure used for the Tub Floor with Wall.

In this example, the mud walls are some six inches (15 cm) high all along the edges shown.

The end walls are 5' high, the useable floor space is 90 Square Feet (the mud walls take off half a foot on each side of the floor).

The top edge of the wall can be twisted back to a straight edge if need be.

Used in conjunction with another shelter like a Square Stall, etc, it creates a shelter more like the 'box space' of a traditional room.

Useful for weather control, storage of boxed items, setting up an 'office', or to create a comforting illusion of a 'normal' room.

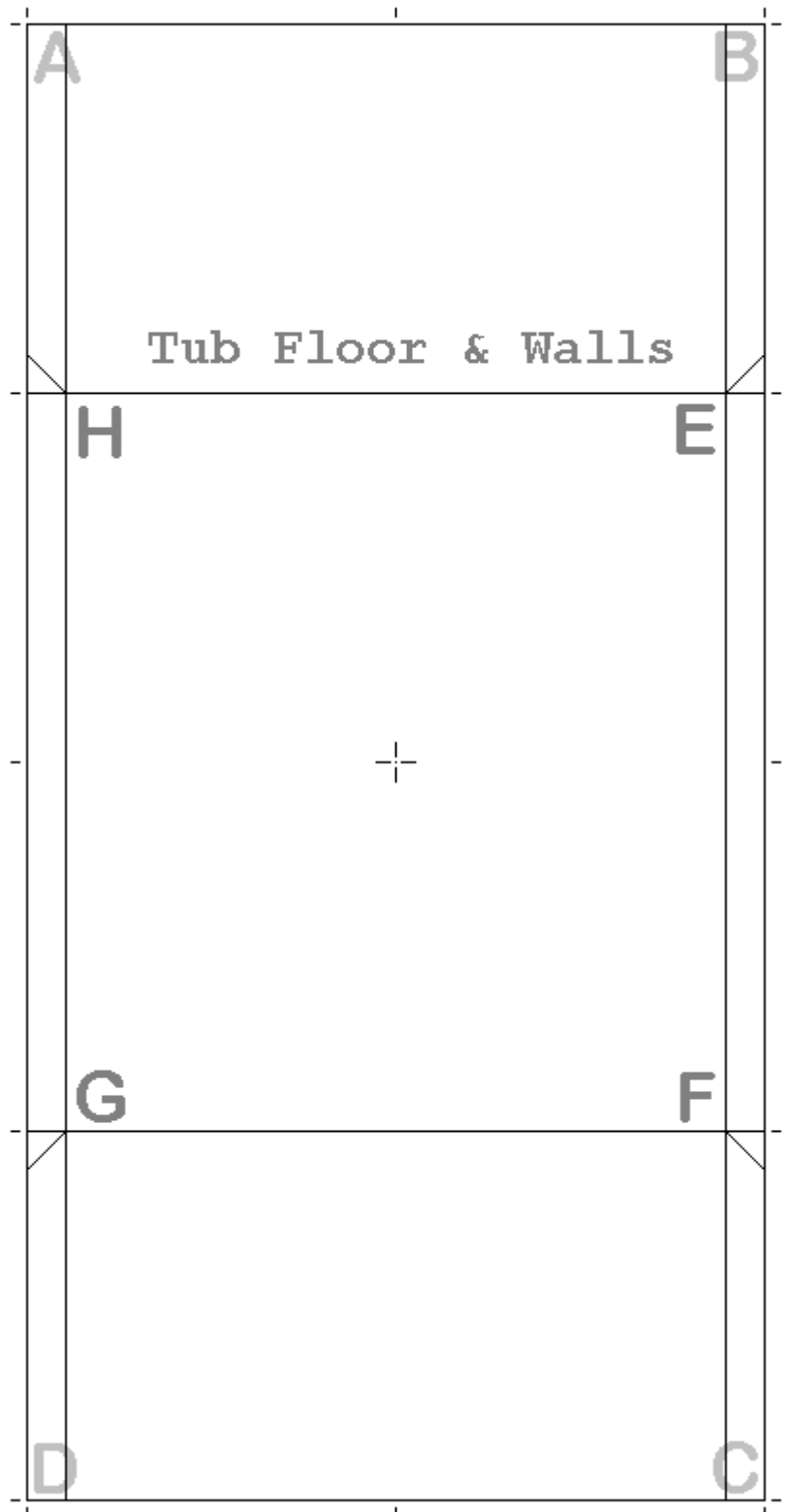

1. A-Frame.

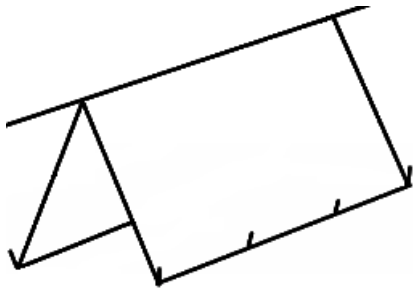

A 10' x 20' tarp gives an A-Frame with walls at...

...30° height is 2.5', shadow is 8.660' x 20'.

At 45° height is 3.535', shadow is 7.071' x 20'.

At 60° height is 4.330', shadow is 5' x 20'.

2. Dining Fly.

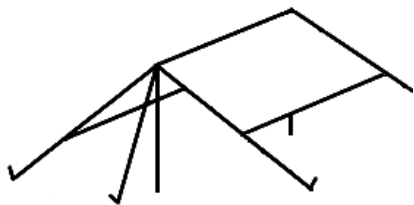

3. Fold Over Wind Shed.

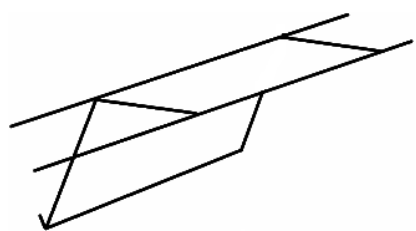
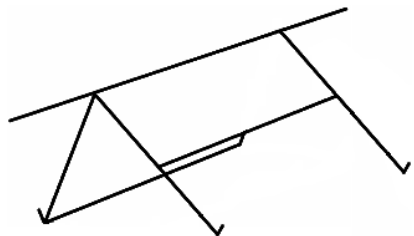

4. Rectangular Stall.

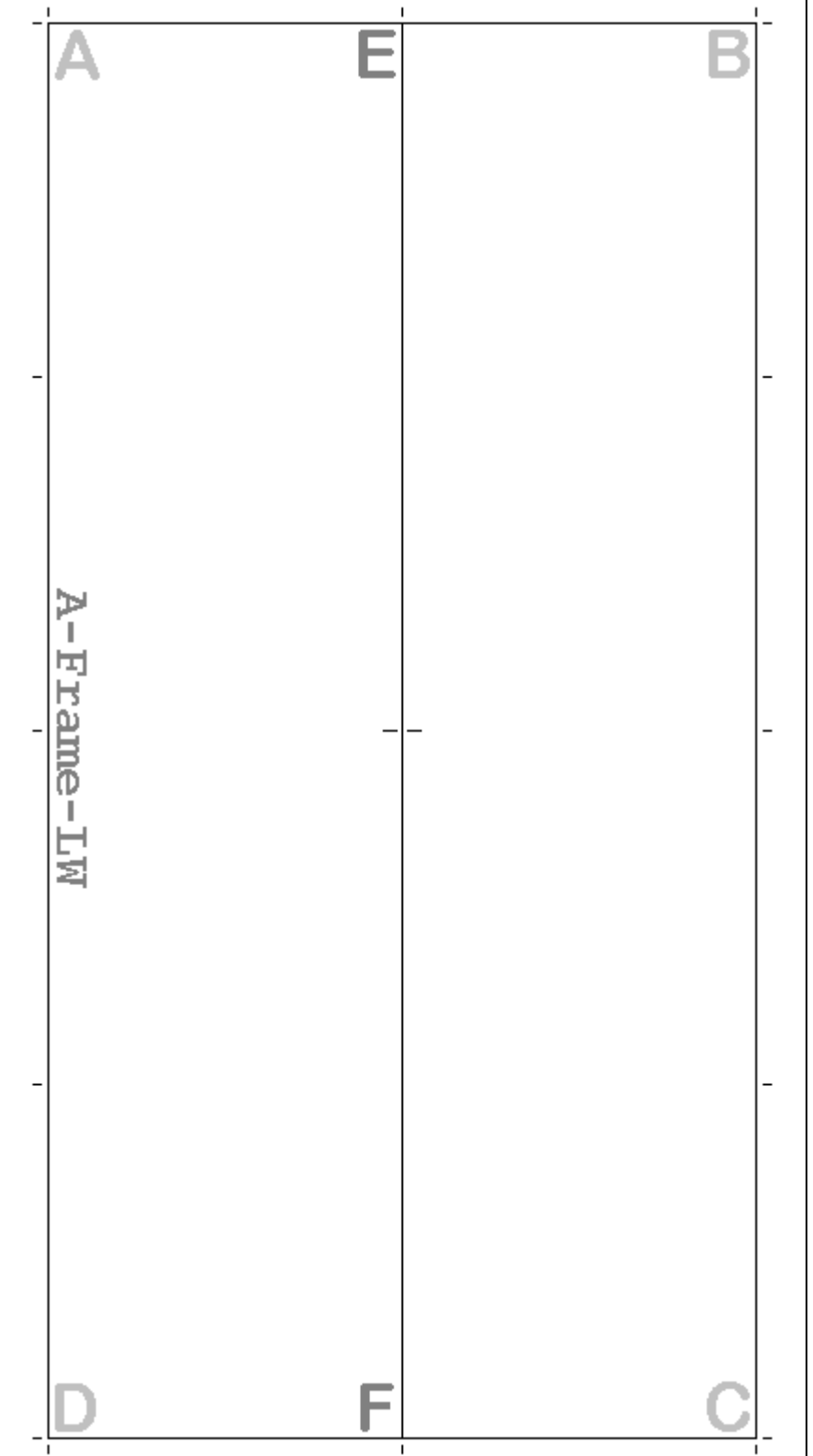
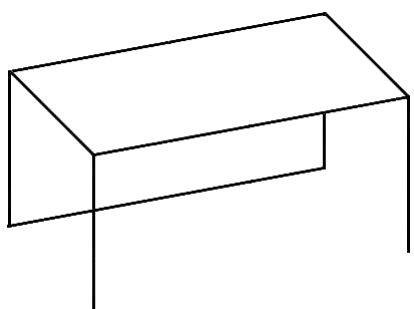

5. Double Wall Lean-To.

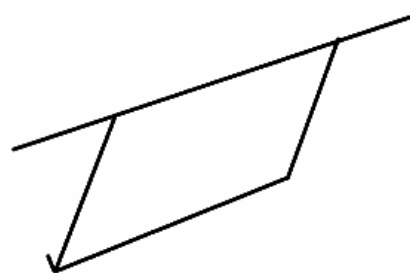

6. Envelope.

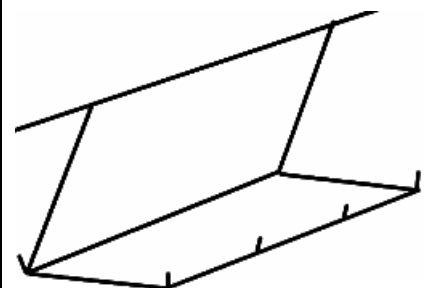

1. A-Frame.

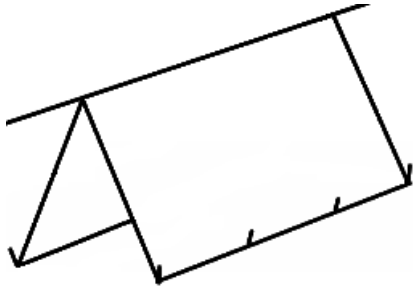

A 10' x 20' Tarp gives an A-Frame with walls at...

...30° height of 5', shadow of 17.320' x 10'.

...45° height of 7.071', shadow of 14.142' x 10'.

...60° height of 8.660', shadow of 10' x 10'.

2. Dining Fly.

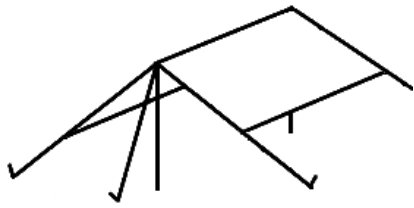

3. Fold Over Wind Shed.

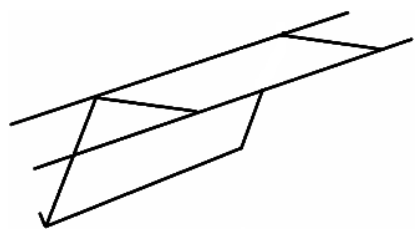
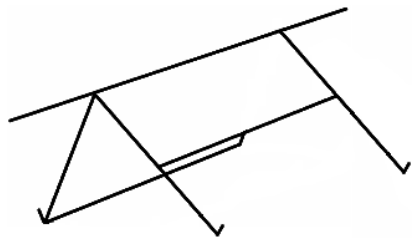

4. Square Stall.

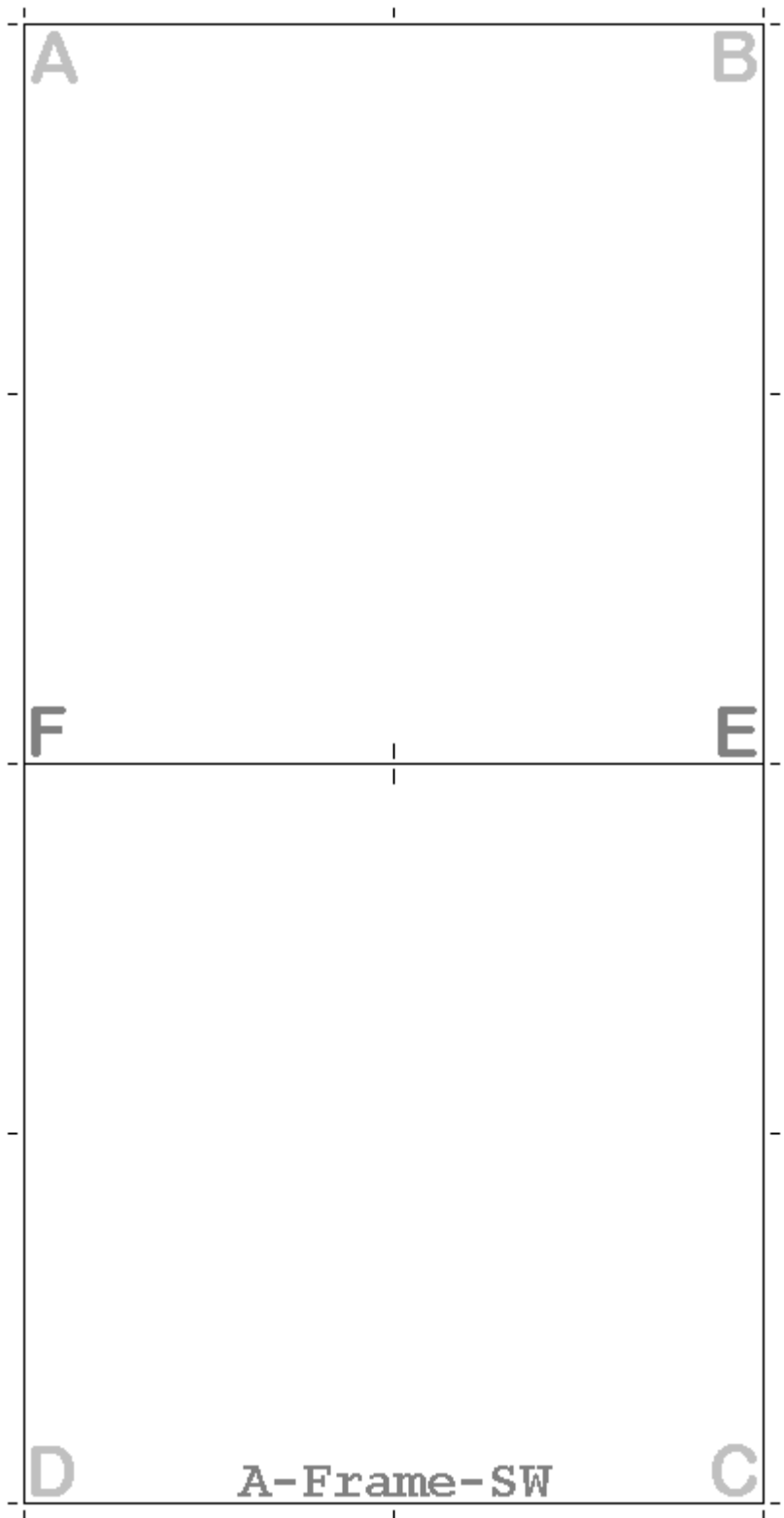
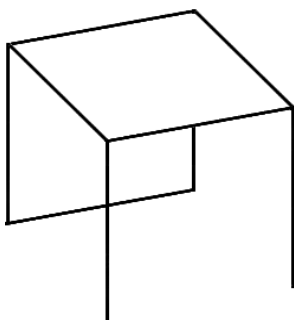

5. Double Wall Lean-To.

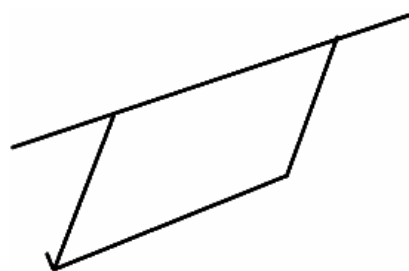

6. Envelope.

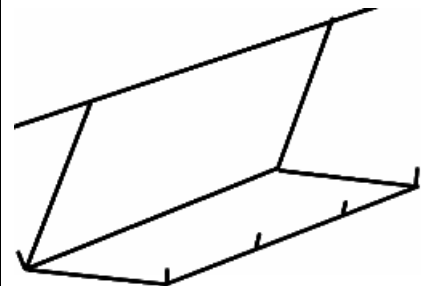

**1. C-Fly**  
(Over & Under Wind Shed)

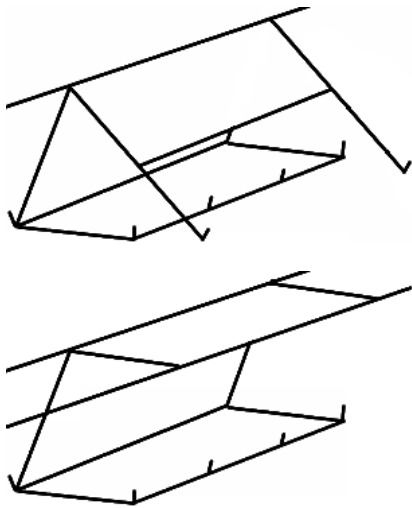

Fold Tarp in thirds.

**2. Floored Stall.**

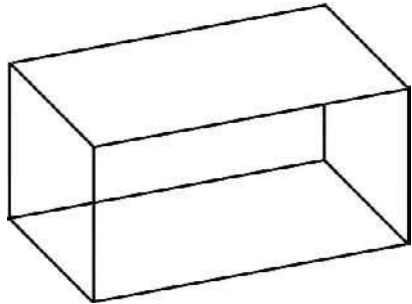

**3. Tube Fly with Full Groundsheet.**

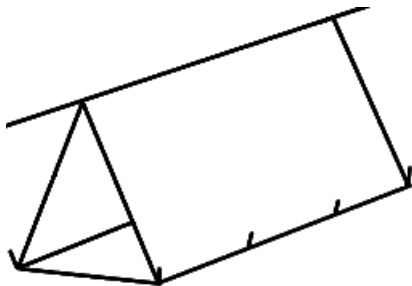

A 10' x 20' Tarp gives a Basic Tube Fly with 60° walls, 5.773' high, shadow of 10' x 6.666'.

**4. Square Arch.**

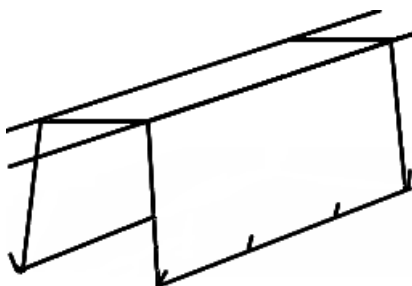

**5. Open Stall.**

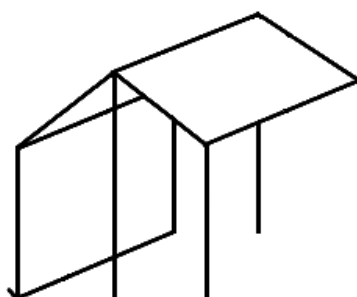

**6. Convention Booth.**

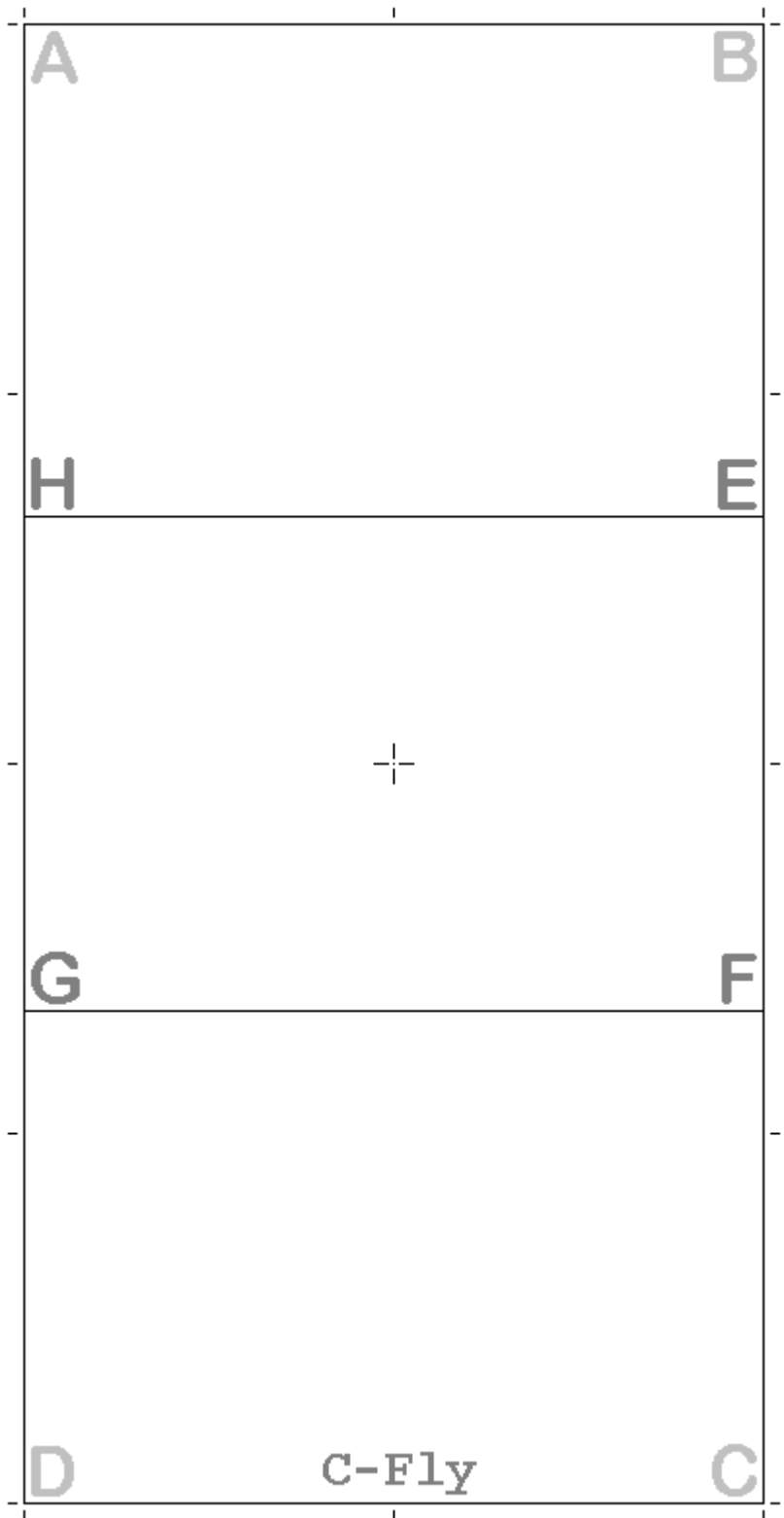
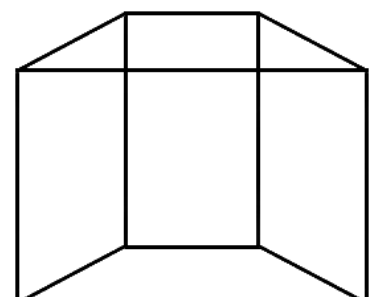

**1. Walled Fly.**

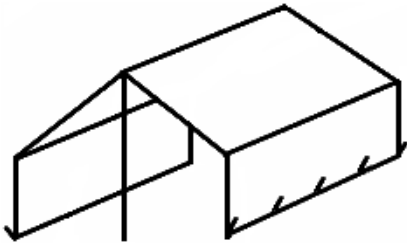

Fold tarp in half. Fold each half into thirds with fold lines parallel to half fold line.

Rectangles at either end of tarp are the end-third of each Half. In real life, the size of the ends varies as required.

Secure edge AB to ground on Windward side.

Support EJ, FI, and GH in air on Lee side, keeping edge FI higher than EJ and GH.

Adjust width between EJ, FI, and GH to suit.

Secure CD to ground

A 10' x 20' tarp gives a Walled Fly with roof slopes of 45°, side walls 3.333' high, 8.047' high at roof peak, rectangular shadow of 9.428' x 10'.

**2. Tube Fly with Split Groundsheet.**

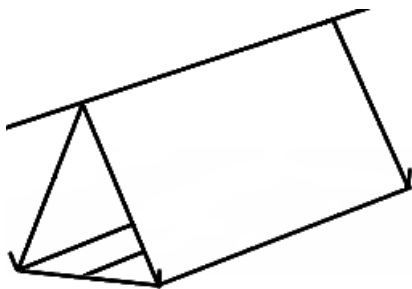

A 10' x 20' Tarp gives a Tube Fly with 60° walls, 5.773' high, with floor space of 66.666' square feet in a rectangular shadow 10' x 6.666'.

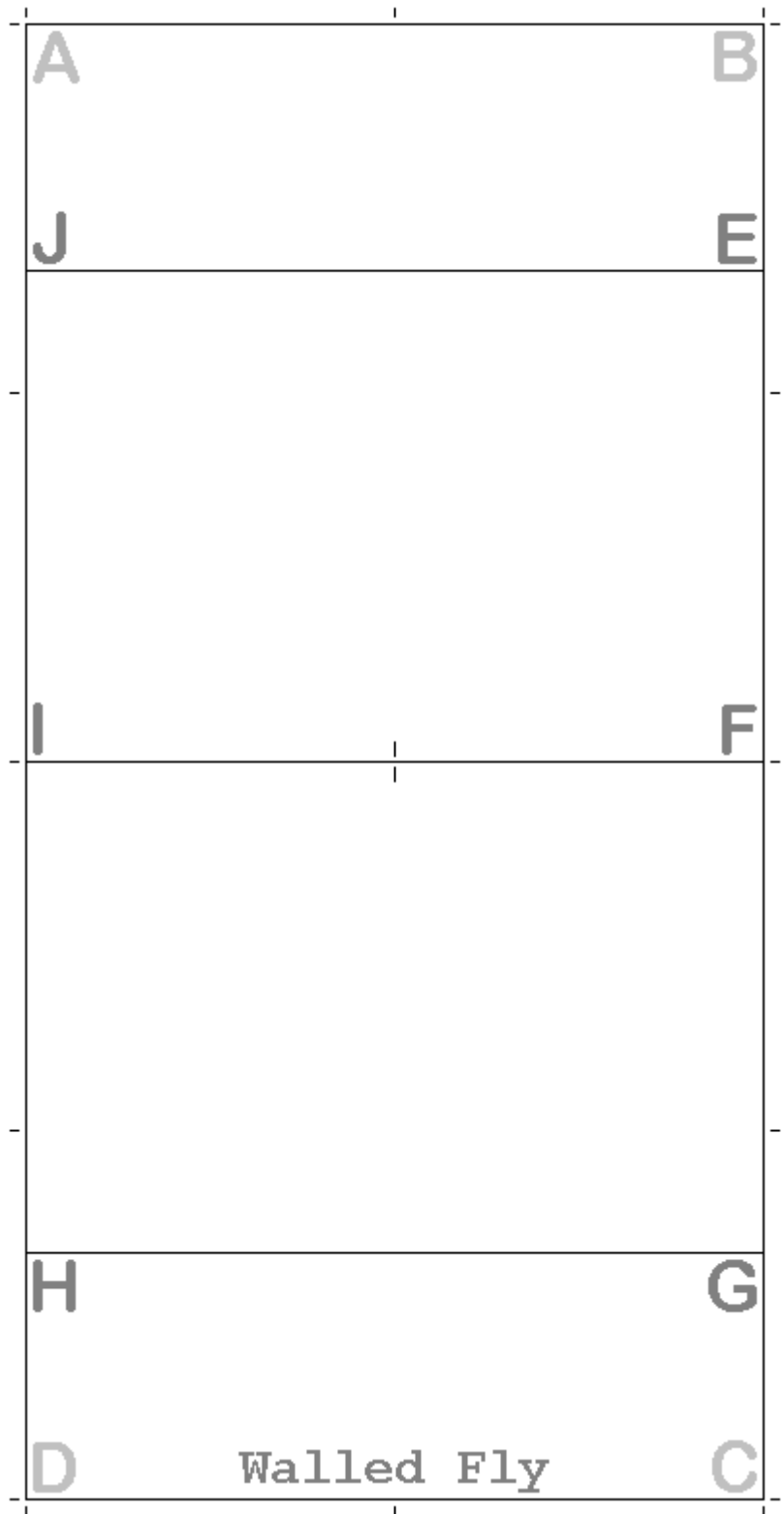

**3. Combo Fly.**

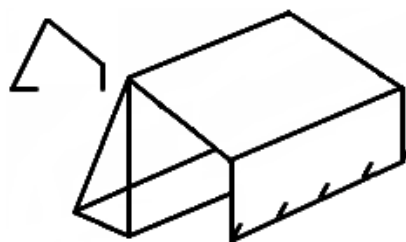

Set up with Tube Fly half on Windward side.

Half and Half combination of the Walled Fly and the Tube Fly with Split Groundsheet.



**1. Boxed Arch.** (Square Arch with groundsheet)

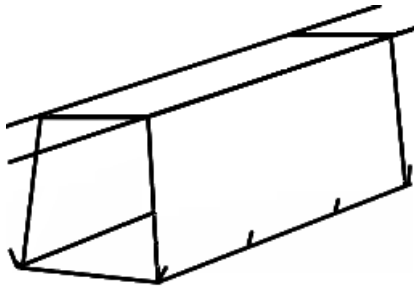

90° walls, 5' high, 5' wide, and 10' long.

**2. Tube Fly with Doubled Up Groundsheet.**

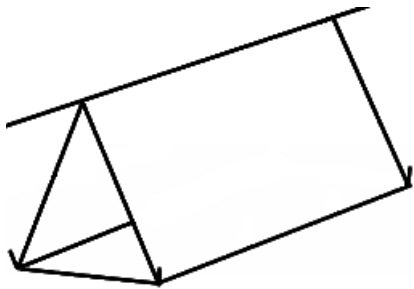

60° walls, 4.330' high, floor space of 10' x 5'.

**3. Privacy Stall**  
(Shower, Toilet, etc)

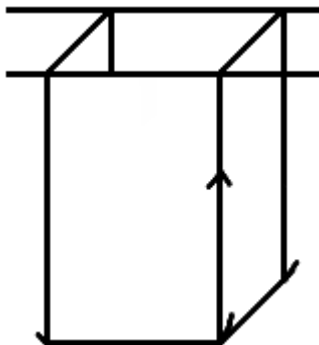

Either secure top of door edge to top of wall and just lift flap, or reinforce door top and edges with sticks and wire for a swinging door.

**4. Enclosed Stall.**

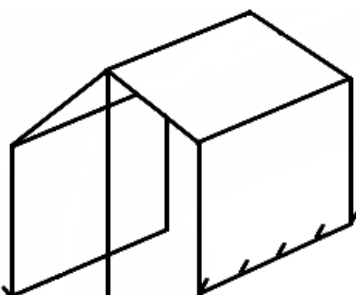

**5. Semi-Floored Stall.**

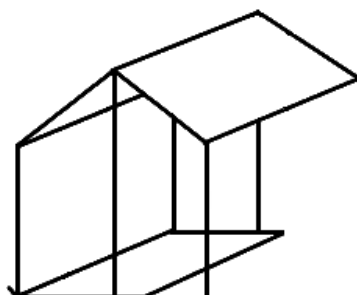

**6. Hanger.**

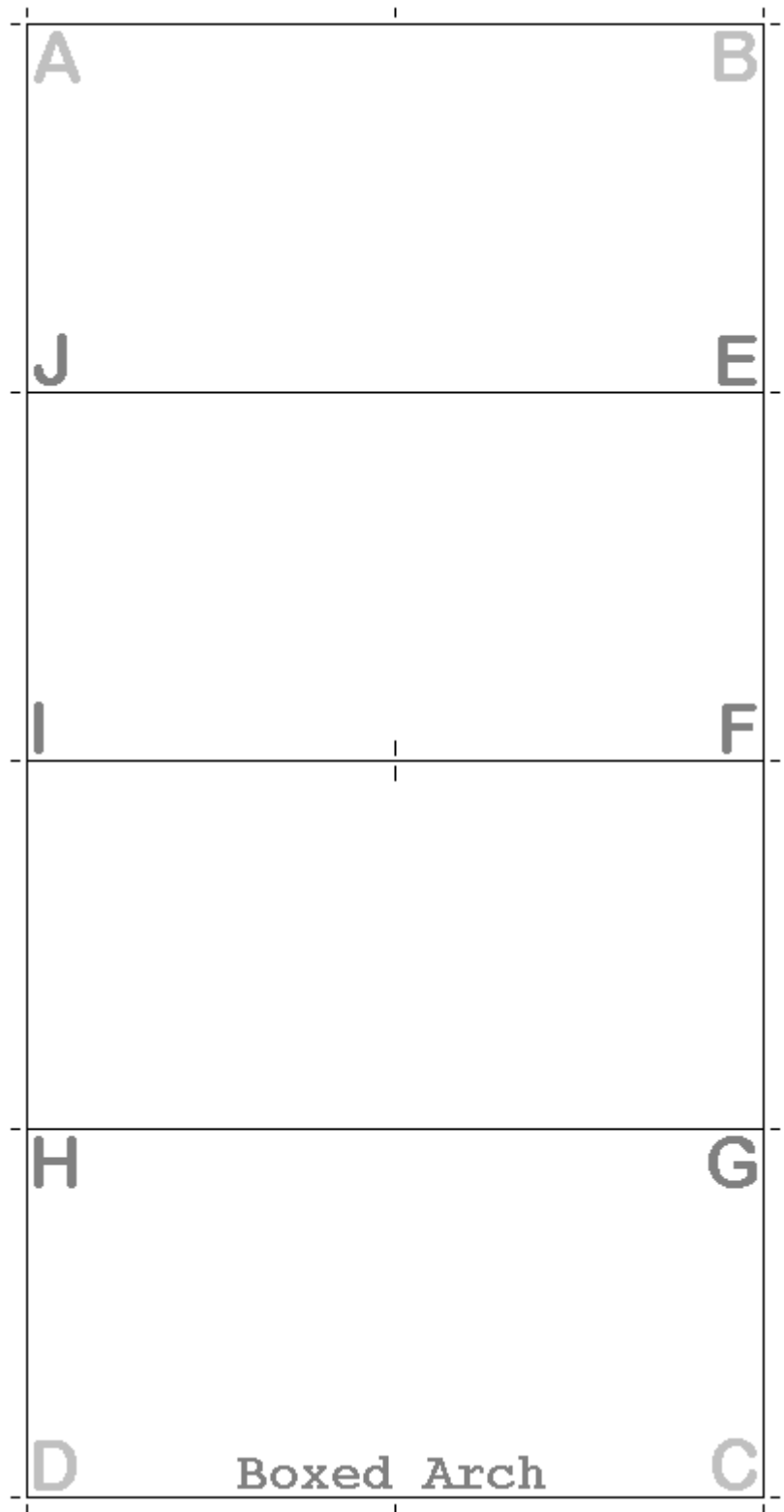
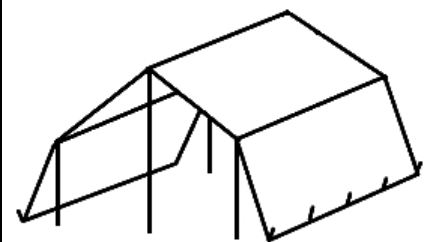

**Changing Room.**

(Shower, Toilet, etc)

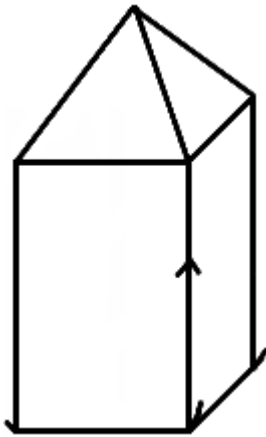

Align edge AB next to CD and secure grommets so that they form one edge.

Align points A-D, N, O, and P on ground in a square 5' per side, with A-D on the Lee side.

Align points F, H, J, and L and secure them into the one point.

Fold up triangles BEF, FGQ, GHQ, HIR, IJR, JKS, KLS, and CLM, 'bellows style' outside of the shelter. Secure relevant points to make them doubled-up flaps.

NOTE - Illustration shows a Changing Room with spare roofing material folded up INSIDE.

Support point F-H-J-L in air some 9.267' feet above ground.

Either reinforce square shape at EMQRS with ridgepoles or sticks, or run ropes out from points E-M, Q, R, and S to pull tarp into shape.

Unlash corners A and D, then secure corner D to ground.

Enter via opening between edges AE and DM - a simple lash will do for a door lock.

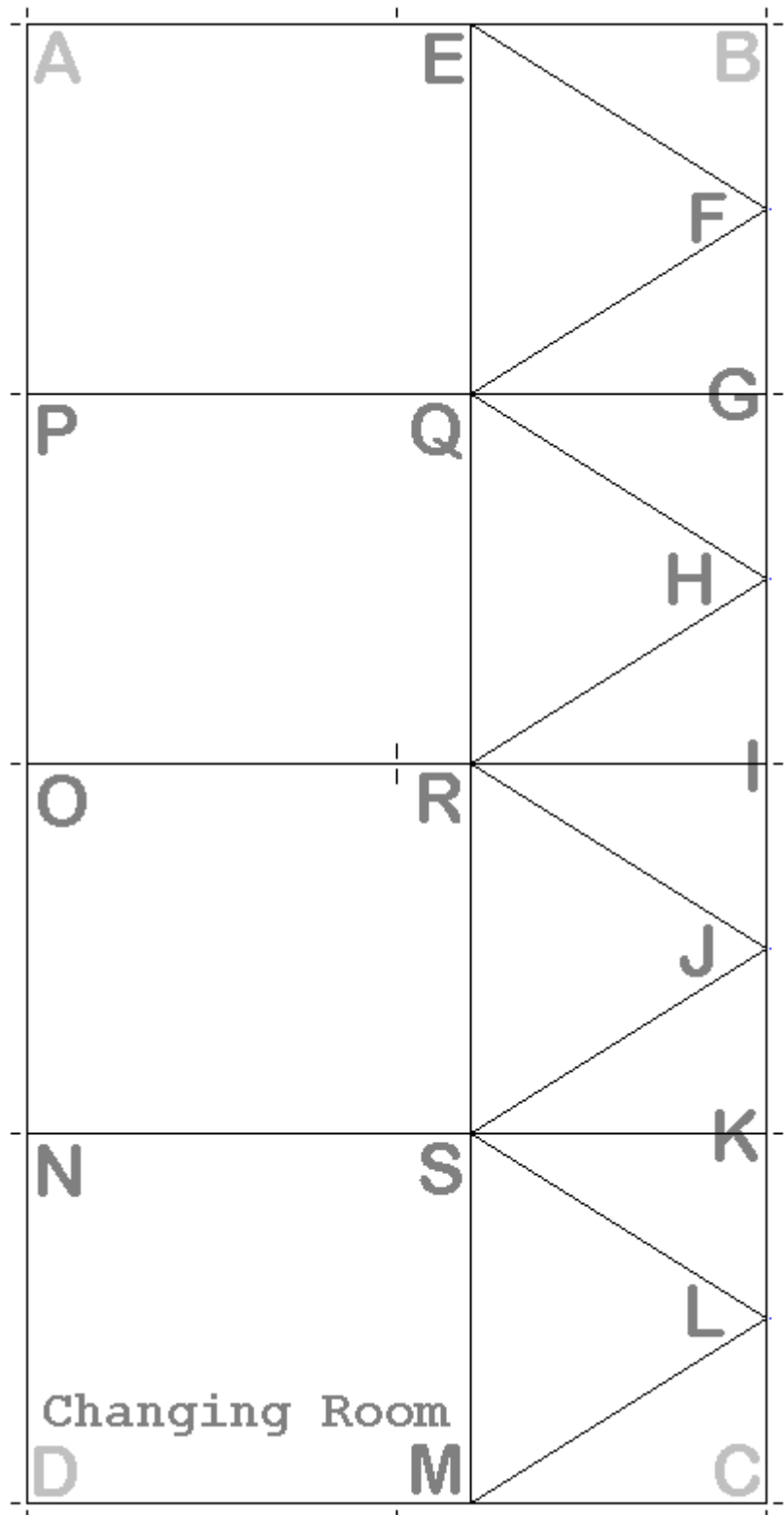

A 10' x 20' tarp gives a Changing Room 9.122' high, door flap AE is 6' high, pyramid roof cap is 3.122' high.

Floor space is 25 square feet in a square with 5' sides.

Suspend a rope down through the top of the pyramid cap, a hook or pulley at the end allows use of a shower bag.

Note if angles at F, H, J, L are 90°, then the roof top is flat.

**Pavilion.**

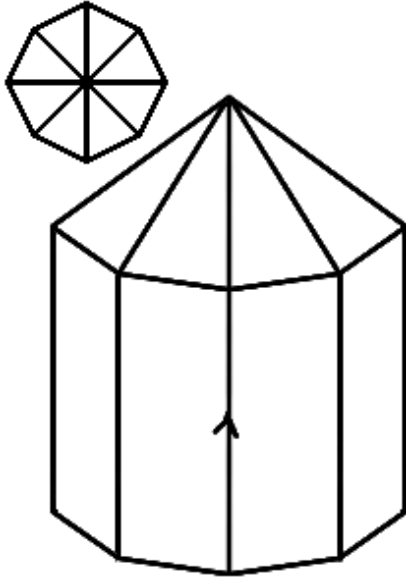

Creates an 8-sided or Octagonal Pavilion.

Most of the points on the folding plan are unnamed due to size constraints.

The roof folding is similar to that of the Changing Room, but with 8 pieces of spare cloth folding up bellows style.

Illustration shows a Pavilion with spare roofing material folded up INSIDE.

Internal folding of spare cloth allows rain to seep inside. External folding of spare cloth helps prevent rain entering, although the external cloth folds will catch the wind.

The lower that the folding for the roof slope starts, the greater the angle of the roof slope. The higher up that the roof slope starts, the less angular the roof slope becomes.

Tarp Clips and Guy-lines will 'round off' base edges of the roof slope, as will a Dome tent pole if tied in a circle.

If using a Dome tent pole, hang it from the central VSS that supports the shelter.

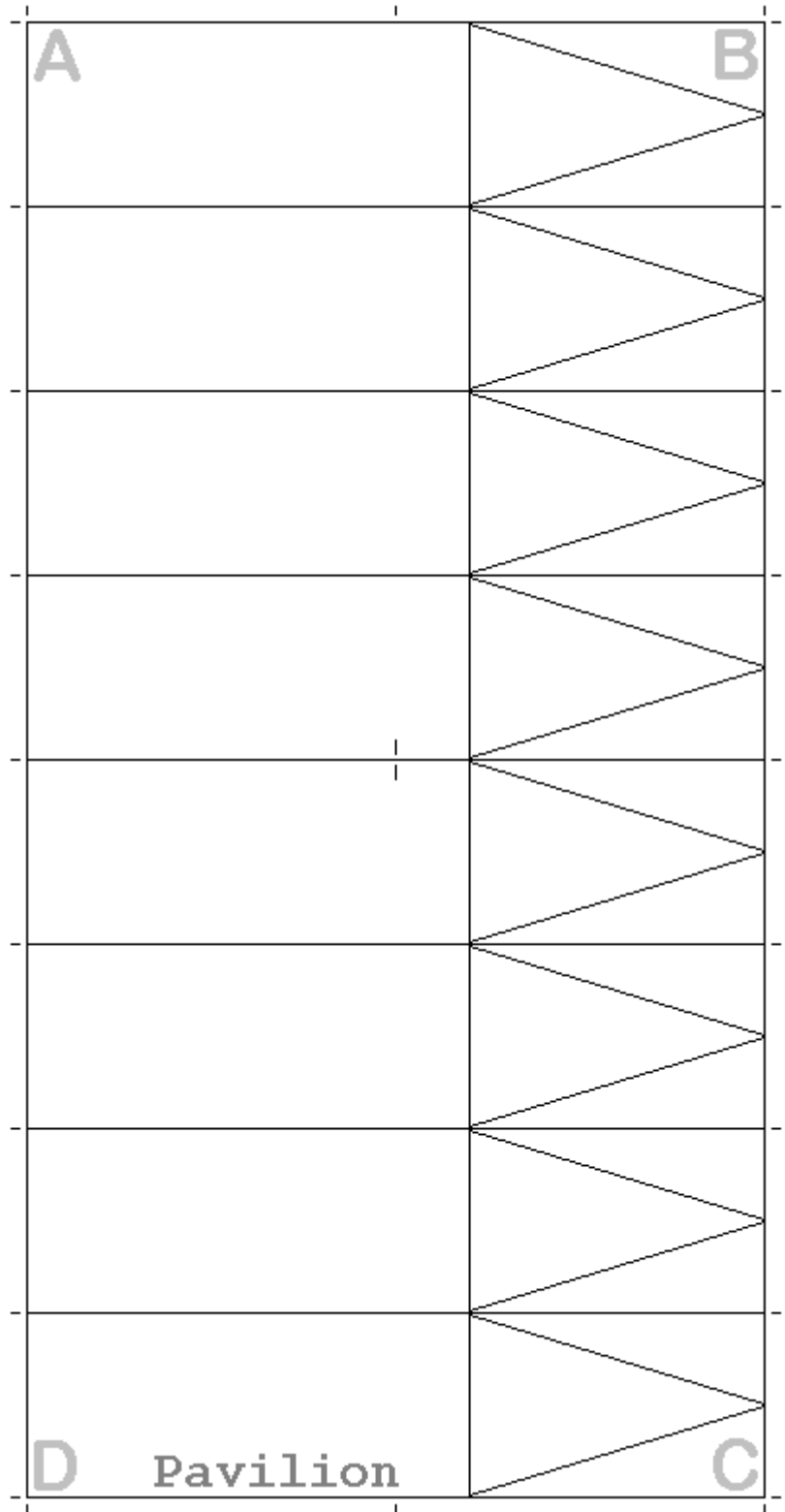

Warning - Eight points of the octagon lie on a circle 6.53' in diameter - this is a circumference of 20.5' instead of 20'.

Difference is because a straight line is shorter than a curved line between two points.

A 10' x 20' tarp gives a Pavilion 8.2625' high, of which 6' is the main walls, with sloping roof some 2.625' high.

Floor space for the octagon is 30.177 square feet, for a circle is 31.818 square feet.

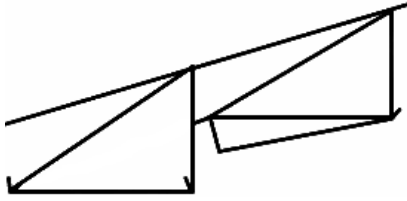
**Baker's Wind Shed.**

Fold tarp at end quarter marks, and then fold each end-quarter diagonally.

Secure edge GH to ground on Windward side. This becomes the base of main rectangular wall EFGH.

Align BH and CG on the Lee side at  $90^\circ$  with GH.

Secure corners B and C to ground.

Support Top edge EF in air on Lee side, with points E and F directly above points B and C.

Secure corners A and D of groundsheets ABH and CDG to ground. They may be either inside or outside the shelter.

A 10' x 20' tarp gives a Baker's Wind Shed with wall slope of about  $26^\circ$ , height of 4.472', total floor space of 89.44 square feet in a rectangular shadow of 8.944' x 10'. Length of edges CG and BH is 11.180'.

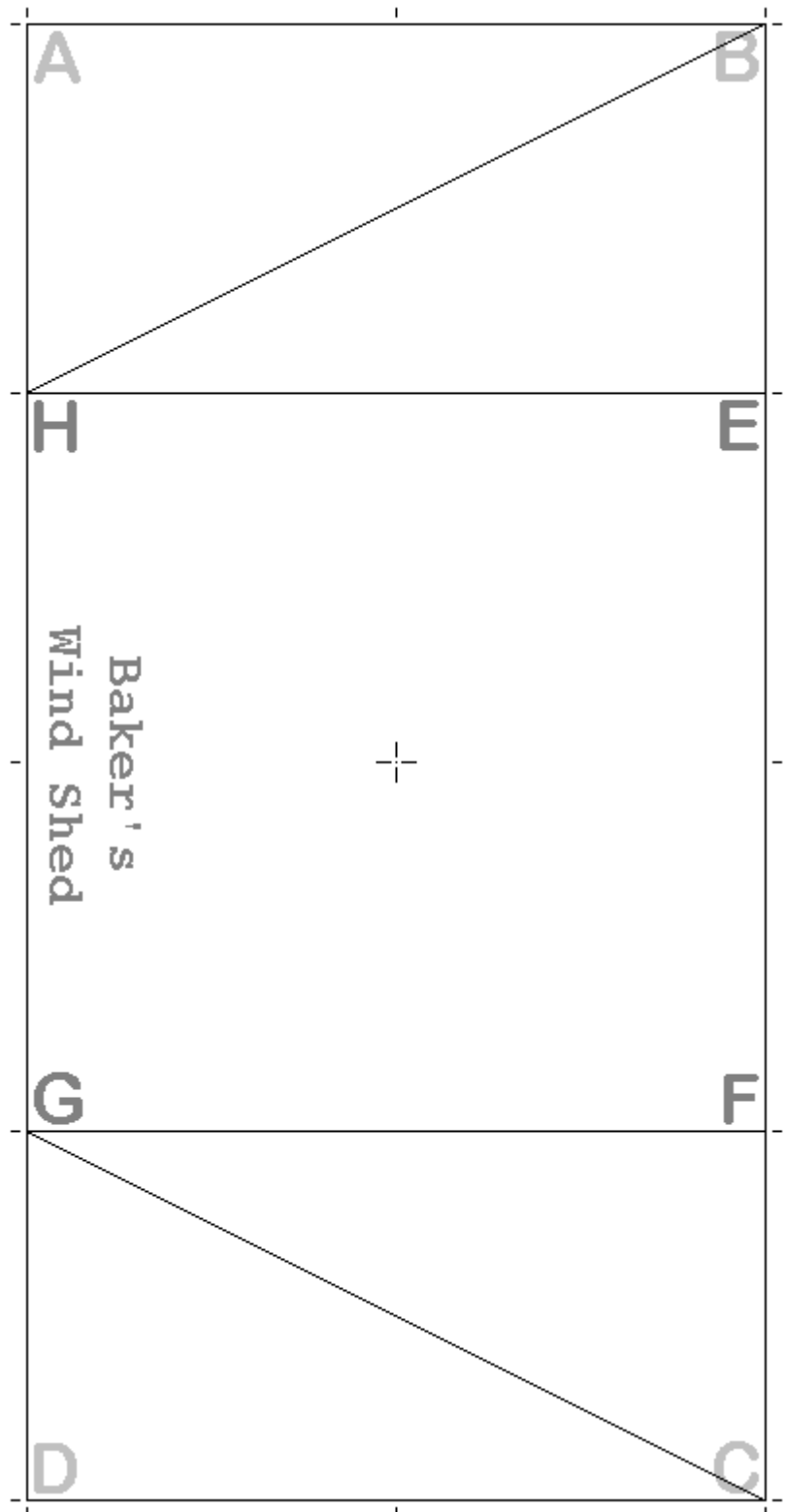

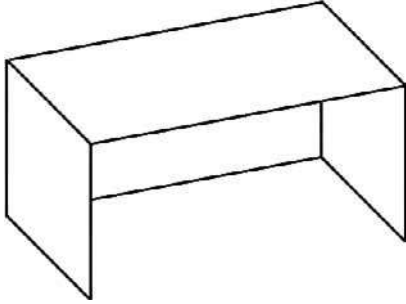
**Boxed In.**

The use of Tent poles and Ridgepoles is highly recommended.

Fold tarp in half lengthwise. Fold tarp crossways at end quarter marks. Fold end squares at either end of same long side diagonally, from tarp corner inwards.

Secure IJ to ground on Windward side as base of back wall IJKL.

Secure point E to ground right beside point J. Secure point H to ground right beside point I.

Align BE and CH at 90° to IJ on Lee side. These edges become bases of end walls BEFK and CGHL.

Secure corners B and C to ground.

Support points K and L in air directly overpoints I and J to form back wall IJKL. Use a blunt pole, these points will have tarp fabric above them.

Support points F and G in air so section FGKL becomes the roof. Edge FG needs ridgepole support.

BEFK and CGHL become end walls.

Squares AEJK and DHIL are spare cloth - bundle them up behind the wall corners, out of sight.

A 10' x 10' tarp gives a Boxed In with 90° walls, 5' high, with 50 square feet of floor space in a rectangular shadow 5' wide by 10' long.

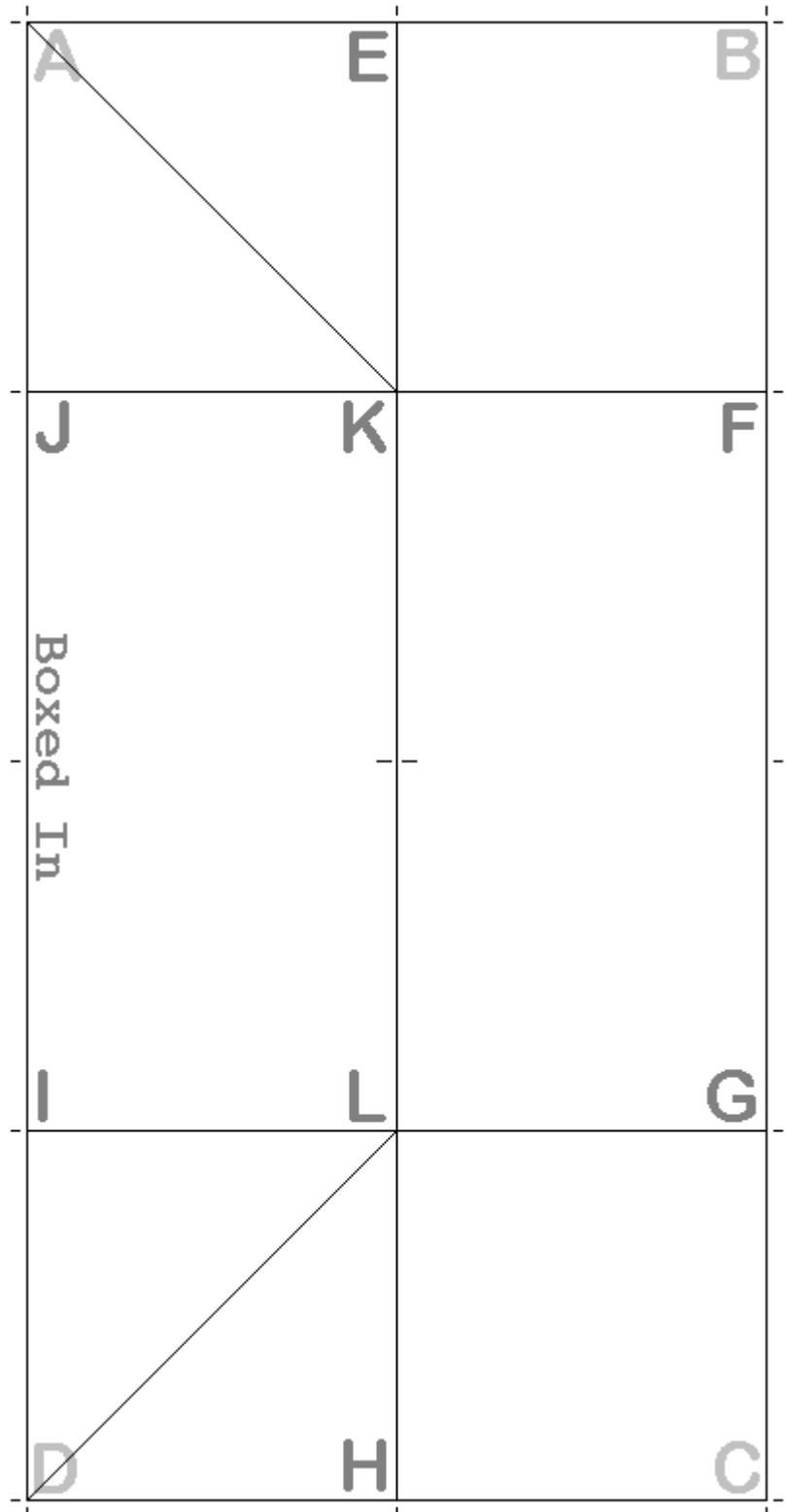

Reinforce front and back rooflines with another VSS in the middle of the span.

Pitching Variant - Swap wall and spare cloth squares to make a stall with a height adjustable front.

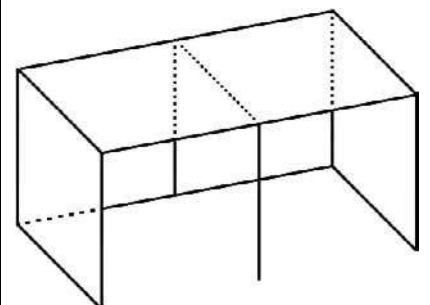

**Bus Stop.**

(Goal, Standing Shed)

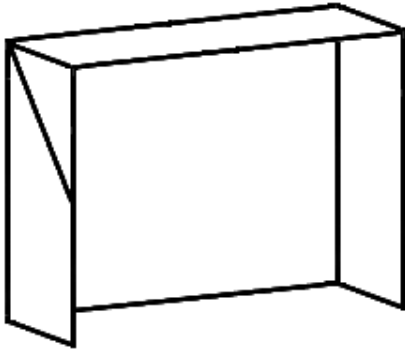

Create a Bus Stop, a shelter for multiple standing people from a simple variation of the Boxed In design.

The use of Tent poles and Ridgepoles is highly recommended.

The end squares mark one-third of the short side, and one-sixth of the long side respectively from the end corner - 3.333' in both cases.

A 10' x 20' tarp gives a Bus Stop some 6.66' high, with 44.44 square feet of floor space in a rectangular shadow 13.33' wide by 3.33' deep.

As the sides of the corner squares decrease in size, the height of the structure will increase.

Using corner squares with sides 3' even, the shelter will be 7' tall, with 42 square feet of floor space in a rectangular shadow 14' wide by 3' deep.

Sheltered locations only.

Flaps BEFK and CGHL can make partial awnings on either side, as shown in the example on the right.

Note that the one rope line supports all the top edges on the Lee side, and that two 'parallel' ropes and tarp clips can provide all the VSS points necessary.

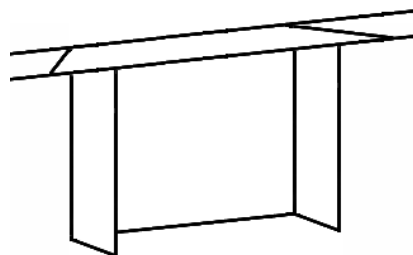
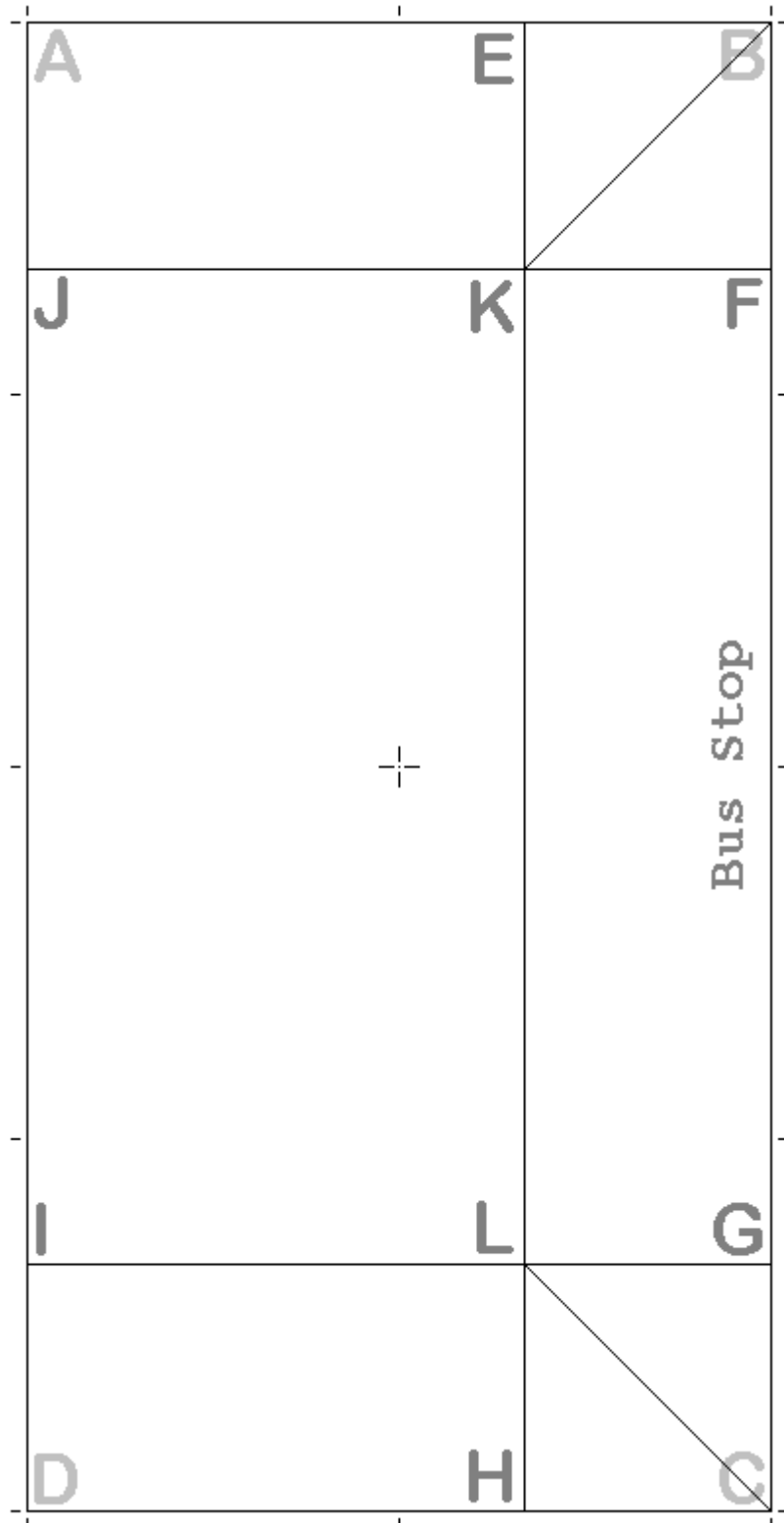

**1. Holden.**

(Rectangular Tent)

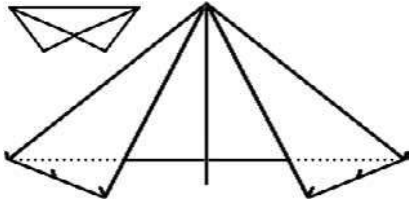

Fold tarp diagonally from midpoint of one long side to opposite end corners.

Spread corners A and D back from point E on the Windward side.

Secure corners A and D to ground on Windward side to make rear triangular wall ADE.

Support point E in air on Lee side and adjust headroom to suit.

Spread corners B and C along ground on Lee side until side walls ABE and CDE are taut.

Secure B and C to ground.

Width of shelter depends on wall angles and amount of headroom. These are adjustable.

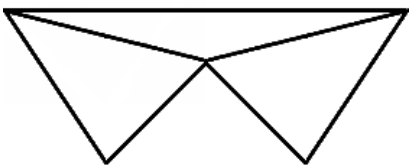
**2. Semi-walled Fly.**

Needs three VSS, one at each corner, as well as a ridgepole for each side of the roof.

Secure hanging wall flaps to ground.

Put against a wall for a semi-enclosed stall, or turn around for an open front stall.

Sheltered locations only.

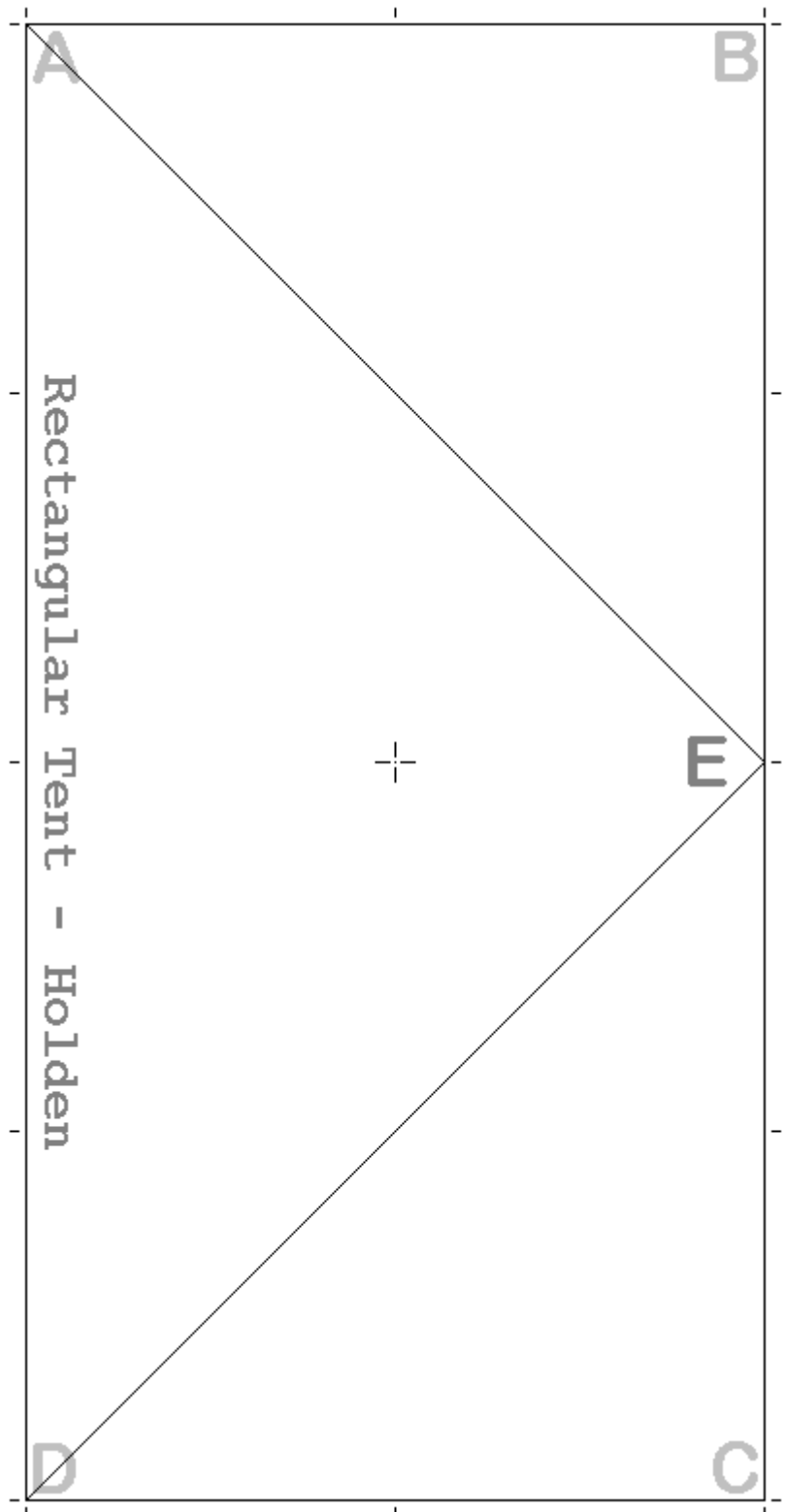

A 10' x 10' tarp gives a Semi-walled Fly with floor space of 100 square feet. Shadow is a triangle 10' high, 20' base, sides of 14.14'.

Hanging walls are 7.07' high (peak to base edge), base edge 14.14', and sloping sides of 10'.

**3. Combos.**

Lashed together with a Diamond Fly as 3 quarters of a square, it makes an over sized Low Tetra.

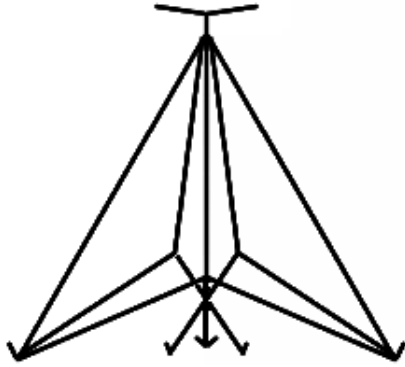
**1. Floating Pyramid.**

Fold tarp in half short ways. Fold each half diagonally from same point on midline fold.

Support point E in air.

Secure corners B and C to each other to make edge BE-CE.

Arrange points B-C and F, and corners A and D into corners of a pyramid.

Secure corners A and D directly to ground.

Secure points B-C and F to ground with guy-lines.

Open up BE-CE to create a doorway if desired.

Sheltered locations only.

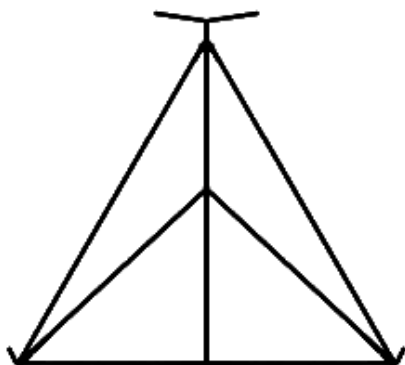
**2. Tilted Pyramid.**

Pitching depends on whether you want a solid or split awning, or a door in the back corner.

Door in back - support point E in air, secure corners B and C to ground directly beneath point E. Spread corners A and D out along ground.

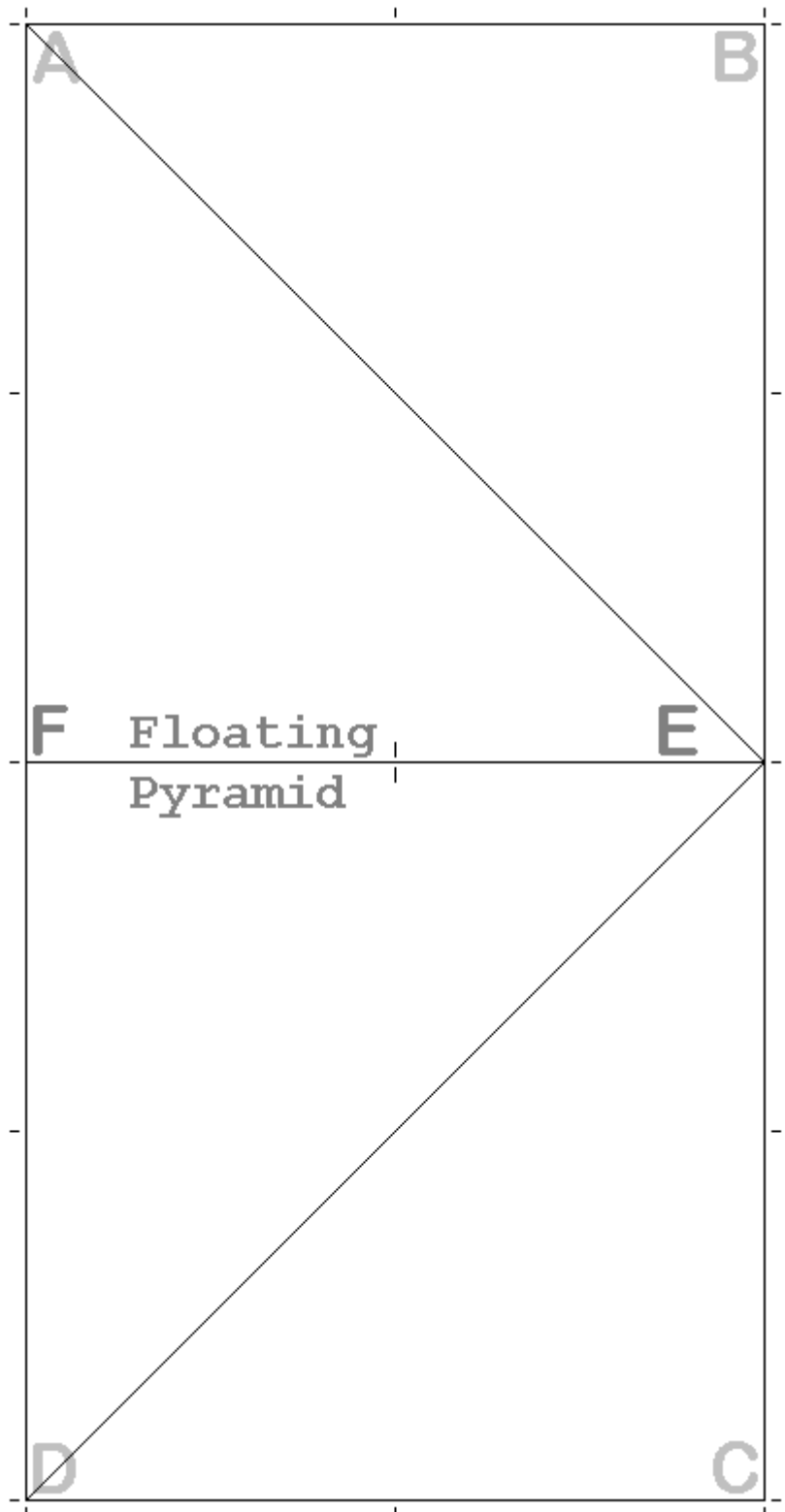

Split awning - support point E in air, secure point F to ground directly beneath point E. Spread corners A and D out along ground.

Sheltered locations only.

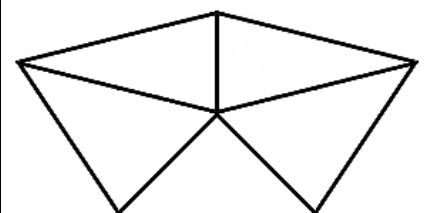
**3. Semi-walled Mushroom.**

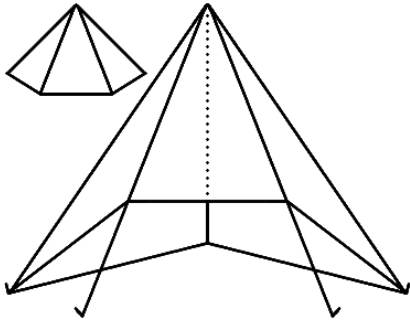

**1. Toque (Split Back).**

Fold from the midpoint G of long side AD, to end corners B and C of the other long side.

Position of points E and F are variable. In this example, they are at the quarter marks on long side BC.

Bring corners A and D together, and secure them to the ground on Windward side as point A-D.

Join edges AG and DG together to make the one edge AG-DG.

Support point G in air directly above A-D.

Spread edges AB and CD along ground on Lee side.

Align edges AB and CD at  $90^\circ$  to each other, using point A-D as origin.

Secure corners B and C to ground.

Use guy-lines to pull points E and F out, and create a low awning.

A 10' x 10' tarp gives a Toque 10' high at peak G. With back angle at  $90^\circ$ , there's over 50 square feet of floor space.

Front awning is slightly over 4' high (estimate from model).

Unsure about weather worthiness of shelter, or strength of the joined back edge AG-DG in winds.

Open the back edge for use as a doorway.

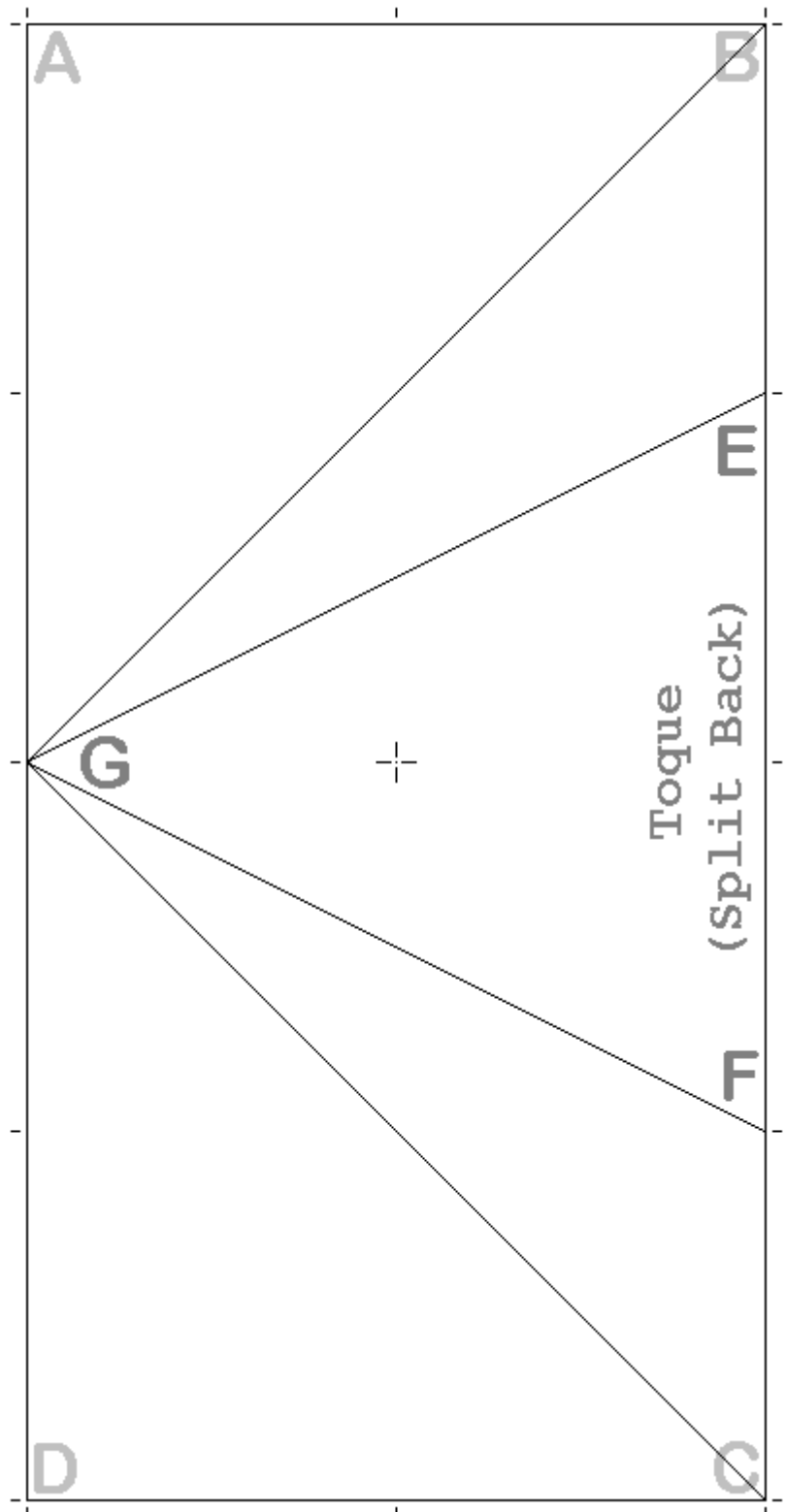
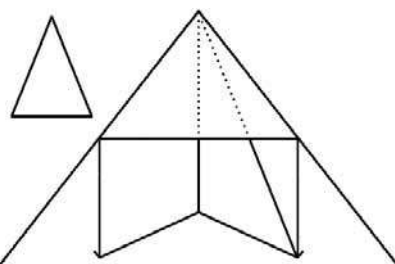
**2. Toque Wedge.**

The Toque with a smaller back angle due to fold lines BG and CG being virtually flat (no fold) - Fold line BG shown in illustration for clarity.

Point G is 10' high, front awning is 5' high.

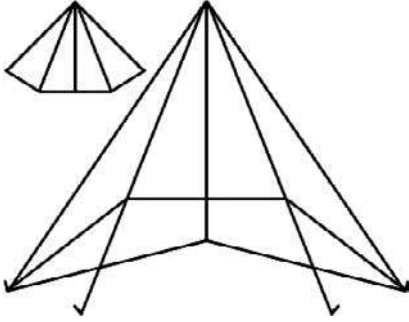
**1. Toque (Split Awning).**

Fold from the midpoint F of long side BC, to end corners A and D of the other long side.

Position of points E and G are variable. In this example, they are at the halfway marks on short sides AB and CD.

Secure point H to ground on Windward side.

Support point G in air directly above point H.

Spread edges AH and DH along ground on Lee side.

Align edges AH and DH at 90° to each other, using point H as origin.

Bring corners B and C together, and secure them as point B-C.

Join edges BF and CF together to make the one edge BF-CF.

Use guy-lines to pull points E and G out, and create a low awning.

A 10' x 10' tarp gives a Toque 10' high at peak H. With back angle at 90°, there's over 50 square feet of floor space.

The awning may be joined together, or split for better ventilation.

The back edge is more weather worthy than the one in the Split Back version, but the Split Awning will admit rain.

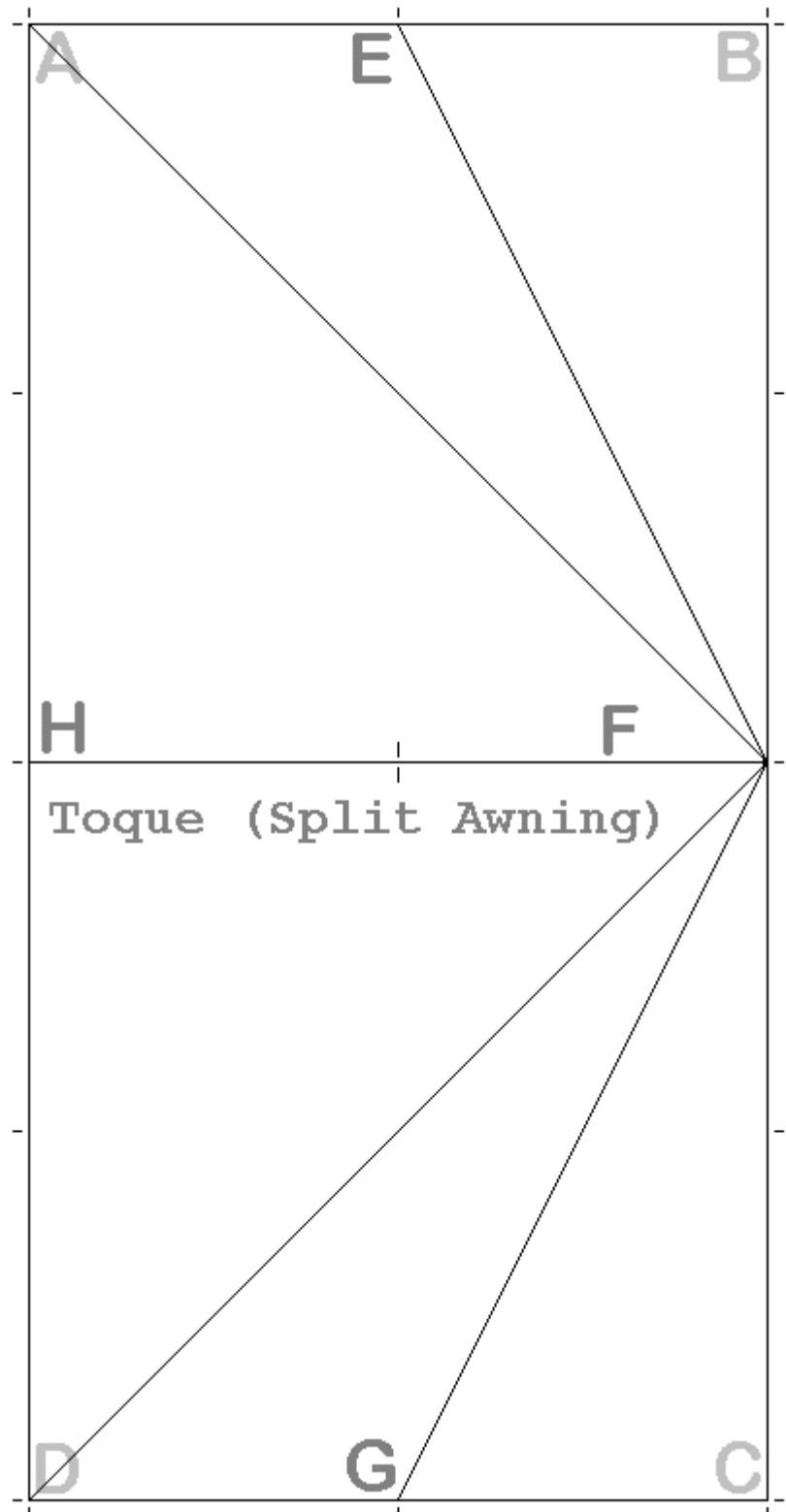
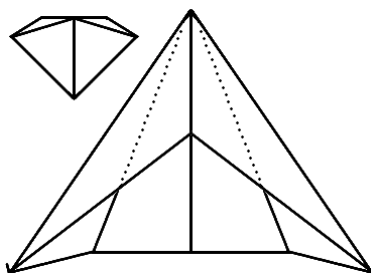
**2. Pitching Variation.**

Tilt the entire thing forward until B, C, E and G are on the ground, F is the highest point of the roof, and H becomes the top of a low awning that stretches along AH and DH to the ground - in this case, the back 'join' can become a door.

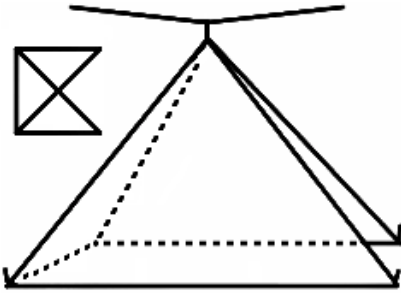
**1. Open Pyramid.**

Fold tarp from the end, quarter, and half way marks on the long sides.

Secure points F and G to ground on Windward side.

Align edges BG and CF on Lee side, at  $90^\circ$  to FG.

Secure corners B and C to ground on Lee side.

Fold triangles ABG and CDF inside main walls as partial groundsheets.

Secure ABG and CDF as partial groundsheets.

Support Multi-Fold point E in air. Lift E to tauten walls.

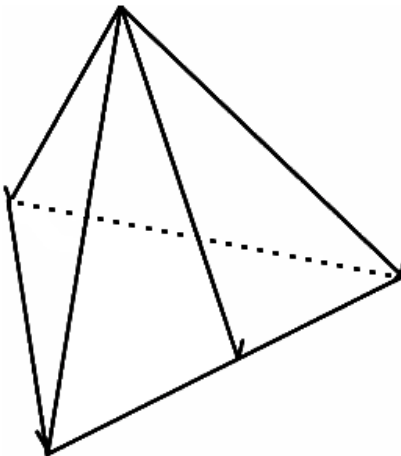
**2. Closed Tetrahedra with Full Groundsheet.**

Large middle triangle EFG becomes groundsheet, two side triangles BEG and CEF become walls that meet at BE and CE.

Triangles ABG and CDF become fully functional door flaps.

Support corners B and C in air to create peak.

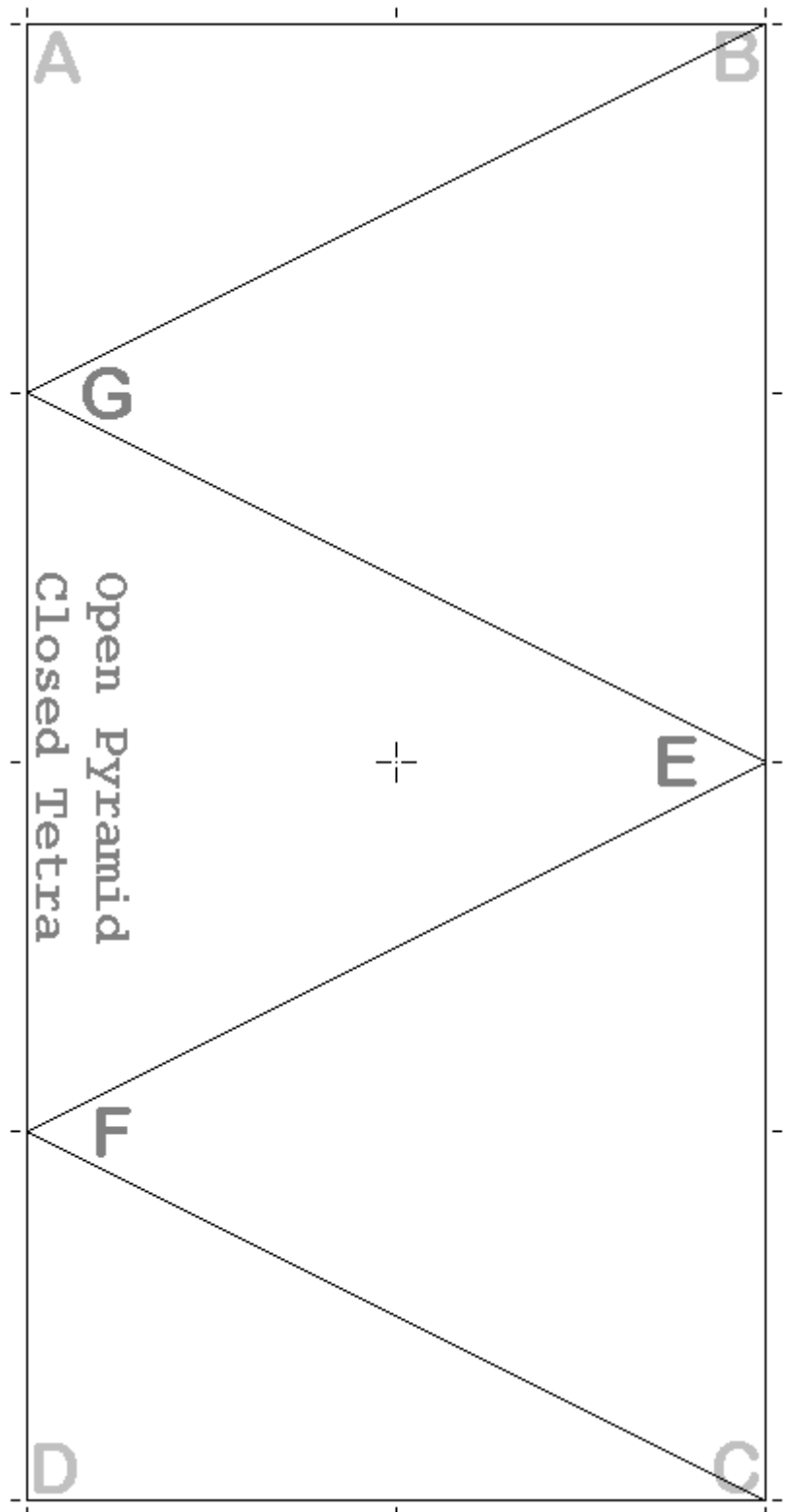

'Back walls' need extra lashings to close gap between their edges and make shelter 'secure'.

The sloping doorway and back wall join will admit rain unless the edges are significantly overlapped, or sealed with waterproof tape.

A 10' x 20' tarp gives a Closed Tetrahedra 8.660' high, floor space of 50 square feet in a triangular shadow 10' high, 10' wide base, with sloping sides of 11.180'.

Door flap edge, back wall join, and groundsheet make an Equilateral triangle with 10' sides.

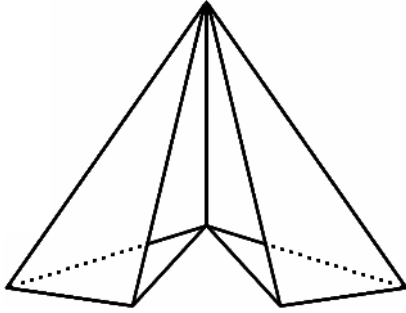
**Open Tetra.**

Fold tarp in half at half way marks on long sides. Fold from end of mid-fold line to halfway marks of short sides.

Secure point H to ground on Windward side.

Bring points A and D together.

Stretch edges HA and HD along ground on Lee side.

Separate points A and D by a couple of feet.

Secure points A and D to ground on Lee side.

Stretch points E and G out along ground on Lee side until triangles AEH and DGH are taut against the ground.

Secure points E and G to ground on Lee side, making AEH and DGH into groundsheets.

Support point F in air on Lee side.

Secure points B and C to ground on Lee side.

NOTE - points B and C end up near points A and D, but there will be a gap between A and B, C and D.

The gap between A and B, C and D, WIDENS as A and D move further apart.

The gap between A and B, C and D, NARROWS as A and D move closer - if A and D are at the same point, B and C will meet at that point as well, resulting in a Closed Tetrahedra with a split groundsheet.

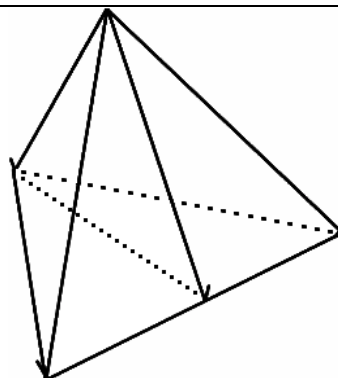
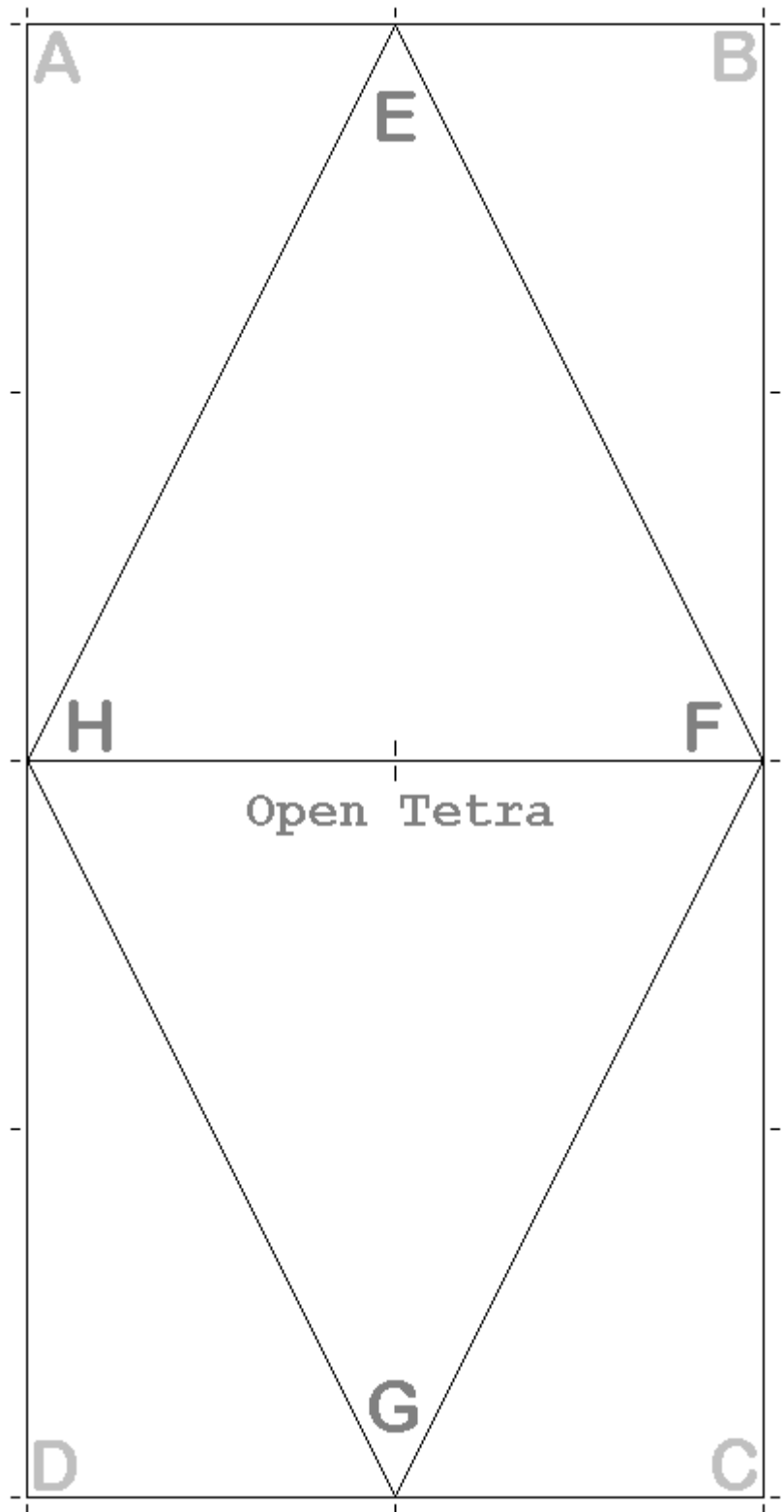

Finished dimensions are the same as a Closed Tetra made from an Open Pyramid folding plan, although the continuous material at back corner FH has greater weather worthiness.

Open version intended for dry conditions.

**Pyramid Fly**

(Miner's tent, Square tent, Range tent, etc)

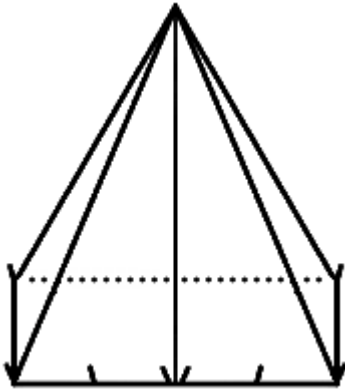

Fold Angles are 45° and 22.5° around point F, and 67.5° for bases of main walls and doors.

Secure points H and I of middle triangle FHI to ground on Windward side.

Align EI and GH on Lee side at 90° to HI.

Tips of corners A and D should meet if folding AEI and DGH under as partial groundsheets.

Stake out base points E and G of main walls.

Bring corners B and C together and secure to ground to complete the square floor plan.

Support Multi-Fold point F in air with an internal pole or an external overhead VSS.

Secure grommets in door edges to each other.

Dimensions of finished shelter depend on tarp sides being in EXACT ratio of 1:2.

A 10' x 20' Tarp makes a Pyramid Fly 9.101' high, floor space of 68.62 square feet in a square shadow with 8.284' sides. Sloping wall edges of 10.823' long.

Use ridgepoles in all corners to make a sturdy shelter.

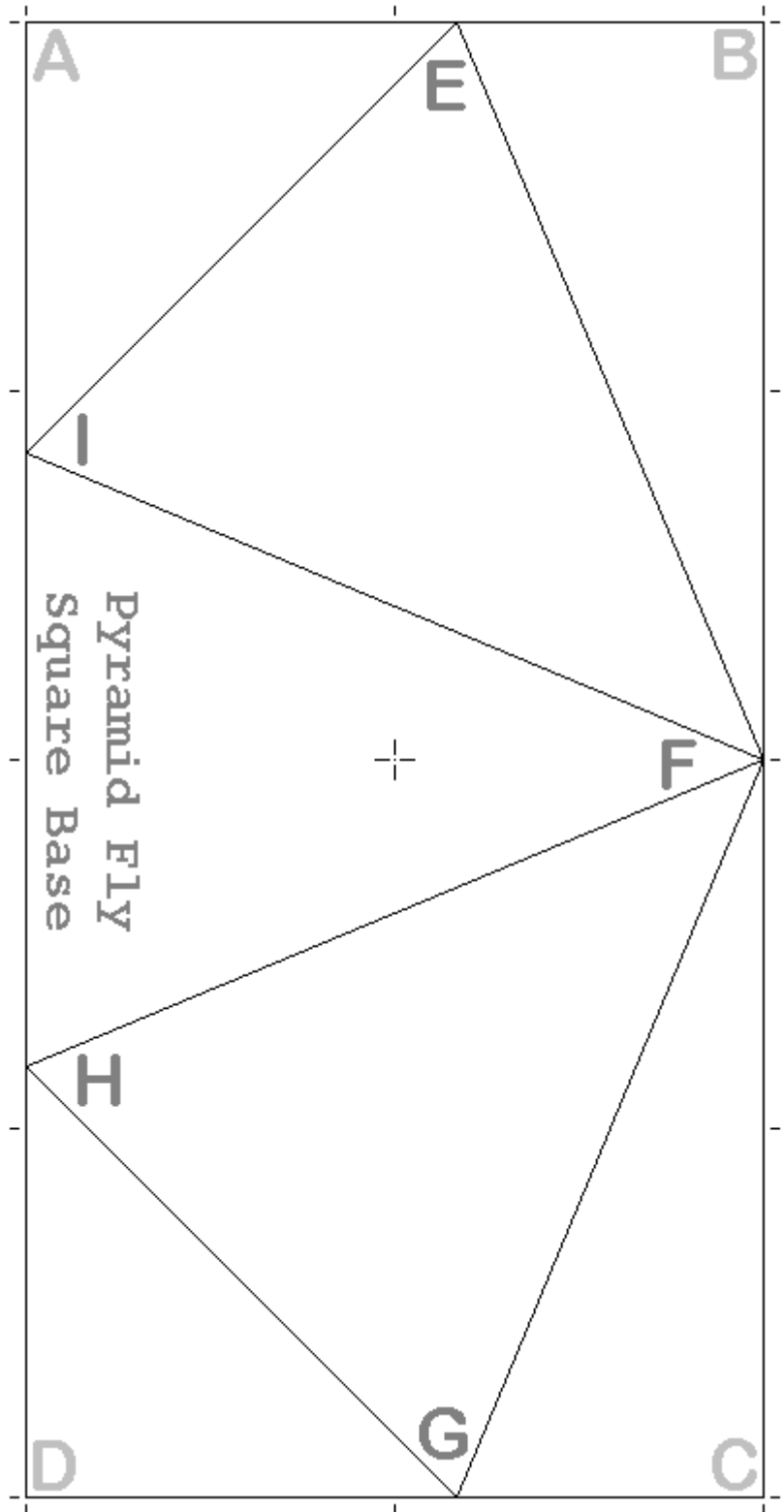

Tarp Size	Pyra High	Pyra Wide	Slope Side
6x12	5.46	4.96	6.49
7x14	6.37	5.79	7.57
8x16	7.28	6.62	8.65
9x18	8.19	7.45	9.73
10x20	9.10	8.28	10.82
12x24	10.92	9.93	12.98
15x30	13.65	12.42	16.23

Use with a Half Pyramid to make a Hexagonal Fly.

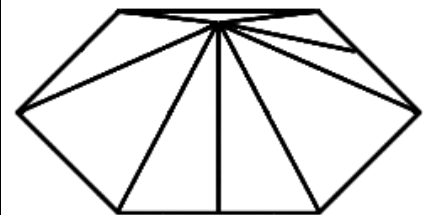

**Rectangular Pyramid Fly**  
(Easy Pyramid Fly)  
Rectangular Pyramids have a rectangular base.

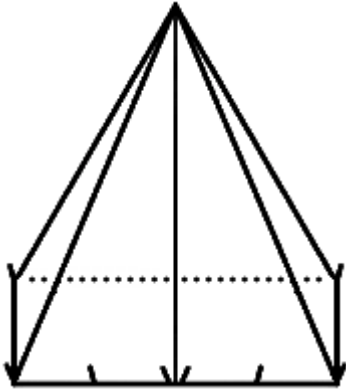

Fold points are mid-side on one long side, first and third quarter marks of other long side, and midpoints of short sides.

Unlike the square based Pyramid Fly, pitch this design with a short side facing the Windward side, rather than have the broad wall FHI bear the full brunt of the wind.

Secure points E and I of end triangle EFI to ground on Windward side.

Align point H of edge HI on Lee side at  $90^\circ$  to EI.

Secure H to ground.

Align GH at  $90^\circ$  to HI.

Secure G to ground.

Bring corners B and C together and secure to ground to complete the RECTANGULAR floor plan.

Tips of corners A and D WILL NOT meet if folding AEI and DGH under as partial groundsheets.

Support Multi-Fold point F in air with an internal pole or an external overhead VSS.

Secure grommets in door flap edges to each other.

Shelter dimensions depend on tarp sides being in EXACT ratio of 1:2.

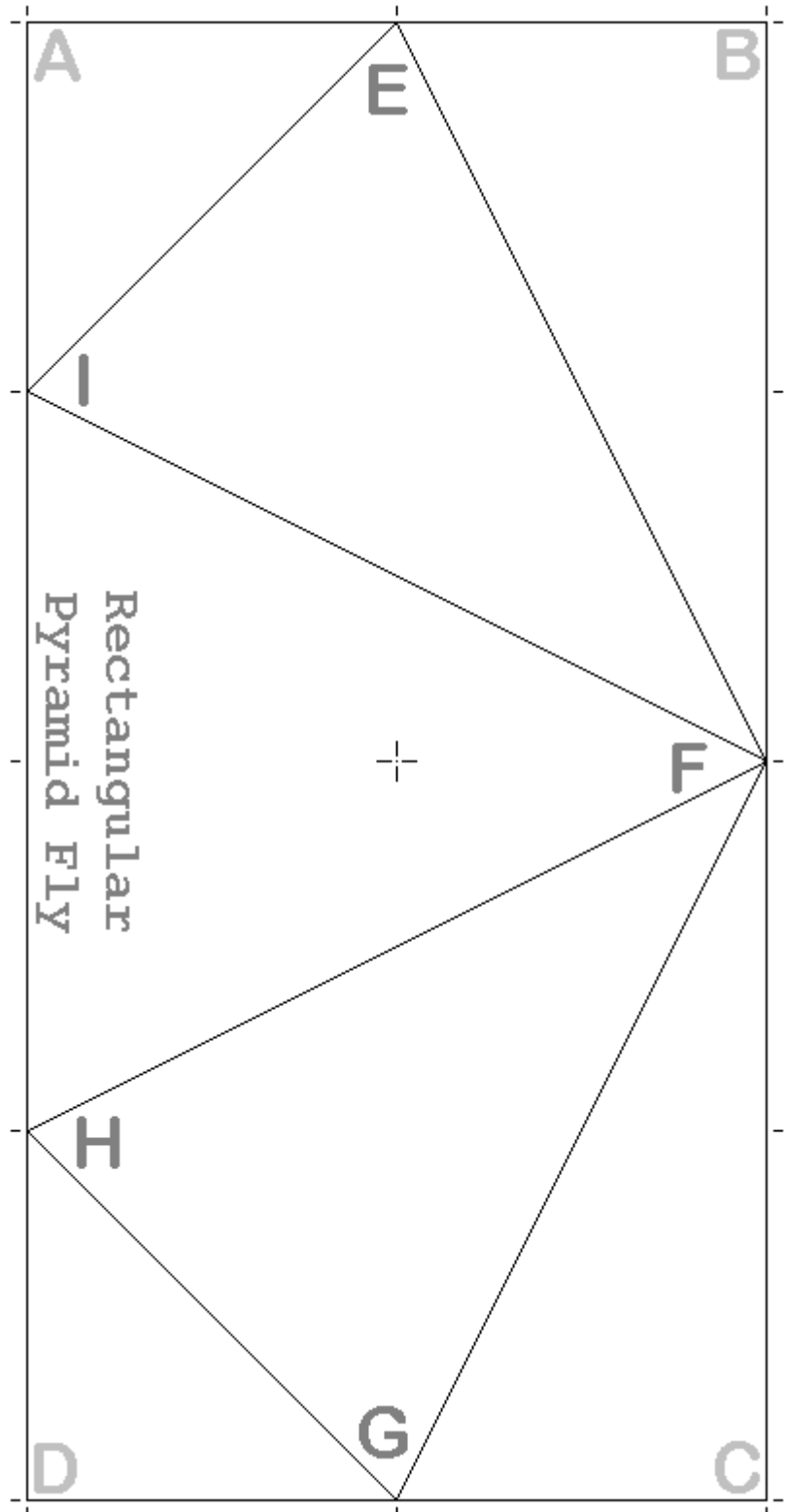

A 10' x 20' tarp gives a Rectangular Pyramid Fly with back wall 10' wide, side walls 7.071' wide, door flaps 5' wide at the base, sloping wall edges of 11.180'. Height at peak is 9.354'. Floor space is 70.71 square feet in a rectangular shadow 7.071' x 10'.

Use with a Arrowhead to make a six-sided Fly.

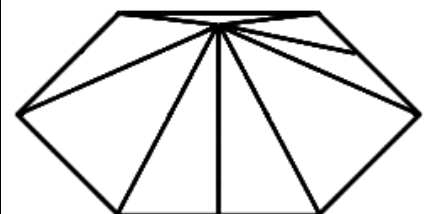

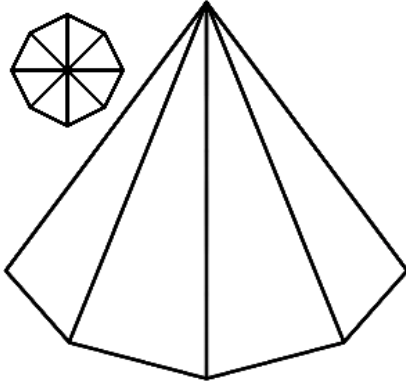
**Wigwam**

Based on the traditional shelters built by the Indigenous Peoples of North America, the Wigwam Tarp-shelter requires a special set-up routine.

Fold tarp in half to form a square, then fold each square diagonally twice. This creates the fold lines for the eight segments shown.

Swing corners B and C in from the midpoint of BC until the corner touches the relevant fold line to find the proper distance.

Not all the edges and points were named due to space constraints.

Use ridgepoles or taut ropes to create an eight-sided skeleton frame, and then drape the tarp over the frame.

Mid-point of edge BC becomes the apex at the top of the VSS.

Roll up spare cloth around ground edges of shelter, or fold beneath as a partial sod cloth.

Securing the tarp to the ground with stakes may require tarp clips.

Secure midpoint of edge AD to ground on the Windward side.

Secure corners B and C to ground on Lee side.

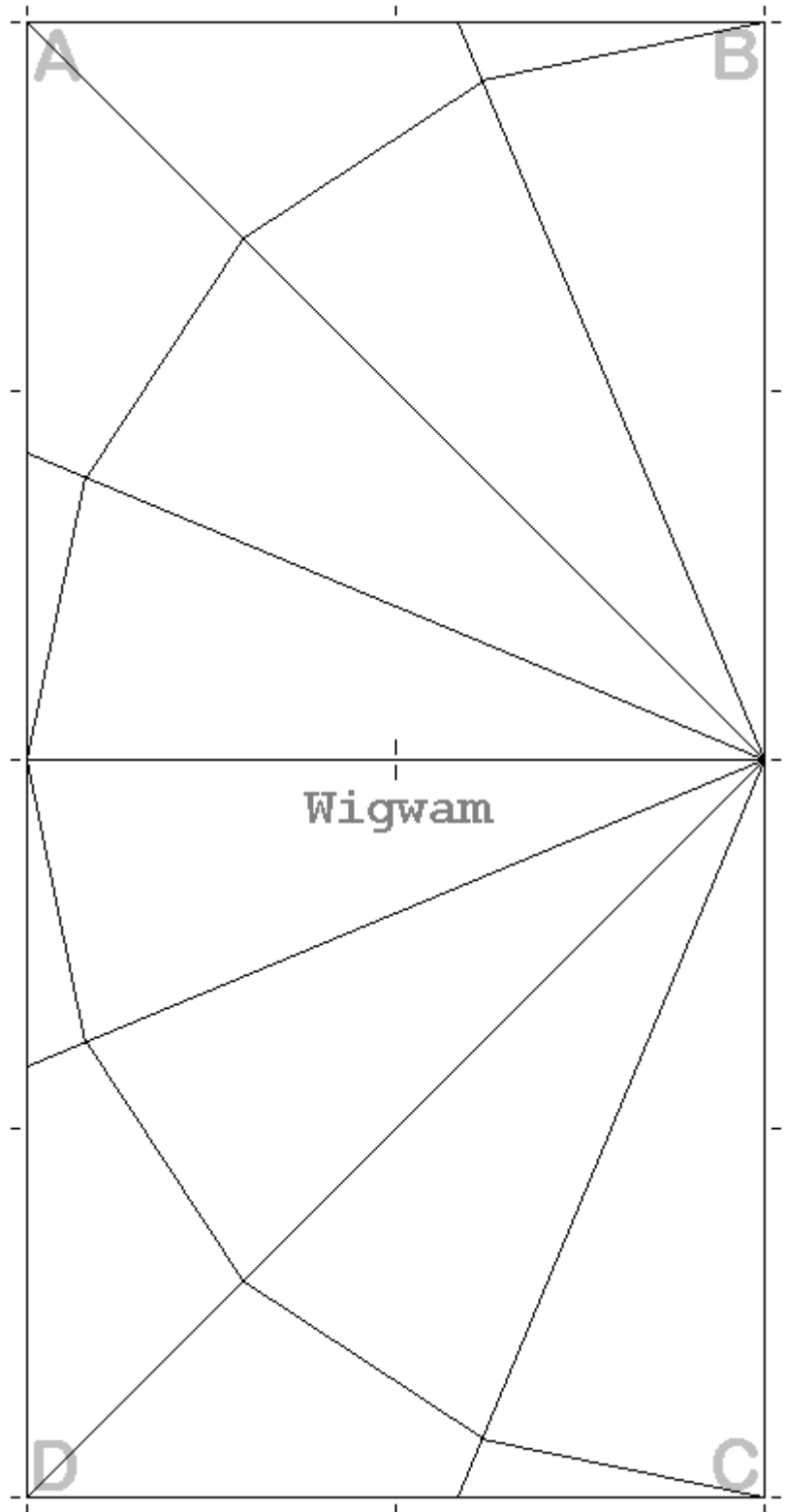

A 10' x 10' tarp gives a Wigwam 8.602' high. Points of the octagon touch a circle 10.1959' wide (radius 5.0979'). Floor space is 79.564 square feet in an octagonal shadow. Walls have bases 3.901' wide, with 10' sides, and are 9.807' high from base.

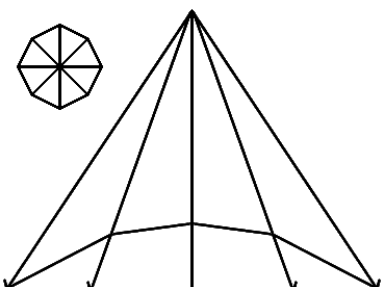
**2. Floating Octagon.**

=====

APPENDIX #1 - Useful Maths (don't worry, it's only the ONE page.)

=====

Trigonometry is a branch of Mathematics that deals with Triangles. At the heart of Trigonometry, are angles.

We measure Angles in degrees ( $^{\circ}$ ). Each degree subdivides into 60 minutes ( $'$ ) or  $1/60$ th of a degree, and each minute subdivides again into 60 seconds ( $"$ ) or  $1/60$ th of a minute. To use the Degree mark ( $^{\circ}$ ) on most computer keyboards, hold down the 'Alt' key and press 0176 on the numeric keypad (Alt + 0176).

There are  $360^{\circ}$  in a Circle, and  $180^{\circ}$  in a Straight Line. A Right Angle is  $90^{\circ}$  (exactly), and a small square is its symbol, unlike the arcs used for other angles. An Acute (sharp) Angle is between  $0^{\circ}$  and  $90^{\circ}$ . An Obtuse (blunt) Angle is between  $90^{\circ}$  and  $180^{\circ}$ . A Reflex (bent back) Angle is between  $180^{\circ}$  and  $360^{\circ}$ .

The sum of the internal angles in a Triangle is  $180^{\circ}$  (half that of a Circle). An Equilateral Triangle has ALL sides equal in length, and ALL angles equal to  $60^{\circ}$ . An Isosceles Triangle has TWO sides equal in length, with TWO angles equal to each other. A Scalene Triangle has NO sides or angles equal to any other.

A Right-Angled Triangle has a Right Angle ( $90^{\circ}$ ) inside it. The Hypotenuse is a special name used for the side of a triangle opposite a Right Angle (note that an 'opposite' side does NOT touch the angle in question). The Hypotenuse is ALWAYS the longest side in a triangle.

Trigonometry makes extensive use of the ratios and proportions between the angles and side lengths of a triangle. The most useful of these functions are..

SINE of an angle = Opposite side/Hypotenuse (where / = divide by)

COSINE of an angle = Adjacent side/Hypotenuse

TANGENT of an angle = Opposite side/Adjacent side (neither side is Hypotenuse)

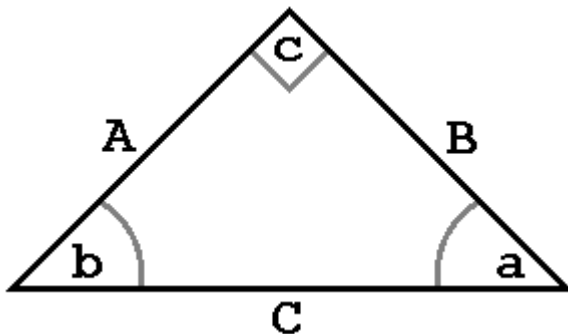

Example - The SINE Rule.

A triangle has A, B, C as the names of the sides, and a, b, c as the names of the angles opposite the similarly named side. The result of dividing the length of any side, by the SINE of the angle opposite it, is equal to the result from dividing any other side by the SINE of the relevant angle.

$$(\text{Length A/SINE Angle a}) = (\text{Length B/SINE Angle b}) = (\text{Length C/SINE Angle c})$$

SINE $7.5^{\circ}$ = 0.130526192	SINE $37.5^{\circ}$ = 0.608761429	SINE $67.5^{\circ}$ = 0.923879533
SINE $15.0^{\circ}$ = 0.258819045	SINE $45.0^{\circ}$ = 0.707106781	SINE $75.0^{\circ}$ = 0.965925826
SINE $22.5^{\circ}$ = 0.382683432	SINE $52.5^{\circ}$ = 0.79335334	SINE $82.5^{\circ}$ = 0.991444861
SINE $30.0^{\circ}$ = 0.5	SINE $60.0^{\circ}$ = 0.866025404	SINE $90.0^{\circ}$ = 1

The Hypotenuse Square Rule.

The length of the Hypotenuse when multiplied by itself (squared), equals the sum of the individually squared lengths of the other two sides of the triangle.

Examples - a Right-Angled Triangle with angles of  $45^{\circ}$ ,  $45^{\circ}$ , and  $90^{\circ}$ , has sides in the ratio of  $1:1:H=(\text{Square root of } 2)$ . A Right Angled Triangle with angles of  $30^{\circ}$ ,  $60^{\circ}$  and  $90^{\circ}$ , has sides in the ratio of  $1:(\text{Square Root of } 3):H=2$ .

$$H^2 = (A^2) + (B^2) \text{ (where } ^2 \text{ means Squared, or multiplied by itself)}$$

$$\text{Square Root of } 2 = 1.414243562 \quad \text{Square Root of } 3 = 1.732050808$$

And here's some other math, useful for Circles and Spheres.

Pi is 3.141592654, or approximately 22 divided by 7 (3.142857 recurring)

Circumference of a circle is =  $2 \times \text{Pi} \times \text{Radius}$  (where x = multiply by)

Area of a circle is =  $\text{Pi} \times R^2$  (where R = Radius of the circle)

Area of a Sphere is =  $4 \times \text{Pi} \times R^2$

Volume of a Sphere is =  $4/3 \times \text{Pi} \times R^3$  (where  $^3$  means Cubed, or  $R \times R \times R$ )



APPENDIX #2 - Custom Tarp Size Template (up to 15' x 25').

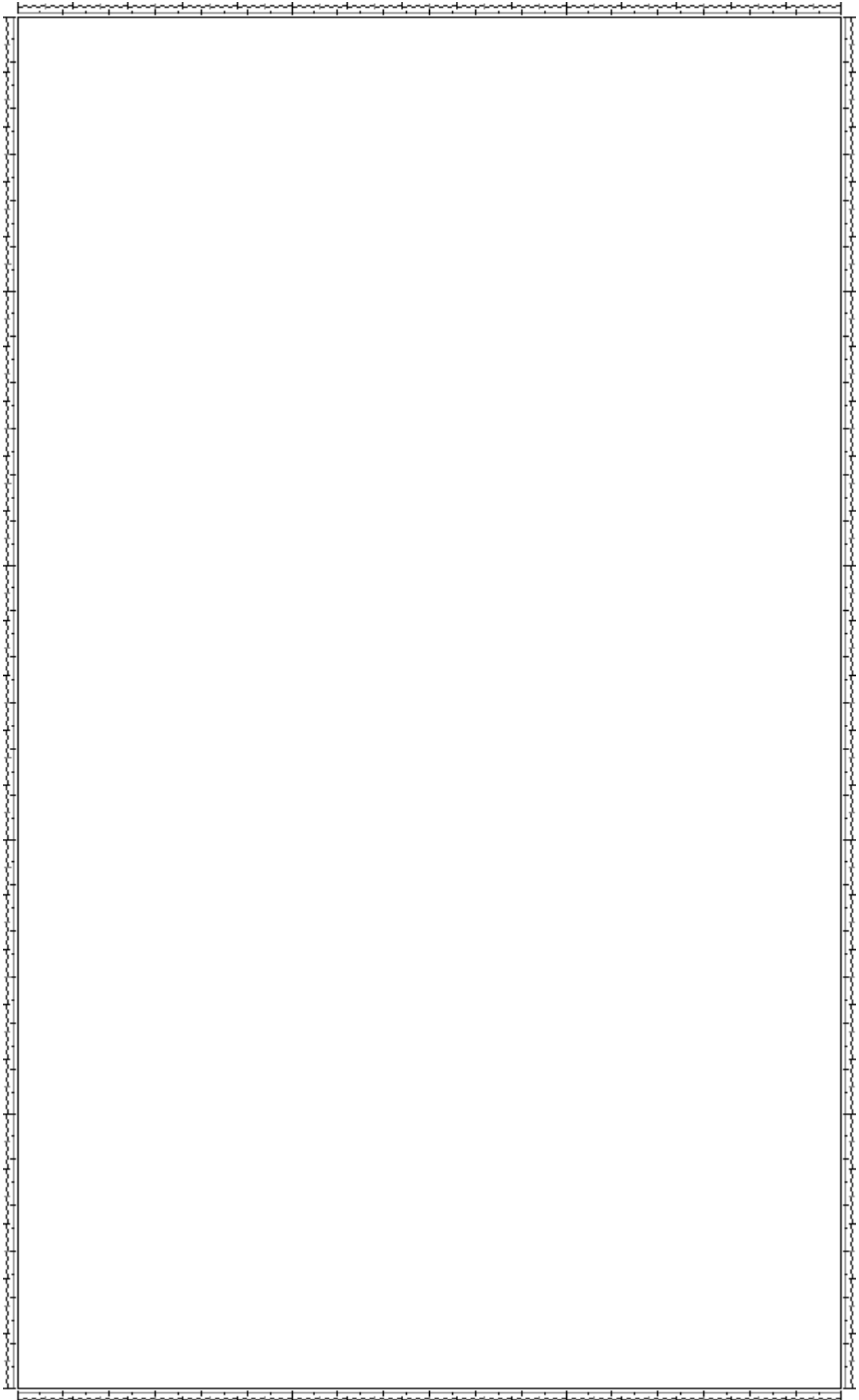

=====

APPENDIX #3 - Common Grommets and Fold Lines on 1:1 and 1:2 Tarps.

=====

When overlaid, some of the folding plans have fold-lines, or grommet points in common with other folding plans - refer diagrams below and on the next page.

When compared to the distance scale markings around the edges of the Overlaid Patterns Diagram, it becomes apparent that the majority of the grommet and fold origin points are at (or very close to) points corresponding to fractions of 12ths, 24ths, or 48ths of the tarp edge.

NOTE - The two sets of scale markings shown on the Overlaid Patterns Diagrams were 'approximated' to suit the scale of the folding plans. As the scales are only 'approximate', they are not reliable enough for exact distance readings.

The 1/10th tarp edge markings ('scale feet') are furthest from the edge of the tarp, and divide the tarp edge length into 1/10ths (or 1/20ths for the long sides of rectangular tarps). The short grey mark at the halfway mark of each segment marks off six 'scale inches'. The black wavy line running through the 1/10th scale further divides each 'scale foot' into 12 sub-segments, to give a rough indication of individual 'scale inches' for tarp sides 10' (or 20') long. The estimated margin of error for the 1/10th scale is less than a single pixel, non-accruing and contained within every 19 pixels - in other words, less than a third of a 'scale inch' (3.16~ pixels) for every six 'scale inches', where a 'scale foot is 38 pixels.

The 1/12th tarp edge markings are the black on grey scale markings nearest the edge of the tarp, and divide the tarp length into 1/12ths and 1/24ths (1/48ths for the long sides of rectangular tarps). The short black mark shows the halfway mark of each segment. The 1/12th scale coincides with the 1/10th scale at a rate of every three segments of the 1/12th scale to two and a half segments of the 1/10th scale. The estimated margin of error for the 1/12th scale is greater than that of the 1/10th scale, and is believed partly responsible for the 'non-perfect' alignment of fold lines with markings on the 1/12th scale - another major factor being the overall accuracy of the general line work at this scale.

**Overlaid Patterns Diagram for 1:1 tarps.**  
**All folds mirrored vertically and horizontally.**

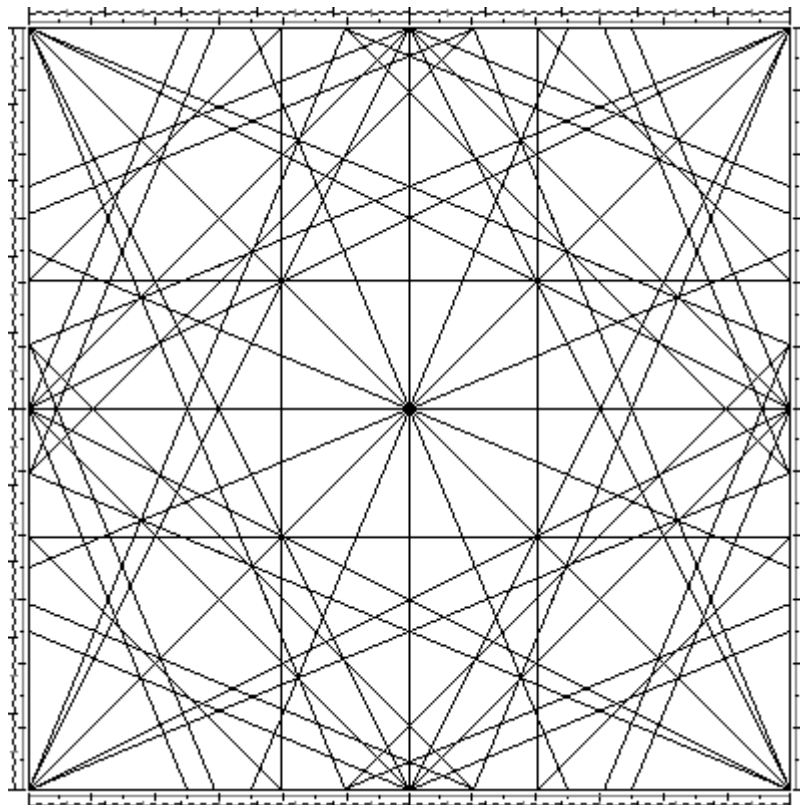

Each of the vertical and horizontal lines shown, are one pixel thick. Things become a bit clearer when enlarging the diagram.

Enlarged section from Top-Left Quadrant of the  
Overlaid Patterns Diagram for 1:1 tarps.

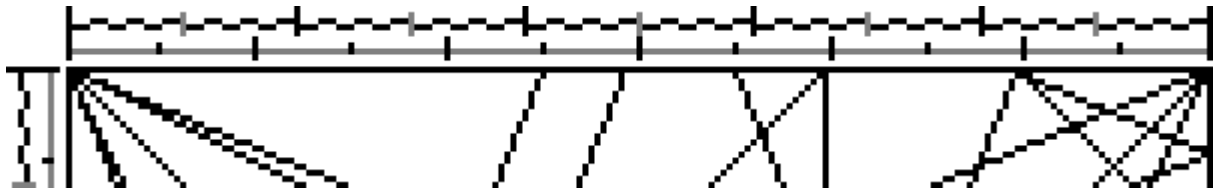

Similar overlapping effects appear with folding plans for 1:2 tarps.

Overlaid Patterns Diagram for 1:2 tarps.  
'Natural' folds mirrored on left, ALL folds shown on right.

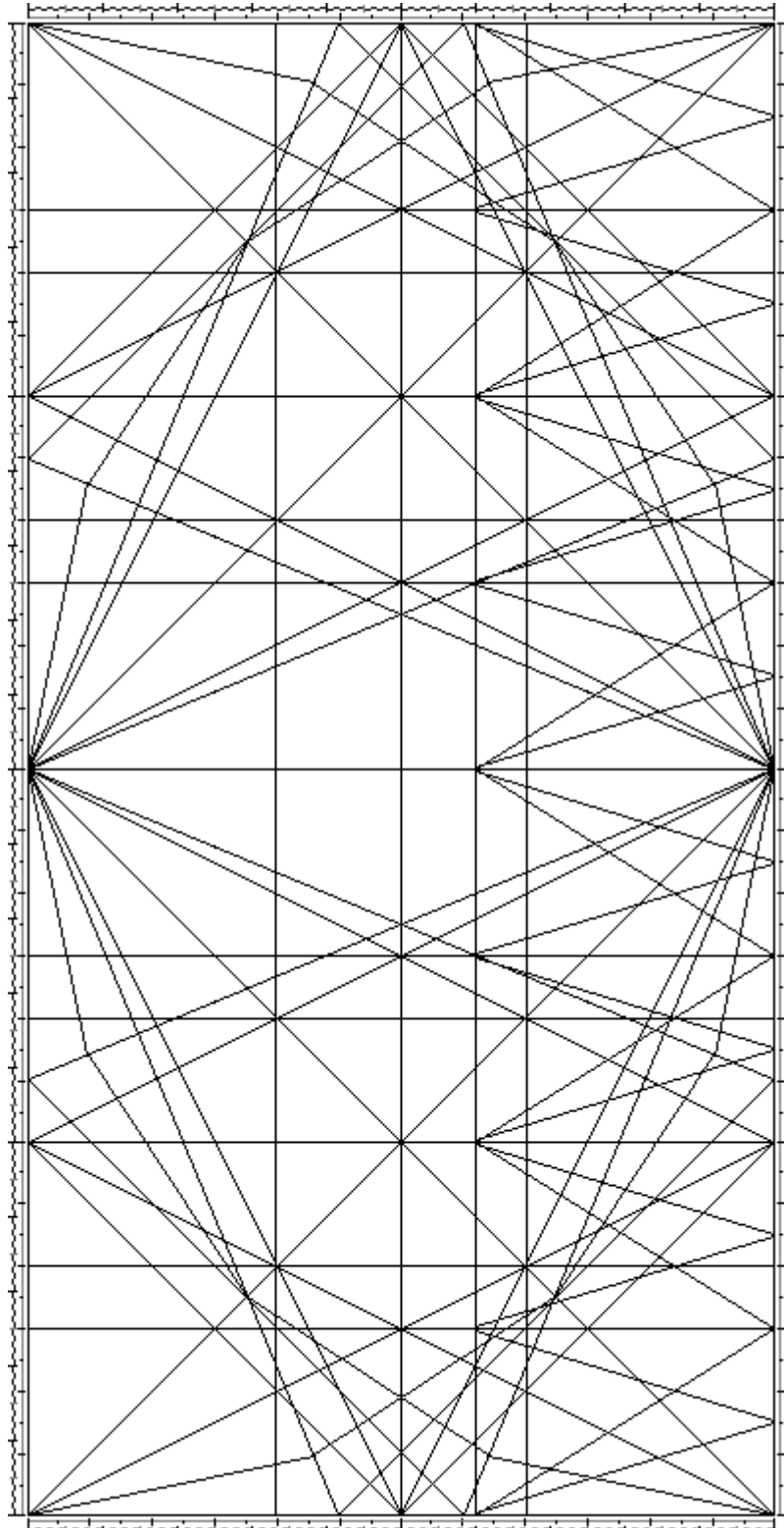

=====

APPENDIX #4 - Combinations, Special Uses, and Woodcraft.

=====

Some Tarp-shelter designs can combine with others to create a better shelter. The most obvious combination is the addition of a 'Tub Floor' groundsheet. The Tub Floor may be a separate tarp to the rest of the Tarp-shelter, or may be part of the Tarp-shelter design, such as a modified ground sheet segment of a 'C-Fly'.

There are many other combinations, depending on the desired result.

- A 'Boxed In' with a 'Lean-To' makes an enclosed shelter
- A 'Tub Floor with 2 Walls', a 'Square Stall' and a 'Lean To' make a room
- A 'Tub Floor with 2 Walls' and a 'Box Arch' make a fully enclosed shelter
- A 'Diamond Fly' and a 'Rectangular Tent' make a large scale 'Low Tetra'
- A 'Diamond Fly' and a 'Half Pyramid' make an enclosed shelter
- A 'Diamond Fly' and a 'Wigwam' make an enclosed teardrop-shaped shelter
- 2 'Diamond Flies' make a large scale 'Rectangular Tent'
- 3 'Diamond Flies' make a large scale 'Low Tetra'
- 2 'Half Tetras' make a 'Rectangular Tent'
- 2 'Half Tetras' make a fully enclosed 'Closed Tetra'
- 2 'Half Tetras' and an 'A-Frame' make an enclosed shelter
- 2 'Half Pyramids' make a 'Pyramid Fly'
- 3 'Half Pyramids' make a 'Hexagonal Fly'
- 2 'Arrowheads' make a 'Rectangular Pyramid Fly'
- 3 'Arrowheads' make a six-sided fly (one that's not quite a 'Hexagonal Fly')

Depending on the specific designs and level of shelter strength needed, such combinations may or may not need extra VSS, ropes or poles.

- - - - -

When brand new, plastic sheeting and poly-tarps are virtually draft proof and waterproof. These qualities allow them to serve as makeshift bathtubs or water reservoirs/troughs. While abrasions and punctures may quickly affect their ability to serve in these capacities, for a while, they ARE able to serve.

The point being, Tarps have other uses than just that of a 'weather shelter'.

With the advent of the War Against Terrorism (2001 AD - ? AD), comes the spectre of Mass Casualty situations from a variety of causes. Casualties may occur from the trauma of the initial event, or from 'cumulative effects' that may not appear for days, weeks or YEARS afterwards (Food Poisoning, Anthrax, AIDS, Asbestosis).

- A chemical agent affects 50,000 people within minutes at a Football Final
- A biological agent infects 100,000 people in a single day at a regional show
- A dust cloud from a demolished building eventually affects 500,000 people

Any of the Tarp-shelter designs/combinations that provide an enclosed shelter can serve as an improvised 'oxygen tent'. While the oxygen-enriched air will leak out wherever it can, the use of 'duct' tape as a sealing agent on joins and seams will improve atmospheric retention ability.

With work, a few of the Tarp-shelter designs (like the 'Closed Tetra') can serve as an improvised Biohazard Isolation unit. In this situation, a normal vacuum cleaner creates 'negative air pressure' inside the enclosure, by sucking air from within the enclosure. This causes a constant stream of fresh air to seep INTO the enclosure through any joins, seams, openings, etc. Use of a HEPA (High Efficiency Particle Arrester) medical mask, or a P2 class welding mask (filters dust, mist, fumes, and asbestos) as a filter over the suction intake INSIDE the enclosure, removes airborne pathogens from the air before it leaves the shelter.

With a little more work, a few of the Tarp-shelter designs can give limited service as an improvised Bio-Chemical Warfare shelter. In this situation, a normal vacuum cleaner (or a hand pump) creates 'positive air pressure' inside the enclosure, making air leak out from within the enclosure through any joins, seams, etc. This keeps airborne contaminants outside. An air filter (made from a gas mask canister) over any air intake OUTSIDE the enclosure, removes chemicals from the air before it enters. Sustained release of air from compressed air bottles (SCUBA, etc), will create the same 'positive pressure' effect. While this method isn't foolproof, it may provide a temporary safe haven until Rescue teams can arrive, or the threat decreases enough to allow leaving the shelter.

That last special use is a modern variant of the 'gas hoods' used to protect baby cribs from Poison Gas in the World Wars. These either used compressed air, or else used a pump mechanism (usually hand-powered) that ensured a constant flow of fresh air into the 'hood' (positive pressure) from a gas mask filter.

With Official education efforts regarding the 'Shelter In Place' (SIP) system of surviving airborne hazard alerts, comes the question of how effectively you can SIP if you can't be sure of securing the airflow/atmospheric constitution in the place you live/work.

While 'plastic sheeting and duct tape' may provide an effective atmospheric seal around windows, doors and vents in an intact building, these sealing methods may not work too well if the building is NOT 'intact', that is, if the walls, floors, and roof have holes, cracks, or other breaches that cannot be easily sealed. Presented above is just ONE solution that is relatively cheap, simple, fully portable, self-contained, and apart from the gas mask filters, readily available to the general population.

- - - - -

Woodcraft is a term that is changing its meaning...

In the 'olden days' (only a few decades ago), 'woodcraft' meant being able to obtain the essentials of life from the natural resources of the wilderness. Among other things, this meant making fire, gathering food, locating water, using natural navigation methods, and making shelter from trees and saplings.

Nowadays, 'woodcraft' means 'Minimum Impact Bushwalking' (MIB), the act of 'Leaving No Trace' of ever having been in the Wilderness. That means no fire pits to scar the landscape, no decimation of wildlife and the natural food cycles, and no destruction of the vegetation for shelter purposes.

However, some 'olden days' practices may still be allowable under MIB guidelines. These are little things that can make life easier, but which don't have a lasting, permanent effect on the natural landscape.

A groundsheet provides an easy to clean surface, one that separates the campsite from the mud and biomass of the ground it lies on. It also provides extra protection to the ground against the 'trampling effect' of pedestrian traffic. Laying the groundsheet over 'heaped up' leaf litter creates a padded floor, one that offers extra thermal insulation compared to a tarp laid on bare ground.

The uphill edge of a groundsheet can divert 'runoff' water without the mud wall of a 'Tub Floor'. Raise the uphill edge of the groundsheet and sweep dirt, leaf litter, etc underneath it to make a ridge that keeps the edge of the ground sheet a couple of inches off the ground. The slight ridge can divert runoff water around the groundsheet. The ridge material may also absorb the water, diverting it to flow through the ground materials beneath the waterproof groundsheet.

The use of overlaid tarps can create a large structure with good ventilation and superior rain shedding capability - the rain runs off a series of angled 'roofs', one onto another, eventually running off the last one and away from the camp, or running off into a rain tank or other water reservoir.

=====

I had fun with this document, doing the research, creating the folding plans, testing out the paper models. All errors are mine (I'm only Human), all credit should go to the originators of these designs, names lost in the passage of time.

**DBM - Friday, 13 June 2003.**

[Contact DBM via email.](#)

© 2003 David B. Macpherson All Rights Reserved

**END DOCUMENT.**