

Solar Cooking

Blue Rock Station Style

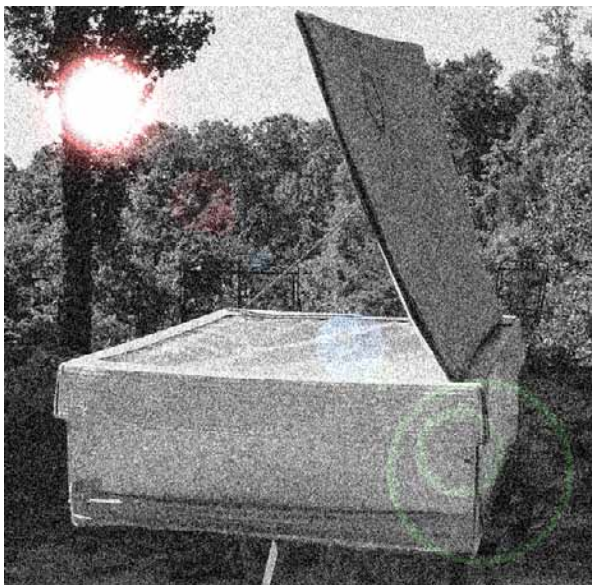

Written by Jay & Annie Warmke



www.bluerockstation.com

Published by Blue Rock Station Press
Text & Illustrations © 2006 Jay and Annie Warmke

Contact us at:
Blue Rock Station
1190 Virginia Ridge Road
Philo, Ohio 43771 USA
Telephone: +1 (740) 674- 4300
Email: annie@bluerockstation.com

www.bluerockstation.com

Printed in the beautiful hills of Appalachian Ohio, USA

Introduction:

In the mid-1990's I had the good fortune to travel to China to participate in the United Nation's Women's Forum. While there I learned from nearly 40,000 women a number of ways to change the world.

While I was traipsing through the hog fields, and taking in all of the scenery, I stumbled upon an amazing group of women from Trinidad and Tobago who were teaching women how to build solar ovens and cook with the sun.

They demonstrated that you could simply put together two cardboard boxes and cover them in tin foil. A piece of glass or a bit of plastic... and there you have it. Those women revolutionized how I thought about many things – not just solar cooking.

Since that time I have enjoyed using a variety of solar ovens that we concocted from waste products or “re-engineered” items. Once I understood the basic concepts, I quickly learned not to be afraid to experiment with cooking materials or food.

Considering the cost of electricity and gas (today and tomorrow), it just makes sense to use the sun to cook or dry food whenever possible. But with a solar cooker, you can do more than heat, bake, fry or steam food. You can also pasteurize water, preserve acid fruits in jars for eating out of season, sanitize dishes and utensils (for gardeners wanting to kill off viruses and bugs), kill insects in grains and other dry food staples, extract wax from honey, dye fabrics, and pasteurize potting soil. With very little effort you can do all of these things right on your own back porch.

Today's cooks usually just want to heat up food that has been prepared somewhere else (few of us actually cook from scratch anymore). Solar ovens are great for this purpose. Preparing everything from cheese nachos to frozen meals work well in solar ovens.

In the 10 years since I met those amazing women from Trinidad and Tobago, I have been using a variety of styles of solar ovens. Solar cookers are versatile and actually enhance the taste of food. It's our hope that you will create your own history with solar ovens. You have the ability to harness the power of the sun by making your very own solar cooker, and experiment with your own recipes.

Let us know how solar ovens works for you

– Annie Warmke



A Very Brief History of Solar Cookers

Ever since Ogg set down his club and remarked that it was hot enough to fry a woolly mammoth's egg on that rock sitting over there in the sun (Ogg was a particularly clever fellow for his day, but still rather dim to our "evolved" way of thinking), there have been attempts at solar cooking.

But most folks credit Horace de Saussure, one of Europe's foremost naturalists of the 18th century with being the first to invent and test a solar cooker (or "hot box"). Horace noticed that a carriage with glass windows got pretty warm as it sat in the sun. So he tinkered around a bit and in 1767 built a box that heated to nearly 200° F. He threw a few bits of fruit in the box and, *voilà – c'est magnifique!*

Successful solar cookers were reported in China and India during the 18th century as well, but they did not write about them nearly as much as old Horace – so he is credited as being the "Father of Solar Cooking".

Over the years, the increased use of glass helped inventors trap additional heat and store the hot air. Soon inventive (or bored) folks around the world made solar ovens bigger and better. In 1870, Augustine Mouchot invented a fairly portable oven for the French Foreign Legion. It could bake a pound of bread in 45 minutes or 2 pounds of potatoes in one hour.

Around the same time, W. A. Adams developed an eight-sided mirrored oven that reflected light through a glass cone located in the center of the oven. The Adams' oven could cook a 12-pound turkey in 4 to 5 hours, and is still a popular design today.

In 1987 a group of solar cooking enthusiasts in California formed a group called Solar Cookers International (www.solarcookers.org). This non-profit agency has since promoted the use of solar cooking techniques around the globe, particularly in the developing world.



So Why Use a Solar Cooker?

Well, of course one obvious reason to use a solar cooker is that the sun shine is free (at least for the time being) – whether we use it or not. As petroleum prices increase, reducing dependency (on a personal and global scale) makes good sense. Obviously you cannot cook with the sun every day – but on those days when the sun is high in the sky, why not take advantage of it?

So for those of us that are fortunate to live a comfortable, relatively affluent lifestyle, a solar cooker may be simply another handy appliance to keep the heat out of the kitchen or to use when the power is temporarily turned off. But for hundreds of millions of people living in poverty around the globe – a solar cooker may be the answer to their prayers. In many nations wood for fires is scarce or distant. Drinking water is contaminated, or unsafe. A solar cooker can replace the need for wood and pasteurize water, making it safe to drink.

But assuming you are currently living a fairly comfortable lifestyle (by global standards), why would you want to use a solar cooker?

- **Solar cookers can be used to *cook food or pasteurize water during emergencies*** when other fuels and power sources may not be available. Natural or man-made disasters can affect any of us at any time. We simply cannot count on help arriving soon (remember Hurricane Katrina?)
- **At moderate solar cooking temperatures food *doesn't need to be stirred and won't burn***— food can simply be placed in a solar cooker and left to cook, unattended, for several hours. In the right circumstances it is possible to put a solar cooker out in the morning and return home in the late afternoon to a hot meal ready to eat.
- **Pots used for solar cooking are *easy to clean*.**
- **Many solar cookers are *portable***, allowing for solar cooking at work sites or while picnicking, trekking or camping.
- **Water can be heated** for household chores while camping or during power outages.
- **Solar cookers are *pollution-free*.**

- **Kitchens remain cool while food solar cooks outdoors.** This reduces the load on air conditioners and refrigerators in summer months, saving fossil fuels (and lowering utility bills). For each dollar spent on conventional cooking inside an air conditioned home, an additional three dollars will be spent cooling the house back down (according to a study done by Arizona Public Service Co.).
- **Solar Cookers will cook any food without dangerous flammable fuels and fire.** A Solar Cooker uses no fire to cook food - so there is no chance of accidental fire. So a solar cooker is ideal for use in hazardous areas where the risk of fire is very real.
- **Solar Cookers produce no smoke during the cooking process.** Smoke from fires can irritate your lungs and adds to the world's pollution.
- Solar cooking uses relatively low temperatures, which helps to **pre-serve nutrients** in the food as it cooks, making it healthier and tastier..



What Else Can you Do Other than Cook?

Alright, so we all agree that cooking with a solar oven is terrific (or you will agree once you try it – trust me). But there are things you can do with this handy little item other than heating up food for lunch or dinner. You can...

- **Make jams, pickles or ketchup.** During the summer months, many vegetables and fruits are available at relatively cheap prices. When the tomatoes are in season (either at the market or in your garden), they usually come on all at once. So use your solar oven to make ketchup, tomato sauce, or meatless tomato sauce. Keep your kitchen cool and clean and you'll have delicious inexpensive condiments during the winter months. Jams and pickles can also be prepared in a solar oven.
- **Drying of vegetables and fruits:** Drying vegetables and fruits for later use is another special use of a solar oven. This is a great way to preserve vegetables or fruits when they are in season. In some cultures, people dry onions, aubergines (eggplants), ginger, tomatoes etc. to eat later in the year when they are more expensive.
- **Baking cake and bread:** Baking bread, cookies or cake is easy in the solar oven.
- **Pasteurize contaminated water,** making it safe for drinking. Do this when you are camping, during power outages or during “boil orders” that seem to occur more and more frequently.
- You can also **sanitize** pots, pans, metal utensils, ceramic pots, wooden items – almost anything. And do so without damaging them.
- And for the gardener – use your solar oven to **sterilize manure or soil**, getting rid of weeds and bugs and other nasties – making the soil clean and safe to use for your potted plants.
- And if you are being really clever, you can use your oven to **extract honey** from honey combs, **dye and dry fabrics**, or anything else that requires a moderate dry heat.



Understanding How These Things Work

There are several fairly simple concepts to a working solar oven. After you understand the basic principles involved, you can experiment with your own designs, making your oven more efficient or creating new designs (leading, no doubt, to fame and fortune).

- 1) **You need a box.** You will need an area where you can place your food. How big an area is really up to you, but remember you have to lug this thing around (we have a friend who made an oven so large – he used a patio door as the glass top – that it takes two men and a boy just to set it up). Also remember that hot air rises. So the heated air inside the box will be hotter at the top than at the bottom. If you make the box too tall, then set the food at the bottom of the box, you are not cooking the food in the hottest part of the oven.

The box can be made of wood, cardboard, metal... Whatever is handy. Just make sure it is not too deep or too large to handle.

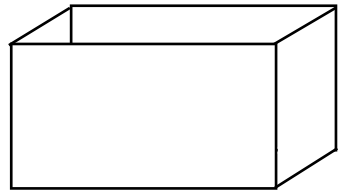

- 2) The box then **needs to be insulated.** Once you heat up the air inside your cooker, you don't want it to simply leak out. So the box needs to be well sealed (nice and tight) and well insulated. The thicker the insulation (usually) the better – but again, be reasonable. If you make the insulating area too thick you won't have any room left to put your food.

Insulate the box so that it will retain heat. You can do this with rigid insulation, a secondary internal box, or other methods.

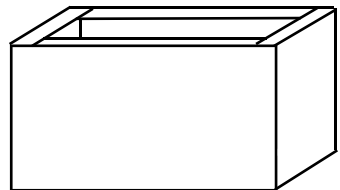

- 3) **The sun needs to get inside the box.** In simple solar ovens, this is accomplished by cutting a hole in the top of the box and covering it with plastic or glass. The angle of this opening can be adjusted (depending on how fancy you want to be), but the principle is the same. But the glass (like a window in your home) tends to leak heat – so use double-insulated glass if possible or two layers of plastic film (4 mil or thicker). If you are using plastic, make sure it is not a type that will cloud over if left in the sun. Clouded plastic will make the oven less effective. They sell plastic that will remain clear in sunlight at most lumber yards or home centers (we use a brand named Flex-O-Glass).

Cut a hole in the lid of the box, and cover that hole with glass or plastic.

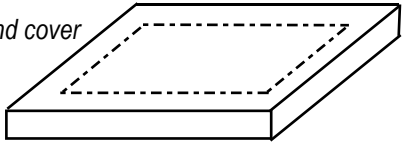

- 4) You can help make your oven more efficient by **reflecting more sunlight into the box.** Most solar ovens have some sort of flap (or multiple flaps) that reflect additional sunlight into the box through the clear film or glass. You can use shiny metal, a reflective film, aluminum foil or mirrors. The more surface area reflected, the more sunlight (and heat) will find its way into your oven.

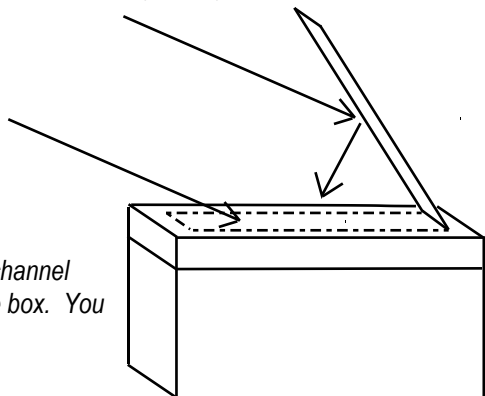

Use a reflective surface to channel more rays of the sun into the box. You can use one panel or many.

Some Guidelines for Cooking With the Sun

Start Early:

Start early in the day. Sometimes it takes a number of hours to cook the food, so start early. From time to time the sun will disappear behind the clouds, so it may take a bit longer to cook items than you are used to.

Solar cookers work best between 9:00 am and 3:00 pm. Often on a clear bright day you will get clouds forming in the late afternoon – so take advantage of the natural clear air of the morning. Cooking in a solar oven is not an exact science (none of that “heat at 325° F for 13 minutes” stuff). Cooking time will vary with season, altitude, latitude and quantity of food.

Let the box warm up before you put the food inside. Before baking cakes, biscuits etc, pre-heat the cooker for about half an hour. Baking is best done during the middle of the day (so you don't end up half-baked).

Solar cooking can take up to twice the normal cooking time. But don't worry, the food will **not** burn or overcook. Time for cooking depends on the temperature of the food when it is placed in the oven, as well as the brightness of the day. Allow plenty of time. Foods hold well in the solar oven without scorching or drying out.

The oven can be used for slow cooking, much like a crock-pot. You can prepare your dinner, put it in the oven, point the oven where the sun will be approximately halfway through the time you will be gone. Leave, and come home to a tasty, slow-cooked dinner. If you run late, there is no need to worry; the oven will keep your food warm, moist, and fresh for hours.

Black is Your Oven's Best Friend:

Place your food in a black pan with a black lid. If you don't have one, you can mix black paint with white glue(3 parts paint, 1 part glue) and paint the container. Stay away from shiny pots & pans that reflect light instead of absorbing it. Cast iron pots with glass lids work well and retain heat. With the glass top, you actually have an oven inside of an oven and you can see the food cooking. Old fashioned enamel roaster pans with lids work great for

bigger foods, such as turkeys, roasts, etc. If you don't want to paint your pot (on the outside that is!), wrap it in a black piece of material.

Always cook with the lid on the pot or container.

Some foods, such as corn on the cob, can be simply placed in an oven cooking bag to cook. It's not the most sustainable method (sorry to all purists out there), but they can be re-used several times and make a great container for cooking things like corn on the cob...just remember to cover the bag with a big black lid or a piece of dark material. Don't be tempted to use a trash bag or anything else that might easily melt (it tends to spoil the taste and texture of the food - not to mention the out-gassing).

This Thing is Hot:

So just how hot will a solar oven get? Depending on the model, typically they will reach temperatures between 200° F to 400° F. In this booklet we will show you how to make your own simple little solar oven that should heat to around 200° F. As you become addicted to solar cooking – you can purchase or make your own more advanced version that will get much hotter. Most recipes calling for a higher temperature will do fine in this lower temperature oven if you give them more time in the oven.

Regardless of your oven size, the pot lids in a solar cooker tend to get very hot. So be careful when picking them up. Use a potholder when removing pots or lids.

Also, do not allow the lid to touch the clear plastic cover of the oven; it will melt. And do not use pots with plastic handles; they can melt as well. *Hint:* – don't put anything in the solar cooker that you wouldn't put in a conventional oven.

Where you Place it Matters:

Protect the cooker from wind and animals: Nothing worse than finding the cat eating your beautiful soy turkey dinner. Also, put your oven where the sun shines (there has to be a joke here somewhere). You don't want the shade from trees or buildings blocking those golden rays. And face the oven towards the sun (in the northern hemisphere that will usually be towards the south).

Keep rotating the oven towards the direct sunshine as the hours pass. No need to get crazy about it, but every hour or so simply adjust the angle so the sun is shining directly into the box.

Other Little Tips:

Tip: You will find that the back of the oven gets hottest. So place your food accordingly. Larger quantities of food, or food that needs more time to cook (potatoes), should be positioned at the back of the cooker where the heat is greatest.

Tip: Food cooks more quickly in several small pots than one large one.

Tip: To pre-heat your oven, heat a brick for two hours and leave it in the oven while baking.

Tip: Most recipes take slightly less liquid when cooked in a solar oven, and if you are cooking in the 200° F range you will not need to add water. Use less than normal water for stews or soups.

High altitude adjustment: The temperature of boiling water is reduced as the altitude increases. For instance the boiling temperature of water is only 203° F at 6000 ft. and this slows the cooking. Vegetables and dried beans may be difficult to cook at high altitudes because of this effect. You may try cooking your food in darkened canning jars with regular canning lids and rings tightened. The rubber seal allows excess pressure to be released but a low increase in pressure is retained and speeds cooking. *Hint:* Standard canning jars and lids are recommended because they are designed for pressure.



Weather Conditions for Using Your Solar Oven:

The weather will affect how well your oven works. Kind of goes without saying... So just as you would not hang your clothes out to dry on a rainy day – you will need to have sunshine to cook in your solar oven.

So what are the best conditions for cooking with a solar oven?

IDEAL: Clear and sunny. The temperature of the air doesn't really matter so much as the intensity of the sunshine. On a crystal clear day, a moderate quality oven will heat to 225° F - 300° F.

OKAY: Hazy or partly cloudy. If the sun is partially obscured by haze or keeps peeking in and out of cloud cover, the oven will heat to about 200° F-225° F.

REALLY BAD: On a completely cloudy day you should just pack it in and eat cereal out of the box. You should not try to cook with the sun. If the clouds move in and completely block the sun while cooking, simply finish the cooking in a non-solar way.

If food partially cooks and then rests in incubation temperatures, pathogens may grow in 2 or 3 hours. Partially cooked food should be removed from the cooker as soon as possible.



How Food Cooks in a Solar Oven

As we mentioned earlier, start long before you plan to eat. In ovens that heat from 225° F - 275° F, it will take you at least twice as long as the same meal would take to cook in a conventional oven. But the sunshine is free, so don't worry about it. The added cooking time will not affect the taste of the food - in fact, slow cooking typically enhances the taste.

Temperatures in the oven rise slowly and evenly, allowing complex carbohydrates time to break down into simple sugars, enhancing the natural flavors of the food. On a partly cloudy day, the temperature will dip slightly as the sun goes behind the clouds, but overall the oven will retain most if not all of its heat (depending on how well it is insulated).

You won't have to stir or check the food (it's extremely hard to burn food in a solar oven - especially if you are cooking at temperatures below 300° F) but you will have to turn the cooker towards the sun as the sun moves across the sky if you want the oven to work at its best. Direct sunlight will cause food to cook more quickly

These guidelines are valid for cookers that maintain temperatures between 200° F - 275° F. If your cooker consistently heats to between 300° F - 350° F, then cooking times will typically be the same as with a conventional oven.

Easy to Cook: (If started early, will be done by evening on a fair day.) Rice, whole grains, rolled grain flakes, cereals, most egg dishes, chops, ribs, fish and most poultry, puddings, crackers, cookies, brownies, fruits, green vegetables, shredded vegetables.

Fair to Midlin': (If started early, ready by noon on a good day or by evening on a fair day.) Cornbread, gingerbread, medium-sized roasts, quick breads, yeast rolls and buns, soufflés, root vegetables such as potatoes, turnips, some beans such as lentils, black-eyed peas, black beans.

Difficult to Cook: (If started early, ready for dinner on a good day.) Whole turkey, large roasts, stews and soup and bean pots (unless brought to a boil before placing in solar oven), most yeast breads and cakes, pre-soaked pinto beans, field peas, garbanzo beans, small navy beans, soybeans, kidney beans, red beans, yellow peas, dried peas, split green or brown peas.



Foods that are Great for Solar Oven Cooking

- **Acid fruits** can be “canned” in a solar cooker by placing fruit, sugar, and water in canning jars. Loosely tighten lids and place the jar in the cooker. Heat them until they have boiled over. Then tighten the lids and allow them to cool. After they cool, if the lids have a concave appearance (bend down towards the jar), then you have a good seal. **DO NOT CAN FOODS OTHER THAN ACID FRUITS IN A SOLAR COOKER.** Pressure and higher temperatures are necessary to kill off possible spores in most foods. So do not can vegetables or meat in a solar box cooker, since these foods need to be canned under pressure or in a hot water bath!
- **Tomatoes** can be "canned" in the solar oven. The process is fairly simple. Pack tomatoes in a clean canning jar. Then add water, leaving 1/2" “head space” at the top of the jar. The dome type canning lids are snugged onto the jars. Then place the jars into a solar oven that has been pre-heated to at least 215° F (at sea level). The contents of the jars will eventually boil past the lids. After this happens, remove the jar, wipe it clean, and allow it to cool. After cooling, check each jar to make sure they are properly sealed. If a lid did not seal, then simply add more water and do the whole thing all over again. This non-pressurization canning method is safe for acid fruits and tomatoes only. Conventional canning methods must be used for non-acid type of foods.
- **Vegetables** cook up well in a solar oven, but **DON'T ADD WATER.** Cooking times:
 - ◆ Artichokes: 2 1/2 hours;
 - ◆ Asparagus: 1 1/2 - 2 hours;
 - ◆ Other fresh green vegetables: about 1-1 1/2 hours. If cooked longer they will taste fine, but tend to lose their nice green color.
 - ◆ Beets, Carrots, Potatoes and other root vegetables: 3 hours.
 - ◆ Cabbage, eggplant: 1 1/2 hours if cut up. Eggplant turns brownish, like a cut apple, but the flavor is good;

- ◆ Corn on the cob: 1 - 1 1/2 hours with or without husk or even in a clean black sock.
- ◆ Squash, zucchini: 1 hour. Will turn mushy if left longer.
- **Eggs** - Add no water. Two hours for hard yolks. If you cook them longer, the whites may turn brownish, but the flavor is still the same.
- **Meats** – Again, don't add any water. Cook whole or in pieces: Season and add enough water to cover pan, cut into pieces if sun is poor or if in a hurry. Slow cooking tenderizes meat.
 - ◆ **Fish:** 1-2 hours; Cut up; fish; Put in pot, season, cover with greased paper to retain moisture, cover pot, bake.
 - ◆ **Chicken:** 2 hours. Whole chicken, 3 hours;
 - ◆ **Beef, Lamb, etc.:** 2 hours cut up, 3 - 5 hours for large pieces;
 - ◆ **Turkey,** large, whole: all day (but not recommended unless it is a clear, bright, sunny day).
 - ◆ If meats are cooked longer they usually get more tender.
- **Pasta** - Heat water in one pot and put dry pasta with a small amount of cooking oil in another pot, then heat until the water is near boiling. Add the hot pasta to the hot water, stir, and cook for about 10 more minutes.
- **Baking** - is best done in the middle of the day (9 am - 3 pm)
 - ◆ Breads: Whole loaves - 3 hours;
 - ◆ Cakes: 1 1/2 hours; Cookies: 1 - 1 1/2 hours.
 - ◆ Baked items do NOT need to be covered. Avoid bottom crusts as they tend to get soggy.
- **Sauces & Gravies made with Flour or Starch** - Heat the juices and flour separately, with or without a little cooking oil in the flour. Then combine them and stir. It will be ready in a relatively short amount of time.
- **Roasting Nuts** - Bake uncovered. Almonds: 1 hour, Peanuts: 2 hours.
- **Dried Cereals and Grains:** such as barley, corn, millet, oats, quinoa, rice, wheat: Cooking these might take a bit of experimentation. But start by adding the amount of water you might normally add when cooking these items on the stovetop. After about 2 hours your bowl of porridge should be ready.

- **Corn Meal** - Preheat 3 cups of water and 2 cups of corn meal separately in the solar cooker. Mix together and bake; stir again if needed. Cornmeal pre-toasted on an open pan in the cooker adds a nutty taste.
- **Rice:** Mix two cups of water and one cup of rice with seasoning, then bake.
- **Whole Wheat Bread:** Mix 3 cups of flour (two kinds for variety), 1 packet instant yeast, 3 tablespoons honey, 2 teaspoons salt, 3 tablespoons oil. Make hollow, add 1.5 cups lukewarm water, thoroughly stir, turn into well-greased loaf pan, cover, and bake.
- **Millet Cake:** Mix 4 cups of ground millet, 1 cup sugar, 3 cups milk until blended and thick; place in baking pan, smear top of cake with butter and bake.
- **Beans:** Soak in water overnight; discard this water, cover with fresh water or stock; cover pot and cook. (Beans take no longer to solar cook than with conventional fuel.)



RECIPES:

Ratatouille

Eggplant - cut in cubes
Zucchini slices – remove the center
Onion pieces
Oil and salt to taste

Tomato chunks – drain juice
Green pepper slices
Garlic - minced

Place in a dish or wrap up in aluminum foil. Cover with a black lid and cook two hours to all day. This is a good dish either hot or cold!

Corn on the Cob

Place the corn (still in the husk) inside of a large black roaster pan or a cooking bag (cover with a black lid if using the bag), and cover the pan or seal the bag. Cook in the oven for two hours or all day. It won't overcook.

Stewed Tomatoes

Place each whole tomato into a greased custard cup and cut tomato into four sections. Spread cheese of your choice onto bread and tear into small pieces. Add cheese/bread pieces to the tomato. Sprinkle with Italian seasoning and pepper. Cover and bake about 45 minutes.

Beets

Clean beets and then coat with olive oil. Place fresh beets in a black pot. Cover and bake for one hour or so. The beets are ready for chilling or adding to salads.

Baked Potatoes

Clean potatoes and rub with shortening or butter. Place in a dark dish. Cover and bake 3 hours or until done.

Fresh Apple Custard

4 eggs
1/2 tsp. Nutmeg
1 tsp. Vanilla

1/3 cup honey or sugar
1 can evaporated milk

Mix all of the above in a blender then pour over 4 cups sliced apples in a 9-inch pan. Cover and bake approximately two hours.

S'mores

Place marshmallows on little sticks or on a black surface inside of the oven. Check periodically to see if the marshmallows are getting soft. As soon as they are soft remove the marshmallows. Have ready a graham cracker sandwich with a small piece of chocolate in the middle. Use the top graham cracker to “grab” a soft marshmallow and pull it onto the chocolate half of the cracker sandwich. Squeeze the cracker sandwich together until the soft marshmallow oozes out of the sides of the cracker. Enjoy!

Fudge Pie

2 ounces unsweetened chocolate
1 stick (1/2 cup) butter
1 cup date sugar
¼ cup whole wheat flour
2 eggs
1 teaspoon vanilla
1/4 teaspoon salt

Preheat solar oven while mixing the pie. (You can also preheat a conventional oven to 375° F)

Lightly oil a 9” pie pan. Place chocolate and butter into a 4-cup Pyrex measure or microwave-safe bowl. Heat on high heat for 1 minute, stir and heat for 30 seconds more. Let sit for a minute or so and stir until chocolate dissolves completely. Add sugar, flour, eggs, vanilla and salt. Stir until well-combined. Pour into prepared pan. Bake for approximately 2 hours in your box solar oven on a sunny day or 25 minutes in a conventional oven. Let cool.

Home Baked Bread

2 cups bread flour	1 ½ cup corn meal or whole wheat flour
1 teaspoon salt	1 tablespoon olive oil
1¼ cups water	2 teaspoons yeast
3 tablespoons honey	

A bread machine can do all the prep work. Just before it starts to bake, remove the dough to a greased loaf pan and place in the microwave oven with 2 cups of hot water. Dough should double in size in about 35 minutes. Remove to your 325° and bake for approx. 45 minutes. For a better crust, brush loaf top with salt water 5 minutes before done. Test for doneness by tapping the loaf; if it sounds hollow, the bread is done.

CORN BREAD

1 package Jiffy Corn Bread Mix
1 chopped green onion
1 egg
Buttermilk

Mix first three ingredients with enough buttermilk to get the right consistency. Bake in preheated at 325° for approx. 70 minutes or until done.

SUN DRIED TOMATOES

Slice tomatoes as thin as possible. Place in wax-paper lined pan in *solar oven* with lid ajar. We use the Roma tomato because the color is better when dried and it tastes better. Turn tomatoes over a few times to keep them from sticking. On a clear, sunny day, it will take 5-6 hours for them to be completely dried. You can use a wire rack to do two batches at a time, one on top of the other.



Making your Own Solar Oven:

The “Half-Baked, Couch Potato” Less Than \$5 Do-It-yourself Solar Oven

So you now know the power and appeal of a solar cooker. So what are you waiting for? Let’s get off the sofa and get busy making one of these beauties. Very little skill is required, and the stuff you will need is probably lying around the house... so no excuses.

Materials You Will Need

- One cardboard box. A beer case box works great, as it is made of heavy cardboard and seems to be just about the right size. This cooker box should be at least 15" wide x 13" deep. The typical beer box we pull from the dumpster of our local convenience store (used to ship 4 six-packs) is about 16" x 13".
- Some additional cardboard, perhaps another large cardboard box or two. We are going to cut these up a bit, so the sizes don't really matter. Heavy cardboard is better than light cardboard, and bigger is better than smaller. If you are lucky enough to find a second box that is about one inch smaller in both directions than the cooker box – grab it. This will save you a bit of time in construction.
- You will also need a large pizza box. I suspect these vary in size as well, but the size we use with the beer box measures just under 17" square and is just under two inches deep.
- One roll of aluminum foil – any grade will do. If you really want to get fancy, buy some metallic contact paper from your home center. One roll should be enough.
- A bit of black paint (use the last bit from a spray can, or you can use flat black paint that you will brush on). The paint should state that it is “non-toxic when dry”, as you are going to use it inside your oven. Or if you would rather not use paint, you could use a black piece of cloth (or black metal) that will fit in the bottom of the box.
- The sports section of the newspaper.

- A roll of duct tape (you simply can't build anything of value without duct tape)
- 2 pieces of UV-resistant plastic film (16" square). You could also use a piece of 16" square glass or Plexiglas, but these will be heavier and more fragile than the plastic. We have been able to buy the UV-resistant film from our local lumber store for under \$2 for the size we need.
- A 12-inch piece of heavy wire or a coat hanger that you can cut to that length.
- A small bottle of white (Elmer's) glue

Tools You Will Need

- A straight-edge ruler (at least 12 inches long)
- A pair of scissors (and a utility knife would be helpful, but you can use the scissors if you can't find the knife).
- A pair of wire cutters (to, what else, cut the wire)
- A pencil or a pen

Building the Solar Cooker

For the purposes of clarity, we are going to assume you found a cardboard box that measures 16" x 13". If your actual box is slightly bigger or smaller – don't sweat it. Just adjust the measurements accordingly. Oh yeah, we will also assume that the pizza box is about 16 1/2" square and two inches deep.

1

Take your beer box and cut the sides so that the box is only about 6 1/2 inches deep.

Cut the box so that it is 6 1/2 inches high all the way around.

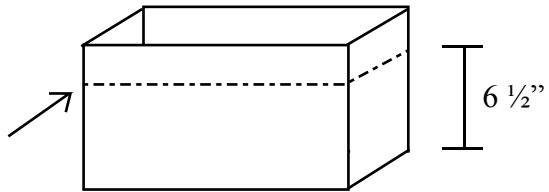

2

Take a piece of cardboard and cut it so it will fit tightly in the bottom of the box. It should be just under 16" x 13" and fit snugly without buckling when you place it in the bottom of your cooker box.

3

Now, if you happen to have handy a box measuring 14" x 11", you are in luck. You can place this inside your larger box and you will have about an inch gap all the way around. Cut this box down to the same 6 1/2 inch height – so you have a nice even box-within-a-box.

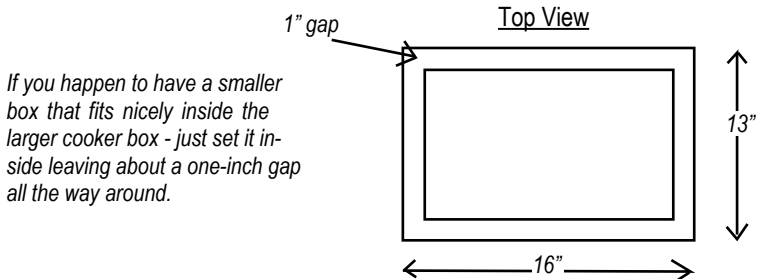

If you happen to have a smaller box that fits nicely inside the larger cooker box - just set it inside leaving about a one-inch gap all the way around.

But the reality is that you aren't likely to find a conveniently sized box to fit inside your cooker box, so we will show you how to make one. Cut two pieces of cardboard into 6 ½" x 16" rectangles. Take a bit of duct tape and tack the bottom of each piece about an inch from the side, on the inside of the cooker box. Then cut the side walls. These will be 6 ½ inches tall, but only 11 inches long (to accommodate the one-inch gap you left on each of the lengthwise walls). Tape these in place.

Tape the cut pieces of cardboard and tape them to the bottom of the larger box, again leaving about a one-inch gap all the way around.

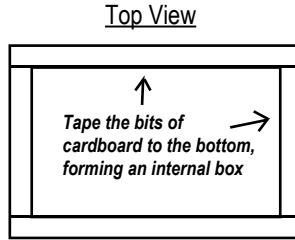

4

Next comes the insulation. We are going to use the sports section of the newspaper – because, heck, what better to go with pizza, beer and duct tape. Crumple up the newspaper (it won't take much) and fit it in the one-inch gap all the way around the inside edge of the cooker box. You will have to tack the sides together with a bit of duct tape to keep the newspaper from pushing the flaps of cardboard towards the center of the box.

Fill the gaps with crumpled newspaper, then hold the flaps of cardboard together with tabs of duct tape.

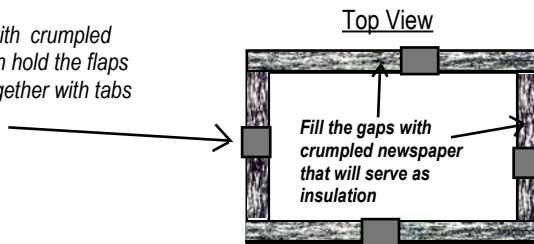

5

With this completed, tape it all up nice and solid. Don't be shy. This is what duct tape lives for. Be sure to use the tape to bridge the gap above the newspaper, tying the two boxes (the main cooker box and the inside box we just created) together.

6

With your can of black spray paint, or paintbrush, paint the inside bottom of the box black. Now set it aside to dry.

7

Next comes the lid. Take your pizza box and cut the top off. You can then lay the bottom portion (upside down) over the cooker box so that three of the four sides of the pizza box fit tightly over the top of the box. Mark the fourth edge of the cooker box with your pencil or pen. Remove the pizza box, cut the sides at your marks, and fold the box along the line you marked. What you are doing is simply reducing the size of the lid to fit the shape of the cooker box. Trim the excess cardboard so it all looks pretty. Then tape up the ends so it holds its shape.

Lay the pizza box over the oven box and mark the overlap. Fold along your mark and trim to size - then tape it up.

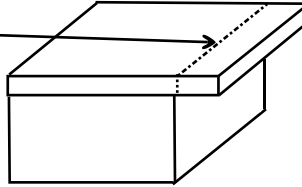

8

You will now have a lid for your solar cooker that is about 16 ½" x 13 ½" in size (and about two inches deep). Check to make sure it fits snugly over the cooker box. Now, measure and mark a two-inch border on the top of your lid (with it snugged down on the cooker).

Cut the flap in the lid, cutting only three sides (the dotted sides) leaving one connected that will be folded back.

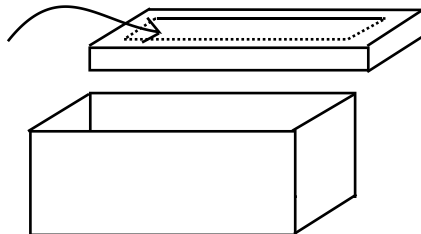

9

With your scissors or box cutter, cut three sides of your mark, creating a flap of cardboard on your lid. Be sure to cut the two shortest

sides and only one of the long sides. Then fold the cardboard upward along the line marked on the uncut long side.

10

Cut another piece of cardboard to a size of $16\frac{1}{2}'' \times 11\frac{1}{2}''$ (the discarded top of the pizza box is handy for this bit)

11

Tape this bit of cardboard ($16\frac{1}{2}'' \times 11\frac{1}{2}''$) to the flap on the lid so that it aligns with the folded cardboard. What we are aiming for here is that the flap (plus the added bit of cardboard) can fold upward from the lid, but when closed will cover the entire lid (except the back two inches behind the fold).

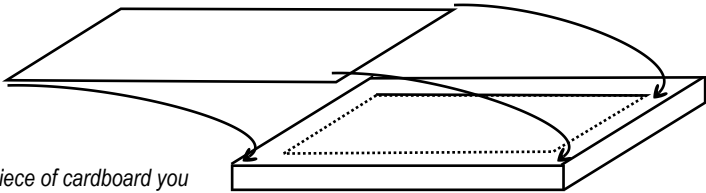

Take the piece of cardboard you just cut, place it on top of the lid, aligned with the folded flap (so the flap can still open and the cardboard covers the rest of the lid. Tape it to the flap.

12

Turn the lid over and tape one piece of your clear plastic ($16'' \times 16''$) to the underside, covering the hole completely. We want to put the second piece of plastic in the same place, but we need a gap between the plastic so it does not lose heat. So take one-inch strips of cardboard and tape them along the edge of the box over the first layer of plastic. Then tape the second piece of plastic on top of those one-inch strips.

13

Now comes time for the reflective material. If you are using aluminum foil, glue the foil to the underside of the now larger lid flap. You can also glue the foil to the inside walls of the cooker box. Be sure to spread the glue evenly over the foil so it attaches securely.

Apply the metallic contact paper or glue the aluminum foil to the underside of the flap.

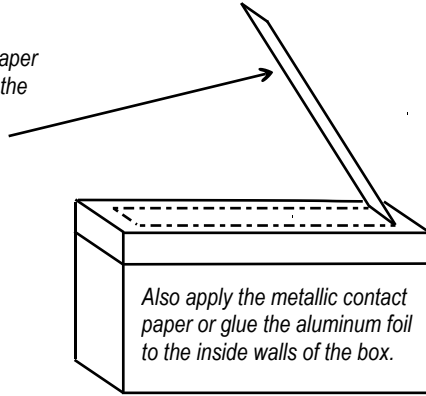

14

Take your bit of heavy wire or coat hanger and cut it to 12 inches in length. About $\frac{3}{4}$ " from each end, bend the wire at a 90 degree angle in opposite directions. This is going to be the brace that holds up the lid flap of your solar oven. Slide one end through the foil and into the corrugated holes of the cardboard in the flap, and the other end will slide into similar holes in the boarder of the lid.

Cut a piece of wire about 12 inches in length, then bend the ends as shown.

Use this wire as a brace for the reflector.

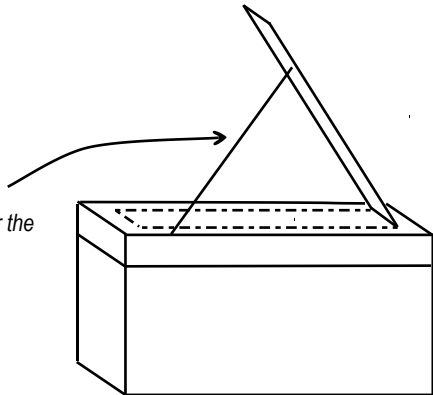

15

Now decorate to suit your tastes. Make it as pretty or as plain as you like. This oven should heat to 200° F when placed in the sun.

About the Authors:

Annie and Jay Warmke own and run Blue Rock Station, a sustainable living center near Philo, Ohio. Besides being full time grandparents they raise llamas and rare-breed chickens, conduct tours of the house (an Earthship) they built out of garbage, serve on several local tourism committees and are avid readers of *THE GUARDIAN*, their favorite British newspaper.

Annie Warmke is a noted activist and writer. Her career spans a lifetime of working with and writing about women in a variety of settings. She has translated for SOS FEMMES, led women's delegations overseas, organized shelters for battered women, founded rape crisis projects, served on think tanks, and traveled around the world raising money and crusading for women's safety.

Annie has been cooking with solar ovens for over 10 years in not-so-sunny southeastern Ohio.

Jay Warmke obtained his degree in Journalism from Ohio University, learning just enough about journalism to know he never wanted to be one.

After working in the comic book industry for a number of years, he then followed a typical career path - becoming executive director of one of the world's largest telecommunications associations. Shortly after being named one of the top ten most influential people in the telecommunications industry by *Cabling & Installation Maintenance Magazine*, he decided it was time to leave (if he was the best they had, the whole industry must be in trouble).

He has eaten food cooked in a solar oven for over 10 years - but is not allowed anywhere near cooking utensils ... and for good reason.