

**AT** MICROFICHE  
REFERENCE  
LIBRARY

A project of Volunteers in Asia

Sun Dry Your Fruits and Vegetables

by: Helen Strow, ed.

Published by:

Federal Extension Service  
Office of International Extension  
US Department of Agriculture  
Washington, D.C. 20250 USA

Available from:

Federal Extension Service  
Office of International Extension  
US Department of Agriculture  
Washington, D.C. 20250 USA

Reproduction of this microfiche document in any form is subject to the same restrictions as those of the original document.

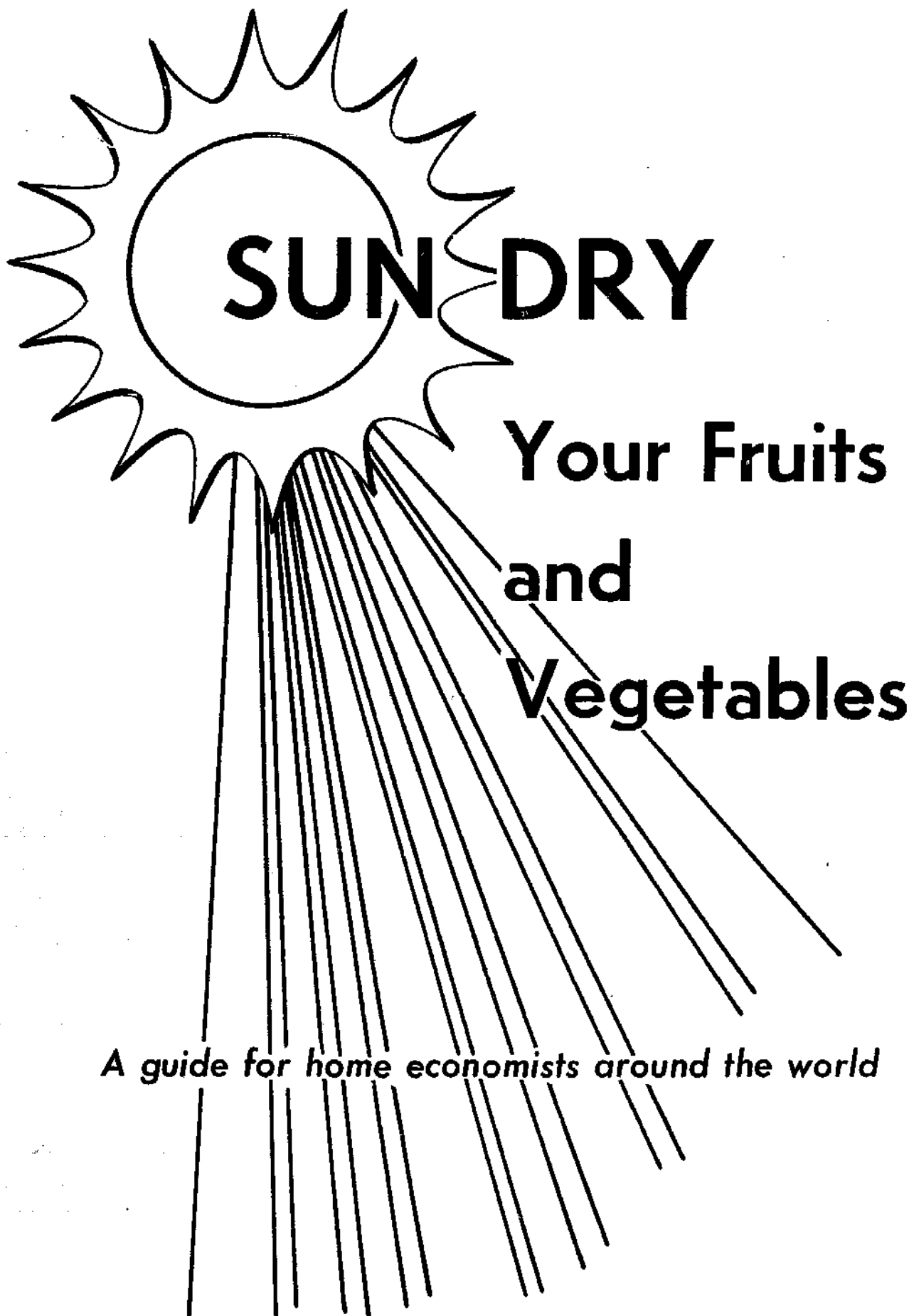

**SUN DRY**

**Your Fruits  
and  
Vegetables**

*A guide for home economists around the world*

**This is for  
YOU  
The Home Economics Extension Worker  
or  
Village Worker**

**It is to aid you in helping  
families to dry foods successfully.**

**Issued July 1958**

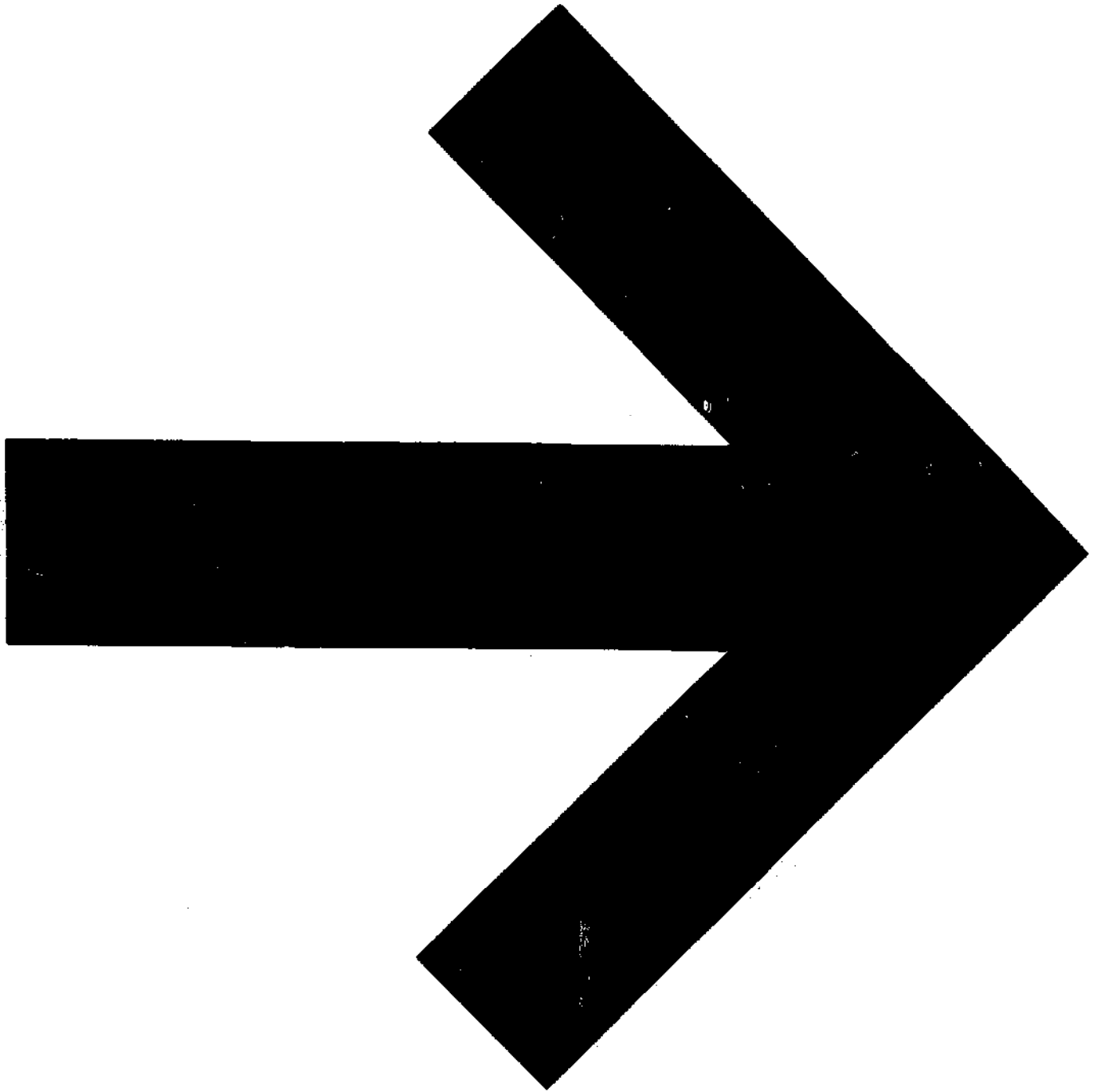

## CONTENTS

	<u>Page</u>
For Greater Health for Your Family .....	1
Just What is Drying .....	1
What Foods Can You Dry? .....	2
Cleanliness Every Step of the Way .....	3
Check the Air .....	4
How to Dry Fruits -	
Equipment Needed .....	5
Steps in Drying Fruits .....	6 - 10
How to Sulphur Fruit .....	11 & 12
Chart for Drying .....	13 & 14
How to Dry Vegetables	
Equipment Needed .....	15
Steps in Drying Vegetables .....	16 & 17
How to Steam Vegetables	
Method I .....	18 & 19
Method II .....	20 & 21
Drying Trays .....	22
Materials for Trays .....	23
Some Good Places to Dry Fruits and Vegetables .....	24
How To Dry Some Special Fruits and Vegetables .....	25
How to Prepare Dried Foods for Use .....	26

# Sun Drying Your Fruits and Vegetables

## For Greater Health for Your Family

Drying the surplus food in the season of plenty can mean more good health foods for the family in seasons when these foods are not available fresh. It can add variety to the diet and make cooking easier because there are more foods from which to plan meals. Drying is not difficult and it requires very little equipment. For the equipment you can use things you already have or can make the necessary pieces easily at home. Drying need cost nothing.

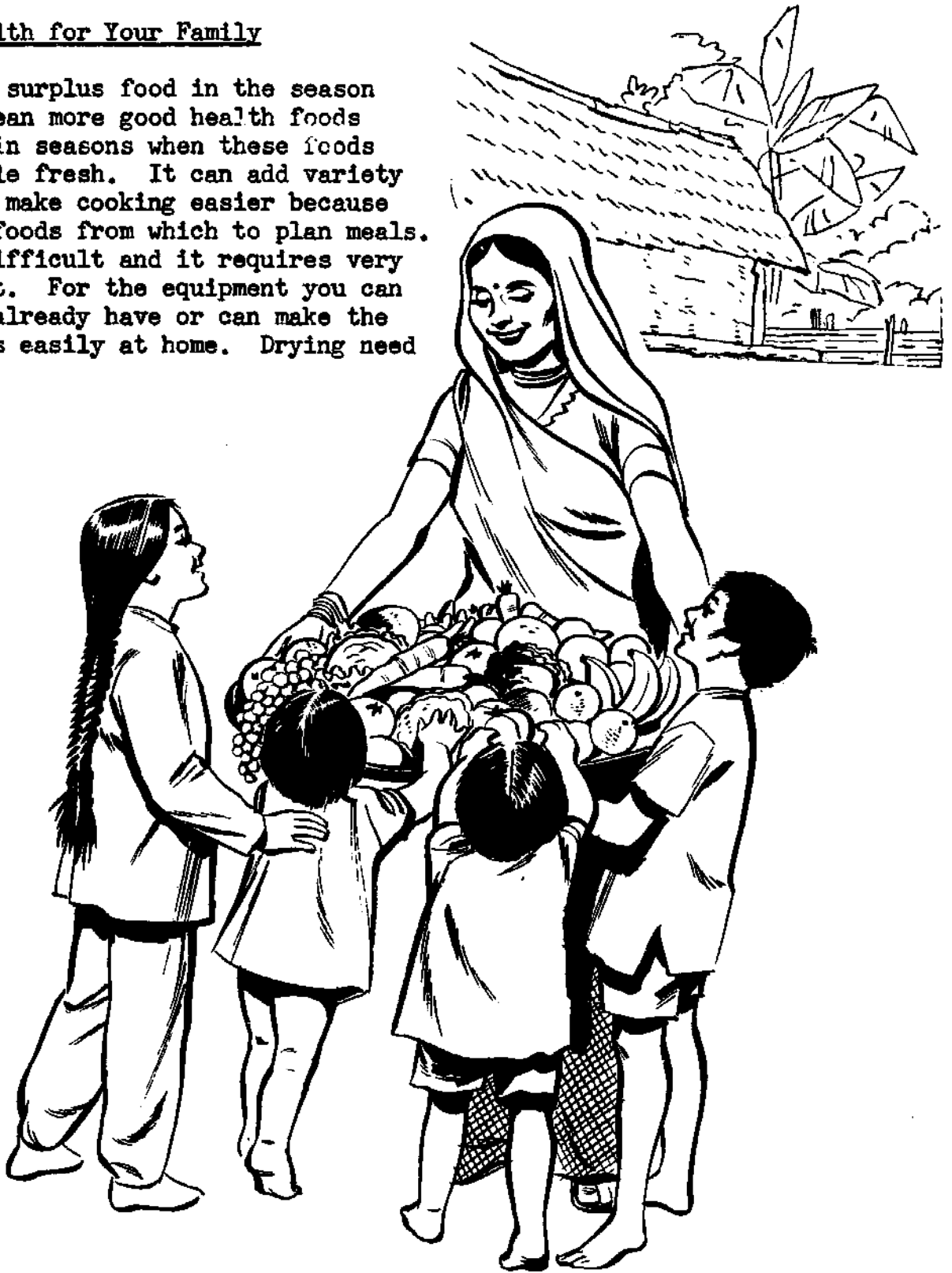

## Just What is Drying?

Drying foods does two things. (1) It removes the water and (2) it checks the chemical change that takes place naturally in food, as for example, fruit when it ripens.

## WHAT FOODS CAN YOU DRY?

Many different foods are being dried today in various parts of the world. Some foods, which in one country may seem unsuitable for drying, are being dried in others. The tomato is an example of this. In the United States it has been less commonly dried than some other vegetable. In some Middle East countries it has been dried frequently. Here are some of the foods most commonly dried. They have been divided into two groups; those which are easier and those harder to dry.

### FRUITS

#### EASIER

APPLES  
APRICOTS  
CHERRIES  
COCOANUT  
DATES  
FIGS  
GUAVA  
NECTERINES  
PEACHES  
PEARS  
PLUMS  
PRUNES

#### HARDER

AVACADO  
BLACKBERRIES  
BANANA  
BREAD FRUIT  
DEWBERRIES  
LOGANBERRIES  
MAMEY  
GRAPES

### VEGETABLES

BEANS - Mature-  
(Kidney, Lima, Mongo, Pinta,  
Pole, Red, Black, Soy)  
BEANS - dried in green state -  
(Lentils, Soy)  
CHILI (Peppers)  
HERBS (Parsley, Celery tops, etc.)  
PEAS - mature -  
(Sugar pea, Cow pea,  
Chuck pea,  
Pigeon pea)  
SWEET CORN  
SWEET POTATOES  
CASSAVA ROOT  
ONION  
SOUP MIXTURE

ASPARAGUS  
BEETS  
BROCCOLI  
CARROTS  
CELERY  
GREENS - (Kintsay, Talinum,  
Kangkong, Collards,  
Mustards, Turnip Tops,  
Beet Tops, Sweet Potato  
Leaves)  
GREEN SNAP BEANS  
GREEN PEAS  
OKRA  
PEPPERS  
PIMENTOS  
PUMPKIN  
SQUASH  
TOMATOES

# Cleanliness Every Step of the Way

GATHERING CLEAN

PREPARING CLEAN

DRYING CLEAN

STORING CLEAN

Cleanliness is of the greatest importance. It is necessary to follow clean practices every step of the way. What causes food to become dirty? Dust and dirt which fall on the food may contain harmful bacteria. Flies or other insects also carry bacteria on their feet. Some of these bacteria may cause it to spoil more easily. Here are some rules for keeping the food clean as you pick it, prepare it, dry it and store it.

1. Pick or collect food into clean containers.
2. Wash hands before handling food.
3. Wash food carefully in clean water.
4. Cover food drying on trays with clean cloths to keep dust, dirt, flies, and other insects out of it.
5. Wash these covering cloths frequently in clean water.
6. Place trays of food while drying away from dust, insects, and flies.
7. Never lay drying food directly on sand, or ground.
8. Store in tight containers from which dirt and insects can be excluded.
9. Scrub trays or mats after using.



## Check the Air

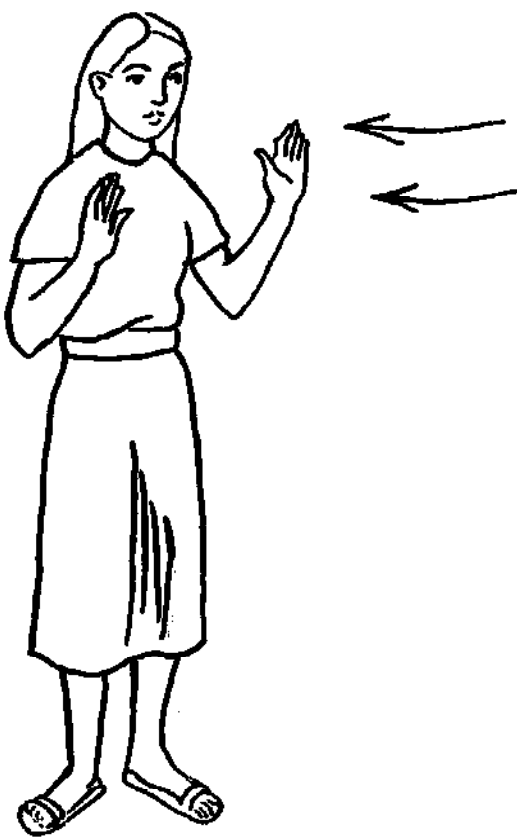

If you are thinking of drying be sure you have conditions which will bring you success. You need to have these three for best results.

### 1. DRYNESS of AIR

Unless the air is reasonably dry the moisture cannot be removed from the food. If it rains all the time it will be hard to dry food.

### 2. WARM or HOT AIR

Hot days when the sun is shining brightly are best for drying food. Then the food can be dried quickly, which is desirable.

### 3. CIRCULATION of AIR

There needs to be free circulation of air around the drying food. Make sure that air can reach the foods from all sides, around and underneath, as well as the top of the food.

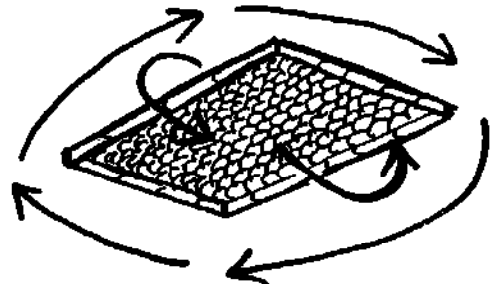

# How to Dry Fruits

## EQUIPMENT NEEDED

Equipment can be very simple for drying fruit. In order to work rapidly after the fruit is picked it will help to get the equipment ready ahead of time. Be sure it is clean. You will need:

### 1. Sharp knife -

to pare and cut fruits  
(A stainless steel knife prevents discoloration)



### 2. Wooden board -

to make cutting easier

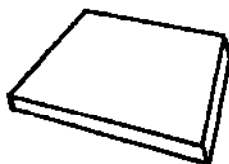

### 3. Fan, kettle or pot -

in which to wash fruit



### 4. Equipment for sulphuring:

Large box to cover trays  
Small container for sulphur  
Sulphur  
Small piece of paper  
Matches



### 5. Plenty of clean water.

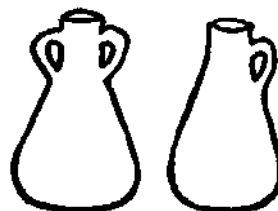

6. Trays or mats on which to spread fruit to dry. Trays should be thoroughly scrubbed and dried. See page 22 for suggestions regarding materials to use in making trays and for directions.



### 7. Pieces of clean, loosely woven cloth -

One for each tray or mat.  
Each piece should be 2 inches (5 centimeters) longer and 2 inches (5 centimeters) wider than tray.

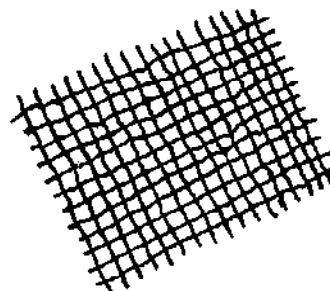

# STEPS IN DRYING FRUITS

## STEPS

## HOW - WHY - WHEN

### 1. Gather fruit



#### a. Select Good Quality Food

The finished food can be no better than the fruit with which you start. Select fresh, ripe, firm and sound fruit. Gather it as early in the morning as possible. When fruit is right for eating it is right for drying.

#### b. Handle Carefully

Fruits bruise easily. Handle with care.

### 2. Wash fruit



Place fruit in pan.  
Pour clean water over fruit  
Wash carefully.  
Lift fruit from water.  
Empty water from pan and repeat  
if necessary.

STEPS IN DRYING FRUITS - Continued

STEPS

HOW - WHY - WHEN

3. Peel or pit fruit



As needed

4. Cut fruit

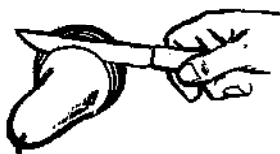

As needed  
Slice into thin pieces  
Thick slices dry slowly

5. Sulphur fruit

Most fruit is improved by sulphuring

Read chart page 13 to see which fruits should be sulphured

See directions page 11 for how to sulphur

Why Sulphur?

Fruit has better color and flavor

Fruit requires less soaking before cooking

Sulphuring helps to:

retain vitamins

prevent souring

prevent insect attacks

6. Spread fruit on clean dry trays or mats

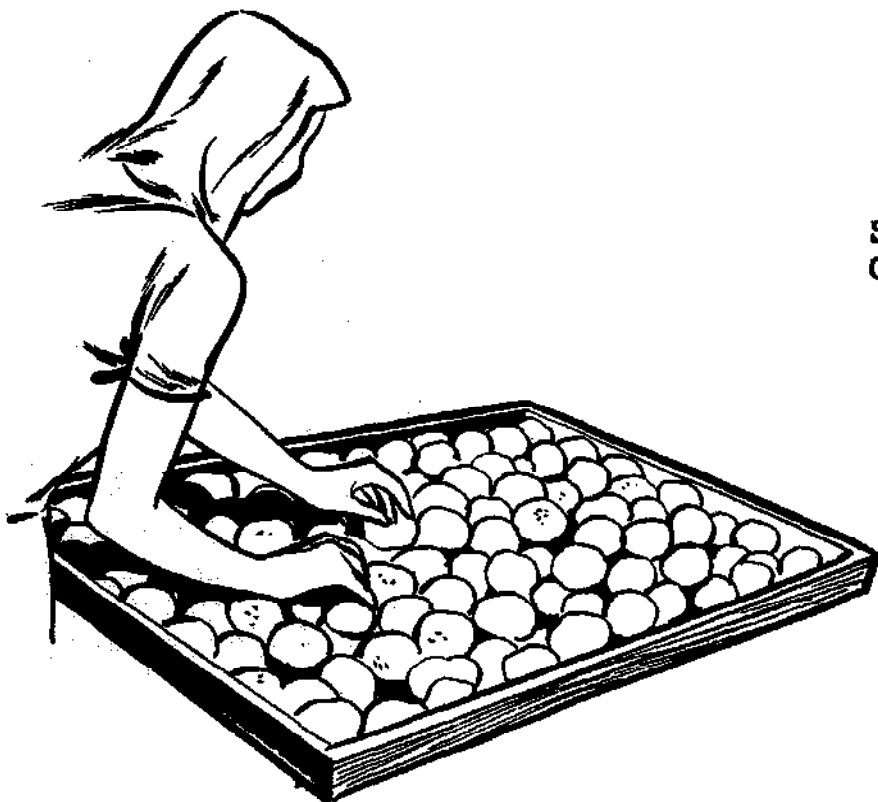

Spread evenly  
One layer in thickness

STEPS IN DRYING FRUITS - Continued

STEPS

HOW-WHY-WHEN

7. Cover with loosely woven clean cloth, mosquito netting, or wire screen.

To keep insects and dust from getting on the food.

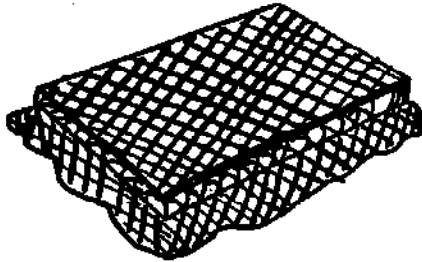

Fasten cloth so it will not blow off.

8. Place trays of fruit in sun to dry.

a. In direct sunlight. This may mean placing the tray flat or it may require raising one edge of the tray.

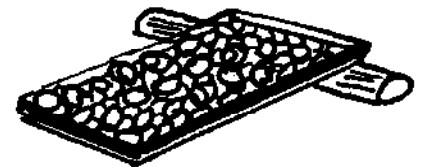
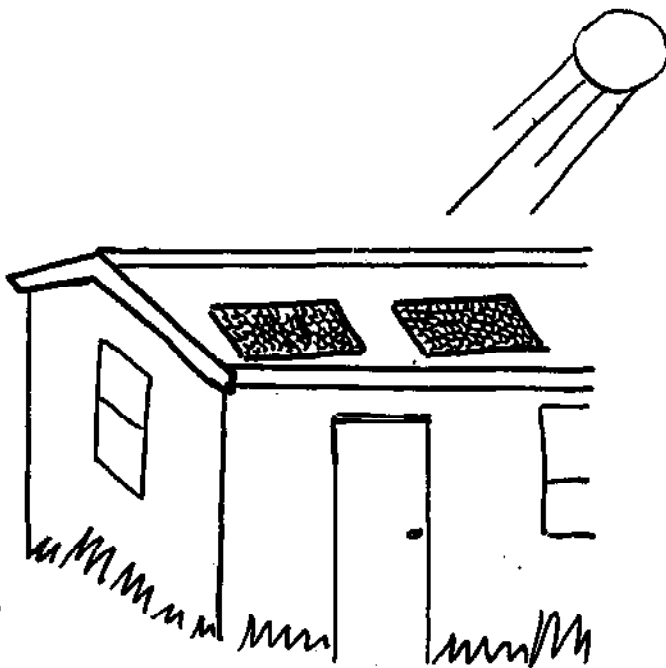

b. Where air can circulate freely over and under food. This may require putting tray on blocks or stones.



c. Away from dust and dirt.  
d. Off the ground.  
e. Away from animals and people.  
f. Protect from storms and dew.  
g. Take in when danger of rain.

9. Turn food.

Two or three times each day to speed drying.

10. Continue drying.

For several days until 2/3 dry.

## STEPS IN DRYING FRUITS - Continued

### STEPS

### HOW - WHY - WHEN

#### 11. Test for dryness.



Squeeze a handful.  
If there is no moisture left on the hand and the fruit springs apart when hand is opened, the fruit is properly dried.  
Berries should rattle on trays.

#### 12. Condition fruit.



Gives fruit opportunity to complete drying process and prevents growth of mold.

Take fruit from trays and put in large container.  
Cover container with cloth or wire screen to prevent insects and dirt from getting into it.  
Stir fruit 2 or 3 times daily.  
Leave 8 to 10 days.

#### 13. Put dried food in containers for storage.

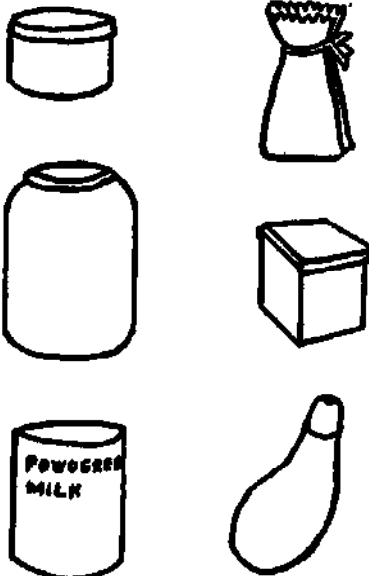

Containers in which food is stored need to:

- a. Be moisture proof.
- b. Keep insects out.
- c. Keep dirt from food.

Some good containers are:

- a. Stone jars.
- b. Jars or pots made of clay or metal.
- c. Dry gourds.
- d. Paper bags.
- e. Cloth bags.
- f. Glass jars.
- g. Tin boxes with tight fitting tops.

Small containers are better than large because the food is less likely to become contaminated by mold or insects.

STEPS IN DRYING FRUITS - Continued

STEPS

HOW - WHY - WHEN

14. Seal containers of food.



For containers with loosely fitting lids:

Place lid on container, dip strip of cloth (about 1" wide) ( $2\frac{1}{2}$  centimeters) in melted paraffin or beeswax. Wrap, while warm, around container at joining of lid. Be sure all space between container and lid is covered by strip of cloth.

15. If the food has been put in bags, place the small bags in a large container.



Large container may be a jar, crock or pot. Seal large container when filled with small packages.

16. Store.

In a clean, dry, dark and cool place. It is well to check foods often to see that it remains dry.

# How to Sulphur Fruit

## MATERIALS AND EQUIPMENT NEEDED

1. Trays or rack on which the fruit is spread for drying must not be made of metal.
2. Platform - stones, bricks or blocks of wood to build a platform 6 - 8 inches (15-20 centimeters) high on which the trays can be stacked.
3. Sulphuring Box - wood or cardboard box to cover trays for sulphuring, needs to be deep enough to cover the stacked trays, plus the platform. It must be wide enough to cover not only the trays but also a small pan of sulphur which will be placed at the side of the stack of trays.
4. Pan, tin can or pottery bowl in which to burn sulphur. It should be shallow and clean.
5. Paper - square piece in which sulphur is wrapped. Minimum size - large enough to wrap around a walnut.
6. Sulphur - Allow one level teaspoon of sulphur to each pound (45 grams) of prepared fruit. Don't use too much sulphur.
7. Matches
8. Tray dividers - pieces of wood, or bamboo, which are as long as the width of trays and  $1\frac{1}{2}$  inches (about 4 centimeters) wide. Allow two pieces for each tray - stones may be substituted for the pieces of wood. Allow four stones per tray.

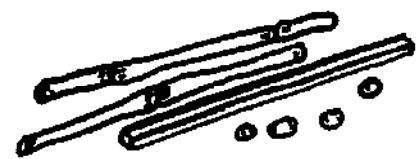
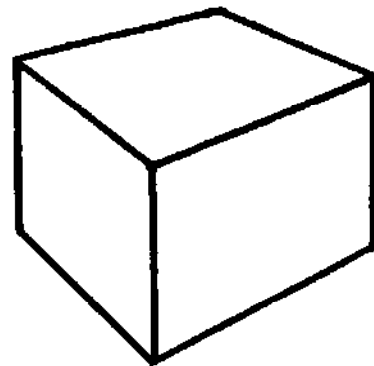
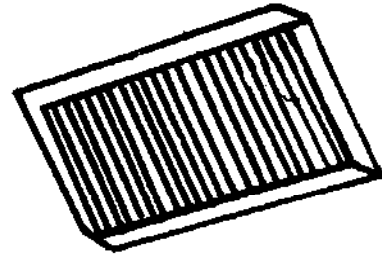



## GETTING READY

1. Cut opening about 1 inch by 6 inches (3 by 15 centimeters) at bottom of box for ventilation.

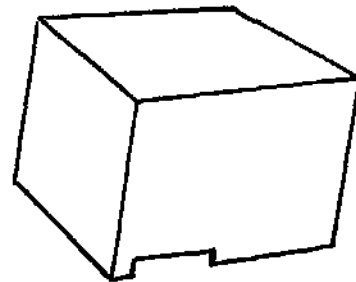

2. Build platform of bricks, blocks or stones on which trays can be stacked.

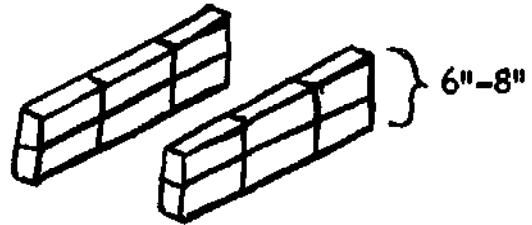

3. Place sulphur on small piece of paper, roll loosely and twist ends so that end of paper may be lighted.

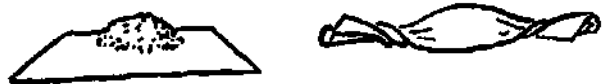

## SULPHUR FRUIT OUT OF DOORS

### STEPS IN DOING THE JOB

1. Place fruit on trays. The fruit should be only one layer deep.

2. Stack the trays one on top of the other with a space of  $1\frac{1}{2}$  inches (about 4 centimeters) between them. Use strips of wood, piece of bamboo or stones to separate the trays. Fumes of sulphur must be able to circulate freely around the fruit.

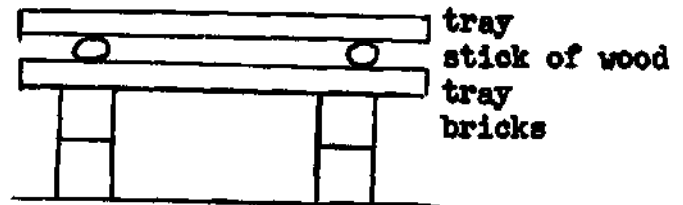

3. Place twist of paper containing sulphur in small metal or crockery container.

4. Set the sulphur container by side of the stack of trays and set fire to the twist of paper containing sulphur.

5. Quickly cover stack of trays and sulphur dish with box. It should cover trays completely. Close opening in box as soon as sulphur is burned to prevent loss of fumes.

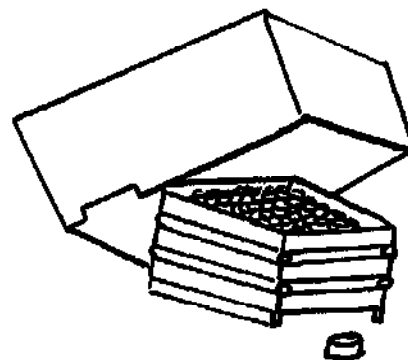

6. For length of time fruit should be sulphured see chart page 13.

7. Remove cover and place trays to dry.

## CONDENSED DIRECTIONS FOR PREPARING AND SUN DRYING SOME FRUITS AND VEGETABLES

ITEM	Selection and Preparation	Treatment before Drying Method	Time in minutes	Tests for Dryness
<b>FRUITS:</b>				
Apples	Peel and core. Cut into slices or rings about 1/8 inch thick.	Sulfur	60	leathery; glove-like; section cut in half, no moist area in center
Pears	Peel, cut in half lengthwise, and core Section or cut into slices about 1/8 inch thick	Sulfur	(60, sliced) (120 quartered)	Springy feel
Large stone fruits	Peel and slice peaches. Cut in half and pit apricots, nectarines, and large plums and prunes. Fruits dry more rapidly if cut in quarters or sliced.	Sulfur	(60, sliced) (120, quartered)	pliable; leathery; a handful of prunes properly dried will fall apart after squeezing.
Berries (except strawberries)	Pick over; remove defective, wash.	Steam	1/2 to 1	hard; no visible moisture when crushed.
Cherries	Pick over, remove defective, wash, pit.	No further treatment		leathery but sticky
Figs	If figs are small or have partly dried on the tree, they may be dried whole without blanching. Otherwise, cut in half	Steam	20	leathery; flesh pliable; slightly sticky.
Grapes	Only seedless varieties should be dried. Pick over remove defective.	No further treatment		Pliable; leathery
<b>VEGETABLES:</b>				
Asparagus	Cut tender green tips only	Steam	4 - 5	Brittle, greenish black
Beans-green snap	Remove defective pods. Wash and remove strings from string varieties. Split pods lengthwise, to hasten drying.	Steam	15 - 20	Brittle
Beets	Select small, tender beets of good color and flavor, free from woodiness. wash; trim the tops but leave the crowns; steam for 30-45 mins. until cooked through. Cool; trim off the roots and crowns; peel. Cut slices about 1/8" thick.	No further treatment		tough; leathery
Broccoli	Trim and cut as for serving. Wash. Quarter stalks lengthwise.	Steam	8 - 10	Brittle
Cabbage	Remove outer leaves, quarter, and core. Cut into shreds about 1/8" thick	Steam	5 - 6 wilt	tough to brittle

Green chili or Peppers	Use full grown pod, bright green Peel and slit pod; remove seeds and dry	No treatment	Crisp, brittle medium green
Red chili or Peppers	Use mature pod, dark red. String and hang in sun. Select crisp, tender, free from woodiness. Wash. Trim off roots and tops. Peel thin. Cut into slices or strips about 1/8" thick	No treatment	Shrunken pod, flexible, dark red
Carrots, turnips rutabagas	Select tender sweet corn. Husk. Steam 10-15 min., or until milk is set. Cut from cob	Steam	8 - 10 tough; leathery
Corn, cut		No further treatment	dry; brittle
Leaves for seasoning; celery, parsley	Wash Remove outer discolored layers.	No treatment	brittle
Onions, garlic	Slice	No treatment	brittle; light colored
Peas	Select young, tender peas of a sweet variety. Shell	steam immediately	hard; wrinkled; shatter when hit with a hammer
Potatoes	Peel, cut into shoestring strips 3/16" in cross section, or cut into slices about 1/8" thick. Select young, tender leaves. Wash. See that leaves are not wadded when placed on trays. Cut large leaves crosswise into several pieces to facilitate drying	Rinse in cold water steam	4 - 6 Brittle
Spinach and other greens		Steam	4, or until thoroughly wilted Brittle
Squash	Wash, peel, and slice in strips 1/4" thick.	Steam	6 tough to brittle
Squash (Hubbard) Pumpkin, yellow	Cut into strips about 1" wide. Peel off the rind. Scrape off the fiber and seeds. Cut peeled strips crosswise into pieces about 1/8" thick.	Steam	Until tender tough to brittle
Sweet potatoes	Wash, peel, trim and cut into 1/4" slices (alternate method-steam before peeling).	Steam	Until tender tough to brittle
Tomatoes for stewing	Select tomatoes of good color. Steam or dip in boiling water to loosen skins. Chill in cold water. Peel. Cut into sections, not over 3/4" wide. Cut small pear or plum tomatoes in half.	No further treatment or may sulfur	10 - 20 leathery

# How to Dry Vegetables

## EQUIPMENT NEEDED.

Collect equipment before gathering vegetables.

1. Knife (for most vegetables).
2. Wooden board for cutting.
3. Pans or pots in which to wash vegetables.
4. Plenty of clean water for thorough washing.
5. Pot or kettle in which to steam vegetables.
6. Lid which fits the pot or kettle in which vegetables are steamed.
7. Equipment for steaming. This may be

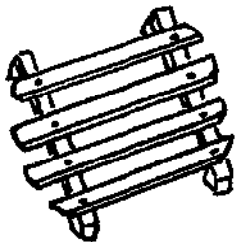

OR



Rack and Basket

Cloth Bag and Stick

8. Rack, trays or mats on which the vegetables can be spread to dry.

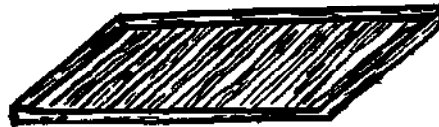
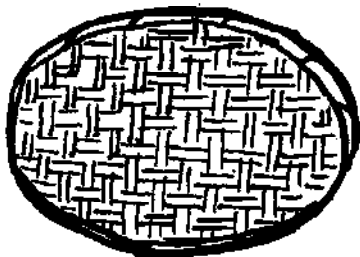

9. One piece of loosely woven, clean cloth for each tray or mat above. These should be slightly larger than the tray or mat on which they are to be used.

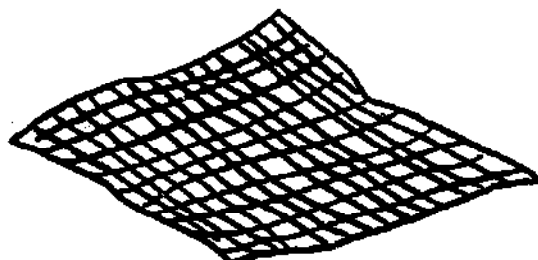

# STEPS IN DRYING VEGETABLES

## STEPS

## HOW - WHY - WHEN

---

1. Gather vegetables.

Select good quality, firm sound vegetables.

Avoid overripe vegetables.

Harvest early in the morning or late in the day.

Avoid delay between harvesting and processing.

---

2. Wash vegetables.

Use plenty of clean water.

Place vegetables in pan.

Pour clean water over vegetables.

Wash thoroughly. Scrub if necessary.

Lift from water.

Empty water from pan.

Repeat if necessary.

---

3. Prepare vegetables.

Follow directions on page 13 for each vegetable.

This may be:

Shelling

Hulling

Peeling

Slicing

Work rapidly.

---

4. Steam most vegetables.  
(See page 13 for length of time to steam.)

Steaming helps to:

a. Retain vitamins.

b. Retain minerals.

c. Give better color and flavor

d. Reduces time needed for soaking before cooking.

See page 18 for directions on how to steam.

---

5. Spread vegetables on clean dry trays or mats.

One layer in thickness.  
Spread evenly.

---

6. Cover with loosely woven clean cloth, mosquito netting or wire screen.

To keep insects and dust off food. Fasten cloth down so it will not blow off.

STEPS IN DRYING VEGETABLES - Continued

STEPS

HOW - WHY - WHEN

- 
- |    |                            |  |
|----|----------------------------|--|
| 7. | Place trays in sun to dry. | a. In direct sunlight.<br>b. Where air can circulate freely.<br>c. Away from dust and dirt.<br>d. Off ground.<br>e. Away from animals and people.<br>f. Protect from storms and dew.<br>(See page 24 for suggested places to dry.) |
|----|----------------------------|--|
- 
- |    |            |  |
|----|------------|--|
| 8. | Turn food. | Two or three times each day to speed drying. |
|----|------------|--|
- 
- |    |                  |                                 |
|----|------------------|---------------------------------|
| 9. | Continue drying. | For several days until 2/3 dry. |
|----|------------------|---------------------------------|
- 
- |     |                   |                  |
|-----|-------------------|------------------|
| 10. | Test for dryness. | Squeeze handful. |
|-----|-------------------|------------------|
- 
- |     |                       |                                       |
|-----|-----------------------|---------------------------------------|
| 11. | Condition vegetables. | In large containers for 8 to 10 days. |
|-----|-----------------------|---------------------------------------|
- 
- |     |                                |  |
|-----|--------------------------------|--|
| 12. | Put in containers for storage. | Several small containers are better than large ones. |
|-----|--------------------------------|--|
- 
- |     |                  |   |
|-----|------------------|---|
| 13. | Seal containers. | To exclude air.<br>To keep out insects. |
|-----|------------------|---|
- 
- |     |  |                       |
|-----|--|-----------------------|
| 14. | If food is in bags, place the small bags in a large container. | Seal large container. |
|-----|--|-----------------------|
- 
- |     |        |                                  |
|-----|--------|----------------------------------|
| 15. | Store. | In clean, dry, dark, cool place. |
|-----|--------|----------------------------------|
-

# How to Steam Vegetables

To steam vegetables they must be suspended in live steam above rapidly boiling water in such a way that the steam reaches all the pieces of the vegetables quickly without the vegetables resting in the water. This means the vegetables must be held loosely and not be allowed to pack. Small amounts of the vegetable pieces need to be steamed at one time to insure the steam reaching all the vegetables and to avoid overcooking some while others remain raw.

Two methods of steaming have been used successfully in different countries. Each method with equipment used is described in the following:

## METHOD I.

### Equipment needed.

1. A deep container with tight fitting cover. A pot or kettle used for preparing soups, main dish or stew for the family would be fine for this. If it does not have a cover which fits tightly, something should be improvised to serve as a cover and hold the steam inside the kettle. A board could be laid over the opening. The board needs to be large enough to cover the opening completely and hold in the steam. Placing a weight on top will help with this.

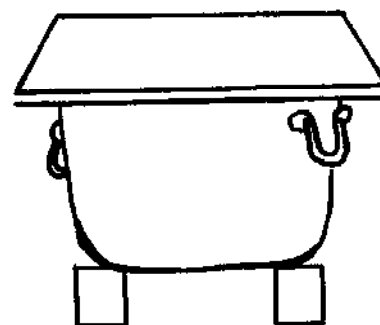
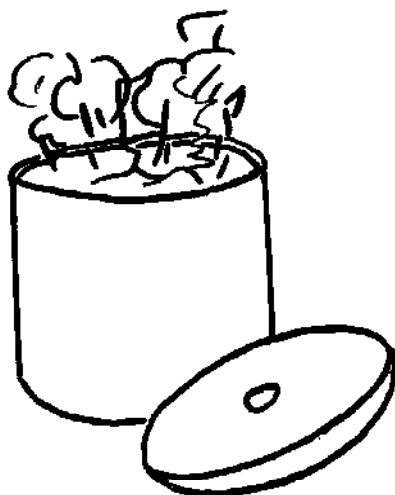

2. Rack which can be put in the bottom of this container and used to hold the vegetables up out of the boiling water. It will need to be  $1\frac{1}{2}$  to 2 inches ( $3\frac{1}{2}$  - 5 centimeters) high and be so constructed that it permits the water to boil freely around or through it. A wooden rack made of slats is often used for this. An equally satisfactory rack can be made of bamboo, or woven of reeds.

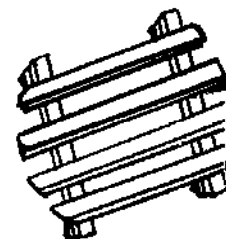

3. Container to hold vegetables while being steamed. This must:

- (a) Fit inside the steaming pot;
- (b) Hold the vegetables loosely,
- (c) Be open enough in construction that the steam can reach all parts of the vegetables.

## STEAMING VEGETABLES - Continued

This container can be a colander, wire basket, or reed basket. Improvised baskets can be made of wire fencing; wire screening; weaving materials such as grasses, reeds, or vines. If none of these are available, a second pot could be set on the rack inside the larger pot.



### STEPS IN STEAMING VEGETABLES

STEPS	HOW - WHY - WHEN
1. Put rack in bottom of deep container.	As a support for the steaming basket.
2. Put 1 inch ( $2\frac{1}{2}$ centimeters) of water in deep container and bring to boil.	Put lid on container to hasten boiling.
3. Put layer of prepared vegetables in basket.	Make layer of vegetables thin - not more than $2\frac{1}{2}$ inches (7 centimeters) deep.
4. Place basket on rack in bottom of deep container.	Vegetables should not touch water.
5. Place lid on container.	Lid needs to fit tightly to keep steam in container. Place weight on lid if necessary.
6. Count time as soon as kettle fills with steam. (See chart p. 13 for steaming time.)	Minimum time indicated on chart has been found best, except when vegetables are older, have been gathered longer, or were grown under very dry conditions. These vegetables may need longer steaming.
7. Test to see if vegetables are completely steamed.	Each piece of vegetable must be heated through and wilted. Remove a piece from center of steamer and press it. It should feel tender but not completely cooked.



METHOD II

EQUIPMENT NEEDED.

1. Deep container with tight fitting lid.



2. Piece of loosely woven, clean cloth in which vegetables can be tied loosely and hung in the container. The size of this will depend on the size of the steaming kettle used. It is important not to crowd the vegetables or the steam will be unable to reach all of them.

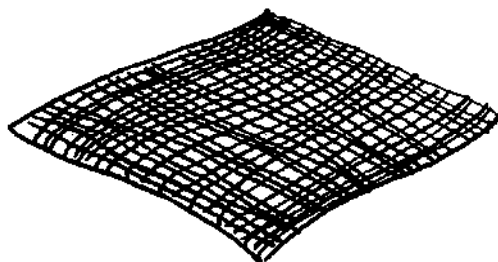

3. A piece of wood, stick or bamboo which can be wedged across the kettle near its opening, to which the bag of vegetables can be hung.

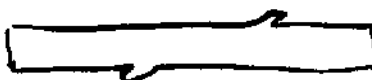

STEPS IN STEAMING VEGETABLES

STEPS	HOW - WHY - WHEN
1. Place piece of wood, stick or bamboo in top of deep container.	Just far enough below rim <u>edge</u> of container to permit lid to be placed tightly on container.
2. Put 1 inch (2½ centimeters) of water in container and bring to boil.	Put lid on container to hasten boiling.
3. Place vegetables in piece of loosely woven clean cloth.	Vegetables must be <u>very loose</u> in bag.

## STEPS IN STEAMING VEGETABLES

### STEPS

### HOW - WHY - WHEN

4. Tie cloth to form a bag.

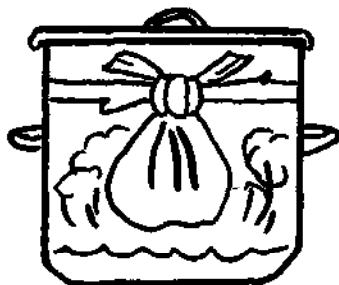

Bring opposite corners of cloth together and tie. Repeat with remaining two corners. This knot should be tied far enough from the corners to:

- (a) Leave ends long enough to tie over stick in top of container.
- (b) Keep the bottom of the bag from touching the water when the bag is tied on the stick.

5. Tie bag to stick securely.

So that bag of vegetables does not touch water.

6. Place lid on container.

Lid needs to fit tightly to keep steam in container.

7. Count time as soon as container fills with steam.

See chart page 13 for time for each vegetable.

Minimum time on chart has been found best, except when vegetables are older, have been gathered longer, or were grown under very dry conditions. These vegetables may need longer steaming.

8. Test to see if vegetables are completely steamed.

Remove a piece from center of vegetables and press it. It should be heated through and wilted. It should feel tender but not completely cooked.

# Drying Trays

## SIZE -

Here are some guides and suggestions to help you select or make your own trays.

1. Since you will need to move the trays after they are loaded they should be no larger than you can handle easily.
2. Under most circumstances a few larger trays will be easier to care for and spread food on than many small trays.
3. Where are you going to place trays so that the sun can reach the food? How large is this space? Will a few large trays rest better here or several smaller trays?
4. What do you already have on hand which can be used for drying trays? It may be better to improvise with something you have in the home now than go to the expense or spend the time to make new ones.
5. Trays of uniform size are easier to stack when you must bring them in at night or out of the rain. It also may make it easier to store them in seasons when you are not using them.
6. A size of trays which has been found to be convenient is 14 by 24 inches. (35 X 60 centimeters)

## SHAPE -

Any shape - round, square, rectangular - is satisfactory. Trays of uniform shape can be easily and quickly stacked.

## BOTTOM OF TRAY -

The bottom of the tray needs to have openings to allow passage of air. Air needs to reach all sides of the food for rapid drying. For trays made of wood, allow spaces between slats. If trays are made of reeds or grasses, use an open work weaving pattern. Do not make the bottom of the tray solid.

## SIDES ON TRAYS -

Trays with sides on them are better than those without sides because they -

1. Keep foods from sliding off when you move the trays.
2. Makes stacking easier.
3. Keeps trays from resting on food when you stack them.
4. Provides an edge to which cloth may be fastened.

## MATERIALS FOR TRAYS

Trays can be made of many materials. Here are a few:

- a. Scrap lumber or wooden boxes are sources of wood to use in building trays.

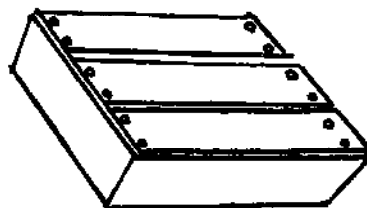

- b. Bamboo, or similar wood



- c. Small limbs of tree for frame and vines like honeysuckle woven in between to form drying surface.

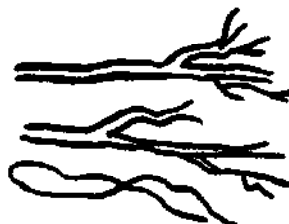

- d. Frame of wood with thongs of leather woven in to form the rack.

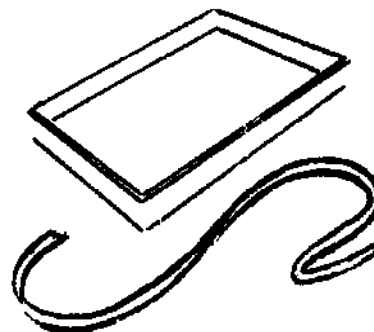

- e. Screen wire attached to bottom of wooden frame.

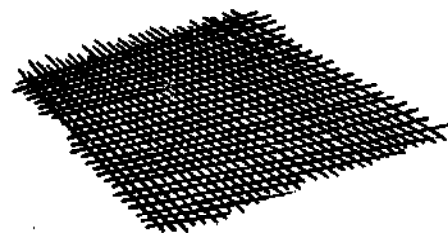
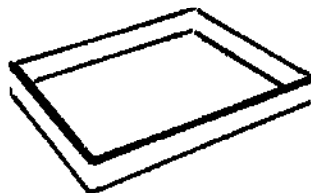

- f. Grass or straw matting woven or cut in suitable sizes.



# Some Good Places to Dry Fruits and Vegetables

1. On the roof of the house.

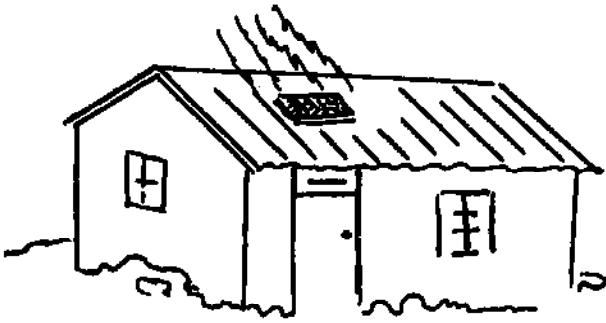

2. On an improvised table by the house.

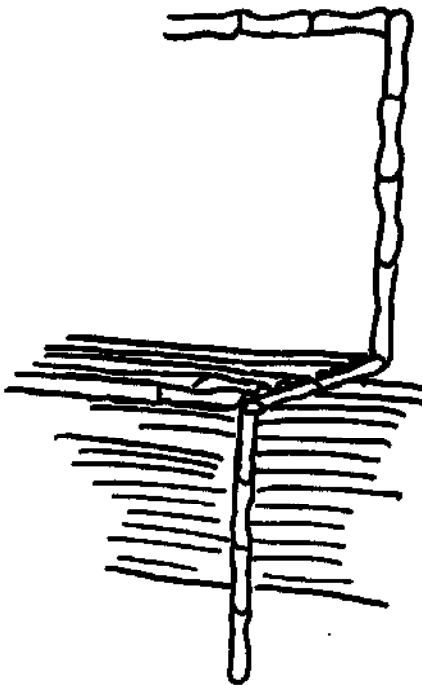

3. On an elevated platform built a few feet above the ground level. Below are suggestions

(a) Wooden or bamboo rack.

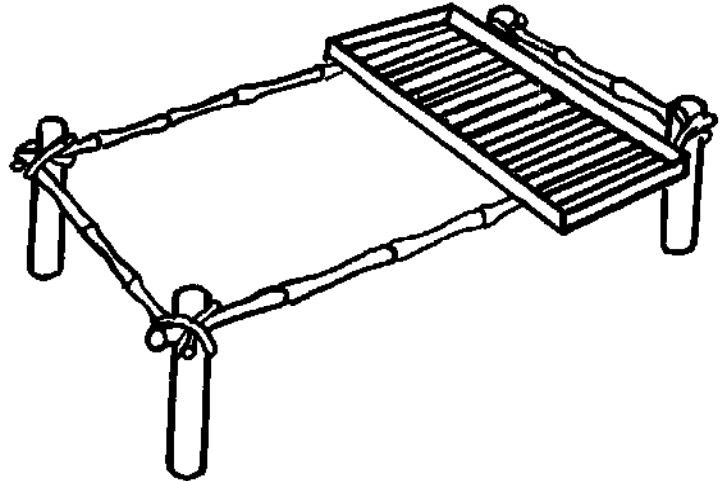

(b) Mound of adobe bricks or stones



## SOME SPECIAL FRUITS AND VEGETABLES

### Cocoanut

Remove meat from shell  
Cut meat in thin slices  
Place on trays  
Cover trays with clean loosely woven cloth and place in sun until well dried. Store in tight cans or jars.

May be added to puddings, candies, eaten as a sweet or used in place of nuts. When sprinkled with salt may be used as appetizer.

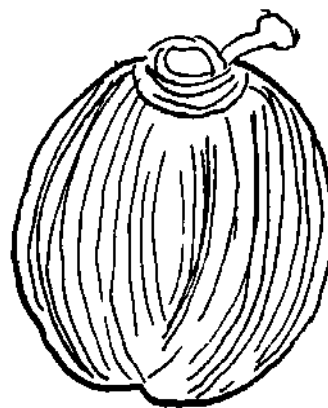

### Peanuts

Peanuts are high in food value and may be served as a part of a meal. They should be gathered when mature and spread on trays to dry in sun. Peanut butter, which can be used as the basis for a number of tasty dishes is made as follows:

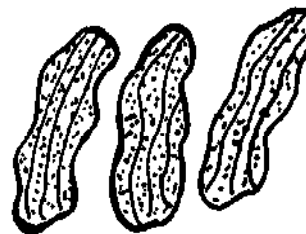

#### Peanut Butter Recipe

2-3/4 cups peanut  
(400 grams)

1/2 teaspoon salt  
2 tablespoons sugar

Roast peanuts, remove skin. Pass peanuts through a stone or meat grinder as many times as needed to make it fine and smooth. Add salt and sugar. Pass again through grinder several times until a very smooth paste is obtained. Pack in sterilized jars and seal tight.

### Cassava

Shred fresh cassava rootstocks into small chips. Dry the shredded chips and cut into small pieces, preferably like rice grains. The cassava chips can then be used to extend the rice or be prepared in a variety of nutritious and delicious dishes. To extend rice, use 1 part cassava chips to 4 parts of rice. Mix with washed rice and cook.

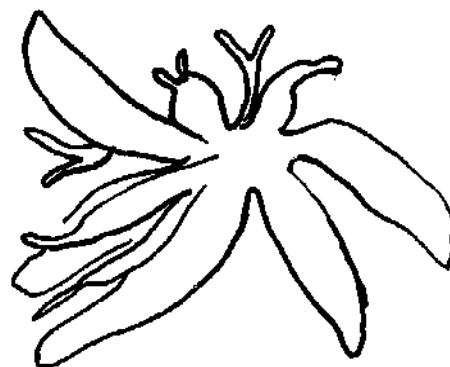

Soup Mixtures - Choose available vegetables that will give a pleasing combination. Dry them separately according to instructions for that vegetable, then combine and store in one container for a soup mixture, chowder, or stew.

Herbs and Seasonings - Parsley leaves, mint, celery leaves, sage, dill, and other herbs, are not blanched before the drying process begins. Choose plants that are well developed, wash and hang up in an airy, breezy, shady place. They are brittle and bone dry when done. The herbs may be broken up when dry to save storage space.

# How to Prepare Dried Food for Use

## RESTORING (Soaking)

Most fruits and vegetables should be covered with cold water and soaked to restore the moisture removed by drying. Usually soaking 1/2 hour to 2 hours will give an acceptable product, although longer soaking, 2 to 6 hours, may result in increased tenderness.

The food should be kept covered while soaking. The amount of water used for soaking should be as near to that which the food can take up as possible. It is better to add water during the soaking process than to start out with more than is needed.

## COOKING

Cook the food in the same water in which it has been soaked because there are some minerals dissolved in the water.

Boil vegetables until tender. Add water for cooking if all the water used in soaking has been absorbed.

Cook greens, cabbage, tomatoes, soup mixtures and powdered vegetables without soaking. Drop them into enough water to cover and cook until tender.

Dried tomatoes, okra, pepper, string beans and corn added to a meat stew or soup make an excellent dish when fresh vegetables are not available in the family garden.

## FLAVORING

Vegetables on drying lose much of their fresh flavor. Therefore, the addition of such flavoring as basil, garlic, onion or other herbs will be desirable.

## FRUIT

Usually 1/4 cup of sugar per cup of dried fruit is sufficient for dried apples, pears, or peaches. Less sugar is needed for dried than for fresh fruit because in the drying process the starch in the fruit is changed to sugar. When sugar is used it should be added at the end of the cooking period so as not to interfere with the absorption of water by the fruit. Adding a few grains of salt helps to bring out the natural sweetness of the fruit. Lemon, orange, or grapefruit juice added to the dried fruit just before serving will give a fresh fruit flavor and add vitamin C to the dish.

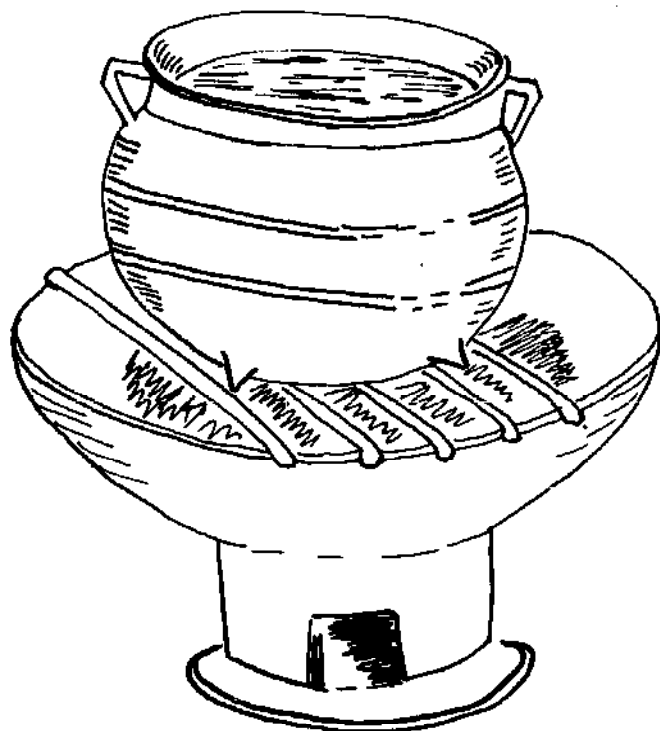

## ACKNOWLEDGMENTS

The following publications were consulted in the preparation of this bulletin. Many of these publications are out of print and no longer available.

Drying Foods At Home, C-170 The Extension Service, Texas

Drying Foods For Victory Meals - Farmers' Bulletin #1918

U. S. Department of Agriculture

Drying Fruits and Vegetables, Circular 477

University of Missouri, Agricultural Extension Service

Drying Fruits and Vegetables At Home, Circular 247

Pennsylvania State College

Drying Fruits and Vegetables At Home - Greek Extension Service,

Athens, Greece

Eat Cassava - Dept. of Agriculture and Natural Resources,

Bureau of Agricultural Extension, Manila, Philippines

Farm and Home Drying of Fruits and Vegetables - Farmers'

Bulletin #984, U. S. Department of Agriculture.

Home Drying of Fruits in War Time - Extension Circular 192

New Mexico College of Agriculture and Mechanical Arts

Home Drying of Vegetables and Fruits - University of California

Peanuts at Meal Time - Dept. of Agriculture and Natural Resources,

Bureau of Agricultural Extension, Manila, Philippines.

Use More Coconuts, Dept. of Agriculture and Natural Resources,

Bureau of Agricultural Extension, Manila, Philippines.



Compiled by Helen Strow, Extension Educationist,  
Foreign Educational Branch, Extension Research  
and Training Division, Federal Extension Service,  
with technical assistance of Dr. Evelyn Spindler,  
Extension Nutritionist, Division of Home Economics  
Programs, Federal Extension Service.