

AT MICROFICHE REFERENCE LIBRARY

A project of Volunteers in Asia

Proceedings of I.T.D.G. Seminar: Simple Vehicles
for Developing Countries
Information Paper No. 3

Edited by: B. Smith-Boyes and I.J. Barwell

Published by:
Intermediate Technology Publications, Ltd.
9 King Street
London WC2E 8HN
United Kingdom

Available from:
Intermediate Technology Publications, Ltd.
9 King Street
London WC2E 8HN
United Kingdom

Reproduced by permission of Intermediate
Technology Publications, Ltd.

Reproduction of this microfiche document in any
form is subject to the same restrictions as those
of the original document.

Transport Panel

Information Paper 3

Proceedings of I.T.D.G. Seminar "Simple Vehicles for Developing Countries"

intermediate
technology Development Group
9 King Street, London WC2E 8HN, U.K.

Telephone: 01-836 9434/39; 836 6379

I.T.D.G. TRANSPORT PANEL

Information Paper No. 3

Proceedings of an I.T.D.G. Seminar,

"Simple Vehicles for Developing Countries"

held at

Lanchester Polytechnic, Coventry

on

June 25th 1976

edited by

B. Smith-Boyes & I.J. Barwell

This series of Information Papers is circulated as a means of disseminating information and soliciting comments about the work of the I.T.D.G. Transport Panel. The Panel welcomes any ideas and suggestions arising from the content of the papers, and these should be forwarded to:

I.J. Barwell,
I.T.D.G. Transport Project Officer,
c/o University of Oxford,
Department of Engineering Science,
Parks Road,
Oxford, U.K.

© Copyright Reserved

Extracts from the text may be reproduced
provided the source is acknowledged.

1977

CONTENTS

	Page
I. Session I	I
I.1 Opening Address - Lord Oram	I
I.2 Introduction: The transport problem in developing countries - J.D.G.F. Howe	I
I.3 Paper 1: Intermediate technology transport in India, China and the Philippines - I.J. Barwell	4
I.4 First discussion period	13
I.5 Paper 2: Bicycle marketing in developing countries - K. Hutcheon	14
I.6 Paper 3: Appropriate pedal driven vehicle design - S.S. Wilson	15
I.7 Paper 4: Pedal-power unit for transport and machine use - D.I. Weightman	23
I.8 Paper 5: Simple vehicles in labour-intensive construction - M. Sharrock	33
I.9 Second discussion period	38
2. Session 2	39
2.1 Paper 6: Small farm vehicle - R. Wijewardene	39
2.2 Paper 7: SNAIL transport - C.P. Crossley, J. Kilgour & J. Morris	42
2.3 Paper 8: The TRANTOR and the cellular production system for indigenous vehicle manufacture - G.A.B. Edwards	52
2.4 Paper 9: Piaggio vehicles for rural transport - K. Salt	58
2.5 Paper 10: The contribution to be made by British industry - M. Sooley & E. Fletcher	60
2.6 Paper 11: Improving the efficiency of rural transport in developing countries - R.P. Sikka	61
2.7 Concluding discussion	63
3. Conclusions	64
4. Acknowledgements	64
5. Appendices	64
5.1 Addresses of contributors	64
5.2 List of participants	65

SIMPLE VEHICLES FOR DEVELOPING COUNTRIES

I. Session I

I.1 Opening Address

by Lord Oram

Intermediate Technology Development Group Ltd. (ITDG)

As Chairman of this morning's session I am happy, on behalf of ITDG, to welcome you to the seminar. ITDG was formed in 1965 by a group of engineers, scientists, economists and others from industry and the professions, to provide practical and effective self-help techniques for developing countries. Its aim is to demonstrate and emphasise that aid must be designed to help the poor to help themselves. Various major UN conferences in recent months have provided the backdrop to the work of ITDG by stressing the key elements of development strategy to which the intermediate technology concept is directed, namely the generation of employment, the conservation of scarce capital, the use of local resources, the re-distribution of benefits, the need to reach the poorest of the poor, and the use of appropriate productive techniques.

The ITDG Panels, which now approach twenty-five in number, embrace all the various sectors which were discussed at these international conferences. The Transport Panel, and its sub-panel on simple vehicles, has proved to be one of the most effective of our groups, and we are very conscious of its links with other aspects of our work, including agriculture, water, power and rural health.

I am particularly pleased to note that this seminar has drawn participants from many fields of activity - manufacturers, academics, representatives of government, and guests from developing countries - a wide spectrum which parallels the individual composition of ITDG Panels.

I.2 Introduction: the Transport Problem in Developing Countries

by J.D.G.F. Howe

Associate of Alastair Dick & Associates, and Chairman, ITDG Transport Panel

The Transport Panel of ITDG is concerned with the application of intermediate technology to the transport problems of developing countries, particularly in the poorest sectors. The purpose of the seminar is to examine what contribution, if any, the institutions of the developed countries can make towards the design and manufacture of more appropriate vehicles for rural developing societies. For this reason we have sought to bring together today the entire spectrum of organisations and individuals involved in the provision of transport; designers, manufacturers, government agencies, the universities and aid agencies. Although initially the intention was to confine the seminar to the U.K. we are fortunate to have with us representatives from the World Bank and the International

Institute of Tropical Agriculture, Nigeria. It is especially fitting that Lord Oram, one of the founder members of ITDG, should introduce the seminar.

Until recently the 'solution' to the rural transport problems of developing countries has been seen by planners as essentially one of changing the infrastructure with a major emphasis on improving and expanding the road system. Progress is often measured in the length of new and improved roads. However since 1969 the International Labour Organisation and the International Bank for Reconstruction and Development (World Bank) have been engaged in a major reappraisal of the methods of building and improving roads, and other civil engineering works, by labour and capital intensive methods. This is not of major concern to this seminar save that an important part of the reappraisal is the examination of the role of simple vehicles in labour-intensive construction. For this reason we have asked Mr. Mark Sharrock of Messrs. Scott, Wilson, Kirkpatrick and Partners to describe the work they have been engaged on in India and elsewhere.

Curiously the efforts to improve the road transport system have concentrated on the route itself: the vehicles have been left to take care of themselves. Possibly one reason for this is that the people who plan and design road transport systems are invariably road and not vehicle planners and engineers. It is arguable in fact that the developed world has never, yet, seriously designed vehicles for the special needs, if there are any, of the developing world (vehicles like the Jeep and the Land Rover have derived from military needs). The well tried and tested strategy is that you produce a vehicle for the home (developed country) market and with the minimum of 'tropical trim' sell it, also, in the developing world.

However, recent years have seen a spontaneous interest by a number of institutions in the transport needs of the rural poor of the developing world. With some of the institutions improved transport does not appear to have been the main objective: it has arisen almost as a by-product of efforts to mechanise agriculture. Pride of place must probably go to the International Rice Research Institute in the Philippines. Another pioneering institution has been the International Institute of Tropical Agriculture, Ibadan, Nigeria and we are pleased to welcome to the seminar Dr. Wijewardene of that institute. The Economic and Science Commission for Asia and the Pacific are also known to be carrying out a study on the improvement of carrying capacity and operational efficiency of rural road transport with particular emphasis on vehicular modes. The ASTRA (Application of Science and Technology in Rural Areas) organisation in Bangalore are also currently engaged on fundamental design studies of bullock carts, of which India has some 12 million, and pedal-driven vehicles.

More recently the World Bank has launched a programme for the "Development of Appropriate Vehicles for Rural Areas" and we are pleased to welcome two of the key instigators, Dr. Curt Carnemark and Dr. Krish Chopra. Lastly there are the efforts of the Transport Panel of ITDG about which more

will be heard later and which have resulted in the organisation of this seminar.

Undoubtedly these organisations have different motivations for their work, but there appears to be a general feeling that the existing choice of vehicles is not appropriate to fundamental needs. It is a technical fact that the design of roads in developing countries is dictated by the characteristics of the private car and the lorry. The 'desired' speed that it is assumed car drivers want dictates the overall horizontal and vertical alignment of the road, whilst the frequency and load carrying capacity of the lorries that will use it decide the strength of the road's structure. It has never been shown that either or both of these vehicles is in any sense necessary, much less optimum, for development to take place. The possibility that other, simpler and probably cheaper, vehicles might be more appropriate to needs does not appear to have been given serious consideration hitherto. In one sense this is surprising since, potentially at least, there is the obvious possibility of an economic trade-off between the standard and cost of the road provided and the type of vehicles that will use the route. The simpler, and thus most probably lighter, the vehicle the cheaper the cost of providing an adequate road.

Apart from the institutional reasons already given the most obvious other reason for the little interest shown by the developed countries in vehicle design for the developing world appears to be a misunderstanding about the nature of movement demands. For passenger transport the existing buses and various forms of share taxis probably meet demands very well. But for goods transport the available evidence suggests that the fundamental demand is for the movement of small consignments over relatively short distances. Smallholder agriculture, almost by definition, gives rise to limited crop surpluses and farm inputs. Support for this contention is to be seen in the popularity of buses and taxis for goods movement. Furthermore in some countries hand, animal and even bicycle powered vehicles play a significant role in meeting normal transport needs. Ian Barwell will show the extent to which these means have been developed in Asia, a phenomenon which surprisingly is rarely the case in Africa. However, as is apparent from Barwell's studies and those of Stuart Wilson of the University of Oxford, despite the ubiquity of the bicycle in the developing world and the wide variety of attempts to adapt it for load carriage its development in this respect remains mechanically crude. Stuart Wilson will describe an attempt to overcome the fundamental problems associated with the movement of goods by bicycle.

Asia also provides numerous examples of a simple vehicle technology which is sensibly absent from the rest of the developing world: the use of simple motorised vehicles based upon motor-cycle technology. Although this development is flourishing it has been confined, almost exclusively, to urban areas. There have been recent attempts to change this situation by the Honda (Japan), Carabela (Mexico) and Piaggio (Italy) companies and we are pleased to welcome the U.K. representatives of the latter firm to

the seminar.

As mentioned previously a number of institutions have been working on the betterment of rural transport indirectly through efforts to improve agricultural mechanisation. The emphasis in these developments is on machines which have a dual agriculture and transport capability, though it is probably fair to say that the agricultural requirements dominate. In this context we are pleased to welcome Mr. Kilgour of the National College of Agricultural Engineering who will describe the SNAIL project, and Mr. Edwards of Trantor International. A further example of dual-mode development is the Pedal Power Unit that will be described by Mr. David Weightman of Lanchester Polytechnic.

Because we wish also to discuss manufacturing and marketing problems we are pleased to receive the contribution of Mr. Edwards on the philosophy underlying the Trantor development and to welcome Mr. Hutcheon of Raleigh Cycles, the largest manufacturer and exporter of bicycles in the world. Lastly we have asked Mr. Cooley of Lucas Aerospace and Mr. Fletcher of the North-East London Polytechnic to discuss some aspects of the contribution that can be made to the transport problems of developing countries by U.K. industry.

1.3 Paper I. Intermediate Transport in India, China and the Philippines

by I.J. Barwell

ITDG Transport Project Officer

In many countries of the developing world there is a limited choice of methods available for the transport of goods. Often the only alternatives are for people to carry the load on their heads or their backs, or for the cargo to be transported in expensive, imported trucks, cars or buses. These two methods represent, in developing country terms, extremes of transport technology. However, in many Asian countries a number of forms of intermediate transport are available. In these countries simple vehicles are used which, from a technological point of view, span the range between the two extremes of headloading and car or truck. These simple vehicles may conveniently be divided into four categories:

- i) hand-drawn vehicles;
- ii) animal-drawn vehicles;
- iii) pedal-driven vehicles;
- iv) simple motorised vehicles.

The purpose of this paper is to describe some examples of simple vehicles used in India, the Peoples Republic of China and the Philippines.

Hand-drawn vehicles

The single-wheeled barrow is widely used in China, particularly in the rural areas where it is suited to use on rough, narrow tracks. The wheelbarrow also plays a crucial role in the labour-intensive construction methods for which China is well known. Figure 1 shows a typical contemporary wheelbarrow, of wooden construction, and utilising a standard spoked wheel similar to those used on pedal tricycles. Traditional Chinese wheelbarrows used a much

larger, wooden wheel but the availability of pneumatic tyres has led to a reduction in wheel size. The Chinese wheelbarrow has significant advantages compared with the configuration normally found in the western world. The cargo is placed directly over the wheel, which thus supports most of the load and eases the task of the operator. His work is further facilitated by the use of a strap passing across his shoulders and tied to each of the barrow handles, which assists both in balancing and supporting the load.

The two-wheeled handcart is a common sight in the urban centres of both India and China where it is a basic means of transporting heavy loads over short distances. Figure 2 shows a traditional Indian handcart design, with large diameter, spoked wooden wheels, and a platform constructed from lengths of bamboo, while Figure 3 shows an Indian handcart which utilises motor vehicle wheels. Once again, the availability of a pneumatic tyre has led to a reduction in wheel size. As shown in the photograph the cart is empty and is being pushed by one man. When loaded it is pulled by two persons, one on each side of the central shaft.

Handcarts are used to carry prodigious loads, particularly in China where, if the task becomes too onerous for one person, a second, third or even fourth person may assist by hauling on leather straps attached to the cart. It is also common practice in China to hoist a crude sail to the cart and harness some of the energy of the wind when this is blowing in the right direction.

Animal-drawn vehicles

In many parts of the world animal carts and wagons are a traditional means of transporting both goods and people, and can carry considerable loads, albeit slowly. In the Philippines the buffalo, or carabao as it is locally known, is used to haul either a two-wheeled cart or a sled mounted on skids. Figure 4 from China shows a two-wheeled cart drawn by three horses. In India there are in excess of 12 million bullock carts (Figure 5) while in some parts of the same country camels are used to haul four-wheeled wagons.

Animal-drawn vehicles have an important role to play in intermediate transport, and some work has recently been carried out in Africa to develop carts which require only basic skills and tools for their construction (Refs. 1 & 2). However there are problems associated with the introduction of this form of transport to societies which do not already use and train appropriate animals. The management of livestock, particularly with regard to care and training, is a skill which is not easily acquired. There are a number of examples of unsuccessful attempts to introduce draught animals to people who have not previously utilised this form of power. Failure of such projects has almost always been caused by poor management of the animals. It is also important to remember that animals consume fuel in the form of food whether or not they are working. Often the smallholder has to set aside part of his land to grow this food.

Pedal-driven vehicles

The bicycle is the basic means of personal transport for the common man in India and China, and bicycles are manufactured in large quantities in

both countries. They are used for urban and rural transport, and for travel into towns and cities from nearby villages. The three-wheeled tricycle developed from the bicycle, and sometimes known as a cycle rickshaw, is a common sight in both India and China, though its use is almost exclusively urban and sub-urban. While in India the cycle rickshaw is used mostly for the carriage of passengers, in China the emphasis is on the transport of cargo.

Figure 6 shows a cargo-carrying Indian tricycle with two front wheels and a single, driven rear wheel. While this configuration is used in several places the alternative layout of one front wheel and two rear wheels is much more common - Figure 7 shows an Indian example. The limitations of these Indian tricycles are best explained by the following quote:

"The health of Indian cycle rickshaw pullers is adversely affected due to overwork and heavy strain. Rickshaw pulling is indeed inhuman, but poverty and unemployment compel poor people to resort to this mode" (Ref. 3)

The major reason why rickshaw pulling is such hard work can be clearly seen in Figure 7. The tricycle retains the same gearing as a conventional bicycle although it may be used to haul up to three times the load. The simple action of fitting a bigger sprocket to Indian tricycles would greatly improve the lot of the riders. It is also noteworthy that there is no braking system for the rear wheels which means that a tricycle carrying possibly three times the load of a bicycle has only half its braking capacity. This example illustrates the surprising lack of innovation in the design of tricycles in India, while in contrast the machines used in China show considerable evidence of adaption and improvement.

A typical cargo-carrying tricycle from Kwengchow in southern China is shown in Figure 8. The major feature of interest is the use of a chainwheel much smaller than that of a bicycle to give a significantly lower overall gear ratio. Braking of the two rear wheels is accomplished by means of brake blocks mounted on levers which swing out from the chassis in a horizontal plane and press against the wheel rim when the brake pedal mounted on the frame is operated. Another tricycle found in southern China incorporates a two-speed gearbox operated by a lever mounted on the top frame tube. The primary chain drives an intermediate shaft mounted under the rear bodywork. Two chain drives, of different ratios, connect this shaft to the rear axle and can be engaged in turn by dog-clutches, thus providing the rider with a choice of two gear ratios. Both rear wheels are braked, by means of standard bicycle brakes mounted on the chassis and actuated by a foot-pedal through a system of rods and bell-cranks.

Perhaps the crudest method of providing a choice of gears is that used on the example from Peking shown in Figure 9. Two chainwheels of different diameters, though both smaller than the size used on bicycles, are mounted side by side on the pedal axle. To change gear the rider simply has to transfer the chain from one chainwheel to the other. Clearly for this method to work the chain must run very slack. This example also illustrates another interesting design feature. Most tricycles, whether Indian or Chinese, drive through only one of the two rear wheels, and thus avoid the need to use a differential in the rear axle. However the machine in Figure 9 has a solid

axle and both rear wheels are driven. The absence of a differential is mitigated by the use of a narrow rear track. With this configuration both rear wheels can be braked by means of the single drum brake fitted on the rear axle and actuated by the chain strung from the head-tube. There are a few Chinese tricycles which have an enclosed rear axle with a differential and drive to both rear wheels, each of which has its own cam operated drum brake.

An unusual pedal-driven vehicle from Chengchow is shown in Figure 10. This is a front wheel pedal-drive unit which is attached to a standard two-wheeled handcart. The shafts of the handcart are fitted alongside the head-tube, and the rear of the unit clamps onto the load platform of the cart. It requires only a few minutes work to attach the drive unit to the handcart or to detach it again.

Simple motorised vehicles

There are several motorised vehicles in Asia which justify the description of simple. These include three-wheelers of various sizes and capabilities, basic four-wheeled vehicles, and small tractors which perform both agricultural and transport roles.

In Manila there are machines which consist of a bicycle and sidecar fitted with a 50cc two-stroke petrol engine driving the rear cycle wheel. The pedal drive is retained and thus the vehicle is best described as being motor-assisted. The sidecar is fitted with a passenger seat but is often used to carry cargo. The three-wheeler shown in Figure 11 comes from southern China and is used for passenger transport. The driver sits astride a single cylinder petrol engine which drives the rear wheels through a chain-drive transmission. Handlebar steering is employed and the other controls follow motor-cycle practice. Two vehicles of very similar conception are used in India, both based on Italian designs and manufactured locally under licence. The vehicle in the foreground of Figure 12 is of Piaggio origin, while the one in the background is Lambretta based. The two examples shown are used to carry fare-paying passengers but several forms of cargo carrying bodywork are also available. Both vehicles rely heavily on motor-scooter technology and use single-cylinder two-stroke petrol engines of about 150cc capacity.

Figure 13 shows a larger and more powerful Indian vehicle based on a twin cylinder Harley Davidson motor cycle. It can carry six passengers in addition to the rider, and is still in use in India though it is no longer manufactured. The three wheeler shown in Figure 14 comes from China and is considerably larger than the previous examples. While they are based on motor-cycle technology this vehicle can be thought of as a simplified truck. The front mounted engine drives the rear wheels through a propeller shaft and the driving position is offset, allowing space for a passenger in the cabin.

When the American forces left the Philippines in 1945 they abandoned a vast stock of surplus war material. This valuable resource was quickly utilised by the enterprising Filipinos, and one of the results of their initiative is the brightly decorated vehicle known as the jeepney. It consists of a

lengthened jeep chassis into which can be fitted a variety of engines. In Manila the jeepneys operate rather like minibuses as a public transport system. Outside the cities the jeepney often carries cargo as well as people, and is frequently seen towing a heavily laden trailer. The use and maintenance of large numbers of these jeepneys over the past thirty years has resulted in the development of a wealth of mechanical expertise amongst Filipinos. This is one of the reasons why the Asian utility vehicles (AUV's) now being produced by a number of major automotive companies have become popular there. An AUV consists of standard drive-train assemblies (engine, gearbox, etc.) built into a simple rugged chassis onto which can be mounted a variety of basic, easily constructed body shapes. The example shown in Figure 15 is by Volkswagen, but Ford, G.M., and Chrysler all make similar vehicles.

Figure 16 shows a Chinese two-wheeled, or single-axle, tractor. These tractors are produced in large numbers and have played a vital role in the mechanisation of Chinese agriculture, being well suited to the small plot cultivation which is so common there. The tractor is driven by a single cylinder 9kW diesel engine and drive to either one or both of the wheels can be selected by means of hand controls. In addition to performing an agricultural role, the tractor can be used as a means of transport, and it is in this mode that it is shown in the photograph, attached to a trailer. Similar tractors are now being manufactured in India and the Philippines.

Conclusions

There is a wide range of vehicles already in use in developing countries which span the gap between headloading and conventional cars, buses and trucks. They form a progression of transport capability and technical complexity from wheelbarrows through to motorised vehicles. Without suggesting either that there are any universal solutions, or that technology is easily transferrable from one continent to another, it is nevertheless striking that while such vehicles are common in Asia, they are almost totally absent from many other developing countries, notably in Africa.

Hand-drawn and animal-drawn vehicles are traditional in Asia, while pedal-driven and motorised vehicles represent imported technology. There has been only limited evolution of that technology in the Asian countries and much of the innovation that has taken place is geographically localised and often technically crude. The vehicles based on imported technology are used largely in urban and suburban situations, with only limited penetration of pedal-driven and motorised devices into rural areas. This is at least partly because of a lack of vehicles designed to meet rural needs.

References

1. MACPHERSON, G A. First steps in village mechanisation. Dar Es Salaam, 1975 (Tanzania Publishing House).
2. I.T.D.G. Carts. Agricultural Equipment and Tools for Farmers designed for local Production. London (I.T. Publications).
3. JAIN, J K. Transport Economics. Allahabad, 1973 (Chaitanya Publishing House)

FIG. 1



FIG. 3

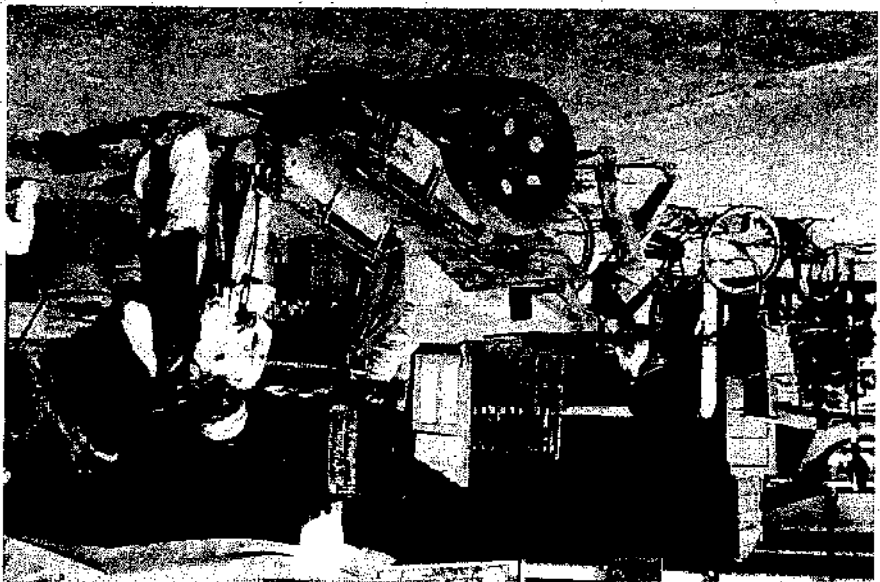

FIG. 2

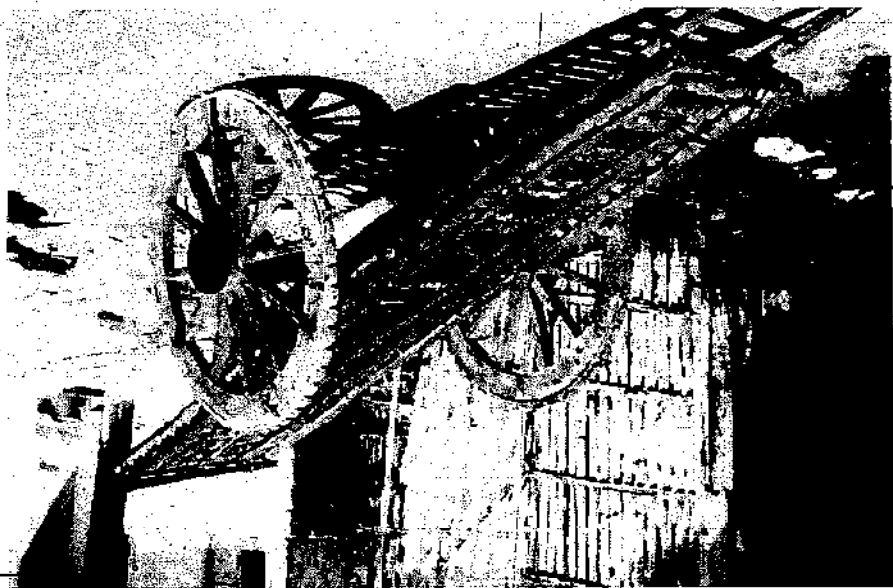

FIG. 4

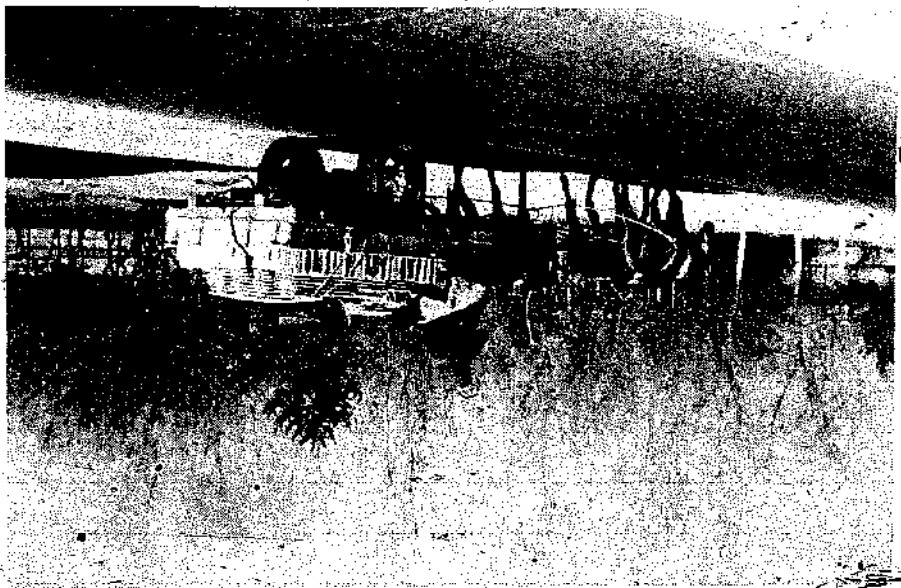



Fig. 5



Fig. 6

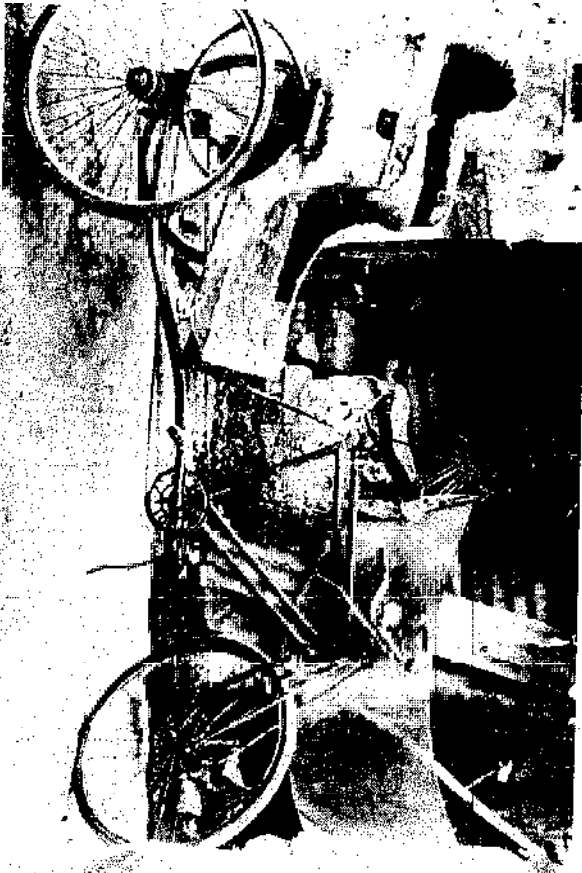

Fig. 7

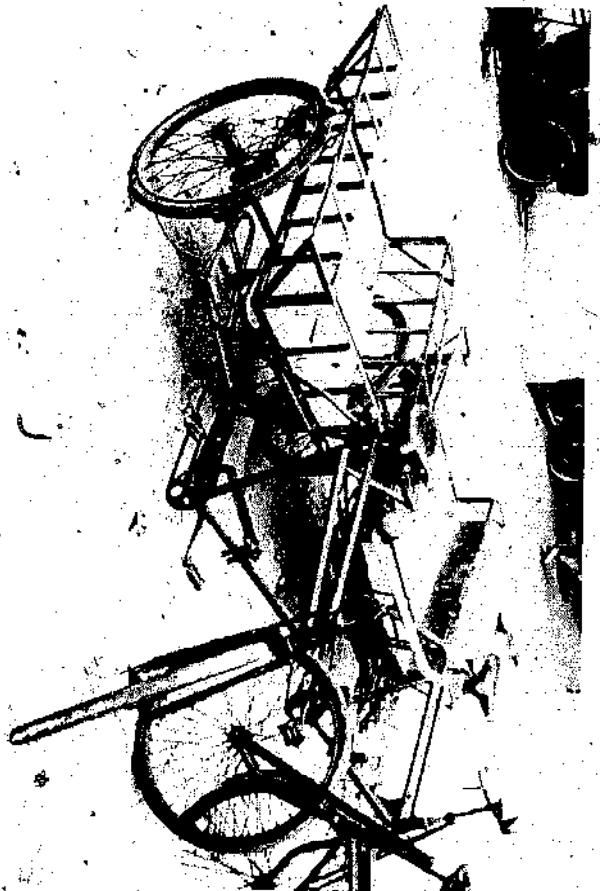

Fig. 8

FIG. 9

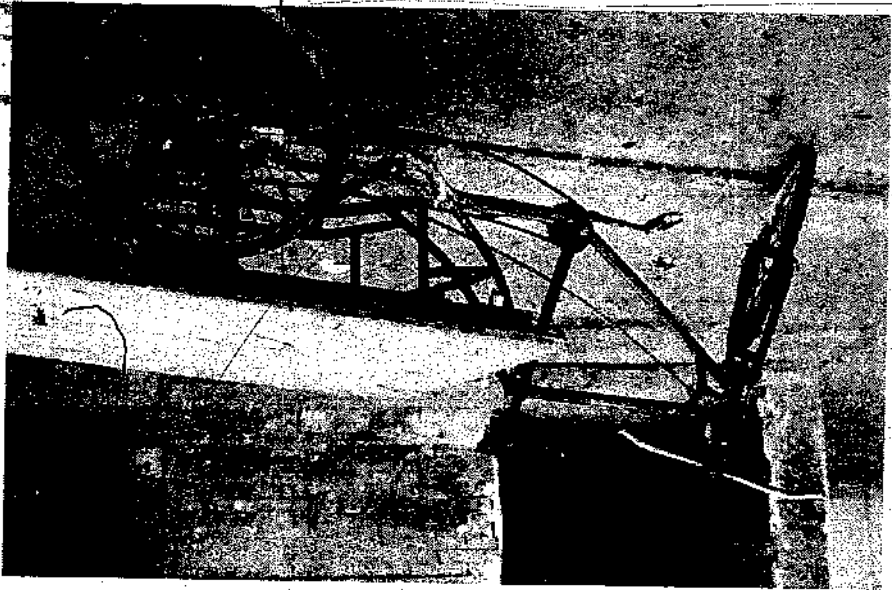

FIG. 10

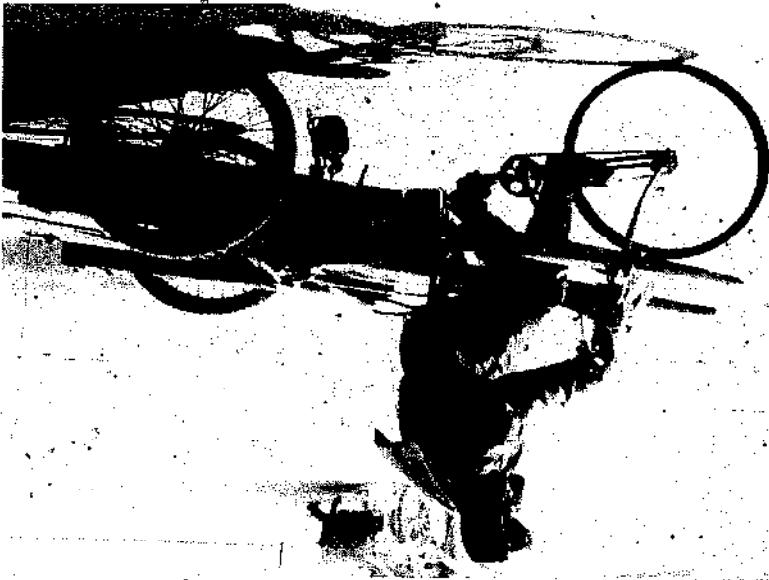

FIG. 11

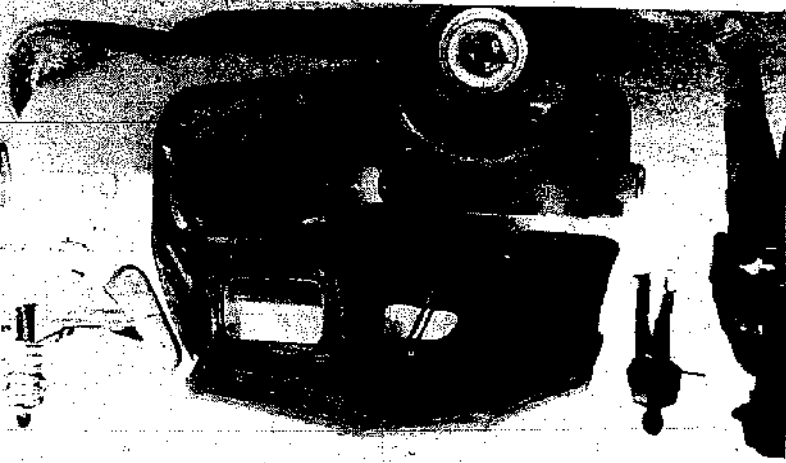

FIG. 12





Fig. 14



Fig. 16

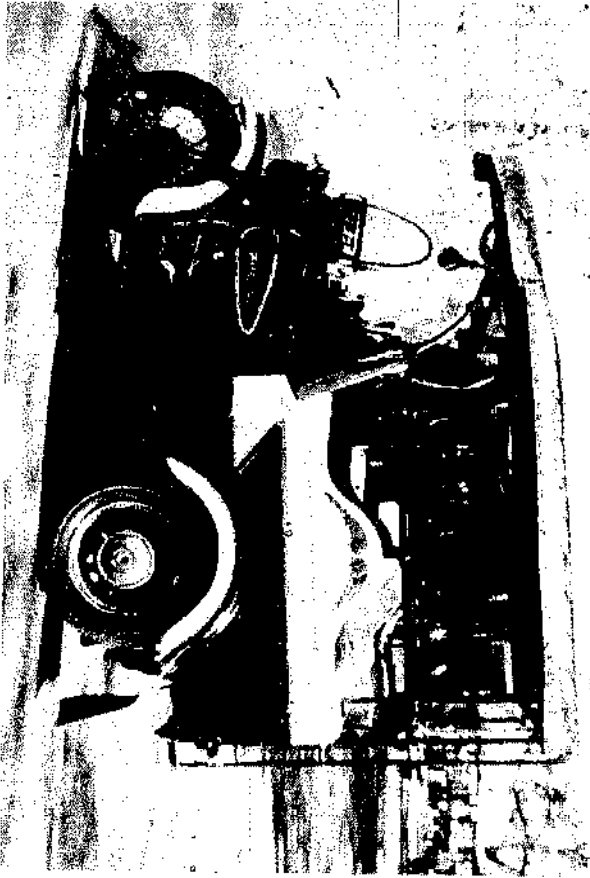

Fig. 13



Fig. 15

1.4 First Discussion Period

The first discussion period covered four topics; the problems of vehicle and track compatibility, methods of reducing vehicle costs, the need for improved designs of traditional carts, and planning problems associated with the differing requirements of various vehicle types.

It was suggested that the vehicles that Mr. Barwell had shown in use in Asia require a smooth running surface, but that 90% of the roads in developing countries are not to this standard, which precludes the use of such vehicles in many of the applications for which they appear to be suitable. In reply it was said that all such vehicles could be used on earth roads provided that account was taken of the axle loadings, that lower speeds were accepted, and that, at certain times of the year the roads might not be passable. If such periods accounted for only a small number of travel days this would not represent a major disadvantage provided that the restriction was accepted.

It was stated that very little work has been carried out into the problems of the tyre/surface interface in relation to small vehicles and that some of the present problems associated with running on earth tracks could possibly be overcome by the use of improved wheels and tyres. This indicates a need for some practical research into suitable wheel/tyre design for a range of simple vehicles.

The second point raised was that of the cost of purchasing currently available vehicles. It was felt that there are a number of possible ways costs could be reduced by improved design, and by the use of local labour and materials. There exist in many developing countries workshop facilities capable of producing a wide range of finished parts or complete vehicles. Certain machines might require a composite approach using some imported materials or finished assemblies. There is often a lack, both of suitable designs readily available to local manufacturers, and of any centrally directed organisation to encourage local production. The use of local labour would have the dual advantages of creating employment and, hopefully, of providing a cheaper product, thus allowing a wider distribution. It was noted however that for many individuals in rural communities even the cost of a bicycle is prohibitive and represents a major investment. Anything larger would be unobtainable by most individuals and would have to be communally owned if such people are to benefit from an improved road network. This form of ownership is dependent upon the existence of an appropriate community structure.

Bullock carts are extensively used throughout Asia and in some parts of Africa. Their design however is often less than optimum, having evolved over centuries with, in most cases, no greater technical advance than the substitution of traditional wooden wheels by a scrap truck axle and wheels. The effective carrying capacity is generally less than it might be because of the very high dead weight of the vehicle. This represents an enormous waste of available animal power which has only been obtained by setting aside land, which could otherwise be used to grow crops, to feed the animal. There is considerable scope for improvement in the design of these carts.

The final point raised was the effect on planning procedures of implementing a road hierarchy where the different levels of quality are related to different vehicle types. Most planning processes in developing countries have evolved directly from American and European practice and are geared to motor cars and commercial vehicles. The need to adopt more appropriate design standards (and construction methods) is being increasingly accepted. The concern of ITDG is to make known the available choices in order to facilitate selection of solutions most appropriate to particular circumstances.

I.5 Paper 2: Overseas Bicycle Markets

by K. Hutcheon

Technical Director, Raleigh Cycles Ltd.

Overseas Manufacture of Bicycles.

Most developing countries wish to establish their own industries, and bicycle manufacture is an obvious choice. The demand for the product, and the labour-intensive nature of many of the manufacturing operations can cause this to occur by normal economic processes, though it is frequently encouraged by government intervention. Raleigh is in a unique position in the world's cycle industry in being the only company which can manufacture almost all its own components, the exceptions being tyres, chains and ball-bearings. It can therefore establish overseas manufacturing plants based upon any selected degree of local content, and this it has done in India, Malaysia, Nigeria, South Africa, Canada, U.S.A. and elsewhere.

Furthermore the process of manufacturing the bicycle can be transferred in a progressive way to the overseas factory. The most labour-intensive operations are frame-building, wheel-building and cycle assembly, so starting from C.K.D. (completely knocked down) activity, the parent factory loses first the frames and the wheels which, as it happens, are bulky and expensive items to ship. Ultimately, local manufacture is developed to the extent that only the complex parts such as the lugs, the bottom bracket, and the geared hub are imported. If there were a significant demand for differentials for use in pedal-tricycles, then this is the sort of item that would be produced in the U.K. and exported.

The process of increasing local manufacturing content is occurring continuously, spurred on both by normal economic pressures, or by government policy expressed in the form of tariffs. Raleigh is currently investing a further £2m in Nigeria for the privilege of not supplying rims from its Nottingham factory. One problem with the overseas manufacture of bicycles is the need to use locally processed materials, which may not necessarily be to the same standards as those prevailing in the U.K.

The Use of Bicycles in Developing Countries

It is necessary to meet local design requirements, and many customers in developing countries are very conservative. They demand bicycles which look the same as those owned by their fathers, and are suspicious of any design

innovations. This is one reason for the preponderance in these countries of bicycles which, in terms of the U.K. market, are old-fashioned. To the Nigerian weight is strength, and the use of stronger, lighter materials is unacceptable. The user in developing countries is usually extremely ingenious and skilled in the art of metal-cutting, bending and joining. He is able to modify his bicycle to any sort of load-carrier by welding and brazing bits on here and there, and his demand is for a sturdy, basic machine to act as a foundation. The basic cycle mechanical parts are an obvious source of components for use in the construction of some special piece of equipment for transport or agricultural purposes, and again the main requirement is for robustness.

Pedal Power compared with Fuel Engines

Using pedal power, the human being can be employed as a prime mover of modest output and low capital cost. This applies particularly to personal transport, since the transportee has nothing else to do. It is worthwhile however, to question whether or not human power should be used for other purposes, such as pumping, when the person might be getting on with something else. Pedal-power can be compared with a fuel engine in the following way. A typical, modest automobile engine produces approximately 1.5 kW hours per litre of petrol. A human being, working at a steady 0.075kW, would have to work for 100 hours, that is to say at least a fortnight, to equal 5litres (1 gallon) of petrol. The standard of living must be low for this to be worthwhile. A more basic reason for using human power may well be that no efficient fuel engines exist which have an output in the region of 0.075 kW, or one-hundredth of the output of a car engine, with a proportionally low capital cost. In the case of the internal combustion engine, the reason is bound up with the heat losses from a tiny combustion chamber, and is quite fundamental.

It is possible that the answer lies in the development of a small external combustion engine. If such an engine could be made as efficient as a car engine, then a powered bicycle could be made which would do over 300km/litre, and a power-assisted bicycle might have a fuel consumption of 600km/litre. These figures serve to demonstrate that fuel cost and pollution need not be significant barriers in either the developed or under-developed worlds. Such a bicycle could have a market at home as well as overseas, and this is a classical requirement for any substantial product.

1.6 Paper 3: Appropriate Pedal Vehicle Design

by S.S. Wilson

Lecturer in Engineering Science, University of Oxford

Pedal carts and cycle rickshaws are used on a large scale in India, China and S.E. Asia, but are limited in their application to urban use on fairly level roads with a reasonable surface. Even so the strain on the driver is immense at starting, due to the use generally of a single-speed gear, commonly the same as that of a conventional bicycle, e.g. with a 650mm

(26in.) wheel, 46-tooth chain wheel and 18-tooth sprocket the 'gear' is equivalent to a 1650mm diameter wheel. This is about optimum for a single rider but quite wrong for a vehicle weighing, with load, perhaps three times as much. Other common deficiencies are inadequate brakes, often on the front wheel only, and the fact that only one rear wheel is driven. The frame, while often quite elaborate, is by no means an optimum structure, even though based on bicycle construction in steel tube.

The first attempt at Oxford to construct a cycle rickshaw is shown in Figure 1, and consists of a complete normal bicycle frame attached by two bolts to a rear section carrying two wheels each on a separate half-axle, supported in the same type of ball bearings as used in the normal bottom bracket. The two halves of the chassis, Figure 2, are connected by means of a bolt in place of the rear axle - this withstands torque about a longitudinal axis - and a clamp on the small cross tube behind the bottom bracket; this locates the front end of a tension member which forms, with a short vertical strut, a truss to resist bending moment in the chassis.

Each half-axle carries a freewheel and sprocket, the right-hand sprocket having 24 teeth to give a lower gear, and the left-hand sprocket is connected to the other by means of six pins, Figure 3. The effect is that under normal conditions both wheels are driven, but when cornering the inner wheel is driven while the outer one freewheels as it is turning faster. Hence the tricycle will turn corners without skidding but in slippery conditions where, with a normal differential, one wheel slipping causes complete loss of traction, the twin freewheel arrangement acts like a limited-slip differential in that if one wheel slips the other drives.

The chief deficiencies of this first design were the lack of adequate brakes and the single speed gear; however it served to show the potential for an improved tricycle chassis and led to OXFAM financing a technician to work on a radical new design, the OXTRIKE, Figure 4. The features incorporated in the design include the use of a 3-speed gear, a standard Sturmey-Archer AW wide-ratio type (Figure 5), used as an intermediate gearbox as on a motor cycle; the ratios chosen are equivalent to wheels of 800mm, 1065mm, and 1420mm diameter, which give a distinct improvement, though an even lower ratio is desirable for hill-climbing. A further feature is the provision of a powerful foot-brake which acts by means of inboard band brakes (Figure 5) on each rear axle; this can also be used as a parking brake. The same type of rear axle is used as before, to give a differential action.

The chassis is made from sheet steel of 1.6mm thickness (16 S.W.G. or 1/16"), which is readily available in most parts of the world, can be cut by treadle guillotine, folded by hand machines and joined by welding (gas, arc or spot), brazing or rivetting. The backbone of the chassis is a box section formed of two channel sections joined by exposed flanges. Being very stiff and strong in torsion and bending no crossbar is required, which makes mounting and dismounting easy for either sex. The whole chassis can be tipped backwards to stand upright on the rear end, which is convenient for tipping out the load, for parking in a small space, for inspection and maintenance purposes.

The front wheel and forks are of carrier bicycle type 500mm diameter, and are therefore very strong, while the rear wheels are 500mm diameter Raleigh Chopper type, again very strong, particularly against side load. An ordinary bicycle wheel does not have to resist side loads, as the rider banks round a curve, but a tricycle or four-wheeled vehicle does impose a side load on the wheels. With its short spokes giving good triangulation the Chopper wheel is well able to endure such loads.

The intention is that OXTRIKES should be built locally in small workshops from kits of parts, as is common practice in India, where Raleigh subsidiaries supply about 2500 kits each month. The OXTRIKE kit would consist of a set of standard bicycle parts plus a few special components, such as brake drums and non-standard sprockets, which would be beyond the capacity of small workshops. If need be, some of the sheet metal parts could also be supplied. Two prototypes have been built at Oxford and three by apprentices at the Engineering Industries Training Board at Sheffield. One kit has been sent to Bangalore in India and there are six more to be allocated for building either abroad or in the U.K. From experience gained in building these a decision will be taken as to the best means of future development at home and abroad. There is already plenty of evidence that OXTRIKES are of interest in Africa, India and elsewhere as well as in the U.K., since the chassis can be adapted to so many different uses. So far only a simple cart body, Figure 6, and a temporary rickshaw, Figure 7, have been built but designs exist for several other bodies, including a proper rickshaw, a multi-use body for carrying two adults facing backwards, three children facing forwards or goods; a box-van body; a hopper body, and a water cart. Further development of the OXTRIKE is hindered at present due to lack of funding.

Although the OXTRIKE should meet many transport needs it is clearly not a complete answer, but its scope can be extended in various ways; to extend its effective range in distance or hill-climbing ability, one method would be to fit a small engine of the 'Velo-Solex' type, which drives the front wheel by means of a roller; some 7 million of these engines have been built in France, so they can be regarded as fully proved. Another more recent development is that of a hub-mounted electric motor of high efficiency. This was recently announced for bicycle use and has an efficiency of 83% at cruise conditions of 250 watts, giving a speed on the level of 20 k.p.h. Maximum power is about 350 watts (approximately the same as the Velo-Solex) and should enable a hill of 1 in 20 to be climbed at about 10 k.p.h., with pedal assistance. The electric drive is an attractive possibility for regions where hydro-electric power is available, thus avoiding reliance on oil fuel and reducing the problem of maintenance.

As a radical alternative for rural use on rough, steep or soft ground a design is being evolved which we have termed the Pedal Rover (Figure 8). This is a four-wheel drive vehicle in which each wheel is directly pedalled, so giving four times the power of the OXTRIKE, while the wheels of 1 or 1.1 m. diameter should give substantially lower rolling resistance than the 500mm. wheels of the OXTRIKE, in rough going. The two halves of the vehicle are articulated at the centre for steering purposes but are also free to

twist relative to each other so that traversing rough ground imposes no strain on the chassis; dump trucks as used for earth moving adopt the same principle.

Each half of the vehicle consists of an open box with a wheel mounted at each side in a semi-circular casing carrying the axle in bearings underneath and a saddle and handlebar on top. The riders sit astride the casing and one has a steering wheel connected by cables and sheaves to the rear half for steering purposes. Several different types of wheel construction are being studied in order to evolve a design which is strong, light, cheap and suitable for local construction; these include spoked wheels, wood and metal, sandwiched construction and thin corrugated sheet steel. The rim will be of channel section to carry strips of rubber cut from old truck tyres, a technique used in Pakistan for farm carts.

It is hoped to construct a prototype as soon as possible; funds are being sought to support this development, which would result in a vehicle of great utility for rural use, a natural counterpart of the OXTRIKE for urban and suburban use.



FIG 1 CYCLE RICKSHAW

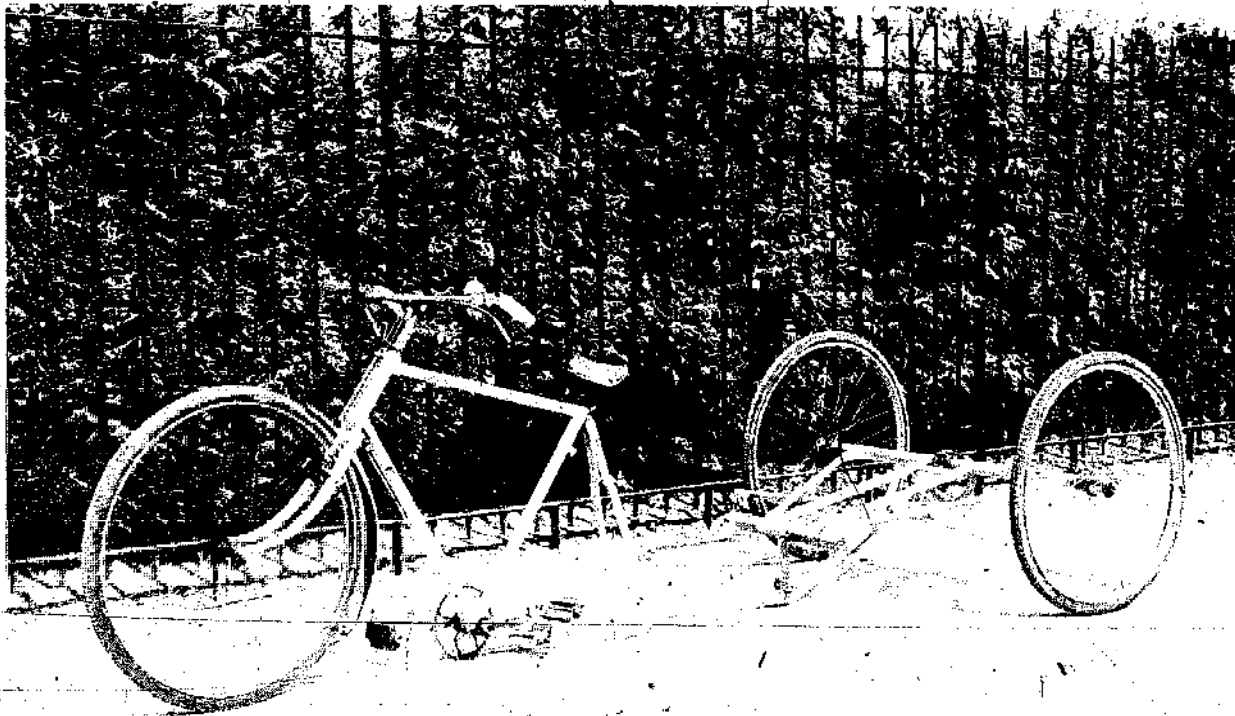

FIG 2 CHASSIS IN TWO SECTIONS

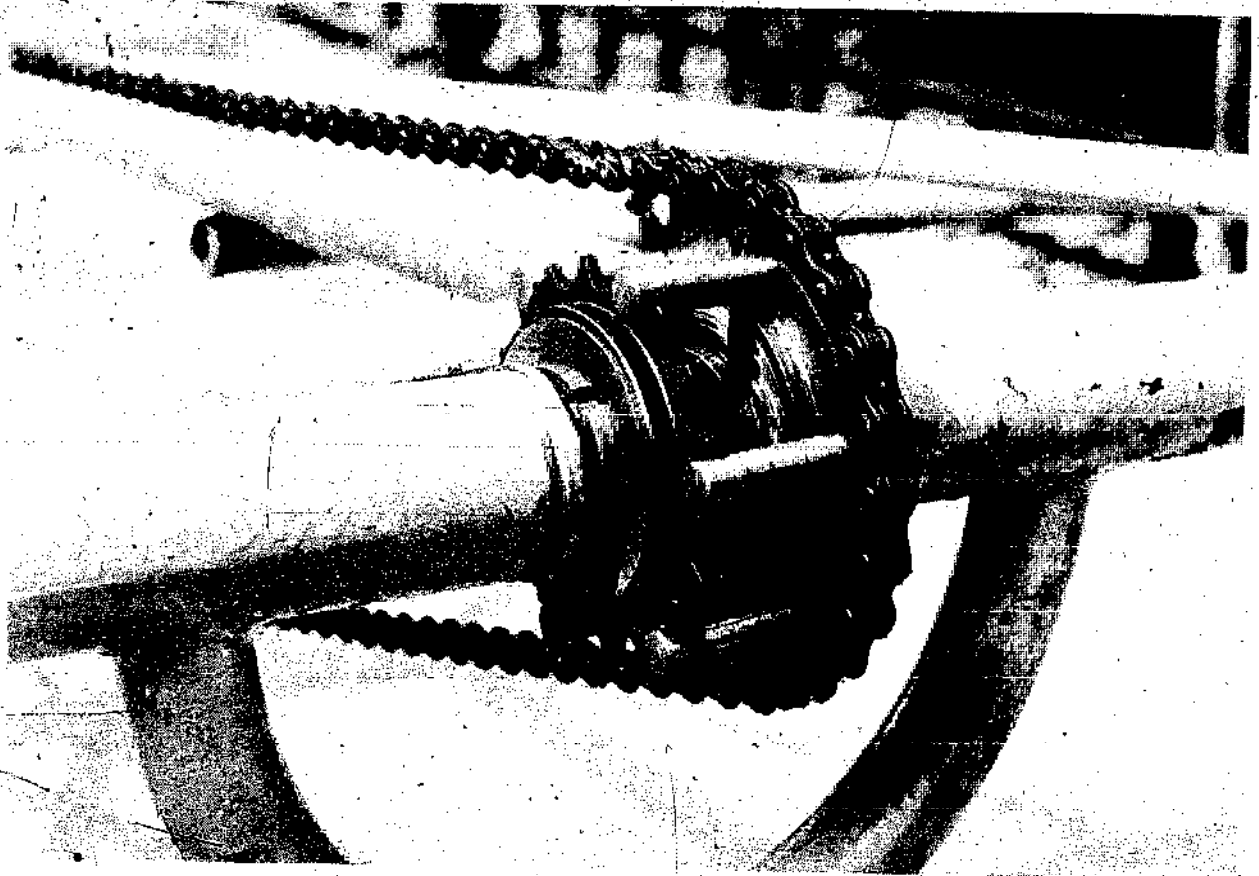

FIG 3 SIMPLE DIFFERENTIAL WITH TWO FREEWHEELS

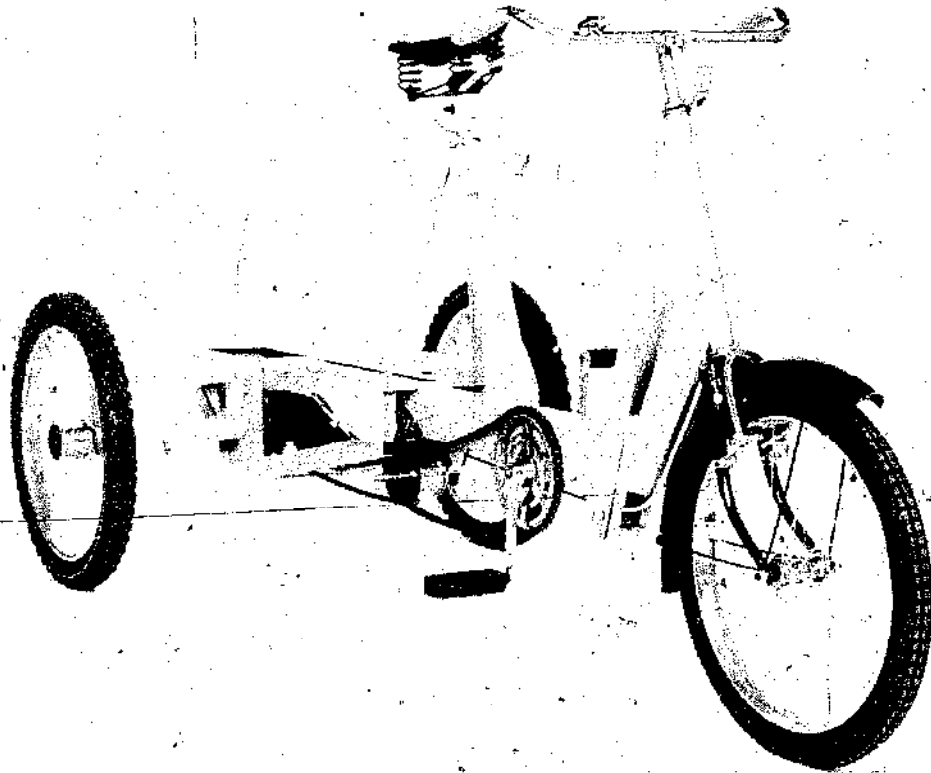

FIG 4 OXTRIKE CHASSIS

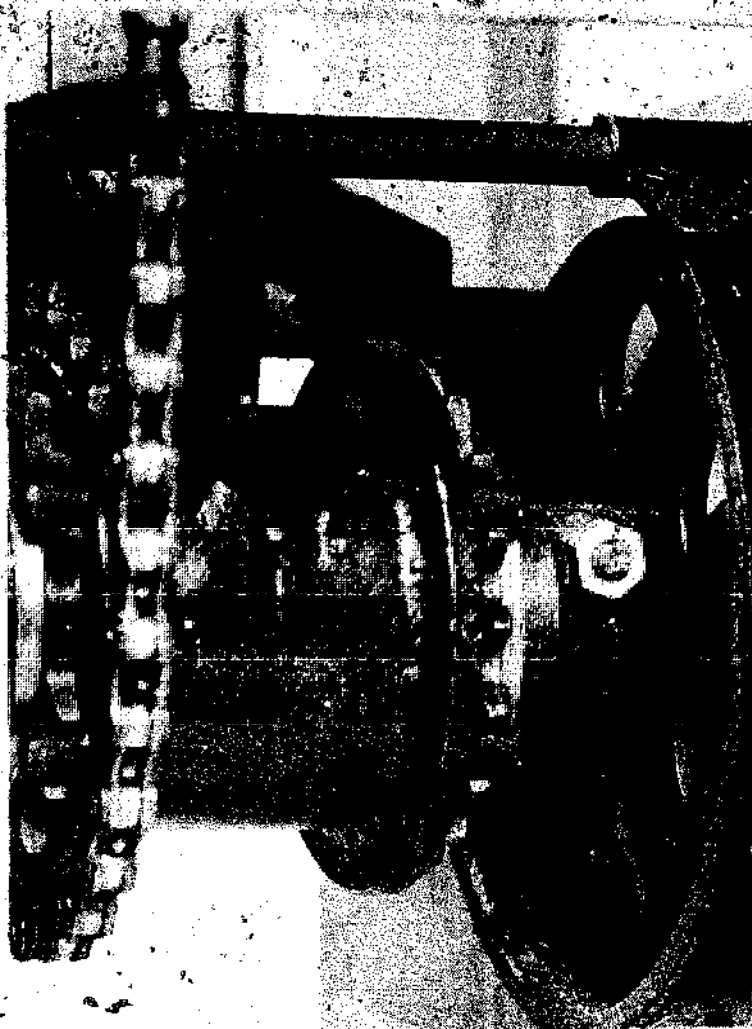

FIG 5
REAR AXLE UNIT
WITH 2 FREEWHEELS,
CONNECTING TUBE
AND BAND BRAKES

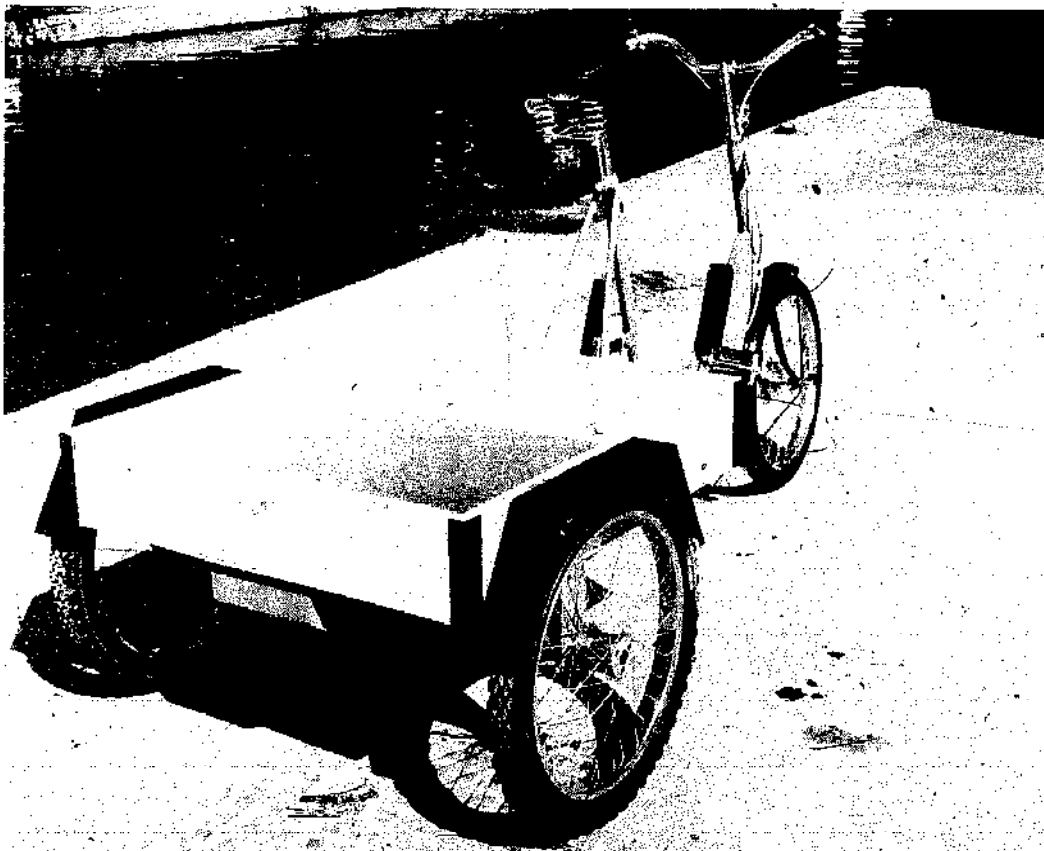

FIG 6
OXTRIKE WITH
CART BODY

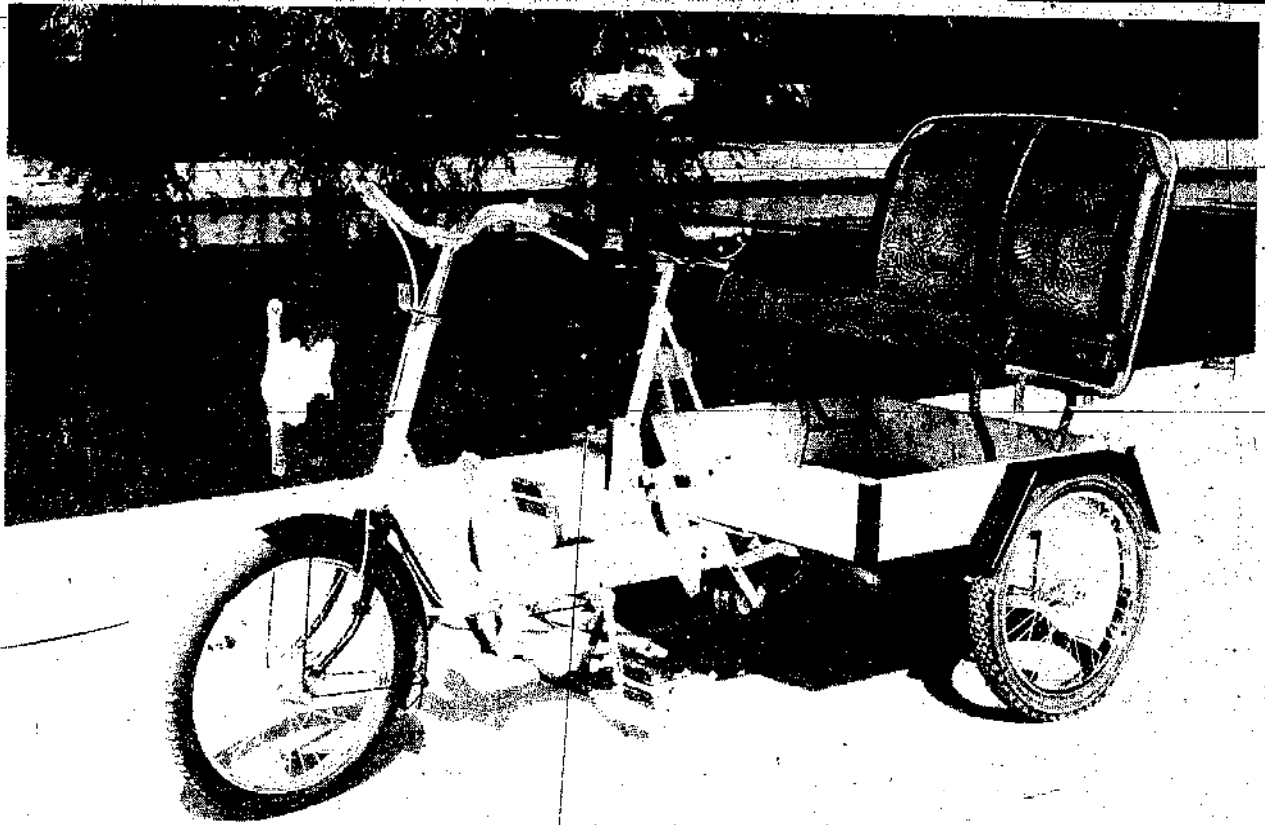

FIG 7 OXTRIKE WITH TEMPORARY SEAT FOR TWO PASSENGERS

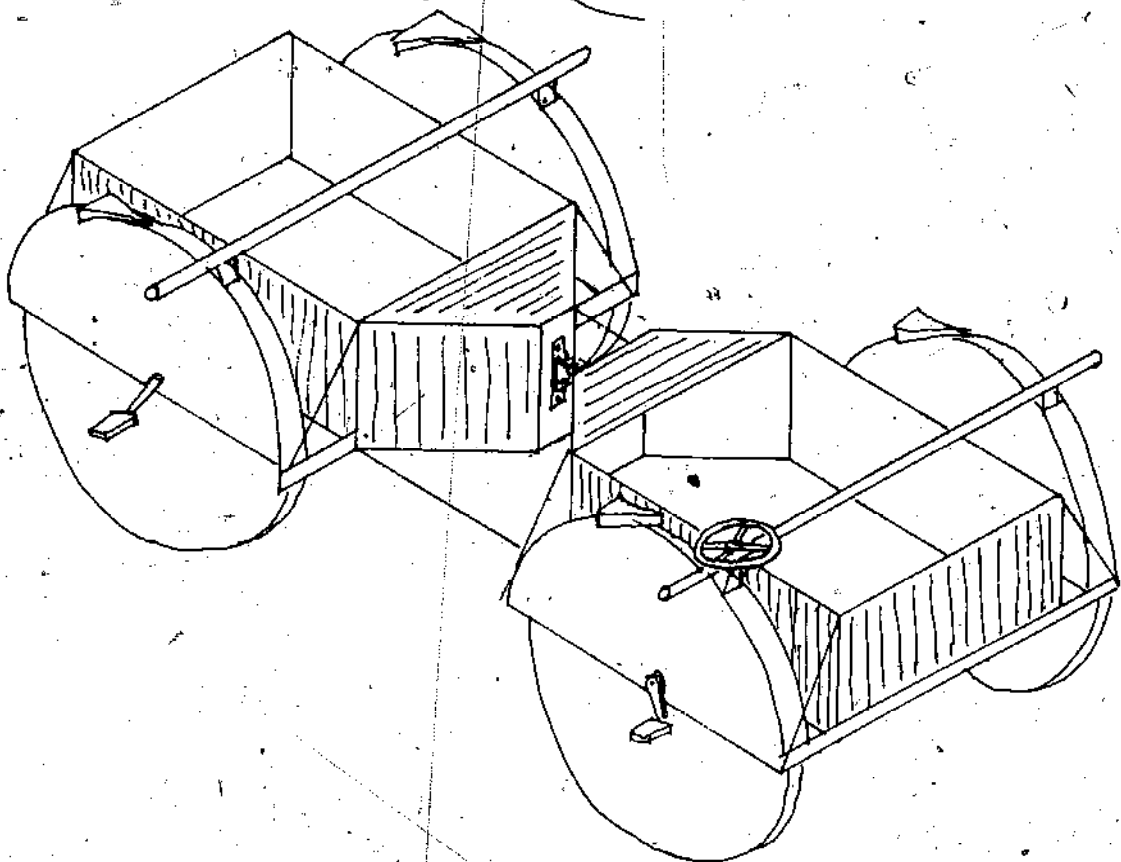

FIG 8 PEDAL ROVER 4-WHEEL-DRIVE ARTICULATED LOAD CARRIER

1.7 Paper 1. Pedal Power Unit for Transport and Machine Use

by D. Weightman

Lecturer in Industrial Design (Transport), Lanchester Polytechnic

Problem Analysis - Power Sources for Rural Areas in Developing Countries

In rural areas power sources are needed for simple agricultural machinery such as winnowers, pumps, mills, graters etc. The use of such machinery, simple and locally manufactured, can result in appreciable advances in agricultural productivity. Power can also be used for local transport and small-scale industrial applications.

The use of human beings and animals as power sources is widespread but the methods used are commonly not efficient. The power available in this case results from the conversion of food calories by muscular action and so can be increased by greater food intake. The effective utilisation of this power can also be increased by the efficient design of machinery. Animal power is widely used and efficiency could no doubt be increased but application will be restricted to those requiring high torque at low speeds (winches, large mills etc.). In those areas under consideration, the efficient use of the muscle power of human beings affords a most flexible and useful solution.

The maximum power output from a human being occurs in a rowing action because most muscle groups in the body are used. However, these outputs are closely approached by those obtained from the legs applied to moving pedals. Little advantage appears to be gained from pedal motions other than simple rotating cranks as on a bicycle (Ref. 1) and the use of cranks gives a fairly smooth rotary motion at speeds of 60-80rev/min. Hand cranking is frequently used but as the arm muscles are smaller than the thighs, power output is reduced. The power output to be expected from normal pedallers is around 0.075kW. This output can be maintained for 60mins or more. Higher outputs can be produced for shorter periods. Due to the poor nutrition levels in developing countries this output is likely to be rather high and a lower figure of 0.06kW would be more reasonable for continuous pedalling. In static applications, the outputs available tend to be lower than those measured from the performance of cyclists because of the effect of the wind in reducing body temperature. It may prove advantageous to provide fans for pedallers in static situations to improve output.

The evolution of the bicycle over the last 100 years has resulted in the determination of the optimum position for continuous pedalling over a long period. This is the position adopted on the standard 'safety' bicycle - the other positions used by racing cyclists are adopted primarily to reduce wind resistance. Some increase in output can be obtained for short periods by a more horizontal relationship between pedals and saddle; leg muscles can push against a back-rest and so exert more force. Maintaining the legs in this horizontal position results in the onset of fatigue after a short period, making the normal upright position the best compromise for most uses.

Because the 'fuel' involved in the use of Pedal Power is food, no irreplaceable fossil fuels are consumed, with obvious benefits. Although

bicycle ownership in the countries of the developing world is not universal, it is equivalent to the level of car ownership in Europe, hence spares and maintenance facilities are commonly available. The capability for indigenous manufacture can be developed from this basis (as in Nigeria, India, China etc.). If this is taken into account at the design stage then material or process substitution can result in simpler methods of construction than with current bicycle practice.

As stated earlier, the other area of need for power sources in rural areas is for transport of goods and passengers. This movement is local, as an intermediate stage between portage and major transport systems (trucks, railways etc.). In areas where pedal driven vehicles exist (primarily in Asia), their suitability has been demonstrated. Bicycles are, of course, the most common type and customarily are used to capacities far beyond their original role as personal transport. Loads of up to 100kg. are not uncommon but problems are imposed by wheel strength, stability and safety.

Methods of using Pedal Power to drive Machinery

A number of different methods have been proposed or used in various applications. These methods fall into four categories - converted bicycles; pedal drives fitted to machines; dynapods and pedal power units (PPU's). The suitability of each method will be determined by the machine type and pattern of usage. Social and economic factors will also affect the use patterns, with the classification of work tasks and the local financing system playing some part in the selection of an appropriate method.

As would be expected, a number of manufacturers already produce machines fitted with pedal drive. Designs have been produced by individuals, notably Stuart Wilson (Oxford University) and Alex Weir (University of Dar-es-Salaam) both of whom have worked for several years in this area. A survey of existing machinery that utilises pedal drive and existing machinery suitable for adaption to pedal drive is given in the Appendix.

A dynapod, as first proposed by Stuart Wilson, is a frame comprising a saddle and pedal drive with a number of power take-offs for connection to machines. In the initial proposal the drive chain was connected to two layshafts, giving two speed take-offs. Connection to the driven machine was by belt or flexible shaft and Wilson suggests the use of bamboo or G.R.P. for this shaft to reduce costs and minimise alignment problems.

The pedal power unit (PPU) was developed by the author from the basic dynapod. This development is described more fully in a report (Ref. 2). The rationale for the PPU arose from consideration of how the machine uses of pedal power relate to potential transport uses. The pedal power unit comprises a pedalled road wheel in forks fitted to a frame with saddle. This unit can be used independently to drive machinery via a power-take-off and can be connected to a two-wheel chassis to form a load carrying tricycle. The unit can also be connected in series with other units for machine applications requiring higher powers.

The link between transport and machine uses can be seen in studying agricultural or industrial production. In a typical agricultural growing

cycle, seed and fertiliser are transported to the field, crops are grown and processed by IT machinery then produce is transported to market. Similar patterns can be seen in construction or small scale industrial production. The use of pedal power in this dual role is exactly analogous to the use of tractors in European agriculture as power sources and transport devices.

The PPU is intended to extend the utility of transport and further work is currently being undertaken by the author to develop the design and evaluate its feasibility. In terms of uses, the PPU would suit the same pattern of usage as the dynapod but with the benefit of this additional use to amortise cost more quickly.

To summarise the methods of use described above:

- i) The utility of bicycles is limited to a number of specific applications such as electricity generation, winnowing fans and certain types of pump, due to the problems of adaption.
- ii) If the potential use of the bicycle as a power source was taken into account at the initial design stage, then this dual use could be accomodated satisfactorily as well as other design changes to enable local manufacture.
- iii) Fitting pedal drive directly to the machine enables optimisation of that particular application and is most suitable for machines which are in constant use or communally owned and hired.
- iv) The dynapod is a feasible solution for communal ownership when a number of machines can be operated in turn, or for a farmer with a range of machines.
- v) The PPU is equally suitable when operating a number of machines but is more economically feasible for an individual farmer due to its capability as a transport device.

Pedal Power Unit Design Proposal

The PPU comprises a frame with a wheel mounted in forks. The wheel is driven by pedal cranks and a chain fitted to the forks and a saddle is fitted to the frame. For transport applications, the unit is connected to a two-wheel chassis and so forms the driven front wheel of the tricycle. The two-wheel chassis is usable independently as a handcart. A sub-frame fitted to the forks carries a secondary chain and layshaft driven from the wheel, for use as a power-take-off. This subframe pivots on the wheel axle and acts as a stand to raise the wheel off the ground, enabling the power-take-off to be used whether or not the unit is fixed to the rear chassis (Figs. 1 & 2).

The primary drive train consists of a 46 tooth pedal sprocket with a 3mm ($\frac{1}{8}$ in) chain driving a 24 tooth wheel sprocket. This gives a lower gearing than a standard bicycle, to be suitable for load carrying. The wheel consists of a Raleigh Chopper (500mm x 50mm) type rim spoked onto either a 3-speed Sturmey-Archer hub or a dual threaded hub with freewheel thread on one side and fixed sprocket lock-ring thread on the other. The Sturmey Archer hub is modified to allow the fixing of a fixed sprocket and lock-ring in the same manner. The fixed 24 tooth sprocket drives a similar sprocket on the

layshaft via the secondary chain. The layshaft is a standard bracket axle with provision at each end for power-take-off. The chains are tensioned by jockey pulley or by moving the PTO axle housing in a slotted hole.

With the gearing arrangement described above the power-take-off speed will be 150rev/min at normal pedalling rates. By substitution of different sprocket sizes in the secondary chain this can be varied. If the Sturmey-Archer hub is fitted, this will give speeds of 112/150/200 rev/min and gives a convenient means of altering ratios. Because the road wheel drives the secondary chain system, it is used as a flywheel for power smoothing and enables the road brake to be used as a machine brake.

At one end of the layshaft is fitted a threaded block to attach the secondary chain sprocket with an extension collar onto which a take-off shaft can be fitted. This shaft can be used to connect two pedal power units together or to drive machinery. On the opposite end of the layshaft is a similar block with provision for attaching either a pulley shaft or chain sprocket to provide drive for machinery. The shaft used for interconnection would be semi-flexible (e.g. bamboo or GRP tube) to overcome alignment problems.

It is envisaged that the unit will use standard bicycle parts for bearings, pedals etc. with a fabricated metal frame. A motorcycle type steering head is used for ease of construction but it may be possible to substitute a carrier bicycle fork. Standard frame pressings can be used for bracket axles if available. The main frame is designed to be fabricated from mild steel sheet folded into rectangular section tubes. A number of other construction procedures can be used, including fabrication from stock tubes etc. The most suitable method will be determined by local conditions.

For transport use, the unit is connected to a two-wheel chassis to form a front-wheel-drive tricycle. The chassis is designed to be used independently as a handcart. Connection between the two sections is made at three points. These are the two rear feet of the unit and the top of the handle member on the chassis. The feet locate in lugs on the chassis and a clamp would connect the chassis handle to a bracket on the unit frame just behind the saddle. As long as the dimensional constraints of the attachment points, vehicle geometry and the requirements of structural strength and stiffness are satisfied, a great variety of chassis designs are possible. These range from wooden structures with fabricated wheels developed from local cart practice to metal frame chassis using available ready-made wheels. The designed payload is 150kg. Two chassis designs are illustrated (Figs. 3 & 4) in the model photographs. One uses Raleigh Chopper wheels in a light tubular space-frame, which supports the wheel axles at each side as normal. The other is designed to be fabricated from steel sheet and uses light motor car or motorcycle sidecar wheels on stub axles. The vehicle has a wheelbase of 1300mm and a track of 1200mm with ground clearance below the chassis of 200mm. The ground clearance can be easily varied in the chassis design to suit operating conditions.

A number of body types can be fitted to the chassis for different uses. The standard body would comprise a platform and two angled sides forming wheel

mudguards. This gives a platform size of 1050mm x 750mm for loads up to 150kg. A seat can be fitted on the sides to carry two passengers with space for luggage underneath the seat. The seat would dismantle to form the front and tailgate of a box trailer for goods carriage. A folding canvas hood can be fitted for weather protection in both applications. For tipping, the front of the vehicle can be lifted, pivoting above the back wheels. Alternatively a removable skip can be fitted for bulk transport. For particular applications other bodies can be used e.g. tanks for water carriage (up to 170 litres).

Motor assistance by means of a small two-stroke engine can also be employed. Although a further refinement, this illustrates the flexibility of the design. The engine would be fitted to the front fork, driving the wheel through the secondary chain system. This gives a moped arrangement, using the pedals to start the engine. 1.5-2.0kW engines would give speeds of 30k.p.h. for the fully laden vehicle on level ground. Greater speeds would require a stronger chassis and much improved brakes so are not advisable. Such an arrangement would be an intermediate stage between pedal driven and conventional motorised vehicles.

Postscript

Since the proposals described above were designed, consideration of bicycle manufacturing methods appropriate for developing countries has led to a variation of the PPU concept. Traditional bicycle manufacture relies on the assembly of high quality steel tube into complex cast or pressed lugged joints and although this results in a light frame, the production of the frame components is a capital intensive operation. For developing countries, frame construction based on box sections fabricated from stock steel sheet would be more appropriate. The use of unit bearings, suitable also for a wide range of machinery, would also simplify hub and crank construction. If such a reappraisal of bicycle construction is undertaken to evolve appropriate manufacturing methods, it would also be sensible to produce a different design of bicycle for developing countries, based on the pattern of use. This bicycle would be designed to carry loads of up to 75kg. or one passenger, in safety, dictating a longer wheelbase with smaller wheels. Additionally, the bicycle would have a power-take-off to drive machinery, thus performing a similar function to the PPU. The bicycle could tow a trailer or could be converted into a tricycle by the addition of a driven rear axle with brakes and differential unit, similar to the Oxtrike (see Paper 3).

A bicycle design similar to that outlined above, though not intended for developing countries, has been produced by the author and Ian Barwell. Having won the Melchett Memorial Award for the design, prototype construction is underway. Many features of the design would be applicable to developing countries although the general configuration would have to be modified. It is hoped to explore the possibility of extending the application of this design to developing countries and such a re-design of the bicycle would complement the development of the PPU and dynapod concepts in extending the number of ways in which pedal power can be exploited in developing countries.

References

1. WHITTY, F R, and D G WILSON. Bicycling science: ergonomics and mechanics. Cambridge (Mass), 1974 (MIT Press).
2. WEIGHTMAN, D W. Pedal power unit for transport and machine applications in developing countries. Lanchester Poly. 1976. (mimeographed).

Appendix: Existing or possible Machinery, and Designs using Pedal Power or suitable for Conversion.

Main source of information is ITDG "Tools for Agriculture - a buyers guide to low-cost agricultural implements" 2nd. edition, ITDG publications 1976.

Numbers refer to codes used in the catalogue, with country of origin.

Short number codes refer to page numbers in 1st. edition of catalogue.

Initials refer to designers or sources of information:

- SW - Stuart Wilson, Department of Engineering Science, Oxford University
- AW - University of Dar-es-Salaam
- WE - ITDG Workshop
- RM - Robert Mann, NCAE, Silsoe

Machine Type	Machines using pedal drive	Machines suitable for conversion (with existing drive method)
I. Agriculture		
Pumps	Automatic pump (SW) Chinese dragon tooth pump (SW)	Climax (UK.053H.01) hand Godwin (UK.053H.05) hand Howl (053H.13) hand Cossul (India.053H.03) 2-man hand
Maize Shellers	Hunts Cobmaster (UK.071H1.09)	Allied (071H1.01) hand CeCoCo (Japan 071H1.02) hand Cossul (India 071H1.03) hand Hunts Atlas (UK 071H1.05) hand Alvan Blanch (UK 073.07) hand
Rotary Cleaners		Siscoma (Senegal 073.08) hand
Grinding Mills	Atlas Mini Mill (SW)	CeCoCo (Japan 091H.01) hand Gaubert (France 091H.02) hand Diamant (Denmark 091H.03) hand Atlas (UK 091H.04) hand Dunia (Kenya 091H.06) hand Amuda (India 091P.09) electric motor

Corn Crushers		Renson & Cie (France 091H.06) hand
Cereal Breaker		CeCoCo (Japan 095.01) hand
Chaff Cutter		Dandekar (India 092.04) hand Hunts (UK 092.05) hand Johnson Silex (South Africa 092.06) hand Ajantz (India 092.08) hand Rajasthan (India 092.09) hand Mohunder (India 071H1.04) Renson & Cie (France 071P1.07) electric motor
Groundnut Decorticators		Dandekar (India 071H2.01) hand Hudsons (India 071H2.03) foot treadle Siscoma (Senegal 071H2.06) hand
Threshers	Akshat (India 07H3.01) Cossul (India 071H3.03) Aplos Doring (Germany, 63) VITA design Malaysian design (RM)	CeCoCo (Japan 071H3.02) foot treadle Midget, 56 Cossul (India 62)
Winnowing Fans	Akshat (India 07H3.01) Cossul (India 071H3.03)	
Winnowing Machines	NCAE design (RM)	CeCoCo (Japan 073.01) hand Hudsons (India 073.02) electric motor Hunts (UK 073.03) hand Rajasthan (India 073.04) hand Rensons & Cie (France 092.12) hand
Rootcutters		CeCoCo (Japan 092.03) hand or motor Rensons & Cie (France 092.11) electric motor
Coffee Hullers		Gordon (UK 094.08) hand
Coffee Pulpers		Bentall (UK 094.02) hand Gordon (UK 094.12) hand & (094.06) hand McKinnon (UK 094.12) hand & (094.13) hand

Palm Nut Crackers		Harrap Wilkinson (UK 094.01) hand Voms (65) Rapid (66)
Rice Hullers		CeCoCo (Japan 094.01) hand, 2man Gordon (UK 094.04) hand
Rice Polishers		CeCoCo (Japan 094.03) hand
Cané Squeezers		CeCoCo (Japan 094.01) hand
Cassava Graters	ITDG design (WE)	
Winch Plough	French design (SW)	
2. Industrial Machines		
Electrical Generator	Design (SW) using bicycle & alternator	
Winch	Design (SW)	
Forge-blower	Zambian design (ITDG)	
Air compressor		
Bandsaw		
Fretsaw		
Lathe		
Pillar Drill		
Grindstone		

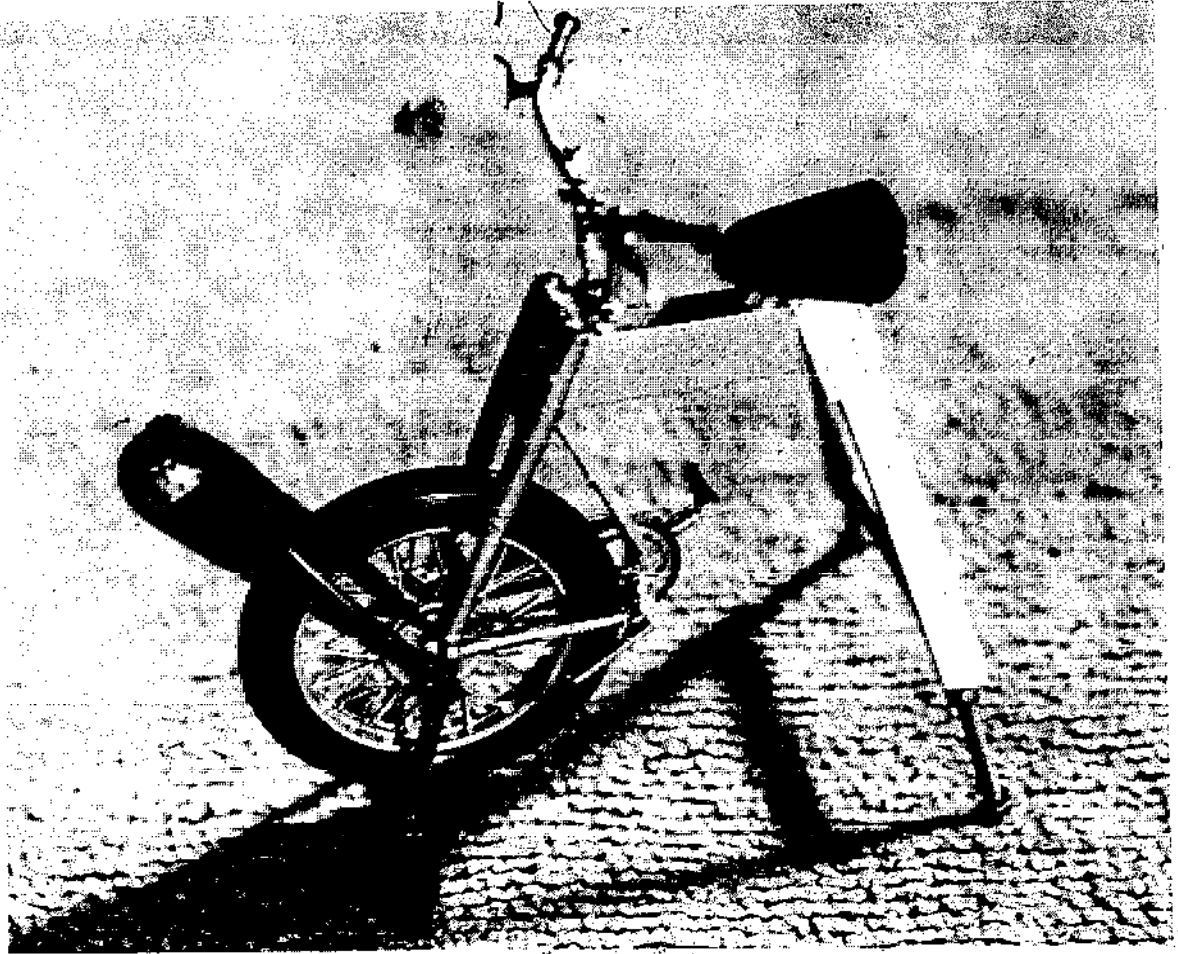

Fig. 1

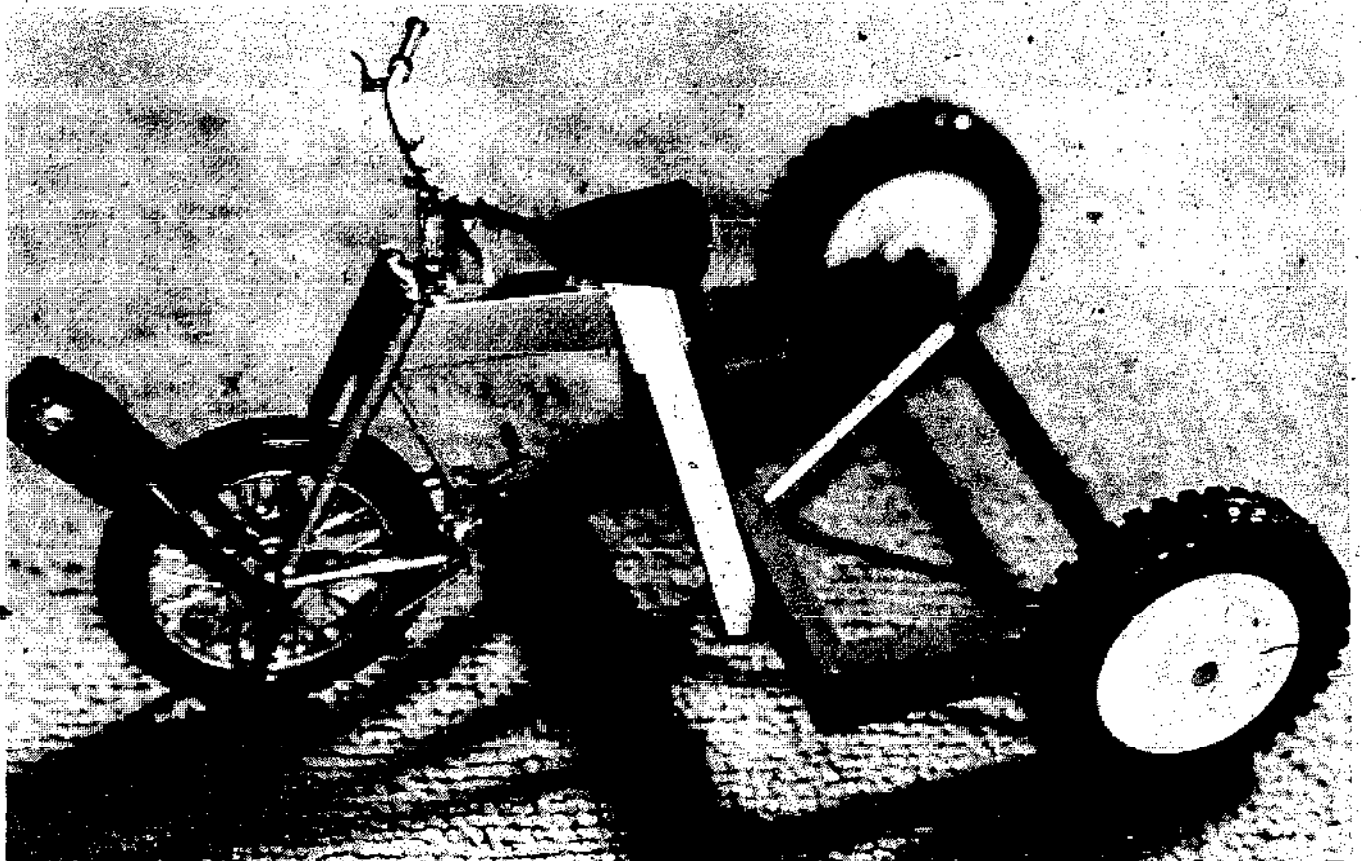

Fig. 2

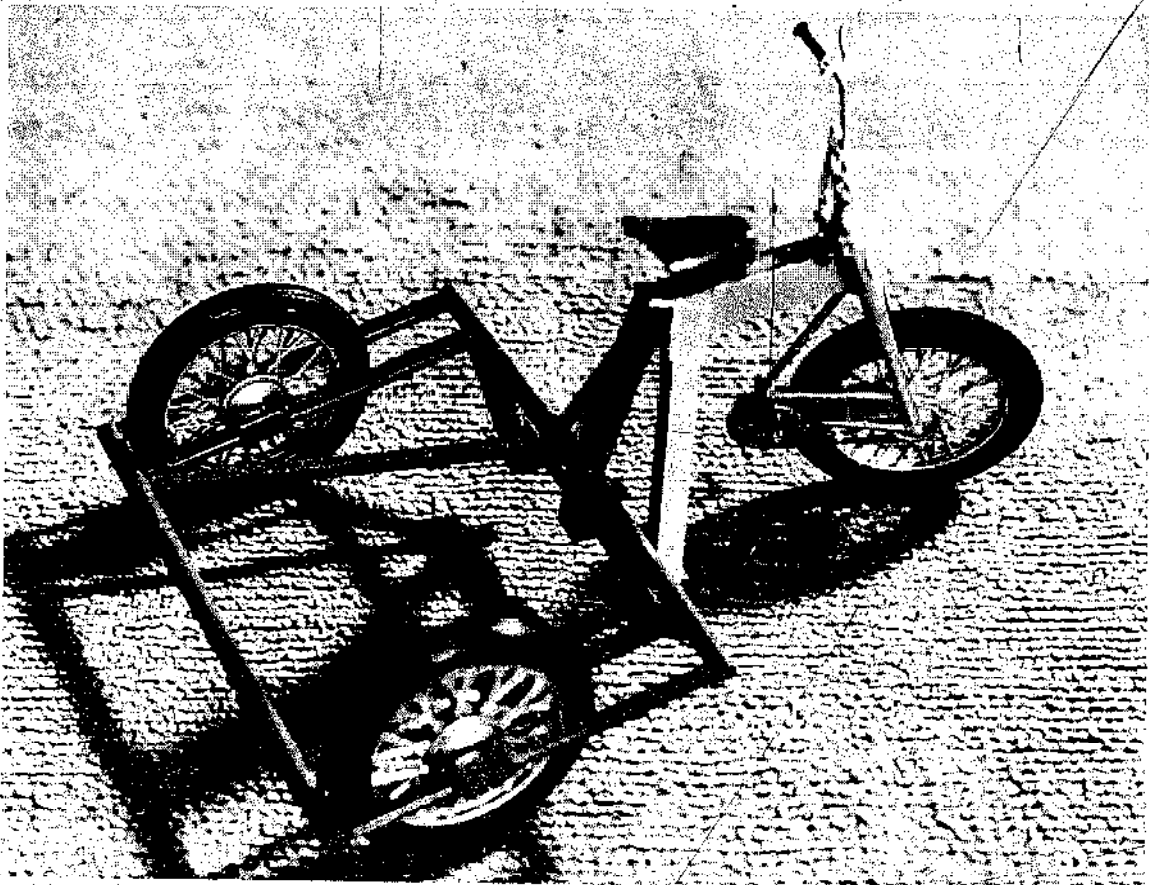

Fig. 3



Fig. 4

I.8 Paper 5: Simple Vehicles in Labour-Intensive Civil Construction

by M. Sharrock

Messrs. Scott, Wilson, Kirkpatrick & Partners

(Note: Although programmed, this paper was not presented at the Seminar, due to the unavoidable absence of the author.)

The work described in this paper has been carried out as a part of the ICRD (World Bank) study of the Substitution of Labour and Equipment in Civil Construction. This is a continuing programme to investigate the prospects for appropriate technologies to employ productively the unemployed or underemployed labour in developing countries. In these countries the extent of completed civil works such as roads, irrigation canals, dams, reservoirs, river control works etc. is of course to a large degree a measure of the development attained by the countries and these projects form a significant part of lending by international agencies. A large proportion, perhaps as much as half, of these investments is accounted for by earthworks tasks of various kinds, and the transportation of earth and locally produced construction materials such as stone aggregates over relatively short distances is usually the single most important activity within such tasks, in terms of expenditure.

Haulage of earth and stone construction materials has therefore been one of the main areas of investigation in the Labour Substitution study. The investigations have consisted of work study measurements of forty or more ongoing construction projects in India and Indonesia, together with experimental field work, and processing and analysis of the collected data. This experience has shown that these haulage activities are characterised by haul distances from a few metres to several kilometres, the most common distances for earthmoving being tens of metres to hundreds of metres, whilst for movement of stone, distances over a kilometre are most frequent. Earthmoving takes place over the rather poor surfaces of temporary haul routes usually, but when longer distances are involved quarries or borrow pits may well be sited to allow use of available permanent roads.

Haulage Methods

A great variety of haulage methods are employed in construction work. In India for example, at the labour-intensive end of the spectrum, earth and stone products are carried in shoulder pans, headbaskets, yoked baskets, and in carts drawn by mules, horses, oxen and camels. Agricultural tractors with two wheel tipping or non-tipping trailers are sometimes employed, and the use of trucks, both tipping and flatbed, is quite common. In addition to these methods, a wide range of heavy, western style earthmoving equipment is to be found, usually on very large projects. However it is now recognised from the results of the study that labour and animal based methods can be fully competitive in terms of direct cost with the latter, machine-intensive methods. It may be noted that where this holds in India, the typical unskilled daily wage during the construction season is about US\$0.5, and piece-workers earn up to US\$1, or even US\$2, exceptionally.

When efficiently organised the labour and animal based haulage modes have a definite pattern of application. With reference to Indian conditions, manual load carrying is the most competitive for short hauls, for short to medium distances the beast of burden is used, for medium hauls the animal drawn cart and finally, on long hauls, trucks give the lowest unit cost. (Unlike China, which is perhaps even better known for labour based construction, in India wheelbarrows do not feature seriously in the existing construction scene at all.) On examination of this pattern it is seen that the size of the load carried in each mode of haulage correlates well with the appropriate haulage distance, as indicated in Table I.

Method	Typical Load (kg)	Preferred Haul Distance (m)
Headbasket, yoked basket	35	0-75
Donkey, mule	100-150	50-250
Camel	400	200-400
Mule cart, ox cart, camel cart	500-1000	200-600
Truck	4000	500 upwards

Table I: Correlation between haulage method, typical load carried, and preferred haul distance

The evidence for the existence of this pattern is extensive; and suggests strongly that the major role in construction work for simple vehicles capable of carrying loads from perhaps 100kg to 1 tonne is the haulage of materials over distances from about 50m to around 1km. Two such vehicles are the wheelbarrow and the animal drawn cart. Although it is well-known historically that these have been employed in earthmoving, little quantitative information has been available even though their use has continued up to the present in some parts of the world. However, some success has been obtained during the Labour Substitution study with wheelbarrows developed for earthmoving tasks and a reasonable amount of productivity data and background information relating to wheelbarrows is now being assessed. In India the use of animal drawn carts for earthmoving has been developed to a very efficient level by petty contractors from particular areas, and as a result of observations at several sites some progress can now be made in analysing this mode of haulage also. Literature studies have been made on human ergonomics and the work output of animals (Refs. 1 & 2) and work is continuing on the analysis of wheelbarrow and animal based haulage methods (Refs. 3 & 4). Some of the initial findings in these areas are discussed briefly in the following sections.

The Work Output of Men and Animals

The physiology of man, and of the mammals used for work purposes is generally similar. It is thought therefore that the following discussion of the work output of men in relation to construction activities should serve to illustrate principles applying also to animals. However some data

on the work output of animals will also be referred to.

It can be helpful, in thinking about man-powered devices, to regard a man as a prime mover capable under ideal conditions of developing roughly 60 watts of power over an extended period. This figure of 60 watts can be arrived at in several ways. For example, it is widely recognised that an 'average' western man has the ability to convert food into energy at a rate of about 5kcal/min. Approximately 1kcal/min of this is required to sustain life processes, leaving 4kcal/min for physical activities. Not much more than a fifth of this remainder can appear as useful external work, due to the level of efficiency of the energy conversion process and of the human mechanism. Hence, converting to the standard unit for power, an output of 60 watts can be postulated for activities utilising a substantial portion of the body's musculature. This quantity is meant to be comparable with the brake horsepower figure for a vehicle, it may be noted.

This simple view is useful to set a perspective for man-powered machines. In civil construction and other heavy work, particular factors to consider are as follows:

- i) The body has a certain reserve capacity of energy which enables greatly increased power outputs to be sustained for short periods - up to perhaps ten times for a period of the order of seconds, but double or treble the 'continuous' rating may frequently be developed for minutes at a time in heavy manual work.
- ii) When the reserve capacity is used up by heavy work, rest is essential so that replenishment of the energy reserve can take place. The higher the maximum work rate, the more frequently rest is required. The overall work output falls somewhat when frequent short peaks of effort are made, compared with a continuous steady effort.
- iii) The work output (and necessarily the food intake) of workers habitually engaged in manual work is likely to be higher than that of the 'average' man, for the same body weight.

Thus in construction haulage activities, since the haulage process is essentially cyclic in nature, with a relatively demanding haul-laden period alternating with a haul-unladen period during which rest can be taken, the rate of working is cyclic also. Brief periods of high power output of the order of a minute or so, alternate with rest periods. In making comparison with continuous effort such as long distance haulage of goods, or much agricultural work, the cyclic nature of construction haulage must be considered carefully.

Characteristics of Wheelbarrow and Animal Cart Haulage

Experience indicates that barrows and carts are very sensitive to gradient and cannot negotiate long slopes of more than 4 or 5% when running on good earth surfaces carrying their normal short-haul loads. This is a consequence of their low power-to-weight ratio. A 'ball park' value for the operative power-to-weight ratio of laden carts and barrows is suggested in Table 2, compiled on the basis of informed guesswork, where the b.h.p. to gross weight ratio appears to be in the region of 0.6kW/tonne, for short-haul work.

Haul Method	Weight (tonne)				Short Period Power Output kW	Power to Weight ratio kW/tonne
	Hauler	Vehicle	Load	Total		
Wheelbarrow	0.055	0.03	0.1	0.185	.12	.65
Mule Cart	0.4	0.5	0.8	1.7	.9	.53
Camel Cart	0.7	0.6	1.0	2.3	1.5	.65

Table 2: Power-to-weight ratio of laden carts and barrows

Special measures such as provision of ramps, use of extra haulers or arrangements for winch assistance are necessary where slopes have to be climbed if a considerable reduction in payload is not to be suffered. In view of the low power-to-weight ratio it is important that rolling resistance is minimised. It seems likely that rolling resistance commonly amounts to 4-5%, given a good earth surface and well inflated smooth pneumatic tyres. Any marked increase in this value has a serious influence on ability to climb slopes with a useful payload. In Indian practice, where a rise of more than 1 to 2 metres occurs in a short haul, animals carrying panniers are generally used in preference to carts, no doubt because their superior climbing ability makes them more economic in these circumstances.

Animal carts used for earthmoving, although similar to road-going carts are specially constructed for the earthmoving task, as follows:

- i) The harnessing arrangement often enables the cart to be partially or completely tipped to speed the unloading process.
- ii) Pneumatic tyres are used - either ADV (Animal Drawn Vehicle) tyres or truck tyres, the tread may be ground off to give a smooth round profile.
- iii) The body has shallow sides or a simple flat platform to make hand loading as easy as possible.

These carts are produced by very small scale manufacturers. Where some advanced technology components such as tyres and roller bearings are employed, used secondhand parts are generally fitted. The body and much of the chassis is of wooden construction. The major reason for fitting pneumatic tyres to these carts is probably that conventional narrow wooden or metal wheels are at a particular disadvantage on earth surfaces because they cause a rapid deterioration of the running surface, with consequent increase of rolling resistance due to deep rutts and deep layers of dust. Tables 3 & 4 give typical details of animals and earthmoving carts.

	Speed km/hr	Typical Load kg	Cart Purchase Price US\$	Typical Tyre Size	Chassis Life yrs
Mule Cart	3-4.5	800	130	6-19 6PR	5
Ox Cart	2-3.5	1500	130	6-19 14PR	5
Camel Cart	3-5	1000	170	9-20 10PR	5

Table 3: Characteristics of animal drawn earthmoving carts

Animal	Approx. Cost US \$	Approx. Working Life yrs	Approx. Feeding Cost \$/day working
Donkey	30-70	10	0.4
Mule	100-180	15	0.5-1.0
Ox	70-100	15	1.0
Camel	220-330	15	1.4

Table 4: Characteristics of draught animals

Some forty wheelbarrows of different types have been used in extensive field work during the study. These have been of five basic patterns:

- i) Two-wheeled barrows
- ii) U.K. style single wheel
- iii) Chinese style large diameter single wheel
- iv) Swedish style single wheel
- v) U.K. body pattern modified for large diameter single wheel.

The types of wheel used have included small cycle wheels, scooter wheels, motorcycle wheels, wheels with solid rubber tyres and all-metal wheels, running on wooden planks, beaten earth, or steel pipe. Load capacity has varied from 60-200kg. Generally all-metal construction has been used and this seems to be justified by the long working life which can be achieved, bearing in mind that equipment used in civil construction has to be of a very robust character. It has been found that wheelbarrows are superior to headbasket haulage beyond about 30m haul distance, and are a viable alternative to animal haulage methods up to perhaps 200m. Generally pneumatic tyred single wheel barrows are to be preferred. Some of the reasons for this choice are as follows. It is seldom possible to obtain a completely smooth running surface, and pneumatic tyres cause considerably less strain for the hauler than the steel or solid rubber type. A good wheel is an expensive item and has to be fairly heavily made to withstand the working conditions, therefore the fact that a single wheel barrow is lighter and cheaper than a two wheel barrow is a significant point. For the range of gradients and running surfaces commonly encountered, the load which can be carried is not high enough to cause balancing problems to an extent which would justify use of two wheels. Preparation of barrow runs is also simplified for single wheel barrows. For hauls longer than 100m a large diameter wheel and greater load capacity as exemplified by the Chinese style barrow is most effective, providing gradients are minimal. Particular circumstances can lead to alternative choices, it should be noted. For example, very good results have been achieved with a metal wheel running on a single steel tube rail, and where the position of a haul route does not have to change frequently this system could be most economical. As another example, for winching heavy loads up long steep slopes the better stability of a two wheel barrow might well be essential.

References

1. INTERNATIONAL BANK FOR RECONSTRUCTION & DEVELOPMENT. A literature review of the ergonomics of labour-intensive civil construction. World

Bank Study of the Substitution of Labour & Equipment in Civil Construction, Technical Memorandum No. II. Washington, 1975 (IBRD).

2. INTERNATIONAL BANK FOR RECONSTRUCTION & DEVELOPMENT. A literature review of the work output of animals with particular reference to their use in civil construction. World Bank Study of the Substitution of Labour & Equipment in Civil Construction, Technical Memorandum No. 21. Washington, 1976 (IBRD).
3. INTERNATIONAL BANK FOR RECONSTRUCTION & DEVELOPMENT. The use of wheelbarrows in civil construction. World Bank Study of the Substitution of Labour & Equipment in Civil Construction, Technical Memorandum No. 13. Washington, 1975 (IBRD).
4. INTERNATIONAL BANK FOR RECONSTRUCTION & DEVELOPMENT. Haulage using animals in civil construction. World Bank Study of the Substitution of Labour & Equipment in Civil Construction, Technical Memorandum (Forthcoming), Washington, (IBRD).

Note: The above papers may be obtained from:

Transportation & Urban Projects Department,
International Bank for Reconstruction & Development,
1818 H Street NW,
Washington DC 20433,
United States of America.

1.9 Second Discussion Period

The discussion centred on the suitability of current bicycle designs to the needs of developing countries; in the U.K. the cost of a bicycle is approximately one week's wages, but for most people in developing countries it represents several months' earnings. It was suggested that there is a need to develop bicycle designs which could be locally manufactured by small scale enterprises at a low unit cost, utilising imported materials and components only when suitable substitutes are not locally available. It was noted that, in addition to the activity outlined in Mr. Wilson's paper work is in progress, under the direction of Messrs. Franchi and Vegoda, on a new bicycle design which might meet many of these criteria, and which would require only a very limited number of imported components. Participants were cautioned that it is dangerous to assume that all developing countries have the same requirements since conditions, and the availability of skills and resources, vary greatly from one place to another.

The discussion moved on briefly to the methods by which ideas could be transmitted to areas of need. It was noted that ITDC is able to work effectively with industrialists in this capacity through its two subsidiaries, the Industrial Liaison Unit and Development Techniques Ltd., who have already undertaken a number of successful projects where such collaboration was involved.

2. Session 2

2.1 Paper 6: Small Farm Vehicle

by R. Wijewardene

International Institute of Tropical Agriculture, Nigeria

(This summary of Dr. Wijewardene's presentation, which included a film and slide series, and the subsequent discussion has been prepared by the editors.)

Dr. Wijewardene's presentation described the development, some six years ago, of a Small Farm Vehicle (S.F.V.). The work began with a survey carried out in Malaysia, which showed that between 70 and 80% of the population were engaged in agricultural activity, and that something of the order of 70% of that activity involved transport. It therefore appeared that appropriate designs of self-moving vehicles for agricultural use were of the utmost importance and could have far reaching effects for a substantial proportion of the population. The conventional farm tractors were not considered appropriate since they are in essence a mechanised replacement for the horse. Their design stemmed from the assumption that the system of farming, based on the use of draught animals, was fixed.

The approach which was adopted was to define the peak labour demands involved in tropical agriculture and to apply modern technology to those demands. The technology had to be of simple form in order to make it both accessible and attractive to the farmers. The result of this work was the S.F.V. The design requirements for the vehicle were that;

- i) it should sell for no more than US\$ 1500 (1971 prices);
- ii) it should be able to negotiate ditches and swamps;
- iii) it should have a high level of manoeuvrability;
- iv) a number of implements could easily be attached;
- v) it could be used as a basic transport vehicle.

The design that evolved had four-wheel-drive, each wheel being independently driven. This enabled steering to be achieved simply by differential wheel speeds, thus allowing very high manoeuvrability with a minimum of mechanical components. Power was provided from an 11kw petrol engine which was also successfully operated on methanol, thereby removing the necessity for an ignition system.

The vehicle had a re-inforced plastic/plywood sandwich shell which formed an integral body/chassis. A modern image was presented in order to make the vehicle compatible with current automotive designs. This was considered necessary so that farmers would not consider that they were buying a second-class product while the urban dweller got the best. Very low pressure (0.16kg/sq. cm.) balloon section tyres were used so that ditches and swamps could be negotiated, and this proved to be very successful. However the latest thinking is that better performance can be achieved using very large diameter tyres with special treads which cut a track through the soft mud to bite on the harder ground below.

Work is currently centred on producing a viable electrically powered vehicle, but there is still a considerable amount of further development required before such a device becomes a practical farming machine.

Discussion

In the discussion that followed various points were raised relating to tyres and wheels. It was stated that a further advantage of large diameter wheels was that it was easier to negotiate rough ground both because of the angle of the tyre to obstacles, and because of the greater ground clearance which could be achieved.

In discussing the power requirements of agricultural activities, Dr. Wijewardene stated that many of the ploughing tasks could be eliminated by greater use of mulching. Were this to be done then total vehicle power requirements could be substantially reduced (perhaps to 4kw) since it is the ploughing operation which uses the most power. This approach would greatly increase the utility of two-wheeled tractors driving a variety of implements.

Illustrations (following page)

Figure 1. Shows the S.F.V. with the seat removed. The engine, body/chassis unit and parts of the transmission system can be seen.

Figure 2. Shows the S.F.V. being used as a transporter.

Figures 3 & 4. Show the S.F.V. performing agricultural operations with implements attached.

FIG. 1

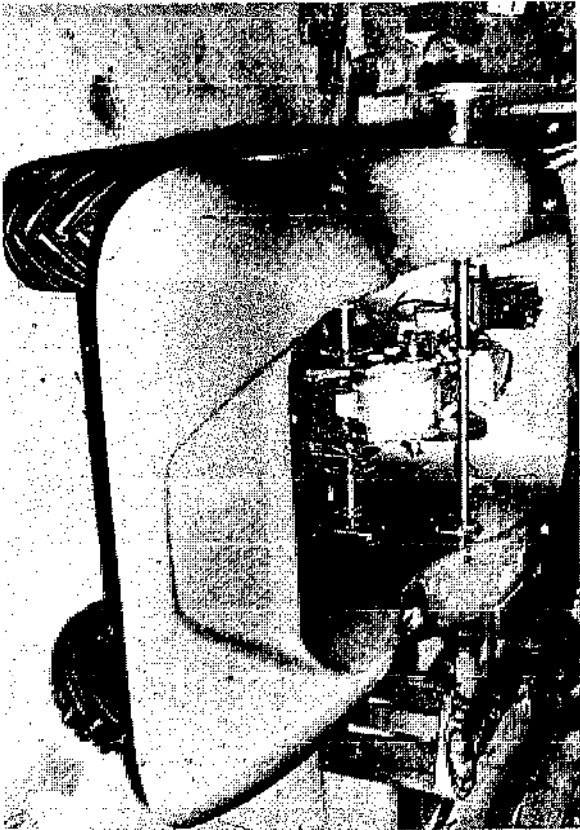

FIG. 2



FIG. 3

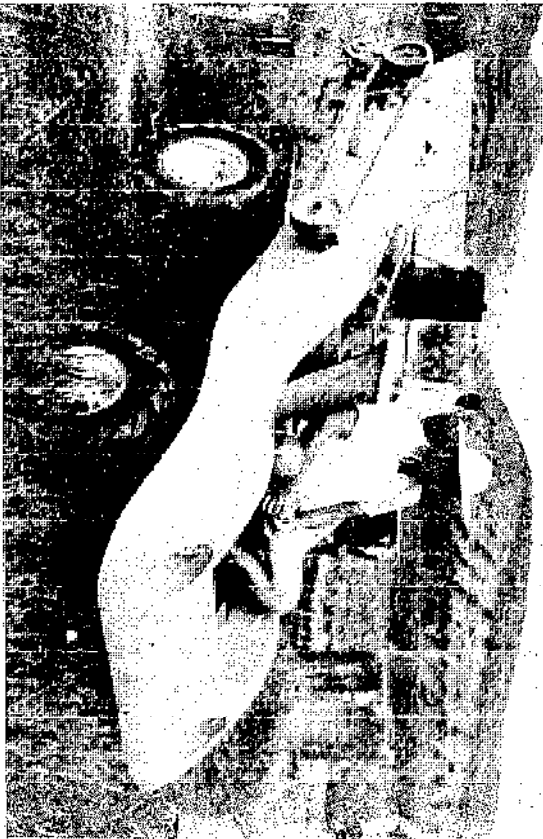
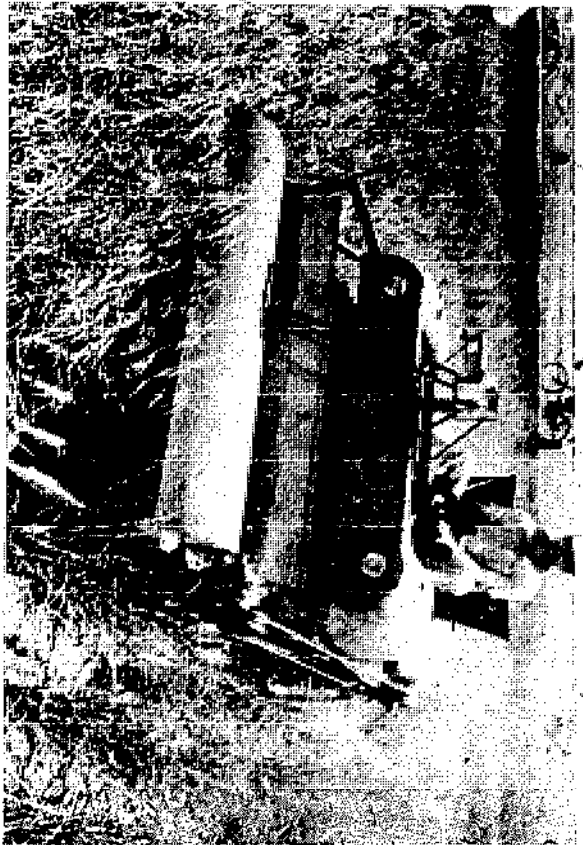

FIG. 4



2.2 Paper 7: SNAIL Transport

by C. Crossley, J. Kilgour & J. Morris

National College of Agricultural Engineering, Silsoe

Technical Considerations

The SNAIL is a simple tractive device designed for manufacture and use in developing countries. One of the problems facing many farmers is the need to cultivate the soil at the end of the dry season to allow the planting of crops at the optimum time to obtain a good yield at harvest. At the time of the year the farmer wishes to do the cultivation the soil is very hard, and neither hand nor animal techniques are very effective, so the farmer usually waits until the first rains. This results in a late planting date, leading to reduced yields. The farmer does not have a large enough holding to be able to afford or use effectively a conventional tractor. Attempts have been made to provide a small tractor but for a number of reasons this is not technically feasible. A possible solution is the SNAIL.

The SNAIL cultivating system consists of a motorised self-propelled winch which can be anchored to the ground with a sprag. A modified ox-type plough is pulled towards the winch by a wire rope. Two men are required, one to drive the winch, the other to drive the plough. The operation is as follows. The implement is placed in the field where cultivation is to start, the wire rope is attached and the winch is driven across the field unwinding the rope. When the rope is fully extended or at the end of the field the driver disengages the wheels and engages the winch drive. As soon as the rope starts to wind in, the sprag enters the ground anchoring the winch firmly. When the implement is pulled up to the winch the drive is disconnected and the winch is driven off again unwinding the rope to start the next cycle. In this way it is possible to use a small engine to pull a large load without the problems of wheel slip and weight for traction.

A number of prototype machines working on this principle have been built and tested in Malawi under an ODM Research Scheme (Refs. 1 & 2). An economic study was made in 1975 (Ref. 3). This showed that the machine is technically capable of primary and secondary cultivation of an 8.1 Ha holding (20 acres) but economically less attractive with the particular design due to the high estimated production costs at the time.

By re-arranging the components and adding a pair of wheels and a box the machine can be made into a self-propelled trailer. The trailer body is 1,700mm long, 1000mm wide and 480mm high. It is fitted with two 400 x 8 tyres and is capable of carrying a 300kg payload at a maximum travel speed on the flat of 7.2k.p.h. (Fig. 1). At full engine power on a hard surface it can negotiate a 1 in 3.5 slope.

Smallholder farming systems vary to suit the natural conditions as do the yields that the farmer can expect. Such a machine is most likely to be introduced in the government development areas where marketing, credit and extension facilities are available. Three major farming situations have

been selected for the purpose of evaluating the appropriateness of the SNAIL system (same situations as used in Ref. 3) as a transport device. Table 1 shows the area under the principal crops in these situations. Table 2 shows the quantities to be transported in kg/ha for the principal crops. The quantities to be transported before harvest are small and are ignored in the following analysis. It is assumed that the farmers will wish to transport all the yield to market.

The transport distances can vary considerably depending on the distance between the garden and the household; where it is assumed cleaning, processing and storage takes place, resulting in an average 33% loss in weight; and between the household and the local market where the crop is sold. Of the range of distances quoted for the land development areas a distance of 0.8km from garden to household (1.6km return journey) and 6.4km from household to market (12.8km return journey) has been taken for the analysis. The travel speed of the transport has been taken at 3.6k.p.h. (half the maximum) to allow for loading and unloading twice and unknown delays. The fuel consumption has been calculated on the basis that the engine is working at 50% of maximum power (de-rated for Lilongwe altitude and ambient temperature) and for the particular engine used is 0.58kg/hr.

Table 3 shows the transport requirement for the crop harvest for garden to household and household to market. The number of hours taken and the fuel used is quoted for the 'average' yield and for the 'best' yield expected by the more progressive farmers.

The harvest time is at the end of the rains and for the crops listed occurs during March, April and May, the precise time depending on the timing, duration and intensity of the rains for the particular year. There is a considerable labour peak at this time of year and in the three cases considered often a labour deficit (Ref 3). This will probably mean that some of the crop will be harvested late and consequently be of lower value or lost entirely. In the worst situation the farmer will have to spend about six days on crop transport from the garden to the household. With head portage as the major transport method, transporting accounts for a large proportion of the total harvesting labour requirement. Since a reasonable head load is 10-20kg for a long distance and 40-50kg for a short distance with a maximum travel speed of 4.8k.p.h. this will take the one man approximately eight times longer than SNAIL transport from garden to household. Using the SNAIL transport system may well avoid the labour deficit at this time, so enabling all the crop to be harvested at the optimum time.

Transport from the household to the market takes considerably longer, even though the quantities of the final product are less, due to the longer distances involved. This is likely to take place during the early part of the dry season when there is little or no work to do on the land, so it would seem that up to thirty days taken on transport would not present a time problem. This is the time of year when people travel socially so this activity may not be considered as just a chore.

From this simple analysis it would seem that the SNAIL transport system could be technically satisfactory for these situations.

Economic Considerations

Generally, transport and communications are both costly and problematic in developing countries. For the peasant farmer, processing inputs and marketing produce is often seriously constrained by inadequate transport infrastructure. Where improved transport services are available, they are often prohibitively expensive. Accordingly, smallholder agricultural schemes emphasise the importance of improving rural transport facilities.

At present in Malawi, feet, bicycles, ox-carts and buses provide the main methods of transport for smallholders (Refs. 5, 6 & 7). Smallholder cash spending on transport is low, accounting for an average 6% of farm expenditure (K1 per holding in 1968) (Ref. 8) and, as mentioned earlier, most transporting of marketable produce in Malawi is performed post harvest by low opportunity cost labour. One recent smallholder transport survey (Ref. 4) estimated that of householders selling produce outside the area under consideration, 70% carried it by foot and 13% by bicycle.

Estimating costs for alternative smallholder transport methods in developing countries is difficult both because few such transport studies have been attempted and because smallholder transport methods do not always lend themselves to conventional costing exercises, particularly where otherwise unemployed family labour represents the major component of the transport system.

Costs of transport vary considerably between commodity types, transport methods and distances covered. The figures of a 1972 survey showed the costs of head portage in Malawi ranging from K0.18 to K10.19 per tonne kilometre over distances ranging from 0.4km to 6.4km, average 2.6km. Average ox-cart distances were 2km., the greatest distance being 4km. and costs ranged from K1.16 to K1.83 per tonne kilometre. Pick-up trucks were considered to have the cost advantage over distances greater than 4.8km, costs per tonne kilometre being K0.55. Over short hauls of 1.6km pick-up truck costs were equivalent to K3.23 per tonne kilometre. Observing the increasing popularity of ox-carts which are relatively inexpensive to purchase and have negligible operating costs, the survey considered that ox transport would take over as the most important short haul mode of conveyance. At present, however, only 5% of Malawi farmers possess work oxen.

In recent years, the smallholder agricultural development schemes, recognising the importance of readily available transport in encouraging farmer marketing response, have provided tractor/trailer transport to peasant farmers at various levels of subsidisation. For example, Lilongwe Land Development Programme, Central Malawi, collects and carts to market the produce of those farmers who participate in the scheme's credit packages. The charge for transport, at K0.30 per bag for maize (equivalent to K3.24 per tonne or K0.61 per tonne kilometre) is deducted together with charges for seeds, sprays, fertilisers and credit, from the farmer's revenue at the point of delivery to market.

The SNAIL transport method is considered to offer an alternative transport mode for short to medium (6.5km) distance hauls. Engine powered transport devices, however small, are expensive to purchase and operate. A major advantage of the SNAIL transport system is that because the power unit is primarily used as a cultivation device, the major part of the annual fixed costs are attributable to field work activities. The multi-purpose aspect of the machine allows fixed costs to be spread amongst different operations. The fixed cost proportion absorbed by transport activities will depend on the relative importance, in terms of annual working hours, of the transport activity. In the farm situations quoted earlier it is estimated that the fixed cost percentage allocated to transport is of the order of 20-30%.

SNAIL Costs

The estimated purchase price of a SNAIL manufactured in Malawi (1975) is K1500. Assuming a life of five years the annual fixed costs of ownership are estimated at K410. The hourly operating costs of repairs and maintenance, fuel and oil total K0.87, excluding labour. Working its annual maximum of 8.1 hectares involves SNAIL in an estimated 600-700 operating hours. The time spent on transport is considered as a fraction of this latter figure to derive a share of fixed costs attributable to transport.

An examination of the costs of SNAIL transport (Table 4) reveals an approximate cost of K3 per tonne kilometre excluding labour. Relative to existing alternatives, particularly the use of ox-carts, the SNAIL appears expensive. The major reasons for the machine's high costs are its considerable annual fixed costs (K400 compared with K80 for a complete oxen and equipment team) and its slow rate of work (capacity x speed) relative to other motorised transport forms. In examining farmer transport requirements, examples are based on 8.1 hectare holdings, as this represents the seasonal capacity of the SNAIL cultivation device. In many developing countries average holdings are much smaller than this. In Malawi average holding size is 1.52 hectares, only 2% of holdings being above 5 hectares. On small holdings the SNAIL device is difficult to justify, the costs of ownership and use being prohibitively high.

Using SNAIL in the transport mode as a substitute for head portage considerably reduces the labour requirement for harvesting and marketing transportation. Improving labour productivity and easing labour bottlenecks during the harvesting period can be particularly important in realising the potential yield increases from better inputs and husbandry practices during the production year. In Malawi, due to the marked unimodal rainfall distribution, the farming calendar is characterised by a period of intense agricultural activity (November-April) after which crops are marketed during the subsequent dry period. During this latter period, labour is underemployed and has very little opportunity cost and no premium for timely marketing is offered to farmers. Generally, transport to market proceeds at a leisurely pace. Where double cropping is possible, however, and the opportunity cost of employing labour in transportation

is considerable, the SNAIL device could prove a valuable transport asset, particularly where farmers are rewarded for timely marketing. In a similar vein, where the opportunity costs of keeping oxen on the land are high, the use of a small, engine powered device such as SNAIL becomes more attractive.

It is in situations where the hidden costs of traditional hand or animal powered transport technology are high that small, engine-powered transport devices prove most beneficial.

References

1. CROSSLEY, C P, and J KILGOUR. The SNAIL in Malawi. World Crops, 1974, 26 (4), 170-2.
2. CROSSLEY, C P, KILGOUR, J, and T B MUCKLE. Low cost primary cultivation. National College of Agricultural Engineering, Occasional Paper No. 1. Silsoe, 1973 (N.C.A.E.).
3. MORRIS, J. A financial economic feasibility study of SNAIL in Malawi. 1975 (N.C.A.E.).
4. ANON. Agricultural produce transportation survey. Chikwawa Cotton Development Programme, Malawi, 1974.
5. AGRO-ECONOMIC SURVEYS. The town markets of Lilongwe. Agro-Economic Surveys Report No. 14. Malawi, 1974.
6. AGRO-ECONOMIC SURVEYS and NATIONAL STATISTICAL OFFICE. Zomba town market survey 1970-1971. Malawi, 1971.
7. AGRO-ECONOMIC SURVEYS. Marketing of smallholder produce in Malawi. Agro-Economic Surveys Report No. 16. Malawi, 1975.
8. NATIONAL STATISTICAL OFFICE. National sample survey of agriculture 68/69. Malawi, 1970. (National Statistical Office).



Fig. I

Table I: Major Farming Situations, Areas under Various Crops (8.1 Hectare Holding)

Crop/Ha	Llongwe	Chikawa Cotton Farm	Karonga Rice Farm
Maize	4.05	2.43	0.81
Groundnuts	1.62	0.16	
Tobacco	1.62		
Pulses	0.81		0.81
Cotton		4.86	
Sorghum *		0.65	
Cassava *			1.20
Rice			5.30
Fallow			

* Assumed to be subsistence crops not requiring transport to market

Many other crops are grown for the farmers own consumption e.g. millet, sweet potatoes, carrots, onions, cabbage, bananas, paw paw and pineapples. Near the centres of population the crops may become cash crops and require transport. Other items requiring transport are wood for domestic cooking and house building materials.

Quantities to be transported kg/Hectare

Table 2:

Item	Maize	Tobacco	Groundnuts	Cotton	Rice	Rainfed Paddy	Coffee	Pulses
Seeds	24.6/66	0.017	67/90	25/31	66			16.8/56
Fertiliser	250	250		617	432 ¹ 370 ²			
Sulphur Dust	88							
Garden	Av.	1513	839	671	1849	5044	503	671
Yield to Household	Best	4202	3362	1444	2688	5044	7061	839
Household	Av.	1009	560	449	1120	1234	3362	449
Yield to Market	Best	2804	2244	963	1881	3362	4708	560

Wet season crop
 2 Dry season crop

Table 3:

Transport Requirement -Crop Harvest

3.1

Lilongwe (8.1 Ha. holding)

Crop/Ha	Garden to Household kg.	Number of Journeys	Total Distance km.	Hours	Fuel Litres	House to Market kg.	Number of Journeys	Total Distance km	Hours	Fuel Litres
Maize 2.05	6127	20	32	8.9	6.5	4086	14	179	49.7	36
	17018	57	91.2	25.3	18.25	11461	38	486	135	97.8
Groundnuts 1.62	1087	4	6.4	1.8	1.3	730	3	38	10.5	7.6
	2339	8	12.8	3.6	2.6	1560	5	64	17.8	12.8
Tobacco 1.62	1359	5	8	2.2	1.6	907	3	38	10.6	7.7
	5446	18	28.8	8	5.77	3630	12	154	43	31
Pulses 0.81	543	2	3.2	0.9	0.62	364	2	26	7.2	5.25
	679	3	4.8	1.3	0.94	454	2	26	7.2	5.25
Totals	Av.			13.8	10.02				78	56.5
	Best			38.2	27.5				203	116.8

Table 3 (Cont.):

3.2 Chikwawa Cotton Farm (8.1 Hectare holding)

Crop/Ha	Garden to Household kg.	Number of Journeys	Total Distance km.	Hours	Fuel Litres	House to Market kg.	Number of Journeys	Total Distance km.	Hours	Fuel Litres
Maize 2.43	3676	12	19.2	5.3	3.84	2452	8	102.4	28.4	20.6
	10211	34	54.4	15	10.87	6808	23	294.4	81.8	59.3
Groundnuts 0.16	107	1	1.6	0.44	0.32	72	1	12.8	3.6	2.61
	231	1	1.6	0.44	0.32	154	1	12.8	3.6	2.61
Cotton 4.86	8170	27	43.2	12	8.7	5443	18	230.4	64	46.4
	13063	44	70.4	19.5	14.1	9142	30	384	106.7	77.3
Sorghum* 0.65										
Totals										
	Av.			17.74	12.86				96	69.6
Best				34.94	25.2				192	139.2

* Subsistence crop

Table 3 (Cont.):

3.3 Karonga Rice Farm (8.1 Hectare holding)

Crop/Ha	Garden to Household kg.	Number of Journeys	Total Distance km.	Hours	Fuel Litres	House to Market kg.	Number of Journeys	Total Distance km.	Hours	Fuel Litres
Maize 0.81	1225	4	6.4	1.8	1.3	817	3	38.4	10.7	7.76
	3404	11	17.6	4.9	3.55	2270	8	102.4	28.4	20.6
Pulses 0.81	544	2	3.2	0.89	0.64	364	1	12.8	3.6	2.61
	679	3	4.8	1.3	0.94	454	2	25.6	7.1	5.15
Rice 5.3	9800	33	52.8	14.7	10.65	6540	22	281.6	78.2	56.7
	26733	89	142.4	39.6	28.7	17819	59	755.2	209.8	152.1
Cassava* 1.2										
Totals										
	Av.			17.39	12.01				92.5	67.07
Best				45.8	33.2				245.3	177.8

* Subsistence crop

2.3 Paper 8: The TRANTOR and the Cellular Production System for Indigenous Vehicle Manufacture

by G.A.B. Edwards

Trantor International Ltd.

Part I: The TRANTOR Project as an Industrialisation Package

General Strategy

The TRANTOR is a general purpose work vehicle and it has been designed and built in Britain. It enters a market which is currently satisfied by the makers of tractors, Land Rover-type vehicles and lorries and trucks up to about 8 tonnes. The combined world population and future market for all the vehicles in these categories produced by Massey-Ferguson, Toyota, General Motors, Fiat, Ford and others is so large that by obtaining 1% of the market, the TRANTOR project would achieve great success. For example, 800,000 tractors are produced and sold each year.

The product is particularly noteworthy because of its wide range of general uses and our policy is to ensure that an appropriate TRANTOR is seen, tested and thoroughly examined in each of the countries and regions of the world where production may be established or the vehicle used. If a country is beginning to establish its own motor vehicle industry then TRANTOR manufacturing and assembly ought to be included in the most basic needs of the nation concerned because of its use as a car, tractor, truck and lorry. TRANTORS plough and take the full range of farming equipment. The trailing capacity is 10 tonnes with unbalanced trailers, and the vehicle, which has an integral safety cab, can cruise at 80 k.p.h. TRANTORS operating as rural buses, with appropriate trailers, can carry up to thirty people. They include Category 2 tractor linkage equipment.

The primary aim of the TRANTOR project is to provide all countries of the world with a motor industry which they will largely own and operate and which will satisfy the home market and provide an export potential. Because TRANTORS can act as passenger cars, trucks and tractors, the project helps the developing country conserve its scarce capital resources. It allows such nations to use their limited resources in other more productive investments elsewhere - for example, the vast range of agricultural equipment needed for efficient food production. The attractions of the TRANTOR project to developing nations also extend to the minimisation of use of foreign currency reserves because TRANTORS are designed to be manufactured, not just assembled in the country concerned. A further basic principle is the way in which the TRANTOR project can be used to extend the range and increase the rate of industrialisation by teaching, in a specially designed training school, the wide range of skills required, which include painting, welding, drilling, milling, turning, grinding and boring.

A Policy for a Collaborative Association

When entering negotiations in a 'new' country, collaboration with Britain usually begins from government agencies, private manufacturing and selling businesses, business consultants, development authorities, agricultural and

transport specialists and those currently working in motor and agricultural engineering.

In all cases it is important to:

- i) make arrangements for a vehicle to be hired or sold for demonstration and test under local conditions
- ii) conduct feasibility studies concerning the potential in home and neighbouring export markets; the skills available to build TRANTORS and to assess the rate and the stage by stage process of factory building (i.e. assembly, manufacturing of chassis, simple skill working, complex skill working). It is necessary also to assess the various details of the product design which would best satisfy the market. Various alternative component supply sources, with costs delivered to site need to be considered. Factory location, land availability and plans for after-sales service all need to be examined as part of the feasibility studies.

Our organisation offers this whole service, from its technical staff led by Stuart Taylor, TRANTOR's designer, through to its work organisation (Group Technology) consultants led by Dr. Pierre Schmitt of France. The work of these consultants is well known in the field of work organisation. Our consultants have been pioneers in this new field of work groups and have advised, amongst others, Platt (Saco-Lowell), Dunlop, British Oxygen, Knorr-Bremse, Ferranti, Rank Xerox and Tube Investments (Matrix). Our advisory work has always concerned the way in which these large, labour-intensive firms should develop in future to increase their productivity, improve their delivery, reduce their work-in-progress and develop their management and labour relations style to meet the needs and changes of the day.

Our whole policy is to offer a complete turn-key operation for any country wishing to have its own motor vehicle industry based partly or wholly or even firstly on TRANTORS. The following information is available:

- 1 A 12 minute colour film of the TRANTOR vehicle
- 2 A colour brochure in English, French and Arabic
- 3 A TRANTOR product specification
- 4 An outline proposal for setting up TRANTOR factories
- 5 A list of bought-out components with detailed part specification (Many alternative engines, electrical equipment and general bought-out parts are available from many different countries)
- 6 A minimum building specification
- 7 The fixed capital equipment needed to make TRANTORS at about 20 per week
- 8 The training school equipment needed for full and complete training in TRANTOR manufacturing and assembly
- 9 A draft legal contract/letter of intent in respect of the factory proposal
- 10 A suggested stage by stage process leading from TRANTOR assembly and chassis manufacture to complete manufacture over a range of different periods from one to five years (Appendix I).

In addition there is a scale model of the plant, designed for Nigeria, which

can be seen at our Stockport (UK) offices. All drawings, jig and tool designs and special fixture drawings can be seen at Stockport. Production vehicles began to be produced in January 1977 and can be seen in the course of construction. Twelve prototypes can be viewed in different applications. Of particular interest are the TRANTOR assembly work groups, the rear axle sub-assembly group and the transmission work group, as well as chassis manufacture and panel assembly.

Part 2. The Design and Manufacturing Strategy

The TRANTOR project conducted firstly at Manchester University and then at Bradford University Management Centre concerns a new type of agricultural transport and work vehicle, which is designed in a new way to embrace the new kind of small group production system of manufacture and assembly. An unusually practice-centred University research team led by the author originated the project with W.S.H. Taylor, TRANTOR's designer, at UMIST, Manchester. The work concerned with the design of the organisation of work was conducted by Edwards and Taylor with the assistance of the former's research team, which received its support from the Science Research Council.

There are two problems which prevent developing countries from successfully producing their own vehicles and, in general, they have, up to date, only assembled such products. These products which have been assembled have usually been fundamentally designed for the requirements of the western world. The requirement of the developing countries' home market invariably, however, is for a more functional, harder wearing, more durable product than that designed for the west. Top speed and acceleration may be important to the market of the United States but it is the ease with which a leaf spring can be replaced or the strength of the front bumper which are often more important to a developing country. A product which is designed for the environment of the western world is also designed so that it can easily be produced within relatively advanced western production systems. Vehicle products are usually made on a mass production basis in large batches (manufacture) and on flow lines in assembly. They are invariably built in large plants employing several thousand people and they are situated in heavily populated areas. These factories require enormous amounts of capital investment before the first production machine flows from the line and they usually demand large home markets and well-established servicing networks to be economically successful. Developing countries are generally short of capital, for which there are many competing demands. Developing countries usually have smaller centres of population and insufficient skilled and semi-skilled labour in one centre to support a large plant.

Any regional development planning, which is such a vital feature of planned industrialisation, requires that small pockets of industrial factory practice be made available in region after region. The TRANTOR project is a serious attempt to design a new product and a new kind of factory unit which considers regional planning, minimum capital, durable products etc as its fundamental constraints. We have tried to begin here at a new kind of beginning for the developing nations.

The fundamental specification of the product was drawn up following a two-year study by W.S.H. Taylor of the transport requirements in agriculture and where

tractors are used in rural areas, for forestry and in other general work tasks. The TRANTOR has been designed to carry out virtually all the tasks and operate with the same attachments as the conventional agricultural tractor. It can, however, be driven light at speeds up to 90 k.p.h. and it can also haul trailer loads of up to 8 tonnes at speeds of 55 k.p.h. As stated earlier, it spans three markets, each of which is conventionally supplied by a different product and it, therefore, competes against the agricultural tractor, general purpose vehicles (such as the Land Rover) and small commercial lorries. The home market in some developing countries may be small for any one of these three products but for the TRANTOR that market size would be considerably increased. The multi-purpose nature of the vehicle can significantly reduce the capital cost to owners (individual or collective) who would need only a TRANTOR instead of a car, a lorry, a Land Rover and a tractor. TRANTORS are competitively priced and cost a little more than the conventional tractor of a similar horsepower.

The product design has been carefully considered from the point of view of the economics of low quantity production (smallness) and the factory design was a second but vital step in the same direction. There are, for example, no high quantity machining requirements for any of those parts which are designed specially for the TRANTOR and which would be manufactured in the factory. All such parts can be produced with simple, inexpensive capital equipment in the form of easily available simple machine tools and specially designed jigs and tools. When designing the production system for the TRANTOR it was clear that it would have to be produced economically in low quantities and that each TRANTOR factory would need to prove its economic viability where the number of employees would be about 100-150. At such a size the output of each plant is about 1000 units per year and if the market demand in a particular country, or region, becomes greater than this number it needs to be sufficiently viable in its usage of capital and give sufficient returns for it to be possible to duplicate the plant in another region of the country.

The basic idea is that the plant should be small and efficient but clearly the restriction of 100 to 150 persons could be adjusted to suit prevailing circumstances. The designers of the factory are firmly of the view that the cost and ease with which the factory can be controlled and managed are vital to the success of the venture and hence the increase in employees has connotations other than those of more production. The idea of the small plant offers other advantages such as the coupling of after-sales service directly to the factory.

As a result of the decision to produce a small factory with the technology designed to suit the economics of smallness the capital required (fixed and working) before the first production machine comes out of the door is proportionately reduced. The capital requirement is further reduced by using only 'standard', 'off the shelf', machine tools throughout the whole plant and not relying on any expensive special-purpose machinery.

It is the design of the tooling which is crucial to the success of smallness and our work group approach follows the principles of Group Technology. It is necessary to begin to manufacture with a low skill requirement and in our TRANTOR factory each man needs only to be trained to operate one machine before the plant commences operation. Our special tooling, jigs and fixtures

have reduced the depth of skill required to handle each machine and so the initial start-up training time is minimised. This does not prevent each operator acquiring a broader knowledge of several different machine tools because he is able, as production gets under way, to move from machine to machine and widen his abilities and skill.

The inevitable question must be asked "how can a small plant produce a vehicular product competitive in price to similar products mass-produced at over twenty times the rate?" It is clear that to machine components in batches of 400 per week is usually accepted as being cheaper per component than machining in batches of 20 per week. TRANTOR manufacture is organised on a group technology basis which considers all the machined components in the plant and groups them into families which have similar machining requirements. It is then possible, because one is dealing with groups of similar components, to set up groups of machine tools with associated jigs, tools and fixtures so that the time taken to change from one family member to another is virtually the same as if they were the same components. As each family can contain anything up to fifty similar components, it is soon possible to substantially increase the effective batch size and reduce the cost per component. Because the TRANTOR has been specifically designed for this type of manufacture it has been possible, at the component design stage, to consider the component family and to standardise on features common in the family, such as hole diameters, tolerances and material.

The TRANTOR project may thus be said to offer an unconventional alternative technology whose many aspects would prove useful in coping with the needs of countries in the third world. It does so by combining the most advanced practices in production with a belief in 'scaling down' for ease of access and control, and providing a product that can meet the special need characteristics of those who work and live in rural towns and villages.

Appendix

A feature of the TRANTOR project is to offer MANUFACTURE, where most of the skills lie, and assembly and the whole project is geared to the idea of assisting a developing country in widening and extending its skill base by offering simple fitting skills and simple machining skills like drilling, but also offering skilled boring and precision turning. In order to satisfy this dual requirement, factories for TRANTORS come in a series of 'staged packages' with a tailor made training school to meet the needs of each stage. The whole factory consists of 17 self-contained work groups each of which employs about 8 people. Each work group has its own particular skills, jigs, inspection facilities, raw materials and machines. Each work group requires different training school equipment and needs a different time duration for training. A developing country may decide to build the whole factory (four stages) at once, or to stagger them over a few years. In order to build the complete factory of 17 work groups, the land required is 9,000 sq.m., with the buildings covering 4,500 sq.m. The training school, which is specified to meet the requirements of a particular factory, includes the capital equipment for all four stages, and it too can come in a series of stages.

A brief description of the four stages of the factory is as follows:

		Work Groups	Approx. Number of Workers
STAGE I	Assembly of TRANTORS, chassis assembly, and servicing of TRANTORS	17.16.15.14. 13.12.11.10. 9.	65
STAGE II	Chassis member welding assembly, accurate welding assembly, panel manufacture	6.7.8.	25
STAGE III	Simple turning and drilling, profile cutting of plate, sawing, drilling stamping & bending	3.2.1.	20
STAGE IV	Gear cutting & hardening, precision machining.	4.5.	15

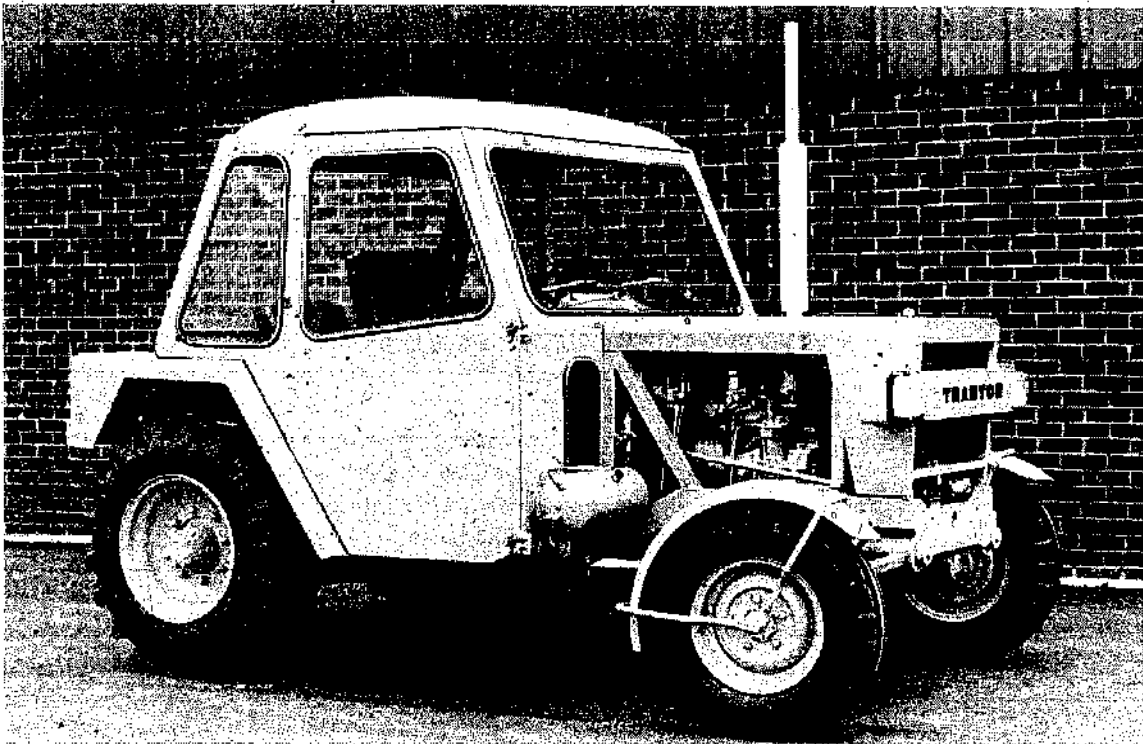

The TRANTOR

2.4 Paper 9: Piaggio Vehicles for Rural Transport

by K. Salt

Managing Director, Andrews Lawn Edgers Ltd. (U.K. Agents, Piaggio Commercial Vehicles)

The Piaggio company was founded in Italy in 1884, specialising in the outfitting of ships. Over the years the company expanded in size and diversified into the manufacture of railway rolling stock and aeroplanes. Following the disruption of the second world war the company developed the very successful range of Vespa motor scooters. Soon after the scooter went into production the company introduced a three-wheeled van, the Vespa Commercial, derived from it. This vehicle quickly became an important means of light transport in southern Italy, and from this beginning a range of three-wheeled commercial vehicles have been evolved which, in addition to their popularity in southern Europe, are now built under licence and used in a number of developing countries, particularly in Asia. Over 600,000 Vespa three-wheelers are now in daily use in more than twenty countries.

The smallest of the current range is the Ciao Porter, which is based on the rear end of a 50cc. Ciao moped, including the engine and transmission, but with two Ackermann steered front wheels with a cargo box mounted between them. This machine has a payload of 100kg. At the other end of the scale is the Ape 'cab' which has a 217cc. engine mounted between the rear wheels, a comfortable cab with seating for two, and a payload of 600kg.

Andrews Lawn Edgers Ltd. are now sole U.K. agents for Vespa Commercial Vehicles and are currently importing two models. The VC200 (Fig 1) has a single cylinder 50cc. two-stroke petrol engine mounted between the rear wheels, and runs on a low-octane petrol and 2% oil mixture. It has an enclosed cab with central handlebar steering, and is available with either pick-up or van bodywork. It is of very rugged construction, well-suited to off-road use where its four speed gearbox enables it to climb a 1 in 4 gradient. The three-wheeled layout endows the vehicle with a high degree of manoevrability (it can out-turn even a London taxi), and the machine offers a low cost form of off-the-road transport with a fuel consumption of approximately 35k.p.l. Its payload is 200kg. Likely applications of the vehicle are on parks, estates and airfields, and in warehouses and factories.

The VC 600 (Fig 2) shares the same basic layout as the VC 200 but is a larger vehicle with a 187cc. single cylinder two-stroke engine. Like the VC 200 it is rugged, highly manoevrable, performs well in difficult off-road conditions and has minimum maintenance requirement. It has an enclosed cab and a choice of steering by handlebar from a central position, or by wheel from an offset position, allowing a passenger to be carried. It is available with either pick-up or van bodywork and has a payload of 600kg. Work is well advanced with getting this machine certified for road use*.

* Homologation certification has now been completed and the VC600 will be available for licenced use from June onwards.

and in this mode it has many applications for use by tradesmen and local delivery services. In addition to its manoevrability it offers low purchase cost and minimal running costs since its fuel consumption is up to 20k.p.l. and servicing is both simple and cheap.

With the cost of operating vehicles escalating rapidly in the U.K. the Andrews-Piaggio range of three-wheelers offer economical transport with many applications. This feature, together with the simplicity of maintenance and the ability to operate in off-road conditions suggest that these vehicles have many potential uses in both urban and rural areas of developing countries.

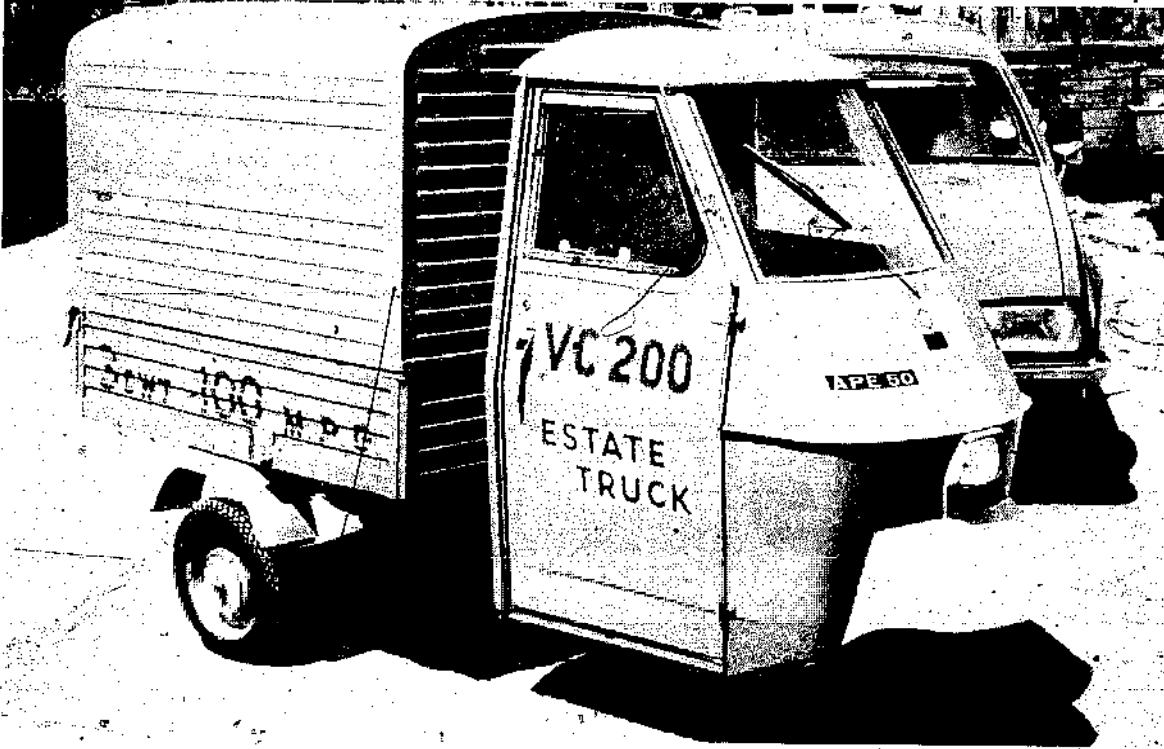

Fig. 1

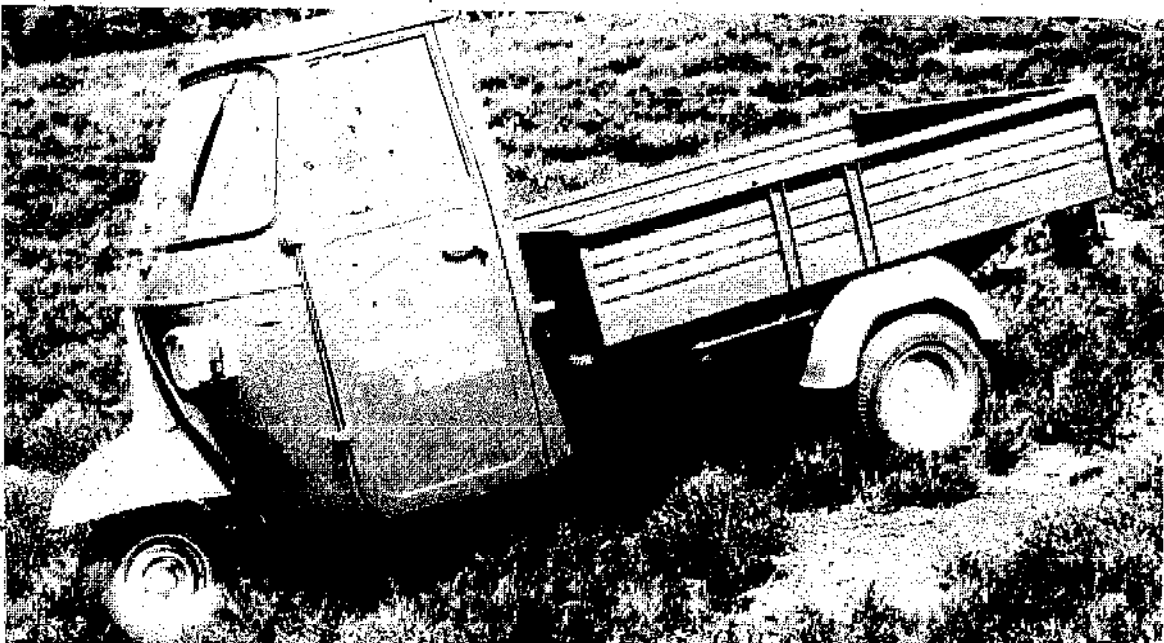

Fig. 2

2.5 Paper 10: The Contribution to be made by British Industry

by M. Cooley

Senior Design Engineer, Lucas Aerospace.Ltd.,

and R. Fletcher

Principal Lecturer in Design, North-East London Polytechnic

(This is a summary, prepared by the editors, of the presentation by the two speakers)

There is in British industry a continuing process of mechanisation which often leads to the displacement of skilled personnel. Such people have up to now been allowed no involvement in decisions as to what products their company should make, or how they should be manufactured. Within the Lucas group of companies a committee was established with the aim of achieving the right of employees to work on socially useful products. An assessment was made of the skills available within the group, and the way in which these skills were being employed. From this information, and with the overall aim in mind, the committee produced an alternative corporate plan for the company which proposed a number of possible new products. From this list of products six were selected for detailed analysis and design work.

One of these products is a hybrid vehicle with potential applications in many developing countries, designed to run on both normal metalled roadways and on steel rails. This requires a system of flange-less guidance to avoid the weight and cost penalties of having two separate wheel systems - this has been the limitation of all previous road/rail vehicles. Using the expertise available at Lucas in the fields of electronics, internal combustion engine performance and electric motors and generators, and in conjunction with North-East London Polytechnic, a 10-wheeled vehicle has been designed with the following major features. Power is provided by an internal combustion engine with re-cycled exhaust, running at constant speed for maximum output efficiency. This drives a generator which feeds a power-pack. There is Ackermann steering on the front four wheels for road use, whilst in the rail mode guidance is achieved using the tread forces in the tyres and a track-sensing mechanism actuating a steering servo. A prototype has been built and was successfully tested in early 1976 on standard gauge track in Sussex.

The object of the vehicle is to provide a flexible means of transport producing a minimum of pollution without recourse to overhead transmission cables or de-toxing equipment. The vehicle is primarily intended for rural use in areas with existing railways. The low wheel loads greatly reduce the maintenance costs and required specification of the track.

2.6 Paper 11: Improving the Efficiency of Rural Transport in Developing Countries

by R.P. Sikka

Ministry of Shipping and Transport (Roads Wing), India *

(This paper was submitted but not presented by the author at the seminar)

Almost forty per cent of the population of Asia are living in conditions of absolute poverty, the majority in rural areas. In order to improve this situation there is a strong emphasis on integrated rural development in which transport plays an important role.

There are a number of ways in which rural transport can be made more efficient, these include; improvement of the road infrastructure, introduction of new vehicles, and design changes to existing vehicles to suit local conditions. Vehicle design for Asia is the subject of current investigations, the following being a summary of some of the work being undertaken based on preliminary findings.

The choice of suitable vehicle designs has to take account of the prevailing conditions, of which the most important are:

- i) Approximately 87% of rural land holdings are less than five hectares in size.
- ii) Because of the size of the holdings most farmers are engaged in subsistence agriculture and have very little marketable surplus. As a result there is no means of investing in mechanical equipment for either agricultural or transport purposes.
- iii) Farm-to-market roads are generally in poor condition, 70-80% being of low grade surface rendering motor vehicle movement difficult, and making the marketing of small quantities of produce uneconomic. (This can be partially offset by co-operatives but these are still rare). In addition the road network density is only about a quarter of that of most developed countries.
- iv) Draft animals are extensively employed on farms, availability being of the order of one to every 0.5-0.7 hectares.

Multi-purpose mechanised vehicles represent one possible design solution to the transport problem, there being numerous examples already available. However their impact in developing countries has been small due to high cost (US\$2000+), heavy maintenance requirements, lack of workshop facilities or limited applications beyond transport, and their general inability to negotiate unimproved road surfaces. These drawbacks have led farmers to prefer tubewells to power tillers.

One well-tried solution to the problem of multi-purpose vehicles is the tractor-trailer combination. These exist in the Philippines, India, Pakistan

* Note: This paper expresses the author's personal views.

and Laos where agriculture has been partially mechanised. The combinations can be used for transport of both goods and passengers in addition to their on-farm functions. As tractors are usually only required for 3-4 months of the year for ploughing they can be released for transport functions for much of the remainder. This has the dual advantages of higher vehicle utilisation and a higher rate of return on the initial investment as rental can be charged for transport operations.

There is still considerable scope for the exploitation of three wheeled vehicles (both mechanically powered and pedal driven) both in terms of design and in usage. Such vehicles are currently used extensively in India and Malaysia, many local design adaptations having emerged as a result of operating experience over a number of years. It should be recognised that many of these local design variations are far from optimum solutions being often dictated by the availability of second-hand components and local skills and equipment. Better designs more suited to rugged conditions could be advantageously developed and could have considerable potential. The popularity of such machines is due to their simple technology and their relatively low initial cost. The travel range (10-20km. for pedal power, 40-50km. for motor power) allows for most of the trips that are likely to be undertaken from smallholdings to market points.

Animal drawn carts are still likely to remain as the major means of rural transport in many regions of Asia despite a generally improving economic situation. This is largely due to availability of both the draft animals and the carts, both of which represent a fixed cost to the farmer. Their use for transport therefore incurs no additional cost. In addition the generally poor road conditions, especially in rainy weather, make it impossible for any other vehicle to negotiate the access roads or tracks within the farms. As with three wheeled vehicles, design improvements could make a substantial difference to the overall efficiency of such carts. The main improvements that are required are the substitution of wooden wheels by pneumatically tyred wheels, lighter axles, and better wheel bearings. However, unless there is an economic advantage to the owner, such improvements will not be undertaken. This has been demonstrated by various unsuccessful attempts by local authorities to improve the efficiency of such vehicles.

Where farmers have started growing cash crops, such as tobacco or cane sugar, and the road network has been improved, efficiency has become more important with the result that improvements have been made in order to increase the size of load that can be carried. There has however been little attempt to apply scientific principles to cart design. Such application could usefully be made to most of the major features of the train; harness design, height and construction of load platform, type and number of axles, and number and size of wheels.

There is still much development work that can be undertaken to improve the transport capability of many of Asia's rural poor. Much of the basis for that development already exists, the hardware is still lacking.

2.7 Concluding Discussion

This period was necessarily short but provided an opportunity both for general discussion and for a review of the major points which had emerged from the papers presented. The chairman noted that although a wide range of clever and intriguing designs had been demonstrated there was not always evidence of their viability. The film which had been shown as part of the SNAIL presentation was refreshing in that it had deliberately identified a number of the problems associated with the use of the prototype machine, thus demonstrating the difficulty of producing simple yet effective hardware.

Dr. Wijewardene's S.F.V., the TRANFOR and the SNAIL all demonstrated the effort currently being directed towards multi-purpose vehicles and emphasised the close link between agriculture and transport. The development of such vehicles was considered by many present to be of critical importance, since they offer the possibility of providing rural communities with both increased returns from their agricultural activities and improved mobility.

Technical developments aimed at improving the efficiency of animal transport were also seen as being of vital importance. The use of this mode still has economic advantages in many parts of the world and these can be maximised by improved vehicle design. The high initial cost of motorised vehicles is likely to remain an obstacle to their widespread use in many rural communities in the foreseeable future. This problem can be partially offset by communal ownership of vehicles or by providing access to a vehicle pool. However such systems are difficult to organise so that they meet the requirements of smallholders, and their establishment may require government assistance.

Clearly no single simple vehicle will meet all the rural transport needs of all developing countries, given the widely varying conditions which exist. The long-term objective should be to provide a choice of vehicle options covering the spectrum of transport needs. However a number of criteria were defined which it was felt that vehicles designed for use in the rural areas of developing countries should meet. These were; minimised initial cost; suitability for local manufacture utilising locally available materials and skills; longevity and ease of maintenance; efficient use of scarce, expensive and usually imported fuels; suitability for use on existing tracks or low-cost roads, and applicability to individual farm operations. It was also argued that vehicle design work should only be undertaken following a thorough assessment and identification of real transport needs in a particular country or countries, and that this must be based on local experience. It was generally agreed that prototype vehicles must be extensively field tested prior to the design being finalised and the machine being made available.

Dr. Howe, the Chairman of the afternoon session, summed up by stating that he considered that the main objectives of the seminar had been achieved in enabling those present to become better acquainted with one another and with the work which each was undertaking. He expressed the hope that there would be continuing cross-fertilisation of ideas and that individual efforts would be aligned to larger programmes in order to achieve the maximum effect.

3. Conclusions

The seminar, which was organised by the Transport Panel of the Intermediate Technology Development Group, was attended by more than fifty people. The papers presented covered many aspects of the subject "simple vehicles for developing countries" including; vehicles presently in use and prototypes currently being developed; the role of transport in agriculture; the use of simple vehicles in labour-intensive construction; manufacturing strategies for local production; and the transport needs and economic constraints in the rural areas of developing countries.

The informal contributions made during open discussion emphasised that efforts should be concentrated on identifying and developing vehicles which meet the real transport needs of rural communities, and highlighted the requirement for such vehicles to be economically appropriate. General consensus was reached on the criteria which should be met by vehicles intended for use in developing countries, and a number of aspects of vehicle design were identified where further work would be of particular value.

4. Acknowledgements

The success of the seminar was the result of the efforts and co-operation of many people. The chairman and members of the ITDG Transport Panel particularly wish to express their thanks to the following:

The Director of Lanchester Polytechnic, for allowing the use of the facilities of the college, and for welcoming the participants to the seminar.

Lord Oram, for opening the seminar and chairing the morning session.

Leonora Stettner, for taking notes of the proceedings.

Chris Bradshaw and Roland Doe, of Andrews Lawn Edgers Ltd., for demonstrating two Piaggio vehicles to the participants.

David Weightman, for playing the major role in organising the seminar.

Renee Green, for secretarial assistance.

5. Appendices

5.1 Addresses of Contributors

Dr. J.D.G.F. Howe, Alastair Dick & Associates, 24, Gravel Hill, Leatherhead, Surrey.

I.J. Barwell, c/o Department of Engineering Science, University of Oxford, Parks Road, Oxford.

K. Hutcheon, Raleigh Cycles Ltd., 177, Lenton Boulevard, Nottingham.

S.S. Wilson, Department of Engineering Science, University of Oxford, Parks Road, Oxford.

D. Weightman, Department of Industrial Design (Transport), Lanchester Polytechnic, Gosford Street, Coventry.

M. Sharrock, Messrs. Scott, Wilson, Kirkpatrick & Partners, Scott House, Basing View, Basingstoke.

Dr. R. Wijewardene, International Institute of Tropical Agriculture, P.O. Box 5320, Ibadan, Nigeria.

P. Crossley, J. Kilgour & J. Morris, National College of Agricultural Engineering, Silsoe, Bedford.

G. Edwards, Trantor International Ltd., 38, Station Road, Stockport.

K. Salt, Andrews Lawn Edgers Ltd., The Garden Centre, Sunningdale, Berks.

M. Cooley, Lucas Aerospace Ltd., Chase Road, London NW 10.

R. Fletcher, North East London Polytechnic, Forest Road, London E 17.

R. Sikka, Ministry of Transport & Shipping (Roads Wing), New Delhi, India.

5.2 List of Participants

W. Armstrong (ex. Armstrong Equipment Ltd.)

R. Bailey (Viscount-Trusty Ltd.)

M. Bennett (Lanchester Polytechnic)

L. Black (Warwick University)

C. Bradshaw (Andrews Lawn Edgers Ltd.)

R. Brocklehurst (Leyland Cars Ltd.)

D. Bryan (AMEX Ltd.)

M. Butt (Lanchester Polytechnic)

J. Cannell (Warwick University)

J. Cares (Cranfield Institute of Technology)

M. Cherry (Freelance journalist)

K. Chopra (World Bank)

C. Carnemark (World Bank)

A. Cowan (Industrial Liaison Unit, ITDG)

F. Crouch (Newcastle University)

R. Doe (Andrews Lawn Edgers Ltd.)

R. Farnell (Lanchester Polytechnic)

A. Franchi (Bicycle manufacturer)

J. Frankel (World Bank)
R. Gillie (Warwick University)
J. Howard (Oxfam)
M. Jahangiri (Royal College of Art)
Dr. Macmillan (Motor Industries Research Association)
Mr. Nicholls (Tropical Products Institute)
W. Palmer (Lancaster Polytechnic)
P. Rose (Moulton Developments Ltd.)
S. Salleh (Royal College of Art)
J. Sheppard (Leyland Cars Ltd.)
B. Smith-Boyes (Polytechnic of Central London)
W. Supple (Surrey University)
T. Thomas (Warwick University)
E. Tingle (Transport & Road Research Laboratory)
V. Vegoda (Bicycle manufacturer)
F. Whitt (co-author, 'Bicycling Science')