

**AT** MICROFICHE  
REFERENCE  
LIBRARY

A project of Volunteers in Asia

Laboratory Testing of Handpumps for Developing Countries,  
World Bank Technical Paper #19 from the Rural Water  
Supply Handpumps Project

Published by:

World Bank Publications  
1818 H. Street, N.W.  
Washington D.C. 20433  
USA

Available from:

same as above

Reproduced by permission.

Reproduction of this microfiche document in any  
form is subject to the same restrictions as those  
of the original document.

# Rural Water Supply Handpumps Project

## Laboratory Testing of Handpumps for Developing Countries: Final Technical Report

Consumers' Association Testing and Research Laboratories

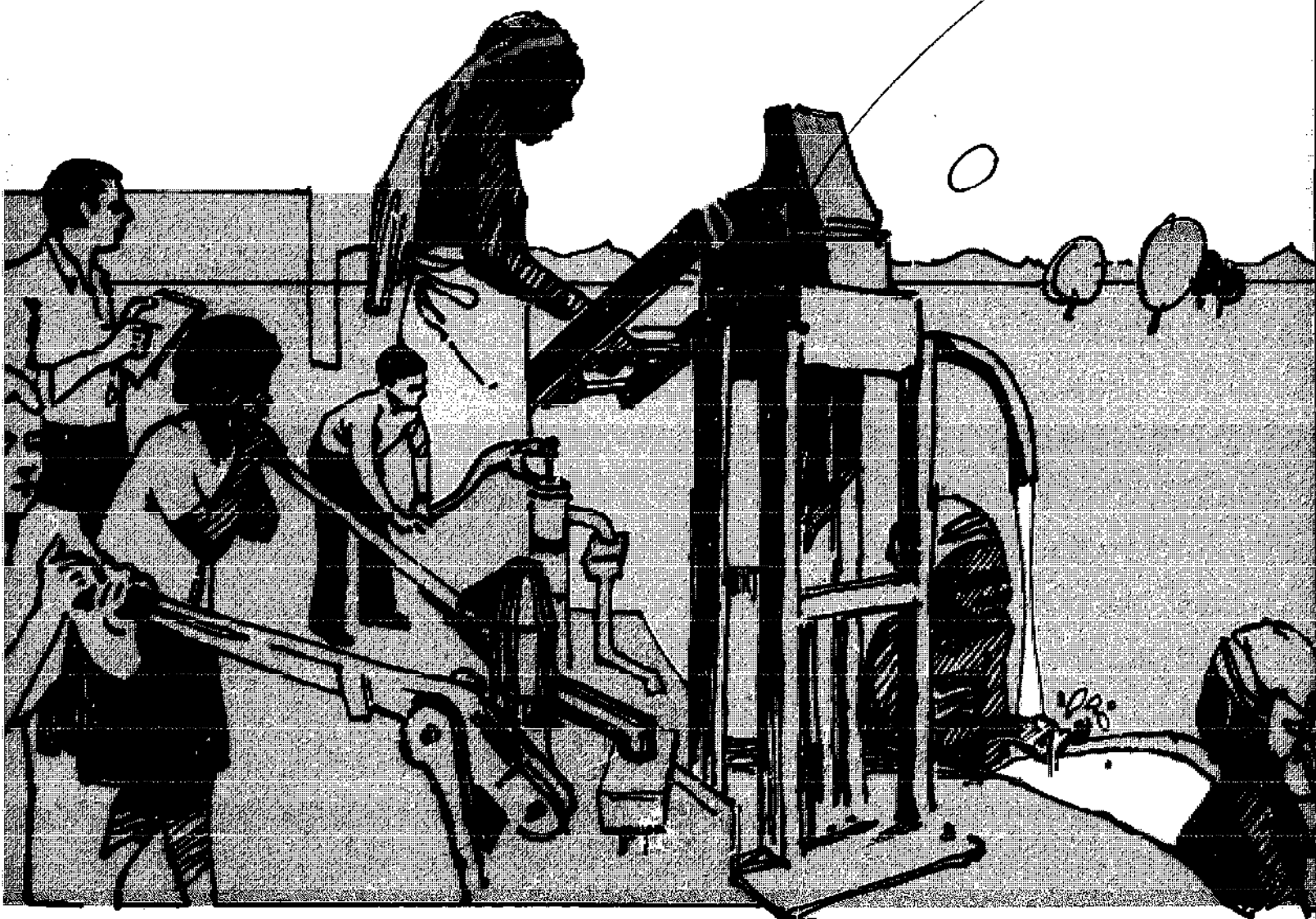

UNDP Project Management Report Number 3



A joint United Nations Development Program and World Bank Contribution  
to the International Drinking Water Supply and Sanitation Decade

WORLD BANK TECHNICAL PAPERS

- No. 1. Increasing Agricultural Productivity
- No. 2. A Model for the Development of a Self-help Water Supply Program
- No. 3. Ventilated Improved Pit Latrines: Recent Developments in Zimbabwe
- No. 4. The African Trypanosomiases: Methods and Concepts of Control and Eradication in Relation to Development
- (No. 5.) Structural Changes in World Industry: A Quantitative Analysis of Recent Developments
- No. 6. Laboratory Evaluation of Hand-operated Water Pumps for Use in Developing Countries
- No. 7. Notes on the Design and Operation of Waste Stabilization Ponds in Warm Climates of Developing Countries
- No. 8. Institution Building for Traffic Management
- (No. 9.) Meeting the Needs of the Poor for Water Supply and Waste Disposal
- No. 10. Appraising Poultry Enterprises for Profitability: A Manual for Investors
- No. 11. Opportunities for Biological Control of Agricultural Pests in Developing Countries
- No. 12. Water Supply and Sanitation Project Preparation Handbook: Guidelines
- No. 13. Water Supply and Sanitation Project Preparation Handbook: Case Studies
- No. 14. Water Supply and Sanitation Project Preparation Handbook: Case Study
- (No. 15.) Sheep and Goats in Developing Countries: Their Present and Potential Role
- (No. 16.) Managing Elephant Depredation in Agricultural and Forestry Projects
- (No. 17.) Energy Efficiency and Fuel Substitution in the Cement Industry with Emphasis on Developing Countries
- No. 18. Urban Sanitation Planning Manual Based on the Jakarta Case Study

( ) Indicates numbers assigned after publication

# **Rural Water Supply Handpumps Project**

**UNDP Project Management Report Number 3**

## RURAL WATER SUPPLY HANDPUMPS PROJECT

INT/81/026

The UNDP/World Bank project for laboratory and field testing and the technological development of handpumps for community water supply is aimed at promoting the use of suitable handpumps for groundwater extraction to meet the goals of the International Drinking Water Supply and Sanitation Decade. In the selection of pumps and in some cases their further development, consideration is given to their durability, capital as well as maintenance costs, suitability for village-level maintenance, and prospects for local manufacture.

Reports on handpumps testing and development are published periodically, at least once a year, for the duration of the project. The following reports have been published or are in preparation:

- Report No. 1. Laboratory Tests on Hand-Operated Water Pumps for Use in Developing Countries: Interim Report. 1982.
- Report No. 2. Laboratory Evaluation of Hand-Operated Water Pumps for Use in Developing Countries. 1983.
- Report No. 3. Laboratory Testing of Handpumps for Developing Countries: Final Technical Report. 1984.
- Report No. 4. Handpump Testing and Development: Interim Report (in preparation). 1984.

---

WORLD BANK TECHNICAL PAPER NUMBER 19

---

# **Laboratory Testing of Handpumps for Developing Countries**

## **Final Technical Report**

Consumers' Association Testing and Research Laboratories

The World Bank  
Washington, D.C., U.S.A.

Copyright © 1984  
The International Bank for Reconstruction  
and Development / THE WORLD BANK  
1818 H Street, N.W.  
Washington, D.C. 20433, U.S.A.

First printing June 1984  
All rights reserved  
Manufactured in the United States of America

This is a document published informally by the World Bank. In order that the information contained in it can be presented with the least possible delay, the typescript has not been prepared in accordance with the procedures appropriate to formal printed texts, and the World Bank accepts no responsibility for errors. The publication is supplied at a token charge to defray part of the cost of manufacture and distribution.

The views and interpretations in this document are those of the author(s) and should not be attributed to the World Bank, to its affiliated organizations, or to any individual acting on their behalf. Any maps used have been prepared solely for the convenience of the readers; the denominations used and the boundaries shown do not imply, on the part of the World Bank and its affiliates, any judgment on the legal status of any territory or any endorsement or acceptance of such boundaries.

The full range of World Bank publications, both free and for sale, is described in the *Catalog of Publications*; the continuing research program is outlined in *Abstracts of Current Studies*. Both booklets are updated annually; the most recent edition of each is available without charge from the Publications Sales Unit, Department T, The World Bank, 1818 H Street, N.W., Washington, D.C. 20433, U.S.A., or from the European Office of the Bank, 66, avenue d'Iéna, 75116 Paris, France.

#### **Library of Congress Cataloging in Publication Data**

Main entry under title:

Laboratory testing of handpumps for developing countries.

(A World Bank technical paper, ISSN 0253-7494 ; no. 19)

1. Hand pumps--Testing. 2. Hand pumps--Developing countries. I. Consumers' Association Testing and Research Laboratories. II. Series.

TJ903.L33 1984 628'.72 83-26059  
ISBN 0-8213-0311-2

ABSTRACT

This is the full technical report on laboratory tests on the third batch of 6 handpumps, carried out at the Consumers' Association Testing and Research Laboratory at Gosfield, U.K. It also includes similar information on the 12 pumps tested for the World Bank in Batches 1 and 2. (A summary of the test results for Batches 1 and 2 was published by the World Bank as UNDP Project Management Report No. 2 in March 1983.)

The test program was extensive, and all aspects of the evaluation are described in detail. Some general observations are noted, and for each pump there are sections on general information, inspection, weights and measures, engineering assessment, pump performance, user trial, endurance, abuse tests, and verdict, as well as examples of the force/displacement diagrams taken during the evaluation.

The information in this report is intended to

- (i) Assist handpump manufacturers in improving the quality of their products
- (ii) Assist authorities and agencies in developing countries in deciding between local manufacturing or importation of handpumps
- (iii) Provide agencies in developing countries with an evaluation of handpumps in order to enable a more informed choice of pump to be made, and to ensure the right pump is selected to suit particular developing country conditions.



ABSTRACT

Le document ci-après est le rapport technique complet du Consumers' Association Testing and Research Laboratory (Laboratoire d'essais et de recherches de l'Association des consommateurs, Gosfield, Royaume-Uni) sur l'essai de la troisième série de six pompes à motricité humaine. Il comprend également des renseignements similaires sur les 12 pompes des séries 1 et 2 testées pour la Banque mondiale. (Un résumé des résultats de ces essais avait été publié en mars 1983 par la Banque mondiale sous le titre "Rapport de la direction du Projet No 2 - PNUD".)

Le programme d'évaluation comprenait de nombreux tests dont tous les aspects sont décrits en détail. Le rapport débute par des observations générales et présente ensuite une évaluation détaillée de chaque pompe (renseignements généraux, inspection, poids et dimensions, évaluation technique, performances, tests des utilisateurs, tests d'endurance, tests de dégradation et verdict), ainsi que des exemples des courbes effort/hauteur établies au cours de l'évaluation.

Les informations du présent rapport visent :

- i) à aider les fabricants de pompes à motricité humaine à améliorer la qualité de leurs produits;
- ii) à aider les autorités et organismes des pays en développement à décider s'il vaut mieux fabriquer ces pompes sur place ou les importer;
- iii) à fournir aux organismes des pays en développement une évaluation des pompes à motricité humaine qui leur permette de choisir en connaissance de cause un appareil adapté aux conditions particulières de leur pays.

ABSTRACTO

Este es el informe técnico completo sobre los ensayos de laboratorio del tercer lote de seis bombas de agua de mano, que se llevaron a cabo en el laboratorio de ensayos e investigación de la asociación de consumidores (Consumers' Association Testing and Research Laboratory) en Gosfield, Reino Unido. Comprende información semejante sobre las 12 bombas que ensayó el Banco Mundial en los lotes 1 y 2. (El Banco Mundial publicó un resumen de los resultados del ensayo de los lotes 1 y 2, con el título de PNUD-INT/81/206, Informe No. 2 sobre la marcha del proyecto, en marzo de 1983.)

El programa de ensayos fue extenso y se describen detalladamente todos los aspectos de la evaluación. Se formulan algunas observaciones generales y para cada bomba se presenta una sección sobre información general, inspección, peso y medidas, evaluación técnica, funcionamiento, ensayo con usuarios, resistencia, ensayo de maltrato y --finalmente-- veredicto, así como ejemplos de diagramas de fuerza/desplazamiento trazados por computadora durante la evaluación.

La información de este informe tiene por objeto:

- i) Ayudar a los fabricantes de bombas de agua de mano a mejorar la calidad de sus productos.
- ii) Ayudar a las autoridades e instituciones de los países en desarrollo a decidir entre fabricar bombas de mano en el país e importarlas.
- iii) Suministrar a las instituciones de los países en desarrollo una evaluación de las bombas de agua de mano a fin de que puedan escoger con mayor conocimiento de causa el tipo de bomba que han de fabricar, y asegurar que cada país en desarrollo escoja la bomba que mejor se adapte a sus condiciones.

CONTENTS

ABSTRACT .....	v
ACKNOWLEDGEMENTS .....	x
PREFACE .....	xi
1. INTRODUCTION TO LABORATORY TESTING .....	1
2. TEST PROCEDURES FOR HANDPUMP EVALUATION .....	4
Summary .....	4
Detailed Description .....	6
Installation for Testing .....	13
Basic Pump Nomenclature .....	15
3. GENERAL OBSERVATIONS AND RECOMMENDATIONS .....	16
Observations .....	16
Recommendations from the 18 Pumps Tested .....	19
4. INDIVIDUAL PUMP EVALUATION .....	20
Abi-Vergnet ASM .....	22
Petro .....	34
Funymaq .....	44
Maldev (head only) .....	54
Rower .....	62
Volanta .....	72
Korat 608 A-1 .....	92
Kawamoto Dragon No. 2 .....	102
Moyno IV 2.6 .....	112
Briau Nepta .....	122
Atlas Copco Kenya .....	132
Bangladesh New No. 6 .....	144
Nira AF-76 .....	154
Ethiopia Type BP50 .....	164
Vereinigte Edelstahlwerke (VEW) A 18 .....	172
Jetmatic .....	182
Bandung Shallow-well .....	192
Sumber Banyu ("SB") .....	202
APPENDIX I Statistical Analysis of User Responses .....	212
APPENDIX II Force Displacement Diagrams .....	216
APPENDIX III Abstract of ODA Handpump Final Report, January 1981 .....	266

ACKNOWLEDGEMENTS

This project, financed by UNDP projects GLO/79/010 and INT/81/026, has benefited from the comments received from many sources following publication in 1980 of the report "Hand and Foot-operated Water Pumps for Use in Developing Countries" by J.A. Kingham. This was the result of two and a half years work funded by the Overseas Development Administration of the United Kingdom Government and laid the foundations of the test protocol for this current project.

C A Testing and Research staff contributing to this project included Frank Jones, John Kingham, Timothy Lister and Clive Wade - testing division; Robert Brown, Michael Clarke, James Horn, Geoffrey Hughes, John Keen and Malcolm Osborne - engineering division; Cate Andrews, Margery Feeney, Dorothy Pattie and Edda Wyatt - administrative division. Tony Reynolds did the pump illustrations.

John M. Reynolds  
Don J. Unwin  
Ken J. Mills

Consumers' Association  
Testing and Research Laboratories  
Harpenden Rise  
Harpenden  
Hertfordshire AL5 3BJ  
England

## PREFACE

Among the 1500 million people in developing countries who do not have access to adequate water supply and sanitation facilities, there are 1200 million who lack these basic services in rural areas.

The importance of providing safe water has been repeatedly stressed by national governments and international agencies. Recognizing the urgent need for improved water and waste management, the United Nations has declared the 1980's to be the International Drinking Water Supply and Sanitation Decade (IWSSD), establishing an ambitious goal to provide adequate water to the total rural population of the developing countries.

Handpumps installed in wells where groundwater is easily available provide one of the simplest and least costly methods of supplying the rural population with water. However, despite all efforts in the past, a number of serious problems remain to be solved.

Among the activities of the Decade is the project on "Laboratory Testing, Field Trials and Technological Development of Handpumps", funded by the United Nations Development Programme (UNDP) Division for Global and Interregional Projects. The World Bank, with responsibility assigned to the Water Supply and Urban Development Department, was selected to be the executing agency to undertake the handpumps project.

In the preparatory phase of the project, laboratory testing of a number of handpumps has started, contracted to the Consumers' Association Testing and Research (CATR) Laboratories, of Harpenden, U.K. Two interim reports on the laboratory test results for the first twelve pumps tested under the Project were issued in March 1982 and March 1983. The present report contains the full technical results of the laboratory tests on the third batch of six pumps as well as the twelve pumps from the previous tests.

Future reports from the Project will deal with laboratory tests on additional pumps, field trial results, and other related subjects. Handpump laboratory tests which are currently in progress at CATR are mostly funded by the manufacturers themselves, since the focus of the Handpumps Project has shifted to field trials in developing countries. The results obtained so far from the field will be described in an interim report, soon to be published as Report No. 4.

The aim of the laboratory tests is to examine and assist in the selection of a wide range of handpumps for further field trials and to provide information to all interested manufacturers to assist them in the production of more efficient and more reliable pumps.

The long-range objective of the project is to promote the improved designs of handpumps locally manufactured in developing countries, pumps that can be maintained by trained village operators (VLOM pumps - Village Level Operated and Maintained). The project is also concerned with the social, organizational, and economic factors which are essential if a handpump programme is to be successful. Although technical evaluation and development are urgent considerations, they alone will not be sufficient to resolve the problems confronted by handpump programmes.

In time, reports on field trials in developing countries and technological development of handpumps will be produced which will show how improvements in design and manufacturing quality of handpumps are materially helping towards reaching the goals of the IWSSD.

Among the major outputs of the project will be a financial analysis based on projected annual costs for maintenance and operation of a variety of handpumps. For this purpose we would be grateful to receive any information on maintenance costs, particularly as related to the frequency of breakdowns and the type of maintenance system employed, obtained from field operations or tests organized by a developing country government, aid agency, non-governmental organization, or others.

Comments on this report are most welcome.

Saul Arlosoroff, Chief  
Applied Research & Technology, WUD  
(UNDP Projects Manager, INT/81/026, GLO/80/004, INT/82/002)  
The World Bank  
1818 H Street, N.W.  
Washington, D.C. 20015 USA  
Telex: RCA 248423 WORLDDBK  
Telephone: (202) 676-1790

## 1. INTRODUCTION TO LABORATORY TESTING

After a series of meetings during which experts recognized the importance of handpumps for community use in the economy of developing countries, the Overseas Development Administration of the U.K. Government decided in 1977 to test 12 different deep-well pump designs in the Consumers' Association Testing and Research Laboratory in an attempt to identify the reasons for early field failures and to obtain better value for the money spent in Overseas aid. The ODA required all the laboratory information, including details of a long endurance test, to be submitted to the manufacturers to assist them in improving the quality and reliability of their products. The pumps tested were the Petropump 95, Vergnet, Dempster, Mono, Climax, Godwin, Abi, GSW (Beatty), Monarch, Kangaroo, India Mk II and Consallen. Their performance is briefly summarized in Appendix III. A summary of the ODA report can be obtained from the Manager, UNDP Handpumps Project, WUD, The World Bank.

UNDP and The World Bank recognized that the aims of the International Decade of Drinking Water Supply and Sanitation would be greatly assisted if this work was continued and, more importantly, coupled with extensive field trials and technological development in developing countries.

Testing of three batches, numbering six pumps each, has now been completed, and is the subject of this technical report. A further batch of pumps containing the Mono lift ES30 (UK), the Mono rotary direct drive (South Africa), the Kardia lever arm pump, two versions of the Turni rotary pump from Preussag (Germany) and the Sihilase pump (Sri Lanka) have almost reached completion of the evaluation. Results of these tests will be published in due course.

Table 1: BRAND LIST of PUMPS TESTED in BATCH 3

Name/Model	Manufacturer/Supplier	Deep or Shallow Well	Price (US\$)* Approx	Country of Origin
Abi-Vergnet ASM	Groupement Abidjan Industrie SNE; Mengin	Deep	836 <sup>a</sup>	Ivory Coast (Pumpstand); France (Pumping element)
Petro	WellDrill Systems AB	Deep	465	Sweden
Funymaq	Georgia Institute of Technology	Deep	Not supplied	Honduras
Maldev	Petroleum Services (Malawi) Limited	#	Not supplied	Malawi
Rower	Mirpur Agricultural Workshop Training School	Shallow	13.50	Bangladesh
Volanta	Jansen Venneboer bv	Deep	845 <sup>a</sup>	Netherlands

\* Cost if 50' purchased in one order

# The Maldev is a pumpstand only. A below-ground assembly is under development for deep wells.

a Supplied complete for 20 m depth.



Table 2: BRAND LIST of PUMPS TESTED in BATCHES 1 and 2

Name/Model	Manufacturer/Supplier	Deep or Shallow Well	Price (US\$)* Approx	Country of Origin
Korat 608 A-1	Saha Kolkarn	Deep	295 <sup>a</sup>	Thailand
Dragon No. 2 (D)	Kawamoto	Deep <sup>+</sup>	362 <sup>b</sup>	Japan
Moyno IV 2.6	Robbins & Myers	Deep	550 <sup>c</sup> 739 <sup>d</sup>	USA
Nepta	Briau	Deep	650 <sup>d</sup>	France
Kenya	Atlas Copco	Deep	(669)	Kenya
New No. 6	Engineers Wood Steel Industries	Shallow Suction	(33)	Bangladesh
Nira AF76	Vammalan Konepaja oy	Deep	203 <sup>e</sup>	Finland
Ethiopia Type BP50	E.W.W.C.A.	Shallow force <sup>o</sup>	(75)	Ethiopia
VEW A18	Vereinigte Edelmetallwerke (VEW)	Deep	1583 <sup>a</sup>	Austria
Jetmatic	Sea Commercial Co.	Deep	32 <sup>f</sup>	Philippines
Bandung	C.V. Malabar	Shallow Suction	(54)	Indonesia
Sumber Banyu ("SB")	P.T. Celco	Deep	(85)	Indonesia

+ Was supplied as shallow-well pump with additional components for conversion to deep-well use  
o 12 metres nominal maximum depth  
\* Cost if 50 purchased in one order. Figures in ( ) are 1981 prices, otherwise 1982.

a Supplied complete for 20 m depth  
b Supplied complete for deep-well use  
c Pump only  
d With 20 m below-ground assembly  
e Pump and cylinder  
f Without connecting rod and rising main

## 2. TEST PROCEDURES FOR HANDPUMP EVALUATION

### 2.1 Summary

- |                           |  |
|---------------------------|--|
| 1. Obtaining Pumps        | 1.1 Manufacturer or Agency<br>1.2 Pump model and type<br>1.3 Cost<br>1.4 Delivery time   |
| 2. Inspection             | 2.1 Packaging<br>2.2 Condition of Pumps<br>2.3 Literature  |
| 3. Weights and Measures   | 3.1 Weights of principal components<br>3.2 Principal dimensions<br>3.3 Cylinder bores<br>3.4 Ergonomic measurements  |
| 4. Engineering Assessment | 4.1 Materials, manufacturing methods, fitness for purpose<br>4.2 Suitability for manufacture in developing countries<br>4.3 Ease of installation, maintenance and repair<br>4.4 Resistance to contamination and abuse<br>4.5 Potential safety hazards<br>4.6 Suggested design improvements |
| 5. Pump Performance       | 5.1 Volume flow, work input and efficiency<br>5.2 Leakage  |
| 6. User Trial             | 6.1 User responses<br>6.2 Observation of users   |

**7. Endurance Test** Four stages of 1000 hours each, using four different and increasingly severe qualities of water:

- 7.1 Stage 1 - clean, hard water, approx. 7.2 pH
- 7.2 Stage 2 - clean, soft water, maintained at approx. 5.5 pH by adding hydrochloric acid, subject to a maximum chloride concentration of 1 g/litre
- 7.3 Stage 3 - hard water to which Kieselguhr, with a particle size of 7.5  $\mu\text{m}$ , was added in the concentration 1 g/litre of water
- 7.4 Stage 4 - hard water to which sharp quartz sand with a particle size between 75 and 500  $\mu\text{m}$  was added in the concentration 1 g/litre of water

For stages 3 and 4, the water was agitated.

At each 1000 hour stage, the volume flow and leakage were checked, and the pumps were dismantled for inspection, and a full performance test was carried out after 4000 hours.

**8. Abuse Tests**

- 8.1 Side impacts on pumpstand, up to 500 Joules and side impacts on handles up to 200 Joules
- 8.2 Handle shock load test at the endurance test stroke rate, where applicable:
  - 96,000 impacts for force pumps
  - 72,000 impacts for suction pumps

**9. Review**

- 9.1 Ease of pump installation
- 9.2 Ease of maintenance and repair
- 9.3 Verdict

**10. Reporting**

- 10.1 Interim report after items 1 to 6, with Data Checking Sheets sent to pump manufacturer
- 10.2 Further interim report(s) where necessary, describing problems encountered during endurance test
- 10.3 Final Summary Report
- 10.4 Final Technical Report

## 2.2 Detailed Description

### 1. Obtaining Pumps

Wherever possible, the test samples were obtained through an independent procurement agency, to prevent manufacturers supplying special samples for test purposes. Two samples of each pump were obtained. One sample was installed in the test tower for the user trial, performance and endurance tests. The second was used for engineering assessments, and to provide a supply of spare parts for the endurance test.

The cost and delivery time were noted.

### 2. Inspection

All the pumps were inspected on arrival at the laboratory.

- 2.1 The packaging was described and assessed for its suitability for export and for crude overland transportation.
- 2.2 The condition of the pumps was assessed, noting any defects on delivery.
- 2.3 Any literature supplied with the pumps was noted, and assessed for usefulness in installing or maintaining the pump.

### 3. Weights and Measures

- 3.1 The weights of the pumpstand, cylinder and connecting assembly were recorded.
- 3.2 The principal dimensions of the pump were recorded. These included, where applicable:
  - the bore, the actual stroke and maximum usable length of the cylinder
  - the nominal volume per stroke
  - the maximum usable cylinder length
  - the diameters of the rising main and pump rod
  - the maximum outside diameter of the below-ground assembly
- 3.3 The cylinder bores were measured at five points along their length. A second series of measurements was taken at right angles to the first, to check for taper or ovality and to provide a datum for measurements of cylinder wear after endurance testing. With any flexible plunger seal, ovality within  $\pm 0.5$  mm is not significant, due to the compliance of the seal. However, the constant flexing induced by taper will accelerate fatigue failure and taper should therefore not exceed  $\pm 0.1$  mm.

The surface roughness average (Ra) of the cylinder bores was measured in three places in a direction parallel to the cylinder axis.

3.4 Various ergonomic measurements were taken, as follows:

- maximum and minimum handle height
- platform height, where applicable
- angular movement of handle
- handle length
- velocity ratio of handle, measured as the ratio of the distance moved by the normal operating point on the handle to the resultant movement of the pump rod
- height of spout

Pumps were installed in accordance with manufacturer's instructions, where available. Pumps requiring a platform for which suitable information was not available were installed so that the handle height was approximately 900 mm at the mid-point of its travel, subject to a spout height not greater than 600 mm. These preferred heights were suggested by previous user tests of hand pumps tested for the ODA.

4. Engineering Assessment

- 4.1 One sample of each pump was completely dismantled. The materials and methods of manufacture for each part were identified and assessed for fitness for purpose.
- 4.2 Based on the this evaluation the suitability for manufacture in a developing country was assessed in terms of the required manufacturing methods and skills.
- 4.3 The pump was assessed for ease of installation, maintenance and repair. This assessment was reviewed at the end of the test programme, see item 9.
- 4.4 Each pump was assessed for susceptibility to contamination and abuse, including:
  - resistance to contamination by surface water
  - whether sticks or stones could easily be pushed into the spout
  - whether the fixings or other exposed parts of the pump could easily be pilfered or vandalised
  - susceptibility to accidental impacts by domestic animals etc.
  - susceptibility to heavy-handed or deliberately violent usage.
- 4.5 Any potential safety hazards were noted.
- 4.6 Design improvements were suggested initially, to eliminate or reduce:
  - potentially costly or difficult manufacturing operations
  - potentially unreliable aspects of design or manufacturing
  - potential difficulties in installation, maintenance or repair
  - potential safety hazards

These suggestions were reviewed in the light of results from the 4000 hour endurance test.

## 5. Pump Performance

5.1 Apparatus Measurements of volume flow, work input and efficiency were combined in a single test method. Strain gauges were applied to the pump handle to measure the operating forces, while the movement of the handle was measured by a potentiometer. The outputs from the strain gauges and the potentiometer were fed, via an interface unit, to a microcomputer. The computer was programmed to record the data and calculate the work done on the pump as the product of the applied force and the displacement of the handle. The weight of water produced in each test was entered via the computer keyboard. The apparatus is illustrated in Appendix II.

Calibration The strain gauges were calibrated for each pump by noting the outputs corresponding to known weights, suspended from the handle at a fixed distance from the fulcrum, while it was locked in a horizontal position. The potentiometer was calibrated by noting the outputs for the upper and lower limits of handle travel, and the handle's length. This calibration procedure was built into the computer program and preceded each test.

Test Procedure Each pump was operated at three speeds, normally 30, 40 and 50 strokes or revolutions per minute. Where 50 strokes per minute would have been impractical or unrealistic, 20, 30 and 40 strokes/minute were used. For example with shallow-well pumps cavitation was evident at higher pumping rates. Some of the deep-well pumps when set at 25 or 45 metres required very high levels of operating effort, and full stroke operation at 50 strokes per minute was virtually impossible. All the pumps were tested at 7 metres head, the deep-well pumps also at simulated heads of 25 and 45 metres. The same person carried out all the tests, using a metronome to help the timing of his pumping rate.

For the reciprocating pumps, each test comprised 10 or 20 full strokes, depending on the rate of delivery of the pump. For the rotary pump, the tests were limited to 9 revolutions by the 10-turn potentiometer used to measure handle displacement.

Analysis The computer subsequently plotted the applied force against the displacement of the handle for each test. A typical result for a reciprocating pump is illustrated below. Successive strokes retrace the force/displacement loop. The area inside the loop represents the work done on the pump.

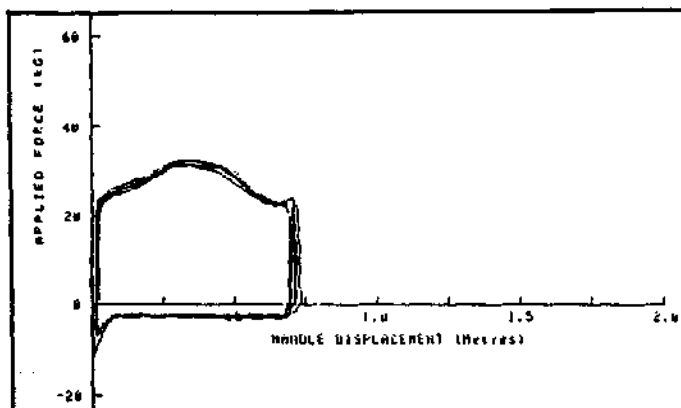

The computer also calculated the average volume flow, in litres per stroke or revolution, the average work input, in Joules per stroke or revolution, and the efficiency, thus:

$$\text{Efficiency} = \frac{Mh}{\sum Fd} \times 100 \text{ per cent}$$

where M = mass of water raised, kg  
h = head, metres  
F = applied force, kgf  
d = handle displacement, metres

so that  $\sum Fd$  = sum of the products of the applied forces  
and handle displacements  
= work done on pump

Mh = useful work done by pump in raising water

Typical results are shown in Appendix II.

#### 6. User Trial

Sixty users were recruited. Adults, women and men, were divided in equal groups of short, medium and tall stature. Children, girls and boys of 11 or 12 years of age, were divided into short and tall groups:

6	Short Men	under 1.68 metres
6	Medium Men	between 1.68 and 1.79 metres
6	Tall Men	over 1.79 metres
6	Short Women	under 1.63 metres
6	Medium Women	between 1.63 and 1.69 metres
6	Tall Women	over 1.69 metres
6	Short Girls	between 1.35 and 1.49 metres
6	Tall Girls	between 1.50 and 1.65 metres
6	Short Boys	between 1.35 and 1.49 metres
6	Tall Boys	between 1.50 and 1.65 metres

60 total

The shallow well pumps were operated at 7 metres head; the deep well pumps were set at a simulated head of 20 metres.

- 6.1 The users were asked to fill a 10-litre bucket with each pump and answer questions about the height and comfort of the handle, the effort required and the overall ease of use. Each user was given an opportunity to familiarise him/herself with each pump before being asked to fill the bucket. The users were instructed to work through the pumps in a controlled random order.
- 6.2 The users were methodically observed, to identify potential ergonomic difficulties in operating the pumps. Experience has shown that users may encounter difficulties of operation which are revealed by their bodily movements, although they are not themselves aware of them. The observations were reinforced by selective video recordings.

### 7. Endurance Tests

For the endurance tests, the pumps were mechanically driven in batches, each of six pumps. The water discharged from each pump was directed into a hopper where the presence of water was monitored by float switches. When a pump failed, so that water was no longer discharged from the spout, the detector system switched off the motor for all the six pumps in that batch, a second detector then indicated the faulty pump. This ensured that all the pumps in each batch were subjected to the same endurance regime. The test continued around the clock until failure of a pump or the end of each 1000 hour interval. The drive mechanism did not impose shock loads on the pump handles.

The deep-well pumps were set at the start of the test at a simulated 45 metres depth, or at the manufacturer's specified maximum depth if less than 45 metres. If persistent failures were revealed, the depth was reduced. The shallow well pumps were operated at a depth of 7 metres.

All the force pumps were operated at 40 strokes or revolutions per minute, representing the highest speed likely to be sustained for any appreciable time in actual use. The shallow-well pumps were operated at 30 strokes/minute, the maximum speed for which cavitation under the piston was not apparent.

The pumps were lubricated at the beginning of the test but thereafter received no maintenance, except when any repair was carried out.

At the end of each stage, the volume flow and foot valve leakage were measured, to compare with the results of the performance test, and the cylinders were dismantled for inspection.

- 7.1 First 1000 hours - clean, hard water with an initial pH value between 7.0 and 7.8. This was the normal piped water supply to the laboratory.
- 7.2 Second 1000 hours - demineralised water to which hydrochloric acid was added to maintain a pH value of approximately 5.5, but not sufficient to raise the chloride concentration above 1 g/litre. In practice, the chloride concentration did not exceed 0.2 g/litre.
- 7.3 Third 1000 hours - hard water to which Kieselguhr, a hard, abrasive mineral, with an average particle size of 7.5  $\mu\text{m}$ , had been added in the proportion of 1 g per litre of water.
- 7.4 Final 1000 hours - hard water to which sharp quartz sand, with a particle size between 75 and 500  $\mu\text{m}$ , had been added in the proportion of 1 g per litre of water.

At the end of the endurance test, the pump performance was re-measured, as described in Section 5, for comparison with the earlier results.



### 8. Abuse Tests

The side impact tests were designed to assess the effect of domestic animals or people blundering into the pump. The impact energy was supplied by a simple pendulum. The mass of the pendulum consisted of a series of bags of lead shot, surrounded by sawdust and contained in a large canvas bag. This "careless cow" was suspended by a rope, pulled to one side to raise it an appropriate amount for the impact energy required, and released.

The handle shock loads were intended to assess the effect of accidental impacts of the handle against its stops during normal pumping. The test was not intended to represent deliberately violent abuse of the pump. The test was intended to be equivalent to 4000 hours of normal usage, assuming that an experienced pump user might allow the handle to hit the stops on average once in every 100 strokes.

- 8.1 A series of side impacts on the mid-point of the pumpstand body, in 100 Joule increments to a maximum of 500 Joules.
- 8.2 A series of side impacts on the handle of the pump, in 50 Joule increments to a maximum of 200 Joules.
- 8.3 The strain gauged handle was fitted, and the outputs from the strain gauges were displayed on an oscilloscope. The pump was operated manually, using normal levels of force but allowing the handle to "carry through" onto the stops on both the delivery and return strokes. The peak outputs of the strain gauges were noted. The handle was connected to a pneumatic drive system, which was then adjusted to produce similar peak strain gauge readings.

Force pumps were subjected to 96,000 impacts.  
Suction pumps were subjected to 72,000 impacts.

### 9. Review

At the end of the endurance test, all the pumps had been dismantled and reinstalled several times and some had needed maintenance and repair. The appropriate topics of the Engineering Assessment were therefore reviewed in the light of this further information and experience:

- 9.1 Installation - an evaluation of the equipment, tools and skills required to install each pump successfully.
- 9.2 Maintenance and Repair - an evaluation of the equipment, tools and skills required to maintain and/or repair each pump successfully, with special reference to the requirements for Village Level Operation and Maintenance (VLOM).

Finally:

- 9.3 A verdict, summarizing in a few sentences the strengths and weaknesses of each pump, as revealed in the laboratory test programme.

10. Reporting

- 10.1 The first interim report was issued in February 1982, detailing the results of Sections 1 to 6 for both batches of pumps, with early indications from the endurance tests.
- 10.2 It was necessary to report several particular endurance problems to individual pump manufacturers. In one case, the manufacturer substantially re-designed the pumpstand, and supplied a sample to the new design, to enable the endurance test to be completed.
- 10.3 The Final Summary Report was published in May 1983 as World Bank Technical Paper No. 6 - "Laboratory Evaluation of Hand-Operated Water Pumps for Use in Developing Countries."
- 10.4 This is the Final Technical Report, and gives details of the test procedures and the results for the individual pumps.

### 2.3 Installation for Testing

The pumps are installed on the top floor of a purpose-built 10 metre tower. They are arranged in batches of six, with a motor and tank for each batch.

The floor beneath the pumps houses the mechanical drives for the endurance tests. Beneath that, each deep-well pump is fitted with a head simulation valve which is designed to simulate well depths down to 45 metres.

The level of water in the tank on the ground floor is maintained by a pump and constant level device.

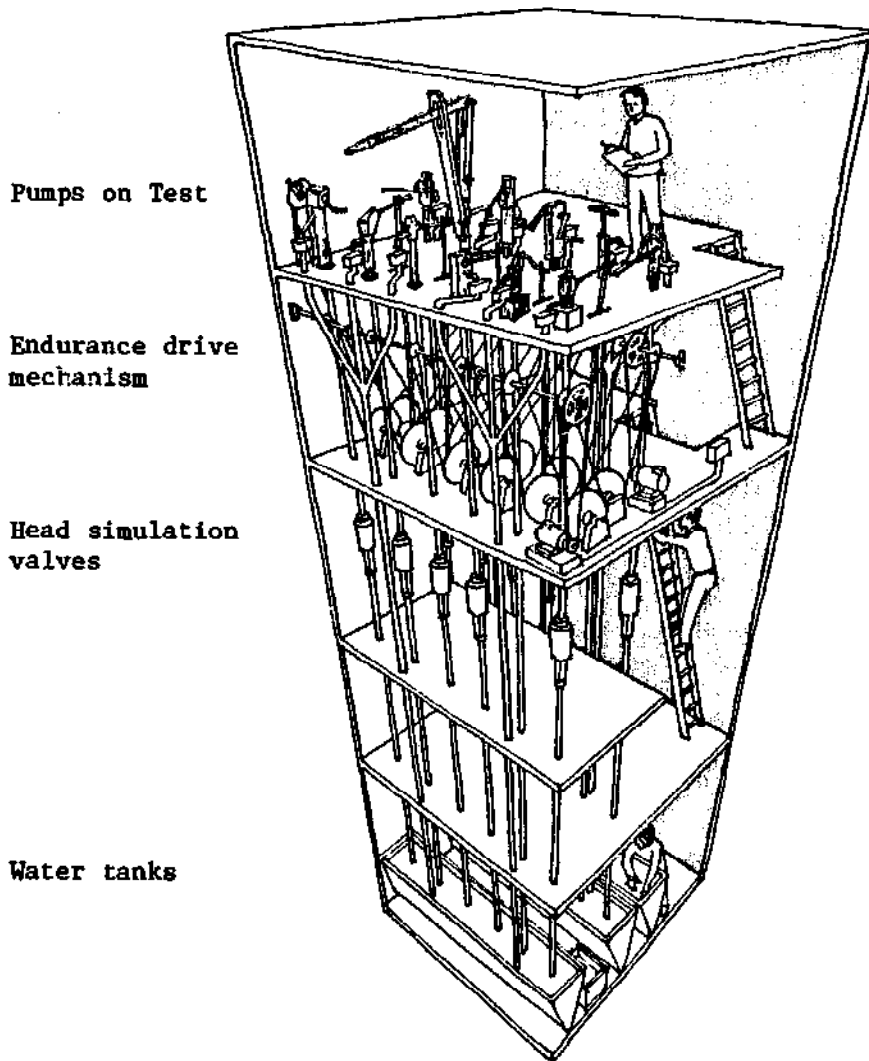

Handpump Testing Tower

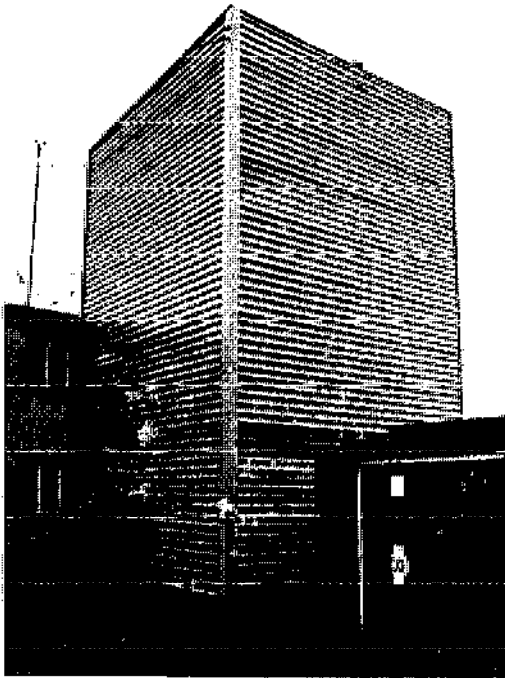

The exterior of the tower



Some of the installed pumps  
on the top floor



The endurance drive mechanisms



Handle shock test

## 2.4 Basic Pump Nomenclature

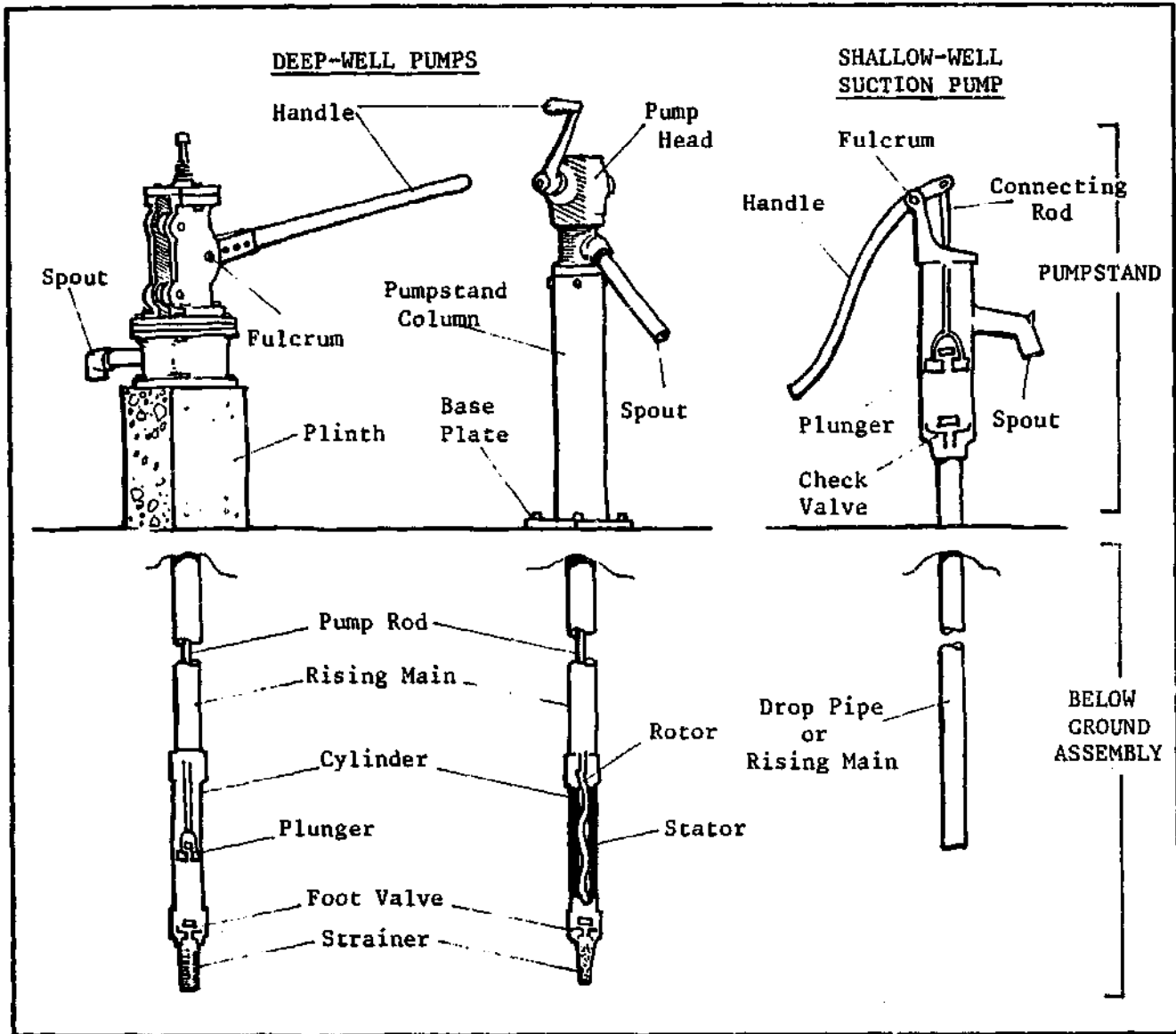

In response to comments received on Report No. 1, the following definitions will be used throughout.

A shallow-well suction pump is one where the plunger is in the body of the pump, above ground. For practical purposes, the maximum operating depth of this type of pump is 7 metres.

A shallow or deep-well force pump is one where the plunger is below static water level, at the bottom of the rising main. Such pumps are self-priming. The maximum operating depth is limited only by the strength of the pump and its operator.

### 3. GENERAL OBSERVATIONS AND RECOMMENDATIONS

#### 3.1 Observations

##### Literature

All pumps should be supplied with instructions for installation, maintenance and use. Plenty of clear illustrations are of particular value in overcoming language and literacy problems. In the majority of pumps the pump rod must be cut accurately to length during installation. In very few cases were adequate instructions provided by the manufacturer.

##### Skills required

All the pumps require basic mechanical skills for installation and maintenance, some needing considerable expertise.

##### Installation

Many pumps require lifting tackle for installation and maintenance because galvanised iron rising main is used. If uPVC or other plastic pipe could be used, the below-ground assembly could be installed or removed without lifting tackle.

##### Baseplate sealing

With some pumps, extra care is needed during the preparation of the base and subsequent installation to ensure an adequate sanitary seal.

##### Mounting Height

Many manufacturers give no indication of the correct height to which the pumps should be installed. The best pump designs are those which do not require a special pedestal built up on a wellhead. Pumps should have an in-built design feature which ensures that they are mounted at the correct height.

##### Spares

All the pumps may in time need manufacturer's spares, some of which can be costly. However the cost per unit of a stock of spares will fall the more pumps are installed in the field. Accent should be placed on development of the VLOM concept with regionally produced spare parts if possible.

##### Two-person Operated Pumps

Rotary pumps which can be operated by two people may have certain advantages. It may be necessary to investigate local cultural/sociological factors to assess the likely problems of this in practice. Throughout the Laboratory tests only one person was used.

##### Safety

Some manufacturers do not pay sufficient attention to the avoidance of safety hazards, even where this involves only a simple design change, i.e. long bolts with ragged ends, finger traps, tails of split pins.

### Design Features

Handle: From observation of users operating reciprocating pumps, one potential cause of wear in the handle pivot could be eliminated by adding a "T" at the end of the handle where applicable. Cast iron is prone to breakage and difficult to repair. Handles should be of resilient material, steel bar or tube, or wood where available.

Valves: Some manufacturers give insufficient attention to the amount of valve lift. It is often excessive which lowers efficiency and introduces a risk of valves jamming open.

Pump rod Constraint: The test results suggest that where the design attempts to constrain the motion of the pump rod into a straight line, bending forces are generated which cause failure at the pump rod joints. (It would be helpful to obtain information from the field on this point).

Glands: These are not an ideal method of sealing the pump rod where it passes through the pumpstand, particularly if also used as rod guides. Wear is inevitable and the subsequent leakage apart from the loss of sanitary seal, could produce difficulties if tank filling is needed.

Faecal Contamination: Manufacturers should, whenever possible, look at the designs of the outlet spout to ensure that users cannot seal off the outlet with their left hand after defecating, to build up water in the body of the pump.

Fasteners: Few manufacturers have considered rationalising the variety of fasteners used on the pump. These could often be all one size or type, therefore needing only one tool.

Discharge Valve: In view of the few applications where tank filling facility is needed, the complication in pumpstand design that this introduces is unnecessary as a standard feature and often creates points of weakness. See also Glands.

### Multiple Plunger Seals

Several manufacturers incorporate two cup seals on their pump plungers, possibly with the idea that the second one will provide a back-up seal in the event of failure of the first one, or perhaps to share the load.

Particularly in the case of leather cup seals, evidence obtained from the laboratory endurance tests shows that the top of the lower seal deforms inwards and becomes ineffective in the event of a top seal failure.

Unless clear evidence can be obtained from the field of the value of the second seal, it is considered to be an unnecessary complication and the plunger design can be simplified for only one seal.

### Multiple Foot Valves

Unlike multiple cup seals, paired foot valves can share the work, since both must open and close in unison. The pump will continue to work when one foot valve has failed. However, we have evidence of one example where this was a disadvantage : broken parts of the failed foot valve became entangled in the plunger and severely damaged the cylinder.

### Quality Control

All designs require a measure of quality control but some of the more complicated pumps need very strict quality control in manufacture, particularly in developing countries. Use of simple jigs and fixtures can greatly help the quality control situation and ensure both correct original construction and interchangeable replacement spares.

### Efficiency

For most deep-well pumps, the efficiency at 25 or 45 metres is generally markedly greater than at 7 metres depth. This occurs because the relative contribution of friction to the total workload is greater at 7 metres than at the deeper settings. The effect is most pronounced for helical pumps of the Mono/Moyno type.

### VLOM

Although some of the pumps satisfy the requirements for VLOM quite closely, none do so completely. Attention to the above points would go a long way towards meeting the VLOM concept.



### 3.2 Recommendations from the 18 Pumps Tested

None of the pumps tested was satisfactory in every respect. All the designs represent some compromise between reliability, performance, ease of installation and maintenance, user convenience and so on.

The selection of the most appropriate pumps for community use depends on the local conditions. In different applications, particular parameters will be of greater or lesser significance. It is therefore very important to define these conditions before deciding which pumps to use. However, for most applications, out of the 18 pumps tested in Batches 1, 2 and 3, we would expect the choice to be made from the following 9 pumps (given in alphabetical order):

#### Deep-well Pumps

- Korat 608 A-1     Reliable below ground, potentially suitable for manufacture in developing countries with foundry skills, needs a small change to eliminate the safety hazard.
- Maldev             Pumpstand only, designed for 2.5 inch uPVC or galvanised iron rising main and for ease of maintenance. Robust and reliable, suitable for manufacture in developing countries.
- Moyno IV 2.6     Robust and reliable, awkward to operate, output low, but not recommended for use at less than 20 metres depth. Unsuitable for manufacture in developing countries.
- Nepta             Easy for children to operate, very efficient, but should be redesigned below-ground to eliminate the spring.
- Nira AF76         Robust for wells down to 20 metres, as a result of many improvements made by the manufacturer. Reasonably good compromise design.
- Volanta           Easy to maintain. Cables were unreliable, but manufacturer now supplies steel rods. Considerable potential for manufacture in developing countries.

#### Shallow-well Pumps

- Ethiopia BP50     Self-priming, not a suction pump, thus very suitable for drinking water. Awkward for children to operate, easy to install and maintain. Not very robust. Suitable for manufacture in developing countries.
- New No.6          Suction pump, suitable for manufacture in developing countries with foundry skills. High output, but needs priming with consequent danger of contamination. Needs attention to corrosion protection of plunger and check valve.
- Rower             Suction pump with high rate of delivery, very suitable for low-lift irrigation though not recommended for drinking water. Easy to manufacture, install and maintain.

#### 4. INDIVIDUAL PUMP EVALUATION

For each pump, the illustration and description are followed by comments and the test results under the headings set out in the Test Procedure.

##### Pump Lubrication

When the pumps were installed all moving parts were correctly lubricated. During the course of the endurance test no further lubrication was provided since it cannot be assumed that regular lubrication will occur in the field. If any components failed in the endurance test requiring the pumps to be dismantled, then correct lubrication was given on re-assembly.

##### Head Simulation Valve Setting for the Endurance Test

This valve was set either to operate at 45 metres or the greatest depth recommended by the manufacturer for the operation of his pump, whichever was the lower figure.

##### Endurance and Performance Stroke Speeds

For force pumps the endurance stroke speed was selected at 40 per minute, as being the highest rate sustainable by a person to fill a 20 litre container. In the performance test the pump rates included 50 strokes per minute since this is humanly possible for a short duration.

For suction pumps a maximum speed of 30 strokes per minute was selected for the endurance test, as operating above this speed produced cavitation under the plunger. Accepting cavitation, the suction pumps functioned at 40 strokes per minute, and this speed was therefore included in the performance test.

In all cases the arc of handle movement was selected to be just within the limit of the stops to avoid the risk of uncontrolled banging of the handle, which was the subject of a separate abuse test.

##### User Trial

Marginal changes were made in the user trial of Batch 3 compared with Batches 1 and 2. These have been explained in the Introduction to Appendix I.

Abuse Tests - Handle Shock Load Test

This test was carried out at the specified endurance stroke speed for 40 hours. Controlled shocks were provided on the handle stops with a force determined from a user test where the handle was allowed to travel with the normal level of effort on to the stops. Force pumps received 96,000 shocks and suction pumps 72,000 shocks.

Requirements for maintenance and repair

The equipment, level of skill and personnel required for installation, maintenance and repair are illustrated by the following symbols:



Clamp



Hacksaw



Hand Tools



Hexagon Key(s)



Lifting tackle



Pipe Wrench(es)



Flat Spanners



Jointing Materials



Lubricant  
(oil and/or  
grease)



Threading  
Die(s) and  
Die Stock



Skilled  
Person



Labourer

Abi-Vergnet

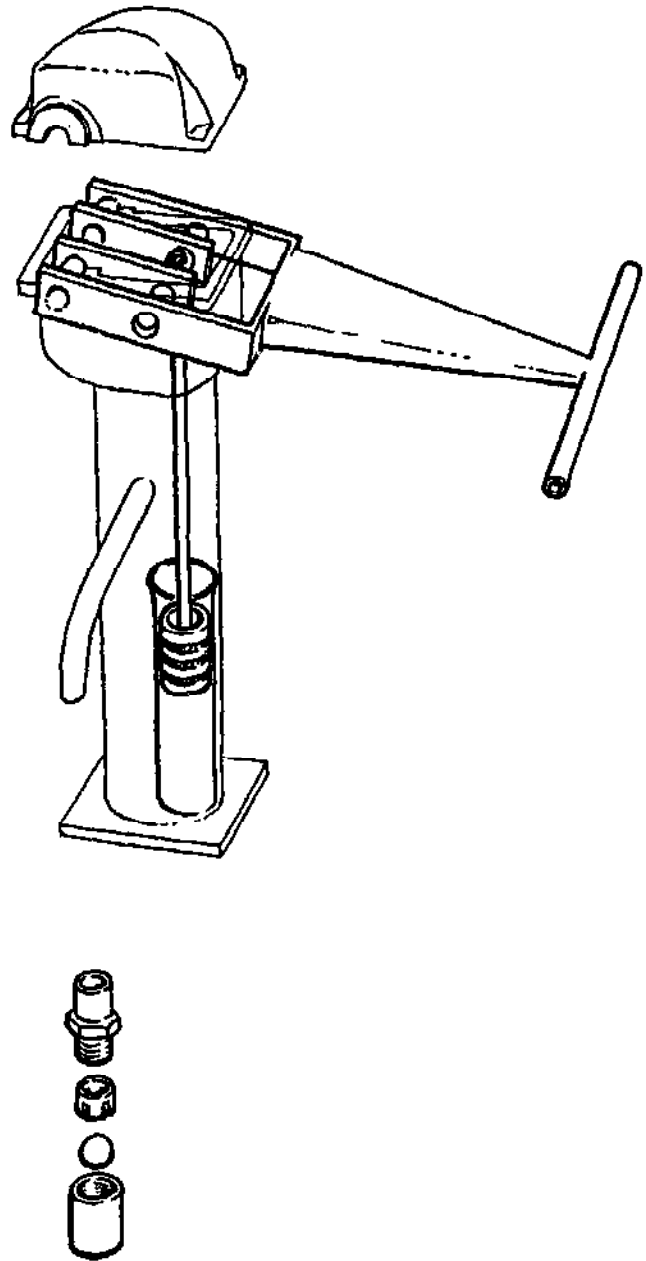
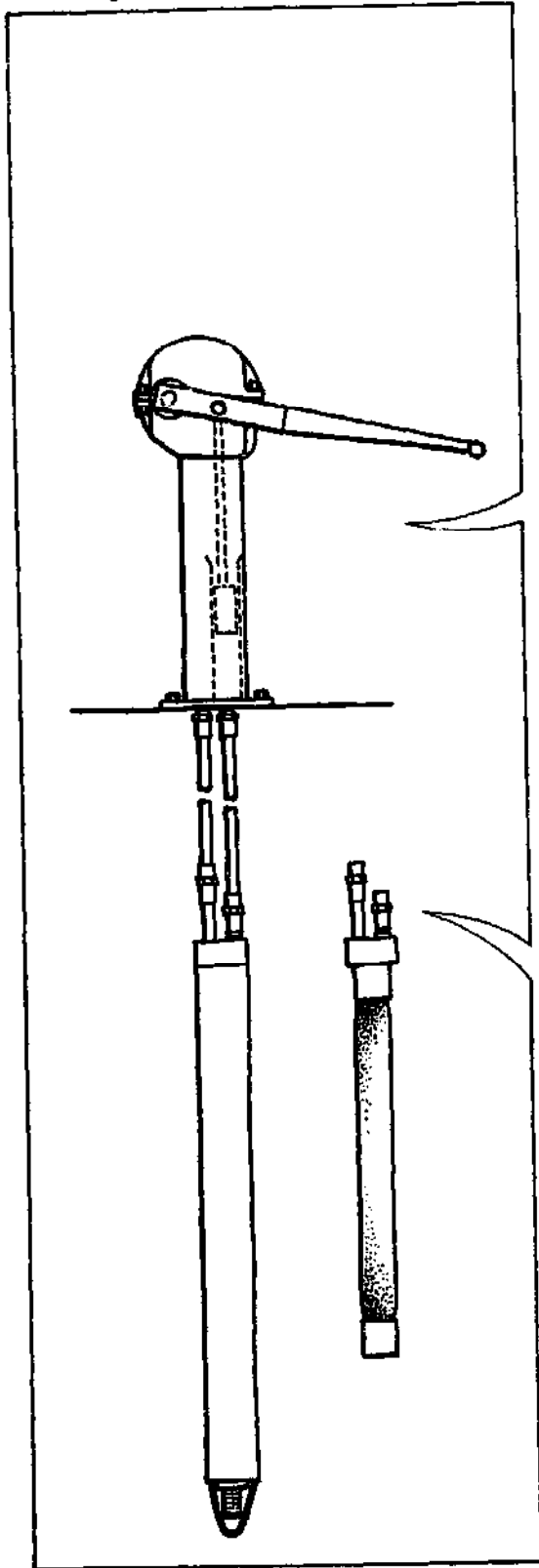

ABI-VERGNET ASM

1.1 Manufacturer                   Groupement Abidjan Industrie SNE Mengin

Address                           Boite Postale 343,  
Abidjan,  
Ivory Coast

1.2 Description                   The Abi-Vergnet is a hybrid pump working on hydraulic principles. There are no mechanical links between the above- and below-ground parts.

The Vergnet cylinder is a product of high manufacturing technology. A flexible rubber tube encased in stainless steel dilates and collapses in response to a primary cylinder in the pumpstand to which it is connected by a plastic hose. When the flexible membrane expands, water is forced to the surface through a second hose.

The pumpstand is partly cast-iron and partly fabricated. The main handle bearings are compressed carbon composite material. The primary cylinder inside the pumpstand column is a stainless steel tube. The primary plunger is machined from brass and uses a number of leather ring seals. The primary cylinder is replenished by water flowing in through a small hole in the part of the cylinder which is exposed by the plunger near the upper limit of its travel.

1.3 Price                           \$836 complete for 20 m depth.

2. INSPECTION

2.1 Packaging                   The pumps were packed in 2 wooden packing cases; one contained the down-well components and the other contained the pump head units. The hose was delivered in a large roll.

This packaging was considered very suitable for export and for crude overland transportation.

2.2 Condition as Received                   On one sample the threads were damaged on the base of the pump head. In the second sample, the rubber buffer in the primary plunger was too short, giving free play in the connecting rod.

The pump pedestal base plates were distorted out of flat in both samples. The component parts of the handles were not correctly aligned.

2.3 Installation & Maintenance Information In French. Comprehensive and quite well illustrated. Useful both for installation and subsequent maintenance and repair.

3. WEIGHTS & MEASURES

3.1 Weights Pumpstand : 60 kg (including handle)  
Cylinder: 9 kg

3.2 Dimensions Nominal cylinder bore: 58 mm  
Actual pump stroke: 145 mm  
Nominal volume per stroke: 383 ml  
Drop pipe size: 26 mm I/D x 32 mm O/D  
Maximum outside diameter of below-ground assembly 96 mm

3.3 Primary Cylinder Bore No significant taper or ovality was found in the primary cylinder of either sample.

The surface roughness average ( $R_a$ ) was measured in three places in a direction parallel to the cylinder axis.

The results are shown below:-

SAMPLE	CYLINDER BORE	ROUGHNESS AVERAGE ( $\mu\text{m}$ )			
		TEST 1	TEST 2	TEST 3	MEAN
1	Machined steel	0.56	0.58	0.58	0.57
2	Machined steel	0.63	0.58	0.60	0.60

Measured at 0.25mm cut-off

3.4 Ergonomic Measurements

HANDLE HEIGHT		PLATFORM HEIGHT (mm)	ANGULAR MOVEMENT OF HANDLE (degrees)	HANDLE LENGTH (mm)	VELOCITY RATIO OF HANDLE	HEIGHT OF SPOUT (mm)
MAX <sup>(1)</sup> (mm)	MIN <sup>(1)</sup> (mm)					
1150	340	0	63	775	5.2	610

(1) Measured without compressing any bump stops

#### 4. ENGINEERING ASSESSMENT

##### 4.1 Materials of Construction

The materials used for the principal components are detailed below:

COMPONENT	MATERIAL(S)
Pumpstand body & cap	Cast iron top and cap Steel body and baseplate
Handle	Mild steel
Cylinder casing	Stainless steel
Pumping element	Rubber, with light alloy fittings
Top cap and valves	Brass with stainless steel balls and acetal fittings
Primary plunger assembly	Gunmetal with leather seals
Foot valve	Brass/gunmetal with stainless steel ball and plastic shield

##### 4.2 Manufacturing Techniques

The manufacturing techniques required to make the pump are listed below:

Above-ground Assembly	Iron and gunmetal foundry Steel fabrication Basic machining
--------------------------	---

This pumpstand demands basic skills in iron foundry and considerable skill in steel fabrication. It may be suitable for manufacture in developing countries where these skills exist. It would not be difficult to modify the pumpstand design for all-fabricated manufacture. The handle requires careful jiggling for welding.

Below-Ground Assembly	Hot pressing of brass Light alloy foundry Plastics moulding Machining Welding (of stainless steel) Specialised processes (pumping element)
--------------------------	---

The pumping element assembly demands advanced, specialised manufacturing techniques, and a high degree of skill. It would be particularly unsuitable for manufacture in a developing country.

#### 4.3 Ease of Installation, Maintenance and Repair

##### 4.3.1 Ease of Installation



Installation although straight-forward demands a good deal of care. The pump is supplied with lightweight polyethylene tubing to connect the cylinder with the pumpstand and will not require lifting tackle.

##### 4.3.2 Ease of Pumpstand Maintenance and Repair

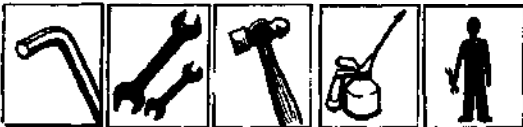

The Pumpstand is likely to require very frequent replacement of the leather sealing rings on the primary plunger, particularly if the replenishing hole in the primary cylinder has not been satisfactorily deburred during manufacture.

##### 4.3.3 Ease of Below-ground Maintenance and Repair



The lightweight connecting tubes mean that the cylinder can be extracted without the need for lifting tackle. The cylinder itself is easy to dismantle provided the appropriate hexagon keys are available.

#### 4.4 Resistance to Contamination and Abuse

##### 4.4.1 Resistance to Contamination

The pump is unlikely to be contaminated by foreign matter but care will be needed during installation to ensure that the pump is satisfactorily sealed against surface water.

##### 4.4.2 Likely Resistance to Abuse

In general the pumpstand should be capable of resisting accidental impacts and heavy handed usage. The spout is long and weak and might therefore be easily damaged.



#### 4.5 Potential Safety Hazards

There is a potential finger trap between the handle and the body of the pumpstand when the handle is at the bottom of its stroke.

#### 4.6 Suggested Design Improvements

Flats should be machined on either side of the crankpin in the handle, to increase the load bearing area for attaching the connecting rod.

The baseplate should be flat - it should either be stiffer or be pre-formed before welding to ensure flatness after welding.

The primary plunger seals should be made of a less soft material - polyethylene may be suitable - or standard proprietary seals may be available.

The replenishing hole in the primary cylinder should be deburred on the inside.

In the pumping element assembly, an effort should be made to rationalise the various bolts, screws, O-rings etc., to minimise the number of different parts.

It may be cost-effective to simplify the handle by eliminating the pressing - see sketch, below:

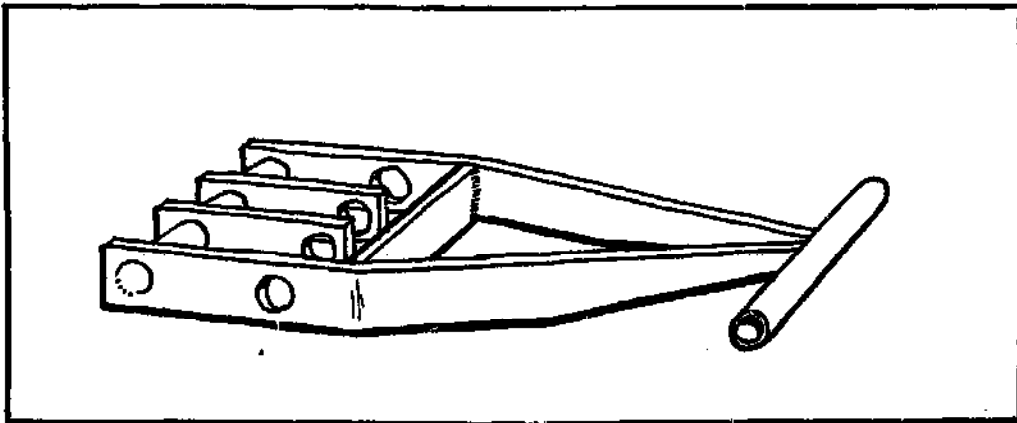

5. PUMP PERFORMANCE

5.1 Volume Flow, Work Input and Efficiency

The description of the method can be found in the Test Procedure.

HEAD	7 m			25 m			45 m		
Pumping Rate (strokes/min)	30	38	49	32	40	50	32	42	50
Vol/stroke (litres)	0.28	0.27	0.27	0.26	0.26	0.26	0.24	0.25	0.25
Work input/stroke (J)	127	130	139	185	194	211	262	250	286
Efficiency (%)	15	14	13	34	32	30	39	43	38

5.2 Leakage Tests

In the leakage test, no leakage was observed from the footvalve at 7, 25 and 45 metres heads.

6. USER TRIAL

Details of the organisation of this trial can be found in the Test Procedure.

Many users needed guidance to find an appropriate method of operation, but then quickly became accustomed to operating the pump at a steady rhythm, timing their efforts to coincide with the characteristics of the pump. Most found the pump tiring to use because of the slow rate of delivery. The handle height seemed satisfactory for a wide range of user heights.

7. ENDURANCE TESTS

A detailed description of the endurance test method can be found in the Test Procedure.

General Comments

The pump was tested at 40 strokes/minute at a simulated head of 45 metres, subsequently reduced to 20 metres.

The below-ground assembly completed the 4000 hour endurance test without failure and remained in good working order at the end. By contrast the pumpstand was very unreliable.

The original leather seals fitted by the manufacturer to the primary plunger wore out in 75 hours. They were replaced twice but it became clear that the average life of leather seals was approximately 80 hours. We believe the seals were damaged by the replenishing hole in the primary cylinder which had not been satisfactorily deburred during manufacture. The leather rings were replaced by polyethylene seals machined from bar stock. The first set of these were worn out at the 1000 hour inspection and they were replaced by a second set. During the second stage the bolt connecting the primary plunger rod to the handle pivot broke twice and was eventually replaced by a high tensile bolt. The handle to primary rod fulcrum had worn out after 1529 hours and the handle assembly was replaced. At the inspection after the second 1000 hour stage the second set of polyethylene primary plunger seals were worn out.

To experiment with alternative materials the polyethylene seals were replaced by others machined from acetal bar stock. These wore out in less than 600 hours however, and a second set in less than 300 hours. They were replaced by textile cord seals but these wore out in less than 200 hours. Polyethylene seals were fitted once again to complete the endurance test and as before these wore out in approximately 1000 hours.

It is clear that the pumpstand needs substantial modification if its reliability is to approach that of the below-ground components.

Breakdown Incidence

Breakdowns are shown in bold type.

Hours:	1042	2083	3125	4167
75				
167				
0 267	1087	1529	2645 2930	
	1306			
Inspection and full performance test	Inspection and volume flow test		Inspection and volume flow test	Inspection and volume flow test
Leather seals on primary plunger worn out - replaced by polyethylene	PE primary seals worn out	Handle to primary rod fulcrum worn out	Acetal primary seals worn out	Textile seals worn out - replaced polyethylene
	Bolt broken on primary plunger rod			PE primary seals worn out
			PE primary seals worn out replaced by acetal	Acetal primary seals worn out replaced Briaux textile cords

Details of the Endurance Test

Breakdowns are shown in bold type.

HOURS

- 75 ) Leather primary plunger seals worn out — examination with an optical  
167 ) fibroscope revealed that a hole drilled in the primary cylinder to  
247 ) replenish it from the main body of the pump had not been  
satisfactorily deburred during manufacture. The leather seals were  
replaced by sealing rings machined from high-density polyethylene bar  
at 247 hours

Estimated Amount of water pumped to breakdown.....less than 0.1 million litres

1042 Inspection after 1st 1000 hours:

- a) Polyethylene plunger sealing rings worn out — replaced  
b) Bolt securing plunger rod to handle loose  
c) One handle-to-pump-rod bush worn out, other loose -- the handle  
was replaced by the second sample  
d) Spots of rust on plunger rod

The pumping depth was re-set to 20 metres to continue the test

Estimated Additional Amount of water pumped to breakdown...0.3 million litres

- 1087 ) Bolt securing plunger rod to handle broken — replaced at 1306 hours  
1306 ) by a high-tensile bolt

Estimated Additional Amount of water pumped to breakdown..< 0.1 million litres

- 1529 Handle to plunger rod bearings worn out and handle damaged — the  
original handle was repaired using bearings from an older ABI pump  
and re-used.

Estimated Additional Amount of water pumped to breakdown...0.1 million litres

2083 Inspection after 2nd 1000 hours:

- a) Polyethylene plunger sealing rings worn out -- replaced by seals  
machined from polyacetal bar  
b) Plunger slightly worn by contact with bore of primary cylinder  
c) Rubber buffer in plunger collapsed -- replaced  
d) Localised rust inside pumpstand  
e) Corrosion on end caps of pumping element

Estimated Additional Amount of water pumped to breakdown...0.3 million litres

Abi-Vergnet Pump

2645 ) Acetal plunger seals worn out — replaced by woven textile seals at  
 2930 ) 2930 hours after increasing width of grooves in plunger to suit

Estimated Additional Amount of water pumped to breakdown...0.3 million litres

3125 Inspection after 3rd 1000 hours:

- a) Textile seals worn out — replaced by wide polyethylene seals
- b) Further corrosion of pumping element end caps

Estimated Additional Amount of water pumped to breakdown...< 0.1 million litres

4167 Final Inspection:

- 1 Seals Final set of polyethylene seals worn out
- 2 Plunger Plunger worn by contact with cylinder bore
- 3 Handle Some wear of handle and bushes but still serviceable
- 4 Pumping Element Pumping element in good condition, including ball valves
- 5 Corrosion Further rust inside pumpstand  
 Further corrosion of pumping element end caps

Estimated Additional Amount of water pumped to breakdown...0.3 million litres

Estimated Total Amount of Water Pumped in 4000 hours.....1.5 million litres

Strokes/min	<u>Volume Flow Tests (litres)</u>			<u>Leakage Tests</u>
	30	40	50	<u>at 7 m (ml/min)</u>
New 25 m depth	0.26	0.26	0.26	<0.1
New 45 m depth	0.24	0.25	0.25	<0.1
After 1000 hours 45 m	0.11	0.16	0.16	<0.1
After 2000 hours 25 m	0.19	0.20	0.20	<0.1
After 3000 hours 20 m	0.16	0.19	0.18	<0.1
After 4000 hours 20 m	0.06	0.06	0.08	<0.1

Pump Performance After Endurance

Not carried out due to continual replacement of seals.

8. ABUSE TESTS

8.1 Side Impact Tests

Undamaged in both handle and body tests.

8.2 Handle Shock Tests

The pump completed the allotted 96,000 cycles without failure.

9. VERDICT

A sharp contrast was observed between the endurance of the pumpstand and of the below-ground pumping element. The latter proved to be very reliable and remained in good condition at the end of the test. The pumpstand was unreliable and quite unsuitable for community water supply. However, this pump is inherently simple to install and to maintain below-ground, and it is therefore strongly recommended that a reliable VLOM pumpstand should be developed.

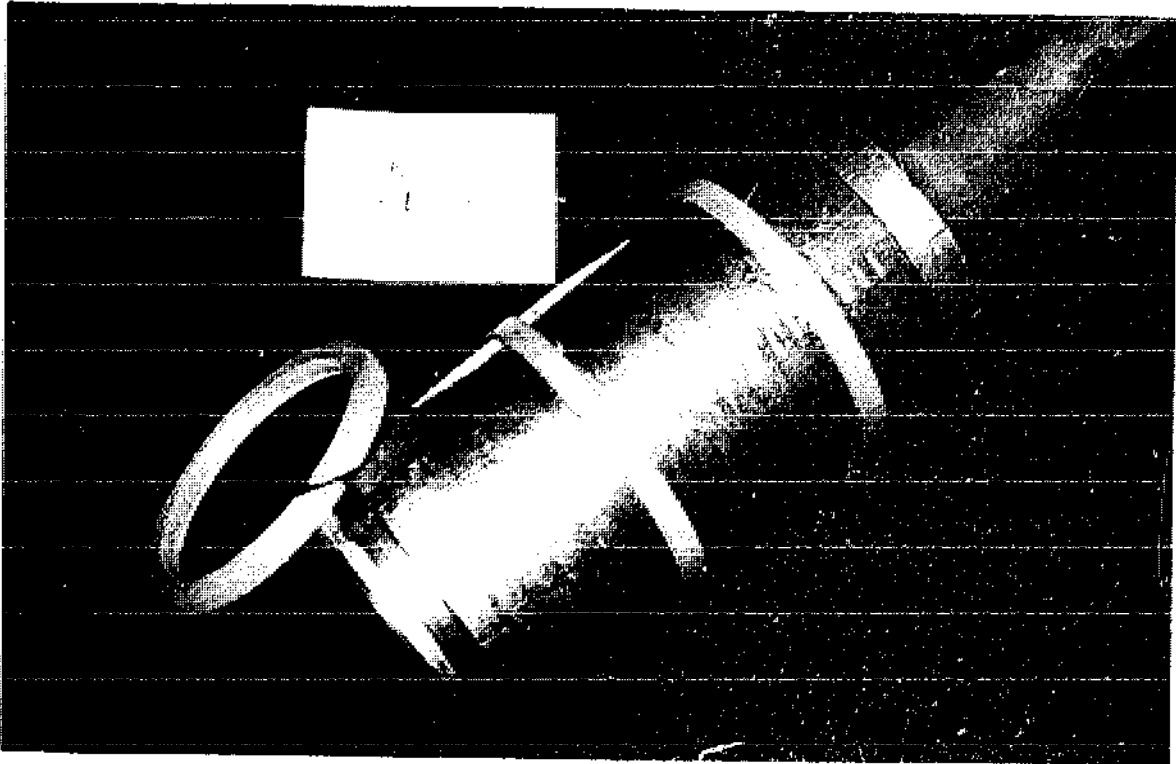

Polyethylene seals made to replace the original leather seals



Handle bearings after 1529 hours

Abi-Vergnet Pump

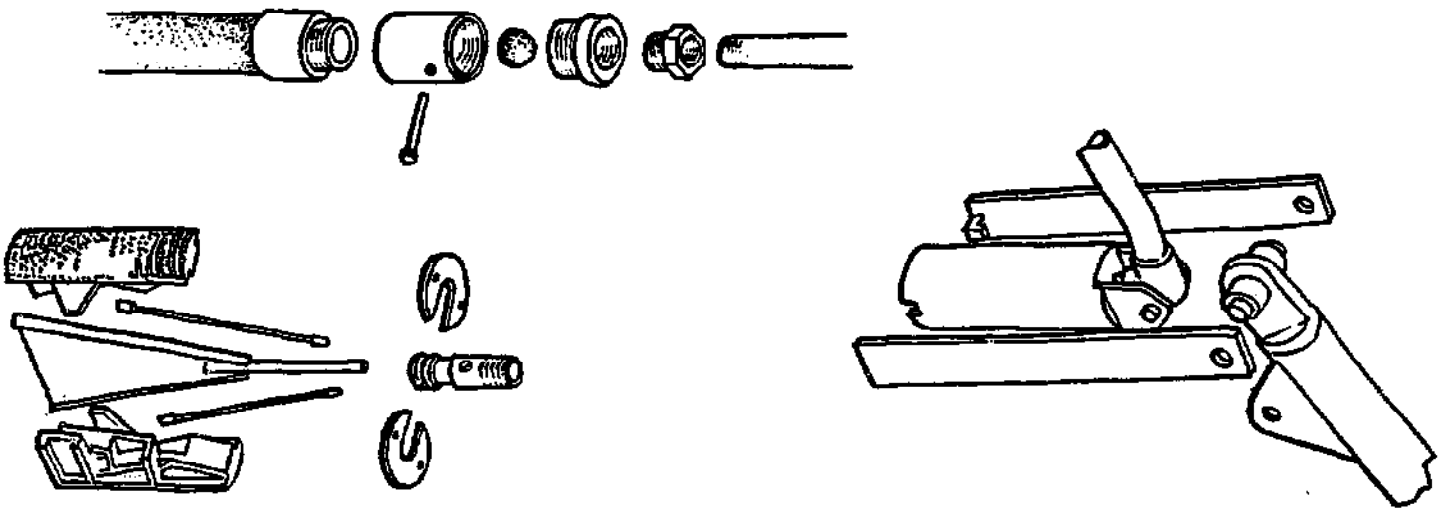
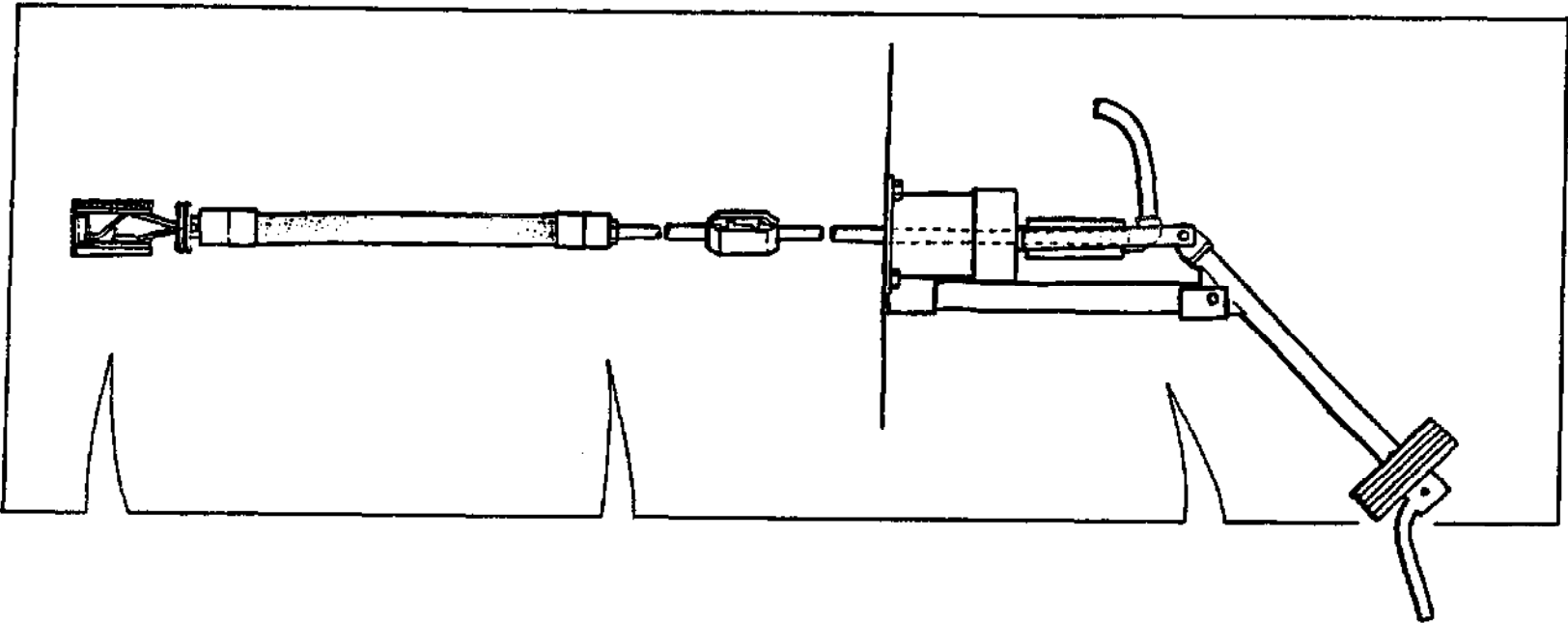



PETRO

1.1 Manufacturer WellDrill Systems AB

Address Tagenevagen 21,  
S-425 90 Hisings Karra,  
Sweden.

1.2 Description The Petro is an unconventional pump using the changing volume of a stretched rubber hose to provide the pumping action. The functions of rising main and pump rod are combined in a single component and the cylinder assembly is anchored in the well casing by an arrangement of two wedges faced with carborundum grit.

The pumpstand is fabricated from steel sections and is designed to ensure that the necessary pre-stress on the rubber hose is applied automatically during installation. Up to 10 counterweight discs may be added to the handle to balance the weight of the below-ground assembly in a particular installation.

1.3 Price \$465 per pump with 20 m below-ground assembly

2. INSPECTION

2.1 Packaging The pumps were packed in wooden packing cases; the pumpstands were well packed in separate cases.

The packaging was considered very suitable for export and for crude overland transportation.

2.2 Condition as Received The 3/4 inch nominal bore rising main would not pass through the outer tube on both samples. A pivot pin was missing from one sample.

2.3 Installation & Maintenance Information In English. Comprehensive and well-illustrated by photographs and line drawings. Useful for both installation and subsequent maintenance and repair.

3. WEIGHTS AND MEASURES

- 3.1 Weights Pump stand : 30.0 kg  
 (excluding handle c/weights)  
 Cylinder: 6.0 kg  
 Handle Counterweights (each): 4.3 kg  
 Rising Main (per metre): 1.6 kg
- 3.2 Dimensions Actual pump stroke: 120 mm  
 Drop pipe size: 0.75 inch  
 Well diameter range 97 mm minimum  
 120 mm maximum
- 3.3 Cylinder Bore Not applicable

3.4 Ergonomic Measurements

HANDLE HEIGHT		PLATFORM	ANGULAR	HANDLE	VELOCITY	HEIGHT
MAX (1)	MIN (1)	HEIGHT	MOVEMENT	LENGTH	RATIO OF	OF
(mm)	(mm)	(mm)	OF HANDLE	(mm)	HANDLE	SPOUT
			(degrees)			(mm)
1122	450	0	53	880	6.3	595 max. 475 min.

(1) Measured without compressing any bump stops

4. ENGINEERING ASSESSMENT

4.1 Materials of Construction

COMPONENT	MATERIAL(S)
Fulcrum upright	Steel
Handle and links	Steel
Spout	Steel
Outer guide tube	Steel
Guide assembly	Glass-filled nylon
Pumping element	Reinforced rubber with light alloy fittings
Clamp assembly	Steel, glass-filled nylon, carborundum grit
Well cap	Steel
Pivot pins	Steel

#### 4.2 Manufacturing Techniques

The techniques required to manufacture the pump are listed below:

Above-ground Assembly	Steel forming and welding Machining - turning, drilling, milling etc.
--------------------------	--

The pumpstand demands well-developed skills in machining and steel fabrication. Specialised processes are not required, however, and the pumpstand may therefore be suitable for manufacture in some developing countries.

Below-ground Assembly	Machining - turning, drilling, milling etc. Plastics moulding Specialised processes (pumping element)
--------------------------	---

The pumping element demands specialised manufacturing techniques and rigorous quality control. It would be particularly unsuitable for manufacture in developing countries.

#### 4.3 Ease of Installation, Maintenance and Repair

##### 4.3.1 Ease of Installation

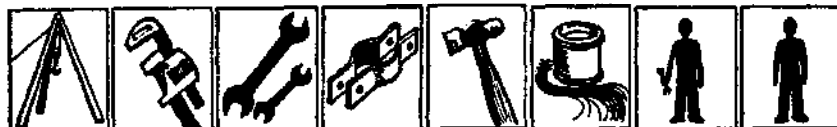

We understand that the manufacturer considers lifting tackle to be unnecessary for installation at depths up to 45 m. However since the weight of a 45 m below-ground assembly would be some 78 kg excluding water, it may be very difficult to manhandle. We recommend the use of simple lifting tackle. The manufacturer's installation manual is clear and well illustrated and installation should be straight-forward. It should not be difficult to ensure that the anchor is secure in the well.

##### 4.3.2 Ease of Pumpstand Maintenance and Repair



Servicing the pumpstand is very straightforward requiring only simple hand tools. The handle pivots may require occasional lubrication.

#### 4.3.3. Ease of Below-ground maintenance and repair

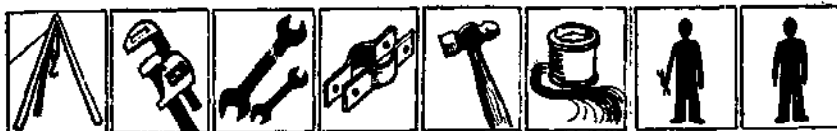

It should not be difficult to release the anchor provided the threaded coupling at the bottom of the pumping element can be successfully detached. In other respects below-ground maintenance will be similar to installation.

#### 4.4. Resistance to Contamination and Abuse

##### 4.4.1 Resistance to Contamination

The pump is unlikely to be contaminated by either surface water or foreign matter.

##### 4.4.3 Likely Resistance to Abuse

The pumpstand is generally robust and is likely to resist accidental damage to the handle or the pump body. The spout might be easily damaged if abused however.

#### 4.5 Potential Safety Hazards

None

#### 4.6 Suggested Design Improvements

##### Pumpstand:

A handle from square steel tube, with an on-site cast concrete counterweight, would be cheaper to manufacture than the all-steel assembly supplied. However, the all-steel assembly will arrive at the wellhead ready for use, whereas the installation crew would be required to cast a suitable concrete counterweight.

If the steel counterweights are retained, it would be easier to turn a recess in the first disc than to mill a slot.

The reason for the slot in the guide tube is not clear - if it could be eliminated the O-ring groove would be simplified.

##### Below-Ground Assembly:

The valve ball may be more efficient with a heavy core, but lead should not be used.

Stainless steel pumping element end fittings, as proposed, would be better than light alloy, as supplied.

#### Petro Pump

Plastic reducers are fitted in some connections, presumably to prevent galvanic corrosion couples. These could be eliminated if all parts were stainless steel.

A much simpler guide for the rising main would be adequate, a simple 3-legged moulding for example. If the present design is retained, the stress riser at the root of the legs should be eliminated.

The method of attaching the pumping element to the anchor must be modified to prevent seizure. This could be achieved by machining the male thread to a point with a corresponding plate welded over one end of the female socket.

## 5. PUMP PERFORMANCE

### 5.1 Volume Flow, Work Input and Efficiency

HEAD	7			25			45		
Pumping Rate (strokes/min)	30	39	51	30	40	49	29	37	49
Vol/stroke (litres)	0.26	0.25	0.25	0.25	0.25	0.25	0.25	0.26	0.24
Work input/stroke (J)	74	78	86	112	120	123	178	202	201
Efficiency (%)	23	22	20	54	50	49	61	57	53

The description of the method can be found in the Test Procedure.

### 5.2 Leakage Tests

No leakage was observed from the foot valve at 7, 25 or 45 m heads.

## 6. USER TRIAL

Details of the organisation of this trial can be found in the Test Procedure. Most users seemed to operate this pump without difficulty, but many found it tiring because of the low rate of delivery.

7. ENDURANCE

A detailed description of the endurance test method can be found in the Test Procedure.

General Comments

The pump was tested at 40 strokes/minute at a simulated head of 45 metres.

This pump proved to be a good deal more reliable than the Petro tested for the ODA in 1978/9.

The pump completed the first three 1000 hour stages without failure. However the down-hole anchor could not be released for inspection of the pumping element at the end of the third 1000 hour stage. Although given three full turns the pumping element sprang back. As it was not possible to free the anchor from the well top, the manufacturer was contacted by telephone for advice and permission to remove the bottom section of the well. With the bottom section removed, the anchor was released easily by pulling down on the wedge. The thread on the anchor wedge rod was found to have locked in the socket. When released the stainless steel threads were found to have seized. This could present a very serious problem in the field where access to the pumping element from below would be impossible.

The manufacturer agreed that we should try to use the same pumping element to complete the endurance test. The element showed no signs of distress other than slight flattening induced by twisting.

After 3634 hours the outflow from the pump was reduced to approximately 30% of the original volume flow due to a split in the pumping element. This is likely to have been caused by twisting the pumping element when attempting to release the down-hole anchor for inspection after the third 1000 hour stage. A new pumping element was fitted and the endurance test was completed with the original down-hole anchor.

Breakdown Incidence

Breakdowns are shown in **bold type**.

Hours	1062	2112	3127	3644	4169
0					
Inspection and full performance test	Inspection and volume flow test	Inspection and volume flow test	Inspection and volume flow test	<b>Pumping element split</b>	Inspection and volume flow test
			<b>Pumping element seized in anchor. Anchor could not be released</b>		

Petro Pump

Details of the Endurance Test

Breakdowns are shown in bold type.

HOURS

1062 Inspection after 1st 1000 hours:

- a) Noticeable free play in all fulcrum points of pumpstand
- b) Pipe polished in region of guide
- c) Anchor slightly displaced - refitted in wellcasing
- d) Slight rust on cylinder anchor

2112 Inspection after 2nd 1000 hours:

- a) Slightly increased free play in pumpstand fulcrum points
- b) Pipe further polished in region of guide
- c) Noticeable corrosion on alloy end caps of pumping element

3127 Inspection after 2nd 1000 hours:

- a) **Pumping element anchor could not be released from above -- it was released for inspection from below but this would be impossible in the field. The thread at the top of the anchor had picked-up in the fitting at the bottom of the pumping element. The pumping element had been distorted by twisting in attempting to release the anchor. In consultation with the manufacturer, the test was continued with the original pumping element.**
- b) Slightly increased free play in pumpstand fulcrum points
- c) Ball valves marked by their seats

Estimated Additional Amount of water pumped to breakdown.....2.3 million litres

3644 **Pumping element split -- as a result of the damage sustained by twisting in trying to release to anchor for inspection after the 3rd 1000 hours -- replaced by the element from the second sample.**

Estimated Amount of water pumped to breakdown.....0.4 million litres

4169 Final Inspection:

1. Pumpstand Further free play in pumpstand fulcrum points; outer connecting links worn and could be disconnected on the upward stroke of the handle
2. Guide Worn but still serviceable
3. Pumping Element Replacement in good condition
4. Corrosion Slight corrosion on pumping element end fittings and rust spots on rising main where guide had rubbed through the zinc coating

Estimated Total Amount of Water Pumped in 4000 hours.....2.7 million litres

Strokes/min	<u>Volume Flow Test at 45 m (litres)</u>			<u>Leakage Tests</u>
	30	40	50	<u>at 7 m (ml/min)</u>
New	0.25	0.26	0.24	<0.1
After 1000 hours	0.24	0.24	0.24	<0.1
After 2000 hours	0.29	0.29	0.29	<0.1
After 3000 hours	0.30	0.30	0.30	<0.1
After 4000 hours	0.27	0.27	0.28	<0.1

Pump performance was not remeasured after endurance because the pumping element had been replaced.

8. ABUSE TESTS

8.1 Impact Tests

Undamaged in both handle and body tests.

8.2 Handle Shock Test

The pump completed the allotted 96,000 cycles without failure.



9. VERDICT

This Petro pump proved to be much more reliable than the sample tested in 1979/80 for the Overseas Development Administration. However, the results of this later test suggest that the anchor may not be suitable for unsupported uPVC well-casings and may also be difficult to dislodge for below-ground repairs. The method of attaching the pumping element to the anchor must be modified to prevent seizure.

The pumpstand may be suitable for manufacture in a developing country but the pumping element demands very specialised manufacturing skills.

Further work by CATR, carried out as a separate project, to investigate the effect of using the anchor in unsupported uPVC pipe has confirmed that this is inadvisable and that alternative arrangements should be made.

Funymaq

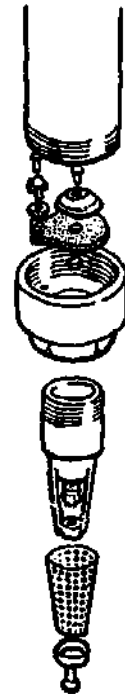
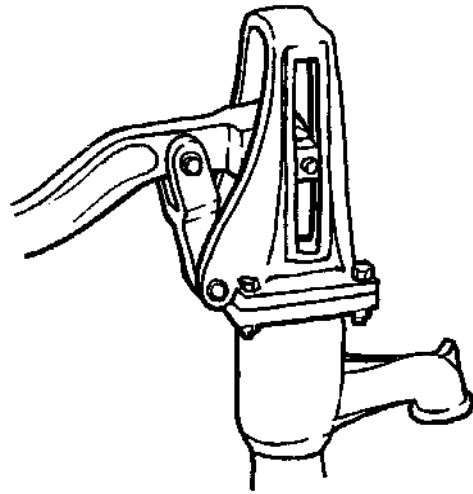
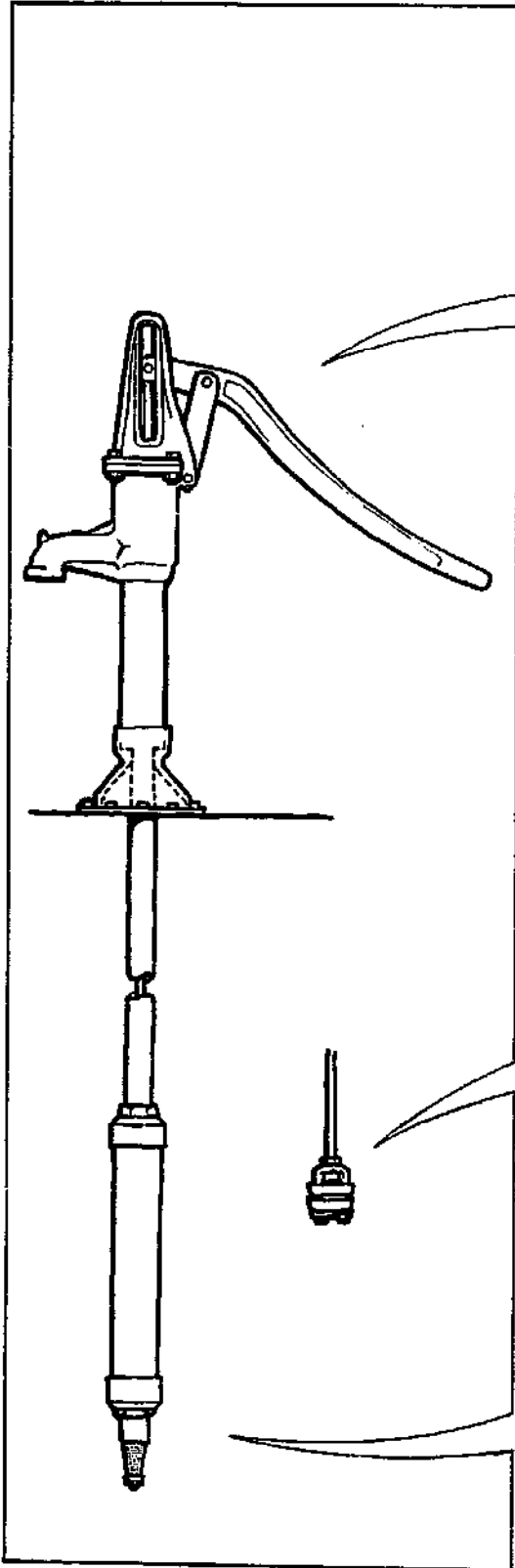

FUNYMAQ

1.1 Manufacturer

Funymaq, Honduras - supplied by the Georgia Institute of Technology

Address

Georgia Institute of Technology,  
Engineering Experimental Station,  
Atlanta,  
Georgia 30332,  
U.S.A.

1.2 Description

This pump is a derivative of a deep-well design from AID/Battelle for manufacture in developing countries. The pumps tested were made in Honduras. The pumpstand is mostly cast iron though the column is a length of steel tube threaded at each end. It features a crosshead mechanism to guide the top of the pump rod.

The cylinder design is conventional except that uPVC tube is used in place of the more usual seamless brass tube, with cast iron end caps. Two leather cup seals are used on the plunger. Two foot valves are fitted. The upper foot valve in the base of the cylinder is a simple flap of leather with a cast iron weight. The lower foot valve is a proprietary Simmons item.

Neither rising main nor pump rods were supplied with the pumps.

1.3 Price

Not supplied

2. INSPECTION

2.1 Packaging

The pumps were packed into an open-slatted wooden case and wired into position.

The pumpstand connecting rods were placed in the pump bodies and not secured. One fell through the bottom slats in transit and was bent. One handle was protruding from the side of the case.

The packing cases were strong, but their slatted construction made them unsatisfactory for export or for crude overland transportation. The cases should at least have solid bases.

2.2 Condition as Received

The pump tops would not fit the bodies - the holes were drilled in the wrong positions - and the holes in the pump cap did not provide sufficient room for the bolt heads. The handles were stiff to operate. One guide block was seized on its pin. The top section of one pump was not tight on the centre section.

One pump rod was bent in transit. Cast iron parts had not been flushed of casting sand. There was some evidence of porosity in some of the iron castings.

2.3 Installation and Maintenance Information

No literature was supplied with the pump.

3. WEIGHTS & MEASURES

3.1 Weights

Pump Stand:	51.0 kg (including handle)
Cylinder:	8.0 kg (including Simmons foot valve)

3.2 Dimensions

Nominal cylinder bore:	70 mm
Actual pump stroke:	190 mm
Nominal volume per stroke:	731 ml
Drop pipe size:	1.25 inch *
Pump rod diameter:	7/16 inch *
Outside dia. of below-ground assembly	105 mm
Maximum usable cylinder length:	320 mm

\* Not supplied but designed for these sizes.

It is interesting to note that there are significant differences between this pump and the Sumber Banyu although both pumps were derived from same design. In particular the castings of the Funymaq were a good deal heavier.

### 3.3. Cylinder Bore

No significant taper or ovality was found in either of the two samples.

The surface roughness average ( $R_a$ ) was measured in three places in a direction parallel to the cylinder axis.

SAMPLE	CYLINDER BORE	ROUGHNESS AVERAGE ( $\mu\text{m}$ )			
		TEST 1	TEST 2	TEST 3	MEAN
1	Extruded uPVC	1.5	1.7	1.4	1.5
2	Extruded uPVC	1.5	1.5	2.0	1.7

Measured at 2.5 mm cut-off

### 3.4 Ergonomic Measurements

HANDLE HEIGHT		PLATFORM HEIGHT (mm)	ANGULAR MOVEMENT OF HANDLE (degrees)	HANDLE LENGTH (mm)	VELOCITY RATIO OF HANDLE	HEIGHT OF SPOUT (mm)
MAX <sup>(1)</sup> (mm)	MIN <sup>(1)</sup> (mm)					
1310	280	0	90	730	5.8	470

(1) Measured without compressing any bump stops

## 4. ENGINEERING ASSESSMENT

### 4.1 Materials of Construction

COMPONENT	MATERIAL(S)
Pumpstand top	Cast iron
Pumpstand column and spout	2 iron castings, 1 steel pipe
Handle	Cast iron
Fulcrum link	Cast iron
Handle fulcrum bushes	Hardened steel )Approximately
Handle fulcrum pins	Hardened steel )50 Rockwell C
Connecting rod	Steel
Eye	Cast iron
Cylinder	PVC body with cast iron end caps
Plunger assembly	Cast gunmetal
Cup seal	Leather
Foot valve in cylinder	Cast iron with leather flap
Simmons foot valve	Cast gunmetal with rubber seal

#### 4.2 Manufacturing Techniques

The techniques required to manufacture the pump are listed below:

Above-Ground Assembly	Iron foundry Simple machining
--------------------------	----------------------------------

Basic skills in iron foundry and machining are required, but careful quality control is essential to ensure smooth operation of the handle assembly and interchangeability of parts for maintenance or repair. It is essential that the handle fulcrum pins and bushes are hardened. The pumpstand would be suitable for manufacture in developing countries with the appropriate skills, provided that the necessary quality control could be assured.

Below-ground Assembly	Iron and gunmetal foundry Simple machining Leatherwork
--------------------------	--

Basic skills in foundry work and machining are required. The cylinder would be suitable for manufacture in many developing countries.

#### 4.3 Ease of Installation, Maintenance and Repair

##### 4.3.1 Ease of Installation



The Funymaq requires a substantial complement of tools and equipment and a good deal of skill or experience to install it. Lifting tackle would not be required if plastic piping main could be used.

##### 4.3.2 Ease of Pumpstand Maintenance and Repair



The pumpstand is likely to require frequent lubrication of the handle and fulcrum link pivots. Eventually these components will need to be replaced but most tasks are easy, requiring only spanners and pliers, though a drift and hammer may be needed to remove the pivot pins.

If our samples were representative of normal production then replacement parts may not be interchangeable with original components, possibly making on-site repair impossible.

#### 4.3.3 Ease of Below-ground Maintenance and Repair



The cylinder is likely to require frequent attention to the leather footvalve and possibly to consequent damage to the cylinder or breakages of the pump rod. Below-ground repairs require removal of the complete below-ground assembly.

#### 4.4 Resistance to Contamination and Abuse

##### 4.4.1 Resistance to Contamination

The spout should be modified to prevent possible faecal contamination. The pump is sealed against surface water but could be contaminated through the connecting rod hole. The connecting rod is a poor fit in the pump top.

##### 4.4.2 Likely Resistance to Abuse

The split pins are easy to remove and there are no locking fixings. Otherwise the pumpstand is generally robust.

#### 4.5 Potential Safety Hazards

There are a number of potential finger traps around the handle fulcrum mechanism and the guide blocks.

#### 4.6 Suggested Design Improvements

A handle in a more resilient material than cast iron, such as steel or wood, where available, would be easier to repair.

The flanges on the pumpstand body and pumpstand cap should be enlarged to allow sufficient clearance for the heads of the fixings.

The check valve in the base of the cylinder should be omitted, or its quality should be improved and the proprietary foot valve omitted.

The spout should be vented or scalloped to prevent faecal contamination.

It is recommended that the design of the handle fulcrum be simplified and the crosshead mechanism eliminated.

## 5. PUMP PERFORMANCE

### 5.1 Volume Flow, Work Input and Efficiency

The description of the method can be found in the Test Procedure.

HEAD	7 m			25 m			45m		
Pumping Rate (strokes/min)	29	38	51	20	29	37	21	30	37
Vol/stroke (litres)	0.69	0.70	0.70	0.69	0.69	0.69	0.68	0.69	0.68
Work input/stroke (J)	125	134	134	261	277	304	404	459	468
Efficiency (%)	37	35	35	64	61	55	74	66	64

### 5.2 Leakage Tests

The measured leakage from the foot valves was not significant, i.e. less than 0.1 ml/min, at 7, 25 and 45 metre heads.

## 6. USER TRIAL

Details of the organisation of this trial can be found in the Test Procedure.

Most users seemed to operate the pump without difficulty. Many muscle groups could be called into play without exaggerated body movements.

## 7. ENDURANCE

A detailed description of the endurance test method can be found in the Test Procedure.

### General Comments

The pump was tested at 40 strokes/minute at a simulated depth of 30 m.

The Funymaq pump proved to be much more durable than the Sumber Banyu pump tested in 1981/82, although both pumps were derived from the same design. In particular the handle pivots which had caused so much trouble in the Sumber Banyu pump endured throughout the test on the Funymaq. However, like the Sumber Banyu, the flap type leather foot valve broke away, in this case after 3127 hours. The pump continued to work because the Simmons foot valve supported the column of water, but the broken parts of the foot valve became entangled in the plunger, bent the pump rod and caused severe damage to the cylinder bore. It is strongly recommended that the flap type valve in the base of the cylinder should be omitted, or its quality should be much improved and the proprietary foot valve omitted.



Breakdown Incidence

Breakdowns are shown in bold type.

Hours:	1062	2112	3127	4169
0				
Inspection and full performance test	Inspection and volume flow	Inspection and volume flow	Inspection and volume flow	Inspection and full performance test
			<b>Foot valve flap broken away, pump rod bent, severe damage to cylinder bore</b>	

Details of the Endurance Test

Breakdowns are shown in bold type.

HOURS

1062 Inspection after 1st 1000 hour stage:

- a) Slight wear in handle bearings and guide blocks
- b) Spots of rust on cylinder end caps and plunger rod
- c) Upper, leather foot valve appeared to be no longer functional and had been deformed into a constant, open position

2112 Inspection after 2nd 1000 hours:

- a) Slight increase in wear in handle bearings and guide blocks
- b) Larger spots of rust on cylinder end caps and considerable corrosion on plunger rod
- c) Upper, leather foot valve redundant

HOURS

3127 Inspection after 3rd 1000 hours:

- a) Severe damage to cylinder bore caused by parts of leather foot valve which had broken away and become entangled in the plunger. The plunger rod had bent and the cylinder bore was deeply scored as a result. The cylinder assembly was replaced by the second sample.
- b) Slight increase in wear in handle bearings and guide blocks
- c) Further corrosion of cylinder end caps and plunger rod

Estimated Amount of water pumped to breakdown.....4.4 million litres

4169 Final Inspection

- 1 Cylinder Replacement cylinder in good condition
- 2 Bearings Considerable wear in handle bearings and guide blocks but all still servicable
- 3 Pumpstand Hole in pumpstand top enlarged by connecting rod
- 4 Corrosion Considerable corrosion of cylinder end caps and plunger rod, latter particularly around joint with plunger body

Estimated Total Amount of Water Pumped in 4000 hours.....6.7 million litres

Strokes/min	<u>Volume Flow Tests at 25 m (litres)</u>			<u>Leakage Tests</u>
	30	40	50	<u>at 7 m (ml/min)</u>
New	0.69	0.69	0.69	<0.1
After 1000 hours	0.68	0.68	0.68	<0.1
After 2000 hours	0.66	0.68	0.66	0.2
After 3000 hours	0.54	0.59	0.61	<0.1
After 4000 hours	0.70	0.70	0.70	<0.1

The performance test was not repeated after the endurance test because the cylinder had been replaced. The results would therefore not have been comparable with the original performance data.

8. ABUSE TESTS

8.1 Side Impact Tests

Undamaged in both tests: body tended to turn on thread at joint with pumpstand column in handle test.

## 8.2 Handle Shock Test

After 89,000 cycles, the top of the pumpstand had worked loose on its thread at the connection with the column, resulting in a leak. The thread was easily tightened and the pump remained in working order.

## 9. VERDICT

Different results were obtained for this Funymaq pump from Honduras than for the similar Sumber Banyu pump from Indonesia, although both pumps were derived from the same AID/Battelle design. In particular, the hardened handle fulcrum pins and bushes endured throughout the test, and the lift of the plunger valve and its location were better.

The leather foot valve is worse than redundant because it can break away and damage the plunger while the lower foot valve continues to support the column of water in the rising main. The damage is therefore worse than it would be if only one foot valve were fitted.

It is potentially suitable for community water supply, and for manufacture in developing countries with established iron foundry skills and effective quality control.

Maidev

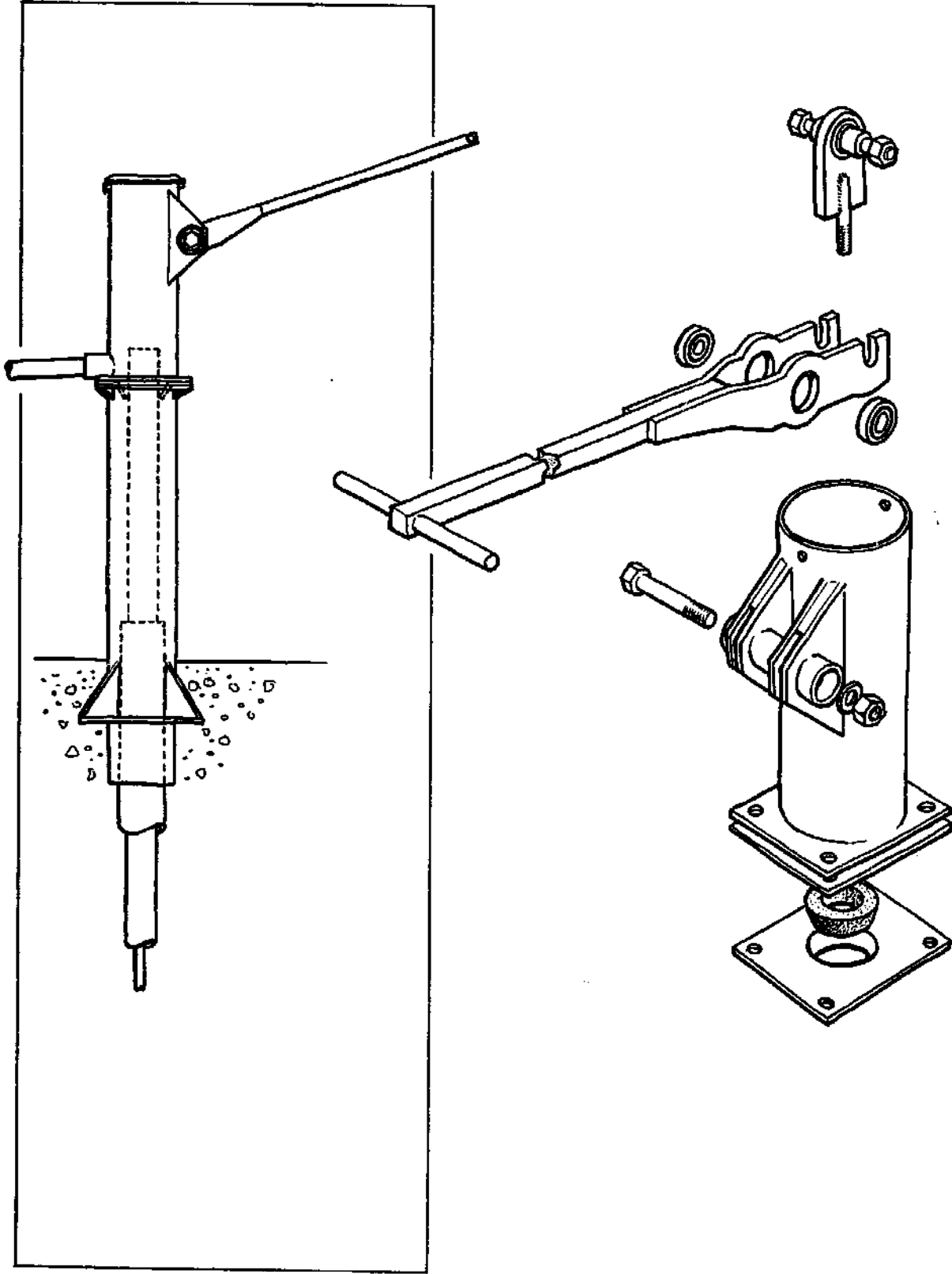

MALDEV

- 1.1 Manufacturer Petroleum Services (Malawi) Ltd.
- Address Box 1900,  
Blantyre,  
Malawi.
- 1.2 Description At present, the Maldev consists of an above-ground assembly only. The pump was tested with a prototype below-ground assembly designed by Ken McLeod and later with a Funymaq cylinder assembly.
- The Maldev pump head was designed and made in Malawi, initially with ODA assistance, for use with conventional reciprocating deep-set cylinders. It is fabricated from steel sections and the pedestal is intended to be concreted-in at the well head. The height and dimensions of the mounting flange are identical to the India Mk II pump. The handle bearings are sealed ball races. It is designed to allow a 2.5 inch diameter plunger to be extracted without the need to dismantle the pumpstand. The handle is offered in various lengths to compensate for operating depth and cylinder size.
- 1.3 Price Not known - Sample supplied by Department of Lands, Valuation & Water, Lilongwe, Malawi
2. INSPECTION
- 2.1 Packaging The pump heads were fixed into one wooden case which was then filled with cotton waste. The mounting flanges were loose in the case. The pedestal was packed in another case.
- The packaging was considered very suitable for export and for crude overland transportation.
- 2.2 Condition as Received Slight distortion on the flanges of one pumphead unit. Paint was peeling off the other sample.
- 2.3 Installation and Maintenance Information None supplied with the pump. However the techniques of installation and maintenance had been demonstrated to CATR personnel by DLVW staff in Malawi.

3. WEIGHTS and MEASURES

3.1 Weights Pumpstand complete: 51.1 kg

3.2 Dimensions Not applicable

3.3 Cylinder Bore Not applicable

3.4 Ergonomic Measurements

HANDLE HEIGHT		PLATFORM HEIGHT (mm)	ANGULAR MOVEMENT OF HANDLE (degrees)	HANDLE LENGTH (mm)	VELOCITY RATIO OF HANDLE	HEIGHT OF SPOUT (mm)
MAX (1) (mm)	MIN (1) (mm)					
Prototype sample						
1500	605	0	75	745	5.0	670
Production sample						
1550	600	0	89	650	5.5	670

(1) Measured without compressing any bump stops

4. ENGINEERING ASSESSMENT

4.1 Materials of Construction

COMPONENT	MATERIAL(S)
Upper body and cap	Steel tube and plate
Handle	Steel bar and plate
Bearings	Sealed ball races
Hanger	Steel
Pedestal	Steel tube and plate

4.2 Manufacturing Techniques

The manufacturing techniques required to make the pump are listed below:

- Simple but heavy steel fabrication
- Skilled welding
- Simple turning, drilling and threading

The Maldev has been designed for manufacture in a developing country. Both the fabrication and machining are straightforward, and no specialised processes are required. However, considerable skill in welding is demanded, and careful quality control is essential. It is suitable for manufacture in developing countries, but potential manufacturers must be carefully selected.

### 4.3 Ease of Installation and Maintenance

#### 4.3.1 Ease of Installation



Installation of the pumpstand is generally straight-forward. Lifting tackle will also be required to cope with the weight of the below-ground assembly unless plastic rising main is used. The pedestal is concreted in at the wellhead around the well casing and the top of the pumpstand assembly can be installed with the handle pre-assembled. Some care is needed to ensure a satisfactory water-tight joint between the rising main and the pumpstand, but otherwise assembly is straight-forward and requires only basic skills.

#### 4.3.2 Ease of Pumpstand Maintenance and Repair



The pumpstand is generally robust and unlikely to require frequent maintenance, however more frequent attention may need to be given to the joint between the rising main and the pumpstand to keep it watertight.

### 4.4 Resistance to Contamination and Abuse

#### 4.4.1 Resistance to Contamination

Very good. The pumpstand is normally installed with a 3 m long delivery pipe to minimise the possibility of spilled water contaminating the wellhead.

#### 4.4.2 Likely Resistance to Abuse

The pumpstand is generally very robust. The T-handle is intended to prevent users applying side forces to the handle bearings.

### 4.5 Potential Safety Hazards

None

#### 4.6 Suggested Design Improvements

The outlet pipe socket should be placed a little higher on the body of the pump to avoid the need to cut the joint flange. A small triangular strut may help to control the angle of the outlet pipe.

To avoid the potential manufacturing problems of alignment of the four handle flange plates, two thicker plates may be sufficiently strong and would be easier to align in manufacture.

If two rather than four handle flange plates are used, the handle bearing ball races might be replaced by bushes of a suitable engineering plastic.

A welded nut should replace the threaded hole to retain the top cap, and the bolt should be the same size as those used for the flange fixings.

Anaerobic adhesive (e.g. Loctite Bearing Fit) should be considered to retain the handle bearings, to eliminate fitting problems if ball races are used.

The hanger should be designed to remove the potential tolerance problem arising out of variable thickness of the bearing retaining nuts. On one side of the bearing at least, a machined shoulder could be provided on the pin.

See illustration, right:

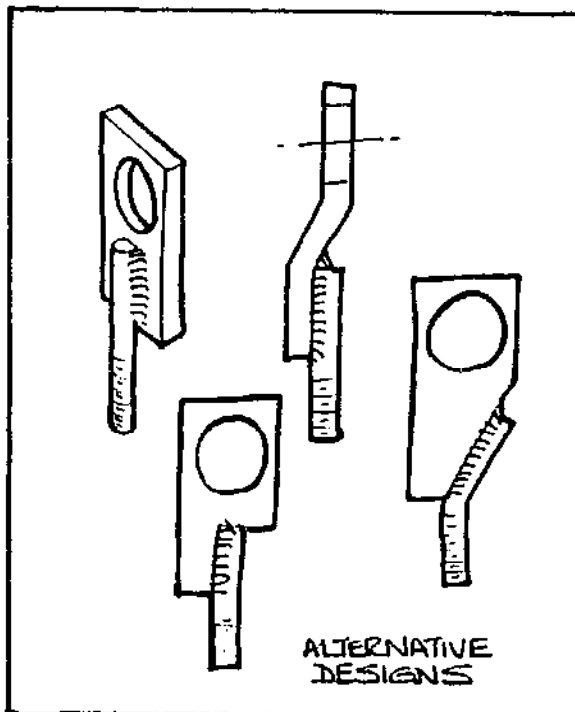
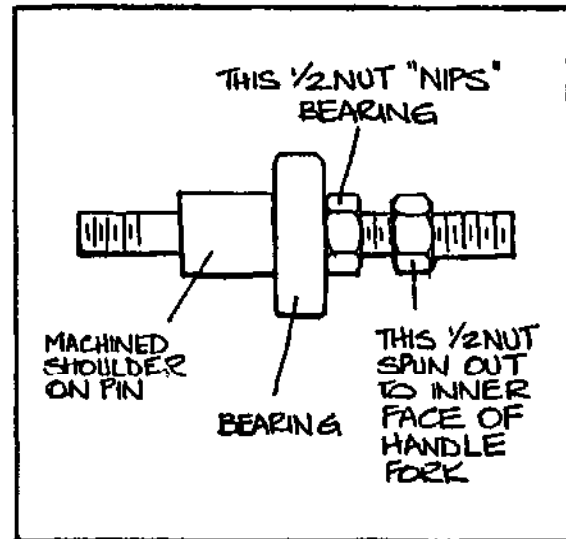

The hanger need not be rounded off at the top and could be designed to eliminate the need for the central slot. See illustration, left.

To reduce, and potentially to eliminate, distortion of the flange plate, it should be cut as a square, with the corners trimmed to avoid any safety hazard. The existing fixing hole centres could be retained.



5. PUMP PERFORMANCE

5.1 Volume Flow, Work Input and Efficiency

The description of the method can be found in the Test Procedure.

HEAD	7 m			25 m			45m			
Pumping Rate (strokes/min)	29	41	48	20	30	37	20	30	37	45
Vol/stroke (litres)	0.47	0.48	0.48	0.52	0.51	0.52	0.46	0.51	0.50	0.48
Work input/stroke (J)	53	55	59	179	185	193	253	271	268	273
Efficiency (%)	60	59	55	70	67	66	80	82	82	76

These results were obtained from the prototype head with an experimental 'McLeod' type cylinder as the below-ground assembly.

6. USER TRIAL

Details of the organisation of this trial can be found in the Test Procedure.

The pump was generally well-liked by users. All users stood behind the pump and grasped the T-handle with one hand on each side. Some children and small women found the handle rather too high; to achieve a full stroke, small users had to change their action, from pull to push, in mid-stroke.

7. ENDURANCE

General Comments on the Pump Head

The pump was tested at 40 strokes per minute at a simulated head of 30 metres.

Several problems were encountered with the original seal between the rising main and the pumpstand. After 2188 hours the rising main was not secure in the pumpstand and slipped through the seal on each upstroke of the cylinder. It was re-tightened but thereafter persistent leaks occurred until the seal was replaced by the later type now supplied with the pump. Even then a persistent slight leak remained between the rising main and the pumpstand until the end of the test.

The original endurance test sample was not representative of current production. One of the handle bearings broke up during the first 1000 hours. Subsequent examination revealed that the ball race had been damaged while being hammered into its housing. The endurance test was therefore restarted using a newer pumpstand, to which the comments in this report refer exclusively. This sample was tested using a Funymaq cylinder as the below-ground part.

Breakdown Incidence

Breakdowns are shown in bold type.

Hours:	1021	2096	2188	2409	3131	4137
0				2426		
				2918		
	Inspection	Inspection			Inspection	Inspection
			<b>Rising main not secure in pumpstand</b>			
				<b>Leaking around rising main inside pumpstand</b>		

Details of the Endurance Test

Breakdowns are shown in bold type.

HOURS

1021 Inspection after 1st 1000 hours:

- a) Leaking joint between rising main and pumpstand due to distortion of the joint flanges -- sealed by flexible gasket compound
- b) No significant corrosion

2096 Inspection after 2nd 1000 hours:

- a) Slight leak at joint between rising main and pumpstand
- b) No significant corrosion

**2188 Rising main not secure in pumpstand -- the grip of the sealing collar on the rising main was insufficient to resist the upward frictional force of the plunger seal on the upstroke: as a result the entire rising main and head simulation valve rose on each stroke. The sealing collar was replaced.**

Estimated Amount of water pumped to breakdown.....2.6 million litres

- 2409 ) Continuing leaks around sealing collar between rising main and
- 2426 ) pumpstand.
- 2918 )

Estimated Additional Amount of water pumped to breakdown....0.3 million litres

3131 Inspection after 3rd 1000 hours:

- a) Slight leak at joint between rising main and pumpstand
- b) Slight free play in handle bearings
- c) No significant corrosion

4137 Final Inspection

- 1. Joint            Slight leak at joint between rising main and pumpstand
- 2. Bearings        Considerable free play in handle bearings
- 3. Corrosion       No significant corrosion

Estimated Total Amount of Water Pumped in 4000 hours.....5.0 million litres

## 8. ABUSE TESTS

### 8.1 Side Impact Tests

Undamaged in both handle and body tests.

### 8.2 Handle Shock Tests

The pump completed the allotted 96,000 cycles without failure.

## 9. VERDICT

A robust pumpstand but still requiring some development of the method of fixing the rising main, clearly designed to use appropriate manufacturing skills with VLOM in mind. Although capital-intensive manufacturing facilities are not necessary, strict quality control is essential to achieve a reliable product.

There is scope for reductions of both cost and difficulty of manufacture by using plastic plain bearings rather than ball races in the handle and hanger.

Polyacetal bearings have therefore been made for both these applications and field trials are in progress. Good preliminary results have been received and further samples have been installed on heavy usage pumps to gain further experience.

Once the principle has been thoroughly tested out successfully, changes can be made to the design which will simplify the manufacture, and reduce the cost of this head.

Rower

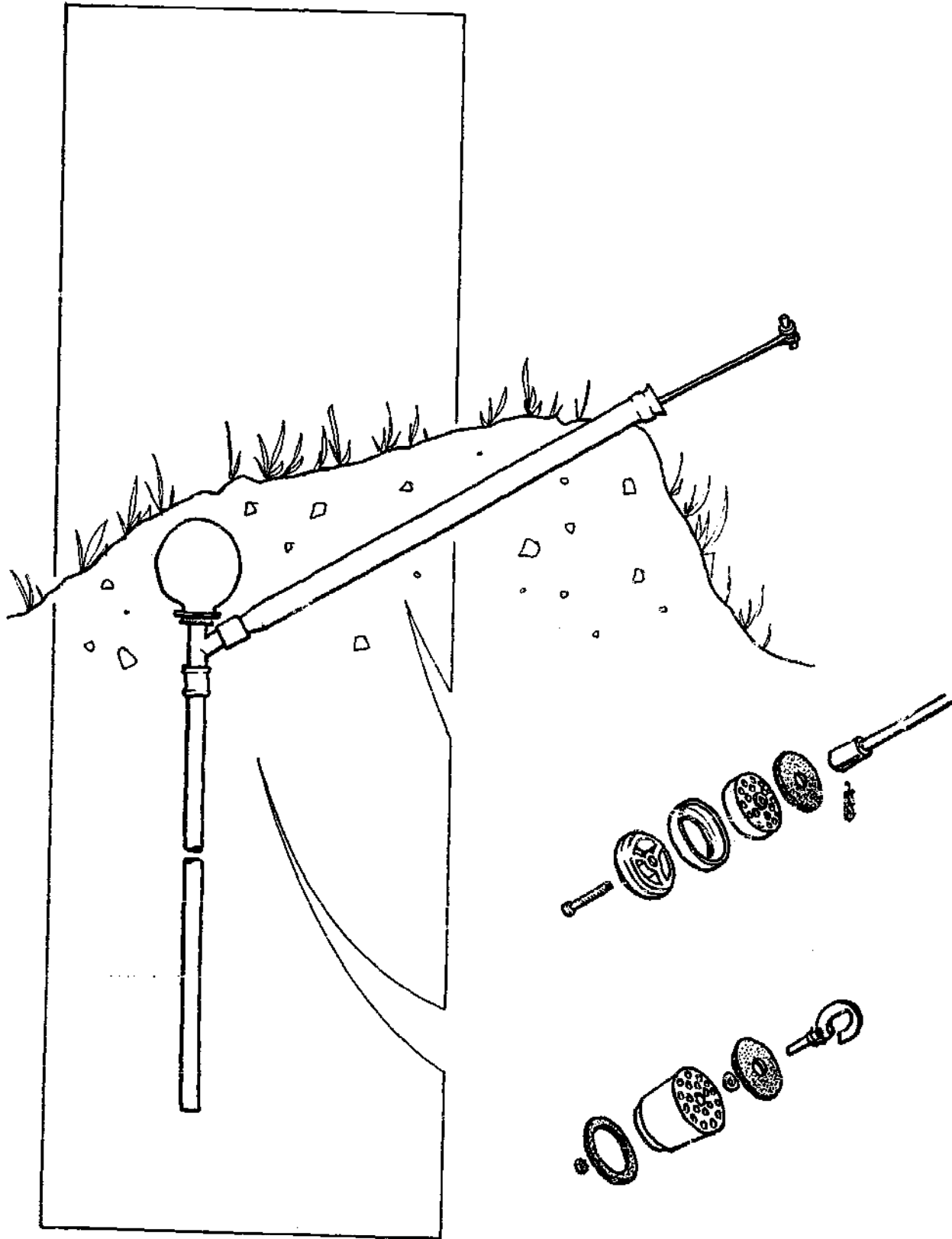

ROWER

- 1.1 Manufacturer Mirpur Agricultural Workshop Training School
- Address c/o The World Bank,  
222 New Eskaton Road  
PO Box 97,  
DHAKA,  
Bangladesh.
- 1.2 Description The Rower pump is a high capacity low-lift pump designed for irrigation, made in Bangladesh. The pump is fitted with a surge chamber. The cylinder is a simple length of extruded uPVC tube with heat swaged ends. The operator pulls directly on the plunger rod by means of a T-handle. The plunger is fitted with a single leather cup washer and simple rubber flap valves cut from tyre inner tubes are used for both the plunger valve and check valve.
- The pump is normally embedded in earth for support and protection, as shown, or alternatively may be supported by a smaller earth bank and protected by strips of bamboo bound around the cylinder. It is usually operated in a seated position.
- 1.3 PRICE \$13.50, local price in Bangladesh.
2. INSPECTION
- 2.1 Packaging The pumps were packed in a hessian sack and cardboard box. The two pump units were tied together with spare parts inside the pump cylinder. The surge chamber was packed in a cardboard box.
- The samples were delivered by hand, and we cannot therefore comment on the suitability of packaging for export and for crude overland transportation.
- 2.2 Condition as Received Both pumps were received in good working order.
- 2.3 Installation & Maintenance Information Engineering drawings were supplied with the test samples: these were useful but not suitable as an alternative to an installation and maintenance manual.

3. WEIGHTS & MEASURES

3.1 Weights Pumpstand complete : 3.5 kg

3.2 Dimensions

Nominal cylinder bore: 54 mm  
 Actual pump stroke (max): 980 mm  
 Nominal volume per stroke: 2.24 litres  
 Drop pipe size: 1.5 inch

Maximum outside diameter of below-ground assembly: 59 mm

3.3 Cylinder Bore No significant taper or ovality was found in either of the two samples.

The surface roughness average ( $R_a$ ) was measured in three places in a direction parallel to the cylinder axis.

SAMPLE	CYLINDER BORE	ROUGHNESS AVERAGE ( $\mu\text{m}$ )			
		TEST 1	TEST 2	TEST 3	MEAN
1	Extruded uPVC	0.55	0.50	0.60	0.55
2	Extruded uPVC	0.60	0.55	0.60	0.58

Measured at 0.25mm cut-off

3.4 Ergonomic Measurements

HANDLE HEIGHT		ANGULAR MOVEMENT OF HANDLE (deg)	HEIGHT OF SPOUT (mm)
MAX <sup>(1)</sup> (mm)	MIN <sup>(1)</sup> (mm)		
1225	840	0	790

(1) Measured without compressing any bump stops

The pump is normally buried in an earth mound to provide support and protection.

4. ENGINEERING ASSESSMENT

4.1 Materials of Construction

COMPONENT	MATERIAL(S)
Handle	Fabricated steel with injection moulded plastic spacers.
Angled Connector	Galvanised steel pipe
Cylinder	uPVC water pipe with heat-swaged ends
Plunger assembly	Aluminium with rubber valve
Cup Seal	Leather
Check valve	Moulded polyethylene with rubber valve flap
Surge chamber	Aluminium

4.2 Manufacturing Techniques

The techniques required to manufacture the pump are listed below:

- Steel cutting and welding
- Simple machining
- Plastics moulding
- Sheet leather and rubber work
- Manipulation of uPVC tube
- Spinning (of aluminium)

The Rower pump has been designed for manufacture in a developing country. Most of the components are easy to make, though some skill is required in heat forming uPVC tube. Care is needed in machining, and spinning the surge chamber is a skilled process.

4.3 Ease of Installation, Maintenance and Repair

4.3.1 Ease of Installation



The Rower pump should be easy to install, particularly if plastic pipe is used. The most important tool may well be a spade or shovel to construct the earth bank. Care must be taken to achieve airtight joints in the drop pipe as any leaks will significantly affect the efficiency of the pump.

#### 4.3.2 Ease of Maintenance and Repair



Pumpstand maintenance is very straightforward and will require only the simplest hand tools.

#### 4.4 Resistance to Contamination and Abuse

##### 4.4.1 Resistance to Contamination

The position of the outlet and the need to prime the pump make the Rower particularly susceptible to contamination. It is not recommended as a pump for drinking water supply.

##### 4.4.2 Likely Resistance to Abuse

Buried in an earth bank the pump cylinder is well protected from accidental damage. The pump rod might be easily bent but would be easy to straighten also.

#### 4.5 Potential Safety Hazards

None

#### 4.6 Suggested Design Improvements

A standard 30° branch connector could replace the fabricated component between the pump and rising main.

In cutting valve discs from old inner tubes, care should be taken to avoid the joint lines. On the reverse side of the joint line, the rubber is distorted out of flat which may reduce the efficiency of the valve.

The metal parts of the plunger should be in direct contact to control the compression of the leather. Adding a spigot to the upper of the two aluminium parts would achieve this and also prevent incorrect assembly.

Any rigid ready-made container of appropriate size could be used in place of the aluminium surge chamber. Alternatively, a second length of uPVC pipe could be used but blocked off at the top. This avoids the use of a skilled manufacturing process.



5. PUMP PERFORMANCE

5.1 Volume Flow, Work Input and Efficiency

The description of the method can be found in the Test Procedure.

Results - with surge chamber

HEAD	7 m		
Pumping Rate (strokes/min)	11	15	19
Vol/stroke (litres)	1.63	1.80	1.72
Work input/stroke (J)	168	192	180
Efficiency (%)	66	64	65

Results - without Surge Chamber

HEAD	7 m		
Pumping Rate (strokes/min)	11	14	19
Vol/stroke (litres)	1.62	1.70	1.72
Work input/stroke (J)	179	194	210
Efficiency (%)	62	59	56

5.2 Leakage Tests

HEAD (m)	VOLUME (ml) in 5 min.	LEAKAGE RATE (ml) per minute
7	34	6.8

The endurance test later showed that leakage in the joints of the drop pipe had contributed to this.

6. USER TRIAL

Details of the organisation of this trial can be found in the Test Procedure.

Once instructed in the appropriate method of operation, only small children found the pump difficult to use: the height and angle of the handle made it difficult for them to apply a straight pull with sufficient force. The lack of an upper stop caused problems - some stronger, larger users pulled the plunger right out of the cylinder. Everyone liked the very high rate of delivery, though some objected to getting wet when water spurted out of the pump at the start of the return stroke.

7. ENDURANCE

General Comments

The pump was tested at 19 strokes/minute at a suction head of 7 metres.

The Rower completed the full endurance test without failure. In the early stages of the test however, the pump seemed to lose its prime more rapidly than had been indicated by the leakage test on the check valve, sometimes within a few minutes. A contributory cause was found to be air leaking into joints in the drop pipe, emphasising the need to ensure airtight joints on installation.

At the end of the test the plunger and check valve remained in good condition. The cylinder bore was worn and there was a 2 mm step in the bore at the top of the swept area. The volume delivered per stroke was somewhat lower than in the original performance test but still remained well over 1 litre.

Breakdown Incidence

Hours:	1062	2112	3127	4169
0				
Inspection and full performance test	Inspection and volume flow	Inspection and volume flow	Inspection and volume flow	Inspection and final performance test

No breakdowns occurred.

Details of the Endurance Test

HOURS

1062 Inspection after 1st 1000 hours:

- a) Check valve in poor condition - rubber valve flap loose on centre spindle - new check valve fitted
- b) Leaking joint between top of drop pipe and surge chamber - sealed
- c) No significant corrosion

2112 Inspection after 2nd 1000 hours:

- a) Some joints in drop pipe found to leak, which would have contributed to the apparent leakage from the check valve observed in earlier tests. Threaded joints were replaced by solvent cemented joints.
- b) Some rust on plunger rod

3127 Inspection after 3rd 1000 hour stage:

- a) Cylinder bore locally scratched, polished elsewhere
- b) Further rust on plunger rod

4169 Final Inspection

- 1 Footvalve In good condition
- 2 Plunger Valve and seal in good condition, but part of the plunger body had scored the cylinder bore
- 3 Cylinder Worn on the lower side, with a step between the used and unused areas of approximately 2 mm
- 4 Corrosion Surface rust on check valve and plunger body fixings; slight pitting of plunger rod; all parts still serviceable

Note

If the pump had been operated in the field for a similar period, it is likely that wear of the plunger rod and of the steel reinforcing ring at the mouth of the cylinder body would be apparent. (We were informed that the manufacturer has subsequently replaced the steel reinforcing ring with a flared steel tubular insert.)

Estimated Total Amount of Water Pumped in 4000 hours.....7.1 million litres

Strokes/min	<u>Volume Flow Tests at 7 m (litres)</u>			<u>Leakage Tests at 7 m (ml/min)</u>
	10	20	30	
New	1.63	1.72	-	6.8
After 1000 hours	1.63	1.47	1.54	14.5 *
After 2000 hours	1.38	1.45	1.32	33 *
After 3000 hours	1.27	1.32	1.52	8.5
After 4000 hours	1.27	1.47	-	2.6

\* Part of this leakage was later found to be due to leaky joints in the rising main.

Pump Performance after Endurance

HEAD	7 m		
Pumping Rate (strokes/min)	11	15	20
Vol/stroke (litres)	1.27	1.29	1.47
Work input/stroke (J)	201	203	213
Efficiency (%)	43	43	47

NB. Tested with surge chamber - not re-tested without the surge chamber because the earlier test had shown that the pump was more efficient when the surge chamber was in operation.

Both volume flow and efficiency were reduced by 4000 hours of endurance testing, because of wear in the cylinder. However the pump continued to deliver a substantial volume of water per stroke.

8. ABUSE TESTS

8.1 Impact Tests

Not applicable

8.2 Handle Shock Test

Not applicable

9. VERDICT

A commendably simple pump, easy to install, maintain, and repair. A true VLOM pump, very suitable for low-lift irrigation, but not for drinking water because contamination is almost inevitable. Likely to wear, with consequent reduction in delivery, but all wearing parts are easy to replace.

Rower Pump

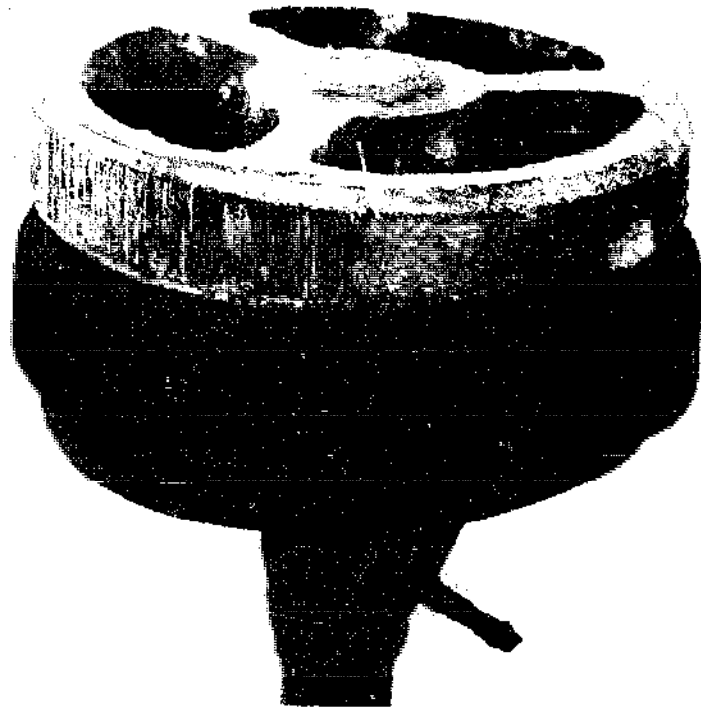

Plunger at end of endurance test

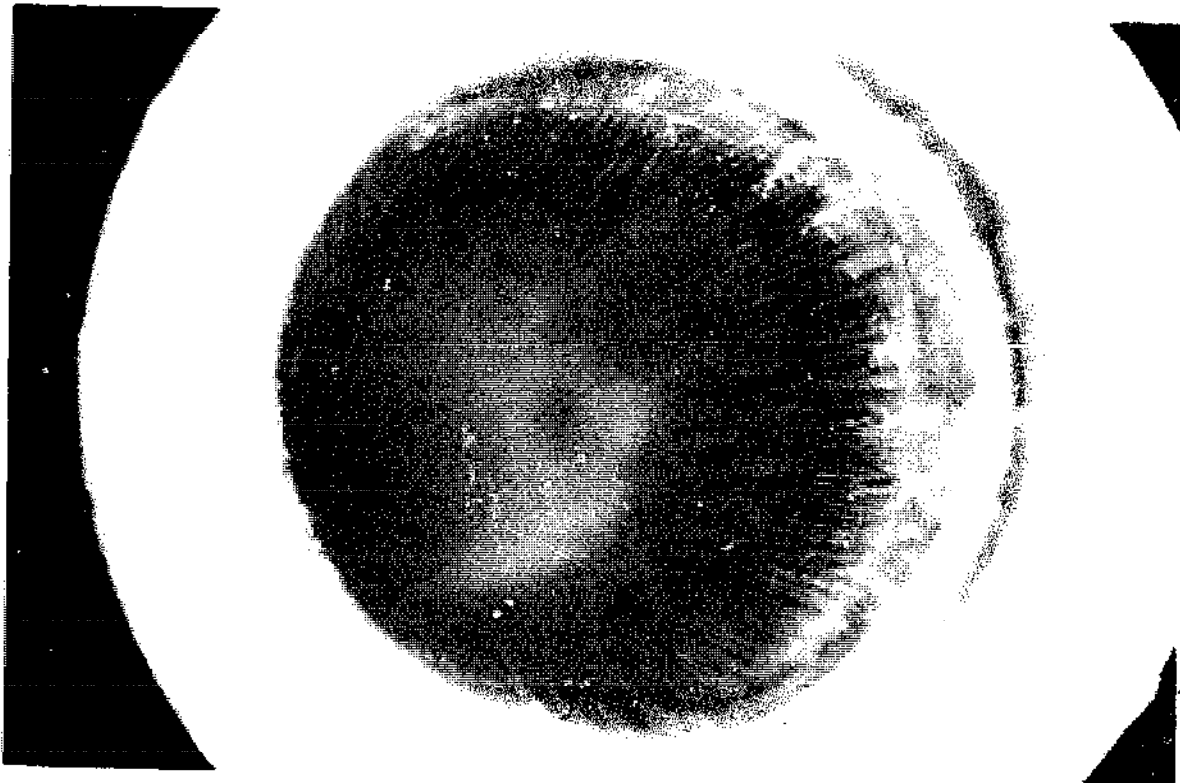

Cylinder bore at end of endurance test

Rower Pump

Volanta Pump (both types)

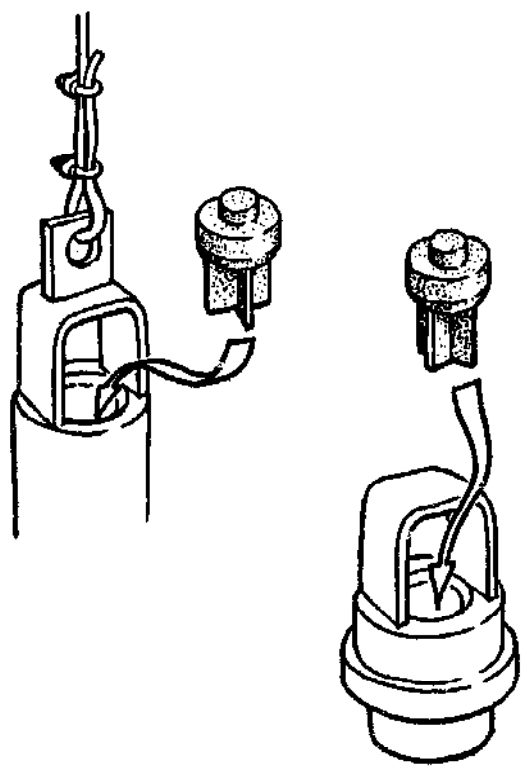
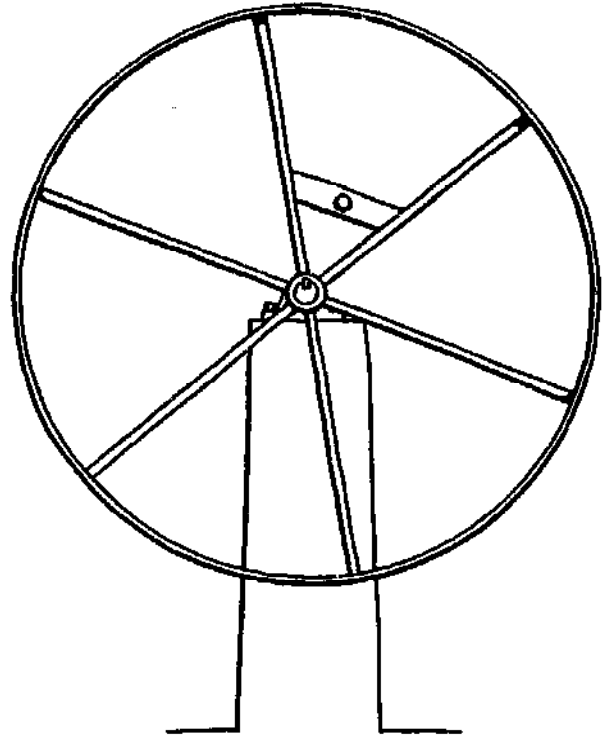
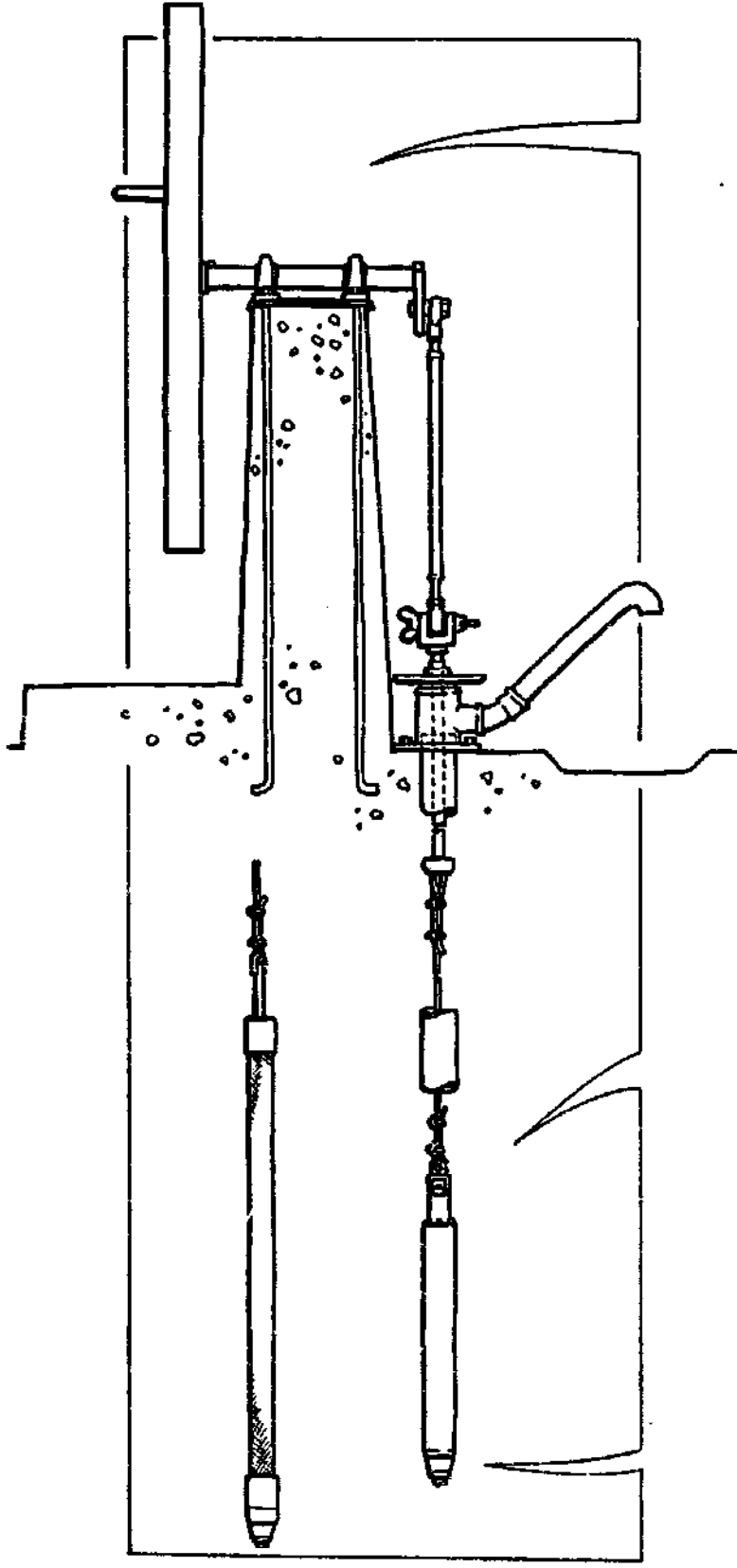

VOLANTA

1.1 Manufacturer Jansen Venneboer B.V.

Address Industrierweg 4,  
Postbus 12, 8130 AA Wijhe  
The Netherlands

1.2 Description The Volanta pump is made in Holland and in Upper Volta. It uses a heavy fly wheel to generate a conventional reciprocating action but in many other ways is unconventional.

Two types of cylinder were supplied; these are referred to hereafter as cylinder types 1 and 2. Type 1 had a machined nylon cylinder body and a stainless steel plunger, with a turned bronze sealing ring. Type 2 had a glass reinforced plastic cylinder body and a long, close-fitting stainless steel plunger, with no other seal.

Connection between the above- and below-ground parts was by cable in the samples supplied for testing, though the manufacturer now supplies steel rods. The complete cylinder is designed to be extractable from the well, using the connecting cable or rods, without the need to remove the uPVC rising main.

Above ground the pumpstand is unusually large. For testing, the pumps were supplied with supporting steel framework, but in field installations the crankshaft would be supported by a concrete pillar as shown, or by a fabricated steel box. The pump stroke is adjustable to compensate for operating depth.

1.3 Price \$845 ex works  
Complete for 20 m depth, lots of 50.

2. INSPECTION

2.1 Packaging The pumps were packed in one wooden case and three reinforced cardboard boxes, plus one bundle of pipes. The wooden case contained two pumpstands. Two of the boxes contained components for two pumps and the other box contained spare parts. The fly-wheels were bound together but not packaged.

Although the wooden case was satisfactory, the cardboard boxes were unsuitable for the amount of weight put in them, and the components were loose inside. Several components were broken or damaged. The packaging of the pipes was completely unsuitable, four of the six pipes bundled together were damaged in transit.

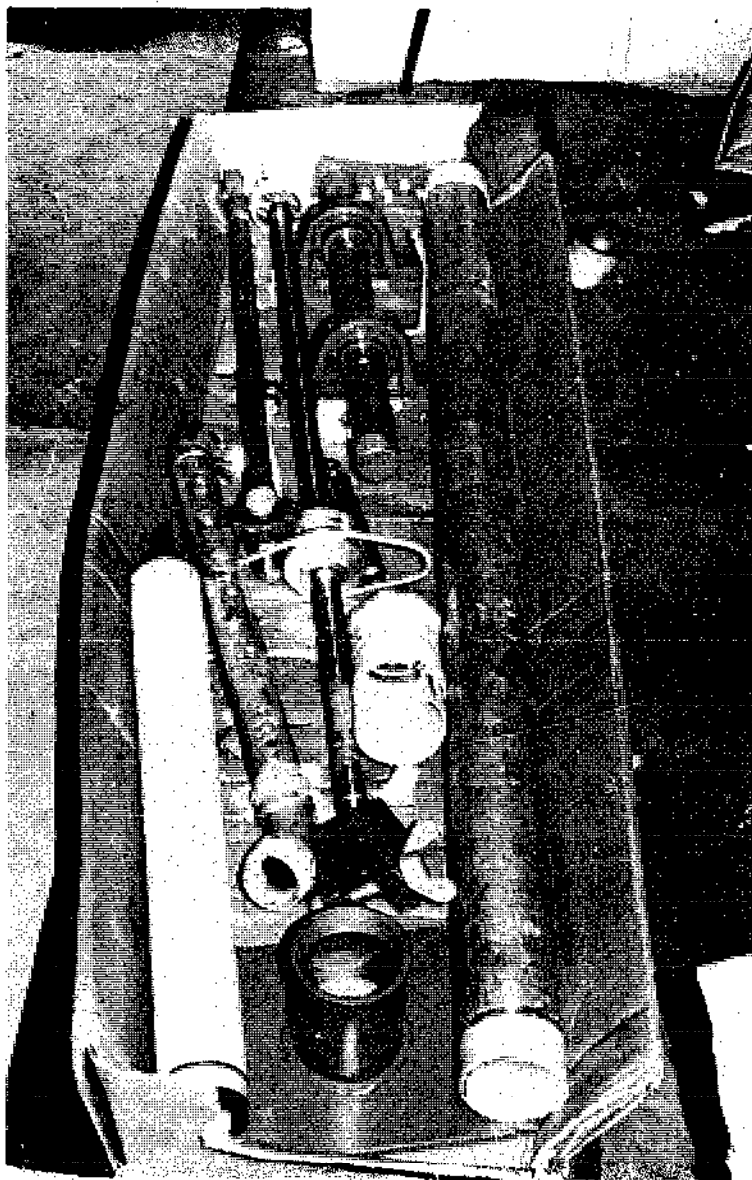

Inadequate Packaging in Cardboard Boxes



### Broken Pipes

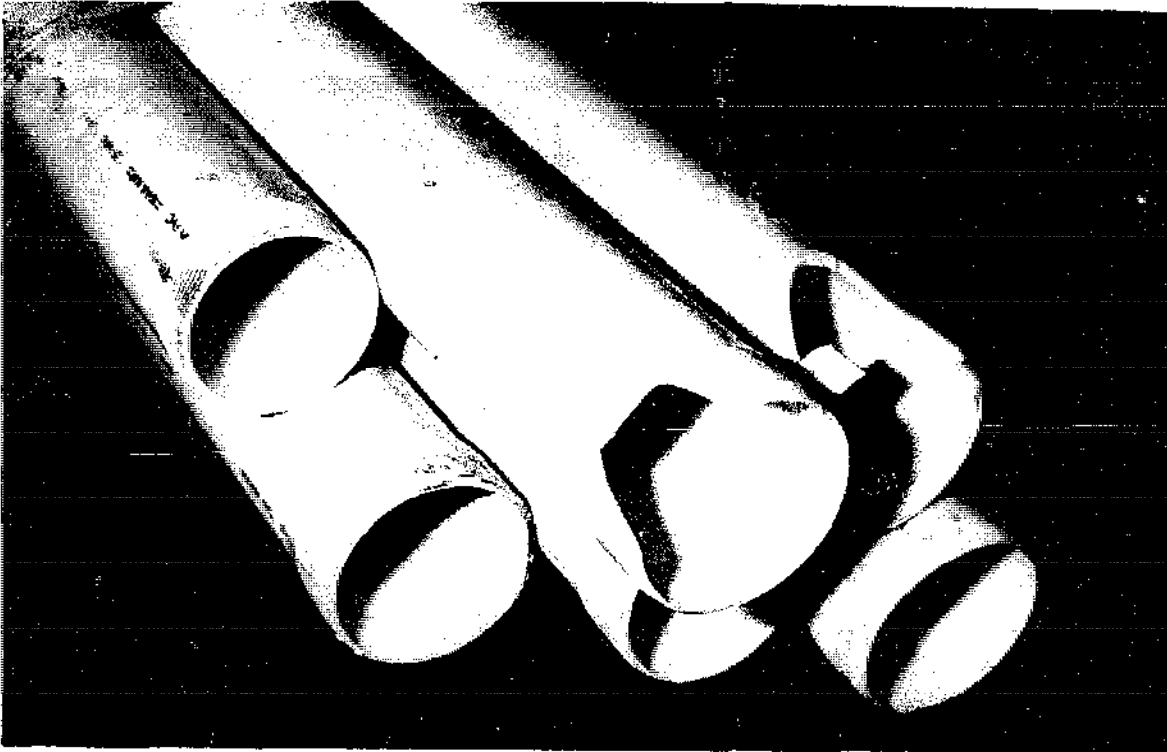

#### 2.2 Condition as Received

The centre bolts were missing from the pumpstand cross braces. One crank arm was bent in transit. One handle was bent. The standard of welding was poor on the flanges of the T-pieces of both samples. The galvanising was poor inside the spout units. Plastic parts of some pipe fittings were broken in transit and the ends on some pipe sections were also damaged.

#### 2.3 Installation and Maintenance Information

Installation and maintenance information was not supplied with the pumps, but a useful brochure and engineering drawings were provided under separate cover.

3. WEIGHTS & MEASURES

3.1 Weights

Pump stand : 76.5 kg  
Cylinder type 1: 9.4 kg  
Cylinder type 2: 10.0 kg  
Drop Pipe (per m): 1.7 kg

3.2 Dimensions

Nominal cylinder bore (both types): 50 mm  
Drop pipe size: 3.0 inch  
Outside diameter of below-ground  
assembly: 101 mm

The pump stroke, and therefore the nominal volume per stroke, are variable depending on depth. (See 5.1)

3.3 Cylinder

The plungers in both types of cylinder assembly were measured: no significant taper or ovality was found in any of the samples.

Cylinder Type 1

In the type 1 cylinder, the maximum diametrical clearance between the plunger and the seal was found to be 0.09 mm. The surface roughness average ( $R_a$ ) of both the plunger and the sealing ring were measured in three places in a direction parallel to the cylinder axis.

The results are shown below:

SAMPLE	ROUGHNESS AVERAGE ( $\mu\text{m}$ )							
	PLUNGER				SEALING RING			
	TEST 1	TEST 2	TEST 3	MEAN	TEST 1	TEST 2	TEST 3	MEAN
1	0.25	0.27	0.24	0.25	1.4	1.5	1.2	1.4
2	0.30	0.30	0.26	0.28	0.6	0.9	0.7	0.7

Measured at 0.25mm cut-off

Cylinder Type 2

The bore was measured at 5 points on two mutually perpendicular axes: no significant taper or ovality was found in either sample.

In the type 2 cylinder, the maximum diametrical clearance between the plunger and the cylinder bore was found to be 0.29 mm, and the average was 0.20mm for one sample and 0.25 mm for the other. The surface roughness average ( $R_a$ ) of both the plunger and the cylinder bore were measured in three places in a direction parallel to the cylinder axis.

The results are shown below:

SAMPLE	ROUGHNESS AVERAGE ( $\mu\text{m}$ )							
	PLUNGER				CYLINDER BORE			
	TEST 1	TEST 2	TEST 3	MEAN	TEST 1	TEST 2	TEST 3	MEAN
1	0.70	0.72	0.70	0.71	0.70	0.75	0.80	0.75
2	0.14	0.17	0.17	0.16	0.50	0.70	0.50	0.57

Measured at 0.25mm cut-off

3.4 Ergonomic Measurements

Both pumps were installed using fabricated steel stands supplied by the manufacturer; in field applications, these would be replaced by concrete plinths constructed on-site, or a box stand fabricated from steel sheet.

The crankshaft requires a supporting structure 1.3 metres high, and a platform 150 mm high is desirable for users to stand on when operating the pump.

HANDLE HEIGHT		ANGULAR MOVEMENT OF HANDLE (degrees)	HANDLE LENGTH (mm)	VELOCITY RATIO OF HANDLE	HEIGHT OF SPOUT (mm)
MAX (mm)	MIN (mm)				
1385	875	360	255	(1)	400

(1) Variable according to operating depth - See 5.1

4. ENGINEERING ASSESSMENT

4.1 Materials of Construction

Above Ground Assembly

COMPONENT	MATERIAL(S)
Crankshaft	Steel
Crankshaft Bearings	Standard self-aligning plummer blocks
Flywheel and Handle	Steel
Connecting Rod	Steel tube with standard self-aligning ball races at each end
Spout	Steel tube, hot dip galvanised
Cable	Steel, contra-wound to resist twisting
Crosshead Assembly	Stainless steel shaft, steel fittings, with PA 10 nylon guide ring

Cylinder Type 1

COMPONENT	MATERIAL(S)
Cylinder Body	PA 10 nylon
Plunger	Stainless steel
Sealing Ring	Bronze
Foot Valve Body	Stainless steel
Valve Poppets	Moulded rubber

Cylinder Type 2

COMPONENT	MATERIAL(S)
Cylinder Body	Epoxy bonded glass fibre composite
Plunger	Stainless steel
Foot Valve Body	Stainless steel
Valve Poppets	Moulded rubber

#### 4.2 Manufacturing Techniques

Above-ground assembly      Steel fabrication  
   Machining of steel and plastic  
   Concrete craft

Manufacturing the pumpstand demands basic skills in machining and steel fabrication. It may be suitable for manufacture in some developing countries.

Cylinder Type 1                      Machining of metals and plastic  
   Rubber moulding.  
   Welding of stainless steel

The cylinder is machined from a solid billet of nylon, the stainless steel plunger and bronze sealing ring must be machined to close tolerances and high standards of finish.

Cylinder Type 2                      Fabrication of glass reinforced plastics  
   Machining  
   Rubber moulding

The cylinder body is fabricated from epoxy resin reinforced with glass fibres. Achieving a consistent high quality in the finished component is likely to demand considerable skill and experience. The plunger must be machined to a close tolerance and with a good standard of finish.

#### 4.3 Ease of Installation, Maintenance and Repair

##### 4.3.1 Ease of Installation



The most time-consuming installation job is likely to be constructing the concrete plinth. In other respects installation is straightforward and will not require lifting tackle. It is necessary to adjust the pump stroke and the length of the connecting rod to suit the depth of water in the well.

#### 4.3.2 Ease of Pumpstand Maintenance and Repair



The most frequent maintenance operation is likely to be tightening the gland at the top of the connecting rod, but this is a very simple task. Indeed all pumpstand maintenance should be straight forward, requiring only a few spanners and simple hand tools.

#### 4.3.3 Ease of Below-ground Maintenance and Repair



Both types of cylinder are designed to be extracted from the well on the end of the connecting assembly without the need to remove the rising main. Our experience suggests that the rods which the manufacturer now supplies are likely to be more reliable than cables.

#### 4.4 Resistance to Contamination and Abuse

##### 4.4.1 Resistance to Contamination

The spout may be contaminated by domestic animals but in other respects contamination is unlikely.

##### 4.4.2 Likely Resistance to Abuse

The pump is generally robust but many fixings have been designed to be easy to remove without the need for tools. This may be a disadvantage in some countries.

#### 4.5 Potential Safety Hazards

The rotating flywheel has a great deal of inertia and is therefore potentially hazardous particularly to children. The rotating crank arm could be dangerous also.

#### 4.6 Suggested Design Improvements

##### Above Ground Assembly

The crank arm should be replaced by a disc, for safety.

The flywheel would be safer to use if:

- it were a smooth disc rather than spoked;
- if it were lighter, and therefore had less inertia.

The flywheel would be easier to use if the handle was 100 mm longer.

It is difficult to reconcile these conflicting requirements of safety and ease of operation in a flywheel-operated handpump.

##### Cylinder Type 1

NOTE: Notification was given on 23 May 1983 that the type 1 cylinder was now discontinued but it was agreed that it should be kept in the test to provide useful comparative information.

The cylinder body, which appears to be turned from a solid billet of material, could be replaced by a length of a suitable standard plastic pipe.

The method of attaching the upper cap, using small setscrews, may not be strong enough to resist the force needed to extract the cylinder.

##### Cylinder Type 2

The method of attachment of the cable imposes a high point load, which is likely to cause premature failure of the cable.

The valves might be more efficient if their lift were reduced, ideally to one quarter of the effective diameter, provided that this will allow the valve mouldings to be inserted and extracted.

NOTE: This cylinder was modified by the manufacturer on the 23 May, 1983. The taper seat is now at the top of the cylinder to alleviate problems of sediment building up between the cylinder body and the rising main. The valve lift was reduced, and weights added to the valve poppets.

##### Connecting Assembly

The manufacturer now supplies rods, with hook and eye connections, rather than cable.

5. PUMP PERFORMANCE

5.1 Volume Flow, Work Input and Efficiency

The description of the method can be found in the Test Procedure. Examples of performance graphs are given in Appendix II.

Rotating crank arm showing positions able to be selected for operation at different water depths.

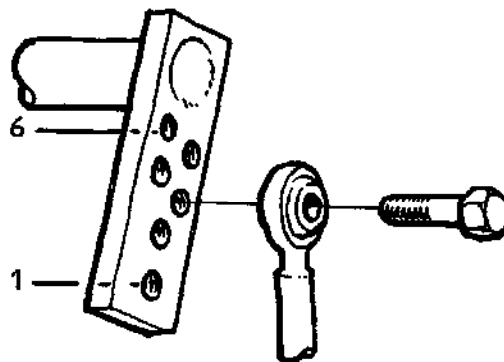

The manufacturer's recommendations for the crank position were as follows:

Position	1	2	3	4	5	6
Depth (m)	< 15	15 - 21	21 - 30	30 - 40	40 - 55	55 - 80
Crank throw (mm)	310	240	190	150	120	100
Position selected for test	7m	Users	25m		45m	



Cylinder Type 1

HEAD	7m			25m			45m				
Pumping Rate (revs/min)	18	24	26	34	19	27	35	21	27	33	37
Vol/revs (litres)	0.61	0.61	0.60	0.58	0.33	0.33	0.33	0.23	0.25	0.25	0.25
Work input/rev(J)	140	119	99	92	140	132	136	157	156	181	181
Efficiency (%)	29	35	41	43	57	61	59	65	69	60	60

Cylinder Type 2

HEAD	7m			25m			45m		
Pumping Rate (revs/min)	23	31	37	22	29	37	20	28	36
Vol/rev (litres)	0.61	0.61	0.61	0.32	0.33	0.34	0.24	0.25	0.25
Work input/rev (J)	128	120	118	148	162	151	144	180	190
Efficiency (%)	32	34	35	53	49	54	73	59	58

NOTE: It was difficult to accelerate the flywheel and sustain the target operating speed within the nine revolution limit of the potentiometer. See the manufacturers comments in the verdict.

## 5.2 Leakage Tests

### Cylinder Type 1

No leakage was observed from the foot valve, but some leakage was noted around the cylinder taper seat as follows

Head (m)	Volume (ml/5 minutes)	Leakage Rate (ml/minute)
7	6	1.2
25	21	4.2
45	35	7.0

The excessive leakage was probably due to dimensional inconsistencies.

### Cylinder Type 2

Head (m)	Volume (ml/5 minutes)	Leakage Rate (ml/minute)
7	1.5	0.3
25	3.0	0.6
45	3.0	0.6

## 6. USER TRIAL

### 6.1 User Responses

Details of the organisation of this trial can be found in the Test Procedure.

### 6.2 Observations

Several small children could not cope with the high starting efforts and never succeeded in completing one revolution; they filled the bucket by "rocking" the flywheel. Some children preferred to turn the wheel by pulling on successive spokes with alternate hands, "climbing" round the wheel, rather than using the handle. Many users found the handle too short and tended to catch their elbows on the spokes when first operating the pump.

Following consultation with the manufacturer, a further user trial was carried out, using a 150 mm plinth on which users could stand when operating the pump. Smaller users found that the plinth offered some advantage, but nevertheless had difficulty in maintaining sufficient force on the handle throughout its movement to establish a smooth rhythm.

Only one user, an adult woman, achieved an operating speed greater than 50 revs/min. All the users criticised the handle as being too short. Several users tended to catch their elbows on the spokes of the flywheel.

## 7. ENDURANCE

A detailed description of the endurance test method can be found in the Test Procedure.

### General Comments

The cable originally supplied broke several times in the early stages of the endurance test. The type 2 cylinder was replaced by the second sample after 24 hours because debris from a broken cable had dropped into the cylinder causing a deep score in the bore. Springs were introduced into the cable to represent the inherent elasticity of 45 m of cable - the actual cable length in the test installation was less than 5 m - but these fatigued very rapidly. The manufacturer supplied thicker cable of galvanised steel rather than stainless steel, and this was used to replace the original cable as necessary when the latter broke.

Because the stresses in the short cable used for this test were not considered to be entirely representative of conditions in the field, cable breakages have not been highlighted as pump failures. However, failures of components related to the cable, but not the cable itself, are noted.

For performance testing the length of the above-ground connecting rod was adjusted to the 7 m depth setting. This enabled the pump stroke to be adjusted for operation at 7, 25 or 45 m. This caused premature wear in the wellhead gland, and for the endurance test it was necessary to adjust the connecting rod for the stroke specified for 45 m.

The upper cable fixing point broke in both pump types, and at the lower fixing point several cable thimbles broke up as a result of localised stress. On one occasion, debris from a broken thimble dropped into the type 2 cylinder causing the plunger to seize in the bore. Conventional steel thimbles were replaced by turned acetal pulleys and the method of attachment was modified to improve the distribution of stress. The modified components were still in good condition at the end of the test.

At the 3000 hour inspection, the type 2 cylinder could not be extracted from the taper seat in the rising main. Kieselguhr, which was added to the water for the third 1000 hour stage, had accumulated between the cylinder body and the rising main, and the cylinder was 'sand locked'. It was released by removing the lower section of rising main, but in the field this would entail removal of the complete below-ground assembly.

Leaking joints in the rising main for the type 2 cylinder could not be cured by conventional pipe sealing compounds. However, worm-drive hose clips applied around the outside of the joints ensured an adequate seal.

Breakdown Incidence

Breakdowns are shown in bold type.

Cylinder Type 1

Hours	1027	2054	2094	2828	3125	3451	3699	4164
0								
Inspection & full performance test	Inspection & volume flow	Cable top fixing point broken	Inspection & volume flow	Cable thimble broken at bottom connection	Inspection & volume flow	Cable thimble broken at bottom connection	Cable top performance test	Inspection & full performance test
						Cable thimble broken at both top and bottom connections - replaced by turned acetal pulleys		

Cylinder Type 2

Hours	1027	2094	2931	3125	3214	3410	4164
0							
Inspection & full performance test	Inspection & volume flow	Inspection & volume flow	Cable top fixing point broken	Inspection & volume flow	Leaking joints in rising main		Inspection & full performance test
				Cylinder 'sand-locked' in rising main		Debris from broken thimble on bottom connection caused plunger to seize - thimble replaced by turned acetal pulley	
				Cable thimble broken at bottom connection			

Details of the Endurance Test

Breakdowns are shown in bold type.

Cylinder Type 1

HOURS

1027 Inspection after first 1000 hour stage

- (a) Some scratching of guide rod where it passed through the gland
- (b) Plunger polished on the working area
- (c) Light scale deposit on plunger and cable, but no corrosion

**2054 Cable top fixing point broken - the steel loop on the underside of the guide plunger had broken at the point of attachment of the cable - the guide plunger was replaced by the component from the second sample**

Estimated amount of water pumped to breakdown ..... 1.0 million litres

2094 Inspection after second 1000 hour stage

- (a) Further polishing of plunger
- (b) Self aligning bushes loose in ends of connecting rod
- (c) No significant corrosion

**2828 Cable thimble broken at connection with plunger - replaced**

Estimated additional amount of water pumped to breakdown... 0.4 million litres

3125 Inspection after third 1000 hour stage

- (a) Self-aligning bushes in connecting rod still loose, but no worse than at 2000 hour inspection
- (b) Filter no longer attached to base of cylinder
- (c) Further polishing of plunger
- (d) No significant corrosion
- (e) **Cable thimble broken at connection with plunger - replaced**

Estimated additional amount of water pumped to breakdown ... 0.1 million litres

**3451 Cable thimbles broken at both top and bottom cable connections - replaced by turned acetal pulleys**

Estimated additional amount of water pumped to breakdown ... 0.2 million litres

**3699 Cable top fixing point broken - the steel loop on the underside of the guide plunger had broken at the point of attachment of the cable - the steel loop was replaced and re-shaped to improve the distribution of stress**

Estimated additional amount of water pumped to breakdown ... 0.1 million litres

Volanta

4164 Final Inspection

1. Cylinder Plunger and seal scratched on one side but otherwise no perceptable wear
2. Valves Some wear on plunger and foot valves, but otherwise in good condition and still serviceable
3. Pumpstand (a) Connecting rod bearings remain loose but still serviceable  
(b) Well head gland leaking slightly when pump stationary but satisfactory when operating pump
4. Filter Thickly coated with sand and general debris but still working
5. Corrosion No significant corrosion

Estimated total amount of water pumped in 4000 hours ..... 1.8 million litres

Cylinder Type 2

HOURS

- 1027 Inspection after first 1000 hour stage
- (a) Some scratching of guide rod where it passed through the gland
  - (b) Light scale deposit on plunger and cable, but no corrosion
- 2094 Inspection after second 1000 hour stage
- (a) Slight scratches on plunger
  - (b) Flywheel loose on spindle - tightened
  - (c) No significant corrosion
- 2931 Cable top fixing point broken - the steel loop on the underside of the guide had broken at the point of attachment of the cable - the loop was replaced

Estimated amount of water pumped to breakdown ..... 1.5 million litres

- 3125 Inspection after third 1000 hour stage
- (a) Cylinder 'sand-locked' in rising main - Kieselguhr had accumulated between the cylinder body and the rising main - the cylinder could not be released without removing the bottom section of rising main
  - (b) Cable thimble broken at connection with plunger
  - (c) Filter liberally coated with Kieselguhr but still working - cleaned
  - (d) Plunger polished on working areas
  - (e) Some rust on cylinder end cap

Estimated additional amount of water pumped to breakdown ... 0.1 million litres

Volanta

Cylinder Type 2

Revs/min	<u>Volume Flow Tests at 45 m (litres)</u>			<u>Leakage Tests at 7 m (ml/min)</u>
	20	30	40	
New	0.24	0.25	0.25	0.3
After 1000 hours	0.12	0.15	0.16	< 0.1
After 2000 hours *	-	0.22	0.22	0.6
After 3000 hours	0.20	0.20	0.23	0.5
After 4000 hours	-	0.14	0.14	0.3

\*NOTE: Springs were fitted between 0 and 1000 hours, to simulate the stretch in 45 m cable - after several breakages, these were removed between 1000 and 2000 hours, with resultant improvements in volume delivered per stroke.

Pump Performance After Endurance Testing

Cylinder Type 1

HEAD	7m			25m			45m		
Pumping Rate (revs/min)	31	39	47	31	38	45	30	40	46
Vol/rev (litres)	0.54	0.54	0.53	0.28	0.28	0.29	0.13	0.13	0.14
Work input/rev(J)	100	112	121	119	147	132	112	119	144
Efficiency (%)	36	32	29	56	46	53	49	46	42

Cylinder Type 2

HEAD	7m			25m				45m		
Pumping Rate (revs/min)	29	37	47	27	35	39	42	29	40	46
Vol/revs (litres)	0.57	0.53	0.50	0.28	0.29	0.32	0.31	0.14	0.14	0.16
Work input/rev (J)	138	144	162	158	170	194	177	129	121	153
Efficiency (%)	28	24	21	42	41	40	43	47	52	46

## 8. ABUSE TESTS

### 8.1 Side Impact Tests

Body test not applicable - tested by impact on spokes of wheel - spokes bent at an impact of 400 Joules but pump still usable.

### 8.2 Handle Shock Test

Not applicable.

## 9. VERDICT

The Volanta pump with the two types of cylinder as supplied for this test proved to be unreliable in use.

Users found the pump difficult to start and maintain a steady rhythm. In the field with more time available there will be an opportunity for users to develop a better technique. Nevertheless it is recommended that consideration be given to a simpler pumpstand using a conventional lever arm at a considerable cost saving.

Many problems were encountered with the method of fixing the cables and some months after starting this test programme the manufacturer decided to discontinue the type 1 cylinder assembly.

The pump has now been substantially modified in response to the results of these laboratory tests and to information from the field. Steel rods with hook-and-eye connections are now used in place of cable.

The type 1 cylinder is no longer in production and it is interesting to note that in the tests it performed generally better than the type 2 cylinder.

If the modifications prove to be successful in future tests, then the Volanta may be suitable for community water supply in developing countries. It also has considerable potential for local manufacture providing adequate skills and quality control can be maintained for the cylinder assembly.

### N.B.

In view of the modifications made to this pump the manufacturer has asked for the latest design to be reassessed. He has also asked for this work to include comparison of the performance of the pump on the 50 m borehole as well as in the tower, using a 'flying start' technique for the performance tests. The manufacturer considers that the performance of his pump in the tower may not be representative of results obtained in the field where it has become apparent that the pump works best at speeds of around 55 rpm.



Korat Pump

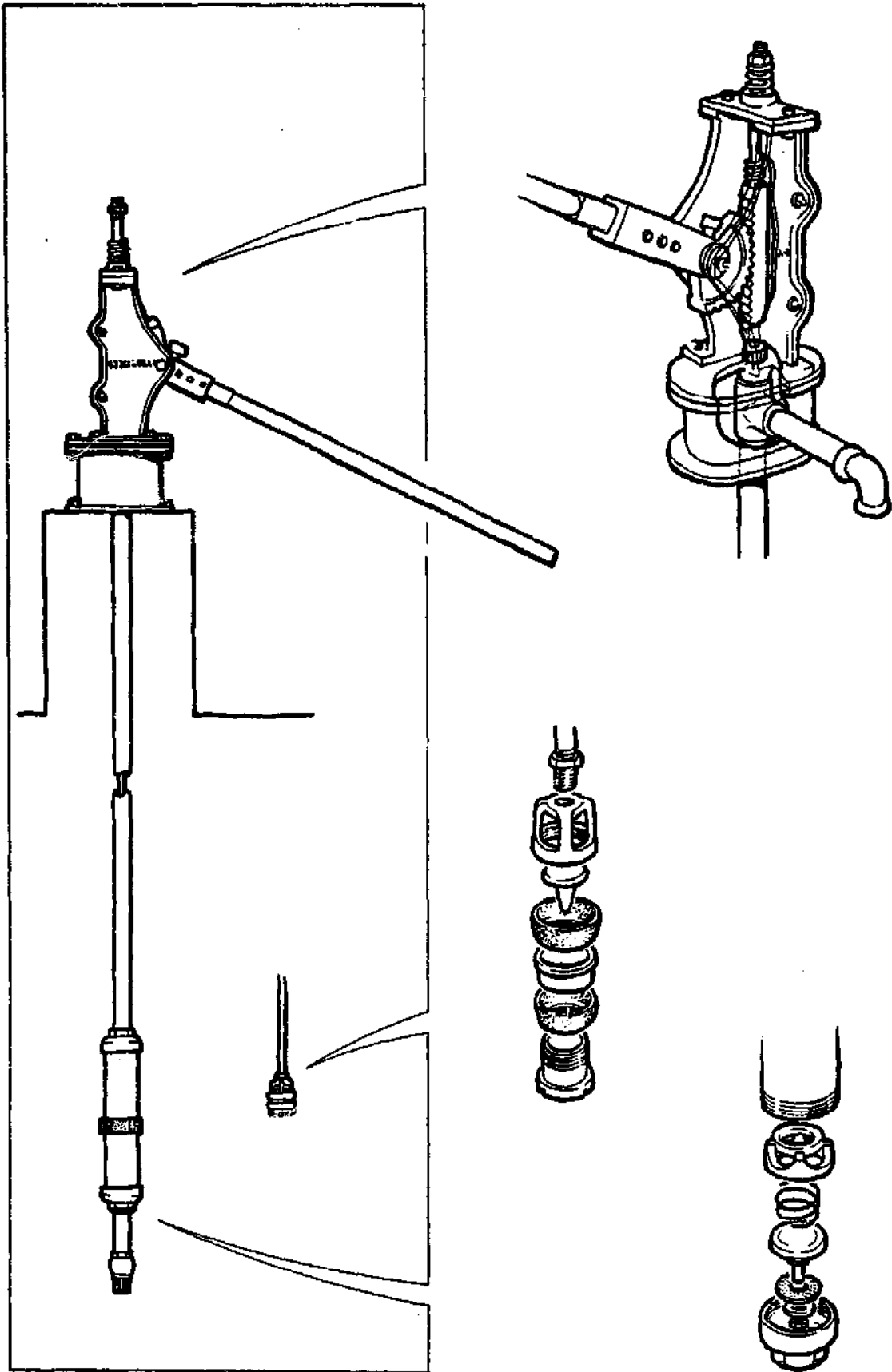

KORAT 608 A-1

1.1 Manufacturer Saha Kolkarn Factory

Address 94-96 Soi Sukapiban 2,  
Ramintra,  
Bangkhen,  
BANGKOK,  
Thailand.

1.2 Description The Korat 608 A-1 is a deep-well force pump, made in Thailand. The pumpstand is mainly cast iron with a rack and quadrant mechanism and a wooden handle. It must be mounted on a plinth at least as tall as the largest container to be used. The cylinder is seamless brass tube, and the plunger has two conventional leather cup seals. There are two foot valves, one in the base of the cylinder, the other at the end of a short dip tube below.

1.3 Price in 1982 \$295, supplied complete for 20 metres depth.

2. INSPECTION

2.1 Packaging The pumps were delivered in two wooden packing cases, one containing the pumpstands, the other the handles, pipes and pump rods.

The case containing the pumpstands had been damaged and the grease cups on the handle castings of both pumps were broken.

2.2 Condition as Received Both samples were in working order as received in spite of minor defects (see Table). Such defects would be likely to cause premature failure of the pump if not remedied before installation.

COMPONENT or FEATURE	NO. of SAMPLES AFFECTED	DEFECTS
Grease cups	2	Broken
Cylinder end caps	7 (8 supplied)	Porous castings
Upper connecting rod nut	1	Misaligned thread
Lower rack roller	1	Seized - not rotating
Handle	1	Small split along half its length starting from holes
Foot valve	1	Rubber washer squeezed out of joint
Various	2	Minor surface corrosion on unprotected ferrous surfaces

2.3 Installation & Maintenance Information None supplied with pump.

3. WEIGHTS & MEASURES

3.1 Weights Pumpstand 47 kg  
 Cylinder assembly 5.5 kg  
 Pump rods 1.1 kg per metre

3.2 Dimensions Nominal cylinder bore: 76 mm  
 Actual pump stroke: 80 mm  
 Nominal volume per stroke: 363 ml  
 Drop pipe size: 1.50 inches  
 Outside diameter of below-ground assembly: 90 mm  
 Pump rod diameter: 0.5 inches  
 Maximum usable cylinder length: 255 mm

3.3 Cylinder Bore No significant taper or ovality was found in either of the samples.

The surface roughness average (Ra) was measured in three places in a direction parallel to the cylinder axis.

SAMPLE	CYLINDER BORE	ROUGHNESS AVERAGE ( $\mu\text{m}$ )			MEAN
		TEST 1	TEST 2	TEST 3	
1	Extruded brass	0.05	0.05	0.07	0.06
2	Extruded brass	0.08	0.07	0.08	0.08

Measured at 0.25 mm cut-off

3.4 Ergonomic Measurements

The pump must be mounted on a plinth to provide clearance under the spout. A plinth of 500 mm height was chosen to present the handle at a suitable height for operation while providing adequate room below the spout for typical containers.

HANDLE HEIGHT		PLATFORM HEIGHT (mm)	ANGULAR MOVEMENT OF HANDLE (degrees)	HANDLE LENGTH (mm)	VELOCITY RATIO OF HANDLE	HEIGHT OF SPOUT (mm)
MAX <sup>(1)</sup> (mm)	MIN <sup>(1)</sup> (mm)					
1365	485	500	50	1055	10.8:1	490

(1) Measured without compressing bump stops.

#### 4. ENGINEERING ASSESSMENT

##### 4.1 Materials of Construction

COMPONENT	MATERIAL(S)
Pumpstand body	Cast iron
Quadrant and rack	Cast iron
Handle	Wood
Handle bearings	Proprietary ball races
Cylinder	Extruded brass
Plunger	Cast gunmetal and bronze
Cup seals	Leather
Foot valve	Cast gunmetal and leather
Drop pipe	Galvanised steel
Pump rods	Mild steel

##### 4.2 Manufacturing Techniques

The manufacturing techniques required to make the pump are listed below:-

Above-ground	Iron foundry
Assembly	Brass & gunmetal foundry
	Basic machining
	Wood work

The pumpstand is principally constructed of 8 iron castings. All involve relatively simple patterns and moulding skills. Machining is mainly straight-forward lathe and drilling work. The designs of the components are suitable for basic tooling and hence inexpensive but effective quality control.

Below-ground	Brass & gunmetal foundry
Assembly	Leather cutting and forming
	Basic machining

Brass foundry work, lathe work, drilling and assembly require similar skill levels to those needed in the pumpstand.

##### 4.3 Ease of Installation, Maintenance and Repair

###### 4.3.1 Ease of Installation



The pump requires a plinth at least as high as the largest water container to be used. The manufacturer supplied a multi-size spanner with the sample pumps. A fabricated steel plinth was used for test purposes.

#### 4.3.2 Ease of Pumpstand Maintenance and Repair



Regular lubrication is required. The most frequent repairs are likely to be to the quadrant and rack although this should not be in less than 2 years; the handle bearings are likely to outlive the gear teeth. The pumpstand is easy to dismantle, and removal from the wellhead is not required. A broken handle could be replaced using indigenous materials, otherwise manufacturer's spares will be required.

#### 4.3.3 Ease of Below-ground Maintenance & Repair



To allow the below-ground assembly to be extracted from the borehole, the pumpstand must first be partially dismantled. This is a relatively simple task; two people could manhandle the pumpstand to remove it from the plinth.

The rising main and rodding must then be extracted length-by-length until the cylinder is brought to the surface. Lifting tackle would be required to cope with the weight of the below-ground assembly.

#### 4.4 Resistance to Contamination and Abuse

##### 4.4.1 Resistance to Contamination

The pumpstand is adequately sealed against contamination, provided care is taken to seal the base of the pumpstand to the wellhead.

##### 4.4.2 Likely Resistance to Abuse

The pumpstand is generally robust, but there are many easily-removed nuts and bolts. The handle would be easy to replace.

#### 4.5 Potential Safety Hazards

The pumpstand is hard and angular, with many exposed fastenings offering potentially hazardous sharp edges.

The quadrant and rack present a potentially dangerous finger trap, particularly in view of the large mechanical advantage of the handle. See photograph, right.



**4.6 Suggested Design Improvements**

The plunger valve lift should be reduced, ideally to one quarter of its effective diameter, and its lateral location improved.

The grease cup lubricators are a good idea in principle, but more robust components are needed.

The quadrant and rack present a safety hazard and should be shrouded. This may be achieved by modifying the casting patterns for the pumpstand side plates as shown, right.

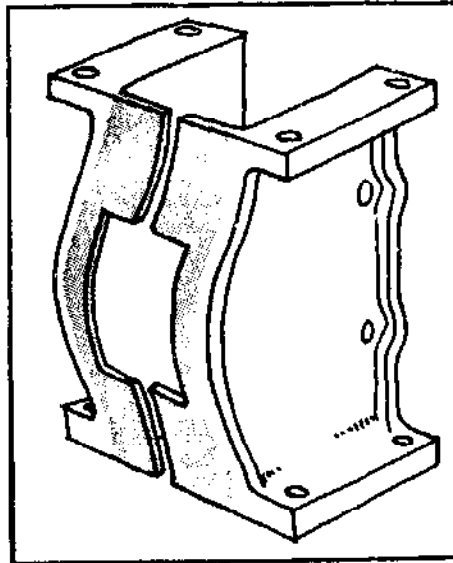

In response, the manufacturer has modified the pumpstand by adding a cover plate shielding the quadrant from above, and by reducing the lift of the plunger valve. The cover plate provides a good deal of protection but can easily be removed and left off. The suggested change to the casting is therefore preferable.

**5. PUMP PERFORMANCE**

**5.1 Volume Flow, Work Input and Efficiency**

The description of the method can be found in the Test Procedure.

HEAD	7 m			25 m			45 m		
Nominal Pumping Rate (strokes/min)	30	40	50	30	40	50	30	40	50
Vol/stroke (litres)	0.39	0.40	0.40	0.36	0.35	0.35	0.34	0.35	0.36
Work input/stroke (J)	57	50	54	175	159	152	218	200	196
Efficiency (%)	46	53	50	50	53	56	68	76	80

## 5.2 Leakage Tests

The leakage through the pump was assessed by first operating the pump that it was fully charged and then draining the water in the tank. The amount of water leaking past the foot valve in 10 minutes was then measured.

HEAD	7 m	25 m	45 m
Leakage rate (ml/minute)	Not significant (less than 0.1 ml/min)	1.7	4.4

This pump was found to be leaking from the cylinder end caps. One of the castings was found to be porous. All spare castings were also found to be defective. The original castings were therefore fitted for the remaining performance and endurance tests. In subsequent tests, leakage of the end caps was found to be not significant.

## 6. USER TRIAL

### 6.1 User Responses

Details of the organisation of this trial can be found in the Test Procedure, and the statistical analysis of user responses is presented in Appendix I.

### 6.2 Observations

Many users complained that the handle of this pump was too high, not the only problem. The handle is long but the stroke is related with a predominantly vertical movement. Users found it difficult to engage several muscle groups into play since most of the effort had to be exerted by the arms and shoulders only.

## 7. ENDURANCE

A detailed description of the endurance test method can be found in the Test Procedure.

### General Comments

The pump was tested at 40 strokes per minute at a simulated head of 4000 hours of endurance testing completely wore out the quadrant teeth were also worn, but could be reversed top to bottom and used longer with a new quadrant.

Both rack guide rollers seized towards the end of endurance test. In the short term this would increase the friction in the pumphead, making the pump slightly harder to operate. In the long term it would generate wear on the rollers which would accelerate the wear on the rack teeth.

The cylinder was generally in good condition after 4000 hours, with no significant wear. The leather cup seals and valves showed signs of wear but still worked satisfactorily.

Breakdown Incidence

Breakdowns are shown in bold type.

Hours:	1072	2044	3060	3595	4029
				<b>Quadrant and Rack Seized</b>	<b>Handle Quadrant and Rack Worn Out</b>
Inspection and full performance test	Inspection and volume flow	Inspection and volume flow	Inspection and volume flow		Inspection and full performance test

Details of the Endurance Test

Breakdowns are shown in bold type.

HOURS

651 Swarf collecting on top of pump from worn rack and quadrant

1072 INSPECTION after 1st 1000 hours:

- (a) Nut adrift from upper foot valve, lodged in lower valve
- (b) Some deterioration of rubber seating of lower foot valve
- (c) Plunger valve head worn
- (d) Plenty of swarf on pump top from worn rack and quadrant
- (e) Some corrosion of ferrous parts
- (f) Gland nut loose - retightened

2044 INSPECTION after 2nd 1000 hours:

- (a) Plunger valve continuing to wear
- (b) Rubber seat on lower foot valve noticeably worn
- (c) More swarf on pump top
- (d) Handle loose in socket
- (e) Noticeable corrosion of ferrous parts

3060 INSPECTION after 3rd 1000 hours:

- (a) Plunger valve continuing to wear
- (b) Quadrant teeth noticeably worn though still serviceable
- (c) Handle loose in socket
- (d) Noticeable corrosion of ferrous parts though still serviceable



HOURS

3595 Bush in top cover adrift, quadrant and rack out of mesh so pump would not operate. Bush replaced, test continued with original rack and quadrant.

Estimated Amount of water pumped to breakdown .....3.1 million litres

3934 Upper guide roller seized though pump still working - no action

4029 Quadrant and rack locked due to wear in gear teeth and seized guide roller - test terminated.

Estimated additional amount of water pumped to breakdown .....0.4 million litres

4029 FINAL INSPECTION

1. Pumpstand
  - (a) Quadrant teeth almost entirely worn away - rack teeth also worn but could be upended and used for a while with a new quadrant
  - (b) Both guide rollers behind rack seized on their shafts
  - (c) Upper guide rod had "picked up" on its bush
2. Cylinder Slight scratching of cylinder bore but no significant wear
3. Plunger
  - (a) Plunger valve noticeably worn on its diameter but still working
  - (b) Some scratches on both cup leathers, and one distorted, but still serviceable
  - (c) Small amounts of sand lodged behind both cup leathers
4. Foot Valves
  - (a) Leather sealing washer in cylinder foot valve has compressed, allowing metal-to-metal contact between valve and seat
  - (b) Split rubber seal in dip tube foot valve
5. Corrosion Noticeable corrosion of all ferrous parts, particularly lock nut between connecting rod and plunger, and dip tube valve body.

Estimated total amount of water pumped in 4000 hours ..... 3.5 million litres.

Strokes/min	Volume Flow Tests at 45m (litres)			Leakage Tests at 7 m (ml/min)
	30	40	50	
New	0.34	0.35	0.36	less than 0.1*
After 1000 hours	0.39	0.39	0.40	0.2
After 2000 hours	0.37	0.37	0.38	less than 0.1
After 3000 hours	0.37	0.38	0.39	less than 0.1
After 4000 hours	0.35	0.35	0.36	4.8

\* After sealing cylinder end caps with shellac

Pump Performance after Endurance

HEAD	7 m			25 m			45 m		
	30	40	50	30	40	50	30	40	50
Nominal Pumping Rate (str/min)	30	40	50	30	40	50	30	40	50
Vol/stroke (litres)	0.38	0.38	0.40	0.38	0.38	0.39	0.35	0.35	0.36
Work input/stroke (J)	56	55	55	143	131	148	219	253	251
Efficiency (%)	46	47	49	65	71	63	70	61	63

If compared with the original performance data these tests show an improvement in volume flow, and therefore in efficiency at 25 m depth. This suggests that bedding-in the cup leathers has improved the seal, but the wear of the quadrant mechanism has increased friction.

8. ABUSE TESTS

8.1 Side Impact Tests

The Korat was undamaged in the side impact tests on both body and handle.

8.2 Handle Shock Tests

In this test the pump completed its allotted 96,000 cycles without failure.

9. VERDICT

A robust pump potentially suitable for community water supply. The rack and quadrant will wear in time but they can be easily replaced. It might be better to consider an India Mk II approach eliminating the rack and simplifying the quadrant. Easy to maintain or repair above-ground, difficult below-ground, though cylinder assembly robust and reliable. Potentially dangerous moving parts should be permanently shrouded. Moderately priced.

Korat Pump

Dragon Pump

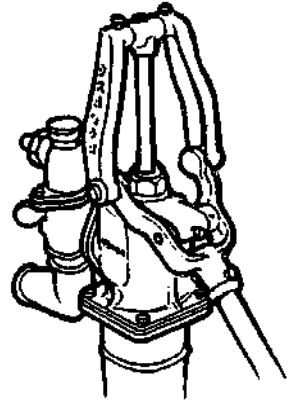
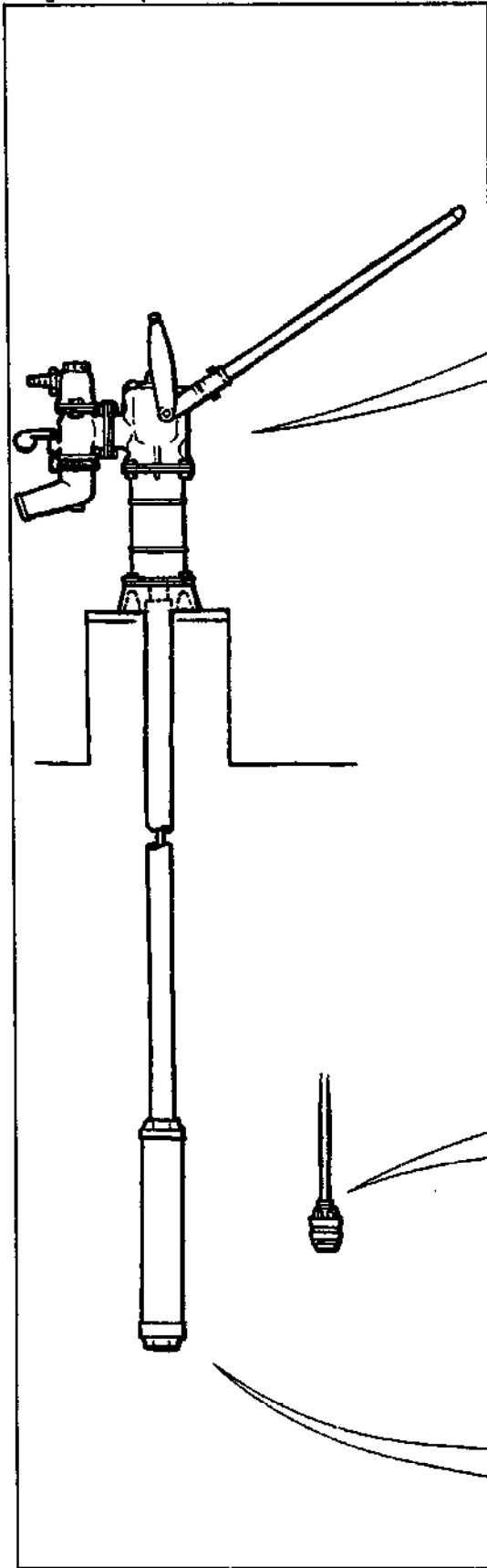

DRAGON

1.1 Manufacturer Kawamoto Pump Mfg. Co. Limited,

Address 11-39 4-Chome, Ohsu,  
Naka-Ku,  
NAGOYA, Japan.

1.2 Description The Dragon pump, made in Japan, can be supplied either as a shallow-well suction pump or as a deep-well force pump. The pump was tested in its deep-well configuration. The pumpstand is principally cast iron, with a discharge valve in the spout allowing either free discharge or delivery under pressure through a hose or pipe. The tubular steel handle moves through an unusually wide arc of 178°.

In the deep-well configuration, the shallow-well cast-iron cylinder body with its enamelled steel liner, is retained as a pedestal. In addition, the pump requires a mounting plinth at least 305 mm high, to provide adequate clearance under the spout. The deep-well cylinder is conventional, seamless brass tube of 63 mm bore with cast iron end caps. The plunger has two leather cup seals, and the foot valve has a rubber seat.

1.2 Price in 1982 \$362 supplied complete for deep-well use

2. INSPECTION

2.1 Packaging The pumps were delivered neatly and securely packed in two corrugated cardboard cartons.

One carton contained the pumpstands with all the components required for shallow-well use. The carton was fully lined with moulded packing for the pump head units.

The second carton contained the additional components needed for deep-well use, packed in expanded polystyrene beads.

Both cartons were unusually easy to handle.

2.2 Condition as Received The pumps were received in excellent condition.

2.3 Installation & Maintenance Information

None supplied with the pump. Setting up was difficult because the cylinder stroke length was virtually the same as the distance through which the pump rod connection moves in the pumphead. This could possibly lead to installation problems in the field if no instructions are provided.

3. WEIGHTS and MEASURES

3.1 Weights Pumpstand 19.0 kg  
 Cylinder assembly 5.0 kg  
 Pump rods 1.1 kg per metre

3.2 Dimensions Nominal cylinder bore: 63 mm  
 Actual pump stroke: 180 mm  
 Nominal volume per stroke: 561 ml  
 Drop pipe size: 1.25 inches  
 Outside diameter of below-ground assembly: 70 mm  
 Pump rod diameter: 0.5 inches  
 Maximum usable cylinder length: 180 mm

3.3 Cylinder Bore No significant taper or ovality was found in either of the samples.

The surface roughness average (Ra) was measured in three places in a direction parallel to the cylinder axis.

SAMPLE	CYLINDER BORE	ROUGHNESS AVERAGE (µm)			MEAN
		TEST 1	TEST 2	TEST 3	
1	Extruded brass	0.10	0.08	0.08	0.09
2	Extruded brass	0.10	0.12	0.13	0.12

Measured at 0.25 mm cut-off

3.4 Ergonomic Measurements The pump must be mounted on a plinth to provide adequate clearance under the spout.

HANDLE HEIGHT		PLATFORM HEIGHT (mm)	ANGULAR MOVEMENT OF HANDLE (degrees)	HANDLE LENGTH (mm)	VELOCITY RATIO OF HANDLE	HEIGHT OF SPOUT (mm)
MAX <sup>(1)</sup> (mm)	MIN <sup>(1)</sup> (mm)					
1139	95	305	178	660	7.8:1	480

(1) Measured without compressing bump stops

#### 4. ENGINEERING ASSESSMENT

##### 4.1 Materials of Construction

COMPONENT	MATERIAL(S)
Pump head	Cast iron
Handle fork and link	Cast iron
Handle bearings	Mild steel pivot pins bear on holes drilled and reamed in iron castings
Spout assembly	Cast iron with plastic cap and hose connector and rubber valve
Operating rod	Mild steel
Handle	Steel tube, plastic end cap
Cylinder	Extruded brass, cast iron end caps
Cup seal	Leather
Foot valve assembly	Cast gunmetal, rubber valve seat

##### 4.2 Manufacturing Techniques

The manufacturing techniques required to make the pump are listed below:-

Above-ground Assembly	Iron foundry Basic machining Plastic moulding Plating
--------------------------	--

Some of the pumpstand castings require careful quality control in manufacture. Machining of the various components of the handle mechanism requires care to ensure correct alignment of the various pivot axes.

Below-ground Assembly	Iron Foundry Brass/Gunmetal foundry Basic machining Leather/rubber crafting
--------------------------	--

The skills required are similar to those needed for the pumpstand.

##### 4.3 Ease of Installation, Maintenance and Repair

###### 4.3.1 Ease of Installation

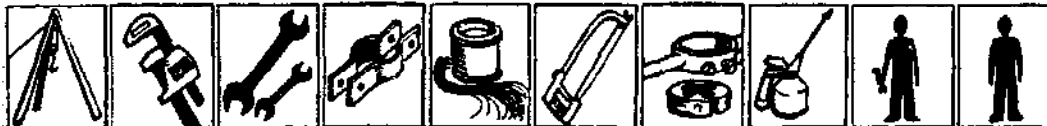

The pump requires a plinth to provide adequate clearance under the spout. The manufacturer supplied a wooden plank, drilled to accept the pump base plate to support the pump over an open well. For the purpose of this test a fabricated steel plinth was used.

#### 4.3.2 Ease of Pumpstand Maintenance and Repair



The pumpstand would benefit from regular lubrication. The repairs most likely to be required are to the handle fulcrum components, the connecting rod and the gland nut. In all these cases, manufacturer's spares would be required. The pumpstand is easy to dismantle, and need not be removed from the wellhead.

#### 4.3.3 Ease of Below-ground Maintenance and Repair



Repairs require removal of the complete below-ground assembly.

#### 4.4 Resistance to Contamination and Abuse

##### 4.4.1 Resistance to Contamination

The top of the pump is adequately sealed, but no attempt is made to seal the wellhead.

##### 4.4.2 Likely Resistance to Abuse

There are many accessible fixings and components which would be easy to remove. The cast iron fork is a potential weakness.

#### 4.5 Potential Safety Hazards

The tubular steel handle is threaded at the outboard end to accept the moulded plastic cap. The cap is easy to remove and could be lost. This exposes the end of the handle, which is sharp because the burrs were not removed after cutting.

#### 4.6 Suggested Design Improvements

The free end of the handle should not be threaded but simply belled out and smoothed, omitting the plastic end cap.

The wishbone link may be simpler to manufacture in a developing country as two joggled steel strips.

The handle fulcrum pinch bolt should be moved 90° to the underside, or replaced by two circlips on the shaft, similar to those on the wishbone link pivots.

The height of the top housing should be reduced to:

- (a) eliminate the counterbore in the gland nut,
- (b) eliminate unnecessary machining of the pivot casting,
- (c) increase the length of thread attaching the connecting rod to the pivot casting.

The discharge valve should be removed as a cost-saving measure and only supplied if needed. We understand that the manufacturer will now supply pumps with a simple discharge spout, if required.

All pump body flanges should be flat or increased in thickness as they are unsupported and can be broken by over-tightening the fixing bolts.

The base casting should be strengthened.

## 5. PUMP PERFORMANCE

### 5.1 Volume Flow, Work Input and Efficiency

The description of the method can be found in the Test Procedure.

HEAD	7 m			25 m			45 m		
Nominal Pumping Rate (strokes/min)	30	40	50	30	40	50	20	30	40
Vol/stroke (litre)	(f) 0.55 (p) 0.26	0.55 0.27	0.55 0.28	0.54	0.54	0.54	0.52	0.53	0.53
Work input/stroke (J)	(F) 122 (p) 52	120 53	128 55	244	252	257	340	358	366
Efficiency (%)	(f) 30 (p) 33	31 34	29 34	53	52	51	67	65	63

(f) = Full stroke

(p) = Partial stroke

The angle of the handle movement was nearly 180° and from observation it was anticipated that an improvement in efficiency could be obtained by using only the central 60° position of the handle movement. Tests conducted at 7 metres confirmed a slight improvement in efficiency which may be significant at greater depths.

### 5.2 Leakage Tests

The measured leakage from the foot valve was not significant, i.e. less than 0.1 ml/minute, at 7, 25 and 45 metre heads.



## 6. USER TRIAL

### 6.1 User Responses

Details of the organisation of this trial can be found in the Test Procedure, and the statistical analysis of the user responses is presented in Appendix I.

### 6.2 Observations

Many users found it difficult to decide on the best method of operation for this pump because the angular movement of the handle is particularly large. In spite of this, some users chose a full stroke but found the exaggerated body movements uncomfortable.

## 7. ENDURANCE

A detailed description of the endurance test method can be found in the Test Procedure.

### General Comments

This pump was tested at 40 strokes per minute at a simulated head of 45 metres.

The pump failed at 2890 and 3207 hours when the pump rod broke within the thread at the top. Components of the handle mechanism including the gland nut had to be replaced after 2487 hours because of wear. The handle fulcrum had broken when wear allowed it to contact the retaining bolt. At each intermediate inspection, the spout discharge valve was found to be seized through lack of use and was freed off.

In the final inspection, the foot valve guide was almost completely worn away, and there was substantial wear of the valve stem. The leather cup seals and cylinder bore were in good condition, with few signs of wear. The gland nut was again very badly worn. The cast iron cylinder end caps and the plunger rod were corroded, but not sufficiently to interfere to any great extent with maintenance or performance.



HOURS

**2890** Connecting rod broken within thread at top. Gland nut and rod eye badly worn. Connecting rod, gland nut and packing, rod eye and pivot pin all replaced.

Estimated additional amount of water pumped to breakdown.....0.5 million litres

**3140** INSPECTION after 3rd 1000 hours:

- (a) Foot valve guide almost worn through
- (b) Plunger remains difficult to remove or refit
- (c) More corrosion on cylinder end caps and on plunger rod
- (d) Outlet diverter valve rusted solid

**3207** Pump rod broken within thread at uppermost joint - rethreaded.

Estimated additional amount of water pumped to breakdown.....0.4 million litres

**4147** FINAL INSPECTION:

- 1. Pumpstand Gland worn, slight wear in handle components, but generally in fair condition
- 2. Cylinder No wear in cylinder bore though some scratches - generally in good condition
- 3. Plunger Generally in good condition, including cup seals
- 4. Foot Valve (a) Valve guide severely worn  
(b) Some wear on foot valve stem
- 5. Corrosion (a) Cylinder end caps rusty  
(b) Considerable rust on plunger rod  
(c) Outlet diverter valve rusted solid

Estimated total amount of water pumped in 4000 hours .....5.1 million litres.

Strokes/min	Volume Flow Tests at 45m (litres)			Leakage Tests at 7 m (ml/min)
	20	30	40	
New	0.52	0.53	0.53	less than 0.1
After 1000 hours	0.52	0.52	0.51	less than 0.1
After 2000 hours	0.44	0.45	0.45	less than 0.1
After 3000 hours	0.41	0.42	0.42	less than 0.1
After 4000 hours	0.50	0.50	0.53	less than 0.1

Pump Performance after Endurance

HEAD	7 m			25 m			45 m		
Nominal Pumping Rate (strokes/min)	20	30	40	20	30	40	20	30	40
Vol/stroke (litres) (f)	0.54	0.54	0.50	0.54	0.54	0.51	0.50	0.50	0.53
Work input/stroke(J)(f)	94	94	101	207	212	215	287	291	327
Efficiency (%) (f)	39	39	33	64	62	58	77	76	70

If compared with the original performance data, these results show a general reduction in the work input requirement, with a consequent increase in efficiency, this suggests that bedding in of the handle pivots, has reduced frictional losses.

8. ABUSE TESTS

8.1 Side Impact Tests

The Dragon failed the side impact test on the handle. Even at the lowest impact energy, 50 Joules, the handle began to bend. At 200 Joules, the base casting on the pumpstand broke. Therefore, the impact test on the body of the pumpstand could not be carried out.

8.2 Handle Shock Test

The handle was bumped against its upper limit stop only. At the lower limit the handle was close to the ground, and it was considered that users would be unlikely to bump the handle on the lower stop. The pump completed its allotted 96,000 cycles without failure.

9. VERDICT

This pump appears to be designed for family use, possibly serving up to 15 people. It is unlikely to be sufficiently robust for community water supply. It is inexpensive, but intensive use will produce rapid wear in the moving parts of the pumpstand, and rod breakages are also likely (see comments on pump rod constraint on page 17). It is understood that the manufacturer is working on a new and more robust pump design for community use.

Mayno Pump

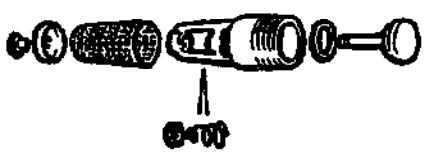
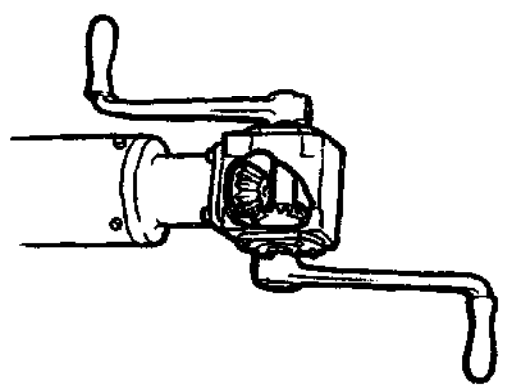
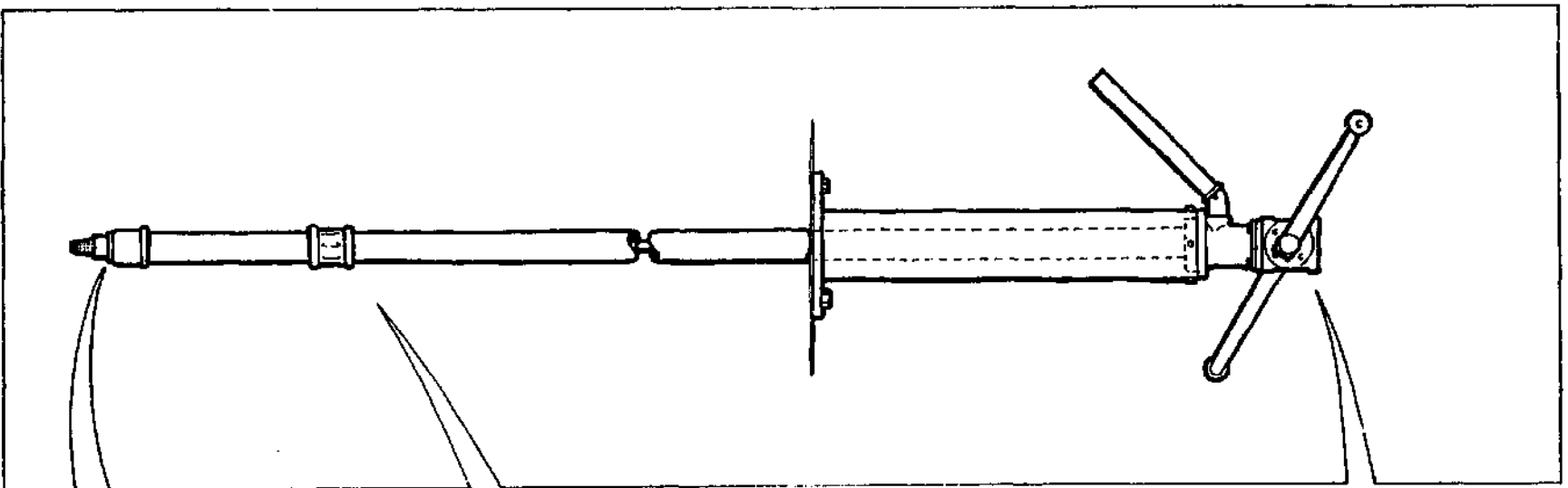

MOYNO IV 2.6

- 1.1 Manufacturer Robbins and Myers Inc.,
- Address Moyno Pump Division,  
1895 Jefferson Street,  
Springfield,  
OHIO 45501, U.S.A.
- 1.2 Description The Moyno pump tested was made by Robbins and Myers in the U.S.A., is a positive displacement pump, which has a plated helical steel rotor within a double-helical elastomeric stator. The pump rods rotate instead of reciprocating up and down. The pump is operated by a pair of rotary crank handles, driving a gearbox and one-way clutch. The pumpstand is very robust, of all-steel construction. The twin handles make the pump suitable for operation either by one or two people.
- 1.3 Price in 1982 \$550, pump only  
\$739, supplied complete for 20 metres depth
2. INSPECTION
- 2.1 Packaging The pumps were packed in two cartons made from heavy-duty corrugated cardboard, approximately 12 mm thick. The carton containing the pumpstands was supported on a wooden pallet. The other carton, containing the pipes and pump rods, had wooden ends and wooden internal reinforcements.
- The cartons were strongly made and should absorb bumps and shocks well. However, if stored or transported in wet conditions they could deteriorate.
- 2.2 Condition as Received The pumps were received in good condition. The only minor defect was a bent foot valve strainer, which was easily straightened.
- 2.3 Installation and Maintenance Information None supplied with the pump.

3. WEIGHTS and MEASURES

3.1 <u>Weights</u>	Pumpstand	48.0 kg
	Cylinder assembly	16.0 kg
	Pump rods	1.2 kg. per metre

3.2 Dimensions

Drop pipe size:	1.25 inches
Outside diameter of below-ground assembly:	75 mm
Pump rod diameter:	0.5 inches

3.3 Cylinder Bore Not applicable

3.4 Ergonomic Measurements

HANDLE HEIGHT		PLATFORM HEIGHT	ANGULAR MOVEMENT OF HANDLE	HANDLE LENGTH	SEPARATION OF HANDLE	HEIGHT OF SPOUT
MAX (mm)	MIN (mm)	(mm)	(degrees)	(mm)	(mm)	(mm)
1244	738	0	360	253	240	563

4. ENGINEERING ASSESSMENT

4.1 Materials of Construction

COMPONENT	MATERIAL(S)
Pumpstand column	Fabricated steel, galvanised
Pump top (gearbox)	Cast steel
Handles	Cast steel
Bearings	Proprietary taper roller bearings
Gears	Mild steel
Rotor	Steel, hard chrome-plated
Stator	Moulded elastomer in steel tube
Foot valve	Gunmetal with brass strainer
Drop pipe	Galvanised steel
Pump rods	Galvanised steel

#### 4.2 Manufacturing Techniques

The manufacturing techniques required to make the pump are listed below:-

Above-ground Assembly	Iron and steel foundry Steel fabrication Complex machining
--------------------------	--

The pumpstand demands advanced manufacturing techniques and skills. It would not be suitable for manufacture in a developing country.

Below-ground Assembly	Iron foundry Gunmetal foundry Simple machining Hard chrome plating Specialised processes (pumping element)
--------------------------	--

The pumping element demands advanced and specialised manufacturing techniques and a high degree of skill. It would be particularly unsuitable for manufacture in a developing country.

#### 4.3 Ease of Installation, Maintenance and Repair

##### 4.3.1 Ease of Installation



A die and diestock for threading the pump rod, together with clamps and hexagon keys were supplied with the test samples.

##### 4.3.2 Ease of Pumpstand Maintenance and Repair



Frequent attention to the pumpstand is unlikely to be required. A broken handle could be replaced in the field, but internal repairs to the gearbox assembly may demand workshop facilities.



#### 4.3.3 Ease of Below-ground Maintenance and Repair

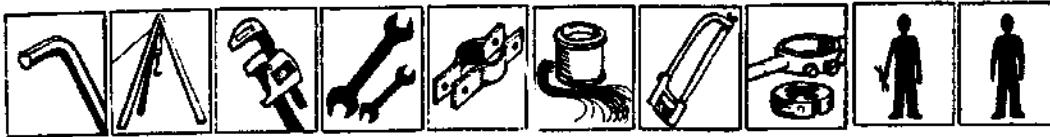

Frequent attention to the below-ground assembly is unlikely to be required. However, any repair requires removal of the complete below-ground assembly, and if the pumping element is faulty it must be replaced as a unit. In general, this pump requires an exchange rather than a maintenance routine.

#### 4.4 Resistance to Contamination and Abuse

##### 4.4.1 Resistance to Contamination

The pumpstand is adequately sealed against contamination, provided care is taken to seal the well head adequately against ground water.

##### 4.4.2 Likely Resistance to Abuse

The pumpstand is very robust and all fixings are secure; socket screws are used for all external fixings. The pump was undamaged in the side impact tests.

#### 4.5 Potential Safety Hazards

The spout on this pump is a length of galvanised steel pipe - on the test samples, the sawn end was sharp and potentially dangerous.

#### 4.6 Suggested Design Improvements

The hand grips are an integral part of the roughcast steel handles and are uncomfortable to grasp and turn. They should be polished or replaced by rotating hand grips.

The sawn end of the spout should be smoothed.

In response to these suggestions, the manufacturer has modified the hand grips - the same casting is used but the hand grips are polished. The sharp edge on the spout is now removed.

## 5. PUMP PERFORMANCE

### 5.1 Volume Flow, Work Input and Efficiency

The description of the method can be found in the Test Procedure.

HEAD	7 m			25 m			45 m		
Nominal pumping rate (rev/min)	30	40	50	30	40	50	30	40	50
Vol/rev (litres)	0.23	0.23	0.23	0.20	0.20	0.20	0.15	0.15	0.16
Work input/rev (J)	130	144	140	139	152	166	195	209	198
Efficiency (%)	11	10	11	35	32	29	34	31	36

### 5.2 Leakage Tests

The measured leakage from the footvalve was not significant, i.e. less than 0.1 ml/minute, at 7, 25 and 45 metres.

## 6. USER TRIAL

### 6.1 User Responses

Details of the organisation of this trial can be found in the Test Procedures, and the statistical analysis of user responses is presented in Appendix I.

### 6.2 Observations

This pump was consistently disliked, especially by smaller users. Most of the effort must be supplied by the arms and shoulders only; there is little opportunity to bring other muscle groups into play. The efforts were high and the rate of delivery slow. Smaller users with limited reach, particularly children, could not maintain a smooth circular motion of the handles. This problem was more acute than for a conventional reciprocating pump because the users could not choose to operate the pump at less than full stroke. Several users tried to operate the pump with one handle only, but all except one reverted to two-handle operation. The rough, non-rotating hand grips were consistently criticised.

## 7. ENDURANCE

A detailed description of the endurance test method can be found in the Terms of Reference.

### General Comments

The pump was tested at 40 revolutions per minute at a simulated head of 45 metres.

The Moyno failed once in the 4000 hour test programme, after 3178 hours. A rubber block is fitted in the bottom of the cylinder to prevent the rotor striking the base of the cylinder during installation. Although when first installed there was a clearance of 30 mm or so between the bottom of the rotor and the block, the block had worked its way up the cylinder bore and fouled the rotor, making the pump very difficult to turn. It was replaced in the correct position and the problem did ~~not~~ recur.

Some grease leaked out of the gearbox through one of the handle bearing seals, see photograph, right, but the final inspection revealed that plenty of grease remained in the gearbox.



At the end of the test, the pump was generally in very good condition, with little corrosion. Wear was confined to the elastomeric stator which had been scored in several places by sand, but this was insignificant.

Breakdown Incidence

Breakdowns are shown in bold type.

Hours:	1072	2044	3060	3178	4063
				<b>Rotor Seized</b>	
	Inspection and full performance test	Inspection and volume flow	Inspection and volume flow	Inspection and volume flow	Inspection and full performance test

Details of the Endurance Test

Breakdowns are shown in bold type.

HOURS

1072 INSPECTION after 1st 1000 hours:

- (a) Rotor marked by particle of swarf - origin unknown
- (b) No corrosion

2044 INSPECTION after 2nd 1000 hours:

- (a) Grease leaking from handle bearing seal in gearbox
- (b) No corrosion

3060 INSPECTION after 3rd 1000 hours:

- (a) Grease leaking from handle bearing seal in gearbox
- (b) No corrosion

**3178 Pump very stiff indeed. Dismantled - rubber block at lower end of cylinder entangled in end of rotor. Reassembled and test continued with all original parts**

Estimated amount of water pumped to breakdown.....1.2 million litres

HOURS

4063 FINAL INSPECTION

1. Pumpstand In good condition throughout
2. Cylinder Assembly
  - (a) Rubber stator grooved by sand particles, but still serviceable
  - (b) Steel rotor in good condition, highly polished
  - (c) Considerable quantity of sand in foot valve, though still working
3. Corrosion No significant corrosion, though paint flaking off cylinder housing

Estimated total amount of water pumped in 4000 hours ..... 1.5 million litres.

Revs/min	Volume Flow Tests at 45m (litres)			Leakage Tests at 7 m (ml/min)
	30	40	50	
New	0.16	0.16	0.17	less than 0.1
After 1000 hours	0.15	0.16	0.18	less than 0.1
After 2000 hours	0.17	0.18	0.19	less than 0.1
After 3000 hours	0.14	0.16	0.17	less than 0.1
After 4000 hours	0.17	0.18	0.19	less than 0.1

Pump Performance after Endurance

HEAD	7 m			25 m			45 m		
	30	40	50	30	40	50	30	40	50
Nominal pumping rate (revs/min)	30	40	50	30	40	50	30	40	50
Vol/revs (litres)	0.23	0.23	0.23	0.21	0.21	0.22	0.17	0.18	0.19
Work input/revs (J)	75	68	70	101	88	94	147	137	144
Efficiency (%)	20	22	22	51	59	57	49	58	58

If compared with the original performance data, these results show a marked general reduction in the work input requirement, with a consequent increase in efficiency. This suggests that slight wear of the stator rubber has reduced the amount of deformation taking place.

8. ABUSE TESTS

8.1 Side Impact Tests The pump was undamaged in the side impact tests.

9. VERDICT

A robust pump, in good condition after 4000 hours of endurance testing. The rate of delivery was low, and the pump was hard work to operate at first, though it became slightly less hard with further use. Although generally reliable in these tests, any repairs needed in the field will be difficult and expensive. It may not be ideal for community water supply because of the difficulties of operation and low rate of delivery. Expensive.

Nepta Pump

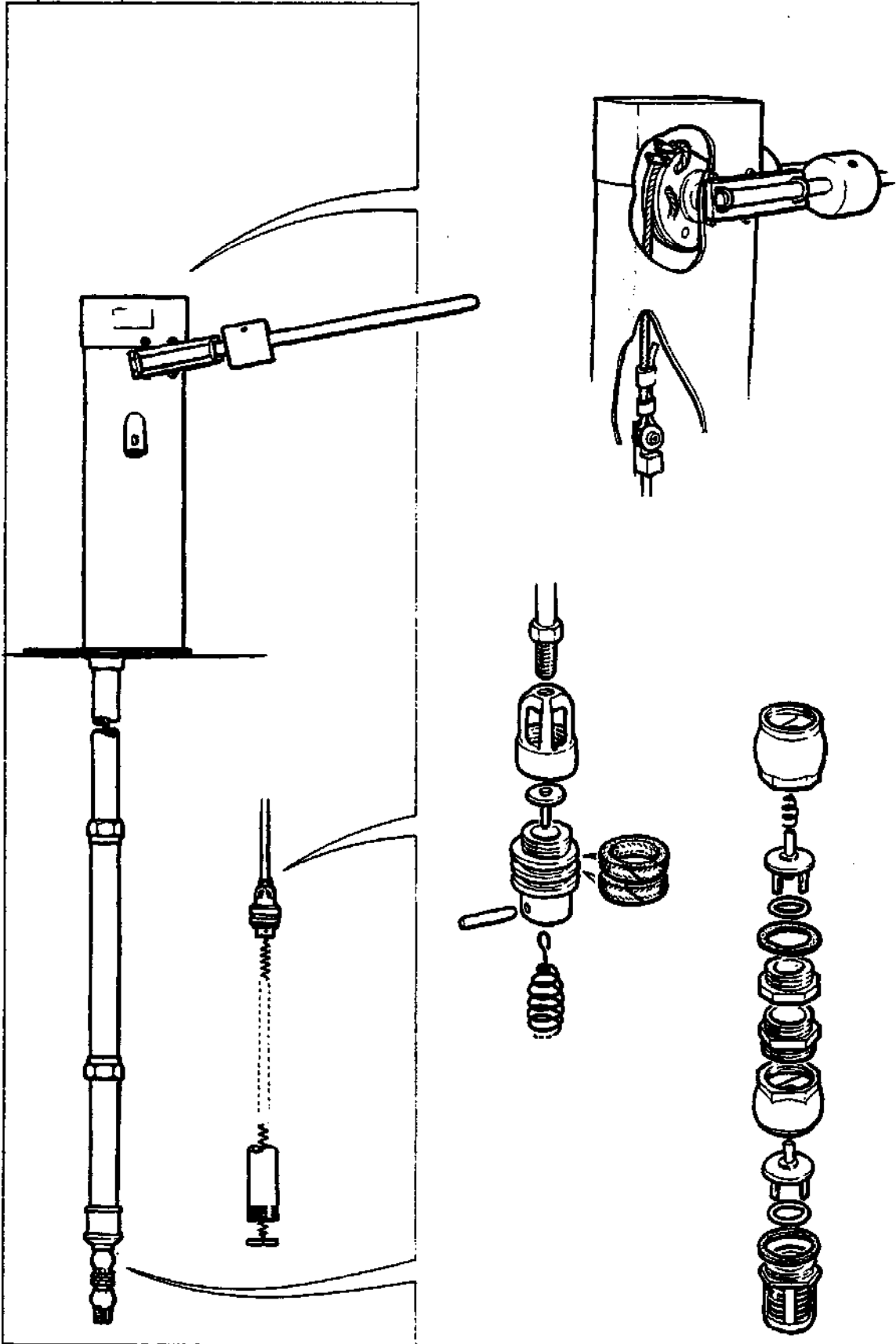

BRIAU NEPTA

1.1 Manufacturer

Briau SA

Address

BP 0903,  
37009 Tours Cedex,  
FRANCE

1.2 Description

The Nepta is a deep-well force pump, made in France. The pumpstand body is fabricated from sheet steel, the handle mechanism machined and fabricated from steel sections. The body is protected by a coating of nylon, the handle is galvanised. The pump rods are stainless steel attached at the top to approximately one metre of polyester cord, which wraps around a machined sector attached to the handle.

The cylinder is seamless brass tube. The machined plunger uses two sealing rings of square-section textile cord in place of conventional cup seals. Tension in the pump rod and polyester cord is provided by a stainless steel spring attached to the bottom of the plunger. Two foot valves are fitted, of similar design, each using a rubber O-ring seal.

1.3 Price in 1982

\$650, supplied with 20 m below-ground assembly

2. INSPECTION

2.1 Packaging

These pumps were very well packaged. All the components except the drop pipe were contained in wooden packing cases.

The pipes were bound together in groups of four. The threaded ends of the pipes were protected by plastic caps, surrounded by wood shavings and wrapped in small plastic sacks.

2.2 Condition as Received

Both samples appeared to be in working order as received, in spite of minor defects. The plungers in both samples were not assembled tight, and one plunger-to-pump rod joint was not tight enough. Although not of immediate significance, these defects might cause premature failure if not remedied before installation. The nylon coating on the spout of one pumpstand had been damaged in transit. Once installed, however, a more significant defect came to light. The pump would work at shallow depths, but was unsatisfactory at 25 metres and very poor at 45 metres. The reason was found to be leakage past



2.2 Condition as  
Received (cont.)

the plunger seals, caused by wrongly-sized sealing cords - see photograph, below. The cords appeared to have been cut to length to suit the machined grooves in the plunger, and with butt joints - as a result they were a poor fit in the cylinder in both samples.



Spare cord had been supplied with the pumps, and new sealing rings were cut to suit the cylinder bore, and with angled, scarf joints. This markedly improved the pump efficiency, from 37% to 71% at 25 metres depth.

2.3 Installation & Maintenance Information

A booklet was supplied with the pumps, giving helpful instructions for installation. The instructions were in French, but were well illustrated and useful.

3. WEIGHTS and MEASURES

3.1 <u>Weights</u>	Pumpstand	41.5 kg
	Cylinder assembly	15.5 kg
	Pump rods	0.7 kg per metre

3.2 <u>Dimensions</u>	Nominal cylinder bore:	50 mm
	Actual pump stroke:	203 mm
	Nominal volume per stroke:	399 ml
	Drop pipe size:	1.25 inches
	Outside diameter of below-ground assembly:	76 mm
	Pump rod diameter:	10 mm
	Maximum usable cylinder length:	620 mm

**3.3 Cylinder Bore**

No significant taper or ovality was found in either of the samples.

The surface roughness average (Ra) was measured in three places in a direction parallel to the cylinder axis.

SAMPLE	CYLINDER BORE	ROUGHNESS AVERAGE ( $\mu\text{m}$ )			MEAN
		TEST 1	TEST 2	TEST 3	
1	Extruded brass	0.05	0.06	0.06	0.06
2	Extruded brass	0.22	0.18	0.22	0.21

Measured at 0.25 mm cut-off

**3.4 Ergonomic Measurements**

HANDLE HEIGHT		PLATFORM HEIGHT (mm)	ANGULAR MOVEMENT OF HANDLE (degrees)	HANDLE LENGTH (mm)	VELOCITY RATIO OF HANDLE	HEIGHT OF SPOUT (mm)
MAX <sup>(1)</sup> (mm)	MIN <sup>(1)</sup> (mm)					
1413	190	0	104	780	7.0:1	530

(1) Measured without compressing bump stops.

**4. ENGINEERING ASSESSMENT**

**4.1 Materials of Construction**

COMPONENT	MATERIAL(S)
Pumpstand	Fabricated steel, nylon-coated
Handle and counterweights	Steel, galvanised
Bearings	Mild steel shafts in plain bronze shell bearings
Quadrant assembly	Fabricated steel, galvanised
Cylinder	Extruded brass
Plunger	Cast gunmetal or brass
Plunger seals	Textile cord
Drop pipe	Galvanised steel
Pump rods	Stainless steel with polyester cable coupling at pumpstand

#### 4.2 Manufacturing Techniques

The manufacturing techniques required to make the pump are listed below:-

Above-ground Assembly	Steel fabrication Sheet metal forming Machining Rubber moulding Plating
--------------------------	---

The pumpstand body is fabricated from formed sheet steel and coated with plastic for corrosion resistance. The machining of the pivot shaft and cable quadrant assembly requires careful quality control. The polyester cable at the top of the pump rod is a proprietary item.

Below-ground Assembly	Brass/gunmetal foundry Hot pressing of brass Machining Rubber moulding
--------------------------	---

Care is needed in fitting the plunger packing to ensure a satisfactory seal in the cylinder bore.

##### 4.3.1 Ease of Installation



Clamps and hexagon keys were supplied with the test samples. This pump needs attention to the final adjustments of the polyester cord and the handle counterweights. Care is needed to ensure a sanitary seal at the wellhead.

##### 4.3.2 Ease of Pumpstand Maintenance and Repair



This pumpstand is unlikely to require frequent maintenance, and need not be removed from the wellhead. The bearings may be replaced when necessary; a hexagon key is needed, but this was supplied by the manufacturer.

#### 4.3.3 Ease of Below-ground Maintenance and Repair



Repairs require removal of the complete below-ground assembly. The valves use O-ring seals which are easy to replace once the cylinder has been dismantled. If the spring is retained, it is likely to demand frequent replacement; care is then needed to avoid damage to the plunger.

#### 4.4 Resistance to Contamination and Abuse

##### 4.4.1 Resistance to Contamination

The pumpstand is adequately sealed against contamination, provided care is taken to seal the base of the pumpstand to the wellhead.

##### 4.4.2 Likely Resistance to Abuse

The rather thin baseplate could be susceptible to abuse but fixings are mostly secure.

#### 4.5 Potential Safety Hazards

The handle on the pump is particularly heavy and would be dangerous if the polyester cord were to break in use.

There are a number of potential finger traps between the handle and the pumpstand, see photograph.

Increased clearances would help considerably.

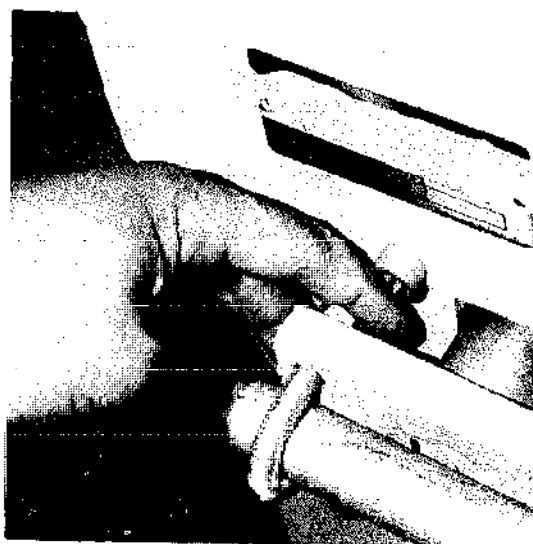

**4.6 Suggested Design Improvements**

The plunger sealing rings should be cut to length to suit the cylinder bore rather than the machined grooves in the plunger body, and the joints should be cut at an angle, as shown, right. The manufacturer has adopted this suggestion.

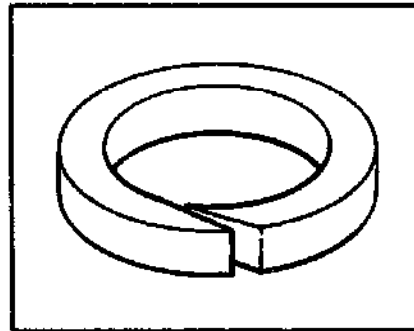

The efficiency of the plunger valve may be improved by providing a rubber or leather valve seat.

The tension spring below the plunger should be omitted. In deep-well applications, the weight of the pump rods should be sufficient to maintain tension in the polyester cord. In shallower applications, thicker, heavier rods or additional weight added to the plunger may be needed.

The baseplate should be strengthened to avoid distortion.

Either the setting instructions for the plunger position should be improved or the cylinder length should be increased.

**5. PUMP PERFORMANCE**

**5.1 Volume Flow, Work Input and Efficiency**

The description of the method can be found in the Test Procedure

HEAD	7 m			25 m			45 m		
Nominal pumping rate (strokes/min)	30	40	50	30	40	50	30	40	50
Vol/stroke (litres)	0.39	0.40	0.39	0.38	0.39	0.40	0.38	0.39	0.39
Work input/stroke (J)	51	45	43	130	123	120	206	216	180
Efficiency (%)	52	60	61	71	76	80	81	78	94

**5.2 Leakage Tests**

The measured leakage from the foot valve was not significant, i.e less than 0.1 ml/minute, for heads of 7, 25 and 45 metres.

6. USER TRIAL

6.1 User Responses

Details of the organisation of this trial can be found in the Test Procedure, and the statistical analysis of the user responses is presented in Appendix I.

6.2 Observations

Many users complained that the handle was too low. The handle moves through a wide arc, 104° for a full stroke. The users were keen to try for a full stroke because of the relatively slow rate of delivery of the pump but they found the exaggerated body movements uncomfortable.

7. ENDURANCE

A detailed description of the endurance test method can be found in the Test Procedure.

General Comments

The pump was tested at 40 strokes per minute at a simulated head of 45 metres.

The only failures in the 4000 hour endurance test were of the tension spring. The spring broke and was replaced during the first 1000 hour period. 289 hours later the replacement spring broke and was replaced. It was not replaced when it broke for the third time since the pump seemed to work satisfactorily without the spring. The pump completed the last 1000 hours of the test without a spring.

In the final inspection, all the valves were found to be in good condition, though there were signs of wear. The upper sealing ring on the plunger was noticeably worn, but the lower ring was in good condition and working well. The cylinder bore was in very good condition, with no signs of wear. There was some play in the handle bearings, but they were still serviceable.

Breakdown Incidence

Breakdown shown in bold type.

Hours:	1072	<b>1318</b>	2044	3060	4063
		<b>Spring replaced</b>			
Inspection and full performance test	Inspection and volume flow. <b>Spring replaced</b>	Inspection and volume flow	Inspection and volume flow	Inspection and volume flow	Inspection and full performance test

Details of the Endurance Test

HOURS

290 Pump noisy - pump rod striking rising main and/or pumpstand. Delivery satisfactory therefore no action

1072 INSPECTION after 1st 1000 hours:

- (a) Return spring in base of cylinder broken - replaced
- (b) No corrosion

1318 Pump noisy - spring broken again - replaced

Estimated amount of water pumped to breakdown ..... 1.3 million litres

2044 INSPECTION after 2nd 1000 hours:

- (a) Return spring satisfactory
- (b) Upper packing in plunger slightly loose in groove - lower satisfactory
- (c) Handle bearings slightly worn
- (d) Thread stripped in cord clamp - longer bolt fitted

3060 INSPECTION after 3rd 1000 hours:

- (a) Return spring broken - not replaced, pump performance satisfactory without spring
- (b) Upper packing in plunger loose but lower still satisfactory
- (c) Handle bearings continuing to wear

4063 FINAL INSPECTION

- 1. Pumpstand Noticeable wear in handle bearings though still serviceable
- 2. Cylinder
  - (a) No sign of wear
  - (b) Leather sealing washer in lower cap split
- 3. Plunger
  - (a) Upper seal worn, lower seal satisfactory and still serviceable
  - (b) Plunger valve in good condition
- 4. Foot Valves Both valves in good condition
- 5. Corrosion
  - (a) Rust on quadrant within pumpstand
  - (b) Rust inside pumpstand casing where surface coating has been damaged
  - (c) Some rust where galvanised iron pipe joins foot valve body

Estimated total amount of water pumped in 4000 hours ..... 3.8 million litres.

Strokes/min	Volume Flow Tests at 45m (litres)			Leakage Tests at 7 m (ml/min)
	30	40	50	
New	0.38	0.39	0.39	less than 0.1
After 1000 hours	0.39	0.38	0.37	less than 0.1
After 2000 hours	0.42	0.43	0.44	less than 0.1
After 3000 hours	0.38	0.40	0.40	0.1
After 4000 hours	0.42	0.43	0.41	less than 0.1

Pump Performance after Endurance

HEAD	7 m			25 m			45 m		
	30	40	50	30	40	50	30	40	50
Nominal Pumping Rate (Strokes/min)	30	40	50	30	40	50	30	40	50
Vol/stroke (litres)	0.45	0.46	0.47	0.43	0.45	0.46	0.42	0.43	0.41
Work input/stroke (J)	56	62	69	147	159	170	324	351	320
Efficiency (%)	53	49	46	71	68	65	57	54	55

If compared with the original performance data the results at 45 m show a marked increase in the work input requirement, with a significant increase in volume flow at all depths. This suggests that during the test period the conformity of the packing rings to the cylinder bore has improved. This has resulted in increased friction.

8. ABUSE TESTS

8.1 Side Impact Tests

The pumpstand baseplate tended to distort at 200 Joules impact on the handle and 400 Joules and above on the centre of the pumpstand.

8.2 Handle Shock Test

After approximately 20,000 cycles the handle bump rubbers began to break up, and the back of the pumpstand body was becoming distorted. The test was terminated after 26,358 cycles because the excessive movement of the handle eventually caused the plunger to jam in the top of the cylinder.

9. VERDICT

A reasonably robust and generally reliable pump, if the spring were designed out. The pump worked satisfactorily without the spring for the last 1000 hours of the endurance test. Adequate performance of this pump depends on accuracy of fitting the plunger seals. Potentially suitable for community water supply, but not suitable for manufacture in many developing countries. Preferred by smaller users. Expensive.



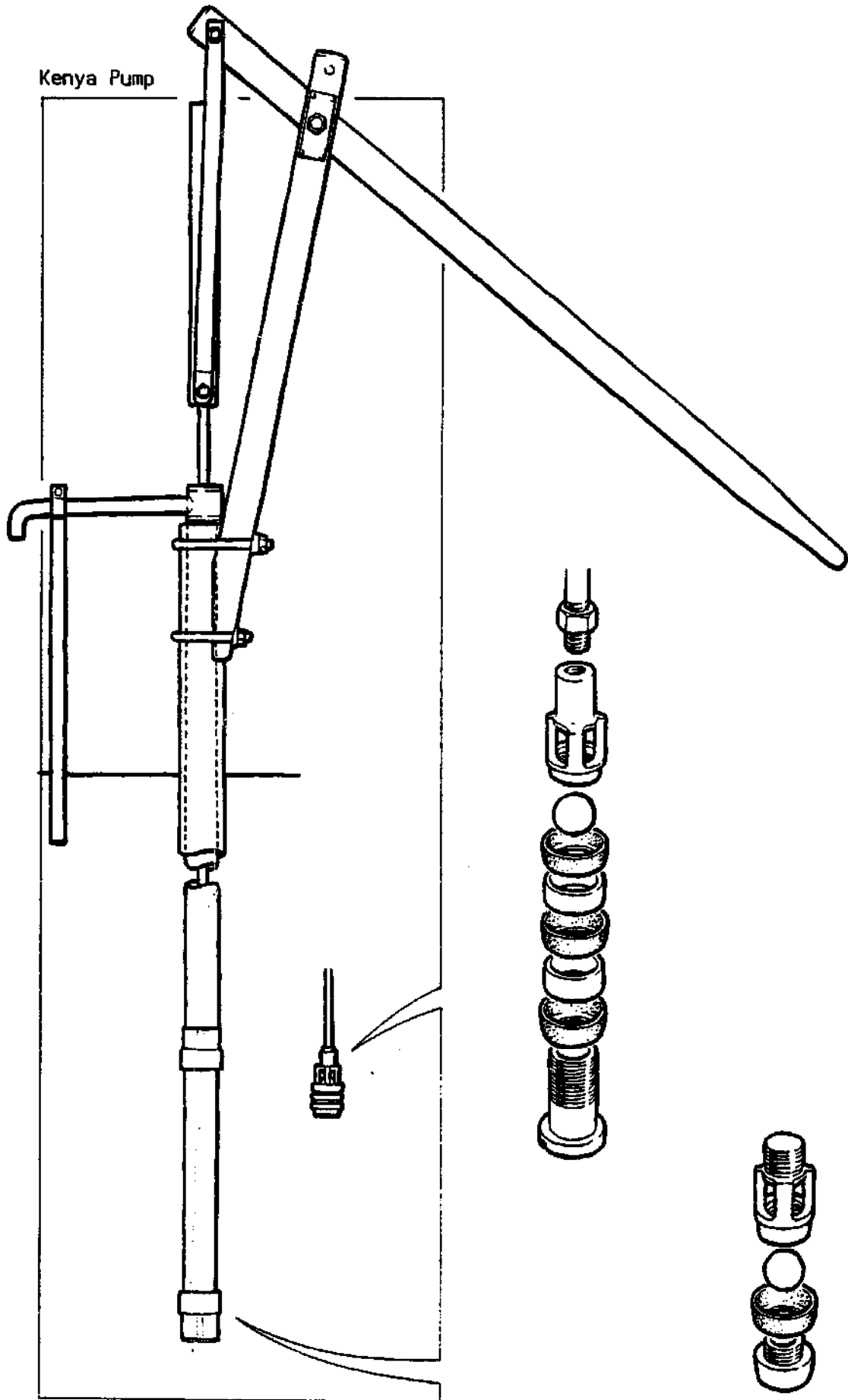

KENYA

- 1.1 Manufacturer Atlas Copco Terratest Limited,  
Address Enterprise Road,  
PO Box 40090,  
NAIROBI,  
Kenya.
- 1.2 Description The Atlas Copco Kenya, made in the country of its name, is a conventional deep-well force pump. The pumpstand is designed to an established, almost traditional, pattern. It is made of wood, steel and standard galvanised iron pipe and pipe fittings. The pumpstand is designed to clamp onto a 4 inch well casing.
- The cylinder is seamless brass tube, the plunger has three cup leathers and both plunger and foot valves contains stainless steel balls. The foot valve has a screw thread to allow it to be attached to the plunger, so that both plunger and foot valve may be extracted without removing the cylinder or rising main, provided at least 2.5 inch pipe is used.
- 1.3 Price in 1981 \$669
2. INSPECTION
- 2.1 Packaging The pumps were securely packed in a robust plywood packing case bound with steel strapping. Although strong enough to resist rough treatment the size and weight of the package might make it difficult to man-handle.
- 2.2 Condition as Received The pumps were received in working order. However, in one sample the spout was partially blocked by surplus zinc from galvanising, which would have restricted the outflow of water, and there was rust on the pump rod connecting tubes and on the split pins of both samples.
- 2.3 Installation & Maintenance Information None supplied with the pump.

3. WEIGHTS and MEASURES

3.1 <u>Weights</u>	Pumpstand	67.0 kg
	Cylinder assembly	6.5 kg
	Pump rods	1.5 kg. per metre

3.2 Dimensions

Nominal cylinder bore:	59 mm
Actual pump stroke:	295 mm
Nominal volume per stroke:	807 ml
Drop pipe size:	2 inches
Outside diameter of below-ground assembly:	84 mm
Pump rod diameter:	21.5 mm (0.5 inch galvanised steel pipe)
Maximum usable cylinder length:	400 mm

3.3 Cylinder Bore No significant taper or ovality was found in either of the samples.

The surface roughness average (Ra) was measured in three places in a direction parallel to the cylinder axis.

SAMPLE	CYLINDER BORE	ROUGHNESS AVERAGE (µm)			MEAN
		TEST 1	TEST 2	TEST 3	
1	Extruded brass	0.09	0.08	0.09	0.09
2	Extruded brass	0.12	0.14	0.12	0.13

Measured at 0.25 mm cut off

3.4 Ergonomic Measurements

A platform is not required. The pumpstand is attached to the protruding top of the well casing.

HANDLE HEIGHT		PLATFORM HEIGHT (mm)	ANGULAR MOVEMENT OF HANDLE (degrees)	HANDLE LENGTH (mm)	VELOCITY RATIO OF HANDLE	HEIGHT OF SPOUT (mm)
MAX <sup>(1)</sup> (mm)	MIN <sup>(1)</sup> (mm)					
2075	320	0	61	1740	5.5:1	525

(1) Measured without compressing bump stops.

4. ENGINEERING ASSESSMENT

4.1 Materials of Construction

COMPONENT	MATERIAL(S)
Fulcrum upright	Wood
Handle	Wood
Bearings	Mild steel pivot shafts bear on drilled holes in wood
Outlet elbow and spout	Galvanised steel pipe fittings
Guide tube and links	Mild steel
Cylinder	Extruded brass, gunmetal end caps
Plunger	Gunmetal, stainless steel ball valve
Cup seals	Leather
Foot valve	Cast gunmetal, stainless steel ball valve, leather seal
Pump rod	Standard 0.5 inch galvanised pipe

4.2 Manufacturing Techniques

The manufacturing techniques required to make the pump are listed below:-

Above-ground Assembly	Steel forging and welding Basic machining Woodwork
--------------------------	--

The pumpstand is simple to manufacture, requiring basic skills in steel fabrication, simple machining and woodwork. It is suitable for manufacture in developing countries where timber of a suitable quality is readily available.

Below-ground Assembly	Brass/gunmetal foundry Machining Leather craft
--------------------------	--

The below-ground assembly requires generally higher levels of manufacturing skill than the pumpstand. It would not be suitable for manufacture in some developing countries.

### 4.3 Ease of Installation, Maintenance and Repair

#### 4.3.1 Ease of Installation

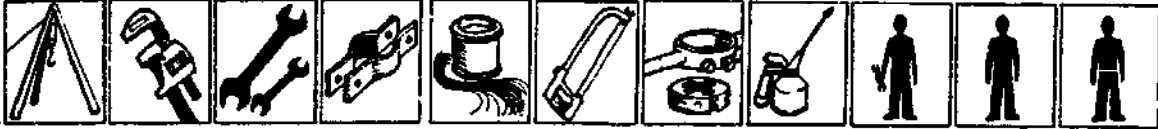

The 4 inch well casing must protrude at least 350 mm above ground, to attach the fulcrum upright. The spout support should be concreted in. The below-ground assembly will be heavy if 2.5 inch galvanised iron rising main is used. Assembly would be straightforward with good diagrammatic instructions.

#### 4.3.2 Ease of Pumpstand Maintenance and Repair



The design of this pumpstand lends itself to innovative repair using indigenous materials and should not be difficult.

#### 4.3.3 Ease of Below-ground Maintenance and Repair



Provided 2.5 inch rising main is used, the plunger and foot valve may be extracted without removing the rising main, so lifting tackle would not be needed.

### 4.4 Resistance to Contamination and Abuse

#### 4.4.1 Resistance to Contamination

Sealed against surface water but needs a better seal at the top of the 4 inch well casing.

#### 4.4.2 Likely Resistance to Abuse

The split pins are easy to remove, nuts only a little more difficult. Otherwise robust.

#### 4.5 Potential Safety Hazards

The U-bolts attaching the wooden fulcrum upright to the rising main have unnecessarily long ends which have not been deburred.

The reciprocating links could be dangerous to bystanders or children.

There are potential finger-traps between the handle and the fulcrum upright.

#### 4.6 Suggested Design Improvements

The angle between the fulcrum upright and the well casing should be better controlled to minimise the angular movement of the connecting links. The bracket used on the Shinyanga pump version would be much more satisfactory.

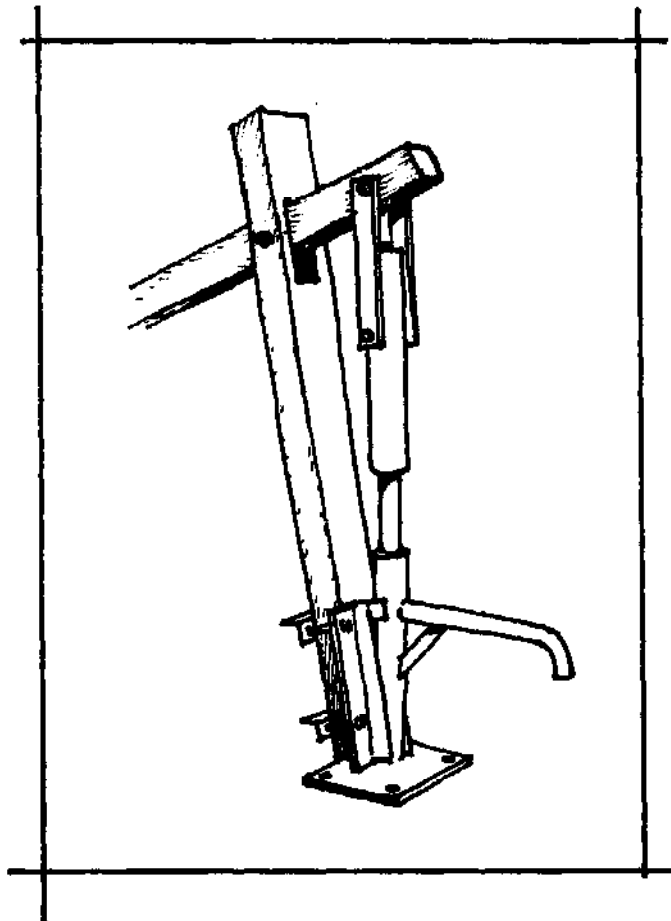

The end-plate of the rod connecting pipe should be thicker, to provide more thread for attaching the pump rod.

The valves would be more efficient if their lift were limited to one quarter of their effective diameter. The valve seats should be either sharp or chamfered, not radiused.

The lower pivots on the connecting pipe should be shorter, to minimise the overhang. This may be achieved by (a) omitting the existing spacers, reversing the connecting links and using shorter threaded studs. Alternatively, (b) the studs might be replaced by short L-shaped lengths of bar welded to the tube.

See illustration, below.

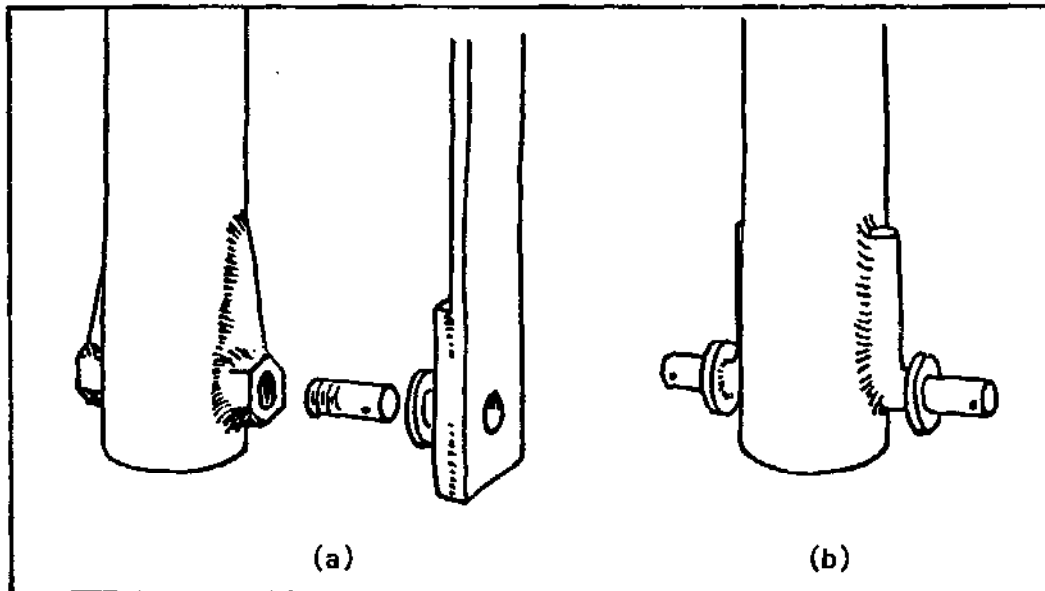

(We are awaiting the comments from the manufacturer.)

Kenya Pump

5. PUMP PERFORMANCE

5.1 Volume Flow, Work Input and Efficiency

The description of the method can be found in the Test Procedure.

HEAD	7 m			25 m			45 m		
Nominal Pumping Rate (strokes/min)	30	40	50	30	40	50	20	30	40
Vol/stroke (litres)	0.76	0.78	0.77	0.75	0.77	0.76	0.77	0.75	0.76
Work input/stroke (J)	119	122	141	271	300	290	500	493	528
Efficiency (%)	43	43	37	67	62	63	67	67	63

5.2 Leakage Tests

HEAD	7 m	25 m	45 m
Leakage rate ml/minute	1.2	1.3	0.5

6. USER TRIAL

6.1 User Responses

Details of the organisation of this trial can be found in the Test Procedure, and the statistical analysis of user responses is presented in Appendix I.

6.2 Observations

At its highest point, the handle of this pump was out of reach of several of the children, and awkward for some smaller women. Full strokes needed exaggerated body movements with a change of grip, from pull to push in mid-stroke.



7. ENDURANCE

A detailed description of the endurance test method can be found in the Test Procedure.

General Comments

The pump was tested at 40 strokes per minute at a simulated head of 45 metres. Within 200 hours of the start of the 4000 hour endurance test, the pump rod connecting tube, and the guide tube on which it slides, were worn through. This rapid wear was caused by misalignment of the connecting links. Alignment of these links depends on the angle of the timber upright, and that in turn depends on the accuracy of the groove cut in its base. This groove had been roughly cut, and as a result the connecting tube was constantly biased to one side. Wedges were inserted between the upright and the well casing to minimise the out-of-line forces in the connecting links.

Breakdown Incidence

Breakdowns are shown in bold type.

Hours:	1024	1350	2037	2153	3140	4147
<b>153</b>						
<b>Connecting Tube Worn Through</b>		<b>Loose connecting link stud</b>		<b>Severe Handle Wear</b>		
Inspection and full performance test	Inspection and volume flow	Inspection and volume flow	Inspection and volume flow	Inspection and volume flow	Inspection and volume flow	Inspection and full performance test

Details of the Endurance Test

Breakdowns are shown in bold type.

HOURS

**153** Connecting tube and guide tube worn through, caused by misalignment of fulcrum upright. Wedges inserted to change original angle of 6° to correct 9°.

Estimated additional amount of water pumped to breakdown..... 0.3 million litres.

HOURS

1024 INSPECTION after 1st 1000 hours:

- (a) Handle fulcrum and connecting link bearings worn
- (b) Cracks in the wooden handle and the fulcrum upright, though both still serviceable
- (c) Some corrosion at joint between plunger and pump rod

1350 One connecting link pin worked loose, causing severe wear of connecting tube and guide tube due to resultant misalignment. Stub pins modified in line with our suggested design improvement - (b) on page 68.

Estimated additional amount of water pumped to breakdown.....2.3 million litres

2037 INSPECTION after 2nd 1000 hours:

- (a) More wear in handle fulcrum - bearing hole elongated to about twice original size
- (b) Cracks in handle have closed up - appears to have shrunk - handle fairly tight in fulcrum upright
- (c) Ball valve cages in foot valve and plunger distorted - plunger worse than foot valve
- (d) More corrosion at joint between plunger and pump rod

2153 Handle reversed to combat wear in pivot hole

Estimated additional amount of water pumped to breakdown.....1.4 million litres

3140 INSPECTION after 3rd 1000 hours:

- (a) Slightly increased distortion of valve cages
- (b) Connecting tube and guide tube noticeably worn
- (c) More corrosion at joint between plunger and pump rod

4147 FINAL INSPECTION

1. Pumpstand (a) Connecting tube and guide tube considerably worn  
(b) All pivot holes in handle noticeably worn - some severely
2. Cylinder Slightly scratched but no significant wear - generally in good condition
3. Plunger (a) Valve cage distorted by hammering from valve ball  
(b) Valve seat pitted  
(c) Cup seals in good condition
4. Foot Valve (a) Valve cage distorted by hammering from valve ball, otherwise in good condition  
(b) Sand has penetrated filter and accumulated in filter cap
5. Corrosion Considerable rust on plunger rod, otherwise little corrosion

Estimated total amount of water pumped in 4000 hours .....7.4 million litres

Strokes/min	Volume Flow Tests at 45m (litres)				Leakage Tests at 7 m (ml/min)
	20	30	40	50	
New	0.77	0.75	0.76	-	1.2
After 1000 hours	-	0.75	0.75	0.75	0.5
After 2000 hours	-	0.68	0.68	0.69	0.7
After 3000 hours	-	0.69	0.70	0.70	0.3
After 4000 hours	0.76	0.76	0.76	-	0.3

Pump Performance after Endurance

HEAD	7 m			25 m			45 m		
	20	30	40	20	30	40	20	30	40
Nominal Pumping Rate (Strokes/min)	20	30	40	20	30	40	20	30	40
Vol/stroke (litres)	0.76	0.77	0.77	0.74	0.76	0.77	0.76	0.76	0.76
Work input/stroke (J)	195	210	211	370	378	381	572	581	594
Efficiency (%)	26	24	24	48	49	49	58	57	56

If compared with the original performance data, these results show a marked increase in the work input requirements with a consequent reduction in efficiency. This suggests that bedding in has increased the frictional losses and may largely be accounted for by the wear caused by the rubbing of the two steel guide tubes.

8. ABUSE TESTS

8.1 Side Impact Tests

The Kenya pump was undamaged by both the handle and body side impact tests. In the handle impact test, some of the energy was absorbed by the pump slipping round the well casing.

8.2 Handle Shock Test

The pump did not break down in the handle shock test, but a burr formed on the bottom of the pump rod connecting tube which caused noticeable wear of the guide tube.

9. VERDICT

A simple but cumbersome pump. Likely to need frequent maintenance above-ground, much of which could be avoided by small design changes. In particular the endurance test showed that more accurate alignment of the fulcrum upright and replacement of the original link pivots greatly increased the durability of the pumpstand. Possibly suitable for community water supply. Very heavy below-ground and therefore difficult to extract rising main, but plunger and footvalve may be removed on rodding, and in many respects could be maintained locally. Approaching a VLOM pump, but requires that at least the upper part of the well casing be made of steel. Expensive.

NB. It would have been helpful to have had some reaction from the manufacturer.

New No. 6 Pump

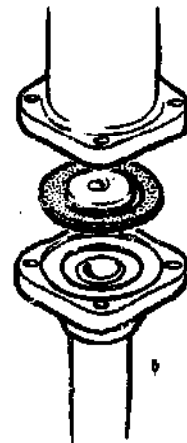
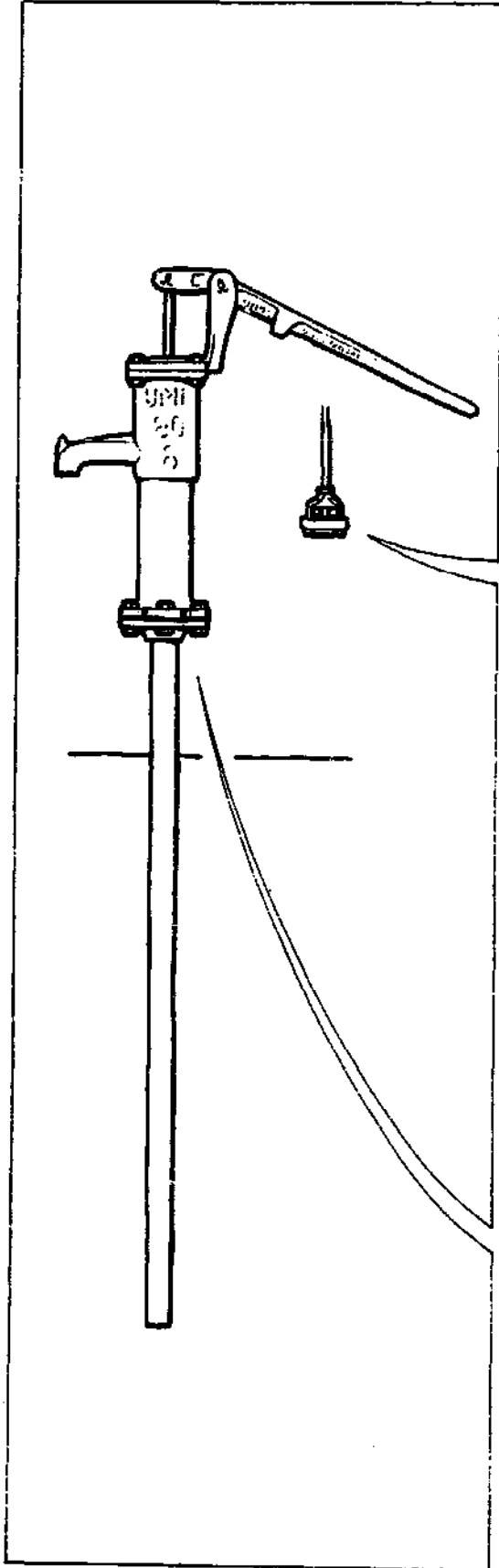

NEW NO. 6

- .1 Manufacturer Engineers Wood Steel Industries Ltd.,  
Address 67 Tejgaon Industrial Area,  
DHAKA-8,  
Bangladesh
- .2 Description The New No. 6 is a shallow-well suction pump, made  
in Bangladesh and constructed almost entirely of  
cast iron. It is mounted directly onto a 1.5 inch  
rising main. The plunger uses a moulded PVC cup  
washer. The check valve is a simple leather flap,  
weighted with cast iron.  
  
It appears crude and rather rough at first sight,  
but is commendably simple and robust.
- 3 Price in 1981 \$33
- INSPECTION
- 1 Packaging The pumps were in a single wooden packing case with  
corrugated cardboard lining.  
  
The cardboard liner would be adversely affected by  
water, but it and its contents were well supported  
by the wooden case.
- 2 Condition as  
Received Both samples were received in working order.  
However, both pump tops were loose, spring washers  
had been placed under the bolt heads rather than  
under the nuts. In one sample, the halves of the  
plunger were not tightly screwed together, and a  
locknut on the plunger rod was not tight. Although  
not of immediate significance, both these defects  
might cause premature failure of the pump if not  
remedied before installation.
- 3 Installation &  
Maintenance  
Information None supplied with the pump. Subsequently a  
maintenance leaflet was received which contained very  
helpful diagrams.

3. WEIGHTS and MEASURES

3.1 Weights Pumpstand 31.0 kg

3.2 Dimensions Nominal cylinder bore: 90 mm  
 Actual pump stroke: 219 mm  
 Nominal volume per stroke: 1393 ml  
 Drop pipe size: 1.5 inches

3.3 Cylinder Bore No significant taper or ovality was found in either of the samples.

The surface roughness average (Ra) was measured in three places in a direction parallel to the cylinder axis

SAMPLE	CYLINDER BORE	ROUGHNESS AVERAGE (µm)			MEAN
		TEST 1	TEST 2	TEST 3	
1	Machined cast iron	2.3	2.5	2.5	2.4
2	Machined cast iron	2.0	2.5	2.8	2.4

Measured at 0.25 mm cut-off

3.4 Ergonomic Measurements The pumpstand is mounted directly on the top of the rising main.

HANDLE HEIGHT		PLATFORM HEIGHT (mm)	ANGULAR MOVEMENT OF HANDLE (degrees)	HANDLE LENGTH (mm)	VELOCITY RATIO OF HANDLE	HEIGHT OF SPOUT (mm)
MAX <sup>(1)</sup> (mm)	MIN <sup>(1)</sup> (mm)					
1190	400	280 <sup>(2)</sup>	100	595	4.7:1	583

- (1) Measured without compressing bump stops.
- (2) Height of protruding rising main

4. ENGINEERING ASSESSMENT

4.1 Materials of Construction

COMPONENT	MATERIAL(S)
Pumpstand body	Cast iron
Handle	Cast iron
Bearings	Mild steel pivot shafts bear on holes drilled in iron castings
Plunger	Cast iron
Cup seal	Moulded PVC
Base valve	Leather

4.2 Manufacturing Techniques

The manufacturing techniques required to make the pump are listed below:-

- Iron Foundry
- Simple machining
- Plastic moulding
- Leather crafting

The New No.6 is well-suited for manufacture in developing countries where adequate skills in iron foundry work and basic machining are available. The pump has been designed intelligently to avoid close tolerances in casting or machining.

For example, the holes for the handle pivot pins are deliberately drilled oversize to avoid any problems arising from misalignment - see photograph, right.





### 4.3 Ease of Installation, Maintenance and Repair

#### 4.3.1 Ease of Installation



The drop pipe must be securely installed to support the pumpstand, otherwise this suction pump is easy to install. Only basic tools and skills are required.

#### 4.3.2 Ease of Maintenance and Repair



This pump is likely to require frequent attention to the plunger and check valve, but is very simple. Most jobs can be done with flat spanners and pliers. A pipe wrench may be needed to dismantle the plunger, which may become heavily corroded.

### 4.4 Resistance to Contamination and Abuse

#### 4.4.1 Resistance to Contamination

The pumpstand is open at top where the connecting rod passes through the top.

#### 4.4.2 Likely Resistance to Abuse

The cast iron handle and pump top are susceptible to accidental damage. The attachment to rising main is potentially weak: the whole pump might be too easily detached. The pivot pins and bolts are easy to remove.

### 4.5 Potential Safety Hazards

Split pins, with sharp ends, are used to retain the pivot pins for the handle.

### 4.6 Suggested Design Improvements

A sliding plate on the connecting rod (in the manner of the Bandung pump) would help to prevent contamination.

The diameter of the rising main should be increased and/or cast mounting lugs should be provided on the pumpstand to provide a more secure mounting at the wellhead.

The quality of the bore should be improved to reduce the rapid wear of the cup washer.

The handle casting pattern should be modified to provide a small bulge at the end to avoid hands slipping off the polished surface.

A small change to the casting pattern for the pump top could increase the strength of the handle fulcrum extensions and act as guides for a sliding plate - see illustration.

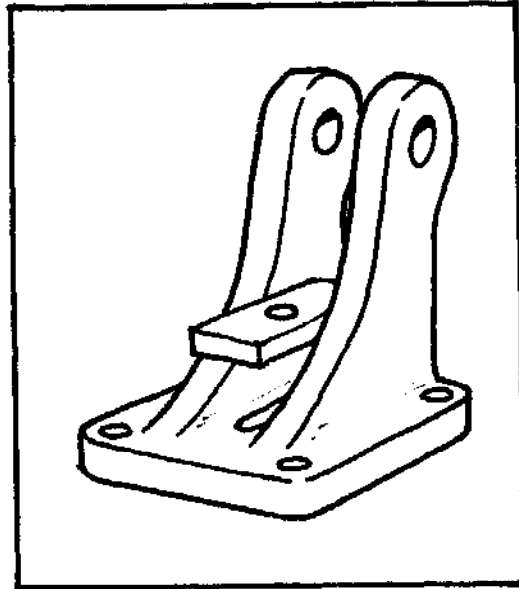

## 5. PUMP PERFORMANCE

### 5.1 Volume Flow, Work Input and Efficiency

The description of the method can be found in the Test Procedure.

HEAD	7 m		
Nominal pumping rate (strokes/min)	20	30	40
Vol/stroke (litres)	1.30	1.20	1.29
Work input/stroke (J)	148	121	134
Efficiency (%)	59	67	65

### 5.2 Leakage Tests

Leakage at 7 m head was 0.25 ml/minute. Leakage of the check valve will mean that the pump will require frequent priming with consequent risk of contamination.

## 6. USER TRIAL

### 6.1 User Responses

Details of the organisation of this trial can be found in the Test Procedure, and the statistical analysis of user responses is presented in Appendix I.

### 6.2 Observations

Many users were pleasantly surprised by the performance of this pump, contrasted with its crude appearance. It delivered plenty of water for each stroke, and the handle movement allowed arms, shoulders, back and legs to contribute. Some disliked the roughness of the handle.

## 7. ENDURANCE

A detailed description of the endurance test method can be found in the Test Procedure.

### General Comments

The pump was tested at 30 strokes per minute at 7 metres head.

The original cup washer and plunger valve were badly worn after 1000 hours, and were replaced. The cup washer failure was probably due to the initial roughness of the bore. The replacements lasted the remaining 3000 hours of the test programme, though both were badly worn at the end. The check valve was also replaced at 1000 hours, and the replacement also lasted out the remainder of the 4000 hours.

The final inspection revealed wear in the handle pivot shafts and the associated holes in the handle, pump top and connecting rod eye. The pump was still working however, and would probably continue for some time.

Corrosion was extensive. The cast iron pumpstand has no protective coating and was rusting wherever it had got wet. Because of rust the plunger was impossible to dismantle and the retaining screw could not be removed from the check valve weight.

The cylinder was in good condition at the end of the test. The original machining marks in the bore were still clearly visible although the high spots had been removed.

Breakdown Incidence

Breakdowns are shown in bold type.

Hours:	1072	2044	3060	4063
	<b>Cup Washer and Check Valve Worn Out</b>			
Inspection and full performance test	Inspection and volume flow	Inspection and volume flow	Inspection and volume flow	Inspection and full performance test

Details of the Endurance Test

Breakdowns are shown in bold type.

HOURS

**1072 INSPECTION** after 1st 1000 hours:

- (a) **Volume flow test results poor, approx. 50% of original condition data. New cup washer and plunger valve fitted. Check valve very hard, also replaced - performance restored.**
- (b) Some surface rust on most parts of pump

Estimated additional amount of water pumped to breakdown.....2.3 million litres

**2044 INSPECTION** after 2nd 1000 hours:

- (a) Cup washer hard and stiff but otherwise in good condition
- (b) Slight wear on side of plunger valve - seating satisfactory
- (c) Check valve in good condition
- (d) Noticeable wear in handle fulcrum components
- (e) More surface rust on most parts of pump

**3060 INSPECTION** after 3rd 1000 hours:

- (a) Plunger seal hard and stiff but working satisfactorily
- (b) Slightly more wear on plunger valve, but still satisfactory
- (c) More wear in handle fulcrum components though still serviceable
- (d) More surface rust on most parts of pump

4063 FINAL INSPECTION

1. Pump Body and handle
  - (a) Pivot holes in handle, pump top and connecting rod eye all noticeably worn - pins also worn though still serviceable
  - (b) Cylinder bore somewhat less rough than when new, but machining marks still clearly evident - no significant wear
2. Plunger
  - (a) Cup seal badly worn
  - (b) Plunger valve noticeably worn on its circumference - both valve faces also worn
3. Check Valve Leather flap deeply indented
4. Corrosion
  - (a) Plunger could not be dismantled because of rusted screw threads
  - (b) Check valve weight could not be removed from leather flap because of corrosion of retaining screw
  - (c) Considerable rust on unprotected cast iron of pump body, but no effect on pump performance

Estimated total amount of water pumped in 4000 hours ..... 8.6 million litres

Strokes/min	Volume Flow Tests at 7 m (litres)			Leakage Tests at 7 m (ml/min)
	20	30	40	
New	1.31	1.20	1.29	0.3
After 1000 hours	0.58	0.86	1.05	4.0
After 2000 hours	0.82	1.02	1.07	0.4
After 3000 hours	1.00	1.18	1.16	less than 0.1
After 4000 hours	0.48	1.01	0.93	8.6

Pump Performance after Endurance

HEAD	7 m		
Nominal Pumping Rate (Strokes/min)	20	30	40
Vol/stroke (litres)	0.48	1.01	0.93
Work input/stroke (J)	73	129	141
Efficiency (%)	45	53	45

These results are not comparable with the original performance test data because the plunger seal was replaced during the performance test.

## 8. ABUSE TESTS

### 8.1 Side Impact Tests

The pump failed in one of the side impact tests. In the body test, the thread in the pumpstand base was partially stripped at an impact of 300 Joules on the centre of the pumpstand. However, plenty of thread remained, and the pump could have been remounted and re-used. In the test on the handle, the pumpstand simply turned on its mounting thread to absorb the impact.

### 8.2 Handle Shock Test

The pump completed its allotted 72,000 cycles without failure.

## 9. VERDICT

A very simple, cheap and sturdy suction pump. Needs to be primed and therefore susceptible to contamination and abuse, hence not very suitable for drinking water supply. Initial roughness of the bore causes early failure of the cup washer and should be improved. Likely to wear considerably when heavily used. Suitable for manufacture in developing countries with iron foundry skills.

Nira Pump

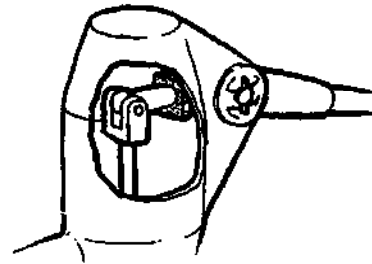
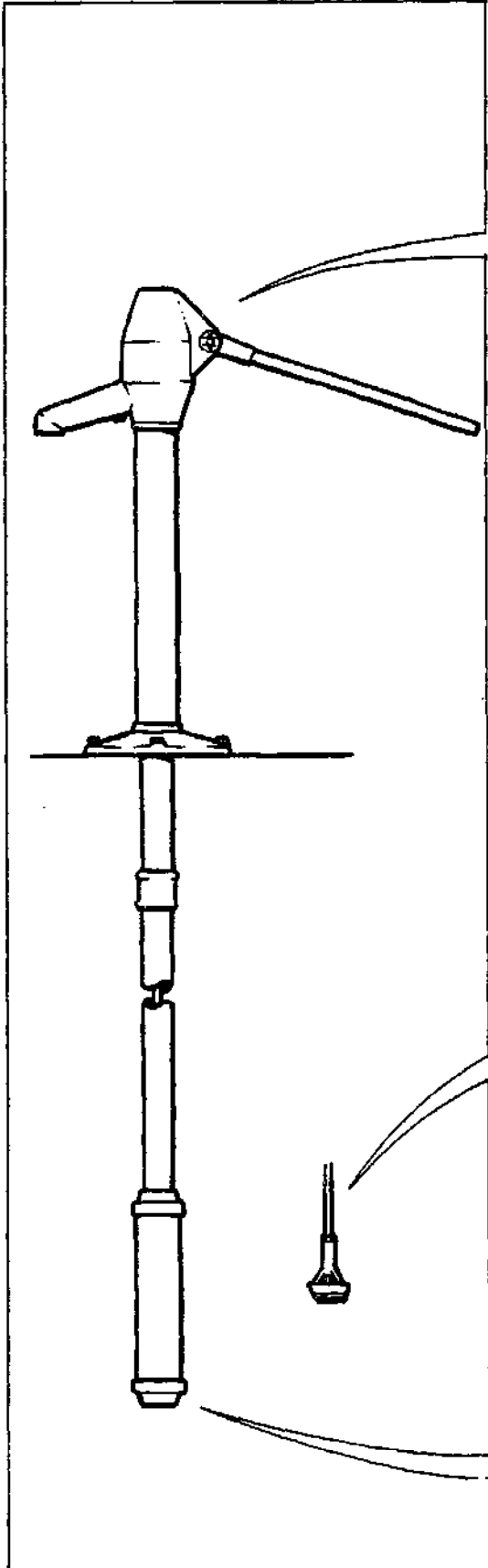

NIRA AF-76

- 1.1 Manufacturer Vammalan Konepaja oy,  
Address 38200 Vammala,  
FINLAND.
- 1.2 Description The Nira is a deep-well force pump, made in Finland. The pumpstand has a tubular steel column with a cast iron base, and a cast iron handle socket and spout assembly. The handle was originally steel bar but has since been changed to steel tube. The steel parts of the pumpstand are galvanised, the iron castings are protected by a nylon coating.
- The 76 mm bore cylinder is seamless brass tube with threaded collars soft-soldered to each end. The cup washer and plunger valve are combined in a single rubber moulding. The foot valve is of similar design, also moulded in rubber.
- 1.3 Price in 1982 \$203 Pump and cylinder
2. INSPECTION
- 2.1 Packaging Delivered in a single large wooden packing case 3.5 m long.
- The packaging was strong but its size and weight would make it difficult to man-handle. On the other hand, by packing all the components in a single case, the chance of components being separated in transit is much reduced.
- 2.2 Condition as Received Both pumpstands were in working order as received. However, one cylinder was externally damaged causing distortion of the bore, and several fixings were insufficiently tight. Although the pumps were in working order, these defects would be likely to cause premature failure if not remedied before installation.
- 2.3 Installation & Maintenance Information A promotional leaflet was supplied with the pumps. It included an annotated sketch of the components, but was not very helpful.



3. WEIGHTS and MEASURES

3.1 <u>Weights</u>	Pumpstand	29.5 kg
	Cylinder assembly	4.0 kg
	Rising main	5.2 kg/metre
	Pump rods	0.7 kg/metre

3.2 <u>Dimensions</u>	Nominal cylinder bore:	76 mm
	Actual pump stroke:	127 mm
	Nominal volume per stroke:	576 ml
	Drop pipe size:	2 inches
	Outside diameter of below-ground assembly:	95 mm
	Pump rod diameter:	10 mm
	Maximum usable cylinder length:	310 mm

3.3 Cylinder Bore No significant taper or ovality was found in any of the samples.

The surface roughness average (Ra) was measured in three places in a direction parallel to the cylinder axis.

SAMPLE	CYLINDER BORE	ROUGHNESS AVERAGE (µm)			MEAN
		TEST 1	TEST 2	TEST 3	
1	Extruded brass	0.06	0.07	0.06	0.06
2	Extruded brass	0.12	0.11	0.11	0.11

Measured at 0.25 mm cut-off

3.4 Ergonomic Measurements

HANDLE HEIGHT		PLATFORM HEIGHT (mm)	ANGULAR MOVEMENT OF HANDLE (degrees)	HANDLE LENGTH (mm)	VELOCITY RATIO OF HANDLE	HEIGHT OF SPOUT (mm)
MAX <sup>(1)</sup> (mm)	MIN <sup>(1)</sup> (mm)					
1155	542	0	58	623	5.0:1	603

(1) Measured without compressing bump stops.

#### 4. ENGINEERING ASSESSMENT

##### 4.1 Materials of Construction

COMPONENT	MATERIAL(S)
Pumpstand column	Steel, galvanised
Pump top	Cast iron
Handle	Mild steel
Bearings	Stub-backed bronze bushes with stainless steel pivot shaft
Fulcrum link	Cast gunmetal
Pivot pin	Stainless steel
Pump rod fork	Hot pressed brass
Cylinder	Brass, with soft-soldered end spigots
Plunger	Cast bronze with brass valve seat
Cup seal	Moulded rubber
Foot valve	Moulded rubber
Drop pipe	Galvanised steel
Pump rods	Stainless steel

##### 4.2 Manufacturing Techniques

The manufacturing techniques required to make the pump are listed below:-

Above-ground	Iron foundry
Assembly	Brass/gunmetal foundry
	Steel fabrication
	Rubber moulding
	Machining
	Plating
	Protective plastic coating

With the exception of the protective plastic coating, no specialised processes are required. However, the Nira is not an ideal design for manufacture in a developing country. Considerable skill in foundry work is demanded, particularly for the pumpstand top, and in steel fabrication, machining and rubber moulding.

Below-ground	Brass/gunmetal foundry
Assembly	Hot brass pressing
	Rubber moulding
	Machining
	Soft soldering

The below ground assembly demands similar levels of manufacturing skill to those needed in the pumpstand. The requirement for soft soldering arises from the need to attach threaded end spigots to the thin brass tube of the cylinder barrel.

#### 4.3 Ease of Installation, Maintenance and Repair

##### 4.3.1 Ease of Installation



The manufacturer supplied thread locking compound with the test samples. A grease gun is needed to lubricate the handle bearing. The below-ground assembly will be heavy, but in other respects installation is straightforward providing care is taken in handling the cylinder to avoid damaging the thin wall, and cutting the pump rod to the correct length.

##### 4.3.2 Ease of Pumpstand Maintenance and Repair



The pumpstand is easy to dismantle, and does not need to be removed from the wellhead. The handle bearings would be easy to replace in a workshop; in the field, replacement of the complete fulcrum casting might be required.

##### 4.3.3 Ease of Below-ground Maintenance and Repair



Repairs require removal of the complete below-ground assembly. For plunger seals and foot valve, manufacturer's spares are essential. Again, care is needed in handling the cylinder to avoid damaging the thin wall.

#### 4.4 Resistance to Contamination and Abuse

##### 4.4.1 Resistance to Contamination

The pump could be affected by surface water - otherwise very sanitary.

##### 4.4.2 Likely Resistance to Abuse

Pump head could be unscrewed from column but otherwise fixings secure. Handle quite easy to remove - would not be easy to improvise a replacement.

#### 4.5 Potential Safety Hazards

There are no significant safety hazards in this pump.

#### 4.6 Suggested Design Improvements

A thicker cylinder wall would be less easily dented and would allow integral threads at each end, thereby eliminating the need for soft-soldered end spigots.

Valve lift should be reduced, ideally to one quarter of the diameter. The manufacturer has adopted this suggestion.

In the newer, tubular handle, the core should be a tighter fit in the outer tube, otherwise the core provides little support.

A stiffer base casting would be advantageous.

The manufacturer now uses stainless shouldered fixing screws with hexagon heads in the plunger, to control the compression of the rubber moulding.

The manufacturer has modified the handle fulcrum, to improve its ability to resist side loads on the handle.

### 5. PUMP PERFORMANCE

#### 5.1 Volume Flow, Work Input and Efficiency

The description of the method can be found in the Test Procedure.

HEAD	7 m			25 m			45 m		
Nominal pumping rate (strokes/min)	30	40	50	30	40	50	30	40	50
Vol/stroke (litres)	0.62	0.63	0.65	0.64	0.65	0.65	0.60	0.59	0.59
Work input/stroke (J)	55	59	72	264	209	254	395	398	404
Efficiency (%)	76	71	61	59	75	63	66	65	63

#### 5.2 Leakage Tests

HEAD	7 m	25 m	45 m
Leakage rate (ml/min)	0.1	less than 0.1	less than 0.1

### 6. USER TRIAL

#### 6.1 User Responses

Details of the organisation of this trial can be found in the Test Procedure, and the statistical analysis of user responses is presented in Appendix I.

**6.2 Observations**

Children and small women found this pump difficult because of the high levels of effort required. Many children found it difficult to bring their weight to bear on the handle at the start of the downstroke.

**7. ENDURANCE**

A detailed description of the endurance test method can be found in the Test Procedure.

General Comments

The Nira was tested at 40 strokes per minute at a simulated depth of 36 metres, the maximum originally specified by the manufacturer. The handle broke several times within the 4000 hours. The original, round bar handle broke after only 314 hours. A new tubular handle was supplied by the manufacturer, but that in turn broke after a further 2200 hours or so, and a second sample 189 hours later. One of the tubular handles was repaired by welding and completed the remainder of the 4000 hour test. In response, the manufacturer now recommends the 76 mm cylinder for a maximum depth of 18 metres, and will offer a 50 mm cylinder for greater depths.

At the 1000 hour intermediate inspection, all the setscrews used to assemble the plunger were badly corroded, and the head of one screw had broken off. Because of this the plunger could not be dismantled and was therefore replaced completely.

In the final inspection, little wear was found in the valves, cup seal, cylinder and handle bearings. The six setscrews in the plunger were corroded but unbroken. There was no significant corrosion elsewhere.

Breakdown Incidence

Breakdowns are shown in bold type.

Hours:	1072	2044	3060	4063
<b>314</b>			<b>2828</b> <b>3017</b>	
<b>Handle Broken</b>			<b>Handles Broken</b>	
Inspection and full performance test	Inspection and volume flow	Inspection and volume flow	Inspection and volume flow	Inspection and full performance test

Details of the Endurance Test

Breakdowns are shown in bold type.

HOURS

**314 Handle broken - replaced**

Estimated amount of water pumped to breakdown.....0.5 million litres

651 New tubular handle from Nira fitted

1072 INSPECTION after 1st 1000 hours:

- (a) 1 of 6 setscrews in plunger broken - all 6 corroded
- (b) No significant corrosion elsewhere

2044 INSPECTION after 2nd 1000 hours:

- (a) 6 setscrews in plunger corroded
- (b) No other corrosion
- (c) Slight side play in handle fulcrum

**2828 Handle broken - replaced with 2nd new tubular type**

Estimated additional amount of water pumped to breakdown.....3.9 million litres

**3017 Handle broken - repaired**

Estimated additional amount of water pumped to breakdown.....0.3 million litres

3060 INSPECTION after 3rd 1000 hours:

- (a) Slightly more side play in handle fulcrum
- (b) 6 setscrews in plunger more corroded
- (c) No other corrosion

HOURS

4063 FINAL INSPECTION

1. Pumpstand Slight wear in handle fulcrum bearing but otherwise in good condition
2. Cylinder Light scratches on bore but no other signs of wear
3. Plunger Both sealing washer and valve in good condition
4. Foot Valve In good condition
5. Corrosion Noticeable corrosion of setscrews used to assemble plunger

Estimated total amount of water pumped in 4000 hours..... 6.2 million litres.

Strokes/min	Volume Flow Tests at 25m (litres)			Leakage Tests at 7 m (ml/min)
	30	40	50	
New	0.64	0.65	0.65	0.1
After 1000 hours	0.67	0.67	0.70	less than 0.1
After 2000 hours	0.68	0.73	0.74	less than 0.1
After 3000 hours	0.68	0.72	0.73	less than 0.1
After 4000 hours	0.62	0.65	0.67	0.8

Pump Performance after Endurance

HEAD	25 m		
Nominal Pumping Rate (Strokes/min)	30	40	50
Vol/stroke (litres)	0.62	0.65	0.67
Work input/stroke (J)	199	218	222
Efficiency (%)	76	72	73

The original performance data showed marked variations in work input requirement with operating speed. After endurance, the results are more consistent. This may be due to improved conformity of the rubber cup washer after bedding-in.

## 8. ABUSE TESTS

### 8.1 Side Impact Tests

In the side impact test on the handle, the pump top absorbed the impact by rotating on the screw threads on the pumpstand column. In the body test, the baseplate cracked at an impact of 400 Joules on the centre of the pumpstand. We understand that the manufacturer now supplies a fabricated, all-steel pumpstand baseplate.

### 8.2 Handle Shock Test

In the handle shock test, the pump was fitted with the later tubular handle, repaired after breaking during the endurance test after 3017 hours. The pump completed its allotted 96,000 cycles without failure.

## 9. VERDICT

The manufacturer now recommends a maximum depth of 18 metres, using a 3 inch cylinder, and supplies a smaller cylinder for greater depths. Some small design changes and a thicker cylinder wall could make this a robust pump, potentially suitable for community water supply. Although the design does not demand highly specialised manufacturing processes, the levels of skill required make it unsuitable for manufacture in many developing countries. Moderately priced.



Ethiopia Pump

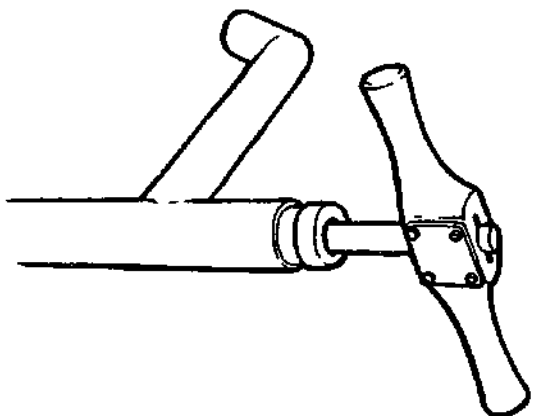
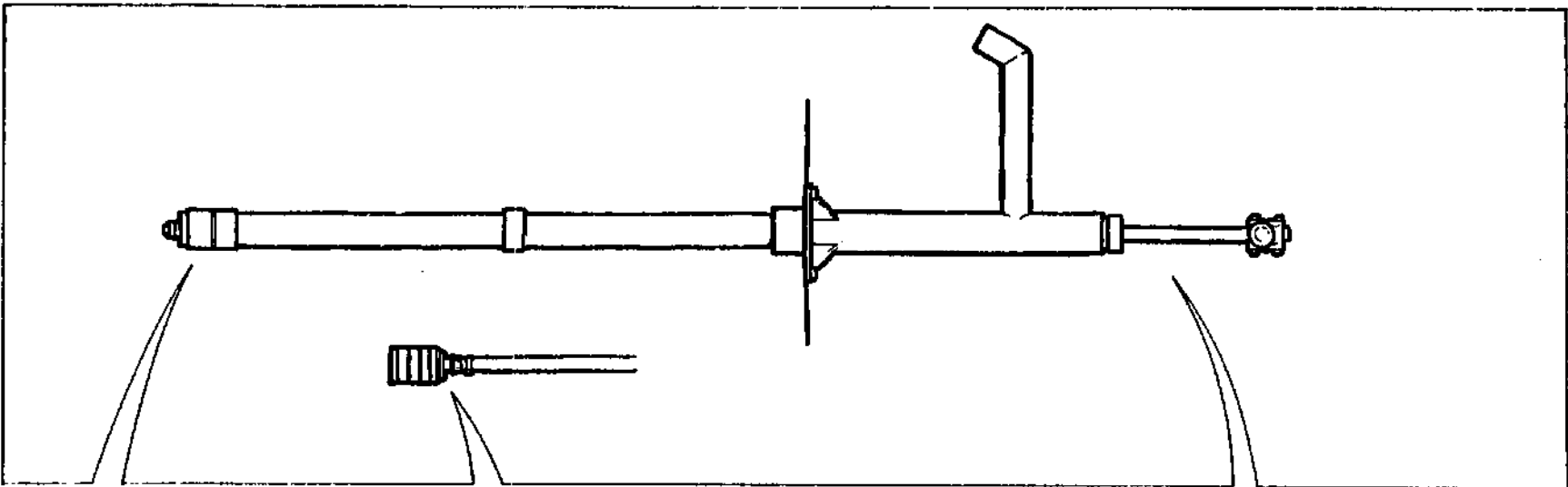

ETHIOPIA TYPE BP50

- 1.1 Manufacturer E.W.W.C.A.
- Address UNICEF,  
PO Box 1169,  
ADDIS ABABA,  
Ethiopia.
- 1.2 Description The Ethiopia Type BP50 is a shallow-well force pump, originally developed from an IDRC design and makes extensive use of plastics below ground. For shallow wells a simple T-handle is attached to the top of the pump rod for direct action pumping. For depths greater than 12 metres, the pumpstand has a lever.
- The pumpstand is fabricated from steel tube and plate. The rising main is 2 inch uPVC pipe, and is itself the cylinder. The maximum outside diameter of the below-ground assembly is 75 mm. The plunger has no separate seals; it is turned from high density polyethylene, and has a simple rubber flap valve backed by a steel washer. The foot valve is similar, its housing made from standard pipe couplings. The rods are also uPVC water pipe, stiffened with steel at the top. The handle is wood.
- 1.3 Price in 1981 \$75
2. INSPECTION
- 2.1 Packaging The pumps arrived in a single wooden packing case. A cardboard carton within the case protected the plungers and valve assemblies. The case was relatively easy to manhandle.
- 2.2 Condition as Received Both samples were received in good working order.
- 2.3 Installation and Maintenance Information A technical report and engineering drawings were sent with the pumps; both accurately described the samples. The technical report was interesting, the drawings helpful in installing the pump. It would be important however, to know what literature would be generally supplied with the pump.

3. WEIGHTS and MEASURES

3.1	<u>Weights</u>	Pumpstand Pump rods Rising main	11.3 kg 0.4 kg per metre 1.4 kg per metre
3.2	<u>Dimensions</u>	Nominal cylinder bore:  Actual pump stroke: Nominal volume per stroke: Drop pipe size: Outside diameter of below-ground assembly: Pump rod diameter:	50 mm - 2 inch rising main used as cylinder  370 mm 726 ml 2 inches 75 mm 22 mm - 0.5 inch bore PVC water pipe

3.3 Cylinder Bore These pumps were not supplied with a cylinder; the plunger is designed to be used directly on the bore of the 2 inch PVC rising main. The pipe used for testing was very smooth on the exterior but the bore was wavy. The surface roughness average (Ra) measurements were approximately 1.50 um at a cut-off of 2.5 mm, 0.60 um at a cut-off of 0.80 mm. This quality of finish provided adequate performance but a smoother finish will improve performance.

3.4 Ergonomic Measurements

HANDLE HEIGHT		PLATFORM	VELOCITY	HEIGHT
MAX <sup>(1)</sup>	MIN <sup>(1)</sup>	HEIGHT	RATIO OF	OF SPOUT
(mm)	(mm)	(mm)	of HANDLE	(mm)
1070	700	0	1:1	310

(1) Measured without compressing bump stops

4. ENGINEERING ASSESSMENT

4.1 Materials of Construction

COMPONENT	MATERIAL(S)
Pumpstand	Steel tube - fabricated
Handle	Wood
Pump rod support	Mild steel
Pump rod bush	HD polyethylene
Plunger	HD polyethylene, rubber valve
Foot valve body	Fabricated from standard steel pipe fittings
Foot valve	HD polyethylene, rubber washer
Pump rod	PVC pipe

#### 4.2 Manufacturing Techniques

The manufacturing techniques required to make the pump are listed below:-

Above-ground Assembly	Steel fabrication Basic machining Woodwork
--------------------------	--

The pumpstand requires basic skills and is therefore particularly suitable for manufacture in a developing country.

Below-ground Assembly	uPVC fabrication Basic machining Rubber crafting
--------------------------	--

Like the pumpstand, the plunger and footvalve demand only basic manufacturing skills.

#### 4.3 Ease of Installation, Maintenance and Repair

##### 4.3.1 Ease of Installation



This pump is light and easy to handle; the main requirement for skill is in making satisfactory joints in uPVC pipe.

##### 4.3.2 Ease of Pumpstand Maintenance and Repair



Very straightforward. The most likely maintenance requirement will be replacement of the top bush, and this is easy.

##### 4.3.3 Ease of Below-ground Maintenance and Repair



The plunger may be removed very easily; only the top bush in the pumpstand need be removed. Care will be needed in handling the pump rods however, and it may be prudent to have sockets and solvent cement on hand to repair accidental breaks. The length of the pump rods may require frequent alteration to compensate for wear in the rising main. Lifting tackle would not be needed to extract the rising main.

Ethiopia Pump

#### 4.4 Resistance to Contamination and Abuse

##### 4.4.1 Resistance to Contamination

Generally good; the spout could be easily modified to prevent possible faecal contamination.

##### 4.4.2 Likely Resistance to Abuse

The handle may be susceptible to impact if left raised; the spout is rather long; there are no locking fixings on handle clamp; the baseplate is thin.

#### 4.5 Potential Safety Hazards

There is a potential finger trap between the handle and the top of the pumpstand, but this is not a major hazard since the handle of this pump offers no mechanical advantage.

#### 4.6 Suggested Design Improvements

The handle should be more securely attached to the pump rod. This might be achieved by using a single bolt, slightly off-centre, locating in a groove cut in the pump rod.

The baseplate should be stiffer.

### 5. PUMP PERFORMANCE

#### 5.1 Volume Flow, Work Input and Efficiency

The description of the method can be found in the Test Procedure

HEAD	7 m		
Nominal pumping rate (strokes/min)	30	40	50
Vol/stroke (litres)	0.60	0.62	0.63
Work Input/stroke (J)	112	117	141
Efficiency (%)	36	35	30

#### 5.2 Leakage Tests

Leakage at 7m head was 0.15 ml/minute.

## 6. USER TRIAL

### 6.1 User Responses

Details of the organisation of this trial can be found in the Test Procedure, and the statistical analysis of user responses is presented in Appendix I.

### 6.2 Observations

Many users found it difficult to operate, especially short children. Most of the effort had to be supplied by the arms and shoulders only. Several smaller children found the handle difficult to lift, and changed their grip between up- and down-strokes. Some could lift the handle only by sliding their forearms beneath it until it rested in the crook of their elbows, then arching their backs. This was a very awkward movement and resulted in very short strokes. Users with such difficulties tended to make matters worse by pulling unevenly on the two sides of the handle, increasing the friction in the bush at the top of the pumpstand.

## 7. ENDURANCE

A detailed description of the endurance test method can be found in the Test Procedure.

### General Comments

The pump was tested at 40 strokes per minute at 7 metres head. It completed the 4000 hour endurance test without failure. Wear in the plunger tended to increase the end float of the centre bolt, and remedial action was taken at the 1000 hour intermediate inspections. The intermediate check tests of volume flow also revealed progressive loss of cylinder performance, with the most pronounced loss during the fourth 1000 hour stage, when sand was introduced to the water.

In the final inspection, most parts of the plunger were clearly worn, particularly those parts forming the valve. Although still operating, the performance had fallen off considerably. The piston diameter had worn by 0.3mm or so, and the cylinder by about 1mm on diameter. Particles of sand were embedded in the HDPE plunger. In actual use the wear in the rising main could be compensated by altering the position of the plunger in the rising main. The pump rod bush in the pumpstand was worn, but this did not affect the performance.

Hours:	1024	2037	3140	4147
Inspection and full performance test	Inspection and volume flow	Inspection and volume flow	Inspection and volume flow	Inspection and full performance test

Details of the Endurance Test

HOURS

1024 INSPECTION after 1st 1000 hours:

- (a) Some wear in swept region of drop pipe - plunger still tight in remainder of drop pipe
- (b) Some corrosion of nuts and bolts in both plunger and foot valve

2037 INSPECTION after 2nd 1000 hours:

- (a) Top bush slightly worn
- (b) Plunger worn where connecting bolt fits - washer added to reduce end float
- (c) More corrosion of nuts and bolts

3140 INSPECTION after 3rd 1000 hours:

- (a) Top bush worn
- (b) Increased end float on plunger bolt
- (c) Plunger tight in unswept areas of rising main - some wear of rising main in swept area
- (d) More corrosion of ferrous parts

4147 FINAL INSPECTION

- 1. Pumpstand Top bush worn but otherwise in good condition
- 2. Rising Main Bore worn approximately 1 mm on diameter throughout swept area - many scratches from sand particles embedded in plunger
- 3. Plunger
  - (a) Worn approximately 0.3 mm on diameter
  - (b) Many sand particles embedded in plunger
  - (c) Plunger valve washer, sleeve and centre bolt all badly worn
  - (d) Bolt hole through plunger noticeably worn
- 4. Check Valve Hole in steel washer worn, but serviceable
- 5. Corrosion Noticeable corrosion of ferrous parts in both plunger and foot valve.

Estimated total amount of water pumped in 4000 hours ..... 5.9 million litres.

Strokes/min	Volume Flow Tests at 7 m (litres)				Leakage Tests
	20	30	40	50	at 7 m (ml/min)
New	—	0.60	0.62	0.63	0.15
After 1000 hours	0.48	0.56	0.59	—	less than 0.1
After 2000 hours	0.40	0.48	0.53	—	less than 0.1
After 3000 hours	0.41	0.45	0.51	—	less than 0.1
After 4000 hours	0.15	0.23	0.34	0.41	less than 0.1

Pump Performance after Endurance

HEAD	7 m			
Nominal Pumping Rate (Strokes/min)	20	30	40	50
Vol/stroke (litres)	0.15	0.23	0.34	0.41
Work input/stroke (J)	82	95	136	155
Efficiency (%)	12	16	17	18

Wear in the plunger and rising main, and hence increase in diametral clearance, has resulted in a marked reduction in volume flow, and consequently in efficiency, particularly at low operating speeds.

8. ABUSE TESTS

8.1 Side Impact Tests

The handle impact test was not applicable to this pump. In the test on the pumpstand body, successive impacts produced progressive distortion of the baseplate.

8.2 Handle Shock Test

The pump completed its allotted 96,000 cycles without failure.

9. VERDICT

An inherently simple, straightforward design, suitable for manufacture in developing countries and satisfying many of the requirements for VLOM. Suitable for community water supply but not for deep wells. Some users found it difficult to operate in the direct action mode. It does not require priming and therefore is not susceptible to contamination. The most likely maintenance requirement will be replacement of the top bush, and this is easy. It is more likely to wear out than to break down. Inexpensive.



VIEW Pump

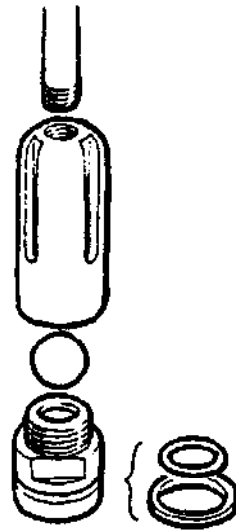
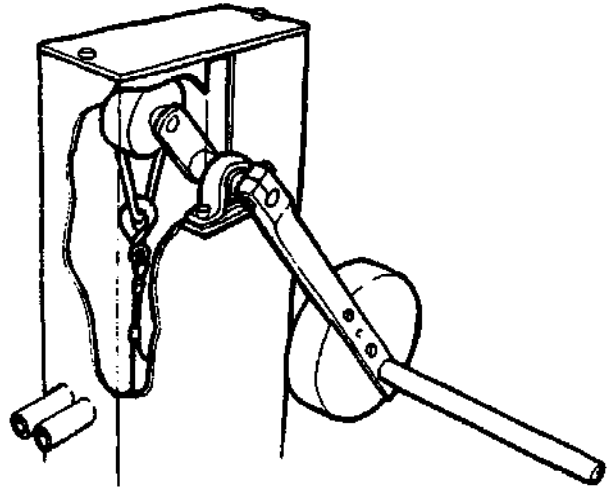
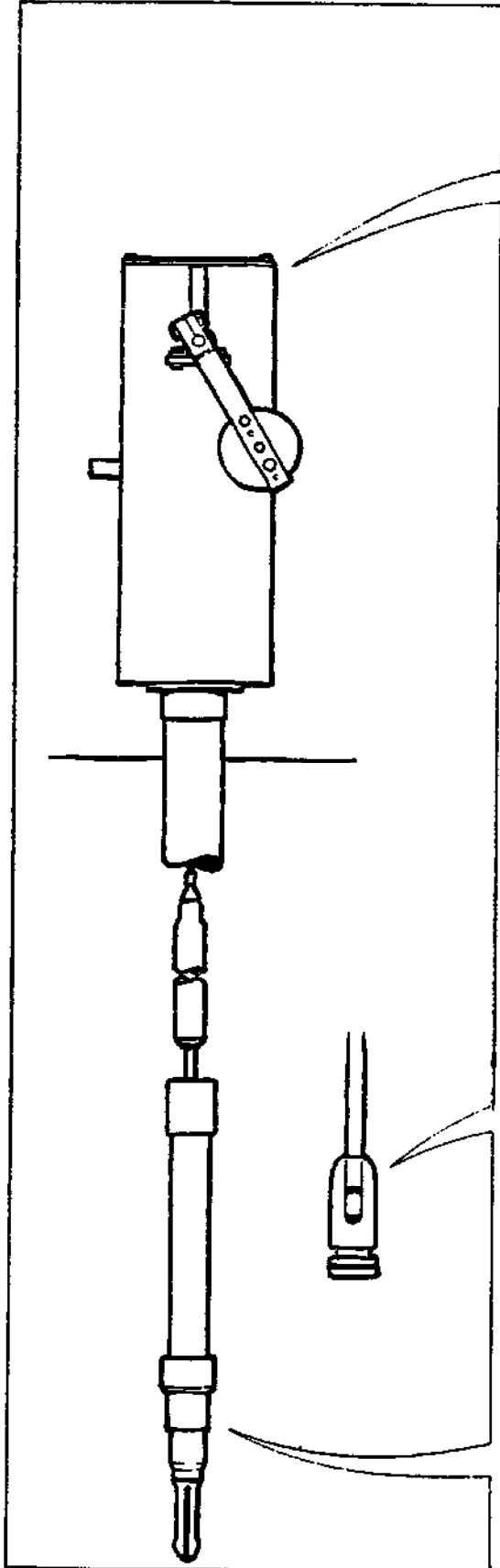

VEW A 18

1.1 Manufacturer Vereinigte Edelstahlwerke AG

Address Franz Josefs-Kai 51,  
A-1011 VIENNA,  
PO Box 56,  
Austria.

1.2 Description The VEW A 18, made in Austria, is a reciprocating, deep-well force pump, with a rotary operating mechanism. The pump uses a cable rather than rods. The pumpstand is fabricated from stainless steel plate, with ball races for the crank pin and journals. As delivered, the top of the cable was attached to a saddle with the outer ring of two ball races running in a track in the crank pin. The handle counterweights were originally fitted on separate arms, at 90° to the handles themselves. The twin handles make the pump suitable for operation by two people, and two spouts are provided.

The heavy cylinder can be withdrawn through the 4 inch rising main and snap fits in a fixture at the bottom of the rising main. The maximum outside diameter of the below-ground assembly is 127 mm. The plunger seal is PTFE, backed by a concealed rubber O-ring. The plunger and foot valves use stainless steel balls.

1.3 Price in 1982 \$1583 - supplied complete for 20 m depth

2. INSPECTION

2.1 Packaging The pumps were delivered in a single wooden packing case, which was robust but awkwardly long - 4 m. There were internal reinforcements to secure the contents. It would be difficult to handle without mechanical assistance. All the below-ground components were wrapped in a strong waxed protective fabric.

2.2 Condition as Received The pumps were generally in good condition as received, though the handles of both pumps had been slightly misaligned in assembly.

2.3 Installation and Maintenance Information

Useful information supplied, but further illustrations would be advantageous.

3. WEIGHTS and MEASURES

3.1	<u>Weights</u>	Pumpstand	84.8 kg
		Cylinder assembly	19.8 kg
		Cable	0.2 kg/m
		Counterweight	14.0 kg
		Strainer assembly	11.5 kg

3.2	<u>Dimensions</u>	Nominal cylinder bore:	70 mm
		Actual pump revolutions:	180 mm
		Nominal volume per rev:	693 ml
		Drop pipe size:	4 inches
		Outside diameter of below-ground assembly:	127 mm
		Maximum usable cylinder length:	390 mm

3.3 Cylinder Bore No significant taper or ovality was found in either of the samples.

The surface roughness average (Ra) was measured in three places in a direction parallel to the cylinder axis.

SAMPLE	CYLINDER BORE	ROUGHNESS AVERAGE (µm)			
		TEST 1	TEST 2	TEST 3	MEAN
1	Chromed brass	0.30	0.10	0.10	0.17
2	Chromed brass	0.20	0.20	0.15	0.18

Measured at 0.25 mm cut-off

3.4 Ergonomic Measurements

HANDLE HEIGHT		PLATFORM HEIGHT (mm)	ANGULAR MOVEMENT OF HANDLE (degrees)	HANDLE LENGTH (mm)	VELOCITY RATIO OF HANDLE	HEIGHT OF SPOUT (mm)
MAX <sup>(1)</sup> (mm)	MIN <sup>(1)</sup> (mm)					
1220	610	0	360	305	3.4:1	620

4. ENGINEERING ASSESSMENT

4.1 Materials of Construction

COMPONENT	MATERIAL(S)
Pumpstand	Stainless steel
Handle	Mild steel
Bearings	Proprietary ball races
Crankshaft	Mild steel
Connecting link	Mild steel
Cylinder	Extruded brass with hard chrome lining
Cylinder end fittings	Stainless steel
Foot valve	Stainless steel
Dip tube	Stainless steel
Plunger assembly	Stainless steel body, brass rod, PTFE seal
Cable and counterweight	Stainless steel

4.2 Manufacturing Techniques

The manufacturing techniques required to make the pump are listed below:-

Above-ground Assembly	Steel fabrication (including stainless steel) Presswork Machining Flame cutting
--------------------------	--

The pumpstand demands considerable skill in manipulating and welding stainless steel, and heavy equipment to deal with the generous material sections.

Below-ground Assembly	Machining Hard chrome plating Plastic moulding
--------------------------	--

The below-ground assembly demands machining to close tolerances, and considerable quantities of stainless steel bar stock. Some sophisticated manufacturing technologies and strict quality control would be essential.

4.3 Ease of Installation, Maintenance and Repair

4.3.1 Ease of Installation



Heavy lifting tackle will be essential to handle the 4 inch rising main, and could not readily be substituted by extra manpower. A cable-cutting tool will be needed. The pipe wrenches must be large enough to cope with 4 inch pipe. The base of the pumpstand is threaded 4 inch API and not to the more common ISO Standard pipe thread.

#### 4.3.2 Ease of Pumpstand Maintenance and Repair



In its modified form, the pumpstand is unlikely to demand frequent attention. The crankshaft assembly must be replaced as a unit, however. The pumpstand need not be removed from the wellhead.

#### 4.3.3 Ease of Below-ground Maintenance and Repair



The cylinder may require replacement of the plunger seal. Until recently, the manufacturer did not recommend this to be carried out on site. Replacement of the complete cylinder was preferred. However, we have been advised that the cylinder is now easier to dismantle in the field. The cylinder assembly can be extracted without removing the rising main, using the operating cable. The cylinder is heavy, but it may be possible to improvise the crankshaft assembly as a simple lifting tackle. If the cable breaks, it may be difficult to extract the cylinder.

#### 4.4 Resistance to Contamination and Abuse

##### 4.4.1 Resistance to Contamination

The short horizontal spouts would be easily contaminated. The base of the pump is sealed against surface water.

##### 4.4.3 Likely Resistance to Abuse

No locking on any nuts or bolts. Handles quite easy to remove. Otherwise very robust.

#### 4.5 Potential Safety Hazards

The newer design of handles has reduced the safety hazard from the rotating counterweights. However, the rotating handles on this pump could be hazardous to both users and bystanders. The handles have high momentum at normal operating speeds.

**4.6 Suggested Design Improvements**

The manufacturer has adopted a number of suggestions, including the following:

- (a) Changing the crankshaft plunger blocks to a heavier pattern and redesigning the crankshaft 'big end' assembly.
- (b) Changing the cable to the type designed for hoists and lifts, which will not twist under tension.
- (c) Supplying polished solid handles.
- (d) Attaching the handles more securely to the ends of the crankshaft and repositioning the counterweights.
- (e) Making the cylinder easier to dismantle, to replace the plunger seals.
- (f) Single rigid spout, with slots to prevent faecal contamination.

**5. PUMP PERFORMANCE**

**5.1 Volume Flow, Work Input and Efficiency**

The description of the method can be found in the Test Procedure.

HEAD	7 m			25 m			45 m		
Nominal pumping rate (revs/min)	30	40	50	30	40	50	30	40	50
Vol/rev (litres)	0.68	0.68	0.69	0.65	0.65	0.66	0.62	0.63	0.64
Work input/rev (J)	121	93	87	280	266	339	429	456	765
Efficiency (%)	38	49	53	56	59	47	63	60	36

**5.2 Leakage Tests**

	7 m	25 m	45 m
Leakage rate (ml/min)	0.1	less than 0.1	less than 0.1

**6. USER TRIAL**

**6.1 User Responses**

Details of the organisation of this trial can be found in the Test Procedure, and the statistical analysis of user responses is presented in Appendix I.

6.2 Observations

Users found this pump difficult to operate. Users with enough strength and bodyweight could attain sufficient momentum to keep the handle turning smoothly. Most could not, and found it difficult to time their efforts on the handle. Several children could not operate the pump at all. However, it should be noted that this pump lends itself to operation by two people. Our testing staff have found the pump easier to operate with the modified handles and re-positioned counterweights.

7. ENDURANCE

A detailed description of the endurance test method can be found in the Test Procedure.

General Comments

The pump was tested at 40 revolutions per minute at a simulated head of 45 metres and failed after only 152 hours. The tendency of the operating cable to twist under tension had made the bearing saddle run out of true, causing rapid wear of the saddle and the crankshaft. Both were replaced, and a swivel was fitted in the cable. The handle broke at 277 hours, and the replacement bearing saddle and crankshaft were worn out after 598 hours.

The response from the manufacturer was commendably quick and the modifications have been noted earlier. The modified handles and crankshaft big end completed the test programme without failure.

In the final inspection, the plunger seal was found to be worn out, the plunger body was worn and also the plunger rod where it passed through the cylinder top. The cylinder bore was in good condition. There was some play in the big end but in all other respects the pumpstand was in good condition.

Breakdown Incidence

Breakdowns are shown in bold type.

Hours:		1024	2037	3062	4082
152	598	1091	1945		
277					
<b>Handle Broken</b>		<b>Cable Broken</b>	<b>Cylinder Jammed</b>		
<b>Crank Worn Out</b>	<b>Crank Worn Out</b>				
Inspection and full performance test	Inspection and volume flow	Inspection and volume flow	Inspection and volume flow	Inspection and volume flow	Inspection and full performance test

VEW Pump

Details of the Endurance Test

Breakdowns are shown in bold type.

HOURS

61 Bearing saddle running out of true, caused by tendency of cable to twist under tension. Ends of bearing axle pins worn - one split pin and washer replaced.

152 Pronounced misalignment of bearing saddle, severe wear with imminent danger of catastrophic failure. Crankshaft and bearing saddle replaced, swivel fitted between bearing saddle and cable.

Estimated amount of water pumped to breakdown.....0.2 million litres

277 Handle broken at weld

Estimated additional amount of water pumped to breakdown.....0.2 million litres

598 Crank pin severely worn, bearing track much too deep. Bearing saddle replaced by nylon block to continue testing

Estimated additional amount of water pumped to breakdown.....0.5 million litres

1024 INSPECTION after 1st 1000 hours:

- (a) Plunger rod worn against cylinder top
- (b) Plunger seal worn
- (c) Some corrosion of cylinder anchor otherwise no significant corrosion

Pump rebuilt with new non-twisting cable and modified parts from manufacturer

1091 Cable broken below head simulation valve - replaced with rod (no spare cable available)

Estimated additional amount of water pumped to breakdown.....0.7 million litres

1945 Plunger jammed at top dead centre - released by pulling cable by hand

Estimated additional amount of water pumped to breakdown.....1.2 million litres



HOURS

2037 INSPECTION after 2nd 1000 hours:

- (a) Plunger rod worn against cylinder top
- (b) Cylinder bore slightly scored
- (c) Some wear of plunger seal
- (d) Some rust at end of cable and cylinder anchor

3062 INSPECTION after 3rd 1000 hours:

- (a) Plunger rod continuing to wear against cylinder top
- (b) Plunger seal slightly scratched
- (c) Kieselguhr has accumulated around the base of the cylinder, where the cylinder snaps into the fitting at the upper end of the dip tube. Similar deposits in real installations may make it difficult to reinstall a cylinder after removal
- (d) Noticeable rust inside rising main and on cylinder snap fitting

4082 FINAL INSPECTION

- 1. Pumpstand      Some play in crankshaft big end bearing, otherwise in good condition
- 2. Cylinder      (a) Some light scratches on cylinder bore, otherwise no signs of wear  
                  (b) Small quantity of sand around cylinder snap fitting
- 3. Plunger        (a) Plunger seal circumference worn down excessively  
                  (b) Scratches and more extensive signs of wear on plunger body  
                  (c) Plunger rod worn against cylinder end fitting
- 4. Foot Valve     In good condition

4082 5. Corrosion      Rust around cylinder snap fitting - no other corrosion

Estimated total amount of water pumped in 4000 hours .....6.0 million litres.

Revs/min	Volume Flow Tests at 45m (litres)				Leakage Tests at 7 m (ml/min)
	20	30	40	50	
New	--	0.62	0.63	0.64	0.1
After 1000 hours	0.23	0.33	0.44	0.51	0.8
After 2000 hours	0.49	0.55	0.58	0.60	0.7
After 3000 hours	--	0.60	0.62	0.62	less than 0.1
After 4000 hours	0.31	0.42	--	0.54	less than 0.1

VEW Pump

Pump Performance after Endurance

HEAD	7 m			25 m				45 m		
Nominal Pumping Rate (revs/min)	30	40	50	20	30	40	50	20	30	50
Vol/rev (litres)	0.59	0.60	0.61	0.42	0.49	0.53	0.56	0.31	0.42	0.54
Work input/rev (J)	192	191	190	223	224	247	236	317	327	337
Efficiency (%)	21	21	22	46	53	53	57	43	56	71

N.B. It was difficult to control the operating speeds accurately within 9 revolutions of the handle due to the inertia of the counter-weights. The actual operating speeds have been rounded to the nearest 10 revs/minute.

These results cannot be compared with the original performance data, because the plunger seal was replaced during the endurance test.

8. ABUSE TESTS

8.1 Side Impact Tests

The test on the handle was not applicable to this pump. The pump sustained no damage in the side impact test on the body of the pumpstand.

9. VERDICT

Very expensive. Robust as modified by the manufacturer. Awkward to use, but designed to be operated by two people. Not suitable for manufacture in developing countries. Needs very heavy lifting tackle for installation, but cylinder may be withdrawn for maintenance on end of cable, possibly using crankshaft as windlass. Not suitable for boreholes of less than 130 mm diameter. Suitable for community water supply where the necessary maintenance skills and facilities are available.

Jetmatic Pump

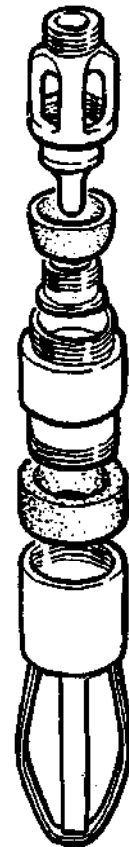
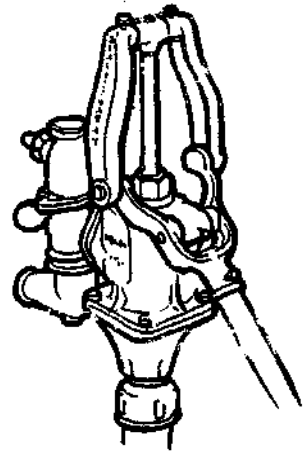
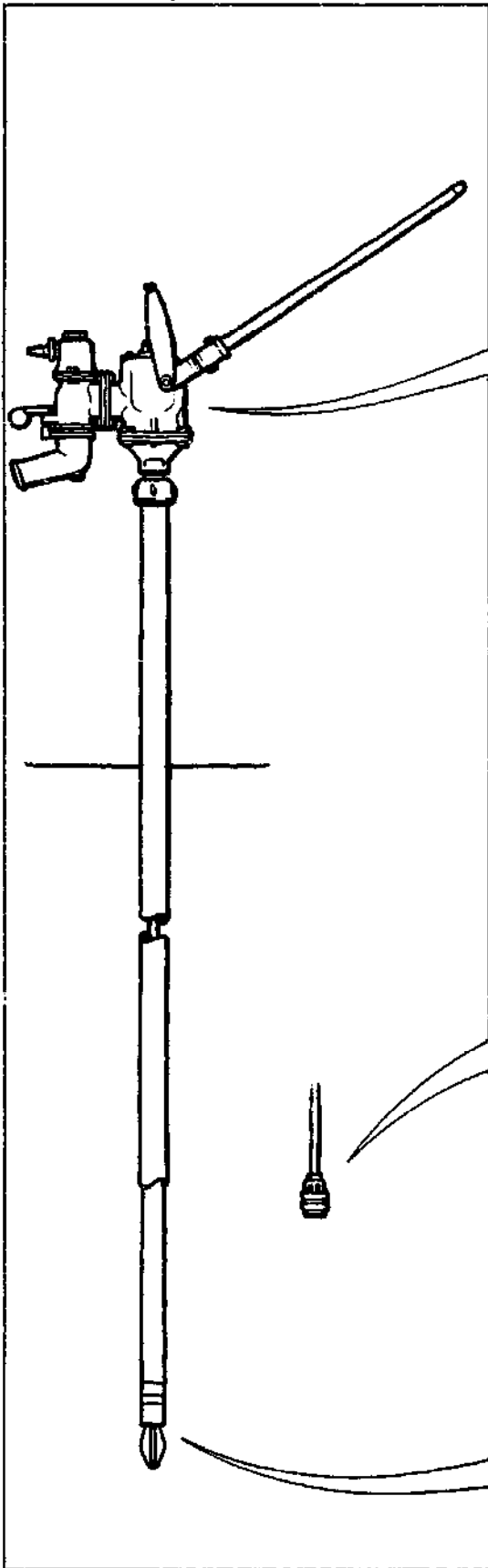

JETMATIC

1.1 Manufacturer Sea Commercial Company Inc.

Address 3085 R. Magsaysay Blvd.,  
Cor. V.Cruz St.,  
MANILA 2806,  
Philippines.

1.2 Description The Jetmatic pump is made in the Philippines, under licence from Kawamoto Pumps of Japan, and is very similar to the Dragon pump. Like the Dragon, it can be supplied either as a shallow-well suction pump or as a deep-well force pump. We have tested the pump in its deep-well configuration. Unlike the Dragon, the shallow-well cylinder is not retained. The pumpstand is therefore very compact, and simply fits on the protruding end of the rising main which must be at least 440 mm above ground, to prevent the handle touching the ground at the lowest point of its travel.

The pumpstand is principally cast iron, with a discharge valve in the spout allowing either free discharge or delivery under pressure through a hose or pipe. The tubular steel handle moves through an unusually wide arc of 178°.

The deep-well cylinder is unusually small, only 46 mm bore, to fit inside 2 inch rising main, which is very much smaller than the cylinder used in the Dragon pump. At the lower end of the cylinder are two steel loops which appear to be designed to grip the inside of the rising main. Turning the cylinder clockwise then expands a rubber ring which anchors and seals the cylinder against the inside of the rising main. The foot valve has a tapered rubber ring which fits a machined taper in the base of the cylinder. The plunger can be screwed onto the foot valve to remove it, without removing the cylinder. In other respects the plunger is conventional, and has two leather cup seals.

1.3 Price in 1982 \$32 without connecting rod and rising main

2. INSPECTION

2.1 Packaging The pumps arrived in a wooden packing case, with internal reinforcements to separate and secure the contents. The case was lined with moistureproof plastic membrane.

2.2 Condition as Received In both sample cylinders, the cup seal retainers were not tight, possibly because the leather had dried out and shrunk in transit. Otherwise the pumps were in good working order.

2.3 Installation & Maintenance Information None supplied with the pump.

3. WEIGHTS and MEASURES

3.1 Weights Pumpstand 16.3 kg  
 Cylinder assembly 3.0 kg  
 Pump rods 1.1 kg per metre

3.2 Dimensions Nominal cylinder bore: 46 mm  
 Actual pump stroke: 175 mm  
 Nominal volume per stroke 291 ml  
 Drop pipe size: 2 inches  
 Outside diameter of below-ground assembly: 74 mm  
 Pump rod diameter: 0.5 inches  
 Maximum usable cylinder length: 553 mm

3.3 Cylinder Bore No significant taper or ovality was found in either of the samples.

The surface roughness average (Ra) was measured in three places in a direction parallel to the cylinder axis.

SAMPLE	CYLINDER BORE	ROUGHNESS AVERAGE ( $\mu\text{m}$ )			MEAN
		TEST 1	TEST 2	TEST 3	
1	Extruded brass	0.03	0.04	0.02	0.03
2	Extruded brass	0.04	0.04	0.05	0.04

Measured at 0.25 mm cut-off

3.4 Ergonomic Measurements

HANDLE HEIGHT		PLATFORM HEIGHT (mm)	ANGULAR MOVEMENT OF HANDLE (degrees)	HANDLE LENGTH (mm)	VELOCITY RATIO OF HANDLE	HEIGHT OF SPOUT (mm)
MAX <sup>(1)</sup> (mm)	MIN <sup>(1)</sup> (mm)					
1410	120	554 <sup>(2)</sup>	174	660	7.8:1	505

(1) Measured without compressing bump stops

(2) Height of protruding rising main

#### 4. ENGINEERING ASSESSMENT

##### 4.1 Materials of Construction

COMPONENT	MATERIAL(S)
Pump head	Cast iron
Handle fork and link	Cast iron
Bearings	Mild steel pivot pins bear on holes drilled and reamed in iron castings
Spout assembly	Cast iron with rubber valve
Operating rod	Mild steel
Handle	Steel tube, rubber end cap
Cylinder	Extruded brass
Plunger	Cast gunmetal or bronze
Cup seals	Leather
Foot valve assembly	Bronze housing, rubber clamp steel guard

##### 4.2 Manufacturing Techniques

The manufacturing techniques required to make the pump are listed below:-

Above-ground Assembly	Iron foundry Brass/gunmetal foundry Basic machining Rubber moulding
--------------------------	--

The pumpstand requires a moderate level of foundry skill, and the ability to carry out simple machining. The handle linkage demands careful manufacturing quality control to ensure easy assembly and satisfactory operation. It may be suitable for manufacture in some developing countries, but is not ideal.

Below-ground Assembly	Brass/gunmetal foundry Steel fabrication Basic machining Rubber moulding Leather craft
--------------------------	--

The below-ground components demand similar levels of manufacturing skill to those required in the pumpstand.

### 4.3 Ease of Installation, Maintenance and Repair

#### 4.3.1 Ease of Installation



The rising main must be secure in the wellhead, to support the pumpstand. It should protrude sufficiently to allow clearance under the spout for the tallest vessel likely to be used. Installing the pumpstand only on an existing rising main would be a simple, one-man task. The rising main should be 2 inch diameter, to allow the cylinder to pass through for maintenance. The bottom of the pumpstand is threaded 1.25 ANPT not the more common ISO Standard pipe thread.

#### 4.3.2 Ease of Pumpstand Maintenance and Repair :



The pumpstand may require frequent attention to worn handle components and the gland nut.

#### 4.3.3 Ease of Below-ground Maintenance and Repair



The foot valve and plunger may be extracted through the rising main, provided pipe of at least 2 inch diameter is used, and lifting tackle would not be required. The pumpstand must first be removed, however.

### 4.4 Resistance to Contamination and Abuse

#### 4.4.1 Resistance to Contamination

Good sealing at top of pump but rising main must be sealed at wellhead.

#### 4.4.2 Likely Resistance to Abuse

Handle fork strong. Cast iron hose connector may be susceptible to damage. Potentially weak pumphead mounting supported only by 1.25 inch rising main.

### 4.5 Potential Safety Hazards

The end of the tubular steel handle is sharp and could be dangerous if the easily removed rubber cap were lost. The handle fulcrum pinch bolt forms a finger trap.

#### 4.6 Suggested Design Improvements

The free end of the handle should be belled out and smoothed and the rubber end cap omitted.

The wishbone link may be easier to manufacture in a developing country as two joggled steel strips.

The handle fulcrum pinch bolt should be moved 90° to the underside, or replaced by two circlips on the shaft, similar to those on the wishbone link pivots.

The height of the top housing should be reduced to:

- (a) eliminate the counterbore in the gland nut
- (b) eliminate unnecessary machining of the pivot casting
- (c) increase the length of thread attaching the connecting rod to the pivot casting.

The discharge valve should be removed as a cost-saving and only supplied if needed.

All pump body flanges should be flat or increased in thickness as they are unsupported and can be broken by over-tightening the fixing bolts.

The lift of both plunger and foot valves should be much reduced, ideally to one quarter of the effective diameter.

The manufacturer has acknowledged these suggestions and his detailed comments are awaited.

As a 2 inch rising main is necessary to allow the cylinder to pass through for maintenance, the diameter of the bottom of the pumpstand should be modified to 2 inch ISO Standard pipe thread.

### 5. PUMP PERFORMANCE

#### 5.1 Volume Flow, Work Input and Efficiency

The description of the method can be found in the Test Procedure.

HEAD	7 m			25 m			45 m		
Nominal pumping rate (strokes/min)	30	40	50	30	40	50	30	40	50
Vol/stroke (litres)	0.29	0.29	0.29	0.28	0.27	0.29	0.28	0.28	0.28
Work input/stroke (J)	60	54	50	110	103	107	173	173	161
Efficiency (%)	32	36	39	62	63	66	71	72	77



## 5.2 Leakage Tests

HEAD	7 m	25 m	45 m
Leakage rate (ml/min)	0.1	less than 0.1	less than 0.1

## 6. USER TRIAL

### 6.1 User Responses

Details of the organisation of this trial can be found in the Test Procedure, and the statistical analysis of user responses is presented in Appendix I.

### 6.2 Observations

This pump is similar to the Dragon pump, and users had similar problems. An additional difficulty arose because vigorous operation of the pump often caused the outlet discharge valve to drop, shutting off the spout which may blow the gaskets. The rate of delivery was considered to be poor.

## 7. ENDURANCE

A detailed description of the test method can be found in the Test Procedure.

### General Comments

The pump was tested at 40 strokes per minute at a simulated head of 45 metres and failed at 280 hours when the cylinder was dislodged within the rising main. It was refitted and the problem did not recur. The pump failed at 3149 and 3875 hours when the pump rod broke within the thread. Components of the handle mechanism had to be replaced after 1000 hours because of wear, though the replacement parts survived until the end of the 4000 hour test programme. At each intermediate inspection, the spout discharge valve was found to be seized through lack of use, and it was freed off.

In the final inspection, the foot valve, plunger, leather cup seals and cylinder were all in good condition, with few signs of wear. The gland nut was badly worn. The plunger rod and the steel loops on the cylinder anchor were corroded and may not have been satisfactory if used again.

Breakdown Incidence

Breakdowns are shown in bold type.

Hours:	1024	2037	3140	3149	3875	4144
	<b>Cylinder Dislodged</b>			<b>Pump Rod Broken</b>	<b>Pump Rod Broken</b>	
	<b>Handle Parts Worn Out</b>					
	Inspection and full performance test	Inspection and volume flow	Inspection and volume flow	Inspection and volume flow	Inspection and full performance test	Inspection and full performance test

Details of the Endurance Test

Breakdowns are shown in bold type.

HOURS

**280 Cylinder dislodged in casing - repositioned**

Estimated amount of water pumped to breakdown.....0.2 million litres

**1024 INSPECTION after 1st 1000 hours:**

- (a) **Handle link bearings and pin badly worn - replaced**
- (b) Some deterioration of rubber retaining ring at bottom of cylinder
- (c) Plunger seals hard and tight in cylinder
- (d) Pump rod gland worn
- (e) Some corrosion at joint of pump rod and plunger

Estimated additional amount of water pumped to breakdown.....0.5 million litres

**2037 INSPECTION after 2nd 1000 hours:**

- (a) Handle fulcrum showing signs of wear
- (b) Further wear in pump rod gland
- (c) Pump rod corroded, particularly at joint with plunger

**3140 INSPECTION after 3rd 1000 hours:**

- (a) Kieselguhr packed tight between cylinder and rising main making cylinder difficult to remove
- (b) Further wear in pump rod gland
- (c) Pump rod further corroded, particularly at joint with plunger

HOURS

3149 Pump rod broken within thread at uppermost joint - new section fitted

Estimated additional amount of water pumped to breakdown.....1.4 million litres

3875 Connecting rod broken within thread at joint with pump rod - replaced with spare part from manufacturer.

Estimated additional amount of water pumped to breakdown.....0.5 million litres

4144 FINAL INSPECTION

1. Pumpstand (a) Gland worn  
(b) Slight wear in pivot pins and bushes
2. Cylinder (a) Some sand between cylinder and rising main but cylinder not difficult to remove  
(b) Slight scratching of bore, but cylinder in good condition
3. Plunger Generally in good condition
4. Foot Valve Generally in good condition
5. Corrosion (a) Considerable rusting of plunger rod  
(b) Rust on steel loops of cylinder retainer

Estimated total amount of water pumped in 4000 hours ..... 2.7 million litres.

Strokes/min	Volume Flow Tests at 45m (litres)				Leakage Tests
	20	30	40	50	at 7 m (ml/min)
New	--	0.28	0.28	0.28	0.1
After 1000 hours	0.25	0.25	0.25	--	0.2
After 2000 hours	0.23	0.25	0.25	--	0.1
After 3000 hours	0.26	0.26	0.26	--	less than 0.1
After 4000 hours	0.29	0.29	0.29	--	less than 0.1

Pump Performance after Endurance

HEAD	7 m			25 m			45 m		
Nominal Pumping Rate (Strokes/min)	20	30	40	20	30	40	20	30	40
Vol/stroke (litres)	0.29	0.30	0.29	0.29	0.29	0.29	0.29	0.29	0.29
Work input/stroke (J)	47	46	44	96	95	91	149	142	139
Efficiency (%)	42	44	45	75	75	78	84	89	91

If compared with the original performance data, these results show a consistent reduction in the work input requirement, and consequently improvements in efficiency, this suggests that bedding-in of the head bearings has reduced the frictional losses.

8. ABUSE TESTS

8.1 Side Impact Tests

In the side impact test on the handle, the impact energy was absorbed by the pumpstand turning on its mounting thread. In the body test, the supporting rising main began to bend at an impact of 200 Joules, and at 300 Joules the pipe was sufficiently bent to prevent movement of the pump rod.

8.2 Handle Shock Test

After 13,341 cycles of the handle shock test, the fixings attaching the body of the pumpstand to the base casting had loosened, allowing the joint to leak. The pump failed after 79,383 cycles when the thread in the base casting was partially stripped, producing severe leakage.

9. VERDICT

The Dragon pump, from which the Jetmatic is derived, was designed for family use, possibly serving up to 15 people. The Jetmatic is unlikely to be sufficiently robust for community water supply, from deep wells. The rate of delivery is low, and intensive use will produce rapid wear, failure in the moving parts of the pumpstand, and pump rod breakage. See comment on pump rod constraint on page 17. The complete cylinder can be extracted without removing the rising main. Possibly suitable for manufacture in some developing countries, but not an ideal design. Cheap.

Bandung Pump

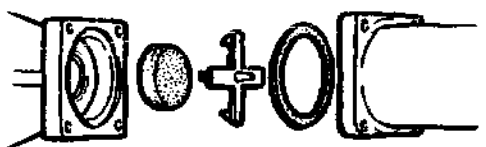
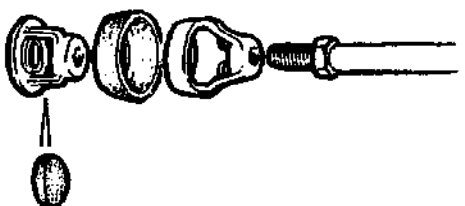
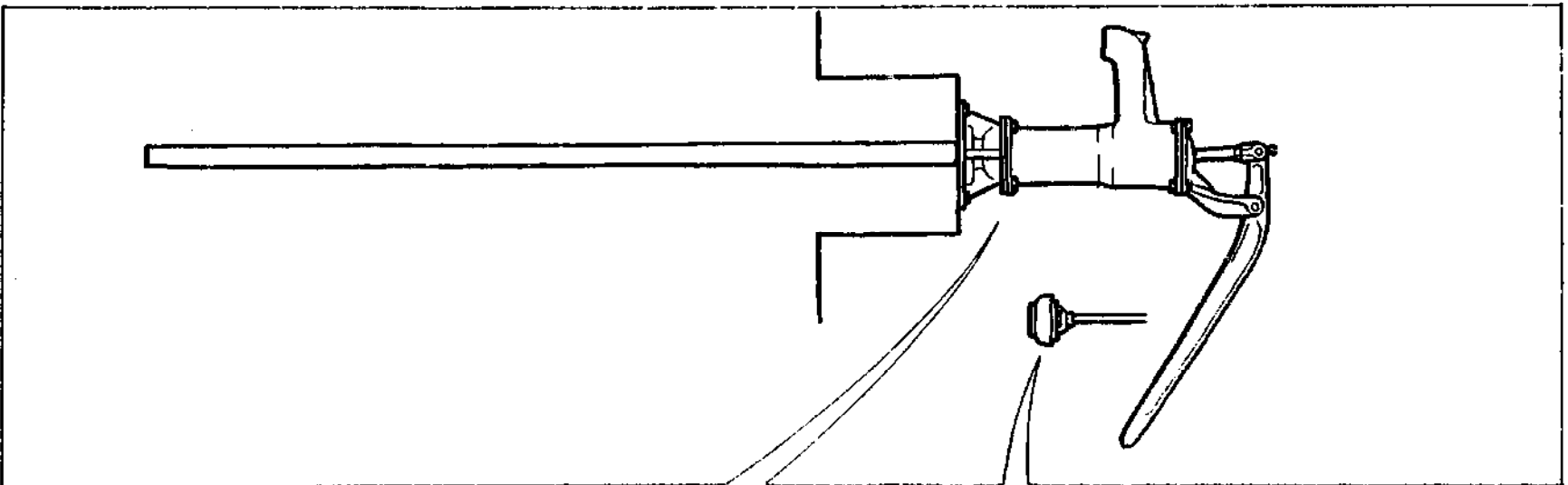

BANDUNG

- 1.1 Manufacturer Iwaco B.V.  
Address: PO Box 183,  
3000 AD Rotterdam,  
The Netherlands.
- 1.2 Description The Bandung is a shallow-well suction pump. It is mainly constructed of cast iron, with an enamelled steel cylinder liner. The plunger uses a moulded rubber cup washer, and rubber discs are used as plunger and check valves.
- 1.3 Price in 1981 \$54

2. INSPECTION

- 2.1 Packaging The packaging in which these pumps were delivered was very unsuitable.



Each pump was wrapped in pieces of corrugated cardboard and then in a plastic sack - see photograph, left.

The handles of both pumps, and a third spare handle, were broken in transit, and the cylinder top casting of one pump was cracked.

These components were replaced by the manufacturer, who said that the pumps left the factory packed together in a wooden crate. They were separated by the carrier, presumably because their weight as a single consignment was too great.

- 2.2 Condition as Received Neither sample was received in working order, because of the broken handles. In addition, one retaining bolt for the connecting rod pivot shaft was broken, and one check valve seat was unevenly coated with filler and paint, preventing a satisfactory seal against the rubber valve block. Even if the handles had been delivered unbroken, the pumps would still have been unusable.
- 2.3 Installation & Maintenance Information None supplied with pump.

3. WEIGHTS and MEASURES

3.1 Weights Pumpstand 25.5 kg

3.2 Dimensions Nominal cylinder bore: 96 mm  
 Actual pump stroke: 135 mm  
 Nominal volume per stroke: 977 ml  
 Drop pipe size: 1.25 inches  
 Maximum usable cylinder length 135 mm

3.3 Cylinder Bore No significant taper or ovality was found in either of the samples.

The surface roughness average (Ra) was measured in three places in a direction parallel to the cylinder axis.

SAMPLE	CYLINDER BORE	ROUGHNESS AVERAGE ( $\mu\text{m}$ )			MEAN
		TEST 1	TEST 2	TEST 3	
1	Enamelled steel	0.72	0.76	0.32	0.60
2	Enamelled steel	0.18	0.40	0.40	0.33

Measured at 0.25 mm cut-off

3.4 Ergonomic Measurements

HANDLE HEIGHT		PLATFORM HEIGHT (mm)	ANGULAR MOVEMENT OF HANDLE (degrees)	HANDLE LENGTH	VELOCITY RATIO OF HANDLE	HEIGHT OF SPOUT (mm)
MAX <sup>(1)</sup> (mm)	MIN <sup>(1)</sup> (mm)					
1107	465	300	69	565	5.0:1	605

(1) measured without compressing bump stops

#### 4. ENGINEERING ASSESSMENT

##### 4.1 Materials of Construction

COMPONENT	MATERIAL(S)
Pumpstand	Cast iron with enamelled steel cylinder liner
Handle	Cast iron
Bearings	Mild steel pivot pins bear on holes drilled and reamed in iron castings
Plunger	Cast iron
Cup seal	Moulded rubber
Base valve	Rubber with moulded plastic cage

##### 4.2 Manufacturing Techniques

The manufacturing techniques required to make the pump are listed below:-

Iron foundry  
Sheet metal forming  
Enamelling of steel  
Simple machining  
Rubber/plastic moulding

Where adequate skills in iron foundry work, simple sheet metalwork and basic machining are available, the Bandung may be well-suited for manufacture in a developing country. However, the Bandung demands stricter quality control during manufacture than the New No.6, which is of similar design.

##### 4.3 Ease of Installation, Maintenance and Repair

###### 4.3.1 Ease of Installation



Very straightforward.

###### 4.3.2 Ease of Maintenance and Repair



The pump may require frequent attention, but most tasks are simple and could be accomplished with a few spanners. A drift and hammer may be needed to remove the pivot pins, however, and a pipe wrench to dismantle the plunger.



#### 4.4 Resistance to Contamination and Abuse

##### 4.4.1 Resistance to Contamination

The pump will need to be primed and is therefore susceptible to contamination.

##### 4.4.2 Likely Resistance to Abuse

Handle and pump top susceptible to accidental damage. No lock washers on fixings.

#### 4.5 Potential Safety Hazards

There is a potential finger trap between the connecting rod fork and the top of the pumpstand.

#### 4.6 Suggested Design Improvements

The relative positions of the fork and eye in the connecting rod and handle should be reversed - i.e. the handle should be forked, with an eye on the end of the connecting rod.

The handle should be more robustly designed or made in a more resilient material.

The design of the plunger should be improved to control the compression of the cup washer, to reduce the tendency of the rubber to extrude outwards.

The webs on the cylinder top casting should be extended to make it more robust - see illustration.

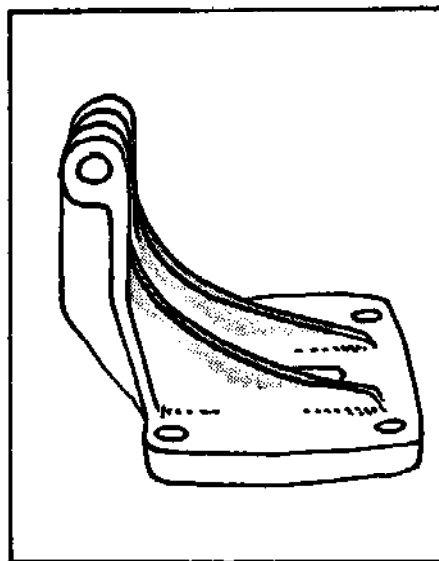

5. PUMP PERFORMANCE

5.1 Volume Flow, Work Input and Efficiency

The description of the method can be found in the Test Procedure.

HEAD	7 m		
Nominal pumping rate (strokes/min)	20	30	40
Vol/stroke (litres)	0.95	0.96	1.04
Work input/stroke (J)	94	93	102
Efficiency (%)	69	70	70

5.2 Leakage Test

Leakage at 7 m head was 0.25 ml/minute

6. USER TRIAL

6.1 User Responses

Details of the organisation of this trial can be found in the Test Procedure, and the statistical analysis of the user responses is presented in Appendix I.

6.2 Observations

Few users criticised this pump, though few singled it out for praise. The handle movement allowed many muscle groups to contribute to operating the pump.

7. ENDURANCE

A detailed description of the endurance test method can be found in the Test Procedure.

General Comments

The pump was tested at 30 strokes per minute at 7 metres head. The cup washer was replaced three times in the 4000 hour endurance test. The seal tended to extrude into the clearance between the plunger and the cylinder wall, and split as a result. The two halves of the plunger were modified so that the cup washer was nipped near its outer edge; this prevented the outward extrusion of the rubber, and the last replacement cup washer did not split in over 1000 hours. However, the final inspection revealed cracks in the upper surface of the cup washer, although it was still working.

The pump proved difficult to prime after the 3000 hour check, but this was corrected by simply turning over the check valve block. Both valve blocks showed signs of wear in the final inspection, but were in working order.

The cylinder was in good condition at the end of the test, with no signs of wear.

The handle pivot pins, and their corresponding holes, were worn but still serviceable at the end of the test.

Breakdown Incidence

Breakdowns are shown in bold type.

Hours:	1072	2044	3017	4063
	<b>809</b>	<b>2018</b>		
	Cup Washer Split	Cup Washer Split	Cup Washer Split	
	Inspection and full performance test	Inspection and volume flow	Inspection and volume flow	Inspection and full performance test

Details of the Endurance Test

Breakdowns are shown in bold type.

HOURS

651 Handle pivot noisy and rusty - no action

**809 Cup washer split - replaced**

Estimated amount of water pumped to breakdown.....1.4 million litres

1072 INSPECTION after 1st 1000 hours:

Some corrosion of ferrous parts

**2018 Cup washer split - replaced**

Estimated additional amount of water pumped to breakdown.....2.1 million litres

HOURS

2044 INSPECTION after 2nd 1000 hours:

- (a) More corrosion of ferrous parts
- (b) Some wear of pins in handle fulcrum and connecting rod end

3017 INSPECTION after 3rd 1000 hours:

- (a) Cup washer beginning to split - plunger machined to nip cup washer on outer edge when retaining nut tightened
- (b) Noticeable wear in handle components
- (c) Noticeable wear on circumference and seat of check valve - priming difficult - valve block turned over
- (d) More corrosion of ferrous parts

Estimated additional amount of water pumped to breakdown.....1.7 million litres

4063 FINAL INSPECTION:

- 1. Pump Body and Handle
  - (a) Cylinder bore in good condition showing no signs of wear
  - (b) Fulcrum pins and bushes all worn, though pump still working
  - (c) Handle no longer contacts bottom stop (because of wear in fulcrum bearings) but fouls on connecting rod eye
- 2. Plunger
  - (a) Plunger valve noticeably worn though still serviceable
  - (b) Some cracks in upper surface of cup washer though still watertight - see photograph, below

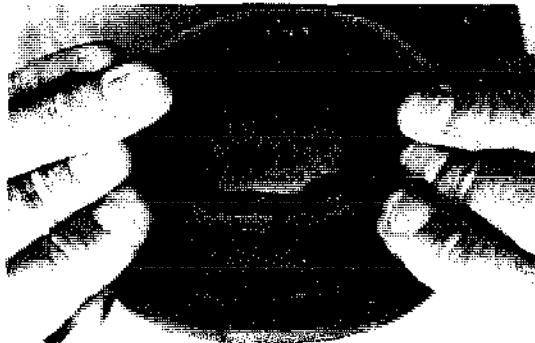

HOURS

- 4063 3. Check Valve Signs of wear but still serviceable
4. Corrosion (a) Rust on sliding plate on pump top and associated contact areas of pumpstand  
 (b) Rust in plunger valve cage  
 (c) Rust inside pump body above cylinder lining

Estimated total amount of water pumped in 4000 hours .....6.9 million litres.

Strokes/min	Volume Flow Tests at 7 m (litres)			Leakage Tests at 7 m (ml/min)
	20	30	40	
New	0.96	0.97	1.04	0.6
After 1000 hours	1.02	1.12	1.07	0.1
After 2000 hours	1.05	1.13	1.10	0.7
After 3000 hours	1.11	1.11	1.04	less than 0.1
After 4000 hours	1.04	1.13	1.02	less than 0.1

Pump Performance after Endurance

HEAD	7 m		
Nominal pumping rate (Strokes/min)	20	30	40
Vol/stroke (litres)	1.04	1.13	1.02
Work input/stroke (J)	109	125	137
Efficiency (%)	65	62	50

These results are not comparable with the original performance data because the cup washer was replaced during the endurance test.

## 8. ABUSE TESTS

### 8.1 Side Impact Tests

The Bandung pump failed in the side impact tests. In the test on the handle, the pump top casting broke at an impact of 150 Joules on the handle, though the handle itself survived. In the body test, the base casting fragmented at an impact of 500 Joules on the centre of the pumpstand.

### 8.2 Handle Shock Test

In the handle shock test, the handle fulcrum extension broke away from the pump top casting after 19,543 cycles, and the test was terminated. The handle itself was undamaged.

## 9. VERDICT

The Bandung pump is susceptible to accidental damage. It requires priming and is therefore susceptible to contamination, and hence is not recommended for drinking water supply. It could be more reliable with some design changes, to the pumpstand castings and the plunger. Cheap.

NB. It would have been helpful to have had some reaction from the manufacturer.

Sumber Banyu Pump

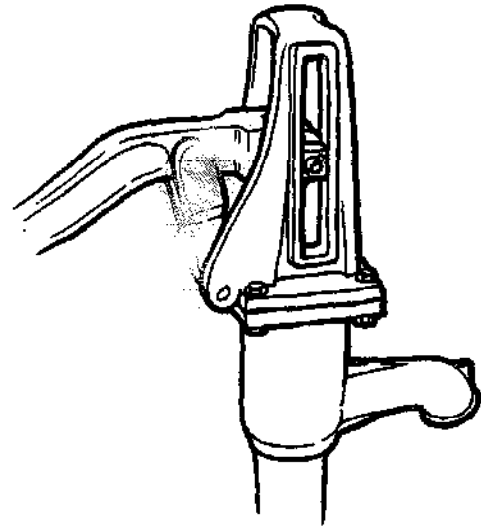
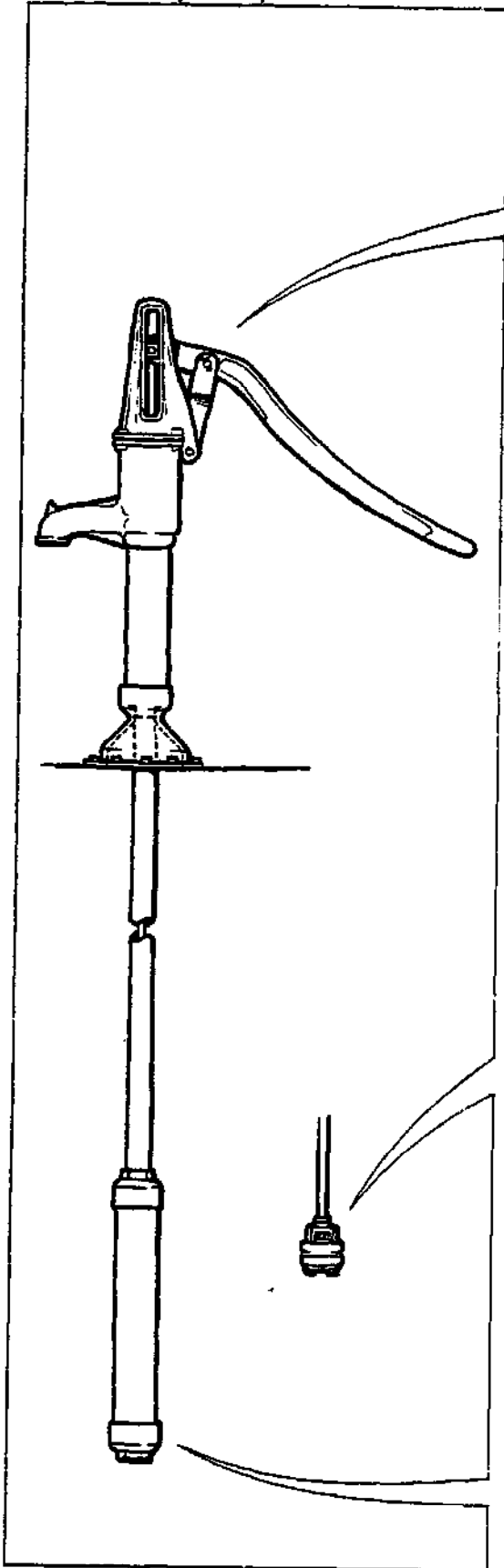

SUMBER BANYU ("SB")

1.1 Manufacturer P.T.Celco Industrial Company, Ltd.,

Address 43A JL Jendral,  
Gatot Subroto,  
BANDUNG, Indonesia

1.2 Description This pump was a derivative deep-well design from AID/Battelle for manufacture in developing countries. The pumps tested were made in Indonesia. The pumpstand is almost entirely cast iron, though the column is a length of steel tube threaded at each end. It features a crosshead mechanism to guide the top of the pump rod.

The cylinder design is conventional, except that uPVC tube is used in place of the more usual seamless brass tube, with cast iron end caps. Two leather cup seals are used on the plunger. The foot valve is a simple flap of leather with a cast iron weight.

1.3 Price in 1981 \$85

2. INSPECTION

2.1 Packaging These pumps were delivered in a slatted wooden packing case. The package weighed 191 kg and might be awkward to man-handle for overland transportation.

2.2 Condition as Received Both samples were generally in good condition as received, though the cup seal retainers on both pumps were insufficiently tight. This may have been due to drying out of the leather in transit.

2.3 Installation & Maintenance Information None supplied with the pump.

3. WEIGHTS and MEASURES

3.1 Weights

Pumpstand	39.5 kg
Cylinder assembly	5.5 kg
Pump rods	0.8 kg per metre

3.2 Dimensions

Nominal cylinder bore:	78 mm
Actual pump stroke:	180 mm
Nominal volume per stroke:	860 ml
Drop pipe size:	1.25 inches
Outside diameter of below-ground assembly:	100 mm
Pump rod diameter:	10 mm
Maximum usable cylinder length:	303 mm



3.3 Cylinder Bore No significant taper or ovality was found in either of the samples.

The surface roughness average (Ra) was measured in three places in a direction parallel to the cylinder axis.

SAMPLE	CYLINDER BORE	ROUGHNESS AVERAGE (um)			MEAN
		TEST 1	TEST 2	TEST 3	
1	Extruded PVC	0.70	0.60	0.80	0.70
2	Extruded PVC	0.65	0.85	0.70	0.73

Measured at 0.80 mm cut-off

3.4 Ergonomic Measurements

HANDLE HEIGHT		PLATFORM	ANGULAR	HANDLE	VELOCITY	HEIGHT
MAX <sup>(1)</sup>	MIN <sup>(1)</sup>	HEIGHT	MOVEMENT	LENGTH	RATIO OF	OF SPOUT
(mm)	(mm)	(mm)	OF HANDLE	(mm)	HANDLE	(mm)
			(degrees)			
1229	250	0	91	860	5.8	500

(1) Measured without compressing bump stops.

4. ENGINEERING ASSESSMENT

4.1 Materials of Construction

COMPONENT	MATERIAL(S)
Pumpstand	Cast iron head, spout and base, steel column
Fulcrum link	Cast iron
Handle	Cast iron
Bearings	Mild steel pivot shafts bear on mild steel wrapped bushes
Connecting rod	Mild steel
Cylinder	Extruded PVC, cast iron end caps
Plunger assembly	Gunmetal body
Cup seals	Leather
Foot valve	Leather with cast iron weight

The original Battelle drawings specify the pins as cold drawn mild steel but do not specify bushes at all. A subsequent amendment by AID and Georgia Institute of Technology specify the pins to be hardened to Rockwell C 40 and the bushes to Rockwell C 60/64.

When measured the pins were found to be 140 Vickers Pyramid Number and the bushes 160 VPN, both less than the lowest number on the Rockwell C scale.

Sumber Banyu Pump

#### 4.2 Manufacturing Techniques

The manufacturing techniques required to make the pump are listed below:-

Above-ground Assembly	Iron foundry Basic machining
--------------------------	---------------------------------

Where facilities and skills in iron foundry work and basic machining are available, this pump may be suitable for manufacture in a developing country. However, the handle mechanism and the crosshead assembly demand careful quality control to ensure proper assembly and smooth running. In the samples supplied, the components of the two pumps were not interchangeable, and the spares did not fit either pump. No jigs and fixtures appear to have been used in manufacture: this is essential to ensure the interchangeability of spares. The pivot shafts and bushes must be hardened.

Below-ground Assembly	Iron foundry Brass/gunmetal foundry Basic machining Leather crafting
--------------------------	---

Similar levels of skill are required for the below-ground components to those needed to manufacture the pumpstand.

#### 4.3 Ease of Installation, Maintenance and Repair

##### 4.3.1 Ease of Installation



The pumpstand may require some re-working of the various handle components to ensure smooth operation.

##### 4.3.2 Ease of Pumpstand Maintenance and Repair



The pumpstand is likely to require frequent attention to the handle, fulcrum link and connecting rod eye, and their respective pivot pins. Most tasks are easy, requiring spanners and pliers only, though a drift and hammer may be needed to remove the pivot pins. Our experience suggests that replacement parts may not be interchangeable with the original components, possibly making on-site repair impossible.

#### 4.3.3 Ease of Below-ground Maintenance and Repair



The cylinder is likely to require frequent attention to the foot valves and to broken pump rod joints. Below-ground repairs require removal of the complete below-ground assembly.

#### 4.4 Resistance to Contamination and Abuse

##### 4.4.1 Resistance to Contamination

The spout should be modified to prevent possible faecal contamination. The pump is sealed against surface water but the pump could be contaminated through the connecting rod hole.

##### 4.4.2 Likely Resistance to Abuse

Split pins easy to remove, no locking fixings. Handle may be susceptible to impact. Otherwise robust.

#### 4.5 Potential Safety Hazards

There are potential finger traps between the pump top and the sliding guide blocks at the top and bottom of the handle stroke.

#### 4.6 Suggested Design Improvements

The bearing bushes in the handle and associated links are of doubtful benefit - the cast iron would provide a satisfactory bearing surface for the steel shafts. If the bushes are retained, both they and the associated pivot pins should be hardened to the original specification.

The lift of the plunger valve should be reduced, ideally to one quarter of its effective diameter, and its location improved.

A handle made from a more resilient material would be less prone to accidental damage.

The foot valve should be redesigned to avoid early failure.

It is recommended that the design of the handle fulcrum be simplified, and the crosshead mechanism eliminated.

No reaction to the above suggestions has yet been received from the manufacturer.

5. PUMP PERFORMANCE

5.1 Volume Flow, Work Input and Efficiency

HEAD	7 m			25 m			45 m		
Nominal pumping rate (strokes/min)	30	40	50	30	40	50	30	40	50
Vol/stroke (litres)	0.83	0.86	0.85	0.82	0.81	0.81	0.80	0.80	0.81
Work input/stroke (J)	101	100	111	290	293	312	458	480	536
Efficiency (%)	55	58	52	69	67	63	76	73	66

5.2 Leakage Tests

HEAD	7 m	25 m	45 m
Leakage rate (ml/min)	less than 0.1	0.4	2.4

6. USER TRIAL

6.1 User Responses

Details of the organisation of this trial can be found in the Test Procedure, and the statistical analysis of user responses is presented in Appendix I.

6.2 Observations

Most users seemed to operate this pump without difficulty. Many muscle groups could be called into play without exaggerated body movements.

7. ENDURANCE

A detailed description of the endurance test method can be found in the Test Procedure.

General Comments

The pump was tested at 40 strokes per minute, initially at a simulated head of 45 metres.

The pump failed several times in the endurance test, due to rapid wear of linkages in the pumpstand, broken rods and worn-out foot valves. After five failures in the first 1000 hours, the simulated head was reduced to 30 metres.

The handle, fulcrum link, connecting rod eye and their associated pivot pins wore rapidly, and had to be replaced several times in 4000 hours. The pump rod broke six times, twice in the connecting rod at the top, twice in the plunger rod, and twice in the intermediate rods. The connecting rod and plunger rod were supplied with the pumps. The plunger rod breakages were caused by failures of the foot valve. In each case, the leather had rotted away allowing the cast iron weight to foul the plunger.

In the final inspection, the plunger and cup seals were still in good condition, and the cylinder bore was polished but otherwise showed few signs of wear. The crosshead blocks and guides were worn but still serviceable. All other moving parts had been replaced at some stage during the 4000 hours. The cylinder end caps were heavily rusted.

Breakdown Incidence

Breakdowns are shown in bold type.

Hours:	248	416	989	1024	1076	2037	2474	3123	4078	4130
	287	596								
<b>Handle Links Worn</b>										
<b>Fulcrum Link Worn</b>										
<b>Pump Rod Broken</b>										
<b>Conn. Rod Broken</b>										
<b>Plunger Rod Broken (foot valve failed)</b>										
<b>Handle Links Worn</b>										
<b>Plunger Rod Broken (foot valve failed)</b>										
Inspection and full performance test				Inspection and volume flow		Inspection and volume flow		Inspection and volume flow		Inspection and full performance test

Details of the Endurance Test

Breakdowns are shown in bold type.

HOURS

**248 Severe wear of handle, fulcrum link and pivot pin**

Estimated amount of water pumped to breakdown.....0.5 million litres

**287 Connecting rod broken at thread on upper end**

Estimated additional amount of water pumped to breakdown.....0.07 million litres

**416 Fulcrum link pin worn**

Estimated additional amount of water pumped to breakdown.....0.2 million litres

**596 Connecting rod eye, handle and pivot pin badly worn**

Estimated additional amount of water pumped to breakdown.....0.3 million litres

**989 Pump rod broken at thread - simulated head reduced from 45 to 30 m**

Estimated additional amount of water pumped to breakdown.....0.8 million litres

1024 INSPECTION after 1st 1000 hours:

- (a) Leather cup washers distorted
- (b) Some corrosion of ferrous parts

**1076 Connecting rod broken at thread**

Estimated additional amount of water pumped to breakdown.....0.2 million litres

2037 INSPECTION after 2nd 1000 hours:

- (a) Some wear in handle pins and bushes
- (b) Plunger valve somewhat worn on its circumference
- (c) More corrosion of ferrous parts

**2474 Plunger rod broken at thread - foot valve leather had rotted away allowing weight to foul plunger causing rod to break. New foot valve assembly and plunger rod fitted.**

Estimated additional amount of water pumped to breakdown.....2.7 million litres

HOURS

3123 INSPECTION after 3rd 1000 hours:

- (a) Bushes in handle fork worn through, pin approx. 50% worn
- (b) Pump rod eye worn
- (c) Some wear in crosshead guides and blocks
- (d) Fulcrum link bushes worn at pump body pivot

Holes in handle fork and pump rod eye bored out but not re-bushed.  
Stepped pivot pin made to suit and fitted.

Estimated additional amount of water pumped to breakdown.....1.2 million litres

4078 Plunger rod broken at thread - foot valve leather had rotted away allowing weight to foul plunger causing rod to break and damaging lower cup seal.  
New foot valve, plunger rod and cup seal fitted.

Estimated additional amount of water pumped to breakdown.....1.8 million litres

4130 FINAL INSPECTION

- 1. Pumpstand
  - (a) Noticeable wear on stepped pivot pin and connecting rod eye fitted at 3000 hour inspection
  - (b) Other handle pivot pins and bushes also worn
  - (c) Crosshead guides and blocks worn but still serviceable
- 2. Cylinder      Cylinder bore highly polished with no significant wear, though some scoring from sand particles - minor damage to cylinder bore from most recent plunger rod breakage
- 3. Plunger        Both seals and valve in good condition
- 4. Foot Valve    Recent replacement still in good condition
- 5. Corrosion     Cylinder end caps heavily rusted - upper worse than lower

Estimated total amount of water pumped in 4000 hours.....7.7 million litres.

Strokes/min	Volume Flow Tests at 25m (litres)			Leakage Tests at 7 m (ml/min)
	30	40	50	
New	0.82	0.81	0.81	less than 0.1
After 1000 hours	0.76	0.76	0.76	0.1
After 2000 hours	0.81	0.79	0.79	0.4
After 3000 hours	0.77	0.79	0.79	0.1
After 4000 hours	0.82	0.82	0.82	0.3

Pump Performance after Endurance

HEAD	7 m			25 m			45 m		
Nominal Pumping Rate (Strokes/min)	20	30	40	20	30	40	20	30	40
Vol/stroke (litres)	0.82	0.82	0.82	0.82	0.82	0.82	0.80	0.80	0.81
Work input/stroke (J)	101	109	111	258	257	285	388	416	452
Efficiency (%)	55	51	50	77	78	70	91	85	79

These results are not comparable with the original performance data because the cup seal was replaced during the endurance test.

8. ABUSE TESTS

8.1 Side Impact Tests

In the side impact test on the handle, the pump absorbed the impact by turning on the thread between the pump top and the column. In the body test, the base casting broke at an impact of 400 Joules at the centre of the pumpstand. There was evidence of porosity in the casting at the point of fracture.

8.2 Handle Shock Test

In the handle shock test, the handle broke after 5,389 cycles. There was evidence of faults in the casting at the point of fracture, probably originating in manufacture.

9. VERDICT

Not a reliable pump for deep-well use. Intensive use will produce rapid wear in the moving parts of the pumpstand. Manufacturing needs much better quality control in both foundry to prevent porosity and in the machine shop to ensure interchangeability of parts, and the pump may therefore not be suitable for manufacture in developing countries, even where foundry skills are available. The leather foot valve was undependable. The pump needs modification to be suitable for community water supply. Inexpensive.

We understand that USAID are offering assistance to manufacturers in order to improve the general quality of the product including interchangeability of spare parts. They are also considering a replacement of the leather footvalve.



APPENDIX I. STATISTICAL ANALYSIS OF USER RESPONSES

IN BATCHES 1 AND 2

Introduction

In Batches 1 and 2, the user trial was conducted as a comparison between pumps. Statistical analysis of the users' subjective responses to a questionnaire revealed their overall preferences, and any correlations between preferred pumps and user type. In the course of that user trial, however, it was apparent that valuable information could be obtained by careful observation of the users, and we experimented with selective video recordings.

Information obtained by observation has the advantage that it can be substantially independent of the particular choice of pumps in any one test. By contrast, the users' subjective responses and the statistical analysis thereof are relevant only in the context of a comparison between the particular pumps in each test. It is not valid to compare subjective data from different user tests, but it is valid to compare data obtained by observation in different tests. Moreover it is possible to carry out an 'observed' user test on a single pump, if necessary.

Batches 1 and 2 were straightforward comparative tests for a single client, but the third batch of pumps was tested on a more individual basis, for a number of clients. The information was only brought together at the final reporting stage. A purely comparative user test, based on the statistical analysis of users' responses, would therefore have been neither practical nor appropriate.

Statistical Analysis of User Responses

Test Procedure

Sixty users were recruited. Adults, women and men, were divided in equal groups of short, medium and tall stature. Children, girls and boys of 11 or 12 years of age, were divided into short and tall groups:

6	Short Men	under 1.68 metres
6	Medium Men	between 1.68 and 1.79 metres
6	Tall Men	over 1.79 metres
6	Short Women	under 1.63 metres
6	Medium Women	between 1.63 and 1.69 metres
6	Tall Women	over 1.69 metres
6	Short Girls	between 1.35 and 1.49 metres
6	Tall Girls	between 1.50 and 1.65 metres
6	Short Boys	between 1.35 and 1.49 metres
6	Tall Boys	between 1.50 and 1.65 metres

60 total

The shallow well pumps were operated at 7 metres head; the deep well pumps were set at a simulated head of 20 metres.

The twelve pumps were tested in two batches of six.

The users were asked to try each pump in turn, following a controlled random order. Each user was asked to fill a 10-litre bucket with each pump and answer the following questions by indicating the appropriate rating:

Q1.	How suitable was the handle height for you?	Much too high	About right	Much too low
		1	2 3	4 5
Q2.	How comfortable was the handle to hold and use?	Not at all comfortable		Very comfortable
		1	2 3	4 5
Q3.	How much effort did you need to operate the pump?	A lot of effort		Very little effort
		1	2 3	4 5
Q4.	Overall, how easy did you find this pump to operate?	Not at all easy		Very easy
		1	2 3	4 5

Additional space was provided for comments.

Statistical Analysis

For each question, separate two-way analyses of variance were performed on the results for each user group. A combined analysis of variance was also carried out to test for overall differences between pumps, between user groups and for any interactions between pumps and user groups.

Any significant differences between pumps were used to establish clusters of pumps. A cluster was defined as a group of pumps for which the mean values were relatively close so that:

- a) two pumps from the same cluster were not significantly different;
- b) two pumps from non-adjacent clusters were significantly different;
- c) two pumps from adjacent clusters were not necessarily significantly different.

The results are shown on the following page.

Results

----- C L U S T E R S -----

Q1. Handle height	Too low	About right				Too high
BATCH 1	Nepta		Bandung New No.6	Moyno Nira		Korat
BATCH 2	Jetmatic	Dragon Ethiopia		S/Banyu VEW		Kenya
Q2. Handle comfort	More comfortable			Less comfortable		
BATCH 1		Korat Nepta Nira Bandung		New No.6		Moyno
BATCH 2		Jetmatic S/Banyu	Dragon VEW	Kenya	Ethiopia	
Q3. Operating Effort	Less effort			More effort		
BATCH 1	Nepta New No.6 Bandung		Korat		Nira	Moyno
BATCH 2	Jetmatic S/Banyu	Dragon		Kenya		Ethiopia Kenya
Q4. Overall ease of operation	Easy			Difficult		
BATCH 1	New No.6 Bandung		Korat Nepta		Nira	Moyno
BATCH 2	S/Banyu		Dragon Jetmatic		Kenya	Ethiopia VEW

APPENDIX II. EXAMPLES OF FORCE DISPLACEMENT DIAGRAMS

Comments on Diagrams. As the pumps were driven by a human operator for the performance tests, a number of slight detail differences are apparent on the graphs. These do not however affect the greater differences between sets of graphs arising from changes in performance.

Although performance is measured over a number of strokes, or revolutions, only a few graphs are drawn to avoid damaging the paper on the graph plotter.

Any differences between the displacements recorded during the initial performance tests and those recorded finally are again due to human variations. In some cases, for instance, the pumps became freer to operate and therefore less easy for the operator to avoid hitting the stops. This is indicated by the peaks at commencement and end of the stroke.

However as the results are computed from averaged measured values during the tests, human variations are insignificant compared with the real differences in pump performance.

To calculate the total work done, all contributions are treated as positive, whatever the direction of the applied force or the direction of motion.

Where significant repairs have been needed in the below-ground equipment during the endurance phase it would not be relevant to compare the efficiency of the pump with original performance figures.

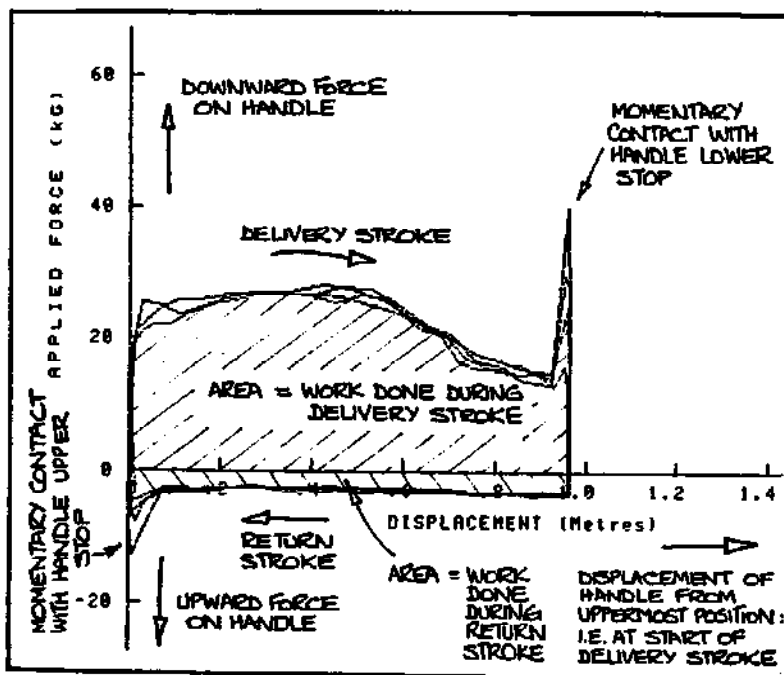

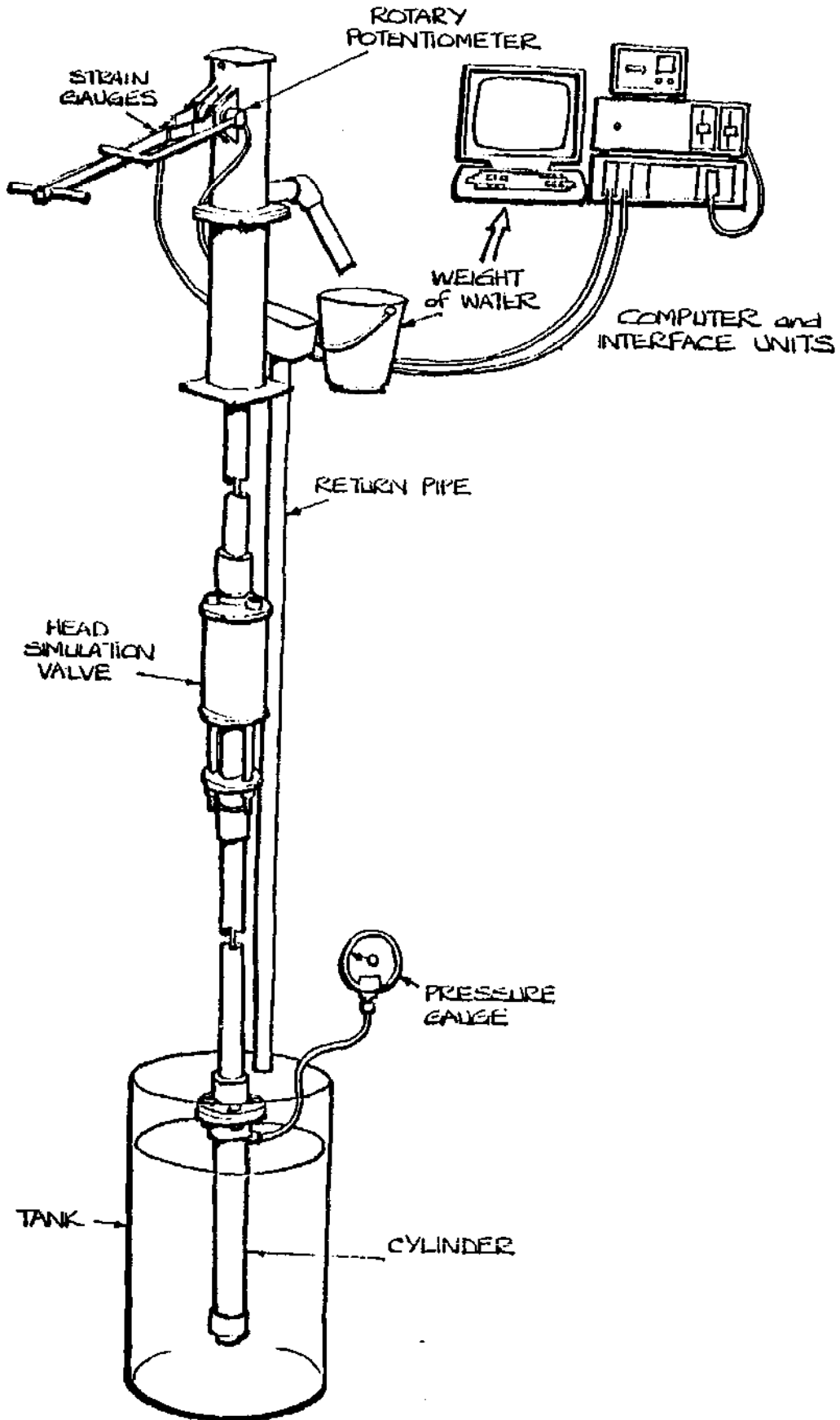

### PUMP PERFORMANCE

CODE N Abi/Vergnet

Water Head 7 Metres --- Pumping Rate 38 Cycles/Minute

Total Height of Water Raised 2.7kG

10 Cycles

Total Work Done On Pump 1309 Joules. (Rate 82.4 Watts )

Average Volume of Water .27 Litres per Cycle
Average Work Done on Pump 130 Joules per Cycle
Efficiency 14%

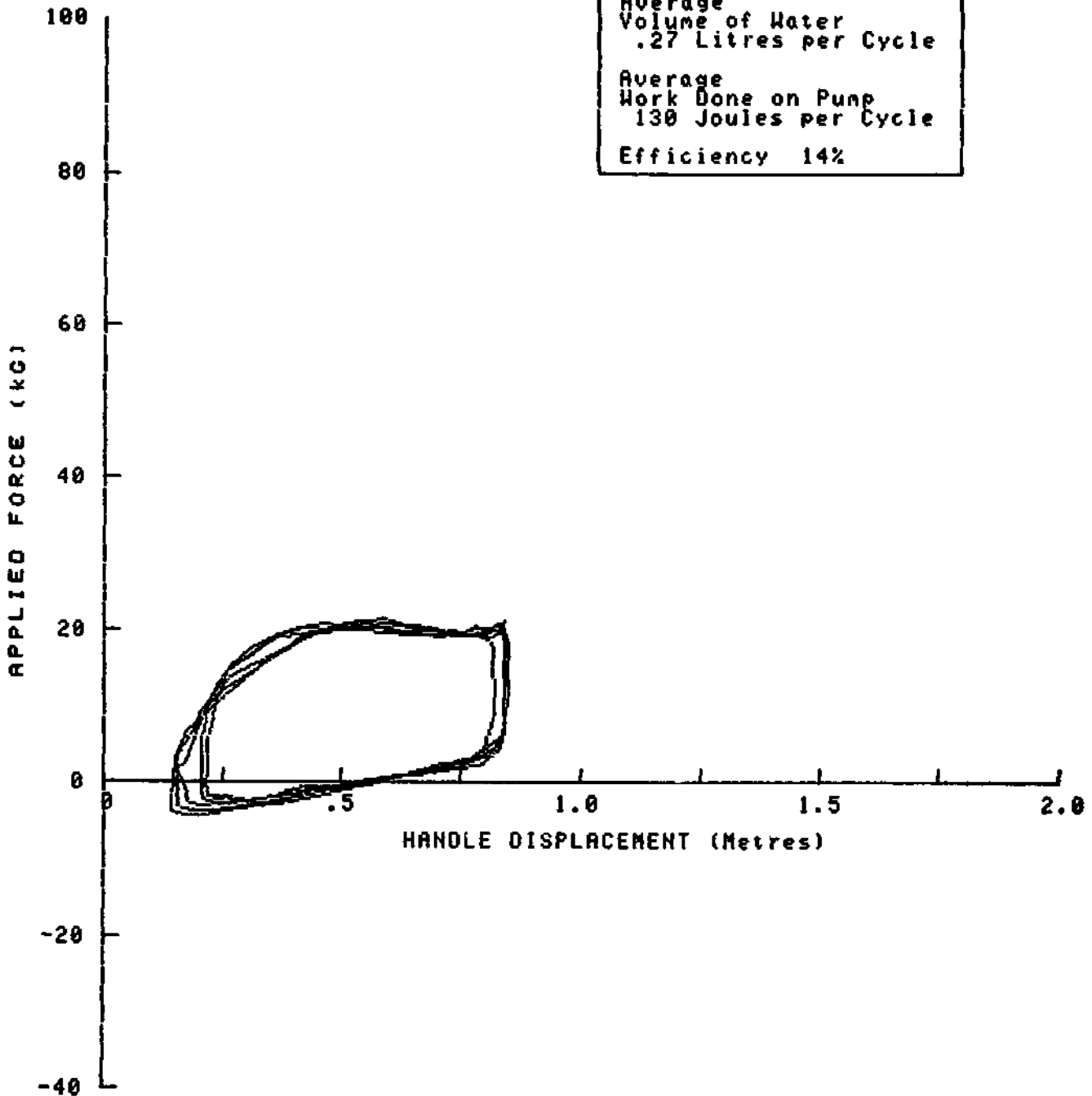

# PUMP PERFORMANCE

CODE N Abi/Vergnet

Water Head 25 Metres --- Pumping Rate 40 Cycles/Minute  
Total Weight of Water Raised 2.6kG  
10 Cycles  
Total Work Done On Pump 1946 Joules. (Rate 130.9 Watts )

Average Volume of Water .26 Litres per Cycle
Average Work Done on Pump 194 Joules per Cycle
Efficiency 32%

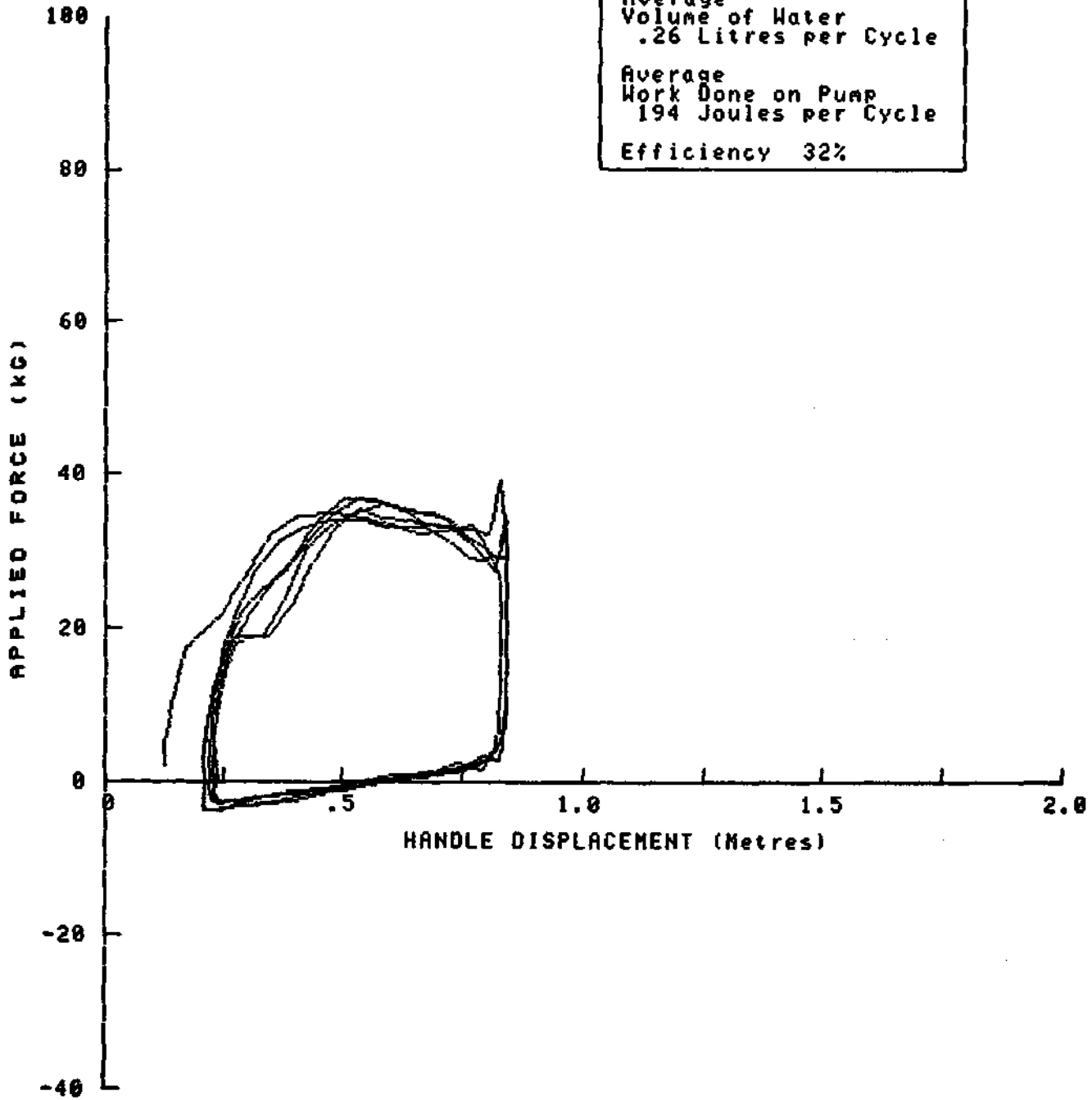



**PUMP PERFORMANCE**

**CODE N Abi/Vergnet**

Water Head 45 Metres --- Pumping Rate 42 Cycles/Minute

Total Weight of Water Raised 2.5kG

10 Cycles

Total Work Done On Pump 2508 Joules. (Rate 177.4 Watts )

Average Volume of Water .25 Litres per Cycle
Average Work Done on Pump 250 Joules per Cycle
Efficiency 43%

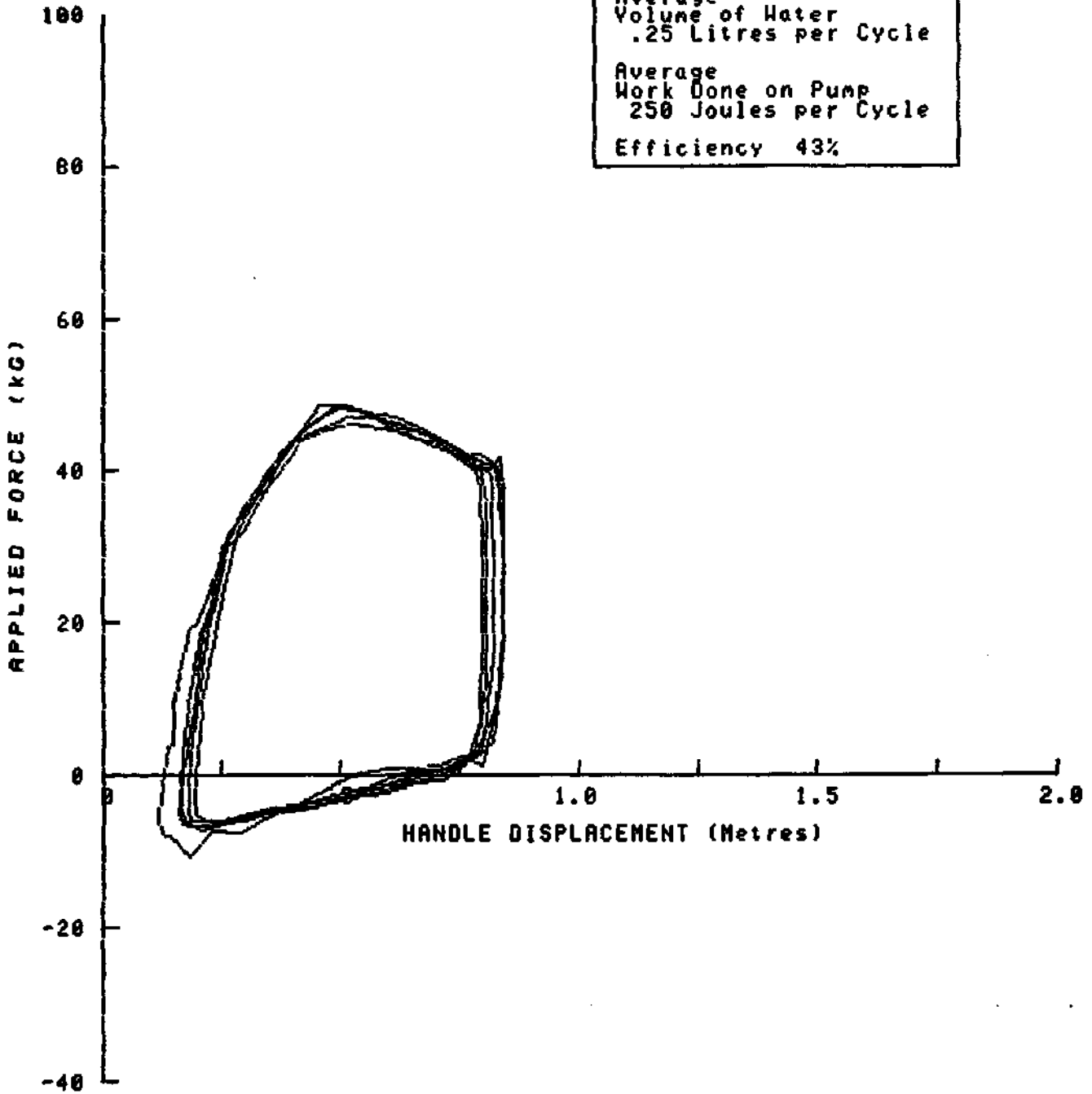

# PUMP PERFORMANCE

CODE 0 Petro

Water Head 7 Metres --- Pumping Rate 39 Cycles/Minute

Total Weight of Water Raised 3.8kG

15 Cycles

Total Work Done On Pump 1170 Joules. (Rate 50.8 Watts )

Average  
Volume of Water  
.25 Litres per Stroke

Average  
Work Done on Pump  
78 Joules per Cycle

Efficiency 22%

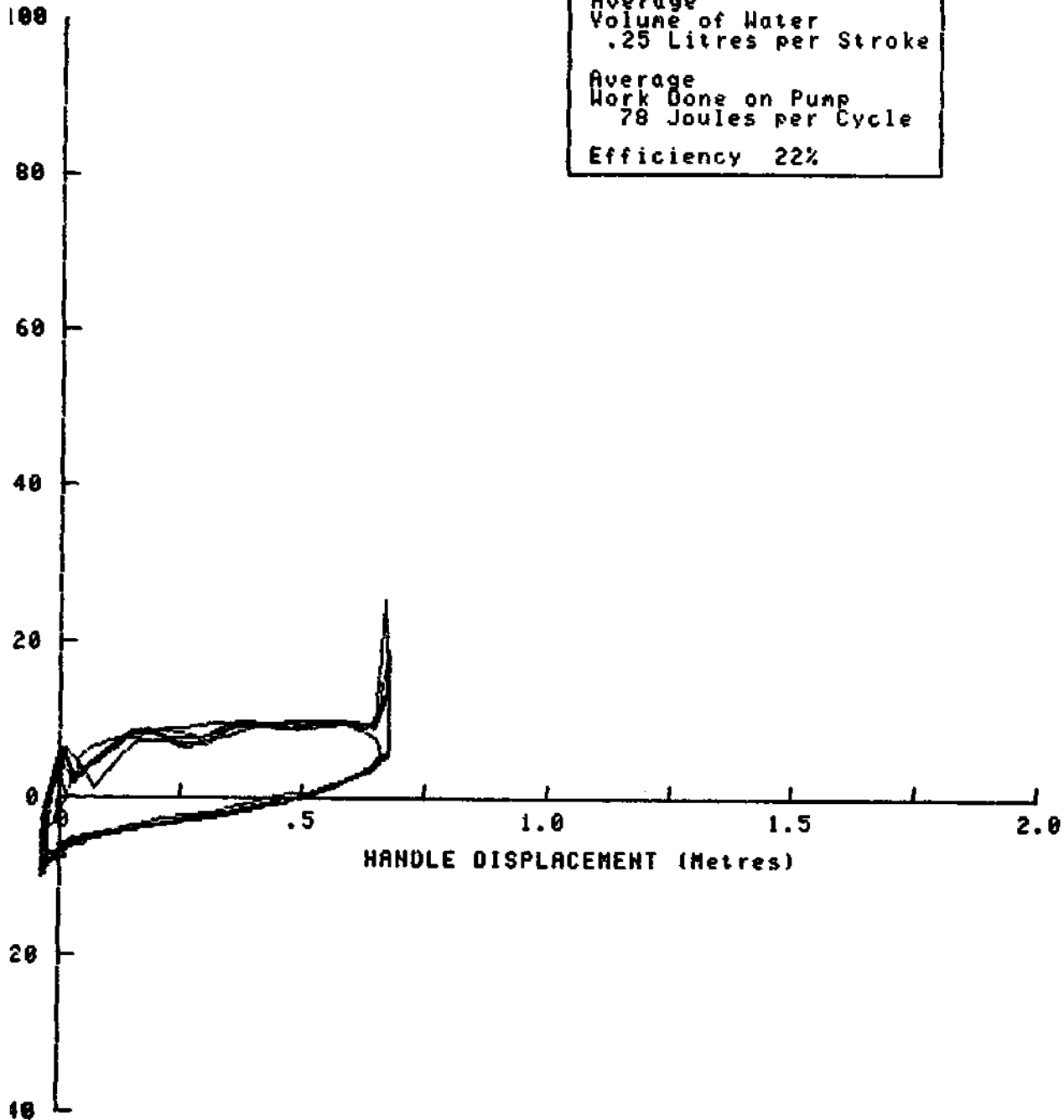

### PUMP PERFORMANCE

CODE 0 Petro

Water Head 25 Metres --- Pumping Rate 40 Cycles/Minute

Total Weight of Water Raised 3.7kG

15 Cycles

Total Work Done On Pump 1802 Joules. (Rate 79.5 Watts )

Average  
Volume of Water  
.25 Litres per Stroke

Average  
Work Done on Pump  
120 Joules per Cycle

Efficiency 50%

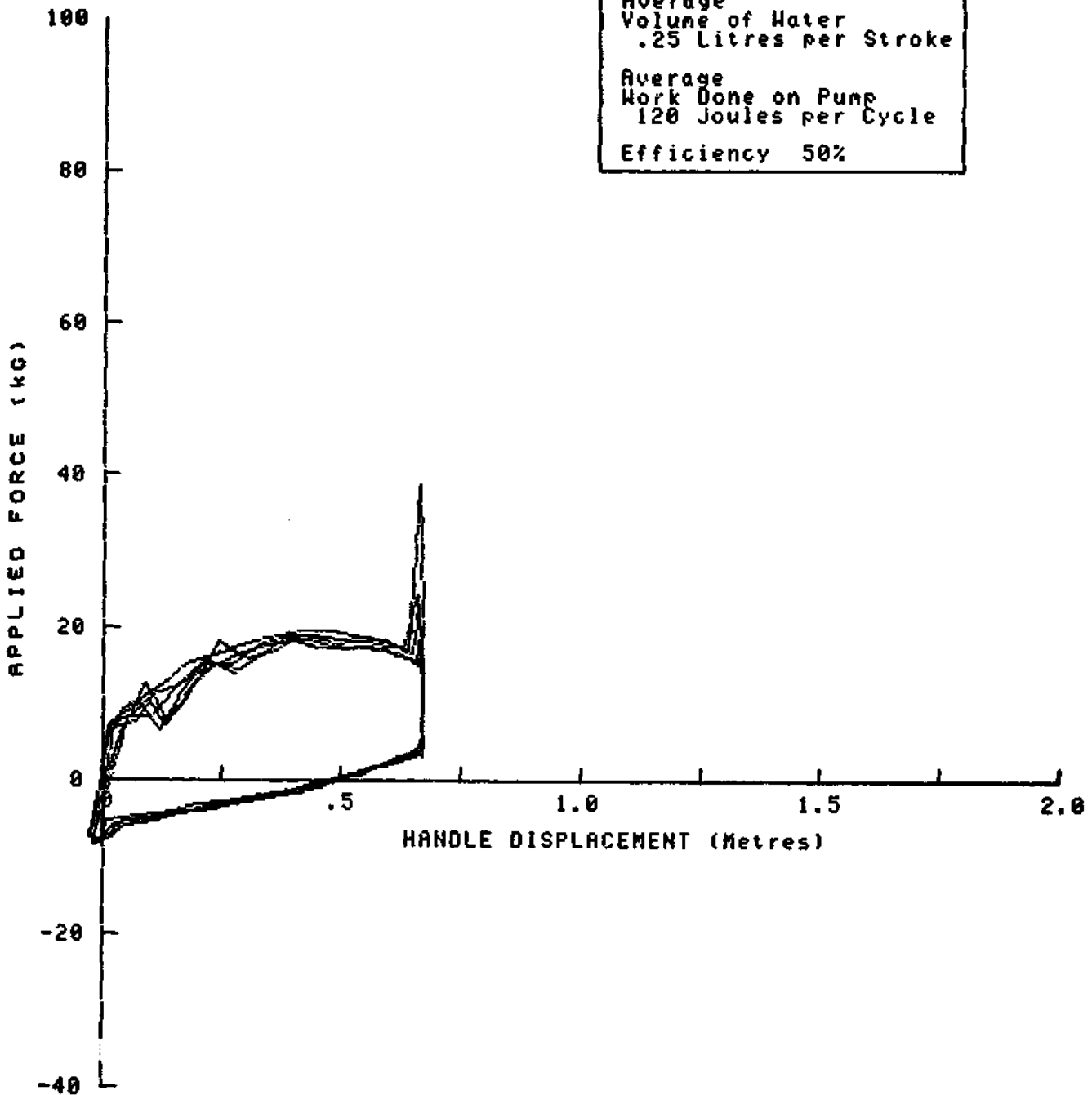

### PUMP PERFORMANCE

CODE 0 Petro

Water Head 45 Metres --- Pumping Rate 37 Cycles/Minute

Total Weight of Water Raised 4.0kg

15 Cycles

Total Work Done On Pump 3032 Joules. (Rate 124.9 Watts )

Average Volume of Water .26 Litres per Stroke
Average Work Done on Pump 202 Joules per Cycle
Efficiency 57%

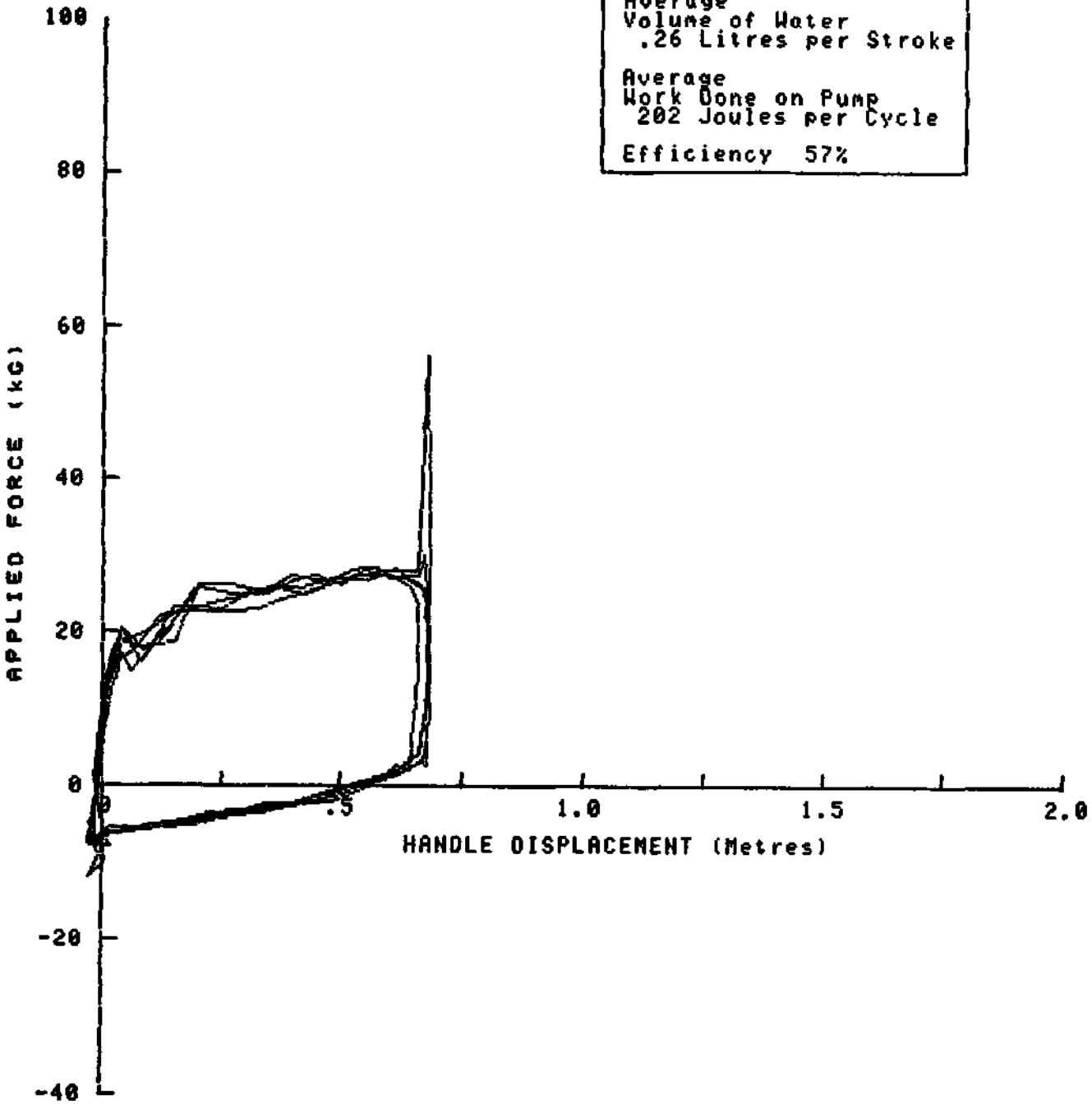

# PUMP PERFORMANCE

## CODE P Funyma9

Water Head 7 Metres --- Pumping Rate 38 Cycles/Minute.  
Total Weight of Water Raised 7.0kg  
10 Cycles  
Total Work Done On Pump 1345 Joules. (Rate 86.1 Watts )

Average Volume of Water .70 Litres per Stroke
Average Work Done on Pump 134 Joules per Cycle
Efficiency 35%

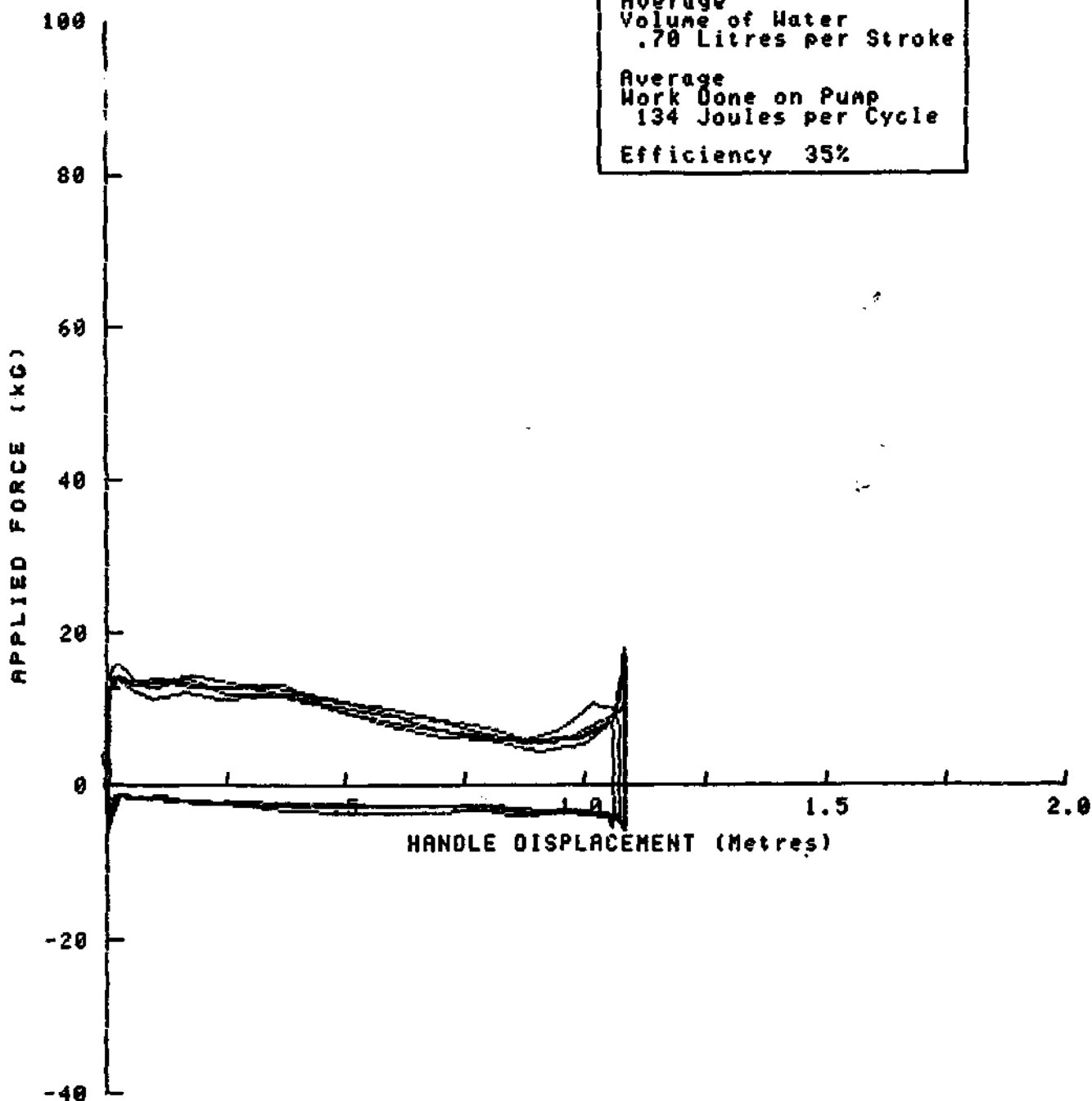

# PUMP PERFORMANCE

## CODE P Funyma9

Water Head 25 Metres --- Pumping Rate 37 Cycles/Minute  
Total Weight of Water Raised 6.9kG  
10 Cycles  
Total Work Done On Pump 3046 Joules. (Rate 188.8 Watts )

Average  
Volume of Water  
.69 Litres per Stroke  
  
Average  
Work Done on Pump  
304 Joules per Cycle  
  
Efficiency 55%

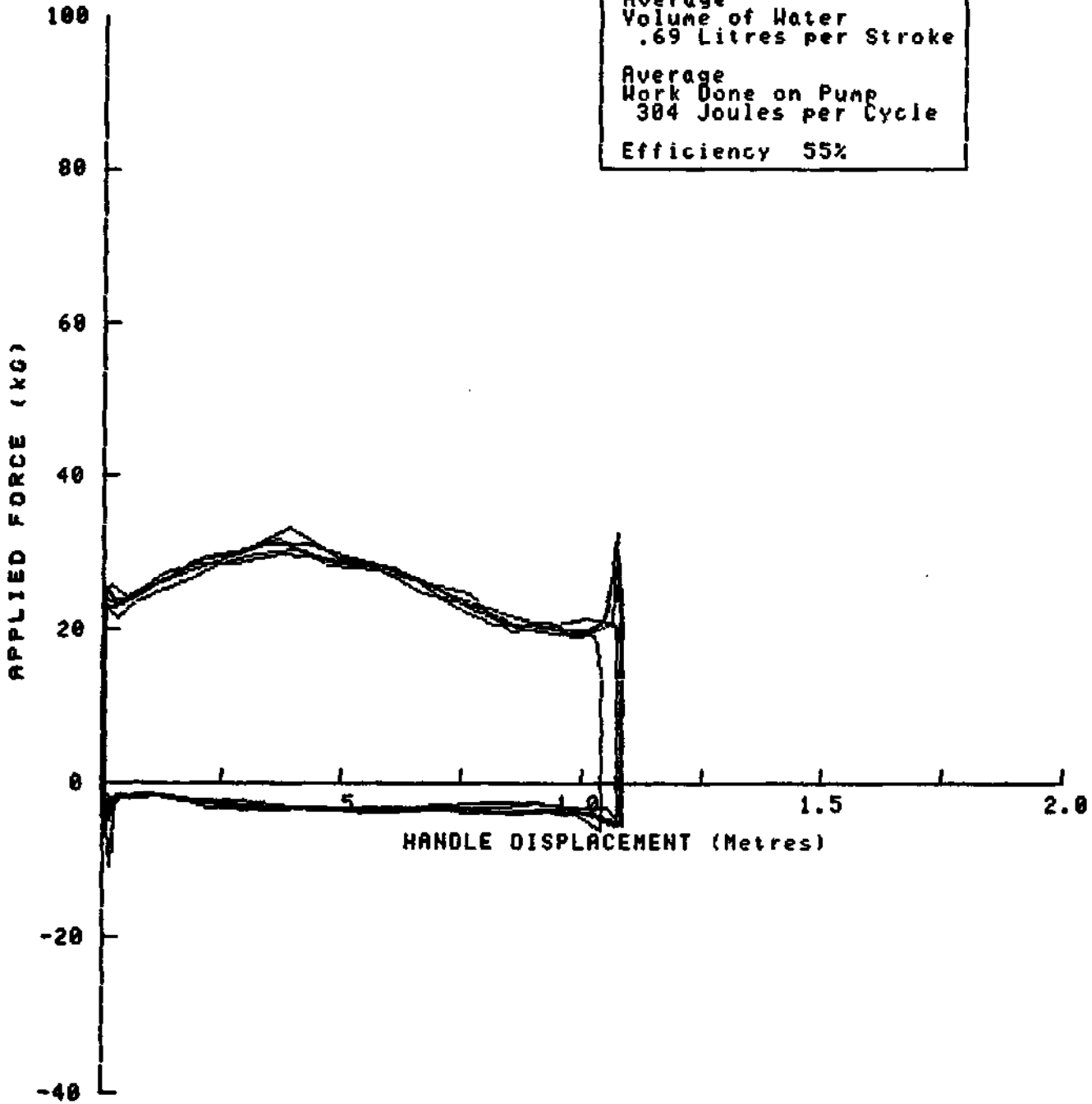

### PUMP PERFORMANCE

CODE P Funyma9

Water Head 45 Metres --- Pumping Rate 37 Cycles/Minute  
Total Weight of Water Raised 6.8kg  
10 Cycles  
Total Work Done On Pump 4687 Joules. (Rate 287.1 Watts )

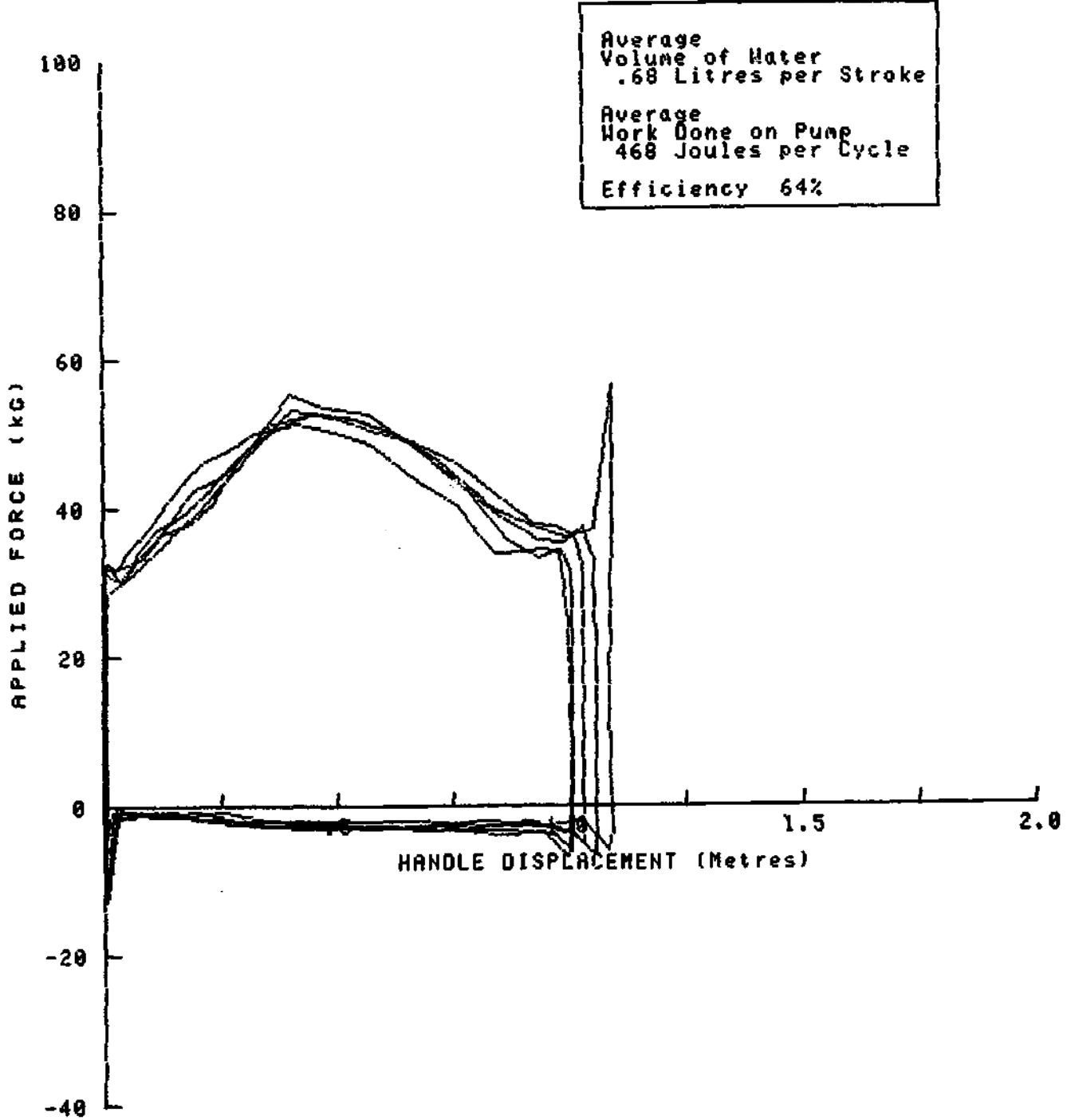

### PUMP PERFORMANCE

CODE R Rower with Surge Chamber

Water Head 7 Metres --- Pumping Rate 15 Cycles/Minute

Total Weight of Water Raised 9.0kg

5 Cycles

Total Work Done On Pump 960 Joules. (Rate 49.2 Watts )

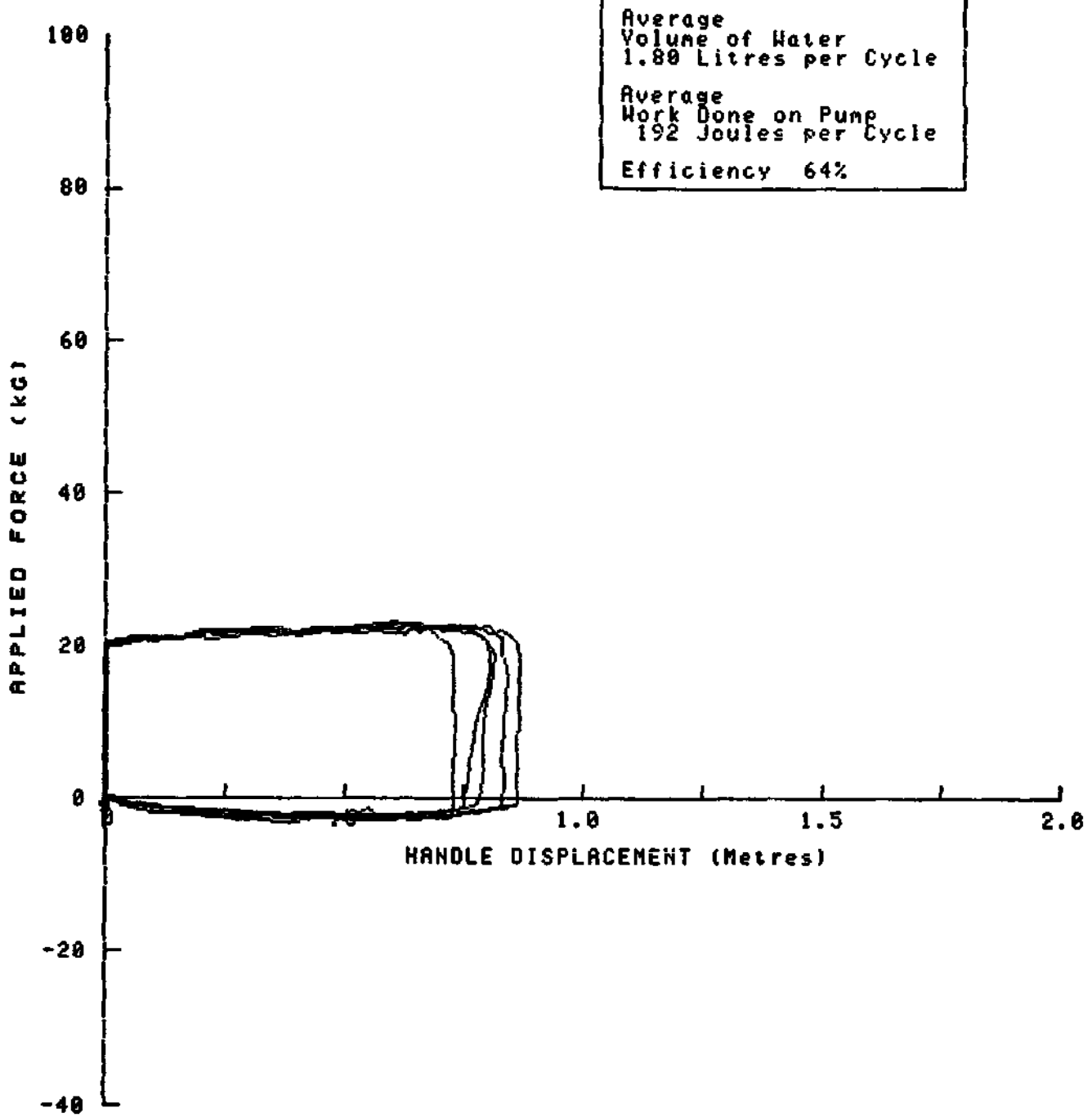



### PUMP PERFORMANCE

CODE R Rower without Surge Chamber

Water Head 7 Metres --- Pumping Rate 14 Cycles/Minute

Total Weight of Water Raised 8.5kg

5 Cycles

Total Work Done On Pump 971 Joules. (Rate 46.5 Watts )

Average Volume of Water 1.70 Litres per Cycle
Average Work Done on Pump 194 Joules per Cycle
Efficiency 59%

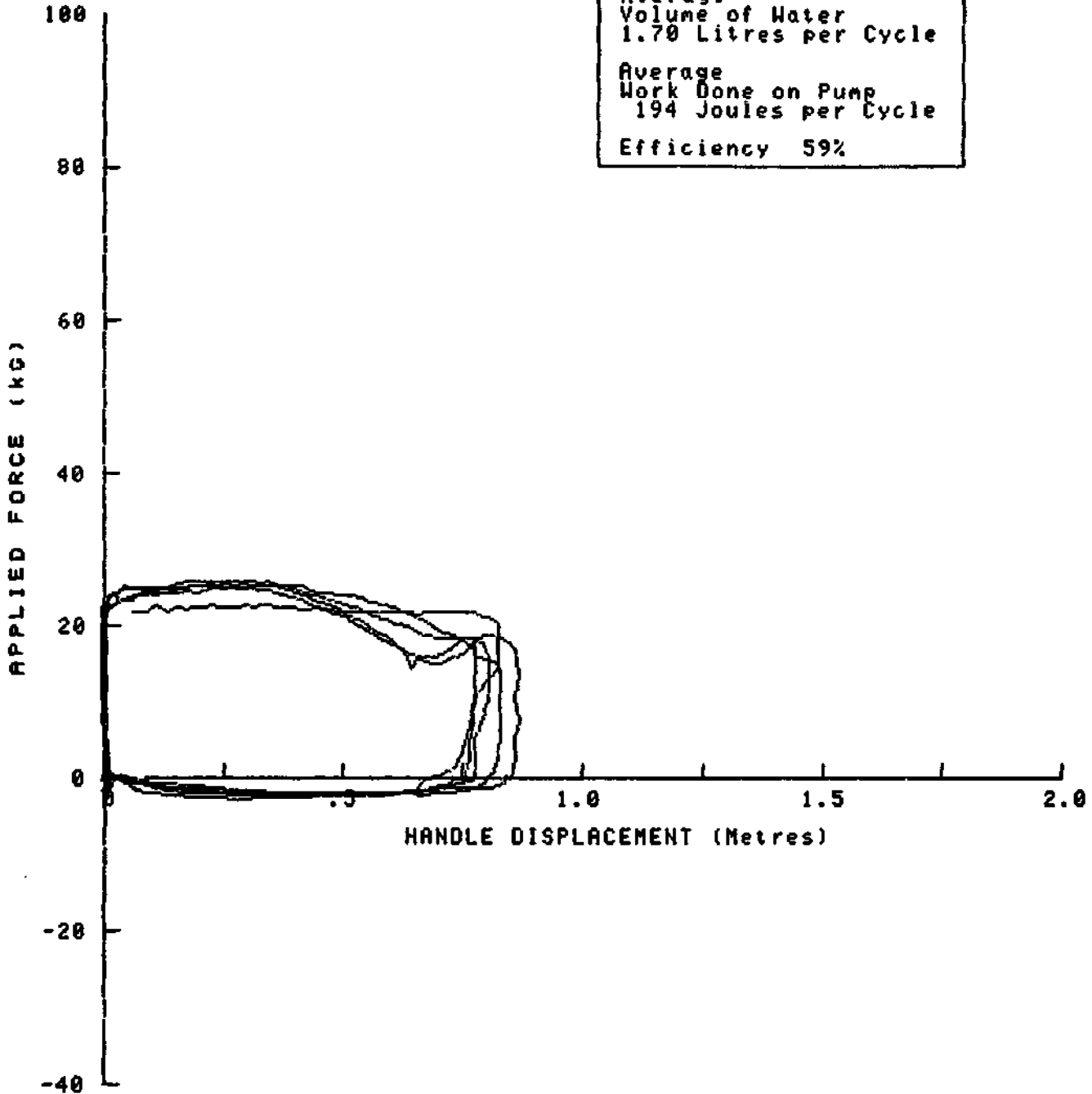

A marginal reduction in efficiency can be seen when the surge chamber is not used.

### PUMP PERFORMANCE after endurance CODE R Rower with Surge Chamber

Water Head 7 Metres --- Pumping Rate 15 Cycles/Minute

Total Weight of Water Raised 6.5kg

5 Cycles

Total Work Done On Pump 1016 Joules. (Rate 50.2 Watts )

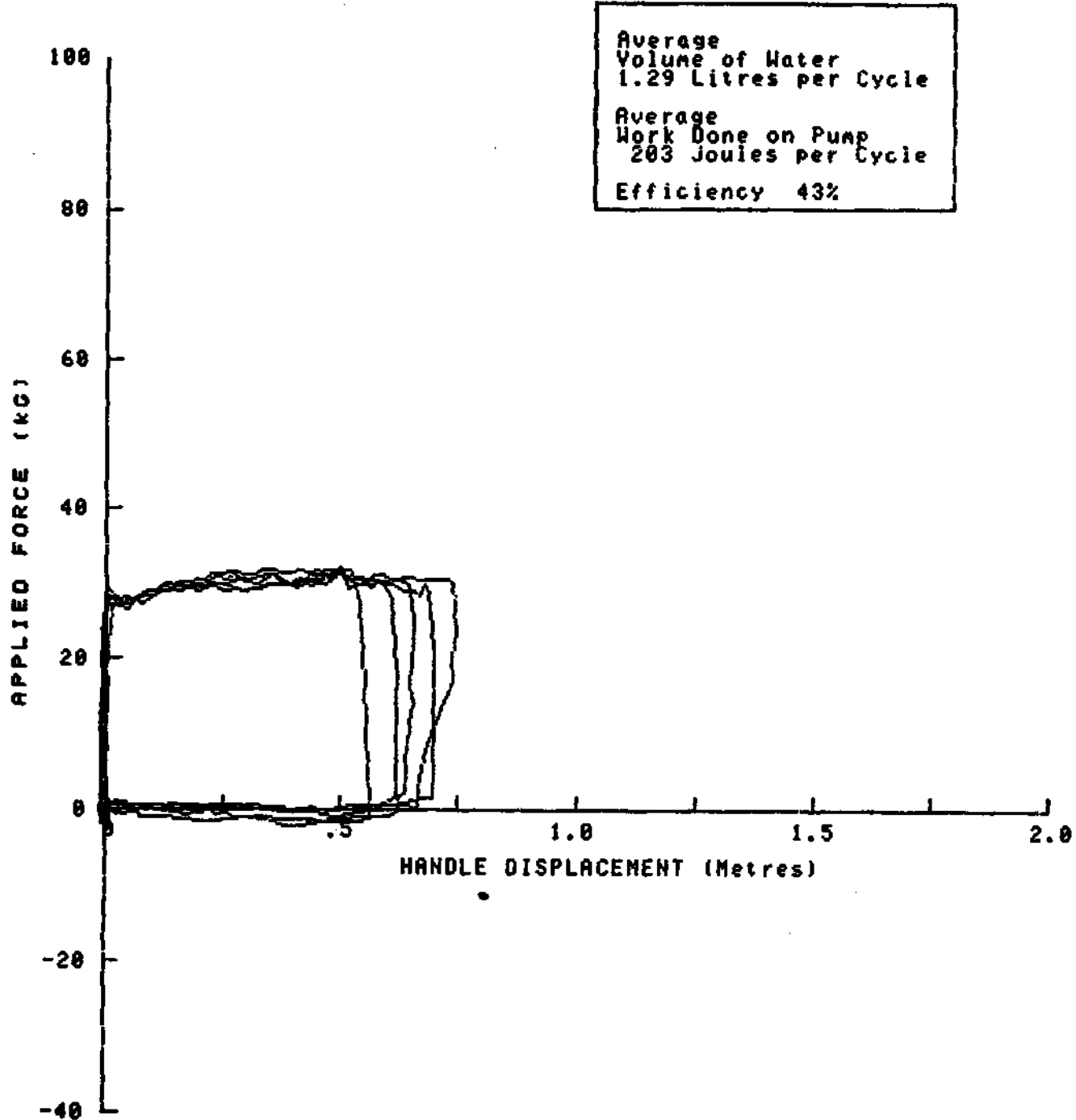

Considerably higher efforts were noted after endurance, possibly due to increased friction between the cup seal and cylinder bore.

### PUMP PERFORMANCE

CODE S Volanta with Cylinder #1

Water Head 7 Metres --- Pumping Rate 34 Revs/Minute

Total Weight of Water Raised 5.6kg

9 Revs

Total Work Done On Pump 879 Joules. (Rate 53.0 Watts )

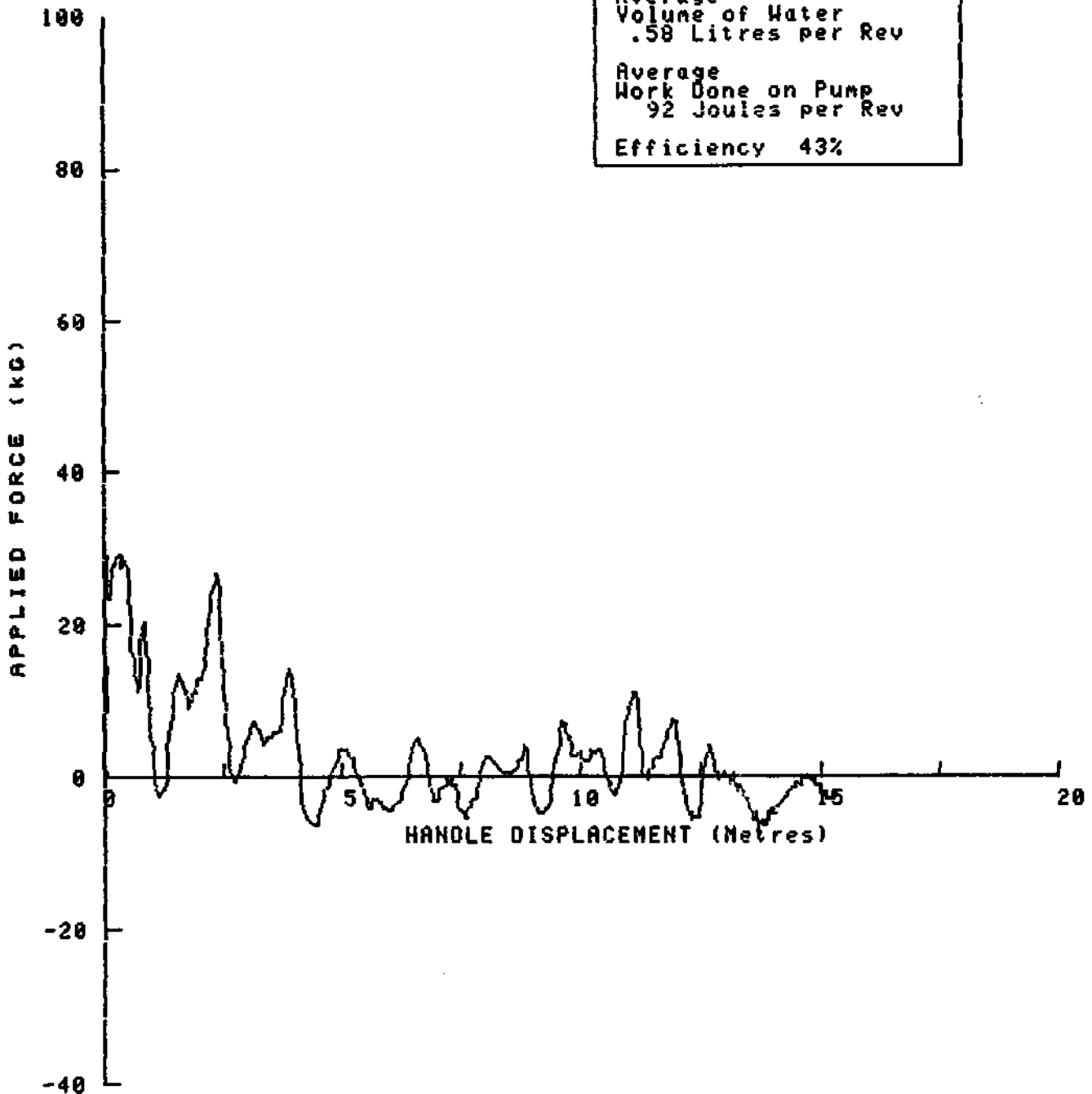

By limiting the test to 9 revolutions the initial effort to start the pump from rest has reduced the average efficiency. This would be higher if the test was carried out over a larger number of revolutions.

**PUMP PERFORMANCE after endurance**  
**CODE S1 Volanta with Cylinder #1**

Water Head 7 Metres --- Pumping Rate 39 Revs /Minute

Total Weight of Water Raised 4.9kG

9 Revs

Total Work Done On Pump 1015 Joules. (Rate 72.4 Watts )

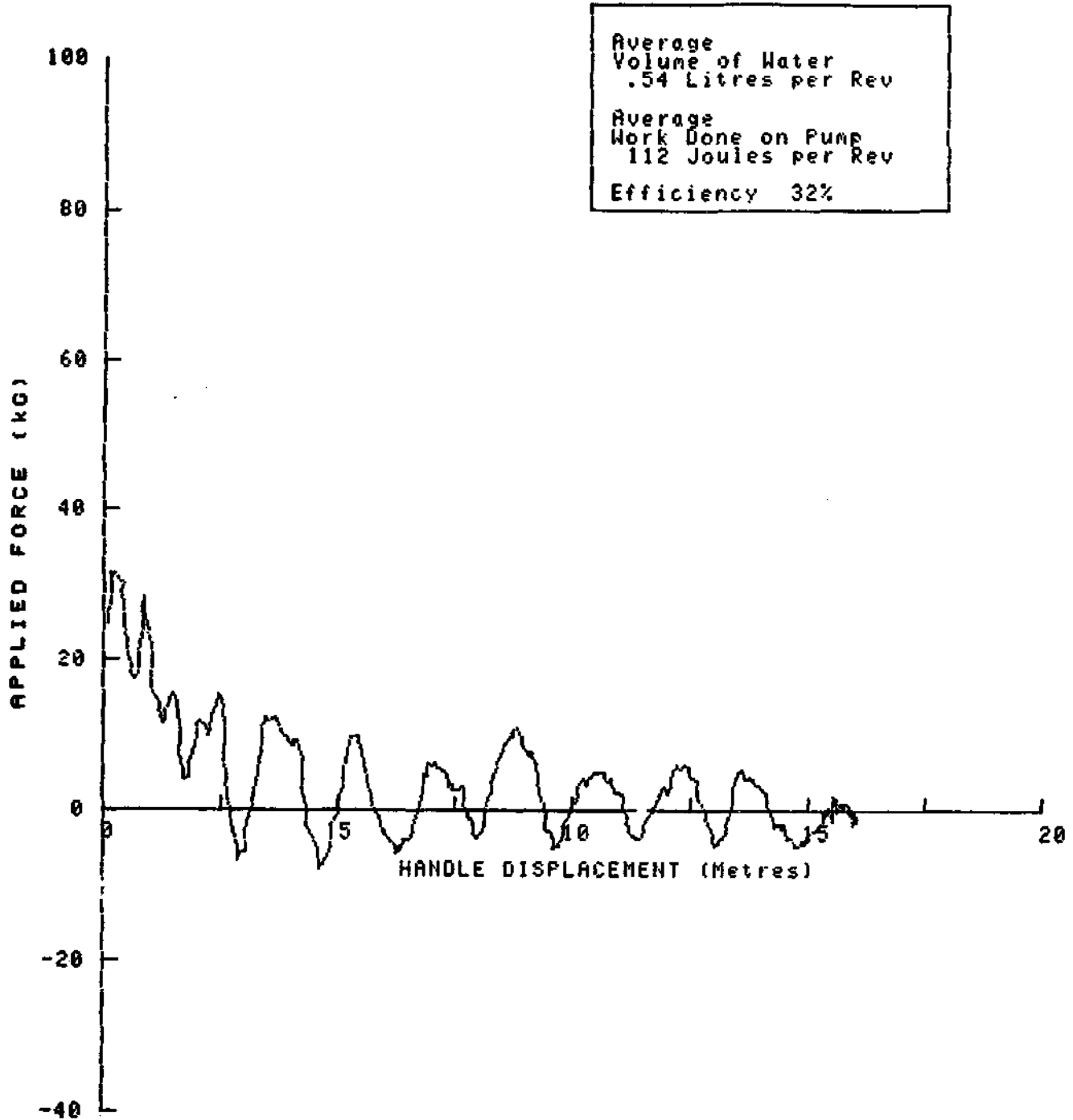

### PUMP PERFORMANCE

CODE S Volanta with Cylinder #1

Water Head 25 Metres --- Pumping Rate 35 Revs/Minute

Total Height of Water Raised 3.1kG

9 Revs

Total Work Done On Pump 1277 Joules. (Rate 80.7 Watts )

Average Volume of Water .33 Litres per Rev
Average Work Done on Pump 136 Joules per Rev
Efficiency 59%

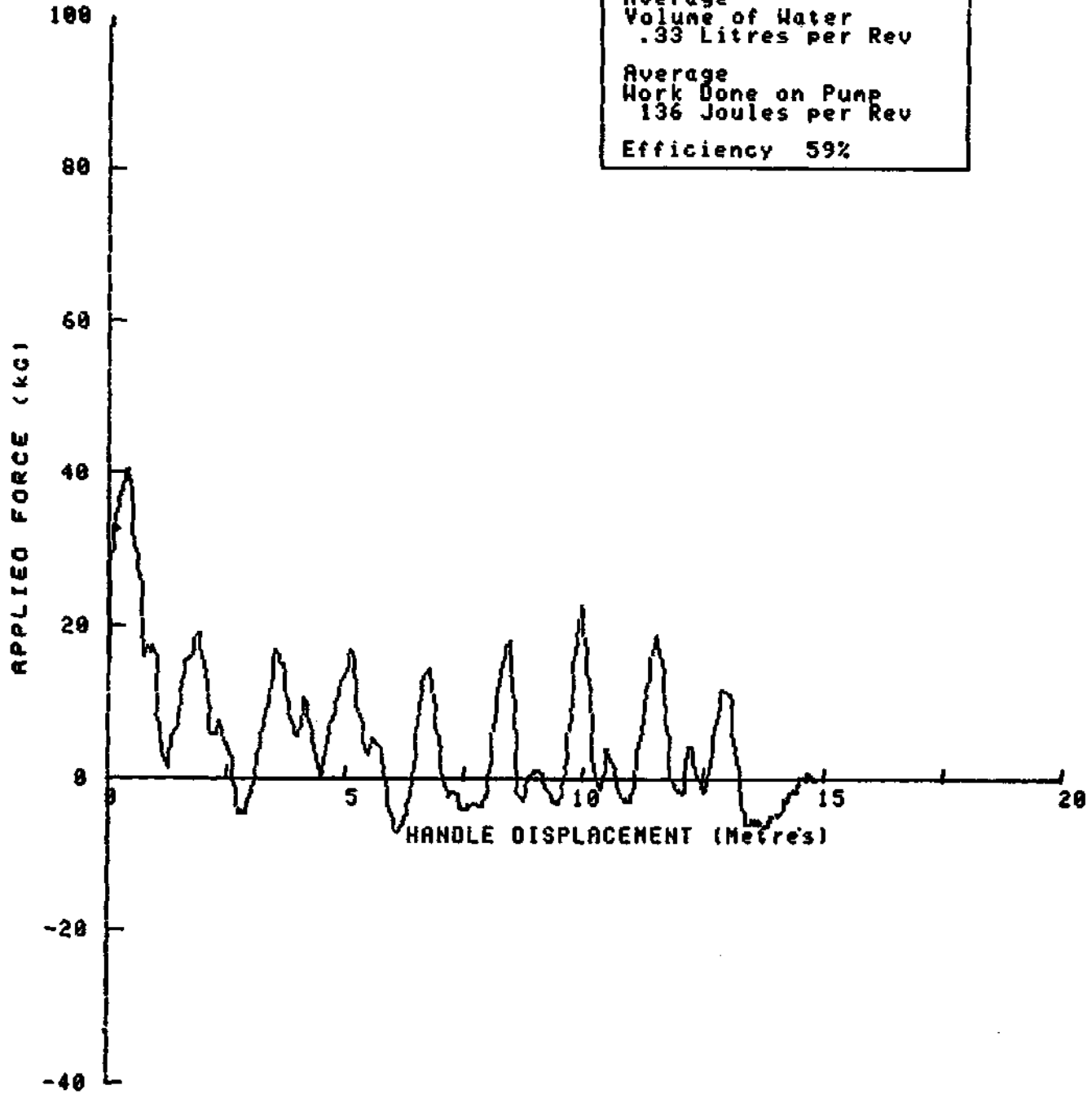

**PUMP PERFORMANCE after endurance  
CODE S1 Volanta with Cylinder #1**

Water Head 25 Metres --- Pumping Rate 38 Revs /Minute  
Total Weight of Water Raised 2.5kg  
9 Revs  
Total Work Done On Pump 1326 Joules. (Rate 94.5 Watts )

Average Volume of Water .28 Litres per Rev
Average Work Done on Pump 147 Joules per Rev
Efficiency 46%

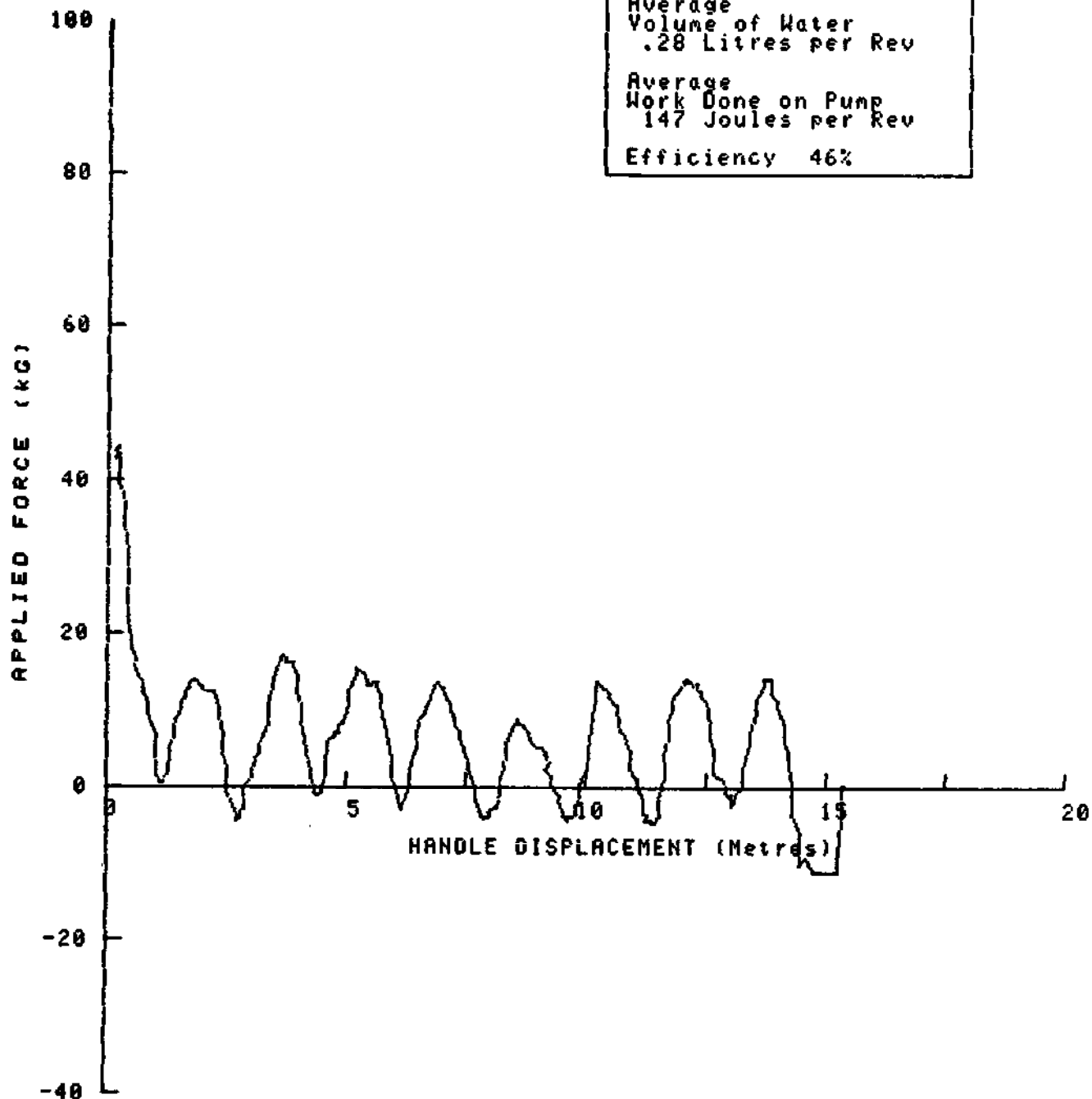

### PUMP PERFORMANCE

CODE S Volanta with Cylinder #1

Water Head 45 Metres --- Pumping Rate 37 Revs/Minute

Total Height of Water Raised 2.3kG

9 Revs

Total Work Done On Pump 1683 Joules. (Rate 113.3 Watts )

Average  
Volume of Water  
.25 Litres per Rev

Average  
Work Done on Pump  
181 Joules per Rev

Efficiency 60%

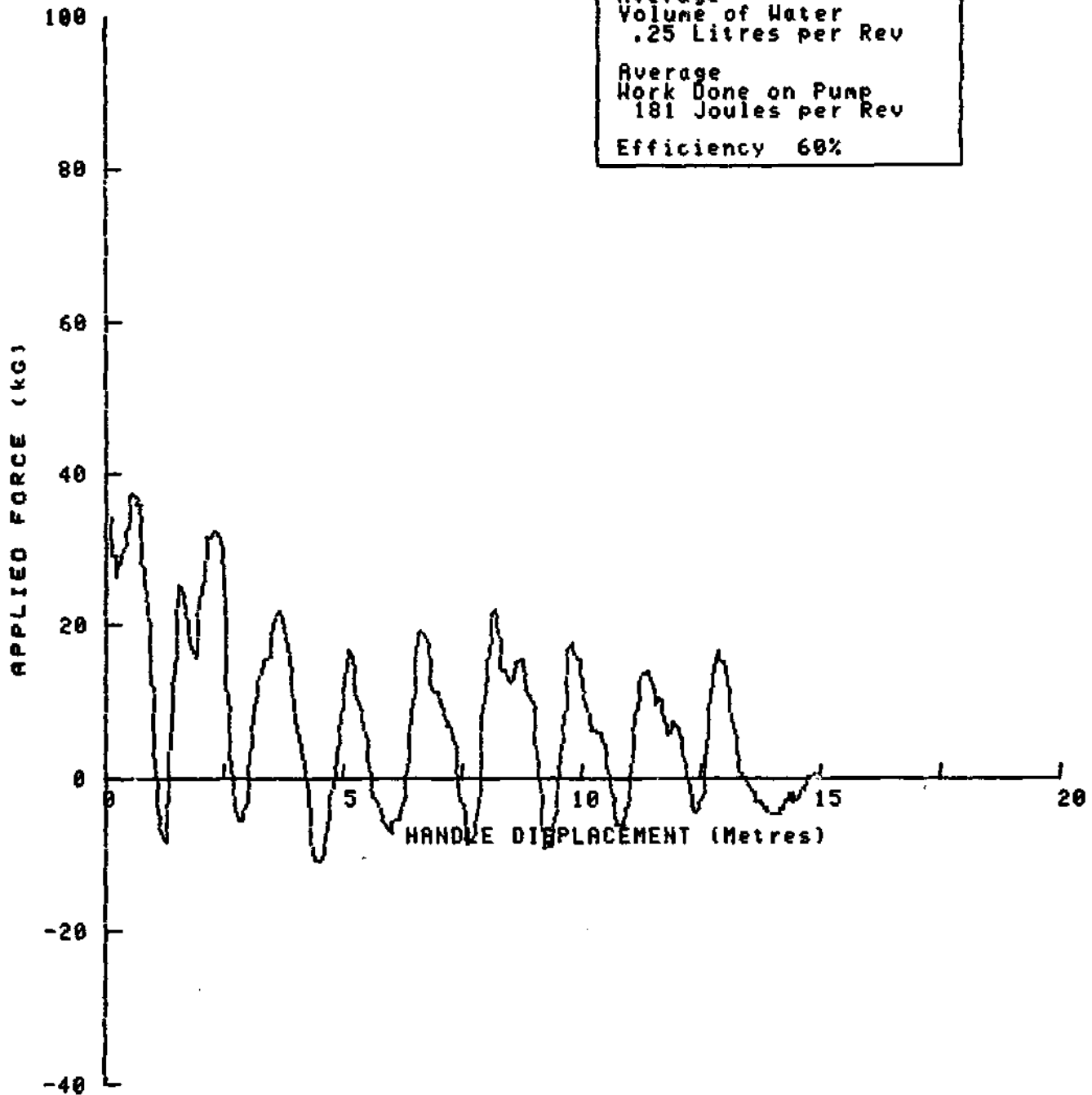

**PUMP PERFORMANCE after endurance**  
**CODE S1 Volanta with Cylinder #1**

Water Head 45 Metres --- Pumping Rate 40 Revs /Minute

Total Weight of Water Raised 1.1kg

9 Revs

Total Work Done On Pump 1076 Joules. (Rate 79.6 Watts )

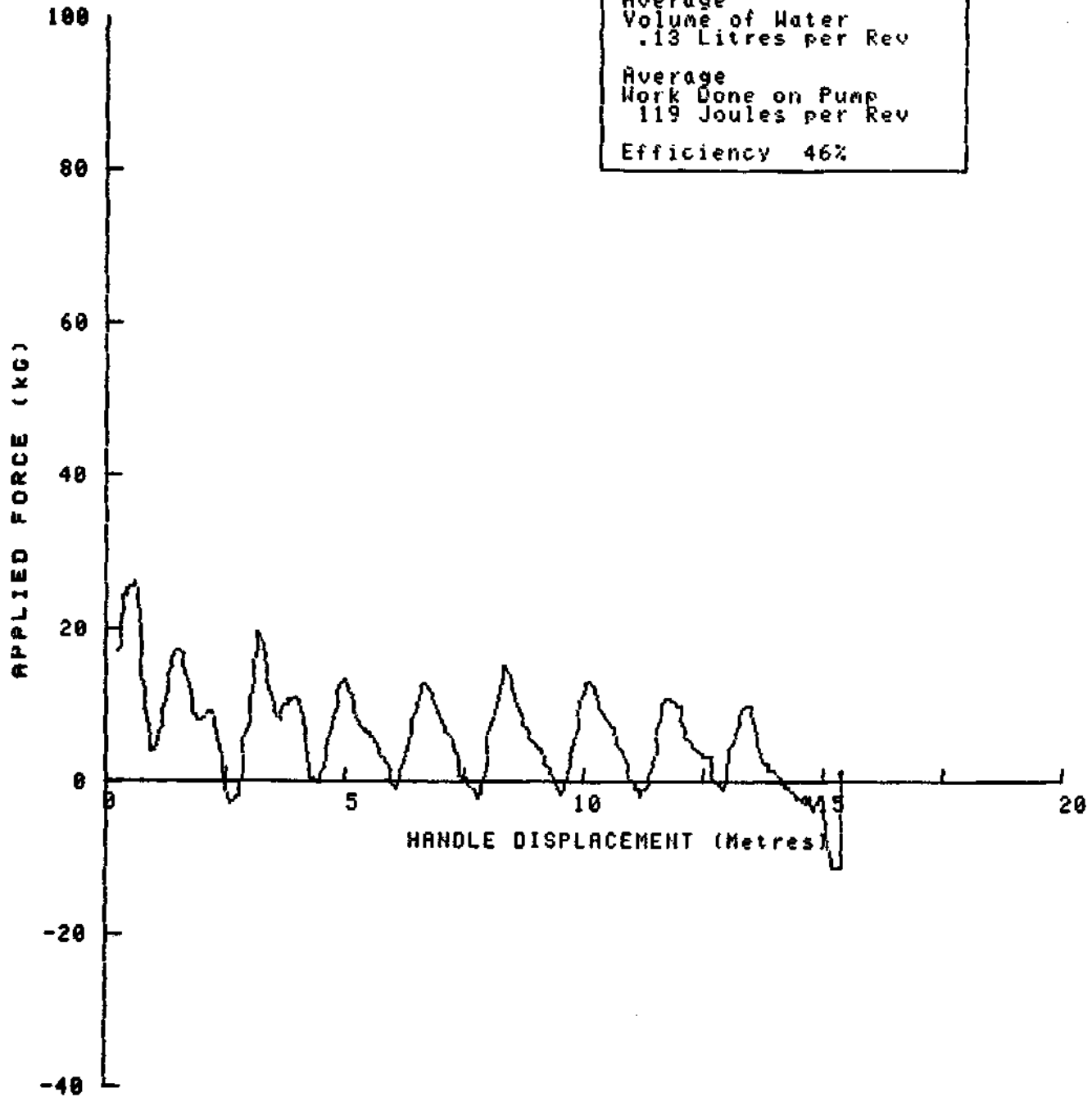



### PUMP PERFORMANCE

CODE S Volanta with Cylinder #2

Water Head 7 Metres --- Pumping Rate 37 Revs/Minute

Total Height of Water Raised 5.8kG

9 Revs

Total Work Done On Pump 1127 Joules. (Rate 73.3 Watts )

Average Volume of Water .61 Litres per Rev
Average Work Done on Pump 118 Joules per Rev
Efficiency 35%

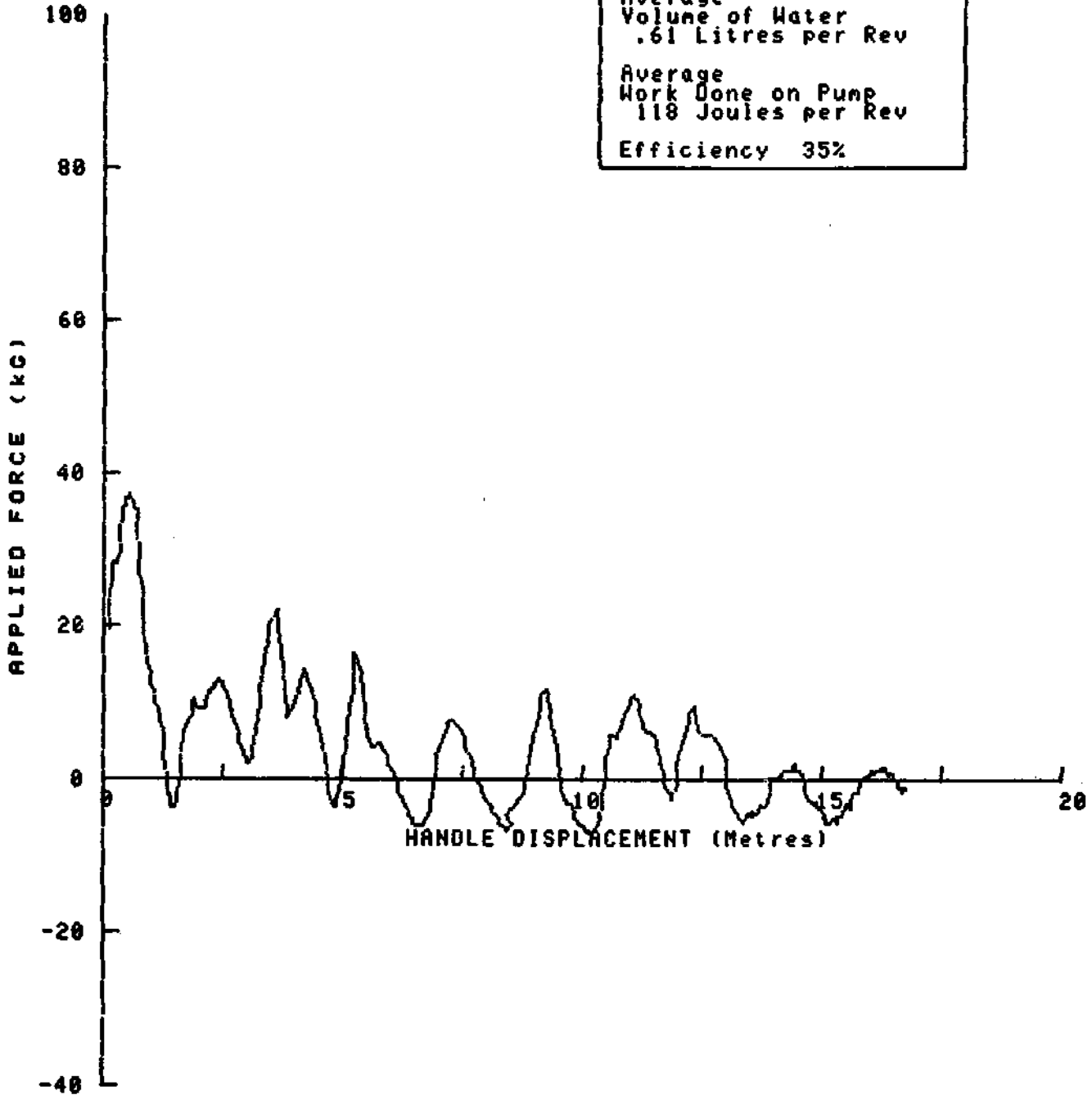

**PUMP PERFORMANCE after endurance  
CODE S2 Volanta with Cylinder #2**

Water Head 7 Metres --- Pumping Rate 37 Revs /Minute  
Total Weight of Water Raised 5.0kg  
9 Revs  
Total Work Done On Pump 1376 Joules. (Rate 88.2 Watts )

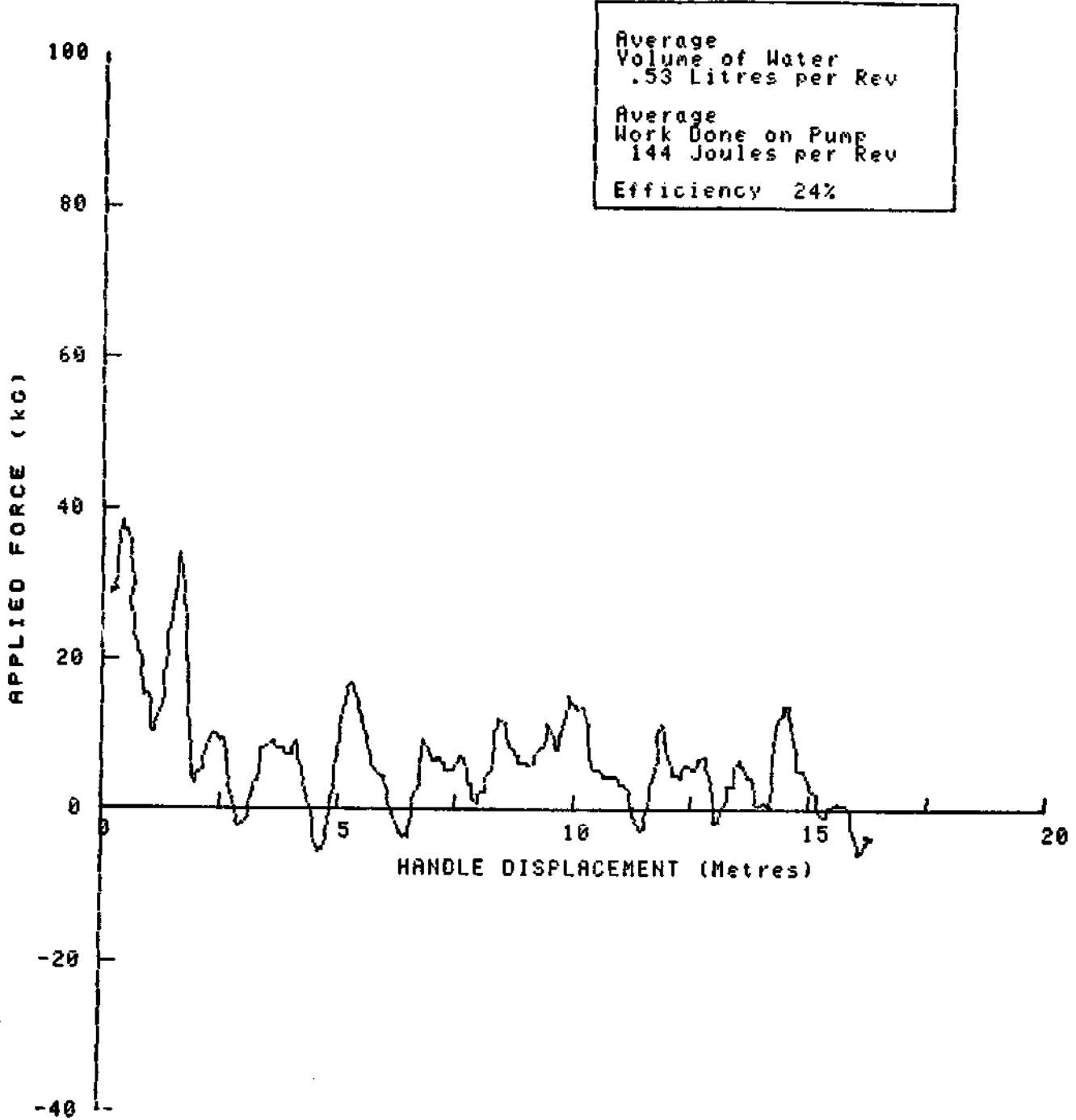

### PUMP PERFORMANCE

CODE S Volanta with Cylinder #2

Water Head 25 Metres --- Pumping Rate 37 Revs/Minute

Total Weight of Water Raised 3.2kG

9 Revs

Total Work Done On Pump 1427 Joules. (Rate 93.1 Watts )

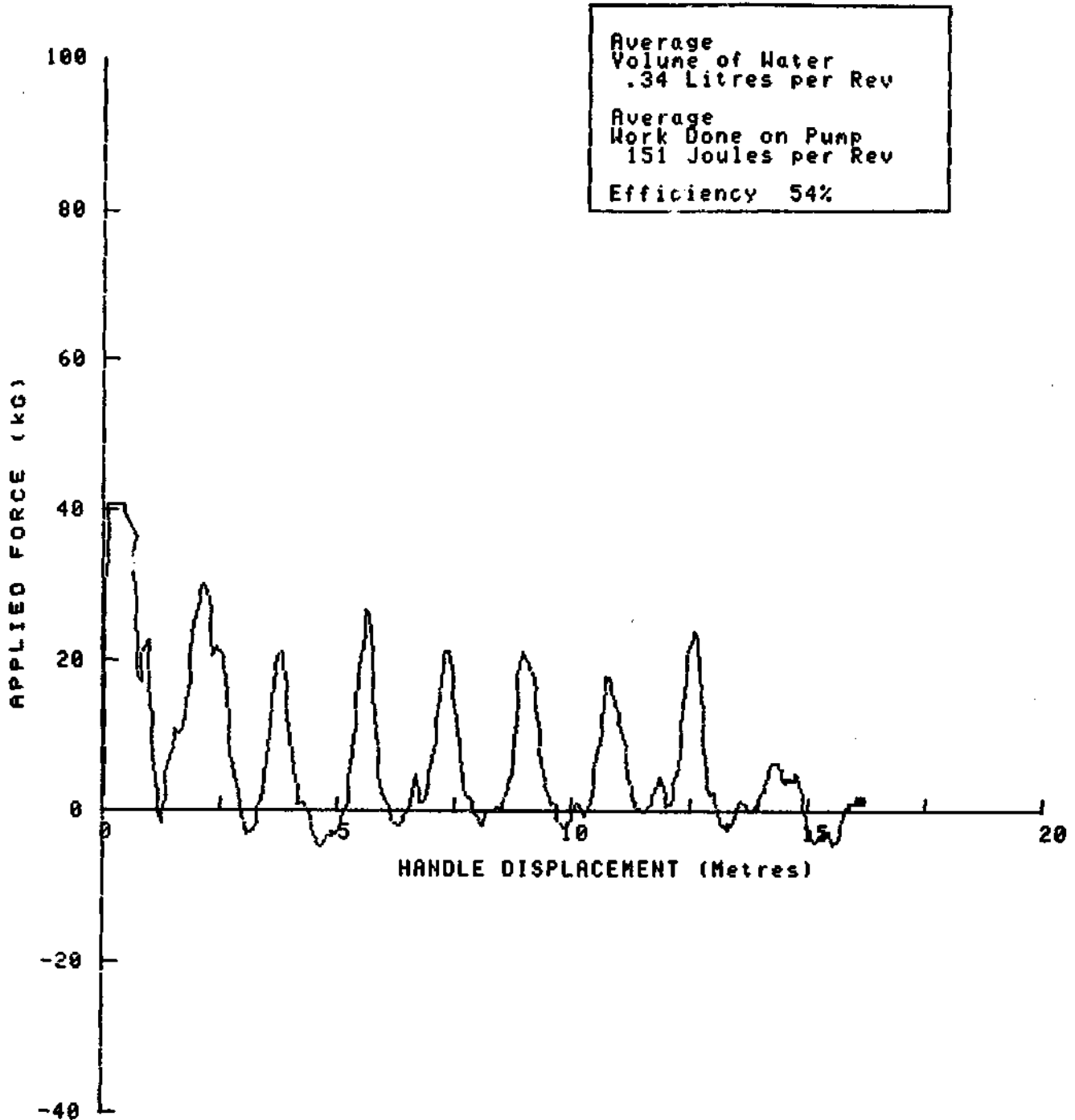

**PUMP PERFORMANCE after endurance**  
**CODE S2 Volanta with Cylinder #2**

Water Head 25 Metres --- Pumping Rate 35 Revs /Minute  
Total Weight of Water Raised 2.7kg  
9 Revs  
Total Work Done On Pump 1617 Joules. (Rate 98.7 Watts )

Average Volume of Water .29 Litres per Rev
Average Work Done on Pump 170 Joules per Rev
Efficiency 41%

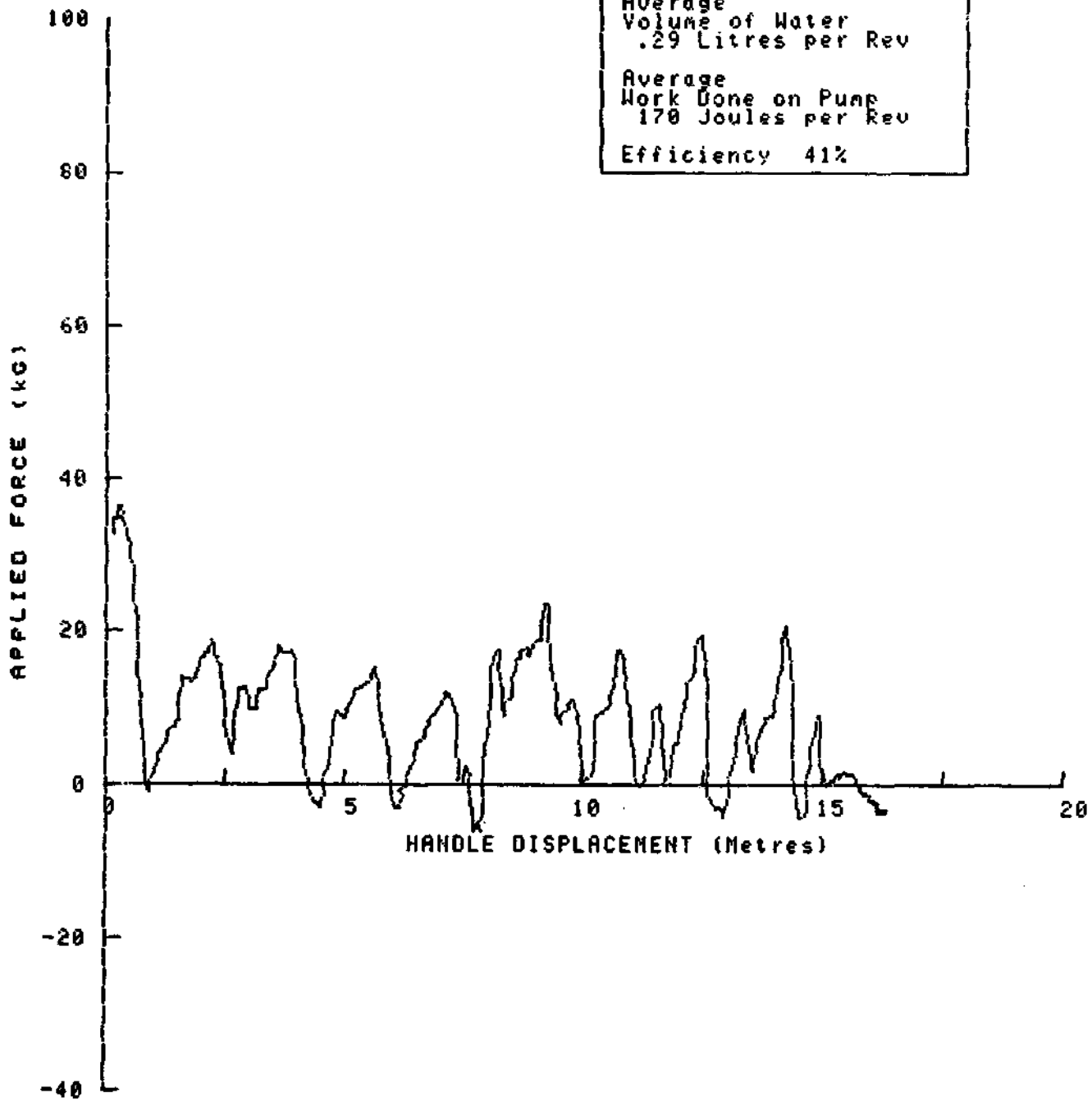

### PUMP PERFORMANCE

CODE S Volanta with Cylinder #2

Water Head 45 Metres --- Pumping Rate 36 Revs/Minute

Total Weight of Water Raised 2.4kG

9 Revs

Total Work Done On Pump 1792 Joules. (Rate 115.3 Watts )

Average Volume of Water .25 Litres per Rev
Average Work Done on Pump 190 Joules per Rev
Efficiency 58%

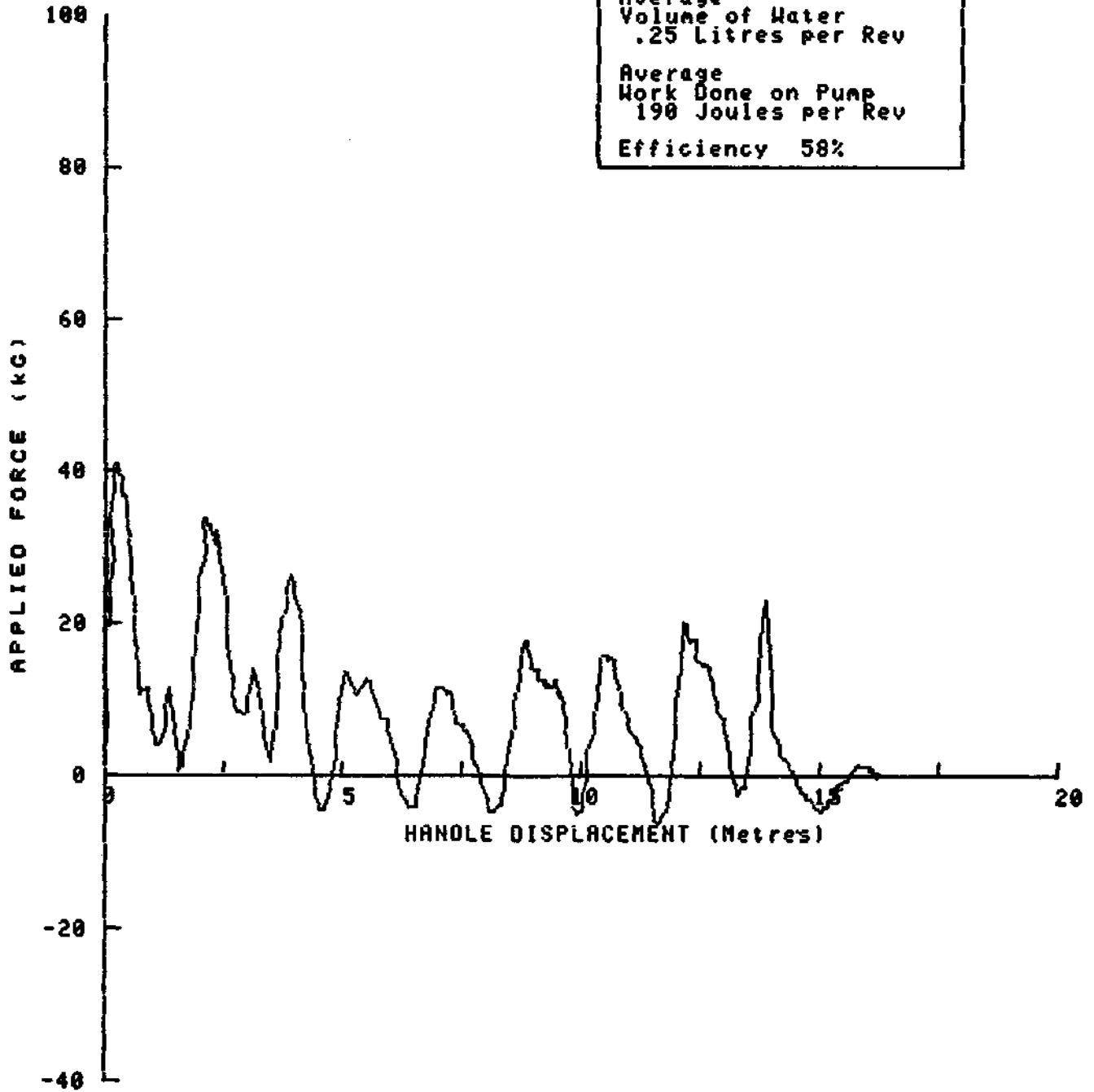

**PUMP PERFORMANCE after endurance  
CODE S2 Volanta with Cylinder #2**

Water Head 45 Metres --- Pumping Rate 40 Revs /Minute

Total Height of Water Raised 1.4kG

9 Revs

Total Work Done On Pump 1154 Joules. (Rate 81.0 Watts )

Average Volume of Water .14 Litres per Rev
Average Work Done on Pump 121 Joules per Rev
Efficiency 52%

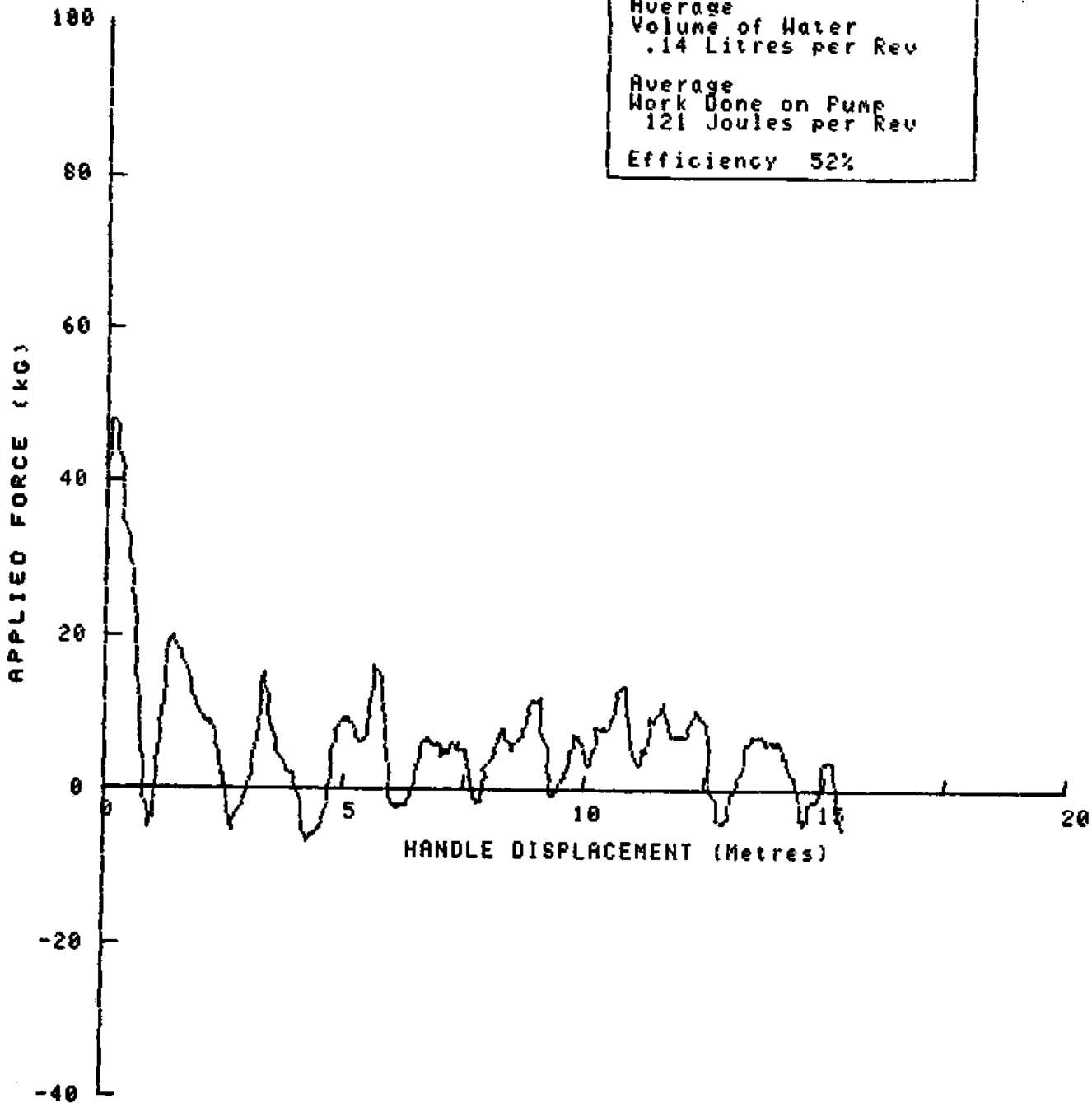

### PUMP PERFORMANCE

CODE A Korat 608 A-1

Water Head 45 Metres --- Pumping Rate 40 Cycles /Minute

Total Weight of Water Raised 6.9kg

20 Cycles

Total Work Done On Pump 4001 Joules. (Rate 133.1 Watts )

Average Volume of Water .35 Litres per Cycle
Average Work Done on Pump 200 Joules per Cycle
Efficiency 76%

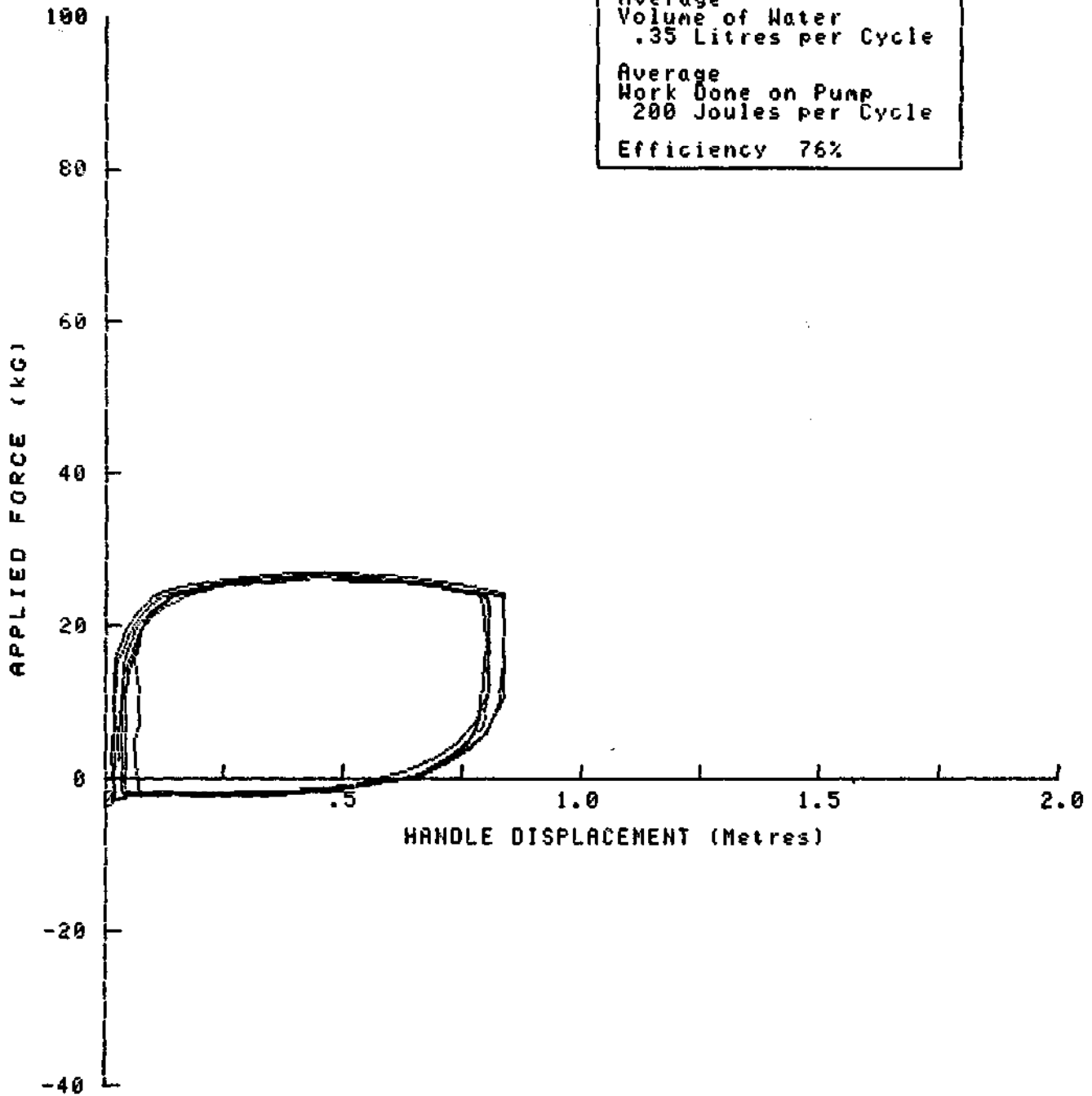

**PUMP PERFORMANCE after endurance**  
**CODE A Korat 608 A-1**

Water Head 45 Metres --- Pumping Rate 36 Cycles /Minute  
Total Weight of Water Raised 3.5kG  
10 Cycles  
Total Work Done On Pump 2539 Joules. (Rate 154.3 Watts )

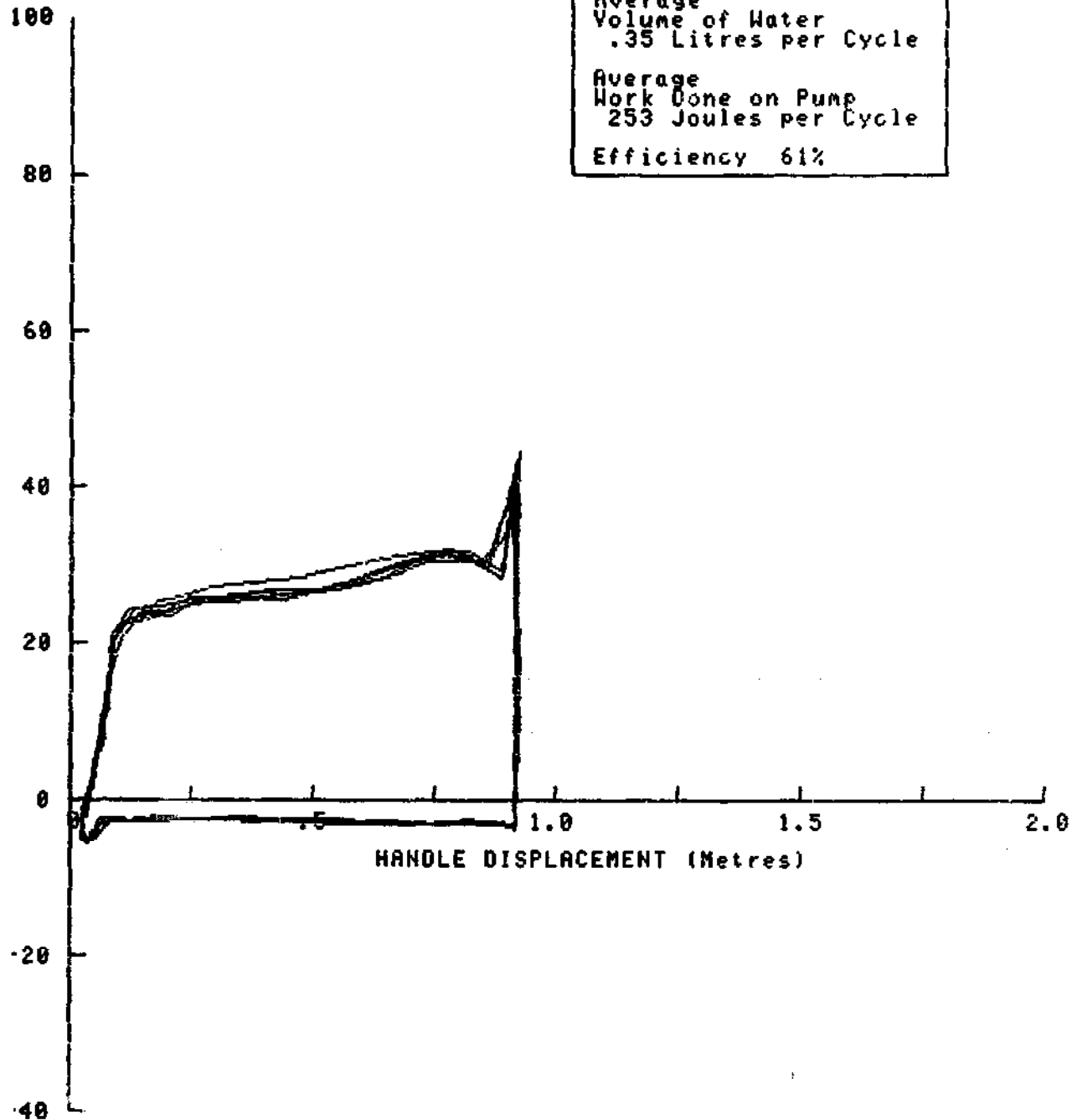

The diagrams illustrate the effects of wear in the pumpstand rack and quadrant:  
(a) greater handle displacement for the same volume flow  
(b) increased frictional losses, particularly at the start of the return stroke.

Initially, the weight of the rods was sufficient to reverse the direction of motion. After endurance testing, the operator had to apply an immediate upward force at the start of the return stroke. The increase in friction is confirmed by a 25% increase in the recorded work done on the handle.



**PUMP PERFORMANCE**  
**CODE B Dragon No. 2**

Water Head 45 Metres --- Pumping Rate 37 Cycles /Minute  
Total Weight of Water Raised 5.3kg  
10 Cycles  
Total Work Done On Pump 3669 Joules. (Rate 229.1 Watts )

Average  
Volume of Water  
.53 Litres per Cycle  
  
Average  
Work Done on Pump  
366 Joules per Cycle  
  
Efficiency 63%

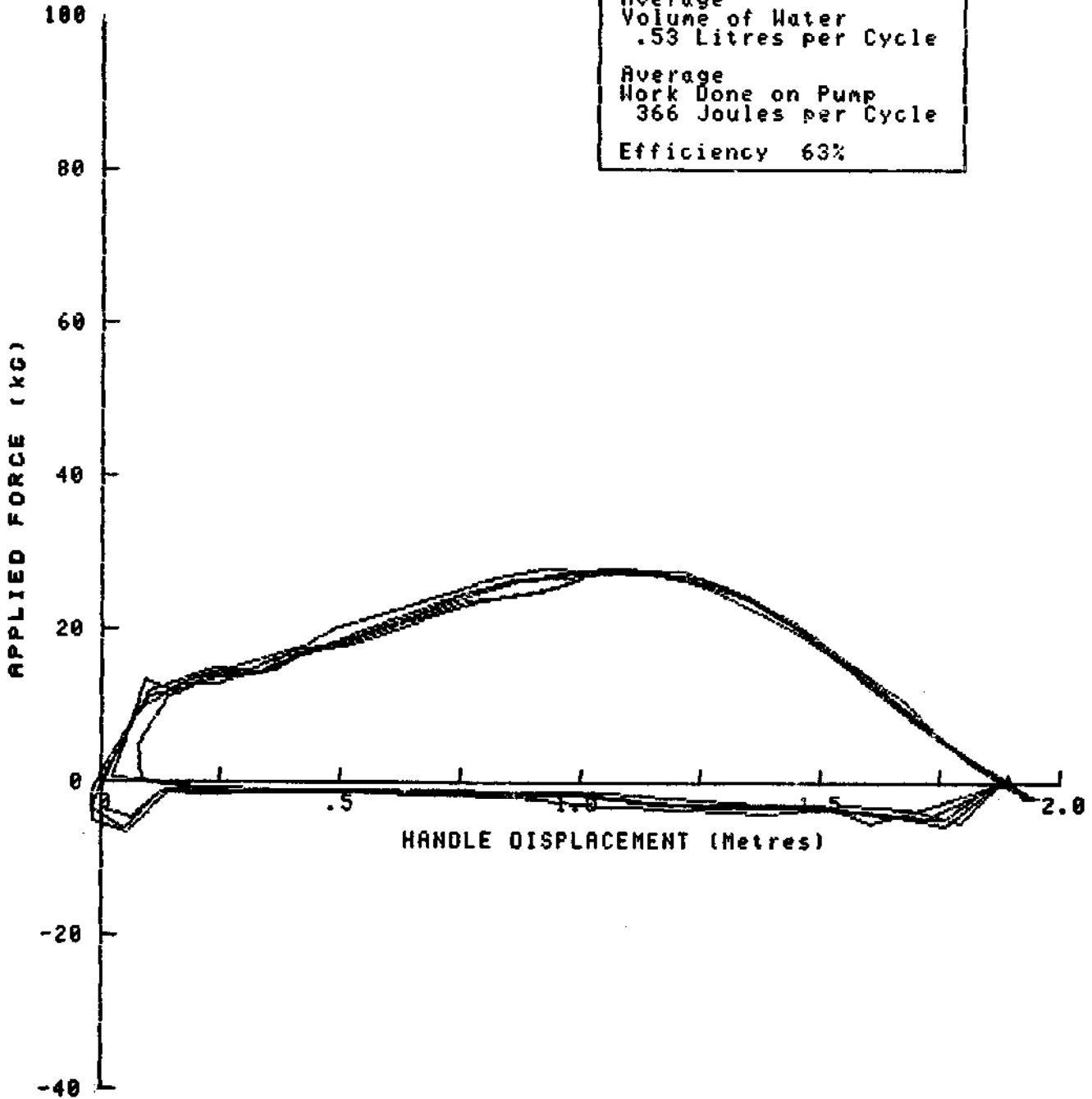

# PUMP PERFORMANCE after ENDURANCE CODE B Dragon No. 2

Water Head 45 Metres --- Pumping Rate 40 Cycles /Minute  
Total Weight of Water Raised 5.3kG  
10 Strokes/Revolutions  
Total Work Done On Pump 3271 Joules. (Rate 215.9 Watts )

Average Volume of Water .53 Litres per Cycle
Average Work Done on Pump 327 Joules per Cycle
Efficiency 70%

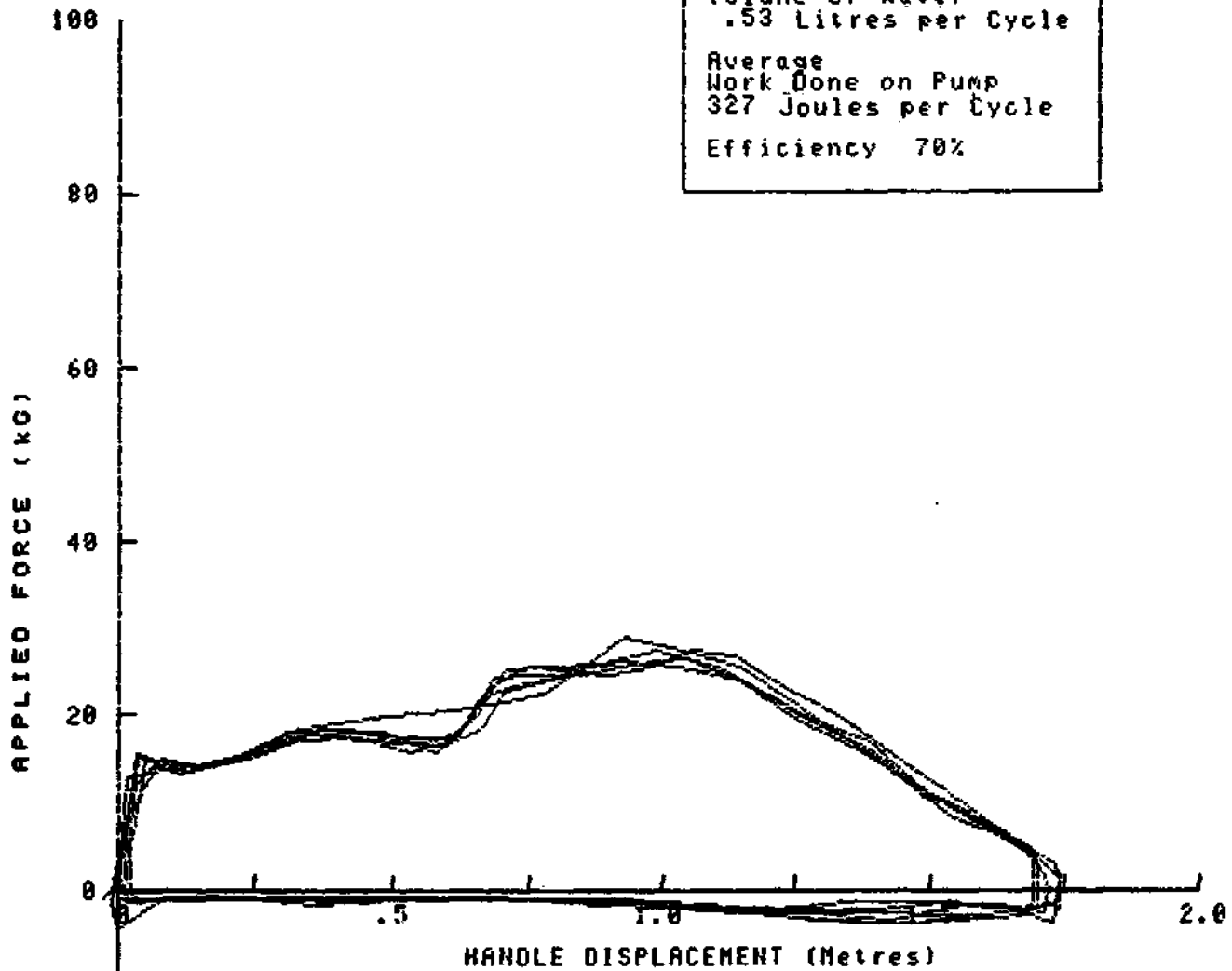

The irregularities on the power stroke are probably caused by variations in the linkage friction due to the wear which has taken place in the linkage mechanism.

### PUMP PERFORMANCE

CODE C Moyno IV 2.6

Water Head 45 Metres --- Pumping Rate 39 Revs /Minute

Total Weight of Water Raised 1.4kG

9 Revs

Total Work Done On Pump 1884 Joules. (Rate 136.8 Watts )

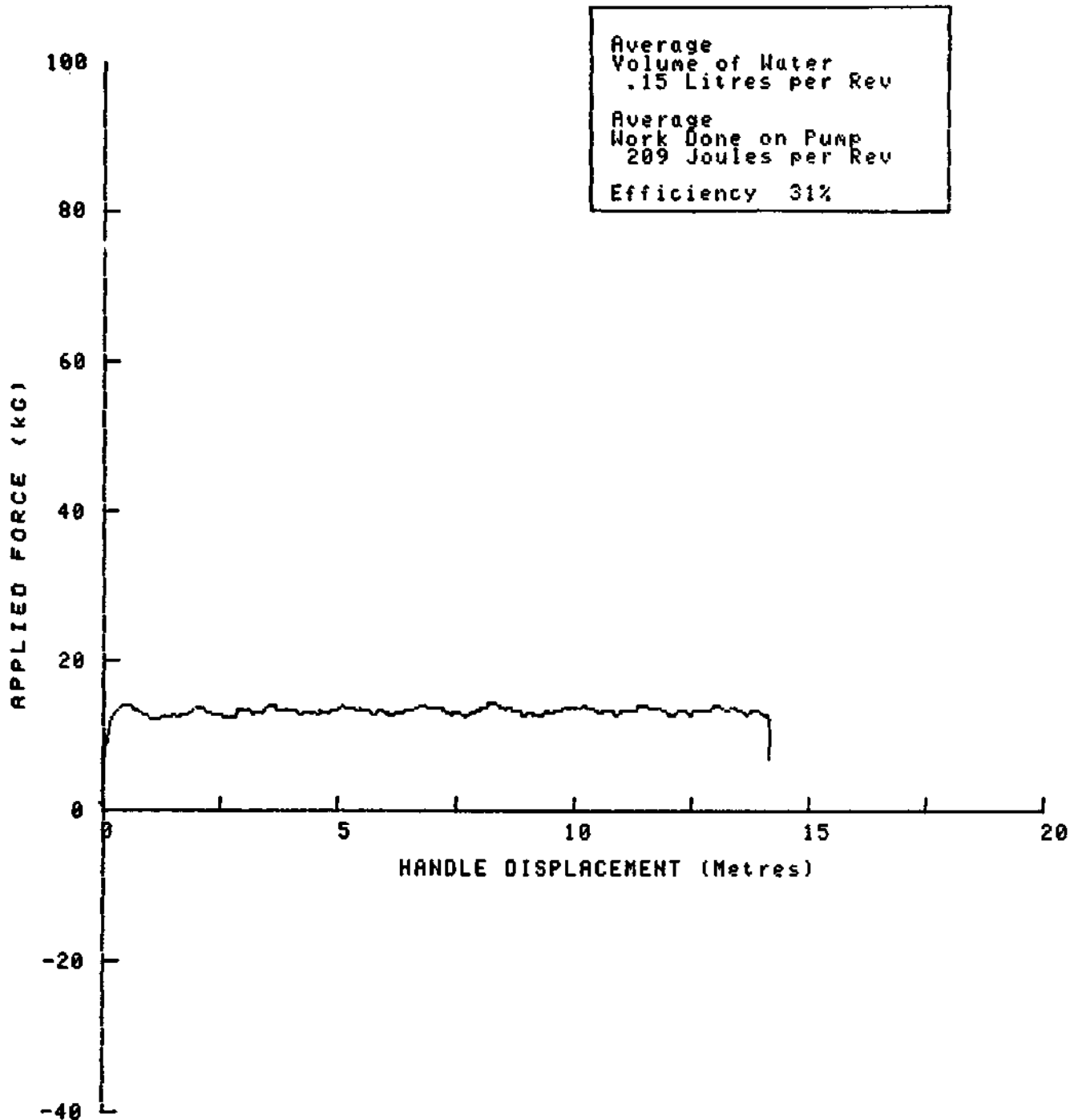

**PUMP PERFORMANCE after ENDURANCE  
CODE C Moyno IV 2.6**

Water Head 45 Metres --- Pumping Rate 40 Revs /Minute  
Total Weight of Water Raised 1.6kg  
9 Strokes/Revolutions  
Total Work Done On Pump 1234 Joules. (Rate 91.8 Watts )

Average Volume of Water .18 Litres per Rev
Average Work Done on Pump 137 Joules per Rev
Efficiency 58%

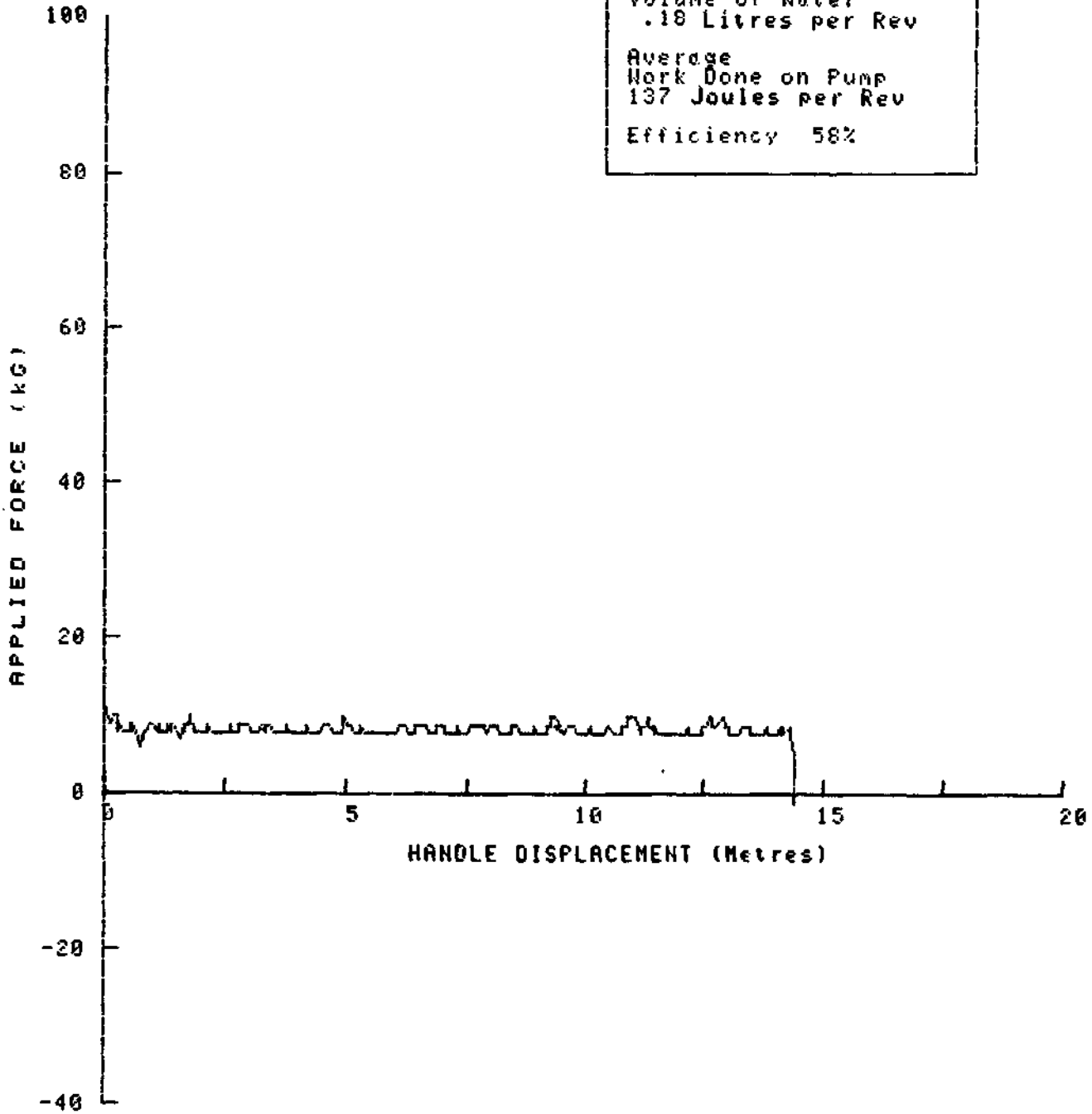

The irregularities on the curves are probably due to system noise.

The diagrams indicate a reduction of friction combined with an increase in volume flow.

### PUMP PERFORMANCE

CODE D Nept a

Water Head 45 Metres --- Pumping Rate 40 Cycles /Minute

Total Weight of Water Raised 7.7kG

20 Cycles

Total Work Done On Pump 4326 Joules. (Rate 143.8 Watts )

Average Volume of Water .39 Litres per Cycle
Average Work Done on Pump 216 Joules per Cycle
Efficiency 78%

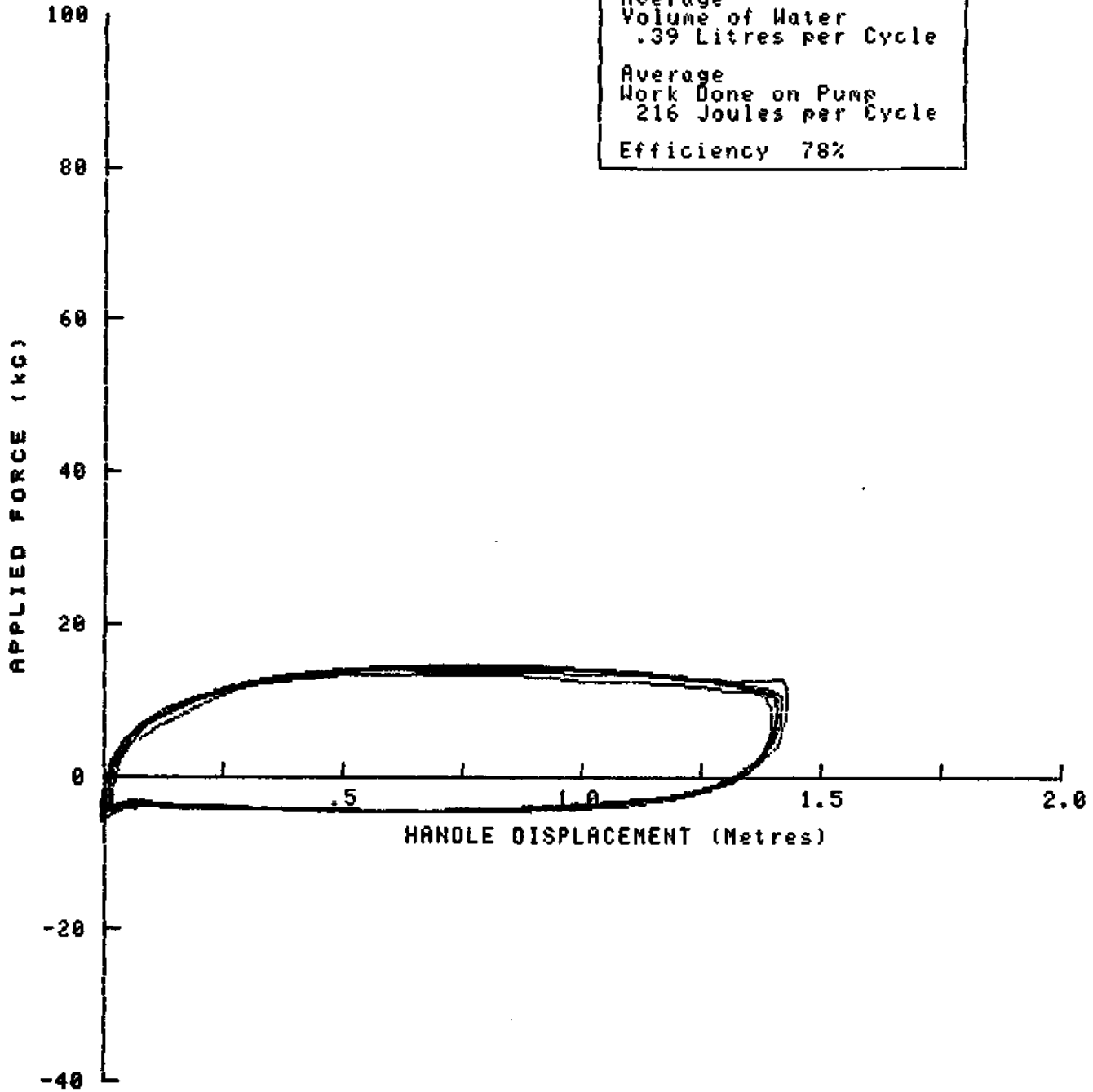

### PUMP PERFORMANCE after endurance CODE D Nepta

Water Head 45 Metres --- Pumping Rate 42 Cycles /Minute  
Total Height of Water Raised 4.3kg  
10 Cycles  
Total Work Done On Pump 3517 Joules. (Rate 247.2 Watts )

Average Volume of Water .43 Litres per Cycle
Average Work Done on Pump 351 Joules per Cycle
Efficiency 54%

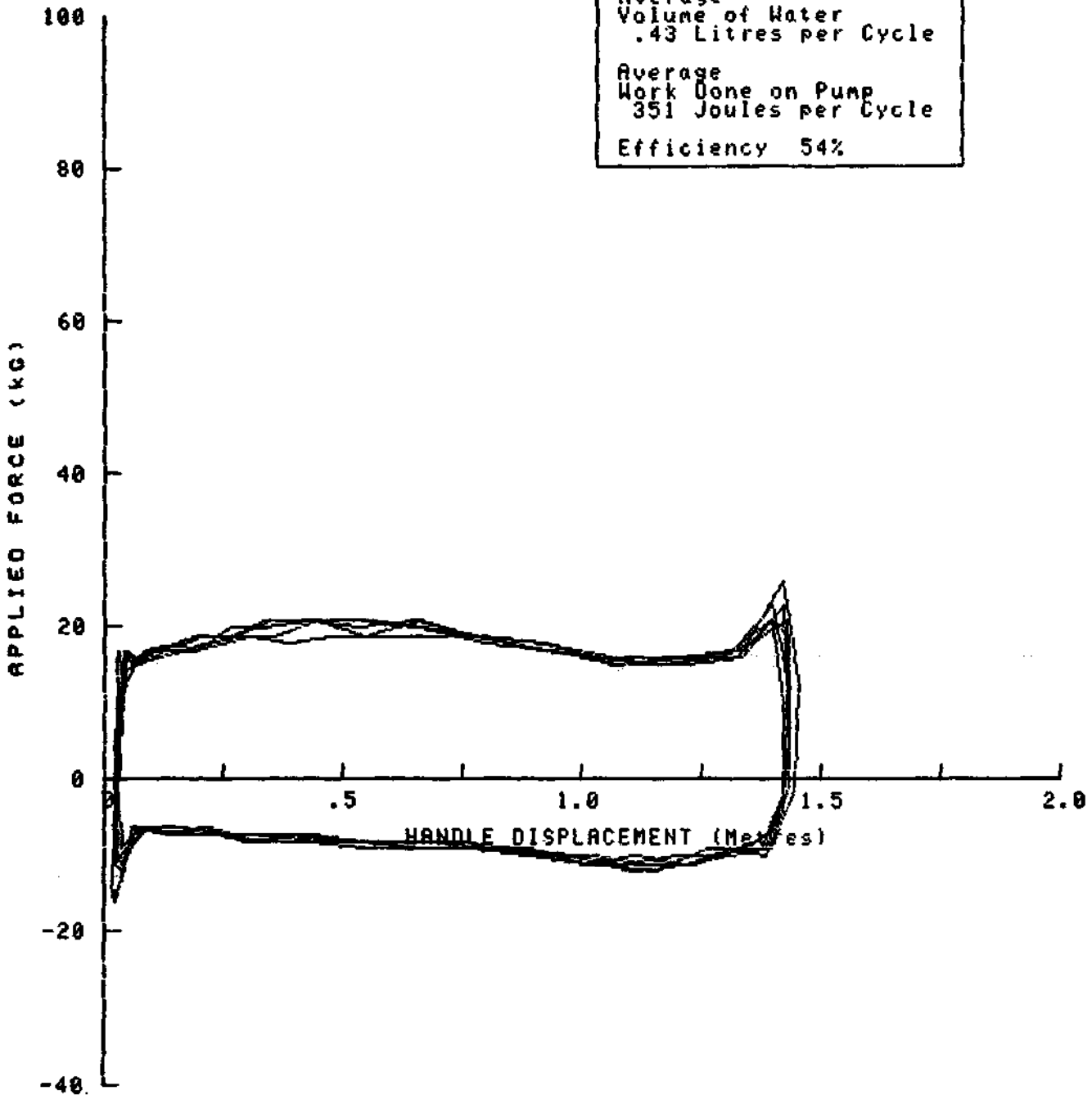

The results show that the work done on the handle increased by over 50% after endurance, with a small increase in volume flow. Friction had therefore increased considerably, probably as a result of the failure of the upper plunger seal.

The change in the profiles of the curves probably illustrates the removal of the return spring.

### PUMP PERFORMANCE

CODE E Kenya

Water Head 45 Metres --- Pumping Rate 40 Cycles /Minute  
Total Weight of Water Raised 7.6kg  
10 Cycles  
Total Work Done On Pump 5280 Joules. (Rate 355.4 Watts )

Average Volume of Water .76 Litres per Cycle
Average Work Done on Pump 528 Joules per Cycle
Efficiency 63%

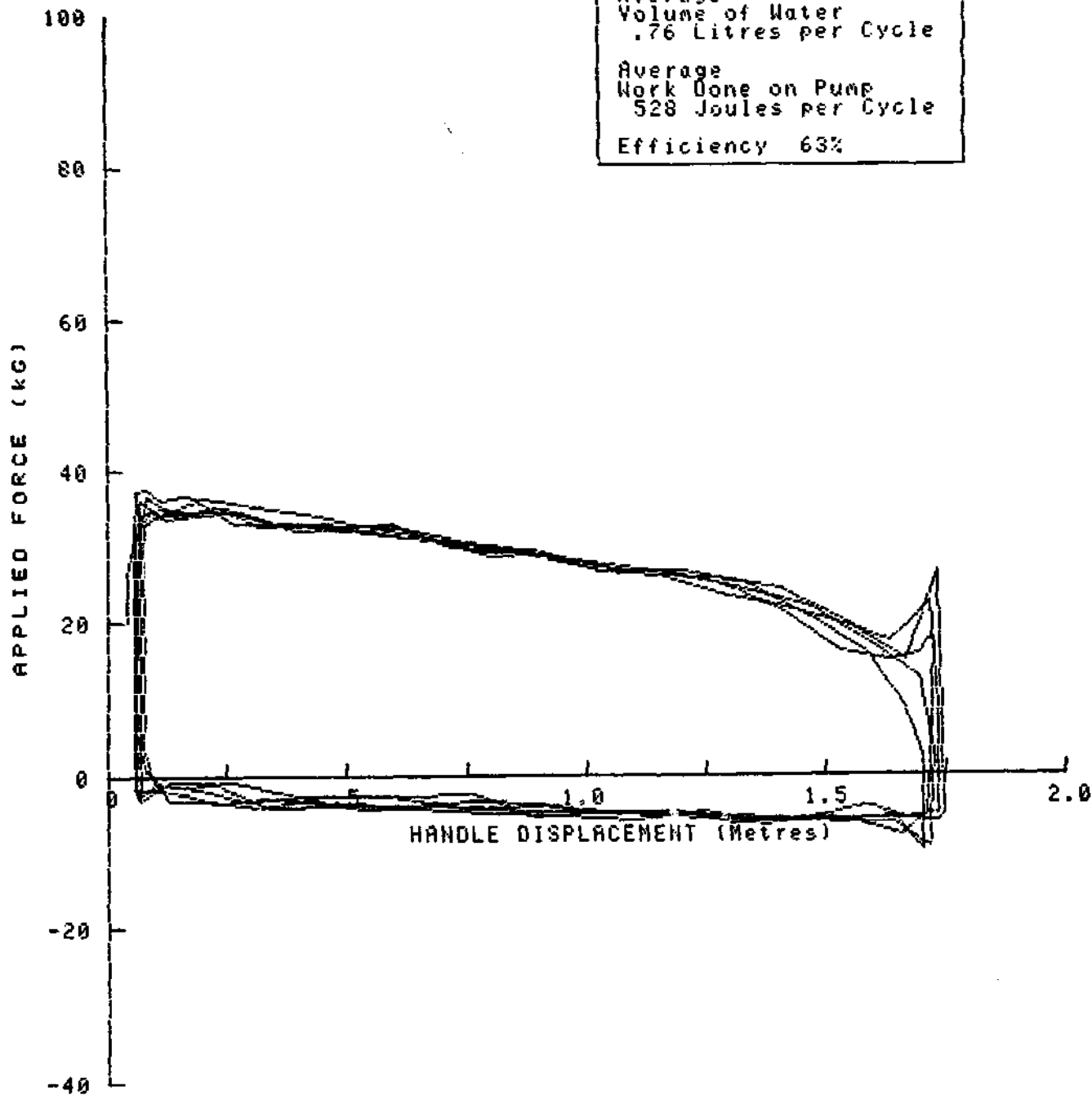

# PUMP PERFORMANCE after ENDURANCE CODE E Kenya

Water Head 45 Metres --- Pumping Rate 40 Cycles /Minute  
Total Weight of Water Raised 7.6kG  
10 Strokes/Revolutions  
Total Work Done On Pump 5945 Joules. (Rate 397.2 Watts )

Average Volume of Water .76 Litres per Cycle
Average Work Done on Pump 594 Joules per Cycle
Efficiency 56%

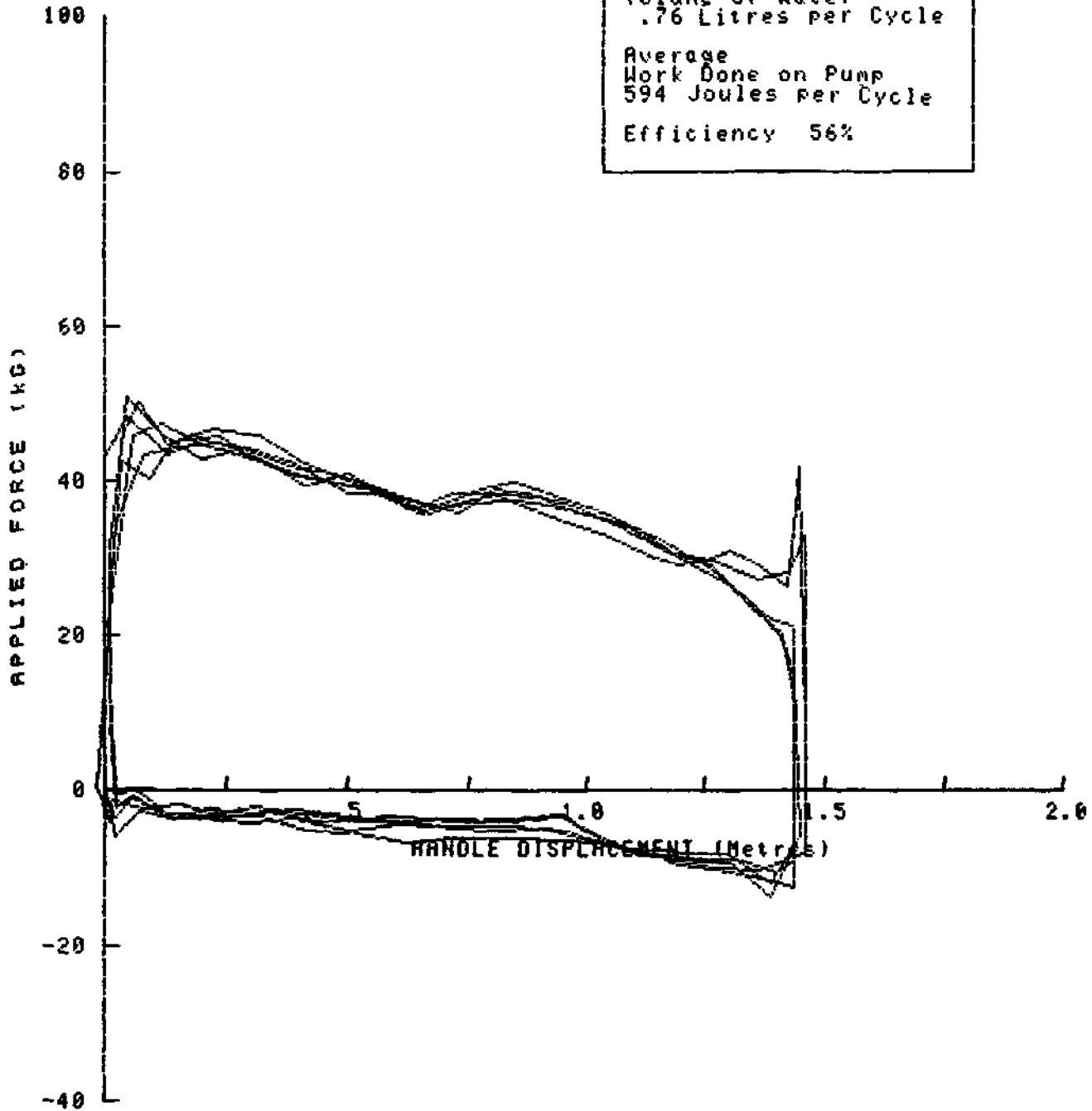

Differences between the profiles of the curves before and after endurance are the result of severe wear at the handle pivot.



# PUMP PERFORMANCE

## CODE F New No. 6

Water Head 7 Metres --- Pumping Rate 30 Cycles /Minute  
Total Weight of Water Raised 24.0kg  
20 Cycles  
Total Work Done On Pump 2437 Joules. (Rate 60.7 Watts )

Average Volume of Water 1.20 Litres per Cycle
Average Work Done on Pump 121 Joules per Cycle
Efficiency 67%

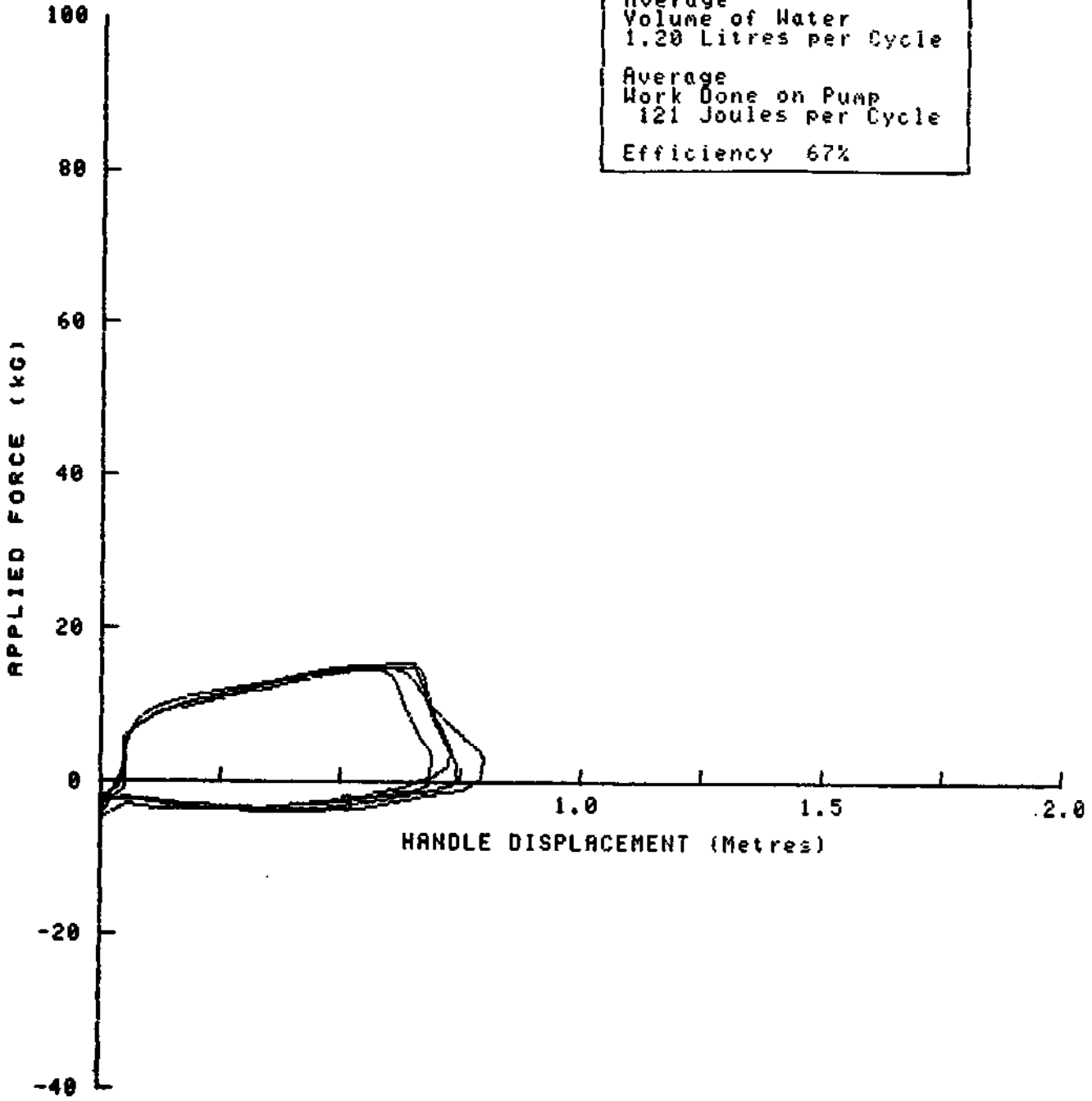

**PUMP PERFORMANCE after endurance**  
**CODE F New No. 6**

Water Head 7 Metres --- Pumping Rate 30 Cycles /Minute  
Total Weight of Water Raised 5.1kg

5 Cycles  
Total Work Done On Pump 647 Joules. (Rate 64.6 Watts )

Average Volume of Water 1.01 Litres per Cycle
Average Work Done on Pump 129 Joules per Cycle
Efficiency 53%

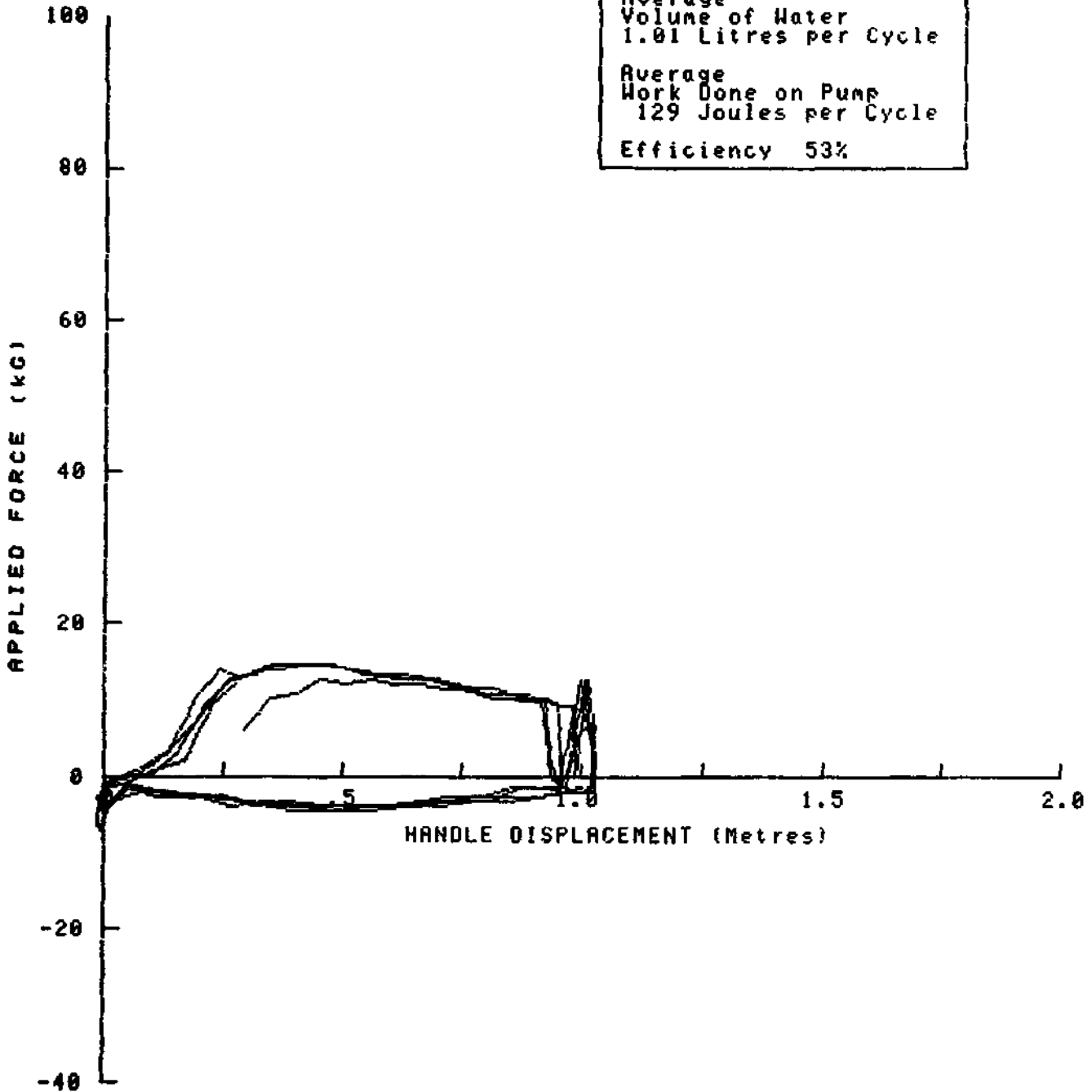

Differences between the profiles of the curves before and after endurance illustrate increased lost motion in the handle pivots.

### PUMP PERFORMANCE

CODE G Nira AF76

Water Head 25 Metres --- Pumping Rate 40 Cycles /Minute  
Total Weight of Water Raised 12.9kg  
20 Cycles  
Total Work Done On Pump 4186 Joules. (Rate 140.4 Watts )

Average Volume of Water .65 Litres per Cycle
Average Work Done on Pump 209 Joules per Cycle
Efficiency 75%

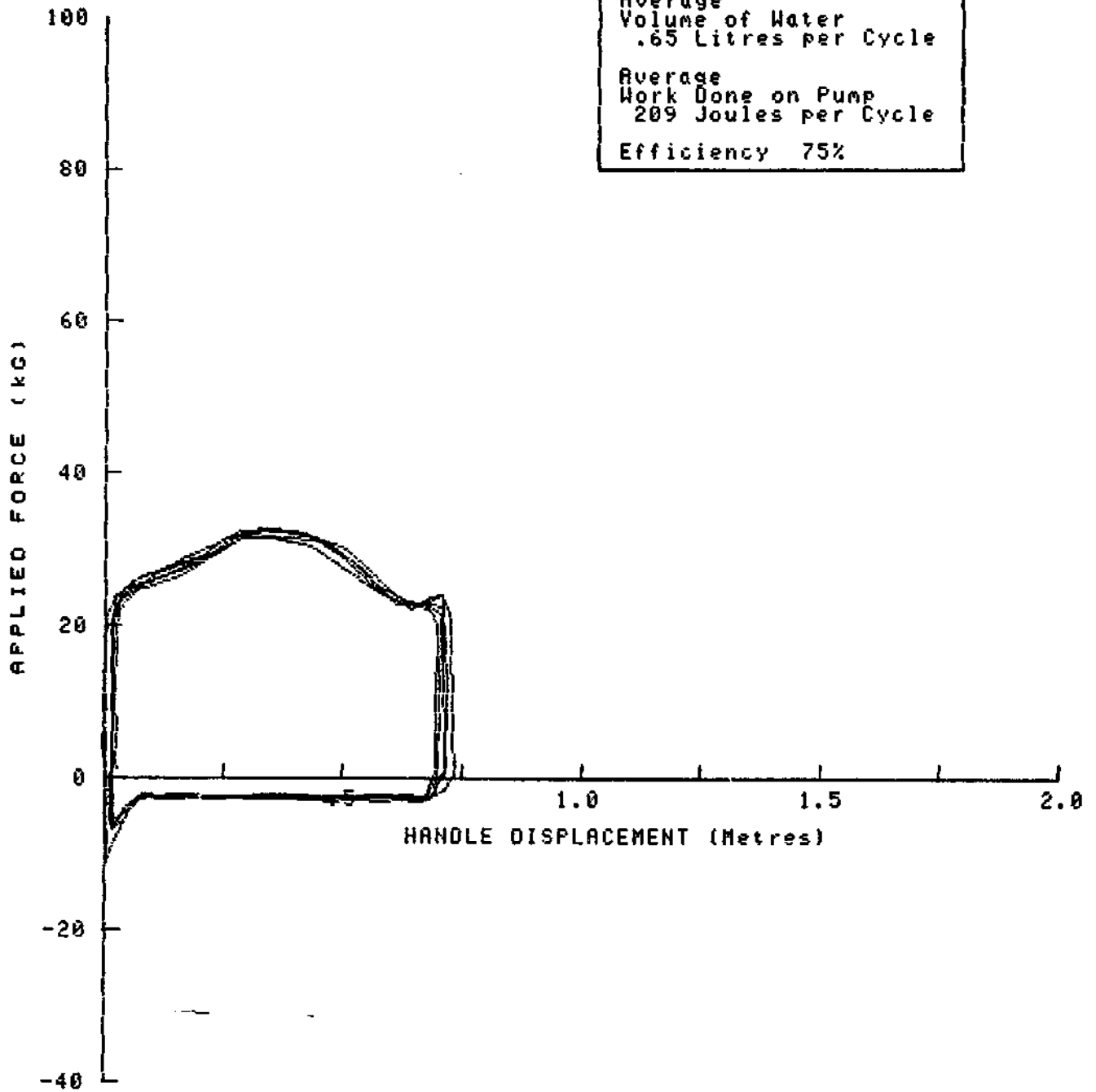

**PUMP PERFORMANCE after endurance  
CODE G Nira AF76**

Water Head 25 Metres --- Pumping Rate 40 Cycles /Minute  
Total Weight of Water Raised 6.5kg  
10 Cycles  
Total Work Done On Pump 2186 Joules. (Rate 145.6 Watts )

Average  
Volume of Water  
.65 Litres per Cycle  
  
Average  
Work Done on Pump  
218 Joules per Cycle  
  
Efficiency 72%

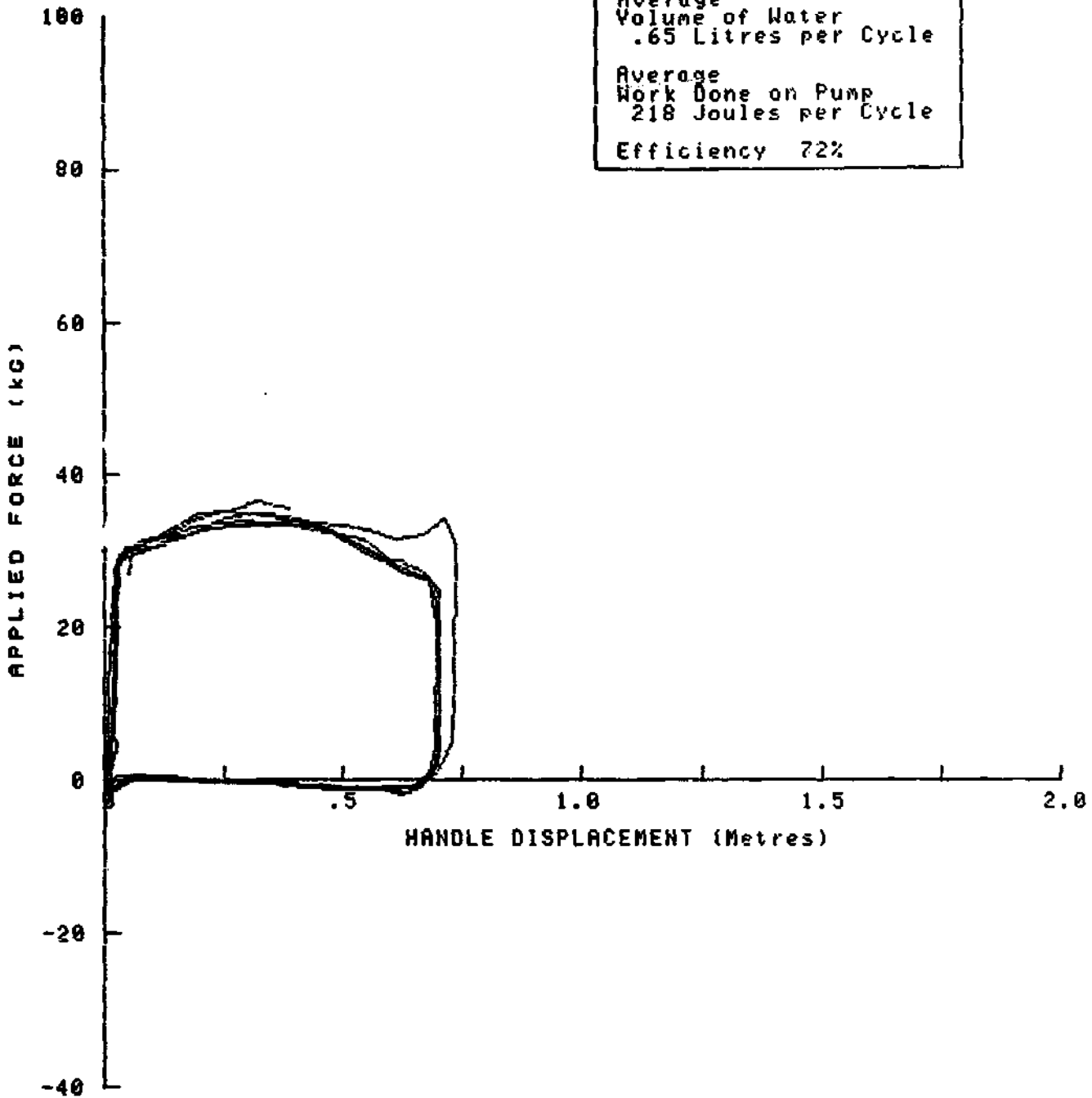

Differences in the profiles of the curves at the beginning of the delivery stroke, and the reduction of effort on the return stroke, probably illustrate the improved conformity of the rubber cup washer after bedding in.

### PUMP PERFORMANCE

CODE H Ethiopia Type BP 50

Water Head 7 Metres --- Pumping Rate 38 Cycles /Minute

Total Weight of Water Raised 6.2kg

10 Cycles

Total Work Done On Pump 1177 Joules. (Rate 74.2 Watts )

Average Volume of Water .62 Litres per Cycle
Average Work Done on Pump 117 Joules per Cycle
Efficiency 35%

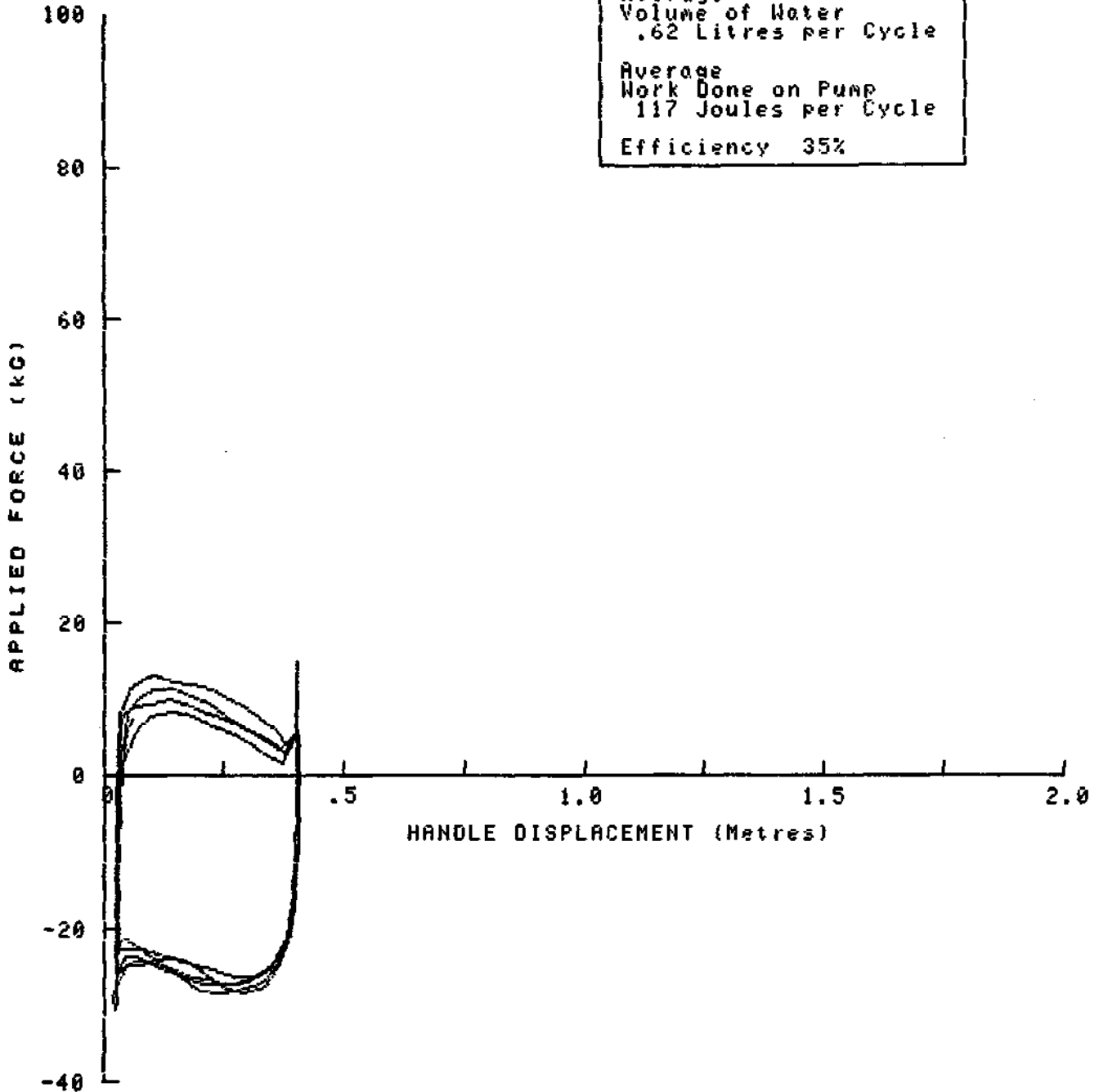

**PUMP PERFORMANCE after ENDURANCE**  
**CODE H Ethiopia Type BP50**

Water Head 7 Metres --- Pumping Rate 40 Cycles /Minute  
Total Weight of Water Raised 3.4kG  
10 Strokes/Revolutions  
Total Work Done On Pump 1362 Joules. (Rate 91.7 Watts )

Average  
Volume of Water  
.34 Litres per Cycle  
  
Average  
Work Done on Pump  
136 Joules per Cycle  
  
Efficiency 17%

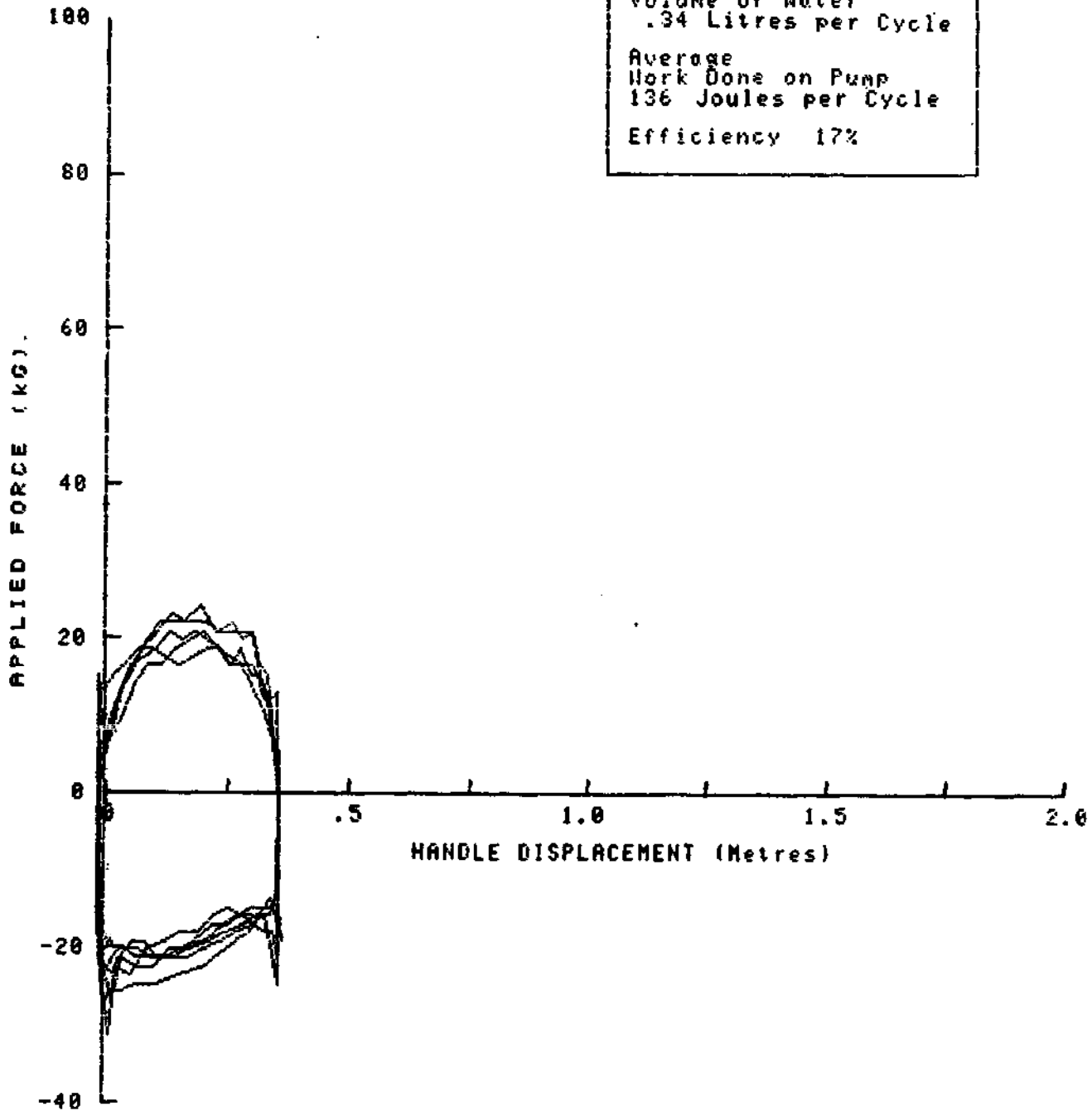

As this pump discharges on the lifting stroke, the power stroke is below the horizontal coordinate. The reduction in force on the power stroke after endurance shows the leakage past the plunger.

# PUMP PERFORMANCE CODE J VEN

Water Head 45 Metres --- Pumping Rate 30 Revs /Minute  
Total Height of Water Raised 5.6kG  
9 Revs  
Total Work Done On Pump 3866 Joules. (Rate 212.9 Watts )

Average Volume of Water .62 Litres per Rev
Average Work Done on Pump 429 Joules per Rev
Efficiency 63%

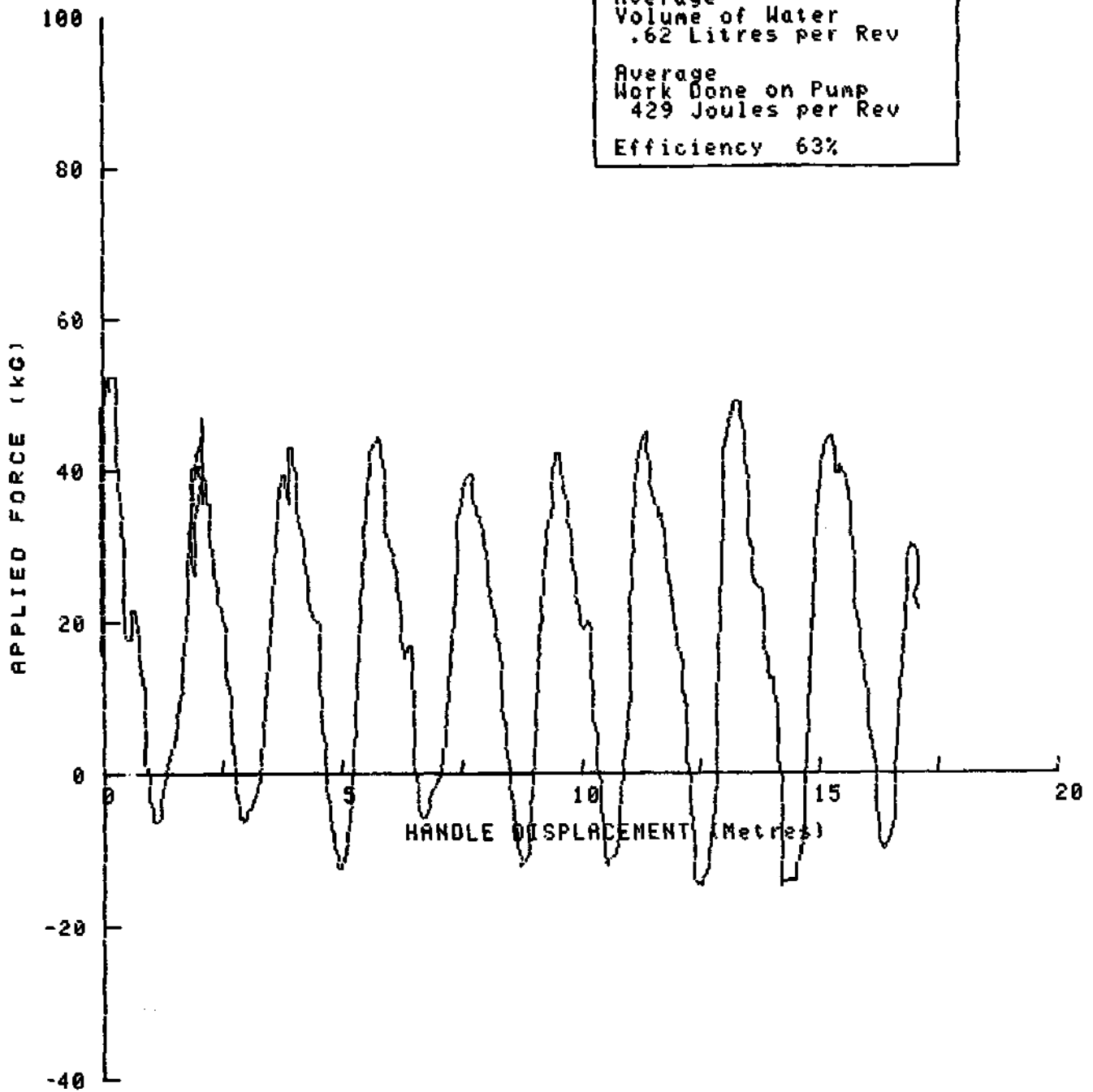

**PUMP PERFORMANCE after ENDURANCE**  
**CODE J VEW A18**

Water Head 45 Metres --- Pumping Rate 27 Revs /Minute  
Total Weight of Water Raised 3.8kg  
9 Strokes/Revolutions  
Total Work Done On Pump 2943 Joules. (Rate 148.6 Watts )

Average Volume of Water .42 Litres per Rev
Average Work Done on Pump 327 Joules per Rev
Efficiency 56%

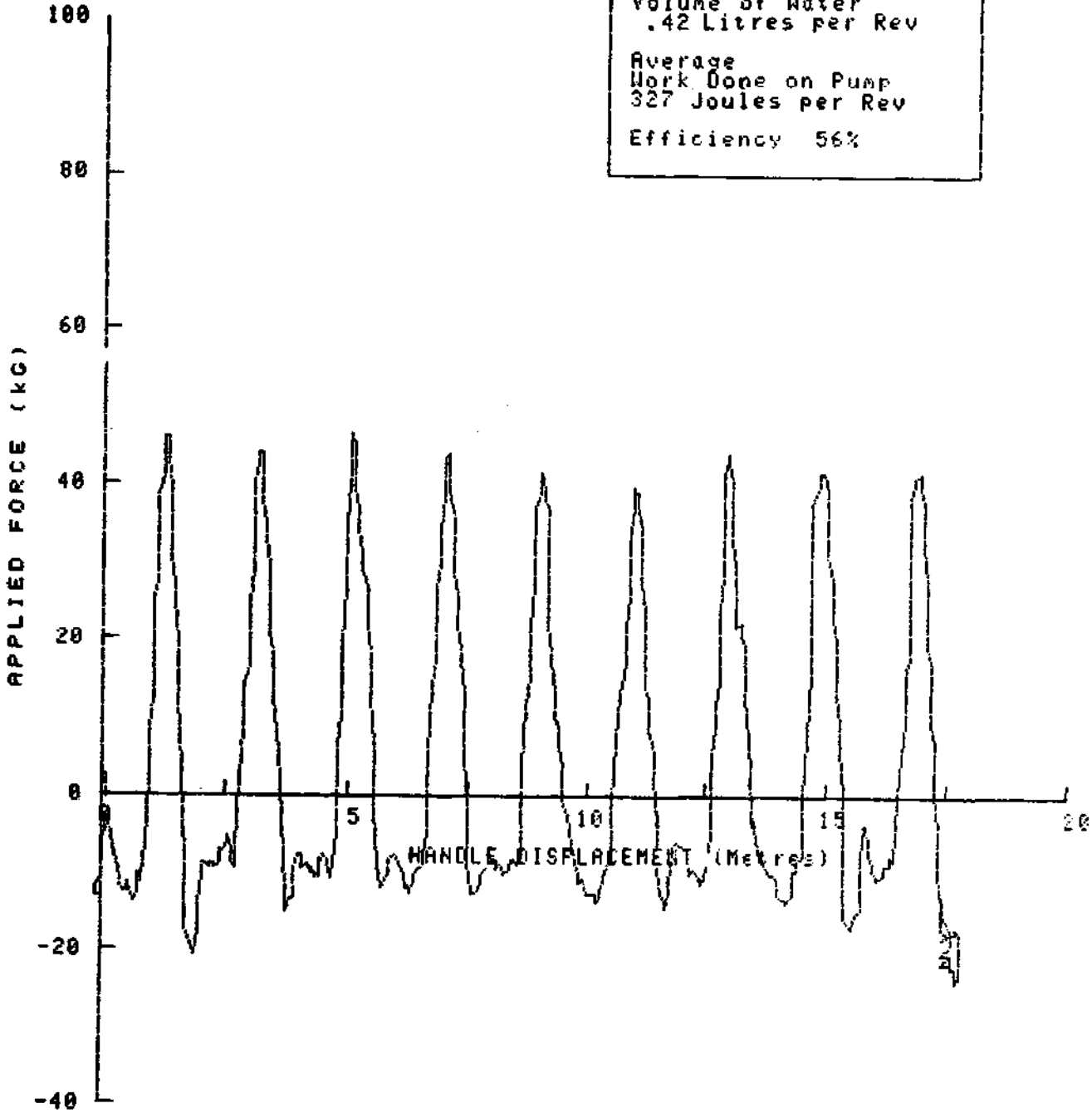

The results before and after endurance should not be directly compared because the plunger seal was replaced during the endurance test. Differences in the profiles of the curves may also reflect the changed position of the handle counterweights.



### PUMP PERFORMANCE CODE K Jetmatic

Water Head 45 Metres --- Pumping Rate 41 Cycles /Minute  
Total Weight of Water Raised 5.7kG  
20 Cycles  
Total Work Done On Pump 3461 Joules. (Rate 119.3 Watts )

Average Volume of Water .28 Litres per Cycle
Average Work Done on Pump 173 Joules per Cycle
Efficiency 72%

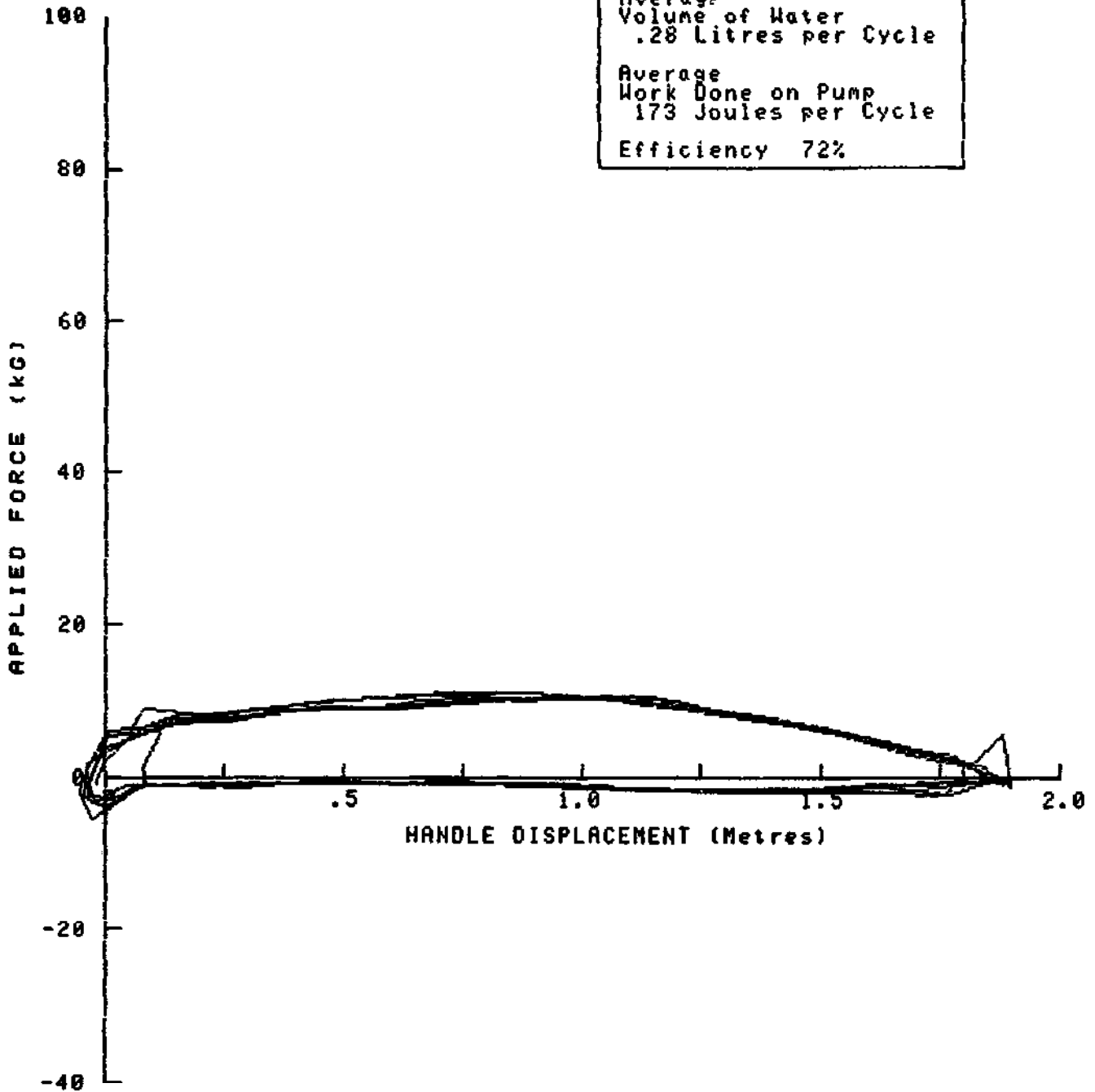

# PUMP PERFORMANCE after ENDURANCE CODE K Jetmatic

Water Head 45 Metres --- Pumping Rate 41 Cycles /Minute  
Total Weight of Water Raised 2.9kg  
10 Strokes/Revolutions  
Total Work Done On Pump 1393 Joules. (Rate 94.3 Watts )

Average Volume of Water .29 Litres per Cycle
Average Work Done on Pump 139 Joules per Cycle
Efficiency 91%

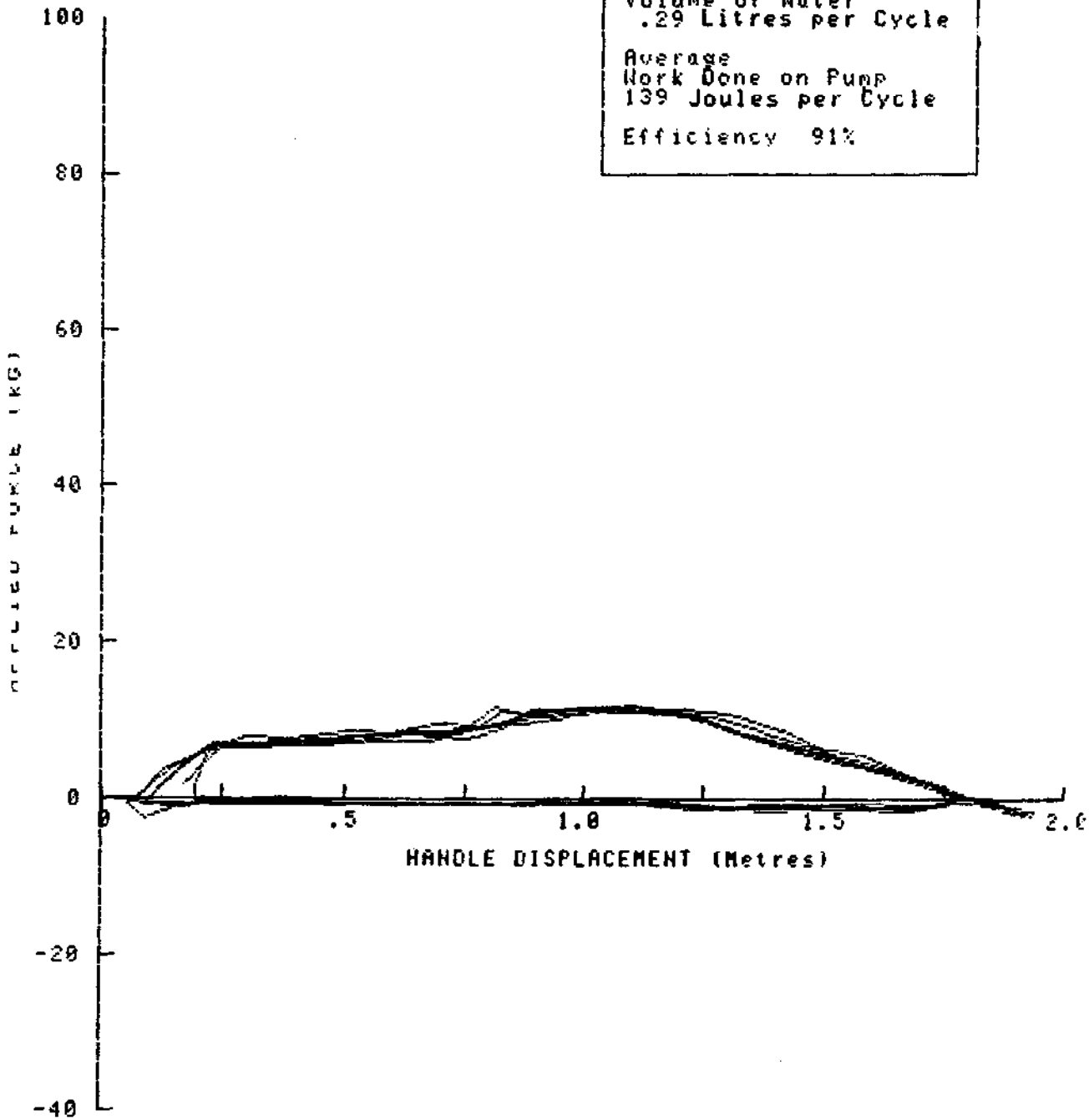

The results illustrate reduced friction after endurance testing.

# PUMP PERFORMANCE

## CODE L Bandung

Water Head 7 Metres --- Pumping Rate 29 Cycles /Minute  
Total Weight of Water Raised 19.3kG  
20 Cycles  
Total Work Done On Pump 1874 Joules. (Rate 44.7 Watts )

Average Volume of Water .96 Litres per Cycle
Average Work Done on Pump 93 Joules per Cycle
Efficiency 70%

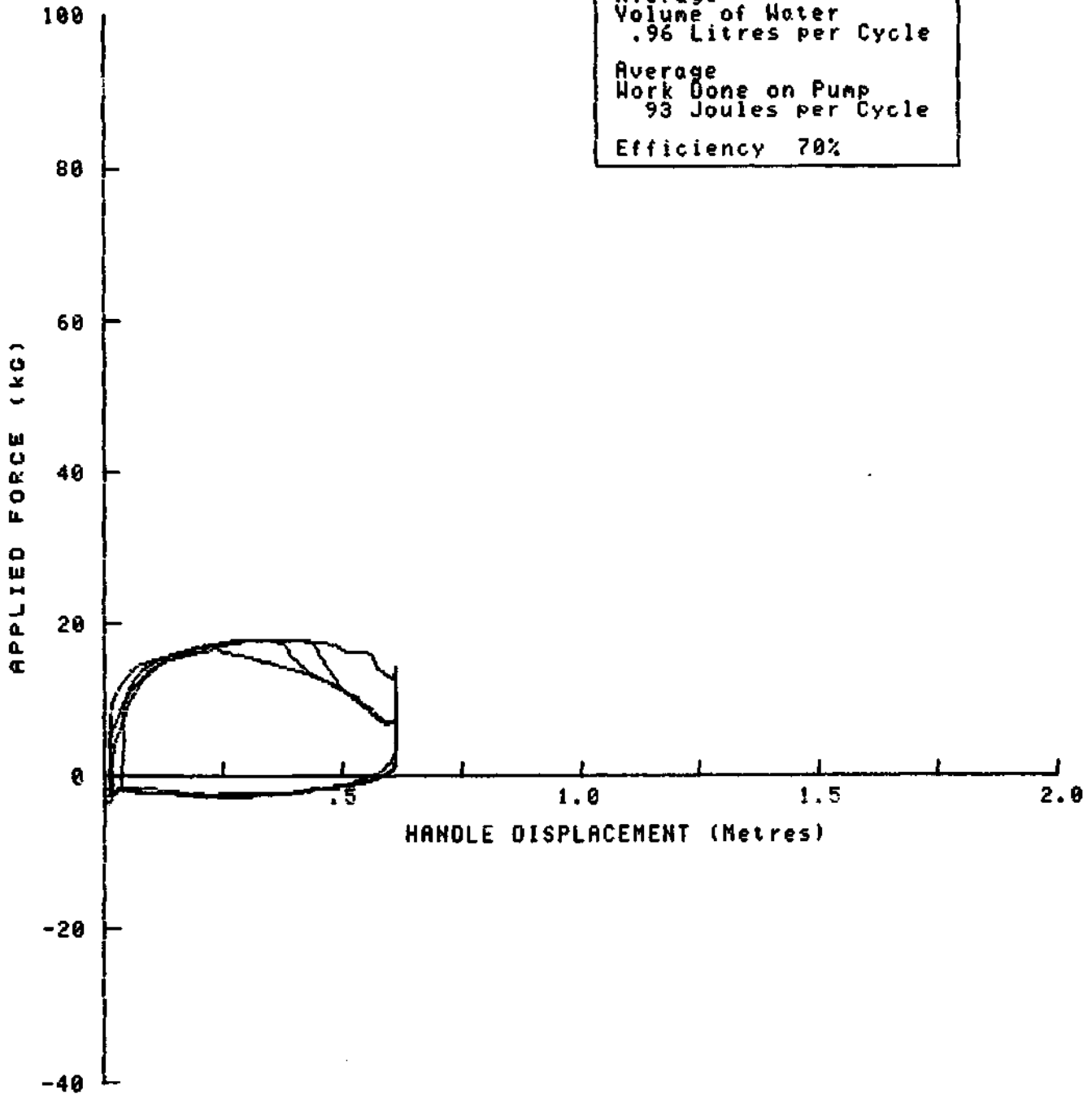

The results before endurance testing suggest some irregularities in the performance of the plunger seal or valve.

### PUMP PERFORMANCE after endurance CODE L Bandung

Water Head 7 Metres --- Pumping Rate 30 Cycles /Minute  
Total Weight of Water Raised 5.7kg  
5 Cycles  
Total Work Done On Pump 625 Joules. (Rate 62.5 Watts )

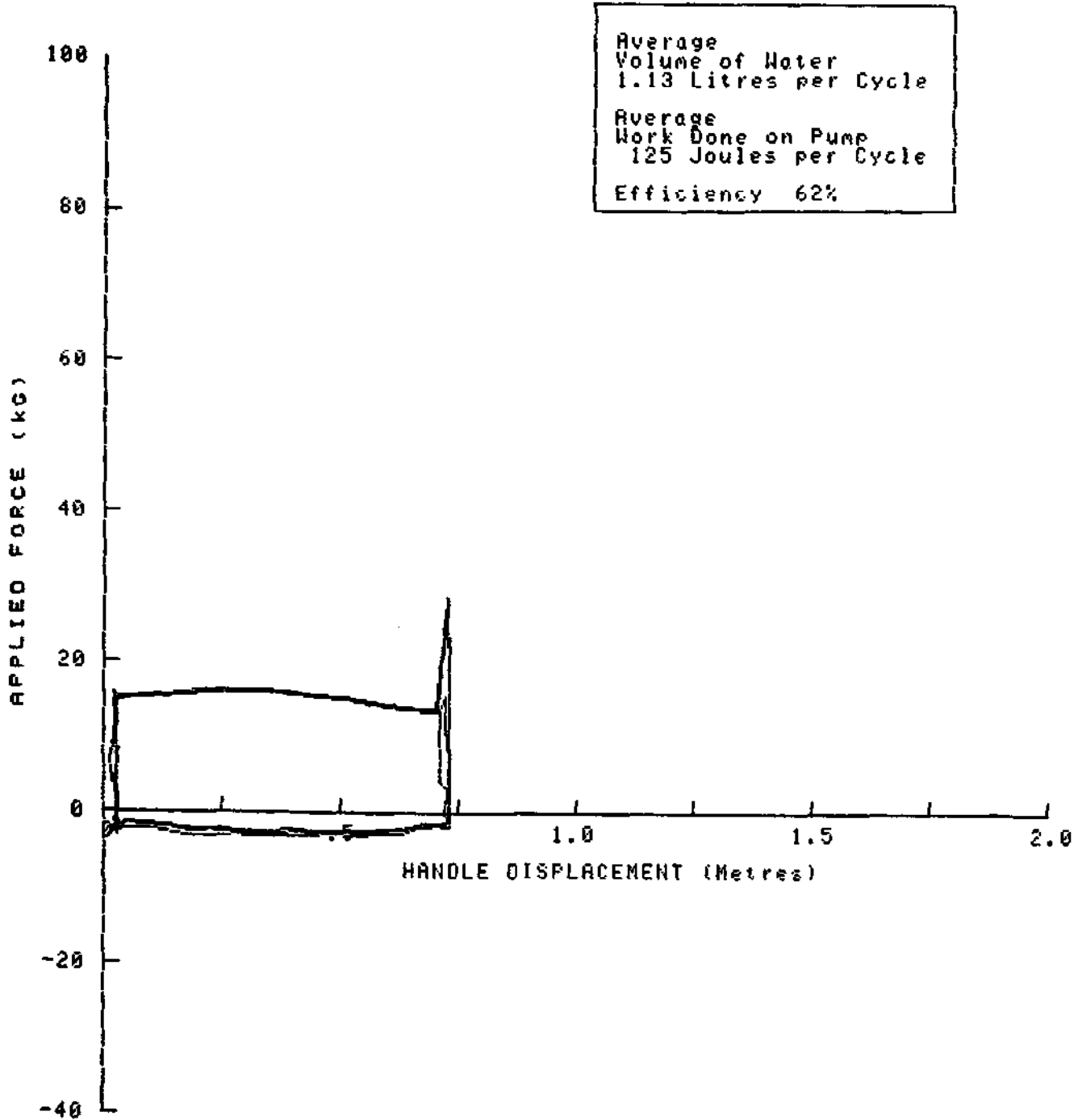

No irregularities are indicated, suggesting that the plunger seal and valve were working satisfactorily during this test. Note that the plunger seal was replaced three times during the endurance test.

# PUMP PERFORMANCE

## CODE M Sumber Banyu

Water Head 45 Metres --- Pumping Rate 39 Cycles /Minute  
Total Weight of Water Raised 8.0kg  
10 Cycles  
Total Work Done On Pump 4809 Joules. (Rate 311.6 Watts )

Average Volume of Water .80 Litres per Cycle
Average Work Done on Pump 480 Joules per Cycle
Efficiency 73%

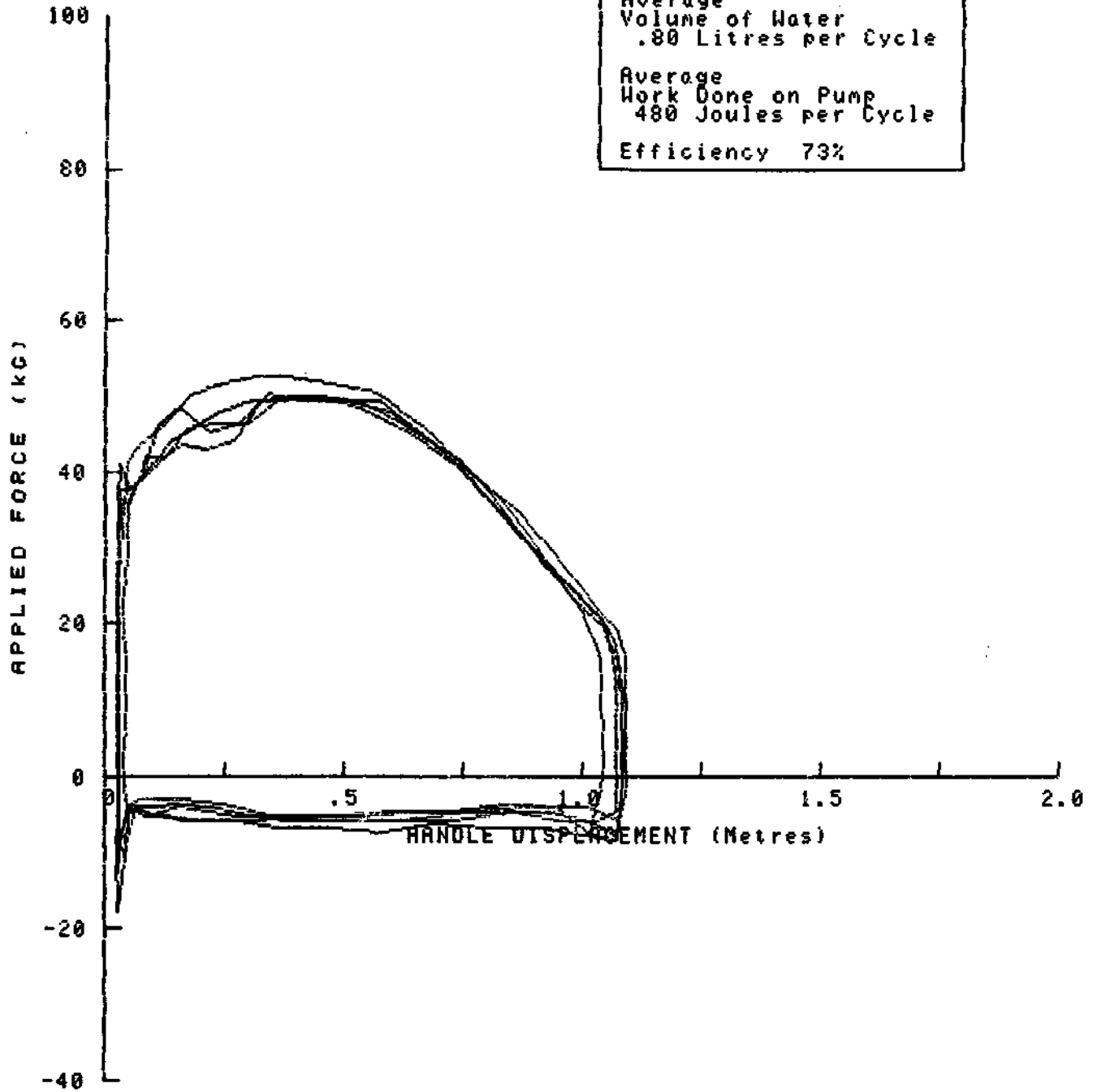

### PUMP PERFORMANCE after ENDURANCE CODE M Sumber Banyu

Water Head 45 Metres --- Pumping Rate 38 Cycles /Minute  
Total Weight of Water Raised 8.1kg  
10 Strokes/Revolutions  
Total Work Done On Pump 4521 Joules. (Rate 288.3 Watts )

Average Volume of Water .81 Litres per Cycle
Average Work Done on Pump 452 Joules per Cycle
Efficiency 79%

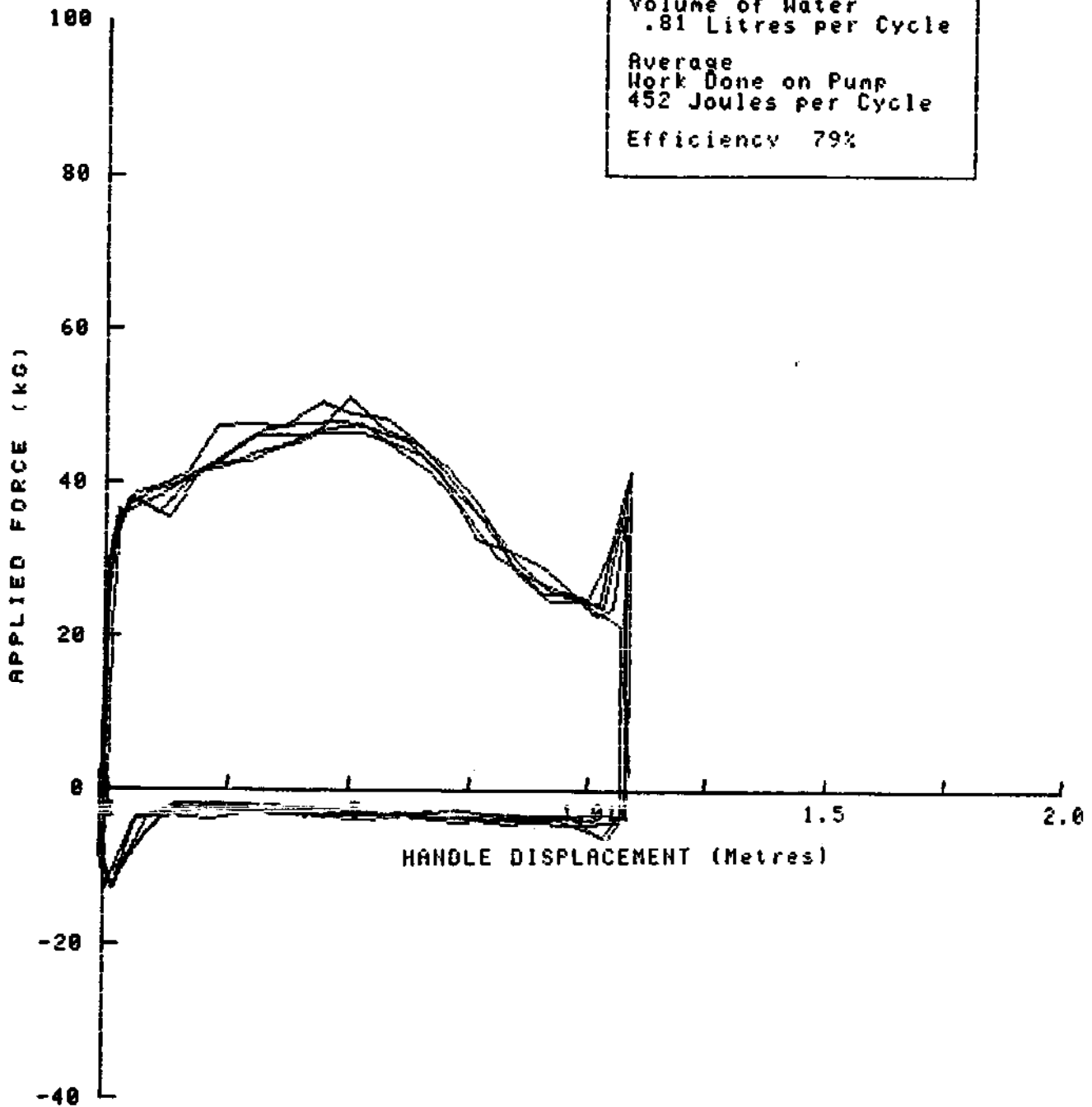

The results before and after endurance should not be directly compared because the cylinder components were replaced during the endurance test.

APPENDIX III. ABSTRACT OF ODA HANDPUMPS LABORATORY TESTING

FINAL REPORT, JANUARY 1981

C O D E	Manufacturer (Country of origin)	Model	Deep/ shallow	Ex-Factory Cost per pump*	Type of pump	Ease of Maintenance & repair
A	Petropump (Sweden)	Type 95	Deep	#221.5 (excluding pipe)	Hand-operated diaphragmatic hose	3
B	Vergnet (France)	Hydropompe Type AC 2	Deep	#421.7 (complete to 50m)	Foot-operated hydraulic oper- ation, diaphra- gmatic hose	4
C	Dempster (USA)	23 F(CS)	Deep	#56.5 (excl. pipe and rod)	Hand-operated lift pump	2
D	Mono (England)	ES 30		#370.4 (complete to 10m)	Hand-operated rotary, helical screw-type operation	2
E	Climax (England)	Not stated	Deep	#730.9 (complete to 21m)	Hand-operated flywheel-lift pump	1
F	Godwin (England)	W1 H51	Deep	#865.5 (complete to 21m)	Hand-operated geared lift pump	1
G	ABI (Ivory Coast)	Type M	Deep	#358.3 (Excl. pipe & rod)	Hand-operated lift pump	2
H	GSW (Beatty) (Canada)	1205	Deep	#163 (Excl. pipe and rod)	Hand-operated lift-pump	2
J	Monarch (Canada)	P 3	Deep	#359 (complete to 30m)	Hand-operated lift pump	2
K	Kangaroo (Holland)	Not stated	Deep	#282.5 (complete to 20m)	Foot/Spring- operated lift pump	2
L	India (India)	Mark II	Deep	#64.9 (excl. pipe and rod)	Hand-operated lift pump	2
M	Consallen (England)	L D 5	Deep	#296.8 (complete to 20m)	Hand-operated lift pump	3

\* Price basis late 1977/early 1978 equivalent in #

Note: This information was compiled in 1981 and has been included for completeness. Many manufacturers, however, have since modified their pumps as a result of both laboratory tests and field information.

<u>Results of Endurance Test</u>				
Hours	Failures	Performance	Reliability	Wear
670	Pumping element disconnected. 962/ nut on handle loose. 1636/ pumping element split. 2848/ pumping element failed. 3212/ pumping element split	Adequate but low efficiency	Somewhat variable	Likely to be small
1317	Significant wear in pedal rod guide	Acceptable, low efficiency	Fairly good	
2000	Pedal rod guide worn right through			
930	Pump rod broken. 1130/pump rod broke again. 3037/split pin on hand fulcrum bearing fracture	Good	Poor	
	No failures occurred. (However, continual oil leakage from gearbox)	Poor	Very good	
1323	Water leaking from pumpstand inspection covers. 1355/ Handle fractured	Good	Very good	Likely to be minimal
	No failures occurred	Adequate	Excellent	
	No failures occurred	Good	Good in test but sharp metal/metal stops may cause field problems	Unlikely to cause problems
	No failures occurred	Fairly good	Quite good	
2772	Wooden handle loose. Pump rod	Good	Quite good	
3692	top guide bush worn through			
251	Spring in pumpstand broken	Poor	Very poor	
400	No spares, pump removed from test			
	No failures occurred	Fairly good	Excellent	Unlikely to be a problem
	No failures occurred	Quite good	Very Good	

\* Rating : 1 poor, 5 very good



**World Bank  
Publications  
of Related  
Interest**



1981-1990

**NEW**

**Laboratory Evaluation of  
Hand-operated Pumps for Use  
in Developing Countries  
Consumers' Association Testing  
and Research Laboratory**

An invaluable guide for selecting water pumps. Paper rates 12 pumps on basis of rigorous testing to determine their strengths and weaknesses. Pumps rated for packaging, condition as received, installation, maintenance, repair, and overall desirability.

*Technical Paper No. 6. 1983. 89 pages.*  
ISBN 0-8213-0133-0. Stock No. BK 0133.  
\$3.

**Laboratory Testing, Field  
Trials, and Technological  
Development**

Contains results of laboratory tests carried out on twelve hand pumps for the World Bank and presents recommendations for improvements in performance, safety, and durability.

1982. 122 pages (including 3 appendixes).  
Stock No. BK 9190. \$5.

**NEW**

**Meeting the Needs of the Poor  
for Water Supply and Waste  
Disposal**

Fredrick L. Golladay

Examines economic, political, social, and cultural obstacles to meeting the needs of low-income people for water supply and waste disposal. Proposes steps to reduce these obstacles. Notes that communities organize and manage resources to carry out activities that cannot be profitably undertaken by households. Proposes methods to facilitate the formation and operation of community organizations to carry out these functions.

*Technical Paper No. 9. 1983. 66 pages.*  
ISBN 0-8213-0238-8. Stock No. BK 0238.  
\$3.

**A Model for the Development  
of a Self-Help Water Supply  
Program**

Colin Glennie

Presents one version of a practical model for developing, with high community participation, water supply programs in developing countries. Consideration is also given to sanitation program development and practical guidelines for program development are included. One of a series of informal Working Papers prepared by the Technology Advisory Group, established under UNDP's Global Project, executed by the World Bank.

*Technical Paper No. 2. 1982. 45 pages (including 2 annexes, references).*  
ISBN 0-8213-0077-6. Stock No. BK 0077.  
\$3.

**Municipal Water Supply  
Project Analysis: Case Studies**

Frank H. Lamson-Scribner, Jr.,  
and John Huang, editors

Eight case studies and fourteen exercises dealing with the water and wastewater disposal sector.

*World Bank (EDI), 1977. 529 pages.*  
Stock No. IB-0655. \$8.50 paperback.

**NEW**

**Notes on the Design and  
Operation of Waste  
Stabilization Ponds in Warm  
Climates of Developing  
Countries**

J. P. Arthur

Practical design criteria for pond systems to fit various ambient temperature and reuse requirements, such as irrigation. Offers suggestions for start-up procedures, operation, and trouble shooting.

*Technical Paper No. 7. 1983. 106 pages.*  
ISBN 0-8213-0137-3. Stock No. BK 0137.  
\$5.

**NEW**

**Ventilated Improved Pit  
Latrines: Recent Developments  
in Zimbabwe**

D. D. Mara and Peter R. Morgan

Describes designs and materials for latrines, one for peri-urban areas costing about US\$150, and a US\$8 version for rural areas. Some 20,000 of the ventilated pit latrines have been built in Zimbabwe. They have been found very effective in eliminating odors and controlling fly breeding.

*Technical Paper No. 3. 1983. 48 pages.*  
ISBN 0-8213-0078-4. Stock No. BK 0078.  
\$3.

**Village Water Supply**

Describes technical aspects, costs, and institutional problems related to supplying water for domestic use in rural areas and proposes guidelines for future World Bank lending in this sector.

*A World Bank Paper. 1976. 98 pages (including 4 annexes).*  
Stock Nos. BK 9099 (English), BK 9100 (French), BK 9044 (Spanish). \$5.

**Village Water Supply:  
Economics and Policy in the  
Developing World**

Robert J. Saunders and Jeremy J. Warford

Addresses the problem of potable water supply and waste disposal in rural areas of developing countries where the majority of the poor tend to be found. Emphasizes the economic, social, financial, and administrative issues that characterize village water supply and sanitation programs.

*The Johns Hopkins University Press, 1976.*  
292 pages (including 4 appendixes, bibliography, index).

LC 76-11758. ISBN 0-8018-1876-1. Stock No. JH 1876. \$22.50 hardcover.

French: *L'alimentation en eau des communes rurales: economie et politique generale dans le monde en developpement. Economica, 1978.*

ISBN 2-7178-0022-0. Stock No. IB 0549.  
\$7.

Spanish: *Agua para zonas rurales y poblados: economia y politica en el mundo en desarrollo. Editorial Tecnos, 1977*

ISBN 84-309-0708-4. Stock No. IB 0532.  
\$7.

*Prices subject to change without notice  
and may vary by country.*

---

**NEW**

**Water Supply and Sanitation Project Preparation Handbook**  
The three companion volumes guide planners, engineers, and community development and public health specialists working in projects related to water and sanitation in developing countries and help users prepare project reports. Case studies illustrate each phase of project development: identification, prefeasibility, and feasibility. It suggests approaches and methods of project evaluation to guide project team members.

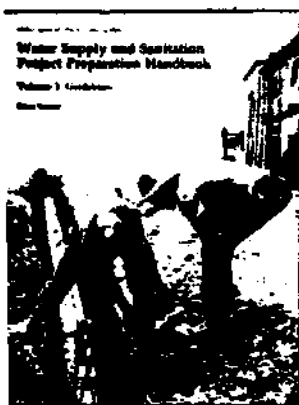

**Volume 1: Guidelines**  
Brian Grover

Technical Paper No. 12. 1983. 190 pages.  
ISBN 0-8213-0230-2. Stock No. BK 0230.

**Volume 2: Case Studies—  
Identification Report for Port  
City, Immediate Improvement  
Project for Port City, Pre-  
feasibility Report for Port City**  
Brian Grover, Nicholas Burnett,  
and Michael McGarry

Technical Paper No. 13. 1983. 352  
pages.  
ISBN 0-8213-0231-0. Stock No. BK  
31. \$15.

**Volume 3: Case Study—  
Feasibility Report for Port City**  
Brian Grover, Nicholas Burnett,  
and Michael McGarry

Technical Paper No. 14. 1983. 308 pages.  
ISBN 0-8213-0232-9. Stock No. BK 0232.  
5. Stock No. BK 0367. 3-volume set:  
5.

---

**World Bank Studies in Water  
Supply and Sanitation**

The United Nations has designated the 1980s as the International Drinking Water Supply and Sanitation Decade. Its goal is to provide two of the most fundamental human needs—safe water and sanitary disposal of human wastes—to all people. To help usher in this important period of international research and cooperation, the World Bank has published several volumes on appropriate technology for water supply and waste disposal systems in developing countries. Since the technology for supplying water is better understood, the emphasis in these volumes is on sanitation and waste reclamation technologies, their contributions to better health, and how they are affected by water service levels and the ability and willingness of communities to pay for the systems.

**Number 1: Appropriate  
Sanitation Alternatives: A  
Technical and Economic  
Appraisal**

John M. Kalbermatten, DeAnne S. Julius, and Charles G. Gunnerson

This volume summarizes the technical, economic, environmental, health, and sociocultural findings of the World Bank's research program on appropriate sanitation alternatives and discusses the aspects of program planning that are necessary to implement these findings. It is directed primarily toward planning officials and sector policy advisers for developing countries.

The Johns Hopkins University Press, 1982.  
172 pages (including bibliography, index).  
LC 80-8963. ISBN 0-8018-2578-4, Stock  
No. JH 2578, \$12.95 paperback.

**Number 2: Appropriate  
Sanitation Alternatives: A  
Planning and Design Manual**

John M. Kalbermatten, DeAnne S. Julius, Charles G. Gunnerson, and D. Duncan Mara

This manual presents the latest field results of the research, summarizes selected portions of other publications on sanitation program planning, and describes the engineering details of alternative sanitation technologies and how they can be upgraded.

The Johns Hopkins University Press, 1982. 172 pages (including bibliography, index).  
LC 80-8963. ISBN 0-8018-2584-9, Stock  
No. JH 2584, \$15 paperback.

---

**NEW**

**Number 3: Sanitation and  
Disease: Health Aspects of  
Wastewater Management**

Richard G. Feachem, David J. Bradley, Hemda Garelick, and D. Duncan Mara

Summarizes knowledge about excreta, night soil, and sewage and their effects on health. Describes the environmental characteristics of specific excreted pathogens and the epidemiology and control of the infections these pathogens cause.

John Wiley and Sons (U.K.). 1983. 528  
pages.

ISBN 0-471-90094-X. Stock No. IB 0558.  
\$39.50 hardcover.

**Appropriate Technology for  
Water Supply and Sanitation**

The following volumes have been published in a less formal format. Some are abridgments of the three foregoing volumes.

**Volume 1: Technical and  
Economic Options**

John M. Kalbermatten, DeAnne S. Julius, and Charles G. Gunnerson

Reports technical, economic, health, and social findings of the research project on "appropriate technology" and discusses the program planning necessary to implement technologies available to provide socially and environmentally acceptable low-cost water supply and waste disposal.

1980. 122 pages (including bibliography).  
Stock No. BK 9186. \$5.

**Volume 1a: A Summary of  
Technical and Economic  
Options**

John M. Kalbermatten, DeAnne S. Julius, and Charles G. Gunnerson

A summary of the final report on appropriate technology for water supply and waste disposal in developing countries, a World Bank research project undertaken by the Energy, Water, and Telecommunications Department in 1976-1978.

1980. 38 pages.  
Stock No. BK 0049. \$3.

**Volume 1b: Sanitation  
Alternative for Low-Income  
Communities—A Brief  
Introduction**

D. Duncan Mara

Describes in nontechnical language the various low-cost sanitation technolo-

gies that are currently available for low-income communities in developing countries and presents a general methodology for low-cost sanitation program planning.

1982. 48 pages.

Stock No. BK 9189. \$3.

**Volume 3: Health Aspects of Excreta and Sullage Management—A State-of-the-Art Review**

Richard G. Feachem, David J. Bradley, Hemda Garelick, and D. Duncan Mara

Provides information on the ways in which particular excreta disposal and reuse technologies affect the survival

and dissemination of pathogens. It is intended for planners, engineers, economists, and health workers.

1980. 303 pages (including 14 appendixes, references).

Stock No. BK 9187. \$15.

**Volume 10: Night-soil Composting**

Hillel I. Shuval, Charles G. Gunnerson, and DeAnne S. Julius

Describes a safe, inexpensive treatment method for night-soil composting that is ideally suited for developing countries because of its simplicity in operation, limited need for mechanical equipment, low cost, and effectiveness in inactivating pathogens.

1981. 81 pages (including bibliography, 2 appendixes).

Stock No. BK 9188. \$3.

---

**World Bank Research in Water Supply and Sanitation—Summary of Selected Publications**

A bibliography summarizing the papers in the Water Supply and Sanitation Series, as well as the World Bank studies in Water Supply and Sanitation published for the World Bank by The Johns Hopkins University Press.

1980.

Stock No. BK 9185. Free.



## Distributors of World Bank Publications

### ARGENTINA

Carlos Hirsch, SRL,  
Attn: Ms. Monica Bustos  
Florida 165 4° piso  
Galeria Guemes  
Buenos Aires 1307

### AUSTRALIA, PAPUA NEW GUINEA, FIJI, SOLOMON ISLANDS, WESTERN SAMOA, AND VANUATU

The Australian Financial Review  
Information Service (AFRIS)  
Attn: Mr. David Jamieson  
235-243 Jones Street  
Broadway  
Sydney, NSW 20001

### BELGIUM

Publications des Nations Unies  
Attn: Mr. Jean de Lannoy  
av. du Roi 202  
1060 Brussels

### CANADA

Le Diffuseur  
Attn: Mrs. Suzanne Vermette  
C.P. 85, Boucherville J4B 5E6  
Quebec

### COSTA RICA

Libreria Trejos  
Attn: Mr. Hugo Chamberlain  
Calle 11-13, Av. Fernandez Guell  
San Jose

### DENMARK

Sanfundslitteratur  
Attn: Mr. Wilfried Roloff  
Rosenderns Alle 11  
DK-1970 Copenhagen V.

### EGYPT, Arab Republic of

Al Ahram  
Attn: Mr. Sayed El-Gabri  
Al Galaa Street  
Cairo

### FINLAND

Akateeminen Kirjakauppa  
Attn: Mr. Kari Litmanen  
Keskuskatu 1, SF-00100  
Helsinki 10

### FRANCE

World Bank Publications  
66, avenue d'Iéna  
75116 Paris

### GERMANY, Federal Republic of

UNO-Verlag  
Attn: Mr. Joachim Krause  
Simrockstrasse 23  
D-5300 Bonn 1

### HONG KONG, MACAU

Asia 2000 Ltd.  
Attn: Ms. Gretchen Wearing Smith  
6 FL., 146 Prince Edward Road  
Kowloon

### INDIA

UBS Publishers' Distributors Ltd.  
Attn: Mr. D.P. Veer  
5 Ansari Road, Post Box 7015  
New Delhi 110002  
(Branch offices in Bombay, Bangalore,  
Kanpur, Calcutta, and Madras)

### INDONESIA

Pt. Indira Limited  
Attn: Mr. Bambang Wahyudi  
Jl. Dr. Sam Ratulangi No. 37  
Jakarta Pusat

### IRELAND

TDC Publishers  
Attn: Mr. James Booth  
12 North Frederick Street  
Dublin 1

### JAPAN

Eastern Book Service  
Attn: Mr. Terumasa Hirano  
37-3, Hongo 3-Chome, Bunkyo-ku 113  
Tokyo

### KENYA

Africa Book Services (E.A.) Ltd.  
Attn: Mr. M.B. Dar  
P.O. Box 45245  
Nairobi

### KOREA, REPUBLIC OF

Pan Korea Book Corporation  
Attn: Mr. Yoon-Sun Kim  
P.O. Box 101, Kwanghwamun  
Seoul

### MALAYSIA

University of Malaya Cooperative  
Bookshop Ltd.  
Attn: Mr. Mohammed Fahim Htj  
Yacob  
P.O. Box 1127, Jalan Pantai Baru  
Kuala Lumpur

### MEXICO

INFOTEC  
Attn: Mr. Jorge Cepeda  
San Lorenzo 153-11, Col. del Valle,  
Deleg. Benito Juarez  
03100 Mexico, D.F.

### NETHERLANDS

MBE BV  
Attn: Mr. Gerhard van Bussell  
Noorderwal 38,  
7241 BL Lochem

### NORWAY

Johan Grundt Tanum A.S.  
Attn: Ms. Randi Mikkelborg  
P.O. Box 1177 Sentrum  
Oslo 1

### PANAMA

Ediciones Libreria Cultural Panamena  
Attn: Mr. Luis Fernandez Fraguera R.  
Av. 7, Espana 16  
Panama Zone 1

### PHILIPPINES

National Book Store  
Attn: Mrs. Socorro C. Ramos  
701 Rizal Avenue  
Manila

### SAUDI ARABIA

Jarir Book Store  
Attn: Mr. Akram Al-Agil  
P.O. Box 3196  
Riyadh

### SINGAPORE, TAIWAN, BURMA

Information Publications Private, Ltd.  
Attn: Ms. Janet David  
02-06 1st Floor, Pei-Fu Industrial  
Building  
24 New Industrial Road  
Singapore

### SPAIN

Mundi-Prensa Libros, S.A.

Attn: Mr. J.M. Hernandez  
Castello 37  
Madrid

### SRI LANKA AND THE MALDIVES

Lake House Bookshop  
Attn: Mr. Victor Walatara  
41 Wad Ramanayake Mawatha  
Colombo 2

### SWEDEN

ABCE Fritzes Kungl. Hovbokhandel  
Attn: Mr. Eide Segerback  
Regeringsgatan 12, Box 16356  
S-103 27 Stockholm

### SWITZERLAND

Librairie Payot  
Attn: Mr. Henri de Perrot  
6, rue Grenus  
1211 Geneva

### TANZANIA

Oxford University Press  
Attn: Mr. Anthony Theobald  
Maktaba Road, P.O. Box 5299  
Dar es Salaam

### THAILAND

Central Department Store, Head Office  
Attn: Mrs. Ratana  
306 Silom Road  
Bangkok

Thailand Management Association  
Attn: Mrs. Sunan  
308 Silom Road  
Bangkok

### UNITED KINGDOM AND NORTHERN IRELAND

Microinfo Ltd.  
Attn: Mr. Roy Selwyn  
Newman Lane, P.O. Box 3  
Alton, Hampshire GU34 2PG  
England

### UNITED STATES

The World Bank Book Store  
600 19th Street, N.W.  
Washington, D.C. 20433  
(Postal address: P.O. Box 37525  
Washington, D.C. 20013, U.S.A.)

Baker and Taylor Company  
501 South Gladiola Avenue  
Mokenca, Illinois, 60954

380 Edison Way  
Reno, Nevada, 89564  
50 Kirby Avenue  
Somerville, New Jersey, 08876  
Commerce, Georgia 30599

Bernan Associates  
9730-E George Palmer Highway  
Lanham, Maryland, 20761

Blackwell North America, Inc.  
1001 Fries Mill Road  
Blackwood, New Jersey 08012

Sidney Kramer Books  
1722 H Street, N.W.  
Washington, D.C. 20006

United Nations Bookshop  
United Nations Plaza  
New York, N.Y. 10017

### VENEZUELA

Libreria del Este  
Attn: Mr. Juan Pericas  
Avda Francisco de Miranda, no. 52  
Edificio Galipan, Aptdo. 60.337  
Caracas 1060-A



**The World Bank**

**Headquarters:**

1818 H Street, N.W.  
Washington, D.C. 20433, U.S.A.

Telephone: (202) 477-1234

Telex: WUI 64145 WORLDBANK  
RCA 248423 WORLDBK

Cable address: INTBAFRAD  
WASHINGTONDC

**European Office:**

66, avenue d'Iéna  
75116 Paris, France

Telephone: (1) 723-54.21

Telex: 842-620628

**Tokyo Office:**

Kokusai Building  
1-1, Marunouchi 3-chome  
Chiyoda-ku, Tokyo 100, Japan

Telephone: (03) 214-5001

Telex: 781-26838



**UNDP**

**New York:**

United Nations Development Programme  
1 United Nations Plaza  
New York, New York 10017

Telephone: (212) 754-1234

Telex: 125980 (domestic)  
232-422 (overseas)

Cable address: UNDEVPRO  
NEW YORK

**Geneva Office:**

Palais des Nations  
CH-1211 Geneva 10  
Switzerland

Telephone: 98-84-00

98-58-50

Telex: (UNDP) 28.96.20 or (UN) 28.96.96

Cable address: UNDEVPRO  
GENEVA (SWITZERLAND)

**Tokyo Office:**

Shin Aoyama Building  
Room 2255  
1-1, Minami-Aoyama 1-Chome  
Minato-Ku  
Tokyo 107, Japan

Telephone: 03-475-1619/20

Telex: J28 334

AB TKOP1 J28 334

Cable: UNDEVPRO

TOKYO (JAPAN)