

AT MICROFICHE REFERENCE LIBRARY

A project of Volunteers in Asia

Slow Sand Filtration for Community Water Supply in
Developing Countries Technical Paper No. 11

by: J.C. Van Dijk and J.H.C. Oomen

Published by:

WHO International Reference Centre for
Community Water Supply
P.O. Box 5500
2280 HM Rijswijk
The Hague
The Netherlands

Free to serious groups.

Available from:

WHO International Reference Centre for
Community Water Supply
P.O. Box 5500
2280 HM Rijswijk
The Hague
The Netherlands

Reproduced by permission of the WHO International
Reference Centre for Community Water Supply.

Reproduction of this microfiche document in any
form is subject to the same restrictions as those
of the original document.



December 1978

Slow Sand Filtration for Community Water Supply in Developing Countries

A Design and Construction Manual

11

Technical Paper Series

ABSTRACT

"Slow Sand Filtration for Community Water Supply in Developing Countries. A Design and Construction Manual".

WHO International Reference Centre for Community Water Supply, Voorburg (The Hague), The Netherlands, approx. 180 pp, December 1978.

Slow sand filtration is an excellent low-cost purification technique for polluted surface waters in tropical developing countries. Topics discussed in this design and construction manual include the principles of slow sand filtration, its performance and applicability, suitable pre-treatment techniques for the removal of turbidity, and comprehensive guidelines for the design and construction of small slow sand filters. The manual comprises four typical designs, with capacities between 25 - 960 m³/d, including sets of construction drawings and bills of quantities.

Key words: Low cost water treatment, slow sand filters, design of slow sand filters, construction of slow sand filters, rural water supply, developing countries, pre-treatment for slow sand filters, implementation of slow sand filters, application of local building materials for slow sand filters.

UDC: 628.163.067 (035.5) (1-773)

Established in 1968 at the Netherlands' National Institute for Water Supply in Voorburg (The Hague), the WHO International Reference Centre for Community Water Supply (IRC) is based on an agreement between the World Health Organization and the Netherlands Government. In close contact with WHO, the IRC operates as the nucleus of a worldwide network of regional and national collaborating institutions, both in developing and industrialized countries.

The general objective of the IRC is to promote international cooperation in the field of community water supply.

Operating as a catalyst, the IRC works closely together with its collaborating institutions as well as international agencies, national entities and individuals.

Request for information on the IRC, or enquiries on specific problems may be directed to the International Reference Centre for Community Water Supply, Information Section, P.O. Box 140, 2260 AC Leidschendam, the Netherlands.

**WHO INTERNATIONAL REFERENCE CENTRE
FOR
COMMUNITY WATER SUPPLY**

**Slow Sand Filtration
for Community Water Supply
in Developing Countries**

A Design and Construction Manual

**PREPARED BY
J. C. VAN DIJK AND J. H. C. M. OOMEN**

TECHNICAL PAPER NO. 11

DECEMBER 1978

**Nw. Havenstraat 6, 2272 AD Voorburg (The Hague)
The Netherlands**

**Postal Address:
P.O. Box 140, 2260 AC Leidschendam, The Netherlands**

| CONTENTS | page |
|---|------|
| PREFACE | 7 |
| 1. INTRODUCTION..... | 9 |
| 2. WATER CONSUMPTION, WATER QUALITY CRITERIA AND WATER RELATED DISEASES..... | 13 |
| 2.1. Water consumption..... | 13 |
| 2.2. Water quality criteria and water related diseases..... | 14 |
| 3. PRINCIPLES OF SLOW SAND FILTRATION..... | 17 |
| 3.1. Introduction..... | 17 |
| 3.2. Description of the basic elements of a slow sand filter..... | 18 |
| 3.3. The principle of the purification process.... | 21 |
| 3.4. Performance of slow sand filters..... | 24 |
| 3.5. Applicability and limitations of slow sand filters..... | 25 |
| 3.6. Advantages of slow sand filters..... | 26 |
| 3.7. Operation and maintenance of slow sand filters..... | 27 |
| 3.8. Pre-treatment and post-treatment in combination with slow sand filters..... | 34 |
| 3.9. A guide for the selection of a water treatment system..... | 36 |

CONTENTS

page

| | | |
|------|---|----|
| 4. | THE DESIGN OF SLOW SAND FILTRATION PLANTS..... | 39 |
| 4.1. | Introduction..... | 39 |
| 4.2. | General design considerations..... | 40 |
| 4.3. | Design example..... | 43 |
| 4.4. | Design criteria..... | 54 |
| 5. | THE CONSTRUCTION AND SPECIFICATION OF ELEMENTS OF SLOW SAND FILTRATION PLANTS..... | 59 |
| 5.1. | Size and layout of filter units..... | 59 |
| 5.2. | Construction of filter box..... | 65 |
| 5.3. | Inlet structure..... | 72 |
| 5.4. | Outlet structure..... | 74 |
| 5.5. | System of underdrains..... | 76 |
| 5.6. | Filter control arrangements..... | 78 |
| 5.7. | Pre-treatment and post-treatment units..... | 81 |
| 5.8. | Clear water storage..... | 82 |
| 5.9. | Piping and pumping arrangements..... | 83 |
| 6. | TYPICAL DESIGNS FOR SLOW SAND FILTERS..... | 87 |
| 6.1. | Protected sloping wall filter..... | 87 |
| 6.2. | Circular ferrocement filter..... | 89 |
| 6.3. | Circular masonry filter..... | 90 |
| 6.4. | Rectangular reinforced concrete filter..... | 91 |
| 6.5. | Lay-out of the treatment plants, incor- porating the four typical designs..... | 92 |
| 6.6. | Production capacity of the four typical designs..... | 95 |
| 6.7. | Quantity of building materials required for the four typical designs..... | 96 |
| 6.8. | The costs of slow sand filters..... | 98 |

| | page |
|---|------|
| CONTENTS | |
| 7. THE IMPLEMENTATION OF SLOW SAND FILTRATION PLANTS..... | 101 |
| 7.1. Introduction..... | 101 |
| 7.2. Tendering..... | 101 |
| 7.3. Planning and organization..... | 103 |
| 7.4. Building instructions..... | 106 |
| 7.5. A checklist for the sequence of operations in the construction of slow sand filters.... | 111 |
| APPENDICES | |
| 1. Water quality criteria..... | 115 |
| 2. Simple pre-treatment systems..... | 121 |
| 3. Safety chlorination and disinfection..... | 129 |
| 4. Soil investigations..... | 133 |
| 5. Building materials..... | 137 |
| 6. Flow measurement devices..... | 143 |
| 7. Water quality analysis..... | 147 |
| 8. Structural calculations of a reinforced concrete filter box..... | 151 |
| 9. Addresses of member organizations of FIDIC.. | 155 |
| BIBLIOGRAPHY..... | 159 |
| GLOSSARY..... | 163 |
| LIST OF REVIEWERS..... | 171 |
| INDEX..... | 173 |

LIST OF TABLES

| TABLE | DESCRIPTION | page |
|-------|---|------|
| 2.1. | Range of average daily consumption per capita in rural areas (litres per capita per day)..... | 13 |
| 2.2. | Average daily consumption and range of daily consumption in litres per capita for various types of rural water supplies..... | 14 |
| 2.3. | Categories of infectious water-related diseases and preventive strategies..... | 15 |
| 3.1. | Performance of slow sand filters..... | 24 |
| 3.2. | Guide for the selection of a water treatment system, incorporating slow sand filtration... | 37 |
| 5.1. | Sizes and plans of slow sand filters for various capacities..... | 64 |
| 5.2. | Various constructions of filter boxes and their applicability for slow sand filtration. | 71 |
| 6.1. | Positioning of valves for design No. III | 91 |
| 6.2. | Daily production capacities of the four typical designs I-IV (for various modes of operation)..... | 95 |
| 6.3. | Number of people which may be served by the four typical designs at a water demand of 40 l/cap,d (for various modes of operation).. | 96 |
| 6.4. | Estimated range of costs (in US \$) of materials for slow sand filters per unit of production (m ³ /h), based on the four typical designs..... | 98 |
| 6.5. | Estimated range of costs (in US \$) of materials for slow sand filters per capita served, based on the four typical designs.... | 99 |

PREFACE

Although the field of water treatment offers a variety of technological choices, only a few of them can in principle fully meet the specific requirements of developing countries. One such method is slow sand filtration - a simple, efficient and reliable technique for the treatment of water. Its costs generally lie within the resources of the community and/or country and the skills for design, construction, operation and maintenance are usually available locally or can be fairly easily acquired.

Because slow sand filtration can readily be adapted to the local situation without using imported equipment, and communities can be actively involved in the various stages of introduction and use of the water supply, slow sand filtration plants may provide a long lasting service.

To demonstrate that rural water supplies can benefit from these characteristics, a number of institutions in developing countries have started a Slow Sand Filtration Project in close collaboration with the IRC. The following institutions carried out applied research programmes in the first phase of the project: the University of Science and Technology, Kumasi and the Ghana Water and Sewerage Corporation, Ghana; the National Environmental Engineering Research Institute, India; the University of Nairobi, Kenya; the Institute of Public Health Engineering and Research, Pakistan; the University of Khartoum, Sudan and the Asian Institute of Technology and the Rural Water Supply Division in Thailand. A special vote of thanks goes to all those involved in these programmes and in particular to the Principal Investigators.

Based on the experiences gained so far in this project, this manual has been prepared under an agreement between the IRC, and J.C. van Dijk and J.H.C.M. Oomen of the Technical Working Group for Development Cooperation (TWO), a non-profit organization associated with the TOOL foundation, and sponsored by DHV Consulting Engineers.

Appreciation is expressed for the extensive work done by the authors in reviewing and processing the available information and in compiling this design and construction manual. The support given by TWO and particularly the unfailing assistance of Messrs. J. Jonker, J. de Lange and C. Pieck is gratefully acknowledged.

A draft version of the manual was circulated to several reviewers. The IRC is grateful for their observations and comments, according to which the manual has been revised. A list of reviewers is attached to this report.

Although the manual covers a range of applications of slow sand filtration and presents typical examples, it is not presumed to be either exhaustive or final. It is recognized that the practical value and accessibility of the manual can only be proven in the field. By exposing it in its present version to an extended readership, the IRC intends to create an opportunity for testing and feedback of information. The reader therefore is invited to give his comments and suggestions for changes, corrections and additions which he considers necessary or useful. Such contributions will be gratefully accepted by the IRC and will be used in the future revision of the manual.

The present document covers only briefly the topic of operation and maintenance of small slow sand filtration schemes. A more comprehensive description of the knowledge and skills required for the task of the caretaker of a slow sand filter, as well as an outline for a training programme will be given in a separate manual to be published soon as a companion document to the present Design and Construction Manual.

P. Kerkhoven
Programme Officer

1. INTRODUCTION

A safe and convenient water supply is of paramount importance to human health and the well-being of society as a whole. A satisfactory water supply for domestic purposes, such as human consumption and personal hygiene, is characterized by adequate standards regarding the availability of water, its quantity, its quality and the reliability of the supply. Data collected periodically by international agencies show that a substantial part of the world's population, in particular a great many people in developing countries, do not have reasonable access to an adequate water supply. In recent years many efforts have been made to improve this situation.

As part of its activities in the field of water supply, the International Reference Centre for Community Water Supply and Sanitation at Voorburg (The Hague) is supporting an international research and demonstration project on Slow Sand Filtration in order to promote this reliable and low cost method for biological treatment of drinking water in rural and urban fringe areas of developing countries. As the first step, reliable information on the design, construction, operation and maintenance of slow sand filters under local conditions is being generated by means of a programme which comprises applied research, field investigations and literature studies. The programme is being carried out simultaneously by institutions in eight participating countries (viz. Colombia, Ghana, India, Jamaica, Kenya, Pakistan, Sudan and Thailand) which represent a wide spectrum of developing countries.

The Design and Construction Manual deals with the application of slow sand filtration for biological purification of surface water polluted by human or animal excreta.

Groundwater treatment by means of slow sand filtration, (for example for iron removal) is not covered in the present document.

The manual is directed towards communal systems (as distinct from household units) for communities ranging from 1.000 to 20.000 inhabitants.

The content, text and illustrations of the manual are primarily attuned to a sub-professional readership, although professional engineers may also find the manual useful.

Specific professional terminology that could not be avoided is explained in the glossary. The use of formulas is restricted to the minimum. Where certain calculations may be difficult to make in practice, "rules of thumb" are also given.

The many practical tables and graphs are meant to provide an instrument for field officers such as field engineers, technicians and public health officers to take initiatives in rural and urban water development activities.

In the second chapter of the manual some background information on domestic water consumption, water quality criteria and water related diseases is given. The third chapter contains a short description of the theory and purification principles of slow sand filtration. Those who would like to obtain more information on this subject are referred to the WHO document "Slow Sand Filtration" by L. Huisman and W.E. Wood (1), and the various reports on the slow sand filtration programmes in the countries that participate in this project (2 to 7). In the following chapters a step-by-step description is given of the most essential activities involved in the design and construction of a slow sand filtration unit. In other words, starting from the need for a water treatment unit for a community of some hundreds or thousands of

people, guidelines are given on how to choose a suitable raw water source, how to select a proper treatment system, how to design this system, how to choose a site, how to carry out the structural designing, etc.

To illustrate the approach, outlined in Chapters 4 and 5, Chapter 6 gives four typical designs for capacities varying from 25 to 960 m³/d, including sets of construction drawings and bills of quantities. The following types of slow sand filters are described:

- protected sloping wall filter
- circular ferro-cement filter
- circular masonry filter
- rectangular reinforced concrete filter

Chapter 7 provides information on the implementation of small slow sand filtration plants. Successively, the major aspects of tendering, planning, organization and building instructions are discussed.

In appendix 2 simple pre-treatment units that may be applied in combination with slow sand filters are described, whereas in appendix 3 additional information on safety chlorination is given.

In appendix 5 attention is paid to the building materials that can be used for the construction of slow sand filters in developing countries.

Although it is believed that the methodology described and the figures given in this manual are generally applicable, it should be born in mind that in principle each raw water source and each community requires its own custom-made water supply.

The user of this manual should note this fact and handle the information given with caution.

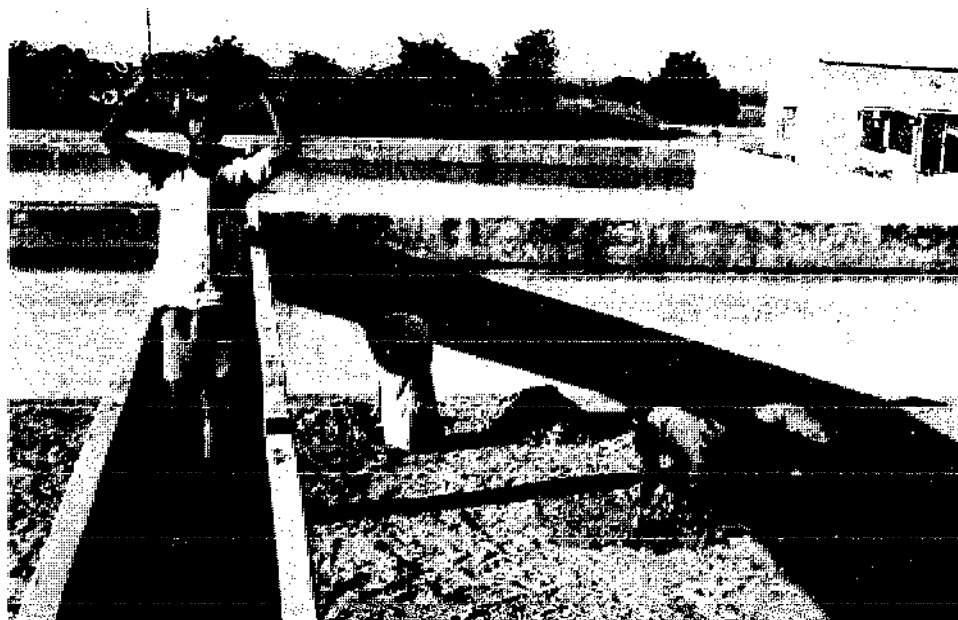

Rectangular stone masonry filters, Umrer, India
(filter in the foreground is being cleaned).

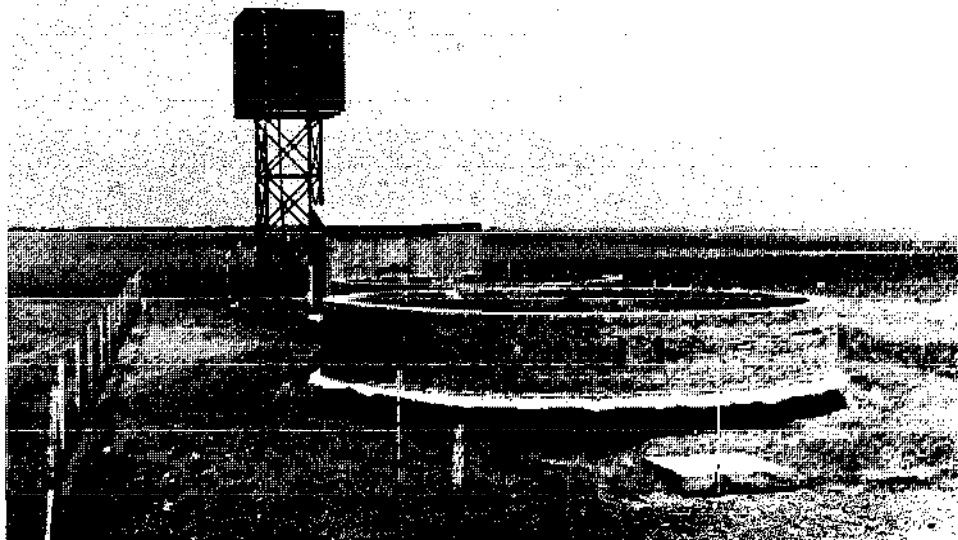

Circular brick masonry filter, Gezira-Region,
Sudan (background: pumphouse and overhead-tank).

2. WATER CONSUMPTION, WATER QUALITY CRITERIA AND WATER RELATED DISEASES

2.1. WATER CONSUMPTION

Water is indispensable to the existence of all living creatures, including man. More than 60% of the weight of the human body is water. To perform its physiological functions properly, the human body needs about 2-10 litres of water per day, depending on climate and work load. Normally about one litre of water is provided by the daily food consumption.

The human body can survive without nutrition for some seven weeks with no lasting harm to its health, but going without drinking water is fatal after only a few days.

Water is also required for other functions such as personal hygiene, washing the dishes and cooking utensils, laundry, house cleaning etc.

The total water consumption per capita per day is determined by a great number of factors such as the availability of water, its quality, the cost of the water, the income and size of the family, cultural habits, standard of living, ways and means of water distribution, climate, etc.

The WHO (10) has published data on the average daily consumption per capita for rural areas in several continents. These data are given in table 2.1.

Table 2.1. Range of average daily consumption per capita (litres per capita per day) in rural areas.

| | | | |
|-----------------------|-------|----------------------|--------|
| Africa | 15-35 | Latin America & | |
| South East Asia | 30-70 | Caribbean Area | 70-190 |
| Western Pacific | 30-75 | World average for | |
| Eastern Mediterranean | 40-85 | developing countries | 35- 90 |

Source: WHO (10)

The average domestic water consumption per capita per day for various types of supplies in rural areas of developing countries is summarized in table 2.2.

The first column contains figures quite suitable for design purposes, whereas the second column shows what variations may occur in the respective consumption-figures.

Table 2.2. Average daily consumption and range of daily consumption in litres per capita for various types of rural water supplies.

| type of supply | average daily consumption | range of daily consumption |
|--------------------------------|---------------------------|----------------------------|
| unpiped supplies | 15 | 5- 25 |
| piped supplies with standpipes | 30 | 10- 50 |
| piped connections (single tap) | 50 | 20-100 |

Source: Feachem et.al. (12)

2.2. WATER QUALITY CRITERIA AND WATER RELATED DISEASES

Various national and international standards exist for drinking water quality. Most developing countries have adopted the WHO standards (see appendix 1) and are aiming to meet these standards to the extent possible in their actual water supply practice. The WHO standards include water quality criteria for physical, chemical and bacteriological aspects. The general characteristics of good drinking water may be formulated as follows: it must be free of pathogenic organisms, toxic substances and an overdose of minerals and organic material; to make it pleasant it should be free of colour, turbidity, taste and odour; moreover, it should contain a high enough oxygen-content and it should have a suitable temperature.

Due to relatively high temperatures which favour the survival chances of pathogenic organisms in the natural waters of many developing countries, the bacteriological quality of the water is one of the main factors in determining whether the drinking water is safe.

But some water-related diseases are not caused by poor bacteriological quality of the water but by a shortage of water, or by inadequate personal and domestic hygiene.

Table 2.3 shows a classification of water-related diseases, with examples for each category and preventive strategies against the occurrence of such diseases.

Table 2.3. Categories of infectious water-related diseases and preventive strategies.

| Categories of transmission mechanisms | Examples | Preventive strategy |
|---|--|---|
| 1. Water borne infections - classical - non-classical | typhoid, cholera infective hepatitis | improve water quality and prevent casual use of other unimproved sources |
| 2. Water washed infections - skin and eye infections - diarrhoeal diseases | trachoma, scabies bacillary dysentery | improve water quantity and water accessibility, improve hygiene |
| 3. Water based infections - penetrating skin - ingested | schistosomiasis guinea worm | decrease need for water contact, control snail populations and improve water quality |
| 4. Infections with water related insect-vectors - biting near water - breeding in water | sleeping sickness yellow fever | improve surface water management, destroy breeding sites of insects and decrease need to visit breeding sites |

Source: White et.al. (11)

The present knowledge of tropical epidemiology indicates that low income groups in particular have high morbidity due to non-waterborne faecal-oral or water-washed infections as a result of lack of water for personal hygiene or of insufficient hygienic practices. As is shown in table 2.3, first the water quantity and the accessibility and reliability of supplies should be improved, then efforts should be made to improve the bacteriological quality of the water. This may be done by measures aimed at the prevention of pollution of raw water sources with faecal material or treatment of the water with purification methods which allow for a considerable improvement of the bacteriological quality, such as slow sand filtration and other disinfection methods.

Recent surveys (12) show that improved village water supplies often have measurable effects on health only if at the same time programmes on health education are implemented which are geared towards improved personal and domestic hygiene.

3. PRINCIPLES OF SLOW SAND FILTRATION

3.1. INTRODUCTION

Slow sand filtration is a purification process in which the water to be treated is passed through a porous bed of filter medium. During this passage the water quality improves considerably by reduction of the number of micro-organisms (bacteria, viruses, cysts), by removal of suspended and colloidal material, and by changes in its chemical composition. In a mature bed a thin layer called the Schmutzdecke forms on the surface of the bed. This Schmutzdecke consists of a great variety of biologically very active micro-organisms which break down organic matter, while a great deal of suspended inorganic matter is retained by straining.

The slow sand filtration process is essentially distinguished from rapid sand filtration by the Schmutzdecke and the purification processes which take place in this thin surface layer. The main feature of rapid sand filters is the removal of relatively large suspended particles by physical processes. Moreover, rapid sand filters require cleaning by a rather complicated backwashing operation, whereas slow sand filters are cleaned by the relatively simple periodical removal of the top of the filter bed, including the Schmutzdecke.

In principle, the porous substance of the filter bed may be any stable material, but in the domestic water supply field the normal practice is to use beds of granular material. Sand in particular is used as it is cheap, inert, durable, widely available and gives excellent results.

3.2. DESCRIPTION OF THE BASIC ELEMENTS OF A SLOW SAND FILTER

Basically, a slow sand filtration unit consists of a box, containing a supernatant raw water layer, a bed of filter medium, a system of underdrains and a set of filter regulation and control devices (see figure 3.1):

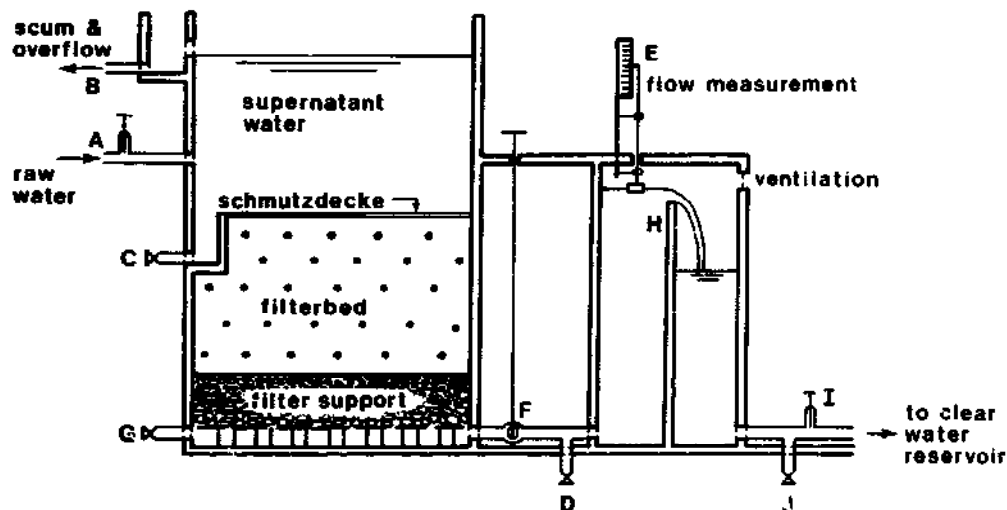

Figure 3.1. Basic elements of a slow sand filter.

the supernatant water layer

The supernatant water layer serves two purposes: first, it provides a head of water sufficient to make the raw water pass through the bed of filter medium; second, it creates a detention time of several hours for the raw water to be treated, during which period particles may settle and/or agglomerate or be subjected to other physical or (bio)chemical processes. By no means, however, should the supernatant water "reservoir" be considered an ordinary sedimentation basin. If the raw water contains a relatively high content of suspended matter, a pre-treatment unit should be installed to prevent rapid clogging of the slow sand filter (see also paragraphs 3.4., 3.5. and 3.8.).

A suitable depth of the supernatant water layer is 1 metre (range 1-1.5 metres). Normal practice is to hold the level of the supernatant water at a constant value, but there are various modes of operation (e.g. declining rate filtration¹⁾).

The walls of the supernatant water reservoir must be high enough to allow for a freeboard²⁾ of 0.2-0.3 m above the water level.

For the removal of scum³⁾, the supernatant water reservoir may be equipped with a (manual) scum removal device and a scum drain channel. The reservoir should also contain an overflow weir which drains the surplus water back to the raw water source.

the bed of filter medium

The filter medium should consist of inert and durable grains. Normally, (washed) sand is chosen. It should be free from clay and loam, and preferably free from organic matter.

The filter medium is characterized by its effective size⁴⁾ and uniformity coefficient⁵⁾. Normally an effective size in the range of 0.15-0.35 mm is selected. When no natural sands with this characteristic are available, the desired value of the effective size may be obtained by mixing two types of sand. At last resort, screening can be used.

The uniformity coefficient should preferably be less than 2, although values up to 5 are acceptable. For a proper functioning of the purification process a minimum filter bed thickness of 0.6 metre should be provided.

Since the top layer (10-20 mm) of the filter bed will have to be removed regularly during operation (see paragraph 3.3 and 3.7) a new filter should be

1) ²⁾: see glossary

provided with a filter bed 1 metre thick (range 1-1.4 metres) so that the bed will not have to be refilled more than once every few years.

the system of underdrains

This drainage system serves two purposes; it provides an unobstructed passage for the collection of treated water and it supports the bed of filter medium, so that a uniform filtration velocity over the entire filter area is guaranteed.

The drainage system may have various configurations such as a layer of coarse gravel or broken durable stones, or structures of main and lateral drains, built up from perforated or non-jointed pipes, concrete blocks or bricks (see figure 5.12). This system of underdrains is covered by layers of gravel.

The gravel is laid in layers commencing with large size pieces at the bottom, reducing in size, progressively to the top.

The gravel prevents filter bed grains from being carried into the drainage system.

Including the gravel layers, the system of underdrains should have a thickness of 0.5 metre (range 0.4-0.7 m), see figure 5.12.

a set of filter regulation and control devices

The most important operations to be regulated and controlled by valves, weirs and other devices are mentioned below. A number of suitable appliances will be described in paragraph 5.6.

- delivery of raw water into the supernatant water reservoir up to a constant level in the filter box (A in figure 3.1.);

- drainage of surplus water and scum by means of an overflow weir (B in figure 3.1.);
- drainage of the supernatant water prior to filter cleaning (C in figure 3.1.);
- drainage of the water in the top layer of the filter bed (D in figure 3.1.);
- measurement of the flow rate of effluent[■] water by means of a calibrated flow rate measurement device (E in figure 3.1.);
- regulation of the filtration rate (F in figure 3.1.);
- backfilling of the filter bed with clean water after cleaning of the filter (G in figure 3.1.);
- prevention of negative pressure[■] in the filter bed (H in figure 3.1.);
- delivery of treated water to the clear water storage reservoir (I in figure 3.1.), or to waste (J in figure 3.1.);

From the above description of the basic elements of a slow sand filter it can be gathered that, including the foundation (0.15 m), the total vertical height of the watertight box should be about 3 metres (range 2.8-3.5 m). Construction materials commonly used are mass or reinforced concrete, ferro-cement, natural stone or brickwork. The filter box, effluent channel and clear water storage reservoir should be watertight for two reasons: to prevent water loss and, in case of a high groundwater table, to prevent ingress of groundwater, which might contaminate the treated water.

3.3. THE PRINCIPLE OF THE PURIFICATION PROCESS

The purification starts in the supernatant raw water layer where large particles will settle onto the filter bed and smaller particles may agglomerate to settleable flocks due to physical or (bio)chemical interactions.

Under the influence of sunlight, algae will grow, producing oxygen which will be suitable for other purposes in the supernatant water layer and in the filter bed.

The number of bacteria will decrease and there will be some reduction of organic matter due to consumption by algae or chemical oxidation.

The major part of the removal of impurities and the considerable improvement of the physical, chemical and bacteriological quality of the raw water takes place in the filter bed and especially in the Schmutzdecke at the top of the filter bed. In this top layer abound micro-organisms such as algae, plankton, diatoms and bacteria, which, through their tremendous biological activity, break down organic matter.

A great deal of inorganic suspended matter is moreover retained by straining.

As the water passes through the bed it is constantly changing direction so that particles carried by the water come into contact with the filter grains by various transport mechanisms. The grains become covered with a sticky layer of mainly organic material which in turn absorbs these particles by various attachment mechanisms. At the same time the active micro-organisms (bacteria, protozoa, bacteriophages) in the sticky layer around the grain feed on the impurities caught as well as on each other. In this way, degradable organic matter, including bacteria and viruses of feecal origin, is gradually broken down and converted into water, carbon dioxide and harmless inorganic salts. The life-filled zone where these purification mechanisms take place extends to about 0.4-0.5 m down from the surface of the filter bed, but it gradually decreases in activity downwards as the water is purified and contains less organic matter and nutrients. At greater depth in the filter bed the products of the biological processes are further removed by physical processes (adsorption) and chemical action (oxidation).

The transport, attachment and purification mechanisms described will only function effectively for the water to be treated if a sufficient detention time in the filter bed is allowed. Especially, when slow sand filtration is the main treatment process, the rate of filtration should be kept at a value of 0.1 and 0.2 metre/hour (or 0.1-0.2 m³/m² bed area per hour). Another important parameter for the purification process is the oxygen content of the water. The activity of the bio-mass will decrease considerably if the oxygen content of the water in the filter medium falls below 0.5 mg/l. If anaerobic conditions occur, various obnoxious impurities may be added to the water by the bio-mass.

Such occurrences may be prevented by aeration[■] of the raw water (see paragraph 3.8), pre-sedimentation of the raw water (see appendix 2) or a recycling of part of the aerated effluent to the supernatant water reservoir.

An oxygen content of more than 3 mg/l in the filter effluent is the normal goal. Since water with this oxygen content may not be very suitable for public supplies, some additional aeration of the filtered water is required.

For this purpose a simple overflow weir which suits a dual purpose with respect to aeration is installed in the effluent channel. The weir increases the oxygen content of the filtered water and simultaneously decreases the content of carbon dioxide and some other obnoxious dissolved gases which have been added to the water as by-products of the bio-chemical processes. For enhancement of this process, the weir chamber must be provided with a ventilation shaft.

The effluent weir has two more important functions: it prevents negative pressure in the filterbed by ensuring a minimum overflow-level slightly above the top-level of the filter bed, and it makes the operation of the filter bed independent of fluctuations of the water level in the clear water reservoir.

3.4. PERFORMANCE OF SLOW SAND FILTERS

The effect of the purification process on the water quality depends on many factors, such as raw water quality, the rate of filtration, grain size of the filter medium, the temperature and the oxygen content of the water. For normal operational conditions, the average performance of slow sand filters with regard to the removal of certain impurities is summarized in table 3.1.

Table 3.1. Performance of slow sand filters.

| parameter | purification effect |
|----------------|---|
| organic matter | slow sand filters produce a clear effluent, virtually free from organic matter |
| bacteria | between 99% and 99.99% of pathogenic bacteria may be removed; cercariae of schistosoma, cysts and ova are removed to an even higher degree; <u>E.Coli</u> ⁸ are reduced by 99-99.9 % |
| viruses | in a mature slow sand filter, viruses are virtually completely removed |
| colour | colour is significantly reduced |
| turbidity | raw water turbidities of 100-200 NTU ⁸ can be tolerated for a few days only; a turbidity more than 50 NTU is acceptable only for a few weeks; preferably the raw water turbidity should be less than 10 NTU; for a properly designed and operated filter the effluent turbidity will be less than 1 NTU |

The performance of slow sand filters for any specific raw water source may be tested by means of a small pilot plant, e.g. consisting of oil vessels.

Algae may play a positive role in the performance of slow sand filters. They are able to build up cell material from simple minerals such as water, carbon dioxide, nitrates and phosphates, thereby producing oxygen which in turn is beneficial to other bio-chemical processes. Algae can also consume organic matter and convert part of it into more biodegradable cell-material; their presence may improve the quality of the Schmutzdecke.

On the other hand, too high an algae content in the supernatant raw water may disrupt the proper functioning of the filter due to clogging or due to the emergence of anaerobic conditions when large amounts of algae die off. Regular harvesting of algae or shading of the filters are good methods to cope with these problems.

Certain types of algae have a detrimental effect on the filter performance, such as short filter run periods notwithstanding proper design criteria. If such algae develop, shading of the filters may be required.

Another consequence of the growth of algae is a daily variation in the oxygen consumption and thus the effluent oxygen content.

This is explained by the fact that in daylight algae produce more oxygen than they consume, but at night the reverse is the case.

Therefore the oxygen content of the effluent will be at a minimum at daybreak, while it will be at a maximum at the end of the afternoon.

3.5. APPLICABILITY AND LIMITATIONS OF SLOW SAND FILTERS

Slow sand filtration is an efficient method for the removal of organic matter and pathogenic organisms.

It is therefore a particularly appropriate treatment method for surface waters containing unwelcome quantities of such impurities. The turbidity of surface waters may, however,

limit the performance of slow sand filters, so that quite often some pre-treatment may have to be applied; see table 3.1 and the last two paragraphs of this chapter.

Slow sand filters have some limitations as they require a large area and a large quantity of filter medium. Moreover it may be necessary to install expensive roof structures to prevent the entrance of sunlight, if the development of unacceptable amounts or certain types of algae is expected. Another limitation may be sudden changes in raw water quality which can upset the performance of biological filters, for example a high turbidity content during the rainy season (or possibly toxic industrial wastes). Apart from the availability of suitable filter medium and the occurrence of high turbidities during certain periods, the above mentioned limitations normally do not apply to rural and urban fringe areas of developing countries or can be obviated without serious constraints.

3.6. ADVANTAGES OF SLOW SAND FILTERS

In comparison with various other treatment methods designed for the removal of organic matter, pathogenic organisms, turbidity and colour, slow sand filtration has many advantages. It is the only known unit-operation which accomplishes such a high degree of simultaneous improvement of the physical, chemical and bacteriological quality of raw water.

In developing countries there are a number of special advantages, such as:

- the simplicity of design, construction and operation enables the application of locally available materials and skills with limited technical supervision; only common pipework and appliances are required and no special equipment or instrumentation is needed

- if sufficient filter bed materials are available the cost of construction is relatively low
- imports of material and equipment can be almost negligible and, apart from a possible disinfection or safety chlorination of effluent, no chemicals are required (if for highly turbid waters advanced pre-treatment techniques such as flocculation/coagulation^m are being used, considerable amounts of chemicals may be required)
- operation and maintenance can be carried out by semi-skilled labour; a slow sand filter does not require back-washing (as compared to a rapid sand filter)
- power may only be required to pump raw water to the supernatant water "reservoir"; the filtration process is carried out by gravity; no other power-driven mechanical parts are present
- fluctuations can be accommodated, provided turbidity does not become excessive for a long period
- no wash water is required for the cleaning of the filter, therefore some water is saved in comparison with other filtration systems
- sludge handling causes no problems; the sludge is small in quantity and has a very high dry matter content.

3.7. OPERATION AND MAINTENANCE OF SLOW SAND FILTERS

Provided that a slow sand filtration unit has been well designed and constructed, it requires only a simple routine of operation and maintenance. Except for some of the physical, chemical and bacteriological analyses of samples of the effluent water, all activities of operation and maintenance can be carried out by local manpower. These operation and maintenance activities are comprehensively described in a companion document (9).

Periodically, comprehensive analyses of water samples may be carried out by the district medical authorities, although the operator can be taught to carry out some simple standard tests by himself. In this respect reference is made to the WHO Monograph No 63 (13).

Some of the main operation and maintenance activities are listed below:

— *initial commissioning of a filter*

When the construction of the filter has been completed, the filter bed is charged with clean water from the bottom of the filter to drive out the air bubbles present in the interstices of the sand.

When the level of the supernatant water reaches well above the sand bed (0.1 m), raw water may be admitted through the raw water inlet, in such a way that no turbulence is caused in the supernatant water (see paragraph 5.3.). By the time the supernatant water has reached the design level, outlet valve D (see figure 3.1) is opened, and the effluent is run to waste or to another filter at a rate (controlled by the filter regulating valve F) of about one quarter of the normal filtration rate.

The filter must now be run for a few weeks to enable the formation of the Schmutzdecke and the sticky layers around the filter bed grains, the so-called "ripening process".

During this process the filtration rate is gradually increased until it reaches the design filtration rate. After comparative physical, chemical and bacteriological analyses of the raw water and the filtered water have shown that the filter is working properly, the drain valve D may be closed and the effluent directed to the clear water tank by opening valve I.

operation of the filter regulating valve

After a proper ripening process the filter will operate successfully for several weeks with the regulating valve F almost fully closed.

Then, as the Schmutzdecke becomes clogged, the valve is gradually opened, a little each day, to compensate for the head loss in the Schmutzdecke and to maintain the flow rate at a constant value.

The flow rate may be measured by a venturi meter⁸ immediately upstream of the regulating valve or by a floating indicator device in the upstream section of the weir chamber (see figure 3.1 and paragraph 5.6.)

Floating effluent weir

A floating effluent weir (see figure 3.3), situated in a weir chamber having the same height as the filter box, may substitute both the flow rate measurement device and the filter regulating valve as indicated in figure 3.1.

The flow rate of a floating weir is determined by the size of the inlet and the immersion depth of the inlet. By adjusting the immersion depth of the inlet, the floating weir will regulate the effluent flow rate to a pre-set value, while the hydraulic resistance of the filter regulating valve is substituted by a higher level of the filtered water in the weir chamber.

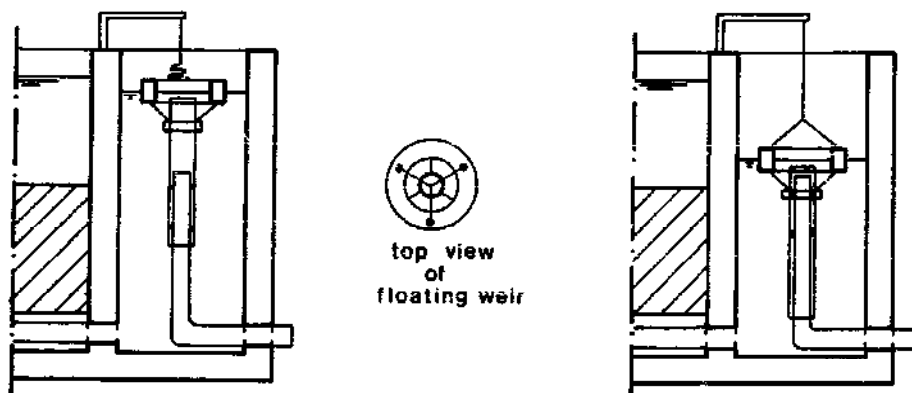

Figure 3.3. The functioning of a floating effluent weir.

Normally, the floating weir should be provided with a small chain which prevents the weir from dropping below a certain level (minimum level of the crest of the effluent weir). The arrival at this level indicates that a filter run period has come to its end. The chain is also used to shut down the filter by pulling the floating weir up to the top of the weir chamber. To make this method of operation independent of the level of the treated water in the clear water tank, another effluent weir should be installed in the inlet section of the clear water tank. Both the crest of this effluent weir and the inlet of the floating weir, at its minimum admitted level, should be situated some distance (e.g. 0.2 m) above the top level of the filter bed to prevent negative pressure.

The hydro-static head of water in the transport line of the floating weir is determined by the level of the crest of the effluent weir just mentioned. To enable backfilling of a filter after a cleaning operation, the length of the chain attached to the floating weir should be extended by some 0.2 m. In this way, filtered water from other filters will flow through the floating weir in the reverse direction and flow into the filter bed from the system of underdrains.

cleaning of the filter

When, after an operation period of several weeks or months, the regulating valve is fully opened and the rate of flow starts to decrease, the resistance of the Schmutzdecke has become too high and the filter must be cleaned. The raw water inlet valve A is closed and the level of the supernatant water is allowed to drop by continuing the filtration process for some hours.

The remaining supernatant water is drained by opening the drain valve C. Finally the water level in the filter bed is lowered to about 0.2 metre below the surface of the bed by opening the drain valve D.

The Schmutzdecke is then carefully removed by using flat-nosed shovels, the cleaning period being as short as possible to prevent deterioration of the filter bed and possible damage to the bed by scavenging birds. The Schmutzdecke, and the sand removed with it, may be tipped or be washed for re-use.

When a filter is being cleaned, the rate of filtration through the remaining filters has to be suitably increased to obtain the normal output from the plant. The procedures to be followed for the start-up of a cleaned filter ("re-ripening period") are similar to those applied for the initial commissioning of a new filter, although the periods required for both back-filling (a few hours) and re-ripening (a few days) are much shorter than the initial commissioning period.

regulation of the supernatant water level

Under normal operational conditions the level of the supernatant water must be kept at a value as constant as possible.

This may be done by a hand-controlled gate valve A, or an overflow weir B which leads the surplus water back to the raw water source. Preferably a combination of the valve and the overflow weir is adopted.

If the raw water is fed to the filter unit by pumping, the quantity of overflow water should be kept to a minimum to save on energy costs.

level regulation of the effluent weir

The crest of the effluent weir H should not be below

a level slightly above the surface of the filter bed to prevent the build up of negative pressure in the filter bed.

If the effluent weir consists of a rigid structure (see figure 3.1), special attention is required during the (re-)sanding of the filter to prevent the top level of the filter bed from reaching above the crest of this weir.

resanding of a filter

After several years of operation (approximately 3-4 years) and about 20-30 scrapings, the filter bed reaches its minimum permissible thickness and new or washed filter medium must be brought in to raise the bed to its original depth. The new filter medium should be placed under the top 0.3-0.5 m of old filter medium by a so-called "throwing-over" process. See figure 3.2.

By doing so, the top layer which is richest in micro-biological life is replaced at the top of the filter bed which will enable the re-sanded filter to become operational with a minimum re-ripening period.

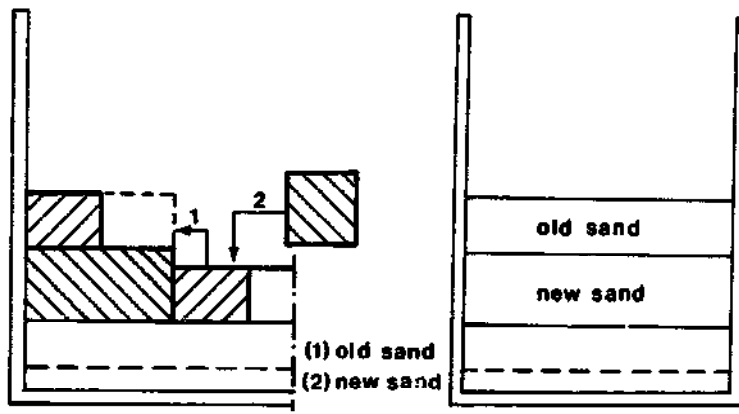

Figure 3.2. Throwing-over process.

ALTERNATIVE MODES OF OPERATION

Declining rate filtration

Declining rate filtration will start as soon as the raw water feedline to the supernatant water "reservoir" is closed, while the filter regulating valve is kept at the same position. The supernatant water will now be filtered at a continuously declining filtration rate due to a continuous reduction of the head of the supernatant water.

This mode of operation may be applied during the night and allows for savings on labour costs and capital investment costs.

If declining rate filtration is applied, the minimum level of the crest of the effluent weir should be 0.2 m above the top of the filter bed. Such a provision prevents a too shallow depth of the supernatant water at the end of a declining rate filtration period. If this water depth should fall below 0.2 m, it could cause unwelcome events such as damage to the Schmutzdecke by scavenging birds, the filter bed running dry due to evaporation, etc.

After a period of declining rate filtration, the supernatant water reservoir will have to be refilled to its normal level to allow for filtration at the normal designed filtration rate. This refilling should be done as quickly as possible (without disturbing the Schmutzdecke!) to make maximum use of the production capacity.

Normally a period of about one hour may be allocated to realize this refilling operation. Raw water pumps and possible pre-treatment units should be designed in accordance with this mode of operation.

Intermittent operation

At intermittent operation the filtration process is stopped completely during certain periods (e.g. night-time). This means that not only the feedline to the supernatant water reservoir is closed, but also the effluent line to the weir chamber. For this purpose it is recommended that an extra valve be installed in the effluent line, so that the filter regulating valve may be kept in its operating position and will function properly as soon as the filtration process is restarted.

There are still some other methods of operation, but it is beyond the scope of this manual to discuss all of them.

3.8. PRE-TREATMENT AND POST-TREATMENT IN COMBINATION WITH SLOW SAND FILTERS

Pre-treatment

For slow sand filters pre-treatment is indispensable if the turbidity of the raw water has an average value of more than 50 NTU for periods longer than a few weeks or values above 100 NTU for periods longer than a few days.

The simplest and most appropriate pre-treatment systems are river bed filtration, storage and plain sedimentation. Other suitable pre-treatment techniques are rapid "roughing" filtration and horizontal-flow coarse-material pre-filtration (6, 7).

In this paragraph these pre-treatment systems will be briefly discussed; more detailed information will be given in appendix 2.

River bed filtration may be applied for the treatment of raw waters with rather low turbidities (10-20 NTU); turbidities up to 200 NTU can be tolerated for short periods. The purification principle is based on the removal of suspended solids in a bed of granular filter material, situated in the river bed.

Storage should be applied if the average annual turbidity is more than 1000 NTU. Suspended matter is removed by natural settlement and biological processes.

Plain sedimentation may be applied for average annual raw water turbidities of 20-100 NTU. For this treatment system turbidities up to 400 NTU for periods not longer than a few weeks are acceptable.

Rapid "roughing" filtration may be successfully applied as a pre-treatment method for raw waters with turbidities of 20-100 NTU, if suitable materials such as coconut fibre or coarse gravel are easily available.

Such a filtration can be carried out in a filter box similar to the slow sand filtration box. In this case the coconut fibre material or coarse gravel will function as filter medium.

Horizontal-flow coarse-material pre-filtration may be applied for raw water turbidities up to 150 NTU.

As filter media coarse gravel or crushed stones are applied; the filter box is comparable to the one used for plain sedimentation.

Aeration of the raw water, or re-cycling of oxygen enriched effluent water to the supernatant water reservoir, will be necessary if the oxygen consumption in the filter bed leads to anaerobic conditions. Aeration of the raw water by means of a simple overflow weir prior to entering the supernatant water reservoir may be sufficient.

Post-treatment

The only post-treatment which may be required for the effluent of a slow sand filter is safety chlorination, which is mainly aimed at the prevention of aftergrowth of bacteria in storage tanks or the distribution system. It should also be applied as a precaution if the raw water source is heavily polluted with organic matter of faecal origin, for instance for raw water with an E.Coli content of 10000/100 ml or more (disinfection).

An example of a suitable chlorination system is described in Appendix 3.

3.9. A GUIDE FOR THE SELECTION OF A WATER TREATMENT SYSTEM

In the previous paragraphs we have discussed topics such as the performance of slow sand filters, their advantages and limitations, and various techniques for pre-treatment and post-treatment. It may be concluded that slow sand filtration represents an excellent technique for a substantial improvement of the physical, chemical and bacteriological quality of most of the surface waters in tropical developing countries. On the other hand, it has been indicated that slow sand filters are sensitive to some raw water quality parameters. In this respect the turbidity of the raw water is of crucial importance to the design of the total treatment system (in particular choice of pre-treatment unit). Another important parameter for the total treatment system (in particular choice of post-treatment system) is the bacteriological quality of the raw water. In this respect, the E.Coli is used as an indicator-organism.

On the basis of the two mentioned parameters, turbidity and E.Coli content, table 3.2 gives a procedure for the selection of a water treatment system incorporating slow sand filtration.

Table 3.2. Guide for the selection of a water treatment system, incorporating slow sand filtration.

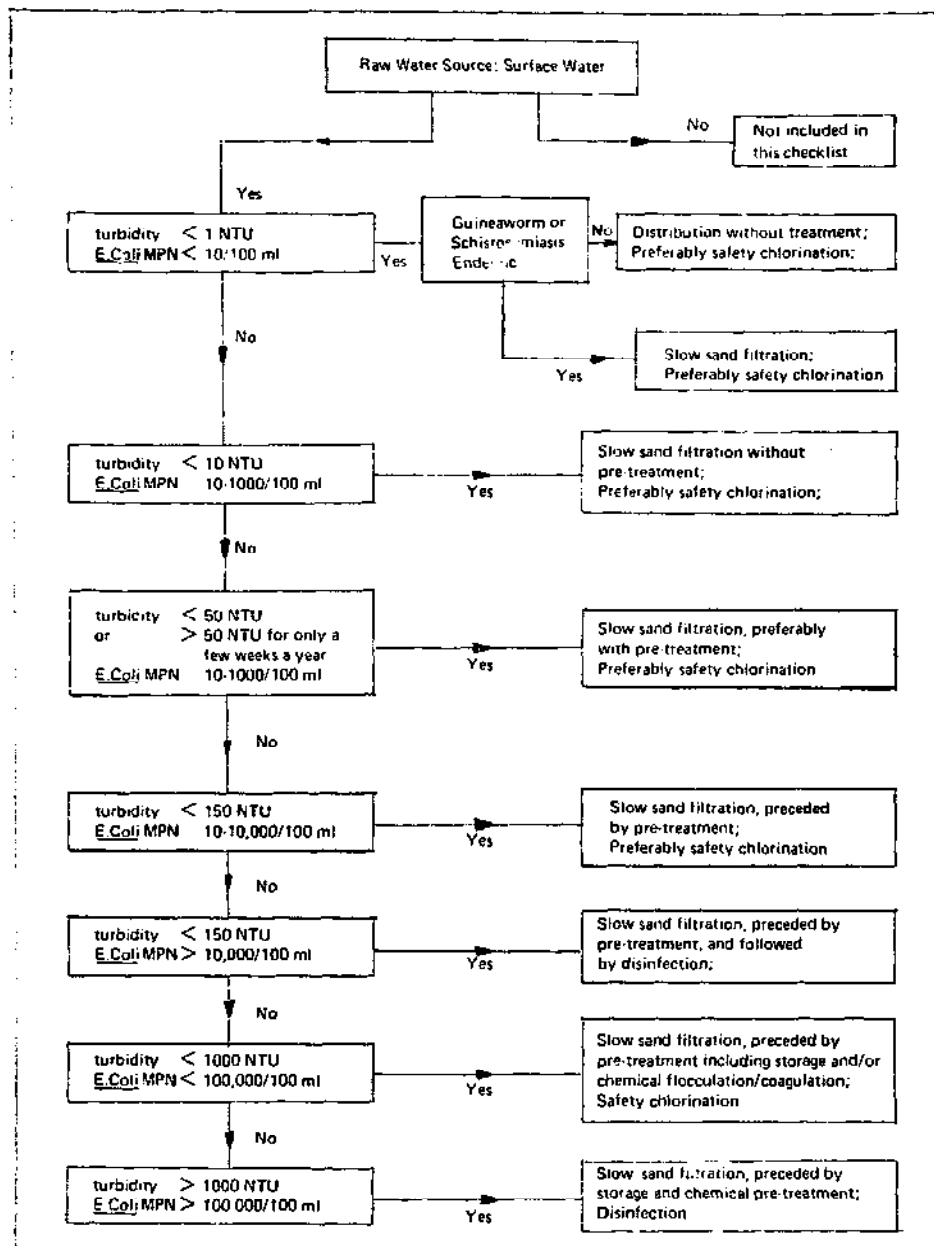

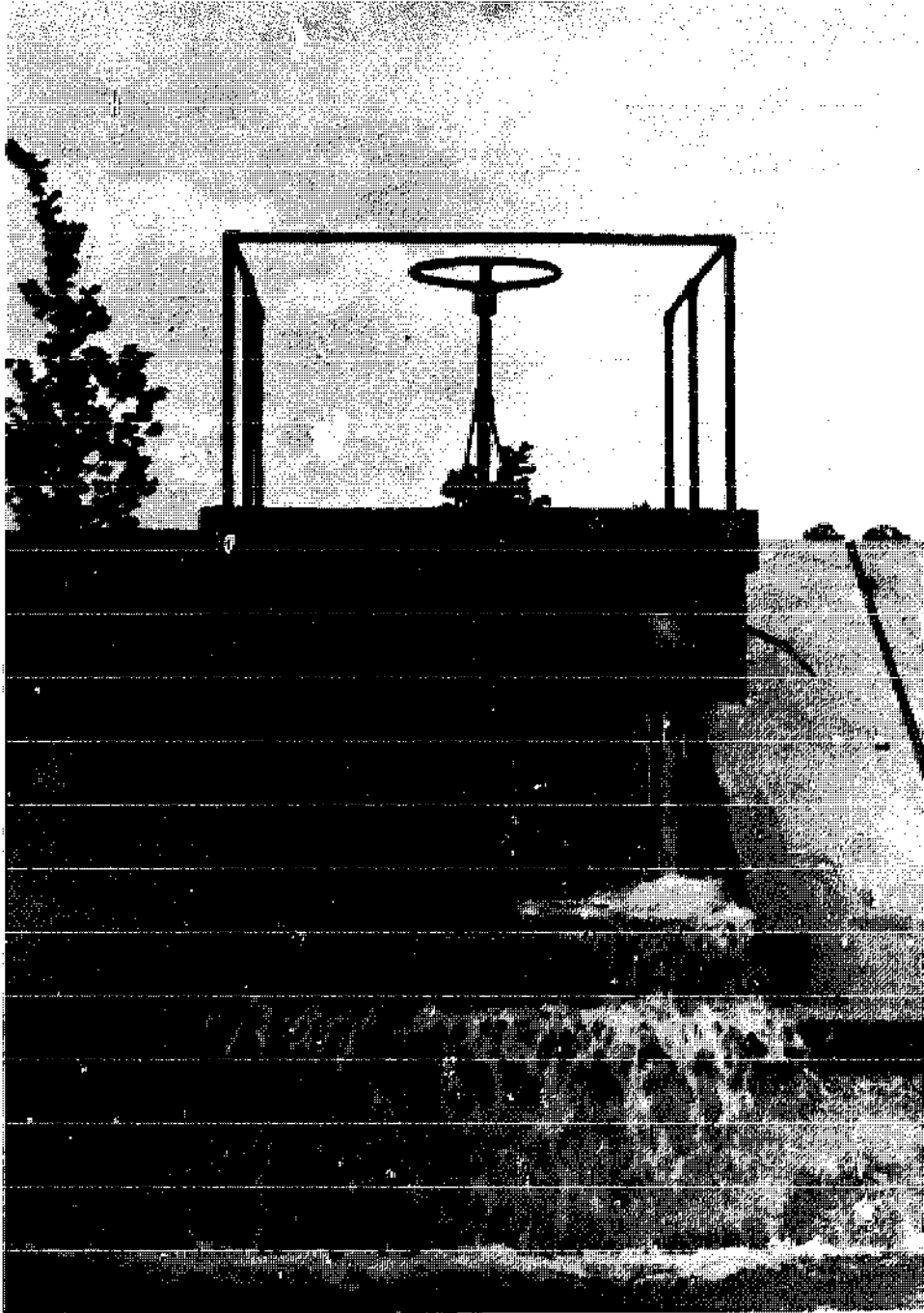

Inlet structure of a slow sand filter, Kranuan,
Thailand.

4. THE DESIGN OF SLOW SAND FILTRATION PLANTS

4.1. INTRODUCTION

The primary objectives of a water supply system are, as mentioned before, availability, quantity, quality and reliability. A sound water supply system should provide the population with water of good quality and in sufficient quantities and with maximum reliability.

It is the designer's job to convert these theoretical objectives into a realistic and economic design, taking into account local circumstances and potentialities.

When working on this responsible job, the designer will constantly have to make decisions on important items, most of which are concerned with:

1. the set-up of the water supply system, i.e. the choice of raw water source, treatment method and distribution system

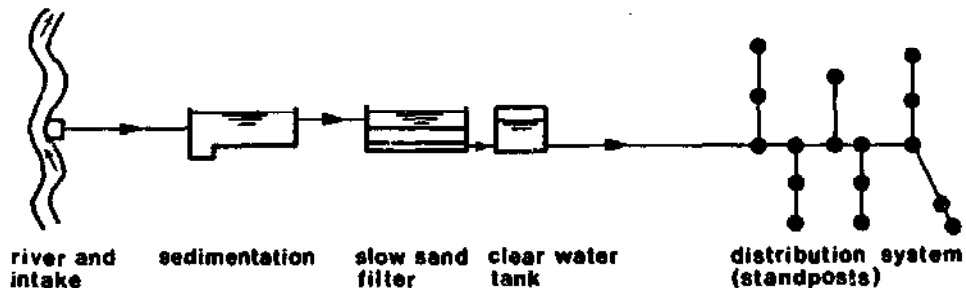

Figure 4.1. Set up of a water supply system

2. the dimensioning of the water supply system, i.e. the determination of the lay-out and size of the various elements and the plant as such.



Figure 4.2. Dimensioning of slow sand filters

3. the specification of the elements; i.e. the detailed design of constructions and appurtenances

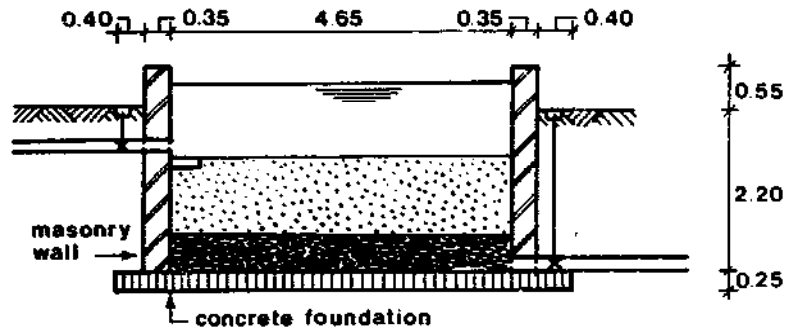

Figure 4.3. Specification of slow sand filter

In practice the set-up and dimensioning of a water supply system usually form the preliminary design, which may be used for raising funds and planning and organisational purposes. These parts of the design will be dealt with in this chapter. In the next chapter the specification of the elements, which may eventually lead to the final design, will be elucidated.

4.2. GENERAL DESIGN CRITERIA

The design of a slow sand filter and indeed of any element of a water supply system is a complex matter. Huisman and Wood (1) got to the root of the matter when stating "slow sand filtration still is an art, more than a science". And an art, unlike a science, cannot be taught by giving rules and regulations.

Nevertheless it is possible to indicate an approach, which may successfully be followed when designing a water supply system, incorporating slow sand filtration.

In general, the following criteria apply:

1. During the projected design period² the quality of the supplied water should under no circumstances deteriorate below certain limits, as indicated in chapter 3.

This implies that provisions should be made to deal with a (possible) future deterioration of raw water

quality, breakdowns of critical elements in the system and malfunctioning of the treatment system due to operational failure or unfavourable conditions (e.g. low temperatures). In this respect a slow sand filter has favourable characteristics i.e. a rather high flexibility with regard to variations in the raw water quality and self-regulating operation.

2. The capacity of the water supply should be such that at no time in the design period (serious) water shortages occur. This is a less stringent condition than the first, because whereas the deterioration of water quality could immediately bring about the outbreak of epidemic diseases, the consequences of shortage of water would appear to be limited to some inconvenience. The population may, however, be tempted to draw their water from unprotected sources, so the reduction of water quantity should also be limited to the minimum. This may lead to the incorporation of spare units, water storage tanks and possibly high level service reservoirs[■] etc.
3. The applied technology should be such that operation, maintenance and preferably repair are within the competence of the local population.

In developing countries this may mean the rejection of advanced techniques and the incorporation and development of appropriate technology. Vulnerable chemical dosing equipment should be waived in favour of robust hydraulic feeders[■] or (still better) be made superfluous by a well-considered choice of raw water source and treatment method.

Slow sand filtration is a very good example of a reliable treatment method which falls within the capabilities of the population of most villages in developing countries.

4. The construction costs of the system should be minimal within the constraints of high quality and lifetime of the components.

This means economical use of materials, particularly those which have to be imported.

Although labour costs may of course influence the construction costs, it is felt that this item should be dealt with separately. In self help projects for instance, labour is provided without charge by the population that will benefit from the results.

5. Operating costs of the system should be minimal.

This is another reason for omitting where possible dosing of chemicals. Furthermore an optimal hydraulic design will result in lower pumping costs. Operators' wages may put a heavy strain on the funds of small communities. It may therefore be decided to operate the intake and treatment works for only 8 or 16 hours per day (1 or 2 shifts, see also paragraph 4.3). In this case, a large service water reservoir, situated at sufficient height, will be necessary to ensure a continuous supply.

6. The mode of construction of the system should preferably be such that it is within the competence of local contractors.

Use of prefabricated construction elements and advanced construction expedients should be avoided, especially in small scale programmes.

Appropriate standards for steadiness and accuracy should be imposed.

It will be clear that these conditions merely form a framework, in which the designer may and must make many design decisions.

A suitable approach to the design of water supply systems is illustrated in the following paragraph.

4.3. DESIGN EXAMPLE

Let us consider a village of say 1200 inhabitants with no public water supply system. People fetch their water in jars and buckets from the neighbouring river. As the river is polluted with animal and human excreta, infectious diseases occur frequently and the need for a safe water supply system is expressed.

The first important factor to be determined when designing the new water supply system is the design period. This is the period during which the designed system must be able to provide the population with water of adequate quality and quantity. This period should not be too short (e.g. not shorter than 10 years) for reasons of undisturbed operation and not too long (e.g. not longer than 50 years) for reasons of predictability and economy.

For our village the design period is set at 15 years, so after a planning and construction period of 2-3 years the plant's capacity will be adequate for at least 12-13 years.

step 1: design period: 15 years

The design period may differ from the economic[■] or physical[■] lifetime of the various elements of the construction. In general, the following depreciation periods[■] are accepted, although financing organizations may - for economic reasons - demand much shorter capital-return periods[■]:

| | | |
|--------------|----------|----------|
| construction | elements | 25 years |
| mechanical | elements | 15 years |
| electrical | elements | 15 years |

Having established the design period, the design population must be determined, where possible using population projection

studies. If demographical data are available, population growth figures and projections for the design period can be derived from them, taking into account socio-economic factors such as family planning, migration, changes in prosperity and changes in medical care. For our village no such data are available, but on the basis of inquiries and estimates of both birth and death rates and migration figures, the design engineer arrived at a yearly growth rate[■] of 3%.

From the following table the population growth factor[■] can be determined as 1.56 (for a design period of 15 years).

| Design period (years) | Yearly growth rate (%) | | |
|--------------------------|------------------------|------|------|
| | 2 | 3 | 4 |
| 10 | 1.22 | 1.34 | 1.48 |
| 15 | 1.35 | 1.56 | 1.80 |
| 20 | 1.49 | 1.81 | 2.19 |

This means the population is likely to increase in 15 years to $1.56 \times 1200 = 1872$, say 1900

step 2: design population: 1900

Next, the design water demand has to be established. In chapter 2 the factors influencing the water demand have already been discussed. A distribution system with various standpipes is chosen for our village and the water consumption is estimated at 30 l/cap per day (maximum day[■] in design period). Including losses and wastage, estimated at 33%, the water demand will be 40 l/cap per day. The design daily water demand can now be calculated as follows:

$$1900 \text{ (cap)} \times 40 \text{ (l/cap,d)} = 76 \text{ m}^3/\text{d}$$

step 3a: design daily water demand: 76 m³/d

The design hourly water demand is estimated at 20% of the design daily water, i.e. 8 l/cap per hour (maximum hour² is design period). This figure is important with regard to the design of the clear water tank and distribution pipes. The design hourly water demand can be calculated at:

$$1900 \text{ (cap)} \times 8 \text{ (l/cap,h)} = 15.2 \text{ m}^3/\text{h} \text{ say } 15 \text{ m}^3/\text{h}$$

step 3b: design hourly water demand: 15 m³/h

For our village, on the basis of estimates of the water used for cooking, washing etc., the designer has come to the following daily pattern of water use.

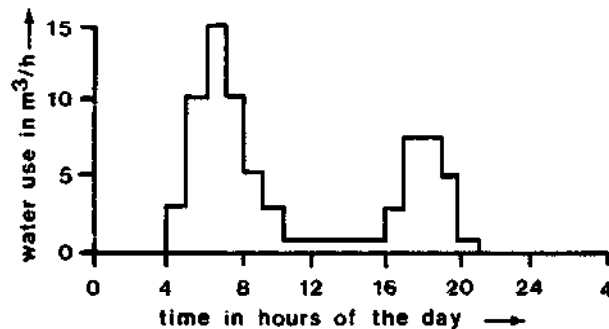

Figure 4.4. Daily pattern of water use

Having established the design water demand, the set-up of the water supply system has to be further elaborated. A proper raw water source and suitable treatment methods have to be chosen in accordance with the given prerequisites. This procedure has already been outlined in chapter 3. From information concerning geological properties of the subsoil and a few test boreholes made with simple equipment

(see appendix 4) it was found that for our village no groundwater was available at reasonable depths, so it is decided to draw the water for the public supply system from the neighbouring river.

The river takes its rises in the highlands and, although hydrological readings are not available, it is estimated that the minimum flow during dry season will not drop below 400 l/sec. The proposed maximum drawoff of 15 m³/h will therefore be only 1% of the minimum flow, which is quite acceptable.

step 4: water source: river

From information gathered from authorities upstream it is found that the water quality parameters are all within acceptable limits for human consumption (see appendix 1) with the exception of turbidity (5-100 NTU) and microbiological parameters (MPN⁸ E.Coli 100-1000/100 ml), while the Chemical Oxygen Demand⁸ (COD) is also fairly high (4-8 mg/l). A number of samples taken at the site of the proposed water intake (one at low flow and one at high flow) and sent to the district water authorities for chemical and microbiological analysis, confirm these findings.

On the basis of the checklist described in chapter 3.9, it is decided to treat the riverwater by means of plain sedimentation, followed by slow sand filtration. This type of treatment is believed to lower the turbidity to less than 1 NTU and the COD to 2-4 mg/l, while the microbiological parameters will adhere to drinking water standards.

step 5: treatment system: plain sedimentation and
slow sand filtration

The site of the water intake will now be determined, taking into account fluctuations in water quality due to the

occurrence of plug flows in the river and stability of the river bank (a location on the inside of a river-bend will be favourable, as flow velocities are low and suspended particles will settle). A sufficient water depth should be available at all times, which may restrict the possible site locations. Taking into account the possible contamination of the river water by excreta from the village, the intake for the treatment unit will be located upstream from the village.

step 6: intake location: upstream from the village

The location of the treatment works is the next thing to consider. Factors which obviously influence this are the location of the water intake and the distribution system. However, availability of a suitable area and topography, soil properties and ground water level are even more important factors.

Compressibility and bearing capacity are the soil properties which determine the mode of foundation. It will be clear that foundation on piles and piers must be avoided if possible.

In appendix 4 a description is given of some simple soil investigation methods that may be used when designing a water treatment plant.

A high ground water table (i.e. close to soil surface) will make excavation difficult and drainage either in the open or by means of filter wells will be necessary. Needless to say this will add to the complexity and cost of the design. Further, a high ground-water table has the disadvantage that special provisions must be taken to prevent both pollution of the treated water by ground water and forcing up of the construction by water pressure. In the following chapter the influence of soil properties and ground water table on the design of the filter box and appurtenances is elucidated further.

Our village was fortunate enough to find a suitable area for the treatment plant near the water intake, so the plant operator(s) can also easily look after the raw water pumps.

step 7: site location: near intake

The layout of the treatment plant must now be considered. The most suitable layout depends on many factors, the most important being plant size, construction materials used and possibility of future extensions. Possible configurations are given in chapter 6.

The dimensioning of the filters is rather simple once the mode of operation and the design filtration rate, usually set at 0.1 m/h, are established.

Continuous operation for 24 hours per day will of course provide the maximum production per filter bed, but on the other hand 3 shifts will be necessary so the costs of the operators' wages will be relatively high. It is therefore recommended that the costs of extra filter bed area should be balanced against the costs of the operators' wages (in case no pumping is necessary, continuous operation with only 1 shift may be possible). Another item of importance in this respect is the consideration that the filters may be operated for part of the day at a so-called declining rate filtration. This is the case when the operator closes the raw water inlet valve at the end of his shift and shuts down the raw water pumps, but keeps the filter outlet valve open.

The supernatant water will drain through the filter at a continuously declining rate. Assuming a filtration rate of 0.1 m/h and a supernatant water level of 0.9 m above the crest of the effluent weir it can be calculated that after 8 hours the water level will have dropped by about 0.5 m and after 16 hours by about 0.7 m. This means an extra water production of 0.5 m³/m² per day for 8 hours of declining rate filtration and 0.7 m³/m² per day for 16 hours. The

required filter bed area can be reduced accordingly.

In the following table, the required filter bed area and the number of operators are given for the design daily water demand of 76 m³/d with various modes of operation.

| Mode of operation | Required filter bed area | Number of operators |
|--|--------------------------|---------------------|
| 3 shifts (24 hours operation) | 31.7 m ² | 3 |
| 2 shifts and declining rate filtration during night-time (8 h) | 36.2 m ² | 2 |
| 2 shifts | 47.5 m ² | 2 |
| 1 shift divided in four hours during morning and four hours during evening and declining rate filtration in between (16 h) | 42.2 m ² | 1 |
| 1 shift and declining rate filtration during night-time (16 h) | 50.7 m ² | 1 |
| 1 shift | 95.0 m ² | 1 |

The filter bed area required may be calculated by the following general formula:

$$X = \frac{Q}{0.1 \times a + b}$$

where: X = required filter bed area (m²)
 Q = design daily water demand (m³/d)
 a = number of daily production hours at normal operation (i.e. filtration rate of 0.1 m/h)
 b = 0.5 if daily period of declining rate filtration amounts to 8 consecutive hours

- = 0.7 if daily period of declining rate filtration amounts to 16 consecutive hours
- = 0 if no declining rate filtration is applied

For our village, it is decided to operate the plant with 1 shift and declining rate filtration during the night. As a rule of thumb it may be stated that for small plants (i.e. smaller than 300 m³/d) this mode of operation will be most appropriate. For plants with a capacity between 300 and 600 m³/d, 2 shifts followed by declining rate filtration may be appropriate, whereas for larger plants 3 shifts will probably be the best choice.

step 8: mode of operation: 1 shift (8 h) and declining rate filtration during the night (16 h)

The filter bed area required may be read from the table given above.

step 9: net filter bed area: 50.7 m² say 52 m²

The total filter bed area being known, the number of filters still has to be determined. The most appropriate size for a filter unit is influenced by many construction, technological and operational aspects, as explained in chapter 5.

In the case of our village a good solution might be to choose 2 filters, each with a net area of 26 m². In this way the shut down of one filter would mean an increase of the load on the other to at the most 0.2 m/h, which is quite acceptable. Further, it would be wise to reserve space for a future third unit of 26 m².

step 10: dimensions of filters: 2 filters each 26 m²,
height 3 m.

The dimensions of the pre-treatment unit (plain sedimentation) can be determined on the basis of the design criteria, set forth in appendix 2.

For our village it is decided to construct a large sedimentation pond by erecting a dam alongside the river bank.

The water is permitted to flow into the pond and suspended matter will settle.

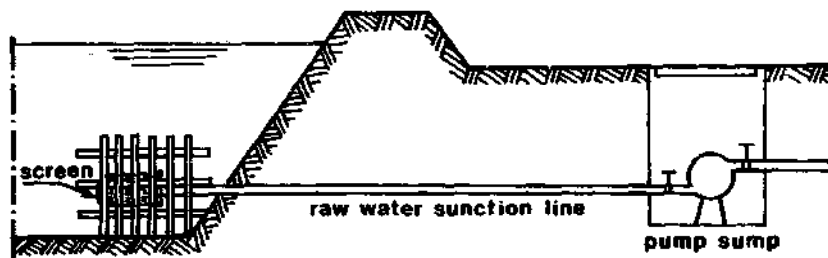

Figure 4.5. Intake from a sedimentation pond

step 11: dimensions of sedimentation pond:

depth 6 m

area 1140 m²

detention time 3 months

The declining rate filtration of the filters calls for special provisions in the supply of raw water. As the water level in the filters drops by 0.7 m during the night, a large flow of water will have to be supplied to the filters in the morning. This means that either the pump capacity will have to be raised or a high level raw water storage tank has to be built. The advantage of the latter is that also during the night water may be allowed to flow to the filters, thereby further increasing the water production.

The dimensions of the clear water tank can be determined from the daily pattern of water use and the water production

by the filters. Assuming that the operator's shift starts at 7 a.m. and ends at 3 p.m., the daily water production can be represented by figure 4.6.

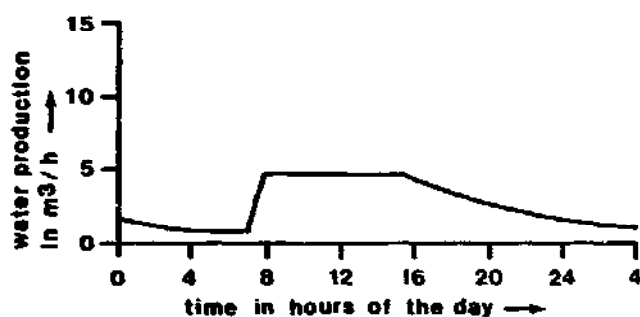

Figure 4.6. Daily pattern of water production

The accumulated difference between water use (given in figure 4.4.) and water production (given in figure 4.6.) determines the size of the clear water tank. If no data are available one may set the size of the clear water tank at 50% of the daily production (rule of thumb). From figure 4.6 it can be seen that for our village a net volume of 30% of the daily production will be sufficient.

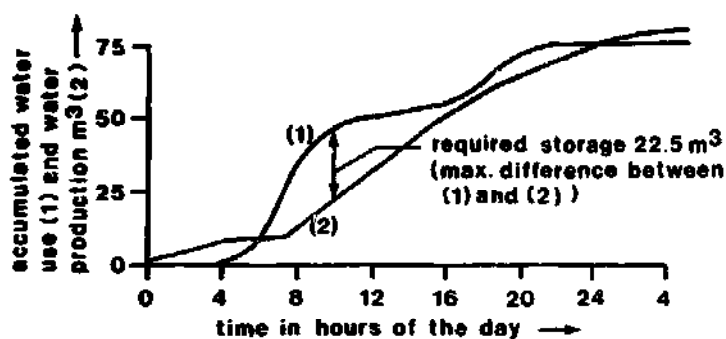

Figure 4.7. Accumulated water production and water use

Therefore the net storage capacity of the tank will have to amount to $0.3 \times 76 = 22.5 \text{ m}^3$. Assuming an acceptable variation in water-level of 1.5 m, the net area will have to be 15 m^2 .

step 13: dimensions of clear water tank:
 area 15 m² (circular 4.5 m)
 height 2.5 m

The mechanical design of the water supply system (raw water pumps, clear water distribution) depends entirely on the topographical characteristics of the area involved and on the loss of head in the treatment units and piping arrangements. The latter will be discussed in chapter 5; with regard to the former, it is generally advisable to plan the treatment plant at a sufficient height to allow for distribution by gravity flow.

The lay-out of the treatment plant is mainly determined by considerations of efficient operation and maintenance; a typical lay-out for a water treatment plant can be seen in figure 4.8.

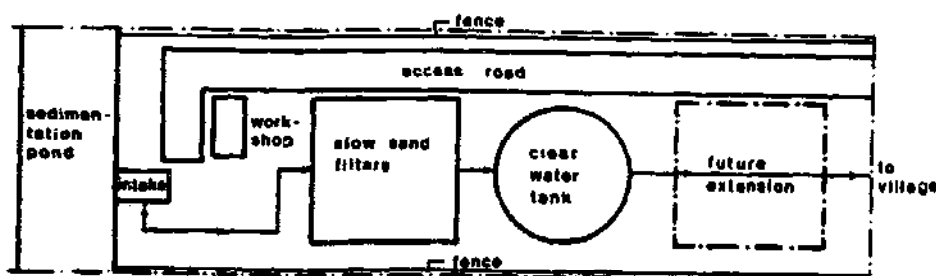

Figure 4.8. Typical lay-out of a water treatment plant

It will be clear that the design procedures discussed above are for use during the preliminary planning (discussions with authorities, raising of funds) and need to be detailed at a later stage. The detailed design of slow sand filter units and, to a limited extent, pre-treatment and post-treatment units are elucidated in the following chapter. In paragraph 4.4. the design criteria that may be used for the design of water supply systems incorporating slow sand filters in rural areas are summarized.

4.4. DESIGN CRITERIA

1. design period
15 years (range 10-25 years)
2. depreciation period

| | |
|-----------------------|------------------------|
| construction elements | 25 years (15-40 years) |
| mechanical elements | 15 years (15-25 years) |
| electrical elements | 15 years (15-25 years) |
3. population growth
entirely dependent on local conditions (birth rate, death rate, migration rate); moreover likely to change with time.
In most cases the annual increase will be between 2 and 4%
4. period of operation
8-24 hours per day depending on number of shifts (1-3); declining rate filtration increases period of operation with 1 or 2 shifts
5. water demand
dependent on local conditions (see chapter 2) and on water supply system installed:

| | |
|--------------------------------|-----------------------------|
| standpipes | 30 l/cap,d (10-50 l/cap,d) |
| private connections (1 tap) | 50 l/cap,d (20-100 l/cap,d) |
6. water quality
the quality of the treated water should conform to drinking water standards (see appendix 1). The following maximum improvements in water quality may be expected by treatment methods:

| | | |
|-----------------------|-------------------|-----------------|
| slow sand filtration: | turbidity | max. 10 NTU |
| | COD | 2-5 mg/l |
| | MPN <u>E.Coli</u> | 100-1000/100 ml |

sedimentation + slow

| | | | |
|-----------------|---|-------------------|-----------------|
| sand filtration | : | turbidity | max. 100 NTU |
| | | COD | 2-10 mg/l |
| | | MPN <u>E.Coli</u> | 100-1000/100 ml |

sedimentation + slow

sand filtration +

| | | | |
|--------------|---|-------------------|-------------------|
| chlorination | : | turbidity | max. 100 NTU |
| | | COD | 2-10 mg/l |
| | | MPN <u>E.Coli</u> | 1000-10000/100 ml |

7. plain sedimentation tanks

| | |
|--------------------|--------------------------|
| depth | 1.5-2.5 m |
| detention time | 4-12 hours |
| surface loading | 2-10 m/d |
| weir overflow rate | 3-10 m ³ /m/h |
| length/width ratio | 4:1 to 6:1 |
| length/depth ratio | 5:1 to 20:1 |

8. rapid roughing filtration

| | |
|---------------------------------|-----------------------|
| filtration velocity | 0.5 m/h (0.5-1 m/h) |
| area per filter bed | 10-100 m ² |
| number of filter beds | minimum of 2 |
| height of supernatant water | 1 m (1-1.5 m) |
| initial depth of filter bed | 1 m (1-1.4 m) |
| depth of system of underdrains | 0.4 m (0.3-0.5 m) |
| specification of filter support | see figure 5.12 |

9. horizontal-flow prefiltration
- | | |
|-------------------------------------|-----------------------|
| filtration velocity (horizontal) | 0.6 m/h (0.4-1 m/h) |
| area per filter bed | 10-100 m ² |
| depth of the filter bed | 1 m (0.8-1.5 m) |
| length | 5 m (4-10 m) |
| specification of filter bed | see drawing A.2.6 |
10. slow sand filters
- | | |
|-------------------------------------|---|
| filtration velocity | 0.1 m/h (0.1-0.2 m/h) |
| area per filter bed | 10-100 m ² |
| number of filter beds | minimum of 2 |
| height of supernatant water | 1 m (1-1.5 m) |
| depth of filter bed | 1 m (1-1.4 m) |
| depth of system of underdrains | 0.4 m (0.3-0.5 m) |
| specification of filter bed | $d_{\text{eff}} = 0.15-0.35 \text{ mm}$ UC = 2-5 |
| specifications of filter support | see figure 5.12 |
11. clear water reservoir
- | | |
|-----------------------------------|-------------------------------------|
| storage capacity | 30-50% of daily water production |
| height of tank | 2.5-4 m |
| level variation of clear water | 1.5 m (1-2 m) |
| area | 10-100 m ² |
12. water conduits
- | | |
|--|-------------|
| velocity of flow in in- fluent*, effluent and drainage mains | 0.3-0.6 m/s |
|--|-------------|

13. chlorination system

| | |
|--|----------------------------------|
| maximum dosage | 1.5 mg/l (1-5 mg/l) |
| contact-period (dis- infection) | 20-30 minutes |
| maximum storage period of chemicals | 1-6 months, depending on type |

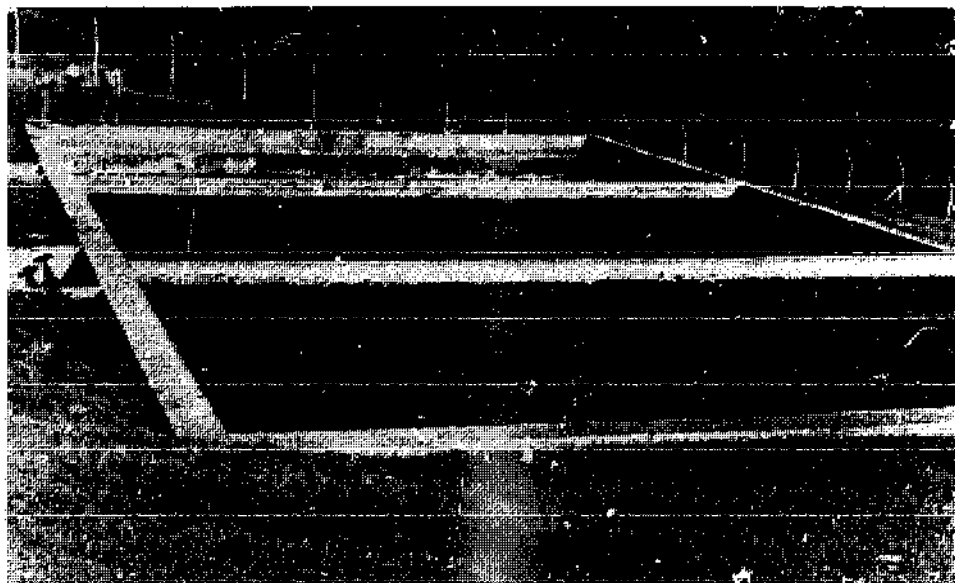

Rectangular reinforced concrete filters, West-Karachuongo, Kenya.

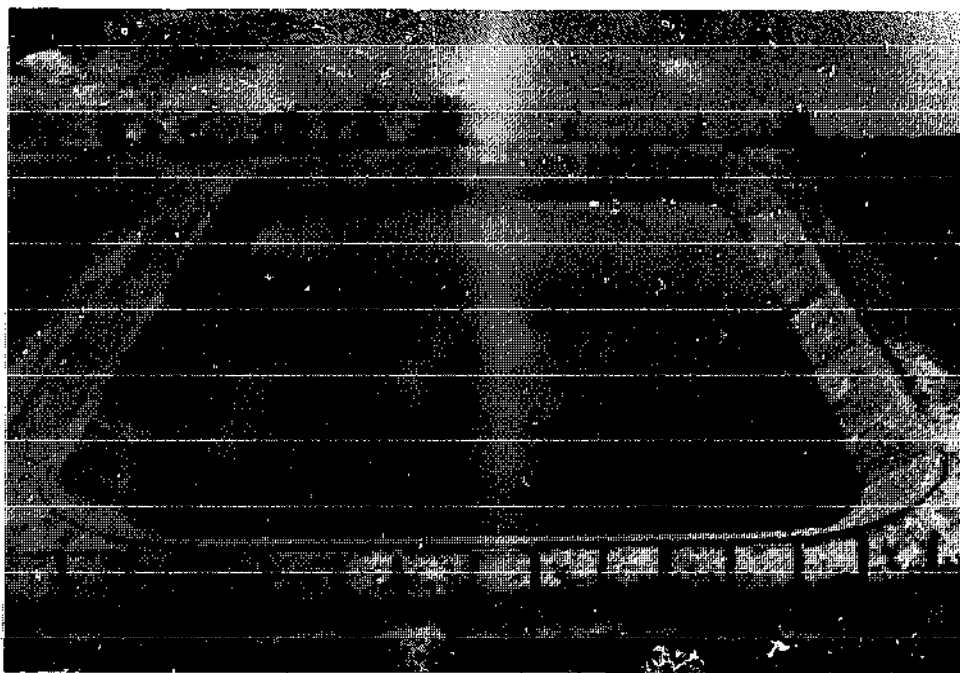

Protected sloping wall filters, Kranuan, Thailand (background pre-sedimentation pond).

5. THE CONSTRUCTION AND SPECIFICATION OF ELEMENTS OF SLOW SAND FILTRATION PLANTS

This chapter deals with aspects of the detailed design and construction of slow sand filters. As a detailed design is greatly influenced by local circumstances it is not possible to provide a "standard design". The intent of this chapter (and indeed of this manual) is more to illustrate methods of design and construction rather than to give prescriptions to be followed under all circumstances.

For the sake of clarity, the detailed design will be explained on the basis of essential items, such as unit size and lay-out, construction of filter box, piping, pumping and filter regulation arrangements, system of underdrains, inlet structure, outlet structure, pre-treatment and post-treatment units and clear water storage.

Four typical designs for slow sand filtration plants are given in chapter 6.

5.1. SIZE AND LAYOUT OF FILTER UNITS

As already discussed in chapter 4, the minimum required area of filter bed A (m²) may be obtained by dividing the design capacityⁿ Q (m³/h) by the design filtration rate v (m/h). However, the number of filter beds N and the area per filter bed F still have to be determined (the product of $N \times F$ being at least equal to A).

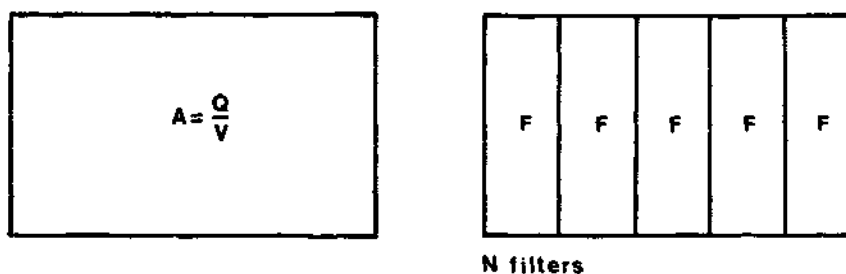

Figure 5.1. Unit size of filter bed

Several considerations will determine the number of filter beds required, for instance:

- a. to provide safe and uninterrupted operation at least two filters are needed (if there are two filter beds and one is being cleaned, the filtration rate of the other filter bed will not exceed 0.2 m/h, which is acceptable)
- b. the danger of short-circuiting and side effects are often mentioned as arguments against the use of small filter units. However, it is felt that these phenomena can easily be prevented by roughening the wall of the filter bed, as shown in figure 5.2.

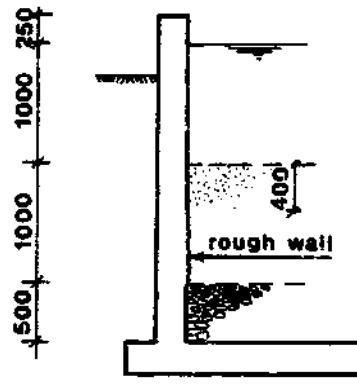

Figure 5.2. Measure to prevent short-circuiting in a slow sand filter

- c. in western countries, designs are directed towards large units, as the initial costs per m² of filtering area tend to decrease with increasing size; however, this may not be the case in developing countries. Larger units generally require more advanced construction techniques (e.g. use of reinforced or pre-stressed concrete) and better skilled labour, which may not be readily available in developing countries. Furthermore, larger units may need more construction materials to resist the larger loads. That is to say, the constructional advantages of the dividing wall in the rectangular

slow sand filter with length L , as shown below, result in a less massive construction of the length wall.

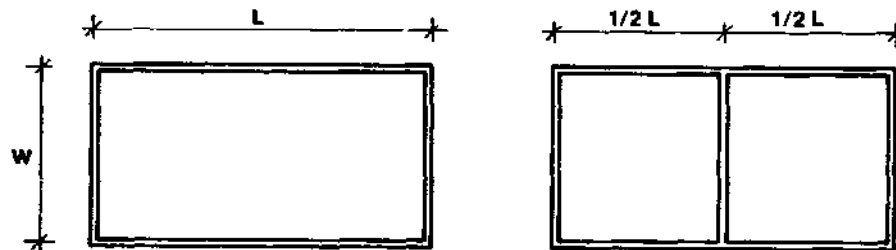

Figure 5.3. Dividing wall in rectangular filter

- d. watertight construction should be guaranteed, especially when the filter box is located below the ground water table. This means that special attention should be paid to shrinkage of concrete and masonry, differential settlements and temperature stresses.

As these phenomena are all dependent on the span of the walls, relatively small filter boxes are favoured in this respect. Although there are other factors which influence these phenomena (e.g. concrete shrinkage is reduced by lowering the water-cement ratio and the quantity of cement and by improving the compression; subsidence is dependent on the properties of the subsoil and the mode of foundation; temperature stresses are climate-dependent), it is suggested here as a general principle that a maximum length of approximately 20 m will not cause problems, whereas larger spans may call for special provisions (expansion joints, side-reinforcement etc.)

- e. the amount of materials needed is influenced by the plan and layout of the filter beds. Some arrangements for the layout of slow sand filter installations are given in figure 5.4.

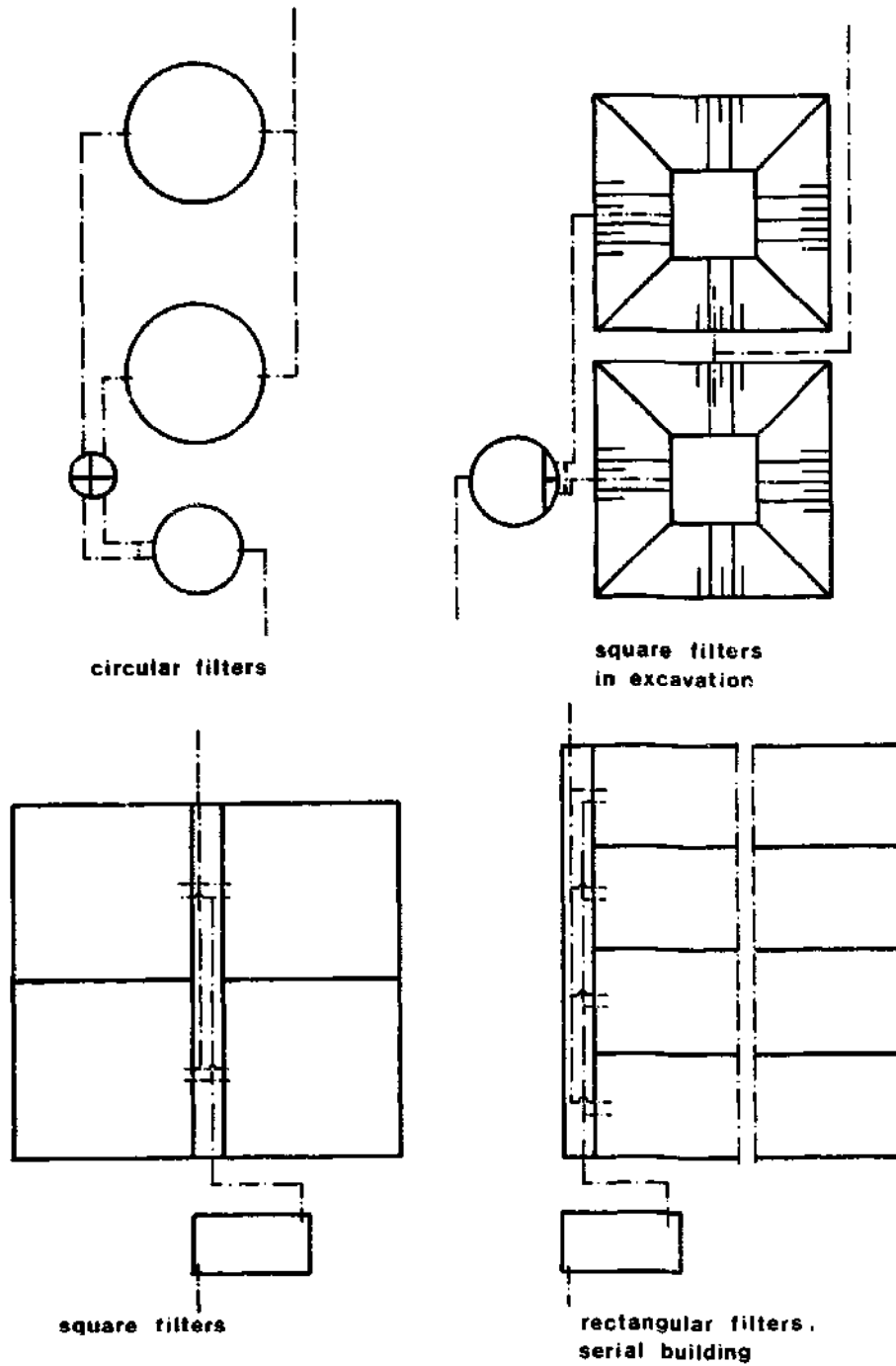

Figure 5.4. Lay-out of slow sand filters.

Circular filters have obvious structural advantages (universal compressive or tensile stresses, no bending moments), which result in economical use of materials.

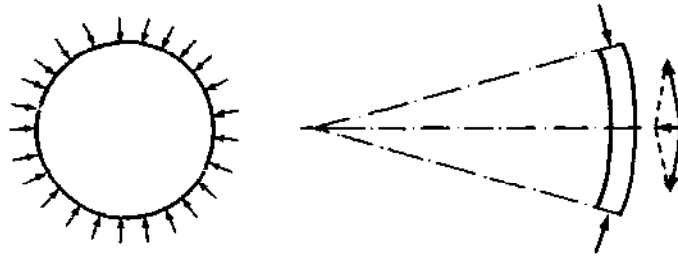

Figure 5.5. Principle of universal pressure

With increasing size of the treatment plant, their disadvantages (no serial building possible, no ready access to piping and filter arrangements) tend to offset their advantages.

If for circular filters a maximum of two units is chosen, with a maximum diameter of 10 metres and a filtration rate of 0.1 m/h, such circular filters may be advantageous for installations up to 20 m³/h.

Rectangular filters arranged along a common pipe gallery are optimal for larger installations (3 or more filters). Piping and filter regulating arrangements are easily accessible, the installation is well-ordered and (future) extensions can be incorporated without any problems. From a structural point of view, rectangular plans have the advantage that all long sides, with the exception of those at both ends, are symmetrically loaded, while the major part of the forces is taken up by the short walls and the supporting long walls. This advantage does not apply if, for one reason or another, the sand bed of one of the filters is excavated.

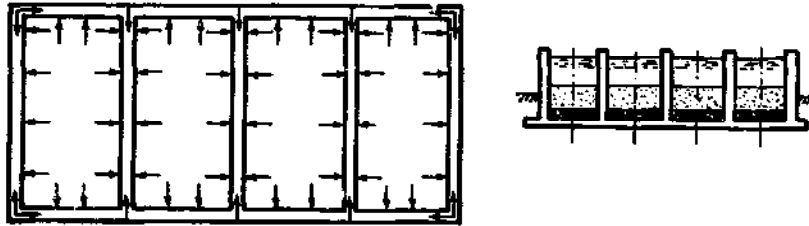

Figure 5.6. Pressure diagram for rectangular filters

Square filters have a shorter total length of walls for a given filter bed area than do rectangular filters, but they are less favourable with respect to the structural design. In addition, a square plan has disadvantages with regard to future extensions (a number of four filters can be considered the maximum for square plans). If the filters are constructed in an excavation, a square plan has the advantage of the least earthwork.

This paragraph concludes with a table indicating the sizes and plans of slow sand filters for different capacities.

Table 5.1. Sizes and plans of slow sand filters for various capacities (for a filtration rate of 0.1 m/h).

| Capacity m ³ /h | Circular plan | Rectangular plan | Square plan |
|-------------------------------|----------------|------------------|-------------------|
| 5 | D = 5.66 m(2x) | - | 5 x 5 m (2x) |
| 10 | D = 8 m (2x) | 5 x 10 m(2x) | 7.1 x 7.1 m(2x) |
| 20 | D = 9.25 m(3x) | 6 x 11 m(3x) | 8.2 x 8.2 m(3x) |
| 50 | - | 6.5 x 20 m(4x) | 11.2 x 11.2 m(4x) |
| 100 | - | 6.5 x 25 m(6x) | - |

where: D = diameter of circular filter
(2x) = two filters

5.2. CONSTRUCTION OF FILTER BOX

The construction of slow sand filters consists of either a closed stiff box of reinforced concrete, a semi-closed hinged structure of mass concrete, masonry, brickwork or ferrocement or an open, excavated structure with protected sloping walls.

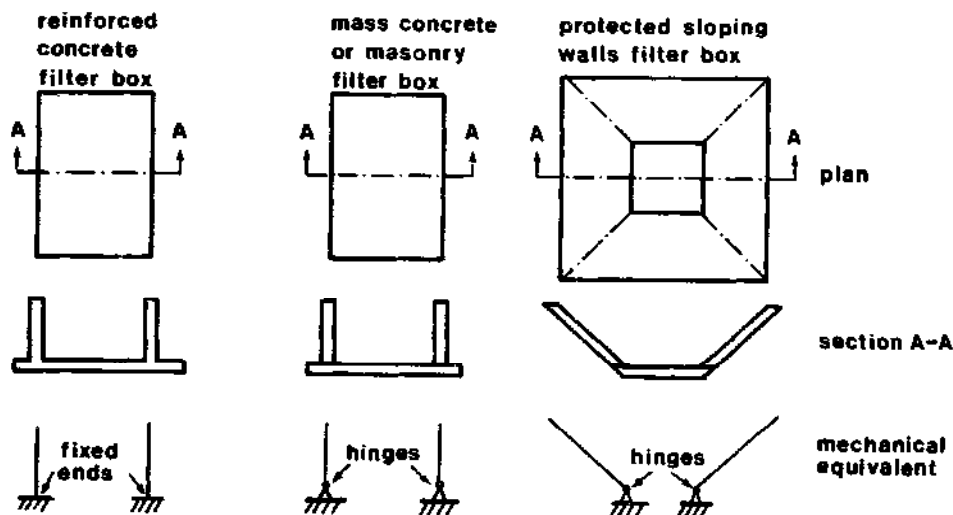

Figure 5.7. Structural design of filter box and mechanical equivalent

- Protected sloping wall filters

A sloping wall filter has the advantage that construction costs are lower than for closed and semi-closed filter-boxes, while less skilled artisans are needed. Access to the filters for cleaning is also somewhat simpler, while there is less danger of short-circuiting along the walls as the sand bed tends to get compacted against the sloping walls by the overlying layers. As materials for the lining, either masonry, riprap[®], puddled clay, mass concrete or mixtures of sand-cement or bitumastic sand reinforced with chicken wire can be chosen.

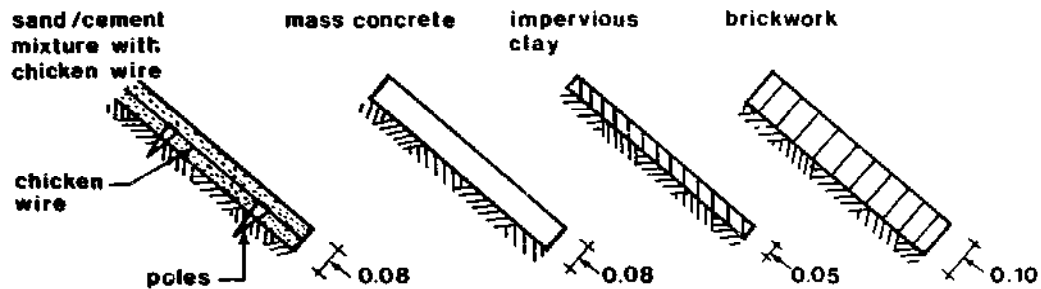

Figure 5.8. Various linings for sloping wall filters

The slope of the walls of course depends on the stability of the subsoil, but a 1:2 slope will generally be suitable. As the filter is excavated in the subsoil, only small settlements will occur even where there are soil layers with high compressibility. Some disadvantages of protected sloping wall filters may be:

1. The land area required is larger than is the case with structures with vertical walls. (N.B. as design area for sloping wall filters should be chosen the net filter bed area at the minimum filter bed depth of 0.6 m).

This aspect need not present great difficulties for villages where sufficient land area is available.

2. Piping and filter control facilities are less accessible
3. The watertightness of the construction can never be guaranteed. When the ground water table is low this may not be of great importance (except for losses), but, at high ground water levels there is the danger of pollution of the filtered water
4. When the filter excavation is dug in the natural soil, the filtered water level at the end of the filter run is more than 1 metre below ground level. This implies that the filter control structure and/or clear water tank may have to be located at great depth. (The clear water tank must of course be built with vertical walls and has to be covered)

5. Fouling of the sloping walls may occur due to growth of reed and other vegetation

A sloping wall filter may of course also be realized by earthwork above ground level. This largely obviates the disadvantages listed under 3 and 4, but also results in higher pressures in the upper layer of the soil, which may cause settlements and fissures.

- Vertical wall filters

The design of filters with vertical walls follows normal structural design practice.

A very important structural design parameter is the depth of the foundation relative to the ground level. Factors to be borne in mind are:

1. The minimum depth of the foundation may be set at 0.3 m in areas where is no danger of sub-zero temperatures
2. The minimum distance between the top of the filter and ground level should be 0.5 m in order to prevent the entrance of dust, animals, and even playing children.
3. A deep location of the filter bed has structural advantages.

The load on the walls lessens because the outside soil pressure compensates for the inside pressure (see pressure diagram). In this regard a distance between the top of the filter box and the ground level of some 0.5-1.0 m may be regarded as optimal

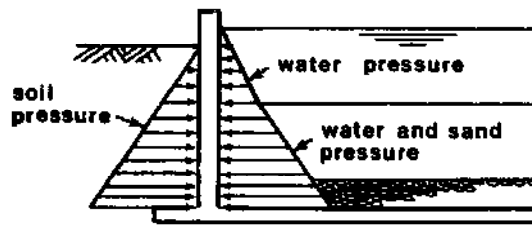

Figure 5.9. Pressure diagram for a wall of the filter box

4. a deep location of the filter bed is advantageous with regard to the load on the soil.
The load on the soil is lower with a deep location and so there will be less settlements and fissure development
5. a high ground water table calls for either a high location of the filter or the construction of a reinforced concrete filter box. In order to prevent pollution of the filtered water, it is essential to guarantee watertightness of the filter box in this case. Mass concrete and masonry need additional protection and a very careful design to guarantee watertightness, so it is better to avoid their use.
6. a high ground water table may also require special provisions to prevent the construction being forced up by water pressure. However, if the filter sand bed is not lowered more than 0.4 m, as indicated in chapter 3, there is no danger of buoyancy of the construction. Nevertheless a check on this and on the clear water reservoir, which falls dry from time to time, is always important. It may also be necessary to take special precautions against forcing up (e.g. lowering the ground water table by pumping) during the construction

of the filter and in repair situations, when the sand bed is completely excavated.

7. the water level desired in the treatment plant and the available head of the raw water may influence the depth of the filter; generally it is desirable to apply gravity flow through the entire treatment plant (sedimentation tank + slow sand filter + clear water tank)

In the case of reinforced concrete filter walls, the filter bottom will also be of reinforced concrete and a stiff joint between bottom and wall (by means of extended reinforcement) will allow side pressures to be transmitted to the foundation.

If the walls are of mass concrete, ferrocement, or masonry, a raft foundation (see figure 5.10) provides equal settlement of the filter box, prevents loss of water through the joint between wall and foundation and simplifies execution. The joint between wall and raft may be considered a hinge in this case, through which only limited side pressures can be conveyed. A structure of mass concrete, ferrocement or masonry can therefore only be applied when inside and outside pressures do not differ greatly. The raft foundation may consist of 0.20 m of mass concrete of a 1:2:3 composition (see also appendix 5).

In this case an unequal loading will result in the development of cracks. It is therefore advisable to reduce the length of the tee of the foundation to the minimum, i.e. 0.10-0.20 m. A minimum reinforcement of e.g. \emptyset 8-200 (i.e. steel bars of 8 mm diameter placed at 200 mm intervals) in both directions and both at the top and the bottom of the raft is quite suitable to prevent the development of cracks. The strength of the joint between foundation and filter wall may be increased by placing steel bars of e.g. 16 mm at large distances of some 500 mm (see also figure 5.10).

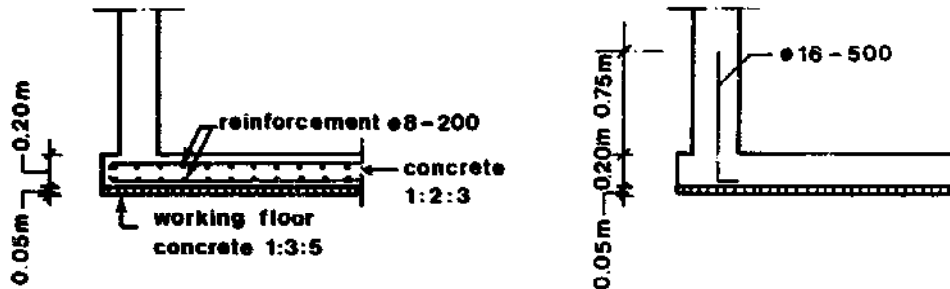

Figure 5.10. Raft foundation for vertical filter walls

Circular filters of mass concrete or masonry may be applied when the depth of foundation is relatively great. The resulting outside soil pressure is then transmitted by compressive forces in the walls of the filter box. However, if a high location of the filterbox is chosen, then the pressure of sand and water in the filterbox will result in tensile forces in the filter walls. The use of mass concrete or masonry is not possible in this case, but circular filters of ferrocement (for details on ferrocement building see appendix 5), reinforced with steel to transmit the tensile forces, can be used for small to medium-sized filters. Circular filters may also be constructed of reinforced concrete, in which case the depth of foundation may either be high or low.

Rectangular filters will generally be executed in reinforced concrete (except for small installations, that may consist of mass concrete or masonry). They are applicable for all sizes and depths of foundation. The thickness of the filter box walls and the amount of reinforcement used will depend on the size, the plan and the depth of the foundation of the filter box.

To conclude this paragraph a summary is given of the possible constructions of the filter box and their applicability.

See table 5.2.

Table 5.2. Various constructions of filter boxes and their applicability for slow sand filtration.

| |
|--|
| <p>1. protected sloping wall filter; applicable for small to medium sized square filters Size 2 - 20 m in length and width Thickness of walls 0.05 - 0.10 m attractive when very low finances are available</p> |
| <p>2. mass concrete or masonry filter; applicable for circular filters with deep foundation Size 1 - 10 m in diameter Thickness of wall 0.2 - 0.3 m for non-circular filters only limited applicability (small filters, low ground water table, careful structural design)</p> |
| <p>3. ferro-cement filter; applicable for small circular filters with deep or high foundation (universal pressure or tensile hoop principle) Size 1 - 5 m in diameter Thickness of wall 0.06 - 0.12 m some deformation of the filter wall will occur and the construction is not completely watertight, but this may be acceptable</p> |
| <p>4. reinforced concrete filter; applicable for all sizes, plans and topographical conditions; circular filters will have a somewhat smaller thickness of wall than rectangular filters (i.e. 0.15 - 0.20 m instead of 0.25 m); attractive when finances and skills are more readily available.</p> |

5.3. INLET STRUCTURE

The functions of the inlet structure may include:

1. to ensure an equal distribution of the raw water over the filter bed area. This is generally achieved if the entrance velocity of the incoming water is low, say in the order of 0.1 m/s.
2. to reduce the energy of the incoming water, so as to prevent turbulence in the supernatant water layer and damage to the Schmutzdecke. This function also requires a low entrance velocity. Furthermore, the inlet structure may be located just above the filter bed, in order to prevent jets of water pouring down onto the filter bed. A rupture of the Schmutzdecke may also be prevented by placing slabs of concrete or natural stone on the filterbed at the point of entrance of the raw water. The minimum total width of the inlet structure may be determined by dividing the design flow (m³/h) by 20. In this way the height of the overflowing water will be a few centimetres only, so a gentle flow is obtained.
3. to drain the supernatant water when the filter needs to be cleaned.

This may be another reason for situating the inlet structure just above the filter bed. However, after the filter bed has been scraped several times, its level sinks up to 0.4 m. This means that the supernatant water cannot be drained fully through the inlet structure, unless a solution by means of removable weir beams (e.g. concrete slabs or wooden planks of 0.05 x 0.10 m) is chosen. Otherwise, the only way to remove the water in the top 0.4 m above the filter bed, is by opening the outlet valve. However, as the filter resistance will then be very high, the drainage time can be expected to be very long.

4. to provide means of adjusting the height of the supernatant water. This can be done either by means of a float-controlled butterfly valve, a manually operated gate valve or by drainage through an overflow weir.
5. to provide a means of shutting down the raw water flow. This is generally done by a hand-operated gate valve

Figure 5.11 shows possible schemes for the inlet structure.

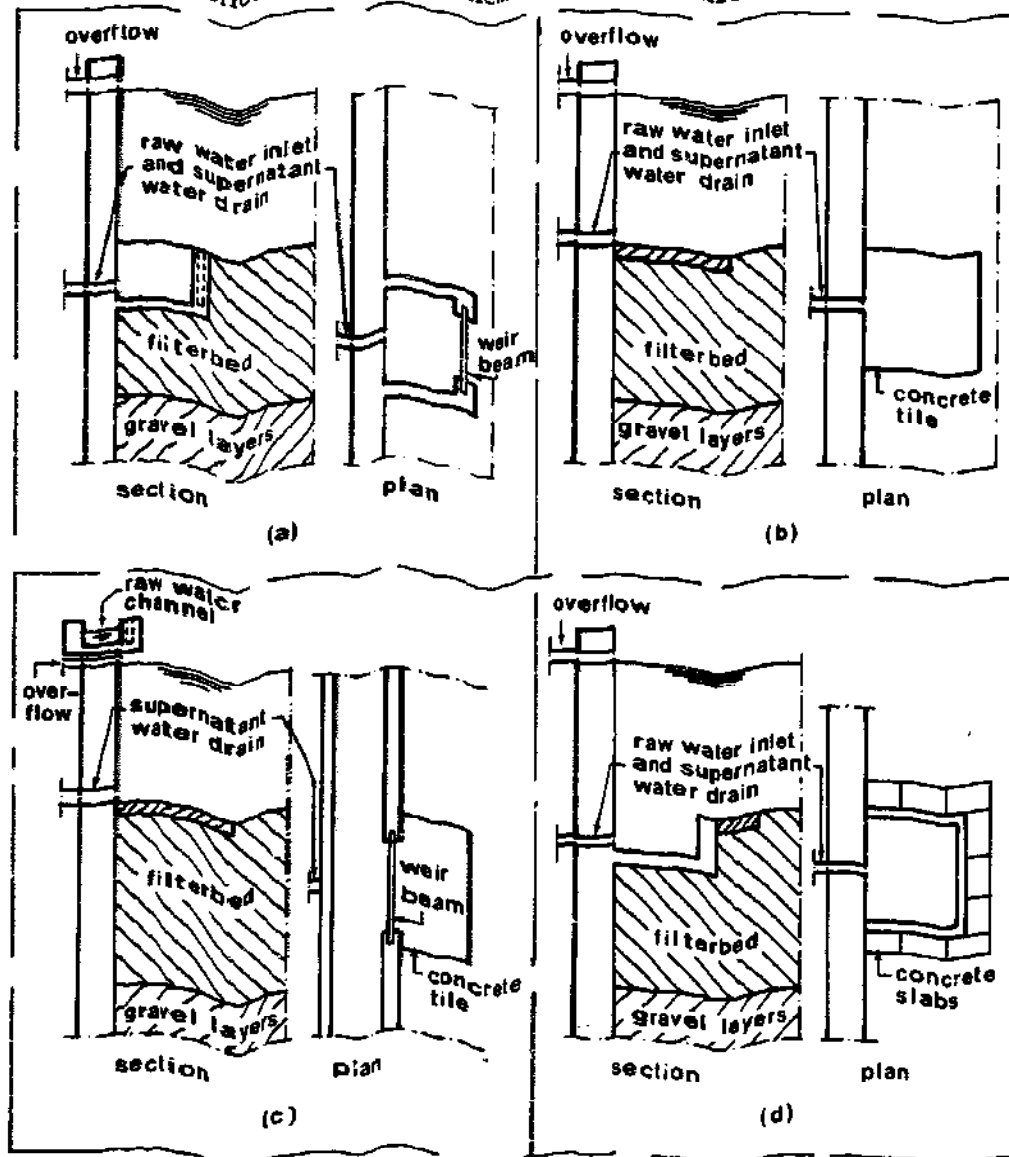

Figure 5.11. Inlet structures

5.4. OUTLET STRUCTURE

The functions of the outlet structure may include:

1. to guarantee exclusion of the occurrence of negative pressures in the filter bed. To this end a simple overflow weir in the effluent line with its crest slightly above the top of the sand bed is usually used. Other possibilities include a vertical outlet pipe or transport pipe with its inlet just above the top level of the sand bed.
2. to provide means of measuring the flow through the filter bed. The above mentioned weir may also be used for this purpose by means of a calibrated float (to increase the accuracy of this reading a V-notch weir may be used). The flow through the filter may also be adjusted to a pre-set value by means of floating weirs.
3. to provide means of adjusting the filtration rate. The simplest way of doing this is by manual adjustment of a butterfly valve.
In case a floating weir is applied which also fulfills the function as described under item 2 above, then the minimum allowable level of its inlet should be adapted in accordance with the top level of the sand bed. If one of the filters is being cleaned, the filtration rate and thus the capacity of the floating weirs of the remaining filters should be increased (by increasing the immersion depth of the inlet of the floating-weir).
4. to provide means of shutting down and draining the filter. The structures using vertical outlet pipes will therefore have to be equipped with separate drain pipes. To shut down the filter a gate valve may be used.

5. to provide means of re-filling a filter with clean water through the system of underdrains after it has been scraped

Although not absolutely necessary, it is a great advantage when the filtered water is aerated by means of an overflow weir. To this end, the outlet structure should be well ventilated.

A manhole is desirable in order to facilitate control of weirs and valves.

The relation between flow and height of water in a V-notch weir² is further explained in appendix 6.

Figure 5.12 gives some suitable schemes for the filter outlet structure.

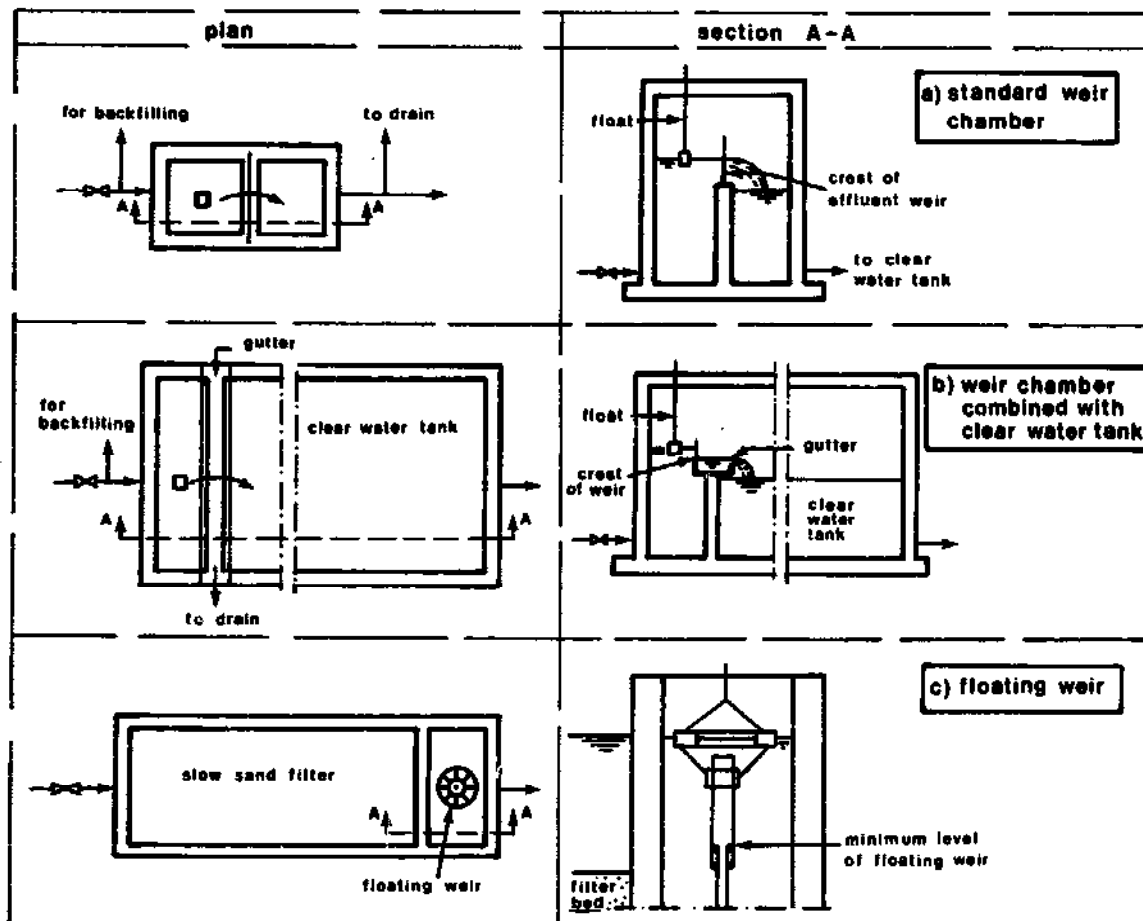

Figure 5.12. Outlet structures

5.5. SYSTEM OF UNDERDRAINS

The function of the system of underdrains is twofold:

1. to support the filter medium and to prevent the filter medium from being carried into the drainage system
2. to ensure a uniform filtration rate over the entire filter area

In order to prevent loss of filter medium a number of gravel layers with increasing grain size are located between the filter medium and the actual underdrain system. The use of three layers of gravel with sizes ranging from 1-1.4, 4-6, 16-23 mm will generally be practical. The thickness of these layers should be about 100-150 mm each.

For the actual system of underdrains (see figure 5.13), it may be stated that in general the hydraulic characteristics of the systems using pre-fabricated concrete slabs, bricks and porous concrete, can be relied upon without further calculation. For these systems the area in which the water flows freely is relatively large. The systems using perforated pipes and gravel or broken stones may be dimensioned on the basis of the following criteria:

| | | | |
|--------------------------------|-------|----------------|-------------|
| perforated pipes | | | |
| maximum velocity in manifold | 0.3 | m/s | |
| maximum velocity in laterals | 0.3 | m/s | |
| spacing of laterals | 1.5 | m | (1-2 m) |
| size of holes in laterals | 3 | mm | (2-4 mm) |
| spacing of holes in laterals | 0.15 | m | (0.1-0.3 m) |
| gravel or broken stones | | | |
| height of layer | 0.15 | m | |
| size of gravel | 25-50 | mm | |
| maximum area of filter bed | 25 | m ² | |

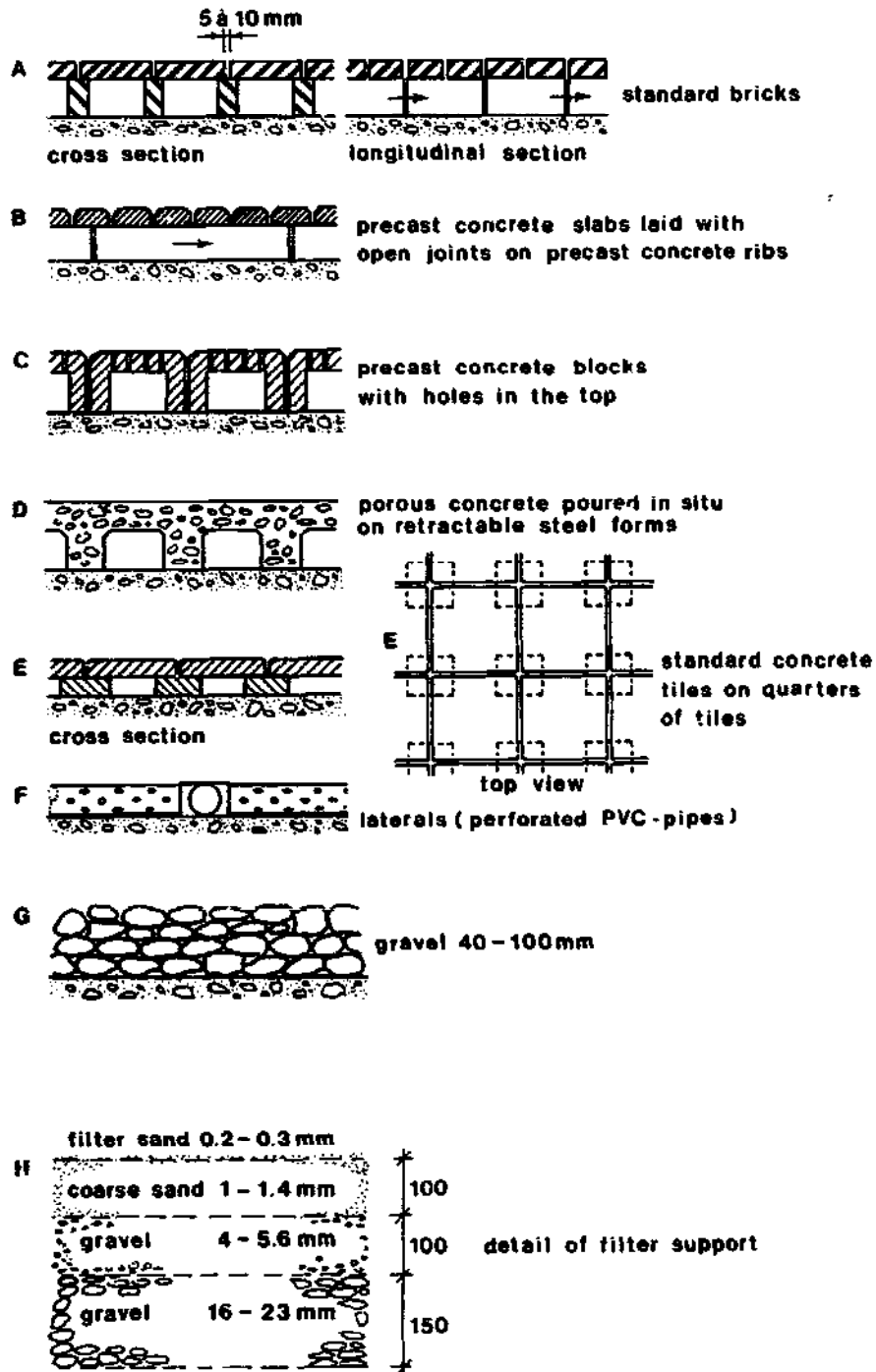

Fig. 5.13. System of underdrains

5.6. FILTER CONTROL ARRANGEMENTS

A flowsheet of a typical slow sand filter installation is given in figure 5.14.

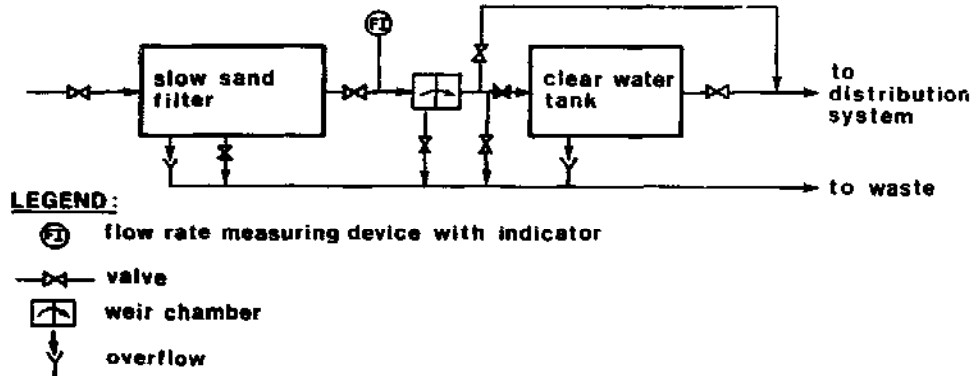

Figure 5.14. Flowsheet of a typical slow sand filter installation

The simplest shut-down arrangement in a pipeline is a gate valve (figure 5.14a), whereas in open conduits removable weir beams may be used (figure 5.14b).

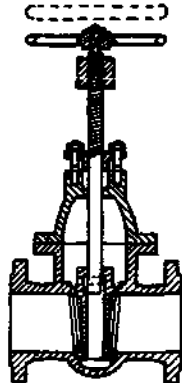

Figure 5.15a. Gate valve

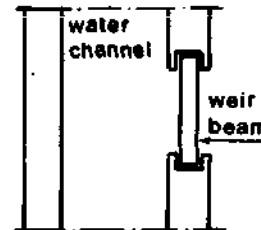

Figure 5.15b. Weir beam

The flow control arrangements both at the inlet and outlet structure have already been discussed in chapter 5.3 and 5.4 respectively. A suitable flow-control arrangement in a pipeline is a butterfly valve, as shown in figure 5.16.a and b.

Although a gate valve may also be used to control the flow in a pipeline, a butterfly valve enables a more convenient and more accurate control. The reason is that the flow characteristics of a gate valve are such that the flow through the valve is relatively independent of the position of the valve. Only when the valve is closed for more than 90%, the flow starts decreasing considerably. This means that an accurate adjustment of the flow is rather troublesome.

However, the butterfly valve is characterized by a more even relation between the percentage of opening and the flow rate.

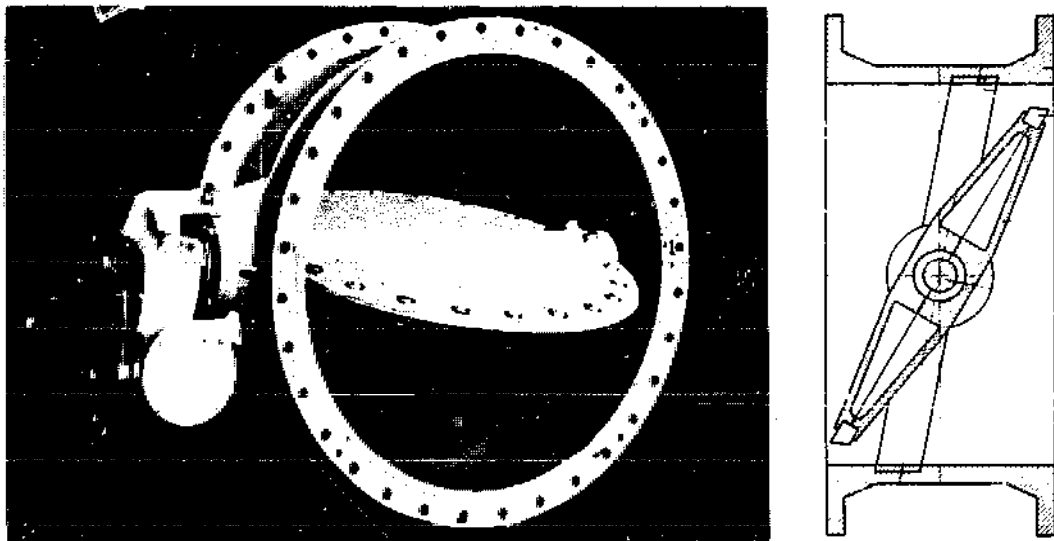
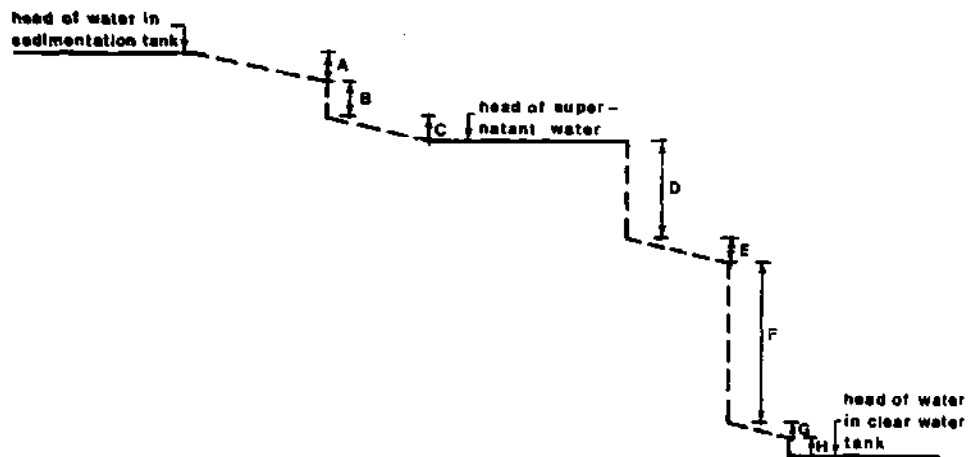

Figure 5.16a and b. Butterfly valve

The filter control arrangement determines the flow and head of the water through the plant. An important parameter in this respect is the hydraulic line, which gives the head of the water when flowing through the plant. In figure 5.17 the hydraulic line^H for a typical installation is given. The head loss over the entire plant is kept at a constant value during the various operational conditions by adjustment of the control valves.



- A** = head loss in pipe between sedimentation tank and valve 1
- B** = head loss over valve 1
- C** = head loss in pipe between valve 1 and slow sand filter
- D** = head loss over slow sand filter; (increases during filter run)
- E** = head loss in pipe between slow sand filter and valve 2
- F** = head loss over filter-regulating valve 2 ; (to be decreased during filter run in order to keep $D + F$ constant)
- G** = head loss in pipe between valve 2 and clear water tank
- H** = head loss over effluent weir

Figure 5.17. Hydraulic line in a slow sand filtration plant (gravity flow)

5.7. PRE-TREATMENT AND POST-TREATMENT UNITS

Design criteria for the design of pre-sedimentation basins and safety-chlorination systems are given in chapter 4.3 and in appendices 2 and 3. The aspects concerning layout, unit size, construction of box etc. described for slow sand filters are essentially the same for the detailed structural design of sedimentation tanks. Of course, the head of the water in the sedimentation tank should be somewhat (e.g. 0.10 m) higher than in the slow sand filter (see figure 5.17), so the top level of the sedimentation tank should be higher accordingly. Furthermore, provisions are necessary for the removal of sludge (sloping bottom, sludge removal device or manual sludge removal) and for inlet and outlet of water.

With regard to the detailed design of chlorination dosing equipment (see appendix 3), for larger plants it may be convenient to build a small chlorine house on top of the clear water tank. Bleaching powder and high-test-hypochlorite both need protection from sunlight, humidity and high temperatures so they are best stored in a closed, well ventilated room.

In a separate room the chlorine solution may be prepared by adding a fixed amount of bleaching powder or hypochlorite to a volume of water. The chlorine solution then flows to the dosing tank, from which a dosing apparatus and pipeline conveys it to the underflowing clear water. A weir is a suitable point to mix the chlorine solution with the clear water.

The chlorine house, which may include an operator's room, may be built of any material locally available, as long as the stored chlorine cannot be affected by humidity. The structural consequences of the chlorine house for the underlying clear water storage are limited to a somewhat higher load on the cover of the storage tank and on the subsoil.

5.8. CLEAR WATER STORAGE

The structural design of the clear water tank differs from that of the slow sand filters in two ways. In the first place the clear water tank will have to be covered, which allows side pressures to be transmitted to the cover. When the joint between cover and wall is stiffened by means of extended reinforcement bars, the strength of the structure increases, and the thickness of the walls may be reduced.

The second difference between the design of slow sand filters and that of a clear water reservoir is that the downward load on the bottom of the clear water reservoir, unlike that on a slow sand filter, may be reduced to nil at some periods. This means that the structure will have to be dimensioned for large outside pressures and the possibility of the construction being forced up by water pressure must also be considered.

Taking both factors into consideration, it may be said that the dimensions of filter walls and reservoirs walls can generally be of the same magnitude. If there is a chance of the construction being forced up, then the walls of the reservoir will have to be somewhat more massive than those of the filter, especially for reservoirs with larger capacities. For small installations the cover of the clear water tank can consist of a simple wooden structure, but for larger tanks a concrete cover of some 0.25 m thickness having a minimum reinforcement of ϕ 8-150 (in both directions and both at the top and bottom of the slab) will generally be advisable.

The foundation for the clear water tanks will of necessity have to be deep, because the loss of head through the filter amounts to 1 m (see chapter 5.6) and some level variation in the clear water tank has to be permitted in order to balance production and demand. If the net level variation is taken as 1.5 m, the depth of foundation for the clear water tank will be the same as is the case with

the slow sand filter.

The clear water tank will have to be provided with ventilation pipes and a manhole for inspection.

If the clear water tank also serves as a chlorine contact chamber, then the clear water outlet pipe should be located at such a height above floor level that a minimum detention time of 30 minutes is obtained.

The net volume of the clear water tank depends on several considerations. As has been set out in chapter 4.3, storage of clear water is necessary in order to balance water production and water demand. On the other hand, it is not necessary to build the clear water storage tank at the treatment plant itself; construction somewhere in the village has the advantage that the production capacity of the transport pipe between treatment plant and village is better utilized.

It is also possible to build more than one clear water tank, the total net volume being at least equal to the calculated required storage volume. The use of 2 or 3 tanks may be advantageous with respect to the reliability of the water supply system (if one tank is out of order, then the other tank(s) can still supply water to the population) and with respect to the costs of the clear water storage, as the construction of large clear water tanks is relatively difficult and expensive.

5.9. PIPING AND PUMPING ARRANGEMENTS

In water supply engineering it has always been good practice to design the major hydraulic elements of a treatment plant to a capacity of at least 1.5 times the design water demand. When at a later stage an extension of the treatment works proves to be necessary it would be very inconvenient to find out that cross-connections are not possible without replacing pipes, valves and other appurtenances. Design velocities as low as 0.3 m/s in major pipes are advisable.

Gate valves and filter control valves should be arranged in such a fashion that future extensions may easily be connected. Valves, control floats and other vulnerable mechanical parts should preferably be easily accessible for control and repair. The use of a pipe gallery or a filter control structure should in any case be given serious consideration. Filter influent and drain conduits should be strictly separated from clear water pipes.

Assuming that the treatment system is based on gravity flow the head losses through pipes and treatment units have to be determined (see also chapter 5.6) for the design of raw water pumps. For the loss through pipes see figure 5.18.

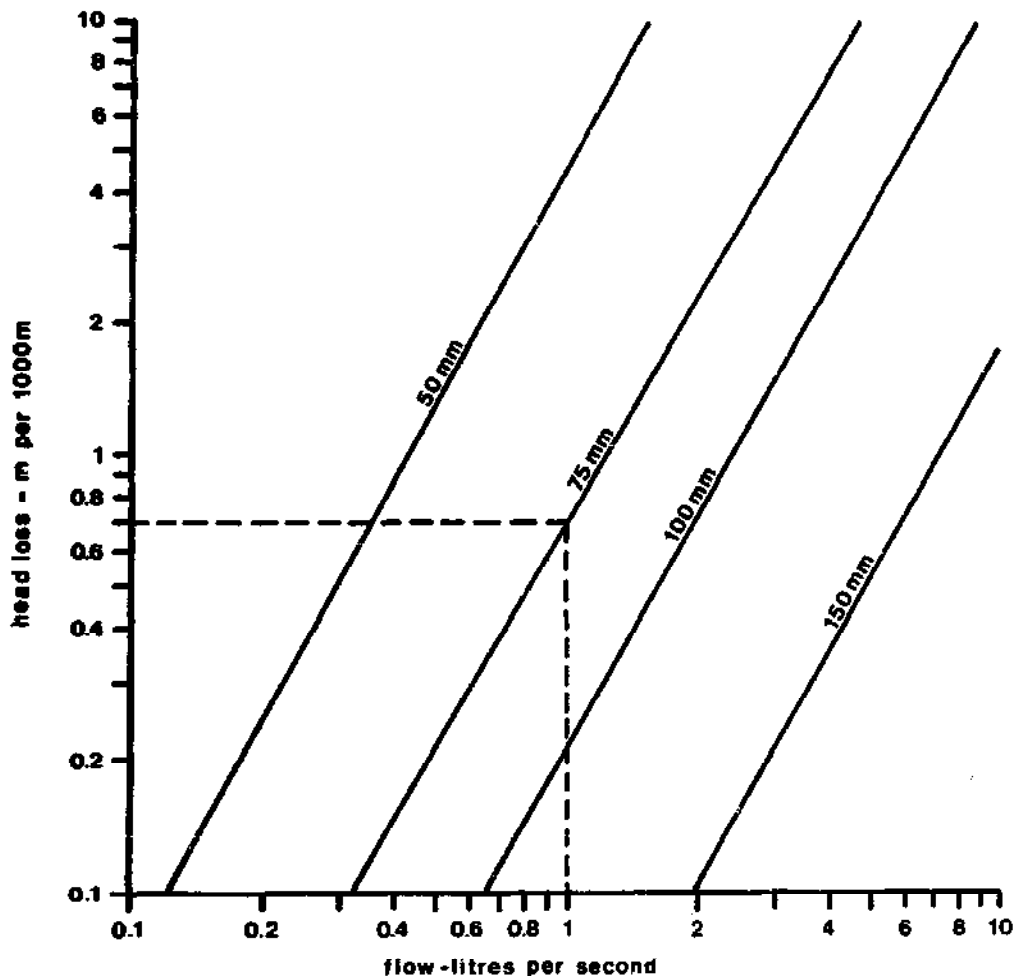

Figure 5.18. Head losses through friction in PVC-pipes

For example, it can be seen that a flow of 1 litre per second (3.6 m³ per hour) will cause a head loss of 0.7 m water column per 1000 m pipeline for a pipeline with a diameter of 75 mm.

The head loss in the slow sand filters amounts to 1 m watercolumn and the head loss in pre-sedimentation tanks will be in the order of 0.05-0.10 m watercolumn. The design flow and the design head for the raw water pumps can thus be specified. Other important specifications of the raw water pumps, such as suction head and pressure head, depend entirely on local circumstances.

In water treatment plants, centrifugal pumps are usually applied. The power required for the pump engine in kW may be estimated by means of the figure below.

The source of power for the engine, i.e. diesel oil, electricity or even water or wind power, will depend on local availability.

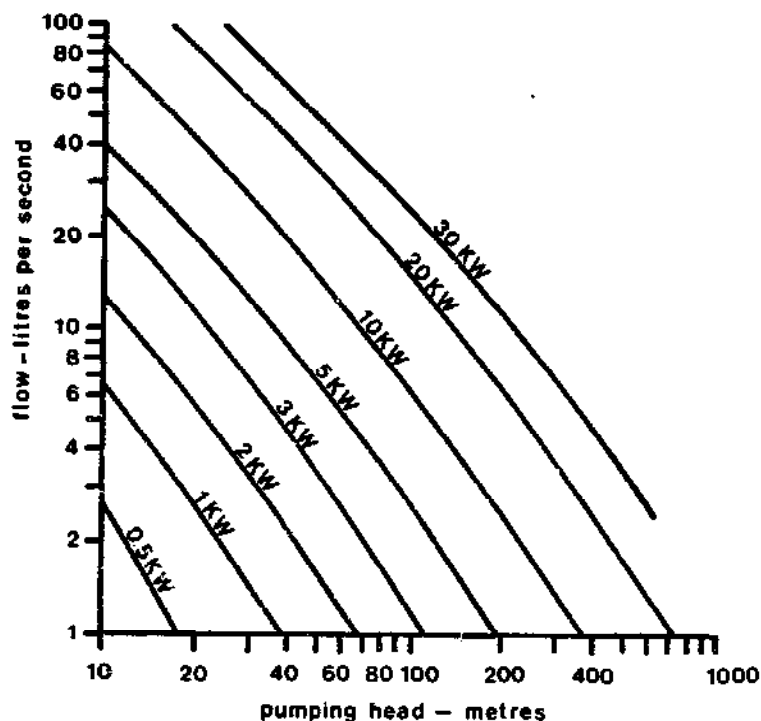

Figure 5.19. Power requirements for a raw water pump (kW)



System of underdrains and supporting gravel layers,
Amsterdam Waterworks, the Netherlands.

6. TYPICAL DESIGNS FOR SLOW SAND FILTERS

To illustrate the outlined approach to the design of slow sand filtration plants, 4 typical designs have been prepared (see figures 6.1-6.4). It should always be borne in mind that these designs apply to specific conditions and may not be suitable under different circumstances. The authors therefore refer once again to the statements made in chapter 1 concerning the use of the information given in this manual. In the paragraphs 6.1-6.4 the four typical designs are described and in the following paragraphs some information is given about suitable lay-outs of treatment plants incorporating these four typical designs, the production capacity of the typical designs, the amount of building materials required and the costs of slow sand filtration.

It should be noted here that in the typical designs no provisions have been made for a pre-treatment of the raw water. The designs therefore can only be applied to relatively pure surface water (turbidity preferably less than 10 NTU, but certainly less than 50 NTU). If the turbidity of the raw water has higher values, a pre-treatment system has to be designed (see paragraph 3.9 and appendix 2).

6.1. PROTECTED SLOPING WALL FILTER

In chapter 5, it is stated that sloping wall filters are in particular applicable for low income villages. However true this may be, it should not lead to the misconception that their purification effect is necessarily inferior to the other conceptions of the slow sand filter principle.

If well designed and constructed with care, a sloping wall filter will prove to be a major step forward in the hygienic and public health conditions of villages.

The design No. I (figure 6.1) is set up as a protected sloping wall filter.

The hourly production can be calculated from the net area of filter bed (i.e. area remaining after the top 0.4 meter of the filter bed has been scraped; in the design 8.4 x 8.4 m) and the filtration rate (0.1 m/h). For the two filters together, this amounts to $2 \times 8.4 \times 8.4 \times 0.1 \text{ m}^3/\text{h} = 14.1 \text{ m}^3/\text{h}$. If an operation period of 8 hours is selected with declining rate filtration during the night (16 hours), then the daily production will amount to $8 \times 14.1 + 141 \times 0.7 = 211.7 \text{ m}^3/\text{d}$ (see chapter 4). With a domestic daily water demand of 40 l/cap,d this unit can serve about 5300 people.

The walls of the filters have been protected with an 0.08 m lining of mass concrete. If due attention is paid to a good execution of the concrete work (see instructions in chapter 7.4 and appendix 5), then the watertightness of walls and bottom will be reasonable. However the structure is not absolutely watertight, so the design can only be applied for locations where the highest ground water table is preferably below the filter bottom and in any case below the top of the sand bed. Instead of mass concrete other linings may be used (see figure 5.8).

For the design of water conduits and filter control facilities, simplicity has been striven after. The raw water flows to the filters through an open, mass concrete channel. The flow to the filters can be shut down by means of simple, removable weir beams, whereas the water level in the filter is controlled by the overflow pipe.

The effluent from the filters flows through PVC-pipes to the clear water tank, which has a storage capacity of about $\frac{1}{4} \times \pi \times 6^2 \times 1.5 \text{ m}^3 = 43 \text{ m}^3$ (20% of daily production).

This storage capacity is rather small because the designer has planned another storage tank in the supply area.

The clear water tank is executed in masonry, with a mass concrete raft foundation.

To prevent pollution of the clear water, a hardwood cover has been provided for the clear water tank.

The filter control is done by manual adjustment of the butterfly valve in the effluent pipes, after inspection of the calibrated floats in the clear water tank. As an alternative to the weir chamber described in paragraph 3.2, this typical design comprises a weir chamber which is part of the clear water tank. The second section of the standard weir chamber is reduced to a simple gutter on top of the weir. During the re-ripening period of a filter the filtered water flowing into the gutter is directly drained, whereas during normal operation the drain valve of this gutter is closed and the water will flow over the crest of the gutter into the clear water tank.

Drains for the supernatant water, filter-to-waste pipes, and a by-pass of the clear water tank (in order to provide the possibility of inspection and repair of the clear water tank) have been provided.

As an example of the operation of the various valves, in paragraph 6.3 a scheme is given for the positioning of the valves during normal operation and backfilling. This scheme applies to design No. III.

6.2. CIRCULAR FERRO-CEMENT FILTER

Circular filters of ferro-cement are very suitable for small villages. They can be built both above and below ground level, depending on the ground water level. The maximum diameter of ferro-cement filters is limited to some 5 metres for reasons of deformation and non-universal loading.

In design No. II, circular filters of ferro-cement have been applied which are placed above ground level so they

are subjected to tensile forces. The hourly production capacity of the two filters together can be calculated at $\frac{1}{2} \times \pi \times 4,5^2 \times 0.1 \times 2 \text{ m}^3/\text{h} = 3.2 \text{ m}^3/\text{h}$.

With an 8-hour shift and declining rate filtration at night (16 hours), the total daily production amounts to 48 m³/d. If the daily water demand is set at 40 l/cap,d, this production will serve a population of 1200 people.

The clear water tank has a storage volume of about $\frac{1}{2} \times \pi \times 4^2 \times 1.5 \text{ m}^3 = 19 \text{ m}^3$ (39% of daily production).

The raw water flows through PVC-pipes in which a gate valve is provided to permit shutting down of the filters. The effluent lines and filter control facilities are designed in accordance with the description given in paragraph 3.2. For details on the technique of ferro-cement construction the reader is referred to appendix 5.

6.3. CIRCULAR MASONRY FILTER

The use of masonry for the construction of slow sand filters is particularly suitable when circular filters below ground level are planned. As building materials natural stones, quarry stones, concrete blocks or bricks may be applied. These filters are subjected to pressure forces only. Ground-water level should preferably be low.

The design No. III, has been prepared for the same village as that of the ferro-cement filters, so the net filter bed area and storage volume are the same as above.

The piping and filter control arrangements are similar to those of design No. I.

When a filter is cleaned, the filtration rate of the other filter should be doubled by opening the filter regulating valve (valve No. 1 or 2 in figure 6.3) slowly until the flow rate measurement device indicates a double flow (3.2 m³/h). After the cleaning operation, the cleaned filter is backfilled by means of filtered water from the other filter.

For instance if filter 1 requires backfilling, part of the filtered water of filter 2 is allowed to flow through the valves Nos. 3 and 4 (which are normally closed) and valve No. 1 (which should be completely open for that purpose). If the water level in filter 1 has reached some 0.1-0.2 m above the top of the filter bed, the valves Nos. 3 and 4 are closed, and the raw water inlet to filter 1 is re-opened. When the supernatant water has reached its normal level, the re-ripening period can start (see paragraph 3.7). During this period the effluent water of filter 1 can be drained by opening the valve No. 7.

As a further illustration of the operation of the valves, a scheme for the positioning of the various valves during normal operation and backfilling is given in table 6.1 (see also figure 6.3.).

Table 6.1: Positioning of valves for design No. III.

| Valve No. | Normal operation filter 1 & 2 | Backfilling filter 1 & 2 | Scraping filter 1 |
|-----------|----------------------------------|-----------------------------|----------------------|
| 1 | open | open | closed |
| 2 | open | open | open |
| 3 | closed | open | closed |
| 4 | closed | open | closed |
| 5 | closed | closed | closed |
| 6 | closed | closed | closed |
| 7 | closed | closed | closed |
| 8 | closed | closed | closed |
| 9 | closed | closed | closed |
| 10 | open | open | open |

6.4. RECTANGULAR REINFORCED CONCRETE FILTERS

Reinforced concrete filters will generally be used for small

towns or somewhat larger villages, whose financial means are not too limited. Furthermore, the skill to construct reinforced concrete has to be available.

The design No. IV has a design capacity of $4 \times 100 \times 0.1 \text{ m}^3/\text{h} = 40 \text{ m}^3/\text{h}$ and a production capacity of $960 \text{ m}^3/\text{d}$ (at a continuous operation).

It could serve a small town of some 12,000 inhabitants with a daily water demand of $80 \text{ l}/\text{cap},\text{d}$. In case of supply to a group of villages with a daily water demand of $40 \text{ l}/\text{cap},\text{d}$ some 24,000 people may be served.

Filter inlet and outlet structures are designed in a more advanced way and the accessibility of piping and control facilities is optimal as a piping gallery alongside the filter units has been provided. Provisions for safety chlorination or disinfection by means of bleaching powder or high-test hypochlorite have been included and an operator's building is placed on top of the clear water reservoir. The piping gallery is covered with a concrete cover with recessed handles for the filter controlling valves.

6.5. LAY-OUT OF THE TREATMENT PLANTS OF THE FOUR TYPICAL DESIGNS

In addition to the designs of the slow sand filters dealt with in paragraphs 6.1 to 6.4, possible lay-outs of treatment plants incorporating these filters are given in this paragraph.

In order to give a general picture of water treatment plants incorporating slow sand filters, on these lay-outs some area is allocated to possible pre-treatment units. Moreover, attention is paid to future extensions to the treatment unit and basic services such as an operator's workshop, store, sanitary services and site roads.

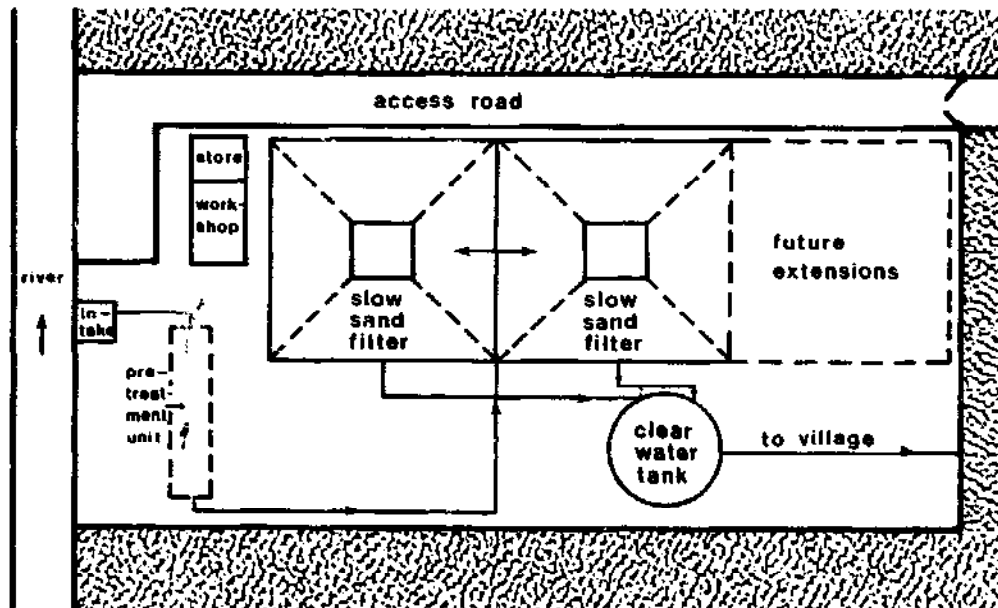

Figure 6.5. Lay-out of a treatment plant, incorporating typical design No. I.

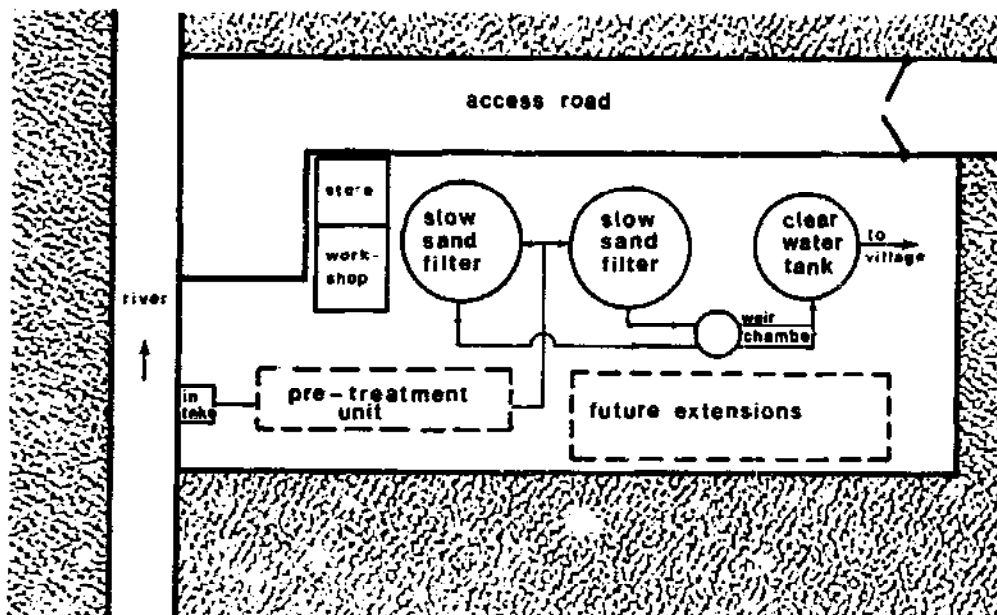

Figure 6.6. Lay-out of a treatment plant, incorporating typical design No. II.

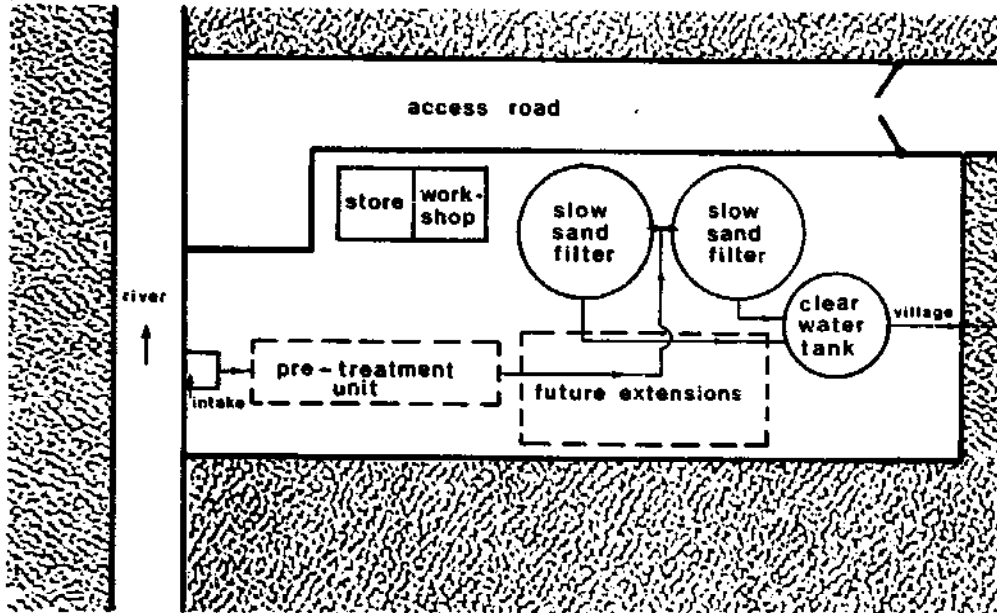

Figure 6.7. Lay-out of a treatment plant, incorporating typical design No. III.

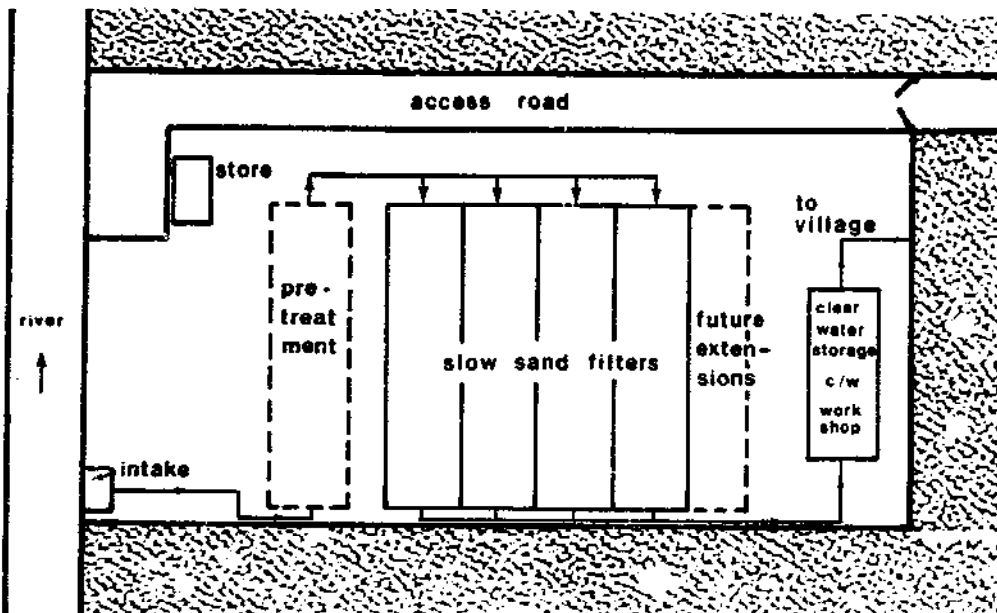

Figure 6.8. Lay-out of a treatment plant, incorporating typical design No. IV

6.6. THE PRODUCTION CAPACITY OF THE FOUR TYPICAL DESIGNS

The hourly production capacity of the four typical designs is determined by the total filter bed area and the filtration rate, which is set at 0.1 m³/m².h.

The daily production capacity is dependent on the mode of operation: number of shifts, continuous operation, declining rate filtration or intermittent operation.

Table 6.1. summarizes the daily production capacities of the four typical designs for various modes of operation.

Table 6.2. Daily production capacities of the four typical designs (I-IV) for various modes of operation.

| Daily operation schedule | | | Daily production capacity (m ³ /d) | | | |
|--------------------------|--------|-------|---|------|------|-----|
| NF(h) | DRF(h) | FC(h) | I | II | III | IV |
| 8 | - | 16 | 112.9 | 25.5 | 25.5 | 320 |
| 8 | 16 | - | 211.7 | 47.8 | 47.8 | 600 |
| 16 | - | 8 | 254 | 50.9 | 50.9 | 640 |
| 16 | 8 | - | 324.6 | 66.8 | 66.8 | 840 |
| 24 | - | - | 338.7 | 76.3 | 76.3 | 960 |

where: NF = normal filtration

DRF = declining rate filtration

FC = filters closed

The number of people which may be served by the four typical designs depends again on the mode of operation, the daily water consumption per capita, losses, wastage etc. If the water demand per capita (including losses and wastage) is set at 40 l/cap d, the number of people serviceable is given in table 6.2.

Table 6.3. Number of people which may be served by the four typical designs at a water demand of 40 l/cap d (for various modes of operation)

| Daily operation schedule | | | Number of people serviceable | | | |
|--------------------------|--------|-------|------------------------------|------|------|-------|
| NF(h) | DRF(h) | FC(h) | I | II | III | IV |
| 8 | - | 16 | 2822 | 636 | 636 | 8000 |
| 8 | 16 | - | 5292 | 1195 | 1195 | 15000 |
| 16 | - | 8 | 6350 | 1272 | 1272 | 16000 |
| 16 | 8 | - | 8115 | 1670 | 1670 | 21000 |
| 24 | - | - | 8467 | 1908 | 1908 | 24000 |

where: NF = normal filtration
 DRF = declining rate filtration
 FC = filters closed

6.7. QUANTITY OF BUILDING MATERIALS REQUIRED FOR THE FOUR TYPICAL DESIGNS

On the basis of the typical designs mentioned before, a graphical representation has been made of the relationship between construction materials required to build a slow sand filtration plant and the capacity of such a plant (in m³/h, as well as m³/d for one mode of operation). Figure 6.9 which shows this relationship, may be used for a rough estimation of the building materials that are required to build a slow sand filtration plant. The graph does not include construction materials required for pre-treatment or post-treatment.

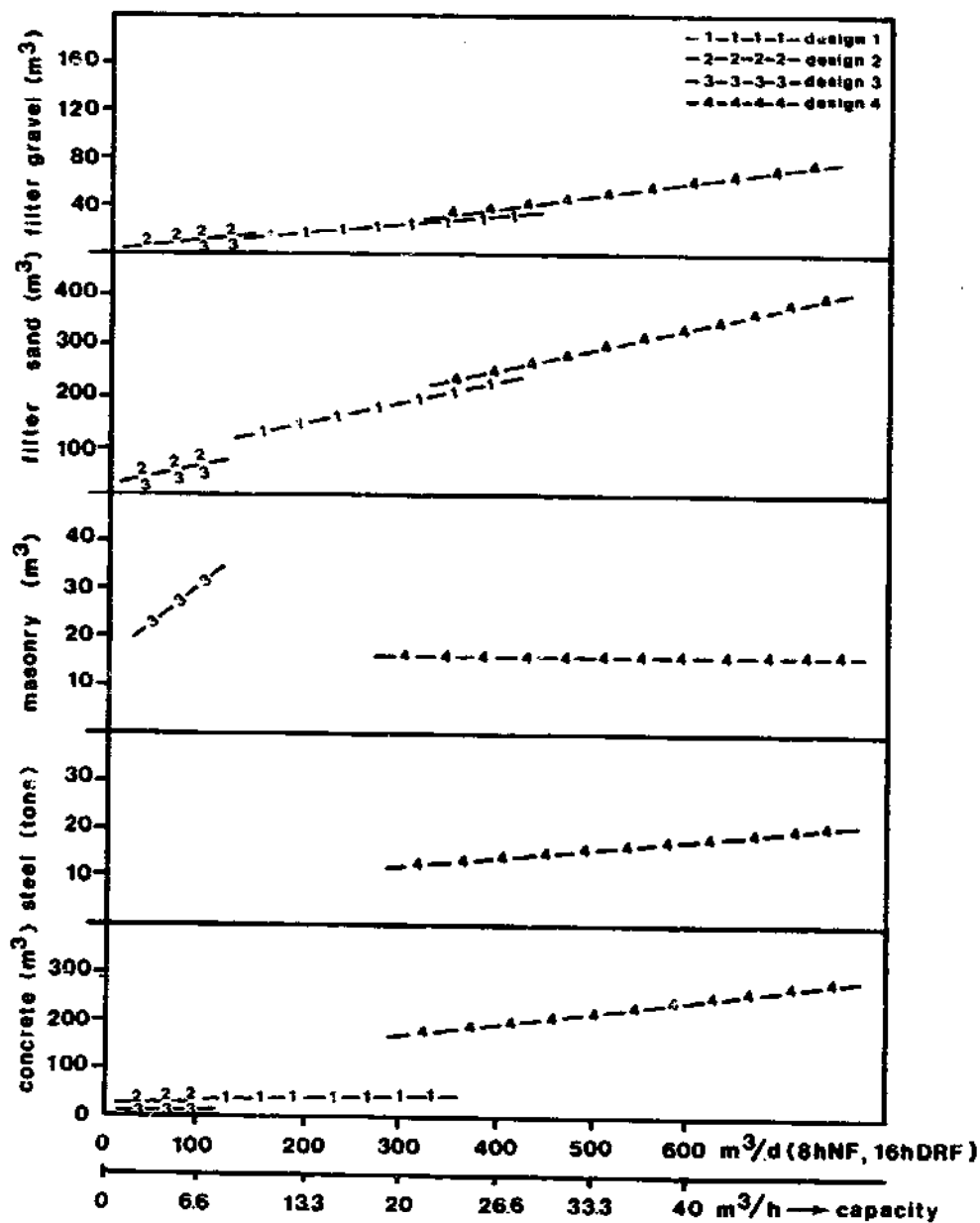

Figure 6.9. Quantity of building materials required for the four typical designs.

6.8 THE COSTS OF SLOW SAND FILTERS

The investment costs of slow sand filters are mainly determined by the costs of materials such as cement, gravel, reinforcement steel, filter sand, pipes, valves and the like. The bills of quantity of the typical designs should be costed, using local prices of materials. Prices for these materials may vary within a broad range depending on various regional and local circumstances. Therefore, in principle, efforts to calculate fairly accurate unit prices (e.g. costs per m³/h of production) are bound to fail. However, as a first estimate of the costs of slow sand filters may be useful for planning purposes, table 6.3 gives an estimate of the costs of materials per unit of production for the 4 typical designs. It should be borne in mind that this table, which is based on information gathered in the slow sand filtration project, does not include costs of construction, such as labour costs and contractors' fees.

Furthermore it is noted that - within the range of filters covered by this manual - economics of scale are included in the table. Nevertheless, deviations from the figures given, may occur in extreme situations, e.g. high costs of transport of materials.

Table 6.4. Estimated range of costs (in US\$) of materials for slow sand filters per unit of production (m³/h), based on the four typical designs.

| | |
|-------------------------------|---|
| protected sloping wall filter | 1000 - 4000 US\$ per m ³ /h |
| ferro-cement filter | 1500 - 6000 US\$ per m ³ /h |
| masonry filter | 1500 - 6000 US\$ per m ³ /h |
| reinforced concrete filter | 3000 - 12000 US\$ per m ³ /h |

If the total water availability is set at 2 l/cap h (or 48 l/cap d) the figures given in table 6.3 may be transferred to costs per capita. See table 6.4.

Table 6.5. Estimated range of costs (in US\$) of materials for slow sand filters per capita served (based on the four typical designs).

| | |
|-------------------------------|-----------------|
| protected sloping wall filter | 2 - 8 US\$/cap |
| ferro-cement filter | 3 - 12 US\$/cap |
| masonry filter | 3 - 12 US\$/cap |
| reinforced concrete filter | 6 - 24 US\$/cap |

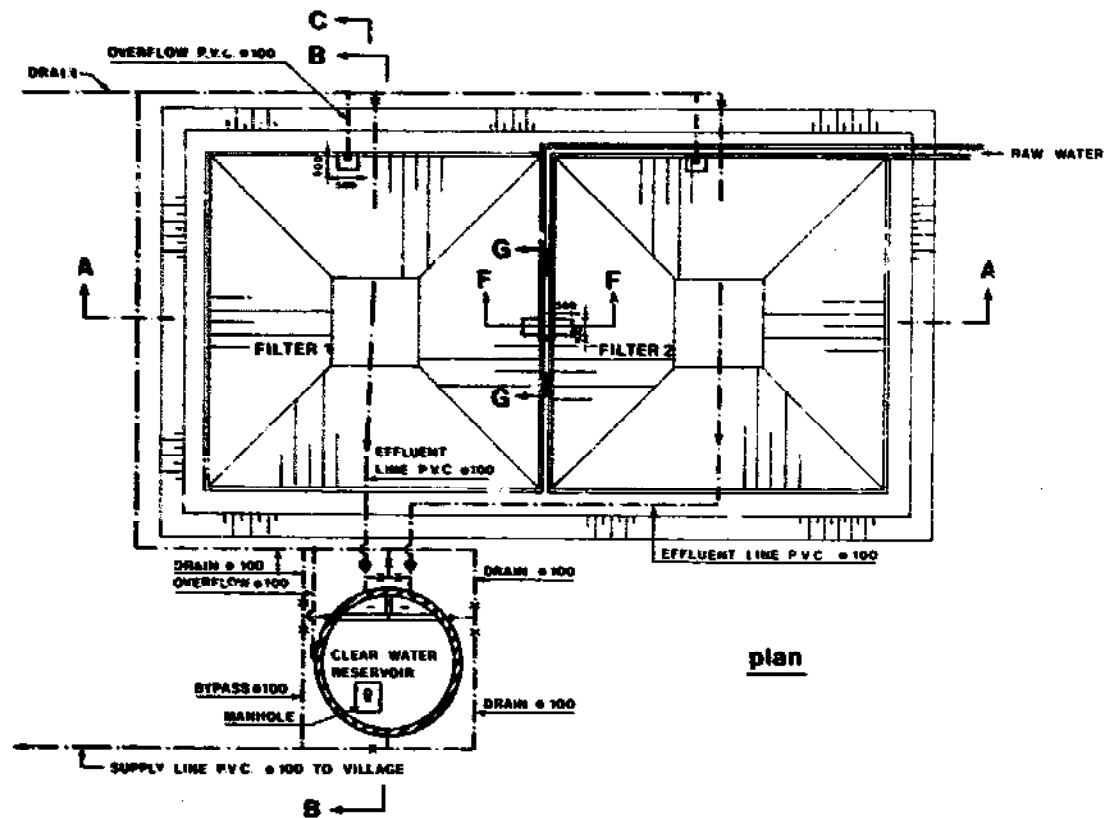

plan

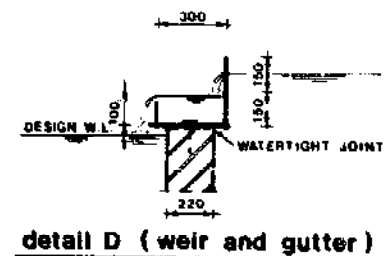

detail D (weir and gutter)

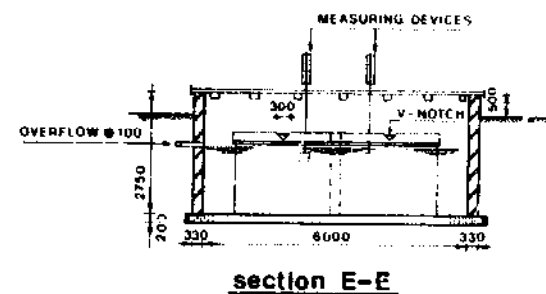

section E-E

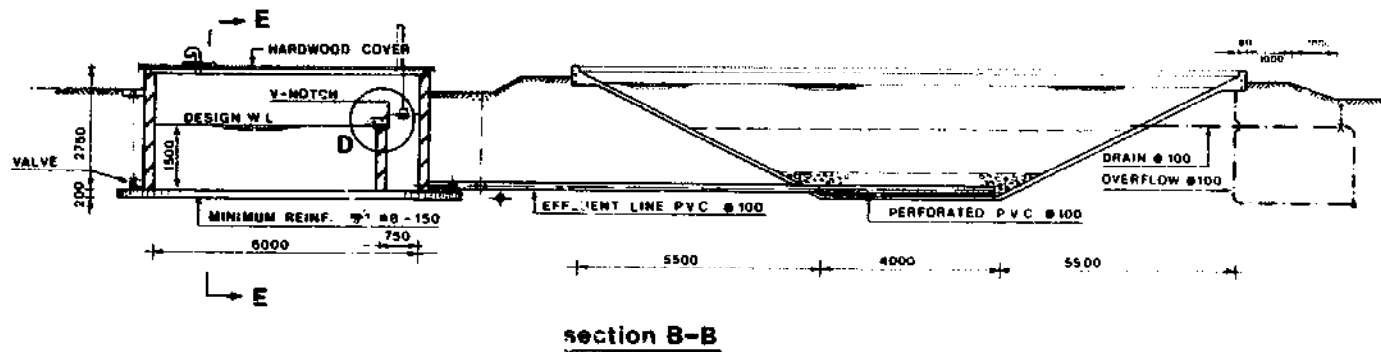

section B-B

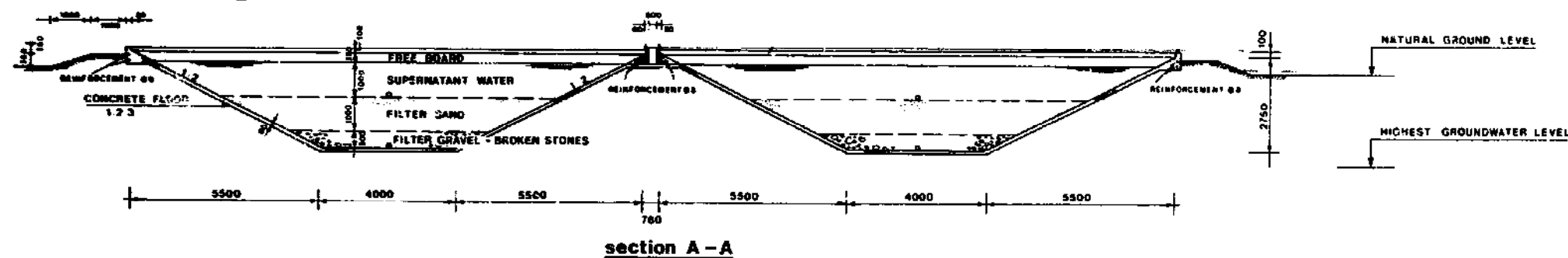

section A-A

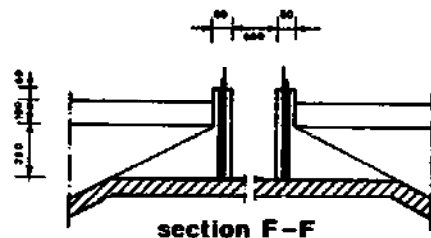

section F-F

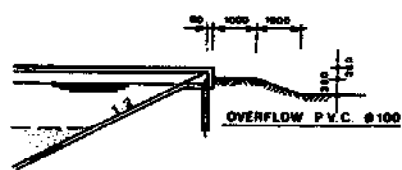

section C

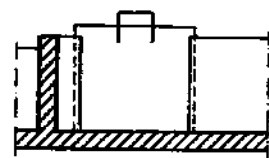

section G-G

| BILL OF QUANTITIES | |
|-------------------------------------|--------------------|
| MATERIAL | QUANTITIES |
| CONCRETE 1:2:3 | 75 m ³ |
| REINFORCEMENT STEEL | 1000 kg |
| MASONRY | 10 m ³ |
| FILTER SAND 0.15 - 0.35 mm; 1000 mm | 200 m ³ |
| COARSE SAND 1.00 - 1.40 mm; 100 mm | |
| GRAVEL 4.00 - 5.60 mm; 100 mm | |
| GRAVEL 16 - 43 mm; 150 mm | 50 m ³ |
| BROKEN STONES 50 - 100 mm; 150 mm | |
| GATE VALVES | 10 |
| BUTTERFLY VALVES | 2 |
| P.V.C. PIPES Ø 100 | 250 m ¹ |
| 90° BENDS | 15 |
| T-JOINTS | 15 |

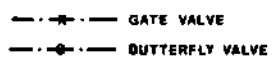

| SLOW SAND FILTRATION | |
|---|----------------|
| TYPICAL DESIGN NO I | Measures in mm |
| PROTECTED SLOPING WALL FILTERS | date 780530 |
| CAPACITY 14.1 m ³ /h (113 - 338 m ³ /day). | T.W.O FIG. 6.1 |

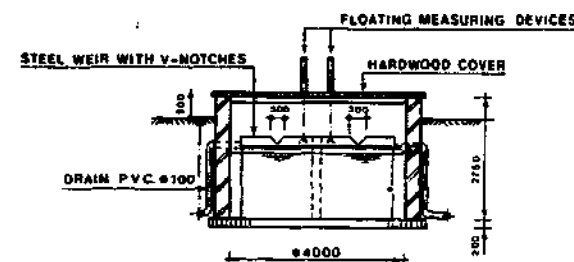
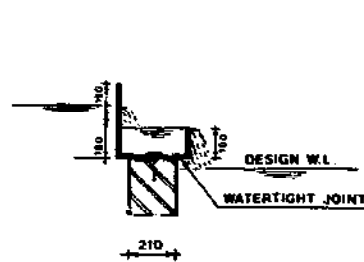
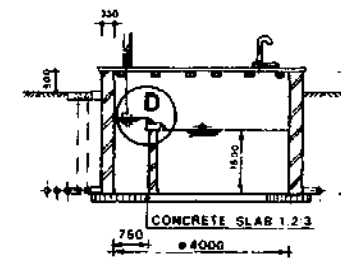
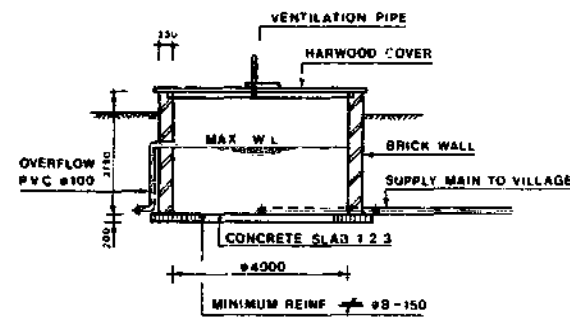
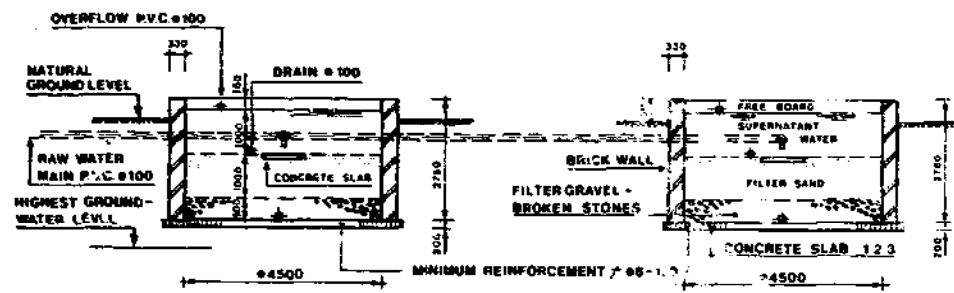
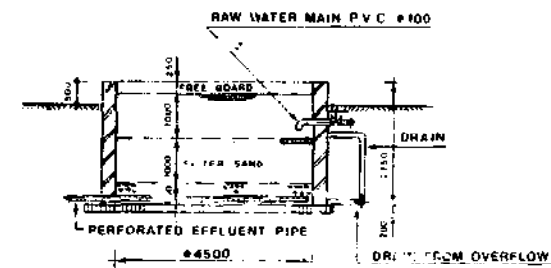
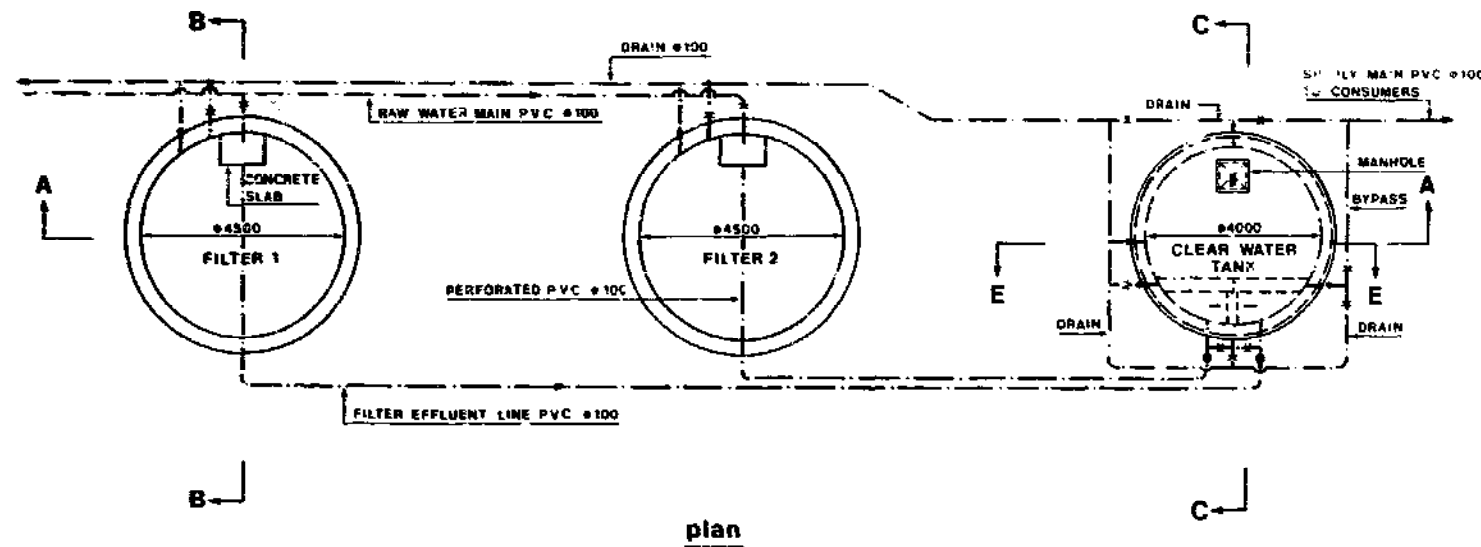

| BILL OF QUANTITIES | |
|---------------------|-------------------------|
| MATERIAL | QUANTITIES |
| CONCRETE 1 2 3 | 10 m ³ |
| REINFORCEMENT STEEL | 1000 kg |
| MASONRY | 40 m ³ |
| FILTER SAND | 0.15 - 0.35 mm, 1000 mm |
| COARSE SAND | 1.00 - 1.10 mm, 100 mm |
| GRAVEL | 4.00 - 5.60 mm, 100 mm |
| GRAVEL | 16 - 23 mm, 150 mm |
| BROKEN STONES | 50 - 100 mm, 150 mm |
| JATE VALVES | 12 |
| BUTTERFLY | 2 |
| P.V.C. PIPES | 150 m |
| 90° BENDS | 26 |
| T-JOINTS | 15 |

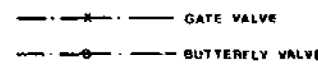

| SLOW SAND FILTRATION | |
|---|----------------|
| TYPICAL DESIGN no II | Measures in mm |
| MASONRY FILTERS | date 780530 |
| CAPACITY 3.2 m ³ /h (25.6 - 76.8 m ³ /day) | T.W.O |
| | FIG. 6.2 |

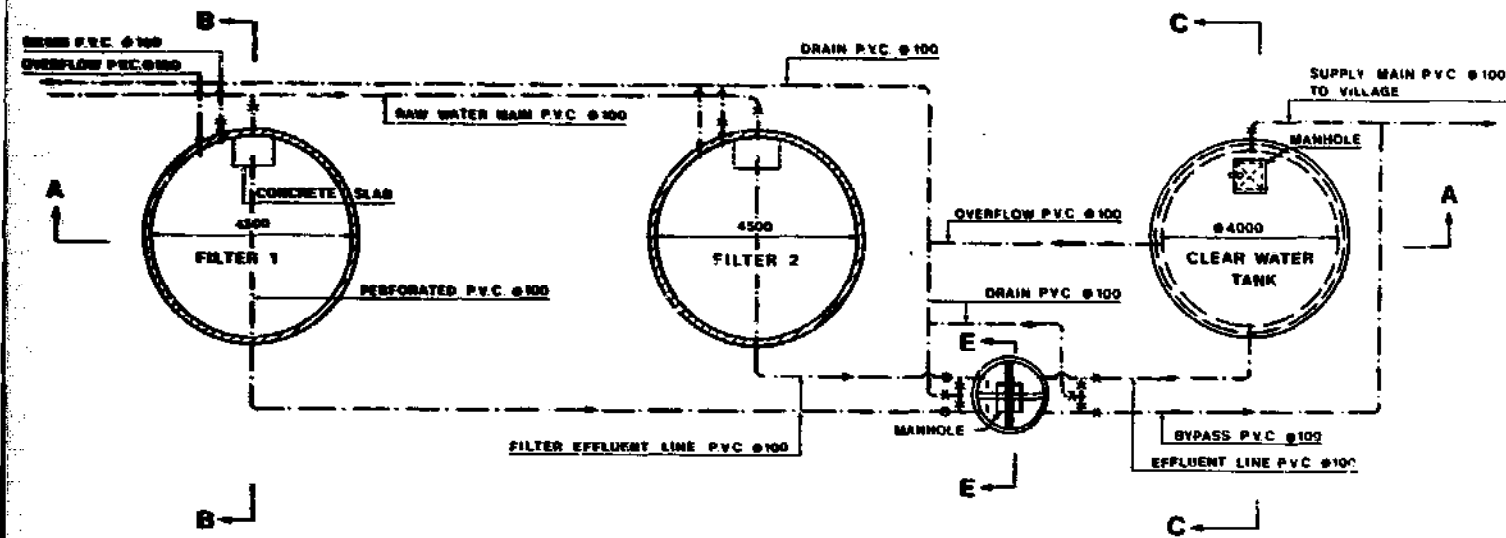

plan

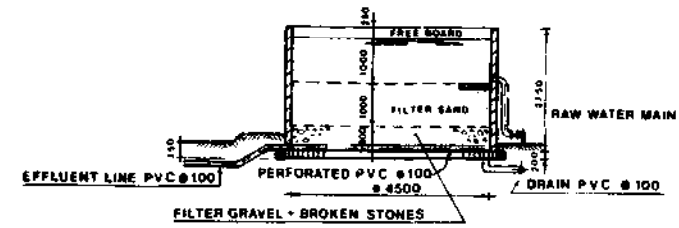

section B-B

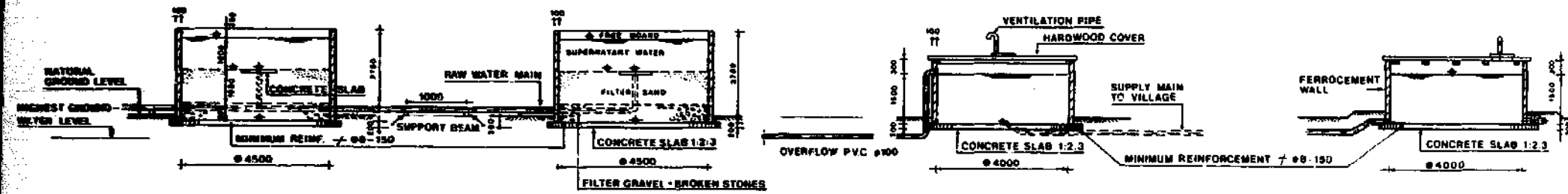

section A-A

section C-C

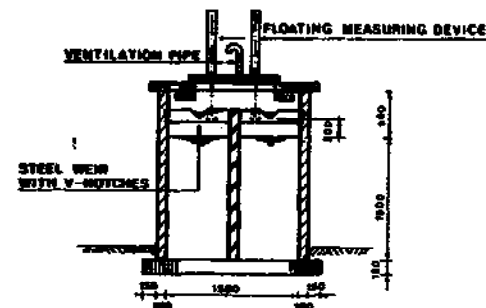

section E-E

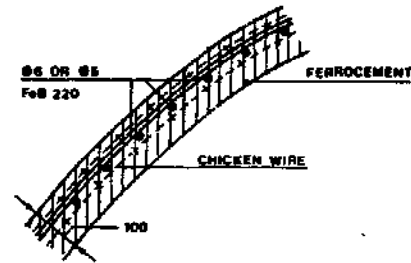

wall section

| BILL OF QUANTITIES | |
|---------------------|-------------------------|
| MATERIAL | QUANTITIES |
| CONCRETE 1:2:3 | 10 m ³ |
| REINFORCEMENT STEEL | 2500 kg |
| FERROCEMENT | 12 m ³ |
| FILTER SAND | 0.15 - 0.35 mm: 1000 mm |
| COARSE SAND | 1.00 - 1.40 mm: 100 mm |
| GRAVEL | 4.00 - 5.60 mm: 100 mm |
| GRAVEL | 15 - 23 mm: 150 mm |
| BROKEN STONES | 50 - 100 mm: 150 mm |
| | 500mm |
| | 15 m ³ |
| GATE VALVES | 13 |
| BUTTERFLY VALVES | 2 |
| P.V.C. PIPES Ø 100 | 150 m ¹ |
| 90° BENDS | 32 |
| T-JOINTS | 14 |
| CHICKEN WIRE | 300 m ² |

—●— GATE VALVE
 —○— BUTTERFLY VALVE

| SLOW SAND FILTRATION | | |
|---|----------------|----------|
| TYPICAL DESIGN NO III | Measures in mm | |
| FERROCEMENT FILTERS | date 780530 | |
| CAPACITY 3.2 m ³ /h (25.6 - 76.8 m ³ /day) | T.W.O | FIG. 6.3 |

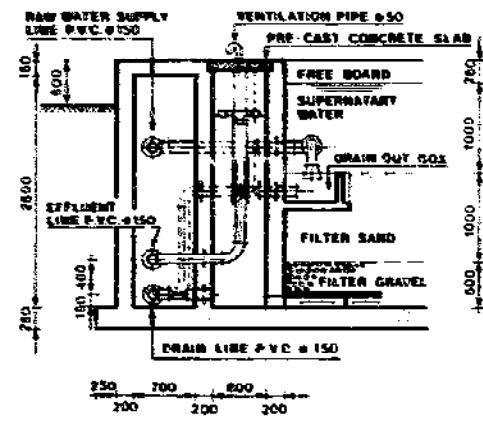

section A-A

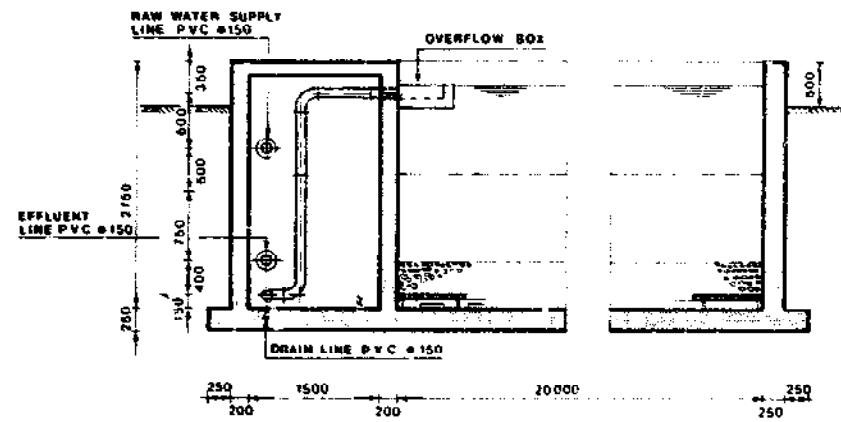

section B-B

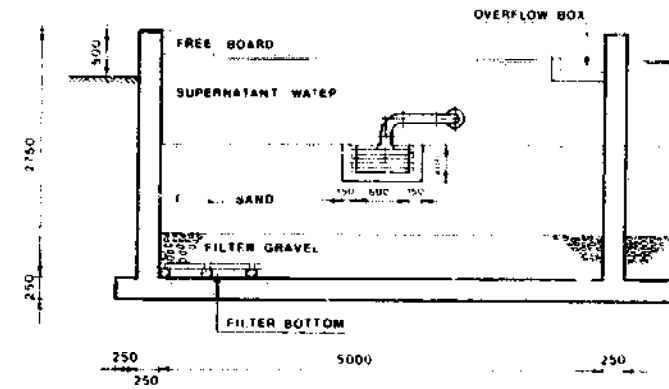

section C-C

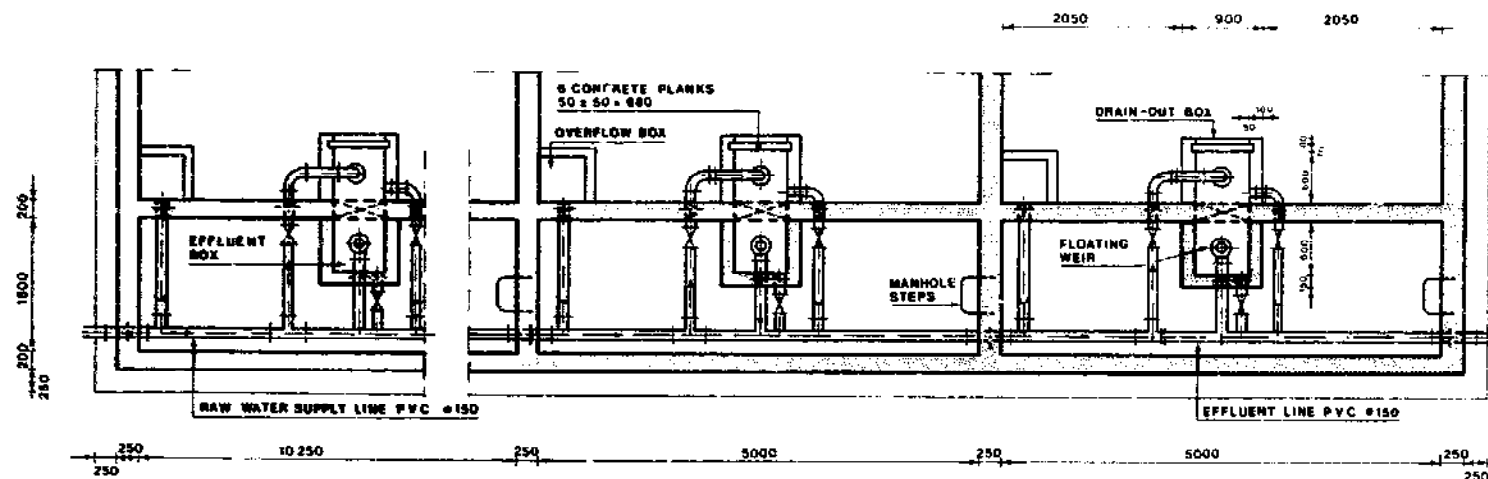

horizontal section of pipe gallery

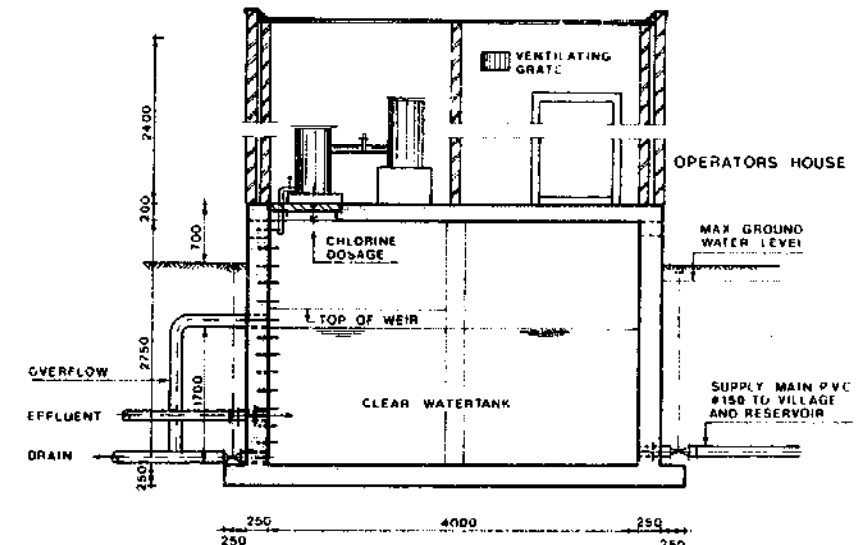

section D

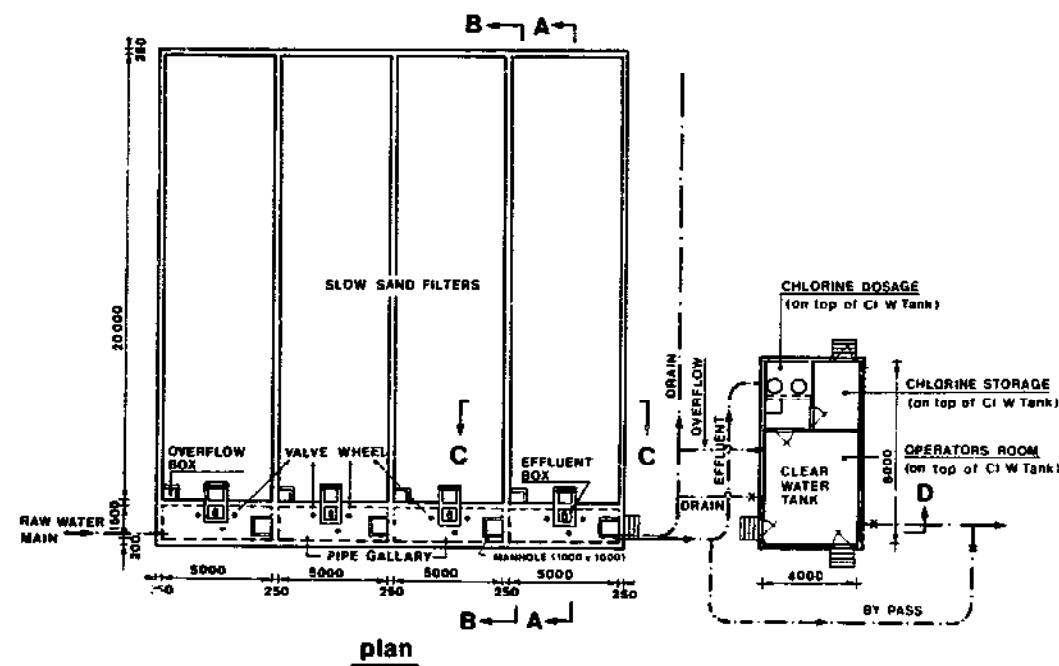

plan

| BILL OF QUANTITIES | |
|----------------------|--------------------|
| MATERIAL | QUANTITIES |
| CONCRETE 1 2 3 | 260 m ³ |
| REINFORCEMENT STEEL | 18000 kg |
| MASONRY | 18 m ³ |
| FILTER SAND | 400 m ³ |
| COARSE SAND | 100 m ³ |
| GRAVEL | 140 m ³ |
| GRAVEL | 150 m ³ |
| GRAVEL | 150 m ³ |
| GATE VALVES | 15 |
| P.V.C. PIPES - 150mm | 150 m ¹ |
| 90° BENDS | 40 |
| T - JOINTS | 25 |

| SLOW SAND FILTRATION | |
|---|-------------------------------|
| TYPICAL DESIGN NO IV | Measures in mm date 780530 |
| REINFORCED CONCRETE FILTERS | |
| CAPACITY 40 m ³ (320 - 960 m ³ /day) | T.W.O FIG.6.4 |

7. THE IMPLEMENTATION OF SLOW SAND FILTRATION PLANTS

7.1. INTRODUCTION

The task of the designer does not usually end when the detailed design of a water treatment plant is completed. Now comes the time for fund-raising, administrative (tender documents and working schedules) and, most of all, coordinating activities.

Of course the design engineer will not have the sole responsibility for the progress of the project, but in any case he should stimulate the other participants in their task. Generally, two different approaches may be distinguished for the implementation of a water supply scheme, i.e. realisation by means of paid contractors or by means of the participation of the benefitting population. The task of the designer will also differ greatly in these two cases. In the first case, the design engineer will act on behalf of the client (probably a governmental or semi-governmental organization) and after the tender documents are drawn up his contribution will be limited to supervision. However, in self help projects the designer may act as a field engineer coordinating the project, the work of the participating population and the activities of suppliers, officials and other people involved. He will have to make reservations for material supply, plan activities ahead and coordinate the daily supervision.

In order to gain insight into these matters, some aspects of tendering, organization and supervision are further discussed below. In the last two paragraphs of this chapter some important aspects related to the building process are dealt with.

7.2. TENDERING

If the works (or parts of them) are carried out by contractors, appropriate tender documents have to be drawn up.

Tender documents comprise:

1. Form of tender
2. Form of contract
3. General conditions of contract
4. Particular conditions of contract
5. Technical specifications for the execution of the works
6. Bills of quantities

Furthermore a list of prequalification data to be furnished by the contractor and instructions to tenderers, general information, list of equipment, tender and performance guaranties, etc., may be included if desired.

The form of tender, the form of contract and the general conditions of contract contain legal and administrative regulations, which have been internationally standardized in the "Conditions of contract (international) for works of civil engineering construction" (15).

Copies from these elaborate documents may be obtained from the addresses, mentioned in appendix 9.

The specific conditions of contract relate to administrative and legal regulations that are particularly applicable for the specific country or work involved, e.g. conditions of payment, overnight labour etc. These can be drawn up on the basis of the general conditions, mentioned above.

The technical specifications, including drawings and the bills of quantities are the "heart" of the tender. They should include an accurate and complete description of the works to be carried out, the way they should be carried out and the materials to be used. The materials to be used may be fixed by referring to national or international standardized quality parameters (see also appendix 5) and the description of the way the works have to be carried out should contain standards of accuracy, bending of shuttering etc. These standards are also frequently described in nationally or internationally used instruction manuals (see bibliography).

National engineering institutes may also be able to furnish instructions for use in tender documents. It should always be remembered that the functions of the tender documents are:

1. Transfer of knowledge and intentions
2. Guide for the execution of the works
3. Legal contract documents
4. Basis for the estimate of the contractor
5. Guide to duties and responsibilities for people involved in the execution
6. Means to inspect and to test the execution of the works

The tendering may be public or by private contract, depending on local circumstances (familiarity with contractor, expected effect on price and quality of work).

Once the contract documents are signed, the implementation of the works may start. The design engineer's job is then usually limited to:

1. co-ordination of the works, if more than one contractor is at the site
2. co-ordination of the activities between contractor and client
3. supervision and control of the performance of the contract
4. control and approval of expenditures

7.3. PLANNING AND ORGANIZATION

Especially in self help projects, a certain knowledge of organization and planning techniques is indispensable for the designer acting as a field engineer.

Wastage of materials and time frequently occur at building plots and are the result of inefficient organization of the works. The effects of delayed ordering of essential materials or tools need no further argument.

It may be stated that a good organization of the work is obtained when the efficiency of the operations of the labourers is at the highest possible level. Inefficiency of course cannot be entirely excluded, as, for example, the labourers themselves may not have enough skill to use the most efficient technique for a certain job. In general, the following organizational measures may improve efficiency:

1. making plans; determining means, sequence of operations, required time and place
2. dividing of tasks; motivation of labourers by describing tasks clearly
3. co-ordinating; keying communication to tasks, improving cooperation
4. control; check results with plans
5. correction; change plans in order to reach goal

It may be clear from the above that planning is an important part of organization. The need for planning can be illustrated by the consequences of its absence; occurrence of bottlenecks, lack of equipment or labour and wastage.

Many techniques for the planning of works have been developed, some of which are so complicated that computer programmes are required to use them. In the scope of this manual only simple planning techniques for the relation between the amount of work, the sequence of unit operations and the required time are discussed.

Time-schedules are usually executed as bar-charts and give a systematic projection of the planned progress of the project.

By comparing the actual progress with the one planned, differences may be registered and corrective measures taken.

To make a time-schedule, the field engineer will have to record:

1. What is to be done?

2. In what amounts is it to be done?
3. When is it to be done?
4. By whom is it to be done?
5. What means are necessary to do it?

Of course, it will not be necessary to make detailed plans far in advance; rough plans may suffice in the first instance, while more detailed plans can be drawn up in a later stage. Besides the time-schedule of the work at the site, sub-schedules will have to be made for preparatory activities (e.g. hiring of personnel, ordering of tools and materials). An important feature of time-schedules is the sequence of operations; for a reinforced concrete foundation for instance, this schedule is:

1. stake out trench
2. excavate
3. make shuttering
4. pour working floor
5. bend and fix reinforcement
6. pour foundation

These operations can be reproduced by means of a bar-chart, for which time periods are given, horizontally divided by so-called plan strokes. For each plan stroke the number of planned operations can be given, as well as the cumulative number of operations. This gives a simple check on the progress of the work.

As an example, the work on the foundations of four reinforced concrete filters could be visualized as in figure 7.1.

| month | month 1 | | | | month 2 | | | | month 3 | | |
|--------------------------|---------|-----|-----|-----|---------|-----|-----|-----|---------|-----|-----|
| week | 1 | 2 | 3 | 4 | 5 | 6 | 7 | 8 | 9 | 10 | 11 |
| operations | | | | | | | | | | | |
| stake out trench | (2) | (2) | | | | | | | | | |
| excavate | | | (1) | (1) | (1) | (1) | | | | | |
| make shuttering | | | | | | | (4) | | | | |
| pour working floor | | | | | | | | (4) | | | |
| mesh rein- forcement | | | | | | | | | | (4) | |
| pour foundation | | | | | | | | | | | (4) |

← reserve

where: number between brackets indicates the number of filters involved

Figure 7.1. Working-schedule for construction of the foundations of 4 reinforced concrete filters.

7.4. BUILDING INSTRUCTIONS

In self help projects, the designer will generally have to act as leader of the construction team. This implies that he will now be actively engaged in construction

and supervision, more than is the case when the works are carried out by contractors. The designer must therefore necessarily have constructional experience. However, there are certain aids and appliances, which he can use to advantage when organizing the work and instructing the labourers. Regional and national authorities will probably have standardized building instructions, but textbooks on construction such as the "Manual of Concrete Practice" (19) and the "A manual on building construction" (20) may also be used.

In countries with a large labour-potential, the designer should concentrate on labour-intensive building, and omit the use of mechanized equipment. An important factor in labour-intensive building is the motivation and interest of the labourers in the project. If the labourers themselves benefit from the works, then there need be no problem, but if this is not the case it may be necessary to promote the interest of the labourers by paying piece-wages.

For information on properties and processing of the building materials used, the reader is referred to appendix 5.

The most important aspect of the execution of the works is to pay the utmost attention to the watertightness of the filter box and clear water mains. This means cleaning of pouring seams, good compaction of concrete in order to prevent the occurrence of gravel spots and using as little water as possible for the processing. Furthermore it is necessary to keep the shuttering and the construction wet for a few weeks after the pouring in order to limit temperature stresses and evaporation of the process water. Fences may also be used to protect the fresh concrete against sun and wind.

The pouring and compaction should be done as quickly as possible; tardiness and delay during pouring should never occur.

Another matter of importance is that the filter sand should not be placed until the excavated soil of the building-pit has been refilled; this is to limit tensile stresses.

Furthermore it is important to pay utmost attention to a good compaction of the subsoil (before the building is started) in order to limit differential settlements and tensile forces in the raft foundation.

With respect to further details on the execution of the building process, the reader is referred to the textbooks on building and construction given in the bibliography.

As an example, aspects of the concrete shuttering of constructional elements for slow sand filtration plants will be discussed below.

Example: Shuttering of concrete works

Asbestos cement and steel may be used for the shuttering, but wood is the most usual material. The minimum size of wooden planks for use in shuttering is 25 x 150 mm for girders and shores; battens of at least 65 x 165 mm are used. The wood has to be dried for some time, as uncured wood shrinks.

Of course the shuttering has to be able to transmit the weight of the concrete mortar without horizontal or vertical displacement or bending. Vertical walls have to be adequately supported. During the construction of the shuttering some openings have to be provided to allow the removal of dirt, wire and sawdust. It is important to see to it that the shuttering is plumb.

The loosening of the shuttering can be promoted by coating the inside of the shuttering with shuttering oil or some other fatty substance.

Shuttering of floor

The floor can be poured direct onto the natural soil or onto a working floor of 50 mm 1:3:5 concrete (see appendix 5). The sides to the floor are lined by means of pickets and shuttering boards (2.5 x 150 mm). The pickets have to be hammered firmly into the soil in order to be able to withstand deformations. The floor of the filter is usually extended 0.10 to 0.20 m in order to provide space for the wall-shuttering (see figure 7.2).

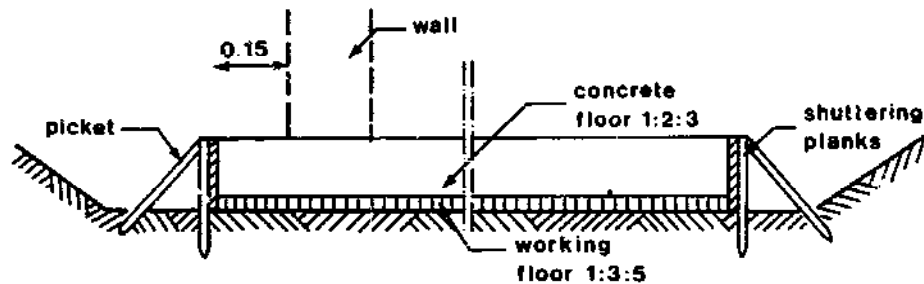

Figure 7.2. Shuttering of floor

Shuttering of walls

The shuttering-boards of the filter walls can be nailed onto vertical battens, placed at 0.75 m intervals. As the horizontal pressure of the concrete mortar is large, the shuttering has to be supported by shores. The battens can be joined together by means of centrepins (see figure 7.3). Loosening of the centrepins soon after the hardening of the concrete has the disadvantage that large holes and cracks in the concrete result. After sufficient hardening the pins only leave small sound holes, which can then be filled up with mortar.

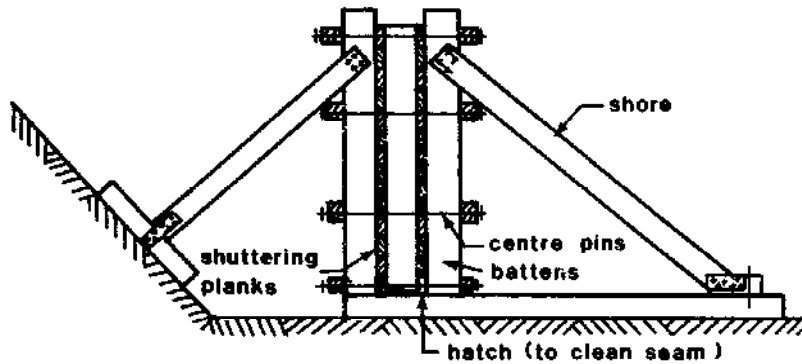

Figure 7.3. Shuttering of walls

Shuttering of cover (clear water tank)

The shuttering can consist of boards (2.5 x 150 mm) which are supported by beams (65 x 165 mm) laid on edge. The beams are supported by cross-beams. The connection between battens and beams is made by nailing short planks of 0.4 m length on both sides. The battens rest on planks with wedges in between for the removal of the shuttering.

The battens are connected by shores to stiffen the shuttering (see figure 7.4).

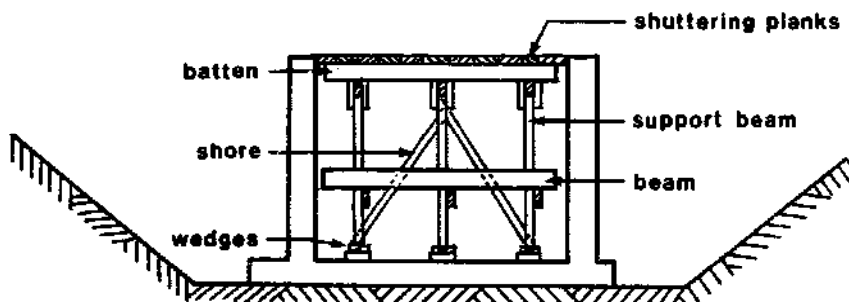
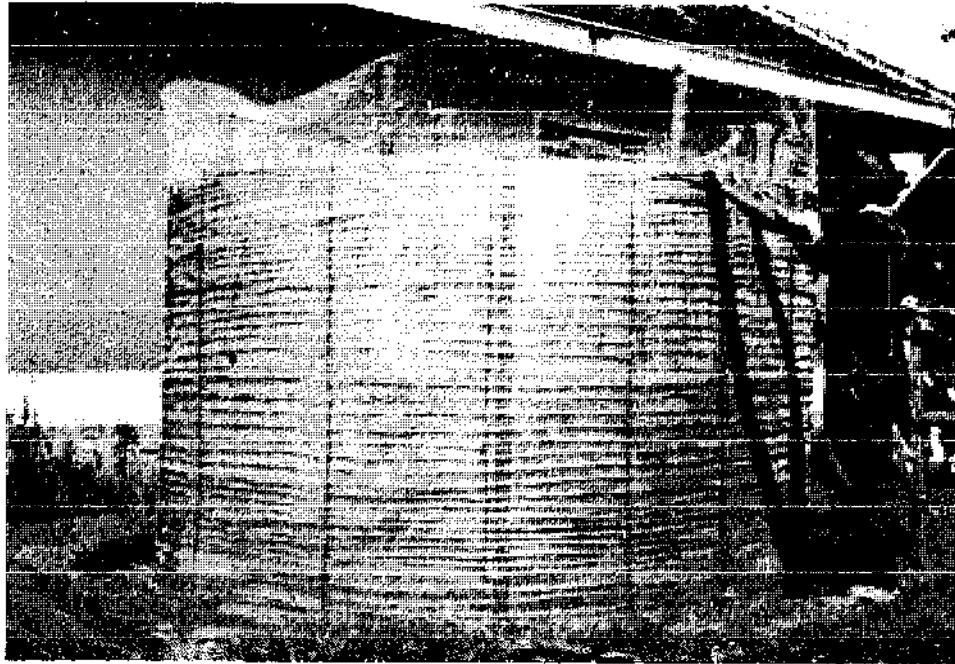

Figure 7.4. Shuttering of cover

**7.5. A CHECKLIST FOR THE SEQUENCE OF OPERATIONS IN THE
CONSTRUCTION OF SLOW SAND FILTERS**

The building of slow sand filters is done in accordance with the normal principles of construction. Amongst others this means that certain operations can only be executed when others are finished, i.e. there is a sequence of operations which is determined by the process of construction and the physical characteristics of the construction materials. In this paragraph a simple checklist is given, in which the sequence of operations in the construction of slow sand filters is summarized:

- site clearance
- setting out
- (drainage of building pit)
- excavation
- concrete work of the foundation
- i.e. placing of shuttering
 - fixing of the reinforcement
 - preparation of concrete
 - pouring of concrete
 - curing of concrete
 - removal of shuttering
- concrete work of the filter walls
 - analogous to the work on the foundation
- installation of pipelines and transits
- finishing of concrete work
- placing of system of underdrains
- placing of gravel layers
- placing of filter sand
- (shutting down of drainage provisions)
- completion of all appurtenances



Construction of a ferro-cement water tank, Lombok, Indonesia.

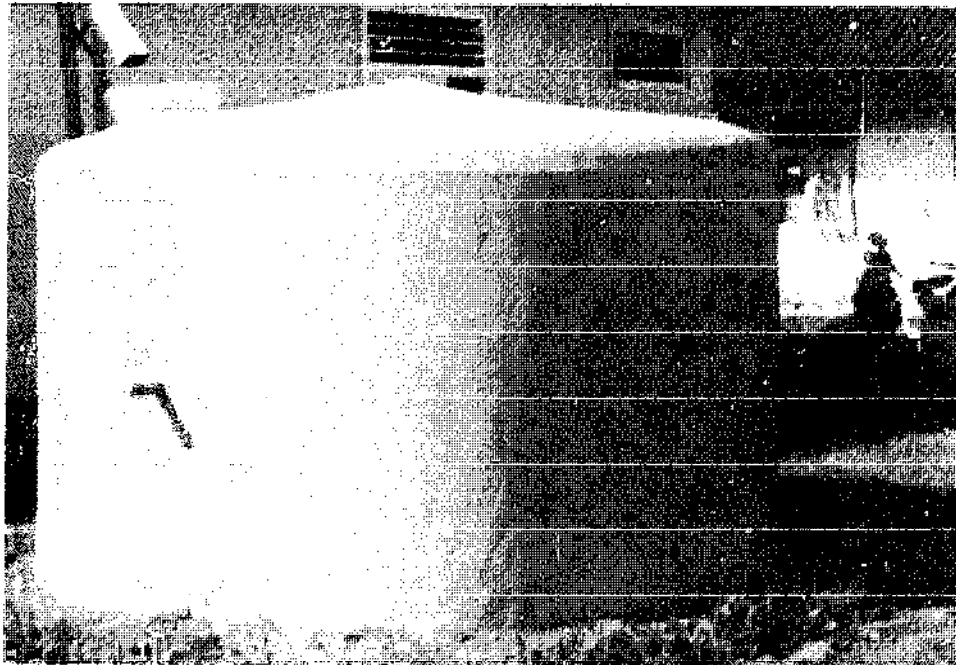

Water tank completed. At top left, inflow pipe and simple filter (containing palm fibre) can be seen.

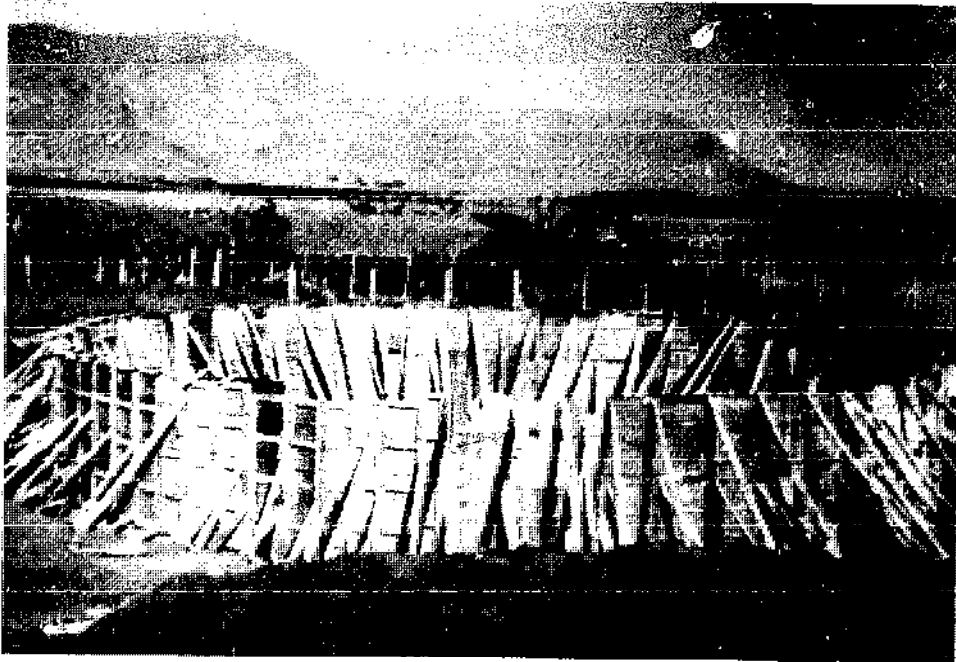

Circular reinforced concrete filter under construction,
Tamil Nadu, India.

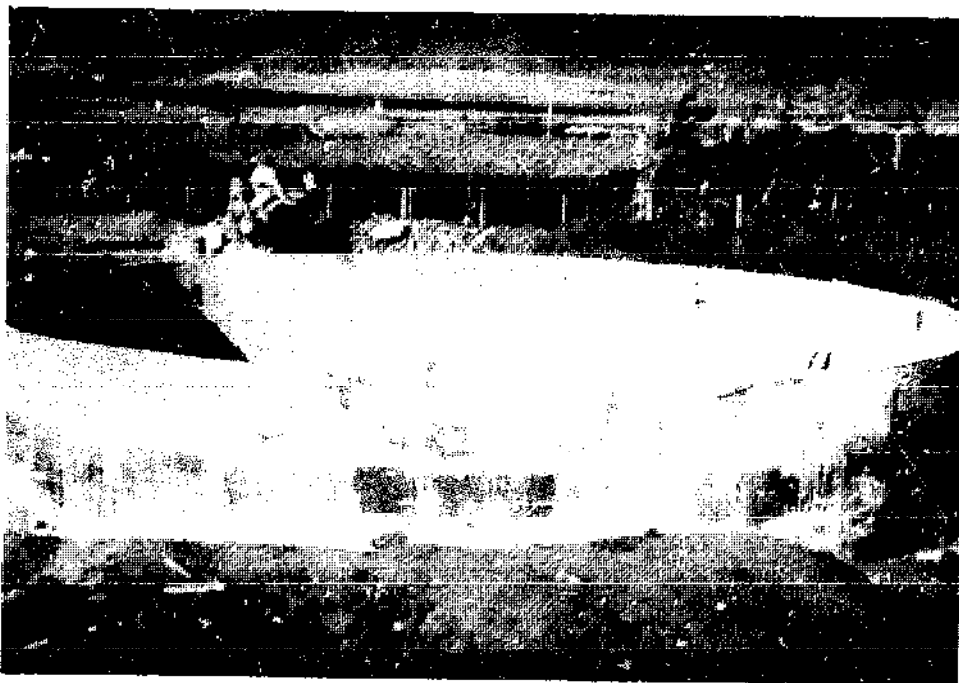

Filter completed.

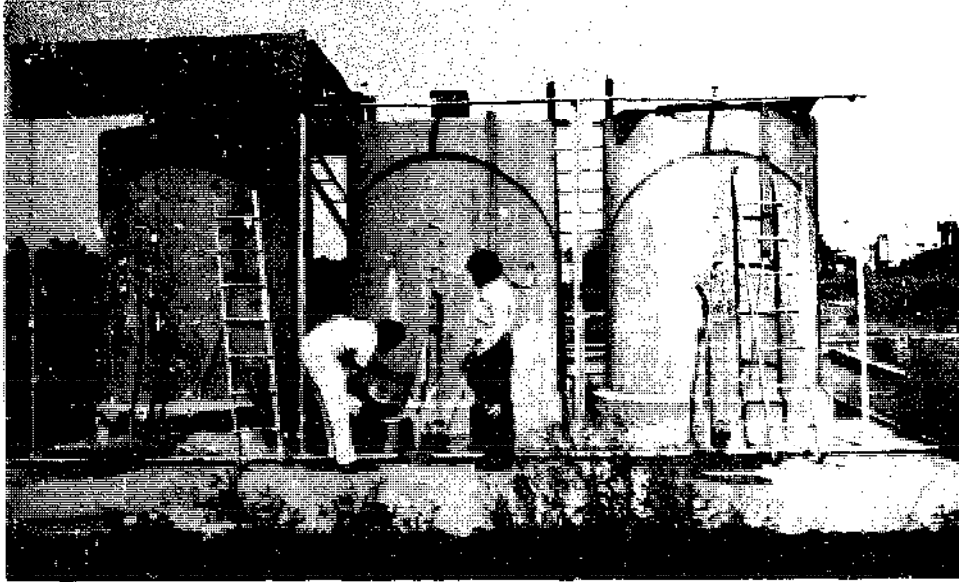

Slow sand filtration pilot unit, Nagpur, India
(National Environmental Engineering Research
Institute).



Slow sand filtration pilot unit, Owabi Waterworks,
Ghana (Ghana Water and Sewerage Corporation,
University of Science and Technology, Kumasi).

APPENDIX 1

WATER QUALITY CRITERIA

This appendix summarizes the WHO International Standards for Drinking Water (16).

- a. Standards for the bacteriological quality of drinking water:
1. Throughout any year, 95% of samples should not contain any coliform organisms in 100 ml.
 2. No sample should contain E.Coli in 100 ml.
 3. No sample should contain more than 10 coliform organisms per 100 ml.
 4. Coliform organisms should not be detectable in 100 ml of any two consecutive samples.
- b. Substances and characteristics affecting the acceptability of water for domestic use:

| Substance or characteristic | Undesirable effect that may be produced | Highest desirable level | Maximum permissible level |
|----------------------------------|---|-------------------------|---------------------------|
| Substances causing discoloration | Discoloration | 5 units ^a | 50 units ^a |
| Substances causing odours | Odours | Unobjectionable | Unobjectionable |
| Substances causing tastes | Tastes | Unobjectionable | Unobjectionable |

| Substance or characteristic | Undesirable effect that may be produced | Highest desirable level | Maximum permissible level |
|---------------------------------|---|---|--|
| Suspended matter | Turbidity Possible gastrointestinal irritation | 5 units ^b | 25 units ^b |
| Total solids | Taste Gastrointestinal irritation | 500 mg/l | 1500 mg/l |
| pH range | Taste Corrosion | 7.0 to 8.5 | 6.5 to 9.2 |
| Anionic detergents ^c | Taste and foaming | 0.2 mg/l | 1.0 mg/l |
| Mineral oil | Taste and odour after chlorination | 0.01 mg/l | 0.30 mg/l |
| Phenolic compounds (as phenol) | Taste, particularly in chlorinated water | 0.001 mg/l | 0.002 mg/l |
| Total hardness | Excessive scale formation | 2mEq/l (100 mg/l CaCO ₃) | 10mEq/l (500 mg/l CaCO ₃) |
| Calcium (as Ca) | Excessive scale formation | 75 mg/l | 200 mg/l |
| Chloride (as Cl) | Taste; corrosion in hot-water systems | 200 mg/l | 600 mg/l |

| Substance or characteristic | Undesirable effect that may be produced | Highest desirable level | Maximum permissible level |
|-----------------------------|---|---|---------------------------|
| Copper (as Cu) | Astringent taste; discoloration and corrosion of pipes, fittings and utensils | 0.05 mg/l | 1.5 mg/l |
| Iron (total as Fe) | Taste, discoloration; deposits and growth of iron bacteria; turbidity | 0.1 mg/l | 1.0 mg/l |
| Magnesium (as Mg) | Hardness; taste; gastrointestinal irritation in the presence of sulfate | Not more than 30 mg/l if there are 250 mg/l of sulfate; if there is less sulfate, magnesium up to 150 mg/l may be allowed | 150 mg/l |
| Manganese (as Mn) | Taste; discoloration; deposits in pipes; turbidity | 0.05 mg/l | 0.5 mg/l |

| Substance or characteristic | Undesirable effect that may be produced | Highest desirable level | Maximum permissible level |
|-------------------------------|--|-------------------------|---------------------------|
| Sulfate (as SO ₄) | Gastrointestinal irritation when magnesium or sodium are present | 200 mg/l | 400 mg/l |
| Zinc (as Zn) | Astringent taste; opalescence and sand-like deposits | 5.0 mg/l | 15 mg/l |

- a. On the platinum-cobalt scale.
- b. Turbidity units.
- c. Different reference substances are used in different countries.
- d. If the hardness is much less than this, other undesirable effects may be caused; for example, heavy metals may be dissolved out of pipes.
- e. 1 meq/l of hardness-producing ion = 50 mg CaCO₃/l = 5.0 French degrees of hardness = 2.8 (approx) German degrees of hardness = 3.5 (approx) English degrees of hardness.

- c. Tentative limits for toxic substances in drinking water:

| Substance | Upper limit of concentration |
|-----------------------|------------------------------|
| Arsenic (as As) | 0.05 mg/l |
| Cadmium (as Cd) | 0.01 mg/l |
| Cyanide (as CN) | 0.05 mg/l |
| Lead (as Pb) | 0.1 mg/l |
| Mercury (total as Hg) | 0.001 mg/l |
| Selenium (as Se) | 0.001 mg/l |

APPENDIX 2

SIMPLE PRE-TREATMENT SYSTEMS

Slow sand filters do not function properly if the raw water has a high turbidity. If the average daily turbidity of raw water is more than 10 NTU pre-treatment is recommended.

Storage

A storage basin (see figure A.2.1) may serve a threefold purpose; it may improve the reliability of the water supply during periods of short supply of raw water, it reduces turbidity by sedimentation and finally it improves the quality of the water because a substantial reduction of pathogenic bacteria may be achieved through the activity of algae, protozoa and other predatory organisms on the one hand and the germicidal effect of ultraviolet rays in sunlight on the other hand.

A storage basin may be constructed by erecting a simple earth dam up to a height of about 6 metres (range 6-10 metres). Allowance should be made for storage of the deposited silt which may amount to 100 ml per litre raw water in arid areas, and for losses due to evaporation and seepage. The dead storage should amount to about 2 metres. Evaporation may be up to about 2 metres a year, and losses by evaporation and seepage of 15 - 25 mm/day are not uncommon. The detention time will be in the order of several weeks to a few months.

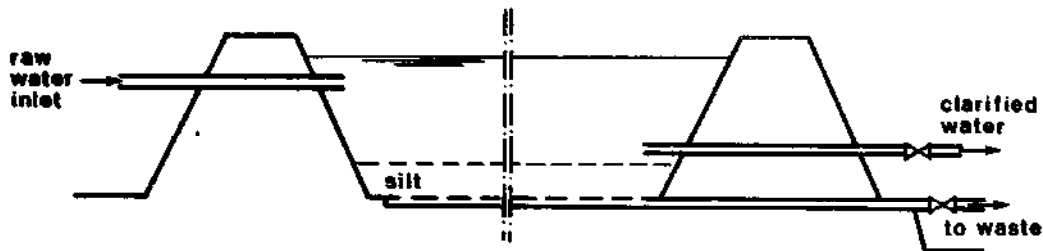

Figure A. 2.1 Storage basin

Small storage reservoirs may be lined with stabilized soil, concrete or masonry to decrease seepage. The silt may be removed by the raw water source itself during flood-flow or by manual labour. In the first case waste drains should be installed, whereas in the second case bottom drains should be provided to improve the removal of the water from the silt. Access to a storage basin should be restricted to a minimum to limit pollution of the water in the basin. Routine maintenance of storage basins should include the removal of vegetation and weeds.

Plain sedimentation

A plain sedimentation basin (see figure A.2.2) mainly serves the purpose of reduction of turbidity and removal of suspended matter. The detention time (maximum of 2 days) is short in comparison with that of a storage reservoir, but should be long enough to allow the suspended solids to settle (particles with a density higher than water) or to float (particles with a density lower than water). The designed detention time should be based on samples typical of all regimes of the river. A sedimentation tank may have a batchwise or a continuous operation. The most common configuration of a continuously operated sedimentation basin is a rectangular box made of concrete or masonry, or a dug basin with protected sloping walls.

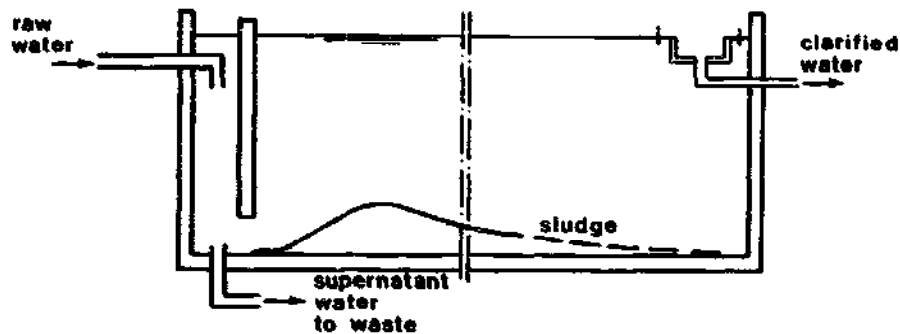

Figure A.2.2 Plain sedimentation basin

The raw water inlet is situated at the one short side of the box, the outlet at the other short side. Inlet and outlet structures (see figure A.2.3) are essential to a proper functioning of the basin. The incoming flow should be distributed as evenly as possible over the whole width of the basin to reduce currents and short-circuiting. The outlet structure usually consists of one or more weirs extending across the whole width of the basin.

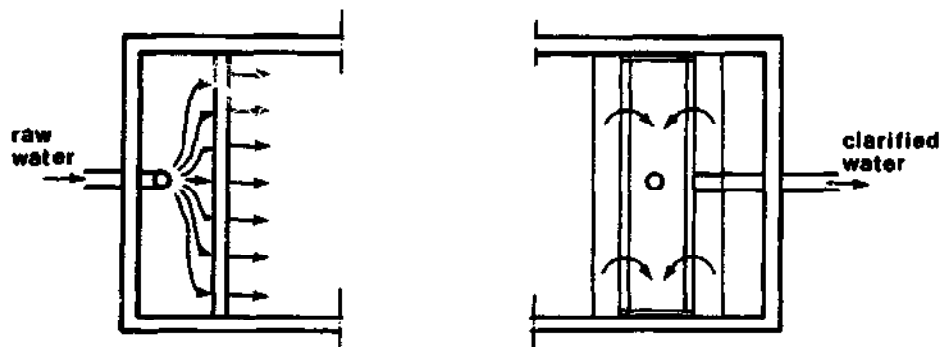

Figure A.2.3 Inlet and outlet structures of a plain sedimentation basin

If there is a high concentration of algae at the water surface, the outlet may be situated some distance below the surface (see Figure A.2.4).

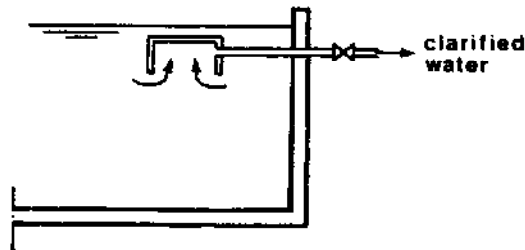

Figure A.2.4 Outlet-structure in submerged position.

Design criteria for rectangular sedimentation basins are summarized in Table A.2.1. It is remarked that the figures mentioned are not universally applicable but may serve as rules of thumb.

Table A.2.1 Design criteria for rectangular sedimentation basins.

| parameter | symbol | range of values |
|---|--------|--|
| detention-time | V/Q | 4 - 12 hours |
| surface loading | Q/A | 2 metre/day - 10 metre/day |
| depth of the basin | H | 1.5 - 2.5 metre |
| weir overflow rate ² (outlet) | Q/R | 3 - 10 m ³ /metre per hour |
| length/width ratio | L/W | 4:1 up to 6:1 |
| length/depth ratio | L/H | 25:1 up to 35:1 or 5:1 up to 20:1 for small basins |

where:

H = depth (in metres)

- L = length (metres)
 W = width (metres)
 V = volume of the basin : $L \times W \times H$ (m³)
 Q = raw water feed flow (m³/hour)
 A = bottom-area of the basin : $L \times W$ (m²)
 R = total length of overflow of the outlet weir (metres)

For the methods of construction of a sedimentation tank the reader is referred to the Chapters 4 and 5 of this manual. Sludge removal may be carried out by a continuous mechanical operation or by a batchwise operation. If the operation is to be carried out manually, which is a very appropriate method for smaller rural water supply systems, the tank should be provided with bottom-drains to remove the supernatant water.

Sludge may be removed by shovels and buckets or wheelbarrows. In case a sedimentation tank will regularly have to be taken out of operation for sludge removal, two sedimentation tanks should be constructed to enable a continuous operation of the water treatment plant.

River bed filtration

A possible lay-out for a pre-treatment by means of river bed filtration is given in figure A.2.5.

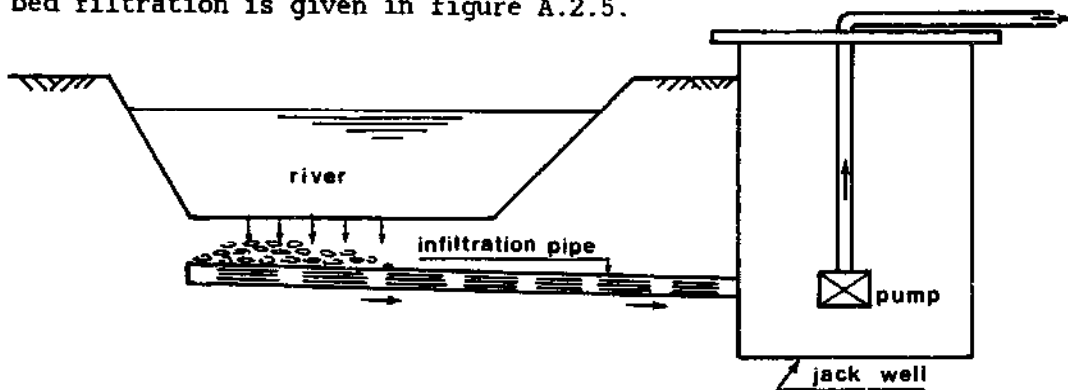

Figure A.2.5. Pre-treatment by means of river bed filtration

Whether such a river bed filtration will operate successfully or not depends on the degree of clogging of the river bed. In the river bed filtration unit, filtration rates of 5-10 m/h may be applied. The filter bed should be built up from various layers of gravel and coarse sand. The effective size of the filter bed material should decrease from the bottom to the top of the filter bed.

Rapid roughing filtration

The filter box of a rapid roughing filtration unit is similar to the filter box for a slow sand filter. The supernatant water layer and the filter bed (e.g. coconut fibres) should have a thickness of about 1 metre and the design filtration rate should be about 0.5 m/h (range 0.5-1 m/h). To clean the filter bed of a roughing filter, water should be drained off completely from the filter box and the coconut fibres should be removed and discarded. To repack the filter, new coconut fibre stock, previously soaked in water for 24 hours to remove organic matter (colour), should be used. Experiments of Thanh and Pescod (8) show that the behaviour of the coconut fibre filters is remarkably consistent, exhibiting considerable potential to absorb turbidity "shock loading" and produce an effluent relatively constant and satisfactory for subsequent slow sand filtration. The overall turbidity removal varies between 60-75%. Other filter materials, such as coarse gravel, can also be used for roughing filtration.

Horizontal-flow coarse-material prefiltration

Horizontal flow prefiltration may be carried out in a rectangular box similar to a basin used for plain sedimentation. The raw water inlet is situated at one side of the box, the outlet at the opposite side. In the main direction of flow the water passes through various layers of graded

coarse material (in the sequence coarse-fine-coarse). The vertical depth of the filter bed may be designed at about 1 m (range 0.8-1.5 m) and suitable filtration rates are in the range of 0.4-1 m/h (horizontal flow).

The total length of the filter bed, run through by the water, may vary between 4 and 10 metres. A typical lay-out of a horizontal flow prefiltration unit is given in figure A.2.6.

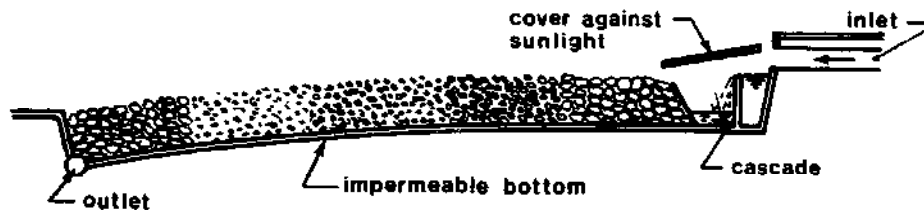

Figure A.2.6. Typical lay-out of a horizontal flow pre-filtration unit.

Thanh and Ouano (7) describe investigations on laboratory scale and pilot scale. The experimental results show that these pre-filtration units, after a maturation period of a few weeks, are quite suitable to remove part of the suspended matter of raw waters having a turbidity content up to about 150 NTU. Turbidity removal of 60-70% is reported.

APPENDIX 3

SAFETY CHLORINATION AND DISINFECTION

Introduction

Disinfection serves to destroy pathogenic organisms which may cause various types of waterborne diseases (see chapter 2). Safety chlorination provides a precautionary measure against future contamination of bacteriologically safe water (e.g. in a distribution system). If the risks of such an event are considered to be acceptable, it may be decided to rely upon the disinfecting properties of the slow sand filter itself.

For rural areas in developing countries the most suitable chemicals for these processes are bleaching powder and high-test-hypochlorite materials, the choice being determined mainly by availability and costs in the particular country or area.

These chemicals are characterised by a certain content of "available chlorine" which is the active disinfecting component.

Chemical disinfectants

Bleaching powder (sometimes called chlorinated lime) consists of calcium hydroxide, calcium chloride and calcium hypochlorite and when fresh it contains between 20% and 35% of available chlorine, i.e. 20-35 parts by weight of chlorine per 100 parts by weight of bleaching powder.

Bleaching powder is easy to handle, although it is bulky and comparatively unstable. When stored in a container that is opened once a day for 10 minutes, it loses some 5% of its initial available chlorine over a span of 40 days, but if left open all the time for the same period, the loss may be up to about 18%. In chlorine solutions made from bleaching

powder and stored in a container in the dark, the loss of chlorine over a 10-day period is not significant, but considerable loss will result in the same period if the solution is exposed to light. Both the powder and the solution should be stored in a dark, cool and dry place in a closed container that is resistant to corrosion. Containers made of wood, ceramic, or plastics are suitable. The concentration of the solution should not be greater than 2.5% as in higher concentration some chlorine may be lost in the sediment. As bleaching powder contains excess lime which is insoluble in water, an aqueous mixture will contain some suspended solids. In preparing a solution it is thus necessary to mix the material with water in one tank and, after allowing the insoluble solids to settle, to decant the clear supernatant liquid into a storage tank. If the insoluble material is not removed in this manner it will soon cause clogging of metering valves and feed lines. If 2 kg of bleaching powder with 25% available chlorine is mixed with 20 litres of water it will give a 2.5% solution of chlorine.

High-Test-Hypochlorite Materials (HTH) contain 60-70% available chlorine. Different brands are available in granular form; these are much more stable than bleaching powder and deteriorate much less during storage. HTH materials are quite soluble in water and relatively clear solutions may be prepared if the concentration of the solution is kept below 5%. The strength of the solution should preferably be between 2% and 4%. If 0.84 kg HTH with 60% available chlorine is mixed with 20 litres of water it will give a 2.5% solution of chlorine.

Similarly to bleaching powder, HTH should be stored in a dark, cool and dry place in a closed container that is resistant to corrosion, otherwise fire or explosions may occur due to exothermic chemical reactions.

Dosing equipment

There are several methods of hypochlorite chlorination which are essentially based on non-mechanical appliances to suit small water supplies. The so-called "solution hypochlorinators" are quite suitable for the treatment units discussed in this manual.

A good example of a solution-type hypochlorinator is the Floating-platform Hypochlorinator (see figure A.3.1.). A glass tube inlet fixed below a float allows for a constant flow of solution to the dosing point while the liquid level falls in the container.

The glass dripper introduced below the stopcock helps to keep the drip outlet free from being blocked by the formation of calcium carbonate. The arrangement is useful to feed chlorine solution into a water supply at a constant rate and therefore it is particularly applicable in combination with slow sand filters which have themselves a constant effluent flow.

The container should hold enough chlorine solution for 3-5 days operation; for larger treatment plants several containers may be placed in parallel position.

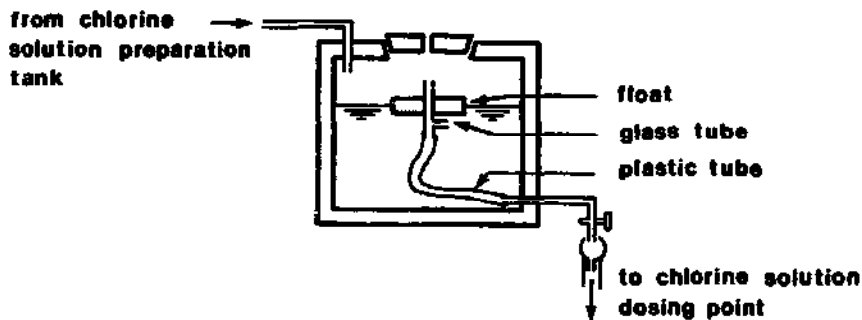

Figure A.3.1. Floating-platform hypochlorinator

Disinfection process

Depending on the quality of the water to be disinfected, between 0.5 and 2 mg available chlorine are added to each litre of water.

For an optimal disinfection the hypochlorite solution should be mixed with the water to be treated as quickly and as thoroughly as possible. This may be realised by situating the dosing point of the chlorine solution just after an overflow weir (see figure A.3.2.).

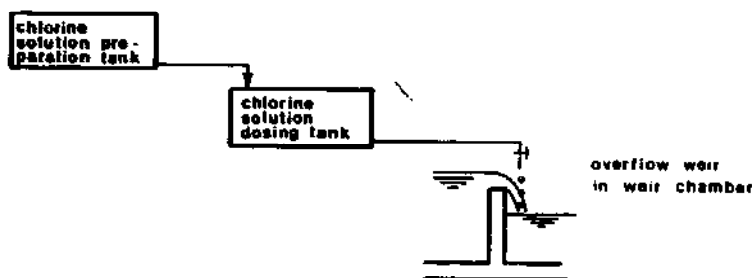

Figure A.3.2. Chlorine mixing system

Because chlorine is an oxidizing agent, part of the chlorine applied will be used by other constituents of the water. Enough chlorine must therefore be applied for reaction with such constituents and the pathogenic organisms. The chlorine requires some time to act on these constituents and the micro-organisms, a period which is called the "contact time".

The effectiveness of the disinfection process is therefore expressed as the chlorine content ("residual chlorine") which remains after a certain contact-time.

In general a residual chlorine content of 0.5 mg/l after 30 minutes contact is recommended for rural supplies (12). If for instance 2 mg available chlorine per litre of water need to be added to reach a residual chlorine content of 0.5 mg/l and a bleaching powder or HTH solution with a strength of 2.5% is being used, 1000 litres of water will require 80 ml of such a hypochlorite solution.

APPENDIX 4

SOIL INVESTIGATIONS

A good knowledge of the composition and properties of soils is of utmost importance to the design engineer, as in any structure, irrespective of its design and the other construction materials used, the weight of the structure and its load will ultimately have to be transmitted to the natural soil.

The behaviour of natural soils is very complex and even highly advanced laboratory experiments cannot supply complete information on the reaction of the soil to the load of the proposed structure. This obviously calls for a large factor of safety in the design. Furthermore, within the scope of rural water supply only simple tests that may be carried out at low cost are justifiable, calling for an even more conservative design.

The site investigations for a treatment plant will generally comprise the following items.

1. Gathering and review of all available information on geological and subsurface conditions of the area involved. Information may be obtained from government institutes keeping records of geological data as well as from the experience of institutes and individuals, e.g. local contractors who have been involved with subsoil exploration in the area. A visual inspection of buildings in the neighbourhood of the plant may also prove useful (cracks in walls and settlements indicate that soil layers with high compressibility are present).
2. Exploratory borings.
In addition to the information mentioned under 1 it may be necessary to drill holes through which samples of the subsoil may be obtained for direct observation.

Shallow holes up to a depth of about 5 m are commonly made with augers. Deeper borings, for which wash borings and rotary borings may be used, will not be discussed here.

Hand drills and augers are easy to construct and operation is not difficult, especially when drilling in sand and clay. Harder layers such as laterite or calcite demand the use of a tripod. To increase the pressure a number of people may sit on the cross handle, while two men rotate the drill.

Holes in non-cohesive soils and holes below ground water level need a casing to prevent the hole from caving in. In cohesive soils, samples of the subsoil can be taken from the contents of the auger, and in non-cohesive soils, with bailers or special sample spoons.

A very important property of the soil is its resistance to penetration of the drill. To measure the degree of compactness of the soil, a standard penetration test has been developed.

This consists of counting the number of blows of a standard weight at a standard height of fall to drive a standard sampling spoon into the soil to a distance of 0.3 m. The standard penetration test gives vital information as the results give an indication of the relative density of the soil and its bearing capacity. From the samples, taken at regular distances and collected in a sample box, information on the physical properties and composition of the soil may be obtained. A number of tests that are useful for discriminating between different kinds of soils are given below:

a. Grain size, and grading.

The coarse and very coarse fractions of the soils are the grains with diameters larger than

approximately 0.06 mm, which can still be inspected with the naked eye. It is customary to classify the 0.06 - 2 mm fraction as sand and the 2 - 300 mm as gravel. Even larger fragments are known as boulders. The grading of the larger fractions can be determined by sieve-analysis, but may also be classified with experience as "well-graded" or "poorly-graded".

Grains smaller than 0.06 mm cannot be investigated with the naked eye, but can be separated from the larger fractions by washing with water. The finer fractions are washed off and the coarse fractions remain.

The fraction from 0.06-0.002 mm is generally called silt, while the even smaller fractions are called clay. These grains can be examined only under a microscope, but a simple discriminating test may be performed by kneading a ball of the soil under water. A silt ball will fall apart while a clay ball will keep its consistency.

b. Dilatancy.

The shaking test gives information on the dilatancy of the soil. A pat of soil is shaken in the palm of the hand and the appearance of its surface is noted.

If the surface appears glossy, the results are described as conspicuous or weak, depending on the intensity of the phenomena observed. This provides another possibility of distinguishing clay and silt. Silt will, unlike clay, react positively.

c. Consistency.

The degree of cohesion between the soil particles and the resistance against deformation is described as hard, stiff, plastic and soft.

These terms correspond with certain values for the unconfined compressive strength; the load per unit area at which unconfined cylindrical samples fail in a simple compression test.

Furthermore the ground water level may be determined from the water content of the samples, while it can be measured with a rope when a casing is installed.

3. Soundings and other field tests

Soundings provide information on the resistance of the soil against penetration. They may be used to make sure that the subsoil does not contain any soft spots between drill holes and to investigate the relative density of non-cohesive layers. One of the most widely used procedures for measuring resistance to penetration is the standard penetration test, mentioned above. Whereas the standard penetration test only furnishes one value of resistance for approximately each metre, many other types of subsurface soundings yield continuous penetration records.

In its most simple form a sounding consists of a rod, pipe or railroad rail which is driven into the ground by a drop weight. Records of the penetration by each blow can give very useful results, especially in combination with a few exploratory borings. Next to these so-called dynamic sounding methods, there are also static sounding methods.

These consist of a standard cone pushed into the ground at a standard rate by means of manual or mechanical power. The pressure exerted on the rod has to be registered by a Bourdon gauge.

APPENDIX 5

BUILDING MATERIALS

The most common building materials used for slow sand filtration plants are mass concrete, reinforced concrete, masonry and ferrocement.

The quality and characteristics of these building materials will vary from place to place and time to time, depending on such items as the nature and quality of the raw materials, climatic conditions and the attention paid to handling, processing and finishing of the materials. In this appendix consideration is given to some aspects of these building materials.

Concrete

Concrete consists of a mixture of sand, gravel, cement and water. It is important to see to it that all the components of concrete are tested. International standard testing methods exist for this purpose. The testing need not to be done at the building site itself; samples may be taken at the site and examined in a laboratory.

The quality of cement is usually locally known and therefore it need not necessarily be tested. Care should be taken that the cement is not stored for too long a period and that it is stored in a dry place.

Sand and gravel have to be tested for their organic matter content (Abram-Harder or fulvic acid test). Furthermore the grain size distribution of the sand and gravel has to fulfil certain (locally differing) conditions.

The water to be used has to be clean, fresh and clear.

The proportion of the components in the concrete mixture will depend on the characteristics of the components, but a mixture of 1 litre cement to 2 litres of sand to 3 litres of gravel will usually give good results.

Some 120-160 litres of water per m³ concrete have to be added to this mixture ($\frac{3}{4}$ litres of water to 1 litre of cement).

In order to guarantee watertightness of the concrete the following measures are important.

1. Attention must be paid to the grain size distribution and especially the content of fine materials. The content of "fines" consists of the cement and the fraction of sand particles smaller than 0.3 mm. Recommended contents of fines are:

Table A.5.1. Recommended contents of fines for concrete.

| | Largest grain size (mm) | Content of fines (kg/m ³) |
|-------------------------------|----------------------------|--|
| "Normal concrete" | 10 | 500-550 |
| | 20 | 425-475 |
| | 30 | 375-425 |
| "Large aggregate concrete" | 50 | 300-350 |
| | 80 | 250-300 |

2. The water-cement ratio, i.e. the ratio of weight of water used and weight of cement used, has to be kept as low as possible. A value of 0.5 will generally be satisfactory. It is advisable to keep the water content down to the lowest workable value.
3. Use as little cement as possible. It may be advisable to increase the largest grain size of the gravel to, for example, 50 mm (instead of the usual 30 mm), so that the content of cement can be decreased

4. Pay due attention to finishing of the concrete. It is important to keep the shuttering and the surface of the poured concrete wet (by spraying with water of a temperature not above 20-25°C) and to prevent high temperatures and strong evaporation. This may be done by erecting a temporary cover.

With regard to steel reinforcement of concrete, it is necessary to have information on the quality of the steel that is locally available. Some details on reinforcement schemes are given in appendix 8.

Ferro-cement

Ferro-cement consists of a heavily reinforced (reinforcement percentage by weight 0.9-2.1) sand-cement mortar. The reinforcement is built up of vertically and horizontally placed rods of small diameter (\emptyset 5 - 6 mm). The rods are embedded in chicken wire.

Ferro-cement is particularly suited for curved construction elements (14).

It may be applied in circular slow sand filters because bending moments do not occur and small deformations are acceptable.

Favourable properties of ferro-cement are its simplicity in construction and its durability. The construction process is labour-intensive, which need not cause serious problems.

There are two ways of constructing a slow sand filter:

1. use of built-in frame
2. use of inside or outside mold

The second possibility seems most promising.

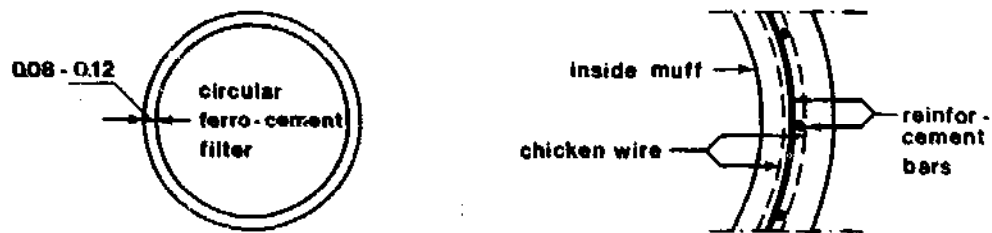

Figure A.5.1. Ferro-cement wall

In figure A.5.1. the design with inside mold is given. The reinforcement consists of vertically and horizontally placed 5 or 6 mm steel bars, at distances of 50 to 120 mm. For the wire mesh, chicken wire with a mesh width of 20 mm is quite suitable.

The building process is as follows: from the outside of the reinforcement structure, the mortar is spread onto the reinforcement with a trowel up to the inside mold. The thickness of the wall is usually between 60 and 120 mm. The composition of the mortar is 1 part cement and 2 parts sand. The sand should not be too coarse. Part of the cement (for instance 10%) may be replaced by puzzilanos, if available, to prevent a high water uptake.

To protect the structure against weather and to obtain a high degree of watertightness, it may be finished with a coating layer of tar epoxy or natural rubber.

Masonry

The quality of the masonry and the mortar should be high in order to obtain a watertight structure. The wall thickness will be in the order of 0.30-0.40 m for circular filters with a diameter of some 5-10 m. Important points in the preparation of the bond for the wall are:

1. vertical joints should never be placed above each other
2. vertical joints should go all over the width of the wall, if possible
3. the bricks should not be split in pieces smaller than half the standard size locally available

Mortars for masonry consist of cement or lime, sand and water.

A mixture of 1 part cement and 2-2.5 parts of sand will be suitable. If the bricks are of low quality, then the quality of the mortar should also be lowered (for instance to 1:4.5) in order to prevent the occurrence of differences in shrinkage between brickwork and mortar.

It should be remembered, however, that this will lead to a less rigid and certainly less watertight construction.

APPENDIX 6

FLOW MEASUREMENT DEVICES

In slow sand filtration plants, it is necessary to measure the flow through the filters in order to adjust the filtration rate to a preset value.

Flow measurements can be carried out in closed pipelines by means of venturi meters or other devices, but they are best done in open channels with measuring weirs. Weirs provide a sound and simple way of measuring the flow. They are based on the principle that the flow over a weir in an open channel is related to the depth of the water above the crest of the weir. In figure A.6.1. some possible types of weirs are given, together with their discharge equations.

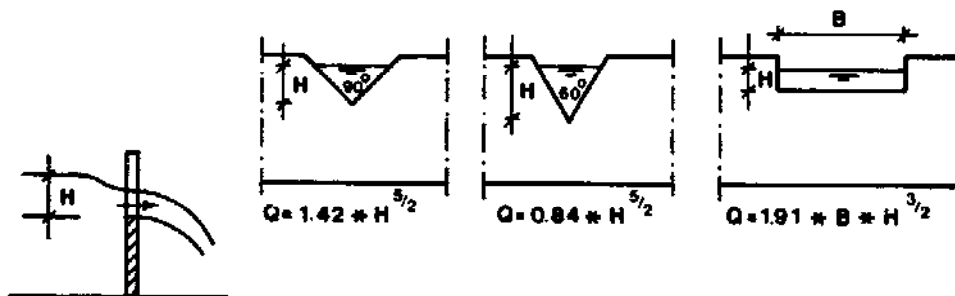

Figure A.6.1. Weirs and discharge equations

In figure A.6.2. the relationship flow versus depth of water for rectangular weirs, 90° - triangular weirs and 60° - triangular weirs is given graphically. Once the level of the water above the lowest point of the weir is known the flow can be determined quite simply on the basis of this figure.

Weirs can be made of wood, but a concrete structure with a steel plate will give more accurate readings. A 90° - weir

is very suitable for accurate readings at low flows. The water level over the crest of the weir must be measured some 0.3 m back from the crest (see typical designs).

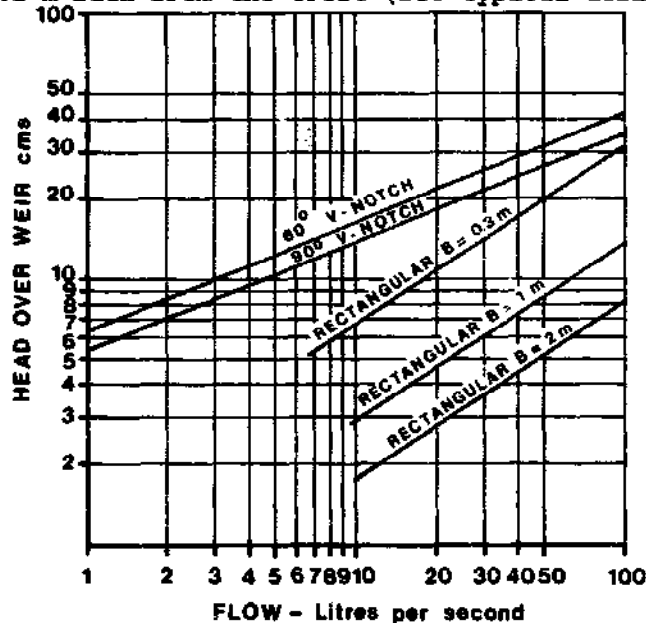

Figure A.6.2. Discharge charts for three types of weirs.

The discharge through floating weirs, discussed in paragraph 5.4., depends on the diameter of the effluent pipe and the distance d between the water level and the crest of the effluent pipe. This distance has to be adjusted to the flow desired. Figure A.6.3. gives an indication of the flow through floating weirs for different pipe diameters and various values of d .

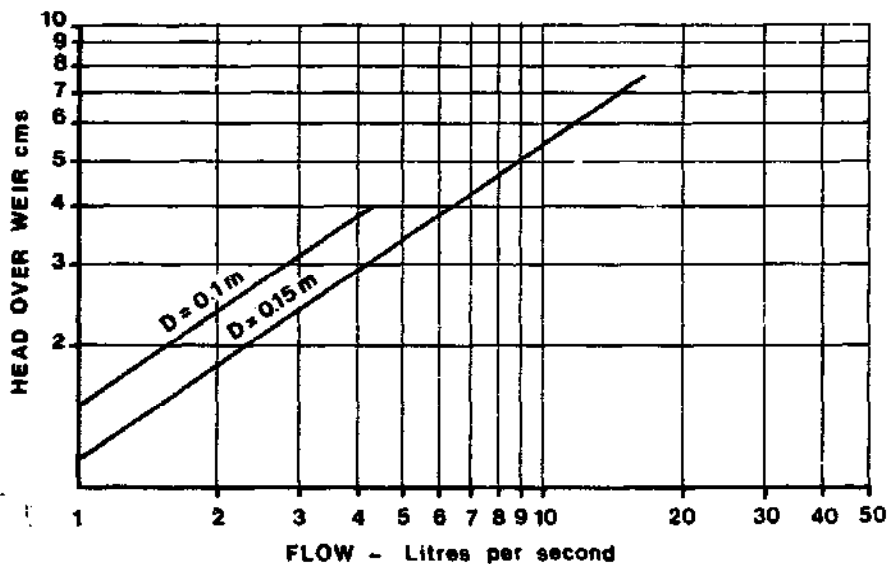

Figure A.6.3. Discharge through floating weirs.

It should be borne in mind that the accuracy of flow measurements is always limited and that a regular calibration of the measuring weir (e.g. by means of vessels and a watch) is advisable.

APPENDIX 7

WATER QUALITY ANALYSIS

In the case of domestic water supply, water quality tests are required, regularly or periodically, for the following purposes:

- selection of a water source
- examination and control of the water source or the performance of a water treatment system

General

Water quality tests may include comprehensive analyses of the physical, bacteriological and chemical constituents of a water sample or an examination of just a few crucial water quality parameters (see also appendix 1).

Comprehensive water analyses require well trained and skilled laboratory workers, who have sufficient suitable laboratory equipment and chemicals at their disposal. Therefore, such analyses should preferably be carried out in a laboratory of the district or regional authorities. If river water is chosen as the source for a slow sand filtration unit, data should be collected during the planning stage on the variations of the water quality of the river for a complete hydrological year[■]. In other words, one should have sufficient data on the river water quality during the dry as well as the wet season. The turbidity of the raw water is a crucial parameter for a slow sand filtration unit, and special attention should be paid to the values of this parameter during the early stages of the rainy season, when the run-off water is likely to carry transportable debris and sediments from the river-basin and the river bed itself is being "cleaned up" by the rapidly increasing surge of water. The data required may be available from the

water authorities; otherwise samples for testing and analysis should be taken and sent to an adequately equipped laboratory. Clean glass or plastic bottles sealed with a rubber or plastic stopper must be used for such samples. The bottle should be washed out at least three times with a small quantity of the water to be sampled and then filled and labelled immediately with time, date and place. The bottle should be plunged in at a point a short distance from the river-bank and care should be taken to prevent gross floating debris or mud disturbed from the bottom from entering the bottle. Samples taken in this way are suitable for physical and chemical examination but not for bacteriological tests. The samples should be not less than 2 litres and should be sent for analysis without delay.

If the data regarding the physical and chemical composition of the samples have shown that the water source can produce water suitable for human consumption by means of slow sand filtration (with or without pre-treatment), further comprehensive tests are only required periodically (i.e. once every 1-3 months). They then serve to check whether the water source remains acceptable and whether the slow sand filtration unit is functioning properly, so that a clean water suitable for human consumption is produced.

Bacteriological examination

One of the parameters which requires a more regular examination (once a week or at least once a month) is the bacteriological quality of the raw and the treated water. The bacteriological quality of the water is a main concern, owing to the risk of epidemics of waterborne diseases (see chapter 2). Such tests have to be carried out on site at the treatment unit, as any delay in analysing a sample will lead to incorrect results due to continuing biological activity in the sampling bottle.

One of the limitations of the various bacteriological testing methods is the length of time required to produce results.

The multiple-tube fermentation test for coliform bacteria needs 48-96 hours from sample collection to results, the membrane filter test 18-22 hours. Furthermore, bacteriological testing requires certain laboratory skills and equipment that are often not available. The tests are also fairly expensive.

A suitable bacteriological test method for developing countries is the membrane filtration technique. The membrane filters used in water bacteriology are flat, porous, flexible plastic discs about 0.15 mm thick and usually 47-50 mm in diameter. Pore size is rigidly controlled; for water bacteriology the pore diameter is usually 0.5 micrometre. A water sample is filtered through the membrane filter, the filter is then placed on agar bacteriological culture medium or on a paper pad impregnated with moist culture medium, and the preparation is incubated for a specified time under prescribed conditions of temperature and humidity. The resulting bacterial culture is then examined and interpreted.

As a more detailed discussion of the various bacteriological test methods is beyond the scope of this manual, the reader is referred to "Surveillance of drinking-water quality" (13) and other publications (23, 24).

Field equipment

In recent years, some field kits have been made available which enable trained laboratory workers to carry out tests at different places during field trips.

For instance, the Hach Chemical Company (21) has developed several field kits which include instruments and chemicals

to determine most of the water quality parameters mentioned in appendix 1, item b. Some of the Hach field kits are equipped to examine 10-20 parameters, while others have been especially developed to examine one specific parameter. A very suitable portable test kit for bacteriological surveys has been developed by Millipore (22). This test kit is based on the membrane filtration technique described above.

Some simple tests, which may provide much useful information, can be carried out by the operator of the slow sand filtration plant, i.e. observation of a sample from the raw water drawn in a glass cylinder. Turbidity can be noted and may be measured by comparison with other samples or with prepared standards. The usefulness of quiescent settlement can be observed and also the nature of suspended matter, whether animal, vegetable, or mineral, can be estimated. If disinfection in a treatment plant is effected by means of chlorine compounds, the tests for residual chlorine can also be carried out by the plant operator. At larger plants an elementary laboratory training for plant operators may be considered, to enable them to use some of the field test kits mentioned above.

APPENDIX 8

STRUCTURAL CALCULATIONS OF A REINFORCED CONCRETE FILTER BOX

For the convenience of the reader, some details of the structural calculations of a reinforced concrete filter box are given below. More elaborate information on this subject can be found in the textbooks, mentioned in the bibliography.

Data :

1. Concrete compressive strength^{fc} 17.5 N/mm²
2. Steel tensile strength^{fy} 220 N/mm²
3. Ground level 0.50 m below top filter level
4. Groundwater level 0.70 m below top filter level
5. Specific gravity of natural soil 1.9
6. Specific gravity of concrete 2.4
7. Specific gravity of sand and gravel 1.6

Diagram

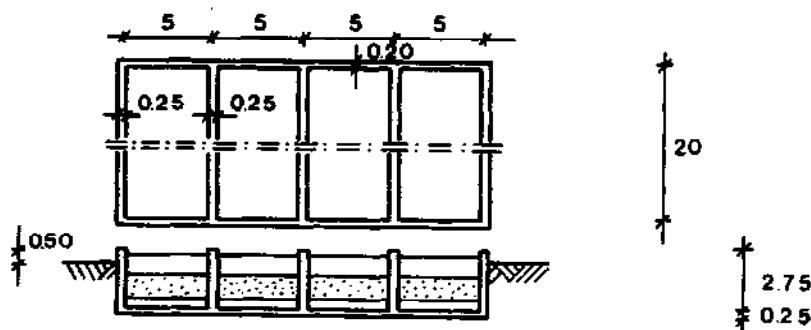

Calculation of filter bottom

Forcing up of the construction by water pressure has to be checked:

1. Weight of the structure:
(length × height × thickness × gravity)

| | | |
|-------|---|----------------|
| walls | $2 \times 20 \times 2.75 \times 0.2 \times 24$ | = 528 kN |
| | $5 \times 20 \times 2.75 \times 0.25 \times 24$ | = 1650 kN |
| floor | $20 \times 20 \times 0.25 \times 24$ | = 2400 kN |
| | | <u>4578 kN</u> |

2. Water pressure (water head \times length \times width \times gravity)

$$2.3 \times 20 \times 20 \times 10 = 9200 \text{ kN}$$

It follows from the calculations that if the filter box is empty, buoyancy will occur. However, the filter gravel and part of the filter sand will remain in the filter, so their weight can be added to the weight of the structure.

(length \times width \times height \times gravity)

$$\text{Weight of gravel} \quad 20 \times 20 \times 0.5 \times 16 = 3200 \text{ kN}$$

$$\text{Weight of sand} \quad 20 \times 20 \times 0.6 \times 16 = 3840 \text{ kN}$$

As the total weight of the structure and the filter bed is more than 1.15 (safety factor) times the water pressure, forcing up need not be feared (during construction drainage of the building pit will of course have to be provided).

As no large bending moments occur in the floor of the filter, a minimum reinforcement of ϕ 10-200 will suffice.

Calculation of filter walls

- Long wall

Diagram

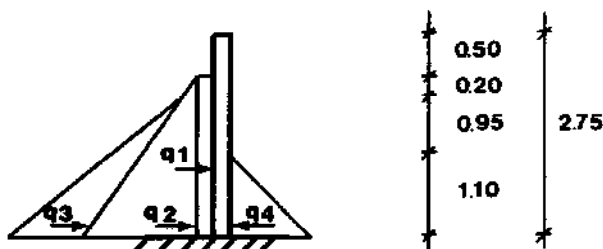

$$\begin{aligned}
 q_1 &= \text{surface load} = 0.67 \text{ kN/m'} \text{ (i.e. 0.67 kN per metre} \\
 &\quad \text{of wall length)} \\
 q_2 &= \text{soil load} = 1/3 \times 9 \times 2.25 = 6.75 \text{ kN/m'} \\
 q_3 &= \text{water load} = 10 \times 2.05 = 20.50 \text{ kN/m'} \\
 q_4 &= \text{gravel and sand} = 1/3 \times 1.1 \times 16 = 5.9 \text{ kN/m'}
 \end{aligned}$$

The entry moment at the filter bottom will amount to:

$$\begin{aligned}
 M_A &= \frac{1}{2} \times 0.67 \times 2.25^2 + \frac{1}{6} \times 6.75 \times 2.25^2 + \frac{1}{6} \times 20.50 \\
 &\quad \times 2.05^2 - \frac{1}{6} \times 5.9 \times 1.1^2 = 20.57 \text{ kNm}
 \end{aligned}$$

Thickness of the wall is set at 0.25 m, so the inner lever arm is $0.8 \times 0.25 = 0.20 \text{ m}$

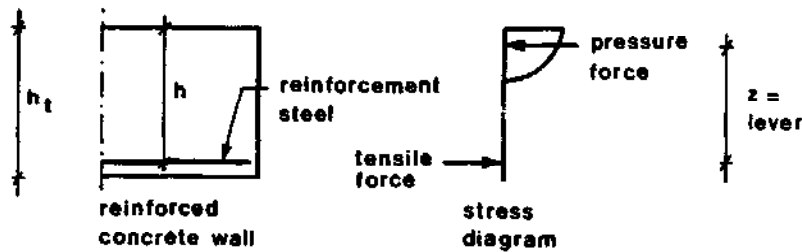

The reinforcement A can be calculated as the entry moment \times a safety factor divided by the inner lever arm times the steel tensile strength, in this case therefore

$$A = \frac{M_A \times 1,8}{0,2 \times 220} = 841 \text{ mm}^2/\text{m}^1, \text{ or } \emptyset 16-200 \text{ (see figure A 8.1.)}$$

- Short wall

Diagram

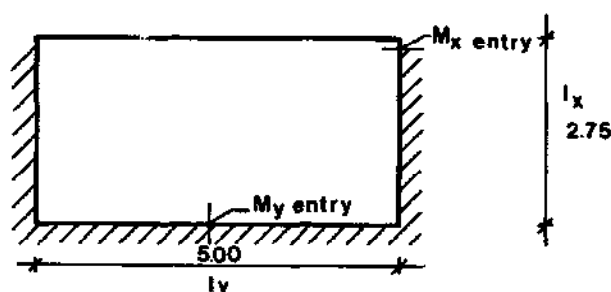

The short wall can be calculated as a three sided fixed plate. The entry moments follow from the l_y/l_x ratio and can be read from tables (lit. 17, 18).

$$M_{x \text{ entry}} = \frac{0.67 * 2.75^2}{6} + \frac{27.25 * 2.75^2}{13} = 16.7 \text{ kNm},$$

so $A = 853 \text{ mm}^2$ ($\phi 16-200$)

$$M_{y \text{ entry}} = \frac{0.67 * 2.75^2}{4} + \frac{27.25 * 2.75^2}{18} = 12.72 \text{ kNm},$$

so $A = 650 \text{ mm}^2$ ($\phi 16-250$)

The influence of the small inside load q_4 has been neglected.

In figure A.8.1. the reinforcement schemes are given, both for the filter boxes and the clear water tank of typical design No. IV (paragraph 6.4).

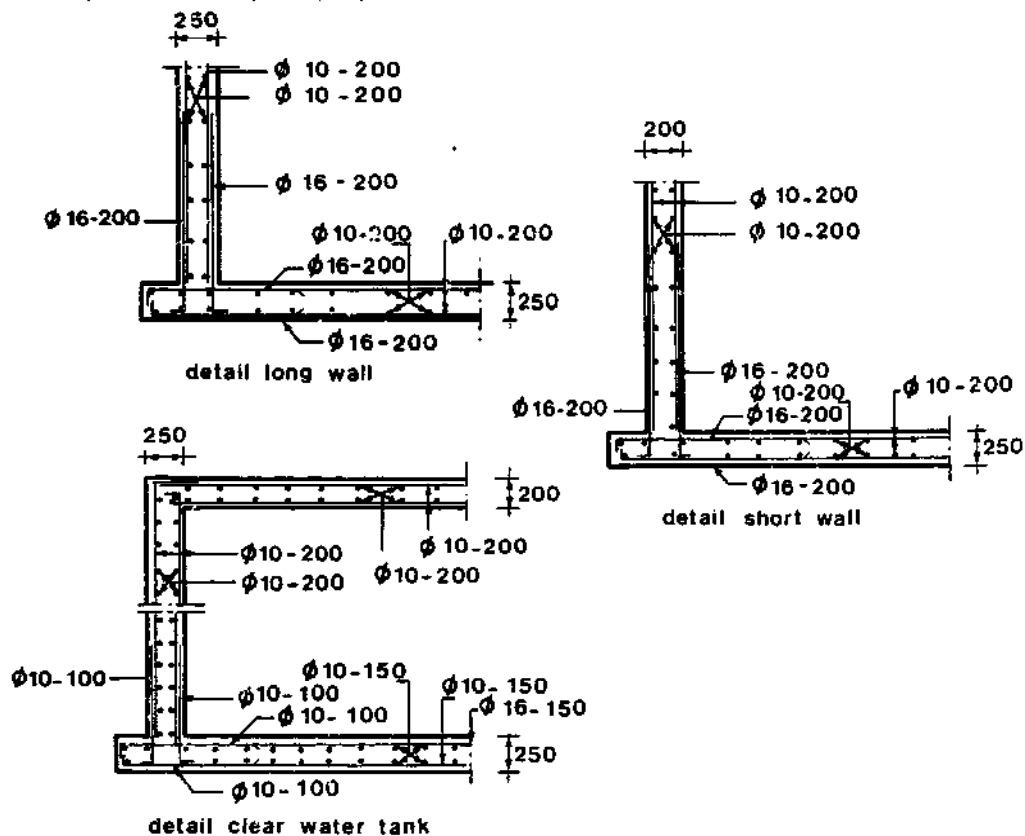

Figure A. 8.1. Reinforcement schemes of filter box and clear water tank.

APPENDIX 9**ADDRESSES OF MEMBER ORGANIZATIONS OF FIDIC**

The FIDIC (Fédération Internationale des Ingénieurs-Conseils) is an international organization, from which information regarding contract documents, tendering etc. may be obtained. Member organizations in countries in the developing world include:

ARGENTINA

Cámara Argentina de la
Construcción,
Av. Paseo Colón 823,
BUENOS AIRES

BANGLADESH

Bangladesh Thikadar Samity,
23 Bangabandhu Avenue,
DACCA 2

BOLIVIA

Cámara Boliviana de la
Construcción
Casila de Correo 3215,
LA PAZ

BRAZIL

Cámara Brasileira de la
Construcción
Rua Do Senado 213,
RIO DE JANEIRO

COLOMBIA

Cámara Colombiana de la
Construcción
A.P.T. Aereo 28588
BOGOTA

COSTA RICA

Cámara Costarricense de la
Construcción
Apt. 5260
SAN JOSE

DOMINICA

Cámara Dominicana de la
Construcción
Calle No. 9,
Reperto Vista Mar,
Zone 7,
SANTA DOMINGO

ECUADOR

Federación Ecuatoriana de
Cámaras de la Construcción
Block Centro Commercial,
Ciudadela Bolivariana,
Casilla 8955
GUAYAQUIL

EL SALVADOR

Cámara Salvadoreña de la
Industria de la Construcción
Avenida Olimpica,
Pasase 3
No. 130
SAN SALVADOR

GUATEMALA

Cámara Guatemalteca de la
Construcción
Apt. Postal 2083,
GUATAMALA CITY

HONDURAS

Cámara Hondurena de la
Construcción
Apartado Postal 905,
TEGUCIGALPA

HONG KONG

The Building Contractors
Association
Ltd., Hong Kong
180-182 Henessy Road, 3rd Floor,
HONG KONG

INDIA

Builders Association of India
G-1/G-20 Commerce Centre,
7th Floor
J. Dadajee (Tardeo)
Main Road, Tardeo
BOMBAY 400034

INDONESIA

Asosiasi Kontraktor Indonesia
(Indonesia Contractors'
Association)
JI.M.H. Thamrin 57,
P.P. Building, 2nd Floor,
JAKARTA

KOREA

Construction Association of
Korea Construction
Building,
32-23, 1-Ka, Taepyung-Ro
Joong-Ku,
SEOUL

MALAYSIA

Master Builders' Association,
Federation of Malaya,
13 Jalan Gereja, 3rd Floor,
KUALA LUMPUR

MEXICO

Cámara Nacional de la
Industria de la Construcción
Colima 254,
MEXICO 7 D.F.

NICARAGUA

Cámara Nicaraguense de la
Construcción
Apartado Postal 3016
MANAGUA

PANAMA

Cámara Panameña de la
Construcción
Apartado Postal 6793,
PANAMA 5

PERU

Cámara Peruana de la
Construcción
Paseo de la Republica
Cuadra SA,
Edificio Caêso Piso 12,
LIMA

SINGAPORE

Singapore Contractors'
Association
150 Neil Road,
SINGAPORE

URUGUAY

Uruguay
Cámara de la Construcción
de Uruguay
Av. Agraciada 1670,
1er piso
MONTEVIDEO

PARAGUAY

Cámara Paraguaya de la
Construcción
Yegros 242,
ASUNCION

PHILIPPINES

Philippine Contractors'
Association Inc.
3rd Floor, Padilla,
Cond. off. Bldg.,
Ortigas Commercial Cenrte,
Pasig, Rizal,
MANILLA

THAILAND

Thai Contractors' Association
110 Vidhuya Road,
BANGKOK

VENEZUELA

Cámara Venezolana de la
Construcción
Calle Villaflor,
Centro Professional del Este,
CARACAS

BIBLIOGRAPHY

1. Huisman, L., Wood, W.E.
Slow Sand Filtration
World Health Organization, Geneva, 1974.
2. Slow Sand Filtration Project - Phase I. First
Progress Report.
University of Science and Technology, Department
of Civil Engineering, Kumasi, Ghana, 1976.
3. Slow Sand Filtration Project. Report - Phase I.
National Environmental Engineering Research Institute,
Nagpur, India (1977).
4. Slow Sand Filtration Project. Report - Phase I.
University of Nairobi, Nairobi, Kenya, 1978.
5. Slow Sand Filtration Project. Phase I. Interim Report.
University of Khartoum, Khartoum, Sudan, 1976.
6. Slow Sand Filtration Project. Report - Phase I.
Asian Institute of Technology, Bangkok, Thailand, 1976.
7. Thanh, N.C., Ouano, E.A.R.
Horizontal-Flow Coarse-Material Prefiltration.
Asian Institute of Technology, Bangkok, Thailand, 1977.
8. Slow Sand Filtration for Community Water Supply in
Developing Countries, A Selected and Annotated Biblio-
graphy.
WHO International Reference Centre for Community Water
Supply, Voorburg (The Hague), The Netherlands, 1977.

9. Slow Sand Filtration for Community Water Supply in Developing Countries, An Operation and Maintenance Manual. WHO International Reference Centre for Community Water Supply, Voorburg (The Hague), The Netherlands. (in preparation).
10. Community Water Supply and Sewage Disposal in Developing Countries. World Health Statistics Report, Vol. 26, No. 11. World Health Organization, Geneva, 1973.
11. White, G.F., Bradley, D.J., White, A.U. Drawers of Water University of Chicago Press, Chicago, 1972.
12. Feachem, R., Mc.Garry, M., Mara, D. Water, Wastes and Health in Hot Climates John Wiley & Sons, London, 1977.
13. Surveillance of Drinking-water Quality WHO Monograph Series, No. 63 World Health Organization, Geneva, 1976.
14. Bingham, B. Ferrocement; Design, Techniques and Application. Carnell Maritime Press, Cambridge, 1974.
15. Conditions of Contract for Works of Civil Engineering Construction. FIDIC, March 1977.
16. International Standards for Drinking Water. (Third Edition). World Health Organization, Geneva, 1971.

17. Reynolds, C.E., Steedman, J.C.C.
Reinforced Concrete Designer's Handbook.
Cement and Concrete Association, London, 1975.
18. Morgan, W.
Students Structural Handbook
Newnes Butterworths, 1976.
19. Manual of Concrete Practice
American Concrete Institute, Detroit, Michigan, 1974.
20. Dancy, H.K.
A Manual on Building Construction.
Intermediate Technology Publications Ltd., London, 1975.
21. Hach Catalogue.
The Hach Chemical Company, Ames, Iowa, 1976.
22. Millipore Catalogue.
Millipore Corporation, Bedford, Massachusetts, 1976.
23. Wagner, E.G., Lancix, J.N.
Water Supply for Rural Areas and Small Communities
WHO Monograph Series, No. 42., Geneva, World Health
Organization, 1959.
24. Cox, C.R.
Operation and Control of Water Treatment Processes.
WHO Monograph Series, No. 49.,
World Health Organization, Geneva, 1964.
25. Mann, H.T., Williamsom, D.
Water Treatment and Sanitation
Intermediate Technology Publications Ltd., London, 1976.

26. Saunders, R.J., Warford, J.J.

Village Water Supply

World Bank, John Hopkins University Press, 1976.

GLOSSARY

- Aeration** A process for continuously creating new air/liquid interfaces to increase the oxygen content of the water.
This may be achieved by:
- a. allowing the liquid to flow in thin films over a weir or plate
 - b. spraying the liquid in the air
 - c. bubbling air through the liquid
 - d. agitating the liquid
- Capital return period** The period elapsing between a capital expenditure and the reimbursement of this capital expenditure by means of recurrent income from the fixed assets.
- Chemical Oxygen Demand (COD)** The amount of oxygen consumed from a specified oxidizing agent in the oxidation of the matter present in a (water)sample. As normally determined, i.e. from silver-catalysed dichromate, it approximates to the oxygen theoretically required for complete oxidation of the carbonaceous matter to carbon dioxide and water. This term is now restricted to the standard test employing oxidation by a boiling solution of acid potassium dichromate.
- Concrete compressive strength** The maximum allowable compressive force per unit of area without the occurrence of shear (deformation).

- Declining rate filtration** A specific mode of operation of slow sand filters. If the raw water inlet to the supernatant water is closed and the filtration regulating valve is kept in its normal operating position, the supernatant water will be filtered at a continuously declining filtration rate. Such an operation may be applied during the night to save labour costs and capital investment costs.
- Depreciation period** An estimated period (on the bases of experience) after which equipment should be replaced due to wear and tear.
- Design capacity** The treatment capacity (in m³/h) of a newly designed water purification unit.
- Design period** The period a treatment unit or water supply system is designed for, or the period during which under normal circumstances no extension of the treatment unit is required to provide the consumers with an unobstructed water supply.
- E.Coli** *Escherichia Coli*: a bacterium living in the alimentary tract of man and other mammals. As it is passed out with faeces in large numbers its presence in water is indicative of faecal contamination and the possible presence of pathogenic organisms of enteric origin; normally it is not itself pathogenic.

- Economic lifetime** The period during which equipment creates an income which more than offsets costs of capital expenditure (interest of loans) and costs of operation and maintenance.
- Effective diameter** The size of the sieve opening through which 10% of the filter bed material will just pass (symbol: d_{10}). Also indicated by "effective size".
- Effluent** Water (or other liquid), treated to a greater or lesser extent, flowing out of a section of the treatment plant.
- Flocculation/
Coagulation** The process by which colloidal and finely-divided suspended matter is caused to coalesce, leading to the formation of flocs and agglomeration of the flocculated matter.
Flocculation/coagulation may be effected by adding a suitable chemical or chemicals, or it may be a biological process.
- Freeboard** The vertical distance between the maximum water level in a tank and the top of the side walls, provided to prevent the contents of the tank from being blown over the walls in a high wind.
- Yearly growth rate** The yearly rate of multiplication, expressed as the rate of increase in population per unit of population present (in percentage).

- Hydraulic feeder** Chemical dosing equipment consisting of non-mechanical appliances. A chemical solution is fed to the water to be treated by means of gravity-forces (see also figure A.3.1.).
- Hydraulic line** A graph showing the subsequent hydraulic gradients in the various sections of a treatment unit passed through by the water to be treated.
A hydraulic gradient represents the loss of head in a liquid flowing in a pipe or channel, through a filter bed or a valve, expressed as a ratio, the slope of a curve, or as a fractional drop (m/km).
When the liquid is flowing under pressure in a pipe line, the hydraulic gradient is the slope of the line joining the elevations to which the liquid would rise in pipes freely vented and under atmospheric pressure.
- Hydrological year** A period in the lifetime of a river (8-12 months) which covers all variations in its hydrological characteristics due to rainfall, run off, evaporation, artificial (man-made) withdrawals or discharges etc.
- Influent** Water (or other liquid), untreated or partially treated, flowing into a section of the treatment plant.

- Maximum day** The maximum water demand during one single day (24 hours).
- Maximum hour** The maximum water demand during one single hour.
- MPN** Most Probable Number:
 a statistical estimate of the numbers of viable bacteria obtained in a dilution count, such as the presumptive coliform count, in which a series of tubes containing a selective growth medium is inoculated with specified volumes of sample, and incubated. The most probable number is obtained by examining the tubes for a positive growth response (such as the production of acid and gas for coliforms) and referring the pattern of such responses to statistical tables.
- N;kN** Newton: kiloNewton
 the unit of force; $1 \text{ N} = g \text{ kg m/s}^2 \sim 9.8 \text{ kg m/s}^2$; $1 \text{ kN} \sim 9800 \text{ kg m/s}^2$; $g =$ acceleration due to gravity ($\sim 9.8 \text{ m/s}^2$).
 (10N = approx. 1 kgwt)
- Negative pressure** If the head loss in a filter bed were more than the available head of the supernatant water layer, then the filtered water could drain away from the supernatant water, leaving a partial vacuum. Under such conditions "air binding" may occur: release of air in the low-pressure region below the filter-skin which forms bubbles in the filter bed pores.

Air-binding may lead to overloading of part of the filterbed and subsequent deterioration of the effluent quality.

NTU

Nephelometric Turbidity Unit:

The turbidity is measured by the interference with the passage of light rays through a liquid caused by the presence of fine suspended matter.

(1 NTU = 1 FTU (Formazin Turbidity Unit)
~ 1 mg SiO₂/l).

Physical lifetime

The physical lifetime of equipment is the period (months/years) it keeps on functioning as long as maintenance and repairs are carried out.

Population growth factor

The total increase in population per unit of population present, during a certain number of years. The population growth factor is determined by the yearly growth rate and the number of years considered (design period).

Riprap

Coarse and durable natural material, e.g. murrum.

Scum

A layer of fats, oils and grease together with particles of plastics, floating wrapping materials, remains of vegetation and algae which rises to the surface of the supernatant water layer due to a specific gravity lower than that of water.

- Service reservoir** A clear water storage tank, within the distribution system, which provides sufficient storage to overcome periods of higher demand and sufficient head to deliver the water to all planned withdrawal points.
- Specific gravity** The ratio of the mass of a given volume of a substance to the mass of an equal volume of water at a temperature of 4°C.
- Surface loading** The maximum rate of flow to be treated per day per unit area, or:
 surface loading (m³/m² d) =

$$\frac{\text{maximum flow (m}^3/\text{d)}}{\text{surface area (m}^2\text{)}}$$
 The surface loading may also be expressed as m³/m² h (or m/h).
- Tensile strength** The maximum allowable tensile force per unit of area without the occurrence of strain (deformation).
- Turbidity** Interference with the passage of light rays through a liquid, caused by the presence of fine suspended matter.
- Uniformity coefficient** The coefficient of uniformity (U.C.) is the ratio d_{60}/d_{10} (see effective diameter).
- Venturi meter** A device used for measuring the flow of liquid in a pipeline, in which there is a gradual contraction to a throat followed by an expansion to normal diameter.

The pressure is measured at the throat where the pressure is reduced and upstream where the diameter is normal, by means of small pipes leading to gauges. The velocity and therefore the rate of flow is related to the pressure difference between these points.

V-notch weir

A measuring weir of V-shape with the angle at the apex usually 90° , used for measuring small discharges (see "weir" and appendix 6).

Weir

A structure over which water flows, the downstream level of the water usually being lower than the crest of the weir. When used for measuring flows the weir may be rectangular, notched or trapezoidal and the rate of flow will be related to be upstream height of the water above the crest and to the geometry of the weir opening.

Weir overflow rate

The volume of liquid passing over the outlet weir of a tank per unit length of weir at maximum flow, calculated as follows:

weir overflow rate (m³/m h) =

$$\frac{\text{maximum rate of flow (m}^3\text{/h)}}{\text{total length of outlet weirs (m)}}$$

LIST OF REVIEWERS

Mr. T.B.V. Acquah, Chief Planning and Research, Ghana Water and Sewerage Corporation, Accra, Ghana.

Mr. Awad Ahmed Abdel Salam, Director Surface Water Section, Rural Water Corporation, Ministry of Agriculture Food and Natural Resources, Khartoum, Sudan.

Dr. R.C. Ballance, Sanitary Engineer, Division of Environmental Health, World Health Organization, Geneva, Switzerland.

Mr. L. Chainarong, Director Rural Water Supply Division, Department of Health, Ministry of Public Health, Bangkok, Thailand.

Drs. F.W.J. van Haaren, Former Chief Amsterdam Waterworks Laboratories, Baki, The Netherlands.

Prof. Ir. L. Huisman, Professor of Sanitary Engineering, Department of Civil Engineering, Technical University of Delft, Delft, The Netherlands.

Prof. K.J. Ives, Professor of Sanitary Engineering, Department of Civil and Municipal Engineering, University College London, United Kingdom.

Dr. M. Nawaz Tariq, Director, Institute of Public Health Engineering and Research, University of Engineering and Technology, Lahore, Pakistan.

Mr. R. Paramasivam, Scientist, National Environmental Engineering Research Institute, Nagpur, India.

Mr. J. Pickford, Senior Lecturer, Loughborough University of Technology, Loughborough, Leicestershire, United Kingdom.

Mr. M. Santacruz, Supervisor of Basic Rural Sanitation Programmes, Instituto Nacional de Salud, Bogota, Colombia.

Mr. P.C. Tyagi, Chief Design Section, Ministry of Water Development, Nairobi, Kenya.

Prof. A.N. Wright, Professor of Sanitary Engineering, Civil Engineering Department, Faculty of Engineering, University of Science and Technology, Kumasi, Ghana.

INDEX

- Advantages of slow sand filters 26, 27
- Aeration 23, 35, 163
- Algae 22, 25
- Anaerobic conditions 23
- Analysis of samples 147-150
- Area requirements of slow sand filter 49
- Available chlorine 129
- Back filling 29
- Bacteria, removal 24
- Bacteriological quality, see water quality
- Bacteriological analysis, see water quality
- Basic elements of slow sand filter 18
- Bar-chart 104, 105
- Bills of quantity 96, 102
- Bleaching powder 129, 130
- Bcrings 133, 134
- Building materials 21, 65, 87-100, 137-141
 , quantities of 96, 97
- Building instructions 105-108
- Buoyancy, see forcing-up
- Butterfly valve 78, 79
- Capacity of water supply, see design capacity
- Capital return period 43, 163
- Chemical Oxygen Demand 46, 163
- Chlorination, see safety chlorination or disinfection
- Chlorine, see available chlorine
- Cleaning of filter 30
- Clear water tank 52, 57, 82, 83
- Clogging of filterbed 25
- Coefficient of uniformity 19
- Colour, removal 24
- Contact time, for chlorination 132
- Commissioning of slow sand filters 28
- Construction of slow sand filters 65-71
- sloping wall filter 87-89
 - masonry filter 90-91
 - ferrocement filter 89-90
 - reinforced concrete filter 91-93
- Construction materials, see building materials
- Contract documents 100
- Control devices, see filter regulation devices
- Costs of slow sand filter 98, 99
- Consumption of water 13
- Declining rate filtration, see operation of filters
- Depreciation period 43, 54, 164
- Design of slow sand filters 39, 56
- Design capacity 41, 95, 164
- Design criteria 40, 54-56
- Design period 40, 43, 53, 164
- Design population 43, 44
- Dimensioning 39, 48, 50
- Disinfection 36, 129-132
- Economic lifetime 43, 165
- Effective size of filtermedium 19, 165
- Effluent weir 31
- Escherichia coli 24, 37, 55, 164
- Ferrocement, see construction of slow sand filters
- Field test kits 149, 150
- Filter-bed area 50, 55
- Filter-bed thickness 19, 20, 57
- Filter-box 21, 55
- Filter controls, see filter regulation devices
- Filter medium 17, 19
- Filter regulation devices 18, 20, 29, 30, 74, 78, 91
- Filter test runs 25
- Filtration rate 23, 56
- Floating effluent weir 29, 30, 144, 145
- Floating platform hypochlorinator 131
- Forcing-up of structures 47, 68, 82, 152
- Foundation 67, 69, 70
- Flow measurement 21, 29, 74, 143-146
- Freeboard 18, 165
- Fulvic acid test 137
- Gate valve 78
- Grain size, of filter sand see effective size
 , of soil 134, 135
- Groundwater, level determination of 136
- Head loss
- through pipes 80, 84, 85
 - through valves 80
 - through filter-bed 80, 84, 85
 - over weir 80, 143-146
- High-test hypochlorite 129-131
- Horizontal-flow coarse material prefiltration 35, 126, 127
- Hydraulic line 79, 80, 166

- Hydrological year 147, 166
- Inlet structure 72, 73
- Intermittent operation, see operation of filters
- Implementation 101
- Labour-intensive building 107
- Lay-out - filter units 59-64
 - of treatment plant 48, 53, 92-94
- Limitations of slow sand filters 26
- Location of treatment works 47
- Measuring weir, see weir
- Mechanical design of treatment plant 53
- Masonry, see construction of slow sand filters
- Mass concrete, see building materials
- Mechanisms of filtration 19
- Membrane filter test 149
- Micro-organisms on sand grains 19
- Mode of operation 50
- Most Probable Numbre. 46, 55, 167
- Multiple Tube Fermentation Test 149
- Negative pressure, prevention of 21, 23, 30, 74
- Number of filters 59
- Operation and maintenance 27-29
- Operation of filters
 - continuous 48
 - with declining rate 48-51, 164
 - intermittent 49
- Organic matter, removal of 24
- Organization 103-105
- Overflow
 - in filter box 19
 - in outlet structure 23
- Outlet structure 74, 75
- Oxygen content 23, 25
- Pathogens, removal of 24
- Performance of slow sand filters 24
- Physical lifetime 43, 168
- Piping arrangements 83-85
- Planning 103-105
- Plain sedimentation 35, 122
- Population growth rate 44, 54, 165-167
- Post-treatment 36, 81, 82
- Power requirements for pumps 85
- Pre-treatment 23, 34, 81, 82
- Production capacity, see design capacity
- Purification processes in slow sand filters 21-24
- Pumping arrangements 83-85
- Rapid "roughing" filtration 35, 55, 126
- Recirculation of effluent 23
- Reinforced concrete see construction of filter
- Reinforcement schemes for slow sand filters 154
- Resanding 32
- Residual chlorine 132
- Ripening 29, 30
- Ripening, see commissioning
- River bed filtration 35, 125, 126
- Safety chlorination 36, 56, 81, 129-132
- Schmutzdecke 17, 22, 28, 33
- Scum, removal of 19, 168
- Sedimentation, as pre-treatment 23, 35, 122-125,
- Selection of water treatment system 36, 37
- Set-up of water supply system 39, 45
- Shading of slow sand filters 25
- Short-circuiting in slow sand filters 60
- Shuttering 108-110
- Site, of treatment plant 48
 - . of water intake 47
- Site investigations 133-137
- Size of filter, see unit size of filter
- Sloping wall filter, see construction of filter
- Soil investigations 133-137
- Soundings 136
- Specifications of construction 40, 59-83
- Supernatant water layer 18
 - . level regulation of 30, 72
- Start-up of filter, see commissioning
- Storage, as pre-treatment 35, 121, 122
- Structural calculations 151-154
- System of underdrains 18, 20, 76, 77
- Tendering 101
- Tensile strength 169
- Throwing over 31
- Time schedules 104, 105
- Turbidity, limits for slow sand filters 24
 - , reduction by pre-treatment 34, 35, 121-128
- Typical designs 87-100
- Under-drainage system, see system of underdrains

Uniformity coefficient of filtermedium 19, 169
Unit size of filter 59-62
Universal pressure 63
Ventilation 23
Water analysis 28, 142-143
Water borne diseases 14-15
Water-cement ratio 138
Water conduits 57
Water consumption, per capita per day 13
- unpiped supplies 14
- supply with stand-pipes 14
- piped connections 14
Water demand, design 44, 54
Water intake 47, 51
Water quality, criteria for 14, 115-118
 , testing of 147-150
 , improvement by treatment methods 24, 54
Water related diseases 14-15
Watertight construction 61, 68, 107, 138, 141
Weir 27, 143-146, 170
Weir beam 72, 78
Weir chamber 23
Working-schedules 105, 106
Yearly growth rate, see population growth rate