

Appropriate Technologies for Semiarid Areas: Wind and Solar Energy for Water Supply

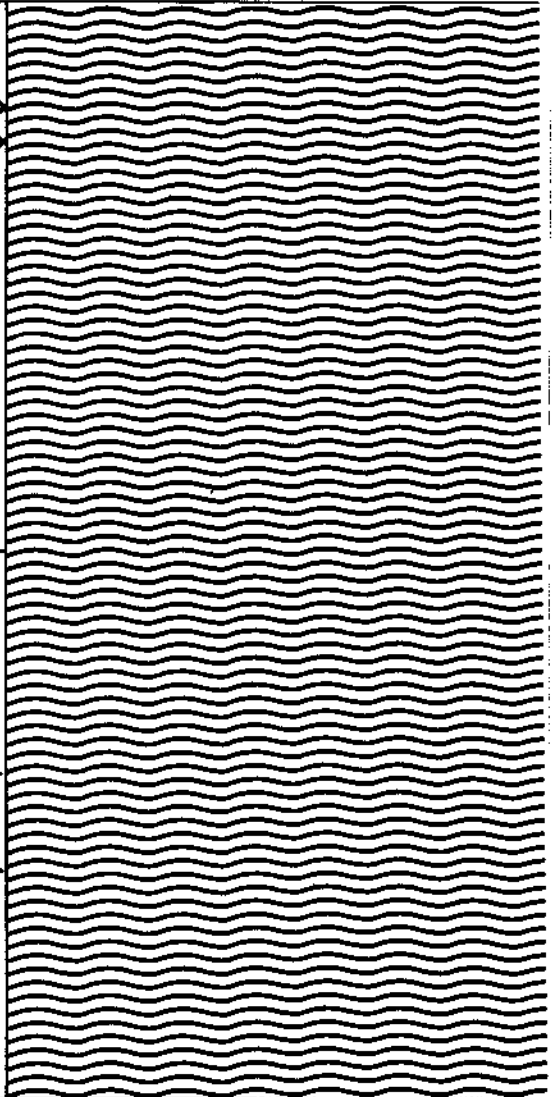
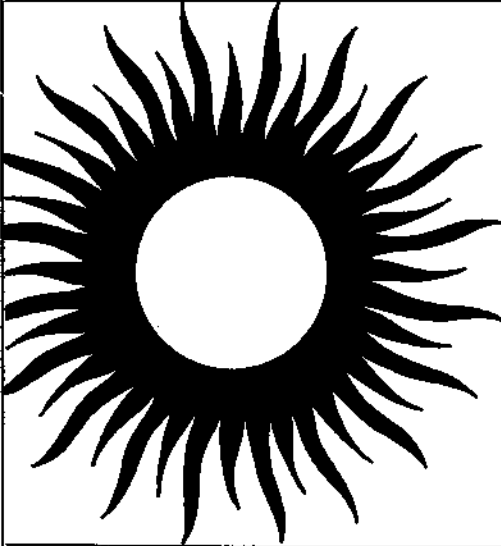
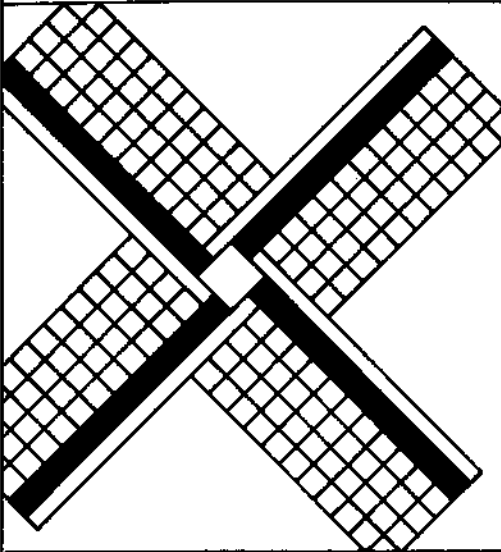

**German Foundation
for International Development**
Seminar Centre for Economic
and Social Development

INTERNATIONAL CONFERENCE
APPROPRIATE TECHNOLOGIES FOR SEMIARID
AREAS: WIND AND SOLAR ENERGY FOR WATER SUPPLY

15 to 20 September 1975
Berlin (West)

CONFERENCE REPORT

GERMAN FOUNDATION FOR INTERNATIONAL DEVELOPMENT
Seminar Centre for Economic and Social Development

AN INTERIM REPORT: THE DESIGN AND CONSTRUCTION OF AN APPROPRIATE WATER PUMPING WINDMILL FOR INDIAN AGRICULTURE

Marcus M. Sherman

I. Introduction

In many parts of India there are adequate supplies of groundwater which are unavailable to farmers for irrigation during the dry season because of inadequate power sources for pumping. Electricity is commonly available for only four hours of pumping per day, due to heavy energy consumption in the cities and overexpansion of the rural power grid without a corresponding increase in generating capability. Many farmers can never use electric pumps because Government regulations prohibit installation of electric pumps within 128 metres of each other.

Three to eight horsepower diesel oil pumps are frequently used for irrigation but are very expensive to operate because of the high cost of imported oil and high maintenance costs. The traditional bullock-operated pumps remain the most common and reliable source of irrigation water for subsistence farming. Water for domestic use is usually lifted by hand with a rope and bucket from open wells.

During the early 1960s the Wind Power Division of the National Aeronautical Laboratory^{1/} developed, tested, and produced 200 12-bladed fan-type windmills which demonstrated the feasibility of using wind power to pump water in India. Several types of imported European and American multi-bladed windmills have also been used to harness India's abundant wind energy resources. However, due to high capital cost of the windmills and high level of technical skills required for maintenance of industrially produced all-metal windmills, windpower is not commonly exploited in India.^{2/}

In 1973 the Indian National Council of Science and Technology Expert Committee on Wind Power^{3/} in their project on water pumping windmills stated that great possibilities

exist in further development of windmills for irrigation as well as water supply, even in areas having low wind velocities of 8-10 k.p.h. They concluded that fabrication of water pumping windmills by indigenous manufacturers is possible and should be encouraged and popularized.

Having observed what appeared to be a classical "take off" of wind pump technology in Crete and Cyprus, Duncan Allsebrook,^{4/} OXFAM water technology advisor, noted that the elements involved seem to be:

- a) the private import of a few sophisticated, efficient windmills;
- b) an agricultural economy without the benefit of mechanical implements;
- c) rainfall totalling less than 30 inches per annum, with a pronounced dry season;
- d) large, flattish basins or plateaus with fertile soils and shallow water tables (15-60 feet below surface);
- e) farmers willing to experiment with more intensive agriculture, particularly vegetable gardening and orchards, than has been possible under conditions of limited irrigation;
- f) the existence of a large corps of local craftsmen, particularly carpenters, masons and blacksmiths.

II. Design Criteria

In order to surmount many of the difficulties encountered by previous wind power development efforts in India, the following design criteria were chosen for an appropriate windmill prototype.

a) Low wind

The windmill must operate in low wind speeds of 6-8 k.p.h. characteristic of many areas of India during the dry winter and must be adjustable to operate in higher wind velocities up to 40 k.p.h.

b) Pump

The windmill must have high starting torque and low r.p.m. to operate a large bore piston pump or a large diameter diaphragm pump.

c) Irrigation

The windmill must lift 28,570 litres per day from a ten-metre-deep well at an average daily wind velocity of 4-6 k.p.h. in order to irrigate one hectare of field with 2 cm water per week.

d) Low cost

The capital cost must be below Rs 3,000 to be competitive with the capital cost of a diesel or electric pump set.

e) Local materials

All windmill construction should be of common sizes of locally available materials to minimize cost and simplify repairs.

f) Local skills

All construction skills should be those of local craftsmen in order to stimulate the rural economy and increase the degree of involvement of the village people.

g) Operator

It was assumed that the operator would be at the site each day, therefore automatic blade adjustment would not be required.

h) Low maintenance

Maintenance costs and skills should be low.

i) Traditional pump

The windmill should not interfere with the continued operation of the traditional pumping device on the same well.

j) Labour-intensive

Basically, a labour-intensive, capital-conservative design was required.

III. Description of the Windmill

This windmill is the fourth in a series of prototypes that have been built near Madurai, South India, by members of the Madurai Windmill Committee, Rev. C. P. Heineman, T. O. Heineman, Manoharan Selvaraj, M. S. Pillai, S. T. Arasu, M. M. Sherman.^{5/ 6/ 7/} It is an adaptation of the traditional Greek sail-wing windmill design which is widely used on Crete.^{8/ 9/} A 25-foot sail-wing windmill with six sails in the classical Greek configuration has been designed by Hans Meyer^{10/} and tested by Brace Research Institute.

Local purchase of materials commenced on 3 February 1975, and construction of the windmill by the author, A. Manoharan Selvaraj, S. M. Thirunavakarasu, and various local craftsmen continued at a regular daily pace until completion on 25 March when the first pumping trial was made. A public demonstration was given on 29 March.

When the author left Madurai on 19 April 1975, the windmill was operating well, pumping 1,635 litres per hour from a depth of 9.2 metres at an average operating speed of 12 r.p.m. in low winds, estimated to be 6-8 k.p.h. Maximum speed observed was 25 r.p.m.; minimum speed before stopping was 8 r.p.m.; starting speed was 12 r.p.m.

The components of this Indo-Greek windmill pumping system are: well, storage tank, foundation, pump, variable stroke pump lever, tower, turntable base, turntable carriage, tail vane, crankshaft connecting rod, crankshaft, shaft bearings, hub, arms, sails, and operator.

a) Well

The prototype was erected over the corner of a 5 m x 6 m x 8 m deep well dug into a fractured rock aquifer. The well was also fitted with a traditional kumalee bullock pump and a 5 h.p. electric pump. The windmill is located over one corner of the well so it does not interfere with the operation of either of these pumps.

b) Storage tank

A concrete or stone storage tank with at least 30,000-litre capacity is necessary to provide a large quantity of water in a short period of time once daily for flooding the fields. A storage tank may serve as a multipurpose structure by being used for aquaculture and partially as foundation for shelter.

c) Foundation

The foundation of the windmill consists of six heavy steel anchors, four of which are imbedded in concrete in 1-metre-deep, .5 m-diameter holes outside the corner of the well and two of which are fastened to a large stone pillar laid across the corner of the well.

d) Pump

The pump used in the first testing of this windmill is a piston pump with a 10 cm bore and a 61 cm maximum stroke. The pump is attached in the bottom of the well at the end of 9.1 m of 5 cm steel pipe suspended from the stone pillar. The top of the pump piston connecting rod passes up through and out of the top end of the pipe and is secured to the end of the variable stroke pump lever.

e) Variable stroke pump lever

Because the seasonal intensity of the wind varies, it is desirable to vary the load on a windmill for optimum use of the available wind. This is accomplished with a 2.5 m long 5 cm x 20 cm teak beam mounted at the base of the windmill by a fixed axis point at one end and attached to the pump piston rod at the other end. The bottom end of the wooden crankshaft connecting rod is fixed to this lever by a steel bracket at a point between the ends of the lever. This point can be varied to change the length of stroke delivered to the pump connecting rod. The pump lever is also important because it increases the stroke of the crankshaft from 13 cm at the crankshaft to a minimum of 18 cm and a maximum of 36 cm at the pump connecting rod. Increasing the

stroke is useful because it permits the use of a smaller bore piston pump which is available in the local market.

f) Tower

The tower is made of six 8-m-long teak poles bolted at the bottom to the steel anchors in the foundation and bolted at the top to the base of the turntable. The base of the tower is 1.8 m in diameter. There are two sets of cross braces nailed to the inside of the tower and a set of internal guy wires. Ladder steps are nailed to the inside. Five additional steps nailed around the tower one metre above ground provide a standing platform for the operator while he is adjusting the sails.

g) Turntable base

The base of the turntable consists of a steel truck tire rim with an inside diameter of 23 cm. The truck rim is drilled and bolted to the tops of the teak poles. The smooth circular platform formed by the inside of the rim is the bearing surface upon which the turntable carriage sits and rotates.

h) Turntable carriage

The turntable carriage is a 1.5 m x 36 cm rectangular iron angle frame which is secured to the turntable base by four bolts which are fixed to two 25 cm pieces of angle iron which rotate on the bottom inside surface of the turntable base. This arrangement keeps the carriage firmly attached to the top of the tower while at the same time allowing it and the attached tail, crankshaft, sails, etc., to turn when the wind direction changes.

i) Tail vane

A 1.3 m x 2.5 m rectangular tail made of bamboo matting in a light teakwood frame is supported by a 3.7 m long piece of heavy duty bamboo pole from the rear of the turntable carriage with two "U" bolts and is braced with guy wires. The tail keeps the sails always facing the wind.

j) Crankshaft connecting rod

This connecting rod was made of two 5 cm x 5 cm x 3 m teak poles bolted together end to end. The bottom of the rod is bolted to a hinged steel bracket which can be moved to different positions along the pump lever. The top of the rod is bolted to a steel swivel which in turn is bolted to a wooden bearing attached to the crank. Since the connecting rod is always in tension and never in compression there are no braces or guides necessary. The swivel allows the crankshaft, etc., to turn in response to changing wind direction without twisting the connecting rod or pump lever.

k) Crankshaft

The crankshaft is the main shaft which directly transfers the horizontal rotary motion from the windmill sails into the vertically reciprocating motion necessary to operate the piston pump. There are no gears or pulleys in the driving mechanism. The crankshaft is made of 3.2 cm mild steel rod which has a crank of 3.2 cm mild steel rod welded at the centre to give a total stroke of 13 cm. A cotter pin at the tail end of the shaft keeps the shaft from sliding forward out of the bearings.

l) Shaft bearings

The crankshaft is supported directly behind the hub and directly behind the crank with two 5 cm thick blocks of hardwood, each with a steel ball bearing in the centre to hold the crank. These wooden bearing blocks are both bolted to the turntable carriage. The front bearing is slightly elevated so that the front of the crankshaft is raised 6° up from the horizontal, thus preventing the tips of the bamboo arms from hitting the legs of the tower.

m) Hub

The hub functions as a connector between the arms of the windmill and the crankshaft. It consists of an ordinary ox cart wheel hub with eight wooden spokes. The spokes are braced to each other with wood. A bamboo arm is attached to

each spoke with two "U" bolts. A hole in the centre of the hub fits onto the front end of the crankshaft and is secured by a 1.6 cm bolt "cotter pin."

n) Arms

Eight 4.5-m-long bamboo poles radiate out from the hub to form a total windmill diameter of ten metres. A central supporting spar of bamboo extends out two metres in front of the hub along the main axis of the crankshaft. Number eight gauge single-strand steel wires radiating out and back from the tip of this central spar to the tip of each bamboo arm provides bracing against strong winds. Wires between the tips of all the radial arms provide additional bracing. Bamboo arms have the advantage of high flexibility and tensile strength as well as widespread availability and low cost. Village craftsmen are familiar with bamboo as a building material. Disadvantage of bamboo is that it will split over a long period of time or if mishandled.

o) Sails

Cloth was chosen for the wind-catching surface of the windmill because it is lightweight, easy to handle, readily and cheaply available and it forms a strong uniform surface for catching the wind when supported at three or more points. The eight right-triangular sails were stitched by a local tailor from khaki cloth normally used for bus conductor uniforms. A 10-cm-wide sleeve on the hypotenuse side of each sail allows it to slip on and off the bamboo arms. The tip and hub ends of the sleeve are tied securely to their respective ends of the bamboo arms. The 90° corner of each sail is secured by a rope of coconut husk fibre to the tip of the adjacent arm.

p) Operator

It is important to have a trained person daily at the site to control the windmill, direct water flow, and make minor repairs.

IV. Control Mechanisms

a) Manual

The operator is the primary control mechanism of this appropriate windmill. The windmill is stopped by one or two ground assistants who pull the ropes hanging from the end of the bamboo tail boom. This pulling of the tail into the wind turns the turntable carriage so that the sails turn out of the wind and stop rotating. The operator wraps each sail one or more times around each arm in order to decrease sail area in higher winds. During highest winds and gusty local storms the sails are fully wrapped and secured around the arms. It is possible to furl only two, four, or six sails during highest operating speeds. The operator adjusts the windmill to seasonal changes in wind velocity by moving the steel bracket at the bottom of the wooden connecting rod to different points along the variable stroke pump lever. Thus the pump stroke can be varied from 18 to 36 cm.

b) Automatic

The tail automatically points the full area of the sails toward the wind in front of the tower. Emergency automatic feathering of the sails is provided for by using a 1.3 cm coconut fibre rope as the tension member from the 90° corner of each sail to the tips of the adjacent arm. When the wind speed increases to a high level this weakest connection in the energy transfer would break before loads on the other materials became destructive. The feathered sails would, however, flap against the tower, chafe, and perhaps tear, if not promptly attended to.

V. Construction Expenses

a) Materials

Hub	Rs 35.00
Lorry rim	40.00
Bolts	248.68
Washers, rivets, nails, cotters, etc. (hardware)	32.68

a) Materials (contd)

Steel flats, plates, rods, angles, clamps	Rs	549.92
5 cm pipes, fittings		264.87
Ball bearings (2)		36.00
G.I. wires		125.12
Wooden reapers, lever beam		271.14
Teakwood poles		197.00
Bamboos		136.50
Paints, turpentine		170.25
Stones		140.00
Cement		158.91
Cloth, thread		702.01
Tools		54.63
Miscellaneous contingencies		149.09

Rs 3,311.80

b) Labour

Honorariums, salaries	Rs	900.00
Bata (food)		150.00
Labourers' cooly		46.00
Blacksmithy, welding, machine shop		317.25
Tailor		73.00
Masons		47.00
Carpenters		172.50

Rs 1,705.75

c) Transportation

Local travel, bus, cycle rent	Rs	149.60
Transport for materials		164.00

Rs 313.60

Total Rs 5,331.15

VI. Power Equation

The eight-bladed Greek sail configuration of this windmill is ten metres in diameter and starts in a minimum wind velocity of 6-8 k.p.h. Theoretical useful power of the windmill is .133 KW at 8 k.p.h.

$$\text{Power equation: } P = KAV^3 C_p E_1 E_2$$

where: P = power in kilowatts delivered to water

K = metric constant, .0000137

A = $3.14 R^2$ (R = 5 metres)

V = wind velocity (8 k.p.h.)

C_p = power coefficient where .593 is theoretical maximum (.3 is used for the sail windmill)

E₁ = efficiency of power transfer 95%

E₂ = efficiency of pump 85%

Theoretically 5,222 litres/hour of H₂O can be pumped up ten metres in an 8 k.p.h. wind.

.133 KW x 737.56 ft lbs/sec x 3,600 sec ÷ 32 ft ÷ 8/lb = 1,379 gallons (5,222 litres).

Actually 1,636 litres (432 US gallons)/hour were pumped from 9.2 metres in 6-8 k.p.h. wind.

VII. Implementation Suggestions

a) Handicraft

Dutch, Mediterranean and Chinese history proves that less industrialized countries can provide themselves with a great deal of applied windpower if local skills and materials are used through the adaptation of handicraft techniques. In order for wide-scale utilization of windpower to occur in India, it is important that there be a widespread diffusion of the knowledge of the possibilities of windmills in favourable areas, in addition to adapting modern windmill technology to traditional skills and materials by

regional engineering institutions. Particularly at the beginning of windmill implementation programmes, the design should be as simple as possible in order to effectively introduce windpower to people having no previous conception of its possibilities.

b) Demonstrations

Real demand by farmers for windmills must be created by actual demonstrations of windmills in practical operation. Questionnaires and information pamphlets should be available to interested persons.

The biggest problem of windmill implementation is that each installation must be engineered to a different load and different wind conditions. This problem may be overcome by developing a standardized technique to properly match local conditions of wind, groundwater depth and water requirements with proper pump sizes and windmill diameters and having regional centres for evaluation of windmill questionnaires and making recommendations for suitable windmill designs.

c) Kit

It may be insufficient to supply local craftsmen with blueprints and written instructions only. Stam^{11/} suggested that it is better to provide a construction kit. Such a kit may include a strip story illustrated instruction, clearly understandable for people who cannot read, together with the essential welded metal parts that cannot be fabricated in a village. The kit should also contain a scale model built from bamboo and paper.

d) Alternative utilization

Efforts should be made to develop alternative means of utilization of wind power for interruptible, variable-speed mechanical tasks such as water pumping for public water supply, grain thrashing, winnowing and grinding, sugar cane crushing, wood cutting and turning, fodder chopping, compost grinding, oil pressing, cable plowing, stirring of

slurry in methane gas plants, stirring of algae cultures, so that these power loads may stop consuming nonrenewable energy resources.

e) Current evaluation

The Indo-Greek windmill is currently being evaluated for use in windpower development schemes in India by the Gandhi-an Institute of Studies,^{12/} Varanasi, and the Indian Agricultural Research Institute,^{13/} New Delhi.

VIII. Conclusion

It is the author's opinion that this appropriate windmill design concept can be used economically in many rural areas of India due to its low cost, high power output, wide availability of the materials and construction skills and a capability for sail and pump adjustments for running in both high and low wind velocities. However, further development work is needed.

IX. Acknowledgements

On behalf of the Madurai Windmill Committee, the author takes this opportunity to express sincere thanks to J. and E. Staley of the Oxford Committee for Famine Relief (OXFAM), Bangalore, South India, for their support. He is pleased to acknowledge the assistance of Dr. K. Kanungo and Dr. D. K. Biswas of the Indian Agricultural Research Institute, New Delhi, in preparing detailed drawings of the windmill. The author is most grateful to the New Alchemy Institute - East for their continuing support of his travel expenses to and from India.

X. Addenda

Rev. C. P. Heineman, Treasurer of the Madurai Windmill Committee, reported on 21 August 1975 that:

"As yet, there has not been much show of interest around in villages, probably because the windmill is not working

now. I feel there are some points that have to be overcome before this type of windmill could be established. It has so far required a lot of adjustment to get it to work after unwrapping the sails. Quite a few points show strain due to the construction materials used, and the power on the mill because of such a large diameter. As it stands at present, I am afraid it will get out of order frequently, and maintenance is not an Indian virtue. More of a compromise has to be made with utilizing sophisticated methods at points, and better materials. This is only my opinion."

Mr. T. O. Heineman, member of the Madurai Windmill Committee, reported on 28 August 1975:

"In considering capital cost it may be noted that the capital cost or materials cost of an experimental prototype will be quite different from the cost to a farmer of a proven design. Even the cost of a proven design will descend after one or two years due to various economic factors typical of all new products. Thus an experimental prototype costing Rs 4,000 (not including salaries of researchers and other establishment costs) could be copied by independent farmers for Rs 3,000 to Rs 3,500 and by entrepreneurs for even less.

Electric pump 5 h.p.: 40-50 thousand lt/hr.

Kumalee: $100 \text{ lt/bucket} \times 3 \text{ buckets/minute} \times 60 \text{ m/hr} = 18,000 \text{ lt/hr.}$

Foundation: I believe that one of the things this prototype proved was that the stone pillar across well corner is unnecessary and mill can be completely aside well corner.

Tower: For durability, seasoning of the teak poles or any treatment to prevent splitting is essential. Unfortunately, letting poles lay around while they season means capital is being locked up which will raise costs. Otherwise the tower has been proven an asset of this design.

The turntable base is an asset of this design.

Turntable carriage: Perhaps wooden beams would give strength economically, with metal seats to ride on base.

The tail vane is a minor liability of the design. It must be redesigned to last years.

Crankshaft: I believe the car or truck crank is the answer for this, combined with brake drum for hub.

Hub: Believe that wood is best avoided here as strength and rigidity are crucial. The force exerted on the hub is tremendous, especially at point of transfer to shaft. The number of problems solved by a metal piece here would be many whereas the problem of weight of this metal would be easier to contend with. The hub is at the root of a number of problems with the arms.

Arms: I think bamboo has potential, but some problems: it gives with wind so much that sails hitting tower are so far the major problem with this mill. First, I'd like to try kull bamboo. And this I'd like to treat the same as flutes and pole vault poles for straightness and durability. The attachment to hub and the hub's spokes must be absolutely rigid as 1" play at hub can multiply along the length to the tip. Also the "nose" must be very rigid, again because just an inch of play can multiply into much play at sail arm tips. Under wind pressure I believe the bamboo flexes so that the tips actually move forward, loosening the circumferential wires and allowing the tied corner of sail to go backwards and hit tower. A certain amount of this flexing will have to be lived with and need not be a problem.

Sails: They will probably fray at the leading edge against the bamboo arm. Perhaps metal rings could be used. It might be noted that the sails are the most expensive, by far, single component and that, since power is proportional to square area, their quantity (in square units) cannot be scrimped on to reduce costs. But if any other way were conceived of to economize here, overall economy would be significantly effected.

Pump: Though not put in final form yet, I doubt if you can beat a piston pump of appropriate size.

I think the biggest problem of windmill implementation is that there is not nearly enough actual live experimentation. Since we are interested in low-tech. and cost, designs must vary from area to area depending on local resources. Since the mathematical number of variations of design, and permutation of design variabilities of each segment, is extremely large, I am very surprised that the various people involved in windpower development that I have seen have actually built so few prototypes. I'd like to see someone hand someone else Rs 100,000 and say: "See how many mills you can build in one year, and then I'll give you enough to see how many times you can rebuild each of those in successive modifications for the next year.". I think two years and 2×10^5 Rs later one could easily have created the splash that would ripple to and change every corner of India. The things that this windmill has proven are enough to warrant that. It attracted community interest and has overcome many major technical problems. Further development depends on people with general technical know-how and lots of creative application skills.

XI. References

- 1/ Nilakantan, P.; Ramakrishnan, K. P.; Venkiteshwaran, S. P.; Windmill Types Considered Suitable for Large-scale Use in India. Tech. Note No TN-WP-3-61, National Aeronautical Laboratory, Bangalore, India, August 1961, 37 pp. Also, Proceedings: UN Conf. New Sources of Energy, Rome, 21-31 August 1961, Vol 7, Paper W/23, pp 382-9.
- 2/ Sherman, M. M.; Wind Powered Water Pumps in India; Past, Present and Future Developments. Proceedings: Seventh Annual All India Workshop on Farm Machinery Research and Development, Punjab Agricultural University, Ludhiana, 1974.
- 3/ National Council of Science and Technology, Report of the NCST Expert Committee on Wind Power, Government of India, New Delhi, 1973.
- 4/ Allsebrook, Duncan; Personal Communication, 25 October 1974.

- 5/ Sherman, M. M.; A Windmill in India. The Journal of the Alchemists I; The New Alchemy Institute, Woods Hole, Massachusetts, 1973.
- 6/ Sherman, M. M.; The Sailwing Windmill and Its Adaptation for Use in Rural India. Proceedings: All India Conference on Solar Energy (Indian Institute of Technology), Madras, 1973. Also: Proceedings: National Science Foundation/National Aeronautics and Space Administration Workshop on Wind Energy Conversion Systems, Washington D.C., 1973.
- 7/ Sherman, M. M.; Madurai Prototype Sailwing Windmill. The Energy Primer Portola Institute, Menlo Park, California, 1975, p 61.
- 8/ Calvert, N. G.; Windpower in Eastern Crete. Transactions Newcomen Society, Vol XLIV, pp 137-144, 1971-1972.
- 9/ Sherman, M. M.; 6,000 Handcrafted Sailwing Windmills of Lassithious, Greece, and Their Relevance to Windmill Development in Rural India. Proceedings: All India Conference on Solar Energy, Motilal Nehru Engineering College, Allahabad, 1974.
- 10/ Meyer, Hans; Plans for a 25' Sailwing Windmill. Windworks, Box 329, Rt. 3, Mukwanago, Wisconsin 51349.
- 11/ Stam, H.; Adaptation of Windmill Designs, with Special Regard to the Needs of the Less Industrialized Areas. Proceedings: UN Conference on New Sources of Energy, 1961, Vol 7, Wind Power W/40, p 354.
- 12/ Hoda, M. M.; Gandhian Institute of Studies, Rajghat, Varanasi, India.
- 13/ Biswas, D. K.; Division of Agricultural Engineering, Indian Agricultural Research Institute, New Delhi, 110012, India.

New Alchemy Institute East
P.O. Box 432
Woods Hole, Mass 02543

MADURAI TYPE SAILWING WINDMILL: An eight meter diameter prototype sail wing windmill was erected Feb-March 1973 on a small farm owned by T.O. Heineman in a dry hill region of Madurai district, Tamilnadu. It lifted three hundred pounds to a height of twenty feet in one minute in a slight breeze. This was accomplished by a rubber rope passing over a six-inch pulley on the horizontal drive shaft.

This sail wing windmill is made of a one meter diameter bullock cart wheel to which three bamboo poles are lashed in a triangular pattern with overlapping ends. Each bamboo pole forms the leading edge of a wing, and a nylon cord stretched from the outer tip of the pole to the rim of the wheel forms the trailing edge. A stable and light weight airfoil results from stretching a long narrow triangular cloth sail "sock" over that bamboo-nylon frame. This wing configuration, a hybrid of low-speed eight bladed jib-sail wings and high speed two-bladed aerodynamic sail wings, produces high starting torque at low wind speeds. The bullock cart wheel is attached at the hub to the end of an automobile axle shaft which rotates in two sets of ball bearings. The shaft and bearing assembly is mounted horizontally on top of a ball bearing turntable.

The principal limiting factor is the availability of the steel turntable. This is the only component that cannot be assembled in an Indian village. A machine shop is required. The turntable consists of two circular steel plates separated with a raceway of ball bearings and held together with a ring of eight bolts which encircle the bottom plate. A dust cover or 2 large "O" rings should be incorporated to provide dust protection to the bearings. The services

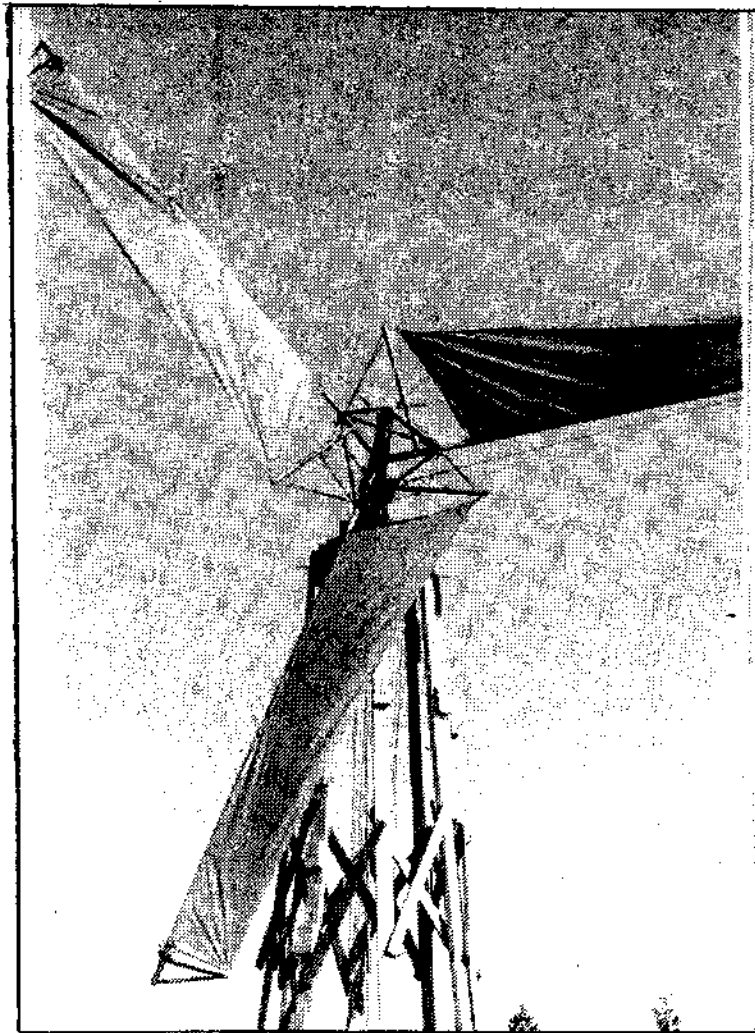

of a village wheel wright cum blacksmith are required for production of the oxcart wheel and mounting the wheel on the turntable shaft, the sails are manufactured on a standard sewing machine. The occasional presence of one person is required for operation. The Windmill is intended for the direct use and operation by its owner-builder.

Marcus Sherman
Madurai, India

Low Cost Sailwing Windmill, Madurai Prototype

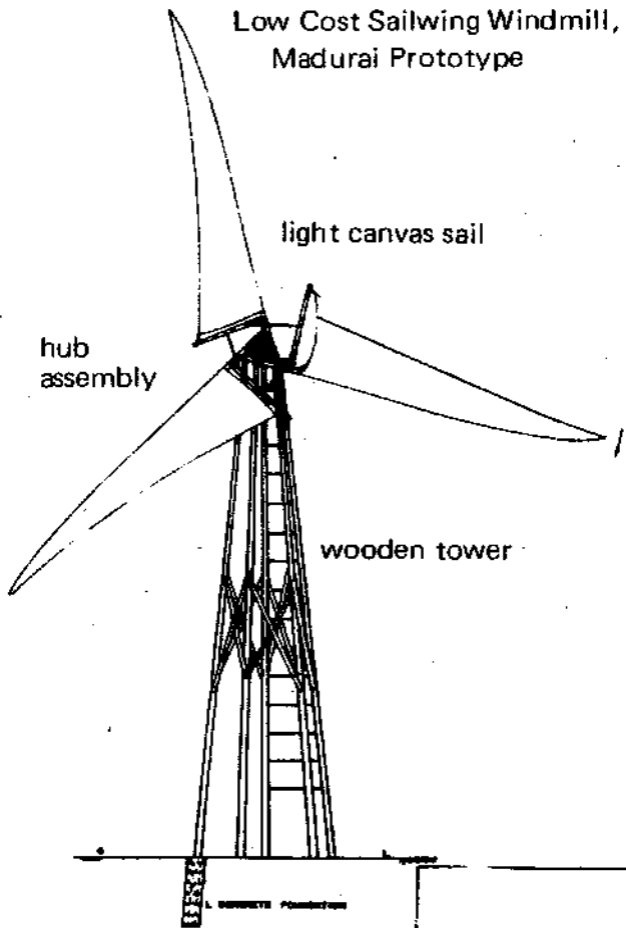

Windmill Turntable and Hub Assembly (side elevation)

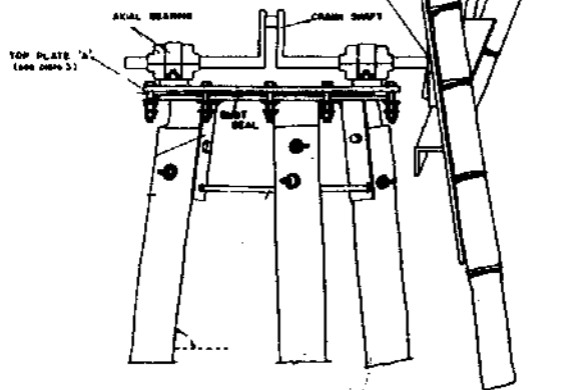

Hub Assembly and Sails
(Front View)

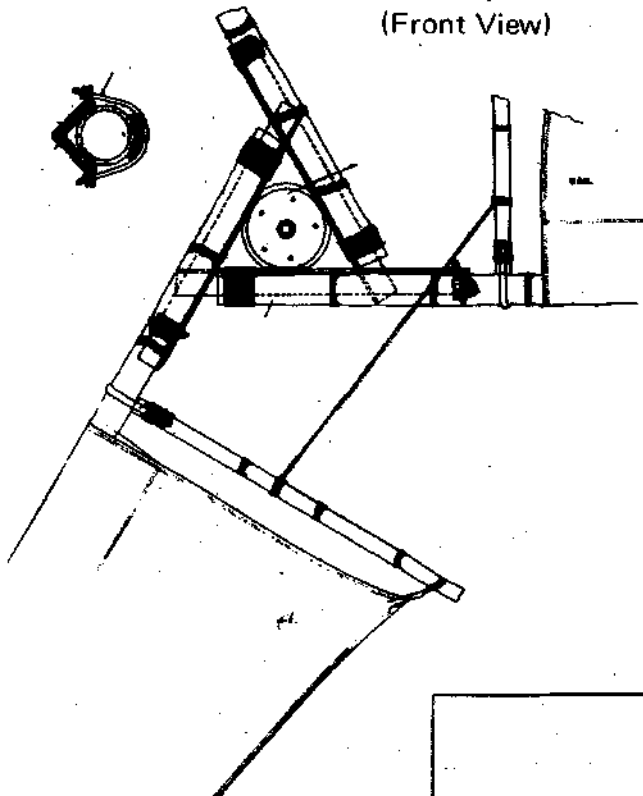

Hub Assembly (Rear View)

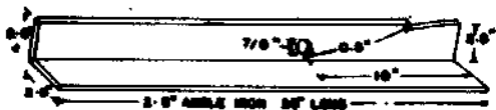
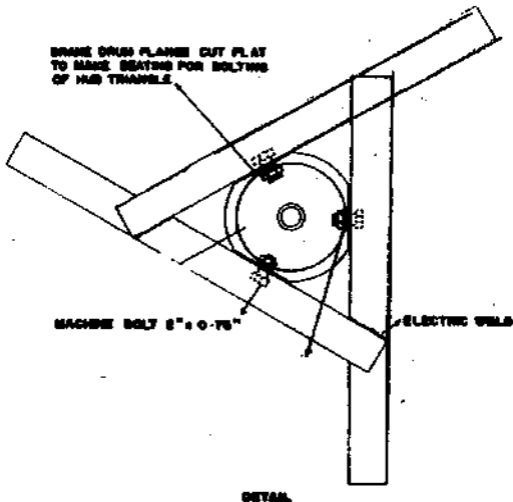

2.5" angle iron – 28" long

height = 2.5"

width = 2.5"

hole dia. = 7/8"

distance from edge to center of hole = 10"

measurement from hole to bottom top surface = 0.5"

cut-out drop measurement = 0.5"

measurement from hole to bottom top surface = 0.5"

cut-out drop measurement = 0.5"

