

AT MICROFICHE
REFERENCE
LIBRARY

A project of Volunteers in Asia

Vertical Axis Sail Windmill Plans

Published by:

Low Energy Systems
3 Larkfield Gardens
Dublin 6
Ireland

Paper copies are \$ 4.00.

Available from:

Low Energy Systems
3 Larkfield Gardens
Dublin 6
Ireland

Reproduced by permission of Low Energy Systems.

Reproduction of this microfiche document in any form is subject to the same restrictions as those of the original document.



3 Larkfield Gardens

Dublin 6

Ireland

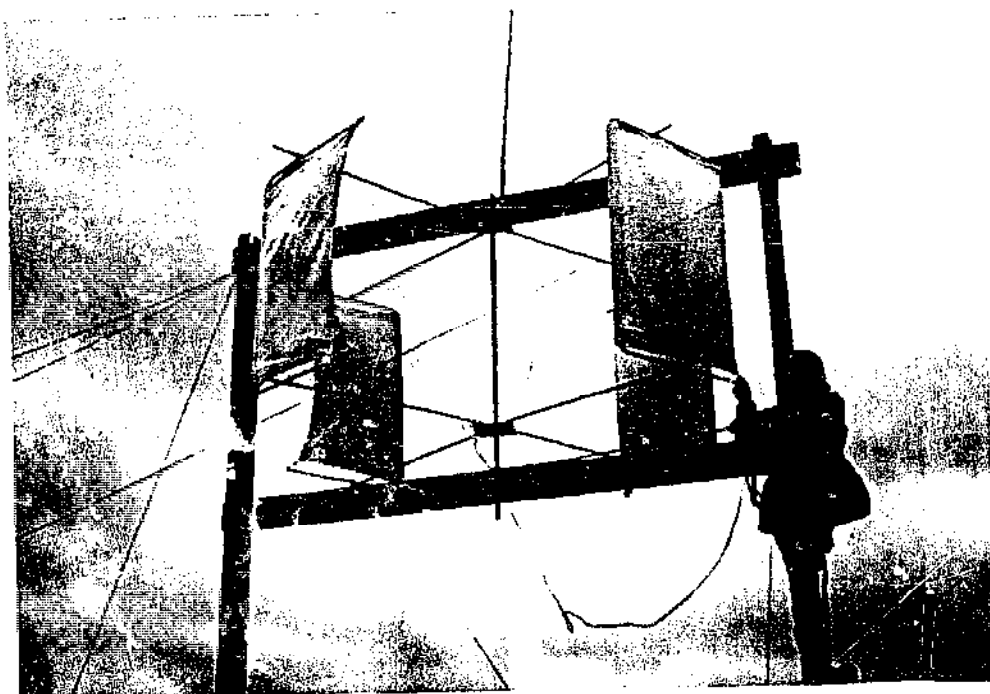

PLANS.

VERTICAL AXIS

SAIL WINDMILL

A VERTICAL AXIS SAILWING ROTOR

A remark of Buckminster Fuller kept returning to me. He suggested that the most likely avenue for development of windpower would come from the study of sailing ships. The ones that came to mind immediately are the sailing clippers, but it was the modern sailing yacht that offered most help in the evolution of the design.

I set out to construct a Savonius rotor from cloth using a rigid frame, without a very clear idea of how exactly I was going to build it. Another thought that was attractive was the possibility of using the wind itself to shape the vanes. The result was a rotor that worked, but was a little clumsy in operation. Further experiments lead to a more elegant solution.

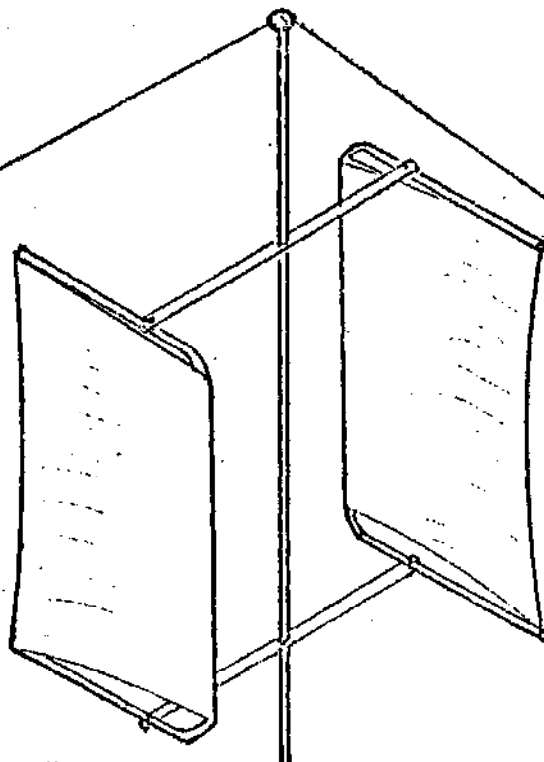

The rotor consists of two or more sailwings mounted vertically at equal distance from a vertical axis. It rotates about this axis. Each sailwing is formed from a rigid spar, which is positioned at the leading edge of the sail. To this spar two or more rigid ribs are attached at right angles. The trailing edge of the sailwing is held in tension between the ends of the spars. The surface of the sailwing is made from a cloth envelope. Other flexible material could be used.

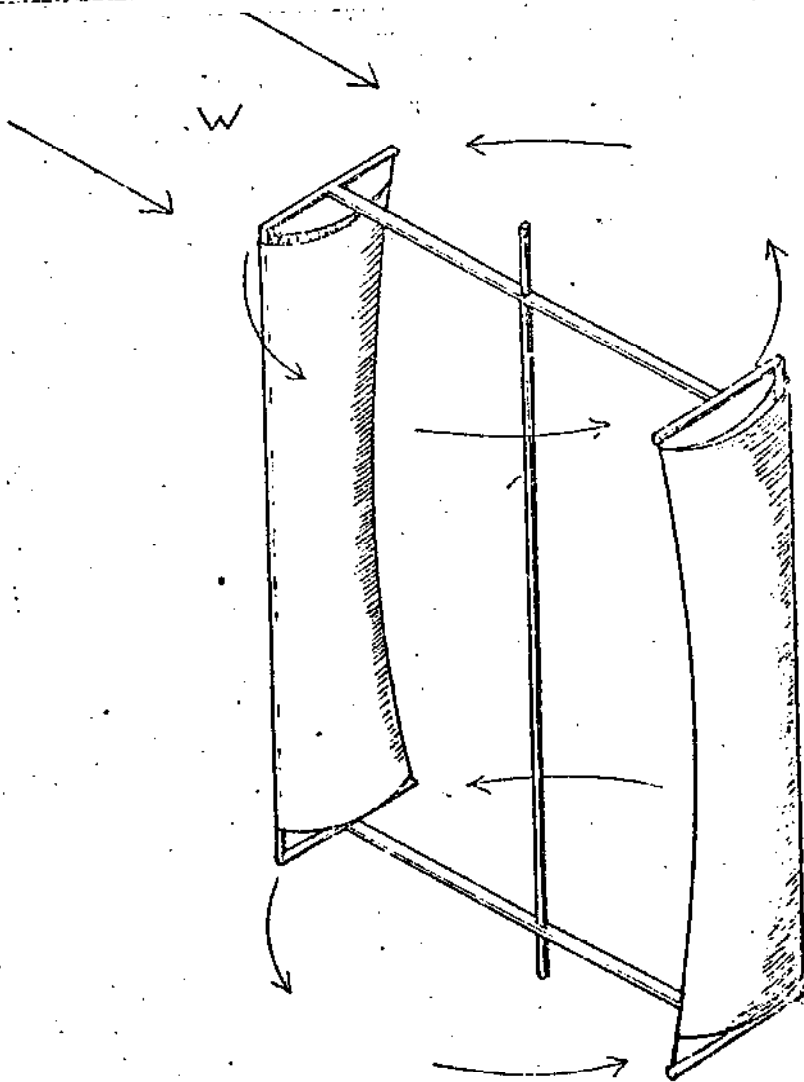

Diag.1

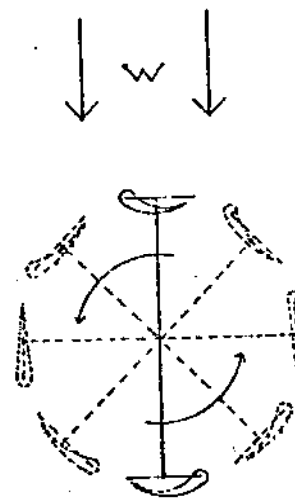

Diag.2

When the wind impinges on the sailwing it takes up an airfoil shape with a concave surface facing into the wind. During rotation the sailwing behaves like an airfoil with constantly changing angle of attack. During one complete revolution of the rotor the sailwing switches the concave surface from one side to the other automatically. This enables the rotor to develop a positive torque even at low r.p.m. for practically all positions of the rotor. It is self starting unlike the Darrieus rotor, to which it is similar in some other respects.

A feature which is of importance is that the trailing edge of the sail shifts its position relative to the leading edge during rotation. The trailing edge is deflected to the side away from the wind due to the belly developed by the sail. This has the effect of reducing the angle of attack of the relative wind. This tends to delay the stalling of the sail.

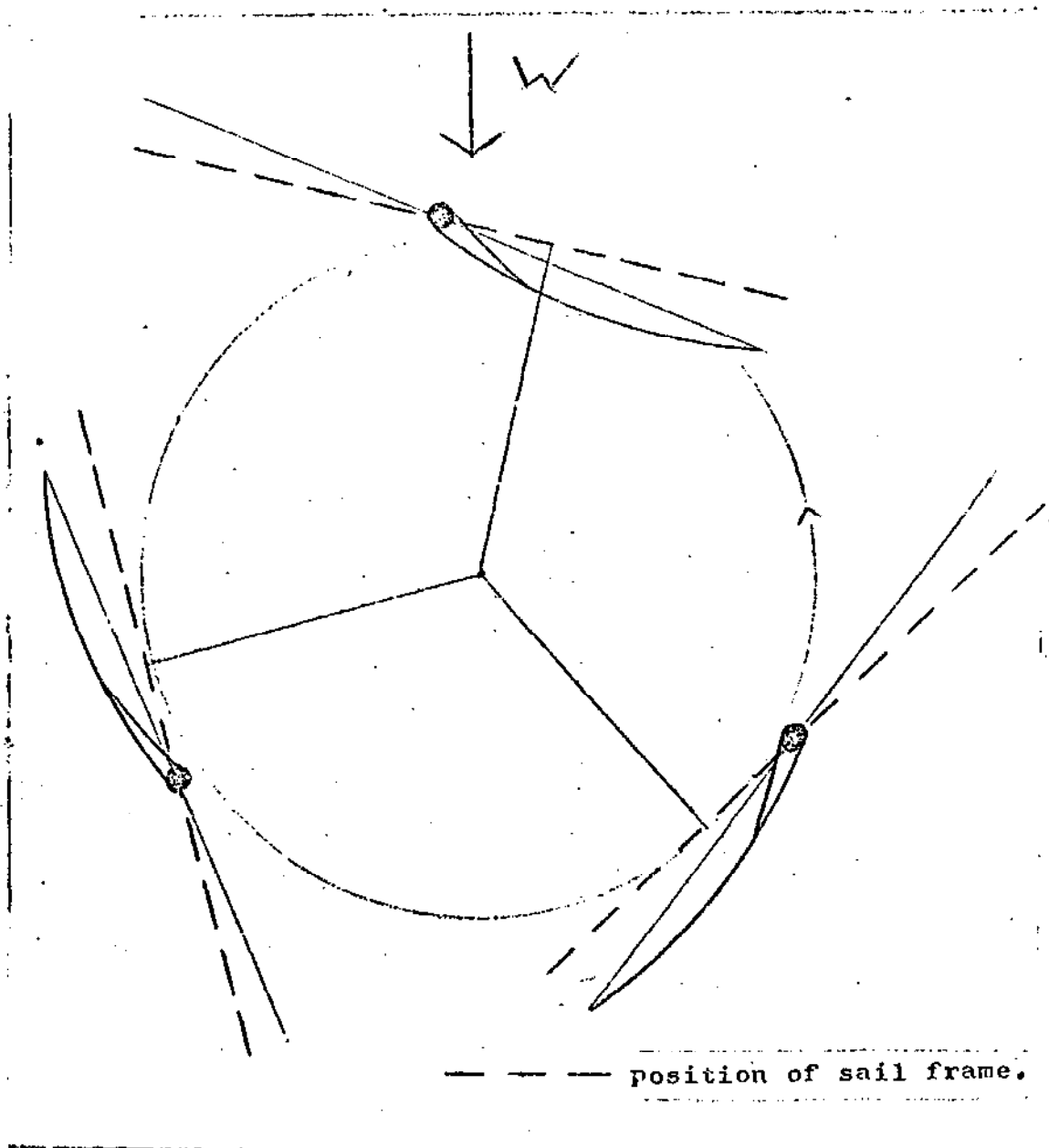

TOWER:

The main framework is constructed of
20 X 10cm. timbers.

There are a number of ways of fastening the pieces together. Large wood screws can be used on their own, or right angle metal brackets with wood screws or bolts and nuts. The base is secured by means of two bolts and nuts on each foot to the metal plates which are anchored in the concrete foundations.

FOUNDATION:

About two sacks of cement will be required. A mix of about 1 part cement to 6 parts ballast (sand and aggregate mixed)

The anchors can be made up of 10 mm steel. The dimensions are not critical although they should be if anything larger than what is specified. The shape can be altered. Maybe some scrap parts can be used.

AXLE:

The axle and hubs present some difficulty. One way is to get it made up in your local engineering workshop. Make sure to tell them it is for an axle and that it needs to be straight.

Alternatively, a composite of wood and metal might be attempted.

GUYS:

Use two eye bolts as near the top of each pole as possible.

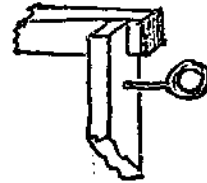

Four cables are tied to each, using the "bulldog grips" to secure the ends of the cable, with thimbles inserted in the loop.

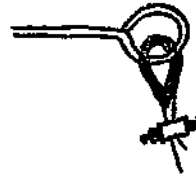

The "strainers go at the lower end, again using thimbles and bulldog grips.

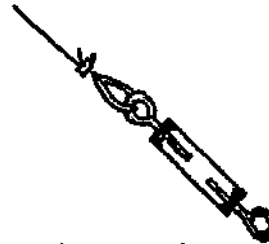

Bulldog grips can be used to secure the strainers to the anchors.

2 m. angle-iron (fencing post) can be used as an anchor. If the soil is soft some concrete should be added.

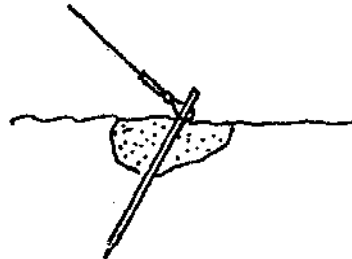

SAIL FRAME: It is constructed of 20 mm electrical conduit (galvanised seamed welded pipe). It is bent to shape using a pipe bending machine - see your local plumber or electrician. The important thing is to get the distance correct between the beginning of the bends. A mark was made on the tube 96 cm from one end. Another mark was made 108 cm from the first mark. The first bend is made with the 96cm mark just at the beginning of the $\frac{1}{4}$ wheel which supports the tube while it is being bent. Similarly with the second mark and the second right angle bend.

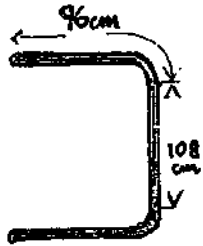

ROTOR ARMS: These are made from 20mm conduit. Although gunbarrel tubing of $\frac{1}{2}$ " might be better. Holes are drilled to take the bolts for fastening to the hubs. The arms are fastened to the sail frames by means of brackets. They could be fastened by one single bolt although this would need some means of making the joint rigid.

BEARINGS: These are standard plumber blocks which are fastened to the cross pieces with 2 bolts each. Make sure they can be loaded vertically to take the weight of the axle and rotor. Wood bearings could be used if made from hardwood, although the vertical loading might present some problems.

SAIL: The sail is made from canvas. The pocket through which the sail frame is inserted is made by turning back the front edge and stitching the doubled up canvas.

The trailing - edge and the two sides are reinforced with cord inside a hem.

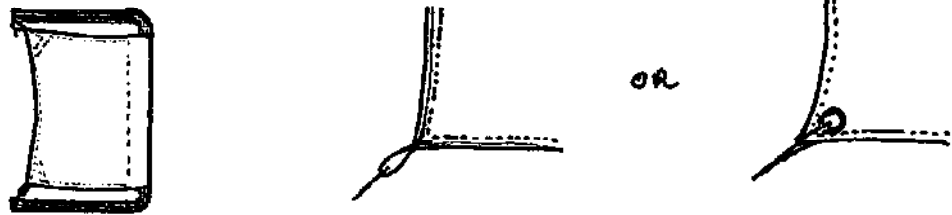

The two corners with the cord loops need extra reinforcing.

The loops are secured to the ends of the sail frame by cord which is sufficiently strong to withstand normal working tension, but which would snap under storm conditions. It is better to make the cord too light than too strong. You can repair the broken cords easily after a storm, a wrecked windmill is another matter.

TOWER

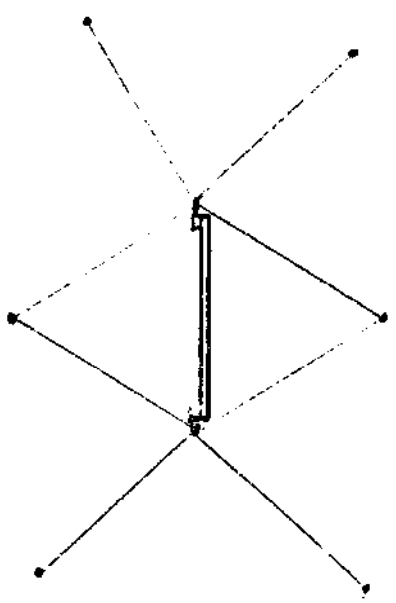

Guy wire plan

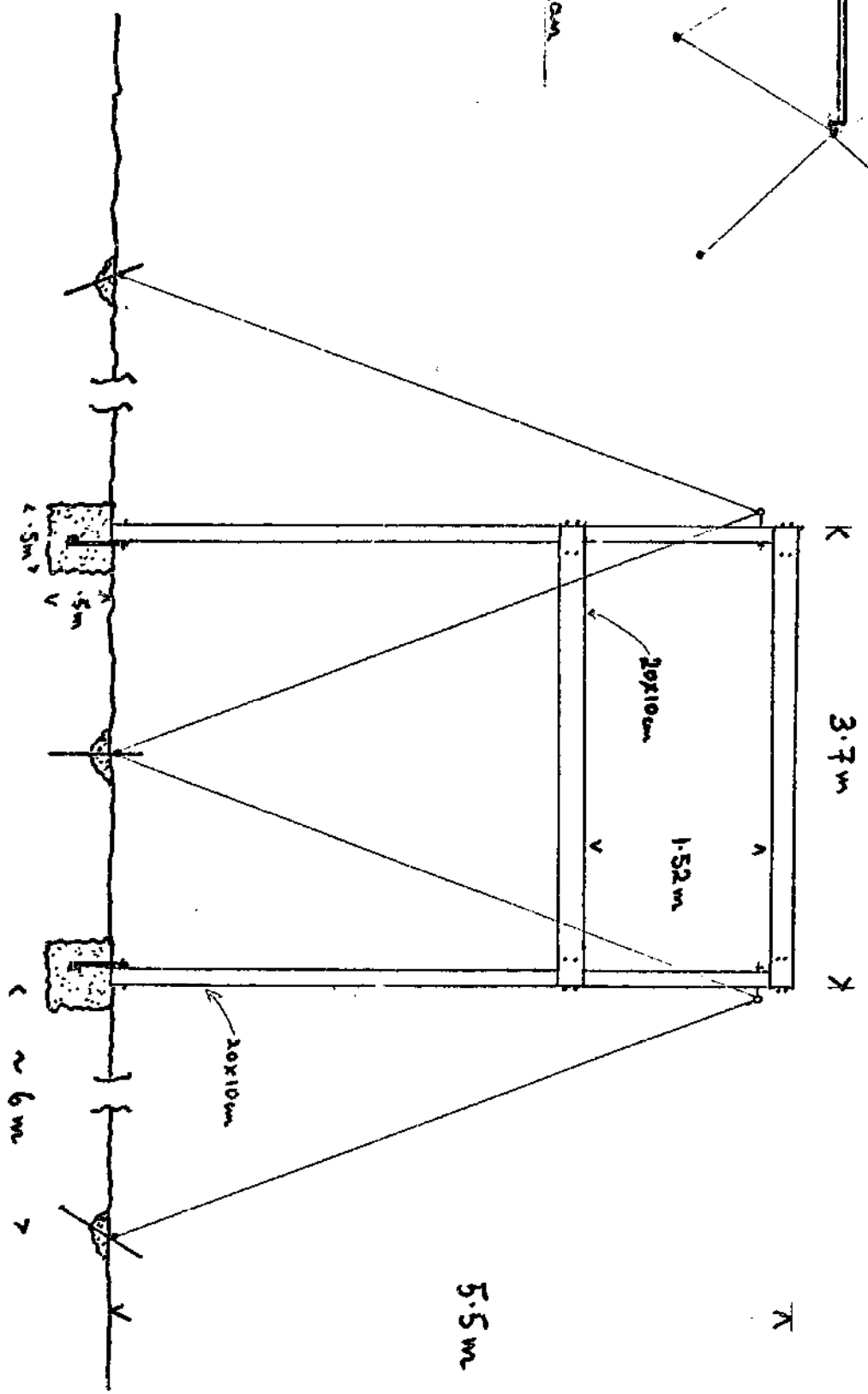

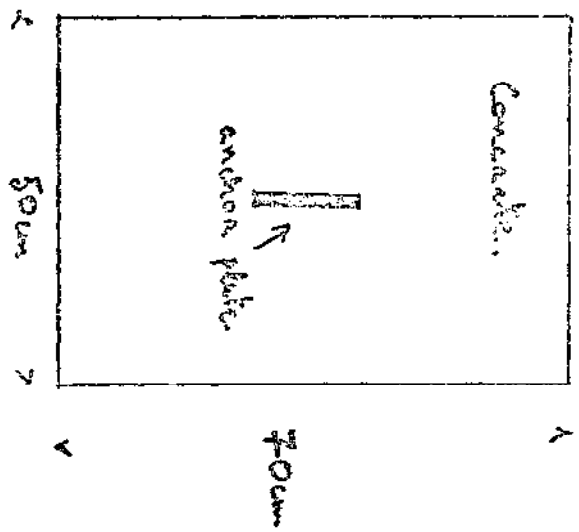

to fit 10mm bolts

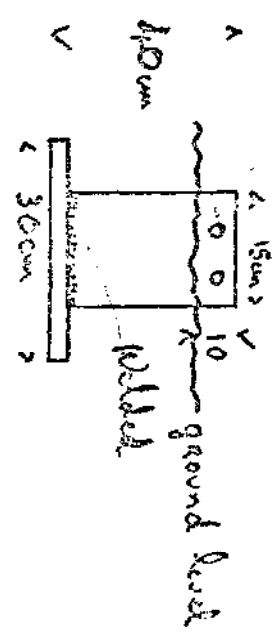

BRACKETS

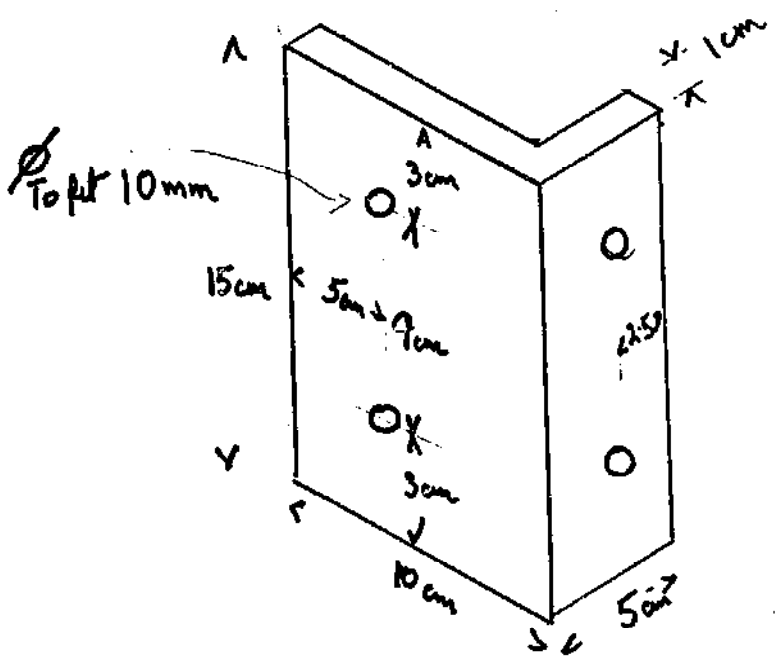

BRUNNEN

Bezeichnet

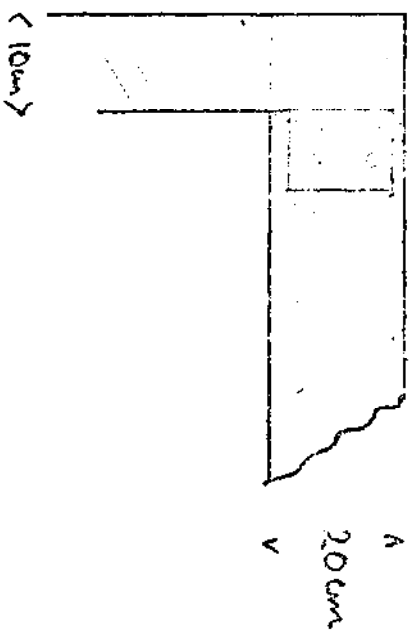

Side View
< 20 cm >
> 10 <
> 3 <

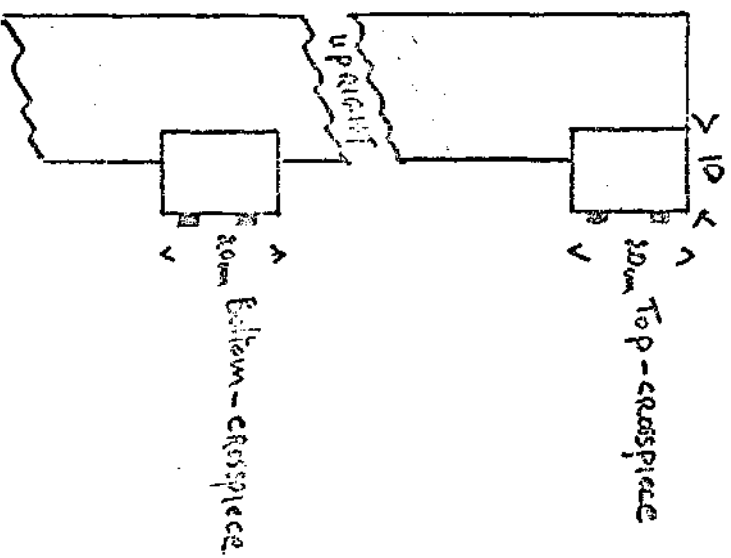

AXLE & HUBS

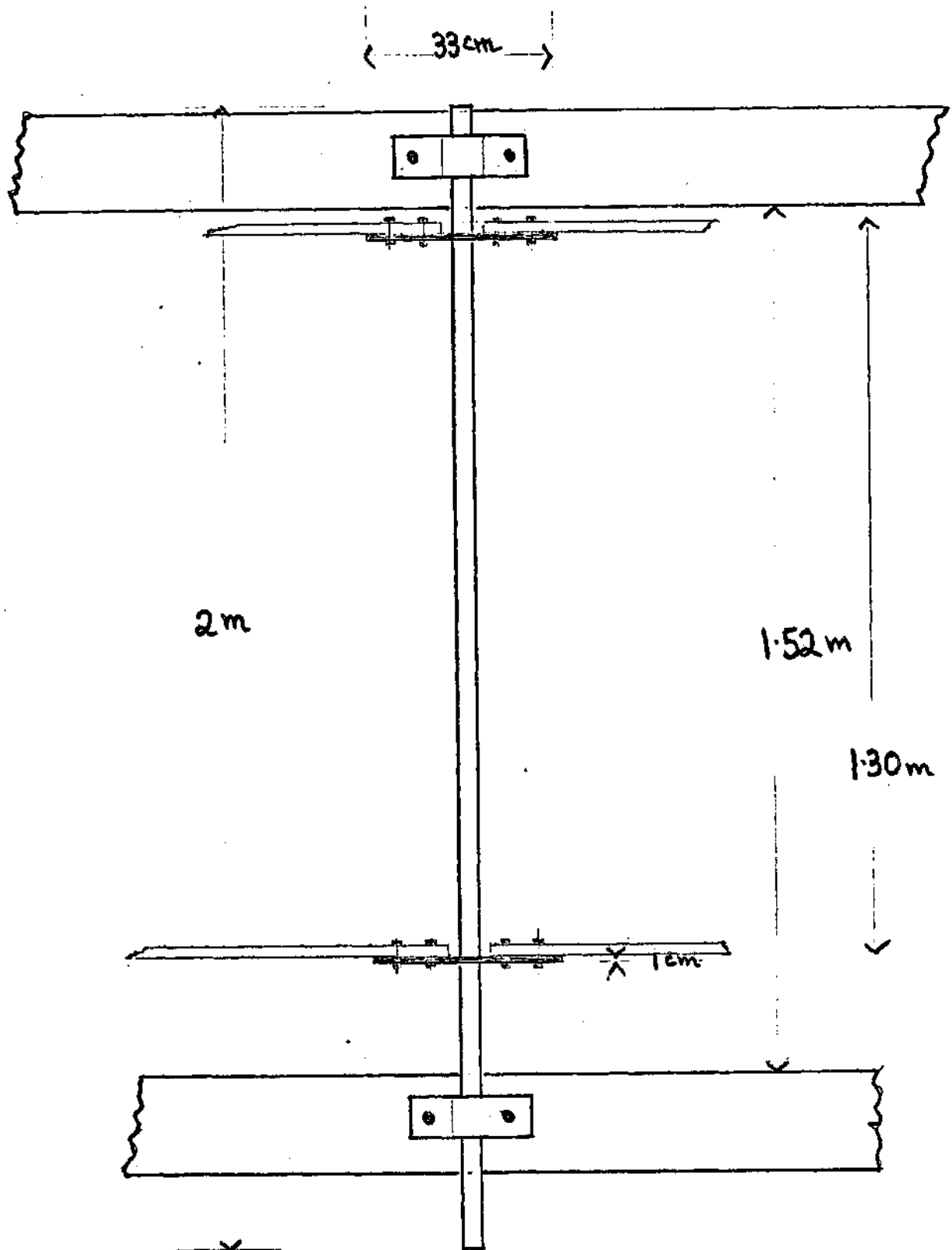

AXLE

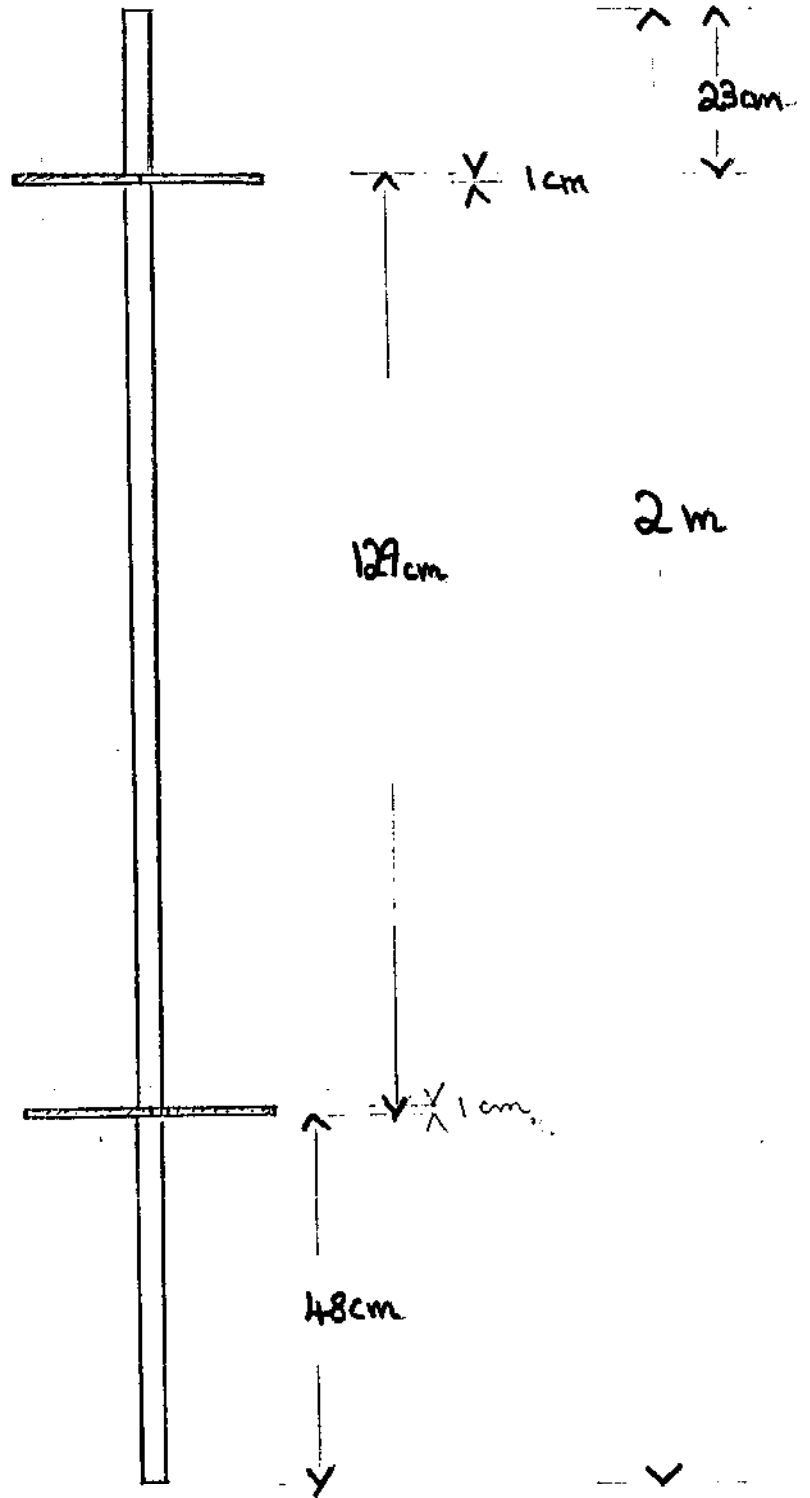

HUBS

To fit 6mm bolts

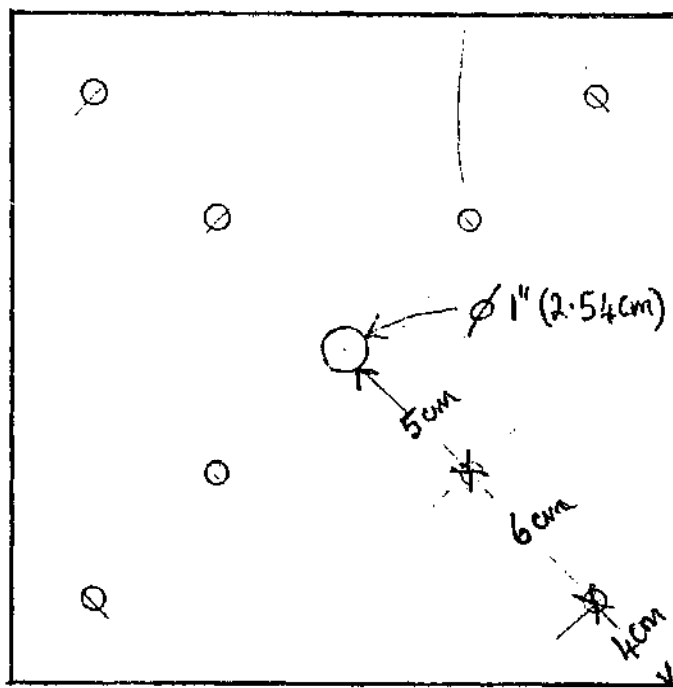

1cm thick

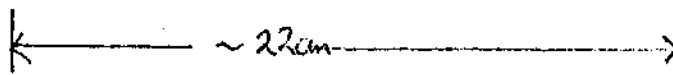

ROTOR

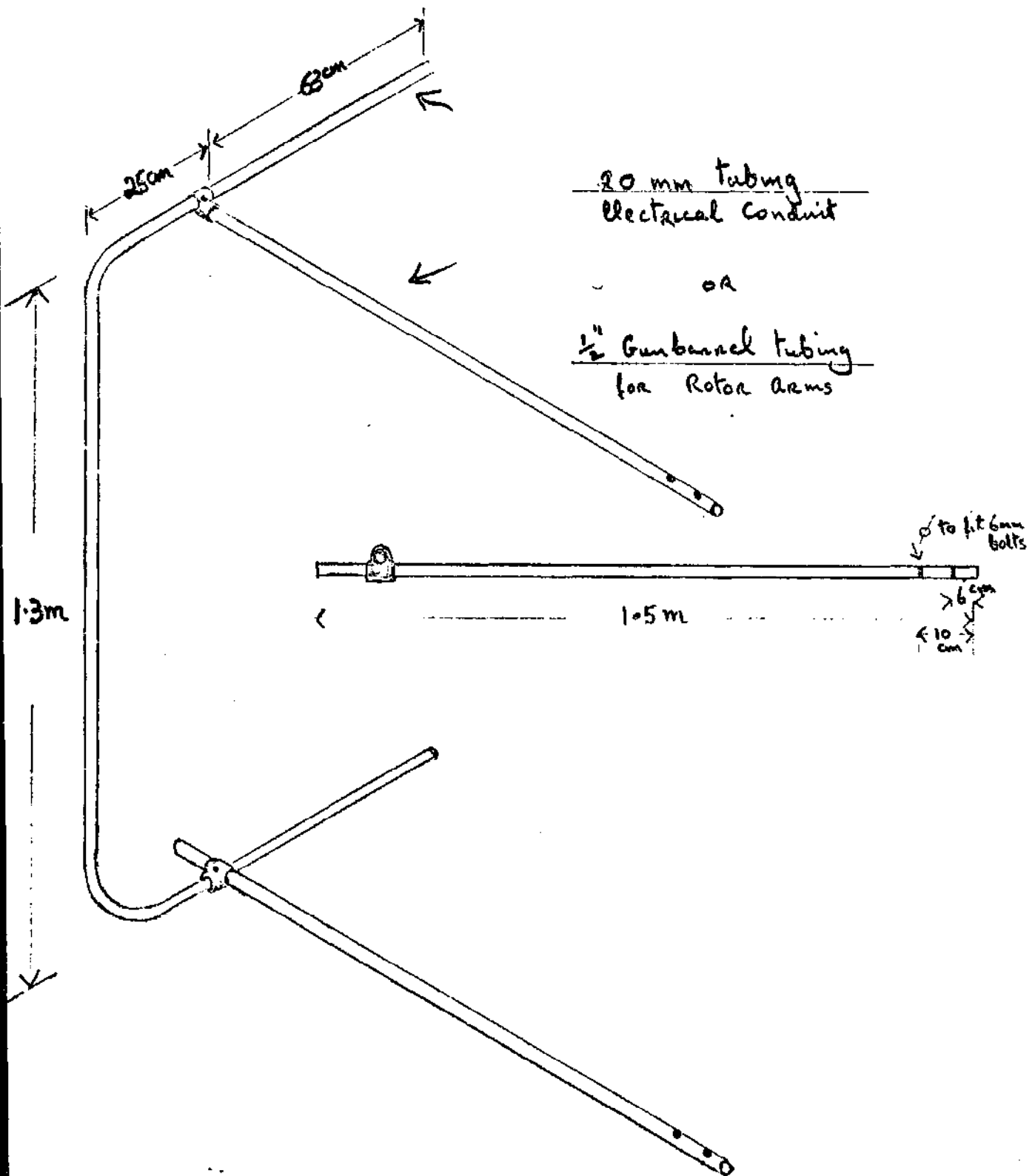

SAIL FRAME

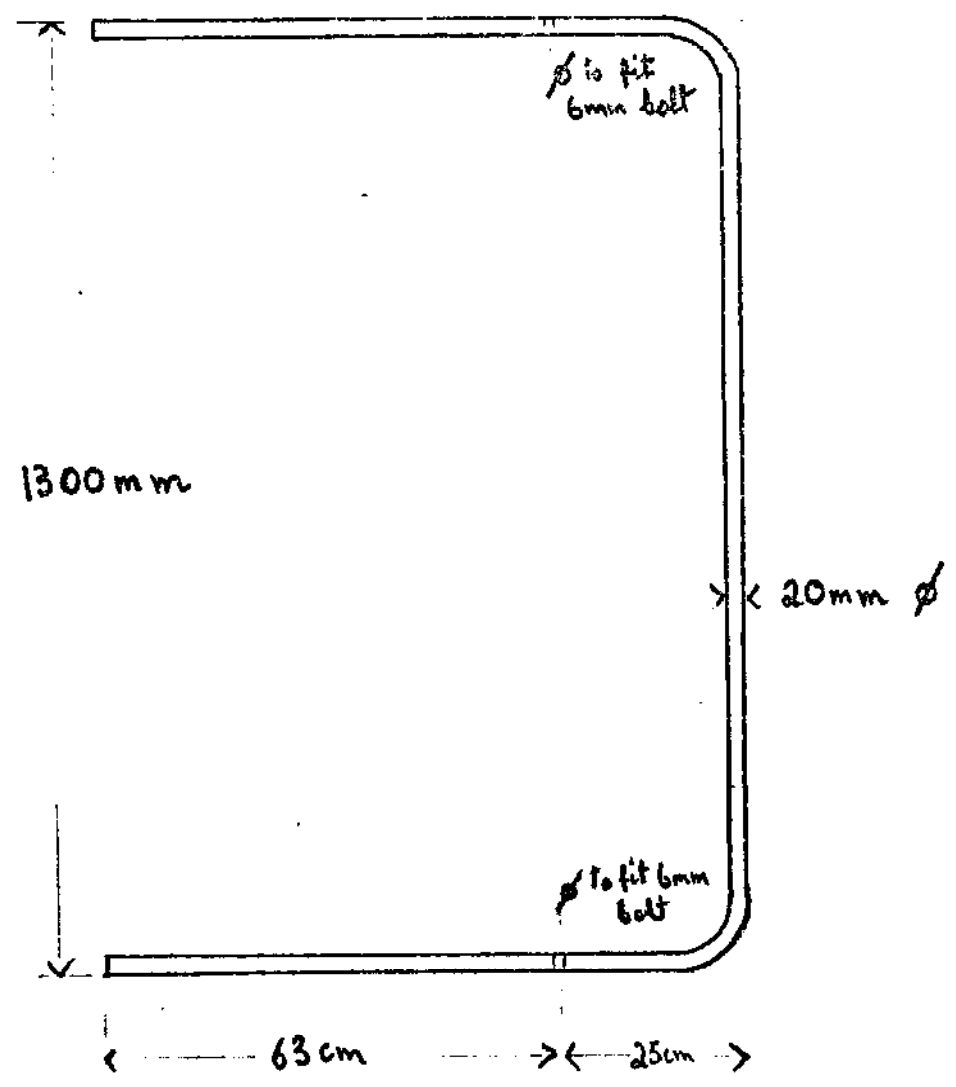

SAIL

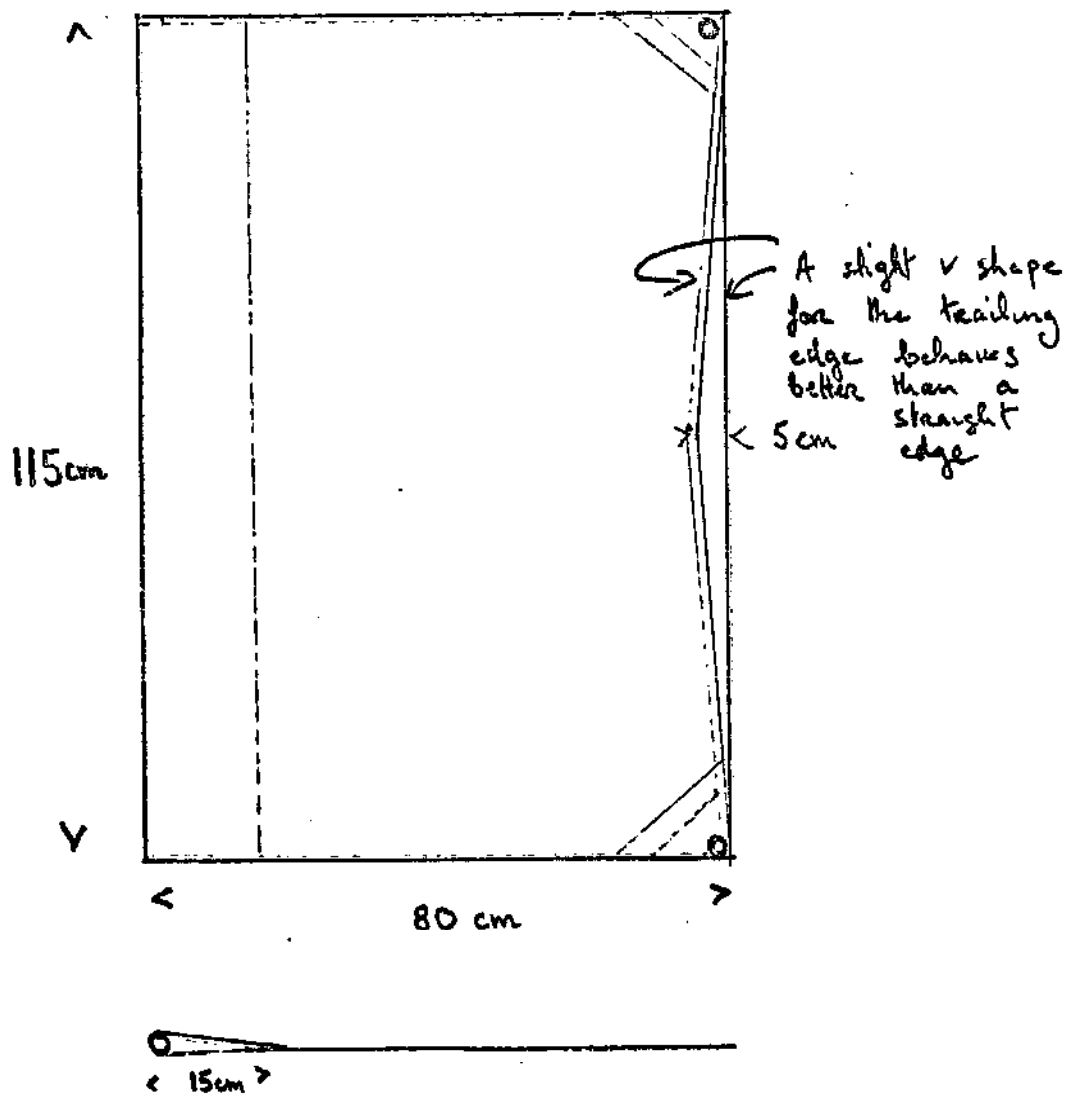

PERFORMANCE.

Accurate performance data is not yet available, but the following data indicates what may be expected.

POWER: ~200watts maximum with a windspeed of 9m/s. (55.6w/m²)

STARTING TORQUE:

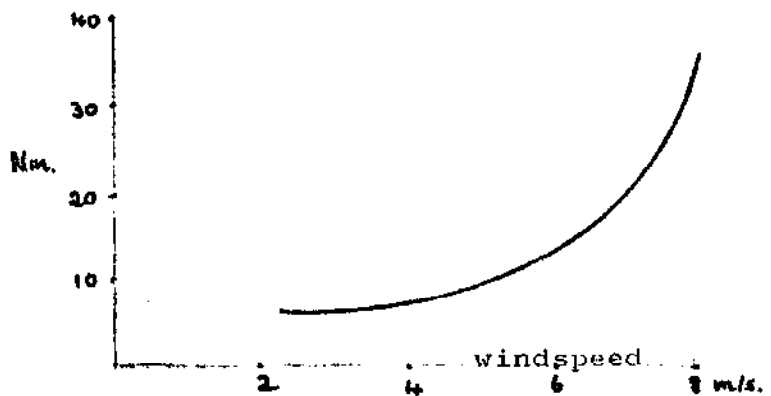

U/V RATIO: ~ I

RATE OF ROTATION: 20 to 60r.p.m. optimum ~30r.p.m.

FRONTAL AREA: 2.7m x 1.3m = 3.5m²