

# The Wood 103

## A Wooden 100 Watt Wind Generator

Dan Bartmann  
& Dan Fink

©2002 Forcefield

The Wood 103 was built mostly of wood in just a day, with very little number crunching. Producing 100 watts in a 30+ mph wind ain't bad for a weekend project!

The initial goal of our project was to build a functional, permanent magnet alternator from scratch, primarily out of wood. When the alternator was together and working, it became clear that wind was the logical energy source for it. This unit (we call it the “Wood 103”) is not intended to be a permanent addition to a remote home energy system, but a demonstration of how simple it really is to produce energy from scratch—and to be a bit silly!

Many homemade wind generator designs require a fully equipped machine shop to build. Our wooden version, built in a day, can be made with mostly local materials and simple hand tools in any remote corner of the world. The alternator design is well suited to hydroelectric, human, or animal power. We plan to use it for a series of magnet and electricity demonstrations at

local schools, and for future experiments with different energy sources, windings, cores, poles, and rotors. This project will cost you only US\$50–75, depending on what you pay for magnets and wire.

### Alternator Basics

Electricity is simply the flow of electrons through a circuit. When a magnet moves past a wire (or a wire past a magnet), electrons within the wire want to move. When the wire is wound into a coil, the magnet passes by more loops of wire. It pushes the electrons harder, and can therefore make more electricity for us to harvest.

The magnetic field can be supplied by either permanent magnets or electromagnets. All of our designs use permanent magnets. In a permanent magnet alternator (PMA), the magnets are mounted on the armature (also sometimes called the “rotor”), which is the part that spins. It is connected directly to the wind generator rotor (the blades and hub). There are no electrical connections to the armature; it simply moves the magnets. Each magnet has two poles, north (N) and south (S). The magnets are oriented in the armature so that the poles alternate N-S-N-S.



The Wood 103 has three, 2 foot, hand-carved blades, creating a swept area of 12.5 square feet.

The other half of a PMA is the stator, which does not move. It consists of an array of wire coils connected together. The coils in our stator alternate in the direction they are wound, clockwise (CW) and counter-clockwise (CCW). The coils and magnets are spaced evenly with each other. So when the north pole of a magnet is passing a clockwise coil, the south pole of the next magnet is passing the counter-clockwise coil next door, and so on.

The coil cores are located inside or behind the coils, and help concentrate the magnetic field into the coils, increasing output. The cores must be of magnetic material, but also must be electrically nonconductive to avoid power-wasting eddy currents. The air gap is the distance between the spinning magnets and the stationary coils (between the armature and the stator), and must be kept as small as possible. But the spinning magnets must not be allowed to touch the coils, or physical damage to them will occur.

**Permanent Magnet Alternator**

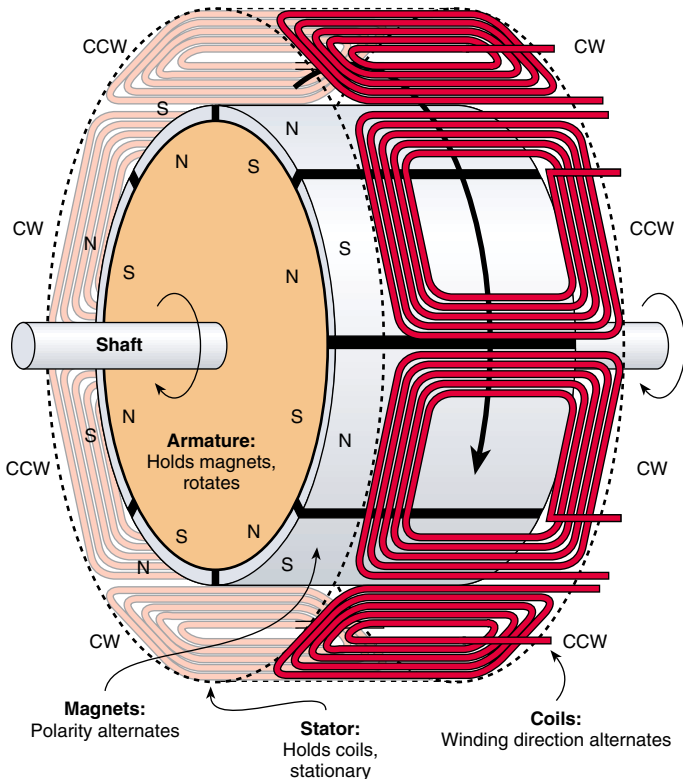

The more loops of wire that each magnet passes, the higher the voltage produced. Voltage is important, since until the alternator voltage exceeds the battery bank voltage, no electrons can flow. The sooner the alternator voltage reaches battery voltage or above in low winds, the sooner the batteries will start to charge.

Increasing the number of turns of wire in each coil allows higher voltage at any given speed. But thinner wire can carry fewer electrons. Using thicker wire allows more electrons to flow, but physical size limits the number of turns per coil. This also explains why enameled magnet wire is always used in coils. The enamel insulation is very thin, and allows for more turns per coil than does thick plastic insulation. Any alternator design is a compromise between the number of turns per coil, the wire size, and the shaft rpm.

The electricity produced by an alternator is called "wild" alternating current (AC). Instead of changing direction at a steady 60 times per second like standard AC house current, its frequency varies with the speed of the alternator.

Since we want to charge batteries, the wild AC is fed to them through a bridge rectifier, which converts AC to DC (direct current) for battery charging. The alternator may produce much higher voltages than the battery bank does, but the batteries will hold the system voltage from the wind generator down to their normal level when charging.

**Design**

We had successfully converted AC induction motors into PMA wind generators before. But starting from scratch was truly a first-time experiment. Our design choices for wire size, number of windings, number of poles, blade pitch, and other factors were intuitive rather than calculated.

Every wind generator, waterwheel, and alternator we've built has produced usable energy, no matter how strange the design. The trick is matching the generator, rotor, and energy source. You can do a lot of study and calculation to get there. But if the design is quick, cheap, and easy to build, why not just make adjustments by observing the unit's performance?

If you try this project and change the wire size, magnet type, rotor design, and stator cores, you'd still be making usable energy and have a great starting point for further research. Just change one thing at a time until the unit performs to your satisfaction. We're aware that many design improvements could be made to the Wood 103—and we hope that others will experiment with variations.

**Wooden Alternator**

The biggest problem with building most wind generator designs at home is the need for machine tools—usually

**Wood 103 PM Alternator: End View**

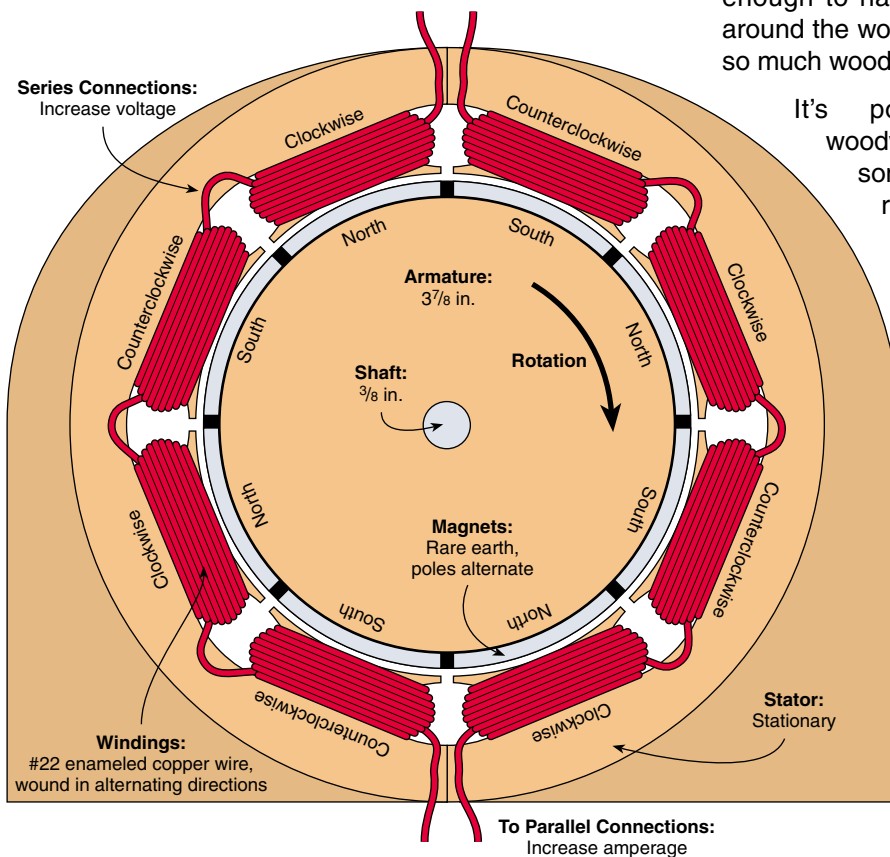

**Materials Used**

The materials we used are not hard to find:

- Wood, the harder the better. We used pine since it was locally available.
- Copper magnet wire, about 100 feet (30 m), enameled #22 (0.64 mm diameter).
- Eight surplus neodymium-iron-boron magnets, four with the south pole on the convex face, and four with the north pole on the convex face.
- Dirt (magnetite sand).
- A 10 inch (25 cm) piece of 3/8 inch (9.5 mm) steel shaft with a nut on the end to hold the hub on.
- Two, 3/8 inch by 2 inch (9.5 mm x 5 cm) bolts, but these are optional.
- Bridge rectifier, rated for least 15 amps, 100 volts.
- Other supplies—glue and linseed oil.

at least a metal lathe is required. Headquarters for our business, Otherpower.com, is high on a mountain, 11 miles (18 km) past the nearest utility line. We are lucky enough to have basic tools up here, but many folks around the world don't. That's the main reason we used so much wood in this design.

It's possible to build human-powered woodworking tools in almost any location. With some patience, only simple hand tools are required for this project. If you want to build it in a day, though, a lathe, drill press, band saw, and power planer can be very helpful!

**Building the Armature**

The key to the Wood 103's armature is the neodymium-iron-boron (NdFeB) magnets. They are the strongest permanent magnets available. Ours are surplus from computer hard drives. They are curved, and measure about 1 3/4 by 1 3/8 by 1/4 inch thick (44 x 35 x 6 mm). Eight fit together in a 3 7/8 inch (9.8 cm) diameter ring. That's why we chose this particular diameter for the armature.

The magnets are available with either the north or south pole on the convex

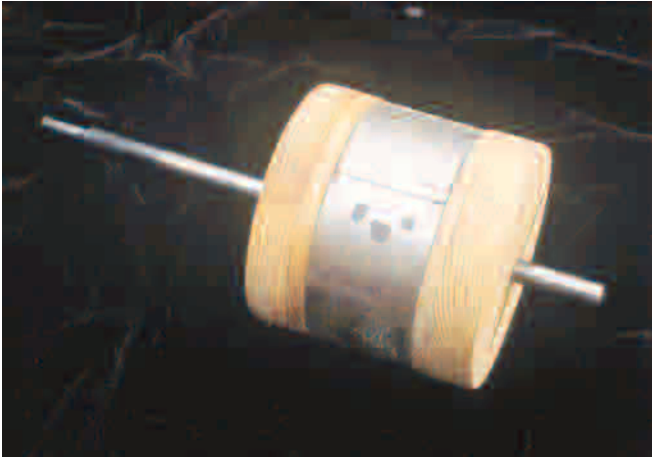

**The wooden armature holds eight NdFeB (neodymium-iron-boron) magnets arranged in alternating polarity around its perimeter.**

face. For this project, you will need four of each configuration. Don't start tearing your computer apart to get these, though! They are from very large hard drives, and you won't find any inside your computer. Check the Access section at the end of this article for suppliers.

To construct the armature, we laminated plywood circles together with glue. The  $3\frac{7}{8}$  inch (9.8 cm) diameter wooden cylinder is  $3\frac{3}{4}$  inches (9.5 cm) long, with a  $1\frac{3}{4}$  inch (4.4 cm) wide slot cut into it  $\frac{1}{4}$  inch (6 mm) deep to tightly accept the magnets. To assure that the magnets would be flush with the armature surface, we cut the plywood disks a bit oversized, and turned them down on the lathe to the proper diameter. The same procedure was used to cut the magnet slot to exactly the right depth.

Using a firm grip, we carefully press-fit and epoxied the magnets into place. Remember that these magnets come in two different configurations—north pole on the convex face and south pole on the convex face. The magnets must have alternating poles facing out, and this is how they naturally want to align themselves.

Next, we drilled the shaft hole through the center of the armature using a lathe, though it could certainly be done with a hand drill if you are careful to align it perfectly. We roughed up the surface of the shaft with a file before epoxying it into the hole. It should be a very tight fit—we had to gently tap it through with a hammer. This may not be strong enough, and it might be wise to actually pin the armature to the shaft. Time will tell!

#### **Construction without a Lathe**

We did cheat by using a lathe to shape the armature, but a coping saw and sandpaper would work just fine. If a lathe is not available, our suggestion is to first cut out the disks, making sure that some of them (enough to

## **Safety Warning!**

The large NdFeB magnets in this project are extremely powerful, and can be dangerous. They are brittle, and if allowed to snap together from a distance, they can break and might send sharp shrapnel flying. They are powerful enough to cause painful damage to your fingers if you allow them to pinch you, and can cause malfunctions in cardiac pacemakers if brought too close.

Use safety glasses, gloves, a firm grip, and Zen-like concentration when handling these magnets. Do not get them anywhere near televisions, computer monitors, floppy discs, videotapes, credit cards, etc. They are not toys, and should be kept out of reach of children!

stack up to  $1\frac{3}{4}$  inches; 4.4 cm) are  $\frac{1}{4}$  inch (6 mm) smaller in diameter than the rest. Once assembled, the armature will then have a recessed slot for the magnets.

Otherwise some means of "lathing" the slot will have to be devised. It could be done on the alternator's pillow blocks with a sanding block mounted below, or in a drill press. It would also be wise to first drill a shaft hole into each plywood disk, and then assemble, glue, and clamp all the plywood disks together on the shaft before turning.

#### **Building the Pillow Blocks**

The pillow block bearings were made from pine, since that's the hardest wood we have available up here on the mountain. Certainly hardwood would be much better. First we drilled a hole slightly under  $\frac{3}{8}$  inch (9.5 mm) diameter in each pillow block. Using a gas stove burner, we heated the shaft to almost red hot, and

**Pillow blocks support the armature. Charred wood creates "carbon" bearings for the shaft to spin on.**



forced it through the holes. This gave a good tight fit, hardened the wood, and made a layer of carbon on the inside for better lubrication. We drilled a small hole in the top of each pillow block, down into the shaft hole, so the bearings can be greased.

After pressing the hot shaft through the pillow blocks, we were very pleased with how freely the armature turned and how little play there was. In a slow waterwheel design, wood/carbon bearings would probably last for years. This wind generator is actually a fairly high-speed unit, and real ball bearings would be a big improvement. Such bearings could be easily scavenged from an old electric motor of any kind. Wooden bearings were certainly simple, fast, and fun though!

### Building the Stator

The stator, on which the coils are wound, is made up of two identical halves. Each half is made from 2 by 4 inch lumber, 6 inches long (5 x 10 x 15 cm). A semi-circular cutout with a 5 inch diameter (12.7 cm) was made on each half. The tolerances are pretty tight, but this allows more than a 1/2 inch (13 mm) to fit the coils and core material inside.

On the sides of the 2 by 4s, right over the cutout, we glued thin (1/8 inch; 3 mm) U-shaped plywood “half disks,” which have an inner diameter of 4 inches (10 cm) and an outer diameter of 6 inches (15 cm). They have slots cut large enough to accept the coils. These were made with a hand saw, 3/8 inch (9.5 mm) drill bit, and a rat tail file. The coils are wound in these slots, and the space inside and behind the coils is filled with the magnetite core material. There are four coils on each half of the stator, and they must be evenly spaced.

Our twin stator halves are wound with #22 (0.64 mm diameter) enameled copper magnet wire. Magnet wire

**The two stator halves—one wound with 100 turns per coil, and one ready to be wound.**



### Stator Construction

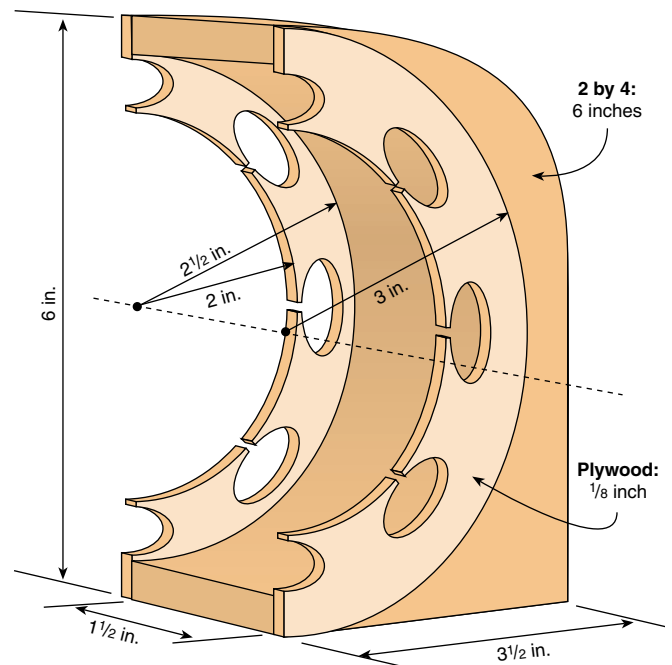

of this type is often available from electronics stores or electric motor repair shops. Each stator half contains four coils. Each coil is 100 turns, and every coil is wound in the opposite direction as its neighbor. It's important to wind the coils neatly and tightly, using a wooden dowel to carefully press each winding loop into place.

Most common alternators use thin steel laminates as cores, to help concentrate the magnetic field through the coils. Magnetism in motion pushes the electrons around in the steel too. The laminates are insulated from each other to block these eddy currents, which would otherwise waste energy.

These laminates are difficult to make in a home shop, so we chose dirt as our stator core—actually magnetite sand mixed with epoxy. It is not as effective as real laminates, but was very easy to use, and available for free by separating it from the dirt in our road. We mixed the magnetite with epoxy and simply spooned it into the open cores. If the cores were left empty (an “air core”) the alternator would still work, but with much less power.

Magnetite is a common mineral, a type of iron oxide. It is a byproduct of some gold mining operations, and can sometimes be purchased. As an alternative, we simply dragged a large neodymium magnet (just like the ones we used for the armature) around on our local dirt road on a string for a while, attracting all the ferrous sand, which stuck to the magnet.

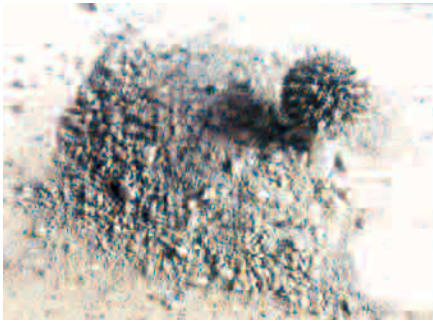

**Magnetite sand collected from Dan's driveway by dragging a magnet around on a string.**



**The stator cores are filled with a mixture of epoxy and magnetite sand.**

We separated this somewhat magnetic sand into a pile, sifted it through a window screen, and sorted that with the magnet one more time. The remaining black sand sticking to the magnet was nearly pure magnetite. A quick test of any local dirt pile with a neodymium magnet should reveal whether your sand contains magnetite. If not, try dragging the magnet along the sandy bottom of a local river. Any deposits of black sand on the river bottom are most likely nearly pure magnetite.

The clearance between the stator coils and the armature surface is very important. It must be extremely close (within  $\frac{1}{16}$  inch; 1.5 mm) without allowing the magnets in the armature to touch the stator. Our model is actually a bit sloppy—the clearances are more like an  $\frac{1}{8}$  inch (3 mm). Tighter tolerances would produce more power.

**Wiring Configuration**

The completed stator consists of two identical sets of four coils. For our wind generator, we connected the stator halves in parallel for more current (amperage). Connecting them in series would double the voltage produced, but halve the amperage. For low wind speeds, a series connection would be the best—the alternator would reach charging voltage at slower speeds. At higher speeds, a parallel connection is optimum for producing the most amperage.

An ideal system would contain a regulator that switched the stator connections from series to parallel when the unit began to spin fast enough. As is the case with many



**An exploded view shows the armature, stator, and pillow blocks ready to assemble into an alternator.**

homebrew and commercial wind turbines, we eliminated this entirely, sacrificing a small amount of efficiency for much greater simplicity and reliability. Many people have experimented with such regulators, both solid state and mechanical.

**Alternator Performance**

We were really surprised by this alternator's performance. We could easily spin it with our fingers and get 12 volts or higher. A cordless drill attached to the shaft would light up a 25 watt, 12 VDC light bulb easily. This might not seem breathtaking, but considering the simplicity of the project and one-day construction time, we were quite impressed.

Our 100 watt rating for the Wood 103 is probably right on, considering the performance we got during testing,

**The finished alternator, ready for a power source.**

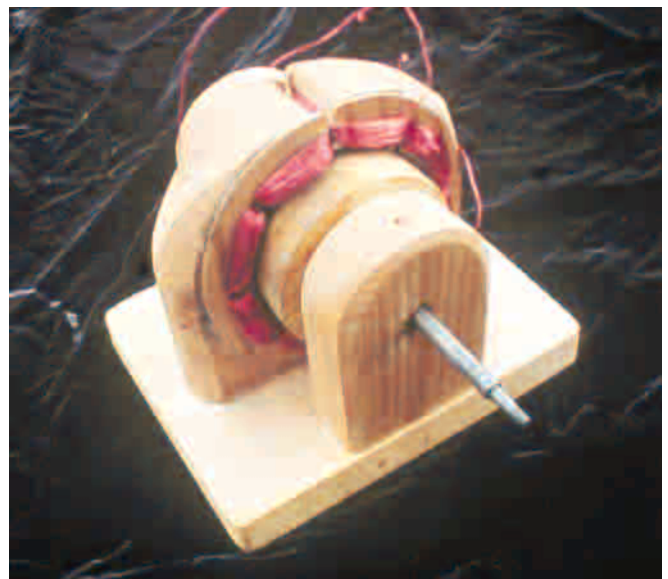



Almost ready—the wooden frame and tail are attached.

and the way commercial wind generator manufacturers rate their products. Our data acquisition system was pretty simple—multimeters and people with pencils and paper to watch them and record measurements.

With a series connection between the stator halves, the unit reached charging voltage for 12 volt batteries at around 300 rpm. With the stator in parallel, it took around 600 rpm to start charging. When installed on our wind machine, the parallel connection gave us 4.8 amps output in a 25 mph (11 m/s) wind.

### Building the Frame

To stay with the style of this project, we chose to build the rest of the wind generator out of wood too. It's a very simple design and should be self-explanatory. It's all glued and pinned with dowels. No bolts are used except to connect the alternator to the frame. We admit that we cheated here!

We did not make any provision for overspeed control, since this was intended to be a demonstration unit for all energy sources, not just wind. A canted tail and spring assembly could be added to control speed during high winds. And of course, making the frame out of surplus steel or aluminum angle would give great improvements in durability.

We also did not include slip rings for power transmission as the wind generator yaws. Instead, we used flexible wire for the first few feet, letting it hang in a loose loop. A piece of aircraft cable cut slightly shorter than the power cable was attached, so if the power wire gets wrapped around the pole too tightly, the connections won't pull loose.

Our normal winds are usually from one direction, and designs without slip rings seem to work fine up here. Wrapping the power wire around the pole is only rarely a problem, and this strain relief cable prevents any damage. Our experience is that if the power cable does wind up all the way, it will eventually unwind itself.

### Designing the Rotor

The "rotor" here refers to the blades and hub of the wind generator. We don't profess to be experts in blade design. Once again, we chose our starting point intuitively rather than trying to calculate the proper blades to match our alternator's power curve. Since the blade carving process took us less than an hour for the whole set of three, we figured that any design changes would be quick and easy to make. However, because we glued the blades to the hub, a new hub will be necessary for any blade changes.

There's a great deal of information out there about building blades. Hugh Piggott's Web site and his *Brakedrum Wind Generator* plans are some of the best sources around.

The rotor was built from  $\frac{3}{4}$  inch by 4 inch (19 mm x 10 cm) pine lumber. Each blade is  $3\frac{1}{2}$  inches wide at the base and  $2\frac{1}{2}$  inches wide at the tip (9 x 6.4 cm). The three blades are 2 feet long (0.6 m), for a total diameter of 4 feet (1.2 m). The pitch of the blades is 10 degrees at the hub, and 6 degrees at the tip.

The hub is made from 2 inch thick (5 cm) wood, press-fit and glued to the roughed-up shaft with epoxy. The blades are held onto the hub by one small nut at the end of the shaft, and several wooden pins with glue.

### Carving the Blades

To prepare the blades for carving, we simply drew a few lines so that we knew what material to remove. Each blade starts out life as a 2 foot (0.6 m) long, 1 by 4 (2.5 x 10 cm). Starting from the leading edge of the blade at the hub, we simply used a protractor to lay out how far into the wood 10 degrees of pitch would take us at the trailing edge—about  $\frac{5}{8}$  inch (16 mm).

At the tip, the pitch is about 6 degrees, so we removed about  $\frac{3}{8}$  inch (9.5 mm) of material on the trailing edge. We made both marks, and connected the two with a line. We then simply took a power planer, and followed the cut depth line all the way up the blade.

### Blade Cross Section

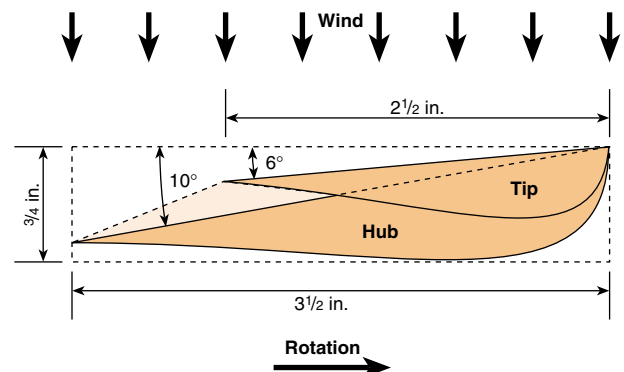

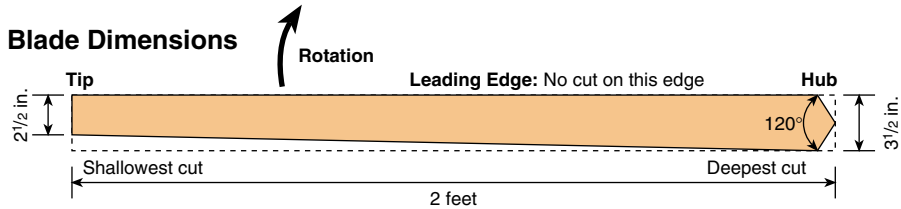

excellent testing facility for wind turbines. It has a perfectly accurate speedometer, which has been carefully checked by the Fort Collins, Colorado Police Department's radar machines!

For better accuracy (or if you don't have a power planer), you can use a hand saw to make cuts across the blade every inch or so, down to the cut depth line on the trailing edge and not cutting at all on the leading edge. Using a hammer and chisel, it's easy to break out the chunks of wood to the proper depth. Then smooth the blade down to the proper angle with a hand plane. When the saw kerfs disappear, the blade pitch is correct.

The blade width taper occurs on the trailing edge. We simply used a saw to cut the first taper, and used that first blade as a template for cutting the others. No calculations were made for the airfoil shape on the other side of the blades. We picked a likely looking profile and started cutting with the power planer. A hand planer is fine for this process, too. After everything looked good and even, we sanded the blades and treated them with linseed oil.

**Balancing the Blades**

To avoid vibration problems and enable easy starting, we made some effort to balance the blades. We considered them reasonably balanced when each blade weighed the same (about 8 ounces; 227 g) and had the same center of gravity. Adjustments can be made quickly with a planer.

Once this is done, and all three blades are assembled on the hub, balance can be double-checked by spinning the rotor and making sure it has no tendency to stop in any one place. This is a quick process, and we certainly were not concerned about great precision here. As it turned out, a small effort in balancing the blades yielded good results, and the machine seems well balanced and vibration free.

Truly, one could write an entire book on blade design, and it can get complicated. Don't worry, though. It is possible to make a very basic blade that will work quite effectively. Often a simple blade with a constant 5 degree pitch from hub to tip and a reasonable airfoil on the backside will work very nicely. If you are interested, explore the books and Web sites listed at the end of this article for more information on blade design.

**Testing**

For testing, we strapped the Wood 103 to our trusty Model A Ford. The Model A serves as a reliable daily driver, and with the bracket we made, it makes an

We carry a 12 volt battery, a voltmeter, an ammeter, and pencil and paper in the test vehicle. On a still day, we can observe the speedometer and take accurate windspeed versus output measurements on any wind turbine. We've used this rig with props over 8 feet (2.4 m) in diameter. The cost of a good Model A (about US\$4,000 if you don't mind a jalopy) is *not* included in the price of this project!

Wind generators should be installed high above human activity. For testing purposes, we've run our generator on low towers within reach of people, and on our Model A. Wind generators have parts that spin very fast! The blades could probably take your head off in a high wind if you were silly enough to walk into them. Make all installations well out of reach of curious organisms. You should treat any wind generator with a great deal of respect. This is not a joking matter, though we always shout "Clear prop!" before we fire up the test vehicle...

**Model A Ford—a high tech test vehicle for a high tech wind machine.**







**The next generation—the WoodAx is for permanent installation, and produces upwards of 300 watts in 30 mph winds.**

### Improvements

Many improvements could be made to this design. But the intention was to use mostly wood and hand tools, and keep it fast and simple. The wooden alternator is easy and quick to build, but for longest life, it would need to be protected from rain and snow. Maybe a small shingled roof over it?

Using real ball bearings would help friction loss and longevity a bunch. A metal frame and tail would improve high-wind survivability significantly. A furling system to keep the Wood 103 from destroying itself during a gale would be a great addition too. We plan to experiment with many improvements, and we hope this project piques the interest of others too.

### Trade-Offs

Designing and building a permanent magnet alternator involves a long series of trade-offs. For example, thicker wire in the windings would give more possible current, but less room for windings and hence lower voltage at the same rpm. Ceramic magnets might be cheaper, but would give far less power than neodymium magnets.

Series wiring on the stator would allow lower rpm at charging voltage, but parallel gives better charging current—and a regulator to switch between the two would be complicated. Using steel laminates instead of air or dirt stator cores would produce more power, but laminate production is extremely difficult.

The trade-offs involved in designing a complete wind generator (or water turbine, or bicycle generator) are even more lengthy and complicated. Wind speed, rotor diameter, number of blades, blade pitch, width and twist, optimum rpm for your winding configuration, generator diameter, and number of poles all factor into a perfect final design.

### Improvise, But Do it!

We've tried to demonstrate how easy it is to produce electricity from scratch. Don't let yourself get hung up on complicated formulas, calculations, and machine tools. Even if you make many changes to this simple design, you'll still almost certainly have a unit that makes usable energy for charging batteries.

Then, you can make small improvements until it performs exactly right for your application. And it could be powered by wind, falling water, a human on a bicycle, a dog on a treadmill, or a yak in a yoke!

### Access

Dan Bartmann and Dan Fink, Forcefield, 2606 West Vine Dr., Fort Collins, CO 80521 • 877-944-6247 or 970-484-7257 • danb@otherpower.com danf@otherpower.com • www.otherpower.com  
Magnets, magnet wire, bridge rectifiers, free information, and a very active discussion board

All Electronics, PO Box 567, Van Nuys, CA 91408  
888-826-5432 or 818-904-0524 • Fax: 818-781-2653  
allcorp@allcorp.com • www.allelectronics.com  
Magnets, rectifiers, and lots of electronics parts at great prices

American Science and Surplus, 3605 Howard St., Skokie, IL 60076 • 847-982-0870 • Fax: 800-934-0722 or 847-982-0881 • info@sciplus.com • www.sciplus.com  
Magnets, magnet wire, surplus electronics, bearings, and other neat stuff

Marlin P. Jones and Assoc., PO Box 530400, Lake Park, FL 33403 • 800-652-6733 or 561-848-8236  
Fax: 800-432-9937 or 561-844-8764 • mpja@mpja.com www.mpja.com • Magnet wire, rectifiers, electronics, tools, test equipment

Hugh Piggott, Scoraig Wind Electric, Scoraig, Dundonnell, Ross Shire, IV23 2RE, UK • +44 1854 633 286 • Fax: +44 1854 633 233  
hugh.piggott@enterprise.net • www.scoraigwind.co.uk  
Wind generator and alternator designs, lots of free information about blade design and carving

WindStuffNow, Edwin Lenz, 10253 S. 34th St., Vicksburg, MI 49097 • 616-626-8029  
elenz@windstuffnow.com • www.windstuffnow.com  
Alternator designs, parts, useful formulas, free information, and blade design software

American Wind Energy Association (AWEA) discussion board • <http://groups.yahoo.com/group/awea-wind-home> • Join the list by sending a blank e-mail to: [awea-wind-home-subscribe@yahoogroups.com](mailto:awea-wind-home-subscribe@yahoogroups.com)  
[www.awea.org](http://www.awea.org)

